

General-Purpose AC Servo

MELSERVO

Servo Configuration Software

MODEL

MRZJW3- SETUP81E

INSTALLATION GUIDE

Thank you for choosing the Mitsubishi general-purpose AC servo MELSERVO Servo Configuration Software.
To optimize the use of the Servo Configuration Software, please read over this Installation Guide and the corresponding AC servo Installation Guide before using the software. After reading the Installation Guide, always place this Installation Guide in a safe place.





● Safety Instructions ●

(Always read these instructions before using the equipment.)





Do not attempt to install, operate, maintain or inspect the servo amplifier and servo motor until you have read through this Installation Guide, and appended documents carefully and can use the equipment correctly. Do not use the servo amplifier and servo motor until you have a full knowledge of the equipment, safety information and instructions.

In this Installation Guide, the safety instruction levels are classified into "WARNING" and "CAUTION".

 WARNING	Indicates that incorrect handling may cause hazardous conditions, resulting in death or severe injury.
 CAUTION	Indicates that incorrect handling may cause hazardous conditions, resulting in medium or slight injury to personnel or may cause physical damage.

Note that the CAUTION level may lead to a serious consequence according to conditions. Please follow the instructions of both levels because they are important to personnel safety.

What must not be done and what must be done are indicated by the following diagrammatic symbols:

	Indicates what must not be done. For example, "No Fire" is indicated by  .
	Indicates what must be done. For example, grounding is indicated by  .

In this Installation Guide, instructions at a lower level than the above, instructions for other functions, and so on are classified into "POINT".

After reading this Installation Guide, always keep it accessible to the operator.

 CAUTION	• Before executing the test mode, always read Section 2.3 "Precaution for test mode".
--	---

- Windows is a trademark of Microsoft Corporation.
- The "Mitsubishi general-purpose AC servo MELSERVO Servo Configuration Software" is a production of Mitsubishi Electric Corporation. Mitsubishi Electric Corporation reserves the copyright and all other rights of this software.
- This Installation Guide may not be reproduced or copied, in whole or part, without written consent of Mitsubishi Electric Corporation.
- All other company and product names contained in this Installation Guide are registered trademarks or trademarks of their respective companies.

CONTENTS

1. INTRODUCTION 1-1 to 1-14

1.1	Specifications	1-1
1.2	System configuration	1-3
1.2.1	Components.....	1-3
1.2.2	Communication cable.....	1-4
1.2.3	Configuration diagrams	1-6
1.3	Basic terms.....	1-7
1.4	Basic operations.....	1-8
1.5	Screen definitions	1-10
1.6	Installation procedure.....	1-11

2. HOW TO USE THE SOFTWARE 2-1 to 2-8

2.1	Operation.....	2-1
2.1.1	Start-up.....	2-1
2.1.2	Command selection procedures.....	2-1
2.1.3	Operation procedures within the window	2-2
2.2	Commands and display windows.....	2-3
2.3	Precautions for test mode	2-5
2.4	Simple language for program operation.....	2-6
2.4.1	Language	2-6
2.4.2	Program example.....	2-7
2.4.3	Instruction	2-7

3. TROUBLESHOOTING 3-1 to 3-2

3.1	Communication error	3-1
3.2	Message at startup	3-1
3.3	Message at program shutdown	3-2
3.4	HELP display.....	3-2

1. INTRODUCTION

1. INTRODUCTION

1.1 Specifications

Using the communication function of the servo amplifier, the Servo Configuration Software allows functions, such as parameter setting change, point data maintenance, graph, program operation mode and test mode, to be implemented from a personal computer.

Servo amplifier		MR-H-A	MR-H-B	MR-H-AC	MR-C	MR-J2-A	MR-J2-B	MR-J2-C	MR-H-TN
Communication signal		Compliant with RS-232C							
Baudrate	9600bps	<input type="radio"/>	<input type="radio"/>	<input type="radio"/>	<input type="radio"/>	<input type="radio"/>	<input type="radio"/>	<input type="radio"/>	<input type="radio"/>
	19200bps	<input type="checkbox"/>	<input type="checkbox"/>	<input type="checkbox"/>	<input type="checkbox"/>	<input type="checkbox"/>	<input type="checkbox"/>	<input type="checkbox"/>	<input type="checkbox"/>
System	Station Selection	<input type="checkbox"/>	<input type="checkbox"/>	<input type="checkbox"/>	<input type="checkbox"/>	<input type="checkbox"/>	<input type="checkbox"/>	<input type="checkbox"/>	<input type="checkbox"/>
	Automatic Demo	<input type="radio"/>	<input type="radio"/>	<input type="radio"/>	<input type="checkbox"/>	<input type="radio"/>	<input type="radio"/>	<input type="checkbox"/>	<input type="radio"/>
Monitor	Amplifier Data, High Speed Monitor	<input type="radio"/>	<input type="radio"/>	<input type="radio"/>	<input type="radio"/>	<input type="radio"/>	<input type="radio"/>	<input type="radio"/>	<input type="radio"/>
	Trend Graph	<input type="radio"/>	<input type="radio"/>	<input type="radio"/>	<input type="radio"/>	<input type="radio"/>	<input type="radio"/>	<input type="radio"/>	<input type="radio"/>
Alarms	Display	<input type="radio"/>	<input type="radio"/>	<input type="radio"/>	<input type="radio"/>	<input type="radio"/>	<input type="radio"/>	<input type="radio"/>	<input type="radio"/>
	History	<input type="radio"/>	<input type="radio"/>	<input type="radio"/>	<input type="radio"/>	<input type="radio"/>	<input type="radio"/>	<input type="radio"/>	<input type="radio"/>
	Amplifier Data	<input type="radio"/>	<input type="radio"/>	<input type="radio"/>	<input type="checkbox"/>	<input type="radio"/>	<input type="radio"/>	<input type="radio"/>	<input type="radio"/>
	Graph display before alarm	<input type="radio"/>	<input type="radio"/>	<input type="radio"/>	<input type="checkbox"/>	<input type="checkbox"/>	<input type="checkbox"/>	<input type="checkbox"/>	<input type="radio"/>
Diagnostics	I/O Display	<input type="radio"/>	<input type="radio"/>	<input type="radio"/>	<input type="radio"/>	<input type="radio"/>	<input type="radio"/>	<input type="radio"/>	<input type="radio"/>
	Function Device Display	<input type="checkbox"/>	<input type="checkbox"/>	<input type="checkbox"/>	<input type="checkbox"/>	<input type="checkbox"/>	<input type="checkbox"/>	<input type="checkbox"/>	<input type="checkbox"/>
	No Motor Rotation	<input type="radio"/>	<input type="radio"/>	<input type="radio"/>	<input type="checkbox"/>	<input type="radio"/>	<input type="radio"/>	<input type="checkbox"/>	<input type="radio"/>
	Settle time	<input type="radio"/>	<input type="radio"/>	<input type="radio"/>	<input type="checkbox"/>	<input type="radio"/>	<input type="radio"/>	<input type="checkbox"/>	<input type="radio"/>
	Total Power-on Time	<input type="radio"/>	<input type="radio"/>	<input type="radio"/>	<input type="checkbox"/>	<input type="radio"/>	<input type="radio"/>	<input type="checkbox"/>	<input type="radio"/>
	Amplifier Version Info	<input type="radio"/>	<input type="radio"/>	<input type="radio"/>	<input type="radio"/>	<input type="radio"/>	<input type="radio"/>	<input type="radio"/>	<input type="radio"/>
	Motor Information	<input type="checkbox"/>	<input type="checkbox"/>	<input type="checkbox"/>	<input type="checkbox"/>	<input type="checkbox"/>	<input type="checkbox"/>	<input type="checkbox"/>	<input type="checkbox"/>
	Tuning data	<input type="radio"/>	<input type="radio"/>	<input type="radio"/>	<input type="radio"/>	<input type="radio"/>	<input type="radio"/>	<input type="radio"/>	<input type="radio"/>
	Absolute Encoder Data	<input type="radio"/>	<input type="radio"/>	<input type="radio"/>	<input type="checkbox"/>	<input type="radio"/>	<input type="radio"/>	<input type="radio"/>	<input type="radio"/>
	Automatic Voltage Control	<input type="radio"/>	<input type="checkbox"/>	<input type="checkbox"/>	<input type="checkbox"/>	<input type="radio"/>	<input type="checkbox"/>	<input type="checkbox"/>	<input type="checkbox"/>
Parameters	Parameter List	<input type="radio"/>	<input type="radio"/>	<input type="radio"/>	<input type="radio"/>	<input type="radio"/>	<input type="radio"/>	<input type="radio"/>	<input type="radio"/>
	I/O Devices	<input type="checkbox"/>	<input type="checkbox"/>	<input type="checkbox"/>	<input type="checkbox"/>	<input type="checkbox"/>	<input type="checkbox"/>	<input type="checkbox"/>	<input type="checkbox"/>
Test	Jog	<input type="radio"/>	<input type="radio"/>	<input type="radio"/>	<input type="radio"/>	<input type="radio"/>	<input type="radio"/>	<input type="radio"/>	<input type="radio"/>
	Positioning	<input type="radio"/>	<input type="radio"/>	<input type="radio"/>	<input type="checkbox"/>	<input type="radio"/>	<input type="radio"/>	<input type="radio"/>	<input type="radio"/>
	Operation w/o Motor	<input type="radio"/>	<input type="radio"/>	<input type="radio"/>	<input type="checkbox"/>	<input type="radio"/>	<input type="radio"/>	<input type="radio"/>	<input type="radio"/>
	Forced output	<input type="radio"/>	<input type="radio"/>	<input type="radio"/>	<input type="radio"/>	<input type="radio"/>	<input type="radio"/>	<input type="radio"/>	<input type="radio"/>
	Demo Mode	<input type="radio"/>	<input type="radio"/>	<input type="radio"/>	<input type="checkbox"/>	<input type="radio"/>	<input type="radio"/>	<input type="checkbox"/>	<input type="radio"/>
	Single-step feed	<input type="checkbox"/>	<input type="checkbox"/>	<input type="radio"/>	<input type="checkbox"/>	<input type="checkbox"/>	<input type="checkbox"/>	<input type="radio"/>	<input type="radio"/>
Position-Data	Position block	<input type="checkbox"/>	<input type="checkbox"/>	<input type="radio"/>	<input type="checkbox"/>	<input type="checkbox"/>	<input type="checkbox"/>	<input type="checkbox"/>	<input type="radio"/>
	Speed block	<input type="checkbox"/>	<input type="checkbox"/>	<input type="radio"/>	<input type="checkbox"/>	<input type="checkbox"/>	<input type="checkbox"/>	<input type="checkbox"/>	<input type="radio"/>
	Teach	<input type="checkbox"/>	<input type="checkbox"/>	<input type="radio"/>	<input type="checkbox"/>	<input type="checkbox"/>	<input type="checkbox"/>	<input type="checkbox"/>	<input type="radio"/>
	Point Table	<input type="checkbox"/>	<input type="checkbox"/>	<input type="checkbox"/>	<input type="checkbox"/>	<input type="checkbox"/>	<input type="checkbox"/>	<input type="radio"/>	<input type="checkbox"/>

1. INTRODUCTION

Specification Item		MR-J2-03A5	MR-J2-03B5	MR-J2-03C5	MR-J2A-XA	MR-J2-C-S100
Communication signal		Compliant with RS-232C				
Baudrate	9600bps	○	○	○	○	○
	19200bps	○	○	○	○	○
System	Station Selection	○	/	○	○	○
	Automatic Demo	○	○	/	○	/
Monitor	Amplifier Data, High Speed Monitor, Trend Graph	○	○	○	○	○
Alarms	Display	○	○	○	○	○
	History	○	○	○	○	○
	Amplifier Data	○	○	○	○	○
	Graph display before alarm	/	/	/	/	/
Diagnostics	Digital I/O Display	○	○	○	○	○
	Function Devices	/	/	○	/	○
	No Motor Rotation	○	○	/	○	/
	Settle time	/	/	/	/	/
	Total Power-on Time	○	○	○	○	○
	Amplifier Version Info	○	○	○	○	○
	Motor Information	○	○	○	/	/
	Tuning data	○	○	○	○	○
	Absolute Encoder Data	○	○	○	○	○
	Automatic Voltage Control	○	/	/	○	/
Parameters	Data set	○	○	○	○	○
	List Display	○	○	○	○	○
	Change list display	○	○	○	○	○
	Details Display	○	○	○	○	○
	I/O Devices	/	/	○	/	○
Test	Jog	○	○	○	○	○
	Positioning	○	○	○	○	/
	Operation w/o Motor	○	○	○	○	○
	Forced output	○	○	○	○	○
	Demo Mode	○	○	/	○	/
	Single-step feed	/	/	○	/	/
	Program Test	/	/	/	/	○
Position	Position/Speed block	/	/	/	/	/
	Teach	/	/	/	/	/
	Point Tables	/	/	○	/	/
Program-Data	Program Data	/	/	/	/	○
	Indirect Addressing	/	/	/	/	○

Trend Graph in the monitor function and Graph display before alarm in the alarm function may be used by the servo amplifiers having the following software versions. If Trend Graph or Graph display before alarm is used by the other servo amplifier, a communication error will occur but the other functions may be used.

Servo Amplifier	Servo Amplifier Software Version
MR-H-A	BCD-B12W002-D0 or later
MR-H-B	BCD-B13W000-B0 or later
MR-H-AC	BCD-B15W000-B0 or later
MR-C	BCD-B18W000-A1 or later
MR-J2-C-S100	BCD-B20W304-A2 or later

1. INTRODUCTION

1.2 System configuration

1.2.1 Components

To use the Servo Configuration Software, the following components are required in addition to the servo amplifier and servo motor. Configure the system according to the Installation Guide of each equipment:

Equipment		(Note 1) Description
(Note 2, 3, 4, 5, 6, 7) Personal computer (IBM PC/AT compatible)	OS	Microsoft® Windows® 8.1 Enterprise Operating System Microsoft® Windows® 8.1 Pro Operating System Microsoft® Windows® 8.1 Operating System Microsoft® Windows® 8 Enterprise Operating System Microsoft® Windows® 8 Pro Operating System Microsoft® Windows® 8 Operating System Microsoft® Windows® 7 Enterprise Operating System Microsoft® Windows® 7 Ultimate Operating System Microsoft® Windows® 7 Professional Operating System Microsoft® Windows® 7 Home Premium Operating System Microsoft® Windows® 7 Starter Operating System Microsoft® Windows Vista® Enterprise Operating System Microsoft® Windows Vista® Ultimate Operating System Microsoft® Windows Vista® Business Operating System Microsoft® Windows Vista® Home Premium Operating System Microsoft® Windows Vista® Home Basic Operating System Microsoft® Windows® XP Professional Operating System Microsoft® Windows® XP Home Edition Operating System Microsoft® Windows® 2000 Professional Operating System Microsoft® Windows NT® Workstation Operating System Version 4.0 Microsoft® Windows® Millennium Edition Operating System Microsoft® Windows® 98 Second Edition Operating System Microsoft® Windows® 98 Operating System Microsoft® Windows® 95 Operating System
	CPU	Pentium133MHz or more(Windows® 95, Windows® 98, Windows NT® Workstation 4.0, Windows® 2000) Pentium150MHz or more(Windows® Me) Pentium300MHz or more(Windows® XP) 32-bit (x86) processor of 1GHz or more(Windows Vista®) 32-bit (x86) or 64-bit (x64) processor of 1GHz or more(Windows® 7, Windows® 8, Windows® 8.1)
	Memory	16MB or more(Windows® 95), 24MB or more(Windows® 98) 32MB or more(Windows® Me, Windows NT® Workstation 4.0, Windows® 2000) 128MB or more(Windows® XP) 1GB or more(Windows Vista®, Windows® 7, Windows® 8, Windows® 8.1)
	Hard Disk	30MB or more of free space
	Communication interfaces	Serial port
Display	One whose resolution is 800×600 or more and that can provide a high color (16 bit) display. Connectable with the above personal computer.	
Keyboard	Connectable with the above personal computer.	
Mouse	Connectable with the above personal computer. Note that a serial mouse is not used.	
Printer	Connectable with the above personal computer.	
Communication cable	MR-HPCATCBL3M, MR-CPCATCBL3M, MR-JRPCATCBL3M When this cannot be used, refer to Section 1.2.2 and fabricate	
RS-232C option unit	MR-C-T01 Required when using the Servo Configuration Software with the MR-C servo amplifier.	

Note 1. Windows and Windows NT are the registered trademarks of Microsoft Corporation in the United State and other countries.

Pentium is the registered trademarks of Intel Corporation.

2. On some personal computers, this software may not run properly.

3. 64-bit Windows® XP, 64-bit Windows Vista® are not supported.

4. If Microsoft® Windows® XP or later is used, the following functions cannot be used. If any of the following functions is used, this product may not operate normally.

- Start of application in Windows® compatible mode
- Fast user switching
- Remote desktop
- Big fonts (Detail settings of screen property)
- DPI setting other than the normal size (96DPI) (Detail settings of screen property)

5. If Windows Vista® or later is used, log in as a user having Administrator privileges.

6. If Windows® 7 or later is used, the following functions cannot be used.

- Windows XP Mode
- Touch

7. If Windows® 8 or later is used, the following functions cannot be used.

- Hyper-V
- Modern UI Style



1. INTRODUCTION

1.2.2 Communication cable

(1) Selection

Use a communication cable for connection of the personal computer and the servo amplifier. Choose the communication cable according to the shape of the RS-232C connector of the personal computer used.

POINT
<ul style="list-style-type: none"> Depending on the personal computer used, any of the following cables may be used. <p>Confirm the RS-232C connector signal carefully, refer to this section and fabricate the cable.</p>

Type	Length [m(feet)]	Servo amplifier or Interface unit	Application	Description
MR-HPCATCBL3M	3 (9.84)	MR-H-A(N) MR-H-B(N) MR-H-AC(N) MR-H-TN	For IBM series (D-SUB 9 pins)	Connector: DE-9PF-N Connector: DE-9SF-N Case: DE-C1-J6-S6 Case: DE-C1-J6-S6 (Japan Aviation Electronics) (Japan Aviation Electronics) 
MR-CPCATCBL3M	3 (9.84)	MR-C MR-J2-A MR-J2-B MR-J2-C MR-J2-C-S100 MR-J2-A-XA	For IBM series (D-SUB 9 pins)	Connector: 10120-6000EL Connector: DE-9SF-N Shell kit: 10320-3210-000 Case: DB-C1-J6-S6 (3M or equivalent) (Japan Aviation Electronics) 
MR-JRPCATCBL3M	3 (9.84)	MR-J2-03A5 MR-J2-03B5 MR-J2-03C5	For IBM series (D-SUB 9 pins)	Connector: 5557-04R-210 Connector: DE-9SF-N Terminal: 5556 Case: DE-C1-J6-S6 (molex) (Japan Aviation Electronics) 

For fabrication, refer to the connection diagram in this section. When fabricating the cable, read and follow the instructions below:

- 1) Always use a multi-core cable with a shield and connect the shield to FG securely.
- 2) Wiring distance depends on surrounding environment but should be as short as possible.

Maximum distance is 15m(49.2feet) in environmentally good places with little noise, e.g. offices.

1. INTRODUCTION

(2) Communication connector signal pin-outs

- a) MR-H-A(N)/B(N)/AC(N)/TN
Servo amplifier side connector (CN4)

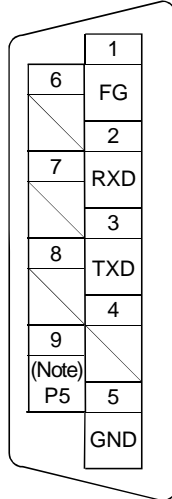

Note: Pin 9 is designed for use with a parameter unit power supply and cannot be used for other purposes.

- b) MR-C: RS-232C option side connector (CN3A)
MR-J2-A/B/C: Servo amplifier side connector
MR-J2-A-XA(CN3)
MR-J2-C-S100

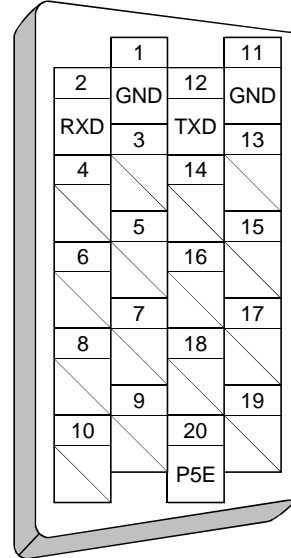

- c) MR-J2-03A5/03B5/03C5
Servo amplifier side connector (CNP3)

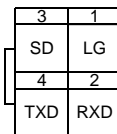

(3) Cable connection diagrams

- MR-HPCATCBL3M
Personal computer side

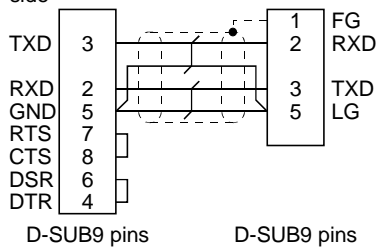

- MR-CPCATCBL3M
Personal computer side

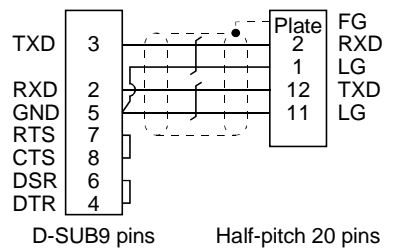

- MR-JRPCATCBL3M
Personal computer side

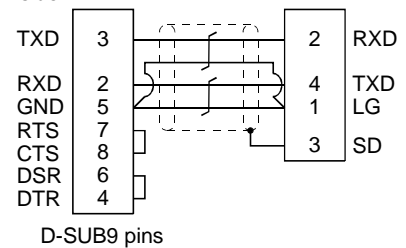

1. INTRODUCTION

1.2.3 Configuration diagrams

(1) MR-H-A(N)/B(N)/AC(N)/TN

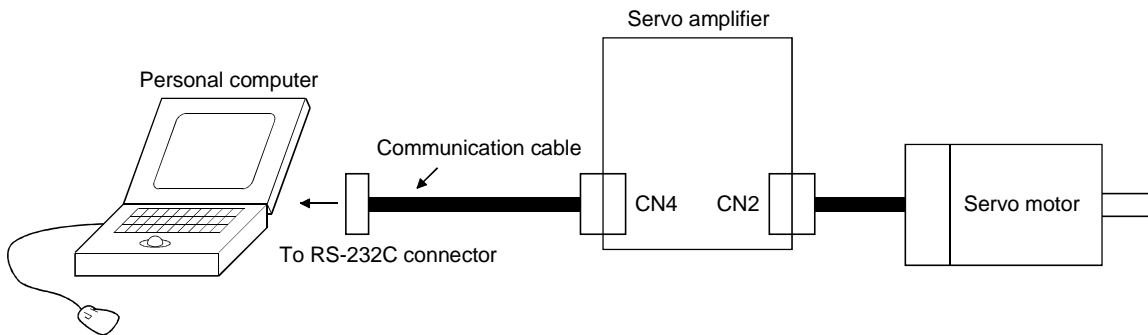

(2) MR-C

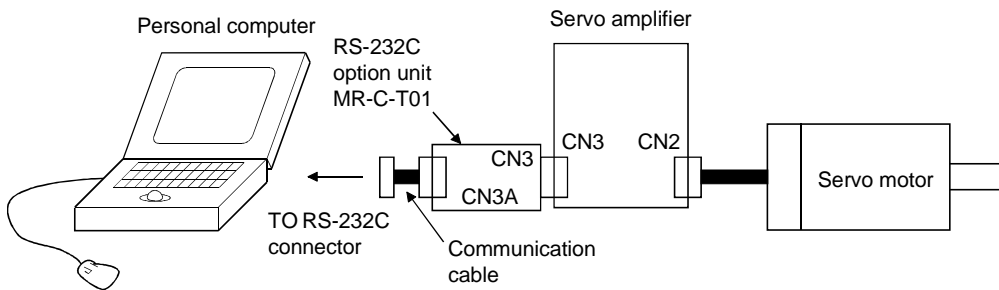

(3) MR-J2-A/B/C

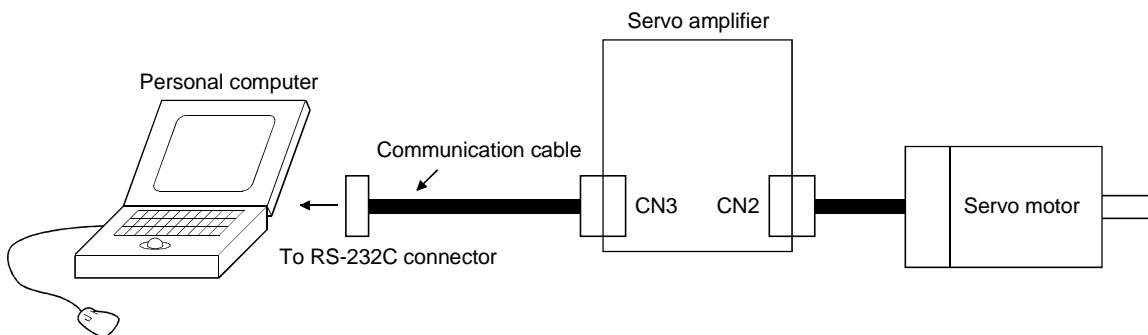

(4) MR-J2-03A5/03B5/03C5

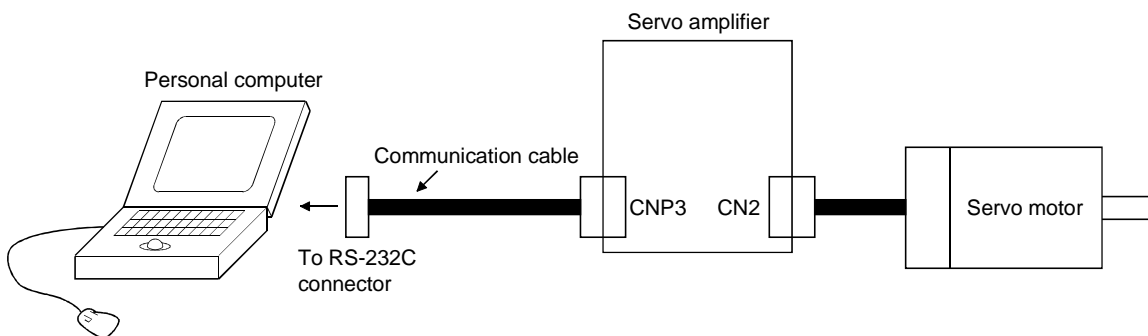

1. INTRODUCTION

1.3 Basic terms

1) Mouse pointer

An on-screen arrow which moves with movements of the mouse.

2) Point

To move the mouse pointer to a particular item or position on the screen.

3) Click

To press and release the left button of the mouse once.

4) Double-click

To press and release the left button of the mouse twice.

5) Drag

To hold down the left button of the mouse and move the mouse.

6) Focus

Highlights characters, button or the like when the menu or button is ready to accept an input from the keyboard.

7) Text box

Box used to enter characters.

8) List box

Box used to select one of several items.

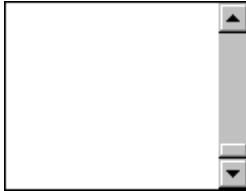

9) Combo box

Box used to select one of several items.



10) Check box

Box used to select one or more of several items. When a choice is made a mark appears in the box.

11) Option button

Button used to select only one of several items. When a choice is changed  moves to a new choice.

1. INTRODUCTION

1.4 Basic operations

(1) Closing the window

Click the closing bottom at top right corner of the window.

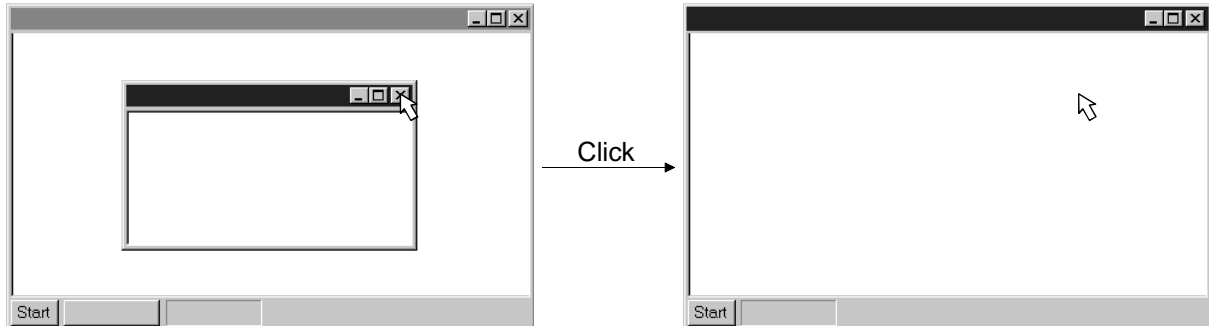

(2) Moving the focus from one window to another

Click the button of the task bar corresponding to the window to be used.

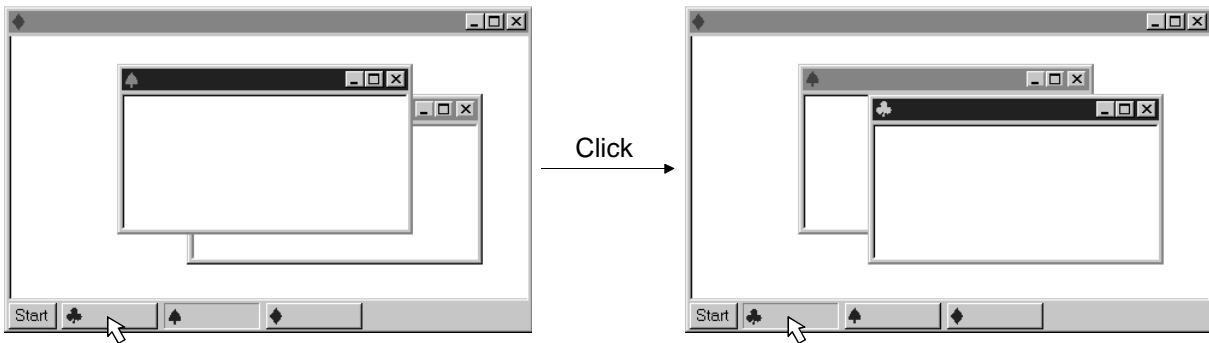

(3) Moving the window

Point to the title bar, drag the window to the required position, and release the button.

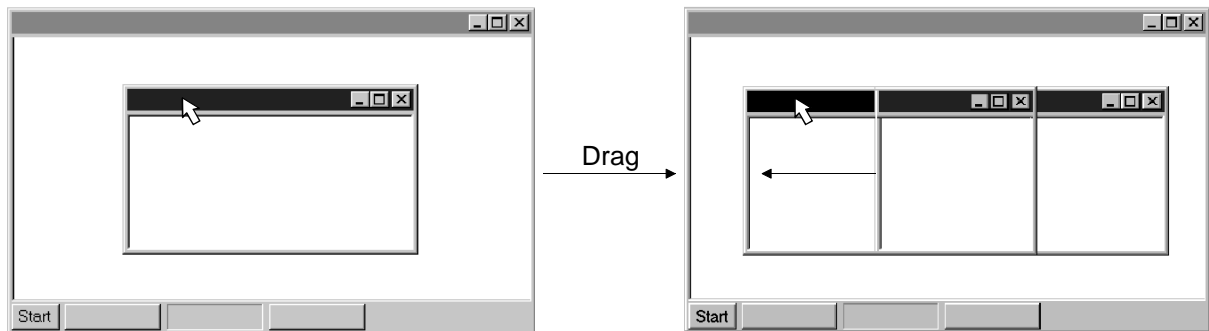

1. INTRODUCTION

(4) Moving the focus to the menu bar

Click the menu bar. To move the focus to a window, click the window.

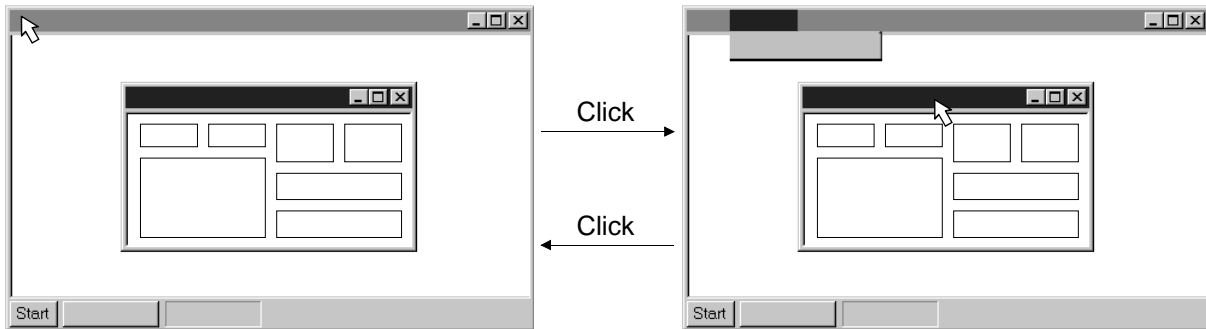

(5) Moving the focus inside the window

Click the object to be operated (such as a text box). When the object to be operated is a button, clicking it will start its processing.

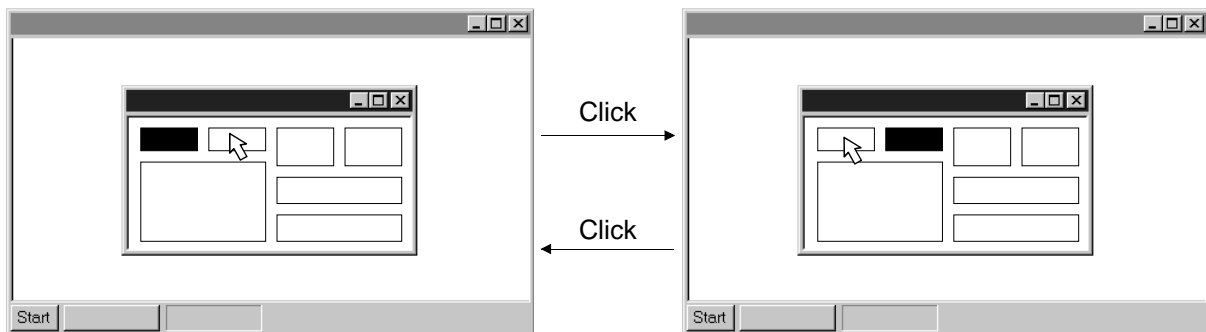

<Short-cut keys>

Any of the following short-cut keys may be used to perform operation from the keyboard:

Intended operation	Keyboard
End program	"Alt" + "F4"
Show start menu	"Ctrl" + "Esc"
Change window	"Alt" + "Tab"
Change object	"Tab"

1. INTRODUCTION

1.5 Screen definitions

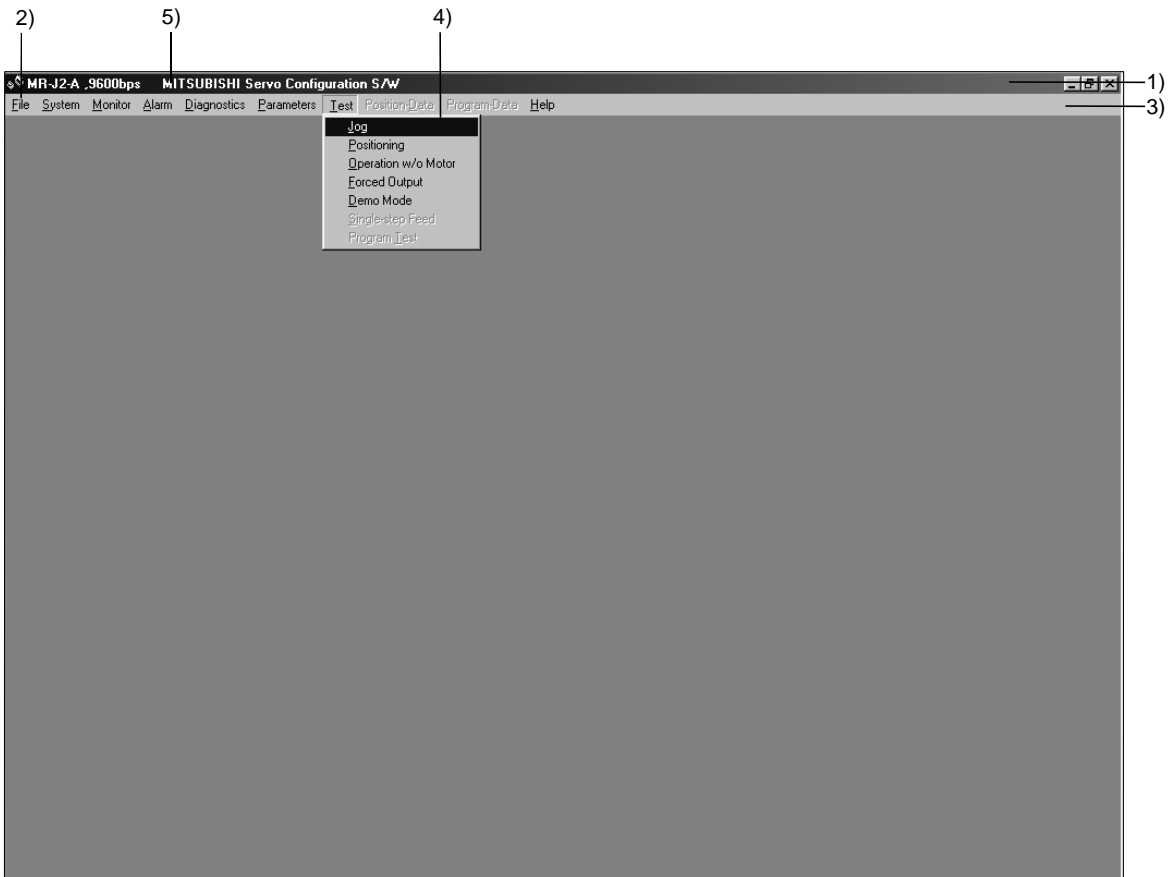

- 1) Title bar
- 2) Menu title
- 3) Menu bar
Shows the menu title.
- 4) MenuCommand menu in tier 1
- 5) System setting display area
Shows the servo amplifier and baudrate which have been set.

1. INTRODUCTION

1.6 Installation procedure

In this procedure, it is assumed that the hard disk drive of the personal computer is C and the CD drive is D.

Before running this program, always close all Windows programs.

- 1) Insert CD-ROM in Drive D (CD drive). Then, click the "Start" button of the task bar to open the start menu, specify the file name, and click "Run". When the following window has appeared, type "D:\SETUP81E\DISK1\SETUP.EXE" and click the "OK" button.

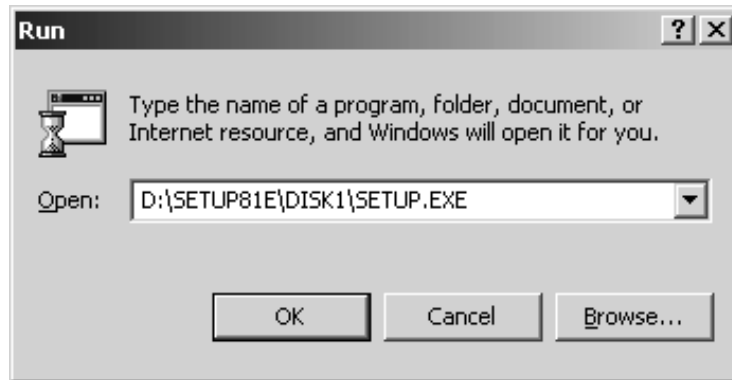

- 2) After the above window, the following window appears. Click "Next>" button.

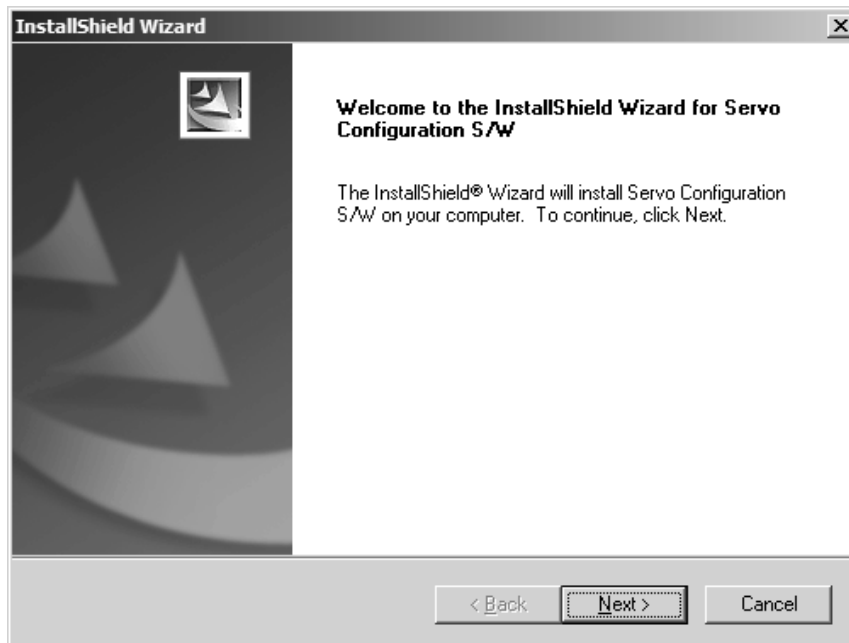

1. INTRODUCTION

3) The User Information screen appears. Type your full name and company name and click “Next>” button.

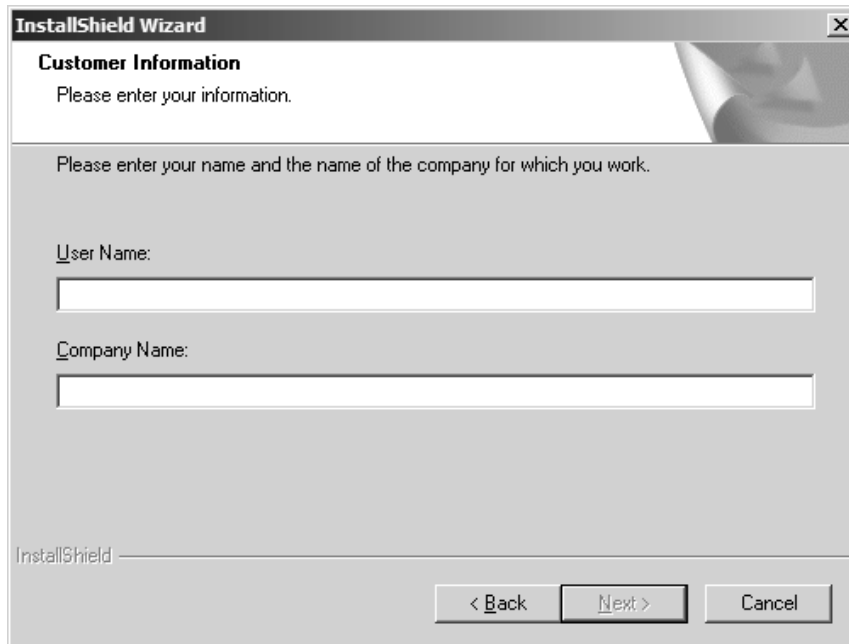

The screenshot shows the 'InstallShield Wizard' window with the 'Customer Information' tab selected. The window title is 'InstallShield Wizard'. The main heading is 'Customer Information' with the instruction 'Please enter your information.' Below this, it says 'Please enter your name and the name of the company for which you work.' There are two text input fields: 'User Name:' and 'Company Name:'. At the bottom, there are three buttons: '< Back', 'Next >', and 'Cancel'. The 'Next >' button is highlighted with a dashed border.

4) The Choose Destination Location screen appears. When you specify the destination folder and click “Next>” button, installation starts.

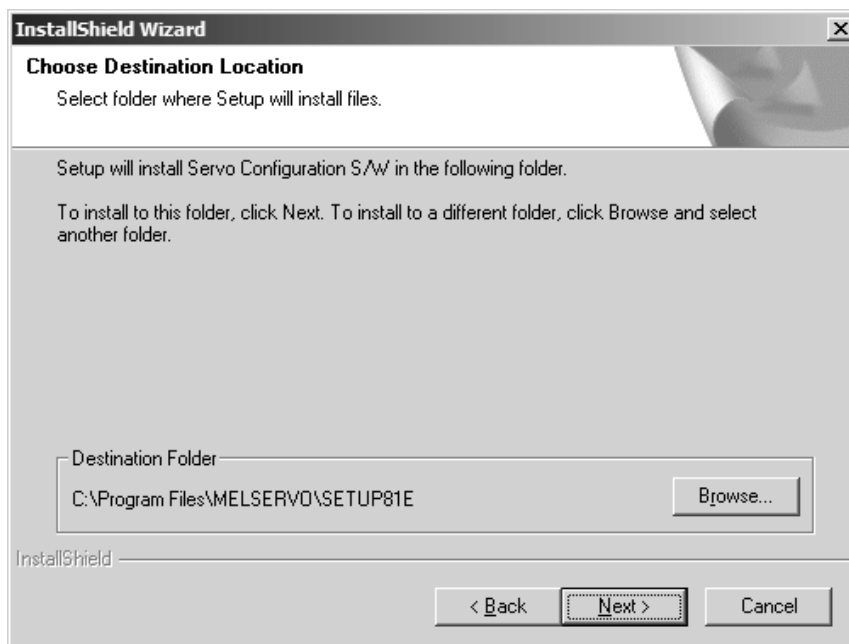

The screenshot shows the 'InstallShield Wizard' window with the 'Choose Destination Location' tab selected. The window title is 'InstallShield Wizard'. The main heading is 'Choose Destination Location' with the instruction 'Select folder where Setup will install files.' Below this, it says 'Setup will install Servo Configuration S/W in the following folder.' and 'To install to this folder, click Next. To install to a different folder, click Browse and select another folder.' There is a text input field for 'Destination Folder' containing the path 'C:\Program Files\MELSERVO\SETUP81E' and a 'Browse...' button. At the bottom, there are three buttons: '< Back', 'Next >', and 'Cancel'. The 'Next >' button is highlighted with a dashed border.

1. INTRODUCTION

5) When installation ends, any of the following screens appears. Click the “Finish” button to exit from Setup.

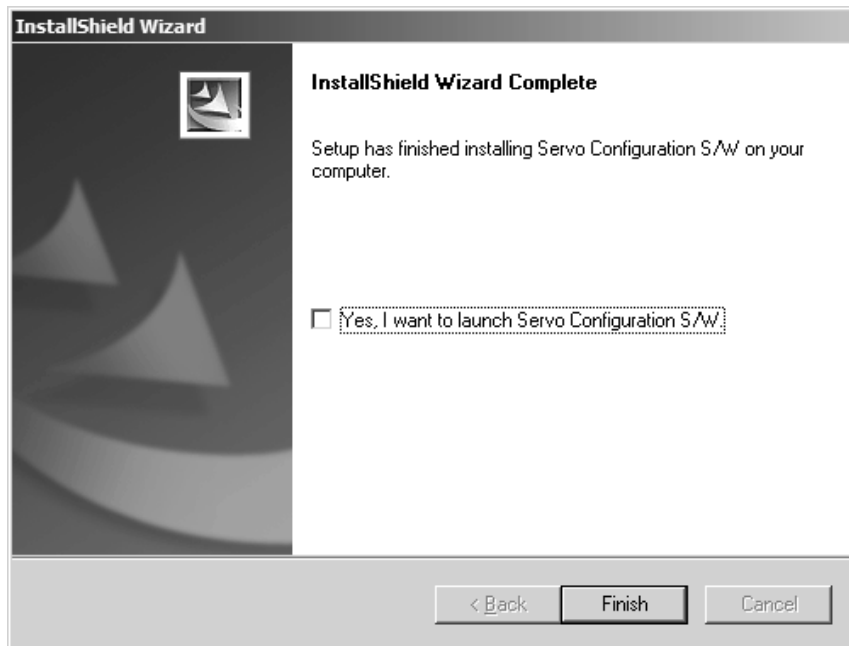

POINT

- | |
|---|
| <ul style="list-style-type: none">▪ In the corresponding window, to stop installation, click the “Cancel” button or press the “Escape”. |
|---|

MEMO

2. HOW TO USE THE SOFTWARE

2. HOW TO USE THE SOFTWARE

2.1 Operation

The method of selecting the command is the operation procedures using the mouse.
Unavailable commands are grayed out.

2.1.1 Start-up

1. Windows® 7 or earlier

- 1) Click the “Start” button of the task bar to open the menu.
- 2) Point to submenu “MELSERVO”, “SETUP_Software” from “Programs”. Then, Click “SETUP81E”.

2. Windows® 8

- 1) Using the mouse, right click on the start screen to display the Apps Views from “All apps”.
- 2) Click on “SETUP81E” from the “MELSERVO” group.

3. Windows® 8.1

- 1) From the arrow button located on the lower left of the start screen, the Apps View is displayed.
- 2) Click on “SETUP81E” from the “MELSERVO” group.

2.1.2 Command selection procedures

1. Clicking method

- 1) Click the menu title on the menu bar to open the menu.
- 2) Point to and click the command to be selected.

2. Dragging method

Point to the menu title on the menu bar, hold down the left button and drag the mouse to the command to be selected, and release the button.

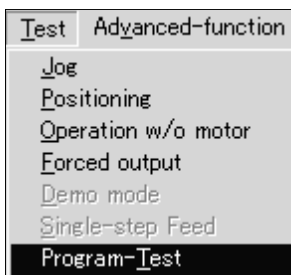

2. HOW TO USE THE SOFTWARE

2.1.3 Operation procedures within the window

Within the operation window, enter data and/or press the button.

(1) Pressing a button

Click the button in the window.



(2) Entering data

Click the setting area to move the focus there, and enter data from the keyboard.

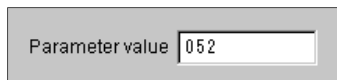

(3) Selecting data

Click the data to be selected.



(4) Selecting the combo box data, etc.

- 1) Click  on the right of the setting portion to open the combo box.
- 2) Make selection by clicking the data or like to be chosen.

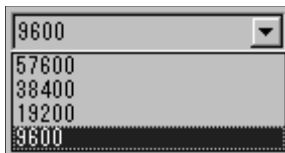

(5) Pressing the option button

Click the item or button.



2. HOW TO USE THE SOFTWARE

2.2 Commands and display windows

The following diagram shows a sequence of commands and windows.

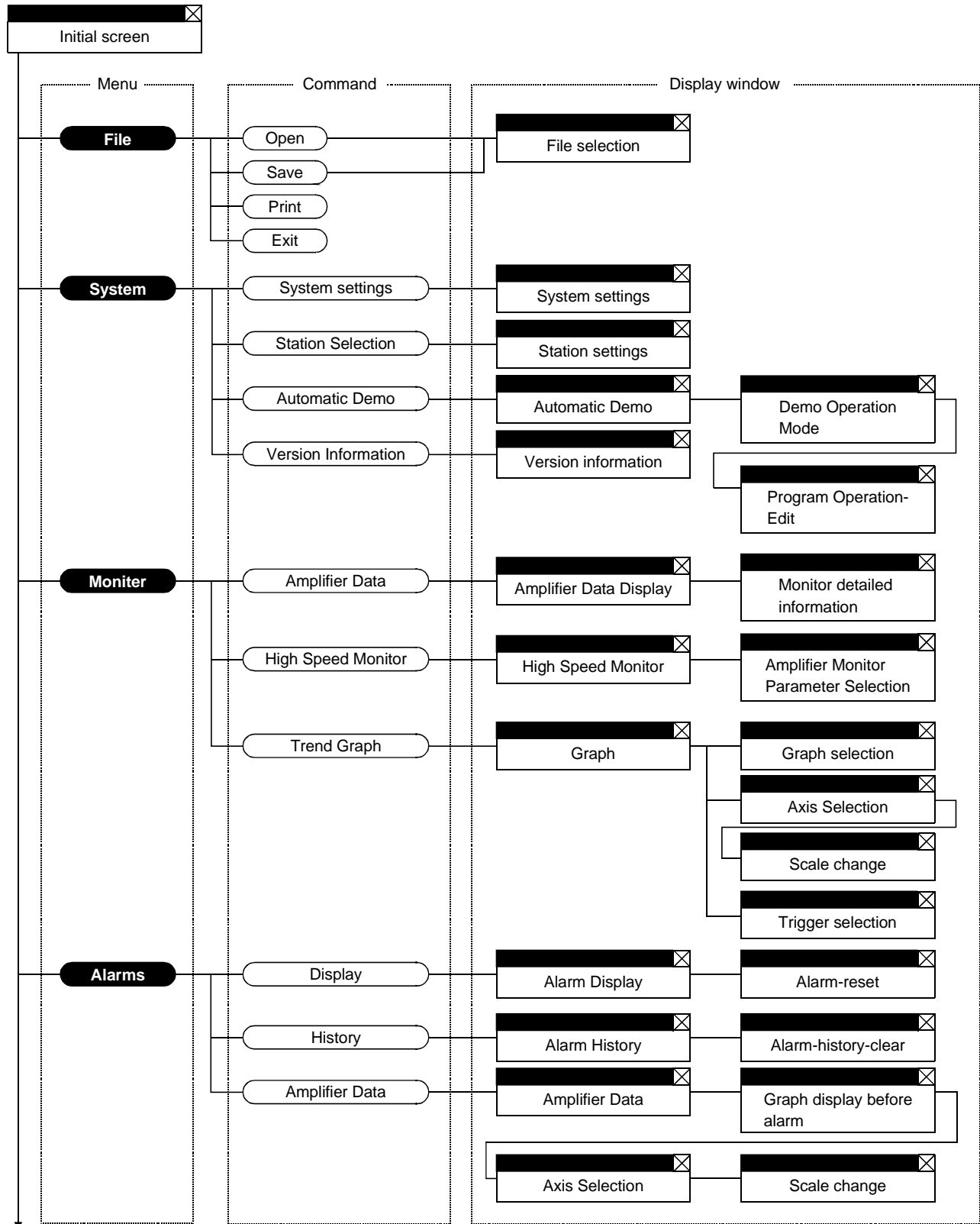

To next page

2. HOW TO USE THE SOFTWARE

Continued from preceding page

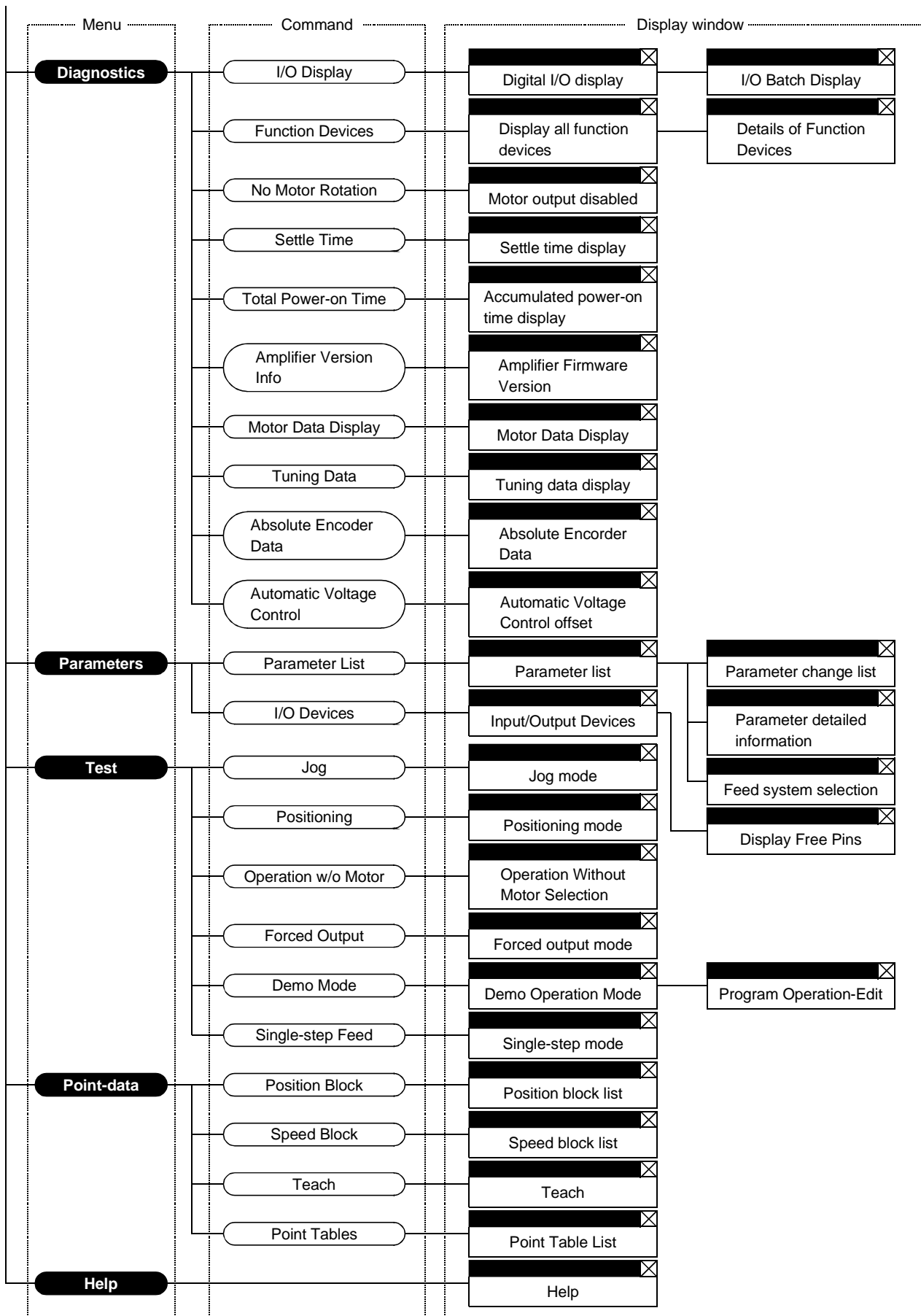

2. HOW TO USE THE SOFTWARE

2.3 Precautions for test mode

⚠ WARNING

- Always touch the switches with dry hands. You may get an electric shock if you touch them with wet hands.
- Always operate the equipment with the front cover installed. Removing the front cover will expose the terminals and charged area having high voltages, which may lead to an electric shock.
- Keep the front cover closed while power is on the equipment is running. Otherwise, you may get an electric shock.

⚠ CAUTION

- Before starting operation, make sure that the parameters are set to correct values. Depending on machines, they may operate unpredictably.
- While power is on or for some time after power-off, keep clear of the servo amplifier's heat sink and regenerative brake resistor, the servo motor, etc. as they may be high temperatures. Otherwise, you may get burned.

(1) Servo on

In the Jog, Positioning, Demo Mode or Single-step Feed available in the Test, the servo amplifier's digital input signal SON is automatically switched on in the servo amplifier to start operation, independently of the ON/OFF status of SON. Also, any external command pulse or input signal (except emergency stop) is not accepted until the test mode window is closed to terminate the command.

SON is automatically switched on by the following operation:

Test mode	Mouse
Jog	Click the "Forward" or "Reverse" button. The servo motor rotates while you are clicking the button.
Positioning	Click the "Forward" or "Reverse" button.
Demo Mode	Click the "Start" button.

(2) Stop

POINT

- To make an emergency stop, switch off the emergency stop signal of the servo amplifier or shut off the input power.

1) Perform the following operation to stop the test mode:

Test mode	Mouse
Jog	Click the "Pause" button.
Positioning	Click the "Pause" button.
Demo Mode	Click the "Reset" button.

2) The servo motor will stop if either of the following situations occurs in the test mode:

- The communication cable is disconnected.
- If the window is dragged or the other menu is opened, communication between the personal computer and the servo amplifier may be suspended temporarily, stopping the servo motor temporarily.

2. HOW TO USE THE SOFTWARE

2.4 Simple language for program operation

The language used in the program operation-edit window will be described below.

2.4.1 Language

The chart below describes the commands in the program operation-edit window to execute the program operation mode, in which the MR-H-A(N) or MR-J2-A and MR-J2-03A5 goes into the position control mode.

Describe a program in upper case characters and Enter or Return at the end of a line. Up to 300 lines may be described.

Command	Name	Setting (**: Set value)	Setting range	Unit	Description																																																																																				
SPN	Feedrate	SPN (**)	0 to permissible instantaneous speed	r/min	Used to set the command speed given to the servo motor for positioning. The set value should be not more than the permissible speed of the servo motor used.																																																																																				
STC	Acceleration/deceleration time	STC (**)	0 to 50000	ms	Used to set the acceleration/deceleration time. (Time required to reach the rated speed of the corresponding servo motor)																																																																																				
MOV	Move command	MOV (**)	−9999999 to 9999999	pulse	Used to execute movement by the preset pulses. Positioning operation is performed with the set values of the feedrate (SPN) and acceleration /deceleration time (STC). No symbol: CCW rotation, −: CW rotation																																																																																				
SYNC	Waiting external signal to switch on	SYNC (**)	As listed in the table at right.		Used to hold the next operation until the preset digital input signal (DI) of the servo amplifier switches on. By setting 99, the next operation will be performed unconditionally. Set the input signal as listed below: For the MR-J2-A, any signal not allocated by signal assignment in the position control mode using parameters No. 43 to 48 will be invalid if it is selected. This command is unavailable for the MR-H-B and MR-J2-B. <table border="1" style="margin-left: auto; margin-right: auto;"> <thead> <tr> <th>Set Value</th> <th>MR-H-A(N)</th> <th>MR-H-AC(N)</th> <th>MR-J2-A</th> <th>MR-H-TN</th> <th>MR-J2-03A5</th> </tr> </thead> <tbody> <tr><td>0</td><td>SON</td><td>SON</td><td>SON</td><td>SON</td><td>SON</td></tr> <tr><td>1</td><td>TL</td><td>DEC</td><td>LSP</td><td>DEC</td><td>LSP</td></tr> <tr><td>2</td><td>PC</td><td>JFS</td><td>LSN</td><td>JFS</td><td>LSN</td></tr> <tr><td>3</td><td>RES</td><td>STP</td><td>TL</td><td>STP</td><td>TL</td></tr> <tr><td>4</td><td>LSP</td><td>LSP</td><td style="text-align: center;">/</td><td>LSP</td><td style="text-align: center;">/</td></tr> <tr><td>5</td><td>LSN</td><td>LSN</td><td>PC</td><td>LSN</td><td>PC</td></tr> <tr><td>6</td><td>CR</td><td>CR</td><td>RES</td><td>CR</td><td>RES</td></tr> <tr><td>7</td><td>DI0</td><td>DI0</td><td>CR</td><td>DI0</td><td>CR</td></tr> <tr><td>8</td><td>DI1</td><td>DI1</td><td style="text-align: center;">/</td><td>DI1</td><td style="text-align: center;">/</td></tr> <tr><td>9</td><td>DI2</td><td>DI2</td><td style="text-align: center;">/</td><td>DI2</td><td style="text-align: center;">/</td></tr> <tr><td>10</td><td>DI3</td><td>ST1</td><td style="text-align: center;">/</td><td>ST1</td><td style="text-align: center;">/</td></tr> <tr><td>11</td><td>DI4</td><td>ST2</td><td style="text-align: center;">/</td><td>ST2</td><td style="text-align: center;">/</td></tr> <tr><td>99</td><td colspan="5" style="text-align: center;">Unconditional</td></tr> </tbody> </table>	Set Value	MR-H-A(N)	MR-H-AC(N)	MR-J2-A	MR-H-TN	MR-J2-03A5	0	SON	SON	SON	SON	SON	1	TL	DEC	LSP	DEC	LSP	2	PC	JFS	LSN	JFS	LSN	3	RES	STP	TL	STP	TL	4	LSP	LSP	/	LSP	/	5	LSN	LSN	PC	LSN	PC	6	CR	CR	RES	CR	RES	7	DI0	DI0	CR	DI0	CR	8	DI1	DI1	/	DI1	/	9	DI2	DI2	/	DI2	/	10	DI3	ST1	/	ST1	/	11	DI4	ST2	/	ST2	/	99	Unconditional				
Set Value	MR-H-A(N)	MR-H-AC(N)	MR-J2-A	MR-H-TN	MR-J2-03A5																																																																																				
0	SON	SON	SON	SON	SON																																																																																				
1	TL	DEC	LSP	DEC	LSP																																																																																				
2	PC	JFS	LSN	JFS	LSN																																																																																				
3	RES	STP	TL	STP	TL																																																																																				
4	LSP	LSP	/	LSP	/																																																																																				
5	LSN	LSN	PC	LSN	PC																																																																																				
6	CR	CR	RES	CR	RES																																																																																				
7	DI0	DI0	CR	DI0	CR																																																																																				
8	DI1	DI1	/	DI1	/																																																																																				
9	DI2	DI2	/	DI2	/																																																																																				
10	DI3	ST1	/	ST1	/																																																																																				
11	DI4	ST2	/	ST2	/																																																																																				
99	Unconditional																																																																																								
TIM	Dwell command time	TIM (**)	1 to 50	s	Used to hold the next operation until the preset time elapses.																																																																																				
TIMES	Program count command	TIMES (**)	1 to 99	Times	Used to specify the number of cycles or times (from TIMES to STOP) that the positioning is to be repeated. Enter the TIMES (**) at the beginning and STOP at the end of a cycle. Not required for one positioning cycle.																																																																																				
STOP	Program stop	/	/	/	Used to stop the program being executed. Need not be described on the last line.																																																																																				

2. HOW TO USE THE SOFTWARE

2.4.2 Program example

As soon as the "Start" button is clicked, SON is switched on automatically to start operation.

Timing chart

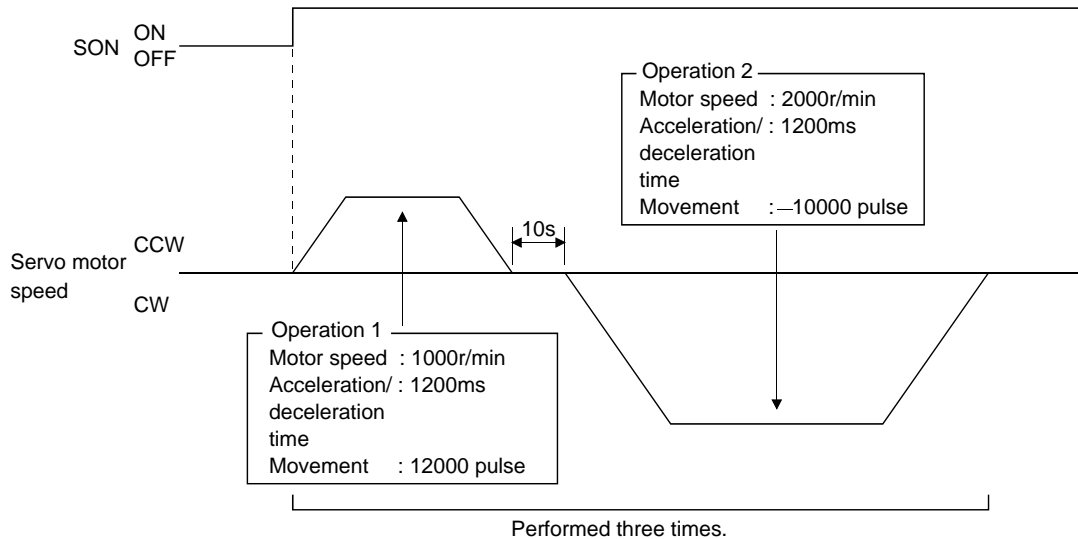

Program

TIMES (3) Repeats the program up to STOP three times.
 SYNC (0) Holds the program from running until the input signal with the set value of 0 (SON) switches on.

SPN (1000) Sets the command speed to 1000r/min.	} Operation 1
STC (1200) Sets the acceleration/deceleration time to 1200ms.	
MOV (12000) Executes movement by 12000 pulses in the CCW direction.	
TIM (10) Hold the next operation for 10s.	} Operation 2
SPN (2000) Sets the command speed to 2000r/min.	
MOV (-100000) Executes movement by 100000 pulses in the CW direction.	

STOP

In this example, the acceleration/deceleration time in Operations 1 and 2 are the same.

In this case, the acceleration/deceleration time in Operation 2 need not be set. In this way, set values different from those in the preceding operation need only be described in the operation program.

2.4.3 Instruction

When the program operation mode is executed with the program operation mode window and another window (Amplifier Data Display window) being displayed at the same time, the program may progress slower, making the dwell command time longer than the set value.

MEMO

3. TROUBLESHOOTING

3. TROUBLESHOOTING

3.1 Communication error

If communication between the personal computer and the servo amplifier is suspended and the communication error as shown in the following window occurs, check the code on the right of the error message and remove its cause.

<Possible cause> Noise entry, hard disk fault, wiring fault, etc.

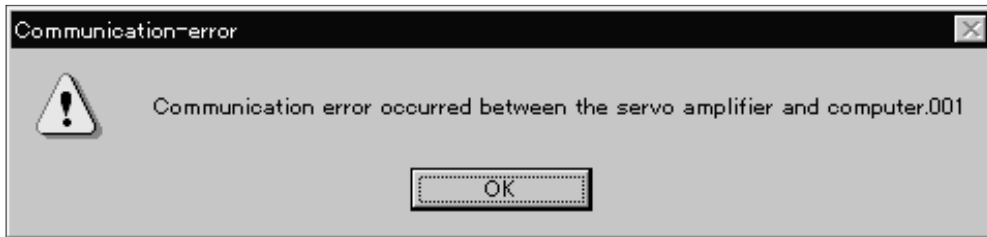

Code	Definition
001	Parity error occurred in the data sent from the personal computer.
002	Checksum error occurred in the data sent from the personal computer.
003	Character not given in the specifications was sent to the servo amplifier.
004	Command not given in the specifications was sent to the servo amplifier.
005	Data number not given in the specifications was sent to the servo amplifier. Data outside the permissible range was sent to the servo amplifier.
None	Checksum error occurred in the data received by the personal computer.

3.2 Message at startup

The window below appears at startup of this setup software when Windows Vista® or later is used. Select "Yes".

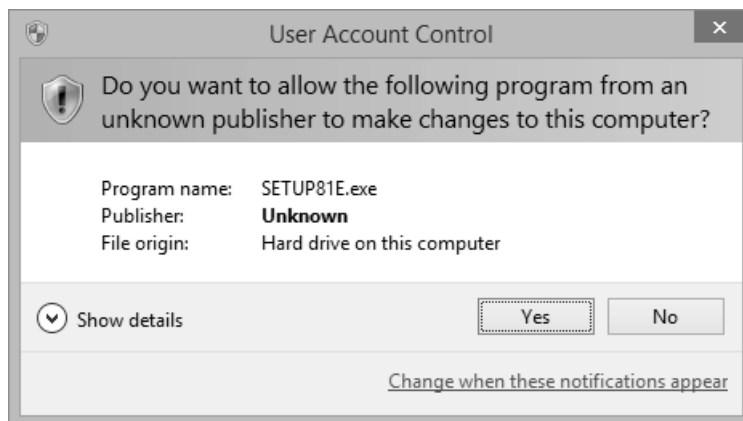

3. TROUBLESHOOTING

3.3 Message at program shutdown

The window below appears at program shutdown when Windows Vista® or later is used. Select “This program is installed correctly”.

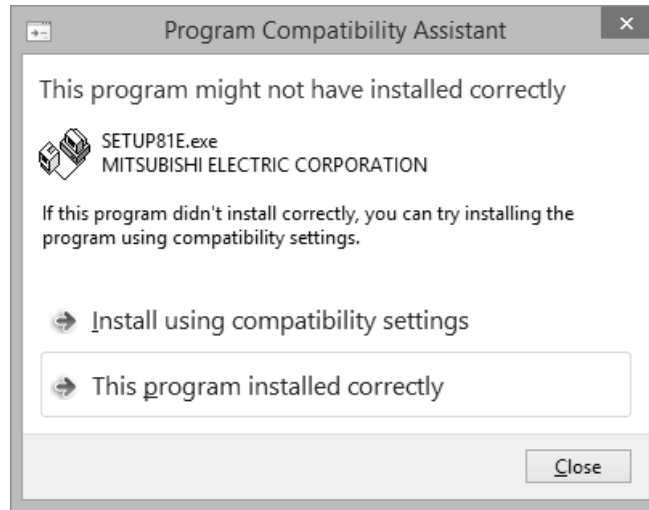

3.4 HELP display

HELP may not be displayed when Windows Vista® or later is used. In that case, follow the window below which always appears at the HELP startup, and install “WinHelp32.exe”, which is required for the HELP display.

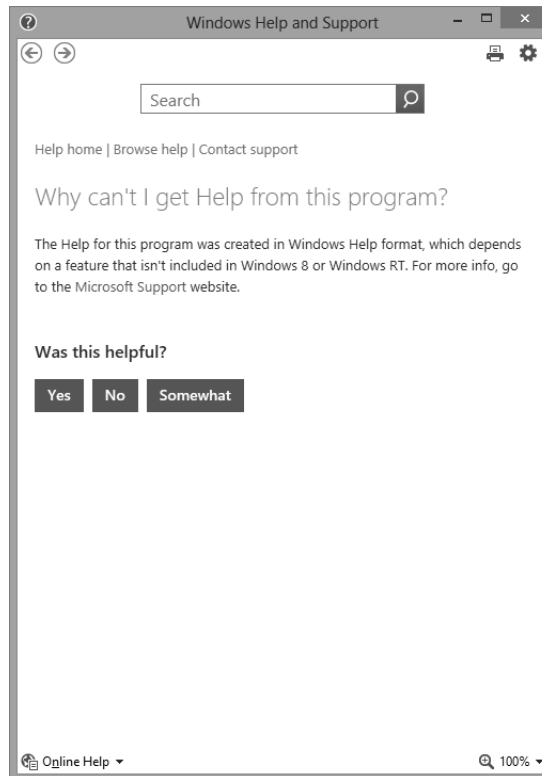

REVISIONS

*The manual number is given on the bottom left of the back cover.

Print Data	*Manual Number	Revision
Nov., 1996	IB (NA) 67253-A	First edition
Aug., 1997	IB (NA) 67253-B	Description changed for compatibility with Windows 95. MR-J2-B servo amplifier added. Section 2-4-1: Note on MR-H-B and MR-J2-B added to command SYNC.
Jan., 1998	IB (NA) 67253-C	Command names, etc. reviewed.
Feb., 2000	IB (NA) 67253-D	MR-J2-C servo amplifier is added. MR-H-TN servo amplifier is added. MR-H-AN/BN/ACN servo amplifier is added. MR-J2-03A5 servo amplifier is added. MR-J2-03C5 servo amplifier is added. Section 1-1: Specification item table change and addition Section 1-3-1: Communication cable addition Section 1-3-2 (1): Communication cable addition Section 1-3-2 (2): Specification addition Section 1-3-2 (3): Cable connection diagram addition Section 1-3-3: Configuration diagram addition Section 2-2: Command name and display window addition Section 2-3 (1): Table modification Section 2-3 (3): Addition Section 2-4-1: Specification item table change Section 2-5: Addition
Jan., 2002	IB (NA) 67253-E	Caution 4: Description changed Caution 5: Deleted Section 1-3-1: Table modified Section 1-3-2 (1): PC98 series deleted Section 1-3-2 (3): MR-HPC98CBL3M diagram deleted Section 1.7: Overall change
Aug., 2003	IB (NA) 67253-F	Overall changes to the form Addition of MR-J2-03B5 servo amplifiers
Jun., 2015	IB (NA) 67253-G	Section 1.2.1: Addition of Windows Vista®, Windows® 7, Windows® 8, Windows® 8.1 Reexamination of table format Note is changed Section 1.4: Reexamination of short-cut keys Section 1.6: Correction of erroneous description The screen is changed Section 2.1.1: Reexamination of startup method Section 2.4.2: Correction of erroneous description Section 3.2: Deletion of "Screen unprintable" Addition of "Message at startup" Section 3.3: Addition of "Message at program shutdown" Section 3.4: Addition of "HELP display"

MODEL	
MODEL CODE	



HEAD OFFICE : TOKYO BLDG MARUNOUCHI TOKYO 100-8310