

MX Component Version 3

Operating Manual

(SX Controller Communication)

mitsubishi

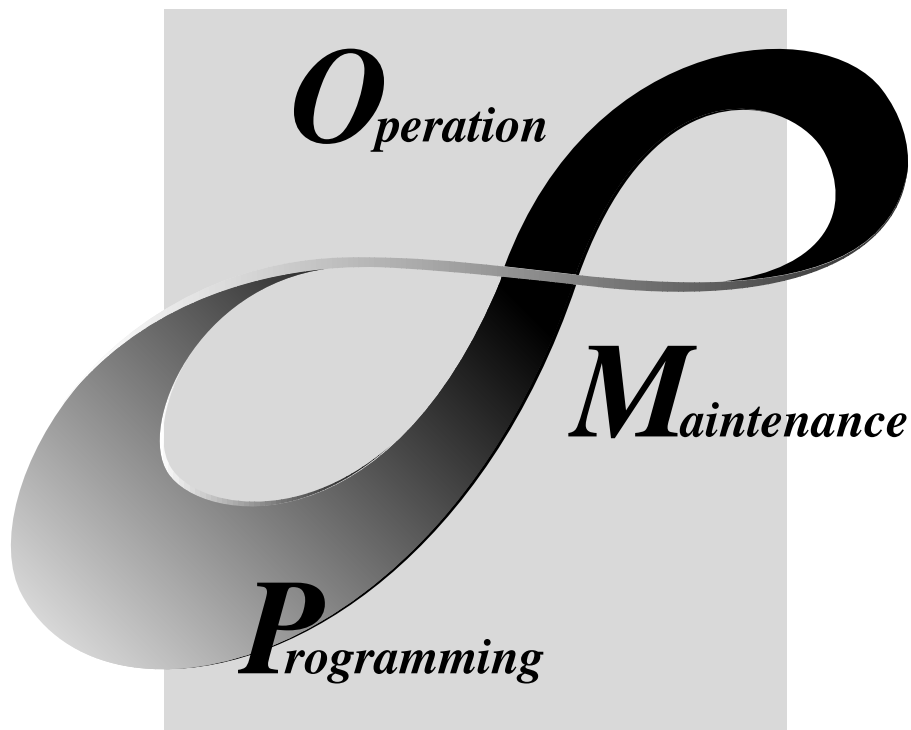

MELSOFT
Integrated FA Software

SW3D5C-ACT-E

REVISIONS

* The manual number is given on the bottom left of the back cover.

Print Date	* Manual Number	Revision
Apr., 2002	SH (NA)-080269-A	First edition

This manual confers no industrial property rights or any rights of any other kind, nor does it confer any patent licenses. Mitsubishi Electric Corporation cannot be held responsible for any problems involving industrial property rights which may occur as a result of using the contents noted in this manual.

© 2002 MITSUBISHI ELECTRIC CORPORATION

Operating Instructions

- (1) The ASP function of VBScript is not available.

Only monitoring pages in the HTML format can be created.

- (2) Instructions for access to other station via Q25SS

When making access to other station using SX Controller communication, use the CC-Link module or Q Series corresponding C24 of the following serial No. or later, for the Q25SS or the QCPU (Q mode) that configures the multiple PLC system with the Q25SS.

- CC-Link module First five digits are "03082" or later
- Q series-compatible C24 First five digits are "03112" or later

INTRODUCTION

Thank you for choosing the Mitsubishi MELSOFT series Integrated FA software.
Read this manual and make sure you understand the functions and performance of MELSOFT Series thoroughly in advance to ensure correct use.

CONTENTS

REVISIONS	A- 1
Operating Instructions	A- 2
CONTENTS.....	A- 3
Manuals	A- 4
Generic Terms and Abbreviations	A- 5

1 OVERVIEW	1- 1 to 1- 2
------------	--------------

2 SX CONTROLLER COMMUNICATION	2- 1 to 2- 2
-------------------------------	--------------

3 SETTING EXAMPLE OF SX CONTROLLER COMMUNICATION	3- 1 to 3- 4
--	--------------

3.1 Accessing Procedure	3- 1
-------------------------------	------

4 ACCESSIBLE DEVICES AND RANGES	4- 1 to 4- 3
---------------------------------	--------------

4.1 Accessible Devices	4- 1
4.2 Accessible Ranges.....	4- 3

5 ACT CONTROLS	5- 1 to 5- 4
----------------	--------------

5.1 ACT Controls.....	5- 1
5.2 Properties	5- 2
5.3 Lists of Properties Possessed by the ActQSS, ActMLQSS control	5- 3

6 FUNCTIONS	6- 1 to 6- 2
-------------	--------------

APPENDIX	APP- 1 to APP- 4
----------	------------------

Appendix 1 Precautions for Access to Q25SS from Communication Paths	APP- 1
---	--------

Manuals

The following lists the manuals related to this software package.
Refer to the following table when ordering manuals.

Related Manuals

Manual Name	Manual Number (Model Code)
MX Component Version 3 Operating Manual (Startup) Describes procedures for installing and MX uninstalling Component and for browsing the manual. (Sold separately)	SH-080270 (13JU31)
MX Component Version 3 Operating Manual Describes the setting and operation methods of each utility on MX Component. (Sold separately)	SH-080271 (13JU32)
MX Component Version 3 Programming Manual Describes the programming procedures, details and error codes for ACT control. (Sold separately)	SH-080272 (13JF66)

Note: The above manuals are included on the CD-ROM with the corresponding software packages as sets.

Any of the manuals is available separately in printed form. Please order the manual by indicating its manual number (model code) in the above list.

Generic Terms and Abbreviations

Unless otherwise stated, this manual uses the following abbreviations and terms for the explanation of MX Component.

Generic Term/Abbreviation	Description
MX Component	Generic product name of the product types SWnD5C-ACT-E and SWnD5C-ACT-EA.(n denotes any of versions 0 or later.) -EA means a volume-license product.
IBM-PC/AT compatible	Abbreviation of the IBM PC/AT or its compatible personal computer
PC CPU module	Abbreviation of the MELSEC-Q series compatible PC CPU module (CONTEC CO., LTD. make).
SX Controller	Generic product name of the product types SWnPNC-Q25SS-E. (n denotes any of versions 1 or later.)
Q25SS	Abbreviation of the PC CPU module where SX Controller Engine has been started.
PPC-DRV-01	Abbreviation of the bus interface driver software for the MELSEC-Q series compatible PC CPU module (CONTEC CO., LTD. make).
GX Developer	Generic product name of the product types SWnD5C-GPPW-E, SWnD5C-GPPW-EA, SWnD5C-GPPW-EV and SWnD5C-GPPW-EVA. (n denotes any of versions 0 or later.) -EA means a volume-license product, and -EV an updated product.
GX Simulator	Generic product name of the product types SWnD5C-LLT -E, SWnD5C-LLT -EA, SWnD5C-LLT-EV and SWnD5C-LLT-EVA.(n denotes any of versions 0 or later.) -EA means a volume-license product, and -EV an updated product.
MELSECNET/10 board	Abbreviation of Type A70BDE-J71QLP23/A70BDE-J71QLP23GE/A70BDE-J71QBR13/A70BDE-J71QLR23 MELSECNET/10 interface board
MELSECNET/H board	Abbreviation of Type Q80BD-J71LP21-25/Q80BD-J71LP21G/ Q80BD-J71LP21GE /Q80BD-J71BR11 MELSECNET/H board
CC-Link board	Abbreviation of Type A80BDE-J61BT11 CC-Link system master/local interface board and Type A80BDE-J61BT13 CC-Link interface board
CPU board	Abbreviation of Type A80BDE-A2USH-S1 PLC CPU board
AnNCPU	Generic term of the A0J2HCPU, A1SCPU, A1SCPU-S1, A1SCPUC24-R2, A1SHCPU, A1SJCPU, A1SJHCPU, A1NCPU, A2CCPU, A2CCPUC24, A2CCPUC24-PRF, A2CJCPU, A2NCPU, A2NCPU-S1, A2SCPU, A2SCPU-S1, A2SHCPU, A2SHCPU-S1, A3NCPU and A1FXCPU
AnACPU	Generic term of the A2ACPU, A2ACPU-S1, A2ACPUP21/R21, A2ACPUP21-S1, A3ACPU and A3ACPUP21/R21
AnUCPU	Generic term of the A2UCPU, A2UCPU-S1, A2USCPU, A2USCPU-S1, A2ASCPU, A2ASCPU-S1, A2ASCPU-S30, A2USHCPU-S1, A3UCPU and A4UCPU
QnACPU	Generic term of the Q2ACPU, Q2ACPU-S1, Q2ASCPU, Q2ASCPU-S1, Q2ASHCPU, Q2ASHCPU-S1, Q3ACPU, Q4ACPU and Q4ARCPU
ACPU	Generic term of the AnNCPU, AnACPU and AnUCPU
QCPU (A mode)	Generic term of the Q02CPU-A, Q02HCPU-A and Q06HCPU-A
QCPU (Q mode)	Generic term for Q00JCPU, Q00CPU, Q01CPU, Q02CPU, Q02HCPU, Q06HCPU, Q12HCPU, Q25HCPU, Q12PHCPU and Q25PHCPU. Note that especially when the CPU is indicated as a different model, Q00JCPU, Q00CPU and Q01CPU are described as Q00J/Q00/Q01CPU, and Q02CPU, Q02HCPU, Q06HCPU, Q12HCPU and Q25HCPU as Q02/Q02H/Q06H/Q12H/Q25HCPU. In addition, Q12PHCPU and Q25PHCPU are described as the Process CPU.
FXCPU	Generic term of the FX0, FX0S, FX0N, FX1, FX1N, FX1NC, FX1S, FX2, FX2C, FX2N and FX2NC series
Motion controller CPU	Generic term of the A171SHCPU, A172SHCPU, A173UHCPU, A173UHCPU-S1, A273UHCPU and A273UHCPU-S3

Generic Term/Abbreviation	Description
PLC CPU	Generic term of the QCPU(Q mode), QCPU(A mode), QnACPU, ACPUCPU, FXCPU and motion controller CPU
C24	Generic term of the A1SCPUC24-R2, A1SJ71C24-PRF, A1SJ71C24-R2, A1SJ71C24-R4, A2CCPUC24, A2CCPUC24-PRF, AJ71C24-S6 and AJ71C24-S8
UC24	Generic term of the AJ71UC24, A1SJ71UC24-R2, A1SJ71UC24-R4 and A1SJ71UC24-PRF
QC24	Generic term of the AJ71QC24, AJ71QC24-R2, AJ71QC24-R4, A1SJ71QC24-R2 and A1SJ71QC24-R2
QC24N	Generic term of the AJ71QC24N, AJ71QC24N-R2, AJ71QC24N-R4, A1SJ71QC24N and A1SJ71QC24N-R2
QC24(N)	Generic term of the QC24 and QC24N
Q series-compatible C24	Generic term of the QJ71C24 and QJ71C24-R2
Computer link module (Serial communication module)	Generic term of the C24, UC24, QC24(N) and Q series-compatible C24 Described as the serial communication module especially to indicate the QC24(N) or Q series-compatible C24.
E71	Generic term of the AJ71E71, AJ71E71-S3, A1SJ71E71-B2, A1SJ71E71-B5, A1SJ71E71-B2-S3, A1SJ71E71-B5-S3, AJ71E71N-B2, AJ71E71N-B5T, A1SJ71E71N-B2 and A1SJ71E71N-B5T.
QE71	Generic term of the AJ71QE71, AJ71QE71-B5, A1SJ71QE71-B2, A1SJ71QE71-B5, AJ71QE71N-B2, AJ71QE71N-B5T, A1SJ71QE71N-B2 and A1SJ71QE71N-B5T.
Q series-compatible E71	Generic term of the QJ71E71, QJ71E71-B2, QJ71E71-100.
Ethernet module	Generic term of the E71, QE71 and Q series-compatible E71
CC-Link G4 module	Generic term of the AJ65BT-G4 GPP function peripheral connection module and the AJ65BT-G4-S3 GPP function peripheral connection module
A6TEL	Generic term of the A6TEL modem interface module.
Q6TEL	Generic term of the Q6TEL modem interface module.
GOT	Generic term of the Graphic operation terminal.
Computer link communication (Serial communication)	Abbreviation of communication made with the PLC CPU using the computer link module Described as serial communication especially in communication that uses the QC24(N) or Q series-compatible C24.
Ethernet communication	Abbreviation of communication made with the PLC CPU using the Ethernet module
CPU COM communication	Abbreviation of communication made by connecting the IBM-PC/AT compatible to the RS-232C or RS-422 connector of the PLC CPU
CPU USB communication	Abbreviation of communication made by connecting the IBM-PC/AT compatible to the USB connector of the QCPU (Q mode)
MELSECNET/10 communication	Abbreviation of communication made with the PLC CPU using the MELSECNET/10 board
MELSECNET/H communication	Abbreviation of communication made with the PLC CPU using the MELSECNET/H board
CC-Link communication	Abbreviation of communication made with the PLC CPU using the CC-Link board
CC-Link G4 communication	Abbreviation of communication made with the PLC CPU using the CC-Link G4 module
CPU board communication	Abbreviation of communication made with the PLC CPU using the CPU board
Q series bus communication	Abbreviation of communication made with the PLC CPU on the same base using the PC CPU module
GX Simulator communication	Abbreviation of communication made with the GX Simulator
Modem communication	Abbreviation of communication made with the PLC CPU via modems using the QC24N (except the AJ71QC24N-R4), Q series-compatible C24, A6TEL, Q6TEL or FXCPU
Gateway function communication	Abbreviation of communication made with the PLC CPU and third-party PLCs using the gateway functions of the GOT
SX Controller communication	Abbreviation of communication made with the SX Controller
Utility setting type	Abbreviation of user program creation using the communication settings utility
Program setting type	Abbreviation of user program creation without using the communication settings utility
ACT controls	Generic term of the ActiveX controls offered by MX Component

1 OVERVIEW

This manual describes the system configuration, procedures, accessible devices/ranges and ACT control details for making SX Controller communication using MX Component.

For any information other than the contents of this manual, refer to the Appendix and make settings with reference to the MX Component Version 3 Operating Manual and MX Component Version 3 Programming Manual.

The following table indicates the reference manuals related to this manual.

Contents of This Manual	Reference Manual
Chapter 1 OVERVIEW	—
Chapter 2 DETAILS OF SX CONTROLLER COMMUNICATION	MX Component Version 3 Operating Manual Chapter 2
Chapter 3 SETTING EXAMPLE OF SX CONTROLLER COMMUNICATION	MX Component Version 3 Operating Manual Chapter 6
Chapter 4 ACCESSIBLE DEVICES AND RANGES	MX Component Version 3 Operating Manual Chapter 8
Chapter 5 DETAILS OF THE ACT CONTROLS	MX Component Version 3 Programming Manual Chapter 3
Chapter 6 FUNCTIONS	MX Component Version 3 Programming Manual Chapter 4

2 SX CONTROLLER COMMUNICATION

This section describes the details of SX Controller communication.

(1) Compatible OS

SX Controller communication is available for the following OSs only.

Compatible OS : Microsoft® Windows NT® Workstation Operating System
Version 4.0 (English version)
Microsoft® Windows® 2000 Professional Operating System
(English version)

(2) Precaution

(a) Always use the following versions of the PC CPU module driver and SX Controller.

Software Type	Description
PC CPU module driver	PRC-DRV-01 or later
SX Controller	SX Controller Version 1 or later

(b) The ASP function of VBScript is not available.

Only monitoring pages in the HTML format can be created.

MEMO

2

3 SETTING EXAMPLE OF SX CONTROLLER COMMUNICATION

This section describes the SX Controller communication procedure and its setting example using the utility setting type.

3.1 Accessing Procedure

The following explains the procedures for making access to the Q25SS by using SX Controller communication.

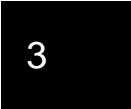
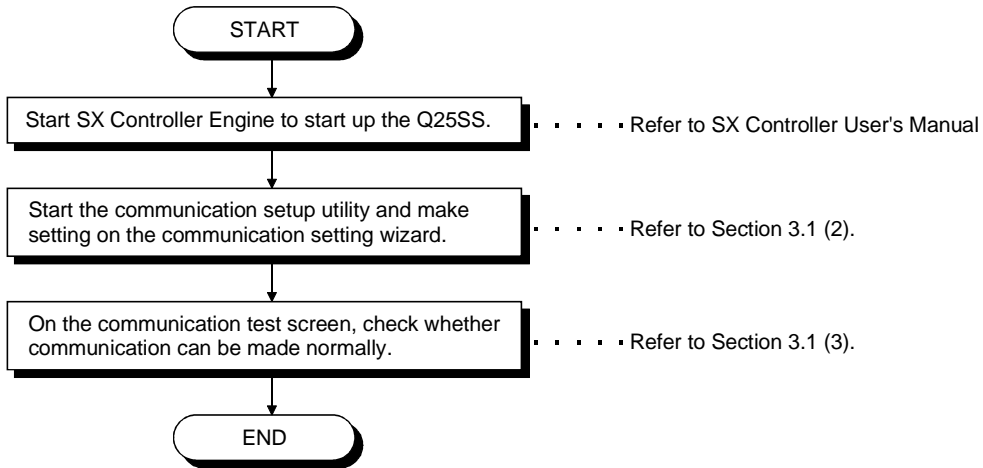

(1) System example

The following is a system example.

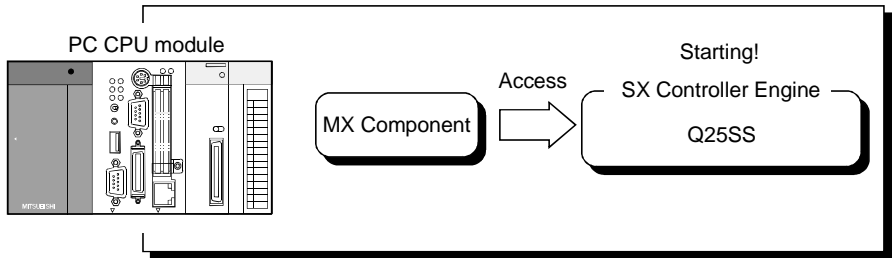

Logical station number of "1" is used.

(2) Setting the logical station number (Setting on communication setting wizard)

Logical station number setting will be described using the system example for (1).

1) Start the communication setup utility and choose the communication setting wizard.

2) Type "1" in Logical station number and click the **Next>** button.

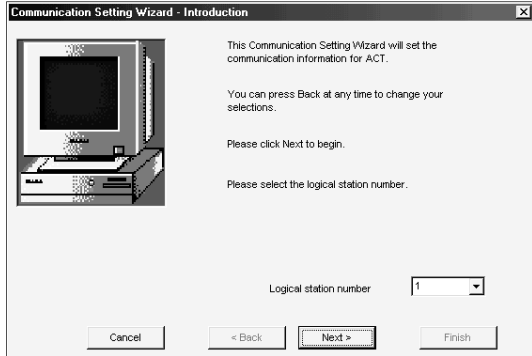

3) Make settings as indicated below and click the **Next>** button.

PC side I/F : SX Controller

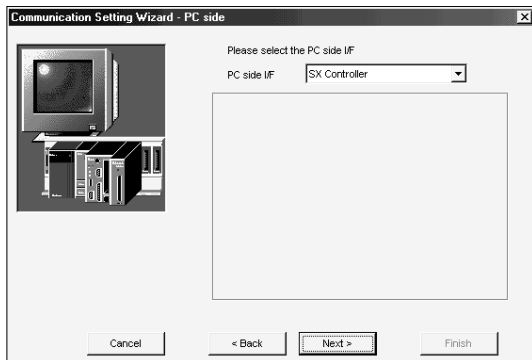

4) Make settings as indicated below and click the **Next>** button.

Station type : Host station
CPU type : Q25SS

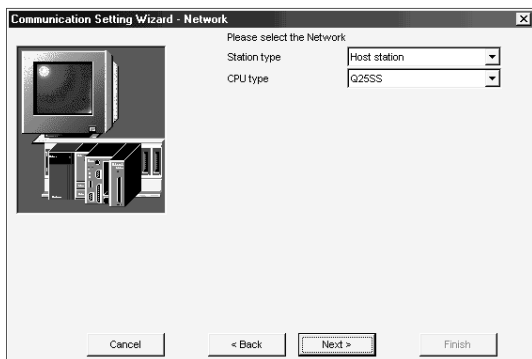

(To the next page)

(From the preceding page)

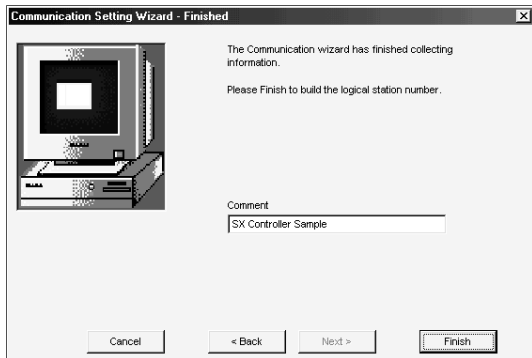

5) Enter a comment and click the **Finish** button.

(Registration complete)

(3) Checking the logical station number settings (Conducting a communication test)

Using the logical station number set in (2), check whether SX Controller communication settings are correct or not.

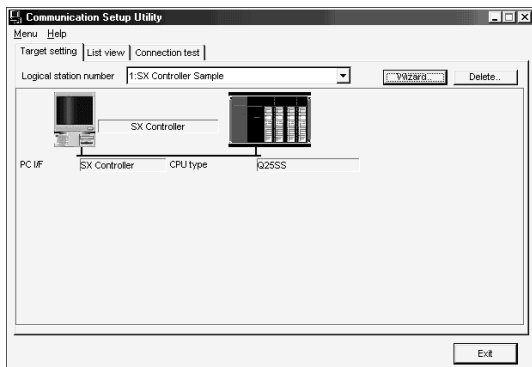

- 1) Display the "Target setting" tab screen and choose the logical station number "1".
Check whether the logical station number settings are correct or not.

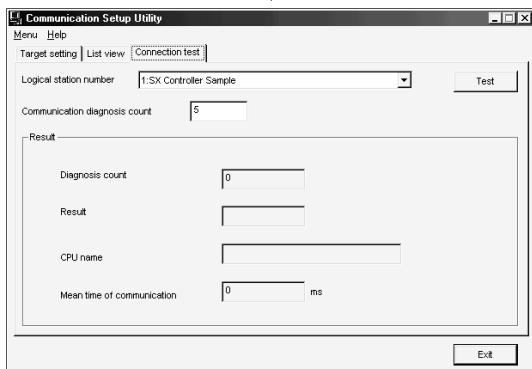

- 2) Display the "Connection test" tab screen and set the logical station number "1".

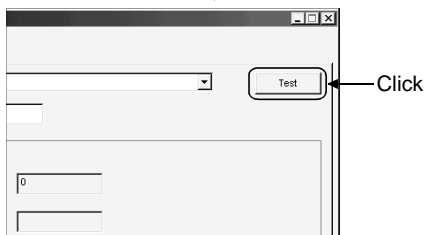

- 3) Click the **Test** button to check whether the PC and the QCPU corresponding to the logical station number are communicating correctly.
If an error occurs, check the error code and remove the error.
The error code appears in "Result". (At normal termination, "0x00000000" appears in "Result".)
Refer to the programming manual for error code details.

(Communication test complete)

- 4) Through the above steps, you can confirm that the logical station number has been set correctly.
Make the logical station number available by creating an user program or with PLC monitor utility.
Then, collect the device data by using the logical station number.

4 ACCESSIBLE DEVICES AND RANGES

This chapter describes the accessible devices and accessible ranges in each communication form.

4.1 Accessible Devices

The following table indicates the accessible devices for SX Controller communication.

Device (Device Name)	Access Target								
	A1N	A0J2H A1S(-S1) A1SH A1SJ(H) A2C(J) A2N(-S1) A2S(-S1) A2SH(-S1) A1FX	A2A(-S1) A2U(-S1) A2US(-S1) A2AS (-S1-S30) A2USH-S1 Q02(H)-A Q06H-A	A3N A3A A3U	A4U	Q2A(-S1) Q2AS(-S1) Q2ASH(-S1) Q3A Q4A Q4AR	Q00J Q00 Q01 Q02(H) Q06H Q12H Q25H Q12PH Q25PH Q25SS	FX _{0(S)} FX _{0N} FX ₁ FX _{1S} FX _{1N(C)} FX _{2(C)} FX _{2N(C)}	A171SH A172SH A173UH(-S1) A273UH(-S3)
Function input (FX)	×	×	×	×	×	○	×	×	
Function output (FY)	×	×	×	×	×	○	×	×	
Function register (FD)	×	×	×	×	×	○	×	×	
Special relay (SM)	○	○	○	○	○	○	×	○	
Special register (SD)	○	○	○	○	○	○	×	○	
Input relay (X)	○	○	○	○	○	○	×	○	
Output relay (Y)	○	○	○	○	○	○	×	○	
Internal relay (M)	○	○	○	○	○	○	×	○	
Latch relay (L)	○	○	○	○	○	○	×	○	
Annunciator (F)	○	○	○	○	○	○	×	○	
Edge relay (V)	×	×	×	×	×	○	×	×	
Link relay (B)	○	○	○	○	○	○	×	○	
Data register (D)	○	○	○	○	○	○	×	○	
Link register (W)	○	○	○	○	○	○	×	○	
Timer	Contact (TS)	○	○	○	○	○	×	○	
	Coil (TC)	○	○	○	○	○	×	○	
	Present value (TN)	○	○	○	○	○	×	○	
Counter	Contact (CS)	○	○	○	○	○	×	○	
	Coil (CC)	○	○	○	○	○	×	○	
	Present value (CN)	○	○	○	○	○	×	○	
Retentive timer	Contact (SS)	×	×	×	×	○	×	×	
	Coil (SC)	×	×	×	×	○	×	×	
	Present value (SN)	×	×	×	×	○	×	×	
Link special relay (SB)	×	×	×	×	×	○	×	×	
Link special register (SW)	×	×	×	×	×	○	×	×	
Step relay (S)	○	○	○	○	○	×	×	○	
Direct input (DX)	×	×	×	×	×	×	×	×	
Direct output (DY)	×	×	×	×	×	×	×	×	
Accumulator (A)	○	○	○	○	○	×	×	○	
Index register	(Z)	○	○	○	○	○	×	○	
	(V)	○	○	○	○	○	×	○	

(To next page)

Device (Device Name)		Access Target							
		A1N	A0J2H A1S(-S1) A1SH A1SJ(H) A2C(J) A2N(-S1) A2S(-S1) A2SH(-S1) A1FX	A2A(-S1) A2U(-S1) A2US(-S1) A2AS (-S1/-S30) A2USH-S1 Q02(H)-A Q06H-A	A3N A3A A3U	A4U	Q2A(-S1) Q2AS(-S1) Q2ASH(-S1) Q3A Q4A Q4AR	Q00J Q00 Q01 Q02(H) Q06H Q12H Q25H Q12PH Q25PH Q25SS	FX0(S) FX0N FX1 FX1S FX1N(C) FX2(C) FX2N(C)
File register	(R)	○	○	○	○	○	○*1	×	○
	(ZR)	×	×	×	×	×	○*1	×	×
Extended file register (ER*\R)		○	○	○	○	○	×	×	○
Direct link	Link input (J*\X)	×	×	×	×	×	○	×	×
	Link output (J*\Y)	×	×	×	×	×	○	×	×
	Link relay (J*\B)	×	×	×	×	×	○	×	×
	Link special relay (J*\SB)	×	×	×	×	×	○	×	×
	Link register (J*\W)	×	×	×	×	×	○	×	×
	Link special register (J*\SW)	×	×	×	×	×	○	×	×
Special direct buffer memory (U*\G)		×	×	×	×	×	○*2	×	×

*1: Inaccessible when the Q00JCPU is used.

*2: In a multiple PLC system, data cannot be read from the shared memory of the host CPU.

Independently of the host or other PLC, data cannot be written to the shared memory.

4

4.2 Accessible Ranges

This section indicates the accessible ranges for SX Controller communication.

(1) Configuration

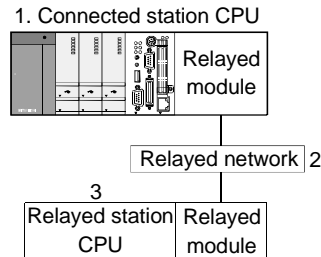

(2) Accessibility list

The following table indicates whether access can be made or not.

The connected station CPUs are all accessible.

Whether the relay target CPU is accessible or not is indicated by ○ (accessible) or × (inaccessible).

1. Connected Station CPU *1 (Usable control name)	2. Relayed Network	3. Relay Target CPU					
		QCPU (Q mode)	QCPU (A mode)	QnACPU	ACPU	FXCPU	Motion controller CPU
QCPU (Q mode), Q25SS (ActQSS, ActMLQSS)	MELSECNET/H	○	×	×	×	×	×
	MELSECNET/10	○	○	○	○	×	○
	MELSECNET(II)	×	×	×	×	×	×
	Ethernet	○*2	×	○*2	×	×	×
	Computer link	○*2	×	○*2	×	×	×
	CC-Link	○	○*3	○*3	○*3	×	○*3

*1: When the connected station CPU is the Q25SS or QCPU (Q mode), use the CC-Link module or Q Series Corresponding C24 of the following serial No.

- CC-Link module First five digits are "03082" or later
- Q Series Corresponding C24 First five digits are "03112" or later

*2: Inaccessible when the connected station CPU is the Q25SS.

*3: As the relayed station CPU side CC-Link system master/local module, use the module of software version "S" or later.

5 ACT CONTROLS

This chapter describes the ACT controls for use of SX Controller communication.

5.1 ACT Controls

The following table indicates the ACT controls for use of SX Controller communication.

DLL Name	Control Name		Application	Applicable Setting Type
	For VB, VC++, VBA	For VBScript		
ActMulti.DLL	ActEasyIF	ActMLEasyIF	Used to make communication settings easily on the communication settings utility to make communication.	U
ActPcModule.DLL	ActQSS	ActMLQSS	Used when communication is made via the Q25SS.	P

U: Utility setting type

P: Program setting type

5.2 Properties

The following table indicates the details of the properties that must be set for SX Controller communication.

For details of the other properties, refer to the MX Component Programming Manual.

Property Name(Type)	Description			
ActCpuType (LONG)	Specify the target CPU to communicate with. In the parameter, specify any of the CPU types in the following table.			
	Property value (Property window input value)	Target CPU	Property value (Property window input value)	Target CPU
	CPU_Q00JCPU (0x30)	Q00JCPU	CPU_A2NCP (0x108)	A2NCP (–S1), A2SCPU (–S1)
	CPU_Q00CPU (0x31)	Q00CPU	CPU_A2SHCPU(0x109)	A2SHCPU (–S1)
	CPU_Q01CPU (0x32)	Q01CPU	CPU_A3NCP (0x10A)	A3NCP
	CPU_Q02CPU (0x22)	Q02(H)CPU	CPU_A2ACPU (0x10C)	A2ACPU (–S1), A2ACPUP21/R21(–S1)
	CPU_Q06CPU (0x23)	Q06HCPU	CPU_A3ACPU (0x10D)	A3ACPU, A3ACPUP21/R21
	CPU_Q12CPU (0x24)	Q12HCPU	CPU_A2UCPU (0x10E)	A2UCPU (–S1), A2USCPU (–S1), A2ASCPU (–S1)
	CPU_Q25CPU (0x25)	Q25HCPU	CPU_A3UCPU (0x110)	A3UCPU, A2ASCPU-S30
	CPU_Q25SSCPU (0x55)	Q25SS	CPU_A4UCPU (0x111)	A4UCPU
	CPU_Q12PHCPU (0x41)	Q12PHCPU	CPU_FX0CPU (0x201)	FX0, FX0s
	CPU_Q25PHCPU (0x42)	Q25PHCPU	CPU_FX0NCP (0x202)	FX0N
	CPU_Q02CPU_A (0x141)	Q02(H)CPU-A	CPU_FX1CPU (0x203)	FX1
	CPU_Q06CPU_A (0x142)	Q06HCPU-A	CPU_FX2CPU (0x204)	FX2, FX2c
	CPU_Q2ACPU (0x11)	Q2ACPU, Q2ASCPU, Q2ASHCPU	CPU_FX2NCP (0x205)	FX2N, FX2NC
	CPU_Q2AS1CPU (0x12)	Q2ACPU-S1, Q2ASCPU(–S1), Q2ASHCPU(–S1)	CPU_FX1SCPU (0x206)	FX1s
	CPU_Q3ACPU (0x13)	Q3ACPU	CPU_FX1NCP (0x207)	FX1N, FX1NC
	CPU_Q4ACPU (0x14)	Q4ACPU, Q4ARCPU	CPU_A171SHCPU (0x601)	A171SHCPU
	CPU_A0J2HCPU (0x102)	A0J2HCPU	CPU_A172SHCPU (0x602)	A172SHCPU
	CPU_A1FXCPU (0x103)	A1FXCPU	CPU_A273UHCPU (0x603)	A273UHCPU (–S3)
	CPU_A1SCPU (0x104)	A1SCPU(–S1), A1SCPUC24-R2, A1SJCPU	CPU_A173UHCPU (0x604)	A173UHCPU (–S1)
	CPU_A1SHCPU (0x105)	A1SHCPU, A1SJHCPU	CPU_BOARD (0x401)	For own board access * 1
	CPU_A1NCP (0x106)	A1NCP	* 1: Except CPU board	
	CPU_A2CCCPU (0x107)	A2CCCPU, A2CCPUC24 (–PRF), A2CJCPU		

5.3 Lists of Properties Possessed by the ActQSS, ActMLQSS control

The following table indicates the properties possessed by the ActQSS, ActMLQSS control and their default values.

For use of the property list and default values, refer to the MX Component Programming Manual.

(1) Configuration

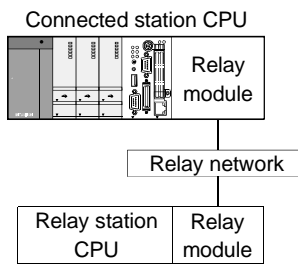

(2) Property patterns

Connected Station CPU *1	Relay Network	Relay Station CPU				
		QCPU (Q mode)	QCPU (A mode)	QnA CPU	ACPU *2	FXCPU
①	MELSECNET/H	②	×	×	×	×
	MELSECNET/10	②	②	②	②	×
	MELSECNET(II)	×	×	×	×	×
	Ethernet	②*3	×	②*3	×	×
	Computer link	③*3	×	③*3	×	×
	CC-Link	④	④*4	④*4	④*4	×

○ : Accessible (Property pattern within circle)
 × : Inaccessible

*1 : When the connected station CPU is the Q25SS or QCPU (Q mode), use the CC-Link module with the first five digits of the serial No. are "03082" or later or the Q Series Corresponding C24 with the first five digits of the serial No. are "03112" or later.

*2 : Including motion controller CPU

*3 : Inaccessible when the connected station CPU is the Q25SS.

*4 : Use the QnA or ACPUs side CC-Link module of ROM version "S" or later.

(3) Property list

Property	Default Value	Property Patterns			
		①	②*1	③	④
ActCpuType	85 (CPU_Q25SSCPU)	CPU type corresponding to target station			
ActDestinationIONumber	0 (0x00)	Fixed to 0x00	Fixed to 0x00	Target station side For single CPU 0x3FF fixed For multiple CPUs Connected CPU: 0x3FF No. 1: 0x3E0 No. 2: 0x3E1 No. 3: 0x3E2 No. 4: 0x3E3	Target station side For single CPU 0x3FF fixed For multiple CPUs Connected CPU: 0x3FF No. 1: 0x3E0 No. 2: 0x3E1 No. 3: 0x3E2 No. 4: 0x3E3
ActDidPropertyBit	1 (0x01)	0x01	0x01	0x00	0x00
ActDisdPropertyBit	1 (0x01)	0x01	0x01	0x00	0x00

*1 Note the following points when making access via the Ethernet module (Q Series Corresponding E71, QE71).

- For ActNetworkNumber and ActStationNumber, specify the value set in the parameter setting of the target station side Q series-compatible E71 or QE71.
- Set the "MNET/10 routing information" in the parameter setting of the Q Series Corresponding E71 or QE71. And then, specify other than the automatic response system (any of the IP address calculation system, table conversion system and combined system) as the "MNET/10 routing system".

(To next page)

Property	Default Value	Property Patterns			
		①	② * 1	③	④
ActIntelligentPreferenceBit	0 (0x00)	Fixed to 0x00	Fixed to 0x00	0x01 (target station is QCPU (Q mode), 0x00 (target station is other than QCPU (Q mode)))	0x01 (target station is QCPU (Q mode), 0x00 (target station is other than QCPU (Q mode)))
ActIOnumber * 2	1023 (0x3FF)	For single CPU 0x3FF fixed For multiple CPUs Connected CPU: 0x3FF No. 1: 0x3E0 No. 2: 0x3E1 No. 3: 0x3E2 No. 4: 0x3E3	For single CPU 0x3FF fixed For multiple CPUs Connected CPU: 0x3FF No. 1: 0x3E0 No. 2: 0x3E1 No. 3: 0x3E2 No. 4: 0x3E3	Connected station side module I/O address	Connected station side module I/O address
ActMultiDropChannelNumber	0 (0x00)	Fixed to 0x00	Fixed to 0x00	Multidrop channel No.	Fixed to 0x00
ActNetworkNumber	0 (0x00)	Fixed to 0x00	Target station side module network number	Fixed to 0x00	Fixed to 0x00
ActStationNumber	255 (0xFF)	Fixed to 0xFF	Target station side module station number	Fixed to 0xFF	Fixed to 0xFF
ActThroughNetworkType	0 (0x00)	QCPU (Q mode): 0x00 (MELSECNET/H only), other than QCPU (Q mode): 0x01 (including MELSECNET/10). Note that the setting must be the same as set in the network parameter of the GX Developer.			
ActUnitNumber	0 (0x00)	Fixed to 0x00	Fixed to 0x00	Target station side module station number	Target station side module station number

* 1: Note the following points when making access via the Ethernet module (Q series-compatible E71, QE71).

- For ActNetworkNumber and ActStationNumber, specify the value set in the parameter setting of the target station side Q series-compatible E71 or QE71.
- Set the "MNET/10 routing information" in the parameter setting of the Q series-compatible E71 or QE71. Also, when making setting, specify other than the automatic response system (any of the IP address calculation system, table conversion system and combined system) as the "MNET/10 routing system".

* 2: As the I/O address, specify the value found by dividing the actual first I/O number by 16.

6 FUNCTIONS

The following tables indicate whether the functions are available for the ActQSS and ActMLQSS controls.

For details of the functions, refer to the MX Component Programming Manual.

Function Name	Availability
Open	○
Close	○
ReadDeviceBlock	○
WriteDeviceBlock	○
ReadDeviceRandom	○
WriteDeviceRandom	○
SetDevice	○
GetDevice	○
ReadBuffer	○
WriteBuffer	○
GetClockData	○
SetClockData	○
GetCpuType	○

Function Name	Availability
SetCpuStatus	○
EntryDeviceStatus	○
FreeDeviceStatus	○
OnDeviceStatus	○
ReadDeviceBlock2	○
WriteDeviceBlock2	○
ReadDeviceRandom2	○
WriteDeviceRandom2	○
SetDevice2	○
GetDevice2	○
Connect	×
Disconnect	×
GetErrorMessage	×

○:Available ×:N/A

APPENDIX

Appendix 1 Precautions for Access to Q25SS from Communication Paths

This section explains the precautions for access to the Q25SS from the communication paths except SX Controller communication.

(1) CPU COM communication

(a) When fabricating an RS-232 cable for connection to the other personal computer and PC CPU module, refer to the following wiring example.

PC CPU Module Side		Cable Connection or and Signal Direction	Personal Computer Side
Signal Name	Pin No.		Signal Name
CD	1		CD
RD(RXD)	2		RD(RXD)
SD(TXD)	3		SD(TXD)
DTR(ER)	4		DTR(ER)
SG	5		SG
DSR(DR)	6		DSR(DR)
RS(RTS)	7		RS(RTS)
CS(CTS)	8		CS(CTS)

(b) When making access to the QCPU (A mode) or ACPU (including the motion controller CPU) via the CC-Link module controlled by the Q25SS, use the CC-Link module with the first five digits of the serial No. are "03082" or later.

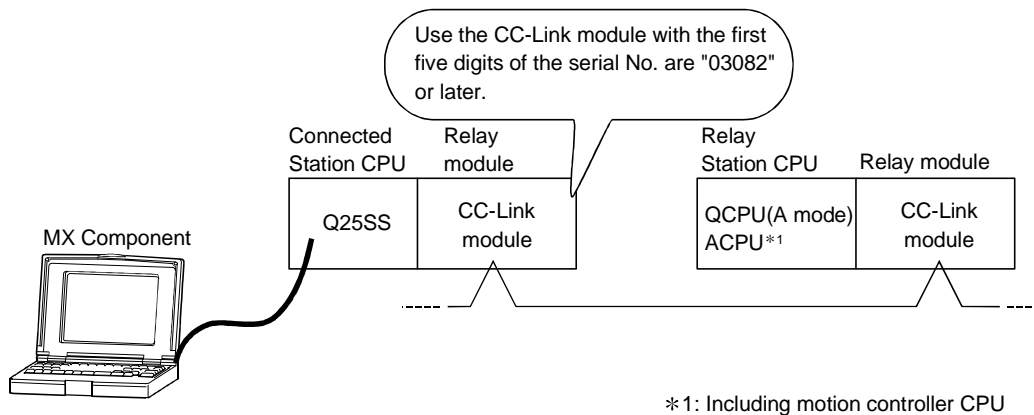

APP

Microsoft, Windows, Windows NT, Visual Basic and Visual C++ are either trademarks or registered trademarks of Microsoft Corporation in the United States and/or other countries.

Ethernet is the registered trademark of Xerox Corporation.

Other company and product names herein may be either trademarks or registered trademarks of their respective owners.

SPREAD

Copyright(C) 1998 Far Point Technologies, Inc.

MX Component Version 3

Operating Manual(SX Controller Communication)

MODEL	MELS3-ACTEL-O-E
MODEL CODE	—
SH(NA)-080269-A(0204)MEE	

 **MITSUBISHI ELECTRIC CORPORATION**

HEAD OFFICE : 1-8-12, OFFICE TOWER Z 14F HARUMI CHUO-KU 104-6212, JAPAN
NAGOYA WORKS : 1-14 , YADA-MINAMI 5 , HIGASHI-KU, NAGOYA , JAPAN

When exported from Japan, this manual does not require application to the Ministry of Economy, Trade and Industry for service transaction permission.

Specifications subject to change without notice.