



Mitsubishi Industrial Robot

**CR750-D/CR751-D series controller
CRnD-700 series controller**

**GOT Direct Connection
Extended Function Instruction Manual**

Safety Precautions

Always read the following precautions and the separate "Safety Manual" before starting use of the robot to learn the required measures to be taken.

-  **CAUTION** All teaching work must be carried out by an operator who has received special training. (This also applies to maintenance work with the power source turned ON.)
Enforcement of safety training
-  **CAUTION** For teaching work, prepare a work plan related to the methods and procedures of operating the robot, and to the measures to be taken when an error occurs or when restarting. Carry out work following this plan. (This also applies to maintenance work with the power source turned ON.)
Preparation of work plan
-  **WARNING** Prepare a device that allows operation to be stopped immediately during teaching work. (This also applies to maintenance work with the power source turned ON.)
Setting of emergency stop switch
-  **CAUTION** During teaching work, place a sign indicating that teaching work is in progress on the start switch, etc. (This also applies to maintenance work with the power source turned ON.)
Indication of teaching work in progress
-  **DANGER** Provide a fence or enclosure during operation to prevent contact of the operator and robot.
Installation of safety fence
-  **CAUTION** Establish a set signaling method to the related operators for starting work, and follow this method.
Signaling of operation start
-  **CAUTION** As a principle turn the power OFF during maintenance work. Place a sign indicating that maintenance work is in progress on the start switch, etc.
Indication of maintenance work in progress
-  **CAUTION** Before starting work, inspect the robot, emergency stop switch and other related devices, etc., and confirm that there are no errors.
Inspection before starting work

The points of the precautions given in the separate "Safety Manual" are given below. Refer to the actual "Safety Manual" for details.

- ⚠ DANGER** When automatic operation of the robot is performed using multiple control devices (GOT, programmable controller, push-button switch), the interlocking of operation rights of the devices, etc. must be designed by the customer.
- ⚠ CAUTION** Use the robot within the environment given in the specifications. Failure to do so could lead to a drop or reliability or faults. (Temperature, humidity, atmosphere, noise environment, etc.)
- ⚠ CAUTION** Transport the robot with the designated transportation posture. Transporting the robot in a non-designated posture could lead to personal injuries or faults from dropping.
- ⚠ CAUTION** Always use the robot installed on a secure table. Use in an instable posture could lead to positional deviation and vibration.
- ⚠ CAUTION** Wire the cable as far away from noise sources as possible. If placed near a noise source, positional deviation or malfunction could occur.
- ⚠ CAUTION** Do not apply excessive force on the connector or excessively bend the cable. Failure to observe this could lead to contact defects or wire breakage.
- ⚠ CAUTION** Make sure that the workpiece weight, including the hand, does not exceed the rated load or tolerable torque. Exceeding these values could lead to alarms or faults.
- ⚠ WARNING** Securely install the hand and tool, and securely grasp the workpiece. Failure to observe this could lead to personal injuries or damage if the object comes off or flies off during operation.
- ⚠ WARNING** Securely ground the robot and controller. Failure to observe this could lead to malfunctioning by noise or to electric shock accidents.
- ⚠ CAUTION** Indicate the operation state during robot operation. Failure to indicate the state could lead to operators approaching the robot or to incorrect operation.
- ⚠ WARNING** When carrying out teaching work in the robot's movement range, always secure the priority right for the robot control. Failure to observe this could lead to personal injuries or damage if the robot is started with external commands.
- ⚠ CAUTION** Keep the jog speed as low as possible, and always watch the robot. Failure to do so could lead to interference with the workpiece or peripheral devices.
- ⚠ CAUTION** After editing the program, always confirm the operation with step operation before starting automatic operation. Failure to do so could lead to interference with peripheral devices because of programming mistakes, etc.
- ⚠ CAUTION** Make sure that if the safety fence entrance door is opened during automatic operation, the door is locked or that the robot will automatically stop. Failure to do so could lead to personal injuries.
- ⚠ CAUTION** Never carry out modifications based on personal judgments, or use non-designated maintenance parts. Failure to observe this could lead to faults or failures.

 **WARNING**

When the robot arm has to be moved by hand from an external area, do not place hands or fingers in the openings. Failure to observe this could lead to hands or fingers catching depending on the posture.

 **CAUTION**

Do not stop the robot or apply emergency stop by turning the robot controller's main power OFF. If the robot controller main power is turned OFF during automatic operation, the robot accuracy could be adversely affected. Moreover, it may interfere with the peripheral device by drop or move by inertia of the arm.

 **CAUTION**

Do not turn off the main power to the robot controller while rewriting the internal information of the robot controller such as the program or parameters. If the main power to the robot controller is turned off while in automatic operation or rewriting the program or parameters, the internal information of the robot controller may be damaged.

 **DANGER**

Do not connect the Handy GOT when using the GOT direct connection function of this product. Failure to observe this may result in property damage or bodily injury because the Handy GOT can automatically operate the robot regardless of whether the operation rights are enabled or not.

 **DANGER**

Do not remove the SSCNET III cable while power is supplied to the controller. Do not look directly at light emitted from the tip of SSCNET III connectors or SSCNET III cables. Eye discomfort may be felt if exposed to the light. (Reference: SSCNET III employs a Class 1 or equivalent light source as specified in JIS C 6802 and IEC60825-1 (domestic standards in Japan).)

 **DANGER**

Attach the cap to the SSCNET III connector after disconnecting the SSCNET III cable. If the cap is not attached, dirt or dust may adhere to the connector pins, resulting in deterioration connector properties, and leading to malfunction.

 **CAUTION**

Make sure there are no mistakes in the wiring. Connecting differently to the way specified in the manual can result in errors, such as the emergency stop not being released. In order to prevent errors occurring, please be sure to check that all functions (such as the teaching box emergency stop, customer emergency stop, and door switch) are working properly after the wiring setup is completed.

 **CAUTION**

Use the network equipments (personal computer, USB hub, LAN hub, etc) confirmed by manufacturer. The thing unsuitable for the FA environment (related with conformity, temperature or noise) exists in the equipments connected to USB. When using network equipment, measures against the noise, such as measures against EMI and the addition of the ferrite core, may be necessary. Please fully confirm the operation by customer. Guarantee and maintenance of the equipment on the market (usual office automation equipment) cannot be performed.

*CR751-D or CR751-Q controller

Notes of the basic component are shown.

⚠ CAUTION

Please install the earth leakage breaker in the primary side supply power supply of the controller of CR751-D or CR751-Q because of leakage protection.

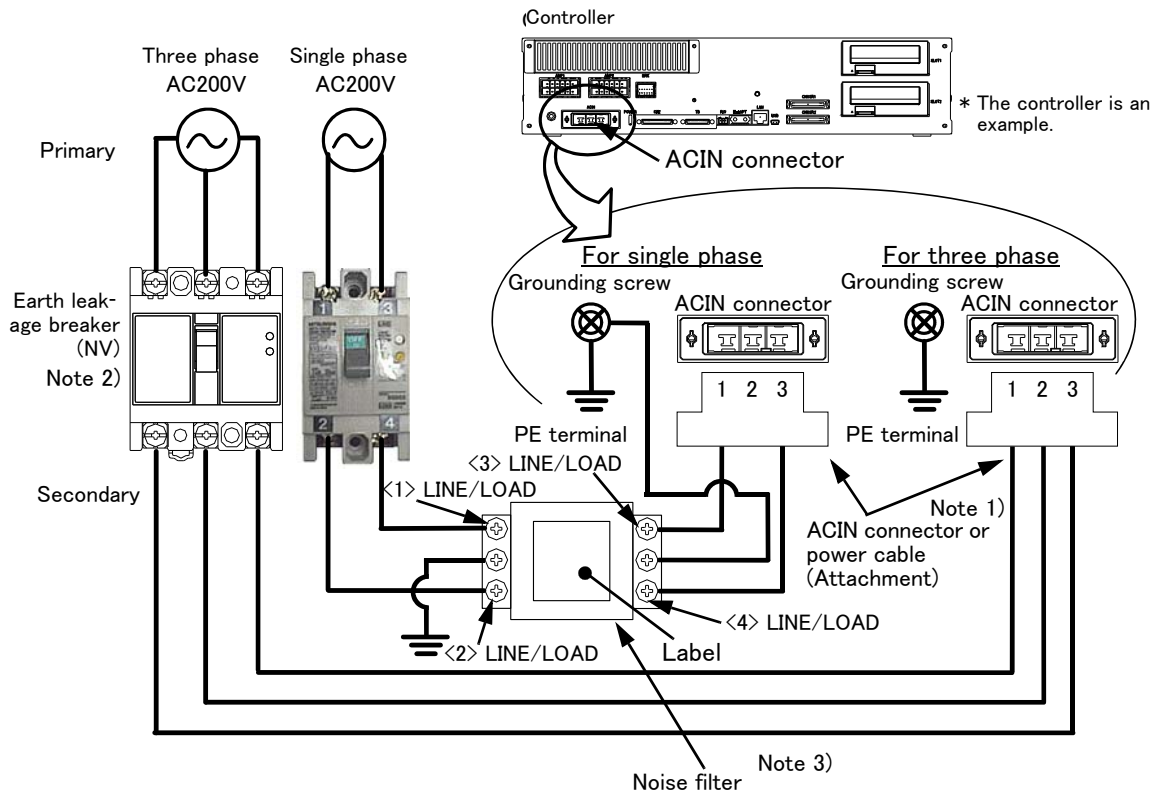

Note 1) Crimping swage is recommended for connecting the attachment ACIN connector (soldering is also possible)
Recommendation compression tools: 234171-1(Tyco Electronics)

Note 2) The earth leakage breaker is the customer preparation. Always use the cover below.
Recommendation:

For single primary power supply NV30FAU-2P-10A-AC100-240V-30mA, (Cover: TCS-05FA2)
For three primary power supply NV30FAU-3P-10A-AC100-240V-30mA, (Cover: TCS-05FA3)

Note 3) If necessary, as shown in the figure, connects the noise filter between ACIN terminal blocks and primary power supply.
(Recommended noise filter: SUP-EL20-ER6 *OKAYA ELECTRIC INDUSTRIES)

- 1) Please prepare the following: Leakage current breaker (with terminal cover), cable for connecting the primary power supply, cable for connecting the secondary power supply (both AWG #14 (2mm²)), cables to ground the primary power supply (AWG #12 (3.5mm² or above).
- 2) Confirm that the primary power matches the specifications.
- 3) Confirm that the primary power is OFF and that the earth leakage breaker power switch is OFF.
- 4) Connect the secondary power cable to secondary terminal (lower terminal) of earth leakage breaker. Connect the opposite side of this cable with following pin numbers of the ACIN connector attached.
For single phase: 1 and 3
For three phase: 1, 2, and 3
Recommends connection by the Solderless terminal.
Or, connect by the attachment power cable.
- 5) Connect this connector to the ACIN connector on the controller.
- 6) Connect the grounding cable to the PE terminal. (M4 screw)
- 7) Connect the primary power cable to the primary side terminal (upper terminal) of the earth leakage breaker.

Revision history

Date of print	Specifications No.	Details of revisions
2011-07-01	BFP-A8849	• First edition created
2012-03-07	BFP-A8849-A	• CR750-D/CR751-D series controller were added.
2012-12-05	BFP-A8849-B	• The statement about trademark registration was added.
2014-08-06	BFP-A8849-C	• The cover and corporate logo mark of this manual was changed. • The statement about trademark registration was modified.
2014-12-11	BFP-A8849-D	• The corporate logo mark of illustrations in this manual was changed.

*Introduction

Thank you for buying the industrial robot MELFA manufactured by Mitsubishi Electric. This manual explains the expanded function and operation when connecting the robot controller and the GOT directly in SD series robot controller (CR750-D/CR751-D series, CRnD-700 series). Monitoring of the robot information and the setup of the data are possible through the shared memory.

Please carefully read and fully understand this document before making use of the extended functions.

Target controller of this document

This document supports the robot controller below:

- CR750-D/CR751-D series controller: ... Ver. S3 or later
- CRnD-700 series controller: Ver. S2g or later
Robot language MELFA BASIC V or later

- No part of this manual may be reproduced by any means or in any form, without prior consent from Mitsubishi.
- The contents of this manual are subject to change without notice.
- The specifications values are based on Mitsubishi standard testing methods.
- The information contained in this document has been written to be accurate as much as possible. Please interpret that items not described in this document "cannot be performed." or "alarm may occur".
Please contact your nearest dealer if you find any doubtful, wrong or skipped point.
- This specifications is original.

- Microsoft, Windows, Windows XP, Windows Vista, Windows 7, Windows 8, Windows 8.1 are either registered trademarks or trademarks of Microsoft Corporation in the United States and/or other countries.
- Windows®XP, Windows Vista®, Windows® 7, Windows® 8, Windows® 8.1 are either product names of Microsoft Corporation in the United States.
- Ethernet is registered trademarks or trademarks of Xerox Corporation in the United States.
- All other company names and production names in this document are the trademarks or registered trademarks of their respective owners.

Contents

	Page
1 Overview	1-1
1.1 Function List	1-1
1.2 Features	1-2
1.3 Shared Memory Configuration	1-3
1.3.1 Memory Configuration for Valid/Invalid Extended Function	1-3
1.3.2 Memory Map of Extended Function Area	1-4
2 Preparation for Using Extended Function	2-5
2.1 Operation flow	2-5
2.1.1 Set up Parameter for Selecting Shared Memory Extended Function	2-5
2.1.2 Check Robot Language Setting	2-6
3 Monitor Robot Information	3-7
3.1 Operation Flow	3-8
3.1.1 Select Monitoring Items	3-9
3.1.2 Select Target Mecha	3-9
3.1.3 Timing Chart	3-10
3.2 Monitoring Item	3-11
3.2.1 Monitor Operation Control Setting Values	3-11
3.2.2 Monitor Activities	3-13
3.2.3 Monitor Current and Aimed Positions	3-14
3.2.4 Monitor Position and Joint Information	3-16
(1) Select Position and Joint Data	3-16
(2) Position and Joint Data	3-18
3.2.5 Monitor Maintenance Information	3-21
4 Reads/Writes Robot's Variables	4-22
4.1 Function Description	4-22
4.2 Operation Flow	4-22
4.3 How to Operate Variables	4-23
4.3.1 Data List	4-23
(1) GOT output data	4-23
(2) Robot output data	4-24
(3) Completion status	4-25
(4) Data description	4-25
4.3.2 Timing Chart	4-27
5 Read Current Line of Robot Program	5-28
5.1 Function Description	5-28
5.2 Operation flow	5-28
5.3 How to Operate Program	5-29
5.3.1 Data List	5-29
5.3.2 Timing Chart	5-33
6 Set up Robot's Maintenance	6-34
6.1 Function Description	6-34
6.2 Operation flow	6-34
6.3 How to Operate Maintenance	6-35
6.3.1 Data List	6-35
6.3.2 Timing Chart	6-37
7 Read Robot Information	7-38
7.1 Function Description	7-38
7.2 Operation flow	7-38
7.3 How to Operate Robot Information	7-39

Contents

	Page
7.3.1 Data List	7-39
7.3.2 Timing Chart	7-42
8 Function Relevant Parameter	8-43
8.1 Function Definition Parameter	8-43
9 Extended Function Relevant Error List	9-44

1 Overview

This manual explains the expanded function and operation when connecting the robot controller and the GOT directly in CR750-D/CR751-D series and CRnD-700 series robot controller.

Monitoring of the robot information and the setup of the data are possible through the shared memory. (The shared memory is extended.)

Note: These shared memory extended functions only support MELFA-BASIC V or later. They do not support MELFA-BASIC IV.

(For more information, refer to [Page 6, "2.1.2 Check Robot Language Setting"](#))

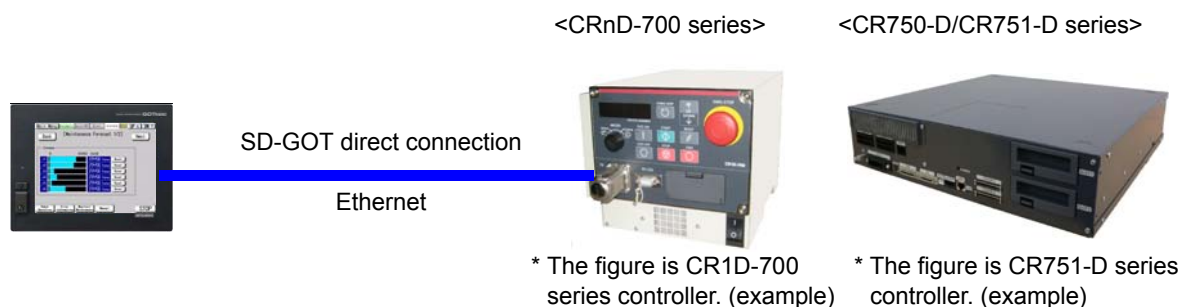

1.1 Function List

These shared memory extended functions are largely classified into monitoring and operation functions. Monitoring function periodically updates and outputs the data in shared memory on the robot. Operation function outputs a request from the GOT to the robot as needed and exchanges the data.

No	Item	Description	I/F btwn Robots	Update Cycle
1	Monitoring function	Monitor operation control setting values	Motoring output (Robot side periodically updates the data in shared memory)	7.1msec
2		Monitor activities		7.1msec
3		Monitor current and aimed positions		7.1msec
4		Monitor general position and joint information		It may differ according to each item. Refer to Page 16, "3.2.4 Monitor Position and Joint Information" .
5		Monitor maintenance information		Depending on the parameter MFINTVL
6	Operation function	Read/write variables	Request reply method (The robot side answers by the output request of the GOT, and delivers the data on the shared memory)	Responds within 1s (It may vary according to the load status of robot control)
7		Read program's current line		
8		Set up maintenance		
9		Read error information		
10		Read product information		

1.2 Features

(1) Fulfilling functions to monitor and operate robot from GOT. Advances T/B and PC-less solution.

→ Various functions can be performed by reading/ writing the data in shared memory from GOT.

- Allows you to check activities, position information, and setting values of operation control command and thereby analyze the operation in case of debugging or problem. (Monitoring current and aimed positions, activities, and operation control setting values)
- Allows you to read and write the contents of program and variables and thereby change the robot's operation in case of debugging or problem.
- Allows you to check and set up maintenance status.
- Allows you to check error's detailed content. (Reading error information)
- Allows you to display and check various information in the robot (product, servo information, etc.)

1.3 Shared Memory Configuration

Here, describes the shared memory configuration among the GOT.

1.3.1 Memory Configuration for Valid/Invalid Extended Function

To use the shared memory extended functions, enable the shared memory extended functions with the parameter "IQMEM".

After enabling the shared memory extended functions, the shared memory is used by extending the robot I/O area by 0.5 K word.

[Supplement]

In this manual, the shared memory address is written by offset. The top address outputted to the robot from the GOT is "U3E0\G10000", and this data is the robot's input signal 10000. And the data of the robot's output signal 10000 can be read by input top address "U3E1\G10000" of the GOT.

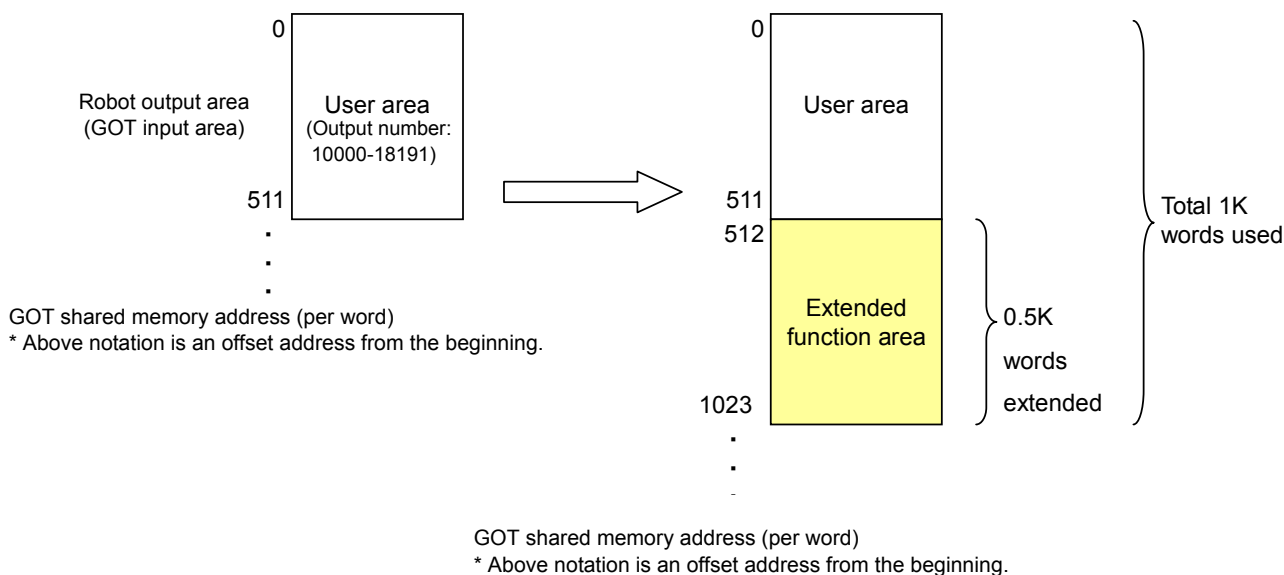
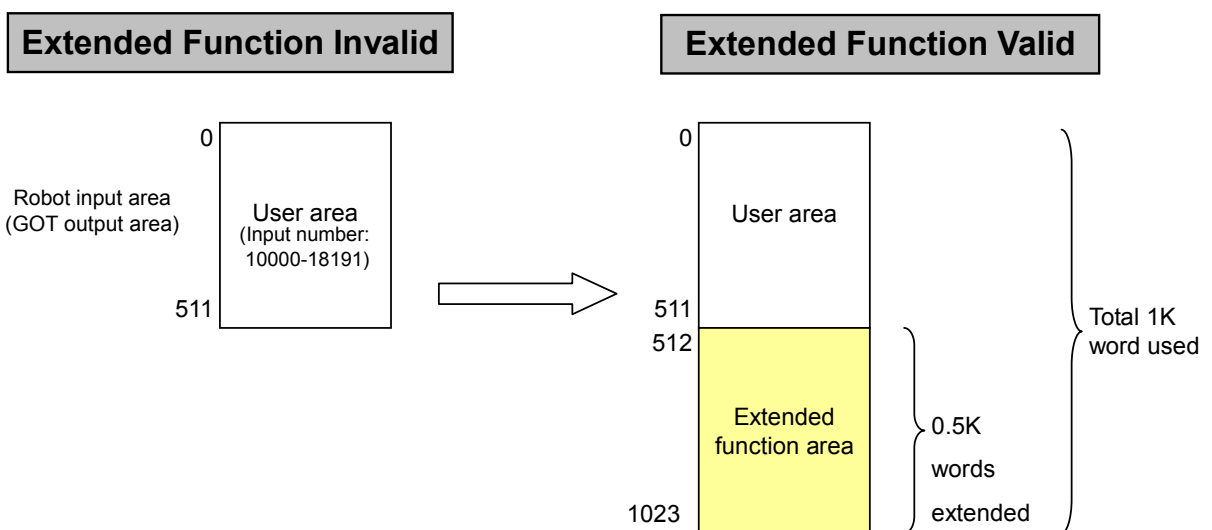

Note) Only the user area can be referred to by robot program, signal monitor, and dedicated I/O signal allocation. They cannot refer to the extended function area.

1.3.2 Memory Map of Extended Function Area

The table below lists the memory map of extended function area in the shared memory among the GOT.

* The GOT address is described in the offset address from start address.

* When not otherwise specified, the values are stored in binary format.

(1) Robot input (GOT output) area

Shared Memory Addr GOT Addr	Description
512	Common setting area of extended function (Reserved: Future extended area)
600	
700	Common area of operation function Reading/ writing/ teaching area of variables Reading area of program's current line
800	Reset area of servo monitor information Reading area of error and product information Common area of monitoring function Monitoring area of general position and joint information (Reserved: Future extended area)
900	
1000	
1023	
1024	

(2) Robot output (GOT input) area

Shared Memory Addr GOT Addr	Description
512	Common setting area of extended function (Reserved: Future extended area)
	Common area of operation function Read/write variables
	Reading area of program's current line
600	
	Reset area of servo monitor information Reading area of information
700	
	Common area of monitoring function Monitoring area of operation control setting values
800	
	Monitoring area of activities Monitoring area of current and aimed positions
900	
	Monitoring area of general position and joint information
	Monitoring area of maintenance information
1000	
	(Reserved)
1023	
1024	

2 Preparation for Using Extended Function

2.1 Operation flow

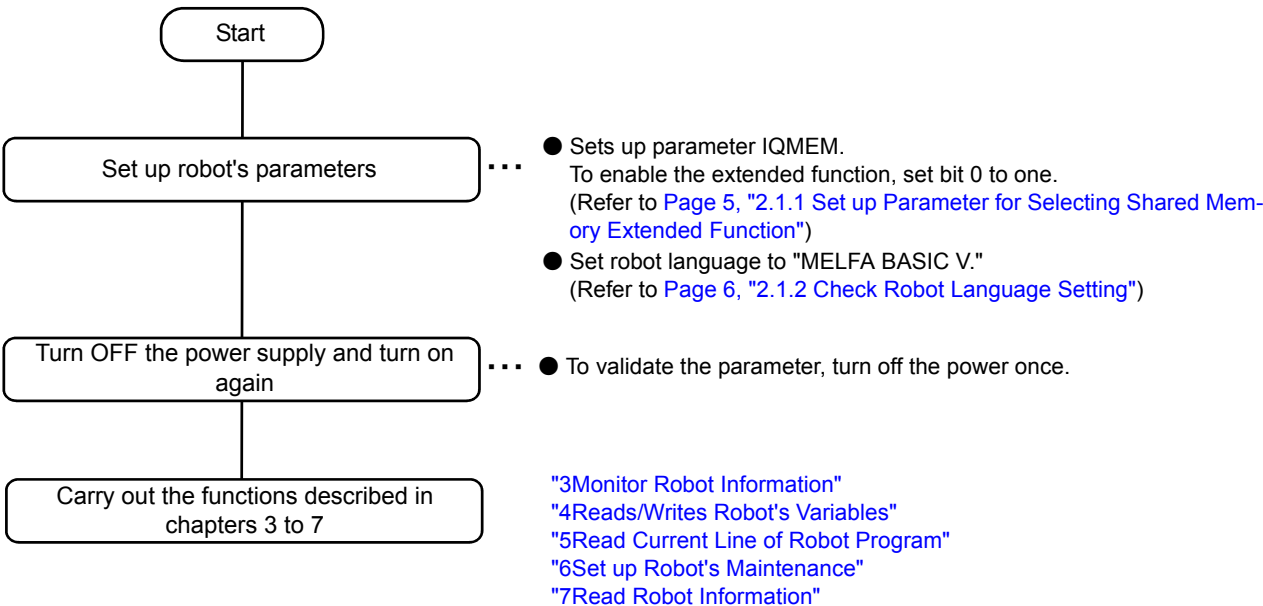

2.1.1 Set up Parameter for Selecting Shared Memory Extended Function

The parameter "IQMEM" for selecting the shared memory extended function is 16bit data. Set the bit 0 to one to use the extended functions.
For information on how to set up a parameter, refer to Supplement volume "Instruction Manual, Detailed Description of Functions and Operations."

Parameter	Parameter Name	Array Qty Character Qty	Description	Factory Default
Select shared memory extended function	IQMEM	1 digit integer	Set validity (1)/ invalidity (0) for the function. Sets each bit by allocating a function to each bit. 0000000000000000 bit1-15: Not used +- bit0: Use the shared memory extended function	0000000000000000

2.1.2 Check Robot Language Setting

The shared memory extended functions can be carried out only when the robot language is set to MELFA-BASIC V.

Check the value of robot language setting parameter "RLNG".

To use the shared memory extended function, set the parameter "RLNG" to 2.

For information on how to set up a parameter, refer to Supplement volume "Instruction Manual, Detailed Description of Functions and Operations."

Parameter	Parameter Name	Array Qty Character Qty	Description	Factory Default
Robot language	RLNG	1 digit integer	Select the robot language to be used: 2: MELFA-BASIC V 1: MELFA-BASIC IV	2

The robot controller's factory default is MELFA-BASIC V. But, when you have selected MELFA-BASIC IV, an error "L3994" occurs on controller startup.



CAUTION

When the robot language setting is changed from MELFA-BASIC V to MELFA-BASIC IV, the extended variable area is cleared. Consequently, be aware that the teaching and setting data for shared memory extended function will disappear.

3 Monitor Robot Information

The [Table 3-1](#) lists the robot information monitored from GOT.

Table 3-1:Monitoring item list

No	Item	Description	I/F betw Robots	Update Cycle	Mecha No Setting	Section No
1	Monitor operation control setting values	Monitors the setting values relating to operation control command and operation control	Monitoring output (Robot side periodically updates the data in shared memory)	7.1msec	○ (necessary)	"3.2.1"
2	Monitor activities	Monitors the robot's activities (current speed, arrival factor to the aimed position, etc.)		7.1msec	○	"3.2.2"
3	Monitor current and aimed positions	Monitors current and aimed positions of robot		7.1msec	○	"3.2.3"
4	Monitor position and joint information	Monitors various position type data (orientation at collision, etc.) and joint type data (current value, load factor, etc.)		Differ according to items	○	"3.2.4"
5	Monitor maintenance information	Monitors the maintenance information (battery and grease remaining times)		Depending on the parameter MFINTVL	○	"3.2.5"

3.1 Operation Flow

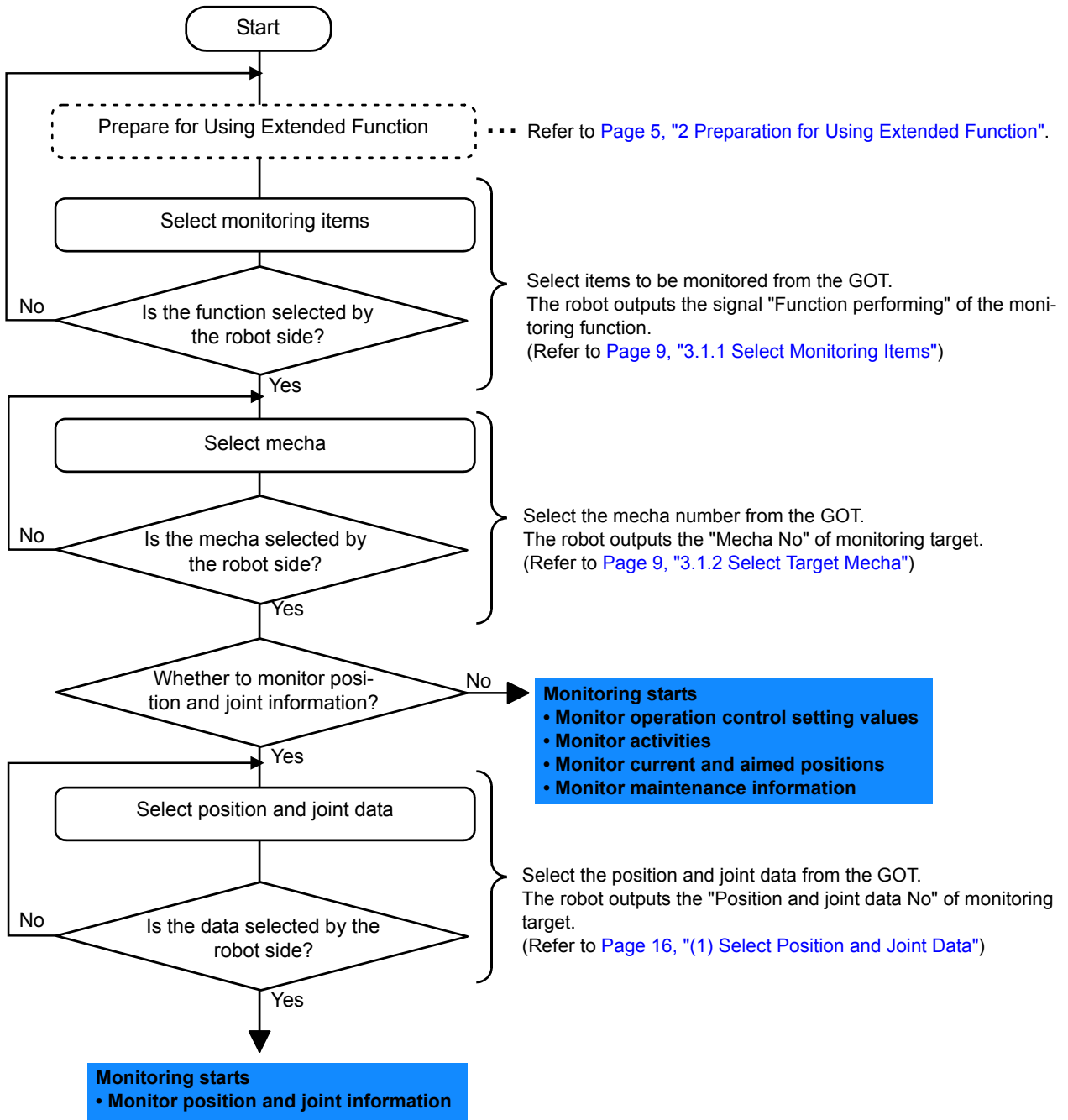

3.1.1 Select Monitoring Items

Here, selects the monitoring functions output by the robot from the GOT.

Only the data specified by items (set to "1") selected with each bit can be monitored. For more information on each monitoring data, refer to [Page 11, "3.2 Monitoring Item"](#) and after.

(1) GOT output data

a) Word data

GOT Addr (offset)	Description	Remarks
512	Function selection [Allocated to each bit, 0: invalid, 1: valid] bit15 0 0000000000000000 +---bit0: (Reserved) +---bit1: (Reserved) +----bit2: Monitor operation control settings +----bit3: Monitor activities +-----bit4: Monitor current and aimed positions +-----bit5: Monitor position and joint information +-----bit6: Monitor maintenance information +-----bit7: (Reserved)	

(2) Robot output data

a) Word data

GOT Addr (offset)	Description	Remarks
512	Function performing [allocated to each bit, 0: invalid, 1: valid] bit15 0 0000000000000000 +---bit0: (Reserved) +---bit1: (Reserved) +----bit2: Monitor operation control settings +----bit3: Monitor activities +-----bit4: Monitor current and aimed positions +-----bit5: Monitor position and joint information +-----bit6: Monitor maintenance information +-----bit7: (Reserved)	

3.1.2 Select Target Mecha

Here, selects the target mecha number of monitoring data output by the robot from the GOT.

The robot outputs the data with selected mecha number. The number (1 to 3) is selectable for mecha numbers. When the number other than 1 - 3 is specified, the data is initialized (zeros are put in the whole target area)

(1) GOT output data

a) Word data

GOT Addr (offset)	Description	Remarks
841	Specify a mecha number [1 - 3]	

(2) Robot output data

a) Word data

GOT Addr (offset)	Description	Remarks
731	Mecha number [1 - 3]	

3.1.3 Timing Chart

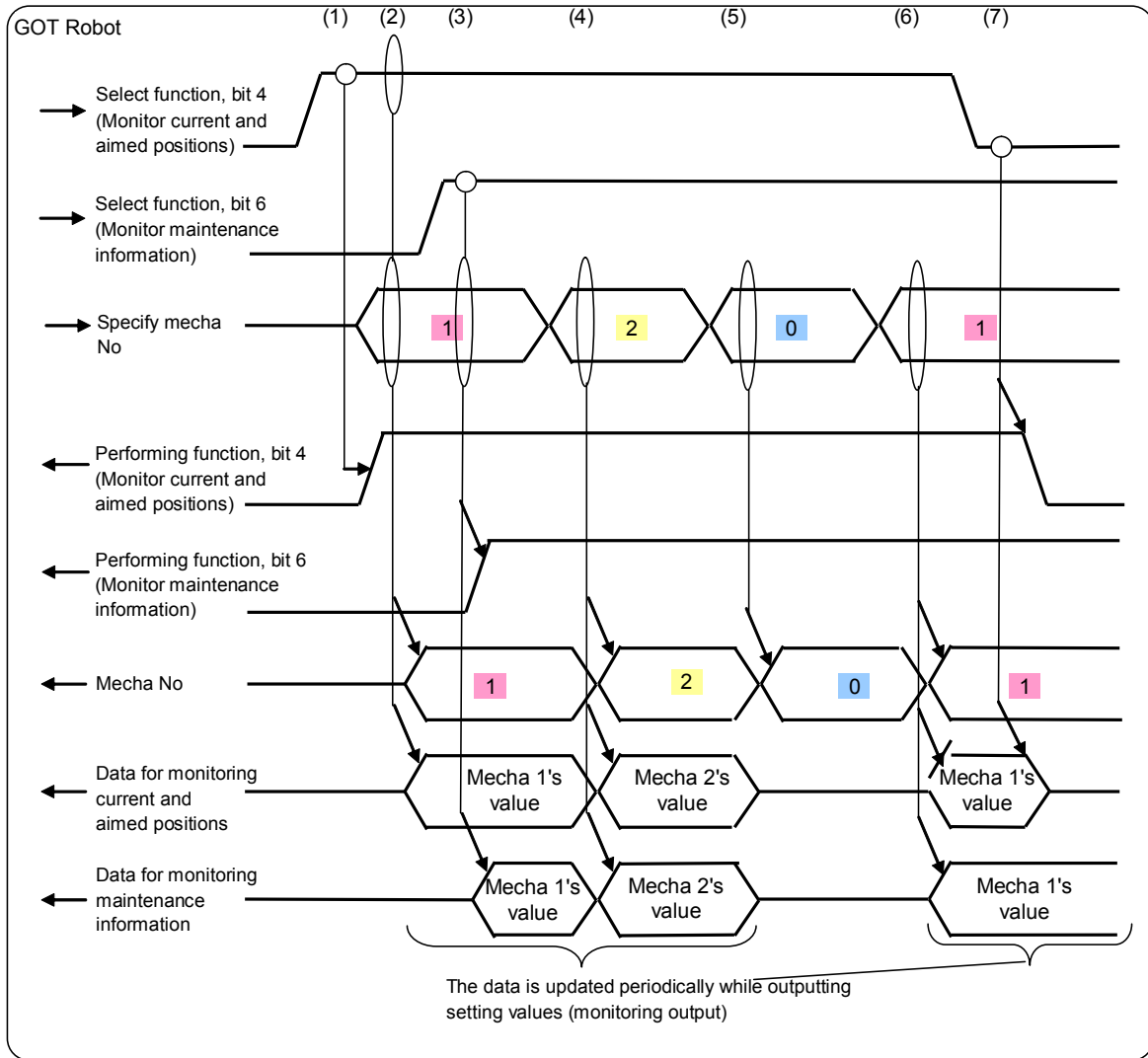

Fig.3-1:Timing chart for selecting monitoring items and target mecha

- (1) When the GOT sets the target bit of "Select function" to "ON", the robot sets the target bit of "Performing function" to "ON" to start the monitoring output of target item. Here, when "Specify mecha number" is other than 1 - 3, the robot waits to update the data.
- (2) When the GOT sets "Specify mecha number" to one, the robot starts to update mecha 1's data.
- (3) When the target bit of "Select function" is set to "ON" while the GOT sets "Specify mecha number", the robot starts to update the data of target item while at the same time the robot sets the target bit of "Performing function" to "ON".
- (4) When the GOT changes "Specify mecha number", the robot outputs the data of specified mecha.
- (5) When the GOT sets "Mecha number" to other than 1 - 3, the robot clears the output data.
- (6) When the GOT re-sets "Mecha number", the robot outputs the data of target mecha.
- (7) When the GOT sets the target bit of "Select function" to "OFF", the robot sets the target bit of "Performing function" to "OFF" to initialize the output data.

CAUTION

The synchronization of data in shared memory is guaranteed on a per 32bit (2 word) basis. But, the synchronization in the unit more than this bit cannot be guaranteed. Therefore, be aware that the position type and joint type data is guaranteed for each axis, the data is not guaranteed as a whole.

3.2 Monitoring Item

3.2.1 Monitor Operation Control Setting Values

Here, periodically outputs the robot's operation control commands and the setting values for operation control to the shared memory.

(1) Monitoring data list

GOT Addr (Offset)	Description	Supported State Variable	Update Cycle
777	ColChk setting value		7.1msec
778	ColLvl setting value		
779			
780			
781			
782			
783			
784			
785			
794	CMP Pos/Tool/Jnt setting values		
795	Compliance coordinate type [0: Invalid/ 1: Perpendicular/ 2: Tool/ 3: Joint] Specify a compliance coordinate type [Specify target axis with bit] [Setting values to specify compliance axis of CMP Pos/Tool/Jnt setting values] The values below are set by setting up bit: bit7 0 00000000 +---bit0:J1/X axis +---bit1:J2/Y axis +----bit2:J3/Z axis +-----bit3:J4/A axis +-----bit4:J5/B axis +-----bit5:J6/C axis +-----bit6: (Reserved) +-----bit7: (Reserved)		
796	CmpG setting value		
797			
798			
799			
800			
801			
802			
803			
804	MvTune/Prec setting values		

<Precautions>

- When the target mecha does not exist, outputs the data zero.
- The value below is output as ColChk:
 - When multiple mechas are in use or when the element 1 of parameter COL is zero (collision detection unavailable),
 - zero is output
 - Otherwise (collision detection available):
 - When being in operation (including step feed, position jump operation),
 - the initial value is the value of element 2 of parameter COL, and then the output value is the value changed by ColChk command.
 - When not being in operation (including suspension and jog operation),
 - it is set to the value of element 3 of parameter COL.
- The value below is output as Collvl:
 - When multiple mechas are in use or when the element 1 of parameter COL is zero (collision detection unavailable) and being in operation,
 - the initial value is the value of parameter COLLVL, and then the output value is the value changed by Collvl command.
 - When not being in operation,
 - it is the value during automatic operation is held when being in suspension, and it is the value of parameter COLLVL when being stopped.
 - Otherwise (collision detection available),
 - When being in operation,
 - the initial value is the value of parameter COLLVL, and then the output value is the value changed by Collvl command.
 - When not being in operation,
 - it is the value of parameter COLLVLJG.
- CMP Pos/Tool/Jnt setting values are set to zero when mechas 2, 3 are selected during using multiple mechas.
(User mecha cannot use compliance)

3.2.2 Monitor Activities

Here, periodically outputs the robot's activities (current speed, arrival factor to the aimed position, etc.) to the shared memory.

(1) Monitoring data list

GOT Addr (offset)	Description	Supported State Variable	Update Cycle
810	Current instruction speed [10^{-4} mm/s]	M_RSpd	7.1msec
811			
812	Current distance remained [10^{-4} mm]	M_RDst	
813			
814	Distance between instructed and feedback positions [10^{-4} mm]	M_Fbd	
815			
816	Arrival factor [%] to the current aimed position	M_Ratio	
817	Current acceleration and deceleration state [0: Stopped/ 1: Accelerated/ 2: Constant speed/ 3: Decelerated]	M_AclSts	
818	Collision detection [1: Collided/ 0: Otherwise] ^{Note1)}	M_ColSts	
819	Going over the limit during performing compliance [1: Almost go over the limit/ 0: Does not go over the limit]	M_CmpLmt	
820	Deviance amount between instructed and actual positions during performing compliance [10^{-4} mm]	M_CmpDst	
821			

Note1) Robot state variable (M_ColSts) is "1" for about 7.1ms between collision detection and servo OFF. But, the data "1" is output to the shared memory for 1sec after the collision is detected.

<Precautions>

- When the target mecha does not exist, outputs the data zero.
- When the data is dependent on a slot and the slot does not exist which has the control of target mecha, outputs the data zero. The data dependent on a slot is as follows:
 - Current distance remained (M_RDst)
 - Arrival factor to the current aimed position (M_Ratio)
 - Current acceleration and deceleration state (M_ActSts)

3.2.3 Monitor Current and Aimed Positions

Here, periodically outputs robot's current and aimed positions to the shared memory.

(1) Monitoring data list

GOT Addr (offset)	Description	Update Cycle	
830	Current position (perpendicular)	7.1msec	
831			X coordinate value [10^{-4} mm/ 10^{-4} deg]
832			Y coordinate value [10^{-4} mm/ 10^{-4} deg]
833			Z coordinate value [10^{-4} mm/ 10^{-4} deg]
834			A coordinate value [10^{-4} mm/ 10^{-4} deg]
835			B coordinate value [10^{-4} mm/ 10^{-4} deg]
836			C coordinate value [10^{-4} mm/ 10^{-4} deg]
837			L1 coordinate value [10^{-4} mm/ 10^{-4} deg]
838			L2 coordinate value [10^{-4} mm/ 10^{-4} deg]
839			Structure flag
840			Multi-turn data
841			X coordinate value [10^{-4} mm/ 10^{-4} deg]
842			Y coordinate value [10^{-4} mm/ 10^{-4} deg]
843			Z coordinate value [10^{-4} mm/ 10^{-4} deg]
844			A coordinate value [10^{-4} mm/ 10^{-4} deg]
845			B coordinate value [10^{-4} mm/ 10^{-4} deg]
846			C coordinate value [10^{-4} mm/ 10^{-4} deg]
847	L1 coordinate value [10^{-4} mm/ 10^{-4} deg]		
848	L2 coordinate value [10^{-4} mm/ 10^{-4} deg]		
849	Structure flag		
850	Aimed position (perpendicular)	7.1msec	
851			X coordinate value [10^{-4} mm/ 10^{-4} deg]
852			Y coordinate value [10^{-4} mm/ 10^{-4} deg]
853			Z coordinate value [10^{-4} mm/ 10^{-4} deg]
854			A coordinate value [10^{-4} mm/ 10^{-4} deg]
855			B coordinate value [10^{-4} mm/ 10^{-4} deg]
856			C coordinate value [10^{-4} mm/ 10^{-4} deg]
857			L1 coordinate value [10^{-4} mm/ 10^{-4} deg]
858			L2 coordinate value [10^{-4} mm/ 10^{-4} deg]
859			Structure flag
860			Multi-turn data
861			X coordinate value [10^{-4} mm/ 10^{-4} deg]
862			Y coordinate value [10^{-4} mm/ 10^{-4} deg]
863			Z coordinate value [10^{-4} mm/ 10^{-4} deg]
864			A coordinate value [10^{-4} mm/ 10^{-4} deg]
865			B coordinate value [10^{-4} mm/ 10^{-4} deg]
866			C coordinate value [10^{-4} mm/ 10^{-4} deg]
867	L1 coordinate value [10^{-4} mm/ 10^{-4} deg]		
868	L2 coordinate value [10^{-4} mm/ 10^{-4} deg]		
869	Structure flag		

GOT Addr (offset)	Description	Update Cycle	
870	Current position (joint)		
871			J1 coordinate value [10^{-4} mm/ 10^{-4} deg]
872			J2 coordinate value [10^{-4} mm/ 10^{-4} deg]
873			
874			J3 coordinate value [10^{-4} mm/ 10^{-4} deg]
875			
876			J4 coordinate value [10^{-4} mm/ 10^{-4} deg]
877			
878			J5 coordinate value [10^{-4} mm/ 10^{-4} deg]
879			
880			J6 coordinate value [10^{-4} mm/ 10^{-4} deg]
881			
882			J7 coordinate value [10^{-4} mm/ 10^{-4} deg]
883			
884			J8 coordinate value [10^{-4} mm/ 10^{-4} deg]
885			
886	Aimed position (joint)		
887			J1 coordinate value [10^{-4} mm/ 10^{-4} deg]
888			J2 coordinate value [10^{-4} mm/ 10^{-4} deg]
889			
890			J3 coordinate value [10^{-4} mm/ 10^{-4} deg]
891			
892			J4 coordinate value [10^{-4} mm/ 10^{-4} deg]
893			
894			J5 coordinate value [10^{-4} mm/ 10^{-4} deg]
895			
896			J6 coordinate value [10^{-4} mm/ 10^{-4} deg]
897			
898			J7 coordinate value [10^{-4} mm/ 10^{-4} deg]
899			
900			J8 coordinate value [10^{-4} mm/ 10^{-4} deg]
901			

<Precautions>

- When the target mecha and axis do not exist, outputs the data zero.
- When the origin is not established, outputs zero for the both perpendicular and joint components of current position.

(2) Data description

[Perpendicular data]

- The unit is 10^{-4} mm or 10^{-4} deg.
- Only lower one word is used for the structure flag. Upper one word is a reserved area.

[Joint data]

- The unit is 10^{-4} mm or 10^{-4} deg.

3.2.4 Monitor Position and Joint Information

Here, periodically outputs the robot's various position type and joint type data to the shared memory. The GOT selects the data output by the robot. The area exists for one pieces of position type data and three pieces of joint type data and the data output for monitoring can be individually set by the GOT.

(1) Select Position and Joint Data

In the GOT, set up the number for position and joint data output by the robot. The robot outputs the monitoring data corresponding to the selected data number. The area exists for one pieces of position type data and three pieces of joint type data and the data can be individually set. When the GOT specifies the data with the number which is out of range, the robot sets all monitoring data to zero.

- (1) Data list
 - a) GOT output

GOT Addr (offset)	Description
850	Position data selection [1 - 4] 1: (Reserved) 2: (Reserved) 3: (Reserved) 4: Direction at the time of collision
851	Joint data selection-1 [1 - 13] 1: (Reserved) 2: (Reserved) 3: Difference between estimated and actual torques when detecting a collision 4: (Reserved) 5: Current instruction 6: Maximum current instruction 1 7: Maximum current instruction 2 8: Current feedback 9: Allowable current instruction, minus side 10: Allowable current instruction, plus side 11: Effective current 12: Axis load level 13: Maximum axis load level
852	Joint data selection-2 [1 - 13] For setting values, refer to 851 above.
853	Joint data selection-3 [1 - 13] For setting values, refer to 851 above.

- b) Robot output

GOT Addr (offset)	Description
906	Position data number [1 - 4]
907	Joint data number-1 [1 - 13]
908	Joint data number-2 [1 - 13]
909	Joint data number-3 [1 - 13]

(2) Timing chart

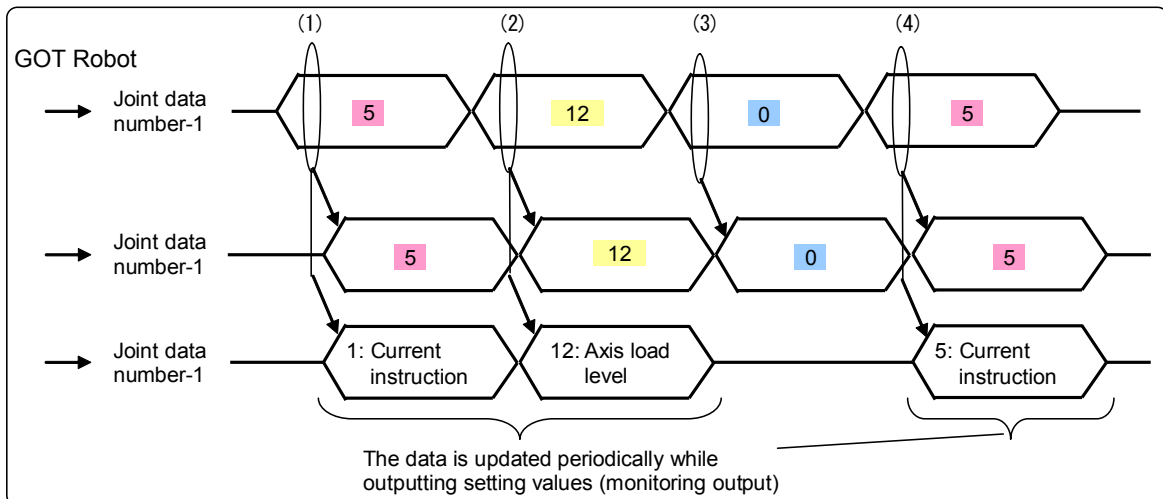

Fig.3-2:Joint data output, Timing chart

- (1) When the GOT selects "Joint data selection-1," the robot outputs the target data to "Joint data-1" area.
- (2) When the GOT changes "Joint data selection-1," the robot outputs the changed target data to "Joint data-1" area.
- (3) When the GOT selects the data out of valid range for "Joint data selection-1," the robot clears "Joint data-1" (set all components to zero) and outputs zero for "Joint number-1."
- (4) When the GOT reselects "Joint data selection-1", the robot outputs the target data to "Joint data-1" area.

* The same applies to Joint data-2, 3 and position data.

(2) Position and Joint Data

(1) Data list

b) Robot output

GOT Addr (offset)	Description	
910	Position data [1 - 4] 1: (Reserved) 2: (Reserved) 3: (Reserved) 4: Direction at the time of collision	X coordinate value
911		
912		Y coordinate value
913		
914		Z coordinate value
915		
916		A coordinate value
917		
918		
919		
920		
921		
922		L1 coordinate value
923		
924		L2 coordinate value
925		
926		Structure flag
927		
928		Multi-turn data
929		
930	Joint data-1 [1 - 13] 1: (Reserved) 2: (Reserved) 3: Difference between estimated and actual torques when detecting a collision 4: (Reserved) 5: Current instruction 6: Maximum current instruction 1 7: Maximum current instruction 2 8: Current feedback 9: Allowable current instruction, minus side 10: Allowable current instruction, plus side 11: Effective current 12: Axis load level 13: Maximum axis load level	J1 coordinate value
931		
932		
933		
934		
935		
936		
937		
938		
939		
940		
941		
942		
943		
944		
945	J8 coordinate value	
946	Joint data-2 [1 - 13] * The data is similar to Joint data-1.	J1 coordinate value
947		
948		J2 coordinate value
949		
950		J3 coordinate value
951		
952		J4 coordinate value
953		
954		
955		J5 coordinate value
956		
957		J6 coordinate value
958		
959		J7 coordinate value
960		
961	J8 coordinate value	

GOT Addr (offset)	Description	
962	Joint data-3 [1 - 13] * The data is similar to Joint data-1	J1 coordinate value
963		
964		J2 coordinate value
965		
966		J3 coordinate value
967		
968		J4 coordinate value
969		
970		J5 coordinate value
971		
972		J6 coordinate value
973		
974		J7 coordinate value
975		
976	J8 coordinate value	
977		

<Precautions>

- When the target mecha and axis do not exist, outputs the data zero.

(2) Data description

The table below lists the content of each data item.

Item		Description	Setting Value (unit)	Supported State Variable	Update cycle
Position data	4: Direction at the time of collision ^{Note1)}	Robot's direction when the collision is detected	Divides the direction at the time of collision to components X, Y, Z. Specify the value with the proportion when the	P_ColDir	7.1msec
	3: Difference between estimated and actual torques when detecting a collision ^{Note1)}	Maximum difference value between estimated and actual torques when detecting a collision is valid	[10 ⁻³ %]	J_Colmxi	7.1msec
Joint data	5: Current instruction	Outputs the current instruction value.	[10 ⁻³ Arms]		57msec
	6: Maximum current instruction 1	Outputs the maximum current instruction value after power-up. Reset when the robot power supply is shut off.	[10 ⁻³ Arms]		1.8sec
	7: Maximum current instruction 2	Outputs the maximum current instruction value for past 2sec.	[10 ⁻³ Arms]		1.8sec
	8: Current feedback	Outputs the current value generated in the servo motor.	[10 ⁻³ Arms]		7.1msec
	9: Allowable current instruction, minus side	Outputs the maximum allowable value (minus side) of the current generated in the servo motor. * The value may vary according to jog and automatic operations.	[10 ⁻³ Arms]		7.1msec
	10: Allowable current instruction, plus side	Outputs the maximum allowable value (plus side) of the current generated in the servo motor. * The value may vary according to jog and automatic operations.	[10 ⁻³ Arms]		7.1msec
	11: Effective current	Outputs the effective value of current feedback.	[10 ⁻³ Arms]		57msec
	12: Axis load level	Outputs the motor's load level. The bigger this value, the heavier the load on the motor. Roughly it should be 80% or less. * It takes a few minutes until the value will stable.	[10 ⁻³ %]		1.8sec
	13: Maximum axis load level	Outputs the maximum value of axis load level after power-up. Reset when the power supply is shut off.	[10 ⁻³ %]		1.8sec

Note1) Because the collision detection function is unavailable during using multiple mechas, outputs zero.

3.2.5 Monitor Maintenance Information

Here, periodically outputs the robot's scheduled maintenance data (battery, grease, and belt remaining times) to the shared memory.

(1) Monitoring data list

GOT Addr (offset)	Description	Update Cycle
980	Battery remaining time [Hr]	Updated at scheduled interval set up in the second element of parameter "MFINTVL"
981		
982	Grease remaining time - J1 axis [Hr]	
983		
984	Grease remaining time - J2 axis [Hr]	
985		
986	Grease remaining time - J3 axis [Hr]	
987		
988	Grease remaining time - J4 axis [Hr]	
989		
990	Grease remaining time - J5 axis [Hr]	
991		
992	Grease remaining time - J6 axis [Hr]	
993		
994	Grease remaining time - J7 axis [Hr]	
995		
996	Grease remaining time - J8 axis [Hr]	
997		
998	Belt remaining time - J1 axis [Hr]	
999		
1000	Belt remaining time - J2 axis [Hr]	
1001		
1002	Belt remaining time - J3 axis [Hr]	
1003		
1004	Belt remaining time - J4 axis [Hr]	
1005		
1006	Belt remaining time - J5 axis [Hr]	
1007		
1008	Belt remaining time - J6 axis [Hr]	
1009		
1010	Belt remaining time - J7 axis [Hr]	
1011		
1012	Belt remaining time - J8 axis [Hr]	
1013		

<Precautions>

- When the target mecha does not exist, outputs all the data with zero.
- When the target mecha exists but the maintenance schedule is not supported, outputs all the data with "-1".
- When the target axis is not updated by the maintenance schedule, outputs the data "-1".

(2) Data description

[Battery remaining time]: Outputs the remaining time until the battery exchange.

[Grease remaining time]: Outputs the remaining time until the grease-up of each axis.

[Belt remaining time]: Outputs the remaining time until the belt exchange of each axis.

4 Reads/Writes Robot's Variables

4.1 Function Description

(1) Function list

The table below lists the variable operations performed from the GOT:

Table 4-1:Variable operation function list

No	Item	Description	Robot's response time
1	Read numeric variable	Reads variable content by specifying slot number and variable name.	Answered within 1sec (it may vary according to the robot control's load state)
2	Write numeric variable	Rewrites variable content by specifying slot number, variable name, and variable content.	
3	Read position variable	Reads variable content by specifying slot number and variable name.	
4	Write position variable	Rewrites variable content by specifying slot number, variable name, and variable content.	
5	Read joint variable	Reads variable content by specifying slot number and variable name.	
6	Write joint variable	Rewrites variable content by specifying slot number, variable name, and variable content.	

(2) Functional requirements

Always available when a program is selected for robot's target slot and the target variable exists. When the target is external variable, the variable operation is possible by specifying zero for a slot number, even when a program is not selected.



CAUTION Be careful fully to change variable value.

The robot's location and behavior may be changed by changing the variable value, thereby interfering with surrounding devices. Because it is especially dangerous when the robot is in operation, sufficiently check the value to be changed.

4.2 Operation Flow

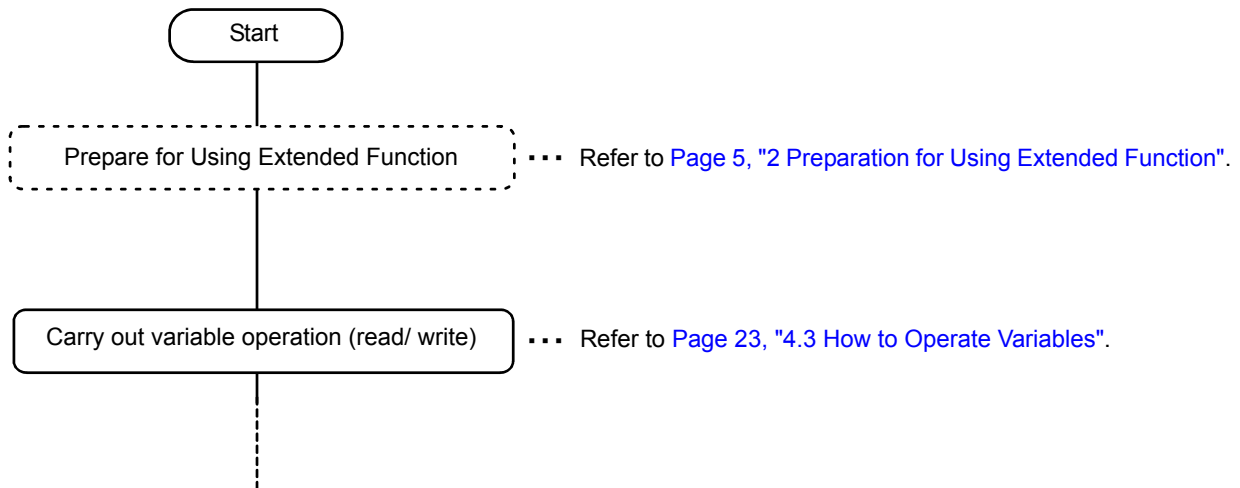

4.3 How to Operate Variables

Here, in the GOT, operates the robot's variables (read/ write variables) by specifying function number, slot number, variable name, and variable data.

Function number setting allows you to select work type (read/ write variable) and variable type (numeric/ position/ joint variables) and specify a variable name (designation of ASCII character).

4.3.1 Data List

(1) GOT output data

1) Word data

Setting values when specifying ASCII character for variable and program names

GOT Addr (offset)	Item	Setting Value for Specifying ASCII Character						
		Numeric Var		Position Var		Joint Var		
		Read	Write	Read	Write	Read	Write	
701	(Reserved)	(Reserved)						
702	Function No	101	102	104	105	107	108	
703	Slot No	Slot number [0, 1 to the value of parameter TASKMAX]						
704	Program name (Not used)	(Not used)						
705								
706								
707								
708								
709	Variable name	Variable name [ASCII data, up to 16 characters]						
710								
711								
712								
713								
714								
715								
716								
717	Variable data	(Not used)	Integer	(Not used)	(Not used)	(Not used)	X coordinate value	J1 coordinate value
719			Y coordinate value				J2 coordinate value	
720			Z coordinate value				J3 coordinate value	
721			A coordinate value				J4 coordinate value	
722			B coordinate value				J5 coordinate value	
723			C coordinate value				J6 coordinate value	
724			L1 coordinate value				J7 coordinate value	
725			L2 coordinate value				J8 coordinate value	
726			Structure flag				(Not used)	
727			Multi-turn data					
728								
729								
730								
731								
732								
733								
734								
735								
736								
737								

2) Bit signal

GOT Address		Description
Addr (offset)	Bit position	
700	0	Request for variable operation

(2) Robot output data

1) Word data

Setting values when specifying ASCII character for variable and program names

GOT Addr (offset)	Item	Setting Value for Specifying ASCII Character							
		Numeric Var		Position Var		Joint Var			
		Read	Write	Read	Write	Read	Write		
551	Completion status	Completion status [1: OK/ other than 1: NG]							
552	Function No	101	102	104	105	107	108		
553	Slot No	Slot number [0, 1 to the value of parameter TASKMAX]							
554	Program name	Program name, ASCII data, up to 12 characters]							
555									
556									
557									
558									
559									
560	Variable name	Variable name [ASCII data, up to 16 characters]							
561									
562									
563									
564									
565									
566									
567									
568	Variable data	Integer		X coordinate value		J1 coordinate value			
569		(Not used)	(Not used)	Y coordinate value		J2 coordinate value			
570				Z coordinate value		J3 coordinate value			
571				A coordinate value		J4 coordinate value			
572				B coordinate value		J5 coordinate value			
573				C coordinate value		J6 coordinate value			
574				L1 coordinate value		J7 coordinate value			
575				L2 coordinate value		J8 coordinate value			
576				Structure flag		(Not used)		(Not used)	
577				Multi-turn data					
578					L1 coordinate value		J7 coordinate value		
579			L2 coordinate value		J8 coordinate value				
580			Structure flag		(Not used)				
581			Multi-turn data						
582			L1 coordinate value		J7 coordinate value				
583			L2 coordinate value		J8 coordinate value				
584			Structure flag		(Not used)				
585			Multi-turn data						
586			L1 coordinate value		J7 coordinate value				
587			L2 coordinate value		J8 coordinate value				

2) Bit signal

GOT Address		Description
Addr (offset)	Bit position	
550	0	Variable operation completed

(3) Completion status

The values below are established as completion status:

Setting Value	Description
1	Successfully completed
2	Specified data (function number, slot number, variable number, element number, or external variable specification) out of range
3	Program not selected for the target slot
4	Target variable does not exist
5	(Reserved)
6	Not the formal variable data (at the time of writing variable)
7	Target variable not writable (at the time of writing variable)
8	Target variable value out of range at the time of reading variable: Not in the range between -32768 and 32767 (at the time of reading numeric variable)
10	NG because of a factor other than 2 to 8

(4) Data description

[Function No]

Select the target function.

Function number setting allows you to select work type (read/ write variable) and variable type (numeric/ position/ joint variables) and specify a variable name (designation of ASCII character).

[Slot number]

Select the target slot.

In general, specify a value between 1 and the value of parameter TASKMAX (factory default: 8). In case of external variable, "0" can be specified.

[Program name]

Program name is displayed in ASCII character.

● Specifying ASCII character

- Specify ASCII program name in 6 words area (12 characters).
- To specify ASCII characters, specify all 12 characters or string data including terminating code. However, leading and ending blank characters (space) are ignored.
- When target is an external variable and zero is specified for slot number, the program name becomes NULL.

[Variable name]

To specify a variable name, specify ASCII characters.

● Specifying ASCII character

- Specify the variable name (including leading character) in the 8 words area (16 characters, robot specification).
- To specify ASCII characters, specify all 16 characters or string data including terminating code. However, leading and ending whitespace characters (space) are ignored.
- The character underscore (_) used in array and external variable is also available, and array or external variable can be specified.

<ASCII data setting example>

- Set up the data in order from low to high byte of start address.
- Specify zero as a terminating code.
(Be compliant with the character input specification of the GOT)

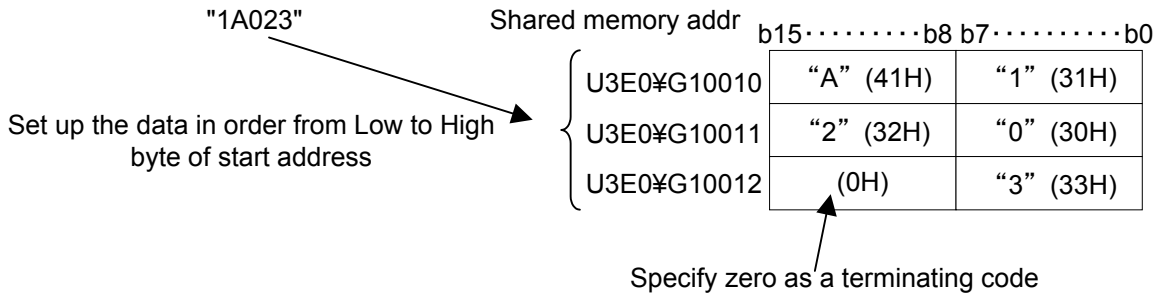

<Available character>

Available characters are compliant with robot specification. (Refer to the table below.)

Category	Available Characters	Program Name	Variable Name
Alphabetic character	A B C D E F G H I J K L M N O P Q R S T U V W X Y Z	○	○
	a b c d e f g h i j k l m n o p q r s t u v w x y z	×	○
Figure	0 1 2 3 4 5 6 7 8 9	○	△ Note1)
Symbol	" ' & () * + - . , / : ; = < > ? [\] ^ { } ~ ! # \$ %	×	×
	' _ ' (underscore)	×	△ Note3)
White space	Whitespace character	×	×

- Note1) Only the alphabetic characters are available at the beginning of variable name. A figure is available for second and after characters.
- Note2) Parentheses "(" for specifying an array are available.
- Note3) Available for second and after characters. The variable whose second character is underscore '_' is an external variable.

[Variable data, numeric variable]

- One word is prepared for a numeric variable and only an integer can be specified.
- Therefore, its range is between -32768 and 32767, and digits after decimal point are discarded.

[Variable data, position and joint variables]

- The unit is 10⁻⁴mm or 10⁻⁴deg.
However, the number of significant figures for position and joint variable data output from the robot is dependent on the parameter PRGDPNTM (digits after decimal point: factory default is 2 or 3 digits (it may vary according to the robot model)), and the portion less than the significant figures is rounded off. For example, when PRGDPNTM is two, to round off 1.2345 gives 12300 and to round off 6.7890 gives 67900.
- Only lower one word is used for the structure flag of position variable, and upper one word is a reserved area.
- When a variable in undefined state (a variable exists but its data is empty) is read, zero is set to the undefined portion of data.
- Because each component value is handled as a single-precision floating type real number in the robot, the number of significant figures is about 7 digits.
(The value which can be expressed with 24bit when expressed in binary number is about 7 digits when expressed in decimal number).
- When the data is successfully written into a variable, the variable data in the robot after the writing is read again and sent.
Therefore, even when writing into a position or joint variable is successfully ended, the data specified by the GOT may be different from the data to be sent by the robot. The robot's posture data or the number of significant figures of data's digits after decimal point may differ.

4.3.2 Timing Chart

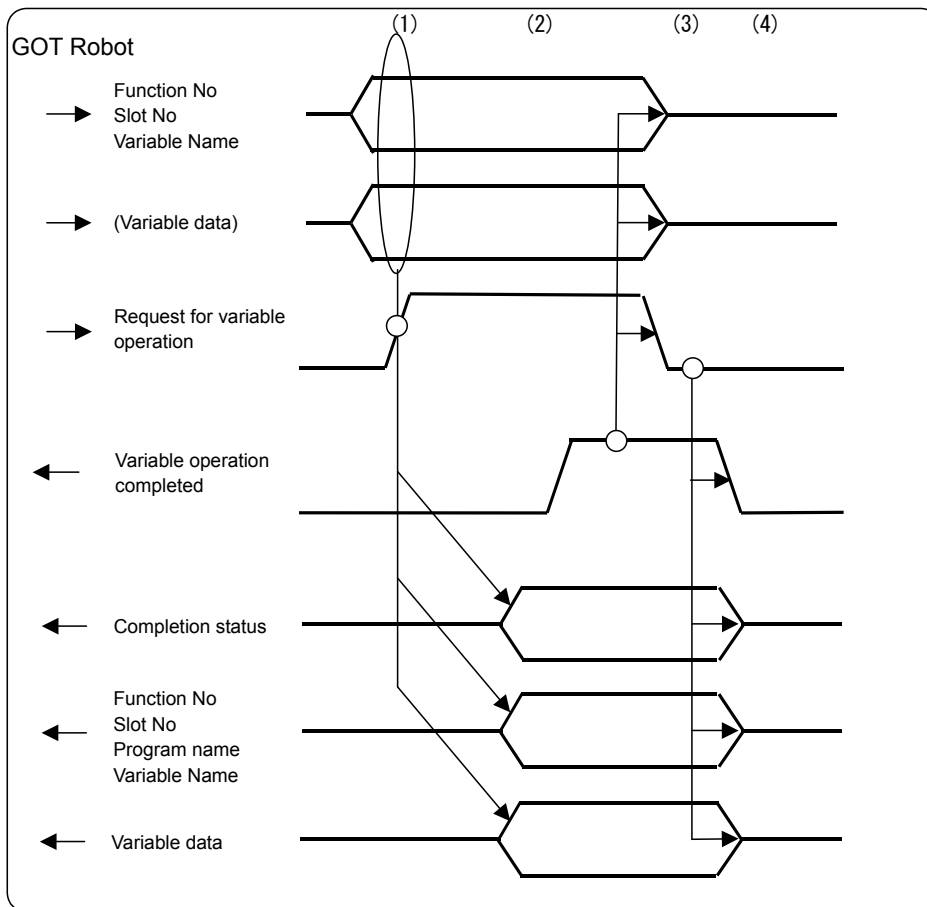

Fig.4-1:Variable operation timing chart

- (1) The GOT sets up "Function number", "Slot number", "Variable name", and "Variable data" (only for writing variable) and turns ON "Request for variable operation".
- (2) When the robot receives "Request for variable operation ON", the robot operates the variable based on received data. When "Function number", "Slot number", "Variable name", "Variable data", and "Completion status" are specified after the operation, the robot turns ON "Variable operation completed".
When the operation cannot be carried out, the robot specifies a number indicating NG and turns ON "Variable operation completed".
- (3) When "Variable operation completed ON" is received, the GOT turns OFF "Request for variable operation".
- (4) When received "Request for variable operation OFF", the robot turns OFF "Variable operation completed" and clears the data.

5 Read Current Line of Robot Program

5.1 Function Description

(1) Function list

The [Table 5-1](#) lists the program operations performed from the GOT.

Table 5-1: Program operation function list

No	Item	Description	Robot's Response Time
1	Read program's current line	<ul style="list-style-type: none"> ● Reads currently performing robot program (one line, 128 characters) by specifying a slot number. ● Practicable when a program is selected for robot's slot. 	Responds within 1s (it may vary according to the robot control's load state)

(2) Program data

The program data is as follows:

- The data is one line of program (up to 128 characters) in ASCII.
- When the data is less than 128 characters, terminating code 0 (NULL) is added at the end of string.
- Shift JIS codes are used for kanji character (similar to GOT specification).

⚠ CAUTION

When a program line can be longer than 128 characters, the data after 128th character cannot be read. Consequently, when the program whose line is longer than 128 characters is read and the data is written as-is into the robot, be careful that the data which exceeds 128 characters will be deleted.

5.2 Operation flow

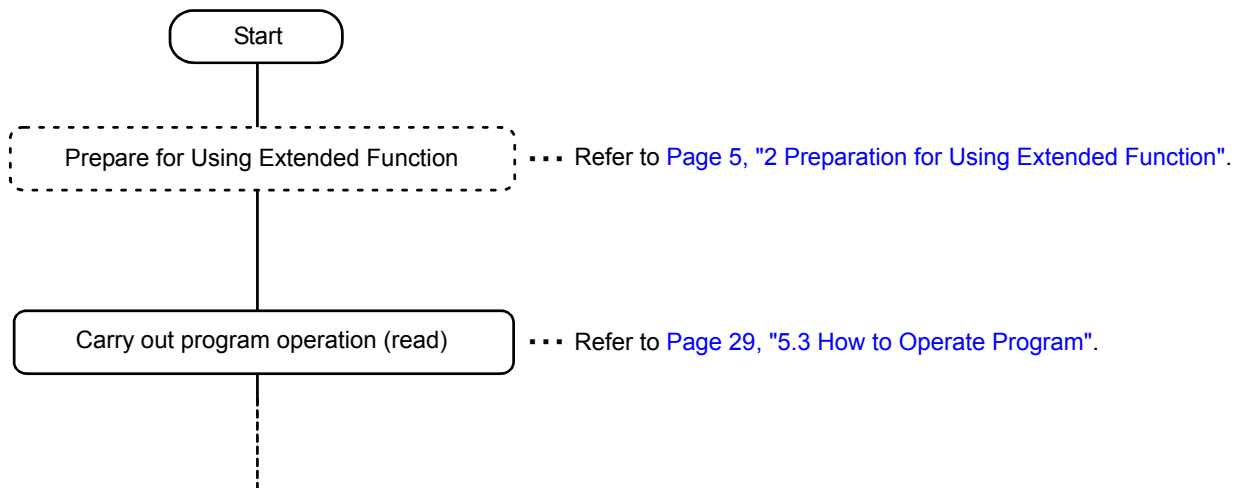

5.3 How to Operate Program

Here, in the GOT, operates the robot program by specifying function number, slot number, program name, and program data.

Setting function number to '103' allows you to select a work type (read current line) and specify a program name (designation of ASCII character).

5.3.1 Data List

(1) GOT output data

1) Word data

GOT Addr (offset)	Item	Setting Value for Specifying ASCII Character
		Program
		Read current line
740	(Reserved)	(Reserved)
741	Function No	103
742	Slot No	Slot number [1 to the value of parameter TASKMAX]
743	Program name	(Not used)
744		
745		
746		
747		
748		
749	Line No	(Not used)
750	(Reserved)	(Reserved)
751	Program data	(Not used)
752		
.		
.		
.		
813		
814		

2) Bit signal

GOT Address		Description
Addr (offset)	Bit position	
700	1	Request for program operation

(2) Robot output data

1) Word data

GOT Addr (offset)	Item	Setting Value for Specifying ASCII Character
		Program
		Read current line
590	Completion status	Completion status [1: OK/ other than 1: NG]
591	Function No	103
592	Slot No	Slot number [1 to the value of parameter TASKMAX]
593	Program name	Program name, ASCII data, up to 12 characters
594		
595		
596		
597		
598		
599	Line No	Line No [1 - 32767]
600	Number of pro- gram characters	Number of program characters
601	Program data	Program to be read [ASCII data, up to 128 characters] * Shift JIS code for kanji
602		
.		
.		
.		
663		
664		

2) Bit signal

GOT Address		Description
Addr (offset)	Bit position	
550	1	Program operation completed

(3) Completion status

The values below are established as completion status:

Setting Value	Description
1	Successfully completed
2	Specified data (function number, slot number, program number) out of range
3	Program not selected for the target slot
4	(Reserved)
5	(Reserved)
6	(Reserved)
7	(Reserved)
10	NG because of a factor other than 2 to 7

(4) Data description

[Function No]

Selects the target function.

Function number setting allows you to select a work type (read current line) and specify a program name (designation of ASCII character).

[Slot number]

Select the target slot. Specify a value (factory default: 8) in the range between 1 and the value of parameter TASKMAX.

[Program name]

ASCII characters of the output program name.

- Specifying ASCII character
- Specify ASCII program name in 6 words area (12 characters).
- To specify ASCII characters, specify all 12 characters or string data including terminating code. However, leading and ending whitespace characters (space) are ignored.

For information about ASCII data, available characters, refer to [Page 25, "\(4\) Data description"](#).

[Line No]

The line number of the read line is output.

When a program is selected but program is in abeyance (program is not running), the line number of first line is output.

[Number of program characters]

Outputs the number of characters of target line in the target program.
Count and specify the number of characters from the leading to final character (exclusive of line feed/ terminating characters) including comment line (exclusive of line number).
When the target line is longer than 128 characters, up to 128 characters are read as a program data, but the number of counted characters is set as-is as the number of program characters.
When writing into a program, the number of characters of written line is set.

Example 1: A line is less than 128 characters:

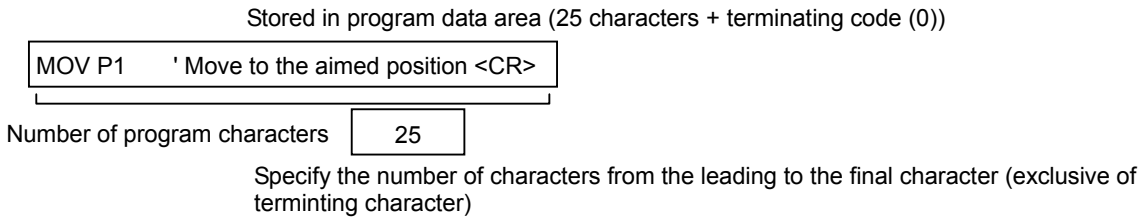

Example 2: A line is more than 128 characters:

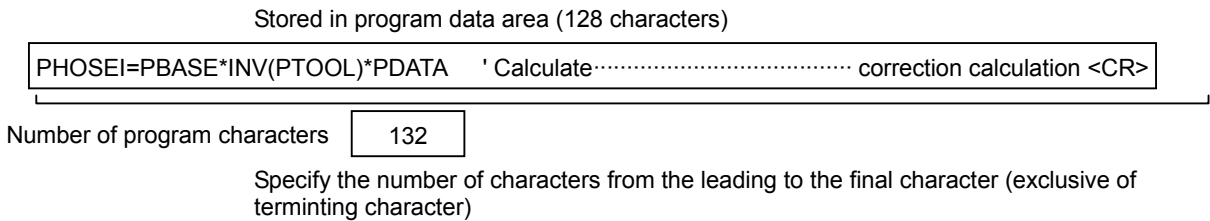

[Program data]

- The data is in ASCII format and up to 128 characters of program content are stored.
- Shift JIS codes are used for kanji.
- Line number is excluded from the program data.

5.3.2 Timing Chart

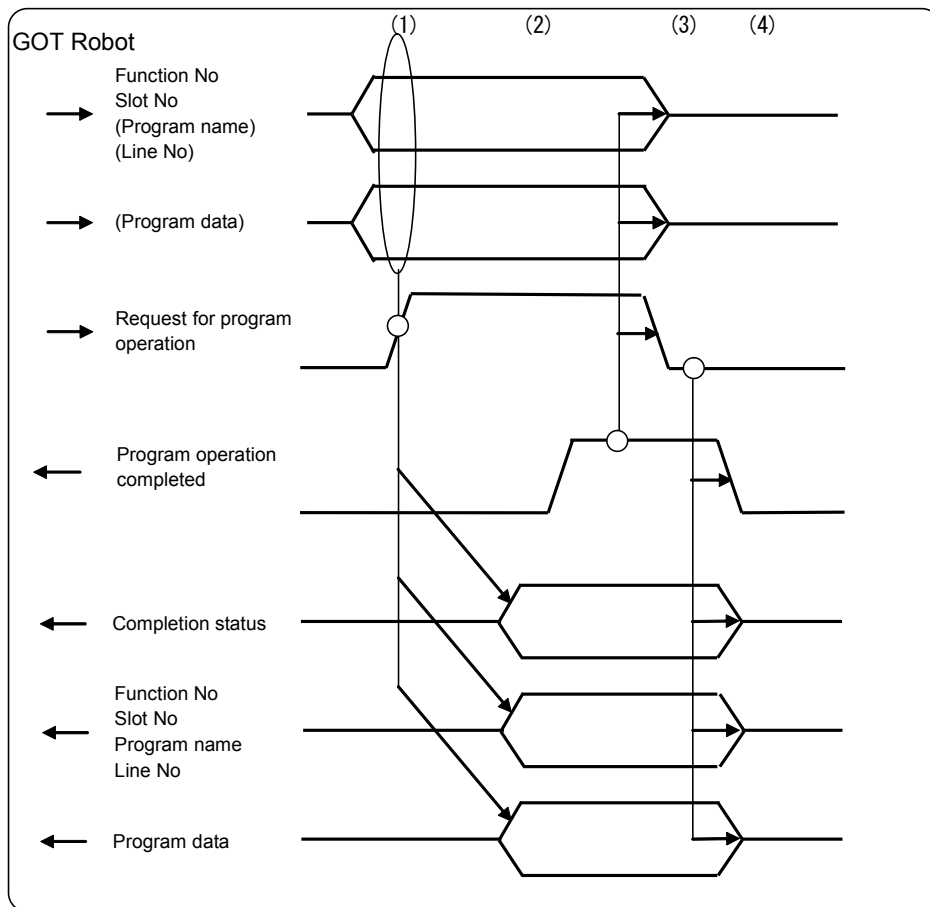

Fig.5-1:Program operation timing chart

- (1) The GOT sets up necessary data of "Function number", "Slot number", "Program name", "Line number", and "Program data" and turns ON "Request for program operation".
- (2) When the robot receives "Request for program operation ON", the robot operates the program based on received data. When "Function number", "Slot number", "Program name", "Program data", and "Completion status" are specified after the operation, the robot turns ON "Program operation completed".
When the operation cannot be carried out, the robot specifies a number indicating NG and turns ON "Program operation completed".
- (3) When "Program operation completed ON" is received, the GOT turns OFF "Request for program operation".
- (4) When received "Request for program operation OFF", the robot turns OFF "Program operation completed" and clears the data.

6 Set up Robot's Maintenance

6.1 Function Description

(1) Function list

The [Table 6-1](#) lists the maintenance setting performed from the GOT.

Table 6-1: Maintenance setting function list

No	Item	Description	Robot's Response Time
1	Reset maximum servomotor value	Resets the servo monitor's maximum values (current value, load factor, etc.) stored by robot to zero.	Responds within 1s (it may vary according to the robot control's load state)

(2) Functional requirements

Always practicable.

6.2 Operation flow

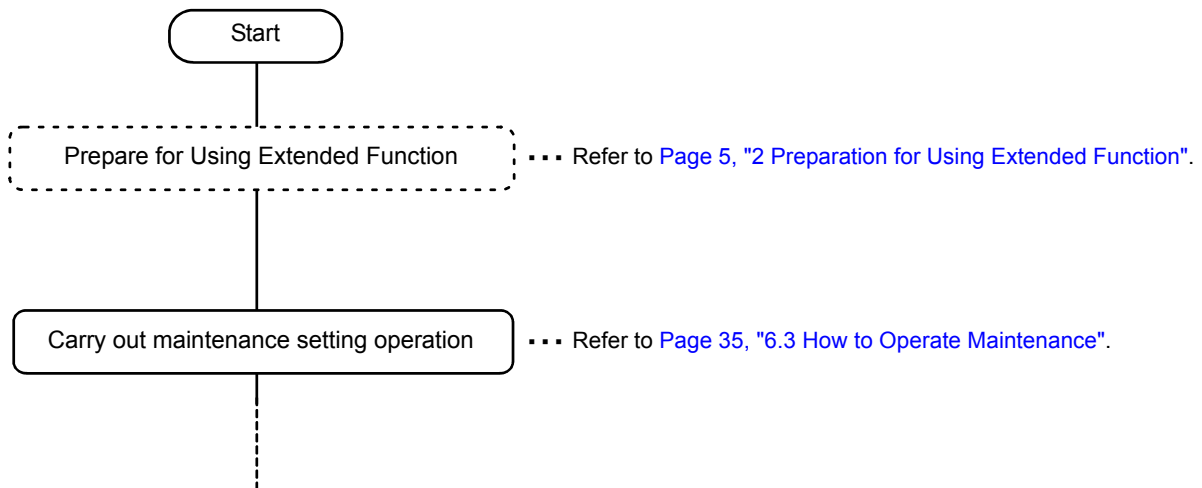

6.3 How to Operate Maintenance

Here, in the GOT, operates the maintenance setting by specifying function number and setting data corresponding to the function.

Function number setting allows you to select function items.

6.3.1 Data List

(1) GOT output data

1) Word data

GOT Addr (offset)	Item	Setting Value
		Reset Servo Monitor's Maximum/Minimum Values
820	(Reserved)	(Reserved)
821	Function No	6
822	Mecha No	Mecha No[1-3]
823	Mecha No	(Not used)
824		
825		
826		
827		
828		

2) Bit signal

GOT Address		Description
Addr (offset)	Addr (offset)	
700	2	Request for maintenance setting

(2) Robot output data

1) Word data

GOT Addr (offset)	Item	Setting Value
		Reset Servo Monitor's Maximum/Minimum Values
670	Completion status	Completion status [1: OK/ other than 1: NG]
671	Function No	6
672	Mecha No	Mecha No[1-3]
673	Mecha No	(Not used)
674		
675		
676		
677		
678		

2) Bit signal

GOT Address		Description
Addr (offset)	Addr (offset)	
550	2	Maintenance setting completed

(3) Completion status

The values below are established as completion status:

Setting Value	Description
1	Successfully completed
2	Specified "Function number" and "Mecha number" are out of range (including the case that the target mecha does not exist).
3	(Not used)
4	No target function (the function specified by target mecha does not exist)
10	NG because of a factor other than 2 to 4

(4) Data description

[Function No]

Selects the target function.

[Mecha No]

Select the target mecha. Specify a mecha in the range of mechas 1 - 3.

6.3.2 Timing Chart

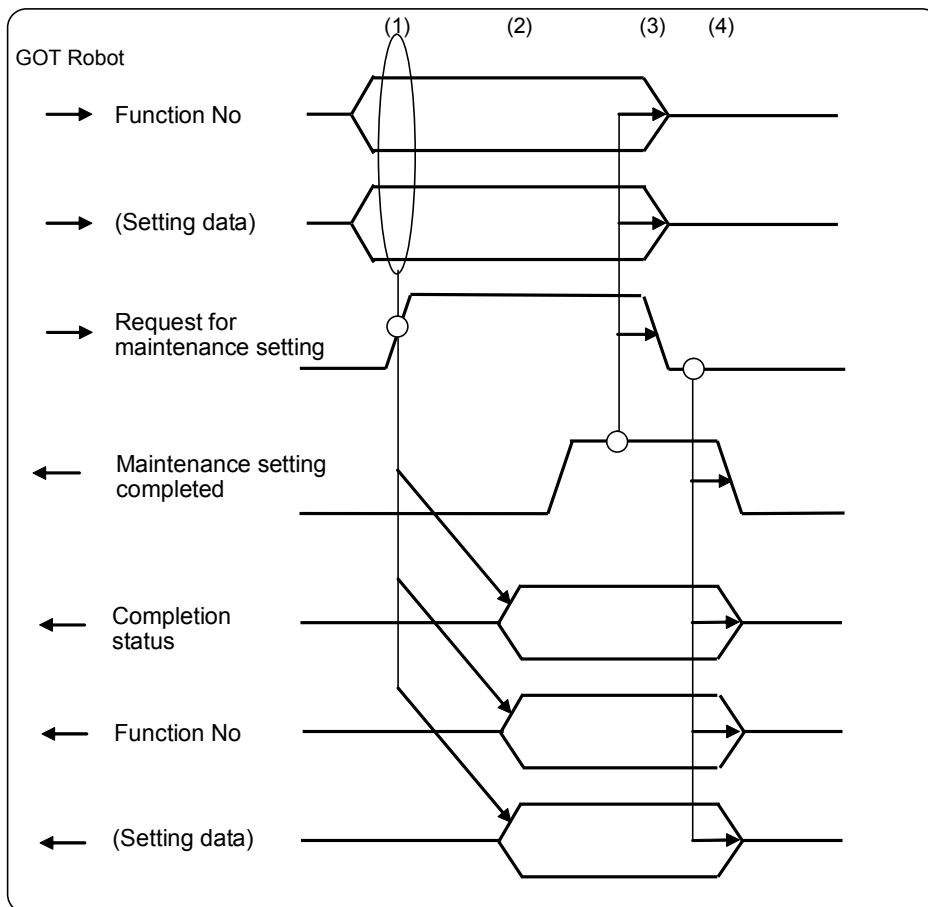

Fig.6-1: Maintenance function timing chart

- (1) The GOT sets up necessary data of "Function number" and "Setting data" and turns ON "Request for maintenance setting."
- (2) When the robot received "Request for maintenance setting ON," the robot operates the maintenance setting based on received data. When "Function number", "Setting data", and "Completion status" are specified after the operation, the robot turns ON "Maintenance setting completed." When the operation cannot be carried out, the robot specifies a number indicating NG and turns ON "Maintenance setting completed."
- (3) When "Maintenance setting completed ON" is received, the GOT turns OFF "Request for maintenance setting."
- (4) When "Request for maintenance setting OFF" is received, the robot turns OFF "Maintenance setting completed" and clears the data.

7 Read Robot Information

7.1 Function Description

(1) Function list

The [Table 7-1](#) lists the robot information reading performed from the GOT.

Table 7-1:Robot information reading function list

No	Item	Description	Robot's Response Time
1	Read error information	Reads the detailed error information generated in the robot. When multiple errors occur, three information can be read at the same time, and the information to be read can be changed by specifying the start number.	Responds within 1s (it may vary according to the robot control's load state)
2	Read product information	Read the robot's product information.	

(2) Functional requirements

Always practicable.

7.2 Operation flow

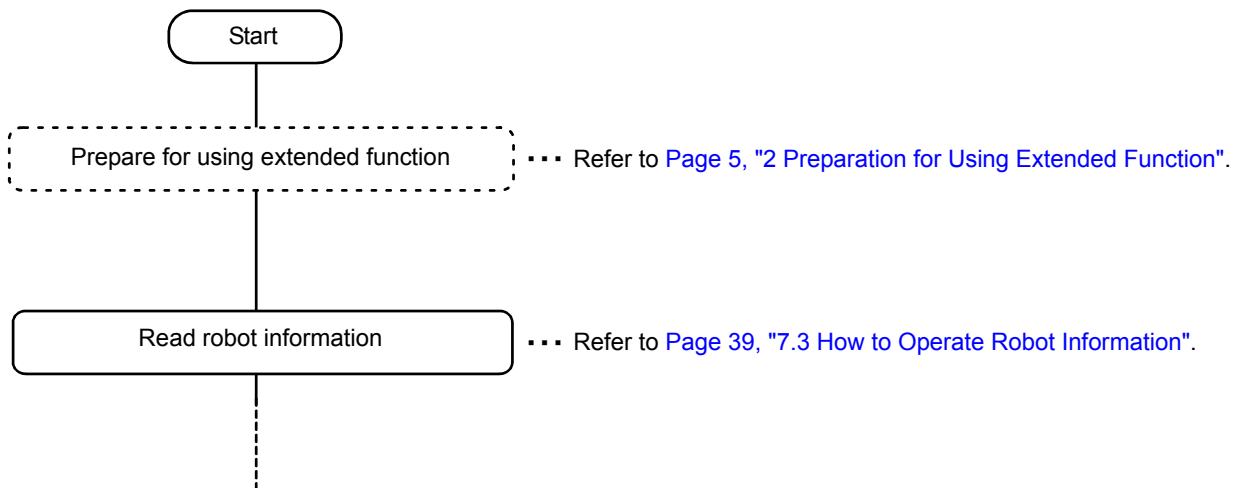

7.3 How to Operate Robot Information

Here, reads the robot information from the GOT by specifying function number and setting data. Function number allows you to select the robot information to be read.

7.3.1 Data List

(1) GOT output data

1) Word data

GOT Addr (offset)	Item	Setting Value	
		Read Error Information	Read Product Information
830	(Reserved)	(Reserved)	
831	Function No	3	4
832	Setting No	Start number [1 -]	(Not used)

2) Bit signal

GOT Address		Description
Addr (offset)	Addr (offset)	
700	3	Request for reading information

(2) Robot output data

1) Word data

GOT Addr (offset)	Item	Setting Value	
		Read Error Information	Read Product Information
680	Completion status	Completion status [1: OK/ other than 1: NG]	
681	Function No	3	4
682	Read data	Start number [1 -]	(Not used)
683		Number of errors occurred	Robot type name [ASCII data, up to 20 characters]
684		Information 1 (error No)	
685		Information 1 (error occurred program name) [ASCII data, up to 12 characters]	
686			
687			
688			
689		Information 1 (occurred line No)	
690			
691			
692		Information 1 (detailed error No)	
693			
694		Information 1 (occurred slot No)	
695		(Reserved)	Controller serial No [ASCII data, up to 16 characters]
696			
697			
698			
699		Information 2 (error No)	Robot serial No [ASCII data, up to 16 characters]
700			
701		Information 2 (error occurred program name) [ASCII data, up to 12 characters]	
702			
703			
704			
705		Information 2 (occurred line No)	Robot serial No [ASCII data, up to 16 characters]
706	Information 2 (detailed error No)		
707			
708	Information 2 (occurred slot No)		
709	(Reserved)	(Not used)	
710			
711			
712			
713			
714			
715			
716			
717	Information 3 (error No)		
718			
719			
720			
721	Information 3 (error occurred program name) [ASCII data, up to 12 characters]		
722			
723			
724			
725	(Reserved)		

2) Bit signal

GOT Address		Description
Addr (offset)	Addr (offset)	
550	3	Reading information completed

(3) Completion status

The values below are established as completion status:

Setting Value	Description
1	Successfully completed
2	Specified "Function number" out of range
3	Specified "Setting data" out of range
10	NG because of a factor other than 2 and 3

(4) Data description

[Function No]

Selects the target function.

[Start No of read data]

Specify the information's start number to be read.

The robot reads and stores three pieces of information from the specified number in the shared memory.

Specify 1: Reads first to third pieces of registered information.

Specify 2: Reads second to fourth pieces of registered information.

Specify 3: Reads third to fifth pieces of registered information.

Of information 1 - 3, the information with small number is a new error.

When the target information with the specified number does not exist, the robot sets all read data to zero.

7.3.2 Timing Chart

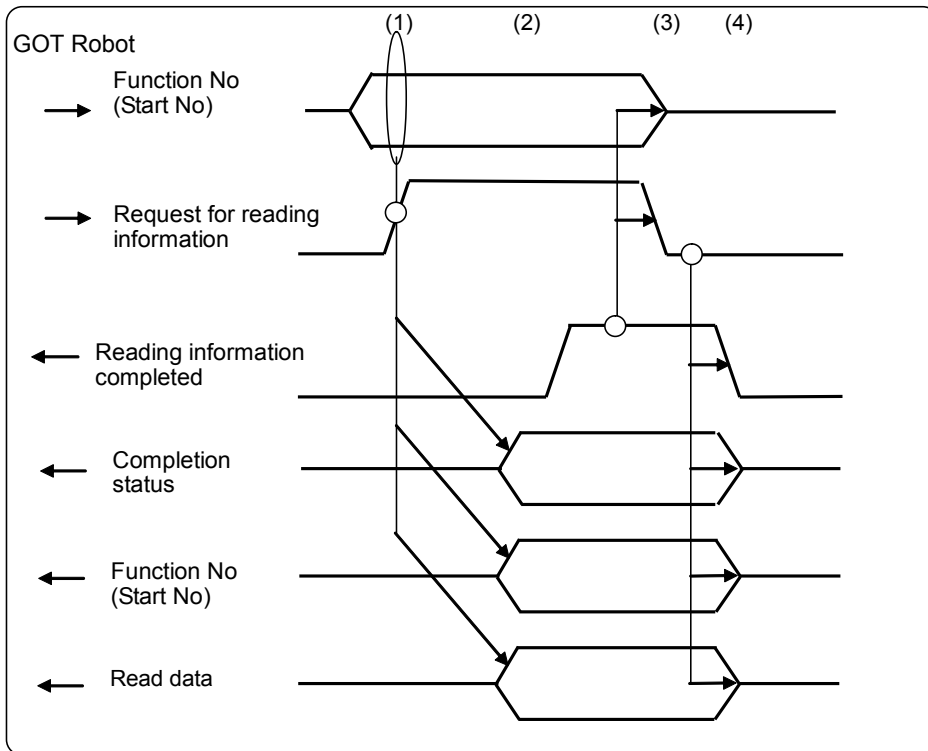

Fig.7-1:Information reading timing chart

- (1) The GOT sets up necessary data of "Function number" and "Start number" and turns ON "Request for reading information."
- (2) When "Request for reading information ON" is received, the robot specifies requested "Read data" and "Completion status" and turns ON "Reading information completed."
When the operation cannot be carried out, the robot specifies a number indicating NG and turns ON "Reading information completed."
- (3) When "Reading information completed" is received, the GOT turns OFF "Request for reading information."
- (4) When "Request for reading information OFF" is received, the GOT turns OFF "Reading information completed."

8 Function Relevant Parameter

8.1 Function Definition Parameter

Parameter	Parameter Name	Array Qty Character Qty	Description	Factory Default
Define function	IQSPEC	1 digit integer	Set up function for robots. Set each function allocated by each bit. 0000000000000000 bit1-15: Not used +--- bit0: Direction to write into shared memory 0: Reads/writes in order from first to last address 1: Reads in order from first to last address, writes in order from last to first address (communication specification among robot CPU of GOT)	0000000000000001

The access sequence of the shared memory of the robot controller is direction to the final address from the top address for both of reading and writing. However, the GOT's communication specification among robot controllers is direction from last to start address for writing. Thus, when a system is designed according to the shared memory map specification, the interlock of dataset may be impossible. (For more information, refer to the Fig. 8-1.)

Therefore, when utilizing shared memory expanded function, it is necessary to make the shared memory access order the same as the specification of the GOT. We provide the parameter (IQSPEC) to solve it. The initial value is set to the same specification as the GOT, so its change by customer is not necessary at all. If the access sequence of the shared memory direction to the final address from the top address for both of reading and writing is necessary, it can specify with this parameter.

Prevention of separation of data over 32 bits

When user's free area is used

The program reads in order from start of user's free area. In write command, the transmission data is written in order from last to start address of user's free area.

Consequently, the interlock device at the start of data for communication can prevent separation of data for communication

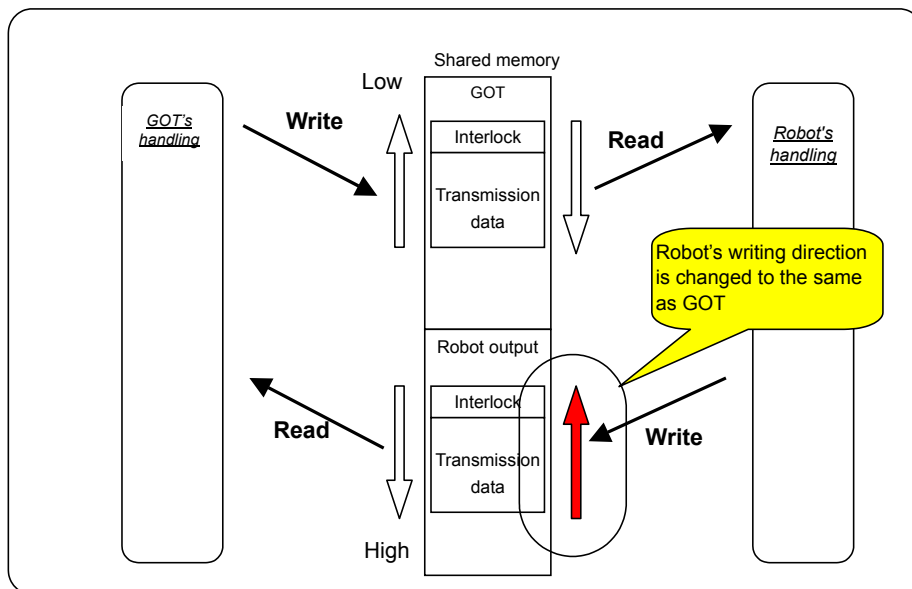

Fig.8-1:Change the writing order of shared memory data

9 Extended Function Relevant Error List

(1) Error occurred when MELFA-BASIC IV is selected while shared memory extended function is valid

Error No	Error Cause and Measure	
L3994	Error message	Shared memory extended function unavailable (MB4)
	Cause	Shared memory extended function is unavailable in MELFA-BASIC IV. The parameter RLNG=1 (MELFA-BASIC IV) is selected while shared memory extended function is valid. Make sure to set the parameter RLNG to 2 (MELFA-BASIC V).
	Measure	Set the parameter RLNG to 2 (MELFA-BASIC V).

mitsubishi electric corporation

HEAD OFFICE: TOKYO BUILDING, 2-7-3, MARUNOUCHI, CHIYODA-KU, TOKYO 100-8310, JAPAN
NAGOYA WORKS: 5-1-14, YADA-MINAMI, HIGASHI-KU NAGOYA 461-8670, JAPAN

Authorised representative:

MITSUBISHI ELECTRIC EUROPE B.V. GERMANY
Gothaer Str. 8, 40880 Ratingen / P.O. Box 1548, 40835 Ratingen, Germany