



Mitsubishi Electric AC Servo System

MITSUBISHI ELECTRIC SERVO SYSTEM
MELSERVO-J5

MR-J5-G/MR-J5W-G
User's Manual
(Communication Function)



-MR-J5- _G_
-MR-J5W _ _G_
-MR-J5D _ _G_

SAFETY INSTRUCTIONS

Please read the instructions carefully before using the equipment.

To use the equipment correctly, do not attempt to install, operate, maintain, or inspect the equipment until you have read through this manual, installation guide, and appended documents carefully. Do not use the equipment until you have a full knowledge of the equipment, safety information and instructions.





In this manual, the safety instruction levels are classified into "WARNING" and "CAUTION".

 WARNING	Indicates that incorrect handling may cause hazardous conditions, resulting in death or severe injury.
 CAUTION	Indicates that incorrect handling may cause hazardous conditions, resulting in medium or slight injury.

Note that the CAUTION level may lead to a serious consequence depending on conditions.

Please follow the instructions of both levels because they are important to personnel safety.

Forbidden actions and required actions are indicated by the following diagrammatic symbols.

	Indicates a forbidden action. For example, "No Fire" is indicated by  .
	Indicates a required action. For example, grounding is indicated by  .

In this manual, precautions for hazards that can lead to property damage, instructions for other functions, and other information are shown separately in the "POINT" area.

After reading this manual, keep it accessible to the operator.

[Installation/wiring]

WARNING

- To prevent an electric shock, turn off the power and wait for 15 minutes or more (20 minutes or more for the converter unit/drive unit) before starting wiring and/or inspection.
 - To prevent an electric shock, ground the servo amplifier.
 - To prevent an electric shock, any person who is involved in wiring should be fully competent to do the work.
 - To prevent an electric shock, mount the servo amplifier before wiring.
 - To prevent an electric shock, connect the protective earth (PE) terminal of the servo amplifier to the protective earth (PE) of the cabinet, then connect the grounding lead wire to the ground.
 - To prevent an electric shock, do not touch the conductive parts.
-

[Setting/adjustment]

WARNING

- To prevent an electric shock, do not operate the switches with wet hands.
-

[Operation]

WARNING

- To prevent an electric shock, do not operate the switches with wet hands.
-

[Maintenance]

WARNING

- To prevent an electric shock, any person who is involved in inspection should be fully competent to do the work.
 - To prevent an electric shock, do not operate the switches with wet hands.
-

ABOUT THE MANUAL

Point

e-Manuals are Mitsubishi Electric FA electronic book manuals that can be browsed with a dedicated tool.

e-Manuals enable the following:

- Searching for desired information in multiple manuals at the same time (manual cross searching)
- Jumping from a link in a manual to another manual for reference
- Browsing for hardware specifications by scrolling over the components shown in product illustrations
- Bookmarking frequently referenced information
- Copying sample programs to engineering tools

If using the servo for the first time, prepare and use the following related manuals to ensure that the servo is used safely. For the related manuals, refer to the User's Manual (Introduction).

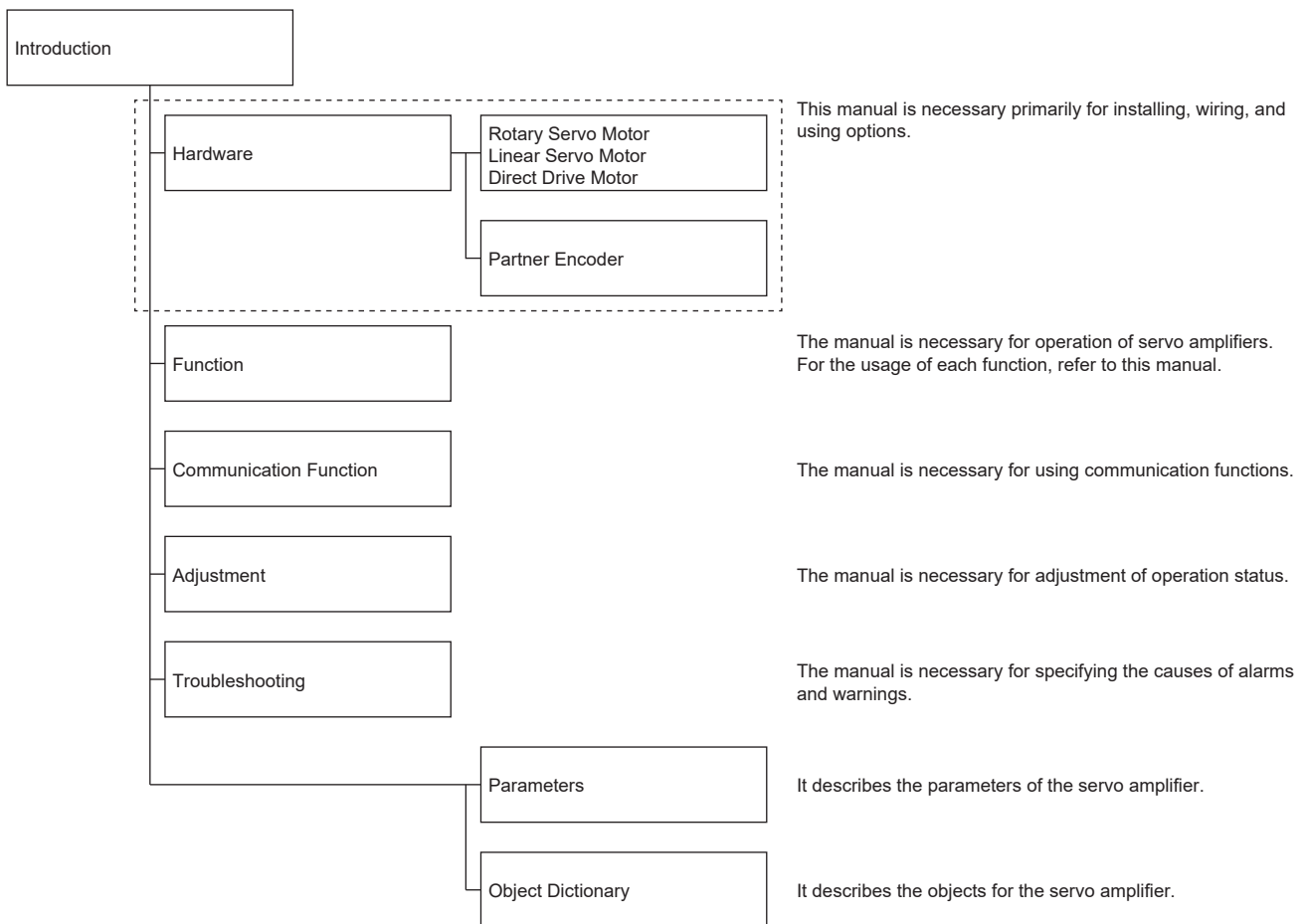

When reading this manual to use a drive unit, substitute "drive unit" for "servo amplifier".

OBJECT UNITS

This section explains the pos units, vel units, and acc units used in this manual.

The degree unit is available on servo amplifiers with firmware version B6 or later.

The mm unit and inch unit are available on servo amplifiers with firmware version B8 or later in the positioning mode (point table method).

pos units

The standard unit can be changed using [Pr. PT01.2 Unit for position data] as shown in the following table.

Setting value	Standard unit
0	mm
1	inch
2	degree
3	pulse

vel units

The speed unit can be changed using [Pr. PT01.1 Speed/acceleration/deceleration unit selection] as shown in the following table. The command unit can be changed to "0.001 mm", "0.0001 inch", "0.001 degree", or "pulse" using [Pr. PT01.2].

Setting value	Unit
0	0.01 r/min, 0.01 mm/s *1
1	Command unit/s

*1 0.01 mm/s is used in the linear servo motor control mode.

acc units

The acceleration unit can be changed using [Pr. PT01.1] as shown in the following table. The command unit can be changed to "0.001 mm", "0.0001 inch", "0.001 degree", or "pulse" using [Pr. PT01.2].

Setting value	Unit
0	ms
1	Command unit/s ²

U.S. CUSTOMARY UNITS

U.S. customary units are not shown in this manual. Convert the values if necessary according to the following table.

Quantity	SI (metric) unit	U.S. customary unit
Mass	1 [kg]	2.2046 [lb]
Length	1 [mm]	0.03937 [inch]
Torque	1 [N·m]	141.6 [oz·inch]
Moment of inertia	1 [(× 10 ⁻⁴ kg·m ²)]	5.4675 [oz·inch ²]
Load (thrust load/axial load)	1 [N]	0.2248 [lbf]
Temperature	N [°C] × 9/5 + 32	N [°F]

CONTENTS

SAFETY INSTRUCTIONS	1
ABOUT THE MANUAL	3
OBJECT UNITS	4
U.S. CUSTOMARY UNITS	4
CHAPTER 1 CC-Link IE TSN	7
1.1 Functions and configuration	7
Outline	7
System configuration	7
Function list	8
Communication specifications	9
Establishing and disconnecting the communication	11
Summary of object dictionary (OD)	11
Engineering tool	12
1.2 Startup	13
Outline	13
Network setting	13
CC-Link IE TSN Class A settings	15
1.3 Application function	16
CC-Link IE TSN Network diagnostics	16
IP address setting function	17
Parameter automatic setting	18
Hold/Clear of output at CPU STOP and at CPU stop error	20
Remote reset	20
Master-slave operation function	21
Clock function	38
Motion mode (high-speed) setting	38
1.4 APPENDIX	39
CC-Link IE TSN communication protocol	39
Cyclic transmission	41
Transient transmission	53
Drive profile	59
Setting of positioning data	79
CHAPTER 2 CC-Link IE Field Network Basic	80
2.1 Functions and configuration	80
Outline	80
System configuration	80
Function list	81
Communication specifications	81
Establishing and disconnecting the communication	82
Summary of object dictionary (OD)	82
Engineering tool	84
2.2 Startup	85
Outline	85
Network setting	85
2.3 Application function	88
CC-Link IE Field Network Basic Diagnostics	88

IP address setting function	88
Hold/Clear of output at CPU STOP and at CPU stop error	89
Remote reset	89
2.4 APPENDIX	90
Cyclic transmission	90
SLMP	110
Drive profile	117
REVISIONS	136
WARRANTY	137
TRADEMARKS	138

1 CC-Link IE TSN

1.1 Functions and configuration

This manual describes communication with the MR-J5_-G_ servo amplifiers using CC-Link IE TSN. In addition to this manual, refer to the following manual when using CC-Link IE TSN.

📖 MR-J5-G/MR-J5W-G User's Manual (Object Dictionary)

Outline

Motion mode

Motion mode is used with a controller supported by a CANopen profile. Combining with Mitsubishi Electric manufactured Motion modules enables advanced motion control such as positioning of multiple axes, synchronous control by sequential command or interpolation control. The positioning function built-in servo amplifier can be used for positioning operation. Motion mode supports CiA 402 drive profile.

Refer to the following for control modes supported by motion mode.

📖 Page 8 Function list

📖 Page 76 Control mode

System configuration

Compatible controller

Category	Model
Motion module	RD78G RD78GH FX5-SSC-G *1
Master/local module	RJ71GN11-T2 *1 RJ71GN11-EIP *2
Motion Control Software	SWM-G

*1 Combine the module with the servo amplifier that has firmware version B9 or later.

*2 Combine the module with the servo amplifier that has firmware version D4 or later.

Function list

Communication-related function list (Application)

Category	Subcategory	Function	Description	Detailed explanation
Network	Open network	CC-Link IE TSN communication protocol	This servo amplifier supports CC-Link IE TSN.	☞ Page 9 Communication specifications
		CC-Link IE TSN communication setting	Network configuration settings and station-specific mode selection are performed by using GX Works3.	☞ Page 13 Startup
	Common protocol	SLMP	This function supports SLMP (SeamLess Message Protocol). Parameter setting and monitoring are enabled.	☞ Page 39 CC-Link IE TSN communication protocol
	Profile	CSP+	File for describing the necessary information for startup, operation, and maintenance of CC-Link family connected products.	—
Application function	Functional safety	Safety communication function	Connecting the servo amplifier with a programmable controller that supports functional safety enables safety sub-functions.	☞ MR-J5 User's Manual (Hardware) ☞ MR-J5D User's Manual (Hardware) ☞ MR-J5 User's Manual (Function)
	Cyclic transmission	Hold/Clear of output at CPU STOP and CPU stop error	When the CPU module of the cyclic master is at STOP, when the stop error occurs, Hold/Clear is automatically set on the refresh device output. The servo amplifier stops regardless of the setting of Hold/Clear of the cyclic master.	☞ Page 20 Hold/Clear of output at CPU STOP and at CPU stop error
	RAS function	Automatic return	When a station that has been disconnected due to a data link error becomes normal, that particular station will automatically reconnect to the network, and restart the data link.	—
	Synchronization	CC-Link IE TSN network synchronous communication function	The control cycle of the device station can be synchronized via the CC-Link IE TSN in accordance with the synchronization cycle specified by the master station. Thus, operation timing of other device stations connected to the same network can be synchronized.	—
		Motion mode (high-speed)	The communication cycle between the master station and the device station can be set to 31.25 μs.	☞ Page 38 Motion mode (high-speed) setting
		Master-slave operation function	This function transmits the torque and speed of the master axis to a slave axis through driver communication, and controls and operates the slave axis using the transmitted torque and speed as commands. This function can be used only on 1-axis servo amplifiers.	☞ Page 21 Master-slave operation function
	Network system startup	Detect Now function	The master station reads the information (a model code, a device version, etc.) of the servo amplifier that is connected to the network and automatically sets the network configuration.	—
		Station mode check	The master station checks whether the master station and the servo amplifier are in the same station mode by obtaining the station mode of the servo amplifier.	—
	Parameter setting	Parameter automatic setting	This is a function where the controller automatically writes the servo parameters when the servo amplifier is returning/entering.	☞ Page 18 Parameter automatic setting
	Setting change	Remote reset	This is a function to reset a servo amplifier via the network. Servo parameters to be enabled at power cycle are reflected by resetting the servo amplifier.	☞ Page 20 Remote reset
		IP address setting	IP addresses are delivered from the controller to servo amplifiers via CC-Link IE TSN.	☞ Page 17 IP address setting function
	CC-Link IE TSN Network diagnostics	Reserved station specification/cancellation	Stations not connected to the network can be included in the total number of stations for future connection.	☞ Page 16 CC-Link IE TSN Network diagnostics
Time synchronization	Clock function	This function is used to acquire time information from the grand master (the station serving as a clock source) via CC-Link IE TSN so that this information may be used for the time management of functions performed by the servo amplifier, such as alarm history.	☞ Page 38 Clock function	

Communication specifications

Communication specifications of CC-Link IE TSN

Item	Description	Remark
Physical layer	1000BASE-T (1 Gbps), 100BASE-TX (100 Mbps)	Twisted pair
Communication connector	RJ-45 × 2	—
Communication cable	Cable type	Category 5e or higher, (double shielded/STP) straight cable
	Standard	One of the following standards must be met. • IEEE802.3 1000BASE-T • ANSI/TIA/EIA-568-B (Category 5e)
	Connector	RJ-45 shielded connector
Network topology	Line, tree (star)	—
Communication speed	1 Gbps, 100 Mbps *3	—
Transmission distance between stations	Max. 100 m	—
Number of connection nodes	Max. 254 stations	The number of connection nodes depends on the specifications of the controller.
Guaranteeing method of communication bandwidth	Time division	—
CC-Link IE TSN Class	Class B/A *5	For Class A, refer to the following. ☞ Page 15 CC-Link IE TSN Class A settings
CC-Link IE TSN protocol version	Class B ver. 1.0/2.0 *5 Class A ver. 2.0 *5	—
Maximum response time in the time-managed polling method (for CC-Link IE TSN Class A)	512 μs	—
Synchronization method	IEEE802.1AS, IEEE1588	—
Communication cycle *1*2*4*6	MR-J5-_G_ MR-J5D1-_G_	31.25 μs, 62.5 μs, 125 μs, 250 μs, 500 μs, 1 ms, 2 ms, 4 ms, 8 ms When setting the communication cycle to 31.25 μs, refer to the following. ☞ Page 38 Motion mode (high-speed) setting
	MR-J5W2-_G_ MR-J5D2-_G_	62.5 μs, 125 μs, 250 μs, 500 μs, 1 ms, 2 ms, 4 ms, 8 ms
	MR-J5W3-_G_	125 μs, 250 μs, 500 μs, 1 ms, 2 ms, 4 ms, 8 ms
	MR-J5D3-_G_	250 μs, 500 μs, 1 ms, 2 ms, 4 ms, 8 ms
Cyclic transmission	[Motion mode] Communicates data cyclically between stations using PDOs. • Maximum RPDO size: 80 bytes/axis • Maximum TPDO size: 80 bytes/axis • The servo amplifiers support variable PDO mapping.	☞ Page 41 Cyclic transmission ☞ Page 46 PDO mapping objects
Transient transmission	[Motion mode] Communicates data non-cyclically between stations using SLMP and other protocols. SDOs can be used to read and write objects of the servo amplifier.	☞ Page 53 Transient transmission
Port No.	No. 161: For system use No. 5010: SLMP communication port (UDP/IP) No. 45237: For system use No. 45238: For system use No. 45239: For system use	—

- *1 The communication cycle depends on the controller specifications and the number of the connected axes. The communication cycles of 31.25 μ s and 62.5 μ s can be used by servo amplifiers with firmware version A6 or later.
- *2 There are restrictions on the communication cycle depending on the function used. For details, refer to "CC-Link IE TSN restrictions" in the following manual.
 - 📖MR-J5-G/MR-J5W-G User's Manual (Introduction)
 - 📖MR-J5D-G User's Manual (Introduction)
- *3 The communication speed can be set to 1 Gbps or 100 Mbps. 100 Mbps can be used with servo amplifiers with firmware version B6 or later. When 100 Mbps is selected, the minimum communication cycle is 500 μ s. When using 100 Mbps, set [Pr. NPA12 Communication speed] to "1h". For details, refer to "Network basic parameters" in the following manual.
 - 📖MR-J5-G/MR-J5W-G User's Manual (Parameters)
- *4 Multiple communication cycles can be set with servo amplifiers with firmware version D0 or later. When using a servo amplifier with a firmware version earlier than D0, set the communication cycle to "Basic Period". For details, refer to the manual for the master station being used.
- *5 "Class B ver. 2.0" and "Class A ver. 2.0" can be selected by servo amplifiers with firmware version D0 or later.
- *6 For Class A, set the communication cycle to a value between 500 μ s and 500 ms inclusive.

Establishing and disconnecting the communication

Establishing the communication

Configure the system and set the parameters or rotary switches that are required for startup of the CC-Link IE TSN master station and the servo amplifier. The communication will be established if the settings of the master station and the servo amplifiers are made correctly. When the communication is established, the 7-segment LED display of the servo amplifiers changes to "controller is connected".

Disconnecting the communication

■Procedure for disconnecting the communication

When shutting off the system power or disconnecting the servo amplifier from the network, be sure to disconnect after servo-off. Failing to do so may trigger [AL. 086 Network communication error].

■Changing the communication configuration

Make sure that the servo amplifier is in servo-off state before changing the network configuration. Failing to do so may trigger [AL. 086].

Summary of object dictionary (OD)

The data that a device holds, such as control parameters, command values, and feedback values, is handled as an object composed of an Index, object name, object type, R/W attribute, and other elements. The data is exchanged between the master and device stations. The aggregate of these objects is called an object dictionary (OD).

Section definition of object dictionary

The following shows the structure of an object dictionary. Each axis (Axes A, B, and C) of 1-axis servo amplifier and multi-axis servo amplifier has the same object dictionary configuration.

Index	Description	Reference
1000h to 1FFFh	Communication profile	MR-J5-G/MR-J5W-G User's Manual (Object Dictionary)
2000h to 5FFFh	Objects group defined by Mitsubishi Electric	
6000h to 9FFFh	CiA 402 drive profile	

The classification of the objects defined by Mitsubishi Electric is as follows.

Index	Description	Reference
2000h to 27FFh	Servo parameter	MR-J5-G/MR-J5W-G User's Manual (Object Dictionary)
2800h to 29FFh	Point table	
2A00h to 2A7Fh	Alarm	
2B00h to 2BFFh	Monitor	
2C00h to 2C7Fh	Diagnostics	
2D00h to 2DFFh	Manufacturer defined control	Page 63 Controlword/Control DI Page 69 Statusword/Status DO

Saving object dictionary data

Some of object dictionary data is stored in a non-volatile memory and some is not. Use [Store parameters (Obj. 1010h)] for storing the object dictionary data in the non-volatile memory.

For details about objects that can be stored in the non-volatile memory, refer to the following manual.

 MR-J5-G/MR-J5W-G User's Manual (Object Dictionary)

■Store parameters

Writing "65766173h" (= reverse order of the ASCII code "save") to [Save all parameters (Obj. 1010h: 01h)] enables the setting value of an object to be stored in the non-volatile memory of the servo amplifier.

It can take up to around 25 s for [Save all parameters (Obj. 1010h: 01h)] to write all the parameters. Do not shut off the power supply during writing.

Index	Sub	Object	Name	Data Type	Access	Description
1010h	0	ARRAY	Store parameters	U8	ro	Number of entries
	1		Save all parameters	U32	rw	Saves all parameters.

Reading [Save all parameters (Obj. 1010h: 01h)] returns any of the following values. Bit 0 is "0" during saving and "1" when not saving.

Bit	Description
0	0: Object cannot be saved by the command (save in progress) 1: Object can be saved by the command (save not in progress)
1	0: Not automatically saved

Point

- To shut off the power supply after executing Store parameters, make sure that a save is not in progress (Bit 0 is on), then shut off the power.

■Restore default parameters

Objects can be reset to the factory setting.

To initialize objects, write "64616F6Ch" (= reverse order of the ASCII code "load") to [Restore all default parameters (Obj. 1011h: 01h)], then cycle the power. Writing a value other than "load" (= 64616F6Ch) triggers an error. Initialization can take up to around 25 s.

Index	Sub	Object	Name	Data Type	Access	Description
1011h	0	ARRAY	Restore default parameters	U8	ro	Number of entries
	1		Restore all default parameters	U32	rw	All parameter initialization

Reading [Restore all default parameters (Obj. 1011h: 01h)] displays "00000001h" (initializing values).

Engineering tool

The following explains the main purposes of the engineering tools used in communication. For specific usages, refer to the manuals of the engineering tool and controller.

Engineering tool list

This list shows engineering tools used in CC-Link IE TSN.

Engineering tool	Description
MR Configurator2	This is a software that has the following functions: servo amplifier adjustment, monitor display, diagnosis, reading/writing of servo parameters, and test operation. Settings, such as a stroke limit, absolute position detection system, communication error detection time, are made with this software. If using MR Configurator2 via a network, start MR Configurator2 from GX Works3. The servo amplifier and the personal computer do not need to be connected with a USB cable because they communicate each other via the controller.
GX Works3	This is a software that comprehensively supports the design and maintenance of the programmable controllers. The software performs settings such as servo amplifier profile (CSP+) registration, network configuration setting (station specific mode, link device setting, etc.), refresh setting, and network synchronization setting.

1.2 Startup

Outline

This chapter describes the setting procedure for CC-Link IE TSN. Refer to the following manual for startup of the servo amplifier.

📖 MR-J5-G/MR-J5W-G User's Manual (Introduction)

📖 MR-J5D-G User's Manual (Introduction)

Point

- To ensure the safety of the system against unauthorized network access, take security measures such as using a firewall.

Network setting

Set GX Works3 as required for the servo amplifier network settings, then configure the network. Set the master station and servo amplifier of CC-Link IE TSN according to the following procedure.

If an alarm has occurred, refer to the following manual.

📖 MR-J5 User's Manual (Troubleshooting)

1. Master station setting

Refer to the GX Works3 manual.

2. IP address setting

Set the IP address with the rotary switches and parameter.

📖 MR-J5-G/MR-J5W-G User's Manual (Introduction)

📖 MR-J5D-G User's Manual (Introduction)

Refer to the following when setting with parameters.

📖 Page 17 IP address setting function

3. Network setting servo parameter setting

📖 MR-J5-G/MR-J5W-G User's Manual (Parameters)

4. Network connection procedure

📖 Page 14 Network connection procedure

Settings when connecting to Mitsubishi Electric Motion Unit

To control the stroke limit on the controller side, set [Pr. PD41]. For details, refer to the manual for the controller being used.

Servo parameter	Name
PD41.2	Limit switch enabled status selection
PD41.3	Sensor input method selection

When using an absolute position detection system, set [Pr. PA03] and [Pr. PC29]. For details, refer to the manual for the controller being used.

Servo parameter	Name
PA03.0	Absolute position detection system selection
PC29.5	[AL. 0E3 Absolute position counter warning] selection

If necessary, set the following servo parameters in accordance with the controller settings.

Servo parameter	Name
PN02	Communication error - Detection time
PN05	Communication error - Detection frequency setting

Set [Pr. NPA12] for use in 100 Mbps. By default, the communication speed in "Network automatic setting" is set to 1 Gbps.

Network parameter	Name
NPA12	Communication speed

Network connection procedure

Follow the procedures below to set up the network.

1. Connect the master station and the servo amplifier with a network cable. There is no difference between CN1A and CN1B.
2. Turn on the power of the master station and the servo amplifier.
3. Open the diagnostic screen of GX Works3 and make sure that there is no error in the network. If the network is not connected, check the following contents.

- Check if an alarm has occurred in the servo amplifier. If an alarm occurs, refer to the following manual and cancel the alarm.

 MR-J5 User's Manual (Troubleshooting)

- Check that the values of the rotary switches or [Pr. NPA02 IP address] match the value of IP address set in the master station.

Network disconnection procedure

Refer to the following.

 Page 11 Disconnecting the communication

Changing the network configuration

Refer to the following.

 Page 11 Changing the communication configuration

CC-Link IE TSN Class A settings

To establish communication between the master and device stations (servo amplifiers) through CC-Link IE TSN Class A, configure the settings as follows.

Master station setting

Update the profile (CSP+) before configuring the network settings of the master station.

For CC-Link IE TSN Class A, the servo amplifier starts in the profile position mode. Set PDO mapping for profile mode operation (pp/pv/tq/hm).

For details, refer to the manual for GX Works3.

Servo parameter setting

Set [Pr. PN03.1 CC-Link IE TSN Class setting] to "1" (Class A ver. 2.0).



Setting the servo parameter using the multi-axis project in MR Configurator2 changes the CC-Link IE TSN Class of multiple servo amplifiers at a time.

Servo parameter	Name
PN03.1	CC-Link IE TSN Class setting

1.3 Application function



CC-Link IE TSN Network diagnostics

The servo amplifier supports the following CC-Link IE TSN Network diagnostic functions. Check the reference destination in the reference column for precautions specific to the servo amplifier. Refer to the GX Works3 manual for details of other functions.

Function type	Function	Description	Reference
Monitoring function of network status	Network map monitor	The current network connection configuration is displayed as a diagram. Information such as the connection status of cables, duplication of IP address, and the disconnection status of stations can be monitored. The error history stored in the servo amplifier can be read and deleted. These operations can be performed by servo amplifiers with firmware version B0 or later.	—
	Selected station communication status monitor	The details of the unit status and the communication status of the selected station are displayed. If an error occurs in the unit, the cause of the error and its remedies can be checked.	 Page 16 Selected station communication status monitor
Setting change function of network status	Reserved station specification/cancellation	This function designates a specified station as a reserved station, or cancels it.	—
Selected Station Operation	Remote Operation	A reset command can be sent to the specified station.	 Page 16 Remote Operation

Selected station communication status monitor

The detailed state of the currently selectable device on the network map monitor is displayed on the selected station communication status monitor. The items displayed on the selected station communication status monitor are shown below.

Setting item	Description	Reference
Status display	The status of the servo amplifier is displayed via LED.	 MR-J5-G/MR-J5W-G User's Manual (Introduction)  MR-J5D-G User's Manual (Introduction)
CC-Link IE TSN status display	The CC-Link IE TSN status (CN1A/CN1B connector LED) is displayed.	

In the selected station communication status monitor, CN1A is displayed as PORT2, and CN1B as PORT1.

Remote Operation

The only executable function on servo amplifiers is Reset. When Reset is executed to the servo amplifier, the servo amplifier resets the software. For details on software reset, refer to "Software reset" in the following manual.

 MR-J5 User's Manual (Function)

IP address setting function

IP addresses are delivered from the controller to servo amplifiers via CC-Link IE TSN.

Set the IP address required for CC-Link IE TSN communication from the following items. The IP address range is between 0.0.0.1 and 223.255.255.254. Set the IP address within the range.

[Pr. NPA01 IP address setting]	Rotary switches (SW1/SW2)	IP address		
"00000000h" (The rotary switch is used.)	00h	1st octet	Use the value of/for [Pr. NPA02 IP address].	
		2nd octet		
		3rd octet		
		4th octet		
	01h to FEh	1st octet	Use the 1st to 3rd octet values of [Pr. NPA02 IP address].	
		2nd octet		
		3rd octet		
		4th octet	The setting value of the rotary switch (SW1/SW2) is used.	
	FFh	—	Not available.	
	"00000001h" (Network parameters are used.)	—	1st octet	Use the value of/for [Pr. NPA02 IP address].
			2nd octet	
			3rd octet	
4th octet				

The initial value of the IP address is as follows.

Item	Initial value
IP address	192.168.3.1
Subnet mask	255.255.255.0

Parameter automatic setting

The parameters of the servo amplifier are held by the master station, and are compared with those of the replaced servo amplifier. When there is a difference in those parameters, the parameters held by the CPU module are automatically written to the replaced servo amplifier.

Storage method of parameters

There are following two ways to store parameters in the master station.

- If data in the non-volatile memory of the servo amplifier are rewritten by the engineering tool when a controller is connected via CC-Link IE TSN, the parameters in the CPU module are also updated automatically.
- If differences from the previously stored parameters are found in a periodical check, the parameters in the CPU module are also updated automatically (Set an interval in [Pr. PN20 Parameter automatic backup update interval] for that periodical check).

Parameters that can be stored

The parameters that can be written on the servo amplifier and stored with this function are as follows.

- Servo parameters
- Network parameters

Point

- When the parameter that requires power cycling after being set is changed by the parameter automatic setting, [AL. 09E.7 Parameter unreflected warning] occurs. Cycle the power of the servo amplifier.
 - Do not turn off the power supply of the controller during backup. Before turning off the power supply of the controller, check the rewrite-status of the parameter file of the device station by using the event history function of the controller.
 - Parameters that are automatically updated by the servo amplifier, such as auto tuning data, may not match the data stored in the device station parameter file on the controller. To match the data, first read the servo amplifier parameters using MR Configurator2 or other engineering tools, then reflect the readings on the device station parameter file on "Detail Setting" in "Parameter Automatic Setting" of GX Works3 before writing the readings to the controller again. Or, set [Pr. PN20 Parameter automatic backup update interval] so that the data can be backed up in the master station periodically.
 - If performing automatic backup with the interval set in [Pr. PN20], use a master station which features power interruption protection. Failing to do so triggers [AL. 19E.1 Parameter automatic backup setting warning]. At this time, the automatic backup is disabled.
 - If the network topology is changed after the power has been turned on, the backup may not be performed.
-

When the parameter automatic setting is used

If the servo amplifier saves (backs up) the parameters to the controller with automatic parameter setting, the destination controller will determine that there is no difference in the parameters from those held by the servo amplifier. Therefore, no parameters are distributed by the parameter automatic setting.

In this case, the following operation may cause differences in the parameters held by the servo amplifier and controller. Actions to be taken differ depending on whether to use the parameters held by the servo amplifier or controller.

Operation	Parameter to be used	Action
A parameter of the servo amplifier was changed without transition to runtime. *1	Servo amplifier side	☞ Page 19 When using the parameters held by the servo amplifier
	Controller side	☞ Page 19 When using the parameters held by the controller
The controller to be connected to the servo amplifier was changed.	Servo amplifier side	☞ Page 19 When using the parameters held by the servo amplifier
	Controller side	☞ Page 19 When using the parameters held by the controller

*1 For servo amplifiers with firmware version D1 or earlier, this operation includes restoration to the factory defaults with "MR Mode Change".

■When using the parameters held by the servo amplifier

Open the servo parameter setting window from the network setting window of the engineering tool for the controller, and read parameters with the controller connected via CC-Link IE TSN. Then, write the parameter data to the controller.

■When using the parameters held by the controller

- For the servo amplifier with firmware version D4 or later

1. Initialize the setting of the servo amplifier.

Initialize the setting of the servo amplifier with "MR Mode Change". For details, refer to "Servo amplifier setting initialization" in the following manual.

📖 MR-J5-G/MR-J5W-G User's Manual (Introduction)

📖 MR-J5D-G User's Manual (Introduction)

- When using the parameters saved in the controller for the servo amplifier with firmware version earlier than D4

1. Initialize the setting of the servo amplifier.

Initialize the setting of the servo amplifier with "MR Mode Change". For details, refer to "Servo amplifier setting initialization" in the following manual.

📖 MR-J5-G/MR-J5W-G User's Manual (Introduction)

📖 MR-J5D-G User's Manual (Introduction)

2. Rewrite the parameters to the controller.

Write the parameters of the servo amplifier to the controller again.

- When using the parameters saved from the servo amplifier to the controller with the parameter automatic setting for the servo amplifier with firmware version earlier than D4

1. Initialize the setting of the servo amplifier.

Initialize the setting of the servo amplifier with "MR Mode Change". For details, refer to "Servo amplifier setting initialization" in the following manual.

📖 MR-J5-G/MR-J5W-G User's Manual (Introduction)

📖 MR-J5D-G User's Manual (Introduction)

2. Read the parameters.

Read the parameters saved in the controller with GX Works3.

3. Update the parameters.

Open the setting window of the servo parameters from the network setting window of GX Works3, and update the servo parameters.

4. Write the parameters.

Write the servo parameters to the controller again with GX Works3.

Hold/Clear of output at CPU STOP and at CPU stop error

This function sets Hold/Clear of the auto refresh device output when CPU module operation of the cyclic master is at STOP or at CPU stop error.

The following shows the servo amplifier status at CPU STOP and at stop error.

Motion mode

When both the motion control axis and motion non-control axis are at CPU STOP, the servo amplifier stops the servo motor in the manner commanded by the controller. At a stop error, the servo amplifier stops the servo motor by activating the dynamic brake.

The operation may vary depending on the type of the servo system controller and firmware version.

Remote reset

Resetting can be done by sending the reset command to the specified station.

The reset command can be sent from the Remote Operation window of GX Works3.

Refer to the following for details.

 Page 16 Remote Operation

Master-slave operation function

The master-slave operation function is available on the following servo amplifiers and also with firmware version D0 or later.

- MR-J5-_G_
- MR-J5D1-_G_

Outline

The master-slave operation function transmits the torque of the master axis through driver communication (servo amplifier communication through CC-Link IE TSN device station communication), and uses the torque as a command to activate slave axes.

Additional wiring is not required because data between the master axis and slave axes is transmitted and received through CC-Link IE TSN communication.

A conceptual figure of master-slave operation communication is shown below. The master axis is activated by receiving the position command and speed command from the Motion module. The slave axes are activated by receiving the servo-on command and control mode from the Motion module and receiving the torque command from the master axis.

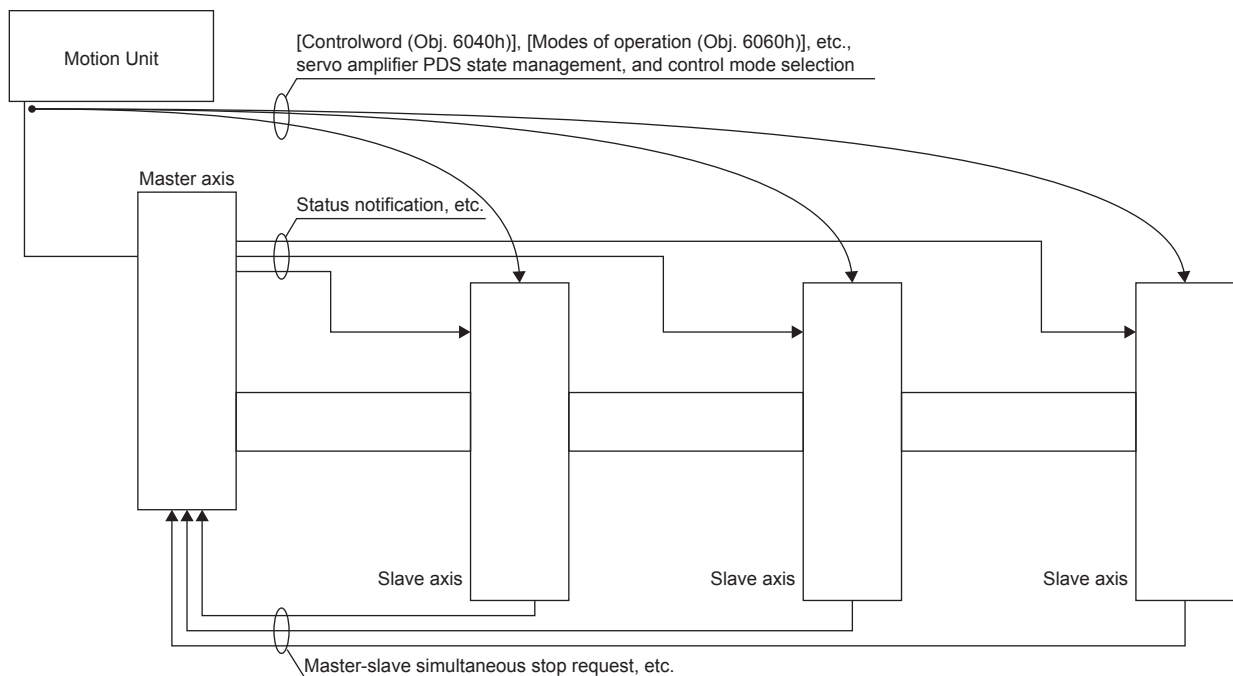

- Use the master-slave operation function together with a Motion module. For details, refer to the Motion module manual.
- When the master-slave operation function is used, "dynamic brake" is the stop method regarding alarms and warnings whose stop methods are "electronic dynamic brake".
- When network communication shut-off or communication time-out has occurred, the servo amplifier stops the servo motor with the dynamic brake.
- If [Pr. PD15.0] or [Pr. PD15.1] is set to "1" while [Pr. PA01.7 High-speed mode selection] is set to "1" (enabled), [AL. 037 Parameter error] will occur. When using the master-slave operation function, set [Pr. PA01.7] to "0" (disabled).
- If [Pr. PD15.0] or [Pr. PD15.1] is set to "1" while [Pr. PT01.2 Unit for position data] is set to "2" (degree), [AL. 037] will occur. When using the master-slave operation function, set [Pr. PT01.2] to a value other than "2".
- If [Pr. PD15.0] or [Pr. PD15.1] is set to "1" while [Pr. PA01.0 Control mode selection] is set to "6" (positioning mode (point table method)), [AL. 037] will occur. When using the master-slave operation function, set [Pr. PA01.0] to "0" (network standard mode).
- In the continuous operation to torque control mode (ct), the master-slave operation function cannot be used.

Precautions

- When the function is used in a vertical axis system, set the same value to the parameters regarding the dynamic brake and electromagnetic brake for both the master and slave axes to prevent the axes from dropping.
- The servo-on command of the master axis and slave axis must be turned on/off simultaneously. If the servo-on command is turned on only for a slave axis, torque will not be generated. Therefore, an excessive load may be applied to the electromagnetic brake of the master axis when using the function in a vertical axis system.
- When the gain switching function is used, the slave axis may not follow the master axis. Check the operation of the machine before using the gain switching function.
- When not using the master-slave operation simultaneous stop function, set [Pr. PA04.3 Forced stop deceleration function selection] to "0" (disabled). When the forced stop deceleration function of the master axis is enabled without using the master-slave operation simultaneous stop function, the master axis stops the motor by forced stop deceleration, and the slave axis stops the servo motor with the dynamic brake. Therefore, an excessive load may be applied to the dynamic brake of the slave axis when the servo motor stops.
- If the 7-segment LED of an axis that enables driver communication keeps displaying "H" and the runtime does not appear, check the conditions of other axes that enable driver communication. If the network is disconnected, reconnect the servo amplifier and the controller. If an alarm has occurred, remove the cause of the alarm. If the network is not disconnected or alarm has not occurred, driver communication may not be established due to noise or other reason. Turn on the power of the servo amplifier and the controller again.

Point

- The master axis and slave axes are recommended to be used in a linked condition for the reason of machine components. When they are not linked, the speed may reach a speed limit level, causing [AL. 031 Overspeed].
- Slave axes use the control command from the master axis. Therefore, the controller mainly controls parameter settings, servo-on command, and acquisition of monitor information from a servo amplifier. Commands regarding absolute positioning control, such as setting absolute position detection and requesting home position setting, from the controller to slave axes must not be made.
- Configure the settings so that servo-off will be applied to all the master and slave axes when a master or slave axis stops due to an alarm or other reason.
- When the STO signal of a servo amplifier is used, configure the settings so that the master axis and slave axes will be turned off simultaneously.

Up to eight master axes can be configured on the same CC-Link IE TSN network.

The master axes can transmit commands to the slave axes by multicast unlimitedly.

Ensure that the total number of master and slave axes is the maximum number of axes supported by the controller or less. For the maximum number of axes, refer to the manual for the controller being used.

Each master axis can receive feedback from up to eight slave axes. The master axis can stop the servo motor in accordance with a stop request from the control slave axis and notify the slave axes of a stop command.

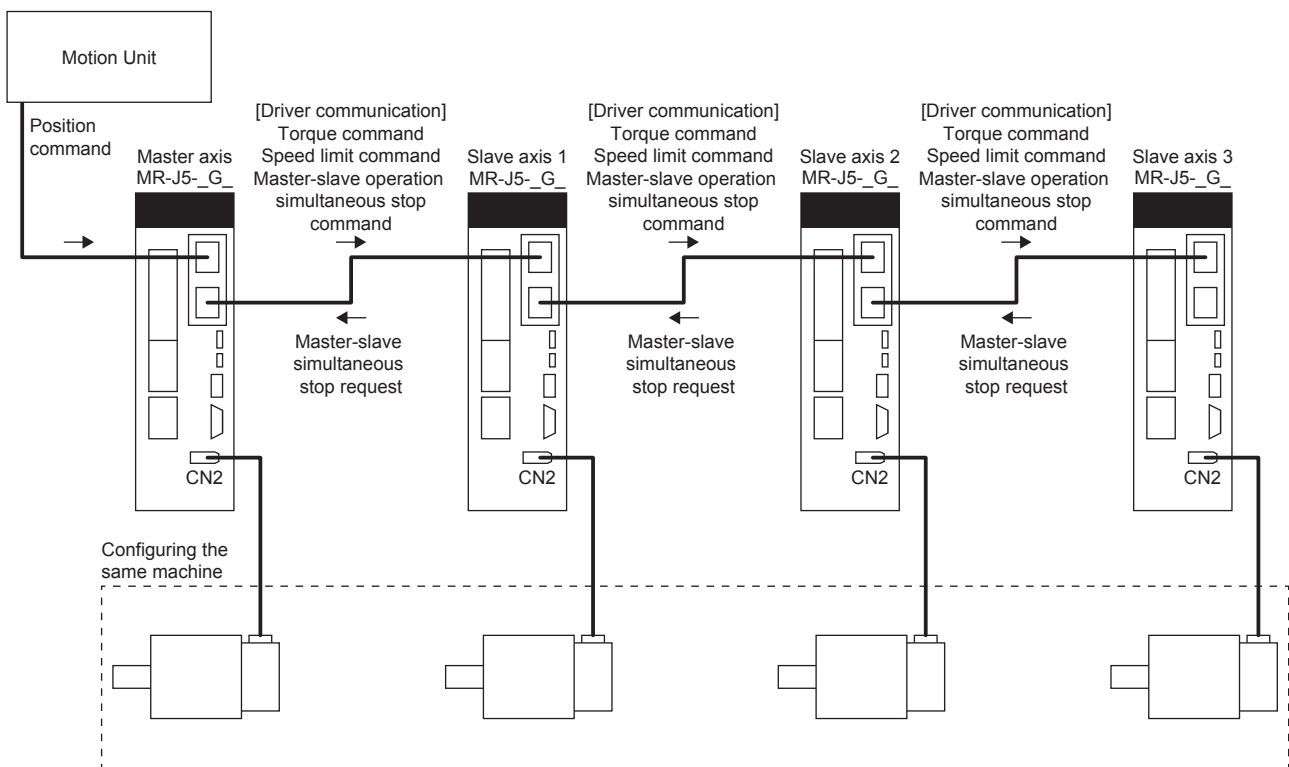

Compatible controller

Use together with a controller that supports the driver communication function. The following controller supports the driver communication function.

Category	Model number
Motion module	RD78G(S) *1

*1 Use a firmware version that enables master-slave operation. For details, refer to the following manual.

 MELSEC iQ-R Motion Module User's Manual (Application for Simple Motion Mode)

Supported control mode

The control modes compatible with the master-slave operation function are as follows. Configuring the master-slave operation setting in a control mode which is not compatible with the master-slave operation function will generate [AL. 037 Parameter error].

Model	Control mode	Supported (master axis)	Supported (slave axis)
MR-J5-_G MR-J5D1-_G_	Standard control mode	○	○
	Fully closed loop control mode	○	—
	Linear servo motor control mode	—	—
	Direct drive motor control mode	—	—

Driver communication specifications

The specifications of driver communication are as follows.

Item	Description
Supported driver communication cycle *1	125 [μs], 250 [μs]
Number of master axes in the same CC-Link IE TSN network	Max. 8
Number of axes to which the master axis enables transmission	No limit *2
Number of axes from which the master axis enables reception	Max. 8 *3
Number of axes to which the slave axis enables transmission	Max. 1
Number of axes from which the slave axis enables reception	Max. 1

*1 The driver communication cycle is the one set in the controller communication cycle interval settings.

*2 The number of stations to which the master axis enables transmission is unlimited, but the number is determined depending on the maximum number of axes supported by the controller. For details, refer to the manual for the controller being used.

*3 The maximum number of axes that can be set as control slave axes per master axis. The master axis receives the master-slave simultaneous stop request from the slave axes set as the control slave axes.

Related parameters

The following servo parameters are related to the master-slave operation function.

Servo parameter	Name	Description
PA04.3	Forced stop deceleration function selection	Set "Forced stop deceleration function" to enabled/disabled.
PA14	Travel direction selection	Set a torque generation direction.
PC29.3	Torque POL reflection selection	Set a torque generation direction.
PD15	Driver communication setting	Select whether to set the servo amplifier as a master axis or slave axis.
PD22	Driver communication setting - Slave - Master axis 1 - Station No. setting	Set the station No. of the master axis.
PD23.1	Driver communication setting - Slave - Master axis 1 - Control slave axis No. setting	Set the control slave axis No. for the master axis.
PD26	Master-slave operation simultaneous stop function operation setting	Configure the settings of the master-slave operation simultaneous stop function.
PD30	Master-slave operation - Slave-side torque command coefficient	Set the ratio of torque command, ratio of speed limit value, and speed limit adjustment value of the slave axis.
PD31	Master-slave operation - Slave-side speed limit coefficient	
PD32	Master-slave operation - Slave-side speed limit adjusted value	



Master-slave operation setting method

To perform master-slave operation, configure the master-slave operation settings and network settings.

To perform master-slave operation, enable the parameter automatic setting in GX Works3, then set parameters in the master station. Refer to the following for the setting methods.

 Page 30 Servo parameter setting

When the parameter automatic setting is disabled, the master-slave operation function cannot be used.

Setting item	Setting details	Reference
Master-slave operation settings	Set servo amplifiers to be used as a master axis and slave axes with servo parameters. Set the servo parameter for the control method to be used.	 Page 26 Master-slave operation settings  Page 33 Master-slave operation simultaneous stop function
Network settings	Set a master axis from which the slave axis receives commands and a control slave axis with servo parameters.	 Page 30 Network settings

Master-slave operation settings

■ Master-slave control with torque command method

The master-slave operation function with the torque command method transmits the torque command and speed feedback of the master axis to slave axes as a torque command and speed limit value through driver communication. Then, the slave axes perform the torque control operation in the slave axis torque mode (slt). It can be used in machines with high rigidity, etc. For the slave axis torque mode, refer to the following.

☞ Page 27 Slave axis torque mode (slt)

- Master-slave operation settings

To use master-slave operation with the torque command method, the following servo parameters need to be set.

Servo parameter	Name	Setting value		Setting details
		Master axis	Slave axis	
PA01.0	Control mode selection	0	0	Select the network standard mode.
PA04.3	Forced stop deceleration function selection	0 or 2 *1	0 or 2 *1	Enable or disable the deceleration to a stop function.
PD15.0	Master axis operation selection	1	0	To set the servo amplifier as a master axis, set "1".
PD15.1	Slave axis operation selection	0	1	To set the servo amplifier as a slave axis, set "1".
PD26.0	Driver communication setting - Slave - Simultaneous stop command permission setting	—	0 or 1	Set whether to enable or disable the master-slave operation simultaneous stop function. Refer to the following for details.
PD26.1	Driver communication setting - Slave - Simultaneous stop request permission setting	—	0 or 1	☞ Page 33 Master-slave operation simultaneous stop function

*1 Set the same value in [Pr. PA04.3 Forced stop deceleration function selection] for both the master and slave axes. When setting [Pr. PA04.3] to "2" (enabled), enable the master-slave operation simultaneous stop function with [Pr. PD26 Master-slave operation simultaneous stop function operation setting] of the slave axis. Refer to the following for details.

☞ Page 33 Master-slave operation simultaneous stop function

- Communication data details

The data transmitted from the master axis to the slave axes is as follows.

Transmission data	Detailed explanation
Master-slave operation simultaneous stop command	If the master axis detects an abnormal stop on itself or a slave axis, a simultaneous stop command will be transmitted, and the slave axes will stop according to the command.
Torque command	The master axis transmits a torque command of itself, and the slave axes are activated assuming that the received value is the torque command. For the slave axes, the value used is the one multiplied by the coefficient set in [Pr. PD30]. If the rotation direction of the slave axes differs from that of the master axis, reverse the rotation direction of the slave axes with [Pr. PA14] or [Pr. PC29.3].
Speed limit	The master axis transmits speed feedback, and the slave axes are activated assuming that the received value is the speed limit value. For the slave axes, the value used is the one obtained as follows: multiplying the value by the coefficient set in [Pr. PD31], then adding the offset set in [Pr. PD32] or [Pr. PV33] to the value after the multiplication.

The data transmitted from the slave axes to the master axis is as follows.

Transmission data	Detailed explanation
Master-slave operation simultaneous stop request	The slave axis transmits a simultaneous stop request when the slave axis itself stops. The master axis stops according to the request, and transmits a simultaneous stop command.

■ Slave axis torque mode (slt)

The following shows the functions and related objects of the slave axis torque mode (slt).

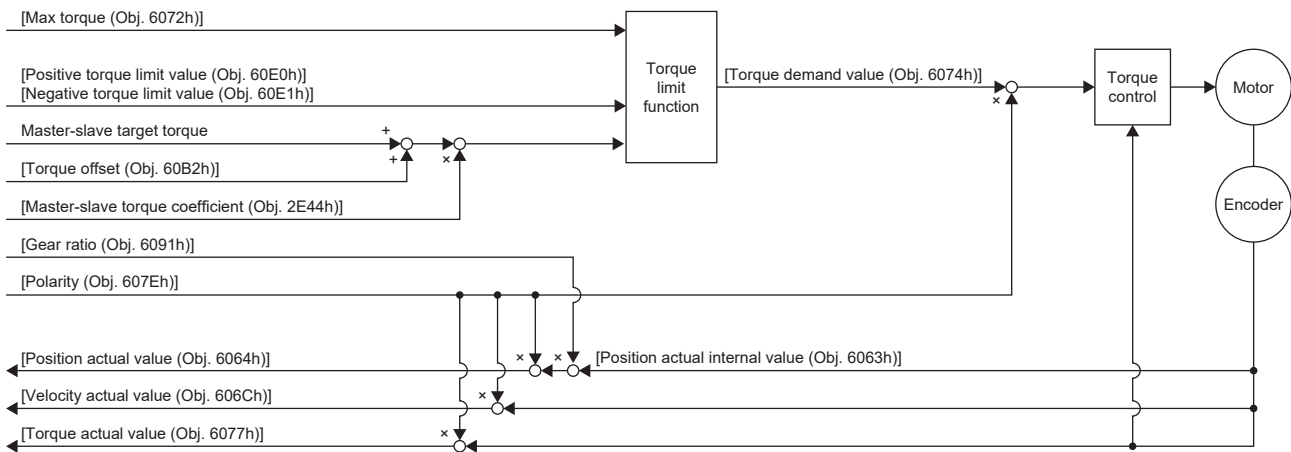

• Related objects

For details of the objects, refer to the following manual.

📖 MR-J5-G/MR-J5W-G User's Manual (Object Dictionary)

Index	Sub	Object	Name	Description
6072h	—	VAR	Max torque	Maximum torque Unit: 0.1 % (with rated torque being 100 %)
6074h	—	VAR	Torque demand value	Command torque (after limit) Unit: 0.1 % (with rated torque being 100 %)
6063h	—	VAR	Position actual internal value	Current position Unit: Enc inc
6064h	—	VAR	Position actual value	Current position Unit: pos units
606Ch	—	VAR	Velocity actual value	Current speed Unit: vel units
6077h	—	VAR	Torque actual value	Current torque Unit: 0.1 % (with rated torque being 100 %)
6092h	0	ARRAY	Feed constant	Travel distance per revolution of an output shaft
	1		Feed	Travel distance setting Unit: pos units
	2		Shaft revolutions	Number of servo motor shaft revolutions Unit: rev
60E0h	—	VAR	Positive torque limit value	Torque limit value (forward) Unit: 0.1 % (with rated torque being 100 %)
60E1h	—	VAR	Negative torque limit value	Torque limit value (reverse) Unit: 0.1 % (with rated torque being 100 %)
6091h	0	ARRAY	Gear ratio	Gear ratio
	1		Motor revolutions	Number of revolutions of the servo motor shaft (numerator) Refer to "Electronic gear function [G]" in the following manual. 📖 MR-J5 User's Manual (Function)
	2		Shaft revolutions	Number of revolutions of the drive shaft (denominator) Refer to "Electronic gear function [G]" in the following manual. 📖 MR-J5 User's Manual (Function)
607Eh	—	VAR	Polarity	Polarity selection Bit 7: Position POL Bit 6: Velocity POL Bit 5: Torque POL Refer to "Rotation/travel direction selection [G]" in the following manual. 📖 MR-J5 User's Manual (Function)
60A8h	—	VAR	SI unit position	SI unit position 00000000h (1 pulse)

Index	Sub	Object	Name	Description
60A9h	—	VAR	SI unit velocity	SI unit velocity The SI unit velocity is returned. FEB44700h (0.01 r/min) FB010300h (0.01 mm/s) 00000300h (pulse/s)
60B2h	—	VAR	Torque offset	Torque offset Unit: 0.1 % (with rated torque being 100 %)
2E44h	—	VAR	Master-slave torque coefficient	Master-slave operation - Slave-side torque command coefficient Unit: %
2E45h	—	VAR	Master-slave velocity limit coefficient	Master-slave operation - Slave-side speed limit coefficient Unit: %
2E46h	—	VAR	Master-slave Lower limit of velocity limit value	Master-slave operation - Slave-side speed limit adjusted value Unit: vel units

- Slave axis adjustment

The following parameters and objects can be used to adjust the torque command value and speed command value.

Servo parameter list for command adjustment

Servo parameter	Name	Unit	Reference
PD30	Master-slave operation - Slave-side torque command coefficient	[%]	MR-J5-G/MR-J5W-G User's Manual (Parameters)
PD31	Master-slave operation - Slave-side speed limit coefficient	[%]	
PD32	Master-slave operation - Slave-side speed limit adjusted value	[r/min]	
PV33	Master-slave operation - Speed limit adjusted value extension setting	[pulse/s]	

Object list for command adjustment

Index	Name	Unit	Reference
2E44h	Master-slave torque coefficient	—	MR-J5-G/MR-J5W-G User's Manual (Object Dictionary)
2E45h	Master-slave velocity limit coefficient	—	
2E46h	Master-slave Lower limit of velocity limit value	—	

- Travel direction setting

Configure the settings for the controller command so that the rotation/travel directions of the master and slave axes are in accordance with the moving direction of the mechanical system.

The following shows an example of setting the rotation/travel direction of a platform truck with one master axis and three slave axes.

To set the servo motor rotation direction in accordance with the moving direction, the command polarity of slave 1 should be the same as that of the master axis and the command polarity of slaves 2 and 3 should be reversed from that of the master axis.

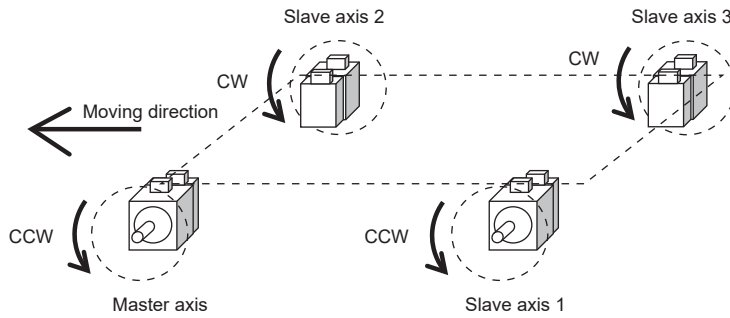

Example of setting with a servo parameter

Axis	[Pr. PA14]
Master	0
Slave 1	0
Slave 2	1
Slave 3	1

Example of setting with an object

Axis	[Polarity (Obj. 607Eh)]
Master	00h
Slave 1	00h
Slave 2	E0h
Slave 3	E0h

Network settings

■Communication cycle settings

The driver communication cycle is set automatically in accordance with the controller being used. For details, refer to the manual for the controller being used.

If the driver communication cycle is shorter than the communication cycle interval that is compatible with the controller, driver communication is not available. Set a longer driver communication cycle than the controller communication cycle interval.

For the compatible driver communication cycle, refer to the following.

 Page 24 Driver communication specifications

■Servo parameter setting

Set the following servo parameters, and configure the driver communication network settings. To set these servo parameters, enable the parameter automatic setting in GX Works3, then set the parameters in the master station. If a servo parameter is set in the servo amplifier directly, driver communication may not be established properly.

Servo parameter	Name
PD15	Driver communication setting
PD22	Driver communication setting - Slave - Master axis 1 - Station No. setting
PD23	Driver communication setting - Slave - Master axis 1 - Control slave axis No. setting

- Master axis settings

Set [Pr. PD15.0 Master axis operation selection] to "1" (enabled).

- Slave axis settings

Set [Pr. PD15.1 Slave axis operation selection] to "1" (enabled).

Set the station No. of the servo amplifier (master axis) in [Pr. PD22 Driver communication setting - Slave - Master axis 1 - Station No. setting].

When transmitting feedback data to the master axis, set a slave axis as a control slave axis. The control slave axis is a slave axis that transmits feedback data to the master axis. The difference between the ordinary slave axis and control slave axis is as follows.

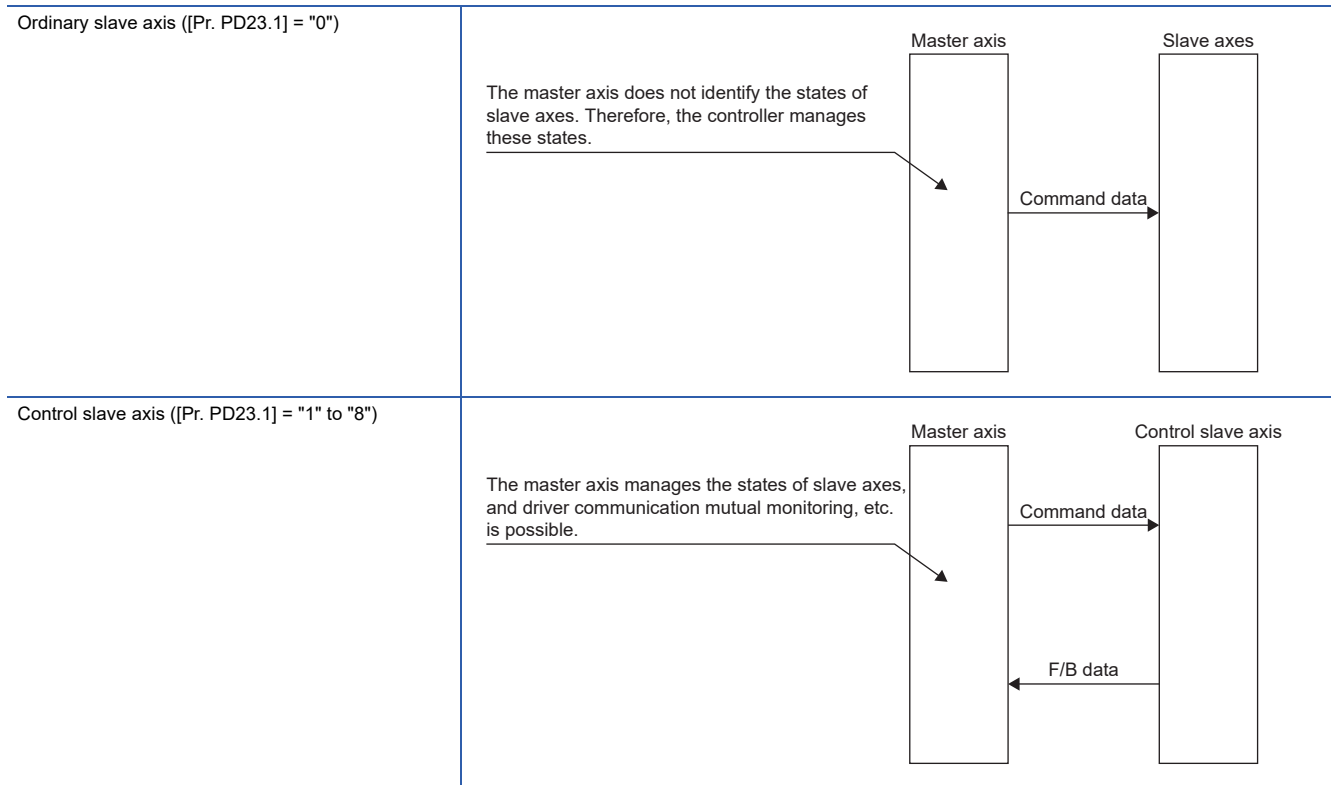

To set a control slave axis, set [Pr. PD23.1 Driver communication setting - Slave - Master axis 1 - Control slave axis No. setting] to any of "1" to "8". If [Pr. PD23.1] of a slave axis is set to "0", the slave axis does not transmit feedback data.

Up to eight slave axes can be set as control slave axes per master axis.

It is not possible to set a slave axis with the same control slave axis number for one master axis. Set slave axes with unique control slave axis numbers.

- Servo parameter setting example (when setting a slave axis as a control slave axis)

The following shows an example of establishing driver communication between the master axis with station No. 1 and the slave axis with station No. 2, and setting a slave axis as a control slave axis.

Servo parameter	Setting value	
	Station 1	Station 2
PD15.0	1 (enabled)	0 (disabled)
PD15.1	0 (disabled)	1 (enabled)
PD22	0	1 (station No. 1)
PD23.1	0	1 (control slave axis No. 1)

- Servo parameter setting example (when not setting a slave axis as a control slave axis)

The following shows an example of establishing driver communication between the master axis with station No. 1 and the slave axis with station No. 2, but not setting a slave axis as a control slave axis.

Servo parameter	Setting value	
	Station 1	Station 2
PD15.0	1 (enabled)	0 (disabled)
PD15.1	0 (disabled)	1 (enabled)
PD22	0	1 (station No. 1)
PD23.1	0	0 (not set as a control slave axis)

Slave axis function

■ Master-slave operation simultaneous stop function

The master-slave operation simultaneous stop function stops slave axes in the following way: When the master axis stops the servo motor due to an error detection or other reason, a stop command is notified to the slave axes without a controller through driver communication.

Setting a slave axis as a control slave axis allows the master axis to stop the servo motor in accordance with a stop request from the control slave axis and notify the slave axes of a stop command.

[AL. 1EA Master-slave operation simultaneous stop warning] occurs on the master and slave axes whose servo motors have stopped with the master-slave operation simultaneous stop function.

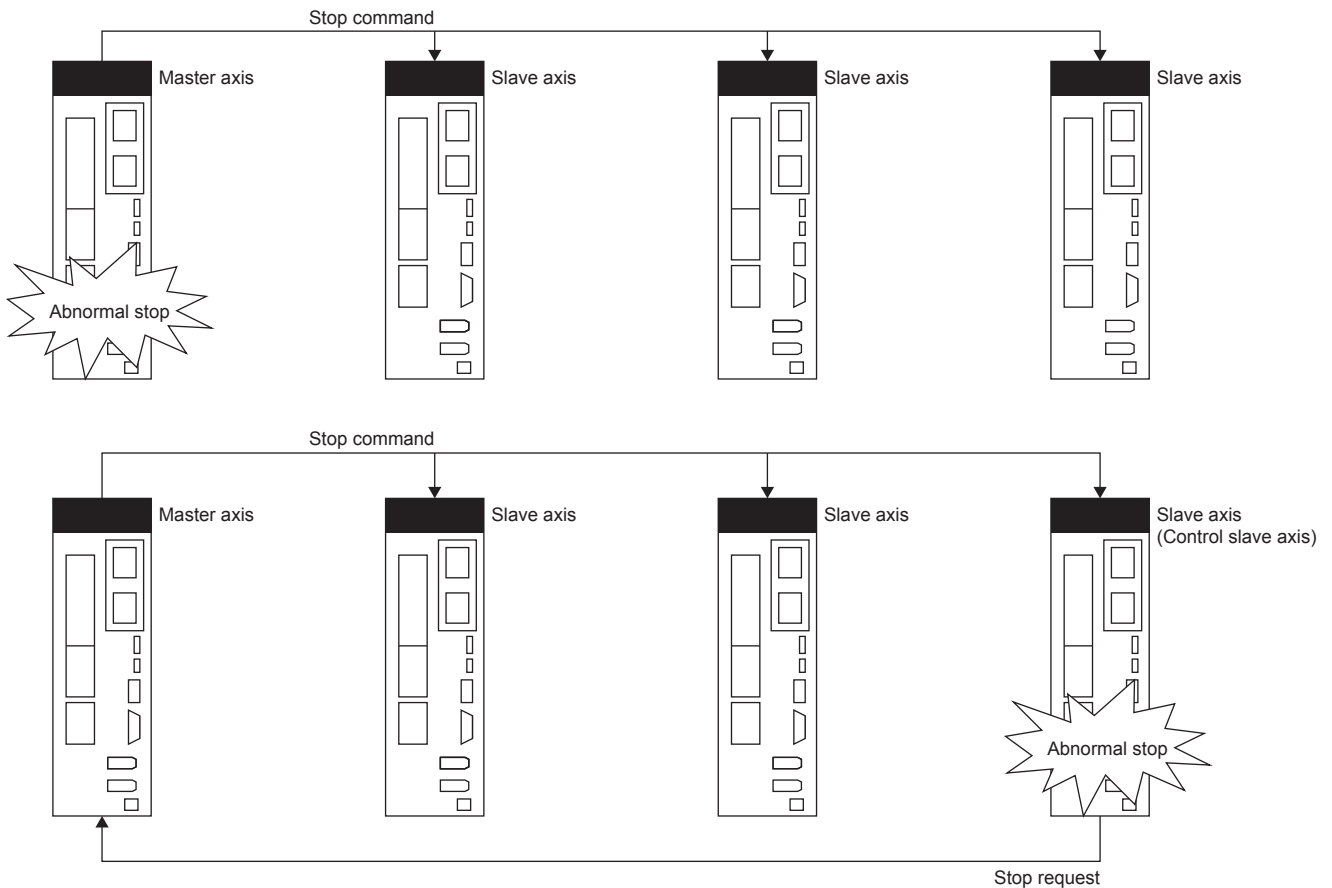

- Precautions regarding the master-slave operation simultaneous stop function

In the initial settings, the master-slave operation simultaneous stop function is enabled. To disable the master-slave operation simultaneous stop function, set [Pr. PD26 Master-slave operation simultaneous stop function operation setting] to "00000011h".

When disabling the master-slave operation simultaneous stop function, configure the settings so that servo-off will be applied to all the master and slave axes when a master or slave axis stops due to an alarm or other reason.

When the master-slave operation simultaneous stop function stops a servo motor, the servo motors may not be stopped at the same time if there is a difference between the loads applied to the master and slave axes.

When not setting a control slave axis, set [Pr. PA04.3 Forced stop deceleration function selection] of the master axis to "0h" (Forced stop deceleration function disabled). If a value other than "0h" is set in [Pr. PA04.3], the servo motors may not be stopped at the same time.

To use the master-slave operation simultaneous stop function, set a slave axis as a control slave axis, and set [Pr. PD26] of the slave axis to "00000000h" (initial value). The servo motors may not be stopped at the same time because a slave axis that is not set as a control slave axis cannot notify the master axis of a stop request.

Additionally, if [Pr. PD26] is set to a value other than "00000000h", the servo motors may not be stopped at the same time because a stop command and stop request are disabled. The following shows how the slave axis operates, and the operation depends on the setting value of [Pr. PD26].

[Pr. PD26.0]	[Pr. PD26.1]	Slave axis operation
0 (enabled)	0 (enabled)	(Initial setting) • Stops in accordance with the stop command from the master axis. • Notifies the master axis of a stop request when the control slave axis being used is stopped.*2
0 (enabled)	1 (disabled)	• Stops in accordance with the stop command from the master axis. • Does not notify the master axis of a stop request when the control slave axis being used is stopped.*1
1 (disabled)	0 (enabled)	• Ignores the stop command from the master axis and continues the operation. • Notifies the master axis of a stop request when the control slave axis being used is stopped.*2
1 (disabled)	1 (disabled)	• Ignores the stop command from the master axis and continues the operation. • Does not notify the master axis of a stop request when the control slave axis being used is stopped.*1

*1 If a stop request is not notified to the master axis, the master axis continues the operation.

*2 The motors of master axes that have received a stop request will stop.

- Usage

To use the master-slave operation simultaneous stop function, set the parameters of the master and slave axes as follows.

Notification of stop requests from slave axes can be used only on slave axes that have been set as control slave axes.

Servo parameter	Name	Setting value		Setting details
		Master axis	Slave axis	
PA04.3	Forced stop deceleration function selection	0 or 2 *1	0 or 2 *1	Set the forced stop deceleration function. 0: Forced stop deceleration function disabled 2: Forced stop deceleration function enabled
PD26.0	Driver communication setting - Slave - Simultaneous stop request permission setting	(No setting required)	0 (Initial value)	Set the behavior of the slave axis for when the slave axis receives a stop command from the master axis in the master-slave operation simultaneous stop function.
PD26.1	Driver communication setting - Slave - Simultaneous stop command permission setting	(No setting required)	0 *2 (Initial value)	Set whether to enable or disable the stop request notification to the master axis in the master-slave operation simultaneous stop function.

*1 It is recommended to set the same value in [Pr. PA04.3] for both the master and slave axes. When stopping the servo motor with the forced stop deceleration using the master-slave operation simultaneous stop function, set [Pr. PA04.3] of the master axis to "2". When [Pr. PA04.3] of the master axis is set to "0", the servo motors will be stopped at the same time with the dynamic brake even if a motor of a slave axis is stopped with the forced stop deceleration.

*2 When [Pr. PD26.1] of a slave axis (not a control slave axis) is set to "0", [AL. 13D Driver communication network setting error] will occur. When setting [Pr. PD26.1] to "0", set a servo amplifier as a control slave axis.

- Stop method using the master-slave operation simultaneous stop function

When the master axis stops the servo motor due to an alarm detection or other reason, a dynamic brake stop command is notified to the slave axes when the dynamic brake of the master axis is activated. The slave axes that have received a dynamic brake stop command activate the dynamic brakes to stop the servo motors.

When the master axis is in the process of forced stop deceleration, the slave axes decelerate the servo motors in accordance with the torque command and speed limit command from the master axis.

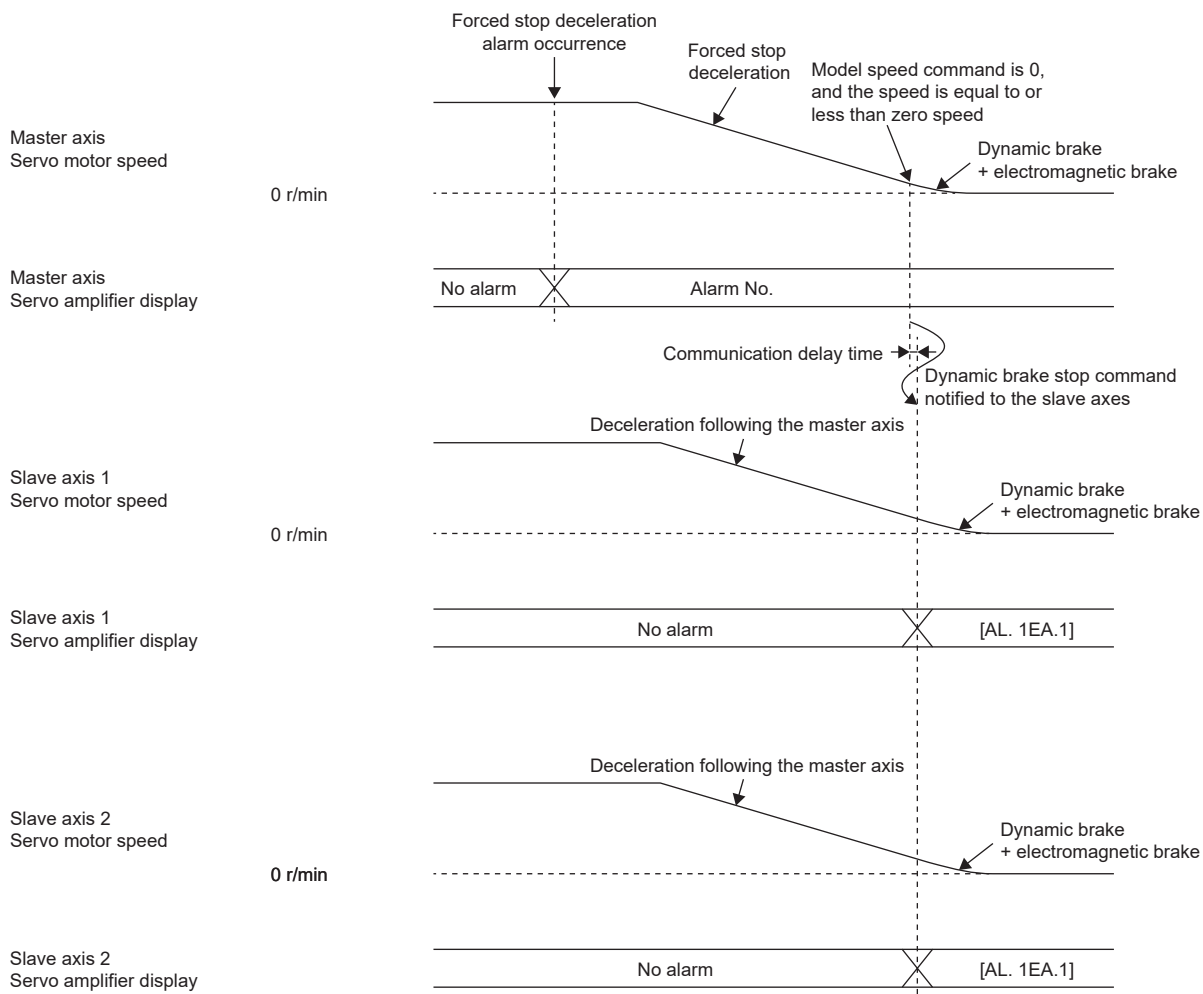

When the slave axes stop the servo motors with the forced stop deceleration due to an alarm detection or other reason, a deceleration request is notified to the master axis. The master axis that has received a deceleration stop request starts forced stop deceleration. When the master axis is in the process of forced stop deceleration, the slave axes decelerate the servo motors in accordance with the torque command and speed limit command from the master axis.

After that, a dynamic brake stop command is notified to the slave axes when the dynamic brake of the master axis is activated. The slave axes that have received a dynamic brake stop command activate the dynamic brakes to stop the servo motors.

This stop method is applied only when [Pr. PA04.3] of the master and slave axes is set to "2".

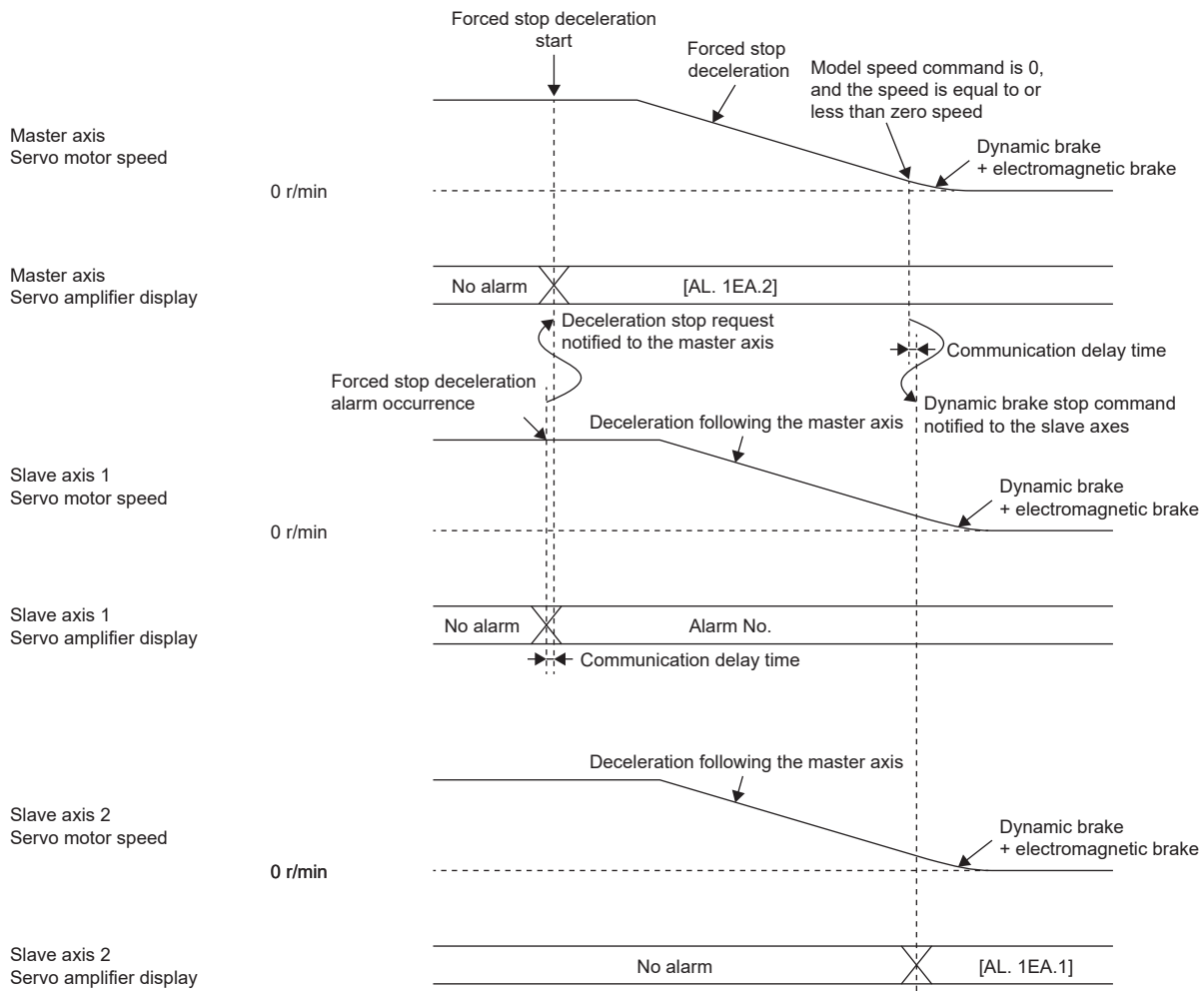

When the slave axes stop the servo motors using the dynamic brakes due to an alarm detection or other reason, the dynamic brakes are activated to stop the servo motors.

A dynamic brake stop request is notified to the master axis when the dynamic brakes of the slave axes are activated. The master axis that has received a dynamic brake stop request activates the dynamic brake to stop the servo motor.

A dynamic brake stop command is notified to the slave axes when the dynamic brake of the master axis is activated. The slave axes that have received a dynamic brake stop command activate the dynamic brakes to stop the servo motors.

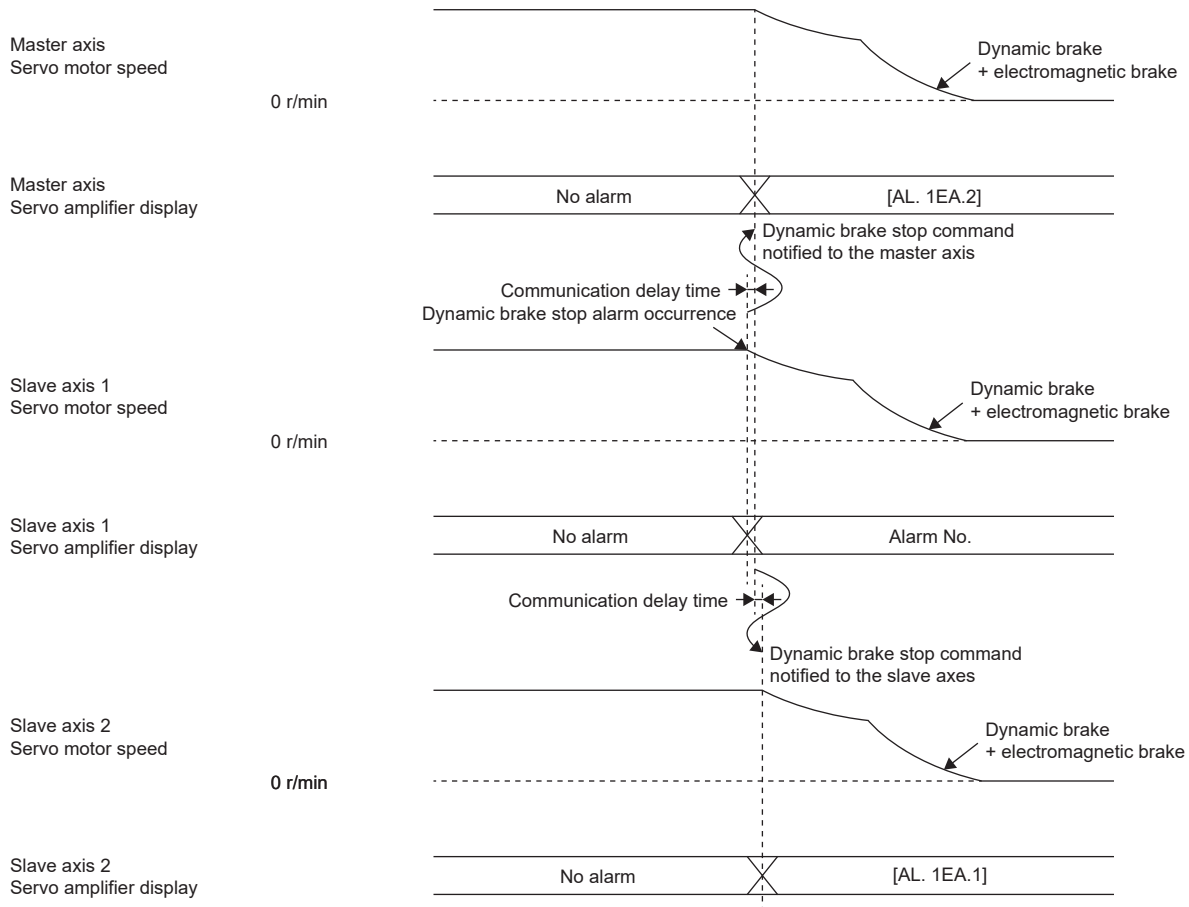

• Resumption of operation stopped by the master-slave operation simultaneous stop function

If the master-slave operation simultaneous stop function stops a servo motor of the master or slave axis, the axis can be ready for operation by deactivating the stop state of a servo motor that was stopped due to a reason other than the function. If [AL. 1EA.2 Master-slave operation stop request detection warning] has been detected on the master axis, a servo motor of a slave axis may have been stopped.

Clock function

This function is used to acquire time information from the grand master (the station serving as a clock source) via CC-Link IE TSN so that this information may be used for the time management of functions performed by the servo amplifier, such as alarm history. The time synchronization protocol for the grand master and the servo amplifier uses IEEE1588 or IEEE802.1AS.

Motion mode (high-speed) setting

The following explains the setting method of the motion mode (high-speed) that enables a communication cycle of 31.25 μ s between a master station (Motion module) and a device station (servo amplifier).

Restriction

- The communication cycles of 31.25 μ s and 62.5 μ s can be used by servo amplifiers with firmware version A6 or later.
 - [AL. 09E.2 Communication cycle setting warning] occurs when using a 31.25 μ s connection to communicate with a servo amplifier that does not have [Pr. PA01.7 High-speed mode selection] set to "1" (enabled).
 - When the communication cycle is set to 31.25 μ s, the maximum size of RPDO is limited to 12 bytes, and the maximum size of TPDO is limited to 24 bytes. If the setting is large, [AL. 09E.3 Number of cyclic points warning] occurs.
-

Setting method

1. Configure the master station network settings with GX Works3.
2. Select module parameter (network) from the module information of the Motion module, and open the network configuration settings.
3. Set "Motion mode (high-speed)" in the station specific mode setting when setting the network configuration.
4. After changing the station specific mode setting, set [Pr. PA01.7 High-speed mode selection] of the servo parameter to "1" (enabled).

1.4 APPENDIX

CC-Link IE TSN communication protocol

Communication management

The communication state of the device unit in CC-Link IE TSN is broadly classified as being either an "initialization phase" or an "under control communication phase" and then managed.

■Communication state management of the motion mode

The motion mode of the servo amplifier support CANopen profile.

For devices that support the CANopen profile, the communication state of CC-Link IE TSN is managed by the Network Management (NMT) state machine.

- Communication state

The NMT state machine manages the four states shown below (Init, Pre-Operational, Safe-Operational, and Operational).

The communication state transitions in each device station. For multi-axis servo amplifiers, the communication state transitions in the whole station (common to all the axes).

State	Main processing details
Init	Operates in accordance with the procedures performed in "initialization phase" of CC-Link IE TSN, such as management master mediation, connection structure detection, propagation delay measurement, and communication band setting. The servo motor cannot be operated.
Pre-Operational	The master station (the Motion module) and the device station (the servo amplifier) send and receive SDOs with transient transmission, and get ready to start or to resume operation by setting the control mode and PDO mappings as well as performing other preparations. The servo motor cannot be operated. Refer to the following for transient transmission. ☞ Page 53 Transient transmission
Safe-Operational	The master station (the Motion module) and the device station (the servo amplifier) send and receive PDOs with cyclic transmission. The servo motor cannot be operated. Refer to the following for cyclic transmission. ☞ Page 41 Cyclic transmission
Operational	The master station (the Motion module) and the device station (the servo amplifier) send and receive PDOs with cyclic transmission. The servo motor can be operated.

The state transition diagram of the NMT state machine is as follows.

The servo amplifier transitions the communication state by receiving the SLMP command (NMT State Download) from the master station or by other means.

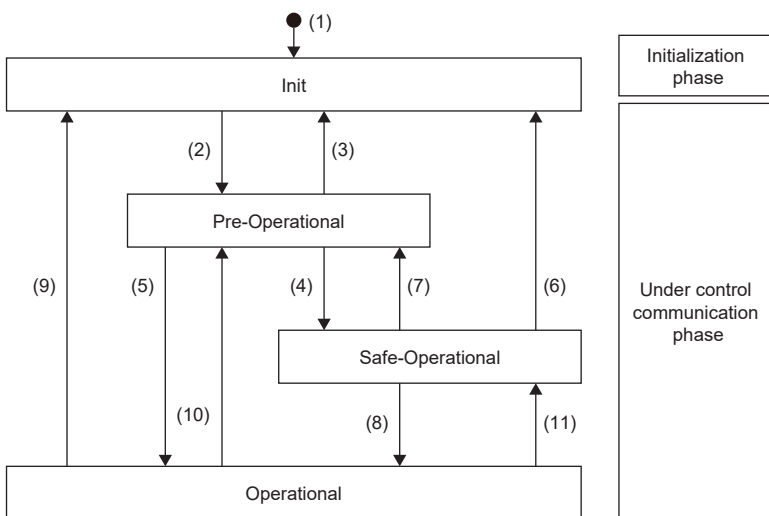

The controller and the servo amplifier perform the following procedure to establish communication (transition to "Operational").

Transition No.	Operation
(1)	Power-on
(2)	During the transition from the initialization phase to the control communication phase of CC-Link IE TSN, the servo amplifier transitions from "Init" to "Pre-Operational".
(3)	When the master station issues NMT State Download (SLMP) for "Init" to the servo amplifier, or when a communication time-out occurs, the servo amplifier transitions from "Pre-Operational" to "Init".
(4)	When the master station issues NMT State Download (SLMP) for "Safe-Operational" to the servo amplifier, the servo amplifier transitions to "Safe-Operational". The master station performs control mode setting and PDO mapping setting on the servo amplifier.
(5)	When the master station issues NMT State Download (SLMP) for "Operational" to the servo amplifier, the servo amplifier transitions to "Operational". When PDO mapping setting is not performed on the servo amplifier, the state transitions on this route.
(6)	When the master station issues NMT State Download (SLMP) for "Init" to the servo amplifier, or when a communication time-out occurs, the servo amplifier transitions from "Safe-Operational" to "Init".
(7)	When the master station issues NMT State Download (SLMP) for "Pre-Operational" to the servo amplifier, the servo amplifier transitions to "Pre-Operational".
(8)	When the master station issues NMT State Download (SLMP) for "Operational" to the servo amplifier, the servo amplifier transitions to "Operational".
(9)	When the master station issues NMT State Download (SLMP) for "Init" to the servo amplifier, or when a communication time-out occurs, the servo amplifier transitions from "Operational" to "Init".
(10)	When the master station issues NMT State Download (SLMP) for "Pre-Operational" to the servo amplifier, the servo amplifier transitions to "Pre-Operational".
(11)	When the master station issues NMT State Download (SLMP) for "Safe-Operational" to the servo amplifier, the servo amplifier transitions to "Safe-Operational".

■SLMP command

The SLMP commands used in communication state management are as follows.

No.	Command name	Command	Sub command	Description
1	NMT State Upload *1	4020h	0007h	NMT State reading
2	NMT State Download *1	4020h	0008h	NMT State writing

*1 The command is executed in the whole station (common to all axes), even if the command is issued to a specific axis of a multi-axis servo amplifier.

Cyclic transmission

Cyclic transmission is a function that cyclically exchanges data between stations.

Cyclic transmission of motion mode

Cyclic transmission of the motion mode is a function that uses PDOs to cyclically exchange data between stations.

A PDO is an aggregate of objects such as [Modes of operation (Obj. 6060h)] and [Modes of operation display (Obj. 6061h)]. The placement of objects in a PDO is called PDO mapping, and the initial placement (default PDO mapping) is defined. The PDO received by each station is called an RPDO, and the PDO transmitted by each station is called a TPDO. On multi-axis servo amplifiers, PDOs are sent and received by each axis.

PDOs are transferred using the cyclic Ms frame (from the master station to the device station) and the cyclic Ss frame (from the device station to the master station).

A conceptual figure of communication between a master station and device stations (1-axis) is shown below.

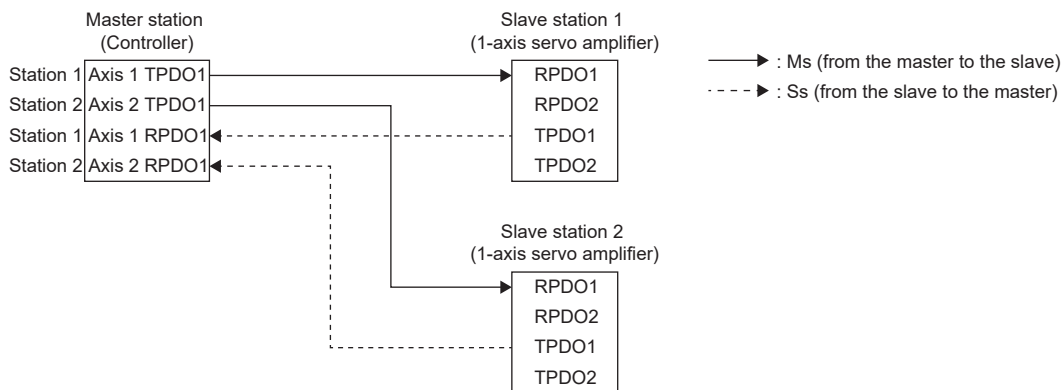

A conceptual figure of communication between a master station and device stations (multi-axis) is shown below.



■ Default PDO mapping

Default PDO mapping is the initial placement of objects included in a PDO. When there is no request from the controller or the engineering tool to change PDO mapping objects, the servo amplifier operates using default PDO mapping.

- RPDO, TPDO 1st mapping ([1st Receive PDO Mapping (Obj. 1600h)] and [1st Transmit PDO Mapping (Obj. 1A00h)])
PDO mapping for cyclic synchronous operation (csp/csv/cst/hm).

RPDO (from the master station to the servo amplifier)		
Offset Address	Index	Device name
0000h	1D01h	Watch dog counter DL
0002h	6060h	Modes of operation
0003h	0000h	GAP
0004h	607Ah	Target position
0008h	60FFh	Target velocity
000Ch	6040h	Controlword
000Eh	60E0h	Positive torque limit value
0010h	60E1h	Negative torque limit value
0012h	6071h	Target torque
0014h	2D20h	Velocity limit value
0018h	2D01h	Control DI 1
001Ah	2D02h	Control DI 2
001Ch	2D03h	Control DI 3
001Eh	2D04h	Control DI 4
0020h	2D05h	Control DI 5
0022h	0000h	GAP
...
TPDO (from the servo amplifier to the master station)		
Offset Address	Index	Device name
0000h	1D02h	Watch dog counter UL
0002h	6061h	Modes of operation display
0003h	0000h	GAP
0004h	6064h	Position actual value
0008h	606Ch	Velocity actual value
000Ch	60F4h	Following error actual value
0010h	6041h	Statusword
0012h	0000h	GAP
0014h	6077h	Torque actual value
0016h	2D11h	Status DO 1
0018h	2D12h	Status DO 2
001Ah	2D13h	Status DO 3
001Ch	2D14h	Status DO 4
001Eh	2D15h	Status DO 5
0020h	2A41h	Current alarm
0024h	2D21h	Reserved
0028h	2D22h	Reserved
...

- RPDO, TPDO 2nd mapping ([2nd Receive PDO Mapping (Obj. 1601h)] and [2nd Transmit PDO Mapping (Obj. 1A01h)])
PDO mapping for the motion mode (high-speed).

RPDO (from the master station to the servo amplifier)		
Offset Address	Index	Device name
0000h	1D01h	Watch dog counter DL
0002h	6060h	Modes of operation
0003h	0000h	GAP
0004h	607Ah	Target position
0008h	6040h	Controlword
000Ah	2D04h	Control DI 4
...
TPDO (from the servo amplifier to the master station)		
Offset Address	Index	Device name
0000h	1D02h	Watch dog counter UL
0002h	6061h	Modes of operation display
0003h	0000h	GAP
0004h	6064h	Position actual value
0008h	6041h	Statusword
000Ah	2D11h	Status DO 1
000Ch	2D14h	Status DO 4
000Eh	6077h	Torque actual value
0010h	606Ch	Velocity actual value
0014h	2A41h	Current alarm
...

- RPDO, TPDO 3rd mapping ([3rd Receive PDO Mapping (Obj. 1602h)] and [3rd Transmit PDO Mapping (Obj. 1A02h)])
PDO mapping for profile mode operation (pp/pv/tq/hm).

RPDO (from the master station to the servo amplifier)		
Offset Address	Index	Device name
0000h	6060h	Modes of operation
0001h	0000h	GAP
0002h	6040h	Controlword
0004h	607Ah	Target position
0008h	60FFh	Target velocity
000Ch	2D20h	Velocity limit value
0010h	6071h	Target torque
0012h	6081h	Profile velocity
0016h	6083h	Profile acceleration
001Ah	6084h	Profile deceleration
001Eh	6087h	Torque slope
0022h	2D01h	Control DI 1
0024h	2D02h	Control DI 2
0026h	2D03h	Control DI 3
0028h	2D04h	Control DI 4
...
TPDO (from the servo amplifier to the master station)		
Offset Address	Index	Device name
0000h	6061h	Modes of operation display
0001h	0000h	GAP
0002h	6041h	Statusword
0004h	6064h	Position actual value
0008h	606Ch	Velocity actual value
000Ch	60F4h	Following error actual value
0010h	6077h	Torque actual value
0012h	2D11h	Status DO 1
0014h	2D12h	Status DO 2
0016h	2D13h	Status DO 3
0018h	2D14h	Status DO 4
001Ah	2D15h	Status DO 5
...

- RPDO, TPDO 4th mapping ([4th Receive PDO Mapping (Obj. 1603h)] and [4th Transmit PDO Mapping (Obj. 1A03h)])
PDO mapping for positioning mode (pt/jg/hm).

RPDO (from the master station to the servo amplifier)		
Offset Address	Index	Device name
0000h	6060h	Modes of operation
0001h	0000h	GAP
0002h	6040h	Controlword
0004h	6081h	Profile velocity
0008h	6083h	Profile acceleration
000Ch	6084h	Profile deceleration
0010h	2D60h	Target point table
0012h	2D01h	Control DI 1
0014h	2D02h	Control DI 2
0016h	2D03h	Control DI 3
0018h	2D04h	Control DI 4
...
TPDO (from the servo amplifier to the master station)		
Offset Address	Index	Device name
0000h	6061h	Modes of operation display
0001h	0000h	GAP
0002h	6041h	Statusword
0004h	6064h	Position actual value
0008h	606Ch	Velocity actual value
000Ch	60F4h	Following error actual value
0010h	6077h	Torque actual value
0012h	2D6Ah	M code actual value
0013h	0000h	GAP
0014h	2D68h	Point demand value
0016h	2D69h	Point actual value
0018h	2D11h	Status DO 1
001Ah	2D12h	Status DO 2
001Ch	2D13h	Status DO 3
001Eh	2D14h	Status DO 4
0020h	2D15h	Status DO 5
0022h	2D17h	Status DO 7
...

■PDO mapping objects

The placement of objects in a PDO can be changed with PDO mapping objects ([1st Receive PDO Mapping (Obj. 1600h)] to [4th Receive PDO Mapping (Obj. 1603h)] and [1st Transmit PDO Mapping (Obj. 1A00h)] to [4th Transmit PDO Mapping (Obj. 1A03h)]).

The following table shows values for items such as the number of objects that can be mapped to the PDO and the initial size of the PDO. Note that when the communication cycle is set to 31.25 μ s, the maximum size of both the RPDO and the TPDO is 32 bytes.

Item	Value
RPDO maximum number of objects	32
TPDO maximum number of objects	32
RPDO initial size [byte]	36
TPDO initial size [byte]	42
RPDO maximum size [byte]	80
TPDO maximum size [byte]	80
Number of RPDO mapping settings	4 ([1st Receive PDO Mapping (Obj. 1600h)], [2nd Receive PDO Mapping (Obj. 1601h)], [3rd Receive PDO Mapping (Obj. 1602h)] and [4th Receive PDO Mapping (Obj. 1603h)])
Number of TPDO mapping settings	4 ([1st Transmit PDO Mapping (Obj. 1A00h)], [2nd Transmit PDO Mapping (Obj. 1A01h)], [3rd Transmit PDO Mapping (Obj. 1A02h)] and [4th Transmit PDO Mapping (Obj. 1A03h)])

The total bytes (per station) of objects that can be assigned to PDOs are limited depending on the communication cycle. The table below shows the relations between the communication cycles and PDO sizes.

Communication cycle [μ s]	1-axis servo amplifier		2-axis servo amplifier		3-axis servo amplifier	
	RxPDO [byte]	TxPDO [byte]	RxPDO [byte]	TxPDO [byte]	RxPDO [byte]	TxPDO [byte]
31.25 *1	12	24	—	—	—	—
62.5 *1	36	42	72	84	—	—
125	80	80	72	84	108	126
250	80	80	108	120	120	126
500 to 8000	80	80	108	120	144	162

*1 Available on servo amplifiers with firmware version A6 or later.

- PDO mapping objects between the master station and the servo amplifier

When changing the PDO mapping between the master station and the servo amplifier, use [1st Receive PDO Mapping] to [4th Receive PDO Mapping] for the RPDO and [1st Transmit PDO Mapping] to [4th Transmit PDO Mapping] for the TPDO.

Index	Sub	Object	Name	Data Type	Access	Default	Description
1600h	0	ARRAY	1st Receive PDO Mapping	U8	rw	10h	Number of entries
	1 to 32		Mapped Object 1 to Mapped Object 32	U32	rw	—	Refer to the following for default mappings. ☞ Page 42 Default PDO mapping
1601h	0	ARRAY	2nd Receive PDO Mapping	U8	rw	06h	Number of entries
	1 to 32		Mapped Object 1 to Mapped Object 32	U32	rw	—	Refer to the following for default mappings. ☞ Page 42 Default PDO mapping
1602h	0	ARRAY	3rd Receive PDO Mapping	U8	rw	0Fh	Number of entries
	1 to 32		Mapped Object 1 to Mapped Object 32	U32	rw	—	Refer to the following for default mappings. ☞ Page 42 Default PDO mapping
1603h	0	ARRAY	4th Receive PDO Mapping	U8	rw	0Bh	Number of entries
	1 to 32		Mapped Object 1 to Mapped Object 32	U32	rw	—	Refer to the following for default mappings. ☞ Page 42 Default PDO mapping
1A00h	0	ARRAY	1st Transmit PDO Mapping	U8	rw	11h	Number of entries
	1 to 32		Mapped Object 1 to Mapped Object 32	U32	rw	—	Refer to the following for default mappings. ☞ Page 42 Default PDO mapping
1A01h	0	ARRAY	2nd Transmit PDO Mapping	U8	rw	0Ah	Number of entries
	1 to 32		Mapped Object 1 to Mapped Object 32	U32	rw	—	Refer to the following for default mappings. ☞ Page 42 Default PDO mapping
1A02h	0	ARRAY	3rd Transmit PDO Mapping	U8	rw	0Ch	Number of entries
	1 to 32		Mapped Object 1 to Mapped Object 32	U32	rw	—	Refer to the following for default mappings. ☞ Page 42 Default PDO mapping
1A03h	0	ARRAY	4th Transmit PDO Mapping	U8	rw	11h	Number of entries
	1 to 32		Mapped Object 1 to Mapped Object 32	U32	rw	—	Refer to the following for default mappings. ☞ Page 42 Default PDO mapping

- Setting contents of PDO mapping objects

The setting contents of PDO mapping objects (Sub Index 1 or later) are as follows.

Bit 31	Bit 16	Bit 15	Bit 8	Bit 0
Index		Sub Index		Bit length

Bit 0 to Bit 7: Bit length of the object to be mapped

Bit 8 to Bit 15: Sub Index of the object to be mapped

Bit 16 to Bit 31: Index of the object to be mapped

If placing [Modes of operation (Obj. 6060h: 00h)] (bit length 8) at the start address of [1st Receive PDO Mapping (Obj. 1600h)], set "60600008h" to [Mapped Object 001 (Obj. 1600h: 01h)].

- PDO mapping setting procedure

When a motion module is used as the motion control axis, the mapping is automatically changed on the motion module side. Using [1st Receive PDO Mapping (Obj. 1600h)] and [1st Transmit PDO Mapping (Obj. 1A00h)] as examples, the following shows the procedure for setting objects one at a time.

This is a procedure to assign [Target velocity (Obj. 60FFh: 00h)] to [Mapped Object 005 (Obj. 1600h: 05h)].

Before the change:

Index	Sub Index	Setting value	Object contents
1600h	00h	4h	Number of entries
1600h	01h	1D010008h	[Watchdog counter DL (Obj. 1D01h: 00h)]
1600h	02h	60600008h	[Modes of operation (Obj. 6060h: 00h)]
1600h	03h	00000008h	[GAP (Obj. 0000h: 00h)]
1600h	04h	60400010h	[Controlword (Obj. 6040h: 00h)]
1600h	05h	00000008h	[GAP (Obj. 0000h: 00h)]

After the change:

Index	Sub Index	Setting value	Object contents
1600h	00h	5h	Number of entries
1600h	01h	1D010008h	[Watchdog counter DL (Obj. 1D01h: 00h)]
1600h	02h	60600008h	[Modes of operation (Obj. 6060h: 00h)]
1600h	03h	00000008h	[GAP (Obj. 0000h: 00h)]
1600h	04h	60400010h	[Controlword (Obj. 6040h: 00h)]
1600h	05h	60FF0020h	[Target velocity (Obj. 60FFh: 00h)]

1. Set the value of [1st Receive PDO Mapping (Obj. 1600h: 00h)] to "0h" in transient communication (SDO message). In order to change Sub Index: 01h and later, the value must first be set to "0h".

Index	Sub Index	Setting value	Object contents
1600h	00h	0h	Number of entries
1600h	01h	1D010008h	[Watchdog counter DL (Obj. 1D01h: 00h)]
1600h	02h	60600008h	[Watchdog counter DL (Obj. 1D01h: 00h)]
1600h	03h	00000008h	[GAP (Obj. 0000h: 00h)]
1600h	04h	60400010h	[Controlword (Obj. 6040h: 00h)]

2. Set the value of [Mapped Object 005 (Obj. 1600h: 05h)] to "60FF0020h" in transient communication (SDO message).

Index	Sub Index	Setting value	Object contents
1600h	00h	0h	Number of entries
1600h	01h	1D010008h	[Watchdog counter DL (Obj. 1D01h: 00h)]
1600h	02h	60600008h	[Modes of operation (Obj. 6060h: 00h)]
1600h	03h	00000008h	[GAP (Obj. 0000h: 00h)]
1600h	04h	60400010h	[Controlword (Obj. 6040h: 00h)]
1600h	05h	60FF0020h	[Target velocity (Obj. 60FFh: 00h)]

3. Set the value of [1st Receive PDO Mapping (Obj. 1600h: 00h)] to "5h" in transient communication (SDO message). If there is an error in PDO mapping, an error code (SDO end code) is returned.

Index	Sub Index	Setting value	Object contents
1600h	00h	5h	Number of entries
1600h	01h	1D010008h	[Watchdog counter DL (Obj. 1D01h: 00h)]
1600h	02h	60600008h	[Modes of operation (Obj. 6060h: 00h)]
1600h	03h	00000008h	[GAP (Obj. 0000h: 00h)]
1600h	04h	60400010h	[Controlword (Obj. 6040h: 00h)]
1600h	05h	60FF0020h	[Target velocity (Obj. 60FFh: 00h)]

4. The mapping contents are not stored in the non-volatile memory. Perform PDO mapping for each network connection.

■ Objects that require PDO mapping

- Objects that require RPDO mapping, categorized by control mode and function

◎: PDO mapping required ○: PDO mapping recommended —: PDO mapping not required

Object name (Index)	Mode								
	csp	csv	cst ct ^{*2}	pp ^{*1}	pv ^{*1}	tq ^{*1}	hm	pt ^{*3}	jg ^{*3}
[Watch dog counter DL (Obj. 1D01h)]	○	○	○	○	○	○	○ ^{*5}	—	—
[Controlword (Obj. 6040h)]	◎	◎	◎	◎	◎	◎	◎	◎	◎
[Control DI 1 (Obj. 2D01h)]	○	○	—	○	○	—	—	○	○
[Control DI 2 (Obj. 2D02h)]	○	—	—	○	—	—	○	○	○
[Control DI 3 (Obj. 2D03h)]	○	○	○	○	○	○	○	○	○
[Touch probe function (Obj. 60B8h)] ^{*1}	○	—	—	—	—	—	—	— ^{*4}	— ^{*4}
[Target position (Obj. 607Ah)]	◎	—	—	◎	—	—	—	—	—
[Target velocity (Obj. 60FFh)]	—	◎	—	—	◎	—	—	—	—
[Target torque (Obj. 6071h)]	—	—	◎	—	—	◎	—	—	—
[Profile velocity (Obj. 6081h)] ^{*1}	—	—	—	○	—	—	—	—	○
[Profile acceleration (Obj. 6083h)] ^{*1}	—	—	—	○	○	—	—	—	○
[Profile deceleration (Obj. 6084h)] ^{*1}	—	—	—	○	○	—	—	—	○
[Torque slope (Obj. 6087h)] ^{*1}	—	—	—	—	—	○	—	—	—
[Velocity limit value (Obj. 2D20h)]	—	—	○	—	—	○	—	—	—
[Positive torque limit value (Obj. 60E0h)]	○	○	○	○	○	○	○	○	○
[Negative torque limit value (Obj. 60E1h)]	○	○	○	○	○	○	○	○	○
[Target point table (Obj. 2D60h)] ^{*3}	—	—	—	—	—	—	—	◎	—

*1 Available on servo amplifiers with firmware version A5 or later.

*2 Available on servo amplifiers with firmware version A8 or later.

*3 Available on servo amplifiers with firmware version B8 or later.

*4 It is "◎" when the touch probe function is used.

*5 It is "—" when the positioning mode (point table method) is used.

- Objects that require TPDO mapping, categorized by control mode and function

⊙: PDO mapping required ○: PDO mapping recommended —: PDO mapping not required

Object name (Index)	Mode								
	csp	csv	cst ct ^{*2}	pp ^{*1}	pv ^{*1}	tq ^{*1}	hm	pt ^{*3}	jg ^{*3}
[Watch dog counter UL (Obj. 1D02h)]	○	○	○	○	○	○	○ ^{*6}	—	—
[Statusword (Obj. 6041h)]	⊙	⊙	⊙	⊙	⊙	⊙	⊙	⊙	⊙
[Status DO 1 (Obj. 2D11h)]	○	○	○	○	○	○	○	○	○
[Status DO 2 (Obj. 2D12h)]	○	○	○	○	○	○	○	○	○
[Status DO 3 (Obj. 2D13h)]	○	○	○	○	○	○	○	○	○
[Status DO 5 (Obj. 2D15h)]	—	—	—	○	—	—	—	○	○
[Status DO 7 (Obj. 2D17h)]	—	—	—	—	—	—	—	○	○
[Touch probe status (Obj. 60B9h)] ^{*1}	○	—	—	—	—	—	—	— ^{*4}	— ^{*4}
[Position actual value (Obj. 6064h)]	○	○	○	○	○	○	○	○	○
[Velocity actual value (Obj. 606Ch)]	○	○	○	○	○	○	○	○	○
[Following error actual value (Obj. 60F4h)]	○	—	—	○	—	—	—	○	○
[Torque actual value (Obj. 6077h)]	○	○	○	○	○	○	○	○	○
[Digital Inputs (Obj. 60FDh)]	○	○	○	○	○	○	○	○	○
[Touch probe pos1 pos value (Obj. 60BAh)] ^{*1}	○	—	—	—	—	—	—	— ^{*5}	— ^{*5}
[Touch probe pos1 neg value (Obj. 60BBh)] ^{*1}	○	—	—	—	—	—	—	— ^{*5}	— ^{*5}
[Touch probe pos2 pos value (Obj. 60BCh)] ^{*1}	○	—	—	—	—	—	—	— ^{*5}	— ^{*5}
[Touch probe pos2 neg value (Obj. 60BDh)] ^{*1}	○	—	—	—	—	—	—	— ^{*5}	— ^{*5}
[Scale cycle counter (Obj. 2D36h)] ^{*1}	○	○	○	○	○	○	○	○	○
[Scale ABS counter (Obj. 2D37h)] ^{*1}	○	○	○	○	○	○	○	○	○
[Scale measurement encoder alarm (Obj. 2D3Ch)] ^{*1}	○	○	○	○	○	○	○	○	○
[Point actual value (Obj. 2D69h)] ^{*3}	—	—	—	—	—	—	—	○	○
[M code actual value (Obj. 2D6Ah)] ^{*3}	—	—	—	—	—	—	—	○	○
[Point demand value (Obj. 2D68h)] ^{*3}	—	—	—	—	—	—	—	○	○

*1 Available on servo amplifiers with firmware version A5 or later.

*2 Available on servo amplifiers with firmware version A8 or later.

*3 Available on servo amplifiers with firmware version B8 or later.

*4 It is "⊙" when the touch probe function is used.

*5 It is "○" when the touch probe function is used.

*6 It is "—" when the positioning mode (point table method) is used.

■ Watchdog counter

The watchdog counter can be used to detect application stop of the cyclic transmission station. When a watchdog counter object is mapped to the RPDO of the servo amplifier, [AL. 086.2 Network communication error 2] is detected on the servo amplifier side. When a watchdog counter object is mapped to the TPDO of the servo amplifier, 1 is added to the watchdog counter on the servo amplifier at the end of each communication cycle, following which the current counter value is sent to the servo amplifier.

The watchdog counter value is an unsigned integer from 0 to 32767 that returns to 0 upon exceeding 32767.

For details of PDO mapping, refer to the following.

☞ Page 42 Default PDO mapping

☞ Page 46 PDO mapping objects

Index	Sub Index	Object	Name	Data Type	Default	Description
1D01h	—	VAR	Watch dog counter DL	U16	—	Watchdog counter (download)
1D02h	—	VAR	Watch dog counter UL	U16	—	Watchdog counter (upload)

■PDO configuration object

To enable the data exchange by PDO mapping, perform settings for the PDO (RPDO and TPDO) by using PDO configuration objects ([1st PDO Config (Obj. 1C00h)] and [2nd PDO Config (Obj. 1C01h)]). In the factory setting, 1st PDO mapping objects ([1st Receive PDO Mapping (Obj. 1600h)] and [1st Transmit PDO Mapping (Obj. 1A00h)]) are assigned to [PDO Assignment (Obj. 1C00h: 01h)].

Index	Sub Index	Object	Name	Data Type	Access	Default	Description
1C00h	0	RECORD	1st PDO Config	U8	ro	—	Number of entries
	1		PDO Assignment	U16	rw	Motion mode: 1600h Motion mode (high-speed): 1601h	Set the address (Index) of PDO mapping object.
	2		PDO Enable	U16	rw	0001h	Enable or disable the PDO set in [PDO Assignment (Obj. 1C00h: 01h)]. 0000h: PDO disabled 0001h: PDO enabled
	3		Error Handling	U16	rw	0001h	This object is available when an object set in [PDO Assignment] is mapped to RPDO. 0000h: Receive error is not detected. 0001h: Receive error is detected. 0002h: Error detection starts after receipt of the initial PDO.
	4		Memory Address	U32	rw	—	For PDO-receiving stations: the memory address of the sub-payload (the address in the memory space) For PDO-sending stations: the address at the start of the data to be stored in the sub-payload
	5		Communication Address	U16	rw	FFFFh	Set the 3rd octet and 4th octet of the source IP address of RPDO. This object is available when an object set in [PDO Assignment] is mapped to RPDO. 0000h to FFFEh: The 3rd octet and 4th octet of the source IP address FFFFh: Not set
1C01h	0	RECORD	2nd PDO Config	U8	ro	—	Number of entries
	1		PDO Assignment	U16	rw	Motion mode: 1A00h Motion mode (high-speed): 1A01h	Refer to [PDO Assignment (Obj. 1C00h: 01h)].
	2		PDO Enable	U16	rw	0001h	Refer to [PDO Enable (Obj. 1C00h: 02h)].
	3		Error Handling	U16	rw	0001h	Refer to [Error Handling (Obj. 1C00h: 03h)].
	4		Memory Address	U32	rw	—	Refer to [Memory Address (Obj. 1C00h: 04h)].
	5		Communication Address	U16	rw	FFFFh	Refer to [Communication Address (Obj. 1C00h: 05h)].

- Initial value of PDO configuration object

The initial values of PDO configuration objects ([1st PDO Config (Obj. 1C00h)] and [2nd PDO Config (Obj. 1C01h)]) are different for Motion mode and Motion mode (high-speed) as shown in the following table.

Index	Sub Index	Name	Default		Description
			Motion mode	Motion mode (high-speed)	
1C00h	1	PDO Assignment	1600h	1601h	Assign RPDO1 to the servo amplifier.
	2	PDO Enable	1	1	1: RPDO1 (from the master station to the servo amplifier) enabled
1C01h	1	PDO Assignment	1A00h	1A01h	Assign TPDO1 to the servo amplifier.
	2	PDO Enable	1	1	1: TPDO1 (from the servo amplifier to the master station) enabled

The following shows an example where PDO configuration objects are used to assign object 1600h to the RPDO and object 1A00h to the TPDO.

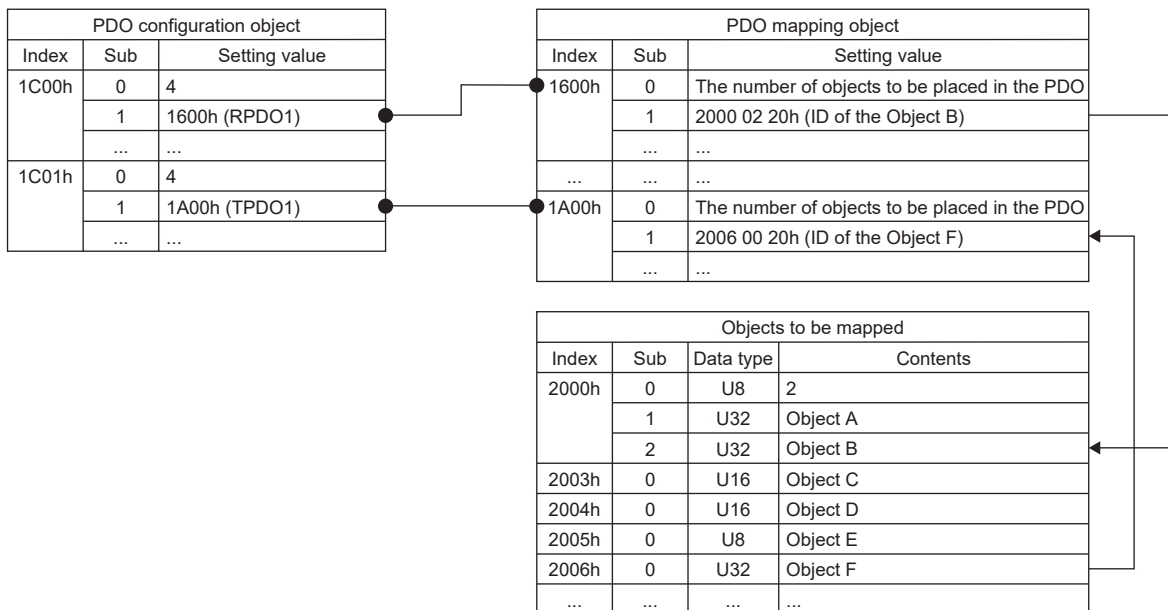

■PDO Enable

PDO can be enabled or disabled with [PDO Enable (Obj. 1C00h: 02h and Obj. 1C01h: 02h)]. When the PDO is disabled, the PDO will be discarded on the receiving station side.

The following shows the PDO Enable setting value and the operation of the PDO receiving station.

PDO Enable (Sub Index 2)	Cyclic communication enabled (control flag Bit 0 of the sub-payload)	Operation of PDO receiving station
0: Disabled	0: Disabled	The PDO is not transferred to the receipt memory
	1: Enabled	The PDO is regarded as disabled
1: Enabled	0: Disabled	The PDO is not transferred to the receipt memory
	1: Enabled	The PDO is regarded as enabled

The following shows the PDO Enable setting value and the operation of the PDO sending station.

PDO Enable (Sub Index 2)	Operation of PDO sending station
0: Disabled	Sends the disabled PDO (sets the control flag Bit 0 of the sub-payload to "0")
1: Enabled	Sends the enabled PDO (sets the control flag Bit 0 of the sub-payload to "1")

Transient transmission

The transient transmission is a function that communicates data only when there is a communication request. Data communication is performed between stations by using SLMP and other protocols, regardless of the communication cycles. For CC-Link IE TSN, transient transmission and cyclic transmission are performed using different communication bands in order to ensure the stability of the cyclic transmission.

Transient transmission in the motion mode

With SLMP, actions such as reading the servo amplifier model code and accessing each object can be performed. For reading and writing each object, the SDO Download command, SDO Upload command, and other commands are used.

On multi-axis servo amplifiers, SLMP is sent and received by each axis. When sending SLMP to a specific axis of a multi-axis servo amplifier, specify the axis No. (0 = A-axis, 1 = B-axis, and 2 = C-axis) for the request destination multi-drop station No. of the SLMP frame (4E frame).

Request message format

The data length of request messages is 2047 bytes max.

Ethernet header	IP header	UDP header	SLMP								Footer
			Subheader	Request destination network No.	Request destination station No.	Request destination module I/O No.	Request destination multi-drop station No.	Request data length	Monitoring timer	Request data	

Response message format

There are two types of response messages, one for normal termination and one for abnormal termination. The data length of response messages is 2048 bytes max.

- At normal termination

Ethernet header	IP header	UDP header	SLMP								Footer
			Subheader	Request destination network No.	Request destination station No.	Request destination module I/O No.	Request destination multi-drop station No.	Response data length	End code	Response data	

- At abnormal termination

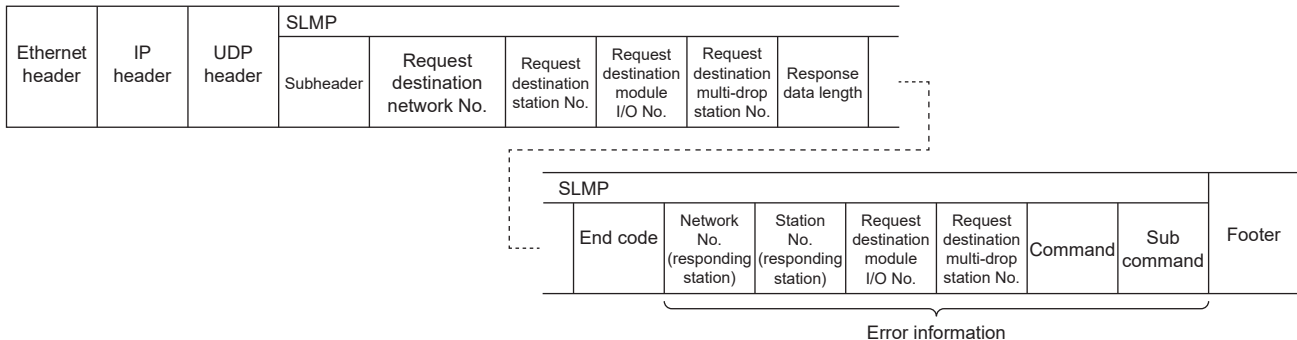

SLMP command

The following is a list of SLMP commands.

Command	Sub command	Remark
0101h	0000h	Model code reading
4020h	0001h	ReadObject
4020h	0002h	WriteObject
4020h	0005h	ObjectSubIDReadBlock
4020h	0006h	ObjectSubIDWriteBlock
4020h	0007h	NMT State Upload *1
4020h	0008h	NMT State Download *1

*1 The command is executed in the whole station (common to all axes), even if the command is issued to a specific axis of a multi-axis servo amplifier.

■Read Object (object read)

This command returns the value of the object corresponding to Index and Sub Index specified by the master station.

- Request message (after the command)

Command		Sub command		Index		Sub Index	Reserved	Number of data value	
L	H	L	H	L	H	—	—	L	H
20h	40h	01h	00h	Refer to "Item list" below for details.					

- Response message (at normal termination (after the end code))



End code		Index		Sub Index	Reserved	Number of data value		Read data
L	H	L	H	—	—	L	H	L variable H
00h	00h	Refer to "Item list" below for details.						

- Response message (at abnormal termination)

It is the same as "At abnormal termination" in the reference below.

 Page 53 Response message format

- Item list

Item	Size	Endian	Description
Command	2 bytes	Little	4020h
Sub command	2 bytes	Little	0001h
Index	2 bytes	Little	Specify Index of the object. ( MR-J5-G/MR-J5W-G User's Manual (Object Dictionary)) The response message stores the value specified in the request message.
Sub Index	1 byte	Little	Specify Sub Index of the object. ( MR-J5-G/MR-J5W-G User's Manual (Object Dictionary)) The response message stores the value specified in the request message.
Reserved	1 byte	—	00h (fixed)
Number of data value	2 bytes	Little	Read data: 00h (fixed)
Read data	Variable	Little	The return data of the object is stored.

■Write Object (object write)

This command writes the specified value to the object corresponding to Index and Sub Index specified by the master station.

- Request message (after the command)

Command		Sub command		Index		Sub Index	Reserved	Number of data value		Write data
L	H	L	H	L	H	—	—	L	H	L variable H
20h	40h	02h	00h	Refer to "Item list" below for details.						

- Response message (at normal termination (after the end code))



End code		Index		Sub Index	Reserved	Number of data value	
L	H	L	H	—	—	L	H
00h	00h	Refer to "Item list" below for details.					

- Response message (at abnormal termination)

It is the same as "At abnormal termination" in the reference below.

 Page 53 Response message format

- Item list

Item	Size	Endian	Description
Command	2 bytes	Little	4020h
Sub command	2 bytes	Little	0002h
Index	2 bytes	Little	Specify Index of the object. ( MR-J5-G/MR-J5W-G User's Manual (Object Dictionary)) The response message stores the value specified in the request message.
Sub Index	1 byte	Little	Specify Sub Index of the object. ( MR-J5-G/MR-J5W-G User's Manual (Object Dictionary)) The response message stores the value specified in the request message.
Reserved	1 byte	—	00h (fixed)
Number of data value	2 bytes	Little	Write data: Specify the size in hexadecimal. (Unit: byte)
Write data	Variable	Little	Specify the write data of the object.

■Object SubID Read Block (object sub-ID continuous read)

When an object sub ID continuous read request is given by the master station, the value of the object corresponding to the specified Index and the continuous Sub Index is returned.

- Request message (after the command)

Command		Sub command		Index		Sub Index	Reserved	Number of data value	
L	H	L	H	L	H	—	—	L	H
20h	40h	05h	00h	Refer to "Item list" below for details.					

- Response message (at normal termination (after the end code))



End code		Index		Sub Index	Reserved	Number of data value		Read data
L	H	L	H	—	—	L	H	L variable H
00h	00h	Refer to "Item list" below for details.						

- Response message (at abnormal termination)

It is the same as "At abnormal termination" in the reference below.

 Page 53 Response message format

- Item list

Item	Size	Endian	Description
Command	2 bytes	Little	4020h
Sub command	2 bytes	Little	0005h
Index	2 bytes	Little	Specify Index of the object. ( MR-J5-G/MR-J5W-G User's Manual (Object Dictionary)) The response message stores the value specified in the request message.
Sub Index	1 byte	Little	Specify Sub Index of the object. ( MR-J5-G/MR-J5W-G User's Manual (Object Dictionary)) The response message stores the value specified in the request message.
Reserved	1 byte	—	00h (fixed)
Number of data value	2 bytes	Little	Read data: Data size In the request message, it is 00h (fixed).
Read data	Variable	Little	The return data of the object is stored.

■ Object SubID Write Block (object sub-ID continuous write)

When an object sub-ID continuous write request is given by the master station, the specified value is written to the object corresponding to the specified Index and the continuous Sub Index.

- Request message (after the command)

Command		Sub command		Index		Sub Index	Reserved	Number of data value		Write data
L	H	L	H	L	H	—	—	L	H	L variable H
20h	40h	06h	00h	Refer to "Item list" below for details.						

- Response message (at normal termination (after the end code))



End code		Index		Sub Index	Reserved	Number of data value	
L	H	L	H	—	—	L	H
00h	00h	Refer to "Item list" below for details.					

- Response message (at abnormal termination)

It is the same as "At abnormal termination" in the reference below.

 Page 53 Response message format

- Item list

Item	Size	Endian	Description
Command	2 bytes	Little	4020h
Sub command	2 bytes	Little	0006h
Index	2 bytes	Little	Specify Index of the object. ( MR-J5-G/MR-J5W-G User's Manual (Object Dictionary)) The response message stores the value specified in the request message.
Sub Index	1 byte	Little	Specify Sub Index of the object. ( MR-J5-G/MR-J5W-G User's Manual (Object Dictionary)) The response message stores the value specified in the request message.
Reserved	1 byte	—	00h (fixed)
Number of data value	2 bytes	Little	Write data: Specify the size in hexadecimal. (Unit: byte)
Write data	Variable	Little	Specify the write data of the object.

■ End code

The following shows end codes that are stored by the servo amplifier for SLMP.

End code	Cause
0000h	The request was processed normally.
C059h	<ul style="list-style-type: none"> • There is an error in the command or subcommand specification. • A command that is not prescribed is received.
C05Ch	There is an error in the request message.
C061h	The requested data length does not match the number of data.
CEE0h	The request cannot be processed because another request is in progress.
CEE1h	The requested message size has exceeded the processable range.
CEE2h	The response message size has exceeded the processable range.
CCCAh	A non-existent Index was specified.
CCD0h	The data size is different from the specified value.
CCD1h	The data size is larger than the specified value.
CCD2h	The data size is smaller than the specified value.
CCD3h	A non-existent Sub Index was specified.
CCC8h	Read operation was performed to a write only object.
CCC9h	<ul style="list-style-type: none"> • Write operation was performed to a read only object. • The object is not read only for all AL states, but it was written to an object that cannot be written in the current AL state.
CCC7h	<p>Write operation was performed to a response message mapped object.</p> <p>The following were written when the response message mapped object was not in the state where change is permitted.</p> <ul style="list-style-type: none"> • Anything other than "0" was written to Sub Index 0. • Write operation was performed to the corresponding Sub Index 1 to 32.
CCCBh	An object for which the response message mapping cannot be performed was written to the response message mapped object.
CCCCh	The total size of the response message mapped objects exceeds 64 bytes.
CCD4h	A value outside the parameter range was written.
CCD5h	A value larger than the parameter range was written.
CCD6h	A value smaller than the parameter range was written.

Drive profile

This section explains the CiA 402 drive profile specification as well as the unique functions of servo amplifiers. Each function can be controlled by using the object dictionary via the network.

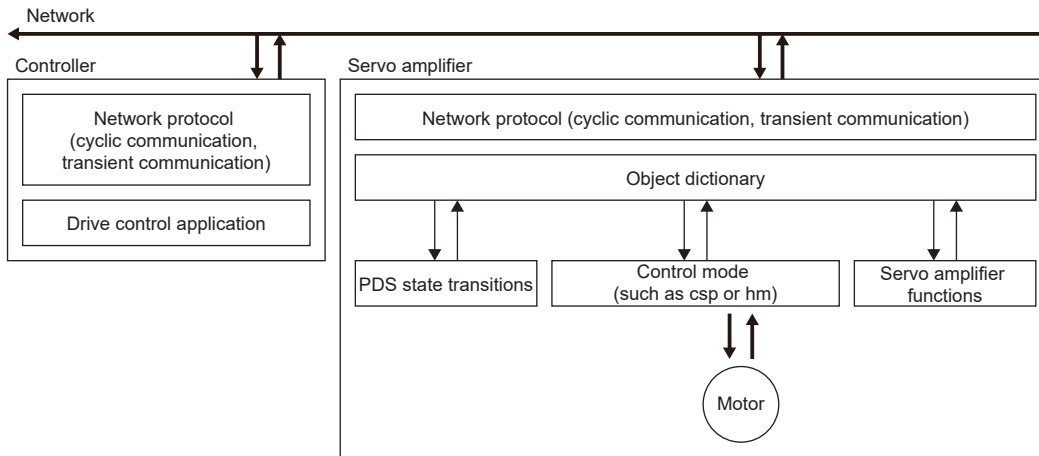

A list of drive profile specifications is as follows.

Function name	Description	Reference
Control mode	Control such as the position mode, speed mode, and torque mode	☞ Page 76 Control mode
PDS state transitions	Control method until the servo motor starts to operate	☞ Page 60 PDS state transitions
Controlword/Control DI	Control of each function	☞ Page 63 Controlword/Control DI
Statusword/Status DO	Monitor of each function	☞ Page 69 Statusword/Status DO

PDS state transitions

The internal state of the servo amplifier is managed by the PDS state defined in the CiA 402 drive profile specification. The servo motor can be operated immediately after turning on the power supply by shifting from the "Not ready to switch on" state to the "Operation enabled" state with the predetermined procedure.

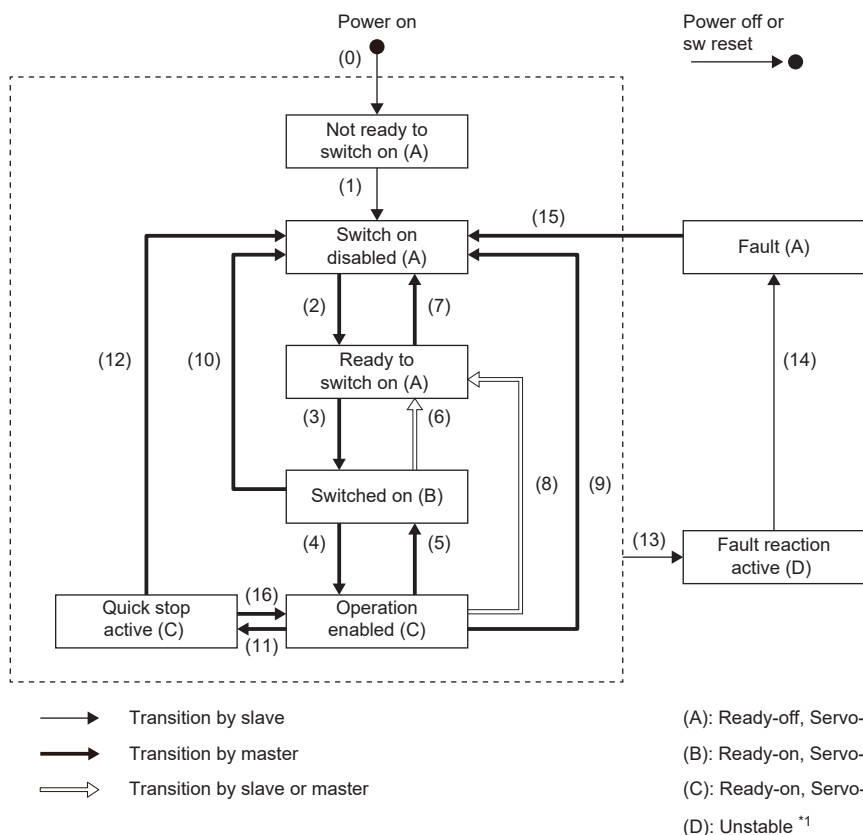

*1 In the controller that displays the servo-on status by referring to the PDS status, the servo-on status on the controller may differ from the actual servo-on status.

Events and PDS state transitions

Setting Controlword enables control of the state transitions.

After the PDO communication is established (after the NMT state has reached "Operational"), the status is controlled by the master station transmitting commands (by setting Controlword) in accordance with the following table.

Each axis of the multi-axis servo amplifier supports the PDS state.

The following shows the PDS state transition events and operations.

Transition No.	Event	Operation
(0)	Control circuit power supply is turned on	Initialization
(1)	Transitions automatically when the control circuit power supply is turned on	Communication setting
(2)	Transitions with the "Shutdown" command from the master station	None
(3)	Transitions with the "Switch On" command from the master station	The dynamic brake is released.
(4)	Transitions with the "Enable Operation" command from the master station	The operation becomes ready after servo-on.
(5)	Transitions with the "Disable Operation" command from the master station	The operation is disabled after servo-off.
(6)	Transitions with the "Shutdown" command from the master station	The dynamic brake operates.
(7)	Transitions with the "Disable Voltage" command or "Quick Stop" command from the master station	None
(8)	(A) Transitions with the "Shutdown" command from the master station (B) Transitions when the main circuit power supply is turned off	The operation is disabled after servo-off or dynamic braking.
(9)	Transitions with the "Disable Voltage" command from the master station	The operation is disabled after servo-off or dynamic braking.
(10)	Transitions with the "Disable Voltage" command or "Quick Stop" command from the master station	The dynamic brake operates.
(11)	(A) Transitions with the "Quick Stop" command from the master station (B) Transitions when the forced stop signal is turned off *1	Quick Stop starts.
(12) *2	(A) Transitions automatically after the completion of Quick Stop (when the value of [Quick stop option code (Obj. 605Ah)] is any of "1", "2", "3", or "4") (B) Transitions with the "Disable Voltage" command from the master station after completion of "Quick Stop" (C) Transitions when the main circuit power supply is turned off (when the value of [Quick stop option code (Obj. 605Ah)] is any of "5", "6", "7", or "8")	The operation is disabled after servo-off or dynamic braking.
(13)	Alarm occurrence	Processing against the alarm is executed.
(14)	Automatic transition	After the completion of the alarm occurrence processing, the operation is disabled by servo-off or the dynamic brake.
(15)	Transitions with the "Fault Reset" command from the master station	An alarm reset is performed. Resettable alarms are cleared.
(16) *3	Transitions with the "Enable Operation" command from the master station (when the value of [Quick stop option code (Obj. 605Ah)] is any of "5", "6", "7", or "8")	The operation becomes ready after Quick Stop is canceled.

*1 This event occurs when "1" (Quick stop active) is selected in [Pr. PF29.1 State selection with forced stop in progress].

*2 (B) and (C) are available on servo amplifiers with firmware version D0 or later.

*3 Available on servo amplifiers with firmware version D0 or later.

The following shows the related correspondence between the command bit setting and the PDS state. In order to avoid missing the command at the time of communication error, maintain the state of Bit 7 = 1 on the Fault Reset command for at least 10 ms when the communication cycle is 4 ms or less, or at least 20 ms when the communication cycle is 8 ms.

0: Off 1: On ×: Either on/off can be used

Command	Command Bit setting of Controlword					Transition No.
	Bit 7 Fault Reset	Bit 3 Enable Operation	Bit 2 Quick Stop	Bit 1 Enable Voltage	Bit 0 Switch On	
Shutdown	0	×	1	1	0	(2), (6), (8)
Switch On	0	0	1	1	1	(3)
Disable Voltage	0	×	×	0	×	(7), (9), (10), (12)
Quick Stop	0	×	0	1	×	(7), (10), (11)
Disable Operation	0	0	1	1	1	(5)
Enable Operation	0	1	1	1	1	(4), (16)
Fault Reset	0 to 1	×	×	×	×	(15)

In order to transition from the "Switch on disabled" state to the "Operation enabled" state, it is necessary to give each command of the "Shutdown", "Switch On", and "Enable Operation" sequentially. However, it is also possible to transit directly from the ongoing state to the target state with one command.

Current state	Command	Status after transition
Switch on disabled	Switch On	Switched on
Switch on disabled	Enable Operation	Operation enabled
Ready to switch on	Enable Operation	Operation enabled

Controlword/Control DI

By rewriting the Controlword and Control DI x objects from the master station, the PDS state can be switched and control instructions for various drive-provided functions can be given. [Controlword (Obj. 6040h)] is used for the control commands defined by CiA 402, and [Control DI 1 (Obj. 2D01h)] to [Control DI 10 (Obj. 2D0Ah)] are used for the control commands defined by Mitsubishi Electric.

The correspondence information of Control DI can be checked with [Supported Control DI (Obj. 2D00h)].

Index	Sub	Object	Name	Data Type	Access	Description
6040h	—	VAR	Controlword	U16	rw	—
2D00h	0	ARRAY	Supported Control DI	U8	ro	Correspondence information of Control DI
2D00h	1	ARRAY	Supported Control DI 1	U16	ro	Correspondence information for Control DI 1 When the signal is unsupported, the corresponding bit is "0". When the signal is supported, the corresponding bit is "1". When the signals corresponding to Control DI are Bit 4 and Bit 5, "0030h" is displayed.
:						
2D00h	10	ARRAY	Supported Control DI 10	U16	ro	Correspondence information for Control DI 10
2D01h	—	VAR	Control DI 1	U16	rw	Object defined by Mitsubishi Electric
:						
2D0Ah	—	VAR	Control DI 10	U16	rw	Object defined by Mitsubishi Electric

Bit definition of Controlword



Bit *1	Symbol	Description	Reference
0	SO	Switch On	☞ Page 61 Events and PDS state transitions
1	EV	Enable Voltage	
2	QS	Quick Stop	
3	EO	Enable Operation	
4	OMS	The contents differ depending on the setting of [Modes of operation (Obj. 6060h)].	Refer to "Control mode [G]" in the following manual. 📖MR-J5 User's Manual (Function)
5			
6			
7	FR	Fault Reset	☞ Page 61 Events and PDS state transitions
8	HALT	0: Operation ready 1: Temporary stop	Refer to "Halt [G]" in the following manual. 📖MR-J5 User's Manual (Function)
9	OMS	The contents differ depending on the setting of [Modes of operation (Obj. 6060h)].	Refer to "Control mode [G]" in the following manual. 📖MR-J5 User's Manual (Function)
10	—	The value at reading is undefined. Set "0" when writing.	—
11	—		—
12	—		—
13	—		—
14	—		—
15	—		—

*1 Bit 0 to 3 and 7 are used for PDS state switching.

■Bit definition of Control DI



With the communication function, reading the following objects enables reading of the on/off state of the input device. In addition, the input device can be set to on/off by writing to the following objects.

• Control DI 1

Bit	Symbol	Description	Reference
0	—	The value at reading is undefined. Set "0" when writing.	—
1	—		—
2	—		—
3	—		—
4	C_CDP	Gain switching	Refer to "Signal (device) explanations" in the following manual.  MR-J5 User's Manual (Hardware)  MR-J5D User's Manual (Hardware)
5	C_CLD *1	Fully closed loop selection	
6	—	The value at reading is undefined. Set "0" when writing.	—
7	—		—
8	—		—
9	—		—
10	—		—
11	—		—
12	—		—
13	—		—
14	—		—
15	—		—

*1 Available on servo amplifiers with firmware version A5 or later.

• Control DI 2

Bit	Symbol	Description	Reference
0	—	The value at reading is undefined. Set "0" when writing.	—
1	—		—
2	—		—
3	—		—
4	—		—
5	—		—
6	—		—
7	—		—
8	C_PC	Proportional control	Refer to "Signal (device) explanations" in the following manual.  MR-J5 User's Manual (Hardware)  MR-J5D User's Manual (Hardware)
9	—	The value at reading is undefined. Set "0" when writing.	—
10	—		—
11	—		—
12	—		—
13	—		—
14	—		—
15	C_ORST *1	Operation alarm reset	—

*1 Available on servo amplifiers with firmware version A5 or later.





- Control DI 3

Bit	Symbol	Description	Reference
0	—	The value at reading is undefined. Set "0" when writing.	—
1	—		—
2	—		—
3	—		—
4	—		—
5	—		—
6	—		—
7	—		—
8	—		—
9	—		—
10	—		—
11	—		—
12	—		—
13	—		—
14	—		—
15	—		—

- Control DI 4

Bit	Symbol	Description	Reference
0	—	The value at reading is undefined. Set "0" when writing.	—
1	—		—
2	—		—
3	—		—
4	—		—
5	—		—
6	—		—
7	—		—
8	—		—
9	—		—
10	—		—
11	—		—
12	—		—
13	—		—
14	—		—
15	—		—

• Control DI 5

Bit	Symbol	Description	Reference
0	—	The value at reading is undefined. Set "0" when writing.	—
1	—		—
2	—		—
3	—		—
4	C_CDP2	Gain switching 2	Refer to "Signal (device) explanations" in the following manual.  MR-J5 User's Manual (Hardware)  MR-J5D User's Manual (Hardware)
5	—	The value at reading is undefined. Set "0" when writing.	—
6	—		—
7	—		—
8	—		—
9	C_FLS	Input of upper stroke limit	Refer to "Stroke limit function [G]" in the following manual.  MR-J5 User's Manual (Function)
10	C_RLS	Input of lower stroke limit	
11	C_DOG	Proximity dog	Refer to "Signal (device) explanations" in the following manual.  MR-J5 User's Manual (Hardware)  MR-J5D User's Manual (Hardware)
12	—	The value at reading is undefined. Set "0" when writing.	—
13	—		—
14	—		—
15	—		—

• Control DI 6

Bit	Symbol	Description	Reference
0	—	The value at reading is undefined. Set "0" when writing.	—
1	—		—
2	—		—
3	—		—
4	—		—
5	—		—
6	—		—
7	—		—
8	—		—
9	—		—
10	—		—
11	—		—
12	—		—
13	—		—
14	—		—
15	—		—

- Control DI 7

Bit	Symbol	Description	Reference
0	—	The value at reading is undefined. Set "0" when writing.	—
1	—		—
2	—		—
3	—		—
4	—		—
5	—		—
6	—		—
7	C_OVR *1	Override selection	Refer to "Override function" in the following manual.  MR-J5 User's Manual (Function)
8	—	The value at reading is undefined. Set "0" when writing.	—
9	—		—
10	—		—
11	—		—
12	—		—
13	—		—
14	—		—
15	—		—

*1 Available on servo amplifiers with firmware version D4 or later.

- Control DI 8

Bit	Symbol	Description	Reference
0	—	The value at reading is undefined. Set "0" when writing.	—
1	—		—
2	—		—
3	—		—
4	—		—
5	—		—
6	—		—
7	—		—
8	—		—
9	—		—
10	—		—
11	—		—
12	—		—
13	—		—
14	—		—
15	—		—

• Control DI 9

Bit	Symbol	Description	Reference
0	—	The value at reading is undefined. Set "0" when writing.	—
1	—		—
2	—		—
3	—		—
4	—		—
5	—		—
6	—		—
7	—		—
8	—		—
9	—		—
10	—		—
11	—		—
12	—		—
13	—		—
14	—		—
15	—		—

• Control DI 10

Bit	Symbol	Description	Reference
0	—	The value at reading is undefined. Set "0" when writing.	—
1	—		—
2	—		—
3	—		—
4	—		—
5	—		—
6	—		—
7	—		—
8	—		—
9	—		—
10	—		—
11	—		—
12	—		—
13	—		—
14	—		—
15	—		—

Statusword/Status DO

The Statusword objects and the Status DO x objects notify the master station of the PDS state and other drive states. States defined by CiA 402 are notified by using [Statusword (Obj. 6041h)], and other states defined by Mitsubishi Electric are notified by using [Status DO 1 (Obj. 2D11h)] to [Status DO 10 (Obj. 2D1Ah)].

Index	Sub	Object	Name	Data Type	Access	Description
6041h	—	VAR	Statusword	U16	ro	—
2D11h	—	VAR	Status DO 1	U16	ro	Object defined by Mitsubishi Electric
:						
2D17h	—	VAR	Status DO 7	U16	ro	Object defined by Mitsubishi Electric
2D1Ah	—	VAR	Status DO 10	U16	ro	Object defined by Mitsubishi Electric

Bit definition of Statusword

Bit	Symbol	Description	Reference
0	RTSO	Ready-to-switch-on	☞ Page 61 Events and PDS state transitions
1	SO	Switch-on	
2	OE	Operation-enabled	
3	F	Fault	
4	VE	Voltage-enabled 0: The bus voltage is lower than the specified (RA) level. 1: The bus voltage is equal to or higher than the specified level.	—
5	QS	Quick stop 0: In a Quick stop 1: Not in a Quick stop (including in the test mode)	☞ Page 61 Events and PDS state transitions
6	SOD	Switch on disabled	
7	W	Warning 0: No warning has occurred. 1: A warning has occurred.	—
8	—	Reserved The value at reading is undefined.	—
9	RM	Remote 0: When not following the Controlword command 1: Operating in accordance with the Controlword command	—
10	OMS	The contents differ depending on the setting of [Modes of operation (Obj. 6060h)].	Refer to "Control mode [G]" in the following manual. 📖 MR-J5 User's Manual (Function)
11	ILA	Internal limit active 0: The forward rotation stroke end, reverse rotation stroke end, and software position limit have not been reached. 1: The forward rotation stroke end, reverse rotation stroke end, or software position limit has been reached. (Enabled in csp, csv, pp, pv, hm, pt, or jg mode)	—
12	OMS	The contents differ depending on the setting of [Modes of operation (Obj. 6060h)].	Refer to "Control mode [G]" in the following manual. 📖 MR-J5 User's Manual (Function)
13			
14	—	Reserved	—
15	—	The value at reading is undefined.	—

- State coding

Bit 0 to Bit 3, Bit 5, and Bit 6 are switched depending on the PDS state (servo amplifier internal state). Details are as follows:





Statusword (bin)	PDS state
x0xx xxx0 x0xx 0000	Not ready to switch on *1
x0xx xxx0 x1xx 0000	Switch on disabled
x0xx xxx0 x01x 0001	Ready to switch on
x0xx xxx0 x01x 0011	Switched on
x0xx xxx0 x01x 0111	Operation enabled
x0xx xxx0 x00x 0111	Quick stop active
x0xx xxx0 x0xx 1111	Fault reaction active
x0xx xxx0 x0xx 1000	Fault

*1 Statusword is not sent when in the "Not ready to switch on" state.

■ Bit definition of Status DO



With the communication function, the on/off state of the output device can be checked by reading the following objects.

- Status DO 1



Bit	Symbol	Description	Reference
0	—	The value at reading is undefined.	—
1	—		—
2	S_SA	Speed reached	Refer to "Signal (device) explanations" in the following manual.  MR-J5 User's Manual (Hardware)  MR-J5D User's Manual (Hardware)
3	S_MBR	Electromagnetic brake interlock	
4	S_CDPS	Variable gain enabled	
5	S_CLDS *1	Fully closed loop control in progress	
6	—	The value at reading is undefined.	—
7	—		—
8	—		—
9	—		—
10	—		—
11	—		—
12	S_INP	In-position	Refer to "Signal (device) explanations" in the following manual.
13	S_TLC	Limiting torque	
14	S_ABSV	Absolute position erased 1: Absolute position is erased	 MR-J5 User's Manual (Hardware)  MR-J5D User's Manual (Hardware)
15	S_BWNG	Battery warning	

*1 Available on servo amplifiers with firmware version A5 or later.

• Status DO 2

Bit	Symbol	Description	Reference
0	S_ZPASS	Z-phase already passed After the Z-phase is passed, S_ZPASS turns on.	—
1	—	The value at reading is undefined.	—
2	—		—
3	S_ZSP	Zero speed detection	Refer to "Signal (device) explanations" in the following manual.  IMR-J5 User's Manual (Hardware)  IMR-J5D User's Manual (Hardware)
4	S_VLC	Limiting speed	
5	—	The value at reading is undefined.	—
6	—		—
7	—		—
8	S_PC		Proportional control in progress S_PC is turned on under proportional control.
9	—	The value at reading is undefined.	—
10	—		—
11	—		—
12	—		—
13	—		—
14	—		—
15	S_ZP2		Homing completion 2 When homing finishes successfully, S_ZP2 turns on.



• Status DO 3

Bit	Symbol	Description	Reference
0	—	The value at reading is undefined.	—
1	—		—
2	—		—
3	—		—
4	—		—
5	S_STO	In STO state S_STO turns on in STO state.	Refer to "Monitor signal (digital) [G]" in the following manual.  IMR-J5 User's Manual (Function)
6	—	The value at reading is undefined.	—
7	—		—
8	—		—
9	S_RSTP	During forced stop deceleration During forced stop deceleration, S_RSTP is on.	—
10	—	The value at reading is undefined.	—
11	S_MTTR	Tough drive in progress	Refer to "Tough drive function" in the following manual.  IMR-J5 User's Manual (Function)
12	—	The value at reading is undefined.	—
13	—		—
14	—		—
15	—		—

• Status DO 4

Bit	Symbol	Description	Reference
0	—	The value at reading is undefined.	—
1	—		—
2	—		—
3	—		—
4	—		—
5	—		—
6	—		—
7	—		—
8	—		—
9	—		—
10	—		—
11	—		—
12	—		—
13	—		—
14	—		—
15	—		—

• Status DO 5

Bit	Symbol	Description	Reference
0	—	The value at reading is undefined.	—
1	—		—
2	—		—
3	—		—
4	S_CDPS2	Variable gain enabled 2	Refer to "GAIN SWITCHING FUNCTION" in the following manual.  IMR-J5 User's Manual (Adjustment)
5	S_CPO *1	Rough match When the command remaining distance is less than the value of the rough match output range set in [Pr. PT12], S_CPO is on. This is not outputted during base circuit shut-off. When the servo amplifier is switched to the servo-on state, S_CPO switches on.	—
6	S_MEND *2	Traveling completion If droop pulses are within the in-position output range set in [Pr. PA10] and the command remaining distance is "0", S_MEND turns on. S_MEND turns on at servo-on. S_MEND is off in the servo-off state.	—
7	—	The value at reading is undefined.	—
8	—		—
9	—		—
10	S_PNLT *3	Open phase condition	Refer to "Disconnection/incorrect wiring detection function" in the following manual.  IMR-J5 User's Manual (Function)
11	—	The value at reading is undefined.	—
12	—		—
13	—		—
14	—		—
15	—		—

*1 Available on servo amplifiers with firmware version A5 or later.

*2 Available on servo amplifiers with firmware version B8 or later.

*3 Available on servo amplifiers with firmware version C4 or later.

- Status DO 6

Bit	Symbol	Description	Reference
0	—	The value at reading is undefined.	—
1	—		—
2	—		—
3	—		—
4	—		—
5	—		—
6	—		—
7	—		—
8	—		—
9	—		—
10	—		—
11	—		—
12	—		—
13	—		—
14	—		—
15	—		—

- Status DO 7

Bit	Symbol	Description	Reference
0	—	The value at reading is undefined.	—
1	—		—
2	S_POT *1	Position range When the actual current position is within the range set in [Pr. PT19] and [Pr. PT21], S_POT is on. When homing is not complete or base circuit shut-off is in progress, S_POT is off.	—
3	—	The value at reading is undefined.	—
4	—		—
5	—		—
6	—		—
7	—		—
8	—		—
9	—		—
10	—		—
11	—		—
12	—		—
13	—		—
14	—		—
15	—		—

*1 Available on servo amplifiers with firmware version A5 or later.

• Status DO 8

Bit	Symbol	Description	Reference
0	—	The value at reading is undefined.	—
1	—		—
2	—		—
3	—		—
4	—		—
5	—		—
6	—		—
7	—		—
8	—		—
9	—		—
10	—		—
11	—		—
12	—		—
13	—		—
14	—		—
15	—		—

• Status DO 9

Bit	Symbol	Description	Reference
0	—	The value at reading is undefined.	—
1	—		—
2	—		—
3	—		—
4	—		—
5	—		—
6	—		—
7	—		—
8	—		—
9	—		—
10	—		—
11	—		—
12	—		—
13	—		—
14	—		—
15	—		—

• Status DO 10

Bit	Symbol	Description	Reference
0	—	The value at reading is undefined.	—
1	—		—
2	—		—
3	—		—
4	—		—
5	—		—
6	—		—
7	—		—
8	—		—
9	—		—
10	—		—
11	—		—
12	—		—
13	—		—
14	—		—
15	—		—

Control mode

Point

- The control mode is set to the cyclic synchronous position mode as a default. When using the cyclic synchronous position mode, perform position follow-up with the controller at servo-on.
- To use the profile mode, switch to the mode in the servo-off state. After the control mode is switched, turn on the servo-on.
- If the control mode is switched without performing position follow-up, unexpected movements such as sudden acceleration of the servo motor may occur.

■ Motion mode

For the list of control modes, refer to the "Function explanation" in the following manual.

MR-J5 User's Manual (Function)

■ Selecting control mode (Modes of operation)

Specify a control mode with [Modes of operation (Obj. 6060h)]. [Modes of operation (Obj. 6060h)] can be rewritten with a PDO or an SDO. The available control modes are limited as follows depending on the setting value of [Pr. PT01.2].

○: Supported, —: Not supported

[Pr. PA01.0]	[Pr. PT01.2]	pp ^{*1}	pv ^{*1}	tq ^{*1}	hm	csp	csv	cst	tg ^{*4}	pt ^{*4}	ct ^{*2}	slt ^{*7}	6061h Initial value
0	0 (mm) ^{*6}	—	—	—	—	—	—	—	—	—	—	—	8 (csp)
	1 (inch) ^{*6}	—	—	—	—	—	—	—	—	—	—	—	
	2 (degree) ^{*3}	○	○	○	○	—	—	—	—	—	—	—	1 (pp)
	3 (pulse)	○	○	○	○	○	○	○	—	—	○ ^{*5}	○	8 (csp)
6	0 (mm)	—	—	—	○	—	—	—	○	○	—	—	-101 (pt)
	1 (inch)	—	—	—	○	—	—	—	○	○	—	—	
	2 (degree)	—	—	—	○	—	—	—	○	○	—	—	
	3 (pulse)	—	—	—	○	—	—	—	○	○	—	—	

*1 Available on servo amplifiers with firmware version A5 or later.

*2 Available on servo amplifiers with firmware version B0 or later.

*3 Available on servo amplifiers with firmware version B6 or later.

*4 Available on servo amplifiers with firmware version B8 or later.

*5 To switch to continuous operation to the torque control mode (ct), the switching must be performed from the cyclic synchronous position mode (csp) or cyclic synchronous velocity mode (csv).

*6 Setting "0" or "1" in [Pr. PT01.2] triggers [AL. 037 Parameter error].

*7 The slave axis torque mode (slt) is a control mode for slave axes in the master-slave operation function. The mode switches automatically depending on the servo parameter setting. Refer to the following for details.

Page 21 Master-slave operation function

• Related objects

Index	Sub Index	Object	Name	Data Type	Access	Default value	Description
6060h	0	VAR	Modes of operation	I8	rw	0h	MR-J5-G/MR-J5W-G User's Manual (Object Dictionary)
6061h	0	VAR	Modes of operation display	I8	ro	—	
6502h	0	VAR	Supported drive mode	U32	ro	000003A0h	

- Control switching between position/speed/torque modes

Point

Changes to the OMS Bit of [Controlword (Obj. 6040h)] are not accepted until control switching finishes. Before inputting commands, check that the control mode has been switched by referring to [Modes of operation display (Obj. 6061h)]. In addition, switch the control modes when the start command is turned off. (For example, when "Homing operation start" is turned off in hm mode.)

As there is a time lag when switching between control modes, the controller needs to keep sending the command values of the corresponding control modes until the mode is completely switched. After the completion of the control mode switching is confirmed by [Modes of operation display (Obj. 6061h)], the controller can stop sending the command value relative to the control mode before switching.

Before switching to or from the position mode, check that the servo motor is in zero speed state. Data of whether the servo motor is in zero speed state can be obtained by Bit 3 (S_ZSP) of [Status DO 2 (Obj. 2D12h)]. If the motor is not in the zero speed state, the control will not be switched and therefore [Modes of operation display (Obj. 6061h)] will not change. To switch the control mode regardless of the zero speed state, set [Pr. PC76.1 ZSP disabled selection at control switching] to "1" to disable the monitoring of zero speed state. Note that a shock may occur at control switching if the monitoring of zero speed state is disabled.

- Control switching between cyclic mode (csp, csv, and cst) and profile mode (pp, pv, and tq)

The control mode is switched between the cyclic mode (csp, csv, and cst) and the profile mode (pp, pv, and tq) only if the condition for control switching is met, following which [Modes of operation display (Obj. 6061h)] is changed. If the condition for control switching is not met, the control mode will not be switched and the value in [Modes of operation display (Obj. 6061h)] will not be changed. The condition for control switching is "Motor being stopped".

"Motor being stopped" means that S_ZSP (Bit 3 of [Status DO 2 (Obj. 2D12h)]) is on.

(Servo motor speed being less than zero speed set in [Pr. PC07])

Setting "1" (disabled (control switching is performed regardless of the range of ZSP)) to [Pr. PC76.1] enables the control mode to be switched without checking the condition "Motor being stopped" on the servo amplifier. Set "1" to [Pr. PC76.1] only if switching the control mode without waiting for the motor to stop. Switching the control mode without waiting for the motor to stop may cause a shock.

The following shows a timing chart of control switching between the cyclic mode (csp, csv, and cst) and the profile mode (pp, pv, and tq).

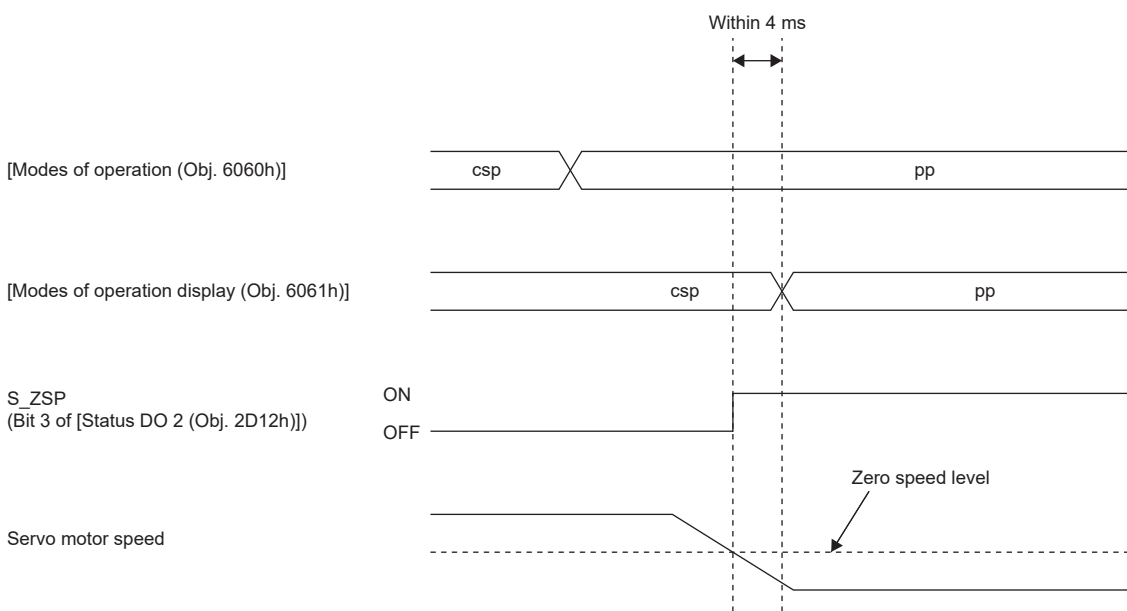

• Control switching for continuous operation to torque control mode (ct)

To switch to continuous operation to the torque control mode (ct), the switching must be performed from the cyclic synchronous position mode (csp) or cyclic synchronous velocity mode (csv). Only the "csp" and "csv" control modes switch to "ct". To switch to "ct", set [Modes of operation (Obj. 6060h)] to "-104" while in the "csp" or "csv" control mode. Once the condition for control switching is met, the control mode will switch to "ct", following which [Modes of operation display (Obj. 6061h)] is changed to "-104". If the condition is not met, the control mode will not be switched and the value in [Modes of operation display] will not be changed.

Continuous operation to torque control cannot be changed to "cst", "hm", etc. Refer to the following table for details.

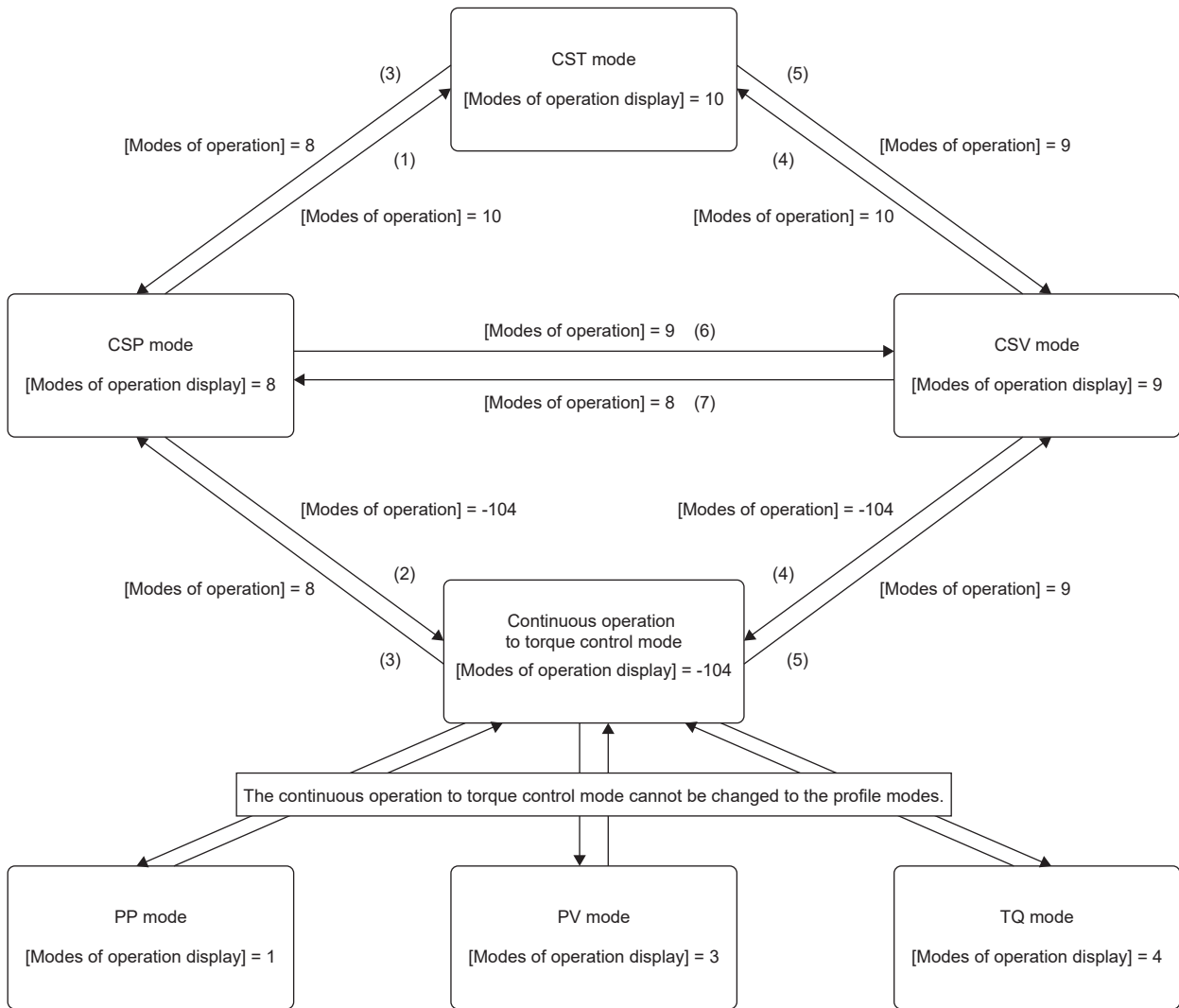

Switching operation		Switching condition
(1)	Cyclic synchronous position mode → Cyclic synchronous torque mode	Servo motor being stopped *1
(2)	Cyclic synchronous position mode → Continuous operation to torque control mode	No condition
(3)	Cyclic synchronous torque mode, Continuous operation to torque control mode → Cyclic synchronous position mode	Servo motor being stopped *1
(4)	Cyclic synchronous velocity mode → Cyclic synchronous torque mode, Continuous operation to torque control mode	No condition
(5)	Cyclic synchronous torque mode, Continuous operation to torque control mode → Cyclic synchronous velocity mode	No condition
(6)	Cyclic synchronous position mode → Cyclic synchronous velocity mode	Servo motor being stopped *1
(7)	Cyclic synchronous velocity mode → Cyclic synchronous position mode	Servo motor being stopped *1

*1 The state where S_ZSP (Bit 3 of [Status DO 2 (Obj. 2D12h)]) is turned on. (Servo motor speed being less than zero speed set in [Pr. PC07])

Setting [Pr. PC76.1 ZSP disabled selection at control switching] to "1" (disabled (control switching is performed regardless of the range of ZSP)) enables switching of the control mode without checking for switching condition "Servo motor being stopped" on the servo amplifier. Set [Pr. PC76.1] to "1" only if switching the control mode without waiting for the servo motor to stop. Note that switching the control mode without waiting for the servo motor to stop may cause a shock.

- Control switching in positioning mode

Refer to "Control switching in positioning mode" in the following manual.

 MR-J5 User's Manual (Function)

- Slave axis control switching in the master-slave operation function

When using the master-slave operation function, the control mode of the slave axis switches to the control mode for slave axes with the servo parameter setting. Other control modes are not available. Refer to the following for details.

 Page 26 Master-slave control with torque command method

Setting of positioning data

Point table access method

Use MR Configurator2 or the object dictionary via a controller to set the point table. Refer to "Setting method of point table" in the following manual.

 MR-J5 User's Manual (Function)

2 CC-Link IE Field Network Basic

2.1 Functions and configuration

This manual describes communication with the MR-JET-_G servo amplifiers using CC-Link IE Field Network Basic communication protocol. Refer to the following manual when using CC-Link IE Field Network Basic.

📖 MR-J5-G/MR-J5W-G User's Manual (Object Dictionary)

Outline

CC-Link IE Field Network Basic is a protocol that utilizes 100 Mbps for general-purpose Ethernet communications. By taking advantage of using general-purpose Ethernet, TCP/IP communications (HTTP, FTP, and the like) can also be used together, allowing for a high flexibility system configuration.

The servo amplifier can be connected to a programmable controller CPU or IPC that supports the CC-Link IE Field Network Basic master station. Positioning operation is possible in profile position mode and point table mode, in which position data (target position) is given via the controller to perform positioning operation.

System configuration

A configuration example is as follows.

A controller can control up to 16 axes per group, for a total of 64 axes of servo amplifiers.

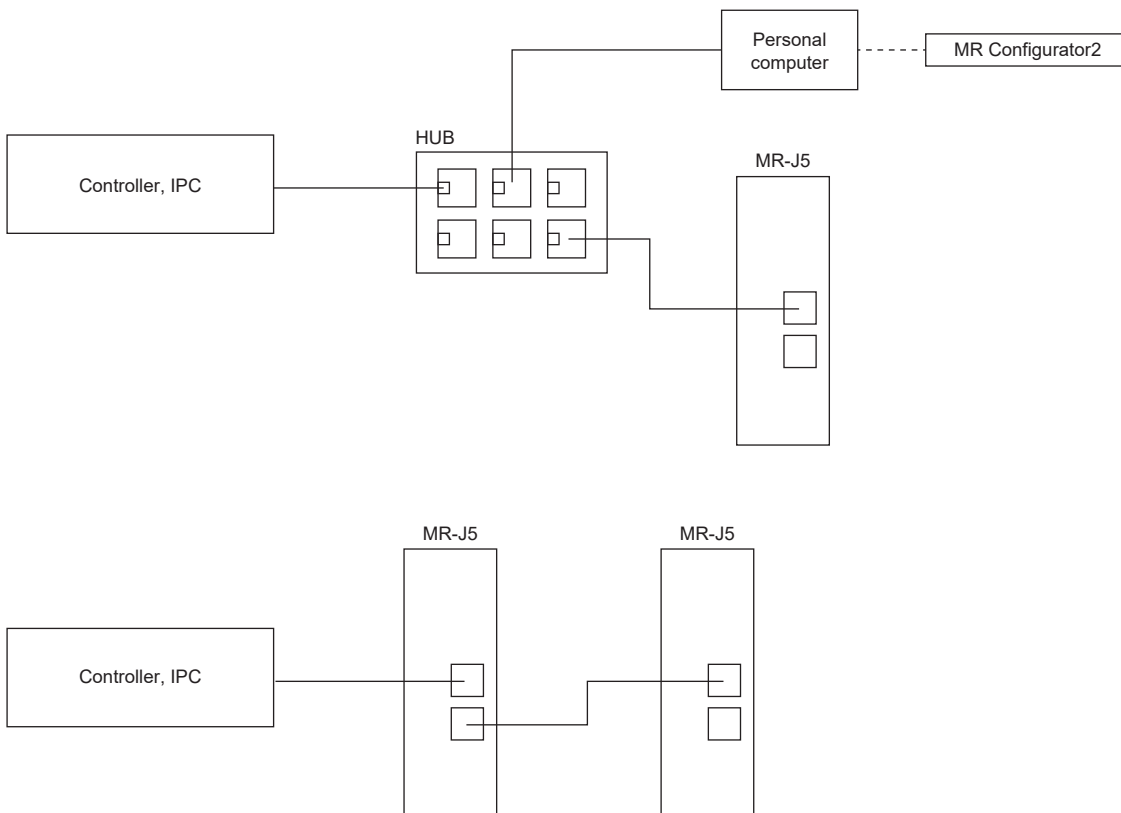

Function list

Communication-related function list (Application)

Category	Subcategory	Functions	Description	Detailed explanation
Network	Open network	CC-Link IE Field Network Basic protocol	This function supports CC-Link IE Field Network Basic.	☞ Page 90 Cyclic transmission
		CC-Link IE Field Network Basic communication settings	Network configuration settings are performed by using GX Works2, GX Works3, and MR Configurator2.	☞ Page 85 Startup
	Common protocol	SLMP	This function supports SLMP (SeamLess Message Protocol). Parameter settings and monitoring are available.	☞ Page 110 SLMP
	Profile	CSP+	File for describing the necessary information for startup, operation, and maintenance of CC-Link family connected products.	☞ Page 86 Profile (CSP+ file) settings
Application function	Cyclic transmission	Hold/Clear of output at CPU STOP and CPU stop error	When the CPU module of the cyclic master is at STOP, when the stop error occurs, Hold/Clear is automatically set on the refresh device output. The servo amplifier stops regardless of the setting of Hold/Clear of the cyclic master.	☞ Page 89 Hold/Clear of output at CPU STOP and at CPU stop error
	Setting change	Remote reset	This is a function to reset a servo amplifier via the network. Servo parameters to be enabled at power cycle are reflected by resetting the servo amplifier.	☞ Page 89 Remote reset
		IP address setting	IP addresses are delivered from the controller to servo amplifiers via CC-Link IE Field Network Basic.	☞ Page 88 IP address setting function

Communication specifications

CC-Link IE Field Network Basic communication

Item	Description
Communication protocol	UDP
Physical layer	100BASE-TX (100 Mbps/100 m)
Communication connector	RJ-45 × 2
Communication cable	CAT5e, shielded twisted pair, shield twisted 4 pair, straight cable
Network topology	Line, tree, star, or hybrid of these three topology types
Communication speed	100 Mbps
Transmission distance between stations	Max. 100 m
Number of connection nodes	Maximum 64 stations (Maximum number of connected stations per group: 16 stations) MR-J5-_G_, MR-J5D1-_G_ (Number of usable stations: 1 station per MR-J5-_G_/MR-J5D1-_G_)
Cyclic transmission	32 points (64 bytes)
Port number	61450 (cyclic data) 61451 (NodeSearch, IPAddressSet for CC-Link IE Field Network Basic)
IP address	IPv4 range: 0.0.0.1 to 223.255.255.254 Use the same network address for the master station and remote station. Network address default value (recommended): 192.168.3.1
Subnet mask	Subnet mask default value (recommended): 255.255.255.0
Message format	☞ Page 90 Message format
Reference response time *1 (Link scan time/timeout time *2*3)	10 ms

*1 The reference response time is the time it takes for the servo amplifier to receive a command from the master station and respond to the master station.

*2 The link scan time is calculated by the following formula. Use the reference response time for Ns.

For MELSEC iQ-R/MELSEC-Q/L: $Ls = Ns + Nm$

For MELSEC iQ-F: $Ls = SM + \{(Ns + Nm)/SM\}$

Ls: Link scan time, Ns: Remote station response time, Nm: Master station request time, SM: Sequence scan time

*3 Check the current link scan time (when all remote stations are normal) with CC-Link IE Field Network Basic diagnostics, and set the timeout time to about 5 times the link scan time (50 ms if the current link scan time is 10 ms).

SLMP communication specifications

Functions	Description
Communication protocol	UDP
Port number	5010 (SLMP communication port) 45237 (iQSS)
Message format	 Page 111 Message format

Establishing and disconnecting the communication

Establishing the communication

Configure the system and set the parameters or rotary switches that are required for startup of the CC-Link IE Field Network Basic master station and the servo amplifier. The communication will be established if the settings of the master station and the servo amplifiers are made correctly.

Disconnecting the communication

■ Procedure for disconnecting the communication

When shutting off the system power or disconnecting the servo amplifier from the network, be sure to set RY (n + 3) F of the master station (controller) to "0" (turn off the cyclic communication ready command) after servo-off. Failing to do so may trigger [AL. 086.1].

Summary of object dictionary (OD)

The data that a device holds, such as control parameters, command values, and feedback values, is handled as an object composed of an Index, object name, object type, R/W attribute, and other elements. The data is exchanged between the master and remote stations.



The aggregate of these objects is called an object dictionary (OD).

Section definition of object dictionary

The following shows the structure of an object dictionary.

Index	Description	Reference
1000h to 1FFFh	Communication profile	 MR-J5-G/MR-J5W-G User's Manual (Object Dictionary)
2000h to 5FFFh	Objects group defined by Mitsubishi Electric	
6000h to 9FFFh	CiA 402 drive profile	

The classification of the objects defined by Mitsubishi Electric is as follows.

Index	Description	Reference
2000h to 27FFh	Servo parameter	 MR-J5-G/MR-J5W-G User's Manual (Object Dictionary)
2800h to 29FFh	Point table	
2A00h to 2A7Fh	Alarm	
2B00h to 2BFFh	Monitor	
2C00h to 2C7Fh	Diagnostics	
2D00h to 2DFFh	Manufacturer defined control	 Page 121 Controlword/Control DI  Page 127 Statusword/Status DO

Saving object dictionary data

Some of object dictionary data is stored in a non-volatile memory and some is not. Use [Store parameters (Obj. 1010h)] for storing the object dictionary data in the non-volatile memory.

For details about objects that can be stored in the non-volatile memory, refer to the following manual.

 MR-J5-G/MR-J5W-G User's Manual (Object Dictionary)

■Store parameters

Writing "65766173h" (= reverse order of the ASCII code "save") to [Save all parameters (Obj. 1010h: 01h)] enables the setting value of an object to be stored in the non-volatile memory of the servo amplifier.

It can take up to around 25 s for [Save all parameters (Obj. 1010h: 01h)] to write all the parameters. Do not shut off the power supply during writing.

Index	Sub	Object	Name	Data Type	Access	Description
1010h	0	ARRAY	Store parameters	U8	ro	Number of entries
	1		Save all parameters	U32	rw	Saves all parameters.

Reading [Save all parameters (Obj. 1010h: 01h)] returns any of the following values. Bit 0 is "0" during saving and "1" when not saving.

Bit	Description
0	0: Object cannot be saved by the command (save in progress) 1: Object can be saved by the command (save not in progress)
1	0: Not automatically saved

Point

To shut off the power supply after executing Store parameters, make sure that a save is not in progress (Bit 0 is on), then shut off the power.

■Restore default parameters

Objects can be reset to the factory setting.

To initialize objects, write "64616F6Ch" (= reverse order of the ASCII code "load") to [Restore all default parameters (Obj. 1011h: 01h)], then cycle the power. Writing a value other than "load" (= 64616F6Ch) triggers an error. Initialization can take up to around 25 s.

Index	Sub	Object	Name	Data Type	Access	Description
1011h	0	ARRAY	Restore default parameters	U8	ro	Number of entries
	1		Restore all default parameters	U32	rw	All parameter initialization

Reading [Restore all default parameters (Obj. 1011h: 01h)] displays "00000001h" (initializing values).

Engineering tool

The following explains the main purposes of the engineering tools used in CC-Link IE Field Network Basic communication. For specific usages, refer to the manuals of the engineering tool and controller.

Engineering tool list

This list shows engineering tools used in CC-Link IE Field Network Basic.

Engineering tool	Description
MR Configurator2	This is a software that has the following functions: servo amplifier adjustment, monitor display, diagnosis, reading/writing of servo parameters, and test operation. These functions are performed using a personal computer. This tool is used to set the IP address and subnet mask in the network parameters.
GX Works2, GX Works3	This is a software that comprehensively supports the design and maintenance of the programmable controllers. The software performs settings such as servo amplifier profile (CSP+) registration, network configuration setting (station specific mode, link device setting, etc.), refresh setting, and network synchronization setting.

2.2 Startup

Outline

This chapter describes the setting procedure for CC-Link IE Field Network Basic. Refer to the following manual for startup of the servo amplifier.

📖 MR-J5-G/MR-J5W-G User's Manual (Introduction)

📖 MR-J5D-G User's Manual (Introduction)

2

Point

- To ensure the safety of the system against unauthorized network access, take security measures such as using a firewall.
- When the value of [Pr. PN02 Communication error - Detection time] is small, [AL. 086 Network communication error] may occur when the power of the servo amplifier is cycled or an instantaneous power failure occurs during CC-Link IE Field Network Basic communication.

Network setting

Point

- [Pr. PN13.0-3 Network protocol setting] is set to "0000h" (CC-Link IE TSN) at the factory setting. When using with CC-Link IE Field Network Basic, set [Pr. PN13.0-3] to "0004h".
- The communication speed is set to 1 Gbps at the factory setting. Since CC-Link IE Field Network Basic communicates at 100 Mbps, communication will not be established if a device whose communication speed is 1 Gbps is also connected. In such case, rewrite [Pr. PN13.0-3] from the engineering tool with a USB connection, or connect a device set with the same communication speed and rewrite [Pr. PN13.0-3] via the network.

Set the parameters of GX Works2 or GX Works3 as required for the servo amplifier network settings, and then configure the network settings of the master station and servo amplifier. Set the network settings of the master station and servo amplifier of CC-Link IE Field Network Basic according to the following procedure.

If an alarm has occurred, refer to the following manual.

📖 MR-J5 User's Manual (Troubleshooting)

1. Profile (CSP+ file) settings

Set the latest profile (CSP+ file).

📖 Page 86 Profile (CSP+ file) settings

2. Master station setting

Refer to the GX Works2 or GX Works3 manual.

3. IP address setting

Set the IP address with the rotary switches and a parameter.

📖 MR-J5-G/MR-J5W-G User's Manual (Introduction)

📖 MR-J5D-G User's Manual (Introduction)

Refer to the following when setting with parameters.

📖 Page 88 IP address setting function

4. Parameter setting

📖 Page 86 Parameter setting

5. Network connection procedure

📖 Page 87 Network connection procedure

6. Cyclic communication establishment procedure

📖 Page 87 Cyclic communication establishment procedure

Profile (CSP+ file) settings

To connect the master station and servo amplifier correctly, a profile (CSP+ file) must be set in GX Works2 or GX Works3. The CSP+ file can be downloaded from the Mitsubishi Electric FA site or the CC-Link Partner Association website.

Parameter setting

Set [Pr. PN13.0-3 Network protocol setting] to "0004h" and switch the network protocol to CC-Link IE Field Network Basic. If necessary, set the following servo parameters in accordance with the controller settings.

Servo parameter	Name
PN02	Communication error - Detection time

If necessary, set the following network parameters in accordance with the controller settings.

Network parameter	Name
NPA01	IP address setting
NPA02	IP address
NPA04	Subnet mask
NPA08	Host name

Network connection procedure

Follow the procedures below to set up the network.

1. Connect the master station and the servo amplifier with a network cable. There is no difference between CN1A and CN1B.
2. Turn on the power of the master station and the servo amplifier.
3. Open the diagnostic screen of GX Works2 or GX Works3 and make sure that there is no error in the network. If the network is not connected, check the following contents.
 - Check if an alarm has occurred in the servo amplifier. If an alarm occurs, refer to the following manual and cancel the alarm.

 MR-J5 User's Manual (Troubleshooting)

- Check that [Pr. PN13.0-3 Network protocol setting] is set to "0004h" (CC-Link IE Field Network Basic).
- Check that the values of the rotary switches and [Pr. NPA02 IP address] match the IP address set in the master station.

Cyclic communication establishment procedure

After connecting to the network, follow the procedure below to establish cyclic communication.

1. Cyclic communication start

Start cyclic communication of the master station (controller).

2. Cyclic communication preparation

Set RY (n + 3) F of the master station (controller) to "1" (turn on the cyclic communication ready command).

The remote stations (servo amplifiers) start importing the word device (RWw) and returns "1" to RX (n + 3) F.

3. Cyclic communication ready

On the master station (controller), check that RX (n + 3) F is set to "1" (Cyclic communication ready is on) before reading the word device (RWr).

Network disconnection procedure

Refer to the following.

 Page 82 Disconnecting the communication

Changing the network configuration

When changing the network configuration such as by adding a remote station, disconnecting a remote station, or adding a hub on the same network as the servo amplifier, follow the procedure below.

1. Turn off servo-on.
2. Set RY (n + 3) F of the master station (controller) to "1" (turn off the cyclic communication ready command).
3. Change the network configuration.

2.3 Application function

CC-Link IE Field Network Basic Diagnostics

The servo amplifier supports the following CC-Link IE Field Network Basic diagnostic functions. CC-Link IE Field Network Basic diagnostics is a function that uses an engineering tool to check the status of the master station and each remote station. This function can be used to check detailed information such as master station parameter settings and network connection status. Refer to the GX Works2 or GX Works3 manual for details of each function.

Function	Description
Master station status monitor	The number of remote stations set with the master parameters, the IP address of the master station, and the error codes of the master station can be checked.
Error details	The error description and corrective actions for the error that occurred can be checked.
Network status monitor	The link scan time (current, maximum, and minimum) for each group and the number of error stations/unchecked stations can be checked.
Selected group communication status monitor	The details of the module status and the communication status of the selected group are displayed. If an error occurs in the module, the cause of the error and its remedies can be checked.

IP address setting function

IP addresses are delivered from the controller to servo amplifiers via CC-Link IE Field Network Basic.

Set the IP address required for CC-Link IE Field Network Basic communication from the following items. The IP address range is between 0.0.0.1 and 223.255.255.254. Set the IP address within the range.

[Pr. NPA01 IP address setting]	Rotary switches (SW1/SW2)	IP address		
"00000000h" (The rotary switch is used.)	00h	1st octet	Use the value of/for [Pr. NPA02 IP address].	
		2nd octet		
		3rd octet		
		4th octet		
	01h to FEh	1st octet	Use the 1st to 3rd octet values of [Pr. NPA02 IP address].	
		2nd octet		
		3rd octet		
		4th octet	The setting value of the rotary switch (SW1/SW2) is used.	
	FFh	—	Not available.	
	"00000001h" (Network parameters are used.)	—	1st octet	Use the value of/for [Pr. NPA02 IP address].
			2nd octet	
			3rd octet	
4th octet				

The initial value of the IP address is as follows.

Item	Initial value
IP address	192.168.3.1
Subnet mask	255.255.255.0

Hold/Clear of output at CPU STOP and at CPU stop error

This function sets Hold/Clear of the auto refresh device output when CPU module operation of the cyclic master is at STOP or at CPU stop error.

The following shows the servo amplifier status at CPU STOP and at stop error.

- At CPU STOP

The servo amplifier behaves in the manner commanded by the controller.

- At stop error

The servo amplifier decelerates the servo motor to a stop.

Remote reset

Resetting can be done by sending the reset command to the specified station.

The reset command can be sent from the Remote Operation window of GX Works2 or GX Works3.

2.4 APPENDIX

Cyclic transmission

Outline

In CC-Link IE Field Network Basic, the command sent from the master station (controller) to the remote station (servo amplifier) is called a request message, and the command sent from the remote station (servo amplifier) to the master station (controller) is called a response message.

The master station (controller) sends the request message to all remote stations (servo amplifiers) by directed broadcast. When a servo amplifier receives a request message, it acquires the data addressed to its own station and returns the response message to the master station (controller) by unicast after the response time of the servo amplifier has passed. The servo amplifier response time varies depending on the command to be sent.

A link device (RWr, RWw, RX, RY) is used for data communications, and the master station (controller) refreshes the link by sending and receiving request messages and response messages at regular intervals. The servo amplifier uses the received data in the object dictionary to drive the servo motor and return monitor data.

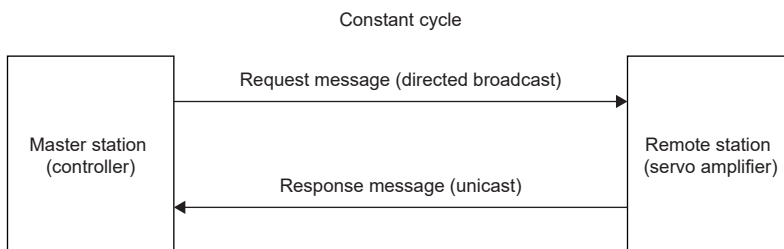

Message format

The request message sent from the master station (controller) and the response message returned from the remote station (servo amplifier) are sent in the following message format.

The message uses UDP/IP.

The PDO uses RWw and RWr. The RPDO (command) uses the request message (RWw), and the TPDO (feedback) uses the response message (RWr).

- Request message format

Ethernet header	IP header	UDP header	CCIEF Basic header	Command, etc.	Link device (for 16 stations) (RY, RWw)
-----------------	-----------	------------	--------------------	---------------	---

- Response message format

Ethernet header	IP header	UDP header	CCIEF Basic header	Remote station notification information	Link device (RX, RWr)
-----------------	-----------	------------	--------------------	---	-----------------------

PDO mapping

The placement of RPDO and TPDO objects is called PDO mapping. This placement has an initial placement defined and can be changed with variable PDO mapping. The following table shows values for items such as the number of objects that can be mapped to the PDO and the initial size of the PDO.

Item	Value
RPDO maximum number of objects	32
TPDO maximum number of objects	32
RPDO initial size [byte]	64
TPDO initial size [byte]	64
RPDO maximum size [byte]	64
TPDO maximum size [byte]	64
Number of RPDO mapping settings	1 [1st Receive PDO Mapping (Obj. 1600h)]
Number of TPDO mapping settings	1 [1st Transmit PDO Mapping (Obj. 1A00h)]

Link device (RYn/RXn)

Point

- If a value outside the range is set for the request (RYn and RWwn) from the master station to the servo amplifier in cyclic communication, the setting value may not be reflected. Set the value within the range.

The sent and received data of the request message and response message of cyclic communication is used as the object data (RYn, RXn) of the servo amplifier.

The setting value of the response message can be changed. To change the initial setting value, change the PDO mapping.

Use RY and RX devices to start cyclic communication.

The PDO mapping for RY and RX devices cannot be changed.

■RYn mapping

Master station → Servo amplifier (RYn)		
Device number *1	Device name	Symbol
RYn0 to RY (n + 3) E	Not used	—
RY (n + 3) F	Cyclic communication ready command	CSR

*1 "n" is a value determined by the station No. setting.

■RXn mapping

Servo amplifier → Master station (RXn)		
Device number *1	Device name	Symbol
RXn0 to RX (n + 3) E	Not used	—
RX (n + 3) F	Cyclic communication ready	SSR

*1 "n" is a value determined by the station No. setting.



Link device (RWwn/RWrn)

Point

If a value outside the range is set for the request (RYn and RWwn) from the master station to the servo amplifier in cyclic communication, the setting value may not be reflected. Set the value within the range.

The sent and received data of the request message and response message of cyclic communication is used as the object data (RWwn, RWrn) of the servo amplifier.

The setting value of the response message can be changed. To change the initial setting value, change the PDO mapping. The initial setting values for RWw and RWr devices are switched by the values of [Pr. PA01.0 Control mode selection] and [Pr. PN22.0 Default mapping mode selection].

[Pr. PA01.0]	[Pr. PN22.0]	Description	Reference
0	0	This is the default mapping for mode 1 in the network standard mode. It corresponds to the profile mode and homing mode. Two touch probes are registered in the link device.	 Page 93 Network standard mode
	1	This is the default mapping for mode 2 in the network standard mode. It corresponds to the profile mode and homing mode. One touch probe is registered in the link device.	
	2	This is the default mapping for mode 3 in the network standard mode. It corresponds to the profile mode and homing mode. One touch probe and input device are registered in the link device.	
6	0	This is the default mapping for mode 1 in the positioning mode (point table method). It corresponds to the positioning mode, JOG operation mode, and homing mode. Two touch probes are registered in the link device.	 Page 99 Positioning mode (point table method)
	1	This is the default mapping for mode 2 in the positioning mode (point table method). It corresponds to the positioning mode, JOG operation mode, and homing mode. One touch probe and input device are registered in the link device.	
	2	This is the default mapping for mode 3 in the positioning mode (point table method). It corresponds to the positioning mode, JOG operation mode, and homing mode. One touch probe and input device are registered in the link device.	

■ Network standard mode

This is the PDO mapping when [Pr. PA01.0] is "0" (network standard mode).

- RWwn mapping (mode 1)

Master station → Servo amplifier (RWwn)		
Device number *1	Index	Device name
RWwn00	6060	Modes of operation
RWwn01	6040	Controlword
RWwn02	2D01	Control DI 1
RWwn03	2D02	Control DI 2
RWwn04	2D03	Control DI 3
RWwn05	2D05	Control DI 5
RWwn06	607A	Target position
RWwn07		
RWwn08	60FF	Target velocity
RWwn09		
RWwn0A	2D20	Velocity limit value
RWwn0B		
RWwn0C	6071	Target torque
RWwn0D	—	—
RWwn0E	6081	Profile velocity
RWwn0F		
RWwn10	6083	Profile acceleration
RWwn11		
RWwn12	6084	Profile deceleration
RWwn13		
RWwn14	6087	Torque slope
RWwn15		
RWwn16	60F2	Positioning option code
RWwn17	60B8	Touch probe function
RWwn18	—	—
RWwn19	—	—
RWwn1A	—	—
RWwn1B	—	—
RWwn1C	—	—
RWwn1D	—	—
RWwn1E	—	—
RWwn1F	—	—

*1 "n" is a value determined by the station No. setting.

- RWrn mapping (mode 1)

Servo amplifier → Master station (RWrn)		
Device number ^{*1}	Index	Device name
RWrn00	6061	Modes of operation display
RWrn01	6041	Statusword
RWrn02	2D11	Status DO 1
RWrn03	2D12	Status DO 2
RWrn04	2D13	Status DO 3
RWrn05	—	—
RWrn06	6064	Position actual value
RWrn07		
RWrn08	606C	Velocity actual value
RWrn09		
RWrn0A	60F4	Following error actual value
RWrn0B		
RWrn0C	6077	Torque actual value
RWrn0D	—	—
RWrn0E	2A41	Current alarm
RWrn0F		
RWrn10	60B9	Touch probe status
RWrn11	—	—
RWrn12	60BA	Touch probe 1 positive edge
RWrn13		
RWrn14	60BB	Touch probe 1 negative edge
RWrn15		
RWrn16	60BC	Touch probe 2 positive edge
RWrn17		
RWrn18	60BD	Touch probe 2 negative edge
RWrn19		
RWrn1A	—	—
RWrn1B	—	—
RWrn1C	—	—
RWrn1D	—	—
RWrn1E	—	—
RWrn1F	—	—

*1 "n" is a value determined by the station No. setting.

- RWwn mapping (mode 2)

Master station → Servo amplifier (RWwn)		
Device number *1	Index	Device name
RWwn00	6060	Modes of operation
RWwn01	6040	Controlword
RWwn02	2D01	Control DI 1
RWwn03	2D02	Control DI 2
RWwn04	2D03	Control DI 3
RWwn05	607A	Target position
RWwn06		
RWwn07	60FF	Target velocity
RWwn08		
RWwn09	2D20	Velocity limit value
RWwn0A		
RWwn0B	6071	Target torque
RWwn0C	6081	Profile velocity
RWwn0D		
RWwn0E	6083	Profile acceleration
RWwn0F		
RWwn10	6084	Profile deceleration
RWwn11		
RWwn12	6087	Torque slope
RWwn13		
RWwn14	60E0	Positive torque limit value
RWwn15	60E1	Negative torque limit value
RWwn16	—	—
RWwn17	60B8	Touch probe function
RWwn18	60F2	Positioning option code
RWwn19	2D05	Control DI 5
RWwn1A	—	—
RWwn1B	—	—
RWwn1C	—	—
RWwn1D	—	—
RWwn1E	—	—
RWwn1F	—	—

*1 "n" is a value determined by the station No. setting.

• RWrn mapping (mode 2)

Master station → Servo amplifier (RWwn)		
Device number ^{*1}	Index	Device name
RWrn00	6061	Modes of operation display
RWrn01	—	—
RWrn02	6041	Statusword
RWrn03	6064	Position actual value
RWrn04		
RWrn05	606C	Velocity actual value
RWrn06		
RWrn07	60F4	Following error actual value
RWrn08		
RWrn09	6077	Torque actual value
RWrn0A	2D11	Status DO 1
RWrn0B	2D12	Status DO 2
RWrn0C	2D13	Status DO 3
RWrn0D	2A42	Current alarm 2
RWrn0E	60B9	Touch probe status
RWrn0F	60BA	Touch probe 1 positive edge
RWrn10		
RWrn11	60BB	Touch probe 1 negative edge
RWrn12		
RWrn13	—	—
RWrn14	—	—
RWrn15	—	—
RWrn16	—	—
RWrn17	—	—
RWrn18	—	—
RWrn19	—	—
RWrn1A	—	—
RWrn1B	—	—
RWrn1C	—	—
RWrn1D	—	—
RWrn1E	—	—
RWrn1F	—	—

*1 "n" is a value determined by the station No. setting.

- RWwn mapping (mode 3)

Master station → Servo amplifier (RWwn)		
Device number ^{*1}	Index	Device name
RWwn00	6060	Modes of operation
RWwn01	6040	Controlword
RWwn02	2D01	Control DI 1
RWwn03	2D02	Control DI 2
RWwn04	2D03	Control DI 3
RWwn05	607A	Target position
RWwn06		
RWwn07	60FF	Target velocity
RWwn08		
RWwn09	2D20	Velocity limit value
RWwn0A		
RWwn0B	6071	Target torque
RWwn0C	6081	Profile velocity
RWwn0D		
RWwn0E	6083	Profile acceleration
RWwn0F		
RWwn10	6084	Profile deceleration
RWwn11		
RWwn12	6087	Torque slope
RWwn13		
RWwn14	60E0	Positive torque limit value
RWwn15	60E1	Negative torque limit value
RWwn16	—	—
RWwn17	60B8	Touch probe function
RWwn18	60F2	Positioning option code
RWwn19	2D05	Control DI 5
RWwn1A	—	—
RWwn1B	—	—
RWwn1C	—	—
RWwn1D	—	—
RWwn1E	—	—
RWwn1F	—	—

*1 "n" is a value determined by the station No. setting.

- RWrn mapping (mode 3)

Servo amplifier → Master station (RWrn)		
Device number ^{*1}	Index	Device name
RWrn00	6061	Modes of operation display
RWrn01	—	—
RWrn02	6041	Statusword
RWrn03	6064	Position actual value
RWrn04		
RWrn05	606C	Velocity actual value
RWrn06		
RWrn07	60F4	Following error actual value
RWrn08		
RWrn09	6077	Torque actual value
RWrn0A	2D11	Status DO 1
RWrn0B	2D12	Status DO 2
RWrn0C	2D13	Status DO 3
RWrn0D	2A42	Current alarm 2
RWrn0E	60B9	Touch probe status
RWrn0F	60BA	Touch probe 1 positive edge
RWrn10		
RWrn11	60BB	Touch probe 1 negative edge
RWrn12		
RWrn13	60FD	Digital inputs
RWrn14		
RWrn15	—	—
RWrn16	—	—
RWrn17	—	—
RWrn18	—	—
RWrn19	—	—
RWrn1A	—	—
RWrn1B	—	—
RWrn1C	—	—
RWrn1D	—	—
RWrn1E	—	—
RWrn1F	—	—

*1 "n" is a value determined by the station No. setting.

■ Positioning mode (point table method)

This is the PDO mapping when [Pr. PA01.0] is "6" (positioning mode (point table method)).

- RWwn mapping (mode 1)

Master station → Servo amplifier (RWwn)		
Device number *1	Index	Device name
RWwn00	6060	Modes of operation
RWwn01	6040	Controlword
RWwn02	2D01	Control DI 1
RWwn03	2D02	Control DI 2
RWwn04	2D03	Control DI 3
RWwn05	2D60	Target point table
RWwn06	6081	Profile velocity
RWwn07		
RWwn08	6083	Profile acceleration
RWwn09		
RWwn0A	6084	Profile deceleration
RWwn0B		
RWwn0C	60B8	Touch probe function
RWwn0D	—	—
RWwn0E	60F2	Positioning option code
RWwn0F	—	—
RWwn10	—	—
RWwn11	—	—
RWwn12	—	—
RWwn13	—	—
RWwn14	—	—
RWwn15	—	—
RWwn16	—	—
RWwn17	—	—
RWwn18	—	—
RWwn19	—	—
RWwn1A	—	—
RWwn1B	—	—
RWwn1C	—	—
RWwn1D	—	—
RWwn1E	—	—
RWwn1F	—	—

*1 "n" is a value determined by the station No. setting.

- RWrn mapping (mode 1)

Servo amplifier → Master station (RWrn)		
Device number *1	Index	Device name
RWrn00	6061	Modes of operation display
RWrn01	6041	Statusword
RWrn02	2D11	Status DO 1
RWrn03	2D12	Status DO 2
RWrn04	2D13	Status DO 3
RWrn05	2D15	Status DO 5
RWrn06	2D17	Status DO 7
RWrn07	—	—
RWrn08	6064	Position actual value
RWrn09		
RWrn0A	606C	Velocity actual value
RWrn0B		
RWrn0C	60F4	Following error actual value
RWrn0D		
RWrn0E	6077	Torque actual value
RWrn0F	2D6A	M code actual value
RWrn10	2D68	Point demand value
RWrn11	2D69	Point actual value
RWrn12	2A41	Current alarm
RWrn13		
RWrn14	60B9	Touch probe status
RWrn15	—	—
RWrn16	60BA	Touch probe 1 positive edge
RWrn17		
RWrn18	60BB	Touch probe 1 negative edge
RWrn19		
RWrn1A	60BC	Touch probe 2 positive edge
RWrn1B		
RWrn1C	60BD	Touch probe 2 negative edge
RWrn1D		
RWrn1E	—	—
RWrn1F	—	—

*1 "n" is a value determined by the station No. setting.

- RWwn mapping (mode 2)

Master station → Servo amplifier (RWwn)		
Device number ^{*1}	Index	Device name
RWwn00	6060	Modes of operation
RWwn01	6040	Controlword
RWwn02	2D01	Control DI 1
RWwn03	2D02	Control DI 2
RWwn04	2D03	Control DI 3
RWwn05	2D60	Target point table
RWwn06	6081	Profile velocity
RWwn07		
RWwn08	6083	Profile acceleration
RWwn09		
RWwn0A	6084	Profile deceleration
RWwn0B		
RWwn0C	60B8	Touch probe function
RWwn0D	—	—
RWwn0E	—	—
RWwn0F	—	—
RWwn10	60F2	Positioning option code
RWwn11	—	—
RWwn12	—	—
RWwn13	—	—
RWwn14	—	—
RWwn15	—	—
RWwn16	—	—
RWwn17	—	—
RWwn18	—	—
RWwn19	—	—
RWwn1A	—	—
RWwn1B	—	—
RWwn1C	—	—
RWwn1D	—	—
RWwn1E	—	—
RWwn1F	—	—

*1 "n" is a value determined by the station No. setting.

- RWrn mapping (mode 2)

Servo amplifier → Master station (RWrn)		
Device number *1	Index	Device name
RWrn00	6061	Modes of operation display
RWrn01	6041	Statusword
RWrn02	6064	Position actual value
RWrn03		
RWrn04	606C	Velocity actual value
RWrn05		
RWrn06	60F4	Following error actual value
RWrn07		
RWrn08	6077	Torque actual value
RWrn09	2D11	Status DO 1
RWrn0A	2D12	Status DO 2
RWrn0B	2D13	Status DO 3
RWrn0C	2D15	Status DO 5
RWrn0D	2D17	Status DO 7
RWrn0E	2D68	Point demand value
RWrn0F	2D69	Point actual value
RWrn10	2D6A	M code actual value
RWrn11	2A42	Current alarm 2
RWrn12	60B9	Touch probe status
RWrn13	60BA	Touch probe 1 positive edge
RWrn14		
RWrn15	60BB	Touch probe 1 negative edge
RWrn16		
RWrn17	—	—
RWrn18	—	—
RWrn19	—	—
RWrn1A	—	—
RWrn1B	—	—
RWrn1C	—	—
RWrn1D	—	—
RWrn1E	—	—
RWrn1F	—	—

*1 "n" is a value determined by the station No. setting.

- RWwn mapping (mode 3)

Master station → Servo amplifier (RWwn)		
Device number ^{*1}	Index	Device name
RWwn00	6060	Modes of operation
RWwn01	6040	Controlword
RWwn02	2D01	Control DI 1
RWwn03	2D02	Control DI 2
RWwn04	2D03	Control DI 3
RWwn05	2D60	Target point table
RWwn06	6081	Profile velocity
RWwn07		
RWwn08	6083	Profile acceleration
RWwn09		
RWwn0A	6084	Profile deceleration
RWwn0B		
RWwn0C	60B8	Touch probe function
RWwn0D	—	—
RWwn0E	—	—
RWwn0F	—	—
RWwn10	60F2	Positioning option code
RWwn11	—	—
RWwn12	—	—
RWwn13	—	—
RWwn14	—	—
RWwn15	—	—
RWwn16	—	—
RWwn17	—	—
RWwn18	—	—
RWwn19	—	—
RWwn1A	—	—
RWwn1B	—	—
RWwn1C	—	—
RWwn1D	—	—
RWwn1E	—	—
RWwn1F	—	—

*1 "n" is a value determined by the station No. setting.

- RWrn mapping (mode 3)

Servo amplifier → Master station (RWrn)		
Device number *1	Index	Device name
RWrn00	6061	Modes of operation display
RWrn01	6041	Statusword
RWrn02	6064	Position actual value
RWrn03		
RWrn04	606C	Velocity actual value
RWrn05		
RWrn06	60F4	Following error actual value
RWrn07		
RWrn08	6077	Torque actual value
RWrn09	2D11	Status DO 1
RWrn0A	2D12	Status DO 2
RWrn0B	2D13	Status DO 3
RWrn0C	2D15	Status DO 5
RWrn0D	2D17	Status DO 7
RWrn0E	2D68	Point demand value
RWrn0F	2D69	Point actual value
RWrn10	2D6A	M code actual value
RWrn11	2A42	Current alarm 2
RWrn12	60B9	Touch probe status
RWrn13	60BA	Touch probe 1 positive edge
RWrn14		
RWrn15	60BB	Touch probe 1 negative edge
RWrn16		
RWrn17	60FD	Digital inputs
RWrn18		
RWrn19	—	—
RWrn1A	—	—
RWrn1B	—	—
RWrn1C	—	—
RWrn1D	—	—
RWrn1E	—	—
RWrn1F	—	—

*1 "n" is a value determined by the station No. setting.

Variable PDO mapping function for PDO communication data



The servo amplifier supports the variable PDO mapping function, which can arrange desired objects in any array for the data sent and received with RPDO and TPDO. For the SDO end code, refer to "End code" below.

 Page 116 End code



The variable PDO mapping is as follows.

■Default mapping



- Network standard mode (mode 1)

Index	Sub	Object	Name	Data Type	Access	Default	Description
1600h	0	ARRAY	1st Receive PDO Mapping	U8	rw	12h	Number of entries
	1 to 32		Mapped Object 1 to Mapped Object 32	U32	rw	—	Refer to the following for default mappings.  Page 93 Network standard mode
1A00h	0	ARRAY	1st Transmit PDO Mapping	U8	rw	13h	Number of entries
	1 to 32		Mapped Object 1 to Mapped Object 32	U32	rw	—	Refer to the following for default mappings.  Page 93 Network standard mode

- Network standard mode (mode 2)

Index	Sub	Object	Name	Data Type	Access	Default	Description
1600h	0	ARRAY	1st Receive PDO Mapping	U8	rw	14h	Number of entries
	1 to 32		Mapped Object 1 to Mapped Object 32	U32	rw	—	Refer to the following for default mappings.  Page 93 Network standard mode
1A00h	0	ARRAY	1st Transmit PDO Mapping	U8	rw	0Fh	Number of entries
	1 to 32		Mapped Object 1 to Mapped Object 32	U32	rw	—	Refer to the following for default mappings.  Page 93 Network standard mode

- Network standard mode (mode 3)

Index	Sub	Object	Name	Data Type	Access	Default	Description
1600h	0	ARRAY	1st Receive PDO Mapping	U8	rw	14h	Number of entries
	1 to 32		Mapped Object 1 to Mapped Object 32	U32	rw	—	Refer to the following for default mappings.  Page 93 Network standard mode
1A00h	0	ARRAY	1st Transmit PDO Mapping	U8	rw	10h	Number of entries
	1 to 32		Mapped Object 1 to Mapped Object 32	U32	rw	—	Refer to the following for default mappings.  Page 93 Network standard mode

• Positioning mode (point table method) (mode 1)

Index	Sub	Object	Name	Data Type	Access	Default	Description
1600h	0	ARRAY	1st Receive PDO Mapping	U8	rw	0Dh	Number of entries
	1 to 32		Mapped Object 1 to Mapped Object 32	U32	rw	—	Refer to the following for default mappings. ☞ Page 99 Positioning mode (point table method)
1A00h	0	ARRAY	1st Transmit PDO Mapping	U8	rw	18h	Number of entries
	1 to 32		Mapped Object 1 to Mapped Object 32	U32	rw	—	Refer to the following for default mappings. ☞ Page 99 Positioning mode (point table method)

• Positioning mode (point table method) (mode 2)

Index	Sub	Object	Name	Data Type	Access	Default	Description
1600h	0	ARRAY	1st Receive PDO Mapping	U8	rw	0Eh	Number of entries
	1 to 32		Mapped Object 1 to Mapped Object 32	U32	rw	—	Refer to the following for default mappings. ☞ Page 99 Positioning mode (point table method)
1A00h	0	ARRAY	1st Transmit PDO Mapping	U8	rw	14h	Number of entries
	1 to 32		Mapped Object 1 to Mapped Object 32	U32	rw	—	Refer to the following for default mappings. ☞ Page 99 Positioning mode (point table method)

• Positioning mode (point table method) (mode 3)

Index	Sub	Object	Name	Data Type	Access	Default	Description
1600h	0	ARRAY	1st Receive PDO Mapping	U8	rw	0Eh	Number of entries
	1 to 32		Mapped Object 1 to Mapped Object 32	U32	rw	—	Refer to the following for default mappings. ☞ Page 99 Positioning mode (point table method)
1A00h	0	ARRAY	1st Transmit PDO Mapping	U8	rw	15h	Number of entries
	1 to 32		Mapped Object 1 to Mapped Object 32	U32	rw	—	Refer to the following for default mappings. ☞ Page 99 Positioning mode (point table method)

• Setting contents of PDO mapping objects

The setting contents of PDO mapping objects (Sub Index 1 or later) are as follows.

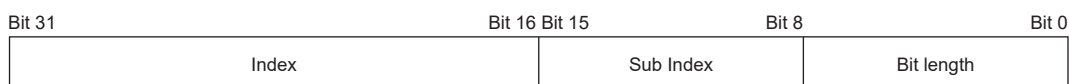

Bit 0 to Bit 7: Bit length of the object to be mapped

Bit 8 to Bit 15: Sub Index of the object to be mapped

Bit 16 to Bit 31: Index of the object to be mapped

If placing [Modes of operation (Obj. 6060h: 00h)] (bit length 8) at the start address of [1st Receive PDO Mapping (Obj. 1600h)], set "60600008h" to [Mapped Object 001 (Obj. 1600h: 01h)].

■PDO mapping setting procedure

The PDO mapping can be changed by using the PDO mapping object.

- How to use PDO mapping objects

The usage is shown using [1st Receive PDO Mapping (Obj. 1600h)] and [1st Transmit PDO Mapping (Obj. 1A00h)] as examples.

Use SLMP to send the PDO mapping to the servo amplifier.

Point

The PDO mapping for response message can be set when CC-Link IE Field Network Basic communication is stopped (RX (n + 3) F is "0").

Follow these procedures to change the PDO mapping.

- 1.** Stop CC-Link IE Field Network Basic communication.
Set RY (n + 3) F to "0" (turn off the cyclic communication ready command).
- 2.** Initialize the number of PDO mapping configurations with SLMP.
[Mapped Object 000 (Obj. 1600h: 00h)] = 0 (number of configurations = 0)
[Mapped Object 000 (Obj. 1A00h: 00h)] = 0 (number of configurations = 0)
- 3.** Set PDO mapping with SLMP.
[Mapped Object 001 (Obj. 1600h: 01h)] - [Mapped Object 032 (Obj. 1600h: 20h)]
[Mapped Object 001 (Obj. 1A00h: 01h)] - [Mapped Object 032 (Obj. 1A00h: 20h)]
- 4.** Set the number of PDO mapping configurations with SLMP.
[Mapped Object 000 (Obj. 1600h: 00h)] = n (number of configurations = n)
[Mapped Object 000 (Obj. 1A00h: 00h)] = n (number of configurations = n)
- 5.** Start CC-Link IE Field Network Basic communication.
Set RY (n + 3) F to "1" (turn on the cyclic communication ready command).

Objects that require PDO mapping

- Objects that require RPDO mapping, categorized by control mode and function

◎: PDO mapping required ○: PDO mapping recommended —: PDO mapping not required

Object name (Index)	Mode					
	pp	pv	tq	hm	pt	jpg
[Controlword (Obj. 6040h)]	◎	◎	◎	◎	◎	◎
[Control DI 1 (Obj. 2D01h)]	○	○	—	—*2	○	○
[Control DI 2 (Obj. 2D02h)]	○	—	—	○	○	○
[Control DI 3 (Obj. 2D03h)]	○	○	○	○	○	○
[Touch probe function (Obj. 60B8h)]	—*1	—*1	—*1	—*1	—*1	—*1
[Target position (Obj. 607Ah)]	◎	—	—	—	—	—
[Target velocity (Obj. 60FFh)]	—	◎	—	—	—	—
[Target torque (Obj. 6071h)]	—	—	◎	—	—	—
[Profile velocity (Obj. 6081h)]	○	—	—	—	—	○
[Profile acceleration (Obj. 6083h)]	○	○	—	—	—	○
[Profile deceleration (Obj. 6084h)]	○	○	—	—	—	○
[Torque slope (Obj. 6087h)]	—	—	○	—	—	—
[Velocity limit value (Obj. 2D20h)]	—	—	○	—	—	—
[Positive torque limit value (Obj. 60E0h)]	○	○	○	○	○	○
[Negative torque limit value (Obj. 60E1h)]	○	○	○	○	○	○
[Target point table (Obj. 2D60h)]	—	—	—	—	◎	—

*1 It is "◎" when the touch probe function is used.

*2 It is "○" when the positioning mode (point table method) is used.

- Objects that require TPDO mapping, categorized by control mode and function

◎: PDO mapping required ○: PDO mapping recommended —: PDO mapping not required

Object name (Index)	Mode					
	pp	pv	tq	hm	pt	jpg
[Statusword (Obj. 6041h)]	◎	◎	◎	◎	◎	◎
[Status DO 1 (Obj. 2D11h)]	○	○	○	○	○	○
[Status DO 2 (Obj. 2D12h)]	○	○	○	○	○	○
[Status DO 3 (Obj. 2D13h)]	○	○	○	○	○	○
[Status DO 5 (Obj. 2D15h)]	—	—	—	— ^{*3}	○	○
[Status DO 7 (Obj. 2D17h)]	—	—	—	—	○	○
[Touch probe status (Obj. 60B9h)]	— ^{*1}	— ^{*1}	— ^{*1}	— ^{*1}	— ^{*1}	— ^{*1}
[Position actual value (Obj. 6064h)]	○	○	○	○	○	○
[Velocity actual value (Obj. 606Ch)]	○	○	○	○ ^{*4}	○	○
[Following error actual value (Obj. 60F4h)]	○	—	—	—	○	○
[Torque actual value (Obj. 6077h)]	○	○	○	○	○	○
[Digital Inputs (Obj. 60FDh)]	—	—	—	—	○	○
[Touch probe 1 positive edge (Obj. 60BAh)]	— ^{*2}	— ^{*2}	— ^{*2}	— ^{*2}	— ^{*2}	— ^{*2}
[Touch probe 1 negative edge (Obj. 60BBh)]	— ^{*2}	— ^{*2}	— ^{*2}	— ^{*2}	— ^{*2}	— ^{*2}
[Touch probe 2 positive edge (Obj. 60BCh)]	— ^{*2}	— ^{*2}	— ^{*2}	— ^{*2}	— ^{*2}	— ^{*2}
[Touch probe 2 negative edge (Obj. 60BDh)]	— ^{*2}	— ^{*2}	— ^{*2}	— ^{*2}	— ^{*2}	— ^{*2}
[Point actual value (Obj. 2D69h)]	—	—	—	—	○	—
[M code actual value (Obj. 2D6Ah)]	—	—	—	—	○	—
[Point demand value (Obj. 2D68h)]	—	—	—	—	○	—

*1 It is "◎" when the touch probe function is used.

*2 It is "○" when the touch probe function is used.

*3 It is "○" when the positioning mode (point table method) is used.

*4 It is "—" when the positioning mode (point table method) is used.

SLMP

Outline

Point

- When sending commands from multiple master stations to one servo amplifier, some commands may not be received if the command transmission interval is too short. If there is no command response, increase the command transmission interval.

SLMP (SeamLess Message Protocol) is a common protocol for seamless inter-application communication that does not consider network hierarchies and boundaries. SLMP communication is possible if the connection is made to an external device such as a programmable controller, personal computer, or display that can send and receive messages using the SLMP control procedure. Servo amplifiers only support binary codes. ASCII codes are not supported.

In SLMP, the command sent from the master station (external device) to the remote station (servo amplifier) is called a request message, and the command sent from the remote station (servo amplifier) to the master station (external device) is called a response message.

When a servo amplifier receives a request message, it returns the response message to the external device after the response time of the servo amplifier has passed.

The external device cannot send the next request message until the response message has been received.

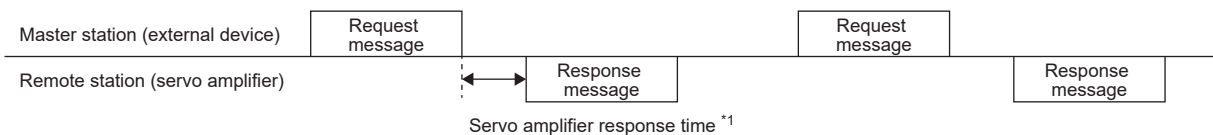

*1 The servo amplifier response time varies depending on the command to be sent.

Message format

The request message sent from the master station (external device) and the response message returned from the remote station (servo amplifier) are sent in the following message format.

Request message format

The data length of request messages is 2047 bytes max.

Ethernet header	IP header	UDP header	SLMP								Footer
			Subheader	Request destination network No.	Request destination station No.	Request destination module I/O No.	Request destination multi-drop station No.	Request data length	Monitoring timer	Request data	

Response message format

There are two types of response messages, one for normal termination and one for abnormal termination. The data length of response messages is 2048 bytes max.

- At normal termination

Ethernet header	IP header	UDP header	SLMP								Footer
			Subheader	Request destination network No.	Request destination station No.	Request destination module I/O No.	Request destination multi-drop station No.	Response data length	End code	Response data	

- At abnormal termination

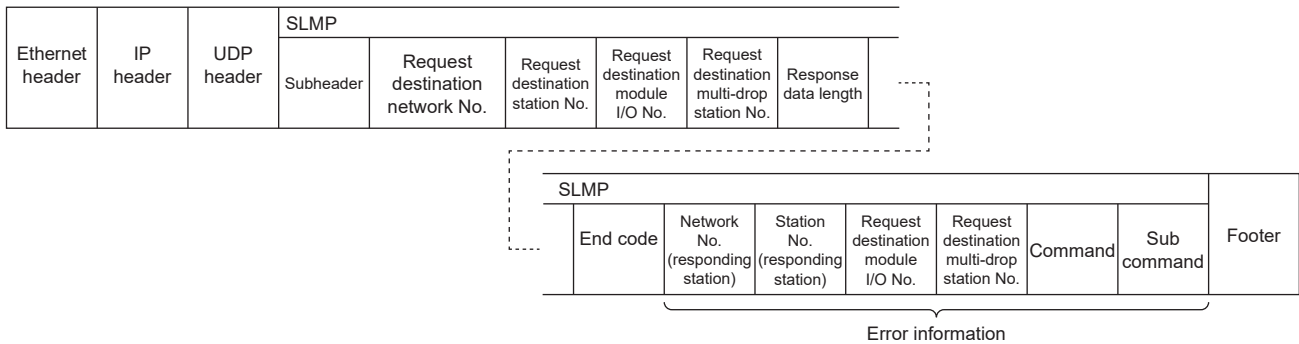

SLMP command

The following commands can be used.

Name	Command	Sub command	Description	Detailed explanation
Read Object (Object read)	4020h	0001h	Reads the data specified by the object from the servo amplifier to the external device.	☞ Page 112 Read Object (object read)
Write Object (Object writing)		0002h	Writes the data specified by the object from the external device to the servo amplifier.	☞ Page 113 Write Object (object write)
Object SubID Read Block (Object Sub Index continuous read)		0005h	Reads the data of the continuous subcommand specified by the object from the servo amplifier to the external device.	☞ Page 114 Object SubID Read Block (object sub-ID continuous read)
Object SubID Write Block (Object Sub Index continuous write)		0006h	Writes the data of the continuous subcommand specified by the object from the external device to the servo amplifier.	☞ Page 115 Object SubID Write Block (object sub-ID continuous write)
NodeSearch	0E30h	0000h	Detects server devices in the network.	—
IPAddressSet	0E31h	0000h	Sets the IP addresses of the server devices in the network.	—

■Read Object (object read)

This command returns the value of the object corresponding to Index and Sub Index specified by the master station (external device).

- Request message (after the command)

Command		Sub command		Index		Sub Index	Reserved	Number of data value	
L	H	L	H	L	H	—	—	L	H
20h	40h	01h	00h	Refer to "Item list" below for details.					

- Response message (at normal termination (after the end code))

End code		Index		Sub Index	Reserved	Number of data value		Read data
L	H	L	H	—	—	L	H	L variable H
00h	00h	Refer to "Item list" below for details.						

- Response message (at abnormal termination)

It is the same as "At abnormal termination" in the reference below.

☞ Page 111 Response message format

- Item list

Item	Size	Endian	Description
Command	2 bytes	Little	4020h
Sub command	2 bytes	Little	0001h
Index	2 bytes	Little	Specify Index of the object. (☞ MR-J5-G/MR-J5W-G User's Manual (Object Dictionary)) The response message stores the value specified in the request message.
Sub Index	1 byte	Little	Specify Sub Index of the object. (☞ MR-J5-G/MR-J5W-G User's Manual (Object Dictionary)) The response message stores the value specified in the request message.
Reserved	1 byte	—	00h (fixed)
Number of data value	2 bytes	Little	Read data: 00h (fixed)
Read data	Variable	Little	The return data of the object is stored.

■Write Object (object write)

This command writes the specified value to the object corresponding to Index and Sub Index specified by the master station (external device).

- Request message (after the command)

Command		Sub command		Index		Sub Index	Reserved	Number of data value		Write data
L	H	L	H	L	H	—	—	L	H	L variable H
20h	40h	02h	00h	Refer to "Item list" below for details.						

- Response message (at normal termination (after the end code))



End code		Index		Sub Index	Reserved	Number of data value	
L	H	L	H	—	—	L	H
00h	00h	Refer to "Item list" below for details.					

- Response message (at abnormal termination)

It is the same as "At abnormal termination" in the reference below.

 Page 111 Response message format

- Item list

Item	Size	Endian	Description
Command	2 bytes	Little	4020h
Sub command	2 bytes	Little	0002h
Index	2 bytes	Little	Specify Index of the object. ( MR-J5-G/MR-J5W-G User's Manual (Object Dictionary)) The response message stores the value specified in the request message.
Sub Index	1 byte	Little	Specify Sub Index of the object. ( MR-J5-G/MR-J5W-G User's Manual (Object Dictionary)) The response message stores the value specified in the request message.
Reserved	1 byte	—	00h (fixed)
Number of data value	2 bytes	Little	Write data: Specify the size in hexadecimal. (Unit: byte)
Write data	Variable	Little	Specify the write data of the object.

■Object SubID Read Block (object sub-ID continuous read)

When an object sub ID continuous read request is given by the master station (external device), the value of the object corresponding to the specified Index and the continuous Sub Index is returned.

- Request message (after the command)

Command		Sub command		Index		Sub Index	Reserved	Number of data value	
L	H	L	H	L	H	—	—	L	H
20h	40h	05h	00h	Refer to "Item list" below for details.					

- Response message (at normal termination (after the end code))



End code		Index		Sub Index	Reserved	Number of data value		Read data
L	H	L	H	—	—	L	H	L variable H
00h	00h	Refer to "Item list" below for details.						

- Response message (at abnormal termination)

It is the same as "At abnormal termination" in the reference below.

 Page 111 Response message format

- Item list

Item	Size	Endian	Description
Command	2 bytes	Little	4020h
Sub command	2 bytes	Little	0005h
Index	2 bytes	Little	Specify Index of the object. ( MR-J5-G/MR-J5W-G User's Manual (Object Dictionary)) The response message stores the value specified in the request message.
Sub Index	1 byte	Little	Specify Sub Index of the object. ( MR-J5-G/MR-J5W-G User's Manual (Object Dictionary)) The response message stores the value specified in the request message.
Reserved	1 byte	—	00h (fixed)
Number of data value	2 bytes	Little	Read data: Data size In the request message, it is 00h (fixed).
Read data	Variable	Little	The return data of the object is stored.

■ Object SubID Write Block (object sub-ID continuous write)

When an object sub-ID continuous write request is given by the master station (external device), the specified value is written to the object corresponding to the specified Index and the continuous Sub Index.

- Request message (after the command)

Command		Sub command		Index		Sub Index	Reserved	Number of data value		Write data
L	H	L	H	L	H	—	—	L	H	L variable H
20h	40h	06h	00h	Refer to "Item list" below for details.						

- Response message (at normal termination (after the end code))



End code		Index		Sub Index	Reserved	Number of data value	
L	H	L	H	—	—	L	H
00h	00h	Refer to "Item list" below for details.					

- Response message (at abnormal termination)

It is the same as "At abnormal termination" in the reference below.

 Page 111 Response message format

- Item list

Item	Size	Endian	Description
Command	2 bytes	Little	4020h
Sub command	2 bytes	Little	0006h
Index	2 bytes	Little	Specify Index of the object. ( MR-J5-G/MR-J5W-G User's Manual (Object Dictionary)) The response message stores the value specified in the request message.
Sub Index	1 byte	Little	Specify Sub Index of the object. ( MR-J5-G/MR-J5W-G User's Manual (Object Dictionary)) The response message stores the value specified in the request message.
Reserved	1 byte	—	00h (fixed)
Number of data value	2 bytes	Little	Write data: Specify the size in hexadecimal. (Unit: byte)
Write data	Variable	Little	Specify the write data of the object.

End code

The following shows end codes that are stored by the servo amplifier for SLMP.

End code	Cause
0000h	The request was processed normally.
C059h	<ul style="list-style-type: none">• There is an error in the command or subcommand specification.• A command that is not prescribed is received.
C05Ch	There is an error in the request message.
C061h	The requested data length does not match the number of data.
CEE0h	The request cannot be processed because another request is in progress.
CEE1h	The requested message size has exceeded the processable range.
CEE2h	The response message size has exceeded the processable range.
CCCAh	A non-existent Index was specified.
CCD0h	The data size is different from the specified value.
CCD1h	The data size is larger than the specified value.
CCD2h	The data size is smaller than the specified value.
CCD3h	A non-existent Sub Index was specified.
CCC8h	Read operation was performed to a write only object.
CCC9h	<ul style="list-style-type: none">• Write operation was performed to a read only object.• The object is not read only for all AL states, but it was written to an object that cannot be written in the current AL state.
CCC7h	Write operation was performed to a response message mapped object. The following were written when the response message mapped object was not in the state where change is permitted. <ul style="list-style-type: none">• Anything other than "0" was written to Sub Index 0.• Write operation was performed to the corresponding Sub Index 1 to 32.
CCCBh	An object for which the response message mapping cannot be performed was written to the response message mapped object.
CCCCh	The total size of the response message mapped objects exceeds 64 bytes.
CCD4h	A value outside the parameter range was written.
CCD5h	A value larger than the parameter range was written.
CCD6h	A value smaller than the parameter range was written.

Drive profile

This section explains the CiA 402 drive profile specification as well as the unique functions of servo amplifiers. Each function can be controlled by using the object dictionary via the network.

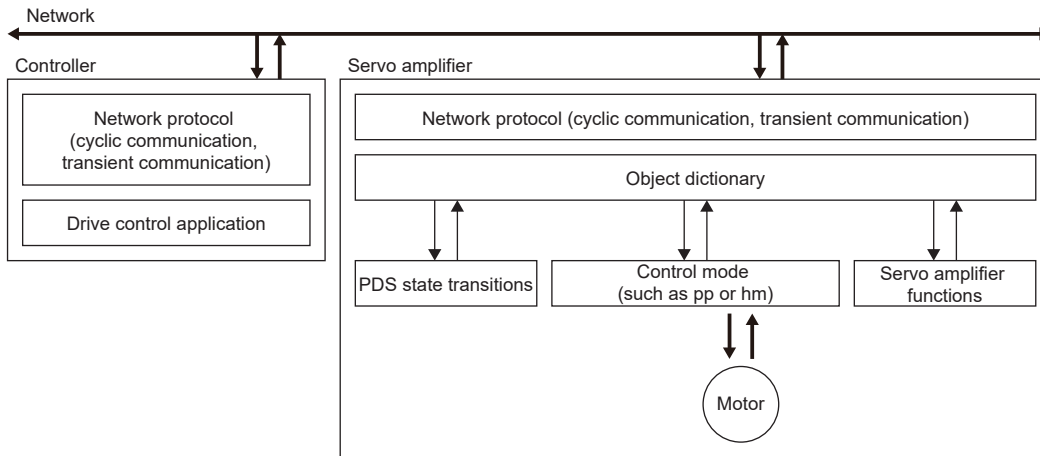

A list of drive profile specifications is as follows.

Function name	Description	Reference
Control mode	Control such as the position mode, speed mode, and torque mode	☞ Page 134 Control mode
PDS state transitions	Control method until the servo motor starts to operate	☞ Page 118 PDS state transitions
Controlword/Control DI	Control of each function	☞ Page 121 Controlword/Control DI
Statusword/Status DO	Monitor of each function	☞ Page 127 Statusword/Status DO

PDS state transitions

The internal state of the servo amplifier is managed by the PDS state defined in the CiA 402 drive profile specification. The servo motor can be operated immediately after turning on the power supply by shifting from the "Not ready to switch on" state to the "Operation enabled" state with the predetermined procedure.

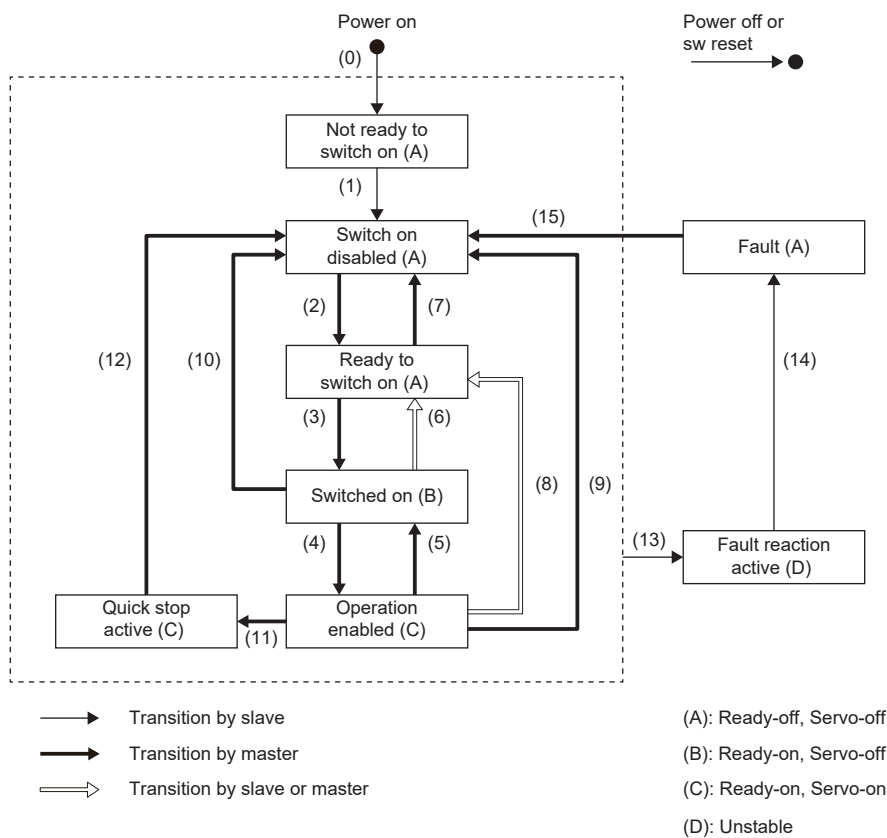

Events and PDS state transitions

Setting Controlword enables control of the state transitions.

After the PDO communication is established (after the AL state has reached "Operational"), the status is controlled by the master station transmitting commands (by setting Controlword) in accordance with the following table.

The following shows the PDS state transition events and operations.

Transition No.	Event	Operation
(0)	Control circuit power supply is turned on	Initialization
(1)	Transitions automatically when the control circuit power supply is turned on	Communication setting
(2)	Transitions with the "Shutdown" command from the master station	None
(3)	Transitions with the "Switch On" command from the master station	The dynamic brake is released.
(4)	Transitions with the "Enable Operation" command from the master station	The operation becomes ready after servo-on.
(5)	Transitions with the "Disable Operation" command from the master station	The operation is disabled after servo-off.
(6)	Transitions with the "Shutdown" command from the master station	The dynamic brake operates.
(7)	Transitions with the "Disable Voltage" command or "Quick Stop" command from the master station	None
(8)	(A) Transitions with the "Shutdown" command from the master station (B) Transitions when the main circuit power supply is turned off	The operation is disabled after servo-off or dynamic braking.
(9)	Transitions with the "Disable Voltage" command from the master station	The operation is disabled after servo-off or dynamic braking.
(10)	Transitions with the "Disable Voltage" command or "Quick Stop" command from the master station	The dynamic brake operates.
(11)	(A) Transitions with the "Quick Stop" command from the master station (B) Transitions when the forced stop signal is turned off *1	Quick Stop starts.
(12)	Transitions automatically after the completion of Quick Stop (when the value of [Quick stop option code (Obj. 605Ah)] is any of "1", "2", "3", or "4")	The operation is disabled after servo-off or dynamic braking.
(13)	Alarm occurrence	Processing against the alarm is executed.
(14)	Automatic transition	After the completion of the alarm occurrence processing, the operation is disabled by servo-off or the dynamic brake.
(15)	Transitions with the "Fault Reset" command from the master station	An alarm reset is performed. Resettable alarms are cleared.

*1 This event occurs when "1" (Quick stop active) is selected in [Pr. PF29.1 State selection with forced stop in progress].

The following shows the related correspondence between the command bit setting and the PDS state. In order to avoid missing the command at the time of communication error, maintain the state of Bit 7 = 1 on the Fault Reset command for at least 10 ms when the communication cycle is 4 ms or less, or at least 20 ms when the communication cycle is 8 ms.

0: Off 1: On ×: Neither on/off has an influence on the process

Command	Command Bit setting of Controlword					Transition No.
	Bit 7 Fault Reset	Bit 3 Enable Operation	Bit 2 Quick Stop	Bit 1 Enable Voltage	Bit 0 Switch On	
Shutdown	0	×	1	1	0	(2), (6), (8)
Switch On	0	0	1	1	1	(3)
Disable Voltage	0	×	×	0	×	(7), (9), (10), (12)
Quick Stop	0	×	0	1	×	(7), (10), (11)
Disable Operation	0	0	1	1	1	(5)
Enable Operation	0	1	1	1	1	(4), (16)
Fault Reset	0 to 1	×	×	×	×	(15)

In order to transition from the "Switch on disabled" state to the "Operation enabled" state, it is necessary to give each command of the "Shutdown", "Switch On", and "Enable Operation" sequentially. However, it is also possible to transit directly from the ongoing state to the target state with one command.

Current state	Command	Status after transition
Switch on disabled	Switch On	Switched on
Switch on disabled	Enable Operation	Operation enabled
Ready to switch on	Enable Operation	Operation enabled

Controlword/Control DI

By rewriting the Controlword and Control DI x objects from the master station, the PDS state can be switched and control instructions for various drive-provided functions can be given. [Controlword (Obj. 6040h)] is used for the control commands defined by CiA 402, and [Control DI 1 (Obj. 2D01h)] to [Control DI 10 (Obj. 2D0Ah)] are used for the control commands defined by Mitsubishi Electric.

The correspondence information of Control DI can be checked with [Supported Control DI (Obj. 2D00h)].

Index	Sub	Object	Name	Data Type	Access	Description
6040h	—	VAR	Controlword	U16	rw	—
2D00h	0	ARRAY	Supported Control DI	U8	ro	Correspondence information of Control DI
2D00h	1	ARRAY	Supported Control DI 1	U16	ro	Correspondence information for Control DI 1 When the signal is unsupported, the corresponding bit is "0". When the signal is supported, the corresponding bit is "1". When the signals corresponding to Control DI are Bit 4 and Bit 5, "0030h" is displayed.
:						
2D00h	10	ARRAY	Supported Control DI 10	U16	ro	Correspondence information for Control DI 10
2D01h	—	VAR	Control DI 1	U16	rw	Objects defined by Mitsubishi Electric
:						
2D0Ah	—	VAR	Control DI 10	U16	rw	Objects defined by Mitsubishi Electric

Bit definition of Controlword



Bit *1	Symbol	Description	Reference
0	SO	Switch On	☞ Page 119 Events and PDS state transitions
1	EV	Enable Voltage	
2	QS	Quick Stop	
3	EO	Enable Operation	
4	OMS	The contents differ depending on the setting of [Modes of operation (Obj. 6060h)].	Refer to "Control mode [G]" in the following manual. 📖 MR-J5 User's Manual (Function)
5			
6			
7	FR	Fault Reset	☞ Page 119 Events and PDS state transitions
8	HALT	0: Operation ready 1: Temporary stop	Refer to "Halt [G]" in the following manual. 📖 MR-J5 User's Manual (Function)
9	OMS	The contents differ depending on the setting of [Modes of operation (Obj. 6060h)].	Refer to "Control mode [G]" in the following manual. 📖 MR-J5 User's Manual (Function)
10	—	The value at reading is undefined. Set "0" when writing.	—
11	—		—
12	—		—
13	—		—
14	—		—
15	—		—

*1 Bit 0 to 3 and 7 are used for PDS state switching.



■Bit definition of Control DI

With the communication function, reading the following objects enables reading of the on/off state of the input device. In addition, the input device can be set to on/off by writing to the following objects.

• Control DI 1

Bit	Symbol	Description	Reference
0	—	The value at reading is undefined. Set "0" when writing.	—
1	—		—
2	—		—
3	—		—
4	C_CDP	Gain switching	Refer to "Signal (device) explanations" in the following manual.  MR-J5 User's Manual (Hardware)  MR-J5D User's Manual (Hardware)
5	C_CLD	Fully closed loop selection	
6	—	The value at reading is undefined. Set "0" when writing.	—
7	—		—
8	—		—
9	—		—
10	—		—
11	—		—
12	—		—
13	—		—
14	—		—
15	—		—

• Control DI 2

Bit	Symbol	Description	Reference
0	—	The value at reading is undefined. Set "0" when writing.	—
1	—		—
2	—		—
3	—		—
4	—		—
5	—		—
6	—		—
7	—		—
8	C_PC	Proportional control	Refer to "Signal (device) explanations" in the following manual.  MR-J5 User's Manual (Hardware)  MR-J5D User's Manual (Hardware)
9	—	The value at reading is undefined. Set "0" when writing.	—
10	—		—
11	—		—
12	—		—
13	—		—
14	—		—
15	C_ORST	Operation alarm reset	—

- Control DI 3

Bit	Symbol	Description	Reference
0	—	The value at reading is undefined. Set "0" when writing.	—
1	—		—
2	—		—
3	—		—
4	—		—
5	—		—
6	—		—
7	—		—
8	C_ABS2	Homing completion (for scale measurement)	—
9	—	The value at reading is undefined. Set "0" when writing.	—
10	—		—
11	—		—
12	—		—
13	—		—
14	—		—
15	—		—

- Control DI 4

Bit	Symbol	Description	Reference
0	—	The value at reading is undefined. Set "0" when writing.	—
1	—		—
2	—		—
3	—		—
4	—		—
5	—		—
6	—		—
7	—		—
8	—		—
9	—		—
10	—		—
11	—		—
12	—		—
13	—		—
14	—		—
15	—		—

• Control DI 5

Bit	Symbol	Description	Reference
0	—	The value at reading is undefined. Set "0" when writing.	—
1	—		—
2	—		—
3	—		—
4	C_CDP2	Gain switching 2	Refer to "Signal (device) explanations" in the following manual. MR-J5 User's Manual (Hardware) MR-J5D User's Manual (Hardware)
5	—	The value at reading is undefined. Set "0" when writing.	—
6	—		—
7	—		—
8	—		—
9	C_FLS	Input of upper stroke limit	Refer to "Stroke limit function [G]" in the following manual. MR-J5 User's Manual (Function)
10	C_RLS	Input of lower stroke limit	
11	C_DOG	Proximity dog	Refer to "Signal (device) explanations" in the following manual. MR-J5 User's Manual (Hardware) MR-J5D User's Manual (Hardware)
12	—	The value at reading is undefined. Set "0" when writing.	—
13	—		—
14	—		—
15	—		—

• Control DI 6

Bit	Symbol	Description	Reference
0	—	The value at reading is undefined. Set "0" when writing.	—
1	—		—
2	—		—
3	—		—
4	—		—
5	—		—
6	—		—
7	—		—
8	—		—
9	—		—
10	—		—
11	—		—
12	—		—
13	—		—
14	—		—
15	—		—

- Control DI 7

Bit	Symbol	Description	Reference
0	—	The value at reading is undefined. Set "0" when writing.	—
1	—		—
2	—		—
3	—		—
4	—		—
5	—		—
6	—		—
7	C_OVR *1	Override selection	Refer to "Override function" in the following manual.  MR-J5 User's Manual (Function)
8	—	The value at reading is undefined. Set "0" when writing	—
9	—		—
10	—		—
11	—		—
12	—		—
13	—		—
14	—		—
15	—		—

*1 Available on servo amplifiers with firmware version D4 or later.

- Control DI 8

Bit	Symbol	Description	Reference
0	—	The value at reading is undefined. Set "0" when writing.	—
1	—		—
2	—		—
3	—		—
4	—		—
5	—		—
6	—		—
7	—		—
8	—		—
9	—		—
10	—		—
11	—		—
12	—		—
13	—		—
14	—		—
15	—		—

• Control DI 9

Bit	Symbol	Description	Reference
0	—	The value at reading is undefined. Set "0" when writing.	—
1	—		—
2	—		—
3	—		—
4	—		—
5	—		—
6	—		—
7	—		—
8	—		—
9	—		—
10	—		—
11	—		—
12	—		—
13	—		—
14	—		—
15	—		—

• Control DI 10

Bit	Symbol	Description	Reference
0	—	The value at reading is undefined. Set "0" when writing.	—
1	—		—
2	—		—
3	—		—
4	—		—
5	—		—
6	—		—
7	—		—
8	—		—
9	—		—
10	—		—
11	—		—
12	—		—
13	—		—
14	—		—
15	—		—

Statusword/Status DO

The Statusword objects and the Status DO x objects notify the master station of the PDS state and other drive states. States defined by CiA 402 are notified by using [Statusword (Obj. 6041h)], and other states defined by Mitsubishi Electric are notified by using [Status DO 1 (Obj. 2D11h)] to [Status DO 10 (Obj. 2D1Ah)].

Index	Sub	Object	Name	Data Type	Access	Description
6041h	—	VAR	Statusword	U16	ro	—
2D11h	—	VAR	Status DO 1	U16	ro	Objects defined by Mitsubishi Electric
:						
2D17h	—	VAR	Status DO 7	U16	ro	Objects defined by Mitsubishi Electric
2D1Ah	—	VAR	Status DO 10	U16	ro	Objects defined by Mitsubishi Electric

Bit definition of Statusword

Bit	Symbol	Description	Reference
0	RTSO	Ready-to-switch-on	☞ Page 119 Events and PDS state transitions
1	SO	Switch-on	
2	OE	Operation-enabled	
3	F	Fault	
4	VE	Voltage-enabled 0: The bus voltage is lower than the specified (RA) level. 1: The bus voltage is equal to or higher than the specified level.	—
5	QS	Quick stop 0: In a Quick stop 1: Not in a Quick stop (including in the test mode)	☞ Page 119 Events and PDS state transitions
6	SOD	Switch on disabled	
7	W	Warning 0: No warning has occurred. 1: A warning has occurred.	—
8	—	Reserved The value at reading is undefined.	—
9	RM	Remote 0: When not following the Controlword command 1: Operating in accordance with the Controlword command	—
10	TR	Target reached The contents differ depending on the setting of [Modes of operation (Obj. 6060h)].	Refer to "Control mode [G]" in the following manual. 📖 MR-J5 User's Manual (Function)
11	ILA	Internal limit active 0: The forward rotation stroke end, reverse rotation stroke end, and software position limit have not been reached. 1: The forward rotation stroke end, reverse rotation stroke end, or software position limit has been reached. (Enabled in pp, pv, hm, pt, or jg mode)	—
12	OMS	Operation Mode Specific	Refer to "Control mode [G]" in the following manual. 📖 MR-J5 User's Manual (Function)
13		The contents differ depending on the setting of [Modes of operation (Obj. 6060h)].	
14	—	Reserved	—
15	—	The value at reading is undefined.	—

- State coding

Bit 0 to Bit 3, Bit 5, and Bit 6 are switched depending on the PDS state (servo amplifier internal state). Details are as follows:





Statusword (bin)	PDS state
x0xx xxx0 x0xx 0000	Not ready to switch on *1
x0xx xxx0 x1xx 0000	Switch on disabled
x0xx xxx0 x01x 0001	Ready to switch on
x0xx xxx0 x01x 0011	Switched on
x0xx xxx0 x01x 0111	Operation enabled
x0xx xxx0 x00x 0111	Quick stop active
x0xx xxx0 x0xx 1111	Fault reaction active
x0xx xxx0 x0xx 1000	Fault

*1 Statusword is not sent when in the "Not ready to switch on" state.



■Bit definition of Status DO

With the communication function, the on/off state of the output device can be checked by reading the following objects.



- Status DO 1

Bit	Symbol	Description	Reference
0	—	The value at reading is undefined.	—
1	—		—
2	S_SA	Speed reached	Refer to "Signal (device) explanations" in the following manual.  MR-J5 User's Manual (Hardware)  MR-J5D User's Manual (Hardware)
3	S_MBR	Electromagnetic brake interlock	
4	S_CDPS	Variable gain enabled	
5	S_CLDS	Fully closed loop control in progress	
6	—	The value at reading is undefined.	—
7	—		—
8	—		—
9	—		—
10	—		—
11	—		—
12	S_INP	In-position	Refer to "Signal (device) explanations" in the following manual.
13	S_TLC	Limiting torque	
14	S_ABSV	Absolute position erased 1: Absolute position is erased	 MR-J5 User's Manual (Hardware)  MR-J5D User's Manual (Hardware)
15	S_BWNG	Battery warning	

• Status DO 2

Bit	Symbol	Description	Reference
0	S_ZPASS	Z-phase already passed After the Z-phase is passed, S_ZPASS turns on.	—
1	—	The value at reading is undefined.	—
2	—		—
3	S_ZSP	Zero speed detection	Refer to "Signal (device) explanations" in the following manual.  IMR-J5 User's Manual (Hardware)  IMR-J5D User's Manual (Hardware)
4	S_VLC	Limiting speed	
5	—	The value at reading is undefined.	—
6	—		—
7	—		—
8	S_PC		Proportional control in progress S_PC is turned on under proportional control.
9	—	The value at reading is undefined.	—
10	—		—
11	—		—
12	—		—
13	—		—
14	—		—
15	S_ZP2	Homing completion 2 When homing finishes successfully, S_ZP2 turns on.	—

• Status DO 3

Bit	Symbol	Description	Reference
0	—	The value at reading is undefined.	—
1	—		—
2	—		—
3	—		—
4	—		—
5	S_STO	In STO state S_STO turns on in STO state.	Refer to "Monitor signal (digital) [G]" in the following manual.  IMR-J5 User's Manual (Function)
6	—	The value at reading is undefined.	—
7	—		—
8	—		—
9	S_RSTP	During forced stop deceleration During forced stop deceleration, S_RSTP is on.	—
10	—	The value at reading is undefined.	—
11	S_MTTR	Tough drive in progress	Refer to "Tough drive function" in the following manual.  IMR-J5 User's Manual (Function)
12	—	The value at reading is undefined.	—
13	—		—
14	—		—
15	—		—

• Status DO 4

Bit	Symbol	Description	Reference
0	—	The value at reading is undefined.	—
1	—		—
2	—		—
3	—		—
4	—		—
5	—		—
6	—		—
7	—		—
8	—		—
9	—		—
10	—		—
11	—		—
12	—		—
13	—		—
14	—		—
15	—		—

• Status DO 5

Bit	Symbol	Description	Reference
0	—	The value at reading is undefined.	—
1	—		—
2	—		—
3	—		—
4	S_CDPS2	Variable gain enabled 2	Refer to "GAIN SWITCHING FUNCTION" in the following manual. IMR-J5 User's Manual (Adjustment)
5	S_CPO	Rough match When the command remaining distance is less than the value of the rough match output range set in [Pr. PT12], S_CPO is on. This is not outputted during base circuit shut-off. When the servo amplifier is switched to the servo-on state, S_CPO switches on.	—
6	S_MEND	Traveling completion If droop pulses are within the in-position output range set in [Pr. PA10] and the command remaining distance is "0", S_MEND turns on. S_MEND turns on at servo-on. S_MEND is off in the servo-off status.	—
7	—	The value at reading is undefined.	—
8	—		—
9	—		—
10	S_PNLT *1	Open phase condition	Refer to "Disconnection/incorrect wiring detection function" in the following manual. IMR-J5 User's Manual (Function)
11	—	The value at reading is undefined.	—
12	—		—
13	—		—
14	—		—
15	—		—

*1 Available on servo amplifiers with firmware version C4 or later.

- Status DO 6

Bit	Symbol	Description	Reference
0	—	The value at reading is undefined.	—
1	—		—
2	—		—
3	—		—
4	—		—
5	—		—
6	—		—
7	—		—
8	—		—
9	—		—
10	—		—
11	—		—
12	—		—
13	—		—
14	—		—
15	—		—

- Status DO 7

Bit	Symbol	Description	Reference
0	—	The value at reading is undefined.	—
1	—		—
2	S_POT	Position range When the actual current position is within the range set in [Pr. PT19] and [Pr. PT21], S_POT is on. When homing is not complete or base circuit shut-off is in progress, S_POT is off.	—
3	—	The value at reading is undefined.	—
4	—		—
5	—		—
6	—		—
7	—		—
8	—		—
9	—		—
10	—		—
11	—		—
12	—		—
13	—		—
14	—		—
15	—		—

• Status DO 8

Bit	Symbol	Description	Reference
0	—	The value at reading is undefined.	—
1	—		—
2	—		—
3	—		—
4	—		—
5	—		—
6	—		—
7	—		—
8	—		—
9	—		—
10	—		—
11	—		—
12	—		—
13	—		—
14	—		—
15	—		—

• Status DO 9

Bit	Symbol	Description	Reference
0	—	The value at reading is undefined.	—
1	—		—
2	—		—
3	—		—
4	—		—
5	—		—
6	—		—
7	—		—
8	—		—
9	—		—
10	—		—
11	—		—
12	—		—
13	—		—
14	—		—
15	—		—

• Status DO 10

Bit	Symbol	Description	Reference
0	—	The value at reading is undefined.	—
1	—		—
2	—		—
3	—		—
4	—		—
5	—		—
6	—		—
7	—		—
8	—		—
9	—		—
10	—		—
11	—		—
12	—		—
13	—		—
14	—		—
15	—		—

Control mode

For the list of control modes, refer to the "Function explanation" in the following manual.

 MR-J5 User's Manual (Function)

■ Selecting control mode (Modes of operation)

Specify a control mode with [Modes of operation (Obj. 6060h)]. [Modes of operation (Obj. 6060h)] can be rewritten with a PDO or an SDO. The available control modes are limited as follows depending on the setting value of [Pr. PT01.2].

○: Supported, —: Not supported

[Pr. PA01.0]	[Pr. PT01.2]	pp	pv	tq	hm	kg	pt	6061h Initial value
0	0 (mm) *1	—	—	—	—	—	—	8 (csp)
	1 (inch) *1	—	—	—	—	—	—	
	2 (degree)	○	○	○	○	—	—	1 (pp)
	3 (pulse)	○	○	○	○	—	—	8 (csp)
6	0 (mm)	—	—	—	○	○	○	-101 (pt)
	1 (inch)	—	—	—	○	○	○	
	2 (degree)	—	—	—	○	○	○	
	3 (pulse)	—	—	—	○	○	○	

*1 Setting "0" and "1" on [Pr. PT01.2] triggers [AL. 037 Parameter error].

• Related objects

Index	Sub Index	Object	Name	Data Type	Access	Default value	Description
6060h	0	VAR	Modes of operation	I8	rw	0h	 MR-J5-G/MR-J5W-G User's Manual (Object Dictionary)
6061h	0	VAR	Modes of operation display	I8	ro	—	
6502h	0	VAR	Supported drive mode	U32	ro	000003A0h	

REVISIONS

*The manual number is given on the bottom left of the back cover.

Revision date	*Manual number	Description
July 2019	SH(NA)-030302ENG-A	First edition
January 2020	SH(NA)-030302ENG-B	<p>■The following functions are added: Profile mode, fully closed loop system</p> <p>■Edited: Section 1.1, Section 1.3, Section 2.1</p>
July 2020	SH(NA)-030302ENG-C	<p>■The following function is added: Continuous operation to torque control mode</p> <p>■Edited: Section 1.1, Section 1.3, Section 2.1</p>
November 2020	SH(NA)-030302ENG-D	<p>■The following functions are added: Degree unit, communication speed of 100 Mbps, PDO mapping for the profile mode</p> <p>■Edited: Section 1.1, Section 1.2, Section 2.1</p>
March 2021	SH(NA)-030302ENG-E	<p>■The following function is added: Positioning mode (point table method)</p> <p>■Edited: Section 1.1, Section 2.1</p>
June 2021	SH(NA)-030302ENG-F	<p>■The following model and function are added: MR-J5D_-_G_, CC-Link IE Field Network Basic</p> <p>■Edited: Section 1.1, Section 1.2, Section 1.3, Section 1.4, Chapter 2</p>
July 2022	SH(NA)-030302ENG-G	<p>■The following functions are added and changed: Master-slave operation function, Quick Stop</p> <p>■Added/edited: Chapter 1, Section 2.4</p>
January 2023	SH(NA)-030302ENG-H	<p>■The following function is added and changed: Override function</p> <p>■Added/edited: Section 1.1, Section 1.3, Section 1.4, Section 2.4</p>

This manual confers no industrial property rights or any rights of any other kind, nor does it confer any patent licenses. Mitsubishi Electric Corporation cannot be held responsible for any problems involving industrial property rights which may occur as a result of using the contents noted in this manual.

© 2019 MITSUBISHI ELECTRIC CORPORATION

WARRANTY

Warranty

1. Warranty period and coverage

We will repair any failure or defect hereinafter referred to as "failure" in our FA equipment hereinafter referred to as the "Product" arisen during warranty period at no charge due to causes for which we are responsible through the distributor from which you purchased the Product or our service provider. However, we will charge the actual cost of dispatching our engineer for an on-site repair work on request by customer in Japan or overseas countries. We are not responsible for any on-site readjustment and/or trial run that may be required after a defective unit are repaired or replaced.

[Term]

For terms of warranty, please contact your original place of purchase.

[Limitations]

(1) You are requested to conduct an initial failure diagnosis by yourself, as a general rule.

It can also be carried out by us or our service company upon your request and the actual cost will be charged. However, it will not be charged if we are responsible for the cause of the failure.

(2) This limited warranty applies only when the condition, method, environment, etc. of use are in compliance with the terms and conditions and instructions that are set forth in the instruction manual and user manual for the Product and the caution label affixed to the Product.

(3) Even during the term of warranty, the repair cost will be charged on you in the following cases;

1. a failure caused by your improper storing or handling, carelessness or negligence, etc., and a failure caused by your hardware or software problem
2. a failure caused by any alteration, etc. to the Product made on your side without our approval
3. a failure which may be regarded as avoidable, if your equipment in which the Product is incorporated is equipped with a safety device required by applicable laws and has any function or structure considered to be indispensable according to a common sense in the industry
4. a failure which may be regarded as avoidable if consumable parts designated in the instruction manual, etc. are duly maintained and replaced
5. any replacement of consumable parts (battery, fan, smoothing capacitor, etc.)
6. a failure caused by external factors such as inevitable accidents, including without limitation fire and abnormal fluctuation of voltage, and acts of God, including without limitation earthquake, lightning and natural disasters
7. a failure generated by an unforeseeable cause with a scientific technology that was not available at the time of the shipment of the Product from our company
8. any other failures which we are not responsible for or which you acknowledge we are not responsible for

2. Term of warranty after the stop of production

(1) We may accept the repair at charge for another seven (7) years after the production of the product is discontinued. The announcement of the stop of production for each model can be seen in our Sales and Service, etc.

(2) Please note that the Product (including its spare parts) cannot be ordered after its stop of production.

3. Service in overseas countries

Our regional FA Center in overseas countries will accept the repair work of the Product. However, the terms and conditions of the repair work may differ depending on each FA Center. Please ask your local FA center for details.

4. Exclusion of loss in opportunity and secondary loss from warranty liability

Regardless of the gratis warranty term, Mitsubishi shall not be liable for compensation to:

- (1) Damages caused by any cause found not to be the responsibility of Mitsubishi.
- (2) Loss in opportunity, lost profits incurred to the user by Failures of Mitsubishi products.
- (3) Special damages and secondary damages whether foreseeable or not, compensation for accidents, and compensation for damages to products other than Mitsubishi products.
- (4) Replacement by the user, maintenance of on-site equipment, start-up test run and other tasks.

5. Change of Product specifications

Specifications listed in our catalogs, manuals or technical documents may be changed without notice.

6. Application and use of the Product

- (1) For the use of our AC Servo, its applications should be those that may not result in a serious damage even if any failure or malfunction occurs in AC Servo, and a backup or fail-safe function should operate on an external system to AC Servo when any failure or malfunction occurs.
- (2) Our AC Servo is designed and manufactured as a general purpose product for use at general industries. Therefore, applications substantially influential on the public interest for such as atomic power plants and other power plants of electric power companies, and also which require a special quality assurance system, including applications for railway companies and government or public offices are not recommended, and we assume no responsibility for any failure caused by these applications when used.
In addition, applications which may be substantially influential to human lives or properties for such as airlines, medical treatments, railway service, incineration and fuel systems, man-operated material handling equipment, entertainment machines, safety machines, etc. are not recommended, and we assume no responsibility for any failure caused by these applications when used. We will review the acceptability of the abovementioned applications, if you agree not to require a specific quality for a specific application. Please contact us for consultation.
- (3) Mitsubishi Electric shall have no responsibility or liability for any problems involving programmable controller trouble and system trouble caused by DoS attacks, unauthorized access, computer viruses, and other cyberattacks.

TRADEMARKS

MELSERVO is a trademark or registered trademark of Mitsubishi Electric Corporation in Japan and/or other countries. All other product names and company names are trademarks or registered trademarks of their respective companies.

SH(NA)-030302ENG-H(2301)MEE

MODEL:

MODEL CODE:

MITSUBISHI ELECTRIC CORPORATION

HEAD OFFICE: TOKYO BLDG., 2-7-3, MARUNOUCHI, CHIYODA-KU, TOKYO 100-8310, JAPAN
NAGOYA WORKS: 1-14, YADA-MINAMI 5-CHOME, HIGASHI-KU, NAGOYA 461-8670, JAPAN

When exported from Japan, this manual does not require application to the
Ministry of Economy, Trade and Industry for service transaction permission.

Specifications are subject to change without notice.

Compliance with the indicated global standards and regulations is current as of the release date of this manual.