

General-Purpose AC Servo

MITSUBISHI SERVO AMPLIFIERS & MOTORS

MELSERVO-JE

Ethernet Interface

MODEL

MR-JE- _C

SERVO AMPLIFIER

INSTRUCTION MANUAL

(PROFILE MODE)

● Safety Instructions ●

Please read the instructions carefully before using the equipment.

To use the equipment correctly, do not attempt to install, operate, maintain, or inspect the equipment until you have read through this Instruction Manual, Installation guide, and appended documents carefully. Do not use the equipment until you have a full knowledge of the equipment, safety information and instructions. In this Instruction Manual, the safety instruction levels are classified into "WARNING" and "CAUTION".



Indicates that incorrect handling may cause hazardous conditions, resulting in death or severe injury.



Indicates that incorrect handling may cause hazardous conditions, resulting in medium or slight injury to personnel or may cause physical damage.

Note that the CAUTION level may lead to a serious consequence according to conditions. Please follow the instructions of both levels because they are important to personnel safety. What must not be done and what must be done are indicated by the following diagrammatic symbols.



Indicates what must not be done. For example, "No Fire" is indicated by .



Indicates what must be done. For example, grounding is indicated by .

In this Instruction Manual, instructions at a lower level than the above, instructions for other functions, and so on are classified into "POINT".

After reading this Instruction Manual, keep it accessible to the operator.

1. To prevent electric shock, note the following

WARNING

- Before wiring and inspections, turn off the power and wait for 15 minutes or more until the charge lamp turns off. Otherwise, an electric shock may occur. In addition, when confirming whether the charge lamp is off or not, always confirm it from the front of the servo amplifier.
- Ground the servo amplifier and servo motor securely.
- Any person who is involved in wiring and inspection should be fully competent to do the work.
- Do not attempt to wire the servo amplifier and servo motor until they have been installed. Otherwise, it may cause an electric shock.
- Do not operate switches with wet hands. Otherwise, it may cause an electric shock.
- The cables should not be damaged, stressed, loaded, or pinched. Otherwise, it may cause an electric shock.
- To prevent an electric shock, always connect the protective earth (PE) terminal (marked \oplus) of the servo amplifier to the protective earth (PE) of the cabinet.
- To avoid an electric shock, insulate the connections of the power supply terminals.

2. To prevent fire, note the following

CAUTION

- Install the servo amplifier, servo motor, and regenerative resistor on incombustible material. Installing them directly or close to combustibles will lead to smoke or a fire.
- Always connect a magnetic contactor between the power supply and the power supply (L1/L2/L3) of the servo amplifier, in order to configure a circuit that shuts down the power supply on the side of the servo amplifier's power supply. If a magnetic contactor is not connected, continuous flow of a large current may cause smoke or a fire when the servo amplifier malfunctions.
- Always connect a molded-case circuit breaker, or a fuse to each servo amplifier between the power supply and the power supply (L1/L2/L3) of the servo amplifier, in order to configure a circuit that shuts down the power supply on the side of the servo amplifier's power supply. If a molded-case circuit breaker or fuse is not connected, continuous flow of a large current may cause smoke or a fire when the servo amplifier malfunctions.
- When using the regenerative resistor, switch power off with the alarm signal. Otherwise, a regenerative transistor malfunction or the like may overheat the regenerative resistor, causing smoke or a fire.
- When you use a regenerative option with an MR-JE-40C to MR-JE-100C, remove the built-in regenerative resistor and wiring from the servo amplifier.
- Provide adequate protection to prevent screws and other conductive matter, oil and other combustible matter from entering the servo amplifier and servo motor.

3. To prevent injury, note the following

CAUTION

- Only the voltage specified in the Instruction Manual should be applied to each terminal. Otherwise, a burst, damage, etc. may occur.
- Connect cables to the correct terminals. Otherwise, a burst, damage, etc. may occur.
- Ensure that polarity (+/-) is correct. Otherwise, a burst, damage, etc. may occur.
- The servo amplifier heat sink, regenerative resistor, servo motor, etc., may be hot while the power is on and for some time after power-off. Take safety measures such as providing covers to avoid accidentally touching them by hands and parts such as cables.

4. Additional instructions

The following instructions should also be fully noted. Incorrect handling may cause a malfunction, injury, electric shock, fire, etc.

(1) Transportation and installation

CAUTION

- Transport the products correctly according to their mass.
- Stacking in excess of the specified number of product packages is not allowed.
- Do not hold the lead wire of the regenerative resistor when transporting the servo amplifier.
- Install the servo amplifier and the servo motor in a load-bearing place in accordance with the Instruction Manual.
- Do not get on or put heavy load on the equipment. Otherwise, it may cause injury.
- The equipment must be installed in the specified direction.
- Leave specified clearances between the servo amplifier and the cabinet walls or other equipment.
- Do not install or operate the servo amplifier and servo motor which have been damaged or have any parts missing.
- Do not block the intake and exhaust areas of the servo amplifier. Otherwise, it may cause a malfunction.
- Do not drop or strike the servo amplifier and servo motor. Isolate them from all impact loads.
- When you keep or use the equipment, please fulfill the following environment.

Item		Environment
Ambient temperature	Operation	0 °C to 55 °C (non-freezing)
	Storage	-20 °C to 65 °C (non-freezing)
Ambient humidity	Operation	5 %RH to 90 %RH (non-condensing)
	Storage	
Ambience		Indoors (no direct sunlight), free from corrosive gas, flammable gas, oil mist, dust, and dirt
Altitude		1000 m or less above sea level
Vibration resistance		5.9 m/s ² , at 10 Hz to 55 Hz (directions of X, Y and Z axes)

- When the product has been stored for an extended period of time, contact your local sales office.
- When handling the servo amplifier, be careful about the edged parts such as corners of the servo amplifier.
- The servo amplifier must be installed in a metal cabinet.
- When fumigants that contain halogen materials such as fluorine, chlorine, bromine, and iodine are used for disinfecting and protecting wooden packaging from insects, they cause malfunction when entering our products. Please take necessary precautions to ensure that remaining materials from fumigant do not enter our products, or treat packaging with methods other than fumigation (heat method). Additionally, disinfect and protect wood from insects before packing products.

(2) Wiring

⚠ CAUTION

- Before removing the CNP1 connector of MR-JE-40C to MR-JE-100C, disconnect the lead wires of the regenerative resistor from the CNP1 connector.
- Wire the equipment correctly and securely. Otherwise, the servo motor may operate unexpectedly.
- Do not install a power capacitor, surge killer, or radio noise filter (optional FR-BIF) on the servo amplifier output side.
- To avoid a malfunction, connect the wires to the correct phase terminals (U/V/W) of the servo amplifier and servo motor.
- Connect the servo amplifier power output (U/V/W) to the servo motor power input (U/V/W) directly. Do not let a magnetic contactor, etc. intervene. Otherwise, it may cause a malfunction.

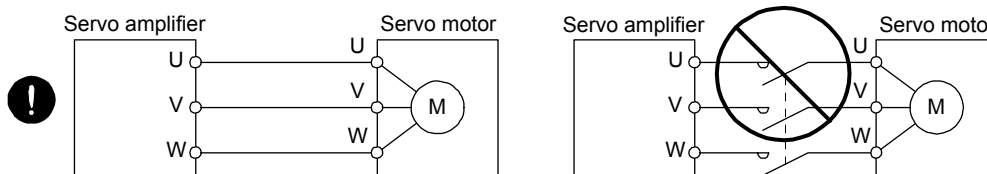

- The connection diagrams in this instruction manual are shown for sink interfaces, unless stated otherwise.
- The surge absorbing diode installed to the DC relay for control output should be fitted in the specified direction. Otherwise, the emergency stop and other protective circuits may not operate.

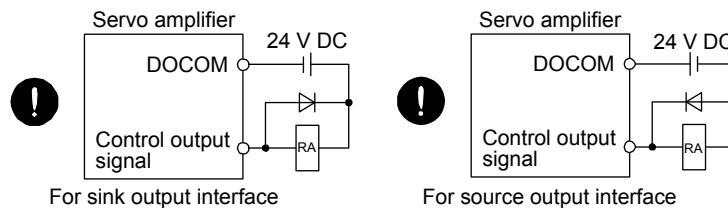

- When the cable is not tightened enough to the terminal block, the cable or terminal block may generate heat because of the poor contact. Be sure to tighten the cable with specified torque.
- Connecting a servo motor of the wrong axis to U, V, W, or CN2 of the servo amplifier may cause a malfunction.
- Configure a circuit to turn off EM2 or EM1 when the power supply is turned off to prevent an unexpected restart of the servo amplifier.

(3) Test run and adjustment

⚠ CAUTION

- Before operation, check the parameter settings. Improper settings may cause some machines to operate unexpectedly.
- Never make a drastic adjustment or change to the parameter values as doing so will make the operation unstable.
- Do not get close to moving parts during the servo-on status.

(4) Usage

⚠ CAUTION

- When it is assumed that a hazardous condition may occur due to a power failure or product malfunction, use a servo motor with an external brake to prevent the condition.
- Do not disassemble, repair, or modify the equipment.
- Before resetting an alarm, make sure that the run signal of the servo amplifier is off in order to prevent a sudden restart. Otherwise, it may cause an accident.
- Use a noise filter, etc. to minimize the influence of electromagnetic interference. Electromagnetic interference may be given to the electronic equipment used near the servo amplifier.
- Burning or breaking a servo amplifier may cause a toxic gas. Do not burn or break it.
- Use the servo amplifier with the specified servo motor.
- The electromagnetic brake on the servo motor is designed to hold the motor shaft and should not be used for ordinary braking.
- For such reasons as service life and mechanical structure (e.g. where a ball screw and the servo motor are coupled via a timing belt), the electromagnetic brake may not hold the motor shaft. To ensure safety, install a stopper on the machine side.

(5) Corrective actions

⚠ CAUTION

- Ensure safety by confirming the power off, etc. before performing corrective actions. Otherwise, it may cause an accident.
- When it is assumed that a hazardous condition may occur due to a power failure or product malfunction, use a servo motor with an electromagnetic brake or external brake to prevent the condition.
- Configure an electromagnetic brake circuit which is interlocked with an external emergency stop switch.

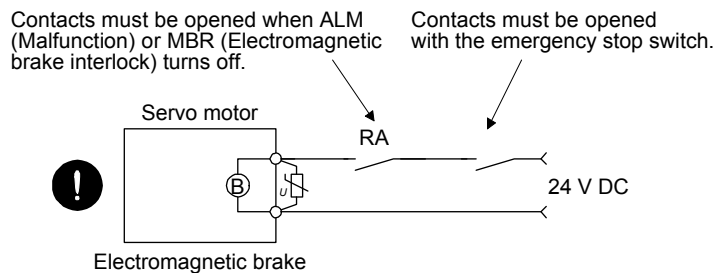

- When any alarm has occurred, eliminate its cause, ensure safety, and deactivate the alarm before restarting operation.
- Provide an adequate protection to prevent unexpected restart after an instantaneous power failure.

(6) Maintenance, inspection and parts replacement

CAUTION

- Make sure that the emergency stop circuit operates properly such that an operation can be stopped immediately and a power is shut off by the emergency stop switch.
- It is recommended that the servo amplifier be replaced every 10 years when it is used in general environment.
- When using a servo amplifier whose power has not been turned on for a long time, contact your local sales office.

(7) General instruction

- To illustrate details, the equipment in the diagrams of this Instruction Manual may have been drawn without covers and safety guards. When the equipment is operated, the covers and safety guards must be installed as specified. Operation must be performed in accordance with this Instruction Manual.

● DISPOSAL OF WASTE ●

Please dispose a servo amplifier, battery (primary battery) and other options according to your local laws and regulations.

EEPROM life

The number of write times to the EEPROM, which stores parameter settings, etc., is limited to 100,000. If the total number of the following operations exceeds 100,000, the servo amplifier may malfunction when the EEPROM reaches the end of its useful life.

- Write to the EEPROM due to parameter setting changes
- Write to the EEPROM due to device changes

Compliance with global standards

For the compliance with global standards, refer to app. 3 of "MR-JE-_C Servo Amplifier Instruction Manual".

«About the manual»

You must have this Instruction Manual and the following manuals to use this servo. Ensure to prepare them to use the servo safely.

Relevant manuals

Manual name	Manual No.
MELSERVO MR-JE-_C Servo Amplifier Instruction Manual	SH(NA)030257ENG
MELSERVO-JE Servo Amplifier Instruction Manual (Troubleshooting)	SH(NA)030166ENG
MELSERVO MR-JE-_C Servo Amplifier Instruction Manual (CC-Link IE Field Network Basic)	SH(NA)030256ENG
MELSERVO HG-KN/HG-SN Servo Motor Instruction Manual	SH(NA)030135ENG
MELSERVO EMC Installation Guidelines	IB(NA)67310ENG

This Instruction Manual does not describe the following items. Refer to the section of the detailed explanation field for details. "MR-JE-_C" means "MR-JE-_C Servo Amplifier Instruction Manual".

Item	Detailed explanation
INSTALLATION	MR-JE-_C chapter 2
NORMAL GAIN ADJUSTMENT	MR-JE-_C chapter 6
SPECIAL ADJUSTMENT FUNCTIONS	MR-JE-_C chapter 7
TROUBLESHOOTING	MR-JE-_C chapter 8
DIMENSIONS	MR-JE-_C chapter 9
CHARACTERISTICS	MR-JE-_C chapter 10
OPTIONS AND PERIPHERAL EQUIPMENT	MR-JE-_C chapter 11
ABSOLUTE POSITION DETECTION SYSTEM (Note)	MR-JE-_C chapter 12
APPENDIX	MR-JE-_C appendix

Note. For the communication-based absolute position transfer system, refer to "MR-JE-_C Servo Amplifier Instruction Manual (CC-Link IE Field Network Basic)".

«Cables used for wiring»

Wires mentioned in this Instruction Manual are selected based on the ambient temperature of 40 °C.

«U.S. customary units»

U.S. customary units are not shown in this manual. Convert the values if necessary according to the following table.

Quantity	SI (metric) unit	U.S. customary unit
Mass	1 [kg]	2.2046 [lb]
Length	1 [mm]	0.03937 [inch]
Torque	1 [N·m]	141.6 [oz·inch]
Moment of inertia	1 [(× 10 ⁻⁴ kg·m ²)]	5.4675 [oz·inch ²]
Load (thrust load/axial load)	1 [N]	0.2248 [lbf]
Temperature	N [°C] × 9/5 + 32	N [°F]

CONTENTS

1. FUNCTIONS AND CONFIGURATION	1- 1 to 1- 4
1.1 Profile mode specification list	1- 2
2. SIGNALS AND WIRING	2- 1 to 2- 4
2.1 I/O signal connection example.....	2- 3
2.2 Connectors and pin assignment.....	2- 4
2.3 Signal (device) explanations.....	2- 4
3. STARTUP	3- 1 to 3- 2
3.1 Startup	3- 1
4. PARAMETERS	4- 1 to 4-32
4.1 Parameter list.....	4- 1
4.1.1 Basic setting parameters ([Pr. PA_ _]).....	4- 1
4.1.2 Gain/filter setting parameters ([Pr. PB_ _]).....	4- 2
4.1.3 Extension setting parameters ([Pr. PC_ _])	4- 4
4.1.4 I/O setting parameters ([Pr. PD_ _])	4- 6
4.1.5 Extension setting 2 parameters ([Pr. PE_ _]).....	4- 7
4.1.6 Extension setting 3 parameters ([Pr. PF_ _]).....	4- 9
4.1.7 Positioning control parameters ([Pr. PT_ _]).....	4-10
4.2 Detailed list of parameters	4-12
4.2.1 Basic setting parameters ([Pr. PA_ _]).....	4-12
4.2.2 Extension setting parameters ([Pr. PC_ _])	4-16
4.2.3 I/O setting parameters ([Pr. PD_ _])	4-19
4.2.4 Extension setting 2 parameters ([Pr. PE_ _]).....	4-21
4.2.5 Positioning control parameters ([Pr. PT_ _]).....	4-22
4.3 Software limit	4-29
4.4 How to set the electronic gear	4-29
4.4.1 Electronic gear setting for the profile mode	4-29
4.5 Restrictions on using objects.....	4-32
4.5.1 Restrictions on input devices	4-32
4.5.2 Restrictions on objects.....	4-32
5. CiA 402 DRIVE PROFILE	5- 1 to 5- 6
5.1 State machine control of the servo amplifier	5- 1
5.1.1 Function description	5- 1
5.1.2 Related object	5- 3
5.1.3 Directions for use	5- 5
5.2 Control mode	5- 6
5.2.1 Function description.....	5- 6
5.2.2 Related object	5- 6
6. SERVO MOTOR DRIVING	6- 1 to 6-44
6.1 Homing mode (hm)	6- 1

6.1.1	Function description	6- 1
6.1.2	Related object	6- 2
6.1.3	Directions for use	6-10
6.2	Profile position mode (pp).....	6-33
6.2.1	Function description	6-33
6.2.2	Related object	6-33
6.2.3	Directions for use	6-36
6.3	Profile velocity mode (pv)	6-37
6.3.1	Function description	6-37
6.3.2	Related object	6-37
6.3.3	Directions for use	6-40
6.4	Profile torque mode (tq).....	6-42
6.4.1	Function description	6-42
6.4.2	Related object	6-42
6.4.3	Directions for use	6-44

1. FUNCTIONS AND CONFIGURATION

1. FUNCTIONS AND CONFIGURATION

This instruction manual describes the items required for using the MR-JE-_C servo amplifier in the profile mode. For details of the objects and communications, refer to "MR-JE-_C Servo Amplifier Instruction Manual (CC-Link IE Field Network Basic)".

The following items are the same as those of MR-JE-_C servo amplifiers. For details, refer to each section indicated in the detailed explanation field. "MR-JE-_C" means "MR-JE-_C Servo Amplifier Instruction Manual".

Item	Detailed explanation
Combinations of servo amplifiers and servo motors	MR-JE-_C section 1.4
Function list	MR-JE-_C section 1.5
Model designation	MR-JE-_C section 1.6
Structure (parts identification)	MR-JE-_C section 1.7
Configuration including peripheral equipment	MR-JE-_C section 1.8

1. FUNCTIONS AND CONFIGURATION

1.1 Profile mode specification list

Only the specifications of the profile mode are listed here. For other specifications, refer to section 1.3 of "MR-JE-_C Servo Amplifier Instruction Manual".

Item		Description		
Servo amplifier model		MR-JE-_C		
Profile mode	Profile position mode	Command position range	Set with objects. Setting range of feed length: -2147483648 to 2147483647 [pulse], Setting range of rotation angle: -360.000 to 360.000 [degree]	
		Command multiplication	Electronic gear A/B multiple, A: 1 to 16777215, B: 1 to 16777215, 1/27649 < A/B < 8484	
		In-position range setting	0 pulse to ±65535 pulses (command pulse unit)	
		Error excessive	±3 revolutions	
		Torque limit	Set with parameters or objects.	
	Profile velocity mode	Command speed range	-21474836.48 r/min to 21474836.47 r/min (Clamped at the permissible speed)	
		Torque limit	Set with parameters or objects (Clamped at the maximum torque).	
	Profile torque mode	Command torque range	-3276.8% to 3276.7% (Clamped at the maximum torque)	
		Speed limit	Set with parameters or objects (Clamped at the permissible speed).	
	Homing mode	Manufacturer-specific	Dog type (Rear end detection, Z-phase reference)	Deceleration starts at the front end of the proximity dog. After the rear end is passed, the position specified by the first Z-phase signal, or the position of the first Z-phase signal shifted by the specified home position shift distance is used as the home position. If the stroke end is detected during home position return, the direction of movement is reversed.
			Count type (Front end detection, Z-phase reference)	At the front end of the proximity dog, deceleration starts. After the front end is passed, the position specified by the first Z-phase signal after the set distance or the position of the Z-phase signal shifted by the set home position shift distance is set as a home position. If the stroke end is detected during home position return, the direction of movement is reversed.
			Data set type	The current position is set as the home position.
			Stopper type (Stopper position reference)	A workpiece is pressed against a mechanical stopper, and the position where it is stopped is set as the home position. If the stroke end is detected during home position return, [AL. 90 Home position return incomplete warning] occurs.
			Home position ignorance (servo-on position as home position)	The current position at servo-on is set as a home position. A home position can be set without switching to the home position return mode (Homing Mode).
Dog type (Rear end detection, rear end reference)			Deceleration starts from the front end of the proximity dog. After the rear end is passed, the position is shifted by the travel distance after proximity dog and the home position shift distance. The position after the shifts is set as the home position. If the stroke end is detected during home position return, the direction of movement is reversed.	
Count type (Front end detection, front end reference)			Deceleration starts from the front end of the proximity dog. The position is shifted by the travel distance after proximity dog and the home position shift distance. The position after the shifts is set as the home position. If the stroke end is detected during home position return, the direction of movement is reversed.	
Dog cradle type			A position, which is specified by the first Z-phase signal after the front end of the proximity dog is detected, is set as the home position. If the stroke end is detected during home position return, the direction of movement is reversed.	
Dog type last Z-phase reference			After the front end of the proximity dog is detected, the position is shifted away from the proximity dog in the reverse direction. Then, the position specified by the first Z-phase signal or the position of the first Z-phase signal shifted by the home position shift distance is used as the home position. If the stroke end is detected during home position return, the direction of movement is reversed.	
Dog type front end reference			Starting from the front end of the proximity dog, the position is shifted by the travel distance after proximity dog and the home position shift distance. The position after the shifts is set as the home position. If the stroke end is detected during home position return, the direction of movement is reversed.	
Dogless Z-phase reference		The position specified by the first Z-phase signal, or the position of the first Z-phase signal shifted by the home position shift distance is used as the home position. If the stroke end is detected during home position return, [AL. 90 Home position return incomplete warning] occurs.		
CIA 402 type		Homing on positive home switch and index pulse (method 3)	Same as the dog type last Z-phase reference home position return. Note that if the stroke end is detected during home position return, [AL. 90 Home position return incomplete warning] occurs.	
		Homing on positive home switch and index pulse (method 4)	Same as the dog cradle type home position return. Note that if the stroke end is detected during home position return, [AL. 90 Home position return incomplete warning] occurs.	
		Homing on negative home switch and index pulse (method 5)	Same as the dog type last Z-phase reference home position return. Note that if the stroke end is detected during home position return, [AL. 90 Home position return incomplete warning] occurs.	

1. FUNCTIONS AND CONFIGURATION

Item		Description	
Profile mode	CIA 402 type	Homing on negative home switch and index pulse (method 6)	Same as the dog cradle type home position return. Note that if the stroke end is detected during home position return, [AL. 90 Home position return incomplete warning] occurs.
		Homing on home switch and index pulse (method 7)	Same as the dog type last Z-phase reference home position return.
		Homing on home switch and index pulse (method 8)	Same as the dog cradle type home position return.
		Homing on home switch and index pulse (method 11)	Same as the dog type last Z-phase reference home position return. The direction of rotation is opposite to that of the method 7.
		Homing on home switch and index pulse (method 12)	Same as the dog cradle type home position return. The direction of rotation is opposite to that of the method 8.
		Homing without index pulse (method 19)	Same as the dog type front end reference home position return. Note that if the stroke end is detected during home position return, [AL. 90 Home position return incomplete warning] occurs.
		Homing without index pulse (method 20)	Although this type is the same as the dog cradle type home position return, the stop position is not on the Z-phase. Starting from the front end of the dog, the position is shifted by the travel distance after proximity dog and the home position shift distance. The position after the shifts is set as the home position. If the stroke end is detected during home position return, [AL. 90 Home position return incomplete warning] occurs.
		Homing without index pulse (method 21)	Same as the dog type front end reference home position return. Note that if the stroke end is detected during home position return, [AL. 90 Home position return incomplete warning] occurs.
		Homing without index pulse (method 22)	Although this type is the same as the dog cradle type home position return, the stop position is not on the Z-phase. Starting from the front end of the dog, the position is shifted by the travel distance after proximity dog and the home position shift distance. The position after the shifts is set as the home position. If the stroke end is detected during home position return, [AL. 90 Home position return incomplete warning] occurs.
		Homing without index pulse (method 23)	Same as the dog type front end reference home position return.
		Homing without index pulse (method 24)	Although this type is the same as the dog cradle type home position return, the stop position is not on the Z-phase. Starting from the front end of the dog, the position is shifted by the travel distance after proximity dog and the home position shift distance. The position after the shifts is set as the home position.
		Homing without index pulse (method 27)	Same as the dog type front end reference home position return.
		Homing without index pulse (method 28)	Although this type is the same as the dog cradle type home position return, the stop position is not on the Z-phase. Starting from the front end of the dog, the position is shifted by the travel distance after proximity dog and the home position shift distance. The position after the shifts is set as the home position.
		Homing on index pulse (method 33)	Although this type is the same as the dogless Z-phase reference home position return, the creep speed is applied as the movement start speed.
		Homing on index pulse (method 34)	Although this type is the same as the dogless Z-phase reference home position return, the creep speed is applied as the movement start speed.
		Homing mode	Homing on current position (method 35)
Homing on current position (method 37)	The current position is set as the home position. This type can be executed not in the Operational enabled state.		

2. SIGNALS AND WIRING

2. SIGNALS AND WIRING

⚠ WARNING

- Any person who is involved in wiring should be fully competent to do the work.
- Before wiring, turn off the power and wait for 15 minutes or more until the charge lamp of the servo amplifier is off. Otherwise, an electric shock may occur. In addition, when confirming whether the charge lamp is off or not, be sure to look at the lamp from the front of the servo amplifier.
- Ground the servo amplifier and servo motor securely.
- Do not attempt to wire the servo amplifier and servo motor until they have been installed. Otherwise, it may cause an electric shock.
- The cables should not be damaged, stressed, loaded, or pinched. Otherwise, it may cause an electric shock.
- To avoid an electric shock, insulate the connections of the power supply terminals.

⚠ CAUTION

- Before removing the CNP1 connector from MR-JE-40C to MR-JE-100C, disconnect the lead wires of the regenerative resistor from the CNP1 connector.
- Wire the equipment correctly and securely. Otherwise, the servo motor may operate unexpectedly, resulting in injury.
- Connect cables to the correct terminals. Otherwise, a burst, damage, etc., may occur.
- Ensure that polarity (+/-) is correct. Otherwise, a burst, damage, etc., may occur.
- The surge absorbing diode installed to the DC relay for control output should be fitted in the specified direction. Otherwise, the converter unit and the drive unit will malfunction and will not output signals, disabling the emergency stop and other protective circuits.

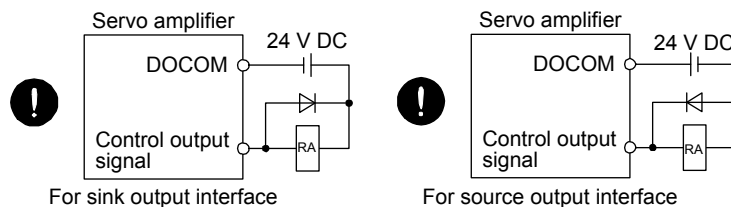

- Use a noise filter, etc., to minimize the influence of electromagnetic interference. Electromagnetic interference may affect the electronic equipment used near the servo amplifier.
- Do not install a power capacitor, surge killer or radio noise filter (optional FR-BIF) with the power line of the servo motor.
- When using the regenerative resistor, shut the power off with an alarm signal. Otherwise, a transistor fault or the like may overheat the regenerative resistor, causing a fire.
- Do not modify the equipment.

2. SIGNALS AND WIRING

CAUTION !

- Connect the servo amplifier power output (U/V/W) to the servo motor power input (U/V/W) directly. Do not connect a magnetic contactor and others between them. Otherwise, it may cause a malfunction.

- Connecting a servo motor of the wrong axis to U, V, W, or CN2 of the servo amplifier may cause a malfunction.

The following items are the same as those of MR-JE-_C servo amplifiers. For details, refer to each section indicated in the detailed explanation field. "MR-JE-_C" means "MR-JE-_C Servo Amplifier Instruction Manual".

Item	Detailed explanation
Connection example of power circuit	MR-JE-_C section 3.1
Explanation of power supply system	MR-JE-_C section 3.3
Signal (device) explanations	MR-JE-_C section 3.5

2. SIGNALS AND WIRING

2.1 I/O signal connection example

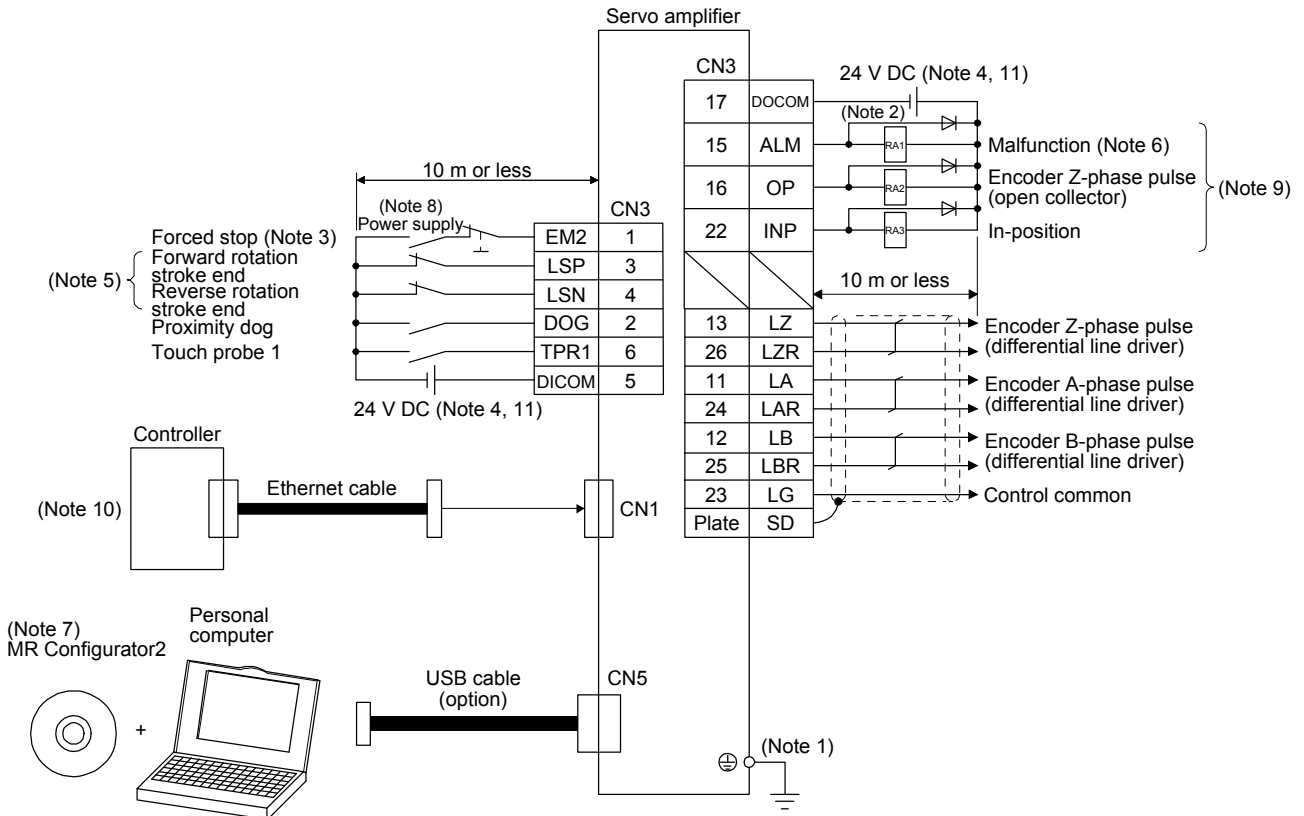

- Note**
- To prevent an electric shock, be sure to connect the protective earth (PE) terminal (marked \oplus) of the servo amplifier to the protective earth (PE) of the cabinet.
 - Connect the diode in the correct direction. If it is connected reversely, the servo amplifier will malfunction and will not output signals, disabling EM2 (Forced stop 2) and other protective circuits.
 - The forced stop switch (normally closed contact) must be installed.
 - Supply 24 V DC \pm 10% to interfaces from outside. The total current capacity of these power supplies must be 300 mA or lower. 300 mA is the value applicable when all I/O signals are used. The current capacity can be decreased by reducing the number of I/O points. Refer to section 3.9.2 (1) of "MR-JE-_C Servo Amplifier Instruction Manual" that gives the current value necessary for the interface. The illustration of the 24 V DC power supply is divided between input signal and output signal for convenience. However, they can be configured by one.
 - When starting operation, always turn on EM2 (Forced stop 2), LSP (Forward rotation stroke end) and LSN (Reverse rotation stroke end) (normally closed contact).
 - ALM (Malfunction) turns on in normal alarm-free condition (normally closed contact). When this signal is switched off (at occurrence of an alarm), the output of the programmable controller should be stopped by the sequence program.
 - Use SW1DNC-MRC2-_. MR-JE-_C Servo Amplifier Instruction Manual section 11.4
 - Configure a circuit to turn off EM2 when the power is turned off to prevent an unexpected restart of the servo amplifier.
 - You can change devices of these pins with [Pr. PD30], [Pr. PD31], [Pr. PD32], and [Pr. PD38].
 - For the network connection, refer to "MR-JE-_C Servo Amplifier Instruction Manual (CC-Link IE Field Network Basic)".
 - This diagram shows sink I/O interface.

2. SIGNALS AND WIRING

2.2 Connectors and pin assignment

For the pins which are given parameters in the related parameter column, their devices can be changed using those parameters.

Pin No.	I/O (Note 1)	I/O signals in control modes (Note 2)	Related parameter
		pp/pv/tq	
1	I	EM2	
2	I	DOG	PD07
3	I	LSP	PD10
4	I	LSN	PD13
5		DICOM	
6	I	TPR1	PD25
7			
8	I	(Note 3)	PD16
9			
10		LG	
11	O	LA	
12	O	LB	
13	O	LZ	
14	O	RD	PD29
15	O	ALM	PD30
16	O	OP	PD31/PD38
17		DOCOM	
18		OPC	
19	I	(Note 4)	PD28
20			
21	I	(Note 3)	PD19
22	O	INP	PD32
23		LG	
24	O	LAR	
25	O	LBR	
26	O	LZR	

Note 1. I: input signal, O: output signal

2. pp: Profile position mode, pv: Profile velocity mode, tq: Profile torque mode

3. Input devices are not assigned by default. Assign the input devices with [Pr. PD16] and [Pr. PD19] as necessary.

4. This is available as an input device of sink interface. Input devices are not assigned by default. Assign the input devices with [Pr. PD28] as necessary. In addition, supply + of 24 V DC to the CN3-18 pin of OPC (Power input for open-collector sink interface).

2.3 Signal (device) explanations

For details of the devices and I/O interfaces (symbols in I/O division column in the table) not described in the table, refer to sections 3.5 and 3.9 in "MR-JE-_C Servo Amplifier Instruction Manual".

Device	Symbol	Connector pin No.	Function and application	I/O division						
Proximity dog	DOG		Turning off DOG will detect a proximity dog. The polarity for dog detection can be changed with [Pr. PT29]. <table border="1" style="margin: 10px auto;"> <thead> <tr> <th>[Pr. PT29]</th> <th>Polarity for proximity dog detection</th> </tr> </thead> <tbody> <tr> <td>___ 0</td> <td>Detection with off</td> </tr> <tr> <td>___ 1</td> <td>Detection with on</td> </tr> </tbody> </table>	[Pr. PT29]	Polarity for proximity dog detection	___ 0	Detection with off	___ 1	Detection with on	DI-1
[Pr. PT29]	Polarity for proximity dog detection									
___ 0	Detection with off									
___ 1	Detection with on									
Touch probe 1	TPR1	CN3-6	The touch probe function that executes current position latch by sensor input can be used. For details of the touch probe function, refer to "MR-JE-_C Servo Amplifier Instruction Manual (CC-Link IE Field Network Basic)".	DI-1						

3. STARTUP

3. STARTUP

The following items are the same as those of MR-JE-_C servo amplifiers. For details, refer to each section indicated in the detailed explanation field. "MR-JE-_C" means "MR-JE-_C Servo Amplifier Instruction Manual".

Item	Detailed explanation
Switching power on for the first time	MR-JE-_C section 4.1
Display and operation section	MR-JE-_C section 4.5
Test operation	MR-JE-_C section 4.6
Test operation mode	MR-JE-_C section 4.7

3.1 Startup

Connect the servo motor with a machine after confirming that the servo motor operates properly alone.

(1) Power on

When the power is switched on, "b01" (when the identification number is 01h) appears on the servo amplifier display.

When you use the absolute position detection system, first power-on results in [AL. 25 Absolute position erased] and the servo-on cannot be ready. [AL. 25] can be deactivated by cycling the power.

Also, if the power is switched on when the servo motor is rotated at a speed of 3000 r/min or higher, a position mismatch may occur due to external force or the like. Power must therefore be switched on when the servo motor is at a stop.

(2) Parameter setting

POINT
● The following encoder cables are of four-wire type. When using any of these encoder cables, set [Pr. PC04] to "1 _ _ _" to select the four-wire type. An incorrect setting will result in [AL. 16 Encoder initial communication error 1]. MR-EKCBL30M-L MR-EKCBL30M-H MR-EKCBL40M-H MR-EKCBL50M-H

Set the parameters according to the structure and specifications of the machine. Refer to chapter 4 for details.

After setting the above parameters, turn off the power as necessary. Then switch power on again to enable the parameter values.

(3) Servo-on

Enable the servo-on with the following procedure.

- (a) Turn on the power.
- (b) Transmit the servo-on command with the controller.

When the servo-on status is enabled, the servo amplifier is ready to operate and the servo motor is locked.

3. STARTUP

(4) Home position return

Always perform home position return before starting positioning operation.

(5) Stop

If any of the following situations occurs, the servo amplifier suspends and stops the operation of the servo motor.

Refer to section 3.10 in "MR-JE-_C Servo Amplifier Instruction Manual" for the servo motor with an electromagnetic brake.

	Operation/command	Stopping condition
Controller	Servo-off command	The base circuit is shut off, and the servo motor coasts.
	Ready-off command	The base circuit is shut off and the dynamic brake operates to bring the servo motor to a stop.
	Quick stop command	The servo motor decelerates to a stop.
Servo amplifier	Alarm occurrence	The servo motor decelerates to a stop. With some alarms; however, the dynamic brake operates to stop the servo motor. (Note)
	EM2 (Forced stop 2) off	The servo motor decelerates to a stop. [AL. E6 Servo forced stop warning] occurs. In the torque control mode, EM2 functions the same as EM1
	LSP (Forward rotation stroke end) off or LSN (Reverse rotation stroke end) off	The servo motor stops immediately and will be servo locked. Operation in the opposite direction is possible.

Note. Refer to "MELSERVO-JE Servo Amplifier Instruction Manual (Troubleshooting)" for details of alarms and warnings.

4. PARAMETERS

4. PARAMETERS

 CAUTION	<ul style="list-style-type: none"> ● Never make a drastic adjustment or change to the parameter values as doing so will make the operation unstable. ● Do not change the parameter settings as described below. Doing so may cause an unexpected condition, such as failing to start up the servo amplifier. <ul style="list-style-type: none"> ▪ Changing the values of the parameters for manufacturer setting ▪ Setting a value out of the range ▪ Changing the fixed values in the digits of a parameter
--	--

4.1 Parameter list

POINT	<ul style="list-style-type: none"> ● To enable a parameter whose symbol is preceded by *, cycle the power after setting it. However, the time will be longer depending on a setting value of [Pr. PF25 Instantaneous power failure tough drive - Detection time] when "instantaneous power failure tough drive selection" is enabled in [Pr. PA20].
-------	--

Refer to chapter 5 in "MR-JE-_C Servo Amplifier Instruction Manual" for the parameters with "MR-JE-_C" in the detailed explanation field.

4.1.1 Basic setting parameters ([Pr. PA_ _])

POINT	<ul style="list-style-type: none"> ● The following parameters cannot be used in the profile mode. <ul style="list-style-type: none"> ▪ [Pr. PA05 Number of command input pulses per revolution] ▪ [Pr. PA13 Command pulse input form]
-------	---

No.	Symbol	Name	Initial value	Unit	Detailed explanation
PA01	*STY	Operation mode	1000h		Section 4.2.1
PA02	*REG	Regenerative option	0000h		MR-JE-_C
PA03	*ABS	Absolute position detection system	0000h		Section 4.2.1
PA04	*AOP1	Function selection A-1	2000h		MR-JE-_C
PA05	*FBP	Number of command input pulses per revolution	10000		
PA06	CMX	Electronic gear numerator (command pulse multiplication numerator)	1		Section 4.2.1
PA07	CDV	Electronic gear denominator (command pulse multiplication denominator)	1		
PA08	ATU	Auto tuning mode	0001h		MR-JE-_C
PA09	RSP	Auto tuning response	16		
PA10	INP	In-position range	100	[pulse]	Section 4.2.1
PA11	TLP	Forward rotation torque limit	1000.0	[%]	
PA12	TLN	Reverse rotation torque limit	1000.0	[%]	
PA13	*PLSS	Command pulse input form	0100h		MR-JE-_C
PA14	*POL	Rotation direction selection	0		Section 4.2.1
PA15	*ENR	Encoder output pulses	4000	[pulse/rev]	MR-JE-_C
PA16	*ENR2	Encoder output pulses 2	1		
PA17		For manufacturer setting	0000h		
PA18			0000h		

4. PARAMETERS

No.	Symbol	Name	Initial value	Unit	Detailed explanation
PA19	*BLK	Parameter writing inhibit	00AAh		MR-JE-_C
PA20	*TDS	Tough drive setting	0000h		
PA21	*AOP3	Function selection A-3	0001h		
PA22		For manufacturer setting	0000h		
PA23	DRAT	Drive recorder arbitrary alarm trigger setting	0000h		
PA24	AOP4	Function selection A-4	0000h		
PA25	OTHOV	One-touch tuning - Overshoot permissible level	0	[%]	
PA26	*AOP5	Function selection A-5	0000h		
PA27		For manufacturer setting	0000h		
PA28	*AOP6	Function selection A-6	0000h		
PA29		For manufacturer setting	0000h		
PA30			0000h		
PA31			0000h		
PA32			0000h		

4.1.2 Gain/filter setting parameters ([Pr. PB_ _])

No.	Symbol	Name	Initial value	Unit	Detailed explanation
PB01	FILT	Adaptive tuning mode (adaptive filter II)	0000h		MR-JE-_C
PB02	VRFT	Vibration suppression control tuning mode (advanced vibration suppression control II)	0000h		
PB03	PST	Position command acceleration/deceleration time constant (position smoothing)	0	[ms]	
PB04	FFC	Feed forward gain	0	[%]	
PB05		For manufacturer setting	500		
PB06	GD2	Load to motor inertia ratio	7.00	[Multiplier]	
PB07	PG1	Model loop gain	15.0	[rad/s]	
PB08	PG2	Position loop gain	37.0	[rad/s]	
PB09	VG2	Speed loop gain	823	[rad/s]	
PB10	VIC	Speed integral compensation	33.7	[ms]	
PB11	VDC	Speed differential compensation	980		
PB12	OVA	Overshoot amount compensation	0	[%]	
PB13	NH1	Machine resonance suppression filter 1	4500	[Hz]	
PB14	NHQ1	Notch shape selection 1	0000h		
PB15	NH2	Machine resonance suppression filter 2	4500	[Hz]	
PB16	NHQ2	Notch shape selection 2	0000h		
PB17	NHF	Shaft resonance suppression filter	0000h		
PB18	LPF	Low-pass filter setting	3141	[rad/s]	
PB19	VRF11	Vibration suppression control 1 - Vibration frequency	100.0	[Hz]	
PB20	VRF12	Vibration suppression control 1 - Resonance frequency	100.0	[Hz]	
PB21	VRF13	Vibration suppression control 1 - Vibration frequency damping	0.00		
PB22	VRF14	Vibration suppression control 1 - Resonance frequency damping	0.00		
PB23	VFBF	Low-pass filter selection	0100h		
PB24	*MVS	Slight vibration suppression control	0000h		
PB25	*BOP1	Function selection B-1	0000h		
PB26	*CDP	Gain switching function	0000h		
PB27	CDL	Gain switching condition	10	[kpulse/s]/ [pulse]/ [r/min]	
PB28	CDT	Gain switching time constant	1	[ms]	
PB29	GD2B	Load to motor inertia ratio after gain switching	7.00	[Multiplier]	
PB30	PG2B	Position loop gain after gain switching	0.0	[rad/s]	
PB31	VG2B	Speed loop gain after gain switching	0	[rad/s]	
PB32	VICB	Speed integral compensation after gain switching	0.0	[ms]	
PB33	VRF11B	Vibration suppression control 1 - Vibration frequency after gain switching	0.0	[Hz]	

4. PARAMETERS

No.	Symbol	Name	Initial value	Unit	Detailed explanation
PB34	VRF12B	Vibration suppression control 1 - Resonance frequency after gain switching	0.0	[Hz]	MR-JE-_C
PB35	VRF13B	Vibration suppression control 1 - Vibration frequency damping after gain switching	0.00		
PB36	VRF14B	Vibration suppression control 1 - Resonance frequency damping after gain switching	0.00		
PB37		For manufacturer setting	1600		
PB38			0.00		
PB39			0.00		
PB40			0.00		
PB41			0000h		
PB42			0000h		
PB43			0000h		
PB44			0.00		
PB45	CNHF	Command notch filter	0000h		
PB46	NH3	Machine resonance suppression filter 3	4500	[Hz]	
PB47	NHQ3	Notch shape selection 3	0000h		
PB48	NH4	Machine resonance suppression filter 4	4500	[Hz]	
PB49	NHQ4	Notch shape selection 4	0000h		
PB50	NH5	Machine resonance suppression filter 5	4500	[Hz]	
PB51	NHQ5	Notch shape selection 5	0000h		
PB52	VRF21	Vibration suppression control 2 - Vibration frequency	100.0	[Hz]	
PB53	VRF22	Vibration suppression control 2 - Resonance frequency	100.0	[Hz]	
PB54	VRF23	Vibration suppression control 2 - Vibration frequency damping	0.00		
PB55	VRF24	Vibration suppression control 2 - Resonance frequency damping	0.00		
PB56	VRF21B	Vibration suppression control 2 - Vibration frequency after gain switching	0.0	[Hz]	
PB57	VRF22B	Vibration suppression control 2 - Resonance frequency after gain switching	0.0	[Hz]	
PB58	VRF23B	Vibration suppression control 2 - Vibration frequency damping after gain switching	0.00		
PB59	VRF24B	Vibration suppression control 2 - Resonance frequency damping after gain switching	0.00		
PB60	PG1B	Model loop gain after gain switching	0.0	[rad/s]	
PB61		For manufacturer setting	0.0		
PB62			0000h		
PB63			0000h		
PB64			0000h		

4. PARAMETERS

4.1.3 Extension setting parameters ([Pr. PC_ _])

POINT
<ul style="list-style-type: none"> ● The following parameters cannot be used in the profile mode. <ul style="list-style-type: none"> ▪ [Pr. PC04 Torque command time constant] ▪ [Pr. PC05 Internal speed command 1/internal speed limit 1] ▪ [Pr. PC06 Internal speed command 2/internal speed limit 2] ▪ [Pr. PC07 Internal speed command 3/internal speed limit 3] ▪ [Pr. PC08 Internal speed command 4/internal speed limit 4] ▪ [Pr. PC09 Internal speed command 5/internal speed limit 5] ▪ [Pr. PC10 Internal speed command 6/internal speed limit 6] ▪ [Pr. PC11 Internal speed command 7/internal speed limit 7] ▪ [Pr. PC12 Analog speed command - Maximum speed/Analog speed limit - Maximum speed] ▪ [Pr. PC13 Analog torque command maximum output] ▪ [Pr. PC32 Command input pulse multiplication numerator 2] ▪ [Pr. PC33 Command input pulse multiplication numerator 3] ▪ [Pr. PC34 Command input pulse multiplication numerator 4]

No.	Symbol	Name	Initial value	Unit	Detailed explanation
PC01	STA	Acceleration time constant	0	[ms]	Section 4.2.2
PC02	STB	Deceleration time constant	0	[ms]	
PC03	STC	S-pattern acceleration/deceleration time constant	0	[ms]	MR-JE- _C
PC04	TQC	Torque command time constant	0	[ms]	
PC05	SC1	Internal speed command 1	100.00	[r/min]	
		Internal speed limit 1			
PC06	SC2	Internal speed command 2	500.00	[r/min]	
		Internal speed limit 2			
PC07	SC3	Internal speed command 3	1000.00	[r/min]	
		Internal speed limit 3			
PC08	SC4	Internal speed command 4	200.00	[r/min]	
		Internal speed limit 4			
PC09	SC5	Internal speed command 5	300.00	[r/min]	
		Internal speed limit 5			
PC10	SC6	Internal speed command 6	500.00	[r/min]	
		Internal speed limit 6			
PC11	SC7	Internal speed command 7	800.00	[r/min]	
		Internal speed limit 7			
PC12	VCM	Analog speed command - Maximum speed	0.00	[r/min]	
		Analog speed limit - Maximum speed			
PC13	TLC	Analog torque command maximum output	100.0	[%]	
PC14		For manufacturer setting	0000h		
PC15			0000h		
PC16	MBR	Electromagnetic brake sequence output	0	[ms]	
PC17	ZSP	Zero speed	50	[r/min]	
PC18	*BPS	Alarm history clear	0000h		
PC19	*ENRS	Encoder output pulse selection	0000h		
PC20		For manufacturer setting	0		
PC21			0000h		
PC22	*COP1	Function selection C-1	0020h		
PC23	*COP2	Function selection C-2	0000h		
PC24	*COP3	Function selection C-3	0000h		

4. PARAMETERS

No.	Symbol	Name	Initial value	Unit	Detailed explanation
PC25	*COP4	Function selection C-4	0000h		Section 4.2.2
PC26	*COP5	Function selection C-5	0000h		MR-JE-_C
PC27	*COP6	Function selection C-6	0000h		
PC28		For manufacturer setting	0000h		
PC29	*COP8	Function selection C-8	0120h		
PC30	STA2	Acceleration time constant 2	0	[ms]	MR-JE-_C
PC31	STB2	Deceleration time constant 2	0	[ms]	
PC32	CMX2	Command input pulse multiplication numerator 2	1		
PC33	CMX3	Command input pulse multiplication numerator 3	1		
PC34	CMX4	Command input pulse multiplication numerator 4	1		
PC35	TL2	Internal torque limit 2	1000.0	[%]	
PC36		For manufacturer setting	0000h		
PC37	VCO	Analog speed command offset	0	[mV]	
		Analog speed limit offset			
PC38	TPO	Analog torque command offset	0	[mV]	
		Analog torque limit offset			
PC39		For manufacturer setting	0		
PC40			0		
PC41			0		
PC42			0		
PC43	ERZ	Error excessive alarm level	0	[rev]	
PC44		For manufacturer setting	0000h		
PC45			0000h		
PC46			0		
PC47			0		
PC48			0		
PC49			0		
PC50			0000h		
PC51	RSBR	Forced stop deceleration time constant	100	[ms]	
PC52		For manufacturer setting	0		
PC53			0		
PC54	RSUP1	Vertical axis freefall prevention compensation amount	0	[0.0001 rev]	
PC55		For manufacturer setting	0		
PC56			100		
PC57			0000h		
PC58			0		
PC59			0000h		
PC60	*COPD	Function selection C-D	0000h		
PC61		For manufacturer setting	0000h		
PC62			0000h		
PC63			0000h		
PC64			0000h		
PC65			0000h		
PC66			0		
PC67			0		
PC68			0		
PC69			0		
PC70			0		
PC71			0040h		
PC72			0000h		
PC73	ERW	Error excessive warning level	0	[rev]	
PC74		For manufacturer setting	0000h		

4. PARAMETERS

No.	Symbol	Name	Initial value	Unit	Detailed explanation
PC75	FEWL	Following error output level	0000h	10 ⁻³ [degree]/ [pulse]	Section 4.2.2
PC76	FEWH		00C0h		
PC77	FEWF	Following error output filtering time	10	[ms]	
PC78		For manufacturer setting	0000h		MR-JE-_C
PC79			0000h		
PC80			0000h		

4.1.4 I/O setting parameters ([Pr. PD_ _])

POINT
<p>● The following parameters cannot be used in the profile mode.</p> <ul style="list-style-type: none"> ▪ [Pr. PD05 Input device selection 1L] ▪ [Pr. PD06 Input device selection 1M] ▪ [Pr. PD08 Input device selection 2L] ▪ [Pr. PD09 Input device selection 2M] ▪ [Pr. PD11 Input device selection 3L] ▪ [Pr. PD12 Input device selection 3M] ▪ [Pr. PD14 Input device selection 4L] ▪ [Pr. PD15 Input device selection 4M] ▪ [Pr. PD17 Input device selection 5L] ▪ [Pr. PD18 Input device selection 5M] ▪ [Pr. PD23 Input device selection 7L] ▪ [Pr. PD24 Input device selection 7M] ▪ [Pr. PD26 Input device selection 8L] ▪ [Pr. PD27 Input device selection 8M]

No.	Symbol	Name	Initial value	Unit	Detailed explanation
PD01	*DIA1	Input signal automatic on selection 1	0000h		MR-JE-_C
PD02		For manufacturer setting	0000h		
PD03			0000h		
PD04			0000h		
PD05	*DI1L	Input device selection 1L	0202h		
PD06	*DI1M	Input device selection 1M	0202h		
PD07	*DI1H	Input device selection 1H	002Bh		Section 4.2.3
PD08	*DI2L	Input device selection 2L	0A0Ah		MR-JE-_C
PD09	*DI2M	Input device selection 2M	0700h		
PD10	*DI2H	Input device selection 2H	000Ah		Section 4.2.3
PD11	*DI3L	Input device selection 3L	0B0Bh		MR-JE-_C
PD12	*DI3M	Input device selection 3M	0800h		
PD13	*DI3H	Input device selection 3H	000Bh		Section 4.2.3
PD14	*DI4L	Input device selection 4L	0703h		MR-JE-_C
PD15	*DI4M	Input device selection 4M	3807h		
PD16	*DI4H	Input device selection 4H	0000h		Section 4.2.3
PD17	*DI5L	Input device selection 5L	0806h		MR-JE-_C
PD18	*DI5M	Input device selection 5M	2008h		
PD19	*DI5H	Input device selection 5H	0000h		Section 4.2.3

4. PARAMETERS

No.	Symbol	Name	Initial value	Unit	Detailed explanation
PD20		For manufacturer setting	0000h		MR-JE-_C
PD21			0000h		
PD22			0000h		
PD23	*DI7L	Input device selection 7L	0000h		
PD24	*DI7M	Input device selection 7M	0000h		
PD25	*DI7H	Input device selection 7H	002Ch		Section 4.2.3
PD26	*DI8L	Input device selection 8L	0000h		MR-JE-_C
PD27	*DI8M	Input device selection 8M	0000h		
PD28	*DI8H	Input device selection 8H	0000h		Section 4.2.3
PD29	*DO1	Output device selection 1	0002h		
PD30	*DO2	Output device selection 2	0003h		
PD31	*DO3	Output device selection 3	0000h		
PD32	*DO4	Output device selection 4	0004h		
PD33		For manufacturer setting	0000h		MR-JE-_C
PD34	*DIF	Input filter setting	0004h		
PD35	*DOP1	Function selection D-1	0101h		Section 4.2.3
PD36		For manufacturer setting	0000h		MR-JE-_C
PD37	*DOP3	Function selection D-3	0000h		
PD38	*DOP4	Function selection D-4	3000h		Section 4.2.3
PD39	*DOP5	Function selection D-5	0000h		MR-JE-_C
PD40		For manufacturer setting	0000h		
PD41			0000h		
PD42			0		
PD43			0000h		
PD44			0000h		
PD45			0000h		
PD46			0000h		
PD47			0000h		
PD48			0000h		

4.1.5 Extension setting 2 parameters ([Pr. PE_ _])

No.	Symbol	Name	Initial value	Unit	Detailed explanation
PE01		For manufacturer setting	0000h		MR-JE-_C
PE02			0000h		
PE03			0000h		
PE04			0		
PE05			0		
PE06			0		
PE07			0		
PE08			0		
PE09			0000h		
PE10			0000h		
PE11			0000h		
PE12			0000h		
PE13			0000h		
PE14			0111h		
PE15			20		
PE16			0000h		
PE17			0000h		
PE18			0000h		

4. PARAMETERS

No.	Symbol	Name	Initial value	Unit	Detailed explanation
PE19		For manufacturer setting	0000h		MR-JE-_C
PE20			0000h		
PE21			0000h		
PE22			0000h		
PE23			0000h		
PE24			0000h		
PE25			0000h		
PE26			0000h		
PE27			0000h		
PE28			0000h		
PE29			0000h		
PE30			0000h		
PE31			0000h		
PE32			0000h		
PE33			0000h		
PE34			0		
PE35			0		
PE36			0.0		
PE37			0.00		
PE38			0.00		
PE39			0		
PE40			0000h		
PE41	EOP3	Function selection E-3	0000h		
PE42		For manufacturer setting	0		
PE43			0.0		
PE44	LMCP	Lost motion compensation positive-side compensation value selection	0	[0.01%]	Section 4.2.4
PE45	LMCN	Lost motion compensation negative-side compensation value selection	0	[0.01%]	
PE46	LMFLT	Lost motion filter setting	0	[0.1 ms]	
PE47	TOF	Torque offset	0	[0.01%]	
PE48	*LMOP	Lost motion compensation function selection	0000h		
PE49	LMCD	Lost motion compensation timing	0	[0.1 ms]	
PE50	LMCT	Lost motion compensation non-sensitive band	0	[pulse]/ [kpulse]	
PE51		For manufacturer setting	0000h		MR-JE-_C
PE52			0000h		
PE53			0000h		
PE54			0000h		
PE55			0000h		
PE56			0000h		
PE57			0000h		
PE58			0000h		
PE59			0000h		
PE60			0000h		
PE61			0.00		
PE62			0.00		
PE63			0.00		
PE64			0.00		

4. PARAMETERS

4.1.6 Extension setting 3 parameters ([Pr. PF__])

No.	Symbol	Name	Initial value	Unit	Detailed explanation
PF01		For manufacturer setting	0000h		MR-JE-_C
PF02			0000h		
PF03			0000h		
PF04			0		
PF05			0		
PF06			0000h		
PF07			1		
PF08			1		
PF09	*FOP5	Function selection F-5	0003h		
PF10		For manufacturer setting	0000h		
PF11			0000h		
PF12			10000		
PF13			100		
PF14			100		
PF15			2000		
PF16			0000h		
PF17			10		
PF18			0000h		
PF19			0000h		
PF20			0000h		
PF21	DRT	Drive recorder switching time setting	0	[s]	
PF22		For manufacturer setting	200		
PF23	OSCL1	Vibration tough drive - Oscillation detection level	50	[%]	
PF24	*OSCL2	Vibration tough drive function selection	0000h		
PF25	CVAT	Instantaneous power failure tough drive - Detection time	200	[ms]	
PF26		For manufacturer setting	0		
PF27			0		
PF28			0		
PF29			0000h		
PF30			0		
PF31	FRIC	Machine diagnosis function - Friction judgment speed	0	[r/min]	
PF32		For manufacturer setting	50		
PF33			0000h		
PF34			0000h		
PF35			0000h		
PF36			0000h		
PF37			0000h		
PF38			0000h		
PF39			0000h		
PF40			0		
PF41			0		
PF42			0		
PF43			0		
PF44			0		
PF45			0000h		
PF46			0		
PF47			0000h		
PF48			0000h		

4. PARAMETERS

4.1.7 Positioning control parameters ([Pr. PT_ _])

No.	Symbol	Name	Initial value	Unit	Detailed explanation
PT01	*CTY	Command mode selection	0300h		Section 4.2.5
PT02		For manufacturer setting	0001h		
PT03	*FTY	Feeding function selection	0000h		Section 4.2.5
PT04		For manufacturer setting	0000h		
PT05	ZRF	Home position return speed	100.00	[r/min]	Section 4.2.5
PT06	CRF	Creep speed	10.00	[r/min]	
PT07	ZST	Home position shift distance	0	10 ⁻³ [degree]/ [pulse]	
PT08		For manufacturer setting	0		
PT09	DCT	Travel distance after proximity dog	0	10 ⁻³ [degree]/ [pulse]	Section 4.2.5
PT10	ZTM	Stopper type home position return stopper time	100	[ms]	
PT11	ZTT	Stopper type home position return torque limit value	15.0	[%]	
PT12		For manufacturer setting	0		
PT13			100.00		
PT14			0		
PT15	LMPL	Software limit +	0000h	10 ⁻³ [degree]/ [pulse]	Section 4.2.5
PT16	LMPH		0000h	10 ⁻³ [degree]/ [pulse]	
PT17	LMNL	Software limit -	0000h	10 ⁻³ [degree]/ [pulse]	
PT18	LMNH		0000h	10 ⁻³ [degree]/ [pulse]	
PT19		For manufacturer setting	0000h		
PT20			0000h		
PT21			0000h		
PT22			0000h		
PT23			0		
PT24			0		
PT25			0		
PT26	*TOP2	Function selection T-2	0000h		Section 4.2.5
PT27		For manufacturer setting	0000h		
PT28			8		
PT29	*TOP3	Function selection T-3	0000h		Section 4.2.5
PT30		For manufacturer setting	0000h		
PT31			0000h		
PT32			0000h		
PT33			0000h		
PT34			0000h		
PT35			0000h		
PT36			0000h		
PT37			10		
PT38			0000h		
PT39			100		
PT40			0		
PT41	ORP	Home position return inhibit function selection	0000h		Section 4.2.5
PT42		For manufacturer setting	0		
PT43			0		
PT44			0000h		

4. PARAMETERS

No.	Symbol	Name	Initial value	Unit	Detailed explanation
PT45	HMM	Home position return method	37		Section 4.2.5
PT46		For manufacturer setting	0000h		
PT47			0000h		
PT48			0000h		
PT49	TQS	Torque slope	0.0	[%/s]	Section 4.2.5
PT50	PVC	Profile speed command	100.00	[r/min]	
PT51	MPVC	Maximum profile speed	20000.00	[r/min]	
PT52	VLMT	Speed limit	500.00	[r/min]	
PT53		For manufacturer setting	0000h		
PT54			0000h		
PT55			0000h		
PT56			0000h		
PT57	ZSTH	Home position shift distance (extension parameter)	0	10 ⁻³ [degree]/ [pulse]	Section 4.2.5
PT58		For manufacturer setting	0		
PT59	DCTH	Travel distance after proximity dog (extension parameter)	0	10 ⁻³ [degree]/ [pulse]	Section 4.2.5
PT60	*TOP8	Function selection T-8	0000h		
PT61	HMA	Home position return acceleration time constant	0	[ms]	
PT62	HMB	Home position return deceleration time constant	0	[ms]	
PT63	ZSP2L	Zero speed 2 level	50.00	[r/min]	
PT64	ZSP2F	Zero speed 2 filtering time	10	[ms]	
PT65	INP2R	In-position 2 output range	100	10 ⁻³ [degree]/ [pulse]	
PT66	INP2F	In-position 2 output filtering time	10	[ms]	
PT67	SA2R	Speed reached 2 output range	20.00	[r/min]	
PT68	SA2F	Speed reached 2 output filtering time	10	[ms]	
PT69		For manufacturer setting	0000h		
PT70			0000h		
PT71			0000h		
PT72			0000h		
PT73			0000h		
PT74			0000h		
PT75			0000h		
PT76			0000h		
PT77			0000h		
PT78			0000		
PT79			0000		
PT80			0000		

4. PARAMETERS

4.2 Detailed list of parameters

POINT
<ul style="list-style-type: none"> ● For parameters which are not described in this section, refer to chapter 5 of "MR-JE-_C Servo Amplifier Instruction Manual". ● Set a value to each "x" in the "Setting digit" columns.

4.2.1 Basic setting parameters ([Pr. PA_ _])

No./symbol/ name	Setting digit	Function	Initial value [unit]
PA01 *STY Operation mode	___x	Control mode selection Select a control mode. 0: Position control mode (P) 1: Position control mode and speed control mode (P/S) 2: Speed control mode (S) 3: Speed control mode and torque control mode (S/T) 4: Torque control mode (T) 5: Torque control mode and position control mode (T/P) 9: Profile mode (pp/pv/tq)	0h
	___x_	For manufacturer setting	0h
	_x__		0h
	x___		1h
PA03 *ABS Absolute position detection system	___x	Absolute position detection system selection Set this digit when using the absolute position detection system. 0: Disabled (used in the incremental system) 2: Enabled (absolute position detection system) Setting "1" will trigger [AL. 37].	0h
	___x_	For manufacturer setting	0h
	_x__		0h
	x___		0h

4. PARAMETERS

No./symbol/ name	Setting digit	Function	Initial value [unit]
PA06 CMX Electronic gear numerator (command pulse multiplication numerator)		<p>Set an electronic gear numerator.</p> <p>To enable the parameter, select "Electronic gear (0 __ _)" of "Electronic gear selection" in [Pr. PA21].</p> <p>In the profile mode, cycle the power to enable the parameter.</p> <p>The following shows a standard of the setting range of the electronic gear.</p> $\frac{1}{27649} < \frac{CMX}{CDV} < 8484$ <p>If the set value is outside this range, noise may be generated during acceleration/deceleration or operation may not be performed at the preset speed and/or acceleration/deceleration time constants.</p> <p>Number of command input pulses per revolution ([Pr. PA05] "1000" to "1000000")</p> <p>Electronic gear selection (x __ _) ([Pr. PA21])</p> <p>Electronic gear ([Pr. PA06]/[Pr. PA07])</p> <p>Command pulse train</p> <p>"0" (initial value)</p> <p>"1"</p> <p>Pt</p> <p>CMX</p> <p>CDV</p> <p>+</p> <p>Deviation counter</p> <p>Servo motor</p> <p>M</p> <p>Encoder</p> <p>Pt (servo motor resolution): 131072 pulses/rev</p> <p>Be sure to set the electronic gear with servo-off state to prevent unexpected operation due to improper setting.</p> <p>This parameter corresponds to "Motor revolutions (Index: 6091h, Sub: 1)". When this parameter is mapped to the link device of CC-Link IE Field Network Basic, the value written with MR Configurator2 is overwritten by the controller. Thus, do not write a value with MR Configurator2.</p> <p>Setting range: 1 to 16777215</p>	1
PA07 CDV Electronic gear denominator (command pulse multiplication denominator)		<p>Set an electronic gear denominator.</p> <p>To enable the parameter, select "Electronic gear (0 __ _)" of "Electronic gear selection" in [Pr. PA21].</p> <p>In the profile mode, cycle the power to enable the parameter.</p> <p>Setting range: 1 to 16777215</p>	1
PA10 INP In-position range		<p>Set an in-position range per command pulse.</p> <p>To change it to the servo motor encoder pulse unit, set [Pr. PC06].</p> <p>When [Pr. PC06] is set to " __ _ 0" in the profile mode, the unit can be changed 10⁻³ [degree] or [pulse] with the setting of [Pr. PT01].</p> <p>Setting range: 0 to 65535</p>	100 Refer to Function column for unit.

4. PARAMETERS

No./symbol/ name	Setting digit	Function	Initial value [unit]
PA11 TLP Forward rotation torque limit		<p>You can limit the torque generated by the servo motor.</p> <p>Set the parameter on the assumption that the rated torque is 100.0 [%]. Set the parameter to limit the torque of the servo motor in the CW power running or CCW regeneration.</p> <p>The polarity of the torque limit changes depending on the [Pr. PA14] setting. Set this parameter to "0.0" to generate no torque.</p> <p>If a value larger than the maximum torque of the servo motor is set, the value will be limited to the maximum torque of the servo motor.</p> <p>This parameter corresponds to "Positive torque limit value (Index: 60E0h)". When this parameter is mapped to the link device of CC-Link IE Field Network Basic, the value written with MR Configurator2 is overwritten by the controller. Thus, do not write a value with MR Configurator2.</p> <p>Setting range: 0.0 to 1000.0</p>	1000.0 [%]
PA12 TLN Reverse rotation torque limit		<p>You can limit the torque generated by the servo motor.</p> <p>Set the parameter on the assumption that the rated torque is 100.0 [%]. Set this parameter when limiting the torque of the servo motor in the CW power running or CCW regeneration.</p> <p>The polarity of the torque limit changes depending on the [Pr. PA14] setting. Set this parameter to "0.0" to generate no torque.</p> <p>If a value larger than the maximum torque of the servo motor is set, the value will be limited to the maximum torque of the servo motor.</p> <p>This parameter corresponds to "Negative torque limit value (Index: 60E1h)". When this parameter is mapped to the link device of CC-Link IE Field Network Basic, the value written with MR Configurator2 is overwritten by the controller. Thus, do not write a value with MR Configurator2.</p> <p>Setting range: 0.0 to 1000.0</p>	1000.0 [%]

4. PARAMETERS

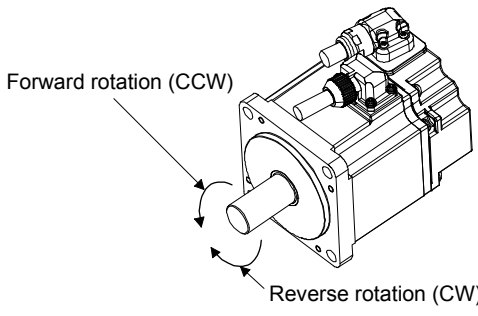
No./symbol/ name	Setting digit	Function	Initial value [unit]																																	
PA14 *POL Rotation direction selection		<p>Select a rotation direction or travel direction.</p> <p>The torque polarity changes depending on the combination of this parameter and [Pr. PC29 POL reflection selection at torque mode].</p> <ul style="list-style-type: none"> In the profile position mode/profile velocity mode <table border="1" data-bbox="438 448 1077 683"> <thead> <tr> <th rowspan="2">Setting value</th> <th colspan="2">Servo motor rotation direction</th> </tr> <tr> <th>Position mode Positioning address increase/ Velocity mode Speed command: Positive</th> <th>Position mode Positioning address decrease/ Velocity mode Speed command: Negative</th> </tr> </thead> <tbody> <tr> <td>0</td> <td>CCW</td> <td>CW</td> </tr> <tr> <td>1</td> <td>CW</td> <td>CCW</td> </tr> </tbody> </table> In the profile torque mode <table border="1" data-bbox="438 750 1284 1086"> <thead> <tr> <th colspan="2">Setting value</th> <th colspan="2">Servo motor rotation direction</th> </tr> <tr> <th>[Pr. PA14]</th> <th>[Pr. PC29]</th> <th>Torque mode Torque command: Forward</th> <th>Torque mode Torque command: Reverse</th> </tr> </thead> <tbody> <tr> <td rowspan="2">0</td> <td>0 ___: Enabled</td> <td>CCW</td> <td>CW</td> </tr> <tr> <td>1 ___: Disabled</td> <td>CCW</td> <td>CW</td> </tr> <tr> <td rowspan="2">1</td> <td>0 ___: Enabled</td> <td>CW</td> <td>CCW</td> </tr> <tr> <td>1 ___: Disabled</td> <td>CCW</td> <td>CW</td> </tr> </tbody> </table> <p>The following shows the servo motor rotation directions.</p>  <p>Setting range: 0, 1</p>	Setting value	Servo motor rotation direction		Position mode Positioning address increase/ Velocity mode Speed command: Positive	Position mode Positioning address decrease/ Velocity mode Speed command: Negative	0	CCW	CW	1	CW	CCW	Setting value		Servo motor rotation direction		[Pr. PA14]	[Pr. PC29]	Torque mode Torque command: Forward	Torque mode Torque command: Reverse	0	0 ___: Enabled	CCW	CW	1 ___: Disabled	CCW	CW	1	0 ___: Enabled	CW	CCW	1 ___: Disabled	CCW	CW	0
Setting value	Servo motor rotation direction																																			
	Position mode Positioning address increase/ Velocity mode Speed command: Positive	Position mode Positioning address decrease/ Velocity mode Speed command: Negative																																		
0	CCW	CW																																		
1	CW	CCW																																		
Setting value		Servo motor rotation direction																																		
[Pr. PA14]	[Pr. PC29]	Torque mode Torque command: Forward	Torque mode Torque command: Reverse																																	
0	0 ___: Enabled	CCW	CW																																	
	1 ___: Disabled	CCW	CW																																	
1	0 ___: Enabled	CW	CCW																																	
	1 ___: Disabled	CCW	CW																																	

4. PARAMETERS

4.2.2 Extension setting parameters ([Pr. PC__])

No./symbol/ name	Setting digit	Function	Initial value [unit]
PC01 STA Acceleration time constant		<p>Set the acceleration time taken from 0 r/min to the rated speed for the command. Set the acceleration time constant in the profile position mode and the profile velocity mode. Setting a value exceeding 20000 ms in the profile position mode will trigger [AL. F4].</p> <p>For example, for the servo motor with the rated speed of 3000 r/min, set 3000 (3 s) to increase speed from 0 r/min to 1000 r/min in 1 s.</p> <p>This parameter corresponds to "Profile acceleration (Index: 6083h)". When this parameter is mapped to the link device of CC-Link IE Field Network Basic, the value written with MR Configurator2 is overwritten by the controller. Thus, do not write a value with MR Configurator2.</p> <p>Setting range: 0 to 50000</p>	0 [ms]
PC02 STB Deceleration time constant		<p>Set the deceleration time taken from the rated speed to 0 r/min for the command. Set the deceleration time constant in the profile position mode and the profile velocity mode. Setting a value exceeding 20000 ms in the profile position mode will trigger [AL. F4].</p> <p>This parameter corresponds to "Profile deceleration (Index: 6084h)". When this parameter is mapped to the link device of CC-Link IE Field Network Basic, the value written with MR Configurator2 is overwritten by the controller. Thus, do not write a value with MR Configurator2.</p> <p>Setting range: 0 to 50000</p>	0 [ms]
PC25 *COP4 Function selection C-4	<p>___ x</p> <p>___ x _</p> <p>_ x _ _</p> <p>x _ _ _</p>	<p>For manufacturer setting</p> <p>[AL. E9 Main circuit off warning] selection Select an occurring condition of [AL. E9 Main circuit off warning]. 0: Detection with ready-on and servo-on command 1: Detection with servo-on command</p> <p>This function will be enabled in the profile mode.</p>	0h 0h 0h 0h

4. PARAMETERS

No./symbol/ name	Setting digit	Function	Initial value [unit]																		
PC29 *COP8 Function selection C-8	___x	For manufacturer setting	0h																		
	__x_		2h																		
	-x__	<p>POL reflection selection at torque mode</p> <p>The polarity of "Target torque (Index: 6071h)", "Torque demand (Index: 6074h)", "Positive torque limit value (Index: 60E0h)", "Negative torque limit value (Index: 60E1h)", and "Torque actual value (Index: 6077h)" changes depending on the combination of this parameter and [Pr. PA14 Rotation direction selection].</p> <p>0: Enabled 1: Disabled</p> <table border="1" style="margin-left: auto; margin-right: auto;"> <thead> <tr> <th rowspan="2">Setting value</th> <th colspan="2">Servo motor rotation direction/travel direction</th> </tr> <tr> <th>Torque mode Torque command: Forward</th> <th>Torque mode Torque command: Reverse</th> </tr> </thead> <tbody> <tr> <td rowspan="2">0</td> <td>0 ___: Enabled</td> <td>CCW or positive direction</td> <td>CW or negative direction</td> </tr> <tr> <td>1 ___: Disabled</td> <td>CCW or positive direction</td> <td>CW or negative direction</td> </tr> <tr> <td rowspan="2">1</td> <td>0 ___: Enabled</td> <td>CW or negative direction</td> <td>CCW or positive direction</td> </tr> <tr> <td>1 ___: Disabled</td> <td>CCW or positive direction</td> <td>CW or negative direction</td> </tr> </tbody> </table>	Setting value	Servo motor rotation direction/travel direction		Torque mode Torque command: Forward	Torque mode Torque command: Reverse	0	0 ___: Enabled	CCW or positive direction	CW or negative direction	1 ___: Disabled	CCW or positive direction	CW or negative direction	1	0 ___: Enabled	CW or negative direction	CCW or positive direction	1 ___: Disabled	CCW or positive direction	CW or negative direction
Setting value	Servo motor rotation direction/travel direction																				
	Torque mode Torque command: Forward	Torque mode Torque command: Reverse																			
0	0 ___: Enabled	CCW or positive direction	CW or negative direction																		
	1 ___: Disabled	CCW or positive direction	CW or negative direction																		
1	0 ___: Enabled	CW or negative direction	CCW or positive direction																		
	1 ___: Disabled	CCW or positive direction	CW or negative direction																		
	x___	For manufacturer setting	0h																		
PC75 FEWL Following error output level (Lower four digits)		<p>Set a following error output level.</p> <p>Upper and lower are a set.</p> <p>This function will be enabled in the profile position mode.</p> <p>When the state in which droop pulses \geq the parameter setting value continues for the time set in [Pr. PC77 Following error output filtering time], "Statusword (Index: 6041h) bit 13 Following error" will be turned on. However, setting "FFFFh FFFFh" will disable it.</p> <p>Set a value in hexadecimal.</p> <p>Setting value:</p> <div style="text-align: center;"> </div> <p>The unit can be changed to 10^{-3} [degree] or [pulse] with the setting of [Pr. PT01].</p> <p>This parameter corresponds to "Following error window (Index: 6065h)". When this parameter is mapped to the link device of CC-Link IE Field Network Basic, the value written with MR Configurator2 is overwritten by the controller. Thus, do not write a value with MR Configurator2.</p> <p>Setting range: 0000h 0000h to FFFFh FFFFh</p>	0000h Refer to Function column for unit.																		
PC76 FEWH Following error output level (Upper four digits)		<p>Set a following error output level.</p> <p>Upper and lower are a set.</p> <p>This function will be enabled in the profile position mode.</p> <p>Refer to [Pr. PC75] for details.</p> <p>The unit can be changed to 10^{-3} [degree] or [pulse] with the setting of [Pr. PT01].</p>	0000h Refer to Function column for unit.																		

4. PARAMETERS

No./symbol/ name	Setting digit	Function	Initial value [unit]
PC77 FEWF Following error output filtering time		<p>Set the time until the following error output turns on.</p> <p>When the state in which droop pulses \geq [Pr. PC75/Pr. PC76 Following error output level] continues for the time set in the parameter setting value, "Statusword (Index: 6041h) bit 13 Following error" will be turned on.</p> <p>This function will be enabled in the profile position mode.</p> <p>The following error output will be disabled when both [Pr. PC75] and [Pr. PC76] are "FFFFh".</p> <p>This parameter corresponds to "Following error time out (Index: 6066h)". When this parameter is mapped to the link device of CC-Link IE Field Network Basic, the value written with MR Configurator2 is overwritten by the controller. Thus, do not write a value with MR Configurator2.</p> <p>Setting range: 0 to 65535</p>	0000h Refer to Function column for unit.

4. PARAMETERS

4.2.3 I/O setting parameters ([Pr. PD_ _])

No./symbol/ name	Setting digit	Function	Initial value [unit]															
PD07	Any input device can be assigned to the CN3-2 pin.																	
*DI1H Input device selection 1H	__ x x	Communication command mode - Device selection Refer to table 4.1 for settings.	2Bh															
	_ x _ _	For manufacturer setting	0h															
	x _ _ _		0h															
<p>Table 4.1 Selectable input devices</p> <table border="1" style="margin: auto;"> <thead> <tr> <th rowspan="2">Setting value</th> <th>Input device (Note)</th> </tr> <tr> <th>pp/pv/tq</th> </tr> </thead> <tbody> <tr> <td>04</td> <td>PC (Proportional control)</td> </tr> <tr> <td>0A</td> <td>LSP (Forward rotation stroke end)</td> </tr> <tr> <td>0B</td> <td>LSN (Reverse rotation stroke end)</td> </tr> <tr> <td>0D</td> <td>CDP (Gain switching)</td> </tr> <tr> <td>2B</td> <td>DOG (Proximity dog)</td> </tr> <tr> <td>2C</td> <td>TPR1 (touch probe 1)</td> </tr> </tbody> </table> <p>Note. pp: profile position mode, pv: profile velocity mode, tq: profile torque mode</p>				Setting value	Input device (Note)	pp/pv/tq	04	PC (Proportional control)	0A	LSP (Forward rotation stroke end)	0B	LSN (Reverse rotation stroke end)	0D	CDP (Gain switching)	2B	DOG (Proximity dog)	2C	TPR1 (touch probe 1)
Setting value	Input device (Note)																	
	pp/pv/tq																	
04	PC (Proportional control)																	
0A	LSP (Forward rotation stroke end)																	
0B	LSN (Reverse rotation stroke end)																	
0D	CDP (Gain switching)																	
2B	DOG (Proximity dog)																	
2C	TPR1 (touch probe 1)																	
PD10	Any input device can be assigned to the CN3-3 pin.																	
*DI2H Input device selection 2H	__ x x	Communication command mode - Device selection Refer to table 4.1 in [Pr. PD07] for settings.	0Ah															
	_ x _ _	For manufacturer setting	0h															
	x _ _ _		0h															
PD13	Any input device can be assigned to the CN3-4 pin.																	
*DI3H Input device selection 3H	__ x x	Communication command mode - Device selection Refer to table 4.1 in [Pr. PD07] for settings.	0Bh															
	_ x _ _	For manufacturer setting	0h															
	x _ _ _		0h															
PD16	Any input device can be assigned to the CN3-8 pin.																	
*DI4H Input device selection 4H	__ x x	Communication command mode - Device selection Refer to table 4.1 in [Pr. PD07] for settings.	00h															
	_ x _ _	For manufacturer setting	0h															
	x _ _ _		0h															
PD19	Any input device can be assigned to the CN3-21 pin.																	
*DI5H Input device selection 5H	__ x x	Communication command mode - Device selection Refer to table 4.1 in [Pr. PD07] for settings.	00h															
	_ x _ _	For manufacturer setting	0h															
	x _ _ _		0h															
PD25	Any input device can be assigned to the CN3-6 pin.																	
*DI7H Input device selection 7H	__ x x	Communication command mode - Device selection Refer to table 4.1 in [Pr. PD07] for settings.	2Ch															
	_ x _ _	For manufacturer setting	0h															
	x _ _ _		0h															
PD28	Any input device can be assigned to the CN3-19 pin.																	
*DI8H Input device selection 8H	__ x x	Communication command mode - Device selection Refer to table 4.1 in [Pr. PD07] for settings.	00h															
	_ x _ _	For manufacturer setting	0h															
	x _ _ _		0h															

4. PARAMETERS

No./symbol/ name	Setting digit	Function	Initial value [unit]																														
PD29 *DO1 Output device selection 1	__ x x	Device selection Any output device can be assigned to the CN3-14 pin. When "CN3-14 (1 __ __)" is selected in "OP output selection" of [Pr. PD38], this digit is disabled and OP (Encoder Z-phase pulse (open collector)) is assigned to the CN3-14 pin. Refer to table 4.2 for settings.	02h																														
	_ x __	For manufacturer setting	0h																														
	x __ __		0h																														
<p>Table 4.2 Selectable output devices</p> <table border="1"> <thead> <tr> <th>Setting value</th> <th>Output device (Note) pp/pv/tq</th> </tr> </thead> <tbody> <tr><td>__ 0 0</td><td>Always off</td></tr> <tr><td>__ 0 2</td><td>RD (Ready)</td></tr> <tr><td>__ 0 3</td><td>ALM (Malfunction)</td></tr> <tr><td>__ 0 4</td><td>INP (In-position)</td></tr> <tr><td>__ 0 5</td><td>MBR (Electromagnetic brake interlock)</td></tr> <tr><td>__ 0 7</td><td>TLC (Limiting torque)</td></tr> <tr><td>__ 0 8</td><td>WNG (Warning)</td></tr> <tr><td>__ 0 9</td><td>BWNG (Battery warning)</td></tr> <tr><td>__ 0 A</td><td>SA (Speed reached)</td></tr> <tr><td>__ 0 B</td><td>VLC (Limiting speed)</td></tr> <tr><td>__ 0 C</td><td>ZSP (Zero speed detection)</td></tr> <tr><td>__ 0 D</td><td>MTTR (During tough drive)</td></tr> <tr><td>__ 0 F</td><td>CDPS (Variable gain selection)</td></tr> <tr><td>__ 1 1</td><td>ABSV (Absolute position undetermined)</td></tr> </tbody> </table> <p>Note. pp: profile position mode, pv: profile velocity mode, tq: profile torque mode</p>				Setting value	Output device (Note) pp/pv/tq	__ 0 0	Always off	__ 0 2	RD (Ready)	__ 0 3	ALM (Malfunction)	__ 0 4	INP (In-position)	__ 0 5	MBR (Electromagnetic brake interlock)	__ 0 7	TLC (Limiting torque)	__ 0 8	WNG (Warning)	__ 0 9	BWNG (Battery warning)	__ 0 A	SA (Speed reached)	__ 0 B	VLC (Limiting speed)	__ 0 C	ZSP (Zero speed detection)	__ 0 D	MTTR (During tough drive)	__ 0 F	CDPS (Variable gain selection)	__ 1 1	ABSV (Absolute position undetermined)
Setting value	Output device (Note) pp/pv/tq																																
__ 0 0	Always off																																
__ 0 2	RD (Ready)																																
__ 0 3	ALM (Malfunction)																																
__ 0 4	INP (In-position)																																
__ 0 5	MBR (Electromagnetic brake interlock)																																
__ 0 7	TLC (Limiting torque)																																
__ 0 8	WNG (Warning)																																
__ 0 9	BWNG (Battery warning)																																
__ 0 A	SA (Speed reached)																																
__ 0 B	VLC (Limiting speed)																																
__ 0 C	ZSP (Zero speed detection)																																
__ 0 D	MTTR (During tough drive)																																
__ 0 F	CDPS (Variable gain selection)																																
__ 1 1	ABSV (Absolute position undetermined)																																
PD30 *DO2 Output device selection 2	__ x x	Device selection Any output device can be assigned to the CN3-15 pin. When "CN3-15 (2 __ __)" is selected in "OP signal output selection" of [Pr. PD38], this digit is disabled and OP (Encoder Z-phase pulse (open collector)) is assigned to the CN3-15 pin. Refer to table 4.2 in [Pr. PD29] for settings.	03h																														
	_ x __	For manufacturer setting	0h																														
	x __ __		0h																														
PD31 *DO3 Output device selection 3	__ x x	Device selection Any output device can be assigned to the CN3-16 pin. This parameter cannot be used to assign output devices since the OP signal is assigned to the CN3-16 pin with "OP signal assignment selection" of [Pr. PD38] in the initial setting. To assign output devices, select a value other than "CN3-16 (3 __ __)" (initial value) in "OP signal assignment selection" of [Pr. PD38]. Refer to table 4.2 in [Pr. PD29] for settings.	00h																														
	_ x __	For manufacturer setting	0h																														
	x __ __		0h																														
PD32 *DO4 Output device selection 4	__ x x	Device selection Any output device can be assigned to the CN3-22 pin. When "CN3-22 (4 __ __)" is selected in "OP signal output selection" of [Pr. PD38], this digit is disabled and OP (Encoder Z-phase pulse (open collector)) is assigned to the CN3-22 pin. Refer to table 4.2 in [Pr. PD29] for settings.	04h																														
	_ x __	For manufacturer setting	0h																														
	x __ __		0h																														

4. PARAMETERS

No./symbol/ name	Setting digit	Function	Initial value [unit]
PD38 *DOP4 Function selection D-4	___x	For manufacturer setting	0h
	__x_		0h
	_x__		0h
	x___	OP signal assignment selection Select a pin to which the OP (Encoder Z-phase pulse (open collector)) is assigned. For example, if the OP is assigned to the CN3-14 pin, the OP is outputted regardless of the setting in [Pr. PD29]. 0: Not assigned 1: CN3-14 ([Pr. PD29] disabled) 2: CN3-15 ([Pr. PD30] disabled) 3: CN3-16 ([Pr. PD31] disabled) 4: CN3-22 ([Pr. PD32] disabled)	3h

4.2.4 Extension setting 2 parameters ([Pr. PE__])

No./symbol/ name	Setting digit	Function	Initial value [unit]
PE44 LMCP Lost motion compensation positive-side compensation value selection	/	Set the lost motion compensation for when reverse rotation (CW) switches to forward rotation (CCW) in increments of 0.01% assuming the rated torque as 100%. This function will be enabled in the profile position mode. Setting range: 0 to 30000	0 [0.01 %]
PE45 LMCN Lost motion compensation negative-side compensation value selection		Set the lost motion compensation for when forward rotation (CCW) switches to reverse rotation (CW) in increments of 0.01% assuming the rated torque as 100%. This function will be enabled in the profile position mode. Setting range: 0 to 30000	0 [0.01 %]
PE46 LMFLT Lost motion filter setting		Set the time constant of the lost motion compensation filter in increments of 0.1 ms. When "0" is set, the torque is compensated with the value set in [Pr. PE44] and [Pr. PE45]. When other than "0" is set, the torque is compensated with the high-pass filter output value of the set time constant, and the lost motion compensation will continue. This function will be enabled in the profile position mode. Setting range: 0 to 30000	0 [0.1 ms]
PE47 TOF Torque offset		Set this when canceling unbalanced torque of vertical axis. Set this assuming the rated torque of the servo motor as 100%. The torque offset does not need to be set for a machine not generating unbalanced torque. The torque offset set with this parameter will be enabled in the position control mode, speed control mode, and torque control mode. Input commands considering the torque offset in the torque control mode. This function will be enabled in the profile mode. Setting range: -10000 to 10000	0 [0.01 %]
PE48 *LMOP Lost motion compensation function selection	___x	Lost motion compensation selection 0: Disabled 1: Enabled This function will be enabled in the profile position mode.	0h
	__x_	Unit setting of lost motion compensation non-sensitive band 0: 1 pulse unit 1: 1 kpulse unit This function will be enabled in the profile position mode.	0h
	_x__	For manufacturer setting	0h
	x___		0h

4. PARAMETERS

No./symbol/ name	Setting digit	Function	Initial value [unit]
PE49 LMCD Lost motion compensation timing		Set the lost motion compensation timing in increments of 0.1 ms. You can delay the timing to perform the lost motion compensation for the set time. This function will be enabled in the profile position mode. Setting range: 0 to 30000	0 [0.1 ms]
PE50 LMCT Lost motion compensation non-sensitive band		Set the lost motion compensation non-sensitive band. When the fluctuation of droop pulses is equal to or less than the setting value, the speed will be 0. The setting unit can be changed in [Pr. PE48]. Set the parameter per encoder unit. This function will be enabled in the profile position mode. Setting range: 0 to 65535	0 [pulse]/ [kpulse]

4.2.5 Positioning control parameters ([Pr. PT_ _])

No./symbol/ name	Setting digit	Function	Initial value [unit]
PT01 *CTY Command mode selection	___x	For manufacturer setting	0h
	__x_		0h
	_x__	Position data unit 2: degree 3: pulse	3h
	x___	For manufacturer setting	0h
PT03 *FTY Feeding function selection	___x	For manufacturer setting	0h
	__x_		0h
	_x__	Shortest rotation selection per degree 0: Rotation direction specifying 1: Shortest rotation 2: Rotation in address decreasing direction 3: Rotation in address increasing direction This parameter corresponds to "Positioning option code (Index: 60F2h)". When this parameter is mapped to the link device of CC-Link IE Field Network Basic, the value written with MR Configurator2 is overwritten by the controller. Thus, do not write a value with MR Configurator2.	0h
	x___	For manufacturer setting	0h
PT05 ZRF Home position return speed		Set the servo motor speed for the home position return. Setting range: 0 to permissible instantaneous speed This parameter corresponds to "Speed during search for switch (Index: 6099h, Sub: 1)". When this parameter is mapped to the link device of CC-Link IE Field Network Basic, the value written with MR Configurator2 is overwritten by the controller. Thus, do not write a value with MR Configurator2.	100.00 [r/min]
PT06 CRF Creep speed		Set a creep speed after proximity dog at home position return. Setting range: 0 to permissible instantaneous speed This parameter corresponds to "Speed during search for zero (Index: 6099h, Sub: 2)". When this parameter is mapped to the link device of CC-Link IE Field Network Basic, the value written with MR Configurator2 is overwritten by the controller. Thus, do not write a value with MR Configurator2.	10.00 [r/min]
PT07 ZST Home position shift distance		Set a shift distance from the Z-phase pulse detection position in the encoder. Up to 2^{31} can be set with [Pr. PT57]. The unit will be changed to 10^{-3} [degree] or [pulse] with the setting of [Pr. PT01]. Refer to the Function column of [Pr. PA10] for the command unit of [pulse].	0 Refer to Function column for unit.
		Setting range: 0 to 65535	

4. PARAMETERS

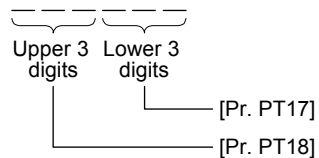
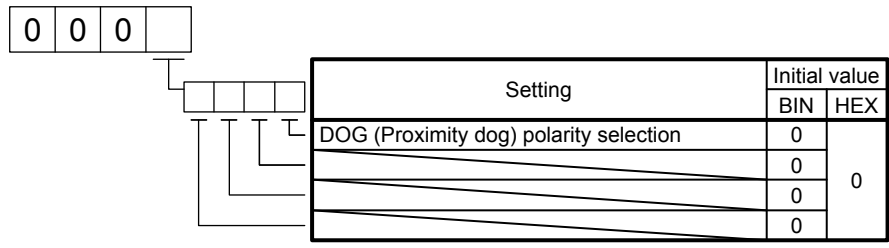
No./symbol/ name	Setting digit	Function	Initial value [unit]														
PT17 LMNL Software limit - (lower three digits)		<p>Set an address decreasing side of the software stroke limit. Upper and lower are a set.</p> <p>Setting address:</p>  <p>Setting a same value with "Software limit +" will disable the software stroke limit. (Refer to section 4.3.)</p>	0 Refer to Function column for unit.														
PT18 LMNH Software limit - (upper three digits)		<p>Set a same sign for [Pr. PT17] and [Pr. PT18]. A different sign will be recognized as minus sign data.</p> <p>When changing the direction to the address increasing direction, change it from the + side of the software limit ([Pr. PT15] and [Pr. PT16]). An incorrect order of the setting will trigger [AL. 37]. Therefore, cycling the power may be required after [Pr. PT15] to [Pr. PT18] are all set. The unit will be changed to 10⁻³ [degree] or [pulse] with the setting of [Pr. PT01].</p> <p>This parameter corresponds to "Min position limit (Index: 607Dh, Sub: 1)". When this parameter is mapped to the link device of CC-Link IE Field Network Basic, the value written with MR Configurator2 is overwritten by the controller. Thus, do not write a value with MR Configurator2.</p> <p>Setting range: -999999 to 999999</p>															
PT26 *TOP2 Function selection T-2	___x	<p>Electronic gear fraction clear selection</p> <p>0: Disabled 1: Enabled</p> <p>Selecting "Enabled" will clear a fraction of the previous command by the electronic gear at start of the profile mode.</p> <p>Setting "2" or more to this digit will be "Disabled".</p>	0h														
	__x_	For manufacturer setting	0h														
	_x__		0h														
	x___		0h														
PT29 *TOP3 Function selection T-3	___x (HEX)	<p>Set the DOG polarity.</p> <p>___x (BIN): DOG (Proximity dog) polarity selection</p> <p>0: Dog detection with off 1: Dog detection with on</p> <p>__x_ (BIN): For manufacturer setting</p> <p>_x__ (BIN): For manufacturer setting</p> <p>x___ (BIN): For manufacturer setting</p>	0h														
	__x_	For manufacturer setting	0h														
	_x__		0h														
	x___		0h														
<p>Convert the setting value into hexadecimal as follows.</p>  <table border="1" style="margin-left: auto; margin-right: auto;"> <thead> <tr> <th rowspan="2">Setting</th> <th colspan="2">Initial value</th> </tr> <tr> <th>BIN</th> <th>HEX</th> </tr> </thead> <tbody> <tr> <td>DOG (Proximity dog) polarity selection</td> <td>0</td> <td rowspan="4">0</td> </tr> <tr> <td></td> <td>0</td> </tr> <tr> <td></td> <td>0</td> </tr> <tr> <td></td> <td>0</td> </tr> </tbody> </table>				Setting	Initial value		BIN	HEX	DOG (Proximity dog) polarity selection	0	0		0		0		0
Setting	Initial value																
	BIN	HEX															
DOG (Proximity dog) polarity selection	0	0															
	0																
	0																
	0																

4. PARAMETERS

No./symbol/ name	Setting digit	Function	Initial value [unit]																																														
PT41 ORP Home position return inhibit function selection	___x	Home position return inhibit selection 0: Disabled (home position return allowed) 1: Enabled (home position return inhibited)	0h																																														
	__x_	For manufacturer setting	0h																																														
	_x__		0h																																														
	x___		0h																																														
PT45 HMM Home position return method		Set a home position return method. Refer to the following table for details. Setting a value other than the setting values will trigger [AL. 37]. This parameter corresponds to "Homing method (Index: 6098h)". When this parameter is mapped to the link device of CC-Link IE Field Network Basic, the value written with MR Configurator2 is overwritten by the controller. Thus, do not write a value with MR Configurator2.	37																																														
		<table border="1"> <thead> <tr> <th>Setting value</th> <th>Home position return direction</th> <th>Home position return method</th> <th>Setting value</th> <th>Home position return direction</th> <th>Home position return method</th> </tr> </thead> <tbody> <tr> <td>-1</td> <td rowspan="11">Address increasing direction</td> <td>Dog type (rear end detection, Z-phase reference)</td> <td>-33</td> <td rowspan="11">Address decreasing direction</td> <td>Dog type (rear end detection, Z-phase reference)</td> </tr> <tr> <td>-2</td> <td>Count type (front end detection, Z-phase reference)</td> <td>-34</td> <td>Count type (front end detection, Z-phase reference)</td> </tr> <tr> <td>-3</td> <td>Data set type</td> <td>-36</td> <td>Stopper type (Stopper position reference)</td> </tr> <tr> <td>-4</td> <td>Stopper type (Stopper position reference)</td> <td>-38</td> <td>Dog type (rear end detection, rear end reference)</td> </tr> <tr> <td>-6</td> <td>Dog type (rear end detection, rear end reference)</td> <td>-39</td> <td>Count type (front end detection, front end reference)</td> </tr> <tr> <td>-7</td> <td>Count type (front end detection, front end reference)</td> <td>-40</td> <td>Dog cradle type</td> </tr> <tr> <td>-8</td> <td>Dog cradle type</td> <td>-41</td> <td>Dog type last Z-phase reference</td> </tr> <tr> <td>-9</td> <td>Dog type last Z-phase reference</td> <td>-42</td> <td>Dog type front end reference</td> </tr> <tr> <td>-10</td> <td>Dog type front end reference</td> <td>-43</td> <td>Dogless Z-phase reference</td> </tr> <tr> <td>-11</td> <td>Dogless Z-phase reference</td> <td></td> <td></td> </tr> </tbody> </table>	Setting value	Home position return direction	Home position return method	Setting value	Home position return direction	Home position return method	-1	Address increasing direction	Dog type (rear end detection, Z-phase reference)	-33	Address decreasing direction	Dog type (rear end detection, Z-phase reference)	-2	Count type (front end detection, Z-phase reference)	-34	Count type (front end detection, Z-phase reference)	-3	Data set type	-36	Stopper type (Stopper position reference)	-4	Stopper type (Stopper position reference)	-38	Dog type (rear end detection, rear end reference)	-6	Dog type (rear end detection, rear end reference)	-39	Count type (front end detection, front end reference)	-7	Count type (front end detection, front end reference)	-40	Dog cradle type	-8	Dog cradle type	-41	Dog type last Z-phase reference	-9	Dog type last Z-phase reference	-42	Dog type front end reference	-10	Dog type front end reference	-43	Dogless Z-phase reference	-11	Dogless Z-phase reference	
Setting value	Home position return direction	Home position return method	Setting value	Home position return direction	Home position return method																																												
-1	Address increasing direction	Dog type (rear end detection, Z-phase reference)	-33	Address decreasing direction	Dog type (rear end detection, Z-phase reference)																																												
-2		Count type (front end detection, Z-phase reference)	-34		Count type (front end detection, Z-phase reference)																																												
-3		Data set type	-36		Stopper type (Stopper position reference)																																												
-4		Stopper type (Stopper position reference)	-38		Dog type (rear end detection, rear end reference)																																												
-6		Dog type (rear end detection, rear end reference)	-39		Count type (front end detection, front end reference)																																												
-7		Count type (front end detection, front end reference)	-40		Dog cradle type																																												
-8		Dog cradle type	-41		Dog type last Z-phase reference																																												
-9		Dog type last Z-phase reference	-42		Dog type front end reference																																												
-10		Dog type front end reference	-43		Dogless Z-phase reference																																												
-11		Dogless Z-phase reference																																															

4. PARAMETERS

No./symbol/ name	Setting digit	Function	Initial value [unit]																																	
PT45 HMM Home position return method		<table border="1"> <thead> <tr> <th>Setting value</th> <th>Home position return direction</th> <th>Home position return method</th> </tr> </thead> <tbody> <tr><td>3</td><td>Address increasing direction</td><td>Method 3</td></tr> <tr><td>4</td><td>Address increasing direction</td><td>Method 4</td></tr> <tr><td>5</td><td>Address decreasing direction</td><td>Method 5</td></tr> <tr><td>6</td><td>Address decreasing direction</td><td>Method 6</td></tr> <tr><td>7</td><td>Address increasing direction</td><td>Method 7</td></tr> <tr><td>8</td><td>Address increasing direction</td><td>Method 8</td></tr> <tr><td>11</td><td>Address decreasing direction</td><td>Method 11</td></tr> <tr><td>12</td><td>Address decreasing direction</td><td>Method 12</td></tr> <tr><td>19</td><td>Address increasing direction</td><td>Method 19</td></tr> <tr><td>20</td><td>Address increasing direction</td><td>Method 20</td></tr> </tbody> </table>	Setting value	Home position return direction	Home position return method	3	Address increasing direction	Method 3	4	Address increasing direction	Method 4	5	Address decreasing direction	Method 5	6	Address decreasing direction	Method 6	7	Address increasing direction	Method 7	8	Address increasing direction	Method 8	11	Address decreasing direction	Method 11	12	Address decreasing direction	Method 12	19	Address increasing direction	Method 19	20	Address increasing direction	Method 20	
	Setting value	Home position return direction	Home position return method																																	
	3	Address increasing direction	Method 3																																	
	4	Address increasing direction	Method 4																																	
	5	Address decreasing direction	Method 5																																	
	6	Address decreasing direction	Method 6																																	
	7	Address increasing direction	Method 7																																	
	8	Address increasing direction	Method 8																																	
	11	Address decreasing direction	Method 11																																	
	12	Address decreasing direction	Method 12																																	
	19	Address increasing direction	Method 19																																	
	20	Address increasing direction	Method 20																																	
		<table border="1"> <thead> <tr> <th>Setting value</th> <th>Home position return direction</th> <th>Home position return method</th> </tr> </thead> <tbody> <tr><td>21</td><td>Address decreasing direction</td><td>Method 21</td></tr> <tr><td>22</td><td>Address decreasing direction</td><td>Method 22</td></tr> <tr><td>23</td><td>Address increasing direction</td><td>Method 23</td></tr> <tr><td>24</td><td>Address increasing direction</td><td>Method 24</td></tr> <tr><td>27</td><td>Address decreasing direction</td><td>Method 27</td></tr> <tr><td>28</td><td>Address decreasing direction</td><td>Method 28</td></tr> <tr><td>33</td><td>Address decreasing direction</td><td>Method 33</td></tr> <tr><td>34</td><td>Address increasing direction</td><td>Method 34</td></tr> <tr><td>35</td><td></td><td>Method 35</td></tr> <tr><td>37</td><td></td><td>Method 37 (Data set type)</td></tr> </tbody> </table>	Setting value	Home position return direction	Home position return method	21	Address decreasing direction	Method 21	22	Address decreasing direction	Method 22	23	Address increasing direction	Method 23	24	Address increasing direction	Method 24	27	Address decreasing direction	Method 27	28	Address decreasing direction	Method 28	33	Address decreasing direction	Method 33	34	Address increasing direction	Method 34	35		Method 35	37		Method 37 (Data set type)	
	Setting value	Home position return direction	Home position return method																																	
21	Address decreasing direction	Method 21																																		
22	Address decreasing direction	Method 22																																		
23	Address increasing direction	Method 23																																		
24	Address increasing direction	Method 24																																		
27	Address decreasing direction	Method 27																																		
28	Address decreasing direction	Method 28																																		
33	Address decreasing direction	Method 33																																		
34	Address increasing direction	Method 34																																		
35		Method 35																																		
37		Method 37 (Data set type)																																		
PT49 TQS Torque slope		<p>Set the rate of change of the torque command per second. However, setting "0.0" will disable the torque slope. This function will be enabled in the profile torque mode.</p> <p>This parameter corresponds to "Torque slope (Index: 6087h)". When this parameter is mapped to the link device of CC-Link IE Field Network Basic, the value written with MR Configurator2 is overwritten by the controller. Thus, do not write a value with MR Configurator2.</p> <p>Setting range: 0.0 to 1000000.0</p>	0.0 [%/s]																																	
PT50 PVC Profile speed command		<p>Set the speed of the profile speed command. The fractional portion of the parameter will be rounded down. This function will be enabled in the profile position mode.</p> <p>This parameter corresponds to "Profile velocity (Index: 6081h)". When this parameter is mapped to the link device of CC-Link IE Field Network Basic, the value written with MR Configurator2 is overwritten by the controller. Thus, do not write a value with MR Configurator2.</p> <p>Setting range: 0.00 to permissible instantaneous speed</p>	100.00 [r/min]																																	
PT51 MPVC Maximum profile speed		<p>Set the maximum profile speed. This function will be enabled in the profile position mode and profile velocity mode. The fractional portion of this parameter will be rounded down in the profile position mode.</p> <p>This parameter corresponds to "Max profile velocity (Index: 607Fh)". When this parameter is mapped to the link device of CC-Link IE Field Network Basic, the value written with MR Configurator2 is overwritten by the controller. Thus, do not write a value with MR Configurator2.</p> <p>Setting range: 0.00 to 20000.00</p>	20000.00 [r/min]																																	
PT52 VLMT Speed limit		<p>Set the maximum speed in the torque control. This function will be enabled in the profile mode.</p> <p>This parameter corresponds to "Velocity limit value (Index: 2D20h)". When this parameter is mapped to the link device of CC-Link IE Field Network Basic, the value written with MR Configurator2 is overwritten by the controller. Thus, do not write a value with MR Configurator2.</p> <p>Setting range: 0.00 to permissible instantaneous speed</p>	500.00 [r/min]																																	

4. PARAMETERS

No./symbol/ name	Setting digit	Function	Initial value [unit]
PT57 ZSTH Home position shift distance (extension parameter)		<p>This parameter is the extension parameter of [Pr. PT07].</p> <p>When [Pr. PT57] is used, the home position shift distance is calculated as follows. Home position shift distance = [Pr. PT07] + ([Pr. PT57] × 65536)</p> <p>This function will be enabled in the profile mode.</p> <p>The unit can be changed to 10⁻³ [degree] or [pulse] with the setting of [Pr. PT01].</p> <p>Setting range: 0 to 32767</p>	0 Refer to Function column for unit.
PT59 DCTH Travel distance after proximity dog (extension parameter)		<p>This parameter is the extension parameter of [Pr. PT09].</p> <p>When [Pr. PT59] is used, the travel distance after proximity dog is calculated as follows. Travel distance after proximity dog = [Pr. PT09] + ([Pr. PT59] × 65536)</p> <p>This function will be enabled in the profile mode.</p> <p>The unit can be changed to 10⁻³ [degree] or [pulse] with the setting of [Pr. PT01].</p> <p>Setting range: 0 to 32767</p>	0 Refer to Function column for unit.
PT60 *TOP8 Function selection T-8	___x	<p>Home position return - Deceleration time constant selection</p> <p>Select a parameter used for setting the deceleration time constant at home position return. The acceleration time constant is fixed to [Pr. PT61].</p> <p>0: Using [Pr. PT61] as deceleration time constant 1: Using [Pr. PT62] as deceleration time constant</p>	0h
	__x_	For manufacturer setting	0h
	_x__		0h
	x___		0h
PT61 HMA Home position return acceleration time constant		<p>Set the acceleration time constant for the home position return. Set an acceleration time taken from 0 r/min to the rated speed.</p> <p>This function will be enabled in the profile mode.</p> <p>When "Using [Pr. PT61] as deceleration time constant (0 __ _)" is selected in "Home position return - Deceleration time constant selection" of [Pr. PT60], the value set in this parameter is used as a deceleration time constant at home position return.</p> <p>This parameter corresponds to "Homing acceleration (Index: 609Ah)". When this parameter is mapped to the link device of CC-Link IE Field Network Basic, the value written with MR Configurator2 is overwritten by the controller. Thus, do not write a value with MR Configurator2.</p> <p>Setting range: 0 to 20000</p>	0 [ms]
PT62 HMB Home position return deceleration time constant		<p>Set the deceleration time constant at the home position return. Set a deceleration time taken from the rated speed to 0 r/min.</p> <p>This function will be enabled in the profile mode.</p> <p>When "Using [Pr. PT62] as deceleration time constant (1 __ _)" is selected in "Home position return - Deceleration time constant selection" of [Pr. PT60], the value set in this parameter is enabled.</p> <p>Setting range: 0 to 20000</p>	0 [ms]
PT63 ZSP2L Zero speed 2 level		<p>Set a speed level for turning on the zero speed 2.</p> <p>When the state in which the absolute value of the servo motor speed exceeds the parameter setting value continues for the time set in [Pr. PT64 Zero speed 2 filtering time] or longer, "Statusword (Index: 6041h) bit 12 Speed" will be turned off.</p> <p>This function will be enabled in the profile velocity mode.</p> <p>This parameter corresponds to "Velocity threshold (Index: 606Fh)". When this parameter is mapped to the link device of CC-Link IE Field Network Basic, the value written with MR Configurator2 is overwritten by the controller. Thus, do not write a value with MR Configurator2.</p> <p>Setting range: 0.00 to 655.35</p>	50.00 [r/min]

4. PARAMETERS

No./symbol/ name	Setting digit	Function	Initial value [unit]
PT64 ZSP2F Zero speed 2 filtering time		<p>Set the zero speed 2 filtering time.</p> <p>When the state in which the absolute value of the servo motor speed exceeds [Pr. PT63 Zero speed 2 level] continues for the time set in this parameter or longer, "Statusword (Index: 6041h) bit 12 Speed" will be turned off.</p> <p>This function will be enabled in the profile velocity mode.</p> <p>This parameter corresponds to "Velocity threshold time (Index: 6070h)". When this parameter is mapped to the link device of CC-Link IE Field Network Basic, the value written with MR Configurator2 is overwritten by the controller. Thus, do not write a value with MR Configurator2.</p> <p>Setting range: 0 to 65535</p>	10 [ms]
PT65 INP2R In-position 2 output range		<p>Set a position range for turning on the in-position 2 output.</p> <p>When the state in which an error between the command position and current position is within the parameter setting value continues for the time set in [Pr. PT66 In-position 2 output filtering time] or longer, "Statusword (Index: 6041h) bit 10 Target reached" will be turned on. However, when this parameter is set to "65535", "Statusword (Index: 6041h) bit 10 Target reached" will be always on.</p> <p>This function will be enabled in the profile position mode and homing mode.</p> <p>The unit can be changed to 10^{-3} [degree] or [pulse] with the setting of [Pr. PT01].</p> <p>This parameter corresponds to "Position window (Index: 6067h)". When this parameter is mapped to the link device of CC-Link IE Field Network Basic, the value written with MR Configurator2 is overwritten by the controller. Thus, do not write a value with MR Configurator2.</p> <p>Setting range: 0 to 65535</p>	100 Refer to Function column for unit.
PT66 INP2F In-position 2 output filtering time		<p>Set the time until the in-position 2 output turns on.</p> <p>When the state in which an error between the command position and current position is within [Pr. PT65 In-position 2 output range] continues for the time set in this parameter or longer, "Statusword (Index: 6041h) bit 10 Target reached" will be turned on. However, when this parameter is set to "65535", "Statusword (Index: 6041h) bit 10 Target reached" will be always on.</p> <p>This function will be enabled in the profile position mode and homing mode.</p> <p>This parameter corresponds to "Position window time (Index: 6068h)". When this parameter is mapped to the link device of CC-Link IE Field Network Basic, the value written with MR Configurator2 is overwritten by the controller. Thus, do not write a value with MR Configurator2.</p> <p>Setting range: 0 to 65535</p>	10 [ms]
PT67 SA2R Speed reached 2 output range		<p>Set a speed range for turning on the speed reached 2 output.</p> <p>When the state in which an error between the command speed and servo motor speed is within the parameter setting value continues for the time set in [Pr. PT68 Speed reached 2 output filtering time] or longer, "Statusword (Index: 6041h) bit 10 Target velocity reached" will be turned on.</p> <p>This function will be enabled in the profile velocity mode.</p> <p>This parameter corresponds to "Velocity window (Index: 606Dh)". When this parameter is mapped to the link device of CC-Link IE Field Network Basic, the value written with MR Configurator2 is overwritten by the controller. Thus, do not write a value with MR Configurator2.</p> <p>Setting range: 0.00 to 655.35</p>	20.00 [r/ms]
PT68 SA2F Speed reached 2 output filtering time		<p>Set the time until the speed reached 2 output turns on.</p> <p>When the state in which an error between the speed command and servo motor speed is within [Pr. PT67 Speed reached 2 output range] continues for the time set in this parameter or longer, "Statusword (Index: 6041h) bit 10 Target velocity reached" will be turned on.</p> <p>This function will be enabled in the profile velocity mode.</p> <p>This parameter corresponds to "Velocity window time (Index: 606Eh)". When this parameter is mapped to the link device of CC-Link IE Field Network Basic, the value written with MR Configurator2 is overwritten by the controller. Thus, do not write a value with MR Configurator2.</p> <p>Setting range: 0 to 65535</p>	10 [ms]

4. PARAMETERS

4.3 Software limit

The limit stop with the software limit ([Pr. PT15] to [Pr. PT18]) is the same as the motion of the stroke end. Exceeding a setting range will stop and servo-lock the shaft. This will be enabled at power-on and will be disabled in the profile velocity mode, profile torque mode, and homing mode. Setting a same value to "Software limit +" and "Software limit -" will disable this function. Setting a larger value to "Software limit -" than "Software limit +" will disable this function.

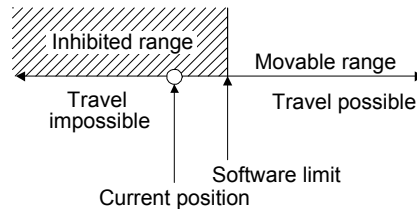

4.4 How to set the electronic gear

4.4.1 Electronic gear setting for the profile mode

(1) Setting [pulse] with "Position data unit" of [Pr. PT01]

Adjust [Pr. PA06] and [Pr. PA07] to match the servo amplifier setting with the travel distance of the machine.

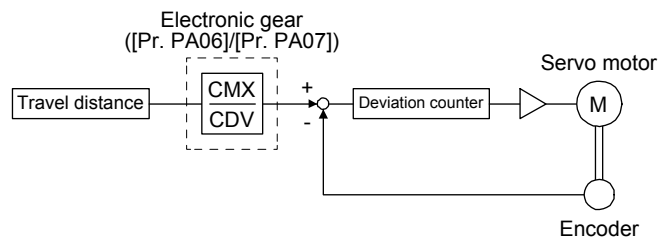

P_i : Servo motor encoder resolution: 131072 [pulse/rev]
 ΔS : Travel distance per servo motor revolution [pulse/rev]
 $CMX/CDV = P_i/\Delta S$

The following setting example explains how to calculate the electronic gear.

POINT
<ul style="list-style-type: none"> ● To calculate the electronic gear, the following specification symbols are required. Pb: Ball screw lead [mm] 1/n: Reduction ratio P_i: Servo motor encoder resolution [pulse/rev] ΔS: Travel distance per servo motor revolution [mm/rev]

4. PARAMETERS

(a) Setting example of a ball screw

Machine specifications

Ball screw lead $P_b = 10$ [mm]

Reduction ratio: $1/n = Z_1/Z_2 = 1/2$

Z_1 : Number of gear teeth on servo motor side

Z_2 : Number of gear teeth on load side

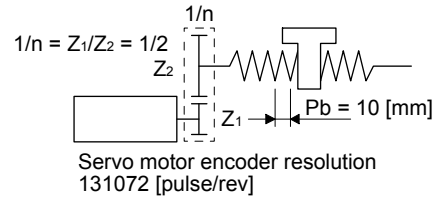

Servo motor encoder resolution: $P_t = 131072$ [pulse/rev]

$$\frac{CMX}{CDV} = \frac{P_t}{\Delta S} = \frac{P_t}{n \cdot P_b \cdot \alpha \text{ (Note)}} = \frac{131072}{1/2 \cdot 10 \cdot 1} = \frac{131072}{5}$$

Note. Because the command unit is "pulse", α is 1.

Therefore, set $CMX = 131072$ and $CDV = 5$.

(b) Setting example of a conveyor

Machine specifications

Pulley diameter: $r = 160$ [mm]

Reduction ratio: $1/n = Z_1/Z_2 = 1/3$

Z_1 : Number of gear teeth on servo motor side

Z_2 : Number of gear teeth on load side

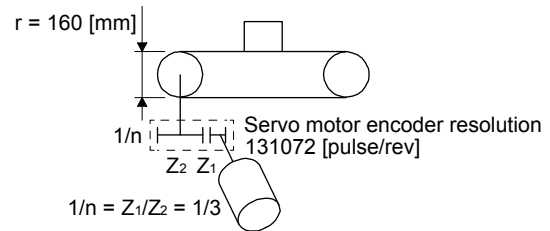

Servo motor encoder resolution: $P_t = 131072$ [pulse/rev]

$$\frac{CMX}{CDV} = \frac{P_t}{\Delta S} = \frac{P_t}{n \cdot r \cdot \pi \cdot \alpha \text{ (Note)}} = \frac{131072}{1/3 \cdot 160 \cdot \pi \cdot 1} = \frac{131072}{167.6} \approx \frac{16384}{21}$$

Note. Because the command unit is "pulse", α is 1.

Reduce CMX and CDV to within the setting range or lower and round off each value to the closest whole number.

Therefore, set $CMX = 16384$ and $CDV = 21$.

4. PARAMETERS

(2) Setting [degree] with "Position data unit" of [Pr. PT01].

Set the number of gear teeth on machine side to [Pr. PA06] and the number of gear teeth on servo motor side to [Pr. PA07].

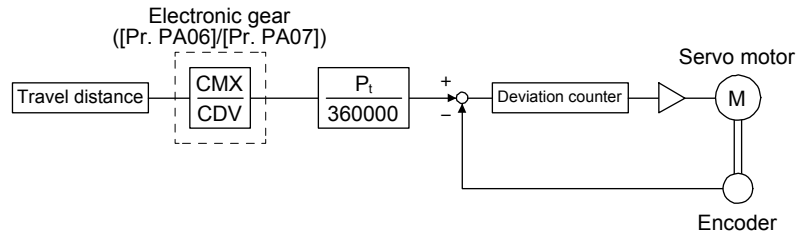

P_t : Servo motor encoder resolution: 131072 [pulse/rev]

Set the electronic gear within the following range. Setting out of the range will trigger [AL. 37 Parameter error].

- (a) Set values to make numerator and denominator 16384 or lower if the electronic gear (CMX/CDV) is reduced to its lowest terms.
- (b) Set values to make numerator and denominator 16777216 or lower if $(CMX \times P_t)/(CDV \times 360000)$ is reduced to its lowest terms.

The following shows a setting example of the electronic gear.

Number of gear teeth on machine side: 25, number of gear teeth on servo motor side: 11

Set [Pr. PA06] = 25 and [Pr. PA07] = 11.

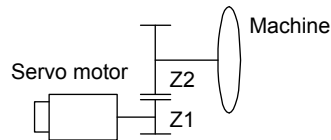

P_t : (servo motor resolution): 131072 pulses/rev

Z1: Number of gear teeth on servo motor side

Z2: Number of gear teeth on machine side

Z1: Z2 = 11:25

4. PARAMETERS

4.5 Restrictions on using objects

4.5.1 Restrictions on input devices

The following input devices can be used when [Pr. PA01] = "___0" to "___5" (Position/velocity/torque control mode). They cannot be used when [Pr. PA01] = "___9" (Profile mode).

Device	Symbol	Pr. PA01	
		___0 to ___5 (Position/velocity/torque control mode)	___9 (Profile control mode)
Servo-on	SON	○	○
Reset	RES	○	○
Control switching	LOP	○	○
Forward rotation start/reverse rotation selection	ST1/RS2	○	○
Reverse rotation start/forward rotation selection	ST2/RS1	○	○

4.5.2 Restrictions on objects

The following objects can be used when [Pr. PA01] = "___9" (Profile mode). They cannot be used when [Pr. PA01] = "___0" to "___5" (Position/velocity/torque control mode).

Object name	Index	Pr. PA01	
		___0 to ___5 (Position/velocity/torque control mode)	___9 (Profile control mode)
Control command (Controlword)	6040h	○	○
Control mode (Modes of operation)	6060h	○	○

5. CiA 402 DRIVE PROFILE

5. CiA 402 DRIVE PROFILE

This chapter describes how to drive a servo motor in the communication. For MR-JE-_C servo amplifier, objects are assigned according to Index of the CiA 402 drive profile. By accessing the assigned objects, the controller can drive the servo motor.

The following table lists the usable functions. For details of the objects, refer to "MR-JE-_C Servo Amplifier Instruction Manual (CC-Link IE Field Network Basic)".

Function	Description	Detailed explanation
State machine control of the servo amplifier	The controller can control the state machine of the servo amplifier to drive the servo motor.	Section 5.1
Control mode	The profile mode can be selected.	Section 5.2
Homing mode	This is a mode where the servo amplifier performs a home position return operation using the method directed by the controller.	Section 6.1
Profile mode	This is a mode which drives the servo motor based on the position data (target position), servo motor speed, and acceleration/deceleration time constants set by the controller.	Section 6.2 Section 6.3 Section 6.4

5.1 State machine control of the servo amplifier

5.1.1 Function description

The servo amplifier status is managed based on the state machine below. Setting the control command (6040h) from the master station (controller) changes the status of the slave stations (servo amplifiers). The current servo amplifier status can be read with the control status (6041h).

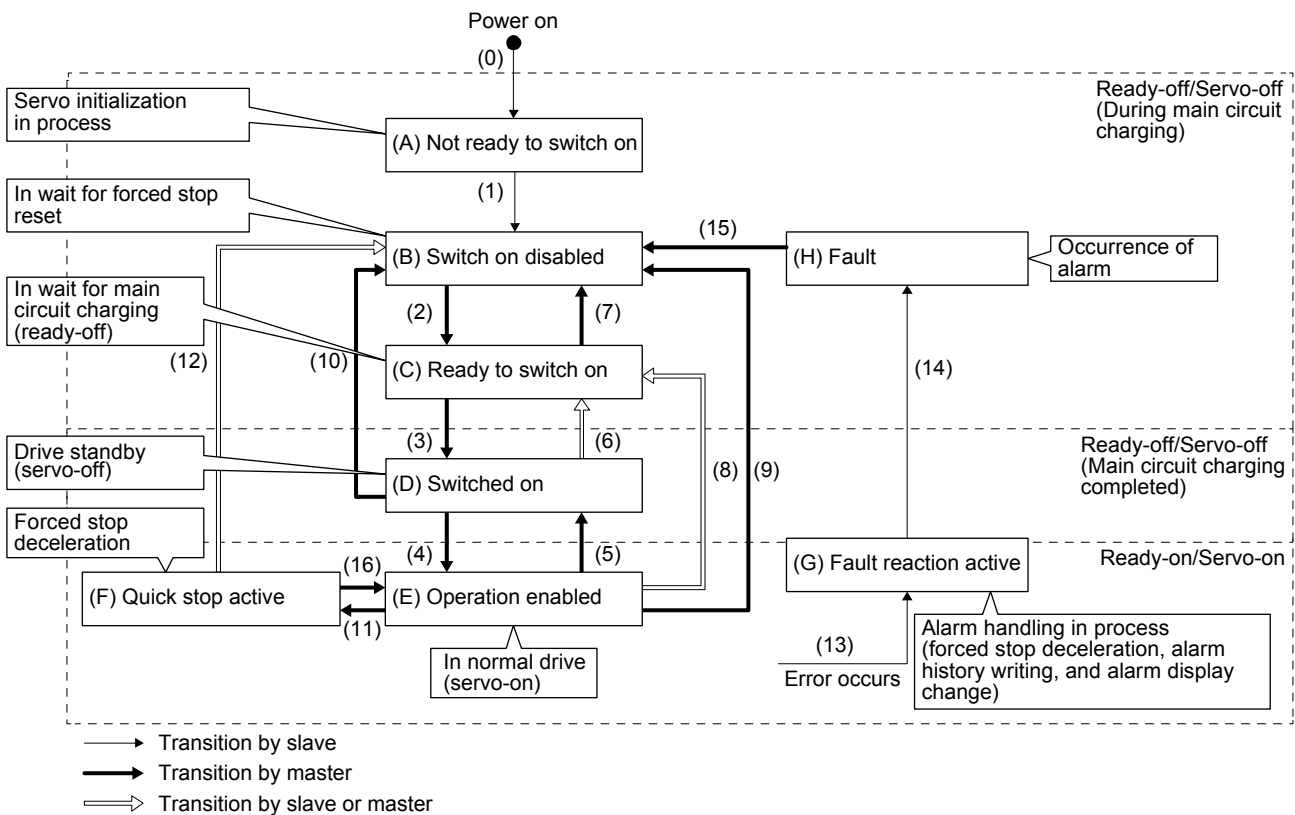

5. CiA 402 DRIVE PROFILE

Table 5.1 State transition

Transition No.	Event	Remark
(0)	The power is turned on.	Initialization
(1)	The state automatically transitions when the power is turned on.	Communication setting
(2)	The state transitions with the Shutdown command from the master.	
(3)	The state transitions with the Switch on command from the master.	RA turns on.
(4)	The state transitions with the Enable operation command from the master.	The operation becomes ready after servo-on.
(5)	The state transitions with the Disable operation command from the master.	The operation is disabled after servo-off.
(6)	The state transitions with the Shutdown command from the master.	RA turns off.
(7)	The state transitions with the Disable Voltage command or Quick Stop command from the master.	
(8)	The state transitions with the Shutdown command from the master.	Operation is disabled after servo-off or RA-off.
(9)	The state transitions with the Disable Voltage command from the master.	Operation is disabled after servo-off or RA-off.
(10)	The state transitions with the Disable Voltage command or Quick Stop command from the master.	RA turns off.
(11)	The state transitions with the Quick Stop command from the master.	Quick Stop starts.
(12)	(a) The state automatically transitions after Quick Stop is completed. (If the Quick Stop option code is 1, 2, 3, or 4) (b) The state transitions with the Disable Voltage command from the master.	Operation is disabled after servo-off or RA-off.
(13)	Alarm occurrence	Processing against the alarm is executed.
(14)	Automatic transition	After processing against the alarm has been completed, servo-off or RA-off is performed and the operation is disabled.
(15)	The state transitions with the Fault Reset command from the master.	Alarms are reset. Alarms that can be reset are reset.
(16) (Not compatible) (Note)	The state transitions with the Enable Operation command from the master. (If the Quick Stop option code is 5, 6, 7, or 8)	The operation becomes ready.

Note. This is not available with MR-JE- C servo amplifier.

5. CiA 402 DRIVE PROFILE

5.1.2 Related object

Index	Sub Index	Read/write	Name	Data type	Initial value
6040h	0	Read/write	Controlword (Control command)	2 bytes	
6041h	0	Read	Statusword (Control status)	2 bytes	

(1) Control command (Controlword: 6040h)

This object issues a command from the master station (controller) to the slave stations (servo amplifiers).

Index	Sub Index	Read/write	Name	Data type	Initial value
6040h	0	Read/write	Controlword (Control command)	2 bytes	

The current control command status can be checked.

In addition, control commands can be written.

The following table lists the bits of this object. The slave can be controlled with bit 0 to bit 3 and bit 7.

Bit	Symbol	Description
0	SO	Switch On
1	EV	Enable Voltage
2	QS	Quick Stop
3	EO	Enable Operation
4 to 6	OMS	Operation Mode Specific Differs depending on Modes of operation (6060h). (Refer to chapter 6.)
7	FR	Fault Reset
8	HALT	Halt 0: Operation ready 1: Temporary stop
9		Operation Mode Specific Differs depending on Modes of operation (6060h). (Refer to chapter 6.)
10 to 14		Reserved The value at reading is undefined. Set "0" when writing.
15		Operation Mode Specific Differs depending on Modes of operation (6060h). (Refer to chapter 6.)

- Note
- The description changes depending on the control mode.
 - The value at reading is undefined. Set "0" when writing.

The following table lists the commands issued to the servo amplifier. Turn on the bit that corresponds to the command.

Command	Command bit setting of Controlword					Transition No.
	Bit 7 Fault Reset	Bit 3 Enable Operation	Bit 2 Quick Stop	Bit 1 Enable Voltage	Bit 0 Switch On	
Shutdown	0		1	1	0	(2)/(6)/(8)
Switch On	0	0	1	1	1	(3)
Disable Voltage	0			0		(7)/(9)/(10)/(12)
Quick Stop	0		0	1		(7)/(10)/(11)
Disable Operation	0	0	1	1	1	(5)
Enable Operation	0	1	1	1	1	(4)
Fault Reset	0 → 1 (Note)					(15)

Note. In faulty communication, hold the state of Bit 7 = 1 for at least 10 ms for the Fault Reset command to prevent the command from failing to be recognized.

5. CiA 402 DRIVE PROFILE

(2) Control status (Statusword: 6041h)

Index	Sub Index	Read/write	Name	Data type	Initial value
6041h	0	Read	Statusword (Control status)	2 bytes	

The current control status can be checked.

The following table lists the bits of this object. The status can be checked with bit 0 to bit 7.

Bit	Symbol	Description
0	RTSO	Ready To Switch On
1	SO	Switched On
2	OE	Operation Enabled
3	F	Fault
4	VE	Voltage-enabled 0: The bus voltage is lower than the certain (RA) level. 1: The bus voltage is equal to or higher than the certain level.
5	QS	Quick stop 0: During a quick stop 1: No during a quick stop (including during the test mode)
6	SOD	Switch On Disabled
7	W	Warning 0: No warning has occurred. 1: A warning is occurring.
8		Reserved The value at reading is undefined.
9	RM	Reserved The value at reading is undefined.
10	TR	Target reached Differs depending on Modes of operation (6060h). (Refer to chapter 6.)
11	ILA	Internal limit active 0: The forward rotation stroke end, reverse rotation stroke end, and software position limit have not been reached. 1: The forward rotation stroke end, reverse rotation stroke end, or software position limit has been reached (Enabled in the pp, pv, or hm mode).
12 to 13	OMS	Differs depending on Operation Mode Specific Modes of operation (6060h). (Refer to chapter 6.)
14 to 15		Reserved The value at reading is undefined.

The following table lists the servo amplifier statuses that can be read with bit 0 to bit 7.

Bit 7	Bit 6	Bit 5	Bit 4	Bit 3	Bit 2	Bit 1	Bit 0	Status
	0			0	0	0	0	Not ready to switch on
	1			0	0	0	0	Switch on disable
	0	1		0	0	0	1	Ready to switch on
	0	1		0	0	1	1	Switch on
	0	1		0	1	1	1	Operation enabled
	0	0		0	1	1	1	Quick stop active
	0			1	1	1	1	Fault reaction active
	0			1	0	0	0	Fault
			1					Main power on (power input on)
1								Warning (warning occurrence)

Bit 11 turns on when the stroke limit, software limit, or positioning command is outside the range.

5. CiA 402 DRIVE PROFILE

Bit 0 to Bit 3, Bit 5, and Bit 6 are switched depending on the state machine (internal state of the MR-JE-_C_ servo amplifier). Refer to the following table for details.

Statusword (bin)	State machine
x0xx xxx0 x0xx 0000	Not ready to switch on (Note)
x0xx xxx0 x1xx 0000	Switch on disabled
x0xx xxx0 x01x 0001	Ready to switch on
x0xx xxx0 x01x 0011	Switched on
x0xx xxx0 x01x 0111	Operation enabled
x0xx xxx0 x00x 0111	Quick stop active
x0xx xxx0 x0xx 1111	Fault reaction active
x0xx xxx0 x0xx 1000	Fault

Note. Statusword is not sent in the Not ready to switch on state.

5.1.3 Directions for use

A control command allows a transition to the target status, skipping the statuses in between.

The statuses can transition as shown in the following table, for example. (Refer to the figure in section 5.1.1.)

Current status	Command	Status after transition
(B) Switch on disabled	Switch on	(D) Switched on
(B) Switch on disabled	Enable operation	(E) Operation enabled
(C) Ready to switch on	Enable operation	(E) Operation enabled

5. CiA 402 DRIVE PROFILE

5.2 Control mode

This section describes the control modes of the MR-JE-_C servo amplifier.

5.2.1 Function description

A control mode of the MR-JE-_C servo amplifier can be selected with the control mode (Modes of operation: 6060h).

The following table shows the correspondence between the control modes before and after switching.

		Control mode after switching						
		Position	Speed	Torque	Profile			Home position return
					pp	pv	tq	
Control mode before switching	Position (Note)		x	x	x	x	x	x
	Velocity (Note)	x		x	x	x	x	x
	Torque (Note)	x	x		x	x	x	x
	Profile	pp	x	x	x	○	○	○
		pv	x	x	x	○	○	○
		tq	x	x	x	○	○	○
Home position return	x	x	x	○	○	○		

○: Switchable ×: Non-switchable

Note. Switch the position, velocity, and torque modes using [Pr. PA01] and DI signal (LOP).

The following table lists the control switching conditions of the profile mode.

	Switching operation	Switching condition
(1)	Profile position mode → Profile velocity mode	While the servo motor is stopped (Note 1)
(2)	Profile velocity mode → Profile position mode	
(3)	Profile position mode → Profile torque mode	
(4)	Profile torque mode → Profile position mode	
(5)	Profile velocity mode → Profile torque mode	Not restricted (Note 2)
(6)	Profile torque mode → Profile velocity mode	
(7)	Profile position mode → Homing mode	While the servo motor is stopped (Note 1)
(8)	Profile velocity mode → Homing mode	
(9)	Profile torque mode → Homing mode	
(10)	Homing mode → Profile position mode	
(11)	Homing mode → Profile velocity mode	
(12)	Homing mode → Profile torque mode	

Note 1. You can switch the control mode in the zero speed status. To ensure safety, switch modes after the servo motor has stopped. For the zero speed, refer to section 3.5 (1) (b) in "MR-JE-_C Servo Amplifier Instruction Manual".

2. When the mode is switched from the profile velocity mode to the profile torque mode, the servo motor speed may fluctuate for a moment. Therefore, it is recommended that the servo motor be stopped before the mode switching from the profile velocity mode to the profile torque mode.

After switching control modes, check that the control modes have been switched by monitoring the control mode display (Modes of operation Display: 6061h).

5.2.2 Related object

Index	Sub Index	Read/write	Name	Data type	Initial value
6060h	0	Read/write	Modes of operation (Control mode)	1 bytes	0
6061h	0	Read	Modes of operation Display (Control mode display)	1 bytes	-20
6502h	0	Read	Supported Drive Modes (Supported control mode)	4 bytes	

6. SERVO MOTOR DRIVING

6. SERVO MOTOR DRIVING

6.1 Homing mode (hm)

This section describes how to perform a home position return operation in the communication.

6.1.1 Function description

Perform a home position return operation following the instruction below.

After setting the home position return method (Homing method: 6098h), home position return speed (Homing speed: 6099h), and home position return acceleration/deceleration time constant, start the operation with the control command (Controlword: 6040h). The specified home position return operation is performed. The completion of the home position return operation can be checked with the control status (Statusword: 6041h).

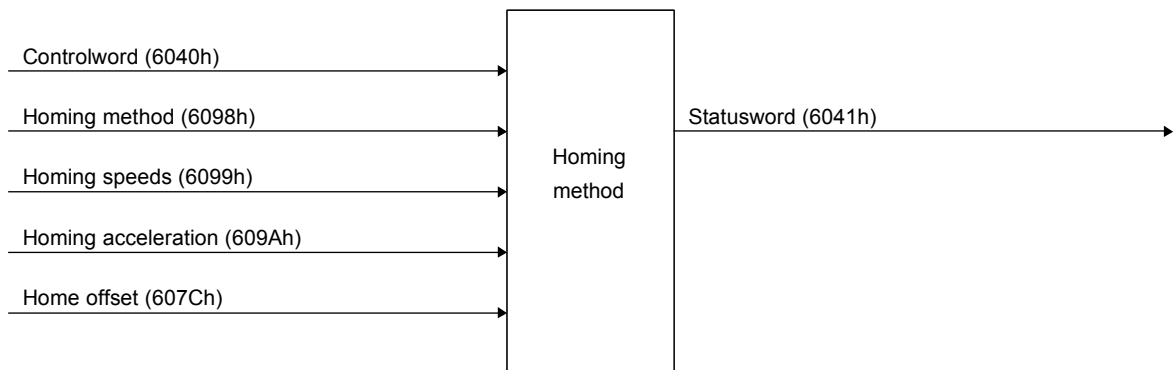

6. SERVO MOTOR DRIVING

6.1.2 Related object

Index	Sub Index	Read/write	Name	Data type	Initial value	Description
607Ch	0	Read	Home offset	4 bytes		The home position saved in EEPROM is stored at power-on. If a home position return is executed in the homing mode (hm), the home position will be updated. If [Pr. PA03 Absolute position detection system] is disabled, 0 is always stored.
6098h	0	Read/write	Homing Method	1 bytes	37	Specify a home position return method. Refer to (2) in this section for supported home position return methods.
6099h	0	Read/write	Homing Speeds	1 bytes	2	Number of entries of the home position return speed
	1	Read/write	Speed during search for switch	4 bytes	10000	Specify the travel speed until dog detection. Unit: Vel unit (0.01 r/min) Range: 0 to servo motor maximum speed
	2	Read/write	Speed during search for zero	4 bytes	1000	Specify the travel speed up to the home position after dog detection. (Note) Unit: Vel unit (0.01 r/min) Range: 0 to servo motor maximum speed
609Ah	0	Read/write	Homing acceleration	4 bytes	0	Acceleration/deceleration time constant at home position return Unit: ms
60E3h	0	Read	Supported Homing Method	1 bytes	38	Number of entries of the supported home position return method
	1	Read	1 st supported homing method	1 bytes	37	The home position return method that uses the current position as a home position is supported.
	to					
	39	Read	39 th supported homing method	1 bytes	-43	The dogless Z-phase reference home position return method (reverse rotation) is supported.

Note. In the homing mode (hm), the servo motor is brought to a sudden stop according to the deceleration time constant when the stroke end is detected. Set the home position return speed carefully.

6. SERVO MOTOR DRIVING

(1) Control command (Controlword: 6040h)

Index	Sub Index	Read/write	Name	Data type	Initial value
6040h	0	Read/write	Controlword (Control command)	2 bytes	

The current control command status can be checked.

In addition, control commands can be written.

The following table lists the bits of this object that relate to the home position return operation.

Bit	Description
0 to 3	Refer to section 5.1.2.
4	Homing Operation Start (Home position return operation start) 0: Do not start homing procedure 1: Start or continue homing procedure
5 to 6	Reserved (Note)
7	Refer to section 5.1.2.
8	Halt (Stop command) 0: Bit 4 enable 1: Stop axis according to halt option code (605Dh)
9	Reserved (Note)
10 to 14	Refer to section 5.1.2.
15	Reserved (Note)

Note. The value at reading is undefined. Set "0" when writing.

To start a home position return operation, turn bit 4 from "0" to "1". When the home position return operation is completed or an alarm is issued during the operation, turn bit 4 from "1" to "0".

When bit 8 (Halt) of the control command (6040h) is set to "1", the servo motor decelerates to a stop.

After that, when bit 8 (Halt) is set to "0" and bit 4 is turned to "0" and then "1", the home position return operation is performed again.

(2) Home position return method (Homing method: 6098h)

Index	Sub Index	Read/write	Name	Data type	Initial value
6098h	0	Read/write	Homing method (Home position return method)	1 bytes	37

The current home position return method can be read.

In addition, a home position return method can be set. To enable the written home position return method after turning the power back on, execute the write command to EEPROM (1010h). After the execution of the write command to EEPROM, the setting value of [Pr. PT45] is changed.

6. SERVO MOTOR DRIVING

The following table lists selectable home position return methods.

Setting value	Home position return method	Direction of rotation	Description
3	Homing on positive home switch and index pulse	Forward rotation	Same as the dog type last Z-phase reference home position return. Note that if the stroke end is detected during home position return, [AL. 90 Home position return incomplete warning] occurs.
4	Homing on positive home switch and index pulse	Forward rotation	Same as the dog cradle type home position return. Note that if the stroke end is detected during home position return, [AL. 90 Home position return incomplete warning] occurs.
5	Homing on negative home switch and index pulse	Reverse rotation	Same as the dog type last Z-phase reference home position return. Note that if the stroke end is detected during home position return, [AL. 90 Home position return incomplete warning] occurs.
6	Homing on negative home switch and index pulse	Reverse rotation	Same as the dog cradle type home position return. Note that if the stroke end is detected during home position return, [AL. 90 Home position return incomplete warning] occurs.
7	Homing on home switch and index pulse	Forward rotation	Same as the dog type last Z-phase reference home position return.
8	Homing on home switch and index pulse	Forward rotation	Same as the dog cradle type home position return.
11	Homing on home switch and index pulse	Reverse rotation	Same as the dog type last Z-phase reference home position return. The direction of rotation is opposite to that of the method 7.
12	Homing on home switch and index pulse	Reverse rotation	Same as the dog cradle type home position return. The direction of rotation is opposite to that of the method 8.
19	Homing without index pulse	Forward rotation	Same as the dog type front end reference home position return. Note that if the stroke end is detected during home position return, [AL. 90 Home position return incomplete warning] occurs.
20	Homing without index pulse	Forward rotation	Although this type is the same as the dog cradle type home position return, the stop position is not on the Z-phase. Starting from the front end of the dog, the position is shifted by the travel distance after proximity dog and the home position shift distance. The position after the shifts is set as the home position. If the stroke end is detected during home position return, [AL. 90 Home position return incomplete warning] occurs.
21	Homing without index pulse	Reverse rotation	Same as the dog type front end reference home position return. Note that if the stroke end is detected during home position return, [AL. 90 Home position return incomplete warning] occurs.
22	Homing without index pulse	Reverse rotation	Although this type is the same as the dog cradle type home position return, the stop position is not on the Z-phase. Starting from the front end of the dog, the position is shifted by the travel distance after proximity dog and the home position shift distance. The position after the shifts is set as the home position. If the stroke end is detected during home position return, [AL. 90 Home position return incomplete warning] occurs.
23	Homing without index pulse	Forward rotation	Same as the dog type front end reference home position return.
24	Homing without index pulse	Forward rotation	Although this type is the same as the dog cradle type home position return, the stop position is not on the Z-phase. Starting from the front end of the dog, the position is shifted by the travel distance after proximity dog and the home position shift distance. The position after the shifts is set as the home position.
27	Homing without index pulse	Reverse rotation	Same as the dog type front end reference home position return.

6. SERVO MOTOR DRIVING

Setting value	Home position return method	Direction of rotation	Description
28	Homing without index pulse	Reverse rotation	Although this type is the same as the dog cradle type home position return, the stop position is not on the Z-phase. Starting from the front end of the dog, the position is shifted by the travel distance after proximity dog and the home position shift distance. The position after the shifts is set as the home position.
33	Homing on index pulse	Reverse rotation	Although this type is the same as the dogless Z-phase reference home position return, the creep speed is applied as the movement start speed.
34	Homing on index pulse	Forward rotation	Although this type is the same as the dogless Z-phase reference home position return, the creep speed is applied as the movement start speed.
35	Homing on current position		The current position is set as the home position. This type can be executed not in the Operational enabled state.
37	Homing on current position		The current position is set as the home position. This type can be executed not in the Operational enabled state.

6. SERVO MOTOR DRIVING

Setting value	Home position return method	Direction of rotation	Description
-1	Dog type (Rear end detection, Z-phase reference)	Forward rotation	Deceleration starts at the front end of the proximity dog. After the rear end is passed, the position specified by the first Z-phase signal, or the position of the first Z-phase signal shifted by the specified home position shift distance is used as the home position. If the stroke end is detected during home position return, the direction of movement is reversed.
-33		Reverse rotation	
-3	Data set type home position return		The current position is set as the home position.
-4	Stopper type (Stopper position reference)	Forward rotation	A workpiece is pressed against a mechanical stopper, and the position where it is stopped is set as the home position. If the stroke end is detected during home position return, [AL. 90 Home position return incomplete warning] occurs.
-36		Reverse rotation	
-5	Home position ignorance (servo-on position as home position)		The current position at servo-on is set as a home position. A home position can be set without switching to the home position return mode (Homing Mode).
-2	Count type (Front end detection, Z-phase reference)	Forward rotation	At the front end of the proximity dog, deceleration starts. After the front end is passed, the position specified by the first Z-phase signal after the set distance or the position of the Z-phase signal shifted by the set home position shift distance is set as a home position. If the stroke end is detected during home position return, the direction of movement is reversed.
-34		Reverse rotation	
-6	Dog type (Rear end detection, rear end reference)	Forward rotation	Deceleration starts from the front end of the proximity dog. After the rear end is passed, the position is shifted by the travel distance after proximity dog and the home position shift distance. The position after the shifts is set as the home position. If the stroke end is detected during home position return, the direction of movement is reversed.
-38		Reverse rotation	
-7	Count type (Front end detection, front end reference)	Forward rotation	Deceleration starts from the front end of the proximity dog. The position is shifted by the travel distance after proximity dog and the home position shift distance. The position after the shifts is set as the home position. If the stroke end is detected during home position return, the direction of movement is reversed.
-39		Reverse rotation	
-8	Dog cradle type	Forward rotation	A position, which is specified by the first Z-phase signal after the front end of the proximity dog is detected, is set as the home position. If the stroke end is detected during home position return, the direction of movement is reversed.
-40		Reverse rotation	
-9	Dog type last Z-phase reference	Forward rotation	After the front end of the proximity dog is detected, the position is shifted away from the proximity dog in the reverse direction. Then, the position specified by the first Z-phase signal or the position of the first Z-phase signal shifted by the home position shift distance is used as the home position. If the stroke end is detected during home position return, the direction of movement is reversed.
-41		Reverse rotation	
-10	Dog type front end reference	Forward rotation	Starting from the front end of the proximity dog, the position is shifted by the travel distance after proximity dog and the home position shift distance. The position after the shifts is set as the home position. If the stroke end is detected during home position return, the direction of movement is reversed.
-42		Reverse rotation	
-11	Dogless Z-phase reference	Forward rotation	The position specified by the first Z-phase signal, or the position of the first Z-phase signal shifted by the home position shift distance is used as the home position. If the stroke end is detected during home position return, [AL. 90 Home position return incomplete warning] occurs.
-43		Reverse rotation	

6. SERVO MOTOR DRIVING

(3) Home position return speed (Homing speed: 6099h)

Index	Sub Index	Read/write	Name	Data type	Initial value	
6099h	0	Read/write	Homing speed (Home position return speed)	Number of entries (Number of entries)	1 bytes	2
	1			Speed during search for switch (Home position return speed)	4 bytes	10000
	2			Speed during search for zero (Creep speed)	4 bytes	1000

The current home position return speed can be read. At this time, "02h" is returned to Number of entries.
 The current home position return speed is returned to Speed during search for switch in units of r/min.
 The current creep speed is returned to Speed during search for zero in units of r/min.

Set a home position return speed. At this time, write "02h" in Number of entries.
 Set a home position return speed in Speed during search for switch in units of r/min.
 Set a creep speed in Speed during search for zero in units of r/min.

6. SERVO MOTOR DRIVING

(4) Control status (Statusword: 6041h)

POINT
<p>● When the mode is switched to the hm mode after home position return completion, the control status (Statusword (6041h)) is "Homing procedure is completed successfully" unless "0" is set in Bit 12. The following shows the conditions when "0" is set in Bit 12.</p> <p>For incremental system</p> <ul style="list-style-type: none"> ▪ At power-on ▪ At communication shut-off by controller reset ▪ At home position return start ▪ At home position erasure <p>for absolute position detection system</p> <ul style="list-style-type: none"> ▪ At home position return start ▪ At home position erasure <p>● To check the home position return status with the control status (Statusword (6041h)), note the following.</p> <ul style="list-style-type: none"> ▪ When the mode is switched to the hm mode, the control mode display (Modes of operation display (6061h)) is changed to 6 (hm) and the control status (Statusword (6041h)) changes at the same time. ▪ The transition of the control status (Statusword (6041h)) may take 50 ms at a maximum after Bit 4 (Homing operation start) of the control command (Controlword (6040h)) is set. To obtain the status of Statusword without any fault, wait 50 ms or more before obtaining the control status (Statusword (6041h)). <p>● Before updating the position after a home position return completion, check that both Bit 12 and Bit 10 of the control status (Statusword (6041h)) are changed to "1" and then wait 8 ms.</p> <p>If 8 ms has not elapsed, the position information may not be updated correctly.</p>

Index	Sub Index	Read/write	Name	Data type	Initial value
6041h	0	Read	Statusword (Control status)	2 bytes	

6. SERVO MOTOR DRIVING

The current control status can be checked.

The following table lists the bits of this object that relate to the home position return operation.

Bit	Description
0 to 9	Refer to section 5.1.2.
10	Target reached (Command position reached) Refer to (a) and the following table for the definition.
11	Refer to section 5.1.2.
12	Homing attained (Home position return complete) Refer to (b) and the following table for the definition.
13	Homing error (Home position return error) Refer to (c) and the following table for the definition.
14 to 15	Refer to section 5.1.2.

(a) Bit 10 of the control status (6041h) (Target reached)

Bit 10 turns on (1) when the command position is reached. If bit 8 (Halt) of the control command is set to "1", bit 10 turns on (1) when a deceleration stop is completed.

If a command is input again, bit 10 turns off (0).

(b) Bit 12 of the control status (6041h) (Homing attained)

Bit 12 turns off (0) when a home position return operation is started and turns on (1) when the operation is completed. For absolute position detection system, bit 12 turns on (1) after the power supply is turned on.

(c) Bit 13 of the control status (6041h) (Homing error)

Bit 13 turns on (1) when an alarm or warning ([AL 90.2], [AL 90.3], [AL 90.5], [AL 96.1], [AL 96.2], or [AL 96.3]) occurs during a home position return operation.

The following shows the definition of Bit 10, Bit 12, and Bit 13 of the control status (Statusword (6041h)) in the hm mode.

Bit 13	Bit 12	Bit 10	Definition
0	0	0	Homing procedure is in progress
0	0	1	Homing procedure is interrupted or not started
0	1	0	Homing is attained, but target is not reached
0	1	1	Homing procedure is completed successfully
1	0	0	Homing error occurred, velocity is not 0
1	0	1	Homing error occurred, velocity is 0
1	1		reserved

6. SERVO MOTOR DRIVING

6.1.3 Directions for use

(1) How to execute home position return in the profile mode

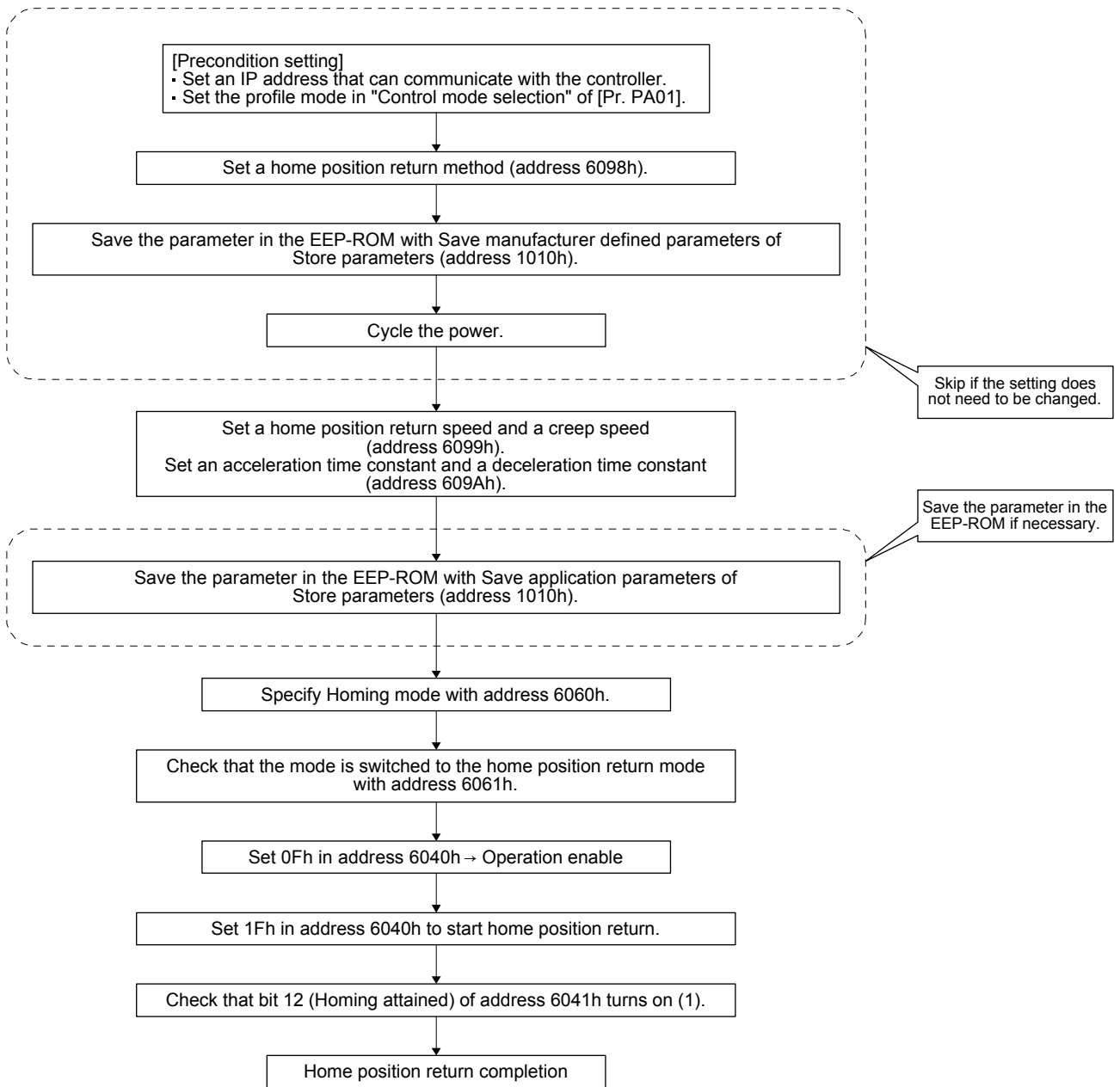

6. SERVO MOTOR DRIVING

(2) CiA 402-type homing method

(a) Home position return type in CiA 402 type

The following shows the CiA 402-type home position return.

1) Method 3 and 4: Homing on positive home switch and index pulse

These home position return types use the front end of the proximity dog as reference and set the Z-phase right before and right after the dog as a home position.

Method 3 has the operation of the dog type last Z-phase reference home position return, and

Method 4 has the operation of the dog cradle type home position return at a forward rotation start.

However, if the stroke end is detected during home position return, [AL. 90] occurs.

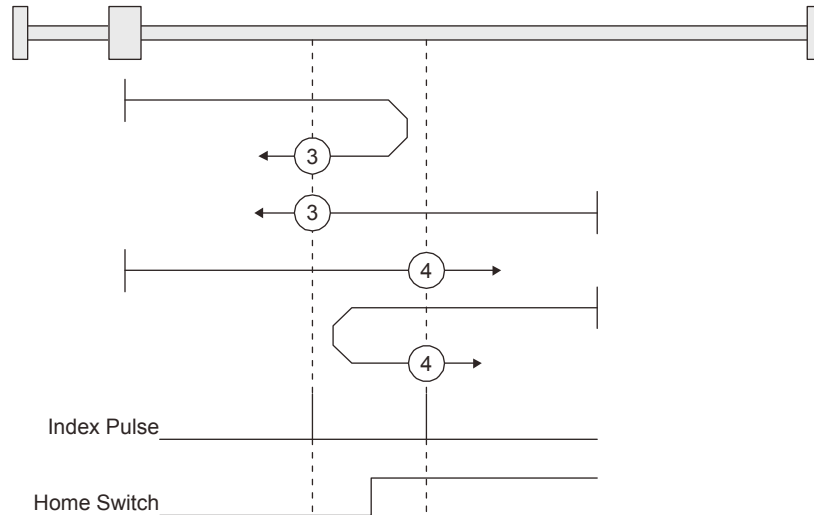

2) Method 5 and 6: Homing on negative home switch and index pulse

These home position return types use the front end of the proximity dog as reference and set the Z-phase right before and right after the dog as a home position. Method 5 and 6 differ from Method 3 and Method 4 in the starting direction: the starting direction of Method 5 and 6 is the reversed direction.

6. SERVO MOTOR DRIVING

3) Method 7, 8, 11, 12: Homing on home switch and index pulse

These types include the operation at stroke end detection in addition to the operation of Method 3 to Method 6. Thus, the home position is the same as that of Method 3 to Method 6. Method 7 has the operation of the dog type last Z-phase reference home position return. Method 8 has the operation of the dog cradle type home position return at a forward rotation start. Method 11 and 12 differ from Method 7 and Method 8 only in the starting direction: the starting direction of Method 11 and 12 is the reversed direction.

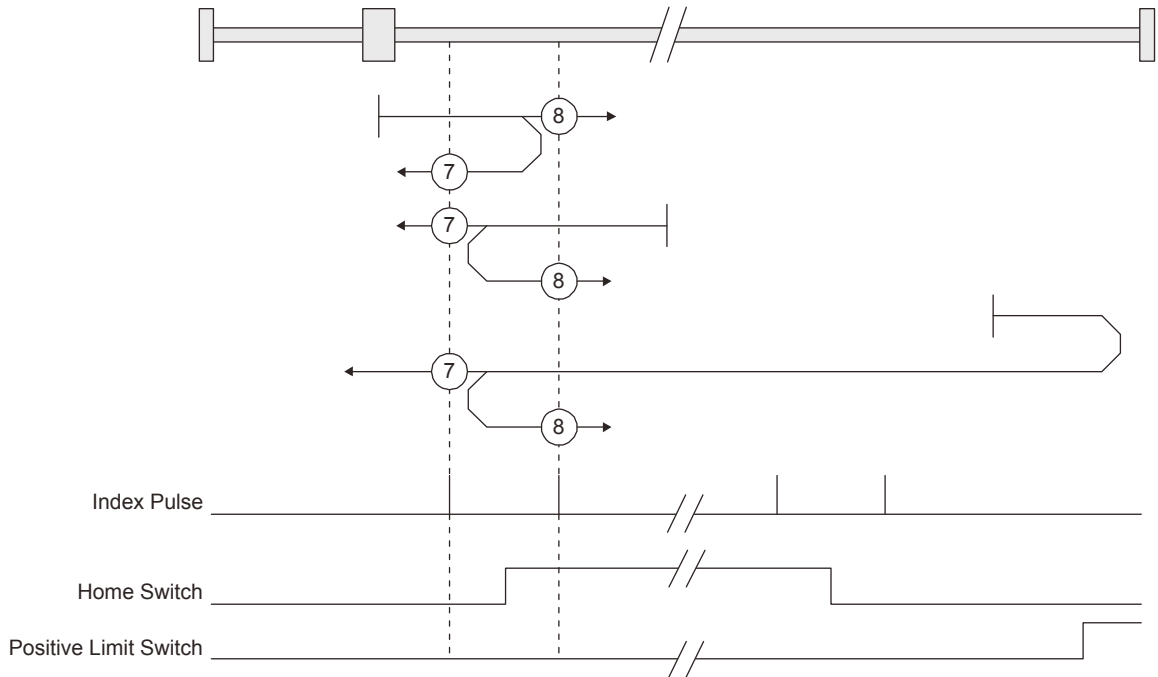

4) Method 17 to 30: Homing without index pulse

Method 17 to 30 have the operation of Method 1 to Method 14; however, these types set the home position not on the Z-phase but on the dog. Method 17 to 30 have the operation of Method 1 to Method 14; however, these types set the home position not on the Z-phase but on the dog. The following figure shows the operation of the home position return type of Method 19 and Method 20. Method 19 and Method 20 have the operation of Method 3 and Method 4; however, these types set the home position not on the Z-phase but on the dog. Method 19 has the operation of the dog type front end reference home position return. Method 20 has the operation of the dog cradle type home position return; however, the stop position is not on the Z-phase but on the dog.

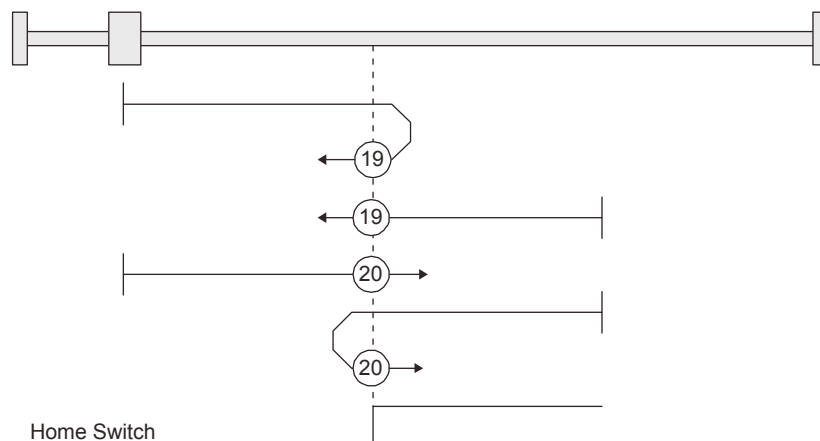

6. SERVO MOTOR DRIVING

5) Method 33 and 34: Homing on index pulse

These home position return types set the Z-phase detected first as a home position. The operation is the same as that of the dogless Z-phase reference home position return except that the creep speed is applied at the start.

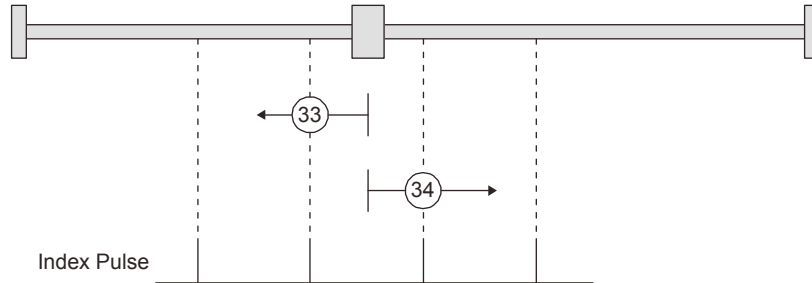

6) Method 35 and 37: Homing on current position

These home position return types set the current position as a home position. The operation is the same as that of the data set type home position return; however, these types can be executed even during servo-off.

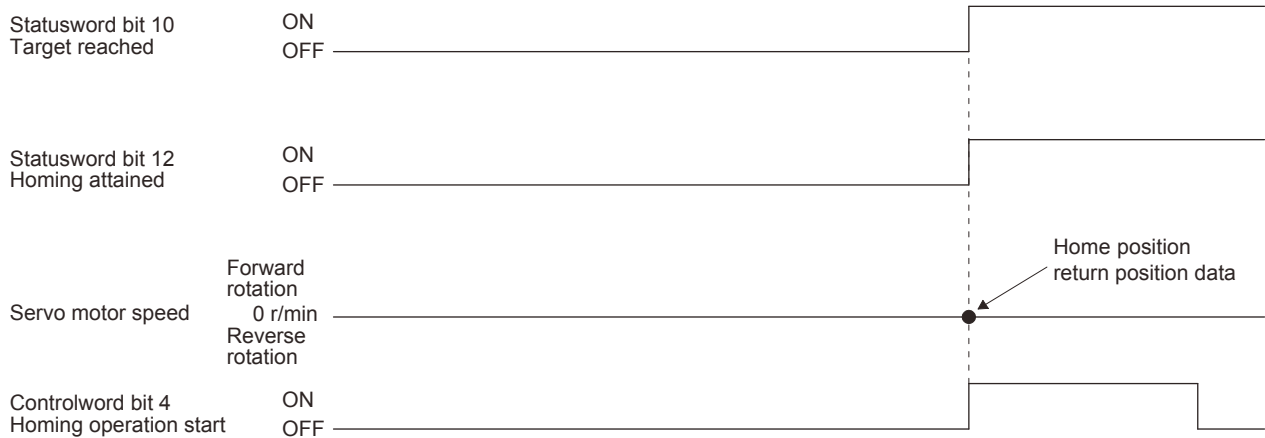

6. SERVO MOTOR DRIVING

(b) Operation example of the CiA 402-type Homing method

The following shows an operation example of the home position return in the CiA 402-type Homing method.

1) Method 3 (Homing on positive home switch and index pulse) and Method 5 (Homing on negative home switch and index pulse)

The following figure shows the operation of Homing method 3. The operation direction of Homing method 5 is opposite to that of Homing method 3.

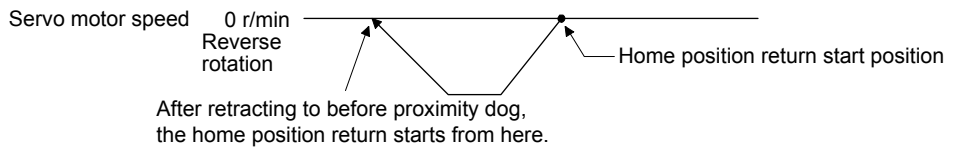
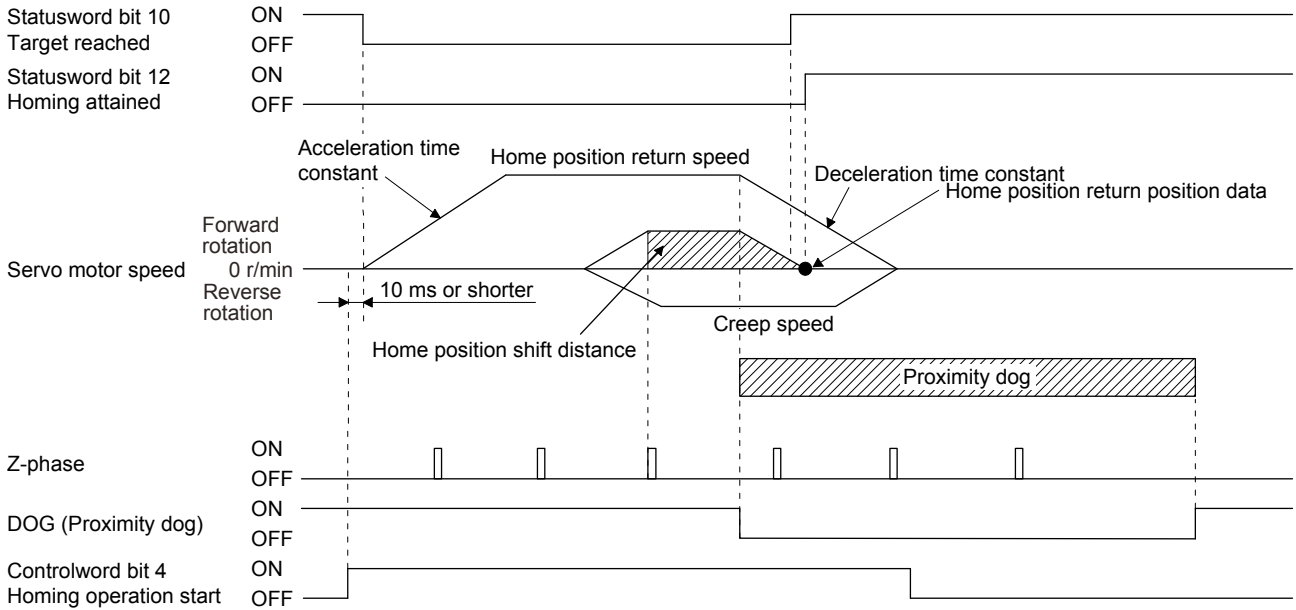

When a home position return is started from the proximity dog

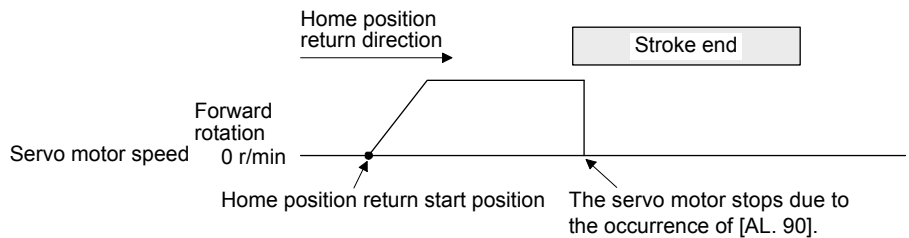

When the stroke end is detected

6. SERVO MOTOR DRIVING

- 2) Method 4 (Homing on positive home switch and index pulse) and Method 6 (Homing on negative home switch and index pulse)

The following figure shows the operation of Homing method 4. The operation direction of Homing method 6 is opposite to that of Homing method 4.

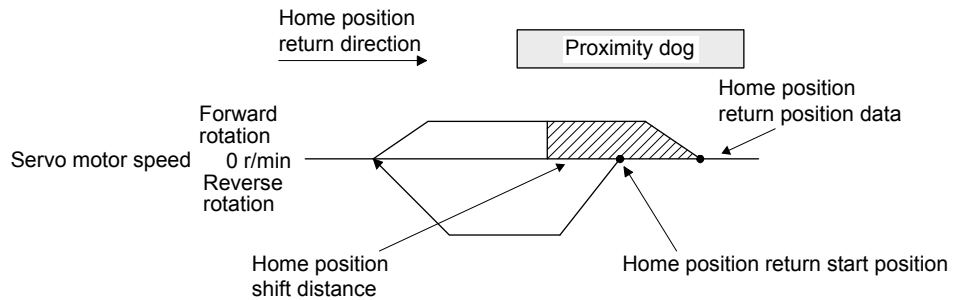
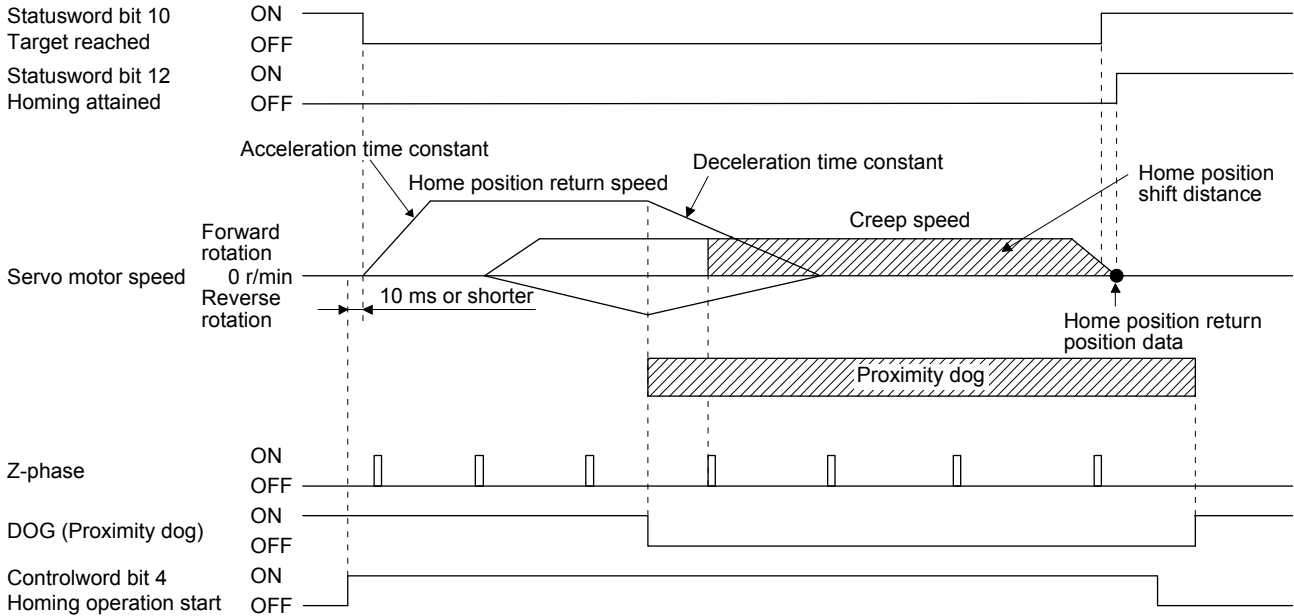

When a home position return is started from the proximity dog

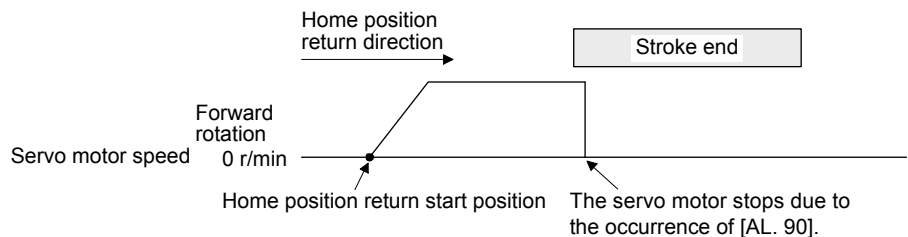

When the stroke end is detected

6. SERVO MOTOR DRIVING

3) Method 7 and Method 11 (Homing on home switch and index pulse)

The following figure shows the operation of Homing method 7. The operation direction of Homing method 11 is opposite to that of Homing method 7.

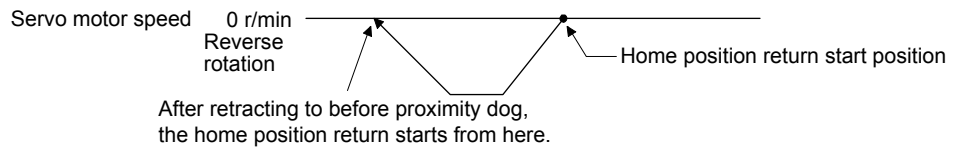
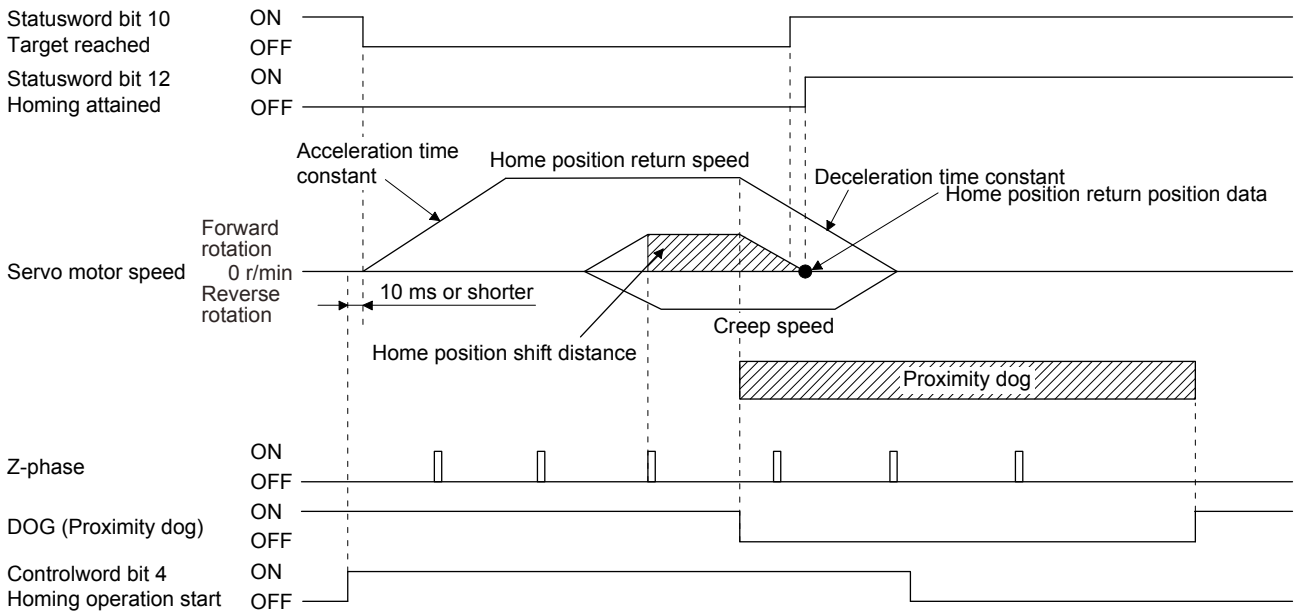

When a home position return is started from the proximity dog

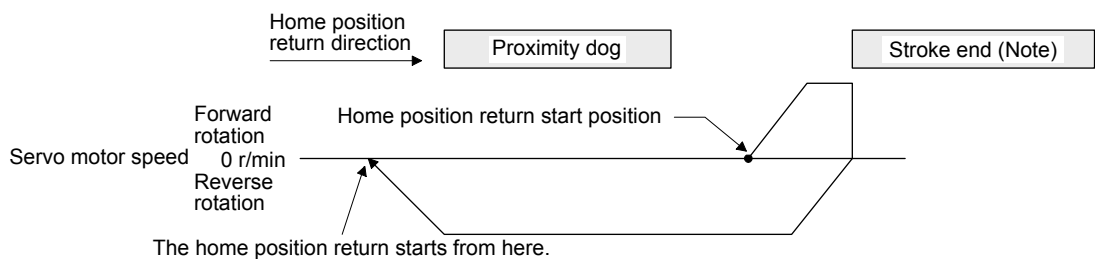

Note. The software limit cannot be used with these functions.

When the movement is returned at the stroke end

6. SERVO MOTOR DRIVING

4) Method 8 and Method 12 (Homing on home switch and index pulse)

The following figure shows the operation of Homing method 8. The operation direction of Homing method 12 is opposite to that of Homing method 8.

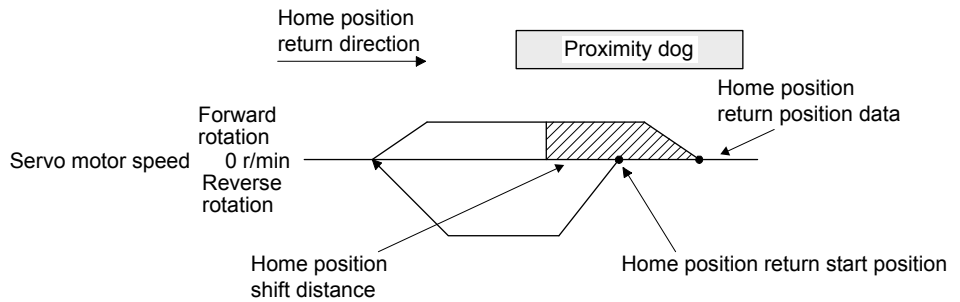
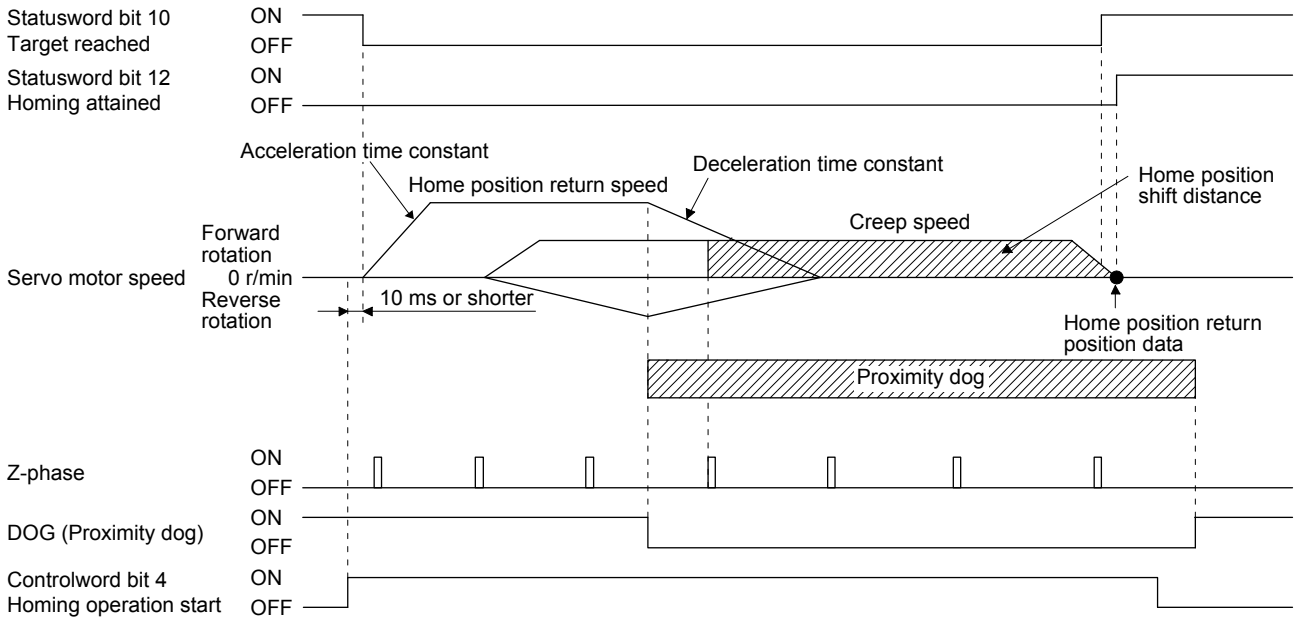

When a home position return is started from the proximity dog

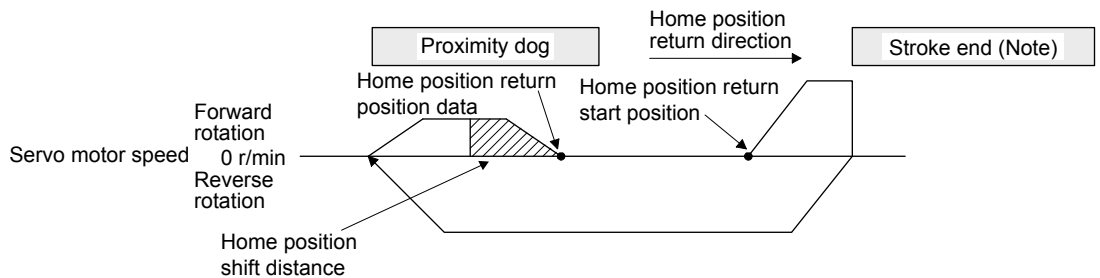

Note. The software limit cannot be used with these functions.

When the movement is returned at the stroke end

6. SERVO MOTOR DRIVING

5) Method 19 and Method 21 (Homing without index pulse)

The following figure shows the operation of Homing method 19. The operation direction of Homing method 21 is opposite to that of Homing method 19.

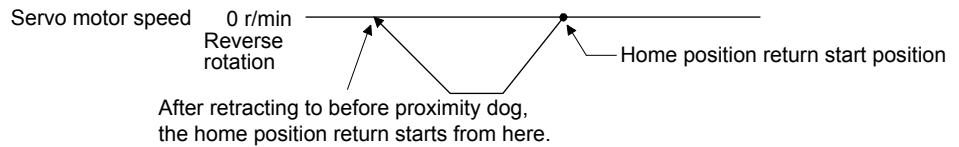
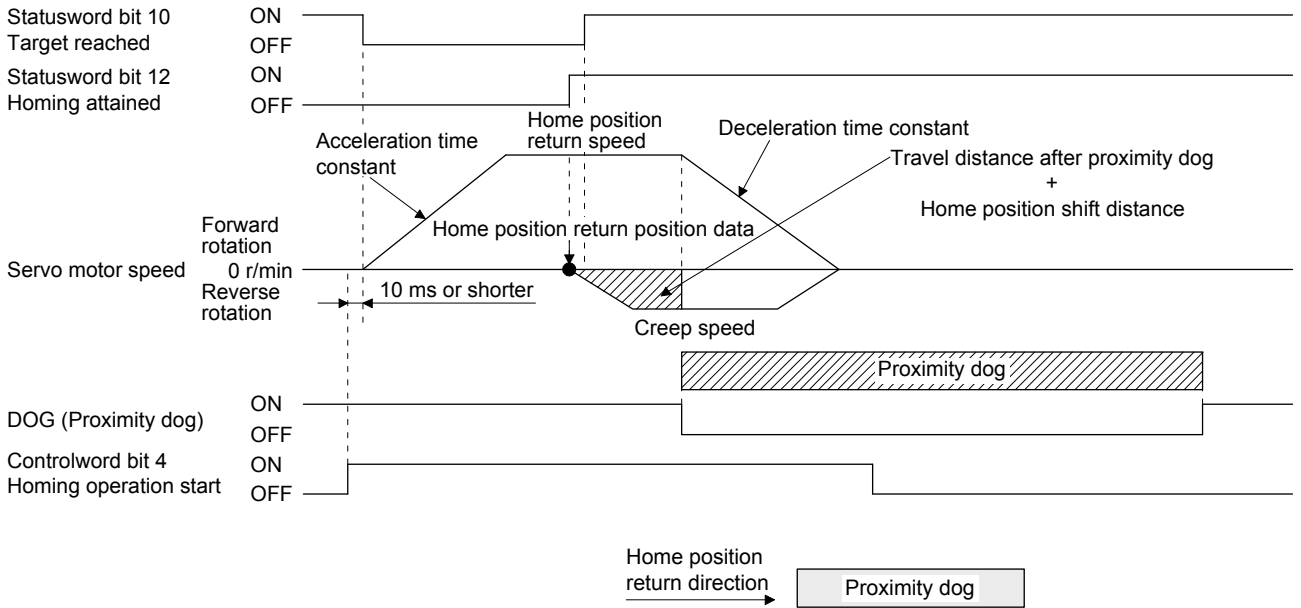

When a home position return is started from the proximity dog

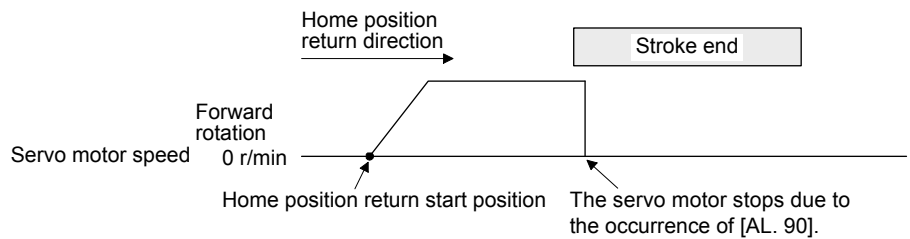

When the stroke end is detected

6. SERVO MOTOR DRIVING

6) Method 20 and Method 22 (Homing without index pulse)

The following figure shows the operation of Homing method 20. The operation direction of Homing method 22 is opposite to that of Homing method 20.

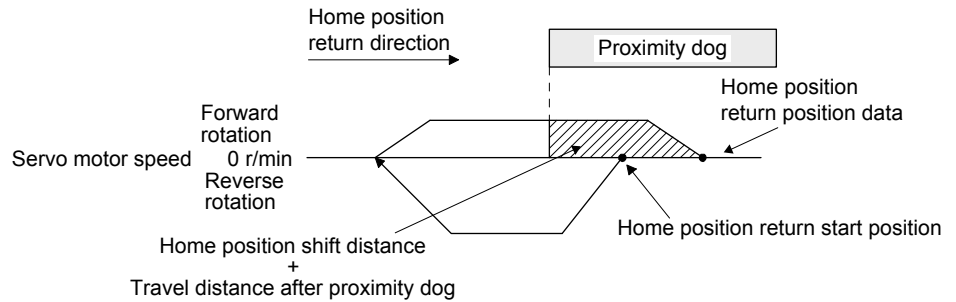
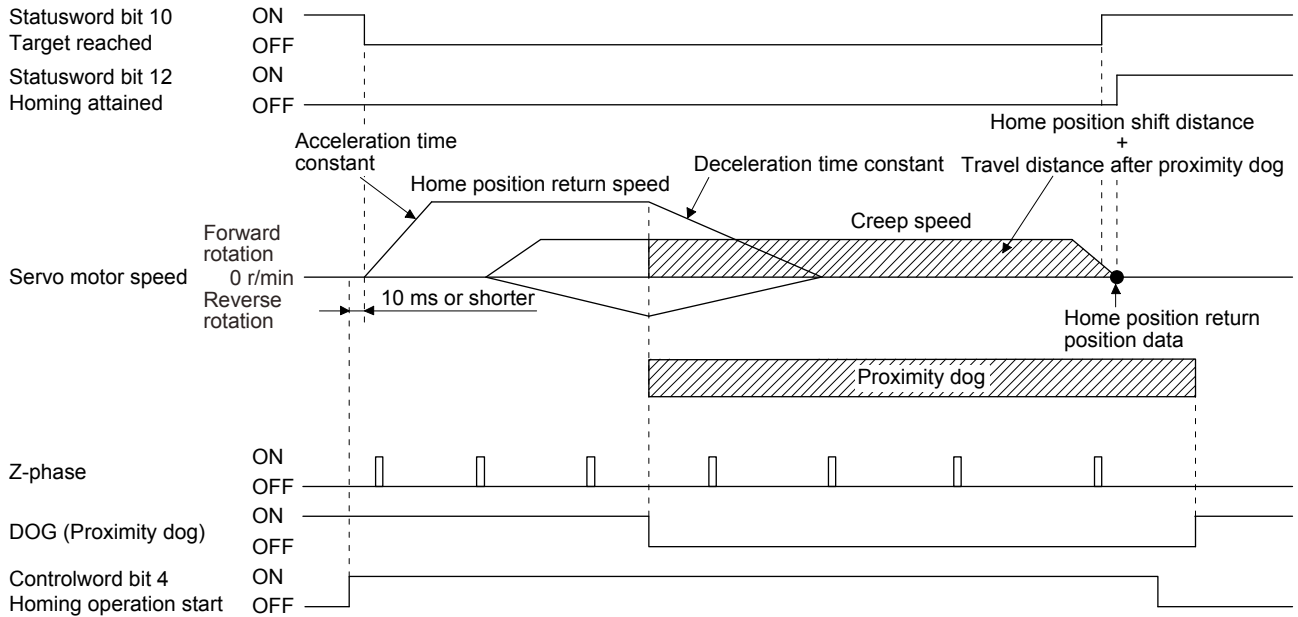

When a home position return is started from the proximity dog

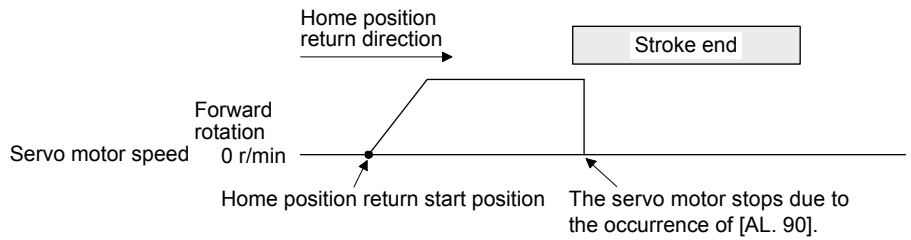

When the stroke end is detected

6. SERVO MOTOR DRIVING

7) Method 23 and Method 27 (Homing without index pulse)

The following figure shows the operation of Homing method 23. The operation direction of Homing method 27 is opposite to that of Homing method 23.

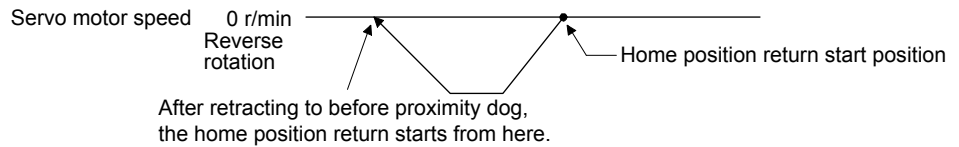
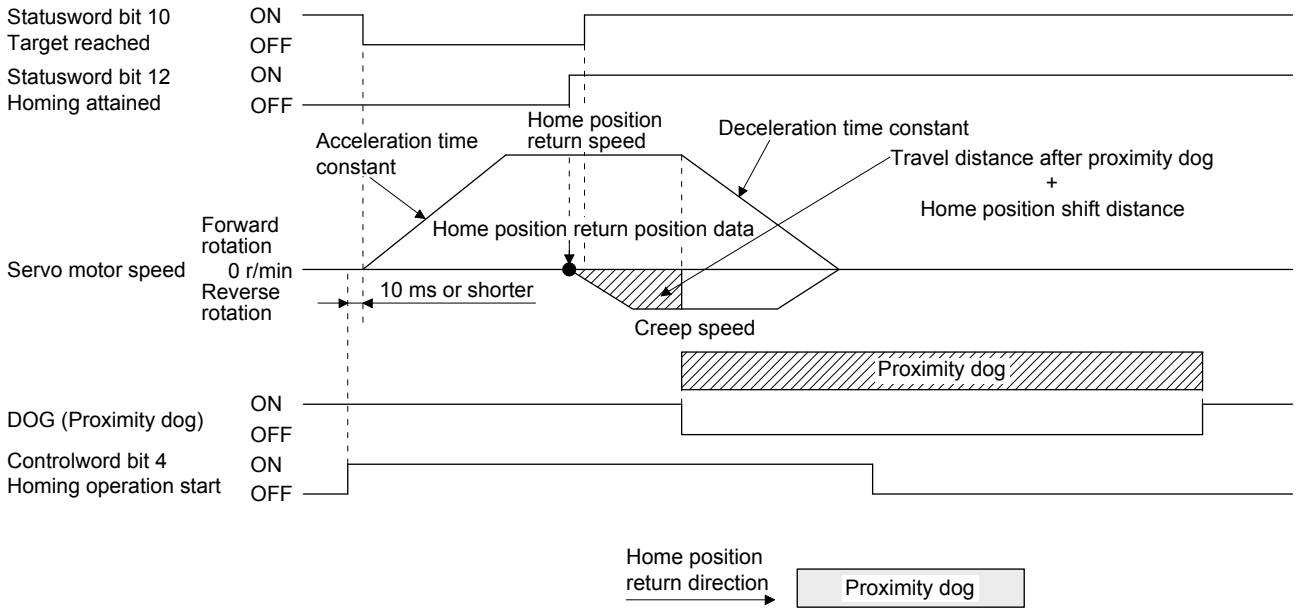

When a home position return is started from the proximity dog

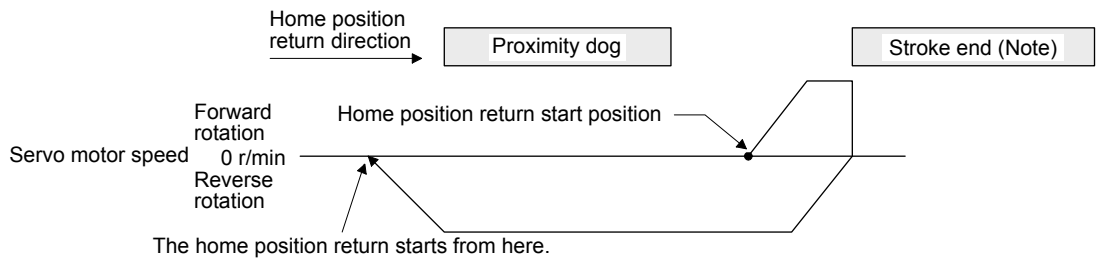

Note. The software limit cannot be used with these functions.

When the movement is returned at the stroke end

6. SERVO MOTOR DRIVING

8) Method 24 and Method 28 (Homing without index pulse)

The following figure shows the operation of Homing method 24. The operation direction of Homing method 28 is opposite to that of Homing method 24.

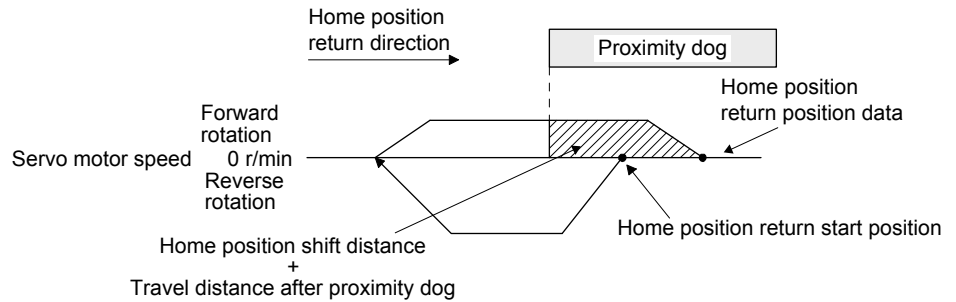
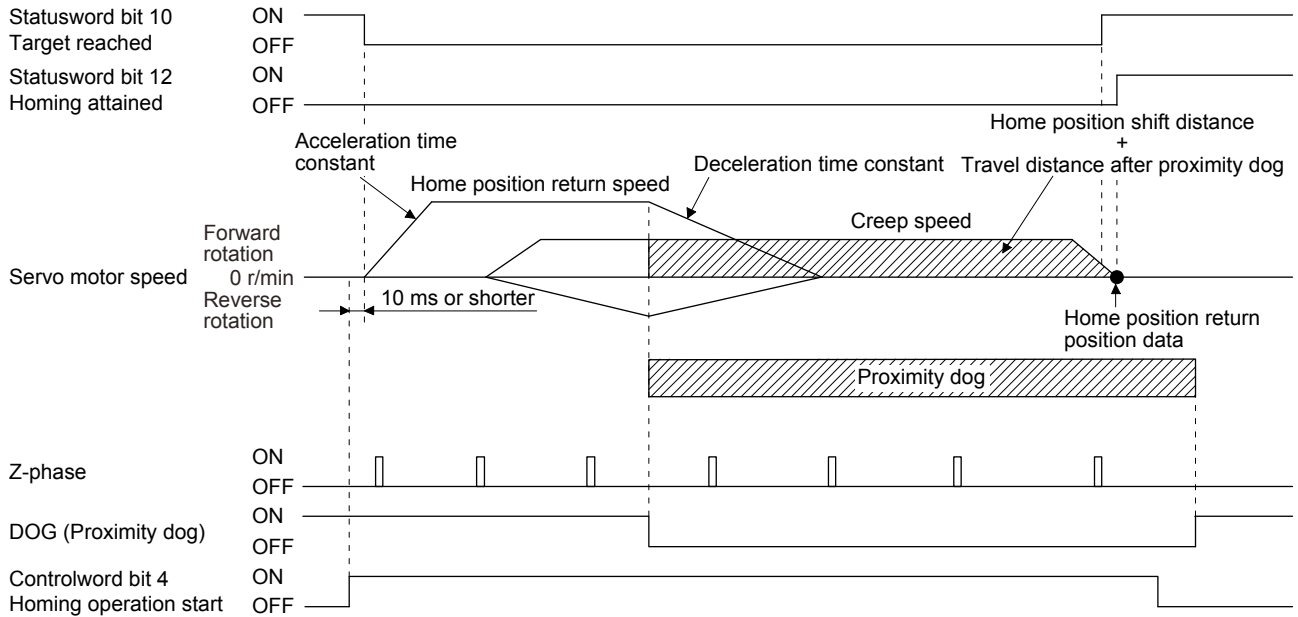

When a home position return is started from the proximity dog

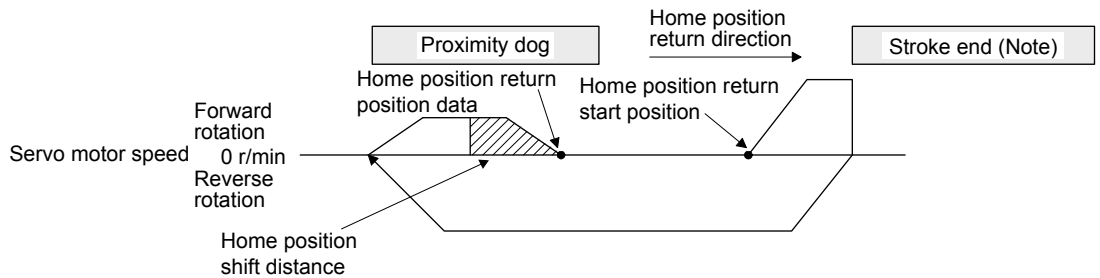

Note. The software limit cannot be used with these functions.

When the movement is returned at the stroke end

6. SERVO MOTOR DRIVING

9) Method 33 and Method 34 (Homing on index pulse)

The following figure shows the operation of Homing method 34. The operation direction of Homing method 33 is opposite to that of Homing method 34.

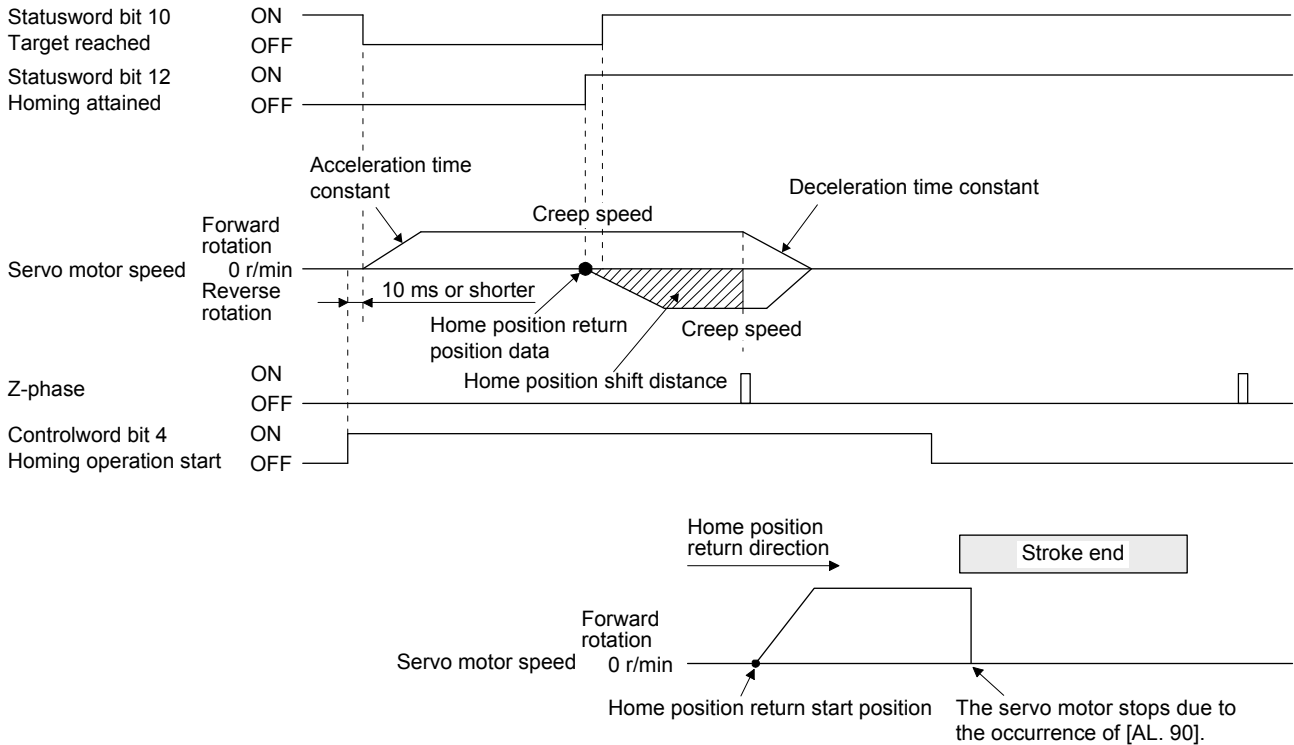

When the stroke end is detected

10) Method 35 and Method 37 (Homing on current position)

The following figure shows the operation of Homing method 35 and Homing method 37. These methods can be performed in the servo-off status.

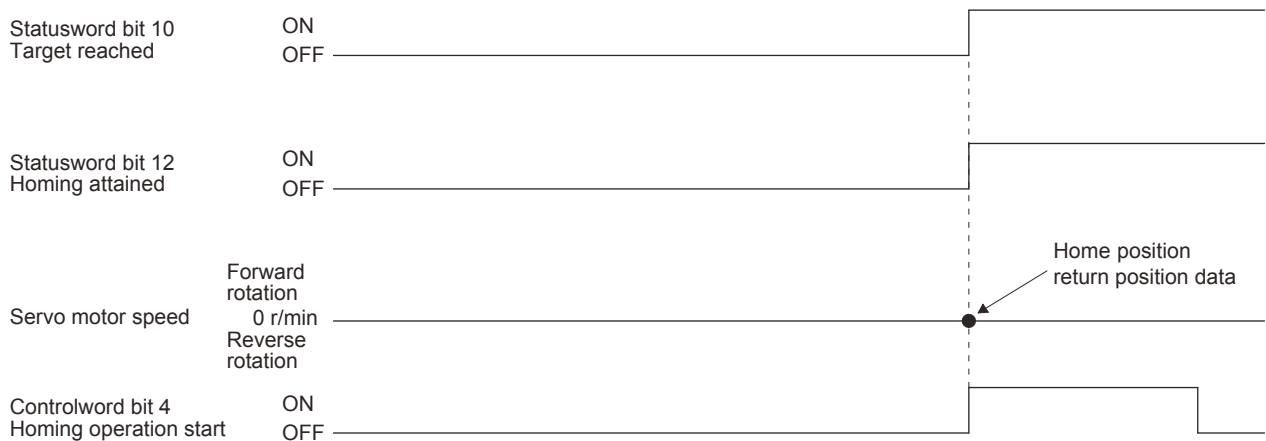

6. SERVO MOTOR DRIVING

(3) Operation example of Manufacturer-specific Homing method

The following shows an operation example of the Manufacturer-specific home return.

(a) Method -1 and -33 (Dog type home position return)

The following figure shows the operation of Homing method -1. The operation direction of Homing method -33 is opposite to that of Homing method -1.

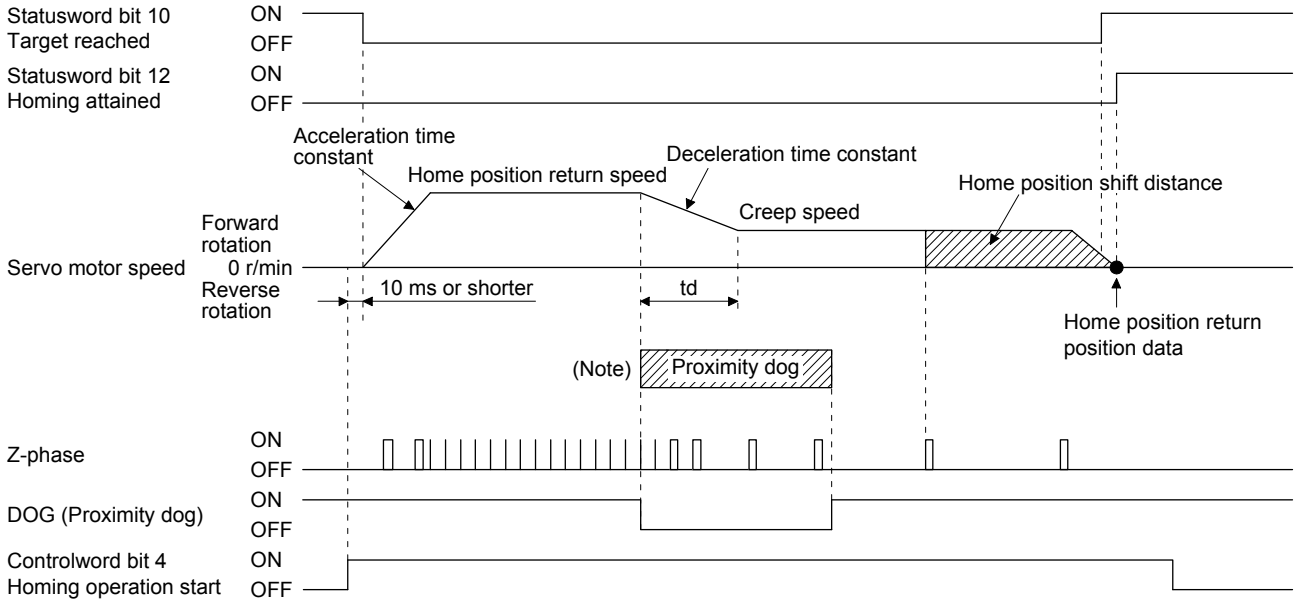

Note. After the front end of the proximity dog is detected, if the distance after proximity dog is traveled without reaching the creep speed, [AL. 90] occurs. Set the travel distance after proximity dog enough for deceleration from the home position return speed to the creep speed.

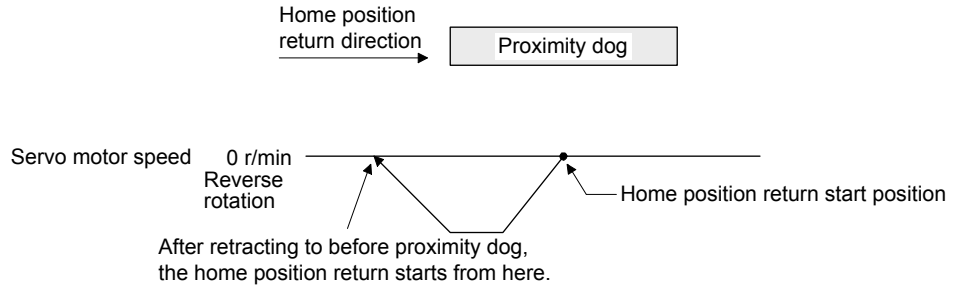

When a home position return is started from the proximity dog

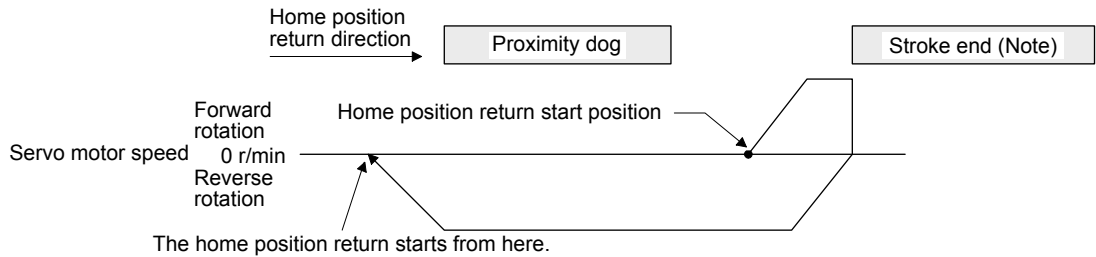

Note. The software limit cannot be used with these functions.

When the movement is returned at the stroke end

6. SERVO MOTOR DRIVING

(b) Method -2 and -34 (Count type home position return)

POINT
<p>● For the count type home position return, after the front end of the proximity dog is detected, the position is shifted by the distance set in the travel distance after proximity dog. Then, the first Z-phase is set as the home position. Therefore, when the on-time of the proximity dog is 10 ms or more, the length of the proximity dog has no restrictions. Use this home position return type when the dog type home position return cannot be used because the length of the proximity dog cannot be reserved or other cases.</p>

The following figure shows the operation of Homing method -2. The operation direction of Homing method -34 is opposite to that of Homing method -2.

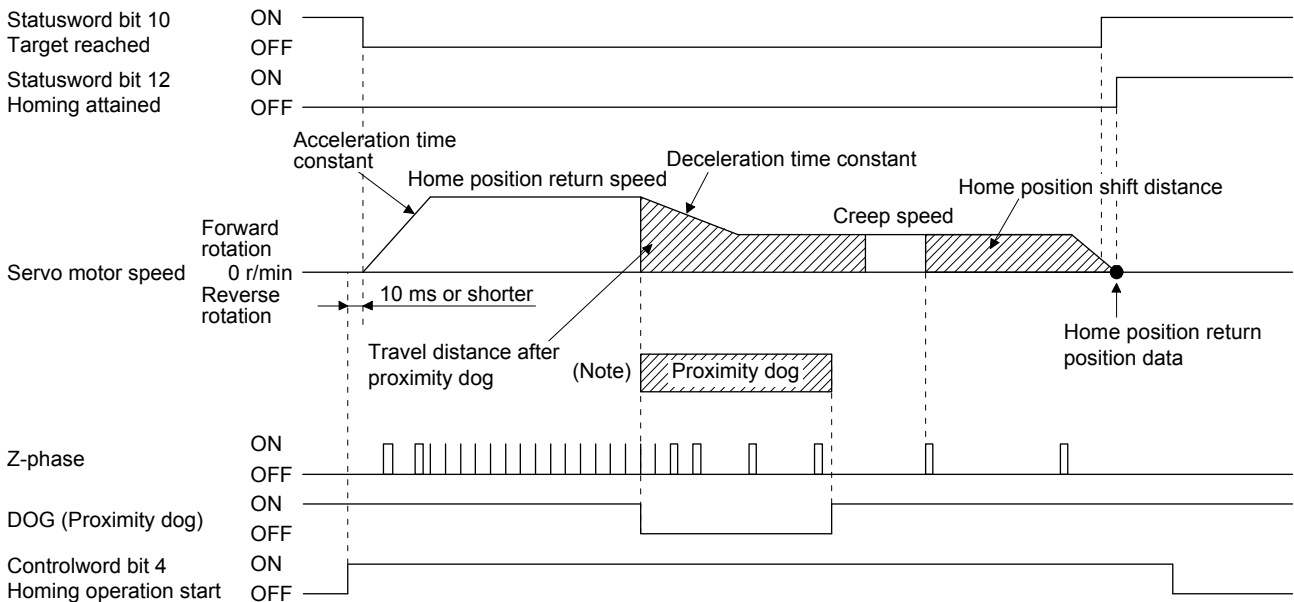

Note. After the front end of the proximity dog is detected, if the distance after proximity dog is traveled without reaching the creep speed, [AL. 90] occurs. Set the travel distance after proximity dog enough for deceleration from the home position return speed to the creep speed.

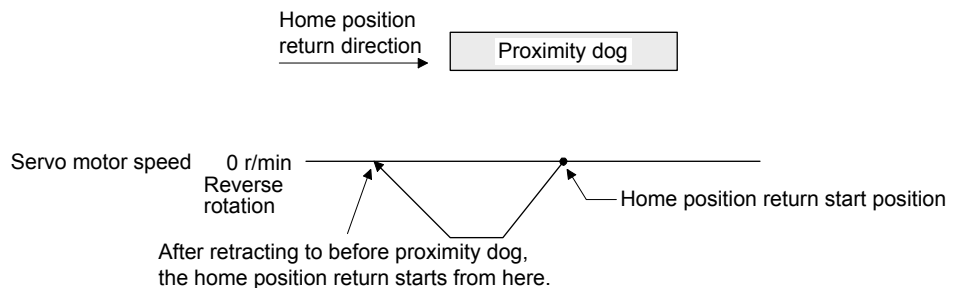

When a home position return is started from the proximity dog

6. SERVO MOTOR DRIVING

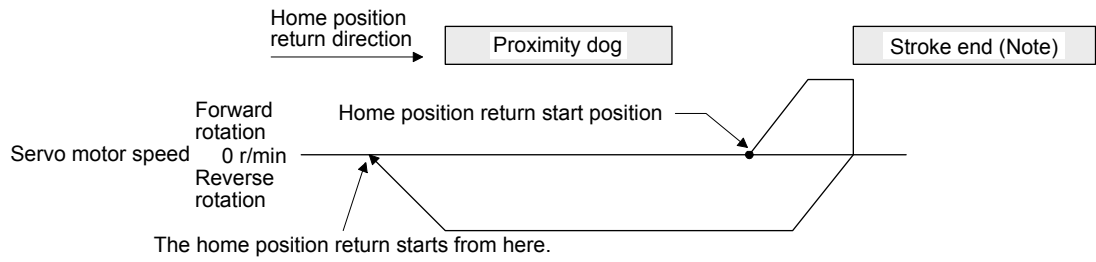

Note. The software limit cannot be used with these functions.

When the movement is returned at the stroke end

(c) Method -3 (Data set type home position return)

The following figure shows the operation of Homing method -3. This type cannot be executed during servo-off.

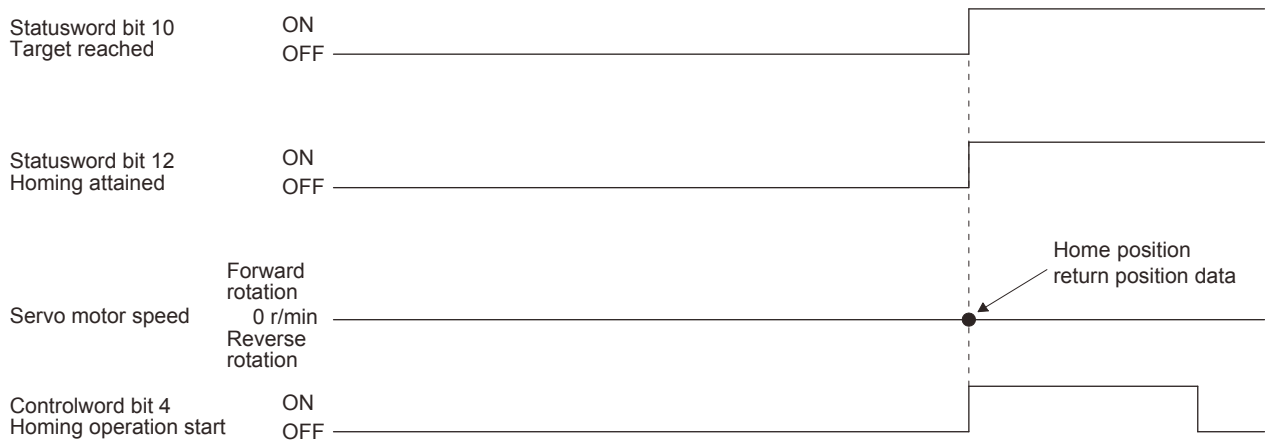

6. SERVO MOTOR DRIVING

(d) Method -4 and -36 (stopper type home position return)

POINT

● Since the workpiece collides with the mechanical stopper, the home position return speed must be low enough.

The following figure shows the operation of Homing method -4. The operation direction of Homing method -36 is opposite to that of Homing method -4.

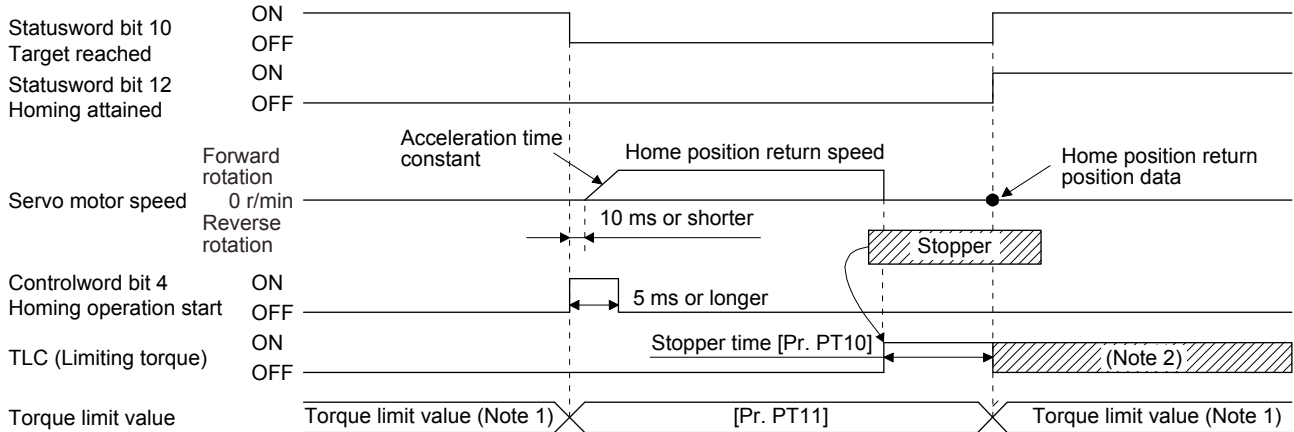

- Note 1. When Method -4 is set, the torque limit value of Positive torque limit value (60E0h) is applied. When Method -36 is set, the torque limit value of Negative torque limit value (60E1h) is applied.
- Note 2. If the torque limit value is reached, TLC remains on after the home position return is completed.

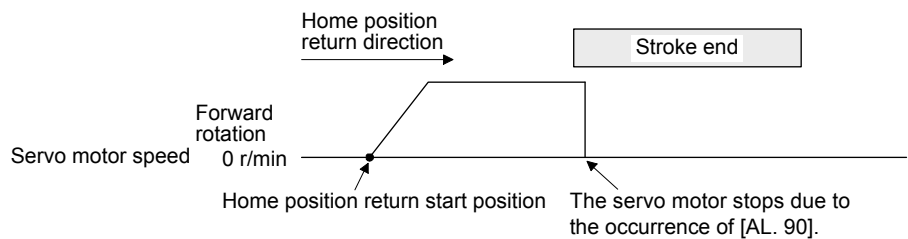

When the stroke end is detected

6. SERVO MOTOR DRIVING

(e) Method -6 and -38 (dog type rear end reference home position return)

POINT

● This home position return type depends on the timing of reading DOG (Proximity dog) that has detected the rear end of the proximity dog. Therefore, when the creep speed is set to 100 r/min and a home position return is performed, the home position has an error of $\pm (\text{Encoder resolution}) \times 100/65536$ [pulse]. The higher the creep speed, the greater the error of the home position.

The following figure shows the operation of Homing method -6. The operation direction of Homing method -38 is opposite to that of Homing method -6.

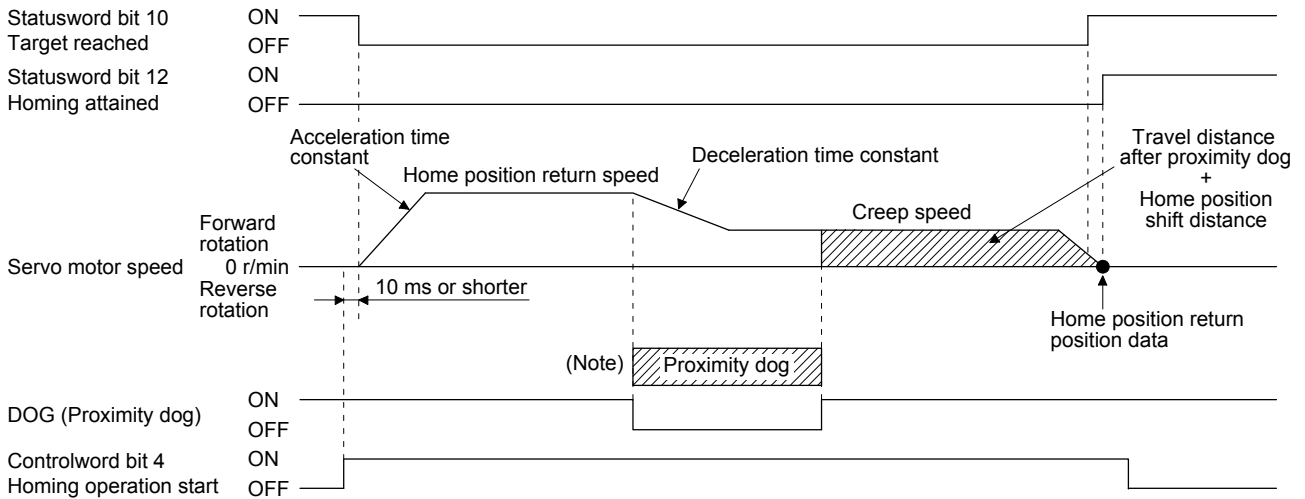

Note. After the front end of the proximity dog is detected, if the rear end of the proximity dog is detected without reaching the creep speed, [AL. 90] occurs. Check the length of the proximity dog or check the home position return speed and creep speed.

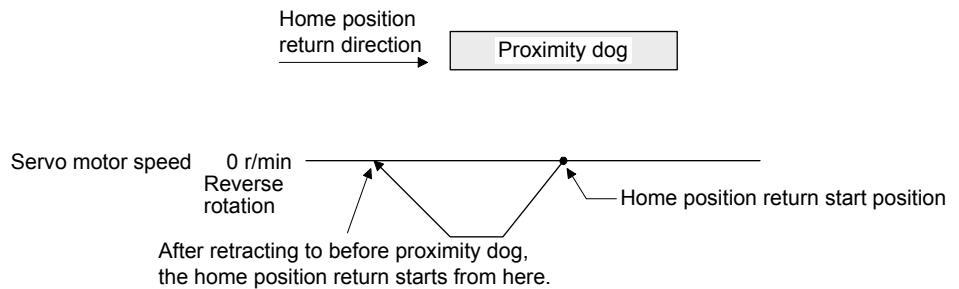

When a home position return is started from the proximity dog

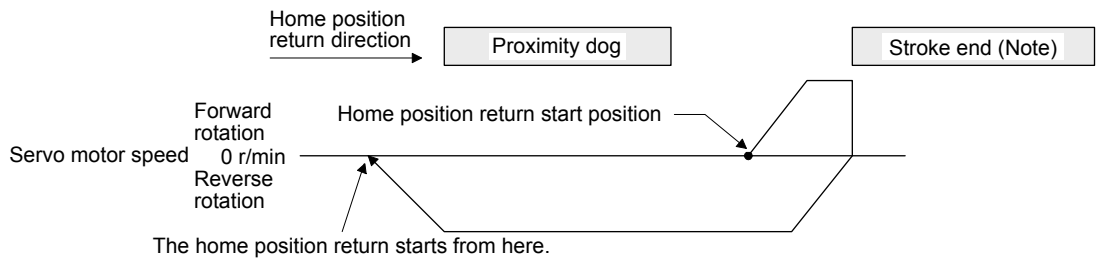

Note. The software limit cannot be used with these functions.

When the movement is returned at the stroke end

6. SERVO MOTOR DRIVING

(f) Method -7 and -39 (count type front end reference home position return)

POINT
<p>● This home position return type depends on the timing of reading DOG (Proximity dog) that has detected the front end of the proximity dog. Therefore, when the creep speed is set to 100 r/min and a home position return is performed, the home position has an error of $\pm (\text{Encoder resolution}) \times 100/65536$ [pulse]. The faster home position return speed sets a larger error in the home position.</p>

The following figure shows the operation of Homing method -7. The operation direction of Homing method -39 is opposite to that of Homing method -7.

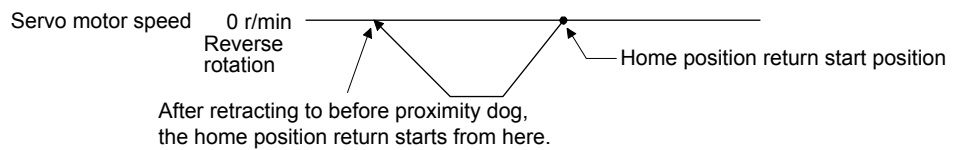
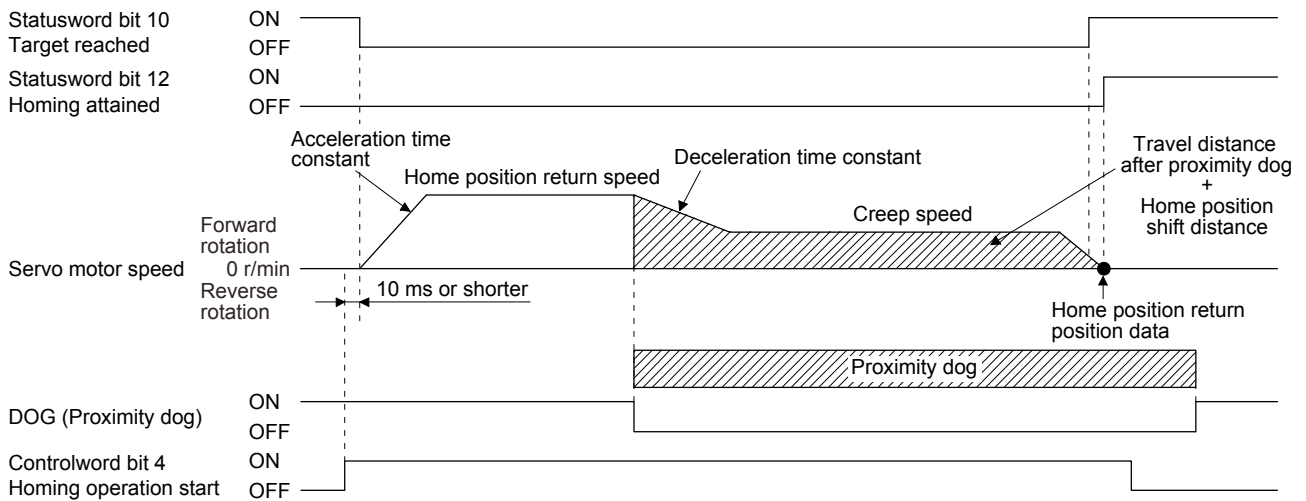

When a home position return is started from the proximity dog

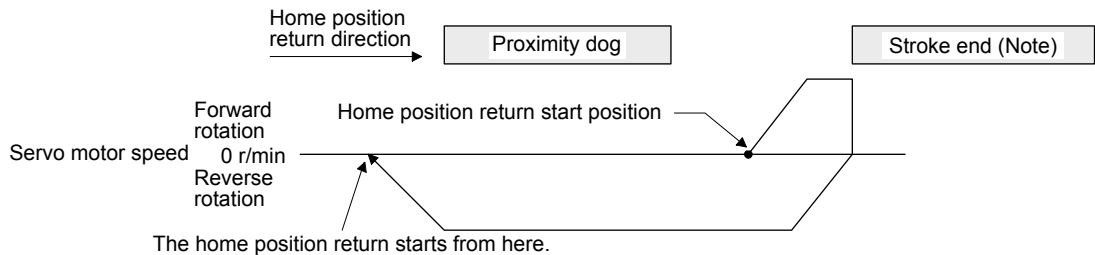

Note. The software limit cannot be used with these functions.

When the movement is returned at the stroke end

6. SERVO MOTOR DRIVING

(g) Method -8 and -40 (dog cradle type home position return)

The following figure shows the operation of Homing method -8. The operation direction of Homing method -40 is opposite to that of Homing method -8.

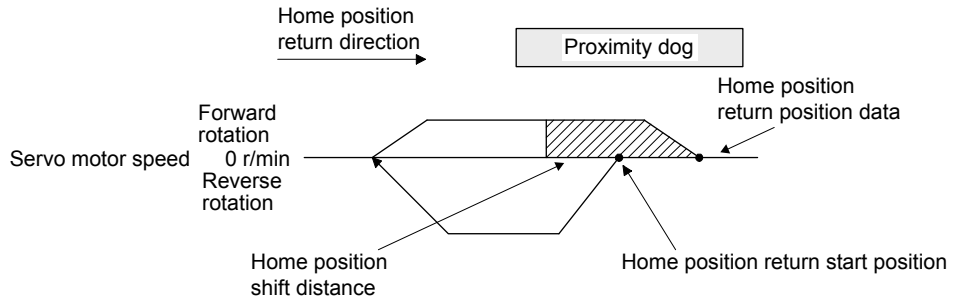
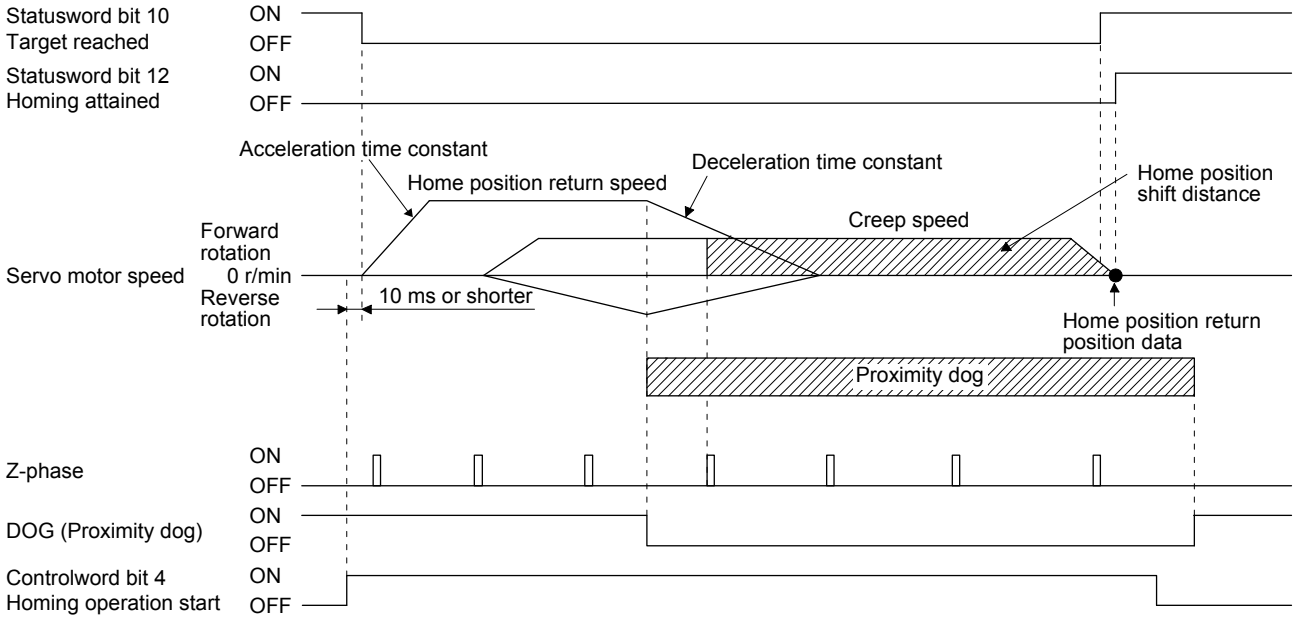

When a home position return is started from the proximity dog

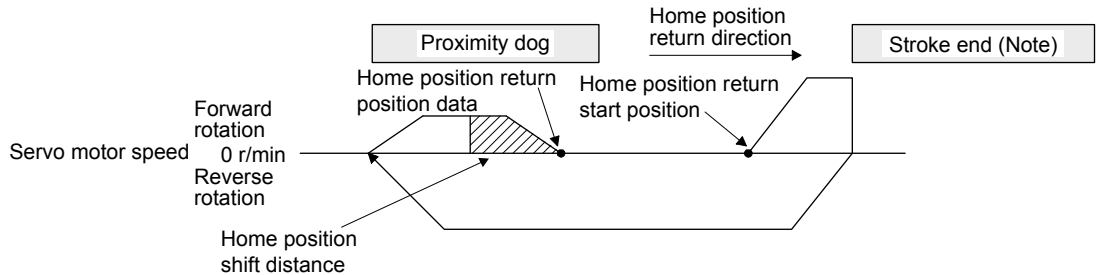

Note. The software limit cannot be used with these functions.

When the movement is returned at the stroke end

6. SERVO MOTOR DRIVING

(h) Method -9 and -41 (dog type last Z-phase reference home position return)

The following figure shows the operation of Homing method -9. The operation direction of Homing method -41 is opposite to that of Homing method -9.

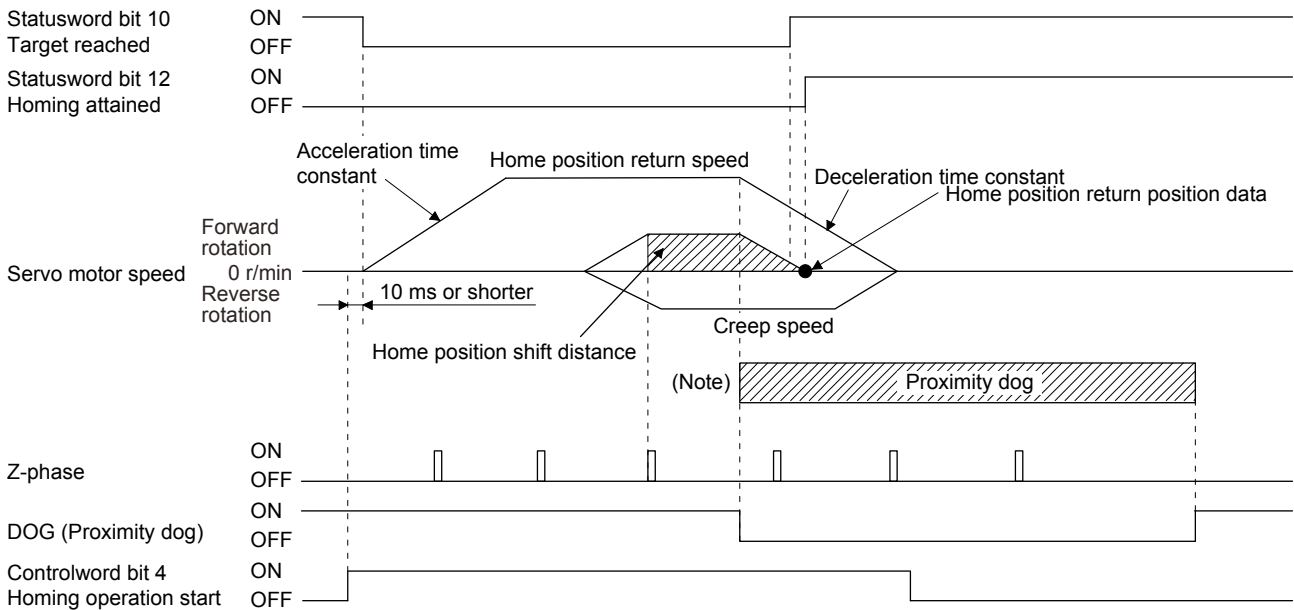

Note. After the front end of the proximity dog is detected, if the rear end of the proximity dog is detected without stop, [AL. 90] occurs. Check the length of the proximity dog or check the home position return speed and creep speed.

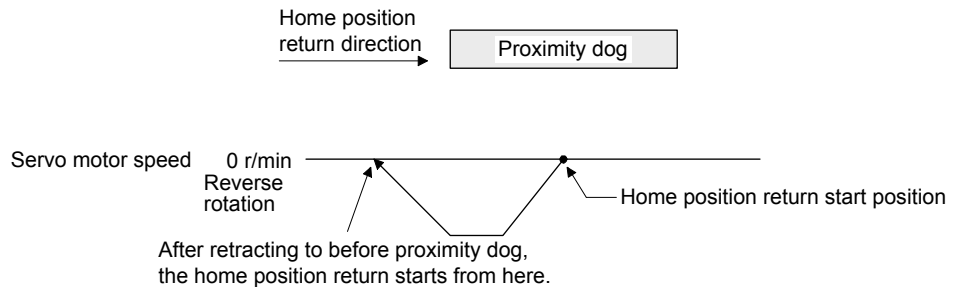

When a home position return is started from the proximity dog

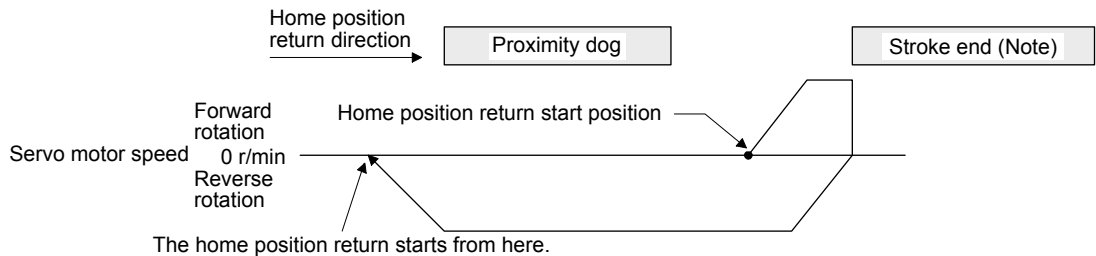

Note. The software limit cannot be used with these functions.

When the movement is returned at the stroke end

6. SERVO MOTOR DRIVING

(i) Method -10 and -42 (dog type front end reference home position return)

The following figure shows the operation of Homing method -10. The operation direction of Homing method -42 is opposite to that of Homing method -10.

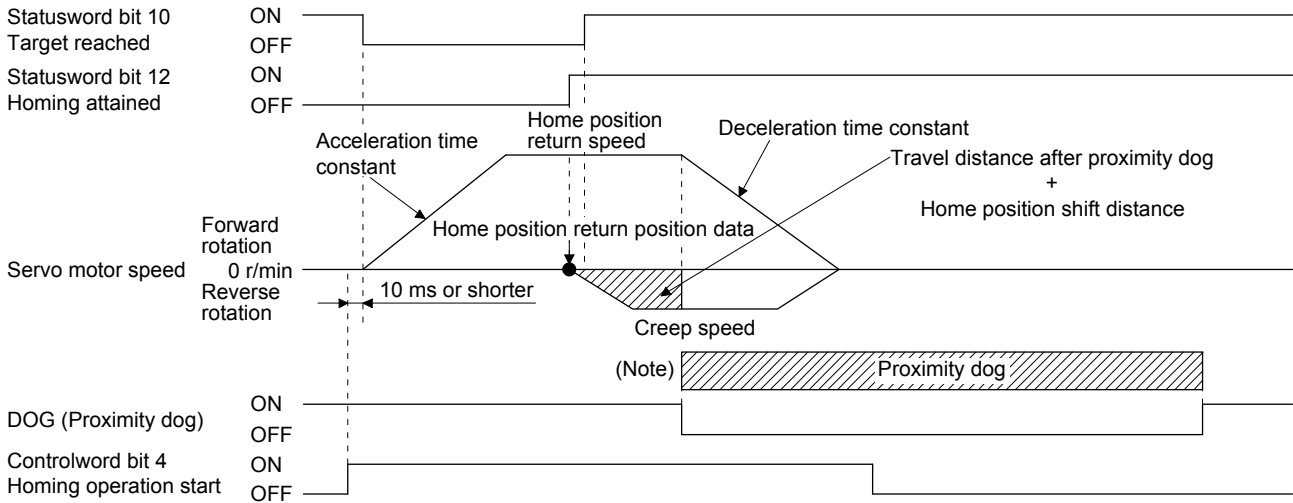

Note. After the front end of the proximity dog is detected, if the rear end of the proximity dog is detected without reaching the creep speed, [AL. 90] occurs. Check the length of the proximity dog or check the home position return speed and creep speed.

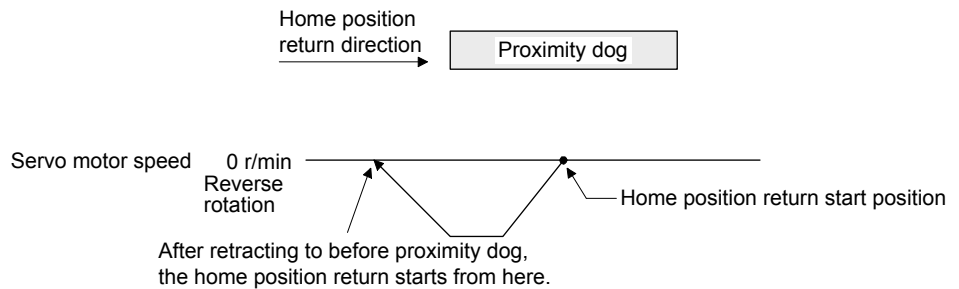

When a home position return is started from the proximity dog

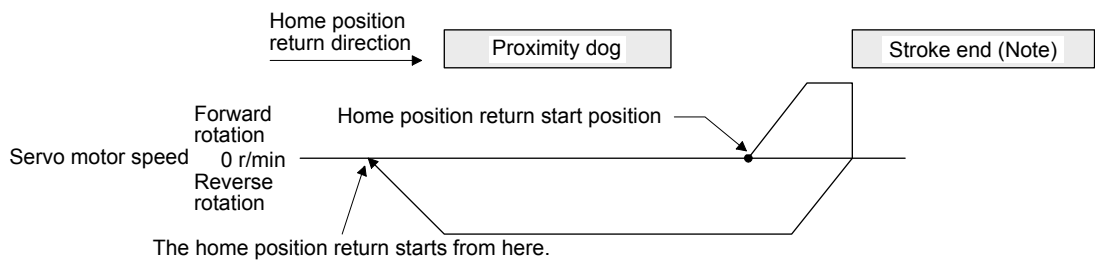

Note. The software limit cannot be used with these functions.

When the movement is returned at the stroke end

6. SERVO MOTOR DRIVING

(j) Method -11 and -43 (dogless Z-phase reference home position return)

The following figure shows the operation of Homing method -11. The operation direction of Homing method -43 is opposite to that of Homing method -11.

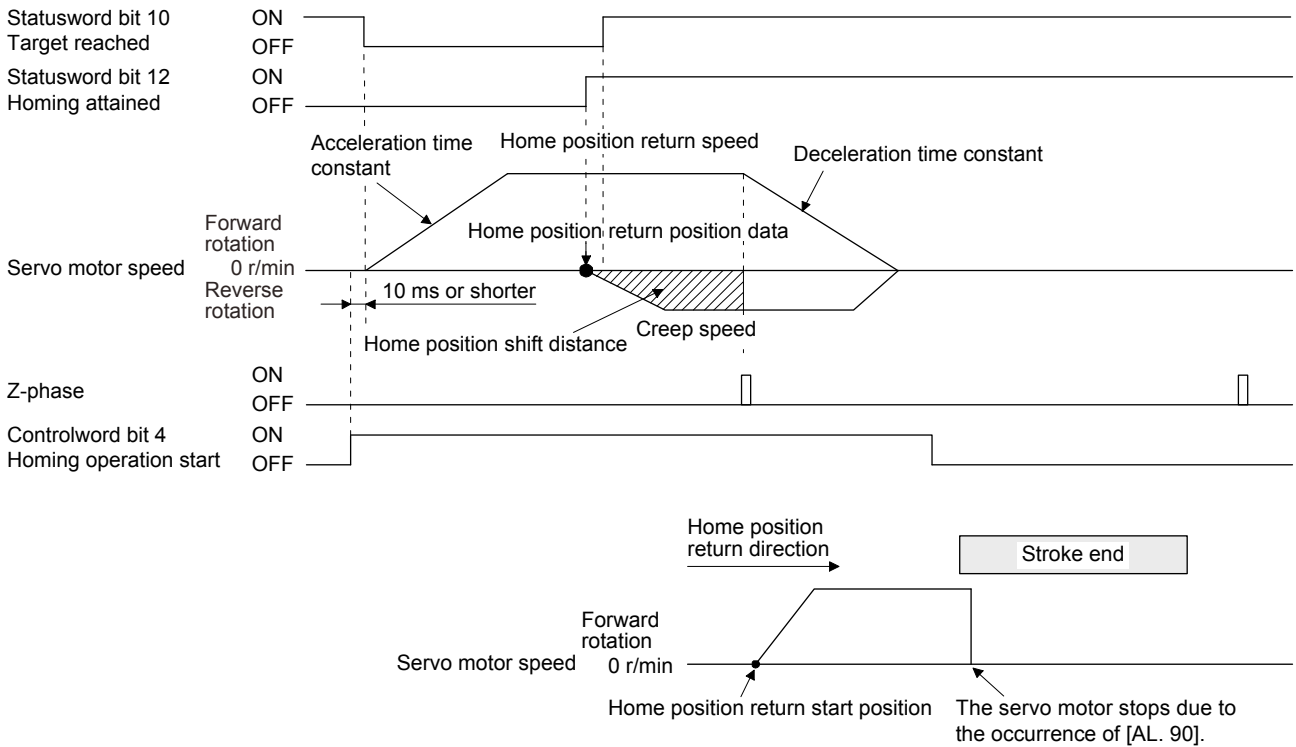

When the stroke end is detected

6. SERVO MOTOR DRIVING

6.2 Profile position mode (pp)

The following shows the functions and related objects of the profile position mode (pp).

6.2.1 Function description

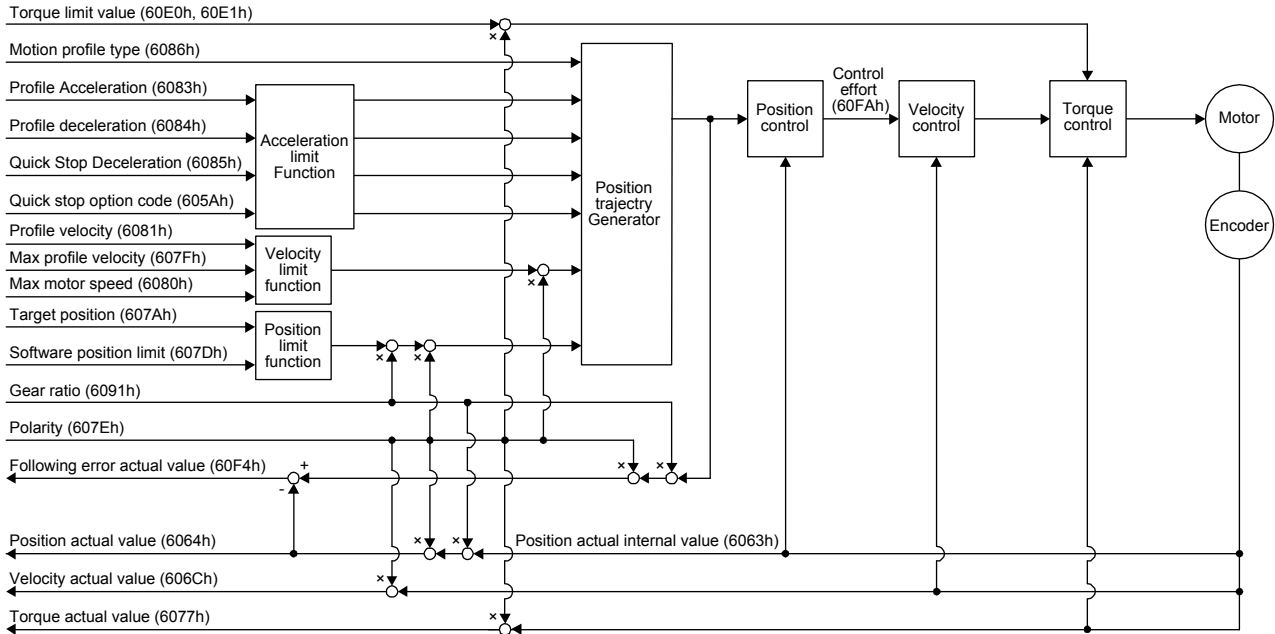

6.2.2 Related object

Index	Sub Index	Read/write	Name	Data type	Initial value	Description
607Ah	0	Read/write	Target position	4 bytes		Command position (Pos units)
607Bh	0	Read	Position range limit	4 bytes		Number of entries
	1	Read/write	Min position range limit	4 bytes		Minimum value of the position range limit The value is automatically set according to the setting of "Position data unit" of [Pr. PT01]. pulse: -2147483648 degree: 0
	2	Read/write	Max position range limit	4 bytes		Maximum value of the position range limit The value is automatically set according to the setting of "Position data unit" of [Pr. PT01]. pulse: 2147483647 degree: 359999
607Dh	0	Read	Software position limit	1 bytes	2	Number of entries
	1	Read/write	Min position limit	4 bytes	0	Minimum position Index (Pos units)
	2	Read/write	Max position limit	4 bytes	0	Maximum position Index (Pos units)
607Fh	0	Read/write	Max profile velocity	4 bytes		maximum speed Unit: Vel unit (0.01 r/min)
6080h	0	Read/write	Max motor speed	4 bytes		Servo motor maximum speed Unit: r/min

6. SERVO MOTOR DRIVING

Index	Sub Index	Read/write	Name	Data type	Initial value	Description
6081h	0	Read/write	Profile velocity	4 bytes		Speed after acceleration completed Unit: Vel unit (0.01 r/min)
6083h	0	Read/write	Profile Acceleration	4 bytes	0	Acceleration at start of movement to target position Unit: ms
6084h	0	Read/write	Profile deceleration	4 bytes	0	Deceleration at arrival at target position Unit: ms
6085h	0	Read/write	Quick stop deceleration	4 bytes	100	Deceleration at deceleration to a stop by Quick stop Unit: ms
6086h	0	Read/write	Motion profile type	2 bytes	-1	Acceleration/deceleration type selection -1: S-pattern 0: Linear ramp (not compatible) (Note 1) 1: Sin ² ramp (not compatible) (Note 1) 2: Jerk-free ramp (not compatible) (Note 1) 3: Jerk-limited ramp (not compatible) (Note 1)
605Ah	0	Read/write	Quick stop option code	2 bytes	2	Operation setting for Quick stop (Note 2)
6063h	0	Read	Position actual internal value	4 bytes		Current position (Enc inc)
6064h	0	Read	Position actual value	4 bytes		Current position (Pos units)
606Ch	0	Read	Velocity actual value	4 bytes		Current speed Unit: Vel unit (0.01 r/min)
6077h	0	Read	Torque actual value	2 bytes		Current torque Unit: 0.1% (rated torque of 100%)
6092h	0	Read	Feed constant	1 bytes	2	Travel distance per revolution of an output shaft
	1	Read/write	Feed	4 bytes		Travel distance setting
	2		Shaft revolutions			Number of servo motor shaft revolutions
60F4h	0	Read	Following error actual value	4 bytes		Droop pulses (Pos units)
60FAh	0	Read	Control effort	4 bytes		Position control loop output (speed command) Unit: Vel unit (0.01 r/min)
60E0h	0	Read/write	Positive torque limit value	2 bytes		Torque limit value (forward) Unit: 0.1% (rated torque of 100%)
60E1h	0	Read/write	Negative torque limit value	2 bytes		Torque limit value (reverse) Unit: 0.1% (rated torque of 100%)
6091h	0	Read	Gear ratio	1 bytes	2	Gear ratio
	1	Read/write	Motor revolutions	4 bytes	1	Number of revolutions of the servo motor axis (numerator)
	2		Shaft revolutions		1	Number of revolutions of the drive axis (denominator)
607Eh	0	Read/write	Polarity	1 bytes	00h	Polarity selection Bit 7: Position POL Bit 6: Velocity POL Bit 5: Torque POL (Note 2)

6. SERVO MOTOR DRIVING

Index	Sub Index	Read/write	Name	Data type	Initial value	Description
60A8h	0	Read/write	SI unit position	4 bytes		SI unit position The value is automatically set according to the setting of "Position data unit" of [Pr. PT01].
60A9h	0	Read/write	SI unit velocity	4 bytes		SI unit velocity 0.01 r/min FEB44700h (0.01 r/min)

- Note
1. This is not compatible with the MR-JE-_C servo amplifier.
 2. Refer to "MR-JE-_C Servo Amplifier Instruction Manual (CC-Link IE Field Network Basic)".

(1) Details on the control command (Controlword: 6040h) (pp mode)

Bit	Symbol	Description
4	New set-point	New positioning parameters are obtained when this bit turns on.
5	Change set immediately	0: Set of set-points 1: Single set-point
6	abs/rel	0: Absolute position command 1: Relative position command When the unit is set to degree, relative position commands are disabled. When the relative position command is specified and positioning is started, [AL. F4.8] occurs and positioning cannot be started.
8	HALT	0: Positioning is executed. 1: The servo motor stops according to Halt option code (605Dh).
9	Change on set-point	Enabled only for Set of set-points (Bit 5 = 0). 0: The next positioning starts after the current positioning is completed (stopped). (Black line (Refer to section 6.2.3 (2).)) 1: The next positioning starts after positioning is executed with Profile velocity (6081h) held up to the current set-point. (Gray line (Refer to section 6.2.3 (2).))
15	(reserved)	The value at reading is undefined. Set "0" when writing.

(2) Details on the control status (Statusword: 6041h) (pp mode)

Bit	Symbol	Description
10	Target reached	0 (Halt (Bit 8) = 0) : Target position not reached. 0 (Halt (Bit 8) = 1) : Axis decelerates 1 (Halt (Bit 8) = 0) : Target position reached. 1 (Halt (Bit 8) = 1) : Velocity of axis is 0 Judgment condition for Target position reached If the error between Actual position and Target position (607Ah) has stayed within Position window (6067h) for Position window time (6068h) or more, Target position reached is stored.
12	Set-point acknowledge	0: Positioning completed (wait for next command) 1: Positioning being executed (The set-point can be overwritten.)
13	Following error	0: No following error 1: Following error

6. SERVO MOTOR DRIVING

6.2.3 Directions for use

(1) Single Set-point

Update of positioning parameters during a positioning operation is immediately accepted. (The current positioning operation is cancelled and the next positioning is started.)

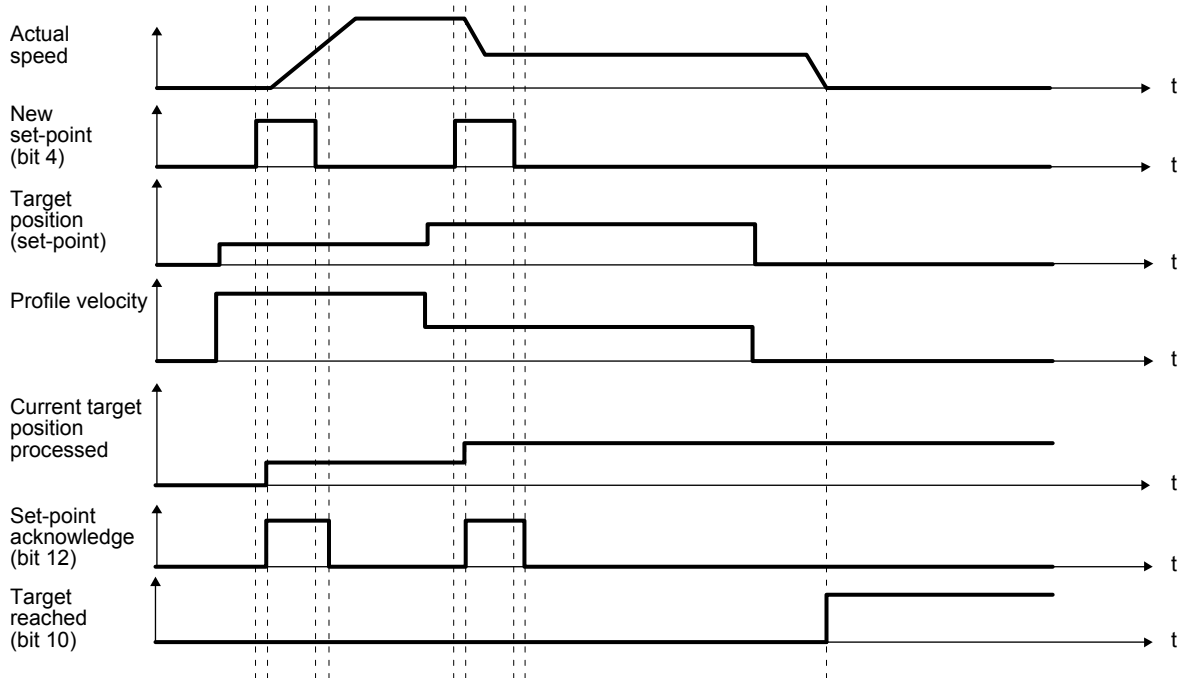

(2) Set of set-points

After the current positioning operation is completed, the next positioning is started. Whether positioning is stopped at the first positioning point when at an update of the positioning parameter before completion of the positioning can be switched. To switch the setting, use Change on set-point (Bit 9 of Controlword).

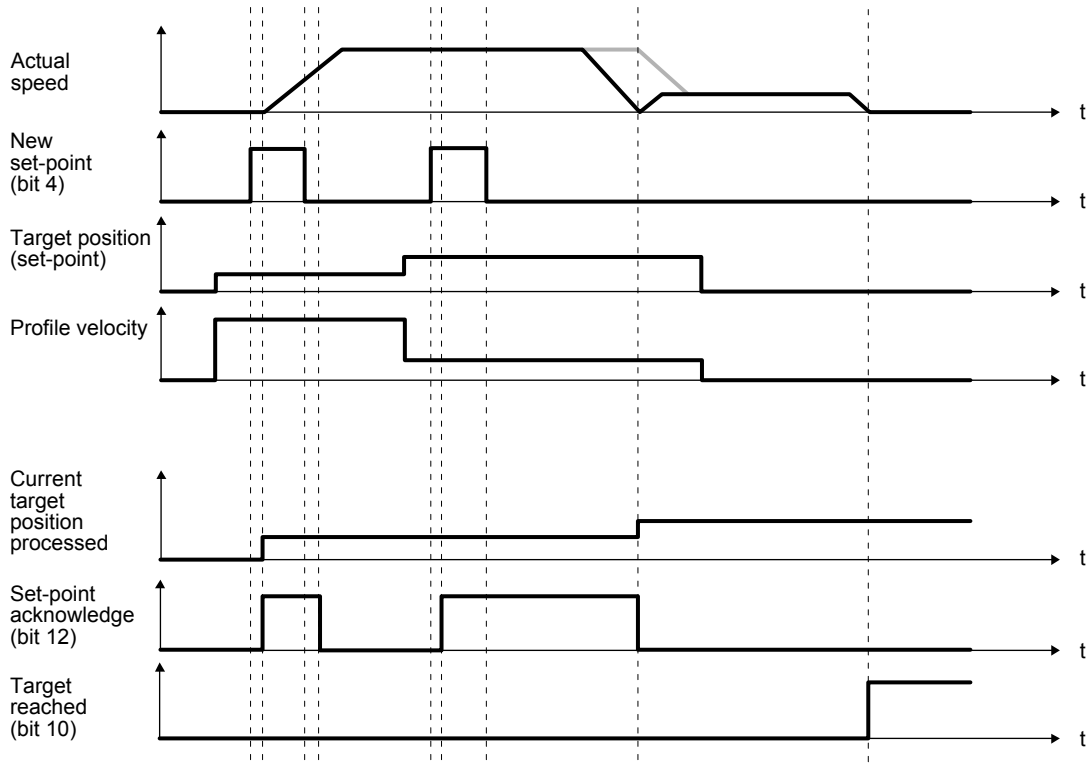

6. SERVO MOTOR DRIVING

6.3 Profile velocity mode (pv)

The following shows the functions and related objects of the profile velocity mode (pv).

6.3.1 Function description

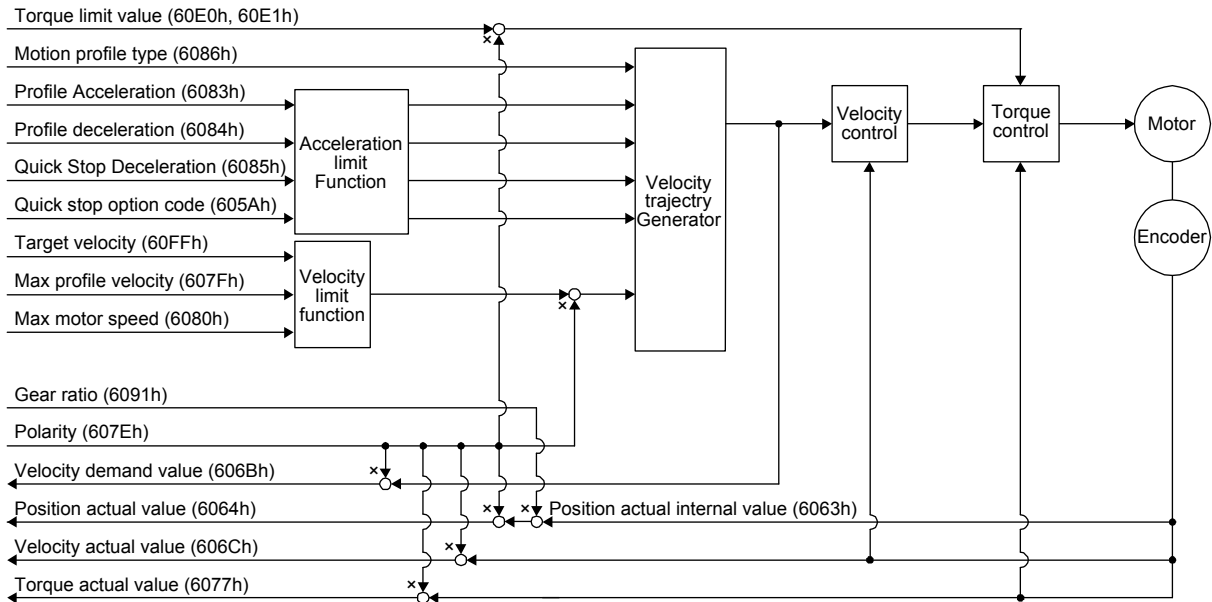

6.3.2 Related object

Index	Sub Index	Read/write	Name	Data Type	Initial value	Description
60FFh	0	Read/write	Target velocity	4 bytes		Command speed Unit: Vel unit (0.01 r/min)
607Fh	0	Read/write	Max profile velocity	4 bytes		maximum speed Unit: Vel unit (0.01 r/min)
6080h	0	Read/write	Max motor speed	4 bytes		Servo motor maximum speed Unit: r/min
6083h	0	Read/write	Profile Acceleration	4 bytes	0	Acceleration at start of movement to target position Unit: ms
6084h	0	Read/write	Profile deceleration	4 bytes	0	Deceleration at arrival at target position Unit: ms
6085h	0	Read/write	Quick stop deceleration	4 bytes	100	Deceleration at deceleration to a stop by Quick stop Unit: ms
6086h	0	Read/write	Motion profile type	2 bytes	-1	Acceleration/deceleration type selection -1: S-pattern 0: Linear ramp (not compatible) (Note 1) 1: Sin ² ramp (not compatible) (Note 1) 2: Jerk-free ramp (not compatible) (Note 1) 3: Jerk-limited ramp (not compatible) (Note 1)
605Ah	0	Read/write	Quick stop option code	2 bytes	2	Operation setting for Quick stop (Note 2)
6063h	0	Read	Position actual internal value	4 bytes		Current position (Enc inc)
6064h	0	Read	Position actual value	4 bytes		Current position (Pos units)

6. SERVO MOTOR DRIVING

Index	Sub Index	Read/write	Name	Data Type	Initial value	Description
606Bh	0	Read	Velocity demand value	4 bytes		Speed command (after trajectory generation)
606Ch	0	Read	Velocity actual value	4 bytes		Current speed Unit: Vel unit (0.01 r/min)
6077h	0	Read	Torque actual value	2 bytes		Current torque Unit: 0.1% (rated torque of 100%)
6092h	0	Read	Feed constant	1 bytes	2	Travel distance per revolution of an output shaft
	1	Read/write	Feed	4 bytes		Travel distance setting
	2		Shaft revolutions			Number of servo motor shaft revolutions
60E0h	0	Read/write	Positive torque limit value	2 bytes		Torque limit value (forward) Unit: 0.1% (rated torque of 100%)
60E1h	0	Read/write	Negative torque limit value	2 bytes		Torque limit value (reverse) Unit: 0.1% (rated torque of 100%)
6091h	0	Read	Gear ratio	1 bytes	2	Gear ratio
	1	Read/write	Motor revolutions	4 bytes	1	Number of revolutions of the servo motor axis (numerator)
	2		Shaft revolutions		1	Number of revolutions of the drive axis (denominator)
607Eh	0	Read/write	Polarity	1 bytes	00h	Polarity selection Bit 7: Position POL Bit 6: Velocity POL Bit 5: Torque POL (Note 2)
606Dh	0	Read/write	Velocity window	2 bytes		Speed error threshold for judging Target reached Unit: 0.01 r/min
606Eh	0	Read/write	Velocity window time	2 bytes		Target reached judgment time Unit: ms
606Fh	0	Read/write	Velocity threshold	2 bytes		Zero speed threshold for judging Speed Unit: 0.01 r/min
6070h	0	Read/write	Velocity threshold time	2 bytes		Speed judgment time Unit: ms
60A8h	0	Read/write	SI unit position	4 bytes		SI unit position The value is automatically set according to the setting of "Position data unit" of [Pr. PT01].
60A9h	0	Read/write	SI unit velocity	4 bytes		SI unit velocity 0.01 r/min FEB44700h (0.01 r/min)

Note 1. This is not compatible with the MR-JE-_C servo amplifier.

2. Refer to "MR-JE-_C Servo Amplifier Instruction Manual (CC-Link IE Field Network Basic)".

6. SERVO MOTOR DRIVING

(1) Details on the control command (Controlword: 6040h) (pv mode)

Bit	Symbol	Description
4	(reserved)	The value at reading is undefined. Set "0" when writing.
5	(reserved)	
6	(reserved)	
8	HALT	0: The servo motor is driven. 1: The servo motor is stopped according to Halt option code (605Dh).
9	(reserved)	The value at reading is undefined. Set "0" when writing.
15	New set-point	0: The servo motor is stopped. 1: The servo motor is driven. Enabled only in the profile velocity mode. When "___0" (enabled) is set in [Pr. PC23 (___x) Servo-lock selection at speed control stop], the servo motor is driven by setting bit 15 to "1". When bit 15 is set to "0" while the servo motor is stopped, the servo motor goes into the servo-lock status. When bit 15 is set to "0" while the servo motor is being driven, the servo motor decelerates to a stop and goes into the servo-lock status. When "___1" (disabled) is set in [Pr. PC23 (___x)], the servo motor is driven by setting Target velocity regardless of the setting of bit 15.

(2) Details on the control status (Statusword: 6041h) (pv mode)

Bit	Symbol	Description
10	Target reached	0 (Halt (Bit 8) = 0) : Target velocity not reached. 0 (Halt (Bit 8) = 1) : Axis decelerates 1 (Halt (Bit 8) = 0) : Target velocity reached. 1 (Halt (Bit 8) = 1) : Velocity of axis is 0 Judgment condition for Target velocity reached If the error between Actual velocity and Target velocity (60FFh) has stayed within Velocity window (606Dh) for Velocity window time (606Eh) or more, Target velocity reached is stored.
12	Speed	0: Speed is not equal 0 1: Speed is equal 0 Judgment condition for Speed is not equal 0 If the absolute value of Actual velocity has exceeded Velocity threshold (606Fh) for Velocity threshold time (6070h) or more, Speed is not equal 0 is stored.
13	Max slippage error	0: Maximum slippage not reached 1: Maximum slippage reached (not compatible) (Note) Max slippage is a maximum slippage of the asynchronous servo motor.

Note. This is not compatible with the MR-JE-_C servo amplifier.

6. SERVO MOTOR DRIVING

6.3.3 Directions for use

(1) pv mode operation sequence

(a) When Servo-lock selection at speed control stop is enabled ([Pr. PC23] = "___0")

When New set-point (bit 15 of Controlword) is set to "1" after Target Velocity (60FFh) has been set, the servo motor is driven. When Target Velocity is set to "0", the servo motor decelerates to a stop. When New set-point is set to "0" while the servo motor is stopped, the servo motor goes into the servo-lock status.

When New set-point is set to "0" while the servo motor is being driven, the servo motor decelerates to a stop and goes into the servo-lock status. When Target Velocity is set after New set-point has been set to "1" in this condition, the servo motor is driven.

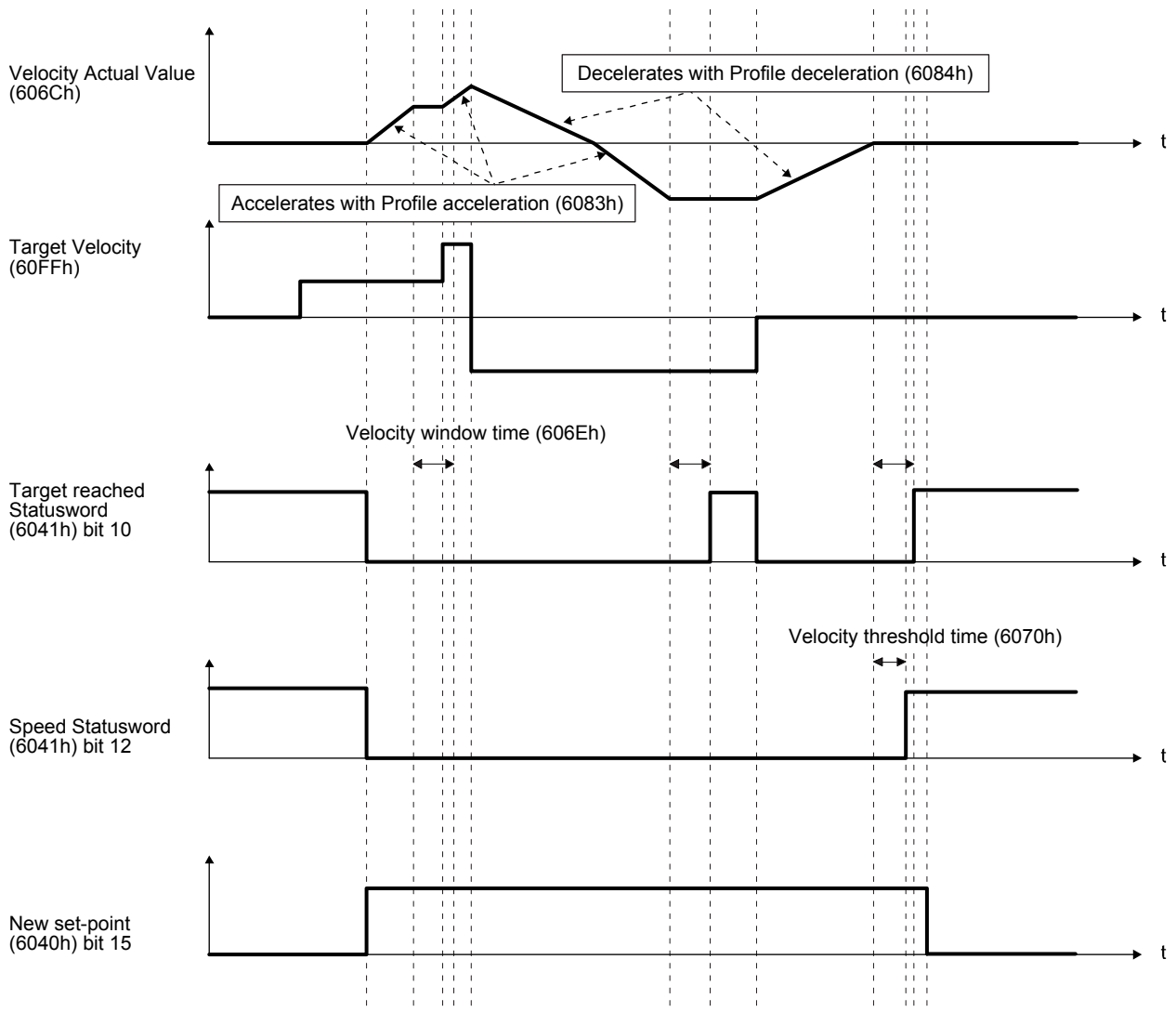

6. SERVO MOTOR DRIVING

(b) When Servo-lock selection at speed control stop is disabled ([Pr. PC23] = "___ 1")

When Target Velocity (60FFh) is set, the servo motor is driven. When Target Velocity (60FFh) is set to "0", the servo motor decelerates to a stop. The servo motor does not go into the servo-lock status while it is stopped.

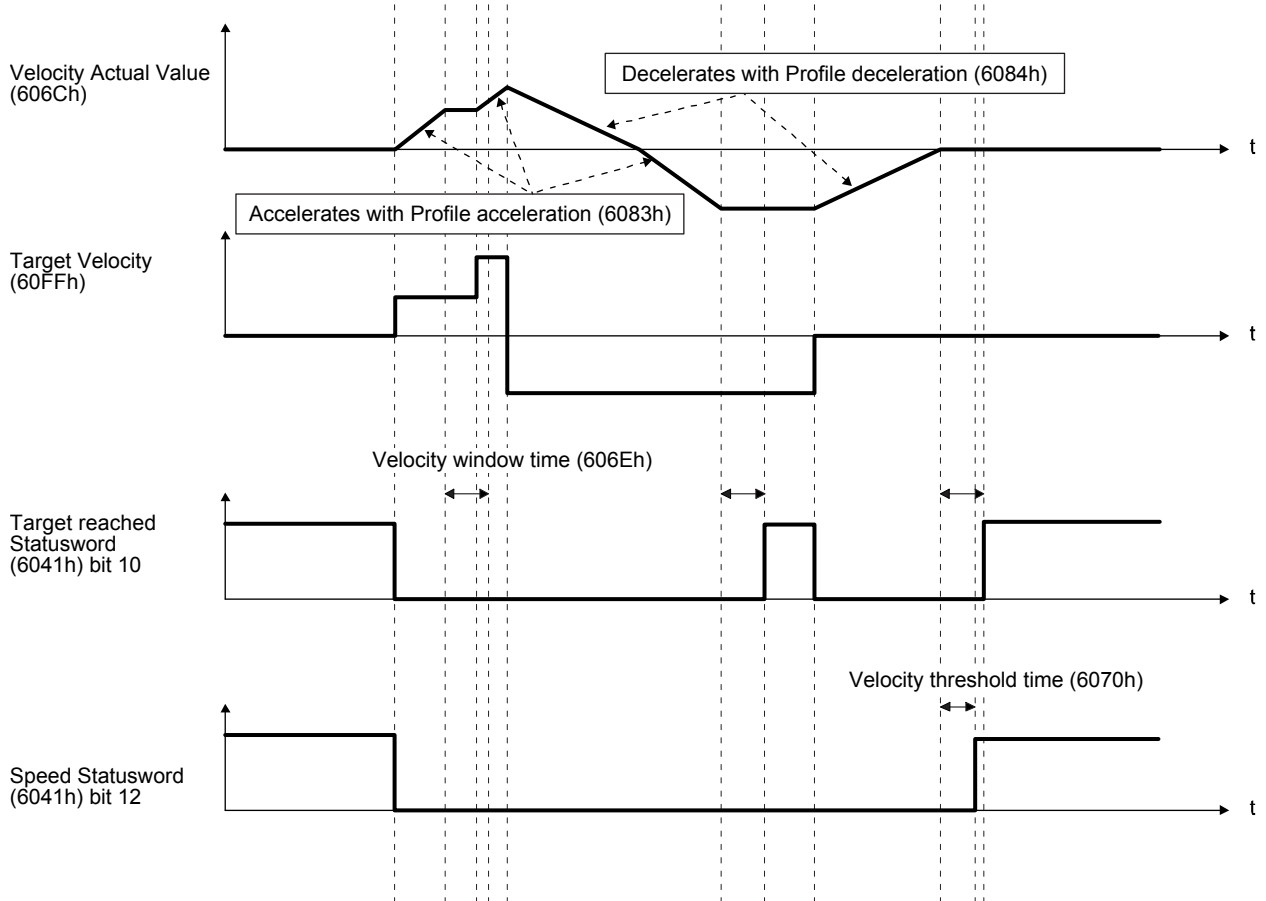

6. SERVO MOTOR DRIVING

6.4 Profile torque mode (tq)

The following shows the functions and related objects of the profile torque mode (tq).

6.4.1 Function description

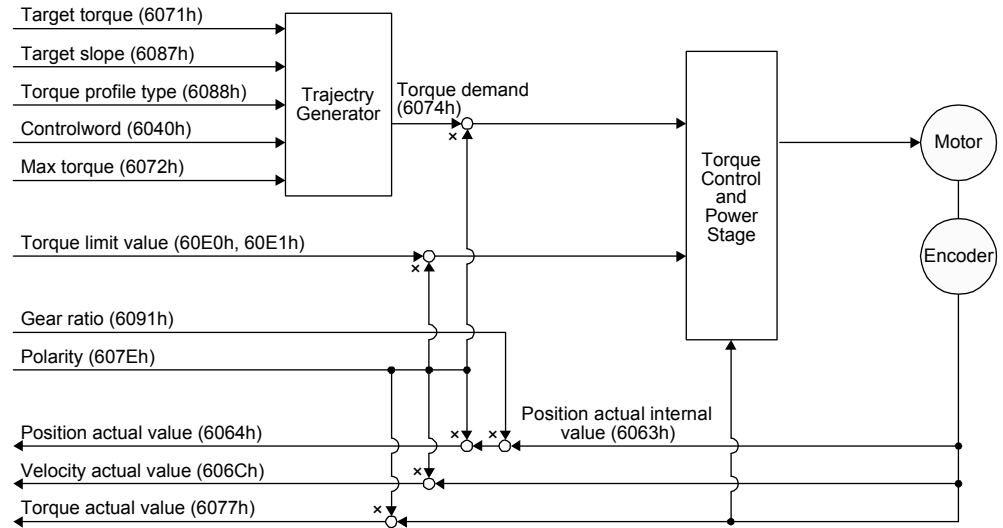

6.4.2 Related object

Index	Sub Index	Read/write	Name	Data Type	Initial value	Description
6040h	0	Read/write	Controlword	2 bytes		Common control command
6071h	0	Read/write	Target torque	2 bytes		Command torque Unit: 0.1% (rated torque of 100%)
6072h	0	Read/write	Max torque	2 bytes		Maximum torque Unit: 0.1% (rated torque of 100%)
6074h	0	Read	Torque demand	2 bytes		Command torque (after limit) Unit: 0.1% (rated torque of 100%)
6087h	0	Read/write	Torque slope	4 bytes	00FFFFFFh	Torque variation Unit: 0.1%/s (rated torque of 100%)
6088h	0	Read/write	Torque profile type	2 bytes	0000h	Torque variation pattern 0000h: Linear ramp 0001h: Sin2 ramp (not compatible) (Note 1) 0002h to 7FFFh: reserved 8000h to FFFFh: Manufacturer specific
6063h	0	Read	Position actual internal value	4 bytes		Current position (Enc inc)
6064h	0	Read	Position actual value	4 bytes		Current position (Pos units)
606Ch	0	Read	Velocity actual value	4 bytes		Current speed Unit: Vel unit (0.01 r/min)
6077h	0	Read	Torque actual value	2 bytes		Current torque Unit: 0.1% (rated torque of 100%)
6092h	0	Read	Feed constant	1 bytes	2	Travel distance per revolution of an output shaft
	1	Read/write	Feed	4 bytes		Travel distance setting
	2		Shaft revolutions			Number of servo motor shaft revolutions

6. SERVO MOTOR DRIVING

Index	Sub Index	Read/write	Name	Data Type	Initial value	Description
60E0h	0	Read/write	Positive torque limit value	2 bytes		Torque limit value (forward) Unit: 0.1% (rated torque of 100%)
60E1h	0	Read/write	Negative torque limit value	2 bytes		Torque limit value (reverse) Unit: 0.1% (rated torque of 100%)
6091h	0	Read	Gear ratio	1 bytes	2	Gear ratio
	1	Read/write	Motor revolutions	4 bytes	1	Number of revolutions of the servo motor axis (numerator)
	2		Shaft revolutions		1	Number of revolutions of the drive axis (denominator)
607Eh	0	Read/write	Polarity	1 bytes	0	Polarity selection Bit 7: Position POL Bit 6: Velocity POL Bit 5: Torque POL (Note 2)
2D20h	0	Read/write	Velocity limit value	4 bytes		Speed limit value Unit: Vel unit (0.01 r/min)
60A8h	0	Read/write	SI unit position	4 bytes		SI unit position The value is automatically set according to the setting of "Position data unit" of [Pr. PT01].
60A9h	0	Read/write	SI unit velocity	4 bytes		SI unit velocity 0.01 r/min FEB44700h (0.01 r/min)

- Note 1. This is not compatible with the MR-JE-_C servo amplifier.
2. Refer to "MR-JE-_C Servo Amplifier Instruction Manual (CC-Link IE Field Network Basic)".

(1) Details on the control command (Controlword: 6040h) (tq mode)

Bit	Symbol	Description
4	(reserved)	The value at reading is undefined. Set "0" when writing.
5	(reserved)	
6	(reserved)	
8	HALT	0: The servo motor is driven. 1: The servo motor is stopped according to Halt option code (605Dh).
9	(reserved)	The value at reading is undefined. Set "0" when writing.
15	(reserved)	

(2) Details on the control status (Statusword: 6041h) (tq mode)

Bit	Symbol	Description
10	Target reached (Not compatible) (Note)	0 (Halt (Bit 8) = 0) : Target torque not reached. 0 (Halt (Bit 8) = 1) : Axis decelerates 1 (Halt (Bit 8) = 0) : Target torque reached. 1 (Halt (Bit 8) = 1) : Velocity of axis is 0 Judgment condition for Target torque reached If the error between Actual torque and Target torque (6071h) has stayed within Torque window for Torque window time or more, Target torque reached is stored.
12	(reserved)	The value at reading is undefined.
13	(reserved)	

Note. This is not compatible with the MR-JE-_C servo amplifier.

6. SERVO MOTOR DRIVING

6.4.3 Directions for use

(1) tq mode operation sequence

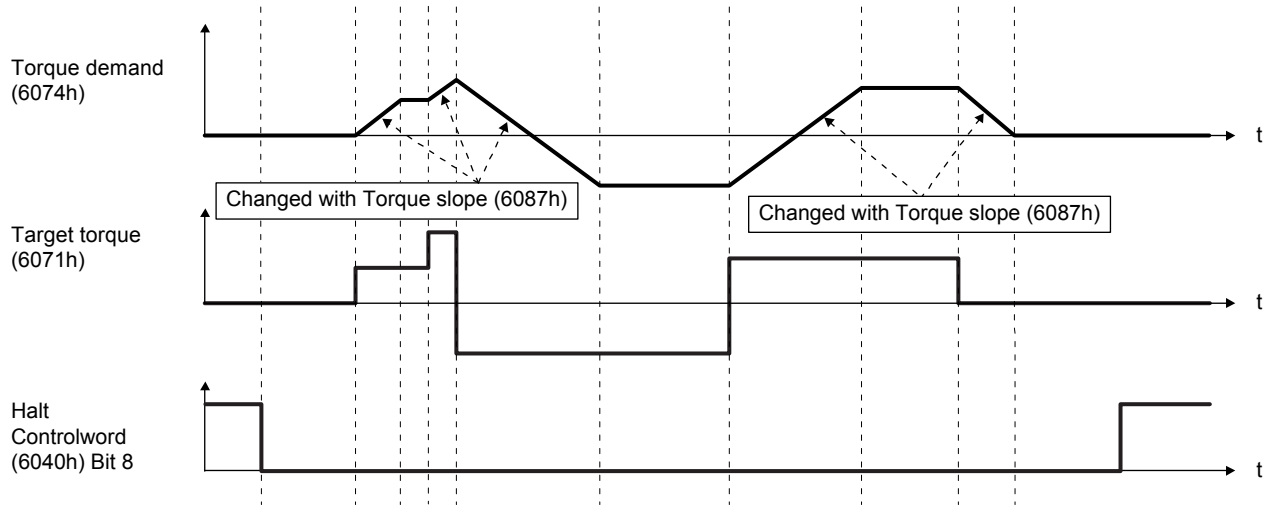

REVISIONS

*The manual number is given on the bottom left of the back cover.

Revision Date	*Manual Number	Revision
Mar. 2017	SH(NA)030254ENG-A	First edition

This manual confers no industrial property rights or any rights of any other kind, nor does it confer any patent licenses. Mitsubishi Electric Corporation cannot be held responsible for any problems involving industrial property rights which may occur as a result of using the contents noted in this manual.

Country/Region	Sales office	Tel/Fax
USA	Mitsubishi Electric Automation, Inc. 500 Corporate Woods Parkway, Vernon Hills, IL 60061, U.S.A.	Tel : +1-847-478-2100 Fax : +1-847-478-2253
Mexico	Mitsubishi Electric Automation, Inc. Mexico Branch Mariano Escobedo #69, Col. Zona Industrial, Tlalnepantla Edo. Mexico, C.P.54030	Tel : +52-55-3067-7500 Fax : -
Brazil	Mitsubishi Electric do Brasil Comercio e Servicos Ltda. Avenida Adelino Cardana, 293, 21 andar, Bethaville, CEP 06401-147, Barueri SP, Brazil	Tel : +55-11-4689-3000 Fax : +55-11-4689-3016
Germany	Mitsubishi Electric Europe B.V. German Branch Mitsubishi-Electric-Platz 1, 40882 Ratingen, Germany	Tel : +49-2102-486-0 Fax : +49-2102-486-1120
UK	Mitsubishi Electric Europe B.V. UK Branch Travellers Lane, UK-Hatfield, Hertfordshire, AL10 8XB, U.K.	Tel : +44-1707-28-8780 Fax : +44-1707-27-8695
Italy	Mitsubishi Electric Europe B.V. Italian Branch Centro Direzionale Colleoni - Palazzo Sirio, Viale Colleoni 7, 20864 Agrate Brianza (MB), Italy	Tel : +39-039-60531 Fax : +39-039-6053-312
Spain	Mitsubishi Electric Europe B.V. Spanish Branch Carretera de Rubi, 76-80-Apdo. 420, 08190 Sant Cugat del Valles (Barcelona), Spain	Tel : +34-935-65-3131 Fax : +34-935-89-1579
France	Mitsubishi Electric Europe B.V. French Branch 25, Boulevard des Bouvets, 92741 Nanterre Cedex, France	Tel : +33-1-55-68-55-68 Fax : +33-1-55-68-57-57
Czech Republic	Mitsubishi Electric Europe B.V. Czech Branch Avenir Business Park, Radlicka 751/113e, 158 00 Praha 5, Czech Republic	Tel : +420-251-551-470 Fax : +420-251-551-471
Poland	Mitsubishi Electric Europe B.V. Polish Branch ul. Krakowska 50, 32-083 Balice, Poland	Tel : +48-12-347-65-00 Fax : +48-12-630-47-01
Russia	Mitsubishi Electric (Russia) LLC St. Petersburg Branch Piskarevsky pr. 2, bld 2, lit "Sch", BC "Benua", office 720; 195027 St. Petersburg, Russia	Tel : +7-812-633-3497 Fax : +7-812-633-3499
Sweden	Mitsubishi Electric Europe B.V. (Scandinavia) Fjellievagen 8, SE-22736 Lund, Sweden	Tel : +46-8-625-10-00 Fax : +46-46-39-70-18
Turkey	Mitsubishi Electric Turkey A.S. Umraniye Branch Serifali Mahallesi Nutuk Sokak No:5, TR-34775 Umraniye / Istanbul, Turkey	Tel : +90-216-526-3990 Fax : +90-216-526-3995
UAE	Mitsubishi Electric Europe B.V. Dubai Branch Dubai Silicon Oasis, P.O.BOX 341241, Dubai, U.A.E.	Tel : +971-4-3724716 Fax : +971-4-3724721
South Africa	Adroit Technologies 20 Waterford Office Park, 189 Witkoppen Road, Fourways, South Africa	Tel : +27-11-658-8100 Fax : +27-11-658-8101
China	Mitsubishi Electric Automation (China) Ltd. Mitsubishi Electric Automation Center, No.1386 Hongqiao Road, Shanghai, China	Tel : +86-21-2322-3030 Fax : +86-21-2322-3000
Taiwan	SETSUYO ENTERPRISE CO., LTD. 6F, No.105, Wugong 3rd Road, Wugu District, New Taipei City 24889, Taiwan	Tel : +886-2-2299-2499 Fax : +886-2-2299-2509
Korea	Mitsubishi Electric Automation Korea Co., Ltd. 7F-9F, Gangseo Hangang Xi-tower A, 401, Yangcheon-ro, Gangseo-Gu, Seoul 07528, Korea	Tel : +82-2-3660-9510 Fax : +82-2-3664-8372/8335
Singapore	Mitsubishi Electric Asia Pte. Ltd. 307 Alexandra Road, Mitsubishi Electric Building, Singapore 159943	Tel : +65-6473-2308 Fax : +65-6476-7439
Thailand	Mitsubishi Electric Factory Automation (Thailand) Co., Ltd. 12th Floor, SV.City Building, Office Tower 1, No. 896/19 and 20 Rama 3 Road, Kwaeng Bangpongpan, Khet Yannawa, Bangkok 10120, Thailand	Tel : +66-2682-6522 to 6531 Fax : +66-2682-6020
Indonesia	PT. Mitsubishi Electric Indonesia Gedung Jaya 11th Floor, JL. MH. Thamrin No.12, Jakarta Pusat 10340, Indonesia	Tel : +62-21-3192-6461 Fax : +62-21-3192-3942
Vietnam	Mitsubishi Electric Vietnam Company Limited Unit 01-04, 10th Floor, Vincom Center, 72 Le Thanh Ton Street, District 1, Ho Chi Minh City, Vietnam	Tel : +84-8-3910-5945 Fax : +84-8-3910-5947
India	Mitsubishi Electric India Pvt. Ltd. Pune Branch Emerald House, EL-3, J Block, M.I.D.C., Bhosari, Pune - 411026, Maharashtra, India	Tel : +91-20-2710-2000 Fax : +91-20-2710-2100
Australia	Mitsubishi Electric Australia Pty. Ltd. 348 Victoria Road, P.O. Box 11, Rydalmere, N.S.W 2116, Australia	Tel : +61-2-9684-7777 Fax : +61-2-9684-7245
Japan	Mitsubishi Electric Corporation Tokyo Building, 2-7-3, Marunouchi, Chiyoda-ku, Tokyo 100-8310, Japan	Tel : +81-3-3218-2111

MELSERVO is a trademark or registered trademark of Mitsubishi Electric Corporation in Japan and/or other countries.
Microsoft, Windows, Internet Explorer, and Windows Vista are registered trademarks or trademarks of Microsoft Corporation in the United States, Japan, and/or other countries.
Intel, Pentium, and Celeron are trademarks of Intel Corporation in the United States and/or other countries.
Ethernet is a registered trademark of Fuji Xerox Co., Ltd. in Japan.
All other product names and company names are trademarks or registered trademarks of their respective companies.

Warranty

1. Warranty period and coverage

We will repair any failure or defect hereinafter referred to as "failure" in our FA equipment hereinafter referred to as the "Product" arisen during warranty period at no charge due to causes for which we are responsible through the distributor from which you purchased the Product or our service provider. However, we will charge the actual cost of dispatching our engineer for an on-site repair work on request by customer in Japan or overseas countries. We are not responsible for any on-site readjustment and/or trial run that may be required after a defective unit are repaired or replaced.

[Term]

The term of warranty for Product is twelve (12) months after your purchase or delivery of the Product to a place designated by you or eighteen (18) months from the date of manufacture whichever comes first ("Warranty Period"). Warranty period for repaired Product cannot exceed beyond the original warranty period before any repair work.

[Limitations]

- (1) You are requested to conduct an initial failure diagnosis by yourself, as a general rule.
It can also be carried out by us or our service company upon your request and the actual cost will be charged. However, it will not be charged if we are responsible for the cause of the failure.
- (2) This limited warranty applies only when the condition, method, environment, etc. of use are in compliance with the terms and conditions and instructions that are set forth in the instruction manual and user manual for the Product and the caution label affixed to the Product.
- (3) Even during the term of warranty, the repair cost will be charged on you in the following cases;
 - (i) a failure caused by your improper storing or handling, carelessness or negligence, etc., and a failure caused by your hardware or software problem
 - (ii) a failure caused by any alteration, etc. to the Product made on your side without our approval
 - (iii) a failure which may be regarded as avoidable, if your equipment in which the Product is incorporated is equipped with a safety device required by applicable laws and has any function or structure considered to be indispensable according to a common sense in the industry
 - (iv) a failure which may be regarded as avoidable if consumable parts designated in the instruction manual, etc. are duly maintained and replaced
 - (v) any replacement of consumable parts (battery, fan, smoothing capacitor, etc.)
 - (vi) a failure caused by external factors such as inevitable accidents, including without limitation fire and abnormal fluctuation of voltage, and acts of God, including without limitation earthquake, lightning and natural disasters
 - (vii) a failure generated by an unforeseeable cause with a scientific technology that was not available at the time of the shipment of the Product from our company
 - (viii) any other failures which we are not responsible for or which you acknowledge we are not responsible for

2. Term of warranty after the stop of production

- (1) We may accept the repair at charge for another seven (7) years after the production of the product is discontinued. The announcement of the stop of production for each model can be seen in our Sales and Service, etc.
- (2) Please note that the Product (including its spare parts) cannot be ordered after its stop of production.

3. Service in overseas countries

Our regional FA Center in overseas countries will accept the repair work of the Product. However, the terms and conditions of the repair work may differ depending on each FA Center. Please ask your local FA center for details.

4. Exclusion of loss in opportunity and secondary loss from warranty liability

Regardless of the gratis warranty term, Mitsubishi shall not be liable for compensation to:

- (1) Damages caused by any cause found not to be the responsibility of Mitsubishi.
- (2) Loss in opportunity, lost profits incurred to the user by Failures of Mitsubishi products.
- (3) Special damages and secondary damages whether foreseeable or not, compensation for accidents, and compensation for damages to products other than Mitsubishi products.
- (4) Replacement by the user, maintenance of on-site equipment, start-up test run and other tasks.

5. Change of Product specifications

Specifications listed in our catalogs, manuals or technical documents may be changed without notice.

6. Application and use of the Product

- (1) For the use of our General-Purpose AC Servo, its applications should be those that may not result in a serious damage even if any failure or malfunction occurs in General-Purpose AC Servo, and a backup or fail-safe function should operate on an external system to General-Purpose AC Servo when any failure or malfunction occurs.
- (2) Our General-Purpose AC Servo is designed and manufactured as a general purpose product for use at general industries. Therefore, applications substantially influential on the public interest for such as atomic power plants and other power plants of electric power companies, and also which require a special quality assurance system, including applications for railway companies and government or public offices are not recommended, and we assume no responsibility for any failure caused by these applications when used
In addition, applications which may be substantially influential to human lives or properties for such as airlines, medical treatments, railway service, incineration and fuel systems, man-operated material handling equipment, entertainment machines, safety machines, etc. are not recommended, and we assume no responsibility for any failure caused by these applications when used. We will review the acceptability of the abovementioned applications, if you agree not to require a specific quality for a specific application. Please contact us for consultation.

MODEL	
MODEL CODE	

MITSUBISHI ELECTRIC CORPORATION

HEAD OFFICE: TOKYO BLDG MARUNOUCHI TOKYO 100-8310