

Battery for junction battery cable MR-BAT6V1BJ Installation Guide



CAUTION

- This product is only for MR J4 servo amplifiers. This is not available with other servo amplifiers.
- To avoid deleting data, replace an MR-BAT6V1BJ according to procedures written in this installation guide.
- This product is compatible only with HG series servo motors.
- When replacing an MR-BAT6V1BJ, use new one.
- Check that the new MR-BAT6V1BJ is within its estimated life.
- The battery built in MR-BAT6V1BJ cannot be replaced. Do not disassemble the MR-BAT6V1BJ. Otherwise, it may cause a malfunction.

1. INTRODUCTION

This product is only for MR J4 servo amplifiers. This is not available with other servo amplifiers. Using MR-BAT6V1BJ battery for junction battery cable enables you to keep the absolute position data recorded in the encoder even if the servo amplifier is removed from machine.

2. SPECIFICATIONS

Item	Description
System	Electronic battery backup type
Model	MR-BAT6V1BJ
Battery pack	2CR17335A (primary lithium battery)
Nominal voltage [V]	6
Nominal capacity [mAh]	1650
Nominal capacity (Note) Battery life	5 years from date of manufacture
Maximum number of connectable axes	1

Note. Quality of the batteries degrades by the storage condition. The battery life is 5 years from the production date regardless of the connection status. Production year and month are indicated in a serial number (SERIAL) on the rating plate. The second digit from left in the number indicates the first digit of the dominical year. The third digit from left indicates a month (Oct: X, Nov: Y, Dec.: Z). For November 2013, the serial is like, "SERIAL: _ 3Y _ _ _ _ _".

3. Parts identification

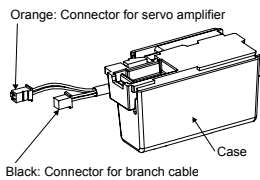

4. Configuration

4.1 Mounting

- (1) Wire the product using the MR-BT6VCBL03M junction battery cable as follows.
- (2) After wiring, startup the absolute position detection system. Even if the connector for branch cable connection (black) is not connected to the MR-BT6VCBL03M junction battery cable, an alarm will not occur. Check that they are connected securely.
- (3) When you transport a servo amplifier and machine apart, disconnect only CN2 and CN4 of the servo amplifier. When other connectors or cables are disconnected, the absolute position data will be deleted.

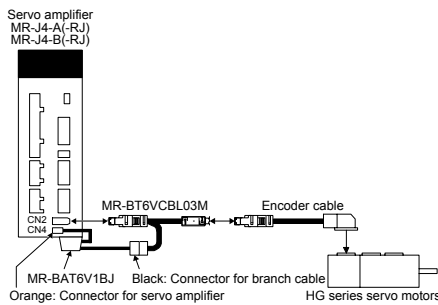

4.2 How to replace MR-BAT6V1BJ

4.2.1 Preparation

Prepare a new MR-BAT6V1BJ as follows.

Model	Number and Use	Remarks
MR-BAT6V1BJ	1 for replacement	Battery within two years from the production date.

4.2.2 Procedures

Replace the product as follows regardless of on/off of the control circuit power supply. When it is replaced with other procedures, the absolute position data will be erased.

- (1) Remove the connector for branch cable connection (black) of the old MR-BAT6V1BJ.

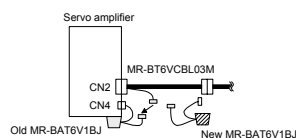

- (2) Connect the connector for branch cable connection (black) of the new MR-BAT6V1BJ.

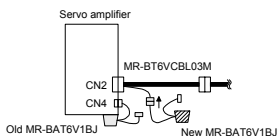

- (3) Remove the connector for servo amplifier (orange) of the old MR-BAT6V1BJ. When the control circuit power supply is on, performing (3) without [AL. 9F.2 Battery degradation warning] will trigger [AL. 9F.2].

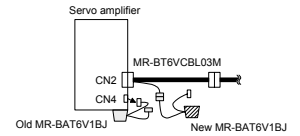

- (4) Remove the old MR-BAT6V1BJ from servo amplifier and mount the new MR-BAT6V1BJ. When the control circuit power supply is on, [AL. 9F.2] will occur after (3).

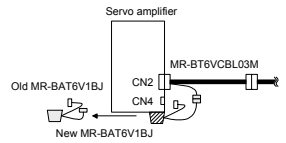

- (5) Mount the connector for servo amplifier (orange) of the new MR-BAT6V1BJ. When the control circuit power supply is on, [AL. 9F.2] will be canceled.

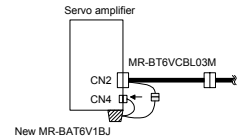

4.3 Troubleshooting

The following shows warnings and alarms which are triggered with power on of the servo amplifier when the wiring of the battery for the junction battery cable is incorrect. When you do not solve a problem even after doing the following actions, refer to troubleshooting of each servo amplifier instruction manual.

Display	Name	Cause	Action
AL. 9F	Battery warning	1. MR-BAT6V1BJ is not connected to CN4. 2. Battery voltage dropped.	Connect MR-BAT6V1BJ to CN4. Replace MR-BAT6V1BJ.
AL. 92	Battery cable disconnection warning	1. Battery voltage dropped. 2. MR-BAT6V1BJ is not connected to CN4 or MR-BT6VCBL03M.	Replace MR-BAT6V1BJ. Connect MR-BAT6V1BJ to CN4 and MR-BT6VCBL03M.
AL. 25	Absolute position erased	1. The power was turned off while MR-BAT6V1BJ was not connected to CN4 or MR-BT6VCBL03M. 2. The servo amplifier was removed from machine while MR-BAT6V1BJ was not connected to MR-BT6VCBL03M. 3. MR-BT6VCBL03M was not connected to an encoder cable.	Connect MR-BAT6V1BJ to CN4 and MR-BT6VCBL03M. Connect MR-BAT6V1BJ to MR-BT6VCBL03M. Connect the MR-BT6VCBL03M to the encoder cable.

4.4 Precautions for using

- (1) The connector for servo amplifier connection (orange) has a lock release lever. When removing the connector, pull out the connector while pressing the lock release lever.
- (2) The connector servo amplifier connection (orange) and the connector for branch cable connection (black) are different in color and shape due to different output voltage. Incorrect connection can cause the machine to be damaged.
- (3) When a cable is cut or shorted due to load or being caught, the built-in battery will have high temperature. Do not disassemble the MR-BAT6V1BJ to prevent getting burnt.

5. DIMENSIONS

[Unit: mm]

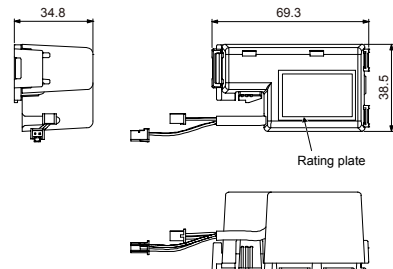

Mass: 66 [g]

6. Battery transportation

When only lithium metal batteries are transported, attachment of a handling label to each package, submission of the Shipper's Declaration for Dangerous Goods, and a 1.2 m drop test will be required. When the batteries are transported with mounted on products, the regulations about package, etc. will not be required.