



INVERTER

Plug-in option

FR-A8AX

INSTRUCTION MANUAL

16-bit digital input function

PRE-OPERATION INSTRUCTIONS

1

INSTALLATION

2

CONNECTION DIAGRAM AND
TERMINAL

3

PARAMETER

4

Thank you for choosing this Mitsubishi inverter plug-in option.

This Instruction Manual provides handling information and precautions for use of this product. Incorrect handling might cause an unexpected fault. Before using this product, always read this Instruction Manual carefully to use this product correctly.

Please forward this Instruction Manual to the end user.

Safety instructions

Do not attempt to install, operate, maintain or inspect the product until you have read through this Instruction Manual and appended documents carefully and can use the equipment correctly. Do not use this product until you have a full knowledge of the equipment, safety information and instructions. In this Instruction Manual, the safety instruction levels are classified into "Warning" and "Caution".



Warning

Incorrect handling may cause hazardous conditions, resulting in death or severe injury.



Caution

Incorrect handling may cause hazardous conditions, resulting in medium or slight injury, or may cause only material damage.

The  **Caution** level may even lead to a serious consequence according to conditions. Both instruction levels must be followed because these are important to personal safety.

◆ Electric Shock Prevention



Warning

- While the inverter power is ON, do not open the front cover or the wiring cover. Do not run the inverter with the front cover or the wiring cover removed. Otherwise you may access the exposed high voltage terminals or the charging part of the circuitry and get an electric shock.
- Do not remove the inverter front cover even if the power supply is disconnected. The only exception for this would be when performing wiring and periodic inspection. You may accidentally touch the charged inverter circuits and get an electric shock.
- Before wiring or inspection, LED indication of the inverter unit operation panel must be switched OFF. Any person who is involved in wiring or inspection shall wait for at least 10 minutes after the power supply has been switched OFF and check that there is no residual voltage using a tester or the like. For some time after the power-OFF, a high voltage remains in the smoothing capacitor, and it is dangerous.
- Any person who is involved in wiring or inspection of this equipment shall be fully competent to do the work.
- The plug-in option must be installed before wiring. Otherwise you may get an electric shock or be injured.
- Do not touch the plug-in option or handle the cables with wet hands. Otherwise you may get an electric shock.
- Do not subject the cables to scratches, excessive stress, heavy loads or pinching. Otherwise you may get an electric shock.

◆ Injury Prevention



Caution

- The voltage applied to each terminal must be the ones specified in the Instruction Manual. Otherwise a burst, damage, etc. may occur.
- The cables must be connected to the correct terminals. Otherwise a burst, damage, etc. may occur.
- The polarity (+ and -) must be correct. Otherwise a burst or damage may occur.
- While power is ON or for some time after power OFF, do not touch the inverter as it will be extremely hot. Touching these devices may cause a burn.

◆ Additional Instructions

The following instructions must be also followed. If the product is handled incorrectly, it may cause unexpected fault, an injury, or an electric shock.

Caution

Transportation and mounting

- Do not install or operate the plug-in option if it is damaged or has parts missing.
- Do not stand or rest heavy objects on the product.
- The mounting orientation must be correct.
- Foreign conductive objects must be prevented from entering the inverter. That includes screws and metal fragments or other flammable substance such as oil.
- If halogen-based materials (fluorine, chlorine, bromine, iodine, etc.) infiltrate into a Mitsubishi product, the product will be damaged. Halogen-based materials are often included in fumigant, which is used to sterilize or disinfest wooden packages. When packaging, prevent residual fumigant components from being infiltrated into Mitsubishi products, or use an alternative sterilization or disinfection method (heat disinfection, etc.) for packaging. Sterilization or disinfection of wooden package should also be performed before packaging the product.

Trial run

- Before starting operation, each parameter must be confirmed and adjusted. A failure to do so may cause some machines to make unexpected motions.

Warning

Usage

- Do not modify the equipment.
- Do not perform parts removal which is not instructed in this manual. Doing so may lead to fault or damage of the product.

Caution

Usage

- When parameter clear or all parameter clear is performed, the required parameters must be set again before starting operations. Because all parameters return to their initial values.
- Static electricity in your body must be discharged before you touch the product.

Maintenance, inspection and parts replacement

- Do not carry out a megger (insulation resistance) test.

Disposal

- The inverter must be treated as industrial waste.

General instruction

- Many of the diagrams and drawings in this Instruction Manual show the inverter without a cover or partially open for explanation. Never operate the inverter in this manner. The cover must be reinstalled and the instructions in the Instruction Manual must be followed when operating the inverter.

— CONTENTS —

1	PRE-OPERATION INSTRUCTIONS	6
1.1	Unpacking and checking the product.....	6
1.1.1	Product confirmation.....	6
1.2	Component names.....	7
1.3	Specifications.....	8
2	INSTALLATION	9
2.1	Pre-installation instructions	9
2.2	Installation procedure	9
2.3	Wiring.....	12
3	CONNECTION DIAGRAM AND TERMINAL	16
3.1	Connection diagram	16
3.2	Terminals	18
3.3	Code input example	19
4	PARAMETER	20
4.1	Parameter list	20
4.2	Setting the parameter	21
4.2.1	Selection of input method (Pr.304).....	21
4.2.2	Read timing operation selection (Pr.305).....	22
4.2.3	Bias and gain adjustment (Pr.300 to Pr.303)	24
4.2.4	Digital input unit selection (Pr.329).....	26
4.2.5	16-bit digital torque command (FR-A800 series only)	27
4.3	Precautions	30



<Notes on descriptions in this Instruction Manual>

Connection diagrams in this Instruction Manual appear with the control logic of the input terminals as sink logic, unless otherwise specified.



1 PRE-OPERATION INSTRUCTIONS

1.1 Unpacking and checking the product

Take the plug-in option out of the package, check the product name, and confirm that the product is as you ordered and intact. This product is a plug-in option dedicated for the FR-A800/F800 series.

1.1.1 Product confirmation

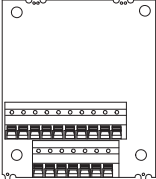
Check the enclosed items.

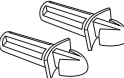
<p>Plug-in option1</p>  A technical drawing of a rectangular plug-in option. It features a central horizontal strip with two rows of pins. There are four circular mounting holes, two at the top and two at the bottom, positioned towards the corners of the rectangle.	<p>Mounting screws (M3 × 8 mm)2 (Refer to page 9.)</p>  Two screws with a Phillips head and a hexagonal base, shown from a top-down perspective.	<p>Spacer2 (Refer to page 9.)</p>  Two cylindrical spacers with a hexagonal base and a wider, flanged top section.
--	---	---

1.2 Component names

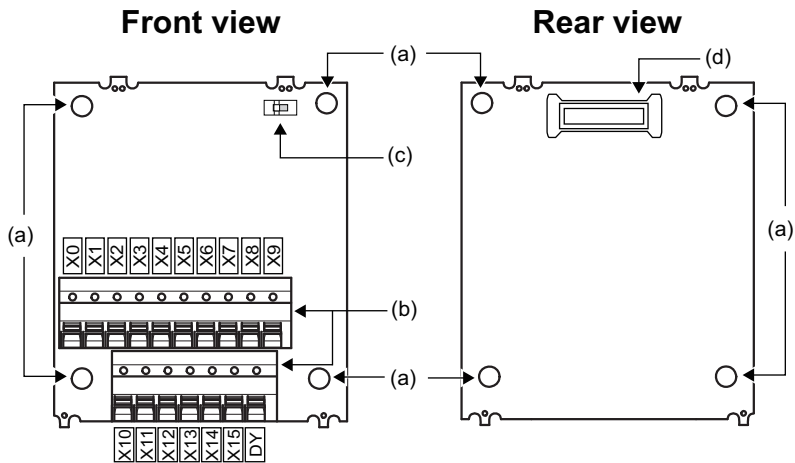

Symbol	Name	Description	Refer to page
a	Mounting hole	Fixes the option to the inverter with screws, or installs spacers.	9
b	Terminal block	Used for connecting devices to input signals to the inverter.	12
c	Switch for manufacturer setting	Switch for manufacturer setting. Do not change the initially-set status ().	—
d	Connector	Connects to the option connector of the inverter.	9

1.3 Specifications

◆ Types of digital input signals

3-digit or 4-digit BCD code

12-bit or 16-bit binary

◆ Selection of digital input signals

On operation panel or parameter unit

◆ Input current

5 mA (24 VDC) ... Per circuit

◆ Input specifications

Relay contact signal or open collector input

◆ Adjustment function

- Bias and gain
- Analog compensation input (set on operation panel)

2 INSTALLATION

2.1 Pre-installation instructions

Check that the inverter's input power and the control circuit power are both OFF.

⚠ Caution

- With input power ON, do not install or remove the plug-in option. Otherwise, the inverter and plug-in option may be damaged.
- To avoid damage due to static electricity, static electricity in your body must be discharged before you touch the product.

2.2 Installation procedure

- (1) Remove the inverter front cover. (Refer to Chapter 2 of the Instruction Manual (Detailed) of the inverter for details on how to remove the front cover.)
- (2) For the two mounting holes (as shown in the next page) that will not be tightened with mounting screws, insert spacers.
- (3) Fit the connector of the plug-in option to the guide of the connector on the inverter unit side, and insert the plug-in option as far as it goes.
- (4) Fit the two locations, the left and right, of the plug-in option securely to the inverter unit by screwing in the supplied mounting screws. (tightening torque 0.33 N·m to 0.40 N·m) If the screw holes do not line up, the connector may not be inserted deep enough. Check the connector.

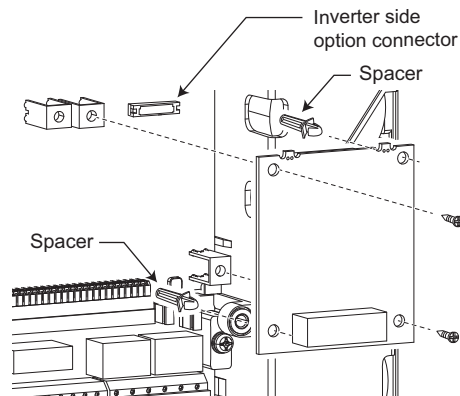

Example of installation to connector 1

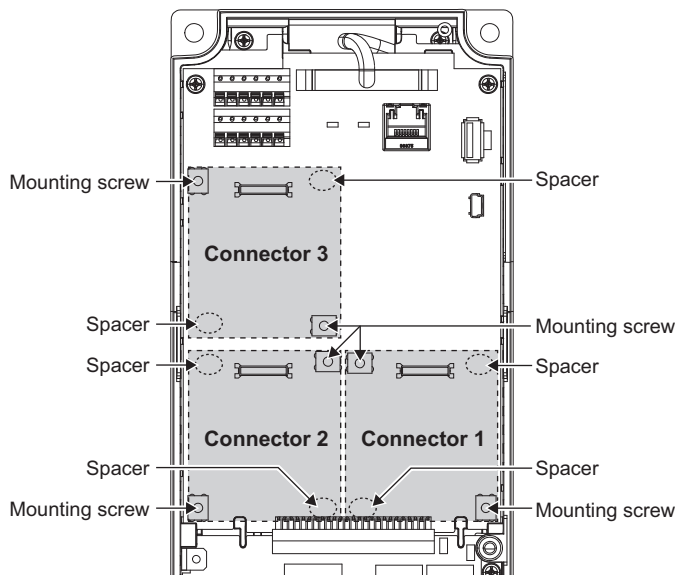

Insertion positions for screws and spacers

 **NOTE**

- When mounting/removing the plug-in option, hold the sides of the option. Do not press on the parts on the option circuit board. Stress applied to the parts by pressing, etc. may cause a failure.
- Caution must be applied to mounting screws falling off when removing and mounting the plug-in option.
- Only one option can be used. When multiple options are mounted, priority is given to option connectors 1, 2 and 3 on the inverter in this order, and options having a lower priority do not function.
- When the inverter cannot recognize that the option unit is mounted due to improper installation, etc., the protective function (E.1 to E.3) is activated. A different indication will appear according to the mounted position (option connector 1 to 3).

Mounted position	Fault indication
Option connector 1	E. 1
Option connector 2	E. 2
Option connector 3	E. 3

- When removing the plug-in option, remove the two screws on the left and right, then pull it straight out. Pressure applied to the connector and to the option board may break the option.

2.3 Wiring

- (1) For the wiring, strip off the sheath of a cable, and use it with a blade terminal. For a single wire, strip off the sheath of the wire and apply directly. Insert the blade terminal or the single wire into a socket of the terminal.

Strip off the sheath for the below length. If the length of the sheath peeled is too long, a short circuit may occur with neighboring wires. If the length is too short, wires might come off.

Wire the stripped cable after twisting it to prevent it from becoming loose. In addition, do not solder it.

Cable sheath stripping length



Crimp the blade terminal.

Insert wires to a blade terminal, and check that the wires come out for about 0 to 0.5 mm.

Check the condition of the blade terminal after crimping. Do not use a blade terminal of which the crimping is inappropriate, or the face is damaged.

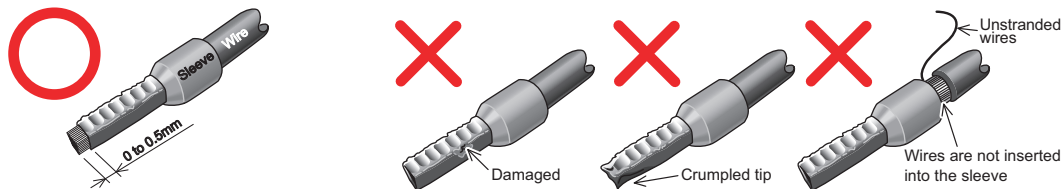

Caution

- After wiring, wire offcuts must not be left in the inverter. They may cause a fault, failure or malfunction.

Blade terminals commercially available (as of February 2012. The product may be changed without notice.)

Cable gauge (mm ²)	Ferrule terminal model			Manufacturer	Crimping tool name
	With insulation sleeve	Without insulation sleeve	For UL wire *1		
0.3	Al 0,5-10WH	—	—	Phoenix Contact Co., Ltd.	CRIMPFOX 6
0.5	Al 0,5-10WH	—	Al 0,5-10WH-GB		
0.75	Al 0,75-10GY	A 0,75-10	Al 0,75-10GY-GB		
1	Al 1-10RD	A 1-10	Al 1-10RD/1000GB		
1.25, 1.5	Al 1,5-10BK	A 1,5-10	—		
0.75 (for two cables)	Al-TWIN 2 × 0,75-10GY	—	—		

*1 A ferrule terminal with an insulation sleeve compatible with the MTW wire which has a thick wire insulation.

Cable gauge (mm ²)	Blade terminal product number	Insulation product number	Manufacturer	Crimping tool product number
0.3 to 0.75	BT 0.75-11	VC 0.75	NICHIFU Co.,Ltd.	NH 69

(2) Insert the cable into a socket.

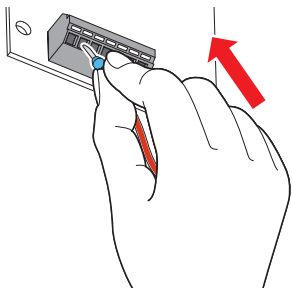

When using a single wire or stranded wires without a blade terminal, push the open/close button all the way down with a flathead screwdriver, and insert the wire.

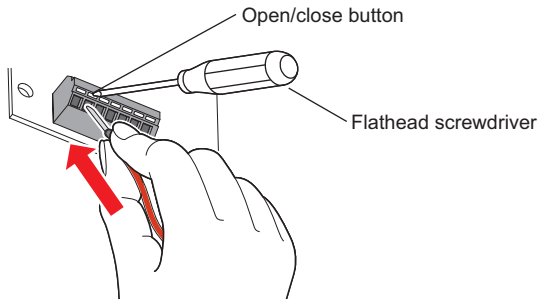

- Wire removal

Pull the wire while pushing the open/close button all the way down firmly with a flathead screwdriver.

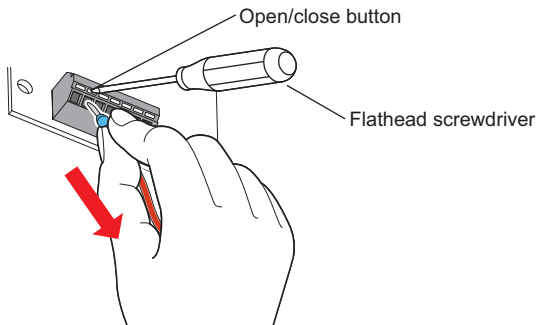

 **NOTE**

- When using stranded wires without a blade terminal, twist enough to avoid short circuit with a nearby terminals or wires.
- Pulling out the wire forcefully without pushing the open/close button all the way down may damage the terminal block.
- Use a small flathead screwdriver (tip thickness: 0.4 mm/tip width: 2.5 mm). If a flathead screwdriver with a narrow tip is used, terminal block may be damaged.

Commercially available product (as of February 2012. The product may be changed without notice.)

Name	Model	Manufacturer
Driver	SZF 0- 0,4 × 2,5	Phoenix Contact Co., Ltd.

- Place the flathead screwdriver vertical to the open/close button. In case the blade tip slips, it may cause an inverter damage or injury.
- When wiring cables to the inverter's RS-485 terminals while a plug-in option is mounted, take caution not to let the cables touch the circuit board of the option or of the inverter. Otherwise, electromagnetic noises may cause malfunctions.

3 CONNECTION DIAGRAM AND TERMINAL

3.1 Connection diagram

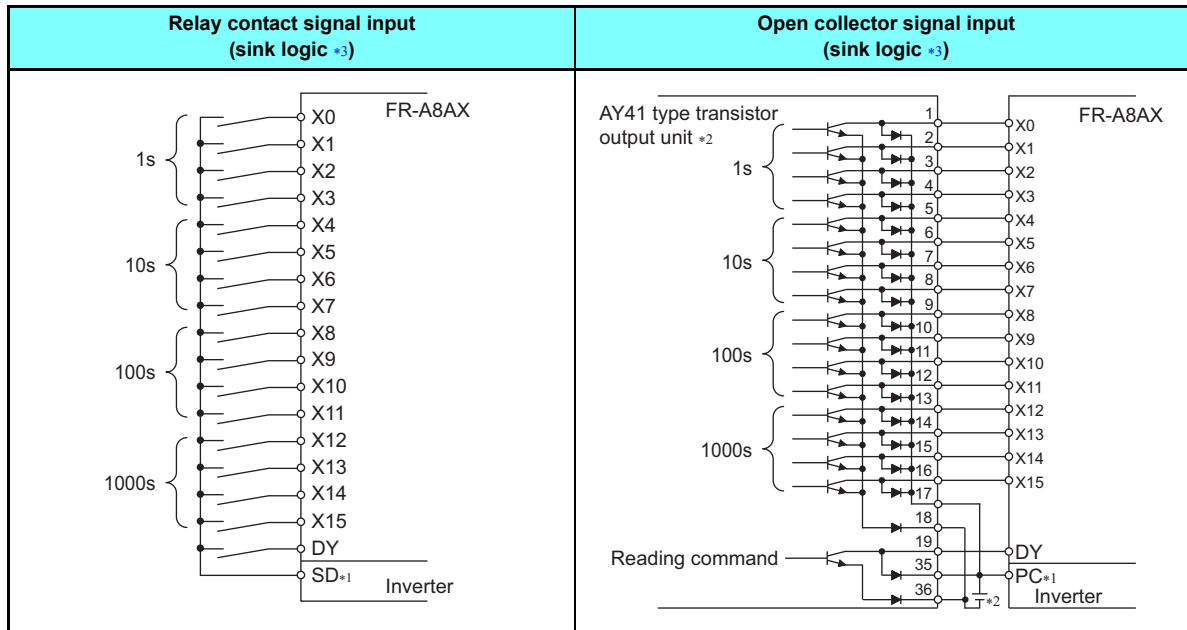

- *1 Use terminal SD or PC on the inverter.
- *2 AY41 type unit requires 24 VDC power.
Example of connection with the output module (AY41 type) of Mitsubishi programmable controller. For details on the output module, refer to the Instruction Manual of the output module.
- *3 The control logic is the same as that of the inverter.
When the logic of the inverter is changed, the option logic also changes. Refer to the Instruction Manual of the inverter for how to switch the control logic of the inverter.

NOTE

- As the input signals are at low level, use two parallel micro signal contacts or a twin contact for relay contact inputs to prevent a contact fault.

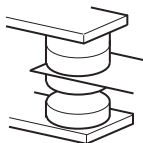

Micro signal contacts

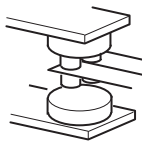

Twin contacts

- A transistor of the following specifications should be selected for the open collector signal:
 - Electrical characteristics of the transistor used
 - $I_c \geq 10 \text{ mA}$
 - Leakage current: 100 μA maximum
 - $V_{CE} \geq 30 \text{ V}$
 - $I_c \geq 10 \text{ mA}$, $V_{CE}(\text{sat})$ voltage is 3 V maximum

3.2 Terminals

• FR-A8AX

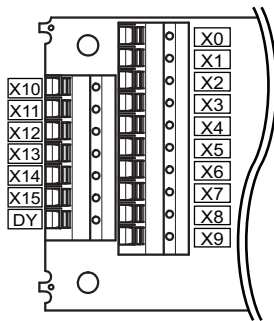

Terminal location	Terminal symbol	Description
Built-in options	X0 to X15	Digital signal input terminal (frequency setting / torque command signal terminal *1). Input the digital signal at the relay contact or open collector terminal. (Refer to page 16 .) For the digital signal input, choose either BCD code or binary. BCD code input is 3-digit (999 maximum) or 4-digit (9999 maximum). Binary input is 12-bit (X0 to X11, HFFF maximum) or 16-bit (X0 to X15, HFFFF maximum).
	DY	Data read timing input signal. Use when a digital signal read timing signal is necessary. When Pr.305 Read timing operation selection = "1", data is read only while the DY signal is ON. In addition, the X0 to X15 data before the signal is turned OFF is retained by turning OFF the DY signal. (Refer to page 22 .)
Inverter	SD	Common terminal (sink). Common terminal for digital and data read timing signals. Use terminal SD of the inverter.
	PC	External transistor common (sink), common terminal (source). Connect this terminal to the external power supply common terminal (+) of a transistor output (open collector output) device, such as a programmable controller, to avoid malfunction by undesirable current. When the source logic is selected, this terminal is used as a common terminal. Use terminal PC of the inverter.

*1 Torque command values can be input to the FR-A800 series only.

3.3 Code input example

The following table explains examples of terminal status and input value during BCD code input and binary input.

BCD code input (when the input value is 6325)			
Digit	Terminal name	Terminal input status	Input value
1	X0	ON	5
	X1	OFF	
	X2	ON	
	X3	OFF	
10	X4	OFF	2
	X5	ON	
	X6	OFF	
	X7	OFF	
100	X8	ON	3
	X9	ON	
	X10	OFF	
	X11	OFF	
1000	X12	OFF	6
	X13	ON	
	X14	ON	
	X15	OFF	

Binary input (when the input value is HAB65)			
Terminal name	Terminal input status	Input value (hexadecimal)	Input value (decimal)
X0	ON	5	43877
X1	OFF		
X2	ON		
X3	OFF		
X4	OFF	6	
X5	ON		
X6	ON		
X7	OFF		
X8	ON	B	
X9	ON		
X10	OFF		
X11	ON		
X12	OFF	A	
X13	ON		
X14	OFF		
X15	ON		

NOTE

- For BCD code input, the input value of each digit is from 0 to 9. When a value greater than 9 is input, it becomes invalid and the last value is retained.
- When **Pr.304 Digital input and analog input compensation enable/disable selection** = any of "0 to 4", X12 to X15 become disabled.

4 PARAMETER

4.1 Parameter list

The following parameters are used for the plug-in option (FR-A8AX).

The FR-A8AX does not function with the initial setting. When a value other than "9999" is set in **Pr.304**, digital input is enabled. Set the following parameters according to applications.

Pr.	Pr. group	Name	Setting range	Minimum setting increments	Initial value	Refer to page
300 *1	D600 *1	BCD input bias	0 to 590 Hz	0.01 Hz	0 Hz	25
301 *1	D601 *1	BCD input gain	0 to 590 Hz, 9999	0.01 Hz	60 Hz/50 Hz *3	25
302 *1	D602 *1	BIN input bias	0 to 590 Hz	0.01 Hz	0 Hz	25
303 *1	D603 *1	BIN input gain	0 to 590 Hz, 9999	0.01 Hz	60 Hz/50 Hz *3	25
304 *1	D604 *1	Digital input and analog input compensation enable/disable selection	0 to 4, 10 to 14, 9999 *4	1	9999	21, 27
305 *1	D605 *1	Read timing operation selection	0, 1, 10	1	0	22
329 *1, *2	D606 *1, *2	Digital input unit selection	0, 1, 2, 3	1	1	26
447 *1, *5	D620 *1, *5	Digital torque command bias	0 to 400%	1%	0	27
448 *1, *5	D621 *1, *5	Digital torque command gain	0 to 400%, 9999	1%	150%	27
804 *5	D400 *5	Torque command source selection	0, 1, 3 to 6	1	0	27

*1 Parameters which can be displayed when the plug-in option (FR-A8AX) is mounted.

*2 For **Pr.329**, write is disabled during operation even when "2" is set in **Pr.77**. To change the parameter setting value, stop the operation. Also, parameter clear is invalid.

*3 The initial values differ for the FM type and CA type of the inverter.

*4 The setting range of **Pr. 304** differs according to the inverter used. (Refer to [page 21](#))

*5 These parameters can be set for the FR-A800 series only.



- For binary input, the input data is taken in hexadecimal, and for BCD code input, the input data is taken in decimal.

4.2 Setting the parameter

4.2.1 Selection of input method (Pr.304)

Pr.304 setting	BCD code input	Binary input	Availability of analog input compensation*1 (O: Enabled, x: Disabled)
0	3 digits	—	x
1	—	12 bits	x
2	3 digits	—	O
3	—	12 bits	O
4*2	—	12 bits. Torque command value input.	—
10	4 digits	—	x
11	—	16 bits	x
12	4 digits	—	O
13	—	16 bits	O
14*2	—	16 bits. Torque command value input.	—
9999 (Initial value)	No function		

*1 Use terminal 1 for analog input compensation. Refer to the Instruction Manual (Detailed) of the inverter for the details of terminal 1.

*2 These parameters can be set for the FR-A800 series only. For the details of the torque command value input, refer to [page 27](#).

NOTE

- Signals X12 to X15 become invalid when 0 to 4 are set in **Pr.304**.
- Refer to **page 19** for a BCD code/binary input example.
- If 0 to 5 V (0 to 10 V) is input at the inverter terminal 1 from the external potentiometer with the FR-A8AX installed, the inverter operates at the frequency obtained by adding the FR-A8AX BCD code input and the compensation input from terminal 1 only when "2, 3, 12, 13" is set in **Pr.304**.
For example, when switching the inputs to perform manual operation with potentiometer input or automatic operation with BCD code input, set the BCD code input to "0" under manual operation.

4.2.2 Read timing operation selection (Pr.305)

Pr.305 setting	Filter	Description
0 (Initial value)	Not used	The set frequency data entered from the digital signal input terminals (X0 to X15) is always imported independently of whether the DY signal is ON or OFF.
1	Not used	The set frequency data entered from the digital signal input terminals (X0 to X15) is imported only when the DY signal is ON. The set frequency data is not imported when the DY signal is OFF. Therefore, even if the input status of the X0 to X15 signal changes, the set frequency data before the DY signal is turned OFF is valid.
10	With	<p>The set frequency data entered from the digital signal input terminals (X0 to X15) is always imported independently of whether the DY signal is ON or OFF. The filter absorbs subtle timing differences of digital signal acquisition.</p>

◆ **When "0 or 10" is set in Pr.305**

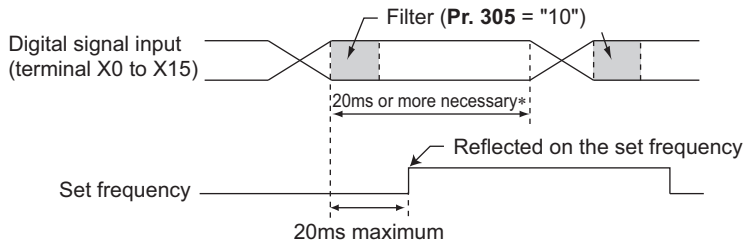

* Hold the digital signal input (X0 to X15) status for 20ms or more. Changing the signal within 20ms may not reflect it on the set frequency.

◆ **How to use the DY signal (when "1" is set in Pr.305)**

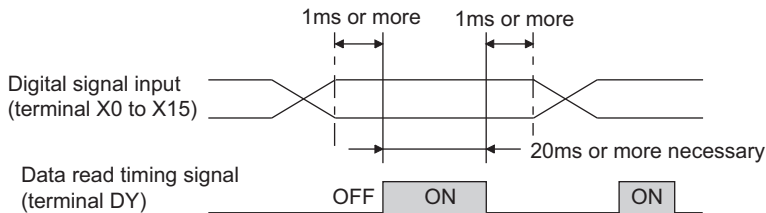

NOTE

- When Pr.305 = "1", all terminals from X0 to X15 are recognized as OFF when the inverter is turned ON in terminal DY OFF status.

4.2.3 Bias and gain adjustment (Pr.300 to Pr.303)

Pr.	Name	Setting range	Initial value
300	BCD input bias	0 to 590 Hz	0 Hz
301	BCD input gain	0 to 590 Hz, 9999	60 Hz/50 Hz *1
302	BIN input bias	0 to 590 Hz	0 Hz
303	BIN input gain	0 to 590 Hz, 9999	60 Hz/50 Hz *1

*1 The initial values differ for the FM type and CA type of the inverter.

◆ How to set the digital input value as the output frequency setting

When "9999" is set in **Pr.301** (BCD code input) or **Pr.303** (binary input), the digital input value is set as the output frequency. (For example, to set the output frequency to 120 Hz when the BCD code input is "120")

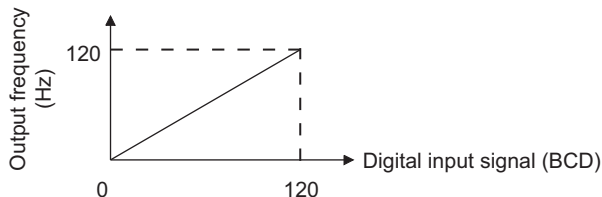

NOTE

- When this setting method is used, the "bias" setting (**Pr.300** or **Pr.302**) cannot be made.

◆ Bias/gain adjustment for digital inputs

◆ Bias adjustment

Bias adjustments can be made for the digital input signal.

Set the set frequency at the digital input signal of 0.

For BCD code input, set using **Pr.300**, and for binary input, set using **Pr.302**.

◆ Gain adjustment

Maximum output frequency (gain) adjustment can be made for the digital input signal.

Set the output frequency when the digital input signal is "999" or "9999" (BCD code input), or "HFFF" or "HFFFF" (binary input).

For BCD code input, set using **Pr.301**, and for binary input, set using **Pr.303**.

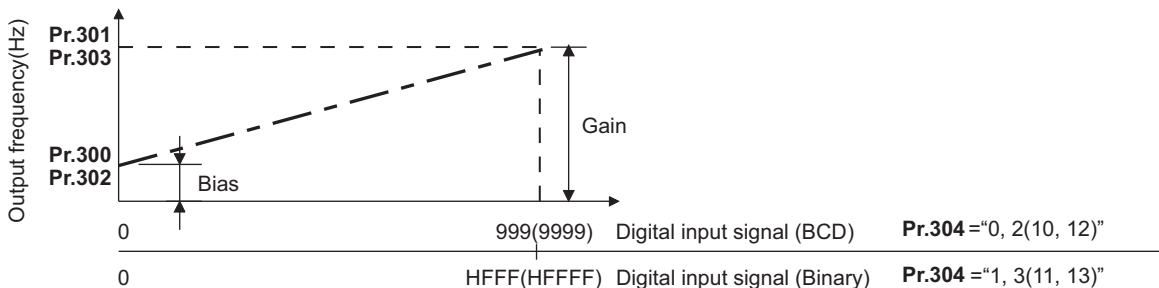

4.2.4 Digital input unit selection (Pr.329)

Pr.	Name	Setting range	Initial value
329	Digital input unit selection	0, 1, 2, 3	1

When "9999" is set in **Pr.301** or **Pr.303**, it is possible to set the increments when the digital input signal is set as the output frequency. (Refer to [page 24](#).)

Frequency = digital input signal value × **Pr.329** input increments

Pr.329 setting	Input value increments	Available frequencies*1			
		12 bits		16 bits	
		BCD code	Binary	BCD code	Binary
0	10	0 to 9990 Hz	0 to 40950 Hz	0 to 99990 Hz	0 to 655350 Hz
1 (Initial value)	1	0 to 999 Hz	0 to 4095 Hz	0 to 9999 Hz	0 to 65535 Hz
2	0.1	0 to 99.9 Hz	0 to 409.5 Hz	0 to 999.9 Hz	0 to 6553.5 Hz
3	0.01	0 to 9.99 Hz	0 to 40.95 Hz	0 to 99.99 Hz	0 to 655.35 Hz

*1 These are not the inverter maximum output frequencies.

<Example>

- **Pr.329** = "0"

BCD code = 111→1110 Hz, binary = H100 (256 in decimal)→2560 Hz

- **Pr.329** = "1"

BCD code = 111→111 Hz, binary = H100 (256 in decimal)→256 Hz

- **Pr.329** = "2"

BCD code = 111→11.1 Hz, binary = H100 (256 in decimal)→25.6 Hz

- **Pr.329** = "3"

BCD code = 111→1.11 Hz, binary = H100 (256 in decimal)→2.56 Hz



- When values other than "9999" are set in **Pr.301** or **Pr.303**, **Pr.329** becomes invalid.

4.2.5 16-bit digital torque command (FR-A800 series only)

Pr.	Name	Setting range	Initial value
304	Digital input and analog input compensation enable/disable selection	0 to 4, 10 to 14, 9999	9999
447	Digital torque command bias	0 to 400%	0
448	Digital torque command gain	0 to 400%, 9999	150%
804	Torque command source selection	0, 1, 3 to 6	0

Digital torque command can be given under torque control using the FR-A8AX.

A digital command can be given using the FR-A8AX when "4 (12-bit)" or "14 (16-bit)" is set in **Pr.304** and "4" is set in **Pr.804**.

Pr.804 setting	Description	Remarks
0	Torque command by terminal 1 analog input	Refer to the Instruction Manual of the inverter for the details.
1	Torque command by parameter setting Setting value of Pr.805 or Pr.806 (-400% to 400%)	
3	Torque command via CC-Link communication (FR-A8NC/FR-A8NCE) Torque command via PROFIBUS-DP communication (FR-A8NP)	Refer to the Instruction Manual of FR-A8NC/FR-A8NCE/FR-A8NP for details.
4	12-bit digital input (FR-A8AX)	When "4" is set in Pr.304
	16-bit digital input (FR-A8AX)	When "14" is set in Pr.304
5	Torque command via CC-Link communication (FR-A8NC/FR-A8NCE)	Refer to the Instruction Manual of FR-A8NC/FR-A8NCE/FR-A8NP for details.
6	Torque command via PROFIBUS-DP communication (FR-A8NP)	

The input signal uses the last 15 (11) bits as torque command and the most significant bit as sign.

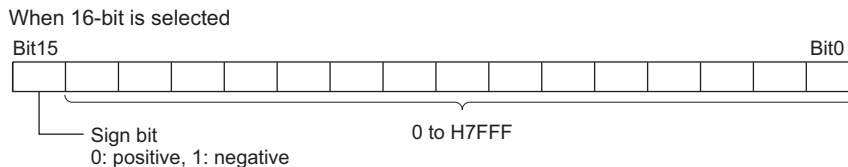

 **NOTE**

- The digital torque command is input only as a binary input.
- When a digital torque command is selected, **Pr.329 Digital input unit selection** becomes disabled.

◆ Input method of torque command

Torque command may be input in either of the following two ways:

◆ Set the torque commands at 0 and H7FFF (H7FF) signal inputs

Set the torque command value when the input signal is "0" in **Pr.447** and the torque command value when the input signal is "H7FFF (H7FF)" in **Pr.448**.

The figure on the right shows the case when the torque command value is set using input signal H7FFF (H7FF) when the torque command value is 150% (initial value of **Pr.448**). When the most significant bit of input signal is positive, a negative torque command value (-150%) is also set at the same time.

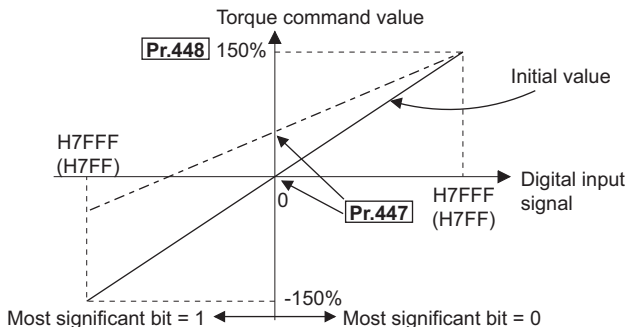

◆ Use the digital input value as the torque command

When "9999" is set in **Pr.448**, the input signal is considered as a torque command value.

For example, the torque command value when the input signal is H190 is 400%, as shown below.

Even if a value higher than H190 is input, the torque command value is clamped at 400%.

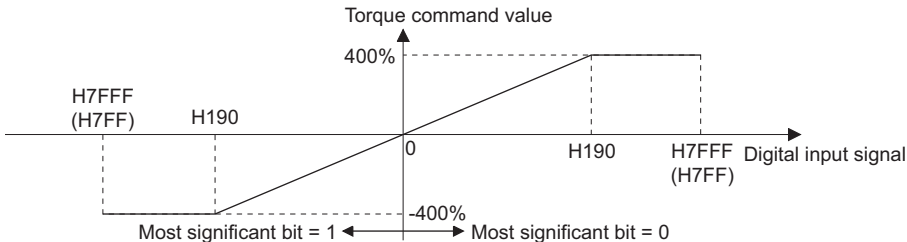

4.3 Precautions

- Acceleration/deceleration time
When the frequency is set with the digital input signal, the acceleration/deceleration time is the period of time required to reach **Pr.20 Acceleration/deceleration reference frequency**.
- The following restrictions are applied on the digital input signal:
When one of H0A to H0F is input to each digit while BCD code input is set, the operation is performed with the inputs previous to H0A to H0F. H0A to H0F inputs are ignored.
If binary input is changed to BCD code input while H0A to H0F are being input, the set frequency becomes 0 Hz.
- The priorities of the frequency setting are as follows:
JOG > Stop-on contact (RT, RL) > Multi-speed command (RH, RM, RL) > PID (X14) > AU (terminal 4) > Pulse train input > Digital command by the FR-A8AX > terminal 2 *1
*1 When digital input is valid, terminal 2 is invalid.

REVISIONS

*The manual number is given on the bottom left of the back cover.

Print date	*Manual number	Revision
Aug. 2013	IB(NA)-0600495ENG-A	First edition
Oct. 2014	IB(NA)-0600495ENG-B	Addition • Compatibility with the FR-F800 series

INVERTER

