

INVERTER FR-A800 Plus

The optimum functions for roll to roll applications are added.



A800 Plus

for Roll to Roll



- System simplification
- Wide range of applications
- Easy startup and adjustment

GLOBAL IMPACT OF MITSUBISHI ELECTRIC



Through Mitsubishi Electric's vision, "Changes for the Better" are possible for a brighter future.

Changes for the Better

We bring together the best minds to create the best technologies. At Mitsubishi Electric, we understand that technology is the driving force of change in our lives. By bringing greater comfort to daily life, maximizing the efficiency of businesses and keeping things running across society, we integrate technology and innovation to bring changes for the better.

Mitsubishi Electric is involved in many areas including the following

Energy and Electric Systems

A wide range of power and electrical products from generators to large-scale displays.

Electronic Devices

A wide portfolio of cutting-edge semiconductor devices for systems and products.

Home Appliance

Dependable consumer products like air conditioners and home entertainment systems.

Information and Communication Systems

Commercial and consumer-centric equipment, products and systems.

Industrial Automation Systems

Maximizing productivity and efficiency with cutting-edge automation technology.

Features	6
Standard specifications	22
Outline dimensions	27
Roll to roll function related parameters	29
Warranty	34
Support	35



Pursuing optimum functions to meet our customers' needs

The text "A800 Plus" is centered in the upper half of the image. "A800" is in a large, bold, black sans-serif font with a blue-to-white gradient and a slight glow. "Plus" is in a smaller, black sans-serif font. The background is a sunset over the ocean with a bright sun low on the horizon, creating a lens flare effect with rays of light extending across the sky and reflecting on the water.

A800 Plus

A new lineup of dedicated inverters for specialized fields are born!
Plus! The optimum functions for each dedicated field are added to the already high performance and high functionality FR-A800 series inverter.

for Roll to Roll

Roll to Roll

In roll to roll applications, control is necessary for machining of elongated products such as paper, film, and thread. Processing types include printing, slitting, coating, and twisting. High productivity can be achieved by stable tension control.

The FR-A800-R2R inverter can be used in a wide variety of systems with various dedicated functions.

1

Features

Roll to roll
dedicated model with
functions optimum for
winding/unwinding

Plus! System simplification

Stable winding/unwinding can be achieved by the inverter alone.

Plus! Wide range of applications

The FR-A800-R2R inverter enables the use in various system applications such as winding/unwinding in the wire drawing machines and printers.

Plus! Easy startup and adjustment

Parameters can be used for mechanical adjustment according to applications.

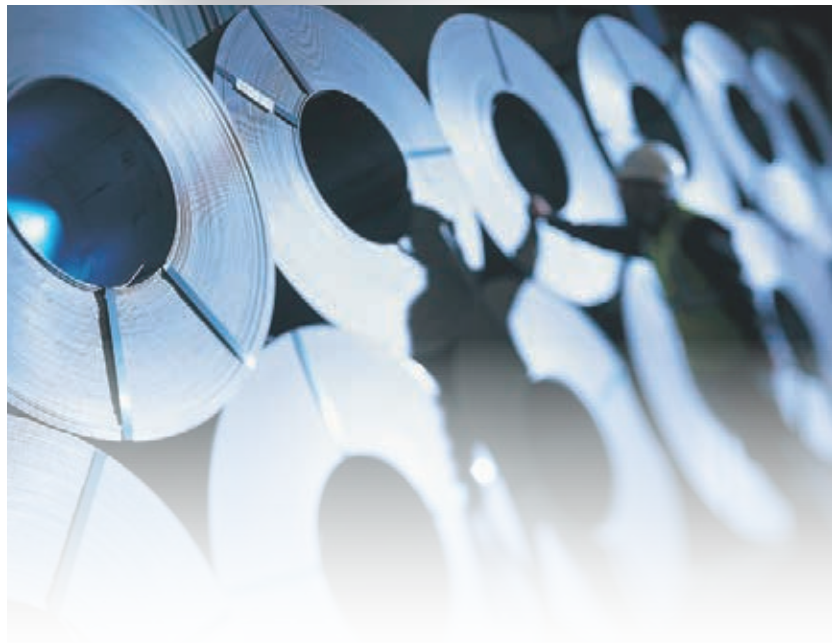
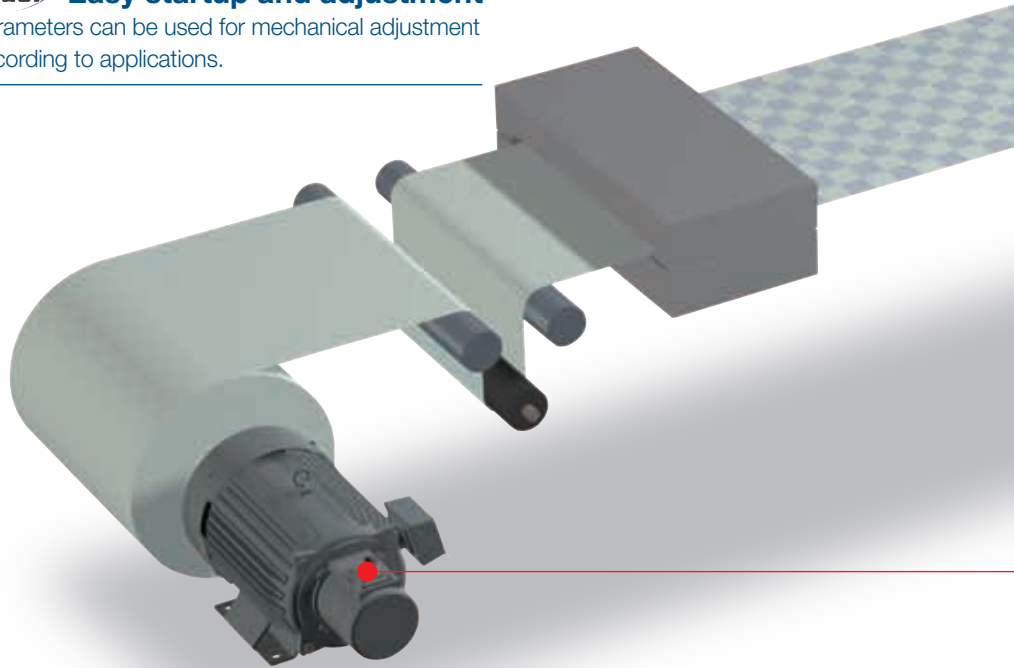

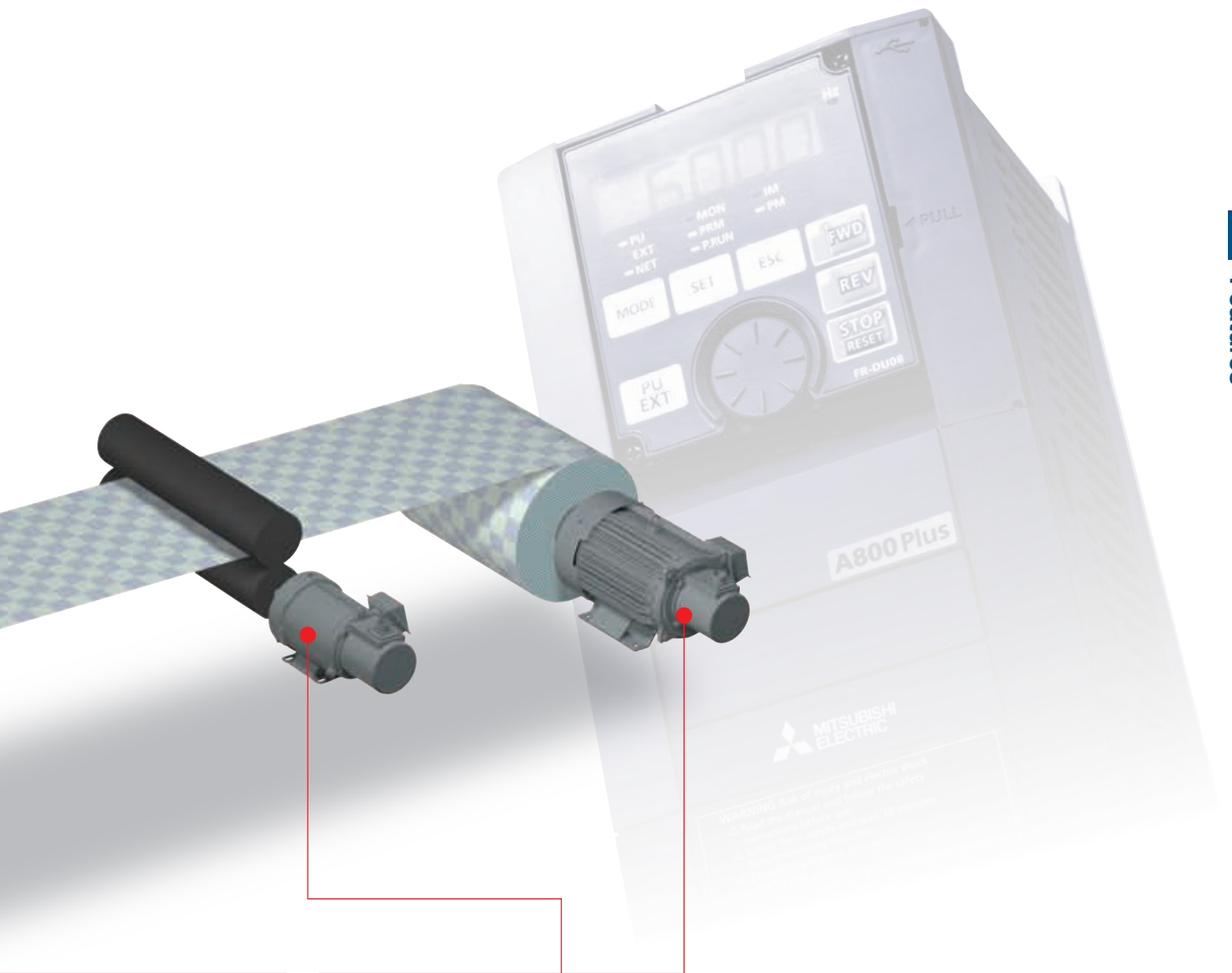

Winding/unwinding shaft

Tension control (speed control / torque control) is enabled by inputting the dancer roll position or the feedback from the tension sensor. Stable control can be achieved by winding diameter calculation, even with a large difference between the maximum and minimum diameters.

Intermediate shaft

The line speed is controlled by driving the intermediate shafts such as a reference shaft with a constant winding diameter or the feeding shaft.



Plus! System simplification

The FR-A800-R2R inverter has various dedicated functions such as winding diameter calculation, providing stable winding/unwinding control independently.

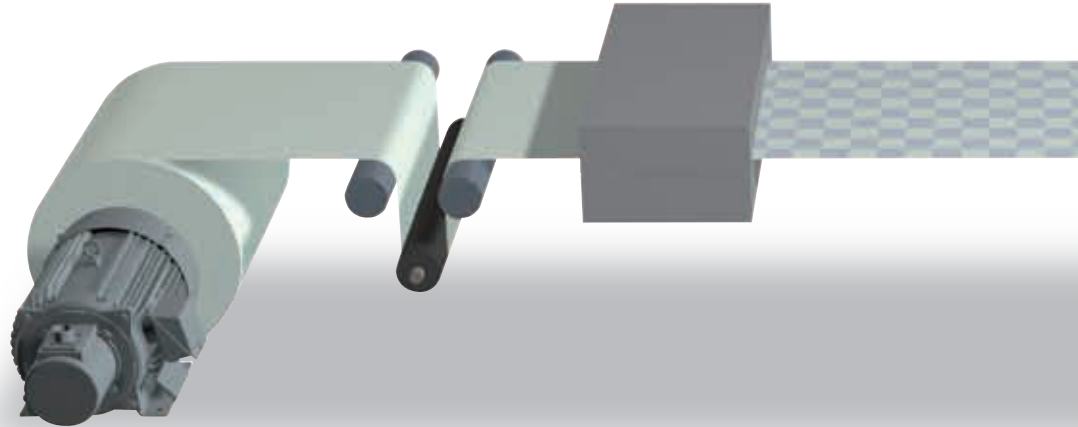

Winding diameter calculation

The present winding diameter for the winding/unwinding shaft is calculated from the actual line speed or the actual motor speed.

Line speed command input selection / actual line speed input selection

The line speed command and actual line speed required for calculating the winding diameter can be input through the analog input terminal or plug-in option.

Winding diameter calculation function selection

The winding diameter calculation method can be selected in order to improve the tension control performance.

- Actual line speed calculation method
The winding diameter is calculated from the line speed and the main speed (actual motor speed).

$$D = \frac{V}{\pi \times n \times Z}$$

- Thickness calculation method
The material thickness is added up to find the overall winding diameter.
 $D = \text{Initial diameter} \pm 2 \times d \times N \times Z$

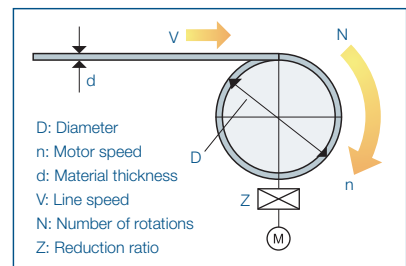

Dancer feedback speed control Tension sensor feedback speed control

PID control is performed using feedback of the detected dancer roll position or feedback from the tension sensor. Stable control can be achieved in combination with the winding diameter calculation.

Speed control proportional gain compensation

By adjusting the speed control proportional gain according to the winding diameter, the response level can be kept constant.

Tension PI gain tuning

By automatically adjusting the tension PI gain for PID control, time required for adjustment is significantly cut down. Anyone can start the system easily.

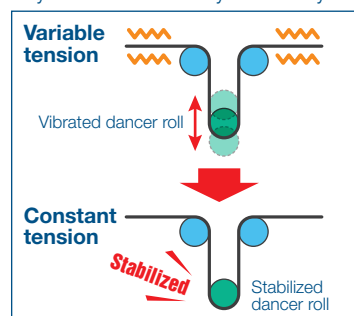

Dancer roll malposition detection

When material rupture (break) occurs and the sensor feedback value (dancer/tension feedback) is held at the upper/lower limit for a certain period of time, the break detection signal is output.

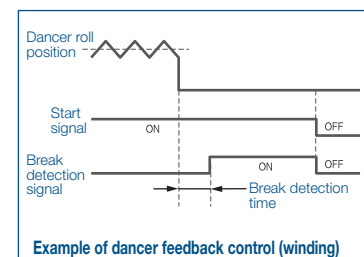



Initial winding diameter calculation

When the winding diameter changes after the material change or others, the present winding diameter is calculated in the following two ways.

- The present winding diameter is calculated based on the dancer roll movement at a start from the lower limit position to the target position.
- The present winding diameter is calculated from the line speed and the actual motor speed. (The system must be started at low speed.)

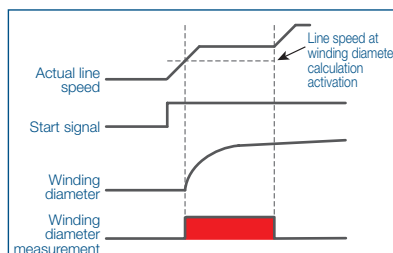
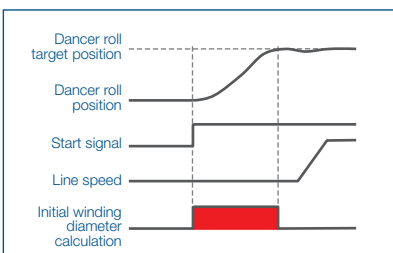

Winding diameter / winding length storage

The present value of winding diameter and winding/unwinding length can be stored.

The winding diameter and winding length values are stored in the inverter even during power-OFF.

Tension sensorless torque control Tension sensor feedback torque control

The output torque of a motor is controlled so that the tension applied to a material is constant by calculating the winding diameter of a roll.

Mechanical loss compensation function

The tension applied to the material is maintained constant by raising a commanded torque to compensate mechanical loss caused by factors such as friction on the dancer roll or winding/unwinding shaft.

Inertia compensation function

During acceleration/deceleration, the tension applied to the material is maintained constant by adjusting the variable tension on the winding and unwinding sides.

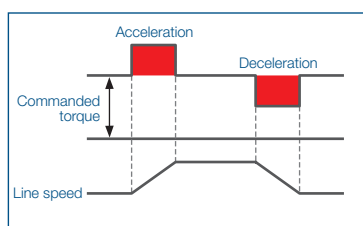

Taper function

By adjusting the tension on the workpiece, it is possible to avoid imperfections such as wrinkles or deformation caused by the increase in diameter.

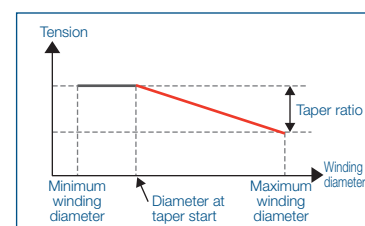

Tension command cushion time

The cushion time is set for the tension command to avoid sudden change in tension.

Plus! Wide range of applications

The FR-A800-R2R inverter offers four types of control functions which enable the use in various system applications such as winding/unwinding in the wire drawing machines and printers.

Dancer feedback speed control	Tension sensor feedback speed control	Tension sensorless torque control	Tension sensor feedback torque control
-------------------------------	---------------------------------------	-----------------------------------	--

During dancer feedback speed control, speed is controlled for keeping a constant tension on the workpiece (winding/unwinding shaft) by using the dancer roll position and line speed data.

Further stable speed control is possible by performing PID control and winding diameter calculation in the inverter.

Tension sensor feedback speed control is a control function to keep the tension constant using feedback from the tension sensor, instead of the dancer roll position.

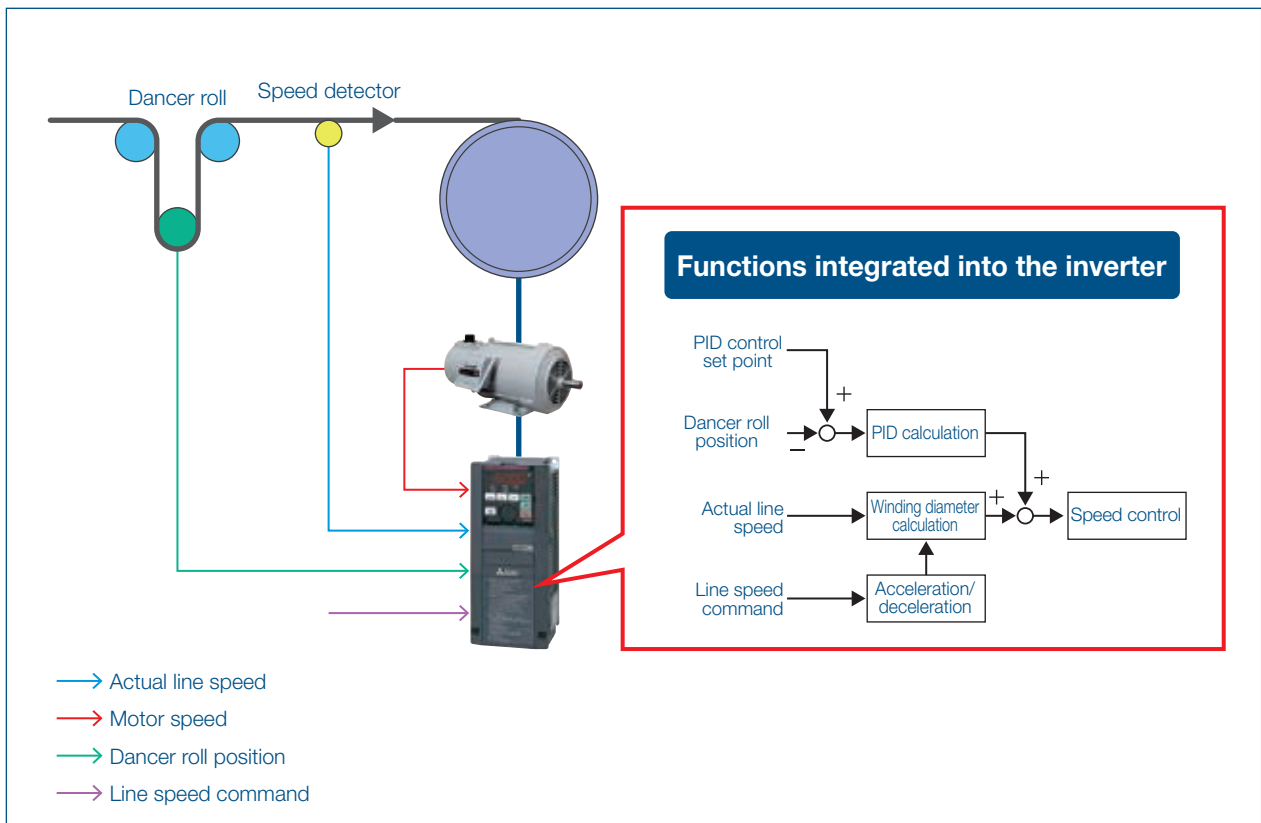

Example of dancer feedback speed control



Wire drawing machine

Dancer feedback speed control

The control function is useful for winding in the wire drawing machine. High-speed winding is offered for high-inertia loads.

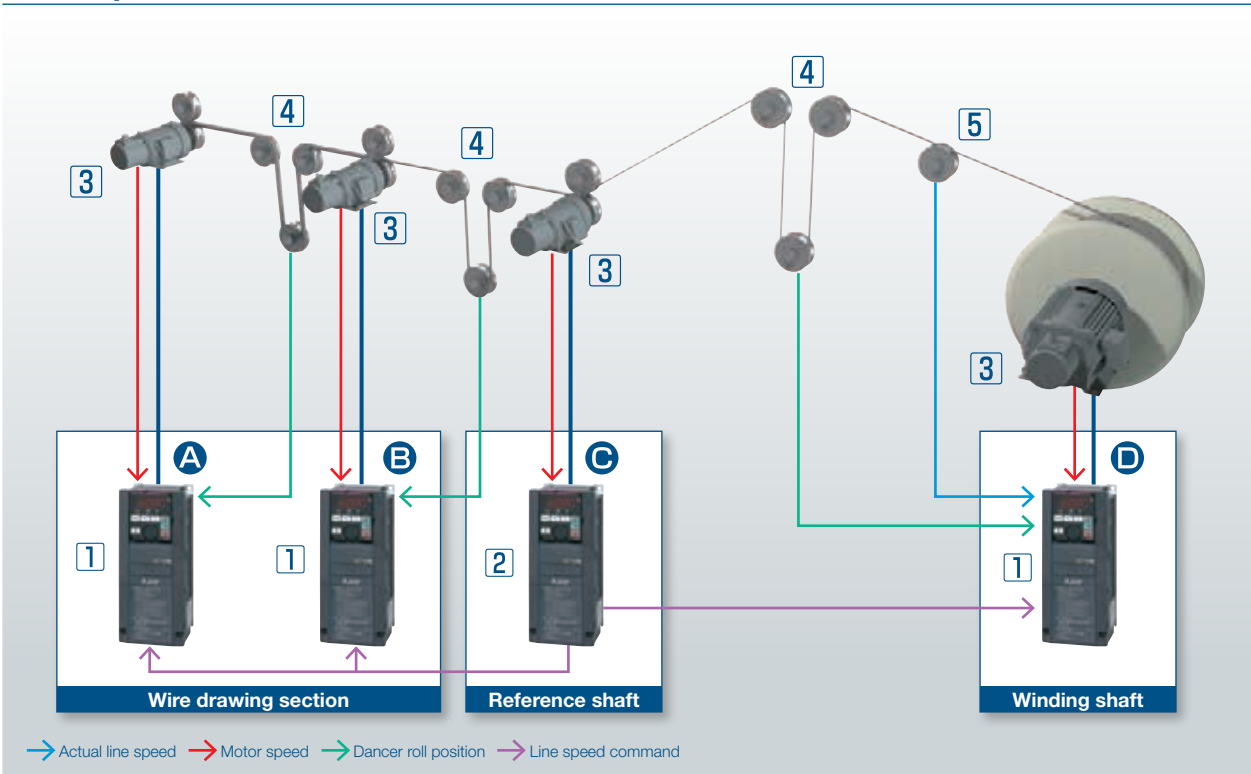

The wire drawing section pulls the wire at a constant speed to make the wire thinner. For the winding shaft, the inverter provides dancer feedback speed control to keep the dancer roll position, achieving constant tension winding. In addition, using the winding diameter calculation function, the circumferential speed of the winding reel is kept constant.

Some systems require peripheral devices such as regenerative options.

1 Inverter FR-A800-R2R (with the FR-A8AP*1 installed)

2 Inverter FR-A800-R2R (with the FR-A8AP*1 and FR-A8AZ*2 installed)

The products in the parentheses are plug-in options.

3 Encoder-equipped motor SF-PR-SC

4 Dancer roll

5 Speed detector

*1 Used for vector control.

*2 Used for the line speed output.

Relevant functions

Dancer feedback speed control A B D

The unwinding shaft rotation speed is controlled to keep the dancer roll position constant. The wire tension is kept constant.

Winding diameter calculation function D

The circumferential speed of the winding shaft is kept constant by calculating the winding diameter of the winding shaft. Hunting can be reduced in dancer roll control.

Speed control proportional gain compensation D

By adjusting the speed control proportional gain according to the winding diameter, the response level can be kept constant.

Initial winding diameter calculation D

The present winding diameter is calculated based on the dancer roll movement at a start from the lower limit position to the target position.

Tension PI gain tuning A B D

By automatically adjusting the tension PI gain, time required for adjustment is significantly cut down. Anyone can start the system easily.

Plus! Wide range of applications

The FR-A800-R2R inverter offers four types of control functions which enables the use in various system applications such as winding/unwinding in the wire drawing machines and printers.

Dancer feedback speed control	Tension sensor feedback speed control	Tension sensorless torque control	Tension sensor feedback torque control
-------------------------------	---------------------------------------	-----------------------------------	--

The torque is controlled for keeping a constant tension on the workpiece (winding/unwinding shaft) by using the tension sensor and line speed information.

Further stable torque control is possible by changing the torque command according to the acceleration/deceleration torque calculation at a speed change (inertia compensation) and the mechanical loss torque compensation, as well as the compensation determined by the winding diameter calculation.

Tension sensor feedback torque control can be used when the PLC function is enabled. (Refer to page 18.)

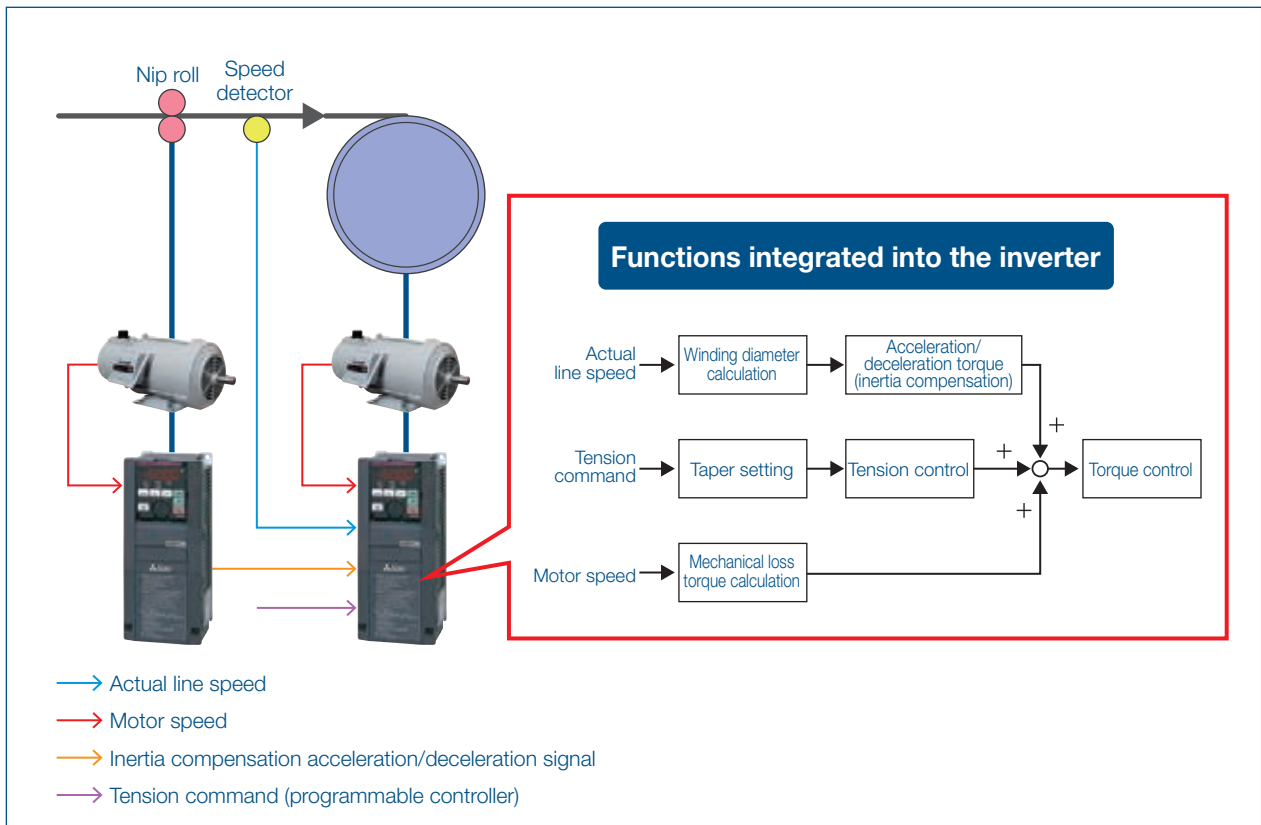

Example of tension sensorless torque control



Printing machine

Tension sensorless torque control

The control function is useful for winding in the printer. The paper can be rolled up without using dancer rolls or tension controllers.

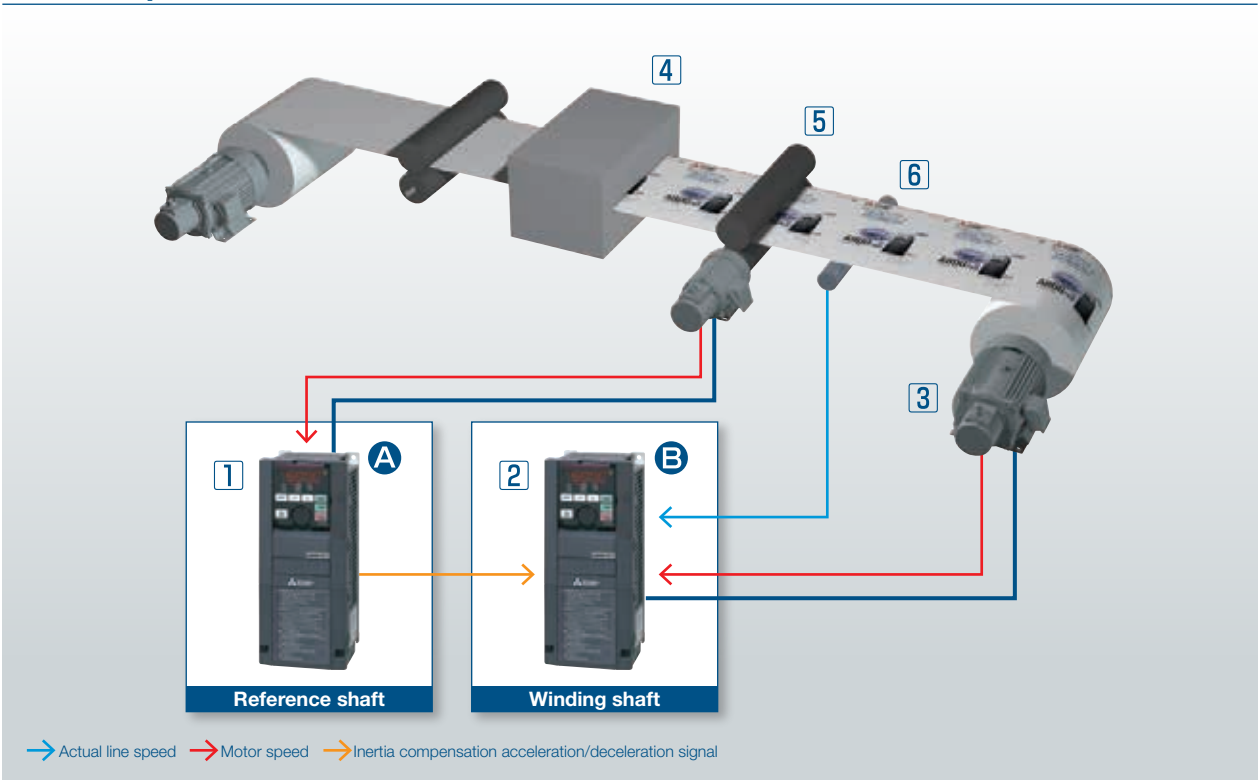

When the paper feed speed of the printer is increased (or decreased), the inverter changes the torque command value according to the inertia of the paper roll to give the acceleration (or deceleration torque) to keep a constant tension. Also, the taper setting can be used to avoid imperfections such as wrinkles or deformation caused by the increase in diameter.

Some systems require peripheral devices such as regenerative options.

1 Inverter FR-A800-R2R (with the FR-A8AP*1 installed)	4 Printing unit
2 Inverter FR-A800-R2R (with the FR-A8AP*1 and FR-A8AZ*2 installed)	5 Nip roll
3 Encoder-equipped motor SF-PR-SC	6 Speed detector

*1 Used for vector control.
*2 Used for the thermistor input.
The products in the parentheses are plug-in options.

Relevant functions

Tension sensorless torque control ③

The winding diameter is calculated from line speed information, and the torque is controlled for keeping a constant tension on the winding shaft.

Taper function ③

By adjusting the tension on the work-piece, it is possible to avoid imperfections such as wrinkles or deformation caused by the increase in diameter.

Inertia compensation function ③

Even if the paper feed speed increases or decreases, the tension applied to the paper is maintained constant.

Mechanical loss compensation function ③

The torque command value is increased for mechanical loss compensation to prevent the tension from changing.

Plus! Easy startup and adjustment

Parameters can be used for mechanical adjustment according to applications, useful for the startup and adjustment work of the system.

Before

Setting and adjusting multiple devices including controllers were required for dancer control, and it took much time to start up the system.

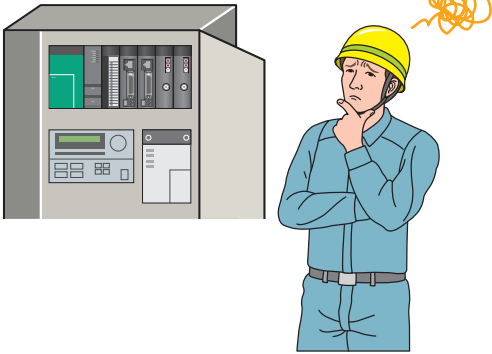

Before

There was a worry about the compatibility with the existing system.

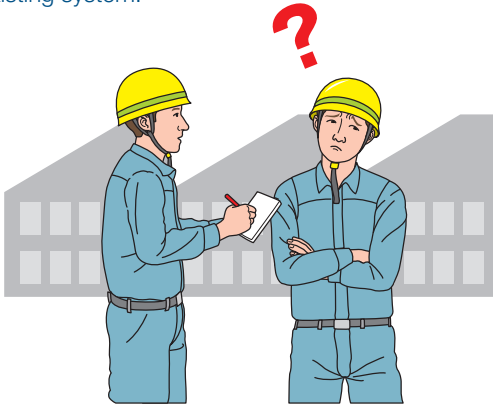

After

- Complex position control of the dancer roll can be achieved by the inverter alone by setting parameters.
- By setting mechanical specifications, optimum control can be performed according to the system and the application.
- Analog/pulse signal input method is selectable at the discretion of the customer. Input via communication is also available.
- PID control enables and simplifies complex control using only the inverter.
- Automatic tension PI gain adjustment enables easy startup. (Tension PI gain tuning)

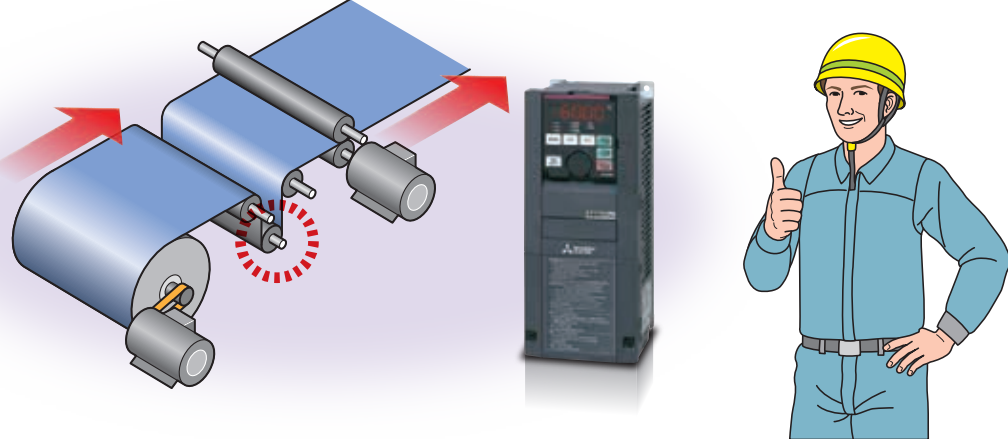

Example of startup procedure

The following procedure shows the parameter setting example for the dancer feedback speed control.

STEP 1

Basic setting of the inverter

Perform setting according to the motor type and the control method.

STEP 2

Basic setting of mechanical specifications

Set the mechanical specifications.

STEP 3

Analog/pulse input method selection

Select the input method and the input terminal function for the line speed command.

STEP 4

PID control adjustment (Dancer roll target position, tension PI gain tuning)

Set parameters to control the dancer roll and adjust the tension PI gain.

Basic parameter setting and control method selection

Set the value for each parameter according to the control method and the motor type. (Speed control gain adjustment or offline auto tuning is required according to the control method.)

Item	Pr.	Item	Pr.	Item	Pr.
Applied motor	71	Rated motor frequency	84	Motor inertia (integer) ^{*2}	707
Electronic thermal O/L relay	9	Control method selection ^{*1}	800	Motor inertia (exponent) ^{*2}	724
Motor capacity	80	Torque limit input method selection	810	Encoder option selection	862
Number of motor poles	81	Encoder rotation direction	359		
Rated motor voltage	83	Number of encoder pulses	369		

*1: For the control method, vector control is recommended. *2: Setting is required for a motor other than a Mitsubishi Electric motor (the SF-PR, SF-JR, SF-HR, SF-JRCA, SF-HRCA, or SF-VSRU (1500 r/min series) motor).

Mechanical specifications setting

Set the mechanical specifications according to application.

Pr.	Name	Intermediate shaft	Winding/unwinding shaft
1235	Maximum winding diameter 1	○	○
1236	Minimum winding diameter 1	○	○
1230	Winding/unwinding selection	—	○
645	Winding diameter storage selection	—	○
1247	Winding diameter change increment amount limit	○	○
1243	Gear ratio numerator (follower side)	○	○
1244	Gear ratio denominator (driver side)	○	○
7	Acceleration time	○	○
8	Deceleration time	○	○
394	First acceleration time for line speed command	○	○
395	First deceleration time for line speed command	○	○
101	Second deceleration time for line speed command	○	○
393	Line speed command acceleration/deceleration reference	○	○
1231	Material thickness d1	—	○
1252	Dancer lower limit position	—	○
1255	Accumulated amount	—	○

Control accuracy improvement by the winding diameter calculation

By calculating the winding diameter of the winding/unwinding shaft, the tension is always optimized even if it changes along with the winding diameter change.

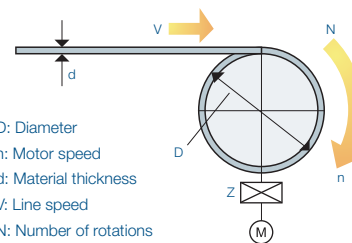

D: Diameter
n: Motor speed
d: Material thickness
V: Line speed
N: Number of rotations
Z: Reduction ratio

Input method selection for the line speed command, dancer signal, and actual line speed

The line speed command input method can be selected from the following: analog input through a terminal (2, 4, 1, 6, etc.), single-phase pulse train input, encoder pulse input, and input via communication (CC-Link IE Field Network communication, DeviceNet™, PROFIBUS-DPv0, etc.).

Dancer roll target position setting

Set the target position, upper limit, and lower limit values for the dancer roll.

Item	Pr.
Set point	133
Upper limit	131
Lower limit	132
PID action selection	128

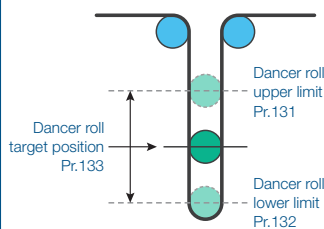

PI gain automatic adjustment

The PI gain is automatically adjusted by tension PI gain tuning. The time required for gain adjustment can be reduced.

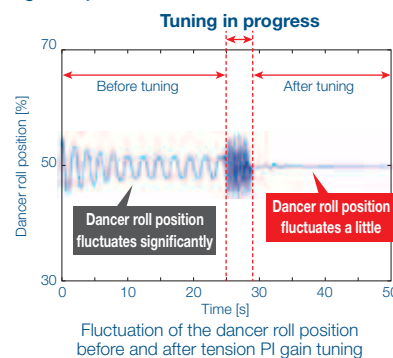

TEST RUN

Turn ON the X114 signal for using dancer feedback speed control and the winding diameter calculation function.

Unparalleled Performance. Uncompromising Quality.

High performance and high quality new inverter of the highest level.

With the enhanced drive performance and usability, the inverter is compliant with applicable safety standards.

Approach to the leading drive performance

Fast response

The improved speed response ensures a minimal speed fluctuation to maintain a constant speed when the load fluctuates.

- Speed response
 - Real sensorless vector control
 - 50 Hz*1 (A700: 20 Hz)
 - Vector control
 - 130 Hz*2 (A700: 50 Hz)

*1: At 3.7 kW with no load Differs depending on the load conditions and motor capacity.

*2: The option (FR-A8AP, FR-A8AL, or FR-A8TP) is required.

- Torque accuracy

	Real sensorless vector control	Vector control
Torque control range	1:20	1:50
Absolute torque accuracy*3	±20%	±10%*5
Repetitive torque accuracy*4	±10%	±5%*5

*3: Difference between the actual torque and the torque command

*4: Fluctuation between the average of the actual torque and the actual measured torque (repeatability of the torque)

*5: When online auto tuning (adaptive magnetic flux observer) enabled

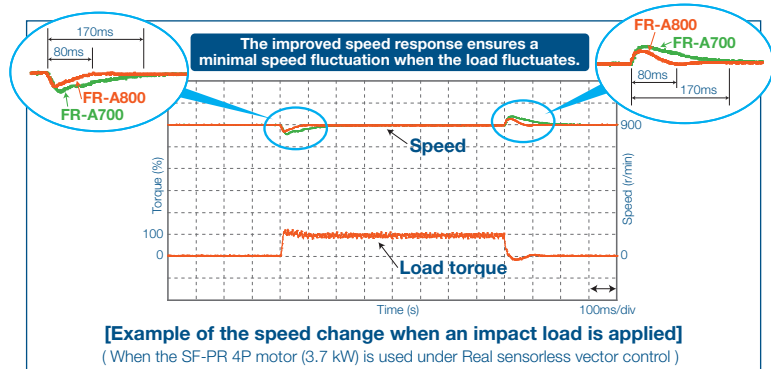

System support

Compatibility to various open networks

A controller can control and monitor an inverter via network. As well as a standard RS-485 interface, communication options are also available for the CC-Link IE Field Network, DeviceNet™, and PROFIBUS-DPVO.

(Not compatible with the SSCNET III(H) or FL remote communication.)

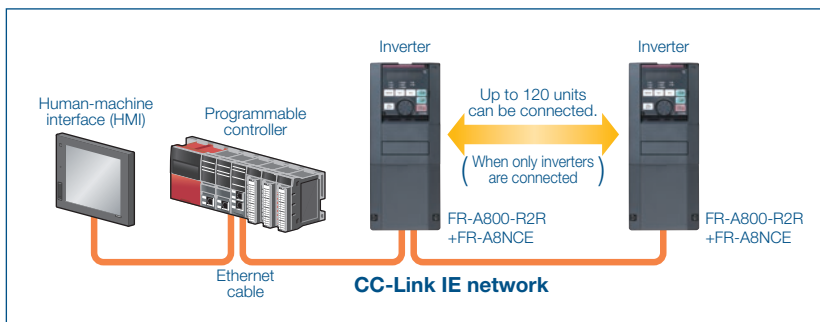

Selection of optimum capacity to suit the application

Five ratings of different rated current and overload capacity (SLD rating (super light duty), LD rating (light duty), SND rating (super normal duty), ND rating (normal duty), HD rating (heavy duty)) can be selected with parameters. The optimal inverter rating can be chosen in accordance with the application.

If using an inverter with capacity of 75K or higher, or motor with capacity of 75 kW or higher, always select and install the inverter based on the capacity of the motor with DC reactor.

Environmental adaptability

Global compatibility

- Complies with UL, cUL, and EC Directives (CE marking), and the Radio Waves Act (South Korea) (KC marking). It is also certified as compliant with the Eurasian Conformity (EAC).
- Being RoHS compliant, the FR-A800-R2R series inverters are friendly to people and to the environment.



Improved environmental resistance

[Measures against dust, dirt, and corrosion]

The inverters with PCB coating (IEC60721-3-3:1994 3C2/3S2) and conductive plating are available for improved environmental resistance. ("-60" or "-06" is affixed to the end of the inverter model name.)

Inverter by rating

• 200 V class

Inverter model FR-A820-□		SLD (Super light duty)		LD (Light duty)		SND (Super normal duty)		ND (Normal duty initial value)		HD (Heavy duty)	
		Motor capacity (kW)*1	Rated current (A)	Motor capacity (kW)*1	Rated current (A)	Motor capacity (kW)*1	Rated current (A)	Motor capacity (kW)*1	Rated current (A)	Motor capacity (kW)*1	Rated current (A)
0.4K	00046	0.75	4.6	0.75	4.2	0.75	4.2	0.4	3	0.2	1.5
0.75K	00077	1.5	7.7	1.5	7	1.5	7	0.75	5	0.4	3
1.5K	00105	2.2	10.5	2.2	9.6	2.2	9.6	1.5	8	0.75	5
2.2K	00167	3.7	16.7	3.7	15.2	3.7	15.2	2.2	11	1.5	8
3.7K	00250	5.5	25	5.5	23	5.5	23	3.7	17.5	2.2	11
5.5K	00340	7.5	34	7.5	31	7.5	31	5.5	24	3.7	17.5
7.5K	00490	11	49	11	45	7.5	36	7.5	33	5.5	24
11K	00630	15	63	15	58	15	58	11	46	7.5	33
15K	00770	18.5	77	18.5	70.5	18.5	70.5	15	61	11	46
18.5K	00930	22	93	22	85	22	85	18.5	76	15	61
22K	01250	30	125	30	114	22	102	22	90	18.5	76
30K	01540	37	154	37	140	30	126	30	115	22	90
37K	01870	45	187	45	170	45	170	37	145	30	115
45K	02330	55	233	55	212	45	190	45	175	37	145
55K	03160	75	316	75	288	55	259	55	215	45	175
75K	03800	90/110	380	90	346	90	346	75	288	55	215
90K	04750	132	475	110	432	90	388	90	346	75	288

• 400 V class

Inverter model FR-A84□-□		SLD (Super light duty)		LD (Light duty)		SND (Super normal duty)		ND (Normal duty initial value)		HD (Heavy duty)	
		Motor capacity (kW)*1	Rated current (A)	Motor capacity (kW)*1	Rated current (A)	Motor capacity (kW)*1	Rated current (A)	Motor capacity (kW)*1	Rated current (A)	Motor capacity (kW)*1	Rated current (A)
0.4K	00023	0.75	2.3	0.75	2.1	0.75	2.1	0.4	1.5	0.2	0.8
0.75K	00038	1.5	3.8	1.5	3.5	1.5	3.5	0.75	2.5	0.4	1.5
1.5K	00052	2.2	5.2	2.2	4.8	2.2	4.8	1.5	4	0.75	2.5
2.2K	00083	3.7	8.3	3.7	7.6	3.7	7.6	2.2	6	1.5	4
3.7K	00126	5.5	12.6	5.5	11.5	5.5	11.5	3.7	9	2.2	6
5.5K	00170	7.5	17	7.5	16	7.5	16	5.5	12	3.7	9
7.5K	00250	11	25	11	23	11	23	7.5	17	5.5	12
11K	00310	15	31	15	29	15	29	11	23	7.5	17
15K	00380	18.5	38	18.5	35	18.5	35	15	31	11	23
18.5K	00470	22	47	22	43	22	43	18.5	38	15	31
22K	00620	30	62	30	57	30	57	22	44	18.5	38
30K	00770	37	77	37	70	37	70	30	57	22	44
37K	00930	45	93	45	85	45	85	37	71	30	57
45K	01160	55	116	55	106	55	106	45	86	37	71
55K	01800	75/90	180	75	144	55	129	55	110	45	86
75K	02160	110	216	90	180	90	180	75	144	55	110
90K	02600	132	260	110	216	90	194	90	180	75	144
110K	03250	160	325	132	260	132	260	110	216	90	180
132K	03610	185	361	160	325	160	325	132	260	110	216
160K	04320	220	432	185	361	185	361	160	325	132	260
185K	04810	250	481	220	432	220	432	185	361	160	325
220K	05470	280	547	250	481	250	481	220	432	185	361
250K	06100	315	610	280	547	280	547	250	481	220	432
280K	06830	355	683	315	610	315	610	280	547	250	481
315K	07700	400	770	355	683	355	683	315	610	280	547
355K	08660	450	866	400	770	400	770	355	683	315	610
400K	09620	500	962	450	866	450	866	400	770	355	683
450K	10940	560	1094	500	962	500	962	450	866	400	770
500K	12120	630	1212	560	1094	560	1094	500	962	450	866

• Overload current rating

SLD	110% 60 s, 120% 3 s (inverse-time characteristics) at surrounding air temperature of 40°C
LD	120% 60 s, 150% 3 s (inverse-time characteristics) at surrounding air temperature of 50°C
SND	150% 60s (inverse-time characteristics) at surrounding air temperature of 50°C
ND	150% 60 s, 200% 3 s (inverse-time characteristics) at surrounding air temperature of 50°C
HD	200% 60 s, 250% 3 s (inverse-time characteristics) at surrounding air temperature of 50°C

*1: The applicable motor capacity is the maximum applicable capacity of a Mitsubishi Electric 4-pole standard motor.

Control the machines as you desire

PLC function

Inverter operation sequence customized for the machine

Inverter control such as inverter operations triggered by input signals, signal output based on inverter operation status, and monitor output can be freely customized based on the machine specifications. Control programs can be created in sequence ladders using the inverter setup software (FR Configurator2). Also, the sample ladders will be available for downloading from the Mitsubishi Electric FA Global Website.

Tension sensor feedback torque control

The control function is used for raising accuracy of the tension control using feedback from the tension detector. PI control is used for compensating the tension value errors arising from errors with the winding diameter or mechanical loss (caused by the temperature change / aging degradation).

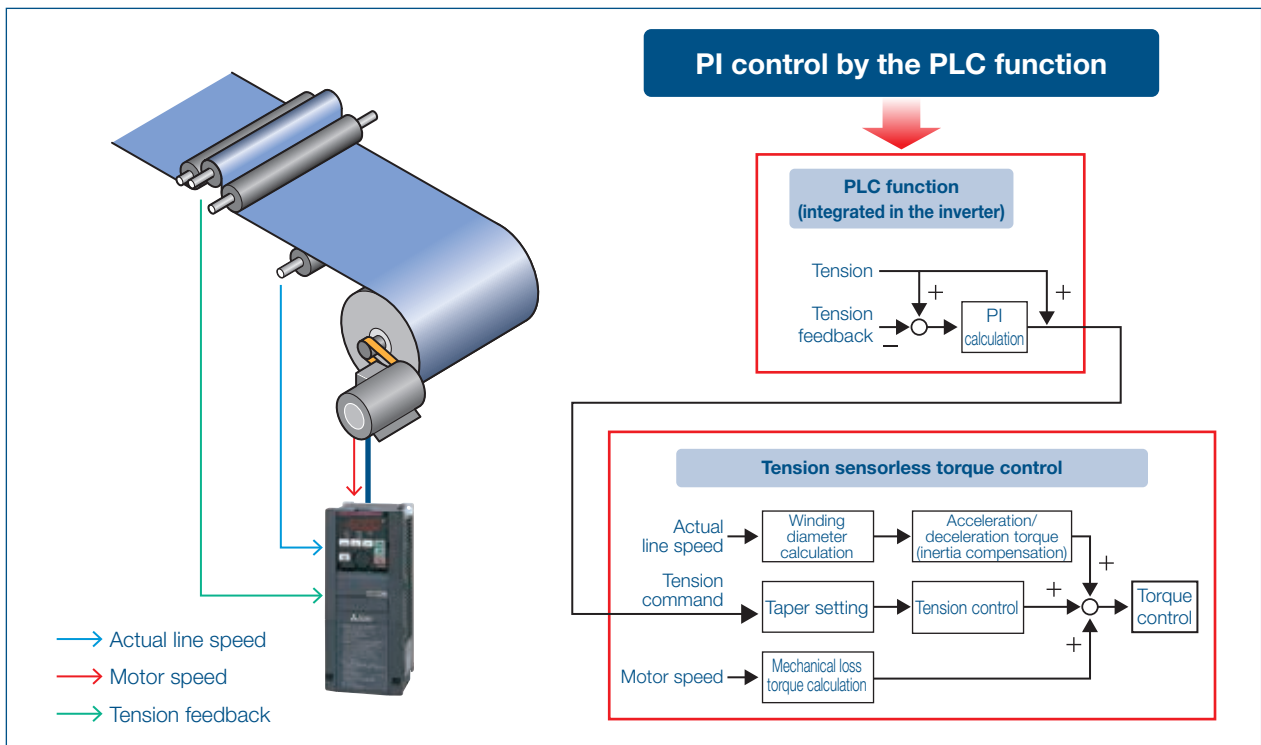

Die schedule function

Combination of the dies can be automatically changed using the PLC function of the inverter by setting values such as the gear ratio or the ratio between the wire diameters at each capstan and after the final die, and calculating the rotation speed of each capstan according to the material.

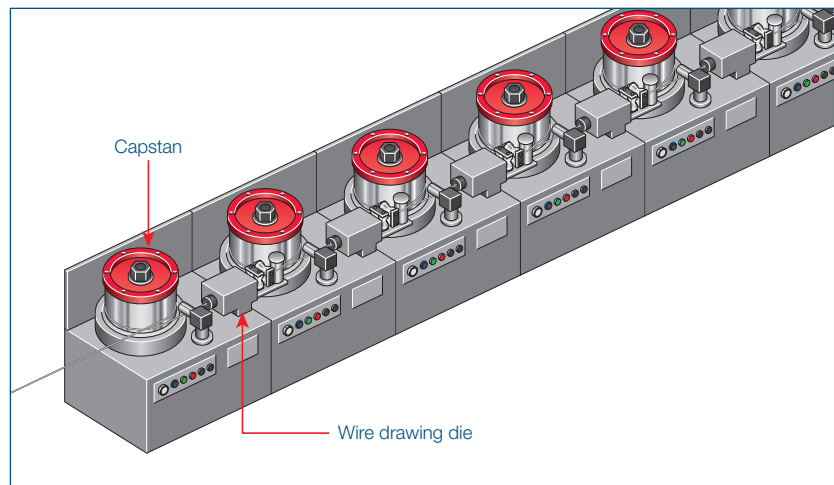

Delivering a comfortable inverter operating environment

FR Configurator2

Easy USB cable connection

A USB connector (mini B connector) is provided as standard. The connection with a personal computer can be established easily without using a converter.

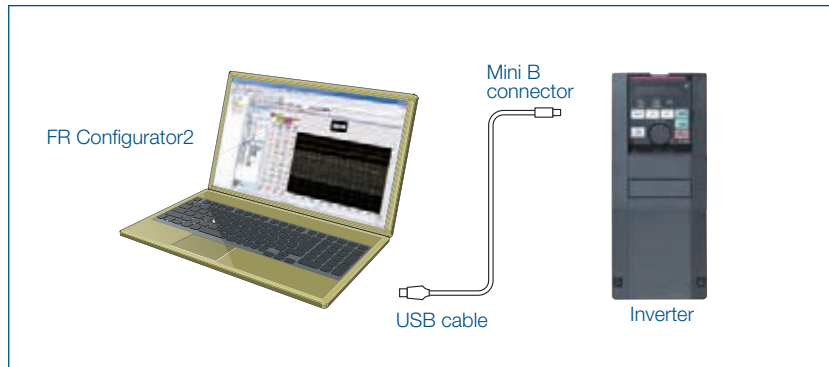

Remote operation

Importing trace data or parameter settings that have been copied in a USB memory device to FR Configurator2 enables analysis or adjustment at a remote place.

Intuitive user interface

Connected inverters are displayed in a tree view. Windows of each function can be switched using tabs, facilitating operations.

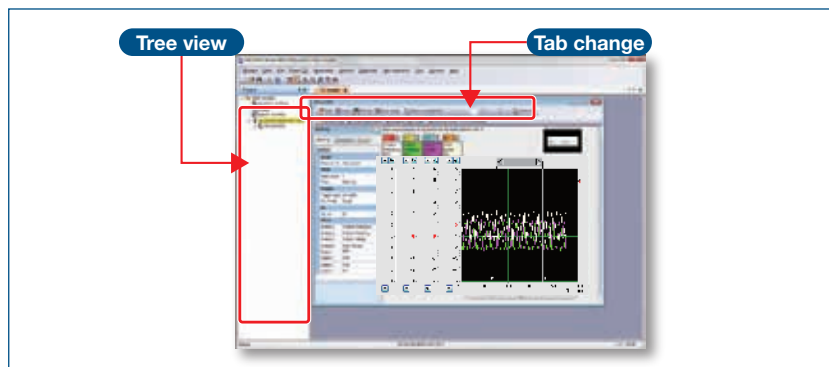

Efficient startup settings

- System setting
- Automatic recognition of connected inverters can also be set. The station number, model, capacity, and any plug-in options of the connected inverters can also be set manually.

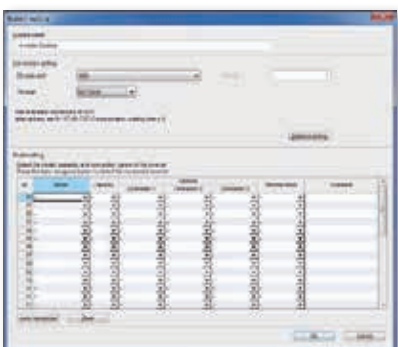

Easy pre-operation adjustment and operation check

- Parameter list
- Parameters for selected station numbers can be displayed and changed. I/O signals can be assigned using settings by function.

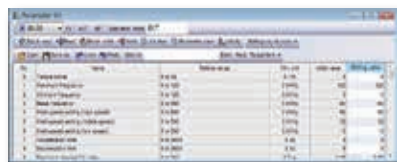

Easy-to-follow platform facilitates easy maintenance

- Graph function
- Inverter data can be sampled and displayed in a graphical format. Trace data can also be read and displayed in a graph.

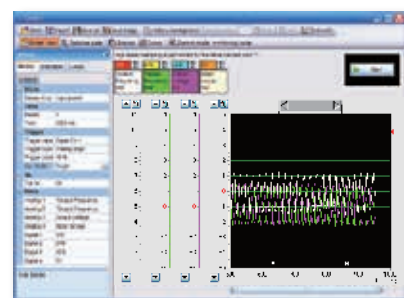

LINEUP

Standard model

FR - A 8 **20** - **0.4K** - **1** - **R2R**

Symbol	Voltage class	Symbol	Structure/function	Capacity* ¹	Description	Symbol	Type* ²	Symbol	Circuit board coating <small>(EC60721-3-3:1994 3C2/3S2 compatible)</small>	Plated conductor	Symbol	Dedicated function
2	200 V class	0	Standard model	00023 to 06830	Inverter SLD rated current (A)	1	FM	None	Without	Without	R2R	Roll to roll dedicated model
4	400 V class			0.4K to 280K	Inverter ND rated capacity (kW)	2	CA	60	With	Without		
								06* ³	With	With		

Three-phase 200 V class FR-A820-□□* ⁴	00046	00077	00105	00167	00250	00340	00490	00630	00770	00930	01250	01540	01870	02330	03160	03800	04750
	0.4K	0.75K	1.5K	2.2K	3.7K	5.5K	7.5K	11K	15K	18.5K	22K	30K	37K	45K	55K	75K	90K
Three-phase 400 V class FR-A840-□□* ⁴	00023	00038	00052	00083	00126	00170	00250	00310	00380	00470	00620	00770	00930	01160	01800	02160	02600
	0.4K	0.75K	1.5K	2.2K	3.7K	5.5K	7.5K	11K	15K	18.5K	22K	30K	37K	45K	55K	75K	90K
	03250	03610	04320	04810	05470	06100	06830										
	110K	132K	160K	185K	220K	250K	280K										

Separated converter type

FR - A 8 **42** - **315K** - **1** - **R2R**

Symbol	Voltage class	Symbol	Structure/function	Capacity* ¹	Description	Symbol	Type* ²	Symbol	Circuit board coating <small>(EC60721-3-3:1994 3C2/3S2 compatible)</small>	Plated conductor	Symbol	Dedicated function
4	400 V class	2	Separated converter type	07700 to 12120	Inverter SLD rated current (A)	1	FM	None	Without	Without	R2R	Roll to roll dedicated model
				315K to 500K	Inverter ND rated capacity (kW)	2	CA	60	With	Without		
								06	With	With		

Three-phase 400 V class FR-A842-□□	07700	08660	09620	10940	12120
	315K	355K	400K	450K	500K

*1 Models can be alternatively indicated with the inverter rated current (SLD rating).

*2 Specification differs by the type as follows.

*3 Available for the 5.5K or higher.

*4 For the 75K or higher inverter, or whenever a 75 kW or higher motor is used, always connect a DC reactor (FR-HEL), which is available as an option.

Type	Monitor output	Initial setting			
		Built-in EMC filter	Control logic	Rated frequency	Pr.19 Base frequency voltage
FM (terminal FM equipped model)	Terminal FM: pulse train output Terminal AM: analog voltage output (0 to ±10VDC)	OFF	Sink logic	60 Hz	9999 (same as the power supply voltage)
CA (terminal CA equipped model)	Terminal CA: analog current output (0 to 20mADC) Terminal AM: analog voltage output (0 to ±10VDC)	ON	Source logic	50 Hz	8888 (95% of the power supply voltage)

Mitsubishi Electric high-performance energy-saving motor with encoder

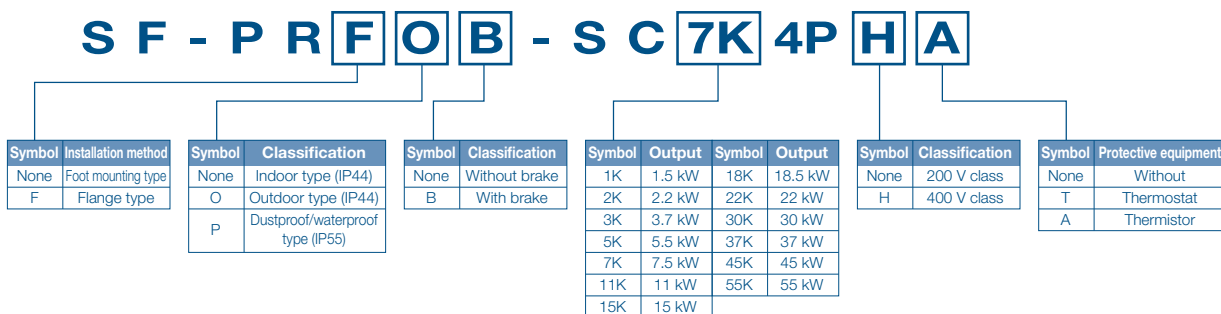

Enables a constant-torque operation in a low-speed range

Excellent speed accuracy

Speed fluctuation ratio:
±0.01% (for power driving)

Wide range of speed control

Speed control range:
1:1800 (for power driving)

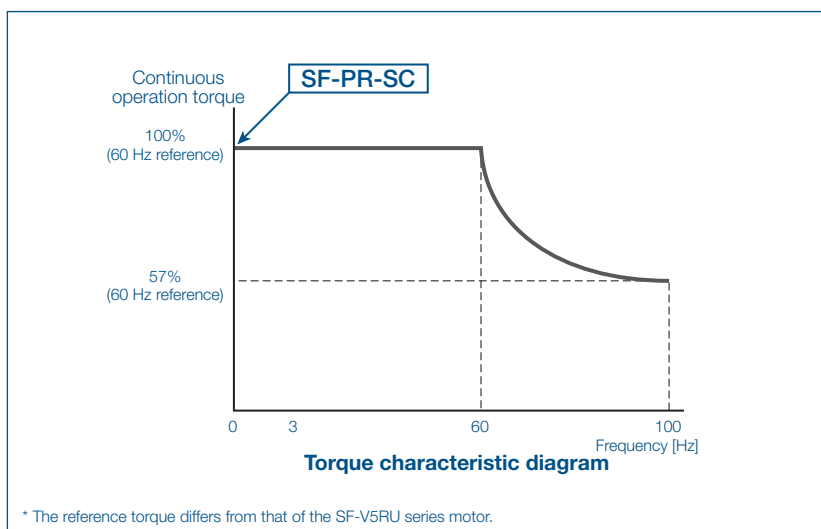

Fast-response / high-accuracy vector control

Fast-response and high-accuracy vector control can be performed by the use in combination with the general-purpose FR-A800-R2R inverter, plug-in option (FR-A8AP/A8AL), and control terminal option (FR-A8TP).

Wide range of constant-torque characteristics

By selecting vector control, constant-torque continuous operation can be performed in the range from 0 Hz to 60 Hz (zero speed control and servo lock are available)

Energy saving / CO₂ emission reduction

The premium efficiency motor with encoder (compatible with IE3) meets the Top Runner Standard in Japan and the Energy Independence and Security Act (EISA) in the United States.

Compatibility with the inverter

The motor is used in combination with an inverter of the same capacity.

Improved environmental resistance

- Environmental resistance was improved due to the change from the fan cooled type to the blower cooled type. The IP55 compatible motor with an encoder is now also available.
- With the wire-saving design, improved reliability can be obtained.
- Anti-corrosive coating (type 3) is also available.

Standard specifications

● Rating (Standard model)

◆ 200 V class

Model FR-A820-[]-R2R		00046	00077	00105	00167	00250	00340	00490	00630	00770	00930	01250	01540	01870	02330	03160	03800	04750		
		0.4K	0.75K	1.5K	2.2K	3.7K	5.5K	7.5K	11K	15K	18.5K	22K	30K	37K	45K	55K	75K	90K		
Applicable motor capacity (kW) *1	SLD	0.75	1.5	2.2	3.7	5.5	7.5	11	15	18.5	22	30	37	45	55	75	90/110	132		
	LD	0.75	1.5	2.2	3.7	5.5	7.5	11	15	18.5	22	30	37	45	55	75	90	110		
	SND *2	0.75	1.5	2.2	3.7	5.5	7.5	11	15	18.5	22	22	30	45	45	55	90	90		
	ND (initial setting)	0.4	0.75	1.5	2.2	3.7	5.5	7.5	11	15	18.5	22	30	37	45	55	75	90		
	HD	0.2*3	0.4	0.75	1.5	2.2	3.7	5.5	7.5	11	15	18.5	22	30	37	45	55	75		
Rated capacity (kVA) *4	SLD	1.8	2.9	4	6.4	10	13	19	24	29	35	48	59	71	89	120	145	181		
	LD	1.6	2.7	3.7	5.8	8.8	12	17	22	27	32	43	53	65	81	110	132	165		
	SND *2	1.6	2.7	3.7	5.8	8.8	12	14	22	27	32	39	48	65	72	99	132	148		
	ND (initial setting)	1.1	1.9	3	4.2	6.7	9.1	13	18	23	29	34	44	55	67	82	110	132		
	HD	0.6	1.1	1.9	3	4.2	6.7	9.1	13	18	23	29	34	44	55	67	82	110		
Rated current (A)	SLD	4.6	7.7	10.5	16.7	25	34	49	63	77	93	125	154	187	233	316	380	475		
	LD	4.2	7	9.6	15.2	23	31	45	58	70.5	85	114	140	170	212	288	346	432		
	SND *2	4.2	7	9.6	15.2	23	31	36	58	70.5	85	102	126	170	190	259	346	388		
	ND (initial setting)	3	5	8	11	17.5	24	33	46	61	76	90	115	145	175	215	288	346		
	HD	1.5	3	5	8	11	17.5	24	33	46	61	76	90	115	145	175	215	288		
Overload current rating *5	SLD	110% 60 s, 120% 3 s (inverse-time characteristics) at surrounding air temperature of 40°C																		
	LD	120% 60 s, 150% 3 s (inverse-time characteristics) at surrounding air temperature of 50°C																		
	SND *2	150% 60 s (inverse-time characteristics) at surrounding air temperature of 50°C																		
	ND (initial setting)	150% 60 s, 200% 3 s (inverse-time characteristics) at surrounding air temperature of 50°C																		
	HD	200% 60 s, 250% 3 s (inverse-time characteristics) at surrounding air temperature of 50°C																		
Rated voltage *6	Three-phase 200 to 240 V																			
Regenerative braking	Brake transistor	Built-in												FR-BU2 (Option)						
	Maximum brake torque*8	150% torque/3%ED *7			100% torque/3%ED *7			100% torque/2%ED *7			20% torque/continuous						10% torque/continuous			
	FR-ABR (when the option is used)	150% torque/10%ED			100% torque/10%ED						100% torque/6%ED			—			—			
Rated input AC voltage/frequency	Three-phase 200 to 240 V 50 Hz/60 Hz																			
Permissible AC voltage fluctuation	170 to 264 V 50 Hz/60 Hz																			
Permissible frequency fluctuation	±5%																			
Power supply	Rated input current (A) *9	Without DC reactor	SLD	5.3	8.9	13.2	19.7	31.3	45.1	62.8	80.6	96.7	115	151	185	221	269	316	380	475
			LD	5	8.3	12.2	18.3	28.5	41.6	58.2	74.8	90.9	106	139	178	207	255	288	346	432
			SND *2	5	8.3	12.2	18.3	28.5	41.6	49	74.8	90.9	106	130	166	207	233	304	346	388
			ND (initial setting)	3.9	6.3	10.6	14.1	22.6	33.4	44.2	60.9	80	96.3	113	150	181	216	266	288	346
			HD	2.3	3.9	6.3	10.6	14.1	22.6	33.4	44.2	60.9	80	96.3	113	150	181	216	215	288
	With DC reactor	SLD	4.6	7.7	10.5	16.7	25	34	49	63	77	93	125	154	187	233	316	380	475	
		LD	4.2	7	9.6	15.2	23	31	45	58	70.5	85	114	140	170	212	288	346	432	
		SND *2	4.2	7	9.6	15.2	23	31	36	58	70.5	85	102	126	170	190	259	346	388	
		ND (initial setting)	3	5	8	11	17.5	24	33	46	61	76	90	115	145	175	215	288	346	
		HD	1.5	3	5	8	11	17.5	24	33	46	61	76	90	115	145	175	215	288	
Power supply capacity (kVA) *10	Without DC reactor	SLD	2	3.4	5	7.5	12	17	24	31	37	44	58	70	84	103	120	145	181	
		LD	1.9	3.2	4.7	7	11	16	22	29	35	41	53	68	79	97	110	132	165	
		SND *2	1.9	3.2	4.7	7	11	16	19	29	35	41	50	63	79	89	116	132	148	
		ND (initial setting)	1.5	2.4	4	5.4	8.6	13	17	23	30	37	43	57	69	82	101	110	132	
		HD	0.9	1.5	2.4	4	5.4	8.6	13	17	23	30	37	43	57	69	82	82	110	
	With DC reactor	SLD	1.8	2.9	4	6.4	10	13	19	24	29	35	48	59	71	89	120	145	181	
		LD	1.6	2.7	3.7	5.8	8.8	12	17	22	27	32	43	53	65	81	110	132	165	
		SND *2	1.6	2.7	3.7	5.8	8.8	12	14	22	27	32	39	48	65	72	99	132	148	
		ND (initial setting)	1.1	1.9	3	4.2	6.7	9.1	13	18	23	29	34	44	55	67	82	110	132	
		HD	0.6	1.1	1.9	3	4.2	6.7	9.1	13	18	23	29	34	44	55	67	82	110	
Protective structure (IEC 60529) *11	Enclose type (IP20)												Open type (IP00)							
Cooling system	Self-cooling									Forced air cooling										
Approx. mass (kg)	2.0	2.2	3.4	3.4	3.4	6.7	6.7	8.3	15.5	15.5	15.5	22	42	42	54	74	74			

*1 The applicable motor capacity indicated is the maximum capacity applicable for use of the Mitsubishi Electric 4-pole standard motor.
 *2 For the SND rating, the carrier frequency is always 2 kHz.
 *3 The 0.2 kW motor capacity is applicable under V/F control only.
 *4 The rated output capacity indicated assumes that the output voltage is 220 V for 200 V class.
 *5 The % value of the overload current rating indicated is the ratio of the overload current to the inverter's rated output current. For repeated duty, allow time for the inverter and motor to return to or below the temperatures under 100% load.
 *6 The maximum output voltage does not exceed the power supply voltage. The maximum output voltage can be changed within the setting range. However, the maximum point of the voltage waveform at the inverter output side is the power supply voltage multiplied by about $\sqrt{2}$.
 *7 Value for the built-in brake resistor
 *8 Value for the ND rating
 *9 The rated input current indicates a value at a rated output voltage. The impedance at the power supply side (including those of the input reactor and cables) affects the rated input current.
 *10 The power supply capacity is the value when at the rated output current. It varies by the impedance at the power supply side (including those of the input reactor and cables).
 *11 FR-DU08: IP40 (except for the PU connector section)

◆ 400 V class

Model FR-A840-[]-R2R		00023	00038	00052	00083	00126	00170	00250	00310	00380	00470	00620	00770	00930	01160	01800	02160	02600	03250	03610	04320	04810	05470	06100	06830		
		0.4K	0.75K	1.5K	2.2K	3.7K	5.5K	7.5K	11K	15K	18.5K	22K	30K	37K	45K	55K	75K	90K	110K	132K	160K	185K	220K	250K	280K		
Applicable motor capacity (kW) *1	SLD	0.75	1.5	2.2	3.7	5.5	7.5	11	15	18.5	22	30	37	45	55	75/90	110	132	160	185	220	250	280	315	355		
	LD	0.75	1.5	2.2	3.7	5.5	7.5	11	15	18.5	22	30	37	45	55	75	90	110	132	160	185	220	250	280	315		
	SND *2	0.75	1.5	2.2	3.7	5.5	7.5	11	15	18.5	22	30	37	45	55	55	90	90	132	160	185	220	250	280	315		
	ND (initial setting)	0.4	0.75	1.5	2.2	3.7	5.5	7.5	11	15	18.5	22	30	37	45	55	75	90	110	132	160	185	220	250	280	315	
	HD	0.2*3	0.4	0.75	1.5	2.2	3.7	5.5	7.5	11	15	18.5	22	30	37	45	55	75	90	110	132	160	185	220	250	280	
Rated capacity (kVA) *4	SLD	1.8	2.9	4	6.3	10	13	19	24	29	36	47	59	71	88	137	165	198	248	275	329	367	417	465	521		
	LD	1.6	2.7	3.7	5.8	8.8	12	18	22	27	33	43	53	65	81	110	137	165	198	248	275	329	367	417	465		
	SND *2	1.6	2.7	3.7	5.8	8.8	12	18	22	27	33	43	53	65	81	98	137	148	198	248	275	329	367	417	465		
	ND (initial setting)	1.1	1.9	3	4.6	6.9	9.1	13	18	24	29	34	43	54	66	84	110	137	165	198	248	275	329	367	417		
	HD	0.6	1.1	1.9	3	4.6	6.9	9.1	13	18	24	29	34	43	54	66	84	110	137	165	198	248	275	329	367		
Rated current (A)	SLD	2.3	3.8	5.2	8.3	12.6	17	25	31	38	47	62	77	93	116	180	216	260	325	361	432	481	547	610	683		
	LD	2.1	3.5	4.8	7.6	11.5	16	23	29	35	43	57	70	85	106	144	180	216	260	325	361	432	481	547	610		
	SND *2	2.1	3.5	4.8	7.6	11.5	16	23	29	35	43	57	70	85	106	129	180	194	260	325	361	432	481	547	610		
	ND (initial setting)	1.5	2.5	4	6	9	12	17	23	31	38	44	57	71	86	110	144	180	216	260	325	361	432	481	547		
	HD	0.8	1.5	2.5	4	6	9	12	17	23	31	38	44	57	71	86	110	144	180	216	260	325	361	432	481		
Overload current rating *5	SLD	110% 60 s, 120% 3 s (inverse-time characteristics) at surrounding air temperature of 40°C																									
	LD	120% 60 s, 150% 3 s (inverse-time characteristics) at surrounding air temperature of 50°C																									
	SND*2	150% 60 s (inverse-time characteristics) at surrounding air temperature of 50°C																									
	ND (initial setting)	150% 60 s, 200% 3 s (inverse-time characteristics) at surrounding air temperature of 50°C																									
	HD	200% 60 s, 250% 3 s (inverse-time characteristics) at surrounding air temperature of 50°C																									
Rated voltage *6	Three-phase 380 to 500 V																										
Regenerative braking	Brake transistor	Built-in															FR-BU2(Optional)										
	Maximum brake torque *8	100% torque/2%ED *7										20% torque/continuous					10% torque/continuous										
	FR-ABR (when the option is used)	100% torque/10%ED										100% torque/6%ED					— *13										
Rated input AC voltage/frequency	Three-phase 380 to 500 V 50 Hz/60 Hz *12																										
Permissible AC voltage fluctuation	323 to 550 V 50 Hz/60 Hz																										
Permissible frequency fluctuation	±5%																										
Rated input current (A) *9	Without DC reactor	SLD	3.2	5.4	7.8	10.9	16.4	22.5	31.7	40.3	48.2	58.4	76.8	97.6	115	141	180	216	260	325	361	432	481	547	610	683	
		LD	3	4.9	7.3	10.1	15.1	22.3	31	38.2	44.9	53.9	75.1	89.7	106	130	144	180	216	260	325	361	432	481	547	610	
		SND *2	3	4.9	7.3	10.1	15.1	22.3	31	38.2	44.9	53.9	75.1	89.7	106	130	154	180	194	260	325	361	432	481	547	610	
		ND (initial setting)	2.3	3.7	6.2	8.3	12.3	17.4	22.5	31	40.3	48.2	56.5	75.1	91	108	134	144	180	216	260	325	361	432	481	547	
		HD	1.4	2.3	3.7	6.2	8.3	12.3	17.4	22.5	31	40.3	48.2	56.5	75.1	91	108	110	144	180	216	260	325	361	432	481	
	With DC reactor	SLD	2.3	3.8	5.2	8.3	12.6	17	25	31	38	47	62	77	93	116	180	216	260	325	361	432	481	547	610	683	
		LD	2.1	3.5	4.8	7.6	11.5	16	23	29	35	43	57	70	85	106	144	180	216	260	325	361	432	481	547	610	
		SND *2	2.1	3.5	4.8	7.6	11.5	16	23	29	35	43	57	70	85	106	129	180	194	260	325	361	432	481	547	610	
		ND (initial setting)	1.5	2.5	4	6	9	12	17	23	31	38	44	57	71	86	110	144	180	216	260	325	361	432	481	547	
		HD	0.8	1.5	2.5	4	6	9	12	17	23	31	38	44	57	71	86	110	144	180	216	260	325	361	432	481	
	Power supply capacity (kVA) *10	Without DC reactor	SLD	2.5	4.1	5.9	8.3	12	17	24	31	37	44	58	74	88	107	137	165	198	248	275	329	367	417	465	521
			LD	2.3	3.7	5.5	7.7	12	17	24	29	34	41	57	68	81	99	110	137	165	198	248	275	329	367	417	465
SND *2			2.3	3.7	5.5	7.7	12	17	24	29	34	41	57	68	81	99	117	137	148	198	248	275	329	367	417	465	
ND (initial setting)			1.7	2.8	4.7	6.3	9.4	13	17	24	31	37	43	57	69	83	102	110	137	165	198	248	275	329	367	417	
With DC reactor		SLD	1.8	2.9	4	6.3	10	13	19	24	29	36	47	59	71	88	137	165	198	248	275	329	367	417	465	521	
		LD	1.6	2.7	3.7	5.8	8.8	12	18	22	27	33	43	53	65	81	110	137	165	198	248	275	329	367	417	465	
		SND *2	1.6	2.7	3.7	5.8	8.8	12	18	22	27	33	43	53	65	81	98	137	148	198	248	275	329	367	417	465	
Power supply capacity (kVA) *10	With DC reactor	ND (initial setting)	1.1	1.9	3	4.6	6.9	9.1	13	18	24	29	34	43	54	66	84	110	137	165	198	248	275	329	367	417	
		HD	0.6	1.1	1.9	3	4.6	6.9	9.1	13	18	24	29	34	43	54	66	84	110	137	165	198	248	275	329	367	
		Protective structure (IEC 60529) *11	Enclose type (IP20)													Open type (IP00)											
Cooling system	Self-cooling													Forced air cooling													
Approx. mass (kg)	3.0	3.0	3.0	3.4	3.4	6.7	6.7	8.3	8.3	15	15	23	41	41	43	52	55	71	78	117	117	166	166	166			

*1 The applicable motor capacity indicated is the maximum capacity applicable for use of the Mitsubishi Electric 4-pole standard motor.
 *2 For the SND rating, the carrier frequency is always 2 kHz.
 *3 The 0.2 kW motor capacity is applicable under V/F control only.
 *4 The rated output capacity indicated assumes that the output voltage is 440 V for 400 V class.
 *5 The % value of the overload current rating indicated is the ratio of the overload current to the inverter's rated output current. For repeated duty, allow time for the inverter and motor to return to or below the temperatures under 100% load.
 *6 The maximum output voltage does not exceed the power supply voltage. The maximum output voltage can be changed within the setting range. However, the maximum point of the voltage waveform at the inverter output side is the power supply voltage multiplied by about $\sqrt{2}$.
 *7 Value for the built-in brake resistor
 *8 Value for the ND rating
 *9 The rated input current indicates a value at a rated output voltage. The impedance at the power supply side (including those of the input reactor and cables) affects the rated input current.
 *10 The power supply capacity is the value when at the rated output current. It varies by the impedance at the power supply side (including those of the input reactor and cables).
 *11 FR-DU08: IP40 (except for the PU connector section)
 *12 For the power voltage exceeding 480 V, set Pr.977 Input voltage mode selection.
 *13 The braking capability of the inverter built-in brake can be improved with a commercial brake resistor. For the details, please contact your sales representative.

Standard specifications

● Rating (Separated converter type)

◆ 400 V class

• Inverter

Model FR-A842-[]-R2R		07700	08660	09620	10940	12120	
		315K	355K	400K	450K	500K	
Applicable motor capacity (kW) *1	SLD	400	450	500	560	630	
	LD	355	400	450	500	560	
	SND *2	355	400	450	500	560	
	ND (initial setting)	315	355	400	450	500	
	HD	280	315	355	400	450	
Output	Rated capacity (kVA) *3	SLD	587	660	733	834	924
		LD	521	587	660	733	834
		SND *2	521	587	660	733	834
		ND (initial setting)	465	521	587	660	733
		HD	417	465	521	587	660
		SLD	770	866	962	1094	1212
	Rated current (A)	LD	683	770	866	962	1094
		SND *2	683	770	866	962	1094
		ND (initial setting)	610	683	770	866	962
		HD	547	610	683	770	866
	Overload current rating *4	SLD	110% 60 s, 120% 3 s (inverse-time characteristics) at surrounding air temperature of 40°C				
		LD	120% 60 s, 150% 3 s (inverse-time characteristics) at surrounding air temperature of 50°C				
SND *2		150% 60 s (inverse-time characteristics) at surrounding air temperature of 50°C					
ND (initial setting)		150% 60 s, 200% 3 s (inverse-time characteristics) at surrounding air temperature of 50°C					
HD		200% 60 s, 250% 3 s (inverse-time characteristics) at surrounding air temperature of 50°C					
Rated voltage *5		Three-phase 380 to 500 V					
Regenerative braking torque *6 (When the converter unit (FR-CC2) is used)		Maximum brake torque 10% torque/continuous					
Input power	DC power supply voltage		430 to 780 VDC				
	Control power supply auxiliary input		Single phase 380 to 500 V 50 Hz/60 Hz *8				
	Permissible control power supply auxiliary input fluctuation		Frequency ±5%, voltage ±10%				
Protective structure (IEC 60529) *7		Open type (IP00)					
Cooling system		Forced air cooling					
Approx. mass (kg)		163	163	243	243	243	

*1 The applicable motor capacity indicated is the maximum capacity applicable for use of the Mitsubishi Electric 4-pole standard motor.

*2 For the SND rating, the carrier frequency is always 2 kHz.

*3 The rated output capacity indicated assumes that the output voltage is 440 V.

*4 The % value of the overload current rating indicated is the ratio of the overload current to the inverter's rated output current. For repeated duty, allow time for the inverter and motor to return to or below the temperatures under 100% load.

*5 The maximum output voltage does not exceed the power supply voltage. The maximum output voltage can be changed within the setting range. However, the maximum point of the voltage waveform at the inverter output side is the power supply voltage multiplied by about $\sqrt{2}$.

*6 ND rating reference value

*7 FR-DU08: IP40 (except for the PU connector section)

*8 For the power voltage exceeding 480 V, set **Pr.977 Input voltage mode selection**.

• Converter unit (FR-CC2)

Model FR-CC2-H[]		315K	355K	400K	450K	500K	560K	630K
Applicable motor capacity (kW)		315	355	400	450	500	560	630
Output	Overload current rating *1	200% 60 s, 250% 3 s				150% 60 s, 200% 3 s	120% 60 s, 150% 3 s	110% 60 s, 120% 3 s
	Rated voltage *2	430 to 780 VDC *4						
Power supply	Rated input AC voltage/frequency	Three-phase 380 to 500 V, 50 Hz/60 Hz						
	Permissible AC voltage fluctuation	Three-phase 323 to 550 V, 50 Hz/60 Hz						
	Permissible frequency fluctuation	±5%						
	Rated input current (A)	610	683	770	866	962	1094	1212
Power supply capacity (kVA) *3		465	521	587	660	733	833	924
Protective structure (IEC 60529)		Open type (IP00)						
Cooling system		Forced air cooling						
DC reactor		Built-in						
Approx. mass (kg)		210	213	282	285	288	293	294

*1 The % value of the overload current rating indicated is the ratio of the overload current to the inverter's rated output current. For repeated duty, allow time for the converter unit and the inverter to return to or below the temperatures under 100% load.

*2 The converter unit output voltage varies according to the input power supply voltage and the load. The maximum point of the voltage waveform at the converter unit output side is approximately the power supply voltage multiplied by $\sqrt{2}$.

*3 The power supply capacity is the value when at the rated output current. The impedance at the power supply side (including those of the input reactor and cables) affects the rated input current.

*4 The permissible voltage imbalance ratio is 3% or less. (Imbalance ratio = (highest voltage between lines - average voltage between three lines) / average voltage between three lines × 100)

Common specifications

Control specifications	Control method		Soft-PWM control, high carrier frequency PWM control (selectable among V/F control, Advanced magnetic flux vector control, Real sensorless vector control), Optimum excitation control, and vector control *1
	Output frequency range		0.2 to 590 Hz (The upper-limit frequency is 400 Hz (200 Hz for the SND rating) under Advanced magnetic flux vector control, Real sensorless vector control, and vector control*1.)
	Frequency setting resolution	Analog input	0.015 Hz/60 Hz (0 to 10 V/12 bits for terminals 2 and 4) 0.03 Hz/60 Hz (0 to 5 V/11 bits or 0 to 20 mA/approx. 11 bits for terminals 2 and 4, 0 to ±10 V/12 bits for terminal 1) 0.06 Hz/60 Hz (0 to ±5 V/11 bits for terminal 1)
		Digital input	0.01 Hz
	Frequency accuracy	Analog input	Within ±0.2% of the max. output frequency (25°C ± 10°C)
		Digital input	Within 0.01% of the set output frequency
	Voltage/frequency characteristics		Base frequency can be set from 0 to 590 Hz. Constant-torque/variable-torque pattern or adjustable 5 points V/F can be selected.
	Starting torque		SLD Rating:120% 0.3 Hz, LD Rating:150% 0.3 Hz, SND Rating:150% 0.3 Hz, ND Rating:200% 0.3 Hz*2, HD Rating:250% 0.3 Hz*2 (Real sensorless vector control, vector control*1)
	Torque boost		Manual torque boost
	Acceleration/deceleration time setting		0 to 3600 s (acceleration and deceleration can be set individually), linear or S-pattern acceleration/deceleration mode, backlash countermeasures acceleration/deceleration can be selected.
DC injection brake (induction motor)		Operation frequency (0 to 120 Hz), operation time (0 to 10 s), operation voltage (0 to 30%) variable	
Operation specifications	Stall prevention operation level		Activation range of stall prevention operation (SLD rating: 0 to 120%, LD rating: 0 to 150%, SND rating: 0 to 220%, ND rating: 0 to 220%, HD rating: 0 to 280%). Whether to use the stall prevention or not can be selected. (V/F control, Advanced magnetic flux vector control)
	Torque limit level		Torque limit value can be set (0 to 400% variable). (Real sensorless vector control, vector control *1)
	Frequency setting signal	Analog input	Terminals 2 and 4: 0 to 10 V, 0 to 5 V, 4 to 20 mA (0 to 20 mA) are available. Terminal 1: -10 to +10 V, -5 to +5 V are available.
		Digital input	Input using the setting dial of the operation panel or parameter unit Four-digit BCD or 16-bit binary (when used with option FR-A8AX)
	Start signal		Forward and reverse rotation or start signal automatic self-holding input (3-wire input) can be selected.
	Input signals (twelve terminals)		Low-speed operation command, Middle-speed operation command, High-speed operation command, Second function selection, Terminal 4 input selection, Jog operation selection, Selection of automatic restart after instantaneous power failure, Flying start, Output stop, Start self-holding selection, Forward rotation command, Reverse rotation command, Inverter reset The input signal can be changed using Pr.178 to Pr.189 (input terminal function selection) .
	Pulse train input		100 kpps
	Operational functions		Dancer feedback speed control, tension sensor feedback speed control, tension sensorless torque control, tension sensor feedback torque control, winding diameter calculation, initial winding diameter calculation, actual line speed detection, reduction ratio setting, maximum/minimum winding diameter setting, winding diameter / winding length storage, line speed acceleration/deceleration function, dancer roll break detection, tension PI gain tuning, speed control proportional gain compensation, reel change function, taper function, inertia compensation function, mechanical loss compensation function, maximum and minimum frequency settings, multi-speed operation, acceleration/deceleration pattern, thermal protection, DC injection brake, starting frequency, JOG operation, output stop (MRS), stall prevention, regeneration avoidance, DC feeding*4, frequency jump, rotation display, automatic restart after instantaneous power failure, retry function, carrier frequency selection, fast-response current limit, forward/reverse rotation prevention, operation mode selection, slip compensation, droop control, speed smoothing control, auto tuning, applied motor selection, gain tuning, RS-485 communication, dancer control, cooling fan operation selection, stop selection (deceleration stop/coasting), power-failure deceleration stop function, PLC function, life diagnosis, maintenance timer, current average monitor, multiple rating, speed control, torque control, pre-excitation, torque limit, test run, 24 V power supply input for control circuit, safety stop function
	Output signal	Open collector output (five terminals) Relay output (two terminals)	Inverter running, Up to frequency, Instantaneous power failure/undervoltage*4, Overload warning, Output frequency detection, Fault The output signal can be changed using Pr.190 to Pr.196 (output terminal function selection) . Fault codes of the inverter can be output (4 bits) from the open collector.
		Pulse train output (FM type)	50 kpps
Indication	For meter	Pulse train output (FM type)	Max. 2.4 kHz: one terminal (output frequency) The monitored item can be changed using Pr.54 FM/CA terminal function selection .
		Current output (CA type)	Max. 20 mADC: one terminal (output current) The monitored item can be changed using Pr.54 FM/CA terminal function selection .
		Voltage output	Max. 10 VDC: one terminal (output voltage) The monitored item can be changed using Pr.158 AM terminal function selection .
	Operation panel (FR-DU08)	Operating status	Output frequency, Output current, Output voltage, Frequency setting value The monitored item can be changed using Pr.52 Operation panel main monitor selection .
Fault record		A fault record is displayed when a fault occurs. Past 8 fault records and the conditions immediately before the fault (output voltage/current/frequency/cumulative energization time/year/month/date/time) are saved.	
Protective/warning function	Protective function		Overcurrent trip during acceleration, Overcurrent trip during constant speed, Overcurrent trip during deceleration or stop, Regenerative overvoltage trip during acceleration, Regenerative overvoltage trip during constant speed, Regenerative overvoltage trip during deceleration or stop, Inverter overload trip (electronic thermal relay function), Motor overload trip (electronic thermal relay function), Heatsink overheat, Instantaneous power failure*4, Undervoltage*4, Input phase loss*3*4, Stall prevention stop, Brake transistor alarm detection*4, Output side earth (ground) fault overcurrent, Output short circuit, Output phase loss, External thermal relay operation*3, PTC thermistor operation*3, Option fault, Communication option fault, Parameter storage device fault, PU disconnection, Retry count excess*3, Parameter storage device fault, CPU fault, Operation panel power supply short circuit/RS-485 terminals power supply short circuit, 24 VDC power fault, Abnormal output current detection*3, Inrush current limit circuit fault*4, Communication fault (inverter), Analog input fault, USB communication fault, Safety circuit fault, Overspeed occurrence*3, Speed deviation excess detection*3, Signal loss detection*3, Encoder phase fault*3, 4 mA input fault*3, PID signal fault*3, Option fault, Opposite rotation deceleration fault*3, Internal circuit fault, Encoder pulse number setting error, Overload trip
	Warning function		Fan alarm, Stall prevention (overcurrent), Stall prevention (overvoltage), Regenerative brake pre-alarm*3*4, Electronic thermal relay function pre-alarm, PU stop, Speed limit indication*3, Parameter copy, Safety stop, Maintenance signal output*3, USB host error, Operation panel lock*3, Password locked*3, Parameter write error, Copy operation error, 24 V external power supply operation
Environment	Surrounding air temperature		-10°C to +50°C (non-freezing) (LD, SND, ND, HD ratings) -10°C to +40°C (non-freezing) (SLD rating)
	Surrounding air humidity		95% RH or less (non-condensing) (With circuit board coating (conforming to IEC60721-3-3: 1994 3C2/3S2)) 90% RH or less (non-condensing) (Without circuit board coating)
	Storage temperature *5		-20°C to +65°C
	Atmosphere		Indoors (without corrosive gas, flammable gas, oil mist, dust and dirt, etc.)
	Altitude/vibration		Maximum 1000 m above sea level *6, 5.9 m/s ² *7 or less at 10 to 55 Hz (directions of X, Y, Z axes)

*1 Available only when a vector control compatible option is installed.
 *2 In the initial setting of the FR-A820-00340(5.5K) or higher and the FR-A840-00170(5.5K) or higher, it is limited to 150% by the torque limit level.
 *3 This protective function is not available in the initial status.
 *4 Enabled only for standard models.
 *5 Temperature applicable for a short time, e.g. in transit.
 *6 For the installation at an altitude above 1,000 m up to 2,500 m, derate the rated current 3% per 500 m.
 *7 2.9m/s² or less for the FR-A840-04320(160K) or higher.

Differences in the functions from the standard inverter

- The following functions of the FR-A800 standard inverter are deleted in the FR-A800-R2R inverter. Parameters, I/O signals, and monitors relative to the deleted functions are also deleted or used differently in the FR-A800-R2R inverter.

Function	Parameter	Input signal*1	Output signal*2	Monitor*3	
PM sensorless vector control	Pr.373, Pr.702, Pr.706, Pr.711, Pr.712, Pr.717, Pr.721, Pr.725, Pr.738 to Pr.743, Pr.746, Pr.747, Pr.788, Pr.791, Pr.792, Pr.998, Pr.1002, Pr.1105 Pr.71 setting range change ("330, 333, 334, 8090, 8093, 8094, 9090, 9093, and 9094" are deleted.) Pr.450 setting range change ("330, 333, 334, 8090, 8093, 8094, 9090, 9093, and 9094" are deleted.)	—	IPM (57)	—	
PID control	Second PID	Pr.753 to Pr.758, Pr.765 to Pr.769, Pr.1136 to Pr.1149	X73 (73) X78 (78) X79 (79) X80 (80)	Y50 (50) Y52 (52) Y54 (54) FDN2 (200) FUP2 (201) RL2 (202) PID2 (203) SLEEP2 (204) Y205 (205)	Second PID set point (92) Second PID measured value (93) Second PID deviation (94) Second PID measured value 2 (95) Second PID manipulated amount (96)
	Set point / deviation / measured value input selection	Pr.609, Pr.610	X14 (14)		
	PID pre-charge function	Pr.760 to Pr.764	X77 (77)	Y49 (49) Y51 (51) Y53 (53)	—
	PID display unit	Pr.759, C42 (Pr.934), C43 (Pr.934), C44 (Pr.935), C45 (Pr.935)	—	—	—
	SLEEP function	Pr.575 to Pr.577 Pr.554 setting range change ("10 to 13" are deleted.) Pr.1015 setting range change ("10 and 11" are deleted.)	—	SLEEP (70)	—
Position control	Pr.419 to Pr.421, Pr.423 to Pr.427, Pr.429, Pr.464 to Pr.494, Pr.1220 to Pr.1290, Pr.1292 to Pr.1297 Pr.451 setting range change ("3 to 5, 13, 14, 103 to 105, 113, and 114" are deleted.) Pr.800 setting range change ("3 to 5, 13, 14, 103 to 105, 113, and 114" are deleted.)	NP(68) CLR (69) X76 (76) X84 (84) X87 (87)	Y36 (36) MEND (38) ZA (56) FP (60) PBSY (61) ZP (63) RDY (84)	Position pulse (19) Position command (lower) (26) Position command (upper) (27) Current position (lower) (28) Current position (upper) (29) Droop pulse (lower) (30) Droop pulse (upper) (31)	
Orientation function	Pr.350 to Pr.358, Pr.360 to Pr.366, Pr.393 to Pr.399, Pr.829	X22 (22)	ORA (27) ORM (28)	Orientation status (22)	
Cumulative pulse monitor	Pr.430, Pr.635 to Pr.638	X52 (52) X53 (53)	—	Cumulative pulse (71) Cumulative pulse overflow times (72) Cumulative pulse (control terminal option) (73) Cumulative pulse overflow times (control terminal option) (74)	
Adjustable 5 points V/F	Pr.100 to Pr.109 Pr.71 setting range change ("2" is deleted.)	—	—	—	
Remote function	Pr.59	—	—	—	
Automatic acceleration/ deceleration	Pr.61 to Pr.64, Pr.292, Pr.293	—	—	—	
Brake sequence control	Pr.278 to Pr.284, Pr.639 to Pr.648, Pr.650, Pr.651	BRI (15) BRI2 (45)	BOF (20) BOF2 (22)	—	
Electronic bypass sequence	Pr.135, Pr.136, Pr.138, Pr.139, Pr.159	—	—	—	
Stop frequency function	Pr.522	—	—	—	
Stop-on-contact control	Pr.270, Pr.275, Pr.276	—	—	—	
Load torque high-speed frequency control	Pr.271 to Pr.274	X19 (19)	—	—	
Anti-sway control function	Pr.1072 to Pr.1079	—	—	—	
Traverse function	Pr.592 to Pr.597	X37 (37)	—	—	
Strengthened excitation deceleration	Pr.660 to Pr.662	—	—	—	
Self power management	Pr.248, Pr.254	—	—	—	
SSCNET III communication (FR-A8NS)	Pr.379, Pr.449, Pr.499	X85 (85) X88 (88) X89 (89)	—	SSCNET III communication status (39)	
Torque control by variable-current limiter control	Pr.451 setting range change ("6 and 106" are deleted.) Pr.800 setting range change ("6 and 106" are deleted.)	—	—	—	
Second motor control method selection	Pr.451 setting range change ("0 to 2 and 100 to 102" are deleted.)	—	—	—	
4 mA input check	Pr.573 setting range change ("4" is deleted.) Pr.777 is deleted.	—	—	—	
Stop mode at communication error	Pr.502 setting range change ("3" is deleted.) Pr.779 is deleted.	—	—	—	
Online auto tuning	Pr.574 setting range change ("2" is deleted.)	—	—	—	

*1 The Pr.178 to Pr.189 (input terminal function selection) setting is shown in the parentheses.

*2 The Pr.190 to Pr.196 (output terminal function selection) setting is shown in the parentheses.

*3 The monitor selection parameter setting is shown in the parentheses.

Option compatibility

- The FR-A8NS or FR-A8NF plug-in option cannot be used in the FR-A800-R2R inverter.

Outline dimensions

● Standard model

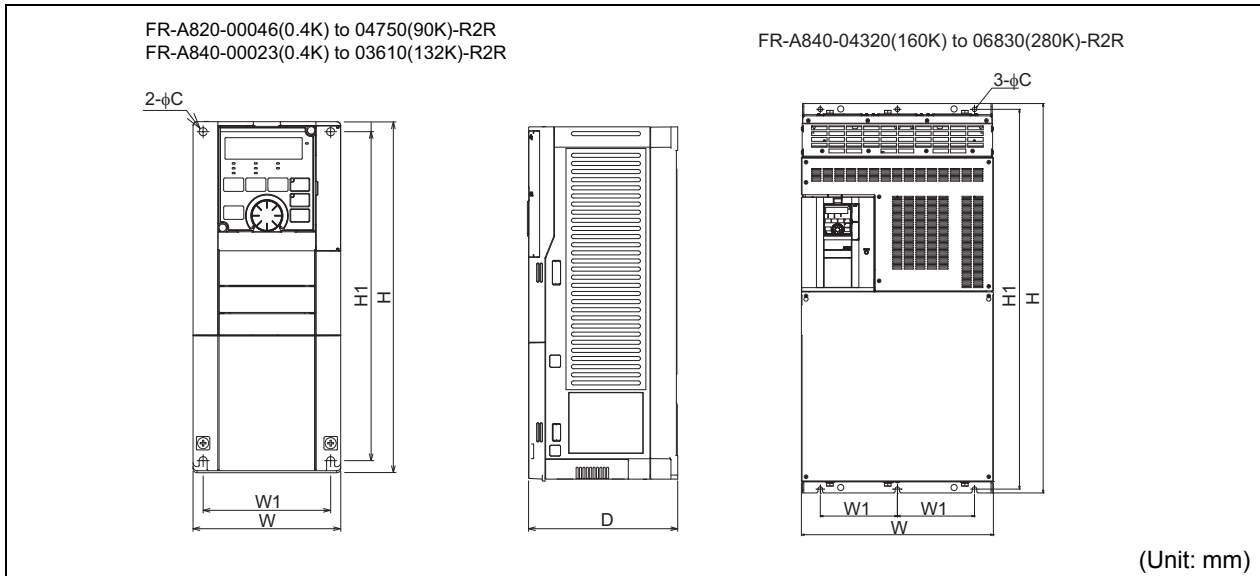

◆ 200 V class

Inverter model	W	W1	H	H1	D	C		
FR-A820-00046(0.4K)-R2R	110	95	260	245	110	6		
FR-A820-00077(0.75K)-R2R					125			
FR-A820-00105(1.5K)-R2R					140			
FR-A820-00167(2.2K)-R2R	150	125			170			
FR-A820-00250(3.7K)-R2R					220		195	190
FR-A820-00340(5.5K)-R2R								
FR-A820-00490(7.5K)-R2R	250	230	300	285	10			
FR-A820-00630(11K)-R2R			400	380		195		
FR-A820-00770(15K)-R2R								
FR-A820-00930(18.5K)-R2R	325	270	550	530	250	12		
FR-A820-01250(22K)-R2R								
FR-A820-01540(30K)-R2R								
FR-A820-01870(37K)-R2R	435	380	700	675	360			
FR-A820-02330(45K)-R2R								
FR-A820-03160(55K)-R2R								
FR-A820-03800(75K)-R2R	465	400	740	715	360			
FR-A820-04750(90K)-R2R								

◆ 400 V class

Inverter model	W	W1	H	H1	D	C
FR-A840-00023(0.4K)-R2R	150	125	260	245	140	6
FR-A840-00038(0.75K)-R2R						
FR-A840-00052(1.5K)-R2R						
FR-A840-00083(2.2K)-R2R						
FR-A840-00126(3.7K)-R2R						
FR-A840-00170(5.5K)-R2R	220	195	300	285	190	
FR-A840-00250(7.5K)-R2R						
FR-A840-00310(11K)-R2R						
FR-A840-00380(15K)-R2R	250	230	400	380	195	
FR-A840-00470(18.5K)-R2R						
FR-A840-00620(22K)-R2R						
FR-A840-00770(30K)-R2R	325	270	550	530	250	
FR-A840-00930(37K)-R2R						
FR-A840-01160(45K)-R2R						
FR-A840-01800(55K)-R2R	465	400	620	595	300	
FR-A840-02160(75K)-R2R						
FR-A840-02600(90K)-R2R						
FR-A840-03250(110K)-R2R	498	200	740	715	360	
FR-A840-03610(132K)-R2R						
FR-A840-04320(160K)-R2R						
FR-A840-04810(185K)-R2R	680	300	1010	985	380	
FR-A840-05470(220K)-R2R						
FR-A840-06100(250K)-R2R						
FR-A840-06830(280K)-R2R				984		

Outline dimensions

● Separated converter type

FR-A842-07700(315K), 08660(355K)-R2R

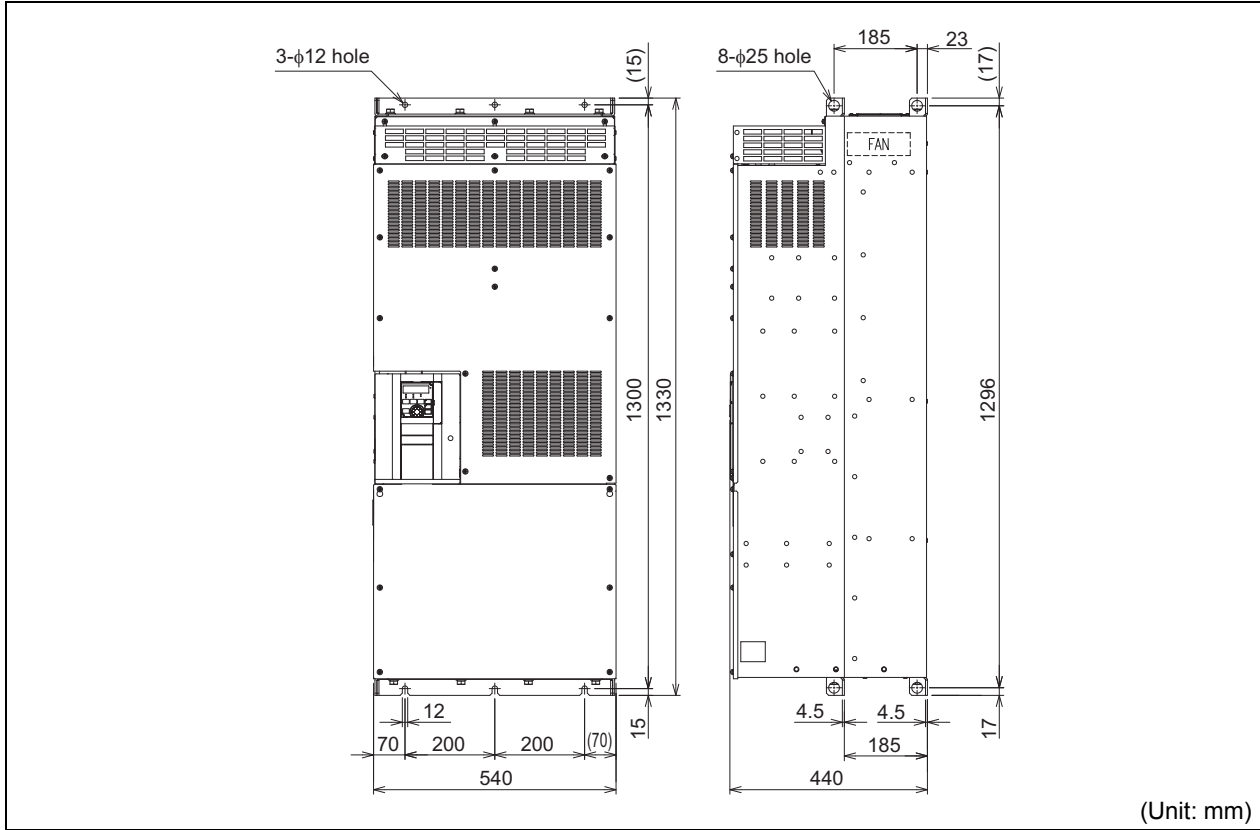

FR-A842-09620(400K), 10940(450K), 12120(500K)-R2R

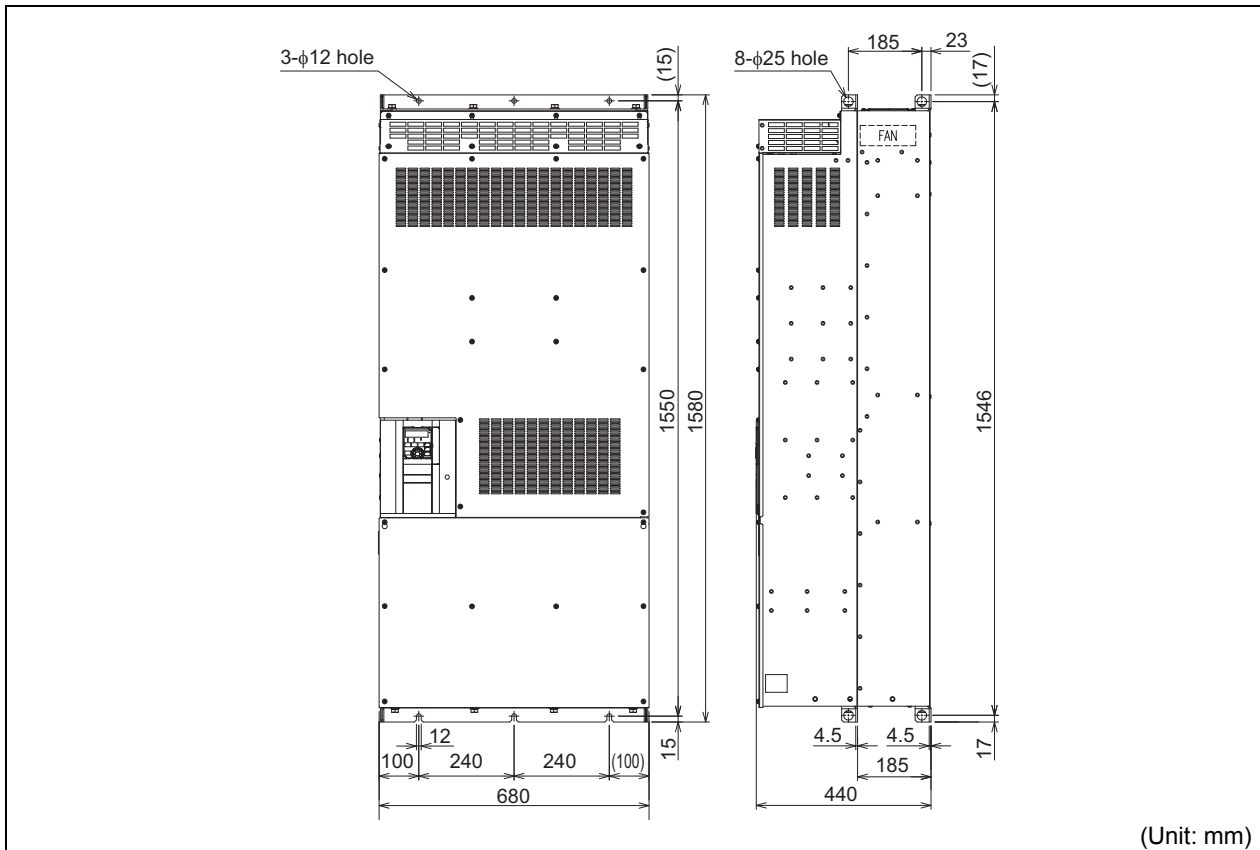

Roll to roll function related parameters

Pr. denotes parameter numbers, **GROUP** denotes group parameter numbers.

● Parameter list

The following parameters are dedicated to the roll to roll functions. Set the parameters according to application. For the parameter details, refer to the FR-A800-R2R Instruction Manual (Roll to Roll Function Manual).

Pr.	GROUP	Name	Setting range	Minimum setting increment	Initial value	Customer setting
52	M100	Operation panel main monitor selection	0, 5 to 14, 17 to 20, 22 to 36, 38, 40 to 46, 50 to 57, 61, 62, 64, 67, 81 to 91, 97, 98, 100	1	0	
54	M300	FM/CA terminal function selection	1 to 3, 5 to 14, 17 to 19, 21, 22, 24, 26 to 28, 30, 32 to 34, 36, 46, 50, 61, 62, 70, 81, 82, 87 to 90, 97, 98	1	1	
71	C100	Applied motor	0, 1, 3 to 6, 13 to 16, 20, 23, 24, 30, 33, 34, 40, 43, 44, 50, 53, 54, 70, 73, 74	1	0	
100	R253	Second acceleration time for line speed command	0 to 3600 s	0.1 s	15 s	
101	R254	Second deceleration time for line speed command	0 to 3600 s	0.1 s	15 s	
102	R255	Third acceleration time for line speed command	0 to 3600 s	0.1 s	15 s	
103	R256	Third deceleration time for line speed command	0 to 3600 s	0.1 s	15 s	
128	A610 R100	PID action selection	0, 40, 41	1	0	
129	A613 R110	PID proportional band	0.1 to 1000%, 9999	0.1%	100%	
130	A614 R111	PID integral time	0.1 to 3600 s, 9999	0.1 s	1 s	
131	A601	PID upper limit	400 to 600%, 9999	0.1%	9999	
132	A602	PID lower limit	400 to 600%, 9999	0.1%	9999	
133	A611 R101	PID action set point	400 to 600%	0.01%	500%	
134	A615 R112	PID differential time	0.01 to 10s, 9999	0.01 s	9999	
135	R161	Integral clamp (positive polarity)	0 to 100%, 9999	0.1%	9999	
136	R162	Integral clamp (negative polarity)	0 to 100%, 9999	0.1%	9999	
158	M301	AM terminal function selection	1 to 3, 5 to 14, 17 to 19, 21, 22, 24, 26 to 28, 30, 32 to 34, 36, 46, 50, 52 to 54, 61, 62, 67, 70, 81 to 84, 87 to 91, 97, 98	1	1	
159	R450	DA1 output sign selection	0 to 2	1	0	
178	T700	STF terminal function selection	0 to 13, 16 to 18, 20, 23 to 28, 42 to 44, 46 to 48, 50, 51, 60, 62, 64 to 67, 70 to 72, 74, 81, 92 to 96, 100 to 109, 111 to 117, 120 to 126, 9999	1	60	
179	T701	STR terminal function selection	0 to 13, 16 to 18, 20, 23 to 28, 42 to 44, 46 to 48, 50, 51, 61, 62, 64 to 67, 70 to 72, 74, 81, 92 to 96, 100 to 109, 111 to 117, 120 to 126, 9999	1	61	
180	T702	RL terminal function selection	0 to 13, 16 to 18, 20, 23 to 28, 42 to 44, 46 to 48, 50, 51, 62, 64 to 67, 70 to 72, 74, 81, 92 to 96, 100 to 109, 111 to 117, 120 to 126, 9999	1	0	
181	T703	RM terminal function selection		1	1	
182	T704	RH terminal function selection		1	2	
183	T705	RT terminal function selection		1	3	
184	T706	AU terminal function selection		1	4	
185	T707	JOG terminal function selection		1	5	
186	T708	CS terminal function selection		1	6	
187	T709	MRS terminal function selection		1	24*1 10*2	
188	T710	STOP terminal function selection		1	25	
189	T711	RES terminal function selection		1	62	

Roll to roll function related parameters

Pr.	GROUP	Name	Setting range	Minimum setting increment	Initial value	Customer setting
190	M400	RUN terminal function selection	0 to 8, 10 to 19, 25, 26, 30 to 35,	1	0	
191	M401	SU terminal function selection	39 to 48, 55, 64, 67, 68, 79, 85,	1	1	
192	M402	IPF terminal function selection	90 to 99, 100 to 108, 110 to 116,	1	2+1	
193	M403	OL terminal function selection	125, 126, 130 to 135, 139 to 148,	1	9999*2	
194	M404	FU terminal function selection	155, 164, 167, 168, 179, 185,	1	3	
195	M405	ABC1 terminal function selection	190 to 199, 206 to 208, 231 to 239,	1	4	
196	M406	ABC2 terminal function selection	306 to 308, 331 to 339, 9999	1	99	
252	T050	Override bias	0 to 8, 10 to 19, 25, 26, 30 to 35,	0.1%	50%	
253	T051	Override gain	39 to 48, 55, 64, 67, 68, 79, 85, 90,	0.1%	150%	
270	R342	Acceleration/deceleration time during stall condition	91, 94 to 99, 100 to 108,	0.1 s	15 s	
271	R537	Second acceleration time for inertia compensation	110 to 116, 125, 126, 130 to 135,	0.1 s	15 s	
272	R538	Second deceleration time for inertia compensation	139 to 148, 155, 164, 167, 168,	0.1 s	15 s	
276	R400	Line speed monitoring reference	179, 185, 190, 191, 194 to 199,	0.1	1000	
278	R051	Actual line speed voltage/current gain	206 to 208, 231 to 239, 306 to 308,	0.1%	9999	
279	R052	Actual line speed gain	331 to 339, 9999	0.1	9999	
280	R053	Actual line speed voltage/current bias	0 to 6553.4	0.1%	9999	
281	R054	Actual line speed bias	0 to 100%, 9999	0.1	9999	
282	R055	Actual line speed pulse input bias	0 to 6553.4, 9999	0.01	9999	
283	R056	Actual line speed pulse input gain	0 to 500, 9999	0.01	9999	
284	R057	Actual line speed input filter time constant	0 to 500, 9999	0.01 s	0.02 s	
350	R210	Line speed command voltage/current bias	0 to 5 s	0.1%	0%	
351	R211	Line speed command bias	0 to 100%	0.1	0	
352	R212	Line speed command voltage/current gain	0 to 6553.4, 9999	0.1%	50%	
353	R213	Line speed command gain	0 to 6553.4, 9999	0.1	1000	
354	R220	Line speed command pulse input bias	0 to 500	0.01	0	
355	R221	Line speed command pulse input gain	0 to 500	0.01	100	
356	R222	Line speed command digital input bias	0 to 65535	1	0	
357	R223	Line speed command digital input gain	0 to 65535	1	65535	
358	R201	Line speed unit	0 to 3	1	0	
360	R202	Line speed command value	0 to 6553.4	0.1	0	
361	R200	Line speed command input selection	0 to 8, 9999	1	9999	
362	R050	Actual line speed input selection	0 to 7, 9999	1	0	
363	R102	Dancer signal / tension feedback input selection	3 to 6, 9999	1	9999	
364	R411	Dancer tension setting input selection	3 to 6, 9999	1	9999	
365	R302	Tension command value (RAM)	0 to 100	0.01	0	
366	R303	Tension command value (RAM, EEPROM)	0 to 100	0.01	0	
393	R250	Line speed command acceleration/ deceleration reference	1 to 6553.4	0.1	1000	
394	R251	First acceleration time for line speed command	0 to 3600 s	0.1 s	15 s	
395	R252	First deceleration time for line speed command	0 to 3600 s	0.1 s	15 s	
423	R422	Dancer position / tension feedback detection level	0 to 100%	0.01%	10%	
424	R104	Dancer / tension feedback input offset	400 to 600%	0.01%	500%	
425	R160	Break detection waiting time	0 to 100 s, 9999	0.01 s	9999	
426	R412	Dancer tension setting bias	0 to 200%	0.1%	0%	
427	R413	Dancer tension setting gain	0 to 200%	0.1%	100%	
430	R410	Dancer tension setting	1 to 100, 9999	0.1	100	
450	C200	Second applied motor	0, 1, 3 to 6, 13 to 16, 20, 23, 24, 30,	1	9999	
451	G300	Second motor control method selection	33, 34, 40, 43, 44, 50, 53, 54, 70,	1	9999	
464	R113	PID proportional band for values below set point	73, 74, 9999	0.1%	9999	
465	R114	PID integral time for values below set point	10 to 12, 20, 110 to 112, 9999	0.1 s	9999	
466	R115	PID differential time for values below set point	0.1 to 3600 s, 9999	0.01 s	9999	
467	R116	Second PID proportional band	0.01 to 10 s, 9999	0.1%	9999	
468	R117	Second PID integral time	0.1 to 1000%, 9999	0.1 s	9999	
469	R118	Second PID differential time	0.1 to 3600 s, 9999	0.01 s	9999	

Roll to roll function related parameters

Pr.	GROUP	Name	Setting range	Minimum setting increment	Initial value	Customer setting
470	R119	Second PID proportional band for values below set point	0.1 to 1000%, 9999	0.1%	9999	
471	R120	Second PID integral time for values below set point	0.1 to 3600 s, 9999	0.1 s	9999	
472	R121	Second PID differential time for values below set point	0.01 to 10 s, 9999	0.01 s	9999	
473	R122	Third PID proportional band	0.1 to 1000%, 9999	0.1%	9999	
474	R123	Third PID integral time	0.1 to 3600 s, 9999	0.1 s	9999	
475	R124	Third PID differential time	0.01 to 10 s, 9999	0.01 s	9999	
476	R125	Third PID proportional band for values below set point	0.1 to 1000%, 9999	0.1%	9999	
477	R126	Third PID integral time for values below set point	0.1 to 3600 s, 9999	0.1 s	9999	
478	R127	Third PID differential time for values below set point	0.01 to 10 s, 9999	0.01 s	9999	
479	R128	Fourth PID proportional band	0.1 to 1000%, 9999	0.1%	9999	
480	R129	Fourth PID integral time	0.1 to 3600 s, 9999	0.1 s	9999	
481	R130	Fourth PID differential time	0.01 to 10 s, 9999	0.01 s	9999	
482	R131	Fourth PID proportional band for values below set point	0.1 to 1000%, 9999	0.1%	9999	
483	R132	Fourth PID integral time for values below set point	0.1 to 3600 s, 9999	0.1 s	9999	
484	R133	Fourth PID differential time for values below set point	0.01 to 10 s, 9999	0.01 s	9999	
485	R149	Integral control activation	0 to 3	1	0	
486	R140	Deviation A	400.1 to 600%	0.1%	600%	
487	R141	Deviation B	400 to 599.9%	0.1%	400%	
488	R142	Deviation C1	400.1 to 599.9%, 9999	0.1%	9999	
489	R143	Deviation C2	400.1 to 599.9%, 9999	0.1%	9999	
490	R144	PID gain A	0.1 to 1000%, 9999	0.1%	9999	
491	R145	PID gain B	0.1 to 1000%, 9999	0.1%	9999	
492	R146	PID gain C1	0.1 to 1000%, 9999	0.1%	9999	
493	R147	PID gain C2	0.1 to 1000%, 9999	0.1%	9999	
494	R148	PID gain D	0.1 to 1000%, 9999	0.1%	9999	
502	N013	Stop mode selection at communication error	0 to 2	1	0	
554	A604	PID signal operation selection	0 to 3	1	0	
570	E301	Multiple rating setting	0 to 3, 12	1	2	
573	A680 T052	4 mA input check selection	1 to 3, 9999	1	9999	
574	C211	Second motor online auto tuning	0, 1	1	0	
620	R570	Line speed bias for reel change	0 to 2000	0.1	1000	
621	R423	Allowable deviation from target line speed	0 to 6553.4	0.1	0	
622	R204	Line speed command for starting	0 to 6553.4	0.1	0	
639	R030	Speed control proportional term applied diameter 1	1 to 99%, 9999	1%	9999	
640	R031	Speed control proportional term applied diameter 2	1 to 99%, 9999	1%	9999	
641	R032	Speed control proportional gain 1	0 to 1000%, 9999	1%	9999	
642	R033	Speed control proportional gain 2	0 to 1000%, 9999	1%	9999	
643	R034	Speed control proportional gain 3	0 to 1000%, 9999	1%	9999	
644	R035	Speed control proportional gain 4	0 to 1000%, 9999	1%	9999	
645	R004	Winding diameter storage selection	0, 1	1	0	
646	R003	Stored winding diameter	1 to 6553 mm	1 mm	1 mm	
647	R041	Operation time with stored winding diameter	0 to 100 s	0.01 s	0 s	
648	R420	Target winding diameter	1 to 6553 mm	1 mm	1 mm	
650	R270	Terminal 4 input compensation selection	0, 1	1	0	
774	M101	Operation panel monitor selection 1	1 to 3, 5 to 14, 17 to 20, 22 to 36,	1	9999	
775	M102	Operation panel monitor selection 2	38, 40 to 46, 50 to 57, 61, 62, 64,	1	9999	
776	M103	Operation panel monitor selection 3	67, 81 to 91, 97, 98, 100, 9999	1	9999	
800	G200	Control method selection	0 to 2, 9 to 12, 20, 100 to 102, 109 to 112	1	20	
829	R504	Taper ratio setting input filter time constant	0 to 5 s	0.01 s	0.02 s	
992	M104	Operation panel setting dial push monitor selection	0 to 3, 5 to 14, 17 to 20, 22 to 36, 38, 40 to 46, 50 to 57, 61, 62, 64, 67, 81 to 91, 97, 98, 100	1	0	
1015	A607	Integral stop selection at limited frequency	0, 1	1	0	

Roll to roll function related parameters

Pr.	GROUP	Name	Setting range	Minimum setting increment	Initial value	Customer setting
1027	A910	Analog source selection (1ch)	1 to 3, 5 to 14, 17 to 20, 22 to 24, 26 to 36, 40 to 42, 46, 52 to 54, 61, 62, 64, 67, 81 to 91, 97, 98, 201 to 213, 230 to 232, 235 to 238	1	201	
1028	A911	Analog source selection (2ch)			202	
1029	A912	Analog source selection (3ch)			203	
1030	A913	Analog source selection (4ch)			204	
1031	A914	Analog source selection (5ch)			205	
1032	A915	Analog source selection (6ch)			206	
1033	A916	Analog source selection (7ch)			207	
1034	A917	Analog source selection (8ch)			208	
1072	R304	Tension reverse selection	0, 1	1	0	
1113	H414	Speed limit method selection	0 to 2, 10	1	0	
1114	D403	Torque command reverse selection	0, 1	1	0	
	R305					
1211	R171	Tension PI gain tuning timeout time	1 to 9999 s	1 s	50 s	
1215	R172	Limit cycle output upper limit	0 to 100%	0.1%	0%	
1217	R173	Limit cycle hysteresis	0.1 to 10%	0.1%	1%	
1219	R170	Tension PI gain tuning start/status	1, 8(0, 2, 3, 9, 12, 13, 90 to 96)	1	0	
1222	R175	Target amplitude	0 to 100%, 9999	0.1%	9999	
1223	R174	Manipulated amount for operation	0 to 10%	0.1%	1%	
1226	R176	Tension PI gain tuning response level setting	1 to 7	1	2	
1227	R103	Dancer / tension feedback input filter time constant	0 to 5 s	0.01 s	0 s	
1230	R002	Winding/unwinding selection	0, 1	1	0	
1231	R010	Material thickness d1	0 to 20 mm, 9999	0.001 mm	9999	
1232	R011	Material thickness d2	0 to 20 mm	0.001 mm	1 mm	
1233	R012	Material thickness d3	0 to 20 mm	0.001 mm	1 mm	
1234	R013	Material thickness d4	0 to 20 mm	0.001 mm	1 mm	
1235	R020	Maximum winding diameter 1	1 to 6553 mm	1 mm	2 mm	
1236	R021	Minimum winding diameter 1	1 to 6553 mm	1 mm	1 mm	
1237	R022	Maximum winding diameter 2	1 to 6553 mm	1 mm	2 mm	
1238	R023	Minimum winding diameter 2	1 to 6553 mm	1 mm	1 mm	
1239	R024	Maximum winding diameter 3	1 to 6553 mm	1 mm	2 mm	
1240	R025	Minimum winding diameter 3	1 to 6553 mm	1 mm	1 mm	
1241	R026	Maximum winding diameter 4	1 to 6553 mm	1 mm	2 mm	
1242	R027	Minimum winding diameter 4	1 to 6553 mm	1 mm	1 mm	
1243	R600	Gear ratio numerator (follower side)	1 to 65534	1	1	
1244	R601	Gear ratio denominator (driver side)	1 to 65534	1	1	
1245	R042	Sampling time for winding diameter calculation	0.01 to 1 s, 9999	0.01 s	9999	
1246	R040	Line speed at winding diameter calculated value activation	0 to 6553.4	0.1	1	
1247	R000	Winding diameter change increment amount limit	0 to 9.998 mm, 9999	0.001 mm	9999	
1248	R001	Winding diameter change limit disable time	0 to 100 s	0.01 s	0 s	
1249	R043	Number of averaging for winding diameter calculation	0 to 10	1	4	
1250	R260	Winding diameter compensation speed filtering waiting time	0 to 100 s	0.01 s	0 s	
1251	R261	Winding diameter compensation speed filter time constant	0 to 100 s	0.01 s	0 s	
1252	R070	Dancer lower limit position	400 to 600%	0.01%	400%	
1253	R071	Initial winding diameter calculation deadband	0 to 50%	0.1%	1%	
1254	R072	Initial winding diameter calculation deadband 2	0 to 50%, 9999	0.1%	9999	
1255	R073	Accumulated amount	1 to 5000, 8888, 9999	1	9999	
1256	R074	Speed control P gain at start	0 to 1000%	1%	60%	
1257	R075	Speed control integral time at start	0 to 20 s	0.001 s	2 s	
1258	R076	Integral term limit at start	0 to 100%	0.1%	2.5%	
1259	R077	PID term limit at start	0 to 100%	0.1%	2.5%	
1262	R005	Winding length increment	0 to 3	1	3	
1263	R006	Stored winding length	0 to 9999	1	0	
1264	R421	Winding length detection	0 to 9999	1	1000	
1265	R230	Line multi-speed setting (high-speed)	0 to 6553.4	0.1	0	
1266	R231	Line multi-speed setting (middle-speed)	0 to 6553.4	0.1	0	
1267	R232	Line multi-speed setting (low-speed)	0 to 6553.4	0.1	0	
1268	R233	Line multi-speed setting (speed 4)	0 to 6553.4	0.1	0	
1269	R234	Line multi-speed setting (speed 5)	0 to 6553.4	0.1	0	
1270	R235	Line multi-speed setting (speed 6)	0 to 6553.4	0.1	0	

Roll to roll function related parameters

Pr.	GROUP	Name	Setting range	Minimum setting increment	Initial value	Customer setting
1271	R236	Line multi-speed setting (speed 7)	0 to 6553.4	0.1	0	
1272	R237	Line multi-speed setting (speed 8)	0 to 6553.4	0.1	0	
1273	R238	Line multi-speed setting (speed 9)	0 to 6553.4	0.1	0	
1274	R239	Line multi-speed setting (speed 10)	0 to 6553.4	0.1	0	
1275	R240	Line multi-speed setting (speed 11)	0 to 6553.4	0.1	0	
1276	R241	Line multi-speed setting (speed 12)	0 to 6553.4	0.1	0	
1277	R242	Line multi-speed setting (speed 13)	0 to 6553.4	0.1	0	
1278	R243	Line multi-speed setting (speed 14)	0 to 6553.4	0.1	0	
1279	R244	Line multi-speed setting (speed 15)	0 to 6553.4	0.1	0	
1280	R401	Winding diameter monitoring reference	1 to 6553 mm	1 mm	1000 mm	
1281	R402	Commanded tension monitoring reference	0 to 100 N	0.01 N	100 N	
1282	R320	Tension command cushion time	0 to 360 s	0.01 s	0 s	
1283	R321	Cushion time reference tension	0.01 to 100	0.01	100	
1284	R500	Taper mode selection	0 to 4	1	0	
1285	R501	Taper setting analog input selection	3 to 6, 9999	1	9999	
1286	R503	Winding diameter at taper start	0 to 6553 mm, 9999	1 mm	9999	
1287	R502	Taper ratio setting	0 to 100%, 9999	0.1%	0%	
1288	R510	Data table winding diameter 1	0 to 6553 mm, 9999	1 mm	9999	
1289	R511	Data table taper ratio 1	0 to 100%	0.1%	0%	
1290	R512	Data table winding diameter 2	0 to 6553 mm, 9999	1 mm	9999	
1291	R513	Data table taper ratio 2	0 to 100%	0.1%	0%	
1292	R514	Data table winding diameter 3	0 to 6553 mm, 9999	1 mm	9999	
1293	R515	Data table taper ratio 3	0 to 100%	0.1%	0%	
1294	R516	Data table winding diameter 4	0 to 6553 mm, 9999	1 mm	9999	
1295	R517	Data table taper ratio 4	0 to 100%	0.1%	0%	
1296	R518	Data table winding diameter 5	0 to 6553 mm, 9999	1 mm	9999	
1297	R519	Data table taper ratio 5	0 to 100%	0.1%	0%	
1401	R301	Tension command increment	0 to 2	1	0	
1402	R310	Tension command input voltage bias	0 to 100%	0.1%	0%	
1403	R311	Tension command bias	0 to 100 N*3	0.01 N*3	0 N	
1404	R312	Tension command input voltage gain	0 to 100%	0.1%	100%	
1405	R313	Tension command gain	0 to 100 N*3	0.01 N*3	100 N*3	
1406	R340	Commanded tension reduction scaling factor during stall condition	0 to 200%	0.1%	20%	
1407	R341	Speed limit during stall condition	0 to 60 Hz	0.01 Hz	1 Hz	
1409	R343	Tension command cushion time during stall condition	0 to 360 s, 9999	0.01 s	9999	
1410	R530	Motor inertia	0 to 500 kg·m ²	0.01 kg·m ²	0 kg·m ²	
1411	R531	Empty reel inertia	0 to 500 kg·m ²	0.01 kg·m ²	0 kg·m ²	
1412	R532	Roll width	0 to 5000 mm	1 mm	0 mm	
1413	R533	Material specific gravity	0 to 20 g/cm ³	0.001 g/cm ³	0 g/cm ³	
1414	R535	First acceleration time for inertia compensation	0 to 3600 s	0.1 s	15 s	
1415	R536	First deceleration time for inertia compensation	0 to 3600 s	0.1 s	15 s	
1418	R534	Inertia compensation cushion time	0 to 360 s	0.01 s	0 s	
1419	R550	Mechanical loss setting frequency bias	900 to 1100%	0.1%	1000%	
1420	R551	Mechanical loss setting frequency 1	0 to 400 Hz, 9999	0.01 Hz	9999	
1421	R552	Mechanical loss 1	900 to 1100%	0.1%	1000%	
1422	R553	Mechanical loss setting frequency 2	0 to 400 Hz, 9999	0.01 Hz	9999	
1423	R554	Mechanical loss 2	900 to 1100%	0.1%	1000%	
1424	R555	Mechanical loss setting frequency 3	0 to 400 Hz, 9999	0.01 Hz	9999	
1425	R556	Mechanical loss 3	900 to 1100%	0.1%	1000%	
1426	R557	Mechanical loss setting frequency 4	0 to 400 Hz, 9999	0.01 Hz	9999	
1427	R558	Mechanical loss 4	900 to 1100%	0.1%	1000%	
1428	R559	Mechanical loss setting frequency 5	0 to 400 Hz, 9999	0.01 Hz	9999	
1429	R560	Mechanical loss 5	900 to 1100%	0.1%	1000%	

- *1 The initial value is for standard models.
- *2 The initial value is for separated converter types.
- *3 The setting varies with the Pr.1401 setting.

Warranty

When using this product, make sure to understand the warranty described below.

1. Warranty period and coverage

We will repair any failure or defect (hereinafter referred to as "failure") in our FA equipment (hereinafter referred to as the "Product") arisen during warranty period at no charge due to causes for which we are responsible through the distributor from which you purchased the Product or our service provider. However, we will charge the actual cost of dispatching our engineer for an on-site repair work on request by customer in Japan or overseas countries. We are not responsible for any on-site readjustment and/or trial run that may be required after a defective unit are repaired or replaced.

[Term]

The term of warranty for Product is twelve months after your purchase or delivery of the Product to a place designated by you or eighteen months from the date of manufacture whichever comes first ("Warranty Period"). Warranty period for repaired Product cannot exceed beyond the original warranty period before any repair work.

[Limitations]

- (1) You are requested to conduct an initial failure diagnosis by yourself, as a general rule. It can also be carried out by us or our service company upon your request and the actual cost will be charged. However, it will not be charged if we are responsible for the cause of the failure.
- (2) This limited warranty applies only when the condition, method, environment, etc. of use are in compliance with the terms and conditions and instructions that are set forth in the instruction manual and user manual for the Product and the caution label affixed to the Product.
- (3) Even during the term of warranty, the repair cost will be charged on you in the following cases;
 - 1) a failure caused by your improper storing or handling, carelessness or negligence, etc., and a failure caused by your hardware or software problem
 - 2) a failure caused by any alteration, etc. to the Product made on your side without our approval
 - 3) a failure which may be regarded as avoidable, if your equipment in which the Product is incorporated is equipped with a safety device required by applicable laws and has any function or structure considered to be indispensable according to a common sense in the industry
 - 4) a failure which may be regarded as avoidable if consumable parts designated in the instruction manual, etc. are duly maintained and replaced
 - 5) any replacement of consumable parts (condenser, cooling fan, etc.)
 - 6) a failure caused by external factors such as inevitable accidents, including without limitation fire and abnormal fluctuation of voltage, and acts of God, including without limitation earthquake, lightning and natural disasters
 - 7) a failure generated by an unforeseeable cause with a scientific technology that was not available at the time of the shipment of the Product from our company
 - 8) any other failures which we are not responsible for or which you acknowledge we are not responsible for

2. Term of warranty after the stop of production

- (1) We may accept the repair at charge for another seven (7) years after the production of the product is discontinued. The announcement of the stop of production for each model can be seen in our Sales and Service, etc.
- (2) Please note that the Product (including its spare parts) cannot be ordered after its stop of production.

3. Service in overseas

Our regional FA Center in overseas countries will accept the repair work of the Product; however, the terms and conditions of the repair work may differ depending on each FA Center. Please ask your local FA center for details.

4. Exclusion of loss in opportunity and secondary loss from warranty liability

Regardless of the gratis warranty term, Mitsubishi shall not be liable for compensation to:

- (1) Damages caused by any cause found not to be the responsibility of Mitsubishi.
- (2) Loss in opportunity, lost profits incurred to the user by Failures of Mitsubishi products.
- (3) Special damages and secondary damages whether foreseeable or not, compensation for accidents, and compensation for damages to products other than Mitsubishi products.
- (4) Replacement by the user, maintenance of on-site equipment, start-up test run and other tasks.

5. Change of Product specifications

Specifications listed in our catalogs, manuals or technical documents may be changed without notice.

6. Application and use of the Product

- (1) For the use of our product, its applications should be those that may not result in a serious damage even if any failure or malfunction occurs in product, and a backup or fail-safe function should operate on an external system to product when any failure or malfunction occurs.
- (2) Our product is designed and manufactured as a general purpose product for use at general industries. Therefore, applications substantially influential on the public interest for such as atomic power plants and other power plants of electric power companies, and also which require a special quality assurance system, including applications for railway companies and government or public offices are not recommended, and we assume no responsibility for any failure caused by these applications when used. In addition, applications which may be substantially influential to human lives or properties for such as airlines, medical treatments, railway service, incineration and fuel systems, man-operated material handling equipment, entertainment machines, safety machines, etc. are not recommended, and we assume no responsibility for any failure caused by these applications when used. We will review the acceptability of the abovementioned applications, if you agree not to require a specific quality for a specific application. Please contact us for consultation.

Support

● Global FA Center

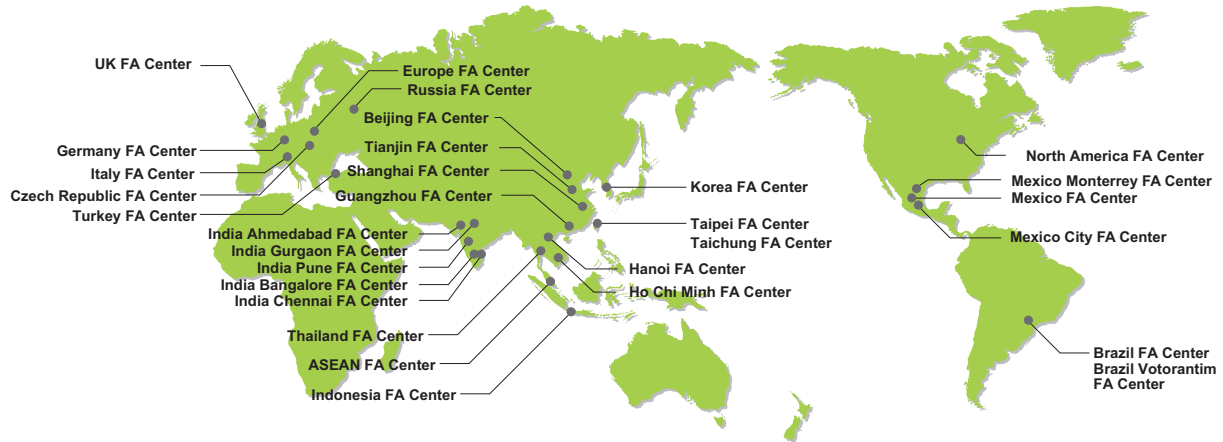

● Shanghai FA Center

MITSUBISHI ELECTRIC AUTOMATION (CHINA) LTD. Shanghai FA Center
Mitsubishi Electric Automation Center, No.1386 Hongqiao Road, Shanghai, China
TEL. 86-21-2322-3030 FAX. 86-21-2322-3000 (9611#)

● Beijing FA Center

MITSUBISHI ELECTRIC AUTOMATION (CHINA) LTD. Beijing FA Center
5/F, ONE INDIGO, 20 Jiuxianqiao Road Chaoyang District, Beijing, China
TEL. 86-10-6518-8830 FAX. 86-10-6518-2938

● Tianjin FA Center

MITSUBISHI ELECTRIC AUTOMATION (CHINA) LTD. Tianjin FA Center
Room 2003 City Tower, No.35, Youyi Road, Hexi District, Tianjin, China
TEL. 86-22-2813-1015 FAX. 86-22-2813-1017

● Guangzhou FA Center

MITSUBISHI ELECTRIC AUTOMATION (CHINA) LTD. Guangzhou FA Center
Room 1609, North Tower, The Hub Center, No.1068, Xingang East Road, Haizhou District, Guangzhou, China
TEL. 86-20-8923-6730 FAX. 86-20-8923-6715

● Korea FA Center

MITSUBISHI ELECTRIC AUTOMATION KOREA CO., LTD.
8F, Gangseo Hangang Xi-tower A, 401, Yangcheon-ro, Gangseo-Gu, Seoul 07528, Korea
TEL. 82-2-3660-9630 FAX. 82-2-3664-0475

● Taipei FA Center

SETSUYO ENTERPRISE CO., LTD.
3F, No.105, Wugong 3rd Road, Wugu District, New Taipei City 24889, Taiwan
TEL. 886-2-2299-9917 FAX. 886-2-2299-9963

● Taichung FA Center

MITSUBISHI ELECTRIC TAIWAN CO.,LTD.
No.8-1, Industrial 16th Road, Taichung Industrial Park, Taichung City 40768 Taiwan
TEL. 886-4-2359-0688 FAX. 886-4-2359-0689

● Thailand FA Center

MITSUBISHI ELECTRIC FACTORY AUTOMATION (THAILAND) CO., LTD.
12th Floor, SV.City Building, Office Tower 1, No. 896/19 and 20 Rama 3 Road, Kwaeng Bangpongpan, Khet Yannawa, Bangkok 10120, Thailand
TEL. 66-2682-6522 to 31 FAX. 66-2682-6020

● ASEAN FA Center

MITSUBISHI ELECTRIC ASIA PTE. LTD.
307, Alexandra Road, Mitsubishi Electric Building, Singapore 159943
TEL. 65-6470-2480 FAX. 65-6476-7439

● Indonesia FA Center

PT. MITSUBISHI ELECTRIC INDONESIA Cikarang Office
Jl. Kenari Raya Blok G2-07A Delta Silicon 5, Lippo Cikarang - Bekasi 17550, Indonesia
TEL. 62-21-2961-7797 FAX. 62-21-2961-7794

● Hanoi FA Center

MITSUBISHI ELECTRIC VIETNAM COMPANY LIMITED Hanoi Branch Office
6th Floor, Detech Tower, 8 Ton That Thuyet Street, My Dinh 2 Ward, Nam Tu Liem District, Hanoi, Vietnam
TEL. 84-4-3937-8075 FAX. 84-4-3937-8076

● Ho Chi Minh FA Center

MITSUBISHI ELECTRIC VIETNAM COMPANY LIMITED
Unit 01-04, 10th Floor, Vincom Center, 72 Le Thanh Ton Street, District 1, Ho Chi Minh City, Vietnam
TEL. 84-8-3910-5945 FAX. 84-8-3910-5947

● India Pune FA Center

MITSUBISHI ELECTRIC INDIA PVT. LTD. Pune Branch
Emerald House, EL -3, J Block, M.I.D.C Bhosari, Pune - 411026, Maharashtra, India
TEL. 91-20-2710-2000 FAX. 91-20-2710-2100

● India Gurgaon FA Center

MITSUBISHI ELECTRIC INDIA PVT. LTD. Gurgaon Head Office
2nd Floor, Tower A & B, Cyber Greens, DLF Cyber City, DLF Phase - III, Gurgaon - 122002 Haryana, India
TEL. 91-124-463-0300 FAX. 91-124-463-0399

● India Bangalore FA Center

MITSUBISHI ELECTRIC INDIA PVT. LTD. Bangalore Branch
Prestige Emerald, 6th Floor, Municipal No. 2, Madras Bank Road, Bangalore - 560001, Karnataka, India
TEL. 91-80-4020-1600 FAX. 91-80-4020-1699

● India Chennai FA Center

MITSUBISHI ELECTRIC INDIA PVT. LTD. Chennai Branch
Citilights Corporate Centre No.1, Vivekananda Road, Sririvasa Nagar, Chetpet, Chennai - 600031, Tamil Nadu, India
TEL. 91-4445548772 FAX. 91-4445548773

● India Ahmedabad FA Center

MITSUBISHI ELECTRIC INDIA PVT. LTD. Ahmedabad Branch
B/4, 3rd Floor, SAFAL Profitaire, Corporate Road, Prahaladnagar, Satellite, Ahmedabad - 380015, Gujarat, India
TEL. 91-7965120063

● North America FA Center

MITSUBISHI ELECTRIC AUTOMATION, INC.
500 Corporate Woods Parkway, Vernon Hills, IL 60061, U.S.A.
TEL. 1-847-478-2334 FAX. 1-847-478-2253

● Mexico FA Center

MITSUBISHI ELECTRIC AUTOMATION, INC. Queretaro Office
Parque Tecnológico Innovacion Queretaro Lateral Carretera Estatal 431, Km 2 200, Lote 91 Modulos 1 y 2 Hacienda la Machorra, CP 76246, El Marques, Queretaro, Mexico
TEL. 52-442-153-6014

● Mexico Monterrey FA Center

MITSUBISHI ELECTRIC AUTOMATION, INC. Monterrey Office
Plaza Mirage, Av. Gonzalitos 460 Sur, Local 28, Col. San Jeronimo, Monterrey, Nuevo Leon, C.P. 64640, Mexico
TEL. 52-55-3067-7521

● Mexico City FA Center

MITSUBISHI ELECTRIC AUTOMATION, INC. Mexico Branch
Mariano Escobedo #69, Col.Zona Industrial, Tlalhepanlta Edo. Mexico, C.P.54030
TEL. 52-55-3067-7511

● Brazil FA Center

MITSUBISHI ELECTRIC DO BRASIL COMERCIO E SERVICOS LTDA.
Avenida Adelino Cardana, 293, 21 andar, Bethaville, Barueri SP, Brazil
TEL. 55-11-4689-3000 FAX. 55-11-4689-3016

● Brazil Votorantim FA Center

MELCO CNC DO BRASIL COMERCIO E SERVICOS S.A.
Avenida Gisele Constantino,1578, Parque Bela Vista - Votorantim-SP, Brazil
TEL. 55-15-3023-9000 FAX. 55-15-3363-9911

● Europe FA Center

MITSUBISHI ELECTRIC EUROPE B.V. Polish Branch
ul. Krakowska 50, 32-083 Balice, Poland
TEL. 48-12-347-65-81

● Germany FA Center

MITSUBISHI ELECTRIC EUROPE B.V. German Branch
Mitsubishi-Electric-Platz 1, 40882 Ratingen, Germany
TEL. 49-2102-486-0 FAX. 49-2102-486-1120

● UK FA Center

MITSUBISHI ELECTRIC EUROPE B.V. UK Branch
Travellers Lane, Hatfield, Hertfordshire, AL10 8XB, UK.
TEL. 44-1707-28-8780 FAX. 44-1707-27-8695

● Czech Republic FA Center

MITSUBISHI ELECTRIC EUROPE B.V. Czech Branch
Pekarska 621/7, 155 00 Praha 5, Czech Republic
TEL. 420-255 719 200

● Italy FA Center

MITSUBISHI ELECTRIC EUROPE B.V. Italian Branch
Centro Direzionale Colleoni - Palazzo Sirio, Viale Colleoni 7, 20864 Agrate Brianza (MB), Italy
TEL. 39-039-60531 FAX. 39-039-6053-312

● Russia FA Center

MITSUBISHI ELECTRIC (Russia) LLC St. Petersburg Branch
Piskarevsky pr. 2, bld 2, lit "Sch", BC "Benua", office 720; 195027, St. Petersburg, Russia
TEL. 7-812-633-3497 FAX. 7-812-633-3499

● Turkey FA Center

MITSUBISHI ELECTRIC TURKEY A.S. Umraniye Branch
Serifali Mahallesi Nutuk Sokak No:5, TR-34775 Umraniye / Istanbul, Turkey
TEL. 90-216-526-3990 FAX. 90-216-526-3995

Mitsubishi Electric FA products

Roll to roll application

Coater/laminator

Mitsubishi Electric offers a line-up of optimum products for each manufacturing process.

When the inverter is used along with other suitable Mitsubishi products, efficient and highly reliable control can be performed for more large-scale facilities.

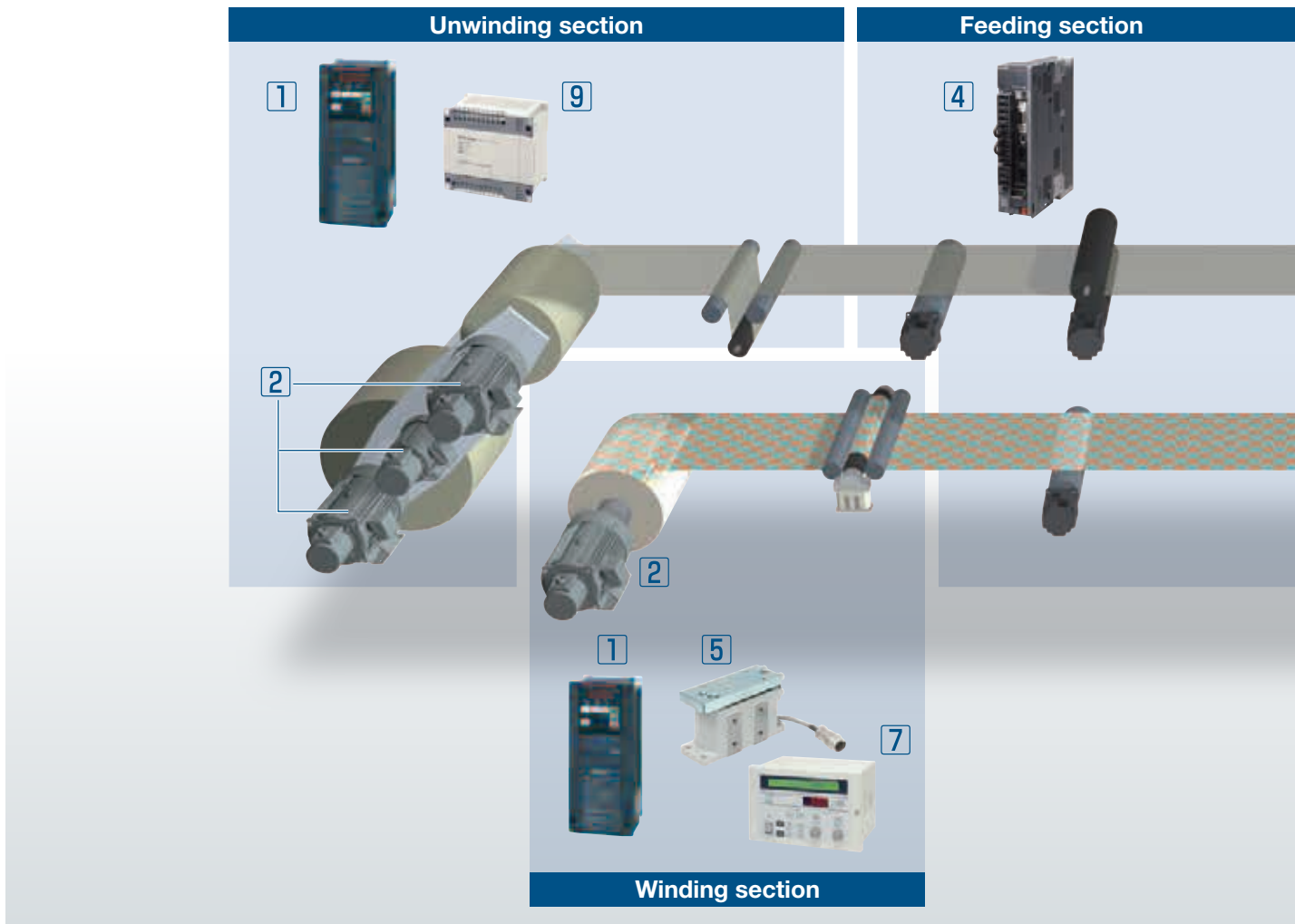

Unwinding section

The unwinding shaft rotation speed is controlled to keep the dancer roll position constant, by which in turn a constant film tension is maintained. Also, the unwinding shaft can be changed without stopping the line.

Feeding section

The feeding section feeds the workpiece at a constant speed using feedback from the tension sensor.

Reference shaft

The reference shaft determines the line speed from the measured value of the dancer roll position. It also sends commands to each section.

Accumulator

By installing the accumulator in the processing line, the reserve portion of the material can be temporarily accumulated, and the roll on the winding shaft can be replaced without stopping the unwinding shaft.

Winding section

High precision torque control is enabled by using feedback from the tension sensor. Tension change due to mechanical loss can be prevented. Even if the film feed speed increases or decreases, the tension applied to the film is maintained constant. By adjusting the tension on the workpiece, it is possible to avoid imperfections such as wrinkles or deformation caused by the increase in winding diameter.

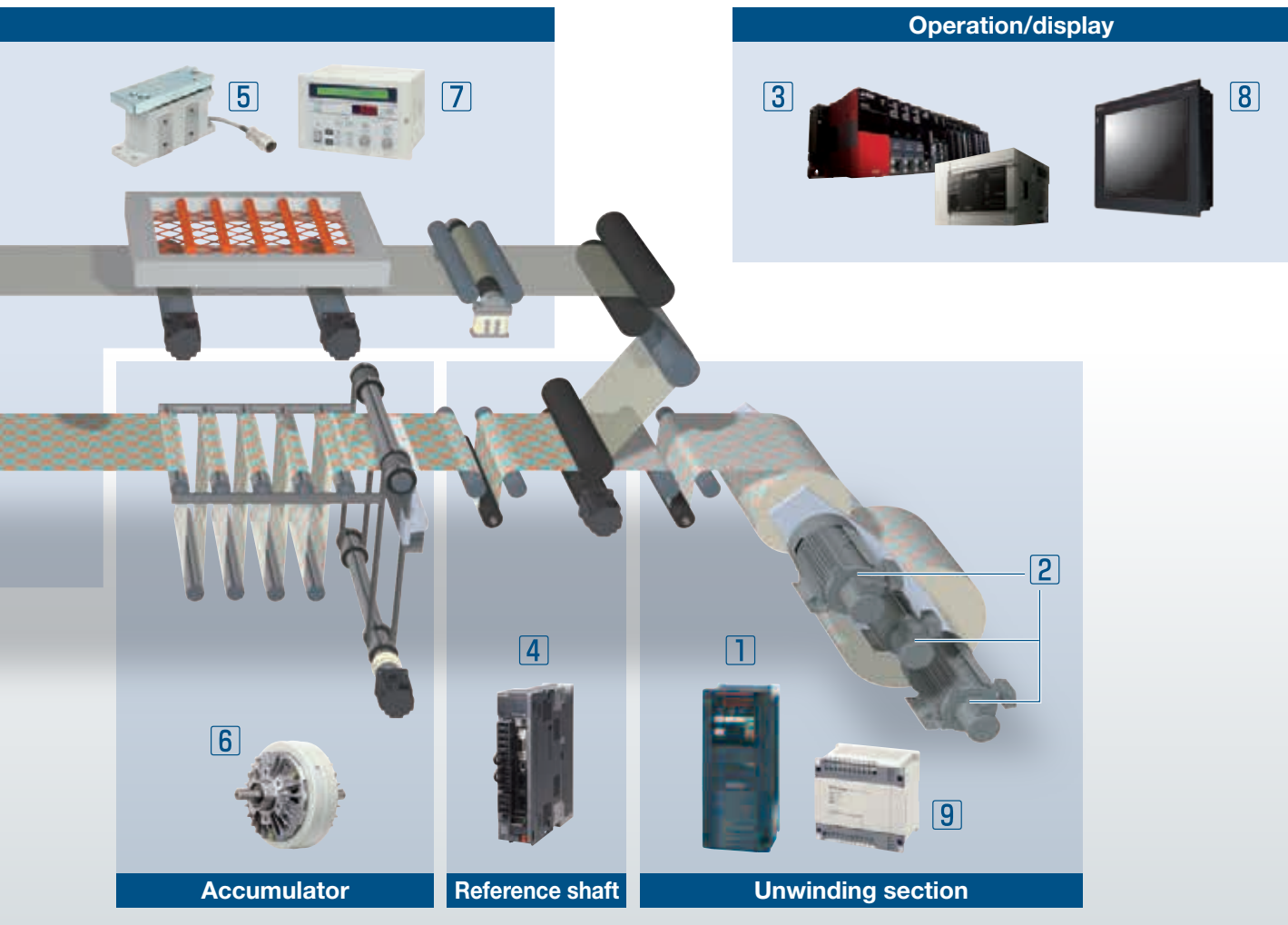

1 Inverter

2 Motor with encoder

The rotation speed of the motor with encoder can be changed easily and flexibly by the inverter according to the commands sent from a programmable controller or the winding diameter calculation unit.

3 Programmable controller

The programmable controller is used for administration of the winding/unwinding control of the material, data collection, inverter operation command transmission, parameter change, and other operations.

4 AC servo

The torque/speed control function of the AC servo enables stable line speed control.

5 Tension detector

The tension detector is used with the full-automatic tension controller or a tension meter to calculate the tension signal.

6 Powder clutch

Torque is controlled for unwinding the material according to the tension controller output.

7 Tension controller

Using the material tension measured by the tension detector, a constant tension is kept for winding by automatic control.

8 Human-machine interface (HMI)

The HMI units are used to operate the connected devices, visualize the line condition, or indicate the faults.

9 Winding diameter calculation unit

Highly accurate winding diameter calculation is performed, which enables the control of the taper tension or the slip rotation speed of the powder clutch.

YOUR SOLUTION PARTNER

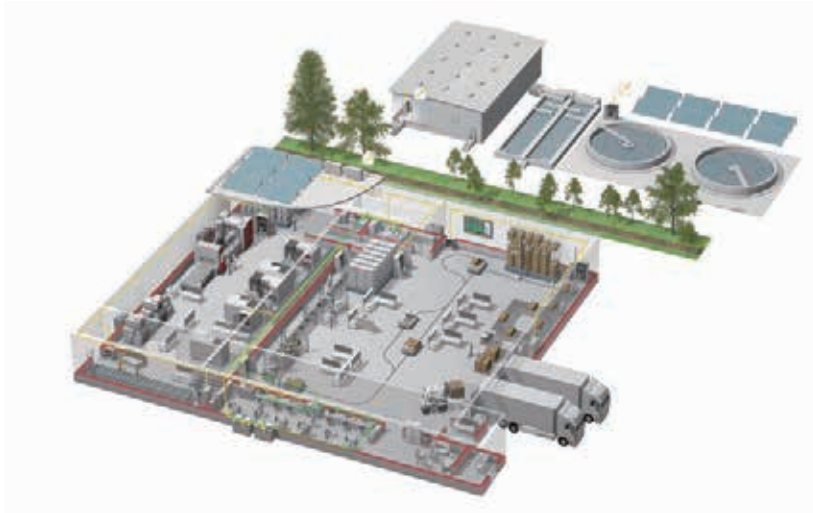

Mitsubishi Electric offers a wide range of automation equipment from PLCs and HMIs to CNC and EDM machines.

A NAME TO TRUST

Since its beginnings in 1870, some 45 companies use the Mitsubishi name, covering a spectrum of finance, commerce and industry.

The Mitsubishi brand name is recognized around the world as a symbol of premium quality.

Mitsubishi Electric Corporation is active in space development, transportation, semi-conductors, energy systems, communications and information processing, audio visual equipment and home electronics, building and energy management and automation systems, and has 237 factories and laboratories worldwide in over 121 countries.

This is why you can rely on Mitsubishi Electric automation solution - because we know first hand about the need for reliable, efficient, easy-to-use automation and control in our own factories.

As one of the world's leading companies with a global turnover of over 4 trillion Yen (over \$40 billion), employing over 100,000 people, Mitsubishi Electric has the resource and the commitment to deliver the ultimate in service and support as well as the best products.



Low voltage: MCCB, MCB, ACB



Medium voltage: VCB, VCC



Power monitoring, energy management



Compact and Modular Controllers



Inverters, Servos and Motors



Visualisation: HMIs



Numerical Control (NC)



Robots: SCARA, Articulated arm



Processing machines: EDM, Lasers, IDS



Transformers, Air conditioning, Photovoltaic systems

* Not all products are available in all countries.

mitsubishi electric corporation

HEAD OFFICE: TOKYO BLDG., 2-7-3, MARUNOUCHI, CHIYODA-KU, TOKYO 100-8310, JAPAN
