



MITSUBISHI
TRANSISTORIZED INVERTER

– INSTRUCTION MANUAL –

DeviceNet[™]
CONFORMANCE TESTED

FR-E5ND

Thank you for choosing the Mitsubishi transistorized inverter option unit.

This instruction manual gives handling information and precautions for use of this product. Incorrect handling might cause an unexpected fault. Before using the equipment, please read this manual carefully to use it to its optimum.

Please forward this manual to the end user.

This instruction manual uses the International System of Units (SI). The measuring units in the yard and pound system are indicated in parentheses as reference values.

DeviceNet™ is the registered trademark of Open DeviceNet Vender Association, Inc.

No part of this manual may be copied or reproduced without the permission of Mitsubishi Electric Corporation.

Other company and product names herein are the trademarks or registered trademarks of their respective owners.

Safety Instructions

Do not attempt to install, operate, maintain or inspect this product until you have read through this instruction manual and appended documents carefully and can use the equipment correctly. Do not use this product until you have a full knowledge of the equipment, safety information and instructions.

In this manual, the safety instruction levels are classified into "WARNING" and "CAUTION".



WARNING

Denotes that incorrect handling may cause hazardous conditions, resulting in death or severe injury.



CAUTION

Denotes that incorrect handling may cause hazardous conditions, resulting in medium or slight injury, or may cause physical damage only.

Note that even the CAUTION level may lead to a serious consequence under some circumstances. Please follow the instructions of both levels as they are important to personnel safety.

SAFETY INSTRUCTIONS

1. Electric Shock Prevention



WARNING

- While power is on or when the inverter is running, do not open the front cover. You may get an electric shock.
- Do not run the inverter with the front cover removed. Otherwise, you may access the exposed high-voltage terminals and charging part and get an electric shock.
- If power is off, do not remove the front cover except for wiring or periodic inspection. You may access the charged inverter circuits and get an electric shock.
- Before starting wiring or inspection, switch power off, wait for more than 10 minutes, and check for no residual voltage with a meter etc.
- Any person who is involved in the wiring or inspection of this equipment should be fully competent to do the work.
- Always install the option unit before wiring. Otherwise, you may get an electric shock or be injured.
- Operate the switches with dry hands to prevent an electric shock.
- Do not subject the cables to scratches, excessive stress, heavy loads or pinching. Otherwise, you may get an electric shock.
- While power is on, do not move the node address setting switches. Doing so can cause an electric shock.

2. Injury Prevention



CAUTION

- Apply only the voltage specified in the instruction manual to each terminal to prevent damage, etc.
- Ensure that the cables are connected to the correct terminals. Otherwise, damage, etc. may occur.
- Always make sure that polarity is correct to prevent damage, etc.
- While power is on or for some time after power-off, do not touch the inverter as it is hot and you may get burnt.

3. Additional instructions

Also note the following points to prevent an accidental failure, injury, electric shock, etc.:

(1) Transportation and installation

 **CAUTION**

- Do not install or operate the option unit if it is damaged or has parts missing.
- Do not stand or rest heavy objects on the product.
- Check that the mounting orientation is correct.
- Prevent screws, metal fragments, conductive bodies or oil, other flammable substance from entering the inverter.

(2) Test operation and adjustment

 **CAUTION**

- Before starting operation, confirm and adjust the parameters. A failure to do so may cause some machines to make unexpected motions.

(3) Usage

 **WARNING**

- Do not modify the equipment.

 **CAUTION**

- When parameter clear or all parameter clear is performed, each parameter returns to the factory setting. Re-set the required parameters before starting operation.
- For prevention of damage due to static electricity, touch nearby metal before touching this product to eliminate static electricity from your body.

(4) Maintenance, inspection and parts replacement

 **CAUTION**

- Do not test the equipment with a megger (measure insulation resistance).

(5) Disposal

 **CAUTION**

- Dispose of this product as general industrial waste.

(6) General instruction

All illustrations given in this manual may have been drawn with covers or safety guards removed to provide in-depth description. Before starting operation of the product, always return the covers and guards into original positions as specified and operate the equipment in accordance with the manual.

CONTENTS

1 PRE-OPERATION INSTRUCTIONS	1
1.1 Unpacking and Product Confirmation	1
1.2 Packing Confirmation	1
1.3 Structure	2
1.4 General Introduction	3
1.4.1 General.....	3
1.4.2 Description.....	3
2 INSTALLATION	4
2.1 Pre-Installation Checks	4
2.2 Installation Procedure	5
2.3 Pre Network Connection Procedure.....	10
2.4 Connection to Network.....	12
2.5 LED Status Indicator	13
3 GETTING STARTED	15
3.1 Changing Node Addresses	15
3.2 Introduction	16
3.2.1 General description.....	16
3.3 Basic Configuration.....	17
3.3.1 Setting the baud rate	17
3.3.2 DeviceNet I/O assembly	18
3.4 Loss of Communications.....	18

4 OPERATION	20
--------------------	-----------

4.1 Operation Modes	20
4.1.1 PU operation mode.....	20
4.1.2 External operation mode.....	20
4.1.3 DeviceNet operation mode	20
4.2 Operation Mode Selection	21
4.3 Functions Available in Operation Modes.....	22
4.4 Input from DeviceNet to Inverter	23
4.4.1 Control input commands.....	23
4.4.2 Output frequency setting.....	23
4.4.3 Inverter reset	23
4.4.4 Parameter writing.....	23
4.5 Output from Inverter to DeviceNet	24
4.5.1 Inverter status.....	24
4.5.2 Inverter monitoring.....	24
4.5.3 Parameter read.....	25
4.6 Operation on Alarm Occurrence	25
4.7 Inverter Reset	26
4.8 Setting Frequency (f) Value	26
4.9 Parameter Clear (Pr Clr) Commands.....	26
4.10 Control Input Commands	26

5 FR-E5ND SPECIFIC PARAMETERS	27
--------------------------------------	-----------

5.1 Pr. 345 to Pr. 348.....	27
5.2 Other Option-Specific Parameters	30

6.1 Class 0x01 - Identity Object	31
6.1.1 Class 0x01 Attributes - Instance 0	31
6.1.2 Class 0x01 Services - Instance 0.....	31
6.1.3 Class 0x01 Instance Attributes - Instance 1	32
6.1.4 Class 0x01 Instance Services - Instance 1	32
6.2 Class 0x03 - DeviceNet Object	33
6.2.1 Class 0x03 Attributes - Instance 0	33
6.2.2 Class 0x03 Services - Instance 0.....	33
6.2.3 Class 0x03 Instance Attributes - Instance 1	33
6.2.4 Class 0x03 Instance Services - Instance 1	33
6.3 Class 0x04 - Assembly Object	34
6.3.1 Class 0x04 - Output Instance 20.....	34
6.3.2 Class 0x04 - Output Instance 21 (Default)	34
6.3.3 Class 0x04 - Output Instance 126.....	35
6.3.4 Class 0x04 - Output Instance 100.....	37
6.3.5 Class 0x04 - Input Instance 70	39
6.3.6 Class 0x04 - Input Instance 71 (Default).....	39
6.3.7 Class 0x04 - Input Instance 176.....	40
6.3.8 Class 0x04 - Input Instance 150.....	41
6.4 Class 0x05 - DeviceNet Connection Object	42
6.4.1 Class 0x05 Attributes - Instance 0	42
6.4.2 Class 0x05 Services - Instance 0.....	42
6.4.3 Class 0x05 Instance Attributes Instance 1 - Explicit Messaging.....	42
6.4.4 Class 0x05 Instance Attributes Instance 2 - Polled I/O	43
6.4.5 Class 0x05 Instance Attributes Instance 3 - Explicit messaging.....	44

6.4.6 Class 0x05 Instance Attributes Instance 4 - Explicit Messaging.....	45
6.4.7 Class 0x05 Instance Attributes Instance 5 - Explicit Messaging.....	46
6.4.8 Class 0x05 Instance Attributes Instance 6 - Explicit Messaging.....	47
6.4.9 Class 0x05 Instance Services - Instances 1, 2, 3, 4, 5, 6.....	47
6.5 Class 0x28 - Motor Data Object.....	48
6.5.1 Class 0x28 Attributes - Instance 0.....	48
6.5.2 Class 0x28 Services - Instance 0.....	48
6.5.3 Class 0x28 Instance Attributes Instance 1.....	48
6.5.4 Class 0x28 Instance Services.....	48
6.6 Class 0x29 - Control Supervisor Object.....	49
6.6.1 Class 0x29 Attributes - Instance 0.....	49
6.6.2 Class 0x29 Services.....	49
6.6.3 Class 0x29 Instance Attributes Instance 1.....	49
6.6.4 Class 0x29 Instance Services.....	50
6.7 Class 0x2A - AC Drive Object.....	51
6.7.1 Class 0x2A Attributes - Instance 0.....	51
6.7.2 Class 0x2A Services.....	51
6.7.3 Class 0x2A Instance Attributes Instance 1.....	51
6.7.4 Class 0x2A Instance Services.....	54
6.8 Class 0x66 - E500 Extended Object 1.....	55
6.8.1 Class 0x66 Attributes - Instance 0.....	55
6.8.2 Class 0x66 Services.....	55
6.8.3 Class 0x66 Instance Attributes Instance 1.....	55
6.8.4 Class 0x66 Instance Services.....	60
6.9 Class 0x67 - FR-E500 Extended Object II.....	60
6.9.1 Class 0x67 Attributes - Instance 0.....	60
6.9.2 Class 0x67 Services.....	60

6.9.3 Class 0x67 Instance Attributes Instance 1	61
6.9.4 Class 0x67 Instance Services	62
6.10 Response Timing	62
6.11 Recommendation For Software Developers	63

7 E500 PARAMETERS	64
--------------------------	-----------

8 TROUBLESHOOTING	71
--------------------------	-----------

8.1 Inspecting the Display on Parameter Unit and Status LED on the FR-E5ND	71
--	----

9 SPECIFICATIONS	72
-------------------------	-----------

APPENDIX 1 ELECTRONIC DATA SHEET	73
---	-----------

1 PRE-OPERATION INSTRUCTIONS

1.1 Unpacking and Product Confirmation

Take the option unit out of the package, check the unit name, and confirm that the product is as you ordered and intact.

1.2 Packing Confirmation

Make sure that the package includes the following accessories:

- Instruction manual..... 1
- Mounting screws M3 × 6.....2
- Seal..... 1

1.3 Structure

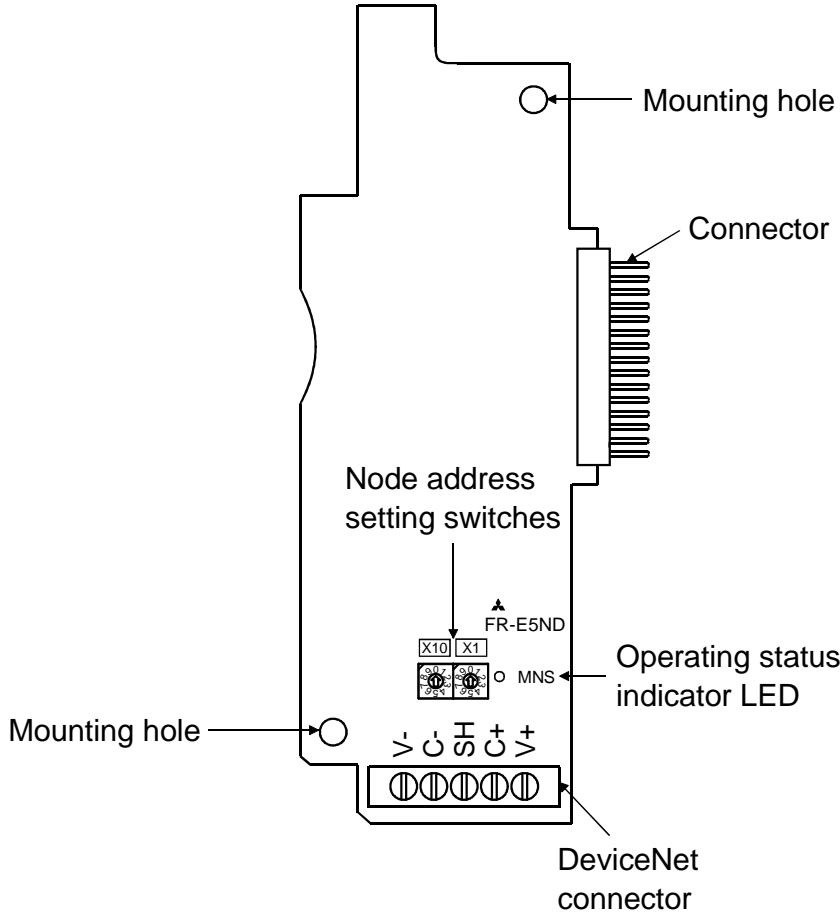

(1) Names and functions

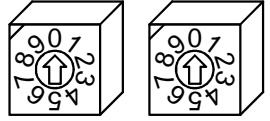
Name	Function
Node address setting switches  SW1(x10) SW2(x1)	Used to set the inverter node address between 0 and 63. For details, refer to page 10, 18.
Operating status indicator LED	The operating status indicator LED is a 2 color (Red and Green) LED. For details on the operating status please refer to page 13 which details the system state and corresponding LED status.

1.4 General Introduction

1.4.1 General

The purpose of this manual is to provide general information, installation, and operation procedures for the FR-E5ND DeviceNet option, used with the FR-E520S-EC/CH and the FR-E540 (all versions) series inverters.

Read this manual completely before installing, operating or servicing the option unit.

This manual is intended for use by qualified personnel.

Installation should only be performed by qualified personnel. You must be able to operate and program serial devices to use the equipment.

This option allows the inverter to be connected to a network adhering to the DeviceNet communications protocol.

Illustrations provided in this manual may have covers or safety guards re-moved to provide a clear view. Before starting operation of the product be sure to install covers and guards into the original position.

The following is a list of important features of the option unit

- Data Rates of 125K baud, 250K baud, and 500K baud
- Up to 64 stations supported on a single network
- Ability to add or remove stations without disrupting network operation.
- Network access to all inverter parameters, Start/Stop commands, and monitor data.

1.4.2 Description

The FR-E5ND option unit consists of a single circuit board as shown on page 2.

The option unit is mounted into the option slot of the inverter. Two station switches allow the assigning of station numbers from 0 to 63 (SW1 and SW2). An LED status light mounted next to the DeviceNet connector provides status information on the communication link.

2 INSTALLATION

INSTALLATION

Installation requires the removal of the inverter cover. The inverter top cover must be removed to install the option unit. After installation, the top cover should be reinstalled and connection to the DeviceNet bus is completed through a connector accessible through the lower connector port on the inverter unit.

 WARNING
⚠ Cover removal can expose charged components. Be sure the proper procedures are followed when removing the cover.

Remove cover following the procedure in the inverter manual.

2.1 Pre-Installation Checks

Verify that the following included components are supplied	<ol style="list-style-type: none">1. FR-E5ND option unit2. Two mounting screws M3 × 63. Instruction manual
Verify the inverter type	This option unit is designed to work with the FR-E520S-EC/CH series and FR-E540 (all versions) series inverters. Do not attempt to use this option unit with any other inverter models. These models use a different connector and if the user forces the connector the inverter may be damaged.
Ensure that the inverter input power is turned off	The inverter and/or the option unit may be damaged if installed with power on. The inverter performs an initialization procedure at power on which includes checking the option port. Adding the option later will cause a hardware conflict, resulting in an option error. Also, this may damage the inverter or the option unit.

2.2 Installation Procedure

Mounting Option Unit In Inverter Option Slot.

1. Verify that power has been turned off and that the inverter top cover has been removed.
2. Using the two mounting holes for alignment reference, carefully insert the option unit connector into the inverter connector and firmly push the unit into place.

Note: If screw holes in option unit do not line up with the inverter mounting holes, check that the connector has been correctly fitted.

3. Secure the option unit to the inverter with the two mounting screws.
4. The option unit is now mechanically installed.

DeviceNet communication signal wiring

Terminal block layout

The terminal layout of the FR-E5ND's DeviceNet communication signals is as shown below.

Terminal screw size: M2.5

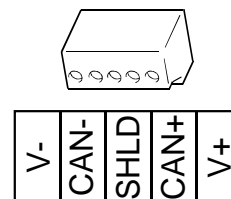

Constructing DeviceNet Drop Cable

A DeviceNet drop cable (see the following diagram) is used to connect the FR-E5ND option unit to the DeviceNet network. The drop cable consists of an ODVA approved “Thin” cable as well as an ODVA approved 5-pin connector that mates with the FR-E5ND DeviceNet option connector. Another connector compatible with the network trunk cable must also be selected by the user/installer.

Note: Only “Thin” type cable should be used.

Recommended part is:

DeviceNet Thin Cable: Belden part number 3082A or equivalent.

5-Pin Connector for FR-E5ND: Phoenix Contact part number MVSTBW2.5/5-ST-5.08-AU.

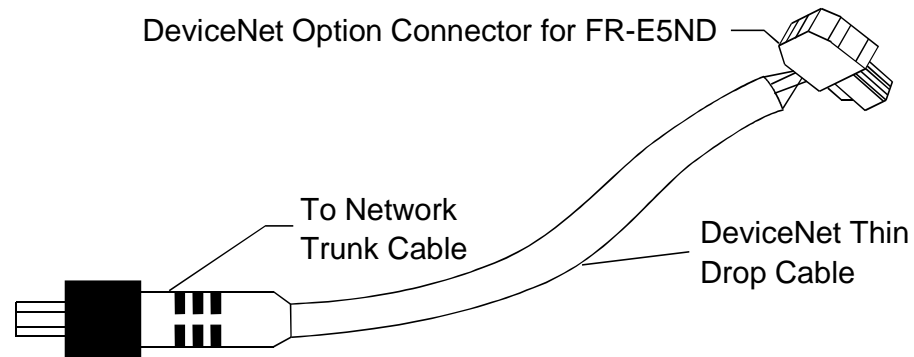

- 1) Strip off the drop cable sheath about 38mm and remove the shield net. In addition to the signal and power wires, there is one drain wire made by twisting the shield net.

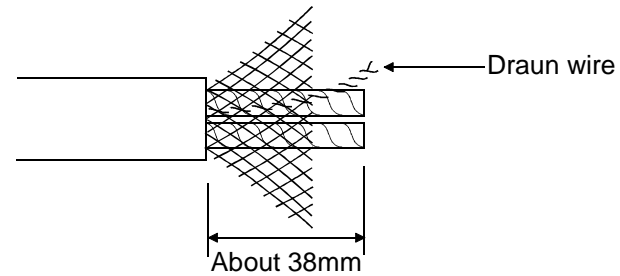

- 2) Peel off the aluminum tapes which wraps the signal and power wires and strip the insulations about 6mm.

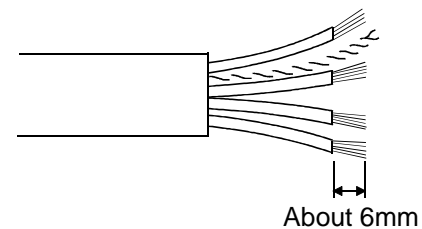
**REMARKS**

To prevent the cable from being disconnected, terminate the cable gently.

- 3) Connect the drop cable to the DeviceNet connector of the option unit as described below.
- (a) Insert a flat-blade screwdriver (max. width 3.75mm) into the upper hole of the connector plug and open the clamp in the lower hole to allow the wire to be inserted.
 - (b) When connecting the DeviceNet drop cable, insert the signal, wire and drain wires into the corresponding connector holes and tighten the fastening screws to the corresponding torques. Also, make sure that the colors of the wires are as indicated in the table on the next page.

Recommended tightening torque: 0.22N·m to 0.25N·m

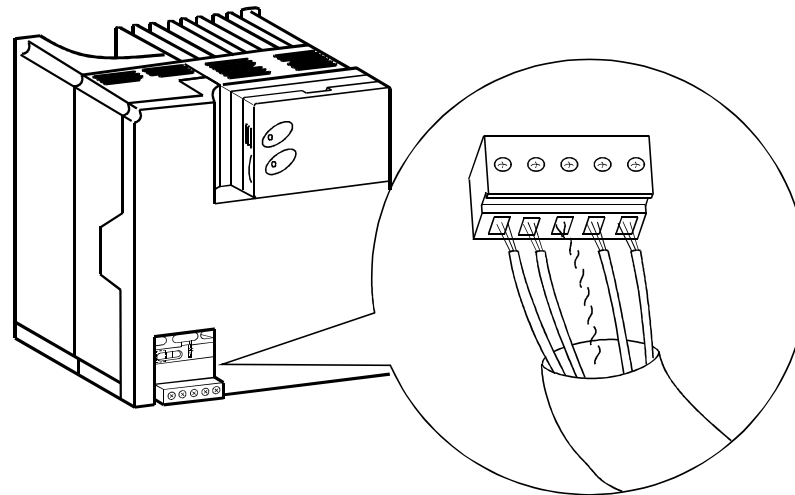

The DeviceNet option connector pin out connections are shown in the below diagram. Refer to the following table for the pin functions.

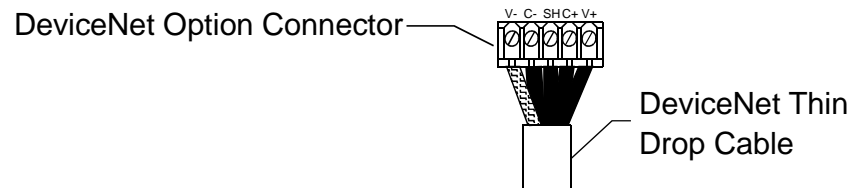

Pin No.	Terminal name	Color	Name	Signal Type
1	V-	Black	V-	Power cable negative end (V-)
2	C-	Blue	CAN-	Communication data low side (CAN L)
3	SH	Bare	SHLD	Drain
4	C+	White	CAN+	Communication data high side (CAN H)
5	V+	Red	V+	Power cable positive end (V+)

DeviceNet has a voltage specification of 24VDC for communication and an input voltage specification of 11VDC to 25VDC for communication to each device. A 5V drop in the system is stipulated for each power supply wire (V+, V-).

2.3 Pre Network Connection Procedure

Note: Each Device on the network must be assigned a unique station number between the values of 0 to 63

1. Set the two node address setting switches (refer to page 2) for a address between 0 and 63. Any number out of the range of 0 to 63 is automatically changed to 63 by the option unit software.

Setting method

- Set the arrows (↑) of the corresponding switches to the required node address.

Example:

- For node address 1: Set (↑) of ×10 to "0" and (↑) of ×1 to "1".
- For node address 26: Set (↑) of ×10 to "2" and (↑) of ×1 to "6".

Node address
setting switches



SW1(×10) SW2(×1)

2. Be sure that the FR-E5ND option unit is correctly inserted into the inverter and the option unit connector is fully and firmly in position before proceeding.
3. Remove the option data port insert (see the following diagram) from the inverter cover.
4. Reinstall the inverter cover making sure that option data port opening is aligned with the DeviceNet connector.

5. Connect the DeviceNet thin drop cable to the inverter by inserting the 5-pin connector through the data port opening, into the DeviceNet standard socket on the option unit.

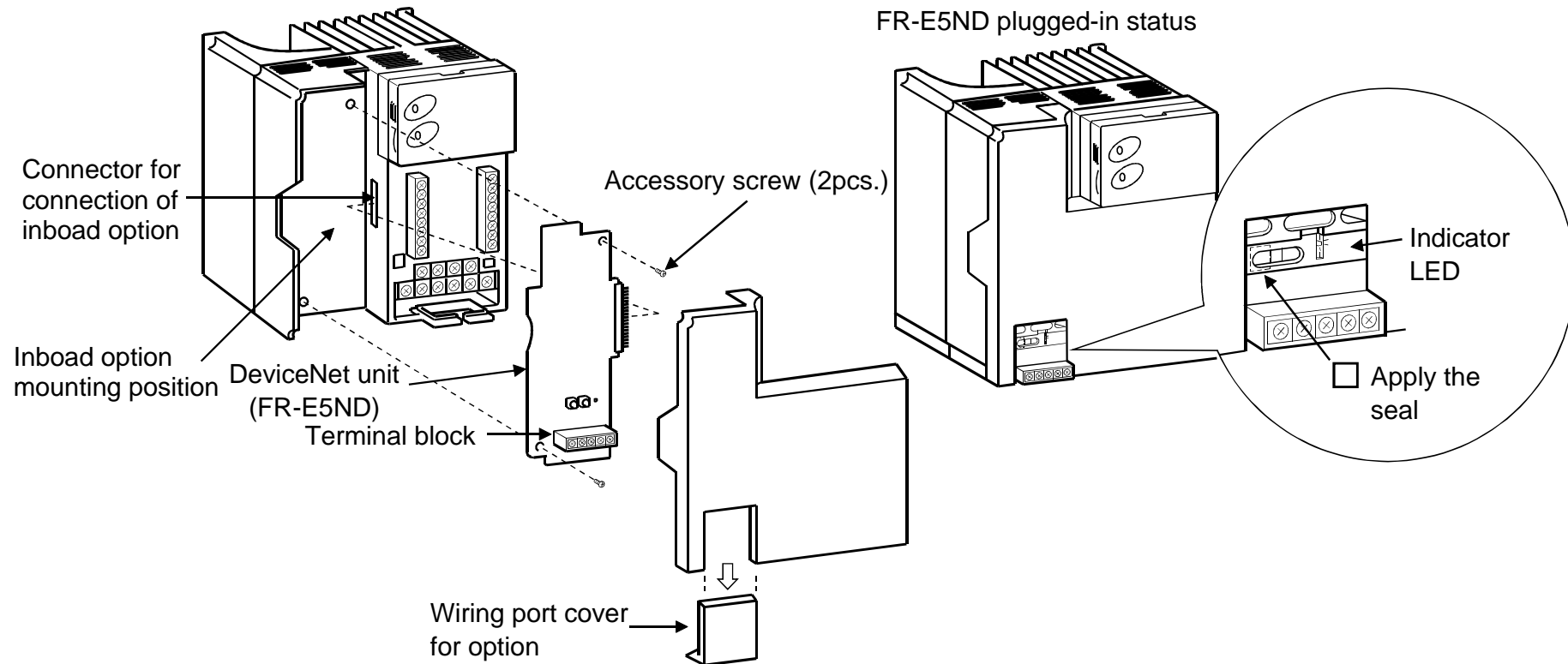

REMARKS

- If any other node has the same address, a serious link error will occur (red lamp is lit). (Refer to page 13)
- If the same node address is found in the network configuration, you can make setting via the network using DeviceNet, Class 0x03 - Instance 1 - Attribute 1. (Refer to page 33)

2.4 Connection to Network

At this point the option unit should be installed in the inverter, the node address setting switches properly set, the cable constructed and the connector connected to the option unit through the option data port.

! CAUTION

! Do not connect cable to the network until told to do so.

1. Check that the inverter power is off.
2. Make sure that a terminating resistor is installed across each end (CAN(+) and CAN(-)) of the trunk cable, as shown in the following diagram.

These resistors must meet the following requirements:

- a) $R = 121\Omega$
- b) 1 % metal film
- c) 0.25W

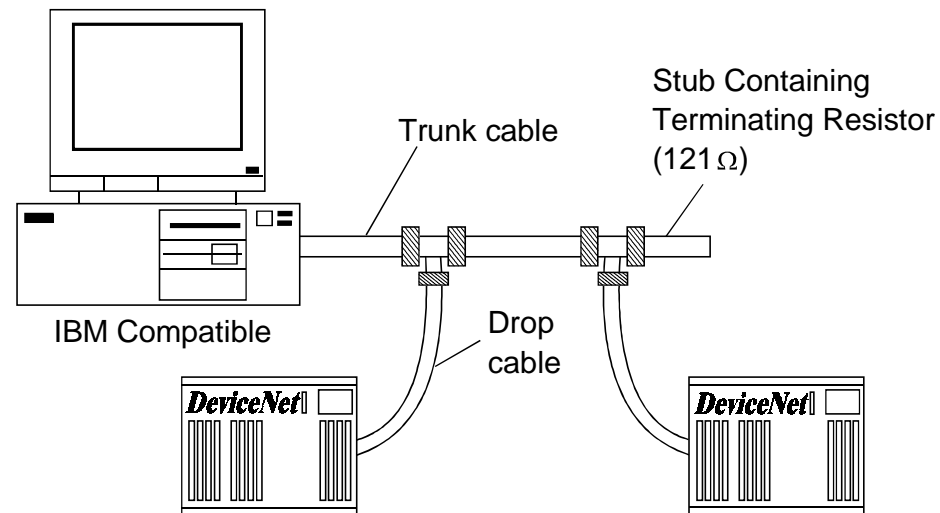

Connection to a DeviceNet network

3. Connect the cable to the network as follows:
 - a) If the trunk connector is a DeviceNet sanctioned pluggable or sealed connector, the connection to the active network can be made at any time whether inverter is on or off. The option unit automatically detects when the connection is completed.
 - b) If connecting to the network with free wires, power to the network and inverter should be shut off as a safety precaution in case two or more signal wires are accidentally shorted together.
4. Check that all connections are completed and all necessary wires not associated with DeviceNet are connected to the inverter unit as needed.
5. It is now safe to apply power to the inverter and run it in the PU or external mode.

2.5 LED Status Indicator

The LED Status indicator labeled LED (refer to page 1) provides information on the status of operation as shown in the following table. The indicator has five states, Off, Blinking Green, Steady Green, Blinking Red, and Steady Red. After connecting the drop cable to the trunk of the active network, observe the condition of the Status LED. The option unit uses the Combined Module/Network status LED scheme described in the DeviceNet communications standard.

Status LED Condition	State of System	Note
Off	Inverter Power off Network Power on	Turn inverter power on. The option unit will then complete duplicate node address test.
	Power on the inverter when network Power is off.	Turn network power on. The option unit will then complete duplicate node address test.
Blinking Green	Network and inverter power on Connection not yet established by master	Though the option unit power is on and it has been confirmed that there is no same node address, the master has not yet established a communication link.
Steady Green	Network and inverter power on Connection established by master	A master device on the Network has designated the device for communications. The LED holds this state also during communications.

Status LED Condition	State of System	Note
Blinking Red	Connection time out	The master station has selected this inverter unit for communication (LED is green). However, no response is given within the waiting time (Note) set in EPR. Check the master for disconnection from the network.
Steady Red	Critical link failure	Failed communication device: <ul style="list-style-type: none">• Duplicate station number• Network power off• Cable from option unit to network not connected or severed• Network damaged Must cycle power to recover this fault.

Note: Time limit = $4 \times \text{EPR}$ (Expected Packet Rate)
This is the EPR as set in the master controller.

3 GETTING STARTED

3.1 Changing Node Addresses

Note: The state of the address switches is sampled once at power on.

Changing the address later on will have no effect and the software will keep the number read at power on. To change the address switches follow the below procedure:

1. Turn power off.
2. Disconnect drop cable from option unit.
3. Remove inverter cover.
4. Set address switches for desired address. (SW1 is the 10 times setting, SW2 is the 1 times setting.)
5. Reinstall inverter cover.
6. Reconnect drop cable to inverter option unit.
7. Turn power on.

Note: Do not set the Node address to 64 or greater.

3.2 Introduction

This section is intended to facilitate the configuration of the FR-E5ND DeviceNet option with minimum effort. The description assumes that each value is the factory setting value. If the user wishes to change these values, the data necessary to do so is provided later in the manual.

This section assumes that network cabling is complete and DeviceNet communication has been established. The status LED on the FR-E5ND should be either blinking green or steady green as described on page 13.

3.2.1 General description

The FR-E5ND DeviceNet option unit is considered a slave device in the DeviceNet communication standard. This means that the FR-E5ND cannot initiate messages on the network. A master device must establish a connection to the option unit and then send commands, requests for information, etc.

Note: When the master station is set-up and turned on, the inverter unit may need up to 1 minute to get set to a ready for communication status. This is a situation may occur for just the DeviceNet configuration stage, so this should not be a general problem.

The FR-E5ND option unit supports Group 3 Messaging as defined in the DeviceNet standard. This feature of the FR-E5ND option unit means that it is possible for one master to control the inverter while another master is able to read data from the same inverter. This also means that the DeviceNet master must support the UCMM protocol for proper operation.

It is strongly recommended that the user configures the DeviceNet network using a software tool designed specifically for that purpose. The use of such a tool greatly simplifies the configuration, reduces confusion, and enhances accuracy. Additionally, the configuration tool will facilitate the elimination of conflicts between network devices and ensure consistency throughout the network.

One such tool is DeviceNet Manager™ as supplied by Rockwell Automation.

Tools are available from many other suppliers but the descriptions contained in the “Getting Started” section are based upon the use of DeviceNet Manager™.

When adding the FR-E5ND DeviceNet Option Unit to a FR-E520S-EC/CH or FR-E540 (all versions) series inverters that have previously been configured for a specific application, it may be necessary to complete a “Parameter All Clear” (PrClr) instruction in the inverter in order to remove unintentional conflicts and to allow the inverter to recognize the presence of the option card.

If this becomes necessary, you will need to record the existing configuration before issuing the PrClr command as this command will restore factory default values to all inverter parameters. Once the command is completed and the inverter has recognized the FR-E5ND option unit, the inverter configuration data may be re-entered either via the parameter unit or the network.

To use the DeviceNet Manager™ software, you will need to acquire the DeviceNet Electronic Data Sheet (EDS) file. The EDS file is a standard DeviceNet file which defines the configurable parameters of a field device and facilitates the network configuration softwares ability to recognize a specific field device. Please refer to the configuration software tool instruction manual for more information about the installation and use of EDS files.

Refer to page 73 for details on how to get this file.

3.3 Basic Configuration

3.3.1 Setting the baud rate

The baud rate must be consistent throughout the network in order to establish communication and allow configuration via the network. Therefore, this step is critical to the success of the FR-E5ND option units configuration.

Upon power-up, the FR-E5ND DeviceNet option unit will default to a communication speed of 125 Kbps.

You can set the baudrate via the network using DeviceNet, Class 0x03 - Instance 1 - Attribute 2. (Refer to page 33)

The baud rate may be set manually via the parameter unit by changing Pr. 346 and Pr. 348. (Refer to page 27)

The node address assigned to the FR-E5ND on page 10 will determine the default node address upon inverter power-up. If the same node address is found in the network configuration, you can make setting via the network using DeviceNet, Class 0x03 - Instance 1 - Attribute 1. (Refer to page 33)

3.3.2 DeviceNet I/O assembly

Communication between a master device and a slave device on the network requires that the DeviceNet Class 0x04 – “Assembly Object” in both devices be the same.

(1) Default I/O Assembly:

Upon power-up, the FR-E5ND option unit will default to Class 0x04 – Output Instance 21 and Class 0x04 – Input Instance 71. Refer to page 34 for further information on DeviceNet Class 0x04 and changing the desired Output and Input Instances.

(2) Polling Rate:

Determination of the proper polling rate of the DeviceNet master device is dependent upon the characteristics of the entire network. To minimize a collision and maximize system reliability, we recommend that you set the polling rate intervals to be at least 30ms. The user may, at their discretion, adjust this rate as network performance allows.

3.4 Loss of Communications

In the default polled communication mode, the FR-E5ND will respond to loss of communication based upon configuration of the EPR bits of Pr. 345 and Pr. 347 as defined on page 27. The default value of these bits is decimal 0. Such loss of polling may occur upon physical disconnection of network cabling, network power loss, failure within the master, etc.

When the EPR bits of Pr. 345 and Pr. 347 are set to decimal 0, the inverter will continue to execute the last command received until the communication time-out is reached. This time out value is equal to 4 times the Expected Packet Rate (EPR) as configured by the user (this is set in the master controller). Once the FR-E5ND times out, the inverter will generate an E.OPT error and coasts (free-run) to a stop.

When the EPR bits of Pr. 345 and Pr. 347 are set to decimal 2, the inverter will continue to execute the last command received until another command is issued. The FR-E5ND will ignore the communication loss, generate no error and automatically reset the connection when communication is restored.

4. OPERATION

Operation of the FR-E520S-EC/CH and FR-E540 (all versions) changes slightly when the FR-E5ND option is installed. These changes are described in the following paragraphs. Parameter definitions including newly created parameters, as well as operation with the FR-E5ND installed are described.

4.1 Operation Modes

4.1.1 PU operation mode

Control of the inverter is from the parameter unit (PU).

4.1.2 External operation mode

Control of the inverter is by external signals connected to the inverters control terminal block.

4.1.3 DeviceNet operation mode

Control of the inverter is via commands from a DeviceNet master. However, FR-E5ND-specific parameters (Pr. 338 and Pr. 339) can be used to select external control for forward/reverse/stop and output frequency setting.

4.2 Operation Mode Selection

The following chart describes the required actions to change the operation mode.

Mode change	Required action
External operation → PU operation	Press the MODE key on the control panel and use the UP and DOWN arrow keys to change to the PU operation mode. For further details please refer to the relevant E500 series inverter manual.
PU operation → External operation	Press the MODE key on the control panel and use the UP and DOWN arrow keys to change to the External operation mode. For further details please refer to the relevant E500 series inverter manual.
External operation → Network operation	DeviceNet connection is allocated.
Network operation → External operation	All DeviceNet connections are released.

For all other mode changes, please consult the FR-E520S-EC/CH and FR-E540 (all versions) Instruction Manual.

The following conditions must also be met before a mode change can be effected:

- Inverter is stopped
- Forward and reverse commands are off

Parameter 340 (Pr. 340) allows selection of network operation mode on power up and after an inverter reset.

4.3 Functions Available in Operation Modes

The functions of the drive depend on the mode of the inverter. The following chart indicates the available commands according to the inverter operation mode.

Control type	Command type	Operation mode		
		DeviceNet	External	PU
DeviceNet	Operation command	Yes (Note 1)	No	No
	Output freq. setting	Yes (Note 1)	No	No
	Monitor	Yes	Yes	Yes
	Parameter write	Yes (Note 3) (while stopped)	No (Note 3)	No (Note 3)
	Parameter read	Yes	Yes	Yes
	Inverter reset	Yes (Note 2)	No	No
External terminals	Operation command	Yes (Note 1)	Yes	No
	Output freq. setting	Yes (Note 1)	Yes	No
	Inverter reset	Yes	Yes	Yes

- Note: 1. Depends on value of Pr. 338 and Pr. 339
 2. The inverter cannot be reset if a communication error occurs.
 3. As set in Pr. 77

4.4 Input from DeviceNet to Inverter

4.4.1 Control input commands

FR-E5ND supports STF and STR. Some other Control Input Commands are also supported.

4.4.2 Output frequency setting

Output frequency setting is possible for the range 0 to 400 Hz in increments of 0.01 Hz.

4.4.3 Inverter reset

The inverter can be reset via DeviceNet using Identity Object reset service. Note that this reset service also performs a parameter clear, the type of which depends on the type of the Identity Object reset service. Refer to page 32, 49, 51.

4.4.4 Parameter writing

For parameter writing, all standard parameters are supported. In addition, the parameters listed in the Option-specific Parameter section of this specification are supported.

4.5 Output from Inverter to DeviceNet

4.5.1 Inverter status

Inverter status can be monitored using class 0x2A, attribute 114, the FR-E520S-EC/CH/FR-E540 inverter status. This is a bit-mapped status byte defined as follows:

Bit	Definition	
0	Running	(RUN)
1	Forward running	(FWD)
2	Reverse running	(REV)
3	Up to frequency	(SU)
4	Overload	(OL)
5	-	-
6	Frequency detection	(FU)
7	Alarm	-

4.5.2 Inverter monitoring

- Output frequency
- Output current
- Output voltage

4.5.3 Parameter read

For parameter reading all standard parameters are supported, also specific type related parameters are also supported. Some inverter parameters require configuration to be viewed via the PU. All supported parameters are fully accessible regardless of inverter configuration in such cases.

4.6 Operation on Alarm Occurrence

The following table shows the behavior of inverter and network communication operation on alarm occurrence.

Type of fault	Item	Operation mode		
		DeviceNet	EXTernal	PU
Inverter (Note 3)	Inverter operation	Stop	Stop	Stop
	Network communication	Continue	Continue	Continue
DeviceNet communication (Note 4)	Inverter operation	Stop (Note 1)	Continue	Continue
	Network communication	Continue (Note 2)	Continue (Note 2)	Continue (Note 2)

Note: 1. Inverter operation stops if the FR-E5ND signals an option error to the inverter on expiration of the Inactivity/Watchdog timer of the connection object.
 2. Depends upon the type of communication fault.
 3. Example, E.OPT
 4. Examples, blinking red LED, red LED.

Please refer to page 71, Troubleshooting in this manual and the Protective Functions section of the FR-E520S-EC/CH and FR-E540 manuals respectively for more details.

4.7 Inverter Reset

Inverter reset behavior is as explained on page 23.

4.8 Setting Frequency (f) Value

Frequency setting in RAM can be made using Class 0x2A - Instance 1 - Attributes 112, 113. (Refer to page 51.)

4.9 Parameter Clear (Pr Clr) Commands

To execute the parameter clear commands, use Class 0x2A - Instance 1 - Attributes 102 to 106.

4.10 Control Input Commands

To send any control input command, use Class 0x2A - Instance 1 - Attribute 114. For example, setting it with value 0x0002 will cause the inverter to run FWD at frequency value set in RAM.

Refer to the following bitmap tables for details:

7	6	5	4	3	2	1	0
0	0	RL	RM	RH	STF	STR	0

15	14	13	12	11	10	9	8
0	0	0	0	0	MRS	0	0

5. FR-E5ND SPECIFIC PARAMETERS

FR-E5ND SPECIFIC PARAMETERS

There are several parameters which are used only when the FR-E5ND is installed in the FR-E520S-EC/CH or FR-E540 inverter. The following sections describe these parameters.

5.1 Pr. 345 to Pr. 348

Pr. No.	Function	Setting range	Minimum increment	Default setting
345	DeviceNet Address Startup Data (Lower byte)	0 to 255	1	63 (0x3F)
346	DeviceNet Baudrate Startup Data (Lower byte)	0 to 255	1	132 (0x84)
347	DeviceNet Address Startup Data (Higher byte)	0 to 255	1	160 (0xA0)
348	DeviceNet Baudrate Startup Data (Higher byte)	0 to 255	1	80 (0x50)

The PU displays only in decimal integers. The hexadecimal integers in the parentheses are used here for easy bitmap reference only.

Pr. 345 and Pr. 347 are bit-mapped parameters. Their definition is as follows.

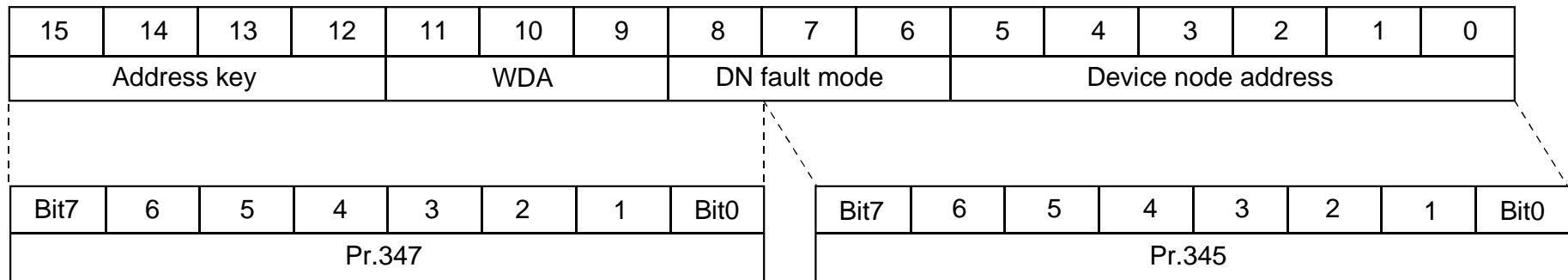

FR-E5ND SPECIFIC PARAMETERS

Pr. 346 and Pr. 348 are bit-mapped parameters. Their definition is as follows.

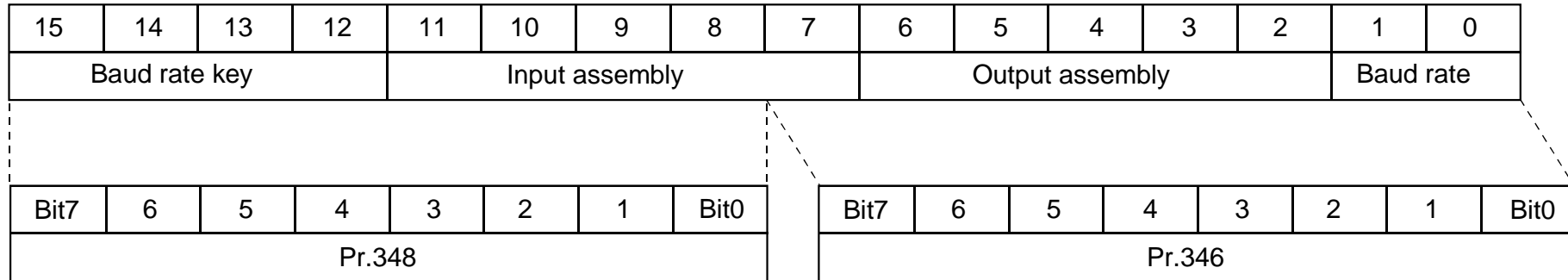

Definitions of each registration.

Name	Description	Definition	Default Setting
Watch dog timeout operation (WDA) (Note)	DeviceNet connection object (Class code 0x05) Instance 2 attribute 12	0 = Transition to timeout 1 = Automatic delete 2 = Automatic reset	0
DN fault mode	Supports the control management object. (Class code 0x29) Instance attribute 16, DN fault mode	0 = Fault + stop 1 = Ignore	0
Input assembly	Value of assembly ID used in connection object. (Class code 0x05) Instance attribute 16, consumed_connection_path	Assembly ID 0 = 70 1 = 71 6 = 176 8 = 150	1

Note: The parameter setting will be changed back to the factory setting (0) when reconnected after a disconnection.

FR-E5ND SPECIFIC PARAMETERS

Name	Description	Definition	Default Setting
Output assembly	Assembly ID value used in connection object. (Class code 0x05) Instance attribute 14, produced_connection_path	Assembly instance ID 0 = 20 1 = 21 6 = 126 8 = 100	1
Baud rate	DeviceNet object value (Class code 0x03) Instance attribute 2, baud rate	0 = 125 kbps 1 = 250 kbps 2 = 500 kbps	0
Device address	DeviceNet object value (Class 0x03) Instance attribute 1, MAC ID	Node address; Range is 0 to 63 (same definition as attribute)	63
Address key	Internal confirmation	1010-setting value; No others	1010
Baud rate key	Internal confirmation	1010-setting value; No others	0101

Normally, these parameters are not accessed via the PU. Instead, a DeviceNet user will access the various fields of these parameters via DeviceNet and set them according to the table above.

5.2 Other Option-Specific Parameters

The following table identifies option-specific parameters which are used for the E5ND. The definition for Pr. 340 is identical to the definitions for use with the previous Mitsubishi communications option unit FR-EPB for FR-A200E.

Pr. No.	Function	Setting range	Minimum increment	Default setting
338	Operation Control Command Source	0, 1	1	0
339	Speed Command Source	0, 1	1	0
340	Link Startup Mode Selection	0, 1	1	0
342	Setting of E ² PROM Write by FR-E5ND	0, 1	1	0

Control Source Selection		Functions										
Pr. 338 (Control)	Pr. 339 (Speed ref.)	STF	STR	STOP	RT	2	4	RH, RM, RL	AU	RES	MRS	OH
0 (DeviceNet)	0 (DeviceNet)	DN	DN	-	-	DN	-	-	-	Both	Ext	Ext
0 (DeviceNet)	1 (External terminal)	DN	DN	-	-	Ext	Ext	Ext	Ext	Both	Ext	Ext
1 (External terminal)	0 (DeviceNet)	Ext	Ext	Ext	Ext	DN	-	-	-	Both	Ext	Ext
1 (External terminal)	1 (External terminal)	Ext	Ext	Ext	Ext	Ext	Ext	Ext	Ext	Both	Ext	Ext

Below is the definition for Pr. 338 and Pr. 339.

- Note: Ext - Control is via input to external terminal
 DN - Control is via DeviceNet
 Both - Control is via either external terminals or DeviceNet
 '-' - Control is via neither external terminals nor DeviceNet
 Aux - Control is via input to external terminal when Pr. 28 (multi-speed input compensation) is 1

Definition of Pr. 340:

Value	Function
0	The inverter always goes to Ext-mode after power-up or Inverter reset.
1	The inverter always goes to Net-mode after power-up or Inverter reset.

6. OBJECT MAP

OBJECT MAP

This section describes the DeviceNet object definitions of the FR-E5ND. For details of the definitions, please consult the DeviceNet documentation available from ODVA.

In the following tables, Get and Set mean:

Get: Read from inverter

Set: Write to inverter

6.1 Class 0x01 - Identity Object

6.1.1 Class 0x01 Attributes - Instance 0

No.	Access	Attribute	Type	Value
1	Get	Revision	Word	1
2	Get	Maximum Instance	Word	1
6	Get	Maximum Class Attributes	Word	7
7	Get	Maximum Instance Attributes	Word	7

6.1.2 Class 0x01 Services - Instance 0

Service Code	Service
0x0E	Get Attribute Single

6.1.3 Class 0x01 Instance Attributes - Instance 1

No.	Access	Attribute	Type	Value
1	Get	Vendor ID	Word	82 (0x0052)
2	Get	Product Type	Word	0x0002
3	Get	Product Code	Word	501 (0x1F5)
4	Get	Revision	Word	1.YYY (Note 1)
5	Get	Status	Word	0x0000
6	Get	Serial Number	Word	xxxxxxx (Note 2)
7	Get	Name	Word	E500 (Note 3)

Note: 1. The upper byte of the read hexadecimal word data indicates the integer part (major revision) and its lower byte indicates the fraction part (minor revision). For example, the read data of 0x010A means version 1.010.

2. The value changes with the product.

3. The actual data stored are 0x04, 0x45, 0x35, 0x30 and 0x30. The first 0x04 indicates the 4-byte data and the others indicate "E500" in ASCII

6.1.4 Class 0x01 Instance Services - Instance 1

Service Code	Service	Description
0x05	Reset	0-Power Reset 1-Parameter All clear and Inverter Reset
0x0E	Get Attribute Single	

6.2 Class 0x03 - DeviceNet Object

6.2.1 Class 0x03 Attributes - Instance 0

Note: Not applicable to the FR-E500 series.

6.2.2 Class 0x03 Services - Instance 0

Note: Not applicable to the FR-E500 series.

6.2.3 Class 0x03 Instance Attributes - Instance 1

No.	Access	Attribute	Value
1	Get/Set	Node Address (Note)	0 to 63
2	Get/Set	Baud Rate (Note)	0 to 2
3	Get/Set	Bus Off Interrupt	0 to 1
4	Get/Set	Bus Off Counter	0 to 255
5	Get	Allocation Information	0 to 0xFFFF
8	Get	MAC ID Switch Value	0 to 63

Note: Class 0x67 Instance 1 Attributes 45 and 46 may also be used to perform read.

6.2.4 Class 0x03 Instance Services - Instance 1

Service Code	Service
0x4B	Allocate
0x4C	Release
0x0E	Get Attribute Single
0x10	Set Attribute Single

6.3 Class 0x04 - Assembly Object

6.3.1 Class 0x04 - Output Instance 20

Instance	Byte	Bit 7	Bit 6	Bit 5	Bit 4	Bit 3	Bit 2	Bit 1	Bit 0
20 0x14	0	–	–	–	–	–	Fault Reset	–	Run Fwd
	1	–							
	2	Speed Reference (Low Byte)							
	3	Speed Reference (High Byte)							

6.3.2 Class 0x04 - Output Instance 21 (Default)

Instance	Byte	Bit 7	Bit 6	Bit 5	Bit 4	Bit 3	Bit 2	Bit 1	Bit 0
21 0x15	0	–	NetRef	NetCtrl	–	–	Fault Reset	Run Rev	Run Fwd
	1	–							
	2	Speed Reference (Low Byte)							
	3	Speed Reference (High Byte)							

6.3.3 Class 0x04 - Output Instance 126

Instance	Byte	Bit7	Bit6	Bit5	Bit4	Bit3	Bit2	Bit1	Bit0
126 0x7E	0	Write Param	NetRef	NetCtrl	–	–	Fault Reset	Run Rev	Run Fwd
	1	00							
	2	(Low Byte) Speed Ref or Parameter Write Data							
	3	(High Byte) Speed Ref or Parameter Write Data							
	4	Parameter Class							
	5	Parameter Attribute No.							

Note: 1. Before directing the inverter via the network, always turn on the bits of "NetCtrl" and "NetRef". If they are off, the inverter will not accept the directives even in the network operation mode.

2. When issuing a command, always hold the forward/reverse rotation flag in the present running status. Transmitting a wrong status will change the running status.

(Example: The inverter will stop the output if bit 0 is turned off during the inverter forward rotation command.)

3. Always set "0" in Byte 1 of output instance 126. The inverter will not recognize any other value as normal data.

Output Instance 126 (0x7E) provides write/read parameter access control of the parameter class, the parameter attribute No., and the parameter data for a write operation.

Output Instance 126 **must** be used together with Input Instance 176 in those applications requiring parameter access.

Output Instance 126 utilizes 6 data bytes.

The Output Instance 126 bytes operate in the following manner:

Byte 0:

Bit 7 - If Write Parameter=1, the Parameter Write Data is written to the parameter and the rest of the parameter is ignored.

Bit 7 - If Write Parameter=0, the Speed Ref in RPM is set, and the rest of the command byte is executed.

Bit 6 - If NetRef=1, the Speed Ref is taken from **Byte 2** and **Byte 3**.

Bit 5 - If NetControl = 0, the Speed Ref from the result of the AC Drive parameter settings.

Bit 4 - Not Used.

Bit 3 - Not Used.

Bit 2 - If Fault Reset makes a transition from 0 to 1 and there is an error in the inverter, the inverter will reset.

Bit 1 - If Run Rev=1 and Run Fwd=0, the drives rotates in the reverse direction.

Bit 0 - If Run Fwd=1 and Run Rev=0, the drives spins in the forward direction.

Note: Net Control must=1 for Bits 2, 1, 0 to have any affect.

Byte 1: Must be 00.

Byte 2: Low Byte of the Speed Ref or Data Value.

Byte 3: High Byte of the Speed Ref or Data Value.

Byte 4: Parameter Class, e.g. 0x2A, 0x66, 0x67.

Byte 5: Parameter Attribute Number, e.g. 0x0A, 0x65.

6.3.4 Class 0x04 - Output Instance 100

Output Instance 100 0x64	Byte	Bit 7	Bit 6	Bit 5	Bit 4	Bit 3	Bit 2	Bit 1	Bit 0
	0	Write Param	Net Ref	Net Ctrl	–	MRS	Fault Reset	Reverse run	Forward run
1	00								
2	Speed setting value (Low Byte)								
3	Speed setting value (High Byte)								
4	Acceleration Time (Pr. 7) (Low Byte)								
5	Acceleration Time (Pr. 7) (High Byte)								
6	Deceleration Time (Pr. 8) (Low Byte)								
7	Deceleration Time (Pr. 8) (High Byte)								

The reading/writing parameter access control, parameter class, parameter attribute number and parameter write data are set with output instance 100 (0x64).

Output instance 100 must be used together in the command requiring parameter access.

Output instance 100 uses 8-byte data.

Output instance 100 is executed with the following rules:

Byte 0:

Bit7 - If Write Parm is set to 1, the acceleration/deceleration time value will be written into the parameter.

(The write conditions follow Pr. 77.)

Bit7 - If Write Parm is set to 0, the acceleration/deceleration time value will not be written into the parameter.

Bit6 - If NetRef is set to 1, the speed setting value will be incorporated from **Byte2** and **Byte3**.

Bit6 - If NetRef is set to 0, the speed setting value will be the value set from the parameter unit.

Bit5 - If NetCtrl is set to 1, MRS, FaultReset, reverse run and forward run can be operated with communication.

Bit5 - If NetCtrl is set to 0, MRS, FaultReset, reverse run and forward run can be operated with the inverter unit's external terminals.

Bit4 - Not used

Bit3 - If MRS is set to 1, the inverter output will be shut off.

Bit3 - If MRS is set to 0, the inverter will cancel the shut off output.

(MRS can be assigned with Pr. 183.)

Bit2 - If FaultReset is changed from 0 to 1, and there is an error in the inverter, the inverter will reset.

Bit1 - If Reverse run is set to **1** and forward run to **0**, the motor will reverse run.

Bit0 - If Forward run is set to **1** and reverse run to **0**, the motor will forward run.

Note: NetCtrl must be set to **1** to validate **Bit3, 2, 1** and **0**.

Byte 1: Must be 00.

Byte 2: Low-order byte of speed setting value (speed).

Byte 3: High-order byte of speed setting value (speed).

Byte 4: Low-order byte of acceleration time.

Byte 5: High-order byte of acceleration time.

Byte 6: Low-order byte of deceleration time.

Byte 7: High-order byte of deceleration time.

If any of the inverter requests, MRS, FaultReset, RunRev, RunFwd, Speed setting value, Acceleration time and Deceleration time, fails, this instance will give an error reply.

6.3.5 Class 0x04 - Input Instance 70

Instance	Byte	Bit 7	Bit 6	Bit 5	Bit 4	Bit 3	Bit 2	Bit 1	Bit 0
70 0x46	0	–	–	–	–	–	Run (1) Fwd	–	Faulted
	1	–							
	2	Speed Actual (Low Byte)							
	3	Speed Actual (High Byte)							

6.3.6 Class 0x04 - Input Instance 71 (Default)

Instance	Byte	Bit 7	Bit 6	Bit 5	Bit 4	Bit 3	Bit 2	Bit 1	Bit 0
71 0x47	0	At Ref Speed	Ref From Net	Ctrl From Net	Ready	Run (2) Rev	Run (1) Fwd	–	Faulted
	1	–							
	2	Speed Actual (Low Byte)							
	3	Speed Actual (High Byte)							

6.3.7 Class 0x04 - Input Instance 176

Instance	Byte	Bit 7	Bit 6	Bit 5	Bit 4	Bit 3	Bit 2	Bit 1	Bit 0
176 0xB0	0	At Ref Speed	Ref From Net	Control From Net	Ready	Run (2) Rev	Run (1) Fwd	–	Faulted
	1	00							
	2	Speed Actual (Low Byte)							
	3	Speed Actual (High Byte)							
	4	Parameter Read (Low Byte)							
	5	Parameter Read (High Byte)							

The Input Instance 176 (0xB0) provide 16 bits of parameter data.

Input Instance 176 **must** be used together with Output Instance 126 in those applications requiring parameter access.

Input Instance 176 utilizes 6 data bytes.

The Input Instance 176 bytes operates in the following manner:

Byte 0:

- Bit 7** - At Ref Speed - The drive is very close to or at the Ref Speed.
- Bit 6** - Ref From Net - Speed setting comes from the DeviceNet master.
- Bit 5** - Control From Net - Fault Reset, Run Rev, Run Fwd come from the DeviceNet Master.
- Bit 4** - Ready.
- Bit 3** - Run Rev - Drive is rotating in the reverse direction.
- Bit 2** - Run Fwd - Drive is rotating in the forward direction.
- Bit 1** - Not Supported.
- Bit 0** - The drive is in a fault state.

Byte 1: Must be zero (00).

Byte 2: Low Byte of the Speed Actual.

Byte 3: High Byte of the Speed Actual.

Byte 4: Low Byte of Parameter or Monitoring Data.

Byte 5: High Byte of Parameter or Monitoring Data.

6.3.8 Class 0x04 - Input Instance 150

Instance	Byte	Bit 7	Bit 6	Bit 5	Bit 4	Bit 3	Bit 2	Bit 1	Bit 0
150 0x96	0	–	–	OL	FU	–	Faulted	Reverse run	Forward run
	1	00							
	2	Actual Speed (Low Byte)							
	3	Actual Speed (High Byte)							
	4	Output Current (Low Byte)							
	5	Output Current (High Byte)							
	6	Error Factor							
	7	00							

16-bit data is executed with the input instance 150 (0x96).

Input instance 150 must be used together in the command requiring parameter access.

Input instance 150 uses 8-byte data.

Input instance 150 is executed with the following rules:

Byte 0:

Bit 7 - Not used

Bit 6 - Not used

Bit 5 - If **OL** is set to **1**, the stall prevention is activated.

Bit 5 - If **OL** is set to **0**, the stall prevention is not activated.

Bit 4 - If **FU** is set to **1**, the output frequency is above the set value.

Bit 4 - If **FU** is set to **0**, the output frequency is less the set value.

Bit 3 - Not used

Bit 2 - **Faulted** - An error has occurred with the inverter.

Bit 1 - Reverse run

Bit 0 - Forward run

Byte 1: 00

Byte 2: Low-order byte of actual speed (speed).

Byte 3: High-order byte of actual speed (speed).

Byte 4: Low-order byte of output current.

Byte 5: High-order byte of output current.

Byte 6: Error cause code when inverter alarm occurs. (Refer to alarm code table provided later.)

Byte 7: 00

6.4 Class 0x05 - DeviceNet Connection Object

FR-E5ND support only Polled I/O and Explicit Msgg, not Bit-Strobed I/O.

6.4.1 Class 0x05 Attributes - Instance 0

Note: Not applicable to the FR-E500 series.

6.4.2 Class 0x05 Services - Instance 0

Note: Not applicable to the FR-E500 series.

6.4.3 Class 0x05 Instance Attributes Instance 1 - Explicit Messaging

No.	Access	Attribute	Value
1	Get	State	0 to 5
2	Get	Instance Type	0 to 1
3	Get	Transport Trigger Class	0x83
4	Get	Produced Connection ID	0 to 0x7F0
5	Get	Consumed Connection ID	0 to 0x7F0
6	Get	Initial Comm Characteristics	0x21
7	Get	Produced Connection Size	7
8	Get	Consumed Connection Size	7
9	Get/Set	Expected Packet Rate (EPR)	Default 2504
12	Get/Set	Watchdog Action	0 to 3
13	Get	Produced Connection Path Length	0
14	Get/Set	Produced Connection Path	(Variable)
15	Get	Consumed Connection Path Length	0
16	Get/Set	Consumed Connection Path	(Variable)

Note: Refer to Vol. I: 5-4 of DeviceNet Specifications for details.

6.4.4 Class 0x05 Instance Attributes Instance 2 - Polled I/O

No.	Access	Attribute	Value
1	Get	State	0 to 5
2	Get	Instance Type	0 to 1
3	Get	Transport Trigger Class	0x83
4	Get	Produced Connection ID	0 to 0x7F0
5	Get	Consumed Connection ID	0 to 0x7F0
6	Get	Initial Comm Characteristics	0x01
7	Get	Produced Connection Size	4
8	Get	Consumed Connection Size	4
9	Get/Set	Expected Packet Rate (EPR)	Default 0
12	Get/Set	Watchdog Action	0 to 3
13	Get	Produced Connection Path Length	3
14	Get	Produced Connection Path	0x62, 0x34, 0x37
15	Get	Consumed Connection Path Length	3
16	Get	Consumed Connection Path	0x62, 0x31, 0x35

Note: 1. Depends on the communication data used. 4 for use of output instances 20, 21 and input instances 70, 71 or 6 for use of output instance 126 and input instance 176.

2. Refer to Vol. I: 5-4 of DeviceNet Specifications for details.

6.4.5 Class 0x05 Instance Attributes Instance 3 - Explicit messaging

No.	Access	Attribute	Value
1	Get	State	0 to 5
2	Get	Instance Type	0 to 1
3	Get	Transport Trigger Class	0x83
4	Get	Produced Connection ID	0 to 0x7F0
5	Get	Consumed Connection ID	0 to 0x7F0
6	Get	Initial Comm. Characteristics	0x33
7	Get	Produced Connection Size	7
8	Get	Consumed Connection Size	7
9	Get	Expected Packet Rate (EPR)	Default 2504
12	Get	Watchdog Action	0 to 3
13	Get	Produced Connection Path Length	0
14	Get/Set	Produced Connection Path	(Variable)
15	Get	Consumed Connection Path Length	0
16	Get/Set	Consumed Connection Path	(Variable)

Note: Refer to Vol. I: 5-4 of DeviceNet Specifications for details.

6.4.6 Class 0x05 Instance Attributes Instance 4 - Explicit Messaging

No.	Access	Attribute	Value
1	Get	State	0 to 5
2	Get	Instance Type	0 to 1
3	Get	Transport Trigger Class	0x83
4	Get	Produced Connection ID	0 to 0x7F0
5	Get	Consumed Connection ID	0 to 0x7F0
6	Get	Initial Comm. Characteristics	0x33
7	Get	Produced Connection Size	7
8	Get	Consumed Connection Size	7
9	Get/Set	Expected Packet Rate (EPR)	Default 2504
12	Get/Set	Watchdog Action	0 to 3
13	Get	Produced Connection Path Length	0
14	Get	Produced Connection Path	(Variable)
15	Get	Consumed Connection Path Length	0
16	Get	Consumed Connection Path	(Variable)

Note: Refer to Vol. I: 5-4 of DeviceNet Specifications for details.

6.4.7 Class 0x05 Instance Attributes Instance 5 - Explicit Messaging

No.	Access	Attribute	Value
1	Get	State	0 to 5
2	Get	Instance Type	0 to 1
3	Get	Transport Trigger Class	0x83
4	Get	Produced Connection ID	0 to 0x7F0
5	Get	Consumed Connection ID	0 to 0x7F0
6	Get	Initial Comm Characteristics	0x33
7	Get	Produced Connection Size	7
8	Get	Consumed Connection Size	7
9	Get	Expected Packet Rate (EPR)	Default 2504
12	Get/Set	Watchdog Action	0 to 3
13	Get	Produced Connection Path Length	0
14	Get/Set	Produced Connection Path	(Variable)
15	Get	Consumed Connection Path Length	0
16	Get/Set	Consumed Connection Path	(Variable)

Note: Refer to Vol. I: 5-4 of DeviceNet Specifications for details.

6.4.8 Class 0x05 Instance Attributes Instance 6 - Explicit Messaging

No.	Access	Attribute	Value
1	Get	State	0 to 5
2	Get	Instance Type	0 to 1
3	Get	Transport Trigger Class	0x83
4	Get	Produced Connection ID	0 to 0x7F0
5	Get	Consumed Connection ID	0 to 0x7F0
6	Get	Initial Comm Characteristics	0x33
7	Get	Produced Connection Size	7
8	Get	Consumed Connection Size	7
9	Get	Expected Packet Rate (EPR)	Default 2504
12	Get/Set	Watchdog Action	0 to 3
13	Get	Produced Connection Path Length	0
14	Get/Set	Produced Connection Path	(Variable)
15	Get	Consumed Connection Path Length	0
16	Get/Set	Consumed Connection Path	(Variable)

Note: Refer to Vol. I: 5-4 of DeviceNet Specifications for details.

6.4.9 Class 0x05 Instance Services - Instances 1, 2, 3, 4, 5, 6

Service Code	Service
0x0E	Get Attribute Single
0x10	Set Attribute Single

6.5 Class 0x28 - Motor Data Object

6.5.1 Class 0x28 Attributes - Instance 0

Note: Not applicable to the FR-E500 series.

6.5.2 Class 0x28 Services - Instance 0

Note: Not applicable to the FR-E500 series.

6.5.3 Class 0x28 Instance Attributes Instance 1

No.	Access	Attribute	Value
3	Get/Set	Motor Type	7 (Induction Motor)
6	Get/Set	Electronic Thermal O/L relay (Rated Current)	Setting Value for Pr. 9
7	Get/Set	Rated Motor Voltage	Setting Value for Pr. 83
9	Get/Set	Rated Motor Frequency	Setting Value for Pr. 84
15	Get/Set	Base Frequency	Setting Value for Pr. 3

Refer to Vol. II: 6-29 of DeviceNet Specifications for details.

6.5.4 Class 0x28 Instance Services

Service Code	Service
0x0E	Get Attribute Single
0x10	Set Attribute Single

6.6 Class 0x29 - Control Supervisor Object

6.6.1 Class 0x29 Attributes - Instance 0

Note: Not applicable to the FR-E500 series.

6.6.2 Class 0x29 Services

Note: Not applicable to the FR-E500 series.

6.6.3 Class 0x29 Instance Attributes Instance 1

No.	Access	Attribute	Value
3	Get/Set	Run1	0 to 1
4	Get/Set	Run2	0 to 1
5	Get/Set	Net Ctrl (Pr. 338)	0 to 1
6	Get	Status	0 to 7
7	Get	Running1	0 to 1
8	Get	Running2	0 to 1
9	Get	Ready	0 to 1
10	Get	Faulted	0 to 1
12	Get/Set	Fault Reset (Note 1)	0 to 1
15	Get	Control From Net (Note 2)	0 to 1
16	Get/Set	DN Fault Mode	0 to 1
140	Get/Set	Input Assembly	70,71,150,176
141	Get/Set	Output Assembly	20,21,100,126

Note: 1. After setting data to 1 and executing a reset, a reset cannot be executed again unless the data is set to 0 once to cancel a reset.

2. This data is updated only after an inverter reset or operation cycle.

3. Refer to Vol. II: 6-29 of DeviceNet Specifications for details.

6.6.4 Class 0x29 Instance Services

Service Code	Service
0x05	The object information has been reset. (Inverter reset is not executed)
0x0E	Get Attribute Single
0x10	Set Attribute Single

6.7 Class 0x2A - AC Drive Object

6.7.1 Class 0x2A Attributes - Instance 0

Note: Not applicable to the FR-E500 series.

6.7.2 Class 0x2A Services

Note: Not applicable to the FR-E500 series.

6.7.3 Class 0x2A Instance Attributes Instance 1

AC Profile Compatibles

No.	Access	Attribute	Value
1	Get	Number of Attributes Supported	1
3	Get	At Reference	0 to 1
4	Get/Set	Net Reference (Pr. 339)	0 to 1
6	Get/Set	Drive Mode	0
7	Get/Set	Speed Actual	0 to 0xFFFF
8	Get/Set	Speed Ref	0 to 0xFFFF
9	Get	Current Actual	0 to 0xFFFF
17	Get	Output Voltage	0 to 0xFFFF
18	Get/Set	AccelerationTime, (Pr. 7)	0 to 3600
19	Get/Set	DecelerationTime, (Pr. 8)	0 to 3600
20	Get/Set	Minimum Frequency (Pr. 2)	0 to 0xFFFF
21	Get/Set	Maximum Frequency (Pr. 1)	0 to 0xFFFF
29	Get	Ref From Net (Note 1)	0 to 1

Note: 1. This data is updated only after an inverter reset or power cycle.

2. Refer to Vol. II: 6-30 of DeviceNet Specifications for details.

The following variables and parameters are vendor-specific, please refer to Mitsubishi FR-E520S-EC/CH /FR-E540 inverter manuals for more details:

FR-E500 System Environment Variables

No.	Access	Attribute	Value
101	Set	Inverter reset (Note 1)	1
102	Set	Parameter Clear	0x965A
103	Set	Parameter All Clear	0x99AA
105	Set	Parameter Clear (Ex Com Pr)	0x5A96
106	Set	Parameter All Clear (Ex Com Pr)	0xAA99
112	Get/Set	Running Frequency (RAM) (Note 2)	30.00Hz
113	Set	Running Frequency (E ² PROM) (Note 2)	30.00Hz
114	Get/Set	Inverter Status/Control Input Command	0 to 0xFFFF
120	Get/Set	Operating Mode/Inverter Config	–

Note: 1. Please refer to page 63 , Item 4 for details.

2. Write to No.112 and No.113 can be read out from No.112.

FR-E500 Real Time Parameters

No.	Access	Attribute	Value
141	Get/Set	Alarm History 1 (Note)/Alarm History All Clear	0 to 0xFFFF
142	Get	Alarm History 2 (Note)	0 to 0xFFFF
143	Get	Alarm History 3 (Note)	0 to 0xFFFF
144	Get	Alarm History 4 (Note)	0 to 0xFFFF
145	Get	Alarm History 5 (Note)	0 to 0xFFFF
146	Get	Alarm History 6 (Note)	0 to 0xFFFF
147	Get	Alarm History 7 (Note)	0 to 0xFFFF
148	Get	Alarm History 8 (Note)	0 to 0xFFFF
170	Get	Output frequency (Minimum setting increments: 0.01Hz)	0 to 0xFFFF
171	Get	Output Current (Minimum setting increments: 0.01A)	0 to 0xFFFF
172	Get	Output Voltage (Minimum setting increments: 0.1V)	0 to 0xFFFF

Note: For the alarm history, refer to the alarm code list on the next page.

Alarm Code List

Code	Definition	Code	Definition	Code	Definition
0x10	OC1	0x81	LF	0xF4	E4
0x11	OC2	0x90	OHT	0xF5	E5
0x12	OC3	0xA0	OPT	0xF6	E6
0x20	OV1	0xB0	PE	0xF7	E7
0x21	OV2	0xB1	PUE	0xF8	E8
0x22	OV3	0xB2	RET	0xF9	E9
0x30	THT	0xC0	CPU	0xFA	E10
0x31	THM	0xC1	CTE	0xFB	E11
0x40	FIN	0xC2	P24	0xFC	E12
0x41	FAN	0xD0	OS	0xFD	E13
0x51	UVT	0xF0	E0	0xFE	E14
0x60	OLT	0xF1	E1	0xFF	E15
0x70	BE	0xF2	E2		
0x80	GF	0xF3	E3		

Note: Please refer to FR-E520S-EC/CH /FR-E540 Instruction Manuals for explanation of Alarm Codes.

6.7.4 Class 0x2A Instance Services

Service Code	Service
0x0E	Get Attribute Single
0x10	Set Attribute Single

6.8 Class 0x66 - E500 Extended Object 1

6.8.1 Class 0x66 Attributes - Instance 0

Note: Not applicable to the FR-E500 series.

6.8.2 Class 0x66 Services

Note: Not applicable to the FR-E500 series.

6.8.3 Class 0x66 Instance Attributes Instance 1

FR-E500 Parameters

(Please refer to the relevant FR-E500 Instruction Manual for parameter details)

(Pr. 0 = No.10)

No.	Access	Attribute		Default Setting
10	Get/Set	Pr. 0	Torque Boost	(Note 2)
11	Get/Set	Pr. 1	Maximum Frequency	120.00 Hz
12	Get/Set	Pr. 2	Minimum Frequency	0.00 Hz
13	Get/Set	Pr. 3	Base Frequency	60.00 Hz
14	Get/Set	Pr. 4	Multi Speed Setting (High Speed	(Note 2)
15	Get/Set	Pr. 5	Multi Speed Setting (Middle Speed)	30.00 Hz
16	Get/Set	Pr. 6	Multi Speed Setting (Low Speed)	10.00 Hz
17	Get/Set	Pr. 7	Acceleration Time	(Note 2)
18	Get/Set	Pr. 8	Deceleration Time	(Note 2)
19	Get/Set	Pr. 9	Electronic Thermal O/L Relay	(Note 2)
20	Get/Set	Pr. 10	DC Injection Brake Operation Frequency	3.00 Hz
21	Get/Set	Pr. 11	DC Injection Brake Operation Time	0.5 s
22	Get/Set	Pr. 12	DC Injection Brake Voltage	6.0 %
23	Get/Set	Pr. 13	Starting Frequency	0.50 Hz

OBJECT MAP

No.	Access	Attribute		Default Setting
24	Get/Set	Pr. 14	Load Pattern Selection	0
25	Get/Set	Pr. 15	Jog Frequency	5.00 Hz
26	Get/Set	Pr. 16	Jog Acceleration/Deceleration Time	0.5 s
28	Get/Set	Pr. 18	High Speed Maximum Frequency	(Note 2)
29	Get/Set	Pr. 19	Base Frequency Voltage	(Note 3)
30	Get/Set	Pr. 20	Acceleration/Deceleration Reference Frequency	60.00 Hz
31	Get/Set	Pr. 21	Acceleration/Deceleration Time Increments	0
32	Get/Set	Pr. 22	Stall Prevention Operation Level	150.0 %
33	Get/Set	Pr. 23	Stall Prevention Operation Level at Double Speed	(Note 3)
34	Get/Set	Pr. 24	Multi-Speed Setting (Speed 4)	(Note 3)
35	Get/Set	Pr. 25	Multi-Speed Setting (Speed 5)	(Note 3)
36	Get/Set	Pr. 26	Multi-Speed Setting (Speed 6)	(Note 3)
37	Get/Set	Pr. 27	Multi-Speed Setting (Speed 7)	(Note 3)
39	Get/Set	Pr. 29	Acceleration/Deceleration Pattern	0
40	Get/Set	Pr. 30	Regenerative Function Selection	0
41	Get/Set	Pr. 31	Frequency Jump 1A	(Note 3)
42	Get/Set	Pr. 32	Frequency Jump 1B	(Note 3)
43	Get/Set	Pr. 33	Frequency Jump 2A	(Note 3)
44	Get/Set	Pr. 34	Frequency Jump 2B	(Note 3)
45	Get/Set	Pr. 35	Frequency Jump 3A	(Note 3)
46	Get/Set	Pr. 36	Frequency Jump 3B	(Note 3)
47	Get/Set	Pr. 37	Speed Display	0
48	Get/Set	Pr. 38	Frequency at 5V (10V) input	(Note 2)
49	Get/Set	Pr. 39	Frequency at 20 mA input	(Note 2)
51	Get/Set	Pr. 41	Up-to-Frequency Sensitivity	10.0
52	Get/Set	Pr. 42	Output Frequency Detection	6.00 Hz
53	Get/Set	Pr. 43	Output Frequency Detection for Reverse Rotation	(Note 3)
54	Get/Set	Pr. 44	Second Acceleration/Deceleration Time	(Note 2)

OBJECT MAP

No.	Access	Attribute		Default Setting
55	Get/Set	Pr. 45	Second Deceleration Time	(Note 3)
56	Get/Set	Pr. 46	Second Torque Boost	(Note 3)
57	Get/Set	Pr. 47	Second V/F (base frequency)	(Note 3)
58	Get/Set	Pr. 48	Second Electronic Overcurrent Protection	150.0 %
62	Get/Set	Pr. 52	PU Main Display Data Selection	0
64	Get/Set	Pr. 54	FM Terminal Function Selection	1 (Note 2)
65	Get/Set	Pr. 55	Frequency Monitoring Reference	60.00 Hz
66	Get/Set	Pr. 56	Current Monitoring Reference	(Note 2)
67	Get/Set	Pr. 57	Restart Coasting Time	(Note 3)
68	Get/Set	Pr. 58	Restart Cushion Time	1.0 s
69	Get/Set	Pr. 59	Remote Setting Function Selection	0
70	Get/Set	Pr. 60	Shortest Acceleration/deceleration Mode	0
71	Get/Set	Pr. 61	Reference Current	(Note 3)
72	Get/Set	Pr. 62	Reference Current for Intelligent Mode Acceleration.	(Note 3)
73	Get/Set	Pr. 63	Reference Current for Intelligent Mode Deceleration.	(Note 3)
75	Get/Set	Pr. 65	Retry Selection	0
76	Get/Set	Pr. 66	Start Prevention Operation Level Reduction Starting Frequency	60.00 Hz
77	Get/Set	Pr. 67	Number of Retries at Alarm Occurance	0
78	Get/Set	Pr. 68	Retry Waiting Time	1.0 s
79	Get/Set	Pr. 69	Retry Count Display Erase	0
80	Get/Set	Pr. 70	Special Regenerative Brake Duty	0.0 %
81	Get/Set	Pr. 71	Applied Motor	0
82	Get/Set	Pr. 72	PWM Frequency Selection	1 kHz
83	Get/Set	Pr. 73	0 to 5 V/0 to 10 V Select	1
84	Get/Set	Pr. 74	Filter Time Constant	1
85	Get/Set	Pr. 75	Reset Selection/disconnected PU detection/PU stop selection	0
87	Get	Pr. 77	Parameter Write Disable Selection	0
88	Get/Set	Pr. 78	Reverse Rotation Prevention Selection	0

OBJECT MAP

No.	Access	Attribute		Default Setting
89	Get	Pr. 79	Operation Mode Selection	0
90	Get/Set	Pr. 80	Motor Capacity	(Note 3)
92	Get/Set	Pr. 82	Motor Exciting Current	(Note 3)
93	Get/Set	Pr. 83	Rated Motor Voltage	(Note 2)
94	Get/Set	Pr. 84	Rated Motor Frequency	60.00 Hz
100	Get/Set	Pr. 90	Motor constant (R1)	(Note 3)
106	Get/Set	Pr. 96	Auto Tuning Setting/Status	0
127	Get/Set	Pr. 117	Station Number	0
128	Get/Set	Pr. 118	Communication Speed	192
129	Get/Set	Pr. 119	Stop Bit Length/data length	1
130	Get/Set	Pr. 120	Parity Check Presence/Absence	2
131	Get/Set	Pr. 121	Number Of Communication Retries	1
132	Get/Set	Pr. 122	Communication Check Time Interval	0.0 s
133	Get/Set	Pr. 123	Waiting Time Setting	(Note 3)
134	Get/Set	Pr. 124	CR, LF Presence/Absence Selection	1
138	Get/Set	Pr. 128	PID Action Selection	10
139	Get/Set	Pr. 129	PID Proportionnal Band	100.0 %
140	Get/Set	Pr. 130	PID Integral Time	1.0 s
141	Get/Set	Pr. 131	PID Upper Limit	(Note 3)
142	Get/Set	Pr. 132	PID Lower Limit	(Note 3)
143	Get/Set	Pr. 133	PID Action Set Point For PU Operation	0.00 %
144	Get/Set	Pr. 134	PID Differential Time	(Note 3)
155	Get/Set	Pr. 145	PU Display Language (FR-PU04)	(Note 2)
156	Get/Set	Pr. 146	Parameter Set by Manufacturer. Do not set.	–
160	Get/Set	Pr. 150	Output Current Detection Level	150.0 %
161	Get/Set	Pr. 151	Output Current Detection Period	0.0 s
162	Get/Set	Pr. 152	Zero-Current Detection Level	5.0 %
163	Get/Set	Pr. 153	Zero-Current Detection Period	0.50 s

OBJECT MAP

No.	Access	Attribute		Default Setting
166	Get/Set	Pr. 156	Stall Prevention Operation Selection	0
168	Get/Set	Pr. 158	AM Terminal Function Selection	1 (Note 2)
170	Get/Set	Pr. 160	User group read selection	0
178	Get	Pr. 168	Parameter set by manufacturer, do not set.	–
179	Get	Pr. 169	Parameter set by manufacturer, do not set.	–
181	Get/Set	Pr. 171	Actual Operation Hour Meter Clear	0
183	Get/Set	Pr. 173	User Group 1 Registration	0
184	Get/Set	Pr. 174	User Group 1 Deletion	0
185	Get/Set	Pr. 175	User Group 2 Registration	0
186	Get/Set	Pr. 176	User Group 2 Deletion	0
190	Get/Set	Pr. 180	(RL) Function Selection	0
191	Get/Set	Pr. 181	(RM) Function Selection	1
192	Get/Set	Pr. 182	(RH) Function Selection	2
193	Get/Set	Pr. 183	MRS Terminal (MRS) Function Selection	3
200	Get/Set	Pr. 190	(RUN) Function Selection	0
201	Get/Set	Pr. 191	(FU) Function Selection	1
202	Get/Set	Pr. 192	A, B, C Terminal (ABC) Function Selection	2
212	Get/Set	Pr. 232	Multi-Speed Setting (Speed 8)	(Note 3)
213	Get/Set	Pr. 233	Multi-Speed Setting (Speed 9)	(Note 3)
214	Get/Set	Pr. 234	Multi-Speed Setting (Speed 10)	(Note 3)
215	Get/Set	Pr. 235	Multi-Speed Setting (Speed 11)	(Note 3)
216	Get/Set	Pr. 236	Multi-Speed Setting (Speed 12)	(Note 3)
217	Get/Set	Pr. 237	Multi-Speed Setting (Speed 13)	(Note 3)
218	Get/Set	Pr. 238	Multi-Speed Setting (Speed 14)	(Note 3)
219	Get/Set	Pr. 239	Multi-Speed Setting (Speed 15)	(Note 3)
220	Get/Set	Pr. 240	Soft-PWM Setting	
224	Get/Set	Pr. 244	Cooling fan operation selection	0
225	Get/Set	Pr. 245	Rated motor slip	9999

No.	Access	Attribute		Default Setting
226	Get/Set	Pr. 246	Slip compensation response time	0.5 s
227	Get/Set	Pr. 247	Constant output region slip compensation selection	9999
229	Get/Set	Pr. 249	Ground fault detection at start	0 (Note 2)
230	Get/Set	Pr. 250	Stop selection	9999

Note: 1. Parameters marked “Special” should not be changed under normal operating conditions. Improper inverter operation and damage to equipment may occur.
 2. Some default settings depend on the capacity, voltage class or type (EC, NA etc.) of the inverter.
 3. The default settings 65535, 6553.5 Unit, 655.35 Unit simply indicate the function is NOT Active. These settings will be reflected as “9999” when viewed via the inverter parameter unit.
 * Changing the value will generate the actual effects, but is NOT reflected correctly in DeviceNet Manager.

6.8.4 Class 0x66 Instance Services

Service Code	Service
0x0E	Get Attribute Single
0x10	Set Attribute Single

6.9 Class 0x67 - FR-E500 Extended Object II

6.9.1 Class 0x67 Attributes - Instance 0

None. Not Applicable, not related to FR-E500.

6.9.2 Class 0x67 Services

None. Not Applicable, not related to FR-E500.

6.9.3 Class 0x67 Instance Attributes Instance 1

More FR-E500 Parameters

(Please refer to the relevant FR-E500 Instruction Manual for Details)

No.	E500 Pr.	Access	Attribute	Default Setting
38	Pr. 338	Get/Set	Operation Control Mode Source	0
39	Pr. 339	Get/Set	Speed Command Source	0
40	Pr. 340	Get/Set	Link Startup Mode Selection	0
42	Pr. 342	Get/Set	Setting of the E ² PROM by the FR-E5ND	0
45	Pr. 345	Get/Set	DeviceNet Address Startup Data (Lower byte)	63
46	Pr. 346	Get/Set	DeviceNet Baudrate Startup Data (Lower byte)	132
47	Pr. 347	Get/Set	DeviceNet Address Startup Data (Higher byte)	160
48	Pr. 348	Get/Set	DeviceNet Baudrate Startup Data (Higher byte)	80

Calibration Functions

No.	E500 Pr.	Access	Attribute	Default Setting
202	Pr. 902 Freq	Get/Set	Frequency Voltage Bias - Frequency	0.00 Hz
203	Pr. 902 %	Get/Set	Frequency Voltage Bias - Percent	0.0 %
204	Pr. 903 Freq	Get/Set	Frequency Voltage Gain - Frequency	60.00 Hz
205	Pr. 903 %	Get/Set	Frequency Voltage Gain - Percent	97.0 %
206	Pr. 904 Freq	Get/Set	Frequency Current Bias - Frequency	0.00 Hz
207	Pr. 904 %	Get/Set	Frequency Current Bias - Percent	18.8 %
208	Pr. 905 Freq	Get/Set	Frequency Current Gain - Frequency	60.00 Hz
209	Pr. 905 %	Get/Set	Frequency Current Gain - Percent	92.7 %

- Note: 1. Parameters marked “Special” should not be changed under normal operating conditions. Improper inverter operation and damage to equipment may occur.
2. Some default settings depend on the capacity, voltage and type (i.e. EC, NA) of inverter.
3. The default settings 65535, 6553.5 Unit, 655.35 Unit simply indicate the function is NOT Active. These settings will be reflected as “9999” when viewed via the inverter parameter unit.

6.9.4 Class 0x67 Instance Services

Service Code	Service
0x0E	Get Attribute Single
0x10	Set Attribute Single

6.10 Response Timing

Item 1. Polling - Reading & Request Without Changing State:

Explicit Messaging (G2 and G3) - Get-Attribute-Reading Data:

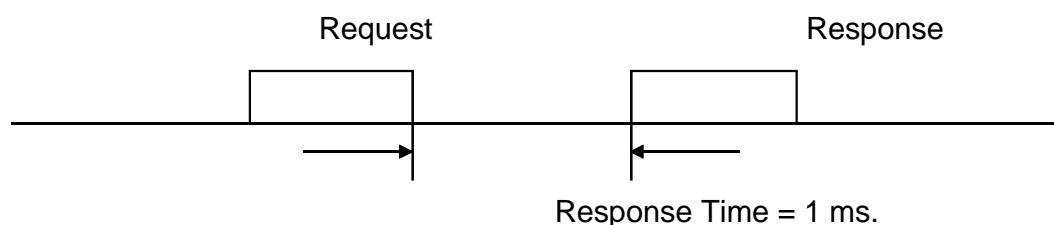

Item 2. Polling - Writing & Request With Changing State:

Explicit Messaging (G2 and G3) - Set-Attribute-Writing Data (Excluding Items 3 and 4):

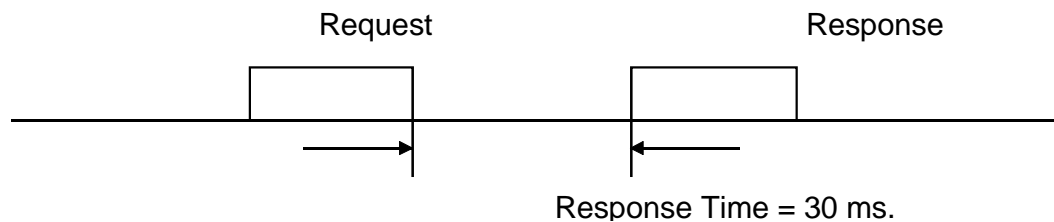

Item 3. PrClr, PrAllClr, PrClr (ECP), PrAllClr (ECP):

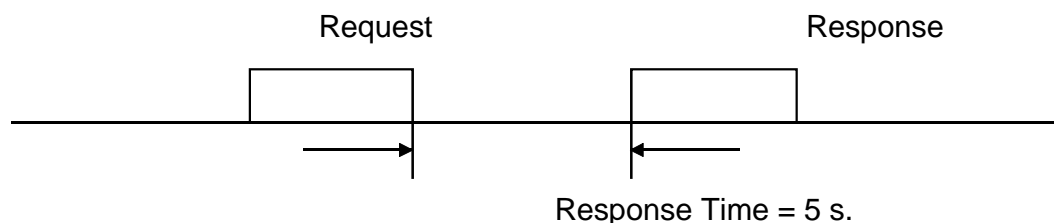

Item 4. Inverter reset and Pr. 340 = 0:

The drive will go to Ext-mode afterwards.

6.11 Recommendation For Software Developers

For software developers only:

- Make a handshake procedure, send a request, wait for response, then go to next request.
- Set waiting time between each message based on FR-E5ND specifications above, e.g. for reading set to 1 ms each time; for writing set to 30 ms each time.

7. E500 PARAMETERS

E500 PARAMETERS

Pr. No.	Function	E5ND	EDS	COM-MON	Object	Attribute/service	Attr id/svc code	Attr/svc name
0	Torque Boost	•	•		E500_66	Attrib	10	
1	Maximum Frequency	•	•	•	AC Drive	Attrib	21	HiSpd Limit
		•	•		E500_66	Attrib	11	
2	Minimum Frequency	•	•	•	AC Drive	Attrib	20	LoSpd Limit
		•	•		E500_66	Attrib	12	
3	Base Frequency	•	•	•	Motr Data/ AC MotrInst	Attrib	9	Rated f
		•	•		E500_66	Attrib	13	
4	Multi-Speed Setting (High Speed)	•	•		E500_66	Attrib	14	
5	Multi-Speed Setting (Middle Speed)	•	•		E500_66	Attrib	15	
6	Multi-Speed Setting (Low Speed)	•	•		E500_66	Attrib	16	
7	Acceleration Time	•	•	•	AC Drive	Attrib	18	Acc t
		•	•		E500_66	Attrib	17	
8	Deceleration Time	•	•	•	AC Drive	Attrib	19	Dec t
		•	•		E500_66	Attrib	18	
9	Electrical Thermal O/L Relay	•	•		E500_66	Attrib	19	
10	DC Injection Brake Operation Frequency	•	•		E500_66	Attrib	20	
11	DC Injection Brake Operation Time	•	•		E500_66	Attrib	21	
12	DC Injection Brake Voltage	•	•		E500_66	Attrib	22	
13	Starting Frequency	•	•		E500_66	Attrib	23	
14	Load Pattern Selection	•	•		E500_66	Attrib	24	
15	Jog Frequency	•	•		E500_66	Attrib	25	
16	Jog Acceleration/Deceleration Time	•	•		E500_66	Attrib	26	
18	High Speed Maximum Frequency	•	•	•	AC Drive	Attrib	21	Hispd Limit
		•	•		E500_66	Attrib	28	

E500 PARAMETERS

Pr. No.	Function	E5ND	EDS	COM-MON	Object	Attribute/service	Attr id/svc code	Attr/svc name
19	Base Frequency Voltage	•	•	•	Motr Data/ ACM MotrInst	Attrib	7	Rated V
		•	•		E500_66	Attrib	29	
20	Acceleration/Deceleration Reference Frequency	•	•		E500_66	Attrib	30	
21	Acceleration/Deceleration Time Increments	•	•		E500_66	Attrib	31	
22	Stall Prevention Operation Level	•	•		E500_66	Attrib	32	
23	Stall Prevention Operation Level at Double Speed	•	•		E500_66	Attrib	33	
24	Multi-Speed Setting (Speed 4)	•	•		E500_66	Attrib	34	
25	Multi-Speed Setting (Speed 5)	•	•		E500_66	Attrib	35	
26	Multi-Speed Setting (Speed 6)	•	•		E500_66	Attrib	36	
27	Multi-Speed Setting (Speed 7)	•	•		E500_66	Attrib	37	
29	Acceleration/Deceleration Pattern	•	•		E500_66	Attrib	39	
30	Regenerative Function Selection	•	•		E500_66	Attrib	40	
31	Frequency Jump 1A	•	•		E500_66	Attrib	41	
32	Frequency Jump 1B	•	•		E500_66	Attrib	42	
33	Frequency Jump 2A	•	•		E500_66	Attrib	43	
34	Frequency Jump 2B	•	•		E500_66	Attrib	44	
35	Frequency Jump 3A	•	•		E500_66	Attrib	45	
36	Frequency Jump 3B	•	•		E500_66	Attrib	46	
37	Speed Display	•	•		E500_66	Attrib	47	
38	Frequency at 20 mA input	•	•		E500_66	Attrib	48	
39	Frequency at 5 V (10 V) input	•	•		E500_66	Attrib	49	
41	Up to Frequency Sensitivity	•	•		E500_66	Attrib	51	
42	Output Frequency Detection	•	•		E500_66	Attrib	52	
43	Output Frequency Detection for Reverse Rotation	•	•		E500_66	Attrib	54	

E500 PARAMETERS

Pr. No.	Function	E5ND	EDS	COM-MON	Object	Attribute/service	Attr id/svc code	Attr/svc name
44	Second Acceleration/Deceleration Time	•	•		E500_66	Attrib	54	
45	Second Deceleration Time	•	•		E500_66	Attrib	55	
46	Second Torque Boost	•	•		E500_66	Attrib	56	
47	Second V/F (base frequency)	•	•		E500_66	Attrib	57	
48	Second Electronic Overcurrent Protection	•	•		E500_66	Attrib	58	
52	PU Main Display Data Selection	•	•		E500_66	Attrib	62	
54	FM Terminal Function Selection	•	•		E500_66	Attrib	64	
55	Frequency Monitoring Reference	•	•		E500_66	Attrib	65	
56	Current Monitoring Reference	•	•		E500_66	Attrib	66	
57	Restart Coasting Time	•	•		E500_66	Attrib	67	
58	Restart Cushion Time	•	•		E500_66	Attrib	68	
59	Remote Setting Function Selection	•	•		E500_66	Attrib	69	
60	Shortest Acceleration/deceleration Mode	•	•		E500_66	Attrib	70	
61	Reference Current	•			E500_66	Attrib	71	
62	Reference Current for Intelligent Mode Acceleration	•			E500_66	Attrib	72	
63	Reference Current for Intelligent Mode Deceleration	•			E500_66	Attrib	73	
65	Retry Selection	•	•		E500_66	Attrib	75	
66	Stall Prevention Operation Level Reduction Starting Frequency	•	•		E500_66	Attrib	76	
67	Number of Retries at Alarm Occurrence	•	•		E500_66	Attrib	77	
68	Retry Waiting Time	•	•		E500_66	Attrib	78	
69	Retry Count Display Erasure	•	•		E500_66	Attrib	79	
70	Special Regenerative Brake Duty	•	•		E500_66	Attrib	80	
71	Applied Motor	•	•		E500_66	Attrib	81	
72	PWM Frequency Selection	•	•		E500_66	Attrib	82	
73	0 to 5 V/0 to 10 V Selection	•	•		E500_66	Attrib	83	

E500 PARAMETERS

Pr. No.	Function	E5ND	EDS	COM-MON	Object	Attribute/service	Attr id/svc code	Attr/svc name
74	Filter Time Constant	•	•		E500_66	Attrib	84	
75	Reset Selection/disconnected PU detection/PU stop selection	•	•		E500_66	Attrib	85	
77	Parameter Write Disable Selection	•	•		E500_66	Attrib	87	
78	Reverse Rotation Prevention Selection	•	•		E500_66	Attrib	88	
79	Operation Mode Selection	•	•		E500_66	Attrib	89	
80	Motor Capacity	•	•		E500_66	Attrib	90	
82	Motor Exciting Current	•			E500_66	Attrib	92	
83	Rated Motor Voltage	•	•	•	Motr Data/ AC MotrInst	Attrib	7	Rated V
		•	•		E500_66	Attrib	93	
84	Rated Motor Frequency	•	•	•	Motr Data/ AC MotrInst	Attrib	9	Rated f
		•	•		E500_66	Attrib	94	
90	Motor Constant (R1)	•	•		E500_66	Attrib	100	
96	Auto Tuning Setting/Status	•	•		E500_66	Attrib	106	
117	Station Number	•	•		E500_66	Attrib	127	
118	Communication Speed	•	•		E500_66	Attrib	128	
119	Stop Bit length/data length	•	•		E500_66	Attrib	129	
120	Parity Check Presence/Absence Selection	•	•		E500_66	Attrib	130	
121	Number Of Communication Retries	•	•		E500_66	Attrib	131	
122	Communication Check Time Interval	•	•		E500_66	Attrib	132	
123	Waiting Time Setting	•	•		E500_66	Attrib	133	
124	CR, LF Presence/Absence Selection	•	•		E500_66	Attrib	134	
128	PID Action Selection	•	•		E500_66	Attrib	138	
129	PID proportional Band	•	•		E500_66	Attrib	139	
130	PID Integral Time	•	•		E500_66	Attrib	140	
131	PID Upper Limit	•	•		E500_66	Attrib	141	

E500 PARAMETERS

Pr. No.	Function	E5ND	EDS	COM-MON	Object	Attribute/service	Attr id/svc code	Attr/svc name
132	PID Lower Limit	•	•		E500_66	Attrib	142	
133	PID Action Set Point For PU Operation	•	•		E500_66	Attrib	143	
134	PID Differential Time	•	•		E500_66	Attrib	144	
145	PU Display Language (FR-PU04)	•	•		E500_66	Attrib	155	
146	Parameter Set by Manufacturer. Do not set.	•	•		E500_66	Attrib	156	
150	Output Current Detection Level	•	•		E500_66	Attrib	160	
151	Output Current Detection Period	•	•		E500_66	Attrib	161	
152	Zero Current Detection Level	•	•		E500_66	Attrib	162	
153	Zero Current Detection Period	•	•		E500_66	Attrib	163	
156	Stall Prevention Operating Selection	•	•		E500_66	Attrib	166	
158	AM Terminal Function Selection	•	•		E500_66	Attrib	168	
160	User group read selection	•	•		E500_66	Attrib	172	
168	Reserved	•	•		E500_66	Attrib	178	
169	Reserved	•	•		E500_66	Attrib	179	
171	Actual Operating Hour Meter Clear	•	•		E500_66	Attrib	181	
173	User Group 1 Registration	•	•		E500_66	Attrib	183	
174	User Group 1 Deletion	•	•		E500_66	Attrib	184	
175	User Group 2 Registration	•	•		E500_66	Attrib	185	
176	User Group 2 Deletion	•	•		E500_66	Attrib	186	
180	RL Terminal Function Selection	•	•		E500_66	Attrib	190	
181	RM Terminal Function Selection	•	•		E500_66	Attrib	191	
182	RH Terminal Function Selection	•	•		E500_66	Attrib	192	
183	MRS Terminal Function Selection	•	•		E500_66	Attrib	193	
190	RUN Terminal Function Selection	•	•		E500_66	Attrib	200	
191	FU Terminal Function Selection	•	•		E500_66	Attrib	201	
192	A, B, C Terminal Function Selection	•	•		E500_66	Attrib	202	
232	Multi-Speed Setting (Speed 8)	•	•		E500_66	Attrib	212	
233	Multi-Speed Setting (Speed 9)	•	•		E500_66	Attrib	213	

E500 PARAMETERS

Pr. No.	Function	E5ND	EDS	COM-MON	Object	Attribute/service	Attr id/svc code	Attr/svc name
234	Multi-Speed Setting (Speed 10)	•	•		E500_66	Attrib	214	
235	Multi-Speed Setting (Speed 11)	•	•		E500_66	Attrib	215	
236	Multi-Speed Setting (Speed 12)	•	•		E500_66	Attrib	216	
237	Multi-Speed Setting (Speed 13)	•	•		E500_66	Attrib	217	
238	Multi-Speed Setting (Speed 14)	•	•		E500_66	Attrib	218	
239	Multi-Speed Setting (Speed 15)	•	•		E500_66	Attrib	219	
240	Soft-PWM Setting	•	•		E500_66	Attrib	220	
244	Cooling fan Operation Selection	•	•		E500_66	Attrib	224	
245	Rated Motor Slip	•	•		E500_66	Attrib	225	
246	Slip Compensation Response Time	•	•		E500_66	Attrib	226	
247	Constant Output Region Slip Compensation Selection	•	•		E500_66	Attrib	227	
250	Stop Selection	•	•		E500_66	Attrib	230	
338	Operation Control Mode Source	•	•		E500_67	Attrib	38	
339	Speed Command Source	•	•		E500_67	Attrib	39	
340	Link Start-up Mode Selection	•	•		E500_67	Attrib	40	
345	DeviceNet Address Startup Data (Lower Byte)	•	•		E500_67	Attrib	45	
346	DeviceNet Baudrate Startup Data (Lower Byte)	•	•		E500_67	Attrib	46	
347	DeviceNet Address Startup Data (Higher Byte)	•	•		E500_67	Attrib	47	
348	DeviceNet Baudrate Startup Data (Higher Byte)	•	•		E500_67	Attrib	48	
367	Special	•	•		E500_67	Attrib	67	
368	Special	•	•		E500_67	Attrib	68	

E500 PARAMETERS

Pr. No.	Function	E5ND	EDS	COM-MON	Object	Attribute/service	Attr id/svc code	Attr/svc name
902	Frequency Voltage Bias (Frequency)	•	•		E500_67	Attrib	202	
	Frequency Voltage Bias (%)	•	•		E500_67	Attrib	203	
903	Frequency Voltage Gain (Frequency)	•	•		E500_67	Attrib	204	
	Frequency Voltage Gain (%)	•	•		E500_67	Attrib	205	
904	Frequency Current Bias (Frequency)	•	•		E500_67	Attrib	206	
	Frequency Current Bias (%)	•	•		E500_67	Attrib	207	
905	Frequency Current Gain (Frequency)	•	•		E500_67	Attrib	208	
	Frequency Current Gain (%)	•	•		E500_67	Attrib	209	
990	Buzzer Beep Control (FR-PU04)	•	•		E500_66	Attrib	250	
991	LCD Contrast (FR-PU04)	•	•		E500_67	Attrib	251	
	Inverter Reset	•	•		AC Drive	Attrib	101	
	Parameter Clear	•	•		AC Drive	Attrib	102	
	Parameter All Clear	•	•		AC Drive	Attrib	103	
	Parameter Clear (Ex Com Pr)	•	•		AC Drive	Attrib	105	
	Parameter All Clear (Ex Com Pr)	•	•		AC Drive	Attrib	106	
	Running Frequency (RAM)	•	•		AC Drive	Attrib	112	
	Running Frequency (E ² PROM)	•	•		AC Drive	Attrib	113	
	Inverter Status/Control Input Cmd	•	•		AC Drive	Attrib	114	
	Jog Operating Frequency (Setting)	•	•		AC Drive	Attrib	115	
	Op Mode/Inverter Configuration	•	•		AC Drive	Attrib	120	
	Alarm History 1/Alarm History All Clear	•	•		AC Drive	Attrib	141	

8. TROUBLESHOOTING

TROUBLESHOOTING

If a fault occurs and the inverter fails to operate properly, locate the cause of the fault and take proper corrective action by referring to the troubleshooting below. If the corresponding information is not found in the table, the inverter has a problem, or the component parts are damaged, contact the nearest service representative.

8.1 Inspecting the Display on Parameter Unit and Status LED on the FR-E5ND

In response to the occurrence of a fault, the display unit of the inverter automatically displays the code of the detected fault and Status LED on FR-E5ND shows the status of the detected fault.

Display		Possible Cause	Check	Corrective Action
FR-E520S /FR-E540	LED (MNS) On FR-E5ND			
E.OPT	Blinking Red	Connection time-out, Master designated FR-E5ND for communication, but sent no msgs within time limit = 4 × EPR.	Host station has not been disconnected from network.	Reset the Inverter. Reconnect the network. Master is up and running. Master sends message(s) within time limit.
0.00	Off	No good contact between FR-E500 and FR-E5ND.	FR-E5ND was not plugged in firmly.	Follow the instructions in Section 2, plug in FR-E5ND firmly.
0.00	Red	Duplicate node address, Network power off, Network cable offline; FR-E5ND is only node, not even a Master is present. Network is damaged.	No duplicate node address; Network power on; No damage to network; All cables are in proper connection; Master is on network.	Check required items in left box, Reset the Inverter, Reset the network.

Note: It should be noted that the EPR setting refers to the EPR set by the DeviceNet master.

9. SPECIFICATIONS

SPECIFICATIONS

- 1) Power supply
 - Control Power: supplied by the inverter.
 - Communication power: supplied by DeviceNet power supply, 11 to 28 V with a 10 A capacity
- 2) Standard
 - Conforms to ODVA DeviceNet Specification Release 2.0 (independently tested by University of Michigan test lab, April, 1999); supports UCMM
- 3) Network topology
 - DeviceNet (linear bus with drop lines)
- 4) Transmission Media
 - DeveiceNet standard thick or thin cable
- 5) Maximum cable distance
 - 500 m at 125 k baud with thick cable (see DeviceNet specification for details on maximum cable distance for different baud rates)
- 6) Transmission speed
 - 125 kbps, 250 kbps, 500 kbps
- 7) Number of inverters connectable
 - 63 inverters with minimum of one node as a master
- 8) Supported inverters
 - FR-E520S-EC/FR-E520S-CH/FR-E540
- 9) Environmental

Ambient temperature	-10 to 50°C (non-freezing)
Ambient humidity	90 % RH or less (non-condensing)
Vibration	5.9 m/s ² or less, conforming to JIS C 0040
Protective structure	Open type (IP00), JEM1030

APPENDIX 1 ELECTRONIC DATA SHEET

Electronic Data Sheets (EDS files)

The EDS file for the FR-E500 series inverters is available in the following. Contact your local distributor.

- Download from the Internet.

The EDS file can be downloaded at no charge from the Open DeviceNet Vender Association, Inc. home page:

<http://www.odva.org/>

Please consult your DeviceNet configuration software instruction manual for the proper installation of the EDS file.

REVISIONS

*The manual number is given on the bottom left of the back cover.

Print Date	*Manual Number	Revision
Apr., 1999	IB(NA)-0600006-A	First edition
Nov., 1999	IB(NA)-0600006-B	Mistakes corrected
Mar., 2001	IB(NA)-0600006-C	<u>Partial change</u> Specification changes made with the receipt of ODVA conformance test version A13 certification