

# CL1Y4-T1B2

## CC-Link/LT Remote I/O Module

### User's Manual

Please read this manual thoroughly before starting to use the product and handle the product properly.

MODEL	CL1Y4-T1B2
MANUAL Number	JY997D04201J
Date	July 2018

CC-link/LT

#### ●SAFETY PRECAUTIONS●

(Read these precautions before using)

Please read this manual carefully and pay special attention to safety in order to handle this product properly. Also pay careful attention to safety and handle the module properly.

These precautions apply only to Mitsubishi equipment. Refer to the user's manual of the CPU module to use for a description of the PLC system safety precautions.

These ●SAFETY PRECAUTIONS● classify the safety precautions into two categories: "WARNING" and "CAUTION".



Procedures which may lead to a dangerous condition and cause death or serious injury if not carried out properly.



Procedures which may lead to a dangerous condition and cause superficial to medium injury, or physical damage only, if not carried out properly.

Depending on circumstances, procedures indicated by **CAUTION** may also be linked to serious results.

In any case, it is important to follow the directions for usage.

Store this manual in a safe place so that you can take it out and read it whenever necessary. Always forward it to the end user.

#### DESIGN PRECAUTIONS



- Configure an interlock circuit in a sequence program so that the system operates on the safety side using the communication status information in the event the data link falls into a communication problem. Otherwise, erroneous output and malfunction may result in accidents.
- Remote input and output can not be switched ON or OFF when a problem occurs in the remote I/O modules. Therefore build an external monitoring circuit that will monitor any input signals that could cause a serious accident.



- Do not have control cables and communication cables bundled with or placed near by the main circuit and/or power cables. Wire those cables at least 100mm(3.94 inch) away from the main circuit and/or power cables. It may cause malfunction due to noise interference.
- Use the module and the flat cable dedicated to CC-Link/LT without applying any force on them. Otherwise, such cables may be broken or fail.

#### INSTALLATION PRECAUTIONS



- Use the module in an environment that meets the general specifications contained in this manual. Using this module in an environment outside the range of the general specifications could result in electric shock, fire, erroneous operation, and damage to or deterioration of the product.
- Do not directly touch the module's conductive parts. Doing so could cause malfunction or trouble in the module.
- Tighten the module securely using DIN rail or installation screws within the specified torque range. If the screws are too loose, the module may drop from its installation position, short circuit, or malfunction. If the screws are too tight, the screws may be damaged, which may cause the module to drop from its installation position or short circuit.
- Install the module on a flat surface. If the mounting surface has concave and/or convex, an excessive force may be applied on the module, and nonconformity may be caused.

#### WIRING PRECAUTIONS



- Perform installation and wiring after disconnecting the power supply at all phases externally. If the power is not disconnected at all phases an electric shock or product damage may result.



- Terminal screws which are not to be used must be tightened always. Otherwise there will be a danger of short circuit against the bare solderless terminals.
- Perform correct wiring for the module according to the product's rated voltage and terminal arrangement. Connecting to a power supply different from rating or miss-wiring may cause fire, product failure or malfunction.
- Fix terminal screws securely within the regulated torque. Loose terminal screws may cause fire and/or malfunction. If the terminal screws are too tight, it may cause short circuit, equipment failures, or erroneous operation due to damage of the screws.
- Make sure foreign objects do not get inside the module, such as dirt and wire chips. It may cause fire, product failure or malfunction.
- Attach a warning label (hazard symbol 417-IEC-5036) concerning the electric shock to the location.

#### STARTING AND MAINTENANCE PRECAUTIONS



- Do not touch the terminals when the power is ON. It may cause an electric shock or malfunction.
- Perform cleaning the module or retightening of terminal screws after turning OFF the all external power supply for sure. Failure to do so may cause failure or malfunction of the modules



- Do not disassemble or modify the module. Doing so may cause failure, malfunction, injury, or fire.
- The module case is made of resin; do not drop it or subject it to strong shock. A module damage may result.
- Make sure to switch all phases of the external power supply OFF before installing or removing the module to/from the panel. Failure to do so may cause failure or malfunction of the modules.

#### DISPOSAL PRECAUTIONS



- When disposing of this product, treat it as industrial waste.

#### TRANSPORTATION AND MAINTENANCE PRECAUTIONS



- During transportation avoid any impact as the module is a precision instrument. Doing so could cause trouble in the module.
- If it is necessary to check the operation of module after transportation, in case of any impact damage.

#### ●Notification of CE marking●

This notification does not guarantee that an entire mechanical module produced in accordance with the contents of the notification comply with the following standards. Compliance to EMC standards of the entire mechanical module should be checked by the user / manufacturer.

#### Attention

This product is designed for use in industrial applications.

#### Standards with which this product complies

Type : Programmable Controller (Open Type Equipment) Remote I/O module

Models : Products manufactured:

from November 1st, 2002 to April 30th, 2006 are compliant with EN61000-6-4:2001 and EN61131-2:1994+A11:1996+A12:2000 after May 1st, 2006 are compliant with EN61131-2:2007

Electromagnetic Compatibility Standards (EMC)	Remark
EN61000-6-4:2001 Electromagnetic compatibility -Generic standards - Emission standard for industrial environment	Compliance with all relevant aspects of the standard. (Radiated Emissions and Mains Terminal Voltage Emissions)
EN61131-2:1994/A11:1996/A12:2000 Programmable controllers -Equipment requirements and tests	Compliance with all relevant aspects of the standard. • Radiated electromagnetic field • Fast transient burst • Electrostatic discharge • Damped oscillatory wave

Electromagnetic Compatibility Standards (EMC)	Remark
EN61131-2: 2007 Programmable controllers -Equipment requirements and tests	Compliance with all relevant aspects of the standard. <b>EMI</b> • Radiated Emission • Conducted Emission <b>EMS</b> • Radiated electromagnetic field • Fast transient burst • Electrostatic discharge • High-energy surge • Voltage drops and interruptions • Conducted RF • Power frequency magnetic field

For more details please contact the local Mitsubishi Electric sales site.

- Notes for compliance to EMC regulation.

It is necessary to install the CL1 series module in a shielded metal control panel.

- Use this product in Zone A<sup>1</sup> as defined in EN61131-2.

<sup>1</sup> Zone defined in EN61131-2

Separation defined in EN61131-2 for EMC LVD regulation decided depending on condition in industrial setting.

Zone C = Factory mains which is isolated from public mains by dedicated transformers.

Zone B = Dedicated power distribution which is protected by secondary surge protection. (300V or less in the rated voltage is assumed.)

Zone A = Local power distribution which is isolated from dedicated power distribution by AC/DC converters, isolation transformers, etc. (120V or less in the rated voltage is assumed.)

#### 1. Outline of Product

This product is a terminal block type output module connected to CC-Link/LT. This product has four output points (transistor output).

#### 2. Name and Setting of Each Part and Terminal Arrangement

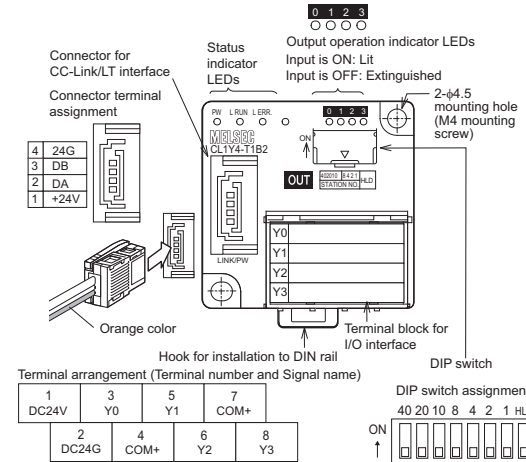

Name	Description
PW	ON while the power is supplied.
L RUN	ON while normal operation is executed.
Status indicator LED	ON: When a communication error or DIP switch setting error occurred Flickering at a constant interval: When the setting of the DIP switch was changed while the power was supplied (even while the LED is flickering, the operation continues. The new setting becomes valid when the power is turned OFF once, then ON again.) Flickering at an intermittent interval: When a terminal resistor is not attached or when the module or a connection cable is affected by noise
	L ERR.

Name	Description																					
Output operation indicator LEDs	ON while the output is ON. Extinguished while the output is OFF.  Output operation indicator																					
Interface	Connector for CC-Link/LT communication line/module power supply (24G/DB/DA/+24V)																					
Terminal block for I/O interface	Terminal block to connect output signals and load power supply																					
DIP switch	Set the 10's digit of the station No. using "STATION NO. 10", "STATION NO. 20" and "STATION NO. 40". Set the 1's digit of the station No. using "STATION NO. 1", "STATION NO. 2", "STATION NO. 4" and "STATION NO. 8". Factory default = All bits are OFF. Make sure to set the station No. in the range from 1 to 64. If any station No. outside the range from 1 to 64 is set, it is regarded as an error and the L ERR. LED lights. Example: When setting the station No. to "32", set the DIP switch as follows. <table border="1"> <thead> <tr> <th>Station No.</th> <th>10's digit</th> <th>1's digit</th> </tr> </thead> <tbody> <tr> <td>40</td> <td>20</td> <td>10</td> </tr> <tr> <td>32</td> <td>OFF</td> <td>ON</td> </tr> <tr> <td>8</td> <td>OFF</td> <td>OFF</td> </tr> <tr> <td>4</td> <td>OFF</td> <td>ON</td> </tr> <tr> <td>2</td> <td>OFF</td> <td>OFF</td> </tr> <tr> <td>1</td> <td>ON</td> <td>OFF</td> </tr> </tbody> </table>	Station No.	10's digit	1's digit	40	20	10	32	OFF	ON	8	OFF	OFF	4	OFF	ON	2	OFF	OFF	1	ON	OFF
	Station No.	10's digit	1's digit																			
40	20	10																				
32	OFF	ON																				
8	OFF	OFF																				
4	OFF	ON																				
2	OFF	OFF																				
1	ON	OFF																				
HL D	Holds the output (when an error has occurred). ON: Holds the output. OFF: Clears the output.																					

#### 3. Installation

The CL1Y4-T1B2 can be installed to DIN rail or directly installed using mounting screws.

Each installation procedure is described below.

##### 3.1 Installation to DIN rail

Align the upper DIN rail installation groove in the module with the DIN rail 1), and press the module in that status 2).

When removing the module, pull the hook downward for installation to DIN rail 3), then remove the module 4).

##### DIN rail mounting screw pitch

When installing the module to the DIN rail, tighten the mounting screws at the pitch of 200mm(7.87") or less.

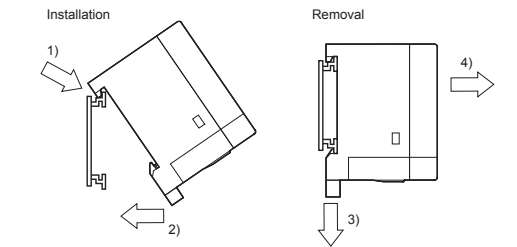

Applicable DIN rail | TH35-7.5F-e and TH35-7.5A|

### 3.2 Direct installation

Screw-tighten the module by attaching M4 screws to the upper and lower mounting holes (two holes in all) provided in the module. Install the module so that the clearance of 1 to 2mm (0.04" to 0.08") is assured for each module.

Applicable screw	M4 × 0.7mm(0.03") × 16mm(0.63") or more (Tightening torque range: 0.78 to 1.08 N·m)
------------------	--

### 4. Wiring

#### 4.1 External wiring

The output terminals of the CL1Y4-T1B2 are fixed to the sink output.

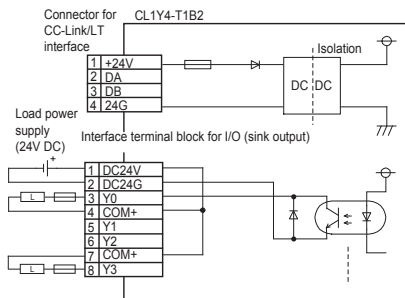

#### 4.2 Crimp-style terminal

For I/O wiring, use crimp-style terminals of the following dimensions.

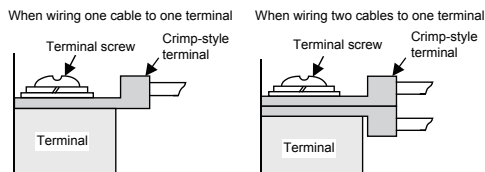
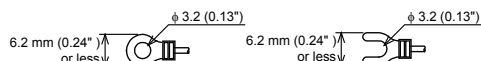

Applicable crimp-style terminal	<ul style="list-style-type: none"> <li>• RAV1.25-3</li> <li>• V1.25-3 (manufactured by JST Mfg. Co., Ltd.)</li> <li>• 1.25-3 and TG1.25-3 (manufactured by NICHIFU Co., Ltd.)</li> </ul>
Applicable wire size	0.3 to 1.25 mm <sup>2</sup>

Use a crimp-style terminal in a status in which no force is applied on the cable.

#### 4.3 Module terminal screw

Tighten the terminal screws (M3 screws) on the terminal block with a tightening torque of 0.42 to 0.58 N·m. Do not tighten terminal screws with a torque outside the above-mentioned range. Failure to do so may cause equipment failures or malfunctions.

### 5. Specifications

#### 5.1 General specifications

Item	Specification	
<b>Ambient working temperature</b>	0 to 55°C (32 to 131°F)	
<b>Ambient storage temperature</b>	-25 to 75°C (-13 to 167°F)	
<b>Ambient operating humidity</b>	5 to 95%RH: Dew condensation shall not be considered.	
<b>Ambient storage humidity</b>	5 to 95%RH: Dew condensation shall not be considered.	
<b>Vibration resistance (*1)</b>	When intermittent vibration is present	Number of times of sweep
	Frequency	Acceleration
	10 to 57Hz	—
	57 to 150Hz	9.8m/s <sup>2</sup>
When continuous vibration is present	Half amplitude	10 times in each of X, Y and Z directions (for 80 min)
Frequency	Acceleration	
10 to 57Hz	—	
57 to 150Hz	4.9m/s <sup>2</sup>	
<b>Impact resistance (*1)</b>	147 m/s <sup>2</sup> , 3 times in each of X, Y and Z directions	
<b>Operating atmosphere</b>	Corrosive gas shall not be present.	
<b>Operating altitude</b>	2,000m(6561'8") or less (*2)	
<b>Installation place</b>	Inside control panel (*3)	
<b>Over-voltage category</b>	II or less (*4)	
<b>Degree of contamination</b>	2 or less (*5)	

Notes:

- \*1 The criterion is shown in IEC61131-2.
- \*2 The module cannot be used in an environment pressurized above the atmospheric pressure which can be generated around the altitude of 0 m. If the module is used in such an environment, it may fail.
- \*3 The module can be used in any environment even outside the control panel as far as the requirements of the ambient operating temperature, the ambient operating humidity, etc. are satisfied.
- \*4 This indicates the section of the power supply to which the equipment is assumed to be connected between the public electrical power distribution network and the machinery within premises. Category II applies to equipment for which electrical power is supplied from fixed facilities. The surge voltage withstand level for up to the rated voltage of 300V is 2500V.
- \*5 This index indicates the degree of conductive generating substances in the environment in which the module is used. The degree of contamination 2 indicates that contamination is caused by generation of only non-conductive substances. In this degree, however, temporary conduction may be caused by accidental condensation.

#### 5.2 Output specifications

Item	Specification	
<b>Output method</b>	Transistor output (Load power supply) (sink)	
<b>Number of outputs</b>	4 points	
<b>Isolation method</b>	Isolation with photocoupler	
<b>Rated load voltage</b>	12/24V DC	
<b>Operating load voltage range</b>	10.2 to 28.8 VDC (Ripple ratio: Within 5%)	
<b>Max. load current</b>	0.1A/point, 0.4 A/1 common	
<b>Max. inrush current</b>	0.4A/10 ms	
<b>Leakage current at OFF</b>	0.1mA or less/30V DC	
<b>Max. voltage drop at ON</b>	0.3V or less (typical)/0.1A	
	0.6V or less (max.)/0.1A	
<b>Response time</b>	OFF→ON	1.0ms or less
	ON→OFF	1.0ms or less
<b>Surge suppression</b>	Zener diode	
<b>Common wiring method</b>	4 points/1 common (2 points) (terminal block two-wire type)	
<b>Internal protection for outputs</b>	Internal protection circuit none Please connect the fuse in the connected load outside.	

### 5.3 Performance specifications

Item	Specification	
<b>Module power supply</b>	<b>Voltage</b>	20.4 to 28.8V DC (24V DC -15% to +20%) Ripple ratio: Within 5%
	<b>Current consumption</b>	60mA (when all points are ON)
	<b>Initial current</b>	70mA
	<b>Max. allowable momentary power failure period</b>	PS1:1ms
<b>Number of stations occupied</b>	4-, 8- or 16-point mode: 1 station	
<b>Noise durability</b>	500Vp-p Noise width: 1μs Cycle: 25 to 60 Hz (by noise simulator)	
<b>Withstand voltage</b>	500V AC for 1 min	
<b>Isolation resistance</b>	10 MΩ or higher between primary area (external DC terminal) and secondary area (internal circuit) by 500V DC insulation resistance tester	
<b>Protection class</b>	IP2X	
<b>I/O part connection method</b>	Connection with terminal block	
<b>Module installation method</b>	DIN rail installation, mounted by screws of type M4 × 0.7mm(0.03") × 16mm(0.63") or larger Can be installed in six directions	
<b>Mass (weight)</b>	0.06kg (0.13lbs)	

### 6. Outside Dimensions

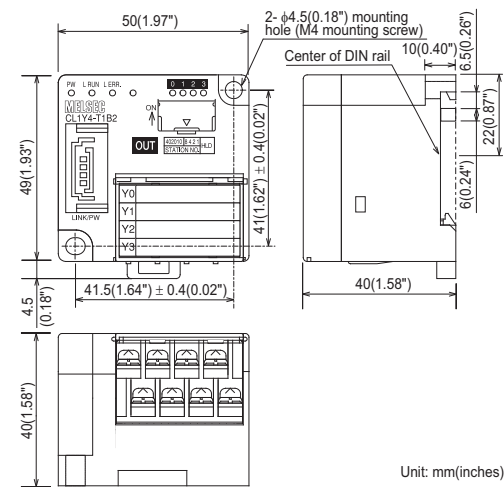

Unit: mm(inches)

「电器电子产品有害物质限制使用标识要求」的表示方式



Note: This symbol mark is for China only.

含有有害6物质的名称, 含有量, 含有部品  
本产品中所含有的有害6物质的名称, 含有量, 含有部品如下表所示。

产品中有害物质的名称及含量

部件名称	有害物质					
	铅 (Pb)	汞 (Hg)	镉 (Cd)	六价铬 (Cr (VI))	多溴联苯 (PBB)	多溴二苯醚 (PBDE)
可编程外壳	○	○	○	○	○	○
控制器印刷基板	×	○	○	○	○	○

本表格依据SJ/T 11364的规定编制。

○: 表示该有害物质在该部件所有均质材料中的含量均在GB/T 26572规定的限量要求以下。  
×: 表示该有害物质至少在该部件的某一均质材料中的含量超出GB/T 26572规定的限量要求。

基于中国标准法的参考规格: GB/T15969.2

This manual confers no industrial property rights or any rights of any other kind, nor does it confer any patent licenses. Mitsubishi Electric Corporation cannot be held responsible for any problems involving industrial property rights which may occur as a result of using the contents noted in this manual.

#### Warranty

Exclusion of loss in opportunity and secondary loss from warranty liability  
Regardless of the gratis warranty term, Mitsubishi shall not be liable for compensation to:  
(1) Damages caused by any cause found not to be the responsibility of Mitsubishi.  
(2) Loss in opportunity, lost profits incurred to the user by Failures of Mitsubishi products.  
(3) Special damages and secondary damages whether foreseeable or not, compensation for accidents, and compensation for damages to products other than Mitsubishi products.  
(4) Replacement by the user, maintenance of on-site equipment, start-up test run and other tasks.



For safe use

- This product has been manufactured as a general-purpose part for general industries, and has not been designed or manufactured to be incorporated in a device or system used in purposes related to human life.
- Before using the product for special purposes such as nuclear power, electric power, aerospace, medicine or passenger movement vehicles, consult with Mitsubishi Electric.
- This product has been manufactured under strict quality control. However when installing the product where major accidents or losses could occur if the product fails, install appropriate backup or failsafe functions in the system.

Country/Region	Sales office/Tel	Country/Region	Sales office/Tel
USA	MITSUBISHI ELECTRIC AUTOMATION, INC. 500 Corporate Woods Parkway, Vernon Hills, IL 60061, U.S.A. Tel: +1-847-478-2100/+1-847-478-2500 (NC) Tel: +1-469-721-2070	Russia	Mitsubishi Electric (Russia) LLC 52, bld. 1, Kosmodamianskaya emb., 115054 Moscow, Russia Tel: +7-495-721-2070
Brazil	MITSUBISHI ELECTRIC DO BRASIL COMERCIO E SERVICOS LTDA. Avenida Adelaide Cardina, 203, 21 andar, Bethaville, Barueri SP, Brazil Tel: +55-11-4688-3000	China	MITSUBISHI ELECTRIC AUTOMATION (CHINA) LTD. Mitsubishi Electric Automation Center, No.1386 Hongqiao Road, Shanghai, China Tel: +86-21-2322-3030
Germany	MITSUBISHI ELECTRIC EUROPE B.V. - German Branch Mitsubishi-Electric-Platz 1, 40882 Ratingen, Germany Tel: +49-2102-488-0	Taiwan	SETSUYO ENTERPRISE CO., LTD. 6F, No.105, Wugong 3rd Road, Wugu District, New Taipei City 24888, Taiwan, R.O.C. Tel: +886-2-2269-2469
UK	MITSUBISHI ELECTRIC EUROPE BV, UK Branch Travellers Lane, Hatfield, Hertfordshire, AL10 8BX, UK Tel: +44-1707-28-8780	Korea	MITSUBISHI ELECTRIC AUTOMATION KOREA CO., LTD. 7F-9F, Gangseo Hang Xi-tower A, 401, Yangcheon-ro, Gangseo-Gu, Seoul, 07528, Korea Tel: +82-2-3960-8500
Italy	MITSUBISHI ELECTRIC EUROPE B.V. - Italian Branch Centro Direzionale Colosani - Palazzo Siro, Viale Colosani 7, 20864 Agrate Brianza (MB), Italy Tel: +39-039-60531/+39-039-6053-342	Singapore	MITSUBISHI ELECTRIC ASIA PTE. LTD. 307 Alexandra Road, Mitsubishi Electric Building, Singapore 159943 Tel: +65-6473-2308
Spain	MITSUBISHI ELECTRIC EUROPE, B.V. - Spanish Branch Carretera de Rubi 76-80-AC, 420, E-08190 Sant Cugat del Valles (Barcelona), Spain Tel: +34-935-65-3131/+34-935-65-2236	Thailand	Mitsubishi Electric Factory Automation (Thailand) Co., Ltd. 12th Floor, SV.City Building, Office Tower 1, No. 896/19 and 20 Rama 3 Road, Kwaeng Bangsonggang, Khet Yankawa, Bangkok 10120, Thailand Tel: +66-2882-6522-31
France	MITSUBISHI ELECTRIC EUROPE B.V. - French Branch 25, Boulevard des Bouvets, 92741 Nanterre Cedex, France Tel: +33-1-55-68-65-68	Indonesia	PT. Mitsubishi Electric Indonesia Gedung Jaya 11th Floor, Jl. MH. Thamrin No. 12, Jakarta Pusat 10340, Indonesia Tel: +62-21-3192-9461
Czech Republic	MITSUBISHI ELECTRIC EUROPE B.V. - Czech Branch Avent Business Park, Radicka 751/1136, 158 00 Praha8, Czech Republic Tel: +420-251-551-470	India	Mitsubishi Electric India Pvt. Ltd. Gurgaon Head Office 2nd Floor, Tower A & B, Cyber Greens, DLF Cyber City, DLF Phase - III, Gurgaon - 122002, Haryana, India Tel: +91-124-4630300
Poland	Mitsubishi Electric Europe B.V. Polish Branch ul. Krakowska 50, 32-083 Balice, Poland Tel: +48-12-347-65-00	Australia	MITSUBISHI ELECTRIC AUSTRALIA PTY. LTD. 348 Victoria Road PO BOX111, Rydalmere, N.S.W. 2116, Australia Tel: +61-2-9684-7777

### MITSUBISHI ELECTRIC CORPORATION

HEAD OFFICE : TOKYO BUILDING, 2-7-3 MARUNOUCHI, CHYODA-KU, TOKYO 100-8310, JAPAN

When exported from Japan, this manual does not require application to the Ministry of Economy, Trade and Industry for service transaction permission.

Specifications subject to change without notice.



CL1Y4-T1B2  
CC-Link/LT Remote I/O Module

Please read this manual thoroughly before starting to use the product and handle the product properly.

User's Manual

MODEL	CL1Y4-T1B2
MANUAL Number	JY997D04201J
Date	July 2018

SAFETY PRECAUTIONS

Read this manual carefully and pay special attention to safety in order to handle this product properly. Also pay careful attention to safely and handle the module properly. These precautions apply only to Mitsubishi equipment. Refer to the user's manual of the CPU module to use for a description of the PLC system safety precautions. These SAFETY PRECAUTIONS classify the safety precautions into two categories: "WARNING" and "CAUTION".

- WARNING** Procedures which may lead to a dangerous condition and cause death or serious injury if not carried out properly.
- CAUTION** Procedures which may lead to a dangerous condition and cause superficial to medium injury, or physical damage only, if not carried out properly.

Depending on circumstances, procedures indicated by CAUTION may also be linked to serious results. In any case, it is important to follow the directions for usage. Store this manual in a safe place so that you can take it out and read it whenever necessary. Always forward it to the end user.

DESIGN PRECAUTIONS

- WARNING** Configure an interlock circuit in a sequence program so that the system operates on the safety side using the communication status information in the event the data link falls into a communication problem. Otherwise, erroneous output and malfunction may result in accidents.
- Remote input and output can not be switched ON or OFF when a problem occurs in the remote I/O modules. Therefore build an external monitoring circuit that will monitor any input signals that could cause a serious accident.

CAUTION

- Do not have control cables and communication cables bundled with or placed near by the main circuit and/or power cables. Wire those cables at least 100mm(3.94 inch) away from the main circuit and/or power cables. It may cause malfunction due to noise interference.
- Use the module and the flat cable dedicated to CC-Link/LT without applying any force on them. Otherwise, such cables may be broken or fail.

INSTALLATION PRECAUTIONS

CAUTION

- Use the module in an environment that meets the general specifications contained in this manual. Using this module in an environment outside the range of the general specifications could result in electric shock, fire, erroneous operation, and damage to or deterioration of the product.
- Do not directly touch the module's conductive parts. Doing so could cause malfunction or trouble in the module.
- Tighten the module securely using DIN rail or installation screws within the specified torque range. If the screws are too loose, the module may drop from its installation position, short circuit, or malfunction. If the screws are too tight, the screws may be damaged, which may cause the module to drop from its installation position or short circuit.
- Install the module on a flat surface. If the mounting surface has concave and/or convex, an excessive force may be applied on the module, and nonconformity may be caused.

WIRING PRECAUTIONS

WARNING

- Perform installation and wiring after disconnecting the power supply at all phases externally. If the power is not disconnected at all phases an electric shock or product damage may result.

CAUTION

- Terminal screws which are not to be used must be tightened always. Otherwise there will be a danger of short circuit against the bare solderless terminals.
- Perform correct wiring for the module according to the product's rated voltage and terminal arrangement. Connecting to a power supply different from rating or miss-wiring may cause fire, product failure or malfunction.
- Fix terminal screws securely within the regulated torque. Loose terminal screws may cause fire and/or malfunction.
- If the terminal screws are too tight, it may cause short circuit, equipment failures, or erroneous operation due to damage of the screws.
- Make sure foreign objects do not get inside the module, such as dirt and wire chips. It may cause fire, product failure or malfunction.
- Attach a warning label (hazard symbol 417-IEC-5036) concerning the electric shock to the location.

STARTING AND MAINTENANCE PRECAUTIONS

WARNING

- Do not touch the terminals when the power is ON. It may cause an electric shock or malfunction.
- Perform cleaning the module or retightening of terminal screws after turning OFF the all external power supply for sure. Failure to do so may cause failure or malfunction of the modules

CAUTION

- Do not disassemble or modify the module. Doing so may cause failure, malfunction, injury, or fire.
- The module case is made of resin; do not drop it or subject it to strong shock. A module damage may result.
- Make sure to switch all phases of the external power supply OFF before installing or removing the module to/from the panel. Failure to do so may cause failure or malfunction of the modules.

DISPOSAL PRECAUTIONS

CAUTION

- When disposing of this product, treat it as industrial waste.

TRANSPORTATION AND MAINTENANCE PRECAUTIONS

CAUTION

- During transportation avoid any impact as the module is a precision instrument. Doing so could cause trouble in the module.
- If it is necessary to check the operation of module after transportation, in case of any impact damage.

Notification of CE marking

This notification does not guarantee that an entire mechanical module produced in accordance with the contents of the notification comply with the following standards. Compliance to EMC standards of the entire mechanical module should be checked by the user / manufacturer.

Attention

This product is designed for use in industrial applications.

Standards with which this product complies

Type : Programmable Controller (Open Type Equipment) Remote I/O module  
Models : Products manufactured from November 1st, 2002 to April 30th, 2006 are compliant with EN61000-6-4:2001 and EN61131-2:1994+A11:1996+A12:2000 after May 1st, 2006 are compliant with EN61131-2:2007

Electromagnetic Compatibility Standards (EMC)	Remark
EN61000-6-4:2001 Electromagnetic compatibility -Generic standards - Emission standard for industrial environment	Compliance with all relevant aspects of the standard. (Radiated Emissions and Mains Terminal Voltage Emissions)
EN61131-2:1994/A11:1996/A12:2000 Programmable controllers -Equipment requirements and tests	Compliance with all relevant aspects of the standard. • Radiated electromagnetic field • Fast transient burst • Electrostatic discharge • Damped oscillatory wave

Electromagnetic Compatibility Standards (EMC)	Remark
EN61131-2: 2007 Programmable controllers -Equipment requirements and tests	Compliance with all relevant aspects of the standard. • Radiated Emission • Conducted Emission • Radiated electromagnetic field • Fast transient burst • Electrostatic discharge • High-energy surge • Voltage drops and interruptions • Conducted RF • Power frequency magnetic field

For more details please contact the local Mitsubishi Electric sales site.  
• Notes for compliance to EMC regulation.  
It is necessary to install the CL1 series module in a shielded metal control panel.

- Use this product in Zone A<sup>1</sup> as defined in EN61131-2.
- <sup>1</sup> Zone defined in EN61131-2  
Separation defined in EN61131-2 for EMC LVD regulation decided depending on condition in industrial setting.  
Zone C = Factory mains which is isolated from public mains by dedicated transformers.  
Zone B = Dedicated power distribution which is protected by secondary surge protection. (300V or less in the rated voltage is assumed.)  
Zone A = Local power distribution which is isolated from dedicated power distribution by AC/DC converters, isolation transformers, etc. (120V or less in the rated voltage is assumed.)

1. Outline of Product

This product is a terminal block type output module connected to CC-Link/LT. This product has four output points (transistor output).

2. Name and Setting of Each Part and Terminal Arrangement

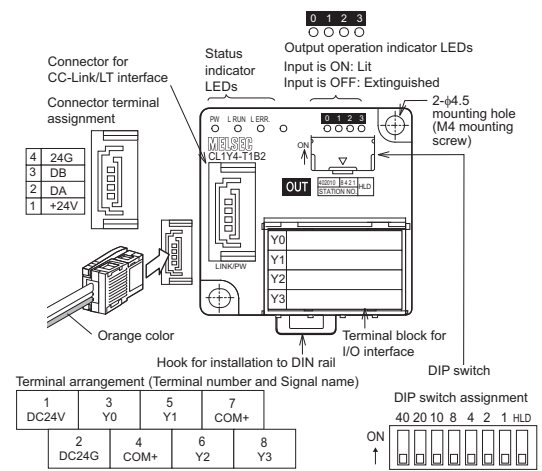

Name	Description
PW	ON while the power is supplied.
L RUN	ON while normal operation is executed.
Status indicator LED	ON: When a communication error or DIP switch setting error occurred Fllickering at a constant interval: When the setting of the DIP switch was changed while the power was supplied (even while the LED is flickering, the operation continues. The new setting becomes valid when the power is turned OFF once, then ON again.) Fllickering at an intermittent interval: When a terminal resistor is not attached or when the module or a connection cable is affected by noise
	L ERR.

Name	Description
Output operation indicator LEDs	ON while the output is ON. Extinguished while the output is OFF. Output operation indicator
Interface	Connector for CC-Link/LT communication line/module power supply (24G/DB/DA+24V)
Terminal block for I/O interface	Terminal block to connect output signals and load power supply
DIP switch	Set the 10's digit of the station No. using "STATION NO. 10", "STATION NO. 20" and "STATION NO. 40". Set the 1's digit of the station No. using "STATION NO. 1", "STATION NO. 2", "STATION NO. 4" and "STATION NO. 8". Factory default = All bits are OFF. Make sure to set the station No. in the range from 1 to 64. If any station No. outside the range from 1 to 64 is set, it is regarded as an error and the L ERR. LED lights. Example: When setting the station No. to "32", set the DIP switch as follows.
	HLD

3. Installation

The CL1Y4-T1B2 can be installed to DIN rail or directly installed using mounting screws. Each installation procedure is described below.

3.1 Installation to DIN rail

Align the upper DIN rail installation groove in the module with the DIN rail 1), and press the module in that status 2). When removing the module, pull the hook downward for installation to DIN rail 3), then remove the module 4).

DIN rail mounting screw pitch

When installing the module to the DIN rail, tighten the mounting screws at the pitch of 200mm(7.87") or less.

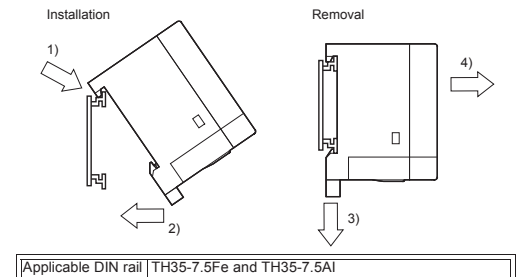

3.2 Direct installation

Screw-tighten the module by attaching M4 screws to the upper and lower mounting holes (two holes in all) provided in the module. Install the module so that the clearance of 1 to 2mm (0.04" to 0.08") is assured for each module.

Applicable screw	M4 x 0.7mm(0.03") x 16mm(0.63") or more (Tightening torque range: 0.78 to 1.08 N-m)
------------------	--

4. Wiring

4.1 External wiring

The output terminals of the CL1Y4-T1B2 are fixed to the sink output.

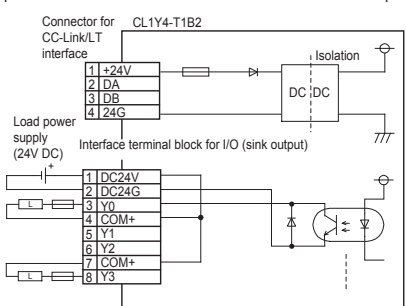

4.2 Crimp-style terminal

For I/O wiring, use crimp-style terminals of the following dimensions.

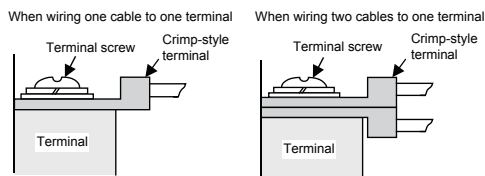
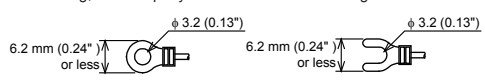

Applicable crimp-style terminal	• RAV1.25-3 • V1.25-3 (manufactured by JST Mfg. Co., Ltd.) • 1.25-3 and TG1.25-3 (manufactured by NICHIFU Co., Ltd.)
Applicable wire size	0.3 to 1.25 mm <sup>2</sup>

Use a crimp-style terminal in a status in which no force is applied on the cable.

4.3 Module terminal screw

Tighten the terminal screws (M3 screws) on the terminal block with a tightening torque of 0.42 to 0.58 N-m. Do not tighten terminal screws with a torque outside the above-mentioned range. Failure to do so may cause equipment failures or malfunctions.

5. Specifications

5.1 General specifications

Item	Specification
Ambient working temperature	0 to 55°C (32 to 131°F)
Ambient storage temperature	-25 to 75°C (-13 to 167°F)
Ambient operating humidity	5 to 95%RH: Dew condensation shall not be considered.
Ambient storage humidity	5 to 95%RH: Dew condensation shall not be considered.
Vibration resistance (*1)	When intermittent vibration is present Frequency Acceleration Half amplitude 10 to 57Hz - 0.075mm 57 to 150Hz 9.8m/s <sup>2</sup> - - When continuous vibration is present Frequency Acceleration Half amplitude 10 to 57Hz - 0.035mm 57 to 150Hz 4.9m/s <sup>2</sup> - -
	10 times in each of X, Y and Z directions (for 80 min)
Impact resistance (*1)	147 m/s <sup>2</sup> , 3 times in each of X, Y and Z directions
Operating atmosphere	Corrosive gas shall not be present.
Operating altitude	2,000m(6561'8") or less (*2)
Installation place	Inside control panel (*3)
Over-voltage category	II or less (*4)
Degree of contamination	2 or less (*5)

Notes:

- The criterion is shown in IEC61131-2.
- The module cannot be used in an environment pressurized above the atmospheric pressure which can be generated around the altitude of 0 m. If the module is used in such an environment, it may fail.
- The module can be used in any environment even outside the control panel as far as the requirements of the ambient operating temperature, the ambient operating humidity, etc. are satisfied.
- This indicates the section of the power supply to which the equipment is assumed to be connected between the public electrical power distribution network and the machinery within premises. Category II applies to equipment for which electrical power is supplied from fixed facilities. The surge voltage withstand level for up to the rated voltage of 300V is 2500V.
- This index indicates the degree of conductive generating substances in the environment in which the module is used. The degree of contamination 2 indicates that contamination is caused by generation of only non-conductive substances. In this degree, however, temporary conduction may be caused by accidental condensation.

5.2 Output specifications

Item	Specification
Output method	Transistor output (Load power supply) (sink)
Number of outputs	4 points
Isolation method	Isolation with photocoupler
Rated load voltage	12/24V DC
Operating load voltage range	10.2 to 28.8 VDC (Ripple ratio: Within 5%)
Max. load current	0.1A/point, 0.4 A/1 common
Max. inrush current	0.4A/10 ms
Leakage current at OFF	0.1mA or less/30V DC
Max. voltage drop at ON	0.3V or less (typical)/0.1A 0.6V or less (max.)/0.1A
Response time	OFF→ON
	ON→OFF
Surge suppression	Zener diode
Common wiring method	4 points/1 common (2 points) (terminal block two-wire type)
Internal protection for outputs	Internal protection circuit none Please connect the fuse in the connected load outside.

5.3 Performance specifications

Item	Specification	
Module power supply	Voltage	20.4 to 28.8V DC (24V DC -15% to +20%) Ripple ratio: Within 5%
	Current consumption	60mA (when all points are ON)
	Initial current	70mA
	Max. allowable momentary power failure period	PS1:1ms
Number of stations occupied	4-, 8- or 16-point mode: 1 station	
Noise durability	500Vp-p Noise width: 1μs Cycle: 25 to 60 Hz (by noise simulator)	
Withstand voltage	500V AC for 1 min	
Isolation resistance	10 MΩ or higher between primary area (external DC terminal) and secondary area (internal circuit) by 500V DC insulation resistance tester	
Protection class	IP2X	
I/O part connection method	Connection with terminal block	
Module installation method	DIN rail installation, mounted by screws of type M4 x 0.7mm(0.03") x 16mm(0.63") or larger Can be installed in six directions	
Mass (weight)	0.06kg (0.13lbs)	

6. Outside Dimensions

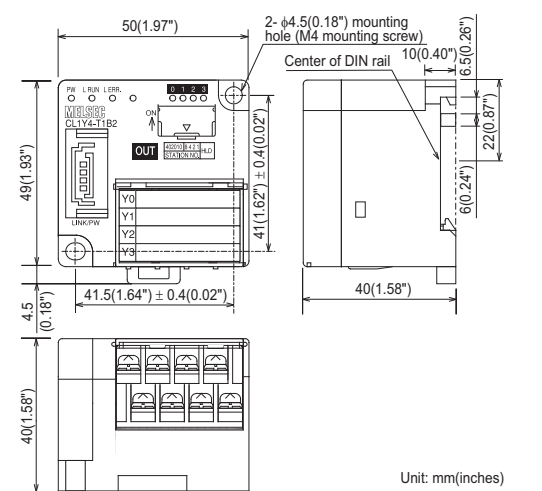

「电器电子产品有害物质限制使用标识要求」的表示方式

Note: This symbol mark is for China only.

含有害6物质的名称, 含有量, 含有部品  
本产品中所含有的有害6物质的名称, 含有量, 含有部品如下表所示。

部件名称	产品中有害物质的名称及含量					
	铅 (Pb)	汞 (Hg)	镉 (Cd)	六价铬 (Cr (VI))	多溴联苯 (PBB)	多溴二苯醚 (PBDE)
可编程控制器	○	○	○	○	○	○
印刷基板	×	○	○	○	○	○

本表格依据SJ/T 11364.4的规格制定。

○: 表示该有害物质在该部件所有均质材料中的含量均在GB/T 26572规定的限量要求以下。  
×: 表示该有害物质至少在该部件的某一均质材料中的含量超出GB/T 26572规定的限量要求。

基于中国标准法的参考规格: GB/T15969.2

This manual confers no industrial property rights or any rights of any other kind, nor does it confer any patent licenses. Mitsubishi Electric Corporation cannot be held responsible for any problems involving industrial property rights which may occur as a result of using the contents noted in this manual.

Warranty

Exclusion of loss in opportunity and secondary loss from warranty liability  
Regardless of the gratis warranty term, Mitsubishi shall not be liable for compensation to:  
(1) Damages caused by any cause found not to be the responsibility of Mitsubishi.  
(2) Loss in opportunity, lost profits incurred to the user by Failures of Mitsubishi products.  
(3) Special damages and secondary damages whether foreseeable or not, compensation for accidents, and compensation for damages to products other than Mitsubishi products.  
(4) Replacement by the user, maintenance of on-site equipment, start-up test run and other tasks.

For safe use

- This product has been manufactured as a general-purpose part for general industries, and has not been designed or manufactured to be incorporated in a device or system used in purposes related to human life.
- Before using the product for special purposes such as nuclear power, electric power, aerospace, medicine or passenger movement vehicles, consult with Mitsubishi Electric.
- This product has been manufactured under strict quality control. However when installing the product where major accidents or losses could occur if the product fails, install appropriate backup or failsafe functions in the system.

Country/Region	Sales office/Tel	Country/Region	Sales office/Tel
USA	MITSUBISHI ELECTRIC AUTOMATION, INC. 500 Corporate Woods Parkway, Vernon Hills, IL 60061, U.S.A. Tel: +1-847-478-2100/+1-847-478-2500 (NC) MITSUBISHI ELECTRIC DO BRASIL COMERCIO E SERVICOS LTDA. Avenida Adelfino Cardana, 203, 21 andar: Bela Vista, Saracá, Belo Horizonte, Brazil Tel: +55-11-4689-3000	Russia	Mitsubishi Electric (Russia) LLC 52, bld. 1, Kosmodamianskaya emb., 115064 Moscow, Russia Tel: +7-495-721-2070
Brazil	MITSUBISHI ELECTRIC EUROPE BV -German Branch Mitsubishi-Electric-Platz 1, 40882 Ratingen, Germany Tel: +49-2102-486-0 MITSUBISHI ELECTRIC EUROPE BV (UK Branch) Travelers Lane, Hatfield, Hertfordshire, AL10 8XB, UK Tel: +44-1473-28-8780 MITSUBISHI ELECTRIC EUROPE BV -Italian Branch Centro Direzionale Colonna - Palazzo Siro, Viale Colonna 7, 20964 Agrate Branzia (MB), Italy Tel: +39-039-605311/+39-039-6053-342 MITSUBISHI ELECTRIC EUROPE BV -Spanish Branch Carretera de Rubí 75-80-AC.420, E-08190 Sant Cugat del Valles (Barcelona), Spain Tel: +34-935-65-3131/+34-935-65-2236 MITSUBISHI ELECTRIC EUROPE BV -French Branch 25, Boulevard des Bouviers, 92741 Nanterre Cedex, France Tel: +33-1-46-66-98-49 MITSUBISHI ELECTRIC EUROPE BV -Czech Branch Avenue Business Park, Radkova 751/113e, 158 00 Praha8, Czech Republic Tel: +420-251-551-470 Mitsubishi Electric Europe B.V. Polish Branch ul. Krakowska 50, 32-063 Balice, Poland Tel: +48-12-347-95-00	China	MITSUBISHI ELECTRIC AUTOMATION (CHINA) LTD. No. 1388 Hongtao Road, Shanghai, China Tel: +86-21-2322-3030 SEISUJO ENTERPRISE CO., LTD. 6F, No.105, Wugong 3rd Road, Wugu District, New Taipei City 24889, Taiwan, R.O.C. Tel: +886-2-2259-2469 Mitsubishi Electric Automation KOREA CO., LTD. 7F-8F, Gangseo Hangang 30-tower A, 401, Yangcheon-ro Gangseo-Gu, Seoul, 07528, Korea Tel: +82-2-2622-4499 MITSUBISHI ELECTRIC ASIA PTE. LTD. 367 Alexandra Road, Mitsubishi Electric Building, Singapore 159943 Tel: +65-6473-2308 Mitsubishi Electric Factory Automation (Thailand) Co., Ltd. 12th Floor, SV City Building, Office Tower 1, No. 888/19 and 20 Rama 3 Road, Keweenaw Bangpongkong, Khai Yannawa, Bangkok 10120, Thailand Tel: +66-2682-6522-31 PT. Mitsubishi Electric Indonesia Gedung Jina 11th Floor, J. MH. Thamrin No.12, Jakarta Pusat 10340, Indonesia Tel: +62-21-3162-6461 Mitsubishi Electric India Pvt. Ltd. Gurgaon Head Office 2nd Floor, Tower A B.B. Cyber Greens, DLF Cyber City, DLF Phase - II, Gurgaon, India Tel: +91-124-4630300 MITSUBISHI ELECTRIC AUSTRALIA PTY. LTD. 348 Victoria Road PO BOX111, Rydalmere, N.S.W 2118, Australia Tel: +61-2-9684-7777

MITSUBISHI ELECTRIC CORPORATION

HEAD OFFICE: TOKYO BUILDING, 2-7-3 MARUNOUCHI, CHYUO-KU, TOKYO 100-8310, JAPAN

When exported from Japan, this manual does not require application to the Ministry of Economy, Trade and Industry for service transaction permission.

Specifications subject to change without notice.