

# CL1XY8-DTE1B2 CC-Link/LT Remote I/O Module

Please read this manual thoroughly before starting to use the product and handle the product properly.

## User's Manual

MODEL	CL1XY8-DTE1B2
MANUAL Number	JY997D05901A
Date	NOVEMBER 2002

### SAFETY PRECAUTIONS

(Read these precautions before using)

Please read this manual carefully and pay special attention to safety in order to handle this product properly. Also pay careful attention to safety and handle the module properly.

These precautions apply only to Mitsubishi equipment. Refer to the user's manual of the CPU module to use for a description of the PLC system safety precautions.

These SAFETY PRECAUTIONS classify the safety precautions into two categories: "DANGER" and "CAUTION".



Procedures which may lead to a dangerous condition and cause death or serious injury if not carried out properly.

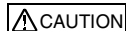

Procedures which may lead to a dangerous condition and cause superficial to medium injury, or physical damage only, if not carried out properly.

Depending on circumstances, procedures indicated by CAUTION may also be linked to serious results.

In any case, it is important to follow the directions for usage. Store this manual in a safe place so that you can take it out and read it whenever necessary. Always forward it to the end user.

### DESIGN PRECAUTIONS



- Configure an interlock circuit in a sequence program so that the system operates on the safety side using the communication status information in the event the data link falls into a communication problem. Otherwise, erroneous output and malfunction may result in accidents.
- Remote input and output can not be switched ON or OFF when a problem occurs in the remote I/O modules. Therefore build an external monitoring circuit that will monitor any input signals that could cause a serious accident.

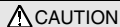

- Do not have control cables and communication cables bundled with or placed near by the main circuit and/or power cables. Wire those cables at least 100mm(3.94 inch) away from the main circuit and/or power cables. It may cause malfunction due to noise interference.
- Use the module and the flat cable dedicated to CC-Link/LT without applying any force on them. Otherwise, such cables may be broken or fail.

### INSTALLATION PRECAUTIONS

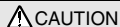

- Use the module in an environment that meets the general specifications contained in this manual. Using this module in an environment outside the range of the general specifications could result in electric shock, fire, erroneous operation, and damage to or deterioration of the product.
- Do not directly touch the module's conductive parts. Doing so could cause malfunction or trouble in the module.
- Tighten the module securely using DIN rail or installation screws within the specified torque range. If the screws are too loose, the module may drop from its installation position, short circuit, or malfunction. If the screws are too tight, the screws may be damaged, which may cause the module to drop from its installation position or short circuit.
- Install the module on a flat surface. If the mounting surface has concave and/or convex, an excessive force may be applied on the module, and nonconformity may be caused.

### WIRING PRECAUTIONS



- Perform installation and wiring after disconnecting the power supply at all phases externally. If the power is not disconnected at all phases an electric shock or product damage may result.

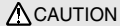

- Terminal screws which are not to be used must be tightened always. Otherwise there will be a danger of short circuit against the bare solderless terminals.
- Perform correct wiring for the module according to the product's rated voltage and terminal arrangement. Connecting to a power supply different from rating or miss-wiring may cause fire, product failure or malfunction.
- Fix terminal screws securely within the regulated torque. Loose terminal screws may cause fire and/or malfunction. If the terminal screws are too tight, it may cause short circuit or erroneous operation due to damage of the screws.
- Make sure foreign objects do not get inside the module, such as dirt and wire chips. It may cause fire, product failure or malfunction.
- Attach a warning label (hazard symbol 417-IEC-5036) concerning the electric shock to the location.

### STARTING AND MAINTENANCE PRECAUTIONS



- Do not touch the terminals when the power is ON. It may cause an electric shock or malfunction.
- Perform cleaning the module or retightening of terminal screws after turning OFF the all external power supply for sure. Failure to do so may cause failure or malfunction of the modules

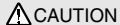

- Do not disassemble or modify the module. Doing so may cause failure, malfunction, injury, or fire.
- The module case is made of resin; do not drop it or subject it to strong shock. A module damage may result.
- Make sure to switch all phases of the external power supply OFF before installing or removing the module to/from the panel. Failure to do so may cause failure or malfunction of the modules.

### DISPOSAL PRECAUTIONS



- When disposing of this product, treat it as industrial waste.

### TRANSPORTATION AND MAINTENANCE PRECAUTIONS



- During transportation avoid any impact as the module is a precision instrument. Doing so could cause trouble in the module.
- If it is necessary to check the operation of module after transportation, in case of any impact damage.

### Notification of CE marking

This notification does not guarantee that an entire mechanical module produced in accordance with the contents of the notification comply with the following standards. Compliance to EMC standards of the entire mechanical module should be checked by the user / manufacturer.

### Standards with which this product complies

Type : Programmable Controller (Open Type Equipment) Remote I/O module  
 Models : Products manufactured from November 1st, 2002.

Electromagnetic Compatibility Standards (EMC)	Remark
EN61000-6-4:2001 Electromagnetic compatibility -Generic standards - Emission standard for Industrial environment	Compliance with all relevant aspects of the standard. (Radiated Emissions and Mains Terminal Voltage Emissions)
EN61131-2:1994 Programmable controllers /A11: 1996 -Equipment requirements and tests /A12: 2000	Compliance with all relevant aspects of the standard. (RF Immunity, Fast transients, ESD and Damped oscillatory wave)

For more details please contact the local Mitsubishi Electric sales site.  
 - Notes For compliance to EMC regulation.  
 It is necessary to install the CL1 series module in a shielded metal control panel.

## 1. Outline of Product

This product is a terminal block type composite I/O module connected to CC-Link/LT.

This product has four input points (24 VDC) and four output points (transistor output).

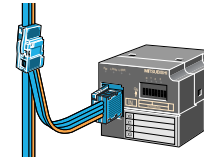

## 2. Name and Setting of Each Part and Terminal Arrangement

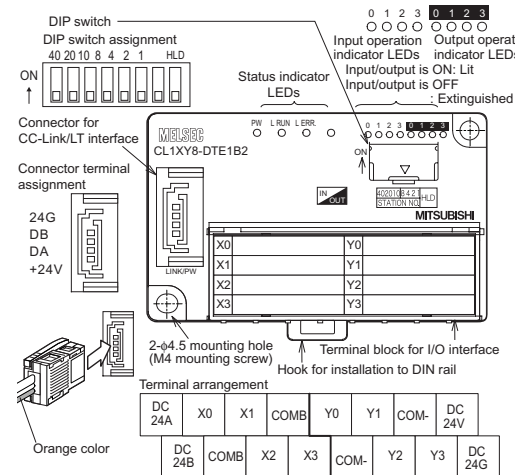

## 3. Cautions on Handling

The CL1XY8-DTE1B2 can be installed to DIN rail or directly installed using mounting screws.

Each installation procedure is described below.

### 3.1 Installation to DIN rail

Align the upper DIN rail installation groove in the module with the DIN rail 1), and press the module in that status 2).

When removing the module, pull the hook downward for installation to DIN rail 3), then remove the module 4).

### DIN rail mounting screw pitch

When installing the module to the DIN rail, tighten the mounting screws at the pitch of 200mm(7.87") or less.

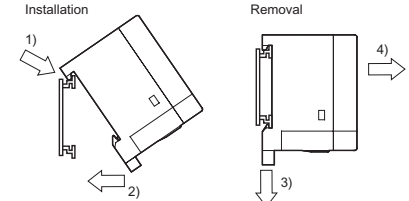

Applicable DIN rail | TH35-7.5Fe and TH35-7.5Al (conforming to JIS C2812)

### 3.2 Direct installation

Screw-tighten the module by attaching M4 screws to the upper and lower mounting holes (two holes in all) provided in the module.

Install the module so that the clearance of 1 to 2mm (0.04" to 0.08") is assured for each module.

Applicable screw | M4 x 0.7mm(0.03") x 16mm(0.63") or more  
 (Tightening torque range: 78 to 108 N-cm)

## 4. Connection to External Equipment and Power Supply

### 4.1 External wiring

The input terminals of the CL1XY8-DTE1B2 can be wired as positive common or negative common depending on the used sensor.

(The output wiring is fixed to the source output.)

#### Positive common

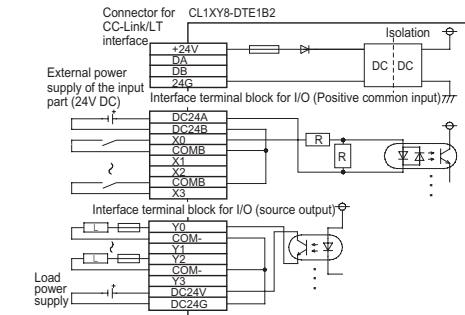

#### Negative common

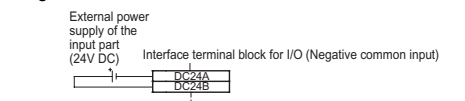

Name	Description																					
PW	ON while the power is supplied.																					
L RUN	ON while normal operation is executed.																					
Status indicator LED	<p>ON: When a communication error or DIP switch setting error occurred</p> <p>Flickering at a constant interval: When the setting of the DIP switch was changed while the power was supplied (even while the LED is flickering, the operation continues. The new setting becomes valid when the power is turned OFF once, then ON again.)</p> <p>Flickering at an intermittent interval: When a terminal resistor is not attached or when the module or a connection cable is affected by noise</p>																					
I/O operation indicator LED	<p>ON while the input or output is ON Extinguished while the input or output is OFF.</p> <p>Input operation indicator    Output operation indicator</p>																					
Interface	Connector for CC-Link/LT communication line/module power supply (24G/DB/DA/+24V)																					
Terminal block for I/O interface	Terminal block to connect input signals, output signals, I/O power supply and load power supply																					
DIP switch	<p>Set the 10's digit of the station No. using "STATION NO. 10", "STATION NO. 20" and "STATION NO. 40". Set the 1's digit of the station No. using "STATION NO. 1", "STATION NO. 2", "STATION NO. 4" and "STATION NO. 8".</p> <p>Factory default = All bits are OFF.</p> <p>Make sure to set the station No. in the range from 1 to 64. If any station No. outside the range from 1 to 64 is set, it is regarded as an error and the L ERR. LED lights.</p> <p>Example: When setting the station No. to "32", set the DIP switch as follows.</p> <table border="1"> <tr> <td>Station No.</td> <td>10's digit</td> <td>1's digit</td> </tr> <tr> <td>40</td> <td>20</td> <td>10</td> </tr> <tr> <td>32</td> <td>OFF</td> <td>ON</td> </tr> <tr> <td></td> <td>8</td> <td>4</td> </tr> <tr> <td></td> <td>2</td> <td>1</td> </tr> <tr> <td></td> <td>OFF</td> <td>OFF</td> </tr> <tr> <td></td> <td>ON</td> <td>OFF</td> </tr> </table>	Station No.	10's digit	1's digit	40	20	10	32	OFF	ON		8	4		2	1		OFF	OFF		ON	OFF
Station No.	10's digit	1's digit																				
40	20	10																				
32	OFF	ON																				
	8	4																				
	2	1																				
	OFF	OFF																				
	ON	OFF																				
HLD	<p>Holds the output (when an error has occurred).</p> <p>ON: Holds the output.</p> <p>OFF: Clears the output.</p>																					

## 4.2 Connection to sensor

### Positive common (NPN)

- When using a two-wire type sensor
- When using a three-wire type sensor

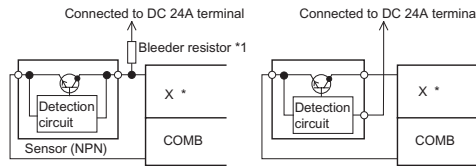

- When using a three-wire type sensor (when using the power supply for sensor other than 24V DC)

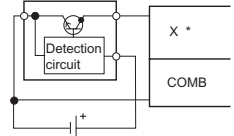

### Negative common (PNP)

- When using a two-wire type sensor
- When using a three-wire type sensor

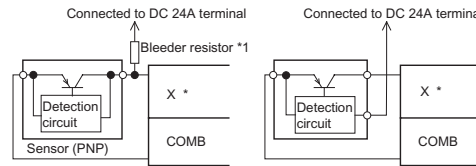

- When using a three-wire type sensor (when using the power supply for sensor other than 24V DC)

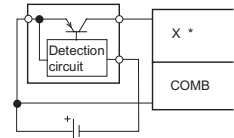

Replace \* in the figure with the used input No.

Notes:

#### \*1 Bleeder resistor

When connecting a two-wire type sensor or input equipment containing a parallel resistor, select a sensor or equipment whose leakage current is 1.7mA or less.

If the leakage current is more than 1.7mA, connect a bleeder resistor obtained in the following calculation formula.

Circuit image

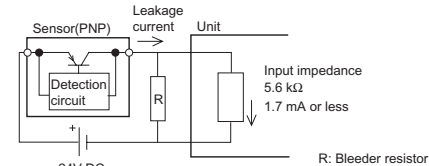

$$R(k\Omega) < 1.7(mA) / \text{Leakage current}(mA) - 1.7(mA) \times 5.6(k\Omega)$$

The power capacity W of the bleeder resistor R is as follows:  
 $W = (\text{Input voltage})^2/R$

- Make sure that both the ON and OFF time of the input signal are 1.5ms or more.

## 4.3 Crimp-style terminal

For I/O wiring, use crimp-style terminals of the following dimensions.

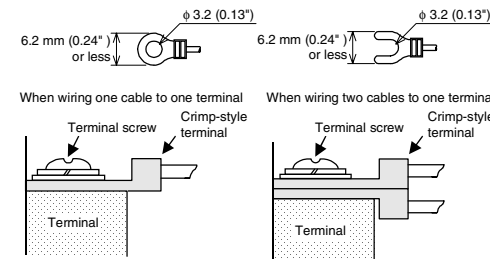

Applicable crimp-style terminal	• RAV1.25-3 (conforming to JIS C2805)
	• V1.25-3 (manufactured by JST Mfg. Co., Ltd.)
Applicable wire size	• 1.25-3 and TG1.25-3 (manufactured by NICHIFU Co., Ltd.)
	0.3 to 1.25 mm <sup>2</sup>

Use a crimp-style terminal in a status in which no force is applied on the cable.

## 4.4 Module terminal screw

Tighten the terminal screws (M3 screws) on the terminal block with the tightening torque of 42 to 58 N-cm.

## 5. Specifications

### 5.1 General specifications

Item	Specification
<b>Ambient working temperature</b>	0 to 55°C (32 to 131°F) (*1)
<b>Ambient storage temperature</b>	-25 to 75°C (-13 to 167°F) (*1)
<b>Ambient operating humidity</b>	Conforming to JIS B3502 and IEC61131-2, Level RH-2 (5 to 95%RH: Dew condensation shall not be considered.)
<b>Ambient storage humidity</b>	Conforming to JIS B3502 and IEC61131-2, Level RH-2 (5 to 95%RH: Dew condensation shall not be considered.)
<b>Vibration resistance</b>	When intermittent vibration is present
	Frequency   Acceleration   Half amplitude
	10 to 57Hz   -   0.075mm
	57 to 150Hz   9.8m/s <sup>2</sup>   -
When continuous vibration is present	
Frequency   Acceleration   Half amplitude	
10 to 57Hz   -   0.035mm	
57 to 150Hz   4.9m/s <sup>2</sup>   -	
<b>Impact resistance</b>	Conforming to JIS B3502 and IEC61131-2 (147 m/s <sup>2</sup> , 3 times in each of X, Y and Z directions)
<b>Operating atmosphere</b>	Corrosive gas shall not be present.
<b>Operating altitude</b>	Conforming to JIS B3502 and IEC61131-2 (2,000m(6561'8") or less)(*2)
<b>Installation place</b>	Inside control panel (*3)
<b>Over-voltage category</b>	Conforming to JIS B3502 and IEC61131-2 (Category II or less)(*4)
<b>Degree of contamination</b>	Conforming to JIS B3502 and IEC61131-2, Degree of contamination 2 or less (*5)

Notes:

- The ambient operating/storage temperature satisfies the requirements beyond the specification in the JIS B3502 and the IEC61131-2.
- The module cannot be used in an environment pressurized above the atmospheric pressure which can be generated around the altitude of 0 m. If the module is used in such an environment, it may fail.
- The module can be used in any environment even outside the control panel as far as the requirements of the ambient operating temperature, the ambient operating humidity, etc. are satisfied.
- This indicates the section of the power supply to which the equipment is assumed to be connected between the public electrical power distribution network and the machinery within premises. Category II applies to equipment for which electrical power is supplied from fixed facilities. The surge voltage withstand level for up to the rated voltage of 300V is 2500V.

\*5 This index indicates the degree of conductive generating substances in the environment in which the module is used. The degree of contamination 2 indicates that contamination is caused by generation of only non-conductive substances. In this degree, however, temporary conduction may be caused by accidental condensation.

### 5.2 Input specifications

Item	Specification
<b>Input method</b>	DC input (External power supply of the input part) EN61131-2, Section 3.3.1.2-Type1
<b>Number of inputs</b>	4 points
<b>Isolation method</b>	Isolation with photocoupler
<b>Rated input voltage</b>	24V DC
<b>Rated input current</b>	Approx. 4 mA
<b>Operating voltage range</b>	20.4 to 28.8V DC (24V DC -15% to +20%) Ripple ratio: Within 5%
<b>Max. simultaneous ON input points</b>	100% (at 24V DC)
<b>ON voltage/ON current</b>	19 V or more/3 mA or more
<b>OFF voltage/OFF current</b>	11 V or less/1.7 mA or less
<b>Input resistance</b>	5.6 kΩ
<b>Response time</b>	OFF→ON
	ON→OFF
<b>Common wiring method</b>	4 points/1 common (2 points) (terminal block two-wire type)

### 5.3 Output specifications

Item	Specification
<b>Output method</b>	Transistor output (Load power supply) (source)
<b>Number of outputs</b>	4 points
<b>Isolation method</b>	Isolation with photocoupler
<b>Rated load voltage</b>	12/24V DC
<b>Operating load voltage range</b>	10.2 to 28.8V DC (Ripple ratio: Within 5%)
<b>Max. load current</b>	0.1A/point, 0.4 A/1 common
<b>Max. rush current</b>	0.4A/10 ms
<b>Leakage current at OFF</b>	0.1mA or less/30V DC
<b>Max. voltage drop at ON</b>	0.3V or less (typical)/0.1A 0.6V or less (max.)/0.1A
<b>Response time</b>	OFF→ON
	ON→OFF
<b>Surge suppression</b>	Zener diode
<b>Common wiring method</b>	4 points/1 common (2 points) (terminal block two-wire type)
<b>Internal protection for outputs</b>	Internal protection circuit none Please connect the fuse in the connected load outside.

### 5.4 Performance specifications

Item	Specification
<b>Module power supply</b>	<b>Voltage</b>
	20.4 to 28.8V DC (24V DC -15% to +20%) Ripple ratio: Within 5%
	<b>Current consumption</b>
65mA (when all points are ON)	
<b>Initial current</b>	70mA
<b>Max. allowable momentary power failure period</b>	PS1:1ms
<b>Number of stations occupied</b>	4-, 8- or 16-point mode: 1 station
<b>Noise durability</b>	500Vp-p Noise width: 1μs Cycle: 25 to 60 Hz (by noise simulator)
<b>Withstand voltage</b>	500V AC for 1 min
<b>Isolation resistance</b>	10 MΩ or more between primary area (external DC terminal) and secondary area (internal circuit) by 500 VDC megger
<b>Protection class</b>	IP2X
<b>I/O part connection method</b>	Connection with terminal block
<b>Module installation method</b>	DIN rail installation, mounted by screws of type M4 × 0.7mm(0.03") × 16mm(0.63") or larger Can be installed in six directions
<b>Mass (weight)</b>	0.1kg (0.22lbs)

## 6. Outside Dimensions

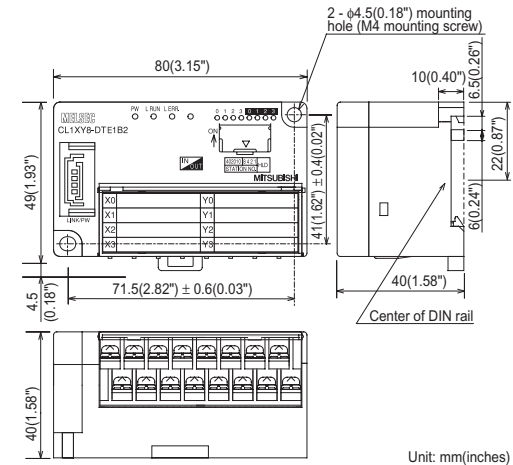

### Warranty

Mitsubishi will not be held liable for damage caused by factors found not to be the cause of Mitsubishi; machine damage or lost profits caused by faults in the Mitsubishi products; damage, secondary damage, accident compensation caused by special factors unpredictable by Mitsubishi; damages to products other than Mitsubishi products; and to other duties.



For safe use

- This product has been manufactured as a general-purpose part for general industries, and has not been designed or manufactured to be incorporated in a device or system used in purposes related to human life.
- Before using the product for special purposes such as nuclear power, electric power, aerospace, medicine or passenger movement vehicles, consult with Mitsubishi.
- This product has been manufactured under strict quality control. However when installing the product where major accidents or losses could occur if the product fails, install appropriate backup or failsafe functions in the system.

Country/Region	Sales office/Tel	Country/Region	Sales office/Tel
U.S.A	Mitsubishi Electric Automation Inc. 500 Corporate Woods Parkway Vernon Hills, IL 60061 Tel : +1-847-478-2100	China	Ryoden International Shanghai Ltd. 3F Blocks Building Automation Instrumentation Plaza 103 Cao Bao Rd. Shanghai 200233 China Tel : +86-21-6475-3228
Brazil	MELCO-TEC Rep. Com.e Assessoria Tecnica Ltda. Av. Rio Branco, 123-15, and S/1507, Rio de Janeiro, RJ CEP 20040-005, Brazil Tel : +55-21-221-8343	Taiwan	Setsuyo Enterprise Co., Ltd. 6F, No.105 Wu-Kung 3rd RD, Wu-Ku Hsiang, Taipei Hsin, Taiwan Tel : +886-2-2299-2499
Germany	Mitsubishi Electric Europe B.V. German Branch Gohseer Strasse 8 D-40880 Ratingen, GERMANY Tel : +49-2102-486-0	Korea	HAN NEUNG TECHNO CO.LTD. 1F Dong Seo Game Channel Bldg, 660-11, Deungchon-dong Kangse-ku, Seoul, Korea Tel : +82-2-3660-9552
U.K	Mitsubishi Electric Europe B.V. UK Branch Travellers Lane, Hatfield, Herts, AL10 8XB, UK Tel : +44-1707-276100	Singapore	Mitsubishi Electric Asia Pte, Ltd. 307 ALEXANDRA ROAD #05-01/02, SINGAPORE 159943 Tel : +65-473-2480
Italy	Mitsubishi Electric Europe B.V. Italian Branch Centro Dir. Colsoni, Pal. Persico - Ingr 2 Via Paracelso 12, 20041 Agrate B., Milano, Italy Tel : +39-039-60531	Thailand	F. A. Tech Co., Ltd. 890/28,29,30 S.V.City Building,Office Tower 2, Floor 17-18 Rama 3 Road, Bangkokpungang, Yamnawa, Bangkok 10120 Tel : +66-2-682-6522
Spain	Mitsubishi Electric Europe B.V. Spanish Branch Carretera de Rubi 76-80 08190 - Sant Cugat del Valles, Barcelona, Spain Tel : +34-935-653135	Indonesia	P.T. Autotekindo SUMBER MAKMUR Jl. Muara Karang Selatan Block4 Utara No.1 Kav. No.11 KawasanIndustri/ Pergudangan,Jakarta - Utara 14440 Tel : +62-21-663-9833
South Africa	Circuit Breaker Industries LTD. Private Bag 2016, Isando 1600, Johannesburg, South Africa Tel : +27-11-928-2000	India	Electronic Sadan NO:111 Unit No15, M.I.D.C BHOSARI PUNE-411026 Tel : +91-20-7128927
Hong Kong	Ryoden Automation Ltd. 10th Floor, Manulife Tower, 169 Electric Road, North Point, HongKong Tel : +852-2887-8870	Australia	Mitsubishi Electric Australia Pty. Ltd. 348 Victoria Road, PostBag, No.2, Rydalmere, N.S.W 2116, Australia Tel : +61-2-9684-7777

**MITSUBISHI ELECTRIC CORPORATION**  
 HEAD OFFICE : MITSUBISHI DENKI BLDG MARUNOUCHI TOKYO 100-8310 TELEX:24332 CABLE MELCO TOKYO  
 HIMEJI WORKS : 840 CHIVODA CHO, HIMEJI, JAPAN

When exported from Japan, this manual does not require application to the Ministry of Economy, Trade and Industry for service transaction permission.

Specifications are subject to change without notice



CL1XY8-DTE1B2 CC-Link/LT Remote I/O Module

Please read this manual thoroughly before starting to use the product and handle the product properly.

User's Manual

Table with 2 columns: Field (MODEL, MANUAL Number, Date) and Value (CL1XY8-DTE1B2, JY997D05901A, NOVEMBER 2002)

SAFETY PRECAUTIONS

Please read this manual carefully and pay special attention to safety in order to handle this product properly.

These precautions apply only to Mitsubishi equipment. Refer to the user's manual of the CPU module to use for a description of the PLC system safety precautions.

- DANGER: Procedures which may lead to a dangerous condition and cause death or serious injury if not carried out properly. CAUTION: Procedures which may lead to a dangerous condition and cause superficial to medium injury, or physical damage only, if not carried out properly.

Depending on circumstances, procedures indicated by CAUTION may also be linked to serious results. In any case, it is important to follow the directions for usage.

- DESIGN PRECAUTIONS: DANGER: Configure an interlock circuit in a sequence program so that the system operates on the safety side using the communication status information in the event the data link falls into a communication problem. CAUTION: Do not have control cables and communication cables bundled with or placed near by the main circuit and/or power cables.

- INSTALLATION PRECAUTIONS: CAUTION: Use the module in an environment that meets the general specifications contained in this manual. Using this module in an environment outside the range of the general specifications could result in electric shock, fire, erroneous operation, and damage to or deterioration of the product.

WIRING PRECAUTIONS

- DANGER: Perform installation and wiring after disconnecting the power supply at all phases externally. CAUTION: Terminal screws which are not to be used must be tightened always. Otherwise there will be a danger of short circuit against the bare solderless terminals.

STARTING AND MAINTENANCE PRECAUTIONS

- DANGER: Do not touch the terminals when the power is ON. CAUTION: Do not disassemble or modify the module. Do not touch the module, do not drop it or subject it to strong shock.

DISPOSAL PRECAUTIONS

- DANGER: When disposing of this product, treat it as industrial waste.

TRANSPORTATION AND MAINTENANCE PRECAUTIONS

- CAUTION: During transportation avoid any impact as the module is a precision instrument. Do not touch the module after transportation.

Notification of CE marking

This notification does not guarantee that an entire mechanical module produced in accordance with the contents of the notification comply with the following standards.

Standards with which this product complies Type : Programmable Controller (Open Type Equipment) Remote I/O module Models : Products manufactured from November 1st, 2002.

Table with 2 columns: Electromagnetic Compatibility Standards (EMC) and Remark. Includes EN61000-6-4:2001 and EN61131-2:1994.

For more details please contact the local Mitsubishi Electric sales site. - Notes For compliance to EMC regulation. It is necessary to install the CL1 series module in a shielded metal control panel.

Outline of Product

This product is a terminal block type composite I/O module connected to CC-Link/LT. This product has four input points (24 VDC) and four output points (transistor output).

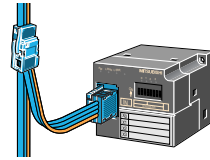

Name and Setting of Each Part and Terminal Arrangement

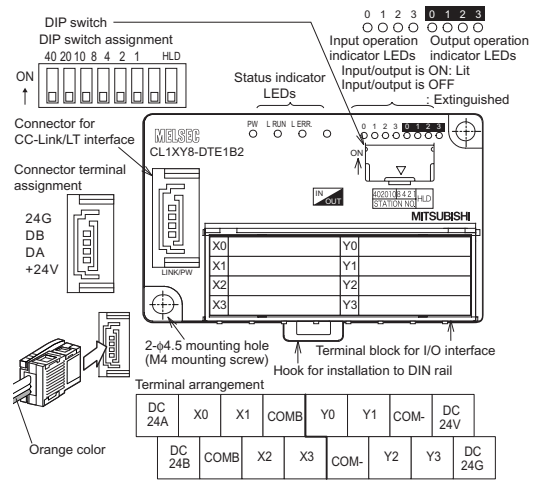

Table with 3 columns: Name, Description, and Settings. Includes Status indicator LED, I/O operation indicator LED, Interface, Terminal block for I/O interface, and DIP switch.

Cautions on Handling

The CL1XY8-DTE1B2 can be installed to DIN rail or directly installed using mounting screws. Each installation procedure is described below.

Installation to DIN rail

Align the upper DIN rail installation groove in the module with the DIN rail 1), and press the module in that status 2). When removing the module, pull the hook downward for installation to DIN rail 3), then remove the module 4).

DIN rail mounting screw pitch

When installing the module to the DIN rail, tighten the mounting screws at the pitch of 200mm(7.87") or less.

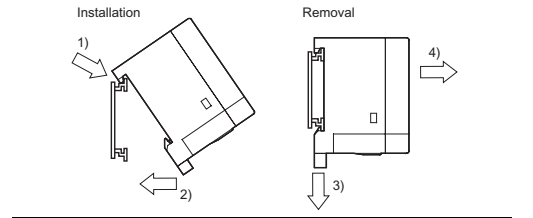

Applicable DIN rail TH35-7.5Fe and TH35-7.5Al (conforming to JIS C2812)

Direct installation

Screw-tighten the module by attaching M4 screws to the upper and lower mounting holes (two holes in all) provided in the module. Install the module so that the clearance of 1 to 2mm (0.04" to 0.08") is assured for each module.

Applicable screw M4 x 0.7mm(0.03") x 16mm(0.63") or more (Tightening torque range: 78 to 108 N-cm)

Connection to External Equipment and Power Supply

External wiring

The input terminals of the CL1XY8-DTE1B2 can be wired as positive common or negative common depending on the user sensor. (The output wiring is fixed to the source output.)

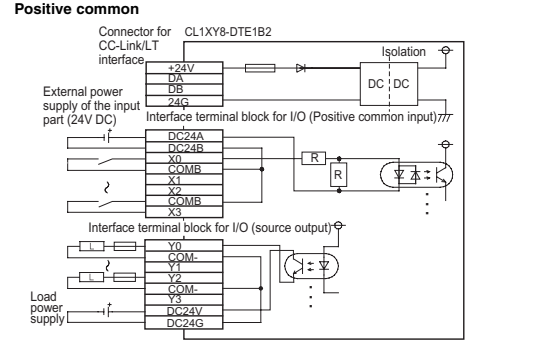

4.2 Connection to sensor

Positive common (NPN)

When using a two-wire type sensor • When using a three-wire type sensor

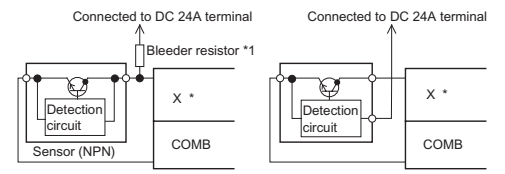

When using a three-wire type sensor (when using the power supply for sensor other than 24V DC)

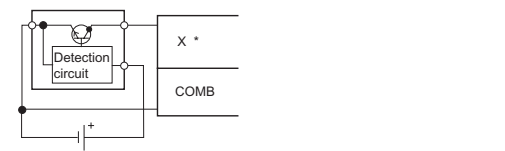

Negative common (PNP)

When using a two-wire type sensor • When using a three-wire type sensor

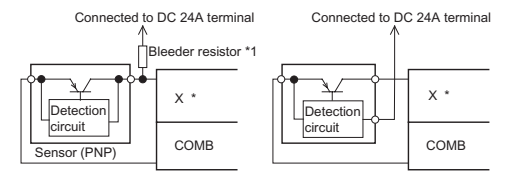

When using a three-wire type sensor (when using the power supply for sensor other than 24V DC)

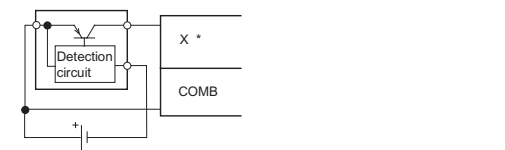

Replace \* in the figure with the used input No.

Notes: \*1 Bleeder resistor When connecting a two-wire type sensor or input equipment containing a parallel resistor, select a sensor or equipment whose leakage current is 1.7mA or less.

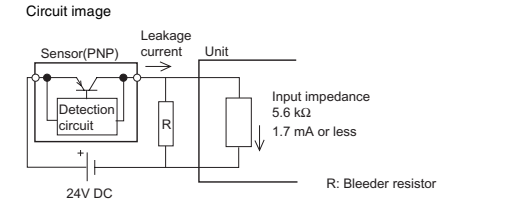

Notes: 1 The ambient operating/storage temperature satisfies the requirements beyond the specification in the JIS B3502 and the IEC61131-2. 2 The module cannot be used in an environment pressurized above the atmospheric pressure which can be generated around the altitude of 0 m.

4.3 Crimp-style terminal

For I/O wiring, use crimp-style terminals of the following dimensions.

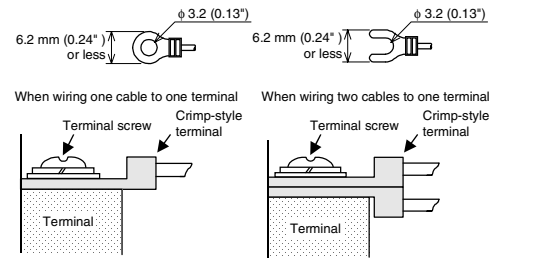

Table with 2 columns: Applicable crimp-style terminal and Applicable wire size. Lists standards like RAV1.25-3 and V1.25-3.

Use a crimp-style terminal in a status in which no force is applied on the cable.

4.4 Module terminal screw

Tighten the terminal screws (M3 screws) on the terminal block with the tightening torque of 42 to 58 N-cm.

5. Specifications

5.1 General specifications

Table with 2 columns: Item and Specification. Includes ambient working temperature, ambient storage temperature, ambient operating humidity, ambient storage humidity, vibration resistance, impact resistance, operating atmosphere, operating altitude, installation place, over-voltage category, and degree of contamination.

- Notes: 1 The ambient operating/storage temperature satisfies the requirements beyond the specification in the JIS B3502 and the IEC61131-2. 2 The module cannot be used in an environment pressurized above the atmospheric pressure which can be generated around the altitude of 0 m.

\*5 This index indicates the degree of conductive generating substances in the environment in which the module is used. The degree of contamination 2 indicates that contamination is caused by generation of only non-conductive substances.

5.2 Input specifications

Table with 2 columns: Item and Specification. Includes input method, isolation method, rated input voltage, rated input current, operating voltage range, max. simultaneous ON input points, ON voltage/ON current, OFF voltage/OFF current, input resistance, response time, and common wiring method.

5.3 Output specifications

Table with 2 columns: Item and Specification. Includes output method, number of outputs, isolation method, rated load voltage, operating load voltage range, max. load current, max. rush current, leakage current at OFF, max. voltage drop at ON, response time, surge suppression, common wiring method, and internal protection for outputs.

5.4 Performance specifications

Table with 2 columns: Item and Specification. Includes voltage, current consumption, initial current, max. allowable momentary power failure period, number of stations occupied, noise durability, withstand voltage, isolation resistance, protection class, I/O part connection method, module installation method, and mass (weight).

6. Outside Dimensions

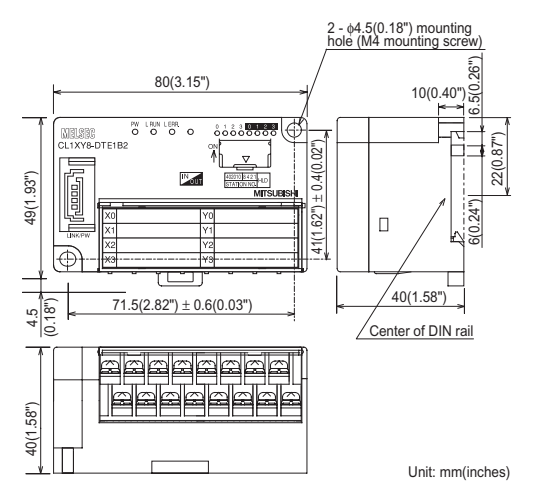

Warranty

Mitsubishi will not be held liable for damage caused by factors found not to be the cause of Mitsubishi; machine damage or lost profits caused by faults in the Mitsubishi products; damage, secondary damage, accident compensation caused by special factors unpredictable by Mitsubishi; damages to products other than Mitsubishi products; and to other duties.

- For safe use • This product has been manufactured as a general-purpose part for general industries, and has not been designed or manufactured to be incorporated in a device or system used in purposes related to human life. • Before using the product for special purposes such as nuclear power, electric power, aerospace, medicine or passenger movement vehicles, consult with Mitsubishi.

Table with 2 columns: Country/Region Sales office/Tel and Mitsubishi Electric Automation Inc. Contact information for various regions including USA, Brazil, Germany, UK, Italy, Spain, South Africa, Hong Kong, China, Taiwan, Korea, Singapore, Thailand, Indonesia, and India.