

CL1X2-D1D3S CC-Link/LT Remote I/O Module

User's Manual

Please read this manual thoroughly before starting to use the product and handle the product properly.

CC-link/LT

MODEL	CL1X2-D1D3S
MANUAL Number	JY997D03901L
Date	July 2018

SAFETY PRECAUTIONS

(Read these precautions before using)

Please read this manual carefully and pay special attention to safety in order to handle this product properly. Also pay careful attention to safety and handle the module properly.

These precautions apply only to Mitsubishi equipment. Refer to the user's manual of the CPU module to use for a description of the PLC system safety precautions.

These SAFETY PRECAUTIONS classify the safety precautions into two categories: "WARNING" and "CAUTION".

WARNING Procedures which may lead to a dangerous condition and cause death or serious injury if not carried out properly.

CAUTION Procedures which may lead to a dangerous condition and cause superficial to medium injury, or physical damage only, if not carried out properly.

Depending on circumstances, procedures indicated by CAUTION may also be linked to serious results.

In any case, it is important to follow the directions for usage.

Store this manual in a safe place so that you can take it out and read it whenever necessary. Always forward it to the end user.

DESIGN PRECAUTIONS

WARNING

- Configure an interlock circuit in a sequence program so that the system operates on the safety side using the communication status information in the event the data link falls into a communication problem. Otherwise, erroneous output and malfunction may result in accidents.
- Remote input and output can not be switched ON or OFF when a problem occurs in the remote I/O modules. Therefore build an external monitoring circuit that will monitor any input signals that could cause a serious accident.

CAUTION

- Do not have control cables and connection cables bundled with or placed near by the main circuit and/or power cables. Wire those cables at least 100mm(3.94 inch) away from the main circuit and/or power cables. It may cause malfunction due to noise interference.
- Use the module in the status in which any force is not applied on the module, flat cables dedicated to CC-Link/LT and flat cables for I/O. If a force is applied, wire breakage or failure may be caused.

INSTALLATION PRECAUTIONS

CAUTION

- Use the module in an environment that meets the general specifications contained in this manual. Using this module in an environment outside the range of the general specifications could result in electric shock, fire, erroneous operation, and damage to or deterioration of the product.
- Do not directly touch the module's conductive parts. Doing so could cause malfunction or trouble in the module.

WIRING PRECAUTIONS

WARNING

- Perform installation and wiring after disconnecting the power supply at all phases externally. If the power is not disconnected at all phases an electric shock or product damage may result.

CAUTION

- Perform correct wiring for the module according to the product's rated voltage and terminal arrangement. Connecting to a power supply different from rating or miss-wiring may cause fire, product failure or malfunction.
- Make sure foreign objects do not get inside the module, such as dirt and wire chips. It may cause fire, product failure or malfunction.
- Do not short-circuit the 24G and +24V terminals. It may result in fire, product failure or malfunction.
- Attach a warning label (hazard symbol 417-IEC-5036) concerning the electric shock to the location.

STARTING AND MAINTENANCE PRECAUTIONS

WARNING

- Do not touch the terminals when the power is ON. It may cause an electric shock or malfunction.
- Perform cleaning the module after turning OFF the all external power supply for sure. Failure to do so may cause failure or malfunction of the modules.

CAUTION

- Do not disassemble or modify the module. Doing so may cause failure, malfunction, injury, or fire.
- The module case is made of resin; do not drop it or subject it to strong shock. A module damage may result.
- Make sure to switch all phases of the external power supply OFF before installing or removing the module to/from the panel. Failure to do so may cause failure or malfunction of the modules.

DISPOSAL PRECAUTIONS

CAUTION

- When disposing of this product, treat it as industrial waste.

TRANSPORTATION AND MAINTENANCE PRECAUTIONS

CAUTION

- During transportation avoid any impact as the module is a precision instrument. Doing so could cause trouble in the module.
- If it is necessary to check the operation of module after transportation, in case of any impact damage.

Notification of CE marking

This notification does not guarantee that an entire mechanical module produced in accordance with the contents of the notification comply with the following standards. Compliance to EMC standards of the entire mechanical module should be checked by the user / manufacturer.

Attention

This product is designed for use in industrial applications.

Standards with which this product complies

Type : Programmable Controller (Open Type Equipment) Remote I/O module
Models : Products manufactured:

from November 1st, 2002 to April 30th, 2006 are compliant with EN61000-6-4:2001 and EN61131-2:1994+A11:1996+A12:2000 after May 1st, 2006 are compliant with EN61131-2:2007

Electromagnetic Compatibility Standards (EMC)	Remark
EN61000-6-4:2001 Electromagnetic compatibility -Generic standards - Emission standard for Industrial environment	Compliance with all relevant aspects of the standard. (Radiated Emissions and Mains Terminal Voltage Emissions)
EN61131-2:1994/A11:1996/A12:2000 Programmable controllers -Equipment requirements and tests	Compliance with all relevant aspects of the standard. • Radiated electromagnetic field • Fast transient burst • Electrostatic discharge • Damped oscillatory wave
EN61131-2: 2007 Programmable controllers -Equipment requirements and tests	Compliance with all relevant aspects of the standard. EMI • Radiated Emission • Conducted Emission EMS • Radiated electromagnetic field • Fast transient burst • Electrostatic discharge • High-energy surge • Voltage drops and interruptions • Conducted RF • Power frequency magnetic field

For more details please contact the local Mitsubishi Electric sales site.

• Notes for compliance to EMC regulation.

It is necessary to install the CL1 series module in a shielded metal control panel.

• Use this product in Zone A¹ as defined in EN61131-2.

¹ Zone defined in EN61131-2
Separation defined in EN61131-2 for EMC LVD regulation decided depending on condition in industrial setting.

Zone C = Factory mains which is isolated from public mains by dedicated transformers.

Zone B = Dedicated power distribution which is protected by secondary surge protection. (300V or less in the rated voltage is assumed.)

Zone A = Local power distribution which is isolated from dedicated power distribution by AC/DC converters, isolation transformers, etc. (120V or less in the rated voltage is assumed.)

1. Outline of Product

This product is a cable type input module connected to CC-Link/LT.

This product has two input points (24V DC).

2. Name and Setting of Each Part

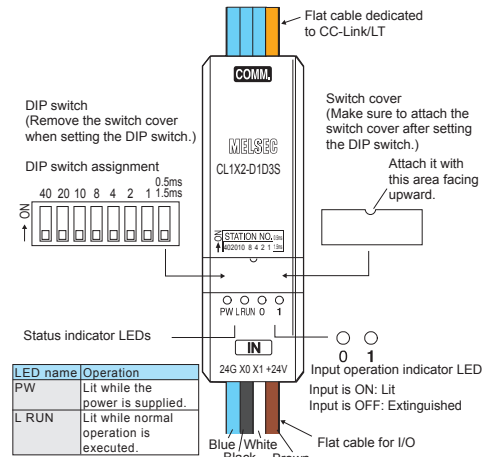

Name	Description
Status indicator LED	PW ON while the power is supplied.
	L RUN ON while normal operation is executed.
Input operation indicator LED	ON while the input is ON. Extinguished while the input is OFF.
	0 X0 input operation indicator LED 1 X1 input operation indicator LED
Flat cable dedicated to CC-Link/LT	24G Connector for CC-Link/LT communication line/ DB module power supply DA +24V
Flat cable for I/O	Blue 24G Black X0 White X1 Brown +24V

Name	Description						
DIP switch	Set the 10's digit of the station No. using "STATION NO. 10", "STATION NO. 20" and "STATION NO. 40". Set the 1's digit of the station No. using "STATION NO. 1", "STATION NO. 2", "STATION NO. 4" and "STATION NO. 8". Factory default = All bits are OFF. Make sure to set the station No. in the range from 1 to 64. Example: When setting the station No. to "32", set the DIP switch as follows. <table border="1"> <tr> <th>Station No.</th> <th>10's digit</th> <th>1's digit</th> </tr> <tr> <td>32</td> <td>OFF ON ON</td> <td>OFF OFF ON OFF</td> </tr> </table>	Station No.	10's digit	1's digit	32	OFF ON ON	OFF OFF ON OFF
Station No.	10's digit	1's digit					
32	OFF ON ON	OFF OFF ON OFF					
0.5ms	Sets the response speed. ON: 0.5 ms (fast response type)						
1.5ms	OFF: 1.5 ms (standard type)						

3. Cautions on Handling

3.1 Handling of flat cable for I/O

The cable length from the module to a sensor shall be within 3m(9'10"). Measure the cable outside the module, and confirm that the driving voltage for the used sensor is assured.

• Input

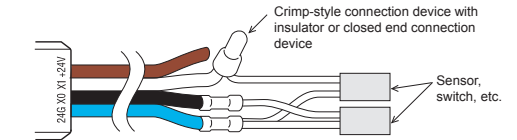

If the diameter of the input equipment connection cable is equivalent to the diameter of the flat cable for I/O of this module, connectors dedicated to CC-Link/LT can be used for connection.

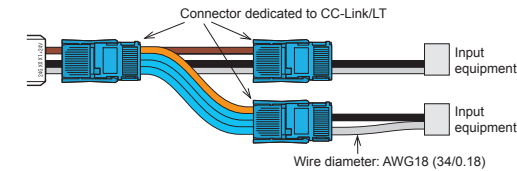

3.2 Handling of cable

Do not bend the cable within 30mm(1.18") from the module.

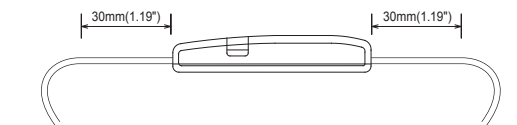

Use a crimp-style terminal in a status in which no force is applied on the cable.

3.3 Mounting with the CL1-HLD (module holder)

Refer to the figures below for details on mounting or removing the remote I/O module when used with the CL1-HLD.

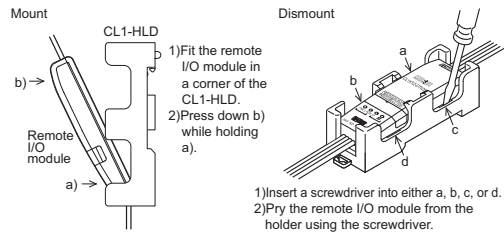

4. Wiring

4.1 External wiring

The input terminals of the CL1X2-D1D3S operate while using the power supplied from the interface.

When connecting a sensor to the input terminal, use a sensor of the NPN open collector transistor type.

Input wiring

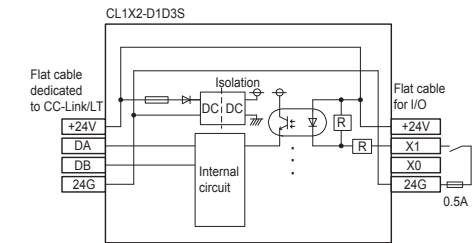

4.2 Connection to sensor

- When using a two-wire type sensor
- When using a three-wire type sensor

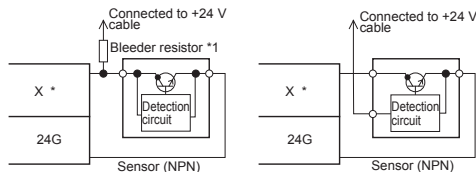

Replace * in the figure with the used input No.

Notes:

*1 Bleeder resistor

When connecting a two-wire type sensor or input equipment having parallel resistor, select a sensor or equipment whose leakage current is 1.7mA or less.

If the leakage current is more than 1.7mA, connect a bleeder resistor obtained in the following calculation formula.

Circuit image

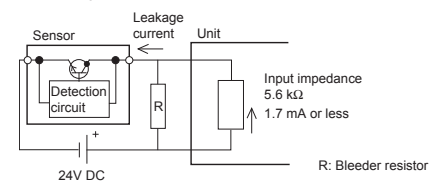

$$R(k\Omega) < 1.7(mA) / \text{Leakage current}(mA) - 1.7(mA) \times 5.6(k\Omega)$$

The power capacity W of the bleeder resistor R is as follows:

$$W = (\text{Input voltage})^2/R$$

- If chattering is present in the external input equipment, set 1.5ms.
- If the ON or OFF time of the input signal is less than 1.5 ms, set it to 0.5 ms. (The ON and OFF time of the input signal are required to be 0.5 ms or more.)

When setting 1.5 ms:
Set both the ON and OFF time of the input signal to 1.5 ms or more.

When setting 0.5 ms:
Set both the ON and OFF time of the input signal to 0.5 ms or more.

5. Specifications

5.1 General specifications

Item	Specification			
Ambient working temperature	0 to 55°C (32 to 131°F)			
Ambient storage temperature	-25 to 75°C (-13 to 167°F)			
Ambient operating humidity	5 to 95%RH: Dew condensation shall not be considered.			
Ambient storage humidity	5 to 95%RH: Dew condensation shall not be considered.			
Vibration resistance (*1)	When intermittent vibration is present		Number of times of sweep	
	Frequency	Acceleration		Half amplitude
	10 to 57Hz	-		0.075mm
	57 to 150Hz	9.8m/s ²	-	
	When continuous vibration is present		10 times in each of X, Y and Z directions (for 80 min)	
Frequency	Acceleration	Half amplitude		
10 to 57Hz	-	0.035mm		
57 to 150Hz	4.9m/s ²	-		
Impact resistance (*1)	147 m/s ² , 3 times in each of X, Y and Z directions			
Operating atmosphere	Corrosive gas shall not be present.			
Operating altitude	2,000m(6561'8") or less (*2)			
Installation place	Inside control panel (*3)			
Over-voltage category	II or less (*4)			
Degree of contamination	2 or less (*5)			

Notes:

*1 The criterion is shown in IEC61131-2.

*2 The module cannot be used in an environment pressurized above the atmospheric pressure which can be generated around the altitude of 0 m. If the module is used in such an environment, it may fail.

*3 The module can be used in any environment even outside the control panel as far as the requirements of the ambient operating temperature, the ambient operating humidity, etc. are satisfied.

*4 This indicates the section of the power supply to which the equipment is assumed to be connected between the public electrical power distribution network and the machinery within premises. Category II applies to equipment for which electrical power is supplied from fixed facilities.

The surge voltage withstand level for up to the rated voltage of 300V is 2500V.

*5 This index indicates the degree of conductive generating substances in the environment in which the module is used. The degree of contamination 2 indicates that contamination is caused by generation of only non-conductive substances.

In this degree, however, temporary conduction may be caused by accidental condensation.

5.2 Input specifications

Item	Specification
Input method	DC input (using module power supply in common)
Number of inputs	2 points
Isolation method	Isolation with photocoupler
Rated input voltage	24V DC
Rated input current	Approx. 4 mA
Operating voltage range	Same as module power supply
Max. simultaneous ON input points	100% (at 24V DC)
ON voltage/ON current	19 V or more/3 mA or more
OFF voltage/OFF current	11 V or less/1.7 mA or less
Input resistance	5.6 kΩ
Response time	OFF→ON
	0.5ms/1.5ms or less (at 24V DC) Selected by DIP switch (default value = OFF/1.5ms).
Common wiring method	ON→OFF
	0.5ms/1.5ms or less (at 24V DC) Selected by DIP switch (default value = OFF/1.5ms).
Common wiring method	2 point/1 common (1 point)

5.3 Performance specifications

Item	Specification	
Module power supply	Voltage	20.4 to 28.8V DC (24V DC -15% to +20%) Ripple ratio: Within 5%
	Current consumption	40mA (when all points are ON) (Current consumption does not contain the input current.)
	Initial current	70mA
	Max. allowable momentary power failure period	PS1:1ms
Number of stations occupied	4-, 8- or 16-point mode: 1 station	
Noise durability	500Vp-p Noise width: 1μs Cycle: 25 to 60 Hz (by noise simulator)	
Withstand voltage	500V AC for 1 min	
Isolation resistance	10 MΩ or higher between primary area (external DC terminal) and secondary area (internal circuit) by 500V DC insulation resistance tester	
Protection class	IP2X	
I/O part connection method	Connection with cable	
Module installation method	Can be installed in six directions	
Flat cable for I/O (wire diameter)	AWG18 (34/0.18)	
Mass (weight)	0.07 kg (0.15 lbs) (including 500mm(19.69") flat cable dedicated to CC-Link/LT and 500mm(19.69") flat cable for I/O)	

6. Outside Dimensions

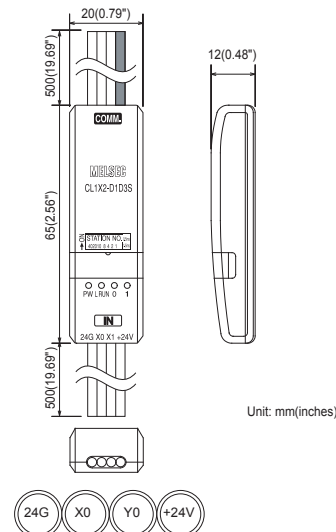

Unit: mm(inches)

「电器电子产品有害物质限制使用标识要求」的表示方式



Note: This symbol mark is for China only.

含有有害物质的名称, 含有量, 含有部品
本产品中所含有的有害物质的名称, 含有量, 含有部品如下表所示。

产品中有害物质的名称及含量

部件名称	有害物质					
	铅 (Pb)	汞 (Hg)	镉 (Cd)	六价铬 (Cr (VI))	多溴联苯 (PBB)	多溴二苯醚 (PBDE)
可编程控制器	○	○	○	○	○	○
印刷基板	×	○	○	○	○	○

本表格依据SJ/T 11364的规定编制。

○:表示该有害物质在该部件所有均质材料中的含量均在GB/T 26572规定的限量要求以下。

×:表示该有害物质至少在该部件的某一均质材料中的含量超出GB/T 26572规定的限量要求。

基于中国标准法的参考规格:GB/T15969.2

This manual confers no industrial property rights or any rights of any other kind, nor does it confer any patent licenses. Mitsubishi Electric Corporation cannot be held responsible for any problems involving industrial property rights which may occur as a result of using the contents noted in this manual.

Warranty

Exclusion of loss in opportunity and secondary loss from warranty liability

Regardless of the gratis warranty term, Mitsubishi shall not be liable for compensation to:

- (1) Damages caused by any cause found not to be the responsibility of Mitsubishi.
- (2) Loss in opportunity, lost profits incurred to the user by Failures of Mitsubishi products.
- (3) Special damages and secondary damages whether foreseeable or not, compensation for accidents, and compensation for damages to products other than Mitsubishi products.
- (4) Replacement by the user, maintenance of on-site equipment, start-up test run and other tasks.

△ For safe use

- This product has been manufactured as a general-purpose part for general industries, and has not been designed or manufactured to be incorporated in a device or system used in purposes related to human life.
- Before using the product for special purposes such as nuclear power, electric power, aerospace, medicine or passenger movement vehicles, consult with Mitsubishi Electric.
- This product has been manufactured under strict quality control. However when installing the product where major accidents or losses could occur if the product fails, install appropriate backup or failsafe functions in the system.

Country/Region	Sales office/Tel	Country/Region	Sales office/Tel
USA	MITSUBISHI ELECTRIC AUTOMATION, INC. 500 Corporate Woods Parkway, Vernon Hills, IL 60061, U.S.A. Tel: +1-847-478-1100/1-847-478-2500 (NC)	Russia	Mitsubishi Electric (Russia) LLC 52, bld. 1, Kosmodanianskaya emb., 115054 Moscow, Russia Tel: +7-495-721-2070
Brazil	MITSUBISHI ELECTRIC DO BRASIL COMERCIO E SERVICOS LTDA. Avenida Adelaide Cardina, 203, 21 andar, Bethaville, Barueri SP, Brazil Tel: +55-11-4688-3000	China	MITSUBISHI ELECTRIC AUTOMATION (CHINA) LTD. Mitsubishi Electric Automation Center, No.1386 Hongqiao Road, Shanghai, China Tel: +86-21-2322-3030
Germany	MITSUBISHI ELECTRIC EUROPE B.V. - German Branch Mitsubishi-Electric-Platz 1, 40882 Ratingen, Germany Tel: +49-2102-488-0	Taiwan	SETSUYO ENTERPRISE CO., LTD. 6F, No.105, Wugong 3rd Road, Wugu District, New Taipei City 24888, Taiwan, R.O.C. Tel: +886-2-2626-2469
UK	MITSUBISHI ELECTRIC EUROPE BV, UK Branch Travellers Lane, Hatfield, Hertfordshire, AL10 8XB, UK Tel: +44-1707-28-8780	Korea	MITSUBISHI ELECTRIC AUTOMATION KOREA CO., LTD. 7F-9F, Gangseo Hangang Xi-tower A, 401, Yangcheon-ro, Gangseo-Gu, Seoul, 07528, Korea Tel: +82-2-3960-8500
Italy	MITSUBISHI ELECTRIC EUROPE B.V. - Italian Branch Centro Direzionale Colosani - Palazzo Sirio, Viale Colosani 7, 20864 Agrate (MB), Italy Tel: +39-039-60531/39-039-6053-342	Singapore	MITSUBISHI ELECTRIC ASIA PTE. LTD. 307 Alexandra Road, Mitsubishi Electric Building, Singapore 120493 Tel: +65-6473-2308
Spain	MITSUBISHI ELECTRIC EUROPE, B.V. - Spanish Branch Carretera de Rubi 76-80-AC, 420, E-08190 Sant Cugat del Valles (Barcelona), Spain Tel: +34-935-65-3131/34-935-65-2236	Thailand	Mitsubishi Electric Factory Automation (Thailand) Co., Ltd. 12th Floor, SV City Building, Office Tower 1, No. 886/19 and 20 Rama 3 Road, Kwaeng Bangsongpan, Khet Yankawa, Bangkok 10120, Thailand Tel: +66-2882-6522-31
France	MITSUBISHI ELECTRIC EUROPE B.V. - French Branch 25, Boulevard des Bouvets, 92741 Nanterre Cedex, France Tel: +33-1-55-68-65-68	Indonesia	PT. Mitsubishi Electric Indonesia Gedung Jaya 11th Floor, JL. MH. Thamrin No.12, Jakarta Pusat 10340, Indonesia Tel: +62-21-3192-9461
Czech Republic	MITSUBISHI ELECTRIC EUROPE B.V. - Czech Branch Avent Business Park, Radicka 751/1136, 158 00 Praha8, Czech Republic Tel: +420-251-551-470	India	Mitsubishi Electric India Pvt. Ltd. Gurgaon Head Office 2nd Floor, Tower A & B, Cyber Greens, DLF Cyber City, DLF Phase - III, Gurgaon - 122002, Haryana, India Tel: +91-124-4630300
Poland	Mitsubishi Electric Europe B.V. Polish Branch ul. Krakowska 50, 32-083 Balice, Poland Tel: +48-12-347-65-00	Australia	MITSUBISHI ELECTRIC AUSTRALIA PTY. LTD. 348 Victoria Road PO BOX111, Rydalmere, N.S.W. 2116, Australia Tel: + 61-2-9684-7777

MITSUBISHI ELECTRIC CORPORATION

HEAD OFFICE : TOKYO BUILDING, 2-7-3 MARUNOUCHI, CHYODA-KU, TOKYO 100-8310, JAPAN

When exported from Japan, this manual does not require application to the Ministry of Economy, Trade and Industry for service transaction permission.

Specifications subject to change without notice.

