



CC-Link System Repeater (T-junction) Module

User's Manual

AJ65SBT-RPT

Thank you for purchasing the Mitsubishi program controller MELSEC series.

Prior to use, please read this and relevant manuals thoroughly to fully understand the product.



| | |
|---------------------------|---------------|
| MODEL | AJ65SBT-RPT-U |
| MODEL CODE | 13JQ81 |
| IB(NA)-0800078-J(1411)MEE | |

● SAFETY PRECAUTIONS ●

(Read these precautions before using this product.)

Before using this product, please read this manual and the relevant manuals carefully and pay full attention to safety to handle the product correctly.

In this manual, the safety precautions are classified into two levels:

"⚠ WARNING" and "⚠ CAUTION".



Indicates that incorrect handling may cause hazardous conditions, resulting in death or severe injury.



Indicates that incorrect handling may cause hazardous conditions, resulting in minor or moderate injury or property damage.

Under some circumstances, failure to observe the precautions given under "⚠ CAUTION" may lead to serious consequences.

Observe the precautions of both levels because they are important for personal and system safety.

Make sure that the end users read this manual and then keep the manual in a safe place for future reference.

[Design Precautions]

WARNING

- Input/output could be switched on or off when a problem occurs in the repeater module.
So build an external monitoring circuit that will monitor any input/output signals that could cause a serious accident.

CAUTION

- Use the programmable controller in the environment that meets the general specifications contained in this Manual.
Using the programmable controller outside the range of the general specifications may result in electric shock, fire or malfunction, or may damage or degrade the module.
- Do not have control cables and communication cables bundled with or placed near by the main circuit and/or power cables. It may cause malfunction due to noise interference. Wire those cables at least 100mm(3.94 inch) away from the main circuit and/or power cables.

[Installation Precautions]

CAUTION

- Do not directly touch the module's conductive parts or electronic components. Doing so may cause malfunctions or failure of the module.
- Tighten the module securely using DIN rail or installation screws within the specified torque range.
Loose terminal screws may cause falling, short circuit or erroneous operation. If the terminal screws are too tight, it may cause falling or short circuit due to damage of the screws.

[Wiring Precautions]

WARNING

- Be sure to shut off all phases of the external power supply used by the system before installation or wiring. If the power is not disconnected at all phases an electric shock or product damage may result.

[Wiring Precautions]

CAUTION

- Always ground the FG terminal to the protective ground conductor. Otherwise there will be an electric shock or misoperation.
- Be sure to tighten any unused terminal screws within a tightening torque range (42 to 50N·cm). Failure to do so may cause a short circuit due to contact with a solderless terminal.
- Use applicable solderless terminals and tighten them with the specified torque. If any solderless spade terminal is used, it may be disconnected when the terminal screw comes loose, resulting in failure.
- Perform correct wiring for the module according to the product's rated voltage and terminal arrangement. Connecting to a power supply different from the rating or mis-wiring may cause fire and/or trouble.
- Fix terminal screws securely with the specified torque. Loose terminal screws may cause short circuit or malfunction. If the terminal screws are too tight, it may cause falling, short circuit or erroneous operation due to damage of the screws or module.
- Make sure foreign objects do not get inside the module, such as dirt and wire chips. It may cause fire, trouble or malfunction.
- Be sure to fix the wires or cables by ducts or clamps when connecting them to the module. Failure to do so may cause damage of the module or the cables due to accidental pull or unintentional shifting of the cables, or malfunctions due to poor contact of the cable.
- Do not install the control lines together with the communication cables, or bring them close to each other. Failure to do so may cause malfunctions due to noise.
- When disconnecting a cable from the module, do not pull on the cable itself. Before disconnecting the cable from the terminal block, loosen off the screws of the terminal block. If you pull the cable connected to the module, the module or cable can be damaged or misoperation can occur due to cable connection fault.

[Startup and Maintenance Precautions]

WARNING

- Do not touch terminals when the power is on.
It may cause an electric shock or malfunction.

CAUTION

- Never try to disassemble or modify module.
It may cause trouble, malfunction, injury or fire.
- Do not drop or apply any strong impact to the module.
Doing so may damage the module.
- Be sure to shut off all phases of the external power supply used by the system before cleaning or retightening the terminal screws. If you do not switch off the external power supply, it will cause trouble or malfunction of the module.
- Be sure to shut off all phases of the external power supply used by the system before mounting or dismounting the module to or from the panel.
If you do not switch off the external power supply, it will cause trouble or malfunction of the module.
- Do not install/remove the terminal block more than 50 times after the first use of the product. (IEC 61131-2 compliant)
- Before handling the module, always touch grounded metal, etc. to discharge static electricity from the human body.
Failure to do so can cause the module to fail or malfunction.

[Disposal Precautions]

CAUTION

- When disposing of this product, treat it as industrial waste.

● CONDITIONS OF USE FOR THE PRODUCT ●

(1) Mitsubishi programmable controller ("the PRODUCT") shall be used in conditions;

- i) where any problem, fault or failure occurring in the PRODUCT, if any, shall not lead to any major or serious accident; and
- ii) where the backup and fail-safe function are systematically or automatically provided outside of the PRODUCT for the case of any problem, fault or failure occurring in the PRODUCT.

(2) The PRODUCT has been designed and manufactured for the purpose of being used in general industries.

MITSUBISHI SHALL HAVE NO RESPONSIBILITY OR LIABILITY (INCLUDING, BUT NOT LIMITED TO ANY AND ALL RESPONSIBILITY OR LIABILITY BASED ON CONTRACT, WARRANTY, TORT, PRODUCT LIABILITY) FOR ANY INJURY OR DEATH TO PERSONS OR LOSS OR DAMAGE TO PROPERTY CAUSED BY the PRODUCT THAT ARE OPERATED OR USED IN APPLICATION NOT INTENDED OR EXCLUDED BY INSTRUCTIONS, PRECAUTIONS, OR WARNING CONTAINED IN MITSUBISHI'S USER, INSTRUCTION AND/OR SAFETY MANUALS, TECHNICAL BULLETINS AND GUIDELINES FOR the PRODUCT.

("Prohibited Application")

Prohibited Applications include, but not limited to, the use of the PRODUCT in;

- Nuclear Power Plants and any other power plants operated by Power companies, and/or any other cases in which the public could be affected if any problem or fault occurs in the PRODUCT.
- Railway companies or Public service purposes, and/or any other cases in which establishment of a special quality assurance system is required by the Purchaser or End User.
- Aircraft or Aerospace, Medical applications, Train equipment, transport equipment such as Elevator and Escalator, Incineration and Fuel devices, Vehicles, Manned transportation, Equipment for Recreation and Amusement, and Safety devices, handling of Nuclear or Hazardous Materials or Chemicals, Mining and Drilling, and/or other applications where there is a significant risk of injury to the public or property.

Notwithstanding the above, restrictions Mitsubishi may in its sole discretion, authorize use of the PRODUCT in one or more of the Prohibited Applications, provided that the usage of the PRODUCT is limited only for the specific applications agreed to by Mitsubishi and provided further that no special quality assurance or fail-safe, redundant or other safety features which exceed the general specifications of the PRODUCTS are required. For details, please contact the Mitsubishi representative in your region.

REVISIONS

* The manual number is given on the bottom right of the cover.

| Print Date | *Manual Number | Revision |
|------------|-------------------|--|
| Oct., 1999 | IB (NA)-0800078-A | First edition (Japanese only) |
| Nov., 1999 | IB (NA)-0800078-B | English is added. |
| Feb., 2000 | IB (NA)-0800078-C | <u>Correction</u> Section 3.2, Chapter 5 |
| Feb., 2005 | IB (NA)-0800078-D | <u>Addition</u> Conformation to the EMC Directive and Low Voltage Instruction, Section 2.2 <u>Correction</u> SAFETY PRECAUTIONS, About the Manuals, Abbreviated names, generic names and terms, Product structure, Chapter 1, Section 1.1, 2.1, 2.3, 3.1, 3.2, 3.3, 3.4, 4.1, 4.2.1, 4.2.2, 4.3, 4.4, 4.6, 4.7, 4.8, Chapter 5, Chapter 6 |
| Mar., 2006 | IB (NA)-0800078-E | <u>Correction</u> REVISIONS, Conformation to the EMC Directive and Low Voltage Instruction, Section 2.2, 2.3 |
| Sep., 2006 | IB (NA)-0800078-F | <u>Correction</u> SAFETY PRECAUTIONS |
| Dec., 2006 | IB (NA)-0800078-G | <u>Correction</u> About the Manuals, Abbreviated names, generic names and terms, Section 2.3, 3.2, 3.3, 4.2.1 |
| Aug., 2007 | IB (NA)-0800078-H | <u>Correction</u> Section 4.3, Chapter 6 |
| Dec., 2011 | IB (NA)-0800078-I | <u>Addition</u> CONDITIONS OF USE FOR THE PRODUCT, SAFETY PRECAUTIONS (Chinese) <u>Correction</u> SAFETY PRECAUTIONS, About the Manuals, Conformation the EMC directive and Low Voltage Instruction, Section 3.1, 4.2.1, 4.7 |

* The manual number is given on the bottom right of the cover.

| Print Date | *Manual Number | Revision |
|------------|-------------------|---|
| Nov., 2014 | IB (NA)-0800078-J | <p data-bbox="511 142 594 165">Addition</p> <p data-bbox="511 174 615 198">Section 2.3</p> <p data-bbox="511 206 615 230">Correction</p> <p data-bbox="511 238 963 311">Related manuals, ABBREVIATED NAMES, GENERIC NAMES AND TERMS, Section 2.4, 3.2, 3.3, 4.3, Chapter 6</p> <p data-bbox="511 320 594 343">Change</p> <p data-bbox="511 352 793 375">from Section 2.3 to Section 2.4</p> |
| | | |

This manual confers no industrial property rights or any rights of any other kind, nor does it confer any patent licenses. Mitsubishi Electric Corporation cannot be held responsible for any problems involving industrial property rights which may occur as a result of using the contents noted in this manual.

CONTENTS

| | |
|---|----|
| 1. OVERVIEW | 14 |
| 1.1 Features..... | 14 |
| 2. SYSTEM CONFIGURATION | 16 |
| 2.1 Total configuration | 16 |
| 2.2 Checking hardware versions..... | 17 |
| 2.3 Checking serial number | 17 |
| 2.4 Cautions on system configuration..... | 18 |
| 3. SPECIFICATIONS | 25 |
| 3.1 General specifications..... | 25 |
| 3.2 Performance specifications..... | 27 |
| 3.3 Specifications of connection cables | 28 |
| 3.4 Max. transmission distance..... | 28 |
| 4. PROCEDURE UP TO START OF DATA LINK | 29 |
| 4.1 Procedure up to start of data link | 29 |
| 4.2 Mounting and installation | 29 |
| 4.2.1 Cautions on handling..... | 29 |
| 4.2.2 Installation environment | 31 |
| 4.3 Names and settings of parts | 32 |
| 4.4 Check of module state (Hardware test) | 35 |
| 4.5 Setting of switches | 36 |
| 4.6 Installation and removal of protective cover..... | 37 |
| 4.7 Connection of module through CC-Link dedicated cable..... | 38 |
| 4.8 Check for state of connection (Line test) | 39 |
| 5. TROUBLESHOOTING | 41 |
| 6. EXTERNAL DIMENSIONS..... | 45 |

ABOUT MANUALS

The following manuals are related to this product.
Referring to this list, please request the necessary manuals.

Related
manuals

| Manual Name | Manual Number (Model Code) |
|--|-------------------------------|
| MELSEC iQ-R CC-Link System Master/Local Module User's Manual (Startup) | SH-081269ENG 13JX10 |
| MELSEC iQ-R CC-Link System Master/Local Module User's Manual (Application) | SH-081270ENG 13JX19 |
| MELSEC-Q CC-Link System Master/Local Module User's Manual | SH-080394E (13JR64) |
| MELSEC-L CC-Link System Master/Local Module User's Manual | SH-080895ENG 13JZ41 |
| CC-Link System Master/Local Module Type AJ61QBT11/A1SJ61QBT11 User's Manual | IB-66722 (13J873) |
| CC-Link System Master/Local Module Type AJ61BT11/A1SJ61BT11 User's Manual | IB-66721 (13J872) |
| CC-Link System Optical Repeater Module User's Manual AJ65SBT- RPS/RPG | IB-0800089 (13JQ85) |
| CC-Link System Space Optical Repeater Module User's Manual AJ65BT-RPI-10A/AJ65BT-RPI-10B | IB-0800090 (13JQ86) |
| CC-Link System Low Profile Waterproof Type Repeater Hub Module User's Manual AJ65FBTA-RPH | IB-0800288 (13JP55) |
| CC-Link System Spring Clamp Terminal Block Type Repeater Hub Module User's Manual AJ65BTS-RPH | IB-0800346 (13JP97) |

COMPLIANCE WITH EMC AND LOW VOLTAGE DIRECTIVE

(1) Method of ensuring compliance

To ensure that Mitsubishi programmable controllers maintain EMC and Low Voltage Directives when incorporated into other machinery or equipment, certain measures may be necessary.

Please refer to one of the following manuals.

- User's manual for the CPU module or head module used
- Safety Guidelines (this manual is included with the CPU module, base unit, or head module)

The CE mark on the side of the programmable controller indicates compliance with EMC and Low Voltage Directives.

(2) Additional measures

To ensure that this product maintains EMC and Low Voltage Directives, please refer to one of the manuals listed under (1).

ABBREVIATED NAMES, GENERIC NAMES AND TERMS

Abbreviated names, generic names and terms Description

| Abbreviated names, generic names and terms | Description |
|--|---|
| AJ65SBT-RPT | Abbreviation of AJ65SBT-RPT type CC-Link system repeater (T-junction) module. |
| AJ65FBTA-RPH | Abbreviation of AJ65FBTA-RPH type CC-Link system low profile waterproof type repeater module. |
| AJ65BTS-RPH | Abbreviation of AJ65BTS-RPH type CC-Link system spring clamp terminal block type repeater hub module. |
| AJ65SBT-RPS/RPG | Abbreviation of AJ65SBT-RPS/AJ65SBT-RPG type CC-Link system optical repeater module. |
| AJ65BT-RPI-10A/10B | Abbreviation of AJ65BT-RPI-10A/AJ65BT-RPI-10B type CC-Link system space optical repeater module. |
| Engineering tool | Generic name of GX Developer, GX Works2, and GX Works3 |
| Master station | A station that controls the entire system. This station can perform cyclic transmission and transient transmission with all stations. Only one master station can be used in a system. |
| Local station | A station that performs cyclic transmission and transient transmission with the master station and other local stations. |
| Remote I/O station | A station that exchanges I/O signals (bit data) with the master station by cyclic transmission. This station cannot perform transient transmission. |
| Remote device station | A station that exchanges I/O signals (bit data) and I/O data (word data) with the master station by cyclic transmission. This station cannot perform transient transmission. |
| Remote station | Generic name of a remote I/O station and a remote device station |
| Intelligent device station | A station that exchanges I/O signals (bit data) and I/O data (word data) with another station by cyclic transmission. This station responds to a transient transmission request from another station and also issues a transient transmission request to another station. |
| Master module | Generic name of modules that can serve as a master station |
| Local module | Generic name of modules that can serve as a local station |
| Remote module | Modules that can serve as a remote I/O station, remote device station, and intelligent device station. Generic name of AJ65BTB□□-□□, AJ65BTC□-□□, AJ65BT-64AD, AJ65BT-64DAV, and AJ65BT-64DAI |
| Segment | System between terminating resistors connected to each other through cross-over cables. The conventional CC-Link system can be said to be configured with one segment (See Section 2.1.). |
| Repeater | Module for expanding the CC-Link system by connecting the segments to each other. |

| Abbreviated names, generic names and terms | Description |
|--|--|
| Transient transmission | A function of communication with another station, which is used when requested by a dedicated instruction or an engineering tool |
| Cyclic transmission | A function by which data are periodically exchanged among stations on the same system using link devices |

PRODUCT STRUCTURE

The product structure of AJ65SBT-RPT is given in the table below.

| Part name | Quantity |
|---|----------|
| AJ65SBT-RPT module | 1 |
| Terminating resistor 110Ω 1/2W (Brown, Brown, Brown) | 2 |
| Terminating resistor 130Ω 1/2W (Brown, Orange, Brown) | 2 |

1. OVERVIEW

This User's Manual describes the specifications, names of parts, and settings of the AJ65SBT-RPT type CC-Link system repeater (T-junction) module (hereafter abbreviated as AJ65SBT-RPT) used in the CC-Link system.

1.1 Features

The AJ65SBT-RPT module is used to increase the flexibility of laying down the cables of the CC-Link system.

Use of this module enables the transmission distance of the CC-Link system to be extended and the wiring to be laid down in the form of T-junction.

(1) Extended transmission distance in CC-Link system

Use of this module enables the transmission distance of the CC-Link system to be extended.

In addition, use of multiple modules enables the transmission distance of the CC-Link system to be extended up to 10 stages.

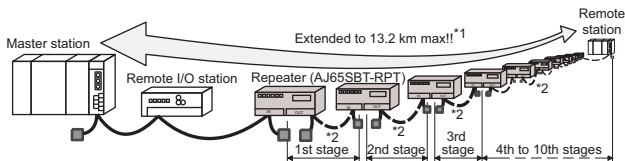

*1 Max. transmission distance at a transmission speed of 156 kbps.

*2 Though it is not shown here, the other remote stations can be connected between the repeaters.

(2) Enabled T-junction wiring in CC-Link system

Arrangement of this module between the modules of the CC-Link system enables the CC-Link system to be wired in the form of T-junction. This is applicable to all CC-Link systems operating at transmission speeds of 10 Mbps, 5 Mbps, 2.5 Mbps, 625 kbps and 156 kbps.

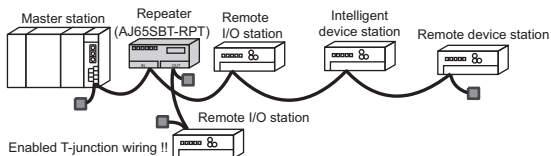

- (3) Mountable to control panel with either screws or DIN rail
This module can be mounted onto the control panel with either screws or DIN rail.
- (4) Compact module size
The module size has been reduced to the same one as that of AJ65SBTB1-8□ type small remote I/O module.

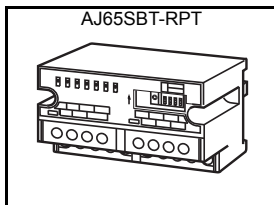

| Item | Size |
|--------|--------------------|
| Height | 50.0mm (1.97 inch) |
| Width | 87.3mm (3.44 inch) |
| Depth | 40.0mm (1.58 inch) |

2. SYSTEM CONFIGURATION

2.1 Total configuration

The total configuration employed when the AJ65SBT-RPT module is used is as shown below.

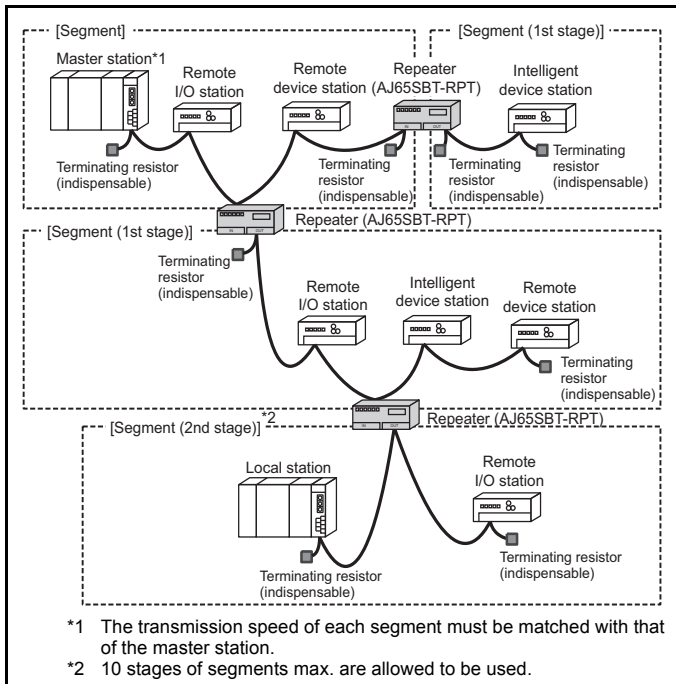

2.2 Checking hardware versions

The hardware versions of the AJ65SBT-RPT can be checked on the DATE section on the rating plate, which is situated on the side on the module.

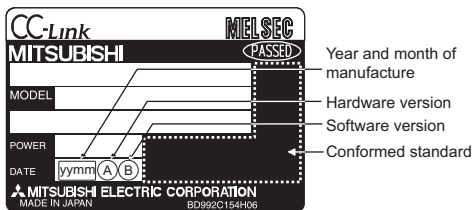

2.3 Checking serial number

The serial number of the AJ65SBT-RPT can be checked on the SERIAL section on the rating plate.

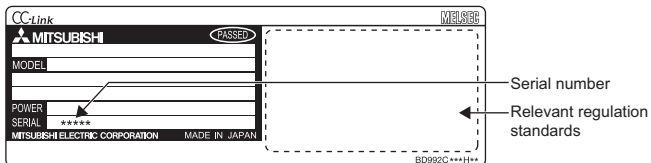

2.4 Cautions on system configuration

(1) Conditions of usable master module

When the AJ61BT11, A1SJ61BT11, AJ61QBT11 and A1SJ61QBT11 modules are used, those of the functional version B or later must be employed. Use the master module bearing the version 9707 B or later in the DATE column of the name plate as shown in the figure below.

When the RJ61BT11, QJ61BT11N, QJ61BT11, LJ61BT11 module is used, any module can be used irrespective of the version.

(a) Rating plate of AJ61BT11 or AJ61QBT11

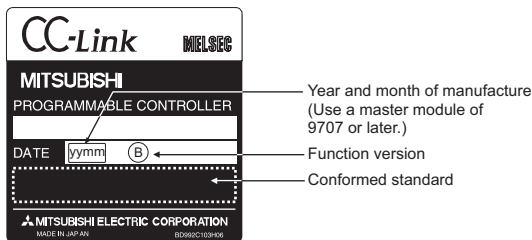

(b) Rating plate of A1SJ61BT11 or A1SJ61QBT11

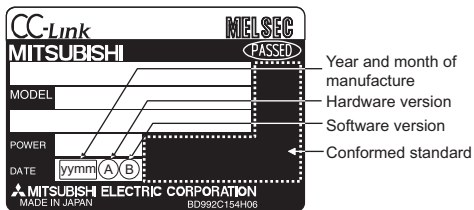

- (2) Max. number of modules connected to configure CC-Link system
Up to 64 modules of repeaters can be connected in one segment.
In the CC-Link system where repeaters are used, also the number of remote stations capable of being controlled by one master station is the same as in the other systems.
For details, refer to the User's Manual of the applicable master module.
- (3) Max. number of stages connected to configure segment
Use of this module enables communication between the master station located in a segment and a remote station located in a segment apart by 10 stages max. from the segment where the master station exists.

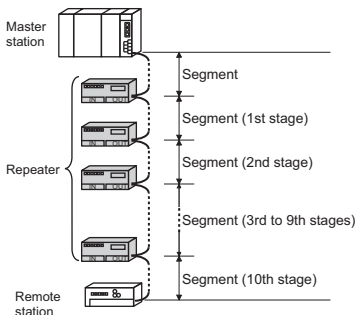

- (4) Instructions for using different models of repeaters in combination
 Note that when combining the repeaters of different models, there are the following restrictions on the number of connectable repeaters and the number of connected stages.

| Combination pattern | Max. number of repeaters | | | | | | Max. number of stages |
|---------------------|--------------------------|------------------|-----------------|-----------------|-----------------|----------------------------|-----------------------|
| | AJ65BTS -RPH | AJ65FBT A-RPH | AJ65SBT -RPH | AJ65SBT -RPS | AJ65SBT -RPG | AJ65BT -RPI -10A/10B | |
| 1) | 1 | — | 2 | — | — | — | 3 |
| | — | 1 | 2 | — | — | — | |
| 2) | 1 | — | — | 2(1 set) | — | — | 2 |
| | 1 | — | — | — | 2(1 set) | — | |
| | — | 1 | — | 2(1 set) | — | — | |
| | — | 1 | — | — | 2(1 set) | — | |
| 3) | 1 | — | — | — | — | 2(1 set) | 2 |
| | — | 1 | — | — | — | 2(1 set) | |
| 4) | — | — | 2 | 4(2 set) | — | — | 4 |
| 5) | — | — | 2 | — | 2(1 set) | — | 3 |
| 6) | — | — | 2 | — | — | 2(1 set) | |
| 7) | — | — | — | 2(1 set) | 2(1 set) | — | 2 |
| 8) | — | — | — | 2(1 set) | — | 2(1 set) | |
| | — | — | — | — | 2(1 set) | 2(1 set) | |
| 9) | 1 | 1 | — | — | — | — | 2 |

POINT

- For the CC-Link system, up to 2 repeater types can be used in combination. Using 3 models or more is not allowed.
 - When repeaters are connected in the same segment by link wiring, up to 64 modules can be connected.
- For details, refer to the user's manual of the master module used.

Ex.) A CC-Link system with combination pattern 6) is built

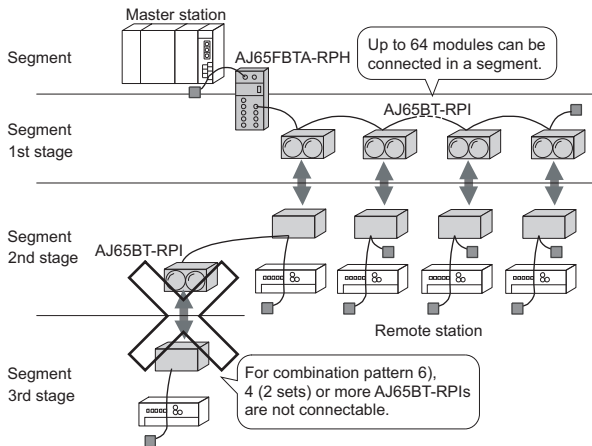

(a) Combination pattern 1)

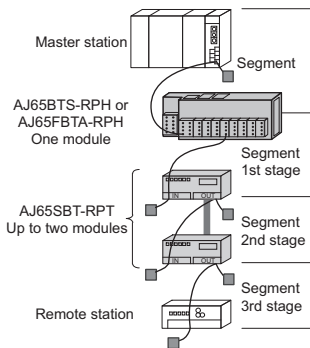

(b) Combination pattern 2)

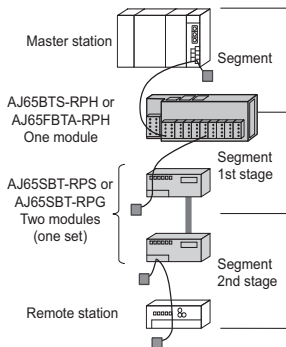

(c) Combination pattern 3)

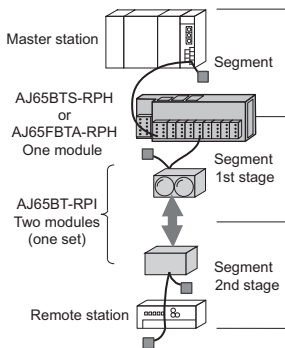

(d) Combination pattern 4)

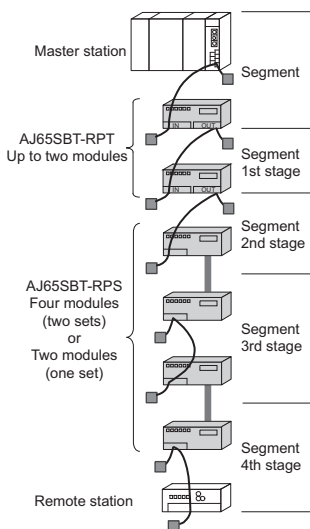

(e) Combination pattern 5)

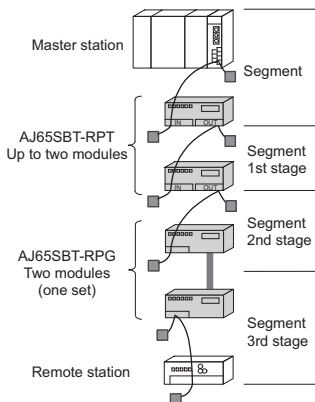

(g) Combination pattern 7)

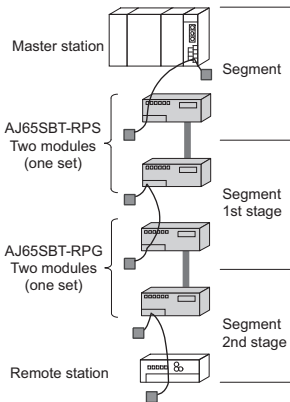

(f) Combination pattern 6)

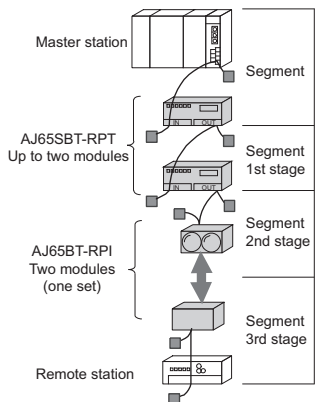

(h) Combination pattern 8)

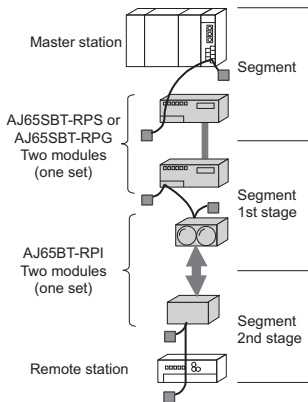

(i) Combination pattern 9)

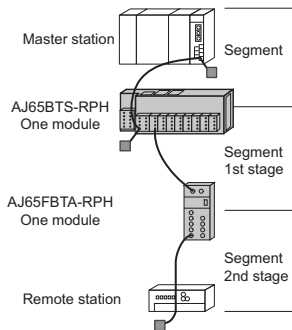

3. SPECIFICATIONS

3.1 General specifications

The general specifications of the AJ65SBT-RPT are shown below.

| Item | Specifications | | | | | |
|-------------------------------|---|------------------------------|--------------|-----------------------|----------------|-------------------------------------|
| Operating ambient temperature | 0 to 55 °C | | | | | |
| Storage ambient temperature | -20 to 75 °C | | | | | |
| Operating ambient humidity | 10 to 90%RH, non-condensing | | | | | |
| Storage ambient humidity | | | | | | |
| Vibration resistance | Compliant with JIS B 3502 and IEC 61131-2 | Under intermittent vibration | Frequency | Constant acceleration | Half amplitude | Sweep Count |
| | | | 5 to 8.4Hz | — | 3.5 mm | 10 times each in X, Y, Z directions |
| | | Under continuous vibration | 8.4 to 150Hz | 9.8 m/s ² | — | |
| | | | 5 to 8.4Hz | — | 1.75mm | — |
| 8.4 to 150Hz | 4.9 m/s ² | — | | | | |
| Shock resistance | Compliant with JIS B 3502 and IEC 61131-2 (147 m/s ² , 3 times each in 3 directions X, Y, Z) | | | | | |
| Operating atmosphere | No corrosive gases | | | | | |
| Operating altitude *3 | 0 to 2000m | | | | | |
| Installation location | Inside a control panel *4 | | | | | |
| Overvoltage category *1 | II or less | | | | | |
| Pollution degree *2 | 2 or less | | | | | |

- *1 This indicates the section of the power supply to which the equipment is assumed to be connected between the public electrical power distribution network and the machinery within premises.
Category II applies to equipment for which electrical power is supplied from fixed facilities. The surge voltage withstand level for up to the rated voltage of 300V is 2500V.
- *2 This index indicates the degree to which conductive material is generated in terms of the environment in which the equipment is used.
Pollution level 2 is when only non-conductive pollution occurs. A temporary conductivity caused by condensing must be expected occasionally.
- *3 Do not use or store the programmable controller under pressure higher than the atmospheric pressure of altitude 0m. Doing so may cause malfunction. When using the programmable controller under pressure, please consult your local Mitsubishi Electric representative.
- *4 It can also be used in an environment other than on the control panel if the conditions such as usage ambient temperature and humidity are satisfied.

3.2 Performance specifications

The performance specifications of the AJ65SBT-RPT module are shown below.

| Item | | Specifications | |
|--|---|---|----------|
| Transmission speed | | Selectable from among 156kbps, 625kbps, 2.5Mbps, 5Mbps and 10Mbps | |
| Max. number of stages connected to configure segment | | AJ65SBT-RPT only (Refer to Section 2.4 (3)) | 10 stage |
| | | Combination of AJ65SBT-RPT and AJ65SBT-RPS (Refer to Section 2.4 (4)) | 4 stage |
| | | Combination of AJ65SBT-RPT and one of AJ65FBTA-RPH, AJ65BTS-RPH, AJ65SBT-RPG, or AJ65BT-RPI (Refer to Section 2.4 (4)) | 3 stage |
| Max. transmission distance of each segment | | Varies according to transmission speed (Refer to Section 3.4.). | |
| Max. number of modules connected | | 64 (Refer to Section 2.4 regarding the conditions for the number of modules connected). | |
| Number of stations occupied | | 0 (none) | |
| Settable station number | | None | |
| Repeater power supply | Voltage | 20.4 to 26.4 V DC | |
| | Current | 60.0 mA (TYP. 24 V DC) | |
| Noise durability | | Simulator noise of 500 Vp-p, obtained by a noise simulator using noise width of 1 μ s and noise frequency of 25 to 60 Hz | |
| Maximum voltage | | 500V AC for 1 minute between all DC external terminals and ground | |
| Insulation resistance | | 10M Ω or higher, measured with a 500V DC insulation resistance tester | |
| Weight | | 0.2 kg | |
| External connection | Communication area, module power supply | 7-point 2-piece terminal block [transmission circuit, module power supply, FG] M3 \times 5.2 Tightening torque: 59 to 88N \cdot cm Applicable solderless terminals: 2 max. | |
| Applicable solderless terminals | | <ul style="list-style-type: none"> • RAV1.25-3 (conforming to JIS C 2805) [Applicable wire size: 0.3 to 1.25mm²] • V2-MS3, RAP2-3SL, TGV2-3N [Applicable wire size: 1.25 to 2.0mm²] | |

3.3 Specifications of connection cables

Use the CC-Link dedicated cables for the CC-Link system. If cable other than the CC-Link dedicated cable is used, the performance of the CC-Link system cannot be guaranteed.

For the specifications of the CC-Link dedicated cables or any other inquiries, visit the following site:

CC-Link Partner Association website: www.cc-link.org

Remark

For details, refer to the CC-Link cable wiring manual issued by the CC-Link Partner Association.

3.4 Max. transmission distance

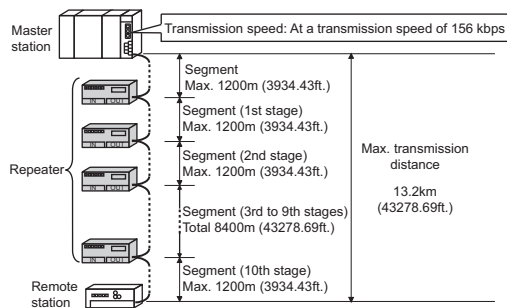

| Conditions | Description |
|--|---|
| Transmission speed | The maximum transmission distance in each segment is the same as that in normal CC-Link system (system configured with one segment only). The maximum transmission distance in each segment varies according to the transmission speed. For details, refer to the User's Manual of the applicable master module. (The length of the cables between repeater stations is treated in the same manner as in the remote I/O station.) |
| Max. number of stages connected to configure segment | When one connection stage is added, the maximum transmission distance is added by an amount equivalent to one segment. |

4. PROCEDURE UP TO START OF DATA LINK

4.1 Procedure up to start of data link

The procedure ranging from the installation of the AJ65SBT-RPT module to the start of data link is described below.

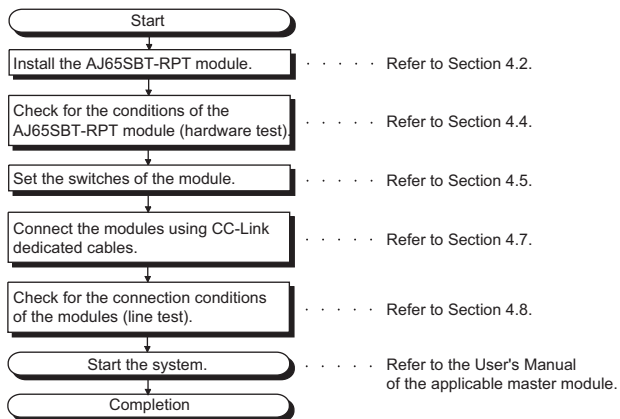

| |
|--------------|
| POINT |
|--------------|

| |
|--|
| <p>The procedure described here is for the AJ65SBT-RPT module only. In order for you to understand the procedure of the entire CC-Link system, refer to the User's Manual of the applicable master module.</p> |
|--|

4.2 Mounting and installation

4.2.1 Cautions on handling

Cautions on handling the AJ65SBT-RPT module are described below.

- (1) Tighten screws (such as a module fixing screw) within the tightening torque range specified in the table below.
Do not over-tighten these screws. The screws and module case may be damaged.

| Screw location | Specified torque range |
|--|------------------------|
| Module fixing screw (M4 thread with finished circular flat washer) | 0.78 to 1.08 N·m |
| Terminal block screw (M3 thread) | 0.59 to 0.88 N·m |
| Terminal block mounting screw (M3.5 thread) | 0.68 to 0.98 N·m |

- (2) A protective film is attached on the module's surface for the purpose of scratch prevention during transportation.
Prior to use, be sure to remove it.
- (3) When a DIN rail is used, install it taking care with the following.
- Applicable DIN rail type (conforming to IEC 60715)
TH35-7.5Fe
TH35-7.5A1
 - Intervals of DIN rail mounting screws
Mount the DIN rail by fixing it with mounting screws at intervals of 200 mm (7.87inch) or shorter.
- (4) To install the AJ65SBT-RPT module on the DIN rail, press, by the finger, the DIN rail hook located on the underside of the module at the centerline until you hear it click.

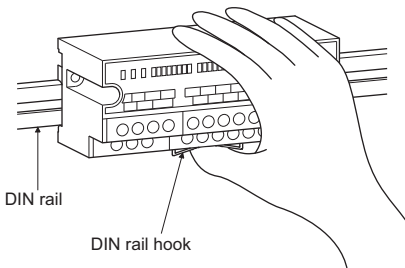

- (5) When installing the AJ65SBT-RPT module on the control panel, to improve the ventilation and facilitate the replacement of the module, provide a distance of 60 mm (2.36inch) or longer between the upper and lower surfaces of the module and the structural members or parts.

(6) Install the AJ65SBT-RPT module on a flat smooth surface.
If there are irregularities on the installation surface, undue force may be applied to the printed circuit boards, and the boards may be damaged.

(7) Depending on the grounding condition of the system, a high-frequency noise may occur between the systems. When these systems are connected through CC-Link dedicated cables, a communication error may occur by the mixing of noise into the repeaters.

If the high-frequency noise occurs between the systems connected through the cables of 10 m (32.79ft.) or shorter, take either of the measures specified below.

- Connect the systems through cables of 2 mm² or larger (across FG terminals of the remote station in each system, or across grounds of the control panel to which the remote station is grounded).
- Use CC-Link cables of 10 m (32.79ft.) or longer between the systems.

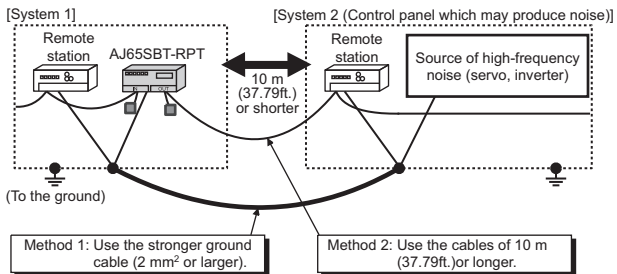

4.2.2 Installation environment

For the installation environment, refer to section 3.1.

4.3 Names and settings of parts

The names of parts of the AJ65SBT-RPT module, indication statuses of LEDs, and settings of switches are described below.

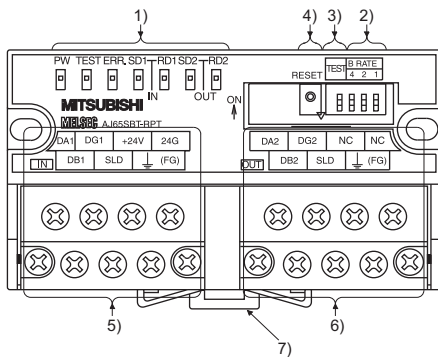

| No. | Name | Application | | |
|-----|------------------------------|---|---|---|
| 1) | Operation status display LED | Check for the module condition by observing the state of lighting of the LED. | | |
| | | LED Name | Application | |
| | | | For hardware test | For normal operation |
| | | PW | Goes on: Power supply is turned ON. Goes off: Power supply is turned OFF or reset switch is pressed. | |
| | | TEST | Goes on: Hardware test is under operation. Goes off: Communication is under operation. | |
| | | ERR. | Goes on: Hardware is faulty. Switch set value is faulty. Flashes : Switch set value was changed during operation. Goes off: Normal | Goes on: Communication is faulty. Switch set value is faulty. Flashes : Switch set value was changed during operation. Goes off: Communication is normal. |
| | | SD1 | Flashes : Circuit is normal. Goes off: Circuit is faulty. | Goes on: Data is being transmitted to IN side. Goes off: Data is not transmitted to IN side. |
| | | RD1 | Flashes : Circuit on IN side is normal. Goes off: Circuit on IN side is faulty. | Goes on: Data is being received from IN side. Goes off: Data is not received from IN side. |
| | | SD2 | Flashes : Circuit is normal. Goes off: Circuit is faulty. | Goes on: Data is being transmitted to OUT side. Goes off: Data is not transmitted to OUT side. |
| | | RD2 | Flashes : Circuit on OUT side is normal. Goes off: Circuit on OUT side is faulty. | Goes on: Data is being received from OUT side. Goes off: Data is not received from OUT side. |

| No. | Name | Application | | | | |
|-----|-----------------------------------|--|-----------------------|-----------------|--------|--------------------|
| 2) | Transmission speed setting switch | Set the transmission speed of the module (set to 0 at the time of delivery). | | | | |
| | | Setting value | Setting switch status | | | Transmission speed |
| | | | 4 | 2 | 1 | |
| | | 0 | OFF | OFF | OFF | 156kbps |
| | | 1 | OFF | OFF | ON | 625kbps |
| | | 2 | OFF | ON | OFF | 2.5Mbps |
| | | 3 | OFF | ON | ON | 5Mbps |
| | 4 | ON | OFF | OFF | 10Mbps | |
| | 5 to 7 | Cannot be set. If set to 5 to 7, the ERR. LED is turned on and data are not transferred. | | | | |
| 3) | Test switch | Set the operating condition of the module (set to OFF at the time of delivery). | | | | |
| | | State of switch | | Operating state | | |
| | | ON | | Hardware test | | |
| | OFF | | Normal operation | | | |
| 4) | Reset switch | Reset the module on the hardware side (set to OFF at the time of delivery). | | | | |
| | | State of switch | | Operating state | | |
| | | ON | | Hardware test | | |
| | OFF | | Normal operation | | | |
| 5) | IN side terminal block | Terminal block for connecting the CC-Link dedicated cable on the side where the power supply and master station are located. | | | | |
| 6) | OUT side terminal block | Terminal block for connecting the CC-Link dedicated cable on the side where the master station is not located. | | | | |
| 7) | Hook for DIN rail | Hook for installing the module on the DIN rail. To install the module, press the DIN rail hook at the centerline until you hear it click. | | | | |

POINT

The states of setting of the test switch and transmission speed set switch obtained when the module power supply is set from OFF to ON or the reset switch is set to OFF become effective.
When the states of setting are changed with the module power supply turned ON, perform the above operations again.

4.4 Check of module state (Hardware test)

Check that the module operates normally using the module proper.
Ensure to perform this check before configuring the system.

Perform the test in accordance with the steps shown below.

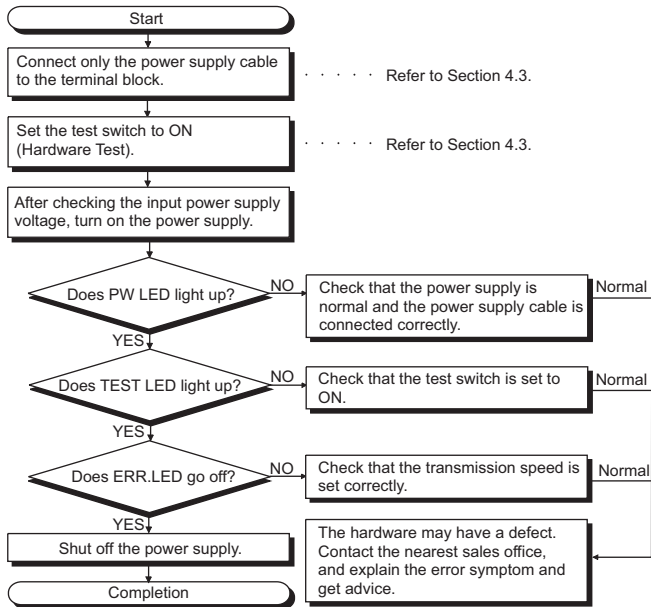

4.5 Setting of switches

The setting of the switches on the AJ65SBT-RPT module is described below.

(1) Test switch

This switch is used to set the operating condition of the AJ65SBT-RPT module.

In normal operation, set it to OFF.

For detail of the setting, refer to Section 4.3.

| |
|-------|
| POINT |
|-------|

| |
|--|
| <p>The states of setting of the test switch obtained when the module power supply is set from OFF to ON or the reset switch is set to OFF become effective. When the states of setting are changed with the module power supply turned ON, perform the above operations again.</p> |
|--|

(2) Transmission speed setting switch

This switch is used to set the transmission speed of the AJ65SBT-RPT module.

For detail of the setting, refer to Section 4.3.

| |
|-------|
| POINT |
|-------|

- | |
|---|
| <ul style="list-style-type: none">• Set to the same state of setting as set in the master station.• The states of setting of the transmission speed setting switch obtained when the module power supply is set from OFF to ON or the reset switch is set to OFF become effective. <p>When the states of setting are changed with the module power supply turned ON, perform the above operations again.</p> |
|---|

4.6 Installation and removal of protective cover

A protective cover can be installed on the front surface of the AJ65SBT-RPT module to prevent foreign matter from entering the terminal blocks. The protective cover applicable to the AJ65SBT-RPT module is specified below.

Procure it as necessary.

| Item | Type | Description | Remarks |
|------------------|---------|---|----------|
| Protective cover | A6CVR-8 | Cover for prevention of entry of foreign matter into terminal blocks (sold in batches of 10). | Optional |

To dismount and mount the protective cover on and from the AJ65SBT-RPT module, follow the steps below.

(1) Mounting

With the upper section of the protective cover hooked to the upper end section of the module, press the lower section of the cover until you hear it click.

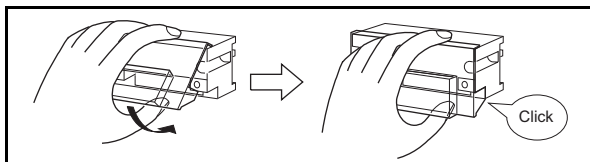

(2) Dismounting

With the finger applied to the lower section of the protective cover, raise the cover upward.

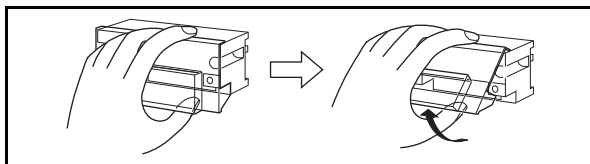

4.7 Connection of module through CC-Link dedicated cable

The method of connecting the AJ65SBT-RPT module to the CC-Link system through the CC-Link dedicated cable is shown below.

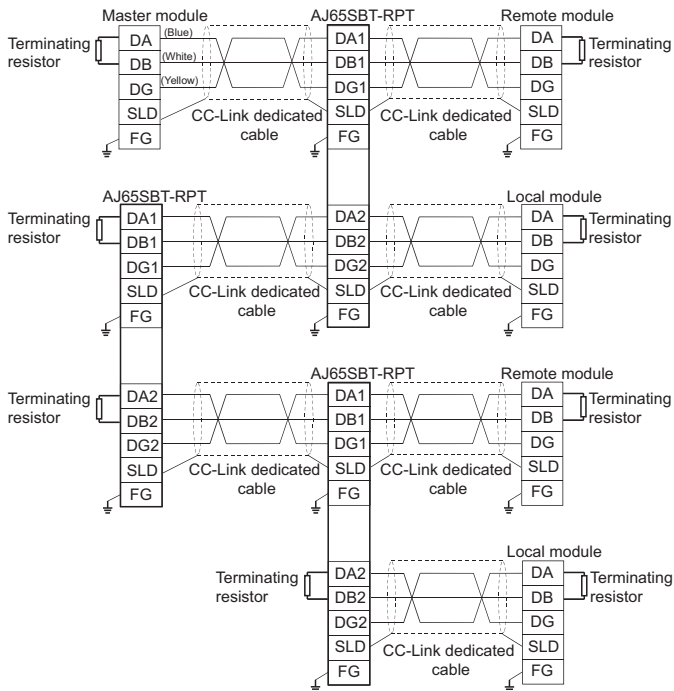

Important

In each segment, ensure to use the same type of CC-Link dedicated cables. If different types of cables are used, normal data transmission will not be assured.

| |
|-------|
| POINT |
|-------|

- Ensure to connect the terminating resistor to both end modules of each segment.
In addition, connect them between DA and DB (DA1-DB1 and DA2-DB2 for AJ65SBT-RPT).
(The terminating resistor are furnished with the module.)
- The terminating resistor vary according to the type of cables in use.
For detail, refer to the User's Manual of the applicable master module.
- Connect the shield wire of the CC-Link dedicated cable to "SLD" of each module, and ground both ends of the shielded wire via "FG".
The SLD and FG are connected within the module.

4.8 Check for state of connection (Line test)

Connect all modules including the AJ65SBT-RPT module through the CC-Link dedicated cable. Then, check that the CC-Link system is in the state capable of performing a data link normally.

Because whether or not a master station can establish a data link with a particular slave station can be checked by the connection status check (circuit test), an error module can be identified.

For the connection status check (circuit test), perform the circuit test 1 of the master module. If an error is detected, perform the circuit test 2 of the master module.

For the details of circuit tests 1 and 2, refer to the user's manual of the master module used.

Perform the test following the steps on the next page.

| |
|-------|
| POINT |
|-------|

Perform the circuit test 2 of the master module by selecting the target stations as described in (1) to (3) below.

- (1) In the segment including the master module, select slave stations in order from the nearest to the master module to the farthest.
- (2) In the segment (1st stage), select slave stations in order from the nearest to the AJ65SBT-RPT to the farthest.
- (3) In the segment (2nd stage), select slave stations in order from the nearest to the AJ65SBT-RPT to the farthest.

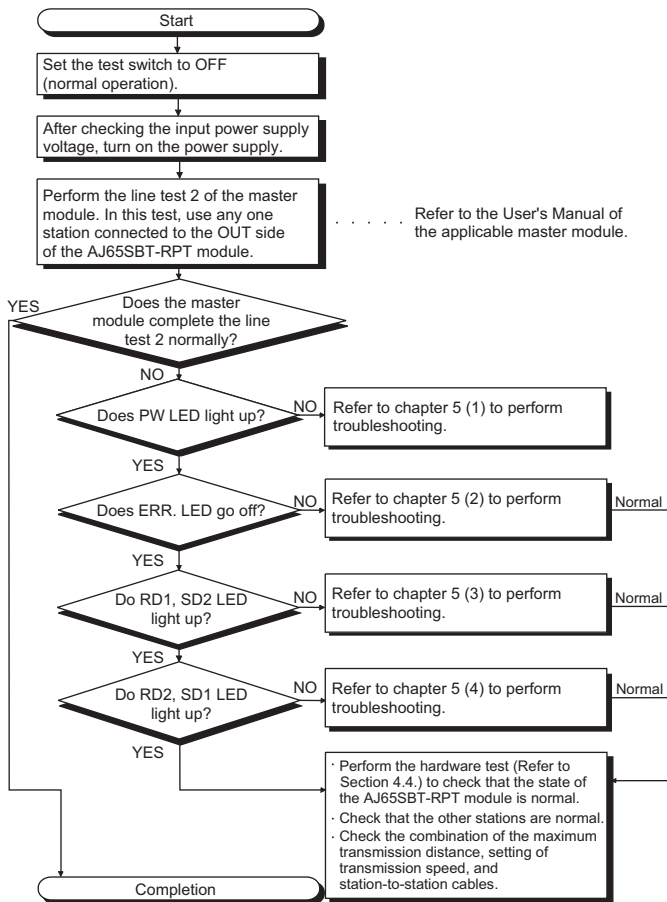

5. TROUBLESHOOTING

This section describes the measures when a trouble occurred in the AJ65SBT-RPT.

Perform the troubleshooting indicated in the reference section.

| No. *1 | Problem | Reference section |
|--------|---|---------------------|
| 1 | The PW LED is not lit while the module power is ON. | (1) in this chapter |
| 2 | The ERR. LED lights up or blinked. | (2) in this chapter |
| 3 | The RD1 or SD2 LED is not lit during data link. | (3) in this chapter |
| 4 | The RD2 or SD1 LED is not lit during data link. | (4) in this chapter |

*1 If more than one problem occurred simultaneously, perform the troubleshooting in order of the item numbers.

- (1) The PW LED is not lit while the module power is ON
Troubleshooting is shown below for the case that the PW LED is not lit while the module power is ON.

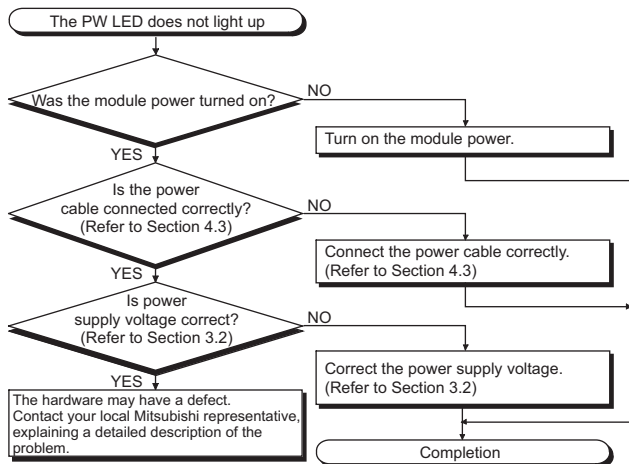

- (2) The ERR. LED lights up or blinks
Troubleshooting is shown below for the case that the ERR. LED lights up or blinks.

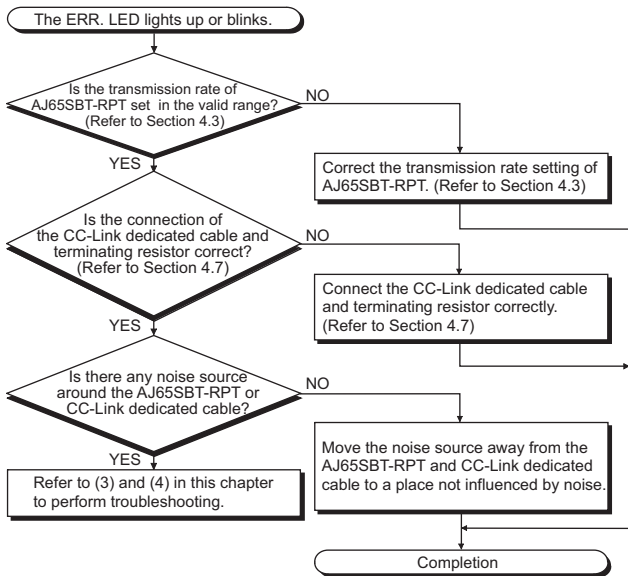

- (3) The RD1 or SD2 LED is not lit during data link
This section describes troubleshooting for the case that the RD1 or SD2 LED is not lit.

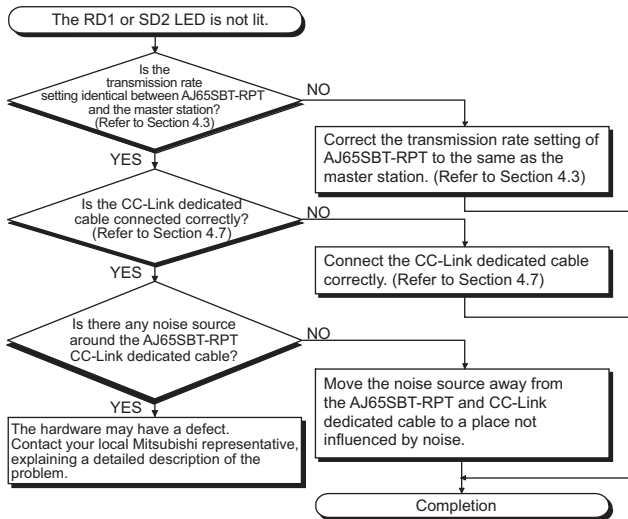

- (4) The RD2 or SD1 LED is not lit during data link
This section describes troubleshooting for the case that the RD2 or SD1 LED is not lit.

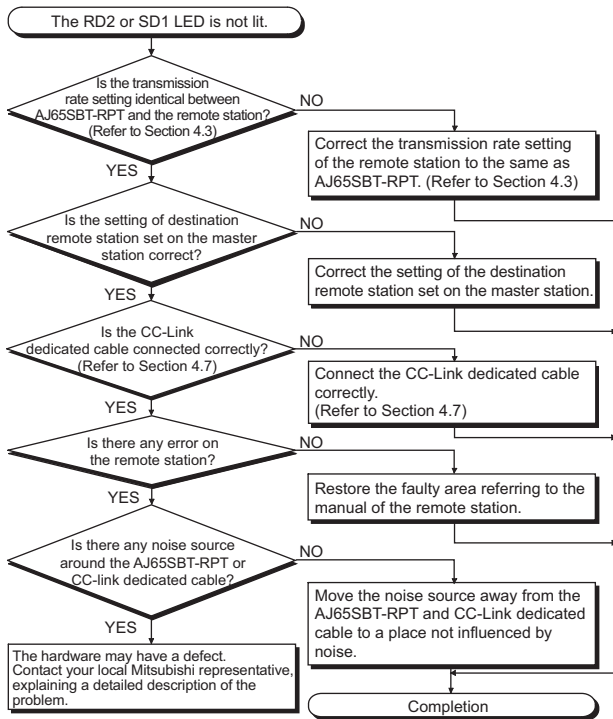

6. EXTERNAL DIMENSIONS

The external dimensions of AJ65SBT-RPT are shown below.
The appearance of the AJ65SBT-RPT varies depending on the hardware version or serial number.

- To check the hardware version, refer to Section 2.2.
- To check the serial number, refer to Section 2.3.

- (1) The hardware version is E or later, or the serial number (first five digits) is "16041" or later

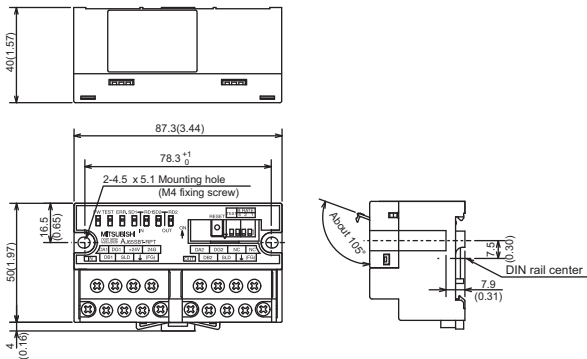

Unit: mm (inch)

- (2) The hardware version is D or earlier, or the serial number (first five digits) is "16031" or earlier

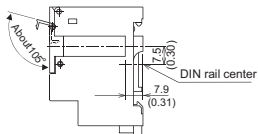
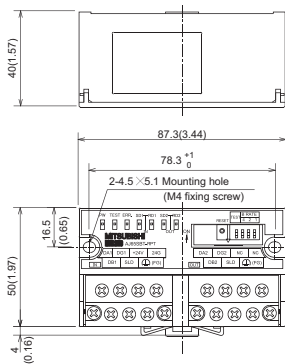

Unit: mm (inch)

WARRANTY

Mitsubishi will not be held liable for damage caused by factors found not to be the cause of Mitsubishi; machine damage or lost profits caused by faults in the Mitsubishi products; damage, secondary damage, accident compensation caused by special factors unpredictable by Mitsubishi; damages to products other than Mitsubishi products; and to other duties.

Country/Region Sales office/Tel

U.S.A Mitsubishi Electric Automation Inc.
500 Corporate Woods Parkway Vernon
Hills, IL 60061, U.S.A.
Tel : +1-847-478-2100

Brazil MELCO-TEC Rep. Com.e Assessoria
Tecnica Ltda.
Rua Correia Dias, 184,
Edificio Paraiso Trade Center-8 andar
Paraiso, Sao Paulo, SP Brazil
Tel : +55-11-5908-8331

Germany Mitsubishi Electric Europe B.V. German
Branch
Gothaer Strasse 8 D-40880 Ratingen,
GERMANY
Tel : +49-2102-486-0

U.K Mitsubishi Electric Europe B.V. UK
Branch
Travellers Lane, Hatfield, Hertfordshire.,
AL10 8XB, U.K.
Tel : +44-1707-276100

Italy Mitsubishi Electric Europe B.V. Italian
Branch
Centro Dir. Colleoni, Pal. Perseo-Ingr.2
Via Paracelso 12, I-20041 Agrate Brianza.,
Milano, Italy
Tel : +39-039-60531

Spain Mitsubishi Electric Europe B.V. Spanish
Branch
Carretera de Rubi 76-80,
E-08190 Sant Cugat del Valles,
Barcelona, Spain
Tel : +34-93-565-3131

France Mitsubishi Electric Europe B.V. French
Branch
25, Boulevard des Bouvets, F-92741
Nanterre Cedex, France
Tel : +33-1-5568-5568

South Africa Circuit Breaker Industries Ltd.
Private Bag 2016, ZA-1600 Isando,
South Africa
Tel : +27-11-928-2000

Country/Region Sales office/Tel

China Mitsubishi Electric Automation
(China) Ltd.
4/F Zhi Fu Plazz, No.80 Xin Chang Road,
Shanghai 200003, China
Tel : +86-21-6120-0808

Taiwan Setsuyo Enterprise Co., Ltd.
6F No.105 Wu-Kung 3rd.Rd, Wu-Ku
Hsiang, Taipei Hsine, Taiwan
Tel : +886-2-2299-2499

Korea Mitsubishi Electric Automation
Korea Co., Ltd.
1480-6, Gayang-dong, Gangseo-ku
Seoul 157-200, Korea
Tel : +82-2-3660-9552

Singapore Mitsubishi Electric Asia Pte, Ltd.
307 Alexandra Road #05-01/02,
Mitsubishi Electric Building,
Singapore 159943
Tel : +65-6470-2480

Thailand Mitsubishi Electric Automation (Thailand)
Co., Ltd.
Bang-Chan Industrial Estate No.111
Moo 4, Serithai Rd, T.Kannayao,
A.Kannayao, Bangkok 10230 Thailand
Tel : +66-2-517-1326

Indonesia P.T. Autoteknindo Sumber Makmur
Muara Karang Selatan, Block A/Utara
No.1 Kav. No.11 Kawasan Industri
Pergudangan Jakarta - Utara 14440,
P.O.Box 5045 Jakarta, 11050 Indonesia
Tel : +62-21-6630833

India Messung Systems Pvt, Ltd.
Electronic Sadan NO:III Unit No15,
M.I.D.C Bhosari, Pune-411026, India
Tel : +91-20-2712-3130

Australia Mitsubishi Electric Australia Pty. Ltd.
348 Victoria Road, Rydalmere,
N.S.W 2116, Australia
Tel : +61-2-9684-7777

MITSUBISHI ELECTRIC CORPORATION

HEAD OFFICE: TOKYO BUILDING, 2-7-3 MARUNOUCHI, CHIYODA-KU, TOKYO 100-8310, JAPAN
NAGOYA WORKS: 1-14, YADA-MINAMI 5-CHOME, HIGASHI-KU, NAGOYA, JAPAN

When exported from Japan, this manual does not require application to the Ministry of Economy, Trade and Industry for service transaction permission.