



# IFC ETTP, IFC ETCX

Manual

.....  
MA00328C 2001-05

English Svensk

# Beijer

ELECTRONICS .....

## **Sweden**

*Beijer Electronics AB  
Box 426  
S-201 24 Malmö  
Telephone 46 40 35 86 00  
Telefax 46 40 93 23 01*

## **USA**

*Beijer Electronics Inc.  
1000 East Woodfield Rd, Suite 102  
Schaumburg, IL 60173-5921  
Telephone 1 (847) 706 6781  
Telefax 1 (847) 706 6783*

## **Norway**

*Beijer Electronics AS  
Boks 487  
N-3002 Drammen  
Telephone 47 32 24 30 00  
Telefax 47 32 84 85 77*

## **Finland**

*Beijer Electronics Oy  
Elannontie 5  
FIN-01510 Vantaa  
Telephone 358-9-6152 011  
Telefax 358-9-6152 0500*

**Internet** [www.beijer.se](http://www.beijer.se) **E-mail** [info@beijer.se](mailto:info@beijer.se)

# Manual IFC ETTP, IFC ETCX

## Foreword

This manual presents installation and function description for the expansion cards IFC ETTP and IFC ETCX.

The module is connectable to the operator terminals with expansion slots.

Besides this manual are the manual for the operator terminals and the programming tool for the operator terminals also available.

© Beijer Electronics AB, MA00328C 2001-05

All examples in this manual are used solely to promote understanding of how the equipment works and its operation. Beijer Electronics AB take no responsibility if these examples are used in real applications.

Because of the great many application areas for this equipment, the user himself must acquire the appropriate knowledge needed to use the equipment correctly for particular applications.

Beijer Electronics AB absolves itself of all responsibilities for damage and injuries that may occur during installation or use of this equipment.

Beijer Electronics AB absolves itself of all responsibilities for any type of modification made to the equipment.

If you have any comments or recommendations about the manual, please fill out this form to help us improve. Post, fax or e-mail this page, or copy of it to our address below.

Comments on the manual MA00328C	Page

Name .....

Company .....

Address .....

City, Zip code .....

Country .....

Telephone.....Telefax .....

E-mail.....

**Marketing Department**  
**Beijer Electronics AB**  
**Box 426, SE-201 24 MALMÖ.**  
**Fax: +46-40-93 23 01**  
**E-mail: info@beijer.se**

# **Safety precautions**

## **General**

- Check the delivery for transport damage. If damage is found, advise your supplier.
- The product fulfils the requirements of article 4 of EMC directive 89/336/EEC.
- Do not use the product in an explosive environment.
- Modifications, changes and additions to the product are forbidden.
- Use only spare parts approved by the manufacture.
- Read the user instructions carefully before use.
- This equipment should only be operated by qualified personnel.

## **At installation**

- The product is constructed for stationary installation.
- Install the product according to the accompanying installation instructions.
- The product must be grounded according to the accompanying installation instructions.
- This equipment must be installed by qualified personnel.
- High voltage-, signal- and supply cables must be separated.

## **In use**

- Keep the equipment clean.
- Emergency stop- and other safety functions should not be controlled from the terminal.

## **Service and maintenance**

- The agreed guarantee applies.
- Repairs should be made by qualified personnel.

## **At disassembly and scrapping**

- Local regulations apply concerning recycling of products or part.

# Content

<b>1 Introduction</b> .....	1
<b>2 Installation</b> .....	3
2.1 Install one expansion card .....	3
2.2 Install two expansion cards .....	5
2.3 The LEDs on IFC ETCX and IFC ETTP .....	6
<b>3 Settings in the programming tool</b> .....	7
3.1 Define slot .....	7
3.2 Settings for TCP/IP .....	9





# **1 Introduction**

IFC ETTP and IFC ETCX are two expansion cards which makes it possible to connect the operator terminals to an Ethernet network for communication via TCP/IP. The connection can be done by either twisted pair (TP) or coaxial cable (CX).

Further information about configuration of the terminals to TCP/IP network are available in the manual for the terminals.



## 2 Installation

This chapter describes how the expansion card is mounted in the terminal.

### 2.1 Install one expansion card

Carry out the following steps to mount an IFC ETTP or IFC ETCX.

1. Switch off the terminal power.
2. Make sure that your ESD protection is good.
3. Remove the cover plates on the rear of the terminal, and the two expansion plates on the short side. The bigger terminals have two expansion slots, Slot 1 and Slot 2. On terminals with one expansion slot, it is called Slot 1.

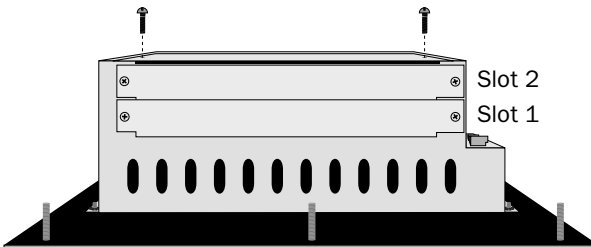

4. Put the jumper J1 on the expansion card in the position SLOT 1 if the expansion card is mounted in Slot 1, and in position SLOT 2 if the card is mounted in Slot 2.

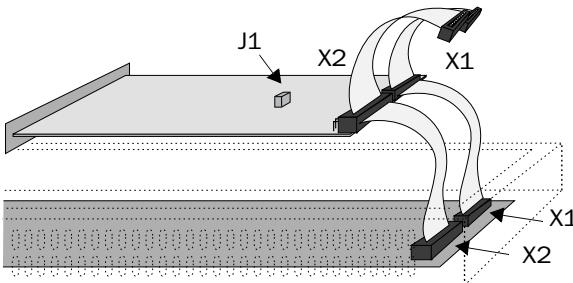

5. Mount the expansion cables with the components of the expansion card placed upwards. One of the expansion cable is mounted between X1 on the CPU card and X1 on the expansion card and the other cable between X2 on the CPU card and X2 on the expansion card.
6. Fasten the card with the spacers or the screws. Use the screws if the expansion card is mounted in Slot 1, and the spacers if the card is mounted in Slot 2.
7. Check that the expansion cable is correctly mounted.
8. Mount the cover plates.

## 2.2 Install two expansion cards

In the bigger terminals you can mount two expansion cards. They are mounted in parallel to the connector on the CPU card in the terminal. Two expansion cards can be connected via one expansion cable since there is a parallel contact on the cable. The connector in the middle is used for the expansion card placed in Slot 1 and the end connector is used for the expansion card placed in Slot 2. If only one card is used it doesn't matter which connector is used.

The connector X1 on the expansion card in Slot 2 is connected to the connector X1 and the CPU card in the terminal via the the X1 connector on the expansion card in Slot 1. If the X2 connector on the CPU card in the terminal is used by any or both cards this connector is connected to the X2 connector in the expansion card.

When two expansion cards are mounted in the same terminal you mount the card in Slot 1 with the distances and the card in Slot 2 with the screws in the distances.

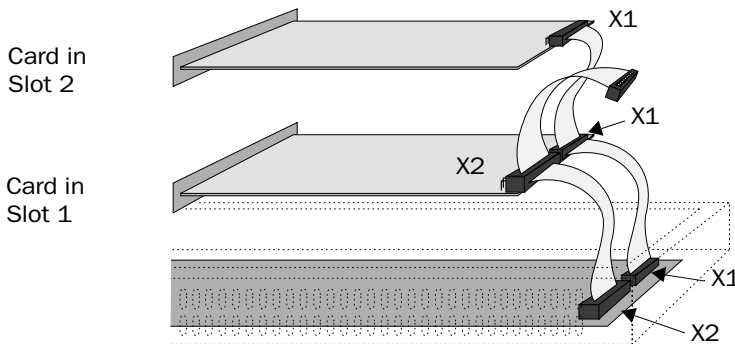

## 2.3 The LEDs on IFC ETCX and IFC ETTP

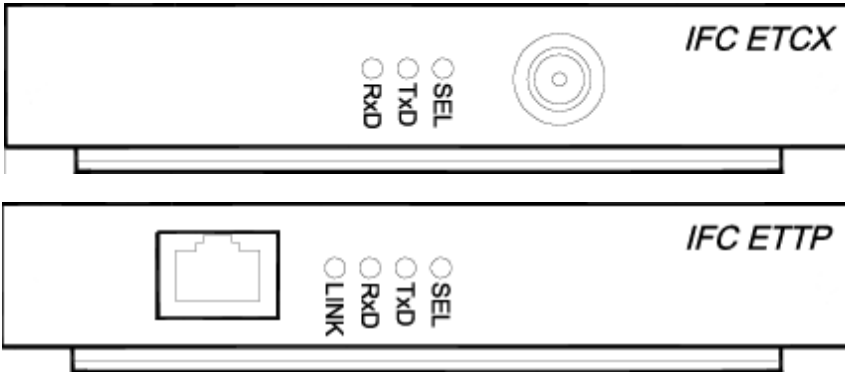

The expansion cards IFC ETCX and IFC ETTP have 3 and 4 LEDs respectively. The LEDs have the following functions:

**SEL**, YELLOW. The LED is activated when the expansion card is accessed from the processor in the terminal.

**TxD**, YELLOW. The LED is activated by transmit activity.

**RxD**, YELLOW. The LED is activated by receive activity.

**LINK**, GREEN. Only valid for IFC ETTP. The LED is activated when connected cables are OK.

## 3 Settings in the programming tool

Make the following steps to use an Ethernet connection with IFC ETTP and IFC ETCX expansion cards.

### 3.1 Define slot

1. Select **Peripherals** in the **Setup** menu.

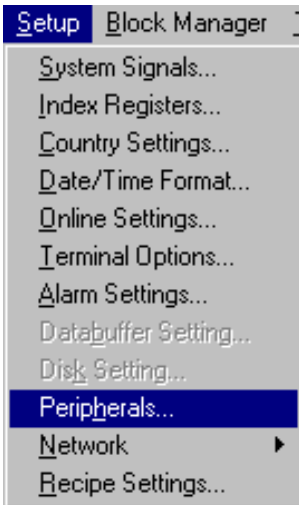

2. Select the slot you define with the jumper J1 on the expansion card and press **Edit**.

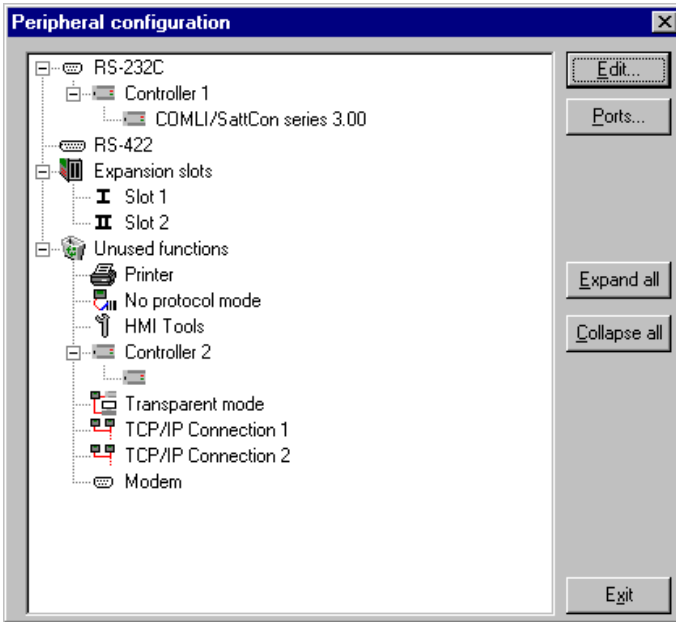

3. Select type of expansion card, in this case **IFC ETTP** i.e. IFC ETTP if connection with twisted pair cable is used or **IFC ETCX** if coaxial cable is used.

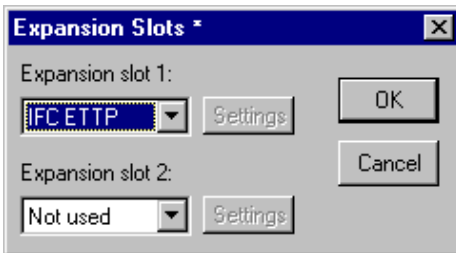

Then click **OK**.



## 3.2 Settings for TCP/IP

1. Make the settings of TCP/IP when you are back in **Peripheral configuration**.

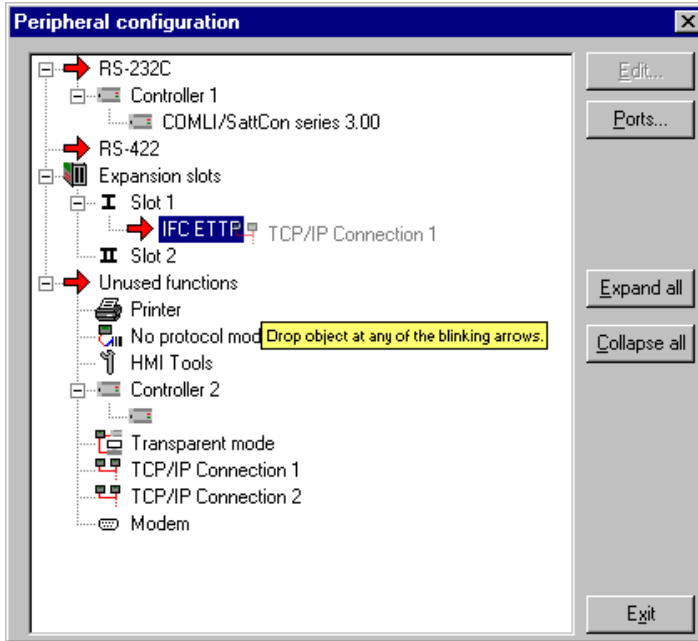

Take the **TCP/IP Connection 1** icon under **Unused functions** and drag it to the **IFC ETTP** or **IFC ETCX**. The blinking arrows points out where it is possible to drop it.

2. Mark **TCP/IP Connection 1** and click on **Edit** to to make the settings for the TCP/IP network.

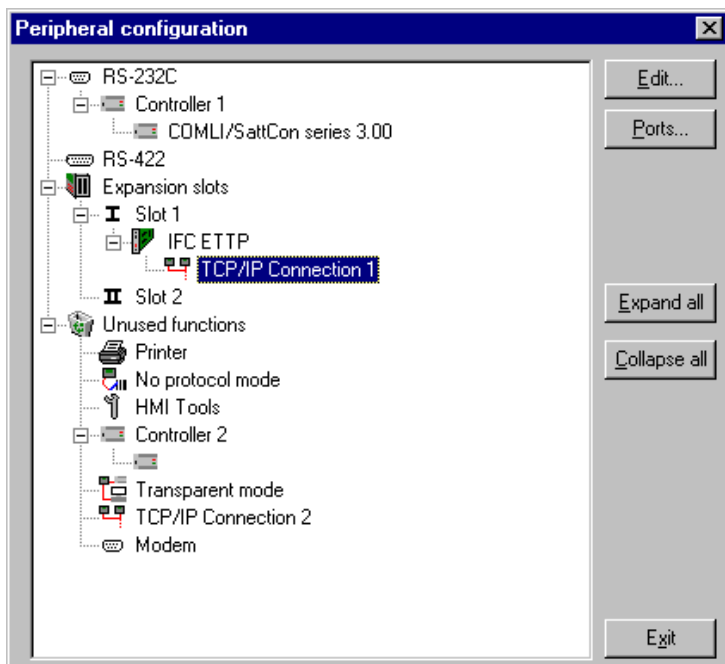

In this menu you have to select a name for your connection and define your IP address and the address for the Subnet mask.

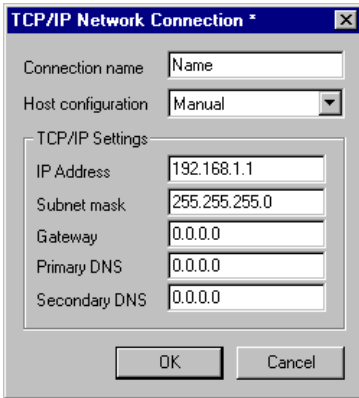

### **Connection name**

Enter freely a name of the connection. The parameter doesn't need to be stated.

### **Host configuration**

Manual means that the settings of the TCP/IP parameters made in the dialog are used. The other alternatives mean that the terminal provides one or several of the TCP/IP parameters from a server.

## **TCP/IP Settings**

### **IP-adress**

State the IP address of your node. For information about which IP address to use please refer to your network manager or to the RFC's from the Internet committee. If you are using a local network between the terminals we recommend you use the addresses 192.168.1.1 – 192.168.1.254.

### **Subnet mask**

State your network identity.

**Gateway**

State the network unit in the local network that can verify the identifiers for the other networks on Internet.

**Primary DNS and Secondary DNS**

State the servers containing information about a part of the DNS database.

Click on **OK** when you have filled out the form.

## ETHERNET connections

The section below shows three examples of ETHERNET connections between two terminals.

### Connection between two terminals via TP

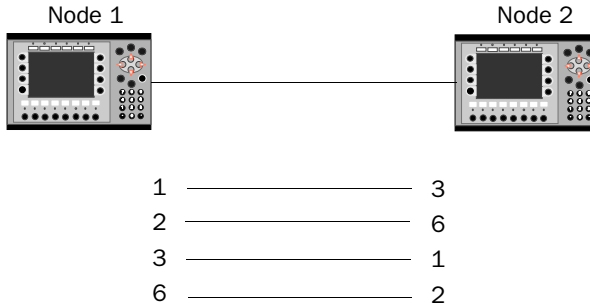

The maximal length between the terminal and the HUB is 100 m. The cable has RJ45 connectors. The cable is a CAT5 pair twisted cable, screened or not screened.

#### Note!

If the communication doesn't work properly, and the LED marked Link on the IFC ETTP card doesn't light, connections 3 and 6 are probably switched.

### TCP/IP settings in the nodes

Node 1

Connection name

Host configuration: Manual

TCP/IP Settings:

IP Address: 192.168.1.1

Subnet mask: 255.255.255.0

Gateway: 0.0.0.0

Primary DNS: 0.0.0.0

Secondary DNS: 0.0.0.0

OK Cancel

Node 2

Connection name

Host configuration: Manual

TCP/IP Settings:

IP Address: 192.168.1.2

Subnet mask: 255.255.255.0

Gateway: 0.0.0.0

Primary DNS: 0.0.0.0

Secondary DNS: 0.0.0.0

OK Cancel

## Connection between more than two terminals via TP

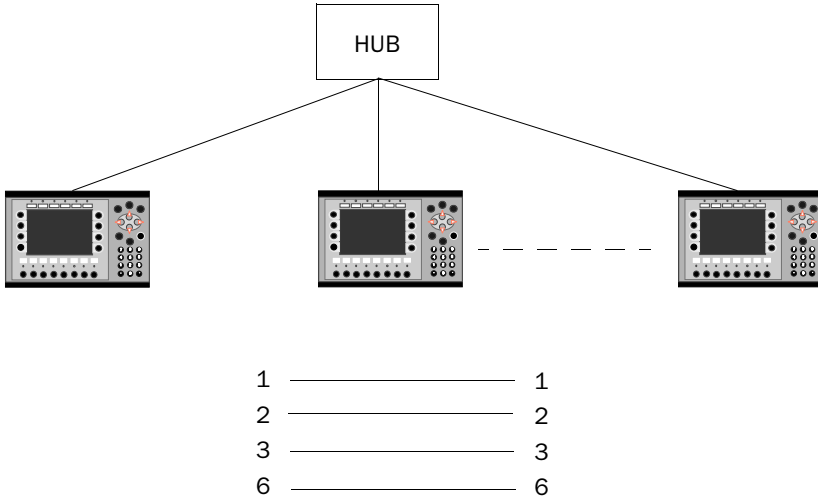

The maximal length between the terminal and the HUB is 100 m. The maximal number of terminals per HUB are limited by the number of connections on the HUB. The cable has RJ45 connectors. The cable is a CAT5 pair twisted cable, screened or unshielded.

### TCP/IP settings in the nodes

Node 1

The screenshot shows the "TCP/IP Network Connection" dialog box for Node 1. The "Connection name" field is empty. The "Host configuration" dropdown is set to "Manual". The "TCP/IP Settings" section contains the following values: IP Address: 192.168.1.1, Subnet mask: 255.255.255.0, Gateway: 0.0.0.0, Primary DNS: 0.0.0.0, and Secondary DNS: 0.0.0.0. There are "OK" and "Cancel" buttons at the bottom.

Node 2

The screenshot shows the "TCP/IP Network Connection" dialog box for Node 2. The "Connection name" field is empty. The "Host configuration" dropdown is set to "Manual". The "TCP/IP Settings" section contains the following values: IP Address: 192.168.1.2, Subnet mask: 255.255.255.0, Gateway: 0.0.0.0, Primary DNS: 0.0.0.0, and Secondary DNS: 0.0.0.0. There are "OK" and "Cancel" buttons at the bottom.

## Connection via coaxial cable

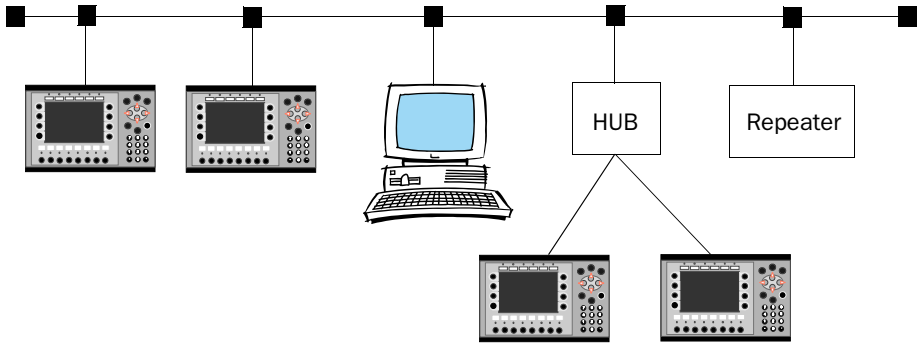

In the network the coaxial cable RG58 is used. There must be bus endings of 50 Ohm. Several coaxial cables can be connected with repeaters to get longer networks. The network will then comprise different segments.

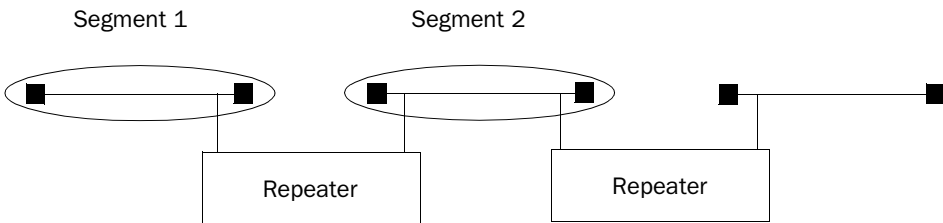

The maximum length of a segment is 185 m and the maximum number of units/segment is 30. Four repeaters can be serial-connected, which means that five segments may be serial connected. Only three of the segments can have units connected. This means that there must be at least two empty segments in the network. The RG58 network cables must be grounded on one side.

## TCP/IP settings in the nodes

Node 1

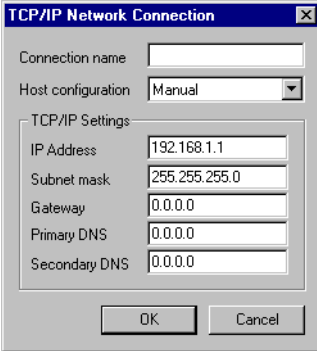

The screenshot shows a dialog box titled "TCP/IP Network Connection" for Node 1. It has a "Connection name" field, a "Host configuration" dropdown menu set to "Manual", and a "TCP/IP Settings" section with fields for IP Address (192.168.1.1), Subnet mask (255.255.255.0), Gateway (0.0.0.0), Primary DNS (0.0.0.0), and Secondary DNS (0.0.0.0). There are "OK" and "Cancel" buttons at the bottom.

Node 2

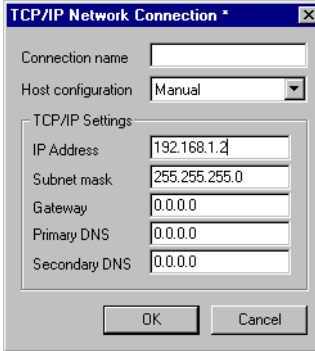

The screenshot shows a dialog box titled "TCP/IP Network Connection" for Node 2. It has a "Connection name" field, a "Host configuration" dropdown menu set to "Manual", and a "TCP/IP Settings" section with fields for IP Address (192.168.1.2), Subnet mask (255.255.255.0), Gateway (0.0.0.0), Primary DNS (0.0.0.0), and Secondary DNS (0.0.0.0). There are "OK" and "Cancel" buttons at the bottom.

For further information we refer to the sections Network services and Network accounts in the chapter Network communication in the manual for the operator terminals.

---

### Note!

Settings for the expansion card can also be done from the Setup menu in the terminal (see the manual for the terminals how to enter the Setup menu). Select slot and IFC ETPP and IFC ETCX in **Expansion cards**.

---