

MITSUBISHI ELECTRIC

GOT2000 Series RGB Output Unit

User's Manual

GT27-ROUT

Thank you for purchasing the GOT2000 Series.

Prior to use, please read both this manual and detailed manual thoroughly to fully understand the product.

MODEL	GT27-ROUT-U-JE
MODEL CODE	1D7MQ1
IB(NA)-0800548-A(1504)MEE	

GOT2000

[INSTALLATION PRECAUTIONS]

- WARNING**
- Be sure to shut off all phases of the external power supply used by the system before mounting or removing this unit to/from the GOT. Not doing so can cause a unit failure or malfunction.
 - Before connecting the Bus connection cable to this unit, always shut off GOT power and PLC CPU power externally in all phases. Not doing so can cause a malfunction.
- CAUTION**
- Use this unit in the environment that satisfies the general specifications described in the User's Manual for the GOT used. Not doing so can cause an electric shock, fire, malfunction or product damage or deterioration.
 - Do not drop the unit or subject it to strong shock. A unit damage may result.
 - When installing this unit to the GOT, fit it to the connection interface of the GOT and tighten the mounting screws in the specified torque range (0.36 N·m to 0.48 N·m) with a Phillips-head screwdriver No.2. Undertightening can cause a drop, failure or malfunction. Overtightening can cause a drop, failure or malfunction due to screw or unit damage.

[WIRING PRECAUTIONS]

- WARNING**
- Be sure to shut off all phases of the external power supply used by the system before wiring. Failure to do so may result in an electric shock, product damage or malfunctions.
- CAUTION**
- Exercise care to avoid foreign matter such as chips and wire cutoffs entering the unit. Not doing so can cause a fire, failure or malfunction.
 - Make sure to securely connect the cable to the connector of unit. Incorrect connection may cause malfunctions.

[STARTUP AND MAINTENANCE PRECAUTIONS]

- WARNING**
- Before starting cleaning, always shut off GOT power externally in all phases. Not doing so can cause a unit failure or malfunction. Undertightening can cause the GOT to drop, short circuit or malfunction. Overtightening can cause a short circuit or malfunction due to the damage of the screws or unit.
 - Do not disassemble or modify any unit. This will cause failure, malfunction, injuries, or fire.
 - Do not touch the conductive areas and electronic parts of this unit directly. Doing so can cause a unit malfunction or failure.
- CAUTION**
- Always secure the cables connected to the unit, e.g. run them in conduits or clamp them. Not doing so can cause unit or cable damage due to dangling, moved or accidentally pulled cables or can cause a malfunction due to a cable contact fault.
 - Do not hold the cable part when unplugging any cable connected to the unit. Doing so can cause unit or cable damage or a malfunction due to a cable contact fault.
 - Always make sure to touch the grounded metal to discharge the electricity charged in the body, etc., before touching the unit. Failure to do so may cause a failure or malfunctions of the unit.

- CAUTION**
- Always secure the cables connected to the unit, e.g. run them in conduits or clamp them. Not doing so can cause unit or cable damage due to dangling, moved or accidentally pulled cables or can cause a malfunction due to a cable contact fault.
 - Do not hold the cable part when unplugging any cable connected to the unit. Doing so can cause unit or cable damage or a malfunction due to a cable contact fault.
 - Always make sure to touch the grounded metal to discharge the electricity charged in the body, etc., before touching the unit. Failure to do so may cause a failure or malfunctions of the unit.

[DISPOSAL PRECAUTIONS]

- CAUTION**
- Dispose of this product as industrial waste.

[TRANSPORTATION PRECAUTIONS]

- CAUTION**
- Make sure to transport the GOT main unit and/or relevant unit(s) in the manner they will not be exposed to the impact exceeding the impact resistance described in the general specifications of the User's Manual for the GOT used, as they are precision devices. Failure to do so may cause the unit to fail. Check if the unit operates correctly after transportation.
 - When fumigants that contain halogen materials such as fluorine, chlorine, bromine, and iodine are used for disinfecting and protecting wooden packaging from insects, they cause malfunction when entering our products. Please take necessary precautions to ensure that remaining materials from fumigant do not enter our products, or treat packaging with methods other than fumigation (heat method). Additionally, disinfect and protect wood from insects before packing products.

Manuals

The following shows manuals relevant to this product.

Manual name	Manual number (Model code)
GOT2000 Series User's Manual (Hardware) (Sold separately)	SH-081194ENG (1D7MJ5)
GOT2000 Series Connection Manual (Microcomputers, MODBUS/Fieldbus Products, Peripherals) For GT Works3 Version1	SH-081200ENG

For detailed manuals, refer to the PDF manuals stored in the DVD-ROM for the drawing software used.

Relevant Manuals

For relevant manuals, refer to the Help or the PDF manuals stored in the DVD-ROM for the drawing software used.

The latest manuals are also available from MITSUBISHI ELECTRIC FA Global Website (<http://www.MitsubishiElectric.co.jp/fa/>).

© 2015 MITSUBISHI ELECTRIC CORPORATION

Compliance with the EMC and Low Voltage Directives

To configure a system meeting the requirements of the EMC and Low Voltage Directives when incorporating the Mitsubishi GOT (EMC and Low Voltage Directives compliant) into other machinery or equipment, refer to "EMC AND LOW VOLTAGE DIRECTIVES" of the General Description included with the GOT used. The CE mark, indicating compliance with the EMC and Low Voltage Directives, is printed on the rating plate of the GOT.

Packing List

After unpacking the box, check that the following products are included.

Model	Product	Quantity
GT27-ROUT	GT27 RGB output unit GT27-ROUT	1
	Mounting screw set (2 screws (26 mm), 2 stickers)	2
	GOT2000 Series RGB Output Unit User's Manual (This manual)	1

1. OVERVIEW

This user's manual describes the GT27 RGB output unit GT27-ROUT (hereinafter referred to as the RGB output unit). By mounting the RGB output unit to a GT27 unit, the screen displayed on the GOT can be displayed on an external display.

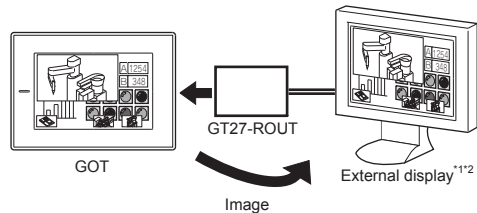

- *1: Depending on the peripheral device connected, noise coming from power cables may cause the GOT or a PLC to malfunction. In this case, install the following line filter to the power lines of the device. Recommended line filter: TDK Lambda RSH-N-2003 (or equivalent products)
- *2: If the screen flickers due to the noise from the RGB cable, attach the following ferrite core to the input section of the RGB cable. Recommended ferrite core: TDK Lambda ZCAT3035-1330 (or equivalent products)

To use the RGB output unit, set the controller settings. For the settings and system configurations, refer to GOT2000 Series Connection Manual (Microcomputer, MODBUS Products, Peripherals) for GT Works3 Version 1. For the details of the RGB output function, refer to GT Designer3 (GOT2000) Help.

2. SPECIFICATIONS

The following shows the performance specifications of the the RGB output unit. The general specifications of the RGB output unit are the same as those of the GOT. For the general specifications of the GOT, refer to the GOT2000 Series User's Manual (Hardware).

Item	Specifications			
	GT2715-X	GT2712-S GT2710-S GT2708-S	GT2710-V GT2708-V	
RGB output section	Output format	Analog RGB		
	Display size	XGA: 1024 X 768 dot	SVGA: 800 X 600 dot	VGA: 640 X 480 dot
	Number of channels	1 channel		
	Dot clock	65,000 MHz	40,000 MHz	25,175 MHz
	Horizontal scanning frequency	48.4 kHz	37.9 kHz	31.5 kHz
	Vertical scanning frequency	60 Hz		
	Timing chart	Refer to 2.2	Refer to 2.3	Refer to 2.4
Connector for external connection	D-Sub15 pin: female			
Internal current consumption	5.0 VDC	0.34 A		
Weight	0.22 kg			

SAFETY PRECAUTIONS

(Always read these precautions before using this equipment.)

Before using this product, please read this manual and the relevant manuals introduced in this manual carefully and pay full attention to safety to handle the product correctly.

The precautions given in this manual are concerned with this product. In this manual, the safety precautions are ranked as "WARNING" and "CAUTION".

WARNING Indicates that incorrect handling may cause hazardous conditions, resulting in death or severe injury.

CAUTION Indicates that incorrect handling may cause hazardous conditions, resulting in medium or slight personal injury or physical damage.

Note that the CAUTION level may lead to a serious accident according to the circumstances. Always follow the precautions of both levels because they are important to personal safety. Please save this manual to make it accessible when required and always forward it to the end user.

DESIGN PRECAUTIONS

- CAUTION**
- Do not bunch the control wires or communication cables with the main circuit or power wires, or lay them close to each other. As a guide, separate the lines by a distance of at least 100mm (3.94 inches) otherwise malfunctions may occur due to noise.

2.2 GT2715-X Timing Chart

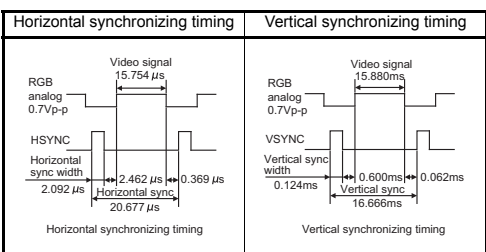

2.3 GT2712-S, GT2710-S, and GT2708-S Timing Chart

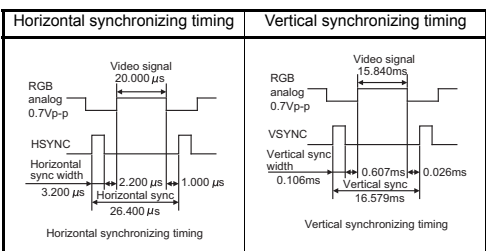

2.4 GT2710-V and GT2708-V Timing Chart

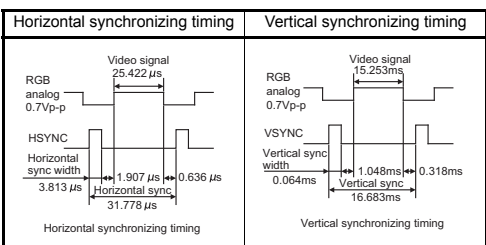

3. PART NAMES AND EXTERNAL DIMENSIONS

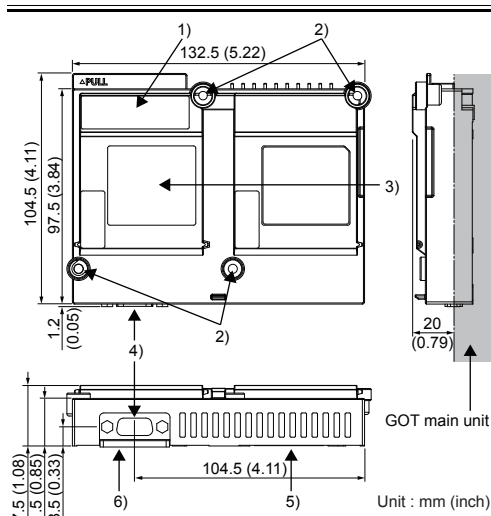

No.	Name	Description
1)	Extension connector	Connector for connecting an extension unit
2)	Mounting screw	Screw for fixing the GOT
3)	Rating plate	-
4)	Connector for RGB output	Connector for connecting RGB cables
5)	Auxiliary extension connector	Auxiliary extension connector connected to the GOT
6)	Interface connector	Extension connector connected to the GOT

4. INSTALLATION AND REMOVAL PROCEDURE

4.1 Unit Installation

The installation procedure for the RGB output unit is explained using the GT2712.

- Turn off the GOT.
- Pull up the two hooks in the extension unit cover (two covers) of the GOT to remove the cover toward the opposite side of the hooks of the cover as a fulcrum.

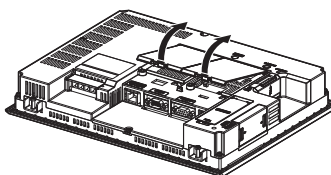

- Connect the RGB output unit to the auxiliary extension interface and the extension interface on the GOT. Then, tighten 4 mounting screws (26 mm) with a torque of 0.36 N·m to 0.48 N·m to fix the unit.

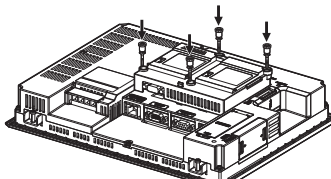

- For connecting an extension unit to the extension connector on the RGB input unit, remove the stickers. For connecting no extension unit to the extension connector, to avoid static electricity, cover over 4 mounting screws with the accessory stickers for the RGB output unit. Leave the stickers in place.

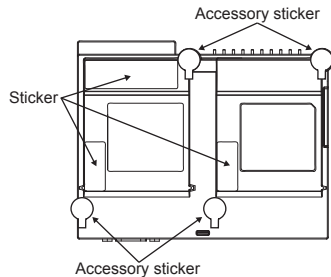

4.2 Unit Removal

For removing the RGB output unit, reverse the procedure of the installation.

Warranty

Mitsubishi will not be held liable for damage caused by factors found not to be the cause of Mitsubishi; machine damage or lost profits caused by faults in the Mitsubishi products; damage, secondary damage, accident compensation caused by special factors unpredictable by Mitsubishi; damages to products other than Mitsubishi products; and to other duties.

For safe use

- This product has been manufactured as a general-purpose part for general industries, and has not been designed or manufactured to be incorporated in a device or system used in purposes related to human life.
- Before using the product for special purposes such as nuclear power, electric power, aerospace, medicine or passenger movement vehicles, consult with Mitsubishi.
- This product has been manufactured under strict quality control. However, when installing the product where major accidents or losses could occur if the product fails, install appropriate backup or failsafe functions in the system.

Country/Region	Sales office/Tel
U.S.A	Mitsubishi Electric Automation Inc. 500 Corporate Woods Parkway Vernon Hills, IL 60061, U.S.A. Tel : +1-847-478-2100
Brazil	MELCO-TEC Rep. Com.e Assessoria Tecnica Ltda. Rua Correia Dias, 164, Edificio Paraiso Trade Center-8 andar Paraiso, Sao Paulo, SP Brazil Tel : +55-11-5908-8331
Germany	Mitsubishi Electric Europe B.V. German Branch Gothaer Strasse 8 D-40880 Ratingen, GERMANY Tel : +49-2102-486-0
U.K	Mitsubishi Electric Europe B.V. UK Branch Travellers Lane, Hatfield, Hertfordshire., AL10 8XB, U.K. Tel : +44-1707-278100
Italy	Mitsubishi Electric Europe B.V. Italian Branch Centro Dir. Colleoni, Pal. Perseo-Ing 2 Via Parcello 12, I-20041 Agrate Brianza., Milano, Italy Tel : +39-039-60531
Spain	Mitsubishi Electric Europe B.V. Spanish Branch Carretera de Rubi 76-80, E-08190 Sant Cugat del Valles, Barcelona, Spain Tel : +34-93-505-3131
France	Mitsubishi Electric Europe B.V. French Branch 25, Boulevard des Bouvets, F-92741 Nanterre Cedex, France Tel : +33-1-5568-5568
South Africa	Circuit Breaker Industries Ltd. Private Bag 2016, ZA-1600 Isando, South Africa Tel : +27-11-928-2000
Hong Kong	Mitsubishi Electric Automation (Hong Kong) Ltd. 10th Floor, Manulife Tower, 169 Electric Road, North Point, Hong Kong Tel : +852-2887-8870
China	Mitsubishi Electric Automation (China) Ltd. 4/F Zhi Fu Plaza, No.80 Xin Chang Road, Shanghai 200003, China Tel : +86-21-6120-0808
Taiwan	Setuwo Enterprise Co., Ltd. 6F No. 105 Wu-Kung 3rd Rd, Wu-Ku Hsiang, Taipei Hsine, Taiwan Tel : +886-2-2299-2499
Korea	Mitsubishi Electric Automation Korea Co., Ltd. 1480-6, Gayang-dong, Gangseo-ku Seoul 157-200, Korea Tel : +82-2-3660-9552
Singapore	Mitsubishi Electric Asia Pte. Ltd. 307 Alexandra Road #05-01/02, Mitsubishi Electric Building, Singapore 159943 Tel : +65-6470-2460
Thailand	Mitsubishi Electric Automation (Thailand) Co., Ltd. Bang-Chan Industrial Estate No.111 Moo 4, Serithai Rd, T.Kannayao, A.Kannayao, Bangkok 10230 Thailand Tel : +66-2-517-1326
Indonesia	P. T. Autoteknik Sumber Makmur Juara Karang Selatan, Blok A/Ujara No.1 Kav. No.11 Kawasan Industri Pergudangan Jakarta - Utara 14440, P.O.Box 5045 Jakarta, 11050 Indonesia Tel : +62-21-6630833
India	Messung Systems Pvt. Ltd. Electronic Sadan NO:III Unit No15, M.I.D.C.Bhosari, Pune-411026, India Tel : +91-20-2712-3130
Australia	Mitsubishi Electric Australia Pty. Ltd. 348 Victoria Road, Rydalmere, N.S.W 2116, Australia Tel : +61-2-9684-7777

MITSUBISHI ELECTRIC CORPORATION
HEAD OFFICE : TOKYO BUILDING, 2-7-3 MARUNOUCHI, CHIYODA-KU, TOKYO 100-8310, JAPAN
NAGOYA WORKS : 1-14, YADA-MINAMI 5-CHOME, HIGASHI-KU, NAGOYA, JAPAN

When exported from Japan, this manual does not require application to the Ministry of Economy, Trade and Industry for service transaction permission.

Specifications subject to change without notice.
Printed in Japan, April 2015.