

**MITSUBISHI ELECTRIC**

# GT27 General Description

GT2715-XTBA-040 GT2715-XTBD-040 GT2712-STBA-040 GT2712-STBD-040  
GT2710-STBA-040 GT2710-STBD-040 GT2710-VTBA-040 GT2710-VTBD-040  
GT2708-STBA-040 GT2708-STBD-040 GT2708-VTBA-040 GT2708-VTBD-040  
GT2705-VTBD-040

Thank you for choosing Mitsubishi Electric Graphic Operation Terminal (GOT).

**Prior to use, please read both this manual and the detailed manual thoroughly to fully understand the product.**

MODEL	GT27-040-U-GD-E
Model code	1D7MW7
IB(NA)-0800674ENG-A(2109)MEE	

© 2021 MITSUBISHI ELECTRIC CORPORATION

### ABOUT THIS PRODUCT

Unlike common GT27 models, this product does not have the extension interface and auxiliary extension interface on the GOT rear face.

Therefore, the following specifications differ from the GT27 models' specifications.

- The communication unit (excluding wireless LAN communication unit and serial multi-drop connection unit) and option unit cannot be used for this product.
- The maximum apparent power and power consumption (at the maximum load) are different.

### SAFETY PRECAUTIONS

(Always read these precautions before using this equipment.) Before using this product, please read this manual and the relevant manuals introduced in this manual carefully and pay full attention to safety to handle the product correctly.

The precautions given in this manual are concerned with this product.

In this manual, the safety precautions are ranked as "WARNING" and "CAUTION".

**WARNING** Indicates that incorrect handling may cause hazardous conditions, resulting in death or severe injury.

**CAUTION** Indicates that incorrect handling may cause hazardous conditions, resulting in medium or slight personal injury or physical damage.

Note that the CAUTION level may lead to a serious accident according to the circumstances.

Always follow the instructions of both levels because they are important to personal safety.

Please save this manual to make it accessible when required and always forward it to the end user.

### DESIGN PRECAUTIONS

**WARNING**

- Some failures of the GOT, communication unit or cable may keep the outputs on or off.
- Some failures of a touch panel may cause malfunction of the input objects such as a touch switch.
- An external monitoring circuit should be provided to check for output signals which may lead to a serious accident.
- Not doing so can cause an accident due to false output or malfunction.
- Do not use the GOT as the warning device that may cause a serious accident.
- An independent and redundant hardware or mechanical interlock is required to configure the device that displays and outputs serious warning.
- Failure to observe this instruction may result in an accident due to incorrect output or malfunction.
- The GOT backlight failure disables the operation on the touch switch(s).
- When the GOT backlight has a failure, the POWER LED blinks (orange/blue), the display section dims, and inputs by a touch switch are disabled.
- The display section of the GOT is an analog-resistive type touch panel. The GOT is multi-touch compliant; however, do not touch three points or more simultaneously on the display section. Doing so may cause an accident due to incorrect output or malfunction.

### WARNING

- When programs or parameters of the controller (such as a PLC) that is monitored by the GOT are changed, be sure to reset the GOT, or turn on the unit again after shutting off the power as soon as possible.
- Not doing so can cause an accident due to false output or malfunction.
- If a communication fault (including cable disconnection) occurs during monitoring on the GOT, communication between the GOT and PLC CPU is suspended and the GOT becomes inoperative.
- A system where the GOT is used should be configured to perform any significant operation to the system by using the switches of a device other than the GOT on the assumption that a GOT communication fault will occur.
- Not doing so can cause an accident due to false output or malfunction.
- To maintain the security (confidentiality, integrity, and availability) of the GOT and the system against unauthorized access, DoS attacks, computer viruses, and other cyberattacks from unreliable networks and devices via network, take appropriate measures such as firewalls, virtual private networks (VPNs), and antivirus solutions.
- Mitsubishi Electric shall have no responsibility or liability for any problems involving GOT trouble and system trouble by unauthorized access, DoS attacks, computer viruses, and other cyberattacks.
- \*1 DoS: A denial-of-service (DoS) attack disrupts services by overloading systems or exploiting vulnerabilities, resulting in a denial-of-service (DoS) state.

### CAUTION

- Do not bundle the control and communication cables with main-circuit, power or other wiring.
- Run the above cables separately from such wiring and keep them a minimum of 100mm apart.
- Not doing so may cause a malfunction.
- Do not press the GOT display section with a pointed material as a pen or driver. Doing so can result in a damage or failure of the display section.
- When the GOT connects to an Ethernet network, the IP address setting is restricted according to the system configuration.
- When a GOT2000 series model and a GOT1000 series model are on an Ethernet network, do not set the IP address 192.168.0.18 for the GOTs and the controllers on this network.
- Doing so can cause IP address duplication at the GOT startup, adversely affecting the communication of the device with the IP address 192.168.0.18. The operation at the IP address duplication depends on the devices and the system.
- Turn on the controllers and the network devices to be ready for communication before they communicate with the GOT.
- Failure to do so can cause a communication error on the GOT.
- When the GOT is subject to shock or vibration, or some colors appear on the screen of the GOT, the screen of the GOT might flicker.

### MOUNTING PRECAUTIONS

**WARNING**

- Be sure to shut off all phases of the external power supply used by the system before mounting or removing the GOT main unit to/from the panel.
- Not doing so can cause the unit to fail or malfunction.
- Be sure to shut off all phases of the external power supply used by the system before mounting or removing the communication unit to/from the GOT.

**CAUTION**

- Use the GOT in the environment that satisfies the general specifications described in this manual. Not doing so can cause an electric shock, fire, malfunction or product damage or deterioration.
- When mounting the GOT to the control panel, tighten the mounting screws in the specified torque range (0.36 N·m to 0.48 N·m) with a Phillips-head screwdriver No. 2.
- Underlighting can cause the GOT to drop, short circuit or malfunction. Overtightening can cause a drop, short circuit or malfunction due to the damage of the screws or the unit.
- When loading the wireless LAN unit to the GOT, fit it to the side interface of GOT and tighten the mounting screws in the specified torque range (0.10 N·m to 0.14 N·m) with a Phillips-head screwdriver No. 1.
- When the GOT is installed vertically, its side interface is positioned on the bottom.
- To prevent the falling of the wireless LAN communication unit from the side interface, install or remove the unit while holding it with hands.
- Underlighting can cause the GOT to drop, failure or malfunction. Overtightening can cause a drop, failure or malfunction due to the damage of the screws or unit.
- When closing the USB environmental protection cover, fix the cover to the GOT by pushing the [PUSH] mark on the latch firmly to comply with the protective structure.
- Remove the protective film of the GOT.
- When the user continues using the GOT with the protective film, the film may not be removed.
- In addition, for the models equipped with the human sensor function, using the GOT with the protective film may cause the human sensor not to function properly.
- Do not operate or store the GOT in the environment exposed to direct sunlight, high temperature, dust, humidity, or vibrations.
- When using the GOT in the environment of oil or chemicals, use the protective cover for oil.
- Failure to do so may cause failure or malfunction due to the oil or chemical entering into the GOT.

### WIRING PRECAUTIONS

**WARNING**

- Be sure to shut off all phases of the external power supply used by the system.
- Failure to do so may result in an electric shock, product damage or malfunctions.

**CAUTION**

- Make sure to ground the FG terminal and LG terminal of the GOT power supply section solely for the GOT (ground resistance: 100 Ω or less, ground cable diameter: 1.6 mm or more).
- Not doing so may cause an electric shock or malfunction.
- When tightening the terminal screws, use a Phillips-head screwdriver No.2.
- Terminal screws which are not to be used must be tightened always at torque 0.5 N·m to 0.8 N·m.
- Otherwise there will be a danger of short circuit against the solderless terminals.
- Use applicable solderless terminals and tighten them with the specified torque.
- If any solderless spade terminal is used, it may be disconnected when the terminal screw comes loose, resulting in failure.
- Correctly wire the GOT power supply section after confirming the rated voltage and terminal arrangement of the product.
- Not doing so can cause a fire or failure.
- Tighten the terminal screws of the GOT power supply section in the specified torque range (0.5 N·m to 0.8 N·m). Underlighting can cause a short circuit or malfunction. Overtightening can cause a short circuit or malfunction due to the damage of the screws or the unit.
- Exercise care to avoid foreign matter such as chips and wire offcuts entering the GOT.
- Not doing so can cause a fire, failure or malfunction.
- The module has an ingress prevention label on its top to prevent foreign matter, such as wire offcuts, from entering the module during wiring. Do not peel this label during wiring.
- Before starting system operation, be sure to peel this label because of heat dissipation.
- Connect the communication cable to the GOT interface, and tighten the mounting screws and terminal screws in the specified torque range. Overtightening can cause a short circuit or malfunction. Underlighting can cause a short circuit or malfunction due to the damage of the screws or unit.

### TEST OPERATION PRECAUTIONS

**WARNING**

- Before testing the operation of a user-created monitor screen (such as turning on or off a bit device, changing the current value of a word device, changing the set value or current value of a timer or counter, and changing the current value of a buffer memory), thoroughly read the manual to fully understand the operating procedures.
- During the test operation, never change the data of the devices which are used to perform significant operation for the system.
- False output or malfunction can cause an accident.

### STARTUP/MAINTENANCE PRECAUTIONS

**WARNING**

- When power is on, do not touch the terminals.
- Doing so can cause an electric shock.
- Correctly connect the battery connector.
- Do not charge, disassemble, heat, short-circuit, solder, or throw the battery into the fire. Doing so will cause the battery to produce heat, explode, or ignite, resulting in injury and fire.
- Before starting cleaning or terminal screw retightening, always switch off the power externally in all phases. Not switching the power off in all phases can cause a unit failure or malfunction. Underlighting can cause a drop, short circuit or malfunction. Overtightening can cause a drop, short circuit or malfunction due to the damage of the screws or unit.

### CAUTION

- Do not disassemble or modify the unit.
- Doing so can cause a failure, malfunction, injury or fire.
- Do not touch the conductive and electronic parts of the unit directly.
- Doing so can cause a unit malfunction or failure.
- The cables connected to the unit must be run in ducts or clamped.
- Not doing so can cause the unit or cable to be damaged due to the dangling, motion or accidental pulling of the cables or can cause a malfunction due to a cable connection fault.
- When unplugging the cable connected to the unit, do not hold and pull from the cable portion. Doing so can cause the unit or cable to be damaged or can cause a malfunction due to a cable connection fault.
- Do not drop the module or subject it to strong shock.
- A module damage may result.
- Do not drop or give an impact to the battery mounted to the unit.
- Doing so may damage the battery, causing the battery fluid to leak inside the battery.
- If the battery is dropped or given an impact, dispose of it without using.
- Before touching the unit, always touch grounded metals, etc. to discharge static electricity from human body, etc.
- Not doing so can cause the unit to fail or malfunction.
- Use the battery manufactured by Mitsubishi Electric Corporation.
- Use of other batteries may cause a risk of fire or explosion.
- Dispose of used battery promptly.
- Keep away from children.
- Do not disassemble and do not dispose of in fire.
- Be sure to shut off all phases of the external power supply before replacing the battery or using the dip switch of the terminating resistor.
- Not doing so can cause the unit to fail or malfunction by static electricity.

### TOUCH PANEL PRECAUTIONS

**CAUTION**

- For the analog-resistive film type touch panels, normally the adjustment is not required.
- However, the difference between a touched position and the object position may occur as the period of use elapses.
- When any difference between a touched position and the object position occurs, execute the touch panel calibration.
- When any difference between a touched position and the object position occurs, other object may be activated.
- This may cause an unexpected operation due to incorrect output or malfunction.

### PRECAUTIONS WHEN THE DATA STORAGE IS IN USE

**WARNING**

- If the SD card is removed from drive A of the GOT while being accessed by the GOT, the GOT may stop processing data for about 20 seconds.
- The GOT cannot be operated during this period.
- The functions that run in the background including a screen updating, alarm, logging, scripts, and others are also interrupted.
- Since this interruption makes an impact to the system operation, it might cause failure.
- Check that the SD card access LED is off before removing the SD card.

**CAUTION**

- If the data storage is removed from the GOT while being accessed by the GOT, the data storage and files may be damaged.
- Before removing the data storage from the GOT, check the SD card access LED, signal system, or others to make sure that the data storage is not accessed.
- Turning off the GOT while it accesses the SD card results in damage to the SD card and files.
- After inserting an SD card into the GOT, make sure to close the SD card cover.
- Not doing so causes the data not to be read or written.
- When removing the SD card from the GOT, make sure to support the SD card by hand as it may pop out.
- Not doing so may cause the SD card to drop from the GOT, resulting in a failure or break.
- When inserting a USB device into a USB interface of the GOT, make sure to insert the device into the interface firmly.
- Not doing so can cause a malfunction due to a contact failure.
- Before removing the data storage from the GOT, follow the procedure for removal on the utility screen of the GOT.
- After the successful completion dialog is displayed, remove the data storage by hand carefully.
- Not doing so may cause the data storage to drop from the GOT, resulting in a failure or break.

### PRECAUTIONS FOR USE

**CAUTION**

- Do not touch the outer edge of the actual display area repeatedly.
- Doing so may result in a failure.
- Do not turn off the GOT while data is being written to the storage memory (ROM) or SD card.
- Doing so may corrupt the data, rendering the GOT inoperative.

### PRECAUTIONS FOR REMOTE CONTROL

**WARNING**

- Remote control is available through a network by using GOT functions, including the Site-GOT link function, the remote personal computer operation function, the VNC server function, and the GOT Mobile function.
- If these functions are used to perform remote control of control equipment, the field operator may not notice the remote control, possibly leading to an accident.
- In addition, a communication delay or interruption may occur depending on the network environment, and remote control of control equipment cannot be performed normally in some cases.
- Before using the above functions to perform remote control, fully grasp the circumstances of the field site and ensure safety.

### PRECAUTIONS FOR EXCLUSIVE AUTHORIZATION CONTROL

**WARNING**

- Make sure to fully understand the GOT network interaction function before using this function to control the authorization among pieces of equipment to prevent simultaneous operations.
- The exclusive authorization control of the GOT network interaction function can be enabled or disabled for each screen.
- (For all screens, the exclusive authorization control is disabled by default.) Properly determine the screens for which the exclusive authorization control is required, and set the control by screen.
- A screen for which the exclusive authorization control is disabled can be operated simultaneously from pieces of equipment.
- Make sure to determine the operation period for each operator, fully grasp the circumstances of the field site, and ensure safety to perform operations.

### DISPOSAL PRECAUTIONS

**CAUTION**

- When disposing of this product, treat it as industrial waste.
- When disposing of batteries, separate them from other wastes according to the local regulations.
- (Refer to the GOT2000 Series User's Manual (Hardware) for details of the battery directive in the EU member states.)

### TRANSPORTATION PRECAUTIONS

**CAUTION**

- When transporting lithium batteries, make sure to treat them based on the transport regulations.
- (Refer to the GOT2000 Series User's Manual (Hardware) for details of the regulated models.)
- Make sure to transport the GOT main unit and/or relevant unit(s) in the manner they will not be exposed to the impact exceeding the impact resistance described in the general specifications of this manual, as they are precision devices.
- Failure to do so may cause the unit to fail.
- Check if the unit operates correctly after transportation.
- When fumigants that contain halogen materials such as fluorine, chlorine, bromine, and iodine are used for disinfecting and protecting wooden packaging from insects, they cause malfunction when entering our products. Please take necessary precautions to ensure that remaining materials from fumigant do not enter our products, or treat packaging with methods other than fumigation (heat method).
- Additionally, disinfect and protect wood from insects before packing products.

#### Manuals

The following shows manuals relevant to this product.

Manual name	Manual number (Model code)
GOT2000 Series User's Manual (Hardware)	SH-081194ENG (1D7MJ5)
GOT2000 Series User's Manual (Utility)	SH-081195ENG (1D7MJ6)

For detailed manuals and relevant manuals, refer to the e-Manual or PDF manuals stored in the DVD-ROM for the screen design software used.

The latest manuals are also available from MITSUBISHI ELECTRIC FA Global Website (www.MitsubishiElectric.com/fa).

**Referenced Standard: GB/T15969.2**  
**(Requirement of Chinese standardized law)**

**Before using the GOT**

Connect the connector of the GOT to the connector of the battery.

Refer to the GOT2000 Series User's Manual (Hardware) for the connection instructions.

For details on the GOT specifications, installing instructions, wiring, maintenance and inspection, or checking procedure for the version and the compatible standard, refer to the GOT2000 Series User's Manual (Hardware).

#### Packing List

The GOT product package includes the following:

Description	Quantity
GT27	1
Battery (GT11-50BAT) (Attached to the GOT)	1
Installation fitting	4, 8(Only GT2715)
GT27 General Description (This manual)	1
GT27 本体概要説明書	1

- ### 1. FEATURES
- Abundant standard equipment
    - Variety of connection with FA devices
    - SD card interface compatible with the SDHC card having a large capacity
    - Easy allowing high-speed communication
    - Connection with various peripheral devices with the USB host
  - Improved usability
    - Abundant troubleshooting
    - Easy and clear screen creation
    - PC-like operation screen
    - Multi-touch function, Gesture function
    - Support for the vertical installation
  - Enhanced compatibility with Mitsubishi Electric FA devices
  - Easy replacement
  - LED backlight
  - Various extended functions supported

## 2. Part Names and Settings

The following shows the part names for GT2715, GT2712, GT2710, GT2708 and GT2705.

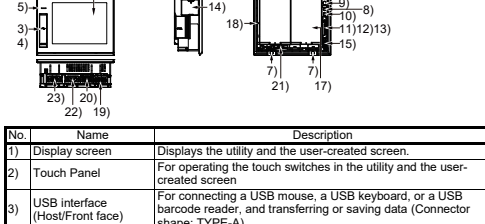
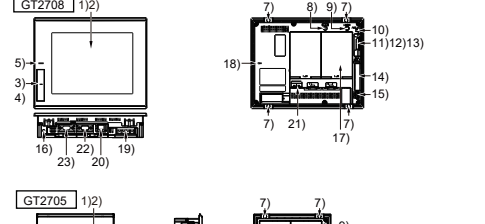
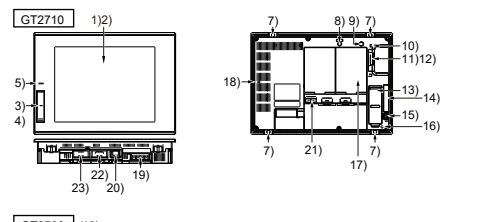
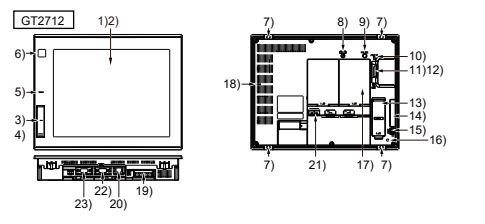
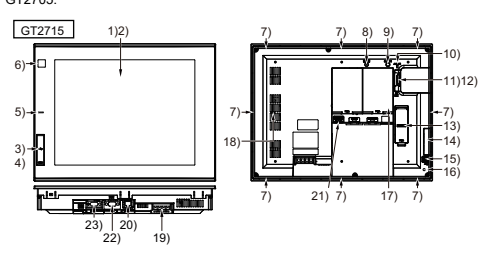

No.	Name	Description
1)	Display screen	Displays the utility and the user-created screen.
2)	Touch panel	For operating the touch switches in the utility and the user-created screen.
3)	USB interface (Host/Front face)	For connecting a USB mouse, a USB keyboard, or a USB barcode reader, and transferring or saving data (Connector shape: TYPE-A)
4)	USB interface (Device/Front face)	For connecting a personal computer (Connector shape: Mini-B)
5)	POWER LED	Lit in blue : Power is properly supplied. Lit in orange : Screen saving Blinks in orange/blue : Backlight failure Not lit : Power is not supplied
6)	Human sensor	Detects human movement. (Only GT2715, GT2712)
7)	Unit installation fitting	Mounting fixtures for fixing the GOT to the control panel
8)	Reset switch	Hardware reset switch
9)	Installation switch	Used for OS installations at the GOT startup
10)	SD card access LED	Lit : SD card mounted Not lit : SD card not mounted or SD card mounted (removable)
11)	SD card interface	For installing a SD card

No.	Name	Description
12)	SD card cover	With a switching function for accepting and stopping the access to the SD card When the cover is opened : Access is prohibited When the cover is closed : Access is allowed
13)	Battery holder	Houses the battery
14)	Site interface	For installing a communication unit
15)	USB interface (Host/Back face)	For connecting a USB mouse, a USB keyboard, or a USB barcode reader, and transferring or saving data (Connector shape: TYPE-A)
16)	Hole for attaching a cable clamp	Hole for attaching a cable clamp for preventing USB cable from being pulled out (Recommended product: RSG-130-V0 of KITAGAWA INDUSTRIES CO., LTD. or equivalent)
17)	Terminating resistor (Inside cover)	For switching on and off of the terminating resistor for the RS-422/485 communication port (Default: Off)
18)	Vertical installation arrow mark	For the vertical installation, install the GOT so that the arrow points upward.
19)	Power terminal	Power input terminal, LG terminal, FG terminal
20)	Ethernet interface	For communicating with a controller or connecting a personal computer (Connector shape: RJ45 (modular jack))
21)	Ethernet communication status LED	SD/RD LED ON: Data sent or received SD/RD LED OFF: Data not sent or received SPEED LED ON: Communicating at 100 Mbps SPEED LED OFF: Communicating at 10 Mbps or disconnected
22)	RS-232 interface	For communicating with a controller (Connector shape: D sub 9-pin (male))
23)	RS-422/485 interface	For communicating with a controller (Connector shape: D sub 9-pin (female))

## 3. Specifications

### 3.1 General Specifications

Item	Specifications																				
Operating ambient temperature <sup>1)</sup> Température ambiante de fonctionnement <sup>1)</sup>	0 to 55°C <sup>2)</sup> 0 à 55°C <sup>2)</sup>																				
Storage ambient temperature	-20 to 60°C																				
Operating ambient humidity	10 to 90% RH, non-condensing																				
Storage ambient humidity	10 to 90% RH, non-condensing																				
Vibration resistance	Compliant with JIS B 3502 and IEC 61131-2 <table border="1"> <thead> <tr> <th>Frequency</th> <th>Acceleration</th> <th>Half-amplitude</th> <th>Sweep count</th> </tr> </thead> <tbody> <tr> <td>5 to 8.4Hz</td> <td>-</td> <td>3.5mm</td> <td>10 times each in X, Y and Z directions</td> </tr> <tr> <td>8.4 to 150Hz</td> <td>9.8m/s<sup>2</sup></td> <td>-</td> <td>-</td> </tr> <tr> <td>5 to 8.4Hz</td> <td>-</td> <td>1.75mm</td> <td>-</td> </tr> <tr> <td>8.4 to 150Hz</td> <td>4.9m/s<sup>2</sup></td> <td>-</td> <td>-</td> </tr> </tbody> </table>	Frequency	Acceleration	Half-amplitude	Sweep count	5 to 8.4Hz	-	3.5mm	10 times each in X, Y and Z directions	8.4 to 150Hz	9.8m/s <sup>2</sup>	-	-	5 to 8.4Hz	-	1.75mm	-	8.4 to 150Hz	4.9m/s <sup>2</sup>	-	-
Frequency	Acceleration	Half-amplitude	Sweep count																		
5 to 8.4Hz	-	3.5mm	10 times each in X, Y and Z directions																		
8.4 to 150Hz	9.8m/s <sup>2</sup>	-	-																		
5 to 8.4Hz	-	1.75mm	-																		
8.4 to 150Hz	4.9m/s <sup>2</sup>	-	-																		
Shock resistance	Compliant with JIS B 3502 and IEC 61131-2 147 m/s <sup>2</sup> (15G), 3 times each in X, Y and Z directions																				
Operating atmosphere	No greasy fumes, corrosive gas, flammable gas, excessive conductive dust, and direct sunlight (Same as storage atmosphere)																				
Operating altitude <sup>3)</sup>	2000 m (6562 ft) max.																				
Installation location	Inside control panel																				
Overvoltage category <sup>4)</sup>	II or less																				
Pollution degree <sup>5)</sup>	2 or less																				
Cooling method	Self-cooling																				
Grounding	Grounding with a ground resistance of 100 Ω or less by using a ground cable that has a cross-sectional area of 2 mm <sup>2</sup> or more. If impossible, connect the ground cable to the control panel.																				

- The operating ambient temperature includes the temperature inside the enclosure of the control panel to which the GOT is installed.  
*La température ambiante de fonctionnement inclut la température à l'intérieur du boîtier du tableau de commande sur lequel le GOT est installé.*
- When the following option is mounted on the GOT, the maximum operating ambient temperature must be 5°C lower than the one described above in the general specifications.
  - Protective cover for oil
  - *Lors du montage de l'option suivante, la température ambiante de fonctionnement doit être réduite de 5°C par rapport à la valeur maximale dans les spécifications générales.*
  - *Couvercle de protection contre l'huile*
- Do not use or store the GOT under pressure higher than the atmospheric pressure of altitude 0m (0ft).  
Failure to observe this instruction may cause a malfunction.  
When an air purge is made inside the control panel by adding pressure, there will be a clearance between the surface sheet and the screen making it difficult to use the touch panel, or the sheet may come off.
- This indicates the section of the power supply to which the equipment is assumed to be connected between the public electrical power distribution network and the machinery within the premises.  
Category II applies to equipment for which electrical power is supplied from fixed facilities.  
The surge voltage withstand level for up to the rated voltage of 300 V is 2500 V.
- This index indicates the degree to which conductive material is generated in the environment where the equipment is used.  
In pollution degree 2, only non-conductive pollution occurs but temporary conductivity may be produced due to condensation.

Point
Refer to the GOT2000 Series User's Manual (Hardware) for details on the performance specifications of each GOT.

### 3.2 Power Supply Specifications

The following indicates the power supply specifications for GT27.

Item	Specifications
Power supply voltage	AC100 to 240VAC (+10%, -15%)
Power frequency	50/60Hz ± 5%
Max. apparent power	122VA 82VA
Power maximum load	44W or less 36W or less 34W or less 33W or less
Power consumption	Stand alone 25W 19W 17W 15W
ption	Stand alone with backlight off 10W
Inrush current	40A or less (2ms, operating ambient temperature 25, maximum load) 60A or less (2ms, operating ambient temperature 25, maximum load)
Allowable momentary power failure time	20 ms or less (100VAC or more)
Noise immunity	1,500Vp-p noise voltage, 1μs noise width (when measuring with a noise simulator under 25 to 60Hz noise frequency)
Dielectric withstand voltage	1500VAC for 1 minute across power terminals and earth
Insulation resistance	10M or more across power terminals and earth by a 500V DC insulation resistance tester
Applicable wire size	0.75[mm <sup>2</sup> ] to 2[mm <sup>2</sup> ]
Applicable solderless terminal	Solderless terminal for M3 screw RAV1.25-3, V2-S3.3, V2-N3A, FV2-N3A
Applicable tightening torque (Terminal block terminal screw)	0.5[N·m] to 0.8[N·m]

### 3.2.1 For GOTs powered from the 100 to 240VAC power supply

Item	Specifications
Power supply voltage	DC24V (+25%, -20%)
Power maximum load	30W or less 27W or less 24W or less 21W or less 18W or less
Power consumption	Stand alone 23W 18W 15W 13W 7W
ption	Stand alone with backlight off 8W 8W 8W 8W 5W
Inrush current	5A or less (20ms, operating ambient temperature 25, maximum load) 6A or less (2ms, operating ambient temperature 25, maximum load)
Allowable momentary power failure time	10 ms or less
Noise immunity	500Vp-p noise voltage, 1μs noise width (when measuring with a noise simulator under 25 to 60Hz noise frequency)
Dielectric withstand voltage	350VAC for 1 minute across power terminals and earth
Insulation resistance	10M or more across power terminals and earth by a 500V DC insulation resistance tester
Applicable wire size	0.75[mm <sup>2</sup> ] to 2[mm <sup>2</sup> ]
Applicable solderless terminal	Solderless terminal for M3 screw RAV1.25-3, V2-S3.3, V2-N3A, FV2-N3A
Applicable tightening torque (Terminal block terminal screw)	0.5[N·m] to 0.8[N·m]

### 3.2.2 For GOTs powered from the 24VDC power supply

Item	Specifications
Power supply voltage	DC24V (+25%, -20%)
Power maximum load	30W or less 27W or less 24W or less 21W or less 18W or less
Power consumption	Stand alone 23W 18W 15W 13W 7W
ption	Stand alone with backlight off 8W 8W 8W 8W 5W
Inrush current	5A or less (20ms, operating ambient temperature 25, maximum load) 6A or less (2ms, operating ambient temperature 25, maximum load)
Allowable momentary power failure time	10 ms or less
Noise immunity	500Vp-p noise voltage, 1μs noise width (when measuring with a noise simulator under 25 to 60Hz noise frequency)
Dielectric withstand voltage	350VAC for 1 minute across power terminals and earth
Insulation resistance	10M or more across power terminals and earth by a 500V DC insulation resistance tester
Applicable wire size	0.75[mm <sup>2</sup> ] to 2[mm <sup>2</sup> ]
Applicable solderless terminal	Solderless terminal for M3 screw RAV1.25-3, V2-S3.3, V2-N3A, FV2-N3A
Applicable tightening torque (Terminal block terminal screw)	0.5[N·m] to 0.8[N·m]

### 3.3 External Dimensions

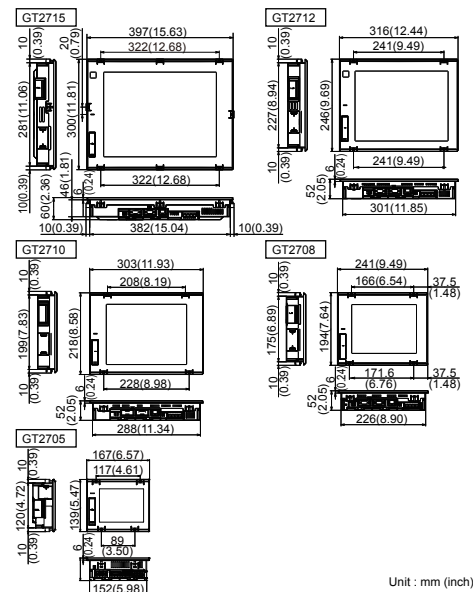

Unit : mm (inch)

### 4. EMC AND LOW VOLTAGE DIRECTIVE

For electromagnetic compatibility (EMC) and electrical safety, regulatory standards are established in each country. Especially, for the products to be sold in European countries, conformance to the EMC Directive, which is one of the European Directives, has been mandatory as the EMC standards since 1996. In addition, conformance to the Low Voltage Directive, another European Directive, has also been mandatory as the electrical safety standards since 1997. In European countries, if a product meets the requirements of the EMC Directive or the Low Voltage Directive, the product's manufacturer must declare conformity of the product and affix the CE mark to the product. In some countries or regions other than European countries, the product's manufacturer also must declare conformity of the product and affix a designated mark to the product (example: UKCA mark in the UK).

- Authorized representative in the EU and the UK
- The authorized representative in the EU and the UK is shown below.
  - Name : Mitsubishi Electric Europe BV
  - Address : Mitsubishi-Elctric-Platz 1, 40882 Ratingen, Germany

This section describes the EMC Directive and Low Voltage Directive as examples for conformance to EMC and electrical safety standards. EMC and electrical safety standards in each country are stipulated to be consistent with the corresponding international standards. When the requirements are consistent with the same standards, common measures are taken to conform to the standards in different countries. For the EMC Directive, regulatory compliance with equivalent EMC standards are required for example in the UK and Korea. For the Low Voltage Directive, regulatory compliance with equivalent electrical safety standards are required for example in the UK.

#### 4.1 Requirements to Meet EMC Directive

EMC Directives are those which require "any strong electromagnetic force is not output to the external. Emission (electromagnetic interference)" and "It is not influenced by the electromagnetic wave from the external. Immunity (electromagnetic sensitivity)". Items 4.1.1 through 4.1.3 summarize the precautions to use GOT and configure the mechanical unit in order to match the EMC directives. Though the data described herein are produced with our best on the basis of the requirement items and standards of the restrictions gathered by Mitsubishi Electric, they do not completely guarantee that all mechanical unit manufactured according to the data do not always match the above.

### 4.1.1 EMC directive

The standards of the EMC Directive are shown below.

Applied standard	Test standard	Test details	Standard value
EN61131-2 : 2007	CISPR16-2-3 Radiated noise <sup>*1</sup>	Electromagnetic emissions from the product are measured.	30M-230MHz QP: 30dB $\mu$ V/m (30m in measurement range) <sup>2, *3</sup> 230M-1000MHz QP: 37dB $\mu$ V/m (30m in measurement range) <sup>2, *3</sup>
	CISPR16-2-1 Conducted noise <sup>*1</sup>	Electromagnetic emissions from the product to the power line is measured.	150K-500KHz QP: 79dB, Mean: 66dB <sup>2</sup> 500K-30MHz QP: 73dB, Mean: 60dB <sup>2</sup>
EN61131-2 : 2007	IEC61000-4-2 Electrostatic Immunity <sup>*1</sup>	Immunity test in which static electricity is applied to the cabinet of the equipment.	$\pm$ 4kV Contact discharge $\pm$ 8kV Aerial discharge
	IEC61000-4-3 Radiated electromagnetic field AM modulation	Immunity test in which field is irradiated to the product.	80-1000MHz: 10V/m 1.4-2GHz: 3V/m 2.0-2.7GHz: 1V/m 80%AM modulation@1kHz
EN61131-2 : 2007	IEC61000-4-4 Fast transient burst noise <sup>*1</sup>	Immunity test in which burst noise is applied to the power line and signal lines.	Power line: 2kV Digital I/O: 1kV Analog I/O: 1kV Signal lines: 1kV
	IEC61000-4-5 Surge immunity <sup>*1</sup>	Immunity test in which lightning surge is applied to the product.	AC power type Power line (between line and ground): $\pm$ 2kV Power line (between lines): $\pm$ 1kV Data communication port: $\pm$ 1kV DC power type Power line (between line and ground): $\pm$ 0.5kV Power line (between lines): $\pm$ 0.5kV Data communication port: $\pm$ 1kV
EN61131-2 : 2007	IEC61000-4-6 Conducted RF immunity <sup>*1</sup>	Immunity test in which a noise induced on the power and signal lines is applied.	Power line: 10V Data communication port: 10V
	IEC61000-4-8 Power supply frequency magnetic field immunity	Test for checking normal operations under the circumstance exposed to the ferromagnetic field noise of the power supply frequency (50/60Hz).	30 A/m
EN61131-2 : 2007	IEC61000-4-11 Instantaneous power failure and voltage dips immunity	Test for checking normal operations at instantaneous power failure.	AC power type 0.5 cycle 0% (interval 1 to 10s) 250/300 cycle 0% 10/12 cycle 40% 25/30 cycle 70%

<sup>\*1</sup>: The GOT is an open type device (device installed to another device) and must be installed in a conductive control panel.  
The above test items are conducted in the condition where the GOT is installed on the conductive control panel and combined with the Mitsubishi Electric PLC.  
<sup>\*2</sup>: QP (Quasi-Peak): Quasi-peak value, Mean: Average value  
<sup>\*3</sup>: The above test items are conducted in the following conditions.  
30M-230MHz QP : 40dB $\mu$ V/m (10m in measurement range)  
230M-1000MHz QP : 47dB $\mu$ V/m (10m in measurement range)

#### 4.1.2 Control panel

The GOT is an open type device (device installed to another device) and must be installed in a conductive control panel. It not only assure the safety but also has a large effect to shut down the noise generated from GOT, on the control panel.

(1) Control Panel

- The control panel must be conductive.
- When fixing a top or bottom plate of the control panel with bolts, do not coat the plate and bolt surfaces so that they will come into contact.  
And connect the door and box using a thick grounding cable in order to ensure the low impedance under high frequency.
- When using an inner plate to ensure electric conductivity with the control panel, do not coat the fixing bolt area of the inner plate and control panel to ensure conductivity in the largest area as possible.
- Ground the control panel using a thick grounding cable in order to ensure the low impedance under high frequency.
- The diameter of cable holes in the control panel must be 10cm (3.94in.). In order to reduce the chance of radio waves leaking out, ensure that the space between the control panel and its door is small as possible.  
Paste the EMI gasket directly on the painted surface to seal the space so that the leak of electric wave can be suppressed.

Our test has been carried out on a panel having the damping characteristics of 37dB max. and 30dB mean (measured by 3m method with 30 to 300MHz).

- (2) Connection of power and ground wires  
Ground and power supply wires for the GOT must be connected as described below.
- Provide a grounding point near the GOT. Short-circuit the LG and FG terminals of the GOT (LG: line ground, FG: frame ground) and ground them with the thickest and shortest wire possible (The wire length must be 30cm (11.81in.), or shorter.)  
The LG and FG terminals function is to pass the noise generated in the PC system to the ground, so an impedance that is as low as possible must be ensured. As the wires are used to relieve the noise, the wire itself carries a large noise content and thus short wiring means that the wire is prevented from acting as an antenna.  
Note) A long conductor will become a more efficient antenna at high frequency.
  - The earth wire led from the earthing point must be twisted with the power supply wires.  
By twisting with the earthing wire, noise flowing from the power supply wires can be relieved to the earthing. However, if a filter is installed on the power supply wires, the wires and the earthing wire may not need to be twisted.

#### 4.1.3 Noise filter (power supply line filter)

The noise filter (power supply line filter) is a device effective to reduce conducted noise. Except some models, installation of a noise filter onto the power supply lines is not necessary. However conducted noise can be reduced if it is installed. (The noise filter is generally effective for reducing conducted noise in the band of 10MHz or less.) Usage of the following filters is recommended.

Model name	FN343-3/05	FN660-6/06	RSHN-2003
Manufacturer	SCHAFFNER	SCHAFFNER	TDK
Rated current	3A	6A	3A
Rated voltage	250V		

The precautions required when installing a noise filter are described below.

- (1) Do not install the input and output cables of the noise filter together to prevent the output side noise will be induced into the input side cable where noise has been eliminated by the noise filter.

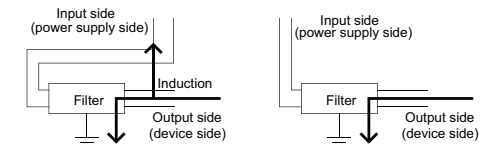

- Installing the input and output cables together will cause noise induction.
  - Separate the input cable from the output cable.
- (2) Connect the noise filter's ground terminal to the control panel with the shortest cable as possible (approx. 10cm (3.94 in.) or less).

#### 4.2 Requirements for Compliance with the Low Voltage Directive

The Low Voltage Directive requires each device which operates with power supply ranging from 50VAC to 1000V and 75VDC to 1500V to satisfy necessary safety items.  
In the Sections from 4.2.1 to 4.2.5, cautions on installation and wiring of the GOT to conform to the Low Voltage Directive requires are described. We have put the maximum effort to develop this material based on the requirements and standards of the Directive that we have collected. However, compatibility of the devices which are fabricated according to the contents of this manual to the above Directive is not guaranteed. Each manufacturer who fabricates such device should make the final judgement about the application method of the Low Voltage Directive and the product compatibility.

##### 4.2.1 Standard subject to GOT

Standard applied to GOT : EN61131-2 Programmable controllers - Equipment requirements and tests

##### 4.2.2 Power supply

The insulation specification of the GOT was designed assuming installation category II. Be sure to use the installation category II power supply to the GOT.  
The installation category indicates the durability level against surge voltage generated by lightning strike.

Category I has the lowest durability, category IV has the highest durability.

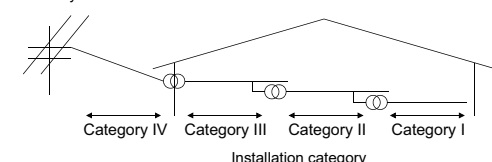

Category II indicates a power supply whose voltage has been reduced by two or more levels of isolating transformers from the public power distribution.

#### 4.2.3 Control panel

Because the GOT is open type equipment (device designed to be stored within another device), be sure to use it only when installed in a control panel.

- Shock Protection  
In order to prevent those who are unfamiliar with power facility, e.g., an operator, from getting a shock, make sure to take the following measures on the control panel.
  - Store the GOT within the control panel locked, and allow only those who are familiar with power facility to unlock the panel.
  - Build the structure in order that the power supply will be shut off when the control panel is opened.
- Dustproof and waterproof features  
The control panel also provides protection from dust, water and other substances. Insufficient insulation protection may lower the insulation withstand voltage, resulting in insulation destruction. The insulation in the GOT is designed to cope with the pollution level 2, so use in an environment with pollution level 2 or better.
  - Pollution level 1: An environment where the air is dry and conductive dust does not exist.
  - Pollution level 2: An environment where conductive dust does not usually exist, but occasional temporary conductivity occurs due to the accumulated dust. Generally, this is the level for inside the control panel equivalent a control room or on the floor of a typical factory.
  - Pollution level 3: An environment where conductive dust exists and conductivity may be generated due to the accumulated dust. An environment for a typical factory floor.
  - Pollution level 4: Continuous conductivity may occur due to rain, snow, etc. An outdoor environment.

#### 4.2.4 Grounding

The following are applicable ground terminals. Use them in the grounded state.  
Be sure to ground the GOT for ensuring the safety and complying with the EMC Directive.  
Functional grounding  $\downarrow$  : Improves the noise resistance.

#### 4.2.5 External wiring

- External devices  
When a device with a hazardous voltage circuit is externally connected to the GOT, select a model which complies with the Low Voltage Directive's requirements for isolation between the primary and secondary circuits.
- Insulation requirements  
Dielectric withstand voltages are shown in the following table.  
Reinforced Insulation Withstand Voltage (Installation Category II, source : IEC664)

Rated voltage of hazardous voltage area	Surge withstand voltage (1.2/50 $\mu$ s)
150 VAC or below	2500V
300 VAC or below	4000V

### 5. INSTALLATION

#### 5.1 Control Panel Inside Dimensions for Mounting GOT

Install the GOT on the control panel out of the way for the equipment inside the control panel. Do not install the GOT and the unit in prohibited areas for the installation.

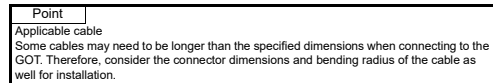

#### 5.2 Panel Cutting Dimensions

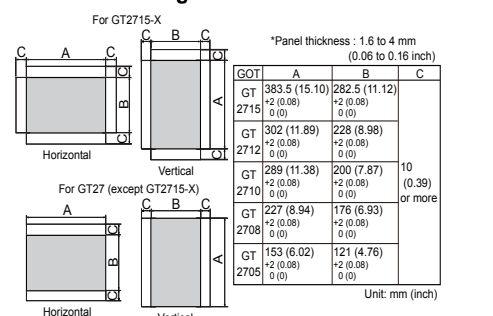

#### 5.3 Mounting Position

When mounting the GOT, the following clearances must be maintained from other structures and devices. Some cables may need to be longer than the specified dimensions when connecting to the GOT.  
Therefore, consider the connector dimensions and bending radius of the cable as well for installation.  
For the lead-in allowance for cables at the bottom of the GOT, refer to the GOT2000 Series User's Manual (Hardware).  
For the vertical installation, install the GOT so that the vertical installation arrow printed on the GOT rear face points upward.

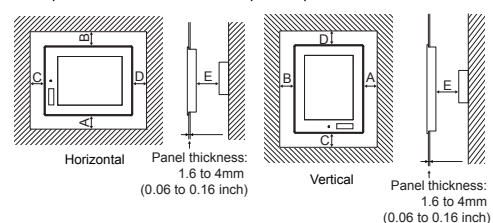

According to the dimensions in the following table, leave clearances between the GOT and the other devices. The values enclosed in square brackets apply to the case where no other equipment generating radiated noise (such as a contactor) or heat is installed near the GOT. However, keep the ambient temperature of the GOT to 55°C or lower.

Item	GT2715	GT2712	GT2710	GT2708	GT2705
A	48(1.89) or more[18(0.71) or more]				
B	Horizontal: 78(3.07) or more[18(0.71) or more] Vertical: 48(1.89) or more[18(0.71) or more]				
C	When the SD card is used: 50(1.97) or more[20(0.79) or more] When the SD card is not used: 50(1.97) or more[20(0.79) or more]				
D	Horizontal: 50(1.97) or more[20(0.79) or more] Vertical: 80(3.15) or more[20(0.79) or more]				
E <sup>*1</sup>	100(3.94) or more[20(0.79) or more]				

<sup>\*1</sup>: When opening or closing the battery cover: 72(2.83) or more

#### 5.4 Control Panel Inside Temperature and Installation Angle

When installing the GOT to a panel, set the display section as shown below. Using the GOT with the installation angle other than the following deteriorates the GOT earlier.

Installing the GOT horizontally  
When installing the GOT with the installation angle between 60 to 105°, the temperature inside the control panel must be within 55°C. When installing the GOT with the installation angle other than between 60 to 105°, the temperature inside the control panel must be within 40°C.

Installing the GOT vertically  
When the GOT is installed a 90° angle, the control panel inside temperature must be within 55°C. When the GOT is installed at any angle other than 90°, the control panel inside temperature must be within 40°C.

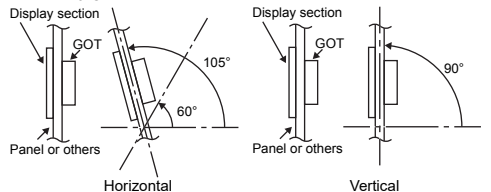

### 5. INSTALLATION

#### 5.1 Dimensions intérieures du tableau de commande pour le montage du GOT

Installez le GOT sur le tableau de commande en laissant de l'espace pour le dispositif à l'intérieur du tableau de commande. N'installez pas le GOT et le module dans des zones où l'installation est interdite.

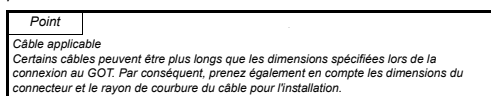

#### 5.2 Cotes de découpe du panneau

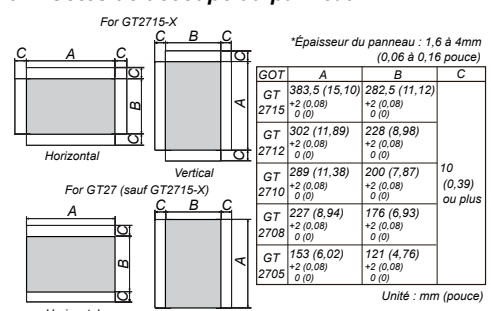

#### 5.3 Position de montage

Lors du montage du GOT, laissez les espaces suivants pour les autres structures et dispositifs. Certains câbles peuvent être plus longs que les dimensions spécifiées lors de la connexion au GOT.  
Par conséquent, prenez également en compte les dimensions du connecteur et le rayon de courbure du câble pour l'installation.  
Pour connaître l'espace à laisser pour les câbles sous le GOT, référez-vous au manuel GOT2000 Series User's Manual (Hardware).  
Pour l'installation à la verticale, installez le GOT de sorte que la flèche d'installation à la verticale imprimée sur la face arrière du GOT pointe vers le haut.

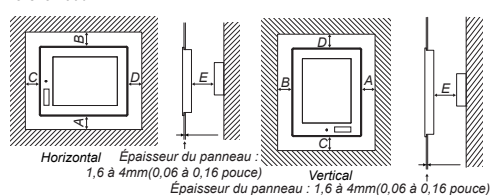

Laissez les espaces entre le GOT et les autres dispositifs en fonction des dimensions contenues dans le tableau suivant. Les valeurs entre parenthèses s'appliquent au cas où aucun dispositif générant des émissions sonores (comme un contacteur) ou de la chaleur n'est installé près du GOT. Toutefois, maintenez la température ambiante du GOT à 55°C ou moins.

Article	Unité: mm (pouce)			
	GT2715	GT2712	GT2710	GT2708 GT2705
A	48 (1.89) ou plus[18 (0.71) ou plus]			
B	Horizontal: 78 (3.07) ou plus[18 (0.71) ou plus] Vertical: 48 (1.89) ou plus[18 (0.71) ou plus]			
C	Quand la carte SD est utilisée: 50 (1.97) ou plus [20 (0.79) ou plus] Quand la carte SD n'est pas utilisée: 50 (1.97) ou plus[20 (0.79) ou plus]			
D	Horizontal: 50 (1.97) ou plus[20 (0.79) ou plus] Vertical: 80 (3.15) ou plus[20 (0.79) ou plus]			
E <sup>*1</sup>	100 (3.94) ou plus[20 (0.79) ou plus]			

<sup>\*1</sup>: Pour ouvrir ou fermer le couvercle de la batterie : 72 (2.83) ou plus

#### 5.2 Température intérieure et angle d'installation du tableau de commande

Lors de l'installation du GOT sur un panneau, réglez la zone d'affichage comme indiqué ci-dessous.  
Si l'angle d'installation est différent de celui indiqué, le GOT se détériore plus tôt.

Installation du GOT à l'horizontale  
Lors de l'installation du GOT avec un angle d'installation compris entre 60 et 105°, la température à l'intérieur du tableau de commande doit être d'environ 55°C. Lors de l'installation du GOT avec un angle d'installation non compris entre 60 et 105°, la température à l'intérieur du tableau de commande doit être d'environ 40°C.

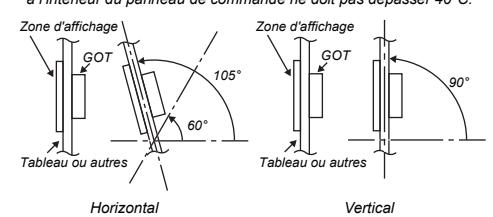

### 6. MAINTENANCE AND INSPECTION

Refer to the GOT2000 Series User's Manual (Hardware) for maintenance and inspection for the GOT.

### Warranty

Mitsubishi Electric will not be held liable for damage caused by factors found not to be the cause of Mitsubishi Electric; machine damage or lost profits caused by faults in the Mitsubishi Electric products; damage, secondary damage, accident compensation caused by special factors unpredictable by Mitsubishi Electric; damages to products other than Mitsubishi Electric products; and to other duties.

#### For safe use

- This product has been manufactured as a general-purpose part for general industries, and has not been designed or manufactured to be incorporated in a device or system used in purposes related to human life.
- Before using the product for special purposes such as nuclear power, electric power, aerospace, medicine or passenger movement vehicles, consult with Mitsubishi Electric.
- This product has been manufactured under strict quality control. However, when installing the product where major accidents or losses could occur if the product fails, install appropriate backup or failsafe functions in the system.

Country/Region	Sales office/Tel
USA	Mitsubishi Electric Automation, Inc. 500 Corporate Woods Parkway, Vernon Hills, IL 60061, U.S.A. Tel: +1-847-478-2100
Brazil	Mitsubishi Electric do Brasil Comercio e Servicos Ltda. Avenida Adelfino Cardana, 293, 21 andar, Bethaville, Barueri SP, Brazil Tel: +55-11-4689-3000
Mexico	Mitsubishi Electric Automation, Inc. Mexico Branch Centro Direccional Coleoni - Palazzo Siro, Viale Coleoni 7, 20864 Agrate Brianza (MB), Italy Tel: +39-039-60531
Germany	Mitsubishi Electric Europe B.V. German Branch Mitsubishi-Elctric-Platz 1, 40882 Ratingen, Germany Tel: +49-2102-486-0
UK	Mitsubishi Electric Europe B.V. UK Branch Travelers Lane, UK-Hatfield, Hertfordshire, AL10 8XB, U.K. Tel: +44-1707-28-8780
Italy	Mitsubishi Electric Europe B.V. Italian Branch Centro Direzionale Colleoni - Palazzo Siro, Viale Colleoni 7, 20864 Agrate Brianza (MB), Italy Tel: +39-039-60531
Spain	Mitsubishi Electric Europe B.V. Spanish Branch Carretera de Rubí, 78-80-Appdo. 420, E-08190 Sant Cugat del Valles (Barcelona), Spain Tel: +34-935-65-3131
France	Mitsubishi Electric Europe B.V. French Branch 25, Boulevard des Bouvets, 92741 Nanterre Cedex, France Tel: +33-1-55-68-55-68
Czech	Mitsubishi Electric Europe B.V. Czech Branch Pekarska 62/17, 155 00 Praha 5, Czech Republic Tel: +420-255 719 200
Turkey	Mitsubishi Electric Turkey A.S. Umraniye Branch Serifali Mahallesi Nutuk Sokak No:5, TR-34775 Umraniye / Istanbul, Turkey Tel: +90-216-526-3990
Poland	Mitsubishi Electric Europe B.V. Polish Branch ul. Krakowska 48, 32-063 Balice, Poland Tel: +48-12-347-65-00
Russia	Mitsubishi Electric (Russia) LLC St. Petersburg Branch Pskarskyy pr. 2, bld 2, It "Sch", BC "Benus", office 720, 195027 St. Petersburg, Russia Tel: +7-812-633-3487
South Africa	Adrol Technologies 20 Waterford Office Park, 189 Witkoppen Road, Fourways, South Africa Tel: +27-11-658-8100
China	Mitsubishi Electric Automation (China) Ltd. Mitsubishi Electric Automation Center, No.1386 Hongqiao Road, Shanghai, China Tel: +86-21-2322-3030
Taiwan	SETSUYO ENTERPRISE CO., LTD. 6F, No.105, Wugong 3rd Road, Wugu District, New Taipei City 24889, Taiwan Tel: +886-2-2299-2499
Korea	Mitsubishi Electric Automation Korea Co., Ltd. 7F to 9F, Gangseo Hangang Xi-tower A, 401, Yangcheon-ro, Gangseo-Gu, Seoul 07528, Korea Tel: +82-2-3660-9569
Singapore	Mitsubishi Electric Asia Pte. Ltd. 307 Alexandra Road, Mitsubishi Electric Building, Singapore 159943 Tel: +65-6473-2308
Thailand	Mitsubishi Electric Factory Automation (Thailand) Co., Ltd. 12th Floor, SV City Building, Office Tower 1, No. 899/19 and 20 Rama 3 Road, Kwang Bangkongkong, Khwaet Yamnawa, Bangkok 10120, Thailand Tel: +66-2682-6522 to 31
Indonesia	PT. Mitsubishi Electric Indonesia Gedung Jaya 8th Floor, Jl. MH. Thamrin No.12, Jakarta Pusat 10340, Indonesia Tel: +62-21 3192-6461
Vietnam	Mitsubishi Electric Vietnam Company Limited 11th & 12th Floor, Viettel Tower B, 285 Cach Mang Thang 8 Street, Ward 12, District 10, Ho Chi Minh City, Vietnam. Tel: +84-28-3910-5545
India	Mitsubishi Electric India Pvt. Ltd. Pune Branch Emerald House, EL-3, Block, M.I.D.C., Bhosari, Pune - 411026, Maharashtra, India Tel: +91-20-2710-2000
Australia	MITSUBISHI ELECTRIC AUSTRALIA PTY. LTD. 348 Victoria Road, P.O. Box 11, Rydalmere, N.S.W 2116, Australia Tel: +61-2-9684-7777

**MITSUBISHI ELECTRIC CORPORATION**  
HEAD OFFICE : TOKYO BUILDING, 2-7-3 MARUNOUCHI, CHYODOKU, TOKYO 100-8310, JAPAN  
NAGOYA WORKS : 1-14, YADA-MINAMI 5-CHOME, HIGASHI-KU, NAGOYA, JAPAN

When exported from Japan, this manual does not require approval to the Ministry of Economy, Trade and Industry for service transaction permission.

Specifications subject to change without notice.  
Printed in Japan, September 2021.