

**MITSUBISHI ELECTRIC**

# GT25 Wide Model

## General Description

GT2510-WXTBD GT2510-WXTSD  
GT2507-WTBD GT2507-WTSD

Thank you for purchasing Mitsubishi Electric Graphic Operation Terminal.

**Prior to use, please read both this manual and the detailed manual thoroughly to fully understand the product.**

MODEL	GT25-U-J-GD-E
Model code	1D7MS5
IB(NA)-0800564ENG-B(1804)MEE	

© 2017MITSUBISHI ELECTRIC CORPORATION

**SAFETY PRECAUTIONS**  
(Always read these precautions before using this equipment.)

Before using this product, please read this manual and the relevant manuals introduced in this manual carefully and pay full attention to safety to handle the product correctly.

The precautions given in this manual are concerned with this product. In this manual, the safety precautions are ranked as "WARNING" and "CAUTION".

**WARNING** Indicates that incorrect handling may cause hazardous conditions, resulting in death or severe injury.

**CAUTION** Indicates that incorrect handling may cause hazardous conditions, resulting in medium or slight personal injury or physical damage.

Note that the CAUTION level may lead to a serious accident according to the circumstances. Always follow the instructions of both levels because they are important to personal safety. Please save this manual to make it accessible when required and always forward it to the end user.

**DESIGN PRECAUTIONS**

- WARNING**
  - Some failures of the GOT or cables may keep the outputs on or off. Some failures of a touch panel may cause malfunction of the input objects such as a touch switch.
  - An external monitoring circuit should be provided to check for output signals which may lead to a serious accident.
  - Not doing so can cause an accident due to false output or malfunction.
  - Do not use the GOT as the warning device that may cause a serious accident.
  - An independent and redundant hardware or mechanical interlock is required to configure the device that displays and outputs serious warning.
  - Failure to observe this instruction may result in an accident due to incorrect output or malfunction.
  - The GOT backlight failure disables the operation on the touch switch(es). When the GOT backlight has a failure, the POWER LED blinks (orange/blue) and the display section dims. In such a case, the input by the touch switch(es) is disabled.
  - The display section of the GOT is an analog-resistive type touch panel. When multiple points of the display section are touched simultaneously, an accident may occur due to incorrect output or malfunction.
  - Do not touch the display section in 2 points or more simultaneously. If you touch the display section simultaneously in 2 points or more, the switch that is located around the center of the touched point, if any, may operate. Doing so may cause an accident due to incorrect output or malfunction.
  - When programs or parameters of the controller (such as a PLC) that is monitored by the GOT are changed, be sure to reset the GOT, or turn on the unit again after shutting off the power as soon as possible.
  - Not doing so can cause an accident due to false output or malfunction.
  - If a communication fault (including cable disconnection) occurs during monitoring on the GOT, communication between the GOT and PLC CPU is suspended and the GOT becomes inoperative.
  - A system where the GOT is used should be configured to perform any significant operation to the system by using the switches of a device other than the GOT on the assumption that a GOT communication fault will occur. Not doing so can cause an accident due to false output or malfunction.

**TRANSPORTATION PRECAUTIONS**

- CAUTION**
  - When transporting lithium batteries, make sure to treat them based on the transport regulations. (Refer to the GOT2000 Series User's Manual (Hardware) for details of the regulated models.)
  - Make sure to transport the GOT main unit and/or relevant unit(s) in the manner they will not be exposed to the impact exceeding the impact resistance described in the general specifications of this manual, as they are precision devices.
  - Failure to do so may cause the unit to fail.
  - Check if the unit operates correctly after transportation.
  - When fumigants that contain halogen materials such as fluorine, chlorine, bromine, and iodine are used for disinfecting and protecting wooden packaging from insects, they cause malfunction when entering our products. Please take necessary precautions to ensure that remaining materials from fumigant do not enter our products, or treat packaging with methods other than fumigation (heat method).
  - Additionally, disinfect and protect wood from insects before packing products.

**Manual**

The following shows manuals relevant to this product.

Manual name	Manual number (Model code)
GOT2000 Series User's Manual (Hardware)	SH-081194ENG (1D7MJ5)
GOT2000 Series User's Manual (Utility)	SH-081195ENG (1D7MJ6)

For detailed manuals and relevant manuals, refer to the Help or the PDF manuals stored in the DVD-ROM for the drawing software used.

The latest manuals are also available from MITSUBISHI ELECTRIC FA Global Website (<http://www.MitsubishiElectric.com/fa/>).

**Compliance with the new China RoHS directive**

GOT 相关的基于“电器电子产品有害物质限制使用管理办法”要求的表示方法

**15** Note: This symbol mark is for China only.

含有有害6物质的名称、含量、含有部件  
本产品中所含有的有害6物质的名称、含量、含有部件如下表所示。  
产品中有有害物质的名称及含量

部件名称	有害物质					
	铅 (Pb)	汞 (Hg)	镉 (Cd)	六价铬 (Cr(VI))	多溴联苯 (PBB)	多溴二苯醚 (PBDE)
电路板组件	×	○	○	○	○	○
树脂壳体、电缆、线材	○	○	○	○	○	○
钣金部件、螺丝等金属部件	×	○	○	○	○	○

本表格依据 SJ/T11364 的规定编制。  
○ : 表示该有害物质在该部件所有均质材料中的含量均在 GB/T26572 规定的限量要求以下。  
× : 表示该有害物质至少在该部件的某一均质材料中的含量超出 GB/T26572 规定的限量要求。

**Referenced Standard: GB/T15699.2 (Requirement of Chinese standardized law)**

**Before using the GOT**

Connect the connector of the GOT to the connector of the battery. Refer to the GOT2000 Series User's Manual (Hardware) for the connection instructions.

For details on the GOT specifications, installing instructions, wiring, maintenance and inspection, or checking procedure for the version and the compatible standard, refer to the GOT2000 Series User's Manual (Hardware).

**WARNING**

- To maintain the safety of the system incorporating the GOT, take measures against unauthorized access from external devices via a network. To maintain the safety against unauthorized access via the Internet, take measures such as installing a firewall.
- Products with the CE, DIV 2 mark on the rating plate are suitable for use in Class I, Division 2, Groups A, B, C and D hazardous locations, or nonhazardous locations only. This mark indicates that the product is certified for use in the Class I, Division 2 environment where flammable gases, vapors, or liquids are not likely to exist under normal conditions. When using the products in the Class I, Division 2 environment, observe the following to reduce the risk of explosion.
  - This device is open-type and is to be installed in an enclosure suitable for the environment and require a tool or key to open.
  - Warning - Explosion Hazard - Substitution of any component may impair suitability for Class I, Division 2.
  - Warning - Explosion Hazard - Do not disconnect equipment unless power has been removed or the area is known to be non-hazardous.
  - The wireless LAN communication unit interface of this device cannot be used in Class I, Division 2 environment.
- Les produits marqués CEI, DIV 2 sur la plaque signalétique peuvent être utilisés en Classe I, Division 2, local dangereux de groupe A, B, C et D, ou uniquement en local non dangereux. Ce logo indique que le produit est homologué pour utilisation en environnement de Classe I, Division 2 où, dans des circonstances anormales, il peut y avoir présence de gaz, vapeurs ou liquides inflammables. Si le produit est utilisé en environnement de Classe I, Division 2, observer les précautions suivantes pour réduire le risque d'explosion.
  - Cet appareil est de type ouvert et il doit être installé dans une enceinte appropriée à l'environnement et ne pouvant être ouverte qu'au moyen d'une clé ou d'un outil.
  - Avertissement - Danger d'explosion - Toute substitution de composant peut compromettre l'aptitude à l'utilisation en Classe I, Division 2.
  - Avertissement - Danger d'explosion - Ne pas déconnecter l'équipement quand le circuit est sous tension, ni avant de s'être assuré de l'absence d'atmosphère inflammable.
  - L'interface de l'unité de communication LAN sans fil de cet équipement ne peut pas être utilisée dans les environnements de Classe I, Division 2.

**CAUTION**

- Do not bundle the control and communication cables with main-circuit, power or other wiring. Run the above cables separately from such wiring and keep them a minimum of 100 mm apart. Not doing so may cause a malfunction.
- Do not press the GOT display section with a pointed material as a pen or driver. Doing so can result in a damage or failure of the display section.
- When the GOT is connected to the Ethernet network, the available IP address is restricted according to the system configuration. When a GOT2000 series model and a GOT1000 series model are on an Ethernet network, do not set the IP address 192.168.0.18 for the GOTs and the controllers on this network. Doing so can cause IP address duplication at the GOT startup, adversely affecting the communication of the device with the IP address 192.168.0.18. The operation at the IP address duplication depends on the devices and the system.
- When using the Ethernet interface, set a different network for port 1 and port 2.
- Turn on the controllers and the network devices to be ready for communication before they communicate with the GOT. Failure to do so can cause a communication error on the GOT.
- When the GOT is subject to shock or vibration, or some colors appear on the screen of the GOT, the screen of the GOT might flicker.

**MOUNTING PRECAUTIONS**

**WARNING**

- Be sure to shut off all phases of the external power supply used by the system before mounting or removing the GOT main unit to/from the panel. Not doing so can cause the unit to fail or malfunction.
- Be sure to shut off all phases of the external power supply used by the system before mounting or removing the option unit onto/from the GOT.

**CAUTION**

- Use the GOT in the environment that satisfies the general specifications described in this manual. Not doing so can cause an electric shock, fire, malfunction or product damage or deterioration.
- When mounting the GOT to the control panel, tighten the mounting screws in the specified torque range (0.36 N·m to 0.48 N·m) with a Phillips-head screwdriver No. 2. Undertightening can cause the GOT to drop, short circuit or malfunction. Overtightening can cause a drop, short circuit or malfunction due to the damage of the screws or the GOT.
- When mounting the wireless LAN communication unit on the GOT, fit it to the wireless LAN communication unit interface and tighten the mounting screws in the specified torque range (0.10 N·m to 0.14 N·m) with a Phillips-head screwdriver No. 1. Under tightening can cause the GOT to drop, short circuit or malfunction. Overtightening can cause a drop, failure or malfunction due to the damage of the screws or unit.
- When closing the USB environmental protection cover, fix the cover to the GOT by pushing the [PULL] mark on the latch firmly to comply with the protective structure.
- Remove the protective film of the GOT. When the user continues using the GOT with the protective film, the film may not be removed.
- Operate and store the GOT in environments without direct sunlight, high temperature, dust, humidity, and vibrations.

**Packing List**

The GOT product package includes the following:

Description	Quantity
GT25 Wide Model	1
Battery (GT11-50BAT) (Attached to the GOT)	1
Installation fitting	4
GT25 Wide Model General Description (This manual)	1
GT25 フォントモデル本体概要説明書	1

**1. FEATURES**

- Abundant standard equipment
  - Variety of connection with FA devices
  - SD card interface compatible with the SDHC card having a large capacity and allowing high-speed communication
  - Connection with various peripheral devices with the USB host
  - One sound output interface
  - Two Ethernet interfaces
- Improved usability
  - Abundant troubleshooting
  - Easy and clear screen creation
  - PC-like operation screen
  - Support for the vertical installation
- Enhanced compatibility with Mitsubishi FA devices
- LED backlight

**2. Part Names and Settings**

The following shows the part names for GT2510 and GT2507.

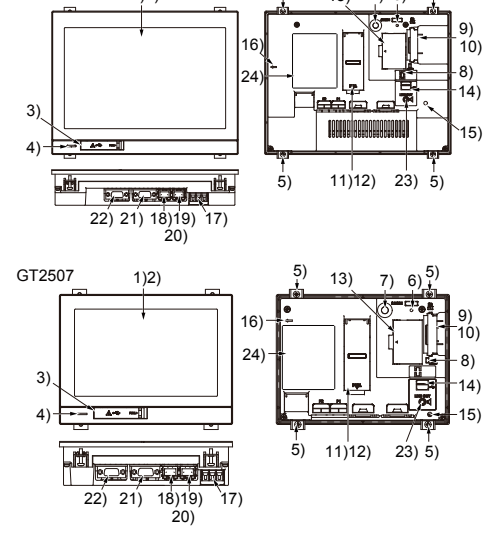

No.	Name	Description
1)	Display screen	Displays the utility and the user-created screen.
2)	Touch panel	For operating the touch switches in the utility and the user-created screen
3)	USB interface (Device/Front face)	For connecting a personal computer (connector type: Mini-B)
4)	POWER LED	Lit in blue : Power is properly supplied. Lit in orange : Screen saving. Blinks in orange/blue : Backlight failure Not lit : Power is not supplied
5)	Unit installation fitting	Mounting fixtures for fixing the GOT to the control panel
6)	Reset switch	Hardware reset switch
7)	Installation switch	Used for OS installations at the GOT startup
8)	SD card access LED	Lit: SD card mounted No lit: SD card not mounted or SD card mounted (removable)
9)	SD card interface	For installing a SD card
10)	SD card cover	With a switching function for accepting and stopping the access to the SD card When the cover is opened : Access is prohibited When the cover is closed : Access is allowed

**WIRING PRECAUTIONS**

**WARNING**

- Be sure to shut off all phases of the external power supply used by the system before wiring. Failure to do so may result in an electric shock, product damage or malfunctions.

**CAUTION**

- Make sure to ground the FG terminal of the GOT power supply section solely for the GOT (ground resistance: 100 Ω or less, ground cable diameter: 1.6 mm or more). Not doing so may result in an electric shock or malfunction.
- When tightening the terminal screws, use a Phillips-head screwdriver No. 2.
- Terminal screws which are not to be used must be tightened always at torque 0.5 N·m to 0.8 N·m. Otherwise there will be a danger of short circuit against the solderless terminals.
- Use applicable solderless terminals and tighten them with the specified torque. If any solderless spade terminal is used, it may be disconnected when the terminal screw comes loose, resulting in failure.
- Correctly wire the GOT power supply section after confirming the rated voltage and terminal arrangement of the product. Not doing so can cause a fire or failure
- Tighten the terminal screws of the GOT power supply section in the specified torque range (0.5 N·m to 0.8 N·m). Undertightening can cause a short circuit or malfunction. Overtightening can cause a short circuit or malfunction due to the damage of the screws or the GOT.
- Exercise care to avoid foreign matter such as chips and wire offcuts entering the GOT. Not doing so can cause a fire, failure or malfunction.
- The module has an ingress prevention label on its top to prevent foreign matter, such as wire offcuts, from entering the module during wiring. Do not peel this label during wiring. Before starting system operation, be sure to peel this label because of heat dissipation.
- Plug the communication cable into the GOT interface or the connector of the connected unit, and tighten the mounting screws and the terminal screws in the specified torque range. Undertightening can cause a short circuit or malfunction. Overtightening can cause a short circuit or malfunction due to the damage of the screws or unit.

**TEST OPERATION PRECAUTIONS**

**WARNING**

- Before performing the test operations of the user creation monitor screen (such as turning ON or OFF bit device, changing the word device current value, changing the settings or current values of the timer or counter, and changing the buffer memory current value), read through the manual carefully and make yourself familiar with the operation method. During test operation, never change the data of the devices which are used to perform significant operation for the system. False output or malfunction can cause an accident.

**STARTUP/MAINTENANCE PRECAUTIONS**

**WARNING**

- When power is on, do not touch the terminals. Doing so can cause an electric shock or malfunction.
- Correctly connect the battery connector. Do not charge, disassemble, heat, short-circuit, solder, or throw the battery into the fire. Doing so will cause the battery to produce heat, explode, or ignite, resulting in injury and fire.
- Before starting cleaning or terminal screw retightening, always switch off the power externally in all phases. Not switching the power off in all phases can cause a unit failure or malfunction. Undertightening can cause a short circuit or malfunction. Overtightening can cause a short circuit or malfunction due to the damage of the screws or unit.

**CAUTION**

- Do not disassemble or modify the unit. Doing so can cause a failure, malfunction, injury or fire.
- Do not touch the conductive and electronic parts of the unit directly. Doing so can cause a unit malfunction or failure.
- The cables connected to the unit must be run in ducts or clamped. Not doing so can cause the unit or cable to be damaged due to the dangling, motion or accidental pulling of the cables or can cause a malfunction due to a cable connection fault.
- When unplugging the cable connected to the unit, do not hold and pull from the cable portion. Doing so can cause the unit or cable to be damaged or can cause a malfunction due to a cable connection fault.
- Do not drop the module or subject it to strong shock. A module damage may result.
- Doing so may damage the battery, causing the battery fluid to leak inside the battery. If the battery is dropped or given an impact, dispose of it without using.
- Before touching the unit, always touch grounded metals, etc. to discharge static electricity from your body, etc. Not doing so can cause the unit to fail or malfunction.
- Use the battery manufactured by Mitsubishi Electric Corporation. Use of other batteries may cause a risk of fire or explosion.
- Dispose of used battery promptly. Keep away from children. Do not disassemble and do not dispose of in fire. Be sure to shut off all phases of the external power supply before replacing the battery or using the dip switch of the terminating resistor. Not doing so can cause the unit to fail or malfunction by static electricity.

No.	Name	Description
11)	Battery holder	Houses the battery
12)	Terminating resistor setting switch (Inside cover)	For switching on and off of the terminating resistor for the RS-422/485 communication port (Default (Off))
13)	Wireless LAN communication unit interface	For installing a communication unit
14)	USB interface (Host/Back face)	For connecting a USB mouse, a USB keyboard, or a USB barcode reader, and transferring or saving data (connector type: TYPE-A)
15)	Hole for attaching a cable clamp	For attaching a cable clamp to prevent the USB cable or the sound output cable from being accidentally pulled out (Recommended product: RSG-130-V0 made by KITAGAWA INDUSTRIES CO.,LTD)
16)	Vertical installation arrow mark	For the vertical installation, install the GOT so that the arrow points upward.
17)	Power terminal	Power input terminal, FG terminal
18)	Ethernet interface (port 1)	For communicating with a controller or connecting a personal computer (connector type: RJ-45 (modular jack))
19)	Ethernet interface (port 2)	For communicating with a controller (Connector type: D sub 9-pin (female))
20)	Ethernet communication status LED	SD/RD LED ON : Data sent or received SD/RD LED OFF: Data not sent or received SPEED LED ON : Communicating at 100 Mbps SPEED LED OFF: Communicating at 10 Mbps or disconnected
21)	RS-422/485 interface	For communicating with a controller (Connector type: D sub 9-pin (female))
22)	RS-232 interface	For communicating with a controller (Connector type: D sub 9-pin (male))
23)	Sound output interface	For outputting sounds (applicable plug: Φ3.5 stereo mini-plug (3-prong))
24)	Rating plate	-

**3. Specifications**

**3.1 General Specifications**

Item	Specifications												
Operating ambient temperature <sup>1)</sup> Température ambiante de fonctionnement <sup>1)</sup>	0 to 55°C 0 à 55°C												
Storage ambient temperature	-20 to 60°C												
Operating ambient humidity	10 to 90% RH, non-condensing												
Storage ambient humidity	10 to 90% RH, non-condensing												
Vibration resistance	Compliant with JIS B 5502 and IEC 61131-2 <table border="1"> <thead> <tr> <th>Frequency</th> <th>Acceleration</th> <th>Half-amplitude</th> <th>Sweep count</th> </tr> </thead> <tbody> <tr> <td>Under intermittent vibration</td> <td>5 to 8.4 Hz : - 8.4 to 150 Hz : 9.8 m/s<sup>2</sup></td> <td>3.5 mm</td> <td>10 times each in X, Y and Z directions</td> </tr> <tr> <td>Under continuous vibration</td> <td>5 to 8.4 Hz : - 8.4 to 150 Hz : 4.9 m/s<sup>2</sup></td> <td>1.75 mm</td> <td>-</td> </tr> </tbody> </table>	Frequency	Acceleration	Half-amplitude	Sweep count	Under intermittent vibration	5 to 8.4 Hz : - 8.4 to 150 Hz : 9.8 m/s <sup>2</sup>	3.5 mm	10 times each in X, Y and Z directions	Under continuous vibration	5 to 8.4 Hz : - 8.4 to 150 Hz : 4.9 m/s <sup>2</sup>	1.75 mm	-
Frequency	Acceleration	Half-amplitude	Sweep count										
Under intermittent vibration	5 to 8.4 Hz : - 8.4 to 150 Hz : 9.8 m/s <sup>2</sup>	3.5 mm	10 times each in X, Y and Z directions										
Under continuous vibration	5 to 8.4 Hz : - 8.4 to 150 Hz : 4.9 m/s <sup>2</sup>	1.75 mm	-										
Shock resistance	Compliant with JIS B 5502 and IEC 61131-2 147 m/s <sup>2</sup> (15G), 3 times each in X, Y and Z directions												
Operating atmosphere	No greasy fumes, corrosive gas, flammable gas, excessive conductive dust, and direct sunlight (Same as storage atmosphere)												
Operating altitude <sup>2)</sup>	2000 m (6562 ft) max.												
Installation location	Inside control panel												
Overvoltage category <sup>3)</sup>	II or less												
Pollution degree <sup>4)</sup>	2 or less												
Cooling method	Self-cooling												
Grounding	Grounding with a ground resistance of 100 Ω or less by using a ground cable that has a cross-sectional area of 2 mm <sup>2</sup> or more. If impossible, connect the ground cable to the control panel.												

<sup>1)</sup> The operating ambient temperature includes the temperature inside the enclosure of the control panel to which the GOT is installed. La température ambiante de fonctionnement inclut la température à l'intérieur du boîtier du tableau de commande sur lequel le GOT est installé.

<sup>2)</sup> Do not use or store the GOT under pressure higher than the atmospheric pressure of altitude 0 m (0 ft.). Failure to observe this instruction may cause a malfunction. When an air purge is made inside the control panel by adding pressure, there may be a clearance between the surface sheet and the screen making it difficult to use the touch panel, or the sheet may come off.

<sup>3)</sup> This indicates the section of the power supply to which the equipment is assumed to be connected between the public electrical power distribution network and the machinery within the premises. Category II applies to equipment for which electrical power is supplied from fixed facilities. The surge voltage withstand level for up to the rated voltage of 300 V is 2500 V.

<sup>4)</sup> This index indicates the degree to which conductive material is generated in the environment where the equipment is used. In pollution degree 2, only non-conductive pollution occurs but temporary conductivity may be produced due to condensation.

**TOUCH PANEL PRECAUTIONS**

**CAUTION**

- For the analog-resistive film type touch panels, normally the adjustment is not required. However, the difference between a touched position and the object position may occur as the period of use elapses. When any difference between a touched position and the object position occurs, execute the touch panel calibration.
- When any difference between a touched position and the object position occurs, other object may be touched. This may cause an unexpected operation due to incorrect output or malfunction.

**PRECAUTIONS WHEN THE DATA STORAGE IS IN USE**

**WARNING**

- If the SD card is removed from drive A of the GOT while being accessed by the GOT, the GOT may stop processing data for about 20 seconds. The GOT cannot be operated during this period. The functions that run in the background including a screen updating, alarm, logging, scripts, and others are also interrupted. Since this interruption makes an impact to the system operation, it might cause failure. After checking the light off of SD card access LED, remove the SD card.

**CAUTION**

- If the data storage is removed from the GOT while being accessed by the GOT, the data storage and files may be damaged. Before removing the data storage from the GOT, check the SD card access LED, system signal, or others to make sure that the data storage is not accessed.
- Turning off the GOT while it accesses the SD card results in damage to the SD card and files.
- When inserting a SD card into the GOT, make sure to close the SD card cover. Failure to do so causes the data not to be read or written.
- When removing the SD card from the GOT, make sure to support the SD card by hand as it may pop out. Failure to do so may cause the SD card to drop from the GOT, resulting in a failure or break.
- When inserting a USB device into a USB interface of the GOT, make sure to insert the device into the interface firmly. Failure to do so may cause the USB device to drop from the GOT, resulting in a failure or break.
- Before removing the USB device from the GOT, follow the procedure for removal on the utility screen of the GOT. After the successful completion dialog is displayed, remove the USB device by hand carefully. Failure to do so may cause the USB device to drop from the GOT, resulting in a failure or break.

**PRECAUTIONS FOR USE**

**CAUTION**

- Do not touch the edges of the touch panel (display section) repeatedly. Doing so may result in a failure.
- Do not turn off the GOT while data is being written to the storage memory (ROM) or SD card. Doing so may corrupt the data, rendering the GOT inoperative.

**PRECAUTIONS FOR REMOTE CONTROL**

**WARNING**

- Remote control is available through a network by using GOT functions, including the SoftGOT-GOT link function, the remote personal computer operation function, the VNC server function, and the GOT Mobile function. If these functions are used to perform remote control of control equipment, the field operator may not notice the remote control, possibly leading to an accident. In addition, a communication delay or interruption may occur depending on the network environment, and remote control of control equipment cannot be performed normally in some cases. Before using the above functions to perform remote control, fully grasp the circumstances of the field site and ensure safety.

**PRECAUTIONS FOR EXCLUSIVE AUTHORIZATION CONTROL**

**WARNING**

- Make sure to fully understand the GOT network interaction function before using this function to control the authorization among pieces of equipment to prevent simultaneous operations. The exclusive authorization control of the GOT network interaction function can be enabled or disabled for each screen. (For all screens, the exclusive authorization control is disabled by default.) Properly determine the screens for which the exclusive authorization control is required, and set the control by screen. A screen for which the exclusive authorization control is disabled can be operated simultaneously from pieces of equipment. Make sure to determine the operation period for each operator, fully grasp the circumstances of the field site, and ensure safety to perform operations.

**DISPOSAL PRECAUTIONS**

**CAUTION**

- When disposing of this product, treat it as industrial waste. When disposing of batteries, separate them from other wastes according to the local regulations. (Refer to the GOT2000 Series User's Manual (Hardware) for details of the battery directive in the EU member states.)

**Point**

Refer to the GOT2000 Series User's Manual (Hardware) for details on the performance specifications of each GOT.

**3.2 Power Supply Specifications**

The following indicates the power supply specifications for GT25 wide model.

Item	Specifications	
	GT2510-WXTSD, GT2510-WXTBD	GT2507-WTSD, GT2507-WTBD
Power supply voltage	DC24V (+23%, -20%)	
Power consumption	Stand alone	16 W or less
	Stand alone with backlight off	9 W
Inrush current	59 A or less (2 ms, operating ambient temperature 25, maximum load)	5 W
	Allowable momentary power failure time	5 ms or less
Noise immunity	500 Vp-p noise voltage, 1/3 noise width (when measuring with a noise simulator under 25 to 60 Hz noise frequency)	
Dielectric withstand voltage	350 VAC for 1 minute across power terminals and earth	
Insulation resistance	10 M or more across power terminals and earth by a 500 V DC insulation resistance tester	
Applicable wire size	0.75[mm <sup>2</sup> ] to 2[mm <sup>2</sup> ]	
Applicable solderless terminal	Solderless terminal for M3 screw RAV1 25-3, V2-N3A, FV2-N3A	
Applicable tightening torque (Terminal block terminal screw)	0.5[N·m] to 0.8[N·m]	

**3.3 External Dimensions**

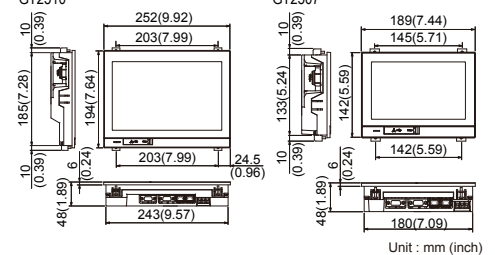

Unit : mm (inch)



## 4. EMC DIRECTIVE

For the products sold in European countries, the conformance to the EMC Directive, which is one of the European Directives, has been a legal obligation since 1996. Also, conformance to the Low Voltage Directive, another European Directives, has been a legal obligation since 1997.

Manufacturers who recognize their products must conform to the EMC and Low Voltage Directive are required to declare that their products conform to these Directives and put a "CE mark" on their products.

- Authorized representative in Europe
- Authorized representative in Europe is shown below.
- Name :Mitsubishi Electric Europe BV
- Address :Mitsubishi-Electric-Platz 1, 40882 Ratingen, Germany

### 4.1 Requirements to Meet EMC Directive

EMC Directives are those which require "any strong electromagnetic force is not output to the external. Emission (electromagnetic interference)" and "It is not influenced by the electromagnetic wave from the external. Immunity (electromagnetic sensitivity)".

Items 4.1.1 through 4.1.3 summarize the precautions to use GOT and configure the mechanical unit in order to match the EMC directives. Though the data described herein are produced with our best on the basis of the requirement items and standards of the restrictions gathered by Mitsubishi, they do not completely guaranteed that all mechanical unit manufactured according to the data do not always match the above.

### 4.1.1 EMC directive The standards of the EMC Directive are shown below.

Applied standard	Test standard	Test details	Standard value
EN61131-2 : 2007	CISPR16-2-3	Electromagnetic emissions from the product are measured.	30 M-230 MHz QP: 30 dB $\mu$ V/m (30 m in measurement range) <sup>3, *4</sup> 230 M-1000 MHz QP: 37 dB $\mu$ V/m (30 m in measurement range) <sup>3, *4</sup>
	IEC61000-4-2	Immunity test in which static electricity is applied to the cabinet of the equipment.	$\pm$ 4 kV Contact discharge $\pm$ 8 kV Aerial discharge
	IEC61000-4-3	Immunity test in which field is irradiated to the product.	80-1000 MHz: 10 V/m 1.4-2 GHz: 3 V/m 2.0-2.7 GHz: 1 V/m 80%AM modulation @ 1 kHz
	IEC61000-4-4	Immunity test in which burst noise is applied to the power line and signal lines.	Power line: 2 kV Digital I/O: 1 kV Analog I/O: 1 kV Signal lines: 1 kV
	IEC61000-4-5	Immunity test in which lightning surge is applied to the product.	DC power type Power line (between line and ground): $\pm$ 0.5 kV Power line (between lines): $\pm$ 0.5 kV Data communication port: $\pm$ 1 kV
	IEC61000-4-6	Immunity test in which a noise induced on the power and signal lines is applied.	Power line: 10 V Data communication port: 10 V
IEC61000-4-8	Test for checking normal operations under the circumstance exposed to the ferromagnetic field noise of the power supply frequency (50/60 Hz).	30 A/m	

- \*1: The GOT is an open type device (device installed to another device) and must be installed in a conductive control panel.
- The above test items are conducted in the condition where the GOT is installed on the conductive control panel and combined with the Mitsubishi PLC.
- \*2: When using the sound output cable, the cable length must be 30 m (118.1 in.) or shorter.
- \*3: QP (Quasi-Peak): Quasi-peak value, Mean: Average value
- \*4: The above test items are conducted in the following conditions.  
30 M-230 MHz QP : 40 dB $\mu$ V/m (10m in measurement range)  
230 M-1000 MHz QP : 47 dB $\mu$ V/m (10m in measurement range)

### 4.1.2 Control panel

The GOT is an open type device (device installed to another device) and must be installed in a conductive control panel.

It not only assure the safety but also has a large effect to shut down the noise generated from GOT, on the control panel.

- Control Panel
  - The control panel must be conductive.
  - When fixing a top or bottom plate of the control panel with bolts, do not coat the plate and bolt surfaces so that they will come into contact.  
And connect the door and box using a thick grounding cable in order to ensure the low impedance under high frequency.
  - When using an inner plate to ensure electric conductivity with the control panel, do not coat the fixing bolt area of the inner plate and control panel to ensure conductivity in the largest area as possible.
  - Ground the control panel using a thick grounding cable in order to ensure the low impedance under high frequency.
  - The diameter of cable holes in the control panel must be 10 cm (3.94 in.). In order to reduce the chance of radio waves leaking out, ensure that the space between the control panel and its door is small as possible.  
Paste the EMI gasket directly on the painted surface to seal the space so that the leak of electric wave can be suppressed.  
Our test has been carried out on a panel having the damping characteristics of 37 dB max. and 30dB mean (measured by 3 m method with 30 to 300 MHz).
- Connection of power and ground wires  
Ground and power supply wires for the GOT must be connected as described below.
  - Provide a ground point near the GOT. Short-circuit the FG terminal of the GOT, and ground it with the thickest and shortest cable possible. (The cable length must be 30 cm (11.81 in.) or shorter.)  
The FG terminal function is to pass the noise generated in the PC system to the ground, so an impedance that is as low as possible must be ensured. As the wires are used to relieve the noise, the wire itself carries a large noise content and thus short wiring means that the wire is prevented from acting as an antenna. Note) A long conductor will become a more efficient antenna at high frequency.
  - The earth wire led from the earthing point must be twisted with the power supply wires.  
By twisting with the earthing wire, noise flowing from the power supply wires can be relieved to the earthing. However, if a filter is installed on the power supply wires, the wires and the earthing wire may not need to be twisted.

### 4.1.3 Noise filter (power supply line filter)

The noise filter (power supply line filter) is a device effective to reduce conducted noise. Except some models, installation of a noise filter onto the power supply lines is not necessary. However conducted noise can be reduced if it is installed. (The noise filter is generally effective for reducing conducted noise in the band of 10 MHz or less.) Usage of the following filters is recommended.

Model name	FN343-3/05	FN660-6/06	RSHN-2003
Manufacturer	SCHAFFNER	SCHAFFNER	TDK
Rated current	3 A	6 A	3 A
Rated voltage	250 V		

The precautions required when installing a noise filter are described below.

- Do not install the input and output cables of the noise filter together to prevent the output side noise will be induced into the input side cable where noise has been eliminated by the noise filter.

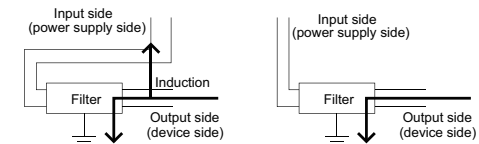

- Installing the input and output cables together will cause noise induction.
  - Separate the input cable from the output cable.
- Connect the noise filter's ground terminal to the control panel with the shortest cable as possible (approx. 10 cm (3.94 in.) or less).

## 5. INSTALLATION

### 5.1 Control Panel Inside Dimensions for Mounting GOT

Install the GOT on the control panel out of the way for the equipment inside the control panel. Do not install the GOT and the unit in prohibited areas for the installation.

Point	Applicable cable
	Some cables may need to be longer than the specified dimensions when connecting to the GOT. Therefore, consider the connector dimensions and bending radius of the cable as well for installation.

### 5.2 Panel Cutting Dimensions

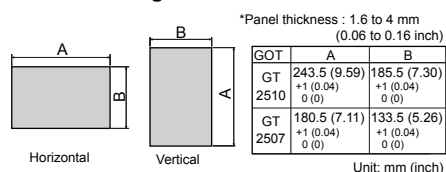

### 5.3 Mounting Position

When mounting the GOT, the following clearances must be maintained from other structures and devices.

Some cables may need to be longer than the specified dimensions when connecting to the GOT.

Therefore, consider the connector dimensions and bending radius of the cable as well for installation.

For the lead-in allowance for cables at the bottom of the GOT, refer to the GOT2000 Series User's Manual (Hardware).

For the vertical installation, install the GOT so that the vertical installation arrow printed on the GOT rear face points upward.

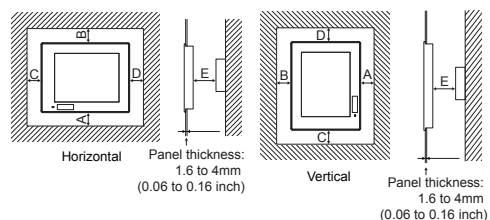

According to the dimensions in the following table, leave clearances between the GOT and the other devices. The values enclosed in square brackets apply to the case where no other equipment generating radiated noise (such as a contactor) or heat is installed near the GOT. However, keep the ambient temperature of the GOT to 55 °C or lower.

Item	GT2510	GT2507
A	51(2.01) or more [23(0.91) or more]	64(2.52) or more
B	Horizontal: 81(3.19) or more [23(0.91) or more] Vertical: 53(2.09) or more [23(0.91) or more]	
C	53(2.09) or more [23(0.91) or more]	53(2.09) or more [32(1.26) or more]
D	Horizontal: 53(2.09) or more [23(0.91) or more] Vertical: 81(3.19) or more [23(0.91) or more]	
E <sup>1</sup>	100(3.94) or more [20(0.79) or more]	

- \*1: When opening or closing the battery cover: 72(2.83) or more

## 5. INSTALLATION

### 5.1 Dimensions intérieures du tableau de commande pour le montage du GOT

Installez le GOT sur le tableau de commande en laissant de l'espace pour le dispositif à l'intérieur du tableau de commande. N'installez pas le GOT et le module dans des zones où l'installation est interdite.

Point	Câble applicable
	Certains câbles peuvent être plus longs que les dimensions spécifiées lors de la connexion au GOT. Par conséquent, prenez également en compte les dimensions du connecteur et le rayon de courbure du câble pour l'installation.

### 5.2 Cotes de découpe du panneau

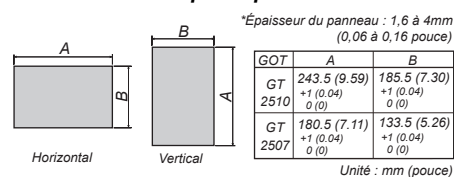

### 5.3 Position de montage

Lors du montage du GOT, laissez les espaces suivants pour les autres structures et dispositifs. Certains câbles peuvent être plus longs que les dimensions spécifiées lors de la connexion au GOT.

Par conséquent, prenez également en compte les dimensions du connecteur et le rayon de courbure du câble pour l'installation.

Pour connaître l'espace à laisser pour les câbles sous le GOT, référez-vous au manuel GOT2000 Series User's Manual (Hardware).

Pour l'installation à la verticale, installez le GOT de sorte que la flèche d'installation à la verticale imprimée sur la face arrière du GOT pointe vers le haut.

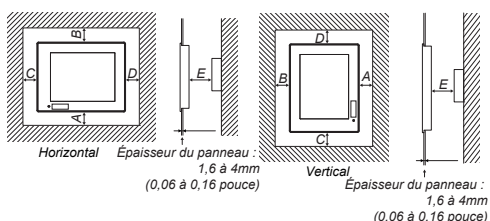

Laissez les espaces entre le GOT et les autres dispositifs en fonction des dimensions contenues dans le tableau suivant. Les valeurs entre parenthèses s'appliquent au cas où aucun dispositif générant des émissions sonores (comme un contacteur) ou de la chaleur n'est installé près du GOT.

Toutefois, maintenez la température ambiante du GOT à 55°C ou moins.

Article	GT2510	GT2507
A	51 (2.01) or plus [23 (0.91) or plus]	64 (2.52) or plus
B	Horizontal: 81 (3.19) or plus [23 (0.91) or plus] Vertical: 53 (2.09) or plus [23 (0.91) or plus]	
C	53 (2.09) or plus [23 (0.91) or plus]	53 (2.09) or plus [32 (1.26) or plus]
D	Horizontal: 53 (2.09) or plus [23 (0.91) or plus] Vertical: 81 (3.19) or plus [23 (0.91) or plus]	
E <sup>1</sup>	100 (3.94) or plus [20 (0.79) or plus]	

- \*1 : Pour ouvrir ou fermer le couvercle de la batterie : 72 (2.83) or plus

### 5.4 Température intérieure et angle d'installation du tableau de commande

Lors de l'installation du GOT sur un panneau, réglez la zone d'affichage comme indiqué ci-dessous.

Si l'angle d'installation est différent de celui indiqué, le GOT se détériore plus tôt.

Installation du GOT à l'horizontale  
Lors de l'installation du GOT avec un angle d'installation compris entre 60 et 105°, la température à l'intérieur du tableau de commande doit être d'environ 55°C. Lors de l'installation du GOT avec un angle d'installation non compris entre 60 et 105°, la température à l'intérieur du tableau de commande doit être d'environ 40°C.

Installation du GOT à la verticale  
Lors de l'installation du GOT avec un angle de 90°, la température à l'intérieur du panneau de commande ne doit pas dépasser 55°C. Lors de l'installation du GOT avec tout autre angle que 90°, la température à l'intérieur du panneau de commande ne doit pas dépasser 40°C.

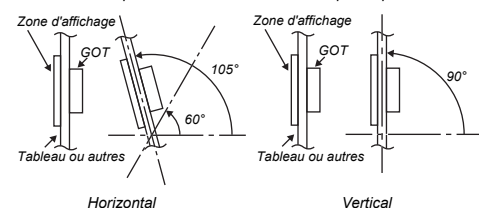

## 6. MAINTENANCE AND INSPECTION

Refer to the GOT2000 Series User's Manual (Hardware) for maintenance and inspection for the GOT.

### 5.4 Control Panel Inside Temperature and Installation Angle

When installing the GOT to a panel, set the display section as shown below. Using the GOT with the installation angle other than the following deteriorates the GOT earlier.

Installing the GOT horizontally  
When installing the GOT with the installation angle between 60 to 105°, the temperature inside the control panel must be within 55 °C. When installing the GOT with the installation angle other than between 60 to 105°, the temperature inside the control panel must be within 40 °C.

Installing the GOT vertically  
When the GOT is installed a 90° angle, the control panel inside temperature must be within 55 °C. When the GOT is installed at any angle other than 90°, the control panel inside temperature must be within 40 °C.

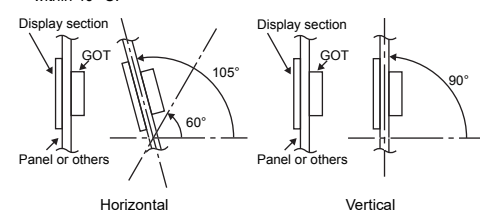

When mounting the GOT, the following clearances must be maintained from other structures and devices.

Some cables may need to be longer than the specified dimensions when connecting to the GOT.

Therefore, consider the connector dimensions and bending radius of the cable as well for installation.

For the lead-in allowance for cables at the bottom of the GOT, refer to the GOT2000 Series User's Manual (Hardware).

For the vertical installation, install the GOT so that the vertical installation arrow printed on the GOT rear face points upward.



According to the dimensions in the following table, leave clearances between the GOT and the other devices. The values enclosed in square brackets apply to the case where no other equipment generating radiated noise (such as a contactor) or heat is installed near the GOT. However, keep the ambient temperature of the GOT to 55 °C or lower.

Item	GT2510	GT2507
A	51(2.01) or more [23(0.91) or more]	64(2.52) or more
B	Horizontal: 81(3.19) or more [23(0.91) or more] Vertical: 53(2.09) or more [23(0.91) or more]	
C	53(2.09) or more [23(0.91) or more]	53(2.09) or more [32(1.26) or more]
D	Horizontal: 53(2.09) or more [23(0.91) or more] Vertical: 81(3.19) or more [23(0.91) or more]	
E <sup>1</sup>	100(3.94) or more [20(0.79) or more]	

- \*1: When opening or closing the battery cover: 72(2.83) or more

### Warranty

Mitsubishi Electric will not be held liable for damage caused by factors found not to be the cause of Mitsubishi Electric; machine damage or lost profits caused by faults in the Mitsubishi Electric products; damage, secondary damage, accident compensation caused by special factors unpredictable by Mitsubishi Electric; damages to products other than Mitsubishi Electric products; and to other duties.

### For safe use

- This product has been manufactured as a general-purpose part for general industries, and has not been designed or manufactured to be incorporated in a device or system used in purposes related to human life.
- Before using the product for special purposes such as nuclear power, electric power, aerospace, medicine or passenger movement vehicles, consult with Mitsubishi Electric.
- This product has been manufactured under strict quality control. However, when installing the product where major accidents or losses could occur if the product fails, install appropriate backup or failsafe functions in the system.

Country/Region	Sales office/Tel
USA	Mitsubishi Electric Automation, Inc. 500 Corporate Woods Parkway, Vernon Hills, IL 60061, U.S.A. Tel: +1-847-478-2100
Brazil	Mitsubishi Electric do Brasil Comercio e Servicos Ltda. Avenida Adelfino Cardana, 293, 21 andar, Bethaville, Barueri SP, Brasil CEP 08401-147 Tel: +55-11-4689-3000
Mexico	Mitsubishi Electric Automation, Inc. Mexico Branch Mariano Escobedo #69, Col. Zona Industrial, Tlalnepantla Edo. Mexico, C.P.54030 Tel: +52-55-3067-7511
Germany	Mitsubishi Electric Europe B.V. German Branch Mitsubishi-Electric-Platz 1, 40882 Ratingen, Germany Tel: +49-2102-486-0
UK	Mitsubishi Electric Europe B.V. UK Branch Travelers Lane, Hatfield, Hertfordshire, AL10 8XB, U.K. Tel: +44-1707-28-8780
Italy	Mitsubishi Electric Europe B.V. Italian Branch Centro Direzionale Colleoni - Palazzo Sirio, Viale Colleoni 7, Agrate Brianza (MB), Italy Tel: +39-039-60531
Spain	Mitsubishi Electric Europe B.V. Spanish Branch Carretera de Rubi 76-80-Appdo.420, 08190 Sant Cugat del Valles (Barcelona), Spain Tel: +34-935-65-3131
France	Mitsubishi Electric Europe B.V. French Branch 25, Boulevard des Bouvets, 92741 Nanterre Cedex, France Tel: +33-1-55-68-55-68
Czech	Mitsubishi Electric Europe B.V. Czech Branch Aventis Business Park, Radlicka 751/113e, 158 00 Praha 5, Czech Republic Tel: +420-251-551-470
Turkey	Mitsubishi Electric Turkey A.S. Umraniye Branch Serfil Mahallesi Nuh Sokak No.5, TR-34775 Umraniye / Istanbul, Turkey Tel: +90-216-526-9900
Poland	Mitsubishi Electric Europe B.V. Polish Branch ul. Krakowska 50, 32-083 Balice, Poland Tel: +48-12-347-65-00
Russia	Mitsubishi Electric (Russia) LLC St. Petersburg Branch Piskarevsky pr. 2, bid 2, lit "Sch", BC "Benua", office 720; RU-195027 St. Petersburg, Russia Tel: +7-812-633-3497
South Africa	Adroit Technologies 20 Waterford Office Park, 189 Wilkoppen Road, Fourways, Johannesburg, South Africa Tel: +27-11-658-8100
China	Mitsubishi Electric Automation (China) Ltd. No.1386 Hongqiao Road, Mitsubishi Electric Automation Center, Shanghai, China Tel: +86-21-3322-9330
Taiwan	SETSUYO ENTERPRISE CO., LTD. 6F, No.105, Wugong 3rd Road, Wugu District, New Taipei City 24889, Taiwan Tel: +886-2-2299-2499
Korea	Mitsubishi Electric Automation Korea Co., Ltd. 7F-9F, Gangseo Hangang Xi-tower A, 401, Yangcheon-ro, Gangseo-Gu, Seoul 07528, Korea Tel: +82-2-3660-9530
Singapore	Mitsubishi Electric Asia Pte. Ltd. 307 Alexandra Road, Mitsubishi Electric Building, Singapore 159943 Tel: +65-6473-2308
Thailand	Mitsubishi Electric Factory Automation (Thailand) Co., Ltd. 12th Floor, 5V City Building, Office Tower 1, No. 888/19 and 20 Rama 3 Road, Kwang Banggongpang, Khet Yamnawa, Bangkok 10120, Thailand Tel: +66-2682-6522 to 31
Indonesia	PT. Mitsubishi Electric Indonesia Gedung Jaya 11th Floor, JL. MH. Thamrin No.12, Jakarta Pusat 10340, Indonesia Tel: +62-21-3322-9330
Vietnam	Mitsubishi Electric Vietnam Co., LTD. Ho Chi Minh Head Office Unit 01-04, 10th Floor, Vincom Center, 72 Le Thanh Ton Street, District 1, Ho Chi Minh City, Vietnam Tel: +84-9-3910-5945
India	Mitsubishi Electric India Pvt. Ltd. Pune Branch Emerald House, EL-3, J Block, M.I.D.C., Bhosari, Pune - 411026, Maharashtra, India Tel: +91-20-2710-2000
A	