



CONNECTOR CONVERSION BOX GT16H-CNB-42S

User's Manual

Manual Number	JY997D40401H
Date	April 2018

This manual describes the part names, dimensions, mounting, and specifications of the product. Before use, read this manual and manuals of relevant products fully to acquire proficiency in handling and operating the product. Make sure to learn all the product information, safety information, and precautions.

And, store this manual in a safe place so that you can take it out and read it whenever necessary. Always forward it to the end user.

Registration
Ethernet is a registered trademark of Xerox Corporation in the United States. MODBUS is a trademark of Schneider Electric SA. The company name and the product name to be described in this manual are the registered trademarks or trademarks of each company.

Effective April 2018
Specifications are subject to change without notice.
© 2010 MITSUBISHI ELECTRIC CORPORATION

Safety Precaution (Read these precautions before using.)

Before using this product, please read this manual and the relevant manuals introduced in this manual carefully and pay full attention to safety to handle the product correctly.

The precautions given in this manual are concerned with this product.

In this manual, the safety precautions are ranked as **WARNING** and **CAUTION**.

WARNING Indicates that incorrect handling may cause hazardous conditions, resulting in death or severe injury.

CAUTION Indicates that incorrect handling may cause hazardous conditions, resulting in medium or slight personal injury or physical damage.

Depending on circumstances, procedures indicated by **CAUTION** may also be linked to serious results.
In any case, it is important to follow the directions for usage.

DESIGN PRECAUTIONS **WARNING**

- Some failures of the GOT or cable may keep the outputs on or off. An external monitoring circuit should be provided to check for output signals which may lead to a serious accident.
Not doing so can cause an accident due to false output or malfunction.
- If a communication fault (including cable disconnection) occurs during monitoring on the GOT, communication between the GOT and PLC CPU is suspended and the GOT becomes inoperative.
A system where the GOT is used should be configured to perform any significant operation to the system by using the switches of a device other than the GOT on the assumption that a GOT communication fault will occur.
Not doing so can cause an accident due to false output or malfunction.
- Do not use the GOT as the warning device that may cause a serious accident. An independent and redundant hardware or mechanical interlock is required to configure the device that displays and outputs serious warning.
Failure to observe this instruction may result in an accident due to incorrect output or malfunction.

DESIGN PRECAUTIONS **CAUTION**

- Do not bundle the control and communication cables with main-circuit, power or other wiring. Run the above cables separately from such wiring and keep them a minimum of 100mm (3.94in.) apart. Not doing so noise can cause a malfunction.

MOUNTING PRECAUTIONS **WARNING**

- Make sure to turn off the Connector Conversion Box's power before attaching or detaching it to/from the GOT.
Failure to do so may cause unit failure or malfunctions.

MOUNTING PRECAUTIONS **CAUTION**

- Use the Connector Conversion Box within the generic environment specifications described in this manual. If the product is used in such conditions, electric shock, fire, malfunctions, deterioration or damage may occur.

WIRING PRECAUTIONS **WARNING**

- Be sure to shut off all phases of the external power supply used by the system before wiring. Failure to do so may result in an electric shock, product damage or malfunctions.
- Please make sure to ground FG terminal of the Connector Conversion Box power supply section by applying 100 or less which is used exclusively for the GOT. Not doing so may cause an electric shock or malfunction.
- Correctly wire the Connector Conversion Box power supply section after confirming the rated voltage and terminal arrangement of the GOT. Not doing so can cause a fire or failure.
- Exercise care to avoid foreign matter such as chips and wire cutoffs entering the GOT. Not doing so can cause a fire, failure or malfunction.

WIRING PRECAUTIONS **CAUTION**

- Plug the communication cable into the connector of the connected unit and tighten the mounting and terminal screws in the specified torque range.
Undertightening can cause a short circuit or malfunction. Overtightening can cause a short circuit or malfunction due to the damage of the screws or unit.

TEST OPERATION PRECAUTIONS **WARNING**

- Before performing the test operations of the user creation monitor screen (such as turning ON or OFF bit device, changing the word device current value, changing the settings or current values of the timer or counter, and changing the buffer memory current value), read through the manual carefully and make yourself familiar with the operation method. During test operation, never change the data of the devices which are used to perform significant operation for the system. False output or malfunction can cause an accident.

STARTUP/MAINTENANCE PRECAUTIONS **WARNING**

- When power is on, do not touch the terminals.
Doing so can cause an electric shock or malfunction.
- Before starting cleaning or terminal screw retightening, always switch off the power externally in all phases. Not switching the power off in all phases can cause a unit failure or malfunction. Undertightening can cause a short circuit or malfunction. Overtightening can cause a short circuit or malfunction due to the damage of the screws or unit.

STARTUP/MAINTENANCE PRECAUTIONS **CAUTION**

- Do not disassemble or modify the unit.
Doing so can cause a failure, malfunction, injury or fire.
- Do not touch the conductive and electronic parts of the unit directly.
Doing so can cause a unit malfunction or failure.
- The cables connected to the unit must be run in ducts or clamped.
Not doing so can cause the unit or cable to be damaged due to the dangling, motion or accidental pulling of the cables or can cause a malfunction due to a cable connection fault.
- When unplugging the cable connected to the unit, do not hold and pull the cable portion. Doing so can cause the unit or cable to be damaged or can cause a malfunction due to a cable connection fault.

DISPOSAL PRECAUTIONS **CAUTION**

- When disposing of the product, handle it as industrial waste.

TRANSPORTATION PRECAUTIONS **CAUTION**

- The Connector Conversion Box is a precision instrument. During transportation, avoid impacts larger than those specified in this manual. Failure to do so may cause failures in the unit. After transportation, verify the operations of the unit.

Certification of UL, cUL standards

UL, cUL Standards are recognized in use by the following combination.

- GT2506HS-VTBD
- GT2505HS-VTBD
- GT1665HS-VTBD (Hardware version F or later)
- GT1455HS-QTBDE (Hardware version B or later)
- GT1450HS-QMBDE (Hardware version B or later)
- GT16H-CNB-42S (Hardware version D or later)
- External cable (GT16H-C30-42P, GT16H-C60-42P, GT16H-C100-42P)
- External cable (GT14H-C30-42P, GT14H-C60-42P, GT14H-C100-42P)*1

*1 Version B or later

General notes on power supply

This equipment must be supplied by a UL Listed or Recognized 24 V dc rated power supply and UL Listed or Recognized fuse rated not higher than 4A, or a UL Listed Class 2 power supply.

Compliance with EC directive (CE Marking)

This note does not guarantee that an entire mechanical module produced in accordance with the contents of this note will comply with the following standards. Compliance to EMC directive for the entire mechanical module should be checked by the user/manufacturer. For more details please contact the local Mitsubishi Electric sales site.

Attention

- This product is designed for use in industrial applications.

Requirement for Compliance with EMC directive

The following products have shown compliance through direct testing (to the identified standards) and design analysis (forming a technical construction file) to the European Directive for Electromagnetic Compatibility (2004/108/EC) when used as directed by the appropriate documentation.
Type: Programmable Controller (Open Type Equipment)

Standard		Remark
EN61131-2 : 2007 Programmable controllers- Equipment, requirement and tests	EMI	Compliance with all relevant aspects of the standard. (Radiated Emissions)
	EMS	Compliance with all relevant aspects of the standard. (ESD, RF electromagnetic field, EFTB, Surge, RF conducted disturbances and Power frequency magnetic field)

For more details please contact the local Mitsubishi Electric sales site.

Notes for compliance to EMC regulation

- General notes on the control panel
Make sure to combine the GT16 Handy GOT with the Connector Conversion Box to comply with the EMC directive. The Connector Conversion Box is an open type device (device installed to another device) and must be installed in a conductive control panel.
- General notes on the use of communication cables
 - External cable (GT16H-C30-42P, GT16H-C60-42P, GT16H-C100-42P)
 - Direct connection cable

Existing Cables	User Made Cables
GT01-C30R4-8P GT11H-C30R2-6P	The cable need to be independently tested by the user to demonstrate EMC compatibility when they are used with the GOT, the PLC of MELSEC-Q series, MELSEC-L series, MELSEC-QnA, MELSEC-A series and MELSEC-FX series.

- Ethernet connection cable (Shielded twisted pair cable (STP))
- PLC (manufactured by other company), microcomputer, temperature controller, inverter, servo amplifier, CNC, MODBUS(R)/RTU or MODBUS(R)/TCP connection
Produce the cable (RS-232 cable, RS-422 / 485 cable) for connecting the GOT to a controller with reference to the following manual.
→ GOT2000/GOT1000 Series Connection Manual for GT Works3 and a controller used

- General notes on Power supply
The Connector Conversion Box requires an additional ferrite filter to be attached to the 24V DC power supply cables. The filter should be attached in a similar manner as shown in the figure opposite, i.e. the power cables are wrapped around the filter. However, as with all EMC situations the more correctly applied precautions the better the systems Electro-magnetic Compatibility. The ferrite recommended is a TDK ZCAT3035-1330 or similar. The ferrite should be placed as near to the 24V DC terminals of the Connector Conversion Box as possible (which should be within 75mm of the GOT terminal).

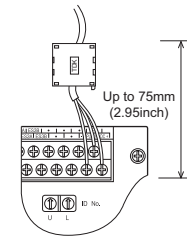

Associated Manuals

The following manuals are relevant to this product. When these loose manuals are required, please consult with our local distributor.

Manual name	Contents	Manual Number (Model Code)
GOT2000 Series User's Manual (Hardware)	Describes the GOT hardware relevant content such as part names, external dimensions, mounting, power supply wiring, specifications, and introduction to option devices	SH-081194ENG (1D7MJ5)
GOT2000 Series Handy GOT Connection Manual For GT Works3 Version1	Describes system configurations of the connection method applicable to GOT2000 Series Handy GOT and cable creation method	SH-081867ENG (1D7MS9)
GT16 Handy GOT User's Manual (Hardware/Utility, Connection) 1/2, 2/2 (sold separately)	Describes the Handy GOT hardware-relevant content such as part names, external dimensions, mounting, power supply wiring, specifications, and introduction to option devices	JY997D41201 JY997D41202 (09R821)
GT14 Handy GOT User's Manual (Hardware/Utility, Connection) 1/2, 2/2 (sold separately)	Describes the Handy GOT hardware-relevant content such as part names, external dimensions, mounting, power supply wiring, specifications, and introduction to option devices	JY997D50201 JY997D50202 (09R825)

For details of a PLC to be connected, refer to the PLC user's manual respectively.
Referenced Standard: GB/T15969.2 (Requirement of Chinese standardized law)

Bundled Items

Bundled item	Quantity
GT16H-CNB-42S Connector conversion box	1
Packing for panel installation	1
Flange for GT10-9PT5S	1
Screws for flange installation (M3×8)	2
CONNECTOR CONVERSION BOX GT16H-CNB-42S User's Manual (This manual)	1

1. Features

The Connector Conversion Box relays the GOT's external 42-pin connector to the power supply/switch and the PLC's connector and terminal block, while enabling users to operate the Handy GOT outside the enclosure.

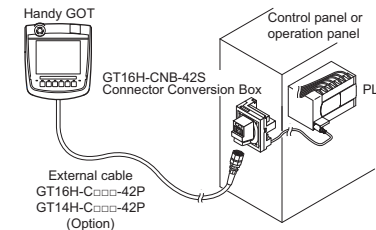

2. Specifications

General Specifications
Other specifications are the same as the Handy GOT main unit.

Item	Specifications				
Operating ambient temperature	0 to 55°C				
Storage ambient temperature	-20 to 70°C				
Vibration resistance	When installing DIN rail	Frequency	Acceleration	Half-amplitude	Sweep Count
		5 to 9Hz	--	1.75mm	10 times each in X, Y and Z directions
		9 to 150Hz	4.9m/s ²	--	
Operating atmosphere	Must be free of lamp black, corrosive gas, flammable gas, or excessive amount of electroconductive dust particles and must be no direct sunlight. (Same as for saving)				

Power Supply Specifications

Item	Specifications
Input power supply voltage	24VDC (+10% -15%)
Power consumption	13.7W or less (570mA/24VDC) (When including the consumption current of Handy GOT)
	2.2W (90mA/24V) (When excluding the consumption current of Handy GOT)
Inrush current	25A or less (at max. load), 2ms
Permissible instantaneous power failure time	Within 5ms

Applicable GOTs

Abbreviations		Model name
GOT 2000	GT25 Handy GOT	GT2506HS-VTBD, GT2505HS-VTBD
GOT 1000	GT16 Handy GOT	GT1655HS-VTBD
	GT14 Handy GOT	GT145□HS-Q□BDE

Internal Relay Contact Specifications

Item	Contact rating	Specifications
Operation switch SW1 to SW6	10mA/24VDC (resistance load only)	Each contact coordinates the operation switch status of Pressed (close)/Not pressed (open). When the external cable is not connected, contacts are always open regardless of the switch status.
Emergency stop switch ES1A to ES3A	1A/24VDC (resistance load) 0.3A/24VDC (induction load)	Each contact coordinates the emergency stop switch status of Pushed (open)/Return (close). When the external cable is not connected, contacts are always open regardless of the emergency stop switch status. Causing a short circuit of the ES□B terminal which is close to the ES□A terminal by a short pin (prepared by user) enables to set each contact in the close status even if the external connection cable is not connected.* →GOT2000 Series User's Manual(Hardware), GT16 Handy GOT User's Manual, GT14 Handy GOT User's Manual When using the short-circuited ES□B terminal which is close to the ES□A terminal <ul style="list-style-type: none"> • Contacts are normally operated in the close status. When pushing the emergency stop switch, the contacts become open. • In the following situations, contacts are closed regardless of the status of the emergency stop switch and the external cable. <ul style="list-style-type: none"> - When GT16H-CNB-42S is turned OFF. - When GT16H-CNB-42S is not supplied with the power supply (DC24V).
Grip switch DSW1, DSW2	1A/24VDC (resistance load) 0.3A/24VDC (induction load)	Each contact coordinates the grip switch status of Pressed (close)/Not pressed (open). When the external cable is not connected, contacts are always open regardless of the grip switch status.
Keylock switch (2-position switch) KSWC, KSW1, KSW2	1A/24VDC (resistance load) 0.3A/24VDC (induction load)	Each contact coordinates the position of the keylock switch. <ul style="list-style-type: none"> • When the key is on the left: KSW1 and KSWC are short-circuited. • When the key is on the right: KSW2 and KSWC are short-circuited. When the external cable is not connected, contacts are always open regardless of the keylock switch.

*1 The system may not match the safety standards. Before using the system, please check the safety standards which are required.

3. Part Names and External Dimensions

The name and the external dimensions of each part of the Connector Conversion Box are described below.

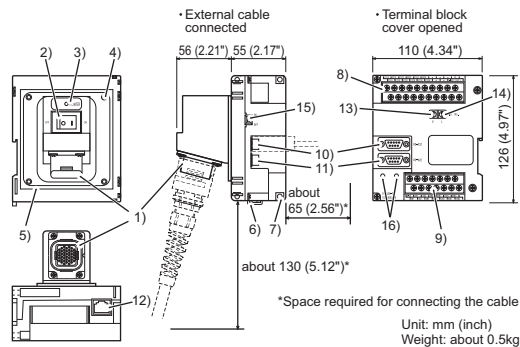

No.	Name	Specifications
1)	Connector for Handy GOT (42-pin, female)	Connects a Handy GOT through an external connection cable.
2)	Power switch	Supplies the power to the Handy GOT. When this switch is set to ON, the power is supplied. Turn off the power when attaching or detaching the Handy GOT.
3)	POWER LED	Lit in green: Power is correctly supplied. Not lit: Power is not supplied.
4)	Hole for the panel installation	Used when mounting the panel. For M4 screw, depth 6mm
5)	Packing attachment chase	Used when mounting the panel.

No.	Name	Specifications
6)	Hook for DIN rail	Used for fixing the Connector Conversion Box when mounting DIN rail (35mm).
7)	Hole for the screw installation	Used for fixing on the board, etc. For M4 screw
8)	Terminal block 1	Connects the GT16H-CNB-42S, the 24VDC power supply of Handy GOT and the emergency stop switch (ES-1 to 3) with M3 terminal screw and the cover.
9)	Terminal block 2	Connects the operation switch of the Handy GOT (SW1 to 6), the grip switch (DSW-1, 2) and the keylock switch (KSW-1, 2) with M3 terminal and the cover.
10)	External connection device communication connector (RS-232: D-Sub, 9-pin, male)	Connects to the external connection device via a GOT2000/GOT1000 series cable. RS-422/485 connector and RS-232 connector cannot be used at the same time. These connectors cannot be used in combination with GT2505HS-VTBD and GT145□HS-Q□BDE.
11)	External connection device communication connector (RS-422/485: D-Sub, 9-pin, female)	Connects to the external connection device via Ethernet with using a LAN cable.
12)	External connection device communication connector (Ethernet with using a LAN cable)	Connects the external connection device via Ethernet with using a LAN cable.
13)	Rotary switch (U)	Sets the ID number of GT16-CNB-42S.
14)	Rotary switch (L)	Sets one ID number with using both rotary switches (U) and (L).
15)	ID number valid/invalid selection switch	Enables the recognition function of ID number (ON=Valid, OFF=Invalid). When connecting the external connection device with using (10) and (11), set OFF (invalid).
16)	Hole for the flange installation	Used for fixing the flange when using the connector conversion adapter.

4. Installation

The Connector Conversion Box can be installed on the panel face directly or on the DIN rail.

4.1 Mounting on the panel face

(When setting the connector for Handy GOT connection and the power supply switch on the panel surface)

- 1) Direct mounting on the panel face
Drill a mounting slot of the following size on the panel face.
- 2) Installation of the packing
Install the accessory packing to the packing attachment chase of the Connector Conversion Box. Be sure to install the packing.

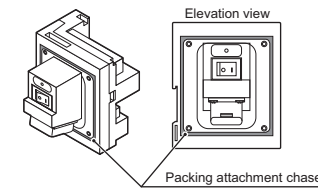
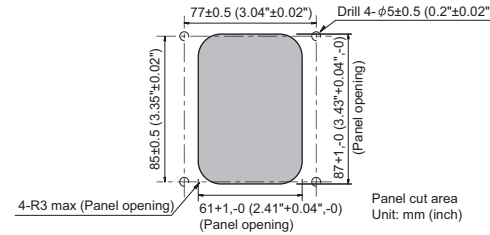

- 3) Mounting on the panel face

Fit the Connector Conversion Box from the back side of the panel face, and fix it with four M4 screws (prepared by user). In the Connector Conversion Box, thread of M4, 6mm (0.23") in depth is cut in each mounting hole. Prepare four M4 mounting screws separately while considering the thickness of the panel face. (Tightening torque: 0.69 to 0.88 N·m)
Make sure that interfering objects are not located within 65mm (2.56") from the rear face so that the connector of a PLC cable is not hindered. To wire the terminal block, keep a space of 25mm (0.98") or more on both sides of the Connector Conversion Box.

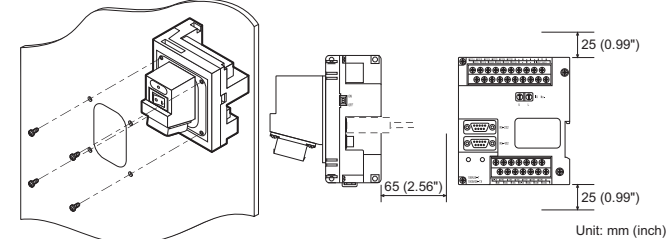

4.2 Mounting on the panel face (When installing the Connector Conversion Box on the panel surface)

- 1) Mounting on the panel face
Install the Connector Conversion Box on the panel face (mounting surface). Drill screw holes on the panel face as follows. Tighten the mounting screw with the specified torque. Tightening screws too much may cause damage. (Tightening torque: 0.69 to 0.88 N·m)

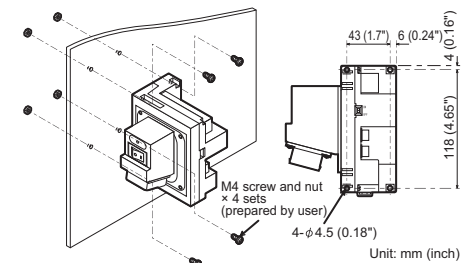

4.3 Installed on the DIN rail

Install the Connector Conversion Box on the DIN rail with using its DIN rail hook. (Applicable DIN rail DIN46277 (width: 35mm (1.37")) The clearance between screws for install the DIN rail should be 150mm (5.9") or less.

- 1) Pull out the hook for DIN rail.
- 2) Adapt the upper side of the DIN rail installation slot to the DIN rail.
- 3) Lock the hook for DIN rail while forcing the product on the DIN rail. When installing the DIN rail, please fix the cables. Otherwise, the hook for DIN rail and other parts may be damaged by the cable load.
- 4) Replacement by the user, maintenance of on-site equipment, start-up test run and other tasks.

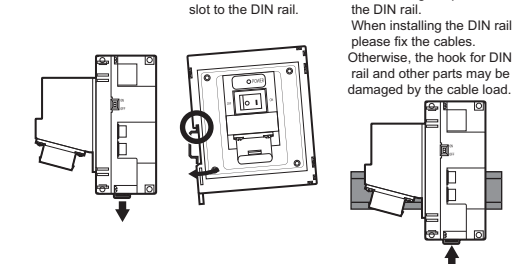

This manual confers no industrial property rights or any rights of any other kind, nor does it confer any patent licenses. Mitsubishi Electric Corporation cannot be held responsible for any problems involving industrial property rights which may occur as a result of using the contents noted in this manual.

Warranty
Exclusion of loss in opportunity and secondary loss from warranty liability
Regardless of the gratis warranty term, Mitsubishi shall not be liable for compensation to:
(1) Damages caused by any cause found not to be the responsibility of Mitsubishi.
(2) Loss in opportunity, lost profits incurred to the user by Failures of Mitsubishi products.
(3) Special damages and secondary damages whether foreseeable or not, compensation for accidents, and compensation for damages to products other than Mitsubishi products.

(4) Replacement by the user, maintenance of on-site equipment, start-up test run and other tasks.

For safe use

- This product has been manufactured as a general-purpose part for general industries, and has not been designed or manufactured to be incorporated in a device or system used in purposes related to human life.
- Before using the product for special purposes such as nuclear power, electric power, aerospace, medicine or passenger movement vehicles, consult with Mitsubishi Electric.
- This product has been manufactured under strict quality control. However when installing the product where major accidents or losses could occur if the product fails, install appropriate backup or failsafe functions in the system.



CONNECTOR CONVERSION BOX GT16H-CNB-42S

User's Manual

Manual Number	JY997D40401H
Date	April 2018

This manual describes the part names, dimensions, mounting, and specifications of the product. Before use, read this manual and manuals of relevant products fully to acquire proficiency in handling and operating the product. Make sure to learn all the product information, safety information, and precautions. And, store this manual in a safe place so that you can take it out and read it whenever necessary. Always forward it to the end user.

Registration
Ethernet is a registered trademark of Xerox Corporation in the United States. MODBUS is a trademark of Schneider Electric SA. The company name and the product name to be described in this manual are the registered trademarks or trademarks of each company.

Effective April 2018
Specifications are subject to change without notice.
© 2010 MITSUBISHI ELECTRIC CORPORATION

Safety Precaution (Read these precautions before using.)

Before using this product, please read this manual and the relevant manuals introduced in this manual carefully and pay full attention to safety to handle the product correctly. The precautions given in this manual are concerned with this product.

In this manual, the safety precautions are ranked as **WARNING** and **CAUTION**.

	Indicates that incorrect handling may cause hazardous conditions, resulting in death or severe injury.
	Indicates that incorrect handling may cause hazardous conditions, resulting in medium or slight personal injury or physical damage.

Depending on circumstances, procedures indicated by **CAUTION** may also be linked to serious results. In any case, it is important to follow the directions for usage.

DESIGN PRECAUTIONS

- Some failures of the GOT or cable may keep the outputs on or off. An external monitoring circuit should be provided to check for output signals which may lead to a serious accident. Not doing so can cause an accident due to false output or malfunction.
- If a communication fault (including cable disconnection) occurs during monitoring on the GOT, communication between the GOT and PLC CPU is suspended and the GOT becomes inoperative. A system where the GOT is used should be configured to perform any significant operation to the system by using the switches of a device other than the GOT on the assumption that a GOT communication fault will occur. Not doing so can cause an accident due to false output or malfunction.
- Do not use the GOT as the warning device that may cause a serious accident. An independent and redundant hardware or mechanical interlock is required to configure the device that displays and outputs serious warning. Failure to observe this instruction may result in an accident due to incorrect output or malfunction.

DESIGN PRECAUTIONS

- Do not bundle the control and communication cables with main-circuit, power or other wiring. Run the above cables separately from such wiring and keep them a minimum of 100mm (3.94in.) apart. Not doing so noise can cause a malfunction.

MOUNTING PRECAUTIONS

- WARNING** Make sure to turn off the Connector Conversion Box's power before attaching or detaching it to/from the GOT. Failure to do so may cause unit failure or malfunctions.

MOUNTING PRECAUTIONS

- CAUTION** Use the Connector Conversion Box within the generic environment specifications described in this manual. If the product is used in such conditions, electric shock, fire, malfunctions, deterioration or damage may occur.

WIRING PRECAUTIONS

- WARNING** Be sure to shut off all phases of the external power supply used by the system before wiring. Failure to do so may result in an electric shock, product damage or malfunctions.
- Please make sure to ground FG terminal of the Connector Conversion Box power supply section by applying 100 or less which is used exclusively for the GOT. Not doing so may cause an electric shock or malfunction.
- Correctly wire the Connector Conversion Box power supply section after confirming the rated voltage and terminal arrangement of the GOT. Not doing so can cause a fire or failure.
- Exercise care to avoid foreign matter such as chips and wire offcuts entering the GOT. Not doing so can cause a fire, failure or malfunction.

WIRING PRECAUTIONS

- CAUTION** Plug the communication cable into the connector of the connected unit and tighten the mounting and terminal screws in the specified torque range. Undertightening can cause a short circuit or malfunction. Overtightening can cause a short circuit or malfunction due to the damage of the screws or unit.

TEST OPERATION PRECAUTIONS

- WARNING** Before performing the test operations of the user creation monitor screen (such as turning ON or OFF bit device, changing the word device current value, changing the settings or current values of the timer or counter, and changing the buffer memory current value), read through the manual carefully and make yourself familiar with the operation method. During test operation, never change the data of the devices which are used to perform significant operation for the system. False output or malfunction can cause an accident.

STARTUP/MAINTENANCE PRECAUTIONS

- WARNING** When power is on, do not touch the terminals. Doing so can cause an electric shock or failure.
- Before starting cleaning or terminal screw retightening, always switch off the power externally in all phases. Not switching the power off in all phases can cause a unit failure or malfunction. Undertightening can cause a short circuit or malfunction. Overtightening can cause a short circuit or malfunction due to the damage of the screws or unit.

STARTUP/MAINTENANCE PRECAUTIONS

- CAUTION** Do not disassemble or modify the unit. Doing so can cause a failure, malfunction, injury or fire.
- Do not touch the conductive and electronic parts of the unit directly. Doing so can cause a unit malfunction or failure.
- The cables connected to the unit must be run in ducts or clamped. Not doing so can cause the unit or cable to be damaged due to the dangling, motion or accidental pulling of the cables or can cause a malfunction due to a cable connection fault.
- When unplugging the cable connected to the unit, do not hold and pull the cable portion. Doing so can cause the unit or cable to be damaged or can cause a malfunction due to a cable connection fault.

DISPOSAL PRECAUTIONS

- CAUTION** When disposing of the product, handle it as industrial waste.

TRANSPORTATION PRECAUTIONS

- CAUTION** The Connector Conversion Box is a precision instrument. During transportation, avoid impacts larger than those specified in this manual. Failure to do so may cause failures in the unit. After transportation, verify the operations of the unit.

Certification of UL, cUL standards

- UL, cUL Standards are recognized in use by the following combination.
- GT2506HS-VTBD
 - GT2505HS-VTBD
 - GT1665HS-VTBD (Hardware version F or later)
 - GT1455HS-QTBDE (Hardware version B or later)
 - GT1450HS-QMBDE (Hardware version B or later)
 - GT16H-CNB-42S (Hardware version D or later)
 - External cable (GT16H-C30-42P, GT16H-C60-42P, GT16H-C100-42P)
 - External cable (GT14H-C30-42P, GT14H-C60-42P, GT14H-C100-42P)^{*1}

General notes on power supply

This equipment must be supplied by a UL Listed or Recognized 24 V dc rated power supply and UL Listed or Recognized fuse rated not higher than 4A, or a UL Listed Class 2 power supply.

Compliance with EC directive (CE Marking)

This note does not guarantee that an entire mechanical module produced in accordance with the contents of this note will comply with the following standards. Compliance to EMC directive for the entire mechanical module should be checked by the user/manufacturer. For more details please contact the local Mitsubishi Electric sales site.

Attention

- This product is designed for use in industrial applications.

Requirement for Compliance with EMC directive

The following products have shown compliance through direct testing (to the identified standards) and design analysis (forming a technical construction file) to the European Directive for Electromagnetic Compatibility (2004/108/EC) when used as directed by the appropriate documentation. Type: Programmable Controller (Open Type Equipment)

Standard	EMI	Remark
EN61131-2 : 2007 Programmable controllers- Equipment, requirement and tests	EMI	Compliance with all relevant aspects of the standard. (Radiated Emissions)
	EMS	Compliance with all relevant aspects of the standard. (ESD, RF electromagnetic field, EFTB, Surge, RF conducted disturbances and Power frequency magnetic field)

For more details please contact the local Mitsubishi Electric sales site.

Notes for compliance to EMC regulation

- General notes on the control panel
Make sure to combine the GT16 Handy GOT with the Connector Conversion Box to comply with the EMC directive. The Connector Conversion Box is an open type device (device installed to another device) and must be installed in a conductive control panel.
 - External cable (GT16H-C30-42P, GT16H-C60-42P, GT16H-C100-42P)
 - Direct connection cable
- General notes on the use of communication cables

Existing Cables	User Made Cables
GT01-C30R4-8P GT1H-C30R2-6P	The cable need to be independently tested by the user to demonstrate EMC compatibility when they are used with the GOT, the PLC of MELSEC-Q series, MELSEC-L series, MELSEC-QnA, MELSEC-A series and MELSEC-FX series.

 - Ethernet connection cable (Shielded twisted pair cable (STP))
 - PLC (manufactured by other company), microcomputer, temperature controller, inverter, servo amplifier, CNC, MODBUS(R)/RTU or MODBUS(R)/TCP connection
Produce the cable (RS-232 cable, RS-422 / 485 cable) for connecting the GOT to a controller with reference to the following manual.
→ GOT2000/GOT1000 Series Connection Manual for GT Works3 and a controller used

- General notes on Power supply
The Connector Conversion Box requires an additional ferrite filter to be attached to the 24V DC power supply cables. The filter should be attached in a similar manner as shown in the figure opposite, i.e. the power cables are wrapped around the filter. However, as with all EMC situations the more correctly applied precautions the better the systems Electro-magnetic Compatibility. The ferrite recommended is a TDK ZCAT3035-1330 or similar. The ferrite should be placed as near to the 24V DC terminals of the Connector Conversion Box as possible (which should be within 75mm of the GOT terminal).

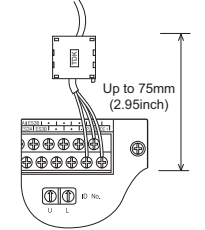

Associated Manuals

The following manuals are relevant to this product. When these loose manuals are required, please consult with our local distributor.

Manual name	Contents	Manual Number (Model Code)
GOT2000 Series User's Manual (Hardware)	Describes the GOT hardware relevant content such as part names, external dimensions, mounting, power supply wiring, specifications, and introduction to option devices	SH-081194ENG (1D7MJ5)
GOT2000 Series Handy GOT Connection Manual For GT Works3 Version 1	Describes system configurations of the connection method applicable to GOT2000 Series Handy GOT and cable creation method	SH-081867ENG (1D7MS9)
GT16 Handy GOT User's Manual (Hardware/Utility, Connection) 1/2, 2/2 (sold separately)	Describes the Handy GOT hardware-relevant content such as part names, external dimensions, mounting, power supply wiring, specifications, and introduction to option devices	JY997D41201 JY997D41202 (09R821)
GT14 Handy GOT User's Manual (Hardware/Utility, Connection) 1/2, 2/2 (sold separately)	Describes the Handy GOT hardware-relevant content such as part names, external dimensions, mounting, power supply wiring, specifications, and introduction to option devices	JY997D50201 JY997D50202 (09R825)

For details of a PLC to be connected, refer to the PLC user's manual respectively.
Referenced Standard: GB/T15969.2 (Requirement of Chinese standardized law)

Bundled Items

Bundled item	Quantity
GT16H-CNB-42S Connector conversion box	1
Packing for panel installation	1
Flange for GT10-9PT5S	1
Screws for flange installation (M3x8)	2
CONNECTOR CONVERSION BOX GT16H-CNB-42S User's Manual (This manual)	1

1. Features

The Connector Conversion Box relays the GOT's external 42-pin connector to the power supply/switch and the PLC's connector and terminal block, while enabling users to operate the Handy GOT outside the enclosure.

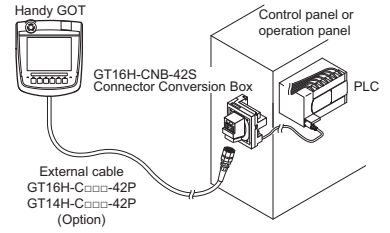

2. Specifications

General Specifications
Other specifications are the same as the Handy GOT main unit.

Item	Specifications				
Operating ambient temperature	0 to 55°C				
Storage ambient temperature	-20 to 70°C				
Vibration resistance	When installing DIN rail	Frequency	Acceleration	Half-amplitude	Sweep Count
		5 to 9Hz	--	1.75mm	10 times each in X, Y and Z directions
		9 to 150Hz	4.9m/s ²	--	
Operating atmosphere	Must be free of lamp black, corrosive gas, flammable gas, or excessive amount of electroconductive dust particles and must be no direct sunlight. (Same as for saving)				

Power Supply Specifications

Item	Specifications
Input power supply voltage	24VDC (+10% -15%)
Power consumption	13.7W or less (570mA/24VDC) (When including the consumption current of Handy GOT)
	Connector Conversion Box only 2.2W (90mA/24V) (When excluding the consumption current of Handy GOT)
Inrush current	25A or less (at max. load), 2ms
Permissible instantaneous power failure time	Within 5ms

Applicable GOTs

Abbreviations	Model name	
GOT 2000	GT25 Handy GOT	GT2506HS-VTBD, GT2505HS-VTBD
GOT 1000	GT16 Handy GOT	GT1655HS-VTBD
	GT14 Handy GOT	GT145HS-QTBDE

Internal Relay Contact Specifications

Item	Contact rating	Specifications
Operation switch SW1 to SW6	10mA/24VDC (resistance load only)	Each contact coordinates the operation switch status of Pushed (close)/Not pressed (open). When the external cable is not connected, contacts are always open regardless of the switch status.
Emergency stop switch ES1A to ES3A	1A/24VDC (resistance load) 0.3A/24VDC (induction load)	Each contact coordinates the emergency stop switch status of Pushed (open)/Return (close). When the external cable is not connected, contacts are always open regardless of the emergency stop switch status. Causing a short circuit of the ESCB terminal which is close to the ESCA terminal by a short pin (prepared by user) enables to set each contact in the close status even if the external connection cable is not connected. ^{*1} →GOT2000 Series User's Manual(Hardware), GT16 Handy GOT User's Manual, GT14 Handy GOT User's Manual When using the short-circuited ESCB terminal which is close to the ESCA terminal <ul style="list-style-type: none"> Contacts are normally operated in the close status. When pushing the emergency stop switch, the contacts become open. In the following situations, contacts are closed regardless of the status of the emergency stop switch and the external cable. <ul style="list-style-type: none"> When GT16H-CNB-42S is turned OFF. When GT16H-CNB-42S is not supplied with the power supply (DC24V).
Grip switch DSW1, DSW2	1A/24VDC (resistance load) 0.3A/24VDC (induction load)	Each contact coordinates the grip switch status of Pushed (close)/Not pressed (open). When the external cable is not connected, contacts are always open regardless of the grip switch status.
Keylock switch (2-position switch) KSWC, KSW1, KSW2	1A/24VDC (resistance load) 0.3A/24VDC (induction load)	Each contact coordinates the position of the keylock switch. <ul style="list-style-type: none"> When the key is on the left: KSW1 and KSWC are short-circuited. When the key is on the right: KSW2 and KSWC are short-circuited. When the external cable is not connected, contacts are always open regardless of the keylock switch.

^{*1} The system may not match the safety standards. Before using the system, please check the safety standards which are required.

3. Part Names and External Dimensions

The name and the external dimensions of each part of the Connector Conversion Box are described below.

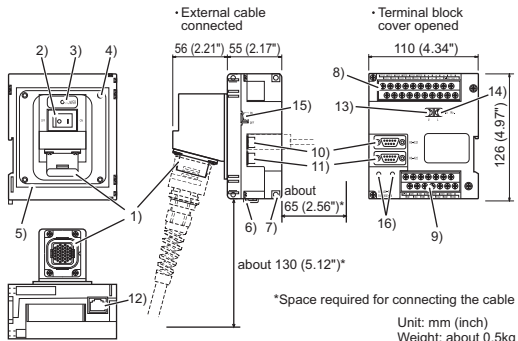

No.	Name	Specifications
1)	Connector for Handy GOT (42-pin, female)	Connects a Handy GOT through an external connection cable.
2)	Power switch	Supplies the power to the Handy GOT. When this switch is set to ON, the power is supplied. Turn off the power when attaching or detaching the Handy GOT.
3)	POWER LED	Lit in green: Power is correctly supplied. Not lit: Power is not supplied.
4)	Hole for the panel installation	Used when mounting the panel. For M4 screw, depth 6mm
5)	Packing attachment chase	Used when mounting the panel.

No.	Name	Specifications
6)	Hook for DIN rail	Used for fixing the Connector Conversion Box when mounting DIN rail (35mm).
7)	Hole for the screw installation	Used for fixing on the board, etc. For M4 screw
8)	Terminal block 1	Connects the GT16H-CNB-42S, the 24VDC power supply of Handy GOT and the emergency stop switch (ES-1 to 3) with M3 terminal screw and the cover.
9)	Terminal block 2	Connects the operation switch of the Handy GOT (SW1 to 6), the grip switch (DSW-1, 2) and the keylock switch (KSW-1, 2) with M3 terminal and the cover.
10)	External connection device communication connector (RS-232: D-Sub, 9-pin, male)	Connects to the external connection device via a GOT2000/GOT1000 series cable. RS-422/485 connector and RS-232 connector cannot be used at the same time. These connectors cannot be used in combination with GT2505HS-VTBD and GT145HS-QTBDE.
11)	External connection device communication connector (RS-422/485: D-Sub, 9-pin, female)	
12)	External connection device communication connector (Ethernet: RJ-45 module jack)	Connects the external connection device via Ethernet with using a LAN cable.
13)	Rotary switch (U)	Sets the ID number of GT16-CNB-42S.
14)	Rotary switch (L)	Sets one ID number with using both rotary switches (U) and (L).
15)	ID number valid/invalid selection switch	Enables the recognition function of ID number (ON=Valid, OFF=Invalid). When connecting the external connection device with using 10) and 11), set OFF (invalid).
16)	Hole for the flange installation	Used for fixing the flange when using the connector conversion adapter.

4. Installation

The Connector Conversion Box can be installed on the panel face directly or on the DIN rail.

4.1 Mounting on the panel face (When setting the connector for Handy GOT connection and the power supply switch on the panel surface)

- Direct mounting on the panel face
Drill a mounting slot of the following size on the panel face.
- Installation of the packing
Install the accessory packing to the packing attachment chase of the Connector Conversion Box. Be sure to install the packing.

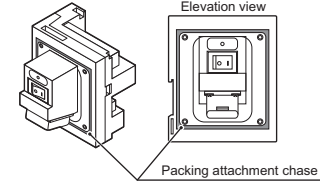
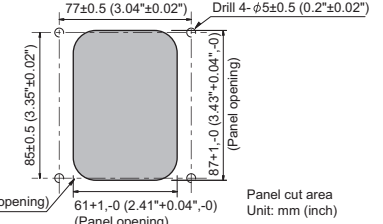

- Mounting on the panel face
Fit the Connector Conversion Box from the back side of the panel face, and fix it with four M4 screws (prepared by user). In the Connector Conversion Box, thread of M4, 6mm (0.23") in depth is cut in each mounting hole. Prepare four M4 mounting screws separately while considering the thickness of the panel face. (Tightening torque: 0.69 to 0.88 N-m)
Make sure that interfering objects are not located within 65mm (2.56") from the rear face so that the connector of a PLC cable is not hindered.
To wire the terminal block, keep a space of 25mm (0.98") or more on both sides of the Connector Conversion Box.

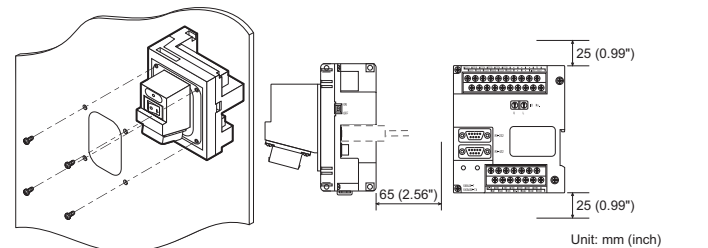

4.2 Mounting on the panel face (When installing the Connector Conversion Box on the panel surface)

- Mounting on the panel face
Install the Connector Conversion Box on the panel face (mounting surface). Drill screw holes on the panel face as follows. Tighten the mounting screw with the specified torque. Tightening screws too much may cause damage. (Tightening torque: 0.69 to 0.88 N-m)

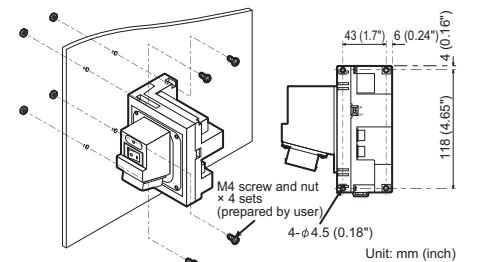

4.3 Installed on the DIN rail

Install the Connector Conversion Box on the DIN rail with using its DIN rail hook. (Applicable DIN rail DIN46277 (width: 35mm (1.37"))
The clearance between screws for install the DIN rail should be 150mm (5.9") or less.

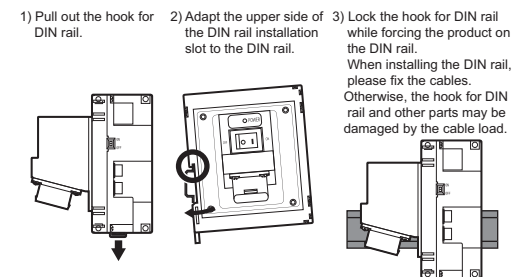

This manual confers no industrial property rights or any rights of any other kind, nor does it confer any patent licenses. Mitsubishi Electric Corporation cannot be held responsible for any problems involving industrial property rights which may occur as a result of using the contents noted in this manual.

Warranty

Exclusion of loss in opportunity and secondary loss from warranty liability
Regardless of the gratis warranty term, Mitsubishi shall not be liable for compensation to:

- Damages caused by any cause found not to be the responsibility of Mitsubishi.
- Loss in opportunity, lost profits incurred to the user by Failures of Mitsubishi products.
- Special damages and secondary damages whether foreseeable or not, compensation for accidents, and compensation for damages to products other than Mitsubishi products.
- Replacement by the user, maintenance of on-site equipment, start-up test run and other tasks.

For safe use

- This product has been manufactured as a general-purpose part for general industries, and has not been designed or manufactured to be incorporated in a device or system used in purposes related to human life.
- Before using the product for special purposes such as nuclear power, electric power, aerospace, medicine or passenger movement vehicles, consult with Mitsubishi Electric.
- This product has been manufactured under strict quality control. However when installing the product where major accidents or losses could occur if the product fails, install appropriate backup or failsafe functions in the system.