

# GT10-C10EXUSB-5S Panel-mounted USB Port Extension

## User's Manual

Manual Number	JY997D37601D
Date	April 2018

This manual describes the part names, installation, and specifications of the product. Before use, read this manual and manuals of relevant products fully to acquire proficiency in handling and operating the product. Make sure to learn all the product information, safety information, and precautions.

And, store this manual in a safe place so that you can take it out and read it whenever necessary. Always forward it to the end user.

Registration  
The company name and the product name to be described in this manual are the registered trademarks or trademarks of each company.



Effective April 2018  
Specifications are subject to change without notice.  
© 2009 MITSUBISHI ELECTRIC CORPORATION

### Safety Precaution (Read these precautions before using.)

Before using this product, please read this manual and the relevant manuals introduced in this manual carefully and pay full attention to safety to handle the product correctly.

The precautions given in this manual are concerned with this product.

In this manual, the safety precautions are ranked as **WARNING** and **CAUTION**.

	Indicates that incorrect handling may cause hazardous conditions, resulting in death or severe injury.
	Indicates that incorrect handling may cause hazardous conditions, resulting in medium or slight personal injury or physical damage.

Depending on circumstances, procedures indicated by **CAUTION** may also be linked to serious results.  
In any case, it is important to follow the directions for usage.

**MOUNTING PRECAUTIONS** 

- Use the panel-mounted USB port extension in the environment that satisfies the general specifications described in this manual. Not doing so can cause an electric shock, fire, malfunction or product damage or deterioration.

**STARTUP/MAINTENANCE PRECAUTIONS** 

- When unplugging the panel-mounted USB port extension connected to the unit, do not hold and pull the cable portion.  
Doing so can cause the unit or cable to be damaged or can cause a malfunction due to a cable connection fault.

**DISPOSAL PRECAUTIONS** 

- When disposing of the product, handle it as industrial waste.

### Related Manuals

The following manuals are relevant to this product. When these loose manuals are required please consult with our local distributor.

Manual name	Manual Number (Model Code)	Contents
GOT2000 Series User's Manual (Hardware)	SH-081194ENG (1D7MJ5)	Describes the GOT hardware relevant content such as part names, external dimensions, mounting, power supply wiring, specifications, and introduction to option devices
GT10 User's Manual	JY997D24701 (09R819)	Describes the GT10 hardware-relevant content such as part names, external dimensions, mounting, wiring, specifications, and introduction to option devices. (sold separately)

**Referenced Standard: GB/T15969.2 (Requirement of Chinese standardized law)**

### Bundled Items

Bundled item	Quantity
GT10-C10EXUSB-5S panel-mounted USB port extension	1
Cap	1
O-ring Seal	1
Nut	1
GT10-C10EXUSB-5S Panel-mounted USB Port Extension User's Manual (This manual)	1

### 1. Overview

The panel-mounted USB port extension GT10-C10EXUSB-5S (hereinafter referred to as "panel-mounted USB port extension") is an extension cable having the waterproof function.

Use it for extending a USB port of the GOT2000/GOT1000 into the control panel. The following GOT models support the panel-mounted USB port extension connection.

GOT	
GOT 2000	GT2712-STWA, GT2712-STWD, GT2710-VTWA, GT2710-VTWD, GT2512F-STNA, GT2512F-STND, GT2510-VTWA, GT2510-VTWD, GT2510F-VTNA, GT2510F-VTND, GT2508-VTWA, GT2508-VTWD, GT2508F-VTNA, GT2508F-VTND, GT2104-RTBD, GT2104-PMBD, GT2104-PMBDS, GT2104-PMBDS2, GT2104-PMBLS, GT2103-PMBD, GT2103-PMBDS, GT2103-PMBDS2, GT2103-PMBLS
GOT 1000	GT1045-QSBD, GT1040-QBBD, GT1055-QSBD, GT1050-QBBD

### 2. Part Names and External Dimensions

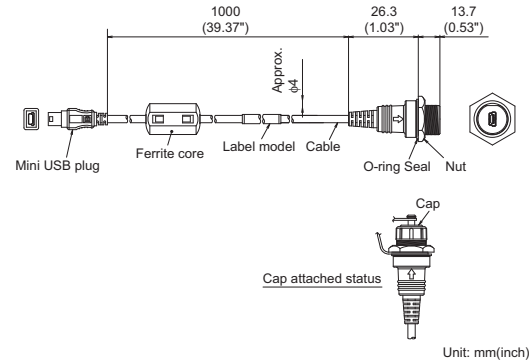

### 3. Specifications

#### 3.1 General Specifications

Item	Specifications
Operating ambient temperature	0 to 55°C
Storage ambient temperature	-20 to 60°C
Operating ambient humidity	10 to 90% RH, non-condensing (STN liquid crystal type to be stored at or below 39°C WBT.)
Storage ambient humidity	10 to 90% RH, non-condensing (STN liquid crystal type to be stored at or below 39°C WBT.)
Operating/Storage atmosphere	Must be free of lamp black, corrosive gas, flammable gas, or excessive amount of electroconductive dust particles and must not be exposed to direct sunlight. (during operation and storage)
Environmental protective structure	Equivalent to IP67 (JEM1030) (front section)

### 4. Installation

#### 4.1 Installing panel-mounted USB port extension on panel surface

Install the panel-mounted USB port extension as shown below while paying attention to prevent bending and distortion of the cap, O-ring seal and nut.

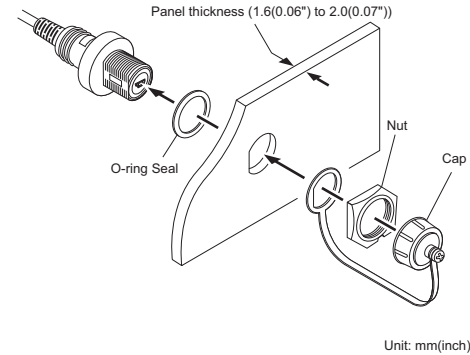

### 5. Cautions on Installation of Panel-mounted USB Port Extension

- Run power lines, servo amplifier drive wires, and panel-mounted USB port extension so that they do not cross each other.
- Keep the panel-mounted USB port extension away from any equipment which can become noise source.
- Do not twist, bend at a sharp or right angle or pull the panel-mounted USB port extension. Such handling may cause wire breakage.

Install the panel-mounted USB port extension under consideration of the dimensions inside the panel shown below.

- Dimension between GOT rear face and structure

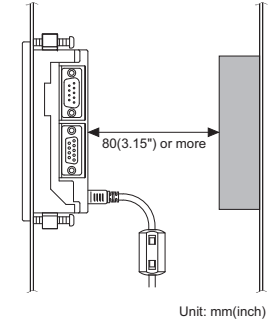

- Cable protrusion dimension

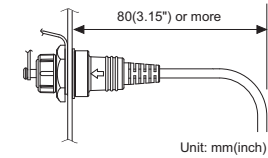

- Insert securely the small USB plug provided at the tip of the panel-mounted USB port extension into the USB port in the GOT.  
Fix the panel-mounted USB port extension itself to a structure inside the board using Insulock, etc. because the small USB plug may become loose or come off due to vibration, impact or tensile force.
- Confirm at the start of work or during operation that this product is offering its function and performance normally, and then use this product.

This manual confers no industrial property rights or any rights of any other kind, nor does it confer any patent licenses. Mitsubishi Electric Corporation cannot be held responsible for any problems involving industrial property rights which may occur as a result of using the contents noted in this manual.

#### Warranty

Mitsubishi will not be held liable for damage caused by factors found not to be the cause of Mitsubishi; opportunity loss or lost profits caused by faults in the Mitsubishi products; damage, secondary damage, accident compensation caused by special factors unpredictable by Mitsubishi; damages to products other than Mitsubishi products; and to other duties.

### For safe use

- This product has been manufactured as a general-purpose part for general industries, and has not been designed or manufactured to be incorporated in a device or system used in purposes related to human life.
- Before using the product for special purposes such as nuclear power, electric power, aerospace, medicine or passenger movement vehicles, consult with Mitsubishi Electric.
- This product has been manufactured under strict quality control. However when installing the product where major accidents or losses could occur if the product fails, install appropriate backup or failsafe functions in the system.