

**MITSUBISHI ELECTRIC**

# GOT2000/GOT1000 Series Printer Unit

## User's Manual

### GT15-PRN

Thank you for choosing Mitsubishi Electric Graphic Operation Terminal (GOT).

**Prior to use, please read both this manual and detailed manual thoroughly to fully understand the product.**

MODEL	GT15-PRN-U
MODEL CODE	1D7M47
IB(NA)-0800334-M(1806)MEE	

© 2005 MITSUBISHI ELECTRIC CORPORATION

#### [DESIGN PRECAUTIONS]

**⚠ WARNING**

- Do not bunch the control wires or communication cables with the main circuit or power wires, or lay them close to each other. As a guide, separate the lines by a distance of at least 100mm (3.94 inches) otherwise malfunctions may occur due to noise.

#### [INSTALLATION PRECAUTIONS]

**⚠ WARNING**

- Be sure to shut off all phases of the external power supply used by the system before mounting or removing this unit to/from the GOT. Not doing so can cause a unit failure or malfunction.
- Before connecting the Bus connection cable to this unit, always shut off GOT power and PLC CPU power externally in all phases. Not doing so can cause a malfunction.

**⚠ CAUTION**

- Use this unit in the environment that satisfies the general specifications described in the User's Manual for the GOT used. Not doing so can cause an electric shock, fire, malfunction or product damage or deterioration.
- When installing this unit to the GOT, fit it to the connection interface of the GOT and tighten the mounting screws in the specified torque range. Undertightening can cause a drop, failure or malfunction. Overtightening can cause a drop, failure or malfunction due to screw or unit damage.

#### [WIRING PRECAUTIONS]

**⚠ WARNING**

- Be sure to shut off all phases of the external power supply used by the system before wiring. Failure to do so may result in an electric shock, product damage or malfunctions.

**⚠ CAUTION**

- Exercise care to avoid foreign matter such as chips and wire offcuts entering the unit. Not doing so can cause a fire, failure or malfunction.

#### [STARTUP AND MAINTENANCE PRECAUTIONS]

**⚠ WARNING**

- Before starting cleaning, always shut off GOT power externally in all phases. Not doing so can cause a unit failure or malfunction. Undertightening can cause the GOT to drop, short circuit or malfunction. Overtightening can cause a short circuit or malfunction due to the damage of the screws or unit.
- Do not disassemble or modify any unit. This will cause failure, malfunction, injuries, or fire.
- Do not touch the conductive areas and electronic parts of this unit directly. Doing so can cause a unit malfunction or failure.

**⚠ CAUTION**

- Always secure the cables connected to the unit, e.g. run them in conduits or clamp them. Not doing so can cause unit or cable damage due to dangling, moved or accidentally pulled cables or can cause a malfunction due to a cable contact fault.
- Do not hold the cable part when unplugging any cable connected to the unit. Doing so can cause unit or cable damage or a malfunction due to a cable contact fault.
- Do not drop the module or subject it to string shock. A module damage may result.
- Always make sure to touch the grounded metal to discharge the electricity charged in the body, etc., before touching the unit. Failure to do so may cause a failure or malfunctions of the unit.

**[DISPOSAL PRECAUTIONS]**

**⚠ CAUTION**

- Dispose of this product as industrial waste.

**[TRANSPORTATION PRECAUTIONS]**

**⚠ CAUTION**

- Make sure to transport the GOT main unit and/or relevant unit(s) in the manner they will not be exposed to the impact exceeding the impact resistance described in the general specifications of the User's Manual for the GOT used, as they are precision devices. Failure to do so may cause the unit to fail. Check if the unit operates correctly after transportation.

### Manual

The following shows manuals relevant to this product.

**Detailed Manuals**

Manual name	Manual number (Model code)
GOT2000 Series User's Manual (Hardware) (Sold separately)	SH-081194ENG (1D7MJ5)
GOT2000 Series Connection Manual (Microcomputers, MODBUS/Fieldbus Products, Peripherals) (Sold Separately)	SH-081200ENG
GT16 User's Manual (Hardware) (Sold separately)	SH-080928ENG (1D7MD3)
GT15 User's Manual (Sold separately)	SH-080528ENG (1D7M23)
GOT1000 Series Connection Manual (Microcomputer, MODBUS Products, Peripherals) for GT Works3 (Sold separately)	SH-080871ENG (1D7MC5)

**Relevant Manuals**

For relevant manuals, refer to the PDF manuals stored in the DVD-ROM for the drawing software used.

#### Compliance with the new China RoHS directive

GOT 相关的基于“电器电子产品有害物质限制使用管理办法”要求的表示方法

**15**

Note: This symbol mark is for China only.

含有有害6物质的名称、含有量、含有部件  
本产品中所含的有害6物质的名称、含有量、含有部件如下表所示。  
产品中有害物质的名称及含量

部件名称	有害物质					
	铅 (Pb)	汞 (Hg)	镉 (Cd)	六价铬 (Cr(VI))	多溴联苯 (PBB)	多溴二苯醚 (PBDE)
电路板组件	○	○	○	○	○	○
树脂壳体、电缆、线材	○	○	○	○	○	○
取金部件、螺栓等金属部件	○	○	○	○	○	○

本表依据 SJ/T11364 的规定编制。  
○：表示该有害物质在该部件所有均质材料中的含量均在 GB/T26572 规定的限量要求以下。  
×：表示该有害物质至少在该部件的某一均质材料中的含量超出 GB/T26572 规定的限量要求。

#### Referenced Standard: GB/T15969.2 (Requirement of Chinese standardized law)

**Packing List**

The following items are included.

Model	Product	Quantity
GT15-PRN	Printer unit	1
	Mounting screw set (2 pieces of screw, 2 pieces of sticker)	1
	Cable clamp set (Connector holder with screw, cable clamp)	1
	GOT2000/GOT1000 Series Printer Unit User's Manual (This manual)	1
GT09-C30USB-5P	Dedicated printer connection cable (3m)	1

### 1. OVERVIEW

This user's manual describes the GOT2000/GOT1000 series printer unit (hereinafter referred to as the printer unit). With the printer unit installed, the GOT can be connected to a printer. Refer to the User's Manual for the GOT used for the applicable GOT. Use PictBridge compatible printers. Printers incompatible with PictBridge cannot be used with the GOT.

### 2. SPECIFICATIONS

The performance specifications of the printer unit are indicated below. The general specifications of the printer unit are the same as those of the GOT. Refer to the User's Manual for the GOT used for the general specifications of the GOT.

Item	Specification
Internal current consumption (5VDC)	0.09A
Weight	0.08kg (0.18lb) (Including connector holder and cable clamp)

#### ● SAFETY PRECAUTIONS ●

(Always read these precautions before using this equipment.)

Before using this product, please read this manual and the relevant manuals introduced in this manual carefully and pay full attention to safety to handle the product correctly. The precautions given in this manual are concerned with this product. In this manual, the safety precautions are ranked as "WARNING" and "CAUTION".

**⚠ WARNING** Indicates that incorrect handling may cause hazardous conditions, resulting in death or severe injury.

**⚠ CAUTION** Indicates that incorrect handling may cause hazardous conditions, resulting in medium or slight personal injury or physical damage.

Note that the ⚠ CAUTION level may lead to a serious accident according to the circumstances. Always follow the precautions of both levels because they are important to personal safety. Please save this manual to make it accessible when required and always forward it to the end user.

### 3. PART NAMES AND EXTERNAL DIMENSIONS

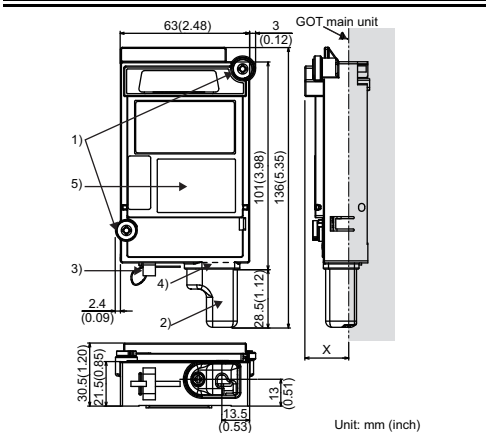

\* The external dimensions of printer unit with a cable clamp and connector holder attached is shown above.

Dimensions of X when the printer unit is mounted to the GOT

GOT	GT27	GT25	GT16	GT15
15"	23 (0.91)	-	19.5 (0.77)	21 (0.83)
12.1"	23 (0.91)	23 (0.91)	18 (0.71)	18 (0.71)
10.4"	23 (0.91)	23 (0.91)	21 (0.83)	21 (0.83)
8.4"	23 (0.91)	23 (0.91)	23 (0.91)	23 (0.91)
5.7"	23 (0.91)	-	23 (0.91)	23 (0.91)

Unit: mm (inch)

No.	Name	Description
1)	Mounting screw	Mounting screws fixed with the front communication unit or GOT
2)	Connector holder	Holder for preventing a dedicated printer connection cable disconnection
3)	Cable clamp	For cable treatment
4)	Connector	USB connector for connecting a dedicated printer connection cable
5)	Rating plate	-

### 4. INSTALLATION PROCEDURE

#### 4.1 Cable Connection

- Connect a dedicated printer connection cable to the printer unit.
- Attach the accessory connector holder to the dedicated printer connection cable and tighten the screw of connector holder with tightening torque of 0.36 to 0.48N·m.

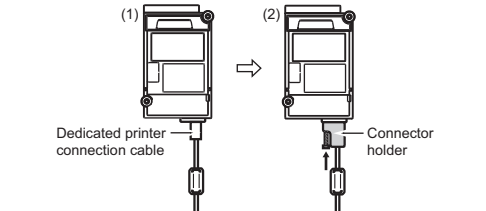

- Depending on the use environment such as when fastening cable is difficult, attach a cable clamp to the printer unit. Be sure to attach the cable clamp to section A (see the following figure) with its band positioned outside and press it until it clicks. For the band inserting direction, refer to the arrow. (In the case a cable clamp is attached)

- Insert the dedicated printer connection cable in the looped cable clamp band and pull the band to fasten the cable.

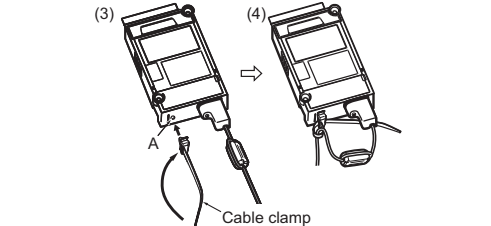

#### 4.2 Unit Installation

The installation procedure for the printer unit is explained using the GT1575.

- Power off the GOT.
- Remove one extension unit cover of the GOT.

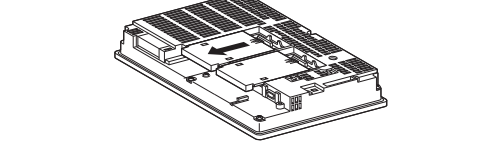

- Fit the printer unit in the GOT case.

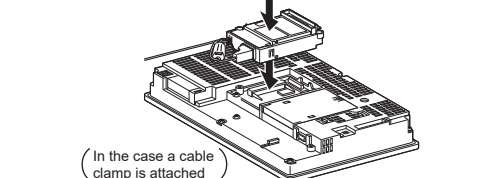

- Fasten the printer unit by tightening its mounting screws (2 places) with tightening torque 0.36 to 0.48 N·m.

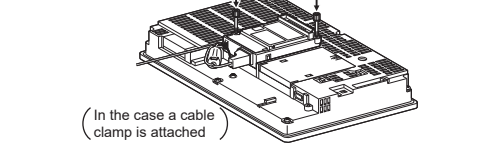

- When mounting any communication unit on the outer stage, refer to the User's Manual for the GOT used. When not mounting any communication unit on the outer layer, stick accessory stickers on the top of mounting screws (2 places) to cover the top of them in order to avoid receiving electrostatic. Keep the connector cover and sticker (see the following figure) fixed.

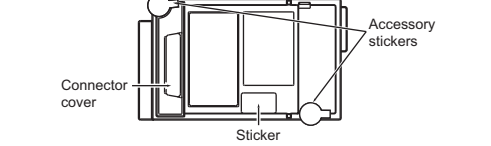

#### Point

- Cable to be used  
When connecting the printer to the GOT, use the supplied dedicated printer connection cable.
- Precautions for connecting the dedicated printer connection cable (USB cable)
  - Wait 5s or more between the connection and disconnection of the dedicated printer connection cable.
  - If connecting or disconnecting the dedicated printer connection cable shortly after disconnecting or connecting the cable, the GOT may not operate normally.
  - Do not connect or disconnect the dedicated printer connection cable during printing.
  - Doing so can cause the GOT operate incorrectly.
  - Connected printer may not be recognized in rare cases.
  - When printer is not recognized, disconnect the dedicated printer connection cable once and connect it again.
  - When the printer has been connected to a personal computer and used before it is connected to GOT, power on the printer again and connect it to GOT.
  - Any printer cannot be connected to GOT via USB hub.
  - Do not connect any devices to the printer while GOT is connected to it.
  - Do not connect any devices other than printer to the printer unit.
- Cable connection/disconnection  
Wait 3s or more between the connecting and disconnecting operations of the dedicated printer connection cable. If not waiting 3s or more, the GOT may not operate normally.
- Printer unit removal  
If you remove the Printer unit, detach it from specified direction (shown PULL) so as not to break a connector.
- Cable clamp
  - Pulling out the cable clamp band  
The cable clamp band can be pulled out after cable treatment. Pull out the band with pressing the tab of the cable clamp outward using a screwdriver etc.
  - Removing from the printer unit  
The dedicated printer connection cable can be removed from the unit with the cable clamp attached. Remove the cable clamp by pressing it in both directions (arrow A).
- Screw of the connector holder  
Do not remove the screw attached to the connector holder. In the case the screw is removed, do not use any other screws. Doing so may damage the unit.

#### Warranty

Mitsubishi Electric will not be held liable for damage caused by factors found not to be the cause of Mitsubishi Electric; machine damage or lost profits caused by faults in the Mitsubishi Electric products; damage, secondary damage, accident compensation caused by special factors unpredictable by Mitsubishi Electric; damages to products other than Mitsubishi Electric products; and to other duties.

#### ⚠ For safe use

- This product has been manufactured as a general-purpose part for general industries, and has not been designed or manufactured to be incorporated in a device or system used in purposes related to human life.
- Before using the product for special purposes such as nuclear power, electric power, aerospace, medicine or passenger movement vehicles, consult with Mitsubishi Electric.
- This product has been manufactured under strict quality control. However, when installing the product where major accidents or losses could occur if the product fails, install appropriate backup or failsafe functions in the system.

Country/Region	Sales office/Tel
USA	Mitsubishi Electric Automation, Inc. 500 Corporate Woods Parkway, Vernon Hills, IL 60061, U.S.A. Tel: +1-847-478-2100
Brazil	Mitsubishi Electric do Brasil Comercio e Servicos Ltda. Avenida Adelino Cardana, 293, 21 andar, Bethaville, Barueri SP, Brasil CEP 06401-147 Tel: +55-11-4889-3000
Mexico	Mitsubishi Electric Automation, Inc. Mexico Branch Mariano Escobedo #69, Col. Zona Industrial, Tlalpan, Edo. Mexico, C.P.54030 Tel: +52-55-3067-7511
Germany	Mitsubishi Electric Europe B.V. German Branch Mitsubishi-Electric-Platz 1, 40882 Ratingen, Germany Tel: +49-2102-486-0
UK	Mitsubishi Electric Europe B.V. UK Branch Travellers Lane, Hatfield, Hertfordshire, AL10 8XB, U.K. Tel: +44-1472-28-8780
Italy	Mitsubishi Electric Europe B.V. Italian Branch Centro Direzionale Colsoni - Palazzo Sirio, Viale Colsoni 7, Agrate Brianza (MB), Italy Tel: +39-039-60531
Spain	Mitsubishi Electric Europe B.V. Spanish Branch Carretera de Rubi 76-80-Apdo.420, 08190 Sant Cugat del Valles (Barcelona), Spain Tel: +34-935-65-3131
France	Mitsubishi Electric Europe B.V. French Branch 25, Boulevard des Bouquets, 92741 Nanterre Cedex, France Tel: +33-1-55-68-55-68
Czech	Mitsubishi Electric Europe B.V. Czech Branch Avenir Business Park, Radlicka 751/113e, 158 00 Praha 5, Czech Republic Tel: +420-251-551-470
Turkey	Mitsubishi Electric Turkey A.S. Umraniye Branch Serfali Mahallesi Nispetiye Sokak No:5, TR-34775 Umraniye / Istanbul, Turkey Tel: +90-216-526-3990
Poland	Mitsubishi Electric Europe B.V. Polish Branch ul. Krakowska 50, 52-063 Balice, Poland Tel: +48-12-347-65-00
Russia	Mitsubishi Electric (Russia) LLC St. Petersburg Branch Piskarevsky pr. 2, bld 2, lit "Sch", BC "Benusa", office 720; RU-195027 St. Petersburg, Russia Tel: +7-812-633-3497
South Africa	Adroit Technologies 20 Waterford Office Park, 189 Wilkoppen Road, Fourways, Johannesburg, South Africa Tel: +27-11-458-8100
China	Mitsubishi Electric Automation (China) Ltd. No. 1386 Hongqiao Road, Mitsubishi Electric Automation Center, Shanghai, China Tel: +86-21-2322-3030
Taiwan	SETSUYO ENTERPRISE CO., LTD. 6F, No.105, Wugong 3rd Road, Wugu District, New Taipei City 24889, Taiwan Tel: +886-2-2299-2499
Korea	Mitsubishi Electric Automation Korea Co., Ltd. 7F-8F, Gangseo Hangang Xi-tower A, 401, Yangcheon-ro, Gangseo-Gu, Seoul 07526, Korea Tel: +82-2-3660-9530
Singapore	Mitsubishi Electric Asia Pte. Ltd. 307 Alexandra Road, Mitsubishi Electric Building, Singapore 159943 Tel: +65-6473-2308
Thailand	Mitsubishi Electric Factory Automation (Thailand) Co., Ltd. 12th Floor, SV City Building, Office Tower 1, No. 896/19 and 20 Rama 3 Road, Kwaeng Bangpoo, Khet Yama, Bangkok 10120, Thailand Tel: +66-2682-6522 to 31
Indonesia	PT. Mitsubishi Electric Indonesia Gedung Jaya 11th Floor, J.L. MH. Thamrin No.12, Jakarta Pusat 10340, Indonesia Tel: +62-21-3192-6481
Vietnam	Mitsubishi Electric Vietnam Co., LTD. Ho Chi Minh Head Office Unit 01-04, 10th Floor, Vincom Center, 72 Le Thanh Ton Street, District 1, Ho Chi Minh City, Vietnam Tel: +84-8-3910-5945
India	Mitsubishi Electric India Pvt. Ltd. Pune Branch Emerald House, EL-3, Block, M.I.D.C., Bhosari, Pune - 411026, Maharashtra, India Tel: +91-20-2710-2000
Australia	Mitsubishi Electric Australia Pty. Ltd. 348 Victoria Road, P.O. Box 11, Rydalmere, N.S.W. 2116, Australia Tel: +61-2-9684-7777

#### MITSUBISHI ELECTRIC CORPORATION

HEAD OFFICE: TOKYO BUILDING, 2-7-3 MARUNOUCHI, CHIYODA-KU, TOKYO 100-8310, JAPAN  
NAGOYA WORKS: 1-14, YADA-MINAMI 5-CHOME, HIGASHI-KU, NAGOYA, JAPAN

When exported from Japan, this manual does not require application to the Ministry of Economy, Trade and Industry for service transaction permission.  
Specifications subject to change without notice.  
Printed in Japan, June 2018.