

**MITSUBISHI ELECTRIC**

# GOT2000/GOT1000 Series Bus Connection Unit

## User's Manual

**GT15-QBUS  
GT15-QBUS2  
GT15-ABUS  
GT15-ABUS2**

Thank you for choosing Mitsubishi Electric Graphic Operation Terminal (GOT).

**Prior to use, please read both this manual and detailed manual thoroughly to fully understand the product.**

MODEL	GT15-BUS-U
MODEL CODE	1D7M39
IB(NA)-0800323-O(1806)MEE	

© 2005 MITSUBISHI ELECTRIC CORPORATION

**SAFETY PRECAUTIONS**

(Always read these precautions before using this equipment.) Before using this product, please read this manual and the relevant manuals introduced in this manual carefully and pay full attention to safety to handle the product correctly. The precautions given in this manual are concerned with this product. In this manual, the safety precautions are ranked as "WARNING" and "CAUTION".

**WARNING** Indicates that incorrect handling may cause hazardous conditions, resulting in death or severe injury.

**CAUTION** Indicates that incorrect handling may cause hazardous conditions, resulting in medium or slight personal injury or physical damage.

Note that the CAUTION level may lead to a serious accident according to the circumstances. Always follow the precautions of both levels because they are important to personal safety. Please save this manual to make it accessible when required and always forward it to the end user.

**DESIGN PRECAUTIONS**

**CAUTION**

- Do not bunch the control wires or communication cables with the main circuit or power wires, or lay them close to each other. As a guide, separate the lines by a distance of at least 100mm (3.94 inch) otherwise malfunctions may occur due to noise.

**[INSTALLATION PRECAUTIONS]**

**WARNING**

- Before mounting or dismounting this unit to or from the GOT, always shut off GOT power externally in all phases.
- Not doing so can cause a unit failure or malfunction.

**CAUTION**

- Use this unit in the environment that satisfies the general specifications described in the User's Manual for the GOT used. Not doing so can cause an electric shock, fire, malfunction or product damage or deterioration.
- When installing this unit to the GOT, fit it to the connection interface of the GOT and tighten the mounting screws in the specified torque range (0.36 N·m to 0.48 N·m) with a Phillips-head screwdriver No.2. Undertightening can cause a drop, failure or malfunction. Overtightening can cause a drop, failure or malfunction due to screw or unit damage.

**[WIRING PRECAUTIONS]**

**WARNING**

- Before connecting the Bus connection cable to this unit, always shut off GOT power and PLC CPU power externally in all phases. Not doing so can cause a malfunction.

**CAUTION**

- Insert and fit the bus connection cable into the connector of the unit to be connected until it "clicks". After fitting, check for lift which can cause a malfunction due to a connection fault.

**[STARTUP AND MAINTENANCE PRECAUTIONS]**

**WARNING**

- Before starting cleaning, always shut off GOT power externally in all phases. Not doing so can cause a unit failure or malfunction.

**CAUTION**

- Do not disassemble or modify any unit. This will cause failure, malfunction, injuries, or fire.
- Do not touch the conductive areas and electronic parts of this unit directly. Doing so can cause a unit malfunction or failure.
- Always secure the cables connected to the unit, e.g. run them in conduits or clamp them. Not doing so can cause unit or cable damage due to dangling, moved or accidentally pulled cables or can cause a malfunction due to a cable contact fault.
- Do not hold the cable part when unplugging any cable connected to the unit. Doing so can cause unit or cable damage or a malfunction due to a cable contact fault.
- Always make sure to touch the grounded metal to discharge the electricity charged in the body, etc., before touching the unit. Failure to do so may cause a failure or malfunctions of the unit.

**DISPOSAL PRECAUTIONS**

**CAUTION**

- Dispose of this product as industrial waste.

**TRANSPORTATION PRECAUTIONS**

**CAUTION**

- Make sure to transport the GOT main unit and/or relevant unit(s) in the manner they will not be exposed to the impact exceeding the impact resistance described in the general specifications of the User's Manual for the GOT used, as they are precision devices. Failure to do so may cause the unit to fail. Check if the unit operates correctly after transportation.

**TRANSPORTATION PRECAUTIONS**

**CAUTION**

- When fumigants that contain halogen materials such as fluorine, chlorine, bromine, and iodine are used for disinfecting and protecting wooden packaging from insects, they cause malfunction when entering our products. Please take necessary precautions to ensure that remaining materials from fumigant do not enter our products, or treat packaging with methods other than fumigation (heat method). Additionally, disinfect and protect wood from insects before packing products.

**Manual**

The following shows manuals relevant to this product.

Manual name	Manual number (Model code)
GOT2000 Series User's Manual (Hardware) (Sold separately)	SH-081194ENG (1D7MJ5)
GOT2000 Series Connection Manual (Mitsubishi Products) For GT Works3 Version1 (Sold separately)	SH-081197ENG (1D7MJ8)
GT16 User's Manual (Hardware) (Sold separately)	SH-080928ENG (1D7MD3)
GT15 User's Manual (Sold separately)	SH-080528ENG (1D7M23)
GOT1000 Series Connection Manual (Mitsubishi Products) for GT Works3 (Sold separately)	SH-080868ENG (1D7MC2)

**Relevant Manuals**

For relevant manuals, refer to the PDF manuals stored in the DVD-ROM for the drawing software used.

**Compliance with the EMC and Low Voltage Directives**

To configure a system meeting the requirements of the EMC and Low Voltage Directives when incorporating the Mitsubishi GOT (EMC and Low Voltage Directives compliant) into other machinery or equipment, refer to "EMC AND LOW VOLTAGE DIRECTIVES" of the General Description included with the GOT used. The CE mark, indicating compliance with the EMC and Low Voltage Directives, is printed on the rating plate of the GOT.

**Compliance with the new China RoHS directive (GT15-QBUS, GT15-QBUS2)**

GOT 相关的基于“电器电子产品有害物质限制使用管理办法”要求的表示方法

**15** Note: This symbol mark is for China only.

含有有害6物质的名称、含量、含有部件  
本产品中所含的有害6物质的名称、含量、含有部件如下表所示。  
产品中含有有害物质的名称及含量

部件名称	有害物质					
	铅 (Pb)	汞 (Hg)	镉 (Cd)	六价铬 (Cr(VI))	多溴联苯 (PBB)	多溴二苯醚 (PBDE)
电路板组件	×	○	○	○	○	○
树脂壳体、电缆、线材	○	○	○	○	○	○
钣金部件、螺栓等金属部件	×	○	○	○	○	○

本表格依据 SJ/T11364 的规定编制。  
○：表示该有害物质在该部件所有均质材料中的含量均在 GB/T26572 规定的限量要求以下。  
×：表示该有害物质至少在该部件的某一均质材料中的含量超出 GB/T26572 规定的限量要求。

**Referenced Standard: GB/T15969.2 (Requirement of Chinese standardized law)**

**Packing List**

The following items are included.

Model	Product	Quantity
GT15-QBUS, GT15-ABUS	Bus connection unit	1
	Mounting screws set (2 screws, 2 stickers)	1
	GOT2000/GOT1000 Series Bus Connection Unit User's Manual (This manual)	1
GT15-QBUS2, GT15-ABUS2	Bus connection unit	1
	Mounting screws set (2 screws, 2 stickers)	2
	Extension interface relay board	1
	GOT2000/GOT1000 Series Bus Connection Unit User's Manual (This manual)	1

**3. PART NAMES AND EXTERNAL DIMENSIONS**

**(1)GT15-QBUS, GT15-ABUS**

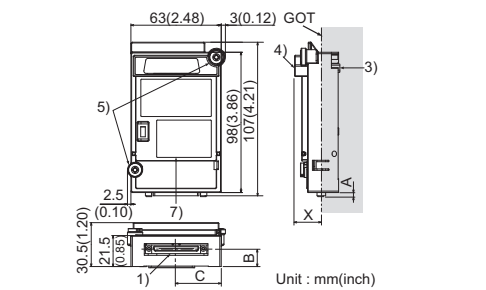

**(2)GT15-QBUS2, GT15-ABUS2**

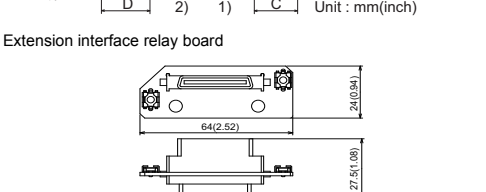
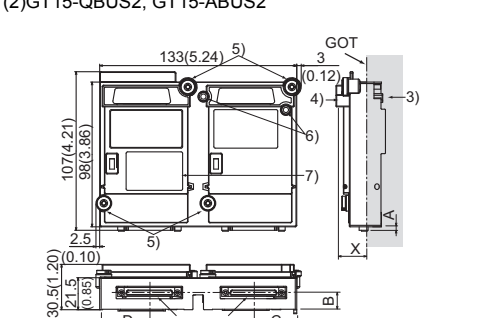

Model	A	B	C	D
GT15-QBUS	2.5 (0.10)	12 (0.47)	31.5 (1.24)	-
GT15-QBUS2	2.5 (0.10)	11 (0.43)	29 (1.14)	33.5 (1.32)
GT15-ABUS	4.5 (0.18)	15 (0.59)	29.5 (1.16)	-
GT15-ABUS2	4.5 (0.18)	11 (0.43)	31 (1.22)	31 (1.22)

Dimensions of X when the bus connection unit is mounted to the GOT

GOT	GT27	GT25	GT16	GT15
15"	23 (0.91)	-	19.5 (0.77)	21 (0.83)
12.1"	23 (0.91)	23 (0.91)	18 (0.71)	18 (0.71)
10.4"	23 (0.91)	23 (0.91)	21 (0.83)	21 (0.83)
8.4"	23 (0.91)	23 (0.91)	23 (0.91)	23 (0.91)
5.7"	23 (0.91)	-	23 (0.91)	23 (0.91)

No.	Name	Description
1)	Bus connector (IN side)	Connector for connecting the bus connection cable (IN side)
2)	Bus connector (OUT side)	Connector for connecting the bus connection cable (OUT side)
3)	Interface connector	Extension connector installed to a front extension unit or the GOT
4)	Extension connector	Extension connector to which a back extension unit is installed
5)	Mounting screw	Mounting screws fixed with a front extension unit or GOT
6)	Board fixing screw	Screw for fixing the extension interface relay board
7)	Rating plate	-

**4. INSTALLATION PROCEDURE**

The installation procedure for the bus connection unit is explained using the GT1575.

**(1)GT15-QBUS, GT15-ABUS**

- Power off the GOT.
- Remove one extension unit cover of the GOT.

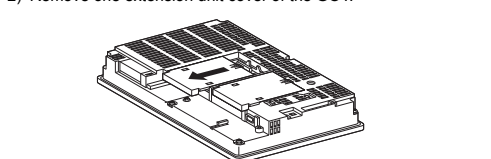

- Fit the bus connection unit in the GOT case.

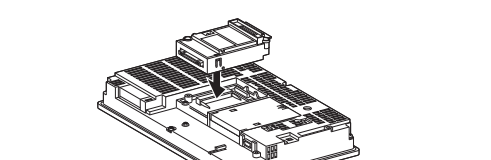

- Fasten the bus connection unit by tightening its mounting screws (2 places) with tightening torque 0.36 to 0.48 N·m.

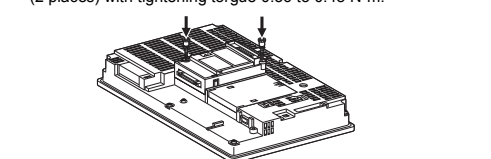

- When installing an extension unit on the unit that has been installed, remove the connector cover and the sticker. When not installing an extension unit on the unit that has been installed, in order to avoid receiving electrostatic, stick accessory stickers to cover the top of mounting screws (2 places). Keep the connector cover fixed. Keep the sticker stuck as it is.

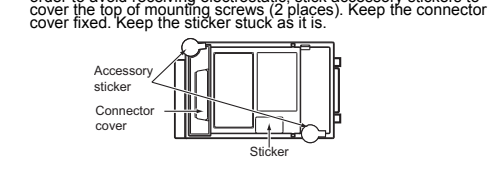

**(2)GT15-QBUS2, GT15-ABUS2**

- Power off the GOT.
- Remove two extension unit covers of the GOT.

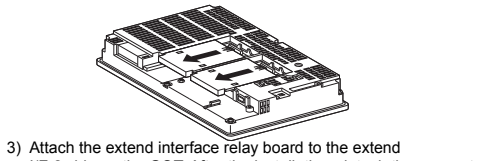

- Attach the extend interface relay board to the extend I/F-2 side on the GOT. After the installation, detach the connector cover from the extend inter face relay board. For the following GOT types, the extension interface relay board is not needed.
  - GT1655, GT155□ of the GOT1000 series
  - GT27, GT25 of the GOT2000 series

- Fit the bus connection unit in the GOT case.

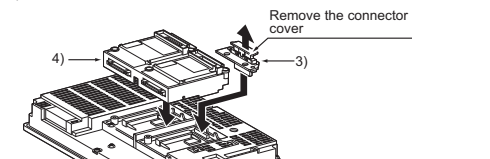

- Fasten the bus connection unit by tightening its mounting screws (4 places) with tightening torque 0.36 to 0.48 N·m.

- Fasten the bus connection unit by tightening the board fixing screws (2 places) with the tightening torque of 0.36 to 0.48 N·m.

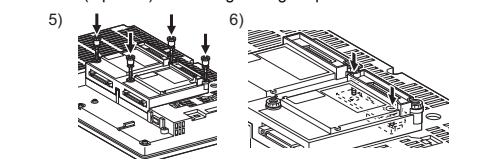

- When installing an extension unit on the unit that has been installed, remove the connector cover and the sticker. When not installing an extension unit on the unit that has been installed, in order to avoid receiving electrostatic, stick accessory stickers to cover the top of mounting screws (4 places). Keep the connector cover fixed. Keep the sticker stuck as it is.

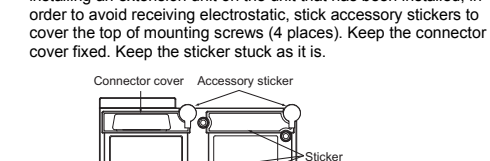

**Point**

Remove the screws that fixes the extend interface relay board before removing the unit.(Above 6))

**1. OVERVIEW**

This user's manual describes the GOT2000/GOT1000 series bus connection unit (hereinafter referred to as the bus connection unit). Use the bus connection unit for making bus connection of the GOT. Refer to the User's Manual for the GOT used for the applicable GOT.

**2. SPECIFICATIONS**

The performance specifications of the bus connection unit are indicated below. The general specifications of the bus connection unit are the same as those of the GOT. Refer to the User's Manual for the GOT used for the general specifications of the GOT.

Item	GT15-QBUS	GT15-QBUS2	GT15-ABUS	GT15-ABUS2
Interface	QCPU (Q Mode) bus connection		QnA/ACPU bus connection	
Connector	IN	1	1	1
	OUT	-	1	-
I/O occupied points	16 points (I/O assignment: 16 intelligent points)		32 points (I/O assignment: Special 32 points)	
Internal current consumption (5VDC)	0.44A	0.44A	0.12A	0.12A
	0.13kg (0.29lb)	0.14kg (0.31lb)	0.13kg (0.29lb)	0.14kg (0.31lb)

\* When the GOT power is on, the internal current consumption is included in the current consumption of the GOT. When the GOT power is off, the internal current is supplied from the power supply of the PLC system.

Select the used bus connection unit according to the connection target and connection position.

**<Bus connection unit selection example>**

- Select the bus connection unit according to the connection target.

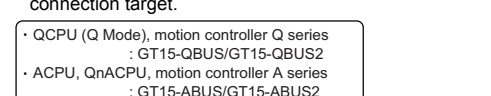

- Select the bus connection unit according to the GOT connection position.

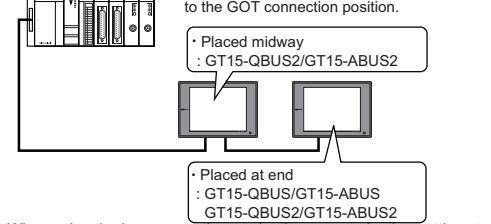

When using the bus connection, make the communication settings to perform communication between the GOT and PLC. For the details of the bus connection, refer to the GOT2000 or GOT1000 Series Connection Manual (Mitsubishi Products).

When using bus connection unit, use a standard monitor OS and communication driver of GT Designer2 Version2.15R or later. With a standard monitor OS and communication driver of an older version, the GOT has cannot recognize the unit to perform monitoring.

**Warranty**

Mitsubishi Electric will not be held liable for damage caused by factors found not to be the cause of Mitsubishi Electric; machine damage or lost profits caused by faults in the Mitsubishi Electric products; damage, secondary damage, accident compensation caused by special factors unpredictable by Mitsubishi Electric; damages to products other than Mitsubishi Electric products; and to other duties.

**For safe use**

- This product has been manufactured as a general-purpose part for general industries, and has not been designed or manufactured to be incorporated in a device or system used in purposes related to human life.
- Before using the product for special purposes such as nuclear power, electric power, aerospace, medicine or passenger movement vehicles, consult with Mitsubishi Electric.
- This product has been manufactured under strict quality control. However, when installing the product where major accidents or losses could occur if the product fails, install appropriate backup or failsafe functions in the system.

Country/Region	Sales office/Tel
USA	Mitsubishi Electric Automation, Inc. 500 Corporate Woods Parkway, Vernon Hills, IL 60061, U.S.A. Tel: +1-847-478-2100
Brazil	Mitsubishi Electric do Brasil Comercio e Servicos Ltda. Avenida Adelfino Cardana, 293, 21 andar, Bethaville, Barueri SP, Brasil CEP 06401-147 Tel: +55-11-4689-3000
Mexico	Mitsubishi Electric Automation, Inc. Mexico Branch Mariano Escobedo #69, Col. Zona Industrial, Tlalnepantla Edo. Mexico, C.P.54030 Tel: +52-55-3067-7511
Germany	Mitsubishi Electric Europe B.V. German Branch Mitsubishi-Electric-Platz 1, 40882 Ratingen, Germany Tel: +49-2102-486-0
UK	Mitsubishi Electric Europe B.V. UK Branch Travellers Lane, Hatfield, Hertfordshire, AL10 8XB, U.K. Tel: +44-1707-28-8780
Italy	Mitsubishi Electric Europe B.V. Italian Branch Centro Direzionale Colosani - Palazzo Siro, Viale Colosani 7, Agrate Brianza (MB), Italy Tel: +39-039-60531
Spain	Mitsubishi Electric Europe B.V. Spanish Branch Carretera de Rubi 76-80-420, 08190 Sant Cugat del Valles (Barcelona), Spain Tel: +34-935-55-3131
France	Mitsubishi Electric Europe B.V. French Branch 25, Boulevard des Bouvets, 92741 Nanterre Cedex, France Tel: +33-1-55-68-55-68
Czech	Mitsubishi Electric Europe B.V. Czech Branch Avenir Business Park, Radlicka 751/113e, 158 00 Praha 5, Czech Republic Tel: +420-251-551-470
Turkey	Mitsubishi Electric Turkey A.S. Umraniye Branch Sarifali Mahallesi Nispetiye Sokak No.5, TR-34775 Umraniye / Istanbul, Turkey Tel: +90-216-526-9900
Poland	Mitsubishi Electric Europe B.V. Polish Branch ul. Krakowska 50, 32-083 Balice, Poland Tel: +48-12-347-65-00
Russia	Mitsubishi Electric (Russia) LLC St. Petersburg Branch Piskarevsky pr. 2, bld 2, lit "Sd", BC "Bernua", office 720; RU-195027 St. Petersburg, Russia Tel: +7-812-633-3497
South Africa	Adroit Technologies 20 Waterford Office Park, 189 Witkoppen Road, Fourways, Johannesburg, South Africa Tel: +27-11-658-8100
China	Mitsubishi Electric Automation (China) Ltd. No.1386 Honggao Road, Mitsubishi Electric Automation Center, Shanghai, China Tel: +86-21-3322-3030
Taiwan	SETSUYO ENTERPRISE CO., LTD. 6F, No.105, Wugong 3rd Road, Wugu District, New Taipei City 24889, Taiwan Tel: +886-2-2299-2499
Korea	Mitsubishi Electric Automation Korea Co., Ltd. 7F-9F, Gangseo Hangang Xi-tower A, 401, Yangcheon-ro, Gangseo-gu, Seoul 07528, Korea Tel: +82-2-3660-9530
Singapore	Mitsubishi Electric Asia Pte. Ltd. 307 Alexandra Road, Mitsubishi Electric Building, Singapore 159943 Tel: +65-6473-2308
Thailand	Mitsubishi Electric Factory Automation (Thailand) Co., Ltd. 12th Floor, 5V City Building, Office Tower 1, No. 998/19 and 20 Rama 3 Road, Kwaeng Bangpoo, Khet Yanwawa, Bangkok 10120, Thailand Tel: +66-2682-6522 to 31
Indonesia	PT. Mitsubishi Electric Indonesia Gedung Jaya 11th Floor, Jl. MH. Thamrin No.12, Jakarta Pusat 10340, Indonesia Tel: +62-21-3192-6461
Vietnam	Mitsubishi Electric Vietnam Co., LTD. Ho Chi Minh Head Office Unit 01-04, 10th Floor, Vincom Center, 72 Le Thanh Ton Street, District 1, Ho Chi Minh City, Vietnam Tel: +84-8-3910-5945
India	Mitsubishi Electric India Pvt. Ltd. Pune Branch Emerald House, EL-3, J Block, M.I.D.C., Bhosari, Pune - 411026, Maharashtra, India Tel: +91-20-2710-2000
Australia	Mitsubishi Electric Australia Pty. Ltd. 348 Victoria Road, P.O. Box 11, Rydalmere, N.S.W. 2116, Australia Tel: +61-2-9684-7777

**MITSUBISHI ELECTRIC CORPORATION**

HEAD OFFICE: TOKYO BUILDING, 2-7-3 MARUNOUCHI, CHYODA-KU, TOKYO 100-8310, JAPAN  
NAGOYA WORKS: 1-14, YADA-MINAMI 5-CHOME, HIGASHI-KU, NAGOYA, JAPAN

When exported from Japan, this manual does not require application to the Ministry of Economy, Trade and Industry for service transaction permission.

Specifications subject to change without notice. Printed in Japan, June 2018.