



GT10-9PT5S Connection Conversion Adapter

User's Manual

Manual Number	JY997D35001G
Date	April 2018

This manual describes the part names, external dimensions, and specifications of the product. Before use, read this manual and manuals of relevant products fully to acquire proficiency in handling and operating the product. Make sure to learn all the product information, safety information, and precautions.

And, store this manual in a safe place so that you can take it out and read it whenever necessary. Always forward it to the end user.

Registration
The company name and the product name to be described in this manual are the registered trademarks or trademarks of each company



Effective April 2018
Specifications are subject to change without notice.
© 2009 MITSUBISHI ELECTRIC CORPORATION

Safety Precaution (Read these precautions before using.)

Before using this product, please read this manual and the relevant manuals introduced in this manual carefully and pay full attention to safety to handle the product correctly.

The precautions given in this manual are concerned with this product.

In this manual, the safety precautions are ranked as **WARNING** and **CAUTION**.

	Indicates that incorrect handling may cause hazardous conditions, resulting in death or severe injury.
	Indicates that incorrect handling may cause hazardous conditions, resulting in medium or slight personal injury or physical damage.

Depending on circumstances, procedures indicated by **CAUTION** may also be linked to serious results.
In any case, it is important to follow the directions for usage.

MOUNTING PRECAUTIONS 

- Use the connection conversion adapter in the environment that satisfies the general specifications described in this manual. Not doing so can cause an electric shock, fire, malfunction or product damage or deterioration.

OPERATION PRECAUTIONS 

- Power OFF the GOT, and then connect securely the connection conversion adapter to the specified connector in the GOT.
- Poor connection may cause malfunction.
- Remove static electricity charged in the human body before handling the connection conversion adapter.
- Static electricity may damage the stored data and elements.

DISPOSAL PRECAUTIONS 

- When disposing of the product, handle it as industrial waste.

Related Manuals

The following manuals are relevant to this product. When these loose manuals are required please consult with our local distributor.

Manual name	Manual Number (Model Code)	Contents
GOT2000 Series User's Manual (Hardware)	SH-081194ENG (1D7MJ5)	Describes the GOT hardware relevant content such as part names, external dimensions, mounting, power supply wiring, specifications, and introduction to option devices
GOT2000 Series Handy GOT Connection Manual For GT Works3 Version1	SH-081867ENG (1D7MS9)	Describes system configurations of the connection method applicable to GOT2000 Series Handy GOT and cable creation method
GT10 User's Manual	JY997D24701 (09R819)	Describes the GT10 hardware-relevant content such as part names, external dimensions, mounting, wiring, specifications, and introduction to option devices. (sold separately)
GT11 User's Manual	JY997D17501 (09R815)	Describes the GT11 hardware-relevant content such as part names, external dimensions, mounting, wiring, specifications, and introduction to option devices. (sold separately)
GOT1000 Series Connection Manual 1/3, 2/3, 3/3	SH-080532ENG (1D7M26)	Describes system configurations of the connection method applicable to GOT1000 series and cable creation method. (sold separately)
GOT1000 Series Connection Manual (Mitsubishi Products) for GT Works3	SH-080868ENG (1D7MC2)	Describes system configurations of the connection method applicable to GOT1000 series and cable creation method. (sold separately)

Referenced Standard: GB/T15969.2 (Requirement of Chinese standardized law)

1. Overview

The connection conversion adapter GT10-9PT5S (hereinafter referred to as "connection conversion adapter") is designed to be attached to the GOT for facilitate crossover wiring in GOT multi-drop connection.
The following GOT models support the connection conversion adapter connection.

	GOT	Hardware version
GOT 2000	GT2505-VTBD, GT2105-QTBDS, GT2105-QMBDS	-
GOT 1000	GT1455-QTBDE, GT1450-QLBDE, GT1455-QTBD, GT1450-QLBD	Version A or later
	GT1155-QTBD	Version C or later
	GT1155-QSBD, GT1150-QLBD	Version F or later
	GT1055-QSBD, GT1050-QBBD	Version C or later
	GT1045-QSBD, GT1040-QBBD	Version A or later

For the confirming method of hardware version, refer to user's manual.

2. Part Names and External Dimensions

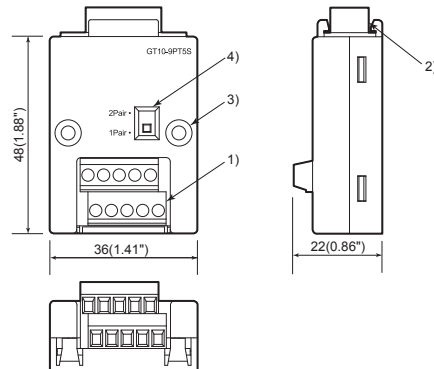

Unit: mm(inch)

No.	Name	Contents
1)	Multi-drop connection terminal block	2 step type terminal block 5-pin
2)	GOT connector	D-Sub 9-pin male
3)	Fixing screw hole	M3 tapping screws (accessory)
4)	1pair/2pair signal selection switch	1Pair/2Pair

3. Specifications

3.1 General Specifications

Item	Specifications
Operating ambient temperature	0 to 55°C
Storage ambient temperature	-20 to 60°C
Operating/Storage ambient humidity	10 to 90% RH, non-condensing
Operating atmosphere	Must be free of lamp black, corrosive gas, flammable gas, or excessive amount of electro conductive dust particles and must not be exposed to direct sunlight (during operation and storage).

4. Pin assignment

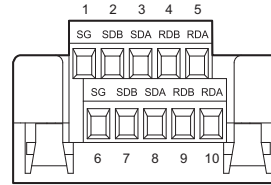

Tightening torque: 0.22 to 0.25N·m

Pin No.	Signal name	Pin No.	Signal name
1	SG	6	SG
2	SDB	7	SDB
3	SDA	8	SDA
4	RDB	9	RDB
5	RDA	10	RDA

5. Installation

1) Connect the connection conversion adapter to the RS-422/485 interface on the GOT.

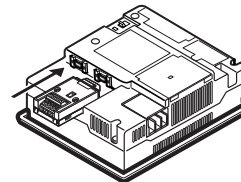

2) Fix the connection conversion adapter to the GOT using the provided M3 tapping screws.
Tightening torque : 0.3 to 0.6 N·m

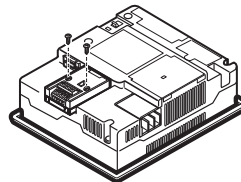

6. Wiring

This paragraph describes connection between the connection conversion adapter and the serial multi-drop connection unit.
For details of GOT multi-drop connection, refer to the GOT1000 Series Connection Manual.

6.1 1 pair wiring

Set the 1pair/2pair signal selection switch to "1Pair" when using the connection conversion adapter.

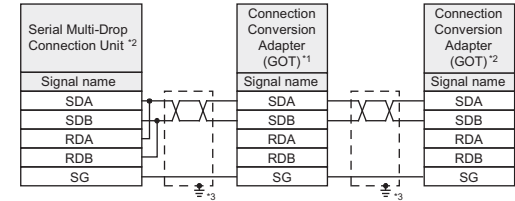

*1 Set the terminating resistor selector to "OPEN".

*2 Set the terminating resistor selector to "110Ω".

*3 Make sure to ground a cable shield line by applying Class D Grounding (100Ω or less).

6.2 2 pair wiring

Set the 1pair/2pair signal selection switch to "2Pair" when using the connection conversion adapter.

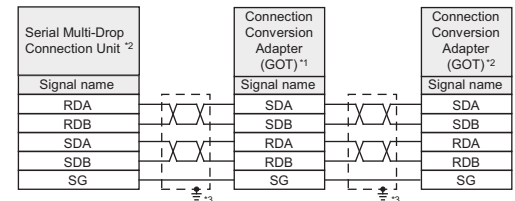

*1 Set the terminating resistor selector to "OPEN".

*2 Set the terminating resistor selector to "330Ω".

*3 Make sure to ground a cable shield line by applying Class D Grounding (100Ω or less).

This manual confers no industrial property rights or any rights of any other kind, nor does it confer any patent licenses. Mitsubishi Electric Corporation cannot be held responsible for any problems involving industrial property rights which may occur as a result of using the contents noted in this manual.

Warranty

Mitsubishi will not be held liable for damage caused by factors found not to be the cause of Mitsubishi; opportunity loss or lost profits caused by faults in the Mitsubishi products; damage, secondary damage, accident compensation caused by special factors unpredictable by Mitsubishi; damages to products other than Mitsubishi products; and to other duties.

For safe use

- This product has been manufactured as a general-purpose part for general industries, and has not been designed or manufactured to be incorporated in a device or system used in purposes related to human life.
- Before using the product for special purposes such as nuclear power, electric power, aerospace, medicine or passenger movement vehicles, consult with Mitsubishi Electric.
- This product has been manufactured under strict quality control. However when installing the product where major accidents or losses could occur if the product fails, install appropriate backup or failsafe functions in the system.