

GRAPHIC OPERATION TERMINAL

GOT1000

GT10 User's Manual



● SAFETY PRECAUTIONS ●

(Always read these precautions before using this equipment.)

Before using this product, please read this manual and the relevant manuals introduced in this manual carefully and pay full attention to safety to handle the product correctly.

The precautions given in this manual are concerned with this product.

In this manual, the safety precautions are ranked as "WARNING" and "CAUTION".



Indicates that incorrect handling may cause hazardous conditions, resulting in death or severe injury.



Indicates that incorrect handling may cause hazardous conditions, resulting in medium or slight personal injury or physical damage.

Note that the  caution level may lead to a serious accident according to the circumstances. Always follow the instructions of both levels because they are important to personal safety.

Please save this manual to make it accessible when required and always forward it to the end user.

[DESIGN PRECAUTIONS]

WARNING

- Some failures of the GOT or cable may keep the outputs on or off.
Some failures of a touch panel may cause malfunction of the input objects such as a touch switch.
An external monitoring circuit should be provided to check for output signals which may lead to a serious accident.
Not doing so can cause an accident due to false output or malfunction.
- If a communication fault (including cable disconnection) occurs during monitoring on the GOT, communication between the GOT and PLC CPU is suspended and the GOT becomes inoperative.
A system where the GOT is used should be configured to perform any significant operation to the system by using the switches of a device other than the GOT on the assumption that a GOT communication fault will occur.
Not doing so can cause an accident due to false output or malfunction.
- Do not use the GOT as the warning device that may cause a serious accident.
An independent and redundant hardware or mechanical interlock is required to configure the device that displays and outputs serious warning.
Failure to observe this instruction may result in an accident due to incorrect output or malfunction.

[DESIGN PRECAUTIONS]

WARNING

- Incorrect operation of the touch switch(s) may lead to a serious accident if the GOT backlight is gone out.

When the GOT backlight goes out, the display section dims, while the input of the touch switch(s) remains active.

This may confuse an operator in thinking that the GOT is in "screensaver" mode, who then tries to release the GOT from this mode by touching the display section, which may cause a touch switch to operate.

Note that the following occurs on the GOT when the backlight goes out.

<When using the GT105□>

The POWER LED blinks (green/orange) and the monitor screen appears blank.

<When using the GT104□>

The monitor screen appears blank.

<When using the GT103□ or GT102□>

The monitor screen appears dimmed.

CAUTION

- Do not bundle the control and communication cables with main-circuit, power or other wiring. Run the above cables separately from such wiring and keep them a minimum of 100mm (3.94in.) apart. Not doing so noise can cause a malfunction.
- Do not press the GOT display section with a pointed material as a pen or driver. Doing so can result in a damage or failure of the display section.
- Before connecting to GOT, turn ON the controller to enable the communication. When the communication of controller is not available, a communication error may occur in GOT.

[MOUNTING PRECAUTIONS]

WARNING

- Be sure to shut off all phases of the external power supply used by the system before mounting or removing the GOT to/from the panel. Not doing so can cause the unit to fail or malfunction.
- When installing the battery or memory board wear an earth band etc. to avoid the static electricity. The static electricity can cause the unit to fail or malfunction.
- Be sure to shut off all phases of the external power supply used by the system before mounting or removing the memory board on to/ from the GOT. Not doing so can cause the unit to fail or malfunction.

 **CAUTION**

- Use the GOT in the environment that satisfies the general specifications described in this manual. Not doing so can cause an electric shock, fire, malfunction or product damage or deterioration.
- When mounting the GOT to the control panel, tighten the mounting screws in the specified torque range.
Undertightening can cause the GOT to drop, short circuit or malfunction, and deteriorate the waterproof effect and oilproof effect.
Overtightening can cause a drop, short circuit or malfunction due to the damage of the screws or the GOT, and deteriorate the waterproof effect and oilproof effect due to distortion of the protective cover for oil, GOT or panel.
- Securely connect the memory board to the connector provided for the board.
- When using the GOT in the environment of oil or chemicals, use the protective cover for oil. Failure to do so may cause failure or malfunction due to the oil or chemical entering into the GOT.

[WIRING PRECAUTIONS]

 **WARNING**

- Be sure to shut off all phases of the external power supply used by the system before wiring. Failure to do so may result in an electric shock, product damage or malfunctions.
- Please make sure to ground FG terminal of the GOT power supply section by applying 100Ω or less which is used exclusively for the GOT.
Not doing so may cause an electric shock or malfunction.
- Correctly wire the GOT power supply section after confirming the rated voltage and terminal arrangement of the product.
Not doing so can cause a fire or failure.
- Tighten the terminal screws of the GOT power supply section in the specified torque range. Undertightening can cause a short circuit or malfunction.
Overtightening can cause a short circuit or malfunction due to the damage of the screws or the GOT.
- Exercise care to avoid foreign matter such as chips and wire offcuts entering the GOT.
Not doing so can cause a fire, failure or malfunction.

 **CAUTION**

- Plug the communication cable into the connector of the connected unit and tighten the mounting and terminal screws in the specified torque range.
Undertightening can cause a short circuit or malfunction.
Overtightening can cause a short circuit or malfunction due to the damage of the screws or unit.

[TEST OPERATION PRECAUTIONS]

WARNING

- Before performing the test operations of the user creation monitor screen (such as turning ON or OFF bit device, changing the word device current value, changing the settings or current values of the timer or counter), read through the manual carefully and make yourself familiar with the operation method.

During test operation, never change the data of the devices which are used to perform significant operation for the system.

False output or malfunction can cause an accident.

[STARTUP/MAINTENANCE PRECAUTIONS]

WARNING

- When power is on, do not touch the terminals.
Doing so can cause an electric shock or malfunction.
- Connect the battery correctly.
Do not discharge, disassemble, heat, short, solder or throw the battery into the fire.
Incorrect handling may cause the battery to generate heat, burst or take fire, resulting in injuries or fires.
- Before starting cleaning or terminal screw retightening, always switch off the power externally in all phases.
Not switching the power off in all phases can cause a unit failure or malfunction.
Undertightening can cause a short circuit or malfunction.
Overtightening can cause a short circuit or malfunction due to the damage of the screws or unit.

CAUTION

- Do not disassemble or modify the unit.
Doing so can cause a failure, malfunction, injury or fire.
- Do not touch the conductive and electronic parts of the unit directly.
Doing so can cause a unit malfunction or failure.
- The cables connected to the unit must be run in ducts or clamped.
Not doing so can cause the unit or cable to be damaged due to the dangling, motion or accidental pulling of the cables or can cause a malfunction due to a cable connection fault.
- When unplugging the cable connected to the unit, do not hold and pull the cable portion.
Doing so can cause the unit or cable to be damaged or can cause a malfunction due to a cable connection fault.
- Do not drop or apply any impact to the battery.
If any impact has been applied, discard the battery and never use it.
The battery may be damaged by the drop or impact.
- Before touching the unit, always touch grounded metal, etc. to discharge static electricity from human body, etc.
Not doing so can cause the unit to fail or malfunction.
- Replace battery with GT11-50BAT by Mitsubishi electric Co. only.
Use of another battery may present a risk of fire or explosion.
- Dispose of used battery promptly.
Keep away from children. Do not disassemble and do not dispose of in fire.

[DISPOSAL PRECAUTIONS]

CAUTION

- When disposing of the product, handle it as industrial waste.
When disposing of batteries, separate them from other wastes according to the local regulations.
(For details of the battery directive in EU member states, refer to 18.4 .)

[TOUCH PANEL PRECAUTIONS]

CAUTION

- For the analog-resistive film type touch panels, normally the adjustment is not required. However, the difference between a touched position and the object position may occur as the period of use elapses. When any difference between a touched position and the object position occurs, execute the touch panel calibration.
- When any difference between a touched position and the object position occurs, other object may be activated. This may cause an unexpected operation due to incorrect output or malfunction.

[TRANSPORTATION PRECAUTIONS]

CAUTION

- When transporting lithium batteries, make sure to treat them based on the transport regulations. (Refer to Appendix 3 for details of the regulated units.)
- Before transporting the GOT, turn the GOT power on and check that the battery voltage status is normal on the Time setting & display screen (utilities screen). In addition, confirm that the adequate battery life remains on the rating plate.
Transporting the GOT with the low battery voltage or the battery the reached battery life may unstabilize the backup data unstable during transportation.
- Make sure to transport the GOT main unit and/or relevant unit(s) in the manner they will not be exposed to the impact exceeding the impact resistance described in the general specifications of this manual, as they are precision devices.
Failure to do so may cause the unit to fail.
Check if the unit operates correctly after transportation.

REVISIONS

The manual number is given on the bottom left of the back cover.

Print Date	Manual Number	Ver.	Revision
Nov., 2006	JY997D24701	A	First edition
Jun., 2007	JY997D24701	B	<p>Partial correcting</p> <p>SAFETY PRECAUTIONS, ABBREVIATIONS AND GENERIC TERMS IN THIS MANUAL, HOW TO READ THIS MANUAL, Section 1.1, 2.2, 3.2, 3.3, Chapter 4, Section 6.2, 6.3, 7.1, 8.1, 8.2, Chapter 9, Section 11.1, Chapter 12, 13, Section 14.1, Chapter 15, Section 16.2, App - 1, App - 2, App - 4</p> <p>Additions</p> <p>Section 8.3, 16.4, App - 3</p>
Dec., 2007	JY997D24701	C	<p>Partial correcting</p> <p>SAFETY PRECAUTIONS, ABBREVIATIONS AND GENERIC TERMS IN THIS MANUAL, HOW TO READ THIS MANUAL, Section 3.2, 9.1, 11.2.3, Chapter 12, App-4</p>
Feb., 2008	JY997D24701	D	<p>Partial correcting</p> <p>ABBREVIATIONS AND GENERIC TERMS IN THIS MANUAL, HOW TO READ THIS MANUAL, Chapter 2, Section 8.2, Chapter 11, Section 15.2, App-1, App-4, Index-1</p> <p>Additions</p> <p>Section 8.4</p>
Oct., 2008	JY997D24701	E	<p>Partial correcting</p> <p>ABBREVIATIONS AND GENERIC TERMS IN THIS MANUAL, HOW TO READ THIS MANUAL, Chapter 1, Chapter 2, Chapter 3, Chapter 4, Chapter 5, Chapter 6, Chapter 7, Chapter 8, Chapter 9, Chapter 11, Chapter 12, Chapter 13, Chapter 14, Chapter 17, Chapter 18, App-1, App-2, Index</p> <p>Additions</p> <p>Chapter 15, 16</p>
Dec., 2008	JY997D24701	F	<p>Partial correcting</p> <p>ABBREVIATIONS AND GENERIC TERMS IN THIS MANUAL, HOW TO READ THIS MANUAL, Section 1.1, Chapter 2, Chapter 3, Chapter 4, Chapter 5, Chapter 6, Chapter 7, Chapter 8, Chapter 9, Chapter 11, Chapter 12, Chapter 13, Chapter 14, Chapter 15, Chapter 17, Chapter 18, App-1, App-2, App-4</p> <p>Additions</p> <p>Section 11.1.4, Section 11.1.5, Section 14.3</p>
Jan., 2009	JY997D24701	G	<p>Partial correcting</p> <p>Section 7.1.2</p>

Print Date	Manual Number	Ver.	Revision
Mar., 2009	JY997D24701	H	<div style="border: 1px solid black; padding: 2px; display: inline-block;">Partial correcting</div> SAFETY PRECAUTIONS, ABBREVIATIONS AND GENERIC TERMS, HOW TO READ THIS MANUAL, Chapter 2, Section 3.1, 3.2, Section 4.2, Section 8.3, Section 9.1, Section 12.1, Section 18.4, App-1, App-2, App-4, Index <div style="border: 1px solid black; padding: 2px; display: inline-block;">Additions</div> Section 8.8, Section 8.9
Aug., 2009	JY997D24701	J	<div style="border: 1px solid black; padding: 2px; display: inline-block;">Partial correcting</div> ABBREVIATIONS AND GENERIC TERMS, HOW TO READ THIS MANUAL, Section 2.2, Chapter 3, Chapter 4, Chapter 5, Section 7.1, Section 8.8, Section 11.1, App-4
Oct., 2009	JY997D24701	K	<div style="border: 1px solid black; padding: 2px; display: inline-block;">Partial correcting</div> ABBREVIATIONS AND GENERIC TERMS, ABOUT MANUALS, HOW TO READ THIS MANUAL, Chapter 1, Section 2.2, Chapter 3, Chapter 8, Chapter 9, Chapter 11, Chapter 12, Chapter 15, Chapter 17, Chapter 18, App-2 <div style="border: 1px solid black; padding: 2px; display: inline-block;">Additions</div> Section 11.1.6, Section 11.1.7, Section 15.3
Apr., 2010	JY997D24701	L	<div style="border: 1px solid black; padding: 2px; display: inline-block;">Partial correcting</div> SAFETY PRECAUTIONS, ABBREVIATIONS AND GENERIC TERMS, Chapter 2, Chapter 3, Chapter 4, Chapter 5, Chapter 8, Chapter 11, Chapter 15, Section 17.3, Index
Jun., 2010	JY997D24701	M	<div style="border: 1px solid black; padding: 2px; display: inline-block;">Partial correcting</div> ABBREVIATIONS AND GENERIC TERMS, HOW TO READ THIS MANUAL, Section 7.1, Section 8.2, Section 8.3, Section 8.4, Section 11.1.8, Section 17.2, App-4
Oct., 2010	JY997D24701	N	<div style="border: 1px solid black; padding: 2px; display: inline-block;">Partial correcting</div> ABBREVIATIONS AND GENERIC TERMS, HOW TO READ THIS MANUAL, Chapter 2, Chapter 3, Section 4.2, Section 5.1, Section 7.1, Chapter 8, Chapter 10, Section 11.1, App-1, Index <div style="border: 1px solid black; padding: 2px; display: inline-block;">Additions</div> Section 8.10
Jan., 2011	JY997D24701	P	<div style="border: 1px solid black; padding: 2px; display: inline-block;">Partial correcting</div> ABBREVIATIONS AND GENERIC TERMS, HOW TO READ THIS MANUAL, Section 4.2, Section 6.5, Section 9.2, Section 11.2, Section 12.2

Print Date	Manual Number	Ver.	Revision
Apr., 2011	JY997D24701	Q	<div style="border: 1px solid black; padding: 2px;">Partial correcting</div> SAFETY PRECAUTIONS, ABBREVIATIONS AND GENERIC TERMS, HOW TO READ THIS MANUAL, Section 2.2, Section 3.2, Section 6.2, Section 6.5, Section 8.7, Chapter 13, Section 15.2
Jul., 2011	JY997D24701	R	<div style="border: 1px solid black; padding: 2px;">Partial correcting</div> SAFETY PRECAUTIONS, ABBREVIATIONS AND GENERIC TERMS, HOW TO READ THIS MANUAL, Section 3.2, Chapter 6, Chapter 8
Jan., 2012	JY997D24701	S	<div style="border: 1px solid black; padding: 2px;">Partial correcting</div> ABBREVIATIONS AND GENERIC TERMS, HOW TO READ THIS MANUAL, Section 2.2, Section 3.2
Jun., 2012	JY997D24701	T	<div style="border: 1px solid black; padding: 2px;">Partial correcting</div> ABBREVIATIONS AND GENERIC TERMS, HOW TO READ THIS MANUAL, Section 2.1, Section 2.2, Section 3.1
Sep., 2012	JY997D24701	U	<div style="border: 1px solid black; padding: 2px;">Partial correcting</div> SAFETY PRECAUTIONS, Section 2.2.2, App-4 <div style="border: 1px solid black; padding: 2px;">Additions</div> Section 15.2.1, 15.2.7
Feb., 2013	JY997D24701	V	<div style="border: 1px solid black; padding: 2px;">Partial correcting</div> SAFETY PRECAUTIONS, Section 9.1, Section 15.1 <div style="border: 1px solid black; padding: 2px;">Additions</div> Section 15.4
Apr., 2013	JY997D24701	W	<div style="border: 1px solid black; padding: 2px;">Partial correcting</div> Section 5.1
Jun., 2013	JY997D24701	X	<div style="border: 1px solid black; padding: 2px;">Partial correcting</div> Section 15.3.15
Apr., 2015	JY997D24701	Y	<div style="border: 1px solid black; padding: 2px;">Partial correcting</div> A part of the cover design is changed.
Oct., 2022	JY997D24701	Z	Some corrections
Apr., 2023	JY997D24701	AA	Some corrections

This manual confers no industrial property rights or any rights of any other kind, nor does it confer any patent licenses. Mitsubishi Electric Corporation cannot be held responsible for any problems involving industrial property rights which may occur as a result of using the contents noted in this manual.

INTRODUCTION

Thank you for choosing the Mitsubishi Graphic Operation Terminal.

Before using the equipment, please read this manual carefully to use the equipment to its optimum.

OUTLINE PRECAUTIONS

- This manual provides information for the use of the graphic operation terminal. The manual has been written to be used by trained and competent personnel. The definition of such a person or persons is as follows;
 - 1) Any engineer who is responsible for the planning, design and construction of automatic equipment using the product associated with this manual should be of a competent nature, trained and qualified to the local and national standards required to fulfill that role. These engineers should be fully aware of all aspects of safety with regards to automated equipment.
 - 2) Any commissioning or service engineer must be of a competent nature, trained and qualified to the local and national standards required to fulfill that job. These engineers should also be trained in the use and maintenance of the completed product. This includes being completely familiar with all associated documentation for the said product. All maintenance should be carried out in accordance with established safety practices.
 - 3) All operators of the completed equipment should be trained to use that product in a safe and coordinated manner in compliance to established safety practices. The operators should also be familiar with documentation which is connected with the actual operation of the completed equipment.
- Note: the term 'completed equipment' refers to a third party constructed device which contains or uses the product associated with this manual.
- This product has been manufactured as a general-purpose part for general industries, and has not been designed or manufactured to be incorporated in a device or system used in purposes related to human life.
- Before using the product for special purposes such as nuclear power, electric power, aerospace, medicine or passenger movement vehicles, consult with Mitsubishi Electric.
- This product has been manufactured under strict quality control. However when installing the product where major accidents or losses could occur if the product fails, install appropriate backup or failsafe functions in the system.
- When using this product combining other products, please confirm the standard and the code, or regulation which a user should suit. Moreover, please confirm the compatibility of this product to the system, machine, and apparatus with which a user is used for user itself.
- If in doubt at any stage of the installation of the product always consult a professional electrical engineer who is qualified and trained to the local and national standards. If in doubt about the operation or use, please consult the nearest Mitsubishi Electric distributor.
- Since the example indicated by this manual, technical bulletin, the catalog, etc. is reference, please use it after confirming the function and safety of equipment and system when employing. Mitsubishi Electric will accept no responsibility for actual use of the product based on these illustrative examples.
- About this manual content, specification etc. may be changed without a notice for improvement.
- The information in this manual has been carefully checked and is believed to be accurate; however, you have noticed a doubtful point, a doubtful error, etc., please contact the nearest Mitsubishi Electric distributor.

CONTENTS

SAFETY PRECAUTIONS	A-1
REVISIONS.....	A-7
INTRODUCTION.....	A-10
OUTLINE PRECAUTIONS.....	A-10
CONTENTS	A-11
ABOUT MANUALS	A-17
ABBREVIATIONS AND GENERIC TERMS.....	A-18
HOW TO READ THIS MANUAL	A-23
1. OVERVIEW.....	1-1 to 1-5
1.1 Features	1-4
1.2 Rough Pre-operation Procedure	1-5
2. SYSTEM CONFIGURATION.....	2-1 to 2-11
2.1 Overall Configuration	2-1
2.2 Component List	2-3
2.2.1 GOT (GT10).....	2-5
2.2.2 Option (Optional components for GT10).....	2-6
3. SPECIFICATIONS	3-1 to 3-14
3.1 General Specifications	3-1
3.2 Performance Specifications	3-2
3.3 Power Supply Specifications.....	3-14
4. PART NAME.....	4-1 to 4-12
4.1 Front Panel.....	4-1
4.1.1 GT1020, GT1030.....	4-1
4.1.2 GT104[].....	4-1
4.1.3 GT105[].....	4-2
4.2 Back Panel	4-3
4.2.1 GT1020-L[]D/L[]DW	4-3
4.2.2 GT1020-L[]D2/L[]DW2	4-5
4.2.3 GT1020-L[]L/L[]LW	4-6
4.2.4 GT1030-L[]D/L[]DW/H[]D/H[]DW	4-7
4.2.5 GT1030-L[]D2/L[]DW2/H[]D2/H[]DW2	4-9
4.2.6 GT1030-L[]L/L[]LW/H[]L/H[]LW.....	4-10
4.2.7 GT1045-QSBD/GT1040-QBBD	4-11
4.2.8 GT1055-QSBD/GT1050-QBBD	4-12
5. UL, cUL STANDARDS AND EMC DIRECTIVE	5-1 to 5-3
5.1 UL, cUL Standards.....	5-1
5.2 EMC DIRECTIVE	5-1
5.2.1 Requirements for Conformance to EMC Directive.....	5-1

6. INSTALLATION.....	6-1 to 6-11
6.1 Control Panel Inside Dimensions for Mounting GOT.....	6-2
6.1.1 GT1020.....	6-2
6.1.2 GT1030.....	6-3
6.1.3 GT104[].....	6-4
6.1.4 GT105[].....	6-5
6.2 Panel Cutting Dimensions.....	6-6
6.2.1 Panel cutting dimensions.....	6-6
6.3 Mounting Position.....	6-7
6.3.1 Mounting position.....	6-7
6.4 Control Panel Temperature and Mounting Angle.....	6-9
6.4.1 Control panel temperature and mounting angle.....	6-9
6.5 Installation Procedure.....	6-10
6.5.1 Installation procedure.....	6-10
7. WIRING.....	7-1 to 7-9
7.1 Power Supply Wiring.....	7-2
7.1.1 Cable types and wire end processing (GT1020, GT1030, GT104[]).....	7-2
7.1.2 Cable types and wire end processing (GT105[]).....	7-3
7.1.3 Wiring example (GT1020, GT1030).....	7-3
7.1.4 Wiring example (GT104[]).....	7-4
7.1.5 Wiring example (GT105[]).....	7-4
7.1.6 GOT's ground.....	7-5
7.1.7 The cause of malfunctions related wiring/Remedy.....	7-6
7.2 Wiring inside and outside the panel.....	7-8
7.2.1 Wiring inside.....	7-8
7.2.2 Outside the panel.....	7-8
7.2.3 Attaching surge killers to control equipment.....	7-9
8. OPTION.....	8-1 to 8-34
8.1 Protective Sheet.....	8-1
8.1.1 Applicable protective sheet.....	8-1
8.1.2 Installing procedure.....	8-2
8.2 RS-232/USB conversion adaptor.....	8-3
8.2.1 Shape, dimensions, and names of adaptor components.....	8-3
8.2.2 Installing procedure.....	8-4
8.2.3 Driver installation.....	8-5
8.2.4 Method for uninstalling driver.....	8-16
8.3 Battery.....	8-17
8.3.1 Applicable battery.....	8-17
8.3.2 Battery specifications.....	8-17
8.3.3 Battery replacement procedure.....	8-18
8.4 Memory loader.....	8-20
8.4.1 Part name.....	8-21
8.4.2 Function specification.....	8-22
8.5 Memory board.....	8-24
8.5.1 Applicable memory board.....	8-24
8.5.2 Installing and removing procedures of the memory board.....	8-24

8.6 Stand	8-26
8.6.1 Applicable stand.....	8-26
8.6.2 Installing procedure.....	8-26
8.7 Protective cover for oil.....	8-27
8.7.1 Applicable protective cover for oil	8-27
8.7.2 Installing procedure.....	8-27
8.8 Serial Multi-Drop Connection Unit.....	8-29
8.8.1 Serial multi-drop connection unit.....	8-29
8.8.2 Applicable serial multi-drop connection unit.....	8-30
8.8.3 Part name	8-30
8.8.4 Installation.....	8-31
8.8.5 Caution for compliance with EMC Directive.....	8-31
8.9 Connector Conversion Adapter.....	8-32
8.9.1 Applicable connector conversion adapter	8-32
8.9.2 Installing procedure.....	8-32
8.10 Panel-Mounted USB Port Extension	8-33
8.10.1 Applicable panel-mounted USB port extension	8-33
8.10.2 Part name	8-33
8.10.3 Installing procedure.....	8-33

9. UTILITY FUNCTION 9-1 to 9-7

9.1 Utility Function List	9-1
9.2 Utility Display.....	9-3
9.2.1 Display operation of main menu	9-3
9.2.2 Utility basic configuration	9-6

10. LANGUAGE SETTING (Language)..... 10-1 to 10-2

10.1 Display language setting	10-1
10.1.1 Display language setting function	10-1
10.1.2 Language display operation.....	10-1
10.1.3 Language setting operation	10-1

11. COMMUNICATION INTERFACE SETTING (COMMUNICATION SETTING)..... 11-1 to 11-24

11.1 Standard I/F Setting	11-1
11.1.1 Standard I/F functions.....	11-1
11.1.2 Standard I/F display operation.....	11-1
11.1.3 Display contents of standard I/F	11-2
11.1.4 Detail information setting operation	11-6
11.1.5 Channel setting operation.....	11-9
11.1.6 Driver setting operation.....	11-10
11.1.7 AT command operation.....	11-11
11.1.8 Installing of communication driver.....	11-12
11.2 Data Transfer	11-13
11.2.1 Data transfer functions.....	11-13
11.2.2 Data transfer operation	11-13
11.2.3 Data transfer display	11-14
11.3 Communication Monitor	11-15
11.3.1 Communication Monitor functions.....	11-15
11.3.2 Communication Monitor display operation.....	11-15
11.3.3 Screen display content.....	11-16

11.4 Keyword.....	11-18
11.4.1 Keyword functions.....	11-18
11.4.2 Keyword display operation.....	11-18
11.4.3 Regist.....	11-19
11.4.4 Delete.....	11-22
11.4.5 Clear.....	11-23
11.4.6 Protect.....	11-24
12. DISPLAY AND OPERATION SETTINGS (GOT SET UP).....	12-1 to 12-16
12.1 Display Settings.....	12-2
12.1.1 Display setting functions.....	12-2
12.1.2 Display operation of display setting.....	12-3
12.1.3 Display setting operations.....	12-4
12.2 Operation Settings.....	12-8
12.2.1 Operation setting functions.....	12-8
12.2.2 Display operation of operation setting.....	12-9
12.2.3 Setting operation of operation.....	12-10
13. CLOCK SETTINGS AND BATTERY STATUS DISPLAY (TIME SETTING AND DISPLAY).....	13-1 to 13-2
13.1 Time Setting and Display.....	13-1
13.1.1 Time setting and display functions.....	13-1
13.1.2 Clock display and setting operation.....	13-1
13.1.3 Clock setting operations.....	13-2
14. FILE DISPLAY (DATA).....	14-1 to 14-10
14.1 Data Storage Location.....	14-1
14.2 OS Information.....	14-2
14.2.1 Function of OS information.....	14-2
14.2.2 Display operation of OS information screen.....	14-2
14.2.3 OS information operation.....	14-3
14.3 Font Data.....	14-4
14.3.1 Function of font data.....	14-4
14.3.2 Display operation of font data screen.....	14-4
14.3.3 Font data operation.....	14-5
14.4 Clear data.....	14-6
14.4.1 Clear data functions.....	14-6
14.4.2 Clear data display.....	14-6
14.4.3 Clear data operation.....	14-6
14.5 GT10-50FMB.....	14-7
14.5.1 GT10-50FMB functions (For GT104[], GT105[] only).....	14-7
14.5.2 GT10-50FMB display operation.....	14-7
14.5.3 GT10-50FMB operation.....	14-8
14.5.4 Error display.....	14-10

15. GOT DEBUG	15-1 to 15-48
15.1 Debug.....	15-1
15.2 Device Monitor	15-1
15.2.1 System configuration	15-1
15.2.2 Devices that can be monitored	15-2
15.2.3 Precautions	15-2
15.2.4 Display operation of device monitor.....	15-3
15.2.5 Information displayed on the device monitor screen and key functions.....	15-4
15.2.6 Basic operation of device monitor.....	15-6
15.2.7 Device registration	15-7
15.2.8 Quick test.....	15-10
15.3 FX List Editor (For GT104[], GT105[] only)	15-13
15.3.1 Display operation of FX list editor	15-13
15.3.2 Specifications.....	15-15
15.3.3 Access range	15-16
15.3.4 Precautions	15-17
15.3.5 Display	15-18
15.3.6 Operation Procedures.....	15-20
15.3.7 Selection and operation of modes	15-22
15.3.8 Sequence program display	15-23
15.3.9 Searching commands and devices	15-25
15.3.10 Writing commands	15-27
15.3.11 Changing operands, set values	15-30
15.3.12 Deleting commands	15-31
15.3.13 Sequence program all clear	15-32
15.3.14 PLC diagnostics	15-33
15.3.15 Parameter setting.....	15-35
15.3.16 Keywords	15-38
15.3.17 List monitor	15-40
15.3.18 Action for an incorrect key input.....	15-42
15.3.19 Error Messages and Corrective Actions	15-42
15.4 FX3U-ENET-ADP Communication Setting Function.....	15-43
15.4.1 SPECIFICATIONS	15-43
15.4.2 Display Operation of FX3U-ENET-ADP Communication Setting Function.....	15-45
15.4.3 Setting operation.....	15-46
16. CLEANING OF DISPLAY SECTION (CLEAN)	16-1
16.1 Clean	16-1
16.1.1 Display operation of clean.....	16-1
17. OS INSTALLATION.....	17-1 to 17-4
17.1 About the OS.....	17-1
17.2 Standard monitor OS/Communication Driver Installation.....	17-1
17.3 Standard Monitor OS/Communication Driver Installation Using Memory Board	17-3
17.3.1 Installation method when the GOT is turned on.....	17-3
18. MAINTENANCE AND INSPECTION.....	18-1 to 18-6
18.1 Daily Inspection	18-2
18.2 Periodic Inspection	18-2
18.3 Cleaning Method	18-3
18.4 Battery Voltage Low Detection and Battery Replacement	18-4

18.5 Backlight Shutoff Detection 18-6
18.5.1 Backlight shutoff detection and external alarm 18-6

APPENDICESApp-1 to App-15

Appendix 1 External Dimensions App- 1
Appendix 2 Usage Condition of Utility Function App- 12
Appendix 3 Transportation Precautions App- 14
Appendix 4 List of Functions Added by GT Designer2 Version Upgrade
(For GOT1000 Series) App- 15

INDEXIndex-1

ABOUT MANUALS

The following manuals are also related to this product.
In necessary, order them by quoting the details in the tables below.

Related Manuals

Manual Name	Manual Number
GT Designer2 Version2 Basic Operation/Data Transfer Manual (For GOT1000 Series) ^{*1} Describes methods of the GT Designer2 installation operation, basic operation for drawing and transmitting data to GOT1000 series	SH-080529ENG
GT Designer2 Version2 Screen Design Manual (For GOT1000 Series) 1/3 ^{*1} GT Designer2 Version2 Screen Design Manual (For GOT1000 Series) 2/3 ^{*1} GT Designer2 Version2 Screen Design Manual (For GOT1000 Series) 3/3 ^{*1} Describes specifications and settings of the object functions used in GT Designer2	SH-080530ENG
GOT1000 Series Connection Manual (1/3, 2/3, 3/3) ^{*1} Describes system configurations of the connection method applicable to GOT1000 series and cable creation method	SH-080532ENG
GT Designer3 Version1 Screen Design Manual (For GOT1000 Series) (Fundamentals)1/2, 2/2 ^{*1} Describes methods of the GT Designer3 installation operation, basic operation for drawing and transmitting data to GOT1000 series	SH-080866ENG
GT Designer3 Version1 Screen Design Manual (For GOT1000 Series) (Functions) 1/2 ^{*1} GT Designer3 Version1 Screen Design Manual (For GOT1000 Series) (Functions) 2/2 ^{*1} Describes methods of the GT Designer3 installation operation, basic operation for drawing and transmitting data to GOT1000 series	SH-080867ENG
GOT1000 Series Connection Manual (Mitsubishi Products) for GT Works3 ^{*1} Describes system configurations of the connection method applicable to GOT1000 series and cable creation method	SH-080868ENG
GOT1000 Series Connection Manual (Non-Mitsubishi Products 1) for GT Works3 ^{*1} Describes system configurations of the connection method applicable to GOT1000 series and cable creation method	SH-080869ENG
GOT1000 Series Connection Manual (Non-Mitsubishi Products 2) for GT Works3 ^{*1} Describes system configurations of the connection method applicable to GOT1000 series and cable creation method	SH-080870ENG
GOT1000 Series Connection Manual (Microcomputer, MODBUS Products, Peripherals) for GT Works3 ^{*1} Describes system configurations of the connection method applicable to GOT1000 series and cable creation method	SH-080871ENG
GOT1000 Series Connection Manual (α2 Connection) for GT Works3 ^{*1} Describes system configurations of the connection method applicable to GOT1000 series and cable creation method	JY997D39201

*1 Contact your local distributor.

ABBREVIATIONS AND GENERIC TERMS

■ GOT

Abbreviations and generic terms		Description
GT1695	GT1695M-X	Abbreviation of GT1695M-XTBA, GT1695M-XTBD
GT1685	GT1685M-S	Abbreviation of GT1685M-STBA, GT1685M-STBD
GT1675	GT1675M-S	Abbreviation of GT1675M-STBA, GT1675M-STBD
	GT1675M-V	Abbreviation of GT1675M-VTBA, GT1675M-VTBD
	GT1675-VN	Abbreviation of GT1675-VNBA, GT1675-VNBD
GT1672	GT1672-VN	Abbreviation of GT1672-VNBA, GT1672-VNBD
GT1665	GT1665M-S	Abbreviation of GT1665M-STBA, GT1665M-STBD
	GT1665M-V	Abbreviation of GT1665M-VTBA, GT1665M-VTBD
GT1662	GT1662-VN	Abbreviation of GT1662-VNBA, GT1662-VNBD
GT1655	GT1655-V	Abbreviation of GT1655-VTBD
GT16		Abbreviation of GT1695, GT1685, GT1675, GT1672, GT1665, GT1662, GT1655, GT16 Handy GOT
GT1595	GT1595-X	Abbreviation of GT1595-XTBA, GT1595-XTBD
GT1585	GT1585V-S	Abbreviation of GT1585V-STBA, GT1585V-STBD
	GT1585-S	Abbreviation of GT1585-STBA, GT1585-STBD
GT157□	GT1575V-S	Abbreviation of GT1575V-STBA, GT1575V-STBD
	GT1575-S	Abbreviation of GT1575-STBA, GT1575-STBD
	GT1575-V	Abbreviation of GT1575-VTBA, GT1575-VTBD
	GT1575-VN	Abbreviation of GT1575-VNBA, GT1575-VNBD
	GT1572-VN	Abbreviation of GT1572-VNBA, GT1572-VNBD
GT156□	GT1565-V	Abbreviation of GT1565-VTBA, GT1565-VTBD
	GT1562-VN	Abbreviation of GT1562-VNBA, GT1562-VNBD
GT155□	GT1555-V	Abbreviation of GT1555-VTBD
	GT1555-Q	Abbreviation of GT1555-QTBD, GT1555-QSBD
	GT1550-Q	Abbreviation of GT1550-QLBD
GT15		Abbreviation of GT1595, GT1585, GT157□, GT156□, GT155□
GT145□	GT1455-Q	Abbreviation of GT1455-QTBDE, GT1455-QTBD
	GT1450-Q	Abbreviation of GT1450-QLBDE, GT1450-QLBD
GT14		Abbreviation of GT1455-Q, GT1450-Q
GT1275	GT1275-V	Abbreviation of GT1275-VNBA, GT1275-VNBD
GT1265	GT1265-V	Abbreviation of GT1265-VNBA, GT1265-VNBD
GT12		Abbreviation of GT1275, GT1265
GT115□	GT1155-Q	Abbreviation of GT1155-QTBDQ, GT1155-QSBDQ, GT1155-QTBDA, GT1155-QSBDA, GT1155-QTBD, GT1155-QSBD
	GT1150-Q	Abbreviation of GT1150-QLBDQ, GT1150-QLBDA, GT1150-QLBD
GT11		Abbreviation of GT115□, GT11 Handy GOT,
GT105□	GT1055-Q	Abbreviation of GT1055-QSBD
	GT1050-Q	Abbreviation of GT1050-QBBD
GT104□	GT1045-Q	Abbreviation of GT1045-QSBD
	GT1040-Q	Abbreviation of GT1040-QBBD
GT1030		Abbreviation of GT1030-LBD, GT1030-LBD2, GT1030-LBL, GT1030-LBDW, GT1030-LBDW2, GT1030-LBLW, GT1030-LWD, GT1030-LWD2, GT1030-LWL, GT1030-LWDW, GT1030-LWDW2, GT1030-LWLW, GT1030-HBD, GT1030-HBD2, GT1030-HBL, GT1030-HBDW, GT1030-HBDW2, GT1030-HBLW, GT1030-HWD, GT1030-HWD2, GT1030-HWL, GT1030-HWDW, GT1030-HWDW2, GT1030-HWLW

(Continued to next page)

Abbreviations and generic terms		Description	
GOT1000 Series	GT1020	Abbreviation of GT1020-LBD, GT1020-LBD2, GT1020-LBL, GT1020-LBDW, GT1020-LBDW2, GT1020-LBLW, GT1020-LWD, GT1020LWD2, GT1020-LWL, GT1020-LWDW, GT1020-LWDW2, GT1020-LWLW	
	GT10	Abbreviation of GT105□, GT104□, GT1030, GT1020	
	Handy GOT	GT16 Handy GOT GT1665HS-V	Abbreviation of GT1665HS-VTBD
		GT11 Handy GOT	GT1155HS-Q
			GT1150HS-Q
GT SoftGOT1000		Abbreviation of GT SoftGOT1000	
GOT900 Series		Abbreviation of GOT-A900 series, GOT-F900 series	
GOT800 Series		Abbreviation of GOT-800 series	

■ Communication unit

Abbreviations and generic terms	Description
Bus connection unit	GT15-QBUS, GT15-QBUS2, GT15-ABUS, GT15-ABUS2, GT15-75QBUSL, GT15-75QBUS2L, GT15-75ABUSL, GT15-75ABUS2L
Serial communication unit	GT15-RS2-9P, GT15-RS4-9S, GT15-RS4-TE
RS-422 conversion unit	GT15-RS2T4-9P, GT15-RS2T4-25P
Ethernet communication unit	GT15-J71E71-100
MELSECNET/H communication unit	GT15-J71LP23-25, GT15-J71BR13
MELSECNET/10 communication unit	GT15-75J71LP23-Z ^{*1} , GT15-75J71BR13-Z ^{*2}
CC-Link IE Controller Network communication unit	GT15-J71GP23-SX
CC-Link IE Field Network communication unit	GT15-J71GF13-T2
CC-Link communication unit	GT15-J61BT13, GT15-75J61BT13-Z ^{*3}
Interface converter unit	GT15-75IF900
Serial multi-drop connection unit	GT01-RS4-M
Connection Conversion Adapter	GT10-9PT5S
RS-232/485 signal conversion adapter	GT14-RS2T4-9P

*1 A9GT-QJ71LP23 + GT15-75IF900 set

*2 A9GT-QJ71BR13 + GT15-75IF900 set

*3 A8GT-J61BT13 + GT15-75IF900 set

■ Option unit

Abbreviations and generic terms	Description	
Printer unit	GT15-PRN	
Video/RGB unit	Video input unit	GT16M-V4, GT15V-75V4
	RGB input unit	GT16M-R2, GT15V-75R1
	Video/RGB input unit	GT16M-V4R1, GT15V-75V4R1
	RGB output unit	GT16M-ROUT, GT15V-75ROUT
Multimedia unit	GT16M-MMR	
CF card unit	GT15-CFCD	
CF card extension unit ^{*1}	GT15-CFEX-C08SET	
External I/O unit	GT15-DIO, GT15-DIOR	
Sound output unit	GT15-SOUT	

*1 GT15-CFEX + GT15-CFEXIF + GT15-C08CF set.

■ Option

Abbreviations and generic terms		Description
Memory card	CF card	GT05-MEM-16MC, GT05-MEM-32MC, GT05-MEM-64MC, GT05-MEM-128MC, GT05-MEM-256MC, GT05-MEM-512MC, GT05-MEM-1GC, GT05-MEM-2GC, GT05-MEM-4GC, GT05-MEM-8GC, GT05-MEM-16GC
	SD card	L1MEM-2GBSD, L1MEM-4GBSD
Memory card adaptor		GT05-MEM-ADPC
Option function board		GT16-MESB, GT15-FNB, GT15-QFNB, GT15-QFNB16M, GT15-QFNB32M, GT15-QFNB48M, GT11-50FNB, GT15-MESB48M
Battery		GT15-BAT, GT11-50BAT
Protective Sheet	For GT16	GT16-90PSCB, GT16-90PSGB, GT16-90PSCW, GT16-90PSGW, GT16-80PSCB, GT16-80PSGB, GT16-80PSCW, GT16-80PSGW, GT16-70PSCB, GT16-70PSGB, GT16-70PSCW, GT16-70PSGW, GT16-60PSCB, GT16-60PSGB, GT16-60PSCW, GT16-60PSGW, GT16-50PSCB, GT16-50PSGB, GT16-50PSCW, GT16-50PSGW, GT16-90PSCB-012, GT16-80PSCB-012, GT16-70PSCB-012, GT16-60PSCB-012, GT16-50PSCB-012, GT16H-60PSC
	For GT15	GT15-90PSCB, GT15-90PSGB, GT15-90PSCW, GT15-90PSGW, GT15-80PSCB, GT15-80PSGB, GT15-80PSCW, GT15-80PSGW, GT15-70PSCB, GT15-70PSGB, GT15-70PSCW, GT15-70PSGW, GT15-60PSCB, GT15-60PSGB, GT15-60PSCW, GT15-60PSGW, GT15-50PSCB, GT15-50PSGB, GT15-50PSCW, GT15-50PSGW
	For GT14	GT14-50PSCB, GT14-50PSGB, GT14-50PSCW, GT14-50PSGW
	For GT12	GT11-70PSCB, GT11-65PSCB
	For GT11	GT11-50PSCB, GT11-50PSGB, GT11-50PSCW, GT11-50PSGW, GT11H-50PSC
	For GT10	GT10-50PSCB, GT10-50PSGB, GT10-50PSCW, GT10-50PSGW, GT10-40PSCB, GT10-40PSGB, GT10-40PSCW, GT10-40PSGW, GT10-30PSCB, GT10-30PSGB, GT10-30PSCW, GT10-30PSGW, GT10-20PSCB, GT10-20PSGB, GT10-20PSCW, GT10-20PSGW
Protective cover for oil		GT05-90PCO, GT05-80PCO, GT05-70PCO, GT05-60PCO, GT05-50PCO, GT16-50PCO, GT10-40PCO, GT10-30PCO, GT10-20PCO
USB environmental protection cover		GT16-UCOV, GT16-50UCOV, GT15-UCOV, GT14-50UCOV, GT11-50UCOV
Stand		GT15-90STAND, GT15-80STAND, GT15-70STAND, A9GT-50STAND, GT05-50STAND
Attachment		GT15-70ATT-98, GT15-70ATT-87, GT15-60ATT-97, GT15-60ATT-96, GT15-60ATT-87, GT15-60ATT-77, GT15-50ATT-95W, GT15-50ATT-85
Backlight		GT16-90XLTT, GT16-80SLTT, GT16-70SLTT, GT16-70VLTT, GT16-70VLTTA, GT16-70VLTN, GT16-60SLTT, GT16-60VLTT, GT16-60VLTN, GT15-90XLTT, GT15-80SLTT, GT15-70SLTT, GT15-70VLTT, GT15-70VLTN, GT15-60VLTT, GT15-60VLTN
Multi-color display board		GT15-XHNB, GT15-VHNB
Connector conversion box		GT11H-CNB-37S, GT16H-CNB-42S
Emergency stop sw guard cover		GT11H-50ESCOV, GT16H-60ESCOV
Memory loader		GT10-LDR
Memory board		GT10-50FMB
Panel-mounted USB port extension		GT14-C10EXUSB-4S, GT10-C10EXUSB-5S

■ Software

Abbreviations and generic terms	Description
GT Works3	Abbreviation of the SW□DNC-GTWK3-E and SW□DNC-GTWK3-EA
GT Designer3	Abbreviation of screen drawing software GT Designer3 for GOT1000 series
GT Simulator3	Abbreviation of screen simulator GT Simulator3 for GOT1000/GOT900 series
GT SoftGOT1000	Abbreviation of monitoring software GT SoftGOT1000
GT Converter2	Abbreviation of data conversion software GT Converter2 for GOT1000/GOT900 series
GT Designer2 Classic	Abbreviation of screen drawing software GT Designer2 Classic for GOT900 series
GT Designer2	Abbreviation of screen drawing software GT Designer2 for GOT1000/GOT900 series
iQ Works	Abbreviation of iQ Platform compatible engineering environment MELSOFT iQ Works
MELSOFT Navigator	Generic term for integrated development environment software included in the SW□DNC-IQWK (iQ Platform compatible engineering environment MELSOFT iQ Works)
GX Works2	Abbreviation of SW□DNC-GXW2-E and SW□DNC-GXW2-EA type programmable controller engineering software
GX Simulator2	Abbreviation of GX Works2 with the simulation function
GX Simulator	Abbreviation of SW□D5C-LLT-E(-EV) type ladder logic test tool function software packages (SW5D5C-LLT (-EV) or later versions)
GX Developer	Abbreviation of SW□D5C-GPPW-E(-EV)/SW D5F-GPPW-E type software package
GX LogViewer	Abbreviation of SW□DNN-VIEWER-E type software package
PX Developer	Abbreviation of SW□D5C-FBDQ-E type FBD software package for process control
MT Works2	Abbreviation of motion controller engineering environment MELSOFT MT Works2 (SW□DNC-MTW2-E)
MT Developer	Abbreviation of SW□RNC-GSV type integrated start-up support software for motion controller Q series
MR Configurator2	Abbreviation of SW□DNC-MRC2-E type Servo Configuration Software
MR Configurator	Abbreviation of MRZJW□-SETUP□E type Servo Configuration Software
FR Configurator	Abbreviation of Inverter Setup Software (FR-SW□-SETUP-WE)
NC Configurator	Abbreviation of CNC parameter setting support tool NC Configurator
FX Configurator-FP	Abbreviation of parameter setting, monitoring, and testing software packages for FX3U-20SSC-H (SW□D5C-FXSSC-E)
FX3U-ENET-L Configuration tool	Abbreviation of FX3U-ENET-L type Ethernet module setting software (SW1D5-FXENETL-E)
RT ToolBox2	Abbreviation of robot program creation software (3D-11C-WINE)
MX Component	Abbreviation of MX Component Version□ (SW□D5C-ACT-E, SW□D5C-ACT-EA)
MX Sheet	Abbreviation of MX Sheet Version□ (SW□D5C-SHEET-E, SW□D5C-SHEET-EA)
QnUDVCPU & LCPU Logging Configuration Tool	Abbreviation of QnUDVCPU & LCPU Logging Configuration Tool (SW1DNN-LLUTL-E)

■ License key (for GT SoftGOT1000)

Abbreviations and generic terms	Description
License	GT15-SGTKEY-U, GT15-SGTKEY-P

■ Others

Abbreviations and generic terms	Description
IAI	Abbreviation of IAI Corporation
AZBIL	Abbreviation of Azbil Corporation (former Yamatake Corporation)
OMRON	Abbreviation of OMRON Corporation
KEYENCE	Abbreviation of KEYENCE CORPORATION
KOYO EI	Abbreviation of KOYO ELECTRONICS INDUSTRIES CO., LTD.
SHARP	Abbreviation of Sharp Manufacturing Systems Corporation
JTEKT	Abbreviation of JTEKT Corporation
SHINKO	Abbreviation of Shinko Technos Co., Ltd.
CHINO	Abbreviation of CHINO CORPORATION
TOSHIBA	Abbreviation of TOSHIBA CORPORATION
TOSHIBA MACHINE	Abbreviation of TOSHIBA MACHINE CO., LTD.
HITACHI IES	Abbreviation of Hitachi Industrial Equipment Systems Co., Ltd.
HITACHI	Abbreviation of Hitachi, Ltd.
FUJI	Abbreviation of FUJI ELECTRIC CO., LTD.
PANASONIC	Abbreviation of Panasonic Corporation
PANASONIC INDUSTRIAL DEVICES SUNX	Abbreviation of Panasonic Industrial Devices SUNX Co., Ltd.
YASKAWA	Abbreviation of YASKAWA Electric Corporation
YOKOGAWA	Abbreviation of Yokogawa Electric Corporation
ALLEN-BRADLEY	Abbreviation of Allen-Bradley products manufactured by Rockwell Automation, Inc.
GE	Abbreviation of GE Intelligent Platforms
LS IS	Abbreviation of LS Industrial Systems Co., Ltd.
SCHNEIDER	Abbreviation of Schneider Electric SA
SICK	Abbreviation of SICK AG
SIEMENS	Abbreviation of Siemens AG
RKC	Abbreviation of RKC INSTRUMENT INC.
HIRATA	Abbreviation of Hirata Corporation
MURATEC	Abbreviation of Muratec products manufactured by Muratec Automation Co., Ltd.
PLC	Abbreviation of programmable controller
Control equipment	Generic term for control equipment manufactured by each corporation
Temperature controller	Generic term for temperature controller manufactured by each corporation
Indicating controller	Generic term for indicating controller manufactured by each corporation
CHINO controller	Abbreviation of indicating controller manufactured by CHINO CORPORATION
PC CPU module	Abbreviation of PC CPU Unit manufactured by CONTEC CO., LTD
GOT (server)	Abbreviation of GOTs that use the server function
GOT (client)	Abbreviation of GOTs that use the client function
Windows® font	Abbreviation of TrueType font and OpenType font available for Windows® (Differs from the True Type fonts settable with GT Designer3)
Intelligent function module	Indicates the modules other than the PLC CPU, power supply module and I/O module that are mounted to the base unit
MODBUS® /RTU	Generic term for the protocol designed to use MODBUS® protocol messages on a serial communication
MODBUS® /TCP	Generic term for the protocol designed to use MODBUS® protocol messages on a TCP/IP network

HOW TO READ THIS MANUAL

1 Functions

This manual describes functions available for the GT Designer2 Version1, GT Designer3 Version1.54G. For the added functions by the product version upgrade, refer to the list of functions added by GT Designer2 version upgrade in Appendices.

2 Symbols

Following symbols are used in this manual.

13.3.3 Memory check operation

Carries out write/read check of memory.

Point When drive is not displayed
When the drive (memory) to check is not displayed, confirm the mounting procedure or memory type with reference to the following.

- CF card inserting/removing method [] Section 7.1 CF Card

When no faults are found in mounting, etc., a memory failure may be arisen. Replace the CF card or Flash memory.
For details of Flash memory, contact your nearest sales office or FA Center.

The following example explains about Memory Check using Flash memory.
For the CF card memory check, install the CF card before carrying out the same key operations as built-in flash memory.

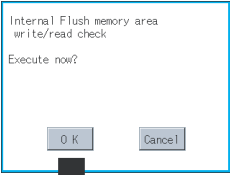
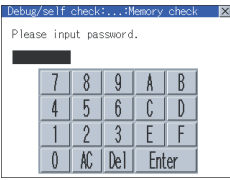
① Select [Flash Memory] in the Memory check setting screen, and touch the [Check] button.
If select the [OK] button, the numeric keyboard window is displayed.
If select the [Cancel] button, the screen returns to the initial menu.

② Touch [5][9][2][0] and then [Enter].
(The password is fixed to 5920.)
Touching [Enter] executes read/write check for the flash memory.

13 - 4 13.3 Memory Check
13.3.3 Memory check operation

Point

Refers to the information required.

Remark

Refers to the supplementary explanations for reference.

Indicates the items in which the detailed explanation is described (manual, chapter, section, item of the manual).

① → ② → ③

Indicates the operation steps.

Menu and items are differentiated with parentheses.

[] : refers to the menu of GOT utility.

[] : refers to the button in the dialog box of GOT utility.

1. OVERVIEW

1 About GOT

A GOT is installed on the panel surface of a control panel or operating panel and connects to the PLC within the control panel. The GOT carries out switch operation, lamp display, data display, message display, etc.

For the display screen, two kinds of screens are available : user screen and utility screen.

(1) User screen

The user screen is a screen drawn by drawing software.

The objects "Touch switch", "Lamp display", "Comment display", and "Numeric display" can be arbitrarily arranged on the display.

A "horizontal format" or "vertical format" may be selected for displaying a user's project.

Moreover, multiple screens created within drawing software can be individually selected or overlapped for the display.

For details, refer to the following.

- ☞ GT Designer2 Version□ Basic Operation/Data Transfer Manual
- ☞ GT Designer2 Version□ Screen Design Manual
- ☞ GT Designer3 Version1 Screen Design Manual

(2) Utility Screen

The utility screen is a factory drawn horizontal screen that cannot be edited.

The utility screen has options for "Contrast ", "Buzzer volume ", etc, and the format is horizontal only.

For details, refer to the following.



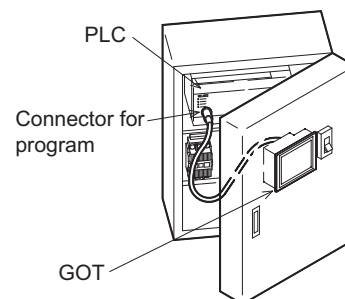



- ☞ Chapter 9 to Chapter 17

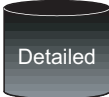
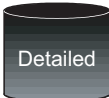
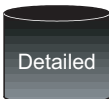

2 About Manual

The following manuals related to GOT 1000 series are available. Refer to each manual in accordance with the intended use.

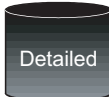

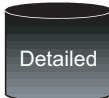
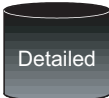







- (1) Installation of the software programs → Drawing → Data transfer
 For operations from creating project data to transferring data to GOT, refer to the following manuals.

		
Purpose	GT Designer2 Version <input type="checkbox"/> Basic Operation/Data Transfer Manual* ¹ GT Designer3 Version1 Screen Design Manual (Fundamentals)* ¹	GT Designer2 Version <input type="checkbox"/> Screen Design Manual* ¹ GT Designer3 Version1 Screen Design Manual (Functions)* ¹
Installing product on PC		
Creating projects		
Creating screens		
Drawing figures		
Making Common Settings		
Placing/Setting objects		
Transferring data to GOT		

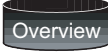
*1 Stored in the GT Works 2/GT Designer2/GT Works 3/GT Designer3 in PDF format.

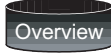
(2) Installing a GOT → connection to a PLC

For the operations from installing a GOT to communicating with a PLC CPU, refer to the following manuals.

	 (Included)		
Purpose	GT15 General Description GT11 General Description GT10 General Description	GT15 User's Manual GT11 User's Manual GT10 User's Manual	GOT1000 Series Connection Manual* ¹
Confirming part names and specifications of the GOT			
Confirming the GOT installation method			
Confirming the mounting method for communication units or option devices			
Confirming the PLC connection method			
Confirming the utility operation method			
Confirming error codes (system alarm) displayed on the GOT			

*1 Stored in the GT Works2/GT Designer2/GT Works 3/GT Designer3 in PDF format.

(3) Other manuals

The following manuals are also available.

The following manuals are stored in the GT Works2/GT Designer2/GT Works3/GT Designer3 in PDF format.

- (a) GOT1000 Series Gateway Functions Manual
Describes how to use the gateway function.
- (b) GT Simulator 2 Version□ Operation Manual
Describes how to simulate the created project data with GT Simulator2.
- (c) GT Converter2 Version□ Operating Manual
Describes how to use the GT Converter2.

1.1 Features

- (1) Improved monitoring performance and connectivity to FA devices
 - Multiple languages are displayed using the Unicode2.1-compatible fonts and beautiful characters are drawn using the TrueType and high quality fonts
 - For GT1020 and GT1030, 3 backlight colors (green, red, orange or white, red, pink) are available for status displays
 - For GT104□ and GT105□, two types of display modes are available: 256 colors display and monochrome
 - In the monochrome display, 16 scales are used to improve the display
 - Improved layout design flexibility with the analog touch panel on the GT1020
 - High speed monitoring through high speed communication at maximum of 115.2kbps
 - High speed display and high speed touch switch response
- (2) More efficient GOT operations including screen design, startup, adjustment, management and maintenance works
 - Recipe function, Device monitor function and FX list editor function (for GT104□, GT105□ only) are standard installed
 - Factory-installed OS on the GOT
 - For GT1020, GT1030 and GT104□, LED-type backlight is adopted (no replacement required)
 - High speed data transfer of project data, OS and others using the USB interface (for GT104□, GT105□ only)
- (3) Enhanced support of FA setup tools
 - Transferring or monitoring the sequence programs using the personal computer connected to GOT, during connection to A, L, Q, QnA, or FX series PLC CPU (Transparent function)
 - Allows the connection of multiple GOT units via the serial interface when connected to the CPU on the A, L, Q, QnA, or FX series of PLC

1.2 Rough Pre-operation Procedure

The outline procedure before operating GOT is shown.

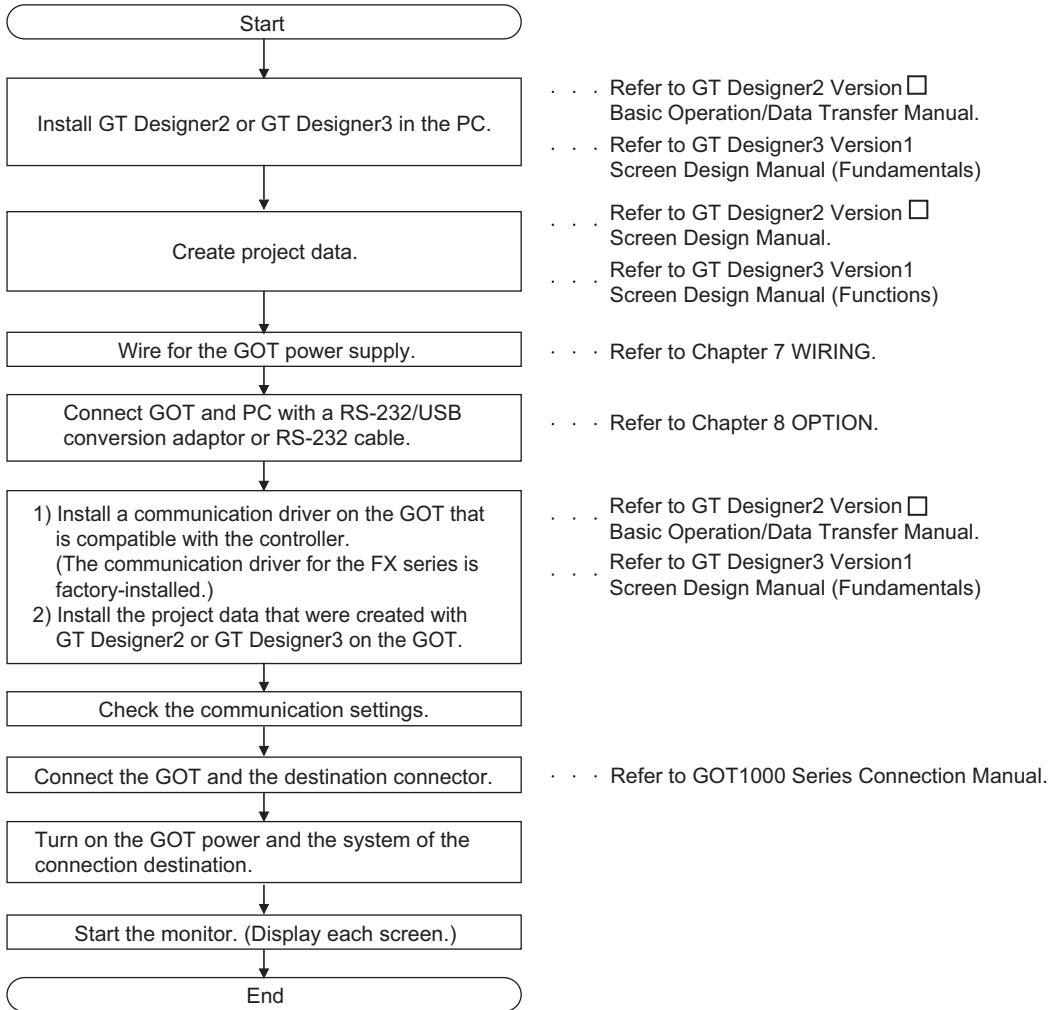

2. SYSTEM CONFIGURATION

2.1 Overall Configuration

The overall configuration of GOT is as follows.

For the connection methods applicable to GOT1000 series and cable, refer to the following.

 GOT1000 Series Connection Manual

(For GT1020, GT1030)

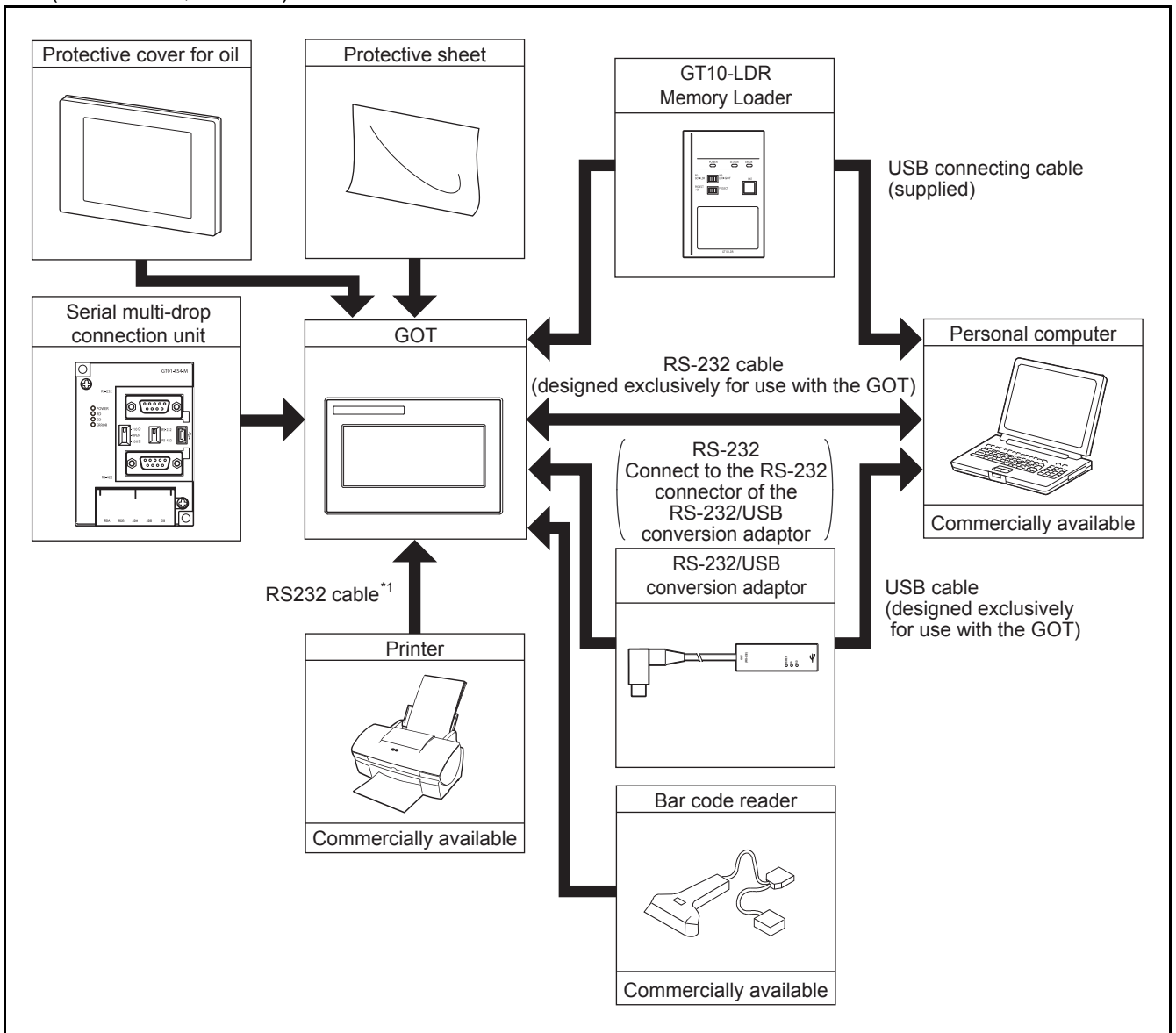

*1: The RS-232 cable vary depending on the specifications of the user's printer. Use the RS-232 cable according to the specifications of the user's printer. Only hard copy of the screen can be printed.

(For GT104□, GT105□)

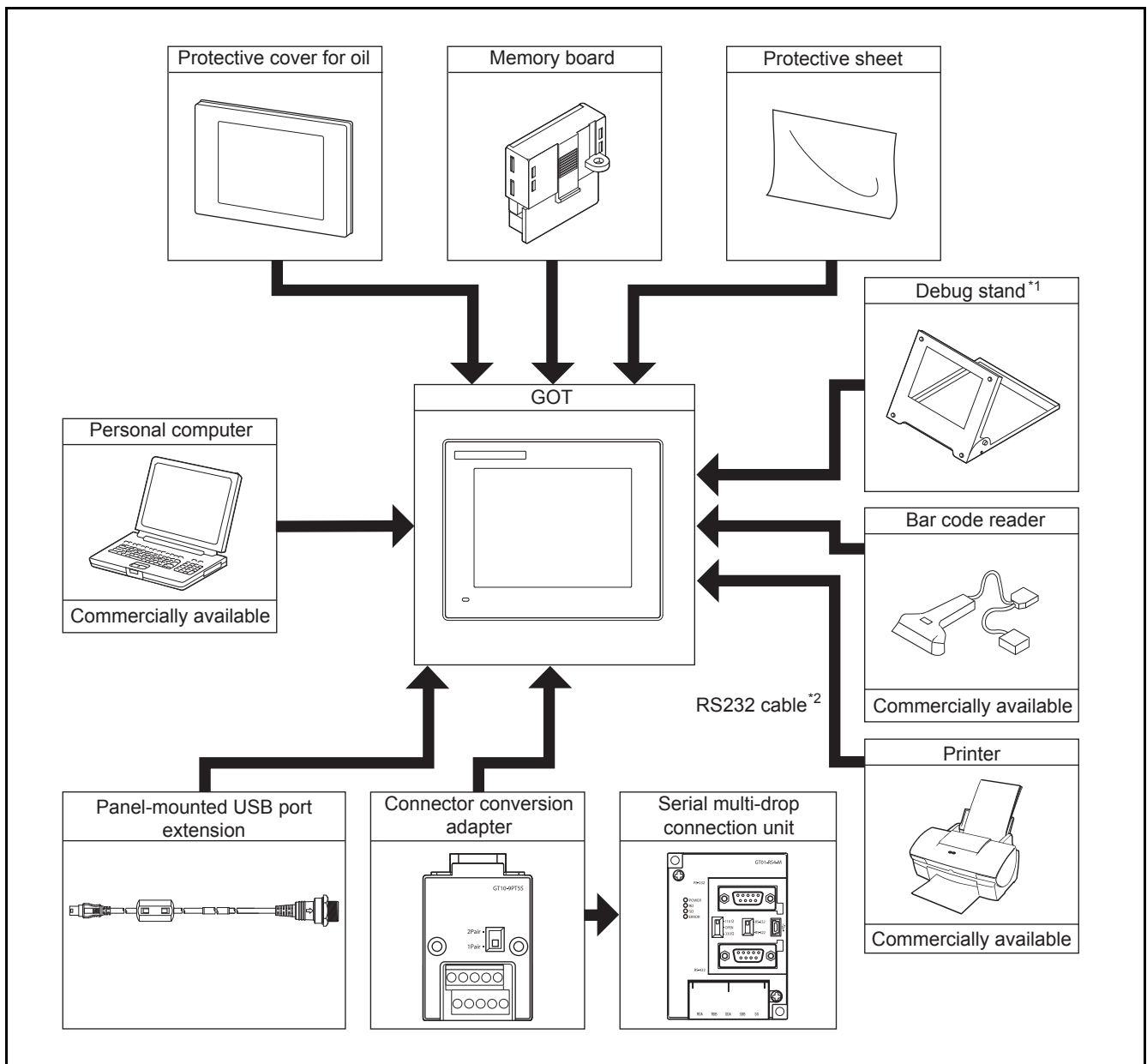

*1: Debug stand is only available for GT105□.

*2: The RS-232 cable vary depending on the specifications of the user's printer. Use the RS-232 cable according to the specifications of the user's printer. Only hard copy of the screen can be printed.

2.2 Component List

(1) Explanation of the GOT model name

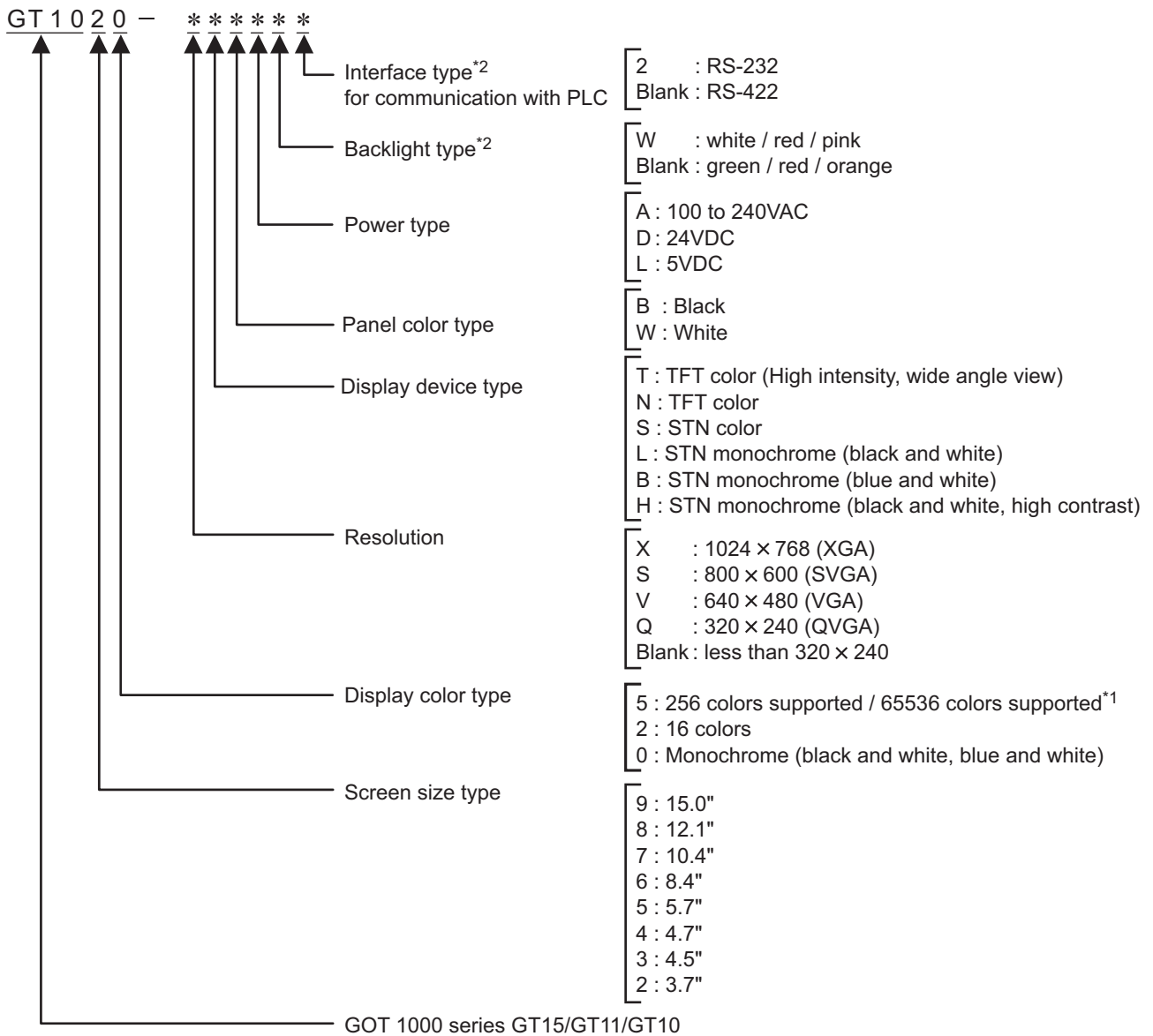

*1: For GT15 that can display 65536 colors, refer to following.

GT15 User's Manual

*2: Dedicated for GT1020, GT1030

(2) Explanation of the option model name

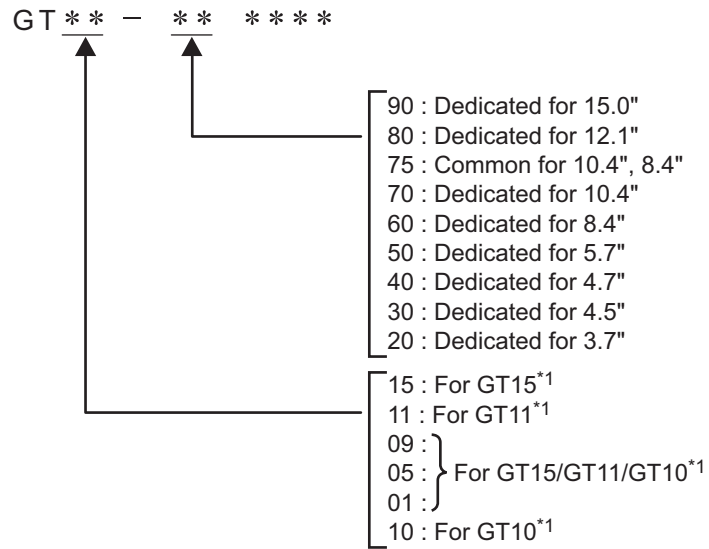

*1: There are optional components common for GT15, GT11 and GT10.

2.2.1 GOT (GT10)

Product name	Model name	Specifications
GOT	GT1020-LBD/LWD	3.7" [160 × 64 dots], STN monochrome (black and white) liquid crystal, 3 colors (green/red/orange) LED backlight, 24VDC, PLC connection interface: RS-422
	GT1020-LBD2/LWD2	3.7" [160 × 64 dots], STN monochrome (black and white) liquid crystal, 3 colors (green/red/orange) LED backlight, 24VDC, PLC connection interface: RS-232
	GT1020-LBL/LWL	3.7" [160 × 64 dots], STN monochrome (black and white) liquid crystal, 3 colors (green/red/orange) LED backlight, 5VDC, PLC connection interface: RS-422
	GT1020-LBDW/LWDW	3.7" [160 × 64 dots], STN monochrome (black and white) liquid crystal, 3 colors (white/red/pink) LED backlight, 24VDC, PLC connection interface: RS-422
	GT1020-LBDW2/LWDW2	3.7" [160 × 64 dots], STN monochrome (black and white) liquid crystal, 3 colors (white/red/pink) LED backlight, 24VDC, PLC connection interface: RS-232
	GT1020-LBLW/LWLW	3.7" [160 × 64 dots], STN monochrome (black and white) liquid crystal, 3 colors (white/red/pink) LED backlight, 5VDC, PLC connection interface: RS-422
	GT1030-LBD/LWD/HBD/ HWD	4.5" [288 × 96 dots], STN monochrome (black and white) liquid crystal, 3 colors (green/red/orange) LED backlight, built-in battery 24VDC, PLC connection interface: RS-422
	GT1030-LBD2/LWD2/HBD2/HWD2	4.5" [288 × 96 dots], STN monochrome (black and white) liquid crystal, 3 colors (green/red/orange) LED backlight, built-in battery 24VDC, PLC connection interface: RS-232
	GT1030-LBL/LWL/HBL/HWL	4.5" [288 × 96 dots], STN monochrome (black and white) liquid crystal, 3 colors (green/red/orange) LED backlight, built-in battery 5VDC, PLC connection interface: RS-422
	GT1030-LBDW/LWDW/HBDW/HWDW	4.5" [288 × 96 dots], STN monochrome (black and white) liquid crystal, 3 colors (white/red/pink) LED backlight, built-in battery 24VDC, PLC connection interface: RS-422
	GT1030-LBDW2/LWDW2/HBDW2/HWDW2	4.5" [288 × 96 dots], STN monochrome (black and white) liquid crystal, 3 colors (white/red/pink) LED backlight, built-in battery 24VDC, PLC connection interface: RS-232
	GT1030-LBLW/LWLW/HBLW/HWLW	4.5" [288 × 96 dots], STN monochrome (black and white) liquid crystal, 3 colors (white/red/pink) LED backlight, built-in battery 5VDC, PLC connection interface: RS-422
	GT1045-QSBD	4.7" [320 × 240 dots], STN color liquid crystal, 256 colors, built-in battery 24VDC, PLC connection interface: RS-422, RS-232
	GT1040-QBBD	4.7" [320 × 240 dots], STN monochrome liquid crystal, monochrome (blue and white), 16 scales, built-in battery 24VDC, PLC connection interface: RS-422, RS-232
	GT1055-QSBD	5.7" [320 × 240 dots], STN color liquid crystal, 256 colors, built-in battery 24VDC, PLC connection interface: RS-422, RS-232
GT1050-QBBD	5.7" [320 × 240 dots], STN monochrome liquid crystal, monochrome (blue and white), 16 scales, built-in battery 24VDC, PLC connection interface: RS-422, RS-232	

2.2.2 Option (Optional components for GT10)

PLC connection cable (Sold separately)

Product name		Model name	Cable length	Contents
RS-422 Cable	FXCPU direct connection cable, FX expansion board connection cable	GT01-C10R4-8P	1m	For connecting FXCPU (MINI DIN 8 pins connector) and GOT, For connecting FXCPU expansion board (MINI DIN 8 pins connector) and GOT(For GT104 □ , GT105 □)
		GT01-C30R4-8P	3m	
		GT01-C100R4-8P	10m	
		GT01-C200R4-8P	20m	
		GT01-C300R4-8P	30m	
		GT10-C10R4-8P	1m	
		GT10-C30R4-8P	3m	
		GT10-C100R4-8P	10m	
		GT10-C200R4-8P	20m	
		GT10-C300R4-8P	30m	
		GT10-C10R4-8PL*1	1m	
		GT10-C10R4-8PC	1m	For connecting FXCPU (MINI DIN 8 pins connector) and GOT, For connecting FXCPU expansion board (MINI DIN 8 pins connector) and GOT(For GT1030, GT1020)
		GT10-C30R4-8PC	3m	
		GT10-C100R4-8PC	10m	
		GT10-C200R4-8PC	20m	
		GT10-C300R4-8PC	30m	

*1: GT10-C10R4-8PL cannot be used for FX0, FX0S, FX0N, FX1, FX2, FX2C, FX1NC, FX2NC, FX3UC(D/DSS), or FX3G PLC.

Product name		Model name	Cable length	Contents
RS-422 Cable	QnA/A/FXCPU direct connection cable, computer link connection cable	GT01-C30R4-25P	3m	For connecting QnA/A/FXCPU (D-sub 25 pins connector) and GOT, For connecting serial communication unit (AJ71QC24(N)-R4) and GOT(For GT104 □ , GT105 □)
		GT01-C100R4-25P	10m	
		GT01-C200R4-25P	20m	
		GT01-C300R4-25P	30m	
		GT10-C30R4-25P	3m	
		GT10-C100R4-25P	10m	
		GT10-C200R4-25P	20m	
		GT10-C300R4-25P	30m	
	Computer link connection cable	GT09-C30R4-6C	3m	For connecting computer link unit/serial communication unit and GOT(For GT104 □ , GT105 □)
		GT09-C100R4-6C	10m	
		GT09-C200R4-6C	20m	
		GT09-C300R4-6C	30m	
RS-232 Cable	QCPU direct connection cable	GT01-C30R2-6P	3m	For connecting QCPU (MINI DIN 6 pins) and GOT(For GT104 □ , GT105 □)
		GT10-C30R2-6P	3m	For connecting QCPU (MINI DIN 6 pins) and GOT(For GT1030, GT1020)
	FX expansion board connection cable, FX special adaptor connection cable	GT01-C30R2-9S	3m	For connecting FXCPU expansion board (D-sub 9pins connector ^{*2}) and GOT(For GT104 □ , GT105 □)
				For connecting FXCPU special adaptor (D-sub 9 pins connector ^{*2}) and GOT(For GT104 □ , GT105 □)
	FX special adaptor connection	GT01-C30R2-25P	3m	For connecting FXCPU special adaptor (D-sub 25 pins connector ^{*2}) and GOT(For GT104 □ , GT105 □)
	Computer link connection cable	GT09-C30R2-9P	3m	For connecting computer link unit/serial communication unit and GOT(For GT104 □ , GT105 □)
		GT09-C30R2-25P	3m	

*2: Connector shape on the cable is shown in ().

1	OVERVIEW
2	SYSTEM CONFIGURATION
3	SPECIFICATIONS
4	PART NAME
5	UL, cUL STANDARDS AND EMC DIRECTIVE
6	INSTALLATION
7	WIRING
8	OPTION

Connection cables for OMRON PLCs (For GT104□, GT105□) (Sold separately)

Product name	Model name	Cable length	Description	
RS-422 cable	GT09-C30R40101-9P	3m	For connecting GOT to OMRON PLC, serial communication module, serial communication board	
	GT09-C100R40101-9P	10m		
	GT09-C200R40101-9P	20m		
	GT09-C300R40101-9P	30m		
	RS-232 cable	GT09-C30R40102-9P	3m	For connecting GOT to OMRON rack type host link unit, communication board
		GT09-C100R40102-9P	10m	
		GT09-C200R40102-9P	20m	
		GT09-C300R40102-9P	30m	
RS-232 cable	GT09-C30R20101-9P	3m	For connecting GOT to OMRON PLC, serial communication module, communication board, serial communication board	
	GT09-C30R20102-25S	3m	For connecting GOT to OMRON connection cable	
	GT09-C30R20103-25P	3m	For connecting GOT to OMRON rack type host link unit	

Connection cables for KEYENCE PLCs (For GT104□, GT105□) (Sold separately)

Product name	Model name	Cable length	Description
RS-422 cable	GT09-C30R41101-5T	3m	For connecting GOT to KEYENCE multi-communication unit
	GT09-C100R41101-5T	10m	
	GT09-C200R41101-5T	20m	
	GT09-C300R41101-5T	30m	
RS-232 cable	GT09-C30R21101-6P	3m	For connecting GOT to KEYENCE PLC
	GT09-C30R21102-9S	3m	For connecting GOT to KEYENCE multi-communication unit
	GT09-C30R21103-3T	3m	For connecting GOT to KEYENCE multi-communication unit

Connection cables for Panasonic PLCs (For GT104□, GT105□) (Sold separately)

Product name	Model name	Cable length	Description
RS-232 cable	GT09-C30R20901-25P	3m	For connecting GOT to Panasonic RS422/232C conversion adaptor
	GT09-C30R20902-9P	3m	For connecting GOT to the tool port or RS232C port of Panasonic PLC, computer communication unit
	GT09-C30R20903-9P	3m	For connecting GOT to the RS232C port of Panasonic PLC
	GT09-C30R20904-3C	3m	For connecting GOT to the RS232C port of Panasonic PLC

Connection cables for YASKAWA PLCs (For GT104□, GT105□) (Sold separately)

Product name	Model name	Cable length	Description
RS-422 cable	GT09-C30R40202-14P	3m	For connecting GOT to YASKAWA PLC
	GT09-C100R40202-14P	10m	
	GT09-C200R40202-14P	20m	
	GT09-C300R40202-14P	30m	
RS-232 cable	GT09-C30R20201-9P	3m	For connecting GOT to YASKAWA PLC
	GT09-C30R20204-14P	3m	
	GT09-C30R20205-25P	3m	For connecting GOT to YASKAWA MEMOBUS module

Connection cables for Allen-Bradley PLCs (For GT104□, GT105□) (Sold separately)

Product name	Model name	Cable length	Description
RS-232 cable	GT09-C30R20701-9S	3m	For connecting GOT to Allen-Bradley PLC

Protective sheet (Sold separately)

Product name	Model name	Contents	
Protective sheet	GT10-20PSGB	3.7" protective sheet (For GT1020)	Display section antiglare (Frame: transparent) 5 sheets
	GT10-20PSCB		Display section clear (Frame: transparent) 5 sheets
	GT10-20PSGW		Display section antiglare (Frame: white), With a logo 5 sheets
	GT10-20PSCW		Display section clear (Frame: white), With a logo 5 sheets
	GT10-30PSGB	4.5" protective sheet (For GT1030)	Display section antiglare (Frame: transparent) 5 sheets
	GT10-30PSCB		Display section clear (Frame: transparent) 5 sheets
	GT10-30PSGW		Display section antiglare (Frame: white), With a logo 5 sheets
	GT10-30PSCW		Display section clear (Frame: white), With a logo 5 sheets
	GT10-40PSGB	4.7" protective sheet (For GT104□)	Display section antiglare (Frame: transparent) 5 sheets
	GT10-40PSCB		Display section clear (Frame: transparent) 5 sheets
	GT10-40PSGW		Display section antiglare (Frame: white), With a logo 5 sheets
	GT10-40PSCW		Display section clear (Frame: white), With a logo 5 sheets
	GT10-50PSGB	5.7" protective sheet (For GT105□)	Display section antiglare (Frame: transparent) 5 sheets
	GT10-50PSCB		Display section clear (Frame: transparent) 5 sheets
	GT10-50PSGW		Display section antiglare (Frame: white), With a logo 5 sheets
	GT10-50PSCW		Display section clear (Frame: white), With a logo 5 sheets

Drawing software (Sold separately)

Product name	Model name	Contents
GT Designer2	SW □ D5C-GTD2-E (□ indicates the version)*1	Drawing software for GOT1000/GOT900 series
GT Designer3	SW □ DNC-GTD3-E (□ indicates the version)	Drawing software for GOT1000 series

*1: The □ is assigned with an integer 2 or more.

Stand (Sold separately) (For GT105□)

Product name	Model name	Contents
Stand	GT05-50STAND	Stand for 5.7" (For GOT1000 Series)

Protective cover for oil (Sold separately)

Product name	Model name	Contents
Protective cover for oil	GT10-20PCO	3.7" protective cover for oil
	GT10-30PCO	4.5" protective cover for oil
	GT10-40PCO	4.7" protective cover for oil
	GT05-50PCO	5.7" protective cover for oil

PC connection cable (Sold separately)

Product name	Model name	Cable length	Contents	
For connection to the RS-232 port on the PC	Data transfer cable	GT01-C30R2-6P	3m	For connecting PC (drawing software) (D-sub 9 pins: female ^{*2}) and GOT(For GT1020, GT1030)
		GT01-C30R2-9S	3m	For connecting PC (drawing software) (D-sub 9 pins: female ^{*2}) and GOT(For GT104□, GT105□)
For connection to the USB port on the PC	RS-232/USB conversion adaptor for data transfer	GT10-RS2USB-5S	-	RS-232/USB conversion adaptor for data transfer (RS-232/USB conversion adaptor and PC are connected with a GT09-C30USB-5P cable.)
	Data transfer cable	GT09-C30USB-5P ^{*3}	3m	For connecting PC (drawing software) (USB) and RS-232/USB conversion adaptor, GOT(For GT104□, GT105□)

*2: Connector shape on the cable is shown in ().

*3: GT09-C30USB-5P is a product of Mitsubishi Electric System Service.

Cable for bar code connections (Sold separately)

Product name	Model name	Cable length	Contents
Cable for bar code connections	GT10-C02H-6PT9P	0.2m	For connecting GOT and bar code reader

Cable for multiple GOT connections (Sold separately)

Product name	Model name	Cable length	Contents
Cable for multiple GOT connections	GT10-C30R2-6P	3m	For connecting GOT(GT1020, GT1030) interface for connection to PC (RS-232) and GOT(GT1020, GT1030) interface for connection to PLC (RS-232) ^{*4}
	GT01-C30R2-9S	3m	For connecting GOT(GT104□, GT105□) RS-232 interface and GOT(GT104□, GT105□) RS-232 interface

*4: When multiple GT10 units are connected, use a GT1020-L□D(W)2 or GT1030-□□D(W)2 for the second GOT unit.

Battery (Sold separately)

Product name	Model name	Contents
Battery ^{*5}	GT11-50BAT	For storing clock data, alarm history, recipe data and time action setting value

*5 At GOT purchase, it is installed in the main unit. (For GT1030, GT104□, GT105□)

Bar code reader (Sold separately)

Product name	Model name	Contents
Bar code reader	-	Commercially-available bar code reader ^{*6}

*6: Some models with the operations checked by our company are usable.
For the operation-checked models, refer to "List of valid devices applicable for GOT1000 series" (T10-0039) separately available, or contact your local distributor.

Memory board (Sold separately) (For GT104□, GT105□)

Product name	Model name	Contents
Memory board	GT10-50FMB	For copying project data, the OS or font data

Serial multi-drop connection unit (Sold separately)

Product name	Model name	Contents
Serial multi-drop connection unit	GT01-RS4-M	For GOT multi-drop connection

Connector conversion adapter (Sold separately) (For GT104□, GT105□)

Product name	Model name	Contents
Connector conversion adapter	GT10-9PT5S	For GOT multi-drop connection

Panel-mounted USB port extension (Sold separately) (For GT104□, GT105□)

Product name	Model name	Contents
Panel-mounted USB port extension	GT10-C10EXUSB-5S	Panel-mounted USB port extension

3. SPECIFICATIONS

3.1 General Specifications

Item		Specifications					
Operating ambient temperature	Display section	0 to 50°C					
	Other than display section	0 to 55°C (when horizontally installed), 0 to 50°C (when vertically installed)					
Storage ambient temperature		-20 to 60°C					
Operating ambient humidity ^{*1}		10 to 90% RH, non-condensing					
Storage ambient humidity ^{*1}		10 to 90% RH, non-condensing					
Vibration resistance		Conforms to JIS B3502 and IEC61131-2		Frequency	Acceleration	Half-amplitude	Sweep Count
			Under intermittent vibration	5 to 8.4Hz	-	3.5mm	10 times each in X, Y and Z directions
				8.4 to 150Hz	9.8m/s ²	-	
			Under continuous vibration	5 to 8.4Hz	-	1.75mm	-
8.4 to 150Hz	4.9m/s ²	-					
Shock resistance		Conforms to JIS B3502, IEC 61131-2 (147 m/s ² , 11 ms, Sine half-wave pulse, 3 times each in the X, Y, and Z directions)					
Operating atmosphere		Must be free of lamp black, corrosive gas, flammable gas, or excessive amount of electro conductive dust particles and must be no direct sunlight. (Same as for saving)					
Operating altitude ^{*2}		2000 m (6562 ft) max.					
Installation location		Inside control panel					
Overvoltage category ^{*3}		II or less					
Pollution degree ^{*4}		2 or less					
Cooling method		Self-cooling					
Grounding ^{*5}		Class D grounding (100Ω or less), To be connected to the panel when grounding is not possible					

*1 : The wet bulb temperature is 39°C or less.

*2 : Do not use or store the GOT under pressures higher than the atmospheric pressure of altitude 0m (0ft.). Failure to observe this instruction may cause a malfunction.

When the air inside the control panel is purged by pressurization, the surface sheet may be lifted by high pressure. As a result, the touch panel may be difficult to press, and the sheet may be peeled off.

*3 : This indicates the section of the power supply to which the equipment is assumed to be connected between the public electrical power distribution network and the machinery within the premises.

Category II applies to equipment for which electrical power is supplied from fixed facilities.

The surge voltage withstand level for up to the rated voltage of 300 V is 2500 V.

*4 : This index indicates the degree to which conductive pollution is generated in the environment where the equipment is used.

In pollution degree 2, only non-conductive pollution occurs but temporary conductivity may be produced due to condensation.



*5: Except 5V power supply type.

3.2 Performance Specifications



- GT1020

Item		Specifications		
		GT1020-LBD/LWD	GT1020-LBD2/LWD2	GT1020-LBL/LWL
Display section*1	Type	STN monochrome (white/black) liquid crystal		
	Screen size	3.7"		
	Resolution	160 × 64 dots (Horizontal format)		
	Display size	W86.4(3.4) × H34.5(1.35) [mm](inch) (Horizontal format)		
	Display character	16-dot standard font: 20 characters × 4 lines (Horizontal format)		
	Display color	Monochrome (white/black)		
	Display angle	Left/Right: 30 degrees, Top: 20 degrees, Bottom: 30 degrees (Horizontal format)		
	Contrast adjustment	16-level adjustment		
	Intensity of LCD only	200 [cd/m ²] (in green)		
Life	Approx. 50,000h. (Time for display intensity to become 1/5 at operating ambient temperature of 25°C)			
Backlight	LED with 3 available colors (green, red, orange) (no replacement required), Backlight status (colors, ON/BLINK/OFF) control, Adjustable screensaver activation time Setting the system information*2 enables PLC to control the backlight status.			
Touch panel	Number of touch keys	Maximum 50 keys/screen (Analog resistive film touch panel)		
	Key size	Minimum 2 × 2 dots (per key)		
	Simultaneous pressing of two (or more) areas (2-point press)	Not supported (Simultaneous pressing of two or more areas on the screen may activate the switch between those areas.)		
	Life	1 million times or more (operating force 0.98N max.)		
Memory	C drive*3	Flash memory (Internal), for storing project data (512 Kbytes or less), OS, Alarm history, Recipe data and time action setting value		
	Life (Number of write times)	100,000 times		
Built-in interface	PLC communication	<ul style="list-style-type: none"> • RS-422 1ch Transmission speed: 115,200/57,600/38,400/ 19,200/9,600/4,800bps Connector shape: Connector terminal block 9 pins Application: PLC communication (Hardware version A to D) • RS-422/485 1ch Transmission speed: 115,200/57,600/38,400/ 19,200/9,600/4,800bps Connector shape: Connector terminal block 9 pins Application: PLC communication Terminating resistor*4: Open/110Ω/330Ω (Switched by terminating resistor selector switch) (At factory shipment: 330Ω) (Hardware version E or later) 	RS-232 1ch Transmission speed: 115,200/57,600/38,400/ 19,200/9,600/4,800bps Connector shape: Connector terminal block 9 pins Application: PLC communication	RS-422 1ch Transmission speed: 115,200/57,600/38,400/ 19,200/9,600/4,800bps Connector shape: Connector terminal block 9 pins Application: PLC communication
	PC communication	RS-232 1ch Transmission speed : 115,200/57,600/38,400/19,200/9,600/4,800bps Connector shape : MINI DIN 6 pins (Female) Application : PC communication (Project data upload/download, OS installation, transparent function)		
Buzzer output (a buzzer that sounds when touch keys are pressed)		Single tone (LONG/SHORT/OFF adjustable)		
Environmental protective structure*5		Equivalent to IP67 (JEM1030) (front section) (Horizontal format)		
External dimensions		W113(4.44) × H74(2.91) × D27(1.06) [mm](inch) (Horizontal format)		
Panel cutting dimensions		W105(4.13) × H66(2.59) [mm](inch) (Horizontal format)		

Item	Specifications		
	GT1020-LBD/LWD	GT1020-LBD2/LWD2	GT1020-LBL/LWL
Weight	0.2kg (Excluding mounting fixtures)		0.18kg (Excluding mounting fixtures)
Compatible software package	GT Designer2 Version2.43V or later/GT Designer3 Version1.01B or later		

- *1:
- Bright dots (always lit) and dark dots (unlit) may appear on a liquid crystal display panel. It is impossible to completely avoid this symptom, as the liquid crystal display comprises of a great number of display elements. Flickers may be observed depending on the display color. Please note that these dots appear due to its characteristic and are not caused by product defect.
 - Flickers and partial discoloration may be generated on the liquid crystal display panel due to the display contents or the contrast adjustment. However, please note that these phenomena appear due to its characteristic and are not caused by product defect.
 - There is a difference in the display brightness and the color tones between liquid crystal display panels. When using multiple liquid crystal display panels, please note that there is an individual difference between them.
 - A crosstalk (shadow as an extension of the display) may appear on the liquid crystal display panel. Please note that it appears due to its characteristic.
 - When the display section is seen from the outside of the display angle, the display color seems like it has changed. Please note that it is due to its characteristic.
Please note that the response time, brightness and color of the liquid crystal display panel may vary depending on the usage environmental temperature.
Especially in the low temperature environment, the display response becomes slow due to the characteristics of the STN liquid crystal. Please check the display response in advance for using this product.
 - When the same screen is displayed for a long time, an incidental color or partial discoloration is generated on the screen due to heat damage, and it may not disappear. To prevent heat damage, the screen saver function is effective. For details on the screen saver function, refer to the following.
 Chapter 12 DISPLAY AND OPERATION SETTINGS (GOT SET UP)
- *2: For the details of system information, refer to the following.
-  GT Designer2 Version□ Screen Design Manual
 - GT Designer3 Version1 Screen Design Manual
- *3: ROM in which new data can be written without deleting the written data.
- *4: Set the terminating resistor selector switch of the GOT in accordance with the connection type when adopting GOT multidrop connection. For details of GOT multidrop connection, refer to the following.
-  GOT1000 Series Connection Manual
- *5: Note that this does not guarantee all users' operation environment.
In addition, the product may not be used in environments under exposition of oil or chemicals for a long period of time, or in environments filled with oil-mist.

Item	Specifications			
	GT1020-LBDW/LWDW	GT1020-LBDW2/LWDW2	GT1020-LBLW/LWLW	
Display section*1	Type	STN monochrome (white/black) liquid crystal		
	Screen size	3.7"		
	Resolution	160 × 64 dots (Horizontal format)		
	Display size	W86.4(3.4) × H34.5(1.35) [mm](inch) (Horizontal format)		
	Display character	16-dot standard font: 20 characters × 4 lines (Horizontal format)		
	Display color	Monochrome (white/black)		
	Display angle	Left/Right: 30 degrees, Top: 20 degrees, Bottom: 30 degrees (Horizontal format)		
	Contrast adjustment	16-level adjustment		
	Intensity of LCD only	300 [cd/m ²] (in white)		
	Life	Approx. 50,000h. (Time for display intensity to become 1/5 at operating ambient temperature of 25°C)		
Backlight	LED with 3 available colors (white, red, pink) (no replacement required), Backlight status (colors, ON/BLINK/OFF) control, Adjustable screensaver activation time Setting the system information*2 enables PLC to control the backlight status.			
Touch panel	Number of touch keys	Maximum 50 keys/screen (Analog resistive film touch panel)		
	Key size	Minimum 2 × 2 dots (per key)		
	Simultaneous pressing of two (or more) areas (2-point press)	Not supported (Simultaneous pressing of two or more areas on the screen may activate the switch between those areas.)		
	Life	1 million times or more (operating force 0.98N max.)		
Memory	C drive*3	Flash memory (Internal), for storing project data (512 Kbytes or less), OS, Alarm history, Recipe data and time action setting value		
	Life (Number of write times)	100,000 times		
Built-in interface	PLC communication	<ul style="list-style-type: none"> RS-422 1ch Transmission speed: 115,200/57,600/38,400/ 19,200/9,600/4,800bps Connector shape: Connector terminal block 9 pins Application: PLC communication (Hardware version A to D) RS-422/485 1ch Transmission speed: 115,200/57,600/38,400/ 19,200/9,600/4,800bps Connector shape: Connector terminal block 9 pins Application: PLC communication Terminating resistor*4: Open/110Ω/330Ω (Switched by terminating resistor selector switch) (At factory shipment: 330Ω) (Hardware version E or later) 	RS-232 1ch Transmission speed: 115,200/57,600/38,400/ 19,200/9,600/4,800bps Connector shape: Connector terminal block 9 pins Application: PLC communication	RS-422 1ch Transmission speed: 115,200/57,600/38,400/ 19,200/9,600/4,800bps Connector shape: Connector terminal block 9 pins Application: PLC communication
	PC communication	RS-232 1ch Transmission speed : 115,200/57,600/38,400/19,200/9,600/4,800bps Connector shape : MINI DIN 6 pins (Female) Application : PC communication (Project data upload/download, OS installation, transparent function)		
Buzzer output (a buzzer that sounds when touch keys are pressed)	Single tone (LONG/SHORT/OFF adjustable)			
Environmental protective structure*5	Equivalent to IP67 (JEM1030) (front section) (Horizontal format)			
External dimensions	W113(4.44) × H74(2.91) × D27(1.06) [mm](inch) (Horizontal format)			
Panel cutting dimensions	W105(4.13) × H66(2.59) [mm](inch) (Horizontal format)			
Weight	0.2kg (Excluding mounting fixtures)	0.18kg (Excluding mounting fixtures)		
Compatible software package	GT Designer2 Version2.58L or later/GT Designer3 Version1.01B or later			

- *1:
 - Bright dots (always lit) and dark dots (unlit) may appear on a liquid crystal display panel. It is impossible to completely avoid this symptom, as the liquid crystal display comprises of a great number of display elements. Flickers may be observed depending on the display color.
Please note that these dots appear due to its characteristic and are not caused by product defect.
 - Flickers and partial discoloration may be generated on the liquid crystal display panel due to the display contents or the contrast adjustment. However, please note that these phenomena appear due to its characteristic and are not caused by product defect.
 - There is a difference in the display brightness and the color tones between liquid crystal display panels. When using multiple liquid crystal display panels, please note that there is an individual difference between them.
 - A crosstalk (shadow as an extension of the display) may appear on the liquid crystal display panel. Please note that it appears due to its characteristic.
 - When the display section is seen from the outside of the display angle, the display color seems like it has changed. Please note that it is due to its characteristic.
Please note that the response time, brightness and color of the liquid crystal display panel may vary depending on the usage environmental temperature.
Especially in the low temperature environment, the display response becomes slow due to the characteristics of the STN liquid crystal. Please check the display response in advance for using this product.
 - When the same screen is displayed for a long time, an incidental color or partial discoloration is generated on the screen due to heat damage, and it may not disappear.
To prevent heat damage, the screen saver function is effective.
For details on the screen saver function, refer to the following.
 Chapter 12 DISPLAY AND OPERATION SETTINGS (GOT SET UP)
- *2: For the details of system information, refer to the following.
 GT Designer2 Version□ Screen Design Manual
GT Designer3 Version1 Screen Design Manual
- *3: ROM in which new data can be written without deleting the written data
- *4: Set the terminating resistor selector switch of the GOT in accordance with the connection type when adopting GOT multidrop connection. For details of GOT multidrop connection, refer to the following.
 GOT1000 Series Connection Manual
- *5: Note that this does not guarantee all users' operation environment.
In addition, the product may not be used in environments under exposition of oil or chemicals for a long period of time, or in environments filled with oil-mist.

• GT1030

Item	Specifications			
	GT1030-LBD/LWD/HBD/HWD	GT1030-LBD2/LWD2/HBD2/HWD2	GT1030-LBL/LWL/HBL/HWL	
Display section*1	Type	STN monochrome (white/black) liquid crystal		
	Screen size	4.5"		
	Resolution	288 × 96 dots (Horizontal format)		
	Display size	W109.42(4.3) × H35.98(1.41) [mm](inch) (Horizontal format)		
	Display character	16-dot standard font: 36 characters × 6 lines (Horizontal format) 12-dot standard font: 48 characters × 8 lines (Horizontal format)		
	Display color	Monochrome (white/black)		
	Display angle	Left/Right: 30 degrees, Top: 20 degrees, Bottom: 30 degrees (Horizontal format)		
	Contrast adjustment	16-level adjustment		
	Intensity adjustment	8-level adjustment		
	Intensity of LCD only	200 [cd/m ²] (in green)		
Life	Approx. 50,000h. (Time for display intensity to become 1/5 at operating ambient temperature of 25°C)			
Backlight	LED with 3 available colors (green, red, orange) (no replacement required), Backlight status (colors, ON/BLINK/OFF) control, Adjustable screensaver activation time Setting the system information*2 enables PLC to control the backlight status.			
Touch panel	Number of touch keys	Maximum 50 keys/screen (Matrix resistive film touch panel)		
	Key size	Minimum 16 × 16 dots (per key)		
	Simultaneous pressing of two (or more) areas (2-point press)	Enable		
	Life	1 million times or more (operating force 0.98N max.)		
Memory	C drive*3	Flash memory (Internal), for storing project data (1.5Mbytes or less), OS		
	Life (Number of write times)	100,000 times		
	D drive	SRAM (Internal), for storing alarm history, recipe data and time action setting value		
Battery		GT11-50BAT lithium battery		
	Backup target	Clock data, alarm history, recipe data and time action setting value		
	Life	Approx. 5 years (Operating ambient temperature of 25°C)		
Built-in interface	PLC communication	<ul style="list-style-type: none"> • RS-422 1ch Transmission speed: 115,200/57,600/38,400/19,200/9,600/4,800bps Connector shape: Connector terminal block 9 pins Application: PLC communication (Hardware version A) • RS-422/485 1ch Transmission speed: 115,200/57,600/38,400/19,200/9,600/4,800bps Connector shape: Connector terminal block 9 pins Application: PLC communication Terminating resistor*4: Open/110Ω/330Ω (Switched by terminating resistor selector switch) (At factory shipment: 330Ω) (Hardware version B or later) 	RS-232 1ch Transmission speed: 115,200/57,600/38,400/19,200/9,600/4,800bps Connector shape: Connector terminal block 9 pins Application: PLC communication	RS-422 1ch Transmission speed: 115,200/57,600/38,400/19,200/9,600/4,800bps Connector shape: Connector terminal block 9 pins Application: PLC communication
	PC communication	RS-232 1ch Transmission speed : 115,200/57,600/38,400/19,200/9,600/4,800bps Connector shape : MINI DIN 6 pins (Female) Application : PC communication (Project data upload/download, OS installation, transparent function)		
Buzzer output (a buzzer that sounds when touch keys are pressed)	Single tone (LONG/SHORT/OFF adjustable)			
Environmental protective structure*5	Equivalent to IP67 (JEM1030) (front section) (Horizontal format)			

1	OVERVIEW
2	SYSTEM CONFIGURATION
3	SPECIFICATIONS
4	PART NAME
5	STANDARDS AND EMC DIRECTIVE
6	INSTALLATION
7	WIRING
8	OPTION

Item	Specifications		
	GT1030-LBD/LWD/HBD/HWD	GT1030-LBD2/LWD2/HBD2/HWD2	GT1030-LBL/LWL/HBL/HWL
External dimensions	W145(5.7) × H76(2.99) × D29.5(1.16) [mm](inch) (Horizontal format)		
Panel cutting dimensions	W137(5.39) × H66(2.59) [mm](inch) (Horizontal format)		
Weight	0.3kg (Excluding mounting fixtures)		0.28kg (Excluding mounting fixtures)
Compatible software package	<ul style="list-style-type: none"> • GT1030-L□D/L□D2 GT Designer2 Version2.58L or later/ GT Designer3 Version1.01B or later • GT1030-H□D/H□D2 GT Designer3 Version1.19V or later 		<ul style="list-style-type: none"> • GT1030-L□L GT Designer2 Version2.97B or later/ GT Designer3 Version1.01B or later • GT1030-H□L GT Designer3 Version1.19V or later

- *1:
- Bright dots (always lit) and dark dots (unlit) may appear on a liquid crystal display panel. It is impossible to completely avoid this symptom, as the liquid crystal display comprises of a great number of display elements. Flickers may be observed depending on the display color. Please note that these dots appear due to its characteristic and are not caused by product defect.
 - Flickers and partial discoloration may be generated on the liquid crystal display panel due to the display contents or the contrast adjustment. However, please note that these phenomena appear due to its characteristic and are not caused by product defect.
 - There is a difference in the display brightness and the color tones between liquid crystal display panels. When using multiple liquid crystal display panels, please note that there is an individual difference between them.
 - A crosstalk (shadow as an extension of the display) may appear on the liquid crystal display panel. Please note that it appears due to its characteristic.
 - When the display section is seen from the outside of the display angle, the display color seems like it has changed. Please note that it is due to its characteristic.
Please note that the response time, brightness and color of the liquid crystal display panel may vary depending on the usage environmental temperature.
Especially in the low temperature environment, the display response becomes slow due to the characteristics of the STN liquid crystal. Please check the display response in advance for using this product.
 - Please note that the response in low temperatures tend to be slower as a characteristic of the liquid crystal display panel.
 - When the same screen is displayed for a long time, an incidental color or partial discoloration is generated on the screen due to heat damage, and it may not disappear.
To prevent heat damage, the screen saver function is effective.
For details on the screen saver function, refer to the following.
☞ Chapter 12 DISPLAY AND OPERATION SETTINGS (GOT SET UP)
- *2: For the details of system information, refer to the following.
- ☞ GT Designer2 Version□ Screen Design Manual
 - GT Designer3 Version1 Screen Design Manual
- *3: ROM in which new data can be written without deleting the written data.
- *4: Set the terminating resistor selector switch of the GOT in accordance with the connection type when adopting GOT multidrop connection. For details of GOT multidrop connection, refer to the following.
- ☞ GOT1000 Series Connection Manual
- *5: Note that this does not guarantee all users' operation environment.
In addition, the product may not be used in environments under exposition of oil or chemicals for a long period of time, or in environments filled with oil-mist.

Item	Specifications			
	GT1030-LBDW/LWDW/ HBDW/HWDW	GT1030-LBDW2/LWDW2/ HBDW2/HWDW2	GT1030-LBLW/LWLW/ HBLW/HWLW	
Display section*1	Type	STN monochrome (white/black) liquid crystal		
	Screen size	4.5"		
	Resolution	288 × 96 dots (Horizontal format)		
	Display size	W109.42(4.3) H35.98(1.41) [mm](inch) (Horizontal format)		
	Display character	16-dot standard font: 36 characters × 6 lines (Horizontal format) 12-dot standard font: 48 characters × 8 lines (Horizontal format)		
	Display color	Monochrome (white/black)		
	Display angle	Left/Right: 30 degrees, Top: 20 degrees, Bottom: 30 degrees (Horizontal format)		
	Contrast adjustment	16-level adjustment		
	Intensity adjustment	8-level adjustment		
	Intensity of LCD only	<ul style="list-style-type: none"> GT1030-L□DW/L□DW2/L□LW 300 [cd/m²] (in white) GT1030-H□DW/H□DW2/H□LW 500 [cd/m²] (in white) 		
Life	Approx. 50,000h. (Time for display intensity to become 1/5 at operating ambient temperature of 25°C)			
Backlight	LED with 3 available colors (white, red, pink) (no replacement required), Backlight status (colors, ON/BLINK/OFF) control, Adjustable screensaver activation time Setting the system information*2 enables PLC to control the backlight status.			
Touch panel	Number of touch keys	Maximum 50 keys/screen (Matrix resistive film touch panel)		
	Key size	Minimum 16 × 16 dots (per key)		
	Simultaneous pressing of two (or more) areas (2-point press)	Enable		
	Life	1 million times or more (operating force 0.98N max.)		
Memory	C drive*3	Flash memory (Internal), for storing project data (1.5Mbytes or less), OS		
	Life (Number of write times)	100,000 times		
	D drive	SRAM (Internal), for storing alarm history, recipe data and time action setting value		
Battery		GT11-50BAT lithium battery		
	Backup target	Clock data, alarm history, recipe data and time action setting value		
	Life	Approx. 5 years (Operating ambient temperature of 25°C)		
Built-in interface	PLC communication	<ul style="list-style-type: none"> RS-422 1ch Transmission speed: 115,200/57,600/38,400/ 19,200/9,600/4,800bps Connector shape: Connector terminal block 9 pins Application:PLC communication (Hardware version A) RS-422/485 1ch Transmission speed: 115,200/57,600/38,400/ 19,200/9,600/4,800bps Connector shape: Connector terminal block 9 pins Application:PLC communication Terminating resistor*4: Open/110Ω/330Ω (Switched by terminating resistor selector switch) (At factory shipment: 330Ω) (Hardware version B or later) 	RS-232 1ch Transmission speed: 115,200/57,600/38,400/ 19,200/9,600/4,800bps Connector shape: Connector terminal block 9 pins Application: PLC communication	RS-422 1ch Transmission speed: 115,200/57,600/38,400/ 19,200/9,600/4,800bps Connector shape: Connector terminal block 9 pins Application: PLC communication
	PC communication	RS-232 1ch Transmission speed : 115,200/57,600/38,400/19,200/9,600/4,800bps Connector shape : MINI DIN 6 pins (Female) Application : PC communication (Project data upload/download, OS installation, transparent function)		

1	OVERVIEW
2	SYSTEM CONFIGURATION
3	SPECIFICATIONS
4	PART NAME
5	STANDARDS AND EMC DIRECTIVE
6	INSTALLATION
7	WIRING
8	OPTION



Item	Specifications		
	GT1030-LBDW/LWDW/ HBDW/HWDW	GT1030-LBDW2/LWDW2/ HBDW2/HWDW2	GT1030-LBLW/LWLW/ HBLW/HWLW
Buzzer output (a buzzer that sounds when touch keys are pressed)	Single tone (LONG/SHORT/OFF adjustable)		
Environmental protective structure*5	Equivalent to IP67 (JEM1030) (front section) (Horizontal format)		
External dimensions	W145(5.7) × H76(2.99) × D29.5(1.16) [mm](inch) (Horizontal format)		
Panel cutting dimensions	W137(5.39) × H66(2.59) [mm](inch) (Horizontal format)		
Weight	0.3kg (Excluding mounting fixtures)		0.28kg (Excluding mounting fixtures)
Compatible software package	<ul style="list-style-type: none"> • GT1030-L□DW/L□DW2 GT Designer2 Version2.58L or later/ GT Designer3 Version1.01B or later • GT1030-H□DW/H□DW2 GT Designer3 Version1.19V or later 		<ul style="list-style-type: none"> • GT1030-L□LW GT Designer2 Version2.97B or later/ GT Designer3 Version1.01B or later • GT1030-H□LW GT Designer3 Version1.19V or later

- *1:
- Bright dots (always lit) and dark dots (unlit) may appear on a liquid crystal display panel. It is impossible to completely avoid this symptom, as the liquid crystal display comprises of a great number of display elements. Flickers may be observed depending on the display color. Please note that these dots appear due to its characteristic and are not caused by product defect.
 - Flickers and partial discoloration may be generated on the liquid crystal display panel due to the display contents or the contrast adjustment. However, please note that these phenomena appear due to its characteristic and are not caused by product defect.
 - There is a difference in the display brightness and the color tones between liquid crystal display panels. When using multiple liquid crystal display panels, please note that there is an individual difference between them.
 - A crosstalk (shadow as an extension of the display) may appear on the liquid crystal display panel. Please note that it appears due to its characteristic.
 - When the display section is seen from the outside of the display angle, the display color seems like it has changed. Please note that it is due to its characteristic.
Please note that the response time, brightness and color of the liquid crystal display panel may vary depending on the usage environmental temperature.
Especially in the low temperature environment, the display response becomes slow due to the characteristics of the STN liquid crystal. Please check the display response in advance for using this product.
 - Please note that the response in low temperatures tend to be slower as a characteristic of the liquid crystal display panel.
 - When the same screen is displayed for a long time, an incidental color or partial discoloration is generated on the screen due to heat damage, and it may not disappear.
To prevent heat damage, the screen saver function is effective.
For details on the screen saver function, refer to the following.
☞ Chapter 12 DISPLAY AND OPERATION SETTINGS (GOT SET UP)
- *2: For the details of system information, refer to the following.
☞ GT Designer2 Version□ Screen Design Manual
GT Designer3 Version1 Screen Design Manual
- *3: ROM in which new data can be written without deleting the written data.
- *4: Set the terminating resistor selector switch of the GOT in accordance with the connection type when adopting GOT multidrop connection. For details of GOT multidrop connection, refer to the following.
☞ GOT1000 Series Connection Manual
- *5: Note that this does not guarantee all users' operation environment.
In addition, the product may not be used in environments under exposition of oil or chemicals for a long period of time, or in environments filled with oil-mist.

• GT104□

Item	Specifications		
	GT1045-QSBD	GT1040-QBBD	
Display section*1	Type	STN color liquid crystal	STN monochrome (white/blue) liquid crystal
	Screen size	4.7"	
	Resolution	320 × 240 dots (Horizontal format)	
	Display size	W96(3.77) × H72(2.83) [mm](inch) (Horizontal format)	
	Display character	16-dot standard font: 40 characters × 15 lines (Horizontal format) 12-dot standard font: 53 characters × 20 lines (Horizontal format)	
	Display color	256 colors	Monochrome (white/blue), 16 scales
	Display angle	Left/Right: 50 degrees, Top: 40 degrees, Bottom: 70 degrees (Horizontal format)	Left/Right: 45 degrees, Top: 20 degrees, Bottom: 40 degrees (Horizontal format)
	Contrast adjustment	16-level adjustment	
	Intensity of LCD only	150 [cd/m ²]	300 [cd/m ²]
Life	Approx. 50,000h. (Time for display intensity to become 1/5 at operating ambient temperature of 25°C)		
Backlight	LED Backlight off/screen saving time can be set.		
Touch panel	Number of touch keys	Maximum 50 keys/screen (Matrix resistive film touch panel)	
	Key size	Minimum 16 × 16 dots (per key)	
	Number of points touched simultaneously	Maximum of 2 points	
	Life	1 million times or more (operating force 0.98N max.)	
Memory	C drive*2	Flash memory (Internal), for storing project data (3Mbytes or less), OS	
	Life (Number of write times)	100,000 times	
	D drive	SRAM (Internal), for storing alarm history, recipe data and time action setting value	
Battery		GT11-50BAT lithium battery	
	Backup target	Clock data, alarm history, recipe data and time action setting value	
	Life	Approx. 5 years (Operating ambient temperature of 25°C)	
Built-in interface	RS-422	RS-422/485 1ch Transmission speed : 115,200/57,600/38,400/19,200/9,600/4,800bps Connector shape : D-sub 9 pins (Female) Application : PLC communication Terminating resistor*4 : Open/110Ω/330Ω (Switched by terminating resistor selector switch)	
		RS-232 1ch Transmission speed : 115,200/57,600/38,400/19,200/9,600/4,800bps Connector shape : D-sub 9 pins (Male) Application : PLC communication, bar code reader connection, PC communication (Project data upload/download, OS installation, transparent function)	
		USB (Full Speed 12Mbps) 1ch Connector shape : Mini-B Application : PC communication (Project data upload/download, OS installation, transparent function)	
		Memory board	
Buzzer output (a buzzer that sounds when touch keys are pressed)	Single tone (LONG/SHORT/OFF adjustable)		
Environmental protective structure*3	Equivalent to IP67 (JEM1030) (front section) (Horizontal format)		
External dimensions	W139(5.47) × H112(4.4) × D41(1.61) (Excluding mounting fixtures) [mm](inch) (Horizontal format)		
Panel cutting dimensions	W130(5.11) × H103(4.05) [mm](inch) (Horizontal format)		
Weight	0.45kg (Excluding mounting fixtures)		
Compatible software package	GT Designer2 Version2.90U or later/GT Designer3 Version1.01B or later		



1 OVERVIEW
2 SYSTEM CONFIGURATION
3 SPECIFICATIONS
4 PART NAME
5 UL, cUL STANDARDS AND EMC DIRECTIVE
6 INSTALLATION
7 WIRING
8 OPTION

- *1:
 - Bright dots (always lit) and dark dots (unlit) may appear on a liquid crystal display panel. It is impossible to completely avoid this symptom, as the liquid crystal display comprises of a great number of display elements. Flickers may be observed depending on the display color. Please note that these dots appear due to its characteristic and are not caused by product defect.
 - Flickers and partial discoloration may be generated on the liquid crystal display panel due to the display contents or the contrast adjustment. However, please note that these phenomena appear due to its characteristic and are not caused by product defect.
 - There is a difference in the display brightness and the color tones between liquid crystal display panels. When using multiple liquid crystal display panels, please note that there is an individual difference between them.
 - A crosstalk (shadow as an extension of the display) may appear on the liquid crystal display panel. Please note that it appears due to its characteristic.
 - When the display section is seen from the outside of the display angle, the display color seems like it has changed. Please note that it is due to its characteristic.
Please note that the response time, brightness and color of the liquid crystal display panel may vary depending on the usage environmental temperature.
Especially in the low temperature environment, the display response becomes slow due to the characteristics of the STN liquid crystal. Please check the display response in advance for using this product.
 - When the same screen is displayed for a long time, an incidental color or partial discoloration is generated on the screen due to heat damage, and it may not disappear.
To prevent heat damage, the screen saver function is effective.
For details on the screen saver function, refer to the following.
 Chapter 12 DISPLAY AND OPERATION SETTINGS (GOT SET UP)
- *2: ROM in which new data can be written without deleting the written data.
- *3: Note that this does not guarantee all users' operation environment.
In addition, the product may not be used in environments under exposition of oil or chemicals for a long period of time, or in environments filled with oil-mist.
- *4: Set the terminating resistor selector switch of the GOT in accordance with the connection type when adopting GOT multidrop connection.
For details of GOT multidrop connection, refer to the following.
 GOT1000 Series Connection Manual

• GT105□

Item	Specifications		
	GT1055-QSBD	GT1050-QBBD	
Display section*1	Type	STN color liquid crystal	STN monochrome (white/blue) liquid crystal
	Screen size	5.7"	
	Resolution	320 × 240 dots (Horizontal format)	
	Display size	W115(4.53) × H86(3.39) [mm](inch) (Horizontal format)	
	Display character	16-dot standard font: 40 characters × 15 lines (Horizontal format) 12-dot standard font: 53 characters × 20 lines (Horizontal format)	
	Display color	256 colors	Monochrome (white/blue), 16 scales
	Display angle	Left/Right: 55 degrees, Top: 65 degrees, Bottom: 70 degrees (Horizontal format) (Hardware version K or earlier) Left/Right: 50 degrees, Top: 50 degrees, Bottom: 70 degrees (Horizontal format) (Hardware version L or later)	Left/Right: 45 degrees, Top: 20 degrees, Bottom: 40 degrees (Horizontal format)
	Contrast adjustment	16-level adjustment	
	Intensity of LCD only	380 [cd/m ²]	260 [cd/m ²]
	Life	Approx. 50,000h. (Time for display intensity to become 1/5 at operating ambient temperature of 25°C)	
Backlight	Cold cathode fluorescent tube (irreplaceable by a user) backlight shutoff detection function is included. Backlight off/screen saving time can be set.		
Life*2	Approx. 75,000h or longer (Time for display intensity reaches 50% at the operating ambient temperature of 25°C)	Approx. 54,000h or longer (Time for display intensity reaches 50% at the operating ambient temperature of 25°C)	
Touch panel	Number of touch keys	Maximum 50 keys/screen (Matrix resistive film touch panel)	
	Key size	Minimum 16 × 16 dots (per key)	
	Number of points touched simultaneously	Maximum of 2 points	
	Life	1 million times or more (operating force 0.98N max.)	
Memory	C drive*3	Flash memory (Internal), for storing project data (3Mbytes or less), OS	
	Life (Number of write times)	100,000 times	
	D drive	SRAM (Internal), for storing alarm history, recipe data and time action setting value	
Battery		GT11-50BAT lithium battery	
	Backup target	Clock data, alarm history, recipe data and time action setting value	
	Life	Approx. 5 years (Operating ambient temperature of 25°C)	
Built-in interface	RS-422	<ul style="list-style-type: none"> • RS-422 1ch Transmission speed : 115,200/57,600/38,400/19,200/9,600/4,800bps Connector shape : D-sub 9 pins (Female) Application : PLC communication (Hardware version A to B) • RS-422/485 1ch Transmission speed : 115,200/57,600/38,400/19,200/9,600/4,800bps Connector shape : D-sub 9 pins (Female) Application : PLC communication Terminating resistor*4 : Open/110Ω/330Ω (Switched by terminating resistor selector switch) (At factory shipment: 330Ω) (Hardware version C or later) 	
		<ul style="list-style-type: none"> • RS-232 1ch Transmission speed : 115,200/57,600/38,400/19,200/9,600/4,800bps Connector shape : D-sub 9 pins (Male) Application : PLC communication, bar code reader connection, PC communication (Project data upload/download, OS installation, transparent function) 	
	USB	<ul style="list-style-type: none"> • USB (Full Speed 12Mbps) 1ch Connector shape : Mini-B Application : PC communication (Project data upload/download, OS installation, transparent function) 	
	Memory board	For connecting memory board (GT10-50FMB), 1ch	
	Buzzer output (a buzzer that sounds when touch keys are pressed)	Single tone (LONG/SHORT/OFF adjustable)	
Environmental protective structure*5	Equivalent to IP67 (JEM1030) (front section) (Horizontal format)		
External dimensions	W164(6.46) × H135(5.32) × D56(2.21) (Excluding mounting fixtures) [mm](inch) (Horizontal format)		

Item	Specifications	
	GT1055-QSBD	GT1050-QBBD
Panel cutting dimensions	W153(6.03) × H121(4.77) [mm](inch) (Horizontal format)	
Weight	0.7kg (Excluding mounting fixtures)	
Compatible software package	GT Designer2 Version2.90U or later/GT Designer3 Version1.01B or later	

- *1:
- Bright dots (always lit) and dark dots (unlit) may appear on a liquid crystal display panel. It is impossible to completely avoid this symptom, as the liquid crystal display comprises of a great number of display elements. Flickers may be observed depending on the display color. Please note that these dots appear due to its characteristic and are not caused by product defect.
 - Flickers and partial discoloration may be generated on the liquid crystal display panel due to the display contents or the contrast adjustment. However, please note that these phenomena appear due to its characteristic and are not caused by product defect.
 - There is a difference in the display brightness and the color tones between liquid crystal display panels. When using multiple liquid crystal display panels, please note that there is an individual difference between them.
 - A crosstalk (shadow as an extension of the display) may appear on the liquid crystal display panel. Please note that it appears due to its characteristic.
 - When the display section is seen from the outside of the display angle, the display color seems like it has changed. Please note that it is due to its characteristic.
Please note that the response time, brightness and color of the liquid crystal display panel may vary depending on the usage environmental temperature.
Especially in the low temperature environment, the display response becomes slow due to the characteristics of the STN liquid crystal. Please check the display response in advance for using this product.
 - When the same screen is displayed for a long time, an incidental color or partial discoloration is generated on the screen due to heat damage, and it may not disappear.
To prevent heat damage, the screen saver function is effective.
For details on the screen saver function, refer to the following.
 Chapter 12 DISPLAY AND OPERATION SETTINGS (GOT SET UP)
- *2: Using the GOT Backlight OFF function can prolong the life of the backlight.
For details on the Backlight OFF function, refer to the following.
 Chapter 12 DISPLAY AND OPERATION SETTINGS (GOT SET UP)
- *3: ROM in which new data can be written without deleting the written data.
- *4: Set the terminating resistor selector switch of the GOT in accordance with the connection type when adopting GOT multidrop connection. For details of GOT multidrop connection, refer to the following.
 GOT1000 Series Connection Manual
- *5: Note that this does not guarantee all users' operation environment.
In addition, the product may not be used in environments under exposition of oil or chemicals for a long period of time, or in environments filled with oil-mist.

3.3 Power Supply Specifications

• GT1020, GT1030

Item	Specifications		
	GT1020-L□D GT1020-L□D2 GT1020-L□DW GT1020-L□DW2	GT1030-L□D GT1030-L□D2 GT1030-L□DW GT1030-L□DW2 GT1030-H□D GT1030-H□D2 GT1030-H□DW GT1030-H□DW2	GT1020-L□L GT1020-L□LW GT1030-L□L GT1030-L□LW GT1030-H□L GT1030-H□LW
Input power supply voltage	24VDC (+10% -15%), ripple voltage 200mV or less		5VDC (±5%), supplied from the PLC
Fuse (built-in, not exchangeable)	0.4A	0.5A	-
Power consumption	1.9W (80mA/24VDC) or less	2.2W (90mA/24VDC) or less	1.1W (220mA/5VDC) or less
At backlight off	1.2W (50mA/24VDC) or less	1.7W (70mA/24VDC) or less	0.6W (120mA/5VDC) or less
Inrush current	13A or less (26.4VDC) 1ms	18A or less (26.4VDC) 1ms	-
Permissible instantaneous power failure time	Within 5ms		-
Noise immunity	Noise voltage: 1000Vp-p Noise width: 1 μs (by noise simulator of 30 to 100Hz noise frequency)		
Dielectric withstand voltage	500VAC for 1 minute (across power supply terminals and earth)		-
Insulation resistance	10MΩ or larger by insulation resistance tester (across power supply terminals and earth)		-

• GT104□, GT105□

Item	Specifications			
	GT1045-QSBD	GT1040-QBBD	GT1055-QSBD	GT1050-QBBD
Input power supply voltage	24VDC (+10% -15%), ripple voltage 200mV or less			
Fuse (built-in, not exchangeable)	1.0A			
Power consumption	3.6W (150mA/24VDC) or less		9.84W (410mA/24VDC) or less	9.36W (390mA/24VDC) or less
At backlight off	2.9W (120mA/24VDC) or less		4.32W (180mA/24VDC) or less	
Inrush current	15A or less (26.4VDC) 2ms			
Permissible instantaneous power failure time	Within 5ms			
Noise immunity	Noise voltage : 1000Vp-p Noise width : 1 μs (by noise simulator of 30 to 100Hz noise frequency)			
Dielectric withstand voltage	500VAC for 1 minute (across power supply terminals and earth)			
Insulation resistance	10MΩ or larger by insulation resistance tester (across power supply terminals and earth)			



Remark

Operation at momentary power failure

The GOT continues to operate even upon 5ms or shorter instantaneous power failure.

The GOT stops operating if there is extended power failure or voltage drop, while it automatically resumes operation as soon as the power is restored.

4. PART NAME

4.1 Front Panel

4.1.1 GT1020, GT1030

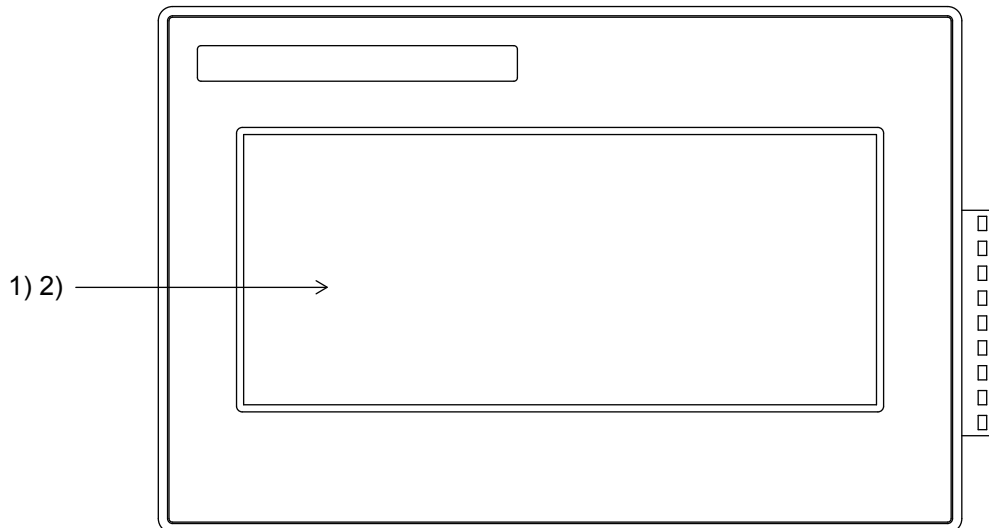

No.	Name	Specifications
1)	Display screen	Displays the utility screen and the user creation screen. GT1020 : 160 × 64 dots, STN monochrome (white/black) liquid crystal GT1030 : 288 × 96 dots, STN monochrome (white/black) liquid crystal
2)	Touch key	For operating the touch switches in the utility screen and the user creation screen

4.1.2 GT104□

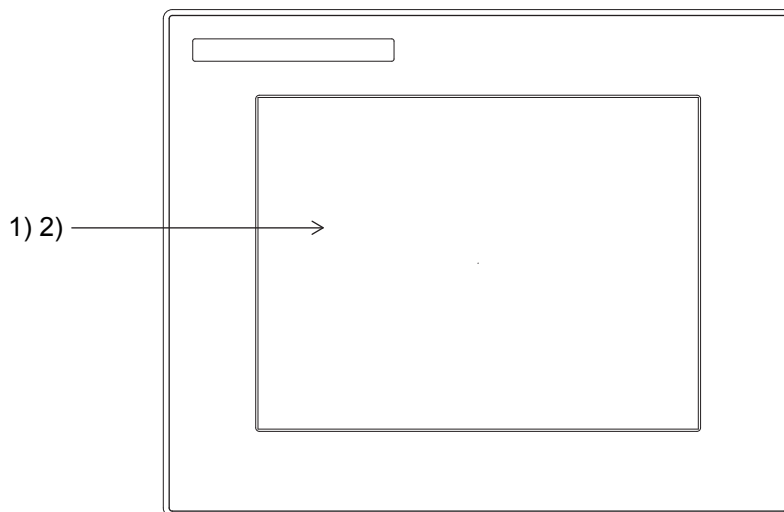

No.	Name	Specifications
1)	Display screen	Displays the utility screen and the user creation screen. GT1045-QSBD : 320 × 240 dots, STN color liquid crystal GT1040-QBBD : 320 × 240 dots, STN monochrome (white/blue) liquid crystal
2)	Touch key	For operating the touch switches in the utility screen and the user creation screen

4.1.3 GT105□

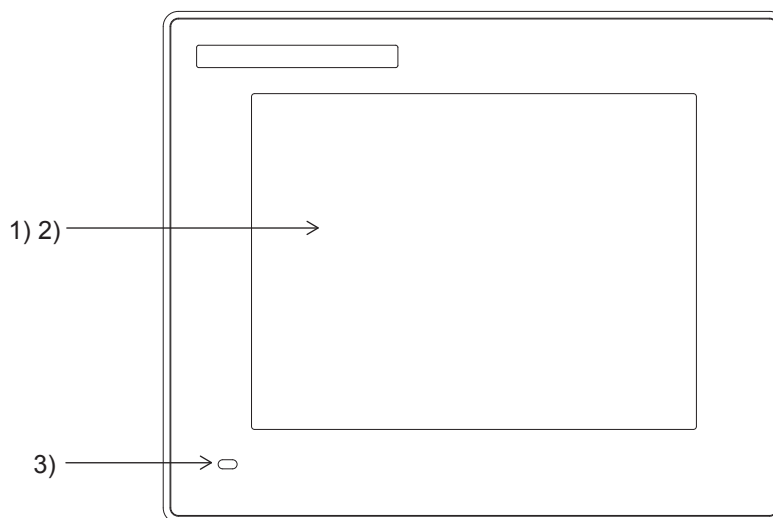

No.	Name	Specifications
1)	Display screen	Displays the utility screen and the user creation screen. GT1055-QSBD : 320 × 240 dots, STN color liquid crystal GT1050-QBBD : 320 × 240 dots, STN monochrome (white/blue) liquid crystal
2)	Touch key	For operating the touch switches in the utility screen and the user creation screen
3)	POWER LED	Green light : Power is supplied Orange light : Screen saving (At backlight off) Green / Orange flashing : Blown backlight bulb POWER LED is not lit : Power is not supplied

4.2 Back Panel

4.2.1 GT1020-L□D/L□DW

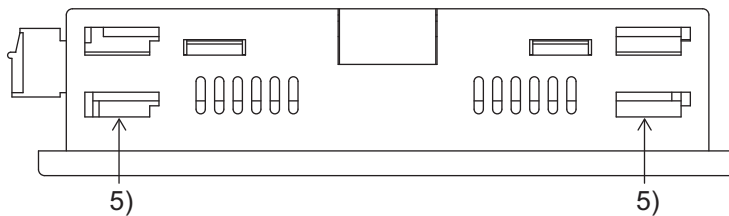
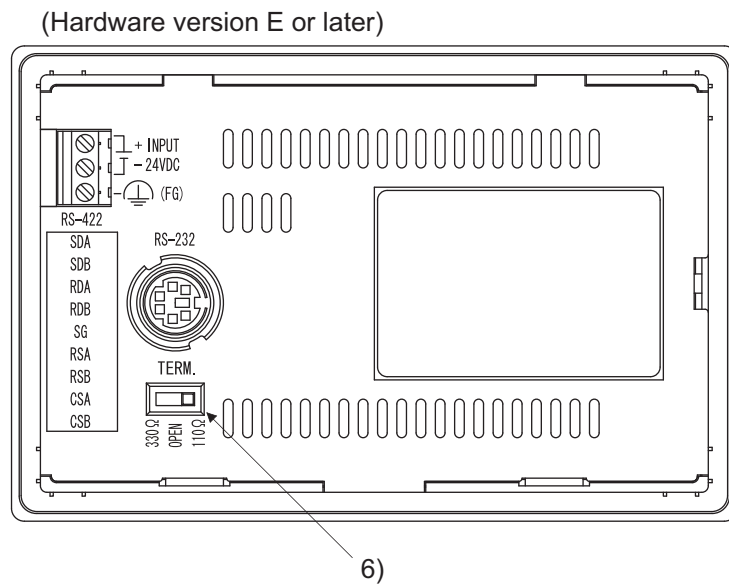
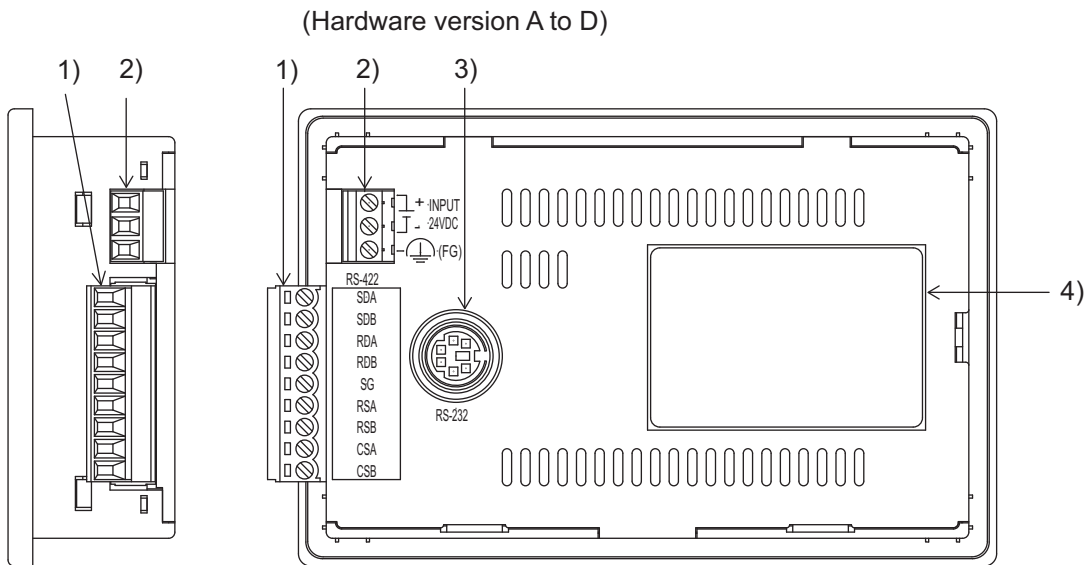

No.	Name	Specifications
1)	PLC connection interface (RS-422)	For connection to a controller (PLC) (9-pin connector terminal block)
2)	Power terminal	24VDC (+10% -15%)
3)	PC connection interface (RS-232)	For PC connection (OS installation, Project data, download, transparent) (MINI-DIN 6 pins, female)
4)	Rating plate (nameplate)	-
5)	Hole for unit installation fitting	Hole for mounting fitting (supplied) to mount the GOT on the panel (4 holes at the top and bottom)
6)	Terminating resistor selector switch (TERM.)	Terminating resistor selector of RS422/485 (330Ω/OPEN/110Ω) (At factory shipment: 330Ω)

For the connection to the controller (PLC) or PC, refer to the following.

 GOT 1000 Series Connection Manual

1	OVERVIEW
2	SYSTEM CONFIGURATION
3	SPECIFICATIONS
4	PART NAME
5	UL, cUL STANDARDS AND EMC DIRECTIVE
6	INSTALLATION
7	WIRING
8	OPTION

4.2.2 GT1020-L□D2/L□DW2

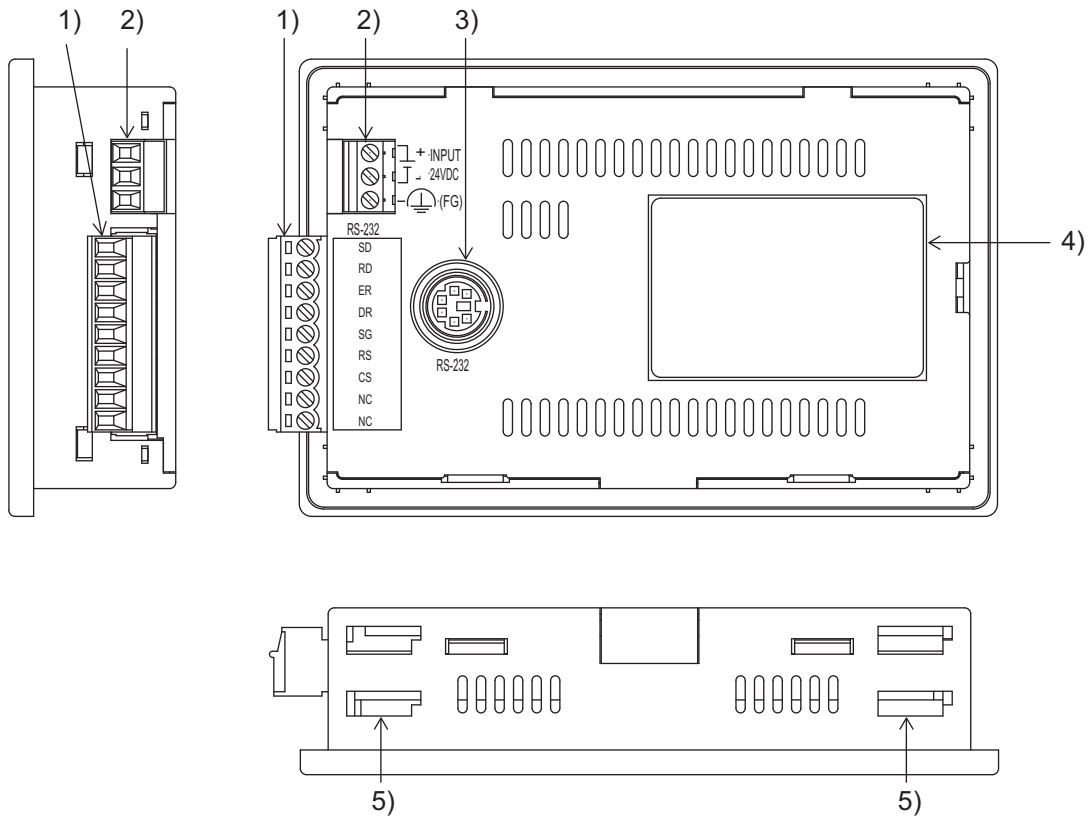

No.	Name	Specifications
1)	PLC connection interface (RS-232)	For connection to a controller (PLC) (9-pin connector terminal block)
2)	Power terminal	24VDC (+10% -15%)
3)	PC connection interface (RS-232)	For PC connection (OS installation, Project data, download, transparent) (MINI-DIN 6 pins, female)
4)	Rating plate (nameplate)	-
5)	Hole for unit installation fitting	Hole for mounting fitting (supplied) to mount the GOT on the panel (4 holes at the top and bottom)

For the connection to the controller (PLC) or PC, refer to the following.

 GOT 1000 Series Connection Manual

4.2.3 GT1020-L□L/L□LW

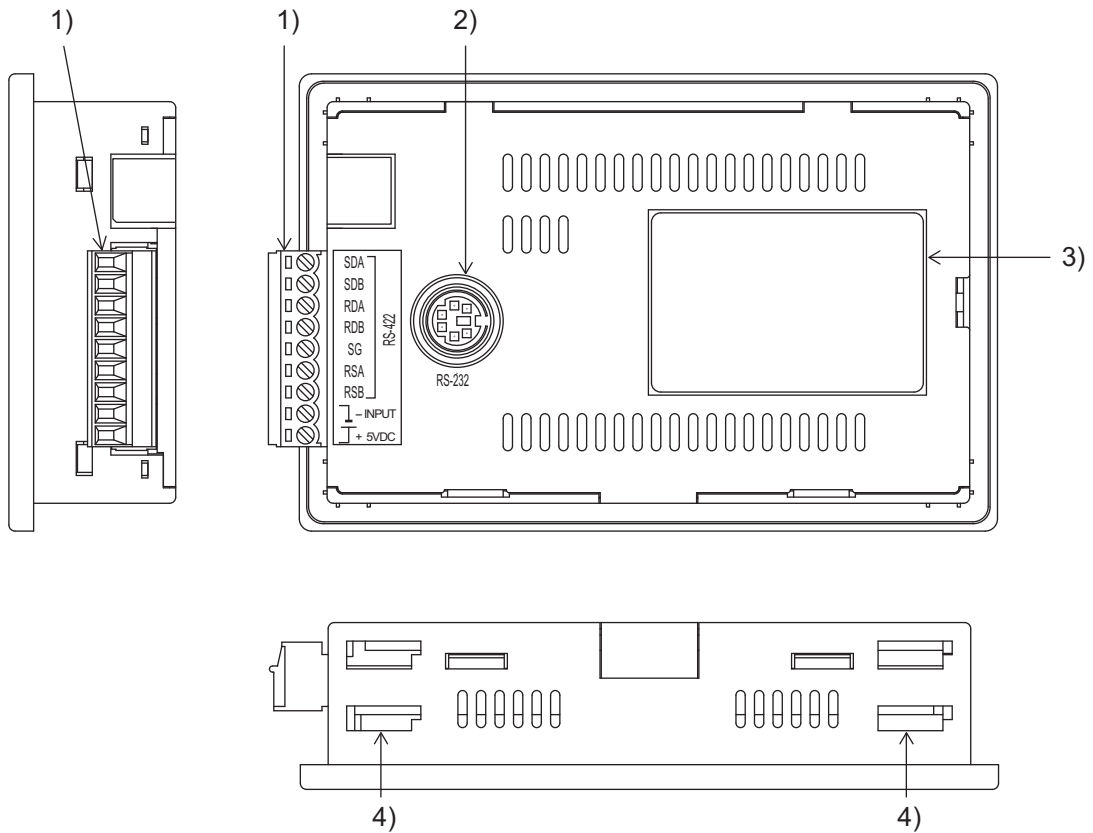

No.	Name	Specifications
1)	PLC connection interface (RS-422)	For connection to a controller (PLC) (9-pin connector terminal block)
2)	PC connection interface (RS-232)	For PC connection (OS installation, Project data download, transparent) (MINI-DIN 6 pins, female)
3)	Rating plate (nameplate)	-
4)	Hole for unit installation fitting	Hole for mounting fitting (supplied) to mount the GOT on the panel (4 holes at the top and bottom)

For the connection to the controller (PLC) or PC, refer to the following.

 GOT 1000 Series Connection Manual

1	OVERVIEW
2	SYSTEM CONFIGURATION
3	SPECIFICATIONS
4	PART NAME
5	UL, cUL STANDARDS AND EMC DIRECTIVE
6	INSTALLATION
7	WIRING
8	OPTION

4.2.4 GT1030-L□D/L□DW/H□D/H□DW

(Hardware version A)

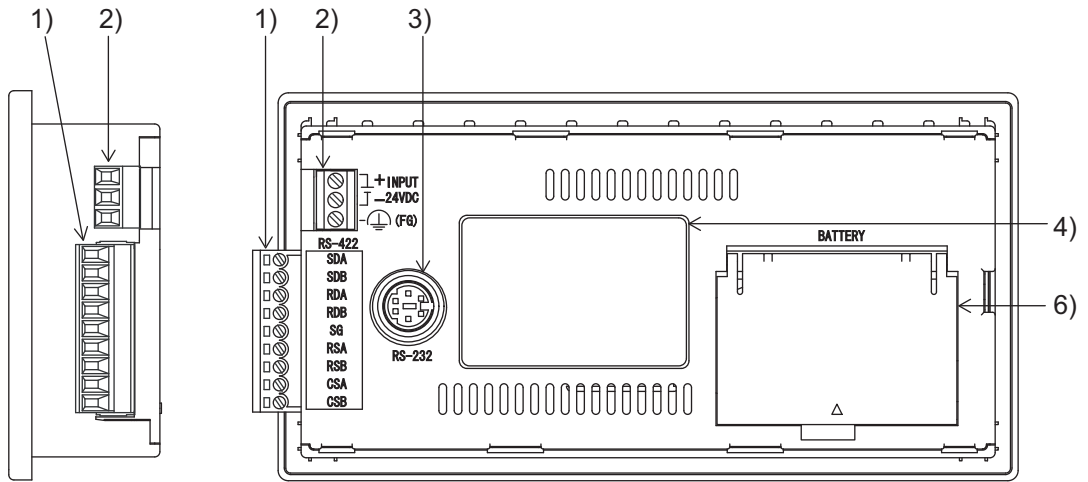

(Hardware version B or later)

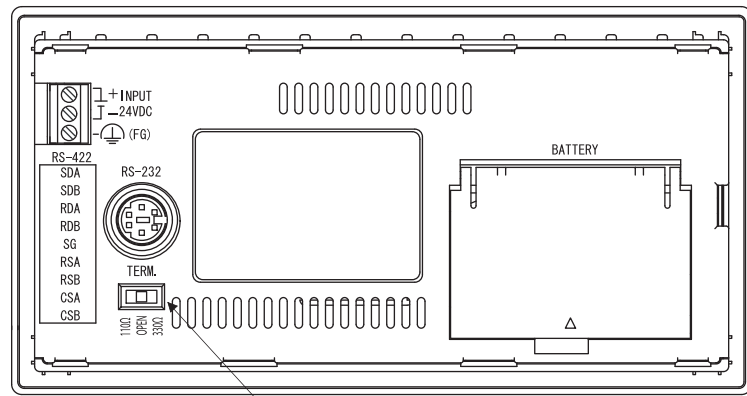

Battery cover opened

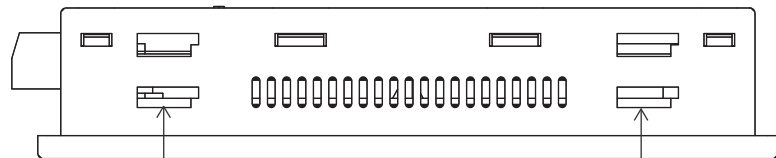
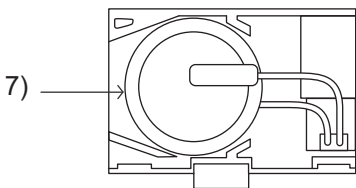

No.	Name	Specifications
1)	PLC connection interface (RS-422)	For connection to a controller (PLC) (9-pin connector terminal block)
2)	Power terminal	24VDC (+10% -15%)
3)	PC connection interface (RS-232)	For PC connection (OS installation, Project data, download, transparent) (MINI-DIN 6 pins, female)
4)	Rating plate (nameplate)	-
5)	Hole for unit installation fitting	Hole for mounting fitting (supplied) to mount the GOT on the panel (4 holes at the top and bottom)
6)	Battery cover	Open or close when replacing the battery.
7)	Battery	GT11-50BAT battery for storing clock data, alarm history, recipe data and time action setting value (The project data is stored in the built-in flash memory.)
8)	Terminating resistor selector switch (TERM.)	Terminating resistor selector of RS422/485 (330Ω/OPEN/110Ω) (At factory shipment: 330Ω)

For the connection to the controller (PLC) or PC, refer to the following.

 GOT 1000 Series Connection Manual

1	OVERVIEW
2	SYSTEM CONFIGURATION
3	SPECIFICATIONS
4	PART NAME
5	UL, cUL STANDARDS AND EMC DIRECTIVE
6	INSTALLATION
7	WIRING
8	OPTION

4.2.5 GT1030-L□D2/L□DW2/H□D2/H□DW2

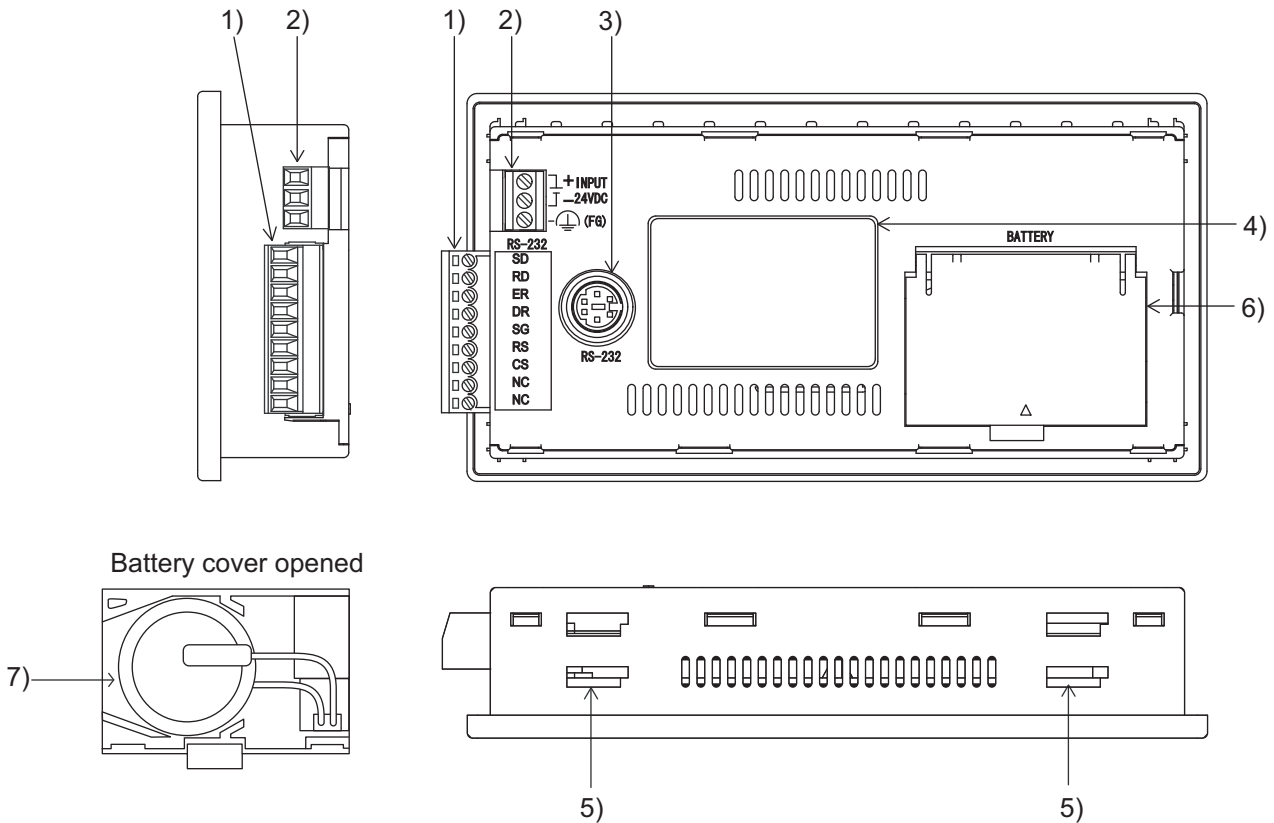

No.	Name	Specifications
1)	PLC connection interface (RS-232)	For connection to a controller (PLC) (9-pin connector terminal block)
2)	Power terminal	24VDC (+10% -15%)
3)	PC connection interface (RS-232)	For PC connection (OS installation, Project data, download, transparent) (MINI-DIN 6 pins, female)
4)	Rating plate (nameplate)	-
5)	Hole for unit installation fitting	Hole for mounting fitting (supplied) to mount the GOT on the panel (4 holes at the top and bottom)
6)	Battery cover	Open or close when replacing the battery.
7)	Battery	GT11-50BAT battery for storing clock data, alarm history, recipe data and time action setting value (The project data is stored in the built-in flash memory.)

For the connection to the controller (PLC) or PC, refer to the following.

 GOT 1000 Series Connection Manual

4.2.6 GT1030-L□L/L□LW/H□L/H□LW

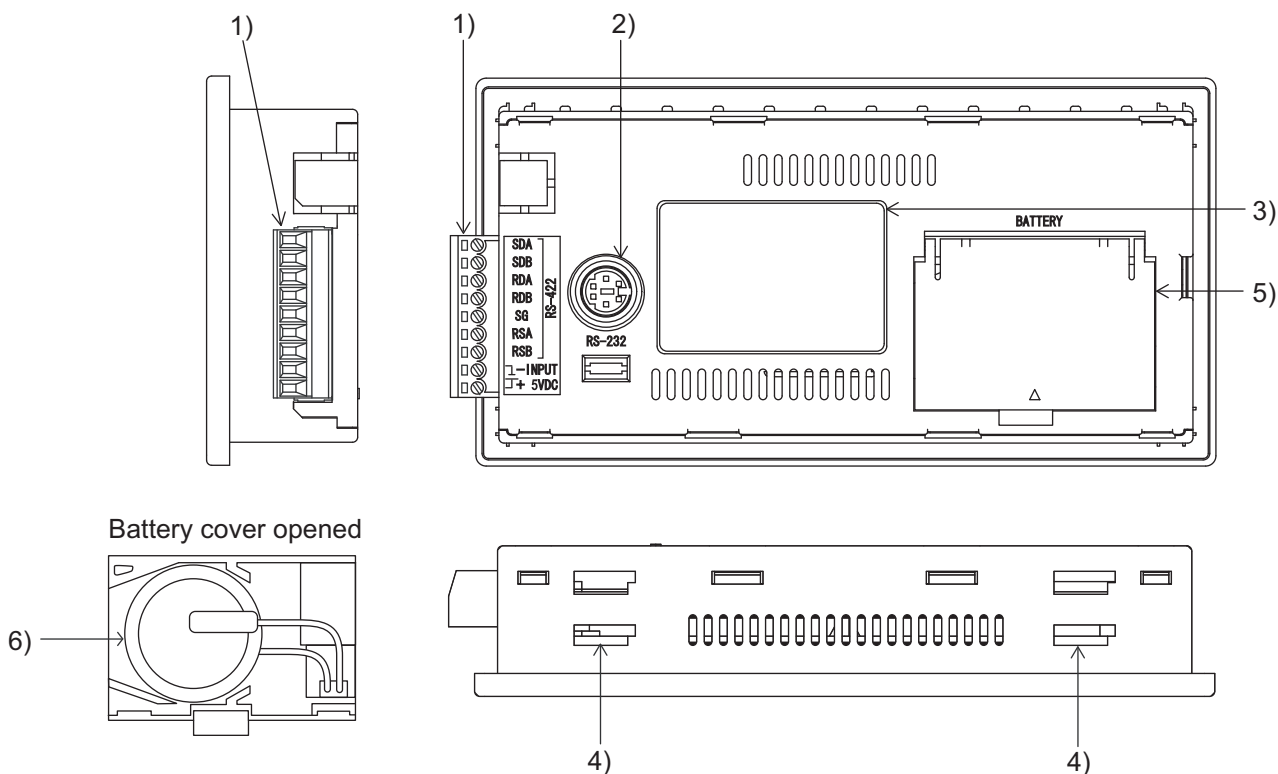

No.	Name	Specifications
1)	PLC connection interface (RS-422)	For connection to a controller (PLC) (9-pin connector terminal block)
2)	PC connection interface (RS-232)	For PC connection (OS installation, Projectdata, download, transparent) (MINI-DIN 6pins, female)
3)	Rating plate (nameplate)	-
4)	Hole for unit installation fitting	Hole for mounting fitting (supplied) to mount the GOT on the panel (4 holes at the top and bottom)
5)	Battery cover	Open or close when replacing the battery.
6)	Battery	GT11-50BAT battery for storing clock data, alarm history, recipe data and time action setting value (The project data is stored in the built-in flash memory.)

For the connection to the controller (PLC) or PC, refer to the following.

 GOT 1000 Series Connection Manual

4.2.7 GT1045-QSBD/GT1040-QBBD

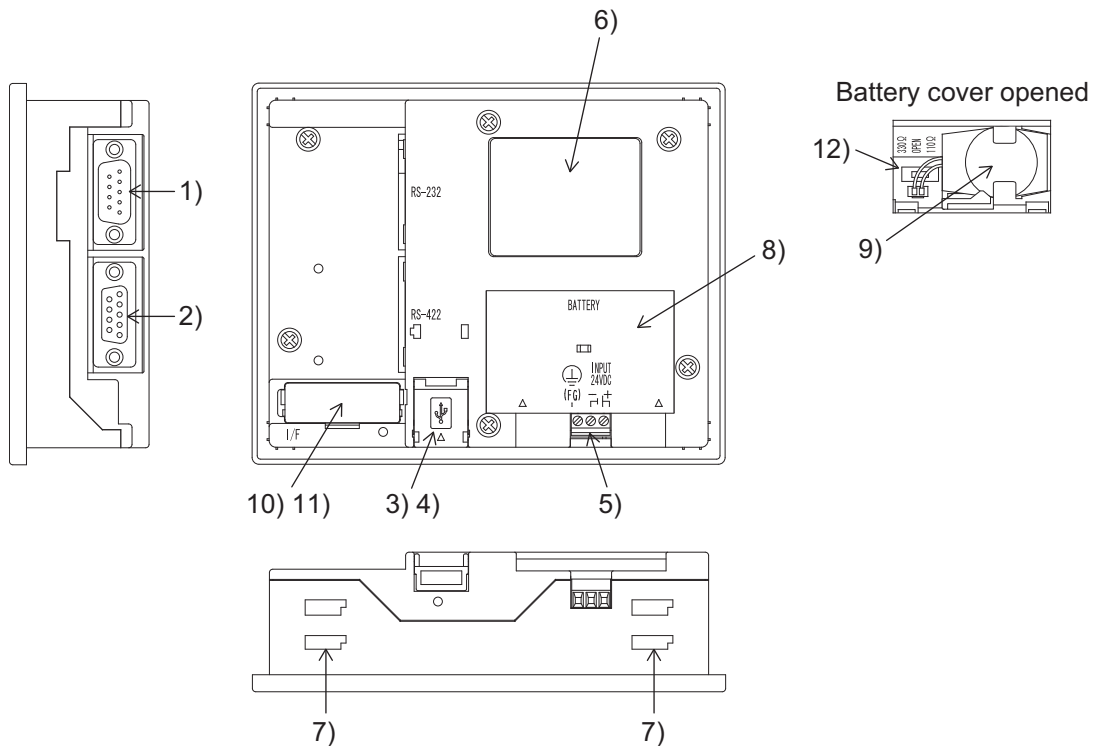

No.	Name	Specifications
1)	PLC connection interface (RS-232)	For communicating with controller (PLC, microcomputer board, bar code reader, etc) or personal computer (OS installation, project data download, transparent) (D-sub 9-pin male)
2)	PLC connection interface (RS-422)	For communicating with controller (PLC, microcomputer board, etc) (D-sub 9-pin female)
3)	USB interface	For PC connection (OS installation, project data download, transparent) (Mini-B)
4)	USB cover	Open or close when using the USB interface
5)	Power terminal	Power terminal and FG terminal (for power supply (24VDC) to GOT and grounding)
6)	Rating plate (nameplate)	-
7)	Hole for unit installation fitting	Hole for the inserting installation fittings (accessory) during the GOT installation to the panel (4 holes at top and bottom)
8)	Battery cover	Open or close when replacing the battery.
9)	Battery	GT11-50BAT battery for storing clock data, alarm history, recipe data and time action setting value (The project data is stored in the built-in flash memory.)
10)	Memory board cover	Remove when using the memory board.
11)	Memory board interface	Interface for mounting the memory board to the GOT.
12)	Terminating resistor selector switch	Terminating resistor selector of RS422/485 (330Ω/OPEN/110Ω) (At factory shipment: 330Ω)

For the connection to the controller (PLC) or PC, refer to the following.

 GOT 1000 Series Connection Manual

4.2.8 GT1055-QSBD/GT1050-QBBD

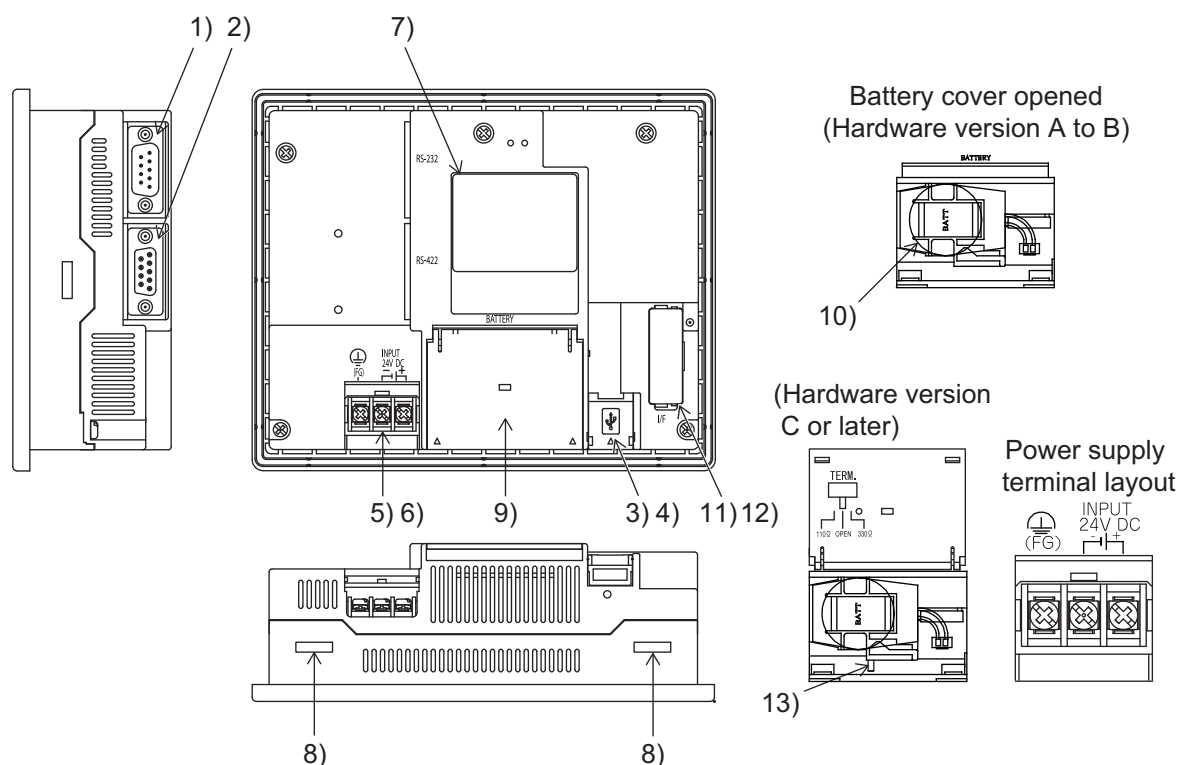

No.	Name	Specifications
1)	PLC connection interface (RS-232)	For communicating with controller (PLC, microcomputer board, bar code reader, etc) or personal computer (OS installation, project data download, transparent) (D-sub 9-pin male)
2)	PLC connection interface (RS-422)	For communicating with controller (PLC, microcomputer board, etc) (D-sub 9-pin female)
3)	USB interface	For PC connection (OS installation, project data download, transparent) (Mini-B)
4)	USB cover	Open or close when using the USB interface
5)	Power terminal	Power terminal and FG terminal (for power supply (24VDC) to GOT and grounding)
6)	Power terminal cover	Open or close when connecting a power terminal. (Color: transparent) (Hardware version B or later)
7)	Rating plate (nameplate)	-
8)	Hole for unit installation fitting	Hole for the inserting installation fittings (accessory) during the GOT installation to the panel (4 holes at top and bottom)
9)	Battery cover	Open or close when replacing the battery.
10)	Battery	GT11-50BAT battery for storing clock data, alarm history, recipe data and time action setting value (The project data is stored in the built-in flash memory.)
11)	Memory board cover	Remove when using the memory board.
12)	Memory board interface	Interface for mounting the memory board to the GOT.
13)	Terminating resistor selector switch (TERM.)	Terminating resistor selector of RS422/485 (330Ω/OPEN/110Ω) (At factory shipment: 330Ω)

For the connection to the controller (PLC) or PC, refer to the following.

GOT 1000 Series Connection Manual

5. UL, cUL STANDARDS AND EMC DIRECTIVE

5.1 UL, cUL Standards

■ Using GOT

GOT is for use on a Flat Surface of a Type 1 Enclosure.

5.2 EMC DIRECTIVE

For the products sold in European countries, the conformance to the EMC Directive, which is one of the European Directives, has been a legal obligation since 1996. Also, conformance to the Low Voltage Directive, another European Directives, has been a legal obligation since 1997. Manufacturers who recognize their products must conform to the EMC required to declare that their products conform to these Directives and put a "CE mark" on their products. Products that the EMC Directive applies to are marked with the CE mark logo.



Authorized representative in Europe

- This product is designed for use in industrial applications.
- Authorized Representative in the European Community: Mitsubishi Electric Europe B.V.
Gothaer Str. 8, 40880 Ratingen, Germany

5.2.1 Requirements for Conformance to EMC Directive

The EMC Directive specifies that products placed on the market must "be so constructed that they do not cause excessive electromagnetic interference (emissions) and are not unduly affected by electromagnetic interference (immunity)".

The applicable products are requested to meet these requirements.

The paragraphs **1** through **3** summarize the precautions on conformance to the EMC Directive of the machinery constructed using the GOT.

The details of these precautions has been prepared based on the requirements and the applicable standards control. However, we will not assure that the overall machinery manufactured according to these details conforms to the above-mentioned directives. The method of conformance to the EMC Directive and the judgment on whether or not the machinery conforms to the EMC Directive must be determined finally by the manufacturer of the machinery.

1 Standards applicable to the EMC Directive

The following products have shown compliance through direct testing (to the identified standards) and design analysis (forming a technical construction file) to the European Directive for Electromagnetic Compatibility (2004/108/EC) when used as directed by the appropriate documentation.

Type : Programmable Controller (Open Type Equipment)

Standard		Remark
EN61131-2 : 2007 Programmable controllers - Equipment, requirement and tests	EMI	Compliance with all relevant aspects of the standard. (Radiated Emissions)
	EMS	Compliance with all relevant aspects of the standard. (ESD,RF electromagnetic field, EFTB, Surge, RF conducted disturbances and Power frequency magnetic field)

For more details please contact the local Mitsubishi Electric sales site.

2 About models applicable to the EMC Directive

The following table lists the modules compliant with the EMC Directive.

○ : Compliant with EMC Directive × : Not compliant with EMC Directive

Item	EMC Directive	Hardware version
GT1020-LBD/LWD/LBD2/LWD2/LBL/LWL/ LBDW/LWDW/LBDW2/LWDW2/LBLW/LWLW	○	A or later
GT1030-LBD/LWD/LBD2/LWD2/LBL/LWL/ LBDW/LWDW/LBDW2/LWDW2/LBLW/LWLW/ HBD/HWD/HBD2/HWD2/HBL/HWL/HBDW/ HWDW/HBDW2/HWDW2/HBLW/HWLW	○	A or later
GT1045-QSBD, GT1040-QBBD	○	A or later
GT1055-QSBD, GT1050-QBBD	○	A or later



Please use the GOT whose hardware version is later than that described.
Confirm the hardware version with the products rating plate.
(Products that the EMC Directive applies to are marked with the CE mark logo.)

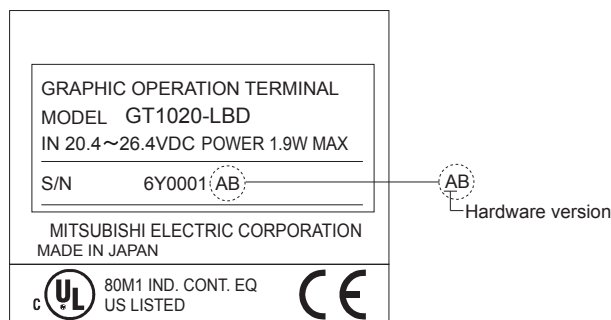

3 About the cable used

(1) General notes on the use of communication cables

Any device which utilizes a data communication function is susceptible to the wider effects of local EMC noise. Therefore, when installing any communication cables care should always be taken with the routing and location of those cables. The GOT units identified on the previous page are compliant with the EMC requirement when the following communication cables are used.

GOT Unit	Existing Cables	User Made Cables
GT1020-LBD/LWD/LBL/LWL/ LBDW/LWDW/LBLW/LWLW GT1030-LBD/LWD/LBL/LWL/ LBDW/LWDW/LBLW/LWLW/ HBD/HWD/HBL/HWL/HBDW/ HWDW/HBLW/HWLW	GT10-C30R4-8P (For Melsec FX series PLC)	-
GT1020-LBD2/LWD2/LBDW2/ LWDW2 GT1030-LBD2/LWD2/LBDW2/ LWDW2/HBD2/HWD2/HBDW2/ HWDW2	GT10-C30R2-6P (For Melsec Q series PLC)	-
GT1045-QSBD GT1040-QBBD	GT01-C30R4-8P modified as shown in EX.1	Those cables need to be independently tested by the user to demonstrate EMC compatibility when they are used with Mitsubishi GOT unit and FX3U Programmable Controllers.
GT1055-QSBD GT1050-QBBD	GT01-C30R4-8P modified as shown in EX.1	Those cables need to be independently tested by the user to demonstrate EMC compatibility when they are used with Mitsubishi GOT unit and FX3U Programmable Controllers.

Ex. 1

F = Ferrite core
Ex. NEC TOKIN - ESD-R-17S or similar

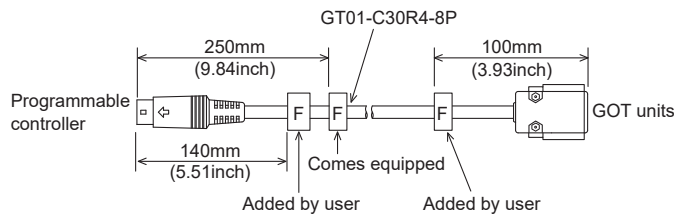

(2) General notes on the use of the power cable

The GT1020-L□D/L□D2/L□DW/L□DW2 and GT1030-L□D/L□D2/L□DW/L□DW2/H□D/H□D2/H□DW/H□DW2 unit demand that the cable for the power supply is 10m or less.

The GT1045-QSBD, GT1040-QBBD, GT1055-QSBD and GT1050-QBBD unit requires an additional ferrite filter to be attached to the 24V DC power supply cables. The filter should be attached in a similar manner as shown in the figure opposite, i.e. the power cables are wrapped around the filter. However, as with all EMC situations the more correctly applied precautions the better the systems Electro-magnetic Compatibility.

The ferrite recommended is a TDK ZCAT3035-1330 or similar.

The ferrite should be placed as near to the 24V DC terminals of the GT1045-QSBD, GT1040-QBBD, GT1055-QSBD and GT1050-QBBD as possible (which should be within 75mm of the GOT terminal).

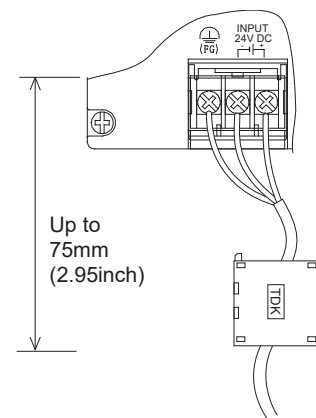

6. INSTALLATION

1	OVERVIEW
2	SYSTEM CONFIGURATION
3	SPECIFICATIONS
4	PART NAME
5	UL, cUL STANDARDS AND EMC DIRECTIVE
6	INSTALLATION
7	WIRING
8	OPTION

MOUNTING PRECAUTIONS

WARNING

- Be sure to shut off all phases of the external power supply used by the system before mounting or removing the GOT to/from the panel.
Not doing so can cause the unit to fail or malfunction.
- Be sure to shut off all phases of the external power supply used by the system before mounting or removing the memory board on to/ from the GOT.
Not doing so can cause the unit to fail or malfunction.
- When installing the memory board and the battery wear an earth band etc. to avoid the static electricity.
The static electricity can cause the unit to fail or malfunction.

MOUNTING PRECAUTIONS

CAUTION

- Use the GOT in the environment that satisfies the general specifications described in this manual.
Not doing so can cause an electric shock, fire, malfunction or product damage or deterioration.
- When mounting the GOT to the control panel, tighten the mounting screws in the specified torque range.
Undertightening can cause the GOT to drop, short circuit or malfunction, and deteriorate the waterproof effect and oilproof effect.
Overtightening can cause a drop, short circuit or malfunction due to the damage of the screws or the GOT, and deteriorate the waterproof effect and oilproof effect due to distortion of the protective cover for oil, GOT or panel.
- Securely connect the memory board to the connector provided for the board.

6.1 Control Panel Inside Dimensions for Mounting GOT

6.1.1 GT1020

Mount the GOT onto the control panel while considering the following control panel inside dimensions.

Horizontal format

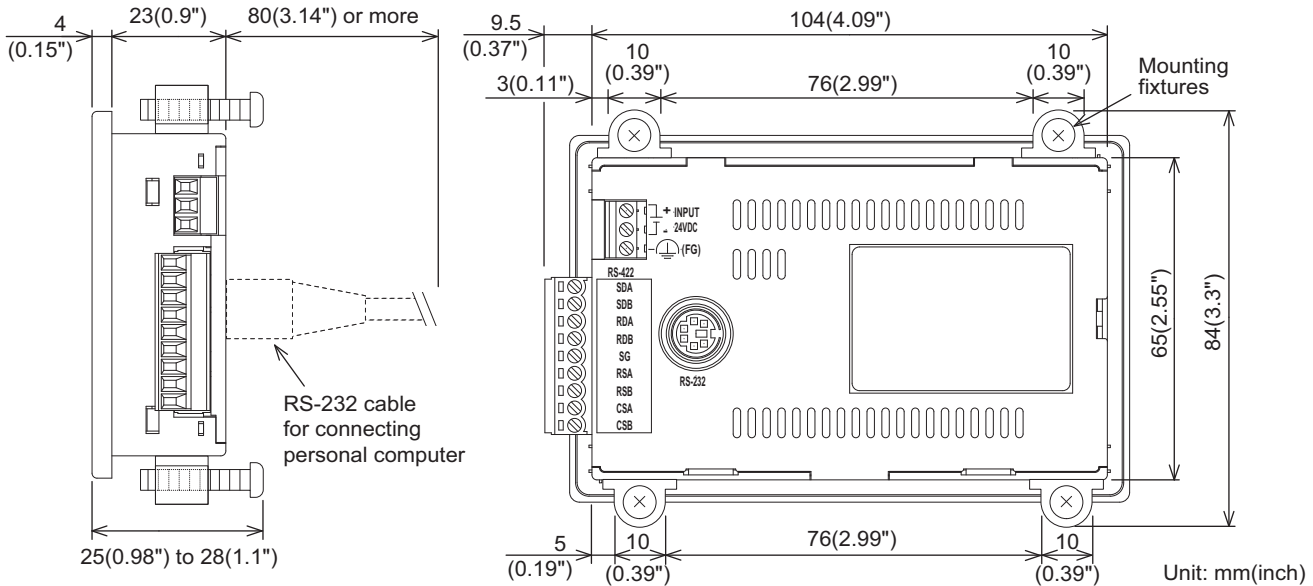

Vertical format

(If the vertical format is selected, the dimension, which is rotated 90 degrees clockwise looking from the display section side, is required.)

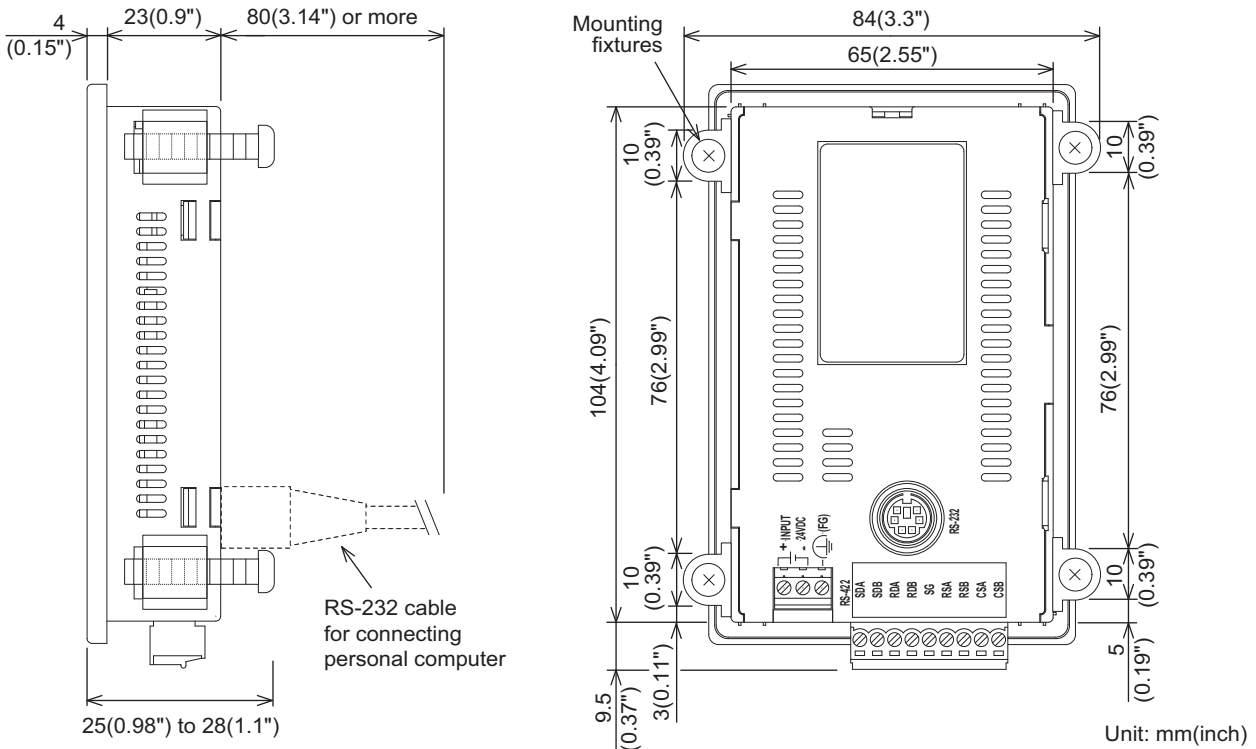

Applicable cable

Some cables may need to be longer than the specified dimensions when connecting to the GOT. Therefore, consider the connector dimensions and bending radius of the cable as well for installation.

6.1.2 GT1030

Mount the GOT onto the control panel while considering the following control panel inside dimensions.

Horizontal format

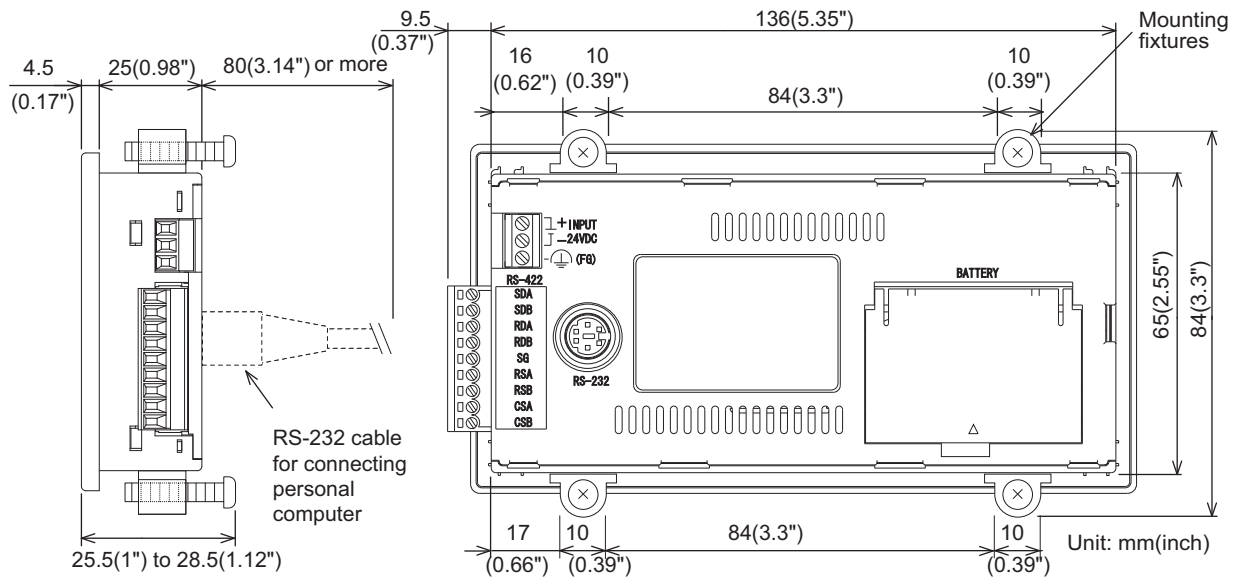

Vertical format

(If the vertical format is selected, the dimension, which is rotated 90 degrees clockwise looking from the display section side, is required.)

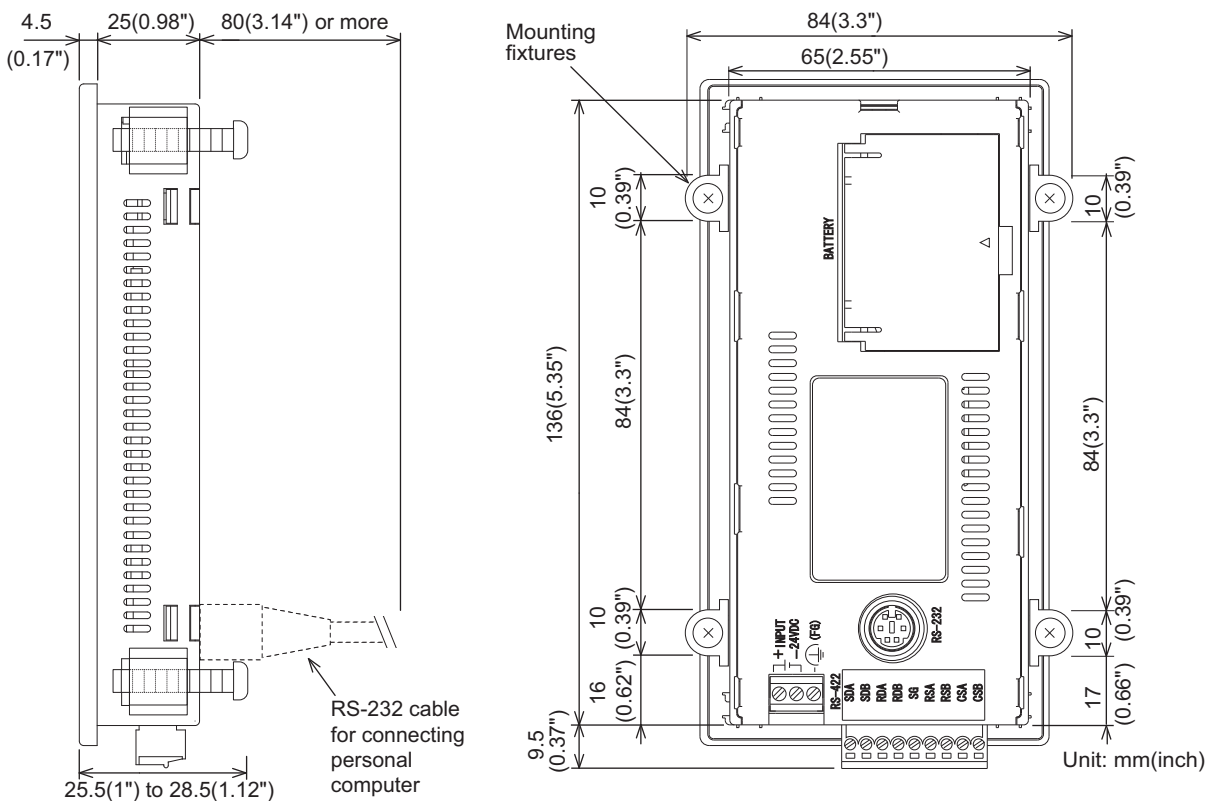

Applicable cable

Some cables may need to be longer than the specified dimensions when connecting to the GOT. Therefore, consider the connector dimensions and bending radius of the cable as well for installation.

1	OVERVIEW
2	SYSTEM CONFIGURATION
3	SPECIFICATIONS
4	PART NAME
5	UL, cUL STANDARDS AND EMC DIRECTIVE
6	INSTALLATION
7	WIRING
8	OPTION

6.1.3 GT104□

Mount the GOT onto the control panel while considering the following control panel inside dimensions.

Horizontal format

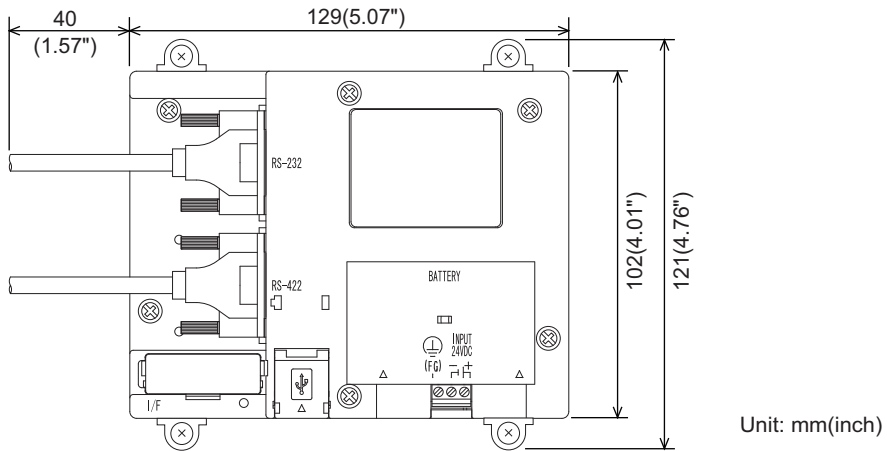

Vertical format

(If the vertical format is selected, the dimension, which is rotated 90 degrees clockwise looking from the display section side, is required.)

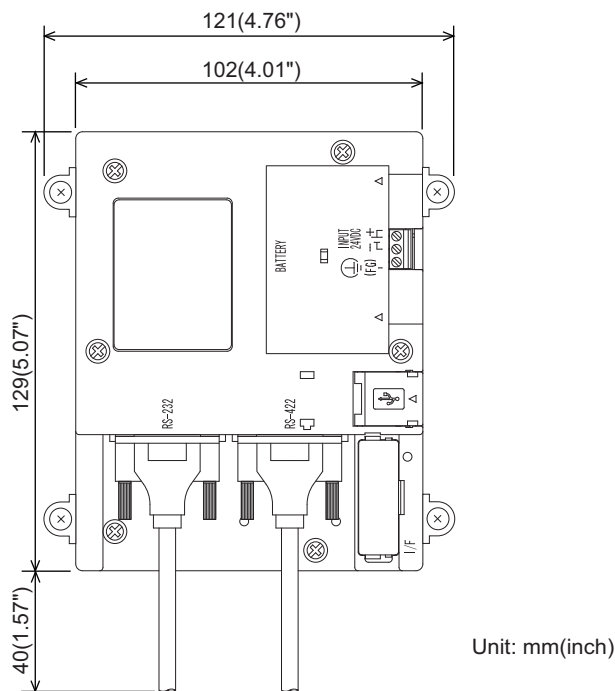

Applicable cable

Some cables may need to be longer than the specified dimensions when connecting to the GOT. Therefore, consider the connector dimensions and bending radius of the cable as well for installation.

6.1.4 GT105□

Mount the GOT onto the control panel while considering the following control panel inside dimensions.
Horizontal format

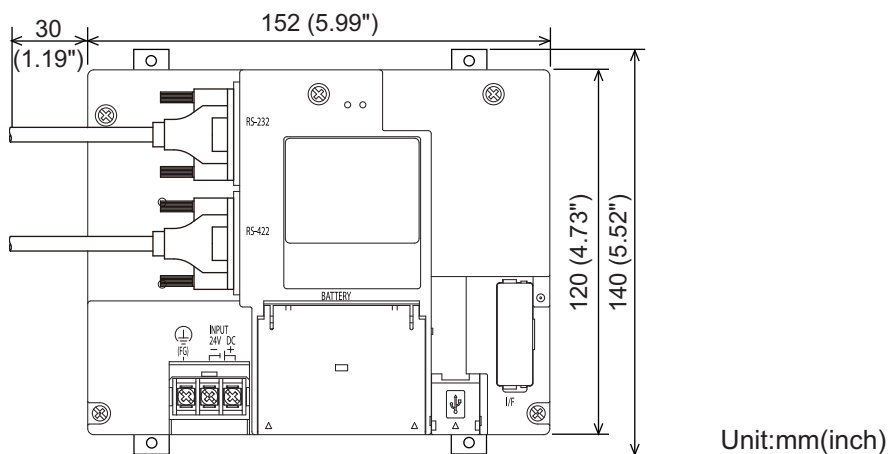

Vertical format

(If the vertical format is selected, the dimension, which is rotated 90 degrees clockwise looking from the display section side, is required.)

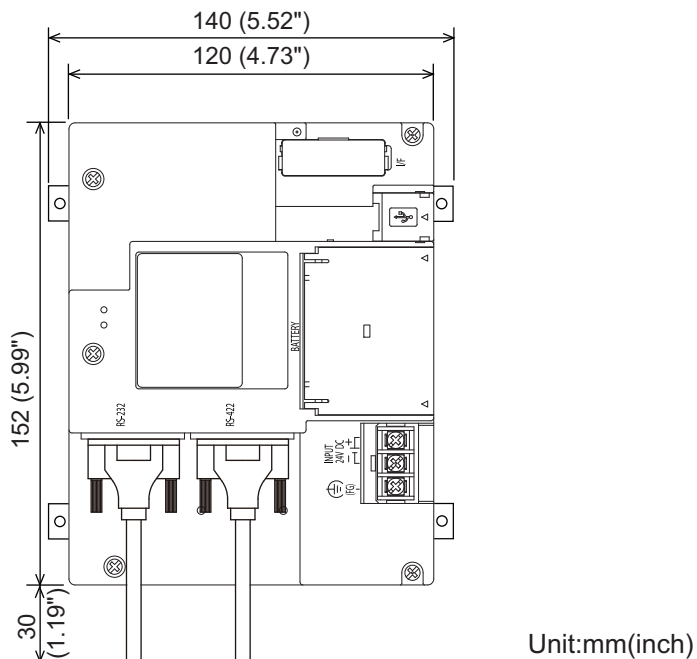

Applicable cable

Some cables may need to be longer than the specified dimensions when connecting to the GOT. Therefore, consider the connector dimensions and bending radius of the cable as well for installation.

6.2 Panel Cutting Dimensions

6.2.1 Panel cutting dimensions

Cut holes in the following dimensions on the panel.

A space of top and bottom is required to allow for the attachment of mounting fixtures.

- Horizontal format

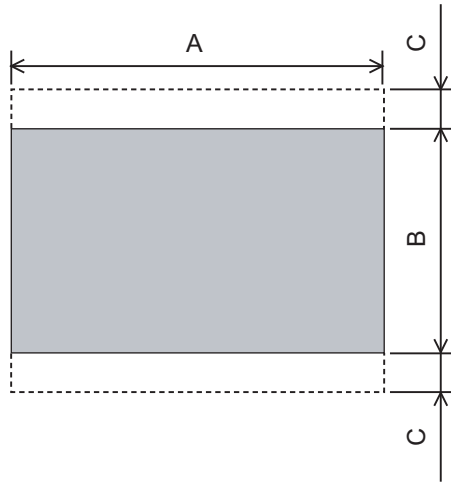

Unit: mm(inch)

- Vertical format

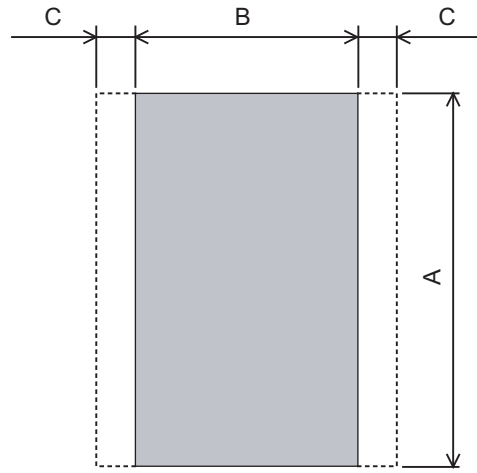

Unit: mm(inch)

GOT	A [mm] (inch)	B [mm] (inch)	C [mm] (inch)	Panel thickness [mm] (inch)
GT1020	105 (4.13") (+1(0.03"), 0(0))	66 (2.59") (+1(0.03"), 0(0))	13 (0.51") or more	Within 1 (0.03") to 4 (0.15")
GT1030	137 (5.39") (+1(0.03"), 0(0))	66(2.59") (+1(0.03"), 0(0))	13 (0.51") or more	
GT104□	130(5.11") (+1(0.03"), 0(0))	103(4.05") (+1(0.03"), 0(0))	13 (0.51") or more	Within 2 (0.07") to 5 (0.19")
GT105□	153 (6.03") (+2(0.07"), 0(0))	121 (4.77") (+2(0.07"), 0(0))	10 (0.39") or more	

6.3 Mounting Position

6.3.1 Mounting position

When mounting the GOT, the following clearances must be maintained from other structures and devices.

Horizontal format (GT1020, GT1030)

Installation Environment	A	B	C	D	E
In the presence of radiated-noise or heat-generating equipment nearby	50 mm (1.97") or more	50 mm (1.97") or more	50 mm (1.97") or more	50 mm (1.97") or more	80 mm (3.14") or more
In the absence of radiated-noise or heat-generating equipment nearby	20 mm (0.79") or more*1	20 mm (0.79") or more	20 mm (0.79") or more		20 mm (0.79") or more*2

*1 50 mm (1.97") or more if an RS-232/USB conversion adaptor is used.

*2 80 mm (3.14") or more if a PC connection cable is used or if an RS-232 interface for PC is used to connect multiple GOT units.

50 mm (1.97") or more if an RS-232/USB conversion adaptor is used and is connected to the RS-232 interface for PC.

Horizontal format (GT104□, GT105□)

Installation Environment	A	B	C	D	E
In the presence of radiated-noise or heat-generating equipment nearby	50 mm (1.97") or more	80 mm (3.14") or more	50 mm (1.97") or more	50 mm (1.97") or more	100 mm (3.94") or more
In the absence of radiated-noise or heat-generating equipment nearby	20 mm (0.79") or more	20 mm (0.79") or more	20 mm (0.79") or more	20 mm (0.79") or more	20 mm (0.79") or more*1

*1 80 mm (3.14") or more if an USB cable, memory board is used.

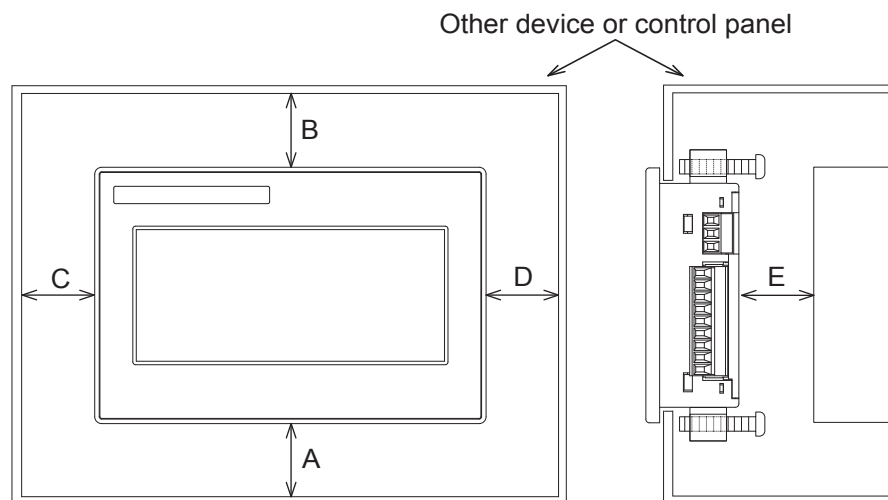

Vertical format (GT1020, GT1030)

Installation Environment	A	B	C	D	E
In the presence of radiated-noise or heat-generating equipment nearby	50 mm (1.97") or more	50 mm (1.97") or more	50 mm (1.97") or more	50 mm (1.97") or more	80 mm (3.14") or more
In the absence of radiated-noise or heat-generating equipment nearby		20 mm (0.79") or more	20 mm (0.79") or more ^{*1}	20 mm (0.79") or more	20 mm (0.79") or more ^{*2}

*1 50 mm (1.97") or more if an RS-232/USB conversion adaptor is used.

*2 80 mm (3.14") or more if a PC connection cable is used or if an RS-232 interface for PC is used to connect multiple GOT units.

50 mm (1.97") or more if an RS-232/USB conversion adaptor is used and is connected to the RS-232 interface for PC.

Vertical format (GT104□, GT105□)

Installation Environment	A	B	C	D	E
In the presence of radiated-noise or heat-generating equipment nearby	50 mm (1.97") or more	50 mm (1.97") or more	80 mm (3.14") or more	50 mm (1.97") or more	100 mm (3.94") or more
In the absence of radiated-noise or heat-generating equipment nearby	20 mm (0.79") or more	20 mm (0.79") or more	20 mm (0.79") or more	20 mm (0.79") or more	20 mm (0.79") or more ^{*1}

*1 80 mm (3.14") or more if an USB cable, memory board is used.

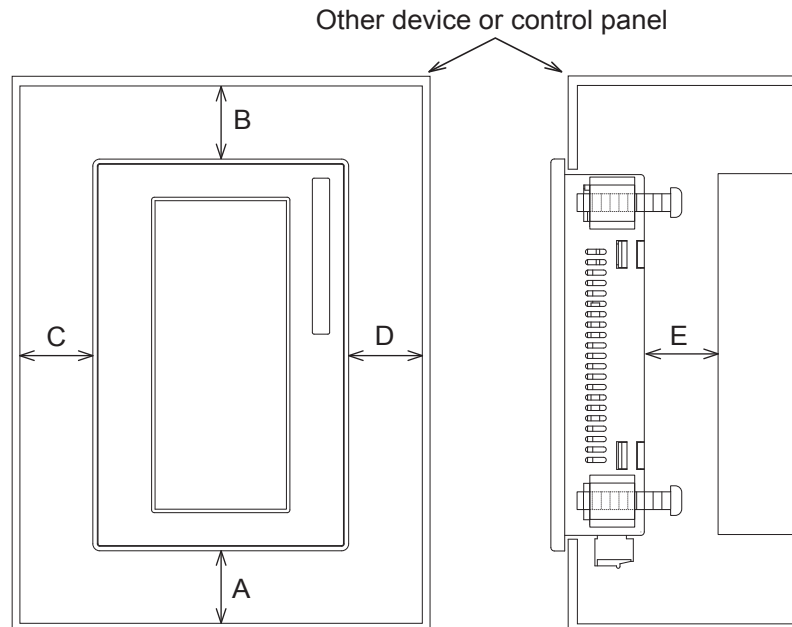

6.4 Control Panel Temperature and Mounting Angle

6.4.1 Control panel temperature and mounting angle

When mounting the main unit to a control panel or similar fixture, set the GOT display section as shown below.

1 Horizontal installation

When the temperature inside the control panel is 40 to 55°C, the mounting angle should be in the range from 60 to 105 degrees.

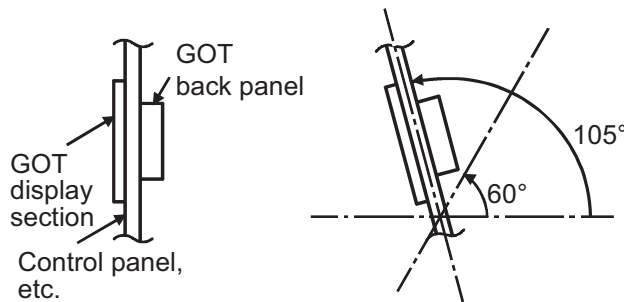

- The GOT will have a longer lifetime if used within the mounting angles shown above. Ideally, the temperature inside the control panel should not exceed 0 to 40°C

2 Vertical installation

When the temperature inside the control panel is 40 to 50°C, the mounting angle should be in the range from 60 to 105 degrees.

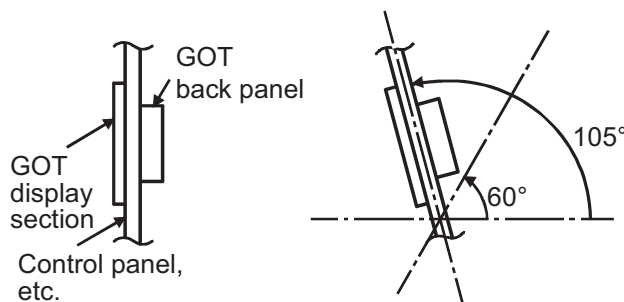

- The GOT will have a longer lifetime if used within the mounting angles shown above. Ideally, the temperature inside the control panel should not exceed 0 to 40°C.

6.5 Installation Procedure

6.5.1 Installation procedure

The GOT is designed to be embedded into a panel.
Mount the GOT by following the procedure below.



Cautions on the installation panel

Refer to "Section 6.2 Panel Cutting Dimensions" for the panel cutting dimensions and panel thickness.

Make sure that the panel surface is free from warpage, flaws and irregularities. Warpage, flaws and irregularities may disable the waterproof effect. Select proper panel thickness under consideration of the panel strength. (For example, the panel strength may be insufficient depending on the panel material and dimensions even if the panel thickness is acceptable. Insufficient panel strength may cause warpage depending on the installation positions of the GOT and other equipment.)

1 Installing the packing

Install packing to the packing installation groove on the back panel of the GOT.

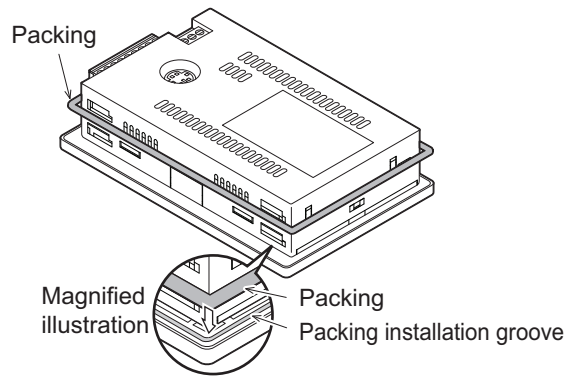

- For GT105 □
While referring to the cross sectional view of the packing shown right, push the thinner side into the packing groove. (Right drawing is the example of lateral format.)

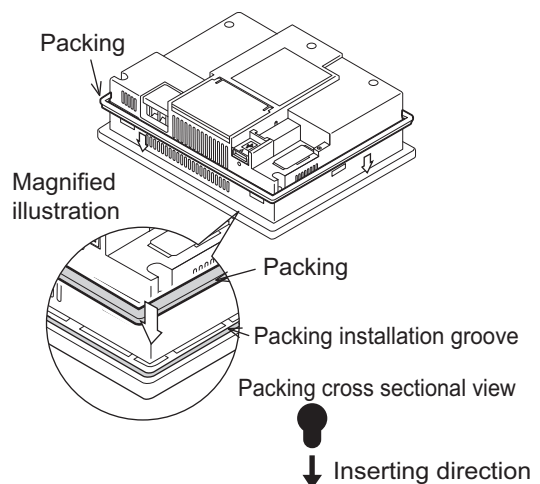

2 Inserting into the panel face

Insert the GOT from the front side of the panel.
(Right drawing is the example of lateral format.)

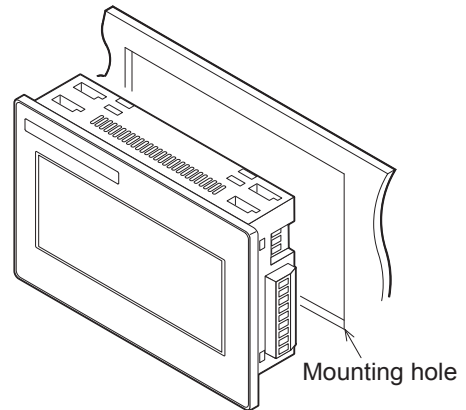

3 Fixing the GOT

- 1) Insert the hooks on the mounting fittings (supplied) into the mounting holes on the GOT unit.
- 2) Slide the mounting fittings to the back end.
- 3) Slide them to the left to lock them in place, and then fix them with the mounting screws (supplied).

The GOT will be fixed in 4 upper/lower parts.

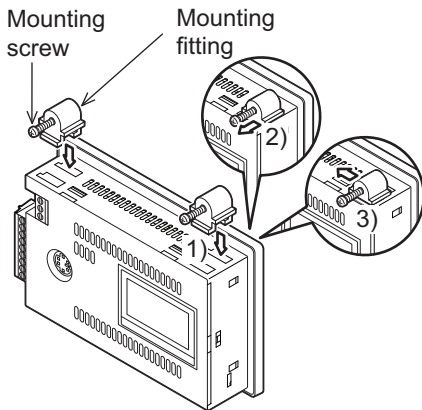

For GT1020, GT1030, GT104□

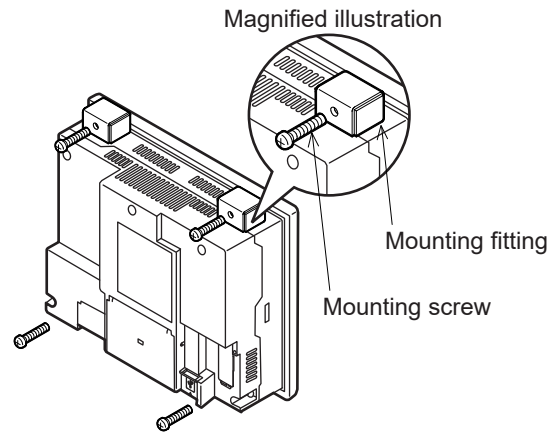

For GT105□

Point

Cautions on installation

Tighten the mounting screw with the specified torque. Undertightening of mounting screws can cause a drop, and deteriorate the waterproof effect and oilproof effect. Failure to do so may damage the unit, or distort the panel and make a surface waviness on the display area, leading to deterioration of the visibility or incorrect input from the touch panel. In addition, the waterproof effect and oilproof effect may not be available due to the "distortion" of GOT or panel.

GOT	GT1020, GT1030, GT104□	GT105□
Tightening torque	0.20 to 0.25 N•m	0.3 to 0.5 N•m

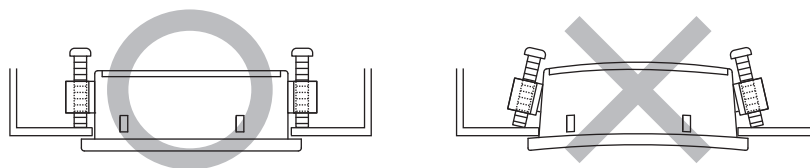

- 4** A protection film is attached on the display section of GOT prior to shipment.
Remove the film when the installation is completed.

7. WIRING

WIRING PRECAUTIONS

WARNING

- Be sure to shut off all phases of the external power supply used by the system before wiring. Failure to do so may result in an electric shock, product damage or malfunctions.
- Please make sure to ground FG terminal of the GOT power supply section by applying 100Ω or less which is used exclusively for the GOT. Not doing so may cause an electric shock or malfunction.
- Correctly wire the GOT power supply section after confirming the rated voltage and terminal arrangement of the product. Not doing so can cause a fire or failure.
- Tighten the terminal screws of the GOT power supply section in the specified torque range. Undertightening can cause a short circuit or malfunction. Overtightening can cause a short circuit or malfunction due to the damage of the screws or the GOT.
- Exercise care to avoid foreign matter such as chips and wire offcuts entering the GOT. Not doing so can cause a fire, failure or malfunction.

WIRING PRECAUTIONS

CAUTION

- Plug the communication cable into the connector of the connected unit and tighten the mounting and terminal screws in the specified torque range. Undertightening can cause a short circuit or malfunction. Overtightening can cause a short circuit or malfunction due to the damage of the screws or unit.

This chapter describes the wiring to the GOT power supply section.

- (1) For the connection with a PLC, refer to the following.

 GOT1000 Series Connection Manual

Remark

General preventive measures against noise

There are two kinds of noises: Radiated noise that is transmitted into the air and Conductive noise that is directly transmitted along connected lines. Countermeasures must be taken considering both kinds of noises and referring to the following 3 points.

- (1) Protecting against noise
 - (a) Keep signal lines away from noise sources such as a power cable or a high-power drive circuit.
 - (b) Shield the signal lines.
- (2) Reducing generated noise
 - (a) Use a noise filter, etc. to reduce the level of the noise generated due to a source such as a high-power motor drive circuit.
 - (b) Attach surge killers to the terminals on the no fuse breakers (NFB), electromagnetic contactors, relays, solenoid valves, and generators to suppress noise interference.
- (3) Releasing noise to the ground
 - (a) Make sure to connect the ground cable to the ground.
 - (b) Use a short and thick cable to lower its ground resistance.
 - (c) Ground the power system and the control system separately.

7.1 Power Supply Wiring

Connect the power supply to the power terminals on the back panel of the GOT.
Use a specified size power supply wire to prevent voltage drop, and tighten the terminal screws firmly to a specified torque.

Do not exceed the number of wires that are allowed to be connected.

Secure the wires to prevent stress from being directly applied to the terminal block or wire connections.
In the case of GT1020-LBL/LWL/LBLW/LWLW and GT1030-LBL/LWL/LBLW/LWLW/HBL/HWL/HBLW/HWLW, GOT power is supplied via the communication cable.

7.1.1 Cable types and wire end processing (GT1020, GT1030, GT104□)

Process the end of the electrical wire (solid or stranded), or attach a ferrules with plastic sleeve to the wire end. Terminal screws should be tightened to between 0.22 to 0.25 N•m. Terminal screws must be secured to prevent a loose connection thus avoiding a malfunction. Failure to do so may cause equipment failures or malfunctions.

1 Electrical wire size

No. of wire per terminal	Electrical wire size		
	Solid wire	Stranded wire	Ferrules with plastic sleeve
1	0.14 to 1.5mm ² AWG26 to AWG16	0.14 to 1.0mm ² AWG26 to AWG16	0.25 to 0.5 mm ² AWG24 to AWG20
2	0.14 to 0.5mm ² AWG26 to AWG20	0.14 to 0.2mm ² AWG26 to AWG24	-

2 Wire end processing

(1) Connecting the wire directly

- (a) Twist the end of the stranded wire. Make sure there are no wire whiskers.
- (b) Do not solder the wire end.

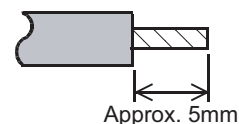

(2) Using a ferrules with plastic sleeve to connect the wire

- A wire with a too thick of a wire sheath may not fit the insulation sleeve.
- Refer to the outline drawing for how to select the proper size wire.

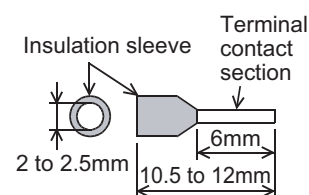

Manufacturer	Model name	Crimper type
Phoenix Contact Inc.	AI 0.25-6BU (AWG24)	CRIMPFOXZA3
	AI 0.34-6TQ (AWG22)	
	AI 0.5-6WH (AWG20)	

3 Tools

Use a small driver with a straight, untapered blade as shown on the right to tighten the power terminals.

Manufacturer	Model name
Phoenix Contact Inc.	SZS 0.4 × 2.5

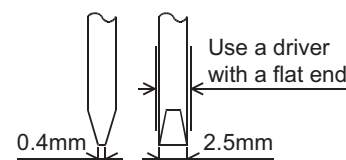

7.1.2 Cable types and wire end processing (GT105□)

Use 0.75mm² or thicker cables to avoid voltage drop and tighten the terminal screw with the specified torque securely.

Terminal screws should be tightened to between 0.5 to 0.8 N•m. Terminal screws must be secured to prevent a loose connection thus avoiding a malfunction. Failure to do so may cause equipment failures or malfunctions.

1 Electrical wire size, Recommended terminal shape

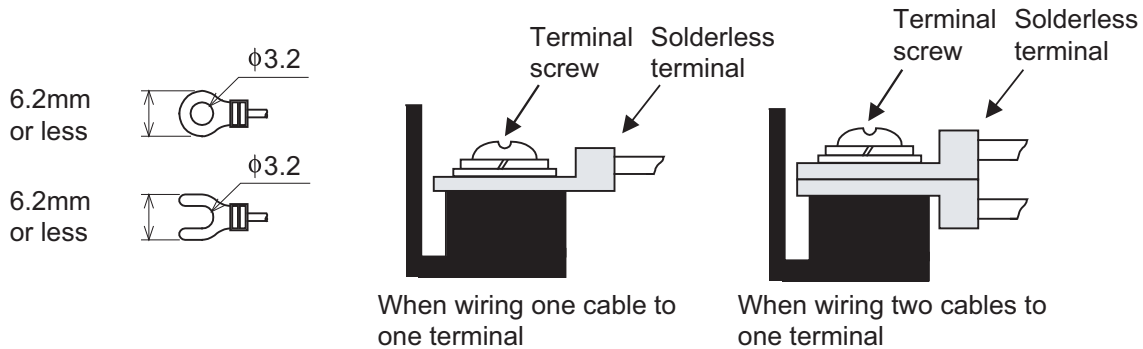

Cable size	For power supply: 0.75mm ² min. For grounding: 2mm ² min.
Solderless terminal	M3 solderless terminal : Recommended applicable solderless terminal JST Part No. FV0.5-3, Pressure Bonding Tool YHT-2622 JST Part No. FV1.25-B3A, Pressure Bonding Tool YNT-2216 JST Part No. FV2-MS3, Pressure Bonding Tool YNT-1614

7.1.3 Wiring example (GT1020, GT1030)

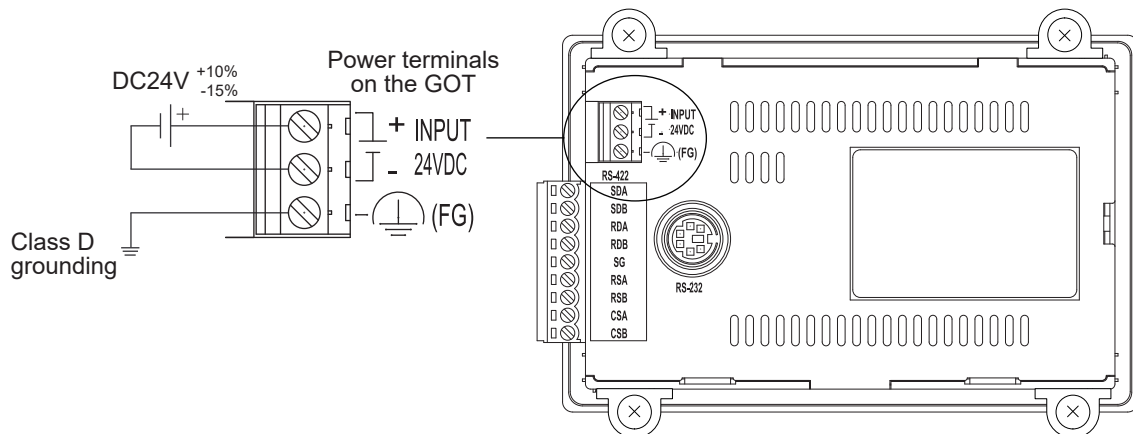

Tightening torque for the power terminals	0.22 to 0.25 N•m
---	------------------

7.1.4 Wiring example (GT104□)

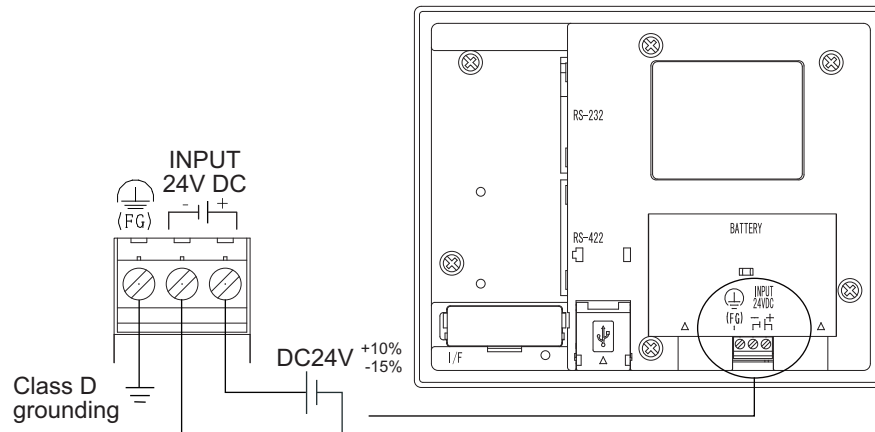

Tightening torque for the power terminals

0.22 to 0.25 N•m

7.1.5 Wiring example (GT105□)

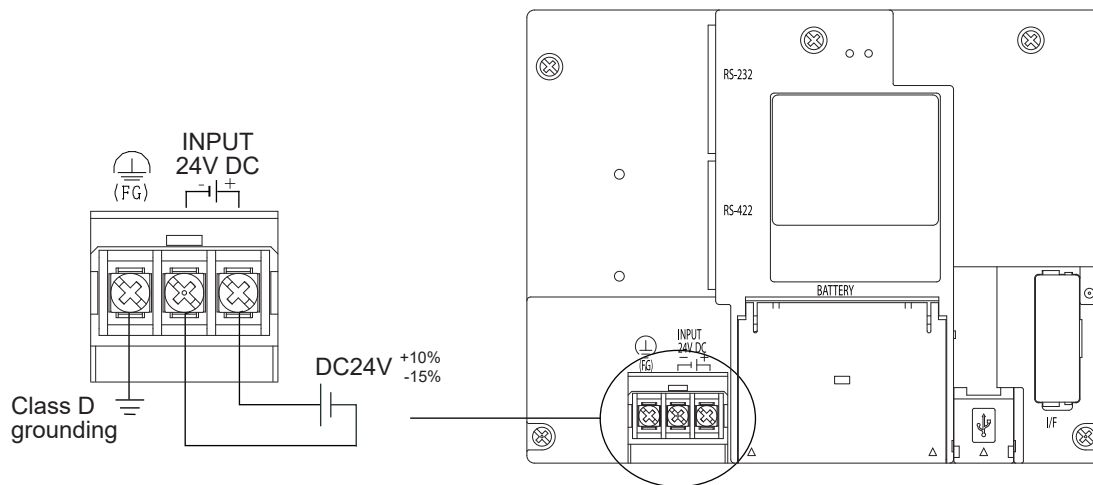

Tightening torque for the power terminals

0.5 to 0.8 N•m

7.1.6 GOT's ground

1 Grounding the GOT and other devices

Make sure to carry out the followings for grounding.

Except 5V power supply type.

- Carry out the independent grounding if possible.
Provide class D (class 3) grounding. (Ground resistance must be 100Ω or less.)
- If the independent grounding is impossible, carry out the shared grounding as shown in fig.2) below.

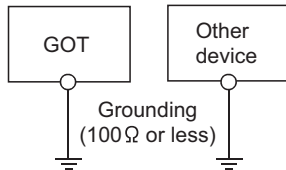

(1) Independent ground
..... Best condition

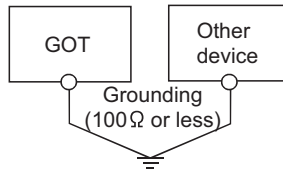

(2) Shared grounding
..... Good condition

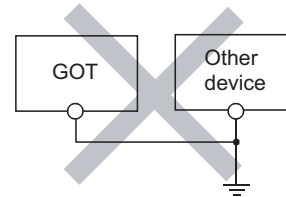

(3) Common grounding
..... Not allowed

- Set the grounding point closer to the GOT to make the grounding cable short as possible.
Provide grounding using a single grounding wire. Refer to the table below to select the proper size grounding wire.

(For GT1020, GT1030, GT104□)

Ground wire size		
Solid wire	Stranded wire	Ferrules with plastic sleeve
1.5mm ² , AWG16	1.0mm ² , AWG16	0.5mm ² , AWG20

(For GT105□)

Ground wire size
2mm ² or more

7.1.7 The cause of malfunctions related wiring/Remedy

Grounding of the GOT may cause electric potential difference and noise interference, which may result in GOT malfunctions.

These problems may be resolved by taking the following measures.

1 Wiring path of the GOT's ground cable and power line

Bundling the GOT's ground cable and power line together can cause interference noise, which may result in malfunctions.

Keeping the GOT's ground cable and power line away from each other will help minimize noise interference.

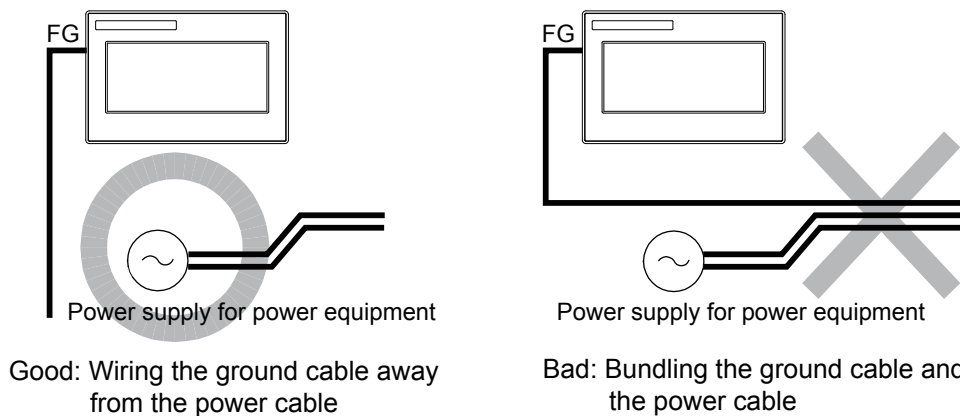

2 Connecting the ground cable from the panel that houses control equipment to the panel to which the GOT is grounded

When running a single ground cable from the panel that houses such piece of control equipment as a sequencer to the panel to which the GOT is grounded, the ground cable may have to be directly connected to the terminal on the GOT.

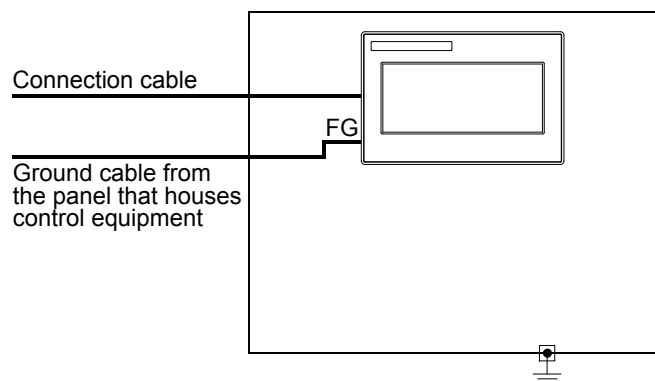

If electric potential difference between the ground points created by it causes malfunctions, lowering the voltage as shown in Remedy 1 below may solve the problem.

- Remedy 1 (Refer to the figures Remedy 1-1 and 1-2 below.)
 If the electric potential difference between the ground cable and the panel that houses the GOT is creating problems, connect the ground cable to the panel also.
 If the wiring method as shown in Remedy 1-1 is not feasible, follow Remedy 1-2.

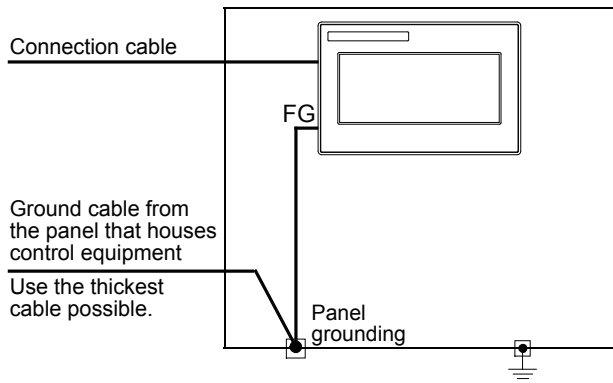

Remedy1-1

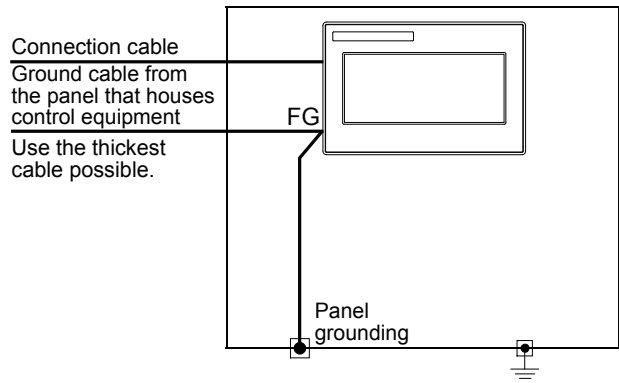

Remedy1-2

If taking Remedy 1 worsens noise interference, taking Remedy 2 may alleviate it.

- Remedy 2 (Refer to the figures Remedy 2-1 and 2-2 below.)
 Attach a ferrite core to the cable if noise from the GOT panel has adverse effects on the GOT when Remedy 1 is taken.
 Wind the wire around the ferrite core several times (approx. 3 times), if a ferrite core is used.
 If the wiring method as shown in Remedy 2-1 is not feasible, follow Remedy 2-2.

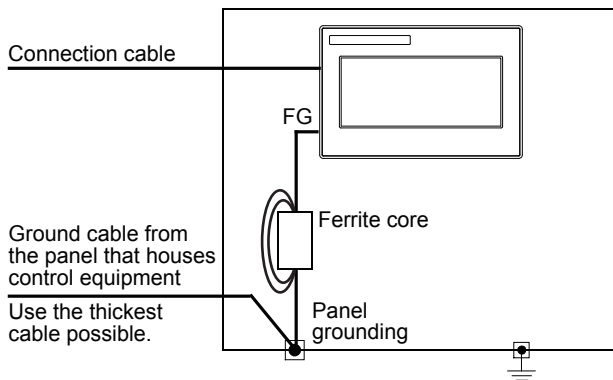

Remedy2-1

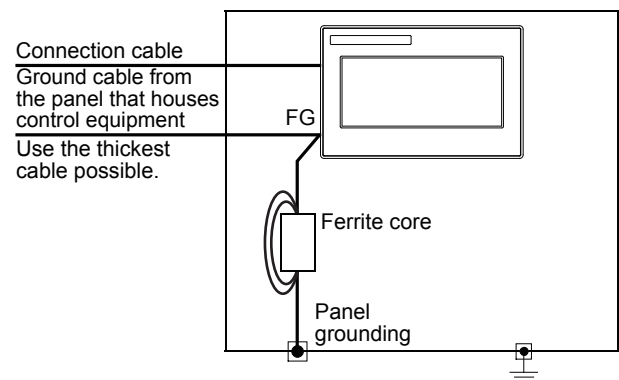

Remedy2-2

7.2 Wiring inside and outside the panel

7.2.1 Wiring inside

Run power lines, servo amplifier drive wires, and communication cables so that they do not cross each other. Noise interference that is generated by cables that cross each other may cause malfunctions. Surge suppressors are an effective way to filter out surge noise that is generated from no fuse breakers (NFB), electromagnetic contactors (MC), relays (RA), solenoid valves, and induction motors. Refer to the section to follow for surge killers.

7.2.3 Attaching surge killers to control equipment

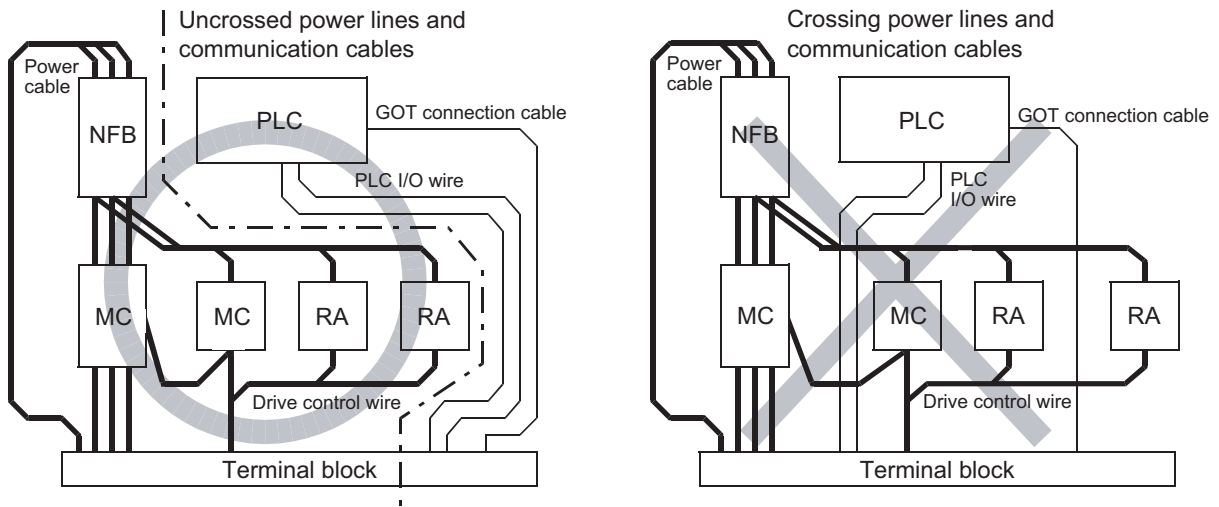

7.2.2 Outside the panel

To pull the power line and communication cable out of the panel, make two pullout holes away from each other and pull the cables through. Putting both cables through the same pullout hole will increase noise interference.

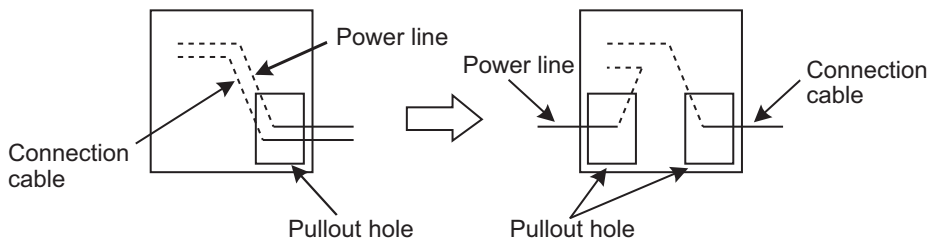

Keep the power line and communication cable inside the duct at least 100 mm away from each other. If that is not possible, the use of a metal separator inside the duct can reduce noise interference.

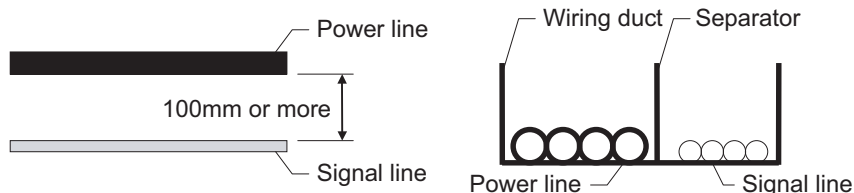

7.2.3 Attaching surge killers to control equipment

If communication errors happen in synch with the on/off signals from certain control equipment (referred to as "load" hereafter) such as no fuse breakers, electromagnetic contactors, relays, solenoid valves, and induction motors, surge noise interference is suspected.

If this problem happens, keep the ground cable and communication cable away from the load.

If that is not possible, an installation of a surge killer will help reduce noise interference.

Place the surge killer as close to the load as possible.

Remedy for AC inductive load

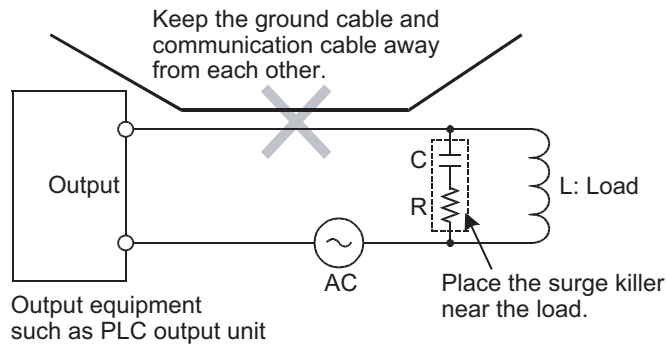

Remedy for DC inductive load

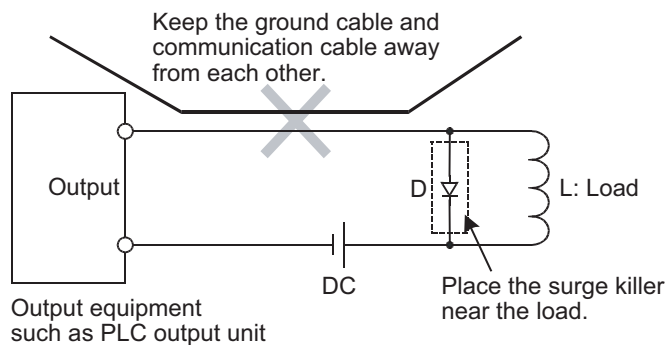

8. OPTION

8.1 Protective Sheet

The protective sheet is used to protect the operation surface from damage or dirt when the touch key of GOT display section is operated.



For the GOT, a protective film is pasted on the display at factory shipment. Remove the film when the installation of the GOT is completed.

8.1.1 Applicable protective sheet

The following protective sheets are applicable for GT10□□.

Product name	Model	Contents	
Protective sheet	GT10-20PSGB	3.7" protective sheet (For GT1020)	Display section antiglare (Frame: transparent) 5 sheets
	GT10-20PSCB		Display section clear (Frame: transparent) 5 sheets
	GT10-20PSGW		Display section antiglare (Frame: white), With a logo 5 sheets
	GT10-20PSCW		Display section clear (Frame: white), With a logo 5 sheets
	GT10-30PSGB	4.5" protective sheet (For GT1030)	Display section antiglare (Frame: transparent) 5 sheets
	GT10-30PSCB		Display section clear (Frame: transparent) 5 sheets
	GT10-30PSGW		Display section antiglare (Frame: white), With a logo 5 sheets
	GT10-30PSCW		Display section clear (Frame: white), With a logo 5 sheets
	GT10-40PSGB	4.7" protective sheet (For GT104□)	Display section antiglare (Frame: transparent) 5 sheets
	GT10-40PSCB		Display section clear (Frame: transparent) 5 sheets
	GT10-40PSGW		Display section antiglare (Frame: white), With a logo 5 sheets
	GT10-40PSCW		Display section clear (Frame: white), With a logo 5 sheets
	GT10-50PSGB	5.7" protective sheet (For GT105□)	Display section antiglare (Frame: transparent) 5 sheets
	GT10-50PSCB		Display section clear (Frame: transparent) 5 sheets
	GT10-50PSGW		Display section antiglare (Frame: white), With a logo 5 sheets
	GT10-50PSCW		Display section clear (Frame: white), With a logo 5 sheets

Logo (removable) Display section Frame Adhesive part (back)

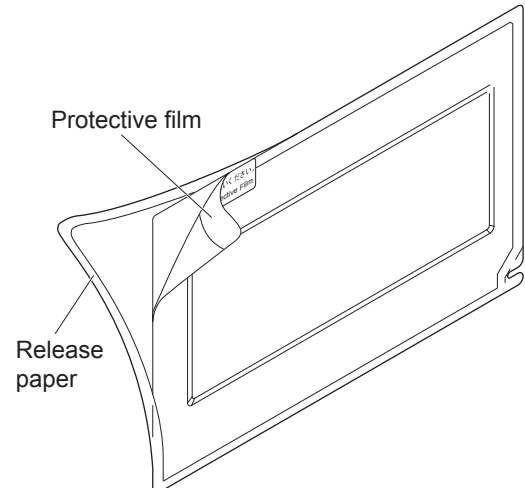
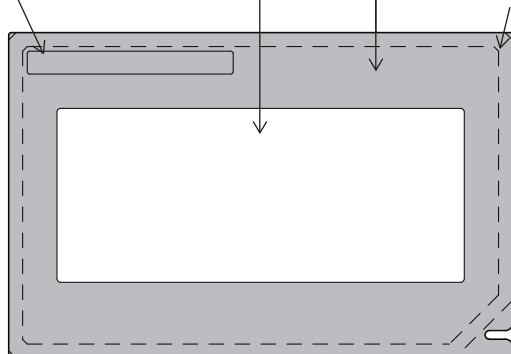

8.1.2 Installing procedure

- 1 If a protective sheet is on the GOT, peel off the protective sheet from the bottom-right corner of the GOT display section, and clean the GOT surface.

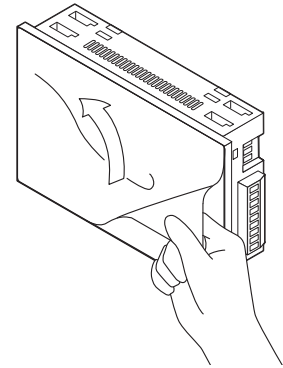

- 2 Peel the release paper from the back of the new protective sheet, and attach its adhesive side to the GOT display section. When attaching the protective sheet, make sure to fit it on the display section closely without leaving any clearance between them.

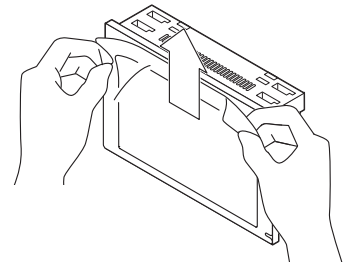

- 3 Peel off the protective film on the protective sheet.

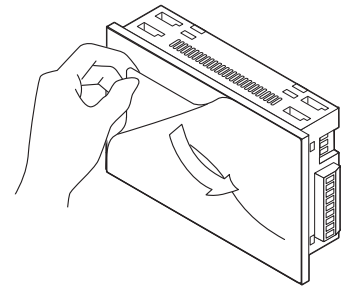

Remark

Replacement time of protective sheet

Check the status of the protection sheet visually by to the daily inspection. The visibility becomes worse when there is too much dirt and cracks, causing malfunction. Proceeds replacement promptly.

8.2 RS-232/USB conversion adaptor

GT10-RS2TUSB-5S RS-232/USB conversion adaptor is an adaptor that converts the RS-232 interface for communication with PC on the GOT (For GT1020, GT1030) to the USB interface.

It is used with a GT09-C30USB-5P USB cable.

The use of a GT10-RS2TUSB-5S RS-232/USB conversion adaptor requires an installation of the USB driver that is supplied with the package.

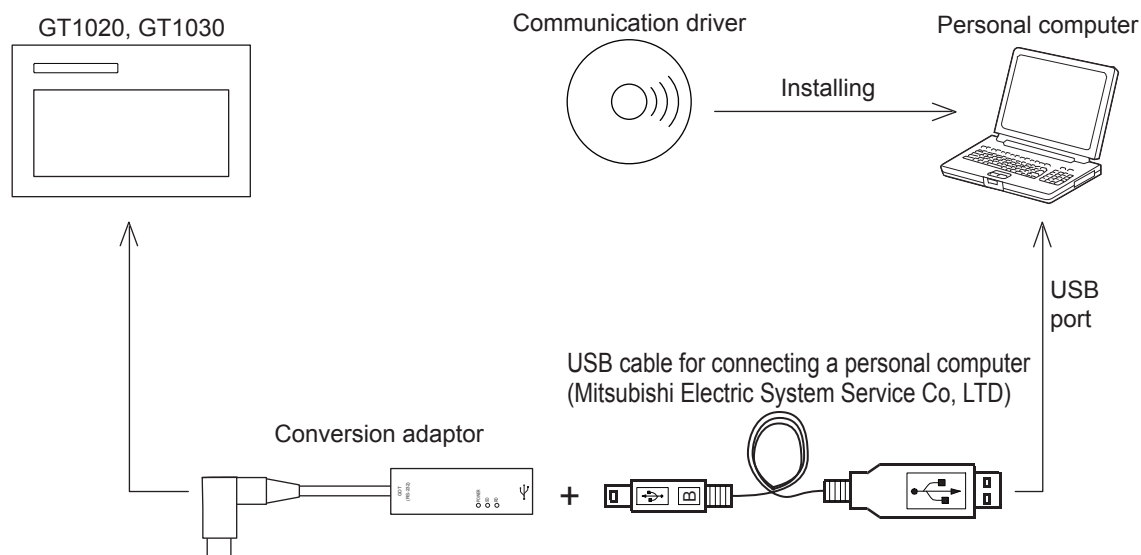

8.2.1 Shape, dimensions, and names of adaptor components

The shape, dimensions, and names of the RS-232/USB conversion adaptor are shown in the figures below.

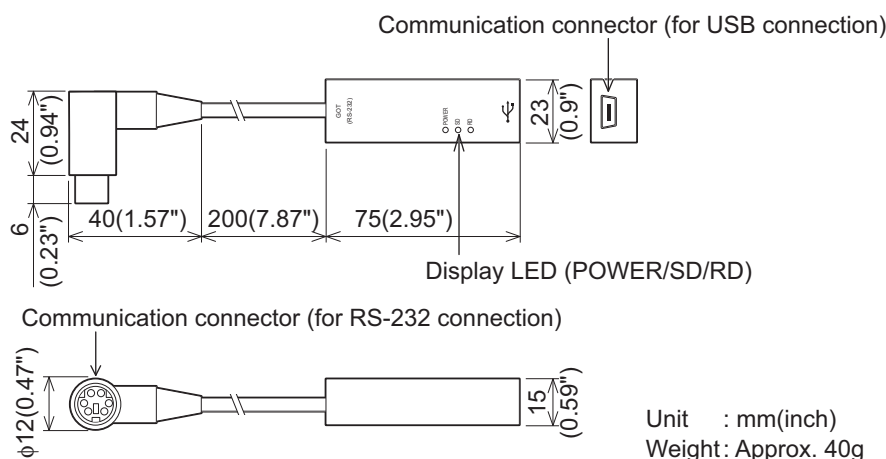

Name	Specifications
Communication connector (for RS-232 connection)	MINI-DIN 6 pins (male): For connection to the interface for communication with PC on the GOT
Communication connector (for USB connection)	USB MINI: For connection to the GT09-C30USB-5P USB cable
Display LED (POWER)	Green : Lit when the power is properly supplied (Lit when connected to the PC with a USB cable)
Display LED (SD)	Red: Lit while sending data (GOT → PC)
Display LED (RD)	Red: Lit while receiving data (PC → GOT)

8.2.2 Installing procedure

- 1 Turn off the GOT power.
- 2 Connect the USB mini connector on the GT09-C30USB-5P USB cable to the RS-232/USB conversion adaptor.
- 3 Connect the RS-232 connector on the RS-232/USB conversion adaptor to the GOT.
- 4 Connect the USB connector on the GT09-C30USB-5P USB cable to the PC.
- 5 Turn on the GOT power.
- 6 Turn on the PC power.
- 7 Confirm that the POWER LED (POWER) on the RS-232/USB conversion adaptor is lit.
(Lit POWER LED on the RS-232/USB conversion adaptor indicates that the power is properly supplied from the PC.)

8.2.3 Driver installation

Procedure for installing the driver is explained below.

Windows® XP installation follows.

- Windows® 98, Windows® 98SE, Windows® Millennium Edition, Windows® 2000, Windows® XP, Windows Vista® and Windows® 7/8 the installation method will vary.

Installation of the driver is canceled during the following process, the installation is not carried out correctly. If the installation is canceled, uninstall the driver and install again. Please refer to Section 8.2.4 for instructions on uninstalling the driver.

Folder structure of USB driver software

<CD drive>

- <Win98> Stores the driver software for Windows® 98, Windows® 98SE and Windows® Me.
- <Win2k> Stores the driver software for Windows® 2000, Windows® XP, Windows Vista® and Windows® 7/8.

1 Windows® 98, Windows® 98SE, Windows® Millennium Edition, Windows® 2000, and Windows® XP



Installation method of driver software

- (1) Two types of drivers are required to be installed.
Make sure to install the two types of drivers by the following procedure.
- (2) When the included CD is not used
For GT Designer2 Version2.109P or later and GT Designer3 Version1.17T or later, the driver software is stored in the following folder.
[\MELSOFT\GT10USBDrivers]
By specifying the above folder, the drivers can be installed.

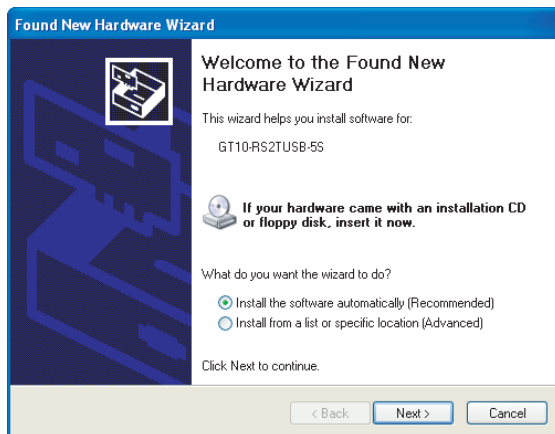

- 1 When the USB cable is connected to the personal computer, the screen on the left is displayed.
(Installation of the software for USB driver)

Insert the included CD into the personal computer's CD drive. Click [Next >].

The installation of the USB driver software will begin.
The installation location selection screen is displayed.

- In Windows® 98, Windows® 98SE or Windows® Millennium Edition, select [Include this location in the search], specify the CD drive [Win98], and then install the driver software.
- In Windows® 2000 or Windows® XP, select [Include this location in the search], specify the CD drive [Win2K], and then install the driver software.



- 2 The screen on the left is displayed. (Only in Windows® XP)

Click [Continue Anyway].

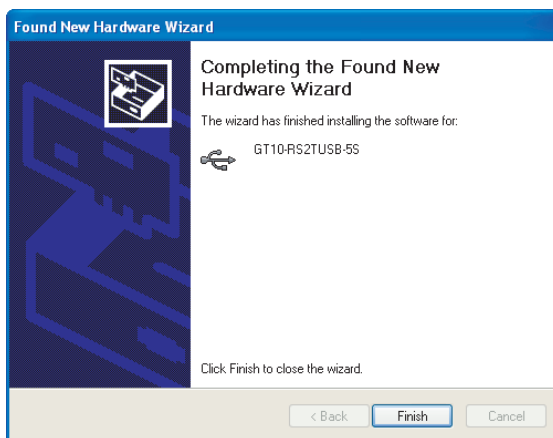

- 3 The screen on the left is displayed.

Click [Finish].

The installation of the USB driver software will finish.

- If Windows® 98, Windows® 98SE or Windows® Millennium Edition is used, installation of the USB Serial Port software begins, and ends automatically. Remove the CD from the personal computer. The installation of the USB driver software is finished. The installation of the USB driver software is finished.

If using Windows® 2000 or Windows® XP, proceed to step 4 .

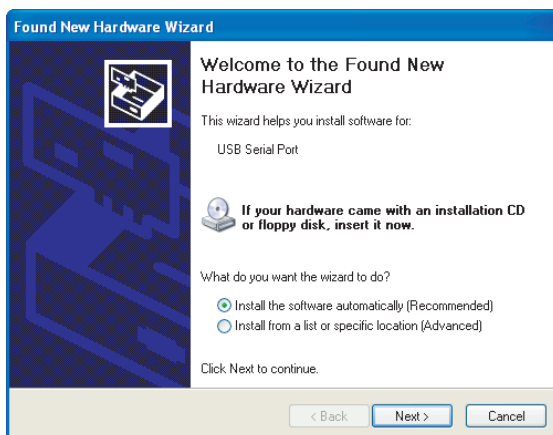

- 4 The screen on the left is displayed.

Click [Next >].

The installation of the USB Serial Port software will begin.

- In Windows® 2000, select [Include this location in the search], specify the CD drive [\\Win2K], and then install the driver software.

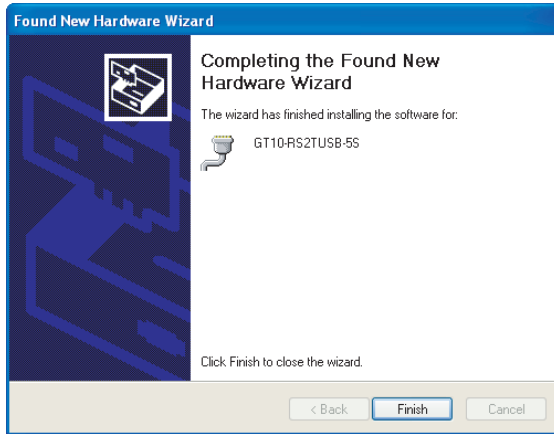

5 The screen of 2 is displayed.
(Only in Windows® XP)
Click [Continue Anyway].

6 The screen on the left is displayed.

Click [Finish].
The installation of the USB Serial
Port software will finish.

Remove the CD (USB driver
software) from the personal
computer.

2 Windows Vista®

Point

Installation method of driver software

- (1) Two types of drivers are required to be installed.
Make sure to install the two types of drivers by the following procedure.
- (2) When the included CD is not used
For GT Designer2 Version2.109P or later and GT Designer3 Version1.17T or later, the driver software is stored in the following folder.
[\MELSOFT\GT10USBDrivers]
By specifying the above folder, the drivers can be installed.
- (3) Insert the included CD in step **3**.
Do not insert it earlier.

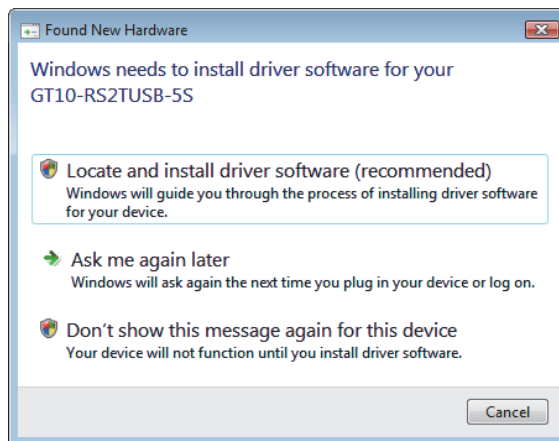

- 1** When the USB cable is connected to the personal computer, the screen on the left is displayed. (Installation of the software for USB driver)

Click [Locate and install software (recommended)].

- 2** The search method confirmation screen is displayed.
Click [Don't search online].

- 3** When the message [Insert the disc that came with your GT10-RS2USB-5S] is displayed, insert the CD into the personal computer's CD drive.
Inserting the CD starts installation.
When specifying the search location manually, specify the CD drive [Win2K].

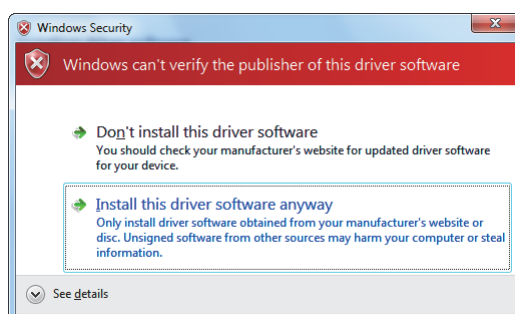

- 4** The warning message on the left is displayed.

Click [Install this driver software anyway].

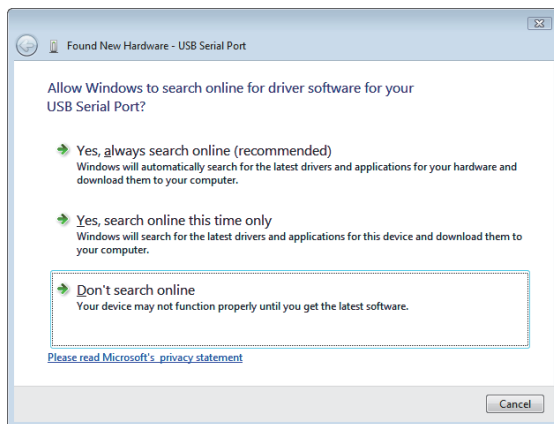

- 5 Installation of the driver software is started.

- 6 When installation of the USB driver software is finished, the COM port driver software is installed continuously.

The screen on the left is displayed.

Click [Don't search online].

- 7 When the message [Insert the disc that came with your USB Serial port] is displayed, insert the CD into the personal computer's CD drive.
Inserting the CD starts installation.
When specifying the search location manually, specify the CD drive [Win2K].

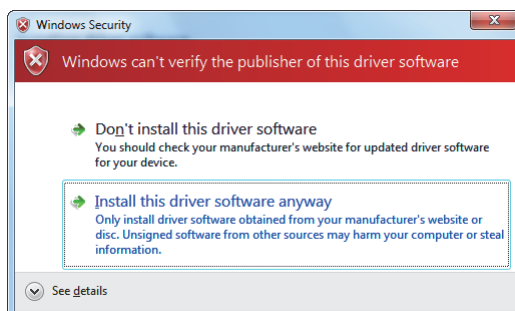

- 8 The warning message on the left is displayed.

Click [Install this driver software anyway].

- 9 Installation of the driver software is started.

- 10 When installation is finished, remove the CD.
Now, installation of the USB driver software is finished.

3 Windows® 7/8 (32bits)



Installation method of driver software

- (1) Two types of drivers are required to be installed.
Make sure to install the two types of drivers by the following procedure.
- (2) When the included CD is not used
For GT Designer2 Version2.109P or later and GT Designer3 Version1.17T or later, the driver software is stored in the following folder.
[\MELSOFT\GT10USBDrivers]
By specifying the above folder, the drivers can be installed.
- (3) Insert the included CD in step 4 .
Do not insert it earlier.

The screen displays in the following instruction are display examples in Windows® 7.
In Windows® 8, use the GT10USBDrivers ver.1.30 or later.

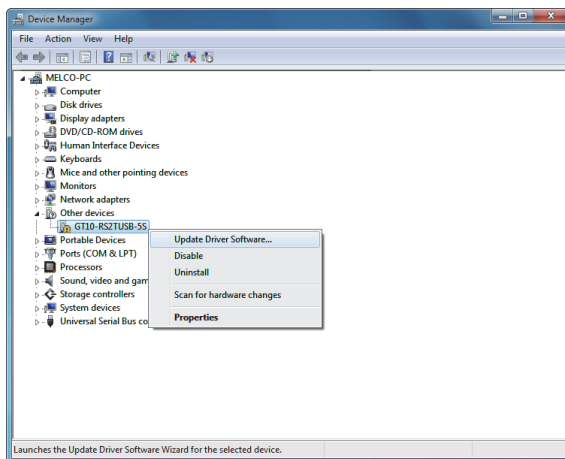

- 1 Connect the USB cable to the personal computer.
- 2 Click [Control Panel] → [Hardware and Sound] → [Device Manager] to display the screen on the left.

Right-click the GT10-RS2TUSB-5S, and select [Update Driver Software].

- 3 When the driver software search method selection screen is displayed, select [Browse my computer for driver software].
- 4 Insert the CD into the personal computer's CD drive.
- 5 The search location specification screen is displayed.
Specify the CD drive [Win2K] as the search location, and click [Next]. Installation is started.

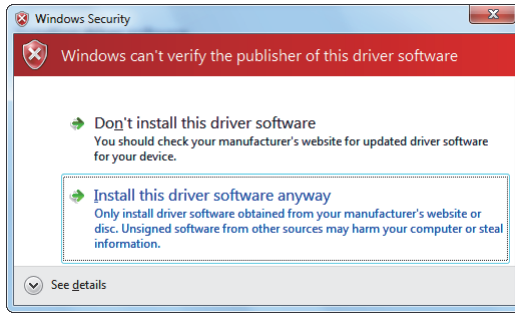

6 The warning message on the left is displayed.

Select [Insert this driver software anyway].

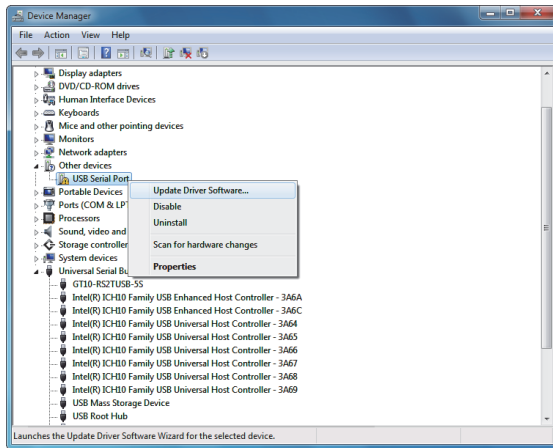

7 Installation of the driver software is started.

8 When installation of the USB driver software is finished, the COM port driver software is installed continuously.

Right-click [USB Serial Port] in the Device Manager.
Select [Update Driver Software].

9 When the driver software search method selection screen is displayed, select [Browse my computer for driver software].

10 The search location specification screen is displayed. Specify the CD drive [Win2K] as the search location, and click [Next]. Installation is started.

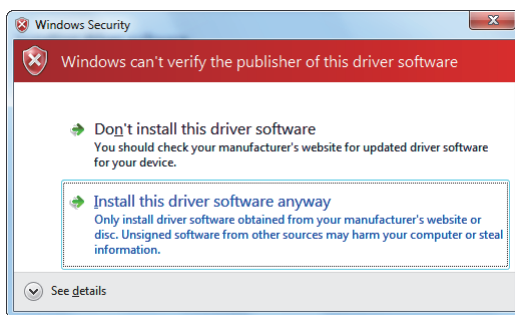

11 The warning message on the left is displayed.

Select [Install this driver software anyway].

12 Installation of the driver software is started.

13 When installation is finished, remove the CD.
Now, installation of the USB driver software is finished.

4 Windows® 7/8 (64bits)



Installation method of driver software

- (1) Two types of drivers are required to be installed.
Make sure to install the two types of drivers by the following procedure.
- (2) When the included CD is not used
For GT Designer3 Version1.31H or later, the driver software is stored in the following folder.
[\MELSOFT\GT10USBDrivers]
By specifying the above folder, the drivers can be installed.
- (3) Insert the included CD in step 6.
Do not insert it earlier.

The screen displays in the following instruction are display examples in Windows® 7.
In Windows® 8, use the GT10USBDrivers ver.1.30 or later.

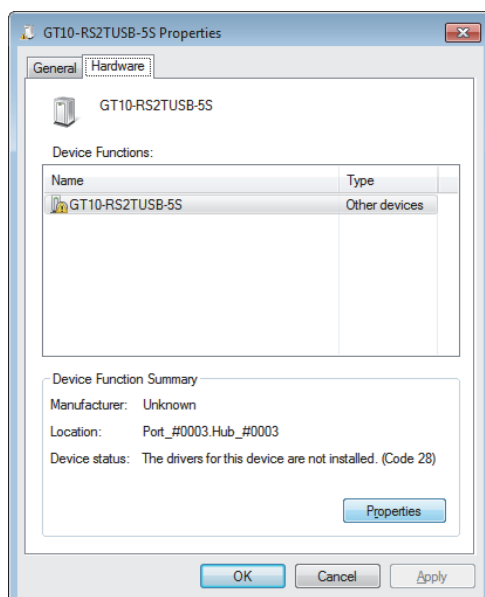
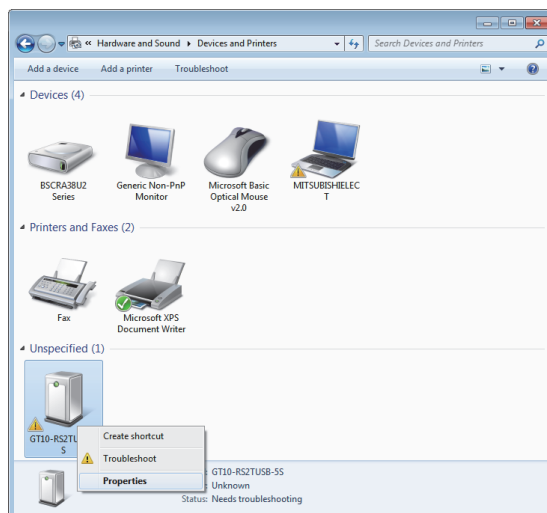

- 1 Connect the USB cable to the personal computer.
- 2 Select [Control Panel] → [Hardware and Sound] → [Devices and Printers] to display the screen on the left.

Right-click the GT10-RS2TUSB-5S, and select [Properties].

- 3 The screen on the left is displayed.

Select [Properties] of the [Hardware] tab.

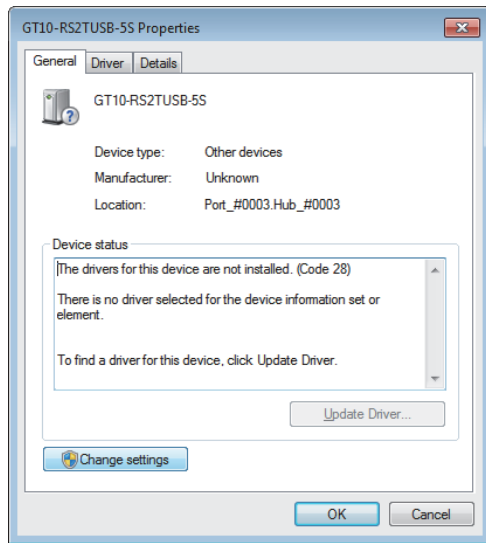

4 The screen on the left is displayed.

Select [Change settings] → [Update Driver].

- 5 When the driver software search method selection screen is displayed, select [Browse my computer for driver software].
- 6 When installing the drivers from the included CD, insert the CD into the personal computer's CD drive.
- 7 The search location specification screen is displayed.
 - Installing from the CD
Specify the CD drive [Win2K] as the search location, and click [Next].
 - Installing from the drawing software
Specify [\MELSOFT\GT10USBDrivers] in the folder where GT Designer3 is installed and click [Next].
Installation is started.

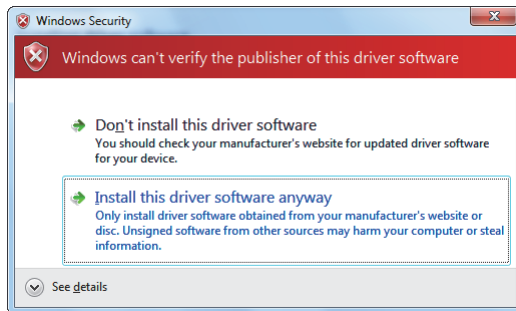

8 The warning message on the left is displayed.

Select [Insert this driver software anyway].

9 Installation of the driver software is started.

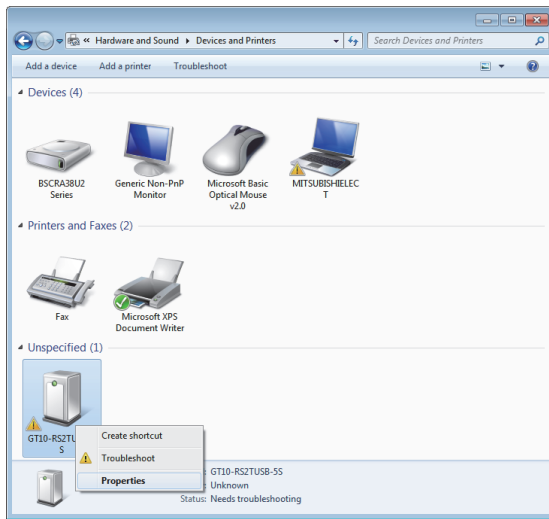

10 When installation of the USB driver software is finished, the COM port driver software is installed continuously.

Select [Control Panel] → [Hardware and Sound] → [Devices and Printers] to display the screen on the left.

Right-click the GT10-RS2TUSB-5S, and select [Properties].

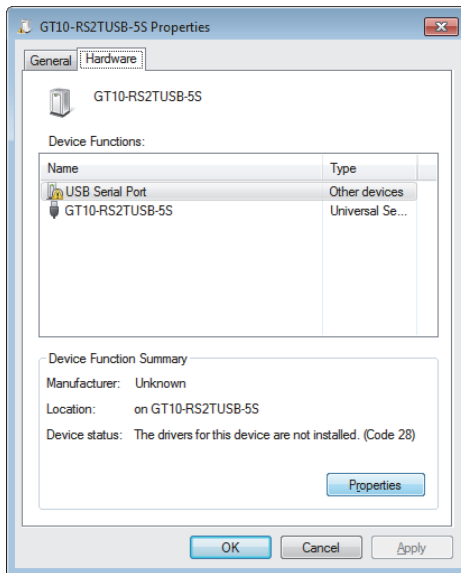

11 The screen on the left is displayed.

Select [USB Serial Port] → [Properties] of the [Hardware] tab.

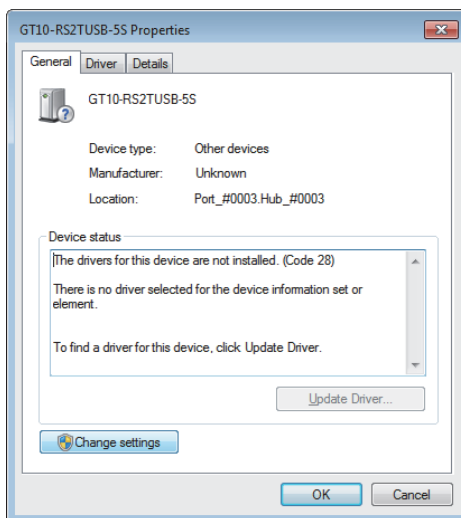

12 The screen on the left is displayed.

Select [Change settings] → [Update Driver].

13 When the driver software search method selection screen is displayed, select [Browse my computer for driver software].

14 The search location specification screen is displayed.

- Installing from the CD
Specify the CD drive [Win2K] as the search location, and click [Next].
- Installing from the drawing software
Specify [\MELSOFT\GT10USBDrivers] in the folder where GT Designer3 is installed and click [Next].
Installation is started.

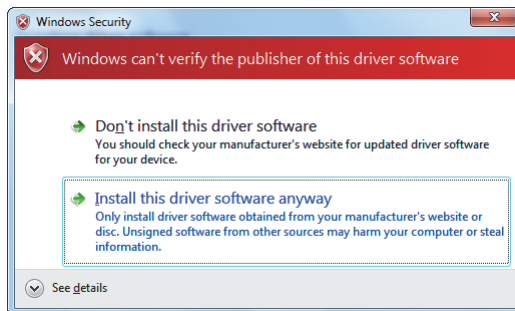

15 The warning message on the left is displayed.

Select [Install this driver software anyway].

16 Installation of the driver software is started.

17 When installation is finished, remove the CD.

Now, installation of the USB driver software is finished.

8.2.4 Method for uninstalling driver

The procedure for uninstalling the driver is explained below.
A Windows® XP example follows.



When the driver softwares for FX-USB-AW/FX3U-USB-BD and GT10-RS2TUSB-5S are installed, uninstalling one of these driver softwares may cause the other not to function properly.
When this happens, reinstall the driver software.

1 Detach the USB cable from the personal computer.

Click [Start] → [Control Panel] → [Add or Remove Programs] in the menu of the personal computer, the window below will be displayed.

- In case of Windows® 98, Windows® 98SE, Windows® Millennium Edition, and Windows® 2000 A screen that is equivalent to the one below is displayed by clicking [My Computer] → [Control Panel] → [Add/Remove Programs] in the menu of the personal computer.
- In Windows Vista® click [Start] → [Control Panel] → [Hardware and Sound] → [Device Manager] and the window below will be displayed.
- In Windows® 7, click [Control Panel] → [Hardware and Sound] → [Device Manager] and the window below will be displayed.

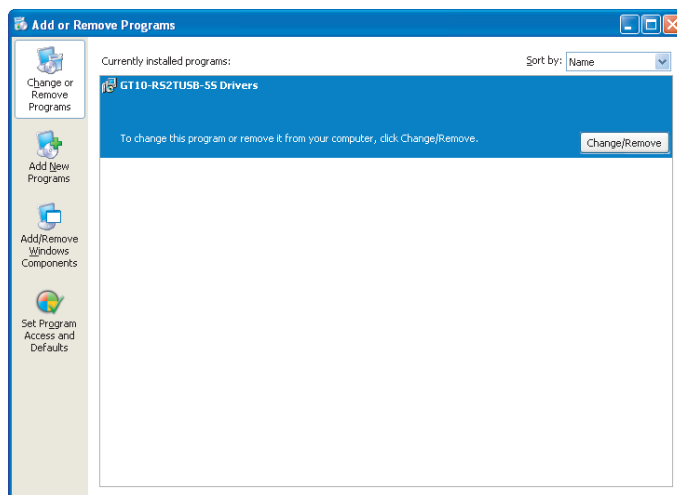

Click [Change/Remove].



- ### 2
- The screen on the left is displayed.
Click [Continue].

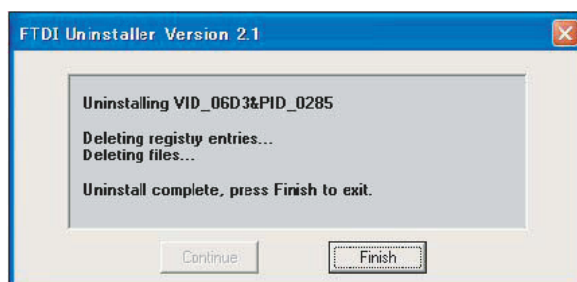

- ### 3
- The screen on the left is displayed.
Click [Finish].

8.3 Battery

The battery backs up clock data, alarm history and recipe data.
At factory shipment, a battery is built in the GT1030, GT104□, GT105□.
For GT1020, a battery cannot be used. (Data is saved by the internal flash ROM.)

8.3.1 Applicable battery

The following battery is applicable for GT1030, GT104□, GT105□.

Model	Contents
GT11-50BAT	Battery for backup of clock data, alarm history, recipe data and time action setting value

8.3.2 Battery specifications

Item	Specifications
Type	Magnesium manganese dioxide lithium primary battery
Initial voltage	3.0V
Storage life	Approx. 5 years (Operating ambient temperature of 25°C)
Application	For backup of clock data, alarm history, recipe data and time action setting value

Remark

For the battery directive in EU member states, refer to 18.4 [2](#) Handling of Batteries and Devices with Built-in Batteries in EU Member States.

8.3.3 Battery replacement procedure

Replace battery periodically at intervals of 4 to 5 years as reference.

- 1 Turn the GOT power off.
- 2 Open the back cover of the GOT.
- 3 Remove the old battery from the holder.

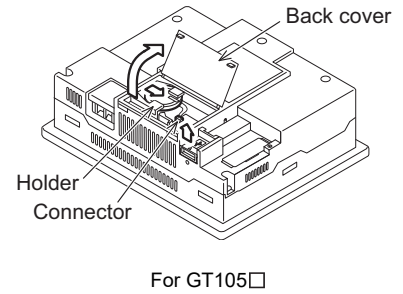
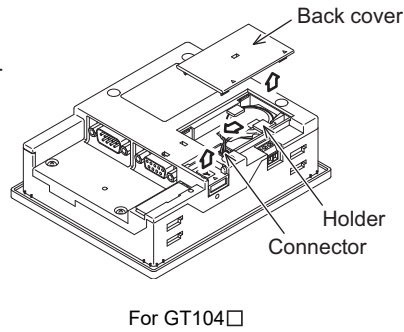
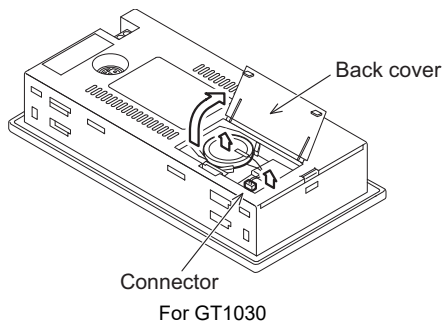

- 4 Disconnect the old battery connector and insert the new battery connector within 30s.
- 5 Insert the new battery into the holder and close the back cover.

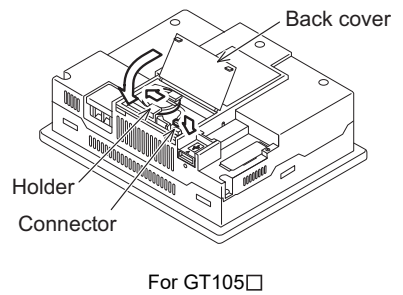
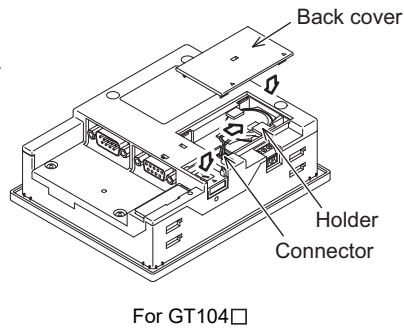
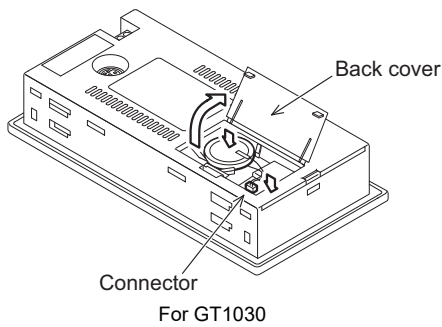

- 6 Turn the GOT power on.
- 7 Check if the battery condition is normal with the utility.
Refer to the following for the details of battery status display.

☞ Chapter 13 CLOCK SETTINGS AND BATTERY STATUS DISPLAY (TIME SETTING AND DISPLAY)

Point

(1) Battery life

The battery life is approximately 5 years.

The production date of the battery built in the purchased GOT can be confirmed by the production No. (S/N) marked on the GOT main unit.

Example nameplate (manufacturer's serial number 1010001)

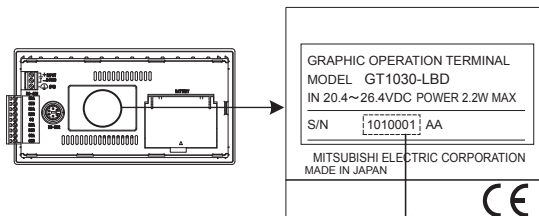

<Jan., 2010 or later> *Actual product nameplate differs from the example shown above.

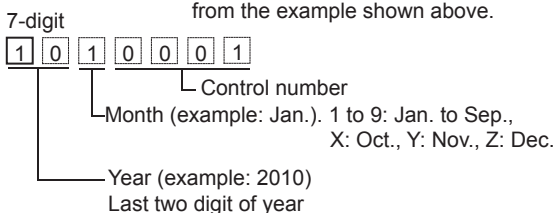

<Dec., 2009 or before>

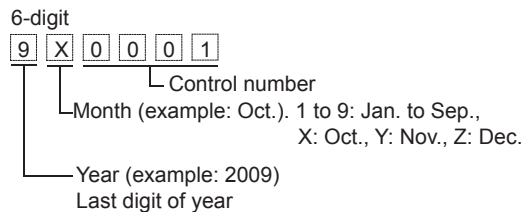

The production date of the optional replacement battery can be confirmed by the lot No. marked on the nameplate (label) affixed on the battery.

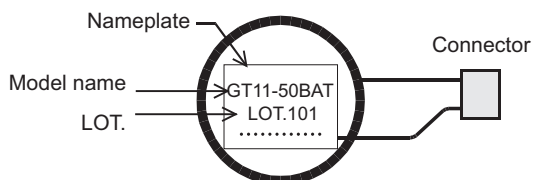

<Jan., 2010 or later>

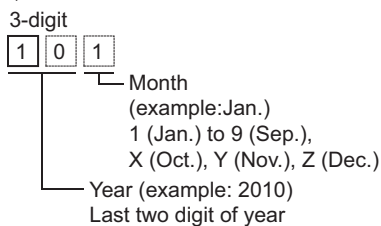

<Dec., 2009 or before>

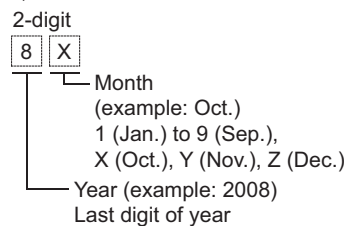

(2) Battery procurement

The battery is susceptible to natural discharge. Order one when necessary.

8.4 Memory loader

GT10-LDR memory loader is the memory transfer module that reads/writes the data to GT1020, GT1030 or between a PC (GT Designer2 Version2.77F or later, GT Designer3 Version1.01B or later) and GT10-LDR. When using the memory loader, driver installation, communication port setting is required. Refer to the following manual for details about driver installation.

☞ GT Designer2 Version □ Basic Operation/Data Transfer Manual
GT Designer3 Version1 Screen Design Manual (Fundamentals)

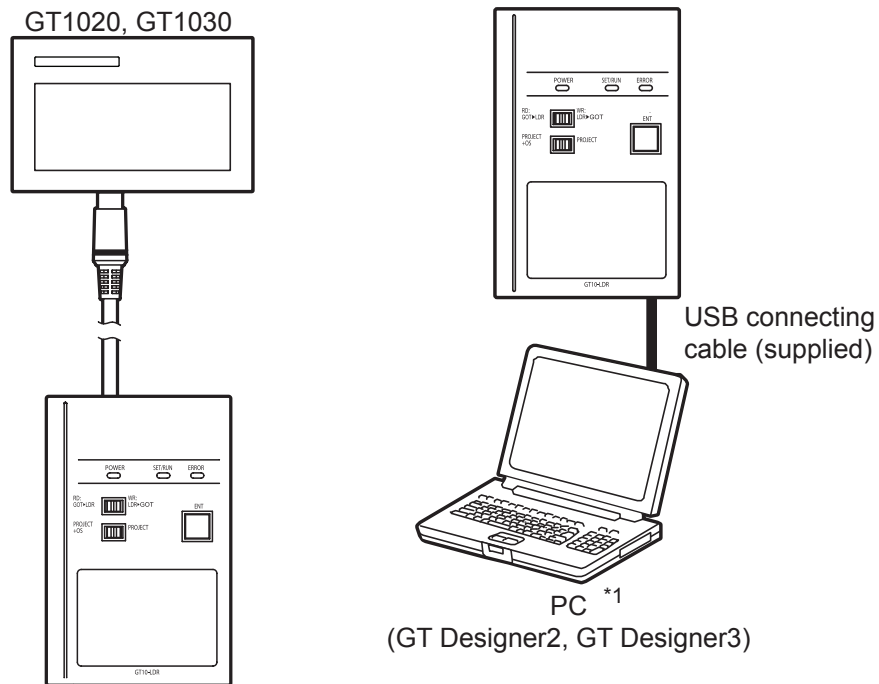

- *1: When GT10-LDR is connected to a PC via the USB hub, the power supply of the USB hub must be supplied by the AC adopter of the USB hub.
GT10-LDR connected to the USB hub may not work properly depending on the PC environment. In the case, connect the GT10-LDR directly to the USB port on the PC.

8.4.1 Part name

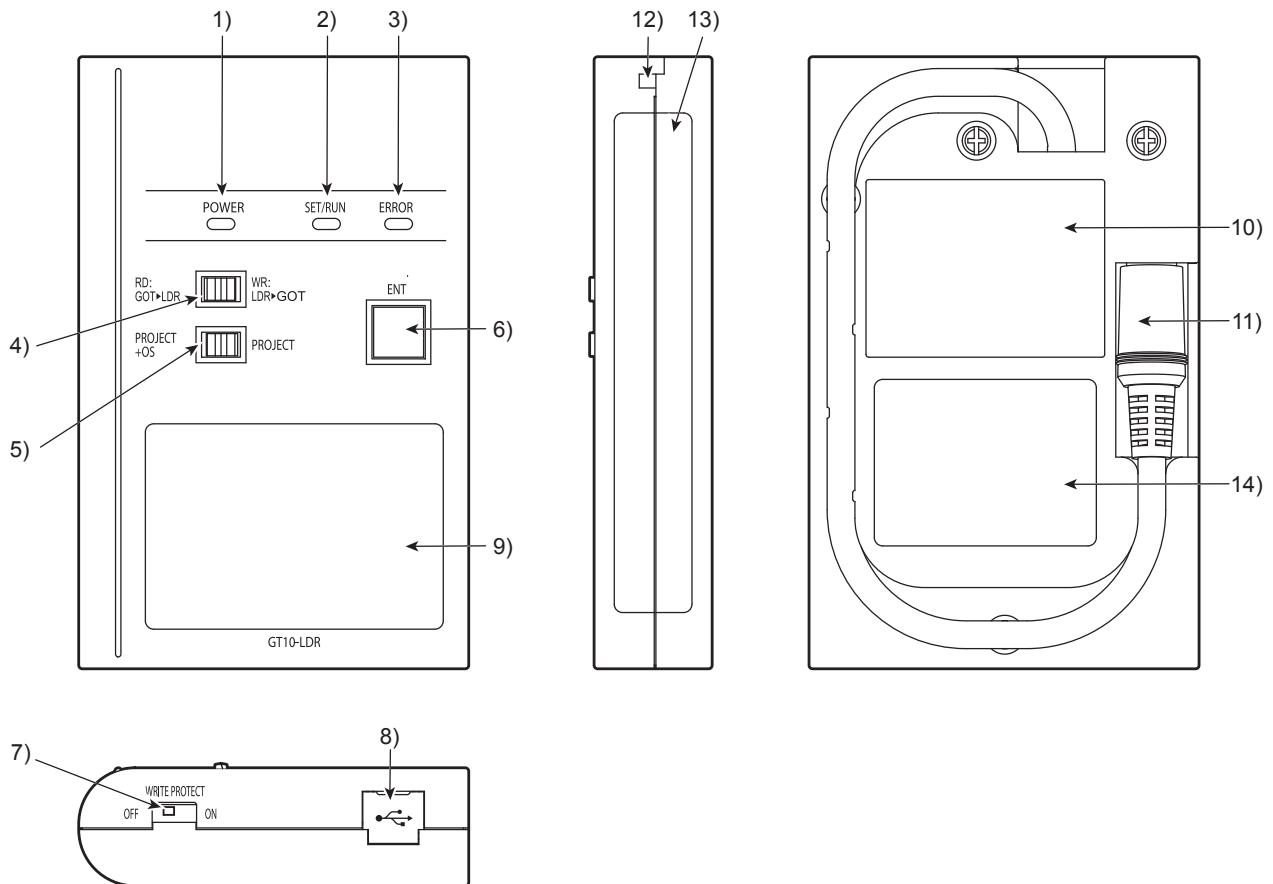

No.	Name	Specifications
1)	POWER LED	LED to show power status
2)	SET/RUN LED	LED to show that the settings are being checked/the transfer is running
3)	ERROR LED	LED to show error status
4)	RD/WR selection switch	Switch to select read/write direction
5)	Data selection switch	Switch to select the data to be transferred
6)	ENT key	Switch to determine the transfer direction and the data to be transferred, and to start the transfer
7)	Write protection switch	Switch to prevent the memory loader from being written to the data
8)	USB port	Connection port with a PC (with protection cap)
9)	Reference plate (operating instructions)	Described operating instructions of the memory loader
10)	Reference plate (error contents)	Described lighting status of ERROR LED
11)	Transfer cable	Cable to be connected with the GOT
12)	Strap hole	A hole to attach a strap
13)	Part to be labeled	Space to be labeled (created by user)
14)	Rating plate (Nameplate)	--

8.4.2 Function specification

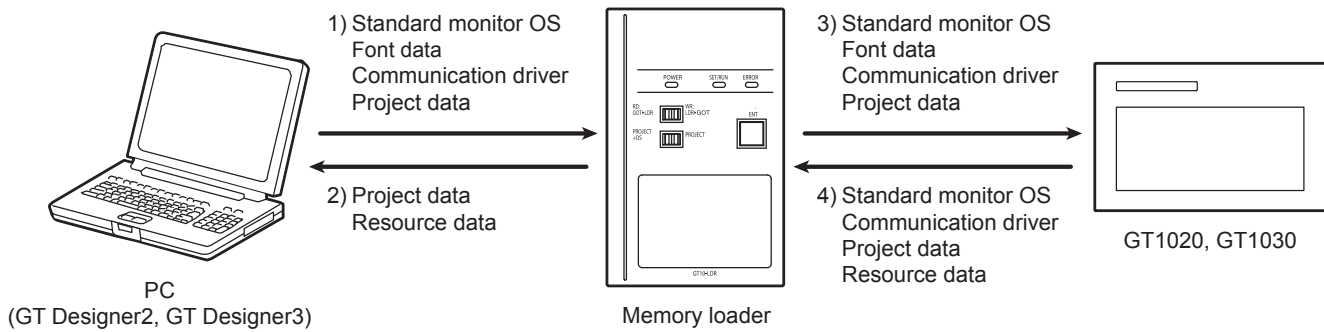

○ : Available to transfer × : Unavailable to transfer

Transfer direction	Data selection switch	Transfer data					Operation
		Project data	Resource data	Standard monitor OS	Font data ^{*2}	Communication driver	
1) PC → Memory loader	--	○	×	○	○	○	After all data in the memory loader is deleted, the data selected with GT Designer2 or GT Designer3 is written to the memory loader all at once.
2) Memory loader → PC	--	○	○	×	×	×	The project data or resource data is read out from the memory loader to a PC
3) Memory loader → GOT	PROJECT + OS	○	×	○	○	○	All data in the memory loader is written to the GOT.
	PROJECT	○	×	×	×	×	Only the project data in the memory loader is written to the GOT.
4) GOT → Memory loader	PROJECT + OS ^{*1}	○	○	○	×	○	After all data in the memory loader is deleted, all data in the GOT is read out to the memory loader.
	PROJECT	○	○	×	×	×	After all data in the memory loader is deleted, only the project data and resource data in the GOT are read out to the memory loader.

*1 : Ver.01.08.00 or later of the standard monitor OS of the GT10 is applicable.

👉 GT10-LDR Memory loader USER'S MANUAL (Chapter 7 Function specification)

*2 : Ver.01.11.00 or later of the standard monitor OS of the GT10 is applicable.
 Supported by the memory loader manufactured in November 2008 or later.
 When transferring the font data with the memory loader manufactured before November 2008, upgrade the version of memory loader OS from GT Designer2 (Ver.2.91V or later).
 For the OS installation to the memory loader, refer to the following.

☞ GT Designer2 Version □ Basic Operation/Data Transfer Manual
 GT Designer3 Version1 Screen Design Manual (Fundamentals)

Point 

- (1) When transferring the font data from the memory loader to the GOT
 When transferring the font data from the memory loader to the GOT, it takes more time than transferring only the standard monitor OS and communication driver.
 - It takes approximately 1 minute and 45 seconds to transfer "Standard monitor OS + Communication driver".
 - It takes approximately 8 minutes and 10 seconds to transfer "Standard monitor OS + Communication driver + Font data". (GT1030)
 Japanese (supporting Europe) is installed in the GT10 before shipment from the factory.
 It is not necessary to transfer the font data when the used font is not changed.

- (2) How to check the manufacturing date of the memory loader
 The manufacturing date of the memory loader can be checked with the SERIAL No. on the memory loader.

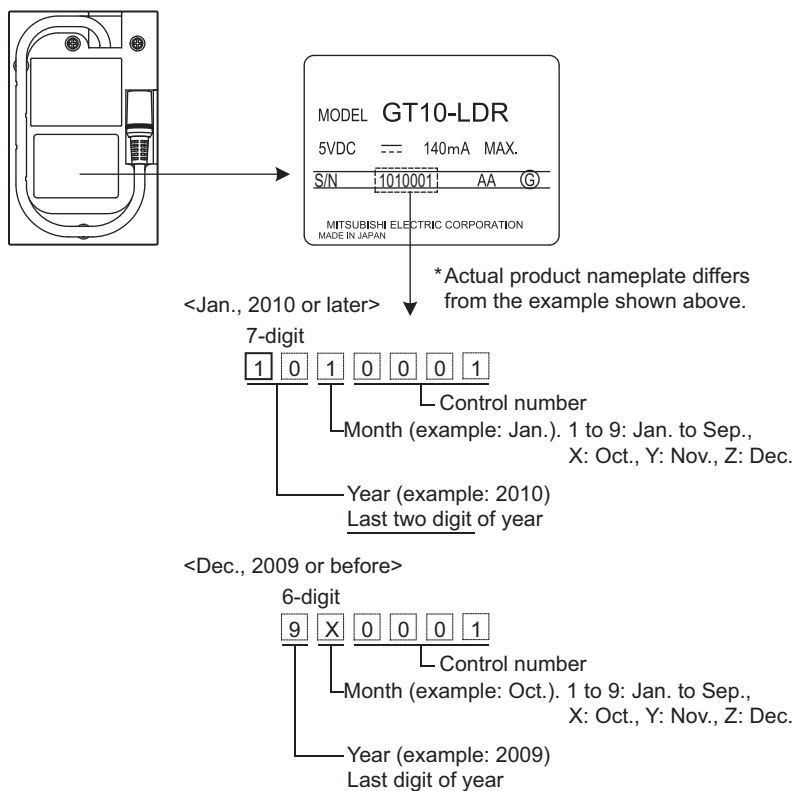

8.5 Memory board

GT10-50FMB type memory board is used for transferring the OS, project data or font data to the GOT (for GT104□, GT105□ only).

8.5.1 Applicable memory board

The following memory board is applicable for GT104□, GT105□.

Model	Contents
GT10-50FMB	For transferring project data, the OS or font data

8.5.2 Installing and removing procedures of the memory board

1 Installation

- 1 Turn the GOT power off.
- 2 Remove the memory board cover.

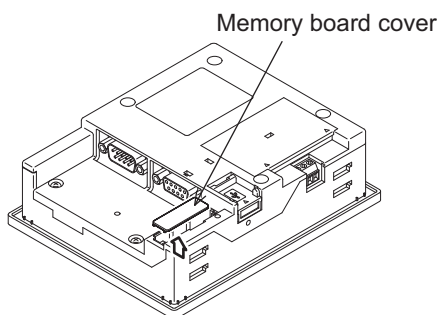

For GT104□

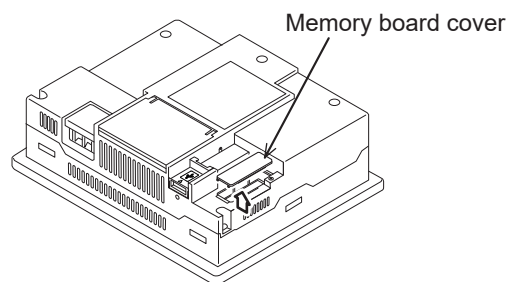

For GT105□

- 3 Set to OFF the protection switch in the memory board.
- 4 Mount the memory board to the memory board connector on the GOT rear face.

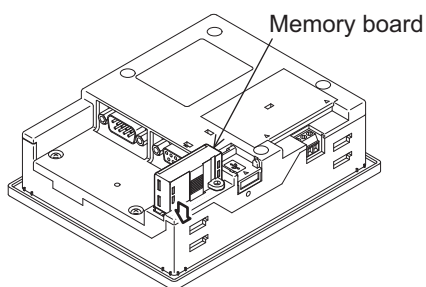

For GT104□

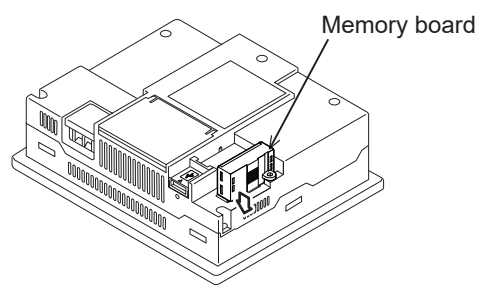

For GT105□

- 5 Turn the GOT power on.
- 6 Make the setting for transferring the data with the utility.

Refer to the following for details.

☞ Section 14.5 GT10-50FMB

2 Removing

- 1 Turn the GOT power off.
- 2 Pull up the memory board vertically and remove it.

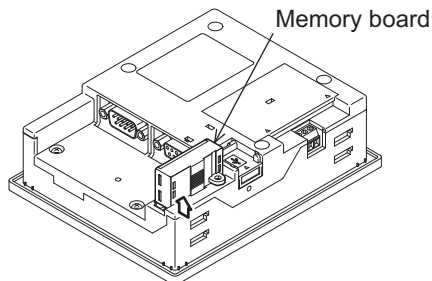

For GT104□

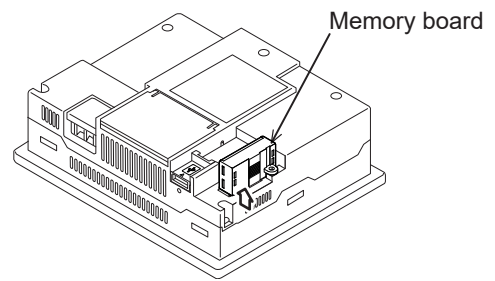

For GT105□



Precautions for installing/removing the memory board

When installing or removing the memory board, be sure to power off the GOT main unit.

Install the memory board cover when not using the memory board.

8.6 Stand

Stand is used to fix the GOT (For GT105□) to standing status in order to debug the monitor screen data easily.

8.6.1 Applicable stand

The following stand is applicable for GT105□.

Product name	Model	Contents
Stand	GT05-50STAND	Stand for 5.7" (For GOT1000 Series)

8.6.2 Installing procedure

- 1 Adjust the mounting angle of GOT with the angle adjusting fitting of the stand.

Adjust to
45°, 55°, 65° or 75°.

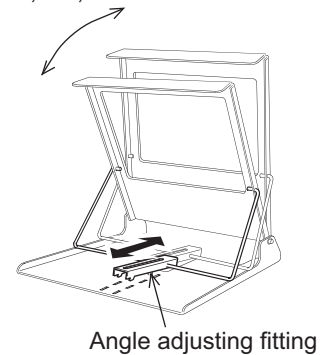

- 2 Put the GOT into the stand from the stand front side and fix it using the fixtures.

For how to mount the GOT, refer to the following.

 Section 6.5 Installation Procedure

For details of the stand, refer to the following.

GT05-50STAND

 GOT1000 Series Stand User's Manual

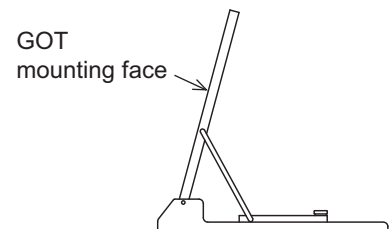

8.7 Protective cover for oil

Use of the protective cover for oil improves oil resistance, and chemical resistance of the GOT.

8.7.1 Applicable protective cover for oil

The following protective covers for oil are applicable to the GT10□□.

Product name	Model	Description
Protective cover for oil	GT10-20PCO	For 3.7" GOT
	GT10-30PCO	For 4.5" GOT
	GT10-40PCO	For 4.7" GOT
	GT05-50PCO	For 5.7" GOT

8.7.2 Installing procedure



Before attaching protective cover for oil

A protective film is attached on the display area when the GOT is shipped. Make sure to remove the protective film before attaching the protective cover for oil. For attaching the protective cover for oil to the GOT already mounted on the control panel, follow the procedures as below.

- Remove the GOT from the control panel. Make sure to externally shut off all phases of the power supply and remove all cables from the GOT in advance.
- Clean dirt off surfaces of the GOT and control panel.

- 1 Position the POWER LED frame of the cover to the POWER LED on the GOT front face, and the direction of the cover is decided. In the case of GT10-30PCO, let the wider side of the under side be located upward.

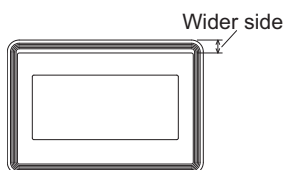

- 2 One corner of the cover is pulled outside, and it hangs on the corner of the front panel of GOT.

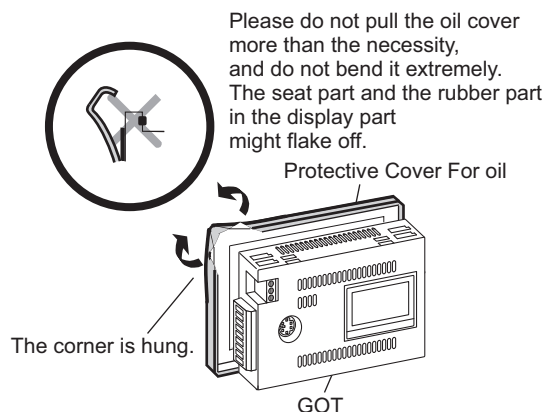
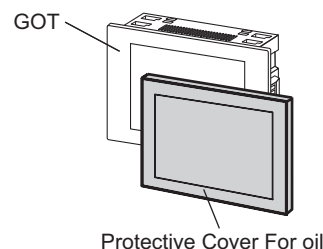

- 3 The oil cover was hung and the edge of the oil cover is sequentially obtained and obtain the oil cover to cover rubber packing parts in the back of GOT of the front panel.
(It is the order of the arrow from A side to D side.)

Please confirm all surroundings.

Check whether the rubber packing is fitted correctly into the groove on the under side of the GOT front panel, and then whether the protective cover for oil securely covers the rubber packing part to prevent invasion of liquids into the board.

The corner on the left is hung and the oil cover is hung from A side to D side on the starting point sequentially.

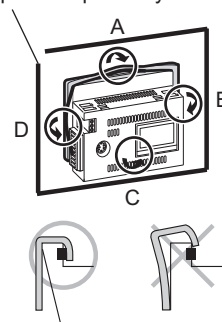

Make sure that corners of protective cover for oil match those of GOT front.

- 4 Mount the GOT onto the control panel.

When the control panel is dirty, clean the control panel.

The panel cutting dimensions and mounting screw tightening torque with the protective cover for oil are the same as those without the cover.

Mount the GOT onto the control panel by referring to Chapter 6.

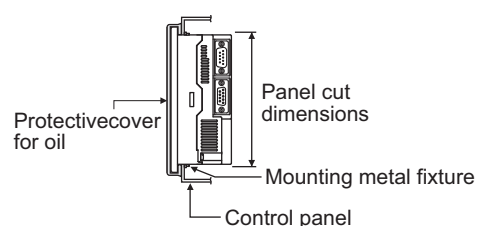

Point

(1) Cautions on installation

The mounting screw should be tightened by specified torque. Undertightening of mounting screws can cause a drop, and deteriorate the waterproof effect and oilproof effect. Overtightening of mounting screws can cause a drop due to damage of the GOT or mounting fixtures, and deteriorate the waterproof effect and oilproof effect.

(2) Precautions for protective cover for oil

- The protective cover for oil is consumable product.
Check the cover for scratch, damage or dirt at regular intervals, and replace with new one if necessary.
- Do not push the protective cover for oil with pointed tools, including mechanical pencils and screwdrivers.
Doing so causes scratches and damages of the cover.
- Do not clean the protective cover for oil with bleaches, thinners, organic solvents, corrosive chemicals, and others. Doing so causes changes in shape and color of the cover.
- When the protective cover for oil is attached to the GOT, do not stretch and bend the cover too much.
Doing so may cause a separation between the sheet and rubber.
- Do not place or use the protective cover for oil in direct sunshine.
- When the protective cover for oil gets dusts, wipe the dusts off with a damp cloth.
- Do not do a frequent detaching the protective cover for oil. It causes deterioration in the oil performance, the medicine performance.
- It is not the one to guarantee all customer's environments. Moreover, it is not likely to be able to use it in the environment to which oil splashes for a long time and the environment with which Oilmist is filled.

8.8 Serial Multi-Drop Connection Unit

8.8.1 Serial multi-drop connection unit

GOT multi-drop connection is a communication method for 1:N communication by connecting multiple GOTs to one PLC, using the GT01-RS4-M serial multi-drop connection module.

For details of GOT multidrop connection, refer to the following.

 GOT1000 Series Connection Manual

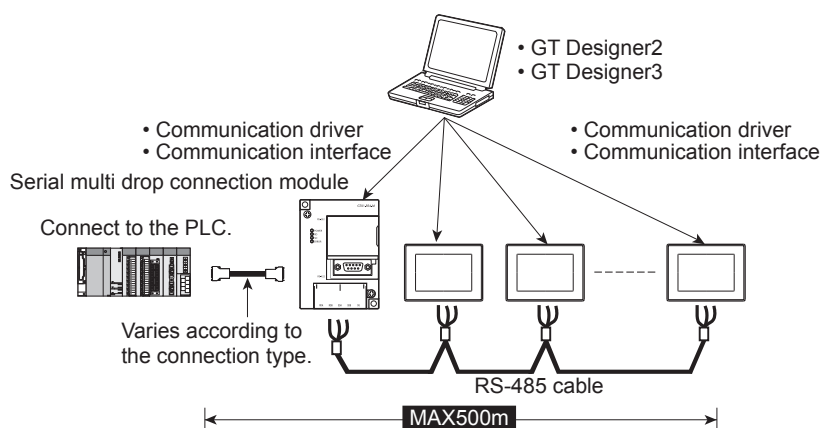

Point

(1) GOTs supporting the GOT multi-drop connection

The followings are the GOTs compatible with the GOT multi-drop connection.

GOT	Hardware version	Standard monitor OS
GT1055-QSBD, GT1050-QBBD	Version C or later	Standard monitor OS[01.12.**]
GT1045-QSBD, GT1040-QBBD	Version A or later	
GT1030-LBD/LWD/HBD/HWD, GT1030-LBDW/LWDW/HBDW/HWDW	Version B or later	
GT1020-LBD/LWD, GT1020-LBDW/ LWDW	Version E or later	

(2) Checking method of hardware version

Confirm the hardware version with the products rating plate.

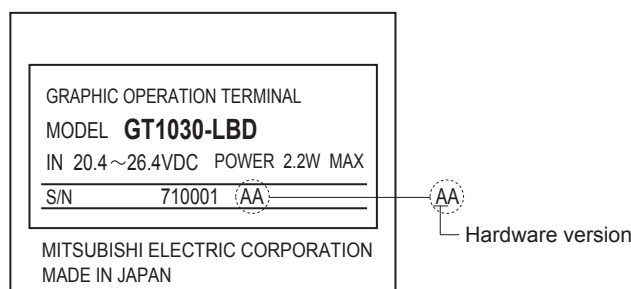

8.8.2 Applicable serial multi-drop connection unit

The following serial multi-drop connection unit is applicable.

Model	Contents
GT01-RS4-M	For GOT multi-drop connection

8.8.3 Part name

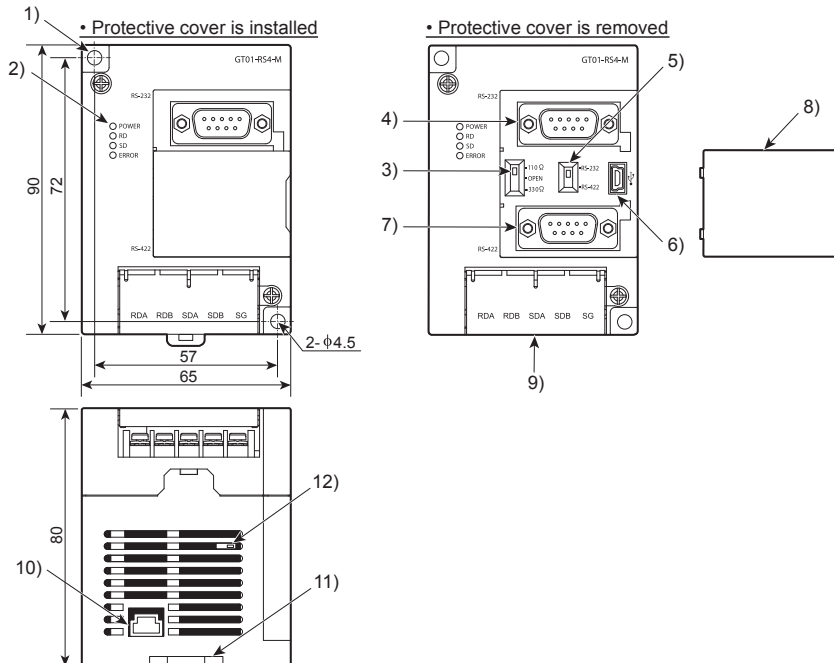

No.	Name	Specifications	
1)	Installation hole for the main unit	Installation hole	
2)	LED	POWER	Lit in green when the power is properly supplied.
		SD	Lit in green when the data is being sent to PLC.
		RD	Lit in green when the data is being received from PLC.
		ERROR	Lit or blinking depending on the status.
3)	Terminating resistor selector	Can be selected among 110Ω, OPEN and 330Ω (set to "OPEN" by default)	
4)	Connector for PLC communication	D-sub 9-pin (male) For RS-232 connection	
5)	Connector selection switch for PLC communication	Switch for selecting RS-422 or RS-232 (set to "RS-422" by default)	
6)	USB port	For connecting to a personal computer (for changing the communication driver)	
7)	Connector for PLC communication	D-sub 9-pin (female) For RS-422 connection	
8)	Protective cover	Protect unused D-sub connector, USB port and switches.	
9)	Terminal block for the serial multi-drop communication	Terminal block 5-pin (with a protective cover) M3 Tightening torque 0.5 to 0.6N.m	
10)	Power supply connector	24VDC power supply connector insertion point (A dedicated cable is included.)	
11)	Slider for installing the DIN rail	—	
12)	Mode selection switch (Slide switch)	Do not operate. (Set to right by default. When set to left, the module does not operate normally.)	

8.8.4 Installation

1 Installed with DIN rail

Install the multi-drop connection module with its hook (1 place) using the DIN rail.

- Applicable DIN rail DIN46277 (width: 35mm)
(Install the DIN rail with screws at intervals of 150mm.)

2 Directly installed to panel

Install the multi-drop connection module to the panel using $\phi 4.5$ mm holes (2 places).

8.8.5 Caution for compliance with EMC Directive

Programmable logic controllers are open-type devices that must be installed and used within conductive control boxes. Please use the Multi-Drop Connection Unit while installed in conductive shielded control boxes. Please secure the control box lid to the control box (for conduction). Installation within a control box greatly affects the safety of the system and aids in shielding noise from the Multi-Drop Connection Unit.

1

OVERVIEW

2

SYSTEM
CONFIGURATION

3

SPECIFICATIONS

4

PART NAME

5

UL, cUL
STANDARDS AND
EMC DIRECTIVE

6

INSTALLATION

7

WIRING

8

OPTION

8.9 Connector Conversion Adapter

GT10-9PT5S type connector conversion adapter enables an easy crossover wiring for the multi-drop-connected GOTs.

For the wiring between the connector conversion adapter and the controller, refer to the following manual.

 GOT1000 Series Connection Manual



(1) GOTs supporting the connector conversion adapter

The followings are the GOTs compatible with the connector conversion adapter.

GOT	Hardware version	Standard monitor OS
GT1055-QSBD, GT1050-QBBD	Version C or later	Standard monitor OS[01.12.**]
GT1045-QSBD, GT1040-QBBD	Version A or later	

(2) Checking method of hardware version

Confirm the hardware version with the products rating plate.

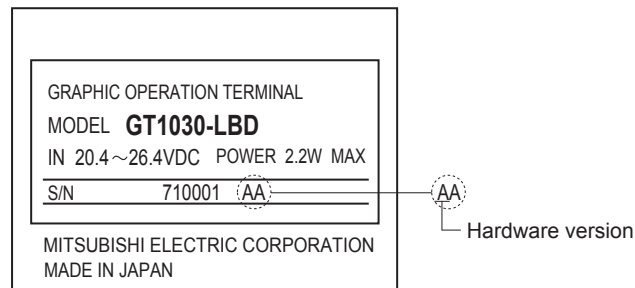

8.9.1 Applicable connector conversion adapter

The following connector conversion adapter is applicable.

Model	Contents
GT10-9PT5S	For GOT multi-drop connection

8.9.2 Installing procedure

- 1 Turn the GOT power off.
- 2 Connect the connection conversion adapter to the RS-422/485 interface on the GOT.
- 3 Fix the connection conversion adapter to the GOT using the provided M3 tapping screws.
Tightening torque: 0.3 to 0.6N · m

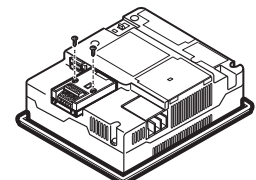
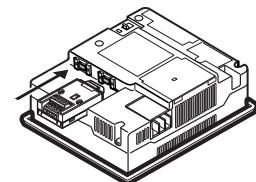

8.10 Panel-Mounted USB Port Extension

The panel-mounted USB port extension GT10-C10EXUSB-5S is an extension cable having the waterproof function.

8.10.1 Applicable panel-mounted USB port extension

The following panel-mounted USB port extension is applicable for GT104□ and GT105□.

Model	Contents
GT10-C10EXUSB-5S	Panel-mounted USB port extension

8.10.2 Part name

The part names of the panel-mounted USB port extension are shown in the figures below.

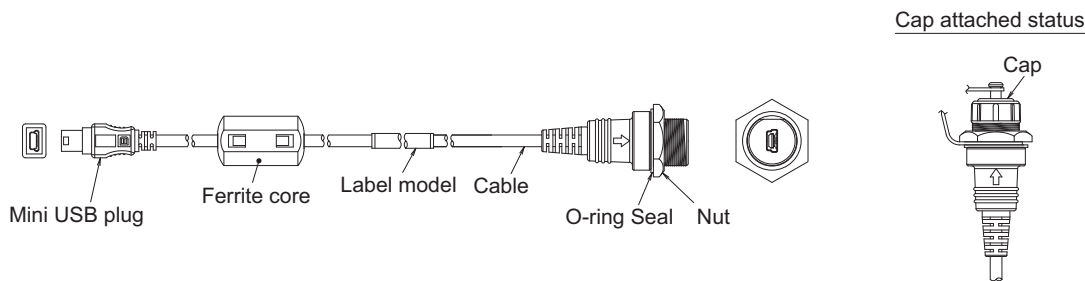

8.10.3 Installing procedure

1 Installing panel-mounted USB port extension on panel surface

Install the panel-mounted USB port extension as shown below while paying attention to prevent bending and distortion of the cap, O-ring seal and nut.

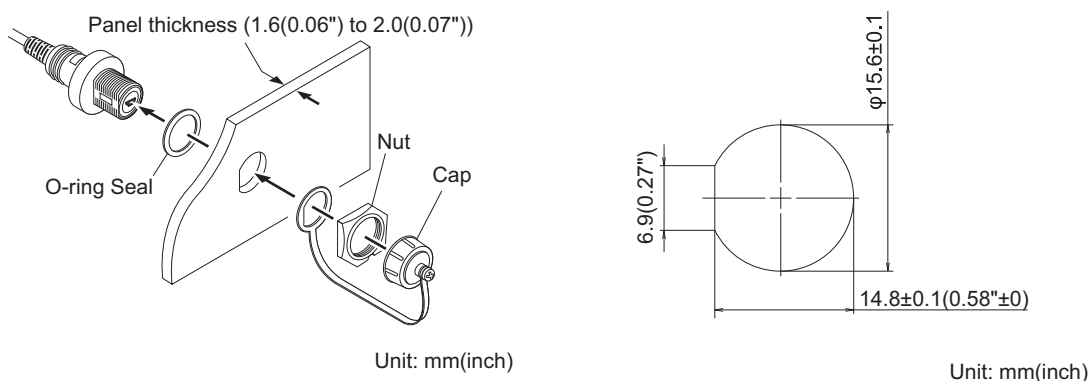

- The panel thickness should be 1.6(0.06") to 2.0(0.07")mm.
- The panel-mounted USB port extension conforms to the protective structure IP67f on the panel surface equipped with the cap.
- The nut tightening torque is 0.28 to 0.32 N•m.
Larger torque and smaller torque may deteriorate the waterproof effect.
- Tighten the cap securely while the panel-mounted USB port extension is not used.

2 Cautions on Installation of panel-mounted USB port extension

- (1) Run power lines, servo amplifier drive wires, and panel-mounted USB port extension so that they do not cross each other.
- (2) Keep the panel-mounted USB port extension away from any equipment which can become noise source.
- (3) Do not twist, bend at a sharp or right angle or pull the panel-mounted USB port extension. Such handling may cause wire breakage.
- (4) Install the panel-mounted USB port extension under consideration of the dimensions inside the panel shown below.
 - Dimension between GOT rear face and structure

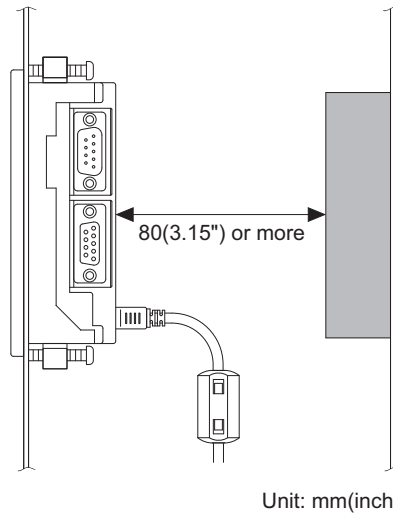

- Cable protrusion dimension

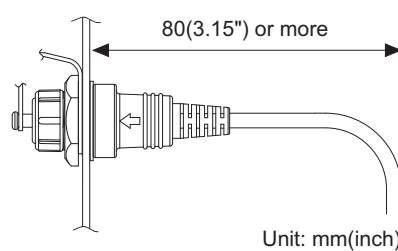

- (5) Insert securely the small USB plug provided at the tip of the panel-mounted USB port extension into the USB port in the GOT.
Fix the panel-mounted USB port extension itself to a structure inside the board using Insulock, etc. because the small USB plug may become loose or come off due to vibration, impact or tensile force.
- (6) Confirm at the start of work or during operation that this product is offering its function and performance normally, and then use this product.

9. UTILITY FUNCTION

The utility functions allow the user to confirm the settings for communication interface, screen display, operation methods, and clock data as well as OS information.

GT10□□ is factory-installed with the Standard monitor OS and BootOS.

(An installation of the Standard monitor OS or BootOS is not required to use the utility functions.)

9.1 Utility Function List

The items in the following list can be set/operated on the utility screens.

Item	Functions overview			
	GT1020	GT1030	GT104□	GT105□
Language	Switches the display language for the utility functions (Japanese/English)			
Standard I/F	Displays the detailed information about the communication method and communication driver			
Data transfer	Displays the screen for transferring project data between the PC and GOT (If any device other than the PC is allocated to the interface for communication with PC, the GOT will not be able to communicate with the PC, except when the Data transfer window is on the screen.)			
Communication monitor	Displays the communication status of each communication port			
Keyword	Sets a keyword of the FX series PLC.			
Screen save	Time	Sets the screensaver activation time (from the last time the screen was touched) Setting range: 0 to 60 min. (Screensaver is disabled when it is set to 0 minute.) Default : 0 min.		
	Backlight	This setting is used to decide whether to turn the backlight on or off when the screensaver comes on Default : OFF		
Contrast	Adjusts the contrast on the liquid crystal display (16 level adjustment, 0 to 15)			
Brightness	-	Adjusts the intensity on the liquid crystal display (8 level adjustment, 0 to 7)	-	
Opening time	The title display period at the main unit boot can be set. (0 to 60 sec) Default : 5 sec			
Buzzer setting	Buzzer volume	Changes the buzzer settings (OFF/SHORT/LONG) Default : SHORT		
	Window move buzzer	Whether turn ON/OFF buzzer when move window can be selected Default : ON		
Calibration	Calibrates the touch panel sensitivity	-		
Security ^{*1}	Security level change (security password input of each object)			
Utility call	Setting of the menu call key			
Key reaction	Display of key reaction speed			
Clock setting	Setup the method to adjust the time between GOT clock data and clock data of PLC CPU connected with GOT			

(Continued to next page)

Item	Functions overview			
	GT1020	GT1030	GT104□	GT105□
Time setting	Sets the clock (clock data) on the PLC	Sets the clock (clock data) on the PLC, Display of battery status		
Data	OS information	Displays the OS (Standard monitor OS, BootOS) and communication driver versions		
	Clear data	Clears the project data and resource data on the GOT		
	GT10-50FMB	-	Datan are transferred between the memory boards.	
Debug	Device monitor	Device monitor of PLC of intelligent module		
	FX list editor	-	The sequence program of FX PLC can be list edited	
	FX3U-ENET-ADP communication setting function	The communication set value of the FX3U-ENET-ADP stored in the CPU can be changed.		
Clean	Display the screen to clean the display section			

*1: It is necessary to set the security level with drawing software.

9.2 Utility Display

9.2.1 Display operation of main menu

The following four types of operation can display the main menu.
(The utility function windows appear in the horizontal format, and this format cannot be changed.)

- (1) When project data is undownloaded
After the GOT is turned on, a dialog box for notifying of absence of project data is displayed.
After the dialog box is displayed, touch the **OK** button to display the main menu.

GOT power on

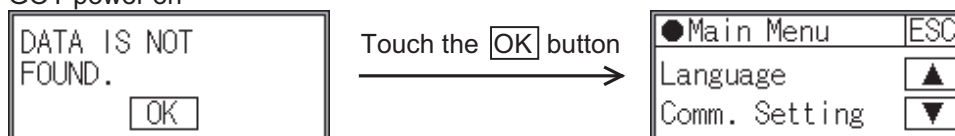

- (2) When touching menu call key
If you touch the menu call key while user-created screen is displayed, the main menu is displayed.
The menu call key can be set with the GOT utility screen or drawing software.
(At factory shipment, menu call key position it is set in the top left corner of the GOT screen on the GT1020.)
(At factory shipment, menu call key is set to "Simultaneous 2 - point presses on GOT screen upper - right and upper - left corners" on the GT1030, GT104□ or GT105□.)

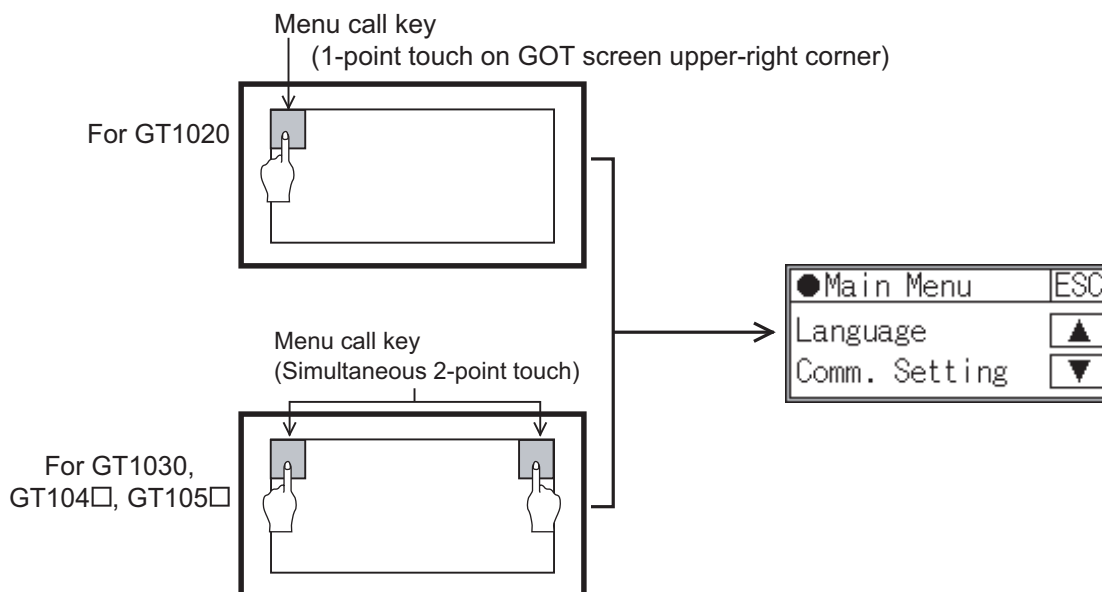

When the utility call key is set to the zero point

Even when the utility call key is set to the zero point, you can display the main menu using either of the following two operations:

- Pressing the special function switch set on the user-created screen
- Selecting [Utility] from the "Select mode" screen

(3) When touching special function switch

If you touch the special function switch (utility) while user-created screen is displayed, the main menu is displayed.

The special function switch (utility) can be set as a touch switch that is displayed on a user-created screen by drawing software.

(When the utilities menu is assigned to the special function switch, the main menu appears when the switch is touched.)

Special function switch (Utility)

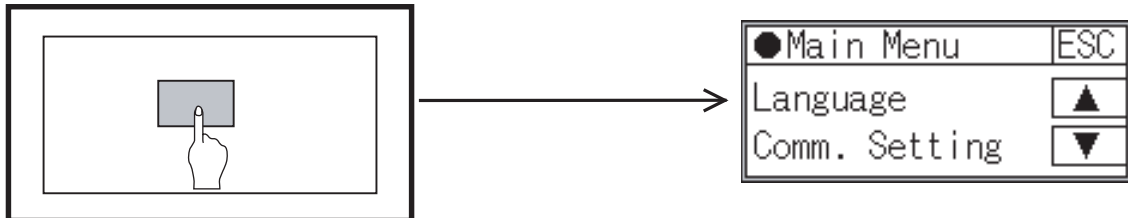

For the details of the special function switch, refer to the following.

☞ GT Designer2 Version□ Screen Design Manual
GT Designer3 Version1 Screen Design Manual (Functions)

(4) When selecting the start mode

The "Select mode" screen appears when you power ON the GOT while touching the upper left corner of the screen.

If you touch [Utility] on the "Select mode" screen, the main menu is displayed.

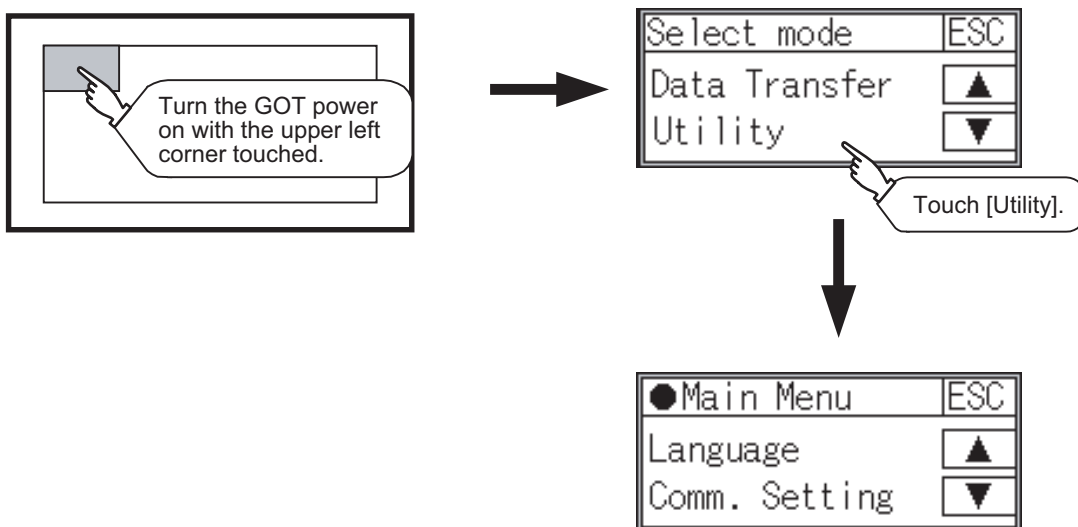

Remark

Lock the utility display by password.

When a password is set on the GOT using drawing software, a password dialog box is displayed when trying to access the main menu of the utility display. (The password setting option in drawing software is located in the common menu.) Enter the password that has been set.

(1) Input operation of password

- 1) Input the password after touching to , to key.
- 2) Define the password by touching key, after inputting password.
- 3) To correct the input character, touch key to delete the correcting character and then reinput/retype the new character.

(2) Password input cancel operation

When button is touched, the screen returns to the monitor screen. Refer to the following for details on setting passwords.

 GT Designer2 Version□ Screen Design Manual
GT Designer3 Version1 Screen Design Manual (Functions)

(3) If an invalid password is entered

If an invalid password is entered, the error message will appear.

Touching the button will take the screen back to the monitor screen.

Point

When starting the GOT without selecting any language (At factory shipment)

The following screen will be displayed at the initial startup of GOT. Touching the button of a desired language restarts the GOT and the language is switched to the selected one.

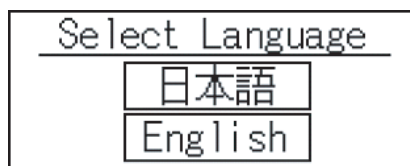

9.2.2 Utility basic configuration

The basic configuration of the screen is as follows.

1 Main Menu

The menu items that can be selected from the GOT utility are displayed.

GT1020



GT104□, GT105□

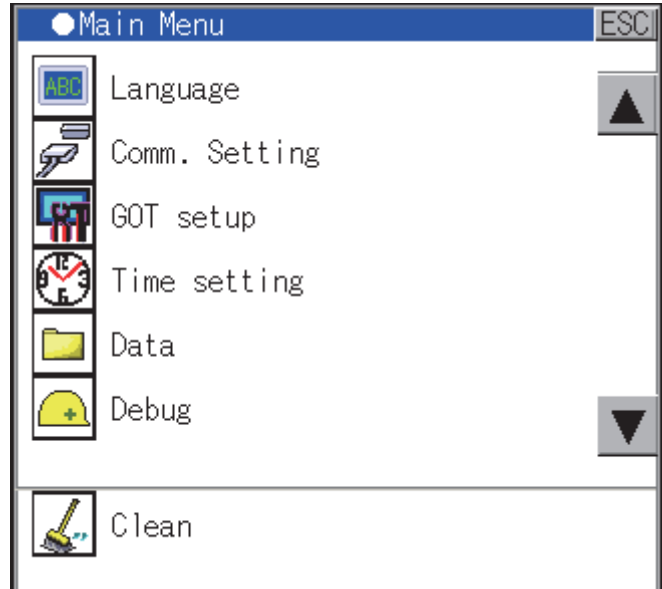

- 1 Use the ▲, ▼ buttons to select an item from the menu.
- 2 Touching a menu item in the main menu will display the setting screen or following selection screen for the item.
- 3 Touching the **ESC** button will take the screen back to the user screen.

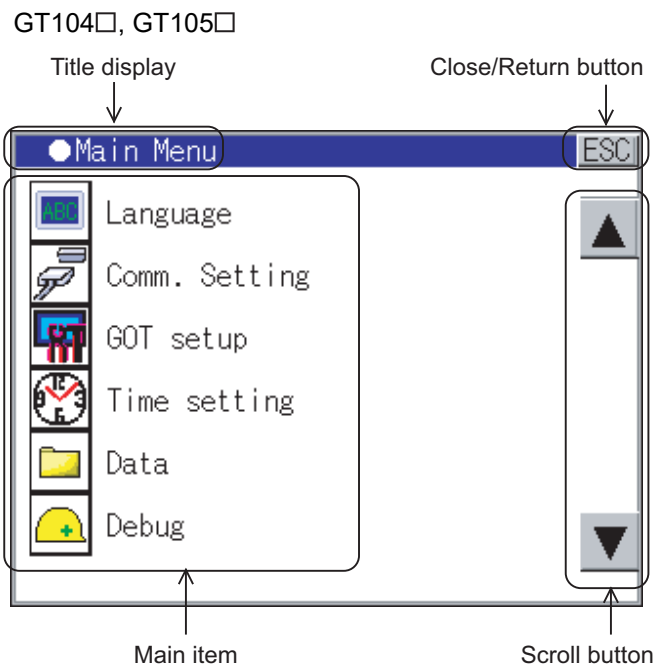
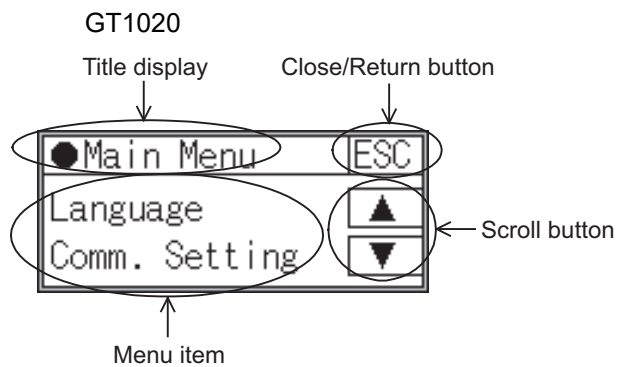

- (1) Title display
The screen title name is displayed in title display part.
- (2) Close/Return button
When a middle screen of the layers is displayed, if the ESC (Close/return) button in the right corner of screen is touched, returns to the previous screen.
If this button is touched when directly displayed from monitor screen, the screen is closed and returns to monitor screen.
- (3) Scroll button
For screens in which the content does not fit on one screen page, there is a right or down scroll button on the screen.

▲ ▼ Scroll one line/window

10. LANGUAGE SETTING (Language)

10.1 Display language setting

10.1.1 Display language setting function

This function allows display language selection.
The items which can be set are shown below.

Item	Contents	Setting range
Language	Display language in which the utility functions and dialog windows are displayed can be selected or confirmed in this menu	Japanese/English <At factory shipment: Japanese>

10.1.2 Language display operation

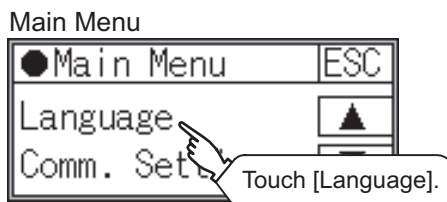

10.1.3 Language setting operation

1 Language

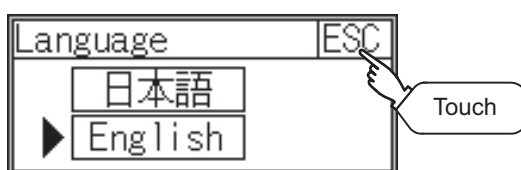
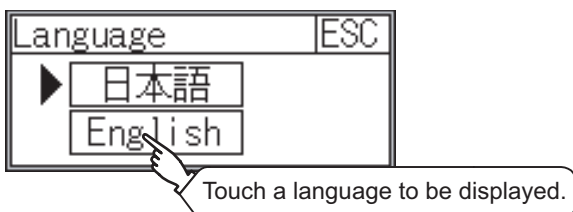
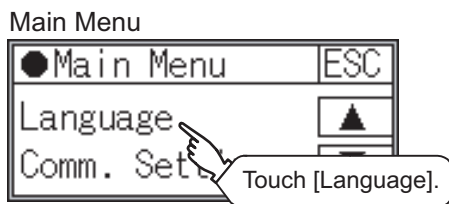

1 Touch [Language] to bring up the set up screen.

2 Select a display language by touching the corresponding button.

3 Touch the **ESC** button to save the setting and close the window.



Switching the display language of the utility by devices

Any device can be used for switching the display language of the utility. For details, refer to the following.

 GT Designer3 Version1 Screen Design Manual (Fundamentals)

When using devices to switch the display language of the utility, it does not change even if the display language is switched from the GOT utility screen.

11. COMMUNICATION INTERFACE SETTING (COMMUNICATION SETTING)

The [Communication Setting] menu has the [Standard I/F], [Data Transfer], [Communication Monitor], and [Keyword] menus.

The [Standard I/F] menu sets the information about the channel numbers, controller name, and detailed settings of the communication parameters that are allocated to the communication interfaces by drawing software.

The [Data Transfer] menu displays the screen for transferring project data between the PC and GOT.

The [Communication Monitor] menu displays the communication status of each communication port.

The [Keyword] menu registers, deletes, clears, and protects a keyword of the FX series PLC.

11.1 Standard I/F Setting

11.1.1 Standard I/F functions

Function	Contents
Channel no. display	Displays the channel number (CH No) that has been assigned by drawing software
Communication driver display	Displays the communication driver that has been assigned by drawing software
Communication parameters display	Displays the communication parameters of the controllers that has been assigned by drawing software

11.1.2 Standard I/F display operation

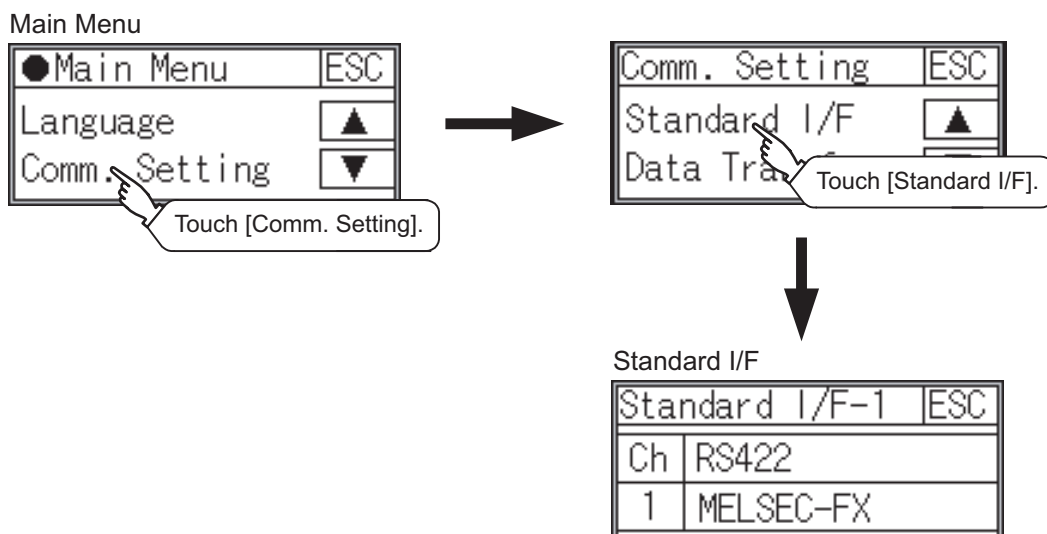

11.1.3 Display contents of standard I/F

Described below are the display items on the standard I/F setting menu and their functions.

1 Display item column

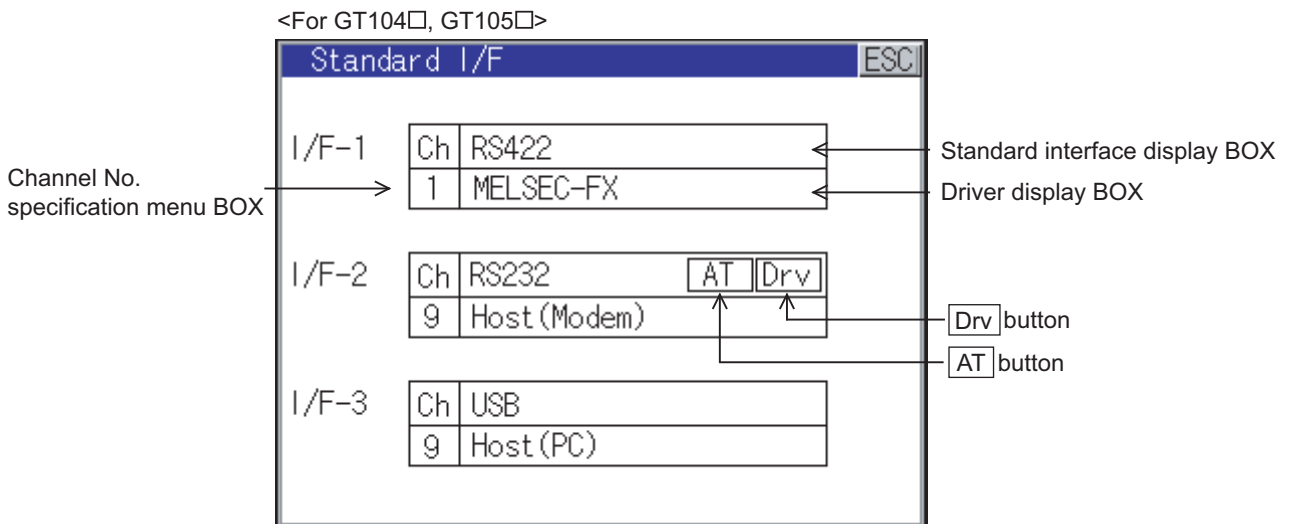
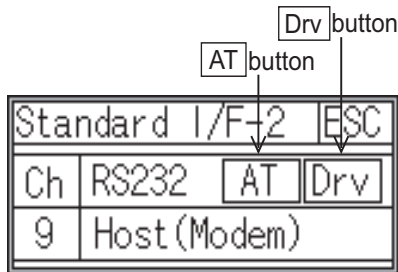
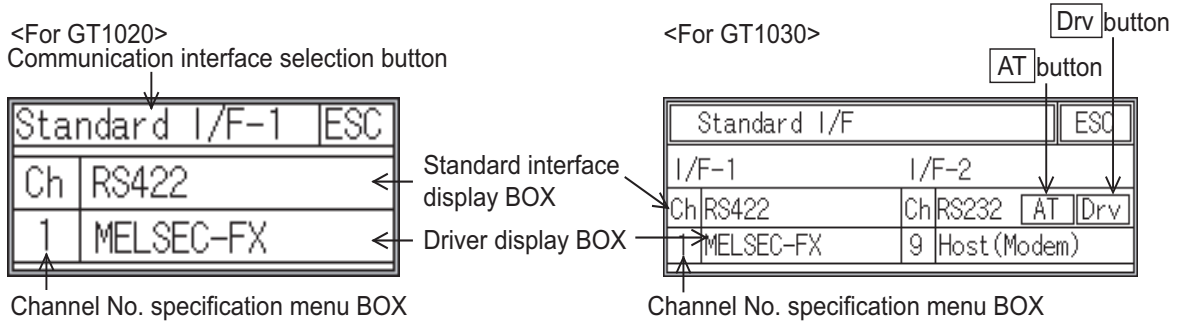

- (1) Communication interface selection button <For GT1020>
 Select the communication interface to be displayed.

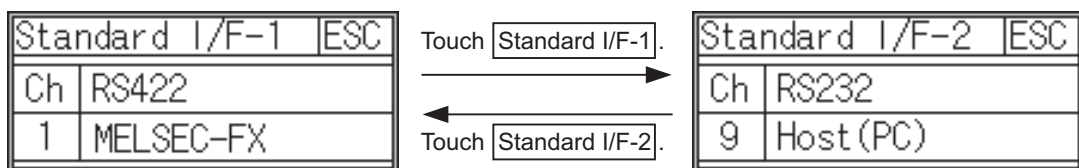

(2) Standard interface display BOX
 Displays communication interface.

(a) GT1020, GT1030

The standard interface includes the following two types.

Standard I/F-1: For communication with PLC, microcomputer and other equipment

Standard I/F-2: For communication with PC (drawing software), modem, bar code reader and transparent

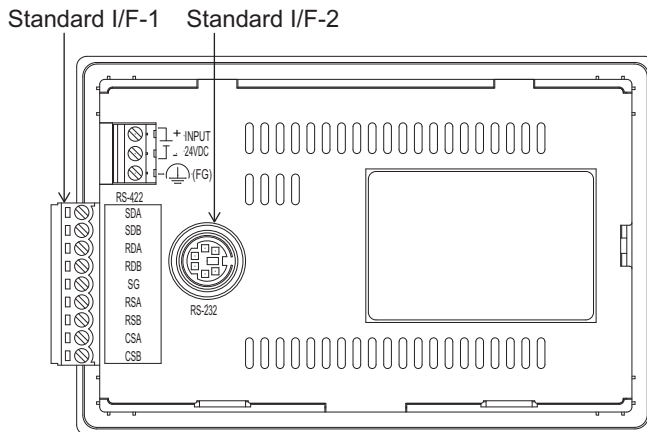

Whether an RS-422 or an RS-232 interface (Standard I/F-1) for communication with PLC is used depends on the GOT model.

- GT1020-LBD/LWD/LBL/LWL/LBDW/LWDW/LBLW/LWLW, GT1030-LBD/LWD/LBL/LWL/LBDW/LWDW/LBLW/LWLW/HBD/HWD/HBL/HWL/HBDW/HWDW/HBLW/HWLW: RS-422 fixed
- GT1020-LBD2/LWD2/LBDW2/LWDW2, GT1030-LBD2/LWD2/LBDW2/LWDW2/HBD2/HWD2/HBDW2/HWDW2: RS-232 fixed

The type of the interface (Standard I/F-2) for connection to PC is always RS-232.

(b) GT104 □

The standard interface includes the following three types.

Standard I/F-1(RS-422): For communication with PLC, microcomputer and other equipment

Standard I/F-2(RS-232): For communication with PLC, PC (drawing software), modem, other equipment, bar code reader and transparent

Standard I/F-3(USB): For communication with PC (drawing software) and transparent

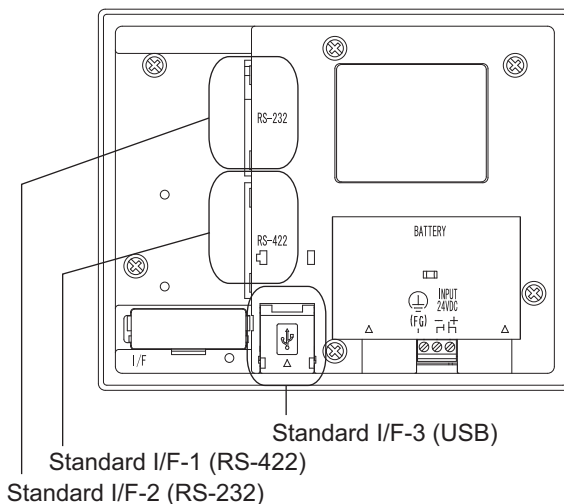

(c) GT105 □

The standard interface includes the following three types.

Standard I/F-1(RS-422): For communication with PLC, microcomputer and other equipment

Standard I/F-2(RS-232): For communication with PLC, PC (drawing software), modem, other equipment, bar code reader and transparent

Standard I/F-3(USB): For communication with PC (drawing software) and transparent

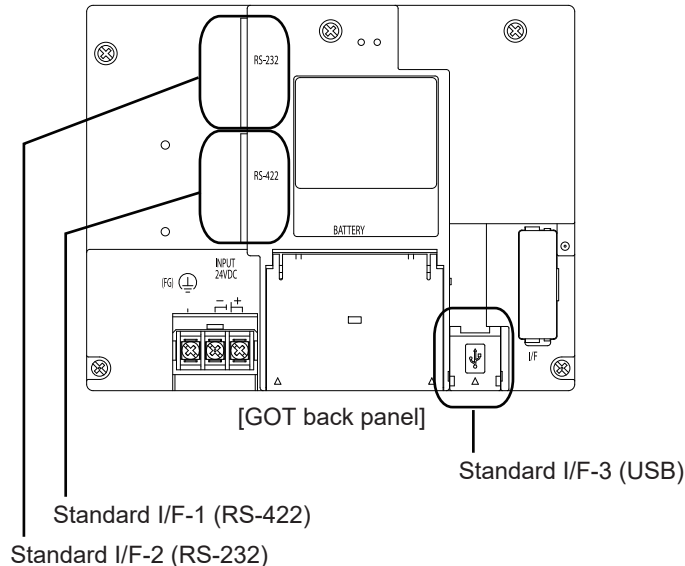

(3) Channel No. specification menu BOX

0: Set when the communication interface is not used.

1: Set when connecting to PLC or microcomputer.

(For GT1020 and GT1030, settable only for the interface (Standard I/F-1) for communication with PLC)

(For GT104□, GT105□, either of standard I/F-1 or standard I/F2 can be set.)

8: Set when connecting to bar code reader.

9: Set when connecting to PC (drawing software), modem. (For standard I/F-2 and standard I/F-3, the simultaneous setting is possible. However, when either interface is communicating, the communication is not allowed for another interface.)

- Setting is not allowed for 2 to 7, *.
- Fixed to 9 for the USB interface.

(4) Driver display BOX

The name of the communication driver for which a channel number is assigned is displayed.

"None" is displayed in the driver display box in the following cases :

- The communication driver is not installed. (☞ Section 14.2 OS Information)
- "0" is set in the channel number specification menu box.

[*****] will appear when the communication driver that was installed on the GOT from drawing software and the controller setting that was downloaded on to the GOT from drawing software do not match.

When setting the channel number to "9", the communication driver "Host (PC)" is automatically assigned.

When the driver display box is touched, the screen jumps to the detail information screen and the communication parameter appears.

(5) button

Displays the driver setting screen.

Select the driver to use on the driver setting screen.

button is displayed in the following cases.

- When setting the "ch9" to standard I/F-2.

(6) button

Displays the AT command setting screen.

Set the AT command to use for initializing the modem on the AT command setting screen.

button is displayed in the following case.

- When "ch9 Host (Modem)" is set to standard I/F-2.

11.1.4 Detail information setting operation

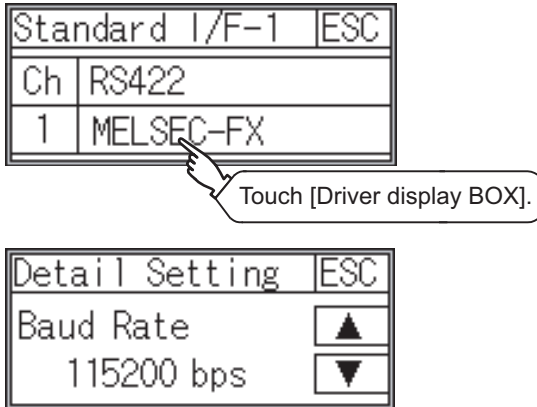

- 1 Touch Standard I/F-1 driver display box in the Standard I/F setting window.

- 2 The screen jumps to the detailed information screen and the communication parameter will appear. Use the ▲, ▼ buttons to toggle through the items when there are multiple items to be set. (The ▲, ▼ buttons will not work when no other items are available.)

- 3 Touch the numerical values of baud rate to switch them repeatedly.

Ex. 4800bps → 9600bps → 19200bps

The numerical values are set using the ten-key depending on the setting.

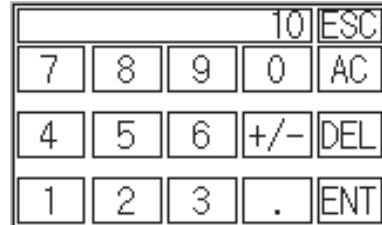

- “0” to “9” : Use these keys to enter numerical values. Enter “0” to disable the screensaver function
- “ESC” : Closes the ten-key window without saving any value entered
- “AC” : Deletes the entire string of numerical characters that are being entered
- “DEL” : Deletes a digit from a string of numerical characters that are being entered
- “ENT” : Enters the value for the clock that has been entered and closes the ten-key pad window
- “+ / -” : Switches between positive and negative values (Only positive values are valid for the clock setting.)
- “ . ” : Invalid key (not used)

Standard I/F-1		ESC
Ch	RS422	
1	MELSEC-FX	

Save the data?

Now rebooting.

- 4 When the button is touched, the settings are fixed and the window returns to the previous one. Therefore, touch the button.

- 5 Touch the button to display the window confirming whether to save the settings.

- 6 Touch the button to save the settings and restart.
 Touch the button to discard the changes.

The types of items that are in the communication parameter setting menu depend on the type of communication driver that is installed on the GOT in use.

Refer to the section below for the setting contents of various drivers.

 GT Designer2 Version□ Screen Design Manual
 GT Designer3 Version1 Screen Design Manual (Fundamentals)

Precautions for communication between GOT and connected devices

(1) Installing [Communication driver] and downloading [Communication Settings]
To perform communication with the connected device, the following actions are necessary.

- 1) Installing [Communication driver] (Up to 1, OS installation)
The driver for [MELSEC-FX] is factory-installed. Install the communication driver to connect a controller other than a MELSEC-FX.
- 2) Assigning channel number and communication driver to communication interface (Communication Setting)
- 3) Downloading [Communication Settings] (project data) assigned in step 2)

Perform 1), 2) and 3) with drawing software.

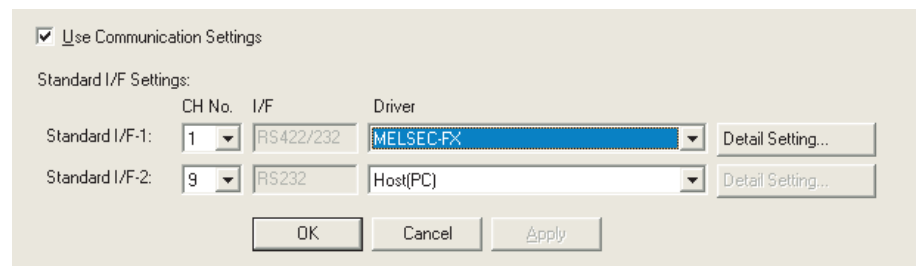

To change the communication parameter setting after downloading project data, change the setting at drawing software again.

For [Communication Settings], refer to the following manual.

-  GT Designer 2 Version□ Screen Design Manual
- GT Designer 3 Version1 Screen Design Manual (Fundamentals)

For installation of [Communication driver] (OS) and download of project data, refer to the following manual.

-  GT Designer 2 Version□ Basic Operation/Data Transfer Manual
- GT Designer 3 Version1 Screen Design Manual (Fundamentals)

(2) When [Communication Settings] has not been downloaded using drawing software

When [Communication Settings] has not been downloaded, the GOT automatically assigns the installed communication driver as the standard I/F-1. When assigning the communication driver to Standard I/F-2 on GT104□ , GT105□ , make the setting in the communication settings of drawing software or in the communication settings of the utility.

11.1.5 Channel setting operation

1 Channel number setting operation

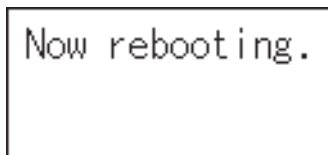
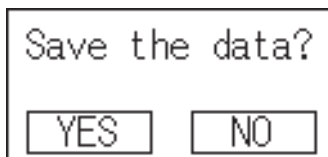
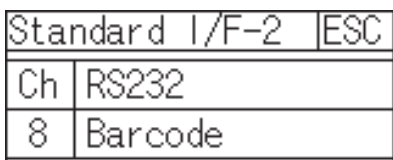
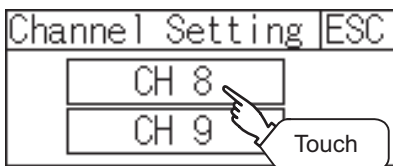
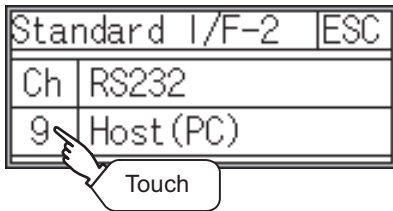

1 Touch the channel No. specification menu box to be set.

2 When the channel setting window appears, select the channel number.

3 When the channel number is selected, the settings are fixed and the window returns to the previous one. Therefore, touch the button.

4 Touch the button to display the window confirming whether to save the settings.

5 Touch the button to save the settings and restart.

Touch the button to discard the changes.

Point

Channel number

- (1) Only channel number 1 is displayed on the standard I/F-1 of GT1020 or GT1030.
- (2) Channel number 8 and 9 are displayed on the standard I/F-2 of GT1020 or GT1030.

11.1.6 Driver setting operation

1 Driver setting operation

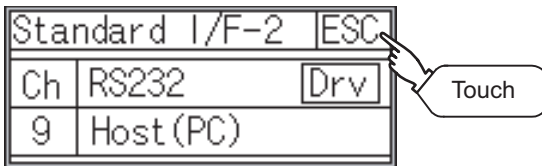
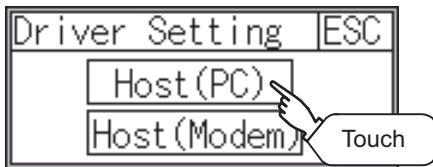
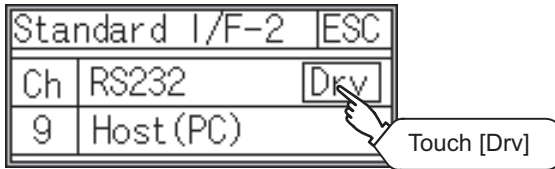

- 1 Touch **Drv** button to bring up the driver setting window.
- 2 The available driver names are displayed on the driver setting screen. Select the driver to use.
- 3 When the driver is selected, the display returns to the standard IF setting screen. Touch **ESC** button.

11.1.7 AT command operation

1 AT command operation

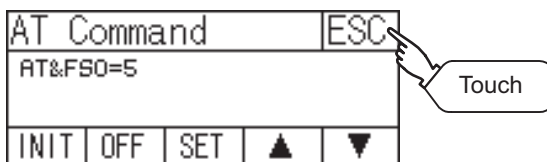
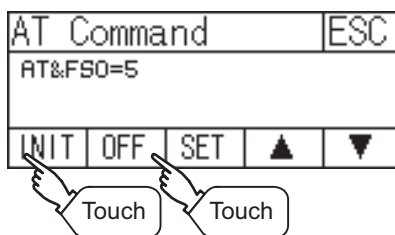
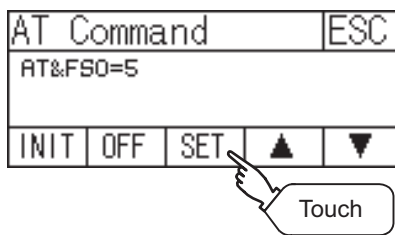
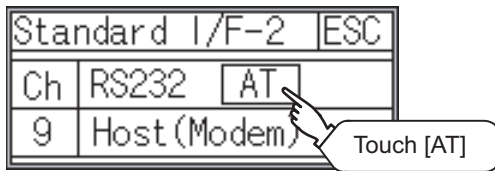

- 1 Touch **[AT]** button to bring up the AT command setting window.
- 2 The AT command, set in the drawing software or in the utility of the main unit, is displayed.
When editing the AT command, touch **[SET]** button to display the ASCII window. Input the AT command in the ASCII window.
- 3 Touch following buttons as necessary.
 - **[INIT]** button: Outputs the AT command to the modem.
 - **[OFF]** button: Disconnects the line.
- 4 After settings are completed, touch **[ESC]** button to close the setting screen.

11.1.8 Installing of communication driver

GT10□□ is factory-installed with the driver for MELSEC-FX.

An installation of the communication driver is required when connected to a controller other than a MELSEC-FX. When installing the communication driver, first bring up the OS installation screen on the GOT, and then install the communication driver from drawing software.

Bringing up the OS installation screen

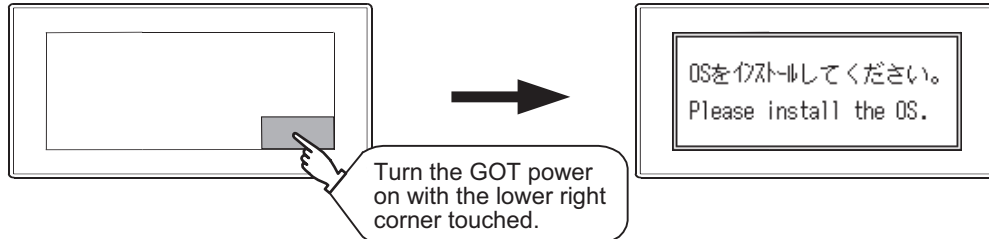

Refer to the chapter below for detailed information on the OS installation screen of the GOT.

☞ Chapter 17. OS INSTALLATION

Point

About the OS installation screen

The OS can be transferred from GT Designer2 or GT Designer3 without displaying the OS installation screen depending on the combination of the GOT and the standard monitor OS.

Model	BootOS version	Standard monitor OS	GT Designer2	GT Designer3
GT1020	BootOS version F or later	Standard monitor OS [01.08.00] or later	Version2.77F or later	From the first version
GT1030	BootOS version F or later			
GT104□	From the first version		Version2.90U or later	
GT105□	From the first version		Version2.90U or later	

Refer to the chapter below for how to install the communication driver from drawing software.

☞ GT Designer 2 Version□ Basic Operation/Data Transfer Manual
GT Designer 3 Version1 Screen Design Manual (Fundamentals)

Point

Checking method of BootOS, Standard monitor OS version

1. Check the version of BootOS or Standard monitor OS installed in GOT at [OS information] of the utility.
Refer to the following for details.

☞ Section 14.2 OS Information

2. Check the version of BootOS installed in GOT at product shipment on the rating plate on GOT rear face.

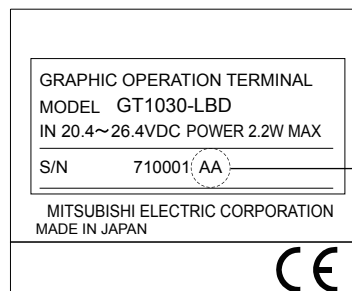

AA → BootOS Version

When the Boot OS version is 2 digits, only the lower digit is printed.
Example H/W version: H
Boot OS version: AD
↓
Rating plate: HD

11.2 Data Transfer

11.2.1 Data transfer functions

Function	Contents
Data transfer screen display	Displays the screen for transferring project data between the PC and GOT. If any device other than the PC is allocated to the interface for communication with PC, the GOT will not be able to communicate with the PC, except when the Data transfer window is on the screen.

11.2.2 Data transfer operation

1 Display from the utility main menu

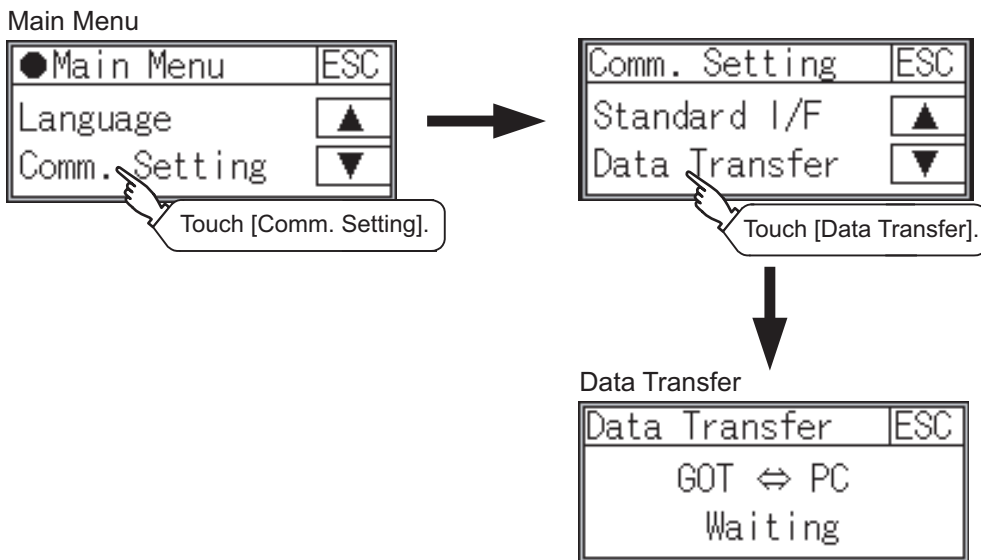

2 Display from the select mode

If data transfer screen cannot be displayed on the user-created screen, power ON to perform select mode while pressing and holding the upper left corner of the screen.

The selection screen of [Normal] or [Data Transfer] appears at the startup.

In the [Normal], an initial screen appears when the monitor screen has been created, and the utility main menu appears when the monitor screen has not been created.

[Data Transfer] screen appears in the [Data Transfer].

Standard I/F-2 is used in the communication mode to the PC.

Bringing up the select mode screen

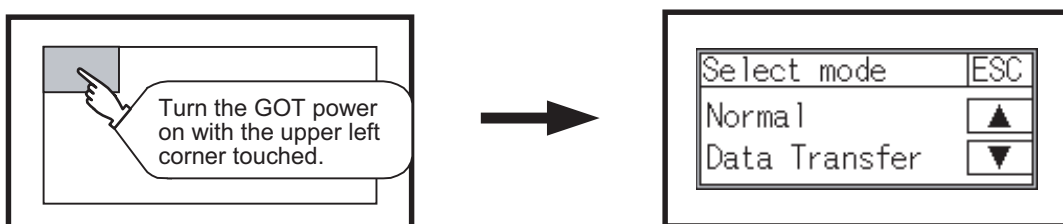

11.2.3 Data transfer display

[Waiting] on the data transfer screen will change to [Transferring...] when project data are transferred from drawing software.

At the completion of data transfer, the user-created screen will appear.

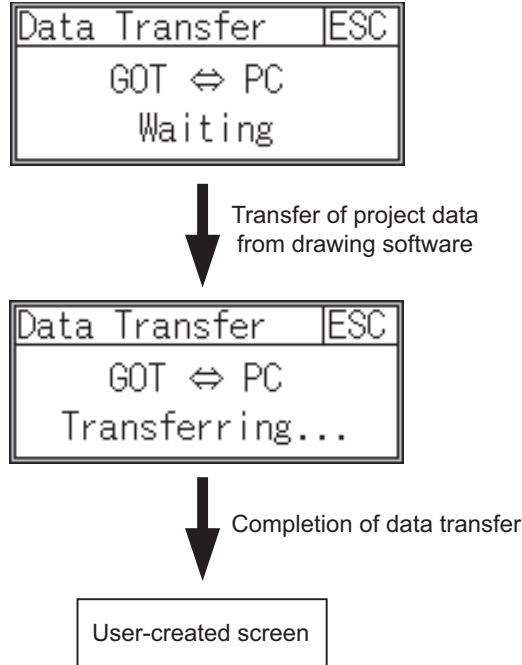

Point

Transfer of project data

If [ESC] button on the display screen is pushed during transfer of project data, transmission of project data is stopped.

In that case, project data are transferred from drawing software again.

11.3 Communication Monitor

11.3.1 Communication Monitor functions

Function	Contents
Communication port-selection status display	Displays the connection status of Standard I/F-1 and I/F-2
Communication status display	Displays the communication status (SD: send, RD: receive)
Communication error status display	Displays an error message when a communication error occurs

11.3.2 Communication Monitor display operation

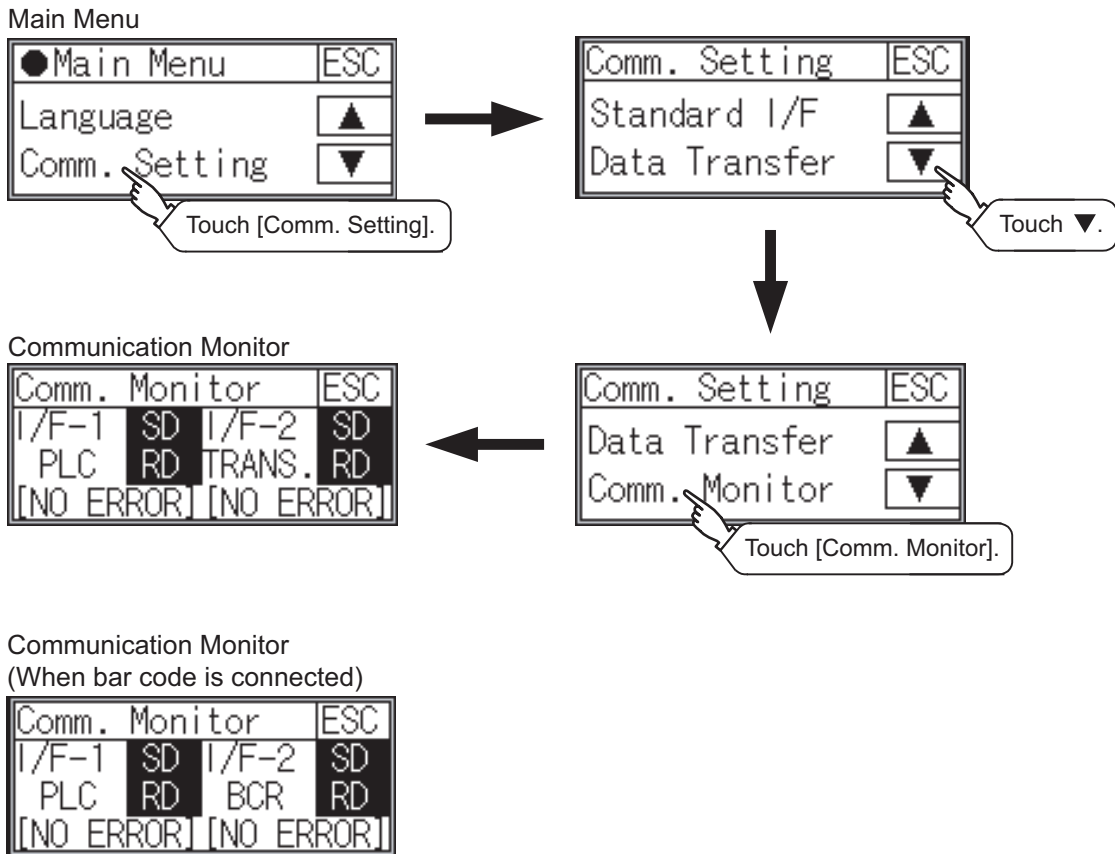

11.3.3 Screen display content

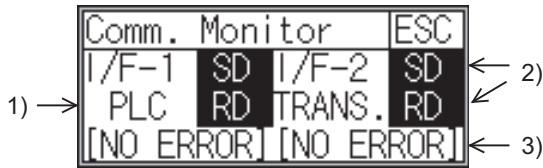

- 1) Connection status of the communication ports
Indicates the connection status of Standard I/F-1 and I/F-2.
Listed in the table below are display items and the connection status (channel number).

Display item	Channel number	Remarks
PLC	Ch1	"PLC" appears when connected to a controller (PLC or microcomputer)
BCR	Ch8	"BCR" appears when connected to a bar code reader
TRANS.	Ch9	"TRANS." appears when the controller that is allocated to one of the communication ports supports the transparent mode "TRANS." automatically changes to "PC" when communicating with drawing software
PC	Ch9	"PC" appears when the controller that is allocated to one of the communication ports does not support the transparent mode

- 2) Communication status
Communication status of each communication port is displayed on this screen.
The SD and RD symbols appear in black on white (**SD**, **RD**) while data are being sent or received, and in white on black (**SD**, **RD**) at other times. They may appear lit depending on the communication status.

The SD and RD symbols on the screen indicate normal communication or cable disconnection.

Port	Channel number	Controller type
I/F-1	Ch1	MELSEC-FX
I/F-2	Ch8, Ch9	-

[During normal communication (with connection to a device that supports the transparent mode)]

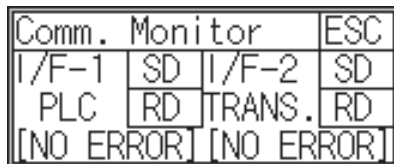

The SD and RD symbols for both I/F-1 and I/F-2 blink.

[When the connecting cable with the controller is disconnected]

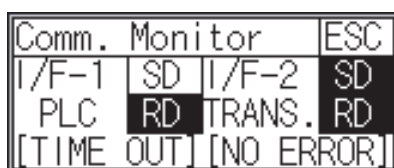

Only the SD symbol next to I/F-1 blinks.

3) Communication error status

Communication error status of each port is displayed on this screen.

The table below summarizes the types and nature of the errors.

Display item	Action
NO ERROR	Communication is executed normally.
ERR Ovr.	The receive data is sent continuously with a short interval. Let the baud rate (communication speed) be equivalent between the GOT and counterpart equipment.
ERR Frm.	The communication frames of GOT and PLC are inconsistent. Confirm the communication settings of GOT and PLC, such as data length, stop bit and baud rate.
ERR Prt.	The parity check conditions of GOT and PLC are inconsistent. Let the parity check condition (odd or even) of GOT and PLC be consistent.
ERR Text	The sum data is inconsistent. Or the contents of the receive data are not consistent with the send command from the GOT. Let the communication settings and contents of data be consistent between the GOT and counterpart equipment. (If NAK is received while the GOT is connected to the microcomputer board, a text error occurs.)
TIME OUT	Though receiving is started, receive data is not sent. Check the wiring between the GOT and its communication target. (When the GOT is connected to the microcomputer board, confirm the terminator, CR, wiring, etc.)
ERR Line	The control line is not operating correctly. Confirm the wiring of the control line.
ERR Cmd.	A command contained in the receive data is not consistent with the send command from the GOT.

11.4 Keyword

11.4.1 Keyword functions

The operation related to a keyword of the FX series PLC can be performed.

Function	Contents
Regist	Keyword is registered.
Delete	Registered keyword is deleted.
Clear	Keyword protection is cancelled.
Protect	A keyword with cancelled protection is reactivated for protection.



How to use the keyword function

To use a keyword, the standard monitor OS[01.10.**] or later and the communication driver MELSEC-FX[01.06.**] or later must be installed on the GOT.

For the details of OS installation, refer to the following images.

17. OS INSTALLATION

11.4.2 Keyword display operation

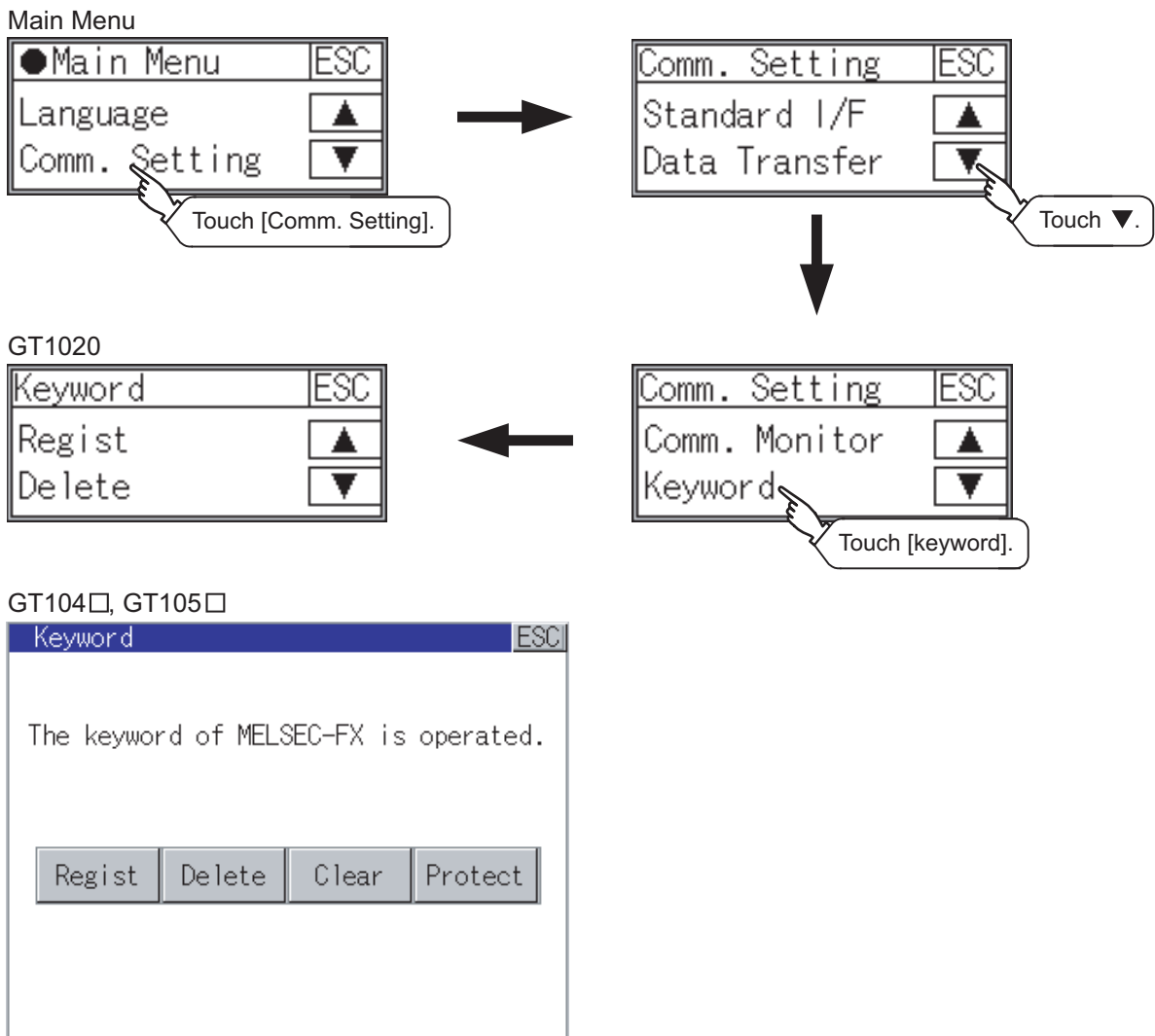

11.4.3 Regist

Keyword is registered.

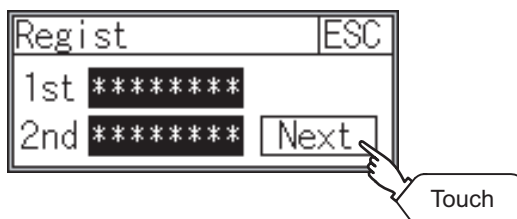
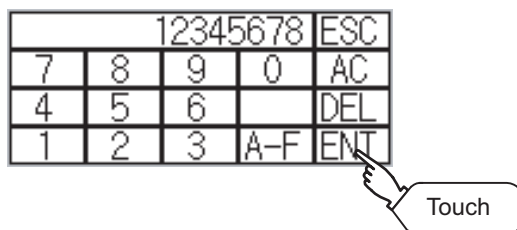
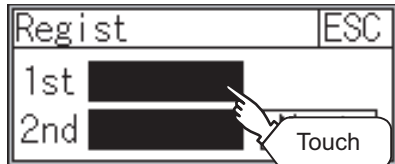
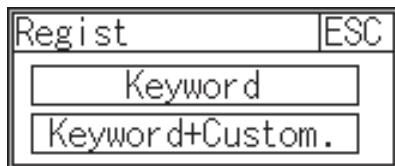
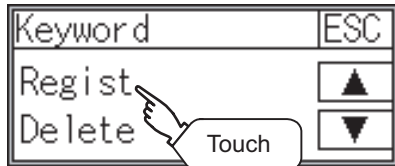

- 1 Touch "Regist" to display the selection screen for the registration.
For the FX series PLC, which is not compatible with Customer Keyword, the keyword entry screen of (3) is displayed. Start the operation from (3).

For the Customer Keyword compatible models, refer to the manual of the PLC to be used.

- 2 Select [Keyword] or [Keyword + Custom].
To register only Keyword and 2nd keyword, touch [Keyword].
To register Customer Keyword, touch [Keyword + Custom].

- 3 Touch the display part of the keyword to be registered.

- 4 The keyboard for entering a keyword is displayed. Enter a keyword and touch the **ENT** key.
For the keyword, 8 digits from 0 to 9 or A to F must be set.

- 5 After completing the keyword entry, touch **Next**.
When [Keyword + Custom] is selected on the selection screen for the registration, the Customer Keyword entry screen is displayed.
Enter it in the same way as for Keyword and 2nd keyword.

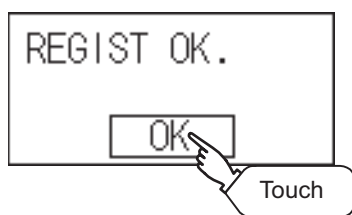
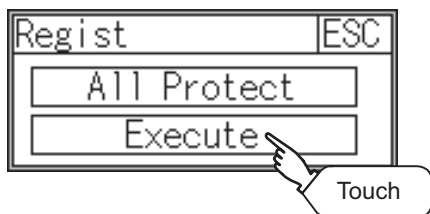
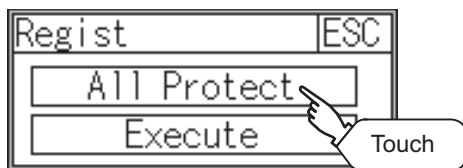

- 6 Set Registration conciliation.
Touch Registration conciliation to change the setting contents.

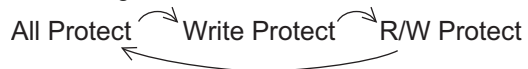

- 7 After setting Registration conciliation, touch the [Execute] key.
The registration of the keyword is completed.

- 8 After the completion of the keyword registration, touch

(1) Selection availability of Registration conciliation

The following table lists the PLCs that can select Registration conciliation.

Target PLC	Settings	
	When keyword and 2nd keyword are registered	When only keyword is registered
FX PLC compatible with 2nd keyword*1	Registration options can be selected.	Registration options*2 cannot be selected.
FX PLC not compatible with 2nd keyword*1	-	

*1: Refer to the manual for the PLC in use for the models that are compatible with the 2nd keyword.

*2: Registration options

Options can be selected among "Read/Write Protect", "Write Protect", or "All online operation protection".

For access restrictions of each setting, refer to the manual of the PLC to be used.

(2) Selection of keyword protection level

For the devices which can perform the online operation of FX PLC, 3 levels of protection can be set.

When the monitoring or setting change by online devices is needed, set the keyword taking the following into consideration.

(a) When only keyword is registered

Protection level is selected by the head character of keyword.

All Protect: Set the keyword starting with one of A, D to F, or 0 to 9.

Read/incorrect write protection: Set the keyword starting with B.

Erroneous write prohibition: Set the keyword starting with C.

(b) When keyword and 2nd keyword are registered

Protection level is selected by "Registration options".

(3) Applicability of monitoring for each keyword protection level

The applicability of monitoring for each protection level is as follows.

Setting items	When only keyword is registered			When keyword and 2nd keyword are registered			Keyword unregistered/ protection cancelled	
	All Protect	Read/ incorrect write protection	Erroneous write prohibition	All online operation protection	Read/ Write prohibition	Write Protect		
Device monitoring	○	○	○	×	○	○	○	
Device change	T, C setting values and file register (from D1000)	× *1	× *1	× *1	×	○	○	○
	Other than the above	○	○	○	×	○	○	○

*1: When the T, C set values are specified indirectly, changing devices is available.

(4) Difference between "All online operation protection" and "All Protect"

When "All online operation protection" is selected, both device display and input by the programming tool or GOT are prohibited.

When "All Protect" is selected, device display and input are possible although operations by the programming tool are all prohibited.

11.4.4 Delete

Registered keyword is deleted.

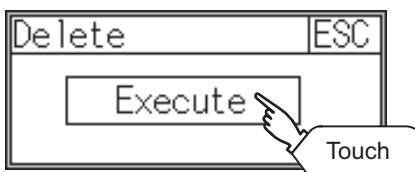
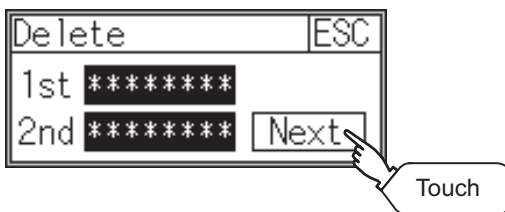
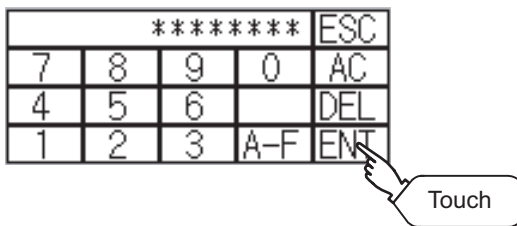
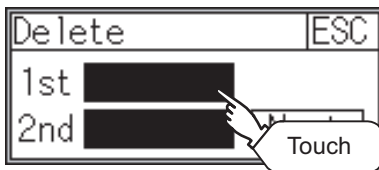
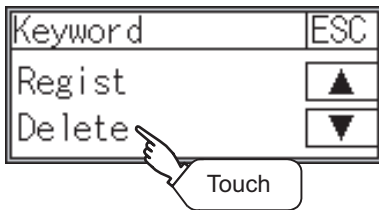

- 1 Touch [Delete] to display the keyword entry screen.

- 2 Touch the display part of the registered keyword.

Target PLC	Settings
FX PLC compatible with 2nd keyword	Input a keyword to be deleted.
FX PLC not compatible with 2nd keyword	Input a keyword to be deleted only into "keyword". "2nd keyword" is ignored.

- 3 The keyboard for entering a keyword is displayed. Enter a keyword and touch the **ENT** key.

- 4 After completing the keyword entry, touch **Next**.

- 5 Touch the [Execute] key.

- 6 The keyword is deleted. Touch **OK**.

11.4.5 Clear

To access an FX PLC where a keyword has been registered, keyword protection is cancelled.

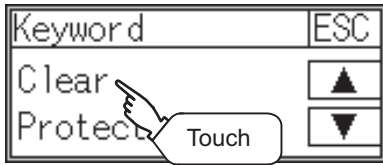

- 1 Touch [Clear] to display the keyword entry screen.



- 2 Touch the display part of the registered keyword.

Target PLC	Settings
FX PLC compatible with customer keyword	Input a keyword or customer keyword to cancel the protection.
FX PLC compatible with 2nd keyword	Input a keyword to cancel the protection.
FX PLC not compatible with 2nd keyword	Input a keyword into "keyword" to cancel the protection. "2nd keyword" is ignored.

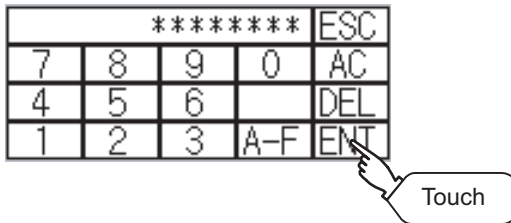

- 3 The keyboard for entering a keyword is displayed. Enter a keyword and touch the **ENT** key.

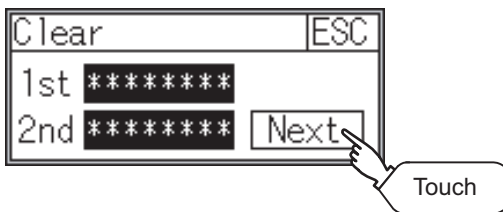

- 4 After completing the keyword entry, touch **Next**.

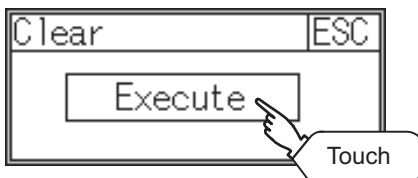

- 5 Touch the [Execute] key.

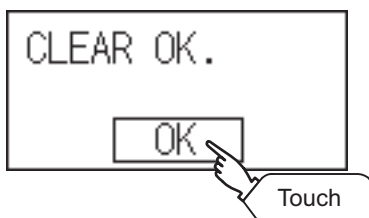

- 6 The protection is cancelled.
Touch **OK**.

11.4.6 Protect

A keyword with cancelled protection is reactivated for protection.
Keyword protection function is valid when the 2nd keyword is registered.

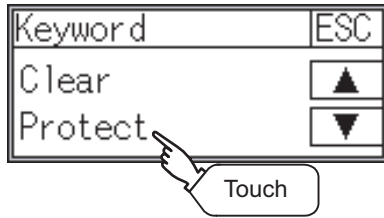

- 1 Touch [Protect] to switch to the keyword protection status.

12. DISPLAY AND OPERATION SETTINGS (GOT SET UP)

Setting screen for display and setting screen for operation can be displayed from GOT setup. In the setting screen for display and the setting screen for operation, the following settings can be set.

Screen	Description			
	GT1020	GT1030	GT104□	GT105□
Setting screen for display	Screen save time			
	Screen save backlight			
	Contrast	Bright/Contrast	Contrast	
	Opening time			
Setting screen for operation	Buzzer volume, Window move buzzer			
	Calibration	-		
	Key reaction			
	Clock setting			
	Security			
	Utility call			



Backlight color change and backlight blink settings

The backlight color change and backlight blink settings of GT1020 and GT1030 are executed on the drawing software.

Right-click the screen to change the backlight settings on the drawing software, and select [Screen Property].

On GT Designer2, the [Auxiliary] tab is displayed. On GT Designer3, the [Basic] tab is displayed.

Select the backlight color and backlight blink and click the button.

For GT Designer3

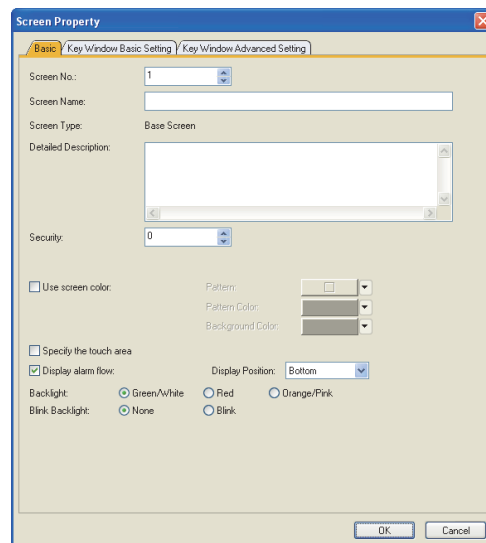

Also, the backlight color can be changed from the system information. For details of the system information, refer to the following manual.

GT Designer2 Version □ Screen Design Manual
 GT Designer3 Version1 Screen Design Manual

12.1 Display Settings

12.1.1 Display setting functions

Setting regarding display is possible. The items which can be set are shown below.

Items	Contents				Setting range
	GT1020	GT1030	GT104□	GT105□	
Screen save time	The period from the user stops the touch panel operation till the screen save function starts can be set.				0 to 60 minutes <At factory shipment: 0 minutes> When set to 0, the function becomes invalid.
Screen save backlight	Whether turn ON or OFF the backlight simultaneously at the screen save function start can be specified.				ON/OFF <At factory shipment: OFF>
Brightness	-	The brightness can be adjusted.	-	-	8-level adjustment (0 to 7)
Contrast	Contrast can be adjusted.				16-level adjustment (0 to 15) <At factory shipment: 10>
Opening time	The title display period at the main unit boot can be set.				0 to 60 seconds <At factory shipment: 5 seconds >



- (1) Display setting by drawing software
Set title display period, opening time, screen save time and screen save backlight at [GOT set up] in [System Environment] of GT Designer2.
When using GT Designer3, execute the settings at [GOT Setup...] in [GOT Environmental Setting] of [Common].
When change a part of the setting after downloading the project data, change the setting by [Display] screen of the GOT.

GT Designer2 Version □ Screen Design Manual
GT Designer3 Version1 Screen Design Manual (Fundamentals)

- (2) Screen save and screen save backlight OFF function
When using the screen save and screen save backlight OFF function, select valid/invalid by the system information reading device in [System Environment] of GT Designer2.
When using GT Designer3, select valid/invalid by the reading device of [System Information...] in [GOT Environmental Setting].
For system information details, refer the following.

GT Designer2 Version □ Screen Design Manual
GT Designer3 Version1 Screen Design Manual (Fundamentals)

12.1.2 Display operation of display setting

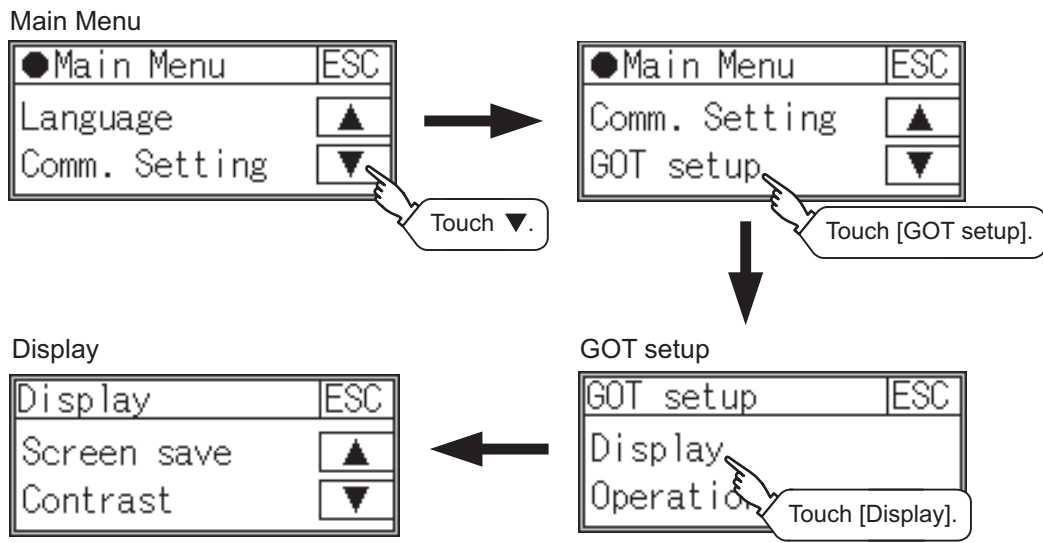

12.1.3 Display setting operations

1 Screen save time

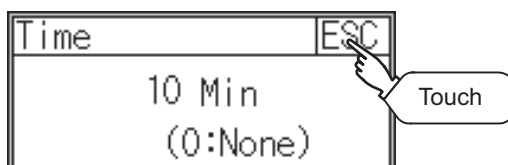
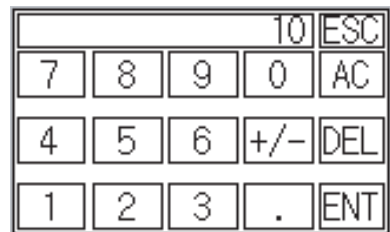
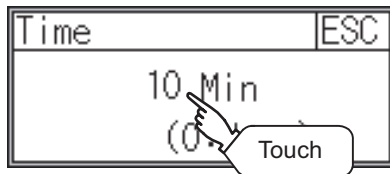
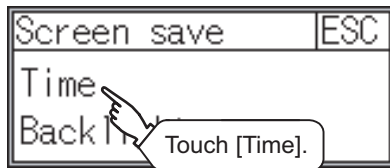
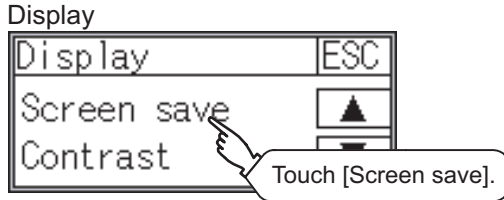

- 1 Touch [Screen Save] to bring up the screensaver setting window.
- 2 Touch [Time] to bring up the time setting window.
- 3 Touch the time that appears on the time setting window to bring up the ten-key pad.
- 4 Enter the time using the ten-key pad.
 - “0” to “9” : Use these keys to enter numerical values. Enter "0" to disable the screensaver function
 - “ESC” : Closes the ten-key window without saving any value entered
 - “AC” : Deletes the entire string of numerical characters that are being entered
 - “DEL” : Deletes a digit from a string of numerical characters that are being entered
 - “ENT” : Enters the value for the clock that has been entered and closes the ten-key pad window
 - “+ / -” : Switches between positive and negative values (Only positive values are valid for the clock setting.)
 - “.” : Invalid key (not used)
- 5 When all the settings have been made, touch the **ESC** button to close the setting window.

2 Screen save backlight

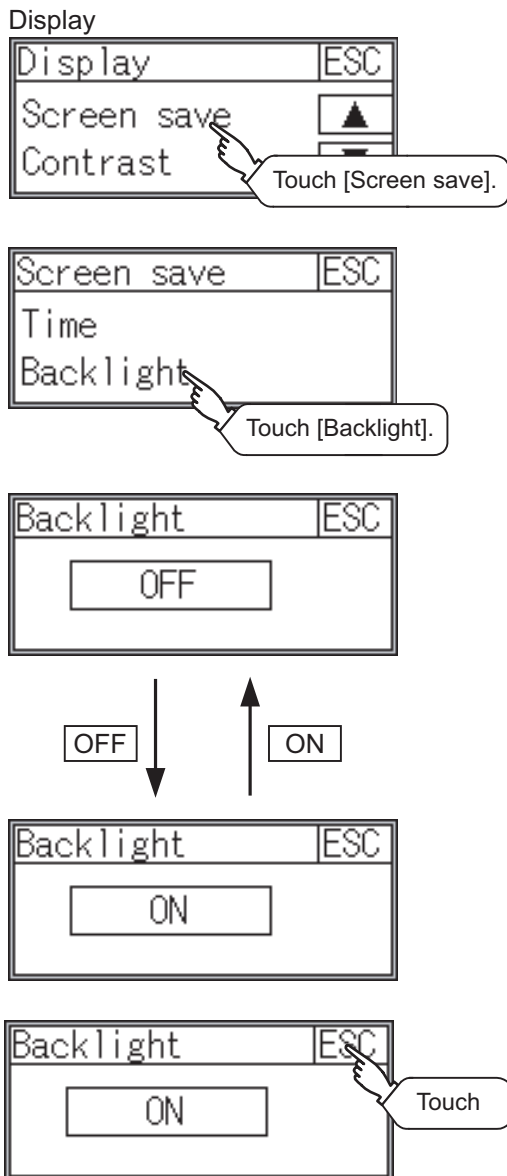

1 Touch [Screen Save] to bring up the screensaver setting window.

2 Touch [Backlight] to bring up the backlight setting window.

3 Touch the OFF / ON button to turn off/turn on the backlight.

- OFF button: Screen save, Transferring..., Backlight, Unlit

- ON button: Screen save, Transferring..., Backlight, Lit

4 After changing the settings, touch the ESC button to save the changes and close the setting window.

3 Contrast

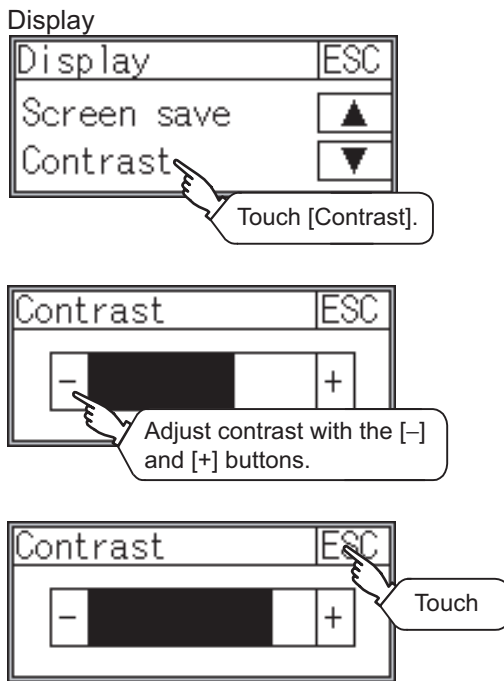

- 1 Touch [Contrast] to bring up the setting window.
- 2 Touch the [-] and [+] buttons to adjust the contrast of the screen.
- 3 After changing the settings, touch the **ESC** button to save the changes and close the setting window.

4 Brightness

<For GT1030>

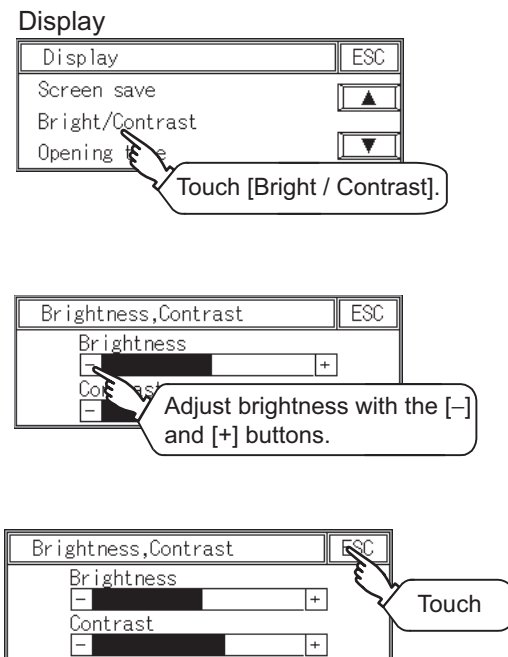

- 1 Touch [Bright/Contrast] to bring up the setting window.
- 2 Touch the [-] and [+] buttons to adjust the brightness of the screen.
- 3 After changing the settings, touch the **ESC** button to save the changes and close the setting window.

5 Opening time

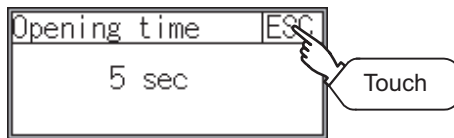
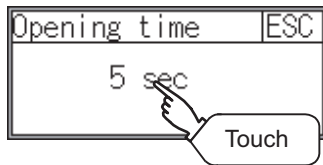
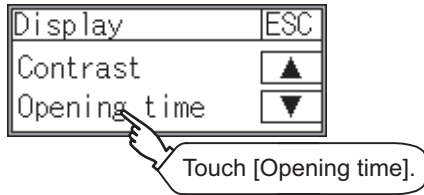
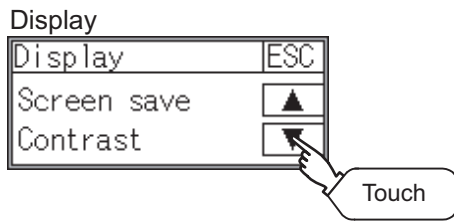

- 1 Touch ▼ to bring up the [Opening time] setting window.
- 2 Touch [Opening time] to bring up the setting window.
- 3 Touching the set time (value) can change the setting.
- 4 After changing the settings, touch the ESC button to save the changes and close the setting window.

12.2 Operation Settings

12.2.1 Operation setting functions

Setting regarding GOT operation can be set.
The items which can be set are described below.

Function	Contents				Setting range
	GT1020	GT1030	GT104□	GT105□	
Buzzer volume	Buzzer volume setting can be changed				OFF/SHORT/LONG <At factory shipment: SHORT>
Window move buzzer volume	Whether turn ON/OFF buzzer when move window can be selected				ON/OFF <At factory shipment: ON>
Calibration	Touch panel sensitivity can be adjusted using this function	-			- <At factory shipment: already adjusted>
Key reaction	The sensitivity of touch panel when GOT screen is touched can be set				±0 to +120 *1
Clock setting	Set the method to adjust the time between the GOT clock data and clock data of the connected controller.				For GT1020 : None, Adjust For GT1030, GT104□, GT105□ : None, Adjust, Broadcast, Both <At factory shipment: Adjust>
Security	Security level screen can be displayed				-
Utility call	Utility call key setting screen can be displayed				-

*1 The more the value set for [Key reaction] is high, the more the key reaction speed slows.

"Key reaction" [ms]	Standard(±0)	+10	+20	+40	+80	+120
---------------------	--------------	-----	-----	-----	-----	------

For example, when the GOT recognizes touching the GOT screen once as touching the screen twice, set a higher value for [Key reaction].



Operation settings by drawing software

Set buzzer volume and window move buzzer volume by [GOT setup] in [System Environment] of GT Designer2.

When using GT Designer3, execute the settings at [GOT Setup...] of [GOT Environmental Setting].

When change a part of the setting, change the setting by the GOT display setting after downloading the project data.

☞ GT Designer2 Version □ Screen Design Manual
GT Designer3 Version1 Screen Design Manual (Fundamentals)

12.2.2 Display operation of operation setting

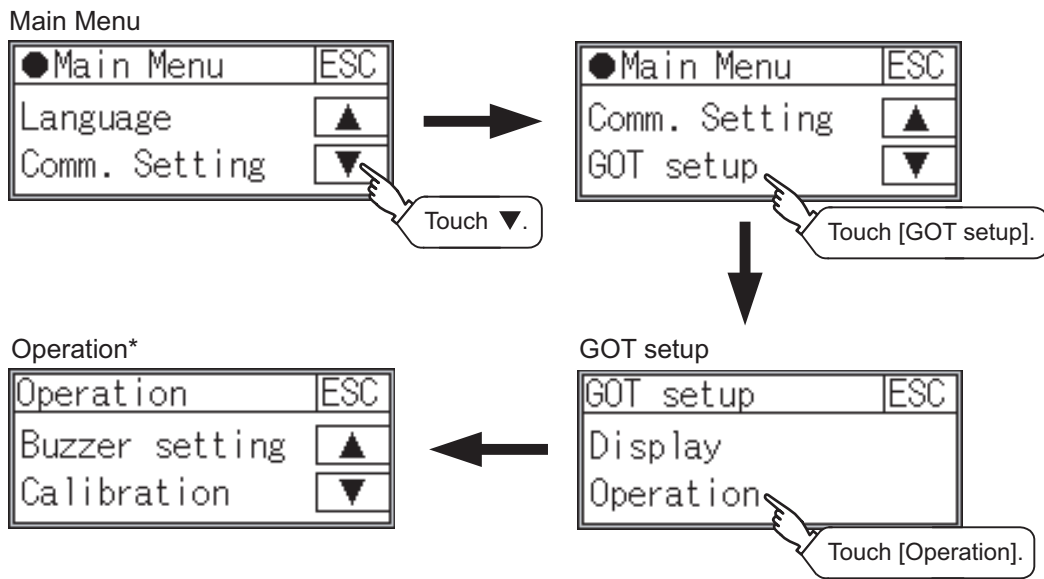

*: GT1030, GT104 □, GT105 □ does not have [Calibration] function.

12.2.3 Setting operation of operation

1 Buzzer volume

Operation

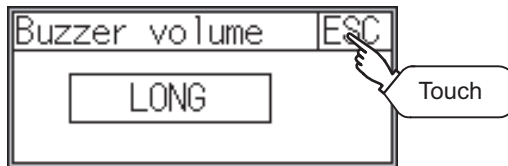
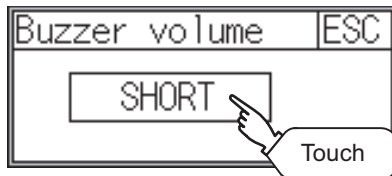
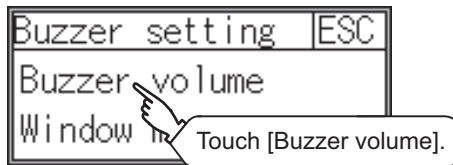
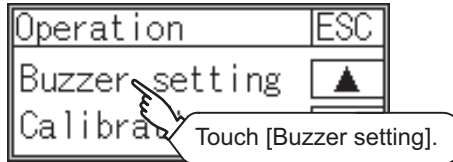

- 1 Touch [Buzzer setting] to bring up the buzzer volume setting window.
- 2 Touch [Buzzer volume] to bring up the setting window.
- 3 Touch a setting item to change the setting.
(Buzzer volume: SHORT \leftrightarrow LONG \leftrightarrow OFF)
- 4 After changing the settings, touch the **ESC** button to save the changes and close the setting window.

2 Window move buzzer

Operation

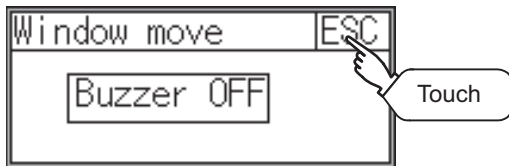
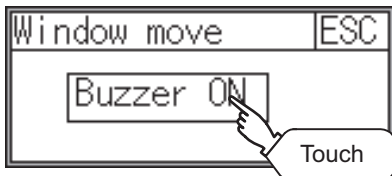
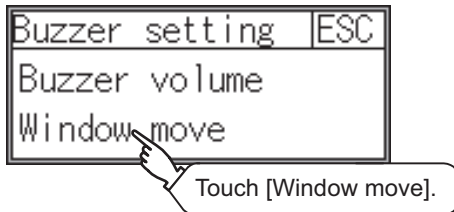
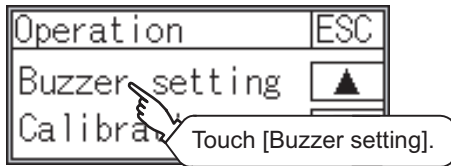

- 1 Touch [Buzzer setting] to bring up the buzzer volume setting window.
- 2 Touch [Window move] to bring up the setting window.
- 3 Touch a setting item to change the setting.
(Window move buzzer: ON ↔ OFF)
- 4 After changing the settings, touch the **ESC** button to save the changes and close the setting window.

3 Calibration

<For GT1020>

Operation

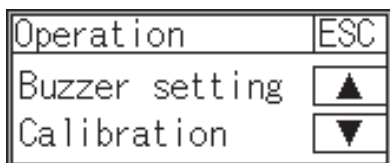
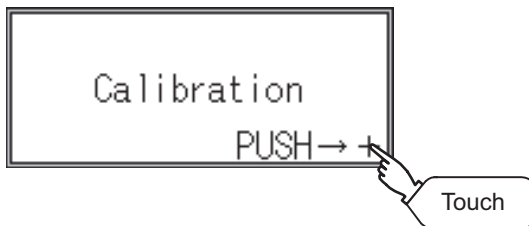
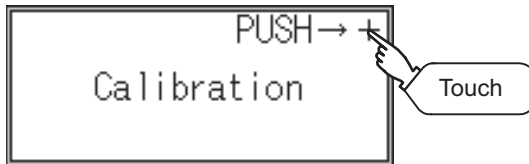
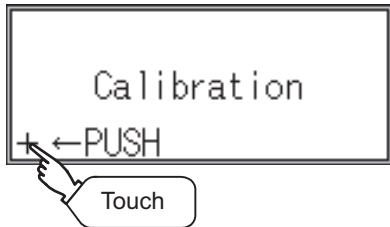
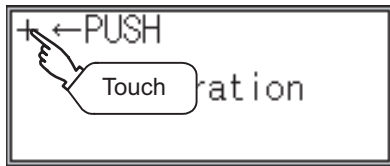
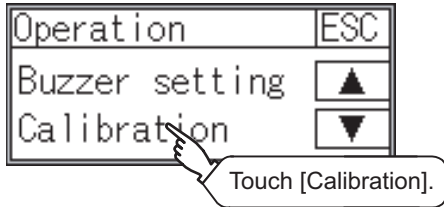

- 1 Touch [Calibration] to bring up the setting screen.
- 2 Touch the "+" symbol at the top left corner.
- 3 Touch the "+" symbol at the bottom left corner.
- 4 Touch the "+" symbol at the top right corner.
- 5 Touch the "+" symbol at the bottom right corner.
- 6 5 completes the calibration process, and the [Operation] window will reappear.

Touch panel calibration error

If touch panel calibration results in inoperability of the panel, the following message will appear.

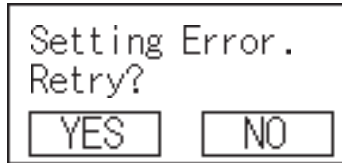

button: Returns to the touch panel calibration screen.

button: Aborts calibration without saving any changes to the touch panel setting.

4 Key reaction

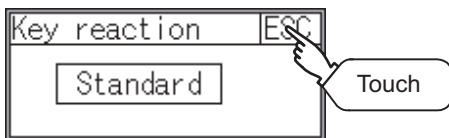
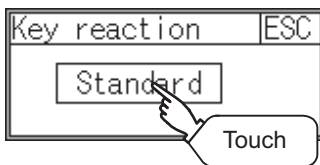
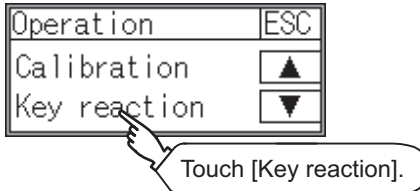
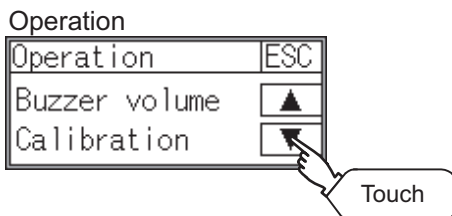

1 Touch to bring up the [Key reaction] setting window.







2 Touch [Key reaction] to bring up the setting window.

3 Touch a setting item to change the setting.

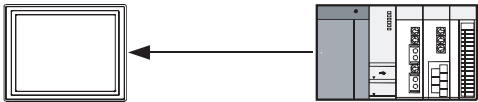
4 After changing the settings, touch the button to save the changes and close the setting window.

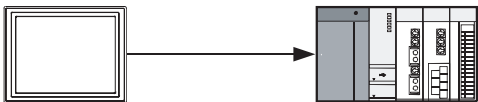
5 Clock setting

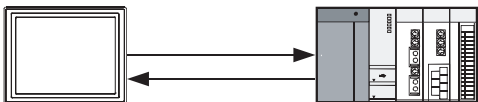
Setup the method to adjust the time between GOT data and the clock data of PLC CPU connected with GOT.

Setting	Contents
Adjust	<p>Adjust the time of GOT clock data to the clock data of PLC CPU.</p>  <p>Same as setting in [GOT setup] in [System Environment] of GT Designer2. Same as setting in [GOT Setup...] in [GOT Environmental Setting] of GT Designer3.</p> <p> GT Designer2 Version <input type="checkbox"/> Screen Design Manual GT Designer3 Version1 Screen Design Manual (Fundamentals)</p>
Broadcast	<p>Adjust the time of PLC CPU clock data to the clock data of GOT.</p>  <p>Same as setting in [GOT setup] in [System Environment] of GT Designer2. Same as setting in [GOT Setup...] in [GOT Environmental Setting] of GT Designer3.</p> <p> GT Designer2 Version <input type="checkbox"/> Screen Design Manual GT Designer3 Version1 Screen Design Manual (Fundamentals)</p>
Both	<p>Adjust and Broadcast can be used appropriately.</p>  <p>Same as setting in [GOT setup] in [System Environment] of GT Designer2. Same as setting in [GOT Setup...] in [GOT Environmental Setting] of GT Designer3.</p> <p> GT Designer2 Version <input type="checkbox"/> Screen Design Manual GT Designer3 Version1 Screen Design Manual (Fundamentals)</p>
None	No adjustment of clock data.

Operation

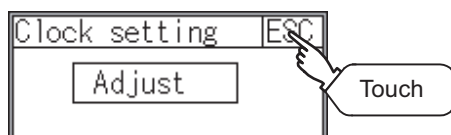
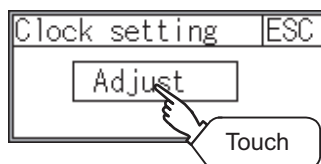
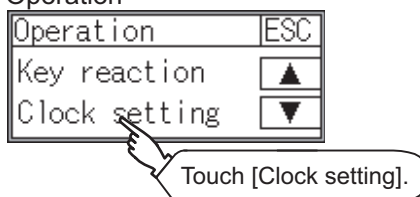

1 Touch [Clock setting] to bring up the setting window.

2 Touch a setting item to change the setting.

GT1020 : None ↔ Adjust
 GT1030 } : None ↔ Adjust ↔ Broadcast ↔ Both
 GT104□ }
 GT105□ }

3 After changing the settings, touch the **ESC** button to save the changes and close the setting window.

6 Security

Operation

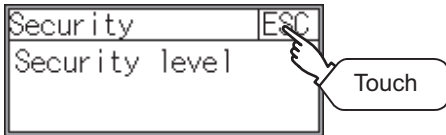
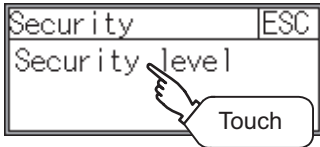
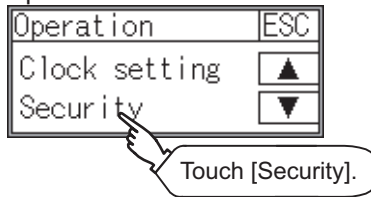

1 Touch [Security] to bring up the setting window.

2 Touching [Security level] displays the password input window. Inputting the password set in the password input window can change the security level.

3 After changing the settings, touch the **ESC** button to save the changes and close the setting window.

7 Utility call

Operation

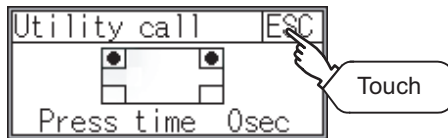
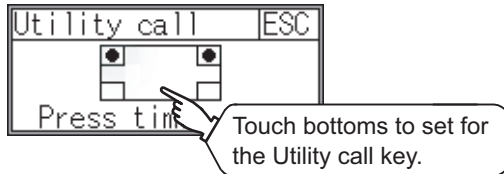
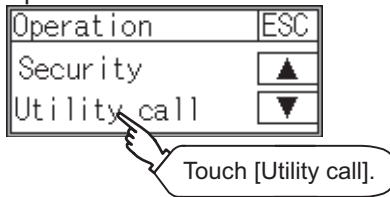

Point

- (1) When using GT1020
For the key position, 1 point only can be set.
- (2) When the utility call key is set to the zero point
Refer to the following for the utility screen displaying method:
 - Pressing the special function switch set on the user-created screen
 - Selecting [Utility] from the "Select mode" screen

☞ Section 9.2.1 Display operation of main menu
- (3) When limiting the display and operation of the utility
When limiting the display and operating users, set a password to the GOT using the drawing software.
If a user tries to display the main menu of the utility, the password is displayed.
Refer to the following for details on setting passwords.
☞ GT Designer2 Version □ Screen Design Manual
GT Designer3 Version1 Screen Design Manual (Fundamentals)

- 1 Touch [Utility call] to bring up the setting window.
- 2 Touch or displayed on the four corners of the setting screen.
The button repeats  every time it is pressed.
Change the part to be set as a key position to .
The key position can be set to the zero point.
- 3 When the key position is specified by one point, the time to switch to the utility when the key position is kept pressing can be set.
Touch the time area.
- 4 After changing the settings, touch the button to save the changes and close the setting window.

13. CLOCK SETTINGS AND BATTERY STATUS DISPLAY (TIME SETTING AND DISPLAY)

The clock data (date and time) are displayed and set in the clock setting menu.
The voltage status of the built-in battery is also displayed.

13.1 Time Setting and Display

13.1.1 Time setting and display functions

Time settings and displaying of the status of GOT built-in battery are possible.

Function	Contents			
	GT1020	GT1030	GT104□	GT105□
Clock display	Carry out the display and setup of PLC CPU clock data.	Carry out the display and setup of PLC CPU or GOT's clock data.		
GOT internal battery voltage status	–	Displays GOT internal battery voltage status.		

13.1.2 Clock display and setting operation

Main Menu(For GT1030)

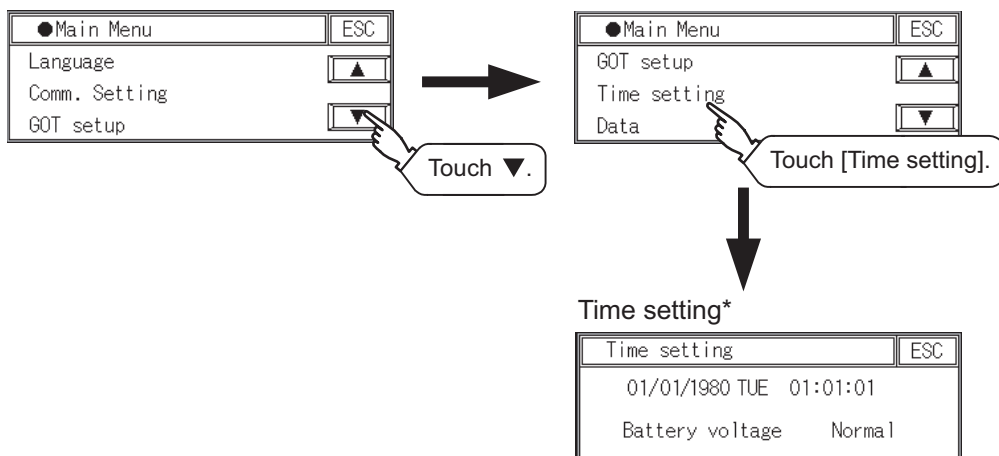

*: GT1020 does not have [Battery voltage].

13.1.3 Clock setting operations

1 Clock display

Displays and sets up the clock data on the GOT.

When setting the clock data, change the clock data on the GOT and controller unless the clock setting is "unused". If you fail to change the clock data on the controller, the clock data on the GOT is not changed as well.

When the GOT is not connected to the controller or is connected the controller which does not have the clock data, set the clock setting to "unused" first, and then change the clock data.

The setup methods of clock data are shown below.

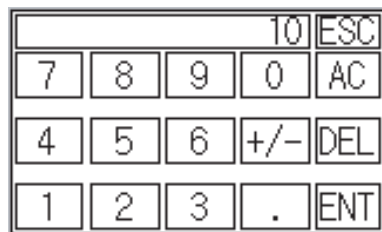
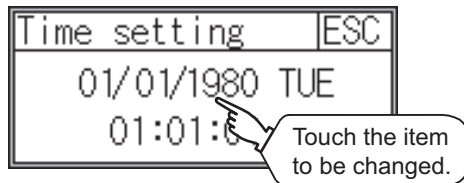

- 1 Touch either the date or time to be changed.

- 2 Enter date or time on the ten-key pad.

The day of the week is displayed automatically according to the input date.

“0” to “9”: Use these keys to enter numerical values

“ESC” : Closes the ten-key window without saving any value entered for the date or time

“AC” : Deletes the entire string of numerical characters that are being entered

“DEL” : Deletes a digit from a string of numerical characters that are being entered

“ENT” : Enters the value for the date or clock that has been entered and closes the ten-key pad window

“+ / -” : Switches between positive and negative values (Only positive values are valid for the date or clock setting.)

“.” : Invalid key (not used)

- 3 After changing the settings, touch the **ESC** button to save the changes and close the setting window.

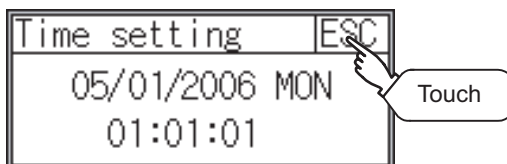

2 GOT internal battery voltage status

Displays battery voltage status. <For GT1030, GT104□, GT105□>

Display	Status
Normal	Normal
Low/None	Low voltage

When the battery voltage is low, replace the battery immediately. Refer to the following for battery replacement procedure.

Section 8.3 Battery

14. FILE DISPLAY (DATA)

This function displays the version of the OS (Standard monitor OS, BootOS) and communication driver that are written to the GOT. Project data and resource data can be deleted with this function.

14.1 Data Storage Location

The following drive name (C or D drive) is assigned to the built-in Flash Memory or SRAM on the GOT.

GOT	Drive name	Allocation
GT1020	C drive	Flash Memory (Internal)
GT1030	C drive	Flash Memory (Internal)
	D drive	Internal SRAM
GT104□	C drive	Flash Memory (Internal)
	D drive	Internal SRAM
GT105□	C drive	Flash Memory (Internal)
	D drive	Internal SRAM

14.2 OS Information

14.2.1 Function of OS information

This function displays the version of the OS (Standard monitor OS, BootOS) and communication driver on the built-in flash memory (C drive).

14.2.2 Display operation of OS information screen

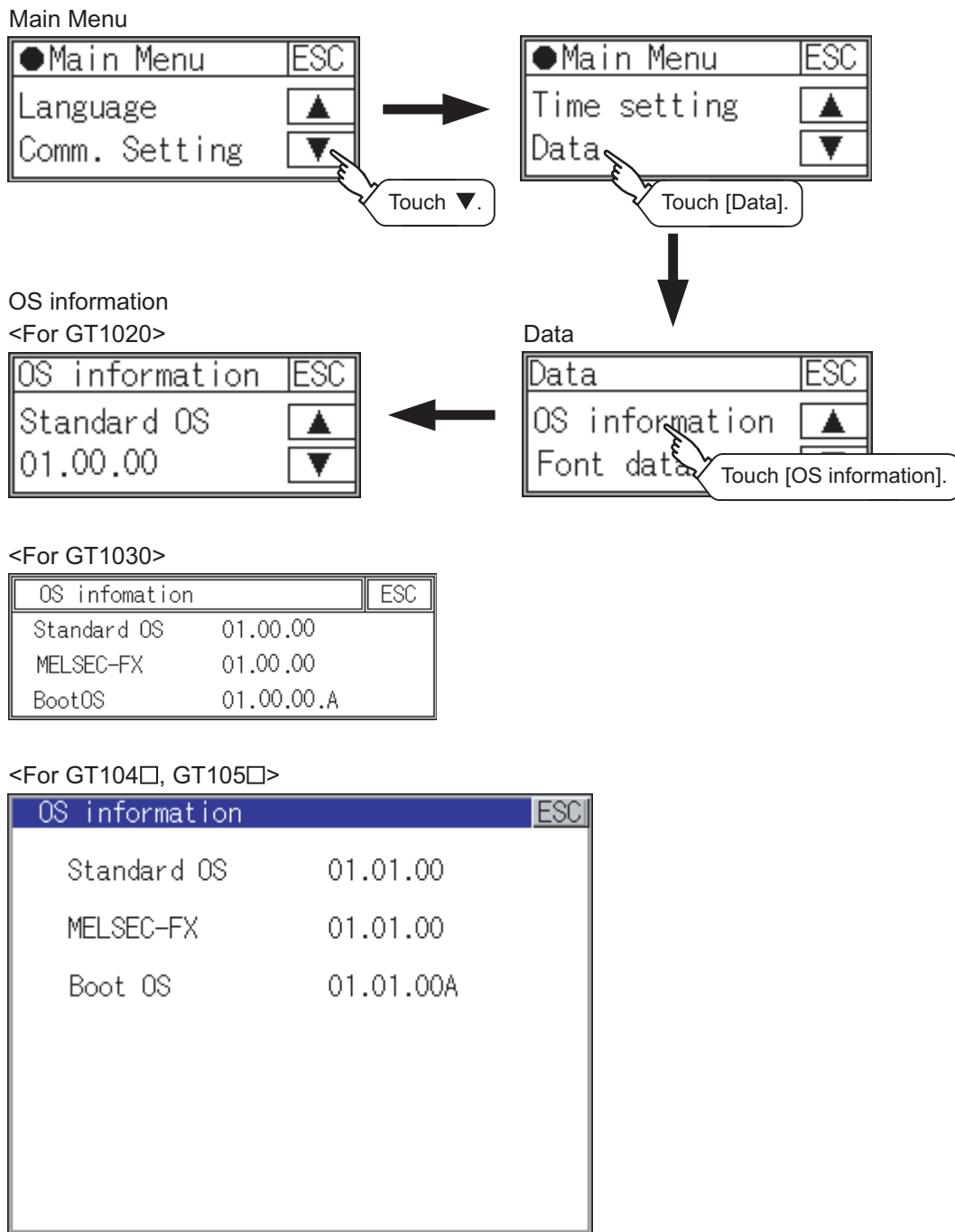

14.2.3 OS information operation

1 OS information display (For GT1020)

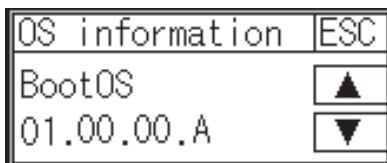
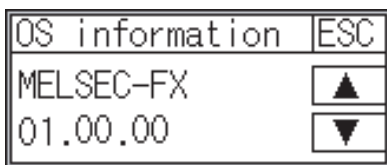
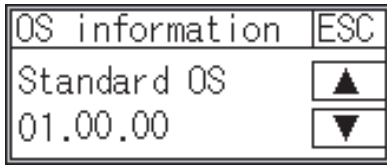

- 1 Touch the ▼ and ▲ buttons to toggle through the version of the [Standard monitor OS], [Communication driver], and [BootOS].
- 2 Touch the ESC button to close the screen.

14.3 Font Data

14.3.1 Function of font data

The types of fonts that are stored in the C: Built-in flash memory.

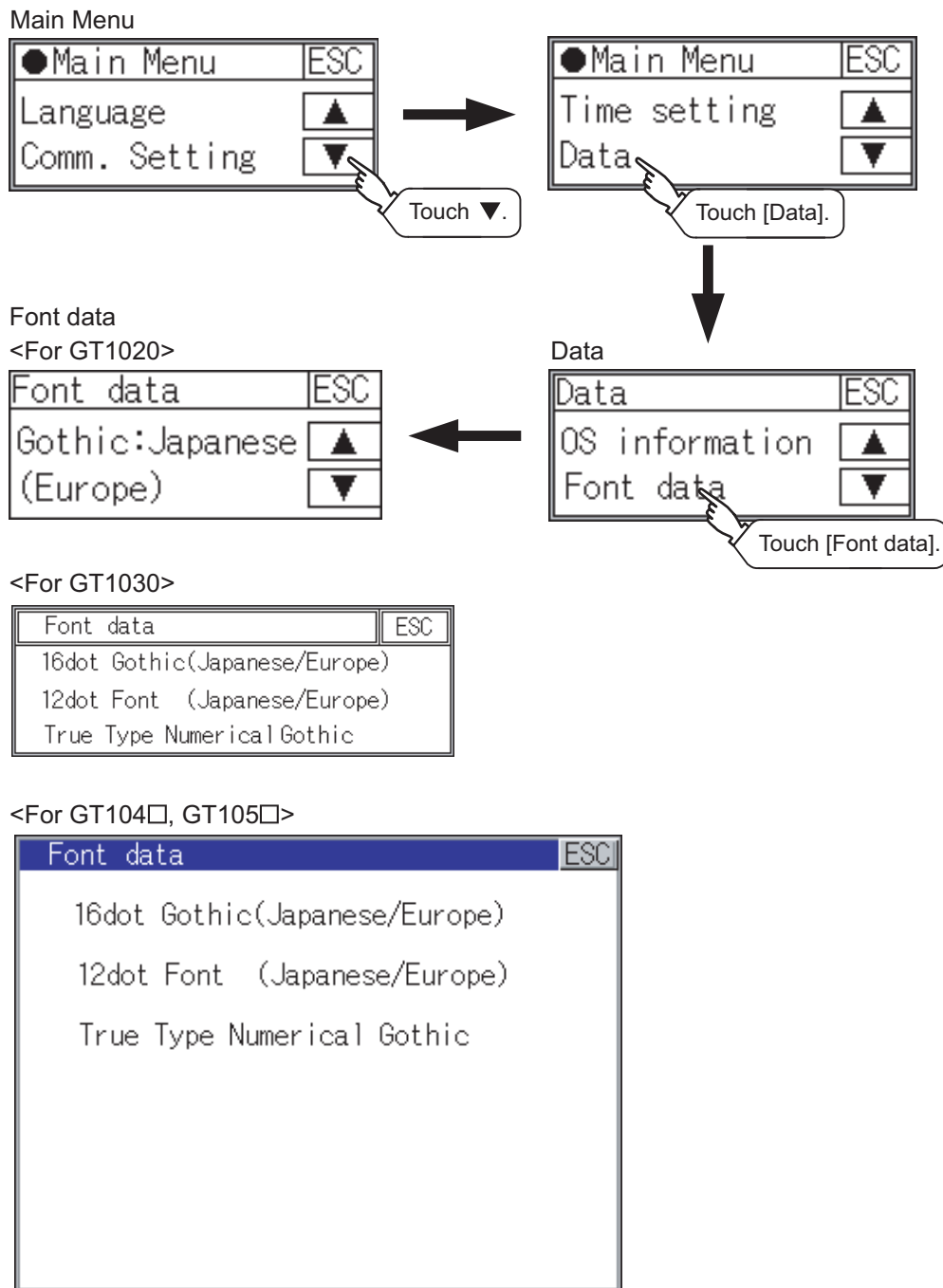

14.3.2 Display operation of font data screen

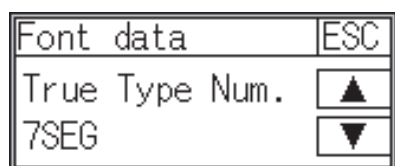
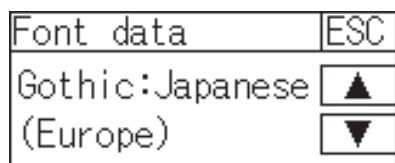

14.3.3 Font data operation

1 Font data display (For GT1020)



- 1 Touch  and  button to switch the display of fonts that are stored in the C: Built-in flash memory.
- 2 Touch the  button to close the screen.

14.4 Clear data

14.4.1 Clear data functions

This function deletes the project data and resource data that are written to the GOT.

14.4.2 Clear data display

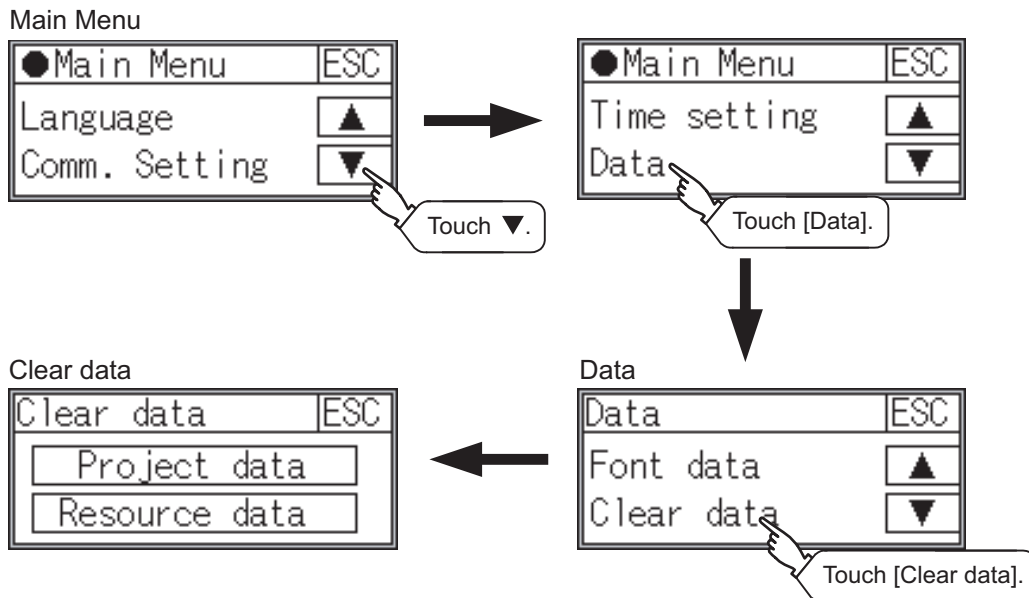

14.4.3 Clear data operation

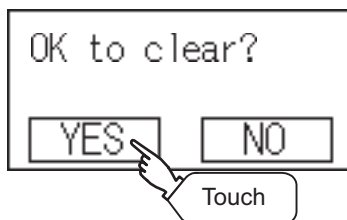
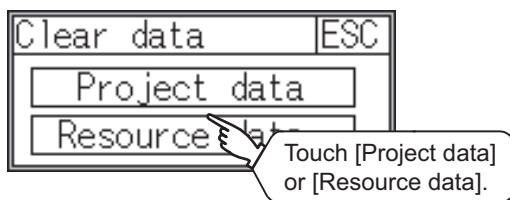

- 1 Touch the type of data on the screen to be deleted.

- 2 The dialog mentioned left is displayed for confirmation.

Touch the **YES** button to delete the data, or the **NO** button to cancel.

Remark

Canceling deletion

Data deletion cannot be cancelled once the **YES** button is pressed at the confirm deletion prompt. Double check before touching the **YES** button.

14.5 GT10-50FMB

14.5.1 GT10-50FMB functions (For GT104□ , GT105□ only)

Use the GT10-50FMB type memory board to transfer the project data or OS.



Copy from the memory board to the GOT

Copying from the memory board to the GOT when turning on the power to the GOT.
Refer to the following.

➔ Section 17.3 Standard Monitor OS/Communication Driver Installation
Using Memory Board

14.5.2 GT10-50FMB display operation

Main menu

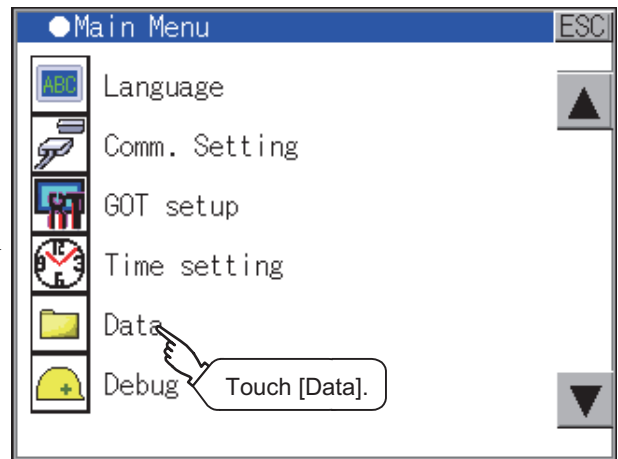
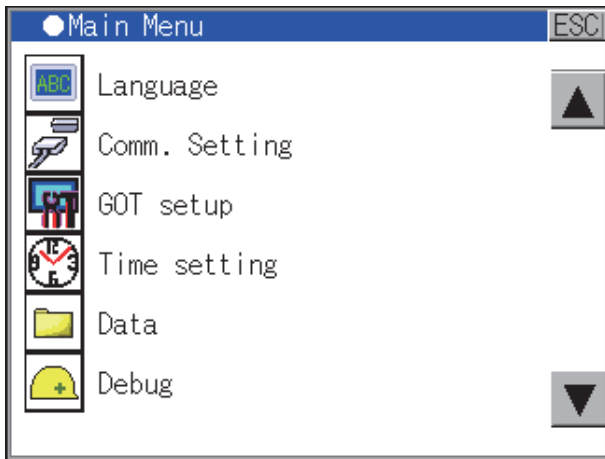

GT10-50FMB

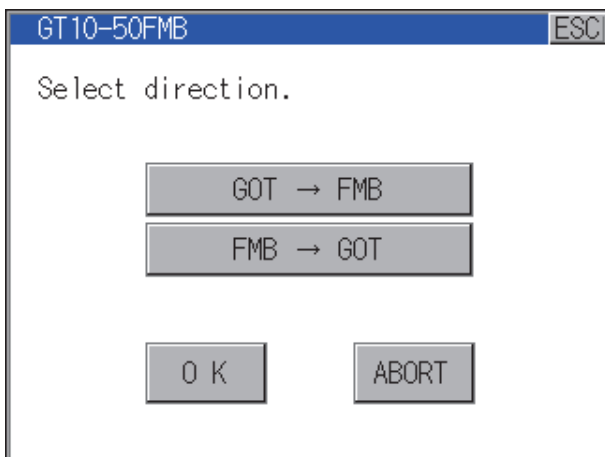

Data

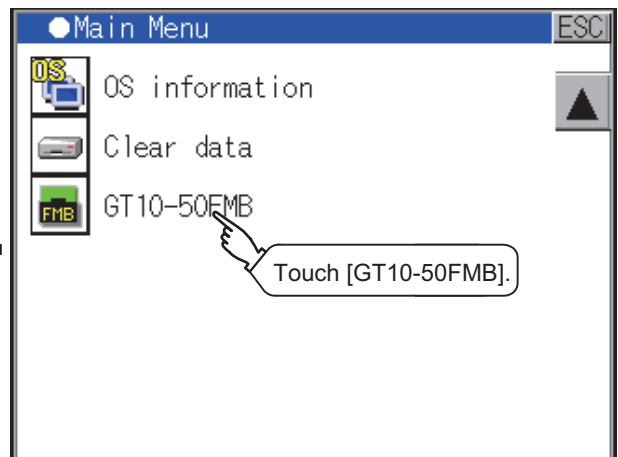

14.5.3 GT10-50FMB operation

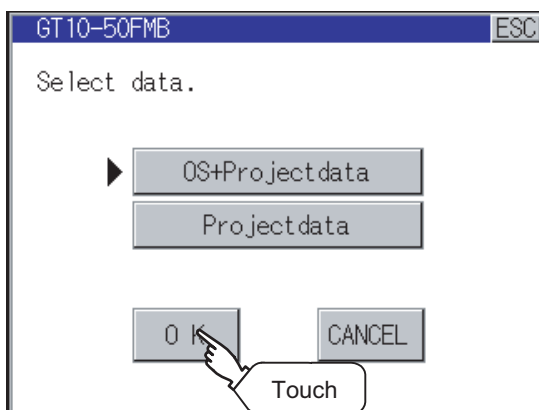
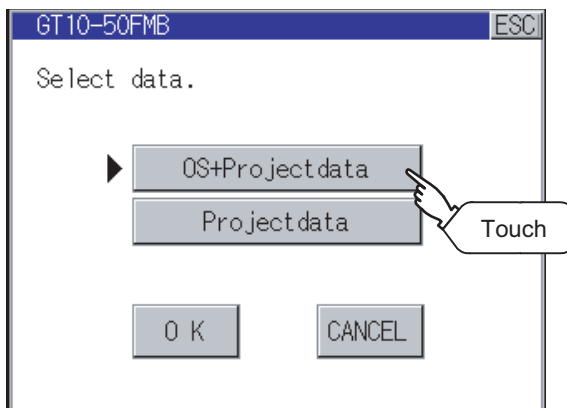
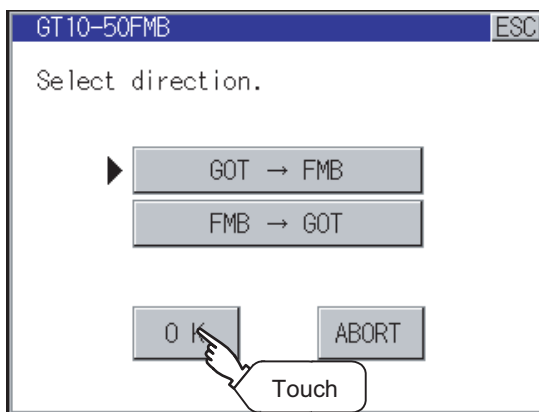
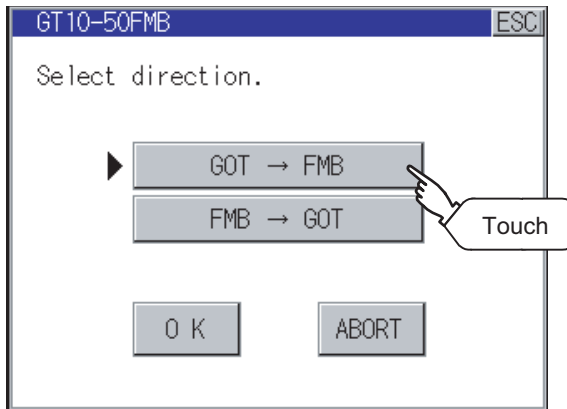

- 1 Select the copy direction.
The selection mark is displayed on the side of the selected key.
 - GOT → FMB: Copy from the GOT to the memory board
 - FMB → GOT: Copy from the memory board to the GOT
- 2 After selecting the direction, touch the [OK] button.
To abort copy touch the [ABORT] button.
- 3 Select the copy target.
The selection mark is displayed on the side of the selected key.
 - OS+Projectdata: Copies the standard OS, communication driver and projectdata
 - Projectdata : Copies the projectdata
- 4 After selecting the copy target, touch the [OK] button.
To return to the copy direction setting screen, touch the [CANCEL] button.

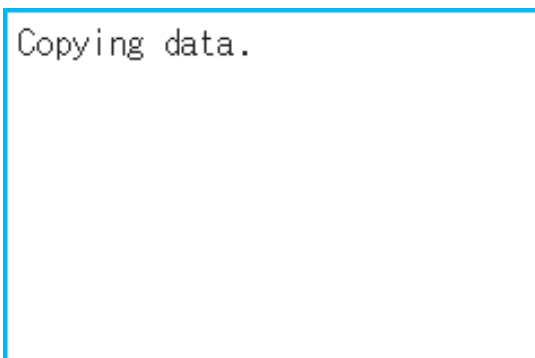
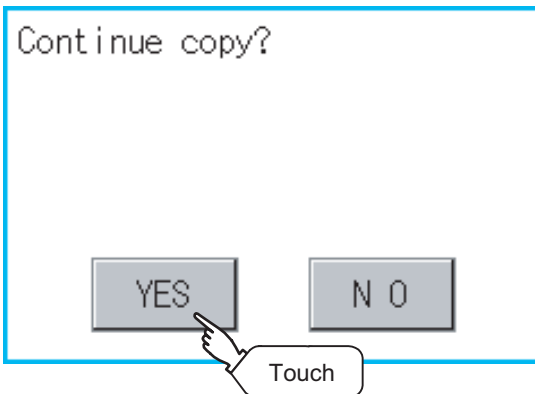
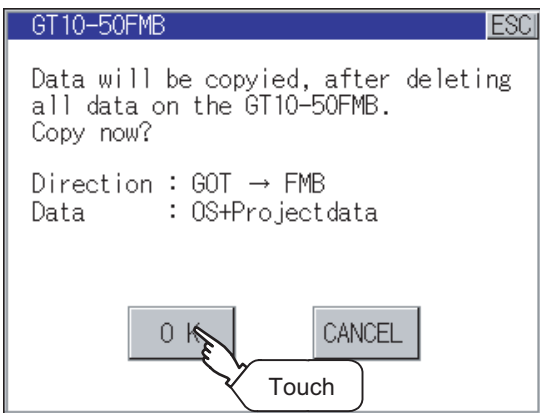
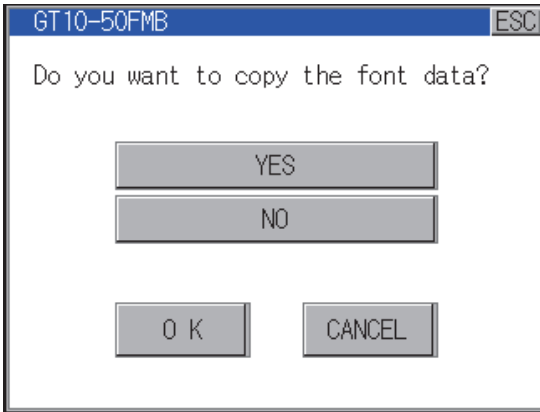

- 5 When the transfer direction is set to "GOT → FMB" and the copy target is set to "OS+Projectdata" with the ver01.11.** or later of the standard monitor OS of the GOT, a window confirming the copy of the font data is displayed.
Select YES/NO to decide whether to copy the font data or not.
The selection mark is displayed on the side of the selected key.
Touch the [OK] button when the setting is correct, and touch the [CANCEL] button to return to the copy direction selection.
- 6 Confirm the copy direction and copy target.
When they are set correctly, touch the [OK] button.
To change the setting, touch the [CANCEL] button.
- 7 The dialog box on the left is displayed for confirmation.
Touch the [YES] button to start copying and [NO] button to abort.
- 8 While the copy is executed, the dialog box on the left is displayed.

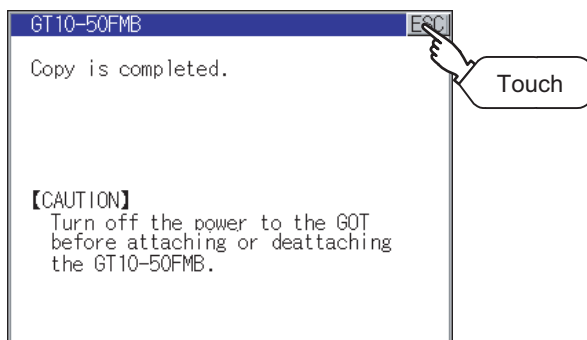

- 9 Copy is completed.
Touch the ESC button to close the screen. If an error occurs during copy, an error message appears.
For details of error messages, refer to the following.

☞ Section 14.5.4 Error display

When only the project data was copied to the GOT, touch the ESC button to restart the GOT and display the user-created screen.

When the standard OS was copied, the GOT will automatically start up and display the user-created screen. (If the project data does not exist, a message appears to notify that the project data does not exist.)



Precautions for installing/removing the memory board

When installing or removing the memory board, be sure to power off the GOT main unit.

14.5.4 Error display

When copying is not available between the GOT and the memory board, check the following contents according to the GOT error display.

Error message	Remedy
The version of the standard monitor OS of the GOT main unit does not match with that of the project data in GT10-50FMB.	The major version of the standard monitor OS of the GOT main unit does not match with that of the project data in GT10-50FMB. Match the version of the standard monitor OS of the GOT main unit to the major version of the project data in GT10-50FMB. The data selected as a copy target is not stored in GT10-50FMB. Select the copy target correctly and copy it again.
The model information does not match.	The model set for the data in GT10-50FMB does not match with that of the copy target GOT. Use the same model data as that of the copy target GOT.
The write protection switch of GT10-50FMB is ON.	The write protection switch of GT10-50FMB is ON. Turn off the write protection switch.
There is no valid copy target data in the copy source.	There is no data to be a copy target in the copy source. Store the data to be copied in the copy source and copy it again.

15. GOT DEBUG

15.1 Debug

The debug includes functions to check the PLC system status and to improve troubleshooting efficiency. The following is available as the debug.

Items	Contents			
	GT1020	GT1030	GT104□	GT105□
Device monitor	For a controller connected to the GOT, forcibly turning on or off devices of the controller and changing the set value or present value are available.			
FX list editor	-		Sequence program and parameter change of FX PLC.	
FX3U-ENET-ADP communication setting function	The communication set value of the FX3U-ENET-ADP stored in the CPU can be changed.			

15.2 Device Monitor

For a controller connected to the GT10□□, forcibly turning on or off devices of the controller and changing the set value or present value are available.

15.2.1 System configuration

This section describes the controller names and connection types between the GOT and a controller that are applicable to the device monitor function.

For details of communication units and cables for each connection type, refer to the following manual.

 GOT1000 Series Connection Manual

1 Target controller

Controller*1	Connection type
QCPU (Q mode)	Direct CPU connection, Computer link connection, CC-Link(G4) connection
QnACPU	Direct CPU connection, Computer link connection
ACPU, QCPU (A mode)	Direct CPU connection, Computer link connection
FXCPU	Direct CPU connection
Microcomputer	Microcomputer connection
MODBUS/RTU	MODBUS/RTU connection
Inverter	Inverter connection

*1 : For details of controllers that can be monitored, refer to the following manual.

 GT Designer2 Version □ Screen Design Manual

GOT1000 Series Connection Manual (Mitsubishi Products) for GT Works3

2 Required OS

The OS shown in the table below is required.

OS		Version
Standard monitor OS		01.09.** or later
Communication driver	MELSEC-FX	01.04.** or later
	QnA/Q	
	MELSEC-A	
	AJ71C24/UC24	
	CC-Link(G4)	01.10.** or later
	Microcomputer connection	
	MODBUS/RTU connection	
Inverter connection	01.10.** or later	



Checking method of OS, Communication driver version

Check the version of OS or communication driver installed in GOT at [OS information] of the utility.

Refer to the following for details.

☞ Section 14.2 OS Information

15.2.2 Devices that can be monitored

For further information about the monitor device names that can be monitored and the scope, see the following:

☞ GT Designer2 Version □ Screen Design Manual

GT Designer3 Version1 Screen Design Manual (Fundamentals)

15.2.3 Precautions

- (1) Monitoring and testing real number data
Real number data cannot be monitored and tested.
All word devices containing real number data are monitored in integer data (binary data).
- (2) Monitoring devices in 32-bit (two-word) module
When monitoring word devices (T, C, D, W, etc.) in 32-bit (two-word) module, those with 32 bits of data remaining are monitored.
Devices with 16 bits (one-word) of data remaining are not monitored.
If an odd number is specified for the first monitor device number, the last device number of the specified controller will not be displayed.
(Example) When the data entry of the A2NCPU is monitored in units of 32 bits from odd numbers (D1, D3 ...)

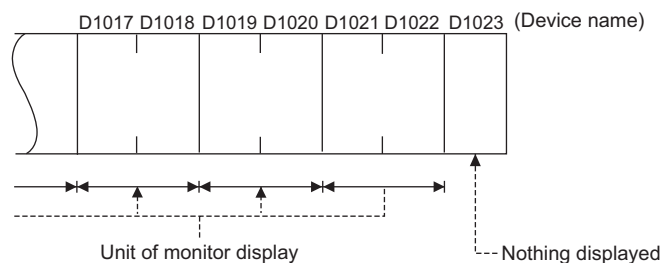

- (3) Changing the timer/counter set values of QnACPU
The timer/counter set values of QnACPU whose date on the CPU rating plate is after [9707B] can be changed.
<Information on the rating plate>

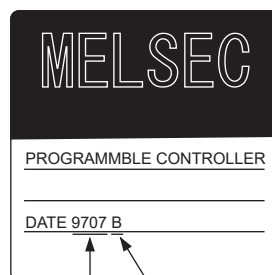

Date of manufacture Function version

- (4) Programs capable of changing timer/counter set values
Only the main program can change the timer/counter set values of AnNCPUs, AnACPU, and AnUCPU.

15.2.4 Display operation of device monitor

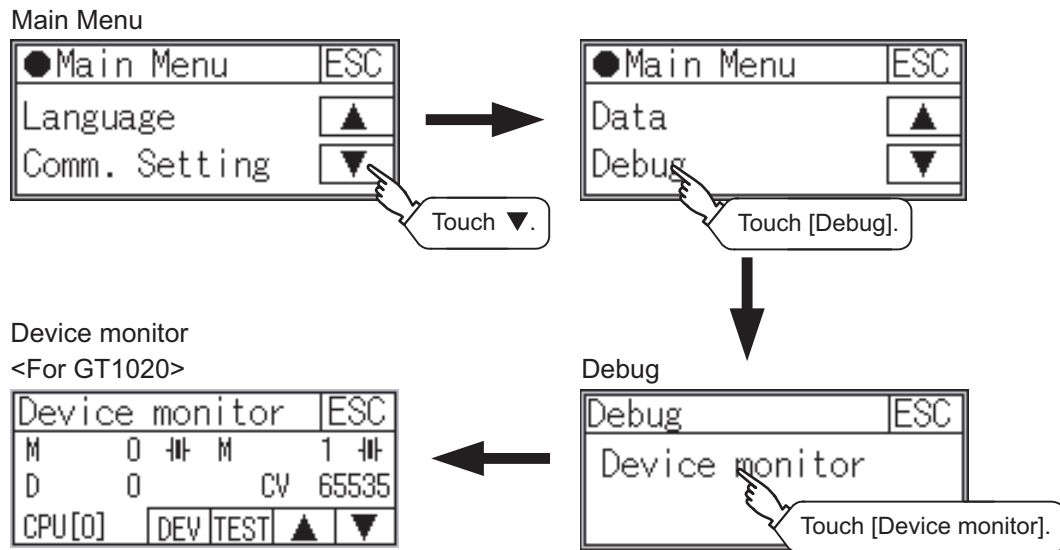

<For GT1030>

Device monitor	ESC		
D 99		M CUR[-1]	
M 2	+	M 3	+
D 0		CUR[100]	
	DEV	TEST	DEC/HEX ▲ ▼

<For GT104□, GT105□>

Device monitor	ESC		
	[QUICK TEST]		
M 0	+	M 1	+
D 0	DW	CUR[-1234567890]	
C 100	+	CUR[1000]	
	RST ●	SET[1000]	
D 100		CUR[0]	
D 101		CUR[0]	
D 102		CUR[0]	
D 103		CUR[0]	
D 104		CUR[0]	
D 105		CUR[0]	
D 106		CUR[0]	
DEV	TEST	DEC/HEX	▲ ▼

15.2.5 Information displayed on the device monitor screen and key functions

1 Device monitor screen

The information displayed on the device monitor screen is described below.

For GT1030

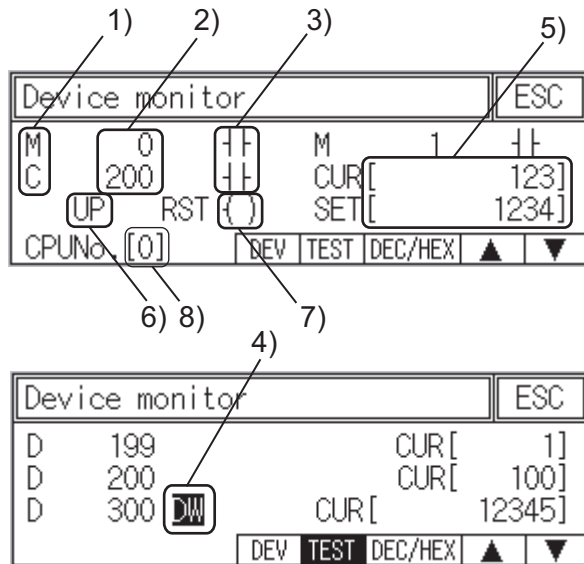

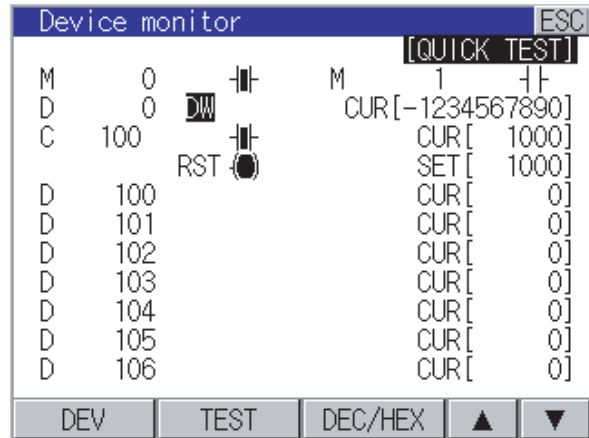

For GT104□, GT105□



For GT1020





No.	Item	Description of setting
1)	Device name	Displays the device name.
2)	Device No.	Displays the device number.
3)	Bit device ON/OFF Timer/Counter contact ON/OFF	Displays ON/OFF information of bit devices and timer/counter contacts : ON : OFF
4)	Data type	DW : Indicates that the device value is a 32-bit (two-word) module. Nothing displayed: Indicates that the device value is a 16-bit (one-word) module.
5)	Present value of word device Present value and set value of timer/counter*1	[Decimal number] 16-bit (one-word) module: Six digits (including a digit for a sign) are displayed. (Display example: -12345) 32-bit (two-word) module: Ten digits (including a digit for a sign) are displayed. (Display example: -123456789) [Hexadecimal number] 16-bit (one-word) module: Four digits are displayed. (Display example: H AB12) 32-bit (two-word) module: Eight digits are displayed. (Display example: H ABCDE123)

No.	Item	Description of setting
6)	Counting method	Displays the counting method when registering the counters from C200 to C255. UP: Up count mode DOWN: Down count mode
7)	Reset coil ON/OFF	Displays the reset coil state when registering the timer/counter for the FXCPU.  : ON { } : OFF
8)	CPU No. specification	0 to 4: This item must be set only when the GOT is connected to the Q series CPU in the multiple CPU system or QnUCPU. Changing the CPU No. cancels the registration for all the devices.  Section 15.2.7 Device registration

*1 : Displays the values set for the timer/counter when registering the timer/counter for the ACPU, QnACPU, or FXCPU.

2 Key functions

The following table describes the key functions displayed on the device monitor screen.

Key switch	Function
DEV	Switches the screen to the device registration key window for registering devices to be monitored.  Section 15.2.7 Device registration
TEST	Switches the quick test mode between enabled and disabled states.  Section 15.2.8 Quick test
DEC/HEX	Switches the numerical notation of word device values between decimal and hexadecimal numbers. (GT1030 only)
▲ ▼	▲ : Scrolls the list up by one line to display the device number right before the device number displayed in the top line. ▼ : Scrolls the list down by one line to display the device number right after the device number displayed in the bottom line.
ESC	Exits the device monitor, and then the screen returns to the debug screen.

15.2.6 Basic operation of device monitor

The following explains basic operations of the device monitor.

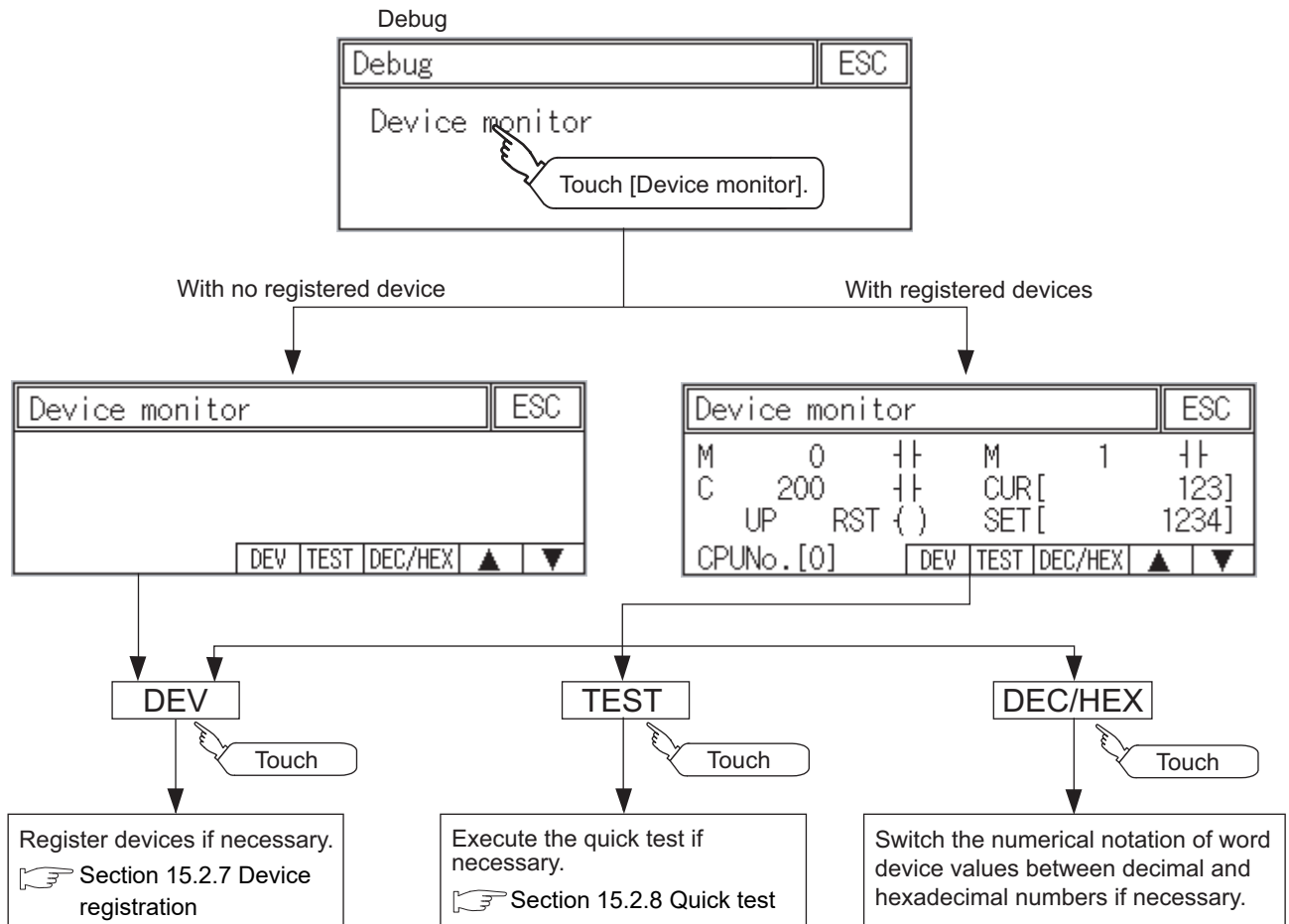

15.2.7 Device registration

The following explains the procedures for device registration.

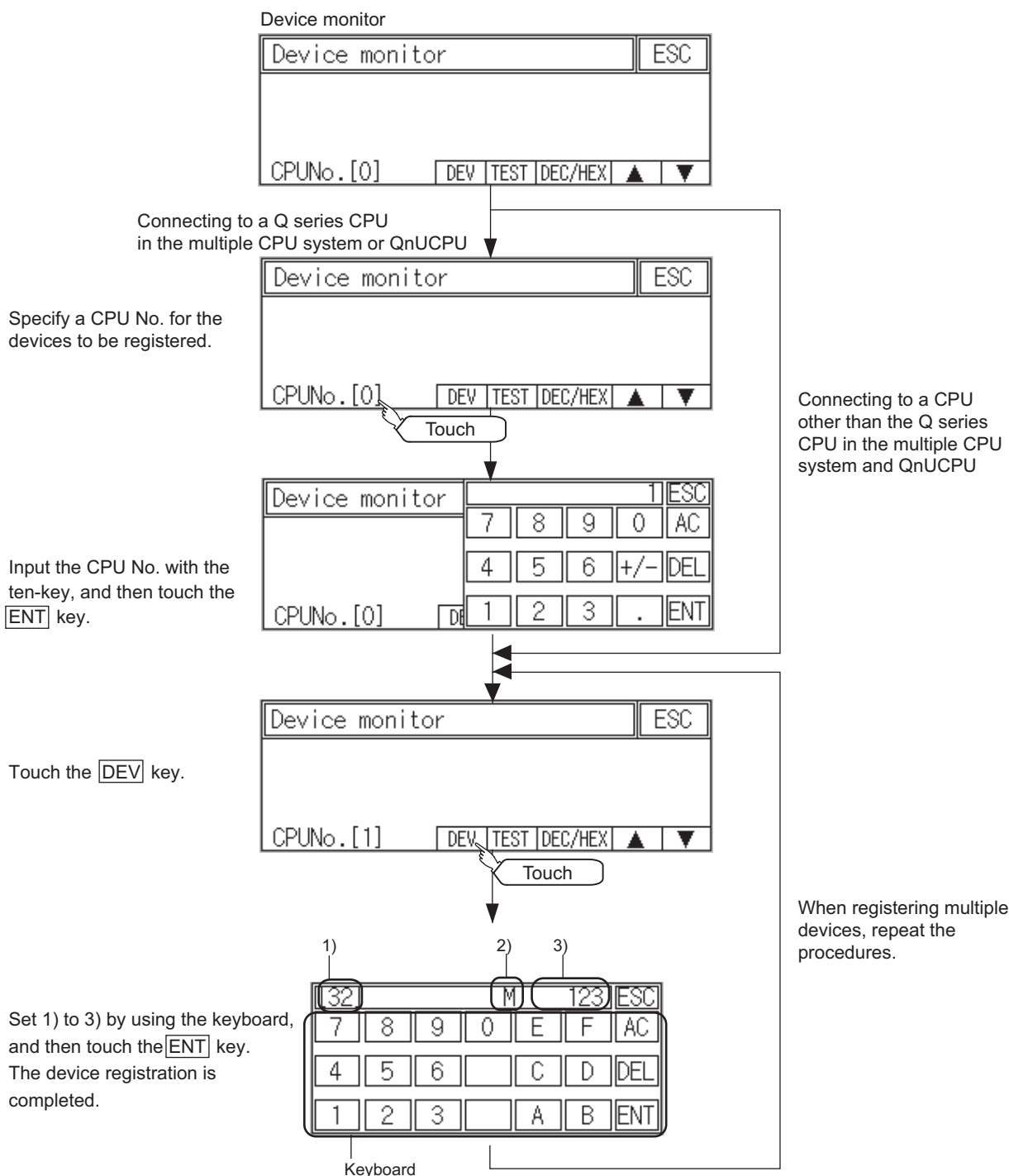

For the keyboard operations, refer to the next page.

No.	Item	Description of setting
1)	Data type	32 : Indicates that the device value is a 32-bit (two-word) module. Nothing displayed: Indicates that the device value is a 16-bit (one-word) module.
2)	Device name	Set the device name and device number to be monitored.
3)	Device No.	



Keyboard operations

(1) Keyboard functions

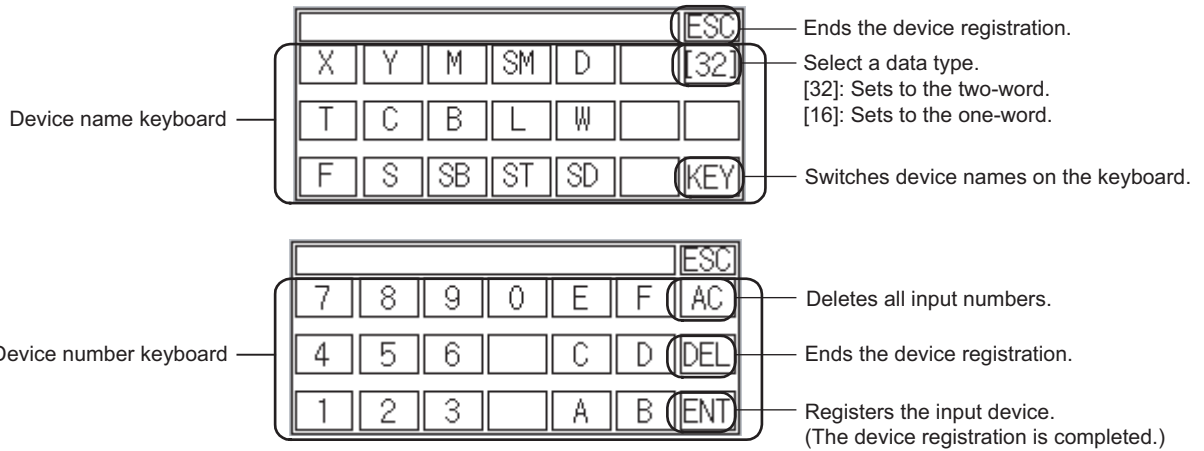

(2) Input procedures

Select a data type. (ex:16 bit)

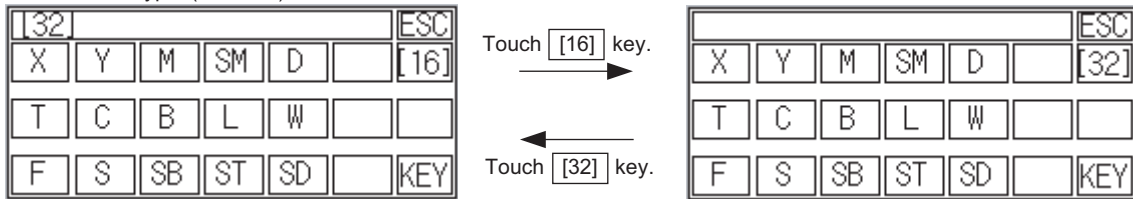

Input a device number. (ex:12)

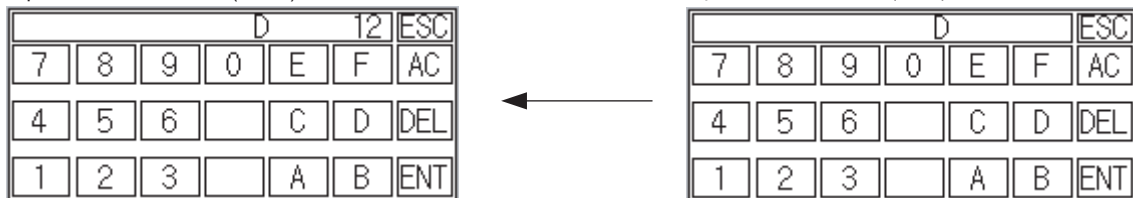

The device registration is completed by touching the ENT key.

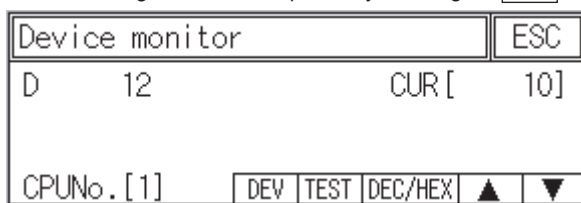

Precautions for device registration

(1) Data type

Device monitor screens display the data type as shown below.

- DW : 32-bit (two-word) module
- Nothing displayed : 16-bit (one-word) module

(2) CPU No. specification

Changing the CPU No. after registering devices cancels the registration for all the devices.

Check the CPU No. before registering the devices.

(3) Station No. specification

Changing the station No. after registering devices cancels the registration for all the devices.

Check the station No. before registering the devices.

For MODBUS/RTU connection, when the station No. is set to "255", the host station set by the communication settings can be specified.

(4) Holding registered devices

The registration for the devices is not canceled after exiting the device monitor.

Restarting the GOT cancels the registration for all the devices.

(5) The number of registered devices

The number of registered devices must be within the maximum number of devices that can be displayed on the GOT.

For registering an additional device, the registration for the device in the top line is canceled and the additional device is displayed in the bottom.

(6) The input method of the device [6] of MODBUS/RTU connection

Input value=File number×10000+Device number *

*: Device number on GT Designer3.



GOT1000 Series Connection Manual (Microcomputer, MODBUS Products, Peripherals) for GT Works3

4.5.1 Communication settings ■ Address

(Input example)

File number	Device number	Input value	Display character string	Remarks
0	00000	00000	6 00000	Input device number only is allowed
0	00001	00001	6 00001	Input device number only is allowed
0	00100	00100	6 00100	Input device number only is allowed
0	09999	09999	6 09999	Input device number only is allowed
1	00000	10000	6 10000	
1	09999	19999	6 19999	
55	00000	550000	6 550000	
55	09999	559999	6 559999	
104	00000	1040000	61040000	
104	09999	1049999	61049999	

(Screen example)



15.2.8 Quick test

WARNING

- Before performing the quick test operations of device monitor (such as turning ON or OFF bit device, changing the word device current value, changing the settings or current values of the timer or counter), read through the manual carefully and make yourself familiar with the operation method. During quick test operation, never change the data of the devices which are used to perform significant operation for the system. False output or malfunction can cause an accident.

The quick test operation procedure for monitor devices is described below.

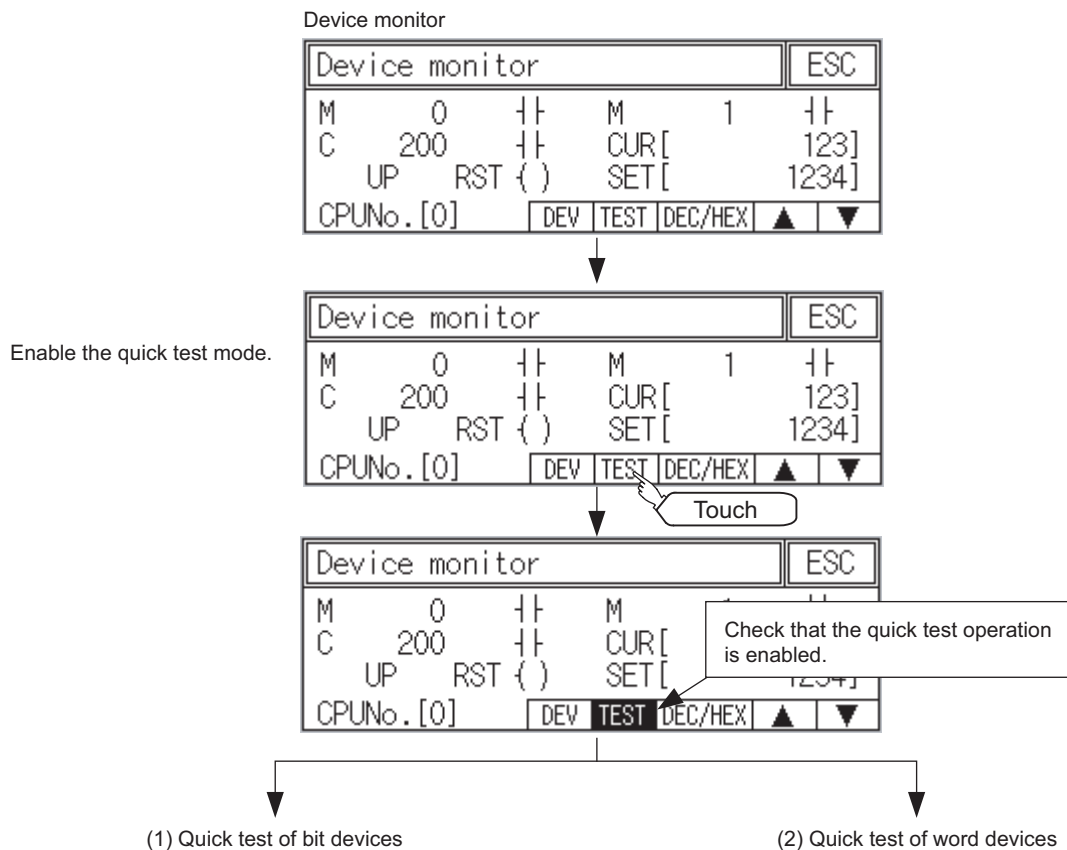

(1) Quick test of bit devices
 (Operation example)

Change the status of bit device M12 from OFF $\uparrow\uparrow$ to ON $\uparrow\downarrow$

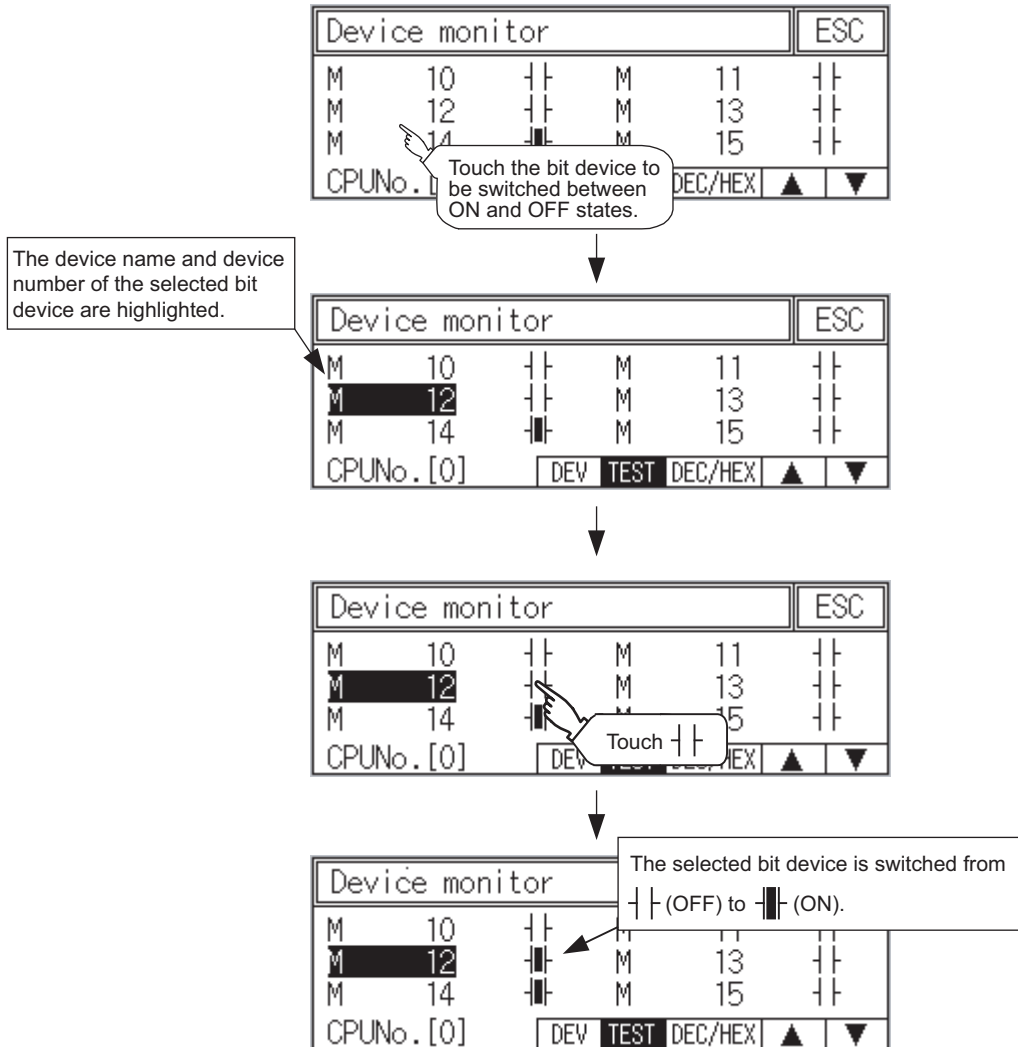

- (2) Quick test of word devices
(Operation example)

Change the device value of word device D200 from 43 to 100.

Conditions: Data range: 16 bits, device value display format: decimal number

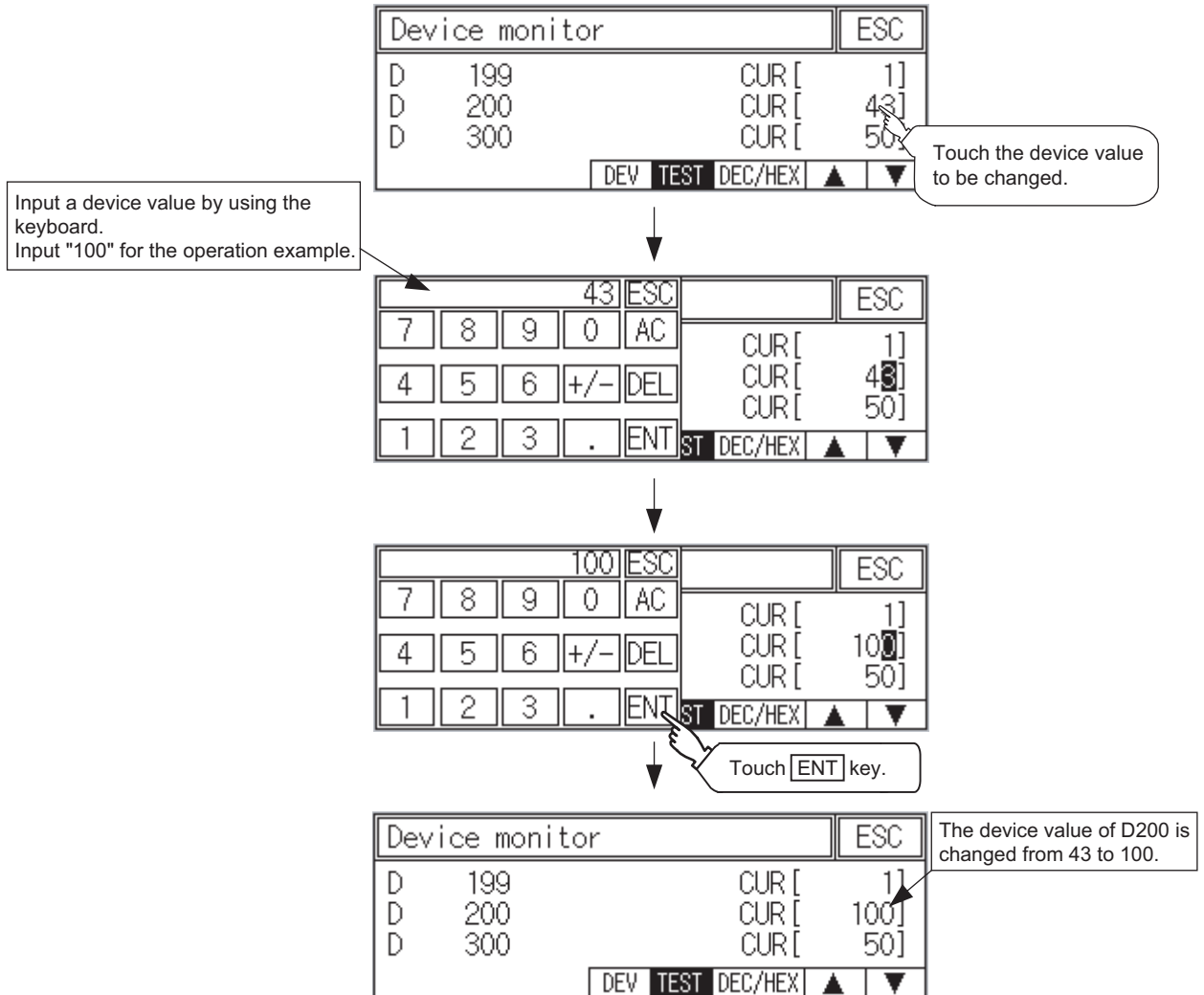

Point

When the cursor is displayed

When the cursor is displayed, touch the [▲] or [▼] key to move the cursor to the upper or lower registered device.

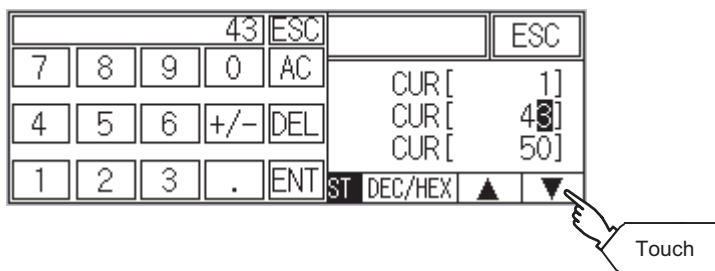

15.3 FX List Editor (For GT104□, GT105□ only)

GT104□, GT105□ can edit the sequence programs of the connected FXCPU using the list editor.

15.3.1 Display operation of FX list editor

Main menu

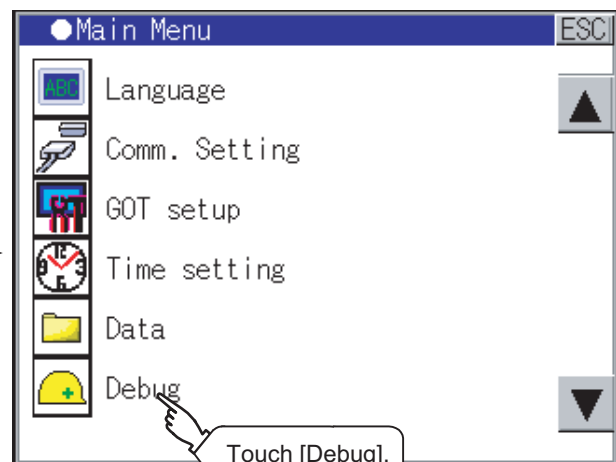
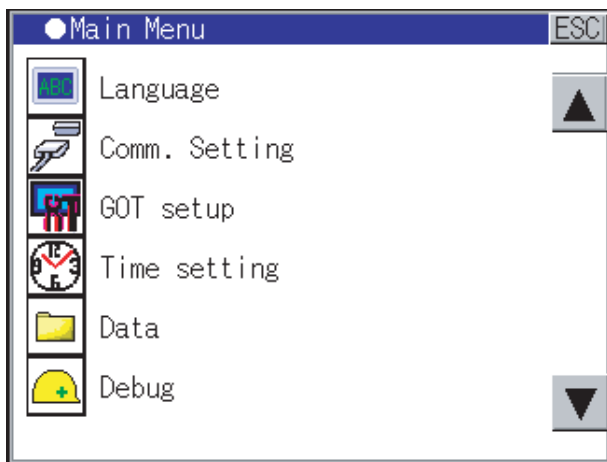

FX list editor

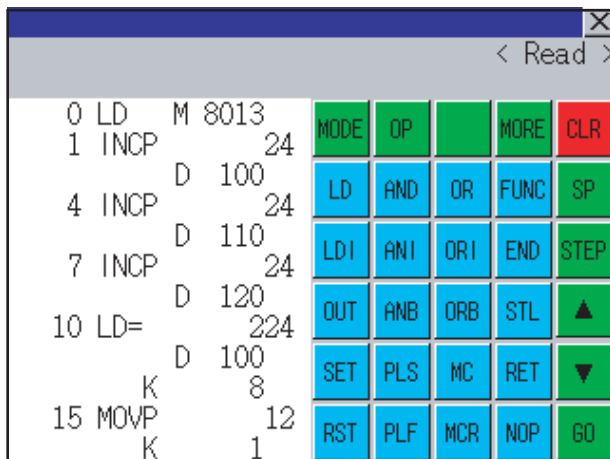

Debug

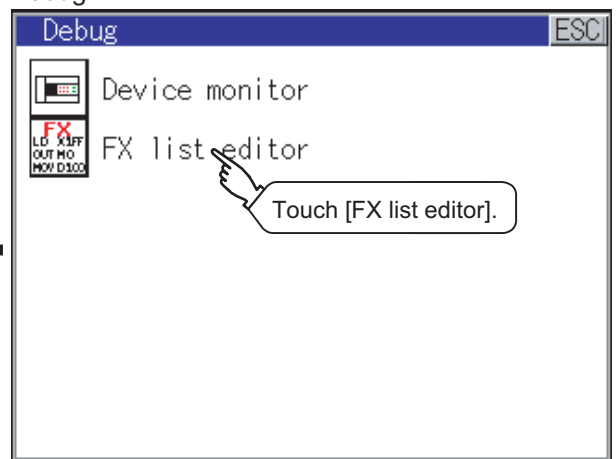

1 Parameters and sequence programs are easy to maintain.

You can check or partly correct, change or add FX PLC CPU parameters and sequence programs simply by operating keys.

You can easily edit sequence programs without preparing any peripheral unit other than the GOT.

(Example of changing sequence program commands)

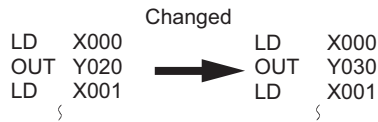

2 Errors that occur during list editing can be checked easily.

Error messages, error codes, and number of steps for errors that occur in the FX PLC can be checked.

Details can be checked immediately even for errors that occur during list editing.

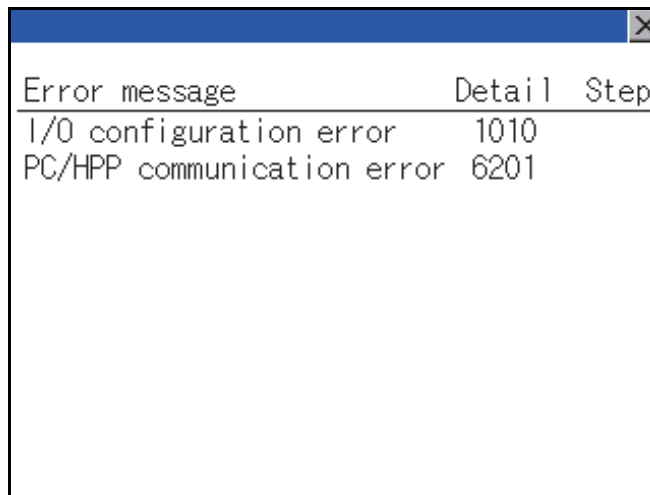

3 Commands and devices can be searched and displayed.

Commands and devices used in sequence programs can be searched.

The correction position can be searched for cases such as when you want to correct a specific device.

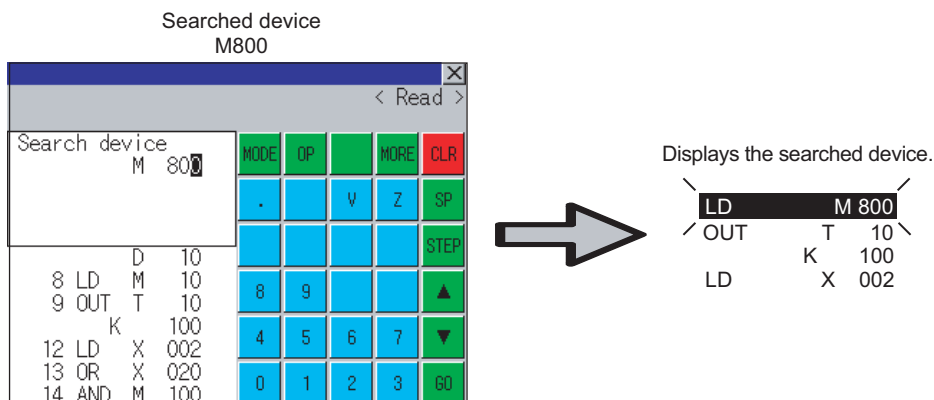

15.3.2 Specifications

1 System configuration

This section describes the system configuration of the MELSEC-FX list editor.

For further information about communication units and cables for each connection form, see the following.

 GOT1000 Series Connection Manual

2 Controllers that can be edited with the MELSEC-FX list editor

Target controller
FXCPU

3 Connection forms

(○: Available, ×: Unavailable)

Function		Connection form between GOT and PLC			
Name	Description	Direct CPU connection	Computer link connection	CC-Link connection	GOT multidrop connection
				G4*1	
MELSEC-FX list editor	Sequence program writing, parameter setting, PLC diagnostics and keyword registration, etc.	○	×	×	×

*1 Indicates CC-Link connection (via G4).

4 Functions list and monitor conditions

The following shows the memory that can be monitored by the MELSEC-FX list editor and the FX PLC status conditions.

(○ : Can be monitored △ : Can be monitored under certain conditions × : Cannot be monitored)

Function		Memory that can be monitored *2				FX PLC status	Reference
		Built-in memory	RAM memory cassette	EEPROM memory cassette, flash memory cassette	EPROM memory cassette		
Reading sequence programs	Displaying sequence programs	○	○	○	○	RUN/STOP	SubSection 15.3.8
	Searching commands/devices						SubSection 15.3.9
Writing sequence programs	Writing commands	○	○	△ *1	×	For Stop only	SubSection 15.3.10
	Changing operands/set values						SubSection 15.3.11
Inserting commands		○	○	△ *1	×	For Stop only	SubSection 15.3.10
Deleting commands							SubSection 15.3.12
Sequence program all clear							SubSection 15.3.13
PLC diagnostics		○	○	○	○	RUN/STOP	SubSection 15.3.14
Parameter setting	Display						SubSection 15.3.15
		Set	○	○	△ *1	×	For Stop only
Keyword		○	○	○	○	RUN/STOP	SubSection 15.3.16

*1 The operation is available only when the protect switch is OFF.

*2 The available memory differs depending on the FX PLC being used.

For further information, see the following manual.

 The hardware manual of the FX PLC being used

15.3.3 Access range

The access range is the same as the access range when the GOT is connected to a controller. Refer to the following manual for details of the access range.

 GT Designer2 Version Screen Design Manual

GOT1000 Series Connection Manual (Mitsubishi Products) for GT Works3

15.3.4 Precautions

- (1) Inapplicable GOT
The FX list editor function cannot be used with the GT1030 and GT1020.
- (2) Using other peripheral equipment for sequence program/parameter change
When using the MELSEC-FX list editor, do not change programs or parameters in the PLC CPU from other peripheral equipment.
If you make a change, temporarily exit the MELSEC-FX list editor after the change is made, then start the MELSEC-FX list editor again.
If you carelessly change the program on one PLC from multiple units of peripheral equipment (including GOT), the contents of the program in the PLC CPU and the peripheral equipment may not be the same, resulting in an unintended operation of the PLC CPU.
- (3) Sequence program change
Stop the FX PLC before changing (writing, inserting, deleting) a sequence program or changing parameters.
Operation is not possible with the FX PLC running.
- (4) If you press the key but the system does not proceed to the next operation (for example, a search)
Check the input contents (applied instruction number, device value, etc.).
- (5) When using list monitor
Only devices to be used for basic instructions can be monitored.
The status of devices (word, bit) to be used for application instructions cannot be monitored.

1 Outline until the start

The following explains the outline until the operation screen of MELSEC-FX list editor is displayed.

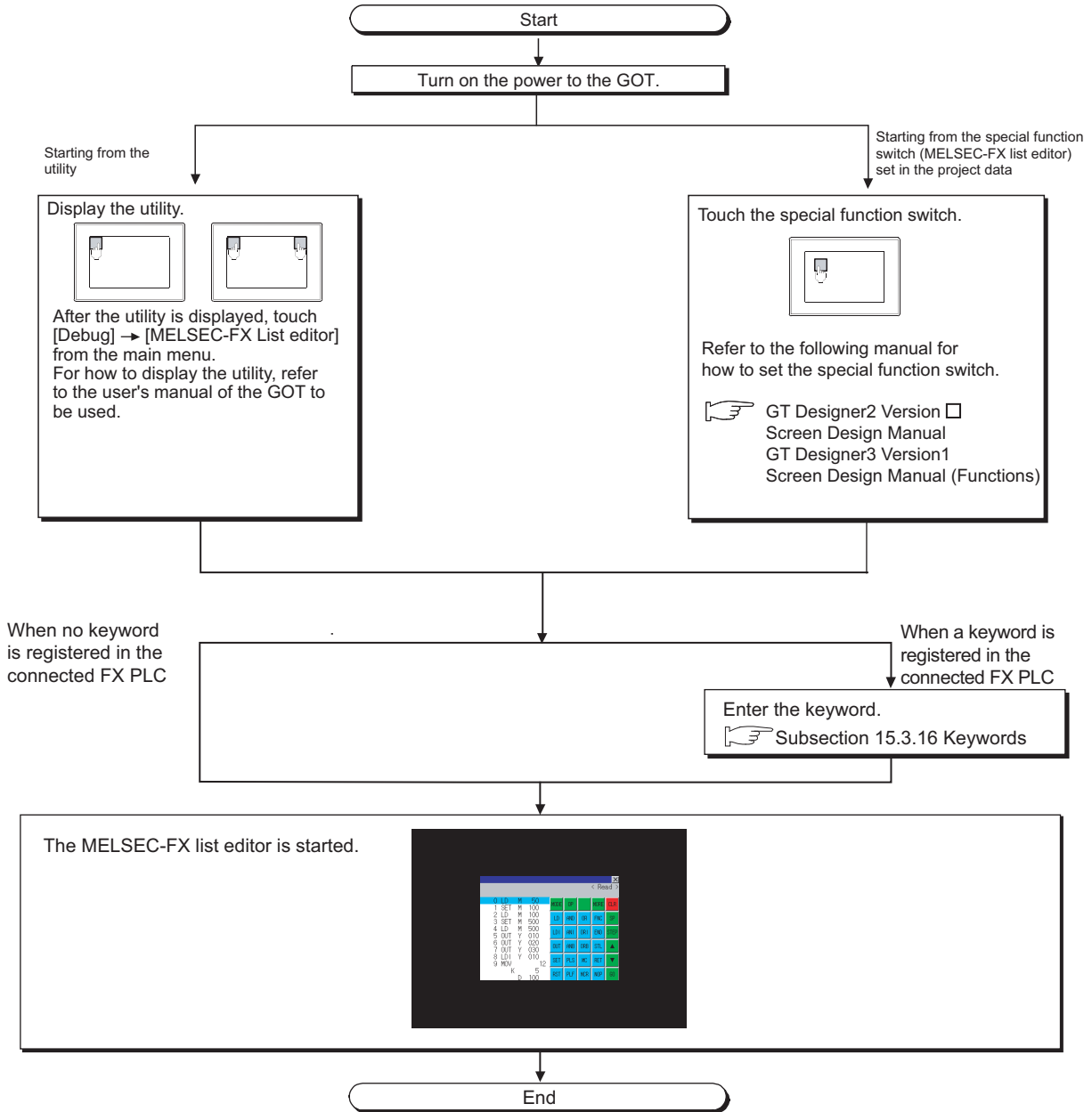

- (1) How to display the utility
For how to display the utility, refer to the following.
☞ Section 9.2 Utility Display

- (2) If the project data has not been downloaded
The MELSEC-FX list editor can be started from the utility even if the project data has not been downloaded to the GOT.

2 Change screens

This section describes how to change the screen.

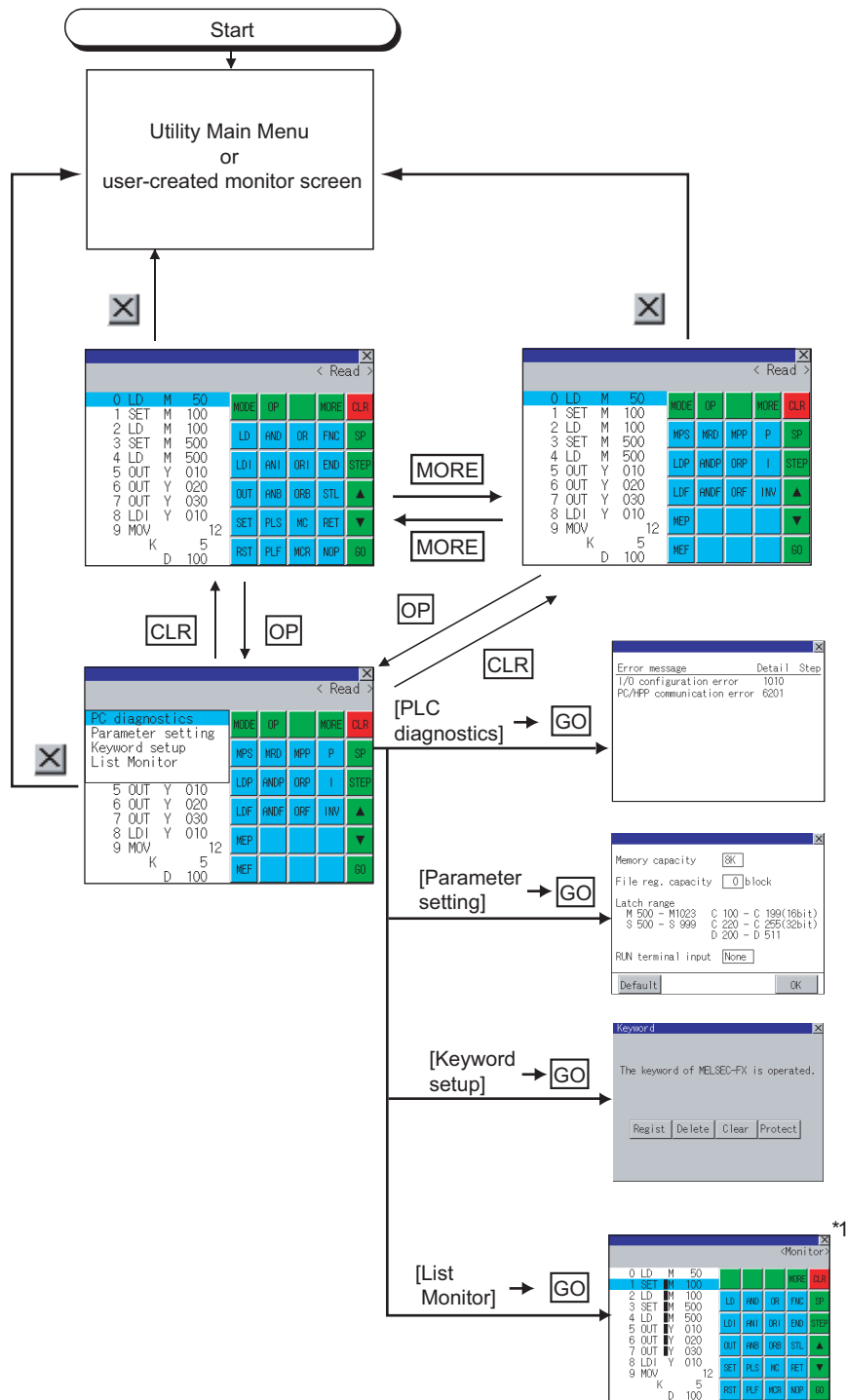

- *1 With setting special function switches (FX list monitor), the list monitor can be started on the monitor screen. When the list monitor is started on the monitor screen, the list editor cannot be used. For how to set special function switches, refer to the following manual.

☞ GT Designer2 Version ☐ Screen Design Manual

GT Designer3 Version1 Screen Design Manual (Functions)

15.3.6 Operation Procedures

This section describes the contents of the MELSEC-FX list editor and the key functions displayed on the screen.

1 Key arrangement and a list of key functions

The arrangement and functions of the keys displayed on the MELSEC-FX List Editor window are described below.

2 Displayed contents

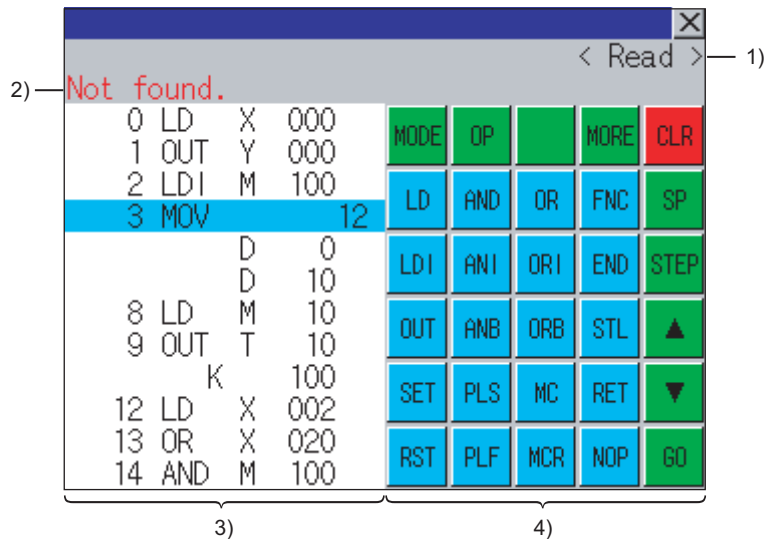

No.	Item	Description
1)	Mode	Displays a mode for MELSEC-FX list editor. (☞ SubSection 15.3.7 Selection and operation of modes) [Monitor] is displayed when the list monitor is executed. (☞ SubSection 15.3.17 List monitor)
2)	Error message	Displays the contents of errors that occur with the MELSEC-FX list editor. (☞ SubSection 15.3.19 Error Messages and Corrective Actions)
3)	List display area	Displays the sequence program in list format (12 digits). The position (line) that can be edited is displayed with a bar.
4)	Key area	Displays the keys that can be used with the MELSEC-FX list editor.

3 Key functions

The table below shows the functions of the keys that are used for the operation on the MELSEC-FX list editor screen.

Key	Function
	Selects a mode for MELSEC-FX list editor. (☞ SubSection 15.3.7 Selection and operation of modes)
	Displays the PLC diagnostics, parameter setting, and keyword selection menu.
	Switches between command keyboard 1 and command keyboard 2. (☞ 4 "Keyboard switching" in this section)
	When inputting commands :Cancels the key input when only part of the command has been input. (☞ SubSection 15.3.18 Action for an incorrect key input) When option menu is displayed: Closes the option menu. Commands cannot be deleted with this key. (☞ SubSection 15.3.12 Deleting commands)
	Space key. This key is used when setting timers and counters, writing applied commands, etc.
	Displays the list from a specified step No. when the step No. is input.
	Moves the list display area bar up and down and switches the line being edited.
	Determines the key operation.
	Inputs commands, device names, etc. The key contents depend on the input contents. The commands that can be used differ depending on the target FX PLC. Refer to the manual for the FX PLC to be used.
	Exits the MELSEC-FX list editor.

4 Keyboard switching

Touching the **MORE** button switches the command keyboard 1 and command keyboard 2.

When you touch the button for a keyboard function, the optimum keyboard for input for that function is displayed automatically.

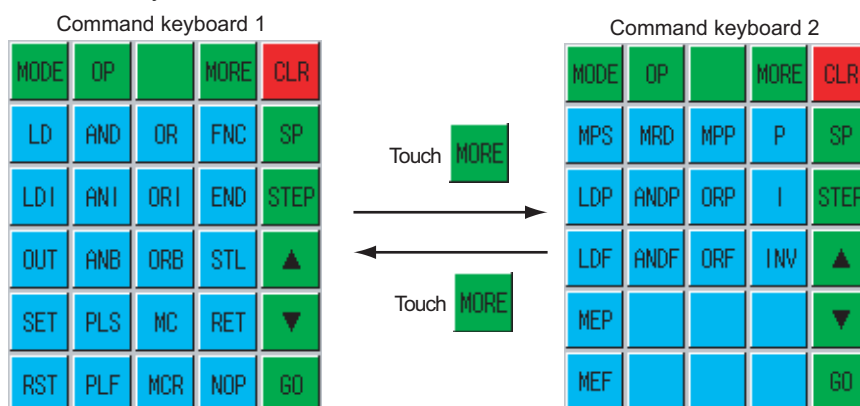

15.3.7 Selection and operation of modes

The MELSEC-FX list editor has four modes: READ, WRITE, INSERT, and DELETE.

Select an appropriate mode for the intended operation.

For more information on the mode to select, refer to the function operations from subsection 15.3.8 onward.

1 How to change modes

Touch the **MODE** button.

Each time you touch this button, the mode changes.

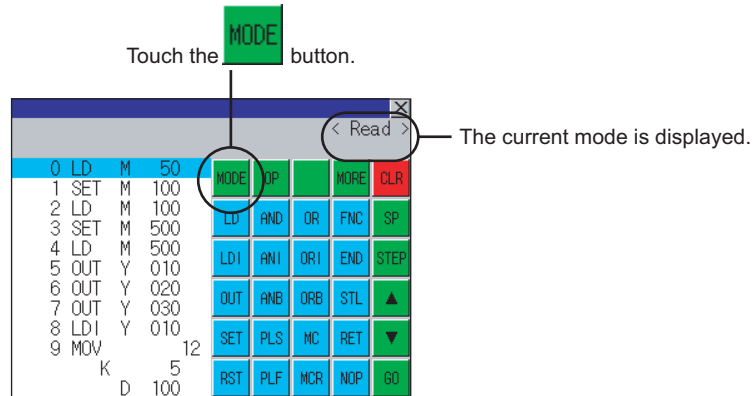

2 In the case the mode cannot be changed

In the following cases, only READ mode is allowed.

If you try to change to other than READ mode, an error message is displayed.

To change to other than READ mode, take the action below.

Error Message	Description	Corrective action
PLC is running	The FX PLC is in the RUN status.	Stop the FX PLC.
Can not write.	The protect switch of the EEPROM memory cassette is on.	Switch off the protect switch of the EEPROM memory cassette.
	The EPROM memory cassette is enabled.	Set a memory other than EPROM as the memory to write to.

15.3.8 Sequence program display

Sequence programs are read from the FX PLC to the GOT and displayed. There are two displaying methods: specifying the step number, and scrolling one screen at a time.

1 Display using cursor keys

(1) Operation

Scroll with  or .

(2) Example

Scroll one line upward or downward.

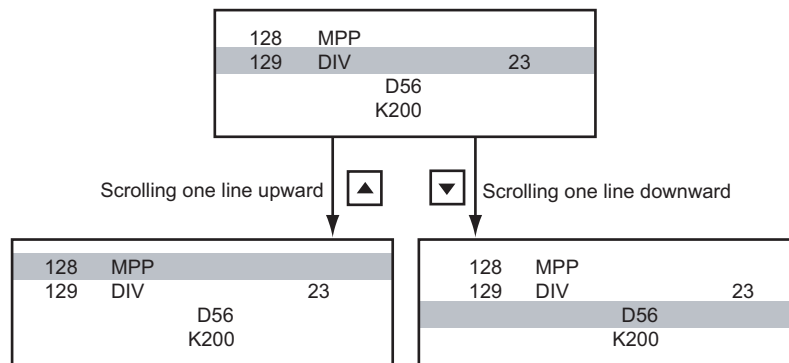

2 Display specifying the step number

(1) Operation

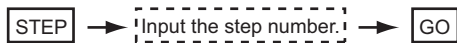

(2) Example

Displaying step number 123.

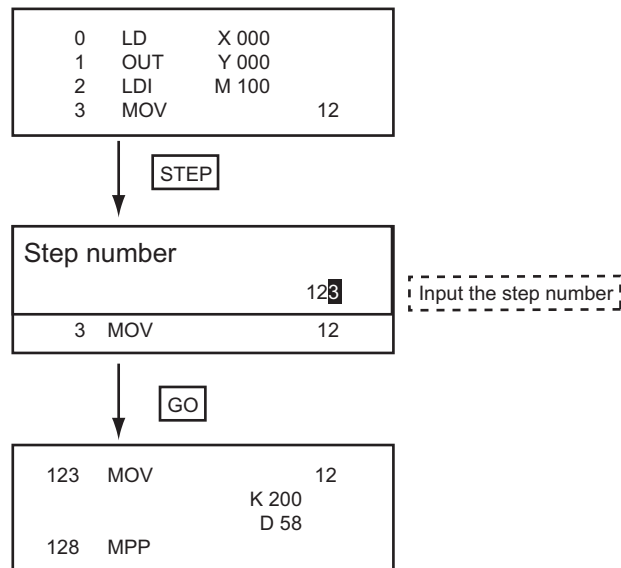

Hint!

When the specified step number is the operand of an applied instruction

If the specified step number is a timer (T) or counter (C) set value or the operand of an applied instruction, that command section is displayed at the head.

3 Display scrolling one screen at a time

(1) Operation

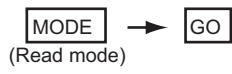

(2) Example

Displaying with scrolling one screen at a time.

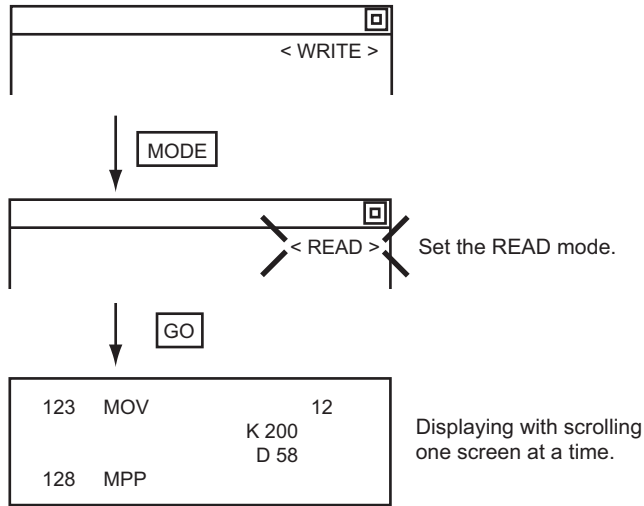

15.3.9 Searching commands and devices

Displays a command or device by searching it in sequence program from Step 0.

1 Command search

(1) Operation



- *1 If the command you want to search for is not on the keyboard, touch the **[MORE]** key to switch to the other keyboard.
When searching for an applied instruction, touch the **[FNC]** key and input the applied instruction number.
When searching for a label, touch **[P]** or **[I]** and input the pointer number.

(SubSection 15.3.10 **2** Writing applied instructions)

- *2 Input only when searching for commands requiring a device name and device number.

- *3 After the search results are displayed, you can continue searching with the same conditions by touching the **[GO]** key.

Touching any key other than the **[GO]** key ends the search.

(2) Example

Searching for LD M8000.

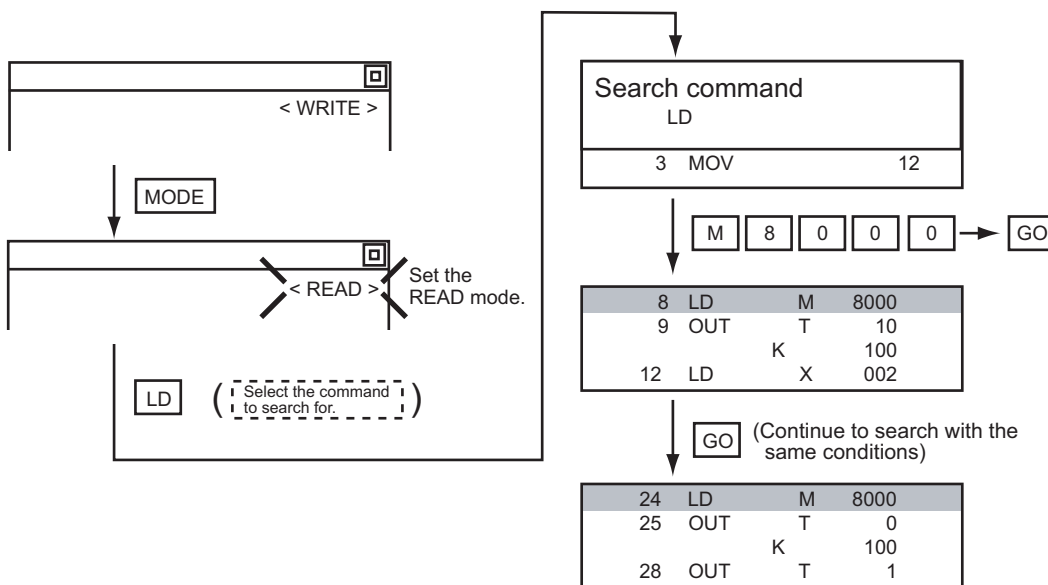

Pointer (P, I) searches

For pointer searches, only labels are searched.

Pointers specified as operands in applied instructions are not searched.

2 Device search

(1) Operation

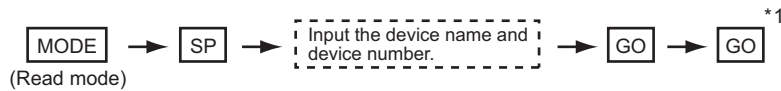

*1 After the search results are displayed, you can continue searching with the same conditions by touching the **GO** key.
Touching any key other than the **GO** key ends the search.

(2) Example

Searching for LD M8000.

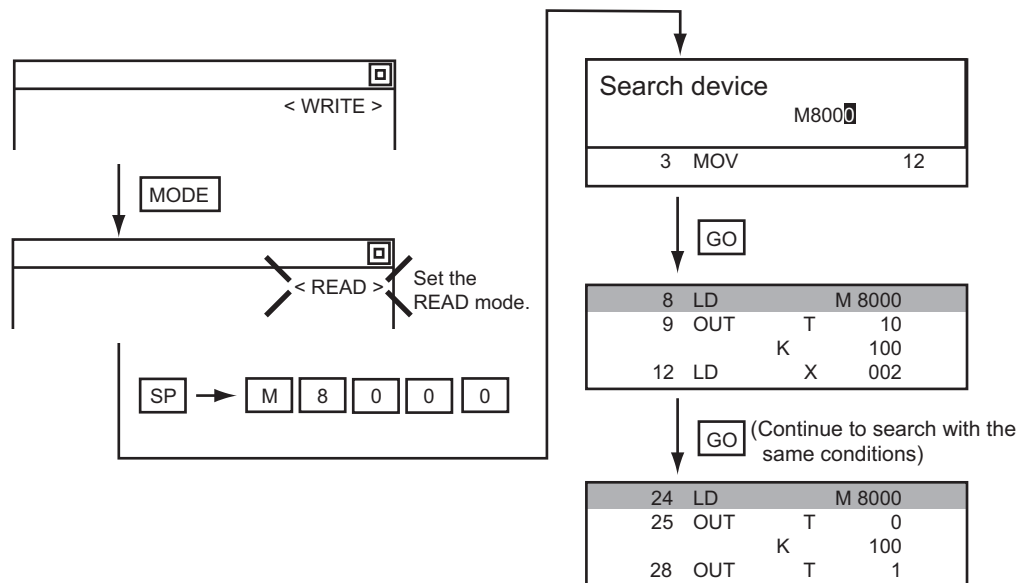

Point

Devices that cannot be searched

The following devices cannot be searched.

- Pointers, interrupt pointers
- Constant K, constant H, constant E
- Bit devices with specifying numbers only
- Special function unit/block buffer memory
- Devices specified with the operand of an applied instruction

Pointers and interrupt pointers can be searched for with command searches.

(1 "Command search" in this section)

15.3.10 Writing commands

Writes a sequence program to the FX PLC. (Overwrite/Insert)

1 Writing basic commands

(1) Operations

(a) Inputting command only (Ex.: ANB, ORB command etc.)

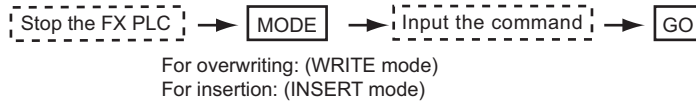

(b) Inputting command and device (LD, AND commands etc.)

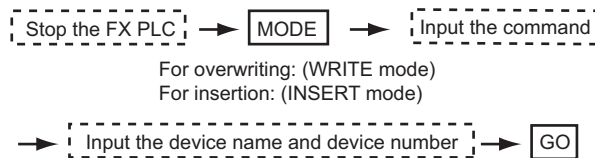

(c) Inputting command, No. 1 device, No. 2 device (MC, OUT (T, C) commands, etc.)

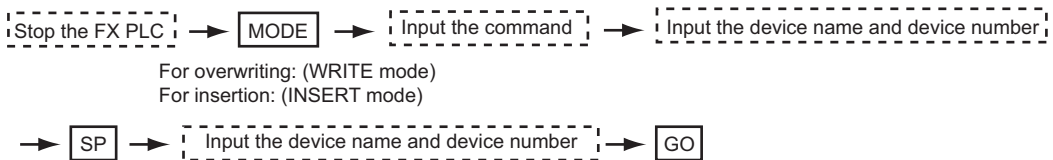

Point

Moving the cursor to the position to write the command

When starting to write a command, place the cursor on the command line (the line on which the step number is displayed).

You cannot write a command with the cursor on an operand or set value line.

2	LDI	M	100	} Command line (Place the cursor on this line.)
3	MOV		12	
		D	0	
		D	10	} Operand, set value line (Cannot operate on this line.)

(2) Example

(a) Writing ORB command

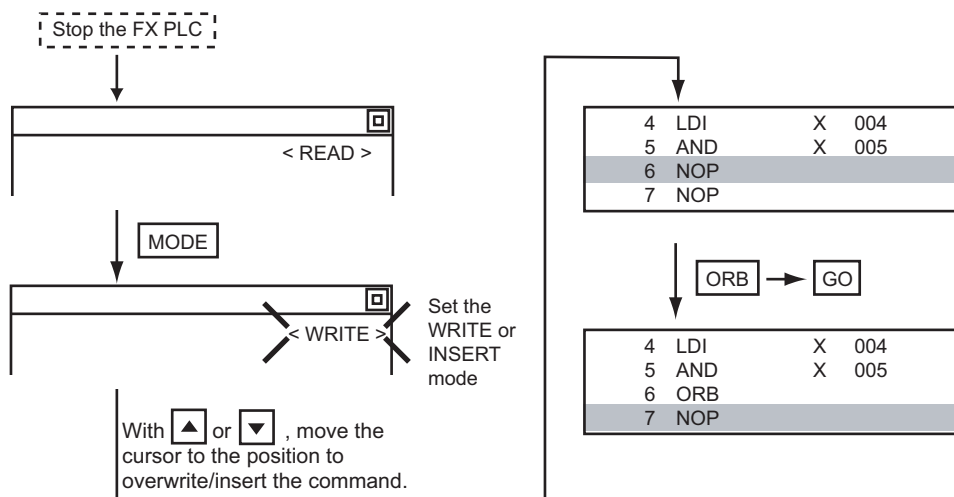

(b) Inputting LD X000

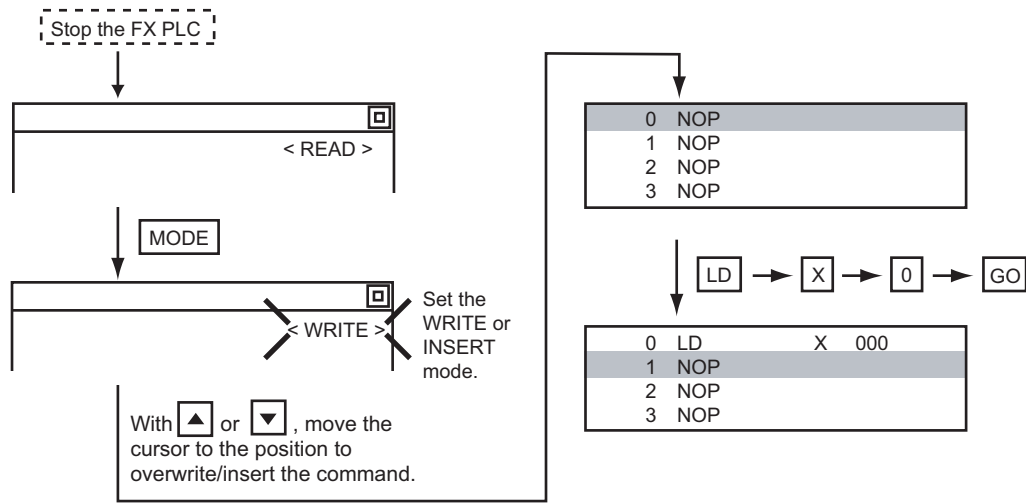

(c) Inputting OUT T100 K19

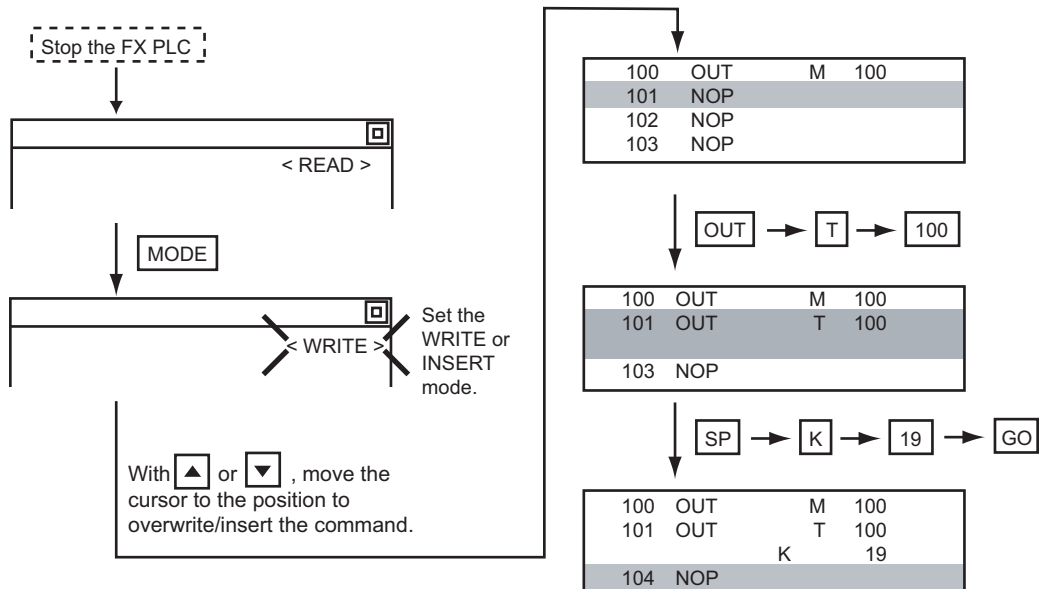

2 Writing applied instructions

(1) Operations

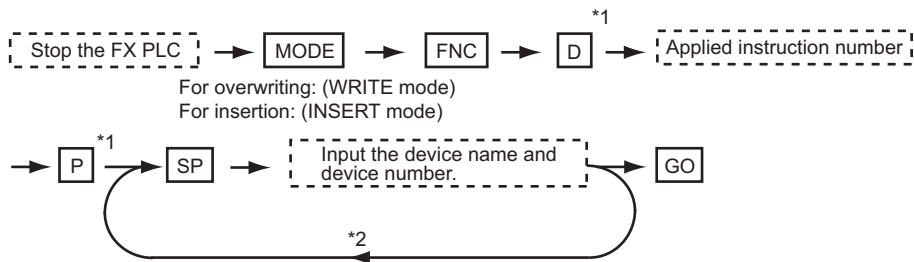

*1 **D** (double word command) and **P** (pulse execution format command) can also be input after the applied instruction number is input. Inputting in the order **P** → **D** is also possible.

*2 When a command specifies multiple devices for operations, input the **SP** key followed by the device name and device number.

Point

(1) Moving the cursor to the position to write the command

When starting to write a command, place the cursor on the command line (the line on which the step number is displayed).

You cannot write a command with the cursor on any other line.

2	LDI	M	100	
3	MOV			12
		D	0	
		D	10	

} Command line (Place the cursor on this line.)

} Operand, set value line (Cannot operate on this line.)

(2) Commands using a text string constant for a command operand (such as ASC command)

With the MELSEC-FX list editor, text string constants cannot be written as operands. (such as ASC commands)

Use GX Developer for writing such commands.

(2) Example

Input "DMOVP D0 D2".

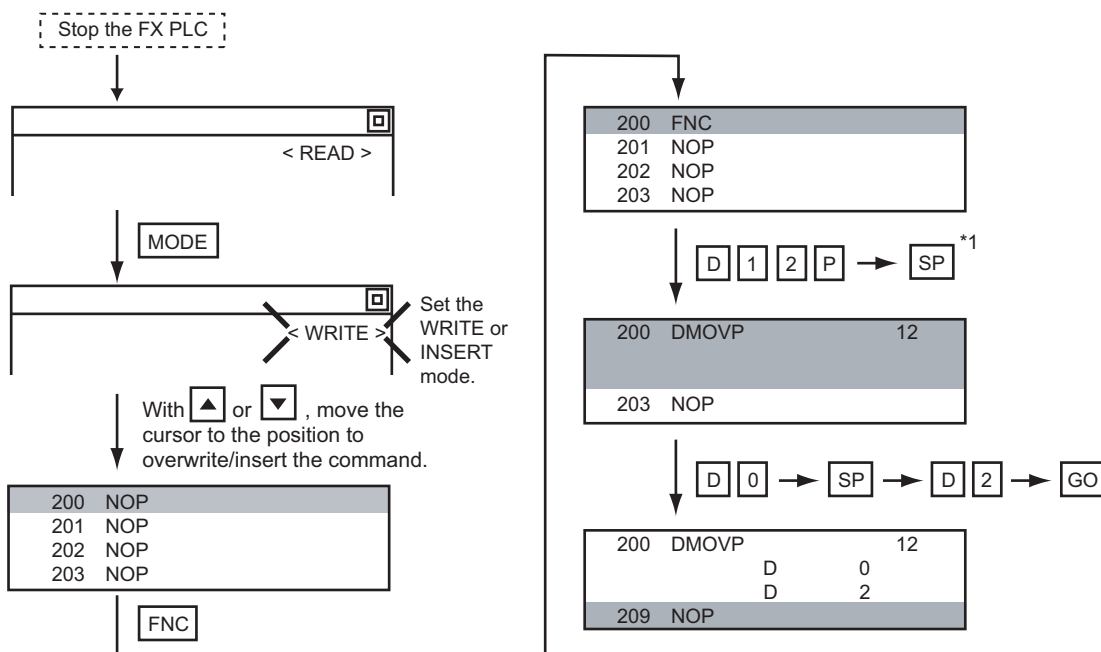

*1 The MOV command is FNC12.

15.3.11 Changing operands, set values

Changes the operand section of an applied instruction and OUT (T, C) command set value.

1 Operation

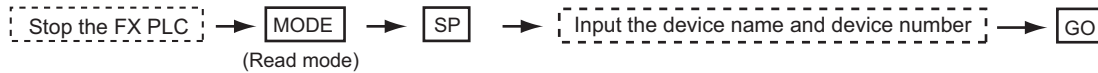

*1 For decimal numbers, input K, then the number.
For hexadecimal numbers, input H, then the number.



Moving the cursor to the line on which the operand or set value is to be changed

When starting to change an operand or a set value, place the cursor on the line of the operand or set value to be changed (the line on which the step number is not displayed).

If you place the cursor on the command line, the input operation is not possible.

2	LDI	M	100	
3	MOV			12
		D	0	
		D	10	

Command line (Cannot operate on this line.)
Operand, set value line (Place the cursor on this line.)

2 Example

Changing "MOV D0 D10" to "MOV D0 D123".

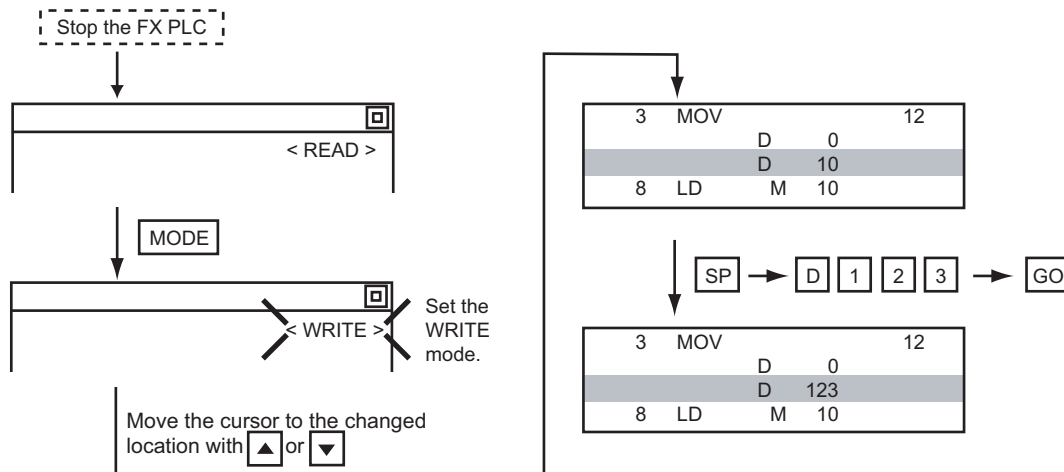

15.3.12 Deleting commands

Deletes one command at a time from a sequence program.

1 Operation

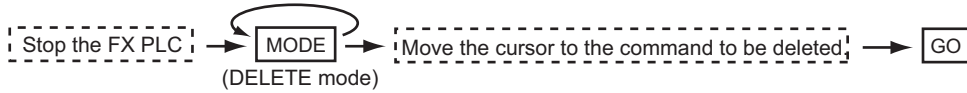

Point

When moving the cursor to the position where the command is to be deleted.

Place the cursor on the command line (the line on which the step number is displayed).

You cannot delete the command if the cursor is placed on the line of an operand or set value.

2	LDI	M	100	} Command line (Place the cursor on this line.)
3	MOV	D	0	
		D	10	

2 Example

Deleting "OUT T10 K100".

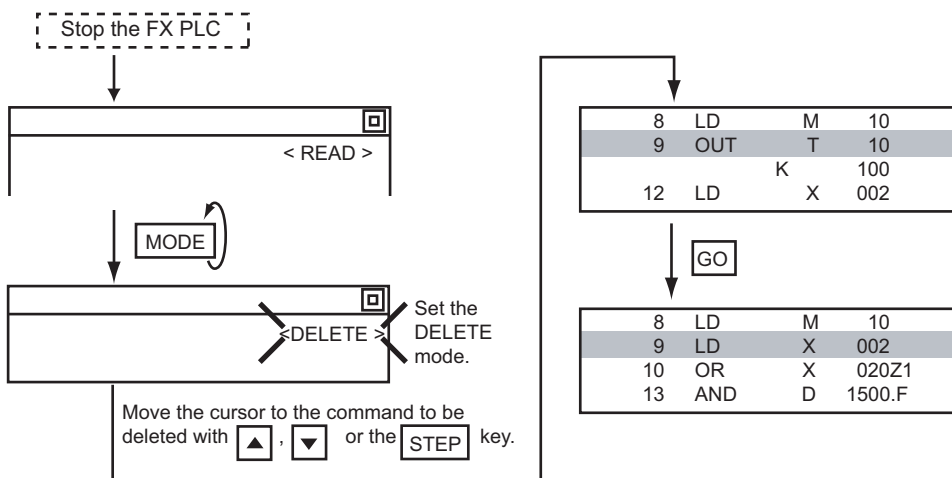

15.3.13 Sequence program all clear

Clears all the sequence programs.

1 Operation



2 Example

Clears all the sequence programs.

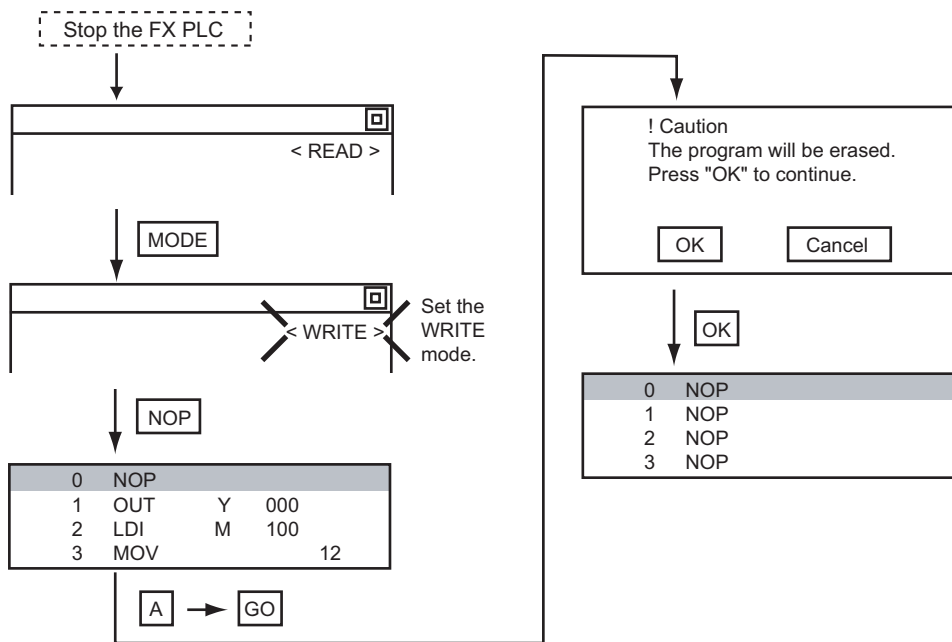

Items cleared when All Clear for a sequence program is performed

When All Clear is executed, the parameters before program execution are initialized and Latch Clear is executed.

The memory space becomes the default value, the comment area a 0 block, the file register space a 0 block, and keywords unregistered.

After All Clear, set the above parameters etc. again.

15.3.14 PLC diagnostics

Displays the FX PLC error message, error code, and step at which the error occurred.

1 Operation

→ [PLC diagnostics] →

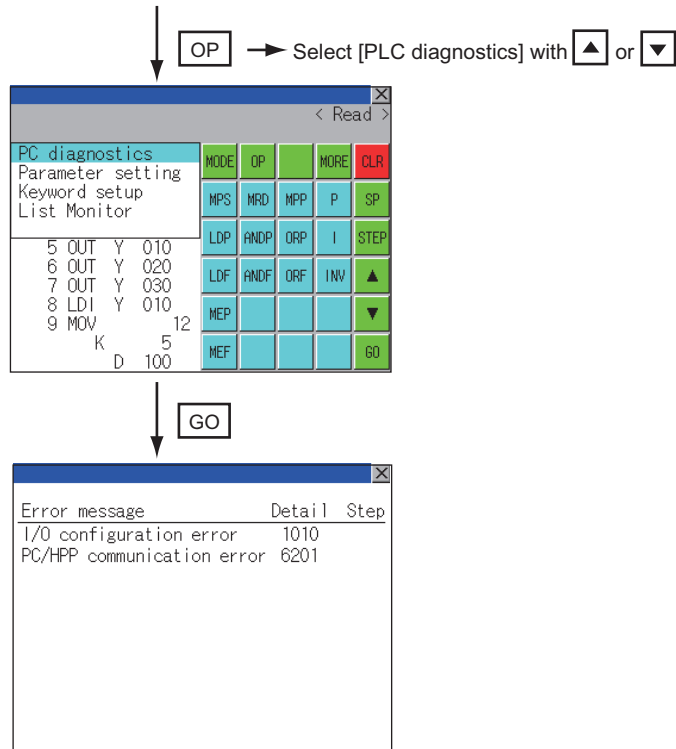

2 PLC diagnostics screen

The following describes the contents displayed on the PLC diagnostics screen and the function of on-screen key.

(1) Displayed contents

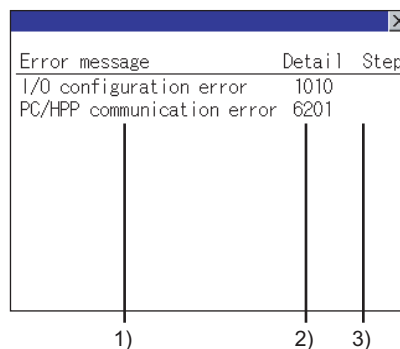

No.	Item	Display contents
1)	Error message	Displays the error message. (I/O configuration error/PLC hardware error/PC/HPP communication error/Serial communication error/Parameter error/Syntax error/Circuit error/Operation error)
2)	Detail	Displays the error code.
3)	Step	Displays the step number in the sequence program at which the error occurred. (This is displayed only for a syntax error, circuit error, or operation error.)

Remark

Error details

For details on an FX PLC error, refer to the manual below.

 Programming manual for the FX CPU used

(2) Key functions

The table below shows the functions of the keys that are used for the operation on the PLC diagnostics screen.

Key	Function
	Exits the PLC diagnostics.

15.3.15 Parameter setting

Sets FX PLC parameters.

1 Parameters that can be changed and change targets

(1) Parameters that can be changed

The parameters that can be changed with the MELSEC-FX list editor and the target FX PLCs are as follows.

(○: Can be set/changed ×: Cannot be set/changed)

Item	Target CPU								
	FX0(S) /FX0N	FX1	FX2(C)	FX1S	FX1N(C)	FX2N(C)	FX3S	FX3G(C)	FX3U(C)
Memory space setting	×	○	○	×	×	○	○	○	○
File register space setting	○*1	×	○	○	○	○	○	○	○
Latch range setting	×	○	○	×	×	○	×	×	○
RUN terminal setting	×	×	×	○	○	○	○	○	○
Initialization of parameters	○	○	○	○	○	○	○	○	○

*1 When connecting an FX0(S), set "0".

Setting other than "0" causes a parameter error.

*2 When the parameters are initialized, the display on the MELSEC-FX list editor is different from the FX PLC default values, but do not change the latch range. Changing the latch range causes an error.

(2) Change targets

When a memory cassette is mounted, the parameters in the memory cassette are targeted for changes.

2 Operation

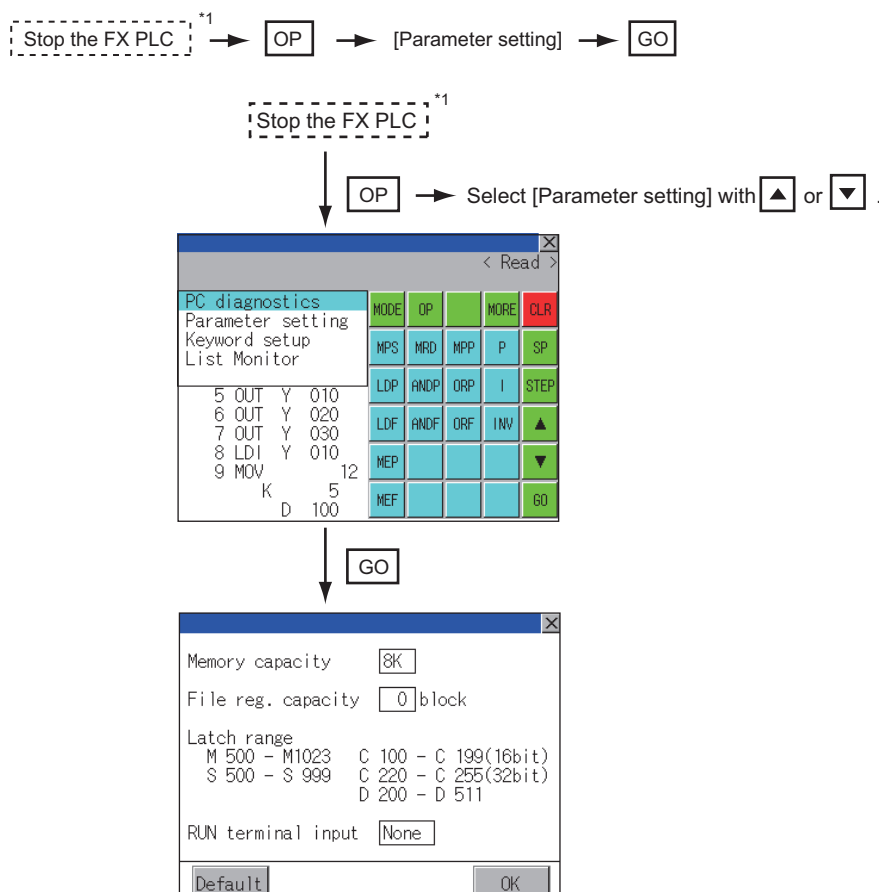

*1 When checking parameters (not changing), it is not necessary to stop the PLC.

3 Parameter setting screen

The following describes the contents displayed on the PLC diagnostics screen and the function of on-screen keys.

(1) Displayed contents

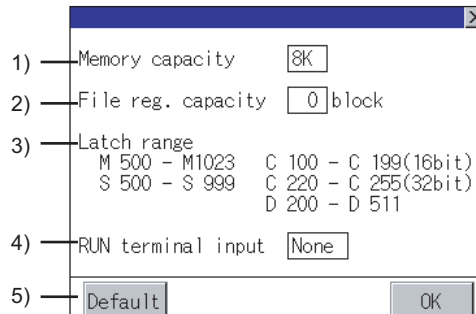

No.	Item	Display contents
1)	Memory capacity	Sets the memory space (number of steps). If you touch the <input type="text" value="8K"/> section, you can change the memory space.
2)	File reg. capacity	Sets the memory space (number of blocks) allocated to the file register. Touch the <input type="text" value="0"/> section and input the number of blocks.
3)	Latch range	Sets the latch range (power failure hold area). Touch the number display section and input the value.
4)	RUN terminal input	Sets whether or not to use one of the FX PLC input terminals for RUN input. Touch the <input type="text" value="None"/> section and set the device to be set for the RUN terminal.
5)	Default	Initializes the parameters



Memory space for kana comments after changing memory space, file register space

If the memory space is set smaller than the total of the file register space and kana comment space, the kana comment space is automatically reduced.

(With the MELSEC-FX list editor, the kana comment space is not displayed.)

Note that if any setting as described below is made, the kana comment space is reduced.

(Settings that reduce kana comment space and the kana comment space after setting change)

Settings resulting in $Nm < Nf \times 500 + Nk \times 500 + 500$

$$\text{Kana comment space (steps) after setting change} = \frac{Nm - Nf \times 500 - 500}{500}$$

Nm: Memory space after change (steps)

Nf: File register space after change (blocks)

Nk: Comment space before change (blocks)



Settable range and default value



The settable range and the default value depend on the FX PLC type.

Refer to the following manual for details of the settable range and the default value.

Programming manual for the FX PLC used

(2) Key functions

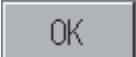
The table below shows the functions of the keys that are used for the operation on the parameter setting screen.

Key	Function
	Initializes the parameters
	Completes the changed setting contents.
	Ends parameter setting.

15.3.16 Keywords

Registers, deletes, releases protection for, and sets protection for the FX PLC keywords.

1 Function usability of the MELSEC-FX list editor for keyword protection levels

The functions that can be used with the MELSEC-FX list editor depend on the keyword protection level.

(○: Available, ×: Unavailable)

Function		Keyword protection level				Reference
		All operation protect (All on-line operation protect) *2	Read/Incorrect write protection (Read/write protect) *2	Incorrect write protect (Write protect) *2	Keyword not registered/keyword protection canceled	
Reading sequence programs	Displaying sequence programs	×	×	○	○	SubSection 15.3.8
	Searching commands/ devices	×	×	○	○	SubSection 15.3.9
Writing sequence programs	Writing commands	×	×	×	○	SubSection 15.3.10
	Changing operands/set values	×	×	×	○	SubSection 15.3.11
Inserting commands		×	×	×	○	SubSection 15.3.10
Deleting commands		×	×	×	○	SubSection 15.3.12
Sequence program all clear		×	×	×	○	SubSection 15.3.13
PLC diagnostics		○*1	○	○	○	SubSection 15.3.14
Parameter setting		×	×	×	○	SubSection 15.3.15

*1 When the 2nd keyword is set to an FX PLC that supports 2nd keyword, it becomes "×" (cannot be used).

*2 The names within the parentheses () are for when a keyword + 2nd keyword is set.

2 Operation

OP → [Keyword setup] → GO

↓ OP → Select [Keyword setup] with ▲ or ▼.

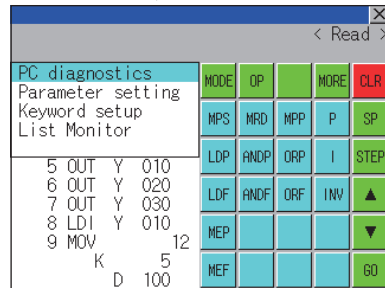

↓ GO

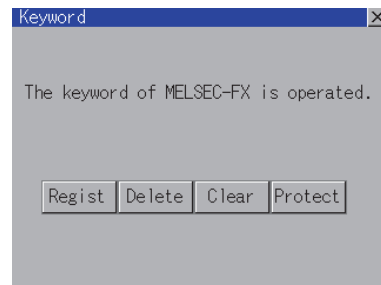

3 Keyword screen and protection level

When [Keyword setup] is selected with the MELSEC-FX list editor, the keyword screen is displayed. Refer to the following manual for the procedure for keyword operations.

☞ Section 11.4 Keyword

Remark

Keywords

Refer to the following manual for details of keyword.

☞ Programming manual for the FX PLC used

15.3.17 List monitor

The status of contacts and coils in a sequence program is displayed.

1 Operation

[OP] → [List Monitor] → [GO]

↓
[OP] → Select [List Monitor] with ▲ or ▼.

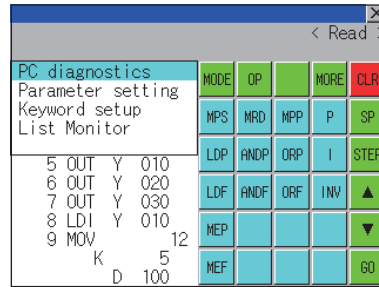

↓
[GO]

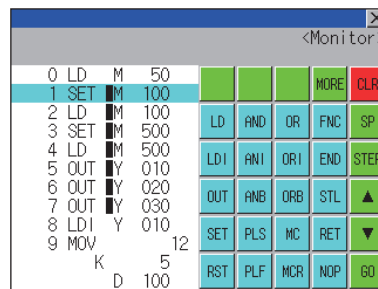

When the list monitor is started on the FX list editor screen, the step numbers displayed on the FX list editor screen is displayed on the list monitor screen.

Point

Starting list monitor with special function switches (FX list monitor)

With setting special function switches (FX list monitor), the list monitor can be started on the monitor screen.

When the list monitor is started on the monitor screen, the list editor cannot be used. For how to set special function switches, refer to the following manual.

☞ GT Designer2 Version □ Screen Design Manual

GT Designer3 Version1 Screen Design Manual (Functions)

2 Displays and key functions

The following describes the displays for the list monitor.

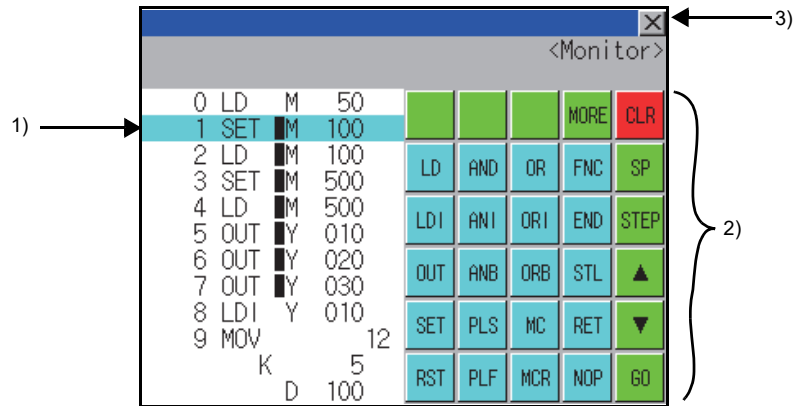

No.	Item	Display contents
1)	List display area* ¹	The status of contacts and coils is displayed on the left of device displays.
2)	Keys	The same operations as in the READ mode of the FX list editor can be executed. (SubSection 15.3.8 Sequence program display)
3)		Ends the list monitor. When the list monitor is executed on the FX list editor screen, the screen is switched to the FX list editor screen.

*1 The status of contacts and coils is displayed as below.

Type of instruction	Description	Status	
		<input type="checkbox"/> Displayed	<input type="checkbox"/> Not displayed
LD, AND, OR(Contact instruction (Normal open))	Contact	ON	OFF
LDI, ANI, ORI(Contact instruction (Normal close))	Contact	OFF	ON
OUT, SET	TC: Coil	ON	OFF
	Except TC: Contact	ON	OFF
RST	TC: Reset	ON	OFF
	Word device	Value: 0	Value: Except 0
	Except TC and word device: Contac	OFF	ON
MC, STL	Contact	ON	OFF
LDP, ANDP, ORP, LDF, ANDF, ORF (Rise or fall contact instruction)	Not monitored	Always <input type="checkbox"/> not displayed	

15.3.18 Action for an incorrect key input



If an incorrect key is input, cancel the input contents.

1 Operation

- (1) Before touching the **GO** key (before reading/writing the input contents)
Before touching the **GO** key, touch the **CLR** key.
- (2) After touching the **GO** key (after reading/writing the input contents)
Write the command again. ( SubSection 15.3.10 Writing commands)
Commands finalized by writing and inserting operations are revised (overwritten) with the program writing.

15.3.19 Error Messages and Corrective Actions

This section describes the error messages displayed when the MELSEC-FX list editor is executed, and corrective action.

Error Message	Description	Corrective action
Can not display while protected.	The all-operation protect, anti-plagiarism, or incorrect write protect keyword is set.	<ul style="list-style-type: none"> · Check the protected operation. · Clear the keyword protection or delete the keyword.  SubSection 15.3.16 Keywords
Can not operate while protected.		
PLC parameter error.	An FX PLC parameter is defective.	Set correct parameters in the FX PLC.
PLC communications error.	The communication with the FX PLC is defective.	<ul style="list-style-type: none"> · Check the FX PLC, cable, and GOT for abnormality. · Check whether the communication settings are correct or not.
PLC is running.	A writing operation etc. has been made while the FX PLC is running.	Stop the FX PLC.
Can not write.	<ul style="list-style-type: none"> · The memory to write to is EPROM. · The protect switch of the EEPROM is on. 	<ul style="list-style-type: none"> · Set other than EPROM for the memory to write to. · Switch off the protect switch of the EEPROM.
Step number is out of a range.	The specified step number exceeded the maximum number.	Specify a step number below the maximum value.
Not found.	The specified command cannot be found.	Proceed to the next operation.
Not found.	The specified device cannot be found.	Proceed to the next operation.
Step overflow.	The program may exceed the available space. (Writing is not executed.)	Check the program memory space and delete commands to keep it within the space.  SubSection 15.3.12 Deleting commands
Command error.	An invalid command (non-existent command) was specified.	Input the correct command.



How to erase an error message

An error message is not erased even if the cause of the error is eliminated.
To erase an error message, touch a key on the MELSEC-FX list editor screen.

15.4 FX3U-ENET-ADP Communication Setting Function

In GX Works2, the communication set value of the FX3U-ENET-ADP stored in the CPU can be changed. This function is not available when the communication set value of the FX3U-ENET-ADP is not set in advance in the CPU.



Communication setting in the CPU

In GX Works2, set in advance the communication set value of the FX3U-ENET-ADP to the CPU.

For the details of the communication setting, refer to the following.

[FX3U-ENET-ADP User's manual](#)

15.4.1 SPECIFICATIONS

1 System configuration

This section describes the system configuration of the FX3U-ENET-ADP communication setting function.

For the setting method in each connection form, used communication unit/cable and cautions on connection form, refer to the following manual.

[GOT1000 Series Connection Manual](#)

2 Required OS

OS		Version
Standard monitor OS		01.31.** or later
Communication driver	MELSEC-FX	01.13.** or later



Checking method of OS, Communication driver version

Check the version of OS or communication driver installed in GOT at [OS information] of the utility.

Refer to the following for details.

[Section 14.2 OS Information](#)

3 Connection forms

(○: Available, ×: Unavailable)

Name	Function Description	Connection form between GOT and PLC	
		Direct CPU connection	GOT multidrop connection
FX3U-ENET-ADP Communication Setting Function	The communication set value of the FX3U-ENET-ADP stored in the CPU can be changed.	○	×

4 Communication setting items

The table below shows the communication setting items and setting range.

Communication setting items	Setting range	Remark
IP address	0.0.0.1 to 223.255.255.254	If a value outside the setting range is entered, the error message "SET NUMBER IS INCORRECT." appears.
Subnet mask pattern ^{*1}	192.0.0.0 to 255.255.255.252	
Default router IP address ^{*1}	0.0.0.1 to 223.255.255.254	

^{*1} Set the value "0.0.0.0" when not using the subnet mask pattern and default router IP address.

15.4.2 Display Operation of FX3U-ENET-ADP Communication Setting Function

This section describes an example of display operation using GT1020.

Main Menu(For GT1020)

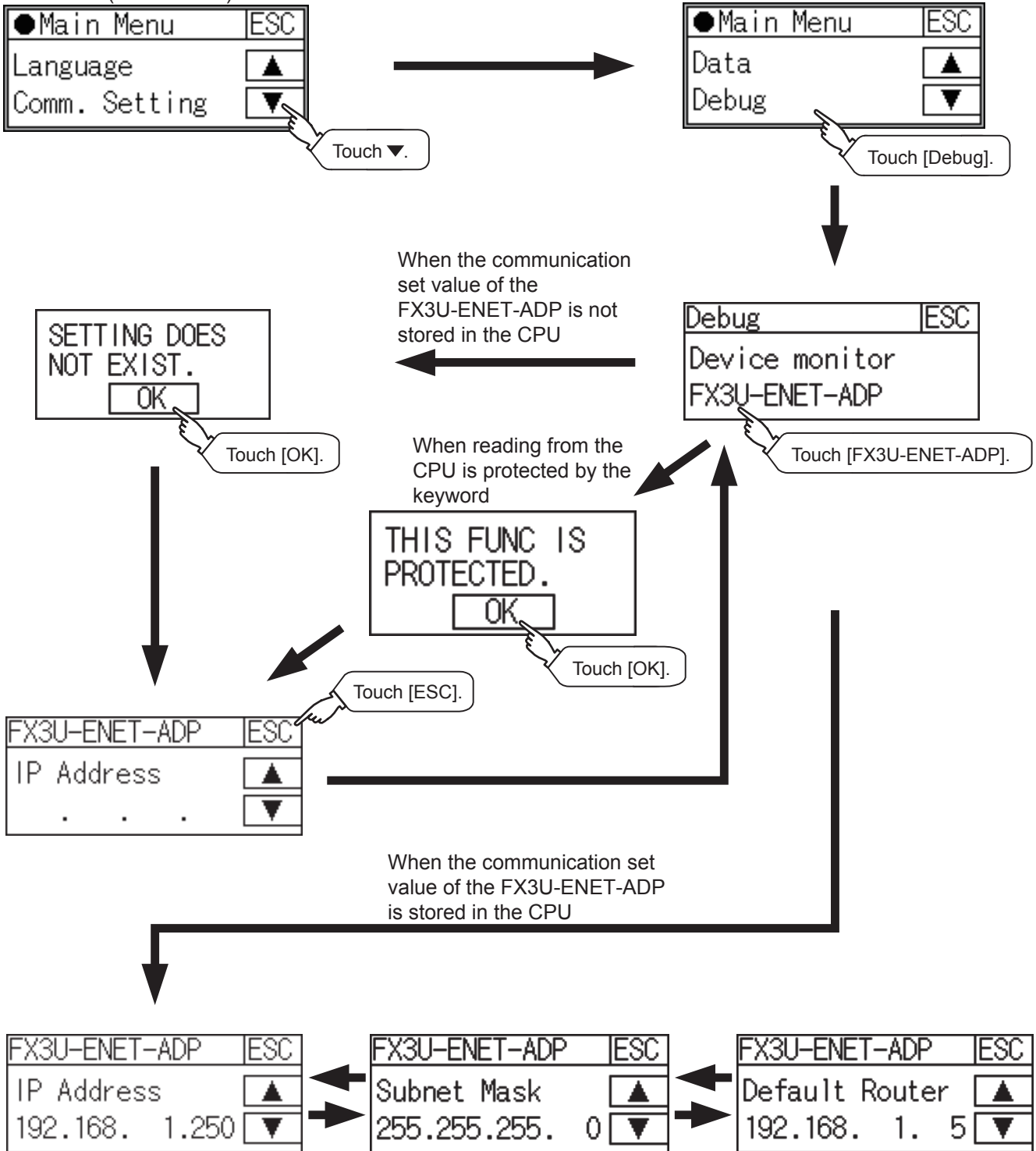

(Select a setting item by touching the scroll keys [▲][▼].)

15.4.3 Setting operation

This section describes an example of setting the IP address using GT1020.

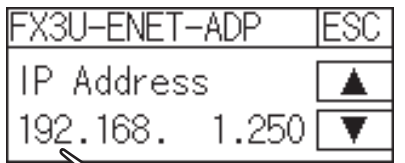

Touch the numerical part of the octet to be changed.

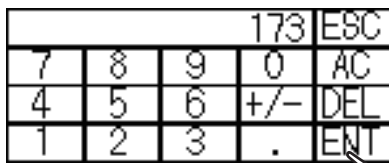

Touch

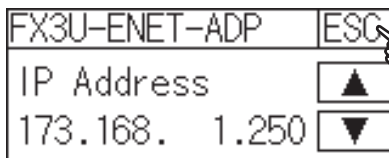

Touch [ESC].

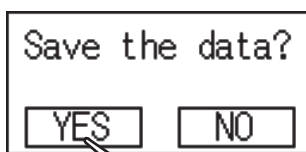

Touch [YES].

- 1 Touch the numerical part of the octet to be changed among the 1st to 4th octets.
- 2 When the ten-key pad appears, enter a numerical value in up to 3 digits, and touch the **ENT** key.
If a numerical value outside the setting range is entered, the following error message appears. Enter a numerical value again.

SET NUMBER IS
INCORRECT.
OK

For the details of the setting range, refer to the following.

SubSection 15.4.1 SPECIFICATIONS
- 5 The changed IP address is displayed.
At this time, the changed communication set value of the FX3U-ENET-ADP is not written to the CPU.
Touch the **ESC** key.
- 4 When the screen shown on the left appears, touch the **YES** key.

Continued to next page

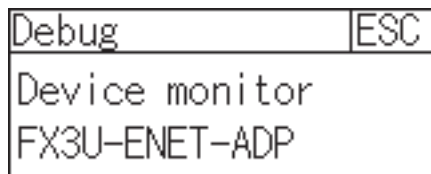

- 5 When the screen shown on the left appears, the changed communication set value of the FX3U-ENET-ADP is written normally to the CPU.

For making valid the contents of setting, turn OFF the power of the CPU, and then turn it ON again.

Change the setting of the subnet mask pattern and default router IP address using the same procedure if necessary.

An error message appears in the following cases.

Touch the key to return to the step ①, and perform the setting procedure again.

- When the CPU is running
The following error message appears.
Stop the running status of the CPU.

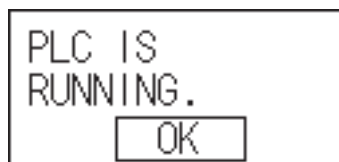

- When a communication error occurs
Set the communication between the GOT and the CPU to the normal status.



- When the memory cassette is write-protected
Set to OFF the write-protect switch of the memory cassette.

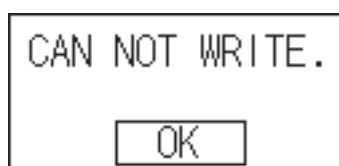

- When writing to the CPU is protected by the keyword
Clear the protection by the keyword against writing.



Point

When the CPU stores the symbolic information

When the setting such as IP address is changed using this function and then the program is read by the programming tool from the CPU that stores the symbolic information, the following warning appears. However, the changed value is read correctly. Convert and compile the project again.

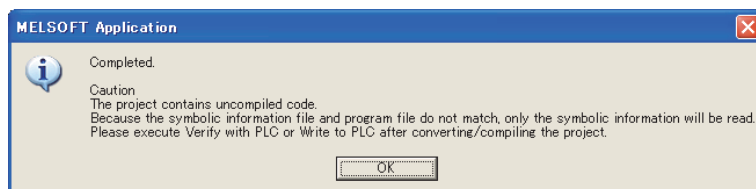

16. CLEANING OF DISPLAY SECTION (CLEAN)

In utility, the screen can be set as not to be effected by touching the screen when clean with clothes.
For cleaning method, refer to "Section 18.3 Cleaning Method".

16.1 Clean

16.1.1 Display operation of clean

Main Menu

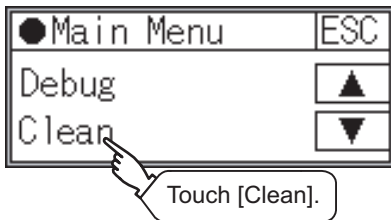

- 1 Touch [Clean] to bring up the setting window.

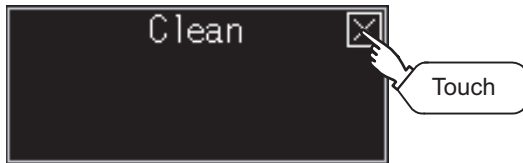

- 2 Touching  key closes the screen.
Even if touch points other than the upper left corner and upper right corner of the screen, the GOT does not operate.

For details of cleaning method, refer to the following.

 Section 18.3 Cleaning Method

17. OS INSTALLATION

17.1 About the OS

GT10□□ is factory-installed with the BootOS, Standard monitor OS, and communication driver ([MELSEC-FX]). Standard monitor OS is upgradeable from drawing software. An installation of the communication driver is required when connected to a controller other than a MELSEC-FX. (BootOS cannot be installed from drawing software.)

17.2 Standard monitor OS/ Communication Driver Installation

When installing the Standard monitor OS or communication driver, first bring up the OS installation screen on the GOT, and then install the communication driver from drawing software.

Point

(1) About the OS installation screen

The OS can be transferred from GT Designer2 or GT Designer3 without displaying the OS installation screen depending on the combination of the GOT and the standard monitor OS

Model	BootOS version	Standard monitor OS	GT Designer2	GT Designer3
GT1020	BootOS version F or later	Standard monitor OS [01.08.00] or later	Version2.77F or later	From the first version
GT1030	BootOS version F or later			
GT104□	From the first version		Version2.90U or later	
GT105□	From the first version		Version2.90U or later	

For the installation using drawing software, refer to the following chapter.

☞ GT Designer 2 Version□ Basic Operation/Data Transfer Manual
GT Designer 3 Version1 Screen Design Manual (Fundamentals)

(2) Checking method of BootOS, Standard monitor OS version

(a) Check the version of BootOS or Standard monitor OS installed in GOT at [OS information] of the utility.

Refer to the following for details.

☞ Section 14.2 OS Information

(b) Check the version of BootOS installed in GOT at product shipment on the rating plate on GOT rear face.

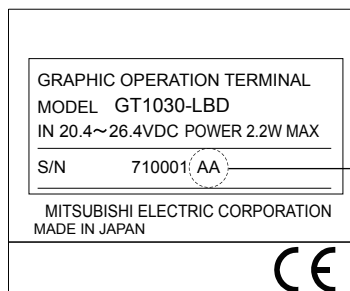

AA → BootOS Version

When the Boot OS version is 2 digits, only the lower digit is printed.
Example H/W version: H
Boot OS version: AD
↓
Rating plate: HD

1 Operation on the OS installation screen

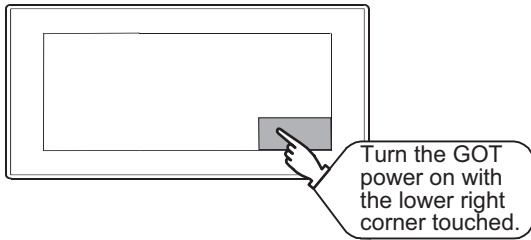

- 1 Turn on the power while pressing and holding the bottom right corner of the screen.



- 2 The OS installation screen will appear.

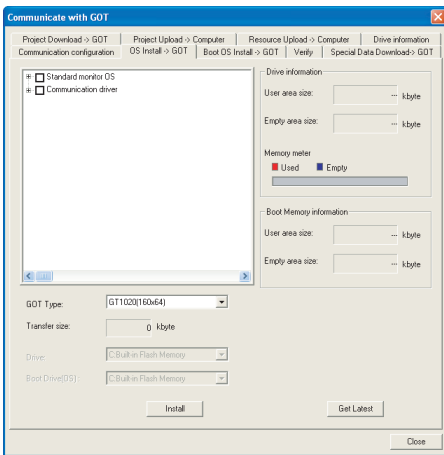

- 3 Install the Standard monitor OS and communication driver from drawing software. Refer to the chapter below for how to install the Standard monitor OS and communication driver from drawing software.



GT Designer2 Version□

Basic Operation/Data Transfer Manual

GT Designer3 Version1

Screen Design Manual (Fundamentals)

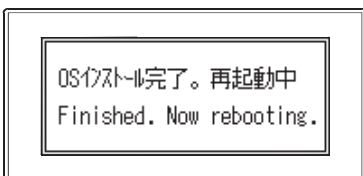

- 4 At the completion of Standard monitor OS/communication driver installation, the GOT reboots itself and the user-created screen will appear.

If no project data exist, a dialog will appear indicating that no project data exist.

Point

Checking the communication driver version

Some versions of the Standard monitor OS and communication driver may not be compatible with each other, and the communication driver may not function properly. (e.g., The version of the Standard monitor OS is too old to recognize the newer version of the communication driver.)

The Standard monitor OS checks the version of the communication driver to see if it is compatible. If it is not compatible, a dialog that recommends Standard monitor OS update will appear.

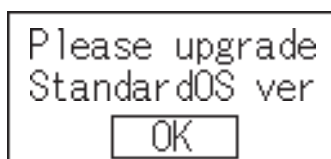

Touching the button will take the screen back to the utility display screen. Normal operation of the unit will require an update of the Standard monitor OS.

17.3 Standard Monitor OS/Communication Driver Installation Using Memory Board

The memory board can be used only for GT104□, GT105□.

There are the following two types for the standard monitor OS, communication driver installation using memory board.

- (1) Installation method when the GOT is turned on
For 2-point press: When the GOT is turned on, all the OS and project data stored in the memory board are transferred to the GOT.
For 1-point press: Use this method to transfer the OS and project data stored in the memory board to the GOT after selecting the copy direction and copy target when the GOT is powered ON.
- (2) Installation using GT10-50FMB function (utility)
Select OS or project data stored in the memory board, and then transfer it to the GOT using the utility function.
For details of GT10-50FMB function, refer to the following.

 Section 14.5 GT10-50FMB

17.3.1 Installation method when the GOT is turned on

1 Operation procedure

- For 2-point press

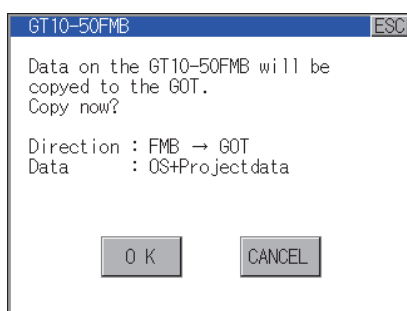
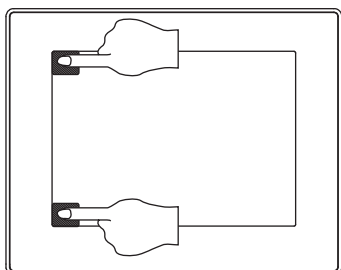

- 1 Power OFF the GOT, and attach the memory board which stores the standard OS and communication driver to the GOT.
- 2 While touching the upper left corner and lower left corner of the GOT screen, power ON the GOT.
- 3 The screen on the left is displayed.

Touch the [OK] button to start the installation, and [CANCEL] for the cancellation.

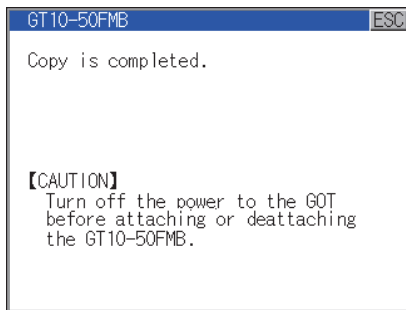
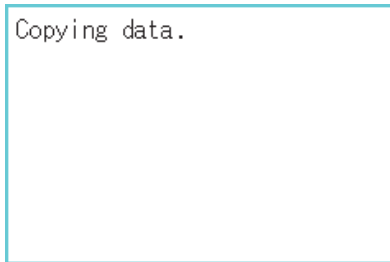
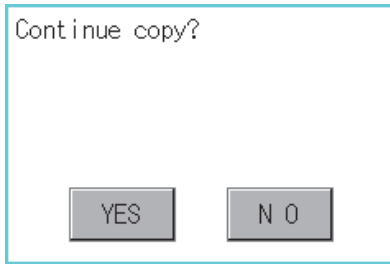

4 The dialog box on the left is displayed for confirmation.
Touch [YES] button to start the installation, and [NO] to abort.

5 While the installation is executed, the dialog box on the left is displayed.

6 Installation is completed.
Touch the ESC button to restart the GOT and displays the user-created to screen.
(If the project data does not exist, a message appears to notify that the project data does not exist.)

If an error occurs during copy, an error message appears.

For details of error messages, refer to the following.

☞ Section 14.5.4 Error display

• For 1-point press

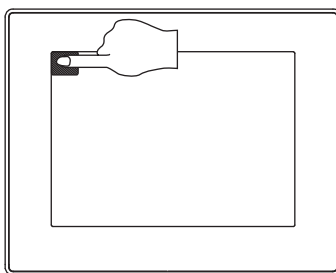

1 Power OFF the GOT, and attach the memory board which stores the standard OS and communication driver to the GOT.

2 While touching the upper left corner of the GOT screen, power ON the GOT.

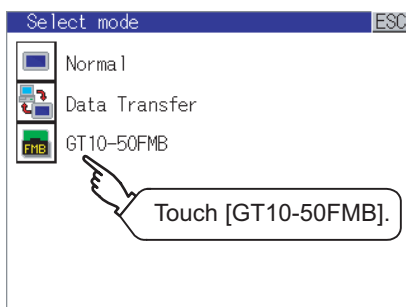

3 When the [Select mode] window appears, select the [GT10-50FMB].

For details of install, refer to the following.

☞ Section 14.5.3 GT10-50FMB operation

18. MAINTENANCE AND INSPECTION

STARTUP AND MAINTENANCE PRECAUTIONS

WARNING

- When power is on, do not touch the terminals.
Doing so can cause an electric shock or malfunction.
- Connect the battery correctly.
Do not discharge, disassemble, heat, short, solder or throw the battery into the fire.
Incorrect handling may cause the battery to generate heat, burst or take fire, resulting in injuries or fires.
- Before starting cleaning or terminal screw retightening, always switch off the power externally in all phases.
Not switching the power off in all phases can cause a unit failure or malfunction.
Undertightening can cause a short circuit or malfunction.
Overtightening can cause a short circuit or malfunction due to the damage of the screws or unit.

STARTUP AND MAINTENANCE PRECAUTIONS

CAUTION

- Do not disassemble or modify the unit.
Doing so can cause a failure, malfunction, injury or fire.
- Do not touch the conductive and electronic parts of the unit directly.
Doing so can cause a unit malfunction or failure.
- The cables connected to the unit must be run in ducts or clamped.
Not doing so can cause the unit or cable to be damaged due to the dangling, motion or accidental pulling of the cables or can cause a malfunction due to a cable connection fault.
- When unplugging the cable connected to the unit, do not hold and pull the cable portion.
Doing so can cause the unit or cable to be damaged or can cause a malfunction due to a cable connection fault.
- Do not drop or apply any impact to the battery.
If any impact has been applied, discard the battery and never use it.
The battery may be damaged by the drop or impact.
- Before touching the unit, always touch grounded metal, etc. to discharge static electricity from human body, etc.
Not doing so can cause the unit to fail or malfunction.

DISPOSAL PRECAUTIONS

CAUTION

- When disposing of the product, handle it as industrial waste.

The GOT does not include consumable components that will cause the shorten life.
However, the battery(For GT1030, GT104□, GT105□), liquid crystal screen and backlight(For GT105□) has life length.
(For the replacement of the liquid crystal screen, please consult your nearest sales office or FA center.)
For the battery, refer to the following.

 Section 3.2 Performance Specifications

For the life of the LCD screen or backlight, refer to the following.

 Section 3.2 Performance Specifications

18.1 Daily Inspection

Daily inspection items

No.	Inspection Item		Inspection Method	Criterion	Action
1	GOT mounting status		Check for loose mounting screws.	Securely mounted	Retighten screws within the specified torque range
2	Connection status	Loose terminal screws	Retighten screws with screwdriver	Not loose	Retighten terminal screws
		Loose connectors	Visual check	Not loose	Retighten connector fixing screws
3	Usage status	Dirt on protection sheet	Visual check	Not outstanding	Replace with new one
		Foreign material attachment	Visual check	No foreign matter sticking	Remove clean

Refer to the following for the model names of the protection sheet or the replacement procedure.

 Section 8.1 Protective Sheet

18.2 Periodic Inspection

Yearly or half-yearly inspection items

The following inspection should also be performed when equipment has been moved or modified or the wiring changed.

No.	Inspection Item		Inspection Method	Criterion		Action
1	Surrounding environment	Ambient temperature	Make measurement with thermometer or hygrometer Measure corrosive gas	Display section	0 to 50°C	For use in control panel, temperature inside control panel is ambient temperature
		Ambient humidity		Other portions	0 to 55°C	
		Atmosphere		10 to 90%RH		
				No corrosive gas		
2	Power supply voltage check		24VDC Measure voltage across terminals.	20.4 to 26.4VDC		Change supply power
3	Mounting status	Looseness	Move module	Should be mounted firmly		Retighten screws
		Dirt, foreign matter	Visual check	No dirt, foreign matter sticking		Remove, clean
4	Connection status	Loose terminal screws	Retighten screws with screwdriver	Not loose		Retighten terminal screws
		Loose connectors	Visual check	Not loose		Retighten connector fixing screws
5	Battery		Check the "Battery voltage" by using the "Time setting" function in the utility.  Section 13.1 Time Setting and Display	(Preventive maintenance)		Replace with new battery when the current battery has reached the specified life span, even if battery voltage is not displayed.

18.3 Cleaning Method

Use the GOT always in a clean condition.

To clean the GOT, wipe the dirty part with a soft cloth using neutral detergent.

For the display operation of the [Clean] screen, refer to the following.

 Chapter 16 CLEANING OF DISPLAY SECTION (CLEAN)

Point

Precautions for cleaning

Do not use chemicals such as thinner, organic solvents and strong acids, since they may cause the protective sheet to be deformed or the dissolvable paint on the surface to peel off.

In addition, do not use spray solvents since they may cause the electrical failure of the GOT and peripheral devices.

18.4 Battery Voltage Low Detection and Battery Replacement

1 Low battery voltage detection and replacement

The battery (For GT1030, GT104□, GT105□) is used for backing up the clock data, alarm history or recipe data.

It is recommended that you replace battery periodically.

Refer to the following for the replacement procedure.

☞ Section 8.3 Battery

The battery voltage low detection can be confirmed by the utility screen and system alarm.

Refer to the following for details of the battery status display by the utility screen.

☞ Chapter 13 CLOCK SETTINGS AND BATTERY STATUS DISPLAY (TIME SETTING AND DISPLAY)

Point

Battery replacement timing

When detecting voltage low, replace the battery immediately.

Data can be saved for approximately a month after the battery voltage low detection and cannot be saved after that.

If it exceeds a month from the voltage low detection to battery replacement, the clock data or D-drive* (Internal SRAM) data may become indefinite.

Adjust the clock and format the D drive (Internal SRAM).

* : GT1020 does not have D drive.

Point

Example of alarm output to external device (lamp, buzzer, etc.) [For GT1030, GT104□, GT105□]

The following describes an example of outputting the battery voltage low signal from a FX series PLC to an external device with system information.

Condition: The Write Device is "D20" and all data is used (the button is clicked on the setting screen of drawing software) for the system information assignment.

D36 b12: Battery voltage low (System Signal 2-2)

Turned on upon a battery voltage drop.

Used as shown below in the sequence program.

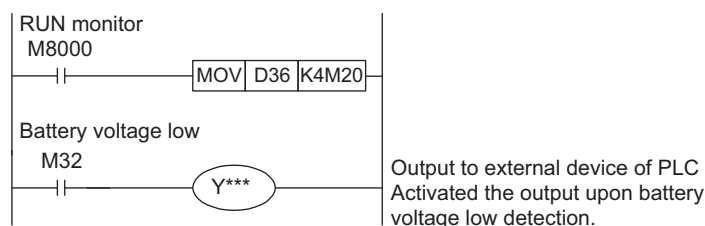

*** indicates the output number at which the external device is connected.

For details of system information, refer to the following.

☞ GT Designer2 Version□ Screen Design Manual
 GT Designer3 Version1 Screen Design Manual (Fundamentals)

2 Handling of Batteries and Devices with Built-in Batteries in EU Member States

This section describes the precautions for disposing of waste batteries in EU member states and exporting batteries and/or devices with built-in batteries to EU member states.

(1) Disposal precautions

In EU member states, there is a separate collection system for waste batteries. Dispose of batteries properly at the local community waste collection/recycling center.

The following symbol is printed on the batteries and packaging of batteries and devices with built-in batteries used for Mitsubishi Graphic Operation Terminal (GOT).



Symbol

Point

This symbol is for EU member states only.

The symbol is specified in the new EU Battery Directive (2006/66/EC) Article 20 "Information for end-users" and Annex II.

The symbol indicates that batteries need to be disposed of separately from other wastes.

(2) Exportation precautions

The new EU Battery Directive (2006/66/EC) requires the following when marketing or exporting batteries and/or devices with built-in batteries to EU member states.

- To print the symbol on batteries, devices, or their packaging
- To explain the symbol in the manuals of the products

(a) Labelling

To market or export batteries and/or devices with built-in batteries, which have no symbol, to EU member states on September 26, 2008 or later, print the symbol shown in (1) on the GOT or their packaging.

(b) Explaining the symbol in the manuals

To export devices incorporating Mitsubishi Graphic Operation Terminal to EU member states on September 26, 2008 or later, provide the latest manuals that include the explanation of the symbol.

If no Mitsubishi manuals or any old manuals without the explanation of the symbol are provided, separately attach an explanatory note regarding the symbol to each manual of the devices.

Remark

The requirements apply to batteries and/or devices with built-in batteries manufactured before the enforcement date of the new EU Battery Directive(2006/66/EC).

18.5 Backlight Shutoff Detection

The backlight is built into GOT(For GT105 □) for the liquid crystal display.

When GOT(For GT105 □) detects backlight shutoff, the POWER LED blinks green/orange alternately.

The brightness of the backlight decreases with the lapse of usage period. When backlight shutoff is detected or the display becomes unclear, replace the backlight.

For replacement of the backlight, contact your nearest sales office or FA Center.

(1) Life of backlight

The usable duration of backlight can be extended by setting to "Screen saving backlight off" in the utility of GOT (GOT set up).

Refer to the following for details.

☞ Chapter 12 DISPLAY AND OPERATION SETTINGS (GOT SET UP)

18.5.1 Backlight shutoff detection and external alarm

When the GOT(For GT105 □) detects a backlight shutoff, the system information set with drawing software is turned on.

You can issue a backlight shutoff of the GOT from the PLC to external devices (such as the lamp or buzzer), using system information.

To avoid any screen touch operation by the user who misunderstands it is in screen saving mode, install an external alarm and interlock the loads that would cause danger.

For details of the system information, refer to the following.

☞ GT Designer2 Version □ Screen Design Manual
GT Designer3 Version1 Screen Design Manual (Fundamentals)



Example of alarm output to external devices (such as lamp or buzzer)

The following provides an example of outputting the backlight shutoff detection signal from a FX Series PLC to an external device, using system information.

Condition: The Written Device is "D20" and all data is used (the button is clicked on the setting screen of drawing software) for the system information assignment.

D36 b14: Backlight shutoff detection (System Signal 2-2)

Turned on upon a backlight shutoff.

Used as shown below in the sequence program.

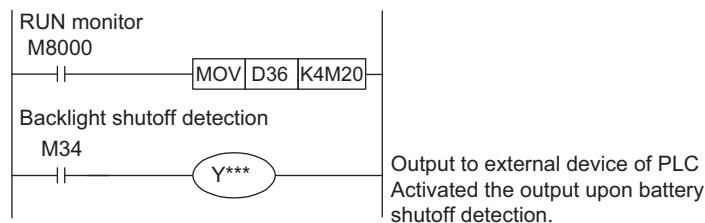

"***" indicates the output number at which the external device is connected.



Precautions for the backlight shutoff status

In the backlight shutoff status, the touch key operates.

APPENDICES

Appendix 1 External Dimensions

External dimensions of GT1020

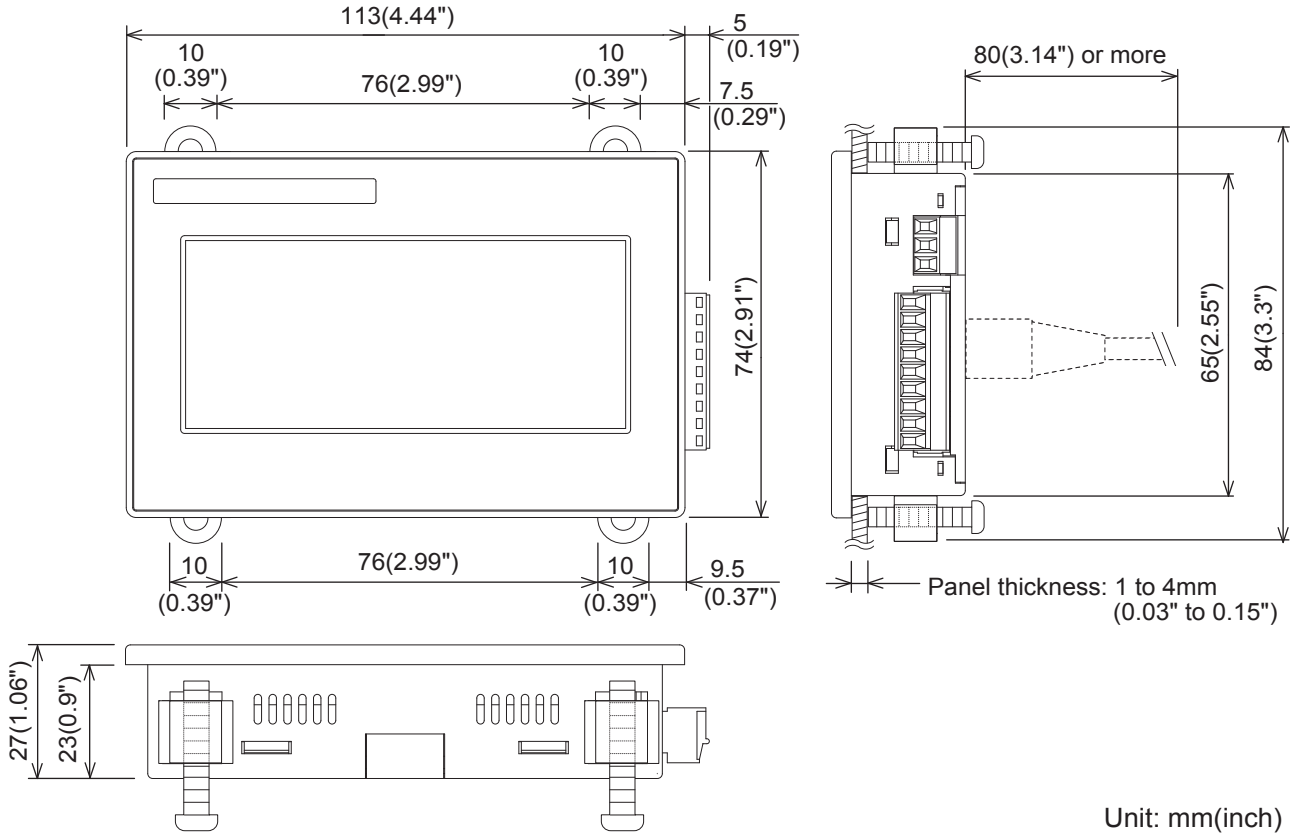

Unit: mm(inch)

External dimensions of GT1030

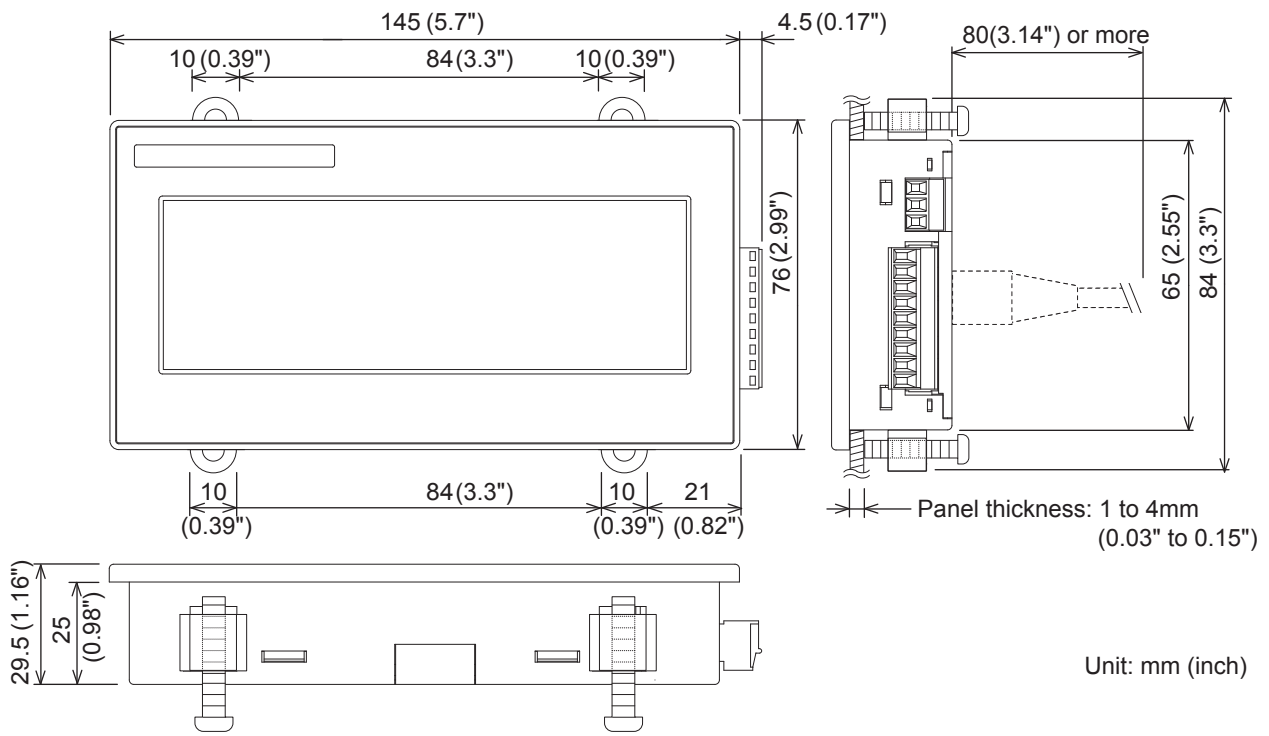

Unit: mm (inch)

External dimensions of GT104□

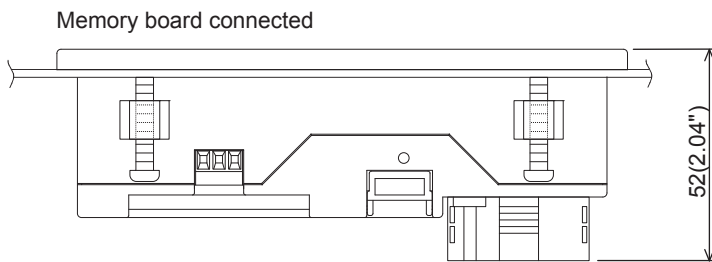
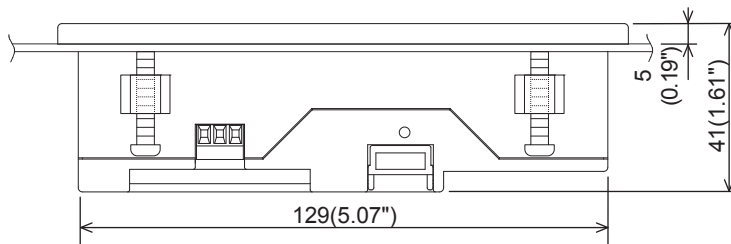
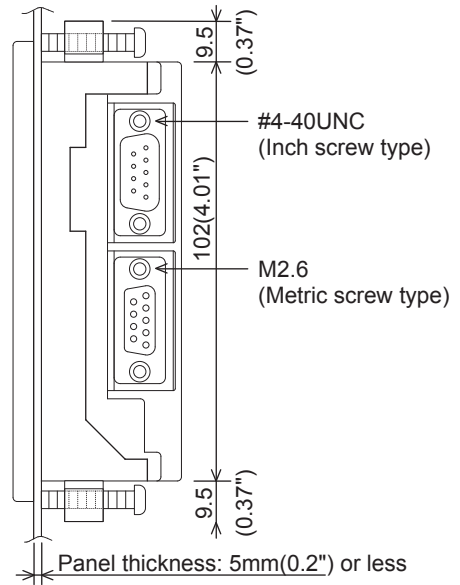
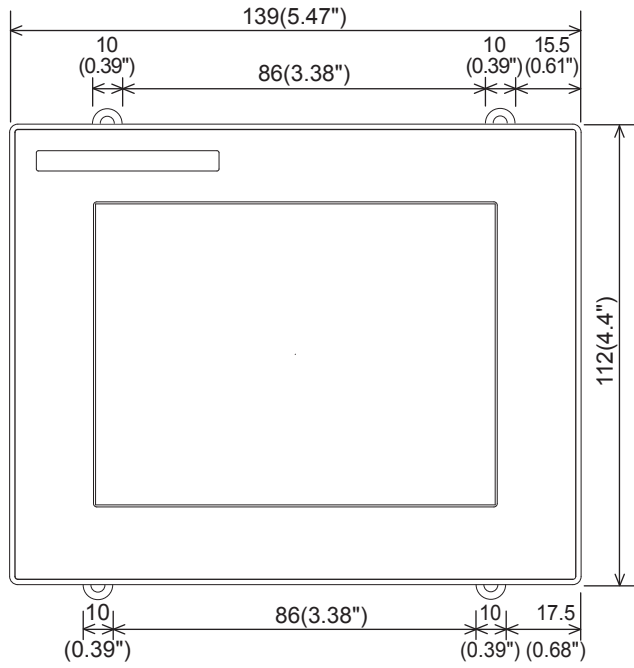

Unit: mm(inch)

External dimensions of GT105□

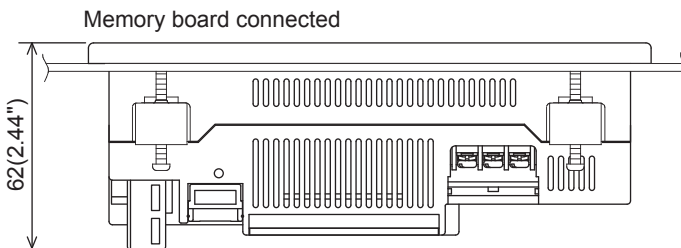
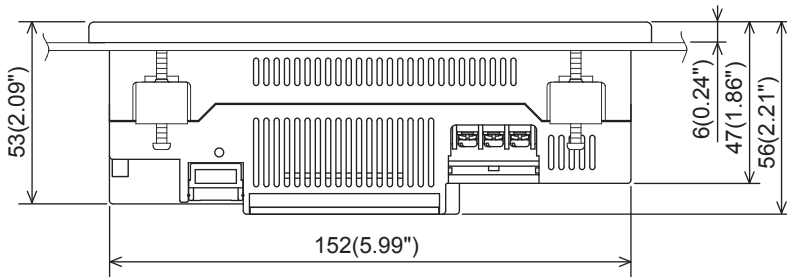
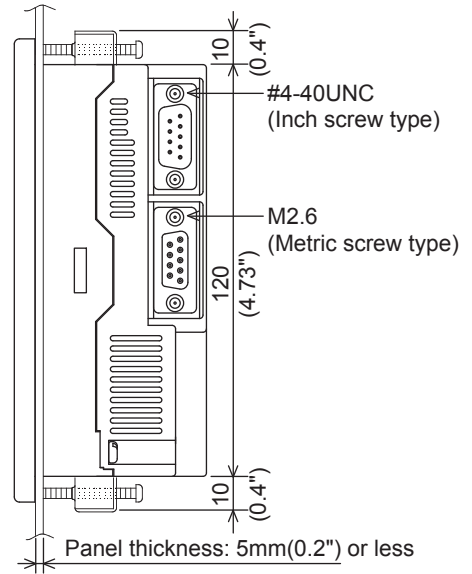
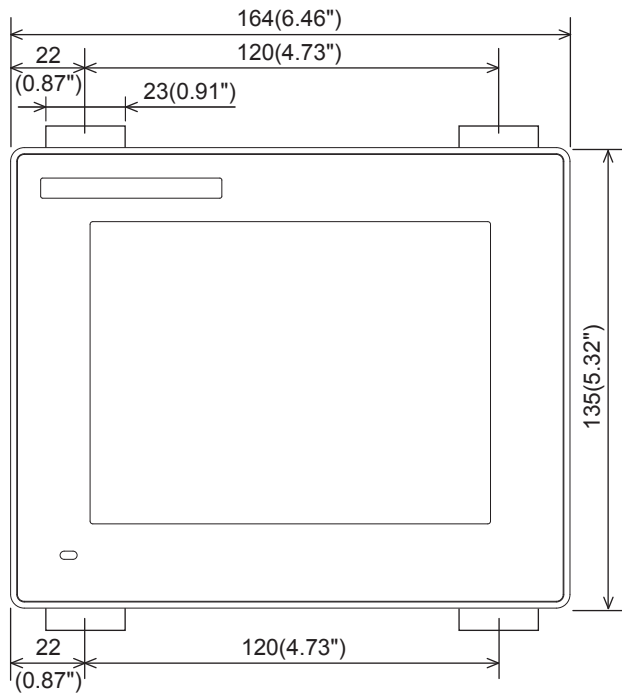

Unit: mm(inch)

External dimensions of communication cable

GT10-C□□R4-8P

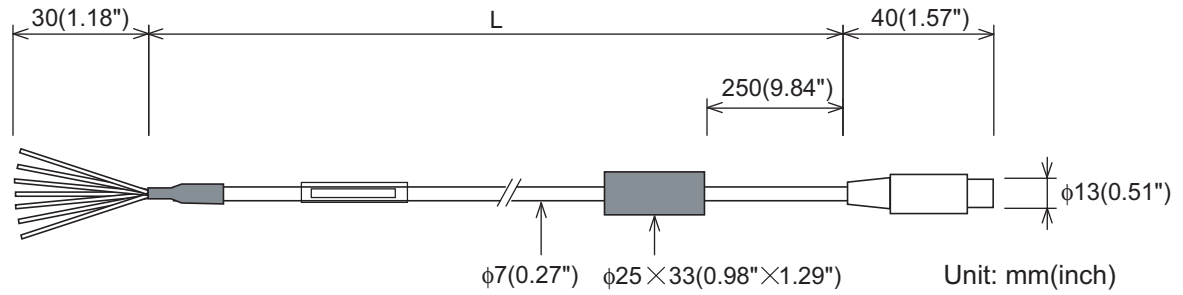

Model name	L (mm (inch))	Remarks
GT10-C10R4-8P	1,000 (39.37")	RS-422 cable for direct connection to FXCPU (8-pin MINI-DIN)
GT10-C30R4-8P	3,000 (118.11")	
GT10-C100R4-8P	10,000 (393.7")	
GT10-C200R4-8P	20,000 (787.4")	
GT10-C300R4-8P	30,000 (1181.1")	

GT10-C□□R4-8PC

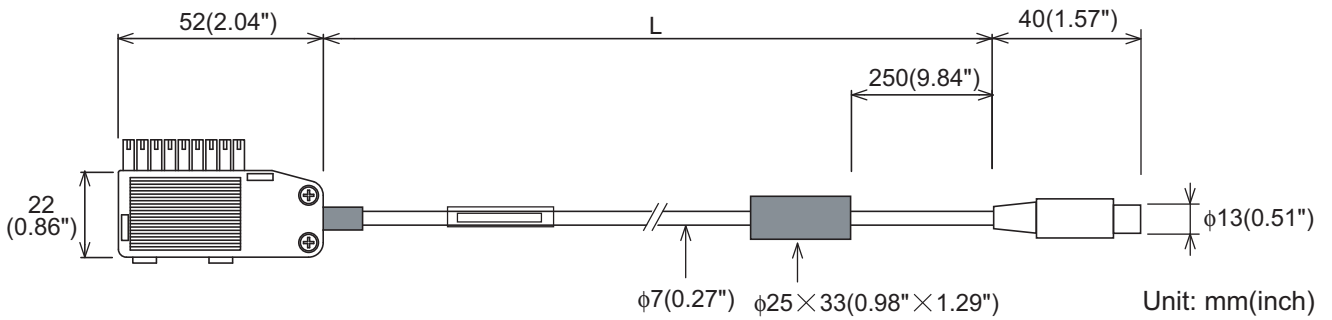

Model name	L (mm (inch))	Remarks
GT10-C10R4-8PC	1,000 (39.37")	RS-422 cable for direct connection to FXCPU (8-pin MINI-DIN)
GT10-C30R4-8PC	3,000 (118.11")	
GT10-C100R4-8PC	10,000 (393.7")	
GT10-C200R4-8PC	20,000 (787.4")	
GT10-C300R4-8PC	30,000 (1181.1")	

GT10-C□□R4-25P

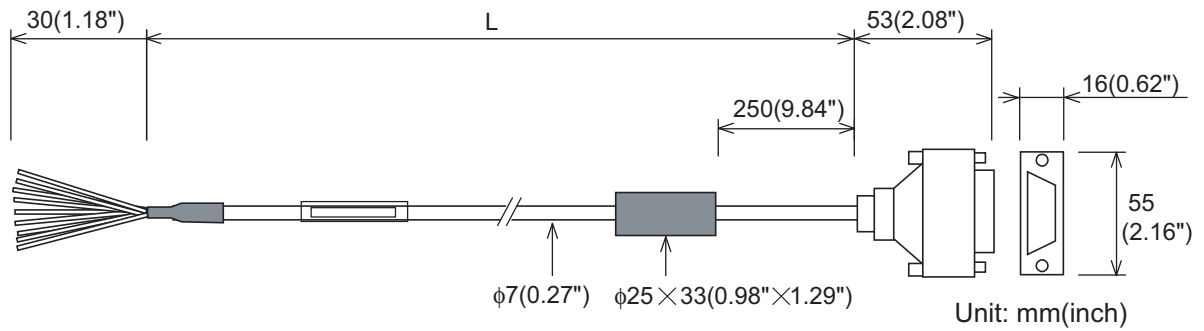

Model name	L (mm (inch))	Remarks
GT10-C30R4-25P	3,000 (118.11")	RS-422 cable for direct connection to FXCPU and A/QnACPU (25-pin D-sub)
GT10-C100R4-25P	10,000 (393.7")	
GT10-C200R4-25P	20,000 (787.4")	
GT10-C300R4-25P	30,000 (1181.1")	

GT10-C30R2-6P

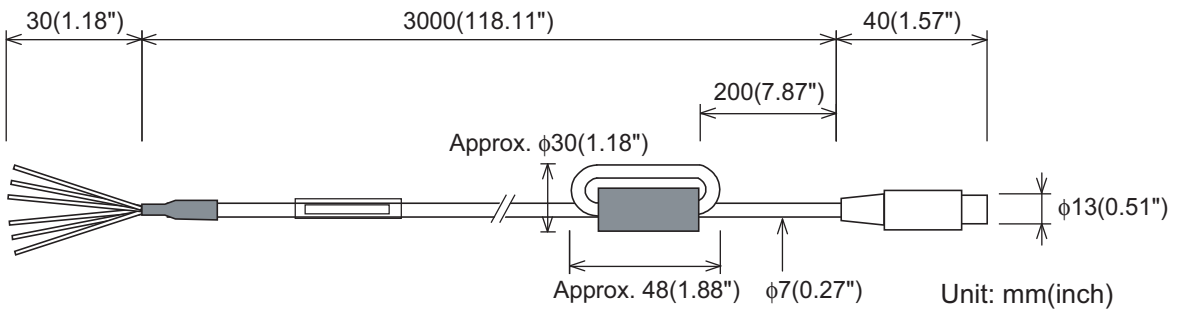

Model name	L (mm (inch))	Remarks
GT10-C30R2-6P	3,000 (118.11")	RS-232 cable for direct connection to QCPU (6-pin MINI-DIN)

GT10-C10R4-8PL

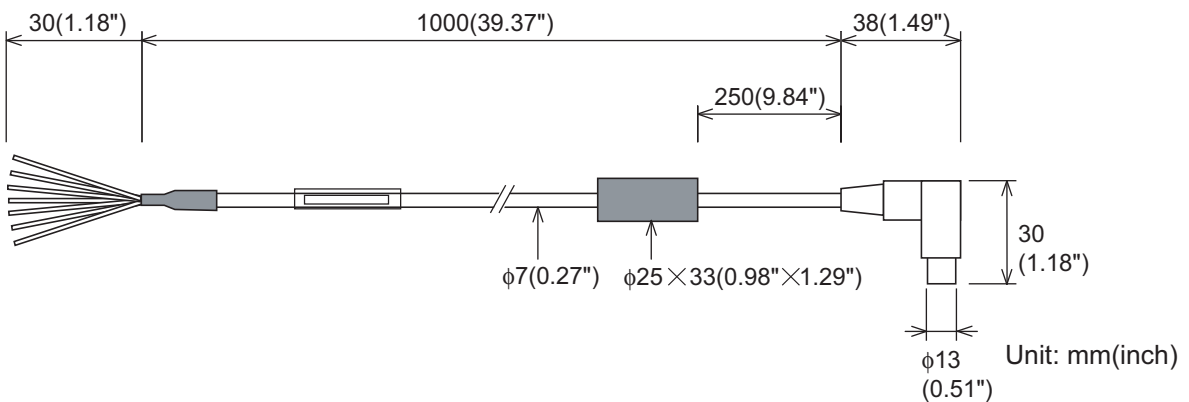

Model name	L (mm (inch))	Remarks
GT10-C10R4-8PL	1,000 (39.37")	RS-422 cable for direct connection to FXCPU (8-pin MINI-DIN)

GT01-C30R4-25P

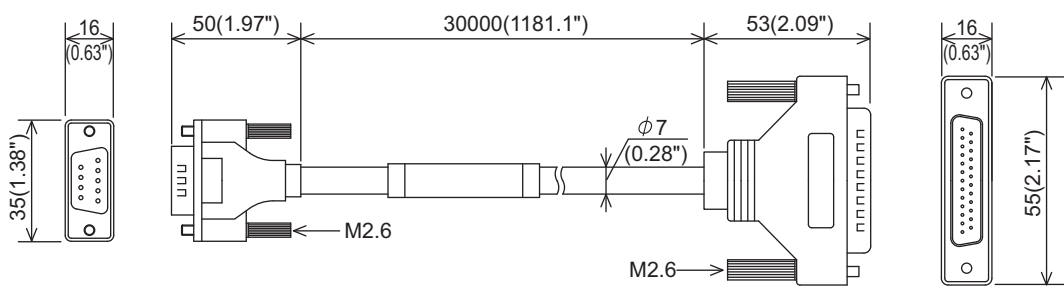

Unit: mm(inch)

Model name	L (mm (inch))	Remarks
GT01-C30R4-25P	3,000 (118.11")	RS-422 cable for direct connection to FXCPU and A/QnACPU (25-pin D-sub)

GT01-C□□□R4-25P

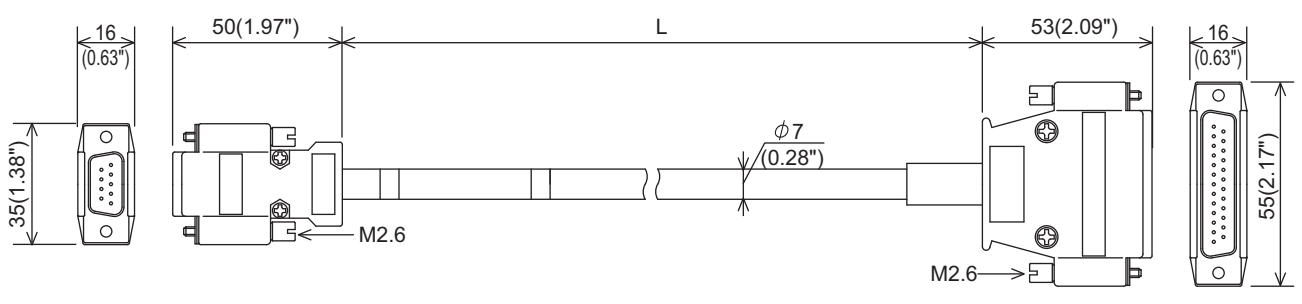

Unit: mm(inch)

Model name	L (mm (inch))	Remarks
GT01-C100R4-25P	10,000 (393.7")	RS-422 cable for direct connection to FXCPU and A/QnACPU (25-pin D-sub)
GT01-C200R4-25P	20,000 (787.4")	
GT01-C300R4-25P	30,000 (1181.1")	

GT01-C□□□R4-8P

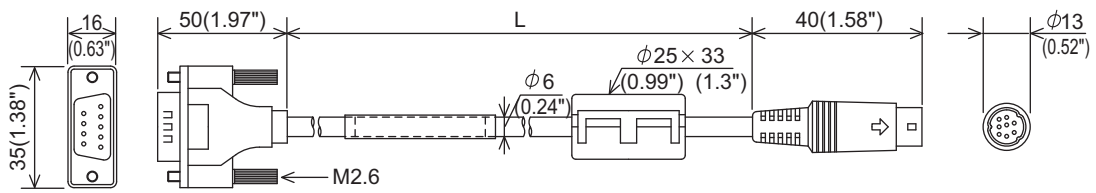

Unit: mm(inch)

Model name	L (mm (inch))	Remarks
GT01-C10R4-8P	1,000 (39.37")	RS-422 cable for direct connection to FXCPU (8-pin MINI-DIN)
GT01-C300R4-8P	3,000 (118.11")	
GT01-C100R4-8P	10,000 (393.7")	
GT01-C200R4-8P	20,000 (787.4")	
GT01-C300R4-8P	30,000 (1181.1")	

GT01-C30R2-25P

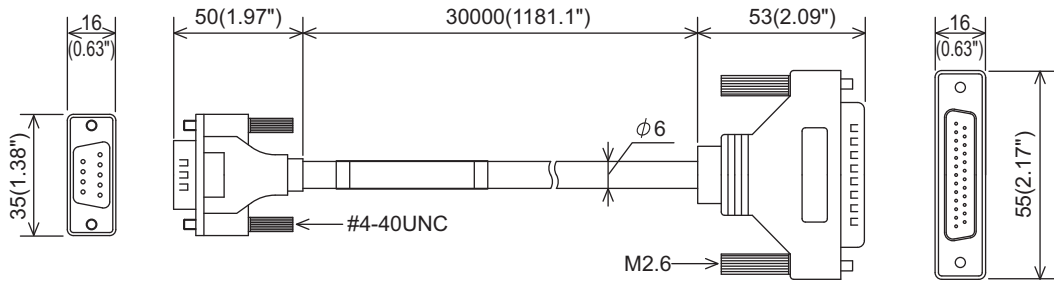

Unit: mm(inch)

Model name	L (mm (inch))	Remarks
GT01-C30R2-25P	3,000 (118.11")	RS-232 cable for direct connection to FXCPU special adaptor (25-pin D-sub)

GT01-C30R2-9S

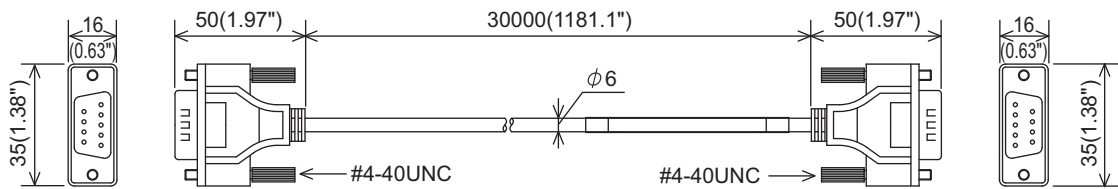

Unit: mm(inch)

Model name	L (mm (inch))	Remarks
GT01-C30R2-9	3,000 (118.11")	RS-232 cable for direct connection to FXCPU expansion board (9-pin D-sub)

GT01-C30R2-6P

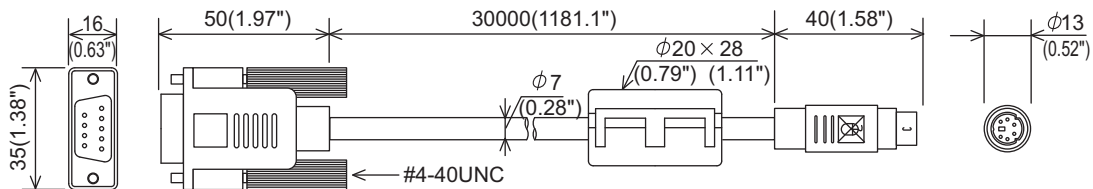

Unit: mm(inch)

Model name	L (mm (inch))	Remarks
GT01-C30R2-6P	3,000 (118.11")	RS-232 cable for direct connection to QCPU (6-pin MINI-DIN)

External dimensions of RS-232/USB conversion adaptor

GT10-RS2TUSB-5S

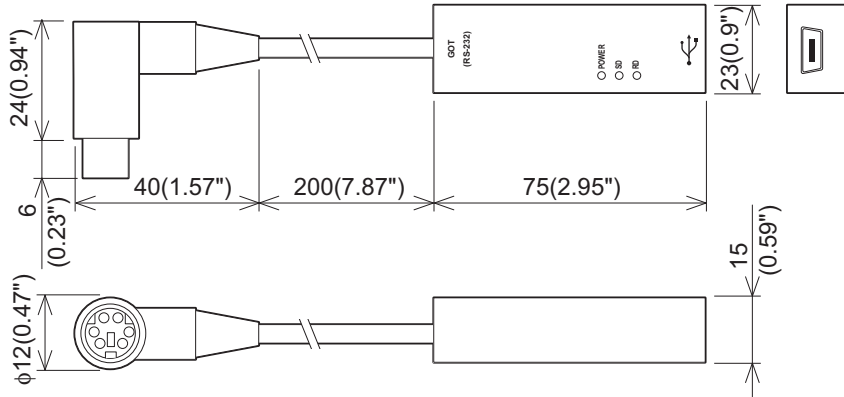

Unit : mm(inch)
Weight: Approx. 40g

External dimensions of GT10-LDR memory loader

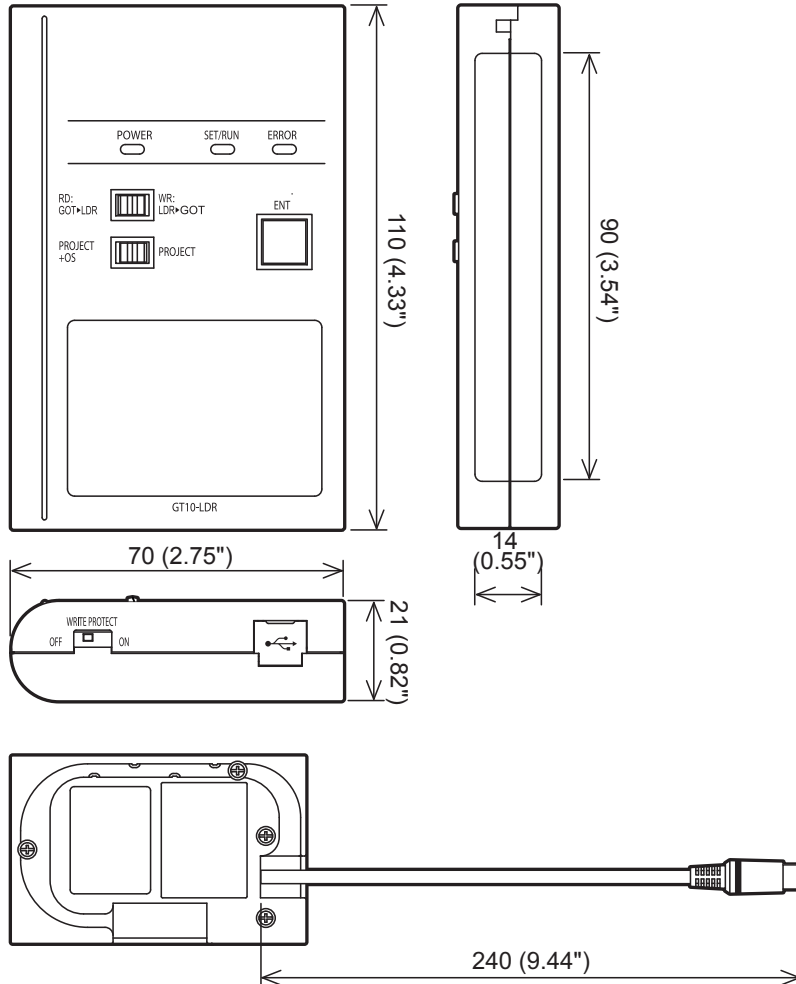

Unit: mm (inch)
Weight: 0.2kg

External dimensions of memory board

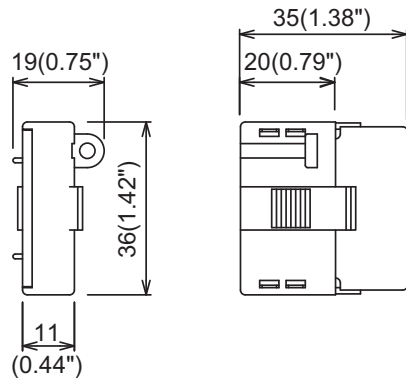

Unit: mm (inch)

External dimensions of debug stand

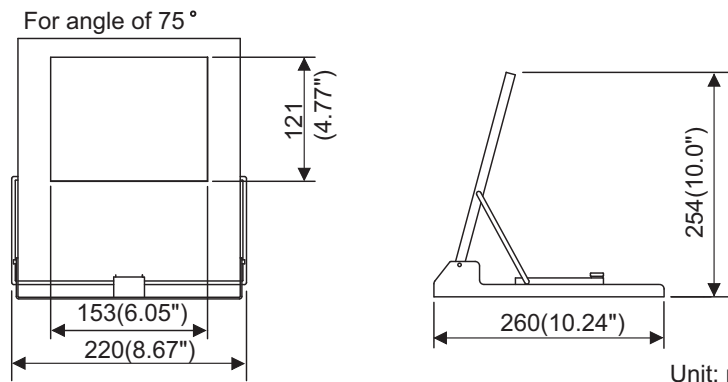

Unit: mm (inch)

External dimensions of serial multi-drop connection unit

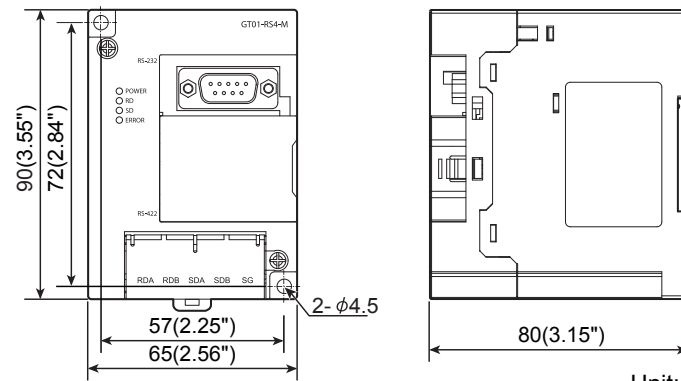

Unit: mm (inch)

External dimensions of connector conversion adapter

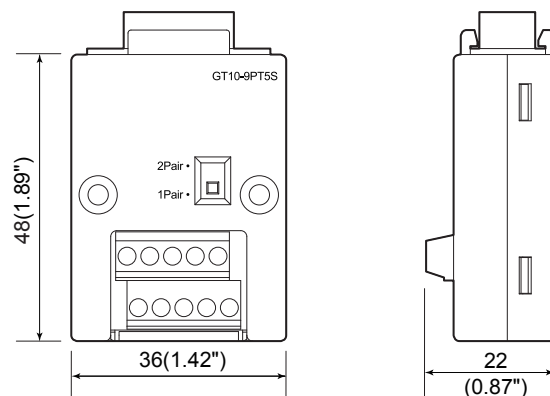

Unit: mm (inch)

External dimensions of panel-mounted USB port extension

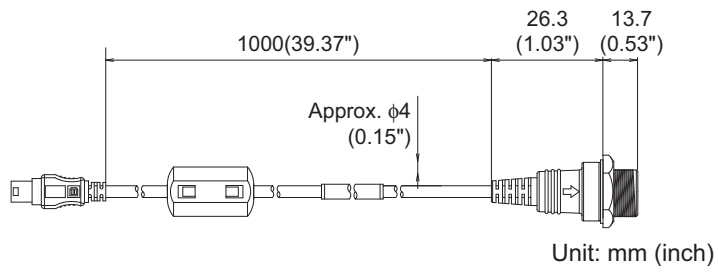

Appendix 2 Usage Condition of Utility Function

Different functions are available on the GOT and drawing software.

○ : Applicable × : Not Applicable

Setting items		Function	GT1020	GT1030	GT104□ GT105□	Drawing Setting (GT Designer2, GT Designer3)	
Language		Message language switching (Japanese/ English)	○	○	○	○	
Connection settings	Standard I/F	Detailed settings for the channel number and communication driver of the communication interface	○	○	○	○	
		Communication parameter display	×	×	×	○	
	Data Transfer	Displays the screen for transferring project data between the PC and GOT	○	○	○	×	
	Communication Monitor	Displays the status of the communication ports	○	○	○	×	
	Keyword	Setting related to a keyword of FX series PLC	○	○	○	×	
GOT Setup	Display	Screen save time setting	○	○	○	○	
		Screen save backlight ON/OFF setting	○	○	○	○	
		Opening time setting	○	○	○	○	
	bright/contrast	Liquid crystal brightness setting	×	○	×	×	
		Liquid crystal contrast setting	○	○	○	×	
	Operation	Buzzer volume setting	○	○	○	○	
		Correcting touch position reading error	○	×	×	×	
		Key reaction	Key reaction display	○	○	○	○
		Clock setting	Setup the method to adjust the time between GOT clock data and clock data of PLC CPU connected with GOT	○	○	○	○
		Security ^{*1}	Security level change (security password input of each object)	○	○	○	×
Utility call	Setting of the menu call key	○	○	○	○		
Time setting		Displaying the present time of the clock	○	○	○	×	
		Setting the present time of the clock	○	○	○	×	
		Displaying the battery status	×	○	○	×	
Data	OS information	Displays the version of the OS (Standard monitor OS, BootOS) and communication driver versions	○	○	○	×	
	Font data	Displays the font type	○	○	○	×	
	Clear data	Deletes project data and resource data	○	○	○	×	
	GT10-50FMB	Data transfer using a memory board	×	×	○	×	
Debug	Device monitor	Device monitor of PLC of intelligent module	○	○	○	×	
	FX list editor	List editing PLC program of FX PLC	×	×	○	×	

Setting items		Function	GT1020	GT1030	GT104□ GT105□	Drawing Setting (GT Designer2, GT Designer3)
Clean	Clean	Display the screen to clean the display section	○	○	○	×

*1: It is necessary to set the security level with drawing software.

Appendix 3 Transportation Precautions

When transporting lithium batteries, make sure to treat them based on the transport regulations.

Appendix 3.1 Relevant models

The battery for the GOT1000 Series is classified as shown in the table below.

Product name	Model	Description	Handled as
Battery for GOT1000 Series	GT11-50BAT	Lithium coin battery	Non-dangerous goods

Appendix 3.2 Transport guidelines

Products are packed properly in compliance with the transportation regulations prior to shipment. When repacking any of the unpacked products to transport it to another location, make sure to observe the IATA Dangerous Goods Regulations, IMDG Code and other local transportation regulations. For details, please consult your transportation company.

Appendix 4 List of Functions Added by GT Designer2 Version Upgrade (For GOT1000 Series)

For the functions added by version upgrade of the GT Designer2, refer to the following, or contact your local distributor.

 GT Designer2 Version2 Screen Design Manual

INDEX

- [B]
 - Bar code 2-1,2-2,2-11
 - Battery 4-8,4-9,8-17,18-4
 - Buzzer volume 12-10

- [C]
 - Clean 16-1
 - Cleaning of display 18-3
 - Clock setting 12-14,13-1
 - Communication monitor 11-15
 - Communication setting screen 11-2
 - Component list 2-3
 - Connector conversion adapter 2-1,2-2,8-32
 - Contrast 12-6

- [D]
 - Daily inspection 18-2
 - Debug 15-1
 - Device monitor 15-1
 - Display of OS information 14-2
 - Display settings 12-2

- [E]
 - External dimensions App-1

- [F]
 - Features 1-4
 - File display 14-1

- [G]
 - General specifications 3-1
 - GOT set up 12-1

- [I]
 - Installation 6-1

- [K]
 - Key reaction 12-13
 - Keyword 11-18

- [M]
 - MELSEC-FX List Editor 15-13
 - Memory board 2-2,8-24,14-7
 - Memory loader 2-1,2-2,8-20

- [O]
 - Opening time 12-7
 - Operation setting 12-9
 - Option 2-6,8-1
 - OS installation 17-1
 - Overall configuration 2-1

- [P]
 - Panel cutting dimensions 6-6
 - Panel mounted USB port extension 2-2,8-33
 - Part name 4-1
 - Performance specifications 3-2
 - Periodic inspection 18-2
 - Power supply specifications 3-14
 - Protective cover for oil 2-1,2-2,8-27
 - Protective sheet 2-1,2-2,8-1,18-2

- [R]
 - Rough pre-operation procedure 1-5
 - RS-232 cable 2-6
 - RS-232/USB conversion adaptor 2-1,8-3
 - RS-422 cable 2-6

- [S]
 - Security 12-15
 - Serial multi-drop connection unit 2-1,2-2,8-29
 - Set up 12-1
 - Specifications 3-1
 - General specifications 3-1
 - Performance specifications 3-2
 - Power supply specifications 3-14
 - Stand 2-2,8-26
 - Standard monitor OS 14-2,17-1
 - System alarm 18-4
 - System configuration 2-1

- [T]
 - Time setting and display 13-1

- [U]
 - Utility call 12-16
 - Utility display 9-3
 - Utility function list 9-1

- [W]
 - Wiring 7-1

WARRANTY

Please confirm the following product warranty details before using this product.

1. Gratis Warranty Term and Gratis Warranty Range

If any faults or defects (hereinafter "Failure") found to be the responsibility of Mitsubishi occurs during use of the product within the gratis warranty term, the product shall be repaired at no cost via the sales representative or Mitsubishi Service Company. However, if repairs are required onsite at domestic or overseas location, expenses to send an engineer will be solely at the customer's discretion. Mitsubishi shall not be held responsible for any re-commissioning, maintenance, or testing on-site that involves replacement of the failed module.

[Gratis Warranty Term]

The gratis warranty term of the product shall be for one year after the date of purchase or delivery to a designated place. Note that after manufacture and shipment from Mitsubishi, the maximum distribution period shall be six (6) months, and the longest gratis warranty term after manufacturing shall be eighteen (18) months. The gratis warranty term of repair parts shall not exceed the gratis warranty term before repairs.

[Gratis Warranty Range]

- (1) The range shall be limited to normal use within the usage state, usage methods and usage environment, etc., which follow the conditions and precautions, etc., given in the instruction manual, user's manual and caution labels on the product.
- (2) Even within the gratis warranty term, repairs shall be charged for in the following cases.
 1. Failure occurring from inappropriate storage or handling, carelessness or negligence by the user. Failure caused by the user's hardware or software design.
 2. Failure caused by unapproved modifications, etc., to the product by the user.
 3. When the Mitsubishi product is assembled into a user's device, Failure that could have been avoided if functions or structures, judged as necessary in the legal safety measures the user's device is subject to or as necessary by industry standards, had been provided.
 4. Failure that could have been avoided if consumable parts (battery, backlight, fuse, etc.) designated in the instruction manual had been correctly serviced or replaced.
 5. Failure caused by external irresistible forces such as fires or abnormal voltages, and Failure caused by force majeure such as earthquakes, lightning, wind and water damage.
 6. Failure caused by reasons unpredictable by scientific technology standards at time of shipment from Mitsubishi.
 7. Any other failure found not to be the responsibility of Mitsubishi or that admitted not to be so by the user.

2. Onerous repair term after discontinuation of production

- (1) Mitsubishi shall accept onerous product repairs for seven (7) years after production of the product is discontinued. Discontinuation of production shall be notified with Mitsubishi Technical Bulletins, etc.
- (2) Product supply (including repair parts) is not available after production is discontinued.

3. Overseas service

Overseas, repairs shall be accepted by Mitsubishi's local overseas FA Center. Note that the repair conditions at each FA Center may differ.

4. Exclusion of loss in opportunity and secondary loss from warranty liability

Regardless of the gratis warranty term, Mitsubishi shall not be liable for compensation of damages caused by any cause found not to be the responsibility of Mitsubishi, loss in opportunity, lost profits incurred to the user or third person by Failures of Mitsubishi products, special damages and secondary damages whether foreseeable or not, compensation for accidents, and compensation for damages to products other than Mitsubishi products, replacement by the user, maintenance of on-site equipment, start-up test run and other tasks.

5. Changes in product specifications

The specifications given in the catalogs, manuals or technical documents are subject to change without prior notice.

6. Product application

- (1) In using the Mitsubishi graphic operation terminal, the usage conditions shall be that the application will not lead to a major accident even if any problem or fault should occur in the graphic operation terminal device, and that backup and fail-safe functions are systematically provided outside of the device for any problem or fault.
- (2) The Mitsubishi graphic operation terminal has been designed and manufactured for applications in general industries, etc. Thus, applications in which the public could be affected such as in nuclear power plants and other power plants operated by respective power companies, and applications in which a special quality assurance system is required, such as for Railway companies or Public service purposes shall be excluded from the graphic operation terminal applications. In addition, applications in which human life or property that could be greatly affected, such as in aircraft, medical applications, incineration and fuel devices, manned transportation, equipment for recreation and amusement, and safety devices, shall also be excluded from the graphic operation terminal range of applications. However, in certain cases, some applications may be possible, providing the user consults their local Mitsubishi representative outlining the special requirements of the project, and providing that all parties concerned agree to the special circumstances, solely at the users discretion.

Intellectual Property Rights

■ Trademarks

GOT is a registered trademark of Mitsubishi Electric Corporation.

Microsoft, Windows, Windows NT, Windows Server, Windows Vista, and Windows 7 are registered trademarks or trademarks of Microsoft Corporation in the United States and other countries.

Adobe and Adobe Reader are registered trademarks of Adobe Systems Incorporated.

Pentium and Celeron are a registered trademarks of Intel Corporation in the United States and other countries.

MODBUS is a trademark of Schneider Electric SA.

VNC is a registered trademark of RealVNC Ltd. in the United States and other countries.

Other company and product names herein may be either trademarks or registered trademarks of their respective owners.

■ Copyrights

The screens (screenshots) are used in accordance with the Microsoft Corporation guideline.

GRAPHIC OPERATION TERMINAL

GOT1000

GT10 User's Manual

MODEL	GT10-U-E
MODEL CODE	_____
JY997D24701AA	

MITSUBISHI ELECTRIC CORPORATION

HEAD OFFICE: TOKYO BLDG., 2-7-3, MARUNOUCHI, CHIYODA-KU, TOKYO 100-8310, JAPAN
NAGOYA WORKS: 1-14, YADA-MINAMI 5-CHOME, HIGASHI-KU, NAGOYA 461-8670, JAPAN

When exported from Japan, this manual does not require application to the Ministry of Economy, Trade and Industry for service transaction permission.

Specifications subject to change without notice.