

GRAPHIC OPERATION TERMINAL

GOT1000 Series

Connection Manual

(α 2 Connection)

for GT Works3

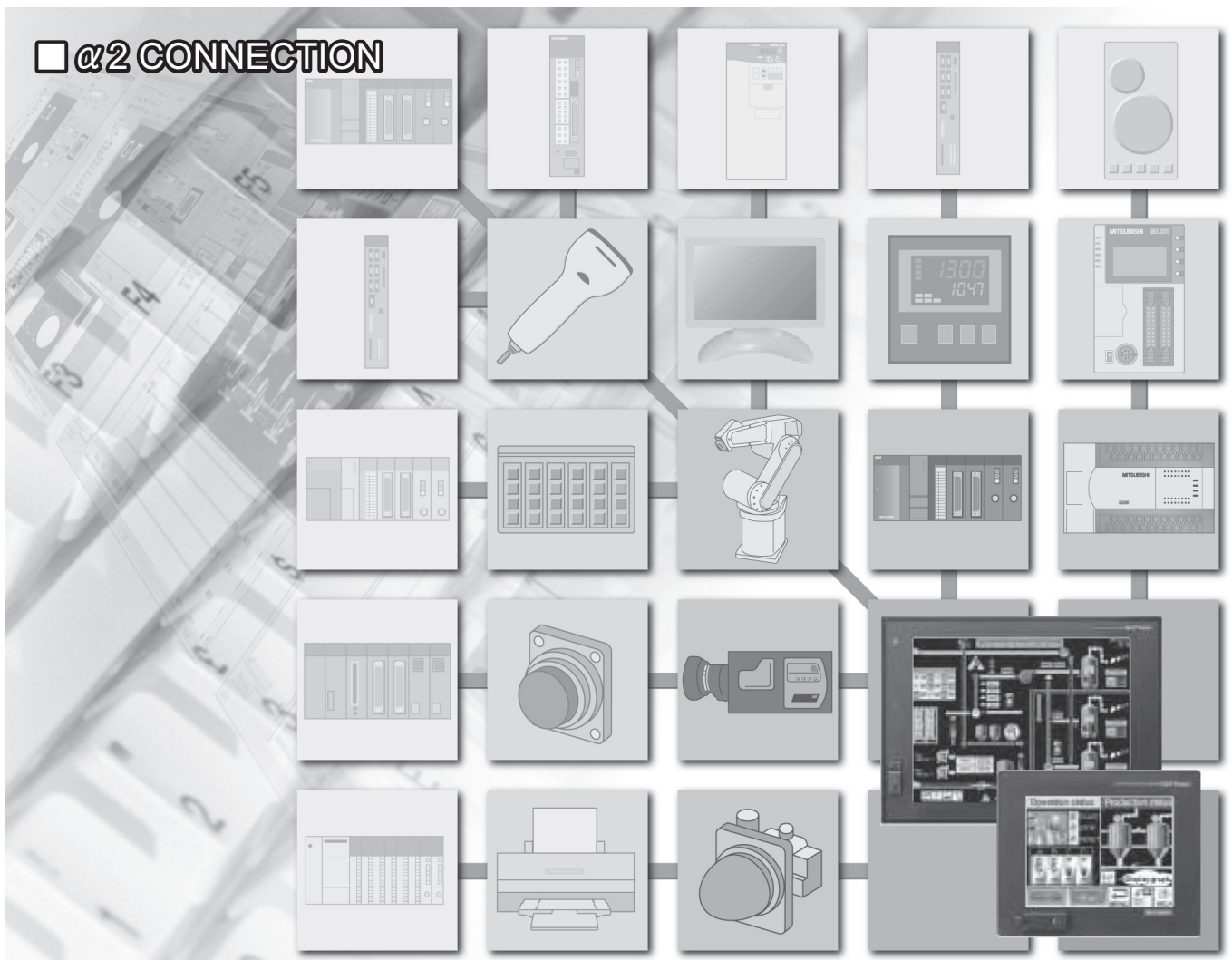

● SAFETY PRECAUTIONS ●

(Always read these precautions before using this equipment.)

Before using this product, please read this manual and the relevant manuals introduced in this manual carefully and pay full attention to safety to handle the product correctly.

The precautions given in this manual are concerned with this product.

In this manual, the safety precautions are ranked as "DANGER" and "CAUTION".



Indicates that incorrect handling may cause hazardous conditions, resulting in death or severe injury.



Indicates that incorrect handling may cause hazardous conditions, resulting in medium or slight personal injury or physical damage.

Note that the  caution level may lead to a serious accident according to the circumstances. Always follow the instructions of both levels because they are important to personal safety.

Please save this manual to make it accessible when required and always forward it to the end user.

[DESIGN PRECAUTIONS]

WARNING

- Some failures of the GOT, communication unit or cable may keep the outputs on or off.
An external monitoring circuit should be provided to check for output signals which may lead to a serious accident.
Not doing so can cause an accident due to false output or malfunction.
- If a communication fault (including cable disconnection) occurs during monitoring on the GOT, communication between the GOT and PLC CPU is suspended and the GOT becomes inoperative.
For bus connection : The CPU becomes faulty and the GOT becomes inoperative.
For other than bus connection : The GOT becomes inoperative.
A system where the GOT is used should be configured to perform any significant operation to the system by using the switches of a device other than the GOT on the assumption that a GOT communication fault will occur.
Not doing so can cause an accident due to false output or malfunction.
- Do not use the GOT as the warning device that may cause a serious accident.
An independent and redundant hardware or mechanical interlock is required to configure the device that displays and outputs serious warning.
Failure to observe this instruction may result in an accident due to incorrect output or malfunction.

[DESIGN PRECAUTIONS]

WARNING

- Incorrect operation of the touch switch(s) may lead to a serious accident if the GOT backlight is gone out.

When the GOT backlight goes out, the POWER LED flickers (green/orange) and the display section turns black and causes the monitor screen to appear blank, while the input of the touch switch(s) remains active.

This may confuse an operator in thinking that the GOT is in "screensaver" mode, who then tries to release the GOT from this mode by touching the display section, which may cause a touch switch to operate.

Note that the following occurs on the GOT when the backlight goes out.

- The POWER LED flickers (green/orange) and the monitor screen appears blank.

- The display section of the GT16 is an analog-resistive type touch panel.

If you touch the display section simultaneously in 2 points or more, the switch that is located around the center of the touched point, if any, may operate.

Do not touch the display section in 2 points or more simultaneously.

Doing so may cause an accident due to incorrect output or malfunction.

- When programs or parameters of the controller (such as a PLC) that is monitored by the GOT are changed, be sure to reset the GOT or shut off the power of the GOT at the same time.

Not doing so can cause an accident due to false output or malfunction.

- To maintain the security (confidentiality, integrity, and availability) of the GOT and the system against unauthorized access, DoS*¹ attacks, computer viruses, and other cyberattacks from unreliable networks and devices via network, take appropriate measures such as firewalls, virtual private networks (VPNs), and antivirus solutions.

Mitsubishi Electric shall have no responsibility or liability for any problems involving GOT trouble and system trouble by unauthorized access, DoS attacks, computer viruses, and other cyberattacks.

*1 DoS: A denial-of-service (DoS) attack disrupts services by overloading systems or exploiting vulnerabilities, resulting in a denial-of-service (DoS) state.

CAUTION

- Do not bundle the control and communication cables with main-circuit, power or other wiring.
Run the above cables separately from such wiring and keep them a minimum of 100mm apart.
Not doing so noise can cause a malfunction.
- Do not press the GOT display section with a pointed material as a pen or driver.
Doing so can result in a damage or failure of the display section.

[MOUNTING PRECAUTIONS]

WARNING

- Be sure to shut off all phases of the external power supply used by the system before mounting or removing the GOT to/from the panel.
Not switching the power off in all phases can cause a unit failure or malfunction.
- Be sure to shut off all phases of the external power supply used by the system before mounting or removing the communication unit, option function board or multi-color display board onto/from the GOT.
Not doing so can cause the unit to fail or malfunction.
- Before mounting an optional function board or Multi-color display board, wear a static discharge wrist strap to prevent the board from being damaged by static electricity.

CAUTION

- Use the GOT in the environment that satisfies the general specifications described in the User's Manual.
Not doing so can cause an electric shock, fire, malfunction or product damage or deterioration.
- When mounting the GOT to the control panel, tighten the mounting screws in the specified torque range.
Undertightening can cause the GOT to drop, short circuit or malfunction.
Overtightening can cause a drop, short circuit or malfunction due to the damage of the screws or the GOT.
- When loading the communication unit or option unit to the GOT (GT16, GT15), fit it to the extension interface of the GOT and tighten the mounting screws in the specified torque range.
Undertightening can cause the GOT to drop, short circuit or malfunction.
Overtightening can cause a drop, failure or malfunction due to the damage of the screws or unit.
- When mounting the multi-color display board onto the GOT (GT15), connect it to the corresponding connector securely and tighten the mounting screws within the specified torque range.
Loose tightening may cause the unit and/or GOT to malfunction due to poor contact.
Overtightening may damage the screws, unit and/or GOT; they might malfunction.
- When mounting the option function board onto the GOT (GT16), connect it to the corresponding connector securely and tighten the mounting screws within the specified torque range.
- When mounting an optional function board onto the GOT (GT15), fully connect it to the connector until you hear a click.
- When mounting an optional function board onto the GOT (GT11), fully connect it to the connector.
- When inserting a CF card into the GOT (GT16, GT15, GT11), push it into the CF card interface of GOT until the CF card eject button will pop out.
Failure to do so may cause a malfunction due to poor contact.

[MOUNTING PRECAUTIONS]

CAUTION

- When inserting/removing a CF card into/from the GOT(GT16, GT15, GT11), turn the CF card access switch off in advance.
Failure to do so may corrupt data within the CF card.
- When removing a CF card from the GOT, make sure to support the CF card by hand, as it may pop out.
Failure to do so may cause the CF card to drop from the GOT and break.
- When installing a USB memory to the GOT(GT16), make sure to install the USB memory to the USB interface firmly.
Failure to do so may cause a malfunction due to poor contact.
- Before removing the USB memory from the GOT(GT16), operate the utility screen for removal.
After the successful completion dialog box is displayed, remove the memory by hand carefully.
Failure to do so may cause the USB memory to drop, resulting in a damage or failure of the memory.
- For closing the USB environmental protection cover, fix the cover by pushing the Δ mark on the latch firmly to comply with the protective structure.
- Remove the protective film of the GOT.
When the user continues using the GOT with the protective film, the film may not be removed.
- Operate and store the GOT in environments without direct sunlight, high temperature, dust, humidity, and vibrations.
- When using the GOT in the environment of oil or chemicals, use the protective cover for oil.
Failure to do so may cause failure or malfunction due to the oil or chemical entering into the GOT.

[WIRING PRECAUTIONS]

WARNING

- Be sure to shut off all phases of the external power supply used by the system before wiring. Failure to do so may result in an electric shock, product damage or malfunctions.

CAUTION

- Please make sure to ground FG terminal and LG terminal and protective ground terminal of the GOT power supply section by applying Class D Grounding (Class 3 Grounding Method) or higher which is used exclusively for the GOT.
Not doing so may cause an electric shock or malfunction.
- Be sure to tighten any unused terminal screws with a torque of 0.5 to 0.8N•m.
Failure to do so may cause a short circuit due to contact with a solderless terminal.
- Use applicable solderless terminals and tighten them with the specified torque.
If any solderless spade terminal is used, it may be disconnected when the terminal screw comes loose, resulting in failure.
- Correctly wire the GOT power supply section after confirming the rated voltage and terminal arrangement of the product.
Not doing so can cause a fire or failure.
- Tighten the terminal screws of the GOT power supply section in the specified torque range.
Undertightening can cause a short circuit or malfunction.
Overtightening can cause a short circuit or malfunction due to the damage of the screws or the GOT.
- Exercise care to avoid foreign matter such as chips and wire offcuts entering the GOT.
Not doing so can cause a fire, failure or malfunction.
- The module has an ingress prevention label on its top to prevent foreign matter, such as wire offcuts, from entering the module during wiring.
Do not peel this label during wiring.
Before starting system operation, be sure to peel this label because of heat dissipation.

[WIRING PRECAUTIONS]

CAUTION

- Plug the bus connection cable by inserting it into the connector of the connected unit until it "clicks".
After plugging, check that it has been inserted snugly.
Not doing so can cause a malfunction due to a contact fault.
- Plug the communication cable into the connector of the connected unit and tighten the mounting and terminal screws in the specified torque range.
Undertightening can cause a short circuit or malfunction.
Overtightening can cause a short circuit or malfunction due to the damage of the screws or unit.
- Plug the QnA/ACPU/Motion controller (A series) bus connection cable by inserting it into the connector of the connected unit until it "clicks".
After plugging, check that it has been inserted snugly.
Not doing so can cause a malfunction due to a contact fault.

[TEST OPERATION PRECAUTIONS]

WARNING

- Before performing the test operations of the user creation monitor screen (such as turning ON or OFF bit device, changing the word device current value, changing the settings or current values of the timer or counter, and changing the buffer memory current value), read through the manual carefully and make yourself familiar with the operation method.
During test operation, never change the data of the devices which are used to perform significant operation for the system.
False output or malfunction can cause an accident.

[STARTUP/MAINTENANCE PRECAUTIONS]

WARNING

- When power is on, do not touch the terminals.
Doing so can cause an electric shock or malfunction.
- Correctly connect the battery connector.
Do not charge, disassemble, heat, short-circuit, solder, or throw the battery into the fire.
Doing so will cause the battery to produce heat, explode, or ignite, resulting in injury and fire.
- Before starting cleaning or terminal screw retightening, always switch off the power externally in all phases.
Not switching the power off in all phases can cause a unit failure or malfunction.
Undertightening can cause a short circuit or malfunction.
Overtightening can cause a short circuit or malfunction due to the damage of the screws or unit.

[STARTUP/MAINTENANCE PRECAUTIONS]

CAUTION

- Do not disassemble or modify the unit.
Doing so can cause a failure, malfunction, injury or fire.
- Do not touch the conductive and electronic parts of the unit directly.
Doing so can cause a unit malfunction or failure.
- The cables connected to the unit must be run in ducts or clamped.
Not doing so can cause the unit or cable to be damaged due to the dangling, motion or accidental pulling of the cables or can cause a malfunction due to a cable connection fault.
- When unplugging the cable connected to the unit, do not hold and pull the cable portion.
Doing so can cause the unit or cable to be damaged or can cause a malfunction due to a cable connection fault.
- Do not drop or apply strong impact to the unit.
Doing so may damage the unit.
- Do not drop or give an impact to the battery mounted to the unit.
Doing so may damage the battery, causing the battery fluid to leak inside the battery.
If the battery is dropped or given an impact, dispose of it without using.
- Before touching the unit, always touch grounded metal, etc. to discharge static electricity from human body, etc.
Not doing so can cause the unit to fail or malfunction.
- Replace battery with GT15-BAT(GT16, GT15) or GT11-50BAT(GT11, GT10) by Mitsubishi electric Co. only.
Use of another battery may present a risk of fire or explosion.
- Dispose of used battery promptly.
Keep away from children. Do not disassemble and do not dispose of in fire.

[TOUCH PANEL PRECAUTIONS]

CAUTION

- For the analog-resistive film type touch panels, normally the adjustment is not required. However, the difference between a touched position and the object position may occur as the period of use elapses. When any difference between a touched position and the object position occurs, execute the touch panel calibration.
- When any difference between a touched position and the object position occurs, other object may be activated. This may cause an unexpected operation due to incorrect output or malfunction.

[BACKLIGHT REPLACEMENT PRECAUTIONS]

WARNING

- Be sure to shut off all phases of the external power supply of the GOT (and the PLC CPU in the case of a bus topology) and remove the GOT from the control panel before replacing the backlight (when using the GOT with the backlight replaceable by the user).

Not doing so can cause an electric shock.

Replacing a backlight without removing the GOT from the control panel can cause the backlight or control panel to drop, resulting in an injury.

CAUTION

- Wear gloves for the backlight replacement when using the GOT with the backlight replaceable by the user.

Not doing so can cause an injury.

- Before replacing a backlight, allow 5 minutes or more after turning off the GOT when using the GOT with the backlight replaceable by the user.

Not doing so can cause a burn from heat of the backlight.

[DISPOSAL PRECAUTIONS]

CAUTION

- When disposing of the product, handle it as industrial waste.
- When disposing of this product, treat it as industrial waste. When disposing of batteries, separate them from other wastes according to the local regulations.

(For details of the battery directive in EU member states, refer to the User's Manual of the GOT to be used.)

[TRANSPORTATION PRECAUTIONS]

CAUTION

- When transporting lithium batteries, make sure to treat them based on the transport regulations. (For details on models subject to restrictions, refer to the User's Manual for the GOT you are using.)

- Make sure to transport the GOT main unit and/or relevant unit(s) in the manner they will not be exposed to the impact exceeding the impact resistance described in the general specifications of the User's Manual, as they are precision devices.

Failure to do so may cause the unit to fail.

Check if the unit operates correctly after transportation.

INTRODUCTION

Thank you for choosing Mitsubishi Graphic Operation Terminal (Mitsubishi GOT).

Read this manual and make sure you understand the functions and performance of the GOT thoroughly in advance to ensure correct use.

CONTENTS

SAFETY PRECAUTIONS	A - 1
INTRODUCTION	A - 9
CONTENTS	A - 9
MANUALS.....	A - 11
QUICK REFERENCE	A - 13
ABBREVIATIONS AND GENERIC TERMS	A - 15
HOW TO READ THIS MANUAL	A - 20

1.PREPARATORY PROCEDURES FOR MONITORING

1.1	Setting the Communication Interface.....	1 - 3
1.1.1	Setting connected equipment (Channel setting).....	1 - 3
1.1.2	I/F communication setting.....	1 - 8
1.1.3	Precautions.....	1 - 10
1.2	Writing the Project Data and OS onto the GOT.....	1 - 11
1.2.1	Writing the project data and OS onto the GOT.....	1 - 11
1.2.2	Checking the project data and OS writing on GOT.	1 - 12
1.3	Option Devices for the Respective Connection	1 - 13
1.3.1	Communication module	1 - 13
1.3.2	Option unit	1 - 14
1.3.3	Conversion cables	1 - 14
1.3.4	Connector conversion adapter	1 - 14
1.3.5	Serial Multi-Drop Connection Unit	1 - 14
1.3.6	Installing a unit on another unit (Checking the unit installation position).....	1 - 15
1.4	Connection Cables for the Respective Connection	1 - 22
1.4.1	GOT connector specifications	1 - 22
1.4.2	Coaxial cable connector connection method.....	1 - 25
1.4.3	Terminating resistors of GOT	1 - 26
1.5	Verifying GOT Recognizes Connected Equipment.....	1 - 28
1.6	Checking for Normal Monitoring	1 - 32
1.6.1	Check on the GOT.....	1 - 32

ALPHA2 CONNECTION

2.ALPHA2 CONNECTION

2.1	List of Connectable Models	2 - 2
2.2	System Configuration	2 - 2
2.2.1	Connecting to AL2-14MR, AL2-24MR	2 - 2
2.3	Connection Diagram	2 - 3
2.3.1	RS-232 cable	2 - 3
2.4	GOT Side Settings	2 - 4
2.4.1	Setting communication interface (Communication settings).....	2 - 4
2.5	PLC Side Settings.....	2 - 5
2.5.1	Communication setting	2 - 5
2.6	Device Range that Can Be Set.....	2 - 5
2.6.1	ALPHA2.....	2 - 6

REVISIONS

Intellectual Property Rights

MANUALS

The following table lists the manual relevant to this product.
Refer to each manual for any purpose.

■ Screen creation software manuals

Manual Name	Delivery method	Manual Number
GT Works3 Version1 Installation Procedure Manual	Enclosed in product	-
GT Designer3 Version1 Screen Design Manual (Fundamentals) 1/2, 2/2	*1	SH-080866ENG
GT Designer3 Version1 Screen Design Manual (Functions) 1/2, 2/2	*1	SH-080867ENG
GT Simulator3 Version1 Operating Manual for GT Works3	*1	SH-080861ENG
GT Converter2 Version3 Operating Manual for GT Works3	*1	SH-080862ENG

*1 Contact your local distributor.

■ Connection manuals

Manual Name	Delivery method	Manual Number
GOT1000 Series Connection Manual (Mitsubishi Electric Products) for GT Works3	*1	SH-080868ENG
GOT1000 Series Connection Manual (Non-Mitsubishi Electric Products 1) for GT Works3	*1	SH-080869ENG
GOT1000 Series Connection Manual (Non-Mitsubishi Electric Products 2) for GT Works3	*1	SH-080870ENG
GOT1000 Series Connection Manual (Microcomputer, MODBUS Products, Peripherals) for GT Works3	*1	SH-080871ENG
GOT1000 Series Connection Manual (α2 Connection) for GT Works3	*1	JY997D39201

*1 Contact your local distributor.

■ Extended and option function manuals

Manual Name	Delivery method	Manual Number
GOT1000 Series Gateway Functions Manual for GT Works3	*1	SH-080858ENG
GOT1000 Series MES Interface Function Manual for GT Works3	*1	SH-080859ENG
GOT1000 Series User's Manual (Extended Functions, Option Functions) for GT Works3	*1	SH-080863ENG

*1 Contact your local distributor.

■ GT SoftGOT1000 manuals

Manual Name	Delivery method	Manual Number
GT SoftGOT1000 Version3 Operating Manual for GT Works3	*1	SH-080860ENG

*1 Contact your local distributor.

■ GT16 manuals

Manual Name	Delivery method	Manual Number
GT16 User's Manual (Hardware)	*1	SH-080928ENG
GT16 User's Manual (Basic Utility)	*1	SH-080929ENG
GT16 Handy GOT User's Manual	*1	JY997D41201 JY997D41202

*1 Contact your local distributor.

■ GT15 manuals

Manual Name	Delivery method	Manual Number
GT15 User's Manual	*1	SH-080528ENG

*1 Contact your local distributor.

■ GT14 manuals

Manual Name	Delivery method	Manual Number
GT14 User's Manual	*1	JY997D44801

*1 Contact your local distributor.

■ GT12 manuals

Manual Name	Delivery method	Manual Number
GT12 User's Manual	*1	SH-080977ENG

*1 Contact your local distributor.

■ GT11 manuals

Manual Name	Delivery method	Manual Number
GT11 User's Manual	*1	JY997D17501
GT11 Handy GOT User's Manual	*1	JY997D20101 JY997D20102

*1 Contact your local distributor.

■ GT10 manuals

Manual Name	Delivery method	Manual Number
GT10 User's Manual	*1	JY997D24701

*1 Contact your local distributor.

QUICK REFERENCE

■ Creating a project

Obtaining the specifications and operation methods of GT Designer3	
Setting available functions on GT Designer3	GT Designer3 Version1 Screen Design Manual (Fundamentals) 1/2, 2/2
Creating a screen displayed on the GOT	
Obtaining useful functions to increase efficiency of drawing	
Setting details for figures and objects	GT Designer3 Version1 Screen Design Manual (Functions) 1/2, 2/2
Setting functions for the data collection or trigger action	
Setting functions to use peripheral devices	
Simulating a created project on a personal computer	GT Simulator3 Version1 Operating Manual for GT Works3

■ Connecting a controller to the GOT

Obtaining information of Mitsubishi Electric products applicable to the GOT	
Connecting Mitsubishi Electric products to the GOT	GOT1000 Series Connection Manual (Mitsubishi Electric Products) for GT Works3
Connecting multiple controllers to one GOT (Multi-channel function)	
Establishing communication between a personal computer and a controller via the GOT (FA transparent function)	
Obtaining information of Non-Mitsubishi Electric products applicable to the GOT	• GOT1000 Series Connection Manual (Non-Mitsubishi Electric Products 1) for GT Works3 • GOT1000 Series Connection Manual (Non-Mitsubishi Electric Products 2) for GT Works3
Connecting Non-Mitsubishi Electric products to the GOT	
Obtaining information of peripheral devices applicable to the GOT	GOT1000 Series Connection Manual (Microcomputer, MODBUS Products, Peripherals) for GT Works3
Connecting peripheral devices including a barcode reader to the GOT	
Connecting α2 with GOT	GOT1000 Series Connection Manual (α2 Connection) for GT Works3

■ Transferring data to the GOT

Writing data to the GOT	
Reading data from the GOT	GT Designer3 Version1 Screen Design Manual (Fundamentals) 1/2, 2/2
Verifying a editing project to a GOT project	

■ Others

Obtaining specifications (including part names, external dimensions, and options) of each GOT	<ul style="list-style-type: none">• GT16 User's Manual (Hardware)• GT16 Handy GOT User's Manual• GT15 User's Manual• GT14 User's Manual• GT12 User's Manual• GT11 User's Manual• GT11 Handy GOT User's Manual• GT10 User's Manual
Installing the GOT	
Operating the utility	<ul style="list-style-type: none">• GT16 User's Manual (Basic Utility)• GT16 Handy GOT User's Manual• GT15 User's Manual• GT14 User's Manual• GT12 User's Manual• GT11 User's Manual• GT11 Handy GOT User's Manual• GT10 User's Manual
Configuring the gateway function	GOT1000 Series Gateway Functions Manual for GT Works3
Configuring the MES interface function	GOT1000 Series MES Interface Function Manual for GT Works3
Configuring the extended function and option function	GOT1000 Series User's Manual (Extended Functions, Option Functions) for GT Works3
Using a personal computer as the GOT	GT SoftGOT1000 Version3 Operating Manual for GT Works3

ABBREVIATIONS AND GENERIC TERMS

■ GOT

Abbreviations and generic terms		Description	
GOT1000 Series	GT1695	GT1695M-X	Abbreviation of GT1695M-XTBA, GT1695M-XTBD
	GT1685	GT1685M-S	Abbreviation of GT1685M-STBA, GT1685M-STBD
	GT1675	GT1675M-S	Abbreviation of GT1675M-STBA, GT1675M-STBD
		GT1675M-V	Abbreviation of GT1675M-VTBA, GT1675M-VTBD
		GT1675-VN	Abbreviation of GT1675-VNBA, GT1675-VNBD
	GT1672	GT1672-VN	Abbreviation of GT1672-VNBA, GT1672-VNBD
	GT1665	GT1665M-S	Abbreviation of GT1665M-STBA, GT1665M-STBD
		GT1665M-V	Abbreviation of GT1665M-VTBA, GT1665M-VTBD
	GT1662	GT1662-VN	Abbreviation of GT1662-VNBA, GT1662-VNBD
	GT1655	GT1655-V	Abbreviation of GT1655-VTBD
	GT16		Abbreviation of GT1695, GT1685, GT1675, GT1672, GT1665, GT1662, GT1655, GT16 Handy GOT
	GT1595	GT1595-X	Abbreviation of GT1595-XTBA, GT1595-XTBD
	GT1585	GT1585V-S	Abbreviation of GT1585V-STBA, GT1585V-STBD
		GT1585-S	Abbreviation of GT1585-STBA, GT1585-STBD
	GT157□	GT1575V-S	Abbreviation of GT1575V-STBA, GT1575V-STBD
		GT1575-S	Abbreviation of GT1575-STBA, GT1575-STBD
		GT1575-V	Abbreviation of GT1575-VTBA, GT1575-VTBD
		GT1575-VN	Abbreviation of GT1575-VNBA, GT1575-VNBD
		GT1572-VN	Abbreviation of GT1572-VNBA, GT1572-VNBD
	GT156□	GT1565-V	Abbreviation of GT1565-VTBA, GT1565-VTBD
		GT1562-VN	Abbreviation of GT1562-VNBA, GT1562-VNBD
	GT155□	GT1555-V	Abbreviation of GT1555-VTBD
		GT1555-Q	Abbreviation of GT1555-QTBD, GT1555-QSBD
		GT1550-Q	Abbreviation of GT1550-QLBD
	GT15		Abbreviation of GT1595, GT1585, GT157□, GT156□, GT155□
	GT145□	GT1455-Q	Abbreviation of GT1455-QTBDE, GT1455-QTBD
		GT1450-Q	Abbreviation of GT1450-QMBDE, GT1450-QMBD, GT1450-QLBDE, GT1450-QLBD
	GT14		Abbreviation of GT1455-Q, GT1450-Q
	GT1275	GT1275-V	Abbreviation of GT1275-VNBA, GT1275-VNBD
	GT1265	GT1265-V	Abbreviation of GT1265-VNBA, GT1265-VNBD
GT12		Abbreviation of GT1275, GT1265	
GT115□	GT1155-Q	Abbreviation of GT1155-QTBDQ, GT1155-QSBDQ, GT1155-QTBDA, GT1155-QSBDA, GT1155-QTBD, GT1155-QSBD	
	GT1150-Q	Abbreviation of GT1150-QLBDQ, GT1150-QLBDA, GT1150-QLBD	
GT11		Abbreviation of GT115□, GT11 Handy GOT	
GT105□	GT1055-Q	Abbreviation of GT1055-QSBD	
	GT1050-Q	Abbreviation of GT1050-QBBD	
GT104□	GT1045-Q	Abbreviation of GT1045-QSBD	
	GT1040-Q	Abbreviation of GT1040-QBBD	
GT1030		Abbreviation of GT1030-LBD, GT1030-LBD2, GT1030-LBL, GT1030-LBDW, GT1030-LBDW2, GT1030-LBLW, GT1030-LWD, GT1030-LWD2, GT1030-LWL, GT1030-LWDW, GT1030-LWDW2, GT1030-LWLW, GT1030-HBD, GT1030-HBD2, GT1030-HBL, GT1030-HBDW, GT1030-HBDW2, GT1030-HBLW, GT1030-HWD, GT1030-HWD2, GT1030-HWL, GT1030-HWDW, GT1030-HWDW2, GT1030-HWLW	
GT1020		Abbreviation of GT1020-LBD, GT1020-LBD2, GT1020-LBL, GT1020-LBDW, GT1020-LBDW2, GT1020-LBLW, GT1020-LWD, GT1020LWD2, GT1020-LWL, GT1020-LWDW, GT1020-LWDW2, GT1020-LWLW	
GT10		Abbreviation of GT105□, GT104□, GT1030, GT1020	

Abbreviations and generic terms			Description	
GOT1000 Series	Handy GOT	GT16 Handy GOT	GT1665HS-V	Abbreviation of GT1665HS-VTBD
		Handy GOT	GT11 Handy GOT	GT1155HS-Q
			GT1150HS-Q	Abbreviation of GT1150HS-QLBD
	GT SoftGOT1000			Abbreviation of GT SoftGOT1000
GOT900 Series			Abbreviation of GOT-A900 series, GOT-F900 series	
GOT800 Series			Abbreviation of GOT-800 series	

■ Communication unit

Abbreviations and generic terms	Description
Bus connection unit	GT15-QBUS, GT15-QBUS2, GT15-ABUS, GT15-ABUS2, GT15-75QBUSL, GT15-75QBUS2L, GT15-75ABUSL, GT15-75ABUS2L
Serial communication unit	GT15-RS2-9P, GT15-RS4-9S, GT15-RS4-TE
RS-422 conversion unit	GT15-RS2T4-9P, GT15-RS2T4-25P
Ethernet communication unit	GT15-J71E71-100
MELSECNET/H communication unit	GT15-J71LP23-25, GT15-J71BR13
MELSECNET/10 communication unit	GT15-75J71LP23-Z ^{*1} , GT15-75J71BR13-Z ^{*2}
CC-Link IE Controller Network communication unit	GT15-J71GP23-SX
CC-Link IE Field Network communication unit	GT15-J71GF13-T2
CC-Link communication unit	GT15-J61BT13, GT15-75J61BT13-Z ^{*3}
Interface converter unit	GT15-75IF900
Serial multi-drop connection unit	GT01-RS4-M
Connection Conversion Adapter	GT10-9PT5S
RS-232/485 signal conversion adapter	GT14-RS2T4-9P

*1 A9GT-QJ71LP23 + GT15-75IF900 set

*2 A9GT-QJ71BR13 + GT15-75IF900 set

*3 A8GT-J61BT13 + GT15-75IF900 set

■ Option unit

Abbreviations and generic terms	Description	
Printer unit	GT15-PRN	
Video/RGB unit	Video input unit	GT16M-V4, GT15V-75V4
	RGB input unit	GT16M-R2, GT15V-75R1
	Video/RGB input unit	GT16M-V4R1, GT15V-75V4R1
	RGB output unit	GT16M-ROUT, GT15V-75ROUT
Multimedia unit	GT16M-MMR	
CF card unit	GT15-CFCD	
CF card extension unit ^{*1}	GT15-CFEX-C08SET	
External I/O unit	GT15-DIO, GT15-DIOR	
Sound output unit	GT15-SOUT	

*1 GT15-CFEX + GT15-CFEXIF + GT15-C08CF set

■ Option

Abbreviations and generic terms		Description
Memory card	CF card	GT05-MEM-16MC, GT05-MEM-32MC, GT05-MEM-64MC, GT05-MEM-128MC, GT05-MEM-256MC, GT05-MEM-512MC, GT05-MEM-1GC, GT05-MEM-2GC, GT05-MEM-4GC, GT05-MEM-8GC, GT05-MEM-16GC
	SD card	NZ1MEM-2GBSD, NZ1MEM-4GBSD, NZ1MEM-8GBSD, NZ1MEM-16GBSD, L1MEM-2GBSD, L1MEM-4GBSD
Memory card adaptor		GT05-MEM-ADPC
Option function board		GT16-MESB, GT15-FNB, GT15-QFNB, GT15-QFNB16M, GT15-QFNB32M, GT15-QFNB48M, GT11-50FNB, GT15-MESB48M
Battery		GT15-BAT, GT11-50BAT
Protective Sheet	For GT16	GT16-90PSCB, GT16-90PSGB, GT16-90PSCW, GT16-90PSGW, GT16-80PSCB, GT16-80PSGB, GT16-80PSCW, GT16-80PSGW, GT16-70PSCB, GT16-70PSGB, GT16-70PSCW, GT16-70PSGW, GT16-60PSCB, GT16-60PSGB, GT16-60PSCW, GT16-60PSGW, GT16-50PSCB, GT16-50PSGB, GT16-50PSCW, GT16-50PSGW, GT16-90PSCB-012, GT16-80PSCB-012, GT16-70PSCB-012, GT16-60PSCB-012, GT16-50PSCB-012, GT16H-60PSC
	For GT15	GT15-90PSCB, GT15-90PSGB, GT15-90PSCW, GT15-90PSGW, GT15-80PSCB, GT15-80PSGB, GT15-80PSCW, GT15-80PSGW, GT15-70PSCB, GT15-70PSGB, GT15-70PSCW, GT15-70PSGW, GT15-60PSCB, GT15-60PSGB, GT15-60PSCW, GT15-60PSGW, GT15-50PSCB, GT15-50PSGB, GT15-50PSCW, GT15-50PSGW
	For GT14	GT14-50PSCB, GT14-50PSGB, GT14-50PSCW, GT14-50PSGW
	For GT12	GT11-70PSCB, GT11-65PSCB
	For GT11	GT11-50PSCB, GT11-50PSGB, GT11-50PSCW, GT11-50PSGW, GT11H-50PSC
	For GT10	GT10-50PSCB, GT10-50PSGB, GT10-50PSCW, GT10-50PSGW, GT10-40PSCB, GT10-40PSGB, GT10-40PSCW, GT10-40PSGW, GT10-30PSCB, GT10-30PSGB, GT10-30PSCW, GT10-30PSGW, GT10-20PSCB, GT10-20PSGB, GT10-20PSCW, GT10-20PSGW
Protective cover for oil		GT05-90PCO, GT05-80PCO, GT05-70PCO, GT05-60PCO, GT05-50PCO, GT16-50PCO, GT10-40PCO, GT10-30PCO, GT10-20PCO
USB environmental protection cover		GT16-UCOV, GT16-50UCOV, GT15-UCOV, GT14-50UCOV, GT11-50UCOV
Stand		GT15-90STAND, GT15-80STAND, GT15-70STAND, A9GT-50STAND, GT05-50STAND
Attachment		GT15-70ATT-98, GT15-70ATT-87, GT15-60ATT-97, GT15-60ATT-96, GT15-60ATT-87, GT15-60ATT-77, GT15-50ATT-95W, GT15-50ATT-85
Backlight		GT16-90XLTT, GT16-80SLTT, GT16-70SLTT, GT16-70VLTT, GT16-70VLTTA, GT16-70VLTN, GT16-60SLTT, GT16-60VLTT, GT16-60VLTN, GT15-90XLTT, GT15-80SLTT, GT15-70SLTT, GT15-70VLTT, GT15-70VLTN, GT15-60VLTT, GT15-60VLTN
Multi-color display board		GT15-XHNB, GT15-VHNB
Connector conversion box		GT11H-CNB-37S, GT16H-CNB-42S
Emergency stop sw guard cover		GT11H-50ESCOV, GT16H-60ESCOV
With wall-mounting Attachment		GT14H-50ATT
Memory loader		GT10-LDR
Memory board		GT10-50FMB
Panel-mounted USB port extension		GT14-C10EXUSB-4S, GT10-C10EXUSB-5S

■ Software

Abbreviations and generic terms		Description
GT Works3		Abbreviation of the SW□DND-GTWK3-E and SW□DND-GTWK3-EA
GT Designer3		Abbreviation of screen drawing software GT Designer3 for GOT1000 series
GT Simulator3		Abbreviation of screen simulator GT Simulator3 for GOT1000/GOT900 series
GT SoftGOT1000		Abbreviation of monitoring software GT SoftGOT1000
GT Converter2		Abbreviation of data conversion software GT Converter2 for GOT1000/GOT900 series
GT Designer2 Classic		Abbreviation of screen drawing software GT Designer2 Classic for GOT900 series
GT Designer2		Abbreviation of screen drawing software GT Designer2 for GOT1000/GOT900 series
iQ Works		Abbreviation of iQ Platform compatible engineering environment MELSOFT iQ Works
MELSOFT Navigator		Generic term for integrated development environment software included in the SW□DNC-IQWK (iQ Platform compatible engineering environment MELSOFT iQ Works)
MELSOFT iQ AppPortal		SW□DND-IQAPL-M type integrated application management software
GX Works3		Abbreviation of SW□DND-GXW3-E and SW□DND-GXW3-EA type programmable controller engineering software
GX Works2		Abbreviation of SW□DNC-GXW2-E and SW□DNC-GXW2-EA type programmable controller engineering software
Controller simulator	GX Simulator3	Abbreviation of GX Works3 with the simulation function
	GX Simulator2	Abbreviation of GX Works2 with the simulation function
	GX Simulator	Abbreviation of SW□D5C-LLT-E(-EV) type ladder logic test tool function software packages (SW5D5C-LLT (-EV) or later versions)
GX Developer		Abbreviation of SW□D5C-GPPW-E(-EV)/SW D5F-GPPW-E type software package
GX LogViewer		Abbreviation of SW□DNN-VIEWER-E type software package
PX Developer		Abbreviation of SW□D5C-FBDQ-E type FBD software package for process control
MT Works2		Abbreviation of motion controller engineering environment MELSOFT MT Works2 (SW□DND-MTW2-E)
MT Developer		Abbreviation of SW□RNC-GSV type integrated start-up support software for motion controller Q series
MR Configurator2		Abbreviation of SW□DNC-MRC2-E type Servo Configuration Software
MR Configurator		Abbreviation of MRJW□-SETUP□E type Servo Configuration Software
FR Configurator		Abbreviation of Inverter Setup Software (FR-SW□-SETUP-WE)
NC Configurator		Abbreviation of CNC parameter setting support tool NC Configurator
FX Configurator-FP		Abbreviation of parameter setting, monitoring, and testing software packages for FX3U-20SSC-H (SW□D5C-FXSSC-E)
FX3U-ENET-L Configuration tool		Abbreviation of FX3U-ENET-L type Ethernet module setting software (SW1D5-FXENETL-E)
FX Configurator-EN		Abbreviation of FX3U-ENET type Ethernet module setting software (SW1D5C-FXENET-E)
RT ToolBox2		Abbreviation of robot program creation software (3D-11C-WINE)
MX Component		Abbreviation of MX Component Version□ (SW□D5C-ACT-E, SW□D5C-ACT-EA)
MX Sheet		Abbreviation of MX Sheet Version□ (SW□D5C-SHEET-E, SW□D5C-SHEET-EA)
CPU Module Logging Configuration Tool		Abbreviation of CPU Module Logging Configuration Tool (SW1DNN-LLUTL-E)

■ License key (for GT SoftGOT1000)

Abbreviations and generic terms	Description
License	GT15-SGTKEY-U, GT15-SGTKEY-P

■ Others

Abbreviations and generic terms	Description
IAI	Abbreviation of IAI Corporation
AZBIL	Abbreviation of Azbil Corporation (former Yamatake Corporation)
OMRON	Abbreviation of OMRON Corporation
KEYENCE	Abbreviation of KEYENCE CORPORATION
KOYO EI	Abbreviation of KOYO ELECTRONICS INDUSTRIES CO., LTD.
SHARP	Abbreviation of Sharp Manufacturing Systems Corporation
JTEKT	Abbreviation of JTEKT Corporation
SHINKO	Abbreviation of Shinko Technos Co., Ltd.
CHINO	Abbreviation of CHINO CORPORATION
TOSHIBA	Abbreviation of TOSHIBA CORPORATION
TOSHIBA MACHINE	Abbreviation of TOSHIBA MACHINE CO., LTD.
HITACHI IES	Abbreviation of Hitachi Industrial Equipment Systems Co., Ltd.
HITACHI	Abbreviation of Hitachi, Ltd.
FUJI	Abbreviation of FUJI ELECTRIC CO., LTD.
PANASONIC	Abbreviation of Panasonic Corporation
PANASONIC INDUSTRIAL DEVICES SUNX	Abbreviation of Panasonic Industrial Devices SUNX Co., Ltd.
YASKAWA	Abbreviation of YASKAWA Electric Corporation
YOKOGAWA	Abbreviation of Yokogawa Electric Corporation
ALLEN-BRADLEY	Abbreviation of Allen-Bradley products manufactured by Rockwell Automation, Inc.
GE	Abbreviation of GE Intelligent Platforms
LS IS	Abbreviation of LS Industrial Systems Co., Ltd.
MITSUBISHI INDIA	Mitsubishi Electric India Pvt. Ltd.
SCHNEIDER	Abbreviation of Schneider Electric SA
SICK	Abbreviation of SICK AG
SIEMENS	Abbreviation of Siemens AG
RKC	Abbreviation of RKC INSTRUMENT INC.
HIRATA	Abbreviation of Hirata Corporation
MURATEC	Abbreviation of Muratec products manufactured by Muratec Automation Co., Ltd.
PLC	Abbreviation of programmable controller
Temperature controller	Generic term for temperature controller manufactured by each corporation
Indicating controller	Generic term for indicating controller manufactured by each corporation
Control equipment	Generic term for control equipment manufactured by each corporation
CHINO controller	Abbreviation of indicating controller manufactured by CHINO CORPORATION
PC CPU module	Abbreviation of PC CPU Unit manufactured by CONTEC CO., LTD
GOT (server)	Abbreviation of GOTs that use the server function
GOT (client)	Abbreviation of GOTs that use the client function
Windows® font	Abbreviation of TrueType font and OpenType font available for Windows® (Differs from the True Type fonts settable with GT Designer3)
Intelligent function module	Indicates the modules other than the PLC CPU, power supply module and I/O module that are mounted to the base unit
MODBUS® /RTU	Generic term for the protocol designed to use MODBUS® protocol messages on a serial communication
MODBUS® /TCP	Generic term for the protocol designed to use MODBUS® protocol messages on a TCP/IP network

HOW TO READ THIS MANUAL

Symbols

Following symbols are used in this manual.

BUS CONNECTION

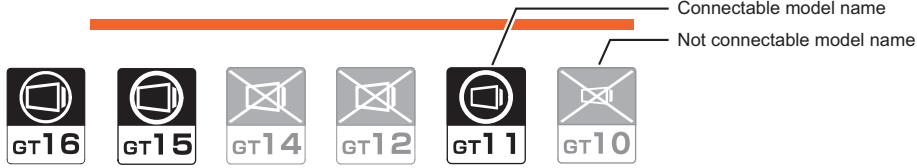

5.1 Connectable Model List 5 - 2

Model name	Computer link module ¹⁾	Communication type	Connection cable		GOT		Number of connectable equipment
			Cable model	Max. distance	Option device	Mode	
MELSEC-Q (A mode)	A1SJ71UC24-R2 A1SJ71C24-R2 A1SJ71UC24-PRF A1SJ71C24-PRF	RS-232C	GT09-C30R2-9P(3m) or RS232C connection diagram 1)	15m	-(Built into GOT)	GT16, GT15, GT11, GT10	1 GOT for 1 computer link module
			RS232C connection diagram 3)	15m	-(Built into GOT)	GT16, GT15, GT10	

Applicable model name

- Shows GT16.
- Shows GT15.
- Shows GT14.
- Shows GT12.
- Shows GT11.
- Shows GT11 (BUS).
- Shows GT11 (SERIAL).
- Shows GT10.
- Shows GT105□, GT104□.
- Shows GT1020, GT1030 (input power supply : 24V).
- Shows GT1020, GT1030 (input power supply : 5V).

5.3 GOT Side Settings

5.3.1 Setting communication interface (Communication settings)

5.3.2 Communication detail settings

Set the channel of the connected equipment.

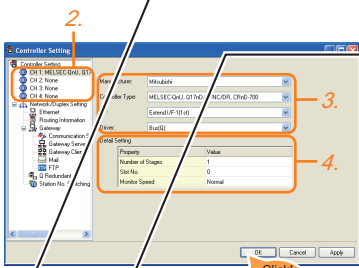

1. Select [Common] → [Controller Setting] from the menu.
2. The Controller Setting window is displayed. Select the channel to be used from the list menu.
3. Select the following.
 - Manufacturer : Mitsubishi
 - Controller Type: Set according to the Controller Type to be connected.
 - I/F: Interface to be used
 - Driver : Set either of the following according to the Controller Type to be connected.
 - BUS (Q)
 - BUS (A/QnA)
4. The detailed setting is displayed after Manufacturer, Controller Type, I/F, and Driver are set. Make the settings according to the usage environment.
 - ☞ 5.3.2 Communication detail settings

(1) Bus(Q)

Property	Value
Number of Stages	1
Slot No.	0
Monitor Speed	Normal

Item	Description	Range
Stage No.	(Default: 1)	1 to 7
Slot No.	(Default: 0)	0 to 9
Monitor	(Default: Normal)	High/Normal/Low

(2) Bus(A/QnA)

Property	Value
Number of Stages	1
Slot No.	0

Item	Description	Range
Stage No.	(Default: 1)	1 to 7
Slot No.	(Default: 0)	0 to 7

POINT

- (1) Communication interface setting by Utility
The communication interface setting can be changed on the Utility's [Communication Settings] after writing [Communication Settings] of project data.
For details on the Utility, refer to the following manual.
- ☞ GT□ User's Manual
- (2) Precedence in communication settings
When settings are made by GT Designer3 or the Utility, the latest setting is effective.
- (3) When changing Stage No. and Slot No.
Change these settings with the PLC CPU turned OFF, and then reapply the power to the PLC CPU and GOT.
Failure to do so may generate a system alarm (No.487).

1. → 2. → 3. ...

Indicates the operation steps.

[]: Indicates the setting items displayed on the software and GOT screen.

POINT Refers to the information required.

HINT Refers to information useful for operation.

Indicates the location of related content.

Since the above page was created for explanation purpose, it differs from the actual page.

■ About system configuration

The following describes the system configuration of each connection included in this manual.

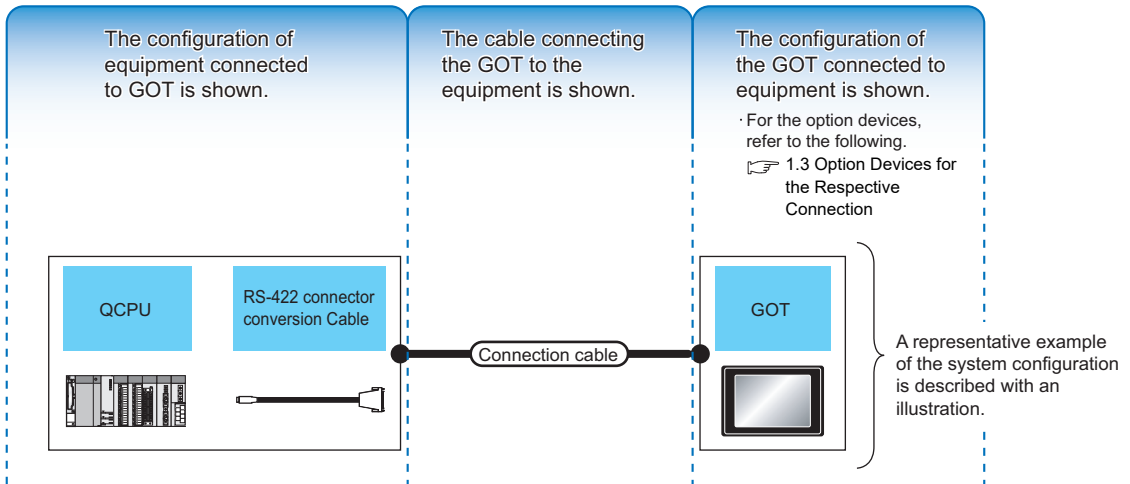

PLC			Connection cable		GOT		Number of connectable equipment
Model name	RS-422 connector conversion cable	Communication type	Cable model	Max. distance	Option device	Model	
MELSEC-Q	-	RS-232	GT01-C30R2-6P(3m)	3m	- (Built into GOT)	GT16, GT15, GT11 Serial, GT10.5P	1 GOT for 1 PLC
			GT15-RS2-9P		GT16, GT15		
			GT01-RS4-M ⁴		-		
			GT10-C30R2-6P(3m)	3m	- (Built into GOT)	GT10.20, GT20	
	FA-CNV2402CBL(0.2m) FA-CNV2405CBL (0.5m)	RS-422	GT01-C30R4-25P(3m)	30m	GT16-C02R4-9S	GT16	
			GT01-C100R4-25P(10m)		GT15-RS2T4-9P ¹	GT16, GT15	
			GT01-C200R4-25P(20m)		GT15-RS4-9S	GT16, GT15	
			GT01-C300R4-25P(30m)		- (Built into GOT)	GT11 Serial, GT10.5P	
					GT01-RS4-M ⁴	-	
					- (Built into GOT)	GT10.20, GT20	

Indicates the connection diagram number of cables to be prepared by the user. Refer to the connection diagram section in each chapter.

Indicates the commercially available cable models that can be used.

Indicates the maximum distance between the PLC and GOT.

System Configuration Examples
 (When connecting the PLC [MELSEC-Q] and GT16, with RS-422 cable)
 1) Connect the RS-422 conversion cable [FA-CNV2402CBL] to the [MELSEC-Q].
 2) Connect the option [GT16-C02R4-9S] to [GT16].
 3) Connect [MELSEC-Q] and [GT16] with the connection cable [GT01-C30R4-25P].

Since the above page was created for explanation purpose, it differs from the actual page.

1

PREPARATORY PROCEDURES FOR MONITORING



1.1	Setting the Communication Interface	1 - 3
1.2	Writing the Project Data and OS onto the GOT	1 - 11
1.3	Option Devices for the Respective Connection	1 - 13
1.4	Connection Cables for the Respective Connection	1 - 22
1.5	Verifying GOT Recognizes Connected Equipment	1 - 28
1.6	Checking for Normal Monitoring.	1 - 32

1. PREPARATORY PROCEDURES FOR MONITORING

The following shows the procedures to be taken before monitoring and corresponding reference sections.

Setting the communication interface

Determine the connection type and channel No. to be used, and perform the communication setting.

-  1.1 Setting the Communication Interface
-  Each chapter GOT Side Settings



Writing the project data and OS

Write the standard monitor OS, communication driver, option OS, project data and communication settings onto the GOT.

-  1.2.1 Writing the project data and OS onto the GOT



Verifying the project data and OS





Verify the standard monitor OS, communication driver, option OS, project data and communication settings are properly written onto the GOT.

-  1.2.2 Checking the project data and OS writing on GOT.



Attaching the communication unit and connecting the cable

Mount the optional equipment and prepare/connect the connection cable according to the connection type.

-  1.3 Option Devices for the Respective Connection
-  1.4 Connection Cables for the Respective Connection
-  Each chapter System Configuration
-  Each chapter Connection Diagram



Verifying GOT recognizes connected equipment

Verify the GOT recognizes controllers on [Communication Settings] of the Utility.

-  1.5 Verifying GOT Recognizes Connected Equipment



Verifying the GOT is monitoring normally

Verify the GOT is monitoring normally using Utility, Developer, etc.

-  1.6 Checking for Normal Monitoring

1.1 Setting the Communication Interface

Set the communication interface of GOT and the connected equipment.

When using the GOT at the first time, make sure to set the channel of communication interface and the communication driver before writing to GOT.

Set the communication interface of the GOT at [Controller Setting] and [I/F Communication Setting] in GT Designer3.

1.1.1 Setting connected equipment (Channel setting)

Set the channel of the equipment connected to the GOT.

■ Setting

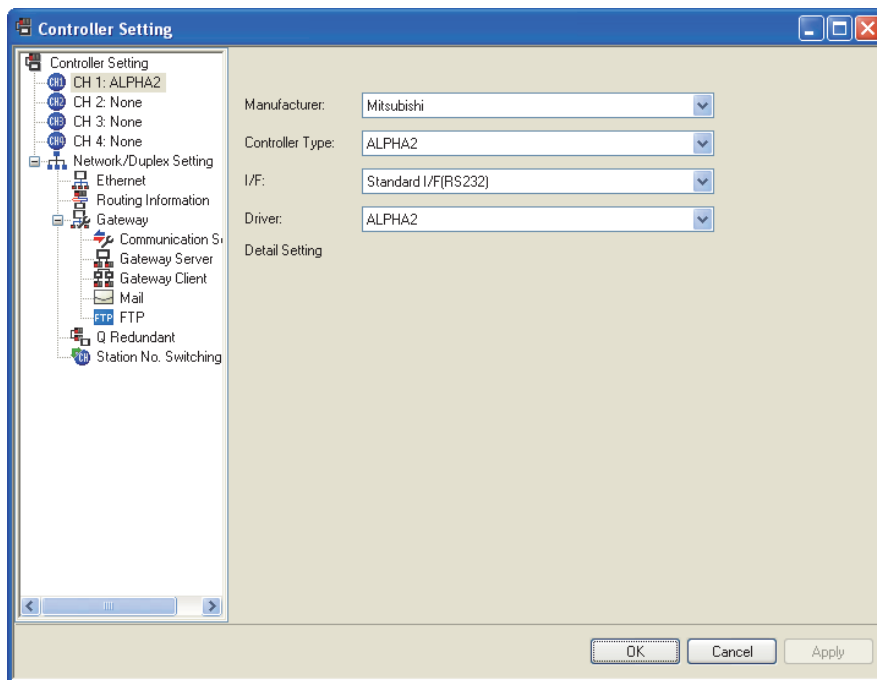

1. Select [Common] → [Controller Setting] from the menu.
2. The Controller Setting dialog box appears. Select the channel No. to be used from the list menu.
3. Refer to the following explanations for the setting.

POINT

Channel No.2 to No.4

Use the channel No.2 to No.4 when using the Multi-channel function.

For details of the Multi-channel function, refer to the following.

 Mitsubishi Products 20. MULTI-CHANNEL FUNCTION

■ Setting item

This section describes the setting items of the Manufacturer, Controller Type, Driver and I/F. When using the channel No.2 to No.4, put a check mark at [Use CH*].

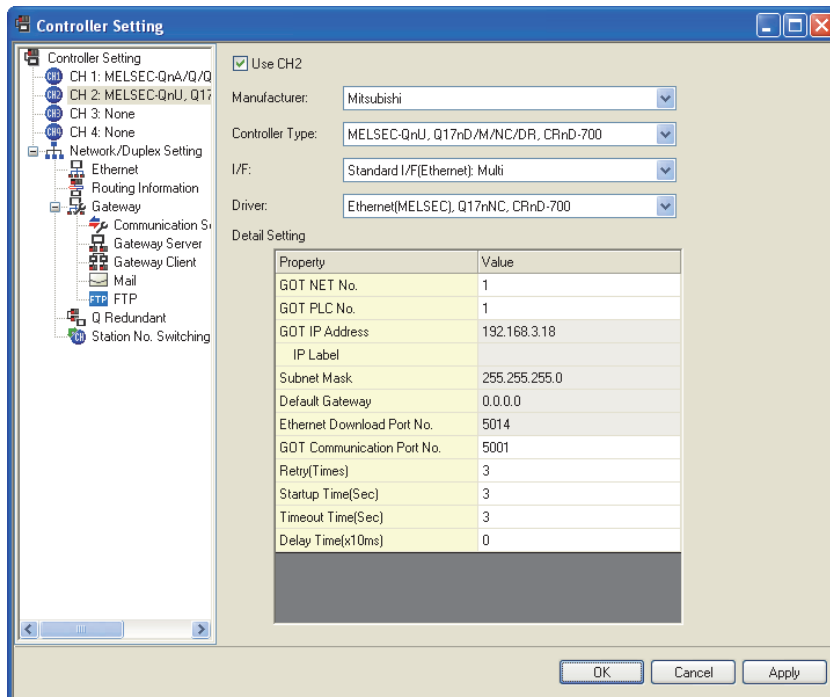

Item	Description
Use CH*	Select this item when setting the channel No.2 to No.4.
Manufacturer	Select the manufacturer of the equipment to be connected to the GOT.
Type	Select the type of the equipment to be connected to the GOT. For the settings, refer to the following. (2)Setting [Controller Type]
I/F	Select the interface of the GOT to which the equipment is connected. For the settings, refer to the following. (3)Setting [I/F]
Driver	Select the communication driver to be written to the GOT. For the settings, refer to the following. (1)Setting [Driver]
Detail Setting	Make settings for the transmission speed and data length of the communication driver. Refer to each chapter of the equipment to be connected to the GOT.

(1) Setting [Driver]

The displayed items for a driver differ according to the settings [Manufacturer], [Controller Type] and [I/F]. When the driver to be set is not displayed, confirm if [Manufacturer], [Controller Type] and [I/F] are correct. For the settings, refer to the following.

[Setting the communication interface] section in each chapter

(2) Setting [Controller Type]

The types for the selection differs depending on the PLC to be used. For the settings, refer to the following.

Type	Model name
ALPHA2	AL2-14MR
	AL2-24MR

(3) Setting [I/F]

The interface differs depending on the GOT to be used.

Set the I/F according to the connection and the position of communication unit to be mounted onto the GOT.

(a) GT16

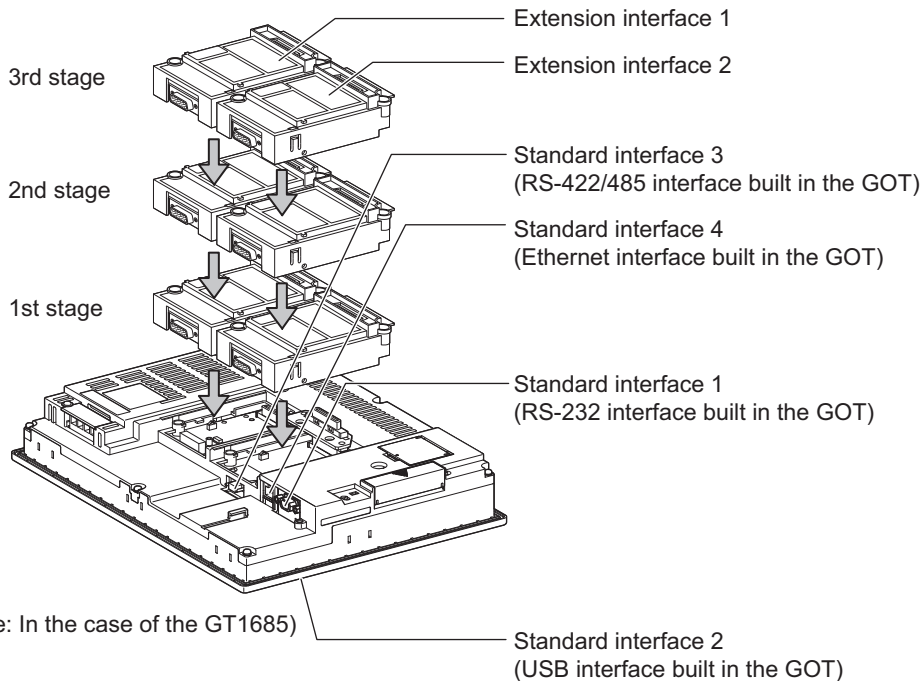

(b) GT15

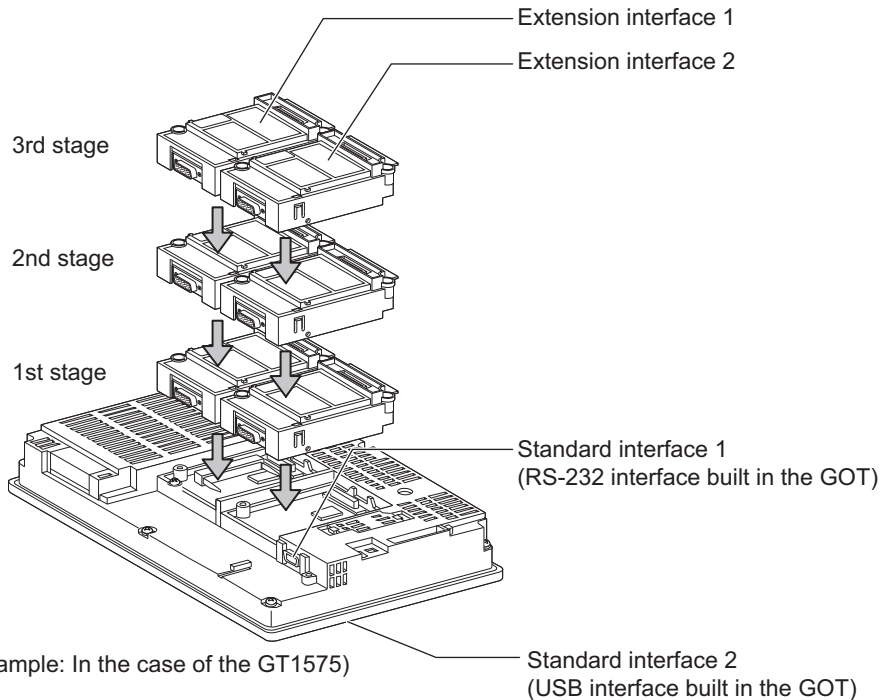

(c) GT11
 • GT11 Serial

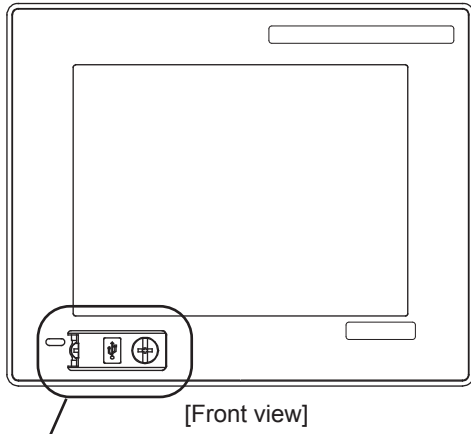

Standard interface 3
 (GOT built-in USB interface)

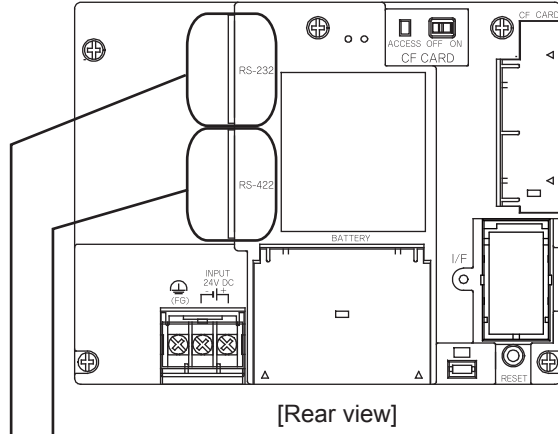

Standard interface 1
 (GOT built-in RS-422 interface)

Standard interface 2
 (GOT built-in RS-232 interface)

• GT11 Bus

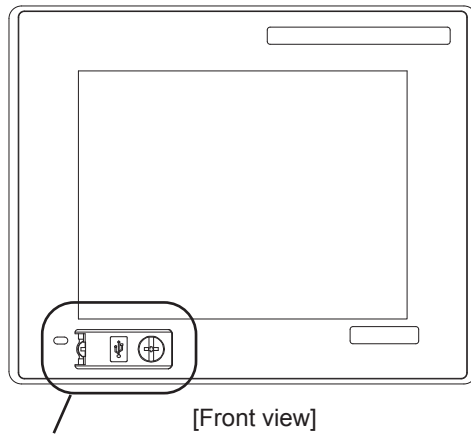

Standard interface 3
 (GOT built-in USB interface)

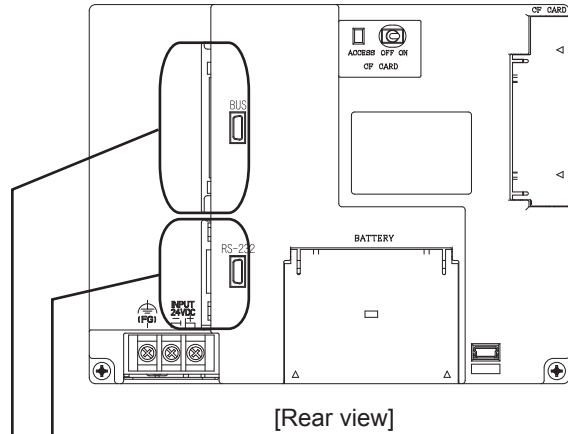

Standard interface 2
 (GOT built-in RS-232 interface)

Standard interface 1
 (GOT built-in Bus interface)

(d) GT105□

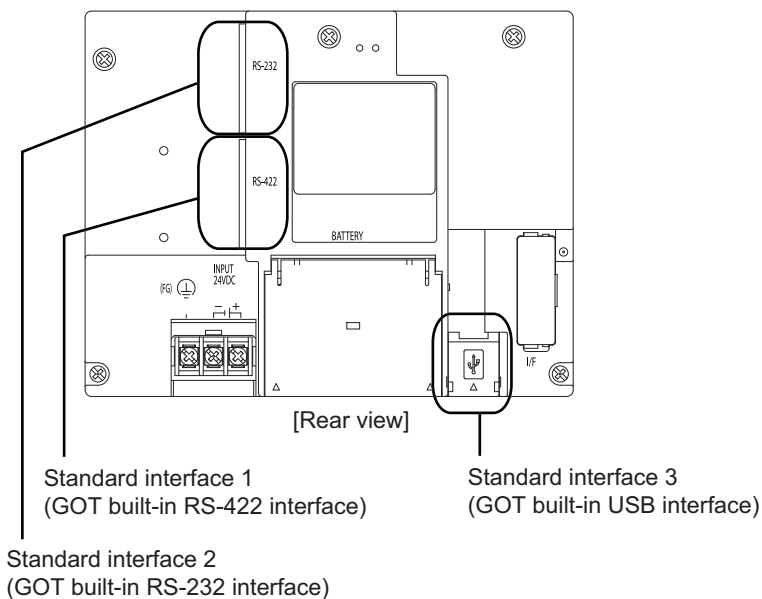

(e) GT104□

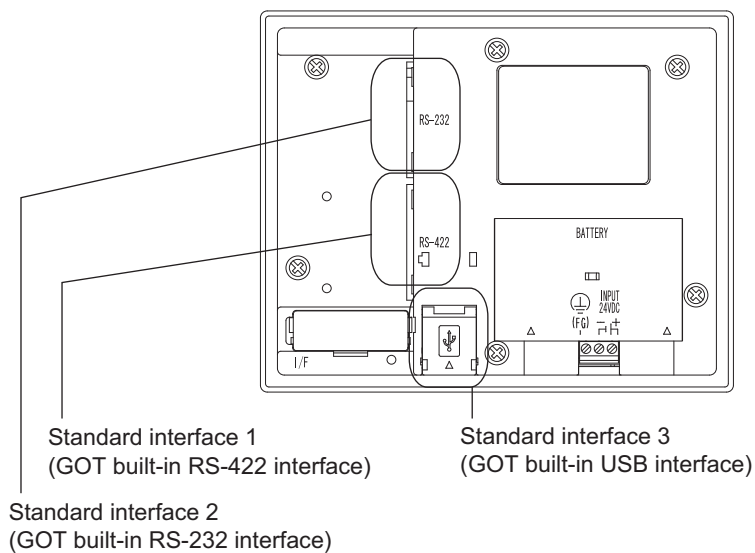

(f) GT1020, GT1030

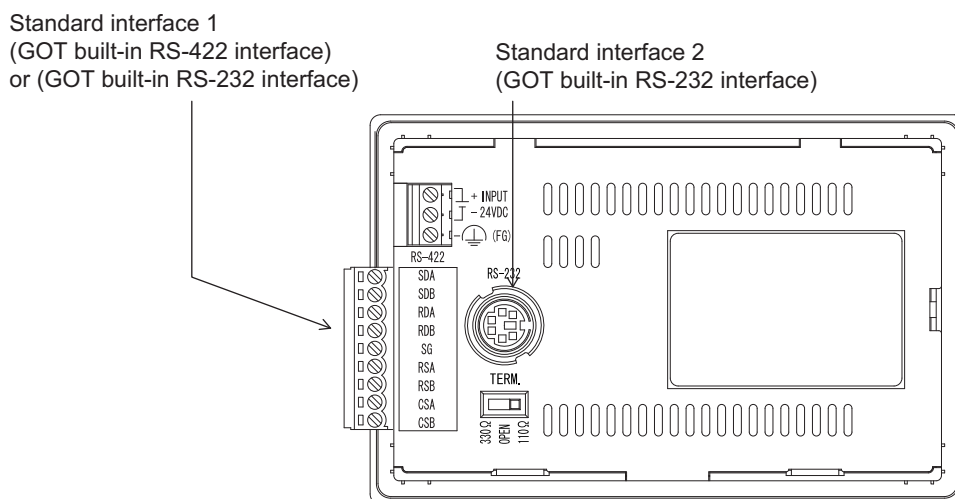

1.1.2 I/F communication setting

This function displays the list of the GOT communication interfaces.
Set the channel and the communication driver to the interface to be used.

■ Setting

Standard I/F Setting			
	CH No.	Driver	
I/F-1: RS232	1	ALPHA2	Detail Setting...
I/F-2: USB	9	Host (PC)	
I/F-3: RS422/485	0	None	Detail Setting...
I/F-4: Ethernet	2	Ethernet(MELSEC), Q17nNC, CRnD-700	Detail Setting...

Extend I/F Setting			
Extend I/F-1			
	CH No.	Driver	
1st	0	None	Detail Setting...
2nd	0	None	Detail Setting...
3rd	0	None	Detail Setting...

Extend I/F-2			
	CH No.	Driver	
1st	0	None	Detail Setting...
2nd	0	None	Detail Setting...
3rd	0	None	Detail Setting...

1. Select [Common] → [I/F Communication Setting] from the menu.
2. The I/F Communication Setting dialog box appears. Make the settings with reference to the following explanation.

■ Setting item

The following describes the setting items for the standard I/F setting and extension I/F setting.

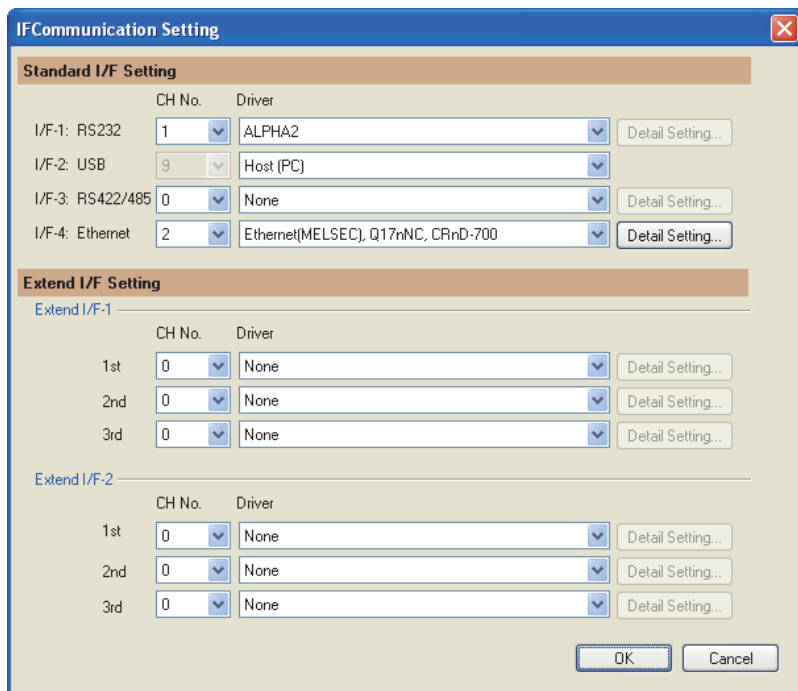

Item	Description
Standard I/F setting	Set channel No. and drivers to the GOT standard interfaces. GT16: Standard I/F-1, Standard I/F-2, Standard I/F-3, Standard I/F-4 GT15, GT1030, GT1020: Standard I/F-1, Standard I/F-2 GT11, GT105□, GT104□: Standard I/F-1, Standard I/F-2, Standard I/F-3
CH No.	Set the CH No. according to the intended purpose. The number of channels differs depending on the GOT to be used. 0: Not used 1 to 4: Used for connecting a controller of channel No. 1 to 4 set in Setting connected equipment (Channel setting) 8: Used for barcode reader connection, RFID connection, PC remote operation connection, or fingerprint authentication device connection 9: Used for connecting Host (Personal computer) *: Used for gateway function, MES interface function, and Ethernet download Multi: Used for Ethernet multiple connection
I/F	The communication type of the GOT standard interface is displayed.
Driver	Set the driver for the device to be connected. · None · Host (Personal computer) · Each communication driver for connected devices
Detail Setting	Make settings for the transmission speed and data length of the communication driver. Refer to each chapter of the equipment to be connected to the GOT.
Extension I/F setting	Set the communication unit attached to the extension interface of the GOT.
CH No.	Set the CH No. according to the intended purpose. The number of channels differs depending on the GOT to be used. 0: Not used 1 to 4: Used for connecting a controller of channel No. 1 to 4 set in Setting connected equipment (Channel setting) 5 to 7: Used for barcode reader connection, RFID connection, and PC remote operation connection *: For the gateway function, MES interface function, Ethernet download, report function, hard copy (For printer output), video/RGB input, RGB output, multimedia function, CF card unit, CF card extension unit, sound output, and external I/O or operation panel
Driver	Set the driver for the device to be connected. · None · Each driver for connected devices
Detail Setting	Make settings for the transmission speed and data length of the communication driver. Refer to each chapter of the equipment to be connected to the GOT.

POINT

Channel No., drivers

(1) Channel No.2 to No.4

Use the channel No.2 to No.4 when using the Multi-channel function.
For details of the Multi-channel function, refer to the following.

 Mitsubishi Products 20. MULTI-CHANNEL FUNCTION

(2) Drivers

The displayed items for a driver differ according to the settings [Manufacturer], [Controller Type] and [I/F].
When the driver to be set is not displayed, confirm if [Manufacturer], [Controller Type] and [I/F] are correct.

 [Setting the communication] section in each chapter

1.1.3 Precautions

■ Precautions for changing model

(1) When devices that cannot be converted are included.

When setting of [Manufacturer] or [Controller Type] is changed, GT Designer3 displays the device that cannot be converted (no corresponding device type, or setting available range is exceeded) as [??]. In this case, set the device again.

(2) When the changed Manufacturer or Controller Type does not correspond to the network.

The network will be set to host station.

(3) When the Manufacturer or Controller Type is changed to [None]

The GT Designer3 displays the device of the changed channel No. as [??]. In this case, set the device again.
Since the channel No. is retained, the objects can be reused in other channel No. in a batch by using the [Device Batch Edit], [CH No. Batch Edit] or [Device List].

1.2 Writing the Project Data and OS onto the GOT

Write the standard monitor OS, communication driver, option OS, project data and communication settings onto the GOT. For details on writing to GOT, refer to the following manual.

 GT Designer3 Version□ Screen Design Manual

1.2.1 Writing the project data and OS onto the GOT

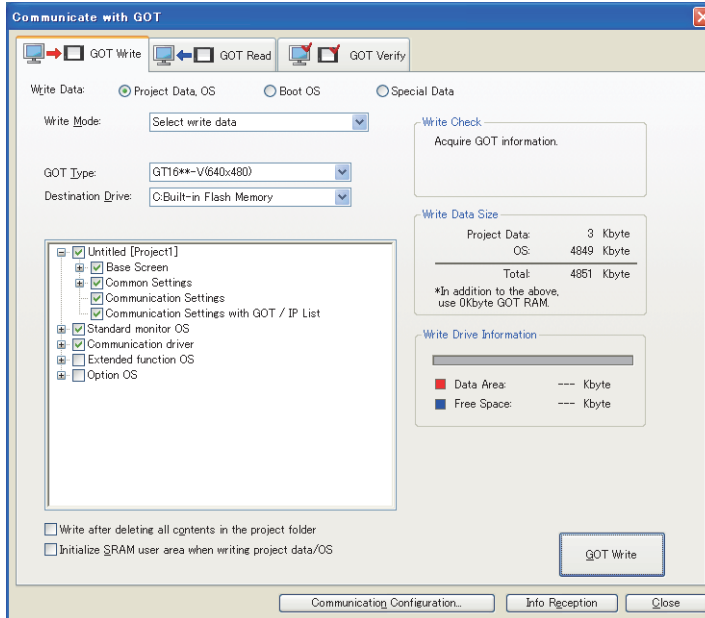

1. Select [Communication] → [Write to GOT...] from the menu.
2. The [Communication configuration] dialog box appears. Set the communication setting between the GOT and the personal computer. Click the **OK** button when settings are completed.
3. The [GOT Write] tab appears on the [Communicate with GOT] dialog box. Select the [Project data, OS] radio button of the Write Data.
4. Check-mark a desired standard monitor OS, communication driver, option OS, extended function OS, and Communication Settings and click the [GOT Write] button.

POINT

Writing communication driver onto GT10

When writing a communication driver onto the GT10 in which a Boot OS Ver. under F or a standard monitor OS Ver. under 01.08.00 is written, turn on the GOT in the OS transfer mode. For details, refer to the following manual.

 GT10 User's Manual

(Operating of transmission mode)

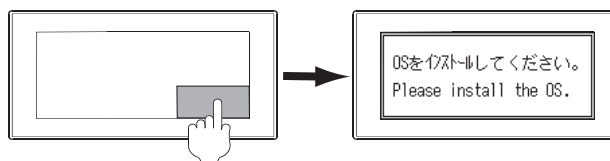

Turn on the GOT while the bottom right corner is touched.

1.2.2 Checking the project data and OS writing on GOT.

Confirm if the standard monitor OS, communication driver, option OS, project data and communication settings are properly written onto the GOT by reading from GOT using GT Designer3.

For reading from the GOT, refer to the following manual.

 GT Designer3 Version□ Screen Design Manual

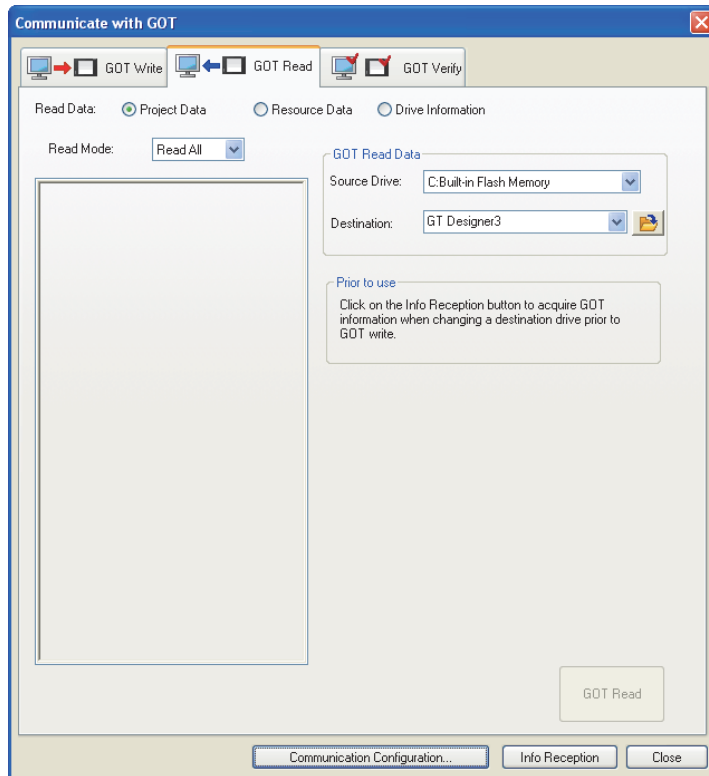

1. Select [Communication] → [Read from GOT...] from the menu.
2. The [Communication configuration] dialog box appears.
Set the communication setting between the GOT and the personal computer.
Click the **OK** button when settings are completed.
3. The [GOT Read] tab appears on the [Communicate with GOT] dialog box.
Select the [Drive information] radio button of the Read Data.
4. Click the [Info Reception] button.
5. Confirm that the project data and OS are written correctly onto the GOT.

1.3 Option Devices for the Respective Connection

The following shows the option devices to connect in the respective connection type.
For the specifications, usage and connecting procedure on option devices, refer to the respective device manual.

1.3.1 Communication module

Product name	Model	Specifications	
Bus connection unit	GT15-QBUS	For QCPU (Q mode), motion controller CPU (Q series) Bus connection (1ch) unit standard model	
	GT15-QBUS2	For QCPU (Q mode), motion controller CPU (Q series) Bus connection (2ch) unit standard model	
	GT15-ABUS	For A/QnACPU, motion controller CPU (A series) Bus connection (1ch) unit standard model	
	GT15-ABUS2	For A/QnACPU, motion controller CPU (A series) Bus connection (2ch) unit standard model	
	GT15-75QBUSL	For QCPU (Q mode), motion controller CPU (Q series) Bus connection (1ch) unit slim model	
	GT15-75QBUS2L	For QCPU (Q mode), motion controller CPU (Q series) Bus connection (2ch) unit slim model	
	GT15-75ABUSL	For A/QnACPU, motion controller CPU (A series) Bus connection (1ch) unit slim model	
	GT15-75ABUS2L	For A/QnACPU, motion controller CPU (A series) Bus connection (1ch) unit slim model	
Serial communication module	GT15-RS2-9P	RS-232 serial communication unit (D-sub 9-pin (male))	
	GT15-RS4-9S	RS-422/485 serial communication unit (D-sub 9-pin (female))	
	GT15-RS4-TE	RS-422/485 serial communication unit (terminal block)	
RS-422 conversion unit	GT15-RS2T4-9P	RS-232 → RS-422 conversion unit	RS-422 side connector 9-pin
	GT15-RS2T4-25P		RS-422 side connector 25-pin
MELSECNET/H Communication module	GT15-J71LP23-25	Optical loop unit	
	GT15-J71BR13	Coaxial bus unit	
MELSECNET/10 Communication module	GT15-75J71LP23-Z	Optical loop unit (A9GT-QJ71LP23 + GT15-75IF900 set)	
	GT15-75J71BR13-Z	Coaxial bus unit (A9GT-QJ71BR13 + GT15-75IF900 set)	
CC-Link IE controller network communication unit	GT15-J71GP23-SX	Optical loop unit	
CC-Link communication unit	GT15-J61BT13	Intelligent device station unit CC-LINK Ver. 2 compatible	
	GT15-75J61BT13-Z	Intelligent device station unit (A8GT-61BT13 + GT15-75IF900 set)	
Ethernet communication unit	GT15-J71E71-100	Ethernet (100Base-TX) unit	

1.3.2 Option unit

Product name	Model	Specifications
Printer unit	GT15-PRN	USB slave (PictBridge) for connecting printer 1 ch
Multimedia unit	GT16M-MMR	For video input signal (NTSC/PAL) 1 ch, playing movie
Video input unit	GT16M-V4	For video input signal (NTSC/PAL) 4 ch
	GT15V-75V4	
RGB input unit	GT16M-R2	For analog RGB input signal 2 ch
	GT15V-75R1	
Video/RGB input unit	GT16M-V4R1	For video input signal (NTSC/PAL) 4 ch, for analog RGB mixed input signal 1 ch
	GT15V-75V4R1	
RGB output unit	GT16M-ROUT	For analog RGB output signal 1 ch
	GT15V-75ROUT	
CF card unit	GT15-CFCD	For CF card installation (B drive) For GOT back face CF card eject
CF card extension unit	GT15-CFEX-C08SET	For CF card installation (B drive) For control panel front face CF card eject
Sound output unit	GT15-SOUT	For sound output
External I/O unit	GT15-DIOR	For the connection to external I/O device or operation panel (Negative Common Input/Source Type Output)
	GT15-DIO	For the connection to external I/O device or operation panel (Positive Common Input/Sink Type Output)

1.3.3 Conversion cables

Product name	Model	Specifications
RS-422 connector conversion Cable	GT16-C02R4-9S	RS-422/485 (Connector) ↔ RS-422 connector conversion cable (D-sub 9-pin)
RS-485 terminal block conversion modules	FA-LTBGTR4CBL05	RS-422/485 (Connector) ↔ RS-485 (Terminal block) Supplied connection cable dedicated for the conversion unit
	FA-LTBGTR4CBL10	
	FA-LTBGTR4CBL20	

1.3.4 Connector conversion adapter

Product name	Model	Specifications
Connector conversion adapter	GT10-9PT5S	RS-422/485 (D-Sub 9-pin connector) ↔ RS-422/485 (Terminal block)

1.3.5 Serial Multi-Drop Connection Unit

Product name	Model	Specifications
Serial multi-drop connection unit	GT01-RS4-M	GOT multi-drop connection module  Mitsubishi Products 18. GOT MULTI-DROP CONNECTION

1.3.6 Installing a unit on another unit (Checking the unit installation position)

This section describes the precautions for installing units on another unit.
For the installation method of each unit, refer to the following manual.

 GT16 User's Manual

 GT15 User's Manual

■ Calculating consumed current

For using multiple extension units, a bar code reader, or a RFID controller, the total current for the extension units, bar code reader, or RFID controller must be within the current that the GOT can supply.
For the current that the GOT can supply and the current for the extension units, bar code reader, or RFID controller, refer to the following tables. Make sure that the total of consumed current is within the capacity of the GOT.

(1) Current supply capacity of the GOT

GOT type	Current supply capacity (A)
GT1695M-X	2.4
GT1685M-S	2.4
GT1675M-S	2.4
GT1675M-V	2.4
GT1675-VN, GT1672-VN	2.4
GT1665M-S	2.4
GT1665M-V	2.4
GT1662-VN	2.4
GT1595-X	2.13

GOT type	Current supply capacity (A)
GT1585V-S	1.74
GT1585-S	1.74
GT1575V-S	2.2
GT1575-S	2.2
GT1575-V, GT1572-VN	2.2
GT1565-V, GT1562-VN	2.2
GT1555-V	1.3
GT1555-Q, GT1550-Q	1.3

(2) Current consumed by an extension unit/barcode reader/RFID controller

Module type	Consumed current (A)
GT15-QBUS, GT15-75QBUSL, GT15-QBUS, GT15-75QBUS2L	0.275 ^{*1}
GT15-ABUS, GT15-75ABUSL, GT15-ABUS2, GT15-75ABUS2L	0.12
GT15-RS2-9P	0.29
GT15-RS4-9S	0.33
GT15-RS4-TE	0.3
GT15-RS2T4-9P	0.098
GT15-J71E71-100	0.224
GT15-J71GP23-SX	1.07
GT15-J71LP23-25	0.56
GT15-J71BR13	0.77
GT15-J61BT13	0.56
Bar code reader	*2
GT15-PRN	0.09
GT16M-V4	0.12 ^{*1}
GT15V-75V4	0.2 ^{*1}

Module type	Consumed current (A)
GT16M-R2	0 ^{*1}
GT15V-75R1	0.2 ^{*1}
GT16M-V4R1	0.12 ^{*1}
GT15V-75V4R1	0.2 ^{*1}
GT16M-ROUT	0.11 ^{*1}
GT15V-75ROUT	0.11
GT16M-MMR	0.27 ^{*1}
GT15-CFCD	0.07
GT15-CFEX-C08SET	0.15
GT15-SOUT	0.08
GT15-DIO	0.1
GT15-DIOR	0.1
RFID controller	*2
GT15-80FPA	0.22

*1 Value used for calculating the current consumption of the multi-channel function.
For the specifications of the unit, refer to the manual included with the unit.

*2 When the GOT supplies power to a barcode reader or a RFID controller from the standard interface, add their consumed current.
(Maximum value is less than 0.3 A)

(3) Calculation example

- (a) When connecting the GT15-J71BR13, GT15-RS4-9S (3 units), GT15-J71E71-100 (For the gateway function) and a bar code reader (0.12 A) to the GT1575-V

Current supply capacity of GOT (A)	Total consumed current (A)
2.2	$0.77+0.33+0.33+0.33+0.224+0.12=2.104$

Since the calculated value is within the capacity of the GOT, they can be connected to the GOT.

- (b) When connecting the GT15-J71BR13, GT15-RS4-9S (2 units), GT15-J71E71-100 (For the gateway function) and a bar code reader (0.12 A) to the GT1585-S

Current supply capacity of GOT (A)	Total consumed current (A)
1.74	$0.77+0.33+0.33+0.224+0.12=1.774$

Since the calculated value exceeds the capacity of the GOT, such configuration is not allowed.

■ When using a bus connection unit

The installation position varies depending on the bus connection unit to be used.

- (1) Wide bus units (GT15-75QBUS(2)L, GT15-75ABUS(2)L, GT15-QBUS2, GT15-ABUS2)

Install a bus connection unit in the 1st stage of the extension interface.

If a bus connection unit is installed in the 2nd stage or above, the unit cannot be used.

Example: Installing a bus connection unit and serial communication units

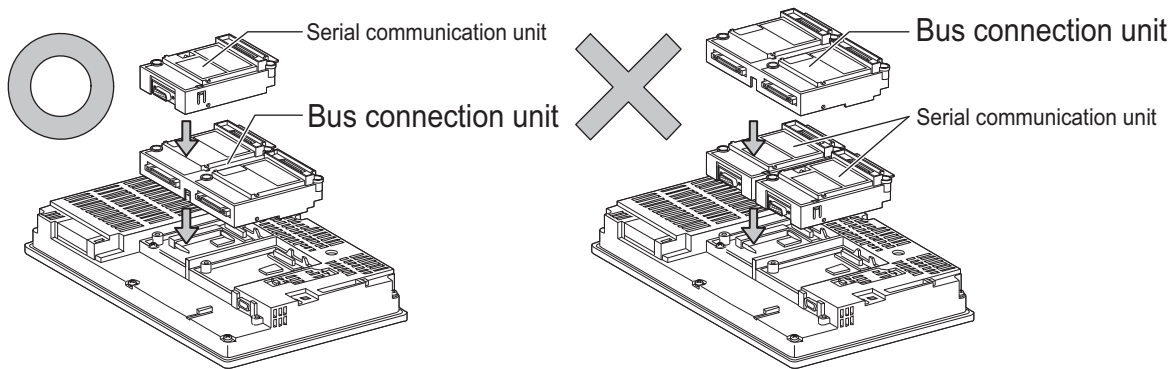

POINT

Cautions for using GT15-QBUS2 and GT15-ABUS2

The stage number of communication units installed on the next stage of GT15-QBUS2 or GT15-ABUS2 are recognized by the GOT differently depending on the extension interface position.

For communication units installed in the extension interface 2 side, even if the communication unit is physically installed in the 2nd stage position, the GOT recognizes the position as the 1st stage.

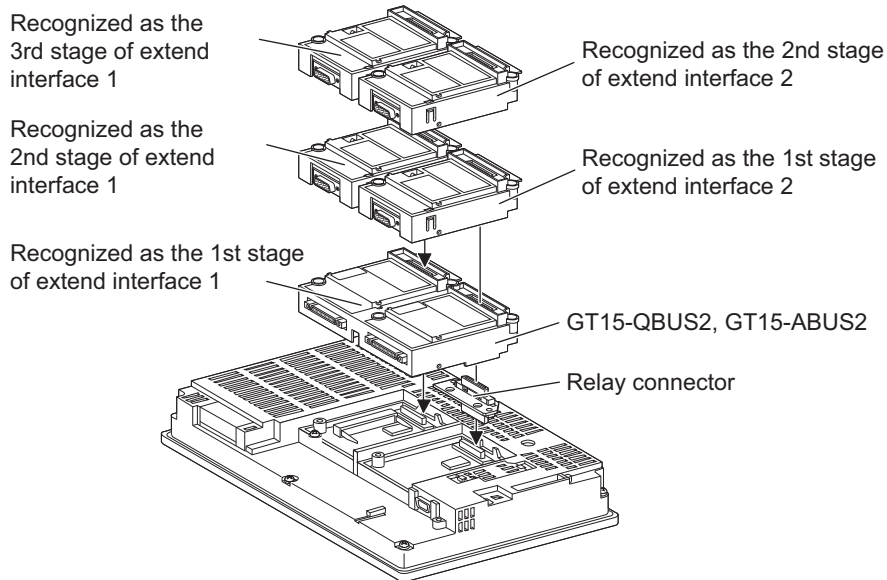

(2) Standard size bus connection unit (GT15-QBUS and GT15-ABUS)

A bus connection unit can be installed in any position (1st to 3rd stage) of the extension interface.

Example: Installing a bus connection unit and serial communication units

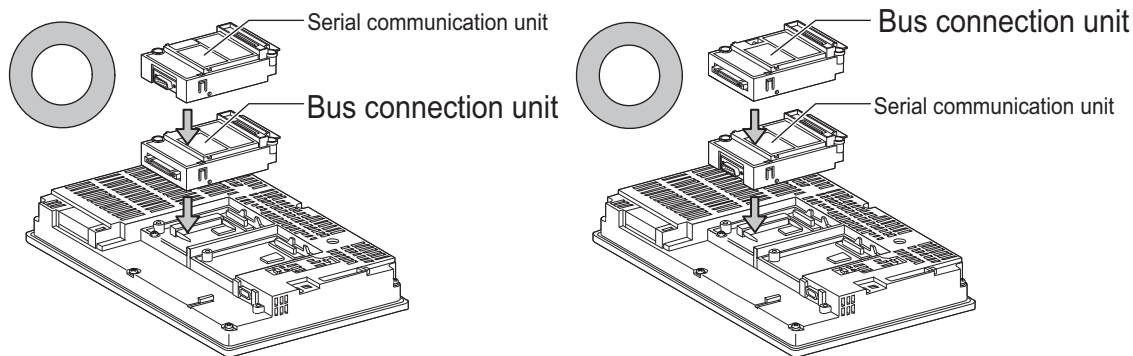

■ When using a MELSECNET/H communication unit, CC-Link IE controller network communication unit, or CC-Link communication unit (GT15-J61BT13)

Install a MELSECNET/H communication unit, CC-Link IE controller network communication unit, or CC-Link communication unit in the 1st stage of an extension interface.

These communication units cannot be used if installed in the 2nd or higher stage.

Example: When installing a MELSECNET/H communication unit and a serial communication unit

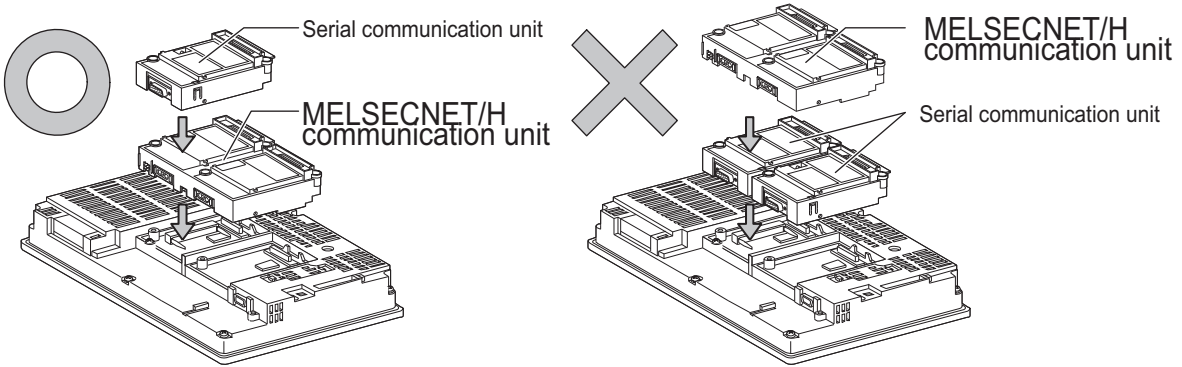

POINT

Precautions for using a MELSECNET/H communication unit, CC-Link IE controller network communication unit, CC-Link communication unit (GT15-J61BT13)

The installed stage number of communication units installed on the next stage of MELSECNET/H communication unit, CC-Link IE controller network communication unit, or CC-Link communication unit are recognized by the GOT differently depending on the extension interface position.

For communication units installed in the extension interface 2 side, even if the communication unit is physically installed in the 2nd stage position, the GOT recognizes the position as the 1st stage.

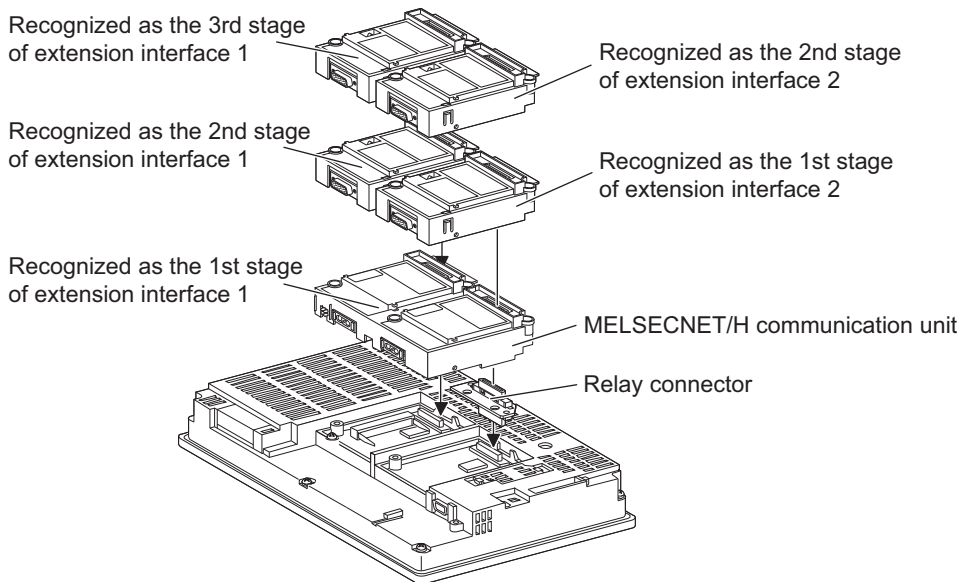

■ **When using a MELSECNET/10 communication unit (GT15-75J71LP23-Z, GT15-75J71BR13-Z) or CC-Link communication unit (GT15-75J61BT13-Z)**

Install a MELSECNET/10 communication unit (GT15-75J71LP23-Z, GT15-75J71BR13-Z) or CC-Link communication unit (GT15-75J61BT13-Z) at the 1st stage of the extension interface.

These communication units cannot be used if installed in the 2nd or higher stage.

For GT16 and the GT155□, the MELSECNET/10 communication unit (GT15-75J71LP23-Z, GT15-75J71BR13-Z) and the CC-Link communication unit (GT15-75J61BT13-Z) are not applicable.

Example: When installing a MELSECNET/10 communication unit and a serial communication unit

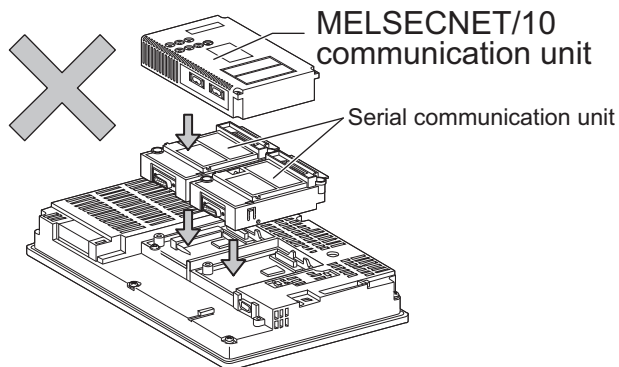

■ **When using an Ethernet communication unit**

An Ethernet communication unit can be installed in any position (1st to 3rd stage) of the extension interface.

For GT16, the Ethernet communication unit is not applicable.

Use the Ethernet interface built in the GOT.

Example: When installing an Ethernet communication unit and a serial communication unit

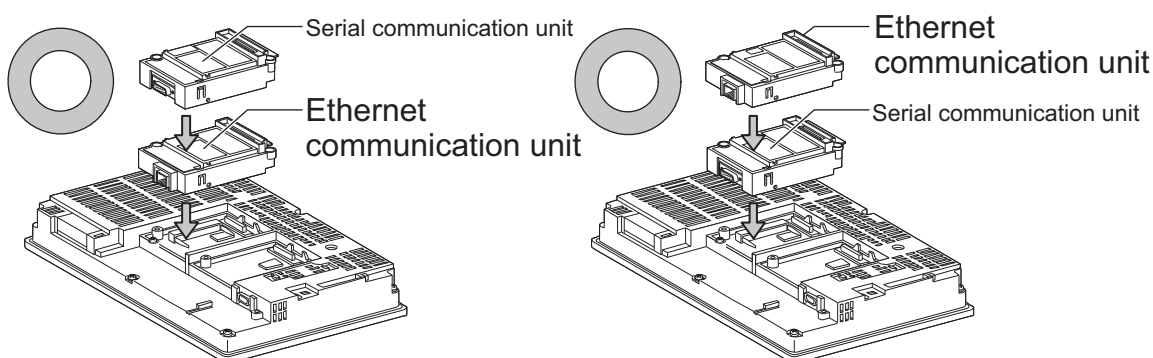

■ **When using a serial communication unit**

A serial communication unit can be installed in any position (1st to 3rd stage) of the extension interface.

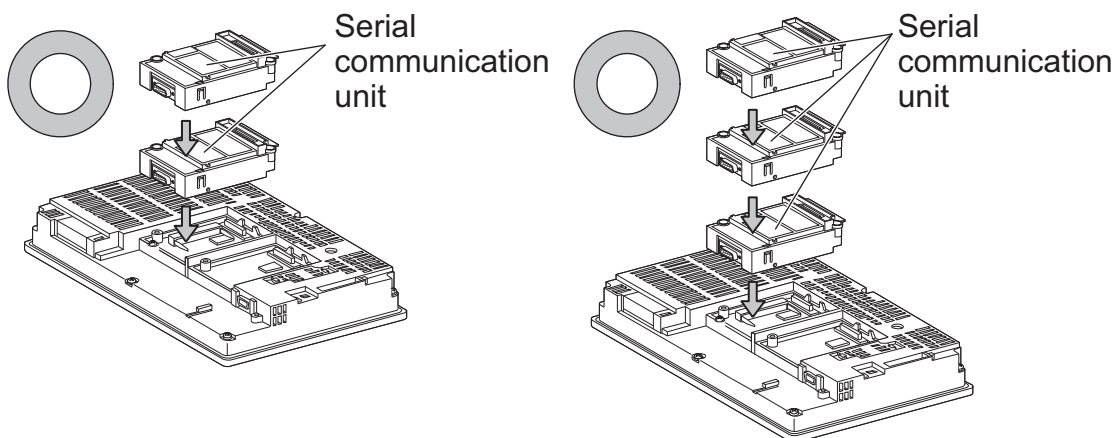

■ When using the printer unit, sound output unit, or external I/O unit

The printer unit, sound output unit, or external I/O unit can be installed in any position (1st to 3rd stage) of the extension interface.

Example: When installing a printer unit

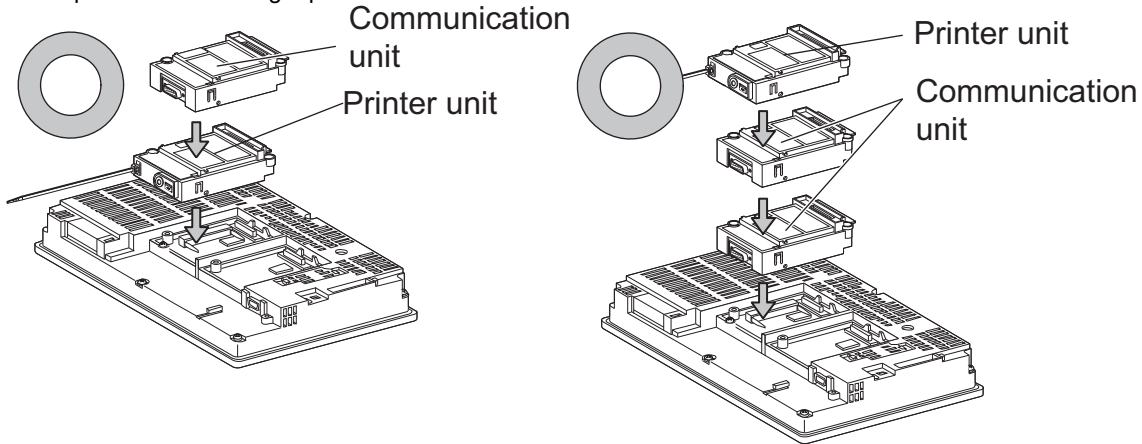

■ When using the video input unit, RGB input unit, video/RGB input unit, RGB output unit, or multimedia unit

Install the video input unit, RGB input unit, video/RGB input unit, RGB output unit, or multimedia unit at the 1st stage of the extension interface. These units cannot be used if installed in the 2nd or higher stage.

When any of these units is used, the communication units indicated below must be installed in the 2nd stage of the extension interface.

Communication unit	Model	
Bus connection unit	GT15-QBUS2,	GT15-ABUS2
MELSECNET/H communication unit	GT15-J71LP23-25,	GT15-J71BR13
CC-Link IE controller network communication unit	GT15-J71GP23-SX	
CC-Link communication unit	GT15-J61BT13	

Example: When installing a video input unit and a MELSECNET/H communication unit

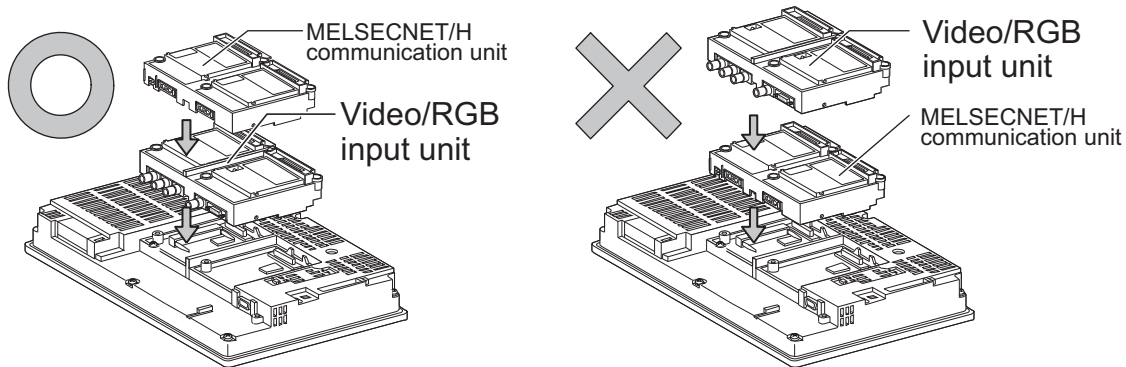

POINT

Precautions for video input unit, RGB input unit, video/RGB input unit, RGB output unit, and multimedia unit
 When a communication unit is installed on any of the units above, the stage number of the communication unit recognized by the GOT varies according to the extension interface.
 For communication units installed in the extension interface 2 side, even if the communication unit is physically installed in the 2nd stage position, the GOT recognizes the position as the 1st stage.

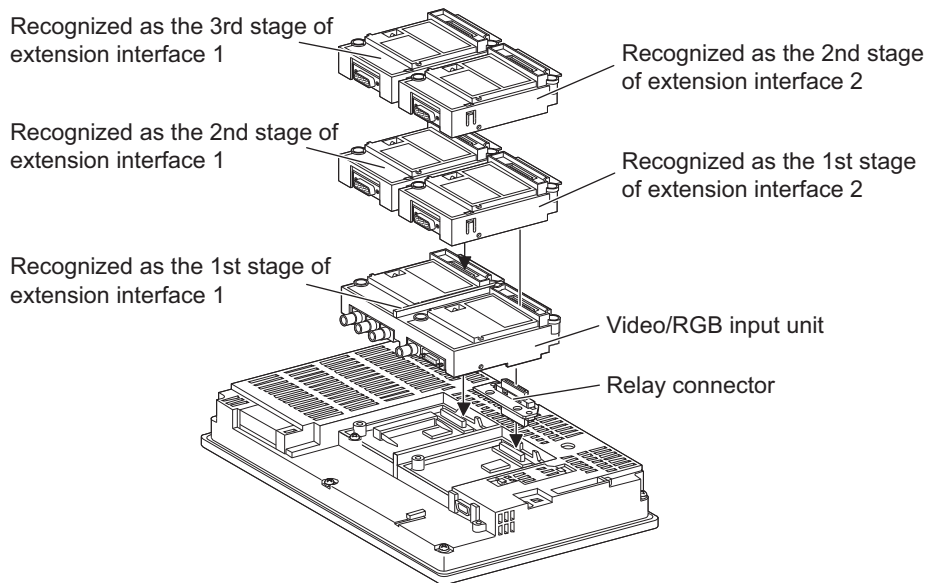

■ When using CF card unit or CF card extension unit

Install the CF card unit or CF card extension unit on the extension interface at the last.
 The following figures show how to install the CF card unit.

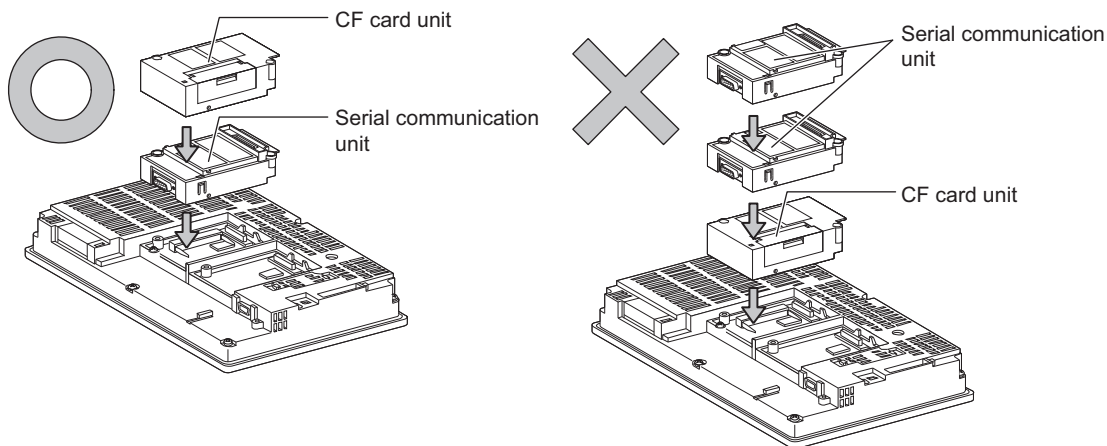

1.4 Connection Cables for the Respective Connection

To connect the GOT to a device in the respective connection type, connection cables between the GOT and a device are necessary.

For cables needed for each connection, refer to each chapter for connection.

1.4.1 GOT connector specifications

The following shows the connector specifications on the GOT side.

Refer to the following table when preparing connection cables by the user.

■ RS-232 interface

Use the following as the RS-232 interface and RS-232 communication unit connector on the GOT. For the GOT side connection cable, use a connector and connector cover applicable to the GOT connector.

(1) Connector specifications

GOT	Hardware version*1	Connector type	Connector model	Manufacturer
GT16	—	9-pin D-sub (male) inch screw fixed type	17LE-23090-27(D4C□)	DDK Ltd.
GT1595-X	—		17LE-23090-27(D4CK)	
GT1585V-S	—			
GT1585-STBA	B or later		GM-C9RMDU11	Honda Tsushin Kogyo Co., Ltd.
	C			
GT1585-STBD	—		17LE-23090-27(D4CK)	DDK Ltd.
GT1575V-S	—			
GT1575-STBA	B or later		GM-C9RMDU11	Honda Tsushin Kogyo Co., Ltd.
	C			
GT1575-STBD	—		17LE-23090-27(D4CK)	DDK Ltd.
GT1575-VTBA	D or later		GM-C9RMDU11	Honda Tsushin Kogyo Co., Ltd.
	E			
GT1575-VTBD	—			
GT1575-VN	—			
GT1572-VN	—			
GT1565-V	—			
GT1562-VN	—			
GT155□	—			
GT115□-Q	—			
GT105□-Q	—			
GT104□-Q	—			
GT1030, GT1020	—	9-pin terminal block*2	MC1.5/9-G-3.5BK	PHOENIX CONTACT Inc
GT15-RS2-9P	—	9-pin D-sub (male) inch screw fixed type	17LE-23090-27(D3CC)	DDK Ltd.
GT01-RS4-M	—			

*1 For the procedure to check the GT15 hardware version, refer to the GT15 User's Manual.

*2 The terminal block (MC1.5/9-ST-3.5 or corresponding product) of the cable side is packed together with the GT1030, GT1020.

(2) Connector pin arrangement

GT16, GT15, GT11, GT105□, GT104□, GT01-RS4-M	GT1030, GT1020
<p>GOT main part connector see from the front</p> <p>9-pin D-sub (male)</p>	<p>See from the back of a GOT main part</p> <p>9-pin terminal block</p>

■ RS-422 interface

Use the following as the RS-422 interface and the RS-422/485 communication unit connector on the GOT.
 For the GOT side of the connection cable, use a connector and connector cover applicable to the GOT connector.

(1) Connector model

GOT	Connector type	Connector model	Manufacturer
RS-422 conversion unit	9-pin D-sub (female) M2.6 millimeter screw fixed type	17LE-13090-27(D2AC)	DDK Ltd.
GT16 ^{*1}	14-pin (female)	HDR-EC14LFDT1-SLE+	Honda Tsushin Kogyo Co., Ltd.
GT115□ -Q	9-pin D-sub (female) M2.6 millimeter screw fixed type	17LE-13090-27(D3AC)	DDK Ltd.
GT105□ -Q			
GT104□ -Q			
GT1030, GT1020	9-pin terminal block ^{*2}	MC1.5/9-G-3.5BK	PHOENIX CONTACT Inc
GT15-RS4-9S	9-pin D-sub (female) M2.6 millimeter screw fixed type	17LE-13090-27(D3AC)	DDK Ltd.
GT01-RS4-M			

*1 When connecting to the RS-422/485 interface, use HDR-E14MAG1+ as a cable connector.
 To use HDR-E14MAG1+, a dedicated pressure welding tool is required.

For details on the connector and pressure welding tool, contact Honda Tsushin Kogyo Co., Ltd..

*2 The terminal block (MC1.5/9-ST-3.5 or corresponding product) of the cable side is packed together with the GT1030, GT1020.

(2) Connector pin arrangement

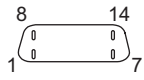
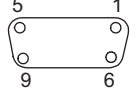
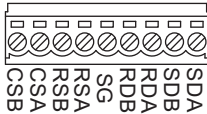
GT16	GT15, GT11, GT105□, GT104□, GT01-RS4-M	GT1030, GT1020
GOT main part connector see from the front	GOT main part connector see from the front	See from the back of a GOT main part
		
14-pin (female)	9-pin D-sub (female)	9-pin terminal block

■ RS-485 interface

Use the following as the RS-485 interface and the RS-422/485 communication unit connector on the GOT.
For the GOT side of the connection cable, use a connector and connector cover applicable to the GOT connector.

(1) Connector model

GOT	Hardware version*1	Connector type	Connector model	Manufacturer
GT16*2	—	14-pin (female)	HDR-EC14LFDT1-SLE+	Honda Tsushin Kogyo Co., Ltd.
GT1155-QTBD	C or later	9-pin D-sub (female) M2.6 millimeter screw fixed type	17LE-13090-27(D3AC)	DDK Ltd.
GT1155-QSBD	F or later			
GT1150-QLBD				
GT105□ -Q	C or later			
GT104□ -Q	A or later			
GT1030	B or later	9-pin terminal block*3	MC1.5/9-G-3.5BK	PHOENIX CONTACT Inc
GT1020	E or later			
GT15-RS4-9S	—	9-pin D-sub (female) M2.6 millimeter screw fixed type	17LE-13090-27(D3AC)	DDK Ltd.
GT15-RS4-TE	—	—	SL-SMT3.5/10/90F BOX	Weidmuller interconnections inc

*1 For the checking procedure of the hardware version, refer to the User's Manual.

*2 When connecting to the RS-422/485 interface, use HDR-E14MAG1+ as a cable connector.

To use HDR-E14MAG1+, a dedicated pressure welding tool is required.

For details on the connector and pressure welding tool, contact Honda Tsushin Kogyo Co., Ltd..

*3 The terminal block (MC1.5/9-ST-3.5 or corresponding product) of the cable side is packed together with the GT1030, GT1020.

(2) Connector pin arrangement

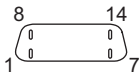
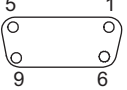
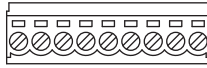
GT16	GT15, GT11, GT105□, GT104□	GT1030, GT1020
<p>GOT main part connector see from the front</p>  <p>14-pin (female)</p>	<p>GOT main part connector see from the front</p>  <p>9-pin D-sub (female)</p>	<p>See from the back of a GOT main part</p>  <p>9-pin terminal block</p>

1.4.2 Coaxial cable connector connection method

The following describes the method for connecting the BNC connector (connector plug for coaxial cable) and the cable.

⚠ CAUTION

- Solder the coaxial cable connectors properly. Insufficient soldering may result in malfunctions.

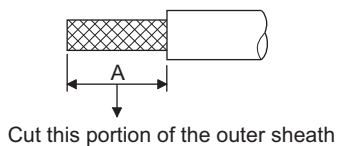
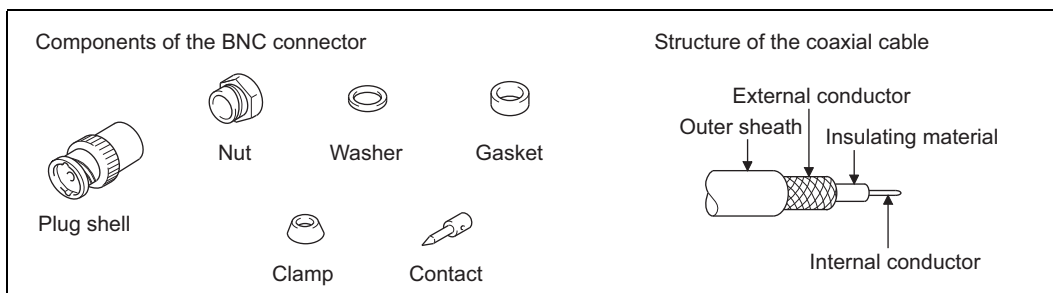

1. Remove the external sheath of the coaxial cable with dimensions as shown below.

Cable in use	A
3C-2V	15mm
5C-2V, 5C-2V-CCY	10mm

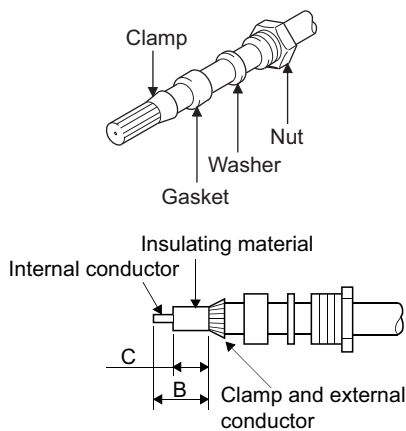

2. Pass the nut, washer, gasket, and clamp through the coaxial cable as shown on the left and loosen the external conductor.

3. Cut the external conductor, insulating material, and internal conductor with the dimensions as shown below. Note that the external conductor should be cut to the same dimension as the tapered section of the clamp and smoothed down to the clamp.

Cable in use	B	C
3C-2V	6mm	3mm
5C-2V, 5C-2V-CCY	7mm	5mm

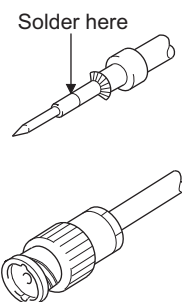

4. Solder the contact to the internal conductor.
5. Insert the connector assembly shown in 4. into the plug shell and screw the nut into the plug shell.

Precautions for soldering

Note the following precautions when soldering the internal conductor and contact.

- Make sure that the solder does not bead up at the soldered section.
- Make sure there are no gaps between the connector and cable insulator or they do not cut into each other.
- Perform soldering quickly so the insulation material does not become deformed.

1.4.3 Terminating resistors of GOT

The following shows the terminating resistor specifications on the GOT side.
When setting the terminating resistor in each connection type, refer to the following.

■ RS-422/485 communication unit

Set the terminating resistor using the terminating resistor setting switch.

Terminating resistor*1	Switch No.	
	1	2
Enable	ON	ON
Disable	OFF	OFF



*1 The default setting is "Disable".

• For RS-422/485 communication unit

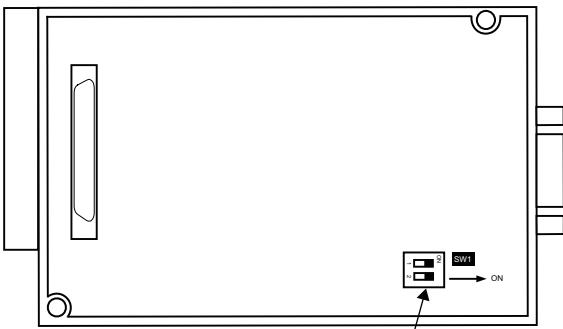

Terminating resistor setting switch

Rear view of RS-422/485 communication unit.

■ GT16

Set the terminating resistor using the terminating resistor setting switch.

Terminating resistor*1	Switch No.	
	1	2
Enable	ON	ON
Disable	OFF	OFF



*1 The default setting is "Disable".

• For GT1685M-S

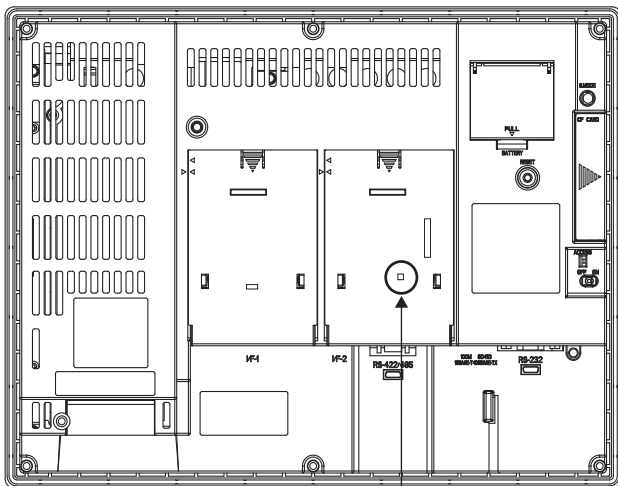

Terminating resistor setting switch
(inside the cover)

■ GT11

Set the terminating resistor using the terminating resistor setting switch.

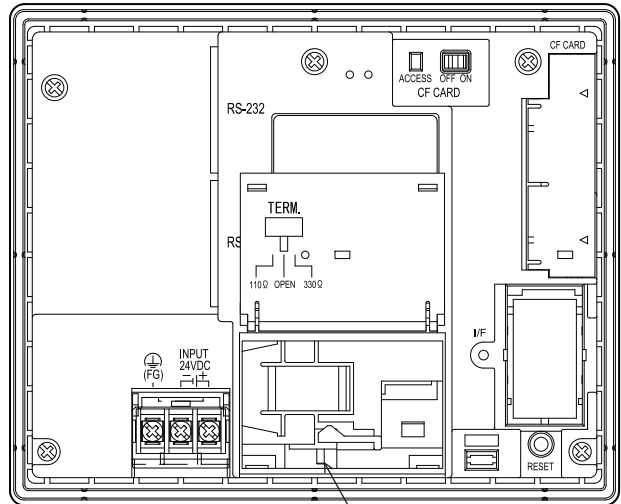

Terminating resistor selector switch

■ GT105□

Set the terminating resistor using the terminating resistor setting switch.

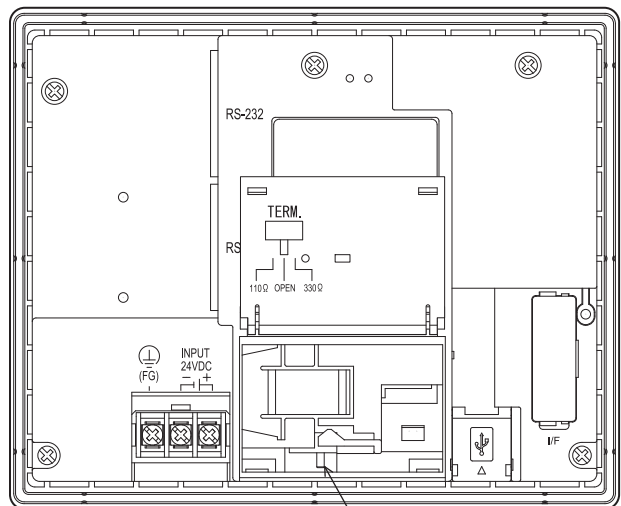

Terminating resistor selector switch

■ GT104□

Set the terminating resistor using the terminating resistor setting switch.

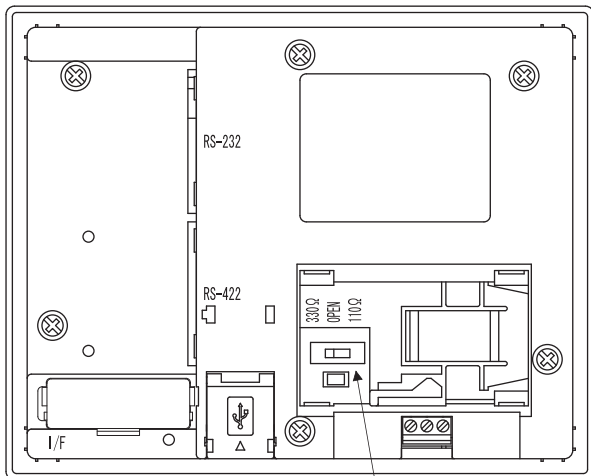

Terminating resistor selector switch

■ GT1030

Set the terminating resistor using the terminating resistor setting switch.

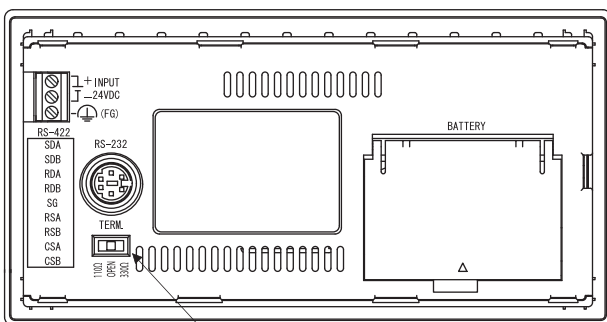

Terminating resistor selector switch

■ GT1020

Set the terminating resistor using the terminating resistor setting switch.

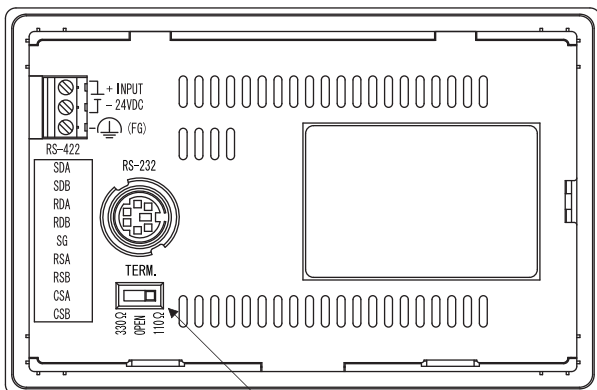

Terminating resistor selector switch

1.5 Verifying GOT Recognizes Connected Equipment

Verify the GOT recognizes controllers on [Communication Settings] of the Utility.

- Channel number of communication interface, communication drivers allocation status
- Communication unit installation status

For details on the Utility, refer to the following manual.

GT□ User's Manual

■ When using GT16

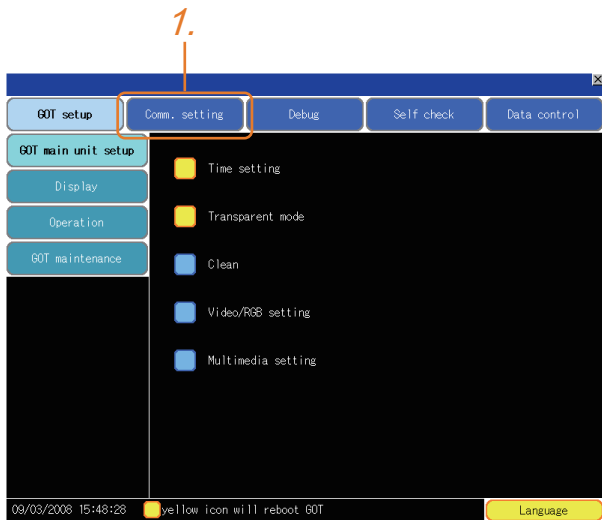

1. After powering up the GOT, touch [Main menu] → [Communication setting] from the Utility.

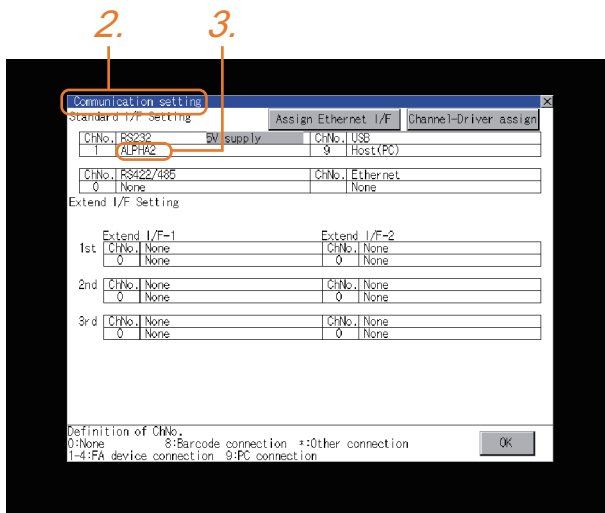

2. The [Communication Settings] appears.

3. Verify that the communication driver name to be used is displayed in the communication interface box to be used.

4. When the communication driver name is not displayed normally, carry out the following procedure again.

1.1 Setting the Communication Interface

■ When using GT15 or GT11

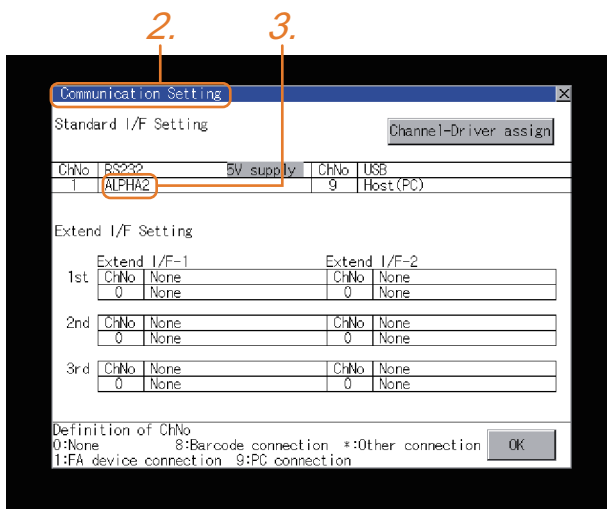
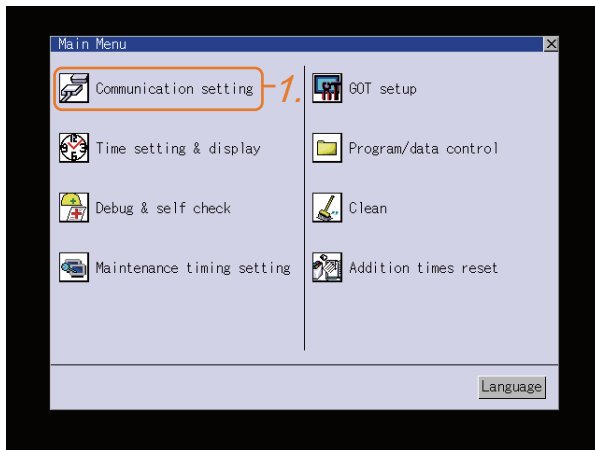

1. After powering up the GOT, touch [Main menu] → [Communication setting] from the Utility.

2. The [Communication Settings] appears.

3. Verify that the communication driver name to be used is displayed in the box for the communication interface to be used.

4. When the communication driver name is not displayed normally, carry out the following procedure again.

☞ 1.1 Setting the Communication Interface

■ For GT10

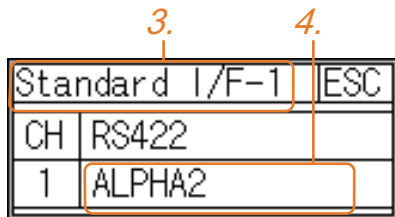
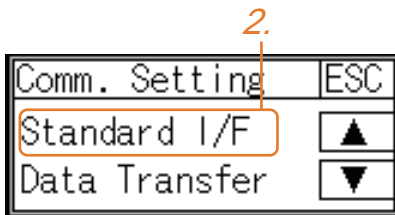
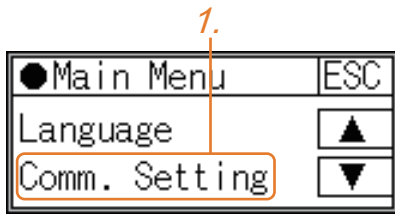

1. After powering up the GOT, touch [Main Menu] → [Comm. Setting] from the Utility.

2. Touch [Standard I/F] on [Comm. Setting].

3. The [Standard I/F] appears.

4. Verify that the communication driver name to be used is displayed in the box for the communication interface to be used.

5. When the communication driver name is not displayed normally, carry out the following procedure again.

☞ 1.1 Setting the Communication Interface

POINT

Utility

(1) How to display Utility (at default)

When using GT16, GT1595 or GT1020

Utility call key
1-point press on GOT screen upper-left corner

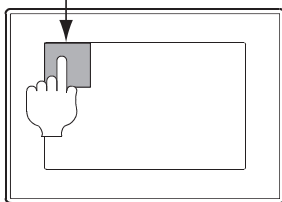

When using GT1585, GT157□, GT156□, GT155□, GT11, GT105□, GT104□ or GT1030

Utility call key
Simultaneous 2-point press

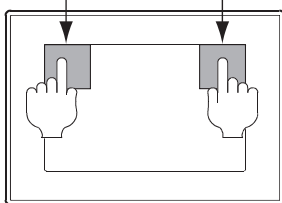

Utility display (When using GT16)

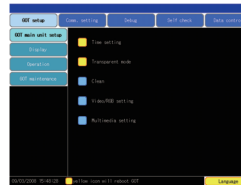

(When using GT15)

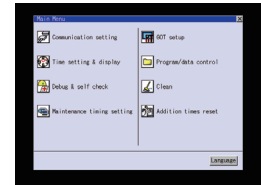

(When using GT11)



(When using GT105□, GT104□)

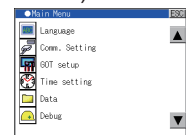

(When using GT1030,GT1020)

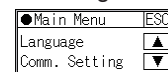

(2) Utility call

When setting [Pressing time] to other than 0 second on the setting screen of the utility call key, press and hold the utility call key until the buzzer sounds. For the setting of the utility call key, refer to the following.

 GT□ User's Manual

(3) Communication interface setting by the Utility

The communication interface setting can be changed on the Utility's [Communication setting] after writing [Communication Settings] of project data.

For details on the Utility, refer to the following manual.

 GT□ User's Manual

(4) Precedence in communication settings

When settings are made by GT Designer3 or the Utility, the latest setting is effective.

1.6 Checking for Normal Monitoring

1.6.1 Check on the GOT

- Check for errors occurring on the GOT



Presetting the system alarm to project data allows you to identify errors occurred on the GOT, PLC CPU, servo amplifier and communications.

For details on the operation method of the GOT Utility screen, refer to the following manual.

 GT□ User's Manual

(When using GT15)

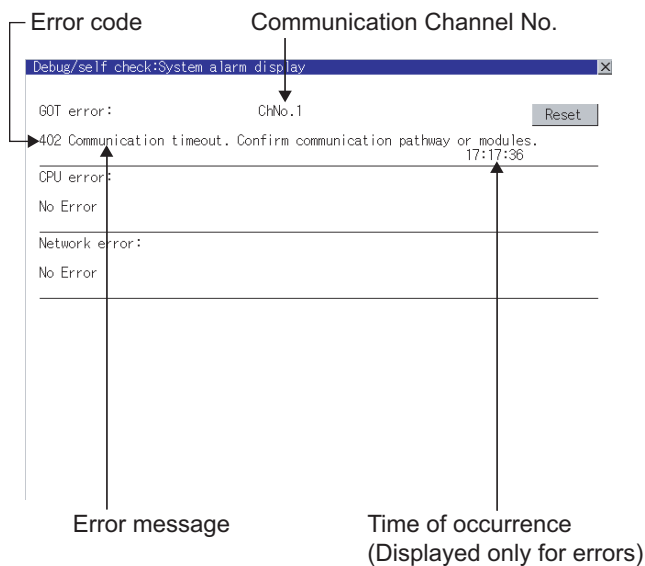

Advanced alarm popup display  

With the advanced alarm popup display function, alarms are displayed as a popup display regardless of whether an alarm display object is placed on the screen or not (regardless of the display screen).

Since comments can be flown from right to left, even a long comment can be displayed all.

For details of the advanced popup display, refer to the following manual.

 GT Designer3 Screen Design Manual

■ Perform an I/O check



Whether the PLC can communicate with the GOT or not can be checked by the I/O check function. If this check ends successfully, it means correct communication interface settings and proper cable connection. Display the I/O check screen by Main Menu.

- For GT16
Display the I/O check screen by [Main menu] → [Self check] → [I/O check].
- For GT15, GT11
Display the I/O check screen by [Main menu] → [Debug & self check] → [Self check] → [I/O check].

For details on the I/O check, refer to the following manual:

 GT□ User's Manual

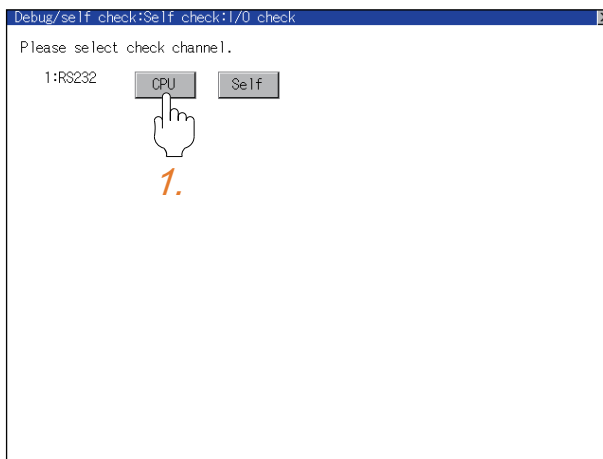

1. Touch [CPU] on the I/O check screen. Touching [CPU] executes the communication check with the connected PLC.

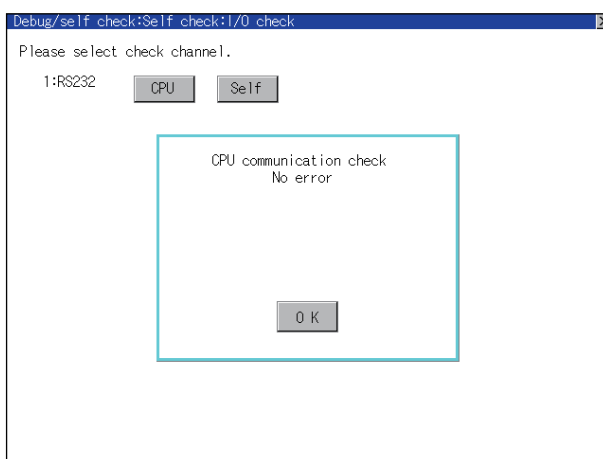

2. When the communication screen ends successfully, the screen on the left is displayed.

■ Communication monitoring function



The communication monitoring is a function that checks whether the PLC can communicate with the GOT. If this check ends successfully, it means correct communication interface settings and proper cable connection. Display the communication monitoring function screen by [Main Menu] → [Comm. Setting] → [Comm. Monitor]. For details on the communication monitoring function, refer to the following manual:

👉 GT10 User's Manual

(Operation of communication monitoring function screen)

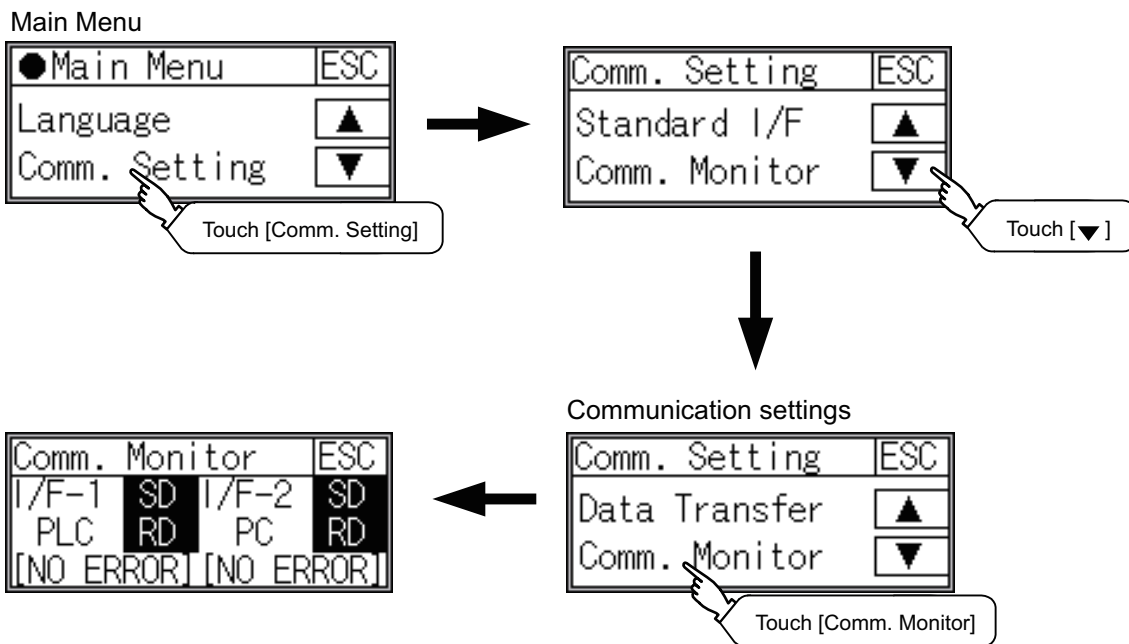

ALPHA2 CONNECTION

2.	ALPHA2 CONNECTION	2 - 1
----	-------------------------	-------

2

ALPHA2 CONNECTION



2.1	List of Connectable Models	2 - 2
2.2	System Configuration	2 - 2
2.3	Connection Diagram	2 - 3
2.4	GOT Side Settings	2 - 4
2.5	PLC Side Settings	2 - 5
2.6	Device Range that Can Be Set	2 - 5

2. ALPHA2 CONNECTION

2.1 List of Connectable Models

The following shows the connectable models.

Model name	Clock	Communication type	GT 16	GT 15	GT11 Bus	GT11 Serial	GT 10 5D 4P	GT 10 20 30	Refer to
AL2-14MR	×	RS-232	○	○	×	○	○	○	 2.2.1
AL2-24MR			○	○	×	○	○	○	

2.2 System Configuration

2.2.1 Connecting to AL2-14MR, AL2-24MR

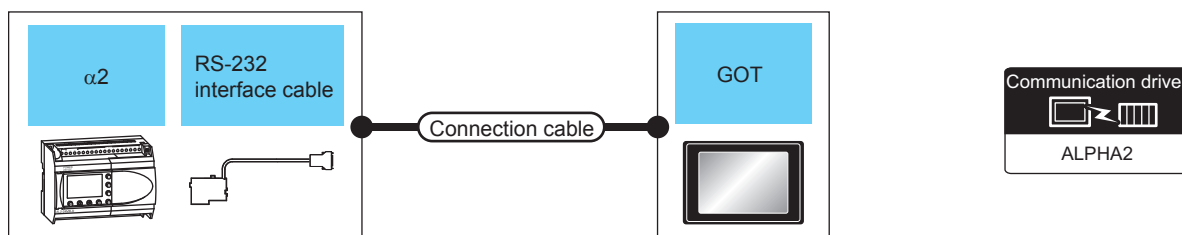

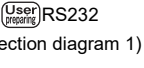
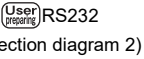
PLC			Connection cable		GOT		Number of connectable equipments
Model name	RS-232 interface cable	Communication type	Connection diagram number	Max. distance	Option device	Model	
AL2-14MR AL2-24MR	AL2-GSM-CAB	RS-232	 RS232 connection diagram 1)	15m	- (Built into GOT)	GT 16 GT 15 GT11 Serial GT 10 5D 4P	1 GOT for 1 PLC
			 RS232 connection diagram 2)		15m	- (Built into GOT)	

2.3 Connection Diagram

The following shows the connection diagrams of cables used for connecting the GOT to a $\alpha 2$.

2.3.1 RS-232 cable

■ Connection diagram

RS232 connection diagram 1)

(For GT16, GT15, GT11, GT105□, GT104□)

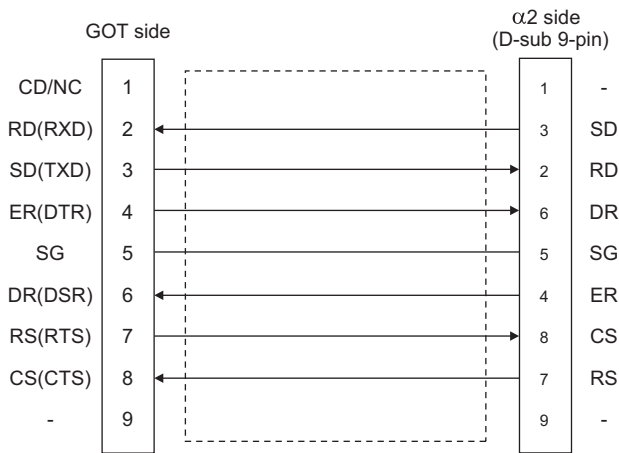

RS232 connection diagram 2)

(For GT1030, GT1020)

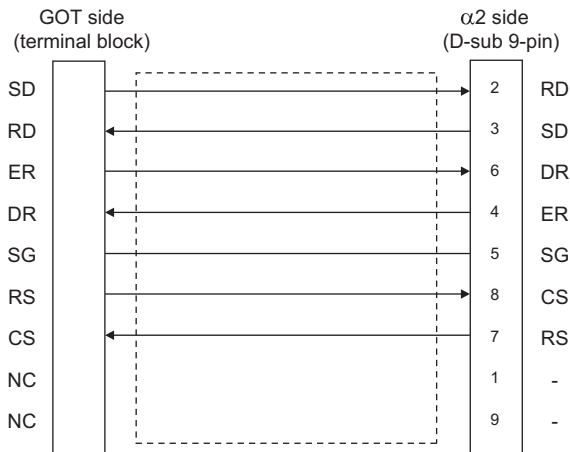

■ Precautions when preparing cable

(1) Cable length

The length of the cable RS-232 must be 15m or less.

(2) GOT side connector

For the GOT side connector, refer to the following.

☞ 1.4.1 GOT connector specifications

(3) $\alpha 2$ side connector

Use the connector compatible with the $\alpha 2$.

For the GOT side connector, refer to the following.

☞ $\alpha 2$ Simple Application Controller HARDWARE MANUAL

2.4 GOT Side Settings

2.4.1 Setting communication interface (Communication settings)

Set the channel of the connected equipments.

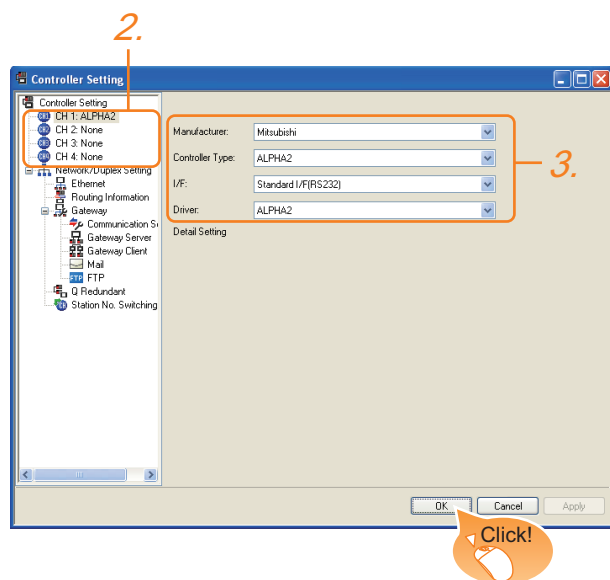

1. Select [Common] → [Controller Setting] from the menu.
2. The Controller Setting window is displayed. Select the channel to be used from the list menu.
3. Select the followings.
 - Manufacturer: Mitsubishi
 - Controller Type: ALPHA2
 - I/F: Interface to be used
 - Driver: ALPHA2

Click the button when settings are completed.

POINT

The settings of connecting equipments can be confirmed in [I/F Communication Setting].
For details, refer to the following.

 1.1.2 I/F communication setting

2.5 PLC Side Settings

For details of the $\alpha 2$, refer to the following manual.

☞ COMMUNICATION MANUAL $\alpha 2$ SIMPLE APPLICATION CONTROLLER

☞ PROGRAMING MANUAL $\alpha 2$ SIMPLE APPLICATION CONTROLLER

2.5.1 Communication setting

Make the communication settings by front panel key or AL-VLS/WIN-E.

Item	Setting
Modem	other
Data Bit	8
Parity	None
Stop Bit	1
Baud Rate	9600

2.6 Device Range that Can Be Set

The device ranges of controller that can be used for GOT are as follows.

Note that the device ranges in the following tables are the maximum values that can be set in GT Designer3.

The device specifications of controllers may differ depending on the models, even though belonging to the same series.

Please make the setting according to the specifications of the controller actually used.

When a non-existent device or a device number outside the range is set, other objects with correct device settings may not be monitored.

■ Setting item

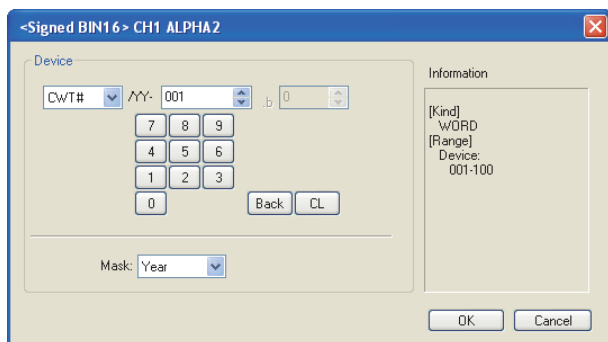

Item	Description
Device	Set the device name, device number, and bit number. The bit number can be set only when specifying the bit of word device.
Information	Displays the device type and setting range which are selected in [Device].
Mask	Set this item when using the "Communication Word Device For Time Switch FB (CWT#)".

(1) Setting of the mask type

(a) Mask type Year (CWT#/YY)

Set "year" of the Time Switch FB.

Device	Setting range	Description
CWT#/YY	1998 to 2053	<ul style="list-style-type: none"> From the year 1998 to the year 2053 This item is valid only while Date setting is valid. Date setting becomes valid when "CWT#/YY" is set while Weekly setting is valid. In that case, "month", "day" and "output ON/OFF status" are initialized to "January", "1" and "OFF" respectively.

(b) Mask type Month (CWT#/MM)

Set "month" of the Time Switch FB.

Device	Setting range	Description
CWT#/MM	1 to 12	<ul style="list-style-type: none"> From January to December This item is valid only while Date setting is valid. Date setting becomes valid when "CWT#/MM" is set while Weekly setting is valid. In that case, "year", "day" and "output ON/OFF status" are initialized to "2009", "1" and "OFF" respectively.

(c) Mask type Day (CWT#/DD)

Set "day" of the Time Switch FB.

Device	Setting range	Description
CWT#/DD	1 to 31	<ul style="list-style-type: none"> From the 1st day to the 31st day This item is valid only while Date setting is valid. Date setting becomes valid when "CWT#/DD" is set while Weekly setting is valid. In that case, "year", "month" and "output ON/OFF status" are initialized to "2009", "January" and "OFF" respectively.

(d) Mask type Hour (CWT#/HH)
Set "hour" of the Time Switch FB.

Device	Setting range	Description
CWT#/HH	0 to 23	• From 0 hour to 23 hours

(e) Mask type Minute (CWT#/MI)
Set "minute" of the Time Switch FB.

Device	Setting range	Description
CWT#/MI	0 to 59	• From 0 minute to 59 minutes

(f) Mask type DMY (CWT#/DM)
Set "monthly" or "yearly" of the Time Switch FB.

Device	Setting range	Description
CWT#/DM	0 to 2	<ul style="list-style-type: none"> • 0: Time settings by date 1: Monthly time settings 2: Yearly time settings • This item is valid only while Date setting is valid. • Date setting becomes valid when "CWT#/DM" is set while Weekly setting is valid. In that case, "year", "month" and "day" are initialized to "2009", "January" and "1" respectively.

(g) Mask type BI (CWT#/BI)
Set "output ON/OFF status" of the Time Switch FB.

Device	Description
CWT#/BI	<ul style="list-style-type: none"> • 0: OFF 1: ON

(h) Mask type Weekday (CWT#/WD)
Set "day of the week" of the Time Switch FB.

Device	Description
CWT#/MD	<ul style="list-style-type: none"> • b0: Sunday b1: Monday b2: Tuesday b3: Wednesday b4: Thursday b5: Friday b6: Saturday b7: Reserved (Fixed to "0") b8: Every day of the week b9 to b14: Reserved (Fixed to "0") b15: 0 = Weekly setting, 2 = Date setting • This item is valid only while Weekly setting is valid. • Date setting becomes valid when "CWT#/WD.b15=1" is written while Weekly setting is valid. In that case, "year", "month", "day" and "output ON/OFF status" are initialized to "2009", "January", "1" and "OFF" respectively. • Weekly setting becomes valid when "CWT#/WD.b15=0" is written while Date setting is valid. In that case, "day of the week" and "week of the month" are initialized to "every day of the week" and "every week" respectively. • Weekly setting becomes valid when "1" is written to either of "CWT#/WD.b0" to "CWT#/WD.b6" and "CWT#/WD.b8" while Date setting is valid. In that case, "week of the month" is initialized to "every week".

(i) Mask type Week (CWT#/WE)
Set "week of the month" of the Time Switch FB.

Device	Description
CWT#/WE	<ul style="list-style-type: none"> • b0: 1st week (1st to 7th days) b1: 2nd week (8th to 14th days) b2: 3rd week (15th to 21st days) b3: 4th week (22nd to 28th days) b4: 5th week (29th day to month end) b5 to b7: Reserved (Fixed to "0") b8: Every week b9 to b15: Reserved (Fixed to "0") • This item is valid only while Weekly setting is valid. • Weekly setting becomes valid when "1" is written to either of "CWT#/WE.b0" to "CWT#/WE.b4" and "CWT#/WE.b8" while Date setting is valid. In that case, "day of the week" is initialized to "every day of the week".

2.6.1 ALPHA2

	Device name	Setting range	Device No. representation
Bit device	System Bit (M) ^{*1}	M01 to M24	Decimal
	Input Terminal (I)	I01 to I15	
	External Input (EI)	EI129 to EI132	
	Output Terminal (O)	O01 to O09	
	External Output (EO)	EO129 to EO132	
	Key Input (K)	K01 to K08	
	Link Input (E)	E01 to E04	
	Link Output (A)	A01 to A04	
Word device	Control Device (N)	N01 to N04	Decimal
	Communication Word Device For Time Switch FB (CWT#BI)	CWT#/BI-001 to CWT#/BI-100	
	Communication Bit Device (CB) ^{*4}	CB001 to CB100	
	Analog Input (AI) ^{*1*2}	AI01 to AI08	
Word device	Communication Word Device (CW) ^{*2*4}	CW001 to CW100	Decimal
	Communication Word Device For Time Switch FB (CWT#**) ^{*2}	CWT#/**-001 to CWT#/**-100	
	Communication Word Device For Time Switch FB (CWT) ^{*3}	CWT001 to CWT100	

*1 Only reading is possible.

*2 Only 16-bit (1-word) specification is possible.

*3 Only 32-bit (2-word) designation is possible. On the PLC side, CWT means CW that related TimeSwitchFunctionBlock.

*4 For details of CW and CB, refer to the following manuals.

 COMMUNICATION MANUAL α2 SIMPLE APPLICATION CONTROLLER

WARRANTY

Please confirm the following product warranty details before using this product.

1. Gratis Warranty Term and Gratis Warranty Range

If any faults or defects (hereinafter "Failure") found to be the responsibility of Mitsubishi occurs during use of the product within the gratis warranty term, the product shall be repaired at no cost via the sales representative or Mitsubishi Service Company. However, if repairs are required onsite at domestic or overseas location, expenses to send an engineer will be solely at the customer's discretion. Mitsubishi shall not be held responsible for any re-commissioning, maintenance, or testing on-site that involves replacement of the failed module.

[Gratis Warranty Term]

The gratis warranty term of the product shall be for thirty-six (36) months after the date of purchase or delivery to a designated place.

Note that after manufacture and shipment from Mitsubishi, the maximum distribution period shall be six (6) months, and the longest gratis warranty term after manufacturing shall be forty-two (42) months. The gratis warranty term of repair parts shall not exceed the gratis warranty term before repairs.

[Gratis Warranty Range]

- (1) The customer shall be responsible for the primary failure diagnosis unless otherwise specified.
If requested by the customer, Mitsubishi Electric Corporation or its representative firm may carry out the primary failure diagnosis at the customer's expense.
The primary failure diagnosis will, however, be free of charge should the cause of failure be attributable to Mitsubishi Electric Corporation.
- (2) The range shall be limited to normal use within the usage state, usage methods and usage environment, etc., which follow the conditions and precautions, etc., given in the instruction manual, user's manual and caution labels on the product.
- (3) Even within the gratis warranty term, repairs shall be charged for in the following cases.
 1. Failure occurring from inappropriate storage or handling, carelessness or negligence by the user. Failure caused by the user's hardware or software design.
 2. Failure caused by unapproved modifications, etc., to the product by the user.
 3. When the Mitsubishi product is assembled into a user's device, Failure that could have been avoided if functions or structures, judged as necessary in the legal safety measures the user's device is subject to or as necessary by industry standards, had been provided.
 4. Failure that could have been avoided if consumable parts designated in the instruction manual had been correctly serviced or replaced.
 5. Replacing consumable parts such as the battery, backlight and fuses.
 6. Failure caused by external irresistible forces such as fires or abnormal voltages, and Failure caused by force majeure such as earthquakes, lightning, wind and water damage.
 7. Failure caused by reasons unpredictable by scientific technology standards at time of shipment from Mitsubishi.
 8. Any other failure found not to be the responsibility of Mitsubishi or that admitted not to be so by the user.

2. Onerous repair term after discontinuation of production

- (1) Mitsubishi shall accept onerous product repairs for seven (7) years after production of the product is discontinued.
Discontinuation of production shall be notified with Mitsubishi Technical Bulletins, etc.
- (2) Product supply (including repair parts) is not available after production is discontinued.

3. Overseas service

Overseas, repairs shall be accepted by Mitsubishi's local overseas FA Center. Note that the repair conditions at each FA Center may differ.

4. Exclusion of loss in opportunity and secondary loss from warranty liability

Regardless of the gratis warranty term, Mitsubishi shall not be liable for compensation to damages caused by any cause found not to be the responsibility of Mitsubishi, loss in opportunity, lost profits incurred to the user by Failures of Mitsubishi products, special damages and secondary damages whether foreseeable or not, compensation for accidents, and compensation for damages to products other than Mitsubishi products, replacement by the user, maintenance of on-site equipment, start-up test run and other tasks.

5. Changes in product specifications

The specifications given in the catalogs, manuals or technical documents are subject to change without prior notice.

6. Product application

- (1) In using the Mitsubishi graphic operation terminal, the usage conditions shall be that the application will not lead to a major accident even if any problem or fault should occur in the graphic operation terminal device, and that backup and fail-safe functions are systematically provided outside of the device for any problem or fault.
- (2) The Mitsubishi graphic operation terminal has been designed and manufactured for applications in general industries, etc. Thus, applications in which the public could be affected such as in nuclear power plants and other power plants operated by respective power companies, and applications in which a special quality assurance system is required, such as for Railway companies or Public service purposes shall be excluded from the graphic operation terminal applications.
In addition, applications in which human life or property that could be greatly affected, such as in aircraft, medical applications, incineration and fuel devices, manned transportation equipment for recreation and amusement, and safety devices, shall also be excluded from the graphic operation terminal range of applications.
However, in certain cases, some applications may be possible, providing the user consults the local Mitsubishi representative outlining the special requirements of the project, and providing that all parties concerned agree to the special circumstances, solely at our discretion.
In some of three cases, however, Mitsubishi Electric Corporation may consider the possibility of an application, provided that the customer notifies Mitsubishi Electric Corporation of the intention, the application is clearly defined and any special quality is not required.

Intellectual Property Rights

■ Trademarks

GOT is a registered trademark of Mitsubishi Electric Corporation.

Microsoft, Microsoft Access, Excel, SQL Server, Visual Basic, Visual C++, Visual C#, Windows, Windows NT, Windows Server, and Windows Vista are trademarks of the Microsoft group of companies.

Adobe and Adobe Reader are registered trademarks of Adobe Systems Incorporated.

Intel, Intel Core, Pentium, and Celeron are trademarks or registered trademarks of Intel Corporation in the United States and other countries.

MODBUS is a trademark of Schneider Electric SA.

VNC is a registered trademark of RealVNC Ltd. in the United States and other countries.

Other company and product names herein are either trademarks or registered trademarks of their respective owners.

■ Copyrights

The screens (screenshots) are used in accordance with the Microsoft Corporation guideline.

GRAPHIC OPERATION TERMINAL

GOT1000 Series

Connection Manual

(α 2 Connection)

for GT Works3

JY997D39201F

MITSUBISHI ELECTRIC CORPORATION

HEAD OFFICE: TOKYO BLDG., 2-7-3, MARUNOUCHI, CHIYODA-KU, TOKYO 100-8310, JAPAN
NAGOYA WORKS: 1-14, YADA-MINAMI 5-CHOME, HIGASHI-KU, NAGOYA 461-8670, JAPAN

When exported from Japan, this manual does not require application to the Ministry of Economy, Trade and Industry for service transaction permission.

Specifications subject to change without notice.