



GT2104-RTBD

GT21 General Description



Manual Number	JY997D63801D
Date	Sep. 2016

This manual describes the part names, dimensions, mounting, and specifications of the product. Before use, read this manual and manuals of relevant products fully to acquire proficiency in handling and operating the product. Make sure to learn all the product information, safety information, and precautions.

And, store this manual in a safe place so that you can take it out and read it whenever necessary. Always forward it to the end user.

Registration
Ethernet is a trademark of Xerox Corporation in the United States. The company name and the product name to be described in this manual are the registered trademarks or trademarks of each company.

Effective Sep. 2016
Specifications are subject to change without notice.

© 2015 Mitsubishi Electric Corporation

Safety Precaution (Read these precautions before using.)

Before using this product, please read this manual and the relevant manuals introduced in this manual carefully and pay full attention to safety to handle the product correctly.

The precautions given in this manual are concerned with this product. In this manual, the safety precautions are ranked as "WARNING" and "CAUTION".

	Indicates that incorrect handling may cause hazardous conditions, resulting in death or severe injury.
	Indicates that incorrect handling may cause hazardous conditions, resulting in medium or slight personal injury or physical damage.

Depending on circumstances, procedures indicated by "CAUTION" may also be linked to serious results. In any case, it is important to follow the directions for usage.

DESIGN PRECAUTIONS

- Some failures of the GOT or cable may keep the outputs on or off. Some failures of a touch panel may cause malfunction of the input objects such as a touch switch. An external monitoring circuit should be provided to check for output signals which may lead to a serious accident. Not doing so can cause an accident due to false output or malfunction.
- Do not use the GOT as the warning device that may cause a serious accident. An independent and redundant hardware or mechanical interlock is required to configure the device that displays and outputs serious warning. Not doing so can cause an accident due to false output or malfunction.
- When the GOT detects its backlight failure, the GOT disables the input operation on the touch switch(s). Thus, operators cannot operate the GOT with touches. The GOT backlight failure can be checked with a system signal of the GOT.
- Even when the display section has dimmed due to a failure of the liquid crystal section or the backlight on the GOT, the input operation of the touch switches may still be enabled. This may cause an incorrect operation of the touch switches. For example, if an operator assumes that the display section has dimmed because of the screen save function and touches the display section to cancel the screen save, a touch switch may be activated, h touches. The GOT backlight failure can be checked with a system signal of the GOT.
- The display section of the GOT is an analog-resistive type touch panel. Simultaneous pressing of two or more areas on the display section may activate the switch between those areas. Do not press two or more areas simultaneously on the display section. Doing so may cause an accident due to incorrect output or malfunction.
- When programs or parameters of the controller (such as a PLC) that is monitored by the GOT are changed, be sure to shut off the power of the GOT promptly and power on the GOT again. Not doing so can cause an accident due to false output or malfunction.
- If a communication fault (including cable disconnection) occurs during monitoring on the GOT, communication between the GOT and PLC CPU is suspended and the GOT becomes inoperative. A system where the GOT is used should be configured to perform any significant operation to the system by using the switches of a device other than the GOT on the assumption that a GOT communication fault will occur. Not doing so can cause an accident due to false output or malfunction.

DESIGN PRECAUTIONS

- When the security of the GOT and relevant information need to be protected against illegal access from an external device via the Internet, take measures at the user's discretion. Failure to do so may cause the configured information to be read out illegally.

DESIGN PRECAUTIONS

- Do not bundle the control and communication cables with main-circuit, power or other wiring. Run the above cables separately from such wiring and keep them a minimum of 100 mm apart. Not doing so may cause a malfunction.
- Do not press the GOT display section with a pointed material as a pen or driver. Doing so can result in a damage or failure of the display section.
- When the GOT is connected to the Ethernet network, the available IP address is restricted according to the system configuration.
- When multiple GOTs are connected to the Ethernet network: Do not set the IP address (192.168.3.18) for the GOTs and the controllers in the network.
- When a single GOT is connected to the Ethernet network: Do not set the IP address (192.168.3.18) for the controllers except the GOT in the network.
- Doing so can cause the IP address duplication. The duplication can negatively affect the communication of the device with the IP address (192.168.3.18). The operation at the IP address duplication depends on the devices and the system.
- Turn on the controllers and the network devices to be ready for communication before they communicate with the GOT. Failure to do so can cause a communication error on the GOT.
- When the GOT is subject to shock or vibration, or some colors appear on the screen of the GOT, the screen of the GOT might flicker.

MOUNTING PRECAUTIONS

- Be sure to shut off all phases of the external power supply used by the system before mounting or removing the GOT main unit to/from the panel. Not doing so can cause the unit to fail or malfunction.

MOUNTING PRECAUTIONS

- Use the GOT in the environment that satisfies the general specifications described in this manual. Not doing so can cause an electric shock, fire, malfunction or product damage or deterioration.
- When mounting the GOT to the control panel, tighten the mounting screws in the specified torque range (0.20 N·m to 0.25 N·m) with a Phillips-head screwdriver No.2. Undertightening can cause the GOT to drop, short circuit or malfunction. Overtightening can cause a drop, short circuit or malfunction due to the damage of the screws or the GOT.
- Remove the protective film of the GOT. When the user continues using the GOT with the protective film, the film may not be removed.
- Operate and store the GOT in environments without direct sunlight, high temperature, dust, humidity, and vibrations.
- Do not use the GOT in an environment with oil or chemicals. Doing so may cause failure or malfunction due to the oil or chemical entering into the GOT.

WIRING PRECAUTIONS

- Be sure to shut off all phases of the external power supply used by the system before wiring. Failure to do so may result in an electric shock, product damage or malfunctions.

WIRING PRECAUTIONS

- Please make sure to ground FG terminal of the GOT power supply section by applying 100 Ω or less which is used exclusively for the GOT. Not doing so may cause an electric shock or malfunction.
- Correctly wire the GOT power supply section after confirming the rated voltage and terminal arrangement of the product. Not doing so can cause a fire or failure.
- Tighten the terminal screws of the GOT power supply section in the specified torque range (0.22 N·m to 0.25 N·m). Undertightening can cause a short circuit or malfunction. Overtightening can cause a short circuit or malfunction due to the damage of the screws or the GOT.
- For a terminal processing of a wire to the GOT power supply section, connect a stranded wire or a single wire directly, or use a rod terminal with an insulation sleeve.
- Exercise care to avoid foreign matter such as chips and wire cuttings entering the GOT. Not doing so can cause a fire, failure or malfunction.
- Plug the communication cable into the GOT interface or the connector of the connected unit, and tighten the mounting screws and the terminal screws in the specified torque range. Undertightening can cause a short circuit or malfunction. Overtightening can cause a short circuit or malfunction due to the damage of the screws or unit.

TEST OPERATION PRECAUTIONS

- Before performing the test operations of the user creation monitor screen (such as turning ON or OFF bit device, changing the word device current value, changing the settings or current values of the timer or counter, and changing the buffer memory current value), read through the manual carefully and make yourself familiar with the operation method. During test operation, never change the data of the devices which are used to perform significant operation for the system. False output or malfunction can cause an accident.

STARTUP/MAINTENANCE PRECAUTIONS

- When power is on, do not touch the terminals. Doing so can cause an electric shock or malfunction.
- Before starting cleaning or terminal screw retightening, always switch off the power externally in all phases. Not doing so can cause the unit to fail or malfunction. Undertightening can cause a short circuit or malfunction. Overtightening can cause a short circuit or malfunction due to the damage of the screws or unit.

STARTUP/MAINTENANCE PRECAUTIONS

- Do not disassemble or modify the unit. Doing so can cause a failure, malfunction, injury or fire.
- Do not touch the conductive and electronic parts of the unit directly. Doing so can cause a unit malfunction or failure.
- The cables connected to the unit must be run in ducts or clamped. Not doing so can cause the unit or cable to be damaged due to the dangling, motion or accidental pulling of the cables or can cause a malfunction due to a cable connection fault.
- When unplugging the cable connected to the unit, do not hold and pull from the cable portion. Doing so can cause the unit or cable to be damaged or can cause a malfunction due to a cable connection fault.
- Do not drop the module or subject it to strong shock. A module damage may result.
- Before touching the unit, always touch grounded metals, etc. to discharge static electricity from human body, etc. Not doing so can cause the unit to fail or malfunction.
- Replace battery with GT11-50BAT by Mitsubishi electric Co. only. Use of another battery may present a risk of fire or explosion.
- Dispose of used battery promptly. Keep away from children. Do not disassemble and do not dispose of in fire.

TOUCH PANEL PRECAUTIONS

- For the analog-resistive film type touch panels, normally the adjustment is not required. However, the difference between a touched position and the object position may occur as the period of use elapses. When any difference between a touched position and the object position occurs, execute the touch panel calibration.
- When any difference between a touched position and the object position occurs, other object may be activated. This may cause an unexpected operation due to incorrect output or malfunction.

PRECAUTIONS WHEN THE DATA STORAGE IS IN USE

- If the SD card mounted on drive A of the GOT is removed while the GOT is accessed, processing for the GOT might be interrupted about for 20 seconds. The GOT cannot be operated during this period. The functions that run in the background including a screen updating, alarm, logging, scripts, and others are also interrupted. Since this interruption makes an impact to the system operation, it might cause failure. After inhibiting access to the SD card on the GOT utility screen, check that the SD card access LED is off and remove the SD card.
- If the data storage mounted on the GOT is removed while the GOT is accessed, the data storage and files are damaged. To remove the data storage from the GOT, check that the access to the data storage in SD card access LED, the system signal, and others is not performed.
- Turning off the GOT while it accesses the SD card results in damage to the SD card and files.
- When removing the SD card from the GOT, make sure to support the SD card by hand as it may pop out. Failure to do so may cause the SD card to drop from the GOT, resulting in a failure or break.
- Before removing the SD card from the GOT, follow the procedure for removal on the utility screen of the GOT. After the successful completion dialog is displayed, remove the SD card by hand carefully. Failure to do so may cause the SD card to drop from the GOT, resulting in a failure or break.

DISPOSAL PRECAUTIONS

- When disposing of this product, treat it as industrial waste.
- When disposing of batteries, separate them from other wastes according to the local regulations. (Refer to the GOT2000 Series User's Manual for details of the battery directive in the EU member states.)

TRANSPORTATION PRECAUTIONS

- When transporting lithium batteries, make sure to treat them based on the transport regulations. (Refer to the GOT2000 Series User's Manual (Hardware) for details of the regulated models.)
- Make sure to transport the GOT main unit and/or relevant unit(s) in the manner they will not be exposed to the impact exceeding the impact resistance described in the general specifications of this manual, as they are precision devices. Failure to do so may cause the unit to fail. Check if the unit operates correctly after transportation.
- When fumigants that contain halogen materials such as fluorine, chlorine, bromine, and iodine are used for disinfecting and protecting wooden packaging from insects, they cause malfunction when entering our products. Please take necessary precautions to ensure that remaining materials from fumigant do not enter our products, or treat packaging with methods other than fumigation (heat method). Additionally, disinfect and protect wood from insects before packing products.

Certification of UL, cUL standards

- Using GOT
GOT is for use on a Flat Surface of a Type 1 Enclosure.

Notification of CE marking

The following products have shown compliance through direct testing (to the identified standards) and design analysis (forming a technical construction file) to the European Directive for Electromagnetic Compatibility (2004/108/EC) when used as directed by the appropriate documentation.

- This product is designed for use in industrial applications
 - Model: Graphic Operation Terminal
 - Type: GOT series

Standard	Remark	
EN61131-2 : 2007 Programmable controllers - Equipment, requirements and tests	EMI	Compliance with all relevant aspects of the standard. (Radiated Emissions)
	EMS	Compliance with all relevant aspects of the standard. (ESD, RF electromagnetic field, EFTB, Surge, RF conducted disturbances and Power frequency magnetic field)

For more details please contact your local Mitsubishi Electric sales site. For details of CE marking, refer to the following.

→GOT2000 series User's Manual

Manual

The following shows manuals relevant to this product.

Detailed Manual

Manual name	Manual number (Model code)
GOT2000 Series User's Manual (Hardware)	SH-081194ENG-A (1D7MJ5)
GOT2000 Series User's Manual (Utility)	SH-081195ENG-A (1D7MJ6)

For detailed manuals, refer to the PDF manuals stored in the DVD-ROM for the drawing software used.

Relevant Manuals

For relevant manuals, refer to the Help or the PDF manuals stored in the DVD-ROM for the drawing software used. The latest manuals are also available from MITSUBISHI ELECTRIC FA Global Website (<http://www.MitsubishiElectric.co.jp/ifa>).

Before using the GOT

Refer to the GOT2000 Series User's Manual (Hardware) for the connection instructions.

For details on the GOT specifications, installing instructions, wiring, maintenance and inspection, or checking procedure for the version and the compatible standard, refer to the GOT2000 Series User's Manual (Hardware).

Bundled Items

Model name	Remark
GT2104-RTBD	GOT main unit (The maintenance supplies below are packed with the product.)

Model name	Remark
PLC Communication Connector	2
Panel Mounting Bracket (with M4 × 20 screws)	4
Panel Mounting Packing	1
GT21 General Description (This manual)	1

1. GOT series User's Manual Specifications

1.1 General Specifications

Item	Specifications					
Operating ambient temperature ¹	0 to 55°C (When mounted horizontally), 0 to 50°C (When mounted vertically)					
Storage ambient temperature	-20 to 60°C					
Operating ambient humidity	10% RH to 90% RH, non-condensing ²					
Storage ambient humidity	10% RH to 90% RH, non-condensing ²					
Vibration resistance	Compliant with JIS B3502 and IEC61131-2	Under intermittent vibration	5 to 8.4 Hz	-	3.5 mm	10 times in each X, Y, or Z direction
			8.4 to 150 Hz	9.8m/s ²	-	
		Under continuous vibration	5 to 8.4 Hz	-	1.75 mm	
			8.4 to 150 Hz	4.9m/s ²	-	
Shock resistant	Compliant with JIS B3502 and IEC61131-2 147m/s ² (15G) Three times in each X, Y, or Z direction					
Operating atmosphere	No greasy fumes, corrosive gas, flammable gas, excessive conductive dust, and direct sunlight (as well as at storage)					
Operating altitude ³	2000 m or less					
Installation location	Inside control panel					
Overvoltage category ⁴	II or less					
Pollution degree ⁵	2 or less					
Cooling method	Self-cooling					
Grounding	Grounding with a ground resistance of 100 Ω or less by using a ground cable that has a cross-sectional area of 0.14 to 1.5 mm ² (solid wire), 0.14 to 1.0 mm ² (stranded wire), or 0.25 to 0.5 mm ² (rod terminal with an insulation sleeve). If impossible, connect the ground cable to the control panel.					

- *1 The operating ambient temperature indicates the temperature inside the enclosure of the control panel to which the GOT is installed.
 *2 If the ambient temperature exceeds 40°C, the absolute humidity must not exceed 90% at 40°C.
 *3 Do not use or store the GOT under pressure higher than the atmospheric pressure of altitude 0 m. Doing so may cause a malfunction. When an air purge is made inside the control panel by adding pressure, there may be a clearance between the surface sheet and the screen, making you difficult to use the touch panel, or the sheet may come off.
 *4 This indicates the section of the power supply to which the equipment is assumed to be connected between the public electrical power distribution network and the machinery within the premises. Category II applies to equipment for which electrical power is supplied from fixed facilities. The withstand surge voltage for the equipment with the rated voltage up to 300 V is 2500 V.
 *5 This indicates the occurrence rate of conductive material in an environment where a device is used. Pollution degree 2 indicates an environment where only non-conductive pollution occurs normally and a temporary conductivity caused by condensation shall be expected depending on the conditions.

1.2 Performance Specifications

Item	Specifications	
GT2104-RTBD		
Display section ^{**2}	Display device	TFT color display
	Screen size	4.3"
	Resolution	480 × 272 dots
	Display size	95.0(3.75) (W) × 53.8(2.12) (H) mm(inch)
	Displayed number of characters	16-dot standard font: 30 characters × 17 lines (two-byte characters) 12-dot standard font: 40 characters × 22 lines (two-byte characters)
	Display color	Color (65536 colors)
	Brightness Adjustment	32 levels
	Backlight	LED (Not replaceable)
Touch panel ⁴	Backlight life ³	Approx. 50000 h (operating ambient temperature: 25°C, display intensity: 50%)
	Type	Analog resistive film
	Key size	Minimum 2 × 2 dots (per a key)
	Simultaneous press	Simultaneous press prohibited ⁵ (only 1 point can be pressed)
User memory capacity	Life	1 million times or more (Operating force: 0.98 N or less)
	User memory capacity	Memory for storage (ROM): 9 MB
Battery	Life (number of write times)	100000 times
	Battery	GT11-50BAT lithium battery
Built-in interface	Life	Approx. 5 years (operating ambient temperature: 25°C)
	RS-232	1 channel Transmission speed: 115200/57600/38400/19200/9600/4800 bps Connector shape: terminal block 9-pin
	RS-422/485	1 channel Transmission speed: 115200/57600/38400/19200/9600/4800 bps Connector shape: terminal block 9-pin Terminating resistor ⁶ : OPEN/110 Ω/330 Ω (Switched with the terminating resistor setting switch)
	Ethernet	1 channel Data transfer method: 10BASE-T/100BASE-TX Connector shape: RJ-45 (modular jack)
	USB (Device)	1 ch Maximum transfer rate: Full-Speed 12 Mbps Connector shape: USB Mini-B
	SD card	1 channel SDHC card supported (max. 32 GB)
Buzzer output	Single tone (tone length adjustable)	
Productive structure	Outside the enclosure: IP67 ⁷ Inside the enclosure: IP2X	
External dimensions	128(5.04) (W) × 102(4.02) (H) × 40(1.58) (D) mm	
Panel cut dimensions	118(4.65) (W) × 92(3.63) (H) mm	
Weight (excluding a fitting)	0.4 kg	
Compatible software package	GT Works3 Version1.122C or later	

- *1 Bright dots (always lit) and dark dots (unlit) may appear on a liquid crystal display panel due to its characteristics. It is impossible to completely avoid this symptom, as the liquid crystal display comprises of a great number of display elements. In addition, color tone difference, unevenness of brightness, or flickers may occur due to individual differences of liquid crystal display panels. Please note that these symptoms occur due to GOT's characteristic and are not caused by product defect.
 *2 Flicker may occur due to vibration, shock, or display color.
 *3 Settings the screen saving backlight to OFF prevents the display screen from burn-in and enables the backlight to lengthen its life.
 *4 When using a stylus pen, it will be 100,000 times. (The specifications must be satisfied the following condition.)
 - Material: Polyacetal resin
 - Tip radius: 0.8 mm or more
 *5 If you touch two or more points on the touch panel simultaneously and a switch is placed between the two points, the switch may be activated. Do not touch two or more points on the touch panel simultaneously.
 *6 Set the terminating resistor selector switch of the GOT in accordance with the connection type when adopting GOT multidrop connection.
 *7 Note that this does not guarantee all users' operation environment. In addition, the GOT may not be usable in the environment where oil or chemicals are splashed over for a long time or where oil mist is filled.

1.3 Power Supply Specifications

Item	Specifications	
GT2104-RTBD		
Input power supply voltage	DC24 V (+10%, -15%)	
Power consumption	Under the maximum load	4.4 W or less
	At backlight off	2.9 W
Inrush current	18 A or less (2ms, 25°C, at the maximum load)	
Permissible instantaneous power failure time	Within 5ms	
Noise immunity	Noise voltage: 1000 Vp-p, Noise width: 1 μs (by noise simulator of 30 to 100 Hz noise frequency)	
Dielectric withstand voltage	500 VAC for 1 minute (between the GOT's power supply terminals and the GOT's grounding terminal)	
Insulation resistance	10 MΩ or larger by insulation resistance tester (between the GOT's power supply terminals and the GOT's grounding terminal)	
Electrical wire size	No. of wire per terminal: 1 Solid wire 0.14 to 1.5 mm ² AWG26 to AWG16, Stranded wire 0.14 to 1.0 mm ² AWG26 to AWG18, Ferrules with plastic sleeve 0.25 to 0.5 mm ² AWG24 to AWG20 No. of wire per terminal: 2 Solid wire 0.14 to 0.5 mm ² AWG26 to AWG20, Stranded wire 0.14 to 0.2 mm ² AWG26 to AWG24	
Wire type	Use copper or copper-clad aluminum conductors.	
Temperature rating of a wire	More than 70°C	
Ferrules with plastic sleeve	Al 0.25-6BU (AWG24), Al 0.34-6TQ (AWG22), Al 0.5-6WH (AWG20) (Phoenix Contact Inc.)	
Crimper type	CRIMPFOXZA3 (Phoenix Contact Inc.)	
Tightening torque (terminal screws)	0.22 to 0.25 N·m	

2. Wiring of connection cable

The diagram below shows cable assignment for GOT port.
 Cable: GT10-C□□□R4-8P, GT10-C□□□R4-25P, GT10-C30R2-6P

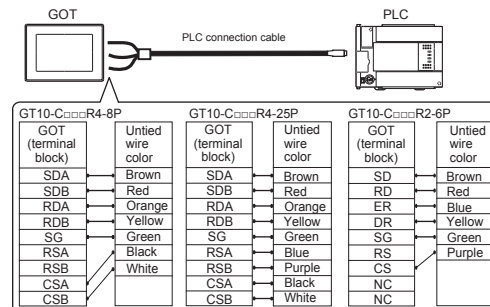

User-made cable is necessary, depending on the PLC.
 For the detail, refer to GOT2000 Series Connection Manual.

Cable jacket to remove	7 mm (0.27")
Tightening torque	0.22 to 0.25 N·m
Recommended Tool (Screwdriver)	SZS 0.4 × 2.5 (Phoenix Contact Inc.)

This manual confers no industrial property rights or any rights of any other kind, nor does it confer any patent licenses. Mitsubishi Electric Corporation cannot be held responsible for any problems involving industrial property rights which may occur as a result of using the contents noted in this manual.

Warranty

Exclusion of loss in opportunity and secondary loss from warranty liability
 Regardless of the gratis warranty term, Mitsubishi shall not be liable for compensation to:

- Damages caused by any cause found not to be the responsibility of Mitsubishi.
- Loss in opportunity, lost profits incurred to the user by Failures of Mitsubishi products.
- Special damages and secondary damages whether foreseeable or not, compensation for accidents, and compensation for damages to products other than Mitsubishi products.
- Replacement by the user, maintenance of on-site equipment, start-up test run and other tasks.

⚠ For safe use

- This product has been manufactured as a general-purpose part for general industries, and has not been designed or manufactured to be incorporated in a device or system used in purposes related to human life.
- Before using the product for special purposes such as nuclear power, electric power, aerospace, medicine or passenger movement vehicles, consult with Mitsubishi Electric.
- This product has been manufactured under strict quality control. However when installing the product where major accidents or losses could occur if the product fails, install appropriate backup or failsafe functions in the system.

MITSUBISHI ELECTRIC CORPORATION

HEAD OFFICE : TOKYO BUILDING, 2-7-3 MARUNOUCHI, CHIYODA-KU, TOKYO 100-8310, JAPAN

JY997D63801D



Side B



Side A

ENGLISH

Side B

CHINESE

GT2104-RTBD

GT21 概述

GRAPHIC OPERATION TERMINAL GOT2000	手册号	JY997D63801D
	日期	2016年9月

非常感谢选购本公司产品。

本手册只对GT2104-RTBD人机界面（以下简称GOT）的安全须知和规格进行说明。关于外部线路，请参阅GOT2000系列 主机使用说明书。因此，有关GOT的设计和施工以及作图等项请分别参照GT Designer3相关手册。在使用本产品之前，请务必必读读本手册以及各相关手册，了解机器本身的功能和安全信息以及注意事项后使用。

Ethernet是美国Xerox Corporation的注册商标。在本手册出现的各种商标分别对应各公司的名称，产品名称。

该印刷品发行于2016年9月
在未告知的情况下产品的规格可能有所变更，请预先了解。
© 2015 Mitsubishi Electric Corporation



安全注意事项

（使用前请务必仔细阅读）

在使用本产品时，请务必必读本手册以及本手册中介绍的相关手册。同时请务必充分注意安全事宜，正确使用。

本手册中所述注意事项仅为本产品直接相关内容。

在本手册中，用“警告”和“注意”对●安全注意事项●进行等级区分。

	警告	错误操作可能引起危险情况发生，造成人员重伤或死亡。
	注意	错误操作可能引起危险情况发生，造成人员中等程度的伤害、轻伤或物品损坏。

此外，即使是△注意的事项，因具体情况不同，也可能引发重大事故。由于记载的都是重要的内容，请务必严格遵守。

设计注意事项		警告
<ul style="list-style-type: none">GOT、电缆的故障，可能会导致输出保持为ON的状态或保持为OFF的状态。触摸面板的故障，可能会导致触摸开关等输入对象发生误动作。对于有可能引起重大事故的输出信号，应设置外部监控电路。误输出或误动作可能导致事故发生。 请不要将GOT作为报警装置使用。这样有可能导致重大事故。显示重要的报警或者输出报警的装置，请使用独立并具有冗余性的硬件或者机械互锁的构成。误输出、误动作有可能导致事故发生。 GOT检测出背光灯故障时，GOT将触摸开关的输入变为无效，操作人员将无法对GOT进行触摸操作。GOT检测出背光灯故障时，可通过GOT的系统信号进行确认。 当GOT的液晶部/背光灯由于故障等原因显示部分变暗时，触摸开关的输入可能仍处于有效状态，而造成触摸开关的误操作。例如，操作人员可能会误认为是屏幕处于保护状态，想要解除屏保而去触摸显示屏上，从而导致触摸开关动作。 GOT的显示屏采用的是模拟电阻膜方式。在显示屏上同时按压2点以上时，如果按压点的中心附近有开关，该开关将可能动作。请勿在显示屏上同时按压2点以上。同时按压2点以上有可能因误输出、误动作而导致事故发生。 更改由GOT执行监控的连接设备（PLC等）的程序或参数等时，请快速切断GOT电源后重新启动。误输出或误动作有可能导致事故发生。 GOT在执行监控时，如果发生通讯故障（包括电缆脱落），GOT与可编程控制器CPU的通讯将被中断，GOT无法动作。在构建使用了GOT的系统时，考虑到可能会发生GOT通讯故障时，对系统进行重大动作的开关操作请设定通过GOT以外的装置进行。否则可能会因为误输出、误动作而导致事故发生。 针对经由互联网的外部机器的非法访问，需要对GOT及相关信息的安全给予保护时，请制定针对不同用户的对策。否则，设置信息可能会被非法读取。		

设计注意事项		注意
<ul style="list-style-type: none">请勿将控制线及通讯电缆与主电路及动力线等捆绑在一起或相互靠得太近。应相距100mm以上距离。因为噪声可能导致误动作。 请勿用钢笔及螺丝刀等尖物按压GOT的显示屏。有可能导致破损及故障发生。 GOT连接及以太网使用时，根据系统配置，可使用的IP地址也有所限制。 <ul style="list-style-type: none">在以以太网网络中连接多台GOT时：请勿将GOT以及连接设备的IP地址设置为192.168.3.18。 在以以太网网络中连接1台GOT时：请勿将除GOT以外的连接设备的IP地址设置为192.168.3.18。 如果上述系统配置中将IP地址设置为192.168.3.18，GOT启动时将会发生IP地址重复，可能会对IP地址设置为192.168.3.18的设备的通讯产生不良影响。IP地址重复时的动作因设备和系统而异。 在与GOT连接前，请接通连接设备以及网络设备的电源，使其处于可通讯状态。连接设备以及通讯线路为不可通讯状态时，GOT可能会发生通讯报警。 GOT受到振动和撞击时，或GOT上显示特定的颜色时，GOT的画面有时会出现闪烁现象。		

安装注意事项		警告
<ul style="list-style-type: none">在将GOT本体安装到控制柜上或从控制柜上拆卸时，必须将系统中正在使用的所有外部供应电源全部断开之后再进行操作。如未全部断开，可能导致产品故障或误动作现象。		

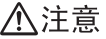
安装注意事项		注意
<ul style="list-style-type: none">请在符合本说明书中所规定的一般规格环境下使用GOT。在不符合说明书中规定的一般规格环境下使用GOT，可能会引起触电、火灾、误动作、产品损坏或使产品性能变差现象。 将GOT安装到控制柜上时，应使用No.2×十字螺丝刀在规定的扭矩范围内（0.20N·m～0.25N·m）拧紧安装螺栓。如果螺栓拧得过松，有可能导致脱落、短路、误动作。如果螺栓拧得过紧，有可能导致螺栓及产品损坏而导致脱落、短路、误动作。 使用时请将保护膜摘下。如果不摘下就使用，日后可能无法将其摘下。 请勿在阳光直射的场所、高温、粉尘、湿气或振动大的场所使用以及保管本产品。 不要将GOT在含油、药品的环境下使用。如果有油、药品浸入设备，会导致故障、误动作。		

配线注意事项		警告
<ul style="list-style-type: none">在进行接线作业时，必须将系统中正在使用的所有外部供应电源全部断开之后再进行操作。如果未全部断开，可能会引起触电、产品损坏、误动作。		

配线注意事项		注意
<ul style="list-style-type: none">必须将GOT电源部分的PG端子与GOT的专用接地线连接。否则，可能引起触电、误动作。 GOT的电源线路，应在确认了产品的额定电压及端子排列之后进行正确安装。连接了与额定电压不匹配的电源、或者错误接线，可能导致火灾、故障。 应在规定的扭矩范围内（0.22N·m～0.25N·m）紧固GOT电源部分的端子螺栓。如果端子螺栓拧得过松，有可能导致短路、误动作。如果端子螺栓拧得过紧，有可能导致螺栓及模块的损坏而引起短路、误动作。 GOT电源部分的电线的终端处理，请直接使用绞线或单线，或使用带绝缘套管的棒状端子。 应注意防止切屑及线头等杂物掉入产品内。否则可能导致火灾、故障、误动作。 通讯电缆安装在GOT的接口或与GOT连接的产品连接器上，应在规定的扭矩范围内拧紧安装螺栓和端子螺栓。如果安装螺栓和端子螺栓拧得过松，有可能导致短路、误动作。如果安装螺栓和端子螺栓拧得过紧，有可能导致螺栓及模块的损坏而引起短路、误动作。		

测试操作注意事项		警告
<ul style="list-style-type: none">应在熟练用户操作手册，充分理解操作方法后，进行用户创建的监控画面的测试操作（位软元件的ON/OFF、字软元件的当前值更改、定时器、计数器的设置值・当前值更改、缓冲存储器的当前值更改）。此外，对于那些对系统有重大影响的软元件请勿通过测试操作更改其数据。否则可能导致误输出、误动作。		

启动/维护注意事项		警告
<ul style="list-style-type: none">通电时请勿触摸端子。可能引起触电。 清洁或者紧固端子螺栓时，必须从外部将电源全部断开之后再进行操作。如果没有全部断开，可能导致设备故障或者误动作。如果螺栓拧得过松，有可能导致短路、误动作。如果螺栓拧得过紧，有可能由于螺栓或模块损坏引起短路、误动作。		

启动/维护注意事项		注意
<ul style="list-style-type: none">请勿拆解或改造产品。可能导致故障、误动作、人身伤害、火灾。 请勿直接触碰产品的导电部分或电子部件。可能导致产品的误动作、故障。 与产品连接的电缆必须收入套管中或者用夹具进行固定处理。如果未将电缆收入套管或未用夹具进行固定处理，可能出现电缆的晃动及移动、不经意的拉拽等造成产品及电缆损坏、电缆接触不良而导致误动作。 在拆卸与产品连接的电缆时，请勿用手拉扯电缆部分。如果在与连接产品的状态下拉扯电缆，可能造成产品或电缆的损坏、电缆接触不良从而导致误动作。 请勿使产品掉落或受到强烈撞击。否则可能造成模块损坏。 在触碰产品前，必须先与接地的金属物等接触，释放掉人体所携带的静电。如果不释放掉静电，可能导致产品故障或者误动作。 电池请使用本公司生产的GT11-50BAT。 如使用本公司生产的GT11-50BAT以外的其他电池，可能会导致火灾或电池破裂。 使用后的电池请立即废弃。请勿让儿童接近。请勿拆解或者投入火中。		

触摸面板的注意事项		注意
<ul style="list-style-type: none">使用模拟电阻膜方式的触摸面板时，通常不需要调整，但是经过长时间使用，对象位置和触摸位置有可能错离。对象位置和触摸领域如发生错离，请调整触摸面板。 对象位置和触摸位置发生错离时，有可能导致其他对象动作、或由于误输出、误动作导致其他意料之外的动作。		

数据存储设备使用时的注意事项		警告
-----------------------	---	-----------

- 如在GOT访问过程中拔下安装在GOT的A驱动器上的SD卡，GOT的处理将会停止约20秒左右。在此期间，将无法操作GOT，且画面的更新、报警、日志、脚本等在后台动作的功能也会停止。卸下SD卡时，请在GOT应用程序画面操作中将SD卡访问设为禁止状态后，确认SD卡访问LED处于熄灭状态后进行。
- 如在GOT访问过程中拔下安装在GOT上的数据存储设备，可能会导致数据存储设备或文件损坏。如需从GOT上拔下数据存储设备，请在通过SD卡存取LED或系统信号等确认当前未对数据存储设备进行访问之后再拔下。
- 在SD卡访问过程中切断GOT的电源，可能会导致SD卡或文件损坏。
- 取出SD卡时，由于SD卡可能会弹出，请用手抵住SD卡将其取出。否则可能会因为脱落而导致SD卡损坏或故障。
- 取出SD卡时，请在GOT的实用菜单画面进行SD卡的取出操作，在弹出正常结束通知对话框后，再用手抵住SD卡将其取出。否则可能会因为脱落而导致SD卡损坏或故障。

报废处理注意事项		注意
<ul style="list-style-type: none">产品报废时，应作为工业废弃物处理。 废弃电池时应根据各地区制定的法令单独进行。（关于欧盟国家的电池规定的详细内容请参阅所使用的GOT的全体使用说明书。）		

运输注意事项		注意
<ul style="list-style-type: none">在运输含锂电池时，必须遵守运输规定。（关于限制对象机种的详细内容，请参阅所使用的GOT的本体使用说明书（硬件篇）。） 产品本身为精密设备，所以在运输时应避免使其受到超过本体使用说明书中记载的一般规格值的撞击。否则可能会导致产品故障。运输后，应进行产品的动作确认。 如果木质包装材料的消毒・除虫用熏蒸剂中所含的卤素类物质（氟、氯、溴、碘等）混入本公司产品，可能会导致故障。请注意防止残留的熏蒸成分混入本公司产品，或采用熏蒸以外的方法（热处理等）进行处理。另外，消毒・除虫措施请在包装前的木材加工阶段实施。		

CE标记通知		

通过直接测试（已认证标准）和设计分析（形成工程技术文件）证实，下述产品在相应文件指导下使用时可对电磁兼容性的欧洲指令（2004/108/EC）。

- 本产品设计符合工业应用
 - 类型：图形操作终端
 - 型号：GOT2000系列

标准	备注	
EN61131-2：2007可编程控制器 - 设备、要求和测试	EMI	对应所有相关联标准。（射频频射测量）
	EMS	对应所有相关联标准。（ESD、RF电磁场、EFTB、浪涌、RF传导干扰和电源频率磁场）

关于更多详细内容，请向当地三菱电机销售商垂询。

关于CE标记详细内容，请参照以下内容。

－GOT2000系列 主机使用说明书

关于操作手册

本产品相关的手册如下所示。

详细手册		
手册名称	手册编号（型号代码）	
GOT2000系列本体使用说明书（硬件篇）	SH-081202CHN（1D7MK4）	
GOT2000系列本体使用说明书（实用菜单篇）	SH-081203CHN（1D7MK5）	

详细的手册内容请参阅存储于所使用绘图软件的DVD-ROM或CD-ROM中的PDF手册。

相关操作手册

相关操作手册请参阅存储于所使用绘图软件的DVD-ROM或CD-ROM中的HELP或PDF手册。

可从三菱电机FA网站

(http://www.MitsubishiElectric.co.jp/fa)获取最新手册。

使用之前
连接方法请参阅GOT2000系列本体使用说明书（硬件篇）。关于GOT的详细规格、安装方法、接线、维护与检查、版本以及适合的规格的确认证方法等，请参阅GOT2000系列本体使用说明书（硬件篇）。

随机配件

型号	备注
GT2104-RTBD	GOT主机（以下配件随主机附送）

随机配件	数量
PLC通讯连接器	2
面板安装支架（配M4×20螺丝）	4
面板安装包	1
GT21概述（本手册）	1

「电器电子产品有害物质限制使用标识要求」的表示方式

	Note: This symbol mark is for China only.
---	---

含有有害6物质的名称，含有量，含有部品
本产品中所含有的有害6物质的名称，含有量，含有部品如下表所示。

产品中有害物质的名称及含量		有害物质					
部件名称		铅	汞	镉	六价铬	多溴联苯	多溴二苯醚
		(Pb)	(Hg)	(Cd)	(Cr (VI))	(PBB)	(PBDE)
显示器GOT	外壳	○	○	○	○	○	○
	印刷基板	×	○	○	○	○	○
	背光灯 (CCFL)	○	×	○	○	○	○
	电缆	×	○	○	○	○	○

本表格依据SJ/T 11364的规定编制。

○：表示该有害物质在该部件所有均质材料中的含量均在GB/T 26572规定的限量要求以下。

×：表示该有害物质至少在该部件的某一均质材料中的含量超出GB/T 26572规定的限量要求。

1. 规格	

1.1 一般规格

项目	规格					
使用环境温度*1	0~55℃（水平放置）、0~50℃（垂直放置）					
保存环境温度	-20℃~60℃					
使用环境湿度	10%RH~90%RH, 无凝露*2					
保存环境湿度	10%RH~90%RH, 无凝露*2					
抗振	适用JIS B 3502、IEC 61131-2	有断续的振动时	频率	加速度	单侧振幅	X、Y、Z各方向10次
			5~8.4Hz	—	3.5mm	
		有连续的振动时	8.4~150Hz	9.8m/s ²	—	—
			5~8.4Hz	—	1.75mm	
8.4~150Hz	4.9m/s ²	—	—			
抗冲击	适用JIS B 3502、IEC 61131-2 147m/s ² (15G) X、Y、Z方向各3次					
使用环境	无油烟、腐蚀性气体、可燃性气体，一般尘埃不严重 无阳光直射（保存时也相同）					
使用海拔*3	2000m以下					
安装场所	控制柜内					
过电压类别*4	II 以下					
污染度*5	2以下					
冷却方式	自冷					
接地	以接地电阻100Ω以下，接地线截面积 单线0.14~1.5mm ² 、绞线0.14~1.0mm ² ，带绝缘套管的棒状端子0.25~0.5mm ² 进行接地。 无法接地时连接至控制柜上。					

- *1 使用环境温度为设置了GOT的控制柜内部温度。
 *2 境温度超过40℃时，不可超过40℃90%的绝对湿度。
 *3 勿在海拔0m的大气压以上的气压环境下使用或保存。
 如在上述环境中使用，可能会出现误动作。
 向控制柜内加压进行吹气清扫后，气压可能会导致表面的保护膜浮起从而影响到触摸面板的灵敏度，甚至保护膜可能会脱落。
 *4 表示假定该机器连接在公共配电网到内部机械装置的哪一处配电部。
 II类，适用于由固定设备供电的机器等。
 额定电压不超过300V的机器的抗浪涌电压为2500V。
 *5 表示该机器使用环境中的导电性物质的发生率的指标。污染度2是指，只发生非导电性污染，根据条件可能会因凝结而发生暂时性导电的环境。

1.2 性能规格

项目	规格		
	GT2104-RTBD		
显示器*1*2	显示软元件	TFT彩色液晶	
	画面尺寸	4.3寸	
	分辨率	480×272点	
	显示尺寸	95.0(W)×53.8(H)mm	
	显示字符数	16点阵标准字体时:30字×17行(全角) 12点阵标准字体时:40字×22行(全角)	
	显示颜色	彩色(65536色)	
	亮度调节	32级	
	背景灯	LED(不能更换)	
触摸屏*4	方式	模拟电阻膜方式	
	键尺寸	最小2×2点(每键)	
	同时按下	不可同时按下*5(只可触摸1点)	
	寿命	100万次以上(操作力度0.98N以下)	
用户存储器容量	用户存储器容量	存储用存储卡(ROM):9MB	
	寿命(写入次数)	10万次	
电池	GT11-50BAT锂电池		
	寿命	约5年(使用环境温度为25℃)	
	RS-232	1ch 传送速度:115200/57600/38400/19200/9600/4800bps	接口形状:9针接口端子排
		1ch 传送速度:115200/57600/38400/19200/9600/4800bps	接口形状:9针接口端子排 终端电阻*6:OPEN/110Ω/330Ω(使用终端电阻设置用开关切换)
	内置接口	以太网	1ch 数据传送方式:10BASE-T/100BASE-TX 接口形状:RJ-45(模块插头)
		USB(设备)	1ch 最大传送速度:Full-Speed 12Mbps 接口形状:USB Mini-B
		SD卡	1ch 支持SDHC(最大32GB)
		蜂鸣器输出	单音(音长可调整)
	保护结构	正面:IP67*7 柜内:IP2X	
	外形尺寸	128(W)×102(H)×40(D)mm	
面板开口尺寸	118(W)×92(H)mm		
重量(安装配件除外)	0.4kg		
对应软件包	GT Works3 Version1.122C以后		

- *1 基于液晶面板的特性，有时会出现亮点(常亮的点)和暗点(常暗的点)。液晶面板由大量显示元件构成，无法100%确保不发生亮点和暗点。而且，由于液晶面板的个体差异，可能会出现色调不同、亮度不均匀、闪烁等现象。这些现象由产品的特性所决定，并非产品不良或故障，敬请谅解。
- *2 受到震动、撞击、或在特定显示颜色下有时会出现闪烁。
- *3 将屏幕保护背景灯设置为OFF，可以防止烧损显示部分，延长背景灯的寿命。
- *4 使用触控笔时的寿命为10万次。请使用符合以下规格的产品。
 • 材质:聚碳酸酯树脂
 • 前端半径:0.8mm以上
- *5 同时按压触摸屏2点或以上时，如果按压点的中心附近有开关，该开关可能动作。因此，请勿同时按压触摸屏2点或以上。
- *6 进行GOT多点连接时，请配合GOT主机的终端电阻切换开关的连接形式切换。
- *7 不保证适合客户的所有环境。此外，在长时间有油、化学品的环境中或充满油雾的环境中可能会无法使用。

1.3 电源规格

项目	规格	
	GT2104-RTBD	
电源电压	DC24V(+10%、-15%)	
耗电量	最大负载时	4.4W以下
	背景灯熄灭时	2.9W
冲击电流	18A以下(2ms、环境温度25℃、最大负载时)	
容许瞬停时间	5ms以内	
噪声耐量	噪声电压1000Vp-p、噪声幅度1μs、通过噪声频率为30~100Hz的噪声模拟器	
耐电压	电源端子总括⇔地线间 AC500V 1分钟	
绝缘电阻	电源端子总括⇔地线间 DC500V 通过绝缘电阻表10MΩ以上	
电线尺寸	1根电线:1 单芯线0.14~1.5mm ² (AWG26~AWG16)、绞线0.14~1.0mm ² (AWG26~AWG18)、带绝缘套管的棒状端子0.25~0.5mm ² (AWG24~AWG20)	
	1根电线:2 单芯线0.14~0.5mm ² (AWG26~AWG20)、绞线0.14~0.2mm ² (AWG26~AWG24)	
	带绝缘套管的棒状端子 AI 0.25-6BU(AWG24)、AI 0.34-6TQ(AWG22)、AI 0.5-6WH(AWG20)(Phoenix・CONTACT公司)	
铆接工具	CRIMPFOXZ3(Phoenix・CONTACT公司)	
适合的紧固扭矩(端子排端子螺栓)	0.22~0.25N・m	

2. 连接电缆

GOT接口电缆分配如下图所示。
 电缆:GT10-C□□□R4-8P、GT10-C□□□R4-25P、GT10-C3OR2-6P

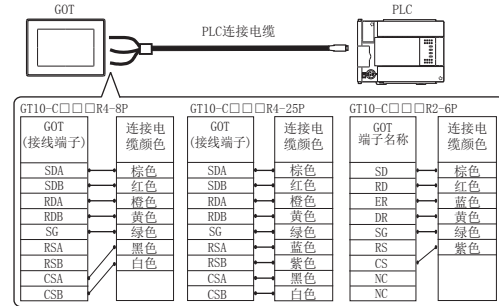

连接某些PLC时需要自制电缆。
 详情请参考GOT2000系列连接手册。

剥线直径	7mm(0.27")
拧紧力矩	0.22~0.25N・m
推荐工具(螺丝刀)	S2S 0.4×2.5(Phoenix公司)

在本书中，并没有对工业知识产权及其它权利的执行进行保证，也没有对执行权进行承诺。对于因使用本书中所记载的内容而引起的工业知识产权上的各种问题，本公司将不负任何责任。

- 关于质保
 机会损失和间接损失不在质保责任范围内
 无论是否在免费质保期内，凡以下事由三菱电机将不承担责任。
 (1)任何非三菱电机责任原因而导致的损失。
 (2)因三菱电机产品故障而引起的用户机会损失、利润损失。
 (3)无论三菱电机能否预测，由特殊原因而导致的损失和间接损失、事故赔偿、以及三菱电机产品以外的损伤。
 (4)对于用户更换设备、现场机械设备的再调试、运行测试及其它作业等的补偿。

⚠ 安全使用注意事项

- 本产品是以一般工业为对象，作为通用产品所制造的产品，不可以用于关系到人身安全的状况下所使用的设备或者系统为目的而设计、制造的产品。
- 在计划将本产品应用于原子能、电力、航空航天、医疗、载人运载工具的设备或者系统等特殊用途时，在对此进行研究商讨之际，请照会本公司的营业窗口。
- 虽然本产品是在严格的质量管理体系下进行制造的，但是在计划将本产品应用于由于本产品的故障有可能导致重大事故或者损失的设备上时，请在系统上设置备用及失效安全系统。

MITSUBISHI ELECTRIC CORPORATION

HEAD OFFICE : TOKYO BUILDING, 2-7-3 MARUNOUCHI, CHIYODA-KU, TOKYO 100-8310, JAPAN

