

MITSUBISHI ELECTRIC

GOT1000 Series CF Card /Memory Card Adaptor

User's Manual

GT05-MEM-16MC	GT05-MEM-1GC
GT05-MEM-32MC	GT05-MEM-2GC
GT05-MEM-64MC	GT05-MEM-4GC
GT05-MEM-128MC	GT05-MEM-8GC
GT05-MEM-256MC	GT05-MEM-16GC
GT05-MEM-512MC	GT05-MEM-ADPC

Thank you for purchasing the GOT1000 Series.

Prior to use, please read both this manual and detailed manual thoroughly to fully understand the product.

MODEL	GT05-MEM-U
MODEL CODE	1D7M08
IB(NA)-0800302-K(1610)MEE	

GRAPHIC OPERATION TERMINAL
GOT1000

SAFETY PRECAUTIONS

(Always read these precautions before using this equipment.)

Before using this product, please read this manual and the relevant manuals introduced in this manual carefully and pay full attention to safety to handle the product correctly.

The precautions given in this manual are concerned with this product.

In this manual, the safety precautions are ranked as "DANGER" and "CAUTION".

DANGER Indicates that incorrect handling may cause hazardous conditions, resulting in death or severe injury.

CAUTION Indicates that incorrect handling may cause hazardous conditions, resulting in medium or slight personal injury or physical damage.

Note that the CAUTION level may lead to a serious accident according to the circumstances. Always follow the precautions of both levels because they are important to personal safety. Please save this manual to make it accessible when required and always forward it to the end user.

TRANSPORTATION PRECAUTIONS

CAUTION

- Make sure to transport the GOT main unit and/or relevant unit(s) in the manner they will not be exposed to the impact exceeding the impact resistance described in the general specifications of the User's Manual for the GOT used, as they are precision devices. Failure to do so may cause the unit to fail. Check if the unit operates correctly after transportation.

INSTALLING PRECAUTIONS

CAUTION

- Before installing/removing the CF card into/from the GOT, be sure to set the CF card access switch to OFF to turn off the CF card access LED. Failure to do so may cause data corruption or malfunction.
- When ejecting the CF card, support it by hand since it may pop out. Failure to do so may cause a fall of the CF card leading to failure or damage of the card.
- Use the CF card and memory card adaptor in the environment that satisfies the general specifications described in the User's Manual for the GOT used. Not doing so can cause an electric shock, fire, malfunction or product damage or deterioration.

STARTUP AND MAINTENANCE PRECAUTIONS

CAUTION

- Never disassemble or modify the CF card and memory card adaptor. To do so may cause a failure, malfunction, injury or fire.
- Before touching the CF card or memory card adaptor, be sure to touch grounded metal or similar object to discharge the static electricity from human body. Failure to do so may cause a malfunction or failure of the unit.

DISPOSAL PRECAUTIONS

CAUTION

- Dispose of this product as industrial waste.

Manual

The following shows manuals relevant to this product.

Detailed Manual

Manual name	Manual number (Model code)
GT16User's Manual (Hardware) (Sold separately)	SH-080928ENG (1D7MD3)
GT16User's Manual (Basic Utility) (Sold separately)	SH-080929ENG (1D7MD4)
GT15 User's Manual (Sold separately)	SH-080528ENG (1D7M23)
GT11 User's Manual (Sold separately)	JY997D17501 (09R815)
GT11 Handy GOT User's Manual (Sold separately)	JY997D20101 (09R817)

Relevant Manuals

For relevant manuals, refer to the PDF manuals stored in the DVD-ROM for the drawing software used.

© 2004 MITSUBISHI ELECTRIC CORPORATION

Compliance with the EMC and Low Voltage Directives

To configure a system meeting the requirements of the EMC and Low Voltage Directives when incorporating the Mitsubishi GOT (EMC and Low Voltage Directives compliant) into other machinery or equipment, refer to "EMC AND LOW VOLTAGE DIRECTIVES" of the General Description included with the GOT used. The CE mark, indicating compliance with the EMC and Low Voltage Directives, is printed on the rating plate of the GOT.

Compliance with the new China RoHS directive

GOT 相关的基于“电器电子产品有害物质限制使用管理办法”要求的表示方法

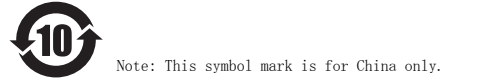

Note: This symbol mark is for China only.

含有有害6物质的名称、含有量、含有部件
本产品中所含有的有害6物质的名称、含有量、含有部件如下表所示。

部品名称	有害物質					
	鉛 (Pb)	汞 (Hg)	鎘 (Cd)	六价铬 (Cr(VI))	多環聯苯 (PBB)	多環二噁英 (PBDE)
电路板组件	×	○	○	○	○	○
树脂壳体、电缆、膜材	○	○	○	○	○	○
钣金部件、螺丝等金属部件	×	○	○	○	○	○

本表格依据 SJ/T11364 的规定编制。
○：表示该有害物质在该部件所有均质材料中的含量均在 GB/T26572 规定的限量要求以下。
×：表示该有害物质至少在该部件的某一均质材料中的含量超出 GB/T26572 规定的限量要求。

Packing List

The following items are included.

Model	Product	Quantity
GT05-MEM-16MC, GT05-MEM-32MC, GT05-MEM-64MC, GT05-MEM-128MC, GT05-MEM-256MC, GT05-MEM-512MC, GT05-MEM-1GC, GT05-MEM-2GC, GT05-MEM-4GC, GT05-MEM-8GC, GT05-MEM-16GC	CF card	1
GT05-MEM-16MC, GT05-MEM-32MC, GT05-MEM-64MC, GT05-MEM-128MC, GT05-MEM-256MC, GT05-MEM-512MC, GT05-MEM-1GC, GT05-MEM-2GC, GT05-MEM-4GC, GT05-MEM-8GC, GT05-MEM-16GC	GOT1000 Series CF Card/Memory Card Adaptor User's Manual (This manual)	1
	Memory card adaptor	1
GT05-MEM-ADPC	GOT1000 Series CF Card/Memory Card Adaptor User's Manual (This manual)	1

1. OVERVIEW

This User's Manual describes the GOT1000 series CF card and memory card adaptor (hereinafter referred to as the CF card and memory card adaptor). By installing the CF card, OS and project data can be transferred and functions can be increased. Refer to the User's Manual for the GOT used for the applicable GOT. Refer to GT Designer2 Version 2.0 Basic Operation/Data Transfer Manual for transfer of the OS and project data. Refer to GT Designer2 Version 2.0 Screen Design Manual for the increased functions. The memory card adaptor converts the CF card into a memory card (TYPE II).

2. SPECIFICATIONS

The performance specifications of the CF card and memory card adaptor are indicated below. The general specifications of the CF card and memory card adaptor are the same as those of the GOT.

Refer to the User's Manual for the GOT used for the general specifications of the GOT.

Model	Memory capacity	Number of write times	Weight	Applicable GOT		
				GT 16	GT 15	GT 11
GT05-MEM-16MC	16M bytes	300,000 times	0.01kg (0.03lb)	○	○	○
GT05-MEM-32MC	32M bytes			○	○	○
GT05-MEM-64MC	64M bytes			○	○	○
GT05-MEM-128MC	128M bytes			○	○	○
GT05-MEM-256MC	256M bytes			○	○	○
GT05-MEM-512MC	512M bytes			○	○	○
GT05-MEM-1GC	1G bytes			○	○	○
GT05-MEM-2GC	2G bytes			○	○	○
GT05-MEM-4GC	4G bytes			○ ¹	X	X
GT05-MEM-8GC	8G bytes			○ ¹	X	X
GT05-MEM-16GC	16G bytes	○ ¹	X	X		
GT05-MEM-ADPC	-	-	0.02kg (0.05lb)	-	-	-

¹: A CF card with more than 2GB can be used for the GT16 with the following versions of OSes installed.
• Boot OS version: 05.09.00AF or later
• Standard monitor OS version: 05.09.00 or later
If the above versions of OSes are not installed, install the OSes to the GOT by using GT Designer3 Version 1.15R or later. If the OS version is earlier than the above OS versions, a CF card with more than 2GB is not recognized correctly. GT Designer2 Version 2.0 is not supported.

Point
When formatting a CF card with more than 2GB by using a personal computer, format the CF card to FAT32.

3. PART NAMES AND EXTERNAL DIMENSIONS

(1) CF card

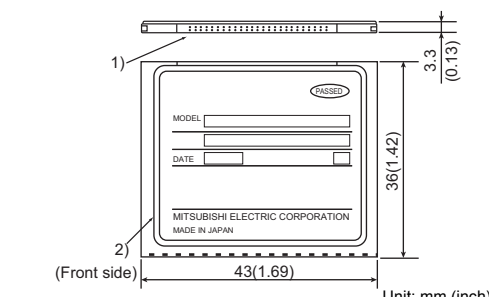

No.	Name	Description
1)	Connector	For connecting the CF card interface of the GOT
2)	Rating plate	-

(2) Memory card adaptor

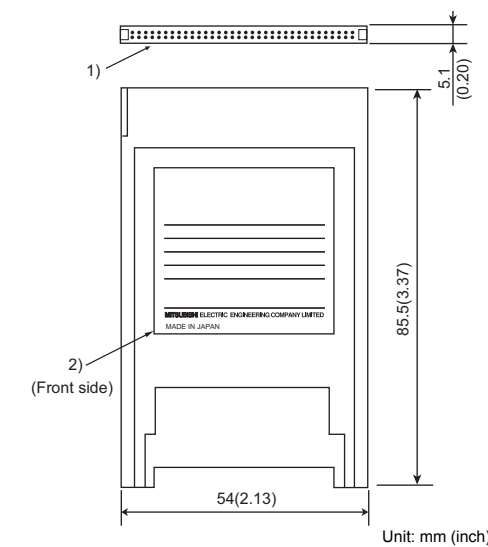

No.	Name	Description
1)	Connector	For connecting the memory card interface of the personal computer
2)	Rating plate	-

4. INSTALLING AND REMOVING PROCEDURES

The installation and removing procedures for the CF card is explained using the GT1575.

4.1 Installing the CF Card

- Turn the CF card access switch of the GOT off.

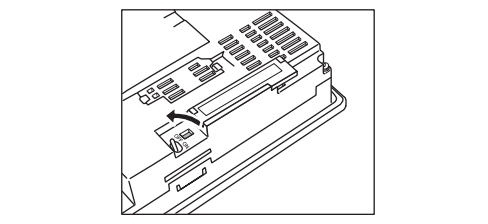

(2) Open the cover of the CF card interface. Insert and install the CF card into the CF card interface with its front side outside. *1

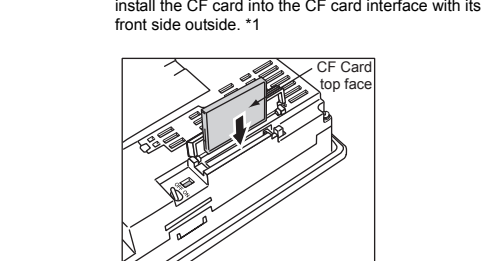

- *1 CF card eject button
For the following GOTs, after installing the CF card, turn the CF card eject button to 90 degree while being pulled.
• GT1585-S, GT1575-S: Hardware version B (April, 2005) or earlier
• GT1575-V, GT1565-V: Hardware version D (April, 2005) or earlier

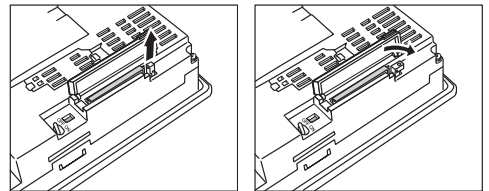

(3) Close the cover of the CF card interface. Set the CF card access switch to ON.

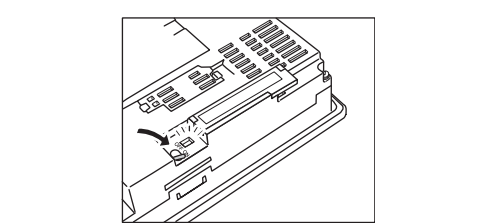

4.2 Removing the CF Card

- Turn the CF card access switch of the GOT off, and make sure that the CF card access LED has been turned off. (When the CF card access LED turns off, the CF card can be removed even during the GOT power on.)

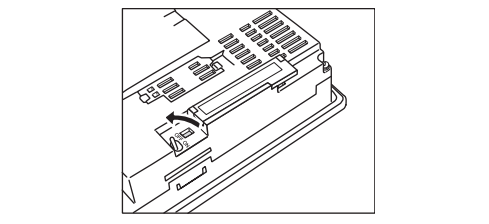

(2) Push the CF card eject button of the GOT. *2 (The CF card eject button is pulled out after pushing at once.)

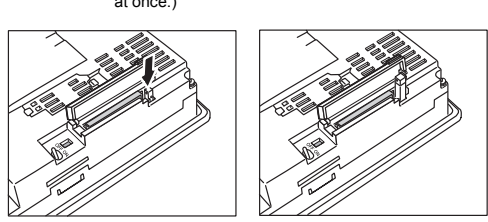

- *2 CF card eject button
For the following GOTs, after opening the cover of the CF card interface, raise the CF card eject button.
• GT1585-S, GT1575-S: Hardware version B (April, 2005) or earlier
• GT1575-V, GT1565-V: Hardware version D (April, 2005) or earlier

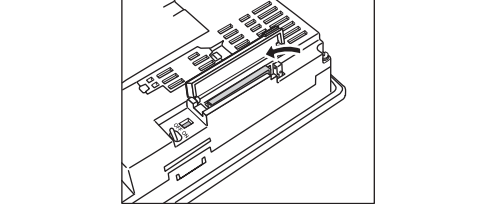

(3) Push the CF card eject button of the GOT to lift the CF card and remove it.

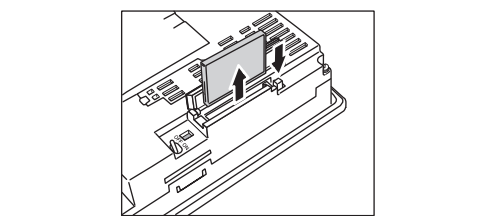

4.3 Precautions for Installing and Removing the CF Card

- While the CF card access LED is on, do not install/remove the CF card or power off the GOT. To do so may cause data corruption or malfunction.
- When ejecting the CF card, support it by hand since it may pop out. Failure to do so may cause a fall of the CF card leading to failure or damage of the card.

Warranty

Mitsubishi will not be held liable for damage caused by factors found not to be the cause of Mitsubishi; machine damage or lost profits caused by faults in the Mitsubishi products; damage, secondary damage, accident compensation caused by special factors unpredictable by Mitsubishi; damages to products other than Mitsubishi products; and to other duties.

For safe use

- This product has been manufactured as a general-purpose part for general industries, and has not been designed or manufactured to be incorporated in a device or system used in purposes related to human life.
- Before using the product for special purposes such as nuclear power, electric power, aerospace, medicine or passenger movement vehicles, consult with Mitsubishi.
- This product has been manufactured under strict quality control. However, when installing the product where major accidents or losses could occur if the product fails, install appropriate backup or failsafe functions in the system.

Country/Region	Sales office/Tel
USA	Mitsubishi Electric Automation, Inc. 500 Corporate Woods Parkway, Vernon Hills, IL 60061, U.S.A. Tel: +1-847-478-2100
Brazil	Mitsubishi Electric do Brasil Comercio e Servicos Ltda. Rua Jussara, 1750- Bloco B Anexo, Jardim Santa Cecilia, CEP 06465-070, Barueri - SP, Brazil Tel: +55-11-4889-3000
Mexico	Mitsubishi Electric Automation, Inc. Mexico Branch Mariano Escobedo #89, Col. Zona Industrial, Tlalnepantla Edo. Mexico, C.P.54030 Tel: +52-55-3067-7511
Germany	Mitsubishi Electric Europe B.V. German Branch Mitsubishi-Electric-Platz 1, 40882 Ratingen, Germany Tel: +49-2102-468-0
UK	Mitsubishi Electric Europe B.V. UK Branch Travellers Lane, Hatfield, Hertfordshire, AL10 8XB, U.K. Tel: +44-1707-28-8780
Italy	Mitsubishi Electric Europe B.V. Italian Branch Centro Direzionale Colleoni - Palazzo Siro, Viale Colleoni 7, 20864 Agrate Brianza (Milano), Italy Tel: +39-039-6031
Spain	Mitsubishi Electric Europe B.V. Spanish Branch Carretera de Rubi 76-80-420, 08190 Sant Cugat del Valles (Barcelona), Spain Tel: +34-93-45-1531
France	Mitsubishi Electric Europe B.V. French Branch 25, Boulevard des Bouvets, 92741 Nanterre Cedex, France Tel: +33-1-55-68-55-48
Czech	Mitsubishi Electric Europe B.V. Czech Branch Avenir Business Park, Radlicka 751/1136, 158 00 Praha 5, Czech Republic Tel: +420-251-651-470
Turkey	Mitsubishi Electric Turkey A.S. Urmaniyev Branch Senfali Mahallesi Nispetiye Sokak No:5, TR-34775 Urmaniyev / Istanbul, Turkey Tel: +90-216-528-9990
Poland	Mitsubishi Electric Europe B.V. Polish Branch ul. Krakowska 50, 32-083 Balice, Poland Tel: +48-12-347-05-00
Russia	Mitsubishi Electric (Russia) LLC St. Petersburg Branch Piskarevsky pr. 2, bld 2, lit "Sch", BC "Bernau", office 720; RU-195027 St. Petersburg, Russia Tel: +7-812-633-3497
South Africa	Adroit Technologies 20 Waterford Office Park, 189 Wilkoppen Road, Fourways, Johannesburg, South Africa Tel: +27-11-658-8100
China	Mitsubishi Electric Automation (China) Ltd. No. 1386 Hongqiao Road, Mitsubishi Electric Automation Center, Shanghai, China Tel: +86-21-2322-8030
Taiwan	SETSUYO ENTERPRISE CO., LTD. 6F, No. 105, Wugong 3rd Road, Wugu District, New Taipei City 24889, Taiwan Tel: +886-2-2293-2499
Korea	Mitsubishi Electric Automation Korea Co., Ltd. 7F-9F, Gangseo Hangang Xi-tower A, 401, Yangcheon Gangseo-Gu, Seoul 07528, Korea Tel: +82-2-3660-9530
Singapore	Mitsubishi Electric Asia Pte. Ltd. 307 Alexandra Road, Mitsubishi Electric Building, Singapore 159943 Tel: +65-6473-2308
Thailand	Mitsubishi Electric Factory Automation (Thailand) Co., Ltd. 12th Floor, SIV City Building, Office Tower 1, No. 898/19 and 20 Rama 3 Road, Kwaeng Bangpoo, Khet Yama, Bangkok 10120, Thailand Tel: +66-2682-6522 to 31
Indonesia	PT. Mitsubishi Electric Indonesia Gedung Jaya 11th Floor, J.L. MH. Thamrin No.12, Jakarta Pusat 10340, Indonesia Tel: +62-21-3192-6461
Vietnam	Mitsubishi Electric Vietnam Co., LTD. Ho Chi Minh Head Office Unit 01-04, 10th Floor, Vincom Center, 72 Le Thanh Ton Street, District 1, Ho Chi Minh City, Vietnam Tel: +84-9-3910-5945
India	Mitsubishi Electric India Pvt. Ltd. Pune Branch Emerald House, EL-3, J Block, M.I.D.C., Bhosari, Pune - 411026, Maharashtra, India Tel: +91-20-2716-2000
Australia	Mitsubishi Electric Australia Pty. Ltd. 348 Victoria Road, P.O. Box 11, Rydalmere, N.S.W. 2116, Australia Tel: +61-2-9684-7777

MITSUBISHI ELECTRIC CORPORATION
HEAD OFFICE: TOKYO BUILDING, 2-7-3 MARUNOUCHI, CHYODA-KU, TOKYO 100-8310, JAPAN
NAGOYA WORKS: 1-14, YADA-MINAMI 5-CHOME, HIGASHI-KU, NAGOYA, JAPAN

When exported from Japan, this manual does not require application to the Ministry of Economy, Trade and Industry for service transaction permission.

Specifications subject to change without notice.
Printed in Japan, October 2016.