



Safety Programmable Controller

**MELSEC** **QS** series

# CC-Link Safety System Remote I/O Module

User's Manual  
(Hardware)

## QS0J65BTS2-4T

Thank you for purchasing the safety programmable controller MELSEC-QS series. The MELSEC-QS programmable controller is suitable for establishing safety functions for general industrial machinery.

Prior to use, please read both this manual and detailed manual thoroughly and familiarize yourself with the product.





MODEL	QS0J65BTS2-4T-U-HW
MODEL CODE	13JY67
IB(NA)-0800415-K(2311)MEE	

## ● SAFETY PRECAUTIONS ●

(Always read these instructions before using this equipment.)

Before using the product, please read this manual, the relevant manuals introduced in this manual, standard programmable controller manuals, and the safety standards carefully and pay full attention to safety to handle the product correctly.

In this manual, the safety instructions are ranked as "⚠ WARNING" and "⚠ CAUTION".

 <b>WARNING</b>	Indicates that incorrect handling may cause hazardous conditions, resulting in death or severe injury.
 <b>CAUTION</b>	Indicates that incorrect handling may cause hazardous conditions, resulting in minor or moderate injury or property damage.

Note that the ⚠ CAUTION level may lead to a serious consequence according to the circumstances.

Always follow the instructions of both levels because they are important to personal safety.

Please save this manual to make it accessible when required and always forward it to the end user.

## [Design Precautions]

### **WARNING**

- When a safety programmable controller detects an error in an external power supply or a failure in programmable controller main module, it turns off all the outputs.  
Create an external circuit to securely stop the power of hazard by turning off the outputs. Incorrect configuration may result in an accident.
- Create short current protection for a safety relay, and a protection circuit such as a fuse, and breaker, outside a safety programmable controller.
- If load current more than the rating or overcurrent due to a short circuit in the load has flowed in the CC-Link Safety remote I/O module, the module defines it as a fault and turns off all the outputs.  
However, if overcurrent flows in the CC-Link Safety remote I/O module for a long time, it may cause smoke or a fire. To prevent it, create a safety circuit such as a fuse outside the module.
- When a safety remote I/O module has detected CC-Link Safety error, it turns off all the outputs.  
Note that the outputs in a sequence program are not automatically turned off. If CC-Link Safety error has been detected, create a sequence program that turns off the outputs in the program.  
If the CC-Link Safety is restored with the outputs on, it may suddenly operate and result in an accident.
- To inhibit restart without manual operation after safety functions was performed and outputs were turned OFF, create an interlock program which uses a reset button for restart.

### **CAUTION**

- Do not bunch the wires of external devices or communication cables together with the main circuit or power lines, or install them close to each other. They should be installed 100 mm or more from each other.  
Not doing so could result in noise that would cause malfunctions.
- Select the external devices to be connected to the CC-Link Safety remote I/O module, considering the maximum inrush current with reference to the CC-Link Safety System Remote I/O Module User's Manual. Connecting the device with inrush current over the maximum value may cause the module to fail or malfunction.

## [Security Precautions]

### **WARNING**

- To maintain the security (confidentiality, integrity, and availability) of the programmable controller and the system against unauthorized access, denial-of-service (DoS) attacks, computer viruses, and other cyberattacks from external devices via the network, take appropriate measures such as firewalls, virtual private networks (VPNs), and antivirus solutions.

## [Installation Precautions]

### **CAUTION**

- Use a safety programmable controller in the environment that meets the general specifications described in the QSCPU User's Manual (Hardware Design, Maintenance and Inspection).  
Using this programmable controller in an environment outside the range of the general specifications could result in electric shock, fire, erroneous operation, and damage to or deterioration of the product.
- Make sure to fix the CC-Link Safety remote I/O module with a DIN rail or mounting screws and tighten the screws with the specified torque.  
If the screws are too loose, it may cause a drop of the screw or module.  
Overtightening may cause a drop due to the damage of the screw or module.
- Do not directly touch the module's conductive parts or electronic components.  
Touching the conductive parts could cause an operation failure or give damage to the module.

## [Wiring Precautions]

### **WARNING**

- Completely turn off the externally supplied power used in the system when placing wiring. Not completely turning off all power could result in electric shock or damage to the product.
- When energizing or operating the module after installation or wiring, be sure to close the attached terminal cover. Not doing so may result in electric shock.

## [Wiring Precautions]

### CAUTION

- Be sure to ground the FG terminals and LG terminals to the protective ground conductor.  
Not doing so could result in electric shock or erroneous operation.
- Wire the module correctly after confirming the rated voltage and terminal layout. Connecting a power supply of a different rated voltage or incorrect wiring may cause a fire or failure.
- Tighten a terminal block mounting screw, terminal screw, and module mounting screw within the specified torque range. If the terminal block mounting screw or terminal screw is too loose, it may cause a short circuit, fire, or malfunctions. If too tight, it may damage the screw and/or the module, resulting in a drop of the screw or module, a short circuit or malfunctions. If the module mounting screw is too loose, it may cause a drop of the screw or module. Overtightening the screw may cause a drop due to the damage of the screw or module.
- Do not install the control lines or communication cables together with the main circuit lines or power cables. Failure to do so may result in malfunction due to noise.
- Be sure there are no foreign substances such as sawdust or wiring debris inside the module.  
Such debris could cause fires, damage, or erroneous operation.
- Be sure to fix the communication cables or power cables by ducts or clamps when connecting them to the module.  
Failure to do so may cause damage of the module or cables due to a wobble, unintentional shifting, or accidental pull of the cables, or malfunctions due to poor contact of the cable.
- When removing the connected communication cables or power cables, do not pull the cable with grasping the cable part.  
Remove the cable connected to the terminal block after loosening the terminal screws.  
Pulling the cable connected to a module may result in malfunctions or damage of the module or cable.

## [Startup and Maintenance Precautions]

### **WARNING**

- Do not touch the terminals while power is on.  
Doing so could cause shock or erroneous operation.
- Turn off all phases of the external supply power used in the system when cleaning the module or retightening the terminal block mounting screws, terminal screws, or module mounting screws.  
Not doing so could result in electric shock. Tighten a terminal block mounting screw, terminal screw, and module mounting screw within the specified torque range. If the terminal block mounting screw or terminal screw is too loose, it may cause a short circuit, fire, or malfunctions. If too tight, it may damage the screw and/or the module, resulting in a drop of the screw or module, a short circuit or malfunctions. If the module mounting screw is too loose, it may cause a drop of the screw or module. Overtightening the screw may cause a drop due to the damage of the screw or module.

### **CAUTION**

- Do not disassemble or modify the modules.  
Doing so could cause trouble, erroneous operation, injury, or fire.  
If the product is repaired or remodeled by other than the specified FA centers or us, the warranty is not covered.
- Do not mount/remove the module to/from the base unit or terminal block more than 50 times (IEC61131-2-compliant), after the first use of the product.  
Failure to do so may cause module malfunctions.
- Since the module case is made of resin, do not drop or apply any strong impact to the module. Doing so may damage the module.
- Completely turn off the externally supplied power used in the system before mounting or removing the module to/from the panel.  
Not doing so could result in damage to the product.

## [Disposal Precautions]

### **CAUTION**

- When disposing of this product, treat it as industrial waste.

## ● PRÉCAUTIONS DE SÉCURITÉ ●

*(Toujours lire ces instructions avant utilisation de l'équipement.)*

*Avant d'utiliser le produit, prière de lire ce manuel et la documentation à laquelle il renvoie, les manuels des automates programmables standard et les normes de sécurité pertinentes, et toujours considérer la sécurité comme de la plus haute importance en manipulant le produit correctement.*

*Dans ce manuel, les instructions de sécurité sont classées "AVERTISSEMENT" ou "ATTENTION".*

**⚠ AVERTISSEMENT**

*Attire l'attention sur le fait qu'une négligence peut créer une situation de danger avec risque de mort ou de blessures graves.*

**⚠ ATTENTION**

*Attire l'attention sur le fait qu'une négligence peut créer une situation de danger avec risque de blessures légères ou de gravité moyennes ou risque de dégâts matériels.*

*On remarquera que même à ce niveau, les conséquences peuvent être graves dans certaines circonstances.*

*Les instructions de ces deux niveaux doivent toujours être respectées car elles concernent la sécurité des personnes.*

*Prière de lire attentivement ce manuel et veiller à le transmettre à l'utilisateur final qui doit pouvoir s'y référer autant que de besoin.*



## **AVERTISSEMENT**

- *Quand l'automate programmable de sécurité détecte une erreur dans une alimentation externe ou une panne de module principal d'automate programmable, il désactive toutes les sorties.  
Constituer un circuit externe coupant infailliblement l'alimentation en cas de danger pour désactiver les sorties. Une configuration incorrecte peut être à l'origine d'un accident.*
- *Prévoir, à l'extérieur de l'automate programmable de sécurité, une protection contre les courants de court-circuit pour les relais de sécurité et un circuit de protection avec fusible ou disjoncteur.*
- *Si le courant de charge excède la valeur nominale ou si une surintensité due à un court-circuit à la charge circule dans le module E/S distant de sécurité CC-Link, le module détecte l'anomalie et désactive toutes les sorties.  
Cependant, une surintensité circulant pendant longtemps dans le module E/S distant de sécurité CC-Link peut être à l'origine d'un dégagement de fumée ou d'un départ de feu. Pour éviter cela, prévoir un circuit de sécurité extérieur au module, avec un fusible par exemple.*
- *Quand le module E/S distant de sécurité détecte une erreur de sécurité CC-Link, il désactive toutes les sorties.  
On remarquera que, dans un programme séquentiel, les sorties ne sont pas toujours automatiquement désactivées.  
Prévoir dans le programme séquentiel la désactivation des sorties dans l'éventualité où une erreur de sécurité CC-Link serait détectée.  
Le rétablissement de la sécurité CC-Link alors que les sorties sont actives pourrait causer un brusque mouvement à l'origine d'un accident.*
- *Pour interdire tout redémarrage sans intervention manuelle après déclenchement de la fonction de sécurité du module et mise hors tension des sorties, prévoir un circuit de mise en sécurité avec poussoir de réarmement.*



## **ATTENTION**

- *Ne pas grouper les fils des dispositifs externes ou câbles de communication avec les fils des circuits principaux ou de l'alimentation, et ne pas les installer à proximité les uns des autres.  
Ils doivent être installés à une distance de 100mm les uns des autres.  
Faute de quoi, il y a risque de bruit entraînant des dysfonctionnements.*
- *En choisissant les dispositifs externes à raccorder au module E/S distant de sécurité CC-Link, prendre en compte l'intensité maximum admissible du courant d'appel en se reportant au manuel de l'utilisateur du module E/S distant pour système de sécurité CC-Link. Le raccordement d'un appareil avec un courant d'appel excédant le maximum admissible peut être à l'origine de pannes ou de dysfonctionnements du module.*

### **[Précautions de sécurité]**

## **AVERTISSEMENT**

- *Pour maintenir la sécurité (confidentialité, intégrité et disponibilité) de l'automate programmable et du système contre les accès non autorisés, les attaques par déni de service (DoS), les virus informatiques et autres cyberattaques d'appareils externes via le réseau, prendre les mesures appropriées telles que la configuration d'un pare-feu ou d'un réseau privé virtuel (VPN), ou l'installation d'un logiciel antivirus sur l'ordinateur.*

## **[Précautions d'installation]**

### **ATTENTION**

- *Un automate programmable de sécurité doit être utilisé dans un environnement conforme aux spécifications générales exposées dans le QSCPU User's Manual (Hardware Design, Maintenance and Inspection) (le Manuel de l'utilisateur QSCPU (conception du matériel, maintenance et inspection)).  
L'utilisation de cet automate programmable dans un environnement autre que celui prévu dans les spécifications générales peut être à l'origine d'un choc électrique, d'un départ de feu ou d'un fonctionnement erratique, ou peut endommager ou détériorer le produit.*
- *Il est indispensable de fixer le module E/S distant de sécurité CC-Link sur rail DIN pour par des vis de fixation serrées au couple prescrit.  
Si le serrage est insuffisant, les vis ou le module risquent de tomber.  
Un serrage excessif peut endommager la vis ou le module et entraîner leur chute.*
- *Éviter tout contact direct avec les parties conductrices ou les composants électroniques du module. Toucher aux parties conductrices pourrait endommager le module ou provoquer des dysfonctionnements.*

## **[Précautions de câblage]**



### **AVERTISSEMENT**

- *Couper complètement l'alimentation externe utilisé par le système avant de mettre en œuvre les câbles. Ne pas couper complètement toutes les alimentations expose au risque de chocs électriques et d'endommagement du produit.*
- *Avant de mettre sous tension et de mettre en marche le module à la fin des travaux d'installation et de câblage, ne pas oublier de refermer le couvercle fourni. Faute de quoi, il y a un risque de choc électrique.*

**⚠ ATTENTION**

- *Il est indispensable de mettre les bornes FG et les bornes LG à la masse sur le conducteur de terre.  
faute de quoi, il y a risque de choc électrique ou de fonctionnement erratique.*
- *Câbler le module correctement après vérification de la tension nominale et de l'affectation des bornes. Le raccordement d'une alimentation d'une tension autre que la tension nominale ou une erreur de câblage peut être à l'origine d'un départ de feu ou d'une panne.*
- *Serrer les vis de fixation du bornier, les vis de borne et les vis de fixation du module dans les limites du couple de serrage prescrit. Une vis de fixation de bornier ou un vis de borne mal serrée peut être à l'origine d'un court-circuit, d'un départ de feu ou de dysfonctionnements. Un serrage excessif peut endommager la vis et/ou le module, et une chute de vis ou de module risque d'entraîner un court-circuit ou des dysfonctionnements. Un serrage insuffisant des vis de fixation de module peut être à l'origine d'une chute des vis ou du module. Un serrage excessif peut endommager la vis ou le module et entraîner leur chute.*
- *Ne pas entremêler les lignes de commandes ou câbles de communication avec les lignes des circuits principaux ou les câbles d'alimentation. Faute de quoi, il y a risque de dysfonctionnement par un bruit.*
- *Veiller à ce qu'il n'y ait pas de sciure ou autre débris de câblage dans le module.  
Tout débris pourrait être à l'origine d'un départ de feu, d'une panne ou d'un dysfonctionnement.*
- *Les câbles de communication ou câbles d'alimentation raccordés au module doivent être placés dans des conduits de câbles ou doivent être attachés. Faute de quoi, il y a risque d'endommagement du module ou du câble par ballottement ou effort de traction exercé accidentellement sur le câble, tout mauvais contact d'un câble pouvant être à l'origine de dysfonctionnement.*
- *Pour débrancher les câbles de communication ou d'alimentation, ne pas tirer sur le câble proprement dit.  
Retirer le câble raccordé au bornier après avoir desserré les vis de bornes. Tirer sur un câble raccordé au module peut endommager le câble ou le module et être à l'origine de dysfonctionnements.*

## **[Précautions de démarrage et de maintenance]**



### **AVERTISSEMENT**

- *Ne pas toucher aux bornes quand l'appareil est sous tension. Cela pourrait être à l'origine de chocs ou d'un fonctionnement erratique.*
- *Couper l'alimentation externe utilisée par le système sur toutes phases avant de nettoyer le module ou de resserrer les vis de fixation du bornier, les vis de bornes ou les vis de fixation du module.*  
*Faute de quoi, il y a risque de choc électrique. Serrer les vis de fixation du bornier, les vis de borne et les vis de fixation du module dans les limites du couple de serrage prescrit. Une vis de fixation de bornier ou un vis de borne mal serrée peut être à l'origine d'un court-circuit, d'un départ de feu ou de dysfonctionnements. Un serrage excessif peut endommager la vis et/ou le module, et une chute de vis ou de module risque d'entraîner un court-circuit ou des dysfonctionnements. Un serrage insuffisant des vis de fixation de module peut être à l'origine d'une chute des vis ou du module. Un serrage excessif peut endommager la vis ou le module et entraîner leur chute.*



### **ATTENTION**

- *Ne pas démonter ni modifier les modules.*  
*Cela pourrait être à l'origine de problèmes de fonctionnement erratique, de blessures ou d'un départ de feu.*  
*Si le produit est réparé ou modifié par quiconque autre que nous-mêmes ou un de nos centre d'automatisation industrielles agréés, il n'est plus couvert par la garantie.*
- *Après la mise en service du produit, ne pas installer/retirer le module de l'unité de base ou de la plaque à bornes plus de 50 fois (selon IEC61131-2).*  
*Faute de quoi, il y a risque de dysfonctionnements du module.*
- *Ne pas faire tomber ou soumettre le module à des chocs car son boîtier en plastique est fragile. Cela risquerait d'endommager le module.*
- *Couper complètement toute alimentation externe utilisée par le système avant de mettre en place ou de retirer le module du tableau.*  
*Faute de quoi, il y a risque d'endommagement du produit.*

## **[Précaution de mise au rebut]**



### **ATTENTION**

- *Lors de sa mise au rebut, ce produit doit être traité comme un déchet industriel.*

## ● CONDITIONS OF USE FOR THE PRODUCT ●

- (1) Although MELCO has declared Product's compliance with the international safety standards IEC61508, ISO13849-1, this fact does not guarantee that Product will be free from any malfunction or failure. The user of this Product shall comply with any and all applicable safety standard, regulation or law and take appropriate safety measures for the system in which the Product is installed or used and shall take the second or third safety measures other than the Product. MELCO is not liable for damages that could have been prevented by compliance with any applicable safety standard, regulation or law.
  
- (2) MELCO prohibits the use of Products with or in any application involving, and MELCO shall not be liable for a default, a liability for defect warranty, a quality assurance, negligence or other tort and a product liability in these applications.
  - (a) power plants,
  - (b) trains, railway systems, airplanes, airline operations, other transportation systems,
  - (c) hospitals, medical care, dialysis and life support facilities or equipment,
  - (d) amusement equipments,
  - (e) incineration and fuel devices,
  - (f) handling of nuclear or hazardous materials or chemicals,
  - (g) mining and drilling,
  - (h) and other applications where the level of risk to human life, health or property are elevated.
  
- (3) Mitsubishi shall have no responsibility or liability for any problems involving programmable controller trouble and system trouble caused by DoS attacks, unauthorized access, computer viruses, and other cyberattacks.

## REVISIONS

\* The manual number is given on the bottom right of the cover.

Print Date	*Manual Number	Revision
Apr., 2008	IB(NA)-0800415-A	First printing
Jul., 2009	IB(NA)-0800415-B	<p><b>Correction</b></p> <p>COMPLIANCE WITH THE EMC AND LOW VOLTAGE DIRECTIVES, Chapter 2, Chapter 3, Section 4.1, Chapter 5</p>
Jun., 2010	IB(NA)-0800415-C	<p><b>Correction</b></p> <p>SAFETY PRECAUTIONS, Section 4.1</p> <p><b>Additions</b></p> <p>CONDITIONS OF USE FOR THE PRODUCT, Section 1.1, 2.5, 2.6, Chapter 7, 8</p>
Apr., 2011	IB(NA)-0800415-D	<p><b>Correction</b></p> <p>SAFETY PRECAUTIONS, Section 2.5, Chapter 8</p>
Aug., 2011	IB(NA)-0800415-E	<p><b>Correction</b></p> <p>SAFETY PRECAUTIONS, Section 2.1, 4.1</p> <p><b>Additions</b></p> <p>SAFETY PRECAUTIONS (Chinese)</p>
Nov., 2013	IB(NA)-0800415-F	<p><b>Correction</b></p> <p>Section 2.1</p> <p><b>Additions</b></p> <p>Section 5.5</p>
Jun., 2014	IB(NA)-0800415-G	<p><b>Correction</b></p> <p>Section 2.1, 2.2, 2.5, 4.1, 5.2, Chapter 8</p> <p><b>Additions</b></p> <p>SAFETY PRECAUTIONS (French)</p>
Dec., 2016	IB(NA)-0800415-H	<p><b>Correction</b></p> <p>Section 2.2, 2.3, 2.4, 2.5, Chapter 3, 6, 8</p>
Jun., 2018	IB(NA)-0800415-I	Descriptions are revised due to compliance with the Chinese standardized law.

Print Date	*Manual Number	Revision
Oct., 2021	IB(NA)-0800415-J	Correction COMPLIANCE WITH THE EMC LOW VOLTAGE AND MACHINERY DIRECTIVES, Chapter 8
Nov., 2023	IB(NA)-0800415-K	Correction CONDITIONS OF USE FOR THE PRODUCT, Chapter 8, WARRANTY

This manual confers no industrial property rights or any rights of any other kind, nor does it confer any patent licenses. Mitsubishi electric Corporation cannot be held responsible for any problems involving industrial property rights which may occur as a result of using the contents noted in this manual.

© 2008 MITSUBISHI ELECTRIC CORPORATION



---

---

# CONTENTS

---

---

1. OVERVIEW .....	1
1.1 Safety Programmable Controller Product List .....	1
2. SPECIFICATIONS .....	2
2.1 General Specifications .....	2
2.2 Performance Specifications .....	3
2.3 Cable Specifications .....	6
2.4 Confirming Production Information .....	6
2.5 Safety Standards .....	6
2.6 Module Replacement .....	7
3. PART NAMES AND SETTINGS .....	8
4. MOUNTING AND INSTALLATION .....	11
4.1 Handling Precautions .....	11
4.2 Installation Environment .....	12
5. WIRING .....	13
5.1 Precautions for Handling CC-Link Dedicated Cables .....	13
5.2 Connecting CC-Link Dedicated Cables .....	13
5.3 Precautions for Wiring Module Power Supply .....	15
5.4 Precautions for Wiring Safety Devices .....	15
5.5 Safety devices and wiring example .....	16
6. EXTERNAL DIMENSIONS .....	18
7. PRECAUTIONS FOR USE .....	19
8. DECLARATION OF CONFORMITY FOR MACHINERY DIRECTIVE .....	20
8.1 Precautions for the Revision of the Declaration of Conformity to Machinery Directive .....	20
8.2 Declaration of Conformity (EU DECLARATION OF CONFORMITY) .....	21
8.3 Declaration of Conformity (UK DECLARATION OF CONFORMITY) .....	23

## **ABOUT MANUAL**

The following manual is also related to this product.  
In necessary, order it by quoting the details in the table below.

Detailed Manual

Manual name	Manual No. (Model code)
CC-Link Safety System Master Module User's Manual QS0J61BT12	SH-080600ENG (13JR88)
CC-Link Safety System Remote I/O Module User's Manual	SH-080612ENG (13JR89)

## **COMPLIANCE WITH THE EMC, LOW VOLTAGE, AND MACHINERY DIRECTIVES**

### (1) Method of ensuring compliance

To ensure that Mitsubishi programmable controllers maintain EMC, Low Voltage, and Machinery Directives when incorporated into other machinery or equipment, certain measures may be necessary. Please refer to the manual included with the base unit.

Certification marks on the side of the programmable controller indicate compliance with the relevant regulations.

### (2) Additional measures

This product complies with the EMC, Low Voltage, and Machinery Directives. Before using this product, please read this manual, the relevant manuals, the manuals for standard programmable controllers, and the safety standards carefully and pay full attention to safety to handle the product correctly.

The descriptions are based on the requirements of the Directives and the harmonized standards. However, they do not guarantee that the entire machinery constructed according to the descriptions complies with the EMC, Low Voltage, and Machinery Directives. The manufacture of the machinery must determine the testing method for compliance and declare conformity to the EMC, Low Voltage, and Machinery Directives.

---

---

## 1. OVERVIEW

---

---

This manual describes the specifications and handling and wiring methods of the safety remote I/O module of the CC-Link Safety system.

After unpacking, confirm that the following are included.

Item	Quantity
QS0J65BTS2-4T	1
CC-Link Safety System Remote I/O Module User's Manual (Hardware)QS0J65BTS2-4T	1

### 1.1 Safety Programmable Controller Product List

Product Name	Model	Description
CC-Link Safety system remote I/O module	QS0J65BTS2-4T	A safety output module connected to external devices. The module has four safety output points and sends/receives safety data to/from the safety programmable controller over CC-Link Safety.

## 2. SPECIFICATIONS

### 2.1 General Specifications

The general specifications of the QS0J65BTS2-4T are shown below.

Item	Specification					
Operating ambient temperature <i>Température ambiante de fonctionnement</i>	0 to 55°C 0 à 55 °C					
Storage ambient temperature	-40 to 75°C					
Operating ambient humidity	5 to 95%RH, non-condensing					
Storage ambient humidity						
Vibration resistance	Compliant with JIS B 3502 and IEC 61131-2		Frequency	Constant acceleration	Half amplitude	Sweep count
		Under intermittent vibration	5 to 8.4Hz	----	3.5mm	10 times each in X, Y, Z directions
			8.4 to 150Hz	9.8m/s <sup>2</sup>	----	
		Under continuous vibration	5 to 8.4Hz	----	1.75mm	----
8.4 to 150Hz	4.9m/s <sup>2</sup>		----			
Shock resistance	Compliant with JIS B 3502 and IEC 61131-2 (147m/s <sup>2</sup> , duration of action 11ms, 3 times each in 3 directions X, Y, Z by sine half-wave pulse)					
Operating atmosphere	No corrosive gases					
Operating altitude <sup>*3</sup>	0 to 2000m					
Installation location	Inside a control panel					
Overvoltage category <sup>*1</sup>	II or less					
Pollution degree <sup>*2</sup>	2 or less					
Equipment class	Class III					

\*1 This indicates the section of the power supply to which the equipment is assumed to be connected between the public electrical power distribution network and the machinery within premises.

Category II applies to equipment for which electrical power is supplied from fixed facilities. The surge voltage withstand level for up to the rated voltage of 300V is 2500V.

\*2 This index indicates the degree to which conductive material is generated in terms of the environment in which the equipment is used. Pollution degree 2 is when only non-conductive pollution occurs. A temporary conductivity caused by condensing must be expected occasionally.

\*3 Do not use or store the programmable controller under pressure higher than the atmospheric pressure of altitude 0m. Doing so may cause malfunction. When using the programmable controller under pressure, please consult your local Mitsubishi representative.

## 2.2 Performance Specifications

The performance specifications of the QS0J65BTS2-4T are shown below.

Item		Transistor output module
		QS0J65BTS2-4T
No. of output points		4 points (source + sink type) 2 points (source + source type)
Isolation method		Photocoupler
Rated load voltage		24V DC (Ripple ratio: 5% or less)
Operating load voltage range		19.2V to 28.8V DC
Maximum load current		0.5A per point
Maximum inrush current		1.0A, 10ms or less
Leakage current at OFF		0.5mA or less
Max. voltage drop at ON		1.0V DC or less
Protection function		Output overload protection function
Output format		Source + sink type Source + source type
Response time	OFF → ON	0.4ms or less (at 24V DC)
	ON → OFF	0.4ms or less (at 24V DC)
Safety remote station output response time		10.4ms or less (at ON → OFF), 11.2ms or less (at OFF → ON)
Surge suppressor		Zener diode
External power supply	Voltage	24V DC (Ripple ratio: 5% or less) (Allowable voltage range 19.2 to 28.8V DC)
	Current	45mA (24VDC, all points ON, excluding external load current)
	Protection function	External power supply overvoltage/overcurrent protection function
	Fuse	8A (Not replaceable)
Wiring method for common		4 output points per common (Spring clamp terminal block 2-wire type)
Common current		Max. 2A
No. of stations occupied		1 station
No. of accesses to nonvolatile memory inside module		10 <sup>12</sup> times
Safety refresh response processing time		9.6ms
Module power supply*1	Voltage	24V DC (Ripple ratio: 5% or less) (Allowable voltage range 19.2 to 28.8V DC)
	Current	95mA or less (24V DC, all points ON)
	Protection function	Module power overvoltage/overcurrent protection function
	Fuse	0.8A (Not replaceable)
	Momentary power failure period	10ms or less

Item		Transistor output module
		QS0J65BTS2-4T
Noise immunity		Tested by a DC-type noise simulator with noise voltage of 500Vp-p, noise width of 1 $\mu$ s and frequency of 25 to 60Hz.
Dielectric withstand voltage		500V AC between all external DC terminals and ground, for 1 minute
Insulation resistance		10M $\Omega$ or more between all external DC terminals and ground, by a 500VDC insulation resistance tester
Level of protection		IP2X
Weight		0.45kg
External connection system Système de connexion externe	Communication section, module power supply section <i>Section communication, section alimentation du module</i>	7-point two-piece terminal block [Transmission circuits, module power, FG] M3 x 5.2 Tightening torque: 0.425 to 0.575N•m, 2 solderless terminals or less <i>Bornier 7-points deux-pièces</i> [Circuit de transmission, alimentation module, FG] M3 x 5,2 Couple de serrage : 0,425 à 0,575 N•m, 2 bornes sans soudure ou moins
	External power supply section, output section <i>Section alimentation externe, section sortie</i>	Two-piece spring clamp terminal block [External power supply, output section] <i>Bornier à étrier deux-pièces</i> [Alimentation externe, section sortie]
Module mounting screw		M4 screw with plain washer finished round (Tightening torque range: 0.824 to 1.11N•m) Mountable with a DIN rail (in 6 orientations)
Applicable DIN rail		TH35-7.5Fe, TH35-7.5Al (Compliant with IEC 60715)

Item		Transistor output module
		QS0J65BTS2-4T
Applicable wire size Taille du fil à utiliser	Communication section, module power supply section Section communication, section alimentation du module	0.3 to 2.0mm <sup>2</sup> 0,3 à 2,0 mm <sup>2</sup>
	Applicable solderless terminal Borne sans soudure à utiliser	<ul style="list-style-type: none"> <li>• RAV1.25-3 [Applicable wire size: 0.3 to 1.25mm<sup>2</sup>]</li> <li>• V2-MS3 (JST Mfg. Co., Ltd.), RAP2-3SL (Nippon Tanshi Co., Ltd.), TGV2-3N (Nichifu) [Applicable wire size: 1.25 to 2mm<sup>2</sup>]</li> <li>• RAV1.25-3 [Taille du fil à utiliser: 0,3 à 1,25 mm<sup>2</sup>]</li> <li>• V2-MS3 (JST Mfg. Co., Ltd.), RAP2-3SL (Nippon Tanshi Co., Ltd.), TGV2-3N (Nichifu) [Taille de fil à utiliser : 1,25 à 2mm<sup>2</sup>]</li> </ul>
	External power supply section, output section Section alimentation externe, section sortie	Twisted wire 0.08 to 1.5mm <sup>2</sup> (28 to 16AWG) *2 Applicable wire strip length: 8 to 11mm Fil torsadé 0,08 à 1,5mm <sup>2</sup> (28 à 16AWG) *2 Longueur de fil à dénuder : 8 à 11mm
	Applicable solderless terminal Borne sans soudure à utiliser	<ul style="list-style-type: none"> <li>• TE0.5 (Nichifu) [Applicable wire size: 0.5mm<sup>2</sup>]</li> <li>• TE0.75 (Nichifu) [Applicable wire size: 0.75mm<sup>2</sup>]</li> <li>• TE1 (Nichifu) [Applicable wire size: 0.9 to 1.0mm<sup>2</sup>]</li> <li>• TE1.5 (Nichifu) [Applicable wire size: 1.25 to 1.5mm<sup>2</sup>]</li> <li>• FA-VTC125T9 (Mitsubishi Electric Engineering Co.,Ltd. [Applicable wire size: 0.3 to 1.65mm<sup>2</sup>])</li> <li>• FA-VTCW125T9 (Mitsubishi Electric Engineering Co.,Ltd. [Applicable wire size:0.3 to 1.65mm<sup>2</sup>])</li> <li>• TE0.5 (Nichifu) [Taille de fil à utiliser : 0,5mm<sup>2</sup>]</li> <li>• TE0.75 (Nichifu) [Taille de fil à utiliser : 0,75mm<sup>2</sup>]</li> <li>• TE1 (Nichifu) [Taille de fil à utiliser :0,9 à 1,0mm<sup>2</sup>]</li> <li>• TE1.5 (Nichifu) [Taille de fil à utiliser : 1,25 à 1,5mm<sup>2</sup>]</li> <li>• FA-VTC125T9 (Mitsubishi Electric Engineering Co.,Ltd. [Taille de fil à utiliser : 0,3 à 1,65mm<sup>2</sup>])</li> <li>• FA-VTCW125T9 (Mitsubishi Electric Engineering Co.,Ltd. [Taille de fil à utiliser : 0,3 à 1,65mm<sup>2</sup>])</li> </ul>

\*1 The power supply connected to the QS0J65BTS2-4T must satisfy the following conditions:

- (1) Reinforced insulation  
SELV (Safety Extra Low Voltage): Hazardous potential part (48V or more)
- (2) Compliance with the LVD (Low Voltage Directive)
- (3) Output voltage within 24V DC (Ripple ratio: 5% or less)  
(Allowable voltage range 19.2 to 28.8V DC)

\*2 Do not insert two or more wires into one terminal.

\*2 Ne pas introduire deux fils, ou plus de deux, dans une même borne.

## 2.3 Cable Specifications

Use CC-Link dedicated cables for the CC-Link Safety system.  
The performance of the CC-Link Safety system cannot be guaranteed when any other cables are used.

For the specifications or any other inquiries, visit the following website:  
CC-Link Partner Association: [www.cc-link.org](http://www.cc-link.org)

### Remark

For details, refer to the CC-Link Cable Wiring Manual issued by the CC-Link Partner Association.

## 2.4 Confirming Production Information

The production information of the QS0J65BTS2-4T can be confirmed on the rating plate located on the side of the module.

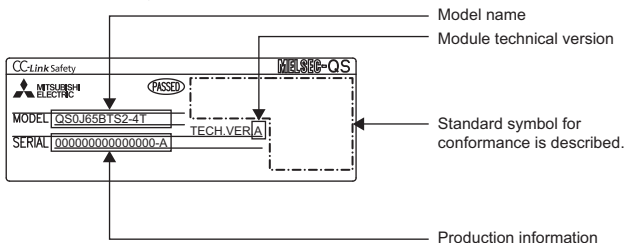

## 2.5 Safety Standards

### *Normes de sécurité*

Use the product according to the following safety standards.

Region	Safety Standards
International	IEC61508 Parts 1-7:1998-2000, ISO13849-1:2015, IEC61131-2:2007, IEC61000-6-2:2005, IEC61000-6-4:2006, IEC61784-3:2010, IEC60204-1:2009
Europe	EN ISO13849-1:2015, EN61131-2:2007, EN61000-6-2:2005, EN61000-6-4:2007
North America	UL508, NFPA79:2015



Utiliser le produit dans le respect des normes de sécurité suivantes.

Région	Normes de sécurité
International	IEC61508 Parts 1-7:1998-2000, ISO13849-1:2015, IEC61131-2:2007, IEC61000-6-2:2005, IEC61000-6-4:2006, IEC61784-3:2010, IEC60204-1:2009
Europe	EN ISO13849-1:2015, EN61131-2:2007, EN61000-6-2:2005, EN61000-6-4:2007
Amérique du Nord	UL508, NFPA79:2015

## 2.6 Module Replacement

Replace the module according to the following replacement cycle.

Module	Replacement Cycle
CC-Link Safety system remote I/O module	5 years

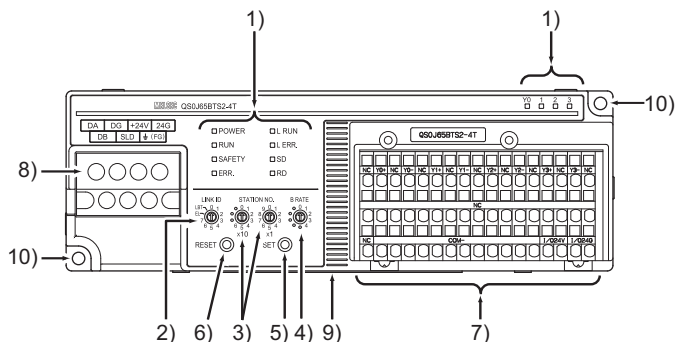

### 3. PART NAMES AND SETTINGS

The name of each part in the QS0J65BTS2-4T is shown.



No.	Name	Description
1)	Indicator LEDs	
	LED name	Indication
	"POWER"	Indicates the power status of the safety remote I/O module. ON (green) : Normally powered OFF : Powered off or error occurred (blown fuse)
	"RUN" <sup>*1</sup>	Indicates the operating status of the safety remote I/O module. ON (green) : Normally operating, or moderate error occurred Flashing at 500ms-intervals (green) : Switch setting has been registered but not fixed yet or reading of error history data have been completed normally. Flashing at 100ms-intervals (green) : Setting has been registered normally. OFF : Major error occurred
	"SAFETY" <sup>*1</sup>	Indicates the CC-Link Safety system connection status of the safety remote I/O module. ON (green) : Connected to CC-Link Safety system <sup>*2</sup> , or self-loopback test completed normally Flash (green): Self-loopback test in execution OFF : Not connected to CC-Link Safety system, or self-loopback test completed in error

No.	Name	Description								
1)	Indicator LEDs	<p>"ERR."<sup>*1</sup></p> <p>ON (red) : Major error occurred, or self-loopback test completed in error  "RUN" LED OFF: Major error occurred  Flashing at 500ms-intervals (red) : Moderate error occurred or reading of error history data have been completed abnormally.  Flashing at 100ms-intervals (red) : The registered switch setting differs from the actual switch setting.  OFF : Normally operating</p> <p>"L RUN"</p> <p>ON (green) : Normally communicating in the CC-Link Safety system  OFF : Communication failure in the CC-Link Safety system (Timeout error)</p> <p>"L ERR."</p> <p>ON (red) : Value set by link ID, station No, or transmission setting switch is out of range  Flash regularly (red) : Setting of link ID, station No, and/or transmission setting switch is different from that of the internal nonvolatile memory  Flash irregularly (red) : Wrong terminal resistor setting, or noise influence  OFF : Normally operating</p> <p>"SD"</p> <p>ON (green) : Data being sent</p> <p>"RD"</p> <p>ON (green) : Data being received</p> <p>"Y0" to "Y3"</p> <p>ON (red) : Output ON  OFF : Output OFF</p>								
2)	Link ID setting switch <sup>*4</sup>	<table border="1" data-bbox="418 1074 926 1214"> <thead> <tr> <th data-bbox="418 1074 586 1108">Setting</th> <th data-bbox="586 1074 926 1108">Description</th> </tr> </thead> <tbody> <tr> <td data-bbox="418 1108 586 1141">0 to 7</td> <td data-bbox="586 1108 926 1141">Link ID setting</td> </tr> <tr> <td data-bbox="418 1141 586 1174">EL</td> <td data-bbox="586 1141 926 1174">Setting for reading error logs</td> </tr> <tr> <td data-bbox="418 1174 586 1214">LBT</td> <td data-bbox="586 1174 926 1214">Setting for self-loopback test</td> </tr> </tbody> </table> <p data-bbox="373 1220 964 1263">To refresh the switch setting, perform the reset operation or turn the power OFF → ON of the safety remote I/O module.</p>	Setting	Description	0 to 7	Link ID setting	EL	Setting for reading error logs	LBT	Setting for self-loopback test
Setting	Description									
0 to 7	Link ID setting									
EL	Setting for reading error logs									
LBT	Setting for self-loopback test									

No.	Name	Description												
3)	Station No. setting switch*4	Set station No. of the safety remote I/O module within a range from 0 to 64.*3 <ul style="list-style-type: none"> <li>• Tens place of station No. is set by  X10.</li> <li>• Units place of station No. is set by  X1.</li> </ul>												
4)	Transmission speed setting switch*4	<table border="1" data-bbox="376 230 888 438"> <thead> <tr> <th>Setting</th> <th>Transmission speed</th> </tr> </thead> <tbody> <tr> <td>0</td> <td>156kbps</td> </tr> <tr> <td>1</td> <td>625kbps</td> </tr> <tr> <td>2</td> <td>2.5Mbps</td> </tr> <tr> <td>3</td> <td>5Mbps</td> </tr> <tr> <td>4</td> <td>10Mbps</td> </tr> </tbody> </table> <p>Always set this switch within a range of 0 to 4.</p>	Setting	Transmission speed	0	156kbps	1	625kbps	2	2.5Mbps	3	5Mbps	4	10Mbps
Setting	Transmission speed													
0	156kbps													
1	625kbps													
2	2.5Mbps													
3	5Mbps													
4	10Mbps													
5)	Setting saving switch*4	Saves the values set by switches 2) to 4) into the nonvolatile memory inside the safety remote I/O module.												
6)	Reset switch*4	Resets the hardware of the safety remote I/O module.												
7)	I/O terminal block	Two-piece spring clamp terminal block for connection of external power supply and I/O signals.												
8)	Power supply, transmission terminal block	Two-piece terminal block for connection of module power supply and transmission signal.												
9)	Hook for DIN rail	Hook used for installing the module to a DIN rail. Press the center part of the hook until a click is heard.												
10)	Mounting hole for screw installation	A hole used when installing a module directly to a panel.												

\*1 Although the "RUN", "SAFETY" and "ERR." LEDs momentarily turn on immediately after power ON or reset, it does not mean any fault.

\*2 The "SAFETY" LED is off when no safety remote I/O station parameters have been received during connection to the CC-Link Safety system.

\*3 Duplicate station number setting is not allowed.

\*4 For the switch setting methods, refer to the CC-Link Safety system Remote I/O Module User's Manual.

---

---

## 4. MOUNTING AND INSTALLATION

---

---

### 4.1 Handling Precautions

This section provides handling precautions for use of the safety remote I/O module.

- (1) Do not drop the safety remote I/O module or apply any strong impact to it.
- (2) Do not remove the printed circuit board (PCB) of the safety remote I/O module from the case.  
Doing so may cause failure.
- (3) Carefully prevent any dust or wiring chips from entering the safety remote I/O module.  
Failure to do so may cause a fire, failure, or malfunction.
- (4) When installing the safety remote I/O module to a control panel, provide clearance of at least 60mm between the module's top/ bottom and any other structure or component to ensure proper airflow and to make module replacement easy.
- (5) Install the safety remote I/O module to a flat surface.  
If it is not flat, an excess force may be applied to the PCB, causing failure.
- (6) Tighten the module mounting screws and terminal screws within the following torque range.  
Overtightening may result in damage to the screws or the module case.

*Serrer les vis de fixation du module et les vis de borne dans les limites du couple de serrage prescrit.*

*Un serrage excessif peut endommager les vis ou le boîtier du module.*

Screw	Specified torque range
Module mounting screw (M4 screw with plain washer finished round)	0.824 to 1.110N·m
Terminal screw (M3 screw) <i>Vis de borne (Vis M3)</i>	0.425 to 0.525N·m <i>0,425 à 0,525 N·m</i>
2-piece terminal block mounting screw (M3.5 screw)	0.680 to 0.920N·m

- (7) When using a DIN rail, pay attention to the following:
- (a) Applicable DIN rail model (conforming to IEC 60715)  
TH35-7.5Fe  
TH35-7.5Al
  - (b) Installation screw intervals  
Tighten the screws at pitches of 200mm (7.88 inch) or less.
- (8) When installing the safety remote I/O module to the DIN rail, press the center part of the hook located on the bottom of the module until a click is heard.

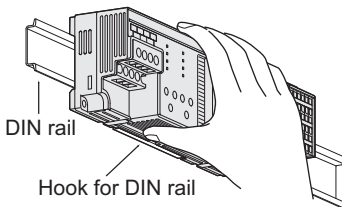

Note: Do not press the front face as shown below. Doing so may cause failure.

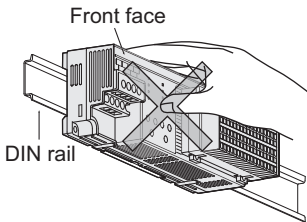

- (9) If the mechanical power supply switch is used for the safety remote I/O module, in rare cases it does not operate, when the excessive chattering is generated at power-on, and safety diagnostics function operates due to the unstable status of the input power supply voltage.
- In this case, turn on power supply again.

## 4.2 Installation Environment

For installation environment, refer to "2.1 General Specifications".

## 5. WIRING

### 5.1 Precautions for Handling CC-Link Dedicated Cables

This section explains how to handle CC-Link dedicated cables. Do not perform any of the following, as each of them will damage CC-Link dedicated cables:

- Compressing the cable with a sharp object
- Twisting the cable excessively
- Pulling the cable too hard (exceeding the allowable tension)
- Stepping on the cable
- Placing an object on the cable
- Scratching the cable sheath

### 5.2 Connecting CC-Link Dedicated Cables

#### *Raccordement des câbles dédiés CC-Link*

The following figure shows how safety remote I/O modules are connected with CC-Link dedicated cables.

*La figure ci-après illustre la méthode de raccordement des modules E/S distants de sécurité par câbles dédiés CC-Link.*

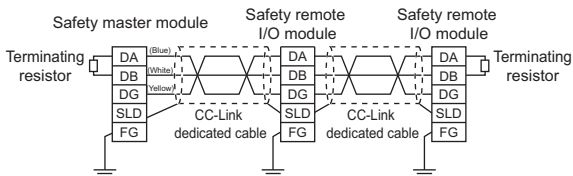

English	French	English	French
Safety master module	<i>Module maître de sécurité</i>	Blue	<i>Bleu</i>
Safety remote I/O module	<i>Module E/S de sécurité distant</i>	White	<i>Blanc</i>
Terminating resistor	<i>Résistance d'extrémité</i>	Yellow	<i>jaune</i>
CC-Link dedicated cable	<i>Câble dédié pour CC-Link</i>		

POINT
-------

1) Connect the shielded wire of the CC-Link dedicated cable to SLD terminal of each module, and ground both ends to the protective ground connectors via FG terminals.

The SLD and FG terminals are connected inside the module.

2) Always connect terminating resistors to the modules located on both ends of the data link network.

Connect a terminating resistor between DA and DB terminals.

*1) Raccorder le fil de blindage du câble dédié CC-Link à la borne SLD de chaque module et mettre les deux extrémités à la masse sur les connecteurs de mise à la terre via les borne FG.*

*Les bornes SLD et FG sont raccordées à l'intérieur du module.*

*2) Toujours placer des résistances d'extrémité sur les modules placés aux deux extrémités de la liaison de données.*

*Raccorder une résistance d'extrémité entre les bornes DA et DB.*



### 5.3 Precautions for Wiring Module Power Supply

When wiring the module power supply of the safety remote I/O module, note the following.

- Cable length of the module power supply must be within 10m (32.81 ft.).

### 5.4 Precautions for Wiring Safety Devices

This section describes the precautions for wiring to each safety device.

#### (1) Wiring of the output terminal section

Use sink outputs in combination with source outputs.

Combinations of two sink outputs or single use of sink output is not allowed.

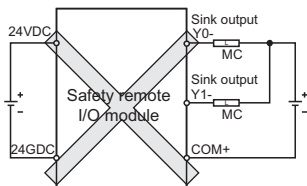
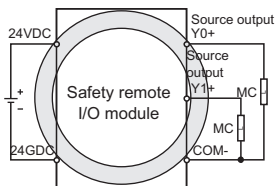
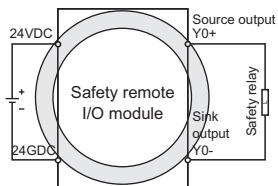

## 5.5 Safety devices and wiring example

This section describes the wiring between the safety remote I/O module and safety devices.

To satisfy the wiring requirements specified in Category 4, the following two points must be executed in the safety remote I/O module.

- Double input/output wiring
- Execution of the self-diagnostic function (dark test)

The following shows an example of wiring between the safety remote I/O module and the safety device to meet the above points.

For details on the wiring with safety devices, refer to the "Safety Application Guide".

### (1) Wiring example of the QS0J65BTS2-4T

#### (a) Wiring example (source and source outputs)

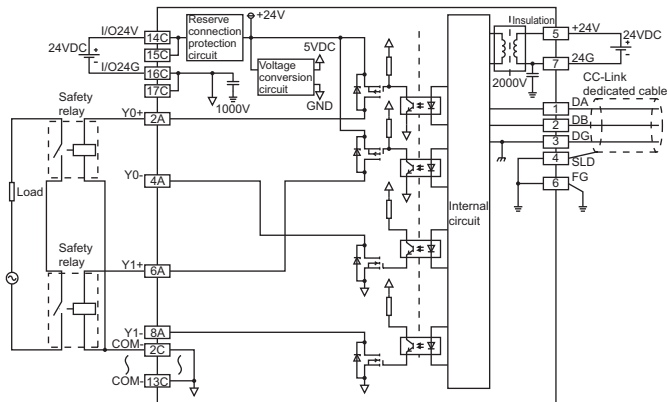

CC-Link terminal

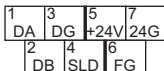

Terminal block

No.	Line C	Line B	Line A
1	COM-	Empty	Empty
2			Y0+
3			Empty
4			Y0-
5			Empty
6			Y1+
7			Empty
8			Y1-
9			Empty
10			Y2+
11			Empty
12			Y2-
13			Empty
14	I/O24V	Empty	Y3+
15			Empty
16	I/O24G		Y3-
17			Empty

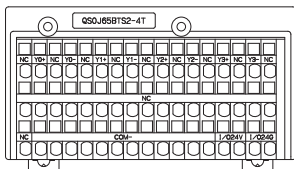

## 6. EXTERNAL DIMENSIONS

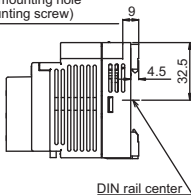
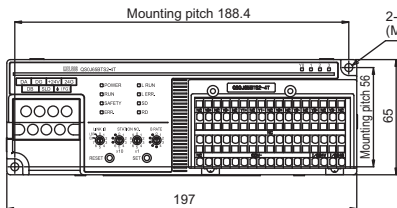
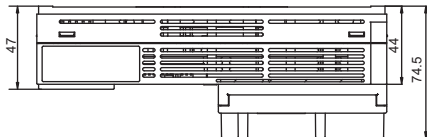

Unit: mm

## 7. PRECAUTIONS FOR USE

Users must prove that their entire safety system complies with the safety standards and the Machinery Directive. The third-party certification organization will validate the safety of product for the entire safety system, including a safety programmable controller and safety components.

To establish a safety system, calculate the target failure measure (PFD/PFH) for each safety application (safety function) based on the PFD/PFH values of the safety programmable controller and connected safety components. The target failure measure (PFD/PFH) is the reliability target value for each Safety Integrity Level (SIL) defined in IEC61508 and can be calculated by the following formula.

$PFD/PFH = A + B + C + D$  ....Calculation formula of PFD/PFH

Variable	Definition
A	Total PFD/PFH of the safety CPU module, safety power supply module, safety main base unit, and CC-Link Safety system master module
B	PFD/PFH of the CC-Link Safety system remote I/O module (1) When safety input device(s) and safety output device(s) are connected to the same CC-Link Safety system remote I/O module: $B=B1$ (2) When safety input device(s) and safety output device(s) are connected to different CC-Link Safety system remote I/O modules: $B=B1+B2$
B1	PFD/PFH of the CC-Link Safety system remote I/O module to which safety input device(s) is connected
B2	PFD/PFH of the CC-Link Safety system remote I/O module to which safety output device(s) is connected
$C^{*1}$	PFD/PFH of safety input device(s)
$D^{*1}$	PFD/PFH of safety output device(s)

\*1 For the values, refer to the manual for the safety component used.

The following tables show the PFD/PFH values for the safety remote I/O module.

Module	PFD	PFH(/h)
PFD/PFH of the QS0J65BTBS2-4T	$1.68 \times 10^{-5}$	$7.46 \times 10^{-10}$

---

## 8. DECLARATION OF CONFORMITY FOR MACHINERY DIRECTIVE

---

### 8.1 Precautions for the Revision of the Declaration of Conformity to Machinery Directive

Mitsubishi Electric revised the declaration of conformity to Machinery Directive from the one certified by TUV Rheinland, an independent third-party inspection body, to the one self-certified as the TUV Rheinland Certificate will expire on December 2nd, 2021.

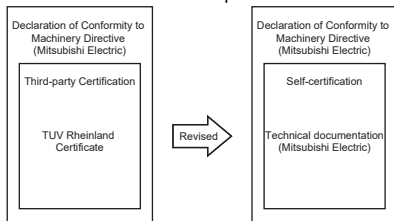

For this reason, note the following when reading the manuals for the product.

- Regard "the declaration is certified by TUV Rheinland/the third-party inspection body" as "the declaration is self-certified by Mitsubishi Electric".
- Regard "the approval/certification for the declaration is issued by TUV Rheinland/the third-party inspection body" as "the declaration is issued by Mitsubishi Electric".

For details, refer to the following technical bulletin:  
Production Discontinuation of MELSEC-QS Series Safety Programmable Controllers (FA-A-0300)

## 8.2 Declaration of Conformity (EU DECLARATION OF CONFORMITY)



### EU DECLARATION OF CONFORMITY

We,

Manufacturer : MITSUBISHI ELECTRIC CORPORATION

Address  
(Place of Declare) : TOKYO 100-8310, JAPAN

Brand Name :  MITSUBISHI ELECTRIC,  MITSUBISHI

declare under our sole responsibility that the product

Description : Safety Programmable Controller

Type of Model : MELSEC-QS series

Notice : Refer to next page about each type name

to which this declaration relates is in conformity with the following standard and directive.

Directive		Harmonized Standard	Notified Body
EMC Directive	2014/30/EU	EN61131-2:2007	—
Machinery Directive	2006/42/EC	EN ISO 13849-1:2015	—
RoHS Directive	2011/65/EU,(EU)2015/863*1	EN IEC 63000:2018	—

\*1 :Category 9 "Industrial monitoring and control instruments" is applicable.

Authorized representative in Europe  
(The person authorized to compile the Technical file or relevant Technical documentation)

Hartmut Pütz  
FA Product Marketing, Director, MITSUBISHI ELECTRIC EUROPE B.V., German Branch  
Mitsubishi-Electric-Platz 1, 40882 Ratingen, Germany  
Issue Date (Date of Declaration): 21 Sep. 2021

Signed for and on behalf of

(Signature) \_\_\_\_\_

[Takahiko Yamanaka]  
Senior Manager, FA Standard Module Development Section  
FA Systems Dept.2  
MITSUBISHI ELECTRIC CORPORATION NAGOYA WORKS

## Appendix List of type name to declare

QS001CPU
QS001CPU-K
QS034B
QS034B-K
QS0J61BT12
QS0J61BT12-K
QS0J65BTB2-12DT
QS0J65BTB2-12DT-K
QS0J65BTS2-4T
QS0J65BTS2-8D
QS0J71GF11-T2
QS061P-A1
QS061P-A1-K
QS061P-A2
QS061P-A2-K



## 8.3 Declaration of Conformity (UK DECLARATION OF CONFORMITY)



### UK DECLARATION OF CONFORMITY

We,

Manufacturer : MITSUBISHI ELECTRIC CORPORATION

Address : TOKYO 100-8310, JAPAN  
(Place of Declare)

Brand Name :  MITSUBISHI ELECTRIC

declare under our sole responsibility that the product

Description : Safety Programmable Controller

Type of Model : MELSEC-QS series

Notice : Refer to next page about each type name

to which this declaration relates is in conformity with the following standard and legislation.

Legislation	Designated Standard	Approved Body
Electromagnetic Compatibility Regulations 2016	EN 61131-2:2007	—
Supply of Machinery (Safety) Regulations 2008	EN ISO 13849-1:2015	—
The Restriction of the Use of Certain Hazardous Substances in Electrical and Electronic Equipment Regulations 2012	EN IEC 63000:2018	—

Issue Date (Date of Declaration): 21 Sep. 2021

Signed for and on behalf of

(Signature) \_\_\_\_\_

[Takahiko Yamanaka]

Senior Manager, FA Standard Module Development Section

FA Systems Dept. 2

MITSUBISHI ELECTRIC CORPORATION NAGOYA WORKS

## Appendix List of type name to declare

QS001CPU
QS001CPU-K
QS034B
QS034B-K
QS0J61BT12
QS0J61BT12-K
QS0J65BTB2-12DT
QS0J65BTB2-12DT-K
QS0J65BTS2-4T
QS0J65BTS2-8D
QS0J71GF11-T2
QS061P-A1
QS061P-A1-K
QS061P-A2
QS061P-A2-K

## **WARRANTY**

Please confirm the following product warranty details before using this product.

### **1. Limited Warranty and Product Support.**

- a. Mitsubishi Electric Company ("MELCO") warrants that for a period of eighteen (18) months after date of delivery from the point of manufacture or one year from date of Customer's purchase, whichever is less, Mitsubishi MELSEC Safety programmable logic controllers (the "Products") will be free from defects in material and workmanship.
- b. At MELCO's option, for those Products MELCO determines are not as warranted, MELCO shall either repair or replace them or issue a credit or return the purchase price paid for them.
- c. For this warranty to apply:
  - (1) Customer shall give MELCO (i) notice of a warranty claim to MELCO and the authorized dealer or distributor from whom the Products were purchased, (ii) the notice shall describe in reasonable details the warranty problem, (iii) the notice shall be provided promptly and in no event later than thirty (30) days after the Customer knows or has reason to believe that Products are not as warranted, and (iv) in any event, the notice must be given within the warranty period;
  - (2) Customer shall cooperate with MELCO and MELCO's representatives in MELCO's investigation of the warranty claim, including preserving evidence of the claim and its causes, meaningfully responding to MELCO's questions and investigation of the problem, grant MELCO access to witnesses, personnel, documents, physical evidence and records concerning the warranty problem, and allow MELCO to examine and test the Products in question offsite or at the premises where they are installed or used; and
  - (3) If MELCO requests, Customer shall remove Products it claims are defective and ship them to MELCO or MELCO's authorized representative for examination and, if found defective, for repair or replacement. The costs of removal, shipment to and from MELCO's designated examination point, and reinstallation of repaired or replaced Products shall be at Customer's expense.
  - (4) If Customer requests and MELCO agrees to effect repairs onsite at any domestic or overseas location, the Customer will pay for the costs of sending repair personnel and shipping parts. MELCO is not responsible for any re-commissioning, maintenance, or testing on-site that involves repairs or replacing of the Products.
- d. Repairs of Products located outside of Japan are accepted by MELCO's local authorized service facility centers ("FA Centers"). Terms and conditions on which each FA Center offers repair services for Products that are out of warranty or not covered by MELCO's limited warranty may vary.
- e. Subject to availability of spare parts, MELCO will offer Product repair services for (7) years after each Product model or line is discontinued, at MELCO's or its FA Centers' rates and charges and standard terms in effect at the time of repair. MELCO usually produces and retains sufficient spare parts for repairs of its Products for a period of seven (7) years after production is discontinued.
- f. MELCO generally announces discontinuation of Products through MELCO's Technical Bulletins. Products discontinued and repair parts for them may not be available after their production is discontinued.

## **2. Limits of Warranties.**

- a. MELCO does not warrant or guarantee the design, specify, manufacture, construction or installation of the materials, construction criteria, functionality, use, properties or other characteristics of the equipment, systems, or production lines into which the Products may be incorporated, including any safety, fail-safe and shut down systems using the Products.
- b. MELCO is not responsible for determining the suitability of the Products for their intended purpose and use, including determining if the Products provide appropriate safety margins and redundancies for the applications, equipment or systems into which they are incorporated.
- c. Customer acknowledges that qualified and experienced personnel are required to determine the suitability, application, design, construction and proper installation and integration of the Products. MELCO does not supply such personnel.
- d. MELCO is not responsible for designing and conducting tests to determine that the Product functions appropriately and meets application standards and requirements as installed or incorporated into the end-user's equipment, production lines or systems.
- e. MELCO does not warrant any Product:
  - (1) repaired or altered by persons other than MELCO or its authorized engineers or FA Centers;
  - (2) subjected to negligence, carelessness, accident, misuse, or damage;
  - (3) improperly stored, handled, installed or maintained;
  - (4) integrated or used in connection with improperly designed, incompatible or defective hardware or software;
  - (5) that fails because consumable parts such as batteries, backlights, or fuses were not tested, serviced or replaced;
  - (6) operated or used with equipment, production lines or systems that do not meet applicable and commensurate legal, safety and industry-accepted standards;
  - (7) operated or used in abnormal applications;
  - (8) installed, operated or used in contravention of instructions, precautions or warnings contained in MELCO's user, instruction and/or safety manuals, technical bulletins and guidelines for the Products;
  - (9) used with obsolete technologies or technologies not fully tested and widely accepted and in use at the time of the Product's manufacture;
  - (10) subjected to excessive heat or moisture, abnormal voltages, shock, excessive vibration, physical damage or other improper environment; or
  - (11) damaged or malfunctioning due to Acts of God, fires, acts of vandals, criminals or terrorists, communication or power failures, or any other cause or failure that results from circumstances beyond MELCO's control.
- f. All Product information and specifications contained on MELCO's website and in catalogs, manuals, or technical information materials provided by MELCO are subject to change without prior notice.
- g. The Product information and statements contained on MELCO's website and in catalogs, manuals, technical bulletins or other materials provided by MELCO are provided as a guide for Customer's use. They do not constitute warranties and are not incorporated in the contract of sale for the Products.
- h. These terms and conditions constitute the entire agreement between Customer and MELCO with respect to warranties, remedies and damages and supersede any other understandings, whether written or oral, between the parties. Customer expressly acknowledges that any representations or statements made by MELCO or others concerning the Products outside these terms are not part of the basis of the bargain between the parties and are not factored into the pricing of the Products.
- i. THE WARRANTIES AND REMEDIES SET FORTH IN THESE TERMS ARE THE EXCLUSIVE AND ONLY WARRANTIES AND REMEDIES THAT APPLY TO THE PRODUCTS.
- j. MELCO DISCLAIMS THE IMPLIED WARRANTIES OF MERCHANTABILITY AND FITNESS FOR A PARTICULAR PURPOSE.

### **3. Limits on Damages.**

- a. MELCO'S MAXIMUM CUMULATIVE LIABILITY BASED ON ANY CLAIMS FOR BREACH OF WARRANTY OR CONTRACT, NEGLIGENCE, STRICT TORT LIABILITY OR OTHER THEORIES OF RECOVERY REGARDING THE SALE, REPAIR, REPLACEMENT, DELIVERY, PERFORMANCE, CONDITION, SUITABILITY, COMPLIANCE, OR OTHER ASPECTS OF THE PRODUCTS OR THEIR SALE, INSTALLATION OR USE SHALL BE LIMITED TO THE PRICE PAID FOR PRODUCTS NOT AS WARRANTED.
- b. Although MELCO has declared Product's compliance with the international safety standards IEC61508, ISO13849-1, this fact does not guarantee that Product will be free from any malfunction or failure. The user of this Product shall comply with any and all applicable safety standard, regulation or law and take appropriate safety measures for the system in which the Product is installed or used and shall take the second or third safety measures other than the Product. MELCO is not liable for damages that could have been prevented by compliance with any applicable safety standard, regulation or law.
- c. MELCO prohibits the use of Products with or in any application involving power plants, trains, railway systems, airplanes, airline operations, other transportation systems, amusement equipments, hospitals, medical care, dialysis and life support facilities or equipment, incineration and fuel devices, handling of nuclear or hazardous materials or chemicals, mining and drilling, and other applications where the level of risk to human life, health or property are elevated.
- d. MELCO SHALL NOT BE LIABLE FOR SPECIAL, INCIDENTAL, CONSEQUENTIAL, INDIRECT OR PUNITIVE DAMAGES, FOR LOSS OF PROFITS, SALES, OR REVENUE, FOR INCREASED LABOR OR OVERHEAD COSTS, FOR DOWNTIME OR LOSS OF PRODUCTION, FOR COST OVERRUNS, OR FOR ENVIRONMENTAL OR POLLUTION DAMAGES OR CLEAN-UP COSTS, WHETHER THE LOSS IS BASED ON CLAIMS FOR BREACH OF CONTRACT OR WARRANTY, VIOLATION OF STATUTE, NEGLIGENCE OR OTHER TORT, STRICT LIABILITY OR OTHERWISE.
- e. In the event that any damages which are asserted against MELCO arising out of or relating to the Products or defects in them, consist of personal injury, wrongful death and/or physical property damages as well as damages of a pecuniary nature, the disclaimers and limitations contained in these terms shall apply to all three types of damages to the fullest extent permitted by law. If, however, the personal injury, wrongful death and/or physical property damages cannot be disclaimed or limited by law or public policy to the extent provided by these terms, then in any such event the disclaimer of and limitations on pecuniary or economic consequential and incidental damages shall nevertheless be enforceable to the fullest extent allowed by law.
- f. In no event shall any cause of action arising out of breach of warranty or otherwise concerning the Products be brought by Customer more than one year after the cause of action accrues.
- g. Each of the limitations on remedies and damages set forth in these terms is separate and independently enforceable, notwithstanding the unenforceability or failure of essential purpose of any warranty, undertaking, damage limitation, other provision of these terms or other terms comprising the contract of sale between Customer and MELCO.

#### **4. Delivery/Force Majeure.**

- a. Any delivery date for the Products acknowledged by MELCO is an estimated and not a promised date. MELCO will make all reasonable efforts to meet the delivery schedule set forth in Customer's order or the purchase contract but shall not be liable for failure to do so.
- b. Products stored at the request of Customer or because Customer refuses or delays shipment shall be at the risk and expense of Customer.
- c. MELCO shall not be liable for any damage to or loss of the Products or any delay in or failure to deliver, service, repair or replace the Products arising from shortage of raw materials, failure of suppliers to make timely delivery, labor difficulties of any kind, earthquake, fire, windstorm, flood, theft, criminal or terrorist acts, war, embargoes, governmental acts or rulings, loss or damage or delays in carriage, acts of God, vandals or any other circumstances reasonably beyond MELCO's control.

#### **5. Choice of Law/Jurisdiction.**

These terms and any agreement or contract between Customer and MELCO shall be governed by the laws of the State of New York without regard to conflicts of laws. To the extent any action or dispute is not arbitrated, the parties consent to the exclusive jurisdiction and venue of the federal and state courts located in the Southern District of the State of New York. Any judgment there obtained may be enforced in any court of competent jurisdiction.

#### **6. Arbitration.**

Any controversy or claim arising out of, or relating to or in connection with the Products, their sale or use or these terms, shall be settled by arbitration conducted in accordance with the Center for Public Resources (CPR) Rules for Non-Administered Arbitration of International Disputes, by a sole arbitrator chosen from the CPR's panels of distinguished neutrals. Judgment upon the award rendered by the Arbitrator shall be final and binding and may be entered by any court having jurisdiction thereof. The place of the arbitration shall be New York City, New York. The language of the arbitration shall be English. The neutral organization designated to perform the functions specified in Rule 6 and Rules 7.7(b), 7.8 and 7.9 shall be the CPR.



Country/ Region	Sales office/ Tel	Country/ Region	Sales office/ Tel
USA	MITSUBISHI ELECTRIC AUTOMATION, INC. 500 Corporate Woods Parkway, Vernon Hills, IL 60061, U.S.A. Tel : +1-847-478-2100	Turkey	MITSUBISHI ELECTRIC TURKEY A.Ş Ümraniye Branch Serifali Mah. Kale Sok. No:41 34775 Ümraniye - Istanbul, Turkey Tel : +90-216-969-2500
Mexico	MITSUBISHI ELECTRIC AUTOMATION, INC. Mexico Branch Mariano Escobedo #69, Col. Zona Industrial, Tlalnepanitla Edo. Mexico, C.P.54030 Tel : +52-55-3067-7500	UAE	MITSUBISHI ELECTRIC EUROPE B.V. Dubai Branch Dubai Silicon Oasis, P.O.BOX 341241, Dubai, U.A.E. Tel : +971-4-3724716
Brazil	MITSUBISHI ELECTRIC DO BRASIL COMÉRCIO E SERVIÇOS LTDA. Avenida Adélino Cardana, 293, 21 andar, Bethaville, Barueri SP, Brazil Tel : +55-11-4689-3000	South Africa	ADROIT TECHNOLOGIES 20 Waterford Office Park, 189 Witkoppen Road, Fourways, South Africa Tel : +27-11-658-8100
Germany	MITSUBISHI ELECTRIC EUROPE B.V. German Branch Mitsubishi-Electric-Platz 1, 40882 Ratingen, Germany Tel : +49-2102-486-0	China	MITSUBISHI ELECTRIC AUTOMATION (CHINA) LTD. No.1386 Hongqiao Road, Mitsubishi Electric Automation Center, Shanghai, China Tel : +86-21-2322-3030
UK	MITSUBISHI ELECTRIC EUROPE B.V. UK Branch Travellers Lane, Hatfield, Hertfordshire, AL10 8XB, U.K. Tel : +44-1707-28-8780	Korea	MITSUBISHI ELECTRIC AUTOMATION KOREA CO., LTD. 7F-9F, Gangseo Hangang Xi-tower A, 401, Yangcheon-ro, Gangseo-Gu, Seoul 07528, Korea Tel : +82-2-3660-9530
Ireland	MITSUBISHI ELECTRIC EUROPE B.V. Irish Branch Westgate Business Park, Ballymount, Dublin 24, Ireland Tel : +353-1-4198800	Singapore	MITSUBISHI ELECTRIC ASIA PTE. LTD. 307, Alexandra Road, Mitsubishi Electric Building, Singapore 159943 Tel : +65-6473-2308
Italy	MITSUBISHI ELECTRIC EUROPE B.V. Italian Branch Centro Direzionale Colleoni-Palazzo Sirio Viale Colleoni 7, 20864 Agrate Brianza(Milano) Italy Tel : +39-039-60531	Thailand	MITSUBISHI ELECTRIC FACTORY AUTOMATION (THAILAND) CO., LTD. 12th Floor, SV.City Building, Office Tower 1, No. 896/19 and 20 Rama 3 Road, Kwaeng Bangpongpan, Khet Yannawa, Bangkok 10120, Thailand Tel : +66-2682-6522
Spain	MITSUBISHI ELECTRIC EUROPE, B.V. Spanish Branch Carretera de Rubi, 76-80-Apdo. 420, 08190 Sant Cugat del Vallés (Barcelona), Spain Tel : +34-935-65-3131	Vietnam	MITSUBISHI ELECTRIC VIETNAM COMPANY LIMITED Hanoi Branch 6th Floor, Detech Tower, 8 Ton That Thuyet Street, My Dinh 2 Ward, Nam Tu Liem District, Hanoi, Vietnam Tel : +84-4-3937-8075
France	MITSUBISHI ELECTRIC EUROPE B.V. French Branch 25, Boulevard des Bouvets, 92741 Nanterre Cedex, France Tel : +33-1-55-68-55-68	Malaysia	MITSUBISHI ELECTRIC SALES MALAYSIA SDN. BHD. Lot 11, Jalan 219, 46100 Petaling Jaya, Selangor Darul Ehsan, Malaysia Tel : +60-3-7626-5000
Czech Republic	MITSUBISHI ELECTRIC EUROPE B.V. Czech Branch Avenir Business Park, Radlicka 751/113e, 158 00 Praha5, Czech Republic Tel : +420-251-551-470	Indonesia	PT. MITSUBISHI ELECTRIC INDONESIA Gedung Jaya 11th Floor, JL. MH. Thamrin No.12, Jakarta Pusat 10340, Indonesia Tel : +62-21-3192-6461
Poland	MITSUBISHI ELECTRIC EUROPE B.V. Polish Branch ul. Krakowska 50, 32-083 Balice, Poland Tel : +48-12-347-65-00	India	MITSUBISHI ELECTRIC INDIA PVT. LTD. Pune Branch Emerald House, EL-3, J Block, M.I.D.C., Bhosari, Pune-411026, Maharashtra, India Tel : +91-20-2710-2000
Sweden	MITSUBISHI ELECTRIC EUROPE B.V. (Scandinavia) Fjellvägen 8, SE-22736 Lund, Sweden Tel : +46-8-625-10-00	Australia	MITSUBISHI ELECTRIC AUSTRALIA PTY. LTD. 348 Victoria Road, P.O. Box 11, Rydalmere, N.S.W 2116, Australia Tel : +61-2-9684-7777
Russia	MITSUBISHI ELECTRIC (RUSSIA) LLC St. Petersburg Branch Piskarevsky pr. 2, bld 2, lit "Sch", BC "Benua", office 720, 195027 St. Petersburg, Russia Tel : +7-812-633-3497		

## MITSUBISHI ELECTRIC CORPORATION

HEAD OFFICE: TOKYO BLDG., 2-7-3, MARUNOUCHI, CHIYODA-KU, TOKYO 100-8310, JAPAN  
NAGOYA WORKS: 1-14, YADA-MINAMI 5-CHOME, HIGASHI-KU, NAGOYA 461-8670, JAPAN

When exported from Japan, this manual does not require application to the Ministry of Economy,  
Trade and Industry for service transaction permission.

Specifications subject to change without notice.