

# ***FATEC***

---

---

## **Mitsubishi Programmable Controllers Training Manual MES Interface Basic Course**



# SAFETY PRECAUTIONS

---

(Always read these instructions before using the products.)

When designing the system, always read the relevant manuals and give sufficient consideration to safety.

During the exercise, pay full attention to the following points and handle the product correctly.

## [EXERCISE PRECAUTIONS]

---

### **WARNING**

---

- Do not touch the terminals while the power is on to prevent electric shock.
  - Before opening the safety cover, turn off the power or ensure the safety.
- 

### **CAUTION**

---

- Follow the instructor's direction during the exercise.
  - Do not remove the module of the demonstration machine or change wirings without permission.  
Doing so may cause failures, malfunctions, personal injuries and/or a fire.
  - Turn off the power before mounting or removing the module.  
Failure to do so may result in malfunctions of the module or electric shock.
  - When the demonstration machine (such as X/Y table) emits abnormal odor/sound, press the "Power switch" or "Emergency switch" to turn off.
  - When a problem occurs, notify the instructor as soon as possible.
-

# REVISIONS

---

\*The manual number is given on the bottom left of the back cover.

Revision date	*Manual number	Description
April 2020	SH(NA)-082342ENG-A	First edition

---

This manual confers no industrial property rights or any rights of any other kind, nor does it confer any patent licenses. Mitsubishi Electric Corporation cannot be held responsible for any problems involving industrial property rights which may occur as a result of using the contents noted in this manual.

---

© 2020 MITSUBISHI ELECTRIC CORPORATION

# TRADEMARKS

---

Ethernet is a registered trademark of Fuji Xerox Co., Ltd. in Japan.

Microsoft, Microsoft Access, Excel, SQL Server, Windows, and Windows Server are either registered trademarks or trademarks of Microsoft Corporation in the United States and/or other countries.

MySQL is either a registered trademark or a trademark of MySQL AB.

Oracle and Java are registered trademarks of Oracle and/or its affiliates.

The company names, system names and product names mentioned in this manual are either registered trademarks or trademarks of their respective companies.

In some cases, trademark symbols such as <sup>™</sup> or <sup>®</sup> are not specified in this manual.

# CONTENTS

SAFETY PRECAUTIONS .....	1
REVISIONS .....	2
TRADEMARKS .....	3
INTRODUCTION .....	6
RELEVANT MANUALS .....	6
TERMS .....	7
<b>CHAPTER 1 OVERVIEW</b> .....	<b>9</b>
1.1 <b>MES Interface Module</b> .....	<b>10</b>
Feature .....	10
1.2 <b>Database</b> .....	<b>12</b>
<b>CHAPTER 2 STARTUP of DEMONSTRATION MACHINE</b> .....	<b>14</b>
2.1 <b>System Configuration</b> .....	<b>14</b>
2.2 <b>Wiring</b> .....	<b>15</b>
2.3 <b>Operation</b> .....	<b>16</b>
2.4 <b>Operation of GOT Screen</b> .....	<b>18</b>
2.5 <b>Procedures before Operation</b> .....	<b>19</b>
Starting up servers .....	19
Starting up the MES interface module and configuration personal computer .....	21
<b>CHAPTER 3 ENVIRONMENT CONFIGURATION</b> .....	<b>23</b>
3.1 <b>MX MESInterface-R</b> .....	<b>23</b>
<b>CHAPTER 4 SETUP</b> .....	<b>25</b>
4.1 <b>Parameter Settings</b> .....	<b>25</b>
Checking parameter settings .....	25
Sequence program .....	28
Connection destination specification .....	31
Writing parameters to CPU module .....	33
4.2 <b>Database Setting</b> .....	<b>34</b>
Database table creation procedure .....	34
4.3 <b>ODBC (Open Database Connectivity) Setting</b> .....	<b>37</b>
ODBC setting procedure .....	37
<b>CHAPTER 5 INFORMATION LINKAGE FUNCTION</b> .....	<b>40</b>
5.1 <b>Functions of MES Interface Module</b> .....	<b>40</b>
Data input/output function .....	42
Information linkage function .....	45
5.2 <b>MES Interface Function Configuration Tool</b> .....	<b>51</b>
Network settings .....	51
Target device settings .....	52
Device tag settings .....	55
Target server settings .....	57
Access table/procedure settings .....	59
Job settings .....	63
Action settings .....	73

Verification settings .....	80
<b>5.3 DB Connection Service and Setting Tool .....</b>	<b>81</b>
DB Connection Service functions .....	81
Setting items .....	84
Help .....	87
<b>CHAPTER 6 LINKING WITH DATABASE .....</b>	<b>88</b>
<hr/>	
<b>6.1 Parameter Settings .....</b>	<b>88</b>
Parameter setting procedure of MES Interface Function Configuration Tool .....	89
Writing parameters to the MES interface module .....	108
Setting DB Connection Service Setting Tool .....	109
<b>6.2 Operation Check .....</b>	<b>110</b>
<b>6.3 Starting MC Works64 .....</b>	<b>113</b>
<b>CHAPTER 7 TROUBLESHOOTING .....</b>	<b>114</b>
<hr/>	
<b>7.1 Troubleshooting Functions .....</b>	<b>114</b>
Communication test function .....	114
Diagnostics .....	115
One-shot execution function .....	123
Access log .....	124
<b>7.2 Troubleshooting Operation Check .....</b>	<b>128</b>
Troubleshooting 1 .....	128
Troubleshooting 2 .....	132
<b>APPENDICES .....</b>	<b>138</b>
<hr/>	
<b>Appendix 1 MC Works64 .....</b>	<b>138</b>
MC Works64 .....	138
SCADA software .....	140
What to learn in this training course .....	141
<b>Appendix 2 Database Management System .....</b>	<b>142</b>
<b>Appendix 3 TCP/IP Setting on Personal Computer .....</b>	<b>148</b>

# INTRODUCTION

To help users acquire the knowledge required for configuring the data collection system using the MES interface module, this manual describes the functions and specifications of hardware and software used in the system, database, and troubleshooting.

## RELEVANT MANUALS

Manual name [manual number]	Description	Available form
MELSEC iQ-R MES Interface Module User's Manual (Startup) [SH-081422ENG]	Specifications, procedures before operation, wiring, and operation examples of the MES interface module	e-Manual PDF
MELSEC iQ-R MES Interface Module User's Manual (Application) [SH-081423ENG]	Functions, MES Interface Function Configuration Tool, DB Connection Service, parameter settings, troubleshooting, input/output, and buffer memory of the MES interface module	e-Manual PDF
GX Works3 Operating Manual [SH-081215ENG]	System configuration, parameter settings, and online operations of GX Works3	e-Manual PDF



e-Manual refers to the Mitsubishi FA electronic book manuals that can be browsed using a dedicated tool.

e-Manual has the following features:

- Required information can be cross-searched in multiple manuals.
- Other manuals can be accessed from the links in the manual.
- The hardware specifications of each part can be found from the product figures.
- Pages that users often browse can be bookmarked.
- Sample programs can be copied to an engineering tool.



# TERMS

Unless otherwise specified, this manual uses the following terms.

Term	Description
Account	A right to use the MES interface module or a server, or an ID necessary for their use
Action	A unit for processing defined in a job. There are three kinds of actions: DB communication action for communicating with a database, operation action for calculating values of device tag component, and external communication action for executing programs in an application server. The DB communication action is a processing unit for sending one SQL statement (Select, Update, Insert, Multiple Select, or Delete) or one DB procedure execution request. The operation action is a processing unit for performing a maximum of 20 binary operations.
Configuration personal computer	A personal computer to set various settings required for operating the MES interface module. This computer can be shared with a server.
Data source	Connection information which is necessary for accessing data using ODBC. With Windows, a data source name is assigned to connection information for management. The database is accessed via ODBC by specifying the data source name with the information linkage function.
Database (DB) or relational database (RDB)	Data management method that follows relational data model logic. A piece of data is expressed as a collection of multiple items (fields) and a data collection is expressed as a table. Data can be easily merged and selected using key data.
DB buffering	A function that temporarily stores SQL statements, that failed to be sent due to a communication error, to an SD memory card, and resends them when the communications have been recovered
DB procedure	A program that combines sequential processing procedures into one program against the database, and saves it to the database management system. This performs processing based on arguments received from the MES interface module, and returns the results to the MES interface module.
Device memory or device	Various memory data in a CPU module. There are devices handled in each bit and in each word.
Device tag (Tag)	Data table that contains a set of information (component) required to access device data in each CPU module on a network. The MES interface module collects device data for each tag at an interval defined in the tag.
Device tag component (Component)	A generic term for components (device data) which configures a device tag. Data that contains communication routes, data types, devices, etc. required to access device data in each CPU module.
Engineering tool	A tool for setting, programming, debugging, and maintaining programmable controllers. For the supported tools, refer to the following.  MELSEC iQ-R Module Configuration Manual
Handshake	For highly reliable processing, devices in a CPU module are used for managing processing between the CPU module and the MES interface module
High-speed access	A generic term for the following access types: <ul style="list-style-type: none"> <li>• High-speed access (interval specification)</li> <li>• High-speed access (each scan)</li> </ul>
Item	A setting group unit that each setting type in the edit items has
Job	A unit of process for linking information by the MES interface module
MES	An acronym for Manufacturing Execution Systems. A system for controlling and monitoring the plant status in real time to optimize production activities. The system enables to speed up responses to changes of a production plan and situation that lead to efficient production processes and optimization of production activities.
MES Interface Function Configuration Tool	An abbreviation for MELSEC iQ-R series MES Interface Function Configuration Tool
MES interface module	An abbreviation for the RD81MES96 MES interface module
MX MESInterface-R	The product name of SW1DND-RMESIF-E
Network module	A generic term for the following modules: <ul style="list-style-type: none"> <li>• CC-Link IE Controller Network module</li> <li>• CC-Link IE Field Network module</li> <li>• MELSECNET/H network module</li> <li>• Ethernet interface module</li> <li>• CC-Link module</li> </ul>
QCPU (Q mode)	A generic term for MELSEC-Q series CPU modules and MELSEC-Q series C Controller modules
RCPU	A generic term for MELSEC iQ-R series CPU modules and MELSEC iQ-R series C Controller modules
Server	A generic term for a database server and application server. Database server is a computer with a relational database which links information with the MES interface module. Application server is a computer with a program which operates upon request from the MES interface module.

Term	Description
SQL	An abbreviation for Structured Query Language. A database manipulation language that is used for operating a relational database.
Transaction	A collection of different interrelated processes that work in synchronization.
Trigger buffering	When trigger conditions (conditions for data transmission) of multiple jobs are satisfied at the same time, their data and times are buffered in an internal memory of a module so that actions (data operation/transmission) can be executed later using the buffered data. Even if the frequency of data transmission triggers is high, jobs are executed without missing any trigger.
Trigger condition	Start conditions for job operation
Update settings	Processing that updates the settings in the MES interface module using MES Interface Function Configuration Tool
Variable (temporary variable)	A variable that can be used for saving values selected from a database temporarily, and for writing operation values to a database or device tag components. There are two types of variables: local variable which has variable area for each job and global variable which can be used for other jobs since it has a common variable area for all jobs.

# 1 OVERVIEW

The MES Interface module enables improved yield and product quality through its direct connectivity between programmable controller systems of production equipment and information system databases. Conventionally, gateway personal computers have performed the polling processing in which programmable controller devices and programs are constantly checked to enable the connectivity. With the MES interface module, the transmission of data can be event-driven by specifying an event as a trigger and it allows the data to be inserted into database records directly. Compared to the conventional connectivity implemented using the gateway computers, the direct database connectivity implemented using the MES interface module will decrease system complexity, improve reliability, and eliminate data loss, resulting in better agility, less maintenance and reduces total cost of ownership (TCO).

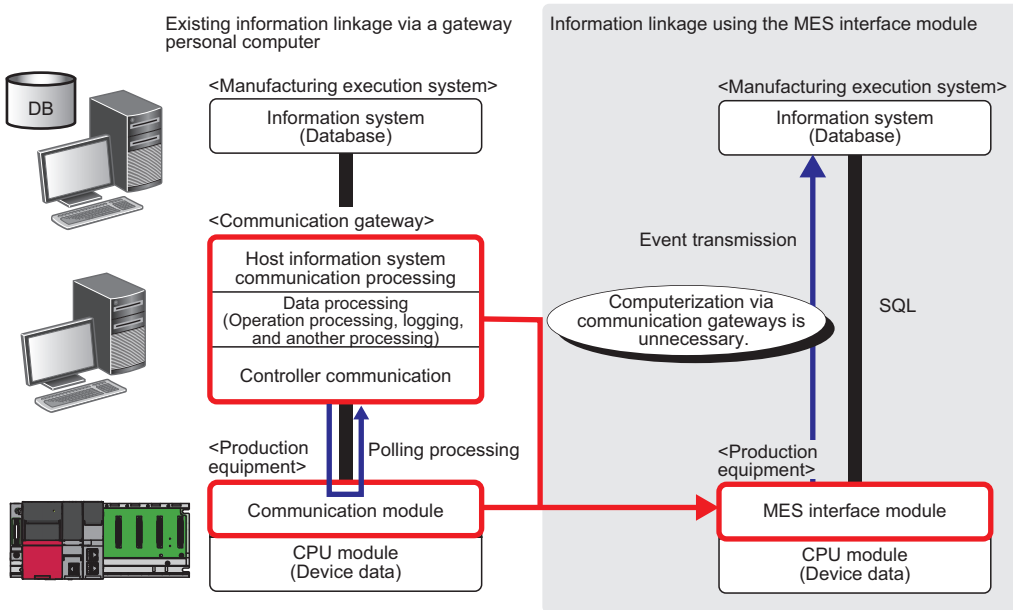

The following describes the overall system configuration when using the MES interface module.

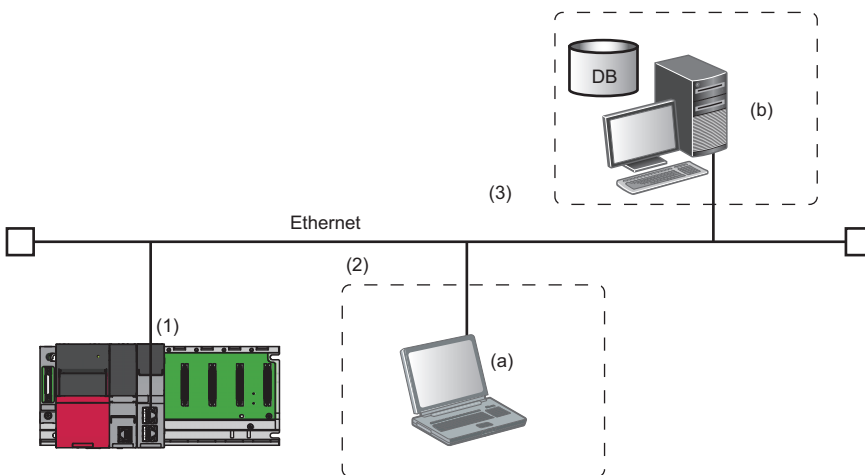

Name	Description
(1) MES interface module	A module to link information between production equipment and host information systems
(2) Configuration personal computer	(a) MES Interface Function Configuration Tool A tool to set various settings required for operating the MES interface module
	Project File Conversion Tool* <sup>1</sup> A tool to convert a MELSEC-Q series MES Interface module project file to a MELSEC iQ-R series MES Interface module project file
(3) Server	(b) DB Connection Service Software to link information between the MES interface module and a database
	DB Connection Service Setting Tool A tool to set DB Connection Service

\*1 Not used in this manual.

# 1.1 MES Interface Module

---

The MES interface module provides a highly reliable and easy method for exchanging data between programmable controller CPUs and common industrial quality databases. Most production execution software applications use a database to source data and store results. The product is named "MES interface module" because it greatly improves MES implementation and operation by providing a high quality, high function link to the factory equipment.

One MES interface module can handle data with up to 32 database connections. Communications between the MES interface module and the host computer system occur in a secure, encrypted format and the messages exist in SQL<sup>\*1</sup> format, which is well suited to passage through common IT infrastructure devices such as firewalls, routers and switches.

The MES interface module is set up using the dedicated configuration software. For most applications, no computer language programming or control logic programming is required. The knowledge of SQL language is not required because the setup processing is executed in a menu driven format and SQL statements are automatically created based on the settings. The idea is that standard engineering staff can easily handle initial setup and subsequent modification of the MES interface module configuration.

\*1 An abbreviation for Structured Query Language.

A database manipulation language that is used for operating a relational database.

## Feature

---

The MES interface module provides enhanced functions with significant benefits beyond simple data transfer.

### Connection with the information system using simple settings without program

---

SQL statements can be automatically created only by specifying necessary settings with the setting tool. Additionally, since the stored procedures can be called from databases, a CPU module, the MES interface module, and databases can be communicated easily. There is no need to write programs for data communications, so the engineering costs for system construction can be reduced and the work period can be shortened.

### Reduction in the information system load

---

The MES interface module monitors conditions for event data generation using the trigger condition monitoring function and when the conditions are satisfied, data, such as production status, is sent to IT system databases using the data Input/output function. Another feature is that data, such as work instructions, can be buffered in and read from databases.

When performing the above processing, data is operated and processed using the data operation and processing function and results can be sent to the information system.

This can reduce the information system loads compared to the conventional system which uses a gateway personal computer to constantly acquire and monitor data.

## Buffering function for reliable data acquisition/transmission

### ■Trigger buffering function

The trigger buffering function buffers trigger information when a trigger condition for a later job is satisfied. After the former job is completed, the later job is executed according to the trigger information.

Even if the frequency of data transmission triggers is high, jobs are executed without missing any trigger.

When conditions for data transmission of multiple jobs are satisfied at the same time, their data and times are buffered in an internal memory of a module.

After the loads are reduced, data operations and transmission are executed using the buffered data.

For details on the trigger buffering function, refer to the following.

☞ Page 47 Trigger buffering function

### ■DB buffering function

This function protects send data to a database even if a communication error occurs.

This function buffers SQL statement or stored procedure call information to the DB buffer on an SD memory card when they cannot be sent due to network disconnection or failure of the server on which the database is installed.

The buffered SQL statement or stored procedure call information is automatically resent to the database after recovery. (They can be also resent manually.)

For details on the DB buffering function, refer to the following.

☞ Page 44 DB buffering function

## Acquisition of log data when access errors occur

After connection with a database, when a communication error occurs, a log of the error definition can be recorded on the database.

Analyzing the log can analyze the error definition.

## Support of various databases

When designing a new system, a suitable database can be selected from the different database types.

Even when connecting to the existing system, the system can be transferred without changing the existing database.

## Access independent of the database table configuration

Flexibly designed database tables can be used for accessing to databases.

When designing a new system, its design is highly flexible. Moreover, when connecting to the existing system, the system can be configured without changing the database tables.

## Time synchronization with a CPU module

The MES interface module can synchronize time with a CPU module. Synchronizing the time of the CPU module with an SNTP server enables to synchronize time of the entire system.

# 1.2 Database

This section describes databases which the MES interface module uses as a source or destination for information exchanged with programmable controller CPU modules.

For this example, a database is defined as software which provides a virtual filing system for storing groups of related data. It also provides a set of commands that enable access, editing and manipulation of the stored data.

The following are some example cases that may occur in a database.

- During processing of a set of data, an error occurs.  
⇒ In response, a user can apply a rollback command that restores the data to its original state.
- While certain stored data is being retrieved in one process, new data that needs to be stored in a second process arrives.  
⇒ The database should handle completion of both actions without conflict or user intervention.
- A researcher desires to retrieve a specific set of 15 data items that was originally stored in the database on July 15th at 2:30 AM 5 years ago.  
⇒ The user will create a "query" or command structure that the database understands as a request for data retrieval. The database will return the specified information when the query is executed.

## Database types

There are different database types including relational, hierarchical, and XML. The MES interface module operates with relational databases provided by Microsoft® and Oracle®.

Relational databases organize data into tables consisting of fields (columns) and records (rows). The contents in one database can range from one table to many thousands.

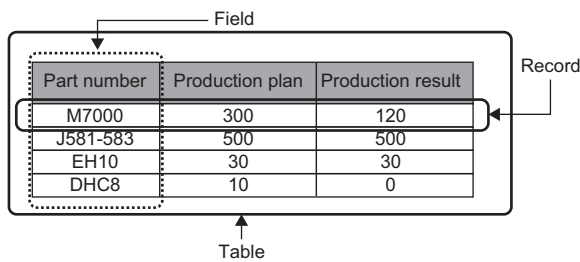

## Database commands

All common databases implement a standardized command format called SQL (Structured Query Language). SQL defines each command action that a user can apply to operate the various database functions and the syntax for the command and response messages paragraph change.

The MES interface module executes the basic commands such as SELECT, INSERT, UPDATE, and DELETE. All other commands or complicated processing must be executed outside the MES interface module or by using a stored procedure.

### ■ Addition of new records and update of table information

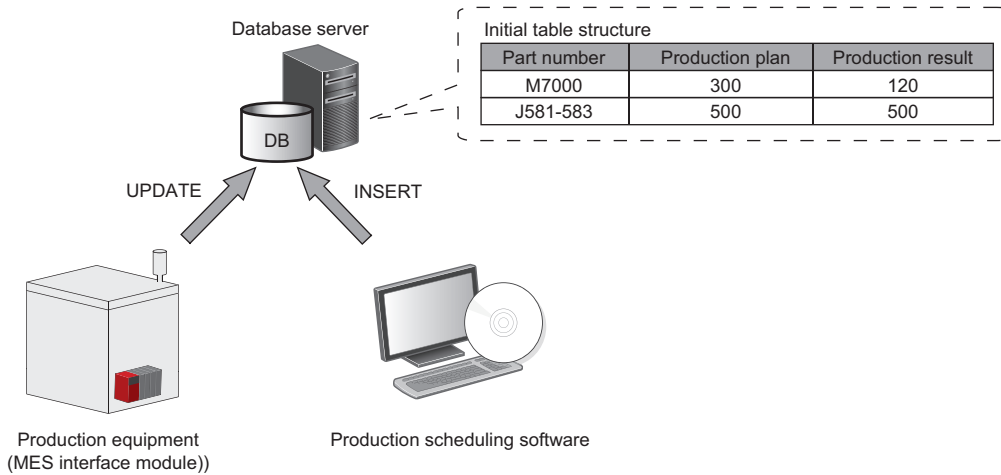

1. Add a new record to the table that has fields for part number, production plan, and production result. (INSERT command is executed via the production scheduling software.)

Part number	Production plan	Production result
M7000	300	120
J581-583	500	500

Insert →

Part number	Production plan	Production result
M7000	300	120
J581-583	500	500
EH10	30	0

INSERT

2. After execution, add the production result to the record. (UPDATE command is executed by the MES interface module and the production result is moved from the programmable controller CPU module to the database.)

Part number	Production plan	Production result
M7000	300	120
J581-583	500	500
EH10	30	0

Update →

Part number	Production plan	Production result
M7000	300	120
J581-583	500	500
EH10	30	12

Final table structure

UPDATE

# 2 STARTUP of DEMONSTRATION MACHINE

## 2.1 System Configuration

This section describes the system configuration of the demonstration machine.

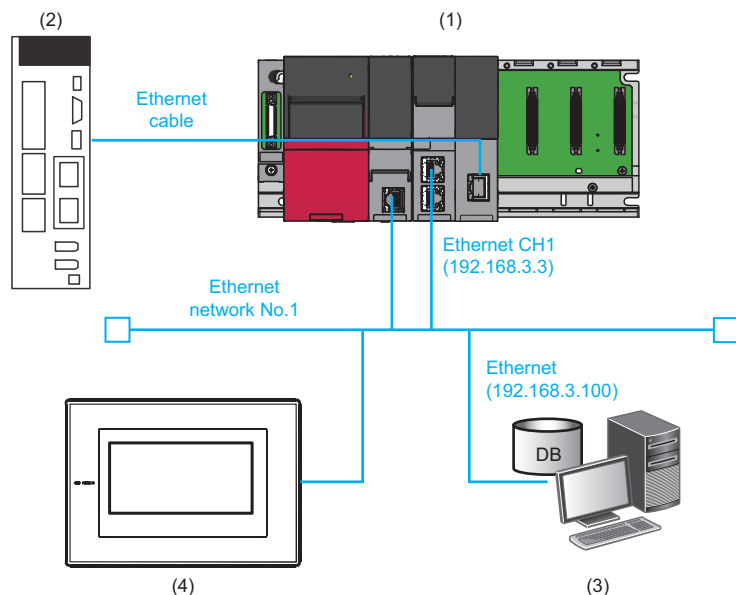

Device/software	Product name/description		Reference	
(1) Programmable controller system	Main base unit	R35B	<a href="#">MELSEC iQ-R Module Configuration Manual</a> <a href="#">MELSEC iQ-R MES Interface Module User's Manual (Startup)</a> — — <a href="#">MELSEC iQ-R MES Interface Module User's Manual (Startup)</a>	
	Power supply module	R61P		
	CPU module	R04CPU		
	MES interface module* <sup>1</sup>	RD81MES96		
	Simple Motion module	RD77GF4 (CC-Link IE Field)		
	SD memory card	NZ1MEM-2GBSD		
(2) MELSERVO AC Servo	MELSERVO-J4	MR-J4-10GF1-RJ	—	
(3) Personal computer (shared in a server and configuration personal computer)* <sup>2</sup>	Operating system		<a href="#">MELSEC iQ-R MES Interface Module User's Manual (Startup)</a> — — <a href="#">Page 23 Software configuration of MX MESInterface-R</a> — <a href="#">GX Works3 Installation Instructions</a> <a href="#">GX Works3 Operating Manual</a> — <a href="#">Page 138 MC Works64</a>	
	Relational database			
	MX MESInterface-R configuration software	MES Interface Function Configuration Tool* <sup>3</sup>		SW1DND-RMESIF-J
		DB Connection Service		
		DB Connection Service Setting Tool		
	Engineering tool	GX Works3		SWnDND-GXW3 ('n' indicates the version.)
SCADA software	MC Works64	SWnDND-MCWDV-ET ('n' indicates the version.)		
(4) GOT2000	GT2708-STBA		—	

\*1 The IP address of the MES interface module is '192.168.3.3'.

\*2 The IP address of the personal computer is '192.168.3.100'.

\*3 The software version of MES Interface Function Configuration Tool used for the training is '1.07H'.



## 2.2 Wiring

This section describes the wiring of the demonstration machine.

**1.** Connect the following devices to a hub using Ethernet cables.

- CPU module
- MES interface module (Connect to the Ethernet port (CH1).)
- GOT2000
- Personal computer

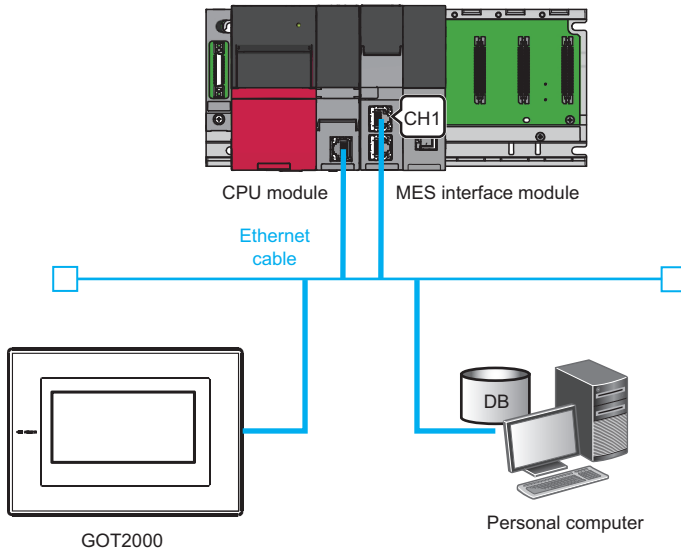

**2.** Connect the AC servo to the Simple Motion module with an Ethernet cable.

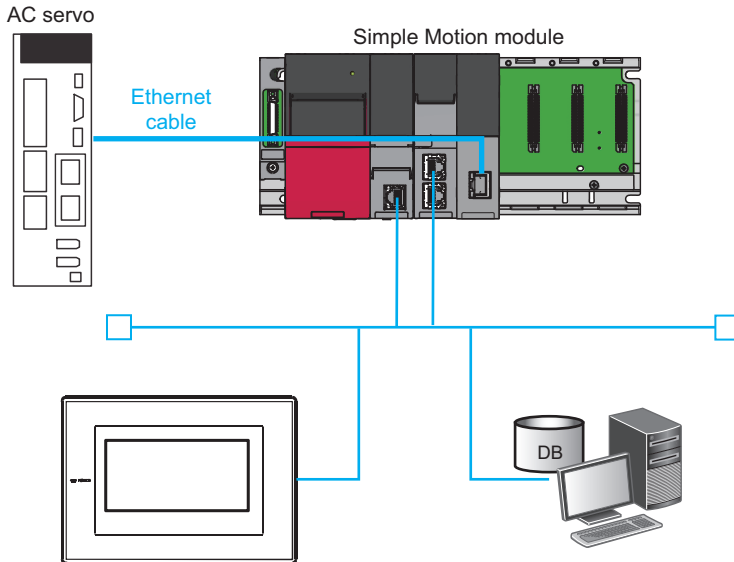

## 2.3 Operation

This section describes an operation example of simple data collection in the system including the MES interface module.

### Overview

The following describes an example of an automated production process of pouring water into containers using the programmable controller system.

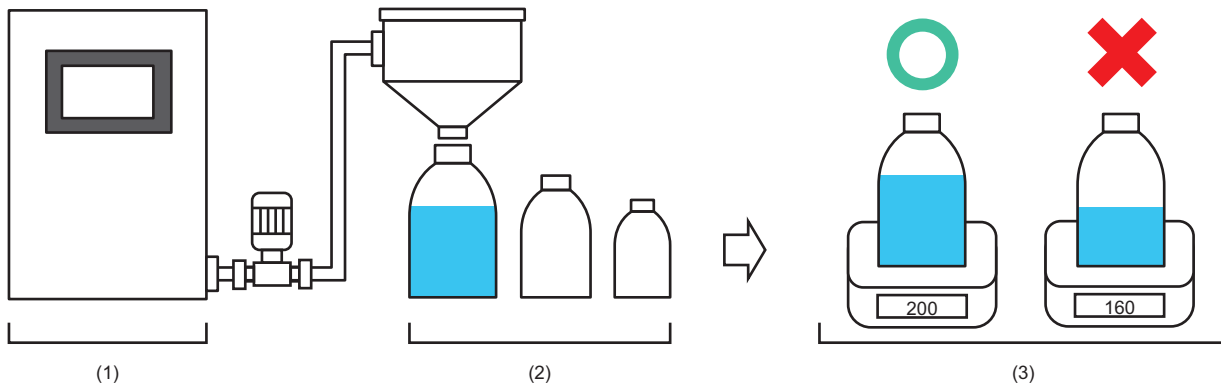

Process		Description
(1)	Production control	Inputs production patterns and starts/stops the production process.
(2)	Production process	Pours water into large, medium, or small containers based on an selected operation pattern.
(3)	Quality determination	Checks the amount of the water poured into each container and determines whether results are acceptable or unacceptable.

### Operation

The following is the operation between the control system and the production control database.

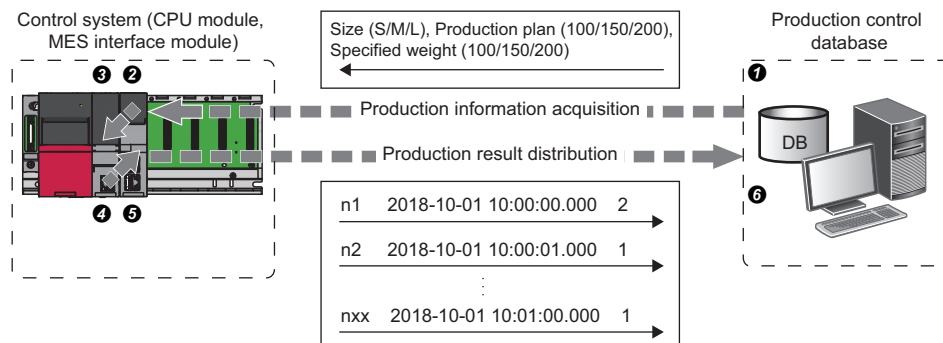

- Select a production pattern from 1 to 3 on GOT.
  - Pattern 1: Supplying water into small containers (size: S, production plan volume: 40, specified weight: 100)
  - Pattern 2: Supplying water into medium containers (size: M, production plan volume: 60, specified weight: 150)
  - Pattern 3: Supplying water into large containers (size: L, production plan volume: 80, specified weight: 200)
- Touch the [Production information acquisition] button on GOT.
- Acquire the production information.
  - Database → 2 MES interface module → 3 CPU module
  - The MES interface module acquires the production information on size, production plan volume, and specified weight from the table of the production control database before starting the production.
  - Containers are produced according to the production plan volume.
  - Finished products are inspected. If poured water weight of a finished product is less than the specified weight, the product is unaccepted.
  - A container size is added to the front of a container ID of each product.
- Touch the [Production start] button on GOT.
- Distribute production results.
  - CPU module → 5 MES interface module → 6 Database
  - The MES interface module collects data, such as container IDs, production time, and inspection results, and transfers the data to the production control database.

## Integration with MC Works64

For IT systems, different types of software are available to meet purposes such as operation monitoring, preventive maintenance, and traceability. The demonstration machine uses one of these softwares, MC Works64, and performs traceability management.

MC Works64 is an SCADA software package that offers the plant-wide monitoring functions. It provides solutions for a wide variety of needs by the high-functionality monitoring control system with variety of FA devices.

Production results, collected by the MES interface module, can be easily viewed by storing them on the database server and communicating them between the database server and MC Works64. For details on MC Works64, refer to the following.

☞ Page 138 MC Works64

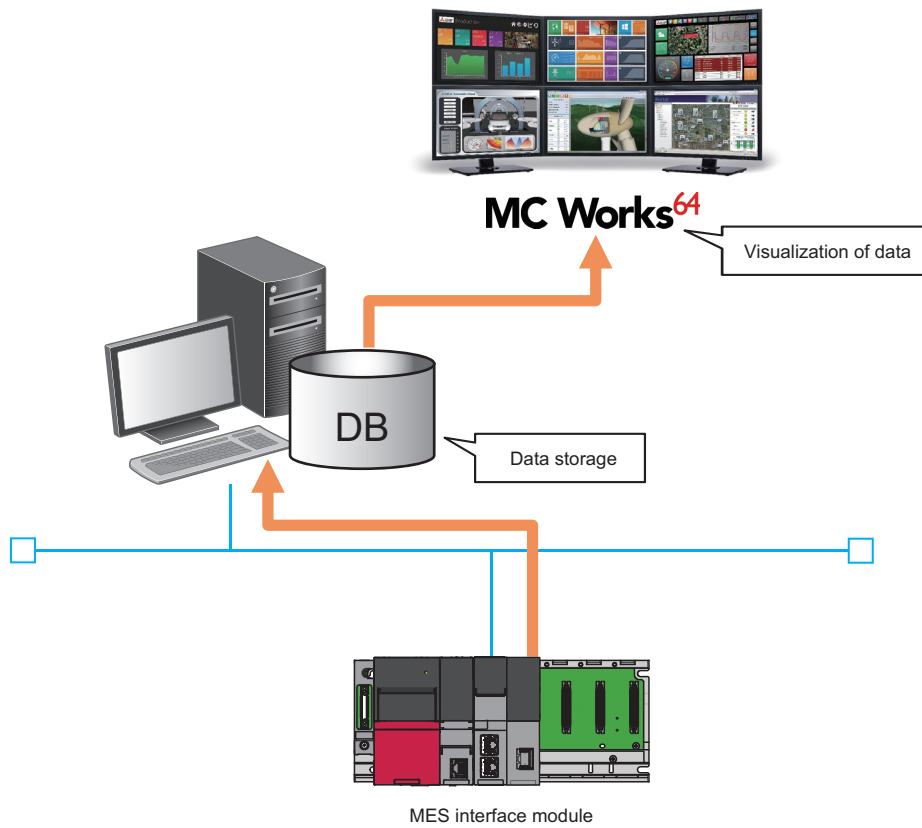

## 2.4 Operation of GOT Screen

This section describes how to operate the GOT screen used in this exercise.  
GOT2000 is connected to the demonstration machine

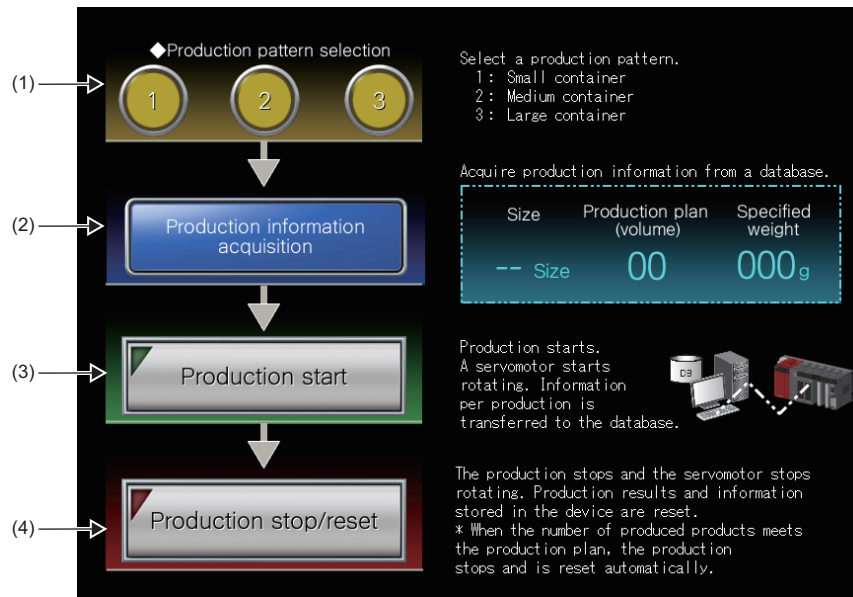

No.	Name	Device	Description
(1)	Production pattern selection	D0	Selects a production pattern. 1: Small container 2: Medium container 3: Large container
(2)	Production information acquisition	X100	Acquires the production information of the selected production pattern.
(3)	Production start	X200	Starts the production based on the acquired production information.
(4)	Production stop/reset	X300	Stops the production.

## 2.5 Procedures before Operation

This section describes the procedure before operation of the MES interface module.

### Operating procedure

#### 1. Start a server.

Start a server used as a database server.

(☞ Page 19 Starting up servers)

#### 2. Start the MES interface module and a configuration personal computer.

Start the MES interface module and a configuration personal computer on which MES Interface Function Configuration Tool has been installed.

(☞ Page 21 Procedures before Operation)

### Starting up servers

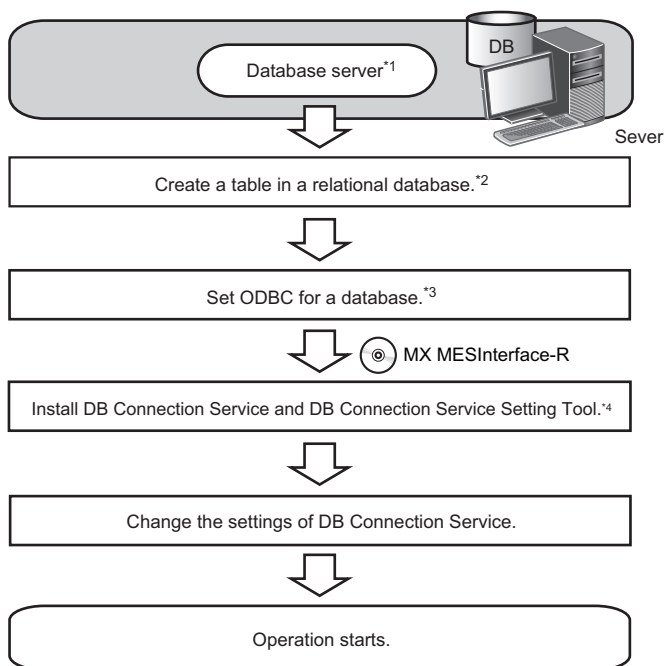

\*1 ☞ Page 142 Database Management System

\*2 Install a relational database, restart the server, and create a table.  
☞ Page 34 Database Setting

\*3 ☞ Page 37 ODBC (Open Database Connectivity) Setting

\*4 For details on MX MESInterface-R, refer to the following.  
☞ MELSEC iQ-R MES Interface Module User's Manual (Startup)

### Point

The MES interface module accesses a database server via DB Connection Service.

☞ Page 81 DB Connection Service and Setting Tool

## DB Connection Service/DB Connection Service Setting Tool

The information linkage function of the MES interface module can be used by installing DB Connection Service on the server. For details on DB Connection Service/DB Connection Service Setting Tool, refer to the following.

 Page 81 DB Connection Service and Setting Tool

### Point

- DB Connection Service needs to be installed on all the database servers and application servers accessed from the MES interface module.
- When using DB Connection Service on an application server, an account for the application program execution needs to be created in advance.
- The settings of DB Connection Service are changed with DB Connection Service Setting Tool.

### ■ODBC setting for database

When using DB Connection Service on a database server, ODBC for a database to be used needs to be set in advance. For the ODBC setting method, refer to the following.

 Page 37 ODBC (Open Database Connectivity) Setting

### Point

Only the ODBC driver installed at the same time as the installation of the database can be used except for the cases below. 'Microsoft Access Driver (\*.mdb)', 'Microsoft ODBC for Oracle', and 'SQL Server' which are supplied with the operating system cannot be used.

- When connecting the database of Oracle using any of the following DB Connection Services, the 32-bit version of Oracle Client for the ODBC setting and the ODBC driver of Oracle need to be installed.  
DB Connection Service which is stored to MX MESInterface-R whose software version is '1.03D' or earlier  
DB Connection Service (32-bit) which is stored to MX MESInterface-R whose software version is '1.04E' or later
- When using PostgreSQL for a database, install an ODBC driver.

# Starting up the MES interface module and configuration personal computer

**Point**

Start a server before starting MES interface module and a configuration personal computer.

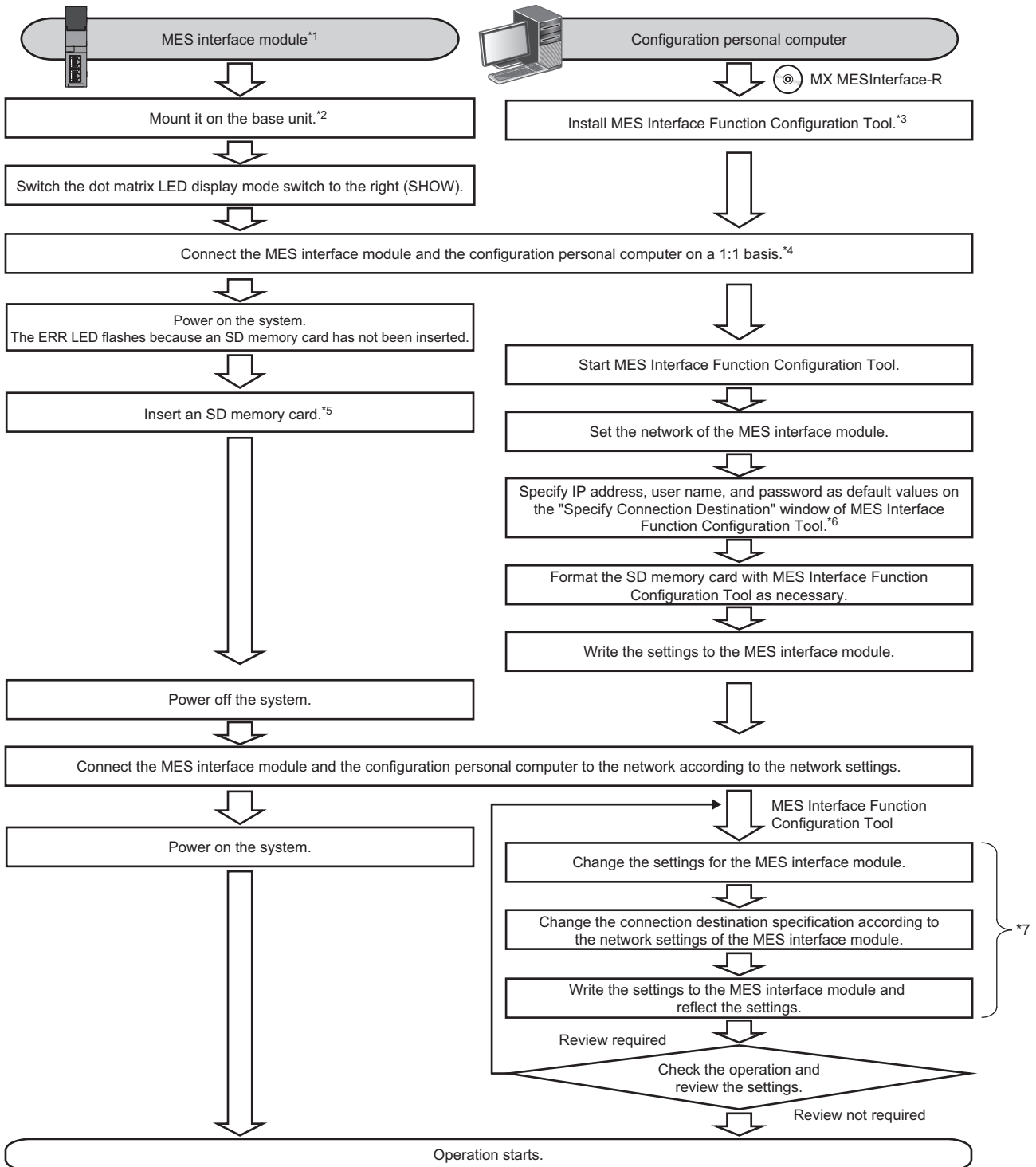

- \*1 Perform the self-diagnostic test as necessary. (📖MELSEC iQ-R MES Interface Module User's Manual (Application))
- \*2 Do not use an electric screwdriver to tighten and remove module fixing screws.
- \*3 Install MX MESInterface-R. (📖MELSEC iQ-R MES Interface Module User's Manual (Startup))
- \*4 Use the Ethernet port (CH1) on the MES interface module.
- \*5 Insert an SD memory card. (📖MELSEC iQ-R MES Interface Module User's Manual (Startup))
- \*6 Specify the following (default network setting and security setting) for connection on the "Specify Connection Destination" window of MES Interface Function Configuration Tool.
  - Connection destination setting  
IP address: 192.168.3.3
  - User authentication setting (optional)  
Use the user authentication: Select the checkbox.  
User name: RD81MES96  
Password: MITSUBISHI
- \*7 Perform these steps to change the setting of the MES interface module.

## MES Interface Function Configuration Tool

MES Interface Function Configuration Tool is a tool to set various settings required for operating the MES interface module. Various operations such as checking each status and the working history, and stopping or restarting the MES interface module can be performed.

For details on MES Interface Function Configuration Tool, refer to the following.

📖 Page 51 MES Interface Function Configuration Tool



# 3 ENVIRONMENT CONFIGURATION

This chapter describes how to install each piece of execution software.

## 3.1 MX MESInterface-R

### Software configuration of MX MESInterface-R

The following table shows the software stored in MX MESInterface-R.

Item	Description
MX MESInterface-R	MES Interface Function Configuration Tool  Software that runs in a configuration personal computer and is used to set various settings required for operating the MES interface module. In addition to the configuration, the following operations are performed. <ul style="list-style-type: none"><li>• Checking the operating status and working history of the MES interface function</li><li>• Stopping/restarting the operation of the MES interface function</li><li>• Creating settings of the MES interface function without modules</li></ul>
	Project File Conversion Tool  Software that runs in a configuration personal computer and converts a MELSEC-Q series MES Interface module project file to a MELSEC iQ-R series MES Interface module project file. This tool is automatically installed when MES Interface Function Configuration Tool is installed.
	DB Connection Service  Software that runs in a server and links a database with the MES interface module. (Required when linking with a database via ODBC of a Windows personal computer.)
	DB Connection Service Setting Tool  Software that runs in a server and is used to change the operation of DB Connection Service.

## System configuration when installing

The following shows the system configuration when installing each piece of software stored in MX MESInterface-R.  
For the installation method, refer to the following.

📖 MELSEC iQ-R MES Interface Module User's Manual (Startup)

### ■When installing MES Interface Function Configuration Tool

Install MES Interface Function Configuration Tool in a configuration personal computer.

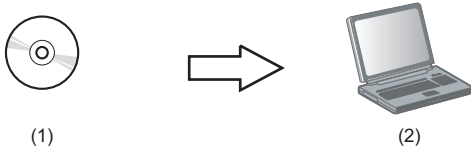

- (1) MX MESInterface-R: MES Interface Function Configuration Tool
- (2) Configuration personal computer: Commercially available product

### ■When installing DB Connection Service and DB Connection Service Setting Tool

Install DB Connection Service and DB Connection Service Setting Tool in the server.

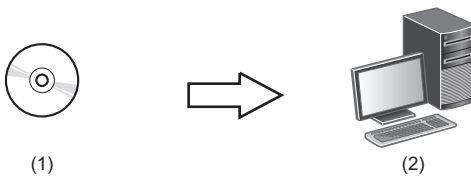

- (1) MX MESInterface-R: DB Connection Service/DB Connection Service Setting Tool
- (2) Server: Commercially available product

## Precautions

- When using Access for a database, select "32-bit" for DB Connection Service and DB Connection Service Setting Tool.
- When selecting "64-bit", configure the ODBC setting which is supported by a 64-bit version DB Connection Service.  
(📖 Page 37 ODBC (Open Database Connectivity) Setting)

# 4 SETUP

## 4.1 Parameter Settings

This section describes the procedures for checking the parameter settings with the engineering tool and writing the data to a CPU module.

### Checking parameter settings

In the project "school\_MES.gx3", the parameter settings and programming have been already completed to meet this exercise. Check the parameter settings of the project "school\_MES.gx3" to be used for this exercise.

#### Operating procedure

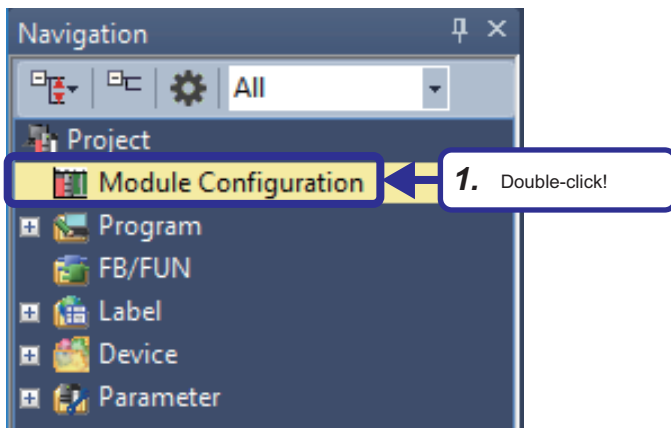

1. Open the project "school\_MES.gx3" and double-click [Module Configuration] in the Navigation window. If a dialog box regarding the parameter information appears, click the [OK] button.

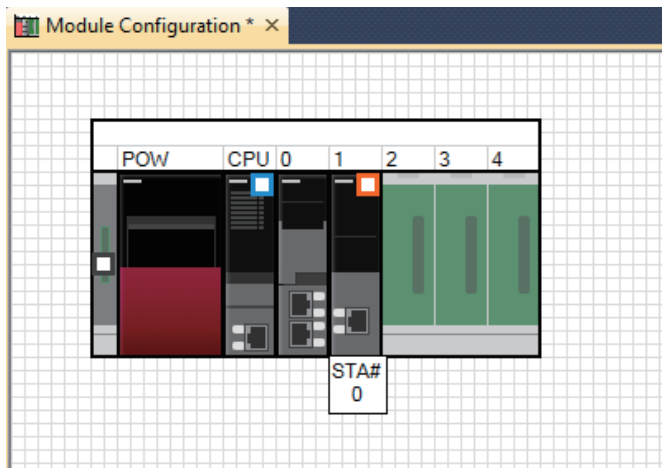

2. On the "Module Configuration" window, a power supply module "R61P", a CPU module "R04CPU", "RD81MES96" in slot 0, and "RD77GF4" in slot 1 are placed in the same manner as the demonstration machine.



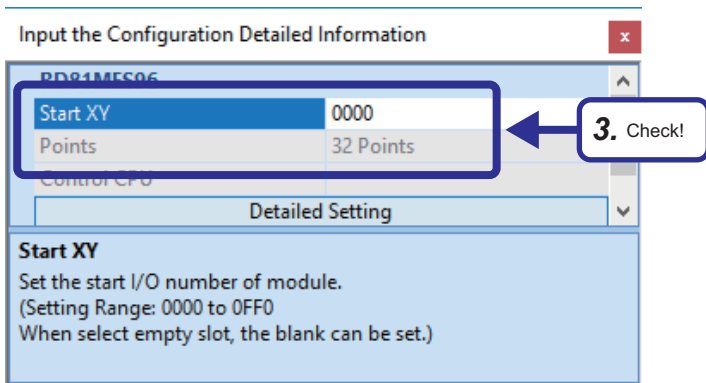

3. Check that the following are set in "Start XY" on the "Input the Configuration Detailed Information" window.  
[Setting details]  
RD81MES96  
Start XY: 0000  
RD77GF4  
Start XY: 0020

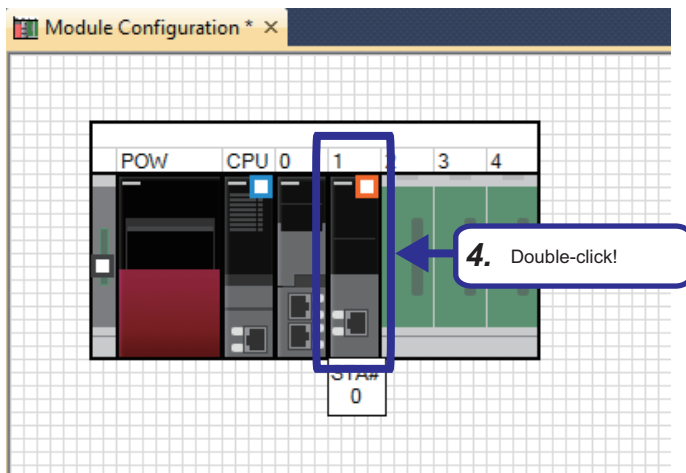

4. Double-click "RD77GF4" in slot 1

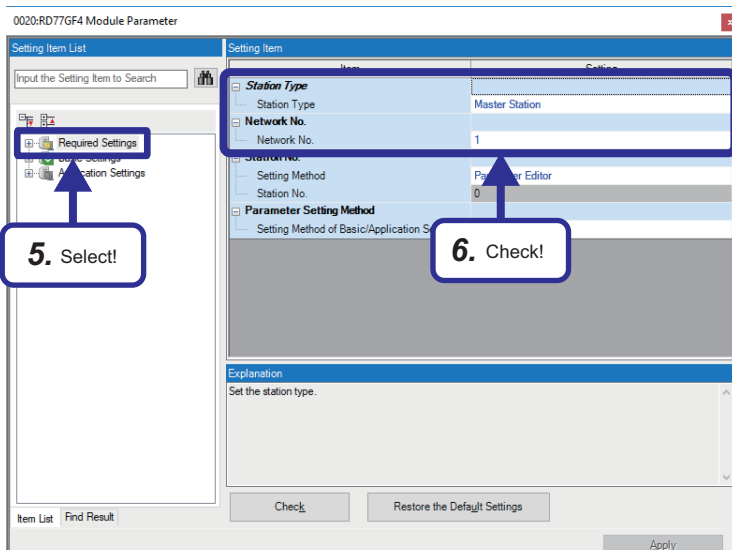

5. Select "Required Settings" in the "Setting Item List" window.
6. Check that the following are set in the "Setting Item" window.  
[Setting details]  
Station Type: Master Station  
Network Number: 1



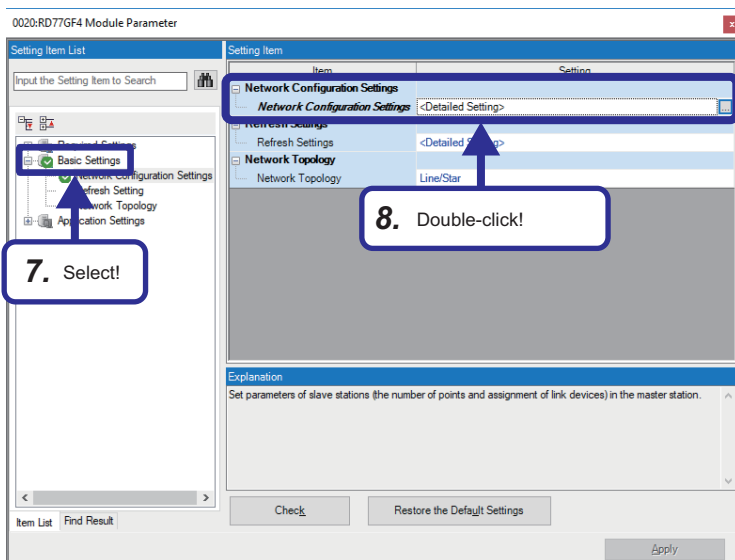

7. Select "Basic Settings" in the "Setting Item List" window.
8. Double-click "Network Configuration Settings".

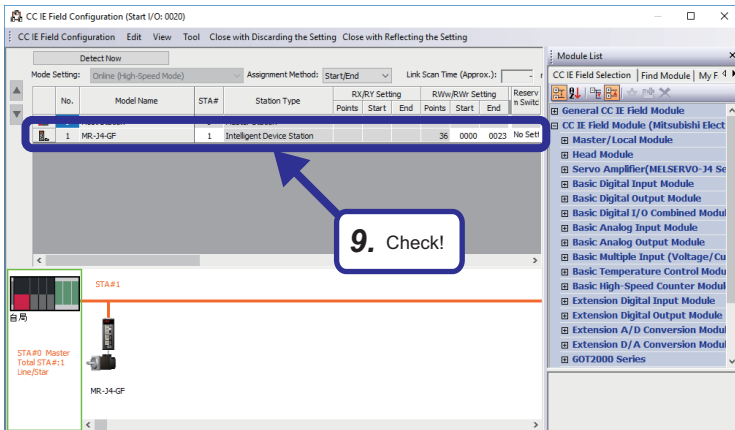

9. "MR-J4-GF" is added to the station list on the "CC-Link IE Field Configuration" window. Check that the following are set on the "CC IE Field Configuration" window. [Setting details]  
 RWw/RWr Setting Start: 0000  
 RWw/RWr Setting End: 0023

# Sequence program

## List of devices to be used

Device name	Description	Device name	Description
X20	Ready	M4	Production end trigger
X21	Synchronization flag	C0	The contact is turned on when a count value reaches the setting value (D100).
X200	Production start	D0	Production pattern
X300	Production information reset	D100	Production plan volumes are stored.
Y20	Programmable controller ready	D110	Specified weight is stored.
Y21	All axis servo ON	D120	Production volume is stored.
SM400	Always ON	D129	Random numbers are stored.
SM403	OFF for one scan after RUN	D130	Random numbers (container weight) are stored.
SM415	Repeating on/off at regular intervals (ms) specified on SD415	D140	Quality determination results are stored.
SM705	Number of conversion digits selection	D150	Total number of accepted products according to the quality determination is stored.
SD415	Storing n of 2n ms clock	D160	Total number of rejected products according to the quality determination is stored.
M1	Production start trigger	D200	Total number of production is stored.
M2	Quality Determination start trigger	D210	Container IDs (sizes) are stored.
M3	Quality determination result storing trigger	D211	Container IDs (numerical values) are stored.

## Precautions

- This manual does not cover the devices used for the Simple Motion modules and servo amplifiers. For details, refer to the user's manual for the module used.
- Program creation is not included in this training. When writing a program to a CPU module, write the pre-programmed project "school\_MES.gx3".

## Sequence program

For details on each instruction, refer to the following.

 MELSEC iQ-R Programming Manual (Instructions, Standard Functions/Function Blocks)

	1	2	3	4	5	6	7	8	9	10	11	12				
1	<b>Initial settings for servo</b>															
2	(0)	SM400										Y20				
3	(11)	X20	X21	Y20								Y21				
4	(15)	SM403	=	D0	K3					DMOV	K360000	U2\G4318				
5			=	D0	K2					DMOV	K240000	U2\G4318				
6			=	D0	K1					DMOV	K121000	U2\G4318				
7	<b>Production processing</b>															
8	(46)	X200	↑							SET	M1					
9	(55)	M1								RND	D129					
10										SET	X201					
11	(59)	SM400								MOV	K500	SD415				
12												SM705				
13	(63)	SM415								MOV	D129	D130				
14												M2				
15	<b>Quality determination</b>															
16	(68)	M2	↑	M4	↘	M1		>	D130	K0	<=	D130	K26213	MOV	K1	D140
17							M1		=	D130	K0					
18								>=	D130	K26214	<=	D130	K32767	MOV	K2	D140
19													INC	D200		
20																M3
21	(106)	M3		=	D140	K1						INC	D150			
22												OUT	C0	D100		
23				=	D140	K2						INC	D160			
24	(123)	X201	M4	↘	SM412								U2\G30101.0			
25	(129)	C0														M4
26	<b>Container ID creation</b>															
27	(131)	M3										BINDA	D200	D211		
28												MOV	D120	D210		

	1	2	3	4	5	6	7	8	9	10	11	12
29	Production information reset											
30	(145)	M4   								OUT	T0	K20
31	(160)	X300 ↑ 									RST	C0
32		T0   									RST	D0
33											RST	M1
34											RST	M4
35											RST	X201
36											RST	X300
37											RST	X200
38											RST	D100
39											RST	D110
40											RST	D120
41											RST	D129
42											RST	D130
43											RST	D140
44											RST	D150
45											RST	D160
46											RST	D200
47											RST	D210
48											RST	D211
49											RST	D212
50	(198)											{END }



# Connection destination specification

This section describes how to specify the connection destination.

## Operating procedure

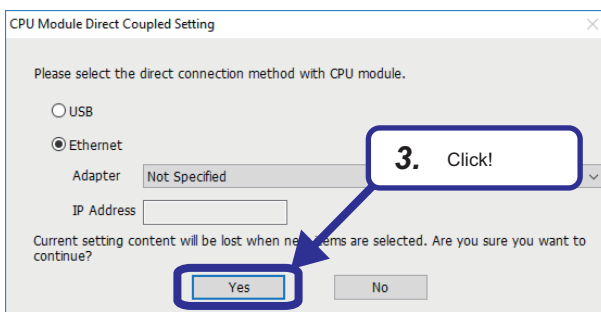
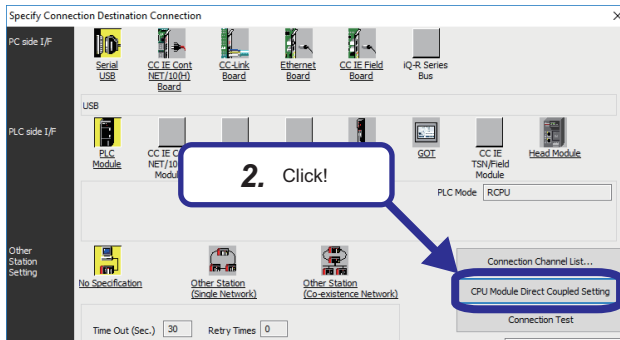
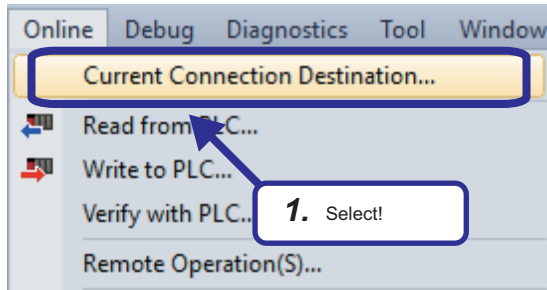

1. On the engineering tool, select [Online] ⇒ [Current Connection Destination] from the menu.

2. Click the [CPU Module Direct Coupled Setting] button on the "Specify Connection Destination Connection" window. The "CPU Module Direct Coupled Setting" window appears.

3. Select a direct communication method with a CPU module, and click the [Yes] button.

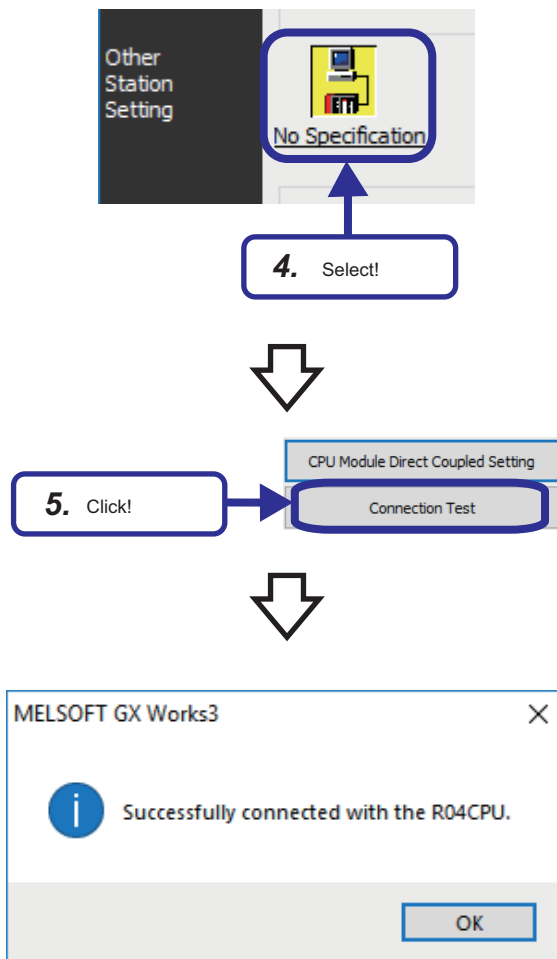

4. Select "No Specification" for "Other Station Setting" on the "Specify Connection Destination Connection" window.

5. Click the [Connection Test] button.

6. Check that the connection to the CPU module has been successfully established.

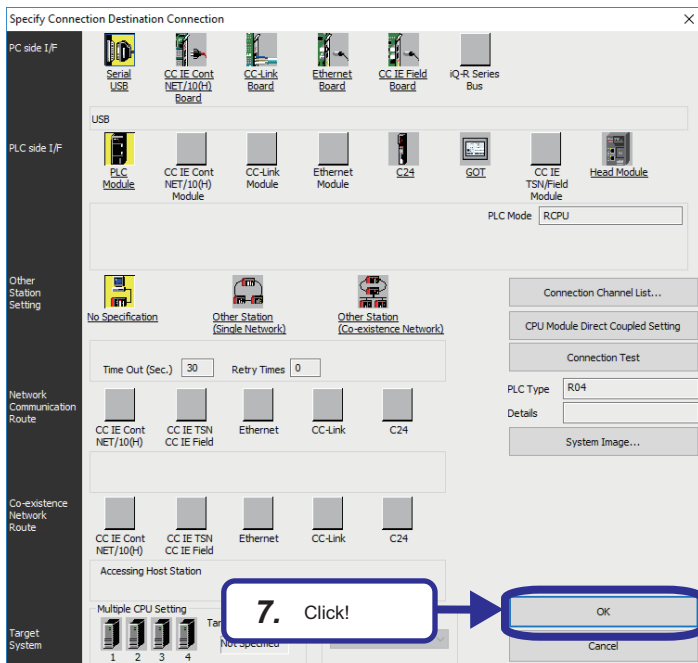

7. Click the [OK] button.

# Writing parameters to CPU module

This section describes how to write the parameters set on GX Works3 to the CPU module.

1. Open the project "school\_MES.gx3" whose the parameter settings and programming have been completed. On the engineering tool, select [Online] ⇒ [Write to PLC] from the menu.

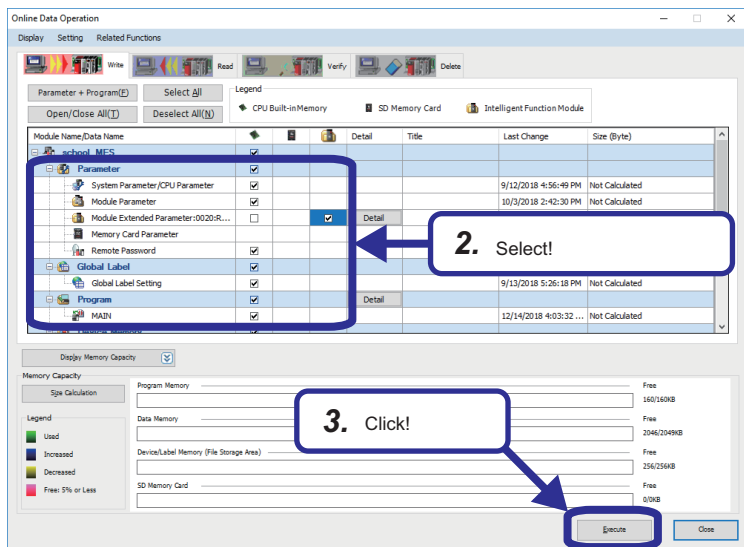
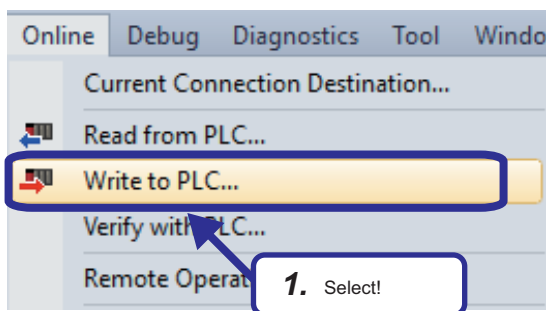

2. The "Online Data Operation" window appears. Select the parameters to be written. When "Module Extended Parameter" is selected, select the "Intelligent Function Module" checkbox.
3. Click the [Execute] button.

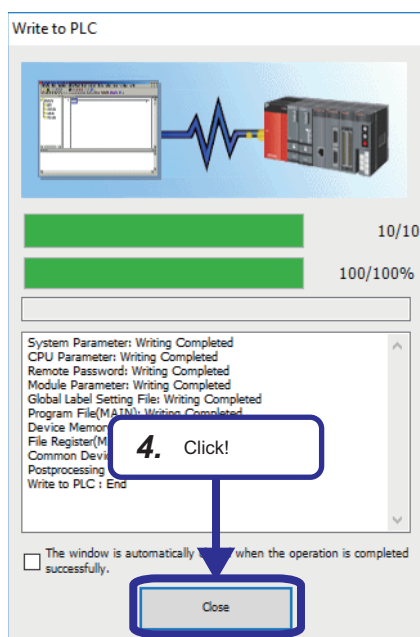

4. The "Write to PLC" window appears. When writing the parameters is completed, "Writing Completed" is displayed. Click the [Close] button.

## 4.2 Database Setting

This section describes how to create two types of database table in Microsoft SQL Server Management Studio. This procedure must be completed before setting the ODBC setting and MES interface function setting.

### Database table creation procedure

#### Creating [Project] table

##### Operating procedure

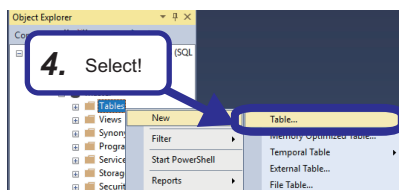
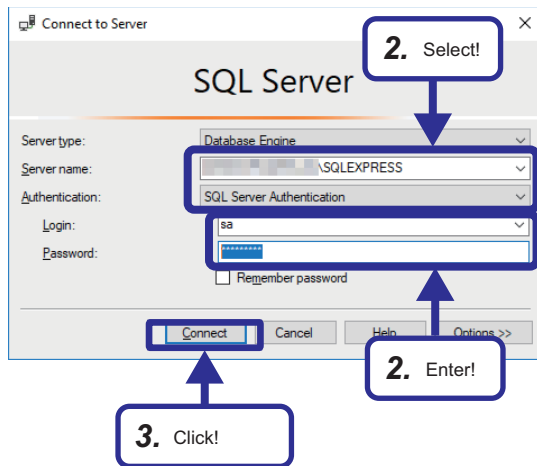

Column Name	Data Type	Allow Nulls
Pattern	int	<input type="checkbox"/>
Size	nvarchar(50)	<input type="checkbox"/>
ProductionPlanVolume	int	<input type="checkbox"/>
SpecifiedWeight	int	<input type="checkbox"/>



1. On Windows<sup>®</sup>, select [Microsoft SQL Server Sever Tools] ⇒ [Microsoft SQL Server Management Studio] from the start menu.
2. Select [SQL Sever Authentication] and enter the following login ID and password.  
[Setting details]  
Login ID: sa  
Password: Fatec\_MES

#### Point

When SQL Server is installed, a user name "sa" is automatically assigned.

3. Click the [Connect] button.
4. A system database "master" has been already existed in the database. Right-click "Databases" ⇒ "System Databases" ⇒ "master" ⇒ "Tables", and select "Table" in the "Object Explorer" window.
5. Set the items for the table as shown on the window. Select [File] and [Save Table\_1] from the menu.

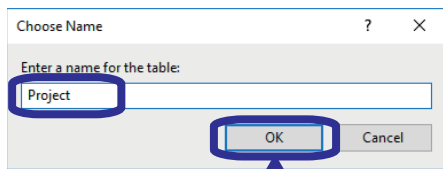

6. Click!

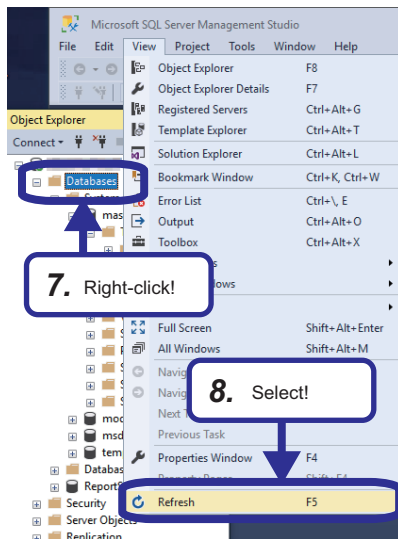

7. Right-click!

8. Select!

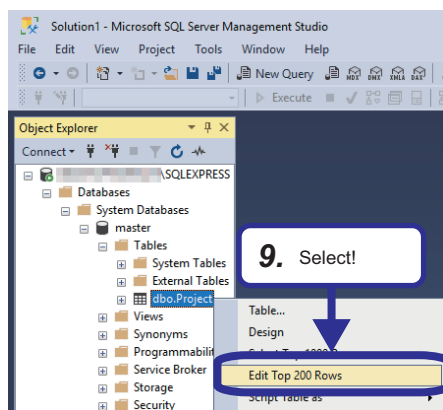

9. Select!



	Pattern	Size	ProductionPlanVolume	SpecifiedWeight
▶	1	S	40	100
	2	M	60	150
	3	L	80	200

6. Enter "Project" on the "Choose Name" window, and click the [OK] button.

7. Right-click "Databases" in the "Object Explorer" window.

8. Select [View] ⇒ [Refresh] from the menu.

9. Right-click the created project "dbo.Project", and select "Edit Top 200 Rows" in the "Object Explorer" window. The number of rows differs depending on the option settings.

10. Set the items for the table as shown on the window. (Set sizes (S, M, and L) in two-byte characters.)

## Creating [Judgement] table

### Operating procedure

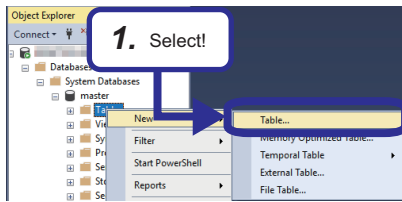

1. Right-click "Tables", and select "Table" in the "Object Explorer" window.



Column Name	Data Type	Allow Nulls
ContainerID	nvarchar(50)	<input type="checkbox"/>
DateAndTime	datetime	<input type="checkbox"/>
QualityDetermination	int	<input type="checkbox"/>
TotalNumberOfAcceptedProducts	int	<input type="checkbox"/>
TotalNumberOfRejectedProducts	int	<input type="checkbox"/>

2. Set the items for the table as shown on the window. Select [File] ⇒ [Save Table\_1] from the menu.

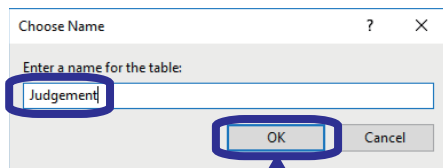

3. Enter "Judgement" on the "Choose Name" window, and click the [OK] button.

## 4.3 ODBC (Open Database Connectivity) Setting

When using DB Connection Service on the database server, the ODBC setting for the database used is needed to be set in advance. Set the ODBC setting before setting parameters with MES Interface Function Configuration Tool.

This section describes the setting method for the following operating system (OS) and relational database.

- Operating system (OS): Microsoft Windows 10 Professional Operating System (64-bit)
- Relational database: Microsoft SQL Server 2016

### ODBC setting procedure

#### Operating procedure

4

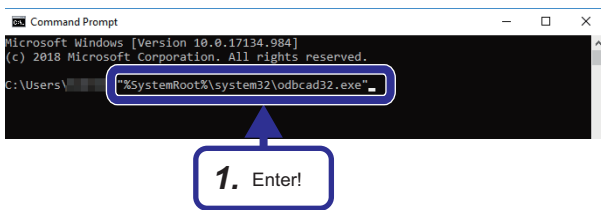

1. Start the ODBC Data Source Administrator.  
Enter the following in the command prompt.  
· "%SystemRoot%\system32\odbcad32.exe"

#### Point

Enter the following commands in the command prompt in accordance with the software version of MX MESInterface-R and the bit version of DB Connection Service to be used.

- Software version '1.03D' or earlier or '1.04E' or later and 32-bit DB Connection Service:  
"%SystemRoot%\SysWOW64\odbcad32.exe"
- Software version '1.04E' or later and 64-bit DB Connection Service:  
"%SystemRoot%\system32\odbcad32.exe"

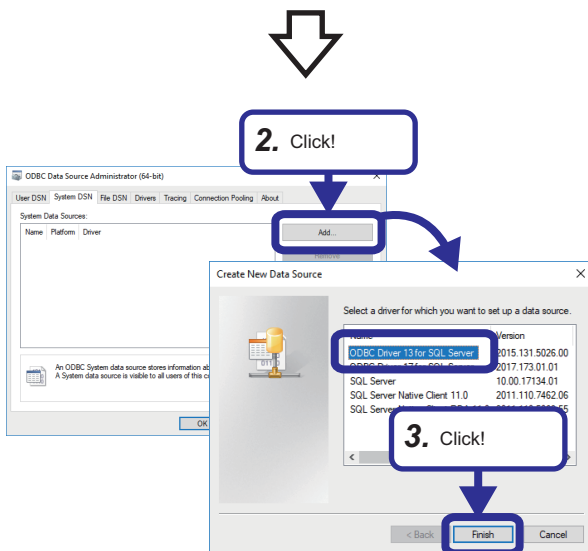

2. Select the [System DSN] tab, and click the [Add] button.
3. Select "ODBC Driver 13 for SQL Server", and click the [Finish] button.

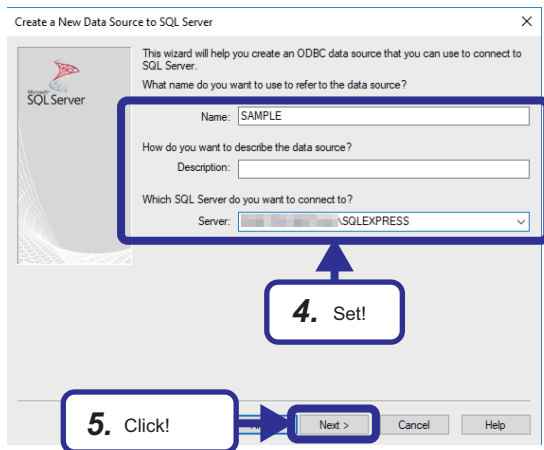

4. Set the following.
    - Data source name: SAMPLE
    - Sever name: (Name of a personal computer for the database)\SQLEXPRESS\*<sup>1</sup>
- \*1 The server name can be checked by starting SQL Server Management Studio.

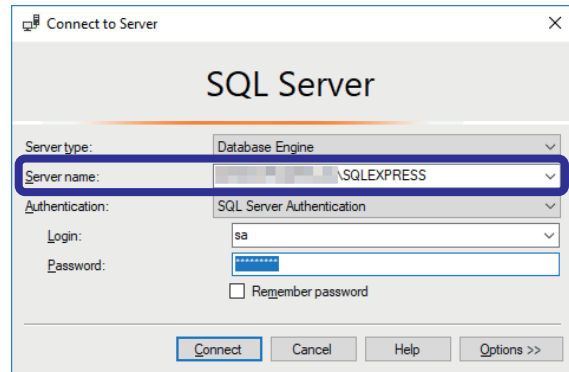

5. Click the [Next] button.

**Point**

- Any data source name can be set.  
The name set above is used for the data source name in the "Target Server Individual Settings" in the "Target Server Settings".
- The sever name is for accessing to the Microsoft SQL Server 2016 database.  
The server name was entered when the Microsoft SQL Server 2016 was installed.

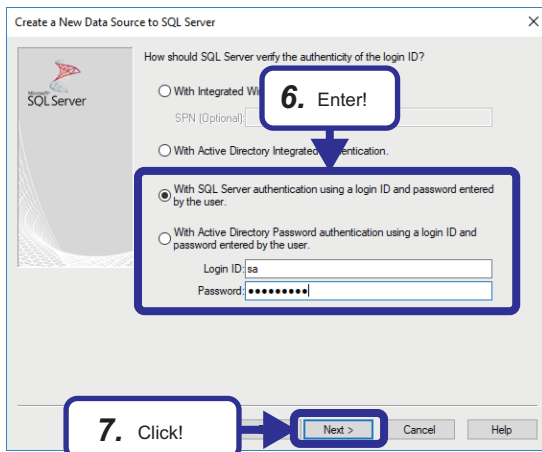

6. Select "With SQL Sever authentication using a login ID and password entered by the user" and enter the login ID and password.  
[Setting details]  
Login ID: sa  
Password: Fatec\_MES
7. Click the [Next] button.





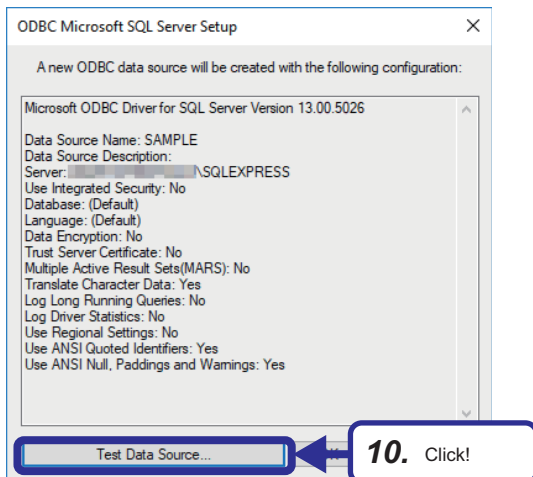
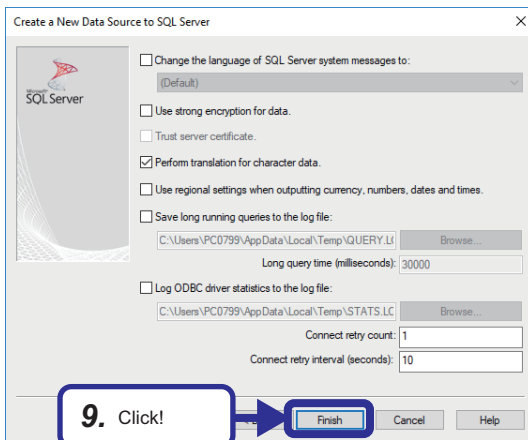
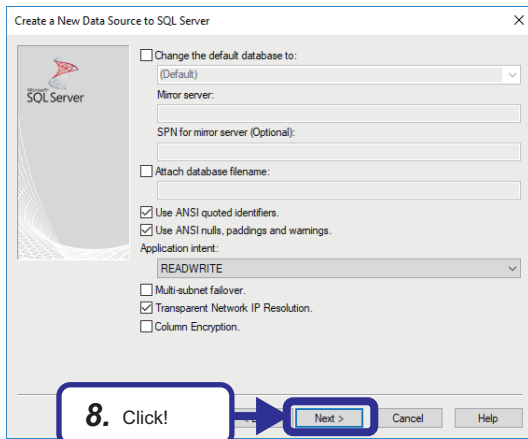

8. Click the [Next] button.

9. Click the [Finish] button.

10. Click the [Test Data Source] button, and check whether the connection is successful.

11. Click the [OK] button on the "Test Data Source" window.

12. Click the [OK] button on the "ODBC Microsoft Server Setup" window.

13. Click the [OK] button on the "ODBC Data Source Administrator" window.

# 5 INFORMATION LINKAGE FUNCTION

This chapter describes the functions of the MES interface module, MES Interface Function Configuration Tool and DB Connection Service.

## 5.1 Functions of MES Interface Module

This section describes the functions of the MES interface module.

For the details of each function, refer to the following.

 MELSEC iQ-R MES Interface Module User's Manual (Application)

Function		Description	
Data input/output function	Device memory input/output function	Device memory input function	A function to read data in the device memory. Data used for trigger judgment is read, and then data used for job is read.
		Device memory output function	A function to write data written in the device tag in the job to the device memory
	DB input/output function	DB record input/output function	A function to read/write data in the database of the host information system
		DB buffering function	A function to buffer data sent to the database, and resend it after recovery, when the data cannot be linked due to the disconnection of the network between the MES interface module and the database or failure of the database etc
	Variable input/output function	System variable input/output function	A function to read/write data of the system variable storing operating status of the module such as the status of the MES interface module
		User variable input/output function	A function to read/write data to a user variable (local variable/global variable) which can be registered arbitrarily. <ul style="list-style-type: none"> <li>Local variable: Can be used in the same job.</li> <li>Global variable: Can be used between jobs.</li> </ul>
External communication client function	Program execution function	A function to execute programs on the application server via DB Connection Service	
Information linkage function	Trigger condition monitoring function	A function to monitor values of the time or device tag components etc., and start jobs when trigger conditions are changed from false to true (the condition is satisfied)	
	Job execution control function	A function to control the job execution such as the availability of the job execution depending on the number of executable jobs at the same time	
	Trigger buffering function	A function to buffer information required for the job execution to trigger information as the trigger buffer	
	One-shot execution function	A function to execute arbitrary jobs at arbitrary timing	
	Data operation and processing function	A function to perform the basic arithmetic operations, remainder, and character string operation of device tag component values	
	Data linkage function	Data assignment function	A function to assign and link the device tag, DB data, and variable which are read by using the data input/output function
	Communication test function	A function to check the communication settings between the MES interface module and access target device or access target server	
External communication server function	REST server function	A function that allows to perform job-related operations and acquire job information from an REST client. This function supports the XML process function for the MELSEC-Q series MES interface module.	
Security function	User authentication function	A function to prevent illegal access to the MES interface module by setting a user name and password	
Other functions	SD memory card management function	A function to format an SD memory card	
	Self-diagnostic function	A function to diagnose whether the MES interface module operates normally	
	Online module change function	A function to replace a module to another without stopping a running system. For the procedure, refer to the following.  MELSEC iQ-R Online Module Change Manual	

The MES interface module provides data linkage between a CPU module and a database by monitoring a trigger condition set to the job settings ( Page 63 Job settings) and executing an action set to the job settings in order when the condition is satisfied.

The information linkage function reads/writes data as a device tag component in order to input/output the device data in the CPU module by using the data input/output function. The data input/output function identifies the target CPU module set in the target device settings.

Additionally, the information linkage function accesses the database as an access table/procedure by using the data input/output function. The data input/output function identifies the target server set in the target server settings.

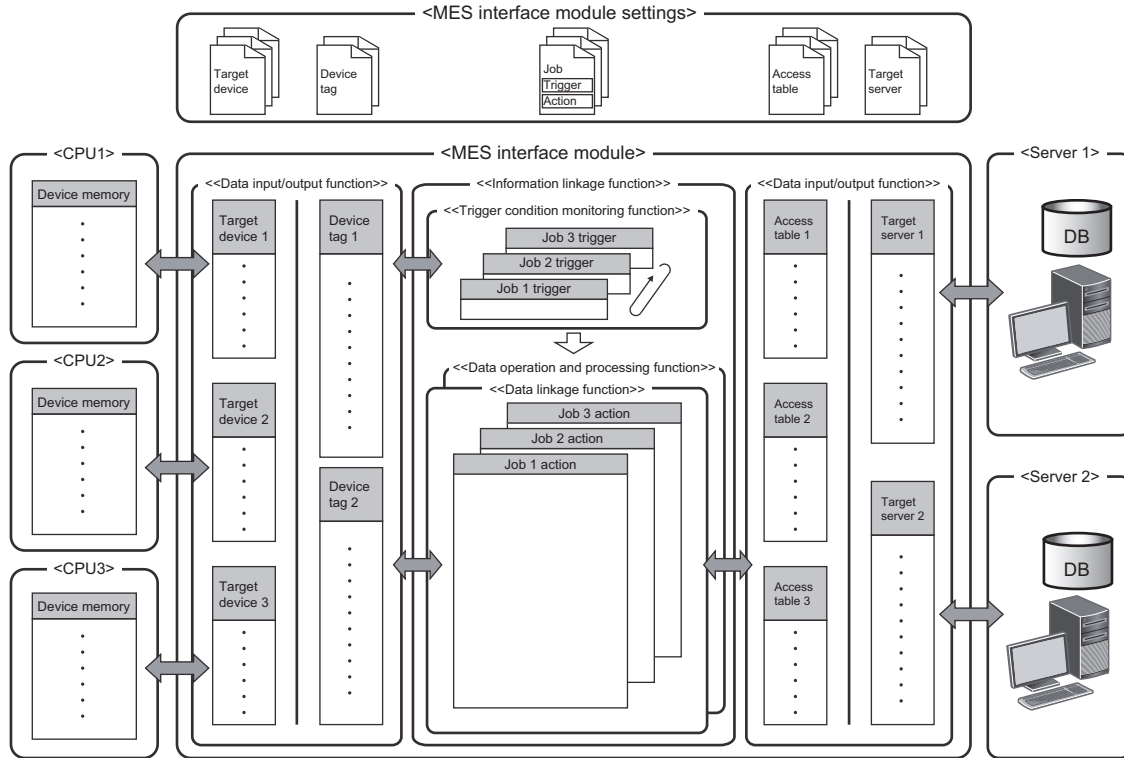

# Data input/output function

---

## Device memory input/output function

The device memory input/output function reads or writes data from the device memory of the target device, and inputs or outputs data between the device memory in the target device and the MES interface module. This function is used for the information linkage function at required timing (at trigger judgment, when trigger condition is satisfied, or before/after executing the action).

Not only to the control CPU of the MES interface module itself but also to other CPU of the host station and a CPU module of other station can be accessed.

For the data types which can be input/output, refer to the following.

📖 MELSEC iQ-R MES Interface Module User's Manual (Startup)

## DB input/output function

The DB input/output function has the following two functions.

Function name	Description	Setting method
DB record input/output function	A function to acquire, update, and delete data from the database at the required timing (at execution of DB communication action) for the information linkage function	☞ Page 43 DB record input/output function
DB buffering function	A function to buffer an SQL statement or stored procedure call information to an SD memory card, and resend it after recovery when communication cannot be established with a database due to the disconnection of the network or failure	☞ Page 44 DB buffering function

### ■DB record input/output function

The DB record input/output function inputs/outputs information (record) stored in the DB table (accessible to a table and view) to/from a programmable controller system.

The operations that can be input/output are as follows:

Operation	Input/output data	Description
Select (Single record)	Maximum: 1024 fields	Selects (acquires) one record from the database.
Insert (Single record)	Maximum: 1024 fields	Inserts (adds) one record to the database.
Update	Maximum: 1024 fields	Updates records in the database. (A function to insert a record at update failure is available.)
Delete	—	Deletes records in the database.
Multiple Select (Multiple records)	Maximum: Number of records × Number of fields ≤ 40960	Selects (acquires) multiple records from the database.
Stored Procedure	Maximum: 256 arguments and 1 return value	Executes processing registered to the database.

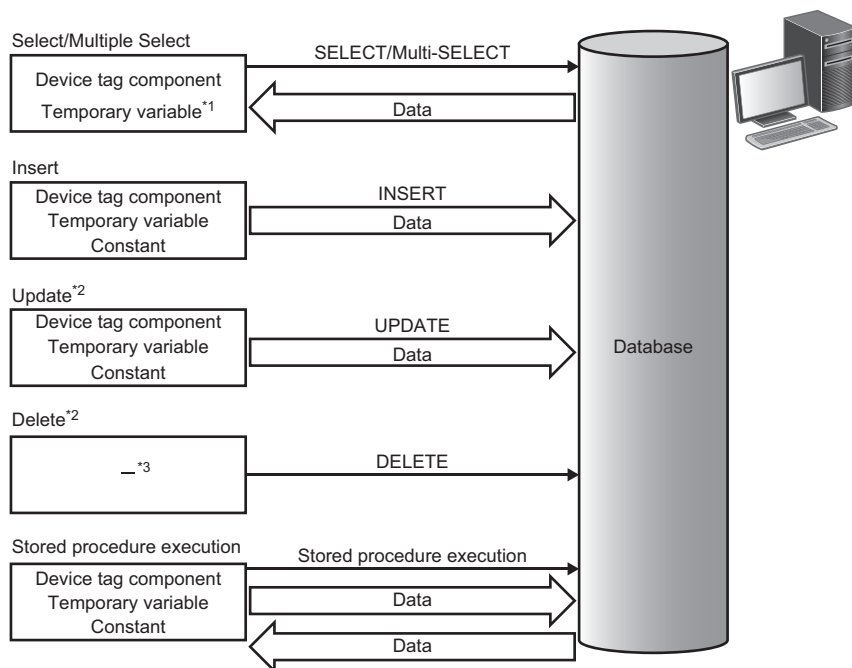

\*1 It cannot be used for Multiple Select.

\*2 When accessing the same data while the data is locked in the database, the processing may be waited until the lock is unlocked. Do not access the data which has the potential to be locked over a prolonged period of time.

\*3 This indicates there is no data communication.

## ■DB buffering function

The DB buffering function buffers SQL statement or stored procedure call information to the DB buffer on an SD memory card when they cannot be sent due to network disconnection or failure of the server on which the database is installed. After the network or server is recovered, the buffered SQL statement or stored procedure call information is resent.

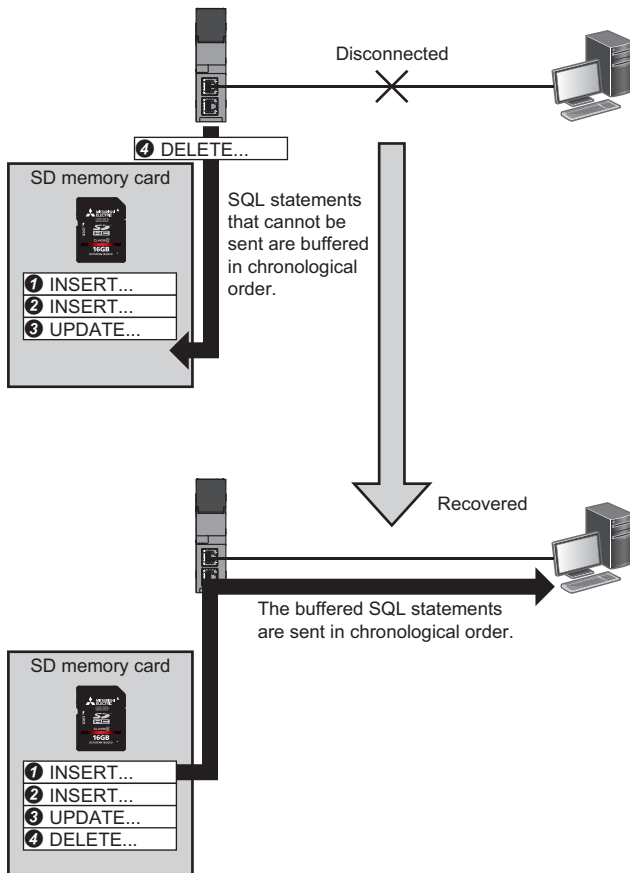

## Variable input/output function

The variable input/output function inputs/outputs data to/from the variable area in which data in the MES interface module can be saved temporarily.

For the setting method of variables, refer to the following.

📖 MELSEC iQ-R MES Interface Module User's Manual (Application)

Variables can be used for the following purposes.

- Storing data which is in calculation temporarily.
- Sharing data with other jobs.
- Referring current time and operating status in the MES interface module from a job.

For data types of variables, refer to the following.

📖 MELSEC iQ-R MES Interface Module User's Manual (Startup)

# Information linkage function

The information linkage function starts and controls jobs which link information between the target device such as a CPU module and target server such as a database server.

The following lists the functions of the information linkage function.

Function	Description	Setting method
Trigger condition monitoring function	Performs job start judgment and job start notification to job execution control.	☞ Page 66 Trigger conditions
Job execution control function	Performs operations from starting a job up to writing the execution result of the job.	☞ Page 64 Job settings
Trigger buffering function	Performs buffering when multiple job start notifications are issued at the same time.	
One-shot execution function	Executes job once after receiving a request from MES Interface Function Configuration Tool.	☞ Page 123 One-shot execution function
Data operation and processing function	Performs data operations and processing which is used for job.	☞ Page 78 Operation action settings
Data linkage function	Performs data linkage among target device, target server, and the MES interface module.	☞ Page 56 Device tag settings ☞ Page 60 Access table/procedure settings
Communication test function	Performs communication test for a target device or target server after receiving a request from MES Interface Function Configuration Tool.	☞ Page 114 Communication test function

## Trigger condition monitoring function

The trigger condition monitoring function reads data to be used for a trigger condition, evaluates the trigger condition, and notifies the satisfaction of the trigger condition to the job execution control function.

Processing	Description
Data read to be used for trigger condition	Reads data to be used for the trigger condition in job units using the Device memory input/output function. The data to be used for jobs can also be read at this time. For details on data read, refer to the following. ☞ Page 42 Device memory input/output function
Trigger judgment	Evaluates trigger condition which is to be a start condition of a job. When the trigger condition is satisfied, this function notifies the satisfaction of the trigger condition to the job execution control function.

### ■Trigger judgment

A trigger condition is configured by combining an event and a condition. (☞ Page 46 Combination of conditions)

A trigger condition is evaluated according to a judgment result of the configuration of the trigger condition.

- Event: Shows that an event occurs, and the trigger condition is satisfied when an event occurs.
- Condition: Shows the status at a certain point, and a precondition for trigger condition satisfaction.

The overview of the trigger condition and outline specifications of event/condition type are as follows.

Event/condition type	Description	Attribute
Condition (Value monitoring)	The condition is satisfied (status = true) while the value of device tag component or variable satisfies the specified condition. The generates an event when the condition turns into the satisfied state from the not-satisfied state (from false to true) for using as an event.	Condition Event
Condition (Period of time)	The condition is satisfied (status = true) from the specified start time to the specified end time.	Condition
Event (Value changed)	Generates an event when the value of device tag component or variable is changed from the previous value.	Event
Event (Fixed time)	Generates an event at the specified time.	Event
Event (Fixed cycle)	Timer interval	Event
	Time interval	
Event (Module monitoring)	MES Interface Module	Event
	Control CPU	
Handshake	Starts a job according to the value of the device tag component in the target device, and notifies the job completion to the device tag component in the target device.	—

## ■Combination of conditions

Configuration type		Number of available events/ conditions	Available event/condition	Condition for trigger condition satisfaction
Single Event (SINGLE EVENT)		1	Other than below • Condition (Period of time)	At the time when the specified event occurred is regarded that the trigger condition is satisfied. When using the condition, at the time when the condition is satisfied is regarded as an event occurrence.
Multiple Events (MULTIPLE EVENT)		2	Other than below • Condition (Period of time) • Handshake	At the time when any of the specified multiple events occurred is regarded that the trigger condition is satisfied. When using the condition, at the time when the condition is satisfied is regarded as an event occurrence.
Condition Combination Event	AND Combination (CONDITIONS(AND))	2	• Condition (Value monitoring)	The specified multiple conditions are combined. When the logical product (AND) or logical sum (OR) of the combined conditions is satisfied is regarded as an event occurrence, and the trigger condition is satisfied.
	OR Combination (CONDITIONS(OR))	2		
Precondition × Event		Precondition: 1	• Condition (Value monitoring) • Condition (Period of time) • Event (Value changed) • Event (Fixed time) • Event (Fixed cycle)	Specify a precondition and event. When the event occurs while the precondition is satisfied, it is regarded that the trigger condition is satisfied.
		Event: 1		

## Job execution control function

The job execution control function determines the availability of the job start based on the number of executable jobs and their execution status.

This function also reads data which is required for the execution of a job and writes the job execution result.

Processing	Description
Job start	Upon the reception of the notification when the trigger condition is satisfied, the availability of the job execution is determined by the number of executable jobs and the execution status.
Data read to be used for job	Reads data required for executing job in job units using the data input/output function. The data which is included in the data to be used for trigger condition is not read.
Exclusive control of database server used for job	Performs exclusive control of the database to be used for jobs to prevent that the multiple jobs which use the same database server are dead-locked.
Execution of action	Executes functions of the MES interface module.
Writing of job execution result	Writes the execution result of the job to data using the data input/output function.
Job verification function	Controls writing operation of the start of job, execution of action, and execution result of job when executing job which is in verification before starting operation or in development.



## Trigger buffering function

The trigger buffering function buffers the following information required for job execution as trigger information to execute later when the job execution operation function receives the trigger condition satisfaction notification of the same job which is in execution without discarding the notification.

- Read data of a device tag component
- Time at trigger monitoring
- Time at trigger ON
- Date and time character string

However, this function cannot be enabled for the job (including a job of which trigger type is handshake) which writes data to the CPU module, except for the specific function.\*1

\*1 The notification when a job execution is not performed normally (job cancellation notification/notification of exception) is available.

### ■Behavior when the trigger buffering function is disabled (normal)

When a trigger condition for a job is satisfied again during execution of the job, the next job is not executed.

Ex.

When value monitoring is regarded as a condition

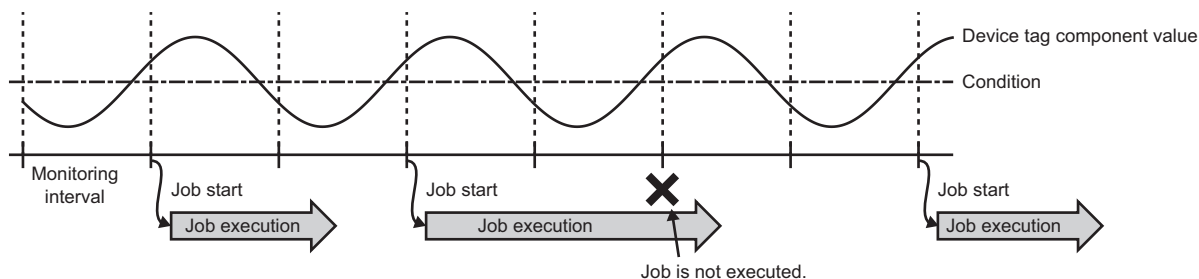

### ■Behavior when the trigger buffering function is enabled

The trigger information is buffered when the latter trigger condition is satisfied. After the former trigger condition is satisfied, a job is executed according to the trigger information.

Ex.

When value monitoring is regarded as a condition

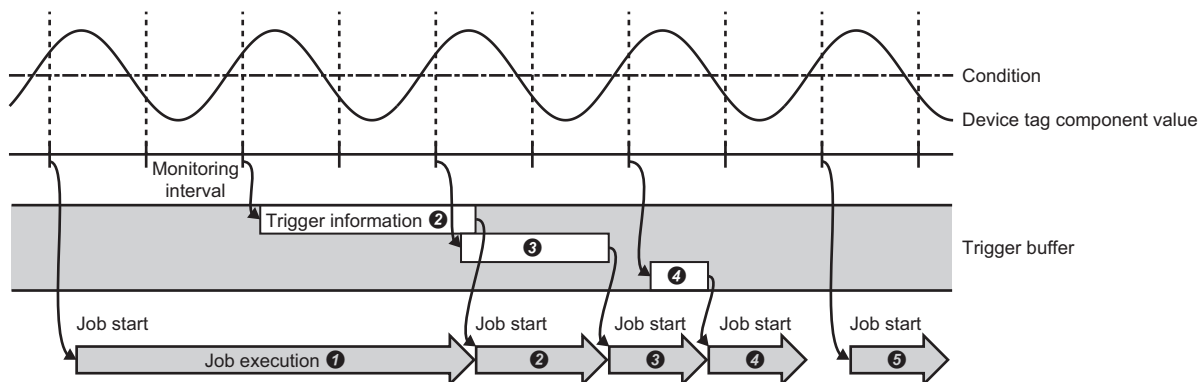

When the trigger buffering function is enabled, the data required for a job operation is always stored to the trigger buffer temporarily, then the job is executed depending on the load state.

## Data operation and processing function

The data operation and processing function calculates value in the first item and second item with the operation specified to the operator, and substitutes it for the substitution item.

This function is used for one of the actions which are to be defined for pre-processing/main-processing/post-processing

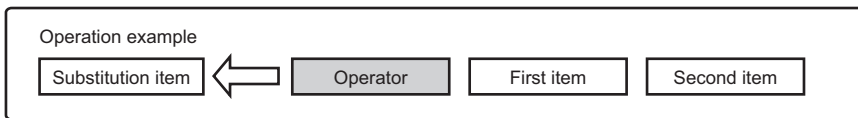

The data categories that can be set for the data operation and processing function are as follows.

○: Available, ×: Not available

Data category	Substitution item	First item	Second item
Device tag component	○ (Data write prohibited tags and array tags cannot be set.)	○ (Array tags cannot be set.)	
Variable	○ (System variables which are write-protected cannot be set.)	○	
Constant	×	○	
Macro	×	○ (Only "Date and Time Character String" can be set.)	

## ■ Specifications of operations

The list of operations is as follows.

Classification	Operator	Description
Substitution operation	ASSIGN	Substitutes data in the first item for the substitution item.
Arithmetic operation	+	Performs addition of numerical value data.
	-	Performs subtraction of numerical value data.
	×	Performs multiplication of numerical value data.
	÷	Performs division of numerical value data.
	%	Calculates remainder of numerical value data.
Character string operation	CONCAT	Combines character string data.
	LENGTH	Acquires the number of characters of the character string data.
	RIGHT	Reads out character string data from the end/rightmost of the character string data for the specified number of characters.
	LEFT	Reads out character string data from the first/leftmost of the character string data for the specified number of characters.
	UPPER	Converts lower-case characters included in character string data to upper-case characters.
	LOWER	Converts upper-case characters included in character string data to lower-case characters.
	RTRIM	Deletes blank characters at the end/rightmost of the character string data.
	LTRIM	Deletes blank characters at the first/leftmost of the character string data.
Bit operation	AND	Performs AND operation of integer data for each bit.
	OR	Performs OR operation of integer data for each bit.
	XOR	Performs XOR operation of integer data for each bit.
	RSHIFT	Shifts integer data to right for the number of specified bits.
	LSHIFT	Shifts integer data to left for the number of specified bits.
Type conversion	STR2INT	Converts character string data to integer data.
	STR2REAL	Converts character string data to real number data.
	INT2STR	Converts integer data to character string data.
	REAL2STR	Converts real number data to character string data.

## Data linkage function

### ■Data assignment function

The data assignment function concatenates data to be input/output in the data input/output function and assigns the data to the specified direction.

This function also reports device data to be used for the operations in the CPU module by writing them to the database, and saves the data in the server or operation result to variables temporarily, then reflects data to the device data in the CPU module simultaneously.

Additionally, the constants specified by user can be used as an assignment data.

The availability of data assignment for each data which inputs/outputs in the data input/output function is as follows.

○Available, ×: Not available

Target	Source				
	Access field (SQL statement)	Access procedure argument (Output argument)	Other DB communication data External communication data	Device tag component* <sup>1</sup> Variable	Constant Macro
Access field (SQL statement)	×	×	×	○: DB communication action (Insert, Update)	
Access procedure argument (Input argument)	×	×	×	○: DB communication action (Stored Procedure)	
Other DB communication data External communication data	×	×	×	○: DB communication action	
Device tag component* <sup>1,2,3,4</sup> Variable* <sup>2</sup>	○: DB communication action (Select, Multiple Select)	○: DB communication action (Stored Procedure)	○: DB communication action ○: External communication action	○: Operation action ○: Notifications* <sup>5</sup>	
Constant Macro	×	×	×	×	

\*1 Array tags cannot be used as an assignment source.

\*2 The assignment for the device tag components and variables which are write-prohibited cannot be performed.

\*3 Only multiple selection processing can be performed for the assignment for array tags.

\*4 Only the same array tags can be assigned for array tags.

\*5 The assignment processing of each notification is performed in accordance with the specifications of the data assignment function.

## 5.2 MES Interface Function Configuration Tool

The MES interface module provides information linkage by operating based on the following settings. The settings are specified with MES Interface Function Configuration Tool.

Setting name	Description
Job settings	Sets a timing to start linking information and processing (contents to be linked) with a trigger condition and an action.
Target device settings	Sets a CPU module to be accessed from a device tag as a target device.
Device tag settings	Sets each piece of data, which is inputted to or outputted from a device such as CPU module by a job, as a device tag component. Sets a table of data, in which multiple device tag components are grouped, as a device tag.
Target server settings	Sets a server, in which a table specified in a access table is included, as a target server. The database server which has a database to be linked and the application server which has an application to be linked can be set.
Access table/procedure settings	Sets a table/procedure of a database to be accessed from a job as an access table/procedure.

### Network settings

This section describes the settings required for network connections.

#### Window

Click the "Network Settings" in the edit items tree.

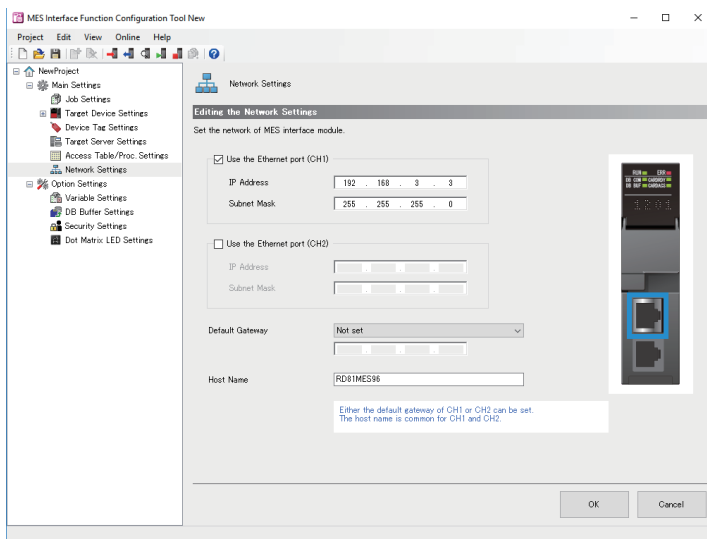

#### Displayed items

Item	Description	
Ethernet Port (CH1)	Use the Ethernet port (CH1)	Selects this to use the Ethernet port (CH1). <sup>*1</sup>
	IP Address	Sets the IP address (CH1) of the MES interface module in decimal. <sup>*2</sup>
	Subnet Mask	Sets the subnet mask in decimal when using the subnet mask.
Ethernet Port (CH2)	Use the Ethernet port (CH2)	Selects this to use the Ethernet port (CH2). <sup>*1</sup>
	IP Address	Sets the IP address (CH2) of the MES interface module in decimal. <sup>*2</sup>
	Subnet Mask	Sets the subnet mask in decimal when using the subnet mask.
Default Gateway	Selects the necessity of default gateway, and set the IP address. <sup>*3</sup>	
Host Name	Sets the host name.	
[OK] button	Reflects the specified settings.	

\*1 CH1 or CH2 must be set to be used.

\*2 The same IP address or an IP address of the same network cannot be set to both CH1 and CH2.

\*3 Only one of CH1 or CH2 can be registered.

Communications with the same network as each CH is performed from each corresponding CH only.  
(Even if a default gateway is set in other CH, communications are not performed from the other CH.)

# Target device settings

This section describes the setting of the target device accessed by the MES interface module.

## Target device setting list

This sets the connection route to access a device existing in the own station or other stations from the MES interface module. The control CPU module is set for the target device name "ControlCPU" in the first item in the default setting. The first item cannot be deleted or changed the settings. Only the target device name and comment can be changed.

## Window

Click the "Target Device Settings" in the edit items tree.

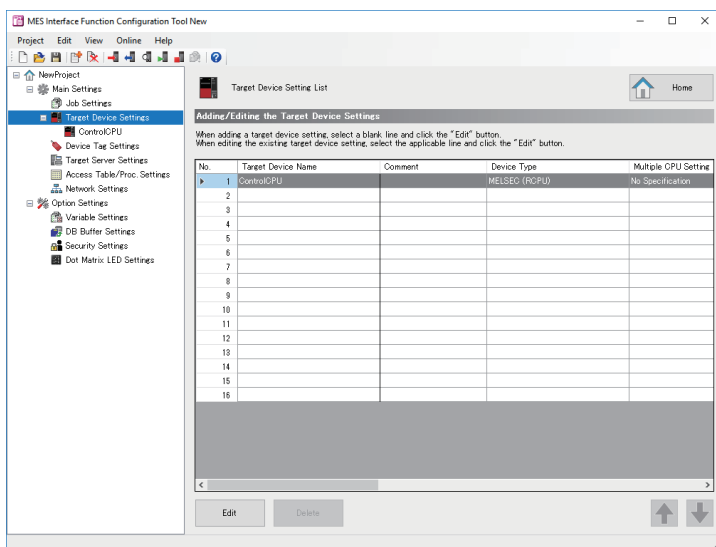

## Displayed items

Item	Description	
Target Device Setting List	Target Device Name	Displays the target device name.
	Comment	Displays the comment set arbitrarily.
	Device Type	Displays the target device type.
	Multiple CPU Setting	Displays the CPU number when the target device is a multiple CPU.
	Communication Route	Displays whether the communication route is set or not.
	Network Communication Route	Displays the settings of the network communication route.
	Co-Existence Network Route	Displays the settings of the co-existence network route.
[Edit] button	Opens the "Target Device Settings" window of the selected row.	
[Delete] button	Deletes the settings of selected rows.	

## Target device settings

This sets the connection route to a device accessed from the MES interface module.

### Window

Click the [Edit] button on the "Target Device Setting List" window.

5

### Displayed items

Item	Description	
Target Device Name* <sup>1</sup>	Sets the target device name.	
Comment	Sets an arbitrary comment.	
Target Device Settings	Device Type	Sets the target device type.
	Multiple CPU Setting	Selects a multiple CPU number.
[Communication Test] button	Performs a communication test with the set access target device.	
Global Label/Common Device Comment Settings (optional)	Use the global label/common device comment	Selects this to import global labels/common device comments to MES Interface Function Configuration Tool.
	Global Label/Common Device Comment Import Source Setting	Displays the project path of the engineering tool specified as an import source. An import source project can be specified in the "Select the Global Label/Common Device Comment Import Source Project" window displayed by clicking the [...] button.
[OK] button	Reflects the specified settings.	

\*1 The same name cannot be used for the target device name.

## ■[Network Communication Route] tab

Item	Description	
Set the network communication route to a device existing over a single network	Selects this to set the route for accessing a device existing over a single network.	
Source System Settings	Module Type* <sup>1</sup>	Sets the module type for the source system.
	Route	Sets the routed system when selecting "MES Interface Module (Ethernet Port)" for the module type.
	Station No.	Sets the station number for the source system. Setting range: 1 to 120
	Start I/O No.	Sets the start I/O No. when selecting "CC-Link System Master/Local Module" for the module type. Setting range: 0 to FE0H
Settings of System to be Routed	IP Address	Sets the IP address of the Ethernet port (Ethernet Interface Module/CPU) on the system to be routed.
	Network No.	Sets the network No. of the Ethernet interface module to be routed. Setting range: 1 to 239
	Station No.	Sets the station No. of Ethernet Interface Module to be routed. Setting range: 1 to 120
	Module Type	Sets the module type of the system to be routed.
Target (Relay Station) System Settings	Module Type	Displays module types which can be used in the target (routed) system depending on the module type selected in the source system.
	IP Address	Sets the IP address of the target (relay station) system.
	Network No.	Sets the network No. of the target system. Setting range: 1 to 239
	Station No.	Sets the station No. of the target system. Setting range: 0 to 63 (for CC-Link System Master/Local Module), 0 to 120 (for other modules)

\*1 When selecting "MES Interface Module (Ethernet Port)", switching to the [Co-existence Network Route] tab is not possible.

## ■[Co-Existence Network Route] tab

Item	Description	
Set the co-existence network route to a device existing over a different network	Selects this to set the route for accessing a device existing over a different network.	
Relay Station System Settings	Module Type	Sets the module type that can be used in a co-existence network route depending on the module type set in the source system.
	Start I/O No.	Sets the start I/O No. of CC-Link System Master/Local Module in the relay station system. Setting range: 0 to FE0H
Co-Existence Target System Settings	Module Type	Displays module types which can be used in the target system depending on the module type selected in the relay station system.
	Network No.	Sets the network No. of CC-Link IE Controller Network module, CC-Link IE Field Network module, MELSECNET/H network module, and Ethernet interface module for the access target. Setting range: 1 to 239
	Station No.	Sets the station number of CC-Link IE Controller Network module, CC-Link IE Field Network module, MELSECNET/H network module, CC-Link System Master/Local Module, and Ethernet interface module for the target. Setting range: 0 to 63 (for CC-Link System Master/Local Module), 0 to 120 (for other modules)



When accessing a QCPU (Q mode) for which the MELSOFT connection extended setting was set, specify "Ethernet Interface Module".



# Device tag settings

This section describes the setting of the device tag accessed by the MES interface module.

## Device tag setting list

This sets a group of device memory accessed from the MES interface module as a tag.

Up to 64 device tags can be set.

### Window

Click the "Device Tag Settings" in the edit items tree.

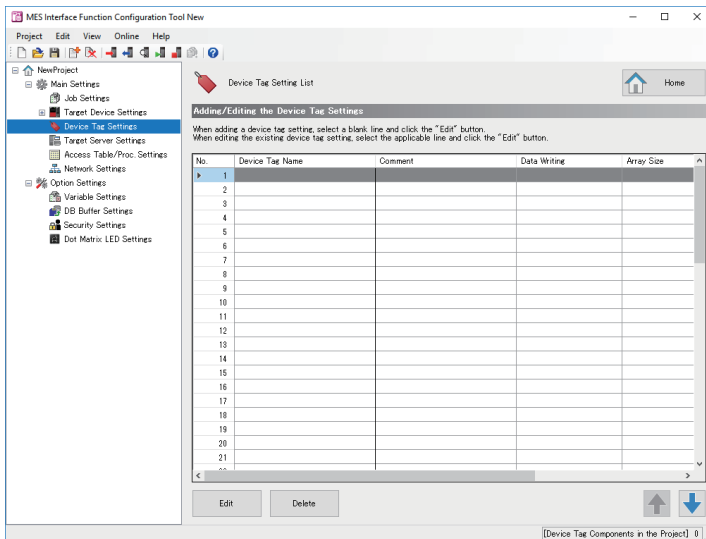

### Displayed items

Item	Description	
Device Tag Setting List	Device Tag Name	Displays the name of device tag setting.
	Comment	Displays the comment set arbitrarily.
	Data Writing	Displays whether the writing to the device tag is protected or not.
	Array Size	Displays the array size of the array tag setting.
	Array Type	Displays the array type of the array tag setting.
[Edit] button	Opens the "Device Tag Settings" window of the selected row.	
[Delete] button	Deletes the settings of selected rows.	

## Device tag settings

This sets the settings for the device memory accessed from the MES interface module.

### Window

Click the [Edit] button on the "Device Tag Setting List" window.

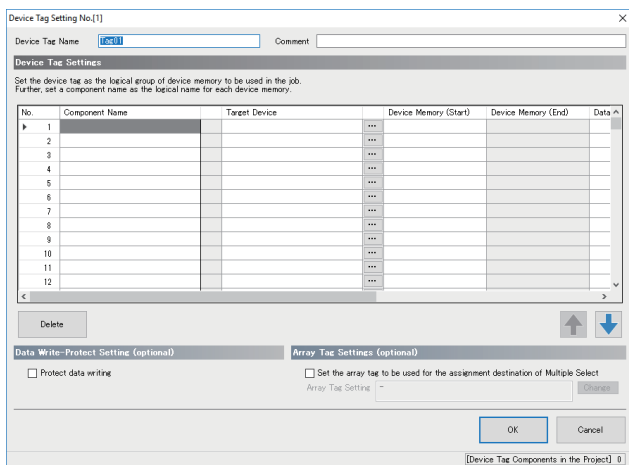

### Displayed items

Item	Description	
Device Tag Name* <sup>1</sup>	Sets the device tag name.	
Comment	Sets an arbitrary comment.	
Device Tag Settings	Component Name	Sets the component name to be accessed.
	Target Device	Selects the device having the component to be accessed.
	[...] button	Opens the "Target Device Settings" window of the corresponding target device. <a href="#">Page 53 Target device settings</a>
	Device Memory (Start)	Specifies the start of the device memory to be accessed.
	Device Memory (End)	Displays the end device obtained by calculating the set start device and the data type and number of characters.
	Data Type	Selects a data type of the device memory to be accessed.
	Length	Set the number of characters when specifying the character string to the data type.
	[Delete] button	Deletes the settings of selected rows.
Data Write-Protect Setting (optional)	Protect data writing	Selects this to protect data writing to the device tag being set.
Array Tag Settings (optional)	Set the array tag to be used for the assignment destination of Multiple Select	Selects this to use a device tag as an array tag.
	Array Tag Setting	Displays the array size and array type.
	[Change] button	Opens the "Array Tag Setting" window for the device tag being set.
[OK] button		Reflects the specified settings.

\*1 A same name cannot be used for the device tag name.

# Target server settings

This section describes the setting of the target server connected with the MES interface module.

## Target server setting list

Servers accessed from the MES interface module are set.

Up to 16 servers can be set for target server.

### Window

Click the "Target Server Settings" in the edit items tree.

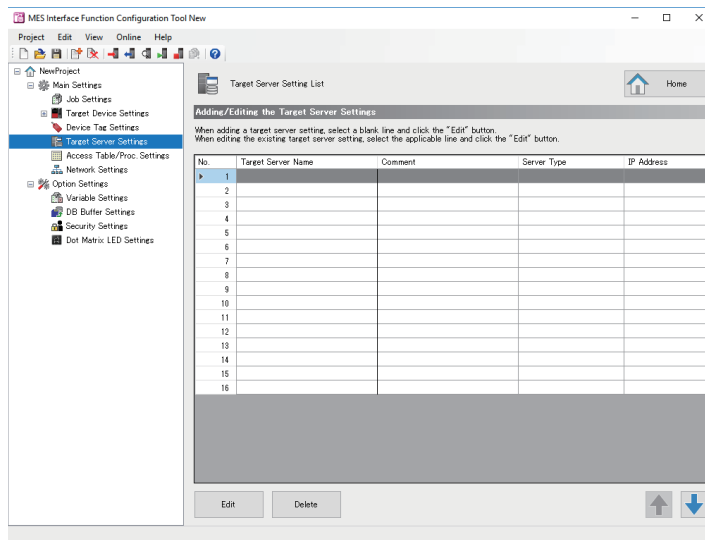

### Displayed items

Item	Description	
Target Server Setting List	Target Server Name	Displays the target server setting name.
	Comment	Displays the comment set arbitrarily.
	Server Type	Displays the server type.
	IP Address	Displays the IP address of the server.
[Edit] button	Opens the "Target Server Settings" window of the selected row.	
[Delete] button	Deletes the settings of selected rows.	

## Target server settings

This sets the settings for the server accessed the from MES interface module.

### Window

Click the [Edit] button on the "Target Server Setting List" window.

### Displayed items

Item	Description	
Target Server Name <sup>*1</sup>	Sets the target server name.	
Comment	Sets an arbitrary comment.	
Target Server Common Settings	Server Type	Sets the target server type.
	IP Address	Sets the IP address of the server in which DB Connection Service is installed in decimal.
	Port No.	Sets a port number of the server. Setting range: 1024 to 65535
	Communication Timeout Time <sup>*2,*3</sup>	Sets the timeout time until the MES interface module detects a communication error when a communication error occurs on the network between the MES interface module and the server. Setting range: 1 to 180 seconds
Target Server Individual Settings	Data Source Name	Sets the name of the ODBC data source to be accessed.
	User Name <sup>*4</sup>	Sets the user name to access the database/application server.
	Password	Sets the password to access the database/application server.
	Database Type <sup>*5</sup>	Selects the database server type.
Access Error Notification Settings (optional)	Access Error Notification Setting	Displays whether or not to notify the current setting status for the access error status.
	[Change] button	Opens the "Access Error Notification Setting" window.
[Communication Test] button	Performs a communication test with the set access target server.	
[OK] button	Reflects the specified settings.	

\*1 A same name cannot be used for the target server name.

\*2 The communication timeout time is treated as timeout value when server is down or network is disconnected. In cases where abnormality can be detected before such occurrence, an error is detected without waiting for timeout time.

\*3 If the communication time out time is set longer, the MES interface function such as setting update, module stop, and SD memory card format may require time to stop.

\*4 When the database type is Oracle 11g, Oracle 12c, the user name is case-sensitive.

\*5 In the communication test function, even if a database which is different than the actual connected database is set, the communication test may succeed.

# Access table/procedure settings

This section describes the setting of the access table/procedure connected by the MES interface module.

## Access table/procedure setting list

This sets the settings for the access table/procedure accessed from the MES interface module.

Up to 1024 access tables/procedures can be registered.

### Window

Click the "Access Table/Proc. Settings" in the edit items tree.

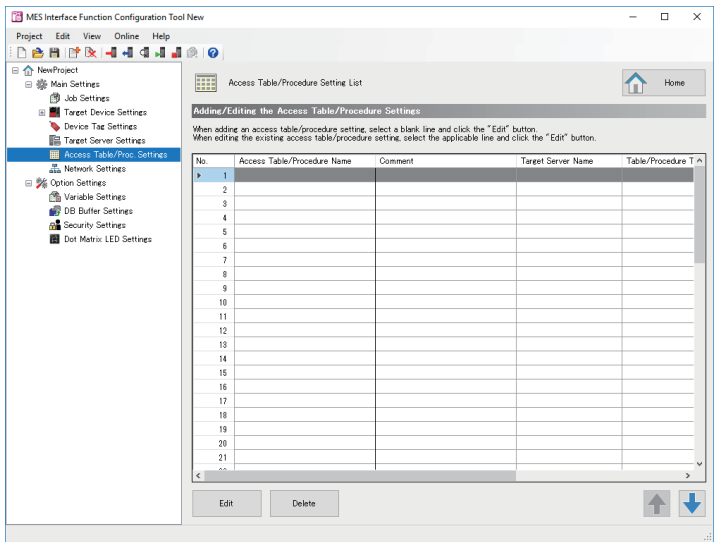

### Displayed items

Item	Description	
Access Table/Procedure Setting List	Access Table/Procedure Name	Displays the setting name of the access table/procedure.
	Comment	Displays the comment set arbitrarily.
	Target Server Name	Displays the setting name of the target server.
	Table/Procedure Type	Displays the set table/procedure type.
	DB Table/Procedure Name	Displays the set DB table/procedure name.
[Edit] button	Opens the "Access Table/Procedure Settings" window of the selected row.	
[Delete] button	Deletes the settings of selected rows.	

## Access table/procedure settings

This sets a group of database field accessed from the MES interface module as access table/procedure.

### Window

Click the [Edit] button on the "Access Table/Procedure Setting List" window.

### Displayed items

Item	Description	
Access Table/Procedure Name *1	Sets the access table/procedure name.	
Comment	Sets an arbitrary comment.	
Access Table/Procedure Settings	Target Server	Selects a target server.
	[...] button	Opens the "Target Server Settings" window for the corresponding target server. Opens a new "Target Server Settings" window when the target server is "(Add)". Page 58 Target server settings
	Table/Procedure Type	Selects a table or a stored procedure to be set.
[OK] button	Reflects the specified settings.	

\*1 A same name cannot be used for the access table/procedure name.

• When selecting "Access Table"

Item	Description	
Access Table Detailed Settings	[Browse DB Table Information] button	Opens the "Browse DB Table Information" window.
	[Browse DB Field Information] button	Opens the "Browse DB Field Information" window.
	DB Table Name	Sets the DB table name to be accessed.
Access field list	Access Field Name	Set the access field name used when assigning data on the "DB Communication Action" window.
	DB Field Name	Sets the field name of the data base.
	Data Type	Sets the data type acquired by selecting manually or browsing DB field arbitrarily.
	Precision Hold	Sets whether or not to set the precision hold when the data is real number and date and time. When enabled at the time of converting to SQL numeric character string, it converts such that there is no occurrence of real number rounding error. In addition, fractional seconds are added in the date and time. This setting is applied when used for the following access fields. <ul style="list-style-type: none"> <li>• Narrowing-down condition for Select</li> <li>• Data assignment for Insert</li> <li>• Data assignment and narrowing-down condition for Update</li> <li>• Narrowing-down condition for Delete</li> <li>• Narrowing-down condition for Multiple Select</li> </ul>
	Default Value Setting	Sets the default value setting.
	Default Value	Sets the default value of the access field.
[Delete] button	Deletes the settings of selected rows.	

• When selecting "Access Procedure"

Item	Description	
Access Procedure Detailed Settings	[Browse DB Procedure Information] button	Opens the "Browse DB Procedure Information" window.
	DB Procedure Name	Sets the DB procedure name to be used as access procedure.
Access procedure list	Access Proc. Argument Name	Sets the access procedure argument by selecting manually or selecting the DB procedure name acquired by browsing DB procedure information.
	Argument No.	Displays the DB procedure argument number.
	Data Type	Sets the data type acquired by selecting manually or browsing DB procedure information.
	Assignment Direction <sup>*2</sup>	Sets the assignment direction for the argument acquired by selecting manually or browsing DB procedure information.
[Delete] button	Deletes the settings of selected rows.	

\*2 In case of SQL Server, because there is no distinction between "OUT" and "INOUT", acquire as "INOUT".  
However, when there is no input usage in the DB communication action (Stored Procedure), the assignment direction is recommended to set to "OUT" manually.

## ■DB table information browse

This selects the DB table name that can be used in the specified target server from the list.

### Operating procedure

1. Click the [Browse DB Table Information] button on the "Access Table/Procedure Settings" window.

2. Select the DB table name to be used from the list.

The DB table name is not displayed on the list in the following cases. If the target DB table name is not displayed, enter it manually.

- When the DB table name exceeds the maximum number of characters (32 characters (Unicode))
- When the number of DB tables exceeds the maximum number of items displayed (1024 tables)
- When the characters that cannot be used for the DB table name are included

Contents of the list can be updated with the [Refresh] button.

3. Click the [OK] button.

## ■DB field information browse

This selects the field name of the specified DB table from the list.

### Operating procedure

1. Click the [Browse DB Field Information] button on the "Access Table/Procedure Settings" window.

2. Select the DB field name to be used from the list.

The DB field name is not displayed on the list in the following cases. If the target DB field name is not displayed, enter it manually.

- When the DB field name exceeds the maximum number of characters (32 characters (Unicode))
- When the number of DB fields exceeds the maximum number of items displayed (1024 fields)
- When the characters that cannot be used for the DB field name are included
- When the data type is not supported by the DB field

Contents of the list can be updated with the [Refresh] button.

3. Click the [OK] button.

## ■DB procedure information browse

This selects the DB procedure name that can be used in the specified target server from the list.

### Operating procedure

1. Click the [Browse DB Procedure Information] button on the "Access Table/Procedure Settings" window.

2. Select the DB procedure name to be used from the list.

The DB procedure name is not displayed on the list in the following cases. If the target DB procedure name is not displayed, enter it manually.

- When the DB procedure name exceeds the maximum number of characters (32 characters (Unicode))
- When the number of DB procedures exceeds the maximum number of items displayed (1024 procedures)
- When the number of DB procedure arguments exceeds 256
- When the characters that cannot be used for the DB procedure name are included

Contents of the list can be updated with the [Refresh] button.

3. Click the [OK] button.



# Job settings

This section describes the job settings for the MES interface module.

## Job setting list

The job settings in the project are listed.

### Window

Click the "Job Settings" in the edit items tree.

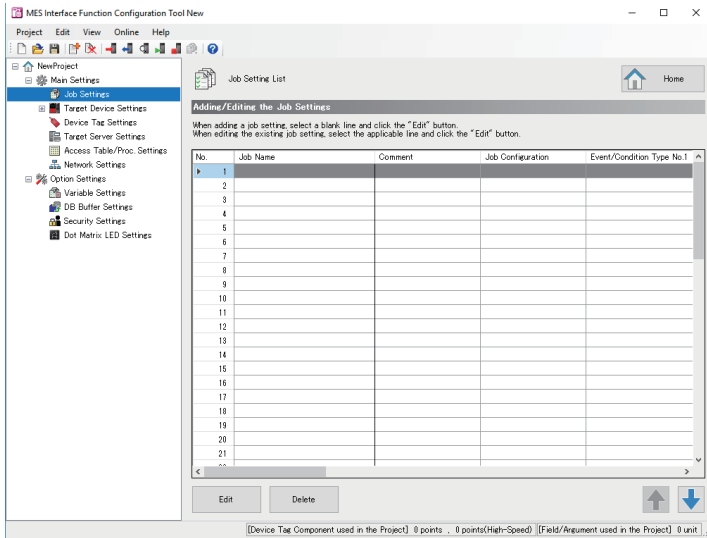

### Displayed items

Item	Description	
Job Setting List	Job Name	Displays the job setting name.
	Comment	Displays the comment set arbitrarily.
	Job Configuration	Displays the job type.
	Event/Condition Type No.1	Displays the event/condition type No.1 of the trigger condition.
	Event/Condition Type No.2	Displays the event/condition type No.2 of the trigger condition.
	Trigger Buffering Setting	Displays whether the trigger buffering setting is enabled or disabled.
	Access Type	Displays the job access type.
	Access Interval	Displays the access interval to read the data used at trigger judgment.
	Reading Target Data	Displays the target data for reading.
	DB Buffering Setting	Displays the settings of the DB buffering.
	DB Buffer Use Size	Displays the size to be a criterion for one DB buffering for the target job.
Verification Settings	Displays the settings of the verification setting.	
[Edit] button	Opens the "Job Settings" window of the selected row.	
[Delete] button	Deletes the settings of selected rows.	

## Job settings

This displays a wizard for editing job settings.

### Window

Click the [Edit] button on the "Job Setting List" window.

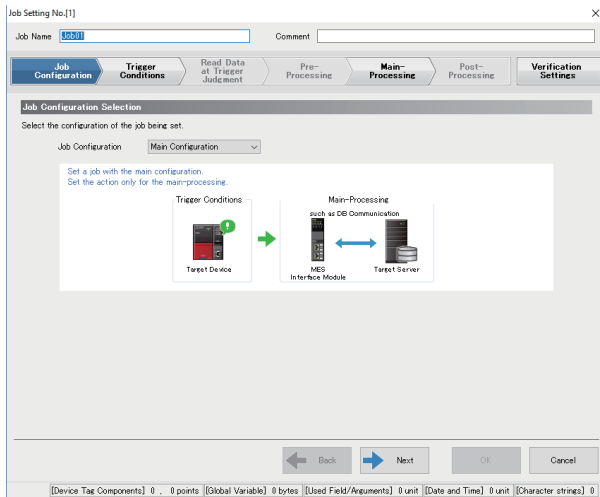

### Displayed items

Item	Description	Reference
Job Name <sup>*1</sup>	Enters a job name.	—
Comment	Sets an arbitrary comment.	—
[Job Configuration] tab	Sets the settings for job configuration.	Page 65 Job configuration
[Trigger Conditions] tab	Sets the settings for trigger condition.	Page 66 Trigger conditions
[Read Data at Trigger Judgment] tab	Selects the data reading method to be used at trigger judgment.	Page 68 Read data at trigger judgment
[Pre-Processing] tab	Sets the settings for pre-processing.	Page 69 Pre-processing
[Main-Processing] tab	Sets the settings for main-processing.	Page 70 Main-processing
[Post-Processing] tab	Sets the settings for post-processing.	Page 72 Post-processing
[Verification Settings] tab	Sets the settings for verification control for a job in verification.	Page 80 Verification settings
[Back] button	Moves to the previous setting window.	—
[Next] button	Moves to the next setting window.	—
[OK] button	Reflects the specified settings.	—

\*1 A same name cannot be used for the job name.

### Point

The setting window can be switched by clicking the set tab directly.  
A set tab has a check mark (☑).

## Job configuration

This selects a job configuration to be set by following the wizard.

### Window

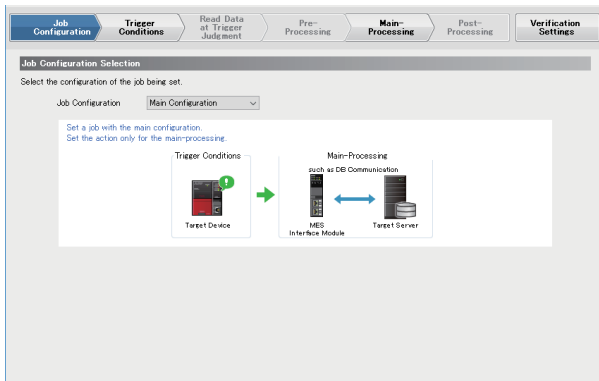

5

### Displayed items

Item		Description
Job Configuration Selection	Job Configuration	Selects the configuration of the job being set.
Settings for No. of Pre-Processing and Post-Processing Actions <sup>*1</sup>	Pre-Processing	Selects this to use the pre-processing.
	No. of Pre-Processing Actions	Specifies the maximum number of settings for actions that are set in the pre-processing.
	Post-Processing	Selects this to use the post-processing.
	No. of Post-Processing Actions	Specifies the maximum number of settings for actions that are set in the post-processing.

\*1 The setting can be set when "Extended Configuration" is selected for the "Job Configuration".

## Trigger conditions

This sets the settings related to job start of the MES interface module.

### Window

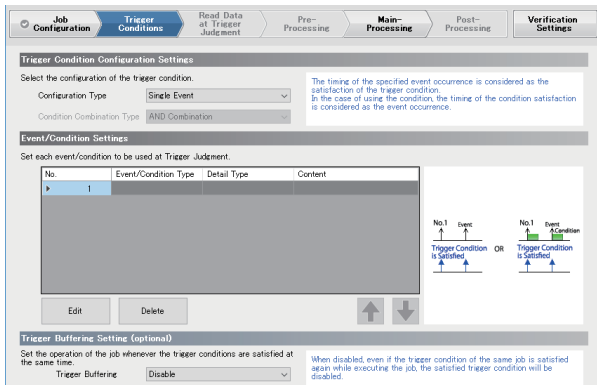

### Displayed items

Item	Description	
Trigger Condition Configuration Settings	Configuration Type	Selects the configuration type for the trigger condition.
	Condition Combination Type	Selects the combination type when combining multiple conditions.
Event/Condition Settings	Event/Condition Type	Displays the event/condition type.
	Detail Type	Displays the detail type.
	Content	Displays the details according to the event/condition type and detail type.
[Edit] button	Opens the "Condition Settings" window of the selected row.	
[Delete] button	Deletes the settings of selected rows.	
Trigger Buffering Setting (optional)	Trigger Buffering	Selects whether the trigger buffering is enabled or disabled.

### Condition settings

This sets the conditions to start a job.

### Operating procedure

1. Click the [Edit] button on the [Trigger Conditions] tab on the "Job Settings" window to set the following items.

Item	Description	
Event/Condition Type Common Settings	Event/Condition Type	Selects the event/condition type.
	Detail Type	Selects the detail type of event/condition.

2. Set the following depending on the event/condition type and detail type.

- Condition (Value Monitoring)

Item	Description	
Event/Condition Type Individual Settings	Monitoring Target	Sets the monitoring target data for the value monitoring.
	(Data Type)	Displays the data type of the monitoring target.
	Condition	Sets the condition for the value monitoring.
	Comparison Target	Sets the comparison target data for the value monitoring.
	(Data Type)	Displays the data type of the comparison target.

- Condition (Period of Time)

Item		Description
Event/Condition Type Individual Settings	Month and Day	Sets the month and day.
	Day of the Week	Sets the day of the week.
	Start Time	Sets the time.
	End Time	

- Event (Value Changed)

Item		Description
Event/Condition Type Individual Settings	Monitoring Target	Sets the monitoring target data for the value changed.
	(Data Type)	Displays the data type of the monitoring target.

- Event (Fixed Time)

Item		Description
Event/Condition Type Individual Settings	Month and Day	Sets the month and day.
	Day of the Week	Sets the day of the week.
	Occurrence Time	Sets the time.

- Event (Fixed Cycle) (Timer Interval)

Item		Description
Event/Condition Type Individual Settings	Timer Interval	Sets the timer interval. Setting range: 1 to 3600

- Event (Fixed Cycle) (Time Interval)

Item		Description
Event/Condition Type Individual Settings	Time Interval	Sets the time interval in an interval and a unit.
	Reference Time	Sets the reference time for the time interval in hours, minutes, and seconds.

- Event (Module Monitoring) (MES Interface Module)

Item		Description
Event/Condition Type Individual Settings	At Start of MES Interface Module	Sets whether to generate an event at start of the MES interface module.
	At Restart/Update of Settings of the MES Interface Function	Sets whether to generate an event when restarting or updating the settings of the MES interface function.

- Event (Module Monitoring) (Control CPU)

Item		Description
Event/Condition Type Individual Settings	Control CPU Status Change	Selects an event for the control CPU status change.

- Handshake

Item		Description
Event/Condition Type Individual Settings	Requirement Source/Notification Destination	Sets the data for the job start request and the job completion notification.
	(Data Type)	Displays the data type of the job start request and the job completion notification.

### 3. Click the [OK] button.

## Read data at trigger judgment

This sets a method, interval, and target to read data used for the trigger condition at trigger judgment.

It can be set when setting "Event/Condition Type" using a device tag in "Event/Condition Settings" on the [Trigger Conditions] tab.

### Window

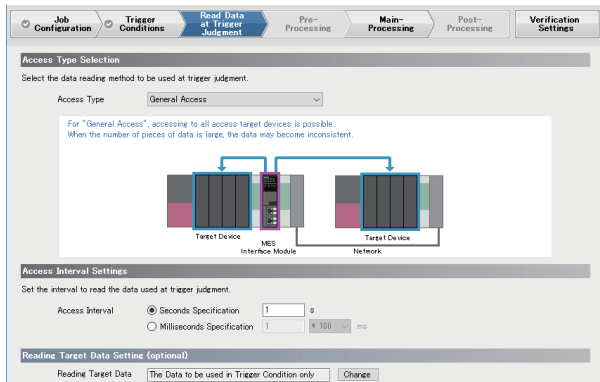

### Displayed items

Item		Description
Access Type Selection	Access Type	Selects the access type.
Access Interval Settings*1	Seconds Specification	Selects this to monitor in seconds and specify the monitoring interval in seconds.
	Milliseconds Specification	Selects this to monitor in milliseconds and specifies the monitoring interval in milliseconds.
Reading Target Data Setting (optional)	Reading Target Data	Displays the reading target data at trigger judgment.
	[Change] button	Opens the "Reading Target Data Setting" window.

\*1 It is not displayed when selecting "High-Speed Access (Each Scan)" for the "Access Type".

## Pre-processing

This sets the action to be executed as the pre-processing of a job.

Pre-processing can be set when selecting "Extended Configuration" for the "Job Configuration" on the [Job Configuration] tab, and selecting "Use".

### Window

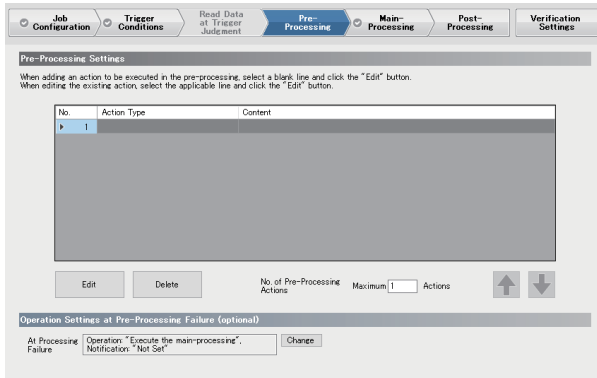

5

### Displayed items

Item		Description
Pre-Processing Settings	Action Type	Displays the action type.
	Content	Displays the outline details of each action according to the action type.
	[Edit] button	Sets an action of the selected row. ☞ Page 73 Action settings
	[Delete] button	Deletes the settings of selected rows.
	No. of Pre-Processing Actions	Specifies the maximum number of settings for the pre-processing action.
Operation Settings at Pre-Processing Failure (optional)	At Processing Failure	Displays the settings of operation at pre-processing failure.
	[Change] button	Opens the "Operation Setting at Pre-Processing Failure" window.

## Main-processing

This sets the action to be executed as the main-processing of a job.

### Window

### Displayed items

Item		Description
Main-Processing Settings	Action Type	Displays the action type.
	Content	Displays the outline details of each action according to the action type.
	[Edit] button	Sets an action of the selected row. Page 73 Action settings
	[Delete] button	Deletes the settings of selected rows.
Operation Settings at Main-Processing Failure/Interruption (optional)	At Processing Failure	Displays the settings when the main-processing is failed (job cancellation).
	At Processing Interruption	Displays the settings when the main-processing is interrupted.
	[Change] button	Opens the "Operation Settings at Main-Processing Failure/Interruption" window.
DB Buffering Settings (optional)	DB Buffering	Displays the settings (following operations) of the "DB Buffering Setting" window.
	DB Buffer Use Size [Byte]	Displays the size to be a criterion for one DB buffering for the job being set.
	[Change] button	Opens the "DB Buffering Setting" window.

### ■ Operation Setting at Main-Processing Failure/Interruption

This sets the job operation when the main-processing is failed or interrupted.

### Operating procedure

1. Click the [Change] button for "Operation Settings at Main-Processing Failure/Interruption (optional)" on the [Main-Processing] tab on the "Job Settings" window to set the following items.

Item		Description
Operation Settings at Main-Processing Failure	Operation	Selects an operation when the main-processing is failed (job cancellation).
	Notification	Selects this to notify the main-processing failure (job cancellation).
	Notification Destination	Specifies the data to be used for the notification destination.
	(Data Type)	Displays the data type to be used for the notification destination.
	Notification Data	Specifies the data to be used as the notification data.
(Data Type)	Displays the data type to be used as the notification data.	
Operation Setting at Main-Processing Interruption	Operation	Selects an operation when the main-processing is interrupted.

2. Click the [OK] button.



## ■DB buffering settings

This sets the DB buffering of the job being set.

### Operating procedure

1. Click the [Change] button for "DB Buffering Settings (optional)" on the [Main-Processing] tab on the "Job Settings" window to set the following items.

Item		Description
DB Buffering Setting	DB Buffering	Selects whether the DB buffering is enabled or disabled, and a buffering area.
	[...] button	Opens the "DB Buffer Settings" window.  MELSEC iQ-R MES Interface Module User's Manual (Application)
Job Operation Settings at DB Buffering	Operation	Selects an operation when the DB buffering is performed in the main-processing.
	Notification	Selects this to notify that the DB buffering is performed in the main-processing.
	Notification Destination	Specifies the data to be used for the notification destination.
	(Data Type)	Displays the data type to be used for the notification destination.
	Notification Data	Specifies the data to be used as the notification data.
(Data Type)	Displays the data type to be used as the notification data.	

2. Click the [OK] button.

## Post-processing

This sets the action to be executed as the post-processing of a job.

Post-processing can be set when selecting "Extended Configuration" for the "Job Configuration" on the [Job Configuration] tab, and selecting "Use".

### Window

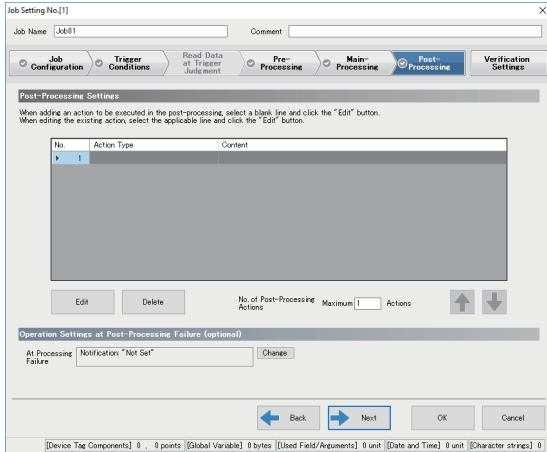

### Displayed items

Item		Description
Post-Processing Settings	Action Type	Displays the action type.
	Content	Displays the outline details of each action according to the action type.
	[Edit] button	Sets an action of the selected row. ☞ Page 73 Action settings
	[Delete] button	Deletes the settings of selected rows.
	No. of Post-Processing Actions	Specifies the maximum number of settings for the post-processing action.
Operation Settings at Post-Processing Failure	At Processing Failure	Displays the settings of operation at post-processing failure.
	[Change] button	Opens the "Operation Setting at Post-Processing Failure" window.

### ■ Operation settings at post-processing failure

This sets the job operation when the post-processing is failed.

### Operating procedure

1. Click the [Change] button on the [Post-Processing] tab on the "Job Settings" window to set the following items.

Item		Description
Operation Settings at Post-Processing Failure	Notification	Selects this to notify the post-processing failure.
	Notification Destination	Specifies the data to be used for the notification destination.
	(Data Type)	Displays the data type to be used for the notification destination.
	Notification Data	Specifies the data to be used as the notification data.
	(Data Type)	Displays the data type to be used as the notification data.

2. Click the [OK] button.

# Action settings

This section describes the settings for processing performed in a job.

## Operating procedure

1. Click the [Edit] button on the [Pre-Processing] tab/[Main-Processing] tab/[Post-Processing] tab on the "Job Settings" window.

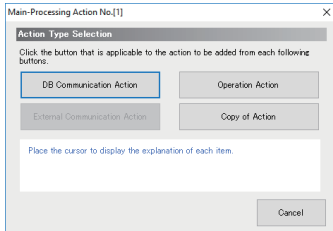

2. Select an action type to be added.

Action type	Description	Reference
DB Communication Action <sup>*1</sup>	Sets the action to input/output data in the target server.	Page 74 DB communication action setting
External Communication Action <sup>*2</sup>	Sets the action to execute the program in the application server.	Page 77 External communication action settings
Operation Action	Sets the action to perform four/remainder arithmetic operations based on the factors such as device tag or variable and constant.	Page 78 Operation action settings
Copy of Action	Copies and adds the set action to utilize.	Page 79 Copy of action

\*1 It cannot be selected for the pre-processing and post-processing.

\*2 It cannot be selected for the main-processing.

3. Set the settings on the setting window of each action.

## DB communication action setting

This sets the action to input/output data in the target server.

### Window

Click the [DB Communication Action] button on the "Action Type Selection" window.

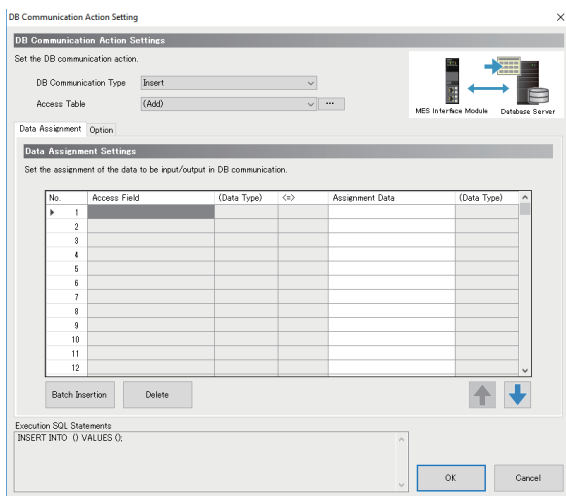

### Displayed items

Item	Description	
DB Communication Action Settings	DB Communication Type	Selects a DB communication type.
	Access Table (Access Procedure)	Selects the target access table (access procedure) for the DB communication.
	[...] button	Opens the "Access Table/Procedure Settings" window of the corresponding access table (access procedure). ☞ Page 60 Access table/procedure settings
[Data Assignment] tab	Sets the data assignment of the MES interface module in the DB communication.	
[Narrowing-Down Conditions] tab	Sets the narrowing-down of the target record in the DB communication.	
[Sorting Order] tab	Sets the priority order of the corresponding record in select.	
[Option] tab	Sets the optional function such as the number of target records notification in each DB communication type.	
[Exception] tab	Sets the operation when an exception occurs in the DB communication.	
Execution SQL Statements (Execution Procedure)	Displays the SQL statements <sup>*1</sup> and procedure executed in the current DB communication action and procedures.	
[OK] button	Reflects the settings.	

\*1 The execution SQL statements may not be displayed properly when using the following combination of modules and software. In that case, update MX MESInterface-R.  
 MES interface module: "06" or later  
 MX MESInterface-R: "1.03D" or earlier

### ■[Data Assignment] tab

Item	Description	
Data Assignment Settings	Access Field (Access Procedure Argument)	Displays the access field (access procedure argument) in the selected access table (access procedure).
	(Data Type)	Displays the data type of the access field (access parameter).
	↔	Displays the data assignment direction.
	Assignment Data	Sets data to be assigned.
	(Data Type)	Displays the data type to be assigned.
[Batch Insertion] button	Opens the "Batch Insertion" window.	
[Delete] button	Deletes the settings of selected rows.	

## ■[Narrowing-Down Conditions] tab

Item		Description
Narrowing-down condition setting list	Combination	Sets the combination method for each narrowing-down condition.
	Access Field	Sets the access field to be used for the narrowing-down condition.
	(Data Type)	Displays the data type of the access field.
	Condition	Sets the condition type of the narrowing-down condition.
	Comparison Target	Sets the data for the comparison target.
	(Data Type)	Displays the data type of the comparison target.
[Batch Insertion] button		Opens the "Batch Insertion" window.
[Delete] button		Deletes the settings of selected rows.

## ■[Sorting Order] tab

Item		Description
Sorting order setting list	Access Field	Sets the access field to be used for the sorting order.
	Order	Selects a sorting order for applicable records.
[Delete] button		Deletes the settings of selected rows.

## ■[Option] tab

- DB Communication Type: Select

Item		Description
Notification Settings of the No. of Applicable Records	Notify the No. of applicable records	Selects this to notify the number of records applied to the narrowing-down condition.
	Notification Destination	Specifies the data to be used for the notification destination.
	(Data Type)	Displays the data type to be used for the notification destination.
Operation Setting at Data Null Field Selection	Substitute the default value	Selects this to store the default value of the access field, if a value (NULL) is selected from a null field.

- DB Communication Type: Insert

Item		Description
Notification Settings of the No. of Inserted Records	Notify the No. of inserted records	Selects this to notify the number of inserted records.
	Notification Destination	Specifies the data to be used for the notification destination.
	(Data Type)	Displays the data type to be used for the notification destination.

- DB Communication Type: Update

Item		Description
Notification Settings of the No. of Updated Records	Notify the No. of updated records	Selects this to notify the number of updated records.
	Notification Destination	Specifies the data to be used for the notification destination.
	(Data Type)	Displays the data type to be used for the notification destination.

- DB Communication Type: Delete

Item		Description
Notification Settings of the No. of Deleted Records	Notify the No. of deleted records	Selects this to notify the number of deleted records.
	Notification Destination	Specifies the data to be used for the notification destination.
	(Data Type)	Displays the data type to be used for the notification destination.

• DB Communication Type: Multiple Select

Item		Description
Notification Settings of the No. of Multiple Selected Records	Notify the record count	Selects this to notify the number of records applied to the narrowing-down condition and the number of selected records.
	Notification Destination	Specifies the data to be used for the notification destination.
	(Data Type)	Displays the data type to be used for the notification destination.
Maximum No. of Records Settings	Set the Maximum No. of Records	Selects this to set the maximum number of records to be selected in Multiple Select.
	Setting Value	Specifies the data to be used for the setting value.
	(Data Type)	Displays the data type to be used for the setting value.
Operation Setting at the No. of Selected Records Insufficient	Clear the unsubstituted assignment data to 0	Selects this to clear the unsubstituted assignment data (up to the maximum number of records) to 0, if the number of selected records is less than the number of array tag components of the assignment data or the specified maximum number of records.
Operation Setting at Data Null Field Selection	Substitute the default value	Selects this to store the default value of the access field, if a value (NULL) is selected from a null field.

• DB Communication Type: Stored Procedure

Item		Description
Return Value Notification Settings	Notify the return value	Selects this to notify the return value of Stored Procedure.
	Notification Destination	Specifies the data to be used for the notification destination.
	(Data Type)	Displays the data type to be used for the notification destination.

■[Exception] tab

Item		Description
No Applicable Record - Exception Settings (optional)	Exception Setting	Displays the operation setting when an exception (no applicable record) occurs.
	[Change] button	Opens the "Exception Settings (No Applicable Record)" window.
Multiple Applicable Records - Exception Settings (optional)	Exception Setting	Displays the operation setting when an exception (multiple applicable records) occurs.
	[Change] button	Opens the "Exception Settings (Multiple Applicable Records)" window.
Applicable Record Overflow - Exception Settings (optional)	Exception Setting	Displays the operation setting when an exception (applicable record overflow) occurs.
	[Change] button	Opens the "Exception Settings (Applicable Records Overflow)" window.

## External communication action settings

This sets the action to execute the program in the application server.

### Window

Click the [External Communication Action] button on the "Action Type Selection" window.

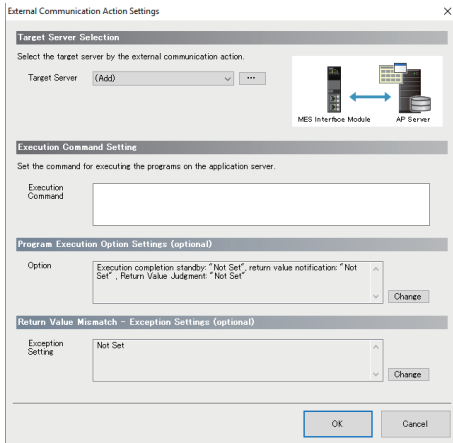

5

### Displayed items

Item	Description	
Target Server Selection	Target Server	Selects the target server for the external communication action.
	[...] button	Opens the "Target Server Settings" window for the corresponding target server. ☞ Page 58 Target server settings
Execution Command Setting	Execution Command	Sets commands to be executed in the program execution.
Program Execution Option Settings (optional)	Option	Displays the settings of the optional function such as execution completion standby.
	[Change] button	Opens the "Program Execution Option Setting" window.
Return Value Mismatch - Exception Settings (optional)	Exception Setting	Displays the settings of the operation when the return value does not match with the expected value.
	[Change] button	Opens the "Exception Settings (Return Value Mismatch)" window.
[OK] button		Reflects the settings.

## Operation action settings

This sets the action to perform four/remainder arithmetic operations based on the factors such as device tag or variable and constant.

### Window

Click the [Operation Action] button on the "Action Type Selection" window.

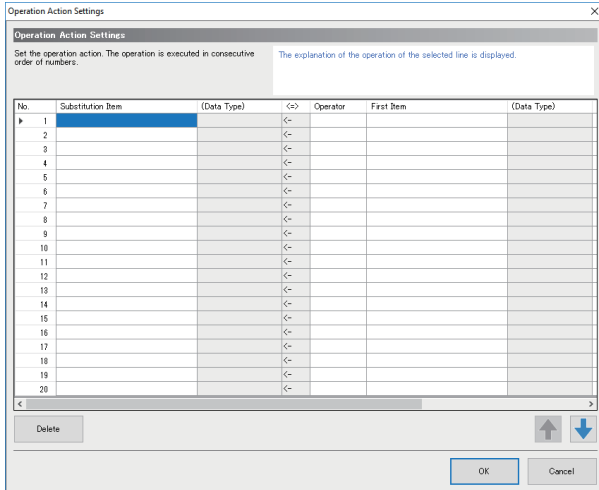

### Displayed items

Item		Description
Operation Action Settings	Substitution Item	Sets the data to substitute the operation result.
	(Data Type)	Displays the data type to substitute the operation result.
	Operator	Selects an operator.
	First Item	Sets the data (first item) to be used for operation.
	(Data Type)	Displays the data type (first item) to be used for operation.
	Second Item	Sets the data (second item) to be used for operation.
	(Data Type)	Displays the data type (second item) to be used for operation.
[Delete] button		Deletes the data corresponding to the selected rows.
[OK] button		Reflects the settings.



## Copy of action

This copies and adds the set action to utilize.

### Window

Click the [Copy of Action] button on the "Action Type Selection" window.

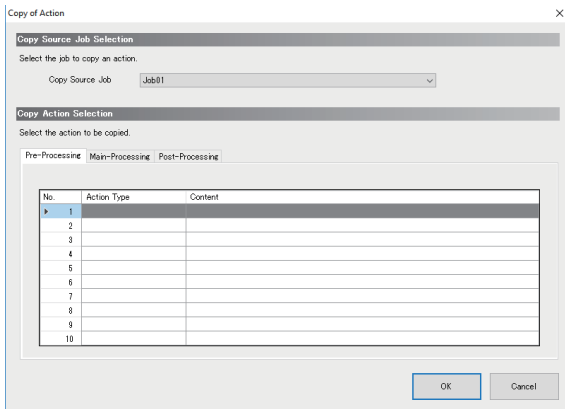

5

### Displayed items

Item		Description
Copy Source Job Selection	Copy Source Job	Selects the job to copy an action.
Copy Action Selection* <sup>1</sup>	Action Type	Displays the action type to be copied.
	Content	Displays the details of action to be copied.
[OK] button		Copies the selected action.

\*1 The display details are the same in the [Pre-Processing] tab, [Main-Processing] tab, and the [Post-Processing] tab.

# Verification settings

This sets log output settings (working history, detailed log) and input/output simulation settings (device tag writing control, DB output control) for job verification.

## Window

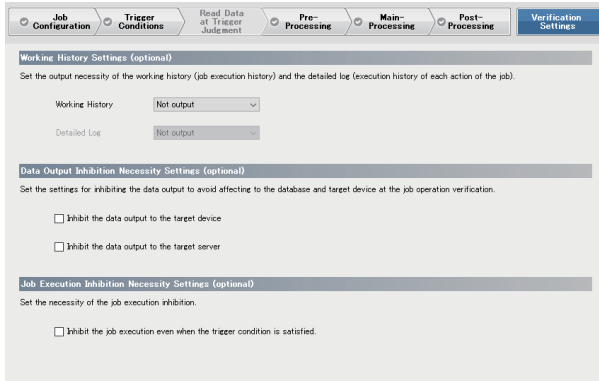

## Displayed items

Item		Description
Working History Settings (optional)	Working History	Selects whether to output or not output the working history.
	Detailed Log	Selects whether to output or not output the detailed log.
Data Output Inhibition Necessity Settings (optional)	Inhibit the data output to the target device	Selects this to inhibit the data output to avoid affecting to the target device at the job operation verification.
	Inhibit the data output to the target server	Selects this to inhibit the data output to avoid affecting to the target server at the job operation verification.
Job Execution Inhibition Necessity Setting (optional)	Inhibit the job execution even when the trigger condition is satisfied.	Selects this to inhibit the job execution even when the trigger condition is satisfied.

## 5.3 DB Connection Service and Setting Tool

This section describes DB Connection Service and DB Connection Service Setting Tool.

### DB Connection Service functions

The information linkage function of the MES interface module can be used by installing DB Connection Service on the server.

#### DB connection function

The DB connection function connects the MES interface module and the ODBC interface for database.

The following shows the operation on the database server.

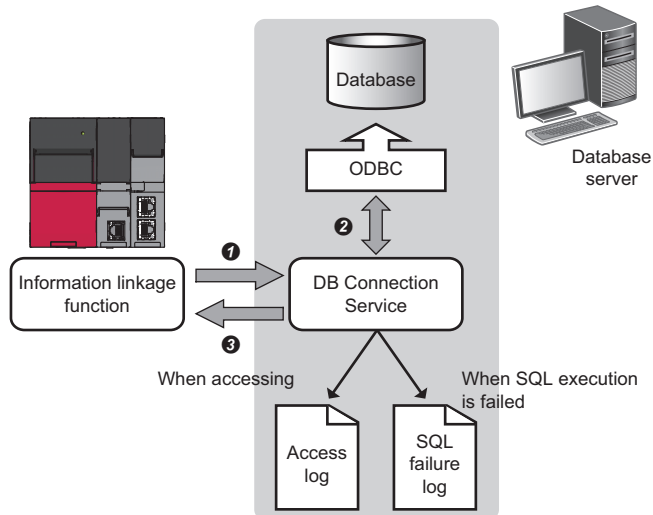

- 1 An SQL statement or stored procedure execution request is received from the information linkage function performing on the MES interface mode.
- 2 The SQL statement or stored procedure is executed by accessing the database via ODBC interface.
- 3 The execution result is sent to the MES interface module.

## Program execution function

The program execution function performs a program on the application server upon request from the MES interface module. The following shows the operation on the application server.

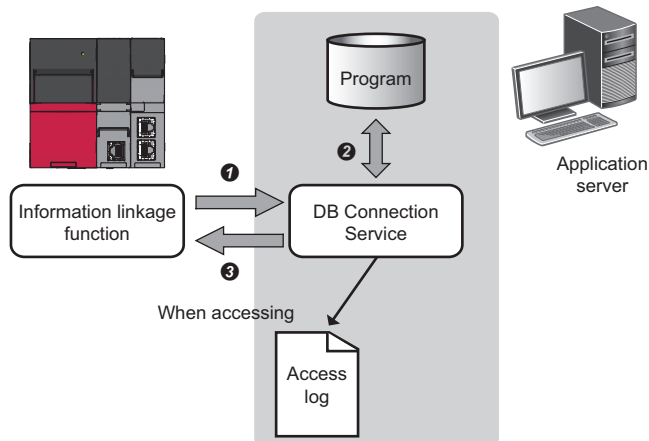

- ❶ A program execution request is received from the information linkage function performing on the MES interface module.
- ❷ The program on the application server is executed. \* 1
- ❸ The program execution result is sent to the MES interface module.

\*1 DB Connection Service Client (user session) executes programs.  
DB Connection Service Client is automatically started at the time of user login.

## DB information browse function

This function sends table information (such as table names and field names) or stored procedure information in the database to MES Interface Function Configuration Tool.

The function is performed when browsing the table information or stored procedure information with the communication action setting of MES Interface Function Configuration Tool.

☞ Page 62 DB table information browse

☞ Page 62 DB field information browse

☞ Page 62 DB procedure information browse

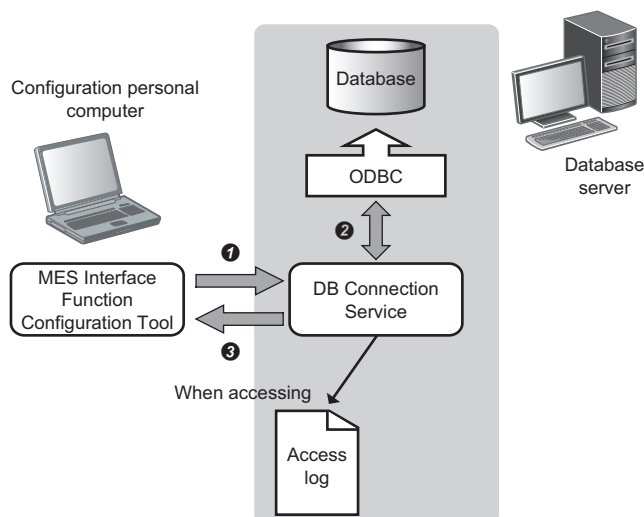

- ❶ When clicking the [Browse DB Table Information] button, the [Browse DB Field Information] button, or the [Browse DB Procedure Information] button of MES Interface Function Configuration Tool, a request to browse the table information or stored procedure information is received from MES Interface Function Configuration Tool.
- ❷ The table information (table name and field name) or stored procedure information in the database is acquired.
- ❸ The table information (table name and field name) or stored procedure information is returned to MES Interface Function Configuration Tool.

## Security function

The security function can specify the IP address of the MES interface module and a configuration personal computer that can connect to DB Connection Service to ensure the security of the server.

Batch specification using the mask bit length specification is possible.

If the security function is not used, any MES interface module and configuration personal computer can be connected to DB Connection Service.

## Log output function

DB Connection Service outputs an access log and an SQL failure log.

### ■Access log

The communication details between the MES interface module and DB Connection Service are output to the access log.

For access log specifications, refer to the following.

 Page 124 Access log

### ■SQL failure log

The error information are output to the SQL failure log when the SQL statement or stored procedure cannot be completed normally in the database due to the reason such as no table exists.

For SQL failure log specifications, refer to the following.

 MELSEC iQ-R MES Interface Module User's Manual (Application)

### ■Log charset specification

A log file (access log, SQL failure log) is output in ASCII/SJIS or Unicode (UTF-8) depending on the log charset specification of DB Connection Service Setting Tool.

When the settings of the "Log charset" are changed, a new log is output by switching the output file, even if the "access log capacity" specified by the user is not achieved.

The file name at the time of switching the output file is changed in the same way as when the file capacity exceeds.

# Setting items

The following shows how to change the settings of DB Connection Service.

The settings of DB Connection Service which is currently in operation are displayed during start.

## Operating procedure

1. Set the following items, then click the [Reflect settings] button.

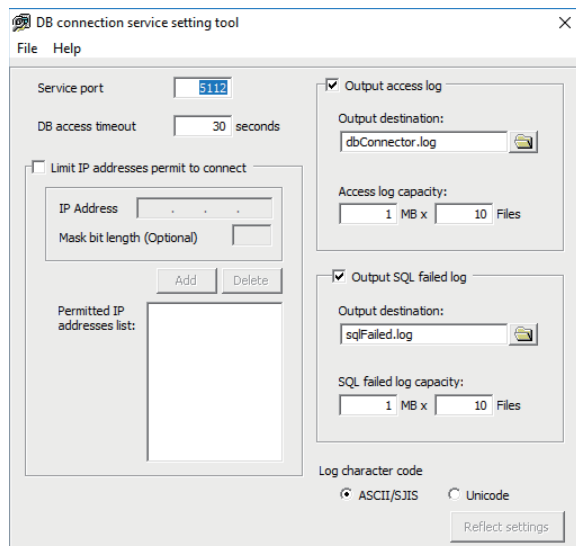

Item	Description
Service port (required)	Sets the port number where DB Connection Service operates.
DB access timeout (required)	Sets the value of "DB access timeout" (unit: second) for the case when no response is returned to the MES interface module after requesting the server to write/read the value to/from the database or execute a program.
Limit IP addresses permit to connect	Specifies whether to set the connection-permitted IP address.
Output access log	Sets whether to output the access log.
Output SQL failed log	Sets whether to output the SQL failure log.
Log character code	Specifies the character code of the log file (access log, SQL failure log) that is output by DB Connection Service in ASCII/SJIS or Unicode.

2. After updating the settings, check whether any errors occurs by selecting [Administrative Tools] ⇒ [Event Viewer] of Windows.

## Precautions

- Change the settings of DB Connection Service when a job using DB Connection Service is not operating.

The status is as follows:

- The programmable controller is powered off.
- The MES interface function is stopped to perform with [Online] ⇒ [Remote operation] of MES Interface Function Configuration Tool. (Page 115 MES interface module diagnostics)
- When reflecting the settings while a job using DB Connection Service is running, the execution of the connected job is canceled and a communication error occurs.

For a job in which the DB buffering is enabled, any SQL statement is buffered in the DB buffer.

## Service port (required)

This sets the port number where DB Connection Service operates. <sup>1,\*2</sup>

The set port number is used for communications with the MES interface module and a configuration personal computer.

\*1 Set the value in [Service port] same as the one set in [Port No.] of [Access Target Server Settings] of MES Interface Function Configuration Tool.

 Page 93 Setting a target server

\*2 Specify a port number that is not being used by any database or other applications. Usually, it does not need to be changed.

### Setting data

Setting range: 1024 to 65535, Default: 5112

## DB access timeout (required)

This sets the value of "DB access timeout" (unit: second) for the case when no response is returned to the MES interface module or a configuration personal computer after requesting the server to write/read the value to/from the database or execute a program.

When a timeout occurs, the connection with the MES interface module or the configuration personal computer is disconnected and job execution is canceled.

Set the setting values in "Connection time out time" for [Access Target Server Settings] in MES Interface Function Configuration Tool and "DB access timeout time" in DB Connection Service Setting Tool as follows:

- Setting value of connection timeout time  $\leq$  setting value of DB access timeout time

### Setting data

Setting range: 1 to 3600, Default: 30

## Limit IP addresses permit to connect

This specifies whether to set the connection-permitted IP address.

By selecting the "Limit IP addresses permit to connect" checkbox, connection is permitted only from the MES interface module and the configuration personal computer with the set IP address.

At least one IP address needs to be set for connection-permitted IP address. Up to 64 IP addresses can be set for it.

When not selecting the "Limit IP addresses permit to connect" checkbox, connection is permitted from any MES interface module and configuration personal computer.

When selecting the "Limit IP addresses permit to connect" checkbox, set the IP addresses with connection permission.

## Outputting access log

For details, refer to the following.

 Page 124 Access log

## Output SQL failed log

This sets whether to output the SQL failure log.

When selecting the "Output SQL failed log" checkbox, set the following items.

Item	Description
Output destination	Sets the output destination of a log file.
SQL failed log capacity	Sets the file capacity for each SQL failure log and number of files.

### Setting data

Default: Output

#### ■Output destination

This sets the output destination of a log file.

If no output destination is set, the log is output to an install folder.

If a read-only file is specified, the log is not output and "SQL failure log output error" is output to [Administrative Tools] ⇒ [Event Viewer] of Windows.

### Setting data

Default: "sqlFailed.log"

#### ■SQL failed log capacity

This sets the file capacity for each SQL failure log and number of files.

If the capacity for a file is exceeded, the log is copied to a file with a numbered file name and a new log file is created.

If the total number of files exceeds the one which is set, the file is deleted from the oldest one.

### Setting data

Setting range: 1 to 10 MB × 2 to 100 files, Default: 1 MB × 10 files

## Specify the log character set

This specifies the character code of a log file (access log, SQL failure log) that is output by DB Connection Service in ASCII/SJIS or Unicode.

The specified character code is enabled after the settings are updated.

### Setting data

Default: ASCII/SJIS



# Help

---

The product information of DB Connection Service Setting Tool and the "Connection to MITSUBISHI ELECTRIC FA Global Website" window are displayed.

## Product information

---

### Operating procedure

1. Select [Help] ⇒ [Product information] from the menu.
2. The "Product information" window of DB Connection Service Setting Tool appears.

## Connection to MITSUBISHI ELECTRIC FA Global Website

---

### Operating procedure

1. Select [Help] ⇒ [Connect to MITSUBISHI ELECTRIC FA Global Website] from the menu.
2. The MITSUBISHI ELECTRIC FA Global Website appears.

# 6 LINKING WITH DATABASE

---

In this chapter, trainees set parameters with MES Interface Function Configuration Tool and check that information is input/output from the database

## 6.1 Parameter Settings

---

This section describes how to set the parameters with MES Interface Function Configuration Tool and DB Connection Service Setting Tool.

The following is the standard setup procedure.

1. Set two Ethernet ports and a common host name in [Network Settings]. (☞ Page 89 Setting a network)
2. Set a connection route to access a device existing in the own station or other stations from the MES interface module in [Target Device Settings]. (☞ Page 90 Setting a target device)
3. Set a logic name to the device memory of the target device as a tag component in [Device Tag Settings]. Also, set the group of device tag components as a device tag. (☞ Page 91 Setting device tags)
4. Set the server type, network information, and user authentication information in [Target Server Settings]. (☞ Page 93 Setting a target server)
5. Set a logic name to the table/procedure and field/procedure argument of the database as an access table/procedure and access field/procedure argument in [Access Table/Proc. Settings]. (☞ Page 94 Setting access tables)
6. Set the trigger condition that collects or transfers data, and create a transaction that relates the specific data with an action in [Job Settings]. (☞ Page 98 Setting jobs (GettingProject), Page 103 Setting jobs (Reporting))

# Parameter setting procedure of MES Interface Function Configuration Tool

## Starting MES Interface Function Configuration Tool

### Operating procedure

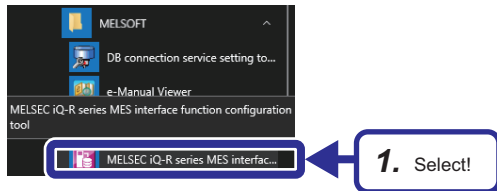

1. Select [MELSOFT] ⇒ [MELSEC iQ-R Series MES interface function configuration tool] from Windows Start.

## Setting a network

### Operating procedure

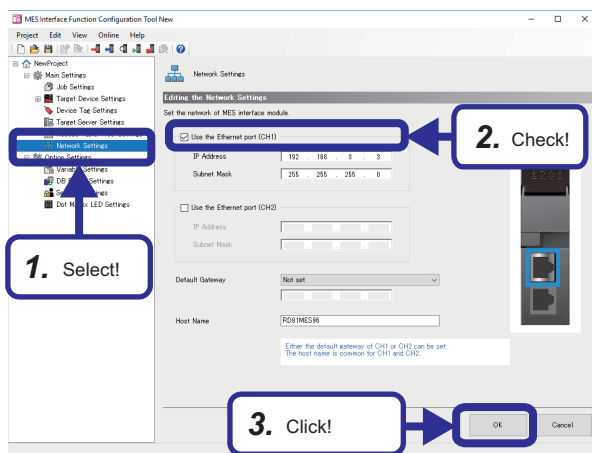

1. Select [Network Settings] in the edit item tree.
2. Check that the "Use the Ethernet port (CH1)" checkbox is selected because the Ethernet port (CH1) is connected.

### Point

This setting is used as a default.

3. Click the [OK] button.

## Setting a target device

### Operating procedure

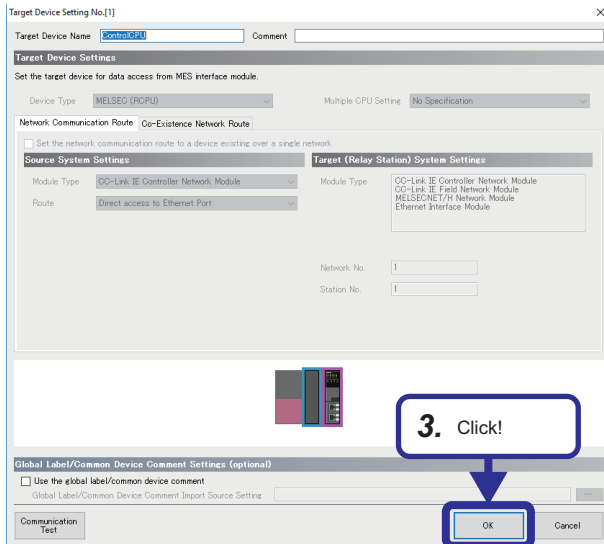
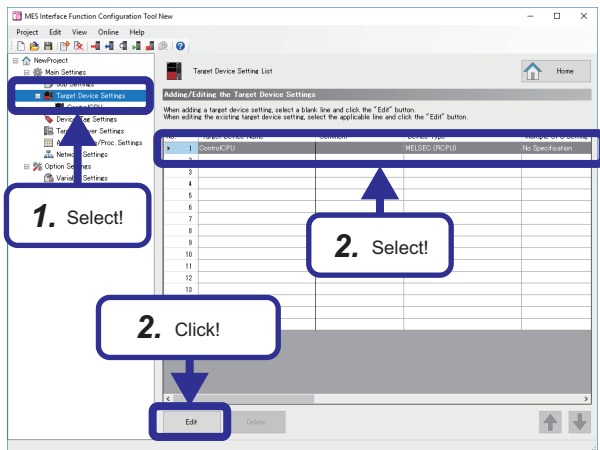

1. Select [Target Device Settings] in the edit item tree.
2. Select "ControlCPU", and click the [Edit] button.

3. Check the details, and click the [OK] button.

**Point**

This setting is used as a default.

## Setting device tags

This sets which data is used in which device(address) in the device specified in the target device setting.

The device tag "GettingData" is set for the device that selects the production information. The device tag "PuttingData" is set for the device that inserts the production result into the database.

### Operating procedure

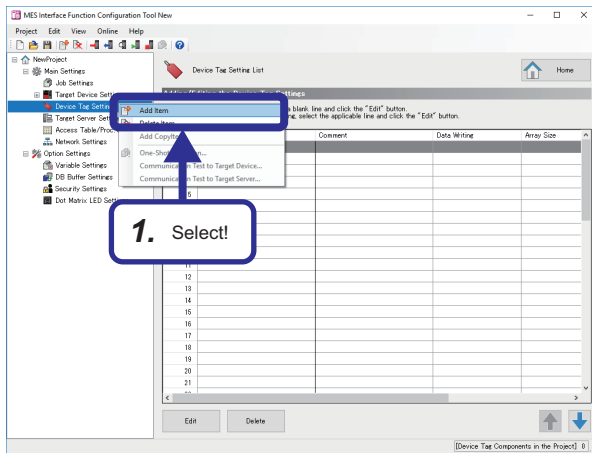

1. Right-click [Device Tag Settings] in the edit item tree, and select [Add Item].

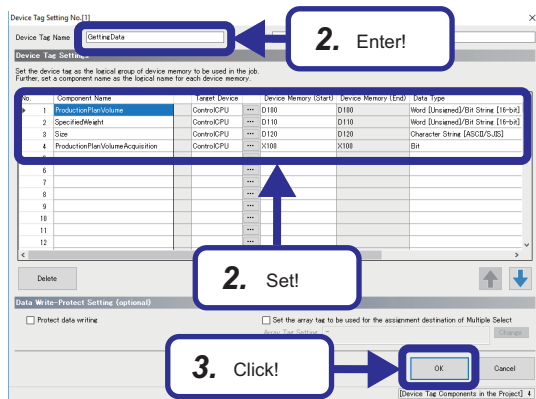

2. Enter "GettingData" in "Device Tag Name", and set each setting item according to the following table.
3. Click the [OK] button.

Component Name	Target Device	Device Memory (Start)	Device Memory (End)	Data Type	Length
Production plan volume	ControlCPU	D100	D100	Word [Unsigned]/Bit String [16-bit]	—
Specified weight	ControlCPU	D110	D110	Word [Unsigned]/Bit String [16-bit]	—
Size	ControlCPU	D120	D120	Character string [ASCII/SJIS]	2
Production plan volume acquisition	ControlCPU	X100	X100	Bit	—



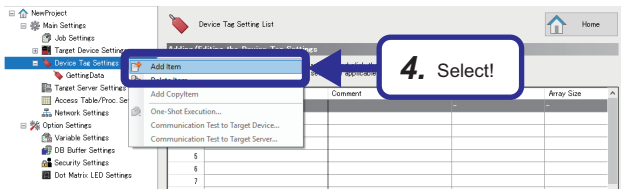

4. Add another device tag.

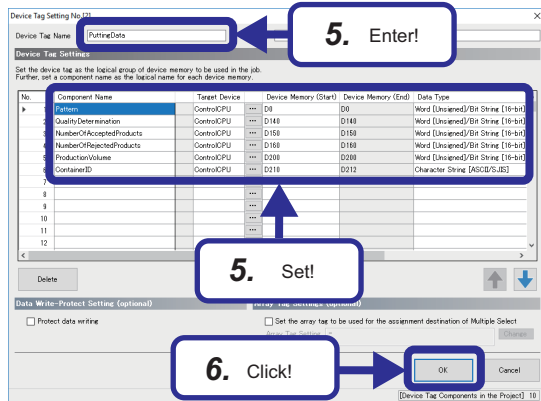

5. Enter "PuttingData" in the "Device Tag Name", and set each setting item according to the following table.

6. Click the [OK] button.

Component Name	Target Device	Device Memory (Start)	Device Memory (End)	Data Type	Length
Pattern	ControlCPU	D0	D0	Word [Unsigned]/Bit String [16-bit]	—
Quality determination	ControlCPU	D140	D140	Word [Unsigned]/Bit String [16-bit]	—
Number of accepted products	ControlCPU	D150	D150	Word [Unsigned]/Bit String [16-bit]	—
Number of rejected products	ControlCPU	D160	D160	Word [Unsigned]/Bit String [16-bit]	—
Production volume	ControlCPU	D200	D200	Word [Unsigned]/Bit String [16-bit]	—
Container ID	ControlCPU	D210	D212	Character string [ASCII/SJIS]	6

# Setting a target server

## Operating procedure

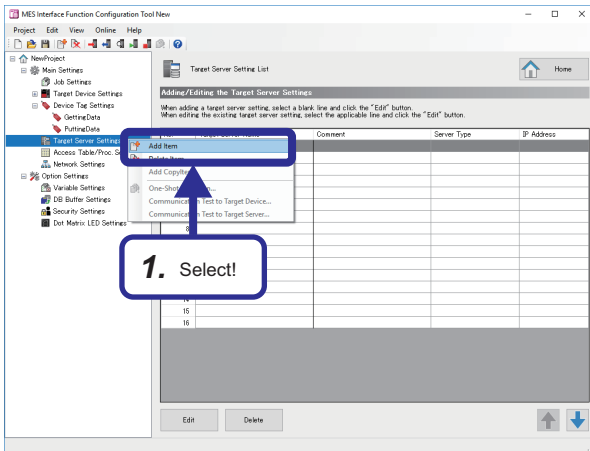

1. Right-click [Target Server Settings] in the edit item tree, and select [Add Item].

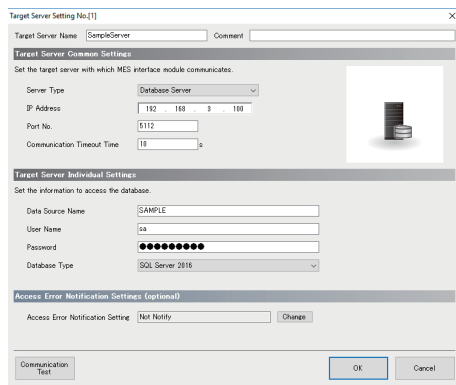

2. Enter "SampleServer" in "Target Server Name", and set each setting item according to the following table.

Setting Item	Settings	
Target Server Name	SampleServer	
Target Server Common Settings	Server Type	Database Server
	IP Address	192.168.3.100
	Port No.	5112
	Communication Timeout Time	10
Target Server Individual Settings	Data Source Name	SAMPLE
	User Name	sa
	Password	Fatec_MES
	Database Type	SQL Server 2016
Access Error Notification Setting (optional)	Access Error Notification Setting	Not Notify

## Precautions

- Set the same IP address as TCP/IP of the personal computer.
  - ☞ Page 148 TCP/IP Setting on Personal Computer
- Set the same data source name as the one set on the [System DSN] in the ODBC setting.
  - ☞ Page 37 ODBC (Open Database Connectivity) Setting
- Set the same user name and password as the one set in the database.
 

The user name/password are the same as the login ID and password that are entered when the device is connected to the following server.

  - ☞ Page 34 Database table creation procedure

## Setting access tables

This sets an access table by grouping some fields in the target database to be accessed from the MES interface module. The access table/procedure name "ProjectTable" is set for the table that selects the production information from the database. The access table/procedure "JudgementTable" is set for the table that inserts the production result into the database.

### Operating procedure

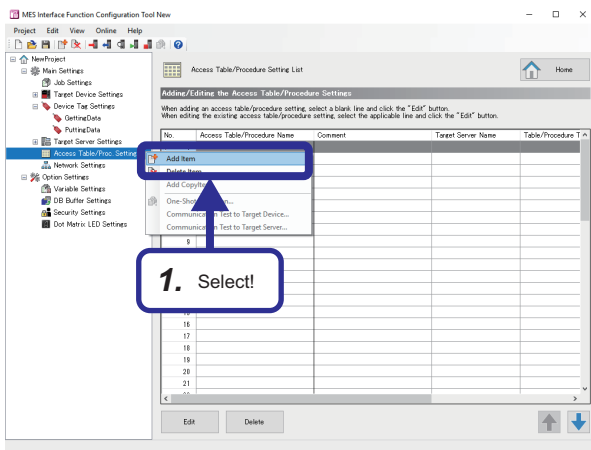

1. Right-click [Access Table/Proc. Settings] in the edit item tree, and select [Add Item].

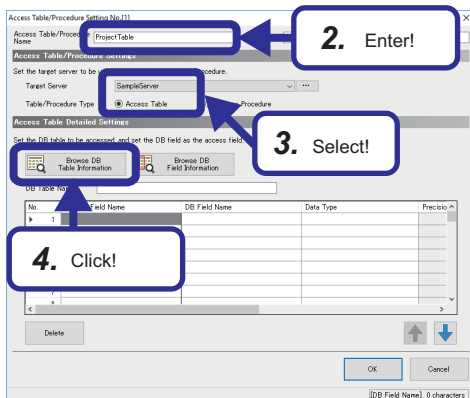

2. Enter "ProjectTable" in "Access Table/Procedure Name".
3. Select "SampleServer" in "Target Server" in "Access Table/Procedure Settings", and select "Access Table" in "Table/Procedure Type".
4. Click the [Browse DB Table Information] button in "Access Table Detailed Settings".

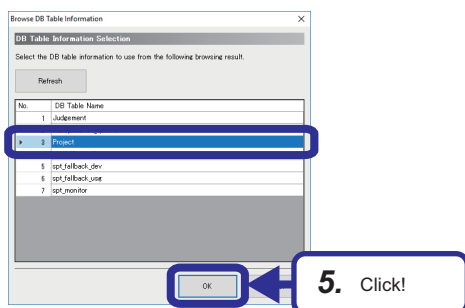

5. Select "Project", and click the [OK] button.





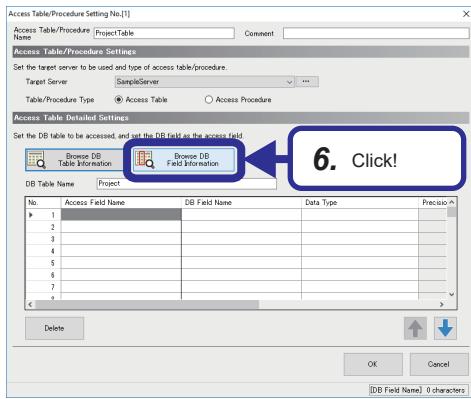

- Click the [Browse DB Field Information] button in "Access Table Detailed Settings".

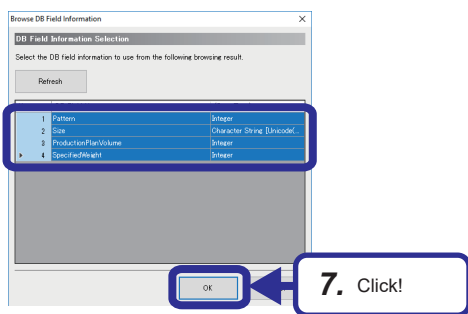

- Select "Pattern", "Size", "ProductionPlanVolume", and "SpecifiedWeight", and click the [OK] button.

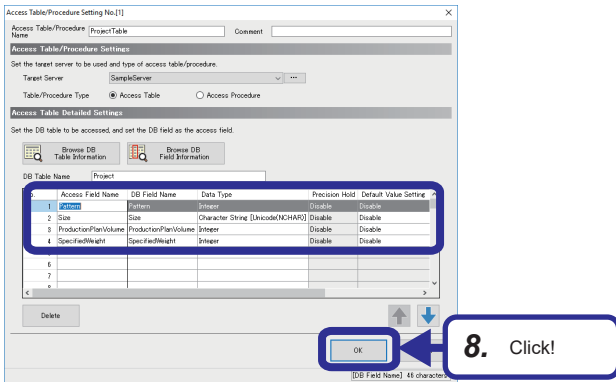

- Set each setting item according to the following table, and click the [OK] button.

Access Field Name	DB Field Name	Data Type	Precision Hold	Default Value Setting	Default Value
Pattern	Pattern	Integer	Disable	Disable	—
Size	Size	Character String [Unicode(NCHAR)]	Disable	Disable	—
ProductionPlanVolume	ProductionPlanVolume	Integer	Disable	Disable	—
SpecifiedWeight	SpecifiedWeight	Integer	Disable	Disable	—



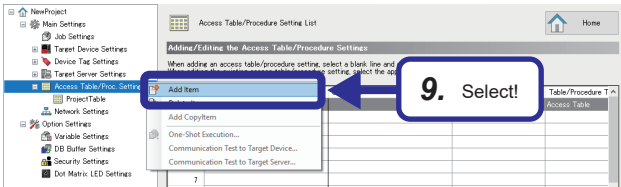

9. Add another access table/procedure.

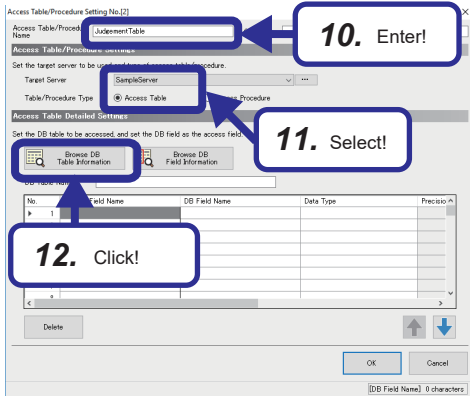

10. Enter "JudgementTable" in "Access Table/Procedure Name".

11. Select "SampleServer" in "Target Server" in "Access Table/Procedure Settings", and select "Access Table" in "Table/Procedure Type".

12. Click the [Browse DB Table Information] button in "Access Table Detailed Settings".

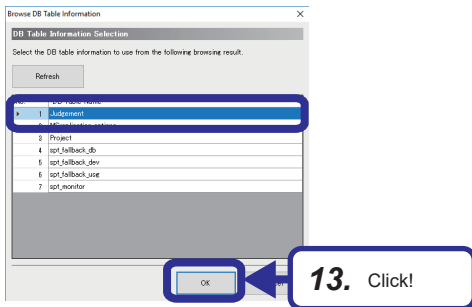

13. Select "Judgement", and click the [OK] button.

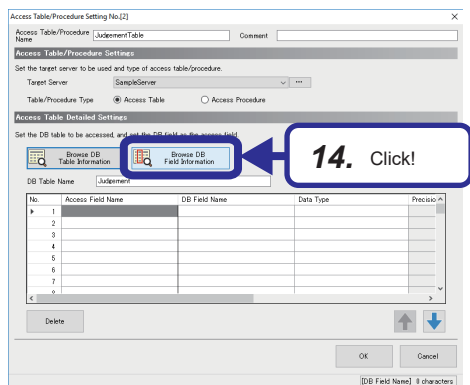

14. Click the [Browse DB Field Information] button in "Access Table Detailed Settings".



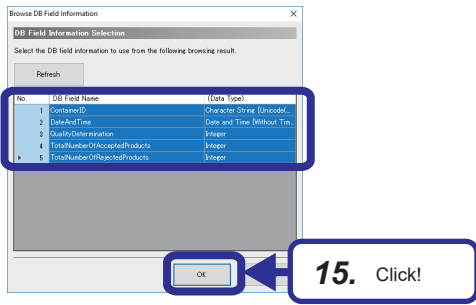

15. Select "ContainerID", "DateAndTime", "QualityDetermination", "TotalNumberOfAcceptedProducts", and "TotalNumberOfRejectedProducts", and click the [OK] button.

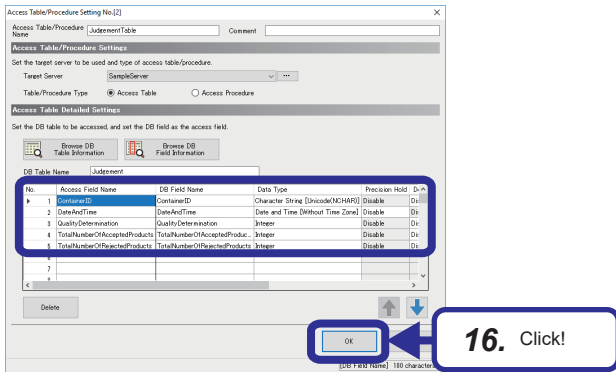

16. Set each setting item according to the following table, and click the [OK] button.

Access Field Name	DB Field Name	Data Type	Precision Hold	Default Value Setting	Default Value
ContainerID	ContainerID	Character String [Unicode(NCHAR)]	Disable	Disable	—
DateAndTime	DateAndTime	Date and Time [Without Time Zone]	Disable	Disable	—
QualityDetermination	QualityDetermination	Integer	Disable	Disable	—
TotalNumberOfAcceptedProducts	TotalNumberOfAcceptedProducts	Integer	Disable	Disable	—
TotalNumberOfRejectedProducts	TotalNumberOfRejectedProducts	Integer	Disable	Disable	—

## Setting jobs (GettingProject)

This sets when and how the MES interface module operates to the database.

When the production information acquisition button is touched (X100 is turned on), set the conditions to select the production information from the database.

### Operating procedure

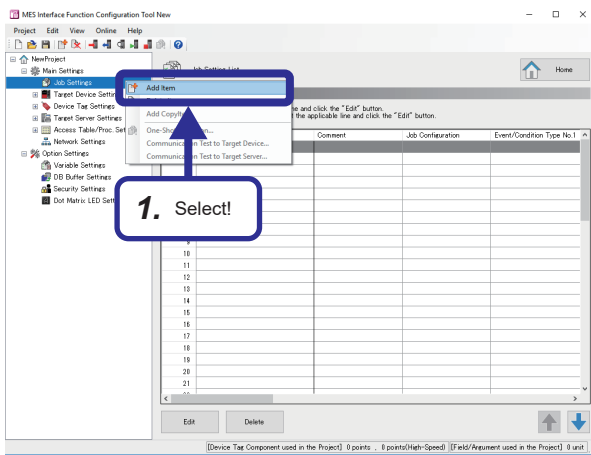

1. Right-click [Job Settings] in the edit item tree, and select [Add Item].

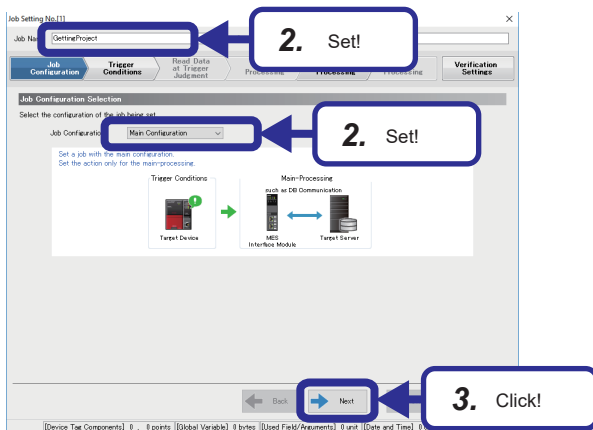

2. Set each setting item as follows in the [Job configuration] tab.  
[Setting details]  
Job Name: GettingProject  
Job Configuration: Main Configuration
3. Click the [Next] button.



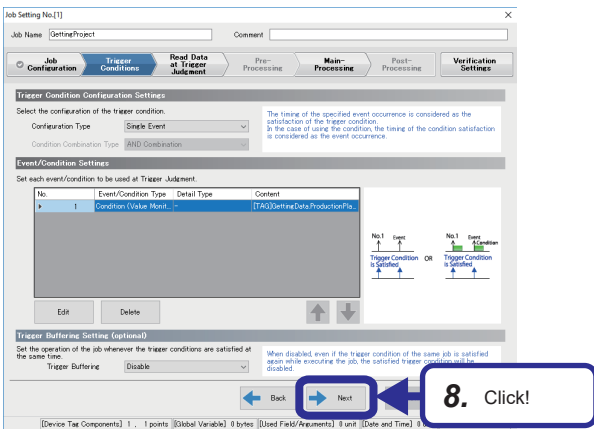
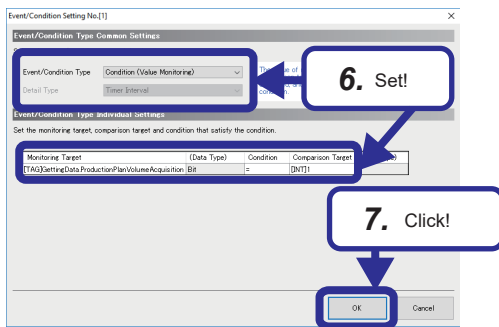
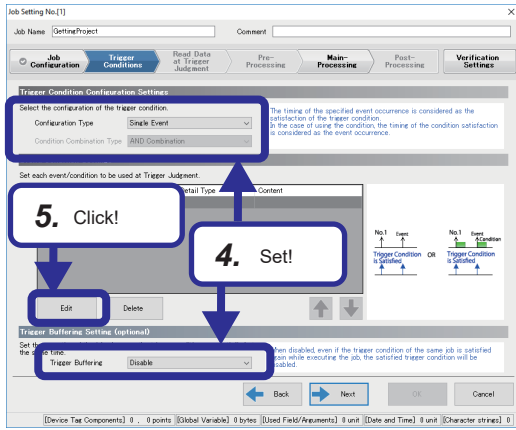

4. Set each setting item as follows in the [Trigger Conditions] tab.  
[Setting details]  
Configuration Type: Single Event  
Condition Combination Type: —  
Trigger Buffering: Disable
5. Click the [Edit] button.

6. Set each setting item as follows on the "Event/Condition Setting" window.  
[Setting details]  
Event/Condition Type: Condition (Value Monitoring)  
Monitoring Target:  
[TAG]GettingData.ProductionPlanVolumeAcquisition  
(Data Type): Bit  
Condition: =  
Comparison Target: [INT]1\*1
- \*1 "[INT]1" is set on the "Integer Type Constant Settings" window.  
"Comparison Target" ⇒ "Constant" ⇒ "[Integer]"

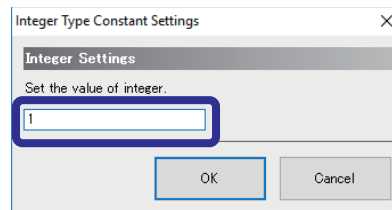

7. Click the [OK] button.
8. Click the [Next] button.

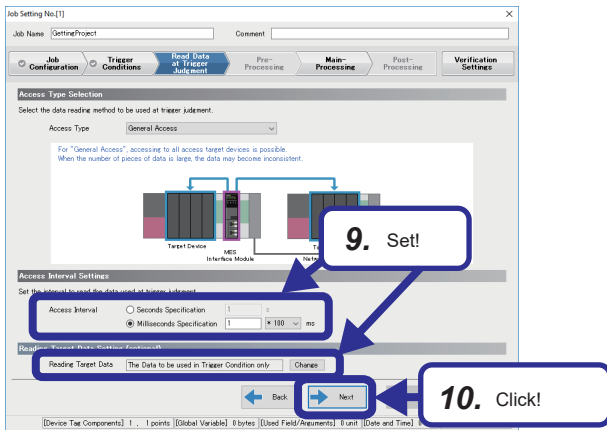

9. Set each setting item as follows in the [Read Data at Trigger Judgment] tab.  
 [Setting details]  
 Access Type: General Access  
 Access Interval: Milliseconds Specification: "1" ×100 ms  
 Reading Target Data: The Data to be used in Trigger Condition only
10. Click the [Next] button.

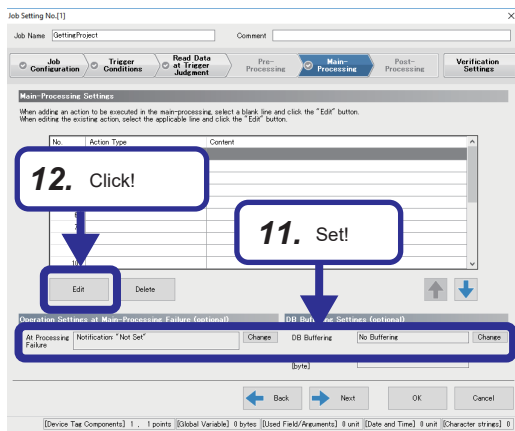

11. Set each setting item as follows in the [Main-Processing] tab.  
 [Setting details]  
 At Processing Failure: Notification: "Not Set"  
 DB Buffering: No Buffering
12. Click the [Edit] button.

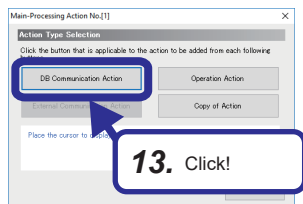

13. Click the [DB Communication Action] button on the "Main-Processing Action" window.



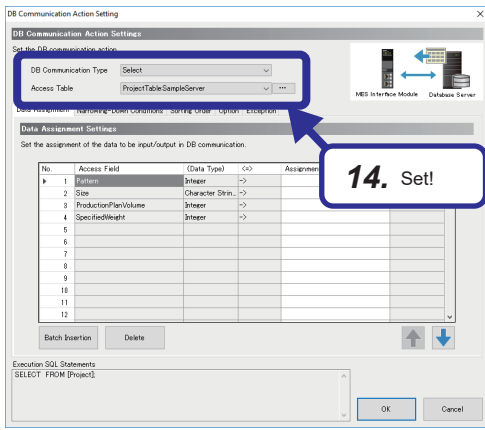

**14.** Set each setting item as follows on the "DB Communication Action Setting" window.  
 [Setting details]  
 DB Communication Type: Select  
 Access Table: ProjectTable.SampleServer

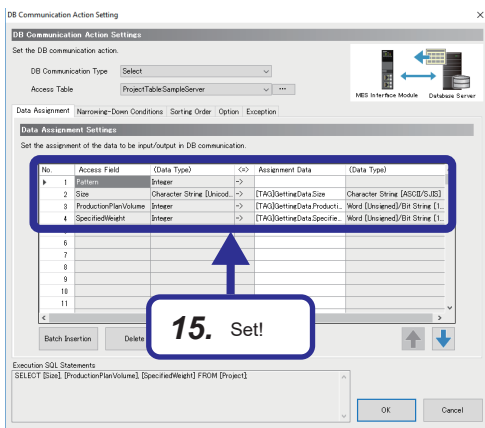

**15.** Set each setting item as follows in the [Data Assignment] tab and the [Narrowing-Down Conditions] tab.

**16.** Click the [OK] button.

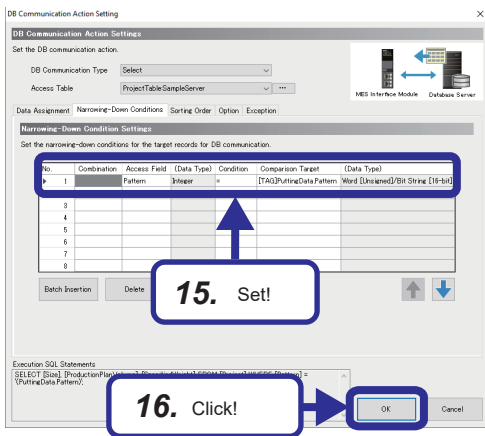

• [Data Assignment] tab

Access Field	(Data Type)		Assignment Data	(Data Type)
Pattern	Integer	→	—	—
Size	Character String [Unicode(NCHAR)]	→	[TAG]GettingData.Size	Character String [ASCII/SJIS]
ProductionPlanVolume	Integer	→	[TAG]GettingData.ProductionVolume	Word [Unsigned]/Bit String [16-bit]
SpecifiedWeight	Integer	→	[TAG]GettingData.SpecifiedWeight	Word [Unsigned]/Bit String [16-bit]

• [Narrowing-Down Conditions] tab

Combination	Access Field	(Data Type)	Condition	Comparison Target	(Data Type)
—	Pattern	Integer	=	[TAG]PuttingData.Pattern	Word [Unsigned]/Bit String [16-bit]



17. Click the [Next] button.

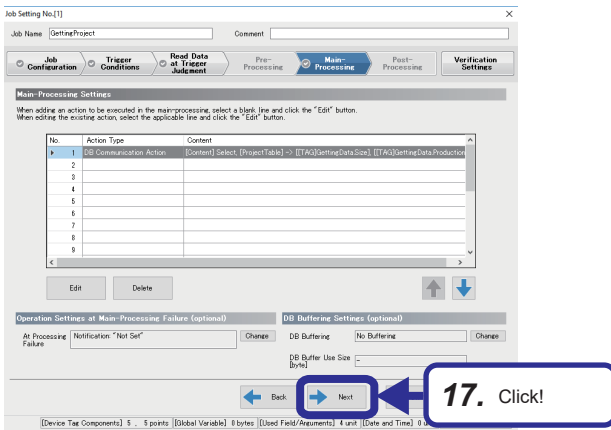

18. Set each setting item as follows in the [Verification Settings] tab.

[Setting details]

Working History: Not output

Detailed Log: —

Inhibit the data output to the target device: Unselected

Inhibit the data output to the target server: Unselected

Inhibit the job execution even when the trigger condition is satisfied.: Unselected

19. Click the [OK] button.

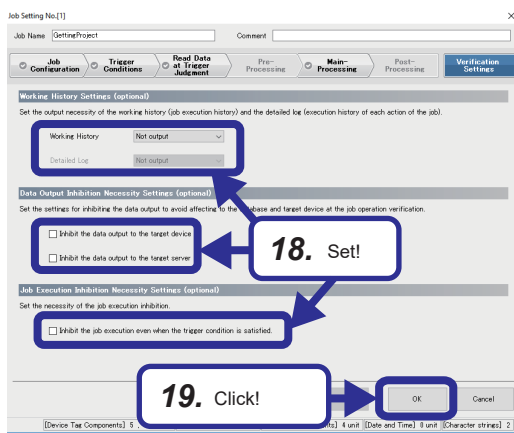



## Setting jobs (Reporting)

When the production has completed and the production volume (D200) is 1 or more and changed, set the conditions to insert the container IDs, production time, and quality determination results on the database.

### Operating procedure

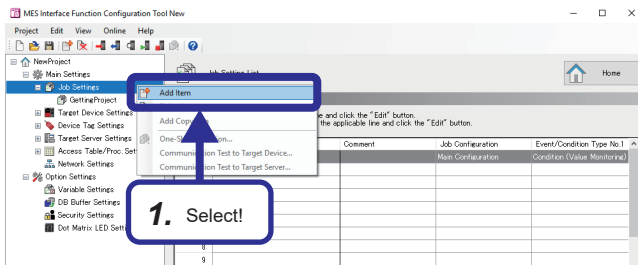

1. Right-click [Job Settings] in the edit item tree, and select [Add Item].

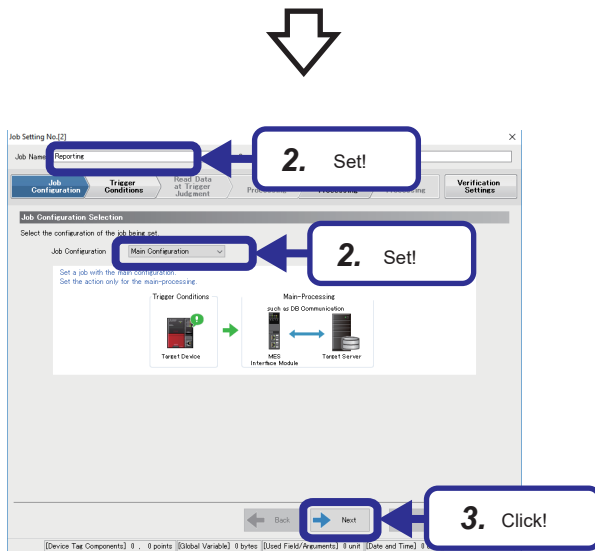

2. Set each setting item as follows in the [Job Configuration] tab.  
[Setting details]  
Job Name: Reporting  
Job Configuration: Main Configuration
3. Click the [Next] button.

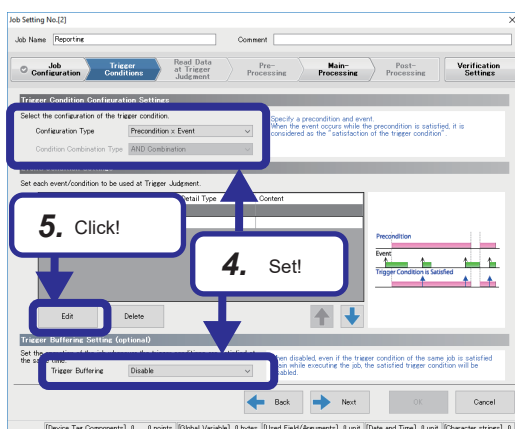

4. Set each setting item as follows in the [Trigger Conditions] tab.  
[Setting details]  
Configuration Type: Precondition × Event  
Condition Combination Type: —  
Trigger Buffering: Disable
5. Click the [Edit] button.

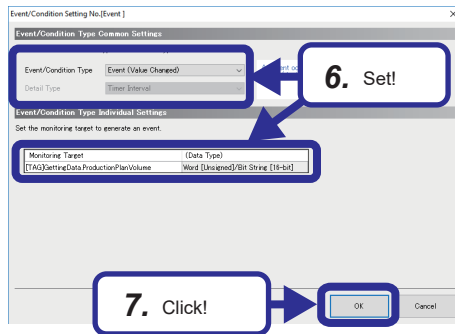

6. Set each setting item as follows on the "Event/Condition Settings" window.

[Setting details (Precondition)]

Event/Condition Type: Condition (Value Monitoring)

Detail Type: —

Monitoring Target: [TAG]PuttingData.ProductionVolume  
(Data Type): Word [Unsigned]/Bit String [16-bit]

Condition: ≥

Comparison Target: [INT]1\*1

(Data Type): —

[Settings (Event)]

Event/Condition Type: Event (Value Changed)

Detail Type: —

Comparison Target:

[TAG]PuttingData.ProductionVolume  
(Data Type): Word [Unsigned]/Bit String [16-bit]

\*1 "[INT]1" is set on the "Integer Type Constant Settings" window.  
"Comparison Target" ⇒ "Constant" ⇒ "[Integer]"

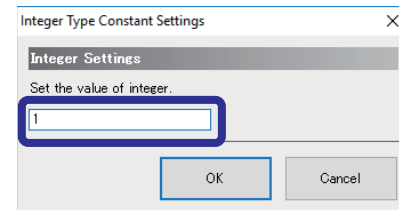

7. Click the [OK] button.

### Point

- When the production is completed, 1 is added to D200 in the ladder program, so whether the production is completed or not is determined according to the change of the value in D200.
- When the [Production stop/reset] button on the GOT is touched, the value in D200 is reset. (The value is changed to 0.)

The condition, the production volume (D200) is 1 or more, is added not to insert the value to the database.



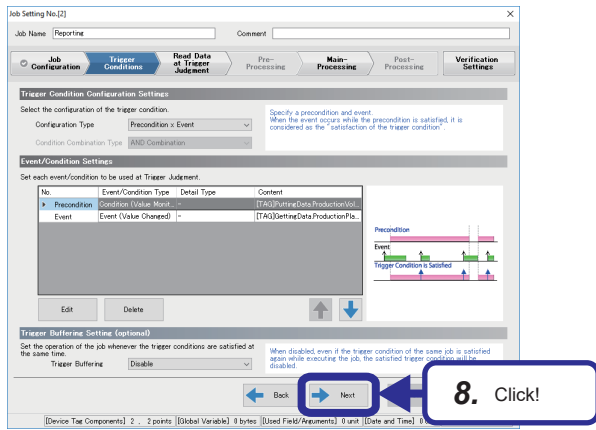

8. Click the [Next] button.

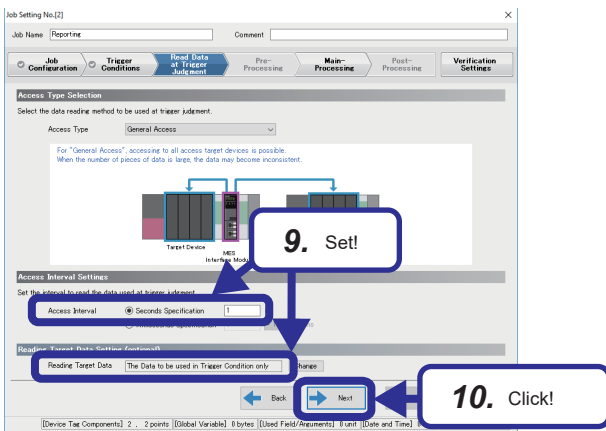

9. Set each setting item as follows in the [Read Data at Trigger Judgment] tab.

[Setting details]

Access Type: General Access

Access Interval: Seconds Specification: 1

Reading Target Data: The Data to be used in Trigger Condition only

10. Click the [Next] button.

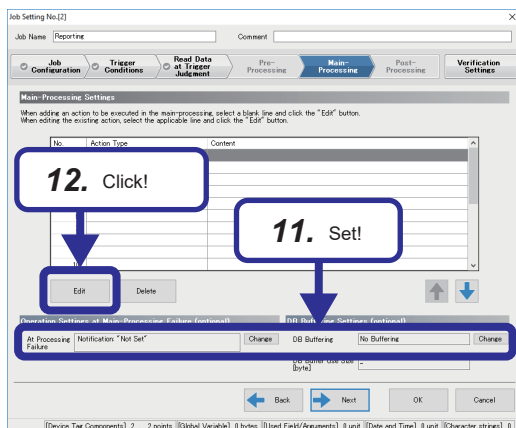

11. Set each setting item as follows in the [Main-Processing] tab.

[Setting details]

At Processing Failure: Notification: "Not Set"

DB Buffering: No Buffering

12. Click the [Edit] button.



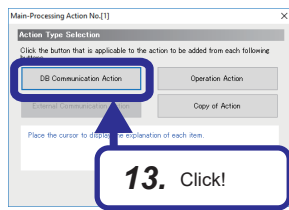

13. Click the [DB Communication Action] button on the "Main-Processing Action" window.

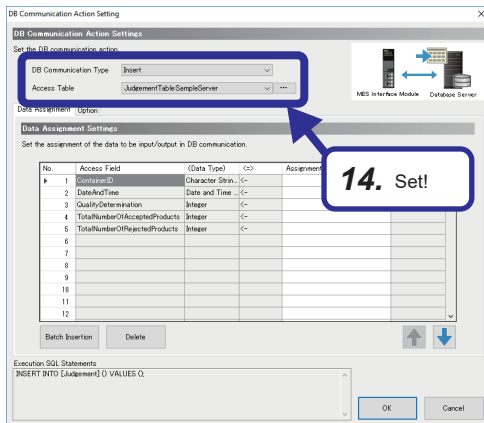

14. Set each setting item as follows on the "DB Communication Action Setting" window.  
[Setting details]  
DB Communication Type: Insert  
Access Table: JudgementTable.SampleServer

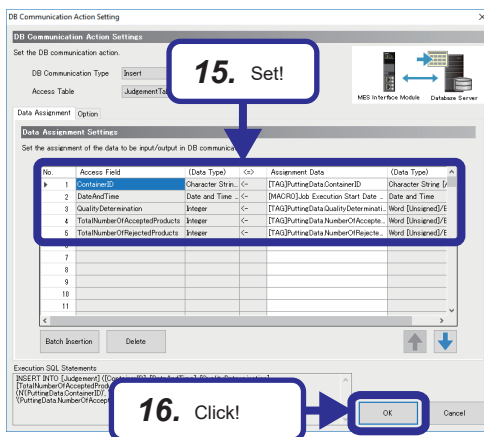

15. Set each setting item in the [Data Assignment] tab according to the following table.  
16. Click the [OK] button.

• [Data Assignment] tab

Access Field	(Data Type)	↔	Assignment Data	(Data Type)
ContainerID	Character String [Unicode(NCHAR)]	←	[TAG]PuttingData.ContainerID	Character string [ASCII/SJIS]
DateAndTime	Date and Time [Without Time Zone]	←	[MACRO]Job Execution Start Date and Time	Date and Time
QualityDetermination	Integer	←	[TAG]PuttingData.QualityDetermination	Word [Unsigned]/Bit String [16-bit]
TotalNumberOfAcceptedProducts	Integer	←	[TAG]PuttingData.NumberOfAcceptedProducts	Word [Unsigned]/Bit String [16-bit]
TotalNumberOfRejectedProducts	Integer	←	[TAG]PuttingData.NumberOfRejectedProducts	Word [Unsigned]/Bit String [16-bit]



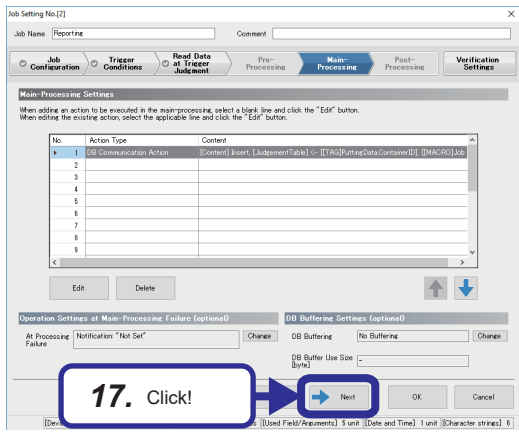

17. Click the [Next] button.

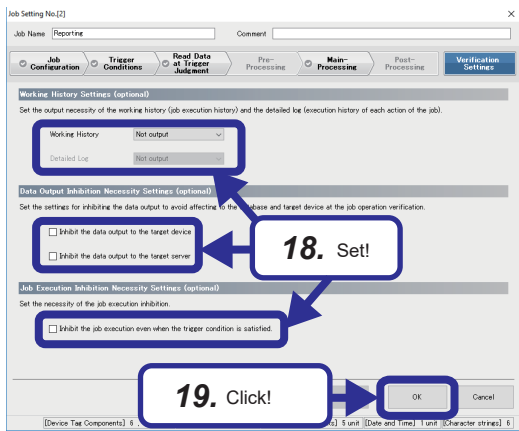

18. Set each setting item as follows in the [Verification Settings] tab.

[Setting details]

Working History: Not output

Detailed Log: —

Inhibit the data output to the target device: Unselected

Inhibit the data output to the target server: Unselected

Inhibit the job execution even when the trigger condition is satisfied.: Unselected

19. Click the [OK] button.

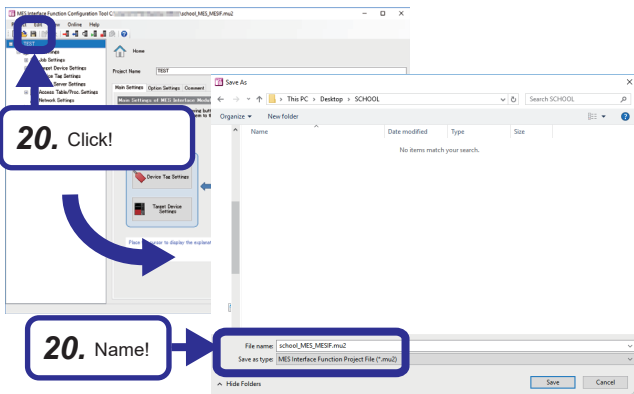

20. Click the save icon, name the file, and save it.

File name: school\_MES\_MESIF.mu2

# Writing parameters to the MES interface module

This section describes how to write the parameters, which have been set with MES Interface Function Configuration Tool, to the MES interface module.

## Operating procedure

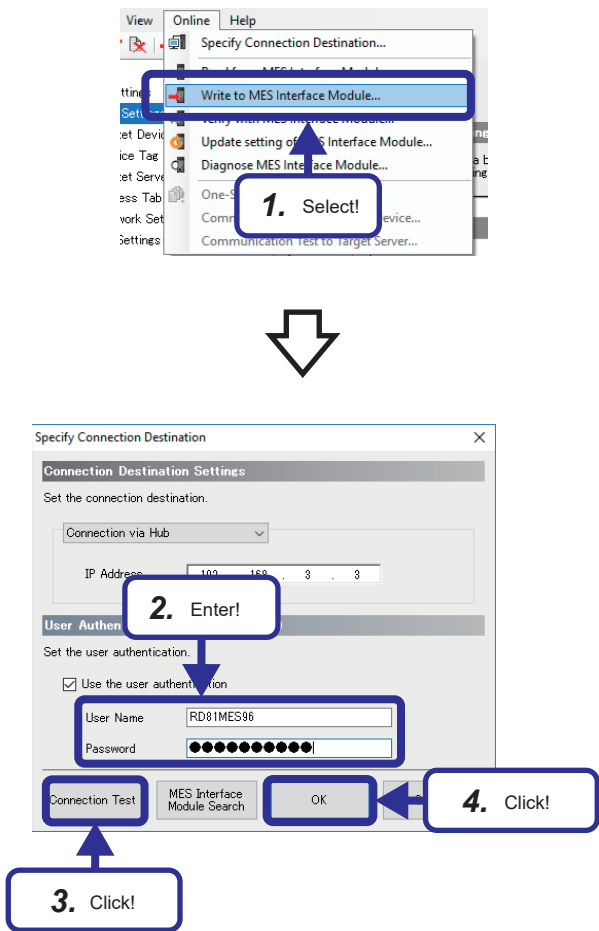

1. Select [Online] ⇒ [Write to MES Interface Module] from the menu in MES Interface Function Configuration Tool.

2. When the "Specify Connection Destination" window appears, enter the user name and password.  
[Default settings]  
User name: RD81MES96  
Password: MITSUBISHI

3. Click the [Connection Test] button. If the connection succeeds, the following window appears.

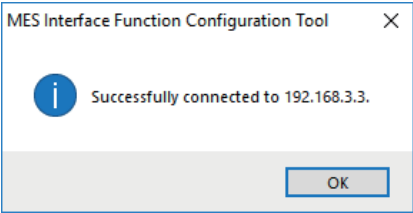

4. Click the [OK] button.  
5. After the parameters are written, reset the CPU module, and restart the MES interface module.  
After resetting the CPU module, change the state of the CPU module to "RUN".

# Setting DB Connection Service Setting Tool

This section describes how to set DB Connection Service Setting Tool.

For details on setting items, refer to the following.

📖 Page 81 DB Connection Service and Setting Tool

## Operating procedure

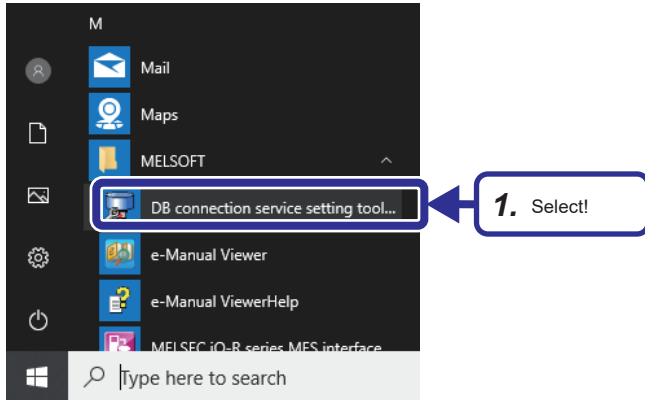

1. Select [MELSOFT] ⇒ [DB connection service setting tool] from Windows® Start.
2. When using an operating system with the User Account Control function, a warning message relating to "DBCnctConf.exe" is displayed. Click the [Yes] button.

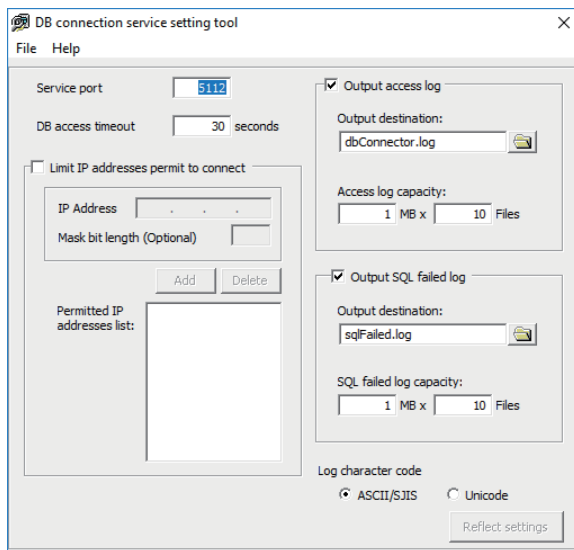

3. The window for DB Connection Service Setting Tool appears.

### Point

This setting is used as a default.

## 6.2 Operation Check

This section describes how to check the operation of the demonstration machine after each parameter is set and written. The following is an example of an operation check for the production pattern 1 (production of small container).

### Operating procedure

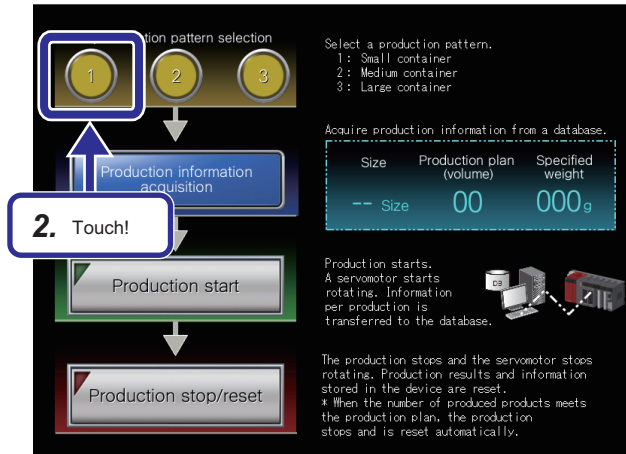

1. Set the RUN/STOP/RESET switch of the CPU module to the RUN position.
2. Touch the [1] button of "Production pattern selection" on the GOT.

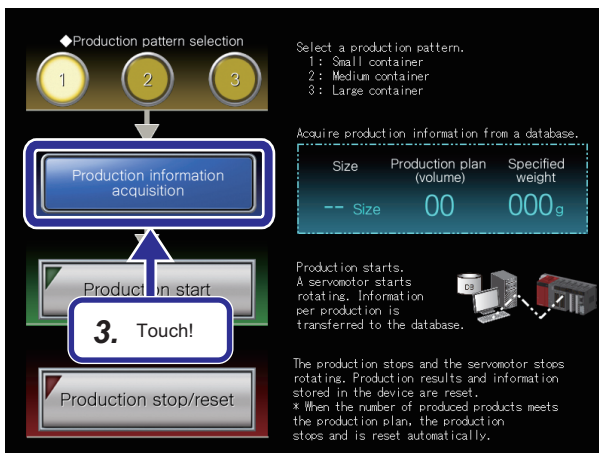

3. Touch the [Production information acquisition] button on the GOT.





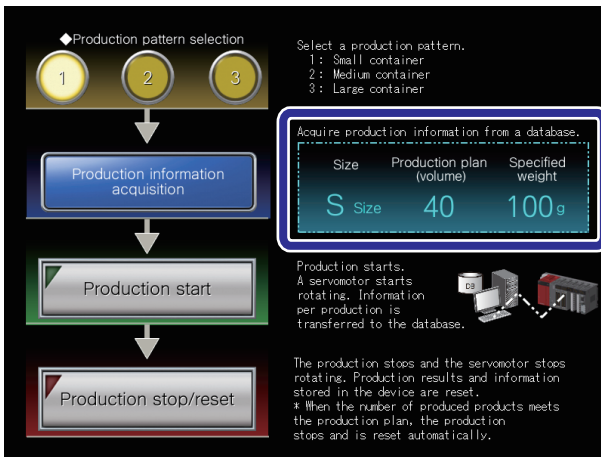

4. The production information on the production pattern 1, acquired from a database, is displayed.

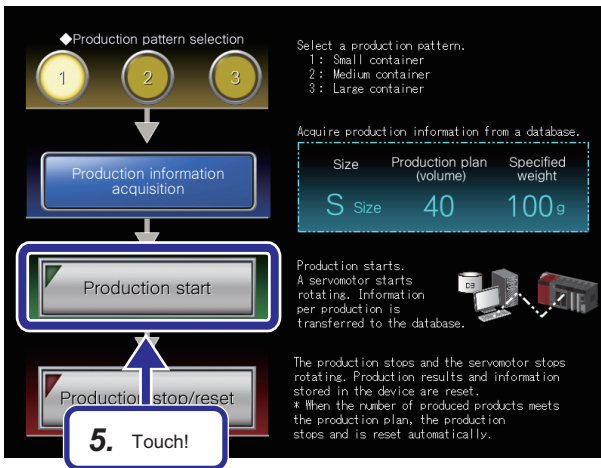

5. Touch the [Production start] button on the GOT.

6

**Point**

When the [Production start] button is touched, the following operations are performed.

- Small containers are produced in every one second.
- ID numbers are assigned to the finished products. (S1, S2, S3, and others.)
- The finished products are checked if they are accepted or rejected.
- When the number of accepted products meets production plan volume, the production stops.
- Servomotor changes its number of rotations depending on the production patterns.  
Small container: 1 rotation  
Medium container: 2 rotations  
Large container: 3 rotations
- If the production is stopped, the servomotor stops its operation.



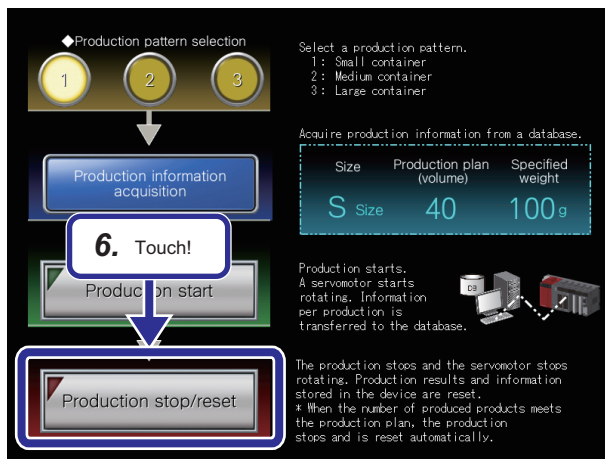

- When the [Production stop/reset] button is touched, or the number of the accepted products meets production plan volume, the production stops.

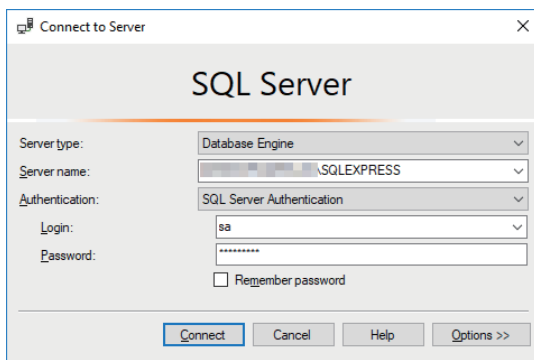

- To check that whether the production results are stored in a database properly or not, start SQL Server Management Studio. For details on how to start SQL Server Management Studio, refer to the following.  
 📖 Page 34 Database Setting

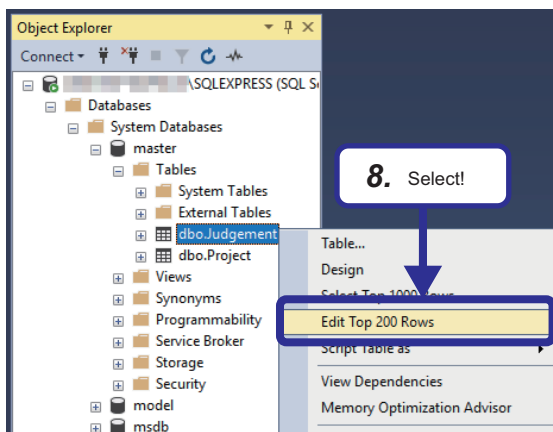

- Right-click "Databases"⇒ "System Databases" ⇒ "master" ⇒ "dbo.Judgement", and then select "Edit Top 200 Rows" in the "Object Explorer" window.



ContainerID	DateAndTime	QualityDetermination	TotalNumberOfAcceptedProducts	TotalNumberOfRejectedProducts
S1	2019-09-06 10:51:45.000	2	0	1
S2	2019-09-06 10:51:46.000	2	0	2
S3	2019-09-06 10:51:47.000	2	0	3
S4	2019-09-06 10:51:48.000	2	0	4
S5	2019-09-06 10:51:49.000	1	1	4
S6	2019-09-06 10:51:53.000	1	1	0

- The results (production results) which are set in the job settings (Insert) of MES Interface Function Configuration Tool can be checked.

## 6.3 Starting MC Works64

This section describes how to check the production results which are stored in the database on MC Works64. The settings for MC Works64 are required in advance, the file which has already been set is used in this training.

### Operating procedure

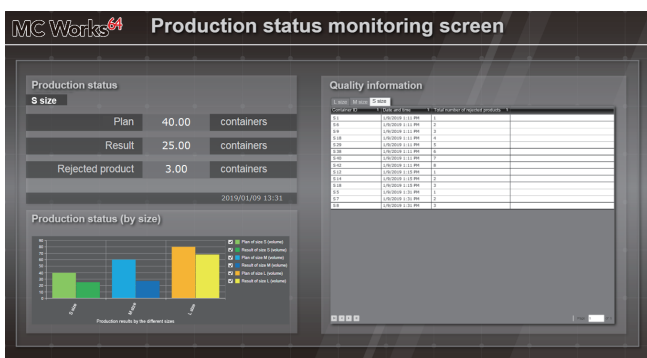
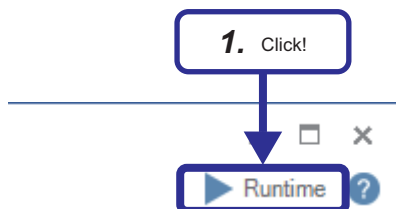

1. Open the file "MC Works64\_Demo.gdxf", and click the [Runtime] button.

2. The production state and quality information per size, which are stored in the database, are displayed in the forms of bar chart or table.

# 7 TROUBLESHOOTING

## 7.1 Troubleshooting Functions

This section describes the troubleshooting with MES Interface Function Configuration Tool and DB Connection Service.

### Communication test function

The communication test function performs the communication test between the MES interface module and an access target device or access target server after receiving a request from MES Interface Function Configuration Tool. Before writing settings to the MES interface module, perform the communication test for a write target using the target device setting or target server setting.

The detailed specification of the communication test function is as follows:

Item		Specification
Number of concurrent tests		Only one communication test can be performed.
Setting information	Target device communication test	Performs the communication test using the target device setting of MES Interface Function Configuration Tool. The communication test does not affect the operating information linkage function.
	Target server communication test	Performs the communication test using the target server setting of MES Interface Function Configuration Tool. The communication test does not affect the operating information linkage function.

#### Precautions

Depending on the operating status of jobs in a module or the status of peripherals (such as network and database), the communication test may take time.

Before the performing communication test, check the operation status of jobs in a module and the status of peripherals.

# Diagnostics

This function performs MES interface module diagnostics by displaying the information in the MES interface module, and by confirming the diagnostic information such as operating status and error status of the module.

In addition, remote operations such as error clear and module stop can be performed for the MES interface module.

Diagnostic function name	Description	Reference
Diagnostics	Displays the module status, error history, and product information of the module, and performs the remote operation for the module status.	Page 115 MES interface module diagnostics
Job Diagnostics	Displays the working history and detailed log of the module. This function changes temporarily the verification settings of the job set in the module.	Page 117 Job diagnostics
Server Access Diagnostics	Displays the connection status of the target server set in the module.	Page 119 Server access diagnostics
Device Access Diagnostics	Displays the connection status of the target device set in the module.	Page 120 Device access diagnostics
DB Buffer Diagnostics	Displays the current use status of the DB buffer in the module and performs operations manually.	Page 121 DB buffer diagnostics
SD Memory Card Diagnostics	Displays the current use status of the SD memory card inserted in the module and formats the SD memory card.	Page 122 SD memory card diagnostics

## MES interface module diagnostics

This function displays the module status, error history, and product information of the MES interface module, and performs the remote operation for the module status.

### Window

Select [Online]⇒[Diagnose MES Interface Module].

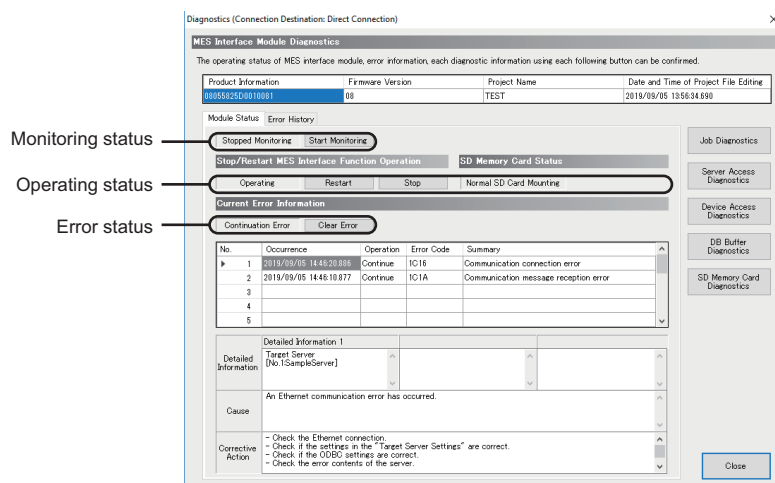

### Displayed items

Item	Description
Product Information	Displays the product information of the MES interface module.
Firmware Version	Displays the firmware version of the MES interface module.
Project Name	Displays the project name of the project operating in the MES interface module.
Date and Time of Project File Editing	Displays the date and time of editing the project operating in the MES interface module.
[Module Status] tab	Displays the monitoring status, operating status, and error status of the MES interface module, and performs the remote operation of each status.
[Error History] tab	Displays the error history of the MES interface module.
[Job Diagnostics] button	Opens the "Job Diagnostics" window.
[Server Access Diagnostics] button	Opens the "Server Access Diagnostics" window.
[Device Access Diagnostics] button	Opens the "Device Access Diagnostics" window.
[DB Buffer Diagnostics] button	Opens the "DB Buffer Diagnostics" window.
[SD Memory Card Diagnostics] button	Opens the "SD Memory Card Diagnostics" window.

## ■[Module Status] tab

Item	Description	
Monitoring status	—	Displays the monitoring status.
	[Start Monitoring] button/ [Stopped Monitoring] button	Switches the start monitoring and stop monitoring.
Operating status	—	Displays the operating status of the MES interface function and SD memory card status.
	[Restart] button/[Stop] button	Switches the restart and stop of the operation of the MES interface function. When stopped, the operating processing is as follows: <ul style="list-style-type: none"> <li>• The trigger buffer will be cleared.</li> <li>• When the job stops during execution before completing the main-processing, the job rolls back to the database. The job returns to the status prior to execution without writing to the device and ends. However, the variable and external communication action operations do not return to the status prior to execution.</li> <li>• The job is completed by performing the post-processing and writing to the device after completing the main-processing.</li> <li>• When the job stops while communicating with the database, and if there is no response even after waiting up till the communication time out time from the corresponding connection, then it changes to unconnected status (In such a case it is not an error).</li> </ul>
Error status	—	Displays the error status of the MES interface module.
	[Clear Error] button	Clears the error status of the MES interface module.
Current error list <sup>*1</sup>	Occurrence	Displays the occurrence date and time.
	Operation	Displays the error status.
	Error Code	Displays the error code.
	Summary	Displays an error outline.
Detailed Information	Detailed Information	Displays the detailed information of error.
	Cause	Displays the cause of error occurrence.
	Corrective Action	Displays the corrective action for clearing error.

\*1 Up to 15 continuation errors and 1 stop error can be displayed.

When a new stop error occurs in the state where a stop error occurs, the information of the stop error is updated.

An error is not displayed in the following cases.

- An error that has already been displayed in the "Current error list" occurs again.
- A new continuation error occurs after a stop error has occurred.
- A new continuation error occurs in the state where 15 continuation errors are displayed.

## ■[Error History] tab

Item	Description	
[Refresh] button	Updates the error history to the latest information.	
[History Clear] button	Clears the error history.	
[Create File] button	Opens the "Create File of Error History" window.	
No. of history	Select the number of errors to display on the error history list.	
Error History List	Occurrence	Displays the occurrence date and time.
	Operation	Displays the error status.
	Error Code	Displays the error code.
	Description	Displays an error outline.
Detailed Information	Detailed Information	Displays the detailed information of error.
	Cause	Displays the cause of error occurrence.
	Corrective Action	Displays the corrective action for clearing error.

## ■To save error history

Save the error history in a CSV file (diagnose information file).

For details on the CSV file (diagnose information file), refer to the following.

📖 MELSEC iQ-R MES Interface Module User's Manual (Application)

## Operating procedure

1. Click the [Create File] button on the [Error History] tab of the "Diagnostics" window.
2. Specify a save location and file name on the "Create File of Error History" window.
3. Click the [Save] button.

## Job diagnostics

This function displays the working history and detailed log of the MES interface module.

The function changes temporarily the verification settings of the job set in the MES interface module.

### Window

Click the [Job Diagnostics] button on the "Diagnostics" window.

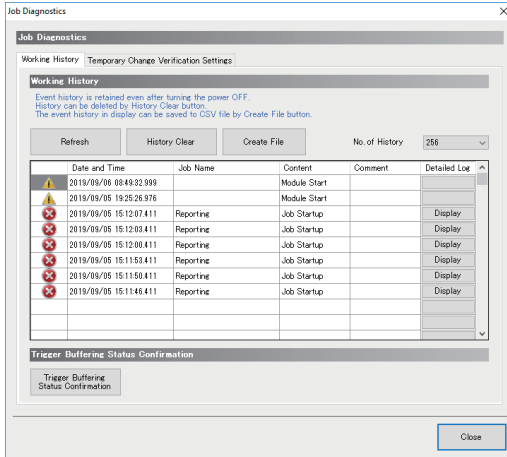

### Displayed items

#### ■[Working History] tab

Item	Description	
[Refresh] button	Updates the working history to the latest information.	
[History Clear] button	Clears the working history.	
[Create File] button	Opens the "Create File of Event History" window. ☞ Page 118 To save working history	
No. of History	Select the number of logs to be displayed on the working history list.	
Working history list <sup>*1,*2</sup>	Warning icon	Displays an icon depending on the error type. : When the job execution result is processing failure and processing interruption. : When the job execution is being inhibited or for the operation history (stop or restart operations of the module) for the MES interface module
	Date and Time	Displays a date and time.
	Job Name	Displays the executed job name.
	Content	Displays the working contents of the job and operations for the module.
	Comment	Displays the comment set arbitrarily.
	Detailed Log <sup>*3</sup>	When the "Detailed Log" is set to "Output" in the verification settings, the "Detailed Log" window appears by clicking the [Display] button. MELSEC iQ-R MES Interface Module User's Manual (Application)
[Trigger Buffering Status Confirmation] button	Opens the "Trigger Buffering Status Confirmation" window. MELSEC iQ-R MES Interface Module User's Manual (Application)	

\*1 When the "Detailed Log" is set to "Output" in the verification settings, it may not be displayed up to the maximum number of items displayed (256).

\*2 If the trigger buffering count reaches to the maximum number (192 counts) when the trigger buffering condition of a job, of which the trigger buffering is enabled, is satisfied, the working history of the job will not be displayed.

\*3 The detailed log may not be output when an error occurs at job execution.

## ■[Temporary Change Verification Settings] tab

Item		Description
[Refresh] button		Updates the verification settings information to the latest information.
Job to be Confirmed/Changed Select	Target Job	Selects the target job to be confirmed and changed.
Confirmation and Change for Verification Settings	Current Settings	Displays the verification settings on the MES interface module.
	Change Item	Selects the items to be changed.
	Settings to be Changed	Displays the settings to be changed.
[Change] button		Requests a verification settings change to the MES interface module.

### ■To save working history

Save the working history in a CSV file (diagnose information file).

For details on the CSV file (diagnose information file), refer to the following.

📖MELSEC iQ-R MES Interface Module User's Manual (Application)

### Operating procedure

1. Click the [Create File] button on the [Working History] tab of the "Job Diagnostics" window.
2. Specify a save location and file name on the "Create File of Event History" window.
3. Click the [Save] button.



## Server access diagnostics



This function displays the connection status of the target server set in the MES interface module.

### Window

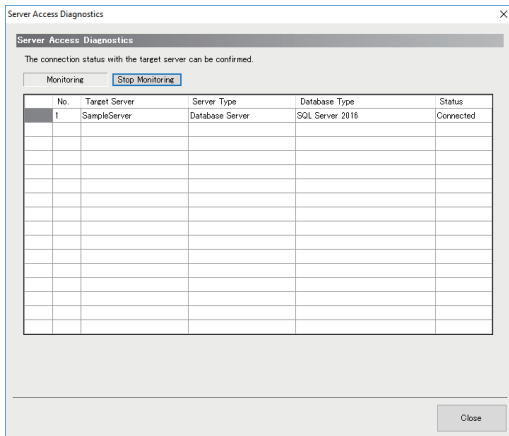
Click the [Server Access Diagnostics] button on the "Diagnostics" window.



### Displayed items

Item	Description	
[Monitoring] button/[Stop Monitoring] button	Switches the start monitoring and stop monitoring.	
Server access connection status list	Warning icon	Displays an icon depending on the error type.  : Disconnected  : Not connected
	Target Server	Displays the server name registered in the target server settings.
	Server Type	Displays the server type registered in the target server settings.
	Database Type	Displays the connected database when the server type is a database server.
	Status	Displays the result of connection to the server from the MES interface module.

## Device access diagnostics



This function displays the connection status of the target device set in the MES interface module.

### Window

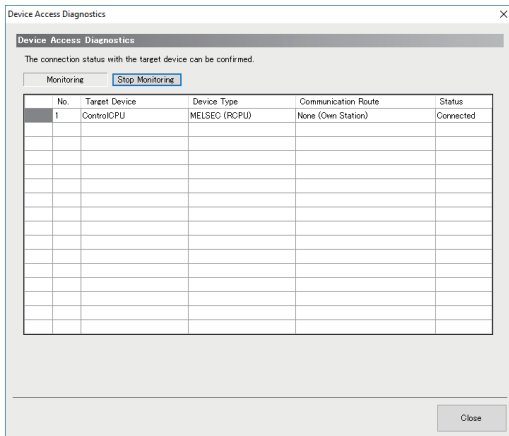
Click the [Device Access Diagnostics] button on the "Diagnostics" window.



### Displayed items

Item	Description	
[Monitoring] button/[Stop Monitoring] button	Switches the start monitoring and stop monitoring.	
Device access connection status list	Warning icon  : Disconnected  : Not connected	
	Target Device	Displays the device name registered in the target device settings.
	Device Type	Displays the device type registered in the target device settings.
	Communication Route	Displays the network settings.
	Status	Displays the result of connection to the device from the MES interface module.

## DB buffer diagnostics

This function displays the current use status of the DB buffer in the MES interface module and performs operations manually.

### Window

Click the [DB Buffer Diagnostics] button on the "Diagnostics" window.

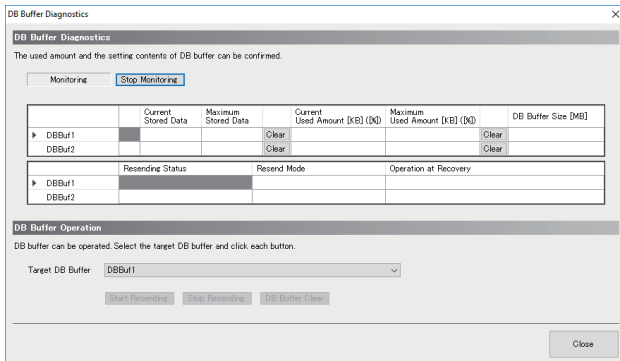

### Displayed items

Item		Description
DB Buffer Diagnostics	[Monitoring] button/[Stop Monitoring] button	Switches the start monitoring and stop monitoring.
	Warning icon	Displays an icon depending on the error type. : When the use rate is 100% : When the use rate is 1% to 99%
	Current Stored Data	Displays the number of jobs that the DB buffering is currently being performed.
	Maximum Stored Data	Displays the maximum number of jobs that the DB buffering is performed after starting the MES interface module.
	[Clear] button	Clears the maximum stored data.
	Current Used Amount [KB] (%)	Displays the current used amount and use rate of the DB buffering.
	Maximum Used Amount [KB] (%)	Displays the maximum used amount and use rate of the DB buffering after starting the MES interface module.
	[Clear] button	Clears the maximum used amount.
	Resending Status	Displays the current resending status of DB buffer.
	Resend Mode	Displays the resend mode of DB buffer.
	Operation at Recovery	Displays the operation at recovery of DB buffer.
	DB Buffer Size [MB]	Displays the DB buffer size currently set.
DB Buffer Operation	Target DB Buffer	Selects the target DB buffering area.
	[Start Resending] button	Starts the resend of the DB buffering data.
	[Stop Resending] button	Stops the resend of the DB buffering data.
	[DB Buffer Clear] button	Clears the DB buffer.

## SD memory card diagnostics

This function displays the current use status of the SD memory card inserted in the MES interface module and format the SD memory card.

### Window

Click the [SD Memory Card] button on the "Diagnostics" window.

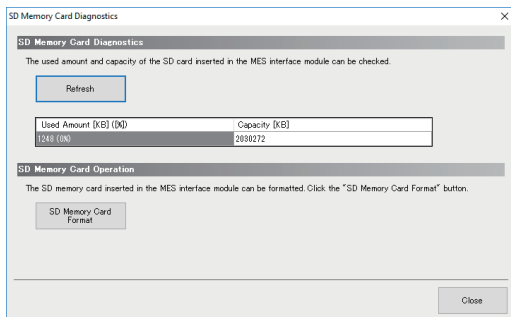

### Displayed items

Item		Description
SD Memory Card Diagnostics	[Refresh] button	Updates the SD memory card status to the latest information.
	Used Amount [KB] ([%])	Displays the used amount and use rate of an SD memory card.
	Capacity [KB]	Displays the capacity of an SD memory card.
SD Memory Card Operation	[SD Memory Card Format] button	Formats an SD memory card.

### Precautions

All the settings of the MES interface module will be lost if the SD memory card is formatted since the settings are saved in the SD memory card.

Read the current setting as necessary, and write the setting after formatting the card.

If the power is OFF to ON or the CPU module is reset without writing the setting in the SD memory card, the IP address of the MES interface module returns to the initial status (192.168.3.3).

# One-shot execution function

The One-shot execution function executes an arbitrary job in an arbitrary timing regardless of the operation status of the MES interface module.

The operation specification of the One-shot execution function is as follows:

1. The following operations can be executed by selecting the target job for one-shot execution (one-shot job) and selecting [Online] ⇒ [One-Shot Execution] in MES Interface Function Configuration Tool.
  - ① MES Interface Function Configuration Tool writes the settings required for the execution of one-shot job to the MES interface module.
  - ② MES Interface Function Configuration Tool notifies the execution request of the one-shot job to the MES interface module.

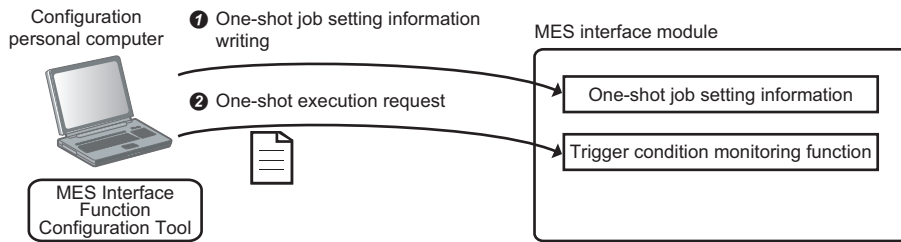

2. The MES interface module in which the notification has been received notifies the one-shot job execution request for the Job execution control function. After that, the job is executed based on the settings written in Operation 1-①.

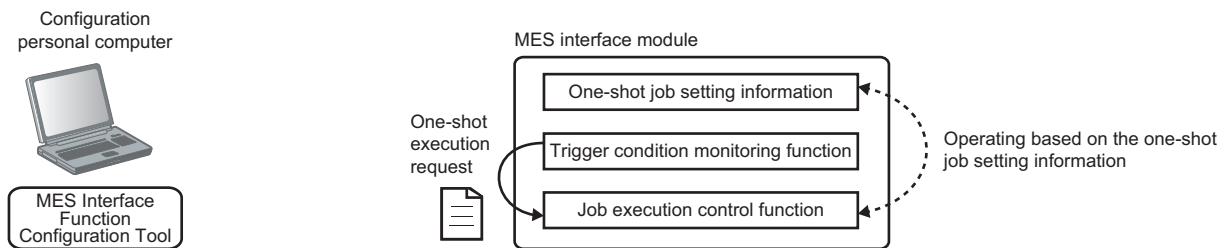

3. After the one-shot job is completed, the MES interface module performs the following operations.
  - ① The execution result of the one-shot job is saved as a detailed log.
  - ② The settings written in Operation 1-① are deleted.
  - ③ Completion of the one-shot job and detailed log of the Operation 3-① is notified to MES Interface Function Configuration Tool.

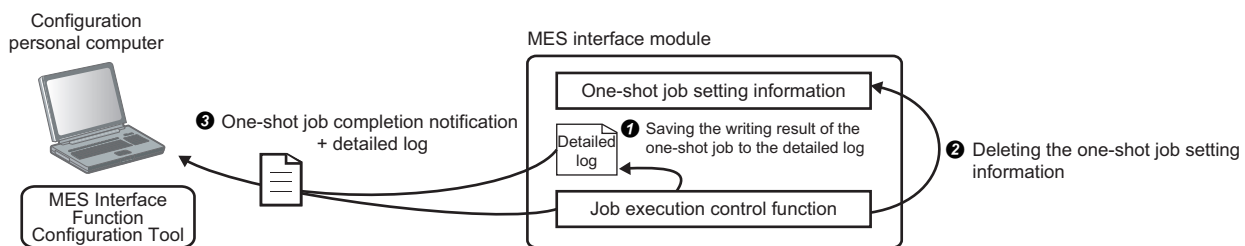

4. If canceling from MES Interface Function Configuration Tool during one-shot execution, or if the communication with the setting tool is disconnected, the MES interface module will operate as follows:
  - ① The one-shot job is canceled.
  - ② The settings written in Operation 1-① and detailed log are deleted.
  - ③ The one-shot execution is ended without notifying the completion of the one-shot job.

# Access log

The communication details between the MES interface module and DB Connection Service are output to the access log.

## Output access log

This function sets whether to output the access log using DB Connection Service Setting Tool.

When checking the "Output access log" checkbox, set the following items.

Item	Description
Output destination	Sets the output destination of a log file.
Access log capacity	Sets the capacity of an access log file and number of files.

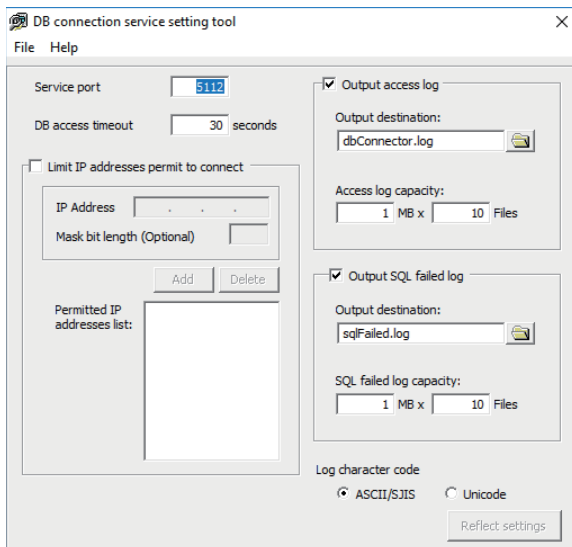

### ■Output destination

The output destination of a log file can be set.

If a file name only is specified, the log is output to an install folder.

If a read-only file is specified, the log is not output and "Access log output error" is output to [Administrative Tools] ⇒ [Event Viewer] of Windows.

### ■Access log capacity

The capacity of an access log file and number of files can be set.

If the capacity for a file is exceeded, the log is copied to a file with a numbered file name and a new log file is created.

If the total number of files exceeds the one which is set, the file is deleted from the oldest one.

**Ex.**

When the output destination is set to 'dbConnector.log' and the access log capacity is set to '1MB × 3 files'

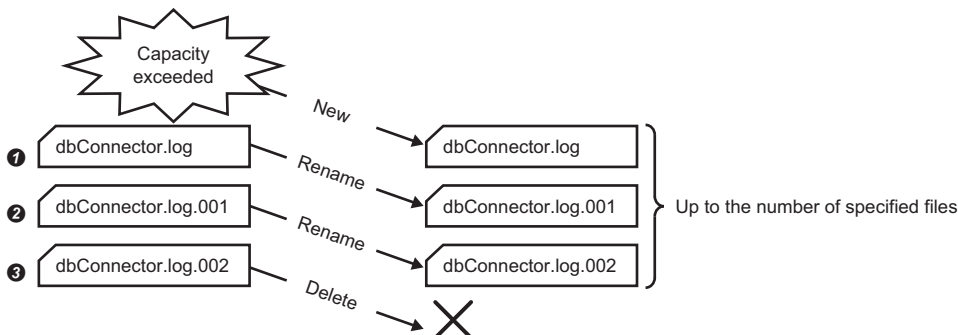

① When "dbConnector.log" exceeds 1M byte, it is renamed as "dbConnector.log.001". A new "dbConnector.log" is created and the logging restarts again.

② "dbConnector.log.001" is renamed as "dbConnector.log.002".

③ "dbConnector.log.002" is deleted because the total number of files exceeds 3.

## Access log details

For details on [Database error number] and [Database error message] in the output log format in the case of failure, refer to the manual for each database.

Depending on the [Error code], the contents after 'Database Message' are not be output.

According to the error code, check the error details and take corrective actions.

📖 MELSEC iQ-R MES Interface Module User's Manual (Application)

### ■Service start

Item	Description
Output log format	[Date] [Error code] Service Start
Example	2015/08/01 12:00:00.000 0x00000000 Service Start

### ■Service end

Item	Description
Output log format	[Date] [Error code] Service Stop
Example	2015/08/01 12:00:00.000 0x00000000 Service Stop

### ■Connection from the MES interface module

Item	Description
Output log format	[Date] [Error code] SID [Session ID]:MIFWS Connected:[Source IP]:[Target data source]:[Connection User Name]
Example	2015/08/01 12:00:00.000 0x00000000 SID 00000001:MIFWS Connected:192.168.3.3:DataSource:UserName

### ■Disconnection from the MES interface module

Item	Description
Output log format	[Date] [Error code] SID [Session ID]:MIFWS Disconnected:[Source IP]:[Target data source]:[Connection User Name]
Example	2015/08/01 12:00:00.000 0x00000000 SID 00000001:MIFWS Disconnected:192.168.3.3:DataSource:UserName

### ■Connection to a database

Item	Description	
Output log format	When succeeded	[Date] [Error code] SID [Session ID]:DB Connect:[Target data source]:[Connection User Name]:Success
	When failed	[Date] [Error code] SID [Session ID]:DB Connect:[Target data source]:[Connection User Name]:Failed Database Message [Database error number] [Database error message]
Example	When succeeded	2015/08/01 12:00:00.000 0x00000000 SID 00000001:DB Connect:DataSource:UserName:Success
	When failed	2015/08/01 12:00:00.000 0x20400022 SID 00000001:DB Connect:DataSource:UserName:Failed Database Message 0x000003f9 [Oracle][ODBC][Ora]ORA-01017: invalid username/password;logon denied

### ■Disconnection from a database

Item	Description	
Output log format	When succeeded	[Date] [Error code] SID [Session ID]:DB Disconnect:[Target data source]:[Connection User Name]:Success
	When failed	[Date] [Error code] SID [Session ID]:DB Disconnect:[Target data source]:[Connection User Name]:Failed Database Message [Database error number] [Database error message]
Example	When succeeded	2015/08/01 12:00:00.000 0x00000000 SID 00000001:DB Disconnect:DataSource:UserName:Success

## ■ SQL statement reception/processing results

### • SELECT

Item		Description
Output log format	When succeeded	[Date] [Error code] SID [Session ID]:SQL<[SQL statement]>:Success([No. of selected records])
	When failed	[Date] [Error code] SID [Session ID]:SQL<[SQL statement]>:Failed Database Message [Database error number] [Database error message]
Example	When succeeded	2015/08/01 12:00:00.000 0x00000000 SID 00000001:SQL<SELECT COL from TABLE;>:Success(1)
	When failed	2015/08/01 12:00:00.000 0x20600023 SID 00000001:SQL<SELECT COLL from TABLE;>:Failed Database Message 0x00000388 [Oracle][ODBC][Ora]ORA-00904: "COLL": invalid identifier

### • UPDATE

Item		Description
Output log format	When succeeded	[Date] [Error code] SID [Session ID]:SQL<[SQL statement]>:Success([No. of updated records])
	When failed	[Date] [Error code] SID [Session ID]:SQL<[SQL statement]>:Failed Database Message [Database error number] [Database error message]
Example	When succeeded	2015/08/01 12:00:00.000 0x00000000 SID 00000001:SQL<UPDATE TABLE SET COL = '1';>:Success(1)
	When failed	2015/08/01 12:00:00.000 0x20600023 SID 00000001:SQL<UPDATE TABLE SET COL = 'COL';>:Failed Database Message 0x000006ba [Oracle][ODBC][Ora]ORA-01722: invalid number

### • INSERT

Item		Description
Output log format	When succeeded	[Date] [Error code] SID [Session ID]:SQL<[SQL statement]>:Success([No. of inserted records])
	When failed	[Date] [Error code] SID [Session ID]:SQL<[SQL statement]>:Failed Database Message [Database error number] [Database error message]
Example	When succeeded	2015/08/01 12:00:00.000 0x00000000 SID 00000001:SQL<INSERT INTO TABLE (COL) VALUES ('1');>:Success(1)
	When failed	2015/08/01 12:00:00.000 0x20600023 SID 00000001:SQL<INSERT INTO TABLE (COL) VALUES ('1');>:Failed Database Message 0x000003ae [Oracle][ODBC][Ora]ORA-00942: table or view does not exist

### • COMMIT

Item		Description
Output log format	When succeeded	[Date] [Error code] SID [Session ID]:COMMIT:Success
	When failed	[Date] [Error code] SID [Session ID]:COMMIT:Failed Database Message [Database error number] [Database error message]
Example	When succeeded	2015/08/01 12:00:00.000 0x00000000 SID 00000001:COMMIT:Success

### • ROLLBACK

Item		Description
Output log format	When succeeded	[Date] [Error code] SID [Session ID]:ROLLBACK:Success
	When failed	[Date] [Error code] SID [Session ID]:ROLLBACK:Failed Database Message [Database error number] [Database error message]
Example	When succeeded	2015/08/01 12:00:00.000 0x00000000 SID 00000001:ROLLBACK:Success

### • GetNext (Request for the next record)

Item		Description
Output log format	When succeeded	[Date] [Error code] SID [Session ID]:GetNext:Success
	When failed	[Date] [Error code] SID [Session ID]:GetNext:Failed Database Message [Database error number] [Database error message]
Example	When succeeded	2015/08/01 12:00:00.000 0x00000000 SID 00000001:GetNext:Success



- DELETE

Item		Description
Output log format	When succeeded	[Date] [Error code] SID [Session ID]:SQL<[SQL statement]>:Success([No. of deleted records])
	When failed	[Date] [Error code] SID [Session ID]:SQL<[SQL statement]>:Failed Database Message [Database error number] [Database error message]
Example	When succeeded	2015/08/01 12:00:00.000 0x00000000 SID 00000001:SQL<DELETE FROM TABLE;>:Success(1)
	When failed	2015/08/01 12:00:00.000 0x20600023 SID 00000c60:SQL<DELETE FROM table1 ;>:Failed Database Message 0x000003ae [Oracle][ODBC][Ora]ORA-00942: table or view does not exist.

### ■ Table name/field name browsing results

- Table name browsing

Item		Description
Output log format	When succeeded	[Date] [Error code] SID [Session ID]:Table Get:Success
	When failed	[Date] [Error code] SID [Session ID]:Table Get:Failed
Example	When succeeded	2015/08/01 12:00:00.000 0x00000000 SID 0:Table Get:Success
	When failed	2015/08/01 12:00:00.000 0x00000000 SID 0:Table Get:Failed

- Field name browsing

Item		Description
Output log format	When succeeded	[Date] [Error code] SID [Session ID]:Field Get:[Table name]:Success
	When failed	[Date] [Error code] SID [Session ID]:Field Get:[Table name]:Failed
Example	When succeeded	2015/08/01 12:00:00.000 0x00000000 SID 0:Field Get: TableName:Success
	When failed	2015/08/01 12:00:00.000 0x00000000 SID 0:Field Get: TableName:Failed

## 7.2 Troubleshooting Operation Check

This section describes how to detect and correct improper settings in the project "school\_MES\_MESIF\_troubleshoot.mu2" using the troubleshooting functions, and check whether the corrected settings operate properly.

The following functions are used as the troubleshooting functions; "communication test function", "diagnose MES interface module", "one-shot execution function", and "access log".

### Writing parameters for the troubleshooting

To write the troubleshooting operation check project "school\_MES\_MESIF\_troubleshoot.mu2" to the MES interface module, follow the procedure described in "Page 108 Writing parameters to the MES interface module".

## Troubleshooting 1

The troubleshooting is performed by using the "communication test function" and "access log".

### Checking errors

#### ■ Communication test function

#### Operating procedure

Target Server Setting No.[1]

Target Server Name: SampleServer Comment: [ ]

**Target Server Common Settings**

Set the target server with which MES interface module communicates.

Server Type: Database Server

IP Address: 192 . 168 . 3 . 100

Port No.: 5112

Communication Timeout Time: 10 s

**Target Server Individual Settings**

Set the information to access the database.

Data Source Name: SAMPLE

User Name: sa

Password: [ ]

Database Type: SQL Server 2016

**Access Error Notification Settings (optional)**

Access Error Notification Setting: Not Notify Change

Communication Test ← 1. Click! OK Cancel



Specify Connection Destination

**Connection Destination Settings**

Set the connection destination.

Connection via Hub: [ ]

IP Address: 192 . 168 . 3 . 3

**User Authentication Setting (optional)**

Set the user authentication.

Use the user authentication

User Name: RD81MES96

Password: [ ]

Connection Test MES Interface Module Search OK ← 2. Click! Cancel



1. Open the project "school\_MES\_MESIF\_troubleshoot.mu2". Click the [Communication Test] button on the "Target Server Setting No.[1]" window of MES Interface Function Configuration Tool.

2. Enter the following in the "Connection Destination Settings" and "User Authorization Setting (optional)", and click the [OK] button.

[Setting details]

IP Address: 192.168.3.3

User Name: RD81MES96

Password: MITSUBISHI

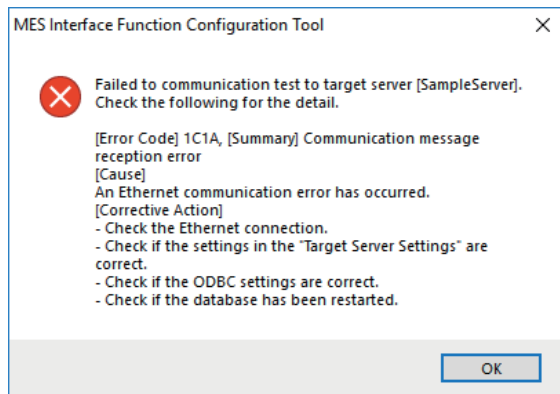
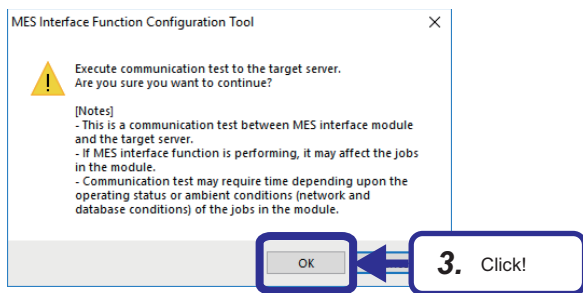

3. Click the [OK] button.

4. The error message window appears as shown on the left. Check [Cause] and [Corrective Action], and correct improper settings.

## Access log

### Operating procedure

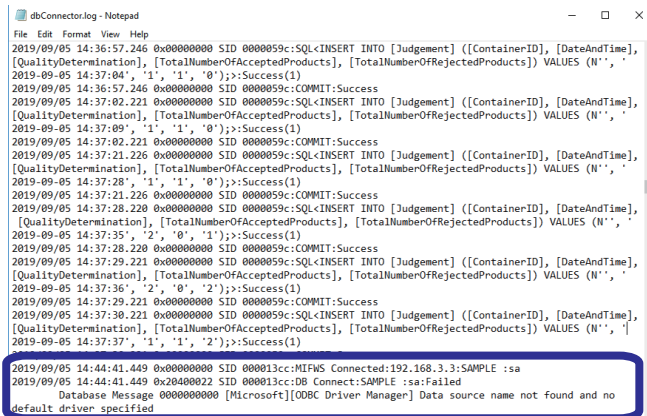
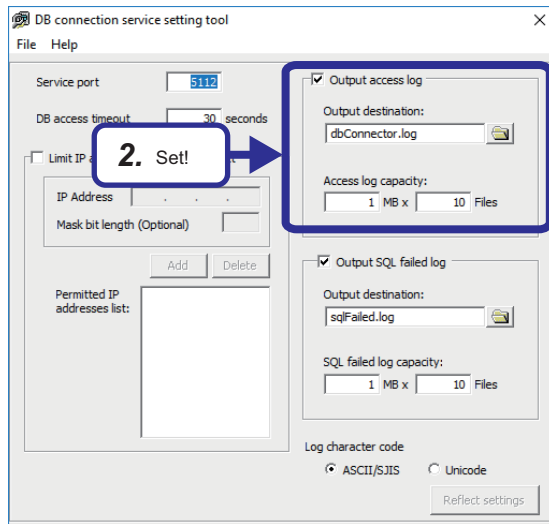

4. Check!

1. On Windows®, select [MELSOFT] ⇒ [DB connection service setting tool] from the start menu.
2. Select the "Output access log" checkbox, and set any location to output an access log file in "Output destination".
3. Perform "Page 128 Communication test function".

4. Open the access log file stored in the location set in Step 2. Check if errors appeared as "-: Failed" in the access log file, and correct improper settings.

## Correcting errors

According to the access log, there is an error in data source name. From this result, it is assumed that the name entered in "Data Source Name" on the "Target Server Setting No.[1]" window is inappropriate.

### Operating procedure

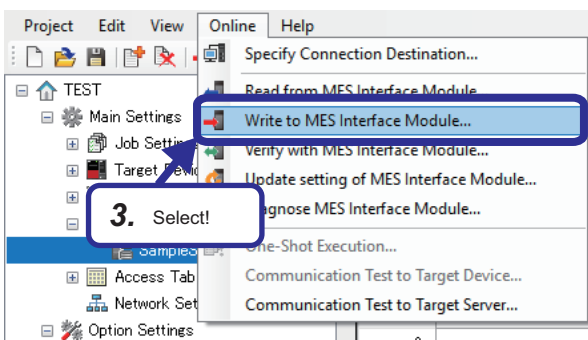
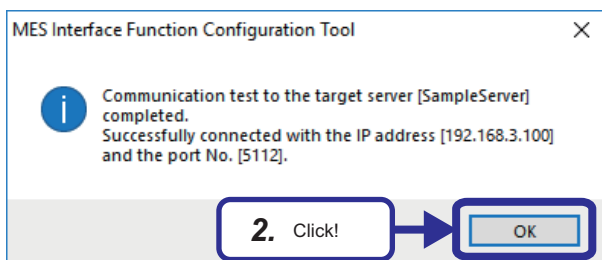
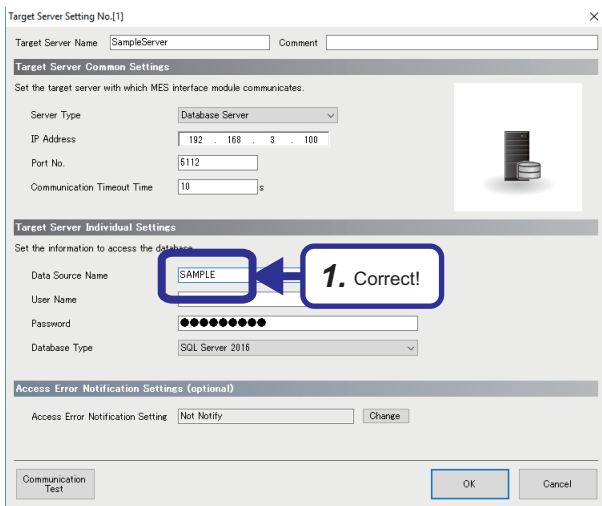

1. An unnecessary one-byte space has been added to the end of the data source name, so the name differs from the data source name set in [Page 37 ODBC \(Open Database Connectivity\) Setting](#). This caused the error. Delete the one-byte space to correct the name in "Data Source Name".

2. After the correction, click the [Communication Test] button again. When communications succeed, the message window appears as shown on the left. Click the [OK] button.

3. Write the setting to the MES interface module. [Page 108 Writing parameters to the MES interface module](#)

## Troubleshooting 2

The troubleshooting is performed by using the MES interface module diagnostics, one-shot execution function, access log, and referring to their results. Although how an error is displayed differs among the these methods, the error occurred is identical.

### Checking errors

#### ■MES interface module diagnostics (Job diagnostics)

##### Operating procedure

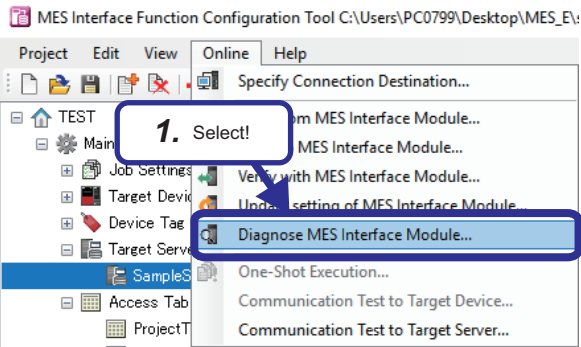

1. Select [Online] ⇒ [Diagnose MES Interface Module] in MES Interface Function Configuration Tool.

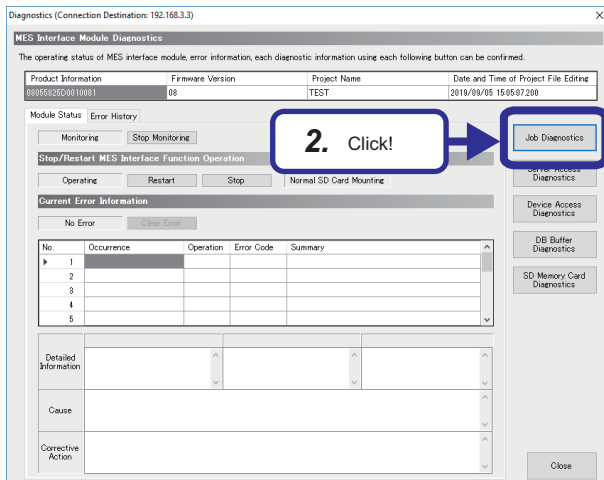

2. Click the [Job Diagnostics] button.



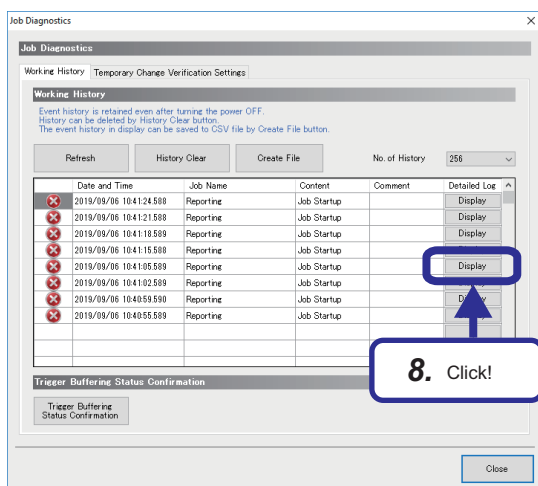
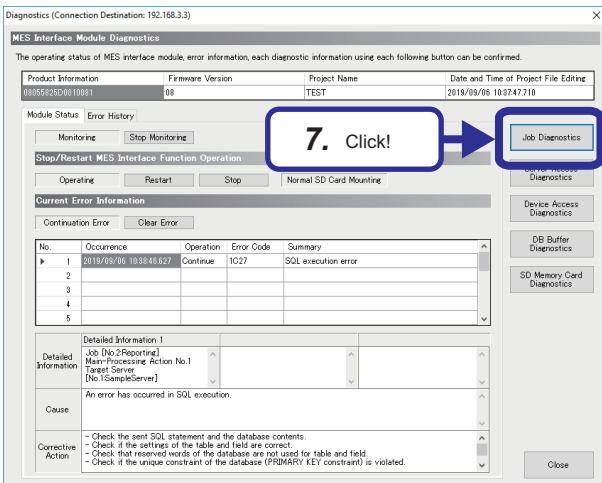
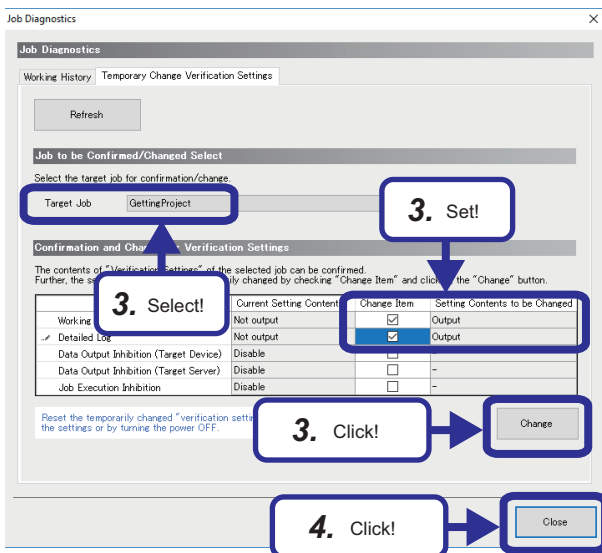

- Click the [Temporary Change Verification Settings] tab, and select the target job to be diagnosed. Select the "Change Item" checkboxes of "Working History" and "Detailed Log" to output them. Click the [Change] button.
- Click the [Close] button.

**Point** When "Output" is selected for "Working History" and "Detailed Log" in the [Verification Settings] tab on the "Job Setting No.[1]" screen, this step is not required.

- Perform "Page 110 Operation Check".
- ERR LED on the MES interface module turns on during the operation check. Check the error details. Select [Online] ⇒ [Diagnose MES Interface Module]. The window on the left appears.
- Click the [Job Diagnostics] button.

- If an execution result is a processing failure or processing interruption, "Job Names" is "Reporting" and an icon for the processing failure or processing interruption is displayed. Display the "Detailed Log" window.

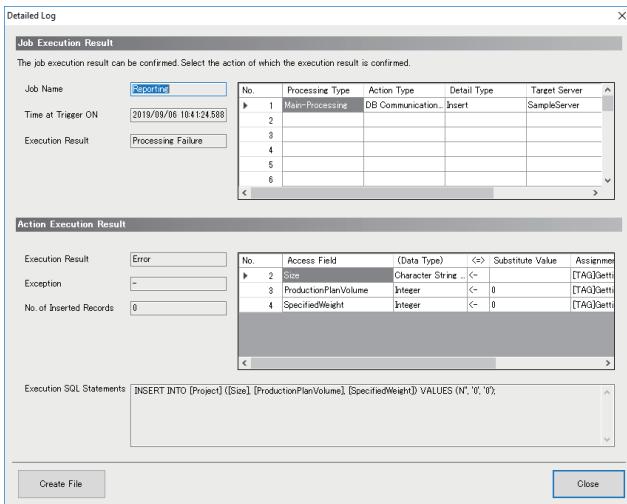

- On the "Detailed Log" window, check execution results of actions actually executed, and correct improper settings.

### ■ One-shot execution function

The one-shot execution function executes an arbitrary job in an arbitrary timing regardless of the operation status of the MES interface module. Therefore, job execution results can be checked without performing "Page 110 Operation Check" while "Page 132 MES interface module diagnostics (Job diagnostics)" requires it.

### Operating procedure

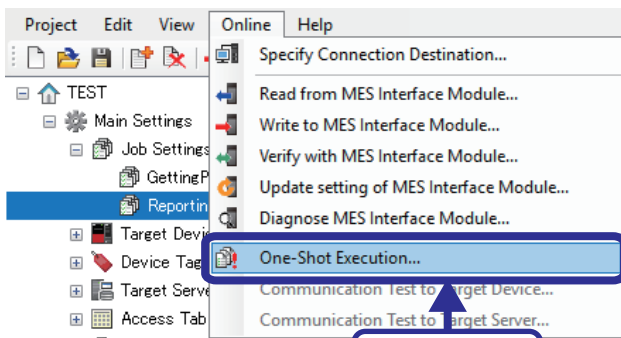

1. Select!

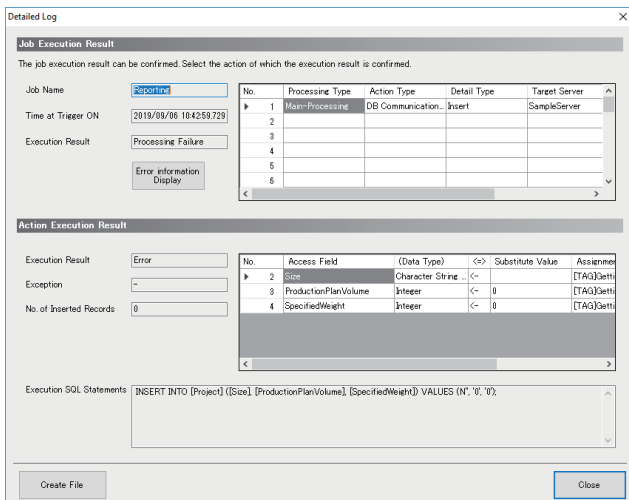

- Select a target job to execute the one-shot execution function, and select [Online] ⇒ [One-Shot Execution] on the "Job Setting No.[1]" window of MES Interface Function Configuration Tool.

- The "Detailed Log" window is displayed. When selecting "GettingProject", "Success" is displayed in "Execution Result", and no error in the target job is confirmed. When selecting "Reporting", "Processing Failure" is displayed in "Execution Result" in the same way as "Page 132 MES interface module diagnostics (Job diagnostics)", and errors in the target job are confirmed. Check execution results of actions actually executed, and correct improper settings.



## Access log

### Operating procedure

```
dbConnector.log - Notepad
File Edit Format View Help
2019/09/06 10:40:57.743 0x20600023 SID 00001344:SQL<INSERT INTO [Project] ([Size], [ProductionPlanVolume], [SpecifiedWeight])
VALUES (N'', '0', '0');>:Failed
Database Message 0x00000203 [Microsoft][ODBC Driver 13 for SQL Server][SQL Server]Cannot insert the value NULL
into column 'Pattern', table 'master.dbo.Project'; column does not allow nulls.
INSERT fails.
2019/09/06 10:40:57.759 0x00000000 SID 00001344:ROLLBACK:Success
2019/09/06 10:41:07.755 0x20600023 SID 00001344:SQL<INSERT INTO [Project] ([Size], [ProductionPlanVolume], [SpecifiedWeight])
VALUES (N'', '0', '0');>:Failed
Database Message 0x00000203 [Microsoft][ODBC Driver 13 for SQL Server][SQL Server]Cannot insert the value NULL
into column 'Pattern', table 'master.dbo.Project'; column does not allow nulls.
INSERT fails.
2019/09/06 10:41:07.755 0x00000000 SID 00001344:ROLLBACK:Success
2019/09/06 10:41:10.751 0x20600023 SID 00001344:SQL<INSERT INTO [Project] ([Size], [ProductionPlanVolume], [SpecifiedWeight])
VALUES (N'', '0', '0');>:Failed
Database Message 0x00000203 [Microsoft][ODBC Driver 13 for SQL Server][SQL Server]Cannot insert the value NULL
into column 'Pattern', table 'master.dbo.Project'; column does not allow nulls.
INSERT fails.
2019/09/06 10:41:10.751 0x00000000 SID 00001344:ROLLBACK:Success
2019/09/06 10:41:13.751 0x20600023 SID 00001344:SQL<INSERT INTO [Project] ([Size], [ProductionPlanVolume], [SpecifiedWeight])
VALUES (N'', '0', '0');>:Failed
Database Message 0x00000203 [Microsoft][ODBC Driver 13 for SQL Server][SQL Server]Cannot insert the value NULL
into column 'Pattern', table 'master.dbo.Project'; column does not allow nulls.
INSERT fails.
2019/09/06 10:41:13.751 0x00000000 SID 00001344:ROLLBACK:Success
2019/09/06 10:41:16.744 0x20600023 SID 00001344:SQL<INSERT INTO [Project] ([Size], [ProductionPlanVolume], [SpecifiedWeight])
VALUES (N'', '0', '0');>:Failed
Database Message 0x00000203 [Microsoft][ODBC Driver 13 for SQL Server][SQL Server]Cannot insert the value NULL
into column 'Pattern', table 'master.dbo.Project'; column does not allow nulls.
INSERT fails.
2019/09/06 10:41:16.760 0x00000000 SID 00001344:ROLLBACK:Success
2019/09/06 10:42:51.893 0x00000000 SID 00000194:MIFMS Connect:Success
2019/09/06 10:42:51.893 0x00000000 SID 00000194:DB Connect:Success
```

3. Check!

1. Perform "Page 110 Operation Check".
2. ERR LED on the MES interface module turns on during the operation check. Check the error details.
3. Check if errors appeared as "~: Failed" in the access log file, and correct improper settings.

## Correcting errors

According to the access log, there are errors in the execution SQL statements of "Reporting" in "Job Names". In the access log, an error "Cannot insert the value NULL into column 'Pattern', table 'master.dbo.Project'; column does not allow nulls." is confirmed. This means that the table and row to which the value should be inserted are container ID and other items in the 'master.dbo.Judgement' row. Therefore, it can be assumed that there is an error in their settings.

### Operating procedure

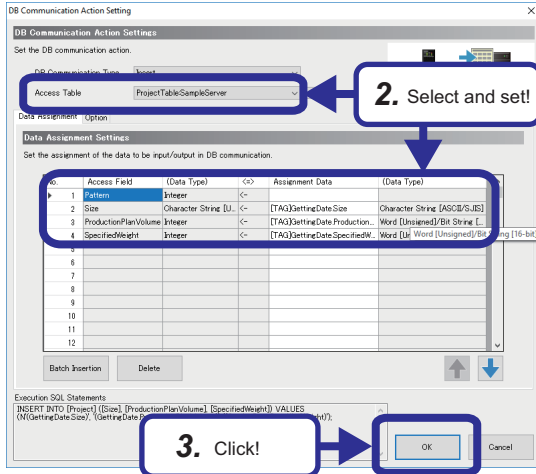

1. Open the "DB Communication Action" for "Main-Processing" of "Reporting".
2. On the "DB Communication Action Setting" window, select "JudgementTable.SampleServer" in "Access table" to re-set data to be assigned.  
For data assignment setting, refer to the following.  
Page 103 Setting jobs (Reporting)
3. Click the [OK] button.

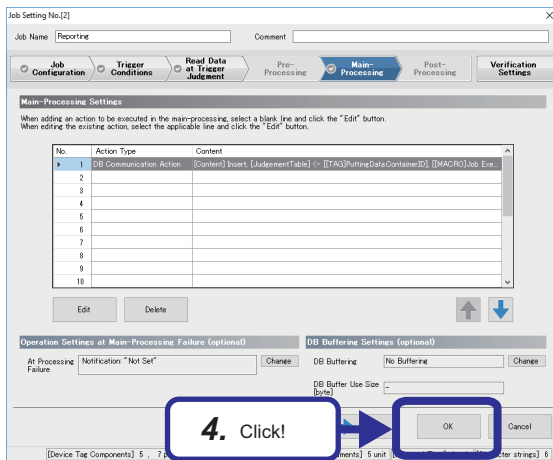

4. Click the [OK] button.



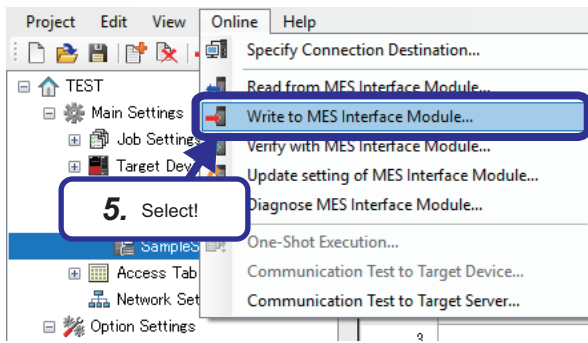

5. Write the setting to the MES interface module.  
 ↳ Page 108 Writing parameters to the MES interface module



ContainerID	DateAndTime	QualityDetermination	TotalNumberOfAcceptedProducts	TotalNumberOfRejectedProducts
S1	2019-09-06 10:51:45.000	2	0	1
S2	2019-09-06 10:51:46.000	2	0	2
S3	2019-09-06 10:51:47.000	2	0	3
S4	2019-09-06 10:51:48.000	2	0	4
S5	2019-09-06 10:51:49.000	1	1	4
S6	2019-09-06 10:51:53.000	1	1	0

6. Perform "↳ Page 110 Operation Check".  
 Check whether the operation check has been performed properly.

# APPENDICES

## Appendix 1 MC Works64

### MC Works64

Mitsubishi Electric provides MC Works64 that is a SCADA software package with a highly functional monitoring control system designed for industrial systems, instrumentation systems in plants, air conditioning/lightening systems in buildings, and social infrastructure.

This software includes the function required for variety of industries and systems and these function can be flexibly integrated to construct unique systems by users.

The functions can be added or changed as desired by the users to customize the systems.

MC Works64 is the advanced software that can operate together with cloud services or business process management systems such as ERP for responding to the lot age.



## MC Works<sup>64</sup>

### Basic functions

Application name	Function
Workbench Desktop	Project management function that builds applications of all the MC Works64 related products
GraphWorX64	Window configuration function that configures advanced monitoring screens allowing the 2D/3D animation, utilization of symbols, linkage with videos, and other functions
TrendWorX64	Trend display function that displays advance trend graphs allowing split and overlapped displays
AlarmWorX64	Alarm function that displays notification lists of the standard alarms and an alarm chart of every alarm type

### Advanced functions

Application name	Function
Workbench-SL	Project management function that builds applications of all the MC Works64 related products
MC AppBuilder	Project auto generation function

## Features

### ■Enhanced visibility and operability

3D graphics enables to monitor devices from various angles with stereoscopic displays that are not achieved with 2D graphics.

On a 3D graphic window, users can shift the window's viewpoint freely and zoom in/out the window, so monitor an entire equipment as well as details of an equipment.

Integrating with 2D graphic windows which are excellent in monitoring device operating status and displaying measurement data enhances the visibility and operability of the monitoring windows.

### ■Enhanced reliability

MC Works64 enables to construct a sever redundant systems and server-and- client systems.

Two servers, a control server and a standby server, can be utilized to enhance the reliability of the system and reduce the communication load on the network.

Server systems can be configured flexibly depending on system scale, from large-scaled systems to standalone systems.

### ■Remote monitoring with any device

MA Works64 client system supports the monitoring on a web browser.

With the MC Works 64 server as the web server, access and monitoring from clients on the web can be performed.

Operating status of equipment can be monitored remotely on any mobile device such as a tablet computer or a smart phone.

### ■Reduced engineering man-hours

Utilizing pre-registered symbols in libraries reduces the man-hours for symbol design on a monitoring window.

Tags can be registered to symbols to change color and display numerical value using the animation function of the pre-registered symbols, so reduces the man-hours for script creation.

### ■Visualization and analysis of energy consumption

Integrating Mitsubishi Electric energy measurement device, energy display, and AX Energy, an energy analysis and visualization tool, enables to visualize energy consumption and CO2 emissions in the whole system or per device.

# SCADA software

SCADA is the abbreviation for Supervisory Control And Data Acquisition. It is a system of software controlled with a personal computer to perform industrial system supervision, system control, and data acquisition.

The basic configuration includes client personal computers, an SCADA server, and programmable controllers as shown below.

Industrial systems are normally controlled using the programmable controllers and relevant data, such as production results and process values, is collected in the SCADA server.

The collected data is interconnected with graphics to operate animations on a screen of an HMI (Human-Machine Interface) on the SCADA server, recorded as logs, and utilized to notify alarms.

When collecting data from programmable controllers, device addresses of the programmable controllers and data elements, known as tags, handled on the SCADA server need to be linked. Tag databases manage this processing//operation.

To check log data, alarms, and graphics, open an HMI screen by accessing the server from a client personal computer.

Alternatively, the HMI screen can be opened directly on the server.

SCADA system primally collect data. In addition to this function, it converts values on the HMI screen to send instructions to control systems and sends signals for production instructions and process values to the programmable controller after the buttons are pressed.

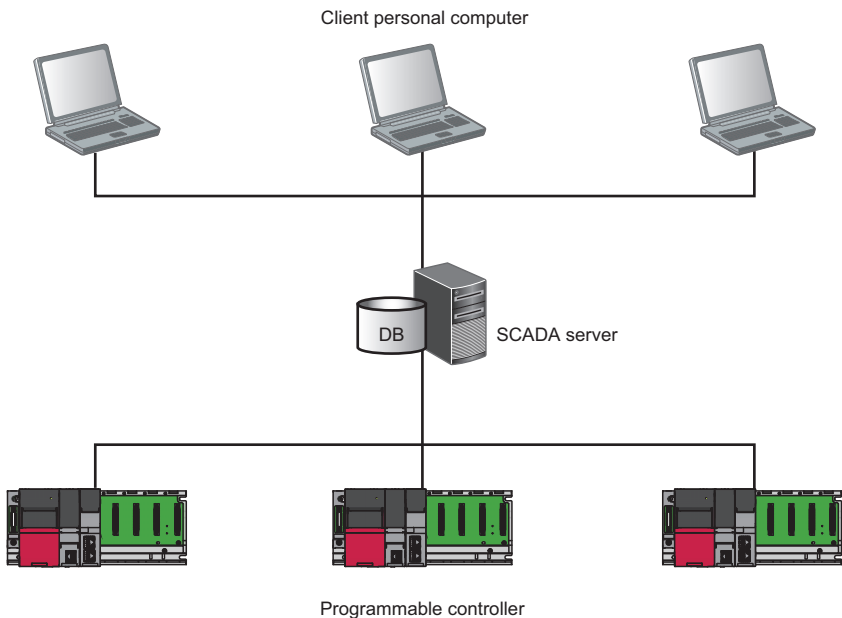

# What to learn in this training course

MC Works64 is used to transfer information which is acquired in a CPU module to databases via the MES interface module and efficiently visualize them. This training practices the operations of (1) and (2). The details on (3) can be learnt in another training course.

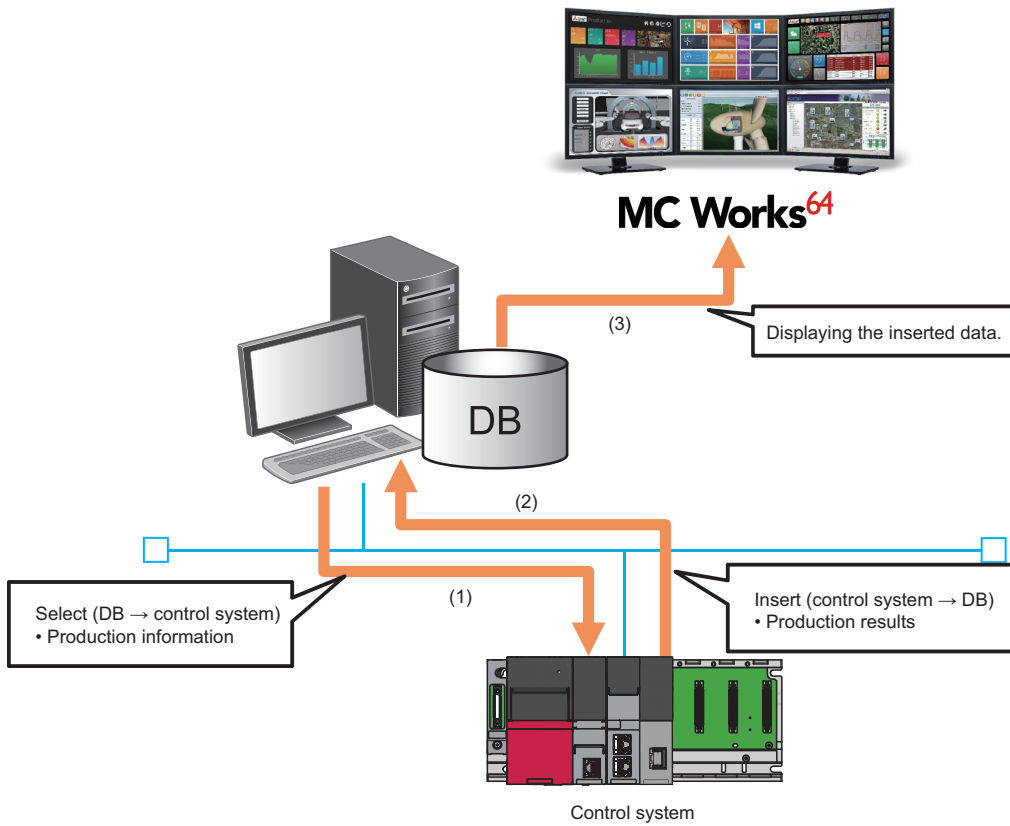

A

# Appendix 2 Database Management System

## Installing database management system

This section describes the procedure for installing Microsoft® SQL Server® in a database server personal computer. In this manual, exercise the installation of Microsoft® SQL Server® with the following conditions.

Item	Description
Database management system	Microsoft® SQL Server® 2016 Express with Advanced Services (64-bit)*1
Operating system	Windows® 10 Pro

\*1 SQL Server Management Studio needs to be the latest version.

Turn on ".NET Framework 4.6 Advanced Services" before installing Microsoft® SQL Server®.

🖱️ "Control Panel" ⇒ "Programs" ⇒ "Programs and Features" ⇒ "Turn Windows features on or off"  
Select the ".NET Framework 4.6 Advanced Services" checkbox.

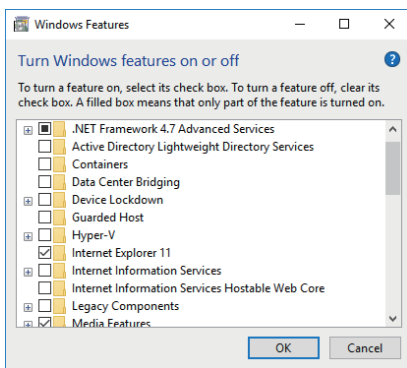

## ■ Installing SQL Server 2016 Express

### Operating procedure

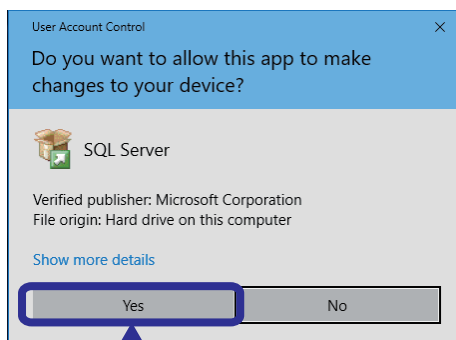

2. Click!



1. Start the downloaded installer.
2. When the "User Account Control" window appears, click the [Yes] button.



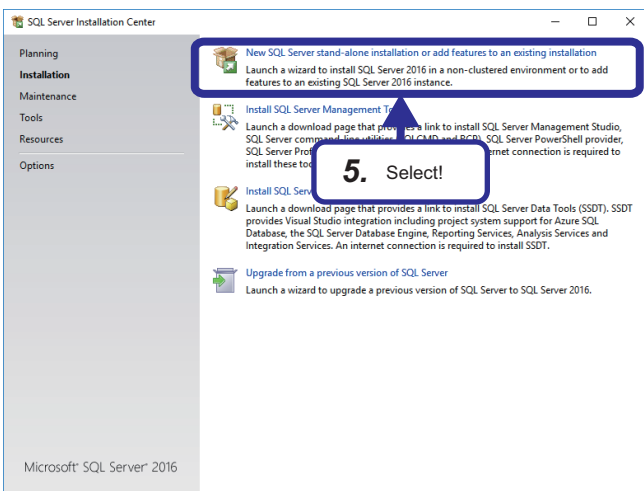
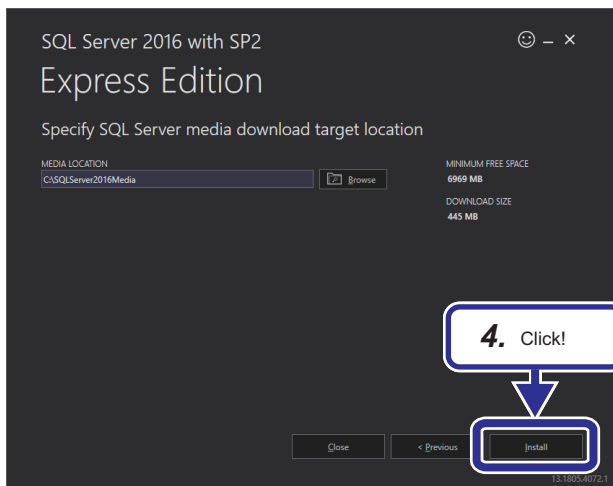
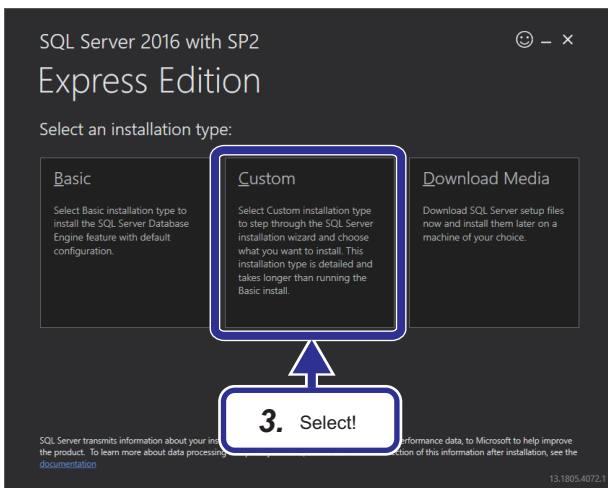

3. Select "Custom" in the installation type.

4. Click the [Install] button.

5. Select "Installation" and "New SQL Server stand-alone installation or add features to an existing installation".



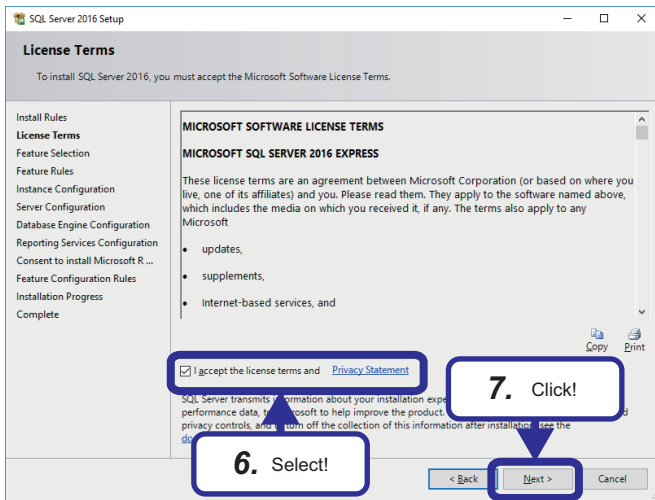

6. Select the "I accept the license terms and Privacy Statement." checkbox.
7. Click the [Next] button.

**Point** When updates for Windows or other programs are detected through Windows Update service, install them by following the instructions on the screen

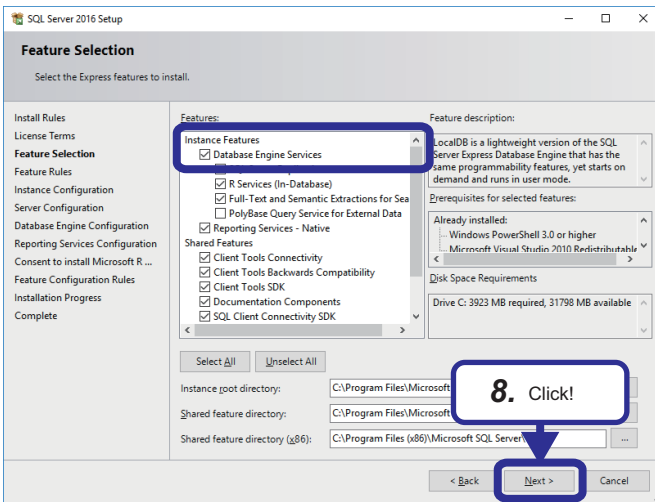

8. Ensure that the "Database Engine Services" checkbox is selected, and click the [Next] button.

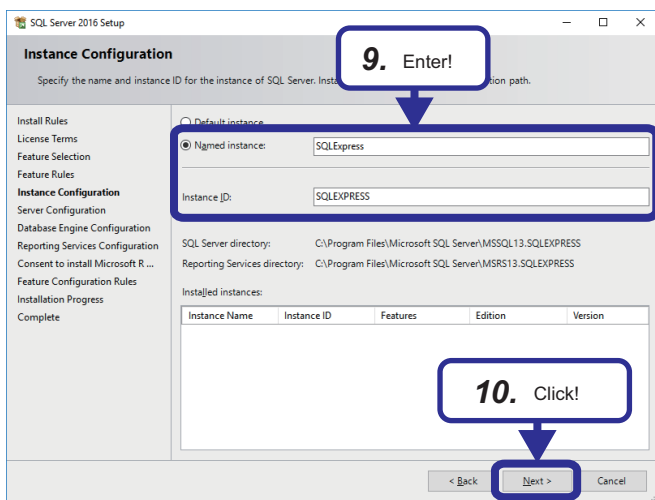

9. Select "Named instance", and enter the following.
  - Named instance: SQLExpress
  - instance ID: SQLEXPRESS
10. Click the [Next] button.



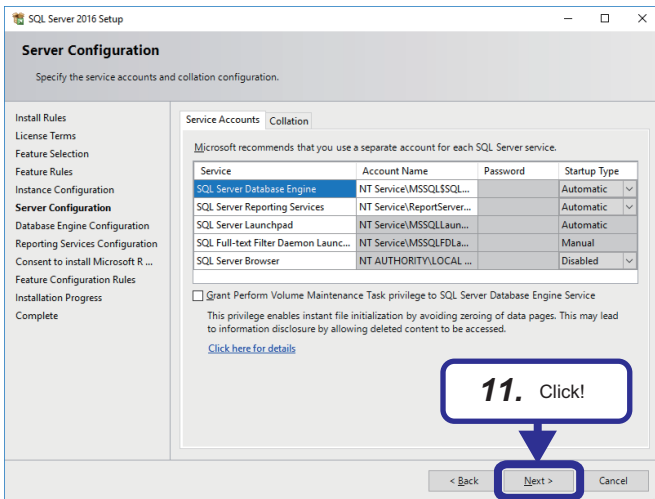

- Set the server configuration according to the database server personal computer to be used and the network environment. Click the [Next] button.



Use the default settings this time.

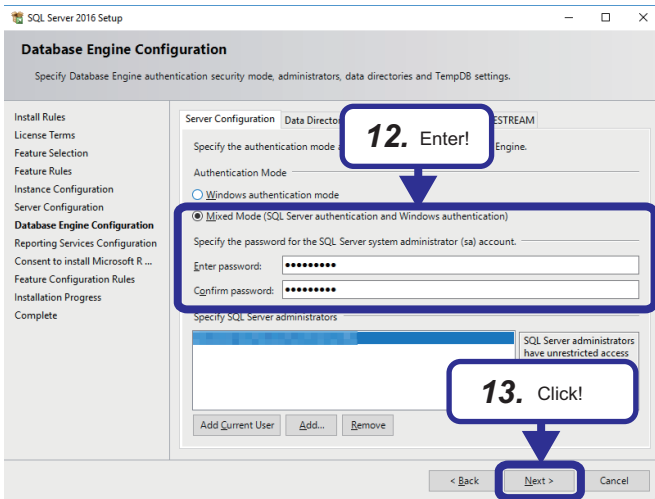

- Select "Mixed mode" and enter the password in "Enter password".

[Setting detail]

Password: Fatec\_MES

- Click the [Next] button.



Login user names for SQL Server can be added using "SQL Server Management Studio" after database generation.

A

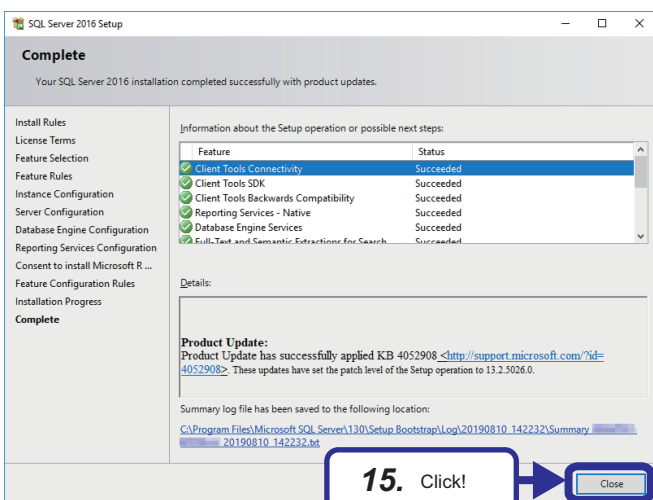

- The "Installation Progress" window appears. When the installation is completed, the "Complete" window appears.

- Click the [Close] button.

## ■ Installing the latest version of SQL Server Management Studio

### Operating procedure

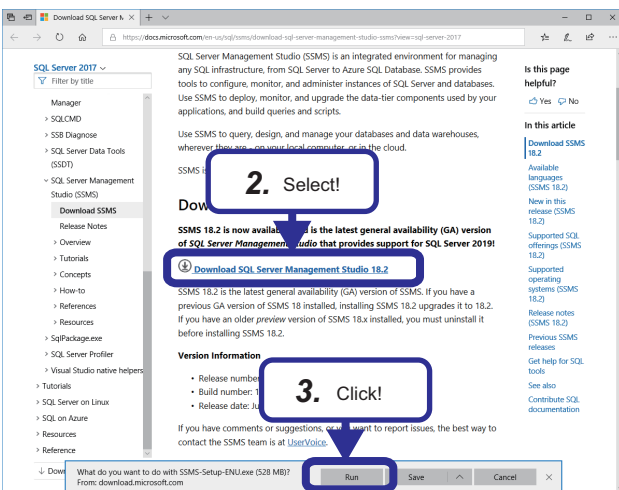
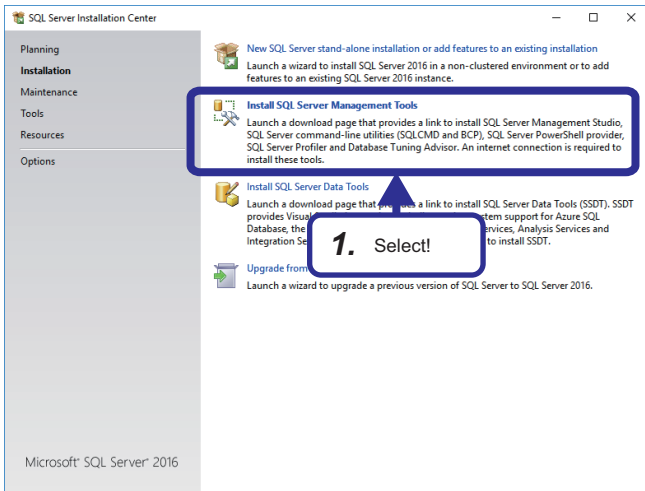

1. Return to the "SQL Server Installation Center" window, and select "Install SQL Server Management Tools".

2. Click "Download SQL Management Studio 18.2" on the link destination website.

3. Click the [Run] button.

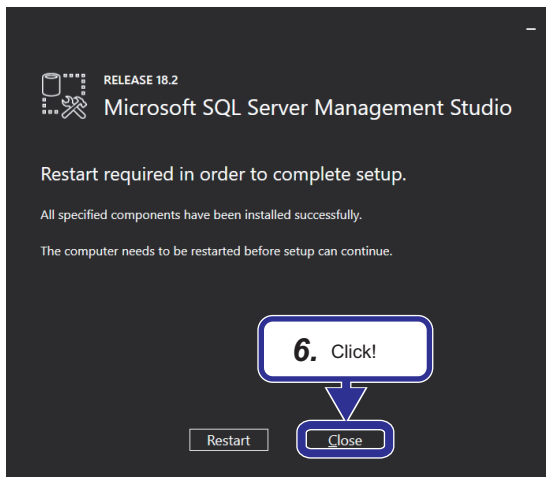
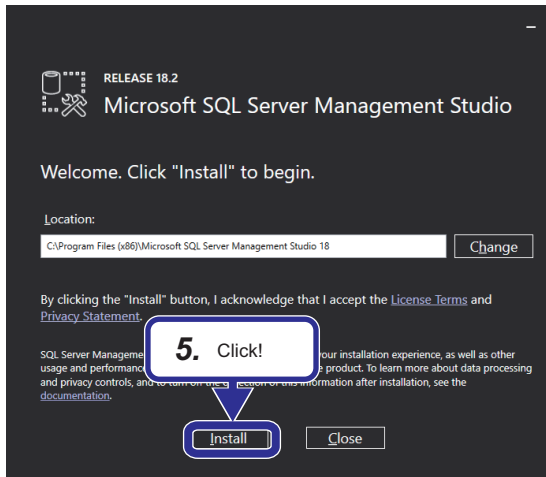

4. When the "User Account Control" window appears, click the [Yes] button.
5. Click the [Install] button.

6. When the installation is completed, click the [Close] button.



# Appendix 3 TCP/IP Setting on Personal Computer

This section describes how to set TCP/IP in a personal computer operated with Microsoft® Windows® 10 Operating System.

## Operating procedure

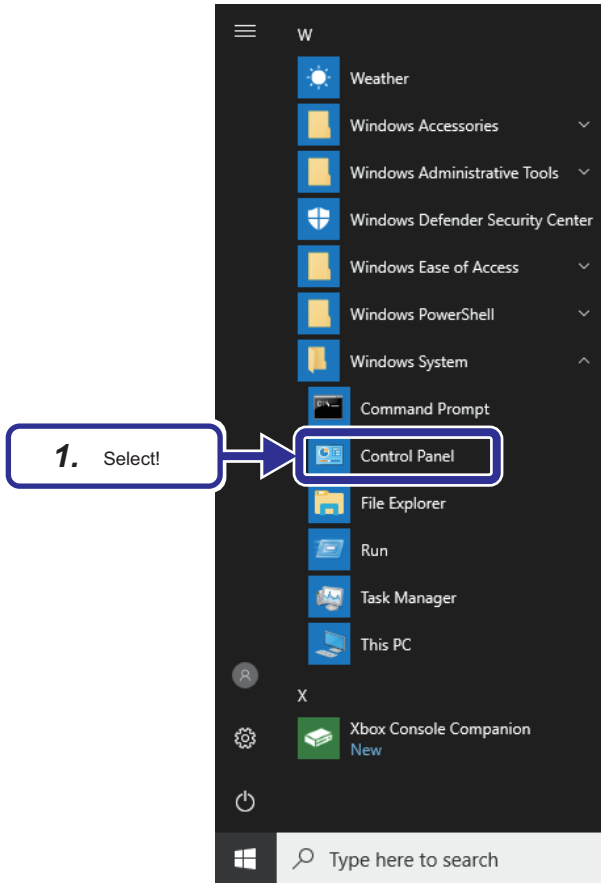

1. On Windows®, select [System Tools] ⇨ [Control Panel] from the start menu.

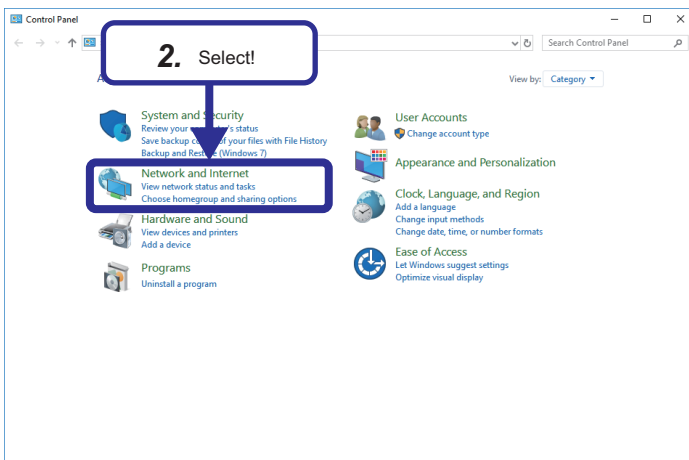

2. The "Control Panel" dialog box appears. Select "Network and Internet".



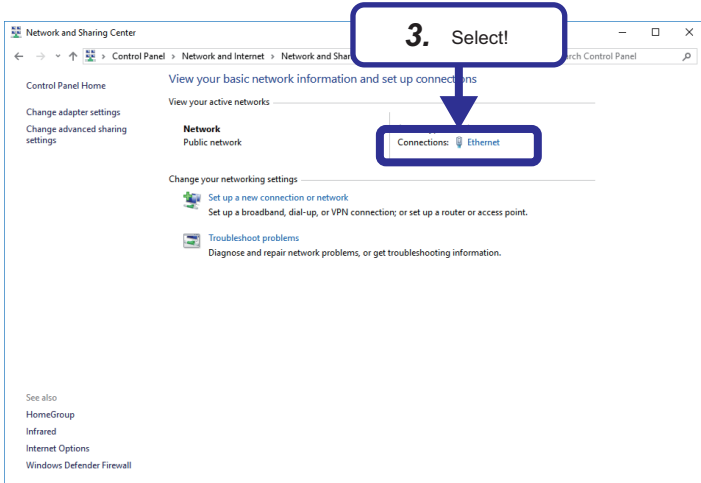

3. Select "Ethernet".

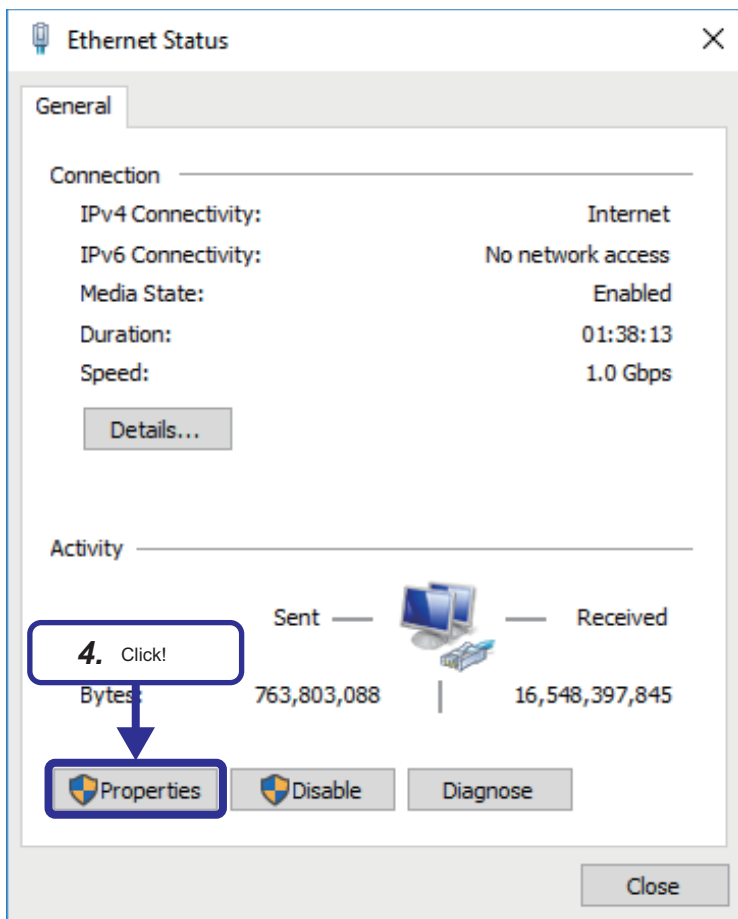

4. Click the [Properties] button.



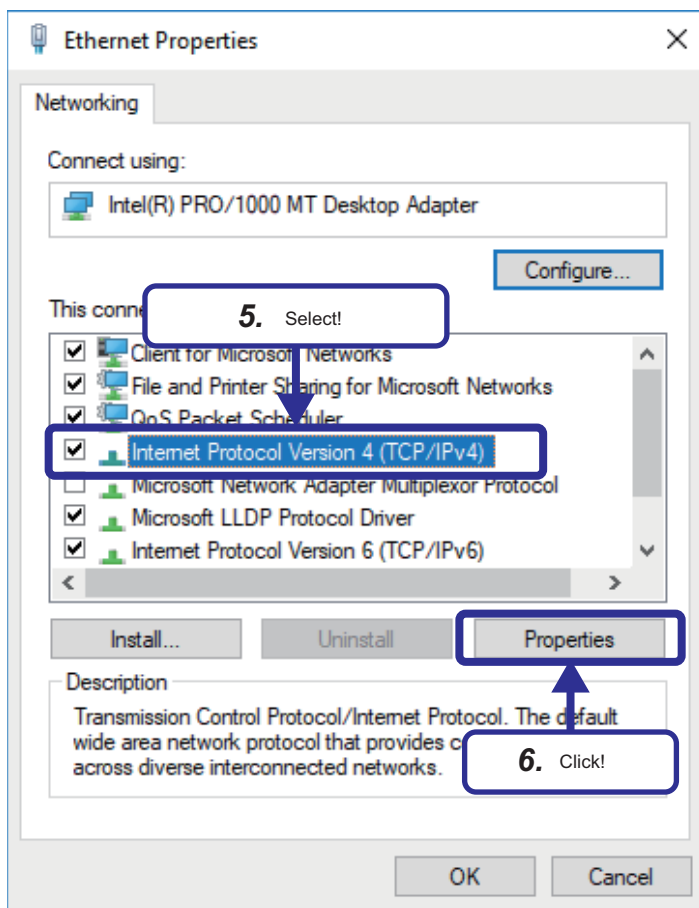

5. Select [Internet Protocol Version 4 (TCP/IPv4)].
6. Click the [Properties] button.

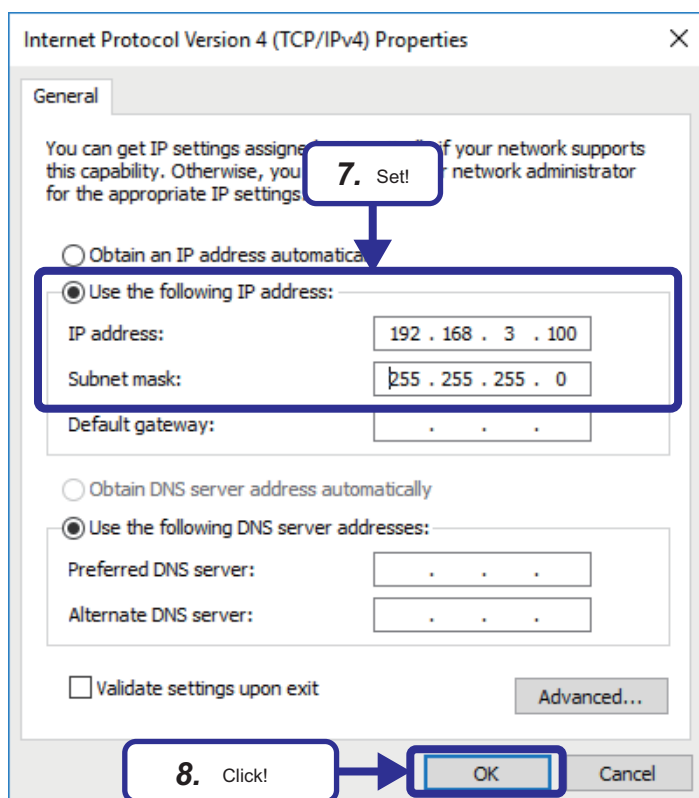

7. Select "Use the following IP address" and set the following.  
[Settings details]  
IP address: 192.168.3.100  
Subnet mask: 255.255.255.0
8. Click the [OK] button.





9. Click the [Close] button.

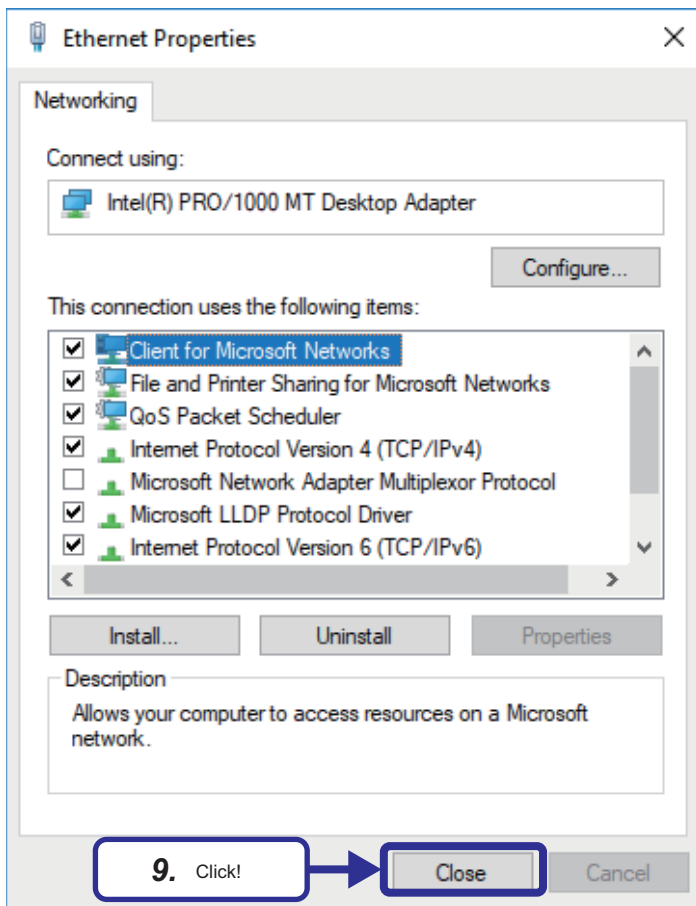

10. Click the [Close] button.

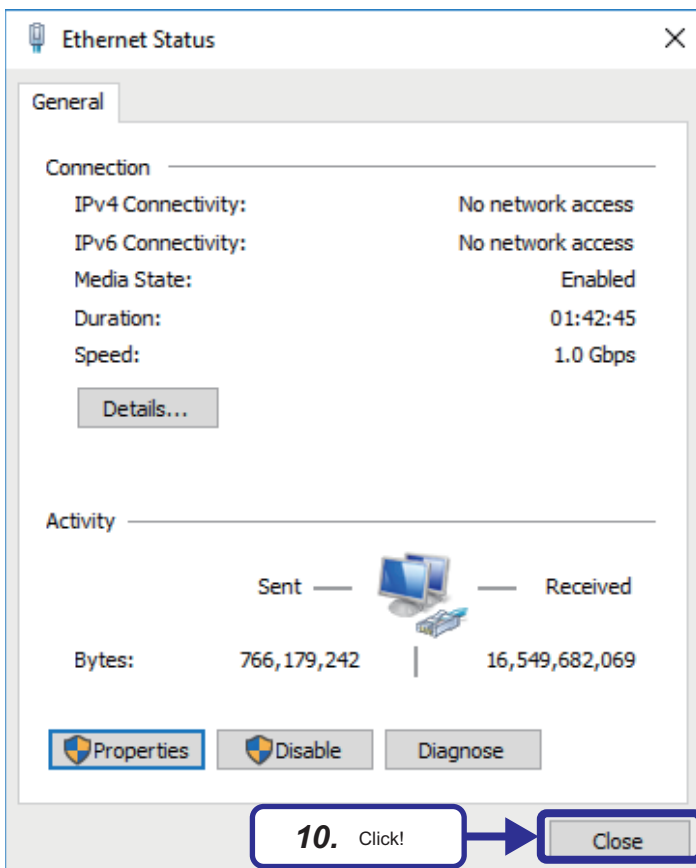

A

# MEMO

---



# Mitsubishi Programmable Controllers Training Manual

## MES Interface Basic Course

MODEL	SCHOOL-R MES-E
MODEL CODE	-
	-

 **MITSUBISHI ELECTRIC CORPORATION**

HEAD OFFICE : TOKYO BUILDING, 2-7-3 MARUNOUCHI, CHIYODA-KU, TOKYO 100-8310, JAPAN  
NAGOYA WORKS : 1-14, YADA-MINAMI 5-CHOME, HIGASHI-KU, NAGOYA, JAPAN

When exported from Japan, this manual does not require application to the Ministry of Economy, Trade and Industry for service transaction permission.

Specifications subject to change without notice.