

Programmable Controller

MELSEC iQ-R
series

MELSEC iQ-R PROFIBUS-DP Module User's Manual (Startup)

-RJ71PB91V



SAFETY PRECAUTIONS

(Read these precautions before using this product.)

Before using this product, please read this manual and the relevant manuals carefully and pay full attention to safety to handle the product correctly.

The precautions given in this manual are concerned with this product only. For the safety precautions of the programmable controller system, refer to the MELSEC iQ-R Module Configuration Manual.

In this manual, the safety precautions are classified into two levels: "⚠️ WARNING" and "⚠️ CAUTION".

 WARNING	Indicates that incorrect handling may cause hazardous conditions, resulting in death or severe injury.
 CAUTION	Indicates that incorrect handling may cause hazardous conditions, resulting in minor or moderate injury or property damage.

Under some circumstances, failure to observe the precautions given under "⚠️ CAUTION" may lead to serious consequences.

Observe the precautions of both levels because they are important for personal and system safety.

Make sure that the end users read this manual and then keep the manual in a safe place for future reference.

[Design Precautions]

WARNING

- Configure safety circuits external to the programmable controller to ensure that the entire system operates safely even when a fault occurs in the external power supply or the programmable controller. Failure to do so may result in an accident due to an incorrect output or malfunction.
 - (1) Emergency stop circuits, protection circuits, and protective interlock circuits for conflicting operations (such as forward/reverse rotations or upper/lower limit positioning) must be configured external to the programmable controller.
 - (2) When the programmable controller detects an abnormal condition, it stops the operation and all outputs are:
 - Turned off if the overcurrent or overvoltage protection of the power supply module is activated.
 - Held or turned off according to the parameter setting if the self-diagnostic function of the CPU module detects an error such as a watchdog timer error.
 - (3) All outputs may be turned on if an error occurs in a part, such as an I/O control part, where the CPU module cannot detect any error. To ensure safety operation in such a case, provide a safety mechanism or a fail-safe circuit external to the programmable controller. For a fail-safe circuit example, refer to "General Safety Requirements" in the MELSEC iQ-R Module Configuration Manual.
 - (4) Outputs may remain on or off due to a failure of a component such as a relay and transistor in an output circuit. Configure an external circuit for monitoring output signals that could cause a serious accident.
 - In an output circuit, when a load current exceeding the rated current or an overcurrent caused by a load short-circuit flows for a long time, it may cause smoke and fire. To prevent this, configure an external safety circuit, such as a fuse.
 - Configure a circuit so that the programmable controller is turned on first and then the external power supply. If the external power supply is turned on first, an accident may occur due to an incorrect output or malfunction.
 - Configure a circuit so that the external power supply is turned off first and then the programmable controller. If the programmable controller is turned off first, an accident may occur due to an incorrect output or malfunction.
 - For the operating status of each station after a communication failure, refer to manuals for the network used. For the manuals, please consult your local Mitsubishi representative. Incorrect output or malfunction due to a communication failure may result in an accident.
 - When connecting an external device with a CPU module or intelligent function module to modify data of a running programmable controller, configure an interlock circuit in the program to ensure that the entire system will always operate safely. For other forms of control (such as program modification, parameter change, forced output, or operating status change) of a running programmable controller, read the relevant manuals carefully and ensure that the operation is safe before proceeding. Improper operation may damage machines or cause accidents.
-

[Design Precautions]

WARNING

- Especially, when a remote programmable controller is controlled by an external device, immediate action cannot be taken if a problem occurs in the programmable controller due to a communication failure. To prevent this, configure an interlock circuit in the program, and determine corrective actions to be taken between the external device and CPU module in case of a communication failure.
 - Do not write any data to the "system area" and "write-protect area" of the buffer memory in the module. Also, do not use any "use prohibited" signals as an output signal from the CPU module to each module. Doing so may cause malfunction of the programmable controller system. For the "system area", "write-protect area", and the "use prohibited" signals, refer to the user's manual for the module used. For areas used for safety communications, they are protected from being written by users, and thus safety communications failure caused by data writing does not occur.
 - If a communication cable is disconnected, the network may be unstable, resulting in a communication failure of multiple stations. Configure an interlock circuit in the program to ensure that the entire system will always operate safely even if communications fail. Failure to do so may result in an accident due to an incorrect output or malfunction. When safety communications are used, an interlock by the safety station interlock function protects the system from an incorrect output or malfunction.
 - If a communication failure occurs with a PROFIBUS-DP network, the operating status of each station is as follows:
 - (1) The DP-Master holds the input data when the communication failure occurs.
 - (2) If the DP-Master goes down, the output status of each DP-Slave depends on the parameter setting of the DP-Master.
 - (3) If a DP-Slave goes down, the output status of other DP-Slaves depends on the parameter setting of the DP-Master.

Check the diagnostic information and configure an interlock circuit in the program to ensure that the entire system will operate safely. Failure to do so may result in an accident due to an incorrect output or malfunction.
 - The assignments of I/O signals and buffer memory areas differ depending on whether the RJ71PB91V is used as the DP-Master or a DP-Slave. Configure an interlock circuit in the program to ensure that the program does not run with the incorrect station type.
-

[Design Precautions]

WARNING

- If a stop error occurs in the CPU module, the operating status of the DP-Master is as follows.
In a redundant system, however, the operation is the same as when "CPU Error Output Mode Setting" is set to "Hold" regardless of its setting value.
 - (1) When "CPU Error Output Mode Setting" is set to "Clear"
 - I/O data exchanges with DP-Slaves are interrupted.
 - Output data in the buffer memory of the DP-Master are cleared and not sent.
 - Input data which have been received from DP-Slaves when a stop error occurs in the CPU module are held in the buffer memory of the DP-Master.
 - (2) When "CPU Error Output Mode Setting" is set to "Hold"
 - I/O data exchanges with DP-Slaves are continued.
 - Output data which have been stored in the buffer memory of the DP-Master when a stop error occurs in the CPU module are held and sent to DP-Slaves.
 - Data in the buffer memory of the DP-Master are updated with input data received from DP-Slaves.
 - If a stop error occurs in the CPU module, the operating status of DP-Slaves is as follows:
 - (1) When "CPU Error Output Mode Setting" is set to "Clear"
 - Input data to be sent from DP-Slaves to the DP-Master are cleared.
 - Output data which have been received from the DP-Master when a stop error occurs in the CPU module are held in the buffer memory of DP-Slaves.
 - (2) When "CPU Error Output Mode Setting" is set to "Hold"
 - Input data to be sent from DP-Slaves to the DP-Master when a stop error occurs in the CPU module are held.
 - Output data which have been received from the DP-Master when a stop error occurs in the CPU module are held in the buffer memory of DP-Slaves.
-

[Design Precautions]

CAUTION

- Do not install the control lines or communication cables together with the main circuit lines or power cables. Doing so may result in malfunction due to electromagnetic interference. Keep a distance of 100mm or more between those cables.
 - During control of an inductive load such as a lamp, heater, or solenoid valve, a large current (approximately ten times greater than normal) may flow when the output is turned from off to on. Therefore, use a module that has a sufficient current rating.
 - After the CPU module is powered on or is reset, the time taken to enter the RUN status varies depending on the system configuration, parameter settings, and/or program size. Design circuits so that the entire system will always operate safely, regardless of the time.
 - Do not power off the programmable controller or reset the CPU module while the settings are being written. Doing so will make the data in the flash ROM and SD memory card undefined. The values need to be set in the buffer memory and written to the flash ROM and SD memory card again. Doing so also may cause malfunction or failure of the module.
 - When changing the operating status of the CPU module from external devices (such as the remote RUN/STOP functions), select "Do Not Open by Program" for "Opening Method" of "Module Parameter". If "Open by Program" is selected, an execution of the remote STOP function causes the communication line to close. Consequently, the CPU module cannot reopen the line, and external devices cannot execute the remote RUN function.
-

[Security Precautions]

WARNING

- To maintain the security (confidentiality, integrity, and availability) of the programmable controller and the system against unauthorized access, denial-of-service (DoS) attacks, computer viruses, and other cyberattacks from external devices via the network, take appropriate measures such as firewalls, virtual private networks (VPNs), and antivirus solutions.
-

[Installation Precautions]

WARNING

- Shut off the external power supply (all phases) used in the system before mounting or removing the module. Failure to do so may result in electric shock or cause the module to fail or malfunction.
-

[Installation Precautions]

CAUTION

- Use the programmable controller in an environment that meets the general specifications in the Safety Guidelines (IB-0800525). Failure to do so may result in electric shock, fire, malfunction, or damage to or deterioration of the product.
 - To mount a module, place the concave part(s) located at the bottom onto the guide(s) of the base unit, and push in the module until the hook(s) located at the top snaps into place. Incorrect interconnection may cause malfunction, failure, or drop of the module.
 - To mount a module with no module fixing hook, place the concave part(s) located at the bottom onto the guide(s) of the base unit, push in the module, and fix it with screw(s). Incorrect interconnection may cause malfunction, failure, or drop of the module.
 - When using the programmable controller in an environment of frequent vibrations, fix the module with a screw.
 - Tighten the screws within the specified torque range. Undertightening can cause drop of the component or wire, short circuit, or malfunction. Overtightening can damage the screw and/or module, resulting in drop, short circuit, or malfunction. For the specified torque range, refer to the Page 35 Wiring Products.
 - When using an extension cable, connect it to the extension cable connector of the base unit securely. Check the connection for looseness. Poor contact may cause malfunction.
 - When using an SD memory card, fully insert it into the SD memory card slot. Check that it is inserted completely. Poor contact may cause malfunction.
 - Securely insert an extended SRAM cassette or a battery-less option cassette into the cassette connector of the CPU module. After insertion, close the cassette cover and check that the cassette is inserted completely. Poor contact may cause malfunction.
 - Beware that the module could be very hot while power is on and immediately after power-off.
 - Do not directly touch any conductive parts and electronic components of the module, SD memory card, extended SRAM cassette, battery-less option cassette, or connector. Doing so can cause malfunction or failure of the module.
-

[Wiring Precautions]

WARNING

- Shut off the external power supply (all phases) used in the system before installation and wiring. Failure to do so may result in electric shock or cause the module to fail or malfunction.
- After installation and wiring, attach a blank cover module (RG60) to each empty slot before powering on the system for operation. Also, attach an extension connector protective cover^{*1} to each unused extension cable connector as necessary. Directly touching any conductive parts of the connectors while power is on may result in electric shock.

*1 For details, please consult your local Mitsubishi Electric representative.

[Wiring Precautions]

CAUTION

- Individually ground the FG and LG terminals of the programmable controller with a ground resistance of 100 ohms or less. Failure to do so may result in electric shock or malfunction.
 - Use applicable solderless terminals and tighten them within the specified torque range. If any spade solderless terminal is used, it may be disconnected when the terminal screw comes loose, resulting in failure.
 - Check the rated voltage and signal layout before wiring to the module, and connect the cables correctly. Connecting a power supply with a different voltage rating or incorrect wiring may cause fire or failure.
 - Connectors for external devices must be crimped or pressed with the tool specified by the manufacturer, or must be correctly soldered. Incomplete connections may cause short circuit, fire, or malfunction.
 - Securely connect the connector to the module. Poor contact may cause malfunction.
 - Do not install the control lines or communication cables together with the main circuit lines or power cables. Doing so may result in malfunction due to noise. Keep a distance of 100mm or more between those cables.
 - Place the cables in a duct or clamp them. If not, dangling cables may swing or inadvertently be pulled, resulting in malfunction or damage to modules or cables.
In addition, the weight of the cables may put stress on modules in an environment of strong vibrations and shocks.
Do not clamp the extension cables with the jacket stripped. Doing so may change the characteristics of the cables, resulting in malfunction.
 - Check the interface type and correctly connect the cable. Incorrect wiring (connecting the cable to an incorrect interface) may cause failure of the module and external device.
-

[Wiring Precautions]

CAUTION

- Tighten the terminal screws or connector screws within the specified torque range. Undertightening can cause drop of the screw, short circuit, fire, or malfunction. Overtightening can damage the screw and/or module, resulting in drop, short circuit, fire, or malfunction.
 - When disconnecting the cable from the module, do not pull the cable by the cable part. For the cable with connector, hold the connector part of the cable. For the cable connected to the terminal block, loosen the terminal screw. Pulling the cable connected to the module may result in malfunction or damage to the module or cable.
 - Prevent foreign matter such as dust or wire chips from entering the module. Such foreign matter can cause a fire, failure, or malfunction.
 - When a protective film is attached to the top of the module, remove it before system operation. If not, inadequate heat dissipation of the module may cause a fire, failure, or malfunction.
 - Programmable controllers must be installed in control panels. Connect the main power supply to the power supply module in the control panel through a relay terminal block. Wiring and replacement of a power supply module must be performed by qualified maintenance personnel with knowledge of protection against electric shock. For wiring, refer to the MELSEC iQ-R Module Configuration Manual.
 - For Ethernet cables to be used in the system, select the ones that meet the specifications in the user's manual for the module used. If not, normal data transmission is not guaranteed.
-

[Startup and Maintenance Precautions]

WARNING

- Do not touch any terminal while power is on. Doing so will cause electric shock or malfunction.
 - Correctly connect the battery connector. Do not charge, disassemble, heat, short-circuit, solder, or throw the battery into the fire. Also, do not expose it to liquid or strong shock. Doing so will cause the battery to produce heat, explode, ignite, or leak, resulting in injury and fire.
 - Shut off the external power supply (all phases) used in the system before cleaning the module or retightening the terminal screws, connector screws, or module fixing screws. Failure to do so may result in electric shock.
-

[Startup and Maintenance Precautions]

CAUTION

- When connecting an external device with a CPU module or intelligent function module to modify data of a running programmable controller, configure an interlock circuit in the program to ensure that the entire system will always operate safely. For other forms of control (such as program modification, parameter change, forced output, or operating status change) of a running programmable controller, read the relevant manuals carefully and ensure that the operation is safe before proceeding. Improper operation may damage machines or cause accidents.
 - Especially, when a remote programmable controller is controlled by an external device, immediate action cannot be taken if a problem occurs in the programmable controller due to a communication failure. To prevent this, configure an interlock circuit in the program, and determine corrective actions to be taken between the external device and CPU module in case of a communication failure.
 - Do not disassemble or modify the modules. Doing so may cause failure, malfunction, injury, or a fire.
 - Use any radio communication device such as a cellular phone or PHS (Personal Handy-phone System) more than 25cm away in all directions from the programmable controller. Failure to do so may cause malfunction.
 - Shut off the external power supply (all phases) used in the system before mounting or removing the module. Failure to do so may cause the module to fail or malfunction.
 - Tighten the screws within the specified torque range. Undertightening can cause drop of the component or wire, short circuit, or malfunction. Overtightening can damage the screw and/or module, resulting in drop, short circuit, or malfunction.
 - After the first use of the product, do not perform each of the following operations more than 50 times (IEC 61131-2/JIS B 3502 compliant).
Exceeding the limit may cause malfunction.
 - Mounting/removing the module to/from the base unit
 - Inserting/removing the extended SRAM cassette or battery-less option cassette to/from the CPU module
 - Mounting/removing the terminal block to/from the module
 - Connecting/disconnecting the extension cable to/from the base unit
 - After the first use of the product, do not insert/remove the SD memory card to/from the CPU module more than 500 times. Exceeding the limit may cause malfunction.
 - Do not touch the metal terminals on the back side of the SD memory card. Doing so may cause malfunction or failure of the module.
 - Do not touch the integrated circuits on the circuit board of an extended SRAM cassette or a battery-less option cassette. Doing so may cause malfunction or failure of the module.
-

[Startup and Maintenance Precautions]

CAUTION

- Do not drop or apply shock to the battery to be installed in the module. Doing so may damage the battery, causing the battery fluid to leak inside the battery. If the battery is dropped or any shock is applied to it, dispose of it without using.
 - Startup and maintenance of a control panel must be performed by qualified maintenance personnel with knowledge of protection against electric shock. Lock the control panel so that only qualified maintenance personnel can operate it.
 - Before handling the module, touch a conducting object such as a grounded metal to discharge the static electricity from the human body. Wearing a grounded antistatic wrist strap is recommended. Failure to discharge the static electricity may cause the module to fail or malfunction.
 - After unpacking, eliminate static electricity from the module to prevent electrostatic discharge from affecting the module. If an electrostatically charged module comes in contact with a grounded metal object, a sudden electrostatic discharge of the module may cause failure.
For details on how to eliminate static electricity from the module, refer to the following.
Antistatic Precautions Before Using MELSEC iQ-R Series Products (FA-A-0368)
 - Use a clean and dry cloth to wipe off dirt on the module.
-

[Operating Precautions]

CAUTION

- When changing data and operating status, and modifying program of the running programmable controller from an external device such as a personal computer connected to an intelligent function module, read relevant manuals carefully and ensure the safety before operation. Incorrect change or modification may cause system malfunction, damage to the machines, or accidents.
 - Do not power off the programmable controller or reset the CPU module while the setting values in the buffer memory are being written to the flash ROM in the module. Doing so will make the data in the flash ROM and SD memory card undefined. The values need to be set in the buffer memory and written to the flash ROM and SD memory card again. Doing so can cause malfunction or failure of the module.
-

[Disposal Precautions]

CAUTION

- When disposing of this product, treat it as industrial waste.
 - When disposing of batteries, separate them from other wastes according to the local regulations. For details on battery regulations in EU member states, refer to the MELSEC iQ-R Module Configuration Manual.
-

[Transportation Precautions]

CAUTION

- When transporting lithium batteries, follow the transportation regulations. For details on the regulated models, refer to the MELSEC iQ-R Module Configuration Manual.
 - The halogens (such as fluorine, chlorine, bromine, and iodine), which are contained in a fumigant used for disinfection and pest control of wood packaging materials, may cause failure of the product. Prevent the entry of fumigant residues into the product or consider other methods (such as heat treatment) instead of fumigation. The disinfection and pest control measures must be applied to unprocessed raw wood.
-

CONDITIONS OF USE FOR THE PRODUCT

- (1) MELSEC programmable controller ("the PRODUCT") shall be used in conditions;
- i) where any problem, fault or failure occurring in the PRODUCT, if any, shall not lead to any major or serious accident; and
 - ii) where the backup and fail-safe function are systematically or automatically provided outside of the PRODUCT for the case of any problem, fault or failure occurring in the PRODUCT.
- (2) The PRODUCT has been designed and manufactured for the purpose of being used in general industries. MITSUBISHI ELECTRIC SHALL HAVE NO RESPONSIBILITY OR LIABILITY (INCLUDING, BUT NOT LIMITED TO ANY AND ALL RESPONSIBILITY OR LIABILITY BASED ON CONTRACT, WARRANTY, TORT, PRODUCT LIABILITY) FOR ANY INJURY OR DEATH TO PERSONS OR LOSS OR DAMAGE TO PROPERTY CAUSED BY the PRODUCT THAT ARE OPERATED OR USED IN APPLICATION NOT INTENDED OR EXCLUDED BY INSTRUCTIONS, PRECAUTIONS, OR WARNING CONTAINED IN MITSUBISHI ELECTRIC USER'S, INSTRUCTION AND/OR SAFETY MANUALS, TECHNICAL BULLETINS AND GUIDELINES FOR the PRODUCT.
- ("Prohibited Application")
- Prohibited Applications include, but not limited to, the use of the PRODUCT in;
- Nuclear Power Plants and any other power plants operated by Power companies, and/or any other cases in which the public could be affected if any problem or fault occurs in the PRODUCT.
 - Railway companies or Public service purposes, and/or any other cases in which establishment of a special quality assurance system is required by the Purchaser or End User.
 - Aircraft or Aerospace, Medical applications, Train equipment, transport equipment such as Elevator and Escalator, Incineration and Fuel devices, Vehicles, Manned transportation, Equipment for Recreation and Amusement, and Safety devices, handling of Nuclear or Hazardous Materials or Chemicals, Mining and Drilling, and/or other applications where there is a significant risk of injury to the public or property.
- Notwithstanding the above restrictions, Mitsubishi Electric may in its sole discretion, authorize use of the PRODUCT in one or more of the Prohibited Applications, provided that the usage of the PRODUCT is limited only for the specific applications agreed to by Mitsubishi Electric and provided further that no special quality assurance or fail-safe, redundant or other safety features which exceed the general specifications of the PRODUCTS are required. For details, please contact the Mitsubishi Electric representative in your region.
- (3) Mitsubishi Electric shall have no responsibility or liability for any problems involving programmable controller trouble and system trouble caused by DoS attacks, unauthorized access, computer viruses, and other cyberattacks.

INTRODUCTION

Thank you for purchasing the Mitsubishi Electric MELSEC iQ-R series programmable controllers.

This manual describes the procedures, system configuration, and wiring of the relevant product listed below.

Before using this product, please read this manual and the relevant manuals carefully and develop familiarity with the functions and performance of the MELSEC iQ-R series programmable controller to handle the product correctly.

When applying the program examples provided in this manual to an actual system, ensure the applicability and confirm that it will not cause system control problems.

Please make sure that the end users read this manual.

Relevant product

RJ71PB91V

COMPLIANCE WITH EMC AND LOW VOLTAGE DIRECTIVES

Method of ensuring compliance

To ensure that Mitsubishi Electric programmable controllers maintain the EMC and Low Voltage Directives or other regulations when incorporated into other machinery or equipment, certain measures may be necessary. Please refer to one of the following manuals.

- MELSEC iQ-R Module Configuration Manual (SH-081262ENG)
- Safety Guidelines (IB-0800525)

Certification marks on the side of the programmable controller indicate compliance with the relevant regulations.

Additional measures

No additional measures are necessary for the compliance of this product with EMC and Low Voltage Directives.

CONTENTS

SAFETY PRECAUTIONS	1
CONDITIONS OF USE FOR THE PRODUCT	12
INTRODUCTION	13
COMPLIANCE WITH EMC AND LOW VOLTAGE DIRECTIVES	14
RELEVANT MANUALS	16
TERMS	17
GENERIC TERMS AND ABBREVIATIONS	18
CHAPTER 1 PART NAMES	19
CHAPTER 2 SPECIFICATIONS	21
2.1 Performance Specifications	21
CHAPTER 3 FUNCTION LIST	23
3.1 Functions of DP-Master	23
3.2 Functions of DP-Slave	23
CHAPTER 4 PROCEDURES BEFORE OPERATION	25
CHAPTER 5 SYSTEM CONFIGURATION	27
5.1 Configuration of PROFIBUS-DP Network	27
5.2 Available Software Packages	31
CHAPTER 6 WIRING	33
6.1 Connectors	33
6.2 Wiring Products	35
CHAPTER 7 COMMUNICATION EXAMPLE	36
7.1 Communication Example of I/O Data Exchanges	36
System configuration example	36
Settings for DP-Master	38
Settings for DP-Slaves	44
Checking the network status	46
Program example	47
APPENDIX	52
Appendix 1 External Dimensions	52
INDEX	54
REVISIONS	56
WARRANTY	57
TRADEMARKS	58

RELEVANT MANUALS

Manual name [manual number]	Description	Available form
MELSEC iQ-R PROFIBUS-DP Module User's Manual (Startup) [SH-081855ENG] (this manual)	Specifications, procedures before operation, system configuration, wiring, and communication examples of the PROFIBUS-DP module	Print book e-Manual PDF
MELSEC iQ-R Module Configuration Manual [SH-081262ENG]	The combination of the MELSEC iQ-R series modules, common information on the installation/wiring in the system, and specifications of the power supply module, base unit, SD memory card, and battery	Print book e-Manual PDF
MELSEC iQ-R PROFIBUS-DP Module User's Manual (Application) [SH-081857ENG]	Functions, parameter settings, PROFIBUS Configuration Tool, programming, troubleshooting, I/O signals, and buffer memory of the PROFIBUS-DP module	Print book e-Manual PDF
MELSEC iQ-R PROFIBUS-DP Module Function Block Reference [BCN-P5999-0914]	Specifications of the MELSEC iQ-R series PROFIBUS-DP module FBs	e-Manual PDF
GX Works3 Operating Manual [SH-081215ENG]	System configuration, parameter settings, and online operations of GX Works3	e-Manual PDF

This manual does not include detailed information on the following:

- General specifications
- Applicable combinations of CPU modules and the other modules, and the number of mountable modules
- Installation

For details, refer to the following.

 MELSEC iQ-R Module Configuration Manual

Point

e-Manual refers to the Mitsubishi Electric FA electronic book manuals that can be browsed using a dedicated tool.

e-Manual has the following features:

- Required information can be cross-searched in multiple manuals.
- Other manuals can be accessed from the links in the manual.
- The hardware specifications of each part can be found from the product figures.
- Pages that users often browse can be bookmarked.
- Sample programs can be copied to an engineering tool.

TERMS

Unless otherwise specified, this manual uses the following terms.

Term	Description
Backup mode	A mode to continue operation in a redundant system. This mode can continue the operation by switching the systems from the control system to the standby system when an error occurs in the control system.
Buffer memory	Memory in an intelligent function module to store data such as setting values and monitor values. For CPU modules, it refers to memory to store data such as setting values and monitor values of the Ethernet function, or data used for data communication of the multiple CPU system function.
Control system	A system that controls a redundant system and performs network communications in a redundant system
Device	A memory of a CPU module to store data. Devices such as X, Y, M, D, and others are provided depending on the intended use.
Diagnostic information	Diagnostic information of PROFIBUS-DP detected from the DP-Master or notified from a DP-Slave.
DP-Master	A device name when the RJ71PB91V is used as the DP-Master (Class 1). This device exchanges I/O data with DP-Slaves.
DP-Master (Class 1)	A device (such as a general master station that uses a PROFIBUS-DP module) that exchanges I/O data with DP-Slaves.
DP-Master (Class 2)	A device (such as a personal computer) that communicates with DP-Slaves to check the FDL address setting and the operating status. This device is capable of performing start-up, maintenance, and diagnostics of the network as the DP-Master for network control.
DP-Slave	A device that exchanges I/O data with the DP-Master (Class 1)
Engineering tool	A tool used for setting up programmable controllers, programming, debugging, and maintenance
Extended diagnostic information	Diagnostic information specific to each DP-Slave. A DP-Slave notifies the DP-Master of an error detection.
FDL address	The numbers assigned to a DP-Master and DP-Slaves. The FDL address is set within the range from 0 to 125.
Global label	A label that is valid for all the program data when multiple program data are created in the project. There are two types of global label: a module specific label (module label), which is generated automatically by GX Works3, and an optional label, which can be created for any specified device.
Intelligent function module	A module that has functions other than an input or output, such as an A/D converter module and D/A converter module
Module label	A label that represents one of memory areas (I/O signals and buffer memory areas) specific to each module in a given character string. For the module used, the engineering tool automatically generates this label, which can be used as a global label.
Process CPU	A CPU module that performs process control and sequence control. Process control function blocks and the online module change function can be executed. This module is also used with a redundant function module as a pair and configures a redundant system.
Process CPU (redundant mode)	A Process CPU operating in redundant mode. A redundant system is configured with this CPU module. Process control function blocks and the online module change function can be used even in this mode.
PROFIBUS-DPV0	Basic version of PROFIBUS-DP. This version can be executed the I/O data exchange function or other functions.
PROFIBUS-DPV1	Version of PROFIBUS-DP that contains the following functions in addition to the basic functions of PROFIBUS-DPV0. <ul style="list-style-type: none"> • Acyclic communication function • Alarm function
PROFIBUS-DPV2	Version of PROFIBUS-DP that contains the time control over DP-Slaves or other functions in addition to the functions of PROFIBUS-DPV1.
Redundant system	A system consisting of two systems that have same configuration (CPU module, power supply module, network module, and other modules). Even after an error occurs in one of the two system, the other system takes over the control of the entire system.  MELSEC iQ-R Module Configuration Manual
Safety CPU	A module that performs both standard control and safety control and is used with a safety function module.
Separate mode	A mode for system maintenance in a redundant system. This mode can maintain a redundant system without stopping control while the system is running.
SIL2 Process CPU	This module is used with a SIL2 function module as a pair, and performs both standard control and safety control. This module is also used with a redundant function module as a pair and configures a redundant system.
Standby system	A backup system in a redundant system
System A	A system that is set as system A to distinguish two systems in a redundant system. It is used to distinguish connected two systems (system A and system B).
System B	A system that is set as system B to distinguish two systems in a redundant system. It is used to distinguish connected two systems (system A and system B).
System switching	A function which switches the systems between the control system and the standby system to continue operation of the redundant system when a failure or an error occurs in the control system

Term	Description
Tracking cable	An optical fiber cable used to connect two redundant function modules in a redundant system

GENERIC TERMS AND ABBREVIATIONS

Unless otherwise specified, this manual uses the following generic terms and abbreviations.

Generic term/abbreviation	Description
CPU module	A generic term for the MELSEC iQ-R series CPU modules
Both systems	A generic term for system A and system B, or control system and standby system

1 PART NAMES

This section describes the names of each part of the RJ71PB91V.

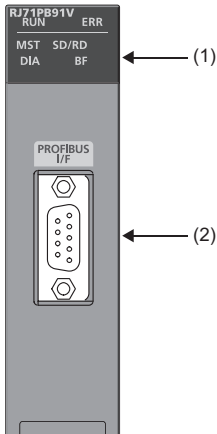

No.	Name	Description	
(1)	RUN LED	Indicates the operating status of the module. On: Normal operation Flashing: During initialization of the flash ROM or during self-diagnostics test Off: Error (MELSEC iQ-R PROFIBUS-DP Module User's Manual (Application))	
	ERR LED	Indicates the error status of the module. On or flashing: Error (MELSEC iQ-R PROFIBUS-DP Module User's Manual (Application)) Off: Normal operation	
	MST LED	Indicates the operating status. On: Operating as the DP-Master (in the redundant system, operating as the DP-Master for the control system or for the standby system) Off: Operating as the DP-Slave	
	SD/RD LED	When operating as the DP-Master	Indicates the communication status with DP-Slaves. On or flashing: During I/O data exchanges ('Data exchange start completed signal' (X0) is on.), or acyclic communication *1 Off: Stopping I/O data exchanges ('Data exchange start completed signal' (X0) is off.)
		When operating as the DP-Slave	Indicates the status of data reception from the DP-Master. On or flashing: During data reception ('During data exchange signal' (X1) is on.) Off: No data received ('During data exchange signal' (X1) is off.)
	DIA LED	When operating as the DP-Master	Indicates diagnostic information or alarm detection. (MELSEC iQ-R PROFIBUS-DP Module User's Manual (Application)) On: Diagnostic information has occurred or alarm has been detected. Off: No diagnostic information has occurred and no alarms have been detected.
		When operating as the DP-Slave	Indicates extended diagnostic information. (MELSEC iQ-R PROFIBUS-DP Module User's Manual (Application)) On: Extended diagnostic information has occurred. Off: No extended diagnostic information has occurred.
BF LED	When operating as the DP-Master	Indicates diagnostic information. (MELSEC iQ-R PROFIBUS-DP Module User's Manual (Application)) On: Diagnostic information has occurred. Off: No diagnostic information has occurred.	
	When operating as the DP-Slave	Indicates the communication status with the DP-Master. On: Stopping I/O data exchanges ('During data exchange signal' (X1) is off.) Off: During I/O data exchanges ('During data exchange signal' (X1) is on.)	
(2)	PROFIBUS-DP interface connector	Connector to connect the PROFIBUS cable (Page 33 WIRING)	

*1 Flashes when the module requests or responds to the acyclic communication.

MEMO

2 SPECIFICATIONS

2.1 Performance Specifications

The following table lists the performance specifications of the RJ71PB91V.

Item		Description		
PROFIBUS-DP station type		DP-Master (Class 1)	DP-Slave	
Transmission specifications	Electrical standard and characteristics		Compliant with EIA-RS485	
	Medium		Shielded twisted pair cable (☞ Page 33 Wiring for PROFIBUS cable)	
	Network configuration		Bus topology (or tree topology when repeaters are used)	
	Data link method		<ul style="list-style-type: none"> Between DP-Masters: Token passing Between DP-Master and DP-Slaves: Polling 	
	Encoding method		NRZ	
	Transmission speed*1		9.6kbps to 12Mbps (☞ Page 21 Transmission distance)	
	Transmission distance		Varies depending on the transmission speed. (☞ Page 21 Transmission distance)	
	Number of connectable modules of the entire network		DP-Masters + DP-Slaves ≤ 126 modules (When the redundant system is configured, DP-Master of the control system + DP-Master of the standby system + DP-Slaves ≤ 126 modules) (☞ Page 29 Maximum configuration of network (using three repeaters))	
	Number of connectable modules per segment		DP-Master + DP-Slave + Repeater ≤ 32 (When the redundant system is configured, DP-Master of the control system + DP-Master of the standby system + DP-Slave + Repeater ≤ 32 modules) (☞ Page 28 Maximum configuration of network (using one repeater))	
	Number of repeaters		Maximum of three repeaters between the DP-Master and a DP-Slave (When the redundant system is configured, maximum of three repeaters between the DP-Master and a DP-Slave of both systems)	
Transmittable data	Input data	Maximum of 8192 bytes (maximum of 244 bytes per DP-Slave)	Maximum of 244 bytes (maximum of 384 bytes in total of I/O data)	
	Output data	Maximum of 8192 bytes (maximum of 244 bytes per DP-Slave)	Maximum of 244 bytes (maximum of 384 bytes in total of I/O data)	
Number of occupied I/O points		32 points		
Internal current consumption (5VDC)		0.42A		
External dimensions	Height	106mm (base unit mounting side: 98mm)		
	Width	27.8mm		
	Depth	110mm		
Weight		0.16kg		

*1 Transmission speed accuracy is within ±0.2% (compliant with IEC 61158-2).

Transmission distance

Transmission speed	Transmission distance	Maximum transmission distance when repeaters are used*1
9.6kbps	1200m/segment	4800m/network
19.2kbps		
45.45kbps		
93.75kbps		
187.5kbps	1000m/segment	4000m/network
500kbps	400m/segment	1600m/network
1.5Mbps	200m/segment	800m/network
3Mbps	100m/segment	400m/network
6Mbps		
12Mbps		

*1 The maximum transmission distance shown in the above table indicates the distance when three repeaters are used. To calculate the maximum transmission distance when repeaters are used and the transmission distance is extended, use the following formula.

$$\text{Maximum transmission distance [m/network]} = (\text{Number of repeaters} + 1) \times \text{Transmission distance[m/segment]}$$

3 FUNCTION LIST

The following table lists the functions of the RJ71PB91V. For details on the functions and constraints of the redundant system, refer to the following.

📖 MELSEC iQ-R PROFIBUS-DP Module User's Manual (Application)

3.1 Functions of DP-Master

Function	Description	Version of PROFIBUS-DP
I/O data exchange function	Exchanges I/O data between the DP-Master and the DP-Slave.	PROFIBUS-DPV0
Acquisition of diagnostic information and extended diagnostic information	Using I/O signals and buffer memory, acquires diagnostic information and extended diagnostic information occurring in DP-Slaves during I/O data exchanges.	PROFIBUS-DPV0
Global control function	By sending the service from the DP-Master via multicast (simultaneous broadcast), simultaneously controls DP-Slaves in the specified group to hold or clear I/O data.	PROFIBUS-DPV0
Acyclic communication function	Reads data of DP-Slaves from DP-Master or writes data to DP-Slaves from the DP-Master at a different timing from the I/O data exchanges.	PROFIBUS-DPV1
Alarm acquisition function	Acquires alarm or status information occurring in a DP-Slave from the DP-Master.	PROFIBUS-DPV1
Time control over DP-Slaves	Sets the time of each DP-Slave from DP-Master by operating it as a time master.	PROFIBUS-DPV2
Data swap function	Swaps upper and lower bytes in units of words when I/O data is sent/received.	—
Data consistency function	Maintains consistency of I/O data when it is read/written from/to the buffer memory.	—
Output status setting function for CPU stop error	Sets the handling of I/O data when a CPU stop error occurs in a CPU module to which the RJ71PB91V is mounted.	—
Temporarily reserved station specification function	Temporarily changes a DP-Slave to a reserved station without changing slave parameters of PROFIBUS Configuration Tool.	—
Operation mode changing function	Changes the operation mode using PROFIBUS Configuration Tool or a program.	—
FDL address setting function	Changes the FDL address of DP-Slaves from the DP-Master.	—
Redundant system function	Configures the network in the redundant system.	—

3.2 Functions of DP-Slave

Function	Description	Version of PROFIBUS-DP
I/O data exchange function	Exchanges I/O data between the DP-Master and the DP-Slave.	PROFIBUS-DPV0
Global control function	By sending the service from the DP-Master via multicast (simultaneous broadcast), simultaneously controls DP-Slaves in the specified group to hold or clear I/O data.	PROFIBUS-DPV0
Notification function of extended diagnostic information	Notifies the DP-Master of extended diagnostic information occurring during I/O data exchanges.	PROFIBUS-DPV0
I/O data read function	Sends I/O data on the request from the DP-Master (Class 2).	PROFIBUS-DPV0
I/O configuration information read function	Sends I/O configuration information on the request from the DP-Master (Class 2).	PROFIBUS-DPV0
FDL address changing function	Changes FDL address of DP-Slaves from the DP-Master (Class 2) or a program.	PROFIBUS-DPV0
Data swap function	Swaps upper and lower bytes in units of words when I/O data is sent/received.	—
Data consistency function	Maintains consistency of I/O data when it is read/written from/to the buffer memory.	—
Output status setting function for CPU stop error	Sets the handling of I/O data when a CPU stop error occurs in a CPU module to which the RJ71PB91V is mounted.	—
Operation mode changing function	Changes the operation mode using a program.	—

4 PROCEDURES BEFORE OPERATION

This chapter describes the procedures before operation.

1. Self-diagnostics test

Turn on the power and perform the self-diagnostics test on the RJ71PB91V alone. (📖 MELSEC iQ-R PROFIBUS-DP Module User's Manual (Application))

When no errors are detected, the LEDs and the relevant buffer memory areas behave as follows.

- ERR LED: Off
- Test results are stored in 'Offline test status area' (Un\G2258).

2. Network configuration

Configure the system and set the parameters which are required for start-up.

- Wiring (👉 Page 33 WIRING)
- Parameter setting (📖 MELSEC iQ-R PROFIBUS-DP Module User's Manual (Application))

3. Start of I/O data exchanges

Start I/O data exchanges of the PROFIBUS-DP network using either of the following procedures.

- Turn on 'Data exchange start request signal' (Y0) on the DP-Master.
- Click "Start/Stop PROFIBUS" of PROFIBUS Configuration Tool. (📖 MELSEC iQ-R PROFIBUS-DP Module User's Manual (Application))

4. Network diagnostics

Check that communications are performed normally. When communications are performed normally, the LEDs and the bits corresponding to the relevant buffer memory areas on the DP-Master behave as follows.

- RUN LED: On
- ERR LED: Off
- BF LED: Off
- Bit corresponding to 'Slave status area (Normal communication detection)' (Un\G23040 to Un\G23047): ON
- Bit corresponding to 'Slave status area (Diagnostic information detection)' (Un\G23056 to Un\G23064): OFF

5. Programming

Create a program. (👉 Page 36 COMMUNICATION EXAMPLE)

Precautions for starting up redundant system

For procedure to start up the redundant system, refer to the following.

📖 MELSEC iQ-R CPU Module User's Manual (Application)

■Self-diagnostics test

- Before performing the self-diagnostics test, change the operation mode of the redundant system to the separate mode (The operation mode at the startup is the backup mode.), and stop the tracking transfer. (📖 MELSEC iQ-R CPU Module User's Manual (Application))
- Perform self-diagnostics test for each DP-Master of both systems.

■Network configuration

- Set the FDL address of the DP-Master of the control system using "FDL address" in the "Master settings" window of PROFIBUS Configuration Tool.
- Set the refresh using "CPU Device Access" in the "Master Settings" window of PROFIBUS Configuration Tool.
- Set the FDL address of the DP-Master of the standby system using "Standby System Master FDL Address" in the "Module Parameter" window of the engineering tool.

Write the parameter settings including the above settings to the DP-Masters of both systems.

MEMO

5 SYSTEM CONFIGURATION

For the configuration of the MELSEC iQ-R series system and the types, number, installation, and wiring of modules connectable to the CPU module, refer to the following.

📖 MELSEC iQ-R Module Configuration Manual

5.1 Configuration of PROFIBUS-DP Network

This section describes the basic configuration of the PROFIBUS-DP network using the RJ71PB91V as the DP-Master or a DP-Slave.

To configure the PROFIBUS-DP network, following conditions should be met.

Configuration condition	Description	When redundant system is configured
Number of connectable modules of the entire network	DP-Master ^{*1} + DP-Slave ≤ 126 modules	DP-Master of the control system ^{*1} + DP-Master of the standby system + DP-Slave ≤ 126 modules
Number of connectable modules per segment	DP-Master ^{*1} + DP-Slave + Repeater ≤ 32 modules (📖 Page 28 Maximum configuration of network (using one repeater))	DP-Master of the control system ^{*1} + DP-Master of the standby system + DP-Slave + Repeater ≤ 32 modules
Number of repeaters	Maximum of three repeaters between the DP-Master and a DP-Slave	Maximum of three repeaters between the DP-Master and a DP-Slave of both systems

*1 Includes the own DP-Master.

Restriction

- In the multi-master system configuration, DP-Master whose communication chips use ASPC2 STEP C or equivalent cannot be connected to the PROFIBUS-DP network to which DP-Master that uses the RJ71PB91V is connected. To use the DP-Master having such communication chips, configure another network. For communication chips used, contact the manufacturer.
- In the redundant system that uses DP-Slaves that are intended to occupy FDL addresses of the control system and those of the standby system separately, the number of connectable DP-Slaves is 62.

Maximum configuration of segment

Maximum of 32 modules can be connected in one segment.

DP-Master: 1

DP-Slave: 31

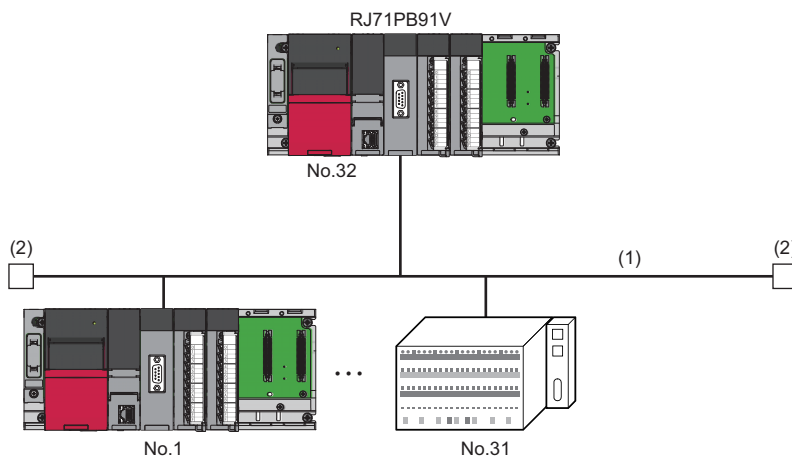

No.: FDL address (1 to 31 are for DP-Slaves, and 32 is for DP-Master)^{*1}

(1) Segment

(2) Bus resistor

*1 Any FDL address can be assigned to the DP-Master.

Maximum configuration of network (using one repeater)

Using a repeater, two segments can be linked to one network.

However, because repeaters are counted as modules for both segments, the number of connectable modules of the entire network is changed as follows.

DP-Master: 1 (2 in the redundant system)

DP-Slave: 61 (60 in the redundant system)

Repeater: 1

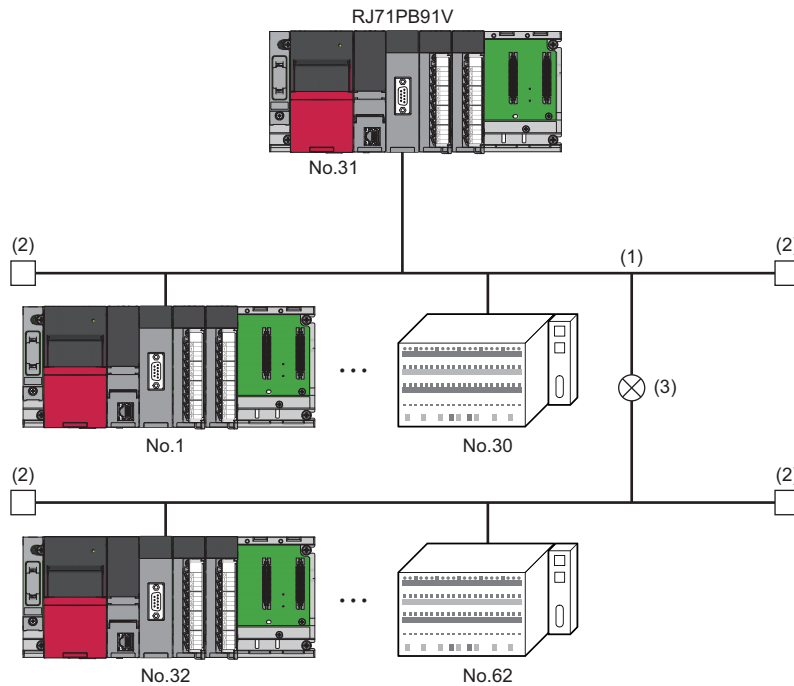

No.: FDL address (1 to 30 and 32 to 62 are for DP-Slaves, and 31 is for DP-Master)*1

- (1) Segment
- (2) Bus resistor
- (3) Repeater

*1 Any FDL address can be assigned to the DP-Master.

Maximum configuration of network (using two repeaters)

When two repeaters are used, the number of connectable modules of the entire network is changed as follows.

DP-Master: 1 (2 in the redundant system)

DP-Slave: 91 (90 in the redundant system)

Repeater: 2

Maximum configuration of network (using three repeaters)

When three repeaters are used, DP-Masters and DP-Slaves can be connected within the FDL address setting range (0 to 125), and the number of connectable modules of the entire network is changed as follows.

DP-Master: 1 (2 in the redundant system)

DP-Slave: 125 (124 in the redundant system)

Repeater: 4 (maximum of 3 repeaters between the DP-Master and a DP-Slave)

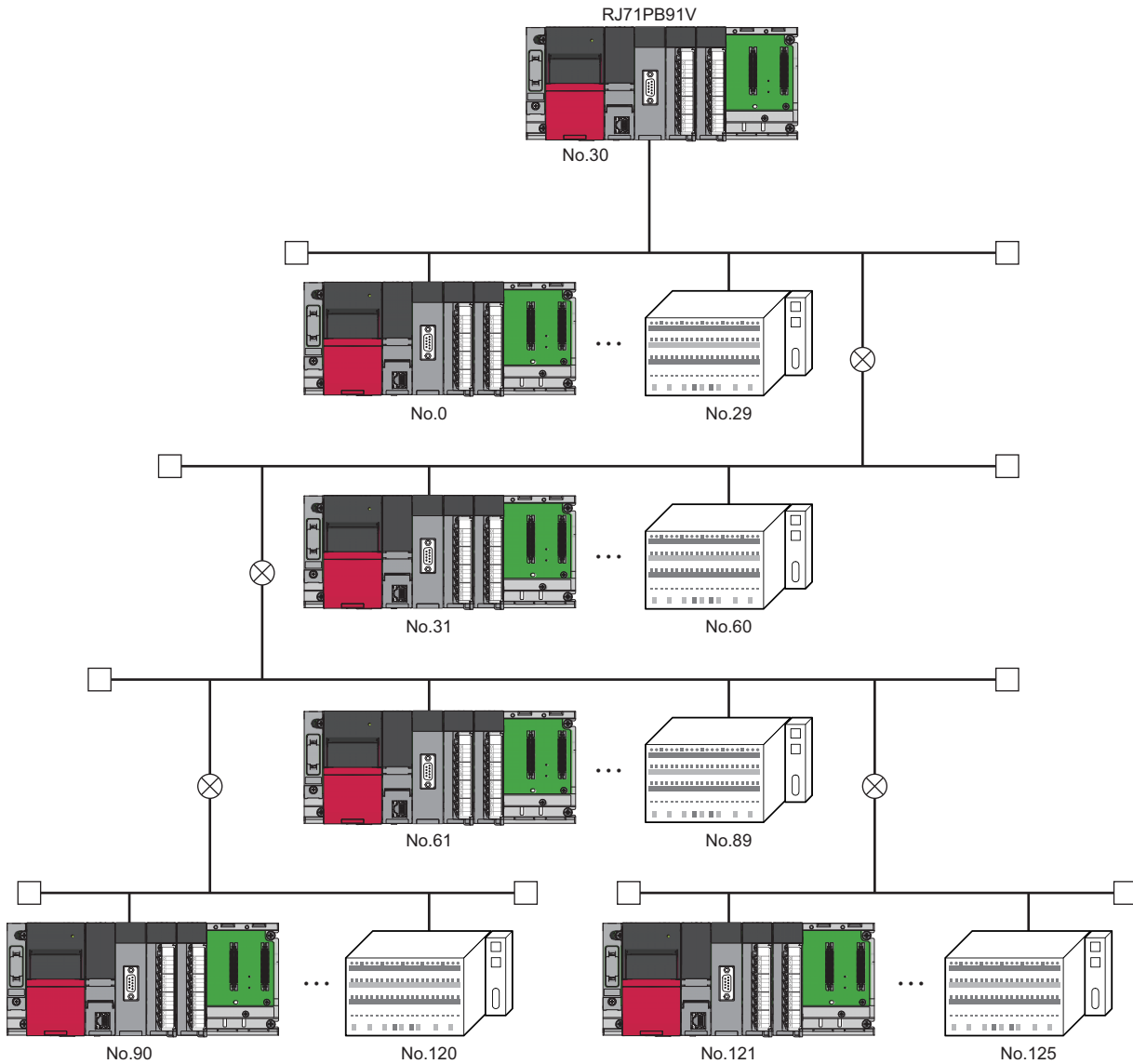

No.: FDL address (0 to 29 and 31 to 125 are for DP-Slaves, and 30 is for DP-Master)^{*1}

*1 Any FDL address can be assigned to the DP-Master.

Multi-master system

Multiple DP-Masters having different FDL addresses can be connected in one network.

Maximum of 123 DP-Slaves can be connected using three DP-Masters as follows.

DP-Master: 3

DP-Slave: 123

Repeater: 4

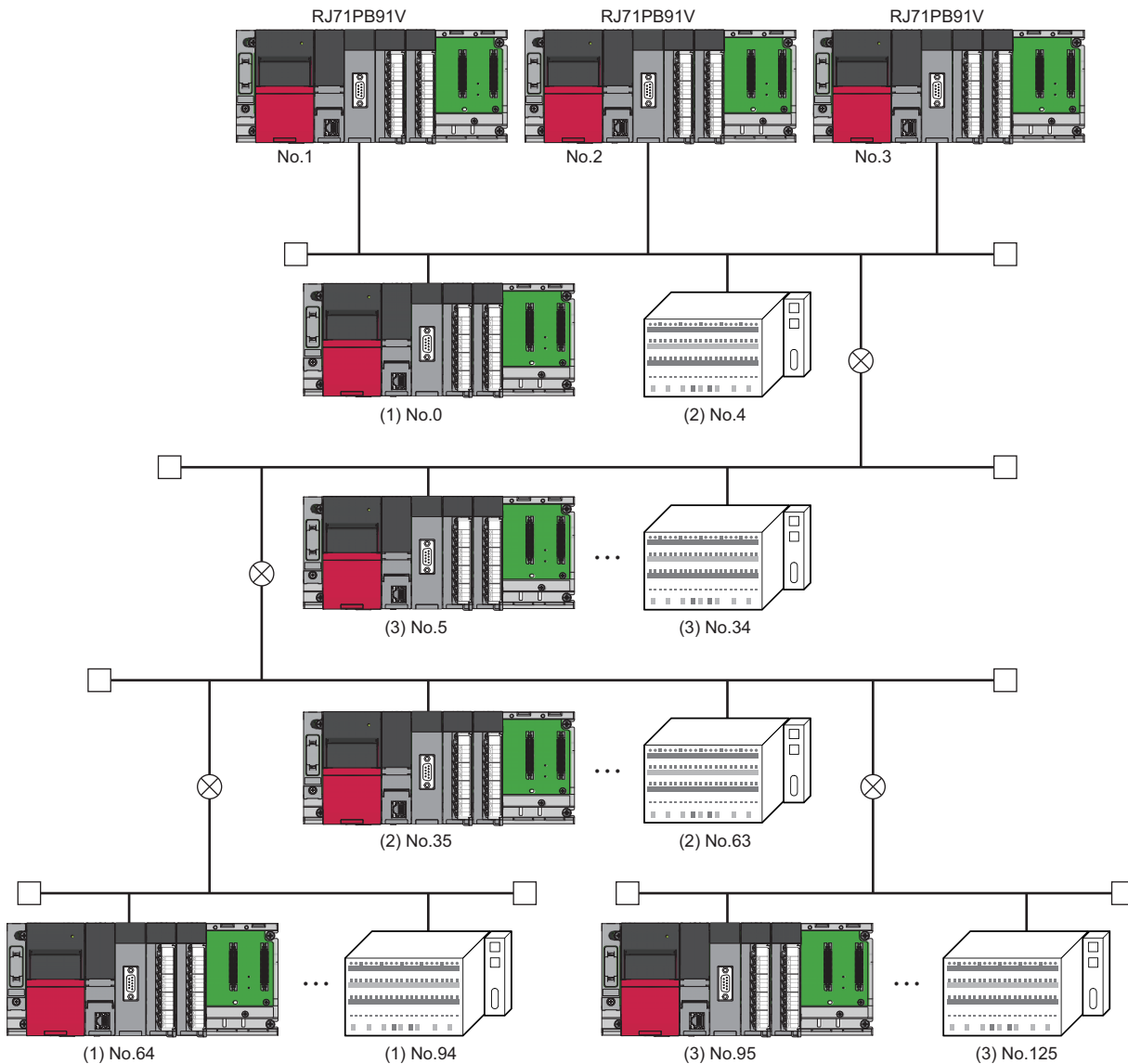

No.: FDL address (0, 4, and 5 to 125 are for DP-Slaves, and 1 to 3 are for DP-Master)*1

- (1) DP-Slaves controlled by the DP-Master (FDL address 1)
- (2) DP-Slaves controlled by the DP-Master (FDL address 2)
- (3) DP-Slaves controlled by the DP-Master (FDL address 3)

*1 Any FDL address can be assigned to the DP-Master.

Redundant system

The RJ71PB91V can be used in the redundant system. (Only DP-Slaves can be mounted on an extension base unit.)

Using the redundant system function, the proper operation can be continued even when the system is switched, and the system switching request can be issued to Process CPU (redundant mode) when an I/O data exchange error occurs.

For details on the redundant system function, refer to the following.

(MELSEC iQ-R PROFIBUS-DP Module User's Manual (Application))

5.2 Available Software Packages

An engineering tool and a configuration tool are required to configure the RJ71PB91V.

Item	Software	Supported version	Setting
Engineering tool	GX Works3	Version 1.042U or later	When operating as the DP-Master
		Version 1.045X or later	When operating as the DP-Slave
		Version 1.047Z or later	<ul style="list-style-type: none"> When configuring the redundant system When using with the Safety CPU When using with the SIL2 Process CPU
		Version 1.090U or later	When reading a PROFIBUS Configuration Tool project*2 from the CPU module or SD memory card on the engineering tool
Configuration tool	PROFIBUS Configuration Tool*1	1.00A or later	When operating as the DP-Master
		1.01B or later	<ul style="list-style-type: none"> When configuring the redundant system When using with the Safety CPU When using with the SIL2 Process CPU
		1.05F or later	When setting the automatic generation option for a program to turn on 'Data exchange start request signal' (Y0) at generation of an unregistered program by PROFIBUS label updates
		1.06G or later	When reading a PROFIBUS Configuration Tool project*2 from the CPU module or SD memory card on the engineering tool

*1 PROFIBUS Configuration Tool Version 1.04E or later can open a project file generated with its Version 1.05F, and PROFIBUS Configuration Tool Version 1.05F can open a project file generated with its Version 1.04E or earlier.

*2 A file for enabling parameters set using PROFIBUS Configuration Tool to be read from the CPU module or SD memory card. For details on PROFIBUS Configuration Tool projects, refer to the following.

 MELSEC iQ-R PROFIBUS-DP Module User's Manual (Application)

Combinations of the engineering tool and configuration tool versions

The following shows the supported combinations of the configuration tool and the engineering tool.

GX Works3 version	PROFIBUS Configuration Tool version
1.072A or earlier	1.00A to 1.03D
1.075D to 1.082L	1.04E
1.085P	1.05F
1.090U	1.06G

Profile of the RJ71PB91V

Profile is data that is registered to GX Works3 and contains information of connected devices (such as model names).

Profile varies depending on the station type of the RJ71PB91V.

Model name displayed on GX Works3	Profile registration	Station type
RJ71PB91V	Registered to GX Works3 at the time of installation of PROFIBUS Configuration Tool.	DP-Master
RJ71PB91V(S)	Registered at the time of installation of the supported versions of GX Works3.	DP-Slave

Restriction

If GX Works3 is installed or upgraded in the system having PROFIBUS Configuration Tool, the parameters of the RJ71PB91V may not be configured properly.

In such a case, uninstall PROFIBUS Configuration Tool → install or upgrade GX Works3 → install PROFIBUS Configuration Tool again.

6 WIRING

6.1 Connectors

Wiring for PROFIBUS cable

This section describes the pin assignment of the PROFIBUS-DP interface connector of the RJ71PB91V, wiring specifications of the PROFIBUS cable, and the bus terminator.

Pin assignment of the PROFIBUS-DP interface connector

The following table shows the pin assignment of the PROFIBUS-DP interface connector (D-sub 9-pin female connector).

Pin assignment	No.	Signal code	Name	Application	Cable color
	(1)	—	SHIELD* ¹	Empty	—
	(2)	—	M24V* ¹	Empty	—
	(3)	B/B'	RxD/TxD-P	Receive/send data-P	Red
	(4)	—	CNTR-P* ¹	Empty	—
	(5)	C/C'	DGND* ²	Data ground	—
	(6)	—	VP* ²	Voltage+	—
	(7)	—	P24V* ¹	Empty	—
	(8)	A/A'	RxD/TxD-N	Receive/send data-N	Green
	(9)	—	CNTR-N* ¹	Empty	—

*1 Optional signal

*2 Signal used for connecting a bus terminator

Precautions

To make full use of the functions of the RJ71PB91V and to configure a highly reliable system, the external wiring should be resistant to noise.

The following are precautions for the external wiring of the RJ71PB91V.

- Do not route the communication cable of the RJ71PB91V near the main circuit, power cable, or load cable other than that of the programmable controller. In addition, do not bundle those cables together. Otherwise the RJ71PB91V may be affected by noise or surge induction.
- Place the PROFIBUS cable as far away from the I/O module cable as possible.

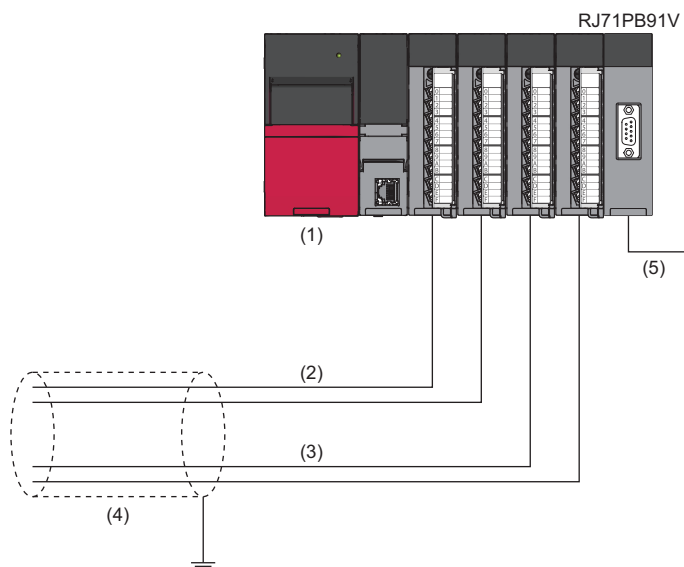

- (1) Power supply module
- (2) Input module wiring
- (3) Output module wiring
- (4) Shield jacket
- (5) PROFIBUS cable

- As a rule, to use the RJ71PB91V, ground the FG and LG terminals of the power supply module of the programmable controller.
- Place the communication cables and power cables connected to the module in a duct or clamp them. If not, dangling cable can swing or inadvertently be pulled, resulting in damage to the module or the cable or malfunction due to poor contact.
- Do not touch the core of the cable-side or module-side connector, and protect it from dirt or dust. If oil from your hand, dirt, or dust is attached to the core, transmission loss can increase, causing communication failures.
- Securely connect the connector to the module.
- Tighten the screws within the specified torque range. Undertightening can cause drop of the screw, short circuit, or malfunction. Overtightening can damage the screw and/or module, resulting in drop, short circuit, or malfunction.
- When disconnecting the cable from the module, do not pull the cable by the cable part. For the cable with connector, hold the connector part of the cable. Pulling the cable connected to the module may result in malfunction or damage to the module or cable.

6.2 Wiring Products

PROFIBUS devices such as PROFIBUS cables and connectors should be prepared by users. For details on PROFIBUS devices, refer to the following.

- PI: www.profibus.com

PROFIBUS cable

Use PROFIBUS cables that satisfy the following specifications (compliant with TypeA (IEC 61158-2)).

Item	Specifications
Applicable cable	Shielded twisted pair cable
Impedance	135 to 165Ω (f = 3 to 20MHz)
Capacity	Less than 30pF/m
Conductor resistance	Less than 110Ω/km
Cross-sectional area	0.34mm ² or larger
Wire diameter	22 AWG
Type	Stranded wire
Material	Copper wire
Temperature rating	60°C or larger

- Wiring specifications

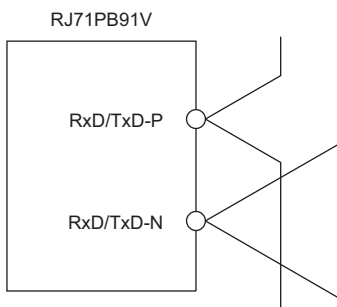

RxD/TxD-P: Red
RxD/TxD-N: Green

Connectors

Use D-sub 9-pin male connectors for PROFIBUS cables.

Use plastic connectors.

Use #4-40 UNC screws for the connector. Tighten the screws within the range of 0.20 to 0.28N·m.

Wiring specifications of bus terminator

When the RJ71PB91V is the terminal station, use the connector with built-in bus terminator that satisfies the following wiring specifications.

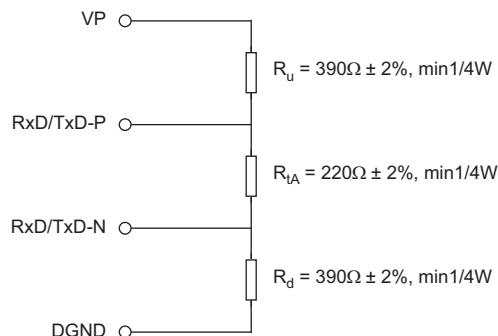

7 COMMUNICATION EXAMPLE

7.1 Communication Example of I/O Data Exchanges

This section describes an example of I/O data exchanges between the DP-Master and DP-Slaves (with the refresh settings enabled).

System configuration example

The following system configuration is used in this section.

System configuration

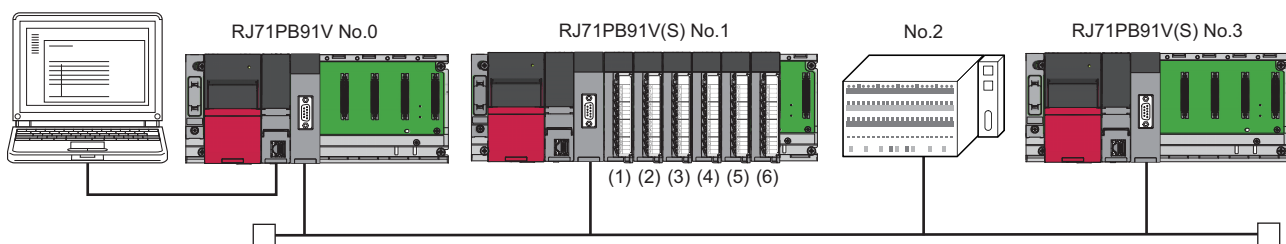

Number and station type	Module
No.0: DP-Master (FDL address 0)	<ul style="list-style-type: none"> Power supply module: R61P CPU module: R04CPU RJ71PB91V (start I/O number: 0000H to 001FH)
No.1: DP-Slave (FDL address 1)	<ul style="list-style-type: none"> Power supply module: R61P CPU module: R04CPU RJ71PB91V (start I/O number: 0000H to 001FH) RX40C7 (start I/O number: 0020H to 002FH) RY41NT2P (start I/O number: 0030H to 004FH) RH42C4NT2P (start I/O number: 0050H to 006FH) RY40NT5P (start I/O number: 0070H to 007FH) RX40NC6B (start I/O number: 0080H to 009FH) RY40NT5P (start I/O number: 00A0H to 00AFH)
No.2: DP-Slave (FDL address 2)	ET200S (HighFeature(Cu)) manufactured by Siemens
No.3: DP-Slave (FDL address 3)	<ul style="list-style-type: none"> Power supply module: R61P CPU module: R04CPU RJ71PB91V (start I/O number: 0000H to 001FH)

I/O data assignment

I/O data of the DP-Slave (FDL address 1) is assigned as follows.

No.	Name	I/O configuration information of slave parameter	Output receive area (Un\G0 to Un\G9)	Input send area (Un\G256 to Un\G265)
(1)	Input module	Data module 0: Input 1 word	—	1 word
(2)	Output module	Data module 1: Output 2 words	2 words	—
(3)	I/O module	Data module 2: I/O 2 words	2 words	2 words
(4)	Output module	Data module 3: Output 1 word	1 word	—
(5)	Input module	Data module 4: Input 2 words	—	2 words
(6)	Output module	Data module 5: Output 1 word	1 word	—
Data for acquiring information		Data module 6: I/O 1 word	1 word	1 word

I/O configuration information of slave parameters is set on the DP-Master. (MELSEC iQ-R PROFIBUS-DP Module User's Manual (Application))

■ I/O data assignment between DP-Master and DP-Slave (FDL address 1)

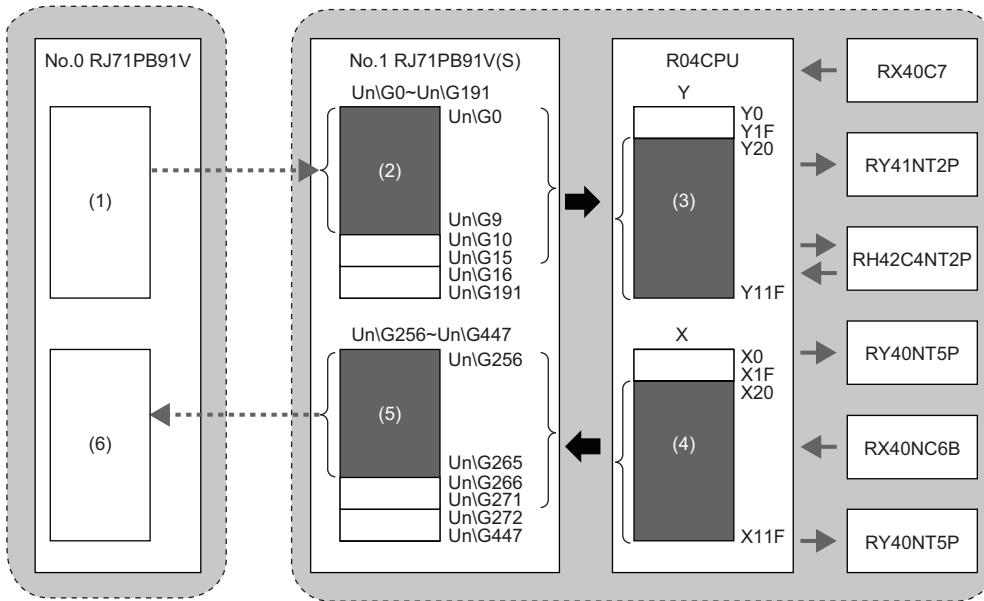

- (1) Output data area (for mode 3) on the DP-Master. Output data is sent to (2) by the I/O data exchange function.
- (2) Output receive area (Un\G0 to Un\G9) on the DP-Slave. Output data is written to (3) by the refresh function.
- (3) Y device on the CPU module. Output data is sent to the output module or the I/O module.
- (4) X device on the CPU module. Input data is received from the input module or the I/O module.
- (5) Input send area (Un\G256 to Un\G265) on the DP-Slave. Input data is read from (4) by the refresh function.
- (6) Input data area (for mode 3) on the DP-Master. Input data is received from (5) by the I/O data exchange function.

Settings for DP-Master

Connect the engineering tool to the CPU module of the DP-Master, and set the parameters.

Creating a new project

1. Set the CPU module as follows.

[Project] ⇒ [New]

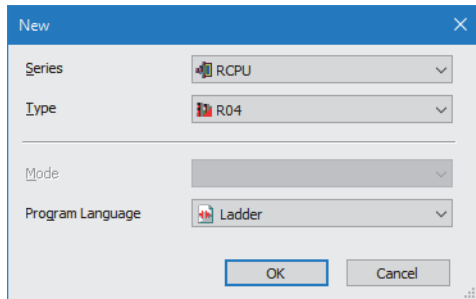

2. Click the [Setting Change] button and set the [Module Label] to [Use].
3. Click the [OK] button to add the module labels of the CPU module.

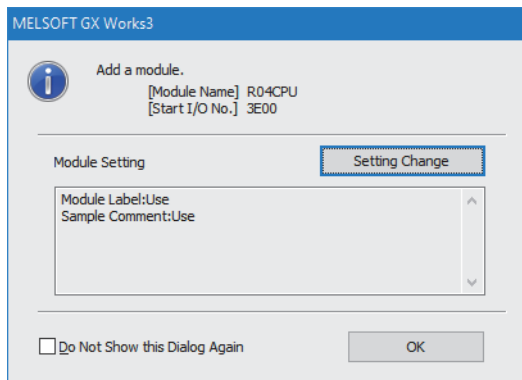

4. Set the RJ71PB91V as follows.

[Navigation window] ⇒ [Parameter] ⇒ [Module Information] ⇒ Right-click ⇒ [Add New Module]

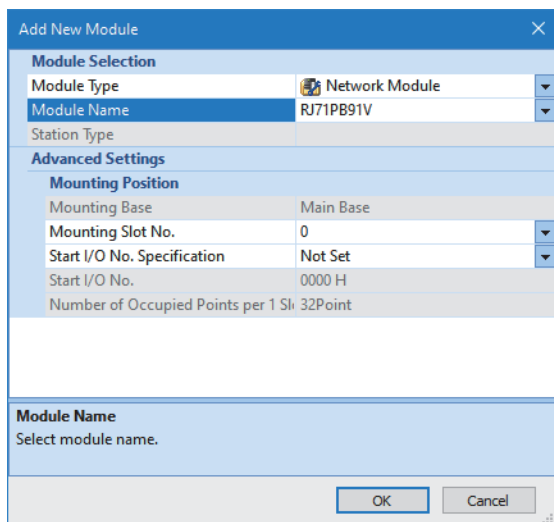

5. To enable the data consistency function, set the items under "Basic Setting" as follows.

[Navigation window] ⇒ [Parameter] ⇒ [Module Information] ⇒ [RJ71PB91V] ⇒ [Module Parameter] ⇒ [Basic Setting]

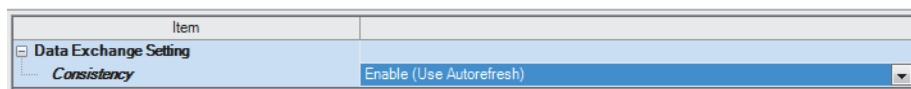

PROFIBUS module setting

1. Start PROFIBUS Configuration Tool from the engineering tool.

[Navigation window] ⇒ [Parameter] ⇒ [Module Information] ⇒ [RJ71PB91V] ⇒ [PROFIBUS Module Setting]

2. Add the DP-Slave to the project.

[Navigation window] ⇒ [Parameter] ⇒ [Module Information] ⇒ [RJ71PB91V] ⇒ [PROFIBUS Module Setting] ⇒ [Global GSD Database] tab ⇒ Target DP-Slave ⇒ Right-click ⇒ [Add Slave to Project]

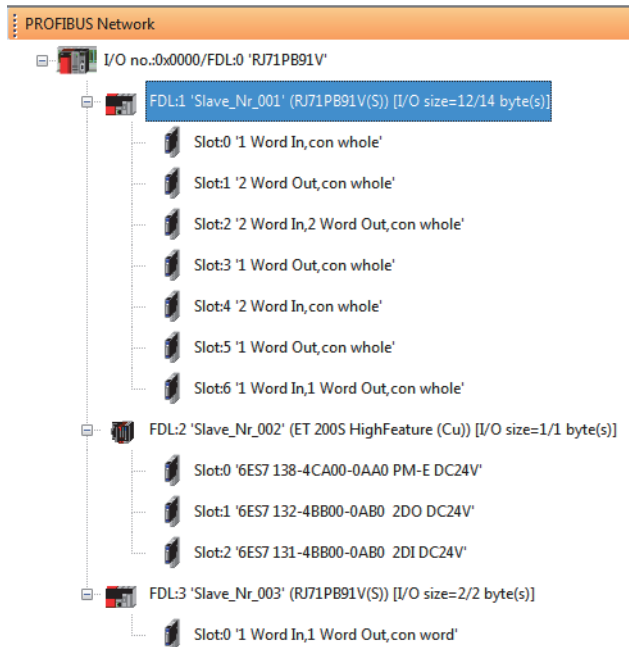

3. Set the items in the "Slave Settings" window as follows.

[Navigation window] ⇒ [Parameter] ⇒ [Module Information] ⇒ [RJ71PB91V] ⇒ [PROFIBUS Module Setting] ⇒ Target DP-Slave ⇒ Right-click ⇒ [Slave Settings]

- DP-Slave (FDL address 1)

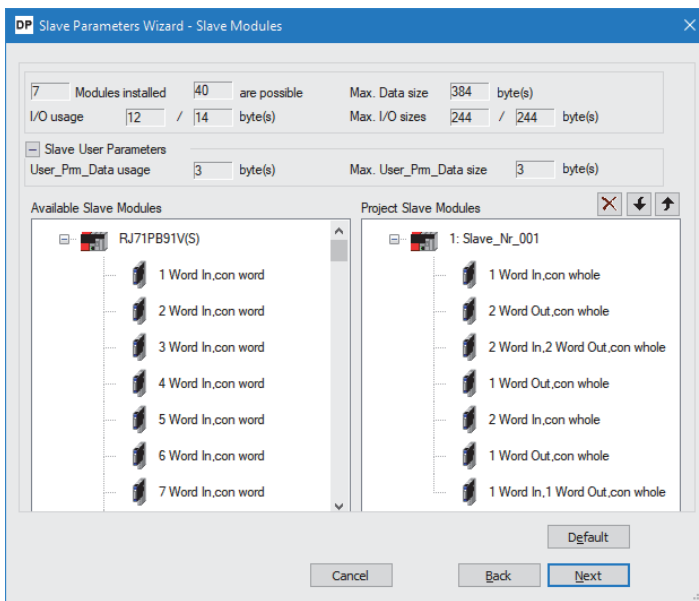
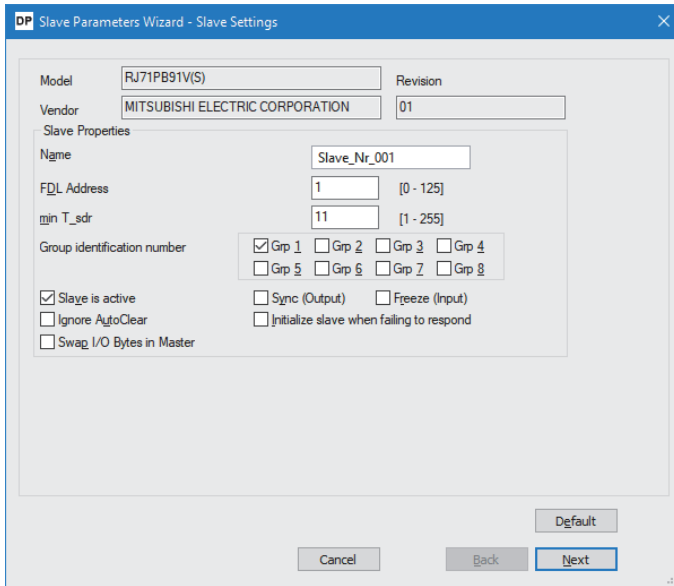

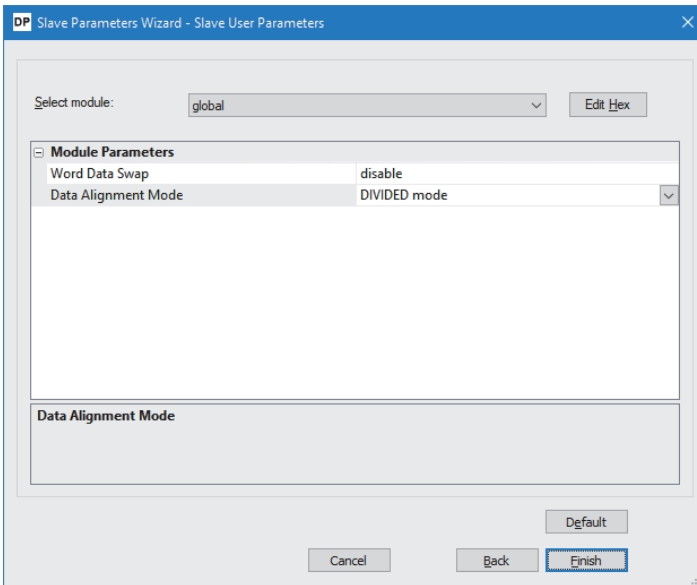

4. Set the items in "Master Settings" as follows.

[Navigation window] ⇒ [Parameter] ⇒ [Module Information] ⇒ [RJ71PB91V] ⇒ [PROFIBUS Module Setting] ⇒ [I/O no.:0x0000/FDL:0 'RJ71PB91V'] ⇒ Right-click ⇒ [Master Settings]

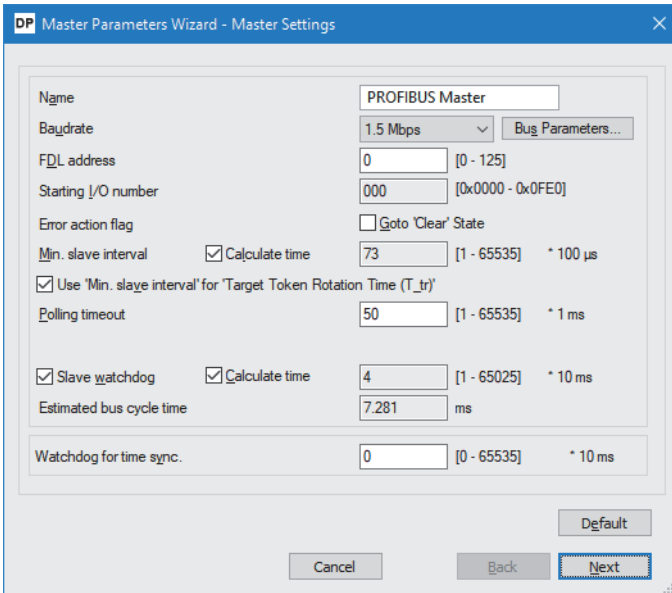

5. Click the [Next] button in the "Master Settings" window, and set the items in "CPU Device Access" as follows.

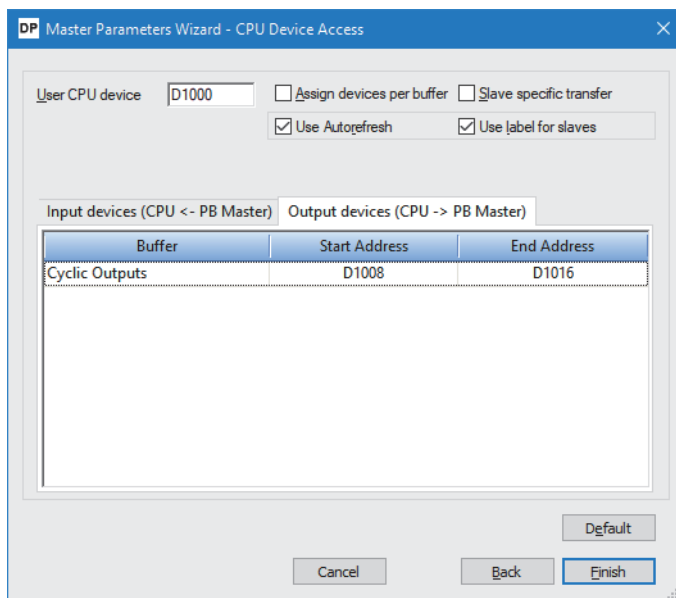
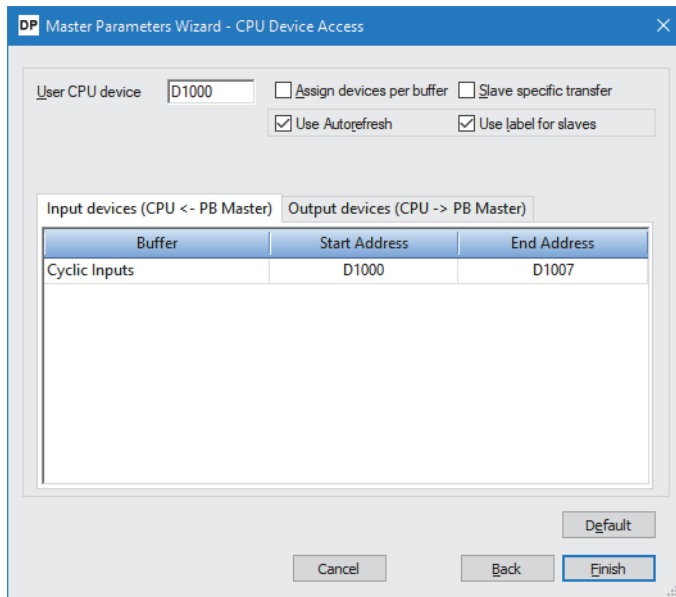

6. Click the [Finish] button to exit the "Master Settings" window.

Update of PROFIBUS labels

This function creates and updates the structures used for global labels and module function blocks by enabling the refresh settings.

1. Click "Update PROFIBUS Label".

 [Navigation window] ⇒ [Parameter] ⇒ [Module Information] ⇒ [RJ71PB91V] ⇒ [PROFIBUS Module Setting] ⇒ [PROFIBUS Configurator Tasks]

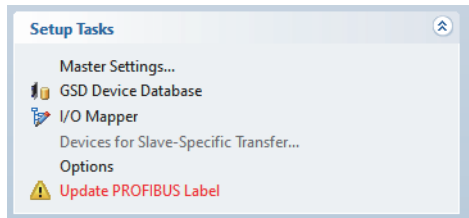

2. Convert some program codes or all program codes.

 [Convert] ⇒ [Convert] or [Rebuild All]

3. Write the set parameters to the CPU module or an SD memory card in the CPU module. Then reset the CPU module or power off and on the system.

 [Online] ⇒ [Write to PLC]

Point

In this example, default values are used for parameters that are not shown above. For the parameters, refer to the following.

 MELSEC iQ-R PROFIBUS-DP Module User's Manual (Application)

Settings for DP-Slaves

Set for DP-Slaves that configure the PROFIBUS-DP network.

For DP-Slaves that use the RJ71PB91V, connect the engineering tool to the CPU module, and set the parameters as follows. Set the same parameters to FDL address 1 and FDL address 3.

For setting DP-Slaves that use the module other than the RJ71PB91V, refer to the manual for the module used.

Creating a new project

1. Set the CPU module, and add the module labels of the CPU module. The procedures for setting the CPU module and for adding the module labels are the same as those for the DP-Master. (👉 Page 38 Settings for DP-Master)
2. Set the RJ71PB91V(S) as follows.

👉 [Navigation window] ⇒ [Parameter] ⇒ [Module Information] ⇒ Right-click ⇒ [Add New Module]

Module Selection	
Module Type	Network Module
Module Name	RJ71PB91V(S)
Station Type	
Advanced Settings	
Mounting Position	
Mounting Base	Main Base
Mounting Slot No.	0
Start I/O No. Specification	Not Set
Start I/O No.	0000 H
Number of Occupied Points per 1 Slot	32Point
Module Name Select module name.	
OK Cancel	

3. Set the items in "Basic Setting" as follows. For FDL address 1, set "1" to "FDL Address Setting". For FDL address 3, set "3" to "FDL Address Setting".

👉 [Navigation window] ⇒ [Parameter] ⇒ [Module Information] ⇒ [RJ71PB91V(S)] ⇒ [Basic Setting]

Item	
FDL Address Setting	
Setting Method Of FDL Address	Parameter Editor
FDL Address	1
Data Exchange Setting	
Data Consistency	Enable

4. Set the items in "Refresh Setting" as follows.

[Navigation window] ⇒ [Parameter] ⇒ [Module Information] ⇒ [RJ71PB91V(S)] ⇒ [Refresh Setting]

Item	Setting Value
<ul style="list-style-type: none"> ▢ Transfer to intelligent module <ul style="list-style-type: none"> ▢ Input Send Area <ul style="list-style-type: none"> 0th to 15th words 16th to 31th words 32th to 47th words 48th to 63th words 64th to 79th words 80th to 95th words 96th to 111th words 112th to 127th words 128th to 143th words 144th to 159th words 160th to 175th words 176th to 191th words 	<p>Transfers the data of the specified device to the buffer memory.</p> <p>Refresh setting of Input send area</p> <p>X20</p>
<ul style="list-style-type: none"> ▢ Transfer to CPU <ul style="list-style-type: none"> ▢ Output Receive Area <ul style="list-style-type: none"> 0th to 15th words 16th to 31th words 32th to 47th words 48th to 63th words 64th to 79th words 80th to 95th words 96th to 111th words 112th to 127th words 128th to 143th words 144th to 159th words 160th to 175th words 176th to 191th words 	<p>Transfer the buffer memory data to the specified device.</p> <p>Refresh setting of Output receive area</p> <p>Y20</p>
<ul style="list-style-type: none"> ▢ Refresh Timing <ul style="list-style-type: none"> Refresh Timing Refresh Group [n][n: 1-64] 	<p>Set refresh timing.</p> <p>At the Execution Time of END Instruction</p> <p>1</p>
<ul style="list-style-type: none"> ▢ Refresh Timing (I/O) <ul style="list-style-type: none"> Refresh Timing 	<p>Specify the timing which transfers the I/O device data.</p> <p>Based on Refresh Timing (Buffer Memory)</p>

5. Write the set parameters to the CPU module or an SD memory card in the CPU module. Then reset the CPU module or power off and on the system.

[Online] ⇒ [Write to PLC]

Point

In this example, default values are used for parameters that are not shown above. For the parameters, refer to the following.

📖 MELSEC iQ-R PROFIBUS-DP Module User's Manual (Application)

Checking the network status

Communications are performed normally if the status of LEDs and bits corresponding to the relevant buffer memory areas are as follows after the program execution.

- LED on DP-Master

Name	Status
RUN LED	On
ERR LED	Off
BF LED	Off

- Bit corresponding to buffer memory area of DP-Master

Name	Status
'Slave status area (Normal communication detection)' (Un\G23040.0 to Un\G23040.2)	ON
'Slave status area (Diagnostic information detection)' (Un\G23057.0 to Un\G23057.2)	OFF

Program example

When the DP-Master starts I/O data exchanges, the DP-Slave automatically starts receiving the output data. However, sending input data from the DP-Slave must be instructed from a program.

- DP-Master (FDL address 0)

Classification	Label name	Description	Device	
Module label	RCPU.stSM.bAfter_RUN1_Scan_ON	After RUN, ON for 1 scan only	SM402	
Global label that was updated in the RJ71PB91V	gIRJ71PB91V_1.stMgmtInputs_D.bDataExchStartCompleted	Data exchange start completed signal	X0	
	gIRJ71PB91V_1.stMgmtInputs_D.bCommunicationReady	Communication READY signal	X1B	
	gIRJ71PB91V_1.stMgmtInputs_D.bModuleReady	Module ready signal	X1D	
	gIRJ71PB91V_1.stMgmtInputs_D.bWatchdogTimerError	Module watchdog timer error signal	X1F	
	gIRJ71PB91V_1.stMgmtOutputs_D.bDataExchStartRequest	Data exchange start request signal	Y0	
	gIRJ71PB91V_1.stMgmtOutputs_D.uSet_DiagnosticInfoInvalid_D	Diagnostic information invalid setting area	U0\G2080	
	gIRJ71PB91V_1.stMgmtOutputs_D.uSet_DiagnosticInfoNon_notificationTime_D	Diagnostic information non-notification time setting area	U0\G2084	
	gIRJ71PB91V_1.stMgmtInputs_D.b128CommunicationStatus_D[0]	Slave status area (Normal communication detection) on the first device	U0\G23040.0	
	gIRJ71PB91V_1.stMgmtInputs_D.b128CommunicationStatus_D[1]	Slave status area (Normal communication detection) on the second device	U0\G23040.1	
	gIRJ71PB91V_1.stMgmtOutputs_D.bnReqTemporarySlaveReservation_D[2]	Temporarily reserved station specification request area on the third device	U0\G23608.2	
	gIRJ71PB91V_1.vSLV002MOD001.outputs	ET200S output data	D1015.0	
	gIRJ71PB91V_1.vSLV001MOD001.outputs[0]	91V output data (Slot 1 output)	D1008	
	gIRJ71PB91V_1.vSLV002MOD002inputs[0]	ET200S input data	D1006.0	
	gIRJ71PB91V_1.vSLV001MOD006.inputs	91V input data (Slot 6 input)	D1005	
gIRJ71PB91V_1.vSLV001MOD006.outputs[0]	91V output data (Slot 6 output)	D1014		
Label to be defined	Define global labels as shown below:			
	Label Name	Data Type	Class	Assign (Device/Label)
1	InitialReq	Bit	VAR_GLOBAL	M400
2	IoLinkReq	Bit	VAR_GLOBAL	X20
3	RefreshStartReq	Bit	VAR_GLOBAL	M0
4	OutputWriteCheck_ET200S	Bit	VAR_GLOBAL	X30
5	OutputWriteCheck_91V	Bit	VAR_GLOBAL	X31
6	InputCarry_ET200S	Bit	VAR_GLOBAL	M500
7	InputCarry_91V	Bit	VAR_GLOBAL	M501

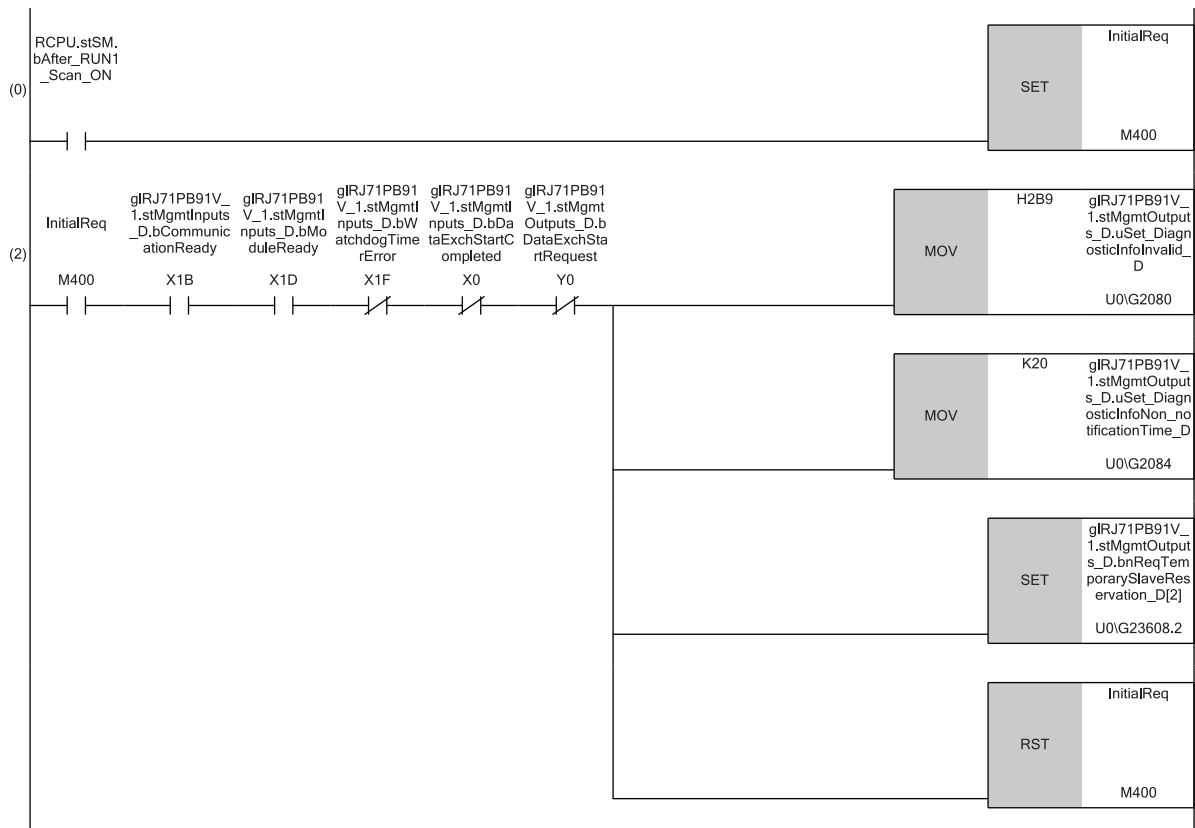

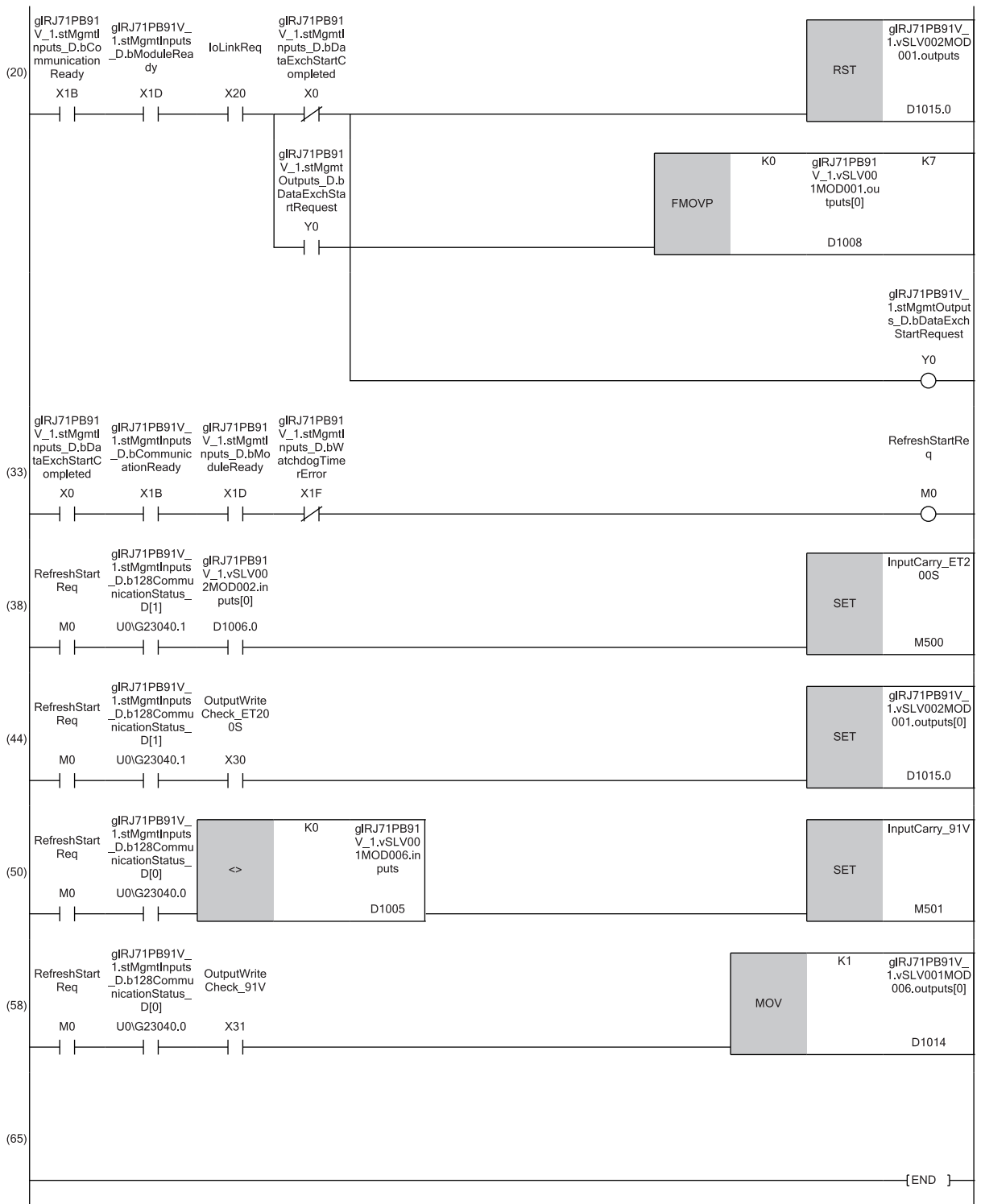

■ Initialization and temporarily reserved station specification

(0) Turn on Initialization command (M400) at the startup.

(2) Set 'Diagnostic information invalid setting area' (U0\G2080), 'Diagnostic information non-notification time setting area' (U0\G2084), and 'Temporarily reserved station specification request area' on the third device (U0\G23608.2).

■ Start of I/O data exchanges

(20) Turn on Condition to write to the output data (first word)_ET200S (X30), Condition to write to the output data (first word)_91V (X31), and 'Data exchange start request signal' (Y0).

(33) Turn on Refresh start request (M0).

■ Control of DP-Slave (for ET200S)

(38) Turn on Input processing_ET200S (M500) based on the input data.

(44) Set the output data according to the output setting of the DP-Slave.

■ Control of DP-Slave (for the RJ71PB91V)

(50) Execute Input processing_91V (M501) based on the input data.

(58) Set 91V output data (slot 6 output) (D1014).

The following is an example of a program to send input data from the DP-Slave during I/O data exchanges.

- DP-Slave (FDL address 1)

Classification	Label name	Description	Device		
Module label	RPB91V_S_1.bSts_ModuleWatchdogTimerError	Module watchdog timer error signal	X0		
	RPB91V_S_1.bSts_DataExchProc	During data exchange	X1		
	RPB91V_S_1.bSts_ModuleReady	Module ready	X1D		
	RPB91V_S_1.bSet_InputSendAreaRefreshDirective	Input send area refresh direction	Y0		
Label to be defined	Define global labels as shown below:				
	Label Name	Data Type	Class	Assign (Device/Label)	Constant
	1 G_uOutputData	Word [Unsigned]/Bit String [16-bit](0..15)	VAR_GLOBAL	K4Y20	
	2 G_uInputData	Word [Unsigned]/Bit String [16-bit](0..15)	VAR_GLOBAL	K4X20	
	3 GC_Offset_InfoData1	Word [Unsigned]/Bit String [16-bit]	VAR_GLOBAL_CONSTANT		K9
	4 GC_uInitial_InputInfoData1	Word [Unsigned]/Bit String [16-bit]	VAR_GLOBAL_CONSTANT		K0
	5 G_uOutputInfoData1	Word [Unsigned]/Bit String [16-bit]	VAR_GLOBAL	D0	
	6 G_uInputInfoData1	Word [Unsigned]/Bit String [16-bit]	VAR_GLOBAL	D10	

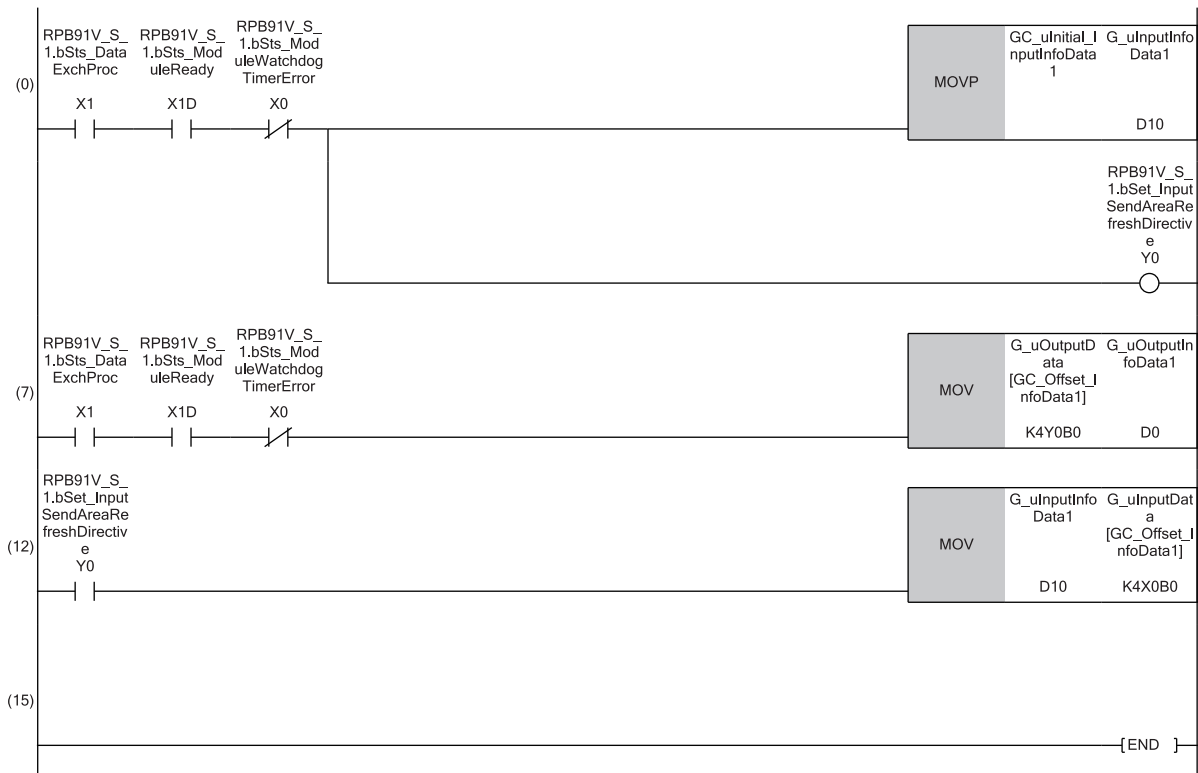

(0) Perform the following to start refreshing the input send area.

- Set the initial value to Information collection data (send data) (D10) to initialize the data to be written to the input send area.
- Turn on Input send area refresh direction (Y0).

(7) Read Information collection data Y0B0 to Y0BF of Output data (receive data) Y20 and later to Information collection data (receive data) (D0).

(12) Write the data in Information collection data (send data) (D10) to Information collection data X0B0 to X0BF of Input data (send data) X20 and later.

■Precautions

- To avoid sending data not yet initialized, initialize the input data (send data) before starting refreshing the input send data. Data that has already been initialized does not need to be initialized every time the input send area is refreshed. Initialize the data at a timing depending on the usage.
- Read the output data (receive data) in (7) before using the receive data.
- Write the input data (send data) in (12) after the send data is created.

APPENDIX

Appendix 1 External Dimensions

This section describes the external dimensions of the RJ71PB91V.

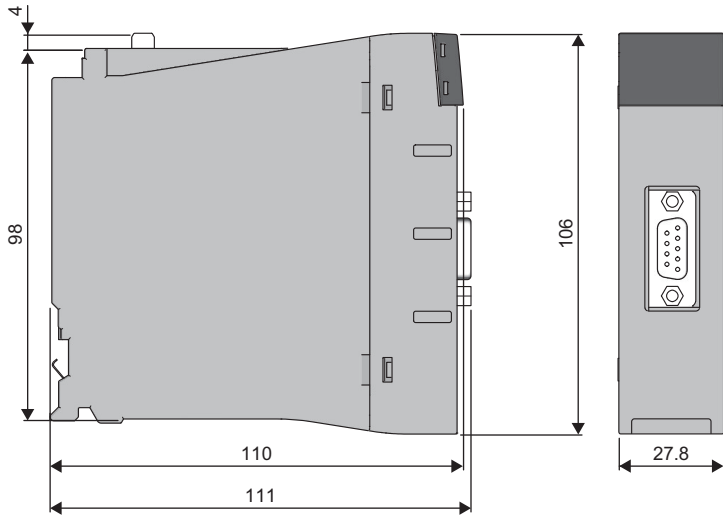

(Unit: mm)

MEMO

A

INDEX

A

Acquisition of diagnostic information and extended diagnostic information	23
Acyclic communication function	23
Alarm acquisition function	23

D

Data consistency function	23
Data swap function	23

F

FDL address changing function	23
FDL address setting function	23

G

Global control function	23
-----------------------------------	----

I

I/O configuration information read function	23
I/O data exchange function	23
I/O data read function	23

L

LED	19
---------------	----

M

Multi-master system	30
-------------------------------	----

N

Notification function of extended diagnostic information	23
--	----

O

Operation mode changing function	23
Output status setting function for CPU stop error	23

P

PROFIBUS Configuration Tool	31
Profile	32

T

Temporarily reserved station specification function	23
Time control over DP-Slaves	23

MEMO

REVISIONS

*The manual number is given on the bottom left of the back cover.

Revision date	*Manual number	Description
December 2017	SH(NA)-081855ENG-A	First edition
April 2018	SH(NA)-081855ENG-B	<ul style="list-style-type: none"> ■Added function DP-Slave type ■Added or modified parts SAFETY PRECAUTIONS, RELEVANT MANUALS, TERMS, Chapter 1, 2, 3, 4, 5, 7
August 2018	SH(NA)-081855ENG-C	<ul style="list-style-type: none"> ■Added function Support of redundant system ■Added or modified parts SAFETY PRECAUTIONS, TERMS, Chapter 1, 2, 3, 4, 5
July 2020	SH(NA)-081855ENG-D	<ul style="list-style-type: none"> ■Added or modified parts TERMS, GENERIC TERMS AND ABBREVIATIONS, Section 6.2
October 2020	SH(NA)-081855ENG-E	<ul style="list-style-type: none"> ■Added or modified parts SAFETY PRECAUTIONS, CONDITIONS OF USE FOR THE PRODUCT, RELEVANT MANUALS, TERMS, Section 5.1
April 2021	SH(NA)-081855ENG-F	<ul style="list-style-type: none"> ■Added or modified parts SAFETY PRECAUTIONS, Section 5.2, 7.1
November 2021	SH(NA)-081855ENG-G	<ul style="list-style-type: none"> ■Added or modified parts SAFETY PRECAUTIONS, COMPLIANCE WITH EMC AND LOW VOLTAGE DIRECTIVES
April 2022	SH(NA)-081855ENG-H	<ul style="list-style-type: none"> ■Added or modified parts SAFETY PRECAUTIONS, Section 5.2
December 2022	SH(NA)-081855ENG-I	<ul style="list-style-type: none"> ■Added or modified parts SAFETY PRECAUTIONS, Section 5.2

Japanese manual number: SH-081854-I

This manual confers no industrial property rights or any rights of any other kind, nor does it confer any patent licenses. Mitsubishi Electric Corporation cannot be held responsible for any problems involving industrial property rights which may occur as a result of using the contents noted in this manual.

© 2017 MITSUBISHI ELECTRIC CORPORATION

WARRANTY

Please confirm the following product warranty details before using this product.

1. Gratis Warranty Term and Gratis Warranty Range

If any faults or defects (hereinafter "Failure") found to be the responsibility of Mitsubishi occurs during use of the product within the gratis warranty term, the product shall be repaired at no cost via the sales representative or Mitsubishi Service Company.

However, if repairs are required onsite at domestic or overseas location, expenses to send an engineer will be solely at the customer's discretion. Mitsubishi shall not be held responsible for any re-commissioning, maintenance, or testing on-site that involves replacement of the failed module.

[Gratis Warranty Term]

The gratis warranty term of the product shall be for one year after the date of purchase or delivery to a designated place. Note that after manufacture and shipment from Mitsubishi, the maximum distribution period shall be six (6) months, and the longest gratis warranty term after manufacturing shall be eighteen (18) months. The gratis warranty term of repair parts shall not exceed the gratis warranty term before repairs.

[Gratis Warranty Range]

- (1) The range shall be limited to normal use within the usage state, usage methods and usage environment, etc., which follow the conditions and precautions, etc., given in the instruction manual, user's manual and caution labels on the product.
- (2) Even within the gratis warranty term, repairs shall be charged for in the following cases.
 1. Failure occurring from inappropriate storage or handling, carelessness or negligence by the user. Failure caused by the user's hardware or software design.
 2. Failure caused by unapproved modifications, etc., to the product by the user.
 3. When the Mitsubishi product is assembled into a user's device, Failure that could have been avoided if functions or structures, judged as necessary in the legal safety measures the user's device is subject to or as necessary by industry standards, had been provided.
 4. Failure that could have been avoided if consumable parts (battery, backlight, fuse, etc.) designated in the instruction manual had been correctly serviced or replaced.
 5. Failure caused by external irresistible forces such as fires or abnormal voltages, and Failure caused by force majeure such as earthquakes, lightning, wind and water damage.
 6. Failure caused by reasons unpredictable by scientific technology standards at time of shipment from Mitsubishi.
 7. Any other failure found not to be the responsibility of Mitsubishi or that admitted not to be so by the user.

2. Onerous repair term after discontinuation of production

- (1) Mitsubishi shall accept onerous product repairs for seven (7) years after production of the product is discontinued. Discontinuation of production shall be notified with Mitsubishi Technical Bulletins, etc.
- (2) Product supply (including repair parts) is not available after production is discontinued.

3. Overseas service

Overseas, repairs shall be accepted by Mitsubishi's local overseas FA Center. Note that the repair conditions at each FA Center may differ.

4. Exclusion of loss in opportunity and secondary loss from warranty liability

Regardless of the gratis warranty term, Mitsubishi shall not be liable for compensation to:

- (1) Damages caused by any cause found not to be the responsibility of Mitsubishi.
- (2) Loss in opportunity, lost profits incurred to the user by Failures of Mitsubishi products.
- (3) Special damages and secondary damages whether foreseeable or not, compensation for accidents, and compensation for damages to products other than Mitsubishi products.
- (4) Replacement by the user, maintenance of on-site equipment, start-up test run and other tasks.

5. Changes in product specifications

The specifications given in the catalogs, manuals or technical documents are subject to change without prior notice.

TRADEMARKS

The company names, system names and product names mentioned in this manual are either registered trademarks or trademarks of their respective companies.

In some cases, trademark symbols such as [™] or [®] are not specified in this manual.

SH(NA)-081855ENG-I(2212)MEE

MODEL: RJ71PB91V-U-IN-E

MODEL CODE: 13JX79

MITSUBISHI ELECTRIC CORPORATION

HEAD OFFICE : TOKYO BUILDING, 2-7-3 MARUNOUCHI, CHIYODA-KU, TOKYO 100-8310, JAPAN
NAGOYA WORKS : 1-14, YADA-MINAMI 5-CHOME, HIGASHI-KU, NAGOYA, JAPAN

When exported from Japan, this manual does not require application to the
Ministry of Economy, Trade and Industry for service transaction permission.

Specifications subject to change without notice.