

Programmable Controller

MELSEC iQ-R
series

MELSEC iQ-R EtherNet/IP Network Interface Module User's Manual (Application)

-RJ71EIP91



SAFETY PRECAUTIONS

(Read these precautions before using this product.)

Before using this product, please read this manual and the relevant manuals carefully and pay full attention to safety to handle the product correctly.

The precautions given in this manual are concerned with this product only. For the safety precautions of the programmable controller system, refer to the CPU module User's Manual used.

In this manual, the safety precautions are classified into two levels: "⚠️ WARNING" and "⚠️ CAUTION".

 WARNING	Indicates that incorrect handling may cause hazardous conditions, resulting in death or severe injury.
 CAUTION	Indicates that incorrect handling may cause hazardous conditions, resulting in minor or moderate injury or property damage.

Under some circumstances, failure to observe the precautions given under "⚠️ CAUTION" may lead to serious consequences.

Observe the precautions of both levels because they are important for personal and system safety.

Make sure that the end users read this manual and then keep the manual in a safe place for future reference.

[Design Precautions]

WARNING

- Configure safety circuits external to the programmable controller to ensure that the entire system operates safely even when a fault occurs in the external power supply or the programmable controller. Failure to do so may result in an accident due to an incorrect output or malfunction.
 - (1) Emergency stop circuits, protection circuits, and protective interlock circuits for conflicting operations (such as forward/reverse rotations or upper/lower limit positioning) must be configured external to the programmable controller.
 - (2) When the programmable controller detects an abnormal condition, it stops the operation and all outputs are:
 - Turned off if the overcurrent or overvoltage protection of the power supply module is activated.
 - Held or turned off according to the parameter setting if the self-diagnostic function of the CPU module detects an error such as a watchdog timer error.
 - (3) All outputs may be turned on if an error occurs in a part, such as an I/O control part, where the CPU module cannot detect any error. To ensure safety operation in such a case, provide a safety mechanism or a fail-safe circuit external to the programmable controller. For a fail-safe circuit example, refer to "General Safety Requirements" in the MELSEC iQ-R Module Configuration Manual.
 - (4) Outputs may remain on or off due to a failure of a component such as a relay and transistor in an output circuit. Configure an external circuit for monitoring output signals that could cause a serious accident.
 - In an output circuit, when a load current exceeding the rated current or an overcurrent caused by a load short-circuit flows for a long time, it may cause smoke and fire. To prevent this, configure an external safety circuit, such as a fuse.
-

[Design Precautions]

WARNING

- Configure a circuit so that the programmable controller is turned on first and then the external power supply. If the external power supply is turned on first, an accident may occur due to an incorrect output or malfunction.
 - For the operating status of each station after a communication failure, refer to manuals relevant to the network. Incorrect output or malfunction due to a communication failure may result in an accident.
 - When connecting an external device with a CPU module or intelligent function module to modify data of a running programmable controller, configure an interlock circuit in the program to ensure that the entire system will always operate safely. For other forms of control (such as program modification, parameter change, forced output, or operating status change) of a running programmable controller, read the relevant manuals carefully and ensure that the operation is safe before proceeding. Improper operation may damage machines or cause accidents.
 - Especially, when a remote programmable controller is controlled by an external device, immediate action cannot be taken if a problem occurs in the programmable controller due to a communication failure. To prevent this, configure an interlock circuit in the program, and determine corrective actions to be taken between the external device and CPU module in case of a communication failure.
 - Do not write any data to the "system area" and "write-protect area" of the buffer memory in the module. Also, do not use any "use prohibited" signals as an output signal from the CPU module to each module. Doing so may cause malfunction of the programmable controller system. For the "system area", "write-protect area", and the "use prohibited" signals, refer to the user's manual for the module used.
 - If a communication cable is disconnected, the network may be unstable, resulting in a communication failure of multiple stations. Configure an interlock circuit in the program to ensure that the entire system will always operate safely even if communications fail. Failure to do so may result in an accident due to an incorrect output or malfunction.
 - For the operating status of each EtherNet/IP device after a communication failure, refer to Page 116 TROUBLESHOOTING in this manual. Incorrect output or malfunction due to a communication failure may result in an accident.
 - Configure an interlock circuit in the program to ensure that the entire system will always operate safely even if communications fail in multiple EtherNet/IP devices. Failure to do so may result in an accident due to an incorrect output or malfunction.
-

[Design Precautions]

CAUTION

- Do not install the control lines or communication cables together with the main circuit lines or power cables. Keep a distance of 100mm or more between them. Failure to do so may result in malfunction due to noise.
 - During control of an inductive load such as a lamp, heater, or solenoid valve, a large current (approximately ten times greater than normal) may flow when the output is turned from off to on. Therefore, use a module that has a sufficient current rating.
 - After the CPU module is powered on or is reset, the time taken to enter the RUN status varies depending on the system configuration, parameter settings, and/or program size. Design circuits so that the entire system will always operate safely, regardless of the time.
 - Do not power off the programmable controller or reset the CPU module while the settings are being written. Doing so will make the data in the flash ROM and SD memory card undefined. The values need to be set in the buffer memory and written to the flash ROM and SD memory card again. Doing so also may cause malfunction or failure of the module.
 - When changing the operating status of the CPU module from external devices (such as the remote RUN/STOP functions), select "Do Not Open by Program" for "Opening Method" of "Module Parameter". If "Open by Program" is selected, an execution of the remote STOP function causes the communication line to close. Consequently, the CPU module cannot reopen the line, and external devices cannot execute the remote RUN function.
-

[Security Precautions]

WARNING

- To maintain the security (confidentiality, integrity, and availability) of the programmable controller and the system against unauthorized access, denial-of-service (DoS) attacks, computer viruses, and other cyberattacks from external devices via the network, take appropriate measures such as firewalls, virtual private networks (VPNs), and antivirus solutions.
-

[Installation Precautions]

WARNING

- Shut off the external power supply (all phases) used in the system before mounting or removing the module. Failure to do so may result in electric shock or cause the module to fail or malfunction.
-

[Installation Precautions]

CAUTION

- Use the programmable controller in an environment that meets the general specifications in the Safety Guidelines included with the base unit. Failure to do so may result in electric shock, fire, malfunction, or damage to or deterioration of the product.
 - To mount a module, place the concave part(s) located at the bottom onto the guide(s) of the base unit, and push in the module until the hook(s) located at the top snaps into place. Incorrect interconnection may cause malfunction, failure, or drop of the module.
 - To mount a module with no module fixing hook, place the concave part(s) located at the bottom onto the guide(s) of the base unit, push in the module, and fix it with screw(s). Incorrect interconnection may cause malfunction, failure, or drop of the module.
 - When using the programmable controller in an environment of frequent vibrations, fix the module with a screw.
 - Tighten the screws within the specified torque range. Undertightening can cause drop of the screw, short circuit, or malfunction. Overtightening can damage the screw and/or module, resulting in drop, short circuit, or malfunction.
 - When using an extension cable, connect it to the extension cable connector of the base unit securely. Check the connection for looseness. Poor contact may cause malfunction.
 - When using an SD memory card, fully insert it into the SD memory card slot. Check that it is inserted completely. Poor contact may cause malfunction.
 - Securely insert an extended SRAM cassette or a battery-less option cassette into the cassette connector of the CPU module. After insertion, close the cassette cover and check that the cassette is inserted completely. Poor contact may cause malfunction.
 - Do not directly touch any conductive parts and electronic components of the module, SD memory card, extended SRAM cassette, battery-less option cassette, or connector. Doing so can cause malfunction or failure of the module.
-

[Wiring Precautions]

WARNING

- Shut off the external power supply (all phases) used in the system before installation and wiring. Failure to do so may result in electric shock or cause the module to fail or malfunction.
 - After installation and wiring, attach a blank cover module (RG60) to each empty slot and an included extension connector protective cover to the unused extension cable connector before powering on the system for operation. Failure to do so may result in electric shock.
-

[Wiring Precautions]

CAUTION

- Individually ground the FG and LG terminals of the programmable controller with a ground resistance of 100 ohms or less. Failure to do so may result in electric shock or malfunction.
 - Use applicable solderless terminals and tighten them within the specified torque range. If any spade solderless terminal is used, it may be disconnected when the terminal screw comes loose, resulting in failure.
 - Check the rated voltage and signal layout before wiring to the module, and connect the cables correctly. Connecting a power supply with a different voltage rating or incorrect wiring may cause fire or failure.
 - Connectors for external devices must be crimped or pressed with the tool specified by the manufacturer, or must be correctly soldered. Incomplete connections may cause short circuit, fire, or malfunction.
 - Securely connect the connector to the module. Poor contact may cause malfunction.
 - Do not install the control lines or communication cables together with the main circuit lines or power cables. Keep a distance of 100mm or more between them. Failure to do so may result in malfunction due to noise.
 - Place the cables in a duct or clamp them. If not, dangling cables may swing or inadvertently be pulled, resulting in malfunction or damage to modules or cables. In addition, the weight of the cables may put stress on modules in an environment of strong vibrations and shocks. Do not clamp the extension cables with the jacket stripped. Doing so may change the characteristics of the cables, resulting in malfunction.
 - Check the interface type and correctly connect the cable. Incorrect wiring (connecting the cable to an incorrect interface) may cause failure of the module and external device.
-

[Wiring Precautions]

CAUTION

- Tighten the terminal screws or connector screws within the specified torque range. Undertightening can cause drop of the screw, short circuit, fire, or malfunction. Overtightening can damage the screw and/or module, resulting in drop, short circuit, fire, or malfunction.
 - When disconnecting the cable from the module, do not pull the cable by the cable part. For the cable with connector, hold the connector part of the cable. For the cable connected to the terminal block, loosen the terminal screw. Pulling the cable connected to the module may result in malfunction or damage to the module or cable.
 - Prevent foreign matter such as dust or wire chips from entering the module. Such foreign matter can cause a fire, failure, or malfunction.
 - A protective film is attached to the top of the module to prevent foreign matter, such as wire chips, from entering the module during wiring. Do not remove the film during wiring. Remove it for heat dissipation before system operation.
 - Programmable controllers must be installed in control panels. Connect the main power supply to the power supply module in the control panel through a relay terminal block. Wiring and replacement of a power supply module must be performed by qualified maintenance personnel with knowledge of protection against electric shock. For wiring, refer to the MELSEC iQ-R Module Configuration Manual.
 - For Ethernet cables to be used in the system, select the ones that meet the specifications described in MELSEC iQ-R EtherNet/IP Network Interface Module User's Manual (Startup). If not, normal data transmission is not guaranteed.
-

[Startup and Maintenance Precautions]

WARNING

- Do not touch any terminal while power is on. Doing so will cause electric shock or malfunction.
 - Correctly connect the battery connector. Do not charge, disassemble, heat, short-circuit, solder, or throw the battery into the fire. Also, do not expose it to liquid or strong shock. Doing so will cause the battery to produce heat, explode, ignite, or leak, resulting in injury and fire.
 - Shut off the external power supply (all phases) used in the system before cleaning the module or retightening the terminal screws, connector screws, or module fixing screws. Failure to do so may result in electric shock.
-

[Startup and Maintenance Precautions]

CAUTION

- When connecting an external device with a CPU module or intelligent function module to modify data of a running programmable controller, configure an interlock circuit in the program to ensure that the entire system will always operate safely. For other forms of control (such as program modification, parameter change, forced output, or operating status change) of a running programmable controller, read the relevant manuals carefully and ensure that the operation is safe before proceeding. Improper operation may damage machines or cause accidents.
 - Especially, when a remote programmable controller is controlled by an external device, immediate action cannot be taken if a problem occurs in the programmable controller due to a communication failure. To prevent this, configure an interlock circuit in the program, and determine corrective actions to be taken between the external device and CPU module in case of a communication failure.
 - Do not disassemble or modify the modules. Doing so may cause failure, malfunction, injury, or a fire.
 - Use any radio communication device such as a cellular phone or PHS (Personal Handy-phone System) more than 25cm away in all directions from the programmable controller. Failure to do so may cause malfunction.
 - Shut off the external power supply (all phases) used in the system before mounting or removing the module. Failure to do so may cause the module to fail or malfunction.
 - Tighten the screws within the specified torque range. Undertightening can cause drop of the component or wire, short circuit, or malfunction. Overtightening can damage the screw and/or module, resulting in drop, short circuit, or malfunction.
-

[Startup and Maintenance Precautions]

CAUTION

- After the first use of the product, do not perform each of the following operations more than 50 times (IEC 61131-2/JIS B 3502 compliant):
Exceeding the limit may cause malfunction.
 - Mounting/removing the module to/from the base unit
 - Inserting/removing the extended SRAM cassette or battery-less option cassette to/from the CPU module
 - Mounting/removing the terminal block to/from the module
 - After the first use of the product, do not insert/remove the SD memory card to/from the CPU module more than 500 times. Exceeding the limit may cause malfunction.
 - Do not touch the metal terminals on the back side of the SD memory card. Doing so may cause malfunction or failure of the module.
 - Do not touch the integrated circuits on the circuit board of an extended SRAM cassette or a battery-less option cassette. Doing so may cause malfunction or failure of the module.
 - Do not drop or apply shock to the battery to be installed in the module. Doing so may damage the battery, causing the battery fluid to leak inside the battery. If the battery is dropped or any shock is applied to it, dispose of it without using.
 - Startup and maintenance of a control panel must be performed by qualified maintenance personnel with knowledge of protection against electric shock. Lock the control panel so that only qualified maintenance personnel can operate it.
 - Before handling the module, touch a conducting object such as a grounded metal to discharge the static electricity from the human body. Failure to do so may cause the module to fail or malfunction.
-

[Operating Precautions]

CAUTION

- When changing data and operating status, and modifying program of the running programmable controller from an external device such as a personal computer connected to an intelligent function module, read relevant manuals carefully and ensure the safety before operation. Incorrect change or modification may cause system malfunction, damage to the machines, or accidents.
 - Do not power off the programmable controller or reset the CPU module while the setting values in the buffer memory are being written to the flash ROM in the module. Doing so will make the data in the flash ROM and SD memory card undefined. The values need to be set in the buffer memory and written to the flash ROM and SD memory card again. Doing so can cause malfunction or failure of the module.
-

[Disposal Precautions]

CAUTION

- When disposing of this product, treat it as industrial waste.
 - When disposing of batteries, separate them from other wastes according to the local regulations. For details on battery regulations in EU member states, refer to the MELSEC iQ-R Module Configuration Manual.
-

[Transportation Precautions]

CAUTION

- When transporting lithium batteries, follow the transportation regulations. For details on the regulated models, refer to the MELSEC iQ-R Module Configuration Manual.
 - The halogens (such as fluorine, chlorine, bromine, and iodine), which are contained in a fumigant used for disinfection and pest control of wood packaging materials, may cause failure of the product. Prevent the entry of fumigant residues into the product or consider other methods (such as heat treatment) instead of fumigation. The disinfection and pest control measures must be applied to unprocessed raw wood.
-

CONDITIONS OF USE FOR THE PRODUCT

- (1) MELSEC programmable controller ("the PRODUCT") shall be used in conditions;
- i) where any problem, fault or failure occurring in the PRODUCT, if any, shall not lead to any major or serious accident; and
 - ii) where the backup and fail-safe function are systematically or automatically provided outside of the PRODUCT for the case of any problem, fault or failure occurring in the PRODUCT.
- (2) The PRODUCT has been designed and manufactured for the purpose of being used in general industries. MITSUBISHI ELECTRIC SHALL HAVE NO RESPONSIBILITY OR LIABILITY (INCLUDING, BUT NOT LIMITED TO ANY AND ALL RESPONSIBILITY OR LIABILITY BASED ON CONTRACT, WARRANTY, TORT, PRODUCT LIABILITY) FOR ANY INJURY OR DEATH TO PERSONS OR LOSS OR DAMAGE TO PROPERTY CAUSED BY the PRODUCT THAT ARE OPERATED OR USED IN APPLICATION NOT INTENDED OR EXCLUDED BY INSTRUCTIONS, PRECAUTIONS, OR WARNING CONTAINED IN MITSUBISHI ELECTRIC USER'S, INSTRUCTION AND/OR SAFETY MANUALS, TECHNICAL BULLETINS AND GUIDELINES FOR the PRODUCT.
- ("Prohibited Application")
- Prohibited Applications include, but not limited to, the use of the PRODUCT in;
- Nuclear Power Plants and any other power plants operated by Power companies, and/or any other cases in which the public could be affected if any problem or fault occurs in the PRODUCT.
 - Railway companies or Public service purposes, and/or any other cases in which establishment of a special quality assurance system is required by the Purchaser or End User.
 - Aircraft or Aerospace, Medical applications, Train equipment, transport equipment such as Elevator and Escalator, Incineration and Fuel devices, Vehicles, Manned transportation, Equipment for Recreation and Amusement, and Safety devices, handling of Nuclear or Hazardous Materials or Chemicals, Mining and Drilling, and/or other applications where there is a significant risk of injury to the public or property.
- Notwithstanding the above restrictions, Mitsubishi Electric may in its sole discretion, authorize use of the PRODUCT in one or more of the Prohibited Applications, provided that the usage of the PRODUCT is limited only for the specific applications agreed to by Mitsubishi Electric and provided further that no special quality assurance or fail-safe, redundant or other safety features which exceed the general specifications of the PRODUCTS are required. For details, please contact the Mitsubishi Electric representative in your region.
- (3) Mitsubishi Electric shall have no responsibility or liability for any problems involving programmable controller trouble and system trouble caused by DoS attacks, unauthorized access, computer viruses, and other cyberattacks.

INTRODUCTION

Thank you for purchasing the Mitsubishi Electric MELSEC iQ-R series programmable controllers.

This manual describes the functions, parameter settings, programming, and troubleshooting of the relevant product listed below.

Before using this product, please read this manual and the relevant manuals carefully and develop familiarity with the functions and performance of the MELSEC iQ-R series programmable controller to handle the product correctly.

When applying the program examples provided in this manual to an actual system, ensure the applicability and confirm that it will not cause system control problems.

Please make sure that the end users read this manual.

Relevant product

RJ71EIP91

CONTENTS

SAFETY PRECAUTIONS	1
CONDITIONS OF USE FOR THE PRODUCT	10
INTRODUCTION	11
RELEVANT MANUALS	14
TERMS	15
GENERIC TERMS AND ABBREVIATIONS	15
CHAPTER 1 FUNCTIONS	16
1.1 EtherNet/IP Communication Functions	16
Class1 instance communications	18
Class1 tag communications	27
Class3 message communications	37
UCMM message communications	40
1.2 Communication Status Setting Function When a CPU Stop Error Occurs	44
CHAPTER 2 PARAMETER SETTINGS	45
2.1 Procedure for Setting Parameters	45
2.2 Basic Setting	46
2.3 Application Setting	48
2.4 Refresh Setting	49
2.5 Setting EtherNet/IP Communications (Starting EtherNet/IP Configuration Tool)	50
2.6 Writing Parameters	51
CHAPTER 3 EtherNet/IP Configuration Tool	52
3.1 Window Structure	52
Menu	53
EtherNet/IP setting	60
Device Library	61
Network Detection	63
Network configuration settings	69
Operation information list	95
3.2 Procedure for Registering EtherNet/IP Devices	96
Adding the EDS file	96
Configuring settings online	98
Configuring settings offline	98
3.3 Setting File	99
Importing the setting file	99
Exporting the setting file	101
Re-editing the setting file uploaded	102
3.4 Checking the Software Version	103
CHAPTER 4 PROGRAMMING	104
4.1 Program Example of UCMM Message Communications	104
System configuration example	104
Setting parameters	105
Program example	108

4.2	Program Example of PING Test	111
	System configuration example	111
	Setting parameters	112
	Program example	114
CHAPTER 5 TROUBLESHOOTING		116
5.1	Checking with LEDs	116
5.2	Checking the Module Status	118
5.3	Checking the Network Status	120
	Network diagnostics of EtherNet/IP Configuration Tool	120
	Checking with the buffer memory	122
	PING test	124
5.4	Hardware Test	125
5.5	Troubleshooting by Symptom	126
5.6	List of Error Codes	129
	Error codes when a module error occurs	129
	Error codes when a communication error occurs	133
5.7	Event List	139
APPENDICES		140
Appendix 1 Module Label		140
Appendix 2 I/O Signals		141
	List of I/O signals	141
	Execution condition of output signal	141
	Details of input signals	142
	Details of output signals	143
Appendix 3 Buffer Memory		148
	List of buffer memory addresses	148
	Details of buffer memory addresses	151
Appendix 4 Details of Message Communication Support Command		163
	Identity	164
	Connection Manager	166
	TCP/IP Interface	167
	Ethernet Link	170
Appendix 5 Processing Time		173
	Transmission delay time	173
Appendix 6 Differences Between QJ71EIP71 and RJ71EIP91		174
Appendix 7 Added Functions		179
INDEX		181
REVISIONS		182
WARRANTY		183
TRADEMARKS		184

RELEVANT MANUALS

Manual name [manual number]	Description	Available form
MELSEC iQ-R Module Configuration Manual [SH-081262ENG]	Common information on the hardware configuration of all modules, overview of each system configuration, and specifications of the power supply module, base unit, SD memory card, and battery.	Print book e-Manual PDF
MELSEC iQ-R EtherNet/IP Network Interface Module User's Manual (Application) [SH-081915ENG] (this manual)	Functions, parameter settings, operation methods of EtherNet/IP Configuration Tool, programming, troubleshooting, I/O signals, and buffer memory of the EtherNet/IP network interface module	Print book e-Manual PDF
MELSEC iQ-R EtherNet/IP Network Interface Module User's Manual (Startup) [SH-081913ENG]	Specifications, procedures before operation, system configuration, wiring, and communication examples of the EtherNet/IP network interface module	Print book e-Manual PDF
GX Works3 Operating Manual [SH-081215ENG]	System configuration, parameter settings, and online operations of GX Works3	e-Manual PDF
MELSEC iQ-R EtherNet/IP Network Interface Module Function Block Reference [BCN-P5999-0942]	Specifications of the FBs, functions, and I/O labels of the EtherNet/IP network interface module	e-Manual PDF



e-Manual refers to the Mitsubishi Electric FA electronic book manuals that can be browsed using a dedicated tool.

e-Manual has the following features:

- Required information can be cross-searched in multiple manuals.
- Other manuals can be accessed from the links in the manual.
- The hardware specifications of each part can be found from the product figures.
- Pages that users often browse can be bookmarked.
- Sample programs can be copied to an engineering tool.

TERMS

Unless otherwise specified, this manual uses the following terms.

Term	Description
Buffer memory	Memory in an intelligent function module to store data such as setting values and monitor values. For CPU modules, it refers to memory to store data such as setting values and monitor values of the Ethernet function, or data used for data communication of the multiple CPU system function.
Engineering tool	A tool used for setting up programmable controllers, programming, debugging, and maintenance
EtherNet/IP Configuration Tool	EtherNet/IP Configuration Tool for RJ71EIP91. A tool for setting the network configuration for EtherNet/IP.
EtherNet/IP device	A device, personal computer, and other equipment connected via EtherNet/IP for data communications
Global label	A label that is valid for all the program data when multiple program data are created in the project. There are two types of global label: a module specific label (module label), which is generated automatically by GX Works3, and an optional label, which can be created for any specified device.
Intelligent function module	A module that has functions other than an input or output, such as an A/D converter module and D/A converter module
Module label	A label that represents one of memory areas (I/O signals and buffer memory areas) specific to each module in a given character string. For the module used, GX Works3 automatically generates this label, which can be used as a global label.

GENERIC TERMS AND ABBREVIATIONS

Unless otherwise specified, this manual uses the following generic terms and abbreviations.

Generic term/abbreviation	Description
API	An abbreviation for Actual Packet Interval. A communication cycle that is decided by the target during communications between EtherNet/IP devices.
Consumer Tag	Another name for the consumed tag
CPU module	A generic term for the MELSEC iQ-R series CPU modules
DHCP	An abbreviation for Dynamic Host Configuration Protocol. A protocol used for automatically assigning the information required for the network such as an IP address.
PPS	An abbreviation for Packets Per Second. The number of packets that can be processed per second.
Producer Tag	Another name for the produced tag
RPI	An abbreviation for Requested Packet Interval. A communication cycle that is decided by the originator during communications between EtherNet/IP devices.

1 FUNCTIONS

1.1 EtherNet/IP Communication Functions

The EtherNet/IP communication functions are used to perform data communications over a network between the RJ71EIP91 and EtherNet/IP devices.

The RJ71EIP91 can perform the following types of EtherNet/IP communications.

- Class1 communications
- Class3 communications
- UCMM communications

Class1 communications

With Class1 communications, data communications are performed periodically with establishing connections between the RJ71EIP91 and EtherNet/IP devices over a network.

Also, Application Trigger can be used to send and receive data with arbitrary timing.

Class1 communications has the following functions.

- Class1 instance communications ( Page 18 Class1 instance communications)
- Class1 tag communications ( Page 27 Class1 tag communications)

Class3 communications

With Class3 communications, data are read or written using message communication support commands with establishing connections between the RJ71EIP91 and EtherNet/IP devices over a network.

Class3 communications has the following function.

- Class3 message communications ( Page 37 Class3 message communications)

UCMM communications

With UCMM communications, message communication support commands are used to read and write data without establishing connections over a network between the RJ71EIP91 and EtherNet/IP devices.

UCMM communications has the following function.

- UCMM message communications ( Page 40 UCMM message communications)

Point

Note that the number of connections for the RJ71EIP91 is the total number for Class1, Class3, and UCMM communications.

For details, refer to the following.

 MELSEC iQ-R EtherNet/IP Network Interface Module User's Manual (Startup)

Applied connection of EtherNet/IP communications

■ When the RJ71EIP91 is the target

○: Requests can be accepted from the EtherNet/IP device, ×: Requests cannot be accepted from EtherNet/IP device, —: No combination

EtherNet/IP communications	Connection settings							
	Connection type	Trigger type			Input type (target to originator)		Output type (originator to target)	
		Cyclic	Application Trigger	Change of State ^{*1}	Fixed ^{*2}	Variable ^{*3}	Fixed ^{*2}	Variable ^{*3}
Class1 tag communications	Input Only ^{*4}	○	○	○	○	×	○	×
Class3 message communications	—	—	—	—	—	—	—	—
UCMM message communications	—	—	—	—	—	—	—	—

*1 A method to send data when the status changes. On the RJ71EIP91, data is sent when Application Trigger is requested.

*2 A method for communicating with a fixed size.

*3 A method for communicating with a variable size.

*4 A connection set from the RJ71EIP91 to the originator only for receiving data.

■ When the RJ71EIP91 is the originator

○: Requests can be sent to the EtherNet/IP device, ×: Requests cannot be sent to EtherNet/IP device, —: No combination

EtherNet/IP communications	Connection settings							
	Connection type	Trigger type			Input type (target to originator)		Output type (originator to target)	
		Cyclic	Application Trigger	Change of State ^{*1}	Fixed ^{*2}	Variable ^{*3}	Fixed ^{*2}	Variable ^{*3}
Class1 instance communications	Exclusive Owner ^{*4}	○	○	○	○	○	○	○ ^{*7}
	Input Only ^{*5}	○	○	○	○	○	○	○ ^{*7}
	Listen Only ^{*6}	○	○	○	○	○	○	○ ^{*7}
Class1 tag communications	Input Only ^{*5}	○	○	○	○	○	○	○ ^{*7}
Class3 message communications	—	—	—	—	—	—	—	—
UCMM message communications	—	—	—	—	—	—	—	—

*1 A method to send data when the status changes. On the RJ71EIP91, data is sent when Application Trigger is requested.

*2 A method for communicating with a fixed size.

*3 A method for communicating with a variable size.

*4 A connection simultaneously set from the RJ71EIP91 to the target for sending data and set from the target to the RJ71EIP91 for receiving data.

*5 A connection set from the target to the RJ71EIP91 only for receiving data.

*6 A connection that monitors the data communications with the target to which a connection has been established.

*7 Connection requests can be set, but are sent from the RJ71EIP91 with a fixed size.



For the connection setting method, refer to the following.

☞ Page 81 [Connections] tab

Class1 instance communications

Data communications between the send/receive data assigned to the buffer memory area and the CPU device can be used the following methods: using by the MOV instruction or the FROM/TO instruction and using with a module FB.

Use a module FB when "Block assurance per connection" under "Application Setting" is set to "Enable".

For details on the communication method with a module FB, refer to the following.

📖 MELSEC iQ-R EtherNet/IP Network Interface Module Function Block Reference

Communication type

Cyclic (Implicit) communications

Function overview

Class1 instance communications are a function for periodically performing data communications between the RJ71EIP91 and an EtherNet/IP device over a connection that has been established using an instance ID.

This function is used for cyclic (Implicit) communications with an adapter.

Data communications are performed between the originator (the device on the sending side that requests the connection) and the target (the device on the receiving side that is requested to connect).

■When the connection type is Exclusive Owner

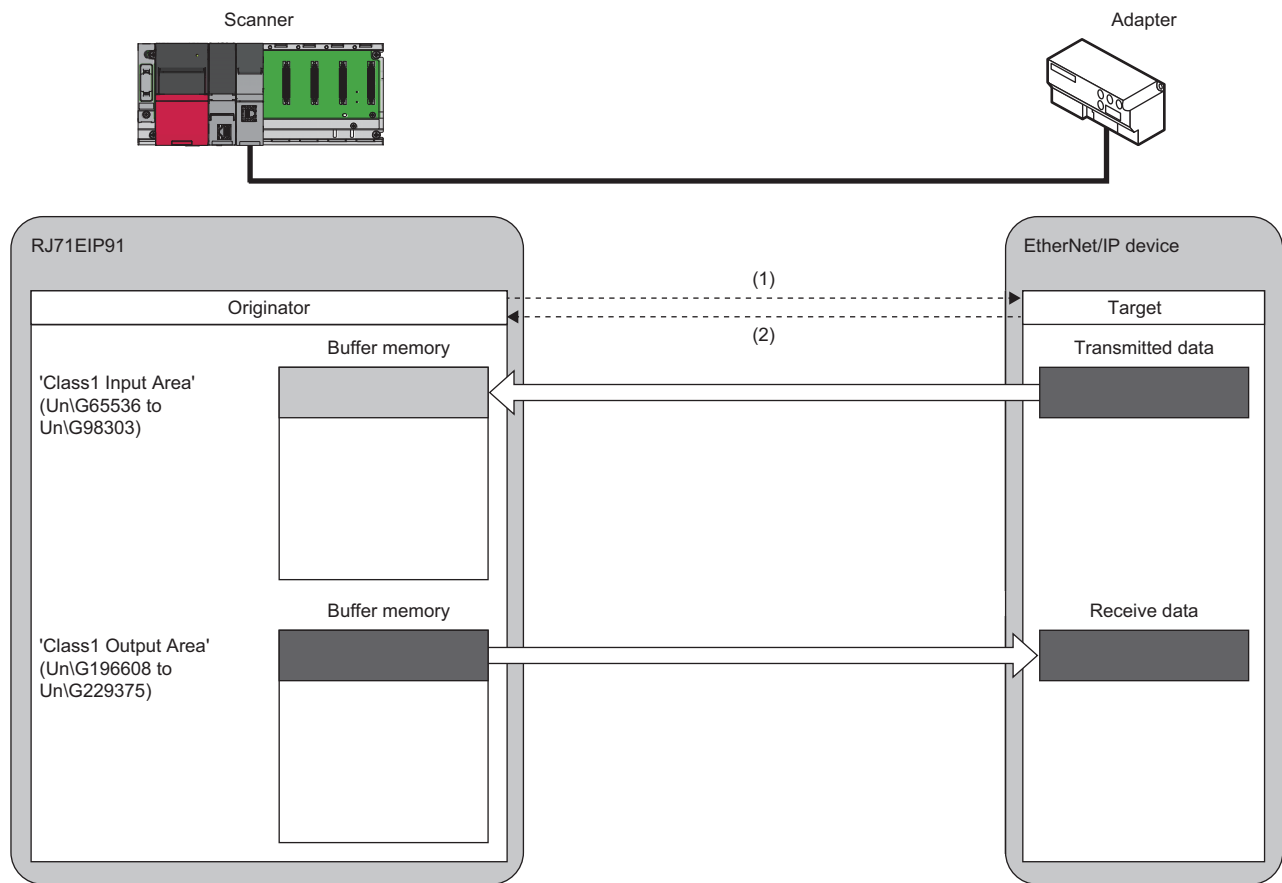

(1) Connection open

(2) Response

■ When the connection type is Input Only

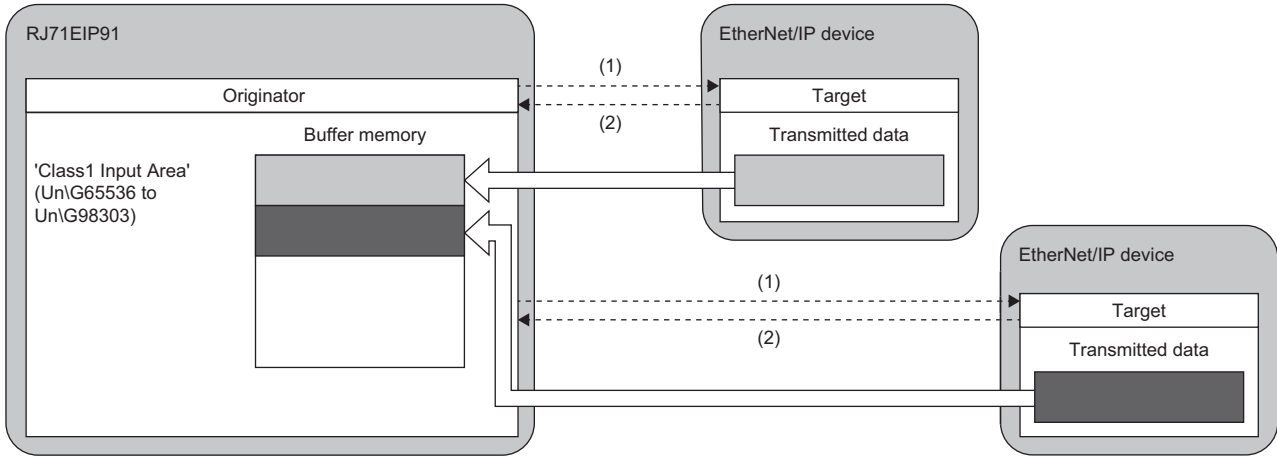

- (1) Connection open
- (2) Response

■ When the connection type is Listen Only

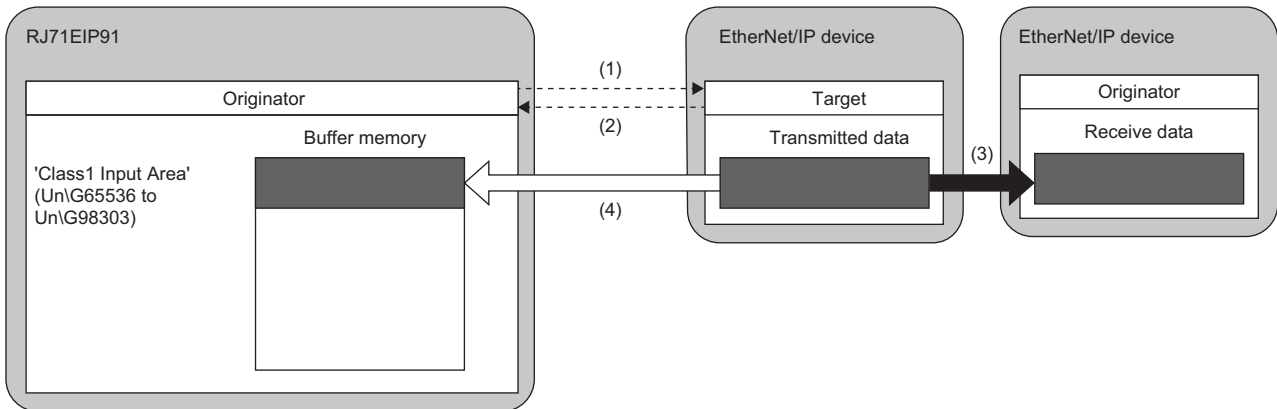

- (1) Connection open
- (2) Response
- (3) Data sent over an Input Only or Exclusive Owner connection
- (4) The same data as (3) is received.

- Listen Only is a connection for the target of which connection such as Exclusive Owner and Input Only that is set for multicast communications is already opened. It can receive only multicast-type data sent to the RJ71EIP91.
- The connection of Listen Only cannot be opened when the connection such as Exclusive Owner and Input Only that is set for multicast communications is not opened.
- Even when communications are performed normally with the target that is opened using Listen Only, the data receiving will be stopped if all the communications with other originators that are opened using the connection such as Exclusive Owner and Input Only that is set for multicast communications.

Instance ID

The instance ID is a number that indicates an EtherNet/IP device and is specified when the EtherNet/IP communication connection is established.

With settings from the RJ71EIP91, the instance ID is not specified. Instead, the connection number is specified to determine the target.

Communication timing

Class1 instance communications are performed at the RPI interval set with the RJ71EIP91 on the scanner side.

The RPI can be set for each connection.

Cyclic, Application Trigger, or Change of State can be selected for the communication trigger type. ( Page 81 [Connections] tab)

Data sending

Data is sent from the originator to the target.

Data can be sent when the connection type is Exclusive Owner.

■ Sending data with the Cyclic trigger type

Set the trigger type to Cyclic in the connection settings to periodically repeat the sending of data.

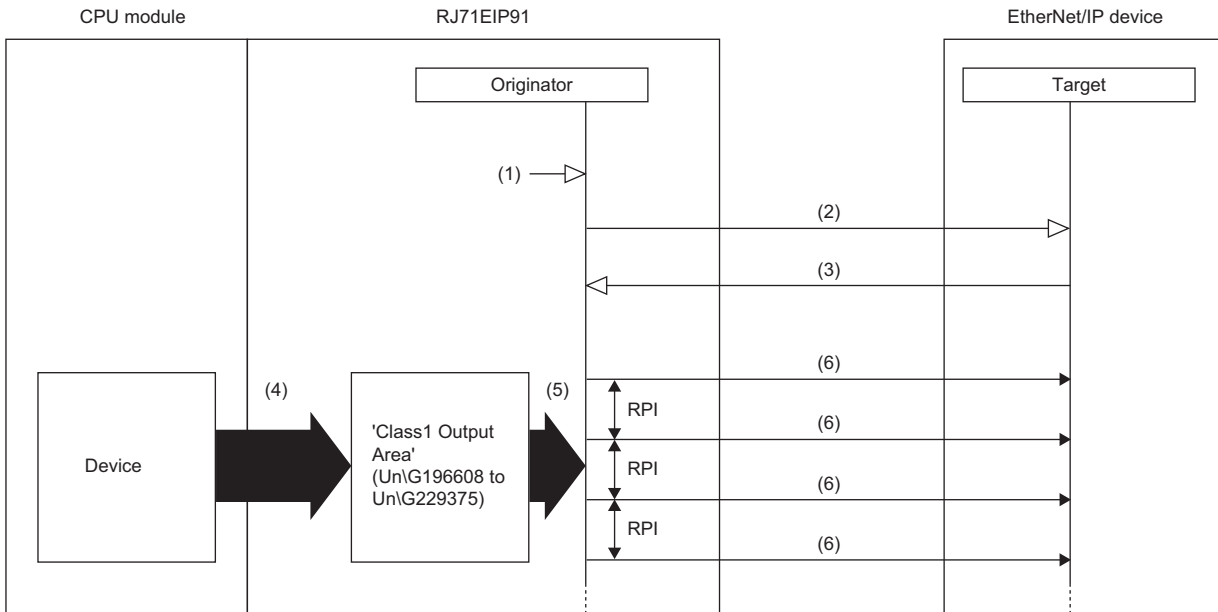

(1) Turn on 'EtherNet/IP communication start request' (Y10).

(2) Connection open

(3) Response (normal)

(4) Transfer the stored data with a program.

(5) Send the stored data at the RPI interval.

(6) Sending data

Data is sent with the Cyclic trigger type according to the following procedure.

1. Connection establishment ((1) to (3) shown above)

The connection is established when 'EtherNet/IP communication start request' (Y10) on the RJ71EIP91 on the scanner side is turned on, the connection open request is sent, and then a response is received from the EtherNet/IP device on the adapter side.

2. Sending data ((5) to (6) shown above)

If the connection is established normally, the originator sends the data stored in 'Class1 Output Area' (Un\G196608 to Un\G229375).

Point

For the operation timing of EtherNet/IP communications, refer to the following.

☞ Page 143 EtherNet/IP communication start request (Y10)

■ Sending data with the Application Trigger or Change of State trigger type

Set the trigger type to Application Trigger or Change of State in the connection settings to send data at a given timing. Use this function in situations such as when it is temporarily necessary to communicate at an interval that is shorter than the communication cycle in a system that has a long RPI interval.

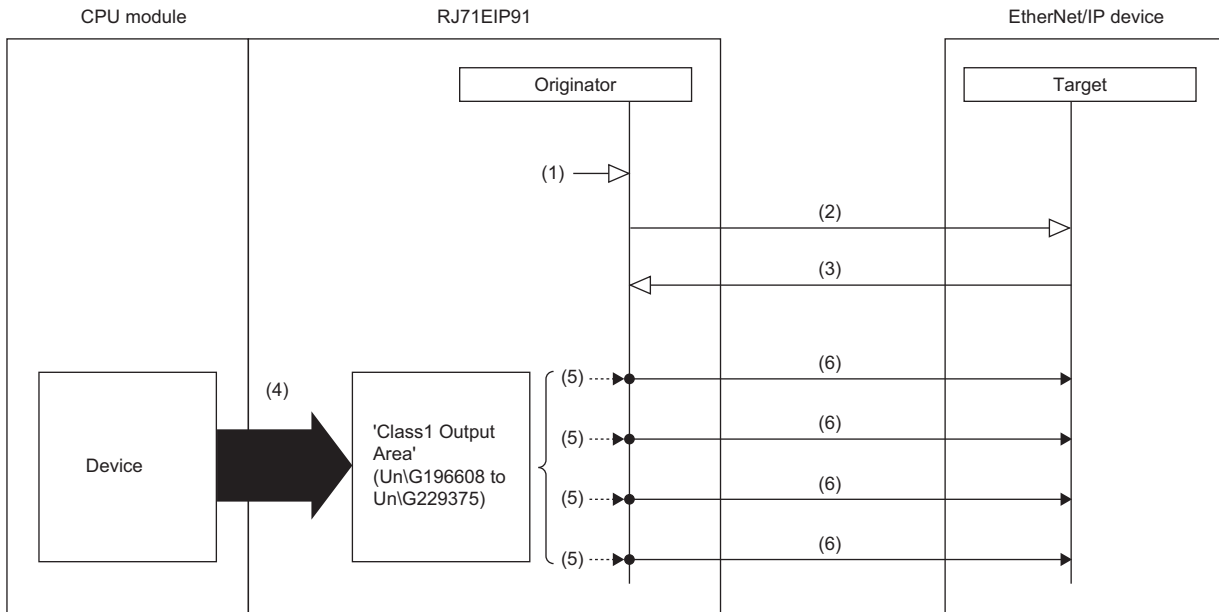

- (1) Turn on 'EtherNet/IP communication start request' (Y10).
- (2) Connection open
- (3) Response (normal)
- (4) Transfer the stored data with a program.
- (5) Turn on 'Application Trigger Request (Class1)' (Un\G27008 to Un\G27023).
- (6) Sending data

Data is sent with the Application Trigger trigger type according to the following procedure.

1. Setting of EtherNet/IP Configuration Tool

Set the trigger type to "Application" in the setting of EtherNet/IP Configuration Tool.

2. Setting of buffer memory

Set 'Application Trigger operating specification request' (Un\G16631). (☞ Page 151 Application Trigger operating specification request (Un\G16631))

3. Connection establishment ((1) to (3) shown above)

The connection is established when 'EtherNet/IP communication start request' (Y10) on the RJ71EIP91 on the scanner side is turned on, the connection open request is sent, and then a response is received from the EtherNet/IP device on the adapter side.

4. Application Trigger request ((5) shown above)

During communication with the EtherNet/IP device, the RJ71EIP91 turns on 'Application Trigger Request (Class1)' (Un\G27008 to Un\G27023).

5. Sending data ((6) shown above)

'Application Trigger Acceptance (Class1)' (Un\G27024 to Un\G27039) on the RJ71EIP91 is turned on and data stored in 'Class1 Output Area' (Un\G196608 to Un\G229375) is sent.

6. Completion of Application Trigger

After the data send processing completes, 'Application Trigger Completion (Class1)' (Un\G27040 to Un\G27055) on the RJ71EIP91 turns on.

Data sending with Change of State is performed according to the following procedure.

1. Setting of EtherNet/IP Configuration Tool

Set the following items in the setting of EtherNet/IP Configuration Tool.

- Set the trigger type to "Change of State".
- Set "Inhibit Time Mode". (When setting "Inhibit Time Mode" to "Custom", set "Inhibit Time".)

2. Connection establishment ((1) to (3) shown above)

The connection is established when 'EtherNet/IP communication start request' (Y10) on the RJ71EIP91 on the scanner side is turned on, the connection open request is sent, and then a response is received from the EtherNet/IP device on the adapter side.

3. Application Trigger request ((5) shown above)

During communication with the EtherNet/IP device, the RJ71EIP91 turns on 'Application Trigger Request (Class1)' (Un\G27008 to Un\G27023).



4. Sending data ((6) shown above)

Data stored in 'Class1 Output Area' (Un\G196608 to Un\G229375) is sent when the specified Inhibit Time has elapsed after 'Application Trigger Acceptance (Class1)' (Un\G27024 to Un\G27039) on the RJ71EIP91 is turned on.

5. Completion of Application Trigger

After the data send processing completes, 'Application Trigger Completion (Class1)' (Un\G27040 to Un\G27055) on the RJ71EIP91 turns on.

Point

- For the operation timing of EtherNet/IP communications, refer to the following.
 -  Page 143 EtherNet/IP communication start request (Y10)
- For the operation timing of data sending using the Application Trigger, refer to the following.
 -  Page 154 Application Trigger (Class1) (Un\G27008 to Un\G27055)
- When Application Trigger or Change of State is used, data will be sent automatically if no data was sent during the period from the last sending of data to the end of the RPI.
- To send data only by turning off and on 'Application Trigger Request (Class1)' (Un\G27008 to Un\G27023), set 'Application Trigger operating specification request' (Un\G16631) to 10H.
- When Change of State is used, data is sent when the specified Inhibit Time has elapsed regardless of the setting of 'Application Trigger operating specification request' (Un\G16631).
- During Class1 tag communications, heartbeat is sent by turning off and on 'Application Trigger Request (Class1)' (Un\G27008 to Un\G27023) when 'Application Trigger operating specification request' (Un\G16631) is set to 10H.
- When 'Application Trigger operating specification request' (Un\G16631) is set to 10H (output data is not transmit automatically at the RPI interval), the request is not transmit automatically. Therefore, when Application Trigger is used, transmit the request within the monitoring time of send/receive timeout.^{*1*2} If the external device cannot receive the request within the monitoring time of send/receive timeout, the timeout is detected and the connection is disconnected. In this case, a re-connection establishment is required to send data again.

*1 Be sure to receive the request on the external device within the monitoring time of send/receive timeout.

Transmit the request in a shorter period of time than the monitoring time of send/receive timeout, considering the transmission processing time and data transmission time in a module.

*2 Transmit the request from Consumer side (originator) to the target because the heartbeat needs to be sent even "Output Size" is 0 bytes.

Data receiving

Data is received by the originator from the target.

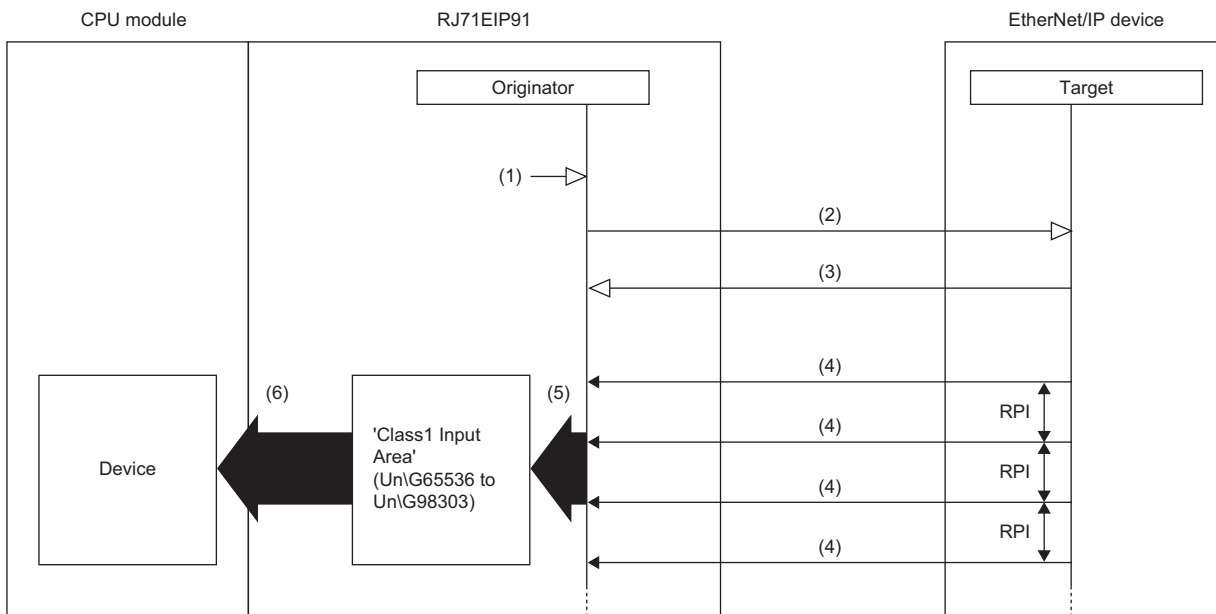

(1) Turn on 'EtherNet/IP communication start request' (Y10).

(2) Connection open

(3) Response (normal)

(4) Receiving data

(5) Store the data received at the RPI interval.

(6) Transfer the stored data with a program.

Data is received according to the following procedure.

1. Connection establishment ((1) to (3) shown above)

The connection is established when 'EtherNet/IP communication start request' (Y10) on the RJ71EIP91 on the scanner side is turned on, the connection open request is sent, and then a response is received from the EtherNet/IP device on the adapter side.

2. Receiving data ((4) to (5) shown above)

If the connection is established normally, the originator stores the received data in 'Class1 Input Area' (Un\G65536 to Un\G98303).



For the operation timing of EtherNet/IP communications, refer to the following.

☞ Page 143 EtherNet/IP communication start request (Y10)

Setting method

For Class1 instance communications, set the originator and target on the RJ71EIP91 on the scanner side.

■Originator (on scanner side) settings

Under "Basic Setting" in the engineering tool, set the IP address, subnet mask, and default gateway of the RJ71EIP91.

☞ [Navigation window] ⇒ [Parameter] ⇒ [Module Information] ⇒ [RJ71EIP91] ⇒ [Basic Setting]

Item	Setting Value
Various Operations Settings	
Mode Settings	Online
Own Node Setting	Set the information of the own node such as IP address.
IP Address Setting	Set the IP address, subnet mask, and default gateway for the own node.
IP Address	
Subnet Mask	
Default Gateway	

For details on the setting window, refer to the following.

☞ Page 46 Basic Setting

■Target (on adapter side) settings

After registering the EtherNet/IP device with EtherNet/IP Configuration Tool, set the adapter side for each connection.

For details on registering EtherNet/IP devices, refer to the following.

☞ Page 96 Procedure for Registering EtherNet/IP Devices

☞ Select the EtherNet/IP device in the network configuration settings ⇒ [Device] ⇒ [Properties] ⇒ [Connections] tab

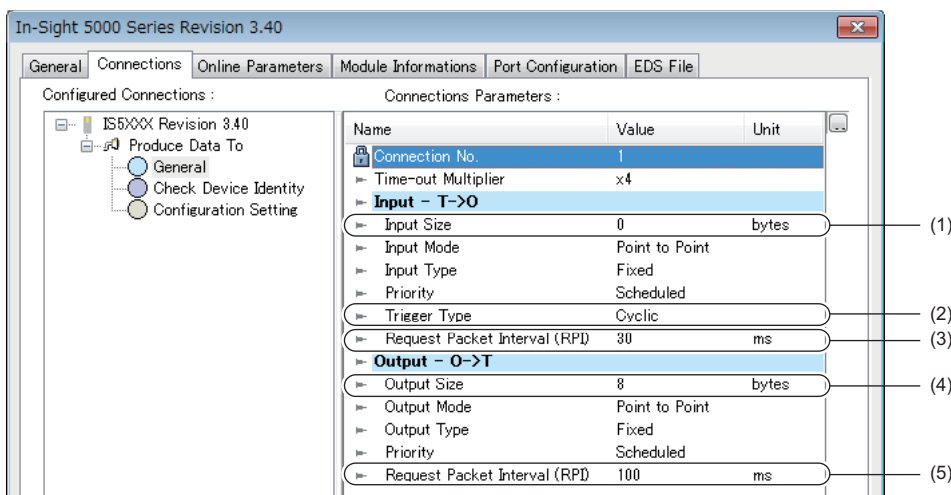

- (1) Input data size
- (2) Trigger type
- (3) RPI
- (4) Output data size
- (5) RPI

For details on the setting window, refer to the following.

☞ Page 81 [Connections] tab

■Application Trigger and Change of State

Data sending with Application Trigger or Change of State is executed by turning off and on 'Application Trigger Request (Class1)' (Un\G27008 to Un\G27023).

When data is sent with Application Trigger, whether or not to send the data automatically can be selected by 'Application Trigger operating specification request' (Un\G16631). When data is sent with Change of State, this setting is ignored.

The following table lists the setting items of Application Trigger and Change of State.

Type	Setting Item of EtherNet/IP Configuration Tool			Buffer memory
	Trigger Type	Inhibit time setting		'Application Trigger Request (Class1)' (Un\G27008 to Un\G27023)
		Inhibit Time Mode	Inhibit time(ms)	
Application Trigger	Application	— (No setting)	— (No setting)	Off → On
Change of State	Change of State	Default* ¹	— (No setting)	Off → On
		Un-Activated* ²	— (No setting)	Off → On
		Custom	Specifies in the range between 1 and 255.	Off → On

*1 When Default is set, a quarter of RPI is specified as the inhibit time.

*2 When Un-Activated is set, no inhibit time is specified.

Class1 tag communications

Data communications between the send/receive data assigned to the buffer memory area and the CPU device can be used the following methods: using by the MOV instruction or the FROM/TO instruction and using with a module FB.

Use a module FB when "Block assurance per connection" under "Application Setting" is set to "Enable".

For details on the communication method with a module FB, refer to the following.

 MELSEC iQ-R EtherNet/IP Network Interface Module Function Block Reference

Communication type

Cyclic (Implicit) communications

Function overview

Class1 tag communications are a function for performing data communications between the RJ71EIP91 or EtherNet/IP devices over a connection that has been established using tag names.

This function is used for performing cyclic (Implicit) communications between scanners supported tag communications on the programmable controller.

A Producer Tag and a Consumer Tag are used, and data communications are performed periodically between tags that have the same Tag Name and Data Size.

Restriction

Cyclic (Implicit) communications cannot be used with tag communications since an adapter does not support tag communications.

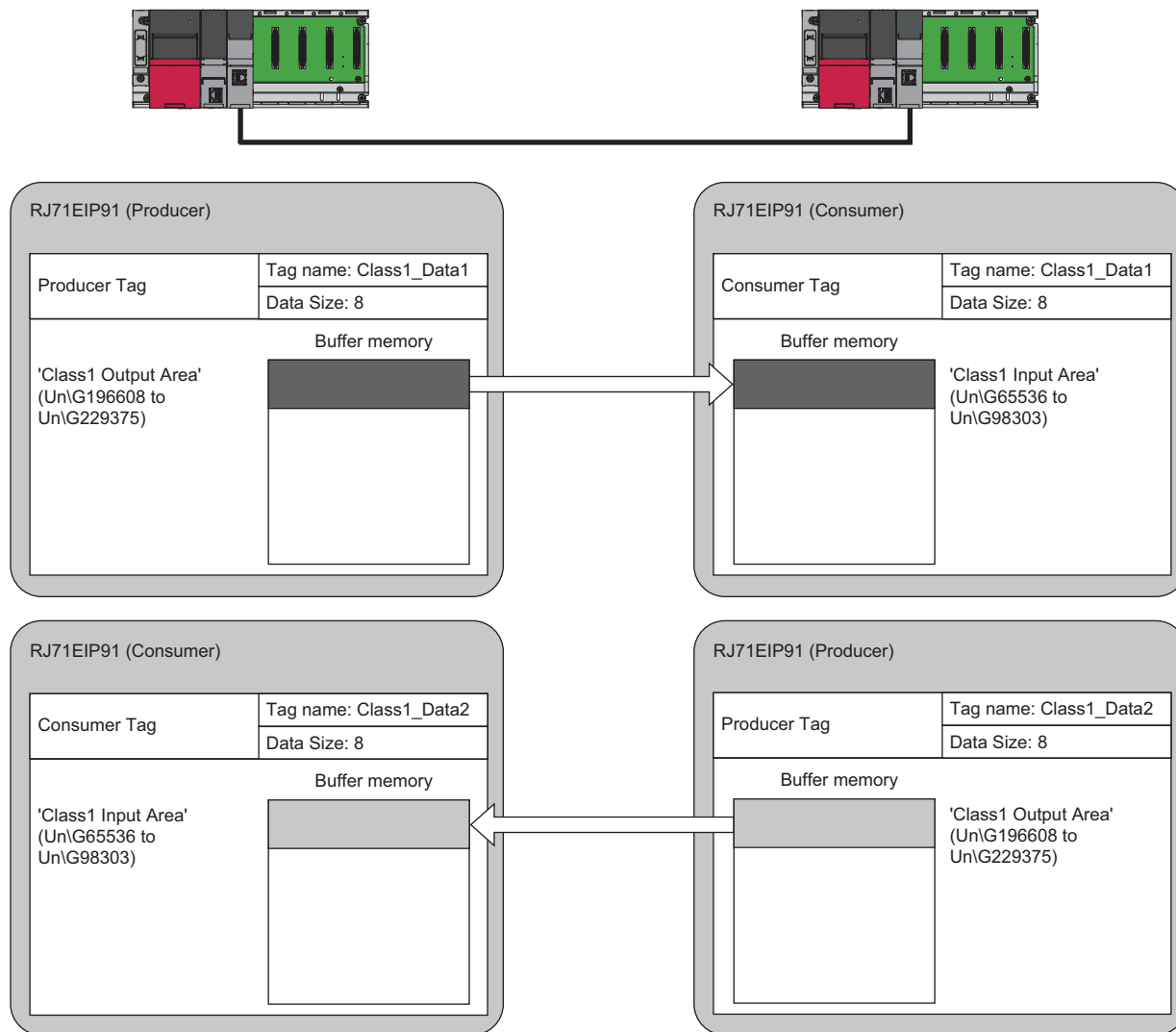

Tag	Description
Producer Tag	Receives a request to establish the connection from Consumer of the other RJ71EIP91, and sends data to Consumer.
Consumer Tag	Sends a request to establish the connection to Producer of the other RJ71EIP91, and receives data from Producer.

Communication timing

Class1 tag communications are performed at the RPI interval set on Consumer.

RPI can be set for each connection.

Cyclic, Application Trigger, or Change of State can be selected for the communication trigger type. (📖 Page 81 [Connections] tab)

Data sending

Data is sent from Producer to Consumer.

■ Sending data with the Cyclic trigger type

Set the trigger type to Cyclic in the connection settings to periodically repeat the sending of data.

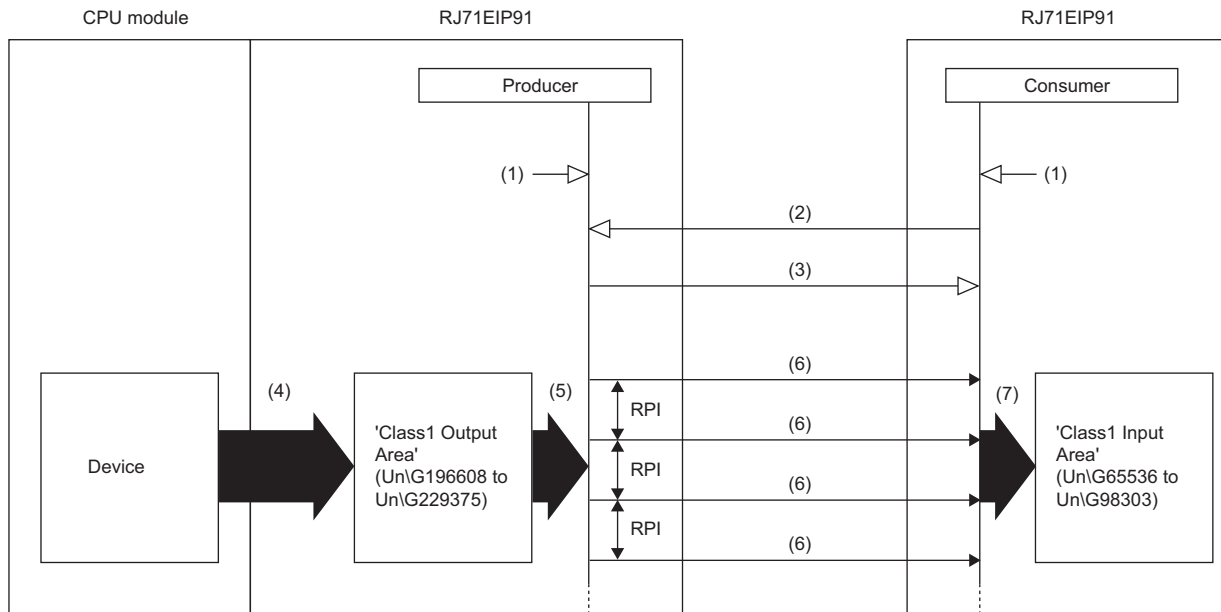

- (1) Turn on 'EtherNet/IP communication start request' (Y10).
- (2) Connection open
- (3) Response (normal)
- (4) Transfer the stored data with a program.
- (5) Send the stored data at the RPI interval.
- (6) Sending data
- (7) Store the data received at the RPI interval.

Data is sent with the Cyclic trigger type according to the following procedure.

1. Connection establishment ((1) to (3) shown above)

The connection is established when 'EtherNet/IP communication start request' (Y10) of the RJ71EIP91 on the Producer side and the RJ71EIP91 on the Consumer side is turned on, a connection open request is received from the RJ71EIP91 on the Consumer side, and then a response is returned by the RJ71EIP91 on the Producer side.

2. Sending data ((5) to (7) shown above)

If the connection is established normally, Producer sends the data stored in 'Class1 Output Area' (Un\G196608 to Un\G229375).

Point

For the operation timing of EtherNet/IP communications, refer to the following.

📖 Page 143 EtherNet/IP communication start request (Y10)

■ Sending data with the Application Trigger or Change of State trigger type

Set the trigger type to Application Trigger or Change of State in the connection settings to send data at a given timing. Use this function in situations such as when it is temporarily necessary to communicate at an interval that is shorter than the communication cycle in a system that has a long RPI interval.

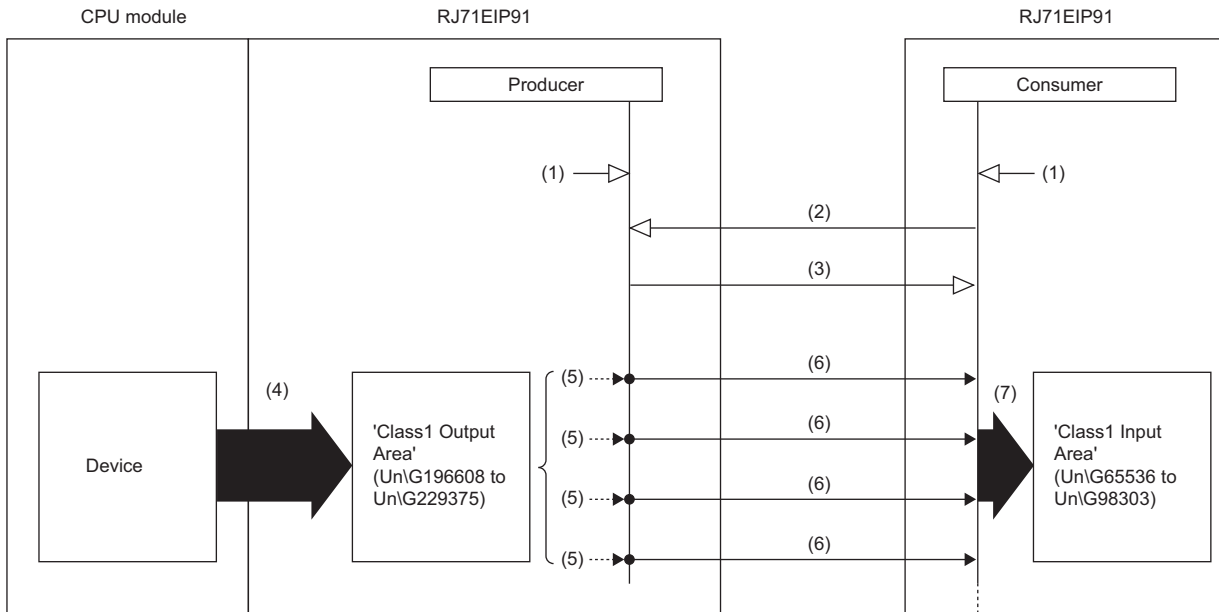

- (1) Turn on 'EtherNet/IP communication start request' (Y10).
- (2) Connection open
- (3) Response (normal)
- (4) Transfer the stored data with a program.
- (5) Turn on 'Application Trigger Request (Class1)' (Un\G27008 to Un\G27023).
- (6) Sending data
- (7) Store the data received at the timing of Application Trigger or Change of State.

Data is sent with the Application Trigger trigger type according to the following procedure.

1. Setting of EtherNet/IP Configuration Tool

Set the trigger type to "Application" in the setting of EtherNet/IP Configuration Tool.

2. Setting of buffer memory

Set 'Application Trigger operating specification request' (Un\G16631). (☞ Page 151 Application Trigger operating specification request (Un\G16631))

3. Connection establishment ((1) to (3) shown above)

The connection is established when 'EtherNet/IP communication start request' (Y10) of the RJ71EIP91 on the Producer side and the RJ71EIP91 on the Consumer side is turned on, a connection open request is received from the RJ71EIP91 on the Consumer side, and then a response is returned by the RJ71EIP91 on the Producer side.

4. Application Trigger request ((5) shown above)

During communications with the RJ71EIP91 on the Consumer side, 'Application Trigger Request (Class1)' (Un\G27008 to Un\G27023) of the RJ71EIP91 on the Producer side is turned on.

5. Sending data ((6) to (7) shown above)

'Application Trigger Acceptance (Class1)' (Un\G27024 to Un\G27039) on the RJ71EIP91 on the Producer side is turned on and the data stored in 'Class1 Output Area' (Un\G196608 to Un\G229375) is sent.

6. Completion of Application Trigger

After the data send processing has completed, 'Application Trigger Completion (Class1)' (Un\G27040 to Un\G27055) on the RJ71EIP91 on the Producer side is turned on.

Data sending with Change of State is performed according to the following procedure.

1. Setting of EtherNet/IP Configuration Tool

Set the following items in the setting of EtherNet/IP Configuration Tool.

- Set the trigger type to "Change of State".
- Set "Inhibit Time Mode". (When setting "Inhibit Time Mode" to "Custom", set "Inhibit Time".)

2. Connection establishment ((1) to (3) shown above)

The connection is established when 'EtherNet/IP communication start request' (Y10) of the RJ71EIP91 on the Producer side and the RJ71EIP91 on the Consumer side is turned on, a connection open request is received from the RJ71EIP91 on the Consumer side, and then a response is returned by the RJ71EIP91 on the Producer side.

3. Application Trigger request ((5) shown above)

During communications with the RJ71EIP91 on the Consumer side, 'Application Trigger Request (Class1)' (Un\G27008 to Un\G27023) of the RJ71EIP91 on the Producer side is turned on.



4. Sending data ((6) to (7) shown above)

Data stored in 'Class1 Output Area' (Un\G196608 to Un\G229375) is sent when the specified Inhibit Time has elapsed after 'Application Trigger Acceptance (Class1)' (Un\G27024 to Un\G27039) on the RJ71EIP91 on the Producer side is turned on.

5. Completion of Application Trigger

After the data send processing has completed, 'Application Trigger Completion (Class1)' (Un\G27040 to Un\G27055) on the RJ71EIP91 on the Producer side is turned on.

Point

- For the operation timing of EtherNet/IP communications, refer to the following.
 -  Page 143 EtherNet/IP communication start request (Y10)
- For the operation timing of data sending using the Application Trigger, refer to the following.
 -  Page 154 Application Trigger (Class1) (Un\G27008 to Un\G27055)
- When Application Trigger or Change of State is used, data will be sent automatically if no data was sent during the period from the last sending of data to the end of the RPI.
- To send data only by turning off and on 'Application Trigger Request (Class1)' (Un\G27008 to Un\G27023), set 'Application Trigger operating specification request' (Un\G16631) to 10H.
- When Change of State is used, data is sent when the specified Inhibit Time has elapsed regardless of the setting of 'Application Trigger operating specification request' (Un\G16631).
- During Class1 tag communications, heartbeat is sent by turning off and on 'Application Trigger Request (Class1)' (Un\G27008 to Un\G27023) when 'Application Trigger operating specification request' (Un\G16631) is set to 10H.

Data receiving

Data is received by Consumer from Producer.

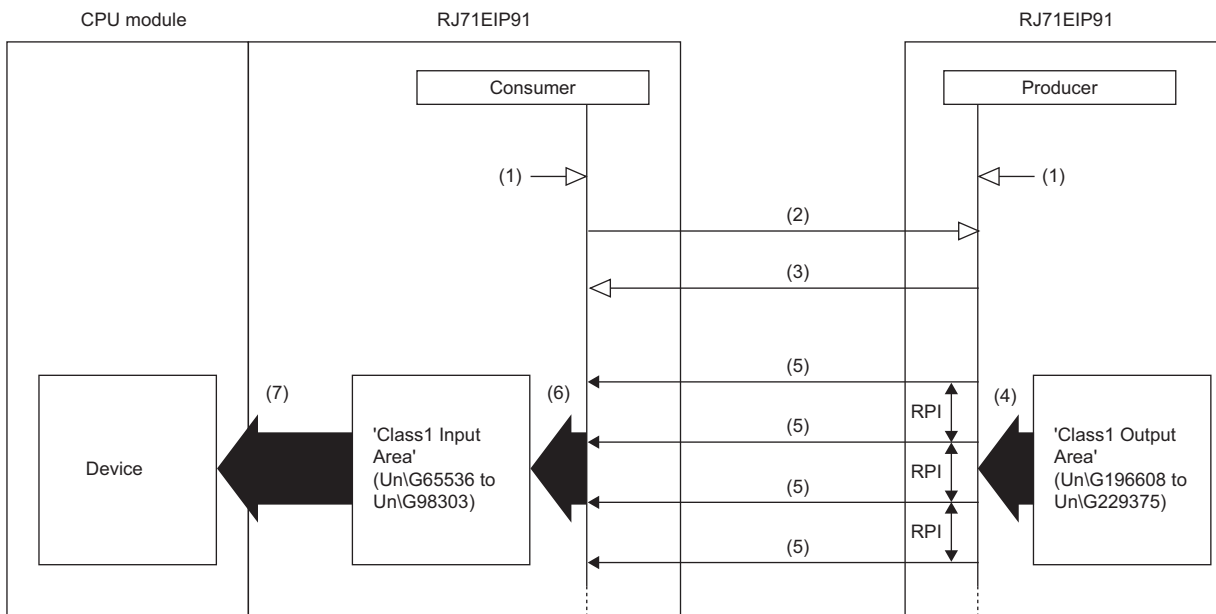

- (1) Turn on 'EtherNet/IP communication start request' (Y10).
- (2) Connection open
- (3) Response (normal)
- (4) Send the stored data at the RPI interval.
- (5) Receiving data
- (6) Store the data received at the RPI interval.
- (7) Transfer the stored data with a program.

Data is received according to the following procedure.

1. Connection establishment ((1) to (3) shown above)

The connection is established when 'EtherNet/IP communication start request' (Y10) of the RJ71EIP91 on the Producer side and the RJ71EIP91 on the Consumer side is turned on, a connection open request is sent from the RJ71EIP91 on the Consumer side to the RJ71EIP91 on the Producer side, and then the response is received by the RJ71EIP91 on the Consumer side.

2. Receiving data ((4) to (6) shown above)

If the connection is established normally, Consumer stores the received data in 'Class1 Input Area' (Un\G65536 to Un\G98303).



For the operation timing of EtherNet/IP communications, refer to the following.

👉 Page 143 EtherNet/IP communication start request (Y10)

Setting method

For Class1 tag communications, set the Producer Tag and the Consumer Tag on the RJ71EIP91 on the Producer side and the RJ71EIP91 on the Consumer side.

Common settings

Set the IP address, subnet mask, and default gateway of the RJ71EIP91 on the Producer side and the RJ71EIP91 on the Consumer side.

 [Navigation window] ⇨ [Parameter] ⇨ [Module Information] ⇨ [RJ71EIP91] ⇨ [Basic Setting]

Item	Setting Value
▣ Various Operations Settings	
Mode Settings	Online
▣ Own Node Setting	Set the information of the own node such as IP address.
▣ IP Address Setting	Set the IP address, subnet mask, and default gateway for the own node.
IP Address	
Subnet Mask	
Default Gateway	

For details on the setting window, refer to the following.

 Page 46 Basic Setting

■ Settings of the RJ71EIP91 on the Consumer side

Use EtherNet/IP Configuration Tool to register an EDS file of the RJ71EIP91(1). Then, set tag communications.

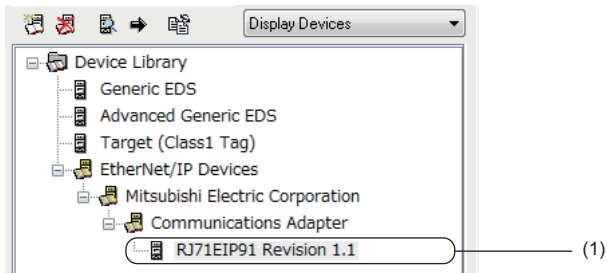

For details on registering the RJ71EIP91, refer to the following.

☞ Page 96 Procedure for Registering EtherNet/IP Devices

Point

The EDS file of the RJ71EIP91 can be found in the compressed file in which the installer of EtherNet/IP Configuration Tool is stored.

Set the parameters of the RJ71EIP91 in the following window.

☞ Select the "RJ71EIP91" in the network configuration settings. ⇒ [Device] ⇒ [Properties] ⇒ [Connections] tab

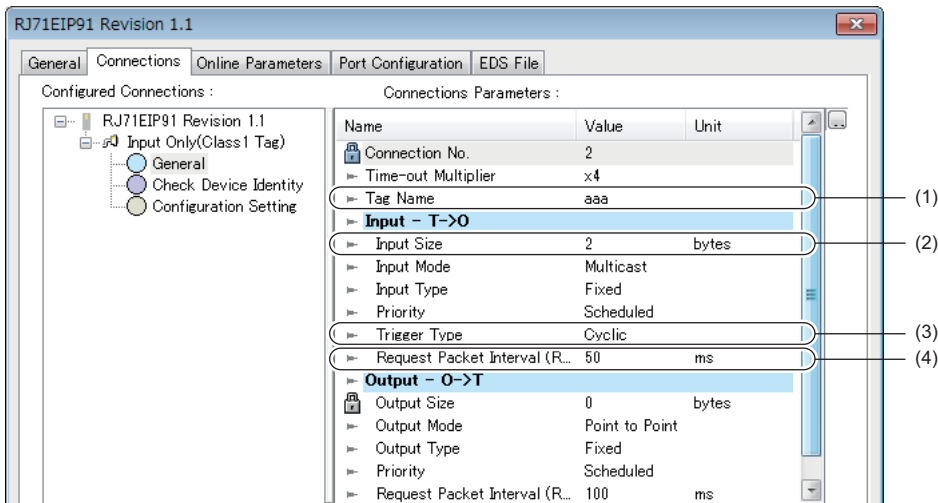

- (1) Tag name
- (2) Data Size
- (3) Trigger type
- (4) RPI

Point

Tag name that is already used for the same IP address on the Consumer side cannot be set.

■ Settings of the RJ71EIP91 on the Producer side

Set tag communications with EtherNet/IP Configuration Tool.

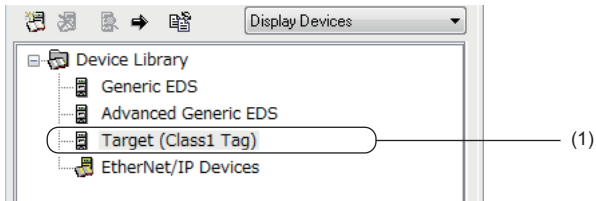

Set the parameters for the Producer Tag in the following window.

Select "Target (Class1 Tag)" in the network configuration settings ⇒ [Device] ⇒ [Properties]

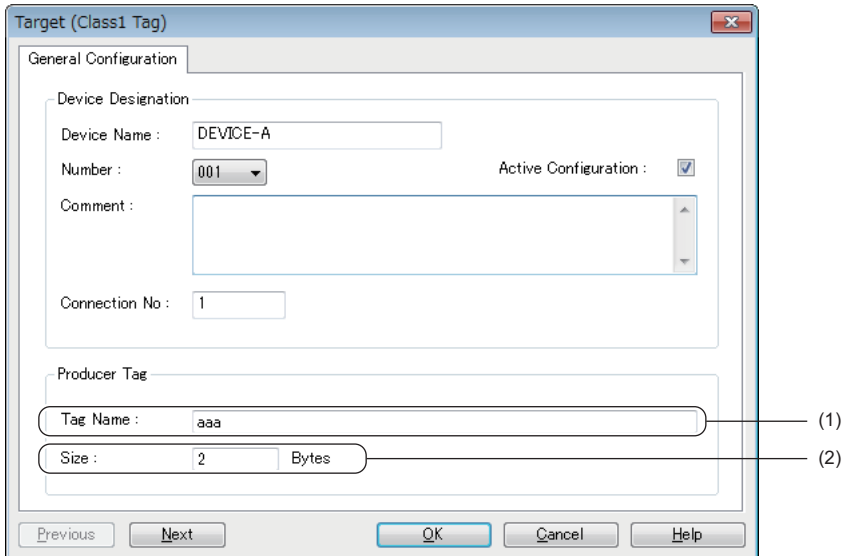

(1) Tag name on the Producer Tag side

(2) Data Size on the Producer Tag side



Tag name that is already used on the Producer side cannot be set.

■Application Trigger and Change of State

Data sending with Application Trigger or Change of State is executed by turning off and on 'Application Trigger Request (Class1)' (Un\G27008 to Un\G27023).

When data is sent with Application Trigger, whether or not to send the data automatically can be selected by 'Application Trigger operating specification request (Class1)' (Un\G16631). When data is sent with Change of State, this setting is ignored.

The following table lists the setting items of Application Trigger and Change of State.

Type	Setting Item of EtherNet/IP Configuration Tool			Buffer memory
	Trigger Type	Inhibit time setting		'Application Trigger Request (Class1)' (Un\G27008 to Un\G27023)
		Inhibit Time Mode	Inhibit time(ms)	
Application Trigger	Application	— (No setting)	— (No setting)	Off → On
Change of State	Change of State	Default* ¹	— (No setting)	Off → On
		Un-Activated* ²	— (No setting)	Off → On
		Custom	Specifies in the range between 1 and 255.	Off → On

*1 When Default is set, a quarter of RPI is specified as the inhibit time.

*2 When Un-Activated is set, no inhibit time is specified.

Class3 message communications

Communication type

Message (Explicit) communications

Function overview

Class3 message communications is a function for performing message (Explicit) communications between the RJ71EIP91 and an EtherNet/IP device over a connection that has been established by specifying the message (Explicit) communication destination with an instance ID.

Class3 message communications is available for the server functions.

With the server function, message communication support commands are used to communicate with arbitrary timing. (👉 Page 38 Server function)

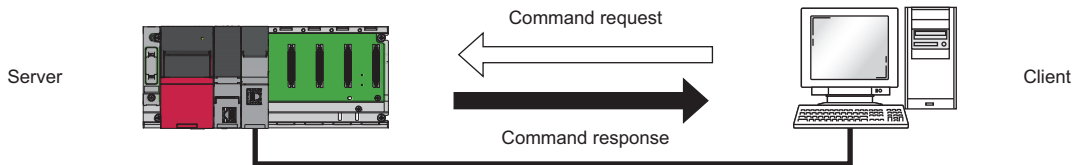

Restriction

Class3 message communications is not available for the client functions.

Message communication support commands

Items such as data and parameters can be read and written with message communication support commands.

For details on message communication support command objects, refer to the following.

👉 Page 163 Details of Message Communication Support Command

Server function

With the Class3 message communication server function, when the RJ71EIP91 receives a command request from an EtherNet/IP device, the RJ71EIP91 executes the command processing and returns the command response.

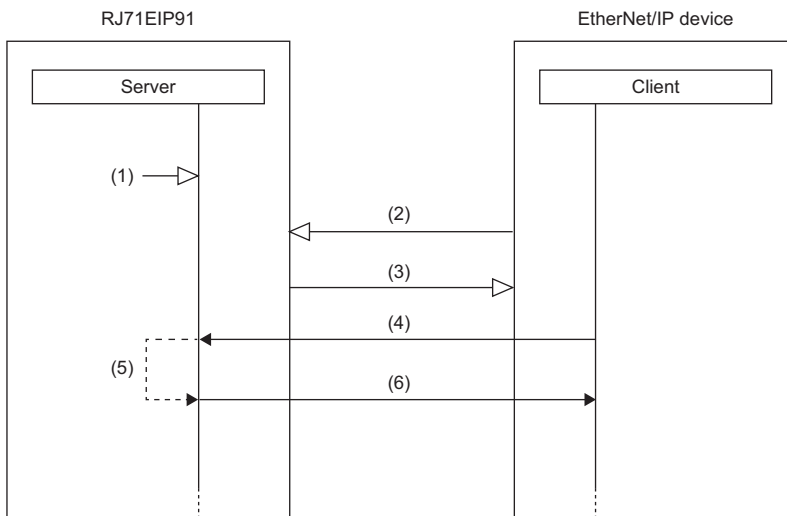

- (1) Turn on 'EtherNet/IP communication start request' (Y10).
- (2) Connection open
- (3) Response (normal)
- (4) Command request
- (5) Command processing execution
- (6) Command response

Class3 message communications with the server function is performed according to the following procedure.

1. Connection establishment ((1) to (3) shown above)

The connection is established when 'EtherNet/IP communication start request' (Y10) of the RJ71EIP91 on the server side is turned on, a connection open request is received from the EtherNet/IP device on the client side, and then a response is returned.

2. Command request acceptance and response ((4) to (6) shown above)

If the connection is established normally, a command request is sent from the EtherNet/IP device with arbitrary timing. When the RJ71EIP91 receives the command request from the EtherNet/IP device, the RJ71EIP91 executes the command processing and returns the command response to the EtherNet/IP device.

Point

For the operation timing of EtherNet/IP communications, refer to the following.

☞ Page 143 EtherNet/IP communication start request (Y10)

Setting method

Set the server on the RJ71EIP91 that will perform Class3 message communications.

Under "Basic Setting" in the engineering tool, set the IP address, subnet mask, and default gateway of the RJ71EIP91.

☞ [Navigation window] ⇒ [Parameter] ⇒ [Module Information] ⇒ [RJ71EIP91] ⇒ [Basic Setting]

Item	Setting Value
▣ Various Operations Settings	
Mode Settings	Online
▣ Own Node Setting	Set the information of the own node such as IP address.
▣ IP Address Setting	Set the IP address, subnet mask, and default gateway for the own node.
IP Address	
Subnet Mask	
Default Gateway	

For details on the setting window, refer to the following.

☞ Page 46 Basic Setting

Communication method

Open the connection from the client side, and execute the command request.

When the server receives the command request, it returns the command response to the client side.

To request commands using EtherNet/IP Configuration Tool, use the "Online Action" window.

1. Start EtherNet/IP Configuration Tool, and set the IP address on the server side.

 Select the RJ71EIP91 in the EtherNet/IP setting ⇒ [Description] ⇒ [Properties]

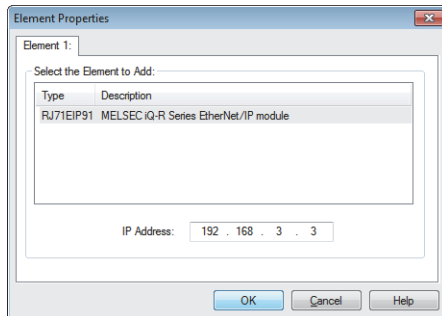

2. Switch EtherNet/IP Configuration Tool to the online state.

 Select the EtherNet/IP device in the network configuration settings. ⇒ [File] ⇒ [Go Online]

3. Execute the command request of Class3 message communications in the "Online Action" window.

 [Network] ⇒ [Online Action]

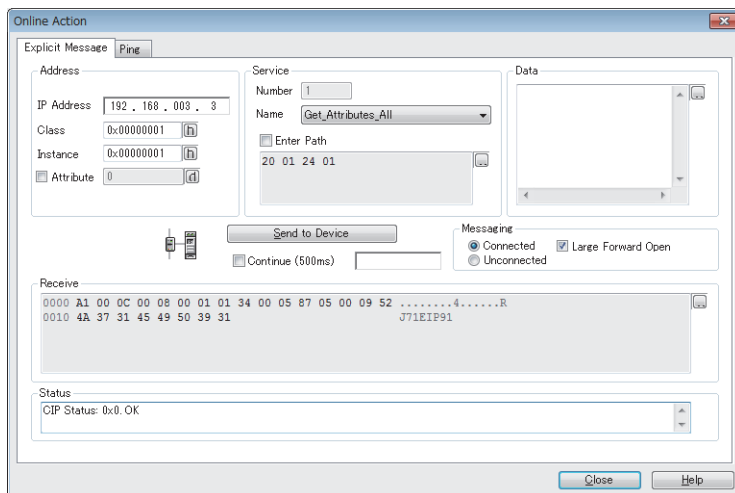

For details on the setting window, refer to the following.

 Page 65 "Online Action" window



With message (Explicit) communications, commands can also be requested from software made by other companies. When requesting commands from software made by other companies, refer to the manual of the software used.

UCMM message communications

Communication type

Message (Explicit) communications

Function overview

UCMM message communications is a function for performing message (Explicit) communications between the RJ71EIP91 and an EtherNet/IP device by specifying the message (Explicit) communication destination with an instance ID and not by establishing a connection.

UCMM message communication supports the client and server functions.

With the client function, the buffer memory is used to communicate with arbitrary timing. (☞ Page 41 Client function)

With the server function, message communication support commands are used to communicate with arbitrary timing. (☞ Page 42 Server function)

- Client function

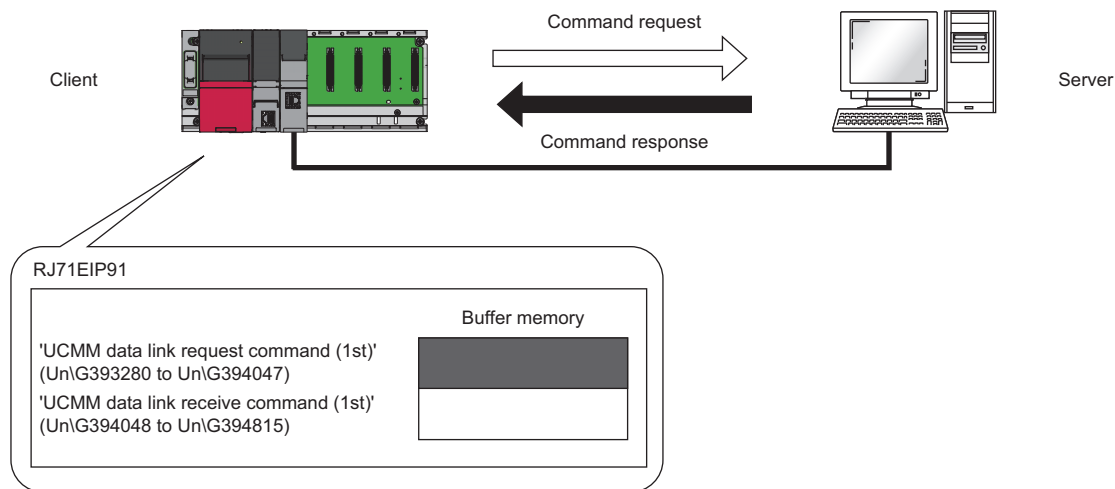

- Server function

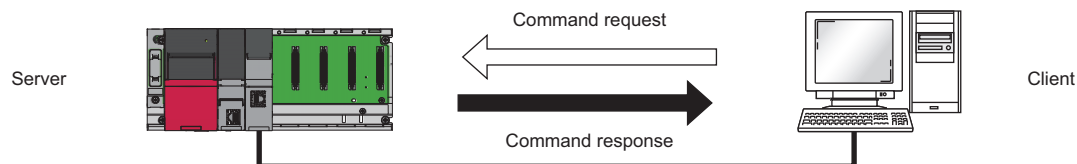

Message communication support commands

Items such as data and parameters can be read and written with message communication support commands.

For details on message communication support command objects, refer to the following.

☞ Page 163 Details of Message Communication Support Command

Client function

With the UCMM message communication client function, the buffer memory of the RJ71EIP91 is used to send command requests to and receive command responses from the EtherNet/IP device.

The client function can be used to access the services of each EtherNet/IP device and thereby read and write items such as the data and parameters with arbitrary timing.

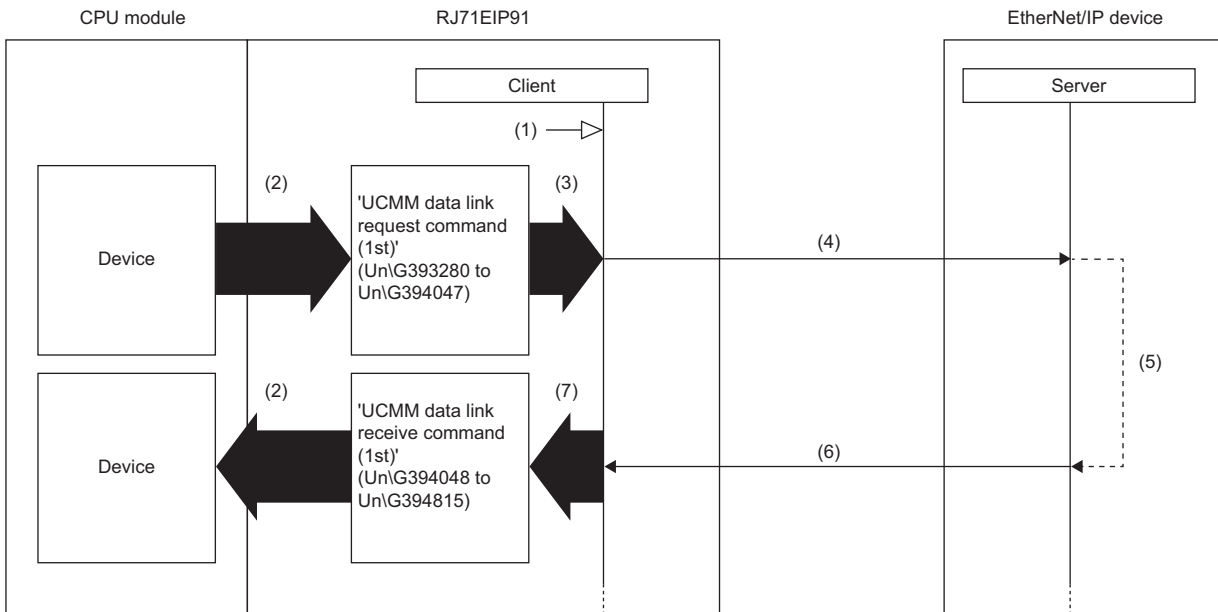

- (1) Turn on 'EtherNet/IP communication start request' (Y10).
- (2) Transfer the stored data with a program.
- (3) Turn on 'UCMM data link execution request' (Un\G393216 to Un\G393217).
- (4) Command request
- (5) Command processing execution
- (6) Command response
- (7) Turn on 'UCMM data link execution completion' (Un\G393248 to Un\G393249).

UCMM message communications with the client function is performed according to the following procedure.

1. Starting the UCMM communication execution request ((1) to (3) shown above)

Turn on 'EtherNet/IP communication start request' (Y10) and then turn on 'UCMM data link execution request' (Un\G393216 to Un\G393217) on the RJ71EIP91 on the client side.

2. Sending the command request ((4) shown above)

When the RJ71EIP91 checks the UCMM data link execution request, 'UCMM data link execution request acceptance' (Un\G393232 to Un\G393233) is turned on, and then the command request is sent to the EtherNet/IP device.

3. Command response acceptance ((5) to (6) shown above)

The EtherNet/IP device executes the command processing, and then returns the command response.

When the RJ71EIP91 receives the command response from the EtherNet/IP device, the RJ71EIP91 turns on 'UCMM data link execution completion' (Un\G393248 to Un\G393249) to complete the processing.

Point

- For the operation timing of EtherNet/IP communications, refer to the following.

☞ Page 143 EtherNet/IP communication start request (Y10)

- For the operation timing of UCMM message communications with the client function, refer to the following.

☞ Page 161 UCMM communication execution command

Server function

With the UCMM message communication server function, when the RJ71EIP91 receives a command request from an EtherNet/IP device, the RJ71EIP91 executes the command processing and returns the command response.

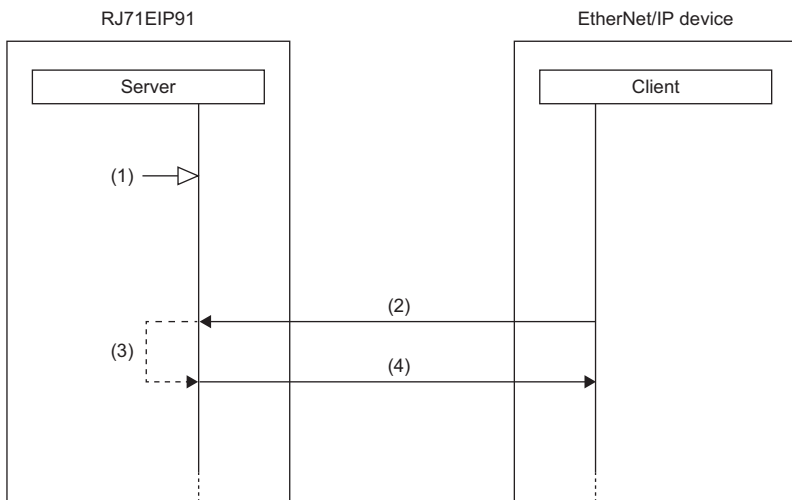

- (1) Turn on 'EtherNet/IP communication start request' (Y10).
- (2) Command request
- (3) Command processing execution
- (4) Command response

UCMM message communications with the server function is performed according to the following procedure.

1. Starting the EtherNet/IP communication start request ((1) shown above)

Turn on 'EtherNet/IP communication start request' (Y10) on the RJ71EIP91 on the server side.

2. Command request acceptance and response ((2) to (4) shown above)

When the RJ71EIP91 receives the command request from the EtherNet/IP device with arbitrary timing, the RJ71EIP91 executes the command processing and returns the command response to the EtherNet/IP device.

Point

For the operation timing of EtherNet/IP communications, refer to the following.

☞ Page 143 EtherNet/IP communication start request (Y10)

Setting method

Set the server and the client for the RJ71EIP91 that performs UCMM message communications.

Under "Basic Setting" in the engineering tool, set the IP address, subnet mask, and default gateway of the RJ71EIP91.

🔍 [Navigation window] ⇨ [Parameter] ⇨ [Module Information] ⇨ [RJ71EIP91] ⇨ [Basic Setting]

Item	Setting Value
▣ Various Operations Settings	
Mode Settings	Online
▣ Own Node Setting	Set the information of the own node such as IP address.
▣ IP Address Setting	Set the IP address, subnet mask, and default gateway for the own node.
IP Address	
Subnet Mask	
Default Gateway	

For details on the setting window, refer to the following.

☞ Page 46 Basic Setting

Communication method

■When the client function is used

Execute a command request from the RJ71EIP91 by operating a program that uses the buffer memory.

For program example of UCMM message communications, refer to the following.

☞ Page 104 Program Example of UCMM Message Communications

■When the server function is used

Open the connection from the client side, and execute the command request.

When the server receives the command request, it returns the command response to the client side.

To request commands using EtherNet/IP Configuration Tool, use the "Online Action" window.

For communication method, refer to the following.

☞ Page 39 Communication method

For UCMM message communications, set "Messaging" to "Unconnected" in the "Online Action" window.

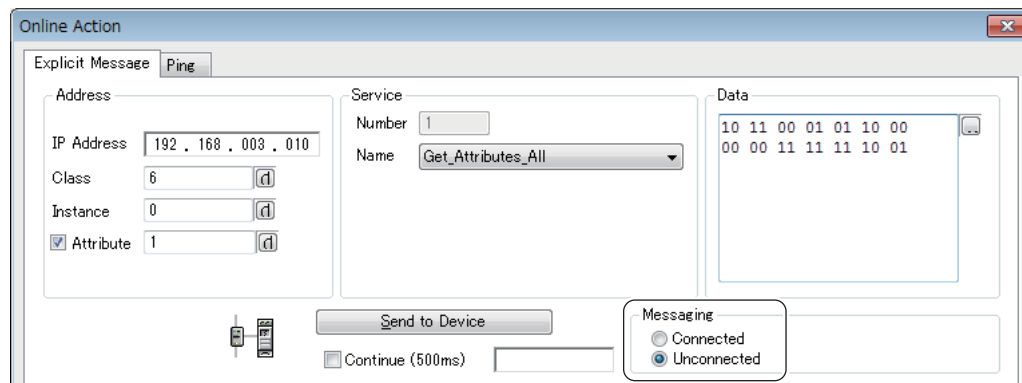

Point

With message (Explicit) communications, commands can also be requested from software made by other companies. When requesting commands from software made by other companies, refer to the manual of the software used.

1.2 Communication Status Setting Function When a CPU Stop Error Occurs

Each RJ71EIP91 can be set to stop or continue EtherNet/IP communications when a stop error occurs on the CPU module on which the RJ71EIP91 is mounted.

Therefore, EtherNet/IP communications can be continued even when the CPU module on which the stop error occurred goes into the STOP state.

Setting method

Use the buffer memory of the RJ71EIP91 to configure the setting.



Address	Buffer memory	Reference
Un\G16634	EtherNet/IP communication continuation setting request	Page 152 EtherNet/IP data link continuation specification request (Un\G16634)

2 PARAMETER SETTINGS

This chapter describes the parameter settings required for communications between the RJ71EIP91 and EtherNet/IP devices.

2.1 Procedure for Setting Parameters

2

1. Add the RJ71EIP91 in the engineering tool.
 [Navigation window] ⇒ [Parameter] ⇒ [Module Information] ⇒ Right-click ⇒ [Add New Module]
2. The basic settings, application settings, and refresh settings are included in the module parameters. Select the settings from the navigation tree in the following window and configure them.
 [Navigation window] ⇒ [Parameter] ⇒ [Module Information] ⇒ [RJ71EIP91]
3. Use the engineering tool to write the module parameters to the CPU module.
 [Online] ⇒ [Write to PLC]
4. The settings are reflected by resetting the CPU module or powering off and on the system.
5. Start EtherNet/IP Configuration Tool, and then set the EtherNet/IP communication parameters.
6. Use EtherNet/IP Configuration Tool to write the EtherNet/IP communication parameters to the RJ71EIP91.

2.2 Basic Setting

Set the operation mode, IP address, and other items of the RJ71EIP91.

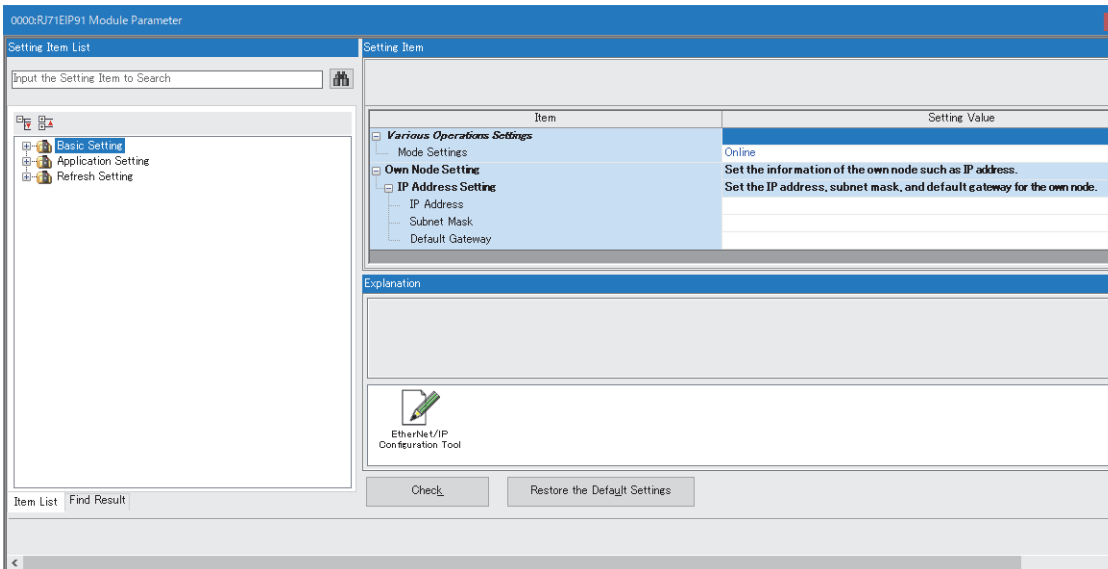

Various Operations Settings

Set the operation mode of the RJ71EIP91.

Item	Description	Setting range
Mode Settings	Sets the operation mode of the RJ71EIP91. <ul style="list-style-type: none"> • Online: Normal operation mode • Automatically H/W Test: Mode in which the module performs a self-diagnostics test. Select this mode when checking the operation of the module due to an error or similar problem. 	<ul style="list-style-type: none"> • Online • Automatically H/W Test (Default: Online)

Own Node Setting

Set the IP address of the RJ71EIP91.

Item	Description	Setting range	
IP Address Setting ^{*1}	IP Address	Sets the IP address of the RJ71EIP91. ^{*2} Set the class and subnet address of the RJ71EIP91 to the same settings as those of the EtherNet/IP devices that communicate with the RJ71EIP91. Contact the network administrator before setting the IP address.	<ul style="list-style-type: none"> • Blank • 0.0.0.1 to 223.255.255.254 (Default: Blank)
	Subnet Mask	Sets the subnet mask of the RJ71EIP91. When setting the IP address of the default gateway and performing communication with an EtherNet/IP device in another network through a router, set the subnet mask pattern of the default gateway. All the devices in the same subnet network should have a common subnet mask. The subnet mask setting is not required for communication in a single network.	<ul style="list-style-type: none"> • Blank • 128.0.0.0 to 255.255.255.252 (Default: Blank)
	Default Gateway	Sets the default gateway of the RJ71EIP91. Set the IP address of the relay device (default gateway) to access the EtherNet/IP device in another network. Set a value that satisfies the following conditions as the IP address of the default gateway. <ul style="list-style-type: none"> • The class of the IP address is A, B, or C. • The subnet address of the default gateway is the same as that of the RJ71EIP91. • The host address part is not a sequence of "0" or "1". 	<ul style="list-style-type: none"> • Blank • 0.0.0.1 to 223.255.255.254 (Default: Blank)

*1 Cannot be set when "Mode Settings" is set to "Automatically H/W Test".

*2 When the parameter is written without the IP address setting (blank), the following address is set.
192.168.3.3

EtherNet/IP Configuration Tool

Double-clicking the EtherNet/IP Configuration Tool icon will start EtherNet/IP Configuration Tool.*¹

*1 This icon is available for the engineering tool with version 1.075D or later.

2.3 Application Setting

Configure the Class1 communication auxiliary setting.

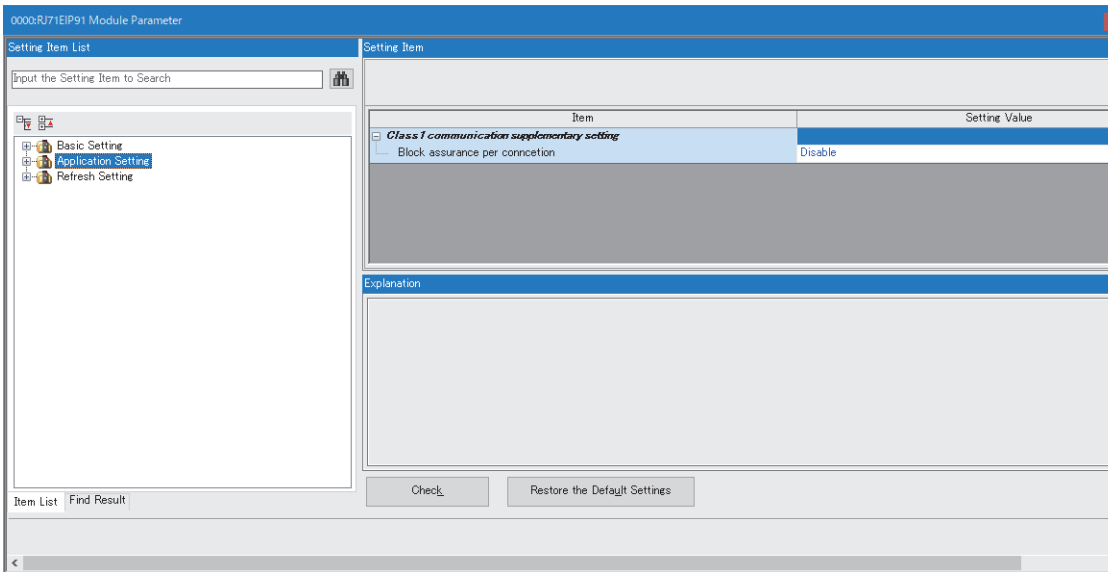

Class1 communication supplementary setting

Set the block data assurance per connection.

Item	Description	Setting range
Block assurance per connection ^{*1}	<p>Sets whether to perform data assurance per connection during Class1 communications.</p> <p>Set this item to "Enable" and use the following module function blocks to prevent data inconsistency.</p> <ul style="list-style-type: none"> • M+RJ71EIP91_Class1GetInputData • M+RJ71EIP91_Class1SetOutputData 	<ul style="list-style-type: none"> • Disable • Enable^{*2} <p>(Default: Disable)</p>

*1 Cannot be set when "Mode Settings" is set to "Automatically H/W Test" under "Basic Setting".

*2 When "Enable" is set and the module FB is not used, it is necessary to read input data and write output data using 'Class1 Connection Input data update state' (Un\G32768 to Un\G33023) and 'Class1 Connection Output data update state' (Un\G33024 to Un\G33279).

2.4 Refresh Setting

Set the timing with which to refresh the specified target.

Refresh Timing

Set the refresh timing in the module parameter.

 [Navigation window] ⇒ [Parameter] ⇒ [Module Information] ⇒ [RJ71EIP91] ⇒ [Refresh Settings]

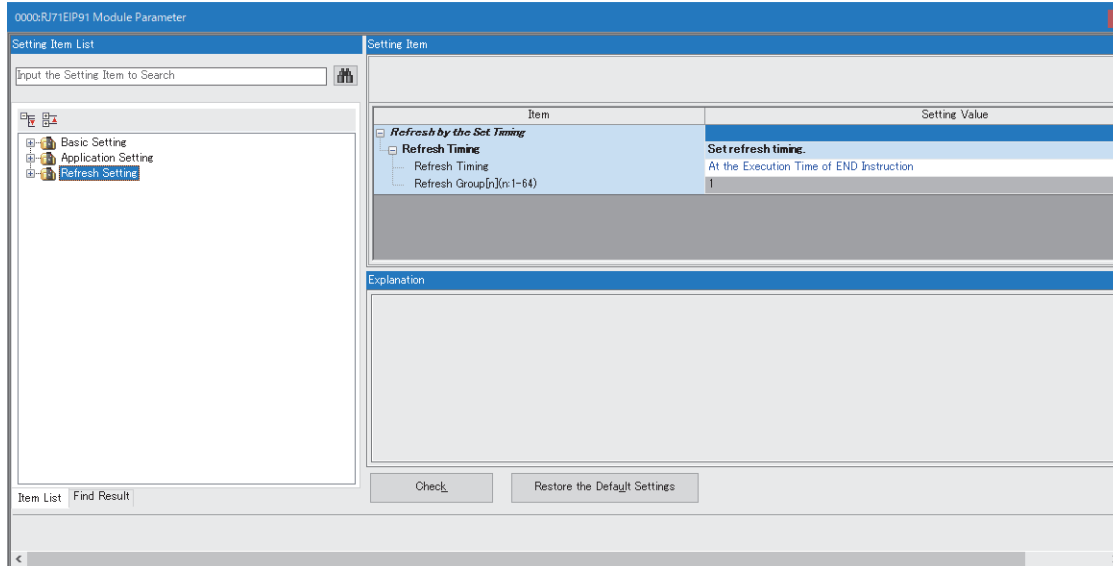

Item	Description	Setting range
Refresh Timing	Sets the refresh timing.	<ul style="list-style-type: none"> At the Execution Time of END Instruction At the Execution Time of Specified Program (Default: At the Execution Time of END Instruction)
Refresh Group[n](n: 1-64)	When "Refresh Timing" is set to "At the Execution Time of Specified Program", specifies the refresh group of programs.	1 to 64 (Default: 1)

Point

When the refresh is enabled, the refresh target values will be valid at the timing set in the engineering tool. At that time, buffer memory areas are overwritten with the refresh target values.

To change the refresh target values in the buffer memory areas, create a program that changes the values in the refresh target module labels and devices.

Refresh processing time

The refresh processing time [μs] is an element that configures the scan time of the CPU module. For the scan time, refer to the following.

 MELSEC iQ-R CPU Module User's Manual (Application)

The following shows the formula to calculate the refresh processing time [μs] with the refresh settings enabled.

- Refresh processing time [μs] = Refresh read (refresh transferred to the CPU module) time + Refresh write (refresh transferred to an intelligent function module) time

Calculate the refresh read time and refresh write time from the number of items where the refresh settings have been set and the number of transfers (words). For the calculation method, refer to the following.

 MELSEC iQ-R CPU Module User's Manual (Application)

2.5 Setting EtherNet/IP Communications (Starting EtherNet/IP Configuration Tool)

Start EtherNet/IP Configuration Tool, and then set EtherNet/IP communications.

For details, refer to the following.

 Page 52 EtherNet/IP Configuration Tool

Point

- Even if the engineering tool is closed while EtherNet/IP Configuration Tool is starting, it can operate independently. Configuration tool operations can continue.
 - While EtherNet/IP Configuration Tool is running, another EtherNet/IP Configuration Tool cannot be started.
-

2.6 Writing Parameters

The parameters set on the RJ71EIP91 have different write destinations.

Parameter type	Configuration tool	Write destination
Module parameter	GX Works3	CPU module
EtherNet/IP communication setting	EtherNet/IP Configuration Tool	RJ71EIP91

2

For writing parameters to the CPU module, refer to the following.

 GX Works3 Operating Manual

This section describes writing procedure to the RJ71EIP91.

Operating procedure

1. Switch EtherNet/IP Configuration Tool to the online state.

 [File] ⇨ [Go Online]

2. Write the set parameters to the RJ71EIP91.

 [File] ⇨ [Download]

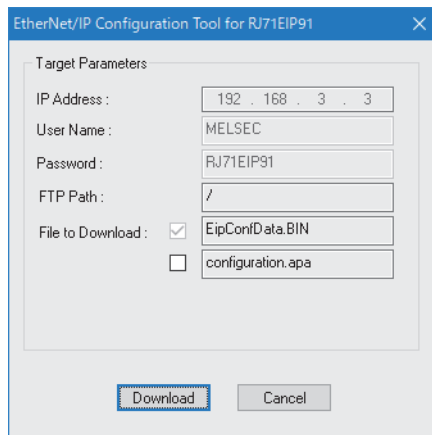

Point

The parameters written to the RJ71EIP91 with EtherNet/IP Configuration Tool are reflected when the following operations are executed.

- 'EtherNet/IP communication start request' (Y10) is turned off and on.
- The module function block execution command is turned off and on.

3 EtherNet/IP Configuration Tool

This chapter describes operations of EtherNet/IP Configuration Tool.

3.1 Window Structure

The following figure shows the window structure.

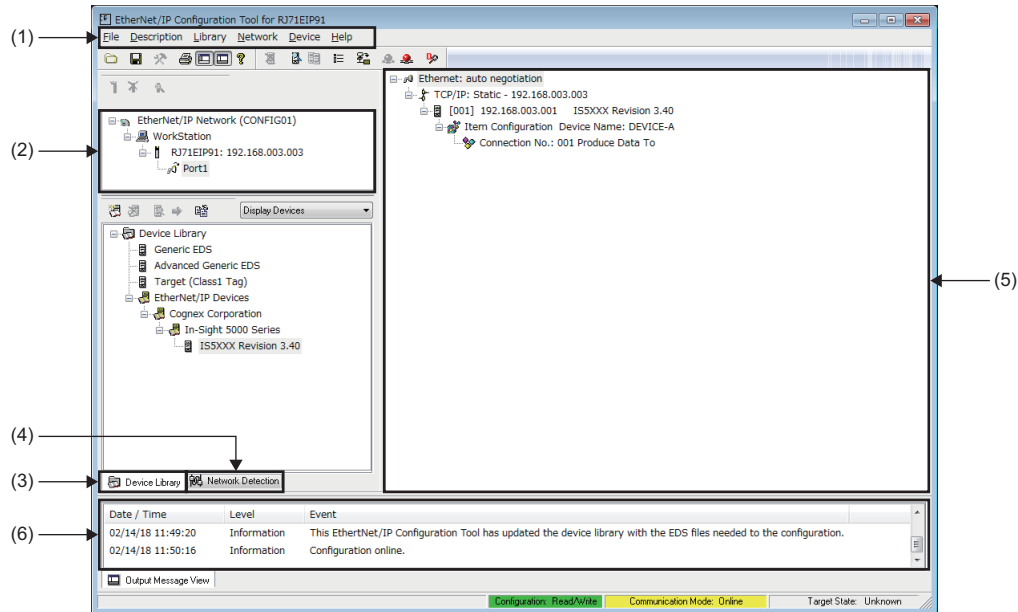

No.	Name	Reference
(1)	Menu	Page 53 Menu
(2)	EtherNet/IP setting	Page 60 EtherNet/IP setting
(3)	Device Library	Page 61 Device Library
(4)	Network Detection	Page 63 Network Detection
(5)	Network configuration setting	Page 69 Network configuration settings
(6)	Operation information list	Page 95 Operation information list

Menu

The following table lists the menu items of EtherNet/IP Configuration Tool.

Item	Description	Reference
File	Saves a project and configures print setting and window structure.	Page 53 File
Description	Sets the RJ71EIP91 information.	Page 57 Description
Library	Performs operations such as adding EDS files, displaying EDS file information, and adding EtherNet/IP devices.	Page 57 Library
Network	Performs operations such as detecting EtherNet/IP devices on the network to add them to the network configuration settings and configuring the settings for EtherNet/IP communications.	Page 58 Network
Device	Performs operations such as adding the selected EtherNet/IP device to the network configuration settings, configuring the settings for EtherNet/IP devices, and enabling diagnostic mode.	Page 59 Device
Help	Displays the help or version information of EtherNet/IP Configuration Tool.	Page 59 Help

File

Save a project and configure print setting and window structure.

Item	Description
Save	Saves an EtherNet/IP Configuration Tool project.
List and Print	Opens the "Preview or Print Listings" window. (Page 54 "Preview or Print Listings" window)
Download	Opens the download window. (Page 54 Download window)
Verify	Opens the structure setting check window. (Page 55 Structure setting check window)
Upload	Opens the upload window. (Page 56 Upload window)
Go Online	Enables online mode.*1
Go Offline	Disables online mode. This mode is disabled by default.
Preferences	Selects a window structure layout and "Advanced Mode". <ul style="list-style-type: none"> Clicking "Workspace": Displays or hides the EtherNet/IP settings, "Device Library", and "Network Detection". Clicking "Output Window": Displays or hides the operation information list. Selecting "Advanced Mode": Enables configuration of detailed EtherNet/IP settings in each setting window.
Message View	Performs the following actions on the operation information list. <ul style="list-style-type: none"> Copy: Copies the information displayed in the operation information list. Clear: Clears the information displayed in the operation information list. Configuration: Sets the information displayed in the operation information list. (Page 95 "Output Message View Configuration" window)
Exit	Exits EtherNet/IP Configuration Tool.

*1 The following dialog appears when the changed project setting is not stored in EtherNet/IP Configuration Tool.
 Click [Yes] to save the project and enable the online mode.
 Click [No] to enable the online mode without saving the project.

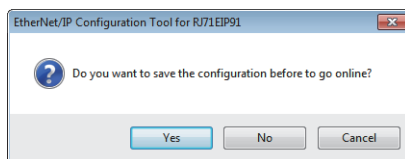

■ "Preview or Print Listings" window

Print the information of the current network configuration settings.

 [File] ⇨ [List and Print]

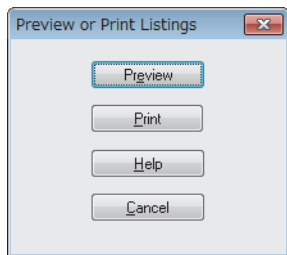

Item	Description
[Preview] button	Displays the information of the network configuration settings in a text file.
[Print] button	Prints the selected information.
[Help] button	Displays the help.
[Cancel] button	Closes the "Preview or Print Listings" window.

■ Download window

The information of the current network configuration settings is written to the RJ71EIP91.

 [File] ⇨ [Download]

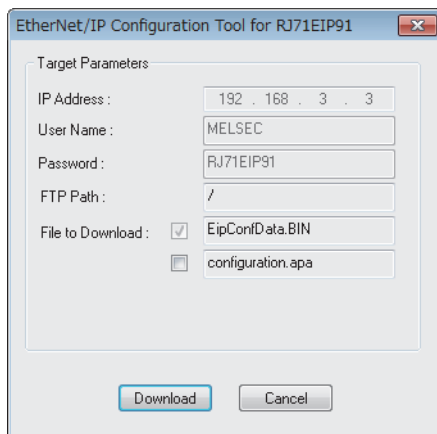

Item	Description	Setting range
IP Address	Displays the IP address of the RJ71EIP91.	—
User Name	Displays the name.	— (Fixed to MELSEC.)
Password	Displays the password.	— (Fixed to the RJ71EIP91.)
FTP Path	Displays the FTP path.	—
File to Download	When these check boxes are selected, EipConfData.BIN and configuration.apa will be overwritten.*1*2 (The check box for EipConfData.BIN cannot be cleared.)	• Selected • Not selected (Default: Not selected)
[Download] button	Performs writing with the set details. The writing result is displayed in a dialog box.	—
[Cancel] button	Closes the download window.	—

*1 EipConfData.BIN is the data used to manage the information of the network configuration settings.

*2 configuration.apa is the data contains the IP address of the RJ71EIP91 set in the EtherNet/IP setting and the EtherNet/IP device configuration and parameter settings set in the network configuration setting.

■ Structure setting check window

Verify the information of the network configuration settings saved on the RJ71EIP91 (EipConfData.BIN) against the information of the network configuration settings of EtherNet/IP Configuration Tool (EipConfData.BIN) to check whether they are the same.

 [File] ⇨ [Verify]

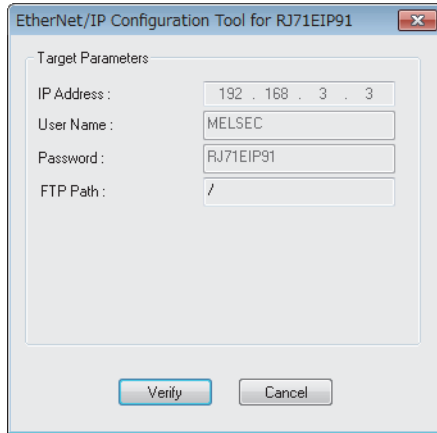

Item	Description	Setting range
IP Address	Displays the IP address of the RJ71EIP91.	—
User Name	Displays the name.	— (Fixed to MELSEC.)
Password	Displays the password.	— (Fixed to the RJ71EIP91.)
FTP Path	Displays the FTP path.	—
[Verify] button	Performs verification with the set details. The verification result is displayed in a dialog box.	—
[Cancel] button	Closes the structure setting check window.	—

■ Upload window

The information of the network configuration settings saved on the RJ71EIP91 is read.

 [File] ⇨ [Upload]

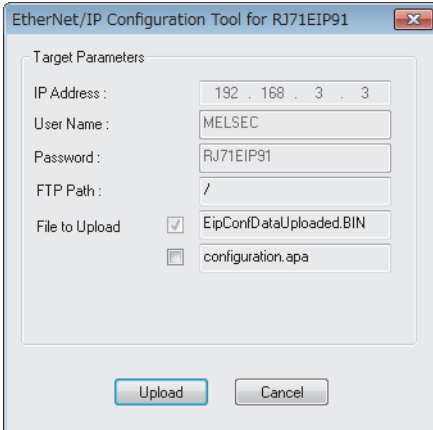

Item	Description	Setting range
IP Address	Displays the IP address of the RJ71EIP91.	—
User Name	Displays the name.	— (Fixed to MELSEC.)
Password	Displays the password.	— (Fixed to the RJ71EIP91.)
FTP Path	Displays the FTP path.	—
File to Upload	When these check boxes are selected, EipConfDataUploaded.BIN and configuration.apa will be overwritten.*1 (The check box for EipConfDataUploaded.BIN cannot be cleared.)	• Selected • Not selected (Default: Not selected)
[Upload] button	Performs reading with the set details. The reading result is displayed in a dialog box.	—
[Cancel] button	Closes the upload window.	—

*1 EipConfDataUploaded.BIN is the data used to manage the information of the network configuration settings.

Description

Set the RJ71EIP91 information.

Item	Description
Add	Adds the RJ71EIP91 information. (The RJ71EIP91 information can be added when the existing information is deleted using "Delete".) ^{*1}
Delete	Deletes the RJ71EIP91 information. ^{*2}
Properties	Opens the "Element Properties" window. (☞ Page 60 "Element Properties" window) ^{*2}

*1 This action can be performed when WorkStation is selected in the EtherNet/IP setting. (☞ Page 52 Window Structure)

*2 This action can be performed when the RJ71EIP91 is selected in the EtherNet/IP setting. (☞ Page 52 Window Structure)

Library

Set operations such as adding EDS files, displaying file information, and adding EtherNet/IP devices.

This item can be selected when "Device Library" is displayed.

Item	Description
Add	Opens the EDS Management wizard to add EDS files. (☞ Page 96 Adding the EDS file)
Delete	Deletes selected EtherNet/IP devices from "Device Library".
Sort	Opens the "Sort Device Library" window. (☞ Page 57 "Sort Device Library" window)
Insert in Configuration	Adds the selected EtherNet/IP device to the network configuration settings. (☞ Page 98 Configuring settings offline)
Properties	Displays the EDS file information of the selected EtherNet/IP device. (☞ Page 62 EDS file information)

■ "Sort Device Library" window

Select the display order of the EtherNet/IP devices added in "Device Library".

☞ [Library] ⇄ [Sort]

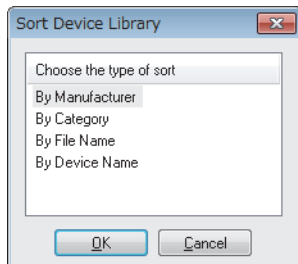







Item	Description
By Manufacturer	Displays EtherNet/IP devices by device manufacturer name.
By Category	Displays EtherNet/IP devices by vendor name.
By File Name	Displays EtherNet/IP devices by EDS file name.
By Device Name	Displays EtherNet/IP devices by name.

Network

Perform operations such as detecting EtherNet/IP devices on the network to add them to the network configuration settings and configuring the settings for EtherNet/IP communications.

This item can be selected when EtherNet/IP Configuration Tool is switched to the online state and "Network Detection" is displayed. ( Page 52 Window Structure)

Item	Description
Choose Network Adapter	Opens the "Choose Network Adapter" window. ( Page 58 "Choose Network Adapter" window)
Read Network Configuration	Scans the network to detect EtherNet/IP devices on the "Network Detection" tab. ( Page 63 Detecting the RJ71EIP91 and EtherNet/IP devices)
Online Action	Opens the "Online Action" window. ( Page 65 "Online Action" window)
Insert in Configuration	Adds the selected EtherNet/IP device to the network configuration settings. ( Page 98 Configuring settings online)
Insert and Replace All	Deletes all the EtherNet/IP devices set in the network configuration settings and adds all the EtherNet/IP devices detected by "Network Detection".
Properties	Opens the properties of the selected EtherNet/IP device. ( Page 64 EtherNet/IP device properties) ^{*1}

*1 This action can be performed when an EtherNet/IP device to which a module can be mounted is selected in "Network Detection". ( Page 52 Window Structure)

■ "Choose Network Adapter" window

Select the network adapter to use in EtherNet/IP communications from the list of network adapters detected with EtherNet/IP Configuration Tool.

When the "Automatic" check box is selected, all the detected network adapters are used in EtherNet/IP communications.



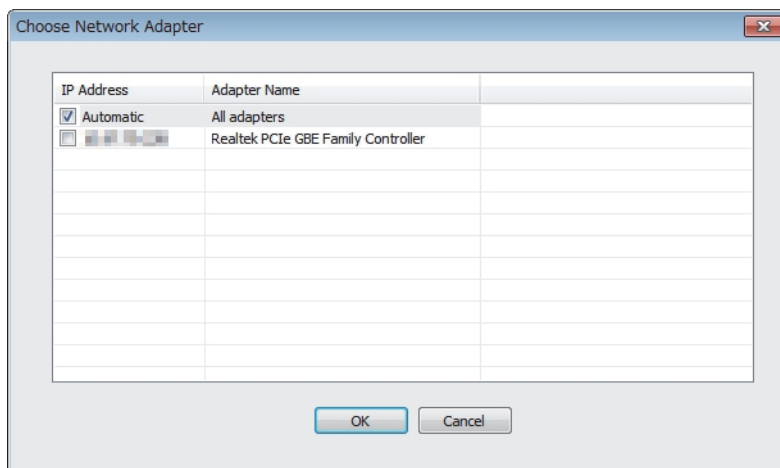



 [Network] ⇨ [Choose Network Adapter]



Item	Description
IP Address	Displays the IP address of the network adapter.
Adapter Name	Displays the name of the network adapter.

Device

Perform operations such as adding the selected EtherNet/IP device to the network configuration settings, configuring the settings for EtherNet/IP devices, and enabling diagnostic mode.

Item	Description
Duplicate	Adds a copy of the selected EtherNet/IP device to the network configuration settings.* ¹
Delete	Deletes the selected EtherNet/IP device from the network configuration settings.* ¹
Add	Adds the modules for EtherNet/IP devices to which modules can be mounted.* ²
Collapse/Expand All	Collapses/expands the module tree in the network configuration settings.
Properties	<p>Opens the properties of a selected item as shown below.</p> <ul style="list-style-type: none"> • When "Ethernet" in the network configuration settings is selected:  Page 71 "Channel Properties" window • When the EtherNet/IP module display in the network configuration settings is selected:  Page 77 IP address management window • When the EtherNet/IP display in the network configuration settings is selected:  Page 77 EtherNet/IP device setting window (Class1 instance communications),Page 92 EtherNet/IP device setting window (Class1 tag communications) • When other item in the network configuration settings is selected: The window corresponding to the selected item is displayed. Displayed content varies depending on the EtherNet/IP device used. <p>For names of each display, refer to the following.</p> <p> Page 69 Display content</p>
Diagnostic	Enables diagnostic mode. ( Page 120 Network diagnostics of EtherNet/IP Configuration Tool)* ³
Options	Opens the "Display Option" window. ( Page 70 "Display Option" window)

*1 This action can be performed when an EtherNet/IP device is selected in the network configuration settings. ( Page 52 Window Structure)

*2 This action can be performed when an EtherNet/IP device to which a module can be mounted is selected in the network configuration settings.

*3 This action can be performed when EtherNet/IP Configuration Tool is switched to the online state. ( Page 53 File)

Help

The help or version information of EtherNet/IP Configuration Tool is displayed.

Item	Description
EIP-CT Help	Opens the help of EtherNet/IP Configuration Tool.
About	Displays the version information of EtherNet/IP Configuration Tool. ( Page 103 Checking the Software Version)

EtherNet/IP setting

EtherNet/IP setting displays the project information of the RJ71EIP91 set with EtherNet/IP Configuration Tool.

"Element Properties" window

Set the IP address of the RJ71EIP91.

Set the same IP address as that set in "Basic Setting" in the engineering tool.

 Select "RJ71EIP91" in the EtherNet/IP setting. ⇒ [Description] ⇒ [Properties]

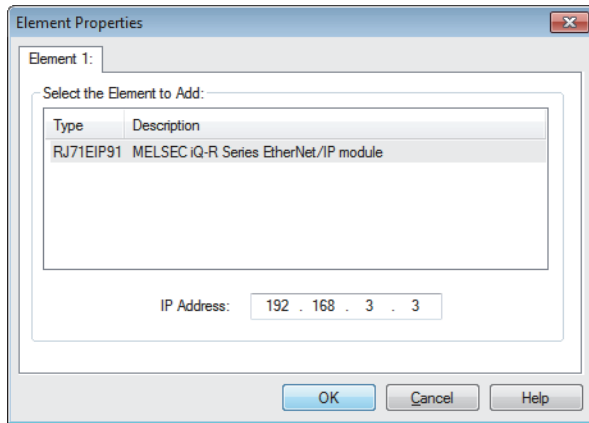

"Configuration Manager" window

Manage the project of EtherNet/IP Configuration Tool.

 Right-click "Ethernet/IP Network" in the EtherNet/IP setting. ⇒ [Configuration Manager]

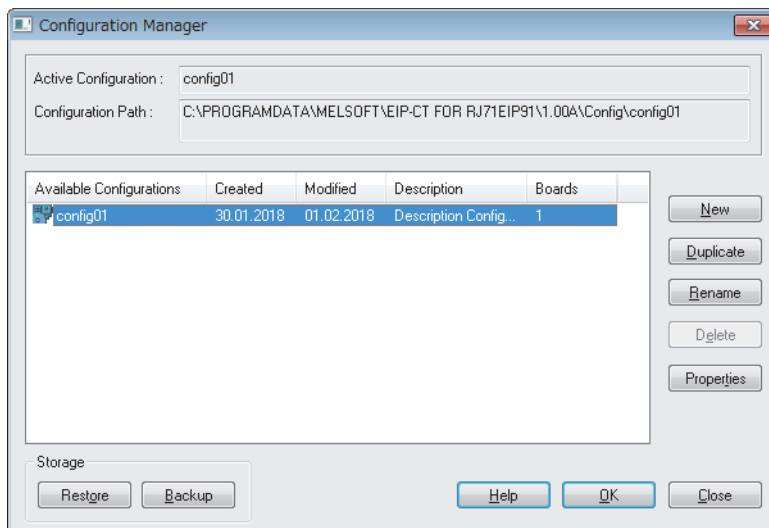

Item	Description
Active Configuration	Displays the name of the currently active project.
Configuration Path	Displays the storage location of the currently active project file.
[New] button	Creates a new project.
[Duplicate] button	Creates a new project from the copy of the selected project.
[Rename] button	Changes the name of the selected project.
[Delete] button	Deletes the selected project.
[Properties] button	Displays the property of the selected project.
[Restore] button	Restores the backup copy of the specified project file.
[Backup] button	Stores the backup copy of the selected project.

Device Library

"Device Library" lists the EtherNet/IP devices added in EtherNet/IP Configuration Tool.

The EtherNet/IP devices added to "Device Library" can be added to the network configuration settings.

When EtherNet/IP device information is displayed at execution of Network Detection, the information of the EtherNet/IP devices added to "Device Library" is used.

To add EtherNet/IP devices to "Device Library", add EDS files provided by manufacturers of the EtherNet/IP devices in EtherNet/IP Configuration Tool. For details, refer to the following.

☞ Page 96 Adding the EDS file

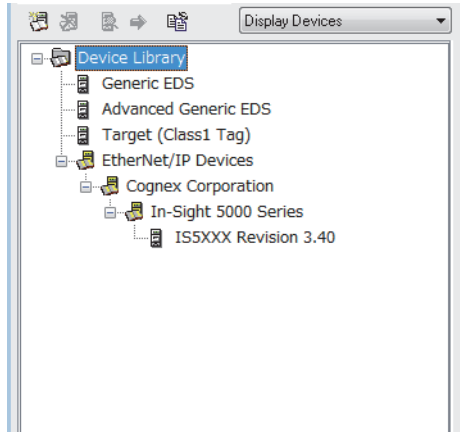

Point

Perform the action related to "Device Library" when it is set offline. For the operating procedure, refer to the following.

☞ Page 98 Configuring settings offline

Display options

The list of display options in the upper-right corner of the "Device Library" can be used to switch its display.

Item	Description
Display Devices	Displays the EtherNet/IP devices not configured by modules.
Display Modules and Chassis	Displays the EtherNet/IP devices configured by modules.
Display all Nodes	Displays all the EtherNet/IP devices.

EDS file information

The EDS file information of the EtherNet/IP device is displayed.

Select the EtherNet/IP device in "Device Library". ⇒ [Library] ⇒ [Properties]

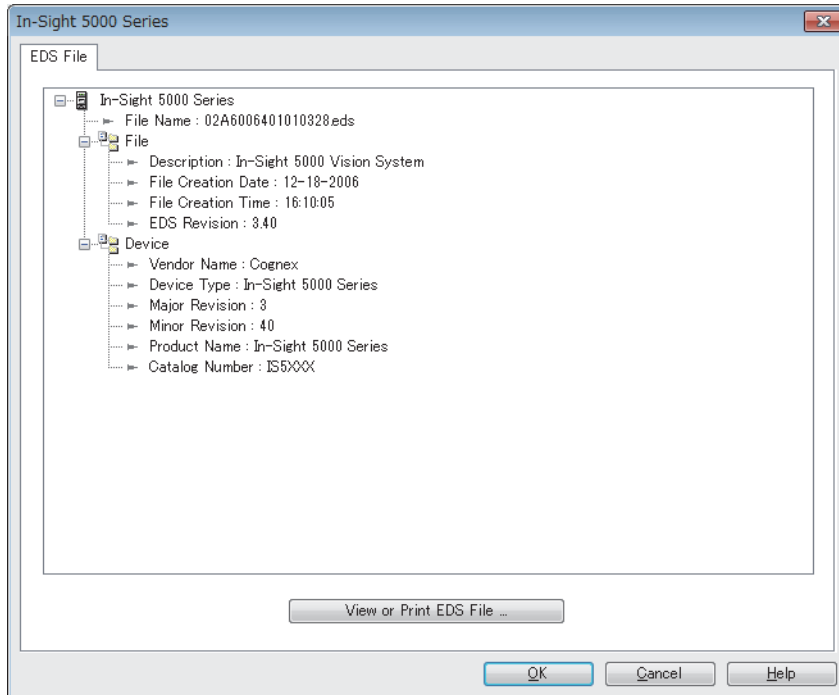

Item	Description
[View or Print EDS File] button	Displays EDS file information in the text format.

Network Detection

"Network Detection" detects EtherNet/IP devices on the network and configures EtherNet/IP communication settings online.

Detecting the RJ71EIP91 and EtherNet/IP devices

Scan the network to detect the RJ71EIP91 and EtherNet/IP devices on the "Network Detection" tab.

Select the [Network Detection] tab.^{*1} ⇒ [Network] ⇒ [Read Network Configuration]

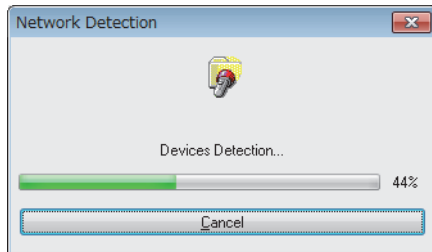

^{*1} For the [Network Detection] tab, refer to the following.
☞ Page 52 Window Structure

Display content

The "Network Detection" content is displayed.

"Network Detection" displays the RJ71EIP91 and EtherNet/IP devices.

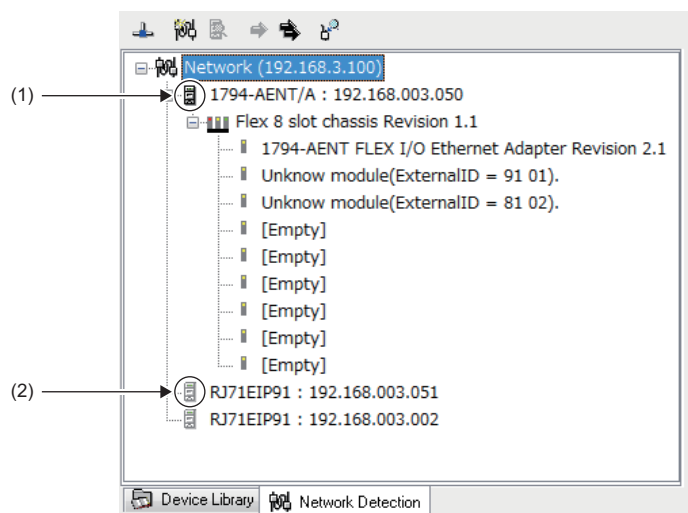

(1) Indicates that the EDS file for the detected RJ71EIP91 or EtherNet/IP device is added in "Device Library".
(2) Indicates that the EDS file for the detected RJ71EIP91 or EtherNet/IP device is not added in "Device Library".

When detecting EtherNet/IP devices on the network, note the following points.

- The RJ71EIP91 and EtherNet/IP devices must be connected to the network.
- An IP address has been set to the EtherNet/IP device, and the IP address does not duplicate the IP addresses of other EtherNet/IP devices.^{*1}
- The EDS file of each EtherNet/IP device has been added to "Device Library". (The EtherNet/IP communication settings are based on the EDS files or Generic EDS.)^{*2}

^{*1} The EtherNet/IP device IP address can be set in the "Online Action" window. (☞ Page 65 "Online Action" window)

^{*2} EDS files can be added in the "EDS Management" window. (☞ Page 96 Adding the EDS file)

Point

Perform the action related to "Network Detection" when it is set online. For the operating procedure, refer to the following.

☞ Page 98 Configuring settings online

EtherNet/IP device properties

The properties of an EtherNet/IP device in "Network Detection" is displayed.

 Select the EtherNet/IP device module in "Network Detection". ⇒ [Network] ⇒ [Properties]

Point

This window shows properties of an EtherNet/IP device to which a module can be mounted.
No properties are displayed for EtherNet/IP devices to which a module cannot be mounted.

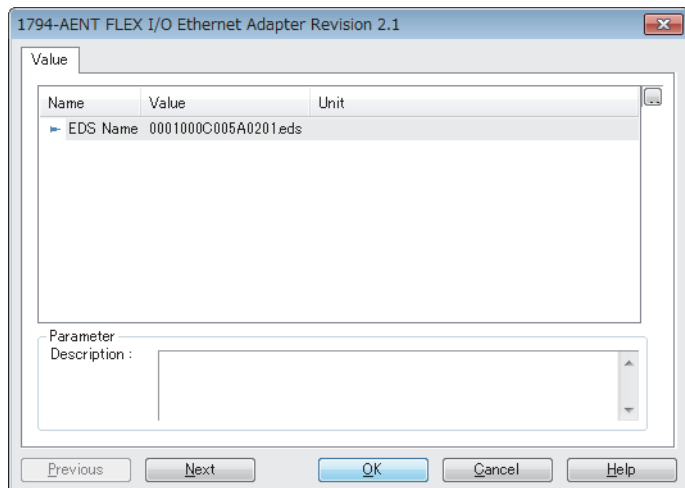

Item	Description
EDS Name	Displays the EDS file name of the EtherNet/IP device.
Description	Displays the description of the selected item.

"Online Action" window

The "Online Action" window is used to perform Class3 message communications and UCMM message communications. Items in this window can be used when EtherNet/IP Configuration Tool is switched to the online state. (📄 Page 53 File)

🖱️ Select the [Network Detection] tab. ⇒ [Network] ⇒ [Online Action]

■[Explicit Message] tab

Use this tab when performing message communications with an EtherNet/IP device.

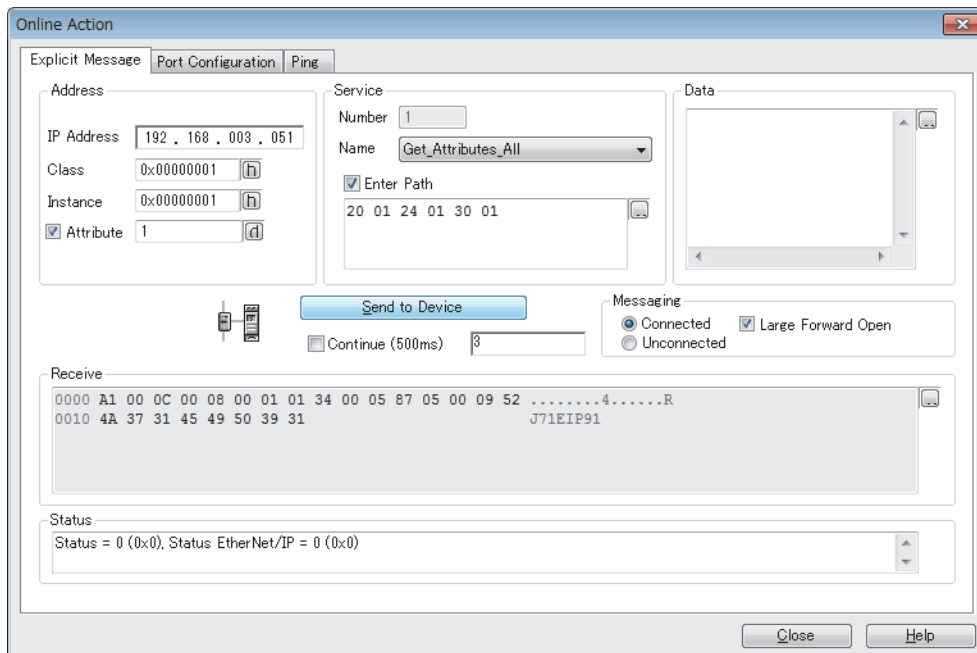

Item	Description	Setting range	
Address	IP Address	Specifies the IP address of the EtherNet/IP device to perform Class3 communications and UCMM communications with. The valid range of IP address is 0.0.0.1 to 223.255.255.254.	0.0.0.0 to 255.255.255.255 (Default: Current IP address of the EtherNet/IP device)
	Class	Specifies the class ID for performing message communications.	0 to 65535 (Default: 0)
	Instance	Specifies the instance ID for performing message communications.	0 to 65535 (Default: 0)
	Attribute	Specifies the attribute ID for performing message communications.	0 to 65535 (Default: 0)
Service	Number	Specifies the service value for performing message communications. This item cannot be entered if a value other than "Customer Service" is specified for "Name".	0 to 255 (Default: 14)
	Name	Specifies the service for performing message communications. To specify the service that is not displayed in this item, specify "Customer Service", and specify a value for "Number". Although there are other setting items than those described to the right, they are not supported on the RJ71EIP91.*1	<ul style="list-style-type: none"> Customer Service Get_Attributes_Single Set_Attributes_Single Get_Attributes_All (Default: Get_Attributes_Single)
	Enter Path*2	When this check box is selected, the following items can be input. <ul style="list-style-type: none"> Identifier of CIP object Instance Attribute of instance 	<ul style="list-style-type: none"> Selected Not selected (Default: Not selected)
Data	Enters the data to send to the EtherNet/IP device.	—	
[Send to Device] button	Starts Class3 communications and UCMM communications.	—	
Continue (500ms)	When this check box is selected, Class3 communications and UCMM communications will be executed repeatedly at intervals of 500ms.	<ul style="list-style-type: none"> Selected Not selected (Default: Not selected)	

Item	Description	Setting range
Messaging	<p>Selects the communication method.</p> <ul style="list-style-type: none"> • Connected: Class3 communications • Unconnected: UCMM communications <p>When selecting "Connected", select whether to use "Large Forward Open".</p> <ul style="list-style-type: none"> • Selected: Performs Class3 communications using Large Forward Open.*³ • Not selected: Performs Class3 communications using Forward Open.*⁴ 	<ul style="list-style-type: none"> • Connected • Unconnected <p>(Default: Unconnected)</p>
Receive	<p>Displays the response data from the EtherNet/IP device.</p> <p>The response data is the data excluding the first four bytes including the CIP service code and the status code.</p>	—
Status	<p>Displays the communication result. For details, refer to the manuals of the EtherNet/IP device.</p>	—

*1 To perform message communications on products other than the RJ71EIP91, refer to the manual of the product used.

*2 This item is displayed when "Advanced Mode" is selected. (📄 Page 53 File)

*3 Large Forward Open is used when the size of data to be sent/received is 512 bytes or more.

*4 Forward Open is used when the size of data to be sent/received is 511 bytes or less.

■[Port Configuration] tab

Read and write the connection status of the EtherNet/IP device.

This tab can be used when the "Online Action" window is displayed with an EtherNet/IP device selected.

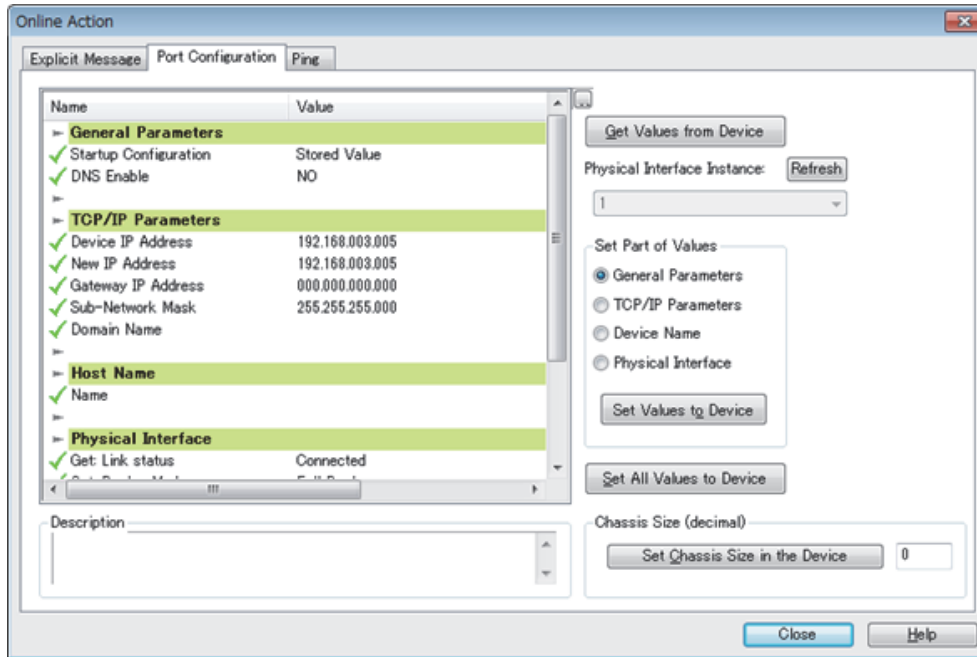

Item	Description
[Get Values from Device] button	Reads and displays the connection status of the EtherNet/IP device.
Physical Interface Instance	Specifies the port number from the list when the EtherNet/IP device is configured with multiple ports.
[Refresh] button	Updates the port number of the "Physical Interface Instance".
Set Part of Values	Selects the items of the values to write to the EtherNet/IP device from the following. <ul style="list-style-type: none"> • General Parameters: Basic parameter settings • TCP/IP Parameters: TCP/IP parameter settings • Device Name: Device name settings • Physical Interface: Physical interface settings
[Set Values to Device] button	Writes the values of the items selected with "Set Part of Values" to the EtherNet/IP device.
[Set All Values to Device] button	Writes all the values of the displayed connection status to the EtherNet/IP device.
Description	Displays the description of the selected item.
[Set Chassis Size in the Device] button	Sets the number of modules to be mounted to the slice-type EtherNet/IP device. Writing the specified number of modules enables error detection when the specified number is different from that of the actual system or when an error occurs on the module.

■[Ping] tab

Check for the existence of the EtherNet/IP device with the specified IP address over EtherNet/IP.

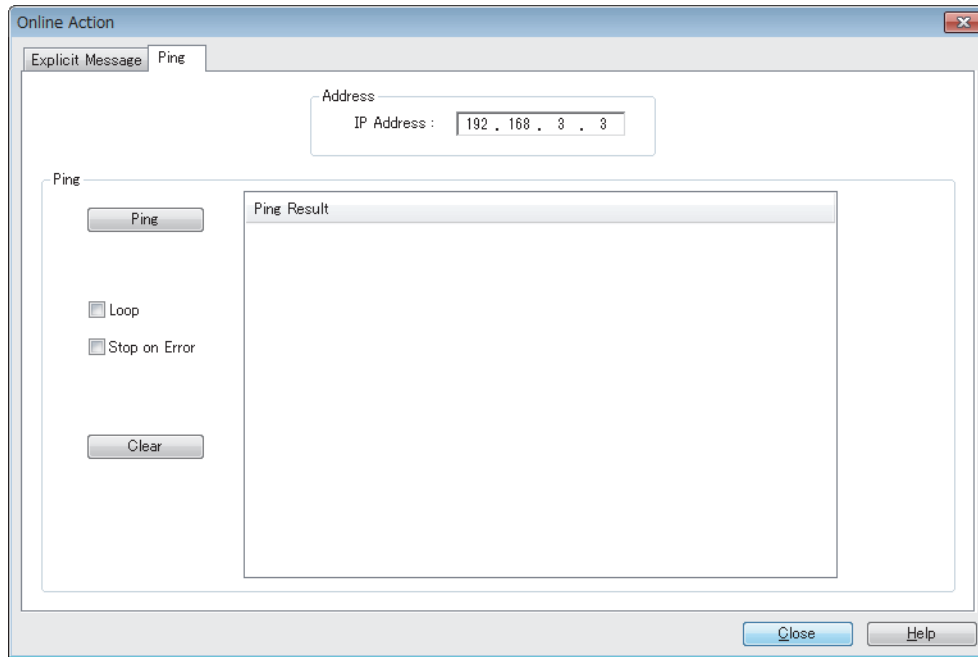

Item		Description	Setting range
Address	IP Address	Specifies the IP address of the EtherNet/IP device to ping.	0.0.0.0 to 255.255.255.255 (Default: Current IP address of the EtherNet/IP device)
Ping	[Ping] button	Pings the specified EtherNet/IP device.	—
	Loop	Select this check box to repeatedly ping the device once every 100ms.	<ul style="list-style-type: none"> • Selected • Not selected (Default: Not selected)
	Stop on Error	Sets whether to interrupt pinging if an error occurs when the "Loop" check box is selected. <ul style="list-style-type: none"> • Selected: Pinging will be interrupted if an error occurs. • Not selected: Pinging will continue even if an error occurs. 	<ul style="list-style-type: none"> • Selected • Not selected (Default: Not selected)
	[Clear] button	Deletes the content of "Ping Result".	—
	Ping Result	Displays the result of pinging.	—

Network configuration settings

Network configuration settings are used for check the EtherNet/IP device settings and the connection status.

Display content

The network configuration settings is displayed.

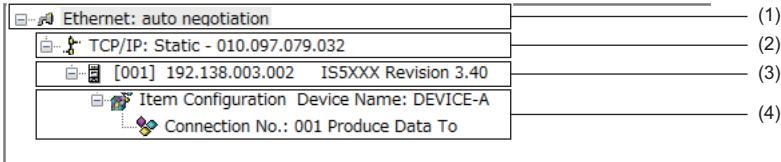

No.	Display area	Display example	Display description
(1)	Ethernet	Ethernet: auto negotiation	— (Fixed to the display shown on the left)
(2)	EtherNet/IP module display	TCP/IP: Static - <input type="text" value="010.097.079.032"/> ①	① IP address of the RJ71EIP91
(3)	EtherNet/IP device display	<div style="display: flex; justify-content: space-around; align-items: center;"> <div style="text-align: center;">① <input type="text" value="[001]"/></div> <div style="text-align: center;">② <input type="text" value="192.138.003.002"/></div> <div style="text-align: center;">③ <input type="text" value="IS5XXX Revision 3.40"/></div> </div>	① Device number of the EtherNet/IP device ^{*1} ② IP address of the EtherNet/IP device ③ Product name of the EtherNet/IP device
(4)	Item display	<div style="display: flex; align-items: center;"> <div style="margin-right: 10px;"></div> <div style="margin-right: 10px;">Item Configuration</div> <div style="border: 1px solid black; padding: 2px;">Device Name: DEVICE-A</div> <div style="margin-left: 10px;">①</div> </div> <div style="display: flex; align-items: center; margin-top: 5px;"> <div style="margin-right: 10px;"></div> <div style="margin-right: 10px;">Connection No.:</div> <div style="border: 1px solid black; padding: 2px;">001 Produce Data To</div> <div style="margin-left: 10px;">②</div> </div>	① Name of the EtherNet/IP device ^{*2} ② Connection number ^{*3}

*1 The device number is used to manage the EtherNet/IP device in EtherNet/IP Configuration Tool.

*2 The name set for "Device Name" in the [General] tab in the EtherNet/IP device setting window is used.

*3 When buffer memory areas are used and their bits need to be specified for each connection, the connection number is used to distinguish each connection.

"Display Option" window

The display of the network configuration settings can be changed.

 [Device] ⇌ [Options]

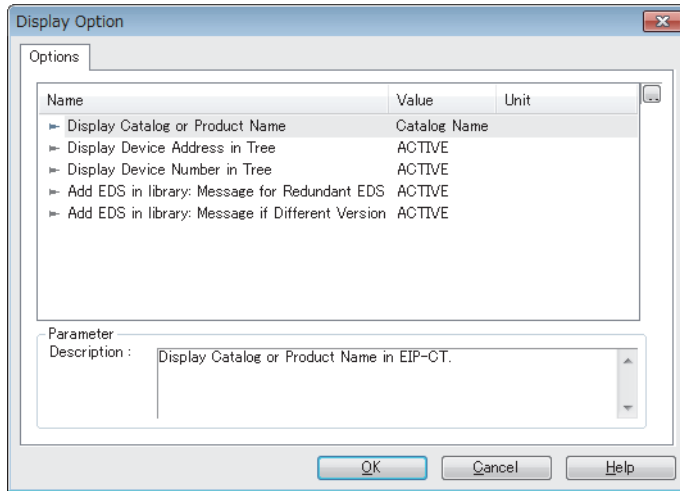

Item	Description	Setting range
Display Catalog or Product Name	Changes the display method according to the EtherNet/IP device product name. Select the Catalog Name or Product Name set with the EDS file.	<ul style="list-style-type: none"> • Product Name • Catalog Name (Default: Catalog Name)
Display Device Address in Tree	Displays the IP address of each EtherNet/IP device in the navigation tree of the network configuration settings when "ACTIVE" is selected.	<ul style="list-style-type: none"> • ACTIVE • INACTIVE (Default: ACTIVE)
Display Device Number in Tree	Displays the device number in the navigation tree of the network configuration settings when "ACTIVE" is selected.	<ul style="list-style-type: none"> • ACTIVE • INACTIVE (Default: ACTIVE)
Add EDS in library: Message for Redundant EDS	Displays a message when an EDS file is added and the same EDS file exists when "ACTIVE" is selected. When "INACTIVE" is selected, the message is not displayed.	<ul style="list-style-type: none"> • ACTIVE • INACTIVE (Default: ACTIVE)
Add EDS in library: Message if Different Version	Displays a message when an EDS file is added and the same EDS file with a different version exists when "ACTIVE" is selected. When "INACTIVE" is selected, the message is not displayed.	<ul style="list-style-type: none"> • ACTIVE • INACTIVE (Default: ACTIVE)
Parameter Description	Displays the description of the selected item.	—

"Channel Properties" window

The information of the EtherNet/IP devices set in the network configuration settings is displayed.

Select "Ethernet" in the network configuration settings.*1 ⇒ [Device] ⇒ [Properties]

*1 For names of each display, refer to the following.

☞ Page 69 Display content

■[General] tab

The basic information related to the communications of the RJ71EIP91 is displayed.

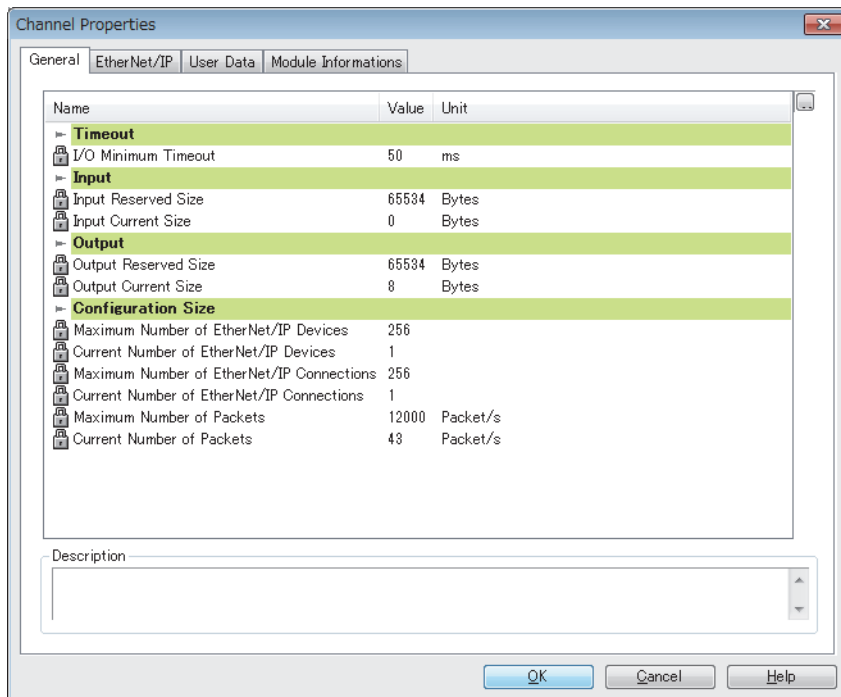

Item		Description
Timeout	I/O Minimum Timeout	Displays the minimum timeout time that can be set for EtherNet/IP communications. (Unit: ms)
Input	Input Reserved Size	Displays the maximum size of the input data. (Unit: Bytes)
	Input Current Size	Displays the total size of the currently set input data. (Unit: Bytes)
Output	Output Reserved Size	Displays the maximum size of the output data. (Unit: Bytes)
	Output Current Size	Displays the total size of the currently set output data. (Unit: Bytes)
Configuration Size	Maximum Number of EtherNet/IP Devices	Displays the number of EtherNet/IP devices that can be connected to the RJ71EIP91.
	Current Number of EtherNet/IP Devices	Displays the number of currently set EtherNet/IP devices.
	Maximum Number of EtherNet/IP Connections	Displays the maximum number of the RJ71EIP91 connections.
	Current Number of EtherNet/IP Connections	Displays the number of currently set connections.
	Maximum Number of Packets	Displays the maximum value of communication processing performance (PPS) of the RJ71EIP91. (Unit: Packet/s)
	Current Number of Packets	Displays the communication processing performance (PPS) in the current settings. (Unit: Packet/s)
Description		Displays the description of the selected item.

■[EtherNet/IP] tab

Configure settings related to the connection between the RJ71EIP91 and the EtherNet/IP device.

The [EtherNet/IP] tab can be set when "Advanced Mode" is selected. (☞ Page 53 File)

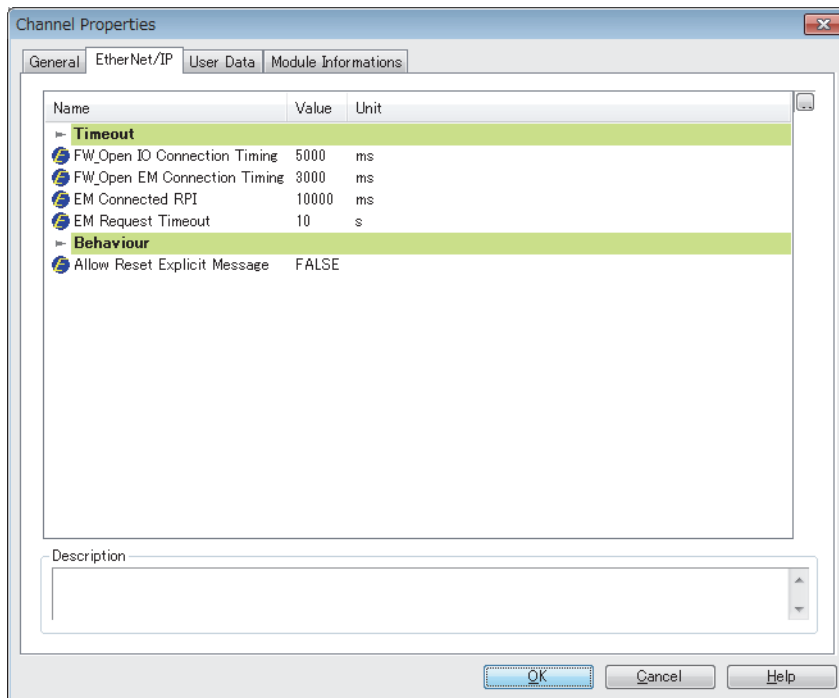

Item	Description	Setting range
Timeout	FW_Open IO Connection Timing	Sets the response waiting time for the connection open request sent from the RJ71EIP91 to the EtherNet/IP device during Class1 communications. (Unit: ms)
	FW_Open EM Connection Timing	Sets the response waiting time for the connection open request sent from the RJ71EIP91 to the EtherNet/IP device during Class3 communications. (Unit: ms)
	EM Connected RPI	Sets the communication cycle (RPI) for Class3 communications. (Unit: ms)
	EM Request Timeout	Sets the response waiting time for Class3 communications. (Unit: s)
Behaviour	Allow Reset Explicit Message	Sets the behavior of the RJ71EIP91 when it receives a reset request message. <ul style="list-style-type: none"> • FALSE: Reset. • TRUE: Do not reset.
Description		Displays the description of the selected item.

■[User Data] tab

This tab is not supported in the RJ71EIP91.

■[Module Informations] tab

The parameters of the RJ71EIP91 is displayed.

The [Module Informations] tab can be checked when EtherNet/IP Configuration Tool is switched to the online state. (☞

Page 53 File)

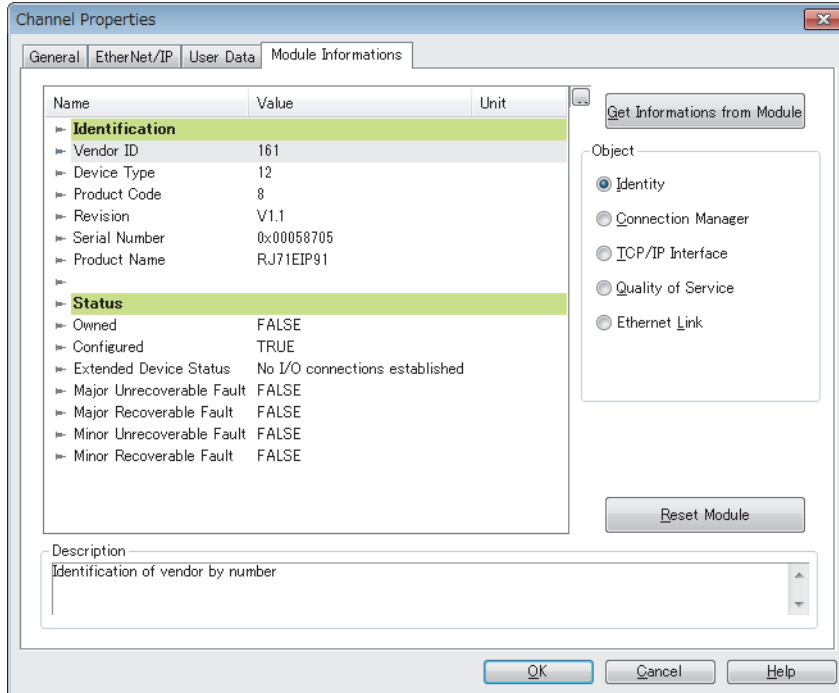

Item	Description
[Get Informations from Module] button	Updates the displayed parameters of the RJ71EIP91.
Object* ¹	Selects the parameter type of the RJ71EIP91. <ul style="list-style-type: none"> • Identity: General device information • Connection Manager: Information about connection • TCP/IP Interface: Information about TCP/IP network interface • Quality of Service: Information about communication quality • Ethernet Link: Information about link-specific counter and IEEE802.3 communication interface status
[Reset Module] button	Resets the displayed parameters of the RJ71EIP91.
Description	Displays the description of the selected item.

*1 This item is displayed when "Advanced Mode" is selected. (☞ Page 53 File)

• When "Identity" is selected for "Object"

Item		Description
Identification	Vendor ID	Displays the vendor code of the RJ71EIP91. (Fixed to 161.)
	Device Type	Displays the module type of the RJ71EIP91. (Fixed to 12.)
	Product Code	Displays the product code of the RJ71EIP91. (Fixed to 8.)
	Revision	Displays the version of the RJ71EIP91.
	Serial Number	Displays the serial number of the RJ71EIP91.
	Product Name	Displays the product name of the RJ71EIP91. (Fixed to the RJ71EIP91.)
Status	Owned	Displays the connection status between the RJ71EIP91 and the EtherNet/IP device (adapter and scanner). <ul style="list-style-type: none"> • TRUE: The adapter and scanner are connected. • FALSE: The adapter and scanner are not connected.
	Configured	Displays whether the settings of the RJ71EIP91 were configured with EtherNet/IP Configuration Tool. (Excluding TCP/IP-related settings) <ul style="list-style-type: none"> • TRUE: Settings have been configured. • FALSE: Settings have not been configured. (Operations are being performed with the default settings.)
	Extended Device Status	Displays the operation mode of the RJ71EIP91. <ul style="list-style-type: none"> • At least one faulted I/O connection: Error occurring on one or more connection • No I/O connections established: No connections established • Major Fault: Major Recoverable Fault or Major Unrecoverable Fault occurring • At least one I/O connection in run mode: One or more connection performing normal communication in RUN mode • At least one I/O connection established, all in idle mode: One or more connection all performing communication in IDLE mode
	Major Unrecoverable Fault	Displays the main major error status of the RJ71EIP91. (Unrecoverable error) <ul style="list-style-type: none"> • TRUE: Major error occurring • FALSE: Major error not occurring
	Major Recoverable Fault	Displays the main moderate error and minor error status of the RJ71EIP91. (Recoverable error) <ul style="list-style-type: none"> • TRUE: Moderate error or minor error occurring • FALSE: Moderate error or minor error not occurring
	Minor Unrecoverable Fault	Displays the major error status of the RJ71EIP91. (Unrecoverable error) <ul style="list-style-type: none"> • FALSE: Major error not occurring (fixed)
	Minor Recoverable Fault	Displays the moderate error and minor error status of the RJ71EIP91. (Recoverable error) <ul style="list-style-type: none"> • TRUE: Moderate error or minor error occurring • FALSE: Moderate error or minor error not occurring

• When "Connection Manager" is selected for "Object"

Item		Description
Open Counters	Open Requests	Displays the number of open requests received from the connected EtherNet/IP device.
	Format Rejects	Among the open requests received by the RJ71EIP91, displays the number of rejected open requests due to message format errors.
	Resource Rejects	Among the open requests received by the RJ71EIP91, displays the number of rejected open requests due to insufficient resources.
	Other Rejects	Among the open requests received by the RJ71EIP91, displays the number of rejected open requests due to reasons other than message format errors and insufficient resources.
Close Counters	Close Requests	Displays the number of close requests received from the connected EtherNet/IP device.
	Format Rejects	Among the close requests received by the RJ71EIP91, displays the number of rejected close requests due to message format errors.
	Other Rejects	Among the close requests received by the RJ71EIP91, displays the number of rejected close requests due to reasons other than message format errors.
Others Counters	Connection Timeouts	Displays the number of timeouts that occurred in connections with EtherNet/IP devices.
	Number of Connection	Not supported in the RJ71EIP91.

• When "TCP/IP Interface" is selected for "Object"

Item	Description
Status	Displays the presence of settings related to TCP/IP. <ul style="list-style-type: none"> • 0: No settings present. • 2: Settings present.
Configuration Capability	Displays the settings related to services. <ul style="list-style-type: none"> • BOOTP Client • DNS Client • Configuration Settable
Startup Configuration	Displays the reference for settings related to TCP/IP on startup.
DNS Enable	Displays whether a DNS server is used. <ul style="list-style-type: none"> • YES • NO
Path to physical Link Object	Displays the path to the physical layer link object.
IP Address	Displays the IP address of the RJ71EIP91.
Network Mask	Displays the subnet mask of the RJ71EIP91.
Gateway Address	Displays the default gateway of the RJ71EIP91.
Primary Name Server Address	Displays the primary DNS server of the RJ71EIP91.
Domain Name	Not supported in the RJ71EIP91.
Host Name	Not supported in the RJ71EIP91.
Safety Network Number	Displays the safety network number.
TTL Value	Displays the TTL (Time-to-Live) value.
Multicast Address Allocation Control	Displays the multicast address allocation method. <ul style="list-style-type: none"> • 0: Multicast address is allocated with the default algorithm. • 1: Allocation is calculated according to "Number of IP Multicast Addresses Allocated" and "Starting Multicast IP Address".
Number of IP Multicast Addresses Allocated	Displays the number of multicast address to be allocated.
Starting Multicast IP Address	Displays the start address for the multicast addresses to be allocated.

• When "Quality of Service" is selected for "Object"

Item	Description
802.1Q frame Enable	Not supported in the RJ71EIP91.
DSCP PTP Event	
DSCP PTP General	
DSCP Urgent	
DSCP Scheduled	
DSCP High	
DSCP Low	
DSCP Explicit	

• When "Ethernet Link" is selected for "Object"

Item		Description
General	Interface Speed	Displays the communication speed of EtherNet/IP communications.
	Link Status	Displays the link status of EtherNet/IP communications.
	Duplex Mode	Displays the communication method (full-duplex/half-duplex) of EtherNet/IP communications.
	Negotiation Status	Displays the auto-negotiation status. <ul style="list-style-type: none"> • 0: Auto-negotiation being executed. • 1: Auto-negotiation failed and operation in progress with the default communication speed and method. • 2: Communication method detection failed, but communication speed detection succeeded. Operation in progress with the default communication method. • 3: Auto-negotiation completed successfully. • 4: Auto-negotiation unexecuted.
	Manual Setting Requires Reset	Displays the reflection method when communication settings are changed. <ul style="list-style-type: none"> • 0: Immediate reflection after the change • 1: Reflection after the reset of the RJ71EIP91
	Local Hardware Fault	Displays the hardware failure status.
	Physical Address	Displays the MAC address of the RJ71EIP91.
	802.3 Link Auto-negotiate	Displays whether auto-negotiation is enabled or disabled.
	Forced Duplex Mode	Displays the default communication method set when auto-negotiation is disabled.
	Forced Interface Speed	Displays the default communication speed set when auto-negotiation is disabled.
	Interface Type	Displays the communication interface type.
	Interface State	Displays the communication interface status.
	Admin State	Displays the administration status.
	Interface Label	Displays the communication interface name (label).
Input	Octets	Displays the length of the received data. (Unit: Octets)
	Ucast Packets	Displays the number of unicast packets received.
	NUcast Packets	Displays the number of non-unicast packets (multicast or broadcast) received.
	Discards	Among the received packets, displays the number of discarded packets.
	Errors	Among the received packets, displays the number of packets that include error information. (Excluding the number of discarded packets)
	In Unknown Protocols	Among the received packets, displays the number of packets with unrecognizable protocols.
Output	Octets	Displays the length of the sent data. (Unit: Octets)
	Ucast Packets	Displays the number of unicast packets sent.
	NUcast Packets	Displays the number of non-unicast packets (multicast or broadcast) sent.
	Discards	Among the sent packets, displays the number of discarded packets.
	Errors	Among the sent packets, displays the number of packets that include error information. (Excluding the number of discarded packets)
Error Counters	Alignment Errors	Displays the number of frames received of which data length is not an octet integral multiple.
	FCS Errors	Displays the number of frames received for which FCS check errors occurred.
	Single Collisions	Displays the number of frames received for which single collisions occurred.
	Multiple Collisions	Displays the number of frames received for which multiple collisions occurred.
	SQE Test Errors	Displays the error count of the SQE test.
	Deferred Transmissions	Displays the number of times that a sending delay occurred.
	Late Collisions	Displays the probability of collisions occurring.
	Excessive Collisions	Displays the number of times that excessive collisions occurred.
	MAC Transmit Errors	Displays the number of MAC frame transmission errors.
	Carrier Sense Errors	Displays the number of errors that occurred during carrier detection.
	Frame Too Long	Displays the receive count of frames that exceeded the maximum size.
	MAC Receive Errors	Displays the number of MAC frame reception errors.

IP address management window

Information such as the IP address of the RJ71EIP91 is displayed.

Set the address of the RJ71EIP91 with the module parameters of the engineering tool. (📖 Page 46 Basic Setting)

🔗 Select the EtherNet/IP module display in the network configuration settings.*1 ⇒ [Device] ⇒ [Properties]

*1 For names of each display, refer to the following.

📖 Page 69 Display content

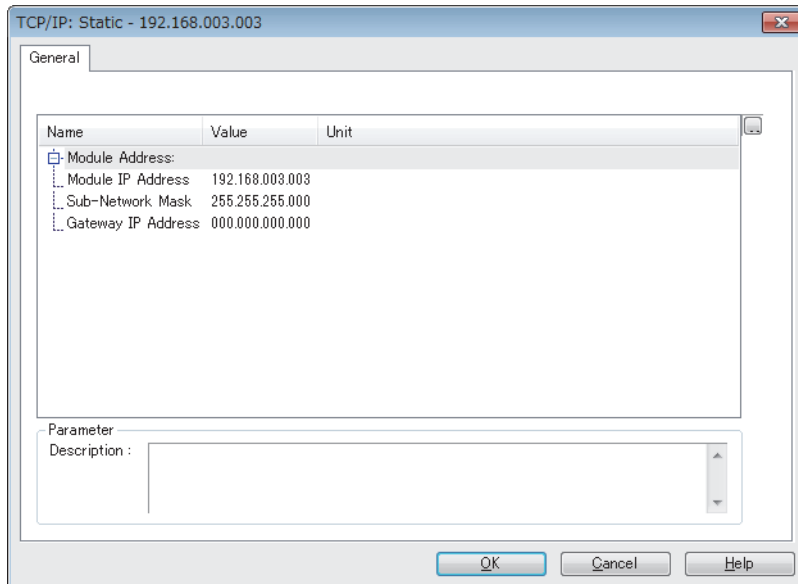

Item		Description
Module Address	Module IP Address	Displays the IP address of the RJ71EIP91.
	Sub-Network Mask	Displays the subnet mask of the RJ71EIP91.
	Gateway IP Address	Displays the gateway IP address of the RJ71EIP91.
Parameter	Description	Displays the description of the selected item.

EtherNet/IP device setting window (Class1 instance communications)

Set the parameters of the EtherNet/IP device used in Class1 instance communications.

🔗 Select the EtherNet/IP display in the network configuration settings.*1 ⇒ [Device] ⇒ [Properties]

*1 For names of each display, refer to the following.

📖 Page 69 Display content

Point

Depending on the connected EtherNet/IP device, some tabs may not be displayed in the EtherNet/IP device setting window.

■[General] tab

Set items such as the name and device number of the EtherNet/IP device.

The screenshot shows the '1794-AENT FLEX I/O Ethernet Adapter Revision 2.1' configuration window. The 'General' tab is active. Under 'Device Designation', 'Device Name' is 'DEVICE-A', 'Number' is '001', and 'Link Parameters' is unchecked. 'Active Configuration' is checked. Under 'Network Properties', 'IP Address' is '192.168.003.001' and 'Description' is 'IP address of the partner device.'. Under 'Ping', there is a 'Ping' button, 'Loop' and 'Stop on Error' checkboxes (unchecked), and a 'Clear' button. The 'Ping Result' area is empty.

Item		Description	Setting range
Device Designation	Device Name	Sets the name to use in management with EtherNet/IP Configuration Tool. By default, names of EtherNet/IP devices not registered in the network configuration setting are displayed in the form such as "DEVICE-A" and "DEVICE-B".	Up to 50 characters ^{*1} (Default: Refer to the left.)
	Number	Sets the control number of the EtherNet/IP device. The control number that has not been set for EtherNet/IP devices can be selected from the list.	000 to 255 (Default: Minimum value of the control numbers of EtherNet/IP devices that have not been set)
	Link Parameters	Enables or disables the link between the IP address and the device number of the EtherNet/IP device. • Selected: Enabled • Not selected: Disabled Enable this item to link the device number of the EtherNet/IP device to the fourth octet of the IP address.	• Selected • Not selected (Default: Not selected)
	Active Configuration	Enables or disables the parameters set for the EtherNet/IP device on the RJ71EIP91. • Selected: Enabled • Not selected: Disabled Disable this item when the parameters of the EtherNet/IP device need to be deleted from the RJ71EIP91 with the settings in EtherNet/IP Configuration Tool held. Clearing of this check box is reflected against 'Reserved station (Class1)' (Un\G27168 to Un\G27183) on the RJ71EIP91.	• Selected • Not selected (Default: Selected)
	Comment	Displays the comment input field. Information about the EtherNet/IP device is described with the default setting.	Up to 255 single-byte characters (Default: Varies depending on the EtherNet/IP device)
Network Properties	IP Address	Specifies the IP address of the EtherNet/IP device.	1.0.0.1 to 223.255.255.254 ^{*2} (Default: Current IP address of the EtherNet/IP device)
	Description	Displays the description of the selected item.	—

Item	Description	Setting range	
Ping ^{*3}	[Ping] button	Pings the specified EtherNet/IP device.	
	Loop	Select this check box to repeatedly ping the device once every 100ms.	<ul style="list-style-type: none"> • Selected • Not selected (Default: Not selected)
	Stop on Error	Sets whether to interrupt pinging if an error occurs when the "Loop" check box is selected. <ul style="list-style-type: none"> • Selected: Pinging will be interrupted if an error occurs. • Not selected: Pinging will continue even if an error occurs. 	<ul style="list-style-type: none"> • Selected • Not selected (Default: Not selected)
	[Clear] button	Deletes the content of "Ping Result".	—
	Ping Result	Displays the result of pinging.	—

*1 Characters from A to Z, numbers from 0 to 9, "." (dot), "-" (hyphen), and "_" (underscore) can be used. For the first character of a name, only characters from A to Z can be used.

*2 Cannot be set to a value from 127.0.0.0 to 127.255.255.255.

*3 Can be selected when EtherNet/IP Configuration Tool is switched to the online state. (📖 Page 53 File)

Point

When an EtherNet/IP device has been added by "Network Detection", its IP address is registered automatically. When an EtherNet/IP device has been added from "Device Library", manually enter its IP address.

For the operations on "Network Detection" and "Device Library", refer to the following.

📖 Page 63 Network Detection

📖 Page 61 Device Library

■[Chassis] tab

Set the modules to be mounted in each slot for EtherNet/IP devices to which modules can be mounted.

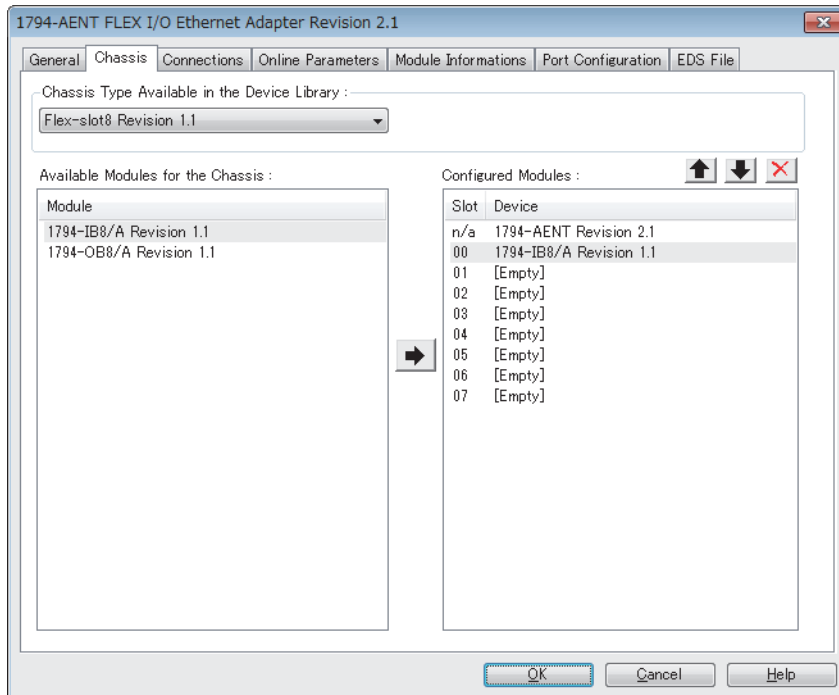

Item		Description
Chassis Type Available in the Device Library	[Set Chassis Size in the Module] button	Selects the number of slots to which modules can be mounted. For the setting range and the default value, refer to the manuals of the EtherNet/IP device.
	[Get Chassis Size in the Module] button	
Available Modules for the Chassis		Displays a list of the modules that can be mounted to the EtherNet/IP device. This content varies depending on the EtherNet/IP device. Select a module and click the [->] button to add the module to the list of "Configured Modules". (When the module is added to the list by a drag-and-drop operation, it can be added to a desired slot.)
Configured Modules		Sets the modules of the EtherNet/IP device for each "Slot" number. Select a module and edit it with the following buttons. <ul style="list-style-type: none"> • [↑] button: Moves the selected module to the upper slot. • [↓] button: Moves the selected module to the lower slot. • [×] button: Deletes the selected module.

■[Connections] tab

Set items such as the communication content when the connection with the EtherNet/IP device is established.

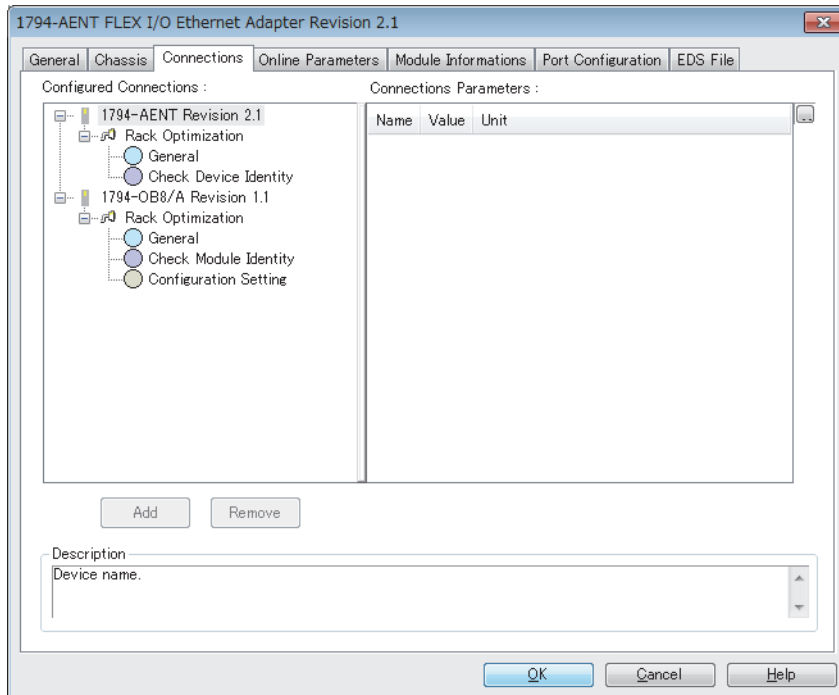

Item	Description
Configured Connections	Displays the connection status of the devices or modules of the EtherNet/IP device.
Connection Parameters	Displays the parameters of the EtherNet/IP device selected under "Configured Connections". <ul style="list-style-type: none"> • General: The parameters are set the connection to the EtherNet/IP device. • Check Device Identity: The parameters are verified the settings against the actual EtherNet/IP device to check whether they match. • Configuration Setting: The parameters are displayed the settings defined in the EDS file for each EtherNet/IP device. For details, refer to the manuals of the EtherNet/IP device.
[Add] button	Displays the following window when clicked with a device or module of an EtherNet/IP device selected. <div data-bbox="592 1238 1070 1435" data-label="Image"> </div> <p>Use "Connection to Add" to select the type to which the RJ71EIP91 connected. The types to be connected vary depending on the used EtherNet/IP device.</p>
[Remove] button	Deletes the selected device or module of the EtherNet/IP device when clicked.
Description	Displays the description of the selected item.

• "General" window

Name	Value	Unit
Connection No.	1	
Time-out Multiplier	x4	
Input - T->O		
Input Mode	Multicast	
Input Type	Fixed	
Priority	Scheduled	
Trigger Type	Cyclic	
Request Packet Interval (RPI)	30	ms
Output - O->T		
Output Mode	Point to Point	
Output Type	Fixed	
Priority	Scheduled	
Request Packet Interval (RPI)	100	ms

Item	Description	Setting range
Connection No.	Displays the connection number of the EtherNet/IP device. Connection numbers of EtherNet/IP devices are assigned from 1 in the order in which they were added.	—
Time-out Multiplier	Specifies the monitoring time of the send/receive timeout as an RPI multiple. (Monitoring time of send/receive timeout = "Request Packet Interval (RPI)" × "Time-out Multiplier") Set the monitoring time of send/receive timeout to 4294967ms or below. • When "Time-out Multiplier" is set to "x4", set "Request Packet Interval (RPI)" to "60000" or below. • When "Time-out Multiplier" is set to "x512", set "Request Packet Interval (RPI)" to "8388" or below.	<ul style="list-style-type: none"> • x4 • x8 • x16 • x32 • x64 • x128 • x256 • x512 (Default: Varies depending on the EtherNet/IP device)
Input - T->O	Input Size	Specifies the size of the input data. (Unit: Bytes) ^{*1} 1 to 1444 (Default: Varies depending on the EtherNet/IP device)
	Input Mode	Specifies the target to read the input data from. • Point to Point: Unicast (one to one) communications are performed. • Multicast: Multicast (one to many) communications are performed. • Null: Communications are not performed. (Default: Varies depending on the EtherNet/IP device)
	Input Type	Specifies the input type (variable or fixed) according to the size of the input data. • Variable: Communications are performed with a variable size. ^{*2} • Fixed: Communications are performed with a fixed size. (Default: Varies depending on the EtherNet/IP device)
	Priority	Specifies the priority of the communication packet for the currently set connection. • High: Processing is performed with high priority. • Low: Priority is given to the processing of connections set to "High". • Scheduled: Packets are processed in the receiving order regardless of priority. (Default: Varies depending on the EtherNet/IP device)
	Trigger Type	Specifies the trigger type (reading timing) of the input data. • Cyclic: Triggers are executed periodically according to the "RPI" setting value. • Application: Triggers are executed with arbitrary timing according to 'Application Trigger Request (Class1)' (Un\G27008 to Un\G27023). • Change of State: Triggers are executed at a given timing according to 'Application Trigger Request (Class1)' (Un\G27008 to Un\G27023). (Default: Varies depending on the EtherNet/IP device)
	Inhibit Time Mode	Specifies the method to manage the inhibit time when "Trigger Type" is set to "Change of State". • Default: A quarter of RPI is specified as the inhibit time. • Un-Activated: No inhibit time is specified. • Custom: Time specified in "Inhibit time" is specified as the inhibit time. (Default: Varies depending on the EtherNet/IP device)
	Inhibit time	Specifies the inhibit time when "Inhibit Time Mode" is set to "Custom". (Unit: ms) 1 to 255 (Default: Varies depending on the EtherNet/IP device)
	Request Packet Interval(RPI)	Specifies the communication cycle. (Unit: ms) 0.5 to 60000 (Default: Varies depending on the EtherNet/IP device)

Item		Description	Setting range
Output - O->T	Output Size	Specifies the size of the output data. (Unit: Bytes) ^{*1}	0 to 1444 (Default: Varies depending on the EtherNet/IP device)
	Output Mode	Specifies the target to which the output data is written. <ul style="list-style-type: none"> Point to Point: Unicast (one to one) communications are performed. Multicast: Multicast (one to many) communications are performed. Null: Communications are not performed. 	<ul style="list-style-type: none"> Point to Point Multicast Null (Default: Varies depending on the EtherNet/IP device)
	Output Type	Specifies the output type (variable or fixed) according to the size of the output data. ^{*3} <ul style="list-style-type: none"> Variable: Communications are performed with a variable size.^{*2} Fixed: Communications are performed with a fixed size. 	<ul style="list-style-type: none"> Variable Fixed (Default: Varies depending on the EtherNet/IP device)
	Priority	Specifies the priority of the communication packet for the currently set connection. <ul style="list-style-type: none"> High: Processing is performed with high priority. Low: Priority is given to the processing of connections set to "High". Scheduled: Packets are processed in the receiving order regardless of priority. 	<ul style="list-style-type: none"> High Low Scheduled (Default: Varies depending on the EtherNet/IP device)
	Request Packet Interval(RPI)	Specifies the communication cycle. (Unit: ms)	0.5 to 60000 (Default: Varies depending on the EtherNet/IP device)

*1 Large Forward Open must be available for the EtherNet/IP device when this item is specified to 505 bytes or more.
For details, refer to the manuals of the EtherNet/IP device.

*2 Variable connections must be available for the EtherNet/IP device when this item is specified to "Variable".
For details, refer to the manuals of the EtherNet/IP device.

*3 Regardless of this setting, the RJ71EIP91 sends data with the size specified with "Output Size".

• "Check Device Identity" window

Name	Value	Unit
▶ Check Identity	Custom	
▶ Compatible Mode	True	
▶ Minor Version	Compatible	
▶ Major Version	Compatible	
▶ Product Code	Compatible	
▶ Product Type	Compatible	
▶ Product Vendor	Compatible	

Item	Description	Setting range
Check Identity	Specifies the policy of the consistency check. The connection is disconnected if the check results in a mismatch. <ul style="list-style-type: none"> • Disable: The check is not performed. • Must Match Exactly: Checks whether all items match exactly. • Must be Compatible: Checks all items and judges there to be no problem if the items are compatible. • Custom: The check items are set with "Compatible Mode" and the subsequent items. • None: The check is not performed. (For EtherNet/IP devices on which check processing is not available) 	<ul style="list-style-type: none"> • Disable • Must Match Exactly • Must be Compatible • Custom • None (Default: Disable)
Compatible Mode ^{*4}	Specifies the compatibility check. <ul style="list-style-type: none"> • True: "Minor Version" and subsequent items must be compatible. • False: "Minor Version" and subsequent items must match exactly. 	<ul style="list-style-type: none"> • True • False (Default: True)
Minor Version ^{*4}	Specifies the minor version check. <ul style="list-style-type: none"> • Compatible: The check is performed. • Not Checked: The check is not performed. 	<ul style="list-style-type: none"> • Compatible • Not Checked (Default: Compatible)
Major Version ^{*4}	Specifies the major version check. <ul style="list-style-type: none"> • Compatible: The check is performed. • Not Checked: The check is not performed. 	<ul style="list-style-type: none"> • Compatible • Not Checked (Default: Compatible)
Product Code ^{*4}	Specifies the product code check. <ul style="list-style-type: none"> • Compatible: The check is performed. • Not Checked: The check is not performed. 	<ul style="list-style-type: none"> • Compatible • Not Checked (Default: Compatible)
Product Type ^{*4}	Specifies the product type check. <ul style="list-style-type: none"> • Compatible: The check is performed. • Not Checked: The check is not performed. 	<ul style="list-style-type: none"> • Compatible • Not Checked (Default: Compatible)
Product Vendor ^{*4}	Specifies the vendor code check. <ul style="list-style-type: none"> • Compatible: The check is performed. • Not Checked: The check is not performed. 	<ul style="list-style-type: none"> • Compatible • Not Checked (Default: Compatible)

*4 This item is displayed when "Custom" is specified for "Check Identity".

■[Online Parameters] tab

Read and write information such as the error information in EDS files.

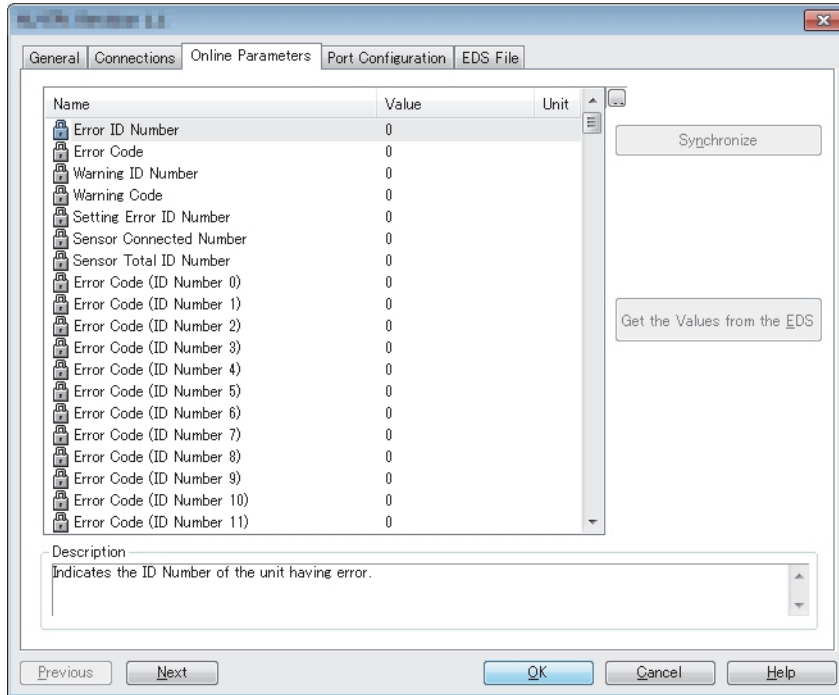

3

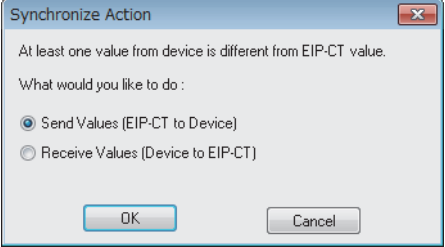
Item	Description
[Synchronize] button	<p>Displays the following window for reading and writing values displayed on the [Online Parameters] tab for the EtherNet/IP device.</p>  <ul style="list-style-type: none"> • Send Values(EIP-CT to Device): Writes the values displayed on the [Online Parameters] tab to the EtherNet/IP device. • Receive Values(Device to EIP-CT): Reads the values displayed on the [Online Parameters] tab from the EtherNet/IP device.
[Get the Values from the EDS] button	Initializes the values displayed on the [Online Parameters] tab (sets the values to the default values in the EDS file).
Description	Displays the description of the selected item.

■[Module Informations] tab

The parameters of the EtherNet/IP device is displayed.

Items in this window can be used when EtherNet/IP Configuration Tool is switched to the online state. (☞ Page 53 File)

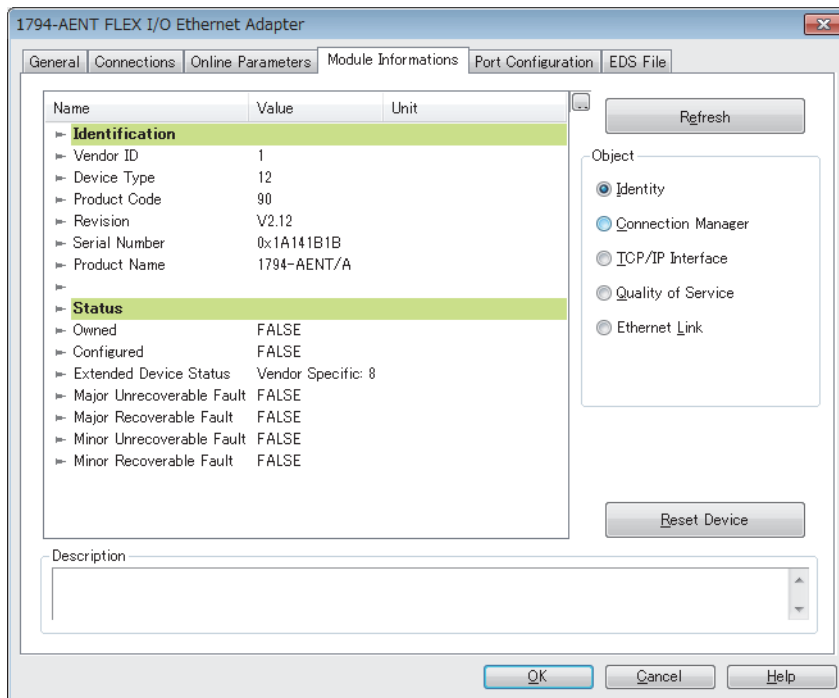

Item	Description
[Refresh] button	Updates the displayed parameters of the EtherNet/IP device. All the initial values are displayed as "###". Clicking the [Refresh] button acquires the information of the item selected in "Object".
Object*1	Selects the type of values to read from the EtherNet/IP device. <ul style="list-style-type: none"> • Identity: General device information • Connection Manager: Information about connection • TCP/IP Interface: Information about TCP/IP network interface • Quality of Service: Information about communication quality • Ethernet Link: Information about link-specific counter and IEEE802.3 communication interface status
[Reset Device] button	Resets the displayed parameters of the EtherNet/IP device.
Description	Displays the description of the selected item.

*1 This item is displayed when "Advanced Mode" is selected. (☞ Page 53 File)

■[Port Configuration] tab

Read and write the connection status of the EtherNet/IP device.

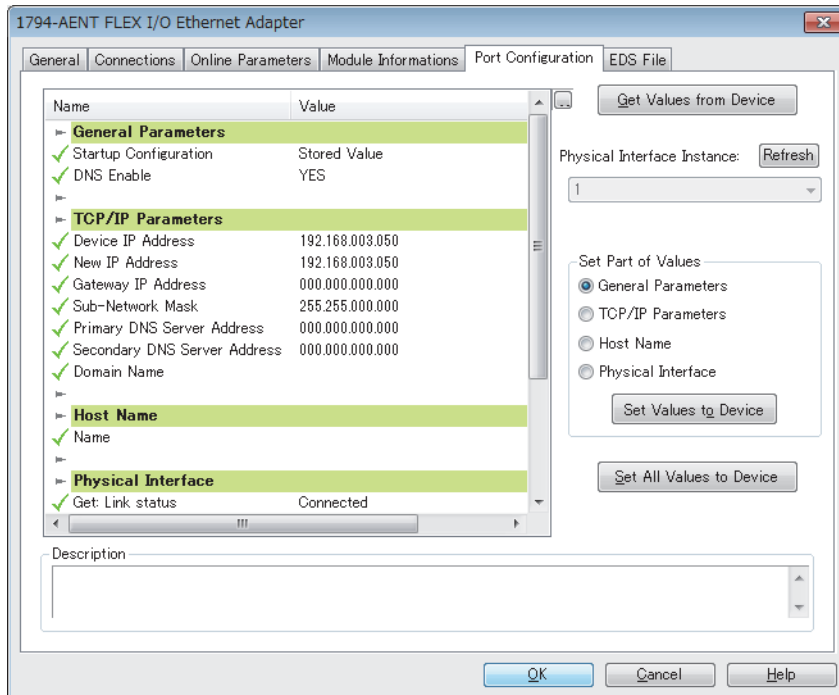

Item	Description
[Get Values from Device] button	Reads and displays the connection status of the EtherNet/IP device.
Physical Interface Instance	Specifies the port number from the list when the EtherNet/IP device is configured with multiple ports.
[Refresh] button	Updates the port number of the "Physical Interface Instance".
Set Part of Values	Selects the items of the values to write to the EtherNet/IP device from the following. <ul style="list-style-type: none"> • General Parameters: Basic parameter settings • TCP/IP Parameters: TCP/IP parameter settings • Host Name: Host name settings • Physical Interface: Physical interface settings
[Set Values to Device] button	Writes the values of the items selected with "Set Part of Values" to the EtherNet/IP device.
[Set All Values to Device] button	Writes all the values of the displayed connection status to the EtherNet/IP device.
Description	Displays the description of the selected item.

■[Diagnostic] tab

The connection status of the EtherNet/IP device is displayed.

This tab can be used when diagnostic mode is enabled. (Page 120 Network diagnostics of EtherNet/IP Configuration Tool)

Point

To display this content, 'EtherNet/IP communication start request' (Y10) must be turned off and on and 'EtherNet/IP communication in process' (X10) must be in the ON state.

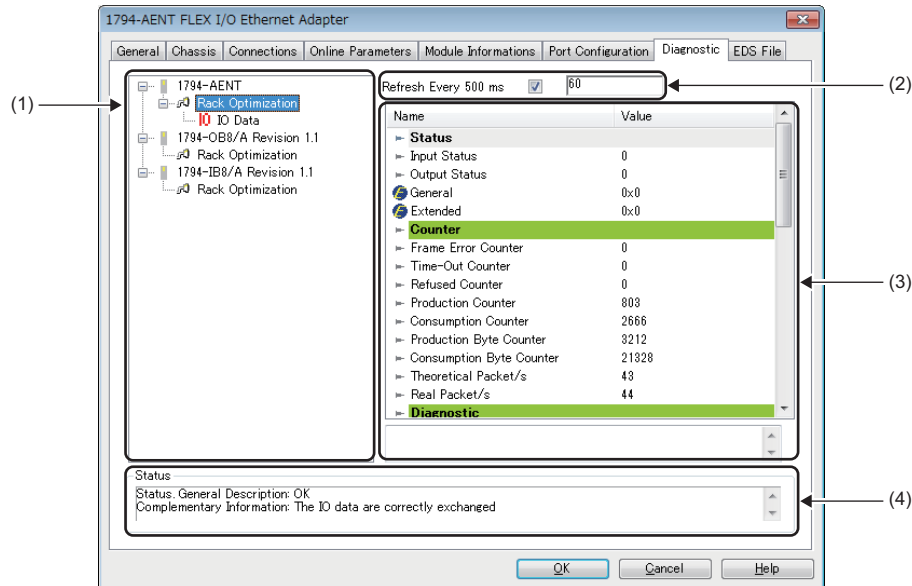

No.	Item	Description	Setting range
(1)	Connection list	Displays the names of the connections set on the [Connections] tab. Diagnostic information is displayed in the connection information when "Monitor Data And External Input" is selected. I/O data is displayed in the connection information when "IO Data" is selected.	—
(2)	Refresh Every	Connection information content is updated at 500ms intervals when this check box is selected. The update count is incremented each time the information is updated.	<ul style="list-style-type: none"> Selected Not selected (Default: Selected)
(3)	Connection information	Displays the diagnostic information and I/O data.	—
(4)	Status	Displays the connection status.	—

• Diagnostic information window

Name	Value
▶ Status	
▶ Input Status	0
▶ Output Status	0
▶ General	0x0
▶ Extended	0x0
▶ Counter	
▶ Frame Error Counter	0
▶ Time-Out Counter	0
▶ Refused Counter	0
▶ Production Counter	803
▶ Consumption Counter	2666
▶ Production Byte Counter	3212
▶ Consumption Byte Counter	21328
▶ Theoretical Packet/s	43
▶ Real Packet/s	44
▶ Diagnostic	

Item	Description	
Status	Input Status	Displays the internal status code of the input connection.
	Output Status	Displays the internal status code of the output connection.
	General*2	Displays the CIP general status code.*1
	Extended*2	Displays the CIP extended status code.*1

Item		Description
Counter	Frame Error Counter	Displays the number of frames that could not be sent/received.
	Time-Out Counter	Displays the number of connection timeouts.
	Refused Counter	Displays the number of connection disconnections.
	Production Counter	Displays the transmission count.
	Consumption Counter	Displays the receive count.
	Production Byte Counter	Displays the number of transmission bytes.
	Consumption Byte Counter	Displays the number of receive bytes.
	Theoretical Packet/s	Displays the number of send/receive packets per second (theoretical value).
	Real Packet/s	Displays the number of send/receive packets per second (process value).
Diagnostic	Production Connection ID	Displays the transmission connection ID for the EtherNet/IP device of the requested connection.* ¹
	Consumption Connection ID	Displays the receive connection ID for the EtherNet/IP device of the requested connection.* ¹
	O->T API (μs)	Displays the originator to target API value for the EtherNet/IP device of the requested connection.* ¹
	T->O API (μs)	Displays the target to originator API value for the EtherNet/IP device of the requested connection.* ¹
	O->T RPI (μs)	Displays the originator to target RPI value for the EtherNet/IP device of the requested connection.* ¹
	T->O RPI (μs)	Displays the target to originator RPI value for the EtherNet/IP device of the requested connection.* ¹
	O->T Net Parameters	Displays the originator to target network parameters for the EtherNet/IP device of the requested connection.* ¹
	T->O Net Parameters	Displays the target to originator network parameters for the EtherNet/IP device of the requested connection.* ¹
	Originator Connection Serial Number	Displays the connection serial number of the originator.* ¹
	Originator Vendor Id	Displays the vendor code of the originator.* ¹
	Originator Serial Number	Displays the serial number of the originator.* ¹
Send Socket Diagnostic* ²	Socket ID	Displays the socket ID of the send connection.
	Remote IP Address	Displays the IP address of the EtherNet/IP device.
	Remote Port	Displays the port number of the EtherNet/IP device.
	Local IP Address	Displays the IP address of the RJ71EIP91. • Multicast: Displays the multicast address. • Unicast: Displays 0.0.0.0.
	Local IP Port	Displays the port number of the RJ71EIP91.
Receive Socket Diagnostic* ²	Socket ID	Fixed to 0
	Remote IP Address	Displays the IP address of the EtherNet/IP device.
	Remote Port	Fixed to 0
	Local IP Address	Displays the IP address of the RJ71EIP91.
	Local IP Port	Fixed to 0

*¹ For details on the displayed content, refer to the EtherNet/IP specifications issued by ODVA (www.odva.org).

*² This item is displayed when "Advanced Mode" is selected. ( Page 53 File)

• I/O data window

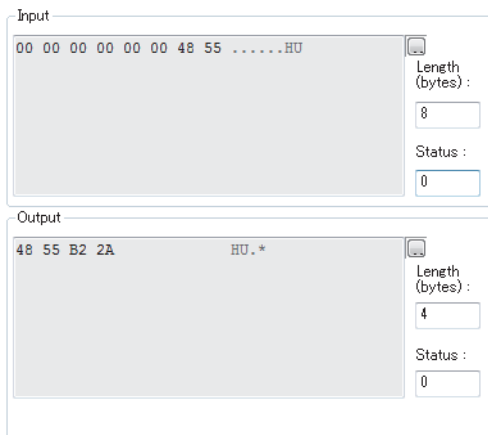

Item		Description
Input	[.] button	Changes the display format of the input data.
	Length(bytes)	Displays the size of the input data. (Unit: Bytes)
	Status	Displays the Status value of the input connection.
Output	[.] button	Changes the display format of the output data.
	Length(bytes)	Displays the size of the output data. (Unit: Bytes)
	Status	Displays the Status value of the output connection.

Point

I/O data of connections that exceed 1400 bytes is not displayed in the I/O data window.

To check I/O data of connections that exceed 1400 bytes, refer to the following.

- Class1 input data area (Un\G65536 to Un\G98303)
- Class1 output data area (Un\G196608 to Un\G229375)

• Status value

The following table lists the values of the "Input Status", "Output Status", and "Status" displayed in the diagnostic information window and I/O data window.

When the RJ71EIP91 is scanner	
Status value	Description
0	EtherNet/IP communications are being performed normally.
33	A timeout has occurred.
53	An Idle notification has been received from the EtherNet/IP device.
54	EtherNet/IP communication connection has been established and no communications are performed.
58	An EtherNet/IP communication error (TCP error) has occurred.
65	An EtherNet/IP communication error (CIP error) has occurred.
68	EtherNet/IP communication connection processing is in progress.
69	Set as a reserved station.
70	An EtherNet/IP communication error (CIP error) has occurred.
77	EtherNet/IP communication is stopping.

When the RJ71EIP91 is adapter	
Status value	Description
0	EtherNet/IP communications are being performed normally.
33	An EtherNet/IP communication error is occurring.
53	An Idle notification has been received from the EtherNet/IP device.
54	EtherNet/IP communication connection has been established and no communications are performed.
69	Set as a reserved station.

■[EDS File] tab

The EDS file information is displayed.

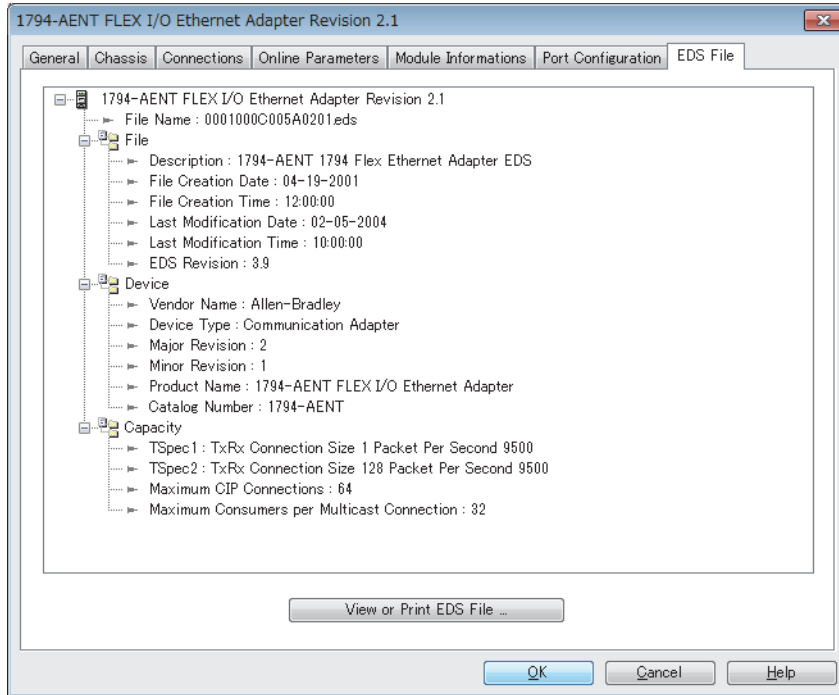

Item	Description
[View or Print EDS File] button	Displays EDS file information in the text format. This button is the same as the [View or Print EDS File] button for the EDS file information of an EtherNet/IP device in "Device Library". (Page 62 EDS file information)

EtherNet/IP device setting window (Class1 tag communications)

Set the parameters of the EtherNet/IP device used in Class1 tag communications.

■Setting window on the Consumer Tag side

Select the RJ71EIP91 in the network configuration settings. ⇒ [Device] ⇒ [Properties] ⇒ [Connections] tab

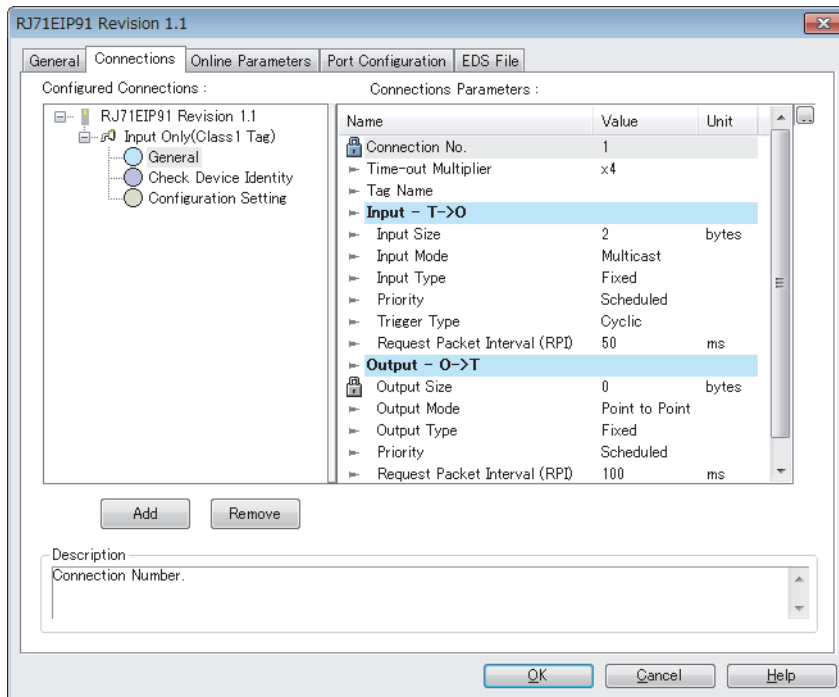

Item	Description	Setting range	
Connection No.	Displays the connection number of the EtherNet/IP device. Connection numbers of EtherNet/IP devices are assigned from 1 in the order in which they were added.	—	
Time-out Multiplier	Specifies the monitoring time of the send/receive timeout as an RPI multiple. (Monitoring time of send/receive timeout = "Request Packet Interval (RPI)" × "Time-out Multiplier") Set the monitoring time of send/receive timeout to 4294967ms or below. • When "Time-out Multiplier" is set to "x4", set "Request Packet Interval (RPI)" to "60000" or below. • When "Time-out Multiplier" is set to "x512", set "Request Packet Interval (RPI)" to "8388" or below.	• x4 • x8 • x16 • x32 • x64 • x128 • x256 • x512 (Default: x4)	
Tag Name	Specifies the tag name used in Class1 tag communications.	Up to 255 single-byte characters (Default: Blank)	
Input - T->O	Input Size	Specifies the size of the input data. (Unit: Bytes) 1 to 1444 (Default: 2)	
	Input Mode	Specifies the target to read the input data from. • Point to Point: Unicast (one to one) communications are performed. • Multicast: Multicast (one to many) communications are performed. (Default: Multicast)	
	Input Type	Specifies the input type according to the size of the input data. (Fixed to Fixed.) • Fixed: Communications are performed with a fixed size.	—
	Priority	Specifies the priority of the communication packet for the currently set connection. (Fixed to Scheduled.) • Scheduled: Packets are processed in the receiving order regardless of priority.	—
	Trigger Type	Specifies the trigger type (reading timing) of the input data. (Fixed to Cyclic.) • Cyclic: Triggers are executed periodically according to the "RPI" setting value.	—
	Request Packet Interval(RPI)	Specifies the communication cycle. (Unit: ms) 0.5 to 60000 (Default: 50)	

Item		Description	Setting range
Output - O->T	Output Size	Specifies the size of the output data. (Fixed to 0.)	—
	Output Mode	Specifies the target to which the output data is written. (Fixed to Point to Point.) • Point to Point: Unicast (one to one) communications are performed.	—
	Output Type	Specifies the output type according to the size of the output data. (Fixed to Fixed.) • Fixed: Communications are performed with a fixed size.	—
	Priority	Specifies the priority of the communication packet for the currently set connection. (Fixed to Scheduled.) • Scheduled: Packets are processed in the receiving order regardless of priority.	—
	Request Packet Interval(RPI)	Specifies the communication cycle. (Unit: ms)	0.5 to 60000 (Default: 100)

Point

For setting windows other than the above, refer to the following.

 Page 77 EtherNet/IP device setting window (Class1 instance communications)

■ Setting window on the Producer Tag side

Select "Target (Class1 Tag)" in the network configuration settings. ⇒ [Device] ⇒ [Properties]

Item	Description	Setting range	
Device Designation	Device Name	Sets the name to use in management with EtherNet/IP Configuration Tool. By default, names of EtherNet/IP devices not registered in the network configuration setting are displayed in the form such as "DEVICE-A" and "DEVICE-B".	Up to 50 characters* ¹ (Default: Refer to the left.)
	Number	Sets the control number of the EtherNet/IP device. The control number that has not been set for EtherNet/IP devices can be selected from the list.	000 to 255 (Default: Minimum value of the control numbers of EtherNet/IP devices that have not been set)
	Active Configuration	Enables or disables the parameters set for the EtherNet/IP device on the RJ71EIP91. • Selected: Enabled • Not selected: Disabled Disable this item when the parameters of the EtherNet/IP device need to be deleted from the RJ71EIP91 with the settings in EtherNet/IP Configuration Tool held. Clearing of this check box is reflected against 'Reserved station (Class1)' (Un\G27168 to Un\G27183) on the RJ71EIP91.	• Selected • Not selected (Default: Selected)
	Comment	Displays the comment input field.	Up to 255 single-byte characters (Default: Blank)
	Connection No	Displays the connection number of the EtherNet/IP device. Connection numbers of EtherNet/IP devices are assigned from 1 in the order in which they were added.	—
Producer Tag	Tag Name	Specifies the tag name used in Class1 tag communications.	Up to 255 single-byte characters (Default: Blank)
	Size	Specifies the data size used in Class1 tag communications. (Unit: Bytes)	2 to 1444* ² (Default: 2)

*1 Characters from A to Z, numbers from 0 to 9, "." (dot), "-" (hyphen), and "_" (underscore) can be used. For the first character of a name, only characters from A to Z can be used.

*2 Only even numbers can be set.

Operation information list

This list displays information such as the operations performed in EtherNet/IP Configuration Tool and error messages.

Date / Time	Level	Event
02/16/18 09:38:21	Information	File 0001000700350101.edc. 1794 - 8 Point 24V DC Output, Source Revision 1.1. Connection Redundant Owner: transport type not authorized or not filled.
02/16/18 09:41:02	Information	Configuration offline.

Output Message View

"Output Message View Configuration" window

Set the information to be displayed in the operation information list.

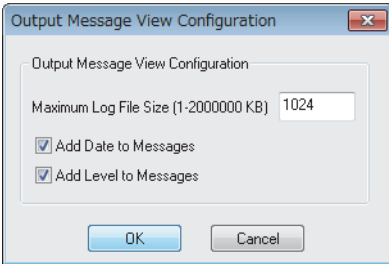

 [File] ⇒ [Message View] ⇒ [Configuration]



Item	Description	Setting range
Maximum Log File Size	Sets the maximum size of a log file. (Unit: KB)	1 to 2000000 (Default: 1024)
Add Date to Messages	Displays the date as a column item in the operation information list.	<ul style="list-style-type: none"> • Not selected • Selected (Default: Selected)
Add Level to Messages	Displays the classification as a column item in the operation information list.	<ul style="list-style-type: none"> • Not selected • Selected (Default: Selected)

3.2 Procedure for Registering EtherNet/IP Devices

This section describes the procedure for registering EtherNet/IP devices to the EtherNet/IP communication settings. The following two methods can be used to register EtherNet/IP devices.

- Configuring settings online ( Page 98 Configuring settings online)
- Configuring settings offline ( Page 98 Configuring settings offline)

Adding the EDS file

Follow the EDS Management wizard to add EtherNet/IP devices to "Device Library".

1. Open the "EDS Management" window.

 [Library] ⇒ [Add]

2. Click the [Next] button in the "EDS Management" window.

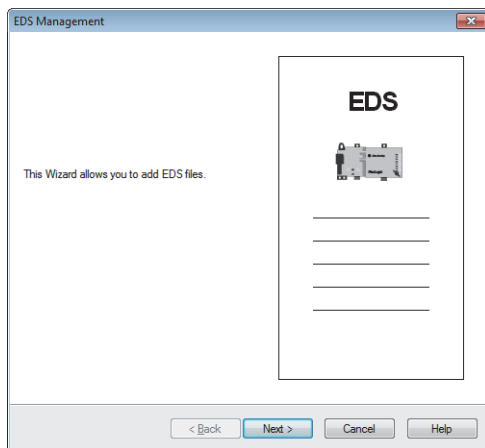

3. Select EDS files to add and click the [Next] button.

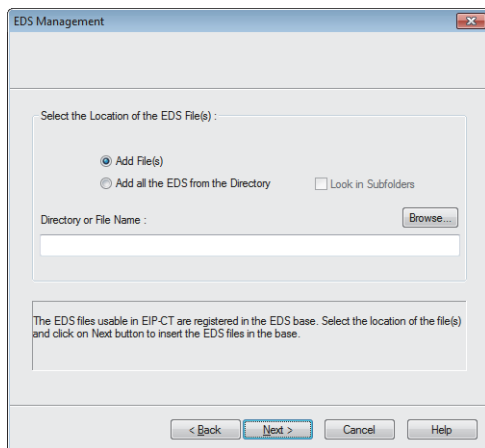

Item	Description	Setting range
Add File(s)	Select this item to add the selected EDS files. (Multiple EDS files can be added at a time.) Click the [Browse] button and select EDS files.	<ul style="list-style-type: none"> • Selected • Not selected (Default: Selected)
Add all the EDS from the Directory	Select this item to add all EDS files in the selected folder. Click the [Browse] button to select a folder.	<ul style="list-style-type: none"> • Selected • Not selected (Default: Not selected)
Look in Subfolders	Select this item to select subfolders in the selected folder when "Add all the EDS from the Directory" has been selected.	<ul style="list-style-type: none"> • Selected • Not selected (Default: Not selected)
Directory or File Name	Displays the path of the selected EDS file or selected folder. The storage location of the EDS file or folder can be directly specified.	—
[Browse] button	Displays the EDS file or the folder where EDS files have been stored.	—

4. The "EDS Management" window displays the additional result of the EDS files added to "Device Library". Check that the files have been properly added and click the [Next] button. (When the files have been properly added, OK is displayed in the "Status" field.)

Selecting an added EDS file and clicking the [View Selected File] button displays information of the EDS file in a text file.

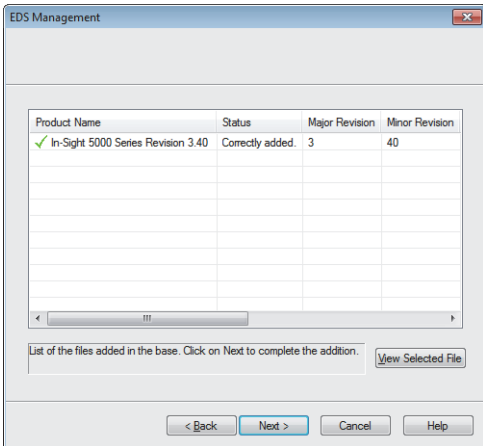

5. Click the [Finish] button to exit the EDS Management wizard.

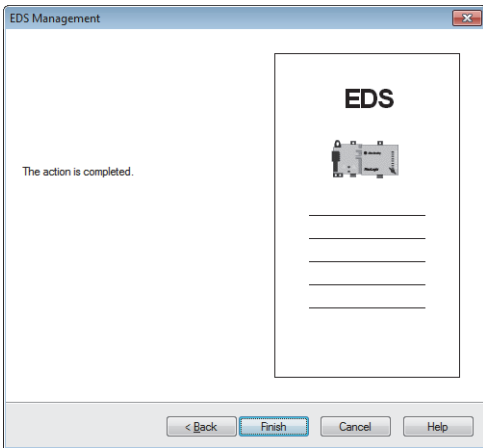

Configuring settings online

When setting EtherNet/IP devices online, the following conditions must be met.

- The RJ71EIP91 and EtherNet/IP device are connected to the network.
- A name has been set to the EtherNet/IP device, and the name does not duplicate the name of other EtherNet/IP devices.
- An IP address has been set to the EtherNet/IP device, and the IP address does not duplicate the IP addresses of other EtherNet/IP devices.

Setting procedure

1. Add the EtherNet/IP devices to be used to "Device Library". (☞ Page 96 Adding the EDS file)

2. Detect the EtherNet/IP devices on the network. (☞ Page 63 Network Detection)

☞ Select the [Network Detection] tab. ⇒ [Network] ⇒ [Read Network Configuration]

3. Add the detected EtherNet/IP devices to the network configuration settings.

[When EtherNet/IP devices are added one by one]

☞ Select the EtherNet/IP device in "Network Detection". ⇒ [Network] ⇒ [Insert in Configuration]

[When EtherNet/IP devices are added as a batch]

☞ Select the [Network Detection] tab. ⇒ [Network] ⇒ [Insert and Replace All]

Configuring settings offline

When settings are configured offline, the EtherNet/IP communication settings can be configured without the RJ71EIP91 and EtherNet/IP devices.

However, check the names of the EtherNet/IP devices used and the network configuration in advance.

Setting procedure

1. Add the EtherNet/IP devices to be used to "Device Library". (☞ Page 96 Adding the EDS file)

2. Add the EtherNet/IP devices to the network configuration settings.

☞ Select the EtherNet/IP device in "Device Library". ⇒ [Library] ⇒ [Insert in Configuration]

3.3 Setting File

A setting file (*.apa) is data that contains an IP address of the RJ71EIP91 set with EtherNet/IP setting, and the EtherNet/IP device configuration and parameter settings set with the network configuration.

Importing the setting file

Import the setting file to EtherNet/IP Configuration Tool.

1. Open the "Configuration Manager" window.

Right-click "EtherNet/IP Network" of the EtherNet/ IP setting ⇒ [Configuration Manager]

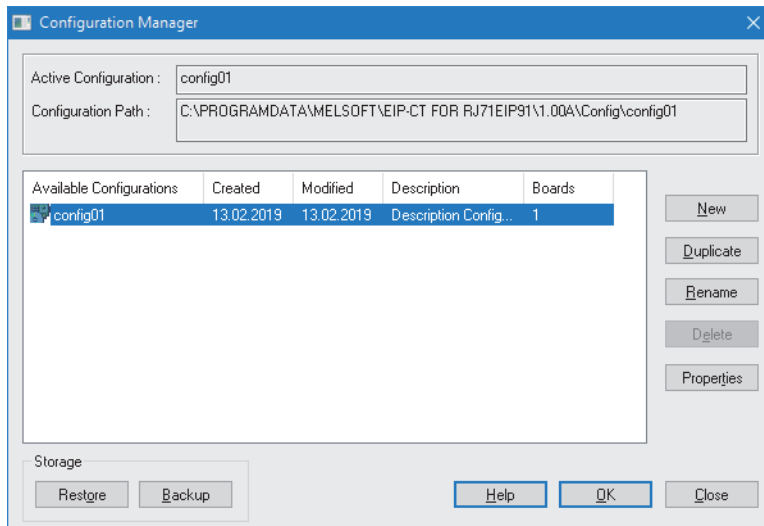

2. Click the [Restore] button to import the setting file to EtherNet/IP Configuration Tool.

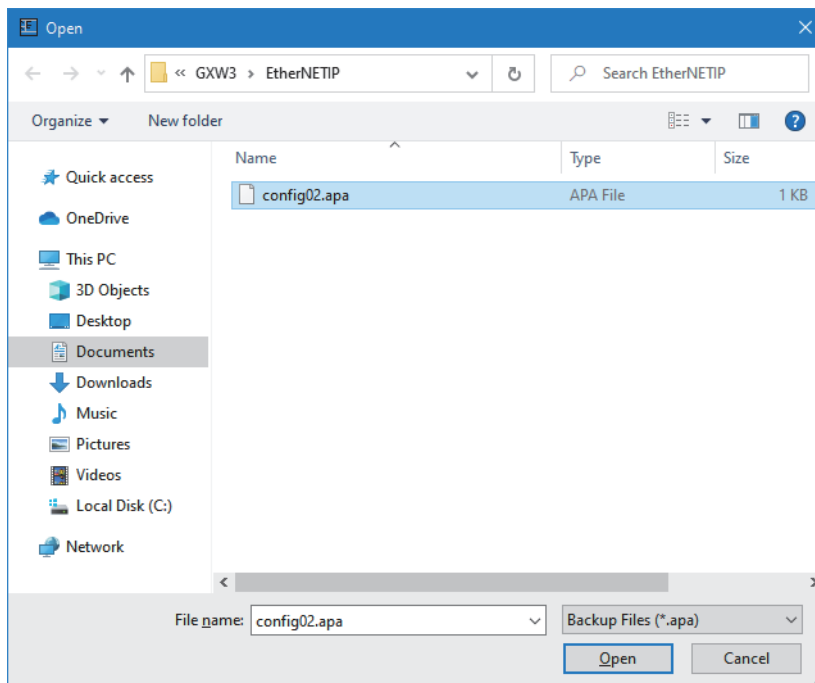

3. Name the file and click the [OK] button.

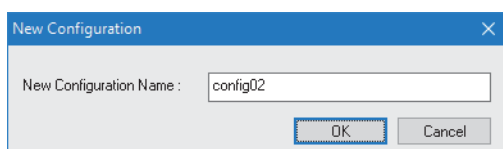

4. The setting files imported are displayed in the list.

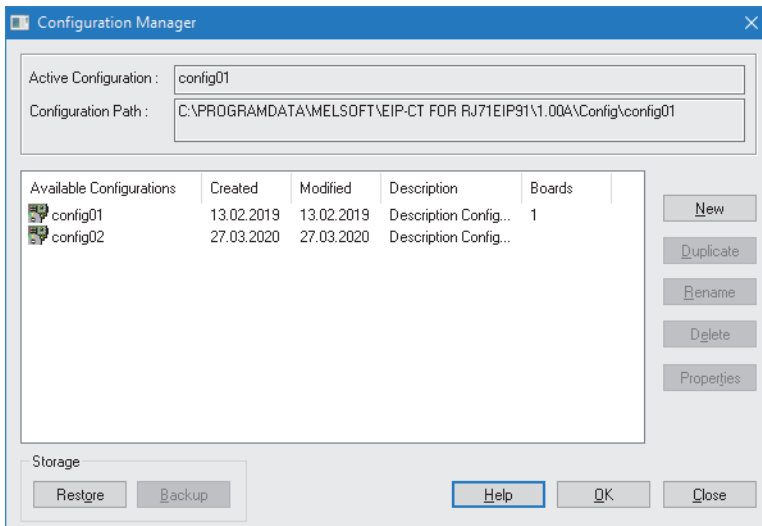

5. Click the [OK] button to exit the "Configuration Manager" window.

Exporting the setting file

Export a setting file from EtherNet/IP Configuration Tool.

1. Open the "Configuration Manager" window.

Right-click "EtherNet/IP Network" of the EtherNet/IP setting ⇒ [Configuration Manager]

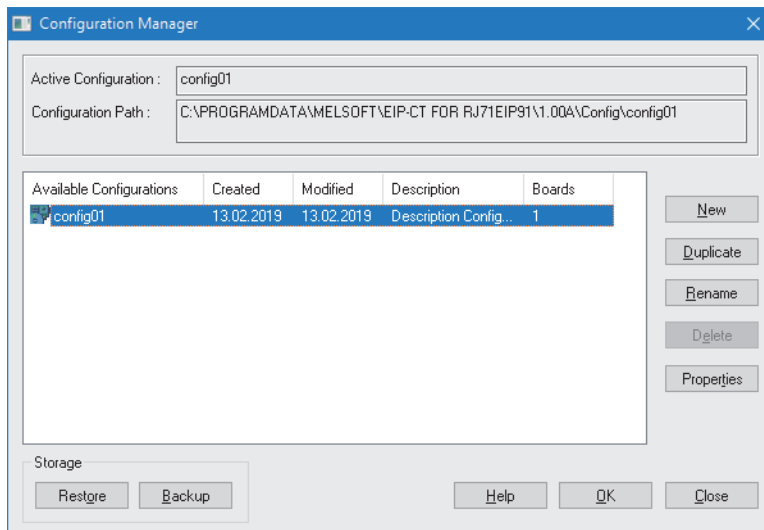

2. Select a project to be exported in the list and click the [Backup] button.

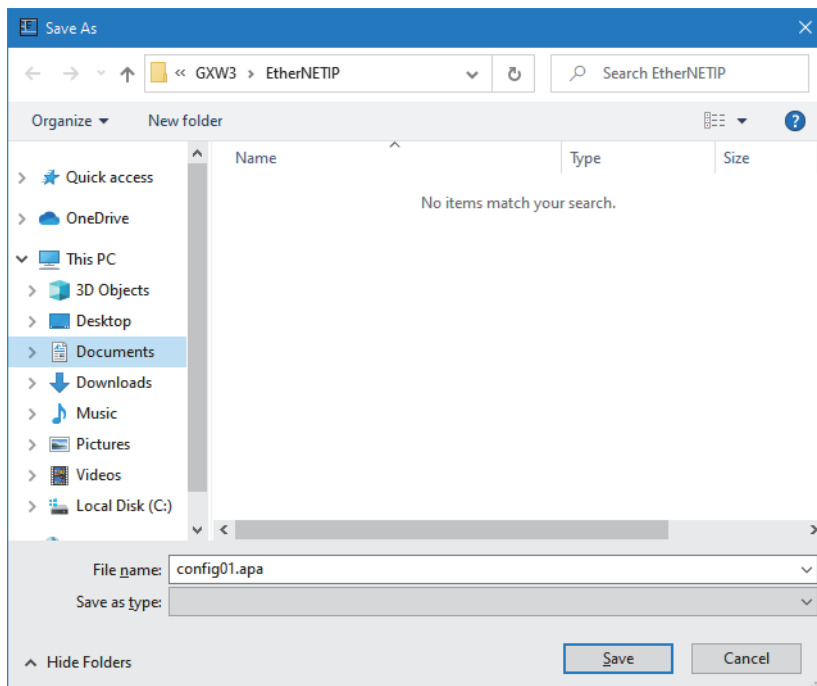

3. Export the setting file (*.apa) by clicking the [Save] button.

4. Click the [OK] button to exit the "Configuration Manager" window.

Re-editing the setting file uploaded

By reading the setting file written to the RJ71EIP91, the setting file can be re-edited with EtherNet/IP Configuration Tool. The setting file must be written to the RJ71EIP91 before uploading the setting file.

1. Read the information on the network configuration saved in the RJ71EIP91.

 [File] ⇒ [Upload]

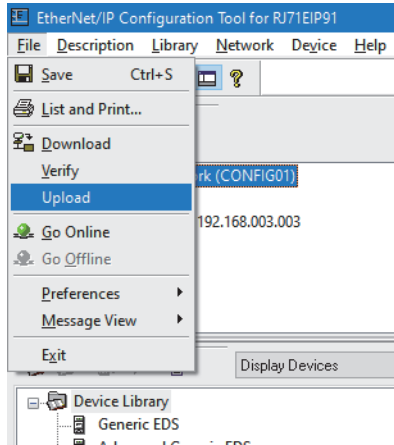

2. Check "configuration.apa" of "File to Upload".

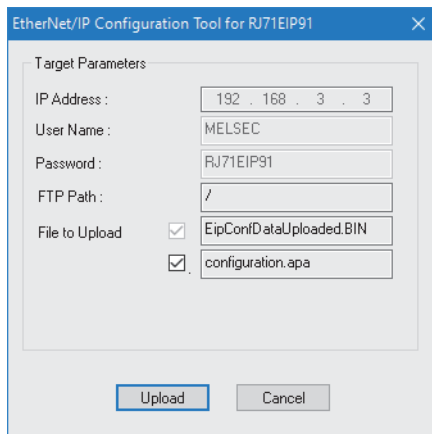

3. Click the [Upload] button.
4. The setting file storage location will be displayed in the message at the completion of uploaded (upload window). Click the [OK] button to close the upload window.

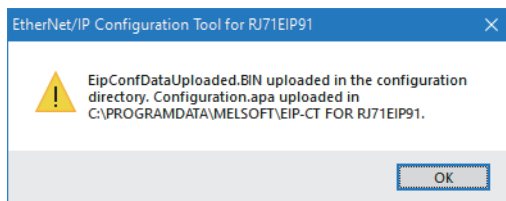

5. Import the setting file uploaded.

3.4 Checking the Software Version

Check the software version of EtherNet/IP Configuration Tool in the following window.

[Help] ⇒ [About]

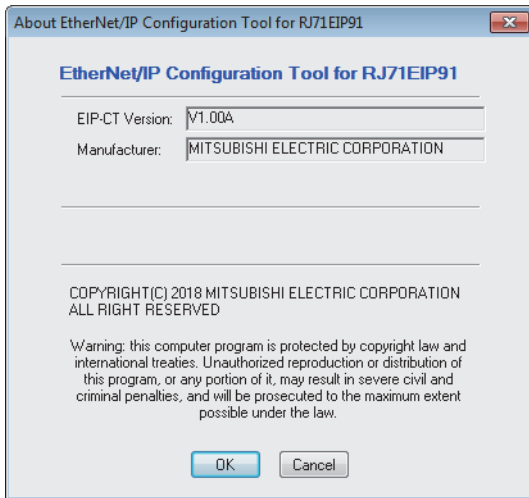

4 PROGRAMMING

This chapter describes program examples of UCMM message communications and PING tests.

For program examples of Class1 instance communications and Class1 tag communications, refer to the following.

📖 MELSEC iQ-R EtherNet/IP Network Interface Module User's Manual (Startup)

4.1 Program Example of UCMM Message Communications

This section provides a program example using the client function of UCMM message communications.

System configuration example

The following system configuration is used to explain the program example of UCMM message communications.

System configuration

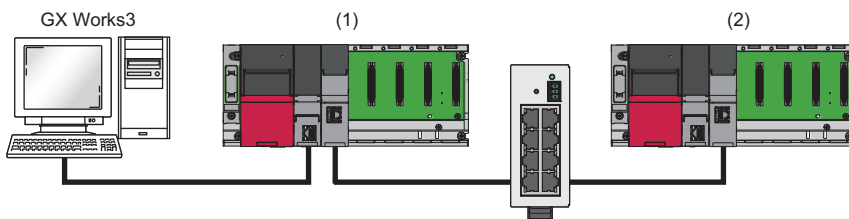

(1) Programmable controller system (scanner)

- Power supply module: R61P
- CPU module: R04CPU
- EtherNet/IP network interface module (client): RJ71EIP91 (start I/O number: 0000H to 001FH, IP address: 192.168.3.51)

(2) Programmable controller system (adapter)

- Power supply module: R61P
- CPU module: R04CPU
- EtherNet/IP network interface module (server): RJ71EIP91 (start I/O number: 0000H to 001FH, IP address: 192.168.3.2)

Communication content

The RJ71EIP91 on the scanner side is set to the client and the RJ71EIP91 on the adapter side is set to the server. Then, command requests are sent from the client to the server.

Command requests use the buffer memory of the RJ71EIP91 on the scanner side to operate the program.

After receiving a command request, the server executes the command processing and returns a command response to the client.

Setting parameters

Use the engineering tool to set the parameters.

Engineering tool settings

■RJ71EIP91 (client) settings

Connect the engineering tool to the scanner-side CPU module and set the parameters.

1. Set the CPU module as follows.

 [Project] ⇒ [New]

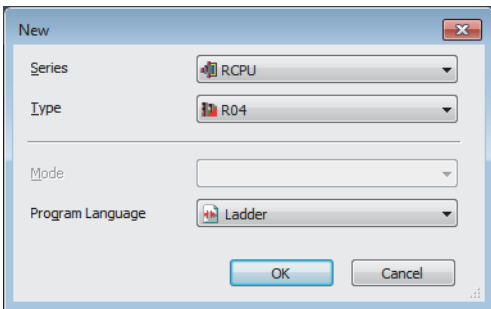

2. Click the [Setting Change] button to use the module label.

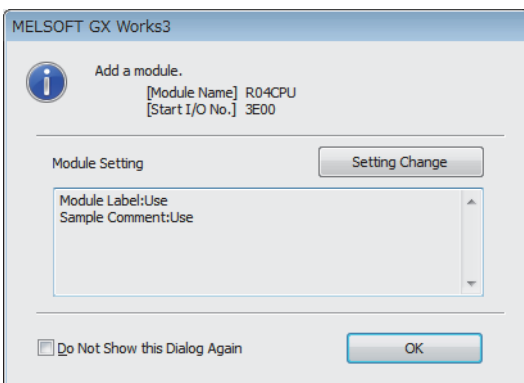

3. Set the RJ71EIP91 as follows.

 [Navigation window] ⇒ [Parameter] ⇒ [Module Information] ⇒ Right-click ⇒ [Add New Module]

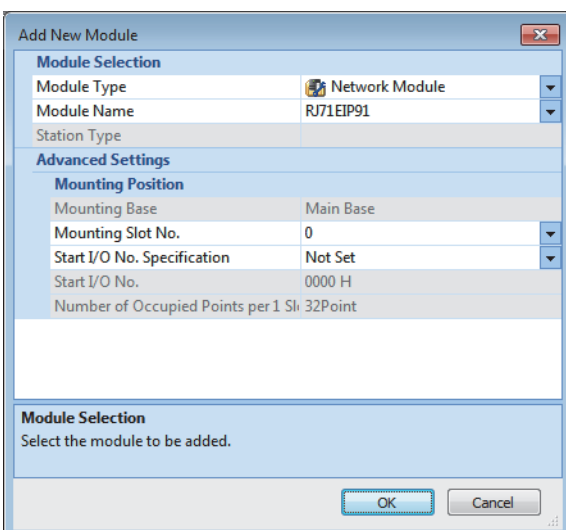

4. Set the items in "Basic Setting" as follows.

[Navigation window] ⇒ [Parameter] ⇒ [Module Information] ⇒ [RJ71EIP91] ⇒ [Basic Setting]

Item	Setting Value
Various Operations Settings	
Mode Settings	Online
Own Node Setting	Set the information of the own node such as IP address.
IP Address Setting	Set the IP address, subnet mask, and default gateway for the own node.
IP Address	192.168.3.51
Subnet Mask	255.255.255.0
Default Gateway	

5. Write the set parameters to the CPU module. Then reset the CPU module or turn the system off and on.

[Online] ⇒ [Write to PLC]

■RJ71EIP91 (server) settings

Connect the engineering tool to the adapter-side CPU module and set the parameters.

1. Set the CPU module as follows.

[Project] ⇒ [New]

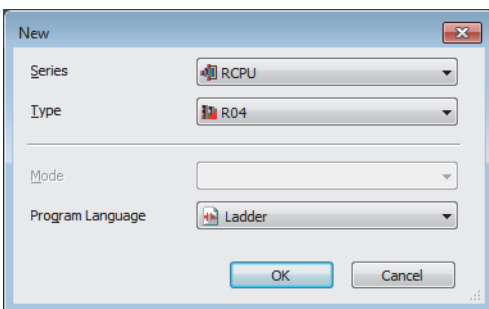

2. Click the [Setting Change] button to use the module label.

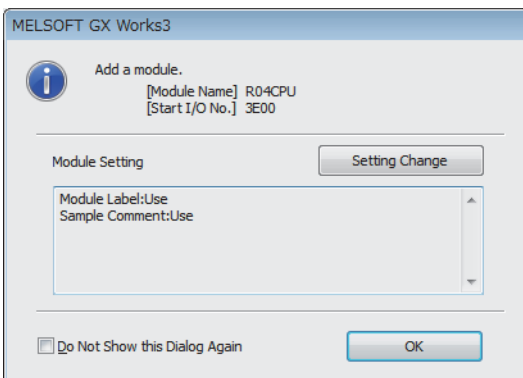

3. Set the RJ71EIP91 as follows.

[Navigation window] ⇒ [Parameter] ⇒ [Module Information] ⇒ Right-click ⇒ [Add New Module]

Add New Module

Module Selection

Module Type: Network Module
Module Name: RJ71EIP91
Station Type:

Advanced Settings

Mounting Position

Mounting Base: Main Base
Mounting Slot No.: 0
Start I/O No. Specification: Not Set
Start I/O No.: 0000 H
Number of Occupied Points per 1 Slot: 32Point

Module Selection

Select the module to be added.

OK Cancel

4. Set the items in "Basic Setting" as follows.

[Navigation window] ⇒ [Parameter] ⇒ [Module Information] ⇒ [RJ71EIP91] ⇒ [Basic Setting]

Item	Setting Value
Various Operations Settings	
Mode Settings	Online
Own Node Setting	Set the information of the own node such as IP address.
IP Address Setting	Set the IP address, subnet mask, and default gateway for the own node.
IP Address	192.168.3.2
Subnet Mask	255.255.255.0
Default Gateway	

5. Write the set parameters to the CPU module. Then reset the CPU module or turn the system off and on.

[Online] ⇒ [Write to PLC]

Point

In the program example, default values are used for parameters that are not shown above. For the parameters, refer to the following.

Page 45 PARAMETER SETTINGS

Program example

The following example shows a program to execute UCMM message communications by turning on the UCMM command send request in the program.

Classification	Label name	Description	Device																
Module label	EIP91_1.bSts_ModuleReady	Module Ready	X0																
	EIP91_1.bSts_CommunicationReady	Communication Ready	X1F																
	EIP91_1.bSet_CommunicationStartupRequest	EtherNet/IP communication start request	Y10																
	EIP91_1.bnSet_UCMMSendRequest_D	UCMM data link execution request	U0\G393216.0																
	EIP91_1.bnSts_UCMMSendRequestAcceptance_D	UCMM data link execution request acceptance	U0\G393232.0																
	EIP91_1.bnSts_UCMMSendCompletion_D	UCMM data link execution completion	U0\G393248.0																
	EIP91_1.stnUCMMCommandArea[1].unSet_Request_TargetIPAddress_D[0]	UCMM data link request command (No.1) Target IP Address (lower)	U0\G393281																
	EIP91_1.stnUCMMCommandArea[1].unSet_Request_TargetIPAddress_D[1]	UCMM data link request command (No.1) Target IP Address (upper)	U0\G393282																
	EIP91_1.stnUCMMCommandArea[1].uSet_Request_Service_D	UCMM data link request command (No.1) Service	U0\G393283																
	EIP91_1.stnUCMMCommandArea[1].uSet_Request_Class_D	UCMM data link request command (No.1) Class	U0\G393286																
	EIP91_1.stnUCMMCommandArea[1].uSet_Request_Instance_D	UCMM data link request command (No.1) Instance	U0\G393287																
	EIP91_1.stnUCMMCommandArea[1].uSet_Request_Attribute_D	UCMM data link request command (No.1) Attribute	U0\G393288																
	EIP91_1.stnUCMMCommandArea[1].uSet_Request_DataLength_D	UCMM data link request command (No.1) Data length	U0\G393289																
	EIP91_1.stnUCMMCommandArea[1].unSet_Request_RequestData_D	UCMM data link request command (No.1) Request data	U0\G393312																
EIP91_1.stnUCMMCommandArea[1].unResult_Response_ReceiveData_D	UCMM data link receive command (No.1) Receive data	U0\G394080																	
Label to be defined	Define global labels as shown below.																		
	<table border="1"> <thead> <tr> <th>Label Name</th> <th>Data Type</th> <th>Class</th> <th>Assign (Device/Label)</th> </tr> </thead> <tbody> <tr> <td>bCommunicationStopRequest</td> <td>Bit</td> <td>VAR_GLOBAL</td> <td>M10</td> </tr> <tr> <td>bUCMMCommandSendRequest</td> <td>Bit</td> <td>VAR_GLOBAL</td> <td>M100</td> </tr> <tr> <td>unGetUCMMResponseData</td> <td>Word [Unsigned]/Bit String [16-bit](0..706)</td> <td>VAR_GLOBAL</td> <td>D1000</td> </tr> </tbody> </table>			Label Name	Data Type	Class	Assign (Device/Label)	bCommunicationStopRequest	Bit	VAR_GLOBAL	M10	bUCMMCommandSendRequest	Bit	VAR_GLOBAL	M100	unGetUCMMResponseData	Word [Unsigned]/Bit String [16-bit](0..706)	VAR_GLOBAL	D1000
Label Name	Data Type	Class	Assign (Device/Label)																
bCommunicationStopRequest	Bit	VAR_GLOBAL	M10																
bUCMMCommandSendRequest	Bit	VAR_GLOBAL	M100																
unGetUCMMResponseData	Word [Unsigned]/Bit String [16-bit](0..706)	VAR_GLOBAL	D1000																

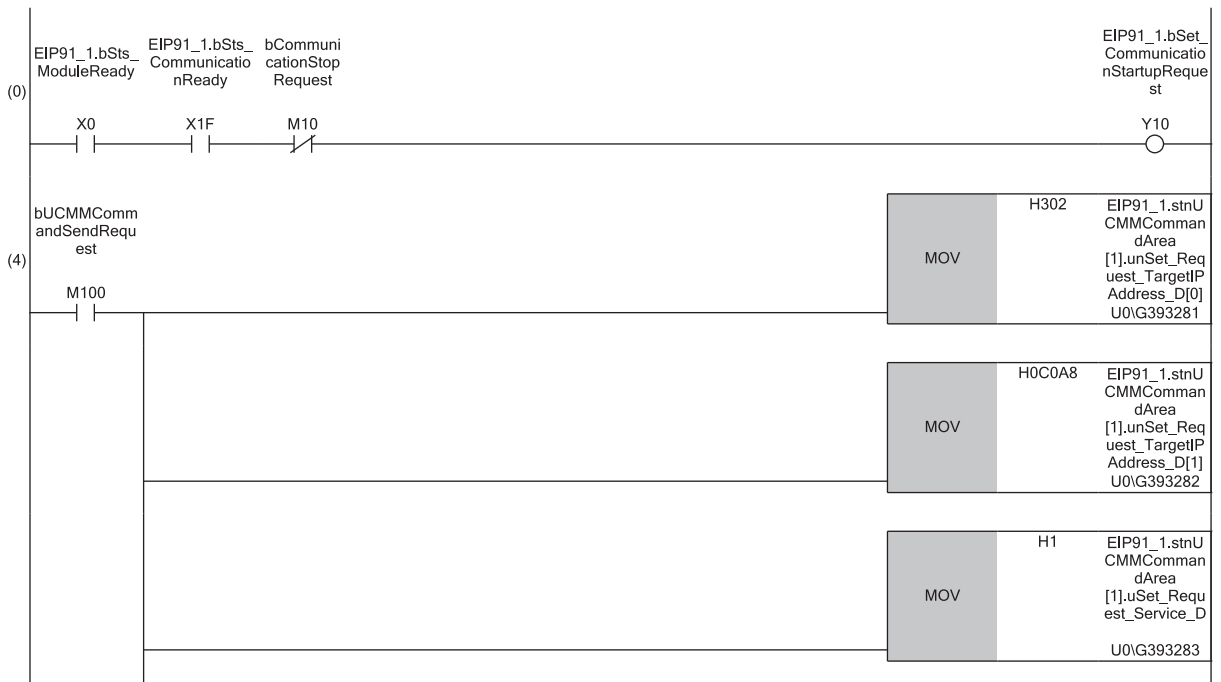

4

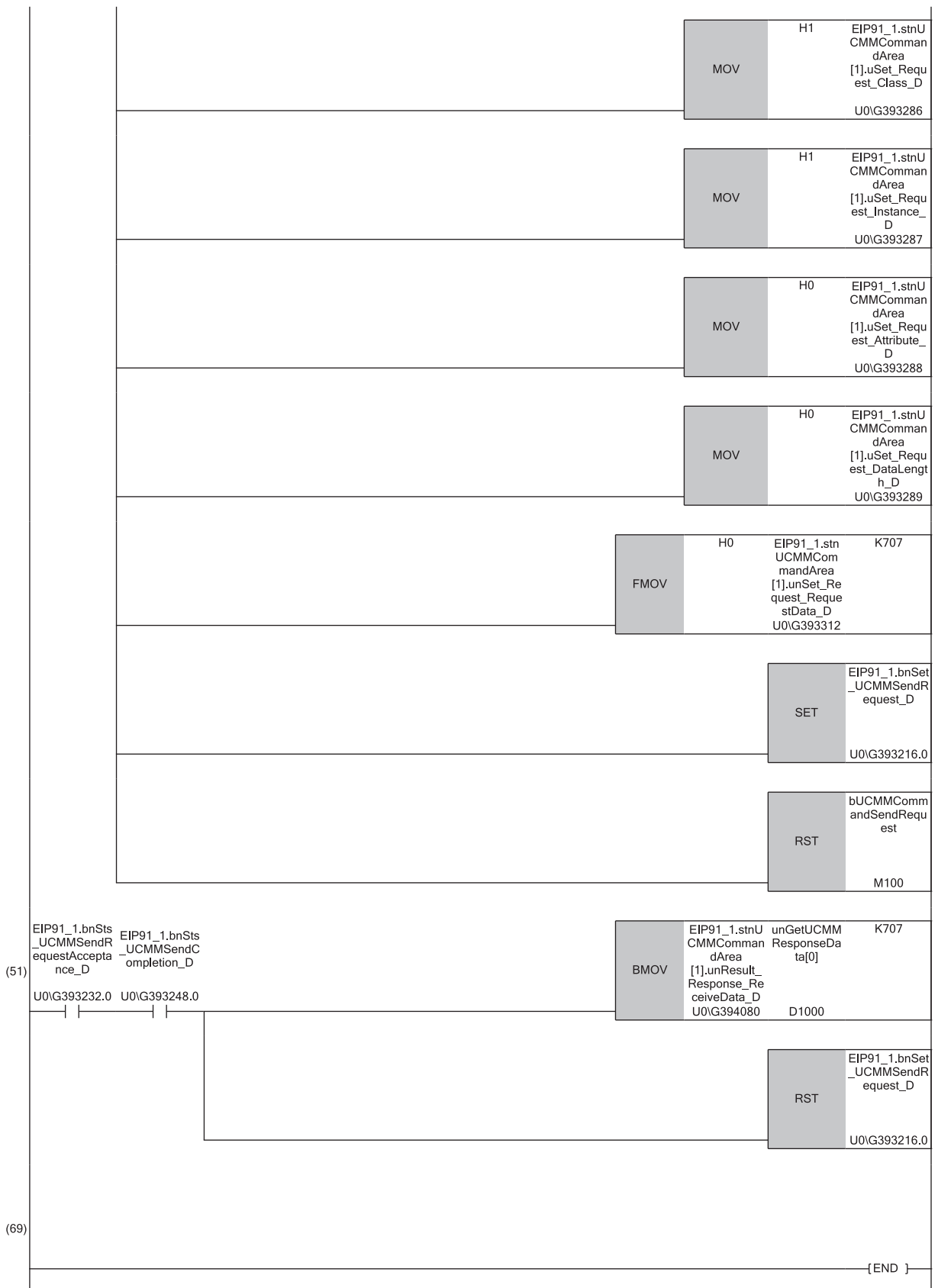

- (0) Communication start processing
- (4) Send processing of command setting and command request of UCMM message communications
- (51) Acquire processing of command response of UCMM message communications

4.2 Program Example of PING Test

This section provides a program example of PING tests.

System configuration example

The following system configuration is used to explain the program example of PING test.

System configuration

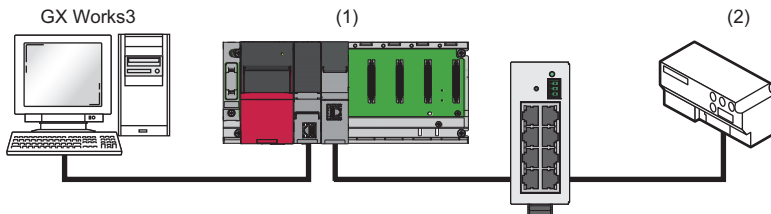

(1) Programmable controller system

- Power supply module: R61P
- CPU module: R04CPU
- EtherNet/IP network interface module: RJ71EIP91 (start I/O number: 0000H to 001FH, IP address: 192.168.3.51)

(2) EtherNet/IP device (IP address: 192.168.3.50)

Communication content

The PING test is performed by sending an echo request from the RJ71EIP91 to the EtherNet/IP device and checking the reception of the echo response from the EtherNet/IP device.

PING tests use the buffer memory of the RJ71EIP91 to operate the program.

The following table lists the buffer memory used by the PING test.

Address	Item	Reference	
Un\G27904	PING test request area	Page 157 PING test request area (Un\G27904 to Un\G27907)	
Un\G27905			Communication time check
Un\G27906 to Un\G27907			Transmission count
		IP Address	
Un\G27908	PING test result area	Page 157 PING test result area (Un\G27908 to Un\G27911)	
Un\G27909			Result
Un\G27910			Total Number of packet transmissions
Un\G27911			Number of success
		Number of failure	

Setting parameters

Use the engineering tool to set the parameters.

Engineering tool settings

■RJ71EIP91 settings

Connect the engineering tool to the CPU module and set the parameters.

1. Set the CPU module as follows.

 [Project] ⇒ [New]

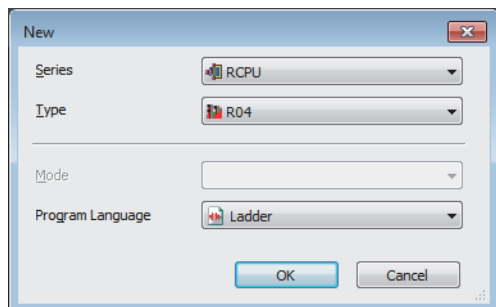

2. Click the [Setting Change] button to set to use the module label.

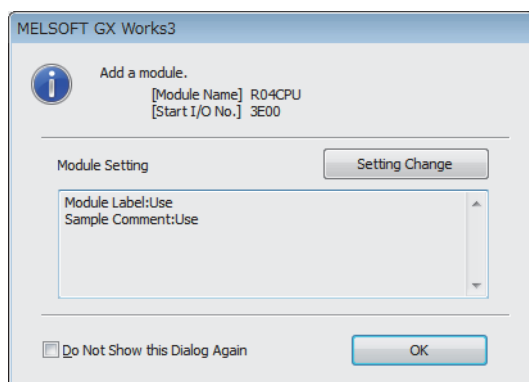

3. Set the RJ71EIP91 as follows.

 [Navigation window] ⇒ [Parameter] ⇒ [Module Information] ⇒ Right-click ⇒ [Add New Module]

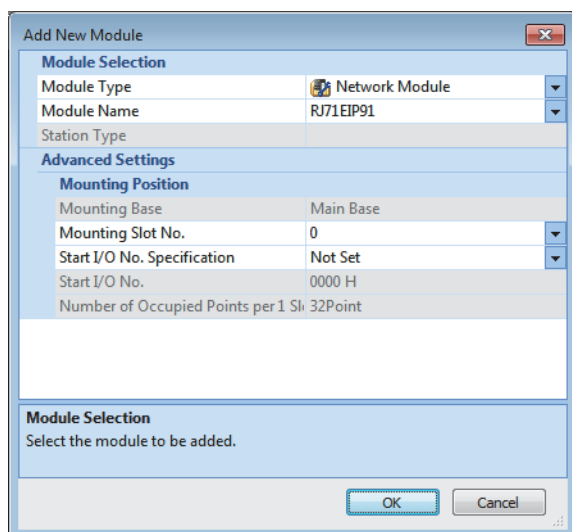

4. Set the items in "Basic Setting" as follows.

[Navigation window] ⇒ [Parameter] ⇒ [Module Information] ⇒ [RJ71EIP91] ⇒ [Basic Setting]

Item	Setting Value
Various Operations Settings	
Mode Settings	Online
Own Node Setting	Set the information of the own node such as IP address.
IP Address Setting	Set the IP address, subnet mask, and default gateway for the own node.
IP Address	192.168.3.51
Subnet Mask	255.255.255.0
Default Gateway	

5. Write the set parameters to the CPU module. Then reset the CPU module or turn the system off and on.

[Online] ⇒ [Write to PLC]

Program example

The following example shows a program to execute the PING test by turning on the PING test request command in the program.

Classification	Label name	Description	Device
Module label	EIP91_1.bSts_ModuleReady	Module Ready	X0
	EIP91_1.bSts_PingTestComplete	PING test completion	X12
	EIP91_1.bSet_PingTestRequest	PING test execution request	Y12
	EIP91_1.uSet_PingTestRequest_CommunicationTimeCheck_D	PING test request area Communication time check	U0\G27904
	EIP91_1.uSet_PingTestRequest_TransmissionsCount_D	PING test request area Transmission count	U0\G27905
	EIP91_1.unSet_PingTestRequest_IPAddress_D[0]	PING test request area IP Address (lower)	U0\G27906
	EIP91_1.unSet_PingTestRequest_IPAddress_D[1]	PING test request area IP Address (upper)	U0\G27907
	EIP91_1.unArea_PingTestReceiveResulteArea_D[0]	PING test result area Result	U0\G27908
	EIP91_1.unArea_PingTestReceiveResulteArea_D[1]	PING test result area Total Number of packet transmissions	U0\G27909
	EIP91_1.unArea_PingTestReceiveResulteArea_D[2]	PING test result area Number of success	U0\G27910
	EIP91_1.unArea_PingTestReceiveResulteArea_D[3]	PING test result area Number of failure	U0\G27911

Label Name	Data Type	Class	Assign (Device/Label)
bPingCommandRequest	Bit	VAR_GLOBAL	M0
unPINGtestresultResult	Word [Unsigned]/Bit String [16-bit](0..3)	VAR_GLOBAL	D300
bPingtesterror	Bit	VAR_GLOBAL	F0

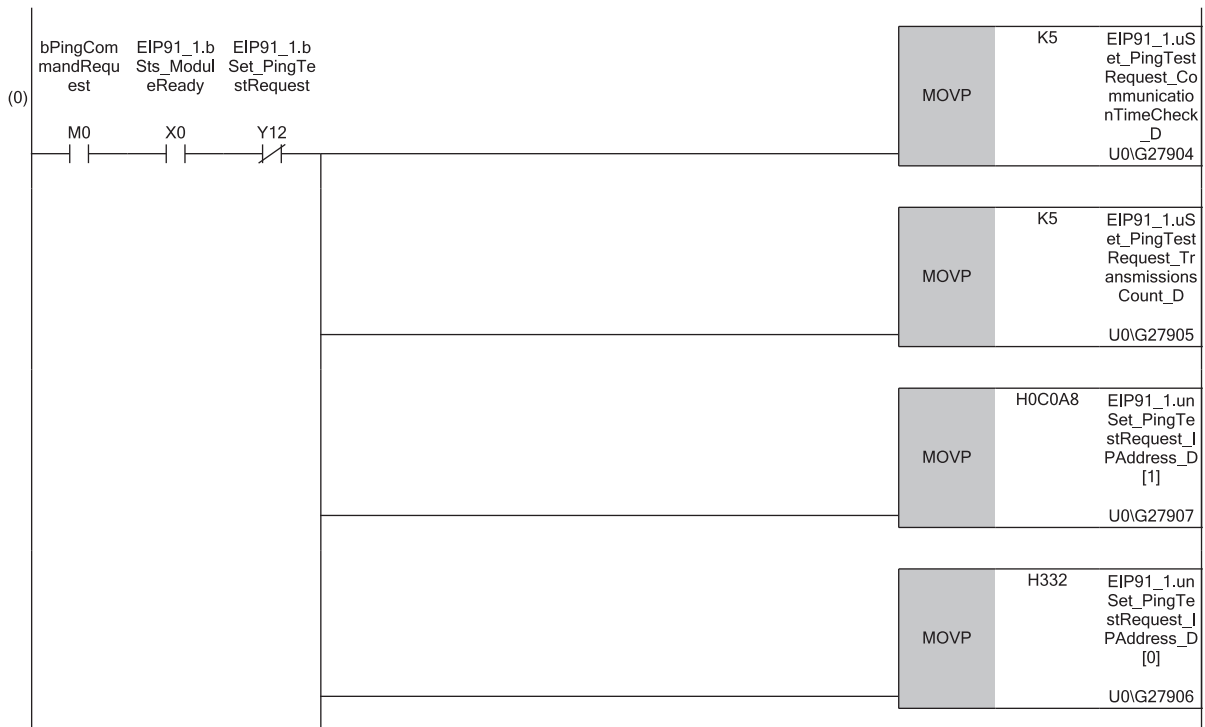

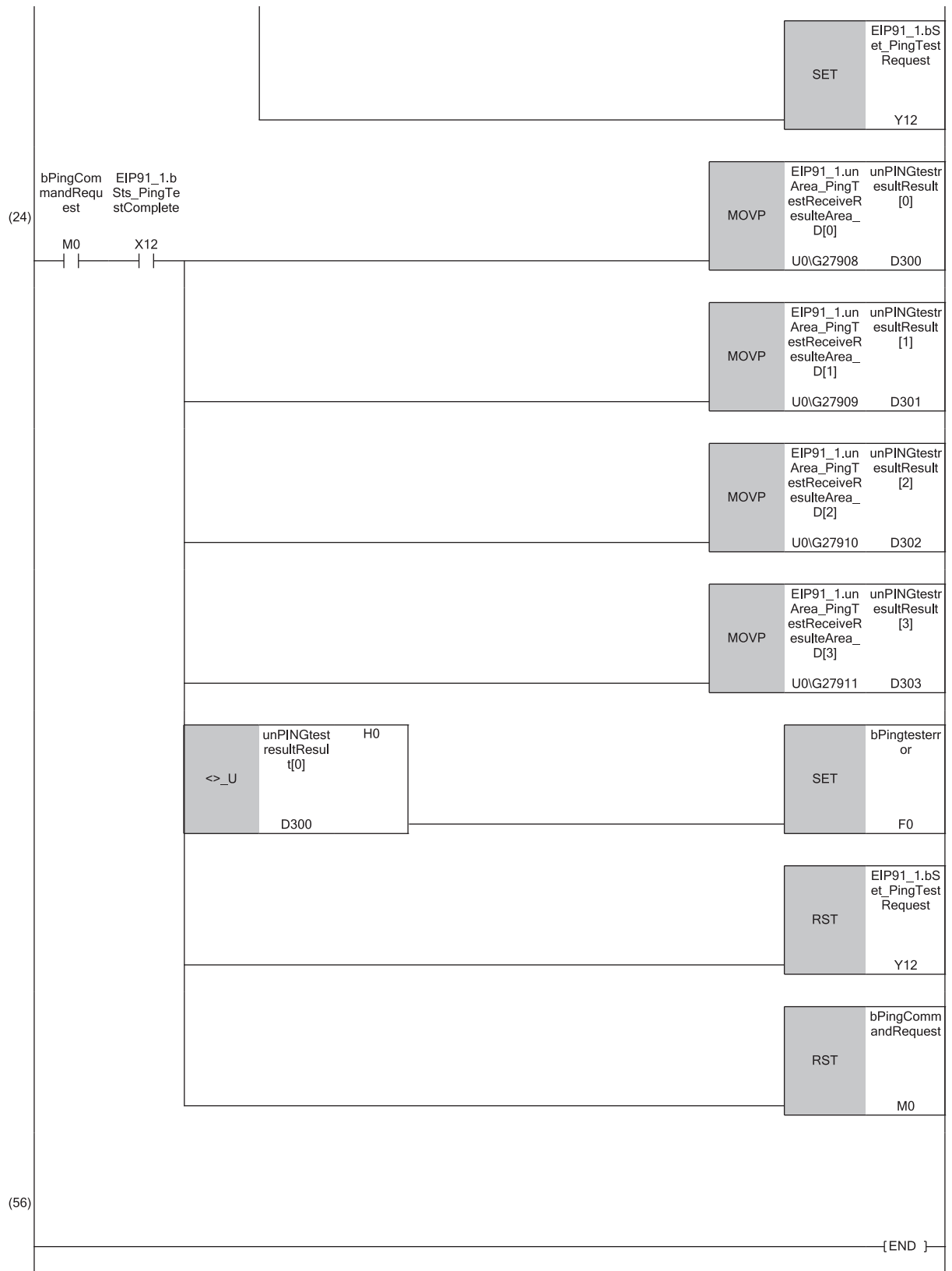

(0) PING test request processing
 (24) PING test response processing

5 TROUBLESHOOTING

This chapter describes troubleshooting of the RJ71EIP91.

5.1 Checking with LEDs

This section describes troubleshooting using the LEDs.

The error status can be determined by the status of the RUN LED, ERR LED, and MS LED.

RUN LED	ERR LED	MS LED	Error status *1	Description
Off	On, flashing	On in red	Major error	An error such as hardware failure or memory failure. The module stops operating.
On	Flashing	On in red	Moderate error	An error such as system bus failure. The module stops operating.
On	On	Flashing in red	Minor error	An error such as communication failure. The module continues operating.

*1 When multiple errors occur, the error status is displayed in the order of major, moderate, and minor.

When the RUN LED turns off

When the RUN LED turns off after the RJ71EIP91 is powered on, check the following.

Check item	Action
Is the RJ71EIP91 mounted correctly?	Securely mount the RJ71EIP91 on the base unit.
Is the system powered off and on or the CPU module reset while parameters are written?	Power off and on the system or reset the CPU module and start the RJ71EIP91. After that, write the parameters again.

If the above actions do not solve the problem, perform the hardware test to check for the RJ71EIP91 failure. (☞ Page 125 Hardware Test)

When the ERR LED turns on or is flashing

When the ERR LED turns on or is flashing, check the following.

Check item	Action
Does any error occur in the module diagnostics?	Take the actions displayed in the module diagnostics. (☞ Page 118 Checking the Module Status)

When the MS LED turns on in red or is flashing in red

When the MS LED turns on in red or is flashing in red, check the following.

Check item	Action
Does any error occur in the module diagnostics?	Take the actions displayed in the module diagnostics. (☞ Page 118 Checking the Module Status)

When the NS LED is flashing in green

When the NS LED is flashing in green, check the following.

Check item	Action
Have the following buffer memory values been checked? • 'Class1 communication status' (UnG27136 to UnG27183) • 'Class1 Connection Behavior Error status' (UnG27392 to UnG27647)	<ul style="list-style-type: none">• Check whether the buffer memory values are normal.• Take the action corresponding to the value of 'Class1 Connection Behavior Error status' (UnG27392 to UnG27647). (☞ Page 157 Class1 Connection Behavior Error status (UnG27392 to UnG27647))
Has communication start processing been performed correctly with 'EtherNet/IP communication start request' (Y10)?	<ul style="list-style-type: none">• Check that 'EtherNet/IP communication start request' (Y10) is on.• If 'EtherNet/IP data link continuation specification request' (UnG16634) is set to 16 (continue EtherNet/IP communication), turn 'EtherNet/IP communication start request' (Y10) on again.

When the NS LED is flashing in red

When the NS LED is flashing in red, check the following.

Check item	Action
Is the EtherNet/IP device connected correctly?	<ul style="list-style-type: none">• Check whether the operating status of the EtherNet/IP device is normal.• Check for errors in the line status.• The line may be busy, so retry at a later time.

When the SD/RD LED does not turn on during data communications

When the SD/RD LED does not turn on during data communications, check the following.

Check item	Action
Is the ERR LED on or flashing?	Take the actions displayed in the module diagnostics. (☞ Page 118 Checking the Module Status)
Is the Ethernet cable connected correctly?	<ul style="list-style-type: none">• Connect the Ethernet cable again.• Perform a PING test to check the line status. (☞ Page 124 PING test)
Are the parameter settings correct?	Revise the following items with EtherNet/IP Configuration Tool. <ul style="list-style-type: none">• Model and name of the connected EtherNet/IP device• IP address of the connected EtherNet/IP device• Version of the registered EDS file
Are there any errors in the program?	<ul style="list-style-type: none">• Check that 'EtherNet/IP communication start request' (Y10) is on.• Check and correct the data communication program.

If the above actions do not solve the problem, perform the hardware test to check for the RJ71EIP91 failure. (☞ Page 125 Hardware Test)

5.2 Checking the Module Status

The following functions can be used in the "Module Diagnostics" window for the RJ71EIP91.

Function	Application
Error Information	Displays the details of the errors currently occurring. Click the [Event History] button to check the history of errors that have occurred on the RJ71EIP91, errors detected for each module, and operations that have been executed.
Module Information List	Displays various status information of the RJ71EIP91.

Error Information

Check the details of the error currently occurring and action to eliminate the error.

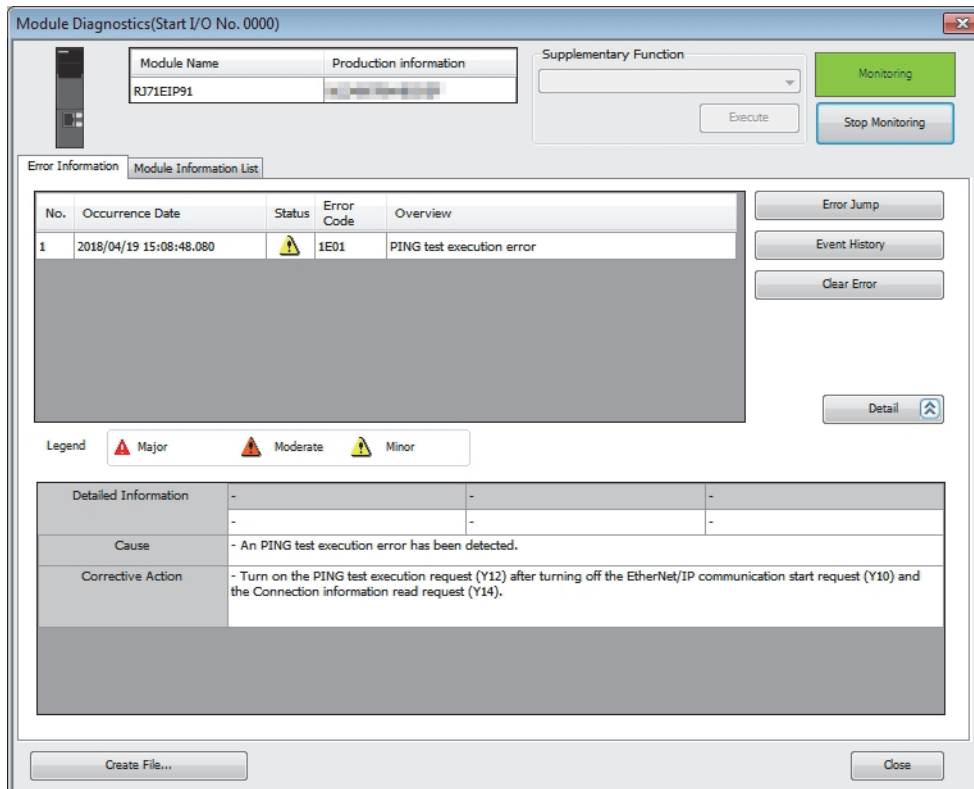

Item	Description
Status	Major: An error such as hardware failure or memory failure. The module stops operating.
	Moderate: An error, such as parameter error, which affects module operation. The module stops operating.
	Minor: An error such as communication failure. The module continues operating.
Detailed Information	Displays detailed information about each error (maximum of three pieces).
Cause	Displays the detailed error causes.
Corrective Action	Displays the actions to eliminate the error causes.

Module Information List

Switch to the [Module Information List] tab to check various status information of the RJ71EIP91.

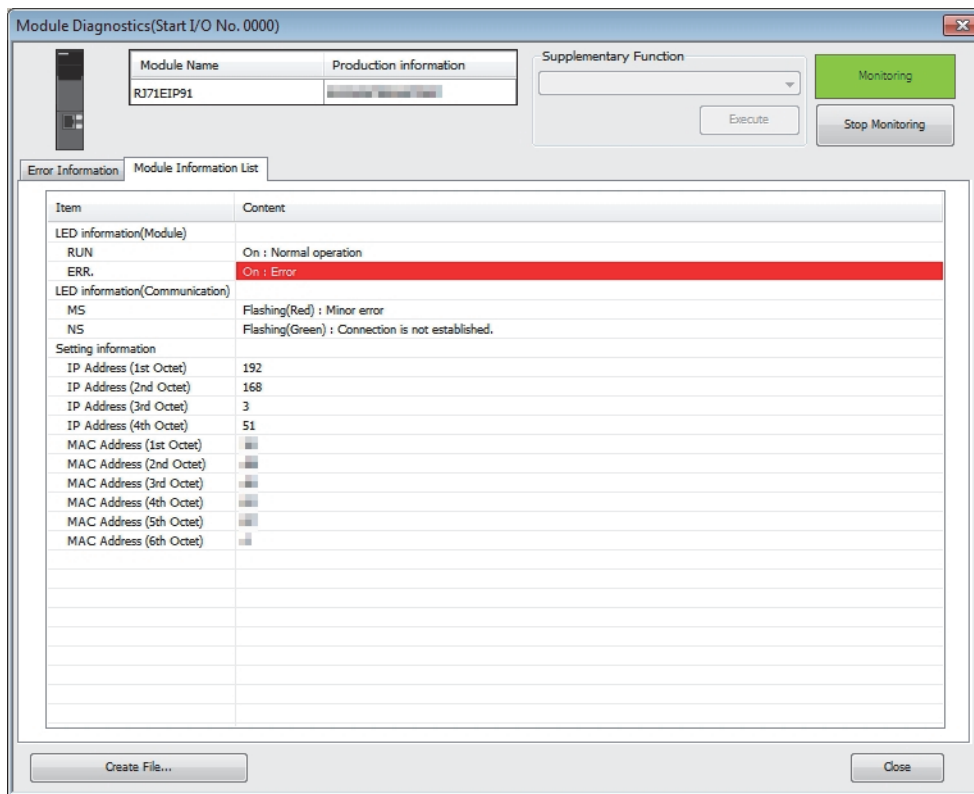

Item	Description	
LED information (Module)	Displays the status of the RUN LED and ERR LED of the RJ71EIP91.	
LED information (Communication) ^{*1}	Displays the status of the MS LED and NS LED of the RJ71EIP91.	
Setting information ^{*1}	IP Address (1st Octet)	Displays the IP address of the RJ71EIP91.
	IP Address (2nd Octet)	
	IP Address (3rd Octet)	
	IP Address (4th Octet)	
	MAC Address (1st Octet)	Displays the MAC address of the RJ71EIP91.
	MAC Address (2nd Octet)	
	MAC Address (3rd Octet)	
	MAC Address (4th Octet)	
MAC Address (5th Octet)		
MAC Address (6th Octet)		

*1 An undefined value is stored during hardware test.

5.3 Checking the Network Status

Use the following methods to check the EtherNet/IP network status.

- Network diagnostics of EtherNet/IP Configuration Tool
- Checking with the buffer memory
- PING test

Network diagnostics of EtherNet/IP Configuration Tool

The network diagnostics of EtherNet/IP Configuration Tool can be used to check the connection information of EtherNet/IP devices.

For details on EtherNet/IP Configuration Tool, refer to the following.

☞ Page 52 EtherNet/IP Configuration Tool

Displaying the connection status of EtherNet/IP device

Enabling diagnostic mode in EtherNet/IP Configuration Tool displays the connection status of the EtherNet/IP device.

Operating procedure

1. Connect a personal computer on which EtherNet/IP Configuration Tool is installed to the same network as the RJ71EIP91.
2. Start EtherNet/IP Configuration Tool.
3. Add the EtherNet/IP device to the network configuration settings. (☞ Page 96 Procedure for Registering EtherNet/IP Devices)
4. Switch EtherNet/IP Configuration Tool to the online state.
☞ [File] ⇒ [Go Online]
5. Write the set parameters to the RJ71EIP91.
☞ [File] ⇒ [Download]
6. Enable diagnostic mode.
☞ [Device] ⇒ [Diagnostic]
7. When the diagnostic mode is enabled, the connection status of EtherNet/IP devices is displayed in the network configuration setting.

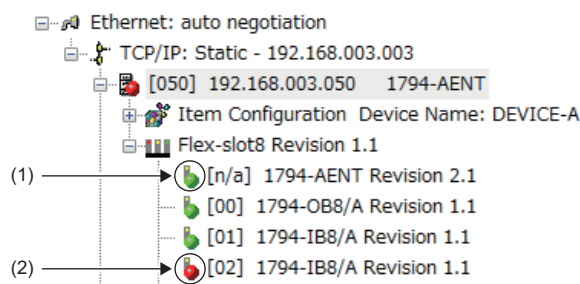

- (1) An EtherNet/IP device is connected, and EtherNet/IP communications are in progress.
(2) An EtherNet/IP device is connected, but EtherNet/IP communications are not in progress.

To check the connection status of EtherNet/IP devices, the actual network configuration needs to be written to the RJ71EIP91 with EtherNet/IP Configuration Tool. When the diagnostic mode is enabled, the network configuration setting cannot be changed.

Point

To start EtherNet/IP communications, 'EtherNet/IP communication start request' (Y10) must be turned off and on and 'EtherNet/IP communication in process' (X10) must be in the ON state.

Checking the connection information of EtherNet/IP devices

This section describes how to check the connection information of EtherNet/IP devices.

Operating procedure

1. Display the EtherNet/IP device setting window.
Select the EtherNet/IP display in the network configuration settings. ⇒ [Device] ⇒ [Properties]
2. Select the [Diagnostic] tab.
3. Select an EtherNet/IP device to display its connection information. For details on the window, refer to the following.
Page 88 [Diagnostic] tab

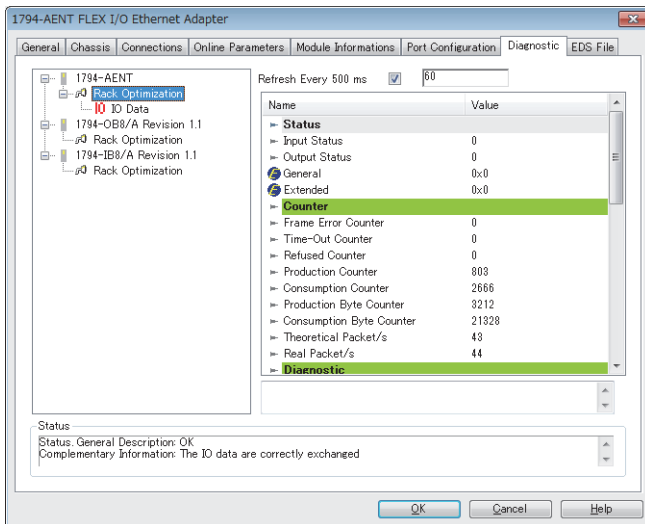

5

Checking the I/O data of EtherNet/IP devices

This section describes how to check the I/O data of EtherNet/IP devices.

Operating procedure

1. Display the EtherNet/IP device setting window.
Select the EtherNet/IP display in the network configuration settings. ⇒ [Device] ⇒ [Properties]
2. Select the [Diagnostic] tab.
3. I/O data information is displayed when "IO Data" is selected. For details on the window, refer to the following.
Page 88 [Diagnostic] tab

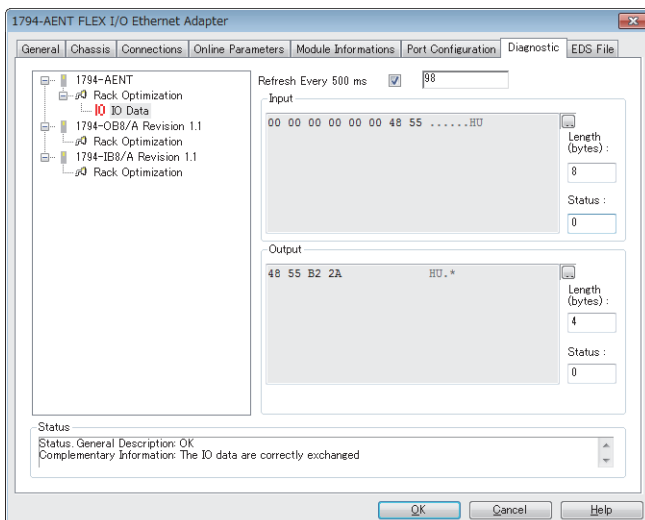

Checking with the buffer memory

The status of the Class1 communication connections and the error details can be checked with the following buffer memory areas.

- 'Data link status (Class1)' (Un\G27136 to Un\G27151)
- 'Error status (Class1)' (Un\G27152 to Un\G27167)
- 'Reserved station (Class1)' (Un\G27168 to Un\G27183)
- 'Class1 Connection Behavior Error status' (Un\G27392 to Un\G27647)
- 'Node information area' (Un\G28160 to Un\G28170)

Connection information can also be checked with the following buffer memory by requesting reading of connection information.

- 'Connection information' (Un\G28291 to Un\G28341)

Status of each connection

The connection status can be checked by checking the bit corresponding to each connection in 'Data link status (Class1)' (Un\G27136 to Un\G27151), 'Error status (Class1)' (Un\G27152 to Un\G27167), and 'Reserved station (Class1)' (Un\G27168 to Un\G27183).

'Data link status (Class1)' (Un\G27136 to Un\G27151)	'Error status (Class1)' (Un\G27152 to Un\G27167)	'Reserved station (Class1)' (Un\G27168 to Un\G27183)	Status of each connection
Off	Off	Off	Not connected or data link not in operation.
Off	Off	On	Set as a reserved station.
On	Off	Off	Data link in operation. No error has occurred.
Off	On	Off	Error has occurred with data link not in operation.
On	On	Off	Error has occurred with data link in operation.

No error is generated for combinations other than those listed above.

For details on the buffer memory, refer to the following.

☞ Page 156 Class1 communication status (Un\G27136 to Un\G27183)

Error details of each connection

The error code of each connection can be checked with 'Class1 Connection Behavior Error status' (Un\G27392 to Un\G27647).

For details on the buffer memory, refer to the following.

☞ Page 157 Class1 Connection Behavior Error status (Un\G27392 to Un\G27647)

For error code descriptions, refer to the following.

☞ Page 133 Error codes when a communication error occurs

Checking node information

The RJ71EIP91 node information can be checked with 'Node information area' (Un\G28160 to Un\G28170).

For details on the buffer memory, refer to the following.

☞ Page 158 Node information area (Un\G28160 to Un\G28170)

Reading connection information

The RJ71EIP91 obtains connection information by sending a connection information reading request to the EtherNet/IP device.

For details on the buffer memory, refer to the following.

 Page 158 Connection information (Un\G28291 to Un\G28341)

■Program example

For the program example of connection information reading, refer to the following.

 MELSEC iQ-R EtherNet/IP Network Interface Module User's Manual (Startup)

■Error details

The reading result of the connection information can be checked from 'Read result' (Un\G28290).

The following table lists the details when an error occurs.

'Read result' (Un\G28290)	Error details and causes	Action
C44EH	The connection of the target connection number is not set.	<ul style="list-style-type: none">• Connection that does not perform communications cannot be set. Start EtherNet/IP communications of the target connection number, and then turn on 'Connection information read request' (Y14).• EtherNet/IP communication parameter of the RJ71EIP91 is incorrect. Check the EtherNet/IP communication settings of the module using EtherNet/IP Configuration Tool.• Check the EtherNet/IP communication settings of the external device.
C44FH	The target connection number is outside the range.	Set the target connection number to a value from 1 to 256.

PING test

A PING test is used to check that an EtherNet/IP device exists on the same EtherNet/IP network.

The RJ71EIP91 sends a packet to the EtherNet/IP device to check its existence (an echo request). Then, the RJ71EIP91 checks whether communication is possible by seeing whether a response (an echo response) is returned.

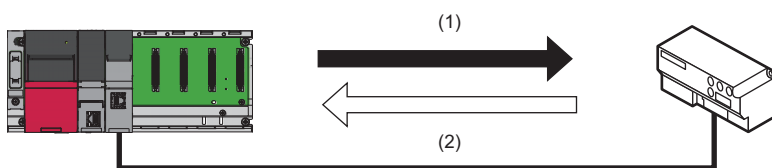

- (1) Echo request
(2) Echo response

Check method

The following methods are available for checking the PING test.

■Checking from EtherNet/IP Configuration Tool

Use EtherNet/IP Configuration Tool to execute a PING test.

For details, refer to the following.

☞ Page 68 [Ping] tab

☞ Page 78 [General] tab

■Checking from the buffer memory

Execute a PING test by operating a program that uses the buffer memory.

For the program example of PING tests, refer to the following.

☞ Page 111 Program Example of PING Test

Error details

When the buffer memory is used to execute a PING test, the result of the PING test can be checked from 'Result' (Un\G27908).

The following table lists the details when an error occurs.

'Result' (Un\G27908)	Error details and causes	Action
C0DBH	The target IP address is incorrect.	<ul style="list-style-type: none">• Set the IP address within the range between 1.0.0.1 and 126.255.255.255 or 128.0.0.0 and 223.255.255.254.• The IP address of the own node cannot be set. Set the IP address of the external device.

5.4 Hardware Test

This section describes how to perform a test related to hardware, such as a ROM/RAM/Ethernet port of the RJ71EIP91.

Restriction

- During the hardware test, values in the buffer memory cannot be referred from the engineering tool or the program.
- Do not change the operating status of the CPU module during the hardware test. If the operating status of the CPU module is changed, the module major error (2442H) occurs in the CPU module.

Operating procedure

1. Set the RJ71EIP91 to the hardware test mode using the engineering tool.

[Navigation window] ⇒ [Parameter] ⇒ [Module Information] ⇒ [RJ71EIP91] ⇒ [Basic Setting] ⇒ [Various Operations Settings] ⇒ [Mode Settings] ⇒ Select "Automatically H/W Test"

2. When a cable is connected to the Ethernet port, disconnect it.

3. Set the CPU module to the STOP state and write parameters.

4. Power off and on the system or reset the CPU module.

5. The hardware test is automatically executed.

The following table shows the LED indications of the RJ71EIP91 for the hardware test.

Status		RUN LED status	ERR LED status
During hardware test		Flashing	Off
Hardware test completed	Completed successfully	On	Off
	Completed with an error	On	On

6. When the test completed successfully, set the RJ71EIP91 to online mode using the engineering tool.

[Navigation window] ⇒ [Parameter] ⇒ [Module Information] ⇒ [RJ71EIP91] ⇒ [Basic Setting] ⇒ [Various Operation Settings] ⇒ [Mode Settings] ⇒ Select "Online"

Write parameters and power off and on the system or reset the CPU module.



7. When the test completed with an error, check that adequate measures to reduce noise are taken for the programmable controller system and retry the hardware test. If the test still completes with an error, a hardware failure may have occurred on the RJ71EIP91. Please consult your local Mitsubishi representative.

5.5 Troubleshooting by Symptom

This section describes troubleshooting by symptom. If an error has occurred in the RJ71EIP91, identify the error cause using the engineering tool. ( Page 118 Checking the Module Status)

Communications with EtherNet/IP devices cannot be performed

The following table lists the actions to be taken if communications with EtherNet/IP devices cannot be performed.

Check item	Action
Is the RUN LED of the RJ71EIP91 off?	If the RUN LED is off, reset the CPU module. If resetting does not cause the RUN LED to turn on, a hardware failure may have occurred. Replace the RJ71EIP91 and restart the connected EtherNet/IP device.
Is the Ethernet cable connected correctly?	<ul style="list-style-type: none"> • Connect the Ethernet cable again. • Use a PING test to check the connection with the EtherNet/IP device.
Is the EtherNet/IP device compatible with the RJ71EIP91 communication functions (Class1 communications, Class3 communications, and UCMM communications)?	Check the specifications of the EtherNet/IP device.
Is the power supply of the EtherNet/IP device on?	Turn on the power supply of the EtherNet/IP device.
Has an error occurred on the EtherNet/IP device, switching hub, or a similar device?	If an error has occurred on the EtherNet/IP device, switching hub, or a similar device, check the manual of each device.
Is the IP address setting of the EtherNet/IP device correct?	Use a PING test to check the connection with the EtherNet/IP device. ( Page 124 PING test)
Is the mode setting of the RJ71EIP91 a value other than "Online"?	Set the mode setting of the RJ71EIP91 to "Online" using the engineering tool. ( Page 46 Various Operations Settings)
Has the initial processing completed successfully?	Check whether communication is starting after 'Module Ready' (X0) and 'Communication Ready' (X1F) turn on.
Has communication start processing been performed correctly with 'EtherNet/IP communication start request' (Y10)?	<ul style="list-style-type: none"> • Check that 'EtherNet/IP communication start request' (Y10) is on. • If 'EtherNet/IP data link continuation specification request' (Un\G16634) is set to 16 (continue EtherNet/IP communication), turn 'EtherNet/IP communication start request' (Y10) on again.
Has a timeout error occurred on the connection that performs communications normally?	Depending on the EtherNet/IP device used, the connection that performs communications normally may be disconnected and a timeout error may occur after the time specified by Encapsulation Inactivity Timeout has elapsed. Therefore, set Encapsulation Inactivity Timeout to 0 (invalid). ( Page 167 TCP/IP Interface)

If the above actions do not solve the problem, perform the hardware test to check for hardware failure. ( Page 125 Hardware Test)

RJ71EIP91 cannot connect to EtherNet/IP Configuration Tool

The following table lists the actions to be taken if the RJ71EIP91 cannot connect to EtherNet/IP Configuration Tool.

Check item	Action
Are the IP address settings for the RJ71EIP91 and the personal computer to connect correct?	Set the IP addresses so that they have the same class and subnet address.
Is the RUN LED of the RJ71EIP91 off?	If the RUN LED is off, reset the CPU module. If resetting does not cause the RUN LED to turn on, a hardware failure may have occurred. Replace the RJ71EIP91 and restart the connected EtherNet/IP device.
Can network diagnostics be performed? ( Page 120 Network diagnostics of EtherNet/IP Configuration Tool)	Check that 'EtherNet/IP communication start request' (Y10) is on.
Has "EIP-CT" been allowed in the firewall settings?	Check that the firewall settings and allow "EIP-CT".

If the above actions do not solve the problem, perform the hardware test to check for hardware failure. ( Page 125 Hardware Test)

Class1 instance communications cannot be performed

The following table lists the actions to be taken if Class1 instance communications cannot be performed.

Check item	Action
Has the EtherNet/IP device to connect been registered in EtherNet/IP Configuration Tool?	If the EtherNet/IP device to connect is not displayed in the network configuration setting of EtherNet/IP Configuration Tool, add the device. (☞ Page 96 Procedure for Registering EtherNet/IP Devices)
Has communication start processing been performed correctly with 'EtherNet/IP communication start request' (Y10)?	<ul style="list-style-type: none"> • Check that 'EtherNet/IP communication start request' (Y10) is on. • If 'EtherNet/IP data link continuation specification request' (Un\G16634) is set to 16 (continue EtherNet/IP communication), turn 'EtherNet/IP communication start request' (Y10) on again.
Is the instance ID specified correctly?	Referring to the manual of the EtherNet/IP device connected, check the parameters of the originator to see that the specified instance ID is available for receiving request. When the specified instance ID is not available for receiving request, change the instance ID and write the parameter again.
Is input data stored in 'Class1 Input Area' (Un\G65536 to Un\G98303)?	When input data is not stored in 'Class1 Input Area' (Un\G65536 to Un\G98303), check the following items. <ul style="list-style-type: none"> • Check whether that the module FB (M+RJ71EIP91_Class1GetInputData) is used. • When "Block assurance per connection" in "Application Setting" is set to "Enable" and the module FB (M+RJ71EIP91_Class1GetInputData) is not used, check 'Class1 Connection Input data update state' (Un\G32768 to Un\G33023) to see that the input data is read.
Is output data set in 'Class1 Output Area' (Un\G196608 to Un\G229375)?	When output data is not sent to EtherNet/IP devices, check the following items. <ul style="list-style-type: none"> • Check whether that the module FB (M+RJ71EIP91_Class1SetOutputData) is used. • When "Block assurance per connection" in "Application Setting" is set to "Enable" and the module FB (M+RJ71EIP91_Class1GetInputData) is not used, check 'Class1 Connection Output data update state' (Un\G33024 to Un\G33279) to see that the output data is written.
Is an external device the NX-EIC202 manufactured by OMRON Corporation?	Change "Check Identity" of "Check Device Identity" in the [Connections] tab to "Must be Compatible".

Class1 tag communications cannot be performed.

The following table lists the actions to be taken if Class1 tag communications cannot be performed.

Check item	Action
Has the EtherNet/IP device to connect been registered in EtherNet/IP Configuration Tool?	If the EtherNet/IP device to connect is not displayed in the network configuration setting of EtherNet/IP Configuration Tool, add the device. (☞ Page 96 Procedure for Registering EtherNet/IP Devices)
Has communication start processing been performed correctly with 'EtherNet/IP communication start request' (Y10)?	<ul style="list-style-type: none"> • Check that 'EtherNet/IP communication start request' (Y10) is on. • If 'EtherNet/IP data link continuation specification request' (Un\G16634) is set to 16 (continue EtherNet/IP communication), turn 'EtherNet/IP communication start request' (Y10) on again.
Is the tag name specified correctly?	Check that the tag name of the external device on the Producer Tag side matches with the tag name on the Consumer Tag side. If they are not matched, check the tag name and write the parameter again.
When the target is the RJ71EIP91, has the multicast communication been performed with other originators?	<ul style="list-style-type: none"> • Match the settings of the RJ71EIP91 (originator) with those of other originators that are being communicated with. • Check the settings of other originators that are being communicated with the EtherNet/IP device. • Configure the system so that the EtherNet/IP device performs communications only with the RJ71EIP91 (originator).
When the target is the RJ71EIP91, is the number of connections of the node information 256?	Configure the system so that the number of EtherNet/IP devices that perform Class1 tag communications is 256 or less including the RJ71EIP91 (originator).

Class3 message communications cannot be performed

The following table lists the actions to be taken if Class3 message communications cannot be performed.

Check item	Action
Are the commands received from the EtherNet/IP device supported by the RJ71EIP91?	Check whether the commands being sent are those listed in the following section. ☞ Page 163 Details of Message Communication Support Command
Has communication start processing been performed correctly with 'EtherNet/IP communication start request' (Y10)?	<ul style="list-style-type: none"> • Check that 'EtherNet/IP communication start request' (Y10) is on. • If 'EtherNet/IP data link continuation specification request' (Un\G16634) is set to 16 (continue EtherNet/IP communication), turn 'EtherNet/IP communication start request' (Y10) on again.

UCMM message communications cannot be performed

The following table lists the actions to be taken if UCMM message communications cannot be performed.

Check item	Action
Are the settings of the commands to request correct?	Check the value set in 'UCMM data link request command' (starting with Un\G393280).
Has communication start processing been performed correctly with 'EtherNet/IP communication start request' (Y10)?	<ul style="list-style-type: none">• Check that 'EtherNet/IP communication start request' (Y10) is on.• If 'EtherNet/IP data link continuation specification request' (Un\G16634) is set to 16 (continue EtherNet/IP communication), turn 'EtherNet/IP communication start request' (Y10) on again.

5.6 List of Error Codes

This section lists the error codes, error details and causes, and actions for the errors that occur in the processing for data communications between the RJ71EIP91 and EtherNet/IP devices or that are caused by processing requests from the CPU module on the own station.

The RJ71EIP91 has the following error codes.

Type	Error code	Reference
Error codes when a module error occurs	1801H to 3FA0H	Page 129 Error codes when a module error occurs
Error codes when a communication error occurs	102H to 2FFH	Page 133 Error codes when a communication error occurs

Error codes when a module error occurs

Error codes when a module error occurs are classified into major error, moderate error, and minor error, and can be checked in the [Error Information] tab of the "Module Diagnostics" window of the RJ71EIP91. (Page 118 Error Information)

Error code	Error details and causes	Action	Detailed information
1801H	The number of writes to ROM exceeded 100000. (Number of writes > 100000)	Replace the module.	Frequency information • Frequency (setting value)
1807H	A parameter error was detected.	Use the engineering tool to write the parameters to the CPU module again.	—
1E00H	An error was detected in the execution condition during EtherNet/IP communications.	Turn off the following signal, and then turn 'EtherNet/IP communication start request' (Y10) on. • 'PING test execution request' (Y12)	—
1E01H	An error was detected in the execution condition during execution of PING test.	Turn off the following signals, and then turn 'PING test execution request' (Y12) on. • 'EtherNet/IP communication start request' (Y10) • 'Connection information read request' (Y14)	—
1E03H	An error was detected in the execution condition during execution of connection information reading.	• Turn off 'PING test execution request' (Y12), and then turn on 'Connection information read request' (Y14). • Start EtherNet/IP communications, and then turn on 'Connection information read request' (Y14).	—
1E10H to 1E12H	An error was detected in the parameters set with EtherNet/IP Configuration Tool.	• Use EtherNet/IP Configuration Tool to write the parameters to the module again. • If the error occurs again even after the above action is taken, the possible cause is a hardware failure of the module on which the error occurred. Please consult your local Mitsubishi representative.	—
1E13H to 1E14H	It was not possible to stop EtherNet/IP communications.	• Check the settings of the connection with the external device. • If the error occurs again even after the above action is taken, the possible cause is a hardware failure of the module on which the error occurred. Please consult your local Mitsubishi representative.	—
2120H to 2121H	A hardware failure has been detected.	• If an SD memory card is loaded in the CPU module, remove the SD memory card, reset the CPU module, and then switch it to RUN mode. • Take measures to reduce noise. • Reset the CPU module, and then switch it to RUN mode. If the error occurs again even after the above action is taken, the possible cause is a hardware failure of the module on which the error occurred. Please consult your local Mitsubishi representative.	Drive/file information • Drive number
2440H	An error was detected in the I/O module or RJ71EIP91 during the initial processing.	• Take measures to reduce noise. • Reset the CPU module, and then switch it to RUN mode. If the error occurs again even after the above action is taken, the possible cause is a hardware failure of the module on which the error occurred. Please consult your local Mitsubishi representative.	System configuration information • I/O number • Base number • Slot number

Error code	Error details and causes	Action	Detailed information
2450H	<ul style="list-style-type: none"> A major error notification from the RJ71EIP91 has been detected. The I/O module or RJ71EIP91 is not mounted properly or was removed during operation. 	<ul style="list-style-type: none"> Take measures to reduce noise. Check the connection status of the extension cable. Check the detailed information (system configuration information) by executing module diagnostics using the engineering tool, and check the module corresponding to the displayed slot number. Reset the CPU module, and then switch it to RUN mode. If the error occurs again even after the above action is taken, the possible cause is a hardware failure of the module on which the error occurred. Please consult your local Mitsubishi representative. 	System configuration information <ul style="list-style-type: none"> I/O number Base number Slot number
24C0H to 24C1H	An error was detected on the system bus.	<ul style="list-style-type: none"> Take measures to reduce noise. Reset the CPU module, and then switch it to RUN mode. If the error occurs again even after the above action is taken, the possible cause is a hardware failure of the CPU module, I/O module, RJ71EIP91, base unit, or extension cable. Please consult your local Mitsubishi representative. 	System configuration information <ul style="list-style-type: none"> I/O number Base number Slot number CPU number
24C2H	<ul style="list-style-type: none"> The I/O module or RJ71EIP91 is not mounted properly or was removed during operation. An error was detected on the system bus. 	<ul style="list-style-type: none"> Check the detailed information (system configuration information), and check the module corresponding to the displayed slot number. Check the connection status of the extension cable. Take measures to reduce noise. Reset the CPU module, and then switch it to RUN mode. If the error occurs again even after the above action is taken, the possible cause is a hardware failure of the CPU module, I/O module, RJ71EIP91, base unit, or extension cable. Please consult your local Mitsubishi representative. 	System configuration information <ul style="list-style-type: none"> I/O number Base number Slot number CPU number
24C3H	An error was detected on the system bus.	<ul style="list-style-type: none"> Take measures to reduce noise. Reset the CPU module, and then switch it to RUN mode. If the error occurs again even after the above action is taken, the possible cause is a hardware failure of the CPU module, I/O module, RJ71EIP91, base unit, or extension cable. Please consult your local Mitsubishi representative. 	System configuration information <ul style="list-style-type: none"> I/O number Base number Slot number CPU number
24C4H	An error was detected on the system bus.	<ul style="list-style-type: none"> Take measures to reduce noise. Reset the CPU module, and then switch it to RUN mode. If the error occurs again even after the above action is taken, the possible cause is a hardware failure of the CPU module, I/O module, RJ71EIP91, base unit, or extension cable. Please consult your local Mitsubishi representative. 	System configuration information <ul style="list-style-type: none"> I/O number Base number Slot number
24C5H	An error was detected on the system bus.	<ul style="list-style-type: none"> Take measures to reduce noise. Reset the CPU module, and then switch it to RUN mode. If the error occurs again even after the above action is taken, the possible cause is a hardware failure of the I/O module, RJ71EIP91, base unit, or extension cable. Please consult your local Mitsubishi representative. 	—
24C6H	An error was detected on the system bus.	<ul style="list-style-type: none"> Take measures to reduce noise. Reset the CPU module, and then switch it to RUN mode. If the error occurs again even after the above action is taken, the possible cause is a hardware failure of the CPU module or extension cable. Please consult your local Mitsubishi representative. 	—
24C8H	An error was detected on the system bus.	<ul style="list-style-type: none"> Take measures to reduce noise. Reset the CPU module, and then switch it to RUN mode. If the error occurs again even after the above action is taken, the possible cause is a hardware failure of the I/O module, RJ71EIP91, or extension cable. Please consult your local Mitsubishi representative. 	—

Error code	Error details and causes	Action	Detailed information
24E0H	An error was detected on the system bus.	<ul style="list-style-type: none"> Take measures to reduce noise. Reset the CPU module, and then switch it to RUN mode. If the error occurs again even after the above action is taken, the possible cause is a hardware failure of the CPU module or base unit. Please consult your local Mitsubishi representative. 	System configuration information <ul style="list-style-type: none"> I/O number Base number Slot number CPU number
300CH to 300DH	A hardware failure has been detected.	<ul style="list-style-type: none"> Take measures to reduce noise. Reset the CPU module, and then switch it to RUN mode. If the error occurs again even after the above action is taken, the possible cause is a hardware failure of the module on which the error occurred. Please consult your local Mitsubishi representative. 	—
300EH	A hardware failure has been detected.	<ul style="list-style-type: none"> Take measures to reduce noise. Reset the CPU module, and then switch it to RUN mode. If the error occurs again even after the above action is taken, the possible cause is a hardware failure of the CPU module. Please consult your local Mitsubishi representative. 	Script position information <ul style="list-style-type: none"> Script step number
3A00H to 3A01H	A file access error was detected.	File access has failed. The files on the module on which the error occurred may be corrupt. Please consult your local Mitsubishi representative.	—
3C00H to 3C03H	A hardware failure has been detected.	<ul style="list-style-type: none"> Take measures to reduce noise. Reset the CPU module, and then switch it to RUN mode. If the error occurs again even after the above action is taken, the possible cause is a hardware failure of the CPU module. Please consult your local Mitsubishi representative. 	—
3C0FH	A hardware failure has been detected.	<ul style="list-style-type: none"> Take measures to reduce noise. Reset the CPU module, and then switch it to RUN mode. If the error occurs again even after the above action is taken, the possible cause is a hardware failure of the CPU module. Please consult your local Mitsubishi representative. 	—
3C22H	An error was detected in the memory.	<ul style="list-style-type: none"> Take measures to reduce noise. Format the memory. After that, write all the files, reset the CPU module, and then switch it to RUN mode. If the error occurs again even after the above action is taken, the possible cause is a hardware failure of the CPU module. Please consult your local Mitsubishi representative. 	—
3C2FH	An error was detected in the memory.	<ul style="list-style-type: none"> Take measures to reduce noise. Reset the CPU module, and then switch it to RUN mode. If the error occurs again even after the above action is taken, the possible cause is a hardware failure of the CPU module. Please consult your local Mitsubishi representative. 	—
3E08H to 3E09H	A hardware failure has been detected.	<ul style="list-style-type: none"> Take measures to reduce noise. Reset the CPU module, and then switch it to RUN mode. If the error occurs again even after the above action is taken, the possible cause is a hardware failure of the CPU module. Please consult your local Mitsubishi representative. 	—
3E0EH	An error was detected in the memory.	<ul style="list-style-type: none"> Take measures to reduce noise. Format the memory. After that, write all the files, reset the CPU module, and then switch it to RUN mode. If the error occurs again even after the above action is taken, the possible cause is a hardware failure of the CPU module. Please consult your local Mitsubishi representative. 	—

Error code	Error details and causes	Action	Detailed information
3E11H	An error was detected in the memory.	<ul style="list-style-type: none"> • Take measures to reduce noise. • Reset the CPU module, and then switch it to RUN mode. If the error occurs again even after the above action is taken, the possible cause is a hardware failure of the CPU module. Please consult your local Mitsubishi representative. 	—
3E19H	An error was detected in the memory.	<ul style="list-style-type: none"> • Take measures to reduce noise. • Format the memory. After that, write all the files, reset the CPU module, and then switch it to RUN mode. • If the error occurs again even after the above action is taken, the possible cause is a hardware failure of the CPU module. Please consult your local Mitsubishi representative. 	—
3E1AH to 3E21H	An error was detected in the memory.	<ul style="list-style-type: none"> • Take measures to reduce noise. • Reset the CPU module, and then switch it to RUN mode. If the error occurs again even after the above action is taken, the possible cause is a hardware failure of the CPU module. Please consult your local Mitsubishi representative. 	—
3E23H to 3E24H	An error was detected in the memory.	<ul style="list-style-type: none"> • Take measures to reduce noise. • Reset the CPU module, and then switch it to RUN mode. If the error occurs again even after the above action is taken, the possible cause is a hardware failure of the CPU module. Please consult your local Mitsubishi representative. 	—
3E26H to 3E2BH	An error was detected in the memory.	<ul style="list-style-type: none"> • Take measures to reduce noise. • Reset the CPU module, and then switch it to RUN mode. If the error occurs again even after the above action is taken, the possible cause is a hardware failure of the CPU module. Please consult your local Mitsubishi representative. 	—
3F80H to 3F87H	An error was detected in the memory.	<ul style="list-style-type: none"> • Take measures to reduce noise. • Reset the CPU module, and then switch it to RUN mode. If the error occurs again even after the above action is taken, the possible cause is a hardware failure of the module on which the error occurred. Please consult your local Mitsubishi representative. 	—
3F8FH to 3F97H	An error was detected in the memory.	<ul style="list-style-type: none"> • Take measures to reduce noise. • Reset the CPU module, and then switch it to RUN mode. If the error occurs again even after the above action is taken, the possible cause is a hardware failure of the module on which the error occurred. Please consult your local Mitsubishi representative. 	—
3FA0H	An error was detected in the memory.	<ul style="list-style-type: none"> • Take measures to reduce noise. • Reset the CPU module, and then switch it to RUN mode. If the error occurs again even after the above action is taken, the possible cause is a hardware failure of the module on which the error occurred. Please consult your local Mitsubishi representative. 	—

Error codes when a communication error occurs

Error codes for communication errors can be checked with 'Class1 Connection Behavior Error status' (Un\G27392 to Un\G27647). (☞ Page 157 Class1 Connection Behavior Error status (Un\G27392 to Un\G27647))

Error code	Error details and causes	Action
102H	EtherNet/IP communication has not started properly.	<ul style="list-style-type: none"> When UCMM communications are performed, check whether a module error occurs in the following pages. <ul style="list-style-type: none"> ☞ Page 116 Checking with LEDs Take measures to reduce noise. Reset the CPU module, and then switch it to RUN mode. If the error occurs again even after the above action is taken, the possible cause is a hardware failure of the module. Please consult your local Mitsubishi representative.
103H	A parameter error was detected.	<ul style="list-style-type: none"> Use EtherNet/IP Configuration Tool to write the parameters to the module again. When UCMM communications are performed, check whether the setting details of the UCMM request area are correct.
104H to 105H	A timeout occurred in the connection with the external device.	<ul style="list-style-type: none"> Check whether the operating status of the external device is normal. Check for errors in the line status. The line may be busy, so retry at a later time. The external device may not be able to send data at the specified RPI due to a high communication load, so specify a larger RPI and connect again. Check the settings of the connection with the external device. When Application Trigger is used, check whether the data send timing is correct.
106H	The target device does not exist.	<ul style="list-style-type: none"> Use EtherNet/IP Configuration Tool to write the parameters to the module again. If the error occurs again even after the above action is taken, the possible cause is a hardware failure of the module on which the error occurred. Please consult your local Mitsubishi representative.
107H	An error was detected in the memory.	<ul style="list-style-type: none"> Take measures to reduce noise. Reset the CPU module, and then switch it to RUN mode. If the error occurs again even after the above action is taken, the possible cause is a hardware failure of the module on which the error occurred. Please consult your local Mitsubishi representative.
10AH	Production processing failed to start.	<ul style="list-style-type: none"> Take measures to reduce noise. Reset the CPU module, and then switch it to RUN mode. If the error occurs again even after the above action is taken, the possible cause is a hardware failure of the module on which the error occurred. Please consult your local Mitsubishi representative.
10BH	Consumption processing failed to start.	<ul style="list-style-type: none"> Take measures to reduce noise. Reset the CPU module, and then switch it to RUN mode. If the error occurs again even after the above action is taken, the possible cause is a hardware failure of the module on which the error occurred. Please consult your local Mitsubishi representative.
10CH	There is insufficient memory available for connection processing.	<ul style="list-style-type: none"> Retry at a later time. Reset the CPU module, and then switch it to RUN mode. If the error occurs again even after the above action is taken, the possible cause is a hardware failure of the module on which the error occurred. Please consult your local Mitsubishi representative.

Error code	Error details and causes	Action
10EH to 10FH	An error has occurred in TCP communications.	<ul style="list-style-type: none"> • Retry at a later time. • Check whether the operating status of the external device is normal. • Check for errors in the line status. • The line may be busy, so retry at a later time. • Reset the CPU module, and then switch it to RUN mode. If the error occurs again even after the above action is taken, the possible cause is a hardware failure of the module on which the error occurred. Please consult your local Mitsubishi representative. • Check the settings of the connection with the external device.
110H	Socket generation has failed.	<ul style="list-style-type: none"> • Retry at a later time. • Reset the CPU module, and then switch it to RUN mode. If the error occurs again even after the above action is taken, the possible cause is a hardware failure of the module on which the error occurred. Please consult your local Mitsubishi representative.
112H	Incorrect send data has been specified.	<ul style="list-style-type: none"> • Take measures to reduce noise. • Reset the CPU module, and then switch it to RUN mode. If the error occurs again even after the above action is taken, the possible cause is a hardware failure of the module on which the error occurred. Please consult your local Mitsubishi representative.
113H	There is insufficient cache memory available.	<ul style="list-style-type: none"> • Retry at a later time. • Restart the RJ71EIP91.
114H	Failed to set the socket option (non-blocking).	<ul style="list-style-type: none"> • Take measures to reduce noise. • Reset the CPU module, and then switch it to RUN mode. If the error occurs again even after the above action is taken, the possible cause is a hardware failure of the module. Please consult your local Mitsubishi representative.
115H	The frame size has exceeded the maximum size.	<ul style="list-style-type: none"> • Use EtherNet/IP Configuration Tool to write the parameters to the module again. • When UCMM communications are performed, check whether the setting details of the UCMM request area are correct.
119H	A timeout occurred in the connection with the external device.	<ul style="list-style-type: none"> • Check whether the operating status of the external device is normal. • There may be a mismatch between the IP address of the external device set with EtherNet/IP Configuration Tool and the external device. Execute PING test and check that a response is received from the external device. • Check whether an IP address of a device on the line is duplicated that of a module. • Check for errors in the line status. • The line may be busy, so retry at a later time. • The external device may not be able to send data at the specified RPI due to a high communication load, so specify a larger RPI and connect again.
11AH	An incorrect Forward Open service request has been received from the external device.	<ul style="list-style-type: none"> • Check whether the operating status of the external device is normal. • Check for errors in the line status. • The line may be busy, so retry at a later time. • The external device may not be able to send data at the specified RPI due to a high communication load, so specify a larger RPI and connect again.
11BH	Incorrect network parameters (originator to target) have been received from the external device.	<ul style="list-style-type: none"> • Check whether the operating status of the external device is normal. • Check for errors in the line status. • The line may be busy, so retry at a later time. • The external device may not be able to send data at the specified RPI due to a high communication load, so specify a larger RPI and connect again.
11CH	Incorrect network parameters (target to originator) have been received from the external device.	<ul style="list-style-type: none"> • Check whether the operating status of the external device is normal. • Check for errors in the line status. • The line may be busy, so retry at a later time. • The external device may not be able to send data at the specified RPI due to a high communication load, so specify a larger RPI and connect again.

Error code	Error details and causes	Action
11DH	An incorrect UDP port specification has been received from the external device.	<ul style="list-style-type: none"> • Check whether the external device is set to use UDP port number 2222 for EtherNet/IP communications. • Check whether the operating status of the external device is normal. • Check for errors in the line status. • The line may be busy, so retry at a later time. • The external device may not be able to send data at the specified RPI due to a high communication load, so specify a larger RPI and connect again.
11EH	Participation in a multicast group has failed.	<ul style="list-style-type: none"> • Take measures to reduce noise. • Reset the CPU module, and then switch it to RUN mode. If the error occurs again even after the above action is taken, the possible cause is a hardware failure of the module on which the error occurred. Please consult your local Mitsubishi representative.
11FH	An error was detected in the memory.	<ul style="list-style-type: none"> • Take measures to reduce noise. • Reset the CPU module, and then switch it to RUN mode. If the error occurs again even after the above action is taken, the possible cause is a hardware failure of the module on which the error occurred. Please consult your local Mitsubishi representative.
120H	The available resources are insufficient.	<ul style="list-style-type: none"> • Take measures to reduce noise. • Reset the CPU module, and then switch it to RUN mode. If the error occurs again even after the above action is taken, the possible cause is a hardware failure of the module on which the error occurred. Please consult your local Mitsubishi representative.
121H	The connection has stopped.	<ul style="list-style-type: none"> • The line may be busy, so retry at a later time. • The external device may not be able to send data at the specified RPI due to a high communication load, so specify a larger RPI and connect again.
126H	An incorrect RegisterSession command has been received.	<ul style="list-style-type: none"> • Check whether the operating status of the external device is normal. • Check for errors in the line status. • The line may be busy, so retry at a later time.
128H	An incorrect request frame has been received.	<ul style="list-style-type: none"> • Check whether the operating status of the external device is normal. • Check for errors in the line status. • The line may be busy, so retry at a later time.
129H	An incorrect session handle has been received.	<ul style="list-style-type: none"> • Check whether the operating status of the external device is normal. • Check for errors in the line status. • The line may be busy, so retry at a later time.
12AH	Request data with an incorrect size has been received.	<ul style="list-style-type: none"> • Check whether the operating status of the external device is normal. • Check for errors in the line status. • The line may be busy, so retry at a later time.
12BH	Request data including an unsupported protocol version has been received.	<ul style="list-style-type: none"> • Check whether the operating status of the external device is normal. • Check for errors in the line status. • The line may be busy, so retry at a later time.
12DH	Request data with an incorrect size has been received.	<ul style="list-style-type: none"> • Check whether the operating status of the external device is normal. • Check for errors in the line status. • The line may be busy, so retry at a later time.
12EH	Communications have been disconnected.	Check whether 'EtherNet/IP communication start request' (Y10) is on.
12FH	The connections have been disconnected.	<ul style="list-style-type: none"> • Check whether the operating status of the external device is normal. • Check for errors in the line status. • The line may be busy, so retry at a later time.
130H to 131H	Forward Close has been received from the external device.	<ul style="list-style-type: none"> • Check whether the operating status of the external device is normal. • Check for errors in the line status. • The line may be busy, so retry at a later time.

Error code	Error details and causes	Action
132H	An error was detected in the memory.	<ul style="list-style-type: none"> Take measures to reduce noise. Reset the CPU module, and then switch it to RUN mode. If the error occurs again even after the above action is taken, the possible cause is a hardware failure of the module on which the error occurred. Please consult your local Mitsubishi representative.
133H	Communications have been disconnected.	Check whether 'EtherNet/IP communication start request' (Y10) is on.
134H	A timeout occurred in the connection with the external device.	<ul style="list-style-type: none"> Check whether the operating status of the external device is normal. Check for errors in the line status. The line may be busy, so retry at a later time.
135H	A timeout occurred in the connection with the external device.	<ul style="list-style-type: none"> Check whether the operating status of the external device is normal. Check for errors in the line status. The line may be busy, so retry at a later time. The external device may not be able to send data at the specified RPI due to a high communication load, so specify a larger RPI and connect again.
136H	A timeout occurred in the connection with the external device.	<ul style="list-style-type: none"> Check whether the operating status of the external device is normal. Check for errors in the line status. The line may be busy, so retry at a later time.
137H to 138H	An error was detected in the memory.	<ul style="list-style-type: none"> Take measures to reduce noise. Reset the CPU module, and then switch it to RUN mode. If the error occurs again even after the above action is taken, the possible cause is a hardware failure of the module. Please consult your local Mitsubishi representative.
17FH	An error was detected in the memory.	<ul style="list-style-type: none"> Take measures to reduce noise. Reset the CPU module, and then switch it to RUN mode. If the error occurs again even after the above action is taken, the possible cause is a hardware failure of the module. Please consult your local Mitsubishi representative.
180H	An error notification has been received from the external device. (Extended Status: 100H) ^{*1}	<ul style="list-style-type: none"> Refer to documentation such as the manuals of the external device to check the conditions under which a notification is made for this error and the action to take. Close the connection of the external device and retry. Retry after the connection of the external device has been timed out.
181H	An error notification has been received from the external device. (Extended Status: 103H) ^{*1}	Refer to documentation such as the manuals of the external device to check the conditions under which a notification is made for this error and the action to take.
182H	An error notification has been received from the external device. (Extended Status: 106H) ^{*1}	Refer to documentation such as the manuals of the external device to check the conditions under which a notification is made for this error and the action to take.
183H	The external device cannot find the connection to close. (Extended Status: 107H) ^{*1}	<p>Check the following items, and then restart the EtherNet/IP communications.</p> <ul style="list-style-type: none"> Is the operating status of the external device normal? Is the line status normal?
184H	An error notification has been received from the external device. (Extended Status: 108H) ^{*1}	Refer to documentation such as the manuals of the external device to check the conditions under which a notification is made for this error and the action to take.
185H	An error notification has been received from the external device. (Extended Status: 109H) ^{*1}	Refer to documentation such as the manuals of the external device to check the conditions under which a notification is made for this error and the action to take.
186H	An error notification has been received from the external device. (Extended Status: 110H) ^{*1}	Refer to documentation such as the manuals of the external device to check the conditions under which a notification is made for this error and the action to take.
187H	An error notification has been received from the external device. (Extended Status: 111H) ^{*1}	Refer to documentation such as the manuals of the external device to check the conditions under which a notification is made for this error and the action to take.
188H	An error notification has been received from the external device. (Extended Status: 112H) ^{*1}	Refer to documentation such as the manuals of the external device to check the conditions under which a notification is made for this error and the action to take.

Error code	Error details and causes	Action
189H	An error notification has been received from the external device. (Extended Status: 113H) ^{*1}	Refer to documentation such as the manuals of the external device to check the conditions under which a notification is made for this error and the action to take.
18AH	An error notification has been received from the external device. (Extended Status: 114H) ^{*1}	Refer to documentation such as the manuals of the external device to check the conditions under which a notification is made for this error and the action to take.
18BH	An error notification has been received from the external device. (Extended Status: 115H) ^{*1}	Refer to documentation such as the manuals of the external device to check the conditions under which a notification is made for this error and the action to take.
18CH	An error notification has been received from the external device. (Extended Status: 116H) ^{*1}	Refer to documentation such as the manuals of the external device to check the conditions under which a notification is made for this error and the action to take.
18DH	An error notification has been received from the external device. (Extended Status: 117H) ^{*1}	Refer to documentation such as the manuals of the external device to check the conditions under which a notification is made for this error and the action to take.
18EH	An error notification has been received from the external device. (Extended Status: 118H) ^{*1}	Refer to documentation such as the manuals of the external device to check the conditions under which a notification is made for this error and the action to take.
18FH	An error notification has been received from the external device. (Extended Status: 119H) ^{*1}	Refer to documentation such as the manuals of the external device to check the conditions under which a notification is made for this error and the action to take.
190H	An error notification has been received from the external device. (Extended Status: 11AH) ^{*1}	Refer to documentation such as the manuals of the external device to check the conditions under which a notification is made for this error and the action to take.
191H	An error notification has been received from the external device. (Extended Status: 11BH) ^{*1}	Refer to documentation such as the manuals of the external device to check the conditions under which a notification is made for this error and the action to take.
192H to 1A8H	An error notification has been received from the external device. (Extended Status: 11CH to 132H) ^{*1}	Refer to documentation such as the manuals of the external device to check the conditions under which a notification is made for this error and the action to take.
1A9H	An error notification has been received from the external device. (Extended Status: 203H) ^{*1}	Refer to documentation such as the manuals of the external device to check the conditions under which a notification is made for this error and the action to take.
1AAH	An error notification has been received from the external device. (Extended Status: 204H) ^{*1}	<ul style="list-style-type: none"> • Check whether the operating status of the external device is normal. • Check for errors in the line status. • The line may be busy, so retry at a later time. • Investigate the conditions under which the external device makes a notification for this error, and then take the appropriate measures.
1ABH	An error notification has been received from the external device. (Extended Status: 205H) ^{*1}	Refer to documentation such as the manuals of the external device to check the conditions under which a notification is made for this error and the action to take.
1ACH	An error notification has been received from the external device. (Extended Status: 206H) ^{*1}	Refer to documentation such as the manuals of the external device to check the conditions under which a notification is made for this error and the action to take.
1ADH	An error notification has been received from the external device. (Extended Status: 207H) ^{*1}	Refer to documentation such as the manuals of the external device to check the conditions under which a notification is made for this error and the action to take.
1AEH	An error notification has been received from the external device. (Extended Status: 301H) ^{*1}	Refer to documentation such as the manuals of the external device to check the conditions under which a notification is made for this error and the action to take.
1AFH	An error notification has been received from the external device. (Extended Status: 302H) ^{*1}	Refer to documentation such as the manuals of the external device to check the conditions under which a notification is made for this error and the action to take.
1B0H	An error notification has been received from the external device. (Extended Status: 303H) ^{*1}	Refer to documentation such as the manuals of the external device to check the conditions under which a notification is made for this error and the action to take.
1B1H	An error notification has been received from the external device. (Extended Status: 304H) ^{*1}	Refer to documentation such as the manuals of the external device to check the conditions under which a notification is made for this error and the action to take.
1B2H	An error notification has been received from the external device. (Extended Status: 311H) ^{*1}	Refer to documentation such as the manuals of the external device to check the conditions under which a notification is made for this error and the action to take.

Error code	Error details and causes	Action
1B3H	An error notification has been received from the external device. (Extended Status: 312H) ^{*1}	Refer to documentation such as the manuals of the external device to check the conditions under which a notification is made for this error and the action to take.
1B4H	An error notification has been received from the external device. (Extended Status: 315H) ^{*1}	<ul style="list-style-type: none"> • Check whether the EtherNet/IP device set with EtherNet/IP Configuration Tool matches the external device. • Check whether the EDS file being used matches the external device.
1B5H	An error notification has been received from the external device. (Extended Status: 316H) ^{*1}	Refer to documentation such as the manuals of the external device to check the conditions under which a notification is made for this error and the action to take.
1B6H	An error notification has been received from the external device. (Extended Status: 317H) ^{*1}	Refer to documentation such as the manuals of the external device to check the conditions under which a notification is made for this error and the action to take.
1B7H	An error notification has been received from the external device. (Extended Status: 318H) ^{*1}	Refer to documentation such as the manuals of the external device to check the conditions under which a notification is made for this error and the action to take.
1B8H	An error notification has been received from the external device. (Extended Status: 319H) ^{*1}	Refer to documentation such as the manuals of the external device to check the conditions under which a notification is made for this error and the action to take.
1B9H	An error notification has been received from the external device. (Extended Status: 31AH) ^{*1}	Refer to documentation such as the manuals of the external device to check the conditions under which a notification is made for this error and the action to take.
1BAH	An error notification has been received from the external device. (Extended Status: 31BH) ^{*1}	Refer to documentation such as the manuals of the external device to check the conditions under which a notification is made for this error and the action to take.
1BBH	An error notification has been received from the external device. (Extended Status: 31CH) ^{*1}	Refer to documentation such as the manuals of the external device to check the conditions under which a notification is made for this error and the action to take.
1BCH	An error notification has been received from the external device. (Extended Status: 31DH) ^{*1}	Refer to documentation such as the manuals of the external device to check the conditions under which a notification is made for this error and the action to take.
1BDH	An error notification has been received from the external device. (Extended Status: 31EH) ^{*1}	Refer to documentation such as the manuals of the external device to check the conditions under which a notification is made for this error and the action to take.
1BEH	An error notification has been received from the external device. (Extended Status: 31FH) ^{*1}	Refer to documentation such as the manuals of the external device to check the conditions under which a notification is made for this error and the action to take.
1BFH	An error notification has been received from the external device. (Extended Status: 320H) ^{*1}	Refer to documentation such as the manuals of the external device to check the conditions under which a notification is made for this error and the action to take.
1C0H to 1C7H	An error notification has been received from the external device. (Extended Status: 133H to 139H) ^{*1}	Refer to documentation such as the manuals of the external device to check the conditions under which a notification is made for this error and the action to take.
1FFH	An error notification has been received from the external device. (Undefined Extended Status) ^{*1}	Refer to documentation such as the manuals of the external device to check the conditions under which a notification is made for this error and the action to take.
200H to 2FFH	A CIP General error notification has been received from the external device. (General Status: Last two digits of the error code) ^{*2}	Refer to documentation such as the manuals of the external device to check the conditions under which a notification is made for this error and the action to take.

*1 For details on the Extended Status, refer to the EtherNet/IP specifications issued by ODVA (www.odva.org).

*2 For details on the General Status, refer to the EtherNet/IP specifications issued by ODVA (www.odva.org).

5.7 Event List

This section lists the events that occur in the RJ71EIP91.
There are two types of events: system and operation.

System

Event code	Overview	Cause
00600	Return	The EtherNet/IP communication connection switched to the normal state.
00E00	Disconnection	The EtherNet/IP communication connection switched to the error state.

Operation

Event code	Overview	Cause
20100	Error clear	An error was cleared.

APPENDICES

Appendix 1 Module Label

Module labels can be used to set the I/O signals and buffer memory of the RJ71EIP91.

Module label structure

Module label names are defined with the following structure.

"instance name"_"module number"."label name"

"instance name"_"module number"."label name"_D

Ex.

EIP91_1.bSts_ModuleReady

■ Instance name

Instance name of the RJ71EIP91 is as shown below.

Module model name	Instance name
RJ71EIP91	EIP91

■ Module number

Module numbers start from 1 and are added to identify modules that have the same instance name.

■ Label name

A label name unique to the module.

■ _D

This symbol indicates that the module label is for direct access. If this symbol is not present, the label is for refreshing.

Refreshing and direct access differ as shown below.

Type	Description	Access timing
Refresh	The values written to and read from the module label are reflected on the module as a batch during refreshing. This function makes it possible to reduce the program execution time.	Refreshing
Direct access	The values written to and read from the module label are immediately reflected on the module. The program execution time is longer than the refresh time, but the responsiveness increases.	Writing to/reading from module labels

Appendix 2 I/O Signals

This section describes the I/O signals sent to or received from the CPU module. The I/O signal assignment for when the start I/O number of the RJ71EIP91 is "0" is listed below.

List of I/O signals

The following tables list I/O signals. The device X is an input signal from the RJ71EIP91 to the CPU module. The device Y is an output signal from the CPU module to the RJ71EIP91.

Input signals

Device No.	Signal name
X0	Module Ready
X1 to XE	Use prohibited
XF	Module Error
X10	EtherNet/IP communication in process
X11	Use prohibited
X12	PING test completion
X13	Use prohibited
X14	Connection information read completion
X15	Connection information read error
X16 to X1E	Use prohibited
X1F	Communication Ready

Output signals

Device No.	Signal name
Y0 to YE	Use prohibited
YF	Module error clear request
Y10	EtherNet/IP communication start request
Y11	Use prohibited
Y12	PING test execution request
Y13	Use prohibited
Y14	Connection information read request
Y15 to Y1F	Use prohibited

A



Do not use (turn on) any "use prohibited" signals as an input or output signal to the CPU module. Doing so may cause malfunction of the programmable controller system.

Execution condition of output signal

The following lists the execution condition to turn on/off the output signal.

I/O signal	Execution condition		Priority when signals are turned on at the same time
	Can be turned on	Can be turned off	
'EtherNet/IP communication start request' (Y10)	When Y10 and Y12 are off	When X10 is on	2
'PING test execution request' (Y12)	When Y10, Y12, and Y14 are off	When X12 is on	1 (high)
'Connection information read request' (Y14)	When Y12 and Y14 are off and Y10 is on	When X14 is on	3 (low)

Details of input signals

Module Ready (X0)

After the CPU module is powered off and on or is reset, this signal turns on at the completion of the preparation for the RJ71EIP91.

- On: The module has been prepared.
- Off: The module is being prepared.

Module Error (XF)

This signal turns on or off depending on the occurrence status of the own station error.

- On: An error (minor error, moderate error, or major error) has occurred.
- Off: No error has occurred.

EtherNet/IP communication in process (X10)

This signal turns on or off depending on the start status of the EtherNet/IP communications.

- On: EtherNet/IP communication is starting.
- Off: EtherNet/IP communication is stopped.

For the timing chart, refer to the following.

 Page 143 EtherNet/IP communication start request (Y10)

PING test completion (X12)

This signal turns on or off depending on the execution status of the PING test.

- On: The PING test has completed.
- Off: The PING test has not completed.

For the timing chart, refer to the following.

 Page 145 PING test execution request (Y12)

Connection information read completion (X14)

This signal turns on when the connection information read processing completes.

- On: Connection information read processing has completed.
- Off: Connection information read processing has not completed.

For the timing chart, refer to the following.

 Page 146 Connection information read request (Y14)

Connection information read error (X15)

This signal turns on when the connection information read processing completes with an error.

- On: Connection information read processing has completed with an error.
- Off: Connection information read processing has not completed or has completed successfully.

For the timing chart, refer to the following.

 Page 146 Connection information read request (Y14)

Communication Ready (X1F)

This signal turns on when the communication preparation for the RJ71EIP91 completes.

- On: Communication preparation has completed.
- Off: Communication preparation is in progress.

Details of output signals

Module error clear request (YF)

This signal is used to clear the minor error that has occurred on the own station.

- On: Minor error clear request
- Off: —

If this signal turns on when an own station error has occurred, the following operations are executed.

- The latest error code is cleared.
- The ERR LED is turned off.
- 'Module Error' (XF) is turned off.

---> Performed by the RJ71EIP91

—> Performed by the program

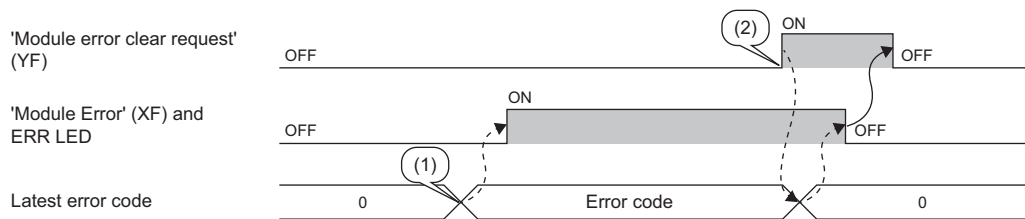

(1) Error occurrence

(2) Elimination of error cause

EtherNet/IP communication start request (Y10)

Turn this signal off and on to make a request to start the EtherNet/IP communications.

- Off to on: EtherNet/IP communication start request
- On to off: EtherNet/IP communication stop request

However, it is possible to make the EtherNet/IP communication continue by setting 'EtherNet/IP data link continuation specification request' (Un\G16634), which changes 'EtherNet/IP communication start request' (Y10) from on to off. (Page 152 EtherNet/IP data link continuation specification request (Un\G16634))

■EtherNet/IP communication has started (normal)

---▶ Performed by the RJ71EIP91

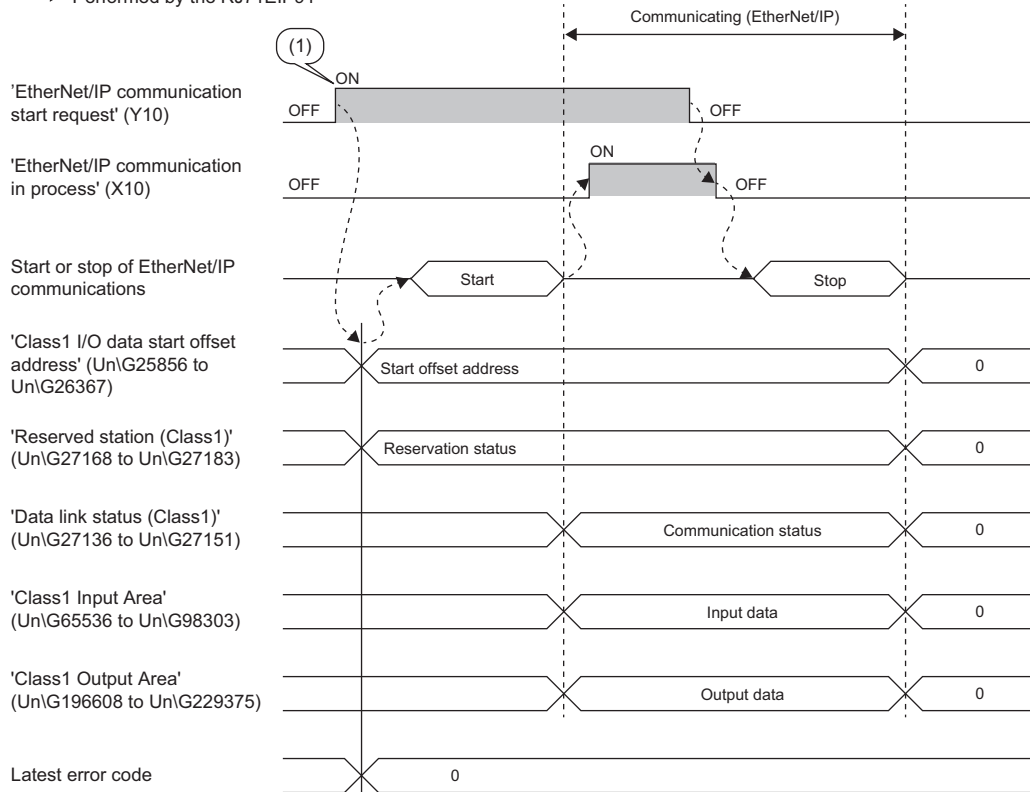

(1) Parameter setting

■EtherNet/IP communication does not start (error)

---▶ Performed by the RJ71EIP91

—▶ Performed by the program

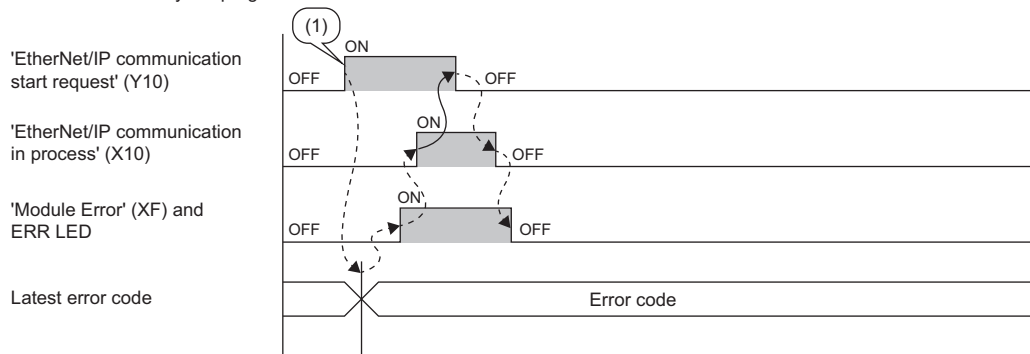

(1) Parameter setting

■ 'EtherNet/IP data link continuation specification request' (Un\G16635) is set

---> Performed by the RJ71EIP91

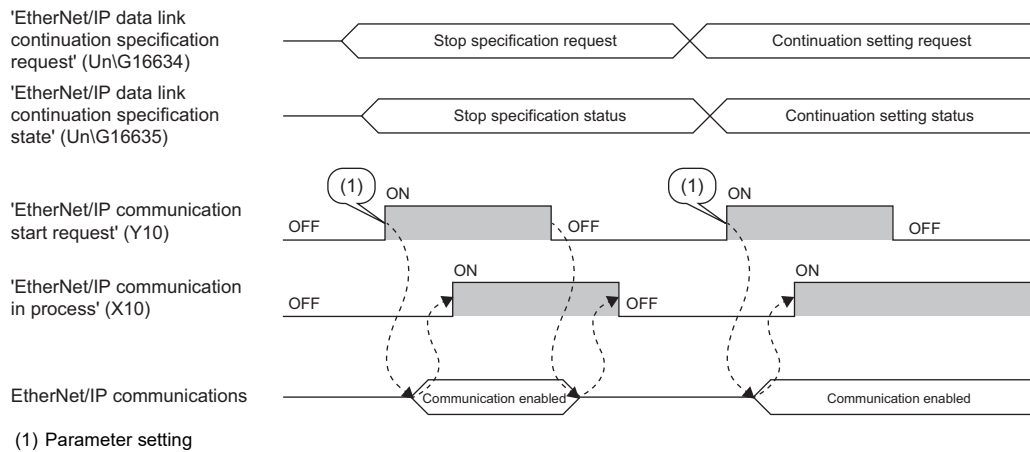

PING test execution request (Y12)

Turn this signal off and on to execute a PING test.

- Off to on: PING test execution request
- On to off: PING test completion request

Turning on 'PING test execution request' (Y12) clears 'PING test result area' (Un\G27908 to Un\G27911).

Turning off 'PING test execution request' (Y12) turns 'PING test completion' (X12) on and off.

---> Performed by the RJ71EIP91

—> Performed by the program

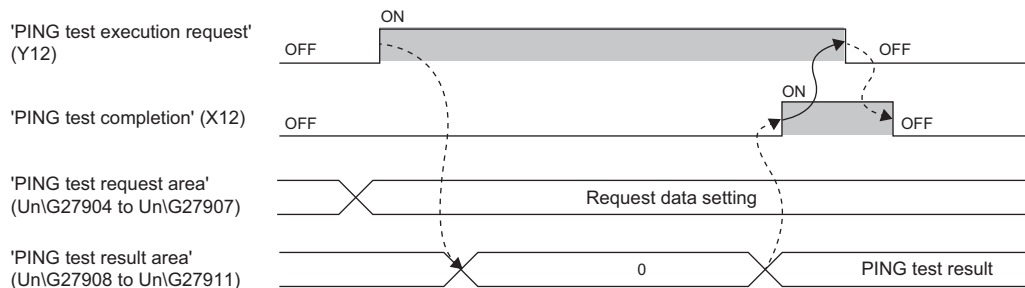

A

Connection information read request (Y14)

Turn this signal off and on to request the reading of connection information.

- Off to on: Connection information reading execution request
- On to off: Connection information reading stop request

Turn on 'Connection information read request' (Y14) to read the connection information from the connection number specified with 'Connection number designation' (Un\G28288).

■When the connection information reading has completed successfully

---> Performed by the RJ71EIP91

—> Performed by the program

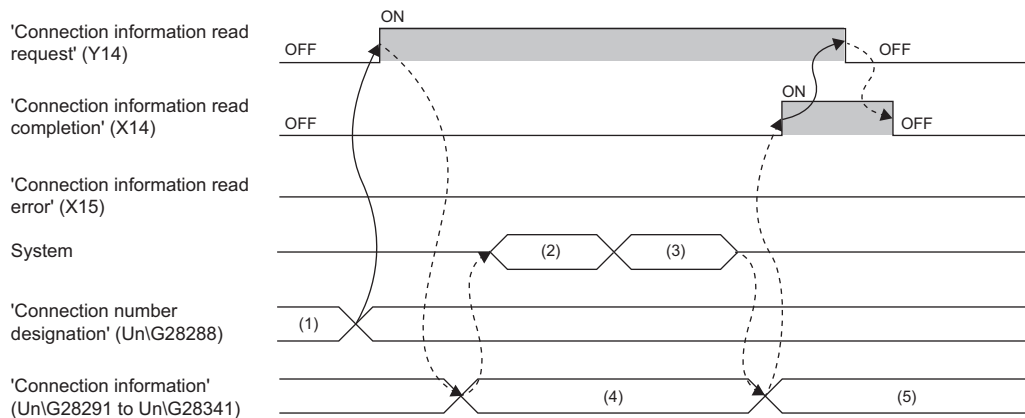

- (1) Specify the connection number.
- (2) Check the read data.
- (3) Read the connection information.
- (4) Clear the area in buffer memory.
- (5) Store the read connection information.

■When the check before connection information reading has completed with an error

---> Performed by the RJ71EIP91

—> Performed by the program

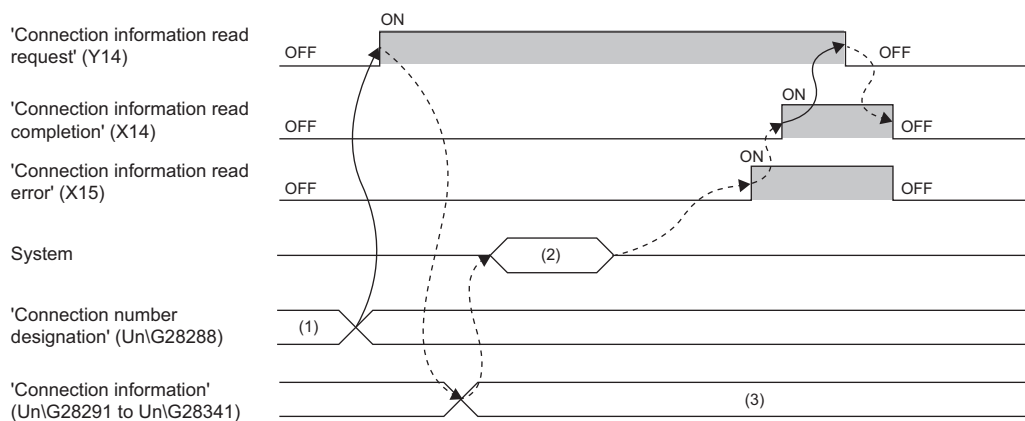

- (1) Specify the connection number.
- (2) Check the read data.
- (3) Clear the area in buffer memory.

■ When the connection information reading has completed with an error

- > Performed by the RJ71EIP91
- > Performed by the program

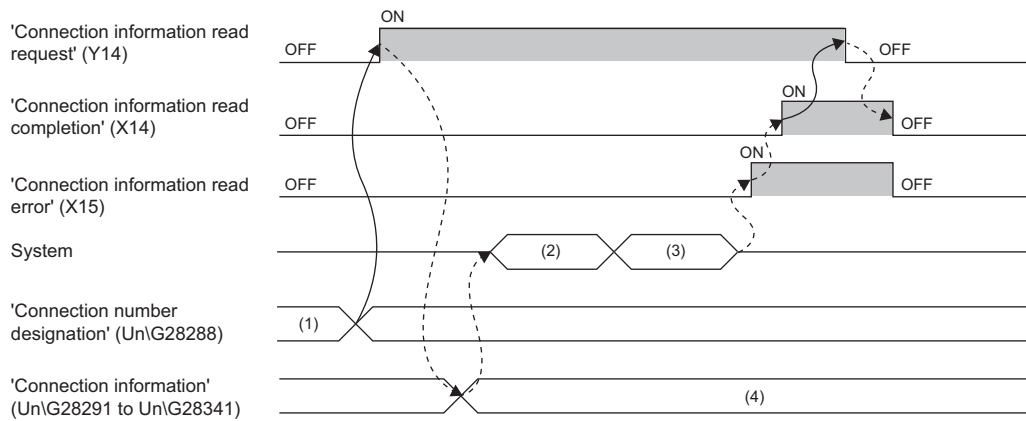

- (1) Specify the connection number.
- (2) Check the read data.
- (3) Read the connection information.
- (4) Clear the area in buffer memory.

Appendix 3 Buffer Memory

The buffer memory is used to exchange data between the RJ71EIP91 and the CPU module or EtherNet/IP devices. Buffer memory values are set to their defaults (initial values) when the system is powered off or the CPU module is reset.

List of buffer memory addresses

Address (decimal)	Address (hexadecimal)	Name	Initial value	Read, write	
0 to 16628	0H to 40F4H	System area			
16629	40F5H	Block assurance specification per connection	Setting value ^{*1}	Read, write	
16630	40F6H	Block assurance state per connection	0	Read	
16631	40F7H	Application Trigger operating specification (Class1)	Application Trigger operating specification request	0	Read, write
16632	40F8H		Application Trigger operating specification state	0	Read
16633	40F9H	System area			
16634	40FAH	EtherNet/IP data link continuation specification	EtherNet/IP data link continuation specification request	0	Read, write
16635	40FBH		EtherNet/IP data link continuation specification state	0	Read
16636 to 16639	40FCH to 40FFH	System area			
16640 to 16895	4100H to 41FFH	Class1 I/O data size	Class1 Input data length	0	Read
16896 to 17151	4200H to 42FFH		Class1 Output data length	0	Read
17152 to 25732	4300H to 6484H	System area			
25733 to 25735	6485H to 6487H	Setting status	MAC Address	Setting value	Read
25736 to 25855	6488H to 64FFH	System area			
25856 to 26111	6500H to 65FFH	Class1 I/O data start offset address	Class1 Start offset address to the input data	65535	Read
26112 to 26367	6600H to 66FFH		Class1 Start offset address to the output data	65535	Read
26368 to 27007	6700H to 697FH	System area			
27008 to 27023	6980H to 698FH	Application Trigger (Class1)	Application Trigger Request (Class1)	0	Read, write
27024 to 27039	6990H to 699FH		Application Trigger Acceptance (Class1)	0	Read
27040 to 27055	69A0H to 69AFH		Application Trigger Completion (Class1)	0	Read
27056 to 27135	69B0H to 69FFH	System area			
27136 to 27151	6A00H to 6A0FH	Class1 communication status	Data link status (Class1)	0	Read
27152 to 27167	6A10H to 6A1FH		Error status (Class1)	0	Read
27168 to 27183	6A20H to 6A2FH		Reserved station (Class1)	0	Read
27184 to 27391	6A30H to 6AFFH	System area			
27392 to 27647	6B00H to 6BFFH	Class1 Connection Behavior Error status	0	Read	
27648 to 27903	6C00H to 6CFFH	System area			
27904	6D00H	PING test request area	Communication time check	0	Read, write
27905	6D01H		Transmission count	0	Read, write
27906 to 27907	6D02H to 6D03H		IP Address	0	Read, write
27908	6D04H	PING test result area	Result	0	Read
27909	6D05H		Total Number of packet transmissions	0	Read
27910	6D06H		Number of success	0	Read
27911	6D07H		Number of failure	0	Read
27912 to 28159	6D08H to 6DFFH		System area		

Address (decimal)	Address (hexadecimal)	Name	Initial value	Read, write		
28160	6E00H	Node information area	Communication state	0	Read	
28161	6E01H		Communication speed	0	Read	
28162 to 28163	6E02H to 6E03H		Send packet per second	0	Read	
28164 to 28165	6E04H to 6E05H		Receive packet per second	0	Read	
28166	6E06H		Send error packet per second	0	Read	
28167	6E07H		Receive error packet per second	0	Read	
28168 to 28169	6E08H to 6E09H		PPS	0	Read	
28170	6E0AH		Connection	0	Read	
28171 to 28287	6E0BH to 6E7FH		System area			
28288	6E80H	Connection information read request area	Connection number designation	0	Write	
28289	6E81H	System area				
28290	6E82H	Connection information read response area	Read result	0	Read	
28291 to 28341	6E83H to 6EB5H		Connection information	0	Read	
28342 to 32767	6EB6H to 7FFFH	System area				
32768 to 33023	8000H to 80FFH	Class1 Block assurance specification per connection	Class1 Connection Input data update state	0	Read, write	
33024 to 33279	8100H to 81FFH		Class1 Connection Output data update state	0	Read, write	
33280 to 65535	8200H to FFFFH	System area				
65536 to 98303	10000H to 17FFFH	Class1 Input Area			0	Read
98304 to 196607	18000H to 2FFFFH	System area				
196608 to 229375	30000H to 37FFFH	Class1 Output Area			0	Read, write
229376 to 393215	38000H to 5FFFFH	System area				
393216 to 393217	60000H to 60001H	UCMM communication execution command	UCMM data link execution request	0	Read, write	
393218 to 393231	60002H to 6000FH		System area			
393232 to 393233	60010H to 60011H		UCMM data link execution request acceptance	0	Read	
393234 to 393247	60012H to 6001FH		System area			
393248 to 393249	60020H to 60021H		UCMM data link execution completion	0	Read	
393250 to 393279	60022H to 6003FH		System area			
393280	60040H	UCMM data link request command (No.1)	System area			
393281 to 393282	60041H to 60042H		Target IP Address	0	Read, write	
393283	60043H		Service	0	Read, write	
393284 to 393285	60044H to 60045H		System area			
393286	60046H		Class	0	Read, write	
393287	60047H		Instance	0	Read, write	
393288	60048H		Attribute	0	Read, write	
393289	60049H		Data length	0	Read, write	
393290 to 393311	6004AH to 6005FH		System area			
393312 to 394018	60060H to 60322H		Request data	0	Read, write	
394019 to 394047	60323H to 6033FH		System area			



Address (decimal)	Address (hexadecimal)	Name	Initial value	Read, write	
394048	60340H	UCMM data link receive command (No.1)	Result storage area	0	Read
394049 to 394050	60341H to 60342H		Target IP Address	0	Read
394051	60343H		Service	0	Read
394052 to 394053	60344H to 60345H		System area		
394054	60346H		Class	0	Read
394055	60347H		Instance	0	Read
394056	60348H		Attribute	0	Read
394057	60349H		Data length	0	Read
394058 to 394079	6034AH to 6035FH		System area		
394080 to 394786	60360H to 60622H		Receive data	0	Read
394787 to 394815	60623H to 6063FH		System area		
394816 to 442431	60640H to 6C03FH		UCMM data link request command (No.2 to No.32) UCMM data link receive command (No.2 to No.32)	0	—
442432 to 2097151	6C040H to 1FFFFFFH		System area		

*1 The value in 'Block assurance specification per connection' (Un\G16629) is reflected.



Do not write data to "System area". Doing so may cause malfunction of the programmable controller system.

Details of buffer memory addresses

The following describes the buffer memory addresses of the RJ71EIP91.

Block assurance specification per connection

■Block assurance specification per connection (Un\G16629)

This address is used to set whether to perform data assurance on the input data or output data used in Class1 communications.

Set data assurance in units of connections or tags.

The setting of "Block assurance per connection" in the module parameter is reflected at the startup of the RJ71EIP91.

However, the setting of 'Block assurance specification per connection' (Un\G16629) is reflected when 'EtherNet/IP communication start request' (Y10) is turned off and on.

The setting is reflected when 'EtherNet/IP communication start request' (Y10) is turned off and on.

- 0: Do not perform data assurance.
- 16: Perform data assurance.

Point

For the setting of "Block assurance per connection" in the module parameter, refer to the following.

 Page 48 Application Setting

Block assurance state per connection

■Block assurance state per connection (Un\G16630)

This address is used to store the data assurance status for the input data or output data of the Class1 communications being executed.

Store data assurance in units of connections or tags.

The setting is reflected when 'EtherNet/IP communication start request' (Y10) is turned off and on.

- 0: EtherNet/IP communication is stopped.
- 1: Data assurance is not being performed.
- 2: Data assurance is being performed.

Application Trigger operating specification (Class1)

■Application Trigger operating specification request (Un\G16631)

This address is used to set the Application Trigger operation to use during Class1 communications.

The setting is reflected when 'EtherNet/IP communication start request' (Y10) is turned off and on.

- 0: The output data is sent automatically at the RPI interval regardless of the execution of 'Application Trigger Request (Class1)' (Un\G27008 to Un\G27023).
- 16: The output data is not sent at the RPI interval and is sent by the execution of 'Application Trigger Request (Class1)' (Un\G27008 to Un\G27023).

■Application Trigger operating specification state (Un\G16632)

This address is used to store the setting status of 'Application Trigger operating specification request' (Un\G16631).

The setting is reflected when 'EtherNet/IP communication start request' (Y10) is turned off and on.

- 0: EtherNet/IP communication is stopped.
- 1: Output data is sent automatically at the RPI interval.
- 2: Output data is not sent automatically at the RPI interval.

EtherNet/IP data link continuation specification

■EtherNet/IP data link continuation specification request (Un\G16634)

This address is used to set whether to continue EtherNet/IP communications when 'EtherNet/IP communication start request' (Y10) is turned on and off.

Set this address to continue EtherNet/IP communications in situations such as when the CPU module changes from the RUN state to the STOP state and when a stop error occurs on the CPU module.

The setting is reflected when 'EtherNet/IP communication start request' (Y10) is turned off and on.

- 0: Stops EtherNet/IP communications.
- 16: Continues EtherNet/IP communications.

■EtherNet/IP data link continuation specification state (Un\G16635)

This address is used to store the setting status of 'EtherNet/IP data link continuation specification request' (Un\G16634).

The setting is reflected when 'EtherNet/IP communication start request' (Y10) is turned off and on.

- 0: The 'EtherNet/IP data link continuation specification request' (Un\G16634) setting has not been reflected.
- 1: Operation is in progress with the setting for continuing EtherNet/IP communications.
- 2: Operation is in progress with the setting for stopping EtherNet/IP communications.

Class1 I/O data size

■Class1 Input data length (Un\G16640 to Un\G16895)

This address is used to store the size of the data received by the RJ71EIP91 from the EtherNet/IP device during Class1 communications. (Unit: words)

Address	Description
Un\G16640	Stores the input data size of connection number 1.
Un\G16641	Stores the input data size of connection number 2.
⋮	⋮
Un\G16895	Stores the input data size of connection number 256.

■Class1 Output data length (Un\G16896 to Un\G17151)

This address is used to store the size of the data to send to the EtherNet/IP device from the RJ71EIP91 during Class1 communications. (Unit: words)

Address	Description
Un\G16896	Stores the output data size of connection number 1.
Un\G16897	Stores the output data size of connection number 2.
⋮	⋮
Un\G17151	Stores the output data size of connection number 256.

Setting status

■MAC Address (Un\G25733 to Un\G25735)

Stores the MAC address of the RJ71EIP91.

The MAC address is stored starting with the lower-order word.

Ex.

For MAC address 08-00-70-00-1A-34

Address	Stored value	Description
Un\G25733	1A34H	First lower-order word of MAC address
Un\G25734	7000H	Second lower-order word of MAC address
Un\G25735	0800H	Third lower-order word of MAC address

Class1 I/O data start offset address

■Class1 Start offset address to the input data (Un\G25856 to Un\G26111)

In relation to the start address of Class1 Input Area (Un\G65536 to Un\G98303), stores the offset address of the input data for each connection.

- 0 to 32767: Offset address of each connection
- 65535: No offset address assignment

Address	Description
Un\G25856	Connection No.1 offset address
Un\G25857	Connection No.2 offset address
⋮	⋮
Un\G26111	Connection No.256 offset address

Ex.

Indicates the offset address stored in Class1 Start offset address to the input data (Un\G25856 to Un\G26111) for the input data stored in Class1 Input Area (Un\G65536 to Un\G98303).

Class1 Input Area (Un\G65536 to Un\G98303)		Class1 Start offset address to the input data (Un\G25856 to Un\G26111)	
Address	Description	Address	Description
Un\G65536	Connection No.1 input data	Un\G25856	0
Un\G65537	Connection No.2 input data	Un\G25857	1
Un\G65538			
Un\G65539			
Un\G65540	Connection No.3 input data	Un\G25858	4
Un\G65541	Connection No.4 input data	Un\G25859	6
Un\G65542			

■Class1 Start offset address to the output data (Un\G26112 to Un\G26367)

In relation to the start address of Class1 Output Area (Un\G196608 to Un\G229375), stores the offset address of the output data for each connection.

- 0 to 32767: Offset address of each connection
- 65535: No offset address assignment

Address	Description
Un\G26112	Connection No.1 offset address
Un\G26113	Connection No.2 offset address
⋮	⋮
Un\G26367	Connection No.256 offset address

Ex.

Indicates the offset address stored in Class1 Start offset address to the output data (Un\G26112 to Un\G26367) for the output data stored in Class1 Output Area (Un\G196608 to Un\G229375).

Class1 Output Area (Un\G196608 to Un\G229375)		Class1 Start offset address to the output data (Un\G26112 to Un\G26367)	
Address	Description	Address	Description
Un\G196608	Connection No.1 output data	Un\G26112	0
Un\G196609	Connection No.2 output data	Un\G26113	1
Un\G196610			
Un\G196611			
Un\G196612	Connection No.3 output data	Un\G26114	4
Un\G196613	Connection No.4 output data	Un\G26115	6
Un\G196614			

A

Application Trigger (Class1)

■Application Trigger (Class1) (Un\G27008 to Un\G27055)

This area requests and checks Application Triggers via Class1 communications.

Address	Item	Description
Un\G27008 to Un\G27023	Application Trigger Request (Class1)	Requests Application Trigger or Change of State for each connection number. If the requested connection number is not a Producer Tag, the request is ignored. <ul style="list-style-type: none"> • On: Request present • Off: Request not present
Un\G27024 to Un\G27039	Application Trigger Acceptance (Class1)	Stores the acceptance status of Application Trigger or Change of State for each connection number. <ul style="list-style-type: none"> • On: Accepted • Off: Not accepted
Un\G27040 to Un\G27055	Application Trigger Completion (Class1)	Stores the completion status of Application Trigger or Change of State for each connection number. <ul style="list-style-type: none"> • On: Completed • Off: Not completed

The following table lists the assignments for each area. The value of each bit indicates the connection number.

Address			Bit															
Application Trigger Request (Class1)	Application Trigger Acceptance (Class1)	Application Trigger Completion (Class1)	b15	b14	b13	b12	b11	b10	b9	b8	b7	b6	b5	b4	b3	b2	b1	b0
Un\G27008	Un\G27024	Un\G27040	16	15	14	13	12	11	10	9	8	7	6	5	4	3	2	1
Un\G27009	Un\G27025	Un\G27041	32	31	30	29	28	27	26	25	24	23	22	21	20	19	18	17
Un\G27010	Un\G27026	Un\G27042	48	47	46	45	44	43	42	41	40	39	38	37	36	35	34	33
Un\G27011	Un\G27027	Un\G27043	64	63	62	61	60	59	58	57	56	55	54	53	52	51	50	49
Un\G27012	Un\G27028	Un\G27044	80	79	78	77	76	75	74	73	72	71	70	69	68	67	66	65
Un\G27013	Un\G27029	Un\G27045	96	95	94	93	92	91	90	89	88	87	86	85	84	83	82	81
Un\G27014	Un\G27030	Un\G27046	112	111	110	109	108	107	106	105	104	103	102	101	100	99	98	97
Un\G27015	Un\G27031	Un\G27047	128	127	126	125	124	123	122	121	120	119	118	117	116	115	114	113
Un\G27016	Un\G27032	Un\G27048	144	143	142	141	140	139	138	137	136	135	134	133	132	131	130	129
Un\G27017	Un\G27033	Un\G27049	160	159	158	157	156	155	154	153	152	151	150	149	148	147	146	145
Un\G27018	Un\G27034	Un\G27050	176	175	174	173	172	171	170	169	168	167	166	165	164	163	162	161
Un\G27019	Un\G27035	Un\G27051	192	191	190	189	188	187	186	185	184	183	182	181	180	179	178	177
Un\G27020	Un\G27036	Un\G27052	208	207	206	205	204	203	202	201	200	199	198	197	196	195	194	193
Un\G27021	Un\G27037	Un\G27053	224	223	222	221	220	219	218	217	216	215	214	213	212	211	210	209
Un\G27022	Un\G27038	Un\G27054	240	239	238	237	236	235	234	233	232	231	230	229	228	227	226	225
Un\G27023	Un\G27039	Un\G27055	256	255	254	253	252	251	250	249	248	247	246	245	244	243	242	241

The following figure shows the timing chart for the execution of the Application Trigger.*1

- ▶ Performed by the RJ71EIP91
- ▶ Performed by the program

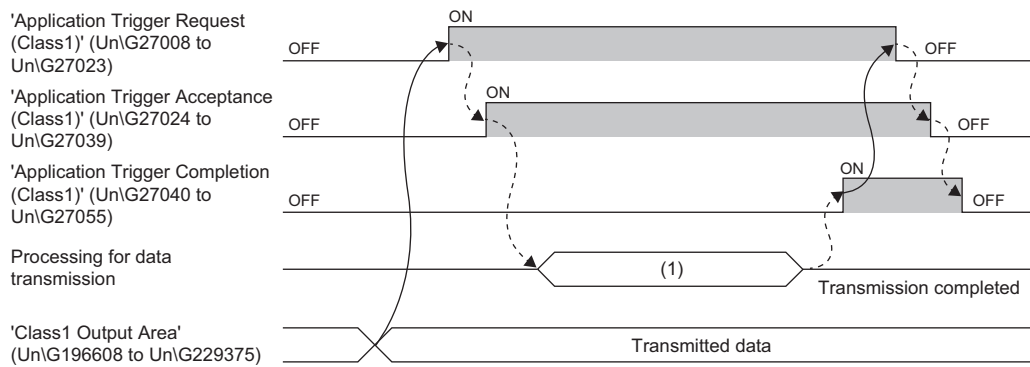

(1) Application Trigger execution

*1 If 'Application Trigger Request (Class1)' (UnG27008 to UnG27023) is turned off before 'Application Trigger Completion (Class1)' (UnG27040 to UnG27055) and 'Application Trigger Acceptance (Class1)' (UnG27024 to UnG27039) are turned on, the Application Trigger will not be executed.

Point

In data send processing, data are sent to EtherNet/IP devices at the completion of sending the data. When the RJ71EIP91 is the target and both of the following conditions are met, data are sent to EtherNet/IP devices after the Inhibit time has elapsed from the completion of sending the data.

- Trigger Type of the connection setting is set to Change of State.
- Inhibit time is set.

For details on the connection setting, refer to the following.

☞ Page 81 [Connections] tab

Class1 communication status

■Class1 communication status (Un\G27136 to Un\G27183)

This area stores the communication status of Class1 communications for each connection number.

Address	Item	Description
Un\G27136 to Un\G27151	Data link status (Class1)	Stores the data link status of connection numbers 1 to 256. It automatically turns on when communication recovers from an error. • On: Data link in operation • Off: Not set, reserved station, data link not in operation, error
Un\G27152 to Un\G27167	Error status (Class1)	Stores the error status of connection numbers 1 to 256. It automatically turns off when communication recovers from an error. • On: Error* ¹ • Off: Not set or data link in operation
Un\G27168 to Un\G27183	Reserved station (Class1)	Stores the setting status of the reserved station of connection numbers 1 to 256. • On: Reserved station • Off: Not set as reserved station

*1 For a Producer Tag during tag communications, it turns on only when communications with all the connected Consumer Tags are stopped.

Point

During tag communications, if one Producer Tag is connected to multiple Consumer Tags through multicast communications, 'Data link status (Class1)' (Un\G27136 to Un\G27151) turns on if even one communication operation is normal.

Note that if the connections with all Consumer Tags are not communicating or have a communication error, 'Data link status (Class1)' (Un\G27136 to Un\G27151) turns off.

The following table lists the assignments for each area.

The value of each bit indicates the connection number.

Address			Bit															
Data link status (Class1)	Error status (Class1)	Reserved station (Class1)	b15	b14	b13	b12	b11	b10	b9	b8	b7	b6	b5	b4	b3	b2	b1	b0
Un\G27136	Un\G27152	Un\G27168	16	15	14	13	12	11	10	9	8	7	6	5	4	3	2	1
Un\G27137	Un\G27153	Un\G27169	32	31	30	29	28	27	26	25	24	23	22	21	20	19	18	17
Un\G27138	Un\G27154	Un\G27170	48	47	46	45	44	43	42	41	40	39	38	37	36	35	34	33
Un\G27139	Un\G27155	Un\G27171	64	63	62	61	60	59	58	57	56	55	54	53	52	51	50	49
Un\G27140	Un\G27156	Un\G27172	80	79	78	77	76	75	74	73	72	71	70	69	68	67	66	65
Un\G27141	Un\G27157	Un\G27173	96	95	94	93	92	91	90	89	88	87	86	85	84	83	82	81
Un\G27142	Un\G27158	Un\G27174	112	111	110	109	108	107	106	105	104	103	102	101	100	99	98	97
Un\G27143	Un\G27159	Un\G27175	128	127	126	125	124	123	122	121	120	119	118	117	116	115	114	113
Un\G27144	Un\G27160	Un\G27176	144	143	142	141	140	139	138	137	136	135	134	133	132	131	130	129
Un\G27145	Un\G27161	Un\G27177	160	159	158	157	156	155	154	153	152	151	150	149	148	147	146	145
Un\G27146	Un\G27162	Un\G27178	176	175	174	173	172	171	170	169	168	167	166	165	164	163	162	161
Un\G27147	Un\G27163	Un\G27179	192	191	190	189	188	187	186	185	184	183	182	181	180	179	178	177
Un\G27148	Un\G27164	Un\G27180	208	207	206	205	204	203	202	201	200	199	198	197	196	195	194	193
Un\G27149	Un\G27165	Un\G27181	224	223	222	221	220	219	218	217	216	215	214	213	212	211	210	209
Un\G27150	Un\G27166	Un\G27182	240	239	238	237	236	235	234	233	232	231	230	229	228	227	226	225
Un\G27151	Un\G27167	Un\G27183	256	255	254	253	252	251	250	249	248	247	246	245	244	243	242	241

Class1 Connection Behavior Error status

■Class1 Connection Behavior Error status (Un\G27392 to Un\G27647)

This area stores the error code of the error that occurred during Class1 communications for each connection number. (0 is stored when communications are normal.)

For details on the error codes, refer to the following.

 Page 133 Error codes when a communication error occurs

Address	Description
Un\G27392	Connection No.1 error code
Un\G27393	Connection No.2 error code
⋮	⋮
Un\G27647	Connection No.256 error code

PING test request area

■PING test request area (Un\G27904 to Un\G27907)

This area executes a PING test request.

Address	Item	Description
Un\G27904	Communication time check	Specifies the PING test end waiting time. <ul style="list-style-type: none">• 0: Operations are performed after one second.• 1 to 5: Operations are performed after the set value. (Unit: seconds)• 6 or higher: Operations are performed after five seconds.
Un\G27905	Transmission count	Specifies the transmission count. <ul style="list-style-type: none">• 0: One transmission is performed.• 1 to 10: Transmissions are performed for the specified number of transmissions. (Unit: times)• 11 or higher: 10 transmissions are performed.
Un\G27906 to Un\G27907	IP Address	Specifies the IP address of the PING test target device. <ul style="list-style-type: none">• Un\G27906: Lower-order word of IP address• Un\G27907: Higher-order word of IP address (Example: If the IP address is 192.1.0.254 [C0H.01H.00H.FEH], the lower-order word is 00FEH and the higher-order word is C001H.)

A

PING test result area

■PING test result area (Un\G27908 to Un\G27911)

This area stores the response result of the PING test.

Address	Item	Description
Un\G27908	Result	Stores the execution result of the PING test. <ul style="list-style-type: none">• 0000H: Completed successfully• C0DBH: Completed with an error ( Page 124 Error details)
Un\G27909	Total Number of packet transmissions	Stores the total packet transmission count during PING test execution.
Un\G27910	Number of success	Stores the success count during PING test execution.
Un\G27911	Number of failure	Stores the failure count during PING test execution.

Node information area

■Node information area (Un\G28160 to Un\G28170)

This area stores the node information of the RJ71EIP91.

Excluding 'Communication state' (Un\G28160) and 'Communication speed' (Un\G28161), these items are available only for Class1 communications.

Address	Item	Description
Un\G28160	Communication state	Stores the EtherNet/IP communication status. • 0000H: Not communicating • 0001H: Communicating
Un\G28161	Communication speed	Stores the communication speed. • 10: 10Mbps • 100: 100Mbps • 1000: 1000Mbps
Un\G28162 to Un\G28163	Send packet per second	Stores the number of packets that were sent per second.
Un\G28164 to Un\G28165	Receive packet per second	Stores the number of packets that were received per second.
Un\G28166	Send error packet per second	Stores the number of packets that were not sent per second.
Un\G28167	Receive error packet per second	Stores the number of packets that were not received per second.
Un\G28168 to Un\G28169	PPS	Stores the number of packets that were processed per second.
Un\G28170	Number of connections	Stores the total number of connections.

Connection information read request area

■Connection number designation (Un\G28288)

This area specifies the connection number for obtaining the connection information of the specified EtherNet/IP device when 'Connection information read request' (Y14) turns off and on.

- 0: Not specified
- 1 to 256: Connection number

Connection information read response area

■Read result (Un\G28290)

This area stores the reading result of the specified connection information when 'Connection information read request' (Y14) turns off and on.



- 0000H: Reading successful
- C44EH: Connection information reading acquisition error
- C44FH: Connection information reading setting error

For details on the errors, refer to the following.

 Page 123 Error details

■Connection information (Un\G28291 to Un\G28341)

This area stores the specified connection information when 'Connection information read request' (Y14) turns off and on.

Address	Item	Description
Un\G28291	Status	Input Status Stores the internal status code of the input connection. ( Page 88 [Diagnostic] tab)
Un\G28292		Output Status Stores the internal status code of the output connection. ( Page 88 [Diagnostic] tab)
Un\G28293		General Stores the CIP general status code.
Un\G28294		Extended Stores the CIP extended status code.

Address	Item		Description
Un\G28295	Counter	Frame Error Counter	Stores the number of frames that could not be sent/received.
Un\G28296		Time-Out Counter	Stores the number of connection timeouts.
Un\G28297		Refused Counter	Stores the number of connection disconnections.
Un\G28298 to Un\G28299		Production Counter	Stores the transmission count.
Un\G28300 to Un\G28301		Consumption Counter	Stores the receive count.
Un\G28302 to Un\G28303		Production Byte Counter	Stores the number of transmission bytes.
Un\G28304 to Un\G28305		Consumption Byte Counter	Stores the number of receive bytes.
Un\G28306 to Un\G28307		Diagnostic	Production Connection ID
Un\G28308 to Un\G28309	Consumption Connection ID		Stores the receive connection ID for the EtherNet/IP device of the requested connection.
Un\G28310 to Un\G28311	O->T API (μs)		Stores the originator to target API value for the EtherNet/IP device of the requested connection. (Unit: μs)
Un\G28312 to Un\G28313	T->O API (μs)		Stores the target to originator API value for the EtherNet/IP device of the requested connection. (Unit: μs)
Un\G28314 to Un\G28315	O->T RPI (μs)		Stores the originator to target RPI value for the EtherNet/IP device of the requested connection. (Unit: μs)
Un\G28316 to Un\G28317	T->O RPI (μs)		Stores the target to originator RPI value for the EtherNet/IP device of the requested connection. (Unit: μs)
Un\G28318 to Un\G28319	O->T Net Parameters		Stores the originator to target network parameters for the EtherNet/IP device of the requested connection.
Un\G28320 to Un\G28321	T->O Net Parameters		Stores the target to originator network parameters for the EtherNet/IP device of the requested connection.
Un\G28322	Originator Connection Serial Number		Stores the originator connection serial number.
Un\G28323	Originator Vendor Id		Stores the originator vendor code.
Un\G28324 to Un\G28325	Originator Serial Number		Stores the originator serial number.
Un\G28326 to Un\G28327	Send Socket Diagnostic		Socket ID
Un\G28328 to Un\G28329		Remote IP Address	Stores the IP address of the EtherNet/IP device of the requested connection.
Un\G28330		Remote Port	Stores the port number of the EtherNet/IP device of the requested connection.
Un\G28331 to Un\G28332		Local IP Address	Stores the IP address of the RJ71EIP91.
Un\G28333		Local Port	Stores the port number of the RJ71EIP91.
Un\G28334 to Un\G28335	Receive Socket Diagnostic	Socket ID	Stores the socket ID of the receive connection.
Un\G28336 to Un\G28337		Remote IP Address	Stores the IP address of the EtherNet/IP device of the requested connection.
Un\G28338		Remote Port	Stores the port number of the EtherNet/IP device of the requested connection.
Un\G28339 to Un\G28340		Local IP Address	Stores the IP address of the RJ71EIP91.
Un\G28341		Local Port	Stores the port number of the RJ71EIP91.

Class1 Block assurance specification per connection

■Class1 Connection Input data update state (Un\G32768 to Un\G33023)

This area stores the update status of the input data when 'Block assurance state per connection' (Un\G16630) is set to "2: Data assurance is being performed".

- 0: No update available or data reading finished*1
- 1: Update available

*1 If a program is used to read the input data after the input data is updated, the buffer memory value changes from 1 to 0.

Address	Description
Un\G32768	Connection No.1 Input data update state
Un\G32769	Connection No.2 Input data update state
⋮	⋮
Un\G33023	Connection No.256 Input data update state

■Class1 Connection Output data update state (Un\G33024 to Un\G33279)

This area stores the update status of the output data when 'Block assurance state per connection' (Un\G16630) is set to "2: Data assurance is being performed".

- 0: No update available or data reading finished
- 1: Update available*1

*1 If a program is used to write the output data, the buffer memory value changes from 0 to 1.

Address	Description
Un\G33024	Connection No.1 Output data update state
Un\G33025	Connection No.2 Output data update state
⋮	⋮
Un\G33279	Connection No.256 Output data update state

Class1 Input Area

■Class1 Input Area (Un\G65536 to Un\G98303)

This area stores the data received by the RJ71EIP91 from the EtherNet/IP device during Class1 communications. Set the data to be received by the RJ71EIP91 from the EtherNet/IP device in the engineering tool. (🔍 Page 81 [Connections] tab)

For details on this area, refer to the following.

🔍 Page 18 Class1 instance communications

Class1 Output Area

■Class1 Output Area (Un\G196608 to Un\G229375)

This area stores the data to send to the EtherNet/IP device from the RJ71EIP91 during Class1 communications.

Set the data to send to the EtherNet/IP device from the RJ71EIP91 in the engineering tool. (🔍 Page 81 [Connections] tab)

For details on this area, refer to the following.

🔍 Page 18 Class1 instance communications

UCMM communication execution command

■UCMM communication execution command (Un\G393216 to Un\G393249)

This area requests and checks communication during UCMM communications.

Address	Item	Description
Un\G393216 to Un\G393217	UCMM data link execution request	Requests execution to send the request command over UCMM communications. • On: Request present • Off: Request not present
Un\G393232 to Un\G393233	UCMM data link execution request acceptance	Stores the acceptance status of the UCMM communication execution request. • On: Accepted • Off: Not accepted
Un\G393248 to Un\G393249	UCMM data link execution completion	Stores the execution status of the UCMM communications. • On: Completed • Off: Not completed or unexecuted

The following table lists the assignments for each area.

The value of each bit indicates the request command number. (No.1 to No.32)

Address			Bit															
UCMM data link execution request	UCMM data link execution request acceptance	UCMM data link execution completion	b15	b14	b13	b12	b11	b10	b9	b8	b7	b6	b5	b4	b3	b2	b1	b0
Un\G393216	Un\G393232	Un\G393248	16	15	14	13	12	11	10	9	8	7	6	5	4	3	2	1
Un\G393217	Un\G393233	Un\G393249	32	31	30	29	28	27	26	25	24	23	22	21	20	19	18	17

The following figure shows the timing chart for the execution of the UCMM communication execution request.

- ▶ Performed by the RJ71EIP91
- ▶ Performed by the program

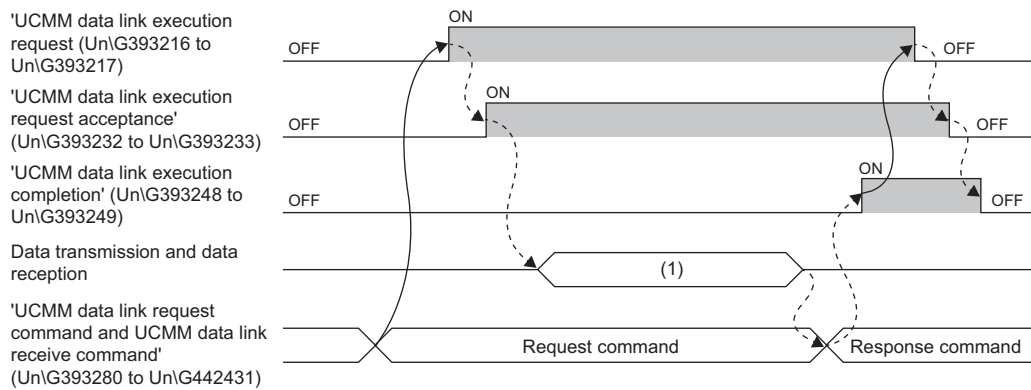

(1) UCMM communication execution



UCMM data link request command, UCMM data link receive command

■UCMM data link request command (No.1) (Un\G393280 to Un\G394047)

This item is used to set the UCMM communication request command.

Address	Item	Description
Un\G393280	System area	—
Un\G393281 to Un\G393282	Target IP Address	Specifies the IP address of the EtherNet/IP device to send the request command to. <ul style="list-style-type: none"> Un\G393281: Lower-order word of IP address Un\G393282: Higher-order word of IP address (Example: If the IP address is 192.1.0.254 [C0H.01H.00H.FEH], the lower-order word is 00FEH and the higher-order word is C001H.)
Un\G393283	Service	Specifies the service code of the EtherNet/IP device.* ¹
Un\G393284 to Un\G393285	System area	—
Un\G393286	Class	Specifies the class ID of the EtherNet/IP device.* ¹
Un\G393287	Instance	Specifies the instance ID of the EtherNet/IP device.* ¹
Un\G393288	Attribute	Specifies the attribute ID of the EtherNet/IP device.* ¹
Un\G393289	Data length	Specifies the data size of the EtherNet/IP device. (Unit: Bytes)* ¹
Un\G393290 to Un\G393311	System area	—
Un\G393312 to Un\G394018	Request data	Specifies the request data of the EtherNet/IP device.* ¹
Un\G394019 to Un\G394047	System area	—

*¹ For the setting value, refer to the manuals of the send destination EtherNet/IP device.

■UCMM data link receive command (No.1) (Un\G394048 to Un\G394815)

This item stores the UCMM communication response command.

Address	Item	Description
Un\G394048	Result storage area	Stores the processing result of 'UCMM data link request command (No.1)' (Un\G393280 to Un\G394047). <ul style="list-style-type: none"> 0: Completed successfully Other than 0: Completed with an error (error code)*¹
Un\G394049 to Un\G394050	Target IP Address	Stores the IP address of the EtherNet/IP device from which the response command was sent. <ul style="list-style-type: none"> Un\G394049: Lower-order word of IP address Un\G394050: Higher-order word of IP address (Example: If the IP address is 192.1.0.254, the lower-order word is 00FEH and the higher-order word is C001H.)
Un\G394051	Service	Stores the service code of the EtherNet/IP device.* ¹
Un\G394052 to Un\G394053	System area	—
Un\G394054	Class	Stores the class ID of the EtherNet/IP device.* ¹
Un\G394055	Instance	Stores the instance ID of the EtherNet/IP device.* ¹
Un\G394056	Attribute	Stores the attribute ID of the EtherNet/IP device.* ¹
Un\G394057	Data length	Stores the data size of the EtherNet/IP device. (Unit: Bytes)* ¹
Un\G394058 to Un\G394079	System area	—
Un\G394080 to Un\G394786	Receive data	Stores the response data of the EtherNet/IP device.* ¹
Un\G394787 to Un\G394815	System area	—

*¹ For the stored value, refer to the manuals of the EtherNet/IP device from which the command was sent.

■UCMM data link request command (No.2 to No.32) and UCMM data link receive command (No.2 to No.32) (Un\G394816 to Un\G442431)

This item sets and stores the information of No.2 to No.32 in the same order as UCMM data link request command (No.1) and UCMM data link receive command (No.1).

Appendix 4 Details of Message Communication Support Command

This section describes the commands used during Class3 message communications and UCMM message communications.

Object list

The following table lists the objects that can be used with message communication support commands.

Object	Description	Reference
Identity	Holds information such as the identification information of the EtherNet/IP module.	Page 164 Identity
Connection Manager	Used when establishing a connection with an EtherNet/IP module.	Page 166 Connection Manager
TCP/IP Interface	Holds the settings and status related to TCP/IP.	Page 167 TCP/IP Interface
Ethernet Link	Holds the settings and status related to Ethernet communications.	Page 170 Ethernet Link

Command explanations

Item	Description
Class attribute	Data possessed by the class of an object.*1
Class service	Service performed by specifying a class.*1
Instance attribute	Data possessed by the instance of an object.*2
Instance service	Service performed by specifying an instance.*2

*1 A class possesses the basic information such as the revision and instance of the object.

*2 An instance possesses the information of each object such as its functions and data.

Access

This item indicates whether reading and writing using instance services are allowed.

- Get: Reading is possible with services such as Get_Attribute_Single.
- Set: Writing is possible with services such as Set_Attribute_Single.

Data type

Item	Description	Data size	Range
BOOL	Bit data	1 byte	• 0: Off (False) • 1: On (True)
SINT	Signed 8-bit data	1 byte	-128 to 127
INT	Signed 16-bit data	2 bytes	-32768 to 32767
DINT	Signed 32-bit data	4 bytes	-2147483648 to 2147483647
USINT	Unsigned 8-bit data	1 byte	0 to 255
UINT	Unsigned 16-bit data	2 bytes	0 to 65535
UDINT	Unsigned 32-bit data	4 bytes	0 to 4294967295
ULINT	Unsigned 64-bit data	8 bytes	0 to 18446744073709551615
REAL	Single-precision floating point real number	4 bytes	$E \pm 1.17549435 - 38$ to $E \pm 3.40282347 + 38$
LREAL	Double-precision floating point real number	8 bytes	$E \pm 2.2250738585072014 - 308$ to $E \pm 1.7976931348623157 + 308$
STRING	Character string data	Depends on the number of characters.	—
BYTE	Bit string (8 bits)	1 byte	—
WORD	Bit string (16 bits)	2 bytes	—
DWORD	Bit string (32 bits)	4 bytes	—
Padded EPATH	CIP path segment	4 bytes	—

Setting value (Set)/stored value (Get)

When "Get" access is available, the setting value (Set)/stored value (Get) can be read from the RJ71EIP91.

When "Set" access is available, the setting value (Set)/stored value (Get) can be set on the RJ71EIP91.

Identity

Object name	Class ID
Identity	01H

Class attribute (instance ID: 00H)

Attribute ID	Access (○: Available, ×: Not available)		Name	Data type	Description	Setting value (Set)/stored value (Get)
	Get	Set				
1	○	×	Revision	UINT	Object revision	0001H
2	○	×	Max Instance	UINT	Maximum instance ID	0001H
3	○	×	Number of instances	UINT	Number of created instances	0001H

Class service

Service code	Service	Remarks
01H	Get_Attributes_All	00H is stored in the fourth to seventh bytes.
0EH	Get_Attribute_Single	—

Instance attribute (instance ID: 01H)

Attribute ID	Access (○: Available, ×: Not available)		Name	Data type	Description	Setting value (Set)/stored value (Get)	
	Get	Set					
1	○	×	Vendor Id	UINT	Vendor ID number	00A1H	
2	○	×	Device Type	UINT	Device type	000CH	
3	○	×	Product Code	UINT	Product ID number	0008H	
4	○	×	Revision	Major Revision	USINT	Major revision	01H
				Minor Revision	USINT	Minor revision	01H
5	○	×	Status	WORD	Product status	 Page 164 Details of product status	
6	○	×	Serial Number	UDINT	Serial number	Varies between modules.	
7	○	×	Product Name	STRING	Product name	"RJ71EIP91"	

■Details of product status

Bit	Description	Value
0	Owned	<ul style="list-style-type: none"> • 0: EtherNet/IP communications are not connected as the target device. • 1: At least one connection of EtherNet/IP communications is connected as the target device.
1	Reserved	Fixed to 0
2	Configured	Fixed to 1
3	Reserved	Fixed to 0
4 to 7	Extended Device Status	<ul style="list-style-type: none"> • 0010 (2H): Error occurring on one or more connections • 0011 (3H): No connections established • 0101 (5H): Major Recoverable Fault or Major Unrecoverable Fault occurring • 0110 (6H): One or more connections performing normal communications in RUN mode • 0111 (7H): One or more connections all performing communications in IDLE mode
8	Minor Recoverable Fault	<ul style="list-style-type: none"> • 0: No error • 1: Minor error occurring
9	Minor Unrecoverable Fault	Fixed to 0
10	Major Recoverable Fault	<ul style="list-style-type: none"> • 0: No error • 1: Moderate error occurring
11	Major Unrecoverable Fault	<ul style="list-style-type: none"> • 0: No error • 1: Major error occurring
12 to 15	Extended Device Status 2	Fixed to 0

Instance service

Service code	Service
01H	Get_Attributes_All
0EH	Get_Attribute_Single

Connection Manager

Object name	Class ID
Connection Manager	06H

Class attribute (instance ID: 00H)

Attribute ID	Access (○: Available, ×: Not available)		Name	Data type	Description	Setting value (Set)/stored value (Get)
	Get	Set				
1	○	×	Revision	UINT	Object revision	0001H
2	○	×	Max Instance	UINT	Maximum instance ID	0001H
3	○	×	Number of instances	UINT	Number of created instances	0001H

Class service

Service code	Service	Remarks
01H	Get_Attributes_All	00H is stored in the fourth to seventh bytes.
0EH	Get_Attribute_Single	—

Instance attribute (instance ID: 01H)

Attribute ID	Access (○: Available, ×: Not available)		Name	Data type	Description	Setting value (Set)/stored value (Get)
	Get	Set				
1	○	×	Open Requests	UINT	Number of received Forward_Open services	Value on the left
2	○	×	Open Format Rejects	UINT	Number of Forward_Open services rejected due to format incompatibility	Value on the left
3	○	×	Open Resource Rejects	UINT	Number of Forward_Open services rejected due to insufficient resources	Value on the left
4	○	×	Open Other Rejects	UINT	Number of Forward_Open services rejected due to reasons other than format incompatibility and insufficient resources	Value on the left
5	○	×	Close Requests	UINT	Number of received Forward_Close services	Value on the left
6	○	×	Close Format Requests	UINT	Number of Forward_Close services rejected due to format incompatibility	Value on the left
7	○	×	Close Other Requests	UINT	Number of Forward_Close services rejected due to reasons other than format incompatibility	Value on the left
8	○	×	Connection Timeouts	UINT	Total number of connection timeouts that occurred in connections controlled by the Connection Manager	Value on the left

Instance service

Service code	Service
01H	Get_Attributes_All
0EH	Get_Attribute_Single
4EH	Forward_Close
54H	Forward_Open
5BH	Large_Forward_Open

TCP/IP Interface

Object name	Class ID
TCP/IP Interface	F5H

Class attribute (instance ID: 00H)

Attribute ID	Access (○: Available, ×: Not available)		Name	Data type	Description	Setting value (Set)/stored value (Get)
	Get	Set				
1	○	×	Revision	UINT	Object revision	0004H
2	○	×	Max Instance	UINT	Maximum instance ID	0001H
3	○	×	Number of instances	UINT	Number of created instances	0001H

Class service

Service code	Service	Remarks
01H	Get_Attributes_All	—
0EH	Get_Attribute_Single	—

Instance attribute (instance ID: 01H)

Attribute ID	Access (○: Available, ×: Not available)		Name	Data type	Description	Setting value (Set)/stored value (Get)	
	Get	Set					
1	○	×	Status	DWORD	Interface status	☞ Page 168 Details of interface status	
2	○	×	Configuration Capability	DWORD	Interface capability flag	☞ Page 169 Details of interface capability flag	
3	○	○	Configuration Control	DWORD	Interface control flag	☞ Page 169 Details of interface control flag	
4	○	×	Physical Link Object	Path size	UINT	Path size of physical link object	0002H
				Path	Padded EPATH	Logical segment that identifies the physical link object	<ul style="list-style-type: none"> • 0: 20H • 1: F6H • 2: 24H • 3: 01H
5	○	×	Interface Configuration	IP Address	UDINT	IP address of the device	Set values of parameters
				Network Mask	UDINT	Network mask of the device	
				Gateway Address	UDINT	Default gateway address	
				Name Server	UDINT	Primary name server	00000000H
				Name Server 2	UDINT	Secondary name server	00000000H
				Domain Name	STRING	Default domain name	" " (null character)
6	○	×	Host Name	STRING	Host name	" " (null character)	
8	○	○ ^{*1,2}	TTL Value	USINT	TTL value for EtherNet/IP multicast packets	1 to 255	
9	○	○ ^{*1,2}	MCast Config	Alloc Control	USINT	IP multicast address setting	☞ Page 169 IP multicast address setting value
				Reserved	USINT	Reserved	00H
				Num Mcast	UINT	Number of IP multicast addresses to assign for EtherNet/IP	1 to 32
				Mcast Start Addr	UDINT	First multicast address from which to start assignment	Value on the left
13	○	○ ^{*1}	Encapsulation Inactivity Timeout	UINT	Sets the time until the TCP connection or DTLS session is closed (unit: seconds)	<ul style="list-style-type: none"> • 1 to 3600 0 is invalid. (Default: 120) 	

*1 The setting data is saved to non-volatile memory.

*2 The setting data is enabled the next time the module starts.

■Details of interface status

Bit	Description	Value
0 to 3	Interface Configuration Status	Fixed to 2 (to set the IP address acquired from the parameter settings)
4	Mcast Pending	<ul style="list-style-type: none"> • 0: No changes to TTL Value and Mcast Config • 1: In the wait-for-restart state due to changes to TTL Value and Mcast Config

■Details of interface capability flag

Bit	Description	Value
0	BOOTP Client	Fixed to 0 (because the BOOTP setting is not supported)
1	DNS Client	Fixed to 0 (because the name resolution setting with DNS is not supported)
2	DHCP Client	Fixed to 0 (because IP address setting with DHCP is not supported)
3	DHCP-DNS Update	Fixed to 0 (because the host name sending setting with DHCP requests is not supported)
4	Configuration Settable	Fixed to 0 (because Interface Configuration attribute setting is not supported)
5	Hardware Configurable	Fixed to 1 (available for IP addresses set with parameters)
6	Interface Configuration Change Requires Reset	Fixed to 0 (because Interface Configuration attribute setting is not supported)
7	AcCapable	Fixed to 0 (because the address duplication detection setting is not supported)
8 to 31	Reserved	Fixed to 0

■Details of interface control flag

Bit	Description	Value
0 to 3	Configuration Method	Fixed to 0 (to use IP addresses set with parameters)
4	DNS Enable	Fixed to 0 (because the name resolution setting with DNS is not supported)
5 to 31	Reserved	Fixed to 0

■IP multicast address setting value

Value	Description
0	The default assignment algorithm is used to create multicast addresses.
1	Multicast addresses are assigned according to the values specified for Num Mcast and Mcast Start Addr.
2	Reserved

Instance service

Service code	Service
01H	Get_Attributes_All
0EH	Get_Attribute_Single
10H	Set_Attribute_Single

A

Ethernet Link

Object name	Class ID
Ethernet Link	F6H

Class attribute (instance ID: 00H)

Attribute ID	Access (○: Available, ×: Not available)		Name	Data type	Description	Setting value (Set)/stored value (Get)
	Get	Set				
1	○	×	Revision	UINT	Object revision	0004H
2	○	×	Max Instance	UINT	Maximum instance ID	0001H
3	○	×	Number of instances	UINT	Number of created instances	0001H

Class service

Service code	Service	Remarks
01H	Get_Attributes_All	—
0EH	Get_Attribute_Single	—

Instance attribute (instance ID: 01H)

Attribute ID	Access (○: Available, ×: Not available)		Name	Data type	Description	Setting value (Set)/stored value (Get)	
	Get	Set					
1	○	×	Interface Speed	UDINT	Communication speed of the current interface in use (unit: Mbps)	<ul style="list-style-type: none"> • 10 • 100 • 1000 	
2	○	×	Interface Flags	DWORD	Interface status flag	 Page 172 Details of status flag	
3	○	×	Physical Address	USINT array [6]	MAC layer address	Varies between modules.	
4	○	×	Interface Counters	In Octets	UDINT	Number of octets received through the interface	Value on the left
				In Ucast Packets	UDINT	Number of unicast packets received through the interface	Value on the left
				In NUCast Packets	UDINT	Number of non-unicast packets received through the interface	Value on the left
				In Discards	UDINT	Number of receive packets received through the interface but discarded	Value on the left
				In Errors	UDINT	Number of receive packets including errors (number of packets not included in In Discards)	Value on the left
				In Unknown Protos	UDINT	Number of receive packets including unknown protocols	Value on the left
				Out Octets	UDINT	Number of octets sent through the interface	Value on the left
				Out Ucast Packets	UDINT	Number of unicast packets sent through the interface	Value on the left
				Out NUCast Packets	UDINT	Number of non-unicast packets sent through the interface	Value on the left
				Out Discards	UDINT	Number of discarded transmission packets	Value on the left
Out Errors	UDINT	Number of transmission packets including errors	Value on the left				

Attribute ID	Access (○: Available, ×: Not available)		Name		Data type	Description	Setting value (Set)/stored value (Get)		
	Get	Set							
5	○	×	Media Counters	Alignment Errors	UDINT	Number of receive frames with lengths that are not octet integers	Value on the left		
				FCS Errors	UDINT	Number of receive frames that do not pass the FCS check	Value on the left		
				Single Collisions	UDINT	Number of frames sent successfully with only one collision	Value on the left		
				Multiple Collisions	UDINT	Number of frames sent successfully with two or more collisions	Value on the left		
				SQE Test Errors	UDINT	Number of times SQE test error messages were created	0		
				Deferred Transmissions	UDINT	Number of frames for which the first transmission test was delayed due to the medium being busy	Value on the left		
				Late Collisions	UDINT	Number of collisions detected in packet transmission after 512 bit time or later in packet transmission	Value on the left		
				Excessive Collisions	UDINT	Number of failed frames in transmission due to excessive collisions	Value on the left		
				MAC Transmit Errors	UDINT	Number of frames that failed to be transmitted due to internal MAC sublayer transmission errors	Value on the left		
				Carrier Sense Errors	UDINT	Number of times the carrier sense condition was lost or was not asserted during attempts to send frames	Value on the left		
				Frame Too Long	UDINT	Number of receive frames that exceeded the maximum allowable frame size	Value on the left		
MAC Receive Errors	UDINT	Number of frames that failed to be received through interface due to internal MAC sublayer receiving errors	Value on the left						
6	○	○	Interface Control	Control Bits	WORD	Interface control bits	0001H		
				Forced Interface Speed	UINT	Forced interface operation speed	0000H		
7	○	×	Interface Type		USINT	Interface type	02H		
8	○	×	Interface State		USINT	Current interface status	01H		
9	○	○	Admin State		USINT	Current administration status	01H		
11	○	×	Interface Capability	Capability Bits		DWORD	Interface function other than Speed/Duplex	00000007H	
				Speed/Duplex Options	Speed/Duplex Array Count		USINT	Number of Speed/Duplex arrays	06H
					Speed/Duplex Array	Interface Speed	UINT	Speed to force the interface to operate at	10, 10, 100, 100, 1000, 1000
						Interface Duplex Mode	USINT	Duplex mode of the interface ^{*1}	0, 1, 0, 1, 0, 1



Attribute ID	Access (○: Available, ×: Not available)		Name	Data type	Description	Setting value (Set)/stored value (Get)	
	Get	Set					
12	○	×	HC Interface Counters	HCInOctets	ULINT	Number of octets received through the interface	Value on the left
				HCInUcastPkts	ULINT	Number of unicast packets received through the interface	Value on the left
				HCInMulticastPkts	ULINT	Number of multicast packets received through the interface	Value on the left
				HCInBroadcastPkts	ULINT	Number of broadcast packets received through the interface	Value on the left
				HCOctets	ULINT	Number of octets sent through the interface	Value on the left
				HCOUcastPkts	ULINT	Number of packets sent through the interface	Value on the left
				HCOMulticastPkts	ULINT	Number of multicast packets sent through the interface	Value on the left
				HCOBroadcastPkts	ULINT	Number of broadcast packets sent through the interface	Value on the left
13	○	×	HC Media Counters	HCStatsAlignmentErrors	ULINT	64-bit version of Alignment Errors	Value on the left
				HCStatsFCSErrors	ULINT	64-bit version of FCS Errors	Value on the left
				HCStatsInternalMacTransmitErrors	ULINT	64-bit version of MAC Transmit Errors	Value on the left
				HCStatsFrameTooLongs	ULINT	64-bit version of Frame Too Long	Value on the left
				HCStatsInternalMacReceiveErrors	ULINT	64-bit version of MAC Receive Errors	Value on the left
				HCStatsSymbolErrors	ULINT	Number of illegal data symbols in the media when a valid carrier exists	0

*1 Arrays are displayed in combination with Interface Speed. This indicates the speed and Duplex mode supported by the module.

■Details of status flag

Bit	Description	Value
0	Link-up status	<ul style="list-style-type: none"> 0: Link-down 1: Link-up
1	Connection status (full-duplex/half-duplex)	<ul style="list-style-type: none"> 0: Half-duplex 1: Full-duplex
2 to 4	Auto-negotiation status	<ul style="list-style-type: none"> 0: Auto-negotiation being executed 1: Auto-negotiation failed and operation in progress with the default communication speed and method 2: Communication method detection failed, but communication speed detection succeeded 3: Auto-negotiation completed successfully 4: Auto-negotiation unexecuted
5	Necessity of restart after manual settings	Fixed to 0 (because manual settings are not supported)
6	Local Hardware Fault detection status	Fixed to 0 (because Local Hardware Faults are not detected)
7 to 31	Fixed value	0

Instance service

Service code	Service
01H	Get_Attributes_All
0EH	Get_Attribute_Single
4CH	Get_and_Clear

Appendix 5 Processing Time

Transmission delay time

The following describes the formulas used to calculate the transmission delay time of EtherNet/IP communications. Note that the processing time may be prolonged depending on the load ratio of the network (degree of line congestion), the processing performance of controllers, and the system configuration.

Class1 communication transmission delay time

The following describes the concept and the calculation formula of the transmission delay time of Class1 communications.

■Concept of send delay time

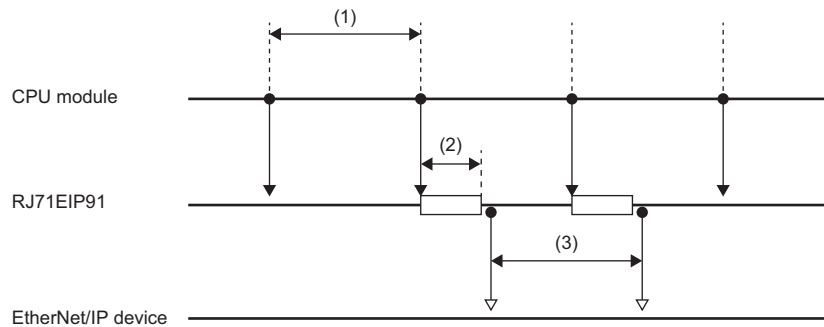

No.	Item name	Description
(1)	Sequence scan	Time required from setting the send data in a program to refreshing the buffer memory on the RJ71EIP91.
(2)	Module processing time	Time required for transferring send data from the buffer memory on the RJ71EIP91 to the send buffer.
(3)	RPI	RPI setting value (transmission interval time)

■Concept of receive delay time

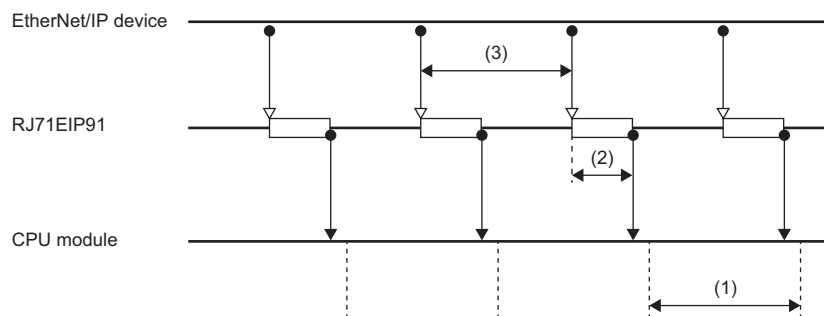

No.	Item name	Description
(1)	Sequence scan	Time required for refreshing the receive data from the buffer memory on the RJ71EIP91 to a program.
(2)	Module processing time	Time required for transferring receive data from the receive buffer to the buffer memory on the RJ71EIP91.
(3)	RPI	RPI setting value (transmission interval time)

■Calculation formula of transmission delay time

Calculation value	Calculation formula (Unit: ms)
Normal value	$0.573 + (\text{sequence scan} \div 2) + \text{module processing time}^{*1} + (\text{RPI} \div 2)$
Maximum value	$0.725 + \text{sequence scan time} + \text{module processing time}^{*1} + \text{RPI}$

*1 Calculate the module processing time using the following formula.
 Module processing time[ms] = 0.0001 × Total data size[byte] + 0.007 × number of connections



Appendix 6 Differences Between QJ71EIP71 and RJ71EIP91

This section describes the differences between the MELSEC-Q series (QJ71EIP71) and MELSEC iQ-R series (RJ71EIP91) EtherNet/IP network interface modules.

Hardware specifications

The following table lists the differences between the QJ71EIP71 and the RJ71EIP91 hardware specifications.

Item	QJ71EIP71	RJ71EIP91
LED	<ul style="list-style-type: none">• RUN LED• ERR. LED• 100M LED• SD/RD LED	<ul style="list-style-type: none">• RUN LED• ERR LED• MS LED• NS LED• SPEED LED• SD/RD LED
Battery	Used	Not used

Available software packages

The following table lists the available software packages for the QJ71EIP71 and the RJ71EIP91.

Item	QJ71EIP71	RJ71EIP91
Available software package	<ul style="list-style-type: none">• GX Developer• GX Works2• Utility package (SW1DNC-EIPUTL-E)	<ul style="list-style-type: none">• GX Works3• EtherNet/IP Configuration Tool

Performance specifications

The following table lists the differences between the QJ71EIP71 and the RJ71EIP91 performance specifications.

Item		QJ71EIP71	RJ71EIP91	
EtherNet/IP communications	Class1 communications	Communication format	Tag communications	Instance communications, tag communications
		Number of connections	256 ^{*1}	256 ^{*2}
		Communication data size	<ul style="list-style-type: none"> Per connection: 1444 bytes All connections: 64K bytes 	<ul style="list-style-type: none"> Per connection: 1444 bytes All connections: 64K bytes
		Transmission trigger	Cyclic, Application Trigger	Cyclic, Application Trigger, Change of State
		Connection type specification	Point-to-point, multicast	Point-to-point, multicast
		RPI (communication cycle)	5ms to 10000ms	0.5ms to 60000ms
		PPS (communication processing performance)	4500PPS (at 128 bytes)	12000PPS (at 500 bytes)
	Class3 communications	Communication format	Tag communications	Message communications
		Communication direction	<ul style="list-style-type: none"> Server: Available Client: Available 	<ul style="list-style-type: none"> Server: Available Client: Not available
		Number of connections	256 ^{*1}	256 ^{*2}
		Communication data size	496 bytes	1414 bytes
	UCMM communications	Communication format	Tag communications	Message communications
		Communication direction	<ul style="list-style-type: none"> Server: Available Client: Available 	<ul style="list-style-type: none"> Server: Available Client: Available
		Number of connections (number of executable modules)	<ul style="list-style-type: none"> Server: 256^{*1} Client: 256^{*1} 	<ul style="list-style-type: none"> Server: 96 Client: 32
		Communication data size	498 bytes	1414 bytes
	Transmission specifications	Data transmission speed	100Mbps/10Mbps	100Mbps 1Gbps/100Mbps ^{*3}
Internal current consumption (5VDC)		0.65A	1.09A	
External dimensions		98(H) × 27.4(W) × 90(D)[mm]	106(H) × 27.8(W) × 110(D)[mm]	
Weight		0.16kg	0.24kg	

*1 The total number of connections for Class1 communications, Class3 communications, and UCMM communications is 256.

*2 The total number of connections for Class1 communications and Class3 communications is 256.

*3 A communication speed of 100Mbps is recommended.

Function

The following table lists the differences between the QJ71EIP71 and the RJ71EIP91 functions.

○: Available, ×: Not available

Item		QJ71EIP71	RJ71EIP91
Class1 communications	Instance communications	×	○
	Tag communications	○	○
Class3 communications	Message communications	×	○
	Tag communications	○	×
UCMM communications	Message communications	×	○
	Tag communications	○	×
Communication status setting function when a CPU stop error occurs		○	○
DHCP client function		○	×

Parameter

The following tables list the differences between the QJ71EIP71 and the RJ71EIP91 parameters.

■Basic setting

○: Settable, ×: Not settable

Item		QJ71EIP71		RJ71EIP91	
		Set with the utility package	Set with a program	Set with the engineering tool	Set with a program
Mode setting		○	×	○	×
IP address setting	IP address	○	○	○	×
	Subnet mask	○	×	○	×
	Default gateway	○	×	○	×

■Application setting

○: Settable, —: No setting item

Item		QJ71EIP71		RJ71EIP91	
		Set with the utility package	Set with a program	Set with the engineering tool	Set with a program
Block data assurance per connection		—	—	○	○

■Refresh settings

○: Settable, ×: Not settable, —: No setting item

Item		QJ71EIP71		RJ71EIP91	
		Set with the utility package	Set with a program	Set with the engineering tool	Set with a program
Refresh timing	Refresh timing	—	—	○	×
	Refresh group[n] (n: 1-64)	—	—	○	×

I/O signal

The following tables list the differences between the QJ71EIP71 and the RJ71EIP91 I/O signals.

■Input signal

Device No.	QJ71EIP71	RJ71EIP91
X0	Tag communication start process completion	Module Ready
X2	PING test completion	Use prohibited
X6	Flash ROM access completion	Use prohibited
X7	Flash ROM access error completion	Use prohibited
X8	TCP/UDP/IP parameter change completion	Use prohibited
XD	Acquiring IP address	Use prohibited
XE	Own station error	Use prohibited
XF	Module READY	Module Error
X10	Use prohibited	EtherNet/IP communication in process
X12	Use prohibited	PING test completion
X14	Use prohibited	Connection information read completion
X15	Use prohibited	Connection information read error
X1F	Watchdog timer error	Communication Ready

■Output signal

Device No.	QJ71EIP71	RJ71EIP91
Y0	Tag communication start request	Use prohibited
Y2	PING test execution request	Use prohibited
Y6	Flash ROM access request	Use prohibited
Y8	TCP/UDP/IP parameter change request	Use prohibited
YE	Own station error clear request	Use prohibited
YF	Use prohibited	Module error clear request
Y10	Use prohibited	EtherNet/IP communication start request
Y12	Use prohibited	PING test execution request
Y14	Use prohibited	Connection information read request

A

Buffer memory

The following tables list the differences between the QJ71EIP71 and the RJ71EIP91 buffer memory areas.

Address (decimal)	Address (hexadecimal)	QJ71EIP71	RJ71EIP91
0 to 4095	0H to FFFH	Class1 Input Area	System area
4096 to 8191	1000H to 1FFFH	Class3/UCMM Input Area	
8192 to 12287	2000H to 2FFFH	Class1 Output Area	
12288 to 16383	3000H to 3FFFH	Class3/UCMM Output Area	
16385	4001H	DHCP setting	
16386 to 16387	4002H to 4003H	IP Address	
16629	40F5H	System area	Block assurance state per connection
16630	40F6H	System area	Block assurance state per connection
16631 to 16632	40F7H to 40F8H	System area	Application Trigger operation specification (Class1)
16633	40F9H	Battery error detection setting	System area
16634	40FAH	Tag com. continue setting	EtherNet/IP data link continuation specification request
16635	40FBH	Tag com. continue setting status	EtherNet/IP data link continuation specification state
16636	40FCH	Class1 Tag Counts	System area
16640 to 17151	4100H to 42FFFH	Class1 Tag Parameter	Class1 I/O data size
17152 to 21119	4300H to 527FH		System area
25728	6480H	Intelligent function module switch status	System area
25733 to 25735	6485H to 6487H	Ethernet address (MAC address)	MAC Address
25783	64B7H	Battery status	System area
25856 to 26367	6500H to 66FFFH	Class1 send/receive data start address	Class1 I/O data start offset address
26368 to 26879	6700H to 68FFFH	Class3/UCMM send/receive data start address	System area
27008 to 27055	6980H to 69AFH	Application Trigger (Class1)	Application Trigger (Class1)
27072 to 27119	69C0H to 69EFH	Application Trigger (Class3/UCMM)	System area
27136 to 27183	6A00H to 6A2FH	Communication status (Class1)	Class1 communication status
27184 to 27231	6A30H to 6A5FH	Communication status (Class3/UCMM)	System area
27264	6A80H	Own station error status	
27265 to 27267	6A81H to 6A83H	TCP/UDP/IP parameter error information	
27268	6A84H	Self-diagnostics execution result	
27392 to 27647	6B00H to 6BFFFH	Class1 Diagnostics Information	Class1 Connection Behavior Error status
27648 to 27903	6C00H to 6CFFFH	Class3/UCMM Diagnostics Information	System area
27904 to 27907	6D00H to 6D03H	PING test request area	PING test request area
27908 to 27911	6D04H to 6D07H	PING test result area	PING test result area
28160 to 28170	6E00H to 6E0AH	System area	Node information area
28288	6E80H		Connection information read request area
28290 to 28341	6E82H to 6EB5H		Connection information read response area
32768 to 33279	8000H to 81FFFH		Class1 Block assurance specification per connection
65536 to 98303	10000H to 17FFFH		Class1 Input Area
196608 to 229375	30000H to 37FFFH		Class1 Output Area
393216 to 393249	60000H to 60021H	UCMM data link execution command	
393280 to 442431	60040H to 6C03FH	UCMM data link request command (No.1 to No.32) UCMM data link receive command (No.1 to No.32)	

Appendix 7 Added Functions

The following table lists the functions added to the RJ71EIP91.

Addition	Firmware version
Safety CPU*1	"03" or later

*1 Safety communications are not supported.

MEMO

INDEX

A

- Application Trigger (Class1) 154
- Application Trigger operating specification (Class1)
 151

B

- Block assurance per connection 48
- Block assurance specification per connection. . . 151
- Block assurance state per connection 151

C

- Class1 Block assurance specification per connection
 160
- Class1 communication status 156
- Class1 communications 16
- Class1 Connection Behavior Error status. 157
- Class1 I/O data size 152
- Class1 I/O data start offset address 153
- Class1 Input Area 160
- Class1 Output Area. 160
- Class3 communications. 16
- Client function. 41
- Communication Ready 142
- Connection information read completion 142
- Connection information read error. 142
- Connection information read request. 146
- Connection information read request area 158
- Connection information read response area. . . . 158
- Consumer Tag 28

E

- EDS Management wizard 96
- Error Information. 118
- EtherNet/IP communication in process 142
- EtherNet/IP communication start request. 143
- EtherNet/IP data link continuation specification . 152
- Exclusive Owner 18

I

- Input Only 19
- IP Address Setting 46

L

- Listen Only 19

M

- Mode Settings 46
- Module error. 142
- Module error clear request. 143
- Module Information List 119
- Module Ready 142

N

- Node information area. 158

O

- Online Action 65

P

- PING test completion 142
- PING test execution request 145
- PING test request area 157
- PING test result area. 157
- Producer Tag 28

S

- Server function 38,42
- Setting status 152

U

- UCMM communication execution command 161
- UCMM communications 16
- UCMM data link receive command 162
- UCMM data link request command 162

REVISIONS

*The manual number is given on the bottom left of the back cover.

Revision date	*Manual number	Description
May 2018	SH(NA)-081915ENG-A	First edition
August 2019	SH(NA)-081915ENG-B	■Added or modified parts TERMS, Section 1.1, 3.1, 4.1, 4.2, 5.5, 5.6, Appendix 3, 6
October 2019	SH(NA)-081915ENG-C	■Added or modified parts SAFETY PRECAUTIONS, TERMS, GENERIC TERMS AND ABBREVIATIONS, Section 1.1
May 2020	SH(NA)-081915ENG-D	■Added or modified parts RELEVANT MANUALS, GENERIC TERMS AND ABBREVIATIONS, TERMS, Section 3.3, 5.6, Appendix 6, 7
April 2021	SH(NA)-081915ENG-E	■Added or modified parts SAFETY PRECAUTIONS, CONDITIONS OF USE FOR THE PRODUCT, Section 2.2, 3.1, 3.3

Japanese manual number: SH-081914-E

This manual confers no industrial property rights or any rights of any other kind, nor does it confer any patent licenses. Mitsubishi Electric Corporation cannot be held responsible for any problems involving industrial property rights which may occur as a result of using the contents noted in this manual.

© 2018 MITSUBISHI ELECTRIC CORPORATION

WARRANTY

Please confirm the following product warranty details before using this product.

1. Gratis Warranty Term and Gratis Warranty Range

If any faults or defects (hereinafter "Failure") found to be the responsibility of Mitsubishi occurs during use of the product within the gratis warranty term, the product shall be repaired at no cost via the sales representative or Mitsubishi Service Company.

However, if repairs are required onsite at domestic or overseas location, expenses to send an engineer will be solely at the customer's discretion. Mitsubishi shall not be held responsible for any re-commissioning, maintenance, or testing on-site that involves replacement of the failed module.

[Gratis Warranty Term]

The gratis warranty term of the product shall be for one year after the date of purchase or delivery to a designated place. Note that after manufacture and shipment from Mitsubishi, the maximum distribution period shall be six (6) months, and the longest gratis warranty term after manufacturing shall be eighteen (18) months. The gratis warranty term of repair parts shall not exceed the gratis warranty term before repairs.

[Gratis Warranty Range]

- (1) The range shall be limited to normal use within the usage state, usage methods and usage environment, etc., which follow the conditions and precautions, etc., given in the instruction manual, user's manual and caution labels on the product.
- (2) Even within the gratis warranty term, repairs shall be charged for in the following cases.
 1. Failure occurring from inappropriate storage or handling, carelessness or negligence by the user. Failure caused by the user's hardware or software design.
 2. Failure caused by unapproved modifications, etc., to the product by the user.
 3. When the Mitsubishi product is assembled into a user's device, Failure that could have been avoided if functions or structures, judged as necessary in the legal safety measures the user's device is subject to or as necessary by industry standards, had been provided.
 4. Failure that could have been avoided if consumable parts (battery, backlight, fuse, etc.) designated in the instruction manual had been correctly serviced or replaced.
 5. Failure caused by external irresistible forces such as fires or abnormal voltages, and Failure caused by force majeure such as earthquakes, lightning, wind and water damage.
 6. Failure caused by reasons unpredictable by scientific technology standards at time of shipment from Mitsubishi.
 7. Any other failure found not to be the responsibility of Mitsubishi or that admitted not to be so by the user.

2. Onerous repair term after discontinuation of production

- (1) Mitsubishi shall accept onerous product repairs for seven (7) years after production of the product is discontinued. Discontinuation of production shall be notified with Mitsubishi Technical Bulletins, etc.
- (2) Product supply (including repair parts) is not available after production is discontinued.

3. Overseas service

Overseas, repairs shall be accepted by Mitsubishi's local overseas FA Center. Note that the repair conditions at each FA Center may differ.

4. Exclusion of loss in opportunity and secondary loss from warranty liability

Regardless of the gratis warranty term, Mitsubishi shall not be liable for compensation to:

- (1) Damages caused by any cause found not to be the responsibility of Mitsubishi.
- (2) Loss in opportunity, lost profits incurred to the user by Failures of Mitsubishi products.
- (3) Special damages and secondary damages whether foreseeable or not, compensation for accidents, and compensation for damages to products other than Mitsubishi products.
- (4) Replacement by the user, maintenance of on-site equipment, start-up test run and other tasks.

5. Changes in product specifications

The specifications given in the catalogs, manuals or technical documents are subject to change without prior notice.

TRADEMARKS

The company names, system names and product names mentioned in this manual are either registered trademarks or trademarks of their respective companies.

In some cases, trademark symbols such as [™] or [®] are not specified in this manual.

SH(NA)-081915ENG-E(2104)MEE

MODEL: RJ71EIP91-U-OU-E

MODEL CODE: 13JX84

mitsubishi electric corporation

HEAD OFFICE : TOKYO BUILDING, 2-7-3 MARUNOUCHI, CHIYODA-KU, TOKYO 100-8310, JAPAN
NAGOYA WORKS : 1-14, YADA-MINAMI 5-CHOME, HIGASHI-KU, NAGOYA, JAPAN

When exported from Japan, this manual does not require application to the
Ministry of Economy, Trade and Industry for service transaction permission.

Specifications subject to change without notice.