

Programmable Controller

MELSEC iQ-R
series

MELSEC iQ-R BACnet Module User's Manual (Startup)

-RJ71BAC96

Powered by

UNITEC CORPORATION

This product was jointly developed and manufactured by Mitsubishi and UNITEC Corporation.

*Note that the warranty on this product differs from that on other programmable controller products.
(Refer to "WARRANTY" in this manual.)

COPYRIGHT

This document is protected by the law of copyright, whereby all rights established therein remain with the company Mitsubishi Electric Corporation. Reproduction of this document or parts of this document is only permissible within the limits of the legal determination of Copyright Law. Alteration or abridgement of the document is not permitted without the explicit written approval of the company Mitsubishi Electric Corporation.

PRECAUTIONS REGARDING WARRANTY AND SPECIFICATIONS

RJ71BAC96 was jointly developed and manufactured by Mitsubishi and Unitec Corporation. Note that there are differences in warranty.

- Warranty

Item	RJ71BAC96	Other programmable controller products (e.g. MELSEC iQ-R series)
Free warranty period	12 months after delivery or 18 months after manufacture	36 months after delivery or 42 months after manufacture
Repair term after discontinuation of production	3 years	7 years

Please note that we will not accept repair and failure analysis of this product.

The faulty product shall be replaced with a new one.

It may take some time to respond to the problem or repair the product depending on the condition and timing.

SAFETY PRECAUTIONS

(Read these precautions before using this product.)

Before using this product, please read this manual and the relevant manuals carefully and pay full attention to safety to handle the product correctly.

The precautions given in this manual are concerned with this product only. For the safety precautions for the programmable controller system, refer to MELSEC iQ-R Module Configuration Manual.

In this manual, the safety precautions are classified into two levels: "⚠️ WARNING" and "⚠️ CAUTION".



WARNING

Indicates that incorrect handling may cause hazardous conditions, resulting in death or severe injury.



CAUTION

Indicates that incorrect handling may cause hazardous conditions, resulting in minor or moderate injury or property damage.

Under some circumstances, failure to observe the precautions given under "⚠️ CAUTION" may lead to serious consequences.

Observe the precautions of both levels because they are important for personal and system safety.

Make sure that the end users read this manual and then keep the manual in a safe place for future reference.

[Design Precautions]

WARNING

- Configure safety circuits external to the programmable controller to ensure that the entire system operates safely even when a fault occurs in the external power supply or the programmable controller. Failure to do so may result in an accident due to an incorrect output or malfunction.
 - (1) Emergency stop circuits, protection circuits, and protective interlock circuits for conflicting operations (such as forward/reserve rotations or upper/lower limit positioning) must be configured external to the programmable controller.
 - (2) When the programmable controller detects an abnormal condition, it stops the operation and all outputs are:
 - Turned OFF if the overcurrent or overvoltage protection of the power supply module is activated.
 - Held or turned OFF according to the parameter setting if the self-diagnostic function of the CPU module detects an error such as a watchdog timer error.
 - (3) All outputs may be turned ON if an error occurs in a part, such as an I/O control part, where the CPU module cannot detect any error. To ensure safety operation in such a case, provide a safety mechanism or a fail-safe circuit external to the programmable controller. For a fail-safe circuit example, refer to "General Safety Requirements" in MELSEC iQ-R Module Configuration Manual.
 - (4) Outputs may remain ON or OFF due to a failure of a component such as a relay and transistor in an output circuit. Configure an external circuit for monitoring output signals that could cause a serious accident.
 - In an output circuit, when a load current exceeding the rated current or an overcurrent caused by a load short-circuit flows for a long time, it may cause smoke and fire. To prevent this, configure an external safety circuit, such as a fuse.
 - Configure a circuit so that the programmable controller is turned ON first and then the external power supply. If the external power supply is turned ON first, an accident may occur due to an incorrect output or malfunction.
 - For the operating status of each station after a communication failure, refer to manuals relevant to the network. Incorrect output or malfunction due to a communication failure may result in an accident.
 - When connecting an external device with a CPU module or intelligent function module to modify data of a running programmable controller, configure an interlock circuit in the program to ensure that the entire system will always operate safely. For other forms of control (such as program modification, parameter change, forced output, or operating status change) of a running programmable controller, read the relevant manuals carefully and ensure that the operation is safe before proceeding. Improper operation may damage machines or cause accidents.
 - Especially, when a remote programmable controller is controlled by an external device, immediate action cannot be taken if a problem occurs in the programmable controller due to a communication failure. To prevent this, configure an interlock circuit in the program, and determine corrective actions to be taken between the external device and CPU module in case of a communication failure.
-

[Design Precautions]

WARNING

- Do not write any data to the "system area" and "write-protect area" of the buffer memory in the module. Also, do not use any "use prohibited" signals as an output signal from the CPU module to each module. Doing so may cause malfunction of the programmable controller system. For the "system area", "write-protect area", and the "use prohibited" signals, refer to the user's manual for the module used.
 - If a communication cable is disconnected, the network may be unstable, resulting in a communication failure of multiple stations. Configure an interlock circuit in the program to ensure that the entire system will always operate safely even if communications fail. Incorrect output or malfunction due to a communication failure may result in an accident.
 - To maintain the safety of the programmable controller system against unauthorized access from external devices via the network, take appropriate measures. To maintain the safety against unauthorized access via the Internet, take measures such as installing a firewall.
-

[Design Precautions]

CAUTION

- Do not install the control lines or communication cables together with the main circuit lines or power cables. Keep a distance of 100 mm or more between them. Failure to do so may result in malfunction due to noise.
 - During control of an inductive load such as a lamp, heater, or solenoid valve, a large current (approximately ten times greater than normal) may flow when the output is turned from OFF to ON. Therefore, use a module that has a sufficient current rating.
 - After the CPU module is powered ON or is reset, the time taken to enter the RUN status varies depending on the system configuration, parameter settings, and/or program size. Design circuits so that the entire system will always operate safely, regardless of the time.
 - Do not power OFF the programmable controller or do not reset the CPU module while the settings are being written. Doing so will make the data in the flash ROM and SD memory card undefined. The values need to be set in the buffer memory and written to the flash ROM and SD memory card again. Doing so may cause malfunction or failure of the module.
 - When changing the operating status of the CPU module from external devices (such as the remote RUN/STOP functions), select "Do Not OPEN in Program" for "Open Method Setting" of "Module Parameter". If "OPEN in Program" is selected, an execution of the remote STOP function causes the communication line to close. Consequently, the CPU module cannot reopen the line, and external devices cannot execute the remote RUN function.
-

[Installation Precautions]

WARNING

- Shut off the external power supply (all phases) used in the system before mounting or removing the module. Failure to do so may result in electric shock or cause the module to fail or malfunction.
-

[Installation Precautions]

CAUTION

- Use the programmable controller in an environment that meets general specifications written in Safety Guidelines included in the base unit. Failure to do so may result in electric shock, fire, malfunction, or damage to or deterioration of the product.
 - To mount a module, place the concave part(s) located at the bottom onto the guide(s) of the base unit, and push in the module until the hook(s) located at the top snaps into place. Incorrect interconnection may cause malfunction, failure, or drop of the module.
 - Secure the module with screws especially when it is used in an environment where constant vibrations may occur.
 - Tighten the screws within the specified torque range. Undertightening can cause drop of the screw, short circuit, or malfunction. Overtightening can damage the screw and/or module, resulting in drop, short circuit, or malfunction.
 - When using an extension cable, connect it to the extension cable connector of the base unit securely. Check the connection for looseness. Poor contact may cause malfunction.
 - When using an SD memory card, fully insert it into the memory card slot. Check that it is inserted completely. Poor contact may cause malfunction.
 - Securely insert an extended SRAM cassette into the cassette connector of a CPU module. After insertion, close the cassette cover and check that the cassette is inserted completely. Poor contact may cause malfunction.
 - Do not directly touch any conductive parts and electronic components of the module, SD memory card, extended SRAM cassette, or connector. Doing so may cause malfunction or failure of the module.
-

[Wiring Precautions]

WARNING

- Shut off the external power supply (all phases) used in the system before installation and wiring. Failure to do so may result in electric shock or cause the module to fail or malfunction.
 - After installation and wiring, attach the included terminal cover to the module before turning it ON for operation. Failure to do so may result in electric shock.
-

[Wiring Precautions]

CAUTION

- Individually ground the FG and LG terminals of the programmable controller with a ground resistance of 100 ohms or less. Failure to do so may result in electric shock or malfunction.
 - Use applicable solderless terminals and tighten them within the specified torque range. If any spade solderless terminal is used, it may be disconnected when the terminal screw comes loose, resulting in failure.
 - Check the rated voltage and signal layout before wiring to the module, and connect the cables correctly. Connecting a power supply with a different voltage rating or incorrect wiring may cause fire or failure.
 - Connectors for external devices must be crimped or pressed with the tool specified by the manufacturer, or must be correctly soldered. Incomplete connections may cause short circuit, fire, or malfunction.
 - Securely connect the connector to the module. Poor contact may cause malfunction.
 - Do not install the control lines or communication cables together with the main circuit lines or power cables. Keep a distance of 100 mm or more between them. Failure to do so may result in malfunction due to noise.
 - Place the cables in a duct or clamp them. If not, dangling cable may swing or inadvertently be pulled, resulting in damage to the module or cables or malfunction due to poor contact. Do not clamp the extension cables with the jacket stripped. Doing so may change the characteristics of the cables, resulting in malfunction.
 - Check the interface type and correctly connect the cable. Incorrect wiring (connecting the cable to an incorrect interface) may cause failure of the module and external device.
 - Tighten the terminal screws or connector screws within the specified torque range. Undertightening can cause drop of the screw, short circuit, fire, or malfunction. Overtightening can damage the screw and/or module, resulting in drop, short circuit, fire, or malfunction.
 - When disconnecting the cable from the module, do not pull the cable by the cable part. For the cable with connector, hold the connector part of the cable. For the cable connected to the terminal block, loosen the terminal screw. Pulling the cable connected to the module may result in malfunction or damage to the module or cable.
 - Prevent foreign matter such as dust or wire chips from entering the module. Such foreign matter can cause a fire, failure, or malfunction.
-

[Wiring Precautions]

CAUTION

- A protective film is attached to the top of the module to prevent foreign matter, such as wire chips, from entering the module during wiring. Do not remove the film during wiring. Remove it for heat dissipation before system operation.
 - Programmable controllers must be installed in control panels. Connect the main power supply to the power supply module in the control panel through a relay terminal block. Wiring and replacement of a power supply module must be performed by qualified maintenance personnel with knowledge of protection against electric shock. For wiring, refer to MELSEC iQ-R Module Configuration Manual.
 - For Ethernet cables to be used in the system, select the ones that meet the specifications in the user's manual for the module used. If not, normal data transmission is not guaranteed.
-

[Startup and Maintenance Precautions]

WARNING

- Do not touch any terminal or connector while power is ON. Doing so will cause electric shock or malfunction.
 - Shut off the external power supply (all phases) used in the system before retightening the terminal screws or cleaning the module. Failure to do so may result in electric shock.
 - Shut off the external power supply (all phases) used in the system before mounting or removing the module. Failure to do so may cause the module to fail or malfunction.
-

[Startup and Maintenance Precautions]

CAUTION

- When connecting an external device with a CPU module or intelligent function module to modify data of a running programmable controller, configure an interlock circuit in the program to ensure that the entire system will always operate safely. For other forms of control (such as program modification, parameter change, forced output, or operating status change) of a running programmable controller, read the relevant manuals carefully and ensure that the operation is safe before proceeding. Improper operation may damage machines or cause accidents.
 - Especially, when a remote programmable controller is controlled by an external device, immediate action cannot be taken if a problem occurs in the programmable controller due to a communication failure. To prevent this, configure an interlock circuit in the program, and determine corrective actions to be taken between the external device and CPU module in case of a communication failure.
 - Do not disassemble or modify the modules. Doing so may cause failure, malfunction, injury, or a fire.
 - Use any radio communication device such as a cellular phone or PHS (Personal Handy-phone System) more than 25 cm away in all directions from the programmable controller. Failure to do so may cause malfunction.
 - Tighten the screws within the specified torque range. Undertightening can cause drop of the component or wire, short circuit, or malfunction. Overtightening can damage the screw and/or module, resulting in drop, short circuit, or malfunction.
 - After the first use of the product, do not mount/remove the module to/from the base unit, and the terminal block to/from the module, and do not insert/remove the extended SRAM cassette to/from the CPU module more than 50 times (IEC 61131-2 compliant) respectively. Exceeding the limit may cause malfunction.
 - After the first use of the product, do not insert/remove the SD memory card to/from the CPU module more than 500 times. Exceeding the limit may cause malfunction.
 - Do not touch the metal terminals on the back side of the SD memory card. Doing so may cause malfunction or failure of the module.
 - Do not touch the integrated circuits on the circuit board of an extended SRAM cassette. Doing so may cause malfunction or failure of the module.
 - Do not drop or apply shock to the battery to be installed in the module. Doing so may damage the battery, causing the battery fluid to leak inside the battery. If the battery is dropped or any shock is applied to it, dispose of it without using.
 - Startup and maintenance of a control panel must be performed by qualified maintenance personnel with knowledge of protection against electric shock. Lock the control panel so that only qualified maintenance personnel can operate it.
 - Before handling the module, touch a conducting object such as a grounded metal to discharge the static electricity from the human body. Failure to do so may cause the module to fail or malfunction.
-

[Operation Precautions]

CAUTION

- When changing data and operating status, and modifying program of the running programmable controller from an external device such as a personal computer connected to an intelligent function module, read relevant manuals carefully and ensure the safety before operation. Incorrect change or modification may cause system malfunction, damage to the machines, or accidents.
 - Do not power off the programmable controller or reset the CPU module while the setting values in the buffer memory are being written to the flash ROM in the module. Doing so will make the data in the flash ROM or SD memory card undefined. The values need to be set in the buffer memory and written to the flash ROM or SD memory card again. Doing so can cause malfunction or failure of the module.
-

[Disposal Precautions]

CAUTION

- When disposing of this product, treat it as industrial waste.
 - When disposing of batteries, separate them from other wastes according to the local regulations. For details on battery regulations in EU member states, refer to MELSEC iQ-R Module Configuration Manual.
-

[Transportation Precautions]

CAUTION

- When transporting lithium batteries, follow the transportation regulations. For details on the regulated models, refer to MELSEC iQ-R Module Configuration Manual.
 - The halogens (such as fluorine, chlorine, bromine, and iodine), which are contained in a fumigant used for disinfection and pest control of wood packaging materials, may cause failure of the product. Prevent the entry of fumigant residues into the product or consider other methods (such as heat treatment) instead of fumigation. The disinfection and pest control measures must be applied to unprocessed raw wood.
-

CONDITIONS OF USE FOR THE PRODUCT

- (1) Mitsubishi programmable controller ("the PRODUCT") shall be used in conditions;
- i) where any problem, fault or failure occurring in the PRODUCT, if any, shall not lead to any major or serious accident; and
 - ii) where the backup and fail-safe function are systematically or automatically provided outside of the PRODUCT for the case of any problem, fault or failure occurring in the PRODUCT.
- (2) The PRODUCT has been designed and manufactured for the purpose of being used in general industries. MITSUBISHI SHALL HAVE NO RESPONSIBILITY OR LIABILITY (INCLUDING, BUT NOT LIMITED TO ANY AND ALL RESPONSIBILITY OR LIABILITY BASED ON CONTRACT, WARRANTY, TORT, PRODUCT LIABILITY) FOR ANY INJURY OR DEATH TO PERSONS OR LOSS OR DAMAGE TO PROPERTY CAUSED BY the PRODUCT THAT ARE OPERATED OR USED IN APPLICATION NOT INTENDED OR EXCLUDED BY INSTRUCTIONS, PRECAUTIONS, OR WARNING CONTAINED IN MITSUBISHI'S USER, INSTRUCTION AND/OR SAFETY MANUALS, TECHNICAL BULLETINS AND GUIDELINES FOR the PRODUCT.

("Prohibited Application")

Prohibited Applications include, but not limited to, the use of the PRODUCT in;

- Nuclear Power Plants and any other power plants operated by Power companies, and/or any other cases in which the public could be affected if any problem or fault occurs in the PRODUCT.
- Railway companies or Public service purposes, and/or any other cases in which establishment of a special quality assurance system is required by the Purchaser or End User.
- Aircraft or Aerospace, Medical applications, Train equipment, transport equipment such as Elevator and Escalator, Incineration and Fuel devices, Vehicles, Manned transportation, Equipment for Recreation and Amusement, and Safety devices, handling of Nuclear or Hazardous Materials or Chemicals, Mining and Drilling, and/or other applications where there is a significant risk of injury to the public or property.

Notwithstanding the above, restrictions Mitsubishi may in its sole discretion, authorize use of the PRODUCT in one or more of the Prohibited Applications, provided that the usage of the PRODUCT is limited only for the specific applications agreed to by Mitsubishi and provided further that no special quality assurance or fail-safe, redundant or other safety features which exceed the general specifications of the PRODUCTS are required. For details, please contact the Mitsubishi representative in your region.

INTRODUCTION

Thank you for purchasing the Mitsubishi Electric MELSEC iQ-R series programmable controllers.

This manual describes the performance specifications, procedures before operation, wiring, and operation examples of the relevant products listed below.

Before using this product, please read this manual and the relevant manuals carefully and develop familiarity with the functions and performance of the MELSEC iQ-R series programmable controller to handle the product correctly.

Please make sure that the end users read this manual.

Point

The program examples shown in this manual are the examples in which a BACnet module (RJ71BAC96) is assigned to the input/output No. X/Y0 to X/Y1F unless otherwise specified.

To use the program examples shown in this manual, the input/output number assignment is required.

For details on the assignment of input/output number, refer to the following manual.

 MELSEC iQ-R Module Configuration Manual



Relevant product

RJ71BAC96

COMPLIANCE WITH EMC AND LOW VOLTAGE DIRECTIVES

Method of ensuring compliance



To ensure that Mitsubishi programmable controllers maintain EMC and Low Voltage Directives when incorporated into other machinery or equipment, certain measures may be necessary. Please refer to one of the following manuals.

-  MELSEC iQ-R Module Configuration Manual
-  Safety Guidelines (included in a base unit)

The CE mark on the side of the programmable controller indicates compliance with EMC and Low Voltage Directives.

Additional measures

To ensure that this product maintains EMC and Low Voltage Directives, please refer to one of the following manuals.

-  MELSEC iQ-R Module Configuration Manual
-  Safety Guidelines (included in a base unit)

CONTENTS

COPYRIGHT	1
PRECAUTIONS REGARDING WARRANTY AND SPECIFICATIONS	1
SAFETY PRECAUTIONS	2
CONDITIONS OF USE FOR THE PRODUCT	10
INTRODUCTION	11
COMPLIANCE WITH EMC AND LOW VOLTAGE DIRECTIVES	11
RELEVANT MANUALS	14
TERMS	15
CHAPTER 1 PART NAMES	16
CHAPTER 2 SPECIFICATIONS	18
2.1 Performance Specifications	18
2.2 BACnet Specifications	19
BACnet standards	19
Available objects	19
Available BIBBs	20
CHAPTER 3 FUNCTION LIST	21
3.1 BACnet Module Function List	21
CHAPTER 4 PROCEDURES BEFORE OPERATION	23
4.1 Configuring Settings Using Engineering Tool	24
4.2 Configuring Settings Using a Web Browser	26
Setting network for a configuration personal computer	26
Setting a web browser	27
Logging into a BACnet module	27
Setting a BACnet module	28
Logging out from the BACnet module	32
CHAPTER 5 SYSTEM CONFIGURATION	33
5.1 Whole System Configuration	33
5.2 Operating Environment	34
5.3 Supported Software Package	34
CHAPTER 6 WIRING	35
6.1 Ethernet Cables	35
Connectable Ethernet cables (sold separately)	35
Wiring of Ethernet cable	35
Wiring considerations	36
CHAPTER 7 OPERATING EXAMPLE	37
7.1 Preparing for Operation	37
Preparing equipment	37
Constructing a system	38
7.2 Writing Values	39
Operating procedure	39
Setting network for a configuration personal computer	39

Setting a BACnet module (BACnet controller)	40
Setting a BACnet module (BACnet workstation)	43
Creating a program	46
Checking the operation	49

APPENDIX **50**

Appendix 1 EXTERNAL DIMENSION	50
---	----

INDEX **52**

REVISIONS	54
WARRANTY	55
TRADEMARKS	56

RELEVANT MANUALS

Manual name [manual number]	Description	Available form
MELSEC iQ-R BACnet Module User's Manual (Startup) [SH-081699ENG] (this manual)	Explains the specifications, procedures before operation, system configuration, wiring, and operation examples of BACnet modules.	Print book e-Manual PDF
MELSEC iQ-R BACnet Module User's Manual (Application) [SH-081700ENG]	Explains the functions, parameter setting, troubleshooting, and buffer memory of BACnet modules.	Print book e-Manual PDF
GX Works3 Operating Manual [SH-081215ENG]	Explains the system configurations, parameter settings, and operation methods for the online function in GX Works3.	e-Manual PDF

This manual does not include detailed information on the following:

- General specifications
- Applicable CPU modules and the number of mountable modules
- Installation

For details, refer to the following manual.

 MELSEC iQ-R Module Configuration Manual



e-Manual refers to the Mitsubishi Electric FA electronic book manuals that can be browsed using a dedicated tool.

e-Manual has the following features:

- Required information can be cross-searched in multiple manuals.
- Other manuals can be accessed from the links in the manual.
- Hardware specifications of each part can be found from the product figures.
- Pages that users often browse can be bookmarked.
- Sample programs can be copied to an engineering tool.

TERMS

Unless otherwise specified, this manual uses the following terms.

Term	Description
BACnet	A communication standard for building automation and control network established by ASHRAE (American Society of Heating, Refrigerating and Air-Conditioning Engineers) in 1995. This indicates a system configured with BACnet.
BACnet controller	A controller which provides input/output information of a BACnet system as a lower-level structure of the BACnet system.
BACnet device	A device connected to a BACnet system.
BACnet module	An abbreviation for MELSEC iQ-R series BACnet module.
BACnet workstation	A central monitoring device which controls and monitors the state of a BACnet system as the upper-level structure of the BACnet system.
COV	An abbreviation for 'Change Of Value'. A BACnet service which notifies the change of a PresentValue or a StatusFlags to a BACnet device at the timing of the change.
Data block	An area which is to be assigned to buffer memory to read/write property values or to receive data in a BACnet device from a BACnet module.
DeviceInstanceNo	An instance number of a BACnet device. An instance number is assigned to each BACnet device to identify each BACnet device.
Engineering tool	A tool for setting, programming, debugging, and maintaining programmable controllers. For the supported tools, refer to the following manual.  MELSEC iQ-R Module Configuration Manual
Event	A communication specification defined in the BACnet standard.
Instance number	A number is assigned for each BACnet device and object type. With this number, BACnet services can be shared in a BACnet system.
Join	To notify the existence of the BACnet controller itself to a BACnet workstation and other BACnet controllers, and to join a BACnet system. A method to join BACnet and its procedure varies depending on the BACnet standard.
Leave	To leave the BACnet system.
Object	Information related to input/output or internal status in a BACnet device. This indicates a BACnet object.
Object type number	A number that is assigned to an ObjectType.
ObjectIdentifier	An identifier of each object that consists of an object type and its instance number.
ObjectType	A type of a BACnet object.
PresentValue	A property that indicates a current value. This property is a main property that handles input/output values which are related to each object.
Priority	A property that indicates priority.
Property	Detail information and the attribute of each object. An object is configured with various properties. The status of a property may affects other properties, and consequently a control status is changed.
PropertyIdentifier	An identifier that distinguishes the type of a property.
RJ71BAC96	An abbreviation for RJ71BAC96 BACnet module.
Service	A function to share information between a BACnet device and external BACnet devices. This indicates BACnet services.

1 PART NAMES

This chapter shows the part names of BACnet module.

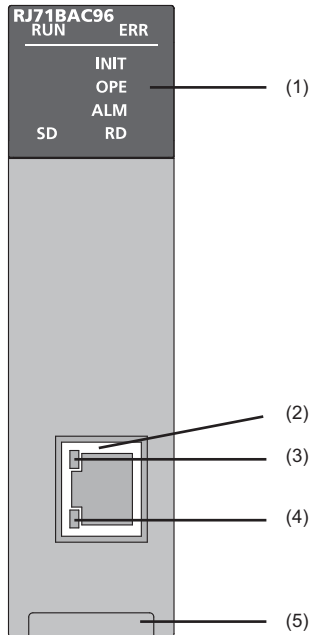

No.	Name	Description
(1)	RUN LED	Indicates the operating status. • ON: Operating normally • OFF: Watch dog timer error or power interruption
	ERR LED	Indicates the status of a major error. • ON: Error or hardware failure • OFF: Operating normally
	INIT LED	Indicates the initial status. • ON: Initialization complete • OFF: Initializing
	OPE LED	Indicates the status of a BACnet module whether the module has joined or left BACnet. • ON: Joining BACnet • OFF: Leaving BACnet
	ALM LED	This LED turns ON when an error is detected in a BACnet module or on the network which is controlled by the BACnet module. • ON: Error • OFF: Operating normally
	SD LED	Indicates the sending status of a communication packet of BACnet. • ON/Flashing: Sending • OFF: Untransmitted
	RD LED	Indicates the reception status of a communication packet of BACnet. • ON/Flashing: Receiving • OFF: Untransmitted
(2)	Ethernet port	A connector to connect a BACnet module to 10BASE-T/100BASE-TX.
(3)	—	Indicates the communication establishment status. • ON: Full-duplex communication established • Flashing: Half-duplex communication established • OFF: Communication not established
(4)	—	Indicates the link status. • ON: Linking-up • OFF: Linking-down
(5)	Product information marking	Indicates the product information (16 digits) of the module.

2 SPECIFICATIONS

This chapter shows the performance specifications of a BACnet module.

2.1 Performance Specifications

The following table shows the performance specifications of a BACnet module.

Item		Value
Transmission specifications	Transmission rate	100 Mbps/10 Mbps
	Communication mode	Full-duplex/half-duplex
	Transmission method	Base band
	Maximum segment length	100 m (distance between switching hub and node)
	IP version	IPv6/IPv4
BACnet specifications	Number of registrable input/output objects ^{*1}	4000 Instance
	Number of registrable CA objects	300 Instance
	Number of registrable SC objects	100 Instance
	Number of registrable TL objects	200 Instance
	Number of registrable NC objects	50 Instance
	Number of registrable access blocks for reading	2176 points in total
	Number of registrable access blocks for writing	
	Number of registrable access blocks for BACnet monitoring	10000 points in total
	Number of registrable access blocks for COV interaction	
Number of registrable access blocks for Event interaction		
Number of occupied I/O points		32 points (I/O assignment: Intelligent 32 points)
5 VDC internal current consumption		0.61 A
External dimensions	Height	106 mm
	Width	27.8 mm
	Depth	110 mm
Weight		0.19 kg

*1 For details on the input/output objects, refer to the following section.

 MELSEC iQ-R BACnet Module User's Manual (Application)

2.2 BACnet Specifications

BACnet standards

BACnet complies with the following BACnet standards.

- IEIEJ-P-0003:2000 addendum-a (ANSI/ASHRAE135-2001)
- IEIEJ-G-0006:2006 addendum-a (ANSI/ASHRAE135-2004)
- ANSI/ASHRAE135-2004 (ISO16484-5-2003)
- ANSI/ASHRAE135-2010

Available objects

The following shows available objects for BACnet modules.

○: Supported, —: Not supported

Name	ANSI/ASHRAE 2010	ANSI/ASHRAE 2004	IEIEJ-P-0003:2000 Addendum-a	IEIEJ-G-0006:2006 Addendum-a
Analog Input Object Type	○	○	○	○
Analog Output Object Type	○	○	○	○
Analog Value Object Type	○	○	○	○
Binary Input Object Type	○	○	○	○
Binary Output Object Type	○	○	○	○
Binary Value Object Type	○	○	○	○
Multi-stateInput Object Type	○	○	○	○
Multi-stateOutput Object Type	○	○	○	○
Multi-stateValue Object Type	○	○	○	○
Accumulator Object Type	○	○	—	○
Keiryo Object Type	—	—	○	—
ElectricDemandMonitoring Object Type	—	—	○	○
ElectricDemandControl Object Type	—	—	○	○
GeneratorLoadControl Object Type	—	—	○	○
Calendar Object Type	○	○	○	○
NotificationClass Object Type	○	○	○	○
Schedule Object Type	○	○	○	○
Trend Log Object Type	○	○	○	○
Device Object Type	○	○	○	○

Available BIBBs

The following shows available BIBBs (BACnet Interoperability Building Blocks) for BACnet modules.

A BIBB is a collection of BACnet services which can be executed between a client and a server which are configured by BACnet devices.

For more details on BIBBs, refer to the BACnet standards.

- IEIEJ-P-0003:2000 addendum-a (ANSI/ASHRAE135-2001)
- IEIEJ-G-0006:2006 addendum-a (ANSI/ASHRAE135-2004)
- ANSI/ASHRAE135-2004 (ISO16484-5-2003)
- ANSI/ASHRAE135-2010

BIBB type	Description	Remarks
Data Sharing	ReadProperty-A	DS-RP-A
	ReadProperty-B	DS-RP-B
	ReadPropertyMultiple-A	DS-RPM-A
	ReadPropertyMultiple-B	DS-RPM-B
	WriteProperty-A	DS-WP-A
	WriteProperty-B	DS-WP-B
	WritePropertyMultiple-A	DS-WPM-A
	WritePropertyMultiple-B	DS-WPM-B
	COV-A	DS-COV-A
	COV-B	DS-COV-B
	COV-Unsolicited-A	DS-COVU-A
	COV-Unsolicited-B	DS-COVU-B
Alarm and Event	Notification-A	AE-N-A
	Notification Internal-B	AE-N-I-B
	ACK-B	AE-ACK-B
	Summary-B	AE-ASUM-B
	Enrollment Summary-B	AE-ESUM-B
	Information-B	AE-INFO-B
Scheduling	Internal-B	SCHED-I-B
	External-B	SCHED-E-B
Trending	Viewing and Modifying Trends Internal-B	T-VMT-I-B
	Viewing and Modifying Trends External-B	T-VMT-E-B
	Automated Trend Retrieval-B	T-ATR-B
Device Management	Dynamic Device Binding-A	DM-DDB-A
	Dynamic Device Binding-B	DM-DDB-B
	Dynamic Object Binding-B	DM-DOB-B
	DeviceCommunicationControl-B	DM-DCC-B
	Automatic Network Mapping-A	DM-ANM-A
	TimeSynchronization-A	DM-TS-A
	TimeSynchronization-B	DM-TS-B
	UTCTimeSynchronization-A	DM-UTC-A
	UTCTimeSynchronization-B	DM-UTC-B
	Manual Time Synchronization-A	DM-MTS-A
	ReinitializeDevice-B	DM-RD-B
	Backup and Restore-B	DM-BR-B
	Restart-A	DM-R-A
	Restart-B	DM-R-B
List Manipulation-B	DM-LM-B	
ObjectCreation and Deletion-B	DM-OCD-B	

3 FUNCTION LIST

This chapter shows the function list of a BACnet module.

For details on the functions, refer to the following manual.

📖 MELSEC iQ-R BACnet Module User's Manual (Application)

3.1 BACnet Module Function List

The following shows the function list of a BACnet module.

Function		Description	
BACnet object function		A function to use a programmable controller system as a BACnet controller. This function is provided by registering BACnet objects.	
Backup function		A function to save property values automatically when the powering OFF of the programmable controller system is detected.	
Data block function		A function to read/write the values of properties and to receive the information of services using a program. This function can be used by assigning data blocks to buffer memory.	
—	BACnet request function	Read function	A function to read the values of properties in a BACnet module or a BACnet device. A data block (access block for reading) is used for this function.
		Write function	A function to write the values of properties in a BACnet module or a BACnet device. A data block (access block for writing) is used for this function.
	BACnet monitoring function		A function to monitor the values of properties in a BACnet module or a BACnet device. A data block (access block for BACnet monitoring) is used for this function.
	COV interaction function		A function to receive COV notifications from a BACnet device. A data block (access block for COV interaction) is used for this function.
	Event interaction function		A function to receive Event notifications from a BACnet device. A data block (access block for Event interaction) is used for this function.
Calendar interaction function		A function to copy the calendar information, which is referenced at the time of performing scheduled operation, from another BACnet device.	
Joining/leaving function		A function to join/leave BACnet automatically by turning an input/output signal ON and OFF.	
Time synchronization function		A function to synchronize the time of a BACnet module or a BACnet device with that of a CPU module.	
Configuration function		A function to set a BACnet module using a web browser.	

4 PROCEDURES BEFORE OPERATION

This chapter explains the procedures before operation.

1. Wire a module.

Connect a cable to a BACnet module.

☞ Page 35 WIRING

2. Power the system ON.

3. Set the BACnet module.

BACnet modules can be set by either engineering tool or web browser.

☞ Page 24 Configuring Settings Using Engineering Tool

☞ Page 26 Configuring Settings Using a Web Browser

4. Create a program.

☞ Page 37 OPERATING EXAMPLE

5. Reset the system.

6. Execute the program.

7. Start the operation of the BACnet module.

4.1 Configuring Settings Using Engineering Tool

This section shows the procedure to configure the settings using an engineering tool.

Addition of a profile

When using any of the following versions of GX Works3, the profile of a BACnet module needs to be registered manually.

- 1.032J
- 1.033K

For the information on how to obtain the profile of BACnet module, please consult your local Mitsubishi representative.

Startup method

Operating procedure

Select [MELSOFT] ⇒ [GX Works3]^{*2} ⇒ [GX Works3] from Windows® Start^{*1}.

- *1 Select [All apps] in the Start screen or [Start] ⇒ [All Programs]/[All apps].
- *2 Does not appear in Windows 8 or later.

Parameter setting

Operating procedure

1. Create a new project.
Select [Project] ⇒ [New] from the menu.
2. Set "Series", "Type", and "Program Language", and click the [OK] button.

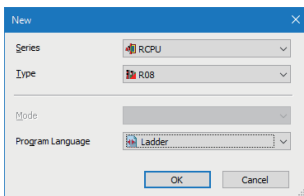

3. Click the [Setting Change] button to set to use module labels.

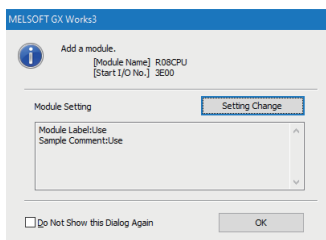

4. The "Add New Module" screen appears.
Navigation window ⇒ [Parameter] ⇒ right-click [Module Information] ⇒ [Add New Module]

5. Add a BACnet module.

Item	Description
Module Type	Select "Network Module".
Module Name	Select "RJ71BAC96".
Mounting Slot No.	Select the slot number where the BACnet module is mounted.
Start I/O Specification	When do not specify the start I/O number of the BACnet module, select "Not Set" to "Start I/O No. Specification". To specify the start I/O number, select "Set".
Start I/O No.	When "Set" is selected in "Start I/O No. Specification", enter the start I/O number of the BACnet module.

6. Set the module parameter of the BACnet module.

Navigation window ⇒ [Parameter] ⇒ [Module Information] ⇒ double-click [RJ71BAC96]

7. After setting parameters, write the settings to the CPU module from the engineering tool.

8. Reset the CPU module, or turn the power OFF and ON to apply the settings.

4.2 Configuring Settings Using a Web Browser

This section shows the procedure to configure the settings using a web browser.

1. Configure the network settings on the configuration personal computer.

☞ Page 26 Setting network for a configuration personal computer

2. Set a web browser.

☞ Page 27 Setting a web browser

3. Log into the BACnet module.

☞ Page 27 Logging into a BACnet module

4. Set the BACnet module.

☞ Page 28 Setting a BACnet module

Setting network for a configuration personal computer

Operating procedure

1. Set the same network portion of the IP address between a configuration personal computer and a BACnet module.

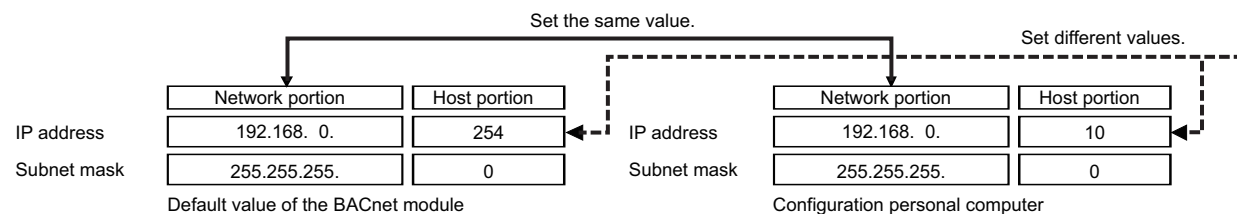

2. Set the network setting for a configuration personal computer in the "Internet Protocol Version 4 (TCP/IPv4) Properties" screen.

(Example) Microsoft® Windows 7 Ultimate

- 1 Select [Control Panel] ⇒ [Network and Internet] ⇒ [Network and Sharing Center] ⇒ [Change adapter settings].
- 2 Select [Local Area Connection], and select [Properties] from the shortcut menu.
- 3 Select "Internet Protocol Version 4 (TCP/IPv4)" in the "Local Area Connection Properties" screen, and click the [Property] button.
- 4 "Internet Protocol Version 4 (TCP/IPv4) Properties" screen appears.

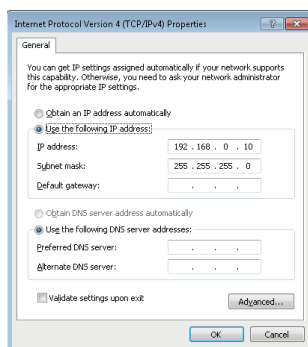

Setting a web browser

Set a local area network (LAN) using Internet Explorer®.

Unselect the "Use a proxy server for your LAN" checkbox in the "Local Area Network (LAN) Settings" screen.

Ex.

Internet Explorer 11

Select [Tool] ⇒ [Internet Options] ⇒ [Connections] tab ⇒ "Local Area Network (LAN) settings", and click the [LAN settings] button.

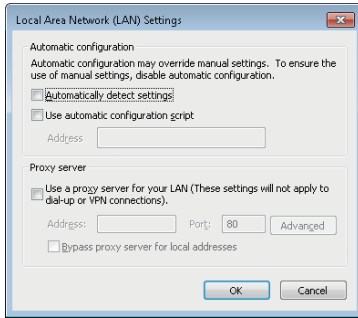

Logging into a BACnet module

Operating procedure

1. Start Internet Explorer and enter the address of a BACnet module, "http://192.168.0.254:8080".

When the IP address of the BACnet module is changed, specify the IP address which has been set in the network information to the "192.168.0.254" part in the address above.

📖 MELSEC iQ-R BACnet Module User's Manual (Application)

Point

- If the configuration personal computer cannot communicate with the BACnet module, issue a PING command from the configuration personal computer to the BACnet module to check the communication of the BACnet module.

2. Enter a user name and a password in the following screen.

- User name: root
- Password: rj71bac96

If a user name or password is changed, enter the user name or password set in the user setting.

📖 MELSEC iQ-R BACnet Module User's Manual (Application)



Setting a BACnet module

Screen configuration

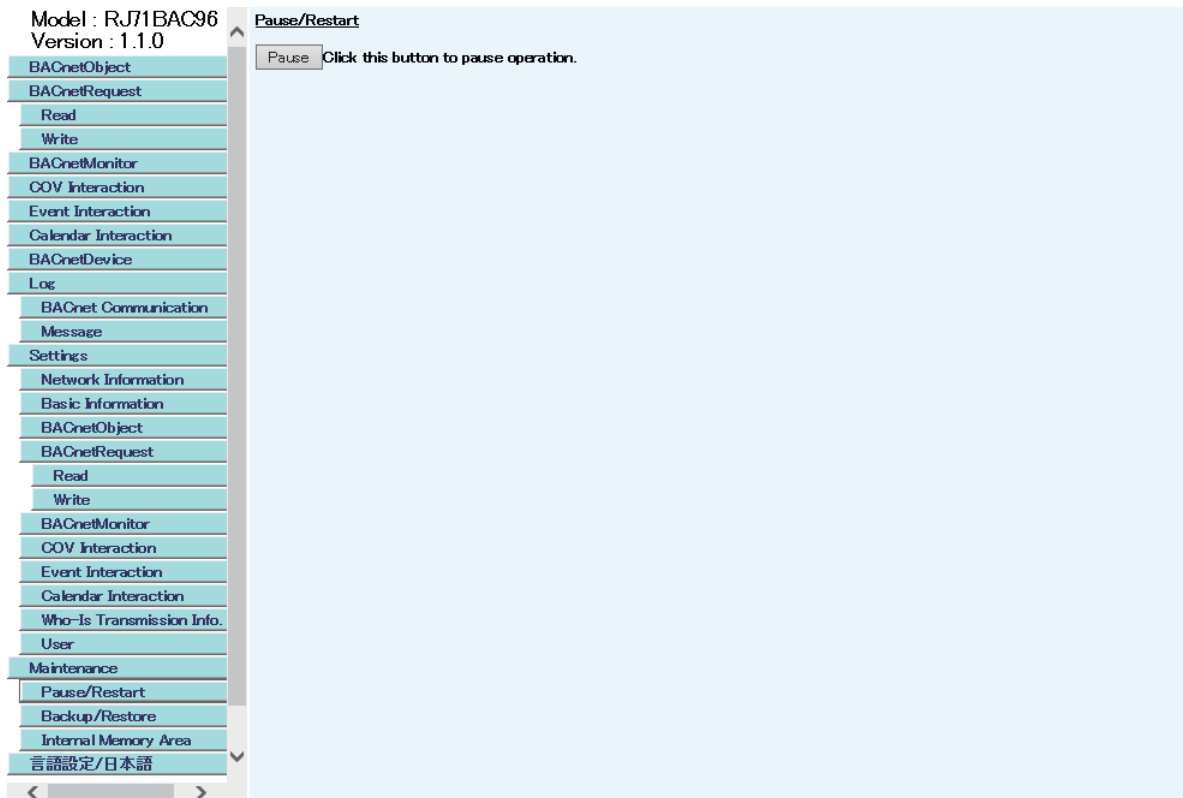

Menu item		Description	
BACnetObject		To register and set the properties of BACnet objects.	
BACnetRequest	Read	To display the values read from a BACnet module or a BACnet device.	
	Write	To display the values written to a BACnet module or a BACnet device.	
BACnetMonitor		To display the values monitored in a BACnet module or a BACnet device.	
COV Interaction		To display the COV notification data received from a BACnet device.	
Event Interaction		To display the Event notification data received from a BACnet device.	
Calendar Interaction		To display the result of reading a Calendar object from a BACnet device.	
BACnetDevice		To register a BACnet device as a recognized BACnet device. The recognized BACnet devices are displayed in the screen.	
Log	BACnet Communication	To display sent/received data to/from a BACnet module.	
	Message	To display errors related to BACnet communication.	
Settings	Network Information	To set the IP address and subnet mask of a BACnet module.	
	Basic Information	To set an instance number, BACnet standard, and BACnet detail setting of a BACnet module.	
	BACnetObject		To configure the settings for saving/registering object data to/from a CSV file.
	BACnetRequest	Read	To assign an access block for reading to the buffer memory.
		Write	To assign an access block for writing to the buffer memory.
	BACnetMonitor		To assign an access block for BACnet monitoring to the buffer memory.
	COV Interaction		To assign an access block for COV interaction to the buffer memory.
	Event Interaction		To assign an access block for Event interaction to the buffer memory.
	Calendar Interaction		To set to automatically read Calendar object data in another BACnet device when joining a BACnet module to BACnet.
	Who-Is Transmission Info.		To set a send target BACnet device to which Who-Is services are constantly sent from a BACnet module.
User		To protect data on a BACnet module by setting authorities for each user.	

Menu item		Description
Maintenance	Pause/Restart	To stop or restart the operation of a BACnet module.
	Backup/Restore	To backup/restore the data of objects and properties.
	Internal Memory Area	To display the internal memory utilization of a BACnet module.
Language/English		To switch the language displayed on the Web browser. This menu is displayed as [Language setting/Japanese] in Japanese.

Setting displayed language

Switch the language displayed in the configuration functions (on a web browser).

Operating procedure

Select [Language/English].



Setting objects and properties

Before setting a BACnet module, stop the operation of the module.

For details on the settings for objects and properties, refer to the following manual.

📖 MELSEC iQ-R BACnet Module User's Manual (Application)

■ Stopping an operation

The following shows how to stop the operation of a BACnet module.

Operating procedure

1. Select [Maintenance] ⇒ [Pause/Restart], and click the [Pause] button in the "Pause/Restart" screen.

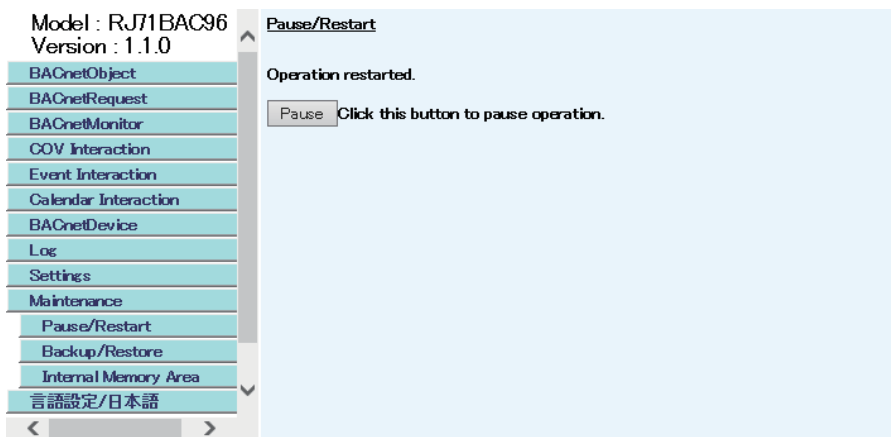

2. Read the displayed message, and click the [OK] button.

The background of the screen changes from blue (in operation) to yellow (pause).

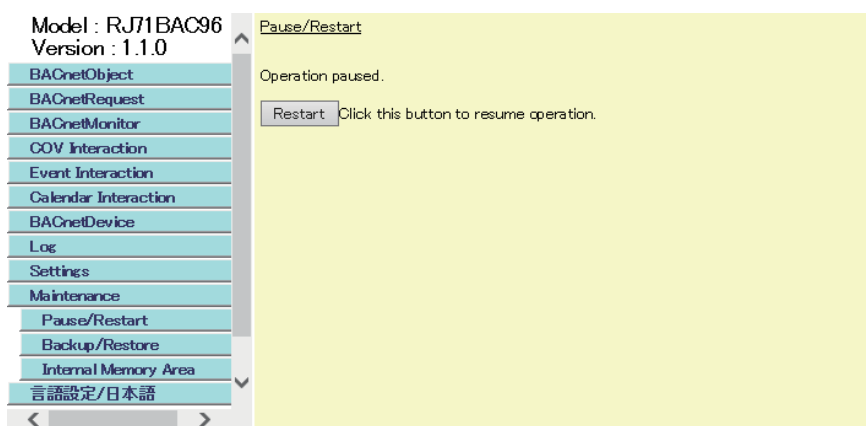

■ Applying settings

The following shows how to apply settings to a BACnet module.

Operating procedure

Reset the CPU module, or turn the power OFF and ON to apply the settings.

Logging out from the BACnet module

There is no procedure to log out.

Close all the open web browsers on the configuration personal computer.

Ex.

Internet Explorer 11

Click the following button in the browser.



5 SYSTEM CONFIGURATION

This chapter explains the system configuration using BACnet modules.

5.1 Whole System Configuration

Setting parameters of a BACnet module with a web browser

Various settings can be configured by connecting a configuration personal computer and a BACnet module with a switching hub using Ethernet cables, then starting a web browser for settings on a personal computer.

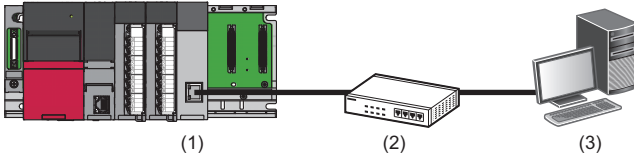

- (1) BACnet module
- (2) Switching hub
- (3) Configuration personal computer

Using a BACnet module as a BACnet controller

A BACnet module manages facilities, such as lights, air-conditioners, security, anti-disaster, and equipment.

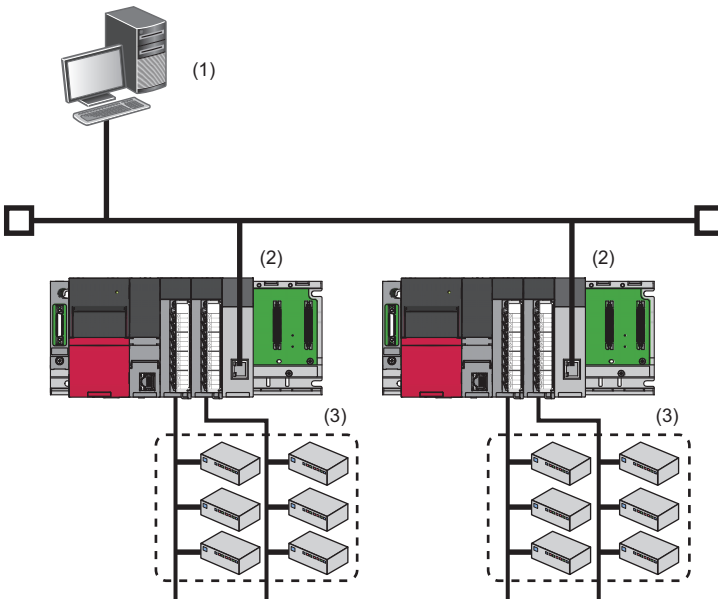

- (1) BACnet workstation
- (2) BACnet module (BACnet controller)
- (3) Lights, air conditioners, etc.

Using a BACnet module as a workstation

BACnet modules sample data of properties on another BACnet controller by using the BACnet request function or the BACnet monitoring function; therefore, a BACnet module can be used as a simplified BACnet workstation.

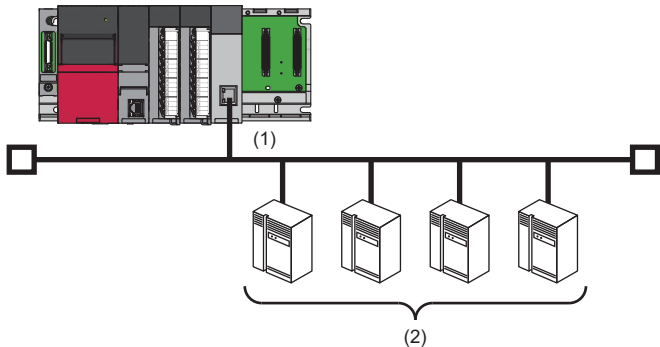

(1) BACnet module (BACnet workstation)

(2) BACnet controller

5.2 Operating Environment

The operating environment for the configuration functions is as follows:

Item	Description
Web browser	Internet Explorer 6.0 Internet Explorer 7.0 Internet Explorer 8.0 Internet Explorer 9.0 Internet Explorer 10.0 Internet Explorer 11.0

5.3 Supported Software Package

The software package supported by BACnet modules is as follows:

Software package	Software version
GX Works3	1.032J or later ^{*1}

*1 When using any of the following software versions, the registration of a BACnet profile is required.

For the information on how to obtain the profile of BACnet module, please consult your local Mitsubishi representative.

·1.032J

·1.033K

6 WIRING

6.1 Ethernet Cables

This section shows the specifications of connectable Ethernet cables.

Connectable Ethernet cables (sold separately)

The twisted pair cable compliant with IEEE802.3 100BASE-TX/10BASE-T standards can be used.

Transmission rate	Unshielded twisted pair cable (UTP cable) Shielded twisted pair cable (STP cable)	
	Straight cable	Crossing cable
100 Mbps	Category 5 or higher	Category 5 or higher
10 Mbps	Category 3 or higher	Category 3 or higher

Considerations for 100BASE-TX connection

A communication error may occur due to high-frequency noise generated from devices other than the programmable controller depending on the installation environment.

The following shows the measures to be taken on the BACnet module to prevent the influence of high frequency noise.

- Do not bundle a cable with the main circuit or power cable, or do not place it near those lines.
- Place a cable in a duct.
- In the environment where a cable is susceptible to noise, use the STP cable.
- Change the target device connected with the BACnet module to one which communicates at 10 Mbps, and decrease the data transmission rate.

Wiring of Ethernet cable

The following shows the connection and disconnection methods of an Ethernet cable.

How to connect an Ethernet cable

1. Check the insertion direction, and insert an Ethernet cable into the Ethernet port on the BACnet module until it clicks.
2. Check if the cable is securely connected by pulling it slightly.
3. Check the lighting status of the LED under the Ethernet port which is connected to the Ethernet cable. (☞ Page 16 PART NAMES)

Point

- The time required from when an Ethernet cable is connected to when the LED under the Ethernet port turns ON may vary. Normally, the LED turns ON in a few seconds. However, it may take longer depending on a device condition on the line.
- When the LED under the Ethernet port does not turn ON, check if the connected Ethernet cable has any failure.

How to disconnect an Ethernet cable

1. Pull out the Ethernet cable while pinching a clip on the connector.

Wiring considerations

- To establish a reliable system and fully use the functions of the BACnet module, a wiring that does not easily receive the effects of noise is required.
- Sufficient safety measures must be taken when constructing the IEEE802.3 100BASE-TX/10BASE-T networks. Consult a specialist when handling the terminal processing of connection cable, installing trunk cables, etc.
- Use the cables compliant with IEEE802.3 100BASE-TX/10BASE-T standards.
- For the connection on the target device side, check the specifications of the target device in advance.
- Place an Ethernet cable in a duct or clamp it.
Otherwise, the dangling cable may swing or inadvertently be pulled. It may cause a BACnet module or an Ethernet cable to damage or malfunction due to the poor contact.
- Protect the core wire in the connector of a cable or the port of the BACnet module to prevent touching by hand and sticking dirt or dust.
If any oil from your hand, dirt or dust sticks the core wire, it may increase the transmission loss and fail a data link.
- Check if the Ethernet cable used is disconnected, a short-circuit is generated, and the connector is properly connected.
- Do not use an Ethernet cable with broken clips.
Doing so may cause the cable to unplug or malfunction.
- Hold the connector on the Ethernet cable when connecting or disconnecting it.
If the cable is pulled while being connected to the module, it may cause the module or Ethernet cable to damage or malfunction due to the poor contact.
- Attach the provided connector cover to protect the unused Ethernet port from dirt and dust.
- The maximum segment length of Ethernet cable is 100 m. However, the length may be shorter depending on the use environment of the cable. For details, contact the manufacturer of the cable used.
- The bend radius of the Ethernet cable is limited. For details, check the specifications of the Ethernet cable used.

7 OPERATING EXAMPLE

7.1 Preparing for Operation

Preparing equipment

The following equipment and software are used in the operating example.

Equipment/Software	Product name/description	Reference
Main base unit	R35B	MELSEC iQ-R Module Configuration Manual
Power supply module	R61P	
CPU module	R08CPU	
BACnet module (BACnet workstation)	RJ71BAC96	—
BACnet module (BACnet controller)	RJ71BAC96	—
Twisted pair cable and switching hub	Cables and switching hubs compliant with IEEE802.3 100BASE-TX/10BASE-T standards	Page 35 WIRING
Configuration personal computer	A personal computer on which Internet Explorer 6.0 to 11.0 operates	—
Web browser	Internet Explorer 6.0 to 11.0	Page 34 Operating Environment
Engineering tool	GX Works3	SWnDND-GXW3 ('n' indicates its version.) Page 34 Supported Software Package GX Works3 Installation Instructions GX Works3 Operating Manual

Constructing a system

Construct a system used for the operation example.

System configuration

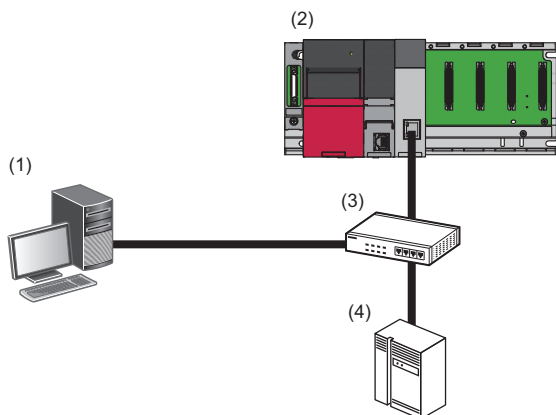

No.	Device	IP address	Subnet mask	BACnet standard	Instance number of a device
(1)	Configuration personal computer	192.168.0.155	255.255.255.0	—	—
(2)	BACnet module (BACnet workstation)	192.168.0.254	255.255.255.0	IEIEJ-G-0006:2006 Addendum-a	254
(3)	Switching hub	—	—	—	—
(4)	BACnet module (BACnet controller)	192.168.0.3	255.255.255.0	IEIEJ-G-0006:2006 Addendum-a	3

Mounting and wiring equipment

Operating procedure

1. Mount each module on a base unit, and wire a power supply.
[MELSEC iQ-R Module Configuration Manual](#)
2. Connect the CPU module and a configuration personal computer with a USB cable.
[MELSEC iQ-R Module Configuration Manual](#)
3. Connect each BACnet module to a switching hub, and connect the switching hub and the configuration personal computer.

Precautions

- If the IP addresses of two BACnet modules are the same, change either of these IP addresses by connecting the configuration personal computer and a BACnet module on a 1:1 basis before connecting BACnet modules to a switching hub.

Starting the system

Operating procedure

1. Power ON the power supply module.
2. Write a program to the CPU module with an engineering tool.
3. Reset the CPU module, or turn the power OFF and ON to run the CPU module.

7.2 Writing Values

This section shows an operating example when writing values to another BACnet device in the system using a BACnet module.

Write a real number '1.0' to the PresentValue property of an AnalogOutput object (instance number: 10) in a BACnet controller (instance number of a device: 3) from a BACnet workstation.

Operating procedure

Configure settings with the following procedure.

1. Setting network for a configuration personal computer.

Set an IP address. ( Page 39 Setting network for a configuration personal computer)

2. Setting a BACnet module (BACnet controller). ( Page 40 Setting a BACnet module (BACnet controller))

Register an AnalogOutput object (instance number: 10) (AO-10).

3. Setting a BACnet module (BACnet workstation). ( Page 43 Setting a BACnet module (BACnet workstation))

Assign a data block (access block for writing) to the buffer memory.

4. Creating a program. ( Page 46 Creating a program)

Create a program to store values to the data block (access block for writing).

5. Checking the operation. ( Page 49 Checking the operation)

Write a real number '1.0' to a PresentValue property, then check the write result on a web browser.

Setting network for a configuration personal computer

1. Set an IP address of a configuration personal computer.

 Page 26 Setting network for a configuration personal computer

Item	Description
IP address	192.168.0.155
Subnet mask	255.255.255.0

2. Set a web browser.

 Page 27 Setting a web browser

Setting a BACnet module (BACnet controller)

Before setting a BACnet module, log in the BACnet module and stop operation.

☞ Page 27 Logging into a BACnet module

☞ Page 31 Stopping an operation

Setting an IP address

The following shows how to set an IP address of a BACnet module.

1. Select [Settings] ⇒ [Network Information], and set the following items.

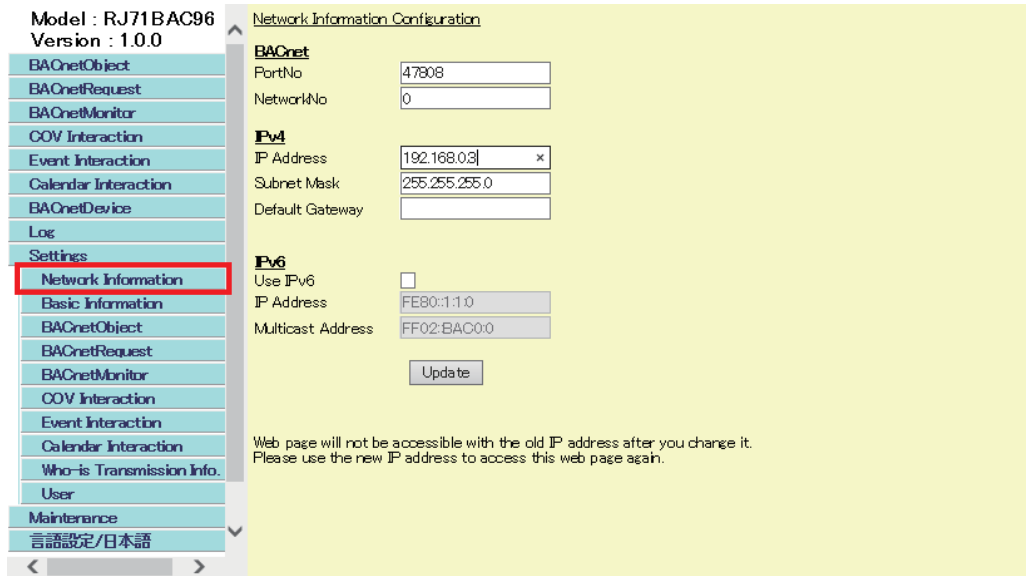

Item		Description
BACnet	PortNo	47808
	NetworkNo	0
IPv4	IP Address	192.168.0.3
	Subnet Mask	255.255.255.0
	Default Gateway	(No settings)

2. Click the [Update] button.

Setting an instance number and a BACnet standard

The following shows how to set an instance number and a BACnet standard of a BACnet module.

1. Select [Settings] ⇒ [Basic Information], and click the [Edit] button in the "BACnet Configuration" screen.

Model : RJ71BAC96
Version : 1.0.0

BACnet Configuration

Item	Setting
DeviceInstanceNo	254
BACnet Standard Applied	IEIEJ-P-0003:2000 Addendum-a

Edit Click this button to edit BACnet configuration. Note: Pause the operation to edit and apply new settings.

BACnet Detail Setting Click this button to browse detailed configuration.

2. Set the following items.

Item	Setting
DeviceInstanceNo	3
BACnet Standard Applied	IEIEJ-G-0006:2006 Addendum-a

Update

Item	Description
DeviceInstanceNo	3
BACnet Standard Applied	IEIEJ-G-0006:2006 Addendum-a

3. Click the [Update] button.

Registering objects

The following shows how to register an object to a BACnet module.

1. Select [BACnetObject] to open the "BACnet Objects" screen.

Model : RJ71BAC96
Version : 1.0.0

BACnetObject

BACnetRequest

BACnetMonitor

COV Interaction

Event Interaction

Calendar Interaction

BACnetDevice

Log

Settings

Maintenance

言語設定/日本語

BACnet_Objects

		ObjectType	Qty.	Limit	Creatable
Browse	Add	AnalogInput	0		False
Browse	Add	AnalogOutput	0		False
Browse	Add	AnalogValue	0		False
Browse	Add	BinaryInput	0		False
Browse	Add	BinaryOutput	0		False
Browse	Add	BinaryValue	0		False
Browse	Add	MultistateInput	0		False
Browse	Add	MultistateOutput	0	4000	False
Browse	Add	MultistateValue	0		False
Browse	Add	Accumulator	0		False
Browse	Add	Keiryo	0		False
Browse	Add	ElectricDemandMonitoring	0		False
Browse	Add	ElectricDemandControl	0		False
Browse	Add	GeneratorLoadControl	0		False
Browse	Add	Calendar	0	300	False
Browse	Add	NotificationClass	0	50	False
Browse	Add	Schedule	0	100	False
Browse	Add	TrendLog	0	200	False
Browse		Device	1	1	False

2. Click the [Add] button of the AnalogOutput.

Model : RJ71BAC96
Version : 1.0.0

BACnetObject

BACnetRequest

BACnetMonitor

COV Interaction

Event Interaction

Calendar Interaction

BACnetDevice

Log

Settings

Maintenance

言語設定/日本語

BACnet_Objects

		ObjectType	Qty.	Limit	Creatable
Browse	Add	AnalogInput	0		False
Browse	Add	AnalogOutput	0		False
Browse	Add	AnalogValue	0		False
Browse	Add	BinaryInput	0		False
Browse	Add	BinaryOutput	0		False
Browse	Add	BinaryValue	0		False
Browse	Add	MultistateInput	0		False
Browse	Add	MultistateOutput	0	4000	False
Browse	Add	MultistateValue	0		False
Browse	Add	Accumulator	0		False
Browse	Add	Keiryo	0		False
Browse	Add	ElectricDemandMonitoring	0		False
Browse	Add	ElectricDemandControl	0		False
Browse	Add	GeneratorLoadControl	0		False
Browse	Add	Calendar	0	300	False
Browse	Add	NotificationClass	0	50	False
Browse	Add	Schedule	0	100	False
Browse	Add	TrendLog	0	200	False
Browse		Device	1	1	False

3. Set '10' to "InstanceNo", '1' to "Qty.", and '0' to "BufferMemoryAddress", then click the [Add] button.

Add BACnet object

Add instance to AnalogOutput object.
Specify any available memory area after 256 (100h) for buffer memory address.
* Specify "0" to automatically allocate available (empty) memory area.
Add "h" to the number to represent hexadecimal number, e.g. 100h (to mean 256 in decimal).

InstanceNo	Qty	BufferMemoryAddress
10	1	0
<input type="button" value="Add"/> <input type="button" value="Cancel"/>		

Setting a BACnet module (BACnet workstation)

Before setting a BACnet module, log in the BACnet module and stop operation.

☞ Page 27 Logging into a BACnet module

☞ Page 31 Stopping an operation

Setting an IP address

The following shows how to set an IP address of a BACnet module.

1. Select [Settings] ⇒ [Network Information], and set the following items.

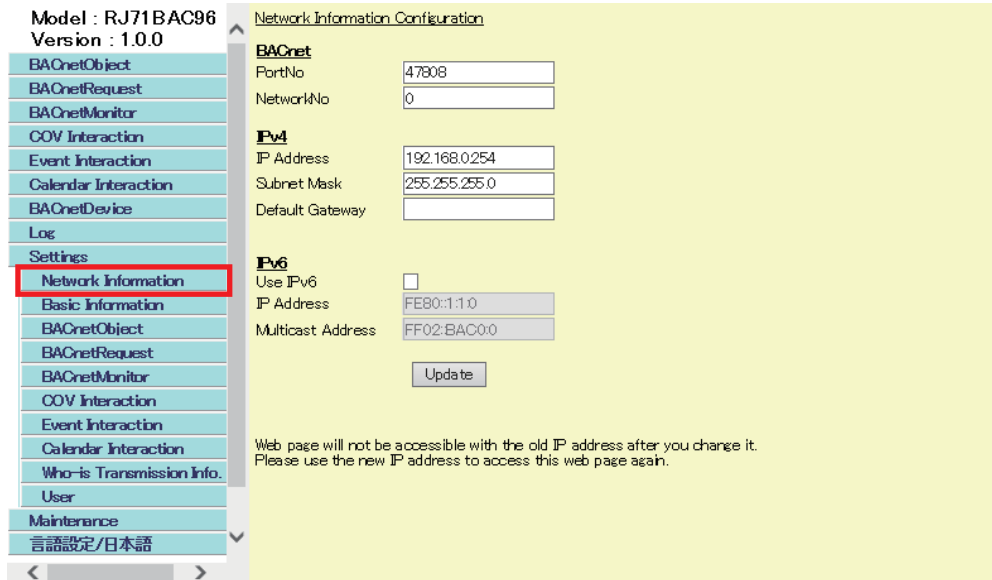

Item	Description	
BACnet	PortNo	47808
	NetworkNo	0
IPv4	IP Address	192.168.0.254
	Subnet Mask	255.255.255.0
	Default Gateway	(No settings)

2. Click the [Update] button.

Setting an instance number and a BACnet standard

The following shows how to set an instance number and a BACnet standard of a BACnet module.

1. Select [Settings] ⇒ [Basic Information], and click the [Edit] button in the "BACnet Configuration" screen.

Model : RJ71BAC96
Version : 1.0.0

BACnet Configuration

Item	Setting
DeviceInstanceNo	254
BACnet Standard Applied	IEIEJ-P-0003:2000 Addendum-a

Edit Click this button to edit BACnet configuration. Note: Pause the operation to edit and apply new settings.

BACnet Detail Setting Click this button to browse detailed configuration.

2. Set the following items.

Item	Setting
DeviceInstanceNo	254
BACnet Standard Applied	IEIEJ-G-0006:2006 Addendum-a

Update

Item	Description
DeviceInstanceNo	254
BACnet Standard Applied	IEIEJ-G-0006:2006 Addendum-a

3. Click the [Update] button.

Assigning a data block

Assign a data block (access block for writing) to the buffer memory.

For the data block (access block for writing), refer to the following manual.

📖 MELSEC iQ-R BACnet Module User's Manual (Application)

Operating procedure

1. Select [Settings] ⇒ [BACnetRequest] ⇒ [Write], and click the [Add] button in the "Reserved access for WriteProperty requests." screen.

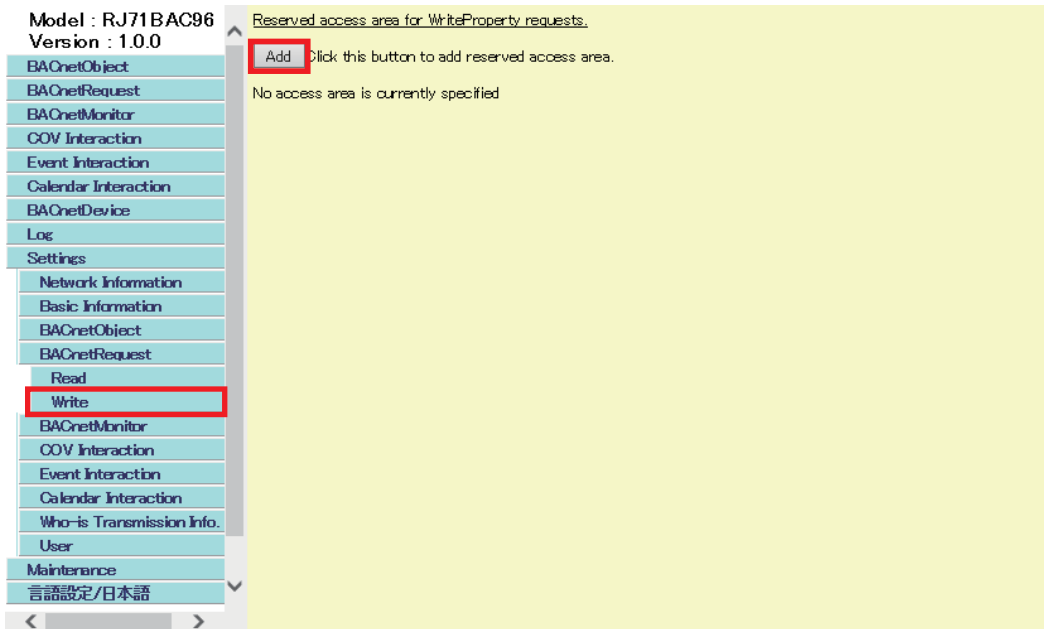

2. Set '400' to "BufferMemoryAddress" and '1' to "Qty.", then click the [Add] button.

Adding access block for writing.
Specify any available memory area after 256 (100h) for buffer memory address.
*Specify "0" to automatically allocate available (empty) memory area.
Add "h" to the number to represent hexadecimal number, e.g. 100h (to mean 256 in decimal).

BufferMemoryAddress

Qty.

Add Close

Creating a program

Create a program to store values to the buffer memory in the CPU module on a BACnet workstation.

Values to be stored to buffer memory

■ Access block for writing

Offset (Decimal address)	Name	Values to be stored	
+0 (400)	CONTROL	When sending a WritePropertyMultiple(WriteProperty) service, store '1' (send request) to a CONTROL.	
+1 (401)	STATUS	— (No settings)	
+2 to +3 (402 to 403)	Instance number of a destination device	3 (instance number of a write target device)	
+4 to +5 (404 to 405)	ObjectIdentifier	K4194314 (4000Ah) b32 to b22: 1 (object type number of an AnalogOutput) b21 to b0: 10 (instance number of an object) For the ObjectIdentifier, refer to the following manual.  MELSEC iQ-R BACnet Module User's Manual (Application)	
+6 (406)	Property-1	PropertyIdentifier	85 (PropertyIdentifier of a PresentValue property)
+7 (407)		ArrayIndex	FFFFh
+8 (408)		Write data	4 (The data type of the PresentValue of an AnalogOutput object is REAL.)
+9 (409)			0 (No priority)
+10 to +11 (410 to 411)			E1 (real number 1.0)
+12 (412)	Property-2	PropertyIdentifier	FFFFh
+13 (413)		ArrayIndex	— (No settings)
+14 to +17 (414 to 417)		Write data	— (No settings)
+18 (418)	Property-3	PropertyIdentifier	FFFFh
+19 (419)		ArrayIndex	— (No settings)
+20 to +23 (420 to 423)		Write data	— (No settings)
+24 (424)	Property-4	PropertyIdentifier	FFFFh
+25 (425)		ArrayIndex	— (No settings)
+26 to +29 (426 to 429)		Write data	— (No settings)

For details on the format of access blocks for writing, refer to the following manual.

 MELSEC iQ-R BACnet Module User's Manual (Application)

Program example

■ Devices to be used

Device name	Device	Description
Special relay	SM400	Always ON
Data register	D200	A device for storing an error code
Internal relay	M100	A device for sending a WritePropertyMultiple(WriteProperty) service
Buffer memory	U0\G400	Refer to the following section.  Page 46 Access block for writing
	U0\G401	
	U0\G402	
	U0\G404	
	U0\G406	
	U0\G407	
	U0\G408	
	U0\G409	
	U0\G410	
	U0\G412	
	U0\G418	
	U0\G424	

■ Example of a ladder program

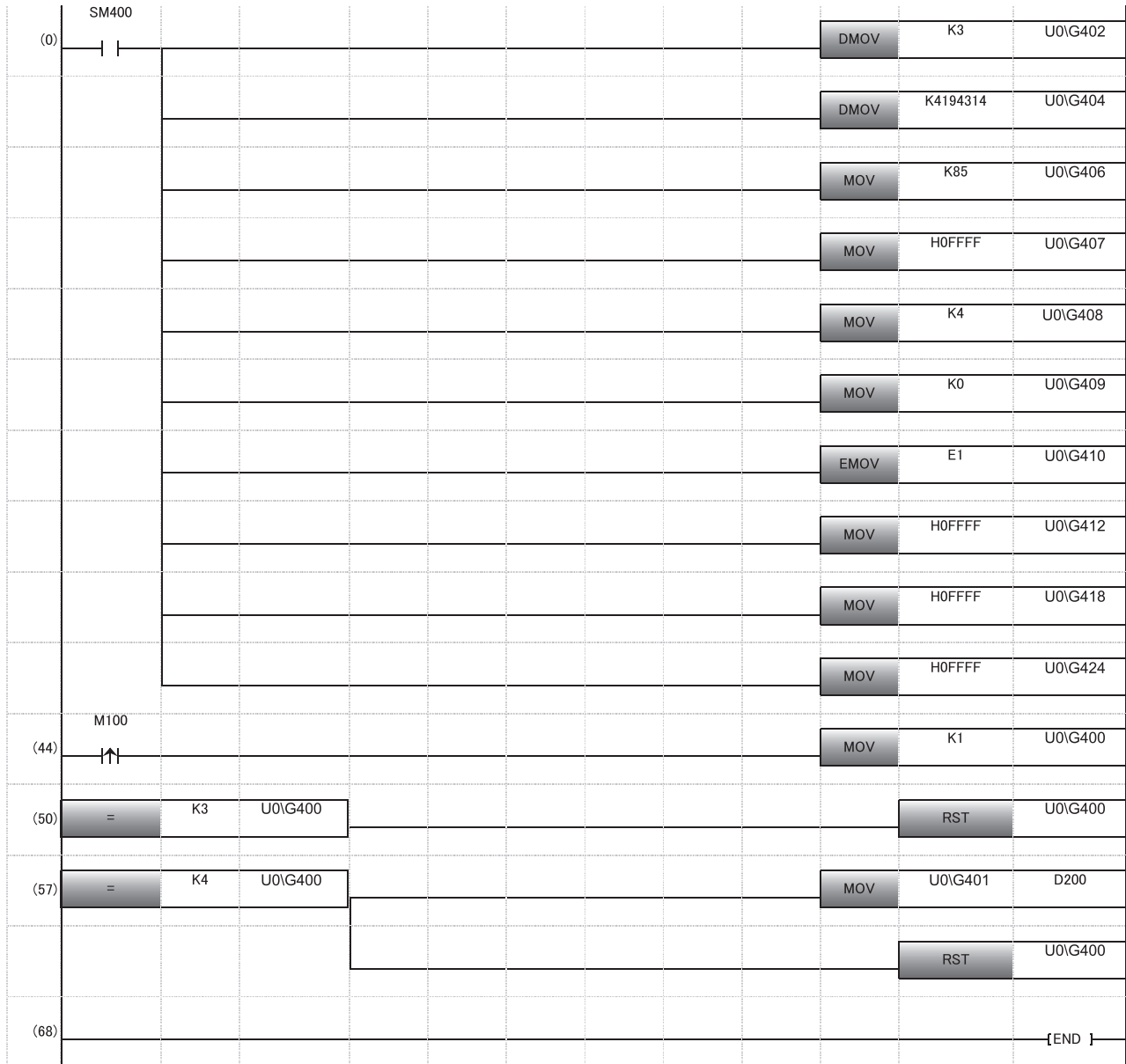

- (0) The instance number of a write destination device is stored.
 The ObjectIdentifier of the write target object is stored.
 The PropertyIdentifier of the write target property is stored.
 'FFFFh' is stored to an ArrayIndex since the write target is not ARRAY type.
 The data type of the write target property is specified.
 '0' is stored since the Priority is not specified for writing.
 The data to be written is stored.
 'FFFFh' is stored since Property-2 to Property-4 are not used.
- (44) When sending a WritePropertyMultiple(WriteProperty) service, '1' (send request) is stored to a CONTROL.
- (50) When the CONTROL is '3' (normal completion), '0' (idling) is stored to reset the CONTROL.
- (57) When the CONTROL is '4' (error end), an error code is stored to D200.
 '0' (idling) is stored to reset the CONTROL.

Checking the operation

1. Write a program to the CPU module on a BACnet workstation.
2. Reset the CPU module, or turn the power OFF and ON on the BACnet workstation to run the CPU module.
3. Turn M100 ON using an engineering tool.

For the change of current values, refer to the following manual.

GX Works3 Operating Manual

4. Open the web browser of the BACnet workstation, select [BACnetRequest] ⇒ [Write] button, and click the [Detail] button in the row where "BufferMemoryAddress" is '190h'.

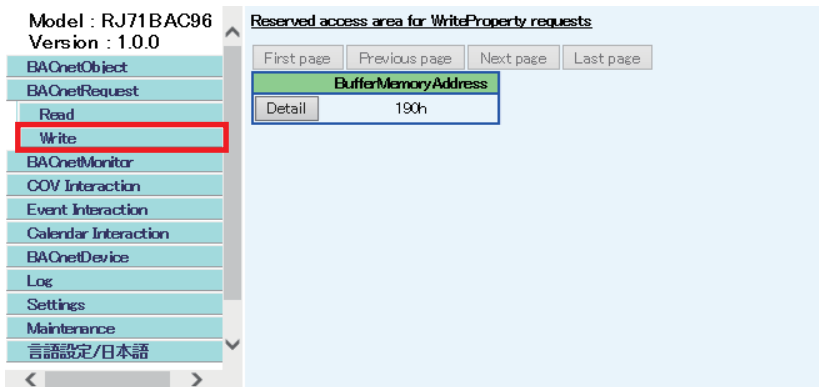

5. Check the writing result of a value.

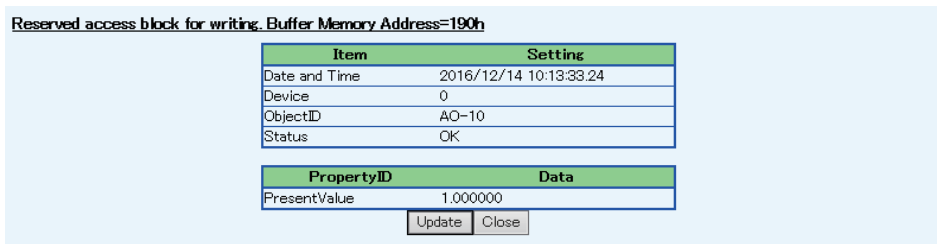

APPENDIX

Appendix 1 EXTERNAL DIMENSION

The following figure shows the external dimension of a BACnet module.

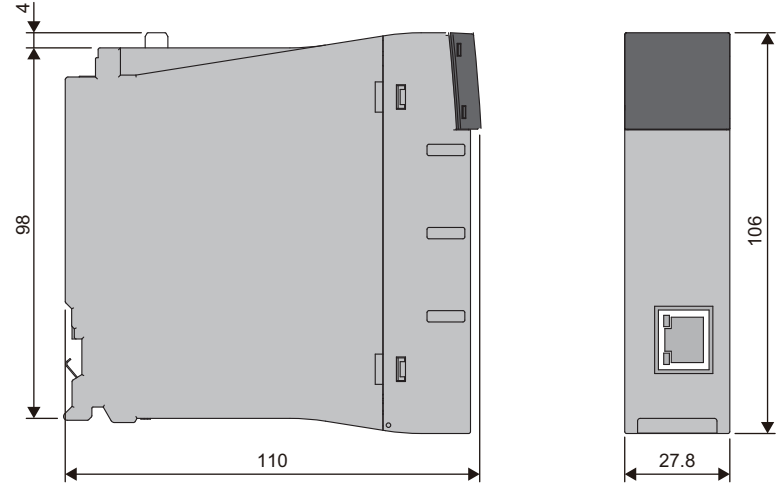

(Unit: mm)

MEMO

A

INDEX

0 to 9

5 VDC internal current consumption 18

B

BACnet controller 33
BACnet standard 19,41,44
BACnet workstation. 34
BIBB 20

C

Communication mode 18

D

Data block 45

E

External dimensions 50

I

Instance number 41,44
IP address 40,43
IP version. 18

M

Maximum segment length 18

N

Number of occupied I/O points 18
Number of registrable access block areas for
BACnet monitoring 18
Number of registrable access block areas for
COV interaction 18
Number of registrable access block areas for
Event interaction 18
Number of registrable access block areas for
reading 18
Number of registrable access block areas for
writing 18
Number of registrable CA objects 18
Number of registrable input/output objects 18
Number of registrable NC objects 18
Number of registrable SC objects 18
Number of registrable TL objects 18

O

Object 42
Operation stop 31

P

Procedures before operation 23

T

Transmission method 18
Transmission rate 18

W

Weight. 18

MEMO

REVISIONS

*The manual number is given on the bottom left of the back cover.

Revision date	*Manual number	Description
February 2017	SH(NA)-081699ENG-A	First edition
June 2017	SH(NA)-081699ENG-B	■Added or modified parts Section 2.2, Section 4.1, Section 5.3
December 2019	SH(NA)-081699ENG-C	■Added or modified parts Section 7.2

Japanese manual number: SH-081697-C

This manual confers no industrial property rights of any other kind, nor does it confer any patent licenses. Mitsubishi Electric Corporation cannot be held responsible for any problems involving industrial property rights which may occur as a result of using the contents noted in this manual.

© 2017 MITSUBISHI ELECTRIC CORPORATION

WARRANTY

Please confirm the following product warranty details before using this product.

1. Gratis Warranty Term and Gratis Warranty Range

If any faults or defects (hereinafter "Failure") found to be the responsibility of Mitsubishi occurs during use of the product within the gratis warranty term, the product shall be replaced at no cost via the sales representative or Mitsubishi Service Company.

However, if repairs are required onsite at domestic or overseas location, expenses to send an engineer will be solely at the customer's discretion. Mitsubishi shall not be held responsible for any re-commissioning, maintenance, or testing on-site that involves replacement of the failed module.

[Gratis Warranty Term]

The gratis warranty term of the product shall be for one year after the date of purchase or delivery to a designated place. Note that after manufacture and shipment from Mitsubishi, the maximum distribution period shall be six (6) months, and the longest gratis warranty term after manufacturing shall be eighteen (18) months. The gratis warranty term of the product shall not exceed the gratis warranty term before product replacement.

[Gratis Warranty Range]

- (1) The range shall be limited to normal use within the usage state, usage methods and usage environment, etc., which follow the conditions and precautions, etc., given in the instruction manual, user's manual and caution labels on the product.
- (2) Even within the gratis warranty term, repairs shall be charged for in the following cases.
 1. Failure occurring from inappropriate storage or handling, carelessness or negligence by the user. Failure caused by the user's hardware or software design.
 2. Failure caused by unapproved modifications, etc., to the product by the user.
 3. When the Mitsubishi product is assembled into a user's device, Failure that could have been avoided if functions or structures, judged as necessary in the legal safety measures the user's device is subject to or as necessary by industry standards, had been provided.
 4. Failure that could have been avoided if consumable parts (battery, backlight, fuse, etc.) designated in the instruction manual had been correctly serviced or replaced.
 5. Failure caused by external irresistible forces such as fires or abnormal voltages, and Failure caused by force majeure such as earthquakes, lightning, wind and water damage.
 6. Failure caused by reasons unpredictable by scientific technology standards at time of shipment from Mitsubishi.
 7. Any other failure found not to be the responsibility of Mitsubishi or that admitted not to be so by the user.

2. Onerous replacement term after discontinuation of production

- (1) Mitsubishi shall accept onerous product replacements for three (3) years after production of the product is discontinued. Discontinuation of production shall be notified with Mitsubishi Technical Bulletins, etc.
- (2) Product supply (including repair parts) is not available after production is discontinued.

3. Overseas service

Overseas, replacements shall be accepted by Mitsubishi's local overseas FA Center. Note that the replacement conditions at each FA Center may differ.

4. Exclusion of loss in opportunity and secondary loss from warranty liability

Regardless of the gratis warranty term, Mitsubishi shall not be liable for compensation to:

- (1) Damages caused by any cause found not to be the responsibility of Mitsubishi.
- (2) Loss in opportunity, lost profits incurred to the user by Failures of Mitsubishi products.
- (3) Special damages and secondary damages whether foreseeable or not, compensation for accidents, and compensation for damages to products other than Mitsubishi products.
- (4) Replacement by the user, maintenance of on-site equipment, start-up test run and other tasks.

5. Changes in product specifications

The specifications given in the catalogs, manuals or technical documents are subject to change without prior notice.

TRADEMARKS

Microsoft, Windows, and Internet Explorer are either registered trademarks or trademarks of Microsoft Corporation in the United States and/or other countries.

The company names, system names and product names mentioned in this manual are either registered trademarks or trademarks of their respective companies.

In some cases, trademark symbols such as '™' or '®' are not specified in this manual.

unitecCORPORATION Unitec Corporation www.uni-tec.co.jp

SH(NA)-081699ENG-C(1912)KWIX

MODEL: RJ71BAC96-U-IN-E

MODEL CODE: 13JX65

MITSUBISHI ELECTRIC CORPORATION

HEAD OFFICE : TOKYO BUILDING, 2-7-3 MARUNOUCHI, CHIYODA-KU, TOKYO 100-8310, JAPAN
NAGOYA WORKS : 1-14, YADA-MINAMI 5-CHOME, HIGASHI-KU, NAGOYA, JAPAN

When exported from Japan, this manual does not require application to the
Ministry of Economy, Trade and Industry for service transaction permission.

Specifications subject to change without notice.