



Programmable Controller

MELSEC iQ-R
series

MELSEC iQ-R Channel Isolated Digital-Analog
Converter Module
User's Manual (Startup)

-R60DA8-G
-R60DA16-G



SAFETY PRECAUTIONS

(Read these precautions before using this product.)

Before using this product, please read this manual and the relevant manuals carefully and pay full attention to safety to handle the product correctly.

The precautions given in this manual are concerned with this product only. For the safety precautions of the programmable controller system, refer to the MELSEC iQ-R Module Configuration Manual.

In this manual, the safety precautions are classified into two levels: "⚠ WARNING" and "⚠ CAUTION".

 WARNING	Indicates that incorrect handling may cause hazardous conditions, resulting in death or severe injury.
 CAUTION	Indicates that incorrect handling may cause hazardous conditions, resulting in minor or moderate injury or property damage.

Under some circumstances, failure to observe the precautions given under "⚠ CAUTION" may lead to serious consequences.

Observe the precautions of both levels because they are important for personal and system safety.

Make sure that the end users read this manual and then keep the manual in a safe place for future reference.

[Design Precautions]

WARNING

- Configure safety circuits external to the programmable controller to ensure that the entire system operates safely even when a fault occurs in the external power supply or the programmable controller. Failure to do so may result in an accident due to an incorrect output or malfunction.
 - (1) Emergency stop circuits, protection circuits, and protective interlock circuits for conflicting operations (such as forward/reverse rotations or upper/lower limit positioning) must be configured external to the programmable controller.
 - (2) When the programmable controller detects an abnormal condition, it stops the operation and all outputs are:
 - Turned off if the overcurrent or overvoltage protection of the power supply module is activated.
 - Held or turned off according to the parameter setting if the self-diagnostic function of the CPU module detects an error such as a watchdog timer error.
 - (3) All outputs may be turned on if an error occurs in a part, such as an I/O control part, where the CPU module cannot detect any error. To ensure safety operation in such a case, provide a safety mechanism or a fail-safe circuit external to the programmable controller. For a fail-safe circuit example, refer to "General Safety Requirements" in the MELSEC iQ-R Module Configuration Manual.
 - (4) Outputs may remain on or off due to a failure of a component such as a relay and transistor in an output circuit. Configure an external circuit for monitoring output signals that could cause a serious accident.
 - In an output circuit, when a load current exceeding the rated current or an overcurrent caused by a load short-circuit flows for a long time, it may cause smoke and fire. To prevent this, configure an external safety circuit, such as a fuse.
 - For the operating status of each station after a communication failure, refer to manuals relevant to the network. Incorrect output or malfunction due to a communication failure may result in an accident.
 - When connecting an external device with a CPU module or intelligent function module to modify data of a running programmable controller, configure an interlock circuit in the program to ensure that the entire system will always operate safely. For other forms of control (such as program modification, parameter change, forced output, or operating status change) of a running programmable controller, read the relevant manuals carefully and ensure that the operation is safe before proceeding. Improper operation may damage machines or cause accidents.
 - Especially, when a remote programmable controller is controlled by an external device, immediate action cannot be taken if a problem occurs in the programmable controller due to a communication failure. To prevent this, configure an interlock circuit in the program, and determine corrective actions to be taken between the external device and CPU module in case of a communication failure.
 - Do not write any data to the "system area" and "write-protect area" of the buffer memory in the module. Also, do not use any "use prohibited" signals as an output signal from the CPU module to each module. Doing so may cause malfunction of the programmable controller system. For the "system area", "write-protect area", and the "use prohibited" signals, refer to the user's manual for the module used.
-

[Design Precautions]

WARNING

- If a communication cable is disconnected, the network may be unstable, resulting in a communication failure of multiple stations. Configure an interlock circuit in the program to ensure that the entire system will always operate safely even if communications fail. Failure to do so may result in an accident due to an incorrect output or malfunction.
- To maintain the safety of the programmable controller system against unauthorized access from external devices via the network, take appropriate measures. To maintain the safety against unauthorized access via the Internet, take measures such as installing a firewall.
- Analog outputs may remain on due to a failure of the module. Configure an external interlock circuit for output signals that could cause a serious accident.

[Precautions for using the channel isolated digital-analog converter modules in standard mode]

- Configure a circuit so that the programmable controller is turned on first and then the external power supply. If the external power supply is turned on first, an accident may occur due to an incorrect output or malfunction.

[Precautions for using the channel isolated digital-analog converter modules in SIL2 mode]

- When the R60DA8-G detects a fault in the external power supply or programmable controller, an analog output value becomes an OFF value (0V/0mA) in all channels. Configure an external circuit to ensure that the power source of a hazard is shut off when an analog output value of the R60DA8-G is an OFF value (0V/0mA). Failure to do so may result in an accident.
 - When a load current exceeding the rated current or an overcurrent caused by a load short-circuit flows, the R60DA8-G detects an error and an analog output value becomes an OFF value (0V/0mA) in all channels. Note that if the overcurrent state continues for a long time, it may cause smoke and fire. To prevent this, configure an external safety circuit, such as a fuse.
 - When a communication failure occurs in CC-Link IE Field Network, an analog output value of the R60DA8-G becomes an OFF value (0V/0mA) in all channels. Check the communication status information and configure an interlock circuit in the program to ensure that the entire system will operate safely. Failure to do so may result in an accident due to an incorrect output or malfunction.
 - Create an interlock circuit which uses reset buttons so that the system does not restart automatically after safety functions are executed and an analog output value becomes an OFF value (0V/0mA).
-

[Design Precautions]

CAUTION

- Do not install the control lines or communication cables together with the main circuit lines or power cables. Keep a distance of 100mm or more between them. Failure to do so may result in malfunction due to noise.
 - During control of an inductive load such as a lamp, heater, or solenoid valve, a large current (approximately ten times greater than normal) may flow when the output is turned from off to on. Therefore, use a module that has a sufficient current rating.
 - After the CPU module is powered on or is reset, the time taken to enter the RUN status varies depending on the system configuration, parameter settings, and/or program size. Design circuits so that the entire system will always operate safely, regardless of the time.
 - Do not power off the programmable controller or reset the CPU module while the settings are being written. Doing so will make the data in the flash ROM undefined. The values need to be set in the buffer memory and written to the flash ROM again. Doing so also may cause malfunction or failure of the module.
 - When changing the operating status of the CPU module from external devices (such as the remote RUN/STOP functions), select "Do Not OPEN in Program" for "Open Method Setting" in the module parameters. If "OPEN in Program" is selected, an execution of the remote STOP function causes the communication line to close. Consequently, the CPU module cannot reopen the line, and external devices cannot execute the remote RUN function.
 - Power on or off the external power supply while the programmable controller is on. Failure to do so may result in incorrect output or malfunction.
 - At on/off of the power or external power supply, or at the output range switching, a voltage may occur or a current may flow between output terminals for a moment. In this case, start the control after analog outputs become stable.
-

[Installation Precautions]

WARNING

- Shut off the external power supply (all phases) used in the system before mounting or removing the module. Failure to do so may result in electric shock or cause the module to fail or malfunction.
-

[Installation Precautions]

CAUTION

- Use the programmable controller in an environment that meets the general specifications in the Safety Guidelines included with the base unit. Failure to do so may result in electric shock, fire, malfunction, or damage to or deterioration of the product.
 - To mount a module, place the concave part(s) located at the bottom onto the guide(s) of the base unit, and push in the module until the hook(s) located at the top snaps into place. Incorrect interconnection may cause malfunction, failure, or drop of the module.
 - When using the programmable controller in an environment of frequent vibrations, fix the module with a screw.
 - Tighten the screws within the specified torque range. Undertightening can cause drop of the screw, short circuit, or malfunction. Overtightening can damage the screw and/or module, resulting in drop, short circuit, or malfunction.
 - When using an extension cable, connect it to the extension cable connector of the base unit securely. Check the connection for looseness. Poor contact may cause malfunction.
 - When using an SD memory card, fully insert it into the SD memory card slot. Check that it is inserted completely. Poor contact may cause malfunction.
 - Securely insert an extended SRAM cassette into the cassette connector of the CPU module. After insertion, close the cassette cover and check that the cassette is inserted completely. Poor contact may cause malfunction.
 - Do not directly touch any conductive parts and electronic components of the module, SD memory card, extended SRAM cassette, or connector. Doing so can cause malfunction or failure of the module.
-

[Wiring Precautions]

WARNING

- Shut off the external power supply (all phases) used in the system before installation and wiring. Failure to do so may result in electric shock or cause the module to fail or malfunction.
 - After installation and wiring, attach the included terminal cover to the module before turning it on for operation. Failure to do so may result in electric shock.
-

[Wiring Precautions]

CAUTION

- Individually ground the FG and LG terminals of the programmable controller with a ground resistance of 100 ohms or less. Failure to do so may result in electric shock or malfunction.
 - Use applicable solderless terminals and tighten them within the specified torque range. If any spade solderless terminal is used, it may be disconnected when the terminal screw comes loose, resulting in failure.
 - Check the rated voltage and signal layout before wiring to the module, and connect the cables correctly. Connecting a power supply with a different voltage rating or incorrect wiring may cause fire or failure.
 - Connectors for external devices must be crimped or pressed with the tool specified by the manufacturer, or must be correctly soldered. Incomplete connections may cause short circuit, fire, or malfunction.
 - Securely connect the connector to the module. Poor contact may cause malfunction.
 - Do not install the control lines or communication cables together with the main circuit lines or power cables. Keep a distance of 100mm or more between them. Failure to do so may result in malfunction due to noise.
 - Place the cables in a duct or clamp them. If not, dangling cable may swing or inadvertently be pulled, resulting in damage to the module or cables or malfunction due to poor contact. Do not clamp the extension cables with the jacket stripped. Doing so may change the characteristics of the cables, resulting in malfunction.
 - Check the interface type and correctly connect the cable. Incorrect wiring (connecting the cable to an incorrect interface) may cause failure of the module and external device.
 - Tighten the terminal screws or connector screws within the specified torque range. Undertightening can cause drop of the screw, short circuit, fire, or malfunction. Overtightening can damage the screw and/or module, resulting in drop, short circuit, fire, or malfunction.
 - When disconnecting the cable from the module, do not pull the cable by the cable part. For the cable with connector, hold the connector part of the cable. For the cable connected to the terminal block, loosen the terminal screw. Pulling the cable connected to the module may result in malfunction or damage to the module or cable.
 - Prevent foreign matter such as dust or wire chips from entering the module. Such foreign matter can cause a fire, failure, or malfunction.
 - A protective film is attached to the top of the module to prevent foreign matter, such as wire chips, from entering the module during wiring. Do not remove the film during wiring. Remove it for heat dissipation before system operation.
 - Programmable controllers must be installed in control panels. Connect the main power supply to the power supply module in the control panel through a relay terminal block. Wiring and replacement of a power supply module must be performed by qualified maintenance personnel with knowledge of protection against electric shock. For wiring, refer to the MELSEC iQ-R Module Configuration Manual.
 - For Ethernet cables to be used in the system, select the ones that meet the specifications in the user's manual for the module used. If not, normal data transmission is not guaranteed.
 - Individually ground the shielded cables of the programmable controller with a ground resistance of 100 ohms or less. Failure to do so may result in electric shock or malfunction.
-

[Startup and Maintenance Precautions]

WARNING

- Do not touch any terminal while power is on. Doing so will cause electric shock or malfunction.
 - Correctly connect the battery connector. Do not charge, disassemble, heat, short-circuit, solder, or throw the battery into the fire. Also, do not expose it to liquid or strong shock. Doing so will cause the battery to produce heat, explode, ignite, or leak, resulting in injury and fire.
 - Shut off the external power supply (all phases) used in the system before cleaning the module or retightening the terminal screws, connector screws, or module fixing screws. Failure to do so may result in electric shock.
-

[Startup and Maintenance Precautions]

CAUTION

- When connecting an external device with a CPU module or intelligent function module to modify data of a running programmable controller, configure an interlock circuit in the program to ensure that the entire system will always operate safely. For other forms of control (such as program modification, parameter change, forced output, or operating status change) of a running programmable controller, read the relevant manuals carefully and ensure that the operation is safe before proceeding. Improper operation may damage machines or cause accidents.
 - Especially, when a remote programmable controller is controlled by an external device, immediate action cannot be taken if a problem occurs in the programmable controller due to a communication failure. To prevent this, configure an interlock circuit in the program, and determine corrective actions to be taken between the external device and CPU module in case of a communication failure.
 - Do not disassemble or modify the modules. Doing so may cause failure, malfunction, injury, or a fire.
 - Use any radio communication device such as a cellular phone or PHS (Personal Handy-phone System) more than 25cm away in all directions from the programmable controller. Failure to do so may cause malfunction.
 - Shut off the external power supply (all phases) used in the system before mounting or removing the module. Failure to do so may cause the module to fail or malfunction.
 - Tighten the screws within the specified torque range. Undertightening can cause drop of the component or wire, short circuit, or malfunction. Overtightening can damage the screw and/or module, resulting in drop, short circuit, or malfunction.
 - After the first use of the product, do not mount/remove the module to/from the base unit, and the terminal block to/from the module, and do not insert/remove the extended SRAM cassette to/from the CPU module more than 50 times (IEC 61131-2 compliant) respectively. Exceeding the limit may cause malfunction.
 - After the first use of the product, do not insert/remove the SD memory card to/from the CPU module more than 500 times. Exceeding the limit may cause malfunction.
 - Do not touch the metal terminals on the back side of the SD memory card. Doing so may cause malfunction or failure of the module.
 - Do not touch the integrated circuits on the circuit board of an extended SRAM cassette. Doing so may cause malfunction or failure of the module.
 - Do not drop or apply shock to the battery to be installed in the module. Doing so may damage the battery, causing the battery fluid to leak inside the battery. If the battery is dropped or any shock is applied to it, dispose of it without using.
 - Startup and maintenance of a control panel must be performed by qualified maintenance personnel with knowledge of protection against electric shock. Lock the control panel so that only qualified maintenance personnel can operate it.
 - Before handling the module, touch a conducting object such as a grounded metal to discharge the static electricity from the human body. Failure to do so may cause the module to fail or malfunction.
-

[Operating Precautions]

CAUTION

- When changing data and operating status, and modifying program of the running programmable controller from an external device such as a personal computer connected to an intelligent function module, read relevant manuals carefully and ensure the safety before operation. Incorrect change or modification may cause system malfunction, damage to the machines, or accidents.
 - Do not power off the programmable controller or reset the CPU module while the setting values in the buffer memory are being written to the flash ROM in the module. Doing so will make the data in the flash ROM undefined. The values need to be set in the buffer memory and written to the flash ROM again. Doing so can cause malfunction or failure of the module.
-

[Disposal Precautions]

CAUTION

- When disposing of this product, treat it as industrial waste.
 - When disposing of batteries, separate them from other wastes according to the local regulations. For details on battery regulations in EU member states, refer to the MELSEC iQ-R Module Configuration Manual.
-

[Transportation Precautions]

CAUTION

- When transporting lithium batteries, follow the transportation regulations. For details on the regulated models, refer to the MELSEC iQ-R Module Configuration Manual.
 - The halogens (such as fluorine, chlorine, bromine, and iodine), which are contained in a fumigant used for disinfection and pest control of wood packaging materials, may cause failure of the product. Prevent the entry of fumigant residues into the product or consider other methods (such as heat treatment) instead of fumigation. The disinfection and pest control measures must be applied to unprocessed raw wood.
-

CONDITIONS OF USE FOR THE PRODUCT

- (1) Mitsubishi programmable controller ("the PRODUCT") shall be used in conditions;
- i) where any problem, fault or failure occurring in the PRODUCT, if any, shall not lead to any major or serious accident; and
 - ii) where the backup and fail-safe function are systematically or automatically provided outside of the PRODUCT for the case of any problem, fault or failure occurring in the PRODUCT.
- (2) The PRODUCT has been designed and manufactured for the purpose of being used in general industries. MITSUBISHI SHALL HAVE NO RESPONSIBILITY OR LIABILITY (INCLUDING, BUT NOT LIMITED TO ANY AND ALL RESPONSIBILITY OR LIABILITY BASED ON CONTRACT, WARRANTY, TORT, PRODUCT LIABILITY) FOR ANY INJURY OR DEATH TO PERSONS OR LOSS OR DAMAGE TO PROPERTY CAUSED BY the PRODUCT THAT ARE OPERATED OR USED IN APPLICATION NOT INTENDED OR EXCLUDED BY INSTRUCTIONS, PRECAUTIONS, OR WARNING CONTAINED IN MITSUBISHI'S USER, INSTRUCTION AND/OR SAFETY MANUALS, TECHNICAL BULLETINS AND GUIDELINES FOR the PRODUCT.

("Prohibited Application")

Prohibited Applications include, but not limited to, the use of the PRODUCT in;

- Nuclear Power Plants and any other power plants operated by Power companies, and/or any other cases in which the public could be affected if any problem or fault occurs in the PRODUCT.
- Railway companies or Public service purposes, and/or any other cases in which establishment of a special quality assurance system is required by the Purchaser or End User.
- Aircraft or Aerospace, Medical applications, Train equipment, transport equipment such as Elevator and Escalator, Incineration and Fuel devices, Vehicles, Manned transportation, Equipment for Recreation and Amusement, and Safety devices, handling of Nuclear or Hazardous Materials or Chemicals, Mining and Drilling, and/or other applications where there is a significant risk of injury to the public or property.

Notwithstanding the above restrictions, Mitsubishi may in its sole discretion, authorize use of the PRODUCT in one or more of the Prohibited Applications, provided that the usage of the PRODUCT is limited only for the specific applications agreed to by Mitsubishi and provided further that no special quality assurance or fail-safe, redundant or other safety features which exceed the general specifications of the PRODUCTS are required. For details, please contact the Mitsubishi representative in your region.

- When SIL2 mode is set
- (1) Although MELCO has obtained the certification for Product's compliance to the international safety standards IEC61508, IEC61511 from TUV Rheinland, this fact does not guarantee that Product will be free from any malfunction or failure. The user of this Product shall comply with any and all applicable safety standard, regulation or law and take appropriate safety measures for the system in which the Product is installed or used and shall take the second or third safety measures other than the Product. MELCO is not liable for damages that could have been prevented by compliance with any applicable safety standard, regulation or law.
- (2) MELCO prohibits the use of Products with or in any application involving, and MELCO shall not be liable for a default, a liability for defect warranty, a quality assurance, negligence or other tort and a product liability in these applications.
- (a) power plants,
 - (b) trains, railway systems, airplanes, airline operations, other transportation systems,
 - (c) hospitals, medical care, dialysis and life support facilities or equipment,
 - (d) amusement equipments,
 - (e) incineration and fuel devices,
 - (f) handling of nuclear or hazardous materials or chemicals,
 - (g) mining and drilling,
 - (h) and other applications where the level of risk to human life, health or property are elevated.

INTRODUCTION

Thank you for purchasing the Mitsubishi Electric MELSEC iQ-R series programmable controllers.

This manual describes the performance specifications, procedures before operation, wiring, and operation examples to use the relevant products listed below in standard mode.

Before using this product, please read this manual and the relevant manuals carefully and develop familiarity with the functions and performance of the MELSEC iQ-R series programmable controller to handle the product correctly.

When applying the program examples provided in this manual to an actual system, ensure the applicability and confirm that it will not cause system control problems.

Please make sure that the end users read this manual.

Point

Unless otherwise specified, this manual provides program examples in which the I/O numbers of X/Y0 to X/YF are assigned to the D/A converter module. Assign I/O numbers when applying the program examples to an actual system. For I/O number assignment, refer to the following.

 MELSEC iQ-R Module Configuration Manual

Relevant products

R60DA8-G, R60DA16-G

Modes

Modes of the R60DA8-G are roughly classified into two groups listed below. A mode is set using the module parameter of GX Works3. Mode transition is not possible while the module is operating.

Mode	Description
Standard mode	<ul style="list-style-type: none">• The mode for using the D/A converter module in a normal system• The standard mode is subdivided into three types: normal mode, offset/gain setting mode, and Q compatible mode.
SIL2 mode	<ul style="list-style-type: none">• The mode is certified according to the safety requirements of IEC 61508: 2010 SIL2 and IEC 61511: 2015 SIL2. This mode is used when a customer builds a SIL2 system using products compliant with IEC 61508: 2010 SIL2 or IEC 61511: 2015 SIL2.• The R60DA8-G in SIL2 mode can be used to build safety functions for general industry machinery.

Note that the R60DA16-G does not support SIL2 mode and operates only in standard mode.

Point

To use the R60DA8-G in SIL2 mode, refer to the following.

 MELSEC iQ-R Channel Isolated Digital-Analog Converter Module User's Manual (Application)

■Enabling/disabling the safety module



To operate the R60DA8-G in SIL2 mode, it is necessary to enable the safety module so that the set parameters become enabled.

To stop the safety I/O of the R60DA8-G operating in SIL2 mode, or to use that module in standard mode in the other system, disabling the safety module is required.

COMPLIANCE WITH EMC AND LOW VOLTAGE DIRECTIVES

Method of ensuring compliance



To ensure that Mitsubishi Electric programmable controllers maintain EMC and Low Voltage Directives when incorporated into other machinery or equipment, certain measures may be necessary. Please refer to one of the following manuals.

-  MELSEC iQ-R Module Configuration Manual
-  Safety Guidelines (This manual is included with the base unit.)

The CE mark on the side of the programmable controller indicates compliance with EMC and Low Voltage Directives.

Additional measures

To ensure that this product maintains EMC and Low Voltage Directives, please refer to one of the following manuals.

-  MELSEC iQ-R Module Configuration Manual
-  Safety Guidelines (This manual is included with the base unit.)

CONTENTS

SAFETY PRECAUTIONS	1
CONDITIONS OF USE FOR THE PRODUCT	10
INTRODUCTION	11
COMPLIANCE WITH EMC AND LOW VOLTAGE DIRECTIVES	12
RELEVANT MANUALS	14
TERMS	14
CHAPTER 1 PART NAMES	16
CHAPTER 2 SPECIFICATIONS	18
2.1 Performance Specifications	18
CHAPTER 3 FUNCTION LIST	20
CHAPTER 4 PROCEDURES BEFORE OPERATION	22
CHAPTER 5 SYSTEM CONFIGURATION	24
CHAPTER 6 WIRING	26
6.1 Wiring Precautions	26
Connectors for external devices	26
6.2 External Wiring	27
Signal layout of the connector for external devices	27
CHAPTER 7 OPERATION EXAMPLES	31
7.1 Programming Procedure	31
7.2 Program Examples	31
CHAPTER 8 OFFSET/GAIN SETTING	36
8.1 Setting Procedure	36
APPENDICES	40
Appendix 1 I/O Conversion Characteristics	40
Appendix 2 Accuracy	44
Appendix 3 External Dimensions	45
INDEX	46
REVISIONS	48
WARRANTY	49
TRADEMARKS	52

RELEVANT MANUALS

Manual name [manual number]	Description	Available form
MELSEC iQ-R Channel Isolated Digital-Analog Converter Module User's Manual (Startup) [SH-081489ENG] (this manual)	Performance specifications, procedures before operation, wiring, operation examples, and offset/gain setting of the D/A converter module	Print book e-Manual PDF
MELSEC iQ-R Channel Isolated Digital-Analog Converter Module User's Manual (Application) [SH-081491ENG]	Functions, parameter settings, troubleshooting, I/O signals, and buffer memory of the D/A converter module	Print book e-Manual PDF
MELSEC iQ-R Programming Manual (Module Dedicated Instructions) [SH-081976ENG]	Dedicated instructions for the intelligent function modules	e-Manual PDF

This manual does not include detailed information on the following:

- General specifications
- Applicable CPU modules and the number of mountable modules
- Installation

For details, refer to the following.

 MELSEC iQ-R Module Configuration Manual

This manual does not include information on the module function blocks.

For details, refer to the Function Block Reference for the module used.

Point

e-Manual refers to the Mitsubishi Electric FA electronic book manuals that can be browsed using a dedicated tool.

e-Manual has the following features:

- Required information can be cross-searched in multiple manuals.
- Other manuals can be accessed from the links in the manual.
- The hardware specifications of each part can be found from the product figures.
- Pages that users often browse can be bookmarked.
- Sample programs can be copied to an engineering tool.

TERMS

Unless otherwise specified, this manual uses the following terms.

Term	Description
Buffer memory	A memory in an intelligent module for storing data (such as setting values and monitored values) to be transferred to the CPU module
D/A converter module	An abbreviation for the MELSEC iQ-R series channel isolated digital-analog converter module
Engineering tool	Another term for GX Works3
Factory default setting	A generic term for analog output ranges of 4 to 20mA, 0 to 20mA, 1 to 5V, 0 to 5V, -10 to 10V, 4 to 20mA (extended mode), and 1 to 5V (extended mode). In the window on the engineering tool, 4 to 20mA (extended mode) and 1 to 5V (extended mode) are displayed as the following: <ul style="list-style-type: none"> • 4 to 20mA (Extension) • 1 to 5V (Extension)
Global label	A label that is valid for all the program data when multiple program data are created in the project. There are two types of global label: a module specific label (module label), which is generated automatically by GX Works3, and an optional label, which can be created for any specified device.
GX Works3	The product name of the software package for the MELSEC programmable controllers
Module label	A label that represents one of memory areas (I/O signals and buffer memory areas) specific to each module in a given character string. For the module used, GX Works3 automatically generates this label, which can be used as a global label.
Normal mode	A mode used for normal D/A conversion. In the engineering tool, the item name of the mode is displayed as "Normal mode (D/A conversion process)".
Offset/gain setting mode	A mode used for the offset/gain setting
Q compatible mode	A mode in which the module operates with the buffer memory map converted to the equivalent one of the MELSEC-Q series

Term	Description
R mode	A mode in which the module operates with the buffer memory map that has been newly laid out in the MELSEC iQ-R series
SIL2 mode	A mode is certified according to the safety requirements of IEC 61508: 2010 SIL2 and IEC 61511: 2015 SIL2.
Standard mode	A mode for using the D/A converter module in a standard system.
User range	An analog output range where any value can be set. This range can be set in the offset/gain setting.
Watchdog timer error	An error that occurs if the internal processing of the D/A converter module fails. The module monitors its own internal processing by using the watchdog timer.

1 PART NAMES

This chapter describes the part names of the D/A converter module.

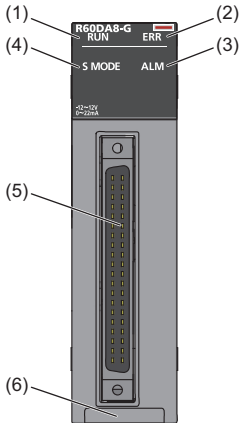

No.	Name	Description
(1)	RUN LED	Indicates the operating status of the module. On: Normal operation Flashing (cycle of 1s): In offset/gain setting mode Flashing (cycle of 400ms): Selected as a module for the online module change Off: 5V power supply interrupted, watchdog timer error occurred, or module change permitted in the process of online module change
(2)	ERR LED	Indicates the error status of the module.*1 On: Error occurred Off: Normal operation
(3)	ALM LED	Indicates the alarm status of the module. Or indicates the wait-for-restart state after the safety module is disabled.*1 On: Alert occurred Flashing (400ms cycles): Wait-for-restart Off: Normal operation
(4)	S MODE LED (Only for the R60DA8-G)*2	Always off in standard mode. Used in SIL2 mode. (📖 MELSEC iQ-R Channel Isolated Digital-Analog Converter Module User's Manual (Application))
(5)	Connector for external devices	Connector for connection to output signal wires from external devices and others For the signal layout, refer to the following. 📄 Page 27 Signal layout of the connector for external devices
(6)	Production information marking	Shows the product information (16 digits) of the module.

*1 For details, refer to the following.

📖 MELSEC iQ-R Channel Isolated Digital-Analog Converter Module User's Manual (Application)

*2 The LED is added to the module with production information (first four digits) of "0307" or later.

2 SPECIFICATIONS

This chapter describes the performance specifications.

2.1 Performance Specifications

This section describes the performance specifications of the D/A converter modules.

R60DA8-G, R60DA16-G

Item	Specifications			
Number of analog output channels	<ul style="list-style-type: none"> • R60DA8-G: 8 channels • R60DA16-G: 16 channels 			
Digital input	16-bit signed binary value (-32768 to 32767)			
Analog output voltage	-12 to 12VDC (external load resistance value 1kΩ or more)			
Analog output current	0 to 20mADC (external load resistance value 0Ω to 600Ω) 0 to 22mADC (external load resistance value ^{*6})			
I/O conversion characteristics, resolution ^{*1}	Analog output range		Digital value	Resolution
	Voltage	0 to 5V	0 to 32000	156.3μV
		1 to 5V		
		-10 to 10V	-32000 to 32000	312.5μV
		-12 to 12V		
		1 to 5V (extended mode)		
		User range setting 2	-32000 to 32000	378.4μV
		User range setting 3		
	Current	0 to 20mA	0 to 32000	625.0nA
		4 to 20mA		
		4 to 20mA (extended mode)	-8000 to 36000 ^{*7}	500.0nA
		User range setting 1	-32000 to 32000	360.1nA
	Accuracy (accuracy for the maximum analog output value) ^{*2}	Reference accuracy: Within ±0.1% (Voltage: ±10mV, Current: ±20μA) ^{*3} Temperature coefficient: ±50ppm/°C (0.005%/°C) ^{*4}		
Conversion speed	1ms/CH			
Number of offset/gain settings ^{*5}	50000 times maximum			
Output short circuit protection	Built-in			
Isolation method	Between I/O terminals and programmable controller power supply: Transformer Between analog output channels: Transformer Between external power supply and analog output channel: Transformer			
Withstand voltage	Between I/O terminals and programmable controller power supply: 500VACrms for 1 minute Between analog output channels: 1000VACrms for 1 minute Between external power supply and analog output channel: 500VACrms for 1 minute			
Insulation resistance	Between I/O terminals and programmable controller power supply: 10MΩ or higher, at 500VDC Between analog output channels: 10MΩ or higher, at 500VDC Between external power supply and analog output channel: 10MΩ or higher, 500VDC			
Number of occupied I/O points	<ul style="list-style-type: none"> • R60DA8-G: 16 points, 1 slot (I/O assignment: Intelligent 16 points) • R60DA16-G: 48 points, 2 slots (I/O assignment: Empty 16 points + Intelligent 32 points) 			
External interface	40-pin connectors			
Applicable wire size	When A6CON1 and A6CON4 are used	0.088 to 0.3mm ² (28 to 22 AWG) (stranded wire)		
	When A6CON2 is used	0.088 to 0.24mm ² (28 to 24 AWG) (stranded wire)		
Connectors for external devices	A6CON1, A6CON2, A6CON4 (sold separately)			

Item		Specifications
External power supply		24VDC +20%, -15%
		Ripple, spike 500mV _{p-p} or lower
		Inrush current <ul style="list-style-type: none"> • R60DA8-G: 5.0A, 810μs or less • R60DA16-G: 5.0A, 810μs or less, for 24VDC_1 and 24VDC_2
		Current consumption <ul style="list-style-type: none"> • R60DA8-G: 0.36A • R60DA16-G: 0.70A
Internal current consumption (5VDC)		<ul style="list-style-type: none"> • R60DA8-G: 0.18A • R60DA16-G: 0.25A
External dimensions	Height	106mm (Base unit mounting side: 98mm)
	Width	<ul style="list-style-type: none"> • R60DA8-G: 27.8mm • R60DA16-G: 56mm
	Depth	110mm
Weight		<ul style="list-style-type: none"> • R60DA8-G: 0.21kg • R60DA16-G: 0.32kg

*1 For details on the I/O conversion characteristics, refer to the following.

☞ Page 40 I/O Conversion Characteristics

*2 Except for the conditions under noise influence.

*3 The accuracy at an ambient temperature when the offset/gain setting is configured. Obtaining sufficient accuracy requires a warm-up of 30 minutes (energization).

*4 The accuracy based on a temperature change of 1°C.

*5 A count more than 50000 times causes Number of writes to offset/gain settings reach limit error (error code: 1080H).

*6 For an output current of 20mA or higher, the corresponding external load resistance value is plotted as shown below.

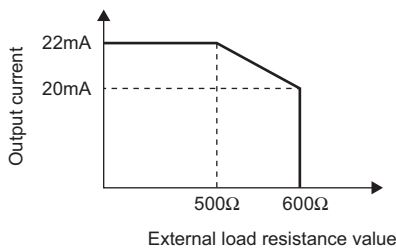

*7 The following table lists the resolution (16 bits, 32 bits) in extended mode.

Input range	16 bits		32 bits	
	Analog value	Digital value	Analog value	Digital value
1 to 5V (extended mode)	0 to 5.095V	-8000 to 32767	0 to 5.5V	-8000 to 36000
4 to 20mA (extended mode)	0 to 20.38mA	-8000 to 32767	0 to 22mA	-8000 to 36000

Restriction

Immediately after power-off of the power supply module, if the input power source is applied to the power supply module again, the D/A converter module may not start up. When applying the input power source to the power supply module again, do so five seconds or more after the shut-off of the power.

Restrictions

The module R60DA16-G takes up two slots and so there are restrictions on the available firmware version of the RCP module. For details, refer to the following.

- ☞ MELSEC iQ-R CPU Module User's Manual (Application)

3 FUNCTION LIST

The following table lists the functions of the D/A converter module. For further details on the function, refer to the following.
 MELSEC iQ-R Channel Isolated Digital-Analog Converter Module User's Manual (Application)

Item	Description
Range switching function	Allows the output range of analog output to be switched for each channel. Switching the range makes it possible to change the I/O conversion characteristics.
D/A conversion enable/disable setting function	Controls whether to enable or disable D/A conversion for each channel. Disabling D/A conversion on unused channels reduces the conversion cycles.
D/A output enable/disable setting function	Controls whether the D/A conversion value or the offset value is to be output for each channel. The conversion speed is constant regardless of whether the output is enabled or disabled.
Analog output HOLD/CLEAR function	Sets whether to hold or clear the analog output value that has been output when the operating status of the CPU module is RUN, STOP, or stop error.
Analog output test function when the CPU module is in the STOP status	Permits an analog output test to be conducted when the CPU module is in the STOP status.
Scaling function	Performs scale conversion on digital values within the range from a scaling upper limit value to a scaling lower limit value, both of which are set at desired values. This function reduces the time and effort to create a program of the scale conversion.
Shift function	Allows the set input value shift amount to be added to a digital value.
Alert output function	Outputs an alert when the digital value is greater than the alert output upper limit value or is smaller than the alert output lower limit value.
Rate control function	Limits the increment and decrement of an analog output value per 1ms to prevent a sudden change in analog output value.
External power supply interruption detection function	Detects that no 24VDC external power supply is supplied or the power supply is stopped.
Disconnection detection function	Detects disconnection by monitoring the analog output value.
Interrupt function	Starts up an interrupt program of the CPU module when an interrupt factor such as disconnection and alert output is detected.
Error history function	Records errors and alarms that have occurred in the D/A converter module, storing the record into the buffer memory area. Up to 16 storage areas are provided for errors and alarms, respectively.
Event history function	Collects generated errors and alarms, and performed operations in the D/A converter module as event information into the CPU module.
Offset/gain setting	Corrects errors in the D/A conversion values for each channel.
Backing up, saving, and restoring offset/gain values	The D/A converter module is capable of backing up, saving, and restoring offset/gain values of the user range setting.
Online module change	Allows module change without stopping the system. For the procedure of the online module change, refer to the following.  MELSEC iQ-R Online Module Change Manual
Q compatible mode function	Allows the buffer memory addresses of the D/A converter module to be the same layout as the MELSEC-Q series module. This compatibility makes it possible to reuse sequence programs that have exhibited high performance on the MELSEC-Q series modules.

4 PROCEDURES BEFORE OPERATION

This chapter describes the procedures before operation.

1. Mounting a module

Mount the D/A converter module in any desired configuration.

2. Wiring

Perform wiring of external devices to the D/A converter module.

 Page 27 External Wiring

3. Adding a module

Add the D/A converter module to a module configuration by using the engineering tool. For details, refer to the following.

 GX Works3 Operating Manual

4. Parameter settings

Set up the parameters of the D/A converter module by using the engineering tool. For details, refer to the following.

 MELSEC iQ-R Channel Isolated Digital-Analog Converter Module User's Manual (Application)

5. Offset/gain setting

Perform the offset/gain setting to use the user range setting, if necessary.

 Page 36 OFFSET/GAIN SETTING

6. Programming

Create a program. For details, refer to the following.

 Page 31 OPERATION EXAMPLES

5 SYSTEM CONFIGURATION

For system configurations using the MELSEC iQ-R series modules, CPU modules that can be used with the D/A converter module, and the number of mountable modules, refer to the following.

 MELSEC iQ-R Module Configuration Manual

6 WIRING

This chapter describes the wiring of the D/A converter module.

6.1 Wiring Precautions

- Check the signal layout before wiring to the D/A converter module, and connect the cables correctly. For the signal layout, refer to the following.

 Page 27 Signal layout of the connector for external devices

- Provide a single-point ground for the shield wire and the shield of the shielded cable.

Connectors for external devices

Precautions

Tighten the connector screws within the specified torque range.

Screw type	Tightening torque range
Connector screw (M2.6)	0.20 to 0.29N·m

- Use copper wire with a temperature rating of 75°C or higher for the connector.
- Use UL listed connectors if necessary for UL compliance.

Applicable connectors

Connectors for external devices to be used for the D/A converter module are sold separately.

The following tables list the applicable connectors, and the reference product of a crimping tool.

■40-pin connectors

Type	Model	Applicable wire size
Soldering type connector (straight type)	A6CON1*1	0.088 to 0.3mm ² (28 to 22 AWG) (stranded wire)
Crimping type connector (straight type)	A6CON2	0.088 to 0.24mm ² (28 to 24 AWG) (stranded wire)
Soldering type connector (dual purpose (straight/oblique) type)	A6CON4*1	0.088 to 0.3mm ² (28 to 22 AWG) (stranded wire)

*1 Select wires with a sheath outside diameter of 1.3mm or shorter when using 40 wires.
Select wires suitable to the current value used.

Point

- The A6CON3 (IDC type connector (straight type)) cannot be used.
- The connector/terminal block converter module and the dedicated cables that are designed for the MELSEC-Q series channel isolated analog module can be used. For details, refer to the following.

 Page 30 When the connector/terminal block converter module is used

■40-pin connector crimping tool

Type	Model	Contact
Crimping tool	FCN-363T-T005/H	FUJITSU COMPONENT LIMITED

For how to wire the connector and how to use the crimping tool, contact the manufacturer.

Wiring method, connection procedure, and disconnection procedure of the connector

For the wiring method, connection procedure, and disconnection procedure, refer to the following.

 MELSEC iQ-R Module Configuration Manual

6.2 External Wiring

Signal layout of the connector for external devices

The following shows the signal layout of the connector for external devices for the D/A converter module.

- R60DA8-G

Pin layout (viewed from the front of the module)	Pin number	Signal name	Pin number	Signal name
A1	A1	CH1 V+/I+	B1	CH1 V-/I-
A2	A2	—	B2	—
A3	A3	CH2 V+/I+	B3	CH2 V-/I-
A4	A4	—	B4	—
A5	A5	CH3 V+/I+	B5	CH3 V-/I-
A6	A6	—	B6	—
A7	A7	CH4 V+/I+	B7	CH4 V-/I-
A8	A8	—	B8	—
A9	A9	—	B9	—
A10	A10	CH5 V+/I+	B10	CH5 V-/I-
A11	A11	—	B11	—
A12	A12	CH6 V+/I+	B12	CH6 V-/I-
A13	A13	—	B13	—
A14	A14	CH7 V+/I+	B14	CH7 V-/I-
A15	A15	—	B15	—
A16	A16	CH8 V+/I+	B16	CH8 V-/I-
A17	A17	—	B17	—
A18	A18	—	B18	—
A19	A19	24VDC	B19	24VDC
A20	A20	24GDC	B20	24GDC

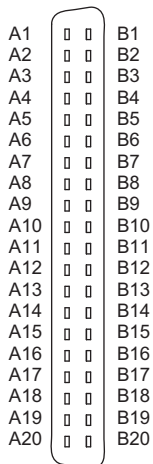

• R60DA16-G

Pin layout (viewed from the front of the module)				Pin number	Signal name	Pin number	Signal name	Pin number	Signal name	Pin number	Signal name		
2A1	□ □	2B1	1A1	□ □	1B1	2A1	CH9 V+/+	2B1	CH9 V-/-	1A1	CH1 V+/+	1B1	CH1 V-/-
2A2	□ □	2B2	1A2	□ □	1B2	2A2	—	2B2	—	1A2	—	1B2	—
2A3	□ □	2B3	1A3	□ □	1B3	2A3	CH10 V+/+	2B3	CH10 V-/-	1A3	CH2 V+/+	1B3	CH2 V-/-
2A4	□ □	2B4	1A4	□ □	1B4	2A4	—	2B4	—	1A4	—	1B4	—
2A5	□ □	2B5	1A5	□ □	1B5	2A5	CH11 V+/+	2B5	CH11 V-/-	1A5	CH3 V+/+	1B5	CH3 V-/-
2A6	□ □	2B6	1A6	□ □	1B6	2A6	—	2B6	—	1A6	—	1B6	—
2A7	□ □	2B7	1A7	□ □	1B7	2A7	CH12 V+/+	2B7	CH12 V-/-	1A7	CH4 V+/+	1B7	CH4 V-/-
2A8	□ □	2B8	1A8	□ □	1B8	2A8	—	2B8	—	1A8	—	1B8	—
2A9	□ □	2B9	1A9	□ □	1B9	2A9	—	2B9	—	1A9	—	1B9	—
2A10	□ □	2B10	1A10	□ □	1B10	2A10	CH13 V+/+	2B10	CH13 V-/-	1A10	CH5 V+/+	1B10	CH5 V-/-
2A11	□ □	2B11	1A11	□ □	1B11	2A11	—	2B11	—	1A11	—	1B11	—
2A12	□ □	2B12	1A12	□ □	1B12	2A12	CH14 V+/+	2B12	CH14 V-/-	1A12	CH6 V+/+	1B12	CH6 V-/-
2A13	□ □	2B13	1A13	□ □	1B13	2A13	—	2B13	—	1A13	—	1B13	—
2A14	□ □	2B14	1A14	□ □	1B14	2A14	CH15 V+/+	2B14	CH15 V-/-	1A14	CH7 V+/+	1B14	CH7 V-/-
2A15	□ □	2B15	1A15	□ □	1B15	2A15	—	2B15	—	1A15	—	1B15	—
2A16	□ □	2B16	1A16	□ □	1B16	2A16	CH16 V+/+	2B16	CH16 V-/-	1A16	CH8 V+/+	1B16	CH8 V-/-
2A17	□ □	2B17	1A17	□ □	1B17	2A17	—	2B17	—	1A17	—	1B17	—
2A18	□ □	2B18	1A18	□ □	1B18	2A18	—	2B18	—	1A18	—	1B18	—
2A19	□ □	2B19	1A19	□ □	1B19	2A19	24VDC_2	2B19	24VDC_2	1A19	24VDC_1	1B19	24VDC_1
2A20	□ □	2B20	1A20	□ □	1B20	2A20	24GDC_2	2B20	24GDC_2	1A20	24GDC_1	1B20	24GDC_1



The R60DA16-G has two 40-pin connectors, each requiring an external power supply. To use CH1 to CH8, connect an external power supply to 24VDC_1 and 24GDC_1. To use CH9 to CH16, connect an external power supply to 24VDC_2 and 24GDC_2.

Examples of external wiring

Here are the examples of external wiring.

■R60DA8-G, R60DA16-G

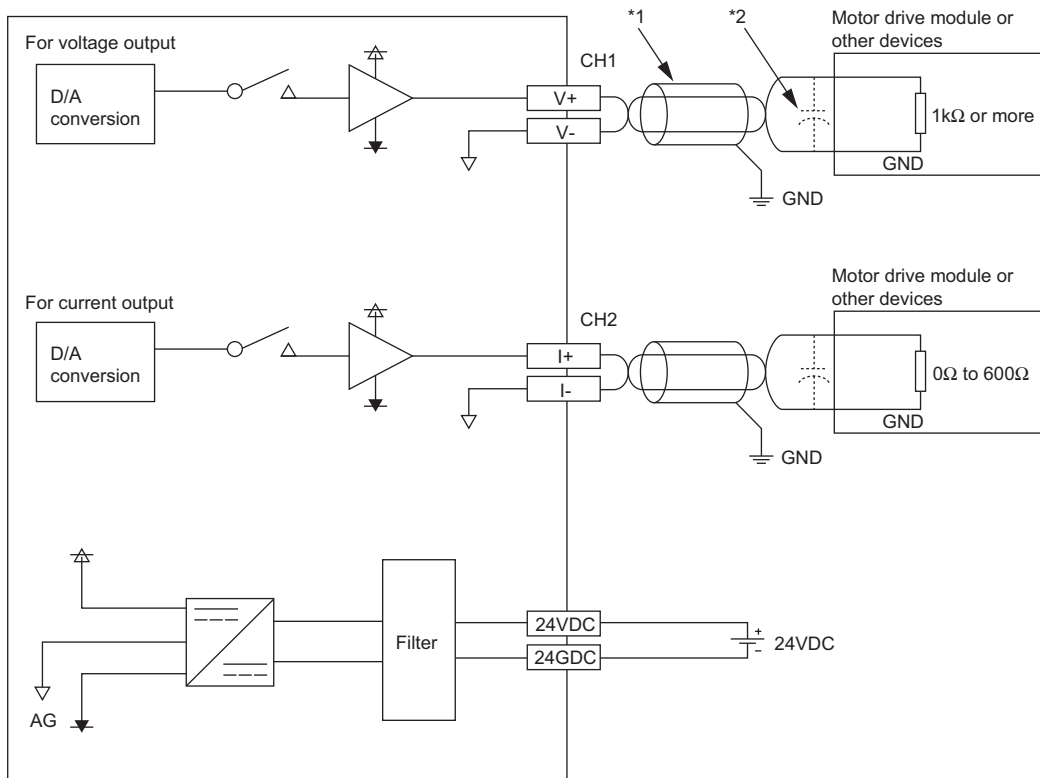

*1 For the wire, use the 2-core twisted cable.

*2 If noise or ripple occurs on the analog signal, connect a capacitor of 0.1 to 0.47μF (withstands a voltage of 25V or higher) to the input terminal of the external device.



Ground the FG terminal of the power supply module.

When the connector/terminal block converter module is used

The D/A converter module allows the use of the connector/terminal block converter module and the dedicated cables that are designed for the R60DA8-G and R60DA16-G.

To use the connector/terminal block converter module, wire the module as shown below.

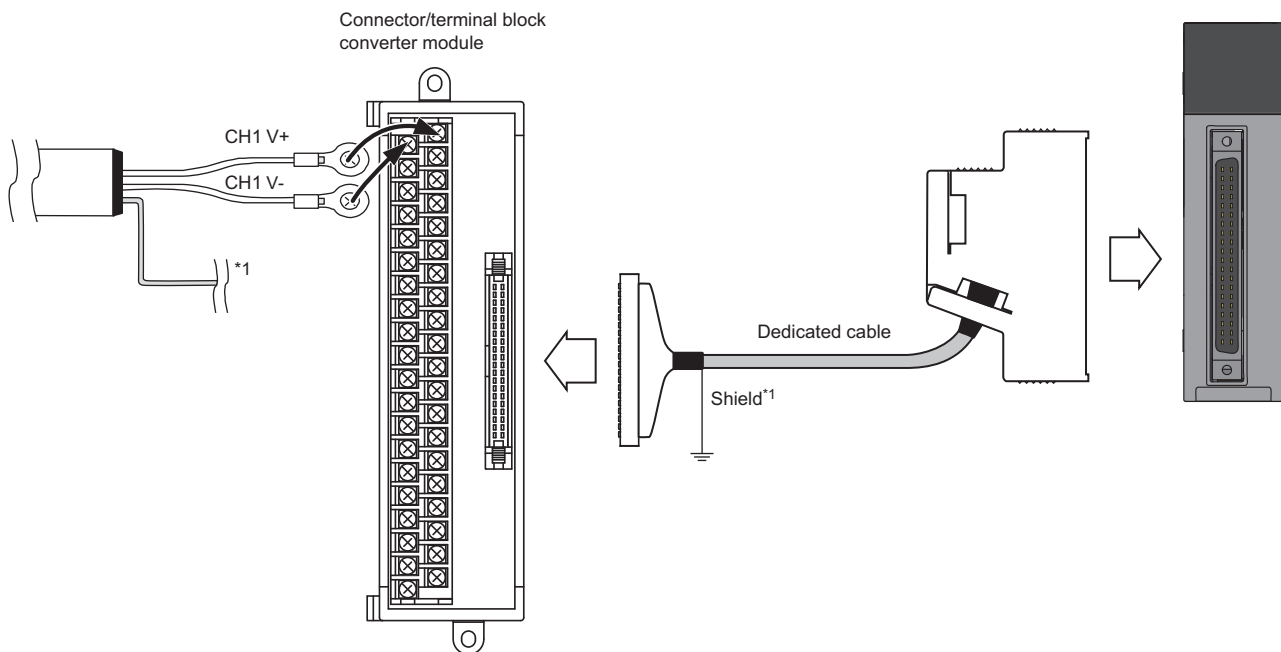

*1 Be sure to use a shielded cable. The shield must be grounded.

Product name	Model	Remarks	Contact
Connector/terminal block converter module	FA1-TBS40DAG	—	Your local Mitsubishi Electric sales office or representative
	FA-LTB40DAG	—	
Dedicated cable	FA1-CBL05R60DA8G	Cable length 0.5m	
	FA1-CBL10R60DA8G	Cable length 1.0m	
	FA1-CBL20R60DA8G	Cable length 2.0m	
	FA1-CBL30R60DA8G	Cable length 3.0m	

Point

In the factory default settings of the modules (the R60DA8-G and R60DA16-G), the offset/gain setting is configured with the module being independent.

For this reason, the use of the connector/terminal block converter module and the dedicated cables may cause an error in conversion characteristics due to the effect of conductor resistance and other factors.

If this effect is a problem, use the user range setting to set the offset and gain values.

For the offset/gain setting, refer to the following.

☞ Page 36 OFFSET/GAIN SETTING

7 OPERATION EXAMPLES

This chapter describes the programming procedure and the basic program of the D/A converter module.

7.1 Programming Procedure

Take the following steps to create a program for executing the D/A conversion:

1. Set parameters.

☞ Page 32 Parameter settings

2. Create a program.

☞ Page 34 Program examples

Point

Using function blocks (FBs) reduces load at programming and improves the readability of programs. For details on the function blocks, refer to the following.

📖 MELSEC iQ-R Analog-Digital Converter Module/Digital-Analog Converter Module Function Block Reference

7.2 Program Examples

System configuration

The following figure is an example of the system configuration.

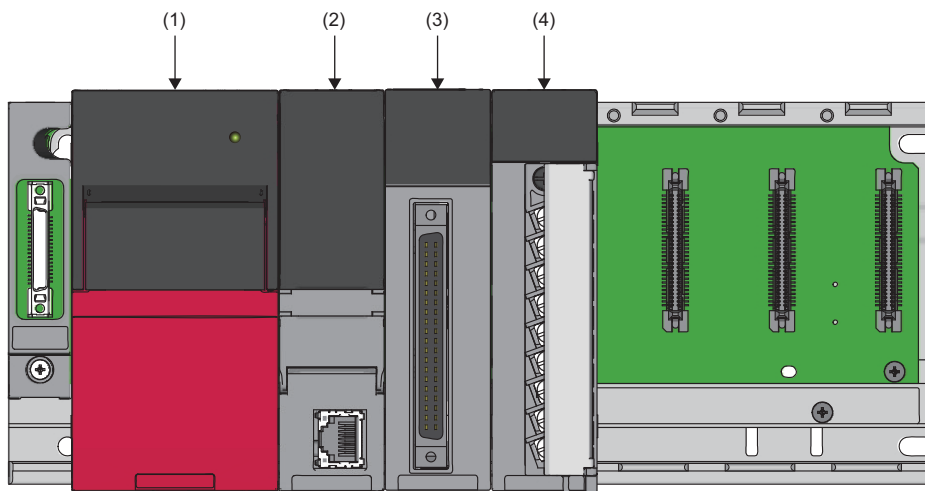

- (1) Power supply module (R61P)
- (2) CPU module (R120CPU)
- (3) D/A converter module (R60DA8-G)
- (4) Input module (RX10)

Conditions in the program

This program writes digital values of the D/A converter module's CH1, CH3, CH5, and CH7 where D/A conversion is enabled. CH1 enables the rate control setting; CH3 enables the alert output setting; and CH5 enables the scaling setting.

Parameter settings

Perform initial settings in the parameter settings of the engineering tool. The auto refresh setting does not need to be changed here.

For details on the parameter settings, refer to the following.

 MELSEC iQ-R Channel Isolated Digital-Analog Converter Module User's Manual (Application)

Function	Setting item	CH1	CH2	CH3	CH4	CH5	CH6	CH7	CH8
Range switching function	Output range setting	-10 to 10V	—	-10 to 10V	—	0 to 20mA	—	4 to 20mA	—
D/A conversion enable/disable setting function	D/A conversion enable/disable setting	D/A conversion enable	D/A conversion disable	D/A conversion enable	D/A conversion disable	D/A conversion enable	D/A conversion disable	D/A conversion enable	D/A conversion disable
Scaling function	Scaling enable/disable setting	Disable	—	Disable	—	Enable	—	Disable	—
	Scaling lower limit value	—	—	—	—	2000	—	—	—
	Scaling upper limit value	—	—	—	—	16000	—	—	—
Shift function	Input value shift amount	0	—	0	—	2000	—	0	—
Alert output function	Alert output setting	Disable	—	Enable	—	Disable	—	Disable	—
	Alert output lower limit value	—	—	0	—	—	—	—	—
	Alert output upper limit value	—	—	32000	—	—	—	—	—
Rate control function	Rate control enable/disable setting	Enable	—	Disable	—	Disable	—	Disable	—
	Increase digital limit value	8000	—	—	—	—	—	—	—
	Decrease digital limit value	1600	—	—	—	—	—	—	—
Output mode setting function	Analog output HOLD/CLEAR setting	HOLD	—	HOLD	—	CLEAR	—	HOLD	—
Disconnection detection function	Disconnection detection enable/disable setting	—	—	—	—	—	—	Enable	—
	Disconnection detection (extended mode) enable/disable setting	—	—	—	—	—	—	Disable	—
	Number of disconnection checks	—	—	—	—	—	—	1	—
	Disconnection detection auto-clear enable/disable setting	—	—	—	—	—	—	Disable	—
	Number of disconnection detection auto-clear checks	—	—	—	—	—	—	—	—

Label settings

GX Works3 provides functions that support the creation of a program.

The following table lists the module labels and global labels used for the program examples in this section.

There is no need to change the settings of the module labels. For details on the global labels, refer to the following.

 MELSEC iQ-R Programming Manual (Program Design)

Classification	Label name	Description	Device		
Module label	R60DAG_1.bModuleREADY	Module READY	X0		
	R60DAG_1.bExternalPowerSupplyREADY_Flag_CH1_8	External power supply READY flag	X7		
	R60DAG_1.bDisconnectionDetectionSignal	Disconnection detection signal	X0D		
	R60DAG_1.bWarningOutputSignal	Alert output signal	X0E		
	R60DAG_1.bErrorFlag	Error flag	X0F		
	R60DAG_1.bCH1OutputEnableDisableFlag	CH1 Output enable/disable flag	Y1		
	R60DAG_1.bCH3OutputEnableDisableFlag	CH3 Output enable/disable flag	Y3		
	R60DAG_1.bCH5OutputEnableDisableFlag	CH5 Output enable/disable flag	Y5		
	R60DAG_1.bCH7OutputEnableDisableFlag	CH7 Output enable/disable flag	Y7		
	R60DAG_1.bWarningOutputClearRequest	Alert output clear request	Y0E		
	R60DAG_1.stnControl[0].wDigitalValue	CH1 Digital value	—		
	R60DAG_1.stnControl[2].wDigitalValue	CH3 Digital value	—		
	R60DAG_1.stnControl[4].wDigitalValue	CH5 Digital value	—		
	R60DAG_1.stnControl[6].wDigitalValue	CH7 Digital value	—		
	R60DAG_1.uDisconnectionDetectionFlag	Disconnection detection flag	—		
	R60DAG_1.uWarningOutputUpperFlag	Alert output upper limit flag	—		
	R60DAG_1.uWarningOutputLowerFlag	Alert output lower limit flag	—		
	Labels to be defined	Define global labels as shown below:			
		Label Name	Data Type	Class	Assign (Device/Label)
1		CH1_DigInVal	Word [Signed]	VAR_GLOBAL	D11
2		CH3_DigInVal	Word [Signed]	VAR_GLOBAL	D12
3		CH5_DigInVal	Word [Signed]	VAR_GLOBAL	D13
4		CH7_DigInVal	Word [Signed]	VAR_GLOBAL	D14
5		CH3_AlmUpLimit	Bit	VAR_GLOBAL	F0
6		CH3_AlmLowLimit	Bit	VAR_GLOBAL	F1
7		CH7_DisconnectDetect	Bit	VAR_GLOBAL	F2
8		DigitWriteSig	Bit	VAR_GLOBAL	X10
9		DAOutputSig	Bit	VAR_GLOBAL	X11
10		WarningOutClrSig	Bit	VAR_GLOBAL	X12
11		ErrResetSig	Bit	VAR_GLOBAL	X13
12		ErrOperationEN	Bit	VAR_GLOBAL	
13		ErrOperationENO	Bit	VAR_GLOBAL	
14		ErrOperationOK	Bit	VAR_GLOBAL	
15		UnitErrFlg	Bit	VAR_GLOBAL	
16	UnitErrCode	Word [Unsigned]/Bit String [16-bit]	VAR_GLOBAL		

Program examples

Program example 1

- This program is an example where digital values for D/A conversion of CH1, CH3, CH5, and CH7 are set up in the D/A converter module, and then the analog output is enabled to start the D/A conversion.

(0)	DigitWriteSig X10 	R60DAG_1.bModule READY X0 	R60DAG_1.bExternalPower SupplyREADY_Flag_CH1_8 X7 							MOV	CH1_DigInVal D11	R60DAG_1.stnControl [0].wDigitalValue
										MOV	CH3_DigInVal D12	R60DAG_1.stnControl [2].wDigitalValue
										MOV	CH5_DigInVal D13	R60DAG_1.stnControl [4].wDigitalValue
										MOV	CH7_DigInVal D14	R60DAG_1.stnControl [6].wDigitalValue
(82)	DAOOutputSig X11 	R60DAG_1.bModule READY X0 	R60DAG_1.bExternalPower SupplyREADY_Flag_CH1_8 X7 									R60DAG_1.bCH1Output EnableDisableFlag Y1 ○
												R60DAG_1.bCH3Output EnableDisableFlag Y3 ○
												R60DAG_1.bCH5Output EnableDisableFlag Y5 ○
												R60DAG_1.bCH7Output EnableDisableFlag Y7 ○
(142)												{END }

(0) CH1 Digital value, CH3 Digital value, CH5 Digital value, and CH7 Digital value are to be set.

(82) Outputs of CH1, CH3, CH5, and CH7 are to be enabled.

Program example 2

- This program is an example to clear the processing and the alert output when an alert is output in CH3 of the D/A converter module.

(0)	R60DAG_1.uWarning OutputUpperFlag,2 									SET	CH3_AlmUpLimit F0	
(30)	R60DAG_1.uWarning OutputLowerFlag,2 									SET	CH3_AlmLowLimit F1	
(50)	WarningOutClrSig X12 	R60DAG_1.bWarning OutputSignal X0E 								SET	R60DAG_1.bWarning OutputClearRequest Y0E	
(69)	R60DAG_1.bWarning OutputSignal X0E 	R60DAG_1.bWarning OutputClearRequest Y0E 								RST	R60DAG_1.bWarning OutputClearRequest Y0E	
(88)												{END }

(0) The processing at the time when an upper limit alert is issued in CH3 is to be performed.

(30) The processing at the time when a lower limit alert is issued in CH3 is to be performed.

(50) 'Alert output clear request' (YE) is to be turned on.

(69) 'Alert output clear request' (YE) is to be turned off.

Program example 3

- This program is an example to display the latest error code when a disconnection is detected or an error is generated in CH7 of the D/A converter module. After this, the program clears Disconnection detection flag, Error flag, and the stored error code.

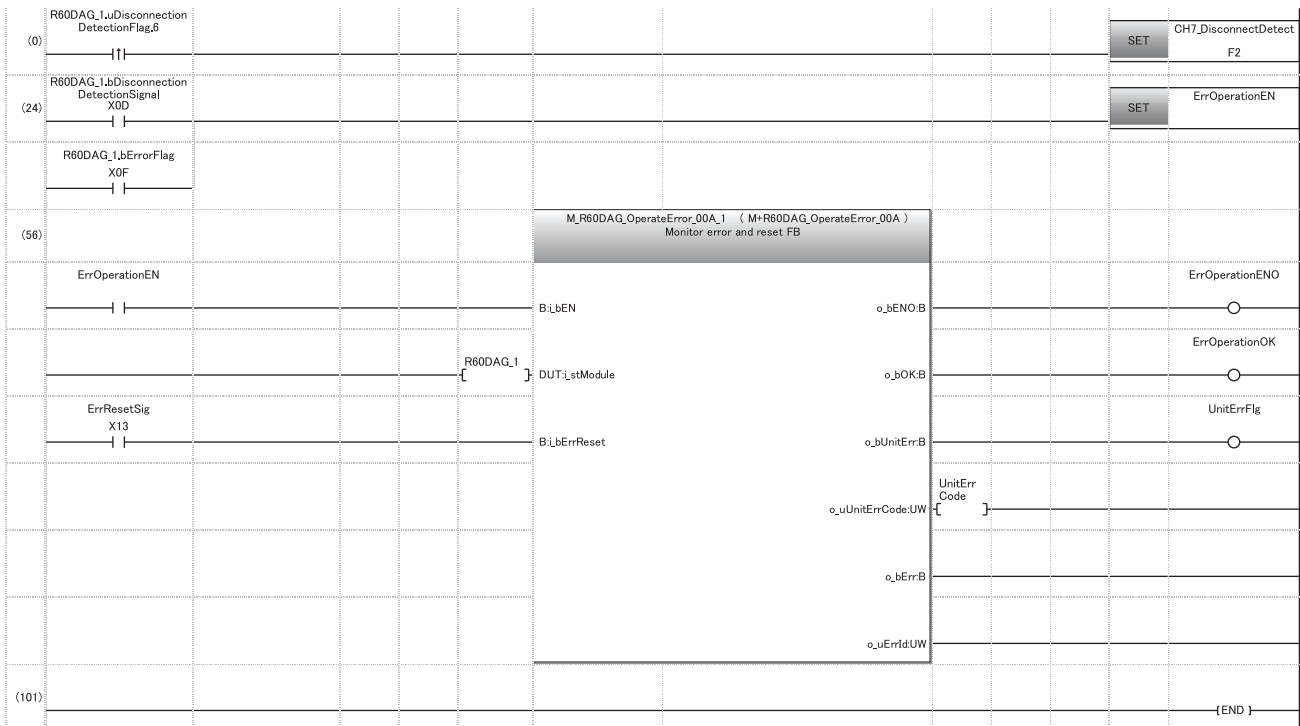

- (0) The processing at the time when a disconnection is detected is to be performed.
 (24) Error manipulation start flag is to be turned on.

8 OFFSET/GAIN SETTING

Using the user range setting requires the offset/gain setting.

Access to the offset/gain setting window in the engineering tool to set the offset and gain values.

8.1 Setting Procedure

The setting procedure for the offset/gain setting of the D/A converter module is as follows:

[Tool] ⇒ [Module Tool List]

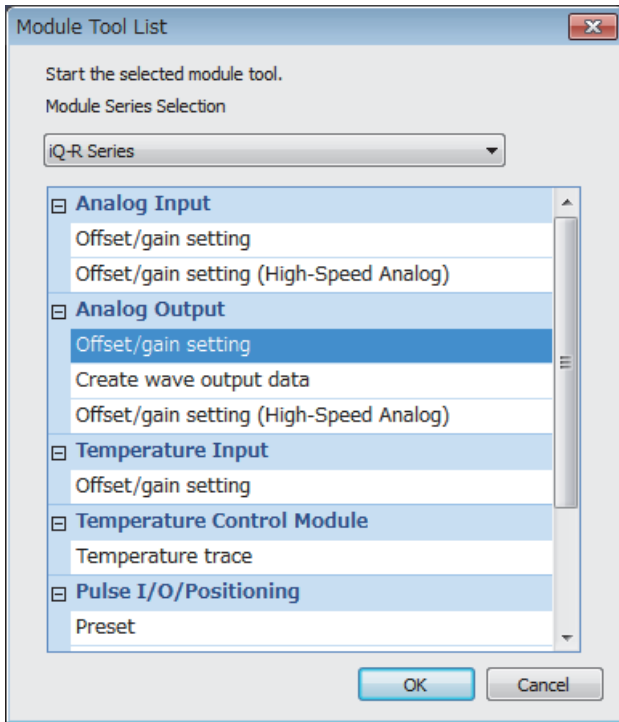

1. In "Analog Output", select "Offset/gain setting" and click the [OK] button.

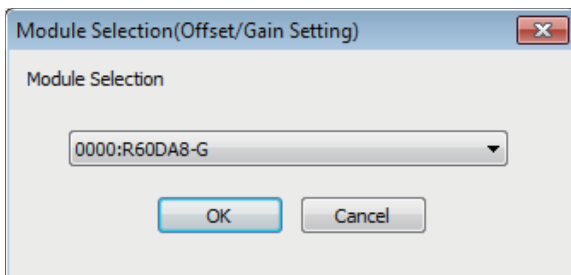

2. Select the target module for the offset/gain setting, and click the [OK] button.

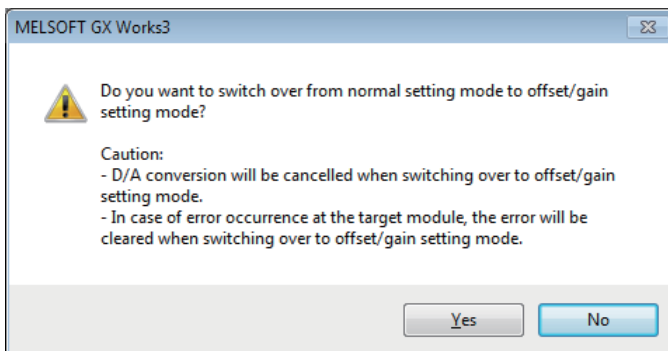

3. Click the [Yes] button.

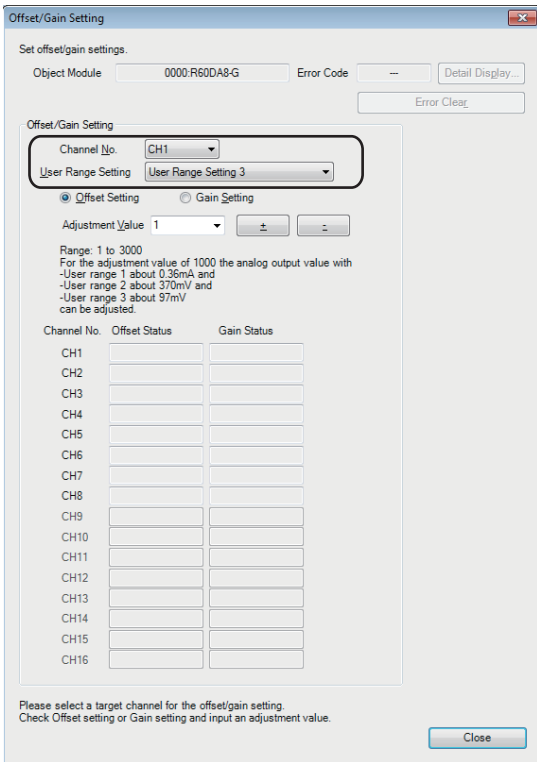

4. Specify the user range setting and channel where offset and gain values are to be set.

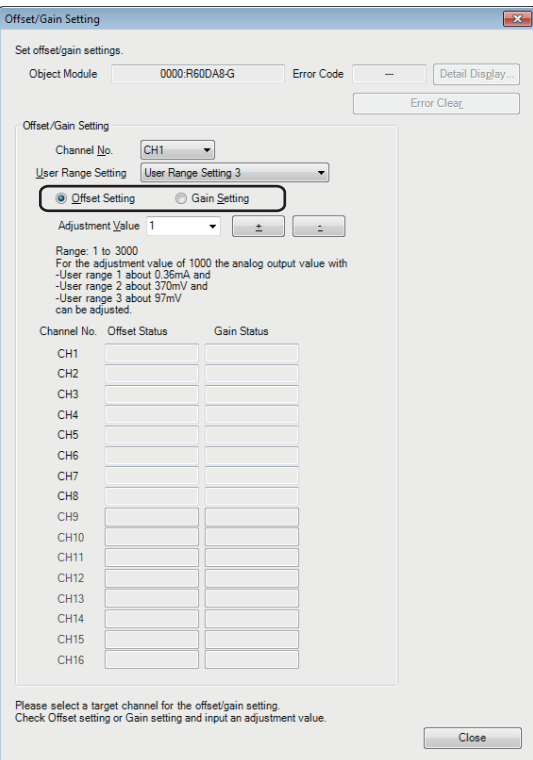

5. Specify whether to configure the offset setting or gain setting with the radio button. (The steps from step 6 assume that the offset setting is specified.)

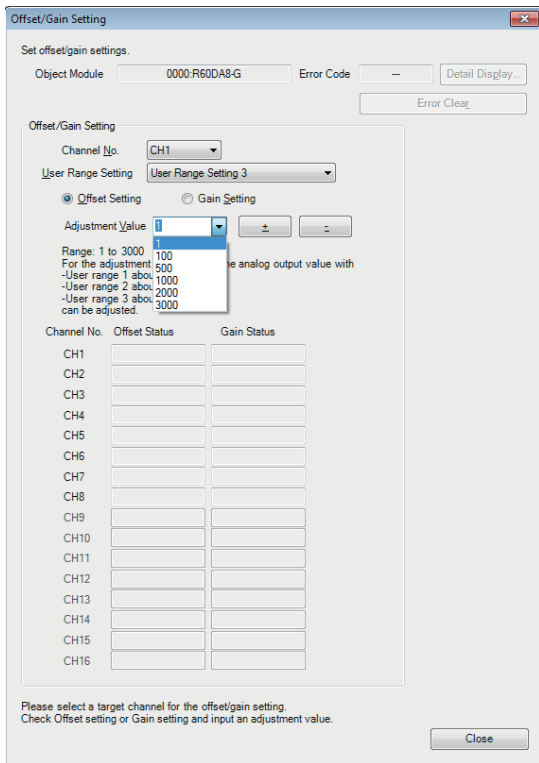

6. The adjustment amount of the offset value or gain value has to be selected from "1", "100", "500", "1000", "2000", and "3000" first; however, further fine adjustments are possible by entering a desired value (1 to 3000).

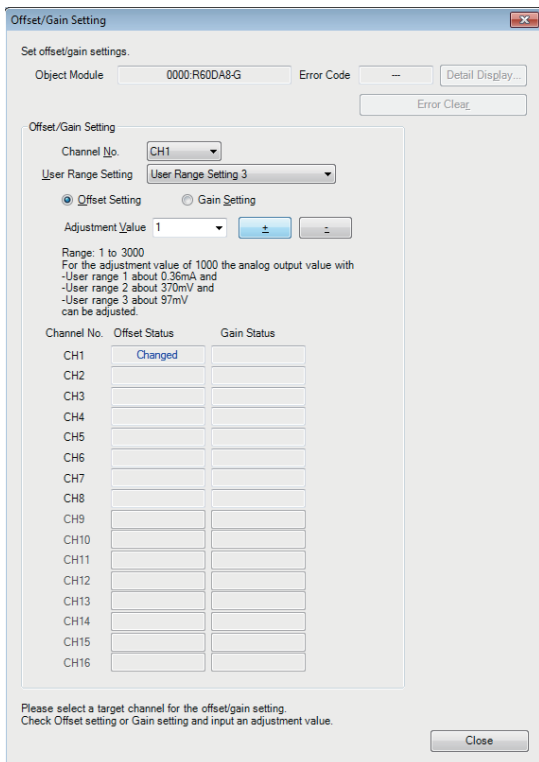

7. Click the [+] button or [-] button to make fine adjustments to the selected adjustment value to obtain the analog output voltage value or analog output current value.

8. The offset setting status of the specified channel is changed to "Changed".

9. To configure the gain setting, repeat the steps from step 5.

10. After the setting is completed, click the [Close] button.

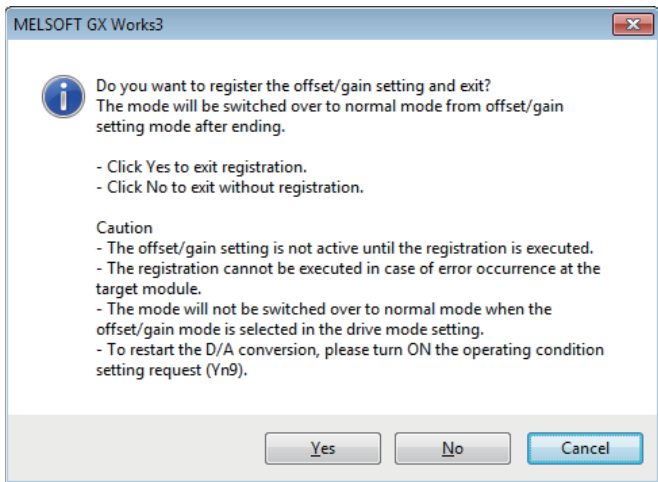

11. Click the [Yes] button.

APPENDICES

Appendix 1 I/O Conversion Characteristics

The I/O conversion characteristics of D/A conversion are expressed by the slope of the straight line connecting the offset value and the gain value, both of which are used when a digital value written from the CPU module is converted to the corresponding analog output value (voltage or current).

Offset value

An analog output value (voltage or current) after conversion from a digital value of 0, which is set up from the CPU module

Gain value

An analog output value (voltage or current) after conversion from a digital value of 32000, which is set up from the CPU module

Voltage output characteristics

The following shows the list of analog output ranges at the voltage output and the graphs of each of the voltage output characteristics.

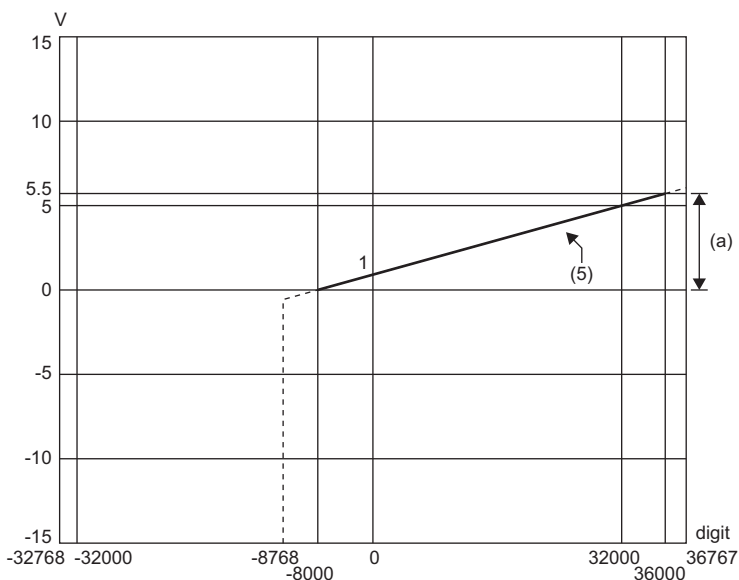
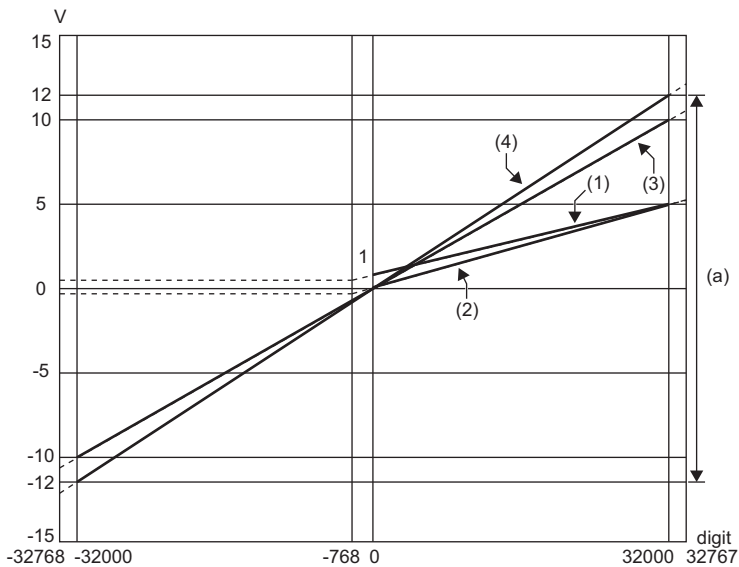

digit: Digital value

V: Analog output voltage (V)

(a): Practical analog output range

No.	Analog output range setting	Offset value	Gain value	Digital value ^{*5}	Resolution
(1)	1 to 5V	1V	5V	0 to 32000	125.0 μ V
(2)	0 to 5V	0V	5V		156.3 μ V
(3)	-10 to 10V	0V	10V	-32000 to 32000	312.5 μ V
(4)	-12 to 12V	0V	12V	-32000 to 32000	378.4 μ V
(5)	1 to 5V (extended mode)	1V	5V	-8000 to 36000 ^{*1}	125.0 μ V
—	User range setting 2	^{*2}	^{*2}	-32000 to 32000	378.4 μ V ^{*3}
—	User range setting 3	^{*4}	^{*4}	-32000 to 32000	312.0 μ V ^{*3}

*1 The digital value can be set within the 16-bit signed value range (-8768 to 32767). To output a voltage corresponding to a digital value of 32768 or greater, use the shift function or the scaling function.

*2 Set the offset value and gain value in user range setting 2 within a range satisfying the following conditions. Failure to satisfy the conditions may result in improper D/A conversion.

- Setting range of offset value and gain value: -12 to 12V
- ((Gain value) - (Offset value)) \geq 4V

- *3 Maximum resolution in the user range setting.
- *4 Set the offset value and gain value in user range setting 3 within a range satisfying the following conditions. Failure to satisfy the conditions may result in improper D/A conversion.
 - Setting range of offset value and gain value: -10 to 10V
 - $((\text{Gain value}) - (\text{Offset value})) \geq 4V$
- *5 If the set data exceeds the range of digital value, the resulting output is an analog output value corresponding to the maximum or minimum of the digital value.

Analog output range setting	Digital value	
	Minimum	Maximum
1 to 5V	-768	32767
0 to 5V		
-10 to 10V		
-12 to 12V		
1 to 5V (extended mode)	-8768	36767
User range setting 2	-32768	32767
User range setting 3	-32768	

Point 

- Set values within the practical ranges of the digital input and the analog output at each output range. If the range is exceeded, the resolution and accuracy may not fall within the range of the performance specifications. (Do not use the values in the dotted line region in the graph of voltage output characteristics.)

Current output characteristic

The following shows the list of the analog output ranges at the current output and the graphs of each of the current output characteristic.

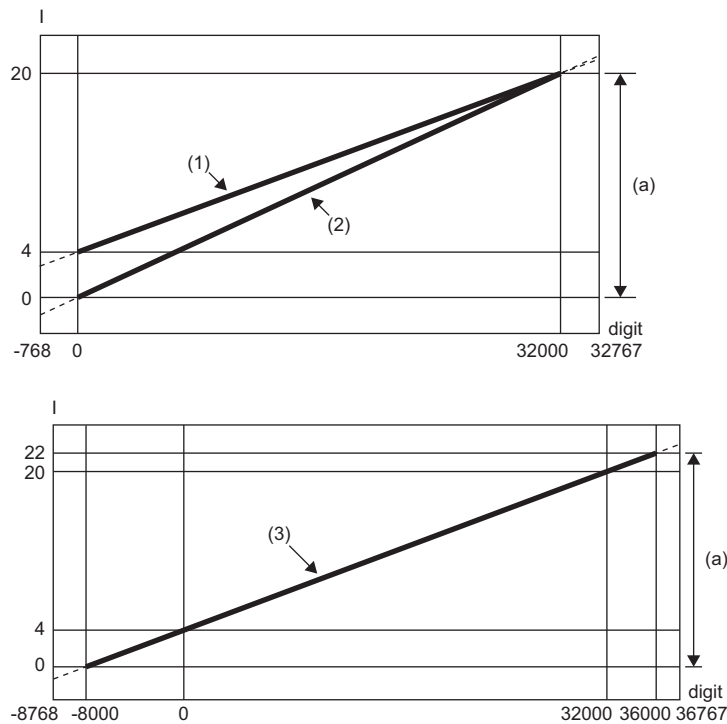

digit: Digital value

I: Analog output current (mA)

(a): Practical analog output range

No.	Analog output range setting	Offset value	Gain value	Digital value ^{*4}	Resolution
(1)	4 to 20mA	4mA	20mA	0 to 32000	500.0nA
(2)	0 to 20mA	0mA	20mA		625.0nA
(3)	4 to 20mA (extended mode)	4mA	20mA	-8000 to 36000 ^{*1}	500.0nA
—	User range setting 1	^{*2}	^{*2}	-32000 to 32000	360.1nA ^{*3}

*1 The digital value can be set within the 16-bit signed value range (-8768 to 32767). To output a current corresponding to a value of 32767 or greater, use the shift function or the scaling function.

*2 Set the offset value and gain value in user range setting 1 within a range satisfying the following conditions. Failure to satisfy the conditions may result in improper D/A conversion.

- Offset value ≥ 0 mA, Gain value ≤ 20 mA
- $((\text{Gain value}) - (\text{Offset value})) \geq 11.7$ mA

*3 Maximum resolution in the user range setting.

*4 If the set data exceeds the range of digital value, the resulting output is an analog output value corresponding to the maximum or minimum of the digital value.

Analog output range setting	Digital value	
	Minimum	Maximum
4 to 20mA	-768	32767
0 to 20mA		
4 to 20mA (extended mode)	-8768	36767
User range setting 1	-32768	32767

Point

- Set values within the practical ranges of the digital input and the analog output at each output range. If the range is exceeded, the resolution and accuracy may not fall within the range of the performance specifications. (Do not use values in the dotted line region in the graph of current output characteristics.)

Appendix 2 Accuracy

The accuracy of D/A conversion is the accuracy for the maximum value of analog output value. The accuracy is given by the following formula:

$$\text{Accuracy} = (\text{Reference accuracy}) + (\text{Temperature coefficient}) \times (\text{Temperature variation})$$

- Reference accuracy: The accuracy at an ambient temperature when the offset/gain setting is configured. ($\pm 0.1\%$ ($\pm 10\text{mV}$))
- Temperature coefficient: The accuracy based on a temperature change of 1°C . ($0.005\%/^\circ\text{C}$)

An output characteristic change resulting from a change in the offset/gain setting or the analog output range does not sacrifice the reference accuracy and temperature coefficient, which are maintained within the described range of the performance specifications.

(except for the conditions under noise influence)

Ex.

Accuracy when the temperature changes by 5°C from 25°C to 30°C

$$(\pm 0.1\%) + (\pm 0.005\%/^\circ\text{C} \times 5^\circ\text{C}) = 0.125\% (\pm 12.5\text{mV})$$

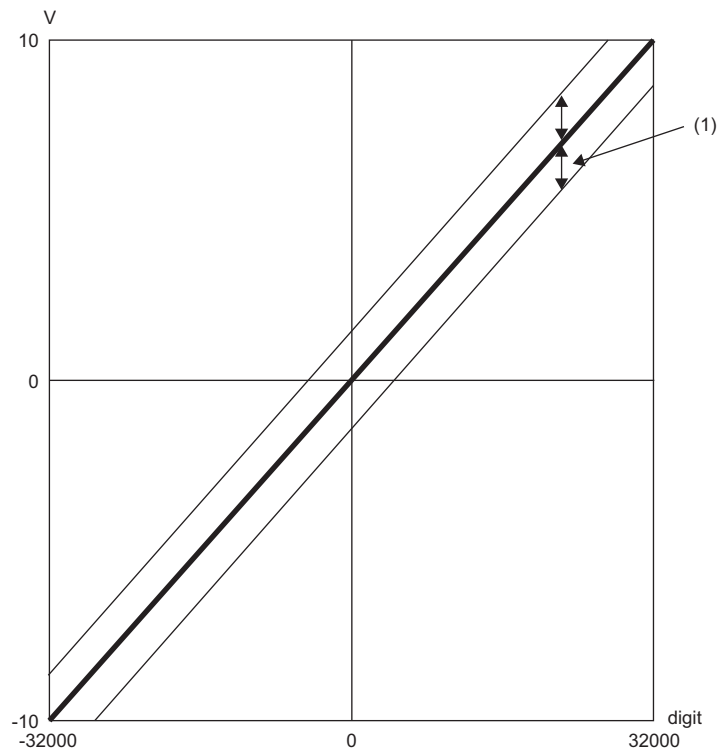

digit: Digital value

V: Analog output value (V)

(1): Fluctuation range

Appendix 3 External Dimensions

The following figure shows the external dimensions of the D/A converter module.

R60DA8-G

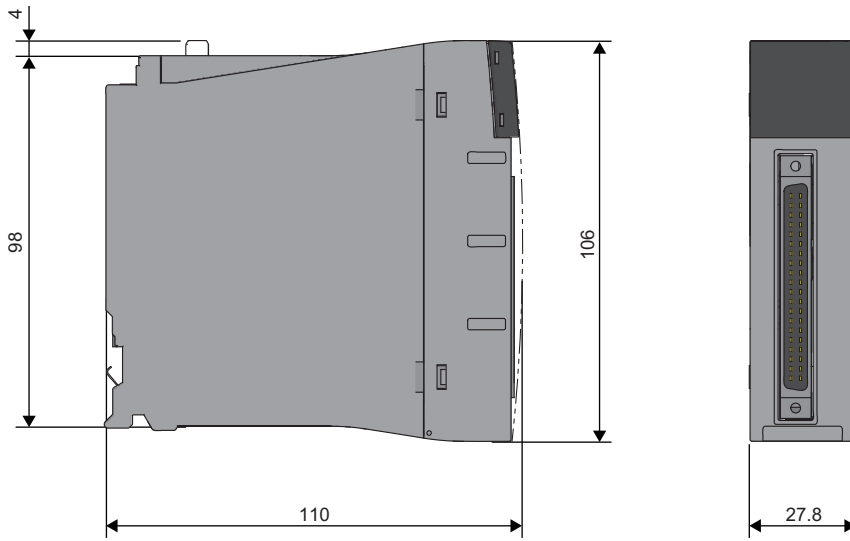

(Unit: mm)

R60DA16-G

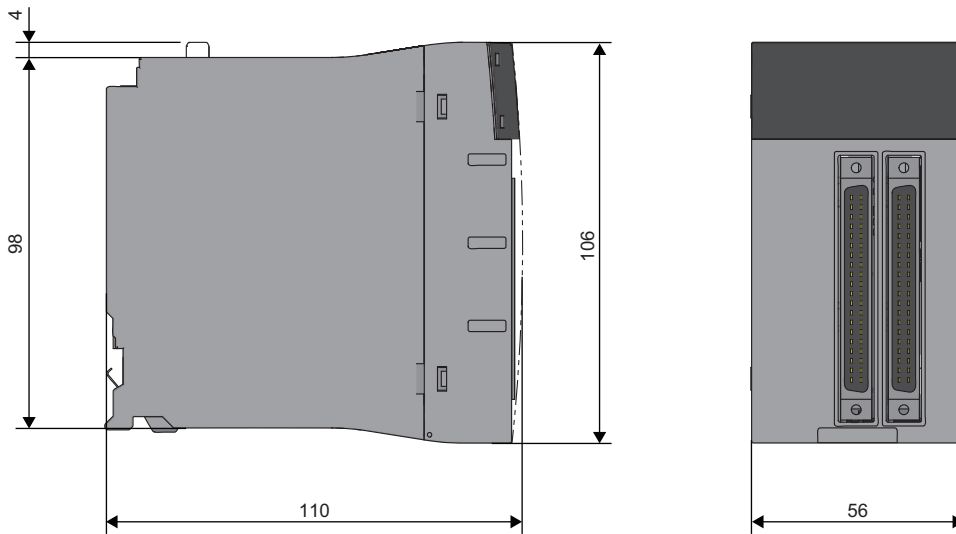

(Unit: mm)

A

INDEX

A

ALM LED 16

C

Connector for external devices 26

Connector/terminal block converter module 30

Current output characteristic 43

D

Dedicated cable 30

E

ERR LED 16

External dimensions 45

External wiring 27

F

Function block (FB) 31

G

Gain value 40

O

Offset value 40

Offset/gain setting 36

P

Performance specifications 18

R

RUN LED 16

S

S MODE LED 16

V

Voltage output characteristics 41

MEMO

REVISIONS

*The manual number is given on the bottom left of the back cover.

Revision date	*Manual number	Description
January 2015	SH(NA)-081489ENG-A	First edition
May 2016	SH(NA)-081489ENG-B	■Added or modified parts RELEVANT MANUALS, Chapter 3, Section 7.1, Appendix 1, Appendix 2
June 2018	SH(NA)-081489ENG-C	■Added or modified parts SAFETY PRECAUTIONS, INTRODUCTION, COMPLIANCE WITH EMC AND LOW VOLTAGE DIRECTIVES, RELEVANT MANUALS, TERMS, Chapter 1, Section 2.1, Chapter 5, Section 6.2, 8.1
April 2019	SH(NA)-081489ENG-D	■Added or modified part Section 7.2
August 2020	SH(NA)-081489ENG-E	■Added or modified part Section 2.1

Japanese manual number: SH-081488-E

This manual confers no industrial property rights or any rights of any other kind, nor does it confer any patent licenses. Mitsubishi Electric Corporation cannot be held responsible for any problems involving industrial property rights which may occur as a result of using the contents noted in this manual.

© 2015 MITSUBISHI ELECTRIC CORPORATION

WARRANTY

Please confirm the following product warranty details before using this product.

1. Gratis Warranty Term and Gratis Warranty Range

If any faults or defects (hereinafter "Failure") found to be the responsibility of Mitsubishi occurs during use of the product within the gratis warranty term, the product shall be repaired at no cost via the sales representative or Mitsubishi Service Company.

However, if repairs are required onsite at domestic or overseas location, expenses to send an engineer will be solely at the customer's discretion. Mitsubishi shall not be held responsible for any re-commissioning, maintenance, or testing on-site that involves replacement of the failed module.

[Gratis Warranty Term]

The gratis warranty term of the product shall be for one year after the date of purchase or delivery to a designated place. Note that after manufacture and shipment from Mitsubishi, the maximum distribution period shall be six (6) months, and the longest gratis warranty term after manufacturing shall be eighteen (18) months. The gratis warranty term of repair parts shall not exceed the gratis warranty term before repairs.

[Gratis Warranty Range]

- (1) The range shall be limited to normal use within the usage state, usage methods and usage environment, etc., which follow the conditions and precautions, etc., given in the instruction manual, user's manual and caution labels on the product.
- (2) Even within the gratis warranty term, repairs shall be charged for in the following cases.
 1. Failure occurring from inappropriate storage or handling, carelessness or negligence by the user. Failure caused by the user's hardware or software design.
 2. Failure caused by unapproved modifications, etc., to the product by the user.
 3. When the Mitsubishi product is assembled into a user's device, Failure that could have been avoided if functions or structures, judged as necessary in the legal safety measures the user's device is subject to or as necessary by industry standards, had been provided.
 4. Failure that could have been avoided if consumable parts (battery, backlight, fuse, etc.) designated in the instruction manual had been correctly serviced or replaced.
 5. Failure caused by external irresistible forces such as fires or abnormal voltages, and Failure caused by force majeure such as earthquakes, lightning, wind and water damage.
 6. Failure caused by reasons unpredictable by scientific technology standards at time of shipment from Mitsubishi.
 7. Any other failure found not to be the responsibility of Mitsubishi or that admitted not to be so by the user.

2. Onerous repair term after discontinuation of production

- (1) Mitsubishi shall accept onerous product repairs for seven (7) years after production of the product is discontinued. Discontinuation of production shall be notified with Mitsubishi Technical Bulletins, etc.
- (2) Product supply (including repair parts) is not available after production is discontinued.

3. Overseas service

Overseas, repairs shall be accepted by Mitsubishi's local overseas FA Center. Note that the repair conditions at each FA Center may differ.

4. Exclusion of loss in opportunity and secondary loss from warranty liability

Regardless of the gratis warranty term, Mitsubishi shall not be liable for compensation to:

- (1) Damages caused by any cause found not to be the responsibility of Mitsubishi.
- (2) Loss in opportunity, lost profits incurred to the user by Failures of Mitsubishi products.
- (3) Special damages and secondary damages whether foreseeable or not, compensation for accidents, and compensation for damages to products other than Mitsubishi products.
- (4) Replacement by the user, maintenance of on-site equipment, start-up test run and other tasks.

5. Changes in product specifications

The specifications given in the catalogs, manuals or technical documents are subject to change without prior notice.

· When SIL2 mode is set

Please confirm the following product warranty details before using this product.

1. Limited Warranty and Product Support.

- a. Mitsubishi Electric Company ("MELCO") warrants that for a period of eighteen (18) months after date of delivery from the point of manufacture or one year from date of Customer's purchase, whichever is less, Mitsubishi programmable logic controllers (the "Products") will be free from defects in material and workmanship.
- b. At MELCO's option, for those Products MELCO determines are not as warranted, MELCO shall either repair or replace them or issue a credit or return the purchase price paid for them.
- c. For this warranty to apply:
 - (1) Customer shall give MELCO (i) notice of a warranty claim to MELCO and the authorized dealer or distributor from whom the Products were purchased, (ii) the notice shall describe in reasonable details the warranty problem, (iii) the notice shall be provided promptly and in no event later than thirty (30) days after the Customer knows or has reason to believe that Products are not as warranted, and (iv) in any event, the notice must be given within the warranty period;
 - (2) Customer shall cooperate with MELCO and MELCO's representatives in MELCO's investigation of the warranty claim, including preserving evidence of the claim and its causes, meaningfully responding to MELCO's questions and investigation of the problem, grant MELCO access to witnesses, personnel, documents, physical evidence and records concerning the warranty problem, and allow MELCO to examine and test the Products in question offsite or at the premises where they are installed or used; and
 - (3) If MELCO requests, Customer shall remove Products it claims are defective and ship them to MELCO or MELCO's authorized representative for examination and, if found defective, for repair or replacement. The costs of removal, shipment to and from MELCO's designated examination point, and reinstallation of repaired or replaced Products shall be at Customer's expense.
 - (4) If Customer requests and MELCO agrees to effect repairs onsite at any domestic or overseas location, the Customer will pay for the costs of sending repair personnel and shipping parts. MELCO is not responsible for any re-commissioning, maintenance, or testing on-site that involves repairs or replacing of the Products.
- d. Repairs of Products located outside of Japan are accepted by MELCO's local authorized service facility centers ("FA Centers"). Terms and conditions on which each FA Center offers repair services for Products that are out of warranty or not covered by MELCO's limited warranty may vary.
- e. Subject to availability of spare parts, MELCO will offer Product repair services for (7) years after each Product model or line is discontinued, at MELCO's or its FA Centers' rates and charges and standard terms in effect at the time of repair. MELCO usually produces and retains sufficient spare parts for repairs of its Products for a period of seven (7) years after production is discontinued.
- f. MELCO generally announces discontinuation of Products through MELCO's Technical Bulletins. Products discontinued and repair parts for them may not be available after their production is discontinued.

2. Limits of Warranties.

- a. MELCO does not warrant or guarantee the design, specify, manufacture, construction or installation of the materials, construction criteria, functionality, use, properties or other characteristics of the equipment, systems, or production lines into which the Products may be incorporated, including any safety, fail-safe and shut down systems using the Products.
- b. MELCO is not responsible for determining the suitability of the Products for their intended purpose and use, including determining if the Products provide appropriate safety margins and redundancies for the applications, equipment or systems into which they are incorporated.
- c. Customer acknowledges that qualified and experienced personnel are required to determine the suitability, application, design, construction and proper installation and integration of the Products. MELCO does not supply such personnel.
- d. MELCO is not responsible for designing and conducting tests to determine that the Product functions appropriately and meets application standards and requirements as installed or incorporated into the end-user's equipment, production lines or systems.
- e. MELCO does not warrant any Product:
 - (1) repaired or altered by persons other than MELCO or its authorized engineers or FA Centers;
 - (2) subjected to negligence, carelessness, accident, misuse, or damage;
 - (3) improperly stored, handled, installed or maintained;
 - (4) integrated or used in connection with improperly designed, incompatible or defective hardware or software;
 - (5) that fails because consumable parts such as batteries, backlights, or fuses were not tested, serviced or replaced;
 - (6) operated or used with equipment, production lines or systems that do not meet applicable and commensurate legal, safety and industry-accepted standards;
 - (7) operated or used in abnormal applications;
 - (8) installed, operated or used in contravention of instructions, precautions or warnings contained in MELCO's user, instruction and/or safety manuals, technical bulletins and guidelines for the Products;
 - (9) used with obsolete technologies or technologies not fully tested and widely accepted and in use at the time of the Product's manufacture;
 - (10) subjected to excessive heat or moisture, abnormal voltages, shock, excessive vibration, physical damage or other improper environment; or
 - (11) damaged or malfunctioning due to Acts of God, fires, acts of vandals, criminals or terrorists, communication or power failures, or any other cause or failure that results from circumstances beyond MELCO's control.
- f. All Product information and specifications contained on MELCO's website and in catalogs, manuals, or technical information materials provided by MELCO are subject to change without prior notice.

- g. The Product information and statements contained on MELCO's website and in catalogs, manuals, technical bulletins or other materials provided by MELCO are provided as a guide for Customer's use. They do not constitute warranties and are not incorporated in the contract of sale for the Products.
- h. These terms and conditions constitute the entire agreement between Customer and MELCO with respect to warranties, remedies and damages and supersede any other understandings, whether written or oral, between the parties. Customer expressly acknowledges that any representations or statements made by MELCO or others concerning the Products outside these terms are not part of the basis of the bargain between the parties and are not factored into the pricing of the Products.
- i. THE WARRANTIES AND REMEDIES SET FORTH IN THESE TERMS ARE THE EXCLUSIVE AND ONLY WARRANTIES AND REMEDIES THAT APPLY TO THE PRODUCTS.
- j. MELCO DISCLAIMS THE IMPLIED WARRANTIES OF MERCHANTABILITY AND FITNESS FOR A PARTICULAR PURPOSE.

3. Limits on Damages.

- a. MELCO'S MAXIMUM CUMULATIVE LIABILITY BASED ON ANY CLAIMS FOR BREACH OF WARRANTY OR CONTRACT, NEGLIGENCE, STRICT TORT LIABILITY OR OTHER THEORIES OF RECOVERY REGARDING THE SALE, REPAIR, REPLACEMENT, DELIVERY, PERFORMANCE, CONDITION, SUITABILITY, COMPLIANCE, OR OTHER ASPECTS OF THE PRODUCTS OR THEIR SALE, INSTALLATION OR USE SHALL BE LIMITED TO THE PRICE PAID FOR PRODUCTS NOT AS WARRANTED.
- b. Although MELCO has obtained the certification for Product's compliance to the international safety standards IEC61508 and IEC61511 from TUV Rheinland, this fact does not guarantee that Product will be free from any malfunction or failure. The user of this Product shall comply with any and all applicable safety standard, regulation or law and take appropriate safety measures for the system in which the Product is installed or used and shall take the second or third safety measures other than the Product. MELCO is not liable for damages that could have been prevented by compliance with any applicable safety standard, regulation or law.
- c. MELCO prohibits the use of Products with or in any application involving power plants, trains, railway systems, airplanes, airline operations, other transportation systems, amusement equipments, hospitals, medical care, dialysis and life support facilities or equipment, incineration and fuel devices, handling of nuclear or hazardous materials or chemicals, mining and drilling, and other applications where the level of risk to human life, health or property are elevated.
- d. MELCO SHALL NOT BE LIABLE FOR SPECIAL, INCIDENTAL, CONSEQUENTIAL, INDIRECT OR PUNITIVE DAMAGES, FOR LOSS OF PROFITS, SALES, OR REVENUE, FOR INCREASED LABOR OR OVERHEAD COSTS, FOR DOWNTIME OR LOSS OF PRODUCTION, FOR COST OVERRUNS, OR FOR ENVIRONMENTAL OR POLLUTION DAMAGES OR CLEAN-UP COSTS, WHETHER THE LOSS IS BASED ON CLAIMS FOR BREACH OF CONTRACT OR WARRANTY, VIOLATION OF STATUTE, NEGLIGENCE OR OTHER TORT, STRICT LIABILITY OR OTHERWISE.
- e. In the event that any damages which are asserted against MELCO arising out of or relating to the Products or defects in them, consist of personal injury, wrongful death and/or physical property damages as well as damages of a pecuniary nature, the disclaimers and limitations contained in these terms shall apply to all three types of damages to the fullest extent permitted by law. If, however, the personal injury, wrongful death and/or physical property damages cannot be disclaimed or limited by law or public policy to the extent provided by these terms, then in any such event the disclaimer of and limitations on pecuniary or economic consequential and incidental damages shall nevertheless be enforceable to the fullest extent allowed by law.
- f. In no event shall any cause of action arising out of breach of warranty or otherwise concerning the Products be brought by Customer more than one year after the cause of action accrues.
- g. Each of the limitations on remedies and damages set forth in these terms is separate and independently enforceable, notwithstanding the unenforceability or failure of essential purpose of any warranty, undertaking, damage limitation, other provision of these terms or other terms comprising the contract of sale between Customer and MELCO.

4. Delivery/Force Majeure.

- a. Any delivery date for the Products acknowledged by MELCO is an estimated and not a promised date. MELCO will make all reasonable efforts to meet the delivery schedule set forth in Customer's order or the purchase contract but shall not be liable for failure to do so.
- b. Products stored at the request of Customer or because Customer refuses or delays shipment shall be at the risk and expense of Customer.
- c. MELCO shall not be liable for any damage to or loss of the Products or any delay in or failure to deliver, service, repair or replace the Products arising from shortage of raw materials, failure of suppliers to make timely delivery, labor difficulties of any kind, earthquake, fire, windstorm, flood, theft, criminal or terrorist acts, war, embargoes, governmental acts or rulings, loss or damage or delays in carriage, acts of God, vandals or any other circumstances reasonably beyond MELCO's control.

5. Choice of Law/Jurisdiction.

These terms and any agreement or contract between Customer and MELCO shall be governed by the laws of the State of New York without regard to conflicts of laws. To the extent any action or dispute is not arbitrated, the parties consent to the exclusive jurisdiction and venue of the federal and state courts located in the Southern District of the State of New York. Any judgment there obtained may be enforced in any court of competent jurisdiction.

6. Arbitration.

Any controversy or claim arising out of, or relating to or in connection with the Products, their sale or use or these terms, shall be settled by arbitration conducted in accordance with the Center for Public Resources (CPR) Rules for Non-Administered Arbitration of International Disputes, by a sole arbitrator chosen from the CPR's panels of distinguished neutrals. Judgment upon the award rendered by the Arbitrator shall be final and binding and may be entered by any court having jurisdiction thereof. The place of the arbitration shall be New York City, New York. The language of the arbitration shall be English. The neutral organization designated to perform the functions specified in Rule 6 and Rules 7.7(b), 7.8 and 7.9 shall be the CPR.

TRADEMARKS

The company names, system names and product names mentioned in this manual are either registered trademarks or trademarks of their respective companies.

In some cases, trademark symbols such as [™] or [®] are not specified in this manual.

SH(NA)-081489ENG-E(2008)MEE

MODEL: R-DA-G-U-IN-E

MODEL CODE: 13JX31

mitsubishi electric corporation

HEAD OFFICE : TOKYO BUILDING, 2-7-3 MARUNOUCHI, CHIYODA-KU, TOKYO 100-8310, JAPAN
NAGOYA WORKS : 1-14, YADA-MINAMI 5-CHOME, HIGASHI-KU, NAGOYA, JAPAN

When exported from Japan, this manual does not require application to the
Ministry of Economy, Trade and Industry for service transaction permission.

Specifications subject to change without notice.