



Programmable Controller

MELSEC iQ-R
series

MELSEC iQ-R Channel Isolated
Analog-Digital Converter Module
User's Manual (Application)

-R60AD8-G
-R60AD16-G



SAFETY PRECAUTIONS

(Read these precautions before using this product.)

Before using this product, please read this manual and the relevant manuals carefully and pay full attention to safety to handle the product correctly.

The precautions given in this manual are concerned with this product only. For the safety precautions of the programmable controller system, refer to the MELSEC iQ-R Module Configuration Manual.

In this manual, the safety precautions are classified into two levels: "⚠️ WARNING" and "⚠️ CAUTION".

 WARNING	Indicates that incorrect handling may cause hazardous conditions, resulting in death or severe injury.
 CAUTION	Indicates that incorrect handling may cause hazardous conditions, resulting in minor or moderate injury or property damage.

Under some circumstances, failure to observe the precautions given under "⚠️ CAUTION" may lead to serious consequences.

Observe the precautions of both levels because they are important for personal and system safety.

Make sure that the end users read this manual and then keep the manual in a safe place for future reference.

[Design Precautions]

WARNING

- Configure safety circuits external to the programmable controller to ensure that the entire system operates safely even when a fault occurs in the external power supply or the programmable controller. Failure to do so may result in an accident due to an incorrect output or malfunction.
 - (1) Emergency stop circuits, protection circuits, and protective interlock circuits for conflicting operations (such as forward/reverse rotations or upper/lower limit positioning) must be configured external to the programmable controller.
 - (2) When the programmable controller detects an abnormal condition, it stops the operation and all outputs are:
 - Turned off if the overcurrent or overvoltage protection of the power supply module is activated.
 - Held or turned off according to the parameter setting if the self-diagnostic function of the CPU module detects an error such as a watchdog timer error.
 - (3) All outputs may be turned on if an error occurs in a part, such as an I/O control part, where the CPU module cannot detect any error. To ensure safety operation in such a case, provide a safety mechanism or a fail-safe circuit external to the programmable controller. For a fail-safe circuit example, refer to "General Safety Requirements" in the MELSEC iQ-R Module Configuration Manual.
 - (4) Outputs may remain on or off due to a failure of a component such as a relay and transistor in an output circuit. Configure an external circuit for monitoring output signals that could cause a serious accident.
 - In an output circuit, when a load current exceeding the rated current or an overcurrent caused by a load short-circuit flows for a long time, it may cause smoke and fire. To prevent this, configure an external safety circuit, such as a fuse.
 - Configure a circuit so that the programmable controller is turned on first and then the external power supply. If the external power supply is turned on first, an accident may occur due to an incorrect output or malfunction.
 - For the operating status of each station after a communication failure, refer to manuals relevant to the network. Incorrect output or malfunction due to a communication failure may result in an accident.
 - When connecting an external device with a CPU module or intelligent function module to modify data of a running programmable controller, configure an interlock circuit in the program to ensure that the entire system will always operate safely. For other forms of control (such as program modification, parameter change, forced output, or operating status change) of a running programmable controller, read the relevant manuals carefully and ensure that the operation is safe before proceeding. Improper operation may damage machines or cause accidents.
 - Especially, when a remote programmable controller is controlled by an external device, immediate action cannot be taken if a problem occurs in the programmable controller due to a communication failure. To prevent this, configure an interlock circuit in the program, and determine corrective actions to be taken between the external device and CPU module in case of a communication failure.
 - Do not write any data to the "system area" and "write-protect area" of the buffer memory in the module. Also, do not use any "use prohibited" signals as an output signal from the CPU module to each module. Doing so may cause malfunction of the programmable controller system. For the "system area", "write-protect area", and the "use prohibited" signals, refer to the user's manual for the module used.
-

[Design Precautions]

WARNING

- If a communication cable is disconnected, the network may be unstable, resulting in a communication failure of multiple stations. Configure an interlock circuit in the program to ensure that the entire system will always operate safely even if communications fail. Failure to do so may result in an accident due to an incorrect output or malfunction.

[Precautions for using the channel isolated analog-digital converter modules in SIL2 mode]

- When the R60AD8-G detects a fault in the external power supply or programmable controller, a digital operation value becomes an OFF value (equivalent to 0V/0mA) in all channels. Configure an external circuit to ensure that the power source of a hazard is shut off when a digital operation value of the R60AD8-G is an OFF value (equivalent to 0V/0mA). Failure to do so may result in an accident.
 - When a communication failure occurs in CC-Link IE Field Network, a digital operation value of the R60AD8-G becomes an OFF value (equivalent to 0V/0mA). Check the communication status information and configure an interlock circuit in the program to ensure that the entire system will operate safely. Failure to do so may result in an accident due to an incorrect output or malfunction.
-

[Design Precautions]

CAUTION

- Do not install the control lines or communication cables together with the main circuit lines or power cables. Keep a distance of 100mm or more between them. Failure to do so may result in malfunction due to noise.
 - During control of an inductive load such as a lamp, heater, or solenoid valve, a large current (approximately ten times greater than normal) may flow when the output is turned from off to on. Therefore, use a module that has a sufficient current rating.
 - After the CPU module is powered on or is reset, the time taken to enter the RUN status varies depending on the system configuration, parameter settings, and/or program size. Design circuits so that the entire system will always operate safely, regardless of the time.
 - Do not power off the programmable controller or reset the CPU module while the settings are being written. Doing so will make the data in the flash ROM and SD memory card undefined. The values need to be set in the buffer memory and written to the flash ROM and SD memory card again. Doing so also may cause malfunction or failure of the module.
 - When changing the operating status of the CPU module from external devices (such as the remote RUN/STOP functions), select "Do Not Open by Program" for "Opening Method" of "Module Parameter". If "Open by Program" is selected, an execution of the remote STOP function causes the communication line to close. Consequently, the CPU module cannot reopen the line, and external devices cannot execute the remote RUN function.
-

[Security Precautions]

WARNING

- To maintain the security (confidentiality, integrity, and availability) of the programmable controller and the system against unauthorized access, denial-of-service (DoS) attacks, computer viruses, and other cyberattacks from external devices via the network, take appropriate measures such as firewalls, virtual private networks (VPNs), and antivirus solutions.
-

[Installation Precautions]

WARNING

- Shut off the external power supply (all phases) used in the system before mounting or removing the module. Failure to do so may result in electric shock or cause the module to fail or malfunction.
-

[Installation Precautions]

CAUTION

- Use the programmable controller in an environment that meets the general specifications in the Safety Guidelines included with the base unit. Failure to do so may result in electric shock, fire, malfunction, or damage to or deterioration of the product.
 - To mount a module, place the concave part(s) located at the bottom onto the guide(s) of the base unit, and push in the module until the hook(s) located at the top snaps into place. Incorrect interconnection may cause malfunction, failure, or drop of the module.
 - When using the programmable controller in an environment of frequent vibrations, fix the module with a screw.
 - Tighten the screws within the specified torque range. Undertightening can cause drop of the screw, short circuit, or malfunction. Overtightening can damage the screw and/or module, resulting in drop, short circuit, or malfunction.
 - When using an extension cable, connect it to the extension cable connector of the base unit securely. Check the connection for looseness. Poor contact may cause malfunction.
 - When using an SD memory card, fully insert it into the SD memory card slot. Check that it is inserted completely. Poor contact may cause malfunction.
 - Securely insert an extended SRAM cassette or a battery-less option cassette into the cassette connector of the CPU module. After insertion, close the cassette cover and check that the cassette is inserted completely. Poor contact may cause malfunction.
 - Do not directly touch any conductive parts and electronic components of the module, SD memory card, extended SRAM cassette, battery-less option cassette, or connector. Doing so can cause malfunction or failure of the module.
-

[Wiring Precautions]

WARNING

- Shut off the external power supply (all phases) used in the system before installation and wiring. Failure to do so may result in electric shock or cause the module to fail or malfunction.
 - After installation and wiring, attach the included terminal cover to the module before turning it on for operation. Failure to do so may result in electric shock.
-

[Wiring Precautions]

CAUTION

- Individually ground the FG and LG terminals of the programmable controller with a ground resistance of 100 ohms or less. Failure to do so may result in electric shock or malfunction.
 - Use applicable solderless terminals and tighten them within the specified torque range. If any spade solderless terminal is used, it may be disconnected when the terminal screw comes loose, resulting in failure.
 - Check the rated voltage and signal layout before wiring to the module, and connect the cables correctly. Connecting a power supply with a different voltage rating or incorrect wiring may cause fire or failure.
 - Connectors for external devices must be crimped or pressed with the tool specified by the manufacturer, or must be correctly soldered. Incomplete connections may cause short circuit, fire, or malfunction.
 - Securely connect the connector to the module. Poor contact may cause malfunction.
 - Do not install the control lines or communication cables together with the main circuit lines or power cables. Keep a distance of 100mm or more between them. Failure to do so may result in malfunction due to noise.
 - Place the cables in a duct or clamp them. If not, dangling cables may swing or inadvertently be pulled, resulting in malfunction or damage to modules or cables.
In addition, the weight of the cables may put stress on modules in an environment of strong vibrations and shocks.
Do not clamp the extension cables with the jacket stripped. Doing so may change the characteristics of the cables, resulting in malfunction.
 - Check the interface type and correctly connect the cable. Incorrect wiring (connecting the cable to an incorrect interface) may cause failure of the module and external device.
 - Tighten the terminal screws or connector screws within the specified torque range. Undertightening can cause drop of the screw, short circuit, fire, or malfunction. Overtightening can damage the screw and/or module, resulting in drop, short circuit, fire, or malfunction.
 - When disconnecting the cable from the module, do not pull the cable by the cable part. For the cable with connector, hold the connector part of the cable. For the cable connected to the terminal block, loosen the terminal screw. Pulling the cable connected to the module may result in malfunction or damage to the module or cable.
 - Prevent foreign matter such as dust or wire chips from entering the module. Such foreign matter can cause a fire, failure, or malfunction.
 - A protective film is attached to the top of the module to prevent foreign matter, such as wire chips, from entering the module during wiring. Do not remove the film during wiring. Remove it for heat dissipation before system operation.
 - Programmable controllers must be installed in control panels. Connect the main power supply to the power supply module in the control panel through a relay terminal block. Wiring and replacement of a power supply module must be performed by qualified maintenance personnel with knowledge of protection against electric shock.
For wiring, refer to the MELSEC iQ-R Module Configuration Manual.
 - For Ethernet cables to be used in the system, select the ones that meet the specifications in the user's manual for the module used. If not, normal data transmission is not guaranteed.
 - Individually ground the shielded cables of the programmable controller with a ground resistance of 100 ohms or less. Failure to do so may result in electric shock or malfunction.
-

[Startup and Maintenance Precautions]

WARNING

- Do not touch any terminal while power is on. Doing so will cause electric shock or malfunction.
 - Correctly connect the battery connector. Do not charge, disassemble, heat, short-circuit, solder, or throw the battery into the fire. Also, do not expose it to liquid or strong shock. Doing so will cause the battery to produce heat, explode, ignite, or leak, resulting in injury and fire.
 - Shut off the external power supply (all phases) used in the system before cleaning the module or retightening the terminal screws, connector screws, or module fixing screws. Failure to do so may result in electric shock.
-

[Startup and Maintenance Precautions]

CAUTION

- When connecting an external device with a CPU module or intelligent function module to modify data of a running programmable controller, configure an interlock circuit in the program to ensure that the entire system will always operate safely. For other forms of control (such as program modification, parameter change, forced output, or operating status change) of a running programmable controller, read the relevant manuals carefully and ensure that the operation is safe before proceeding. Improper operation may damage machines or cause accidents.
 - Especially, when a remote programmable controller is controlled by an external device, immediate action cannot be taken if a problem occurs in the programmable controller due to a communication failure. To prevent this, configure an interlock circuit in the program, and determine corrective actions to be taken between the external device and CPU module in case of a communication failure.
 - Do not disassemble or modify the modules. Doing so may cause failure, malfunction, injury, or a fire.
 - Use any radio communication device such as a cellular phone or PHS (Personal Handy-phone System) more than 25cm away in all directions from the programmable controller. Failure to do so may cause malfunction.
 - Shut off the external power supply (all phases) used in the system before mounting or removing the module. Failure to do so may cause the module to fail or malfunction.
 - Tighten the screws within the specified torque range. Undertightening can cause drop of the component or wire, short circuit, or malfunction. Overtightening can damage the screw and/or module, resulting in drop, short circuit, or malfunction.
 - After the first use of the product, do not perform each of the following operations more than 50 times (IEC 61131-2/JIS B 3502 compliant).
Exceeding the limit may cause malfunction.
 - Mounting/removing the module to/from the base unit
 - Inserting/removing the extended SRAM cassette or battery-less option cassette to/from the CPU module
 - Mounting/removing the terminal block to/from the module
 - After the first use of the product, do not insert/remove the SD memory card to/from the CPU module more than 500 times. Exceeding the limit may cause malfunction.
 - Do not touch the metal terminals on the back side of the SD memory card. Doing so may cause malfunction or failure of the module.
 - Do not touch the integrated circuits on the circuit board of an extended SRAM cassette or a battery-less option cassette. Doing so may cause malfunction or failure of the module.
 - Do not drop or apply shock to the battery to be installed in the module. Doing so may damage the battery, causing the battery fluid to leak inside the battery. If the battery is dropped or any shock is applied to it, dispose of it without using.
 - Startup and maintenance of a control panel must be performed by qualified maintenance personnel with knowledge of protection against electric shock. Lock the control panel so that only qualified maintenance personnel can operate it.
 - Before handling the module, touch a conducting object such as a grounded metal to discharge the static electricity from the human body. Failure to do so may cause the module to fail or malfunction.
-

[Operating Precautions]

CAUTION

- When changing data and operating status, and modifying program of the running programmable controller from an external device such as a personal computer connected to an intelligent function module, read relevant manuals carefully and ensure the safety before operation. Incorrect change or modification may cause system malfunction, damage to the machines, or accidents.
 - Do not power off the programmable controller or reset the CPU module while the setting values in the buffer memory are being written to the flash ROM in the module. Doing so will make the data in the flash ROM and SD memory card undefined. The values need to be set in the buffer memory and written to the flash ROM and SD memory card again. Doing so can cause malfunction or failure of the module.
-

[Disposal Precautions]

CAUTION

- When disposing of this product, treat it as industrial waste.
 - When disposing of batteries, separate them from other wastes according to the local regulations. For details on battery regulations in EU member states, refer to the MELSEC iQ-R Module Configuration Manual.
-

[Transportation Precautions]

CAUTION

- When transporting lithium batteries, follow the transportation regulations. For details on the regulated models, refer to the MELSEC iQ-R Module Configuration Manual.
 - The halogens (such as fluorine, chlorine, bromine, and iodine), which are contained in a fumigant used for disinfection and pest control of wood packaging materials, may cause failure of the product. Prevent the entry of fumigant residues into the product or consider other methods (such as heat treatment) instead of fumigation. The disinfection and pest control measures must be applied to unprocessed raw wood.
-

CONDITIONS OF USE FOR THE PRODUCT

- (1) Mitsubishi programmable controller ("the PRODUCT") shall be used in conditions;
 - i) where any problem, fault or failure occurring in the PRODUCT, if any, shall not lead to any major or serious accident; and
 - ii) where the backup and fail-safe function are systematically or automatically provided outside of the PRODUCT for the case of any problem, fault or failure occurring in the PRODUCT.
- (2) The PRODUCT has been designed and manufactured for the purpose of being used in general industries. MITSUBISHI SHALL HAVE NO RESPONSIBILITY OR LIABILITY (INCLUDING, BUT NOT LIMITED TO ANY AND ALL RESPONSIBILITY OR LIABILITY BASED ON CONTRACT, WARRANTY, TORT, PRODUCT LIABILITY) FOR ANY INJURY OR DEATH TO PERSONS OR LOSS OR DAMAGE TO PROPERTY CAUSED BY the PRODUCT THAT ARE OPERATED OR USED IN APPLICATION NOT INTENDED OR EXCLUDED BY INSTRUCTIONS, PRECAUTIONS, OR WARNING CONTAINED IN MITSUBISHI'S USER, INSTRUCTION AND/OR SAFETY MANUALS, TECHNICAL BULLETINS AND GUIDELINES FOR the PRODUCT.

("Prohibited Application")

Prohibited Applications include, but not limited to, the use of the PRODUCT in;
 - Nuclear Power Plants and any other power plants operated by Power companies, and/or any other cases in which the public could be affected if any problem or fault occurs in the PRODUCT.
 - Railway companies or Public service purposes, and/or any other cases in which establishment of a special quality assurance system is required by the Purchaser or End User.
 - Aircraft or Aerospace, Medical applications, Train equipment, transport equipment such as Elevator and Escalator, Incineration and Fuel devices, Vehicles, Manned transportation, Equipment for Recreation and Amusement, and Safety devices, handling of Nuclear or Hazardous Materials or Chemicals, Mining and Drilling, and/or other applications where there is a significant risk of injury to the public or property.Notwithstanding the above restrictions, Mitsubishi may in its sole discretion, authorize use of the PRODUCT in one or more of the Prohibited Applications, provided that the usage of the PRODUCT is limited only for the specific applications agreed to by Mitsubishi and provided further that no special quality assurance or fail-safe, redundant or other safety features which exceed the general specifications of the PRODUCTS are required. For details, please contact the Mitsubishi representative in your region.
- (3) Mitsubishi shall have no responsibility or liability for any problems involving programmable controller trouble and system trouble caused by DoS attacks, unauthorized access, computer viruses, and other cyberattacks.
 - When SIL2 mode is set
- (1) Although MELCO has obtained the certification for Product's compliance to the international safety standards IEC61508, IEC61511 from TUV Rheinland, this fact does not guarantee that Product will be free from any malfunction or failure. The user of this Product shall comply with any and all applicable safety standard, regulation or law and take appropriate safety measures for the system in which the Product is installed or used and shall take the second or third safety measures other than the Product. MELCO is not liable for damages that could have been prevented by compliance with any applicable safety standard, regulation or law.
- (2) MELCO prohibits the use of Products with or in any application involving, and MELCO shall not be liable for a default, a liability for defect warranty, a quality assurance, negligence or other tort and a product liability in these applications.
 - (a) power plants,
 - (b) trains, railway systems, airplanes, airline operations, other transportation systems,
 - (c) hospitals, medical care, dialysis and life support facilities or equipment,
 - (d) amusement equipments,
 - (e) incineration and fuel devices,
 - (f) handling of nuclear or hazardous materials or chemicals,
 - (g) mining and drilling,
 - (h) and other applications where the level of risk to human life, health or property are elevated.

INTRODUCTION

Thank you for purchasing the Mitsubishi Electric MELSEC iQ-R series programmable controllers.

This manual describes the functions, parameter settings, and troubleshooting of the relevant products listed below.

Before using this product, please read this manual and the relevant manuals carefully and develop familiarity with the functions and performance of the MELSEC iQ-R series programmable controller to handle the product correctly.

When applying the program examples provided in this manual to an actual system, ensure the applicability and confirm that it will not cause system control problems.

Please make sure that the end users read this manual.

Point

Unless otherwise specified, this manual provides program examples in which the I/O numbers of X/Y0 to X/YF are assigned to the A/D converter module. Assign I/O numbers when applying the program examples to an actual system. For I/O number assignment, refer to the following.

 MELSEC iQ-R Module Configuration Manual

Relevant products

R60AD8-G, R60AD16-G

Modes

Modes of the R60AD8-G are roughly classified into two groups listed below. A mode is set using the module parameter of GX Works3. Mode transition is not possible while the module is operating.

Mode	Description
Standard mode	<ul style="list-style-type: none">The mode for using the A/D converter module in a normal systemThe standard mode is subdivided into three types: normal mode, offset/gain setting mode, and Q compatible mode.
SIL2 mode	<ul style="list-style-type: none">The mode is certified according to the safety requirements of IEC61508: 2010 SIL2 and IEC61511: 2015 SIL2. This mode is used when a customer builds a SIL2 system using products compliant with IEC61508: 2010 SIL2 or IEC61511: 2015 SIL2.The R60AD8-G in SIL2 mode can be used to build safety functions for general industry machinery.

Note that the R60AD16-G does not support SIL2 mode and operates only in standard mode.

■Enabling/disabling the safety module

To operate the R60AD8-G in SIL2 mode, it is necessary to enable the safety module so that the set parameters become enabled.

To stop the safety I/O of the R60AD8-G operating in SIL2 mode, or to use that module in standard mode in the other system, disabling the safety module is required.

CONTENTS

SAFETY PRECAUTIONS	1
CONDITIONS OF USE FOR THE PRODUCT	9
INTRODUCTION	10
RELEVANT MANUALS	15
TERMS	16
GENERIC TERMS AND ABBREVIATIONS	16

PART 1 STANDARD MODE

CHAPTER 1 FUNCTIONS	18
1.1 Processing of Each Function	19
1.2 Range Switching Function	20
1.3 A/D Conversion Enable/Disable Setting Function	21
1.4 A/D Conversion Method	22
1.5 Scaling Function	26
1.6 Alert Output Function	30
Process alarm	30
Rate alarm	33
1.7 Input Signal Error Detection Function	38
When the function is used in the Q compatible mode	46
1.8 Shift Function	50
1.9 Digital Clipping Function	53
1.10 Difference Conversion Function	55
1.11 Maximum Value/Minimum Value Hold Function	59
1.12 Logging Function	60
Stopping the logging operation	65
Logging hold request	68
Level trigger	69
Initial settings of the logging function	72
Logging read function	73
Saving to a CSV file	78
Displaying logging data	79
1.13 Interrupt Function	80
1.14 Error History Function	83
1.15 Event History Function	86
1.16 Backing up, Saving, and Restoring Offset/Gain Values	87
When the module-specific backup parameter is used	87
When the module-specific backup parameter is not used	90
1.17 Q Compatible Mode Function	94
CHAPTER 2 PARAMETER SETTINGS	95
2.1 Basic Setting	95
2.2 Application Setting	96
2.3 Interrupt Setting	97
2.4 Refresh Setting	98
Refresh processing time	99

CHAPTER 3	TROUBLESHOOTING	100
3.1	Troubleshooting with the LEDs	100
3.2	Checking the State of the Module	101
3.3	Troubleshooting by Symptom	103
	When the A/D converter module does not start up	103
	When the RUN LED flashes or turns off	103
	When the ERR LED turns on	103
	When the ALM LED turns on or flashes	104
	When a digital output value cannot be read	105
	When the digital output value does not fall within the range of accuracy	106
3.4	List of Error Codes	107
3.5	List of Alarm Codes	111
APPENDICES (STANDARD MODE)		112
Appendix 1	Module Label	112
Appendix 2	I/O Signals	114
	List of I/O signals	114
	Details of input signals	115
	Details of output signals	122
Appendix 3	Buffer Memory Areas	124
	List of buffer memory addresses	124
	Details of buffer memory addresses	144
Appendix 4	Dedicated Instructions	203
	Instruction list	203
Appendix 5	Operation Examples of When the Remote Head Module Is Mounted	204
	System configuration example	204
	Setting in the master station	205
	Setting in the intelligent device station	208
	Checking the network status	212
	Program examples	212
Appendix 6	Disabling the Safety Module	215
Appendix 7	Using the Module in the Redundant System with Redundant Extension Base Unit	216
	Restrictions on functions and specifications	216
	Precautions	216
Appendix 8	Added or Modified Function	217
PART 2	SIL2 MODE	
CHAPTER 4	OVERVIEW	220
CHAPTER 5	PART NAMES	223
CHAPTER 6	SPECIFICATIONS	225
6.1	Performance Specifications	225
6.2	Function List	227
CHAPTER 7	PROCEDURES BEFORE OPERATION	228

CHAPTER 8	SYSTEM CONFIGURATION	235
8.1	Redundant Master Station	236
8.2	Redundant Line	238
8.3	Firmware Version for SIL2 Mode	240
8.4	Reference Product	240
CHAPTER 9	INSTALLATION AND WIRING	241
9.1	Wiring Precautions	241
	Connector for external devices	241
9.2	External Wiring	242
	Signal layout for the connector for external devices	242
	Examples of external wiring	243
	Relay switching wiring	247
	Precautions for channel number and output signal	248
CHAPTER 10	FUNCTIONS	249
10.1	SIL2 Mode	250
10.2	Processing of Each Function	264
10.3	Range Switching Function	265
10.4	A/D Conversion Enable/Disable Setting Function	266
10.5	A/D Conversion Method	266
10.6	Scaling Function	269
10.7	Digital Clipping Function	272
10.8	SIL2 A/D Conversion Function	274
	Double input discrepancy detection function	281
	A/D conversion circuit diagnostic function	285
	Input HOLD function	288
10.9	Self-diagnostic Function	289
10.10	Error History Function	290
10.11	Event History Function	291
CHAPTER 11	PARAMETER SETTINGS	293
11.1	Basic Settings	293
11.2	Application Settings	294
11.3	Refresh Settings	295
CHAPTER 12	EXAMPLE OF OPERATION	296
CHAPTER 13	MAINTENANCE AND INSPECTION	302
CHAPTER 14	TROUBLESHOOTING	304
14.1	Troubleshooting with the LEDs	304
14.2	Checking the State of the Module	305
14.3	Troubleshooting by Symptom	307
	When the R60AD8-G does not start up	307
	When the RUN LED flashes or turns off	307
	When the ERR LED flashes or turns on	307
	When the S MODE LED flashes or turns off	308
	When the ALM LED flashes	309
	When a module parameter error is displayed in the "Module Diagnostics" window	309

When a double input discrepancy detection error occurs	309
When an A/D conversion circuit diagnostic error occurs	310
When it takes time for the SIL2 analog input system to start up	310
When the safety device value is the OFF value (equivalent to 0V/0mA).	311
When the safety device does not fall within the range of accuracy	311
When the module shuts down	311
14.4 Troubleshooting While Proceeding Procedures Before Operation	312
When the module parameter write to the remote head module fails.	312
Troubleshooting on the "Safety Communication Setting" window	312
Troubleshooting on the "Safety Module Operation" window	312
14.5 Troubleshooting SIL2 Diagnostic FB Library	315
When the SIL2 diagnostic FB library is not registered as a product option.	315
When a program conversion error occurs in GX Works3	315
When the execution status of the SIL2 diagnostic FB library is off	315
Checking by status code of the SIL2 safety program FB	315
Checking by error code of the SIL2 safety program FB	318
14.6 List of Error Codes	319
APPENDICES (SIL2 MODE)	322
<hr/>	
Appendix 9 I/O Signals	322
List of I/O signals.	322
Appendix 10 Buffer Memory	323
List of buffer memory addresses	323
Details of buffer memory area	323
Appendix 11 I/O Conversion Characteristics	324
Appendix 12 Accuracy	327
Appendix 13 Calculation Method of Safety Response Time (Maximum Value)	328
Appendix 14 Added or Modified Function	329
Appendix 15 External Dimensions	330
INDEX	332
<hr/>	
REVISIONS	334
WARRANTY	335
TRADEMARKS	338

RELEVANT MANUALS

Manual name [manual number]	Description	Available form
MELSEC iQ-R Channel Isolated Analog-Digital Converter Module User's Manual (Application) [SH-081487ENG] (this manual)	Functions, parameter settings, troubleshooting, I/O signals, and buffer memory of the A/D converter module	Print book e-Manual PDF
MELSEC iQ-R Module Configuration Manual [SH-081262ENG]	Common information on the hardware configuration of all modules, overview of each system configuration, and specifications of the power supply module, base unit, SD memory card, and battery	Print book e-Manual PDF
MELSEC iQ-R Channel Isolated Analog-Digital Converter Module User's Manual (Startup) [SH-081485ENG]	Performance specifications, procedures before operation, wiring, programming, and offset/gain setting of the A/D converter module	Print book e-Manual PDF
MELSEC iQ-R Programming Manual (Module Dedicated Instructions) [SH-081976ENG]	Dedicated instructions for the intelligent function modules	e-Manual PDF
MELSEC iQ-R Analog-Digital Converter Module/Digital-Analog Converter Module Function Block Reference [BCN-P5999-0375]	FBs of the A/D converter modules and D/A converter modules	e-Manual PDF
GX Works3 Operating Manual [SH-081215ENG]	System configuration, parameter settings, and online operations of GX Works3	e-Manual PDF
MELSEC iQ-R Online Module Change Manual [SH-081501ENG]	The online module change, which allows a module to be changed without stopping the system for MELSEC iQ-R series programmable controllers	Print book e-Manual PDF



e-Manual refers to the Mitsubishi Electric FA electronic book manuals that can be browsed using a dedicated tool.

e-Manual has the following features:

- Required information can be cross-searched in multiple manuals.
- Other manuals can be accessed from the links in the manual.
- The hardware specifications of each part can be found from the product figures.
- Pages that users often browse can be bookmarked.
- Sample programs can be copied to the engineering tool.

TERMS

Unless otherwise specified, this manual uses the following terms.

Term	Description
Buffer memory	A memory in an intelligent function module for storing data (such as setting values and monitored values). For a CPU module, it refers to a memory for storing data (such as setting values and monitored values of the Ethernet function, data used for data communications of the multiple CPU system function).
Engineering tool	A tool that is used to configure settings of a programmable controller and perform programming, debug, and maintenance of a programmable controller
Global label	A label that is valid for all the program data when multiple program data are created in the project. There are two types of global label: a module specific label (module label), which is generated automatically by GX Works3, and an optional label, which can be created for any specified device.
Module Label	A label that represents one of memory areas (I/O signals and buffer memory areas) specific to each module in a given character string. For the module used, GX Works3 automatically generates this label, which can be used as a global label.
Normal mode	A mode used for normal A/D conversion. In the engineering tool, the item name of the mode is displayed as "Normal mode (A/D conversion process)".
Offset/gain setting mode	A mode used for performing the offset/gain setting
Q compatible mode	A mode in which the module operates with the buffer memory map converted to the equivalent one of the MELSEC Q series
R mode	A mode in which the module operates with the buffer memory map that has been newly laid out in the MELSEC iQ-R series
Redundant system with redundant extension base unit	A redundant system that is configured using extension base unit(s)
SIL2 mode	An operation mode of the I/O module and the intelligent function module to perform safety input and output at the SIL2 level.
Standard mode	A mode for using the A/D converter module in a normal system
User range	An analog input range where any value can be set. This range can be set in the offset/gain setting.
Watchdog timer error	An error that occurs if the internal processing of the module fails. The module monitors its own internal processing by using the watchdog timer.

GENERIC TERMS AND ABBREVIATIONS

Unless otherwise specified, this manual uses the following generic terms and abbreviations.

Generic term/abbreviation	Description
A/D converter module	An abbreviation for the MELSEC iQ-R series channel isolated analog-digital converter module
Factory default setting	A generic term for analog input ranges of 0 to 10V, 0 to 5V, 1 to 5V, -10 to 10V, 0 to 20mA, 4 to 20mA, 1 to 5V (extended mode), and 4 to 20mA (extended mode). In the window on the engineering tool, 4 to 20mA (extended mode) and 1 to 5V (extended mode) are displayed as the following: <ul style="list-style-type: none"> • 4 to 20mA (Extension) • 1 to 5V (Extension)
Remote head module	The abbreviation for the RJ72GF15-T2 CC-Link IE Field Network remote head module

This part consists of the following chapters. These chapters describe the details on using the A/D converter module in standard mode.

1 FUNCTIONS

2 PARAMETER SETTINGS

3 TROUBLESHOOTING

APPENDICES (STANDARD MODE)

1 FUNCTIONS

This chapter describes the functions of the A/D converter module and the setting procedures for those functions. For details on the I/O signals and the buffer memory, refer to the following.

☞ Page 114 I/O Signals

☞ Page 124 Buffer Memory Areas

Point

- This chapter describes buffer memory addresses for CH1. For details on the buffer memory addresses after CH2, refer to the following.

☞ Page 124 List of buffer memory addresses

- Numerical values corresponding to the channel where an error has occurred and the error description fit in the □ and △ of an error code and alarm code described in this chapter. For details on the numerical values, refer to the following.

☞ Page 107 List of Error Codes

☞ Page 111 List of Alarm Codes

1.1 Processing of Each Function

The functions are processed in the order shown below. If multiple functions are enabled, the output of the first processed function is used as the input of the next function.

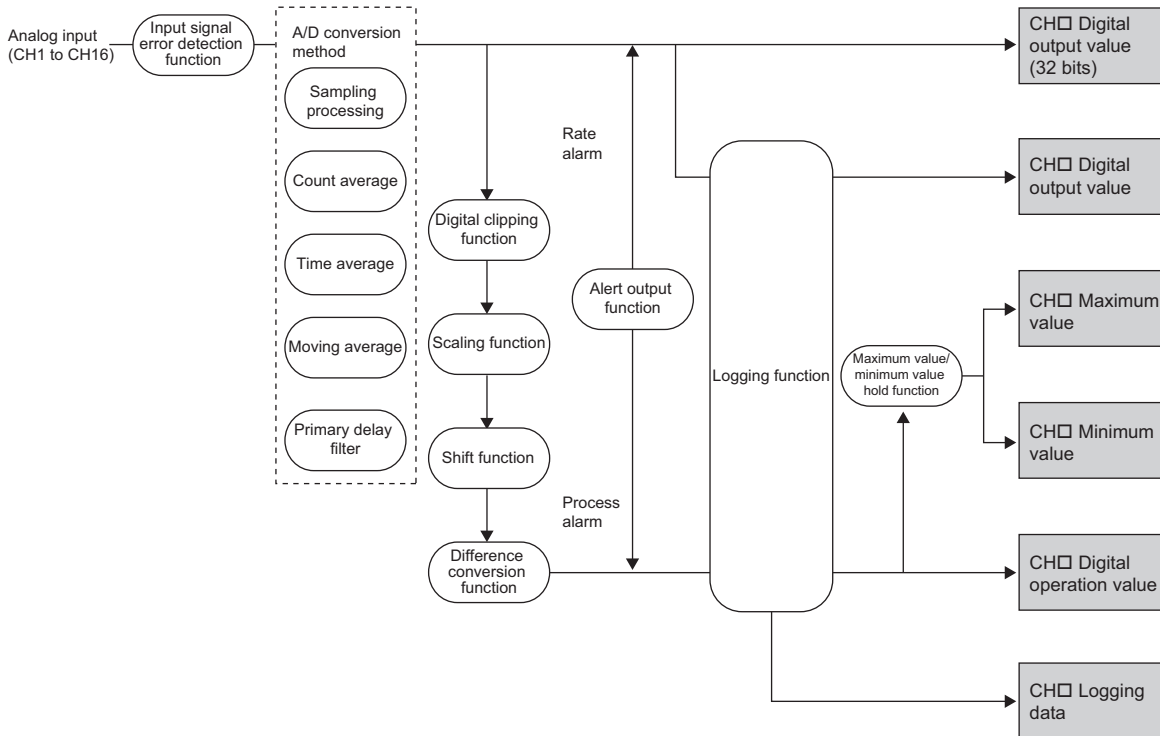

Digital output value (32 bits)

These values are the digital values after the sampling processing, each averaging processing, or primary delay filter has been performed.

Digital output value

These values are the 16-bit digital output values that were converted from 32-bit digital output values.

Digital operation value

These values are obtained by operating a digital output value using the digital clipping function, scaling function, shift function, or difference conversion function. When each function is not used, the same value as the digital output value is stored.

Maximum and minimum value

The maximum and minimum values of the digital operation values are stored.

Logging data

When the logging function is used, digital output values or digital operation values are collected.

1.2 Range Switching Function

This function allows switching the input range of an analog input for each channel. Switching the range makes it possible to change the I/O conversion characteristic.

Operation

Analog input values are converted to digital values within the set input range, and the converted values are stored in the following areas.

- 'CH1 Digital output value' (Un\G400)
- 'CH1 Digital operation value' (Un\G402)
- 'CH1 Digital output value (32 bits)' (Un\G410, Un\G411)

The data of 32768 or more cannot be output to 'CH1 Digital output value' (Un\G400) or 'CH1 Digital operation value' (Un\G402).

To check the data of 32768 or more, monitor 'CH1 Digital output value (32 bits)' (Un\G410, Un\G411).

Point

Digital output values (32768 to 36767) in the extended mode can be monitored within the range of 'CH1 Digital operation value' (Un\G402) with the shift function or scaling function.

For details, refer to the following.

☞ Page 50 Shift Function

☞ Page 26 Scaling Function

Setting procedure

Set the input range to be used in the "Input range setting".

🔍 [Navigation window] ⇒ [Parameter] ⇒ [Module Information] ⇒ Module model name ⇒ [Basic setting] ⇒ [Range switching function]

Input range setting	Digital output value
4 to 20mA	0 to 32000
0 to 20mA	
1 to 5V	
0 to 5V	
-10 to 10V	-32000 to 32000
0 to 10V	0 to 32000
4 to 20mA (extended mode)	-8000 to 36000
1 to 5V (extended mode)	
User range setting	-32000 to 32000

After the data is written, the range is switched when the programmable controller power supply is turned off and on or when the CPU module is reset.

Point

The range can be switched or set with the following buffer memory areas.

- 'CH1 Range setting' (Un\G598)
- 'CH1 Range setting monitor' (Un\G430)

For details on the buffer memory addresses, refer to the following.

☞ Page 193 CH1 Range setting

☞ Page 157 CH1 Range setting monitor

Precautions

The input range cannot be changed for channels with A/D conversion disabled. To change the input range, set "A/D conversion enable/disable setting" to "A/D conversion enable".

1.3 A/D Conversion Enable/Disable Setting Function

This function controls whether to enable or disable the A/D conversion for each channel.
Disabling the A/D conversion for unused channels reduces the A/D conversion cycles.

Setting procedure

Set "A/D conversion enable/disable setting" to "A/D conversion enable" or "A/D conversion disable".

 [Navigation window] ⇒ [Parameter] ⇒ [Module Information] ⇒ Module model name ⇒ [Basic setting] ⇒ [A/D conversion enable/disable setting function]

1.4 A/D Conversion Method

An A/D conversion method can be set for each channel.

Sampling processing

This function converts analog input values to digital values at every sampling period and stores the digital output values in buffer memory areas.

Point

The sampling period is "Conversion speed (10ms) × number of conversion enabled channels".

Whether to enable or disable the A/D conversion can be set for each channel. Disabling the A/D conversion for unused channels reduces the A/D conversion cycles.

Conversion cycle that applies when CH1 to CH3 is set to A/D conversion enabled

- $10 \times 3 = 30$ (ms)

The conversion cycle is 30 (ms).

Digital output values and digital operation values of CH1 to CH3 are updated every 30ms.

Averaging processing

The A/D converter module performs the averaging processing on digital output values for each channel. The processed values are stored in the buffer memory area.

The following three types of averaging processing are provided.

- Time average
- Count average
- Moving average

■Time average

The A/D converter module executes the A/D conversion for the setting time, and performs the averaging processing on the total value excluding the maximum and the minimum values. The processed values are stored in the buffer memory area.

- Setting time

Set a value that satisfies the following condition.

Lower limit value to be set \geq Conversion speed × Number of conversion enabled channels × Minimum number of processing times (4 times)

Ex.

The following shows the lower limit value to be set for when CH1 to CH8 are used.

$$10 \text{ (ms)} \times 8 \text{ (CH)} \times 4 \text{ (times)} = 320 \text{ (ms)}$$

- Processing times

The number of processing times within the set time changes depending on the number of channels where the A/D conversion is enabled.

$$\text{Number of processing times} = \frac{\text{Setting time}}{(\text{Number of conversion enabled channels} \times \text{Conversion speed})}$$

Ex.

The following table shows the processing times with the setting below.

Item	Setting
Number of channels where the A/D conversion is enabled	Four channels (CH1 to CH4)
Setting time	250ms

$$\frac{250}{(4 \times 10)} = 6.25^{*1}$$

*1 Values after the decimal point are omitted.

Conversion is processed 6 times and the mean value is output.

Point

When the number of processing times is less than 4 due to the set time, a time average setting range error (error code: 192□H) occurs. The value 0 is stored in the following buffer memory areas.

- 'CH1 Digital output value' (Un\G400)
- 'CH1 Digital operation value' (Un\G402)
- 'CH1 Digital output value (32 bits)' (Un\G410, Un\G411)

Count average

The A/D converter module executes the A/D conversion for a set number of times, and performs the averaging processing on the total value excluding the maximum and the minimum values. The processed values are stored in the buffer memory area. The time taken for the mean value calculated through the average processing to be stored in the buffer memory changes depending on the number of channels where the A/D conversion is enabled.

Processing time = Set number of times × (Number of conversion enabled channels × Conversion speed)

Ex.

The following table shows the processing time with the setting below.

Item	Setting
Number of channels where the A/D conversion is enabled	Four channels (CH1 to CH4)
Set number of times	Five times

5 (times) × (4 (CH) × 10 (ms)) = 200 (ms)

A mean value is output every 200ms.

Point

Because the count average requires a sum of at least two counts excluding the maximum and minimum values, the set number of times should be four or more.

Moving average

The A/D converter module averages digital output values taken at every sampling period for a specified number of times, and stores the mean value in the buffer memory area. Since the averaging processing is performed on a moving set of sampling, the latest digital output values can be obtained.

The following figure shows the moving average processing of when the set number of times is five.

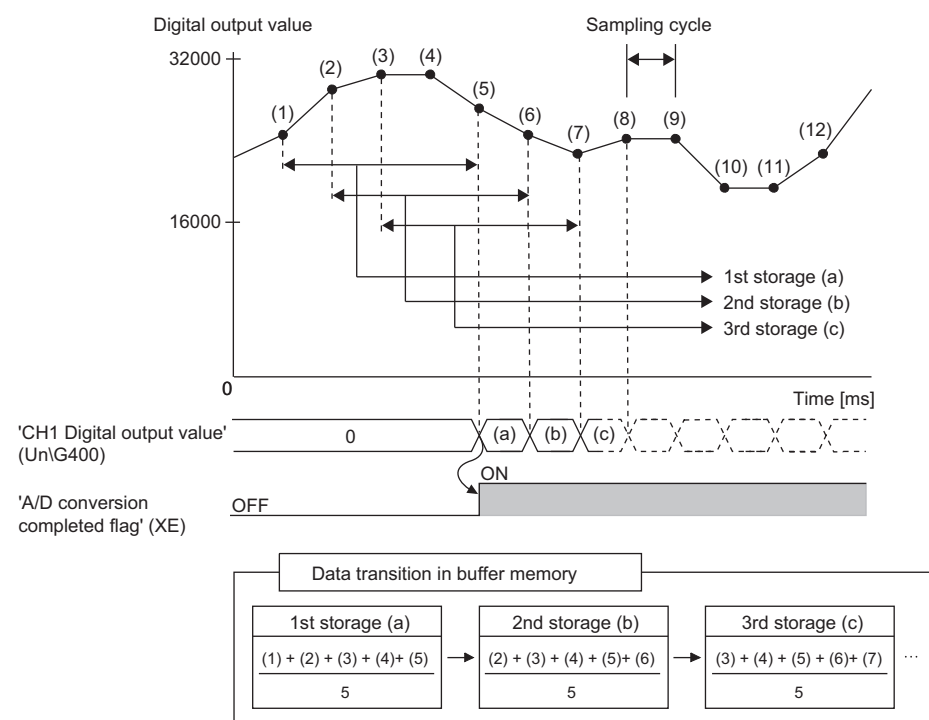

Primary delay filter

Depending on the set time constant, transient noise of analog input is smoothed. The smoothed digital output values are stored in the buffer memory area.

Time constant is the time taken for the digital output value to reach 63.2% of the steady-state value.

The following shows the relational expressions of time constants and digital output values.

When $n = 1$ *1

$$Y_n = 0$$

When $n = 2$

$$Y_n = X_{n-1} + \frac{\Delta t}{\Delta t + TA} (X_n - X_{n-1})$$

When $n \geq 3$

$$Y_n = Y_{n-1} + \frac{\Delta t}{\Delta t + TA} (X_n - Y_{n-1})$$

Y_n : Current digital output value

Y_{n-1} : Last digital output value

n : Number of samplings

X_n : Digital output value before smoothing

X_{n-1} : Last digital output value before smoothing

ΔT : Conversion time

TA : Time constant

*1 The corresponding bit of 'A/D conversion completed flag' (Un\G42) turns on when $n \geq 2$.

Ex.

Digital output value when an analog input value is changed from 0 to 1V

The following figure shows the change of the digital output value with the input range of 0 to 10V and time constant (Conversion cycle \times Primary delay filter) of 40ms.

After 40ms from the analog input value becomes 1V, the digital output value reaches 63.2% of the digital output value of when the sampling processing is selected.

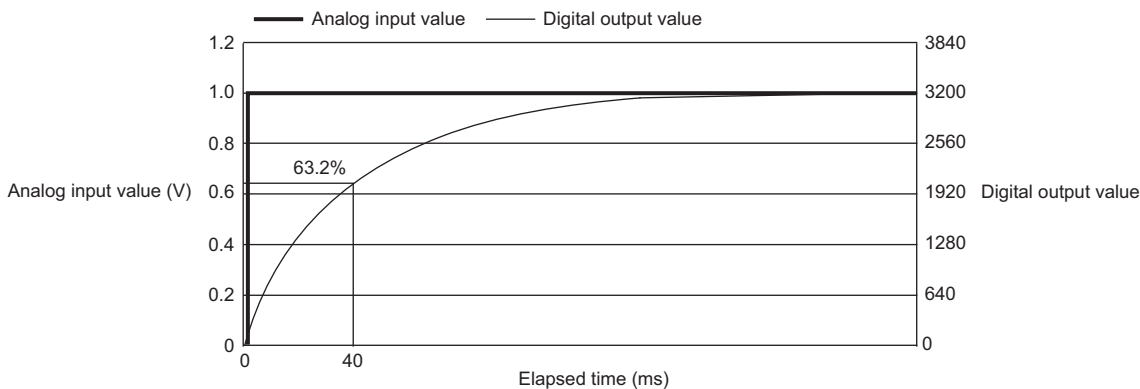

Setting procedure

■ Sampling processing

Set "Averaging process specification" to "Sampling processing".

[Navigation window] ⇒ [Parameter] ⇒ [Module Information] ⇒ Module model name ⇒ [Basic setting] ⇒ [A/D conversion method]

■ Averaging processing and primary delay filter

1. Set "Averaging process specification" to "Time average", "Count average", "Moving average", or "Primary delay filter".

[Navigation window] ⇒ [Parameter] ⇒ [Module Information] ⇒ Module model name ⇒ [Basic setting] ⇒ [A/D conversion method]

2. Set a value for "Time average/Count average/Moving average/Primary delay filter constant setting".

Item	Setting range
Time average	40 to 5000 (ms) ^{*1}
Count average	4 to 500 (times)
Moving average	2 to 200 (times)
Primary delay filter	1 to 500 (times)

*1 Set a value greater than the value calculated by the following formula as the time average.
 Conversion speed × Number of conversion enabled channels × Minimum processing times (4 times)

1.5 Scaling Function

This function performs the scale conversion on digital output values. The values are converted within a specified range between a scaling upper limit value and scaling lower limit value. This function helps reduce the time taken for creating a scale conversion program.

The converted values are stored in 'CH1 Digital operation value' (Un\G402).

Concept of scaling setting

Ex.

When the input range is set to -10 to 10V:

For the scaling lower limit value, set a value corresponding to the lower limit value of the input range (-32000).

For the scaling upper limit value, set a value corresponding to the upper limit value of the input range (32000).

Calculating the scaling value

The scale conversion is based on the following formula. (In scale conversion, values are rounded to the nearest whole number.)

Current: 0 to 20mA, 4 to 20mA, 4 to 20mA (extended mode)^{*1}, user range setting (current)

Voltage: 0 to 10V, 0 to 5V, 1 to 5V, 1 to 5V (extended mode)^{*1}, user range setting (voltage)

$$D_Y = \frac{D_X \times (S_H - S_L)}{D_{Max}} + S_L$$

Voltage: -10 to 10V

$$D_Y = \frac{D_X \times (S_H - S_L)}{D_{Max} - D_{Min}} + \frac{(S_H + S_L)}{2}$$

D_X : Digital output value

D_Y : Scaling value (Digital operation value)

D_{Max} : Maximum digital output value of the input range in use

D_{Min} : Minimum digital output value of the input range in use

S_H : Scaling upper limit value

S_L : Scaling lower limit value

*1 Although the range of the digital output value in the extended mode is -8000 to 36000, this function performs the scale conversion for digital output values within the range of 0 to 32000.

Point

When the calculated digital operation value exceeds 32767, the value 32767 is stored as the digital operation value. When the calculated digital operation value is falls below -32768, the value -32768 is stored.

Setting procedure

1. Set "Scaling enable/disable setting" to "Enable".

[Navigation window] ⇨ [Parameter] ⇨ [Module Information] ⇨ Module model name ⇨ [Application setting] ⇨ [Scaling setting]

2. Set values for "Scaling upper limit value" and "Scaling lower limit value".

Item	Setting range
Scaling upper limit value	-32000 to 32000
Scaling lower limit value	

Point

- Even when the scaling upper limit value and the scaling lower limit value are set so that the change is greater than the resolution, the resolution will not increase.
- If the relation between the values is the scaling lower limit value > the scaling upper limit value, the scale conversion can be performed according to a negative slope.
- Set the scaling with the condition "Scaling upper limit value ≠ Scaling lower limit value".

Setting example

Ex.

When 20000 is set to the scaling upper limit value and 4000 is set to the scaling lower limit value for the module with the input range of 0 to 5V

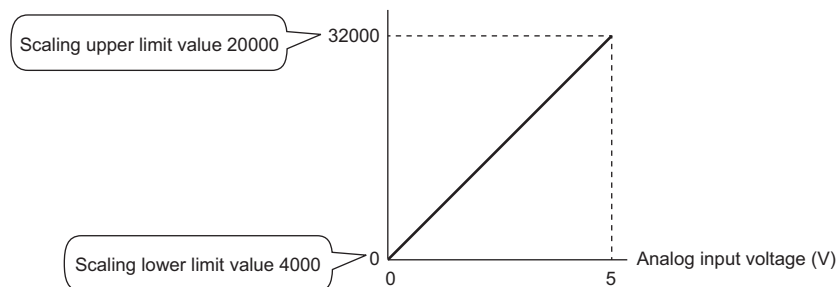

Voltage input (V)	Digital output value*1	Digital operation value (scaling value)
0	0	4000
1	6400	7200
2	12800	10400
3	19200	13600
4	25600	16800
5	32000	20000

*1 These values are also applied to the case of digital output values (32 bits).

Ex.

When 20000 is set to the scaling upper limit value and 4000 is set to the scaling lower limit value for the module with the input range of -10 to 10V

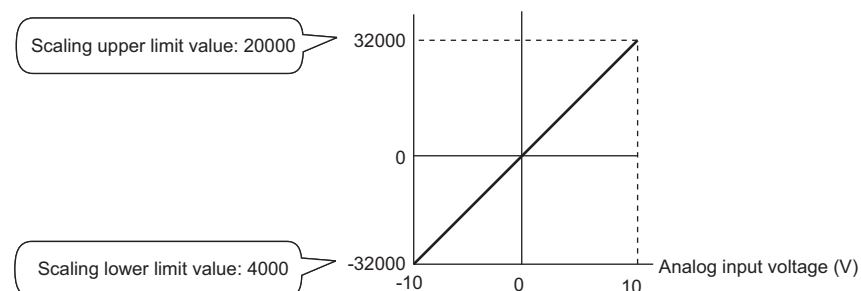

Voltage input (V)	Digital output value*1	Digital operation value (scaling value)
-10	-32000	4000
-5	-16000	8000
0	0	12000
5	16000	16000
10	32000	20000

*1 These values are also applied to the case of digital output values (32 bits).

Ex.

When 20000 is set to the scaling upper limit value and 4000 is set to the scaling lower limit value for the module with the input range of 1 to 5V (extended mode)

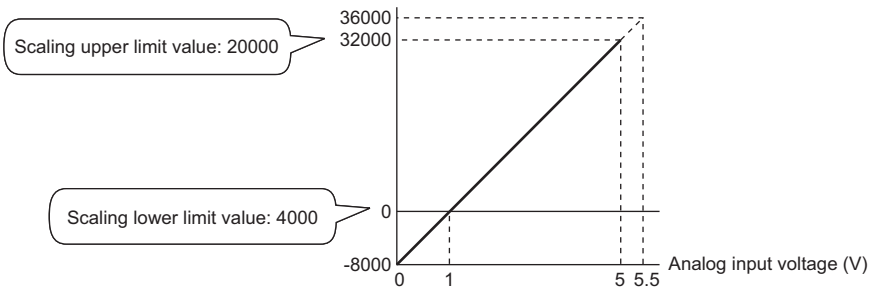

Voltage input (V)	Digital output value		Digital operation value (scaling value)
	16 bits	32 bits	
0	-8000	-8000	0
1	0	0	4000
2	8000	8000	8000
3	16000	16000	12000
4	24000	24000	16000
5	32000	32000	20000
5.5	32767 ^{*1}	36000	22000

*1 Because the value exceeds the range of -32768 to 32767, the value is fixed to 32767 (the upper limit value).

Ex.

When 32000 is set to the scaling upper limit value and -32000 is set to the scaling lower limit value for the module with the input range of 4 to 20mA (extended mode)

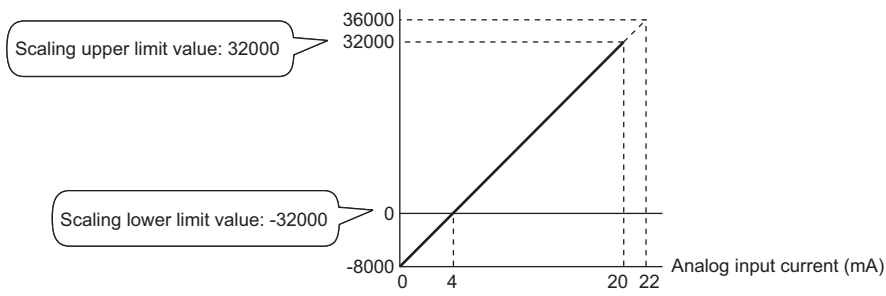

Current input (mA)	Digital output value		Digital operation value (scaling value)
	16 bits	32 bits	
0	-8000	-8000	-32768 ^{*1}
4	0	0	-32000
8	8000	8000	-16000
12	16000	16000	0
16	24000	24000	16000
20	32000	32000	32000
20.24	32480	32480	32767 ^{*2}
22	32767 ^{*2}	36000	32767 ^{*2}

*1 Because the value falls below the range of -32768 to 32767, the value is fixed to -32768 (the lower limit value).

*2 Because the value exceeds the range of -32768 to 32767, the value is fixed to 32767 (the upper limit value).

Point

When the scaling function is used with the digital clipping function, the scale conversion is performed on the digital operation values after digital clipping.

1.6 Alert Output Function

This section describes process alarms and rate alarms used for the alert output function.

Process alarm

This function outputs an alert when a digital operation value enters the preset alert output range.

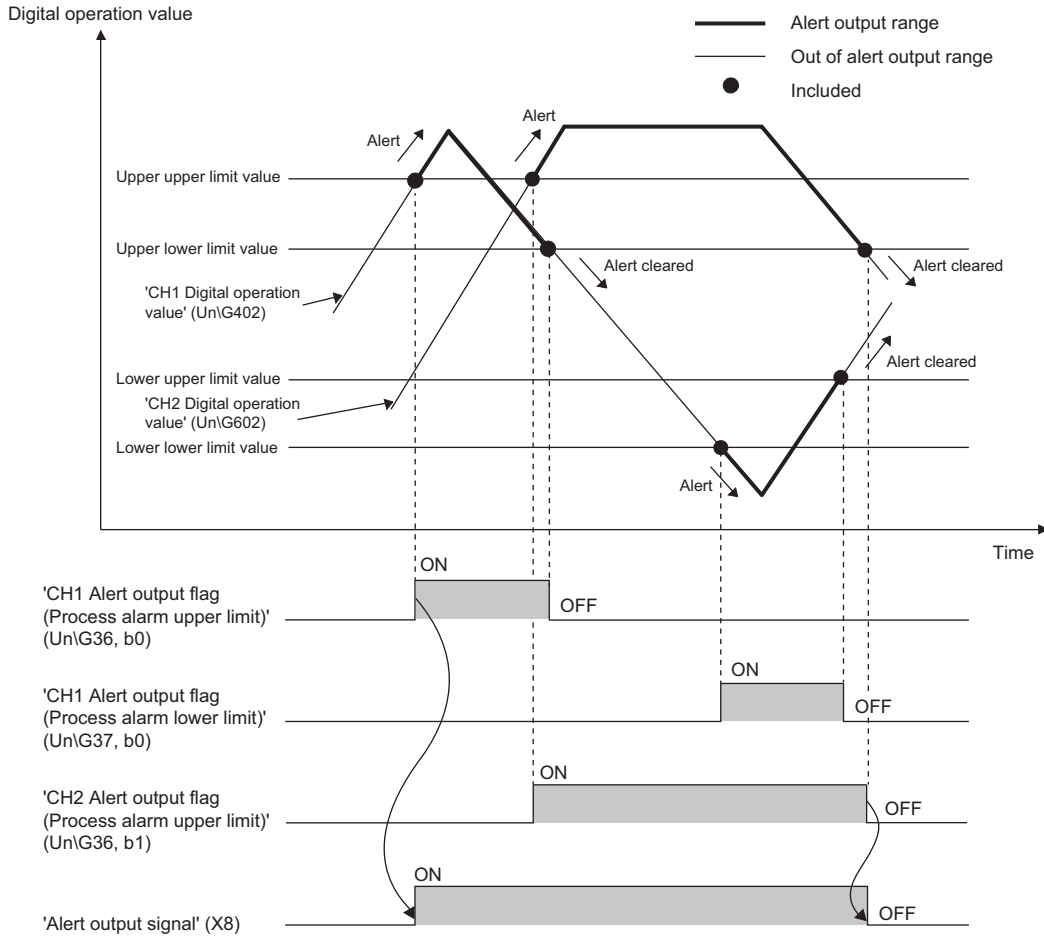

Operation

■ Operation performed when an alert is output

When a digital operation value is equal to or greater than 'CH1 Process alarm upper upper limit value' (Un\G514), or the value is equal to or smaller than 'CH1 Process alarm lower lower limit value' (Un\G520) and the value enters the alarm output range, an alert is output as follows.

- Alarm ON (1) is stored in 'Alert output flag (Process alarm upper limit)' (Un\G36) or 'Alert output flag (Process alarm lower limit)' (Un\G37).
- 'Alert output signal' (X8) turns on.
- The ALM LED turns on.

In addition, an alarm code is stored in 'Latest alarm code' (Un\G2).

For details on the alarm codes, refer to the following.

 Page 111 List of Alarm Codes

Point

The A/D conversion on a channel where an alert was output continues.

■ Operation after an alert was output

After an alert was output, if the digital operation value does not satisfy the alert output condition due to being smaller than 'CH1 Process alarm upper lower limit value' (Un\G516) or being greater than 'CH1 Process alarm lower upper limit value' (Un\G518), Normal (0) is stored in a bit position corresponding to the channel number of 'Alert output flag (Process alarm upper limit)' (Un\G36) or 'Alert output flag (Process alarm lower limit)' (Un\G37).

In addition, when all the bits of 'Alert output flag (Process alarm upper limit)' (Un\G36) and 'Alert output flag (Process alarm lower limit)' (Un\G37) return to Normal (0), 'Alert output signal' (X8) turns off and the ALM LED turns off. However, the alarm code stored in 'Latest alarm code' (Un\G2) is not cleared. To clear the alarm code, turn on and off 'Error clear request (YF)' after all the bits of 'Alert output flag (Process alarm upper limit)' (Un\G36) and 'Alert output flag (Process alarm lower limit)' (Un\G37) return to Normal (0).

Detection cycle

When time average is specified, the function works at every interval of the time (for averaging). When count average is specified, the function works at every count (for averaging).

When the sampling processing, moving average, and primary delay filter is specified, this function works at every sampling cycle.

Detection target for outputting an alert

When the digital clipping function, scaling function, shift function, or difference conversion function is used, the digital operation value obtained after digital clipping, scale conversion, shift-and-add, or difference conversion is performed is the detection target for outputting an alert. Set values for 'CH1 Process alarm upper upper limit value' (Un\G514), 'CH1 Process alarm upper lower limit value' (Un\G516), 'CH1 Process alarm lower upper limit value' (Un\G518), and 'CH1 Process alarm lower lower limit value' (Un\G520) while considering the digital clipping, scale conversion, shift-and-add, and difference conversion.

Setting procedure

1. Set "Alert output setting (Process alarm)" to "Enable".

 [Navigation window] ⇒ [Parameter] ⇒ [Module Information] ⇒ Module model name ⇒ [Application setting] ⇒ [Alert output function (Process alarm)]

2. Set values for "Process alarm upper upper limit value", "Process alarm upper lower limit value", "Process alarm lower upper limit value", and "Process alarm lower lower limit value".

Item	Setting range
Process alarm upper upper limit value	-32768 to 32767
Process alarm upper lower limit value	
Process alarm lower upper limit value	
Process alarm lower lower limit value	

Point

Set values within the range satisfying the condition "Process alarm upper upper limit value \geq Process alarm upper lower limit value \geq Process alarm lower upper limit value \geq Process alarm lower lower limit value". If a value out of the range is set, a process alarm upper lower limit value setting range error (error code: 1B△□H) occurs.

Rate alarm

This function outputs an alert when the change rate of a digital output value is equal to or greater than the rate alarm upper limit value, or the rate is equal to or smaller than the rate alarm lower limit value.

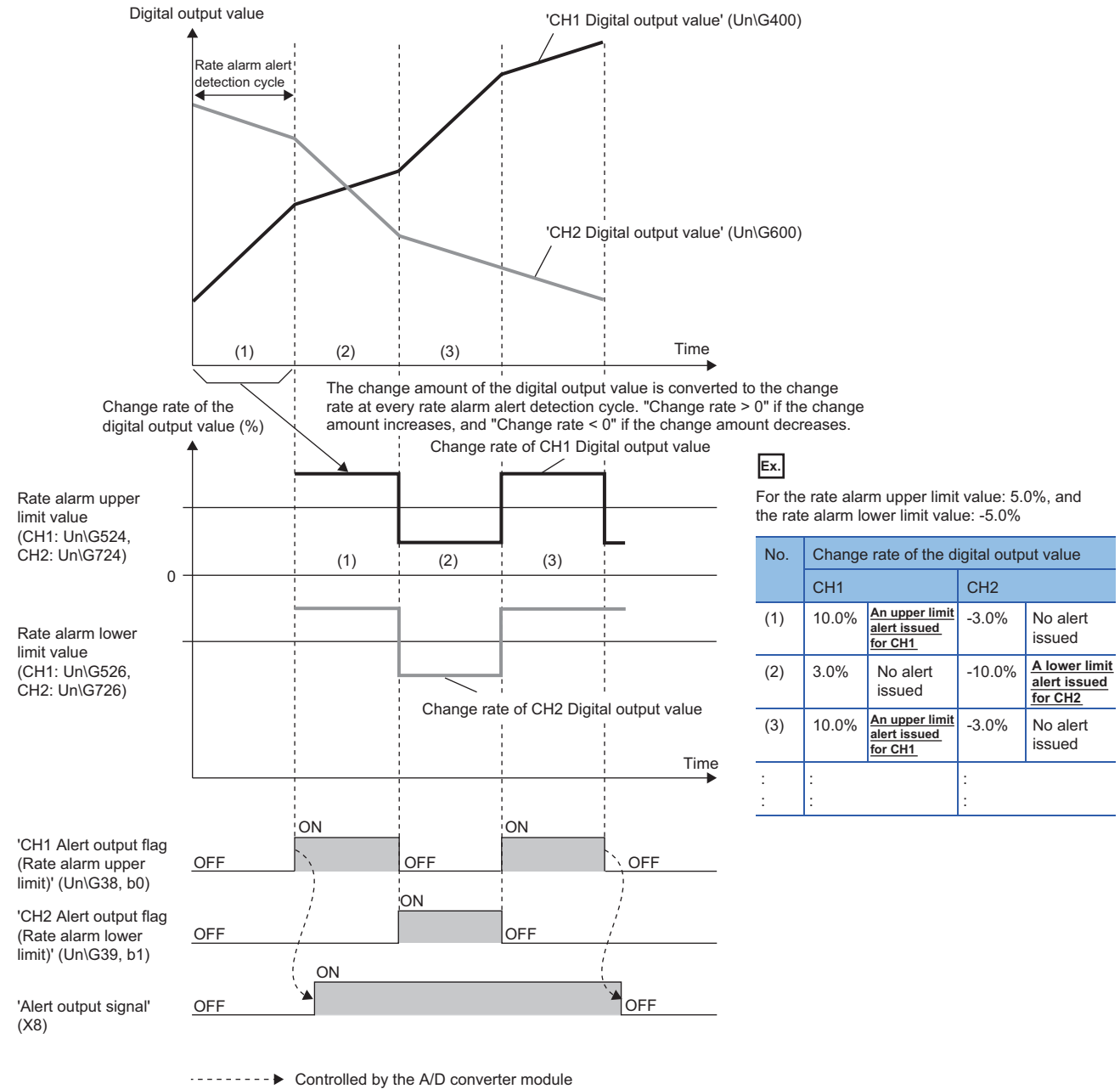

Operation

■ Operation performed when an alert is output

Digital output values are monitored on the rate alarm alert detection cycle. When a change rate of a digital output value (from a previous value) is equal to or more than the rate alarm upper limit value, or the rate is equal to or less than the rate alarm lower limit value, an alert is output as follows.

- Alarm ON (1) is stored in 'Alert output flag (Rate alarm upper limit)' (Un\G38) or 'Alert output flag (Rate alarm lower limit)' (Un\G39).
- 'Alert output signal' (X8) turns on.
- The ALM LED turns on.

In addition, an alarm code is stored in 'Latest alarm code' (Un\G2).

For details on the alarm codes, refer to the following.

 Page 111 List of Alarm Codes

Point

The A/D conversion on a channel where an alert was output continues.

■ Operation after an alert was output

After an alert was output, if the change rate of a digital output value does not satisfy the alert output conditions due to being smaller than the rate alarm upper limit value or being greater than the rate alarm lower limit value, Normal (0) is stored in a bit position corresponding to the channel number of 'Alert output flag (Rate alarm upper limit)' (Un\G38) or 'Alert output flag (Rate alarm lower limit)' (Un\G39).

In addition, when all 'Alert output flag (Rate alarm upper limit)' (Un\G38) and 'Alert output flag (Rate alarm lower limit)' (Un\G39) return to Normal (0), 'Alert output signal' (X8) turns off and the ALM LED turns off. However, the alarm code stored in 'Latest alarm code' (Un\G2) is not cleared. To clear the alarm code, turn on and off 'Error clear request (YF)' after all the bits of 'Alert output flag (Rate alarm upper limit)' (Un\G38) and 'Alert output flag (Rate alarm lower limit)' (Un\G39) return to Normal (0).

Detection cycle

Set the rate alarm alert detection cycle in 'CH1 Rate alarm alert detection cycle setting' (Un\G522).

The rate alarm alert detection cycle is the value calculated by multiplying the set value by the conversion cycle.

Ex.

The rate alarm alert detection cycle under the following conditions

- A/D conversion-enabled channels: CH1 to CH3
- 'CH1 Rate alarm alert detection cycle setting' (Un\G522): 5 (times)

The rate alarm alert detection cycle is 150ms. (10ms × 3 (CH) × 5 (times))

Digital output values are compared in 150ms intervals to check the change rate.

Judgment of rate alarm

A change rate is judged with 'CH1 Rate alarm upper limit value' (Un\G524) and 'CH1 Rate alarm lower limit value' (Un\G526) converted to digital values per rate alarm alert detection cycle.

The following shows the conversion formula of judgment values used for the rate alarm detection.

$$\text{Value used for judgement at each Rate alarm alert detection cycle [digit]} = \left(\frac{R_H \text{ or } R_L}{1000} \right) \times D_{\text{Max}}$$

Item	Description
R _H	Rate alarm upper limit value (Unit: 0.1%)
R _L	Rate alarm lower limit value (Unit: 0.1%)
D _{Max}	Maximum digital output value of the input range <ul style="list-style-type: none"> • Other than extended mode: 32000 • Extended mode: 36000

Point

Values after the decimal point are omitted.

Ex.

The judgment value under the following conditions

- Input range: 4 to 20mA
- A/D conversion-enabled channel: CH1
- 'CH1 Averaging process specification' (Un\G501): Sampling processing (0)
- 'CH1 Rate alarm alert detection cycle setting' (Un\G522): 5 (times)
- 'CH1 Rate alarm upper limit value' (Un\G524): 250 (25.0%)
- 'CH1 Rate alarm lower limit value' (Un\G526): 50 (5.0%)

$$\text{Upper limit value: } \frac{250}{1000} \times 32000 = 8000 \text{ (digit)}$$

$$\text{Lower limit value: } \frac{50}{1000} \times 32000 = 1600 \text{ (digit)}$$

The present value is compared to the previous value (50ms) in a rate alarm alert detection cycle of 50ms (sampling period 10ms × 5). A digital value is judged if it increases 8000 digits (25.0%) or more, or if the increase is 1600 digits (5.0%) or less from the previous value (when the maximum digital output value is 32000).

Use the following formula to calculate a change rate to be set based on the change amount of voltage and current to detect an alert.

$$\text{Change rate to be set (0.1\%)} = \left(\frac{\text{Change amount of the voltage (current) to detect an alert (V(mA))}}{\text{Gain voltage (current) (V(mA)) - Offset voltage (current) (V(mA))}} \times 1000 \right)^{*1}$$

*1 Values after the decimal point are omitted.

Application examples of rate alarms

A rate alarm serves to monitor that the variation rate of a digital output value lies in a limited range as shown below:

Ex.

To monitor that a rising rate of a digital output value is within the specified range

Change rate of the digital output value (%)

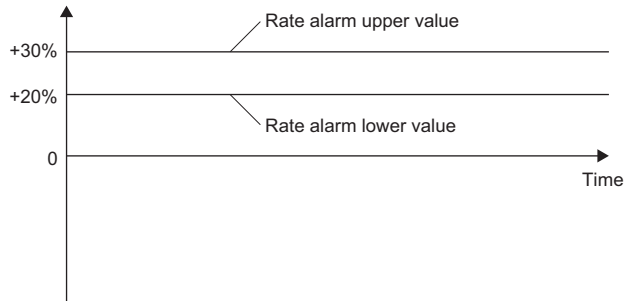

Ex.

To monitor that a drop rate of a digital output value is within the specified range

Change rate of the digital output value (%)

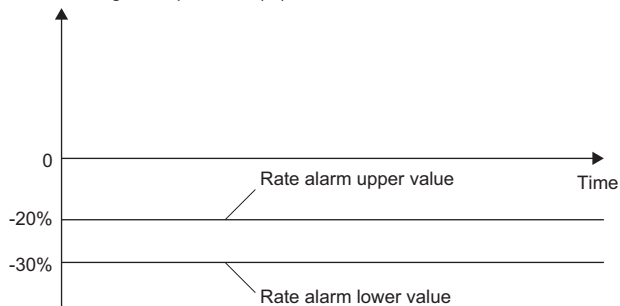

Ex.

To monitor that a change rate of a digital output value is within the specified range

Change rate of the digital output value (%)

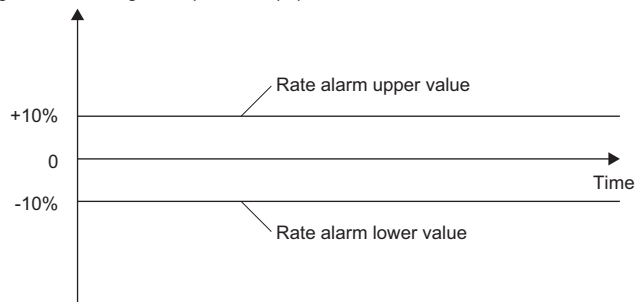

Setting procedure

1. Set "Alert output setting (Rate alarm)" to "Enable".

 [Navigation window] ⇒ [Parameter] ⇒ [Module Information] ⇒ Module model name ⇒ [Application setting] ⇒ [Alert output function (Rate alarm)]

2. Set an alert detection cycle of rate alarms.

Set the cycle in "Rate alarm alert detection cycle setting".

Item	Setting range
Rate alarm alert detection cycle setting	1 to 32000 (times)

Point

In the channel where a value out of the range is set, a rate alarm alert detection cycle setting range error (error code: 1B9□H) occurs.

3. Set values for "Rate alarm upper limit value" and "Rate alarm lower limit value".

Set a value for the maximum value of the digital output value in increments of 0.1%.

- Other than extended mode of the input range: 32000
- Extended mode of the input range: 36000

Item	Setting range
Rate alarm upper limit value	-3276.8 to 3276.7 (%)
Rate alarm lower limit value	

Point

Set values within the range satisfying the condition "Rate alarm upper limit value > Rate alarm lower limit value".

If a value out of the range is set, a rate alarm upper/lower limit setting value inversion error (error code: 1BA□H) occurs.

1.7 Input Signal Error Detection Function

This function outputs an alarm when an analog input value exceeds the preset range.

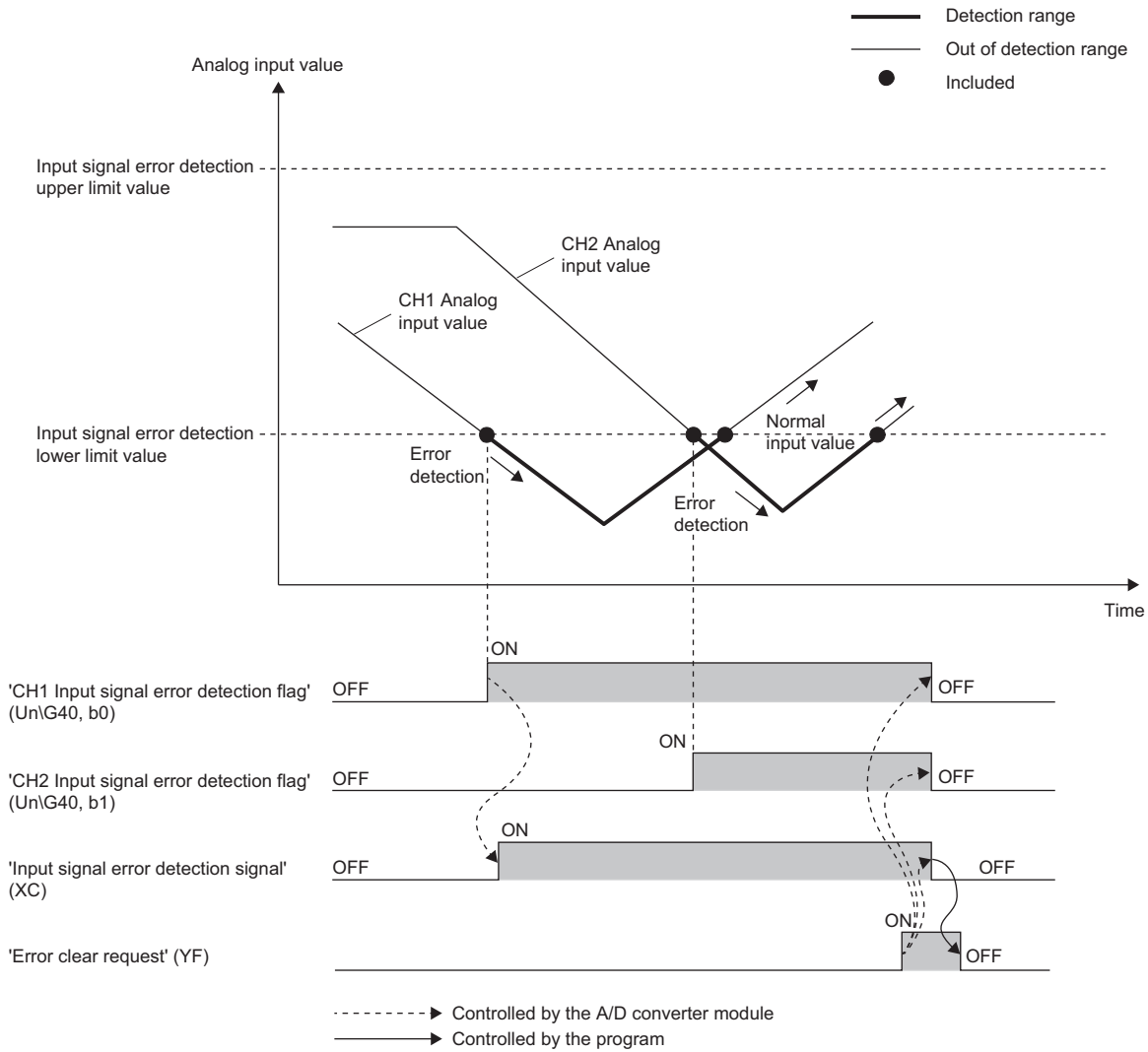

Point

Errors can be cleared using the input signal error detection auto-clear enable/disable setting. For details, refer to the following.

Page 41 Clearing input signal errors

Detection method

One of the following detection methods can be selected.

Detection method	Detection condition	
0: Disable	Input signal errors are not detected.	—
1: Upper and lower limit detection	An input signal error is detected when the analog input value is equal to or greater than the input signal error detection upper limit value, or when the analog input value is equal to or smaller than the input signal error detection lower limit value.	
2: Lower limit detection	An input signal error is detected when the analog input value is equal to or smaller than the input signal error detection lower limit value.	
3: Upper limit detection	An input signal error is detected when the analog input value is equal to or greater than the input signal error detection upper limit value.	
4: Simple disconnection detection	Simple disconnection detection is performed. For details, refer to the following. Page 40 Simple disconnection detection	

■ Simple disconnection detection

This function outputs an alarm when an analog input value is 0.5V or smaller or 2mA or smaller.

By combining this function with the extended mode in the input range setting, simple disconnection detection is enabled.

When an analog input value satisfies either of the following conditions, a disconnection occurs and 'Input signal error detection flag' (Un\G40) turns on.

Input range	Disconnection detection value
4 to 20mA (extended mode)	Analog input value \leq 2mA
1 to 5V (extended mode)	Analog input value \leq 0.5V

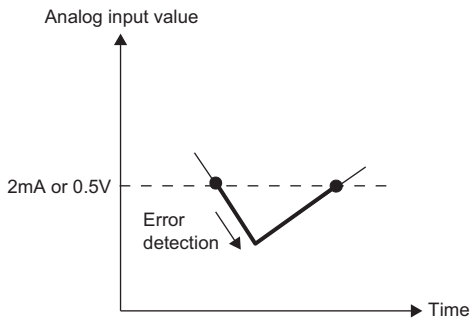

The settings for 'CH1 Input signal error detection lower limit set value' (Un\G529) and 'CH1 Input signal error detection upper limit set value' (Un\G530) are ignored.

Notification

When an input signal error is detected, an error is notified as follows.

- Input signal error (1) is stored in the corresponding bit of 'Input signal error detection flag' (Un\G40).
- 'Input signal error detection signal' (XC) turns on.
- The ALM LED flashes.

In addition, an alarm code is stored in 'Latest alarm code' (Un\G2). Alarm codes are stored whenever the analog input satisfies the condition for the input signal error detection.

For details on the alarm codes, refer to the following.

Page 111 List of Alarm Codes

Operation

On the channel where an error is detected, the last digital output value and digital operation value just before the error was detected are stored.

When the analog input does not satisfy the condition of the input signal error detection, the A/D conversion resumes regardless of the reset on Input signal error detection flag (Un\G40) and Input signal error detection signal (XC). (The ALM LED remains flashing.)

Point

- When an input signal error occurs, the digital output value and digital operation value are not updated.
- The A/D conversion continues on the channel where no Input signal error is detected.
- Whether an input signal error occurred is judged with the value when the first A/D conversion is completed. Thus, the corresponding bit of 'A/D conversion completed flag' (Un\G42) turns on even when an input signal error is detected.

Detection cycle

This function works at every sampling cycle.

Clearing input signal errors

One of the following methods for clearing input signal errors can be selected by setting Input signal error detection auto-clear enable/disable setting (Un\G302).

■When Input signal error detection auto-clear enable/disable setting is set to Enable (0)

After the analog input value returns within the setting range, the A/D converter module arranges the following status automatically. After the analog input value returns within the setting range, turning on and off 'Error clear request' (YF) is not required.

- 'Input signal error detection flag' (Un\G40) is cleared.
- 'Input signal error detection signal' (XC) turns off.
- The ALM LED turns off.

Point

'Latest alarm code' (Un\G2) is not cleared.

After the analog input value returns within the setting range, turn on and off 'Error clear request' (YF) to clear 'Latest alarm code' (Un\G2).

Ex.

The following figure shows the operation when an analog input value falls below 2.4mA and returns within the normal range under the following condition.

- 'Input signal error detection auto-clear enable/disable setting' (Un\G302): Enable (0)
- Input range: 4 to 20mA
- 'CH1 Input signal error detection setting' (Un\G528): Upper and lower limit detection (1)
- Input signal error detection lower limit value: 2.4mA

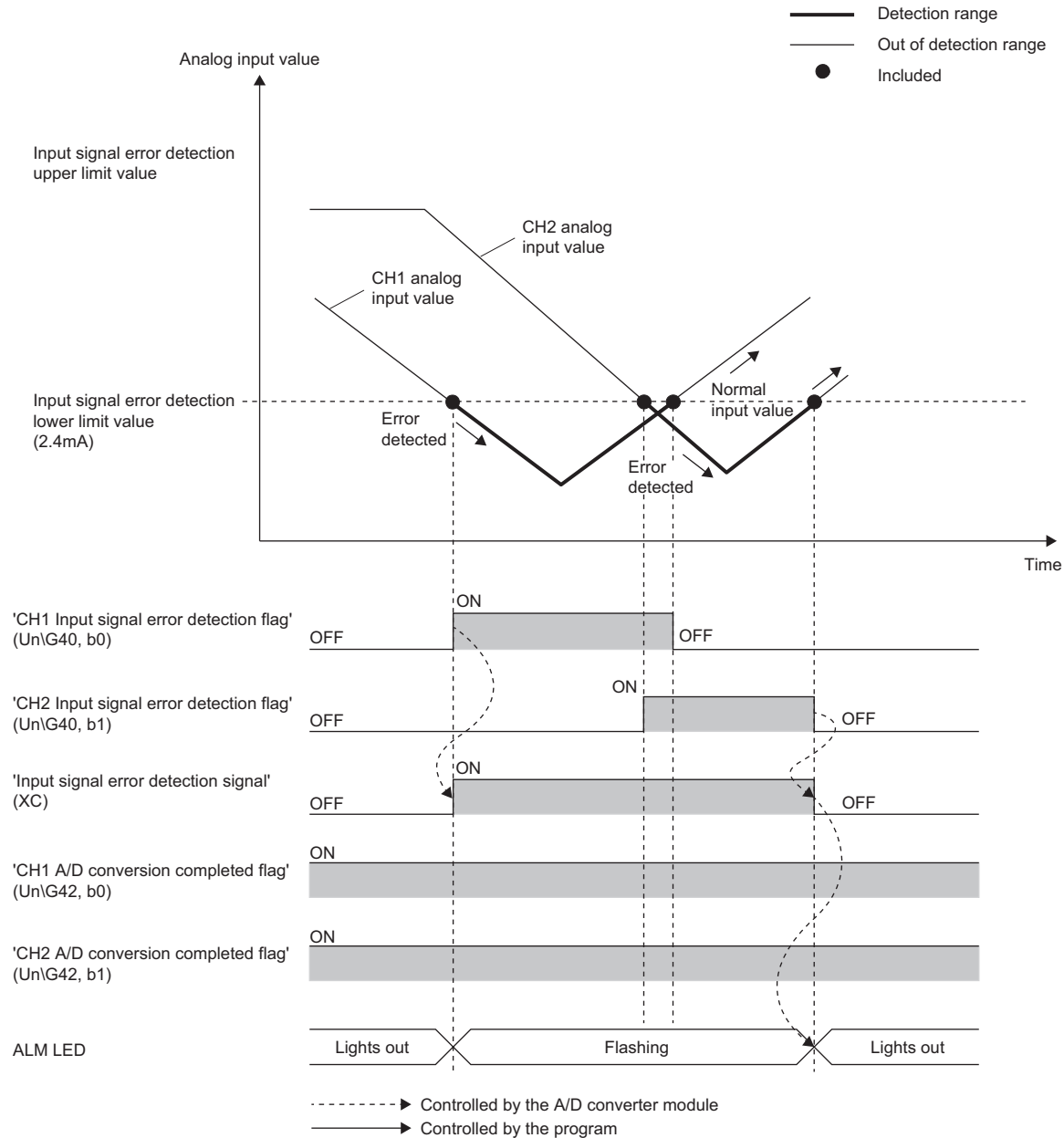

■When Input signal error detection auto-clear enable/disable setting is set to Disable (1)

After the analog input value returns within the set range, turn on and off 'Error clear request' (YF).

The A/D converter module arranges the following status when an input signal error is cleared.

- 'Input signal error detection flag' (Un\G40) is cleared.
- 'Input signal error detection signal' (XC) turns off.
- The ALM LED turns off.
- 'Latest alarm code' (Un\G2) is cleared.

Setting the input signal error detection upper or lower limit value

Input signal error detection upper limit value

Set the input signal error detection upper limit value by 1 (0.1%) based on the input signal error detection upper limit set value. This value is calculated by adding "Analog input range width (Gain value - Offset value) × Input signal error detection upper limit set value (%)" to the gain value. Only a value which is equal to or greater than the gain value can be set.

To calculate the input signal error detection upper limit set value based on the input signal error detection upper limit value, use the following formula.

$$\text{Input signal error detection upper limit setting value} = \frac{\text{Input signal error detection upper limit value} - \text{Gain value of each range}}{\text{Gain value of each range} - \text{Offset value of each range}} \times 1000$$

Input signal error detection lower limit value

Set the input signal error detection lower limit value by 1 (0.1%) based on the input signal error detection lower limit set value. This value is calculated by subtracting "Analog input range width (Gain value - Offset value) × Input signal error detection lower limit set value (%)" from the lower limit value of each range. Only the value which is equal to or smaller than the lower limit value of the range can be set.

To calculate the input signal error detection lower limit set value based on the input signal error detection lower limit value, use the following formula.

$$\text{Input signal error detection lower limit setting value} = \frac{\text{Lower limit value of each range} - \text{Input signal error detection lower limit value}}{\text{Gain value of each range} - \text{Offset value of each range}} \times 1000$$

The following table lists the lower limit value, offset value, and gain value for each range.

Input range		Lower limit value	Offset value	Gain value
Voltage	0 to 10V	0V		10V
	0 to 5V	0V		5V
	1 to 5V	1V		5V
	1 to 5V (extended mode)	1V		5V
	-10 to 10V	-10V	0V	10V
	User range setting	Analog input value equivalent to the digital output value of -32000	Analog input value set as an offset value	Analog input value set as a gain value
Current	0 to 20mA	0mA		20mA
	4 to 20mA	4mA		20mA
	4 to 20mA (extended mode)	4mA		20mA
	User range setting	Analog input value equivalent to the digital output value of -32000	Analog input value set as an offset value	Analog input value set as a gain value

Point

When 'CH1 Input signal error detection setting' (Un\G528) is set to Upper and lower limit detection (1) and the same value is set for 'CH1 Input signal error detection lower limit set value' (Un\G529) and 'CH1 Input signal error detection upper limit set value' (Un\G530), the same operation as the one performed with the following setting can be performed.

- Setting 'CH1 Input signal error detection extension/input signal error detection setting' (Un\G47) to Upper limit value/lower limit value same (0) in the Q compatible mode

For details on the Q compatible mode, refer to the following.

 Page 46 When the function is used in the Q compatible mode

Setting procedure

1. Select a detection method in "Input signal error detection setting".
 [Navigation window] ⇒ [Parameter] ⇒ [Module Information] ⇒ Module model name ⇒ [Application setting] ⇒ [Input signal error detection function]
2. Set values for "Input signal error detection lower limit setting value" and "Input signal error detection upper limit setting value".

Item	Setting range
Input signal error detection lower limit setting value	0.0 to 25.0 (%)
Input signal error detection upper limit setting value	

3. Set "Input signal error detection auto-clear enable/disable setting" to "Enable" or "Disable".

Point

In the channel where a value out of the range is set, an input signal error detection setting value range error (error code: 1C1□H) occurs.

Setting example

■Setting example of the input signal error detection

In the channel where the following values are set, an input error is detected when an analog input value exceeds 21.2mA or falls below 0.4mA.

Item	Setting value
Input range	4 to 20mA
'Input signal error detection auto-clear enable/disable setting' (Un\G302)	Disable (1)
'CH1 Input signal error detection setting' (Un\G528)	Upper and lower limit detection (1)

Assign the following values in a formula to determine the input signal error detection lower limit set value and input signal error detection upper limit set value.

- Input signal error detection lower limit value: 0.4mA
- Input signal error detection upper limit value: 21.2mA
- Offset value: 4.0mA
- Gain value: 20.0mA

Point

For details on the calculation formula, refer to the following.

 Page 43 Setting the input signal error detection upper or lower limit value

[Calculation of lower limit value]

$$\begin{aligned}\text{Input signal error detection lower limit} &= \frac{4.0 - 0.4}{20.0 - 4.0} \times 1000 \\ \text{setting value} &= 225 \text{ (22.5\%)}\end{aligned}$$

Thus, set 'CH1 Input signal error detection lower limit set value' (Un\G529) to 225 (22.5%).

[Calculation of upper limit value]

$$\begin{aligned}\text{Input signal error detection upper limit} &= \frac{21.2 - 20.0}{20.0 - 4.0} \times 1000 \\ \text{setting value} &= 75 \text{ (7.5\%)}\end{aligned}$$

Thus, set 'CH1 Input signal error detection upper limit set value' (Un\G530) to 75 (7.5%).

The following figure shows the operation of the input signal error detection.

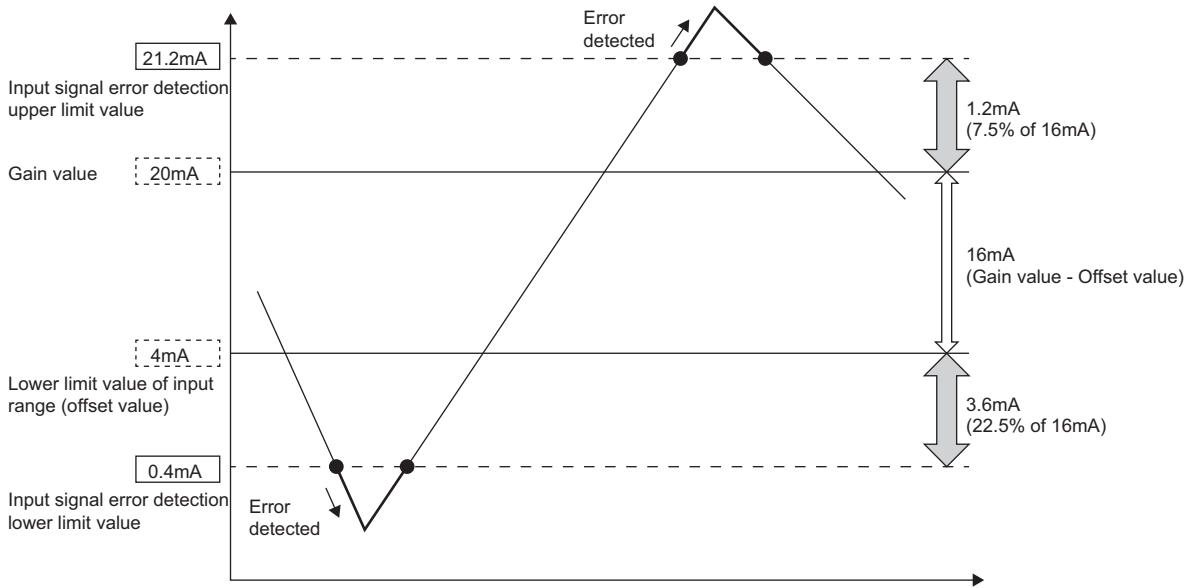

When the function is used in the Q compatible mode

When the input signal error detection function is used in the Q compatible mode, the operation is different from that in the R mode. The following describes only the items that have differences in operation.

Detection condition

An input signal error is detected when the analog input value is equal to or greater than the input signal error detection upper limit value, or when the analog input value is equal to or smaller than the input signal error detection lower limit value.

Detection method

Select a detection method in 'Input signal error detection extension/input signal error detection setting' (Un\G47).

Detection method	Description	
0: Upper limit value/ lower limit value same	The input signal error detection upper limit value and input signal error detection lower limit value are calculated from the same input signal error detection setting value. Thus, the same range can be set for A and B in the right figure.	<p>Input signal error detection setting value: 100 (10%)</p> <p>Analog input value</p> <p>Input signal error detection upper limit value</p> <p>Gain value</p> <p>Offset value</p> <p>Input signal error detection lower limit value</p> <p>Time</p> <p>A 1.6mA (10.0% of 16mA)</p> <p>16mA (Gain value - Offset value)</p> <p>B 1.6mA (10.0% of 16mA)</p>
1: Upper limit value/ lower limit value different	The input signal error detection upper limit value and input signal error detection lower limit value are calculated from different input signal error detection setting values. Thus, different ranges can be set for A and B in the right figure.	<p>Input signal error detection setting value for the input signal error detection upper limit value: 100 (10%)</p> <p>Input signal error detection setting value for the input signal error detection lower limit value: 150 (15%)</p> <p>Analog input value</p> <p>Input signal error detection upper limit value</p> <p>Gain value</p> <p>Offset value</p> <p>Input signal error detection lower limit value</p> <p>Time</p> <p>A 1.6mA (10.0% of 16mA)</p> <p>16mA (Gain value - Offset value)</p> <p>B 2.4mA (15.0% of 16mA)</p>

Point

For details on the input signal error detection upper limit value and input signal error detection lower limit value, refer to the following.

☞ Page 183 CH1 Input signal error detection setting value/lower limit set value [Q compatible mode]

Notification

When an input signal error is detected, an error is notified as follows.

- Input signal error (1) is stored in the corresponding bit of 'Input signal error detection flag' (Un\G49).
- 'Input signal error detection signal' (XC) turns on.
- The corresponding bit of 'A/D conversion completed flag' (Un\G10) turns off.
- The ALM LED flashes.

In addition, an alarm code is stored in 'Latest alarm code' (Un\G3750).

For details on the alarm codes, refer to the following.

 Page 111 List of Alarm Codes

Operation

On the channel where an error is detected, the last digital output value and digital operation value just before the error was detected are stored. Also, the corresponding bit of A/D conversion completed flag (Un\G10) turns off.

When the analog input does not satisfy the condition of the input signal error detection, the A/D conversion resumes regardless of the reset on Input signal error detection flag (Un\G49) and Input signal error detection signal (XC). (The ALM LED remains flashing.)

Clearing input signal errors

One of the following methods for clearing input signal errors can be selected by setting Input signal error detection auto-clear enable/disable setting (Un\G162).

■When Input signal error detection auto-clear enable/disable setting is set to Enable (0)

After the analog input value returns within the setting range, the A/D converter module arranges the following status automatically. After the analog input value returns within the setting range, turning on and off 'Error clear request' (YF) is not required.

- Input signal error detection flag (Un\G49) is cleared.
- Input signal error detection signal (XC) turns off.
- The ALM LED turns off.

Point

Latest alarm code (Un\G3750) is not cleared.

After the analog input value returns within the setting range, turn on and off 'Error clear request' (YF) to clear 'Latest alarm code' (Un\G3750).

Ex.

The following figure shows the operation when an analog input value falls below 2.4mA and returns within the normal range under the following condition.

- Input signal error detection auto-clear enable/disable setting (Un\G162): Enable (0)
- Input range: 4 to 20mA
- Input signal error detection extension/input signal error detection setting (Un\G47): Upper limit value/lower limit value same, Enable (0000H)
- Input signal error detection lower limit value: 2.4mA

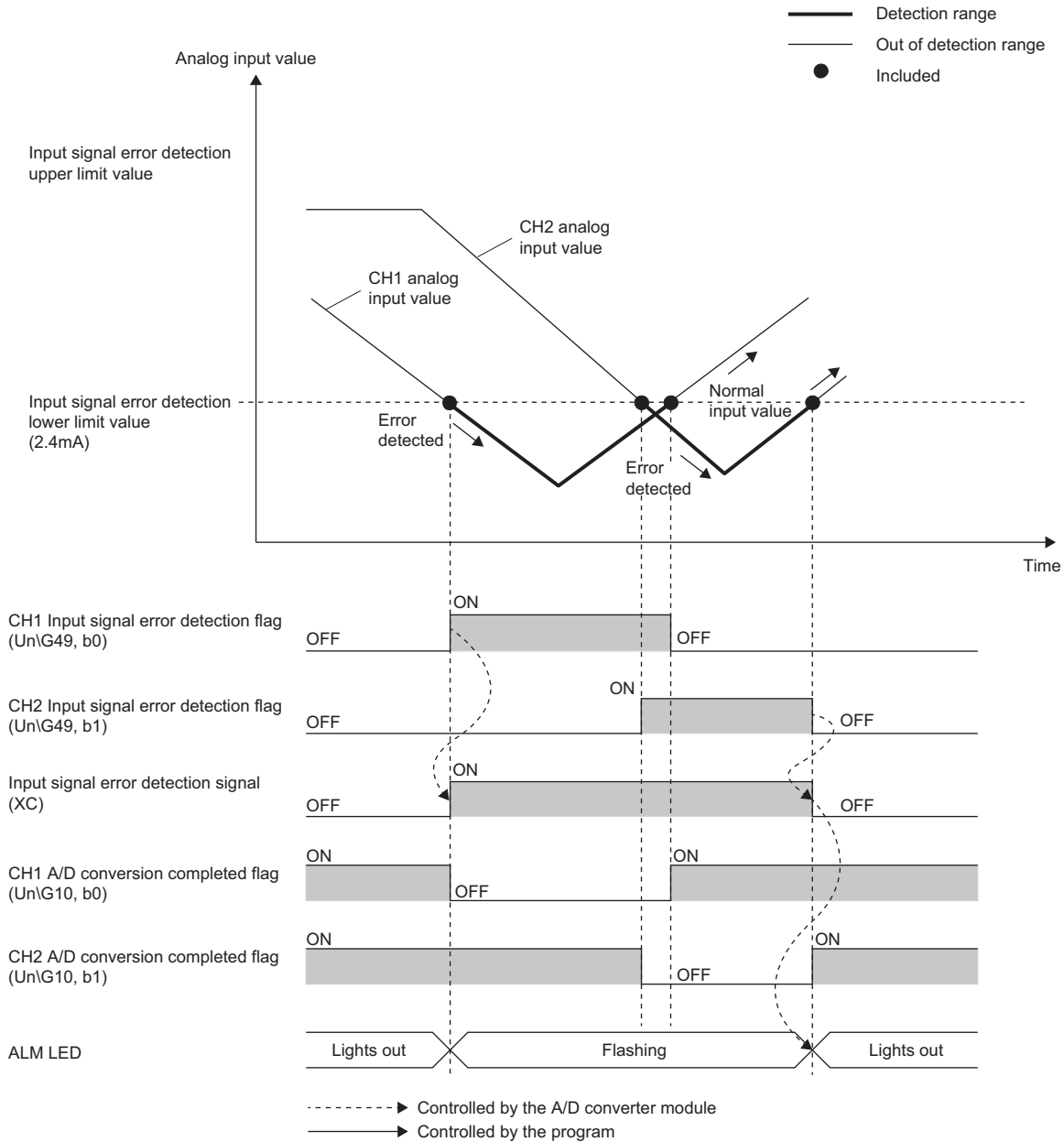

■When Input signal error detection auto-clear enable/disable setting is set to Disable (1)

After the analog input value returns within the set range, turn on and off Error clear request (YF).

The A/D converter module arranges the following status when an input signal error is cleared.

- Input signal error detection flag (Un\G49) is cleared.
- Input signal error detection signal (XC) turns off.
- The ALM LED turns off.
- Latest alarm code (Un\G3750) is cleared.

Setting example

■ Setting example of the input signal error detection

In the channel where the following values are set, an input error is detected when an analog input value exceeds 21.6mA or falls below 0.8mA.

Item	Setting value
Mode	Q compatible mode
Input range	4 to 20mA
Input signal error detection auto-clear enable/disable setting (Un\G162)	Disable (1)
Input signal error detection extension/input signal error detection setting (Un\G47)	Upper limit value/lower limit value different (1)

Assign the following values in a formula to determine the input signal error detection setting value from the input signal error detection upper limit value and input signal error detection lower limit value.

- Input signal error detection upper limit value: 21.6mA
- Input signal error detection lower limit value: 0.8mA
- Offset value: 4.0mA
- Gain value: 20.0mA

Point

For details on the calculation formula, refer to the following.

☞ Page 43 Setting the input signal error detection upper or lower limit value

[Calculation of lower limit value]

$$\begin{aligned} \text{Input signal error detection setting value} &= \frac{4.0 - 0.8}{20.0 - 4.0} \times 1000 \\ &= 200 \text{ (20.0\%)} \end{aligned}$$

Thus, set 'CH1 Input signal error detection setting value/CH1 Input signal error detection lower limit set value' (Un\G142) to the determined input signal error detection setting value (200 (20.0%)).

[Calculation of upper limit value]

$$\begin{aligned} \text{Input signal error detection setting value} &= \frac{21.6 - 20.0}{20.0 - 4.0} \times 1000 \\ &= 100 \text{ (10.0\%)} \end{aligned}$$

Thus, set 'CH1 Input signal error detection upper limit setting' (Un\G150) to the determined input signal error detection setting value (100 (10.0%)).

The following figure shows the operation with the determined input signal error detection setting values.

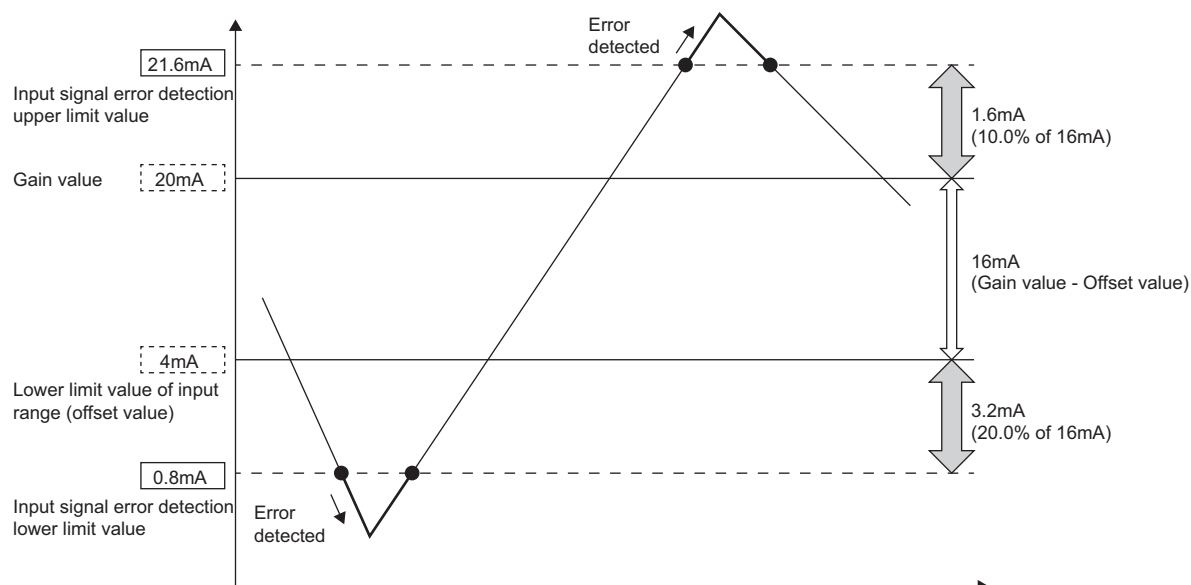

1.8 Shift Function

This function adds (shifts) a set conversion value shift amount to a digital output value and stores the result in the buffer memory area. The digital operation value reflects the change in the conversion value shift amount on a realtime basis. Therefore, fine adjustment can be easily performed when the system starts.

Operation

A set conversion value shift amount is added to the digital operation value. The digital operation value with shift addition is stored in 'CH1 Digital operation value' (Un\G402). The conversion value shift amount is added in every sampling cycle for sampling processing and is added in every averaging process cycle for averaging processing. After that, the added values are stored in 'CH1 Digital operation value' (Un\G402). If a value is set to the conversion value shift amount, the conversion value shift amount is added regardless of turning on and off 'Operating condition setting request' (Y9).

Setting procedure

Set a value for "Conversion value shift amount".

[Navigation window] ⇨ [Parameter] ⇨ [Module Information] ⇨ Module model name ⇨ [Application setting] ⇨ [Shift function]

Item	Setting range
Conversion value shift amount	-32768 to 32767

Setting example

Ex.

When the I/O characteristics is adjusted in a channel where the input range of 0 to 5V is set by the shift function

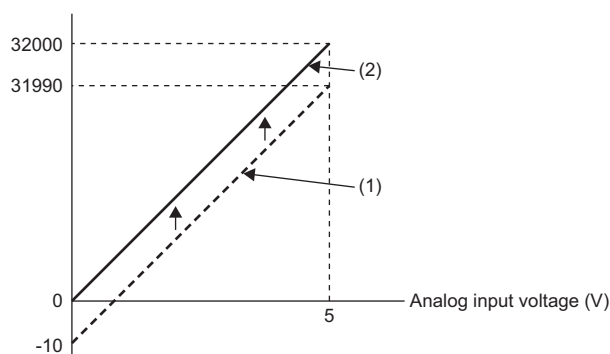

(1) 'CH1 Digital output value' (Un\G400)
 +
 'CH1 Conversion value shift amount' (Un\G472) "+10"
 ↓
 (2) 'CH1 Digital operation value' (Un\G402)

Voltage input	Digital output value*1	Digital operation value
0	-10	0
5	31990	32000

*1 These values are also applied to the case of digital output values (32 bits).

Ex.

When the I/O characteristics is adjusted in a channel where the input range of -10 to 10V is set by the shift function

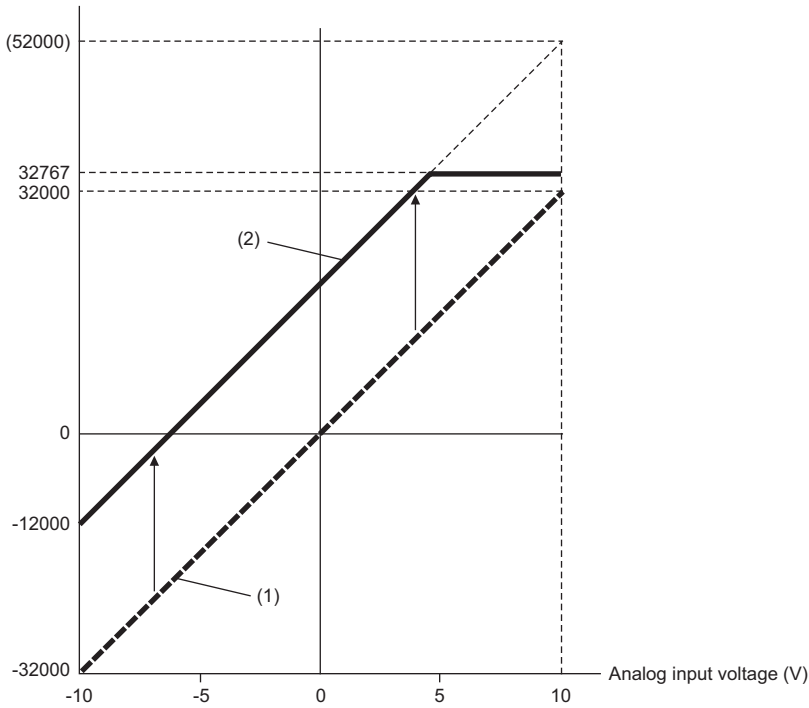

- (1) 'CH1 Digital output value' (Un\G400)
- +
- 'CH1 Conversion value shift amount' (Un\G472) "+20000"
- ↓
- (2) 'CH1 Digital operation value' (Un\G402)

Voltage input	Digital output value ^{*2}	Digital operation value
-10	-32000	-12000
-5	-16000	4000
0	0	20000
5	16000	32767 ^{*1}
10	32000	32767 ^{*1}

*1 Because the value exceeds the range of -32768 to 32767, the value is fixed to 32767 (the upper limit value).

*2 These values are also applied to the case of digital output values (32 bits).

Ex.

When the following values are used for the A/D converter module with the input range of 0 to 5V

- 'CH1 Scaling enable/disable setting' (Un\G504): Enable (0)
- 'CH1 Scaling upper limit value' (Un\G506): 12000
- 'CH1 Scaling lower limit value' (Un\G508): 2000
- 'CH1 Conversion value shift amount' (Un\G472): 2000

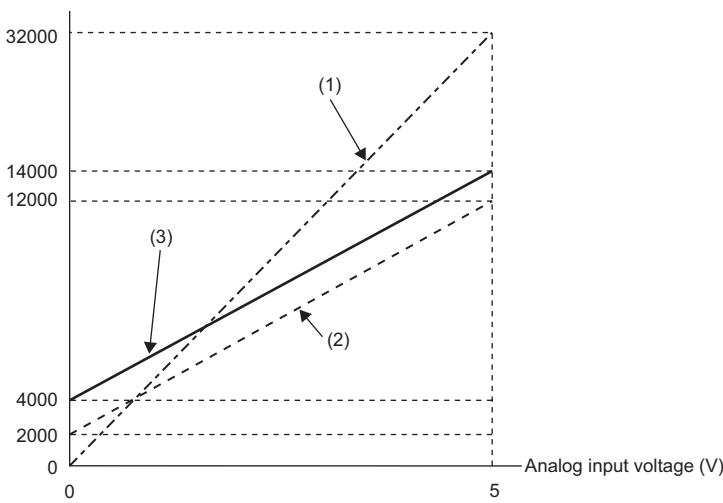

(1) 'CH1 Digital output value' (Un\G400)
 Scaling
 0 to 32000
 ↓
 2000 to 12000
 (2) Value after scaling
 'CH1 Conversion value shift amount' (Un\G472) "+2000"
 ↓
 (3) 'CH1 Digital operation value' (Un\G402)

Voltage input	Digital output value *1	Value after scaling	Digital operation value
0	0	2000	4000
1	6400	4000	6000
2	12800	6000	8000
3	19200	8000	10000
4	25600	10000	12000
5	32000	12000	14000

*1 These values are also applied to the case of digital output values (32 bits).

Point

When the shift function is used with the digital clipping function and scaling function, shift-and-add is performed on the value obtained after digital clipping and scale conversion. Therefore, the range of the digital operation value is determined as -32768 to 32767.

For a setting example of when the digital clipping function, scaling function, and shift function are used together, refer to the following.

👉 [Page 54 Setting example](#)

1.9 Digital Clipping Function

This function fixes the digital operation value with the maximum digital output value and the minimum digital output value when the corresponding current or voltage exceeds the input range.

List of output ranges

The following table lists the output ranges of the digital operation values when the digital clipping function is enabled with each range.

Input range	Output range of digital operation values	
	Digital clipping function is enabled	Digital clipping function is disabled
4 to 20mA	0 to 32000	-768 to 32767
0 to 20mA		
1 to 5V		
0 to 5V		
0 to 10V		
-10 to 10V	-32000 to 32000	-32768 to 32767
User range setting		
4 to 20mA (extended mode)	-8000 to 32767 ^{*1}	-8768 to 32767
1 to 5V (extended mode)		

*1 Since the digital clipping function is effective with the value 36000 (22mA or 5.5V) in the extended mode, the output range is -8000 to 32767.

Point

When the determined digital operation value is out of the range of -32768 to 32767, the digital clipping function is performed to the following values.

- When the digital operation value is 32767 or greater: 32767
- When the digital operation value is -32768 or smaller: -32768

Setting procedure

Set "Digital clipping enable/disable setting" to "Enable".

 [Navigation window] ⇒ [Parameter] ⇒ [Module Information] ⇒ Module model name ⇒ [Application setting] ⇒ [Digital clipping function]

Setting example

Ex.

When the following values are used for the A/D converter module with the input range of 0 to 5V

- 'CH1 Scaling enable/disable setting' (Un\G504): Enable (0)
- 'CH1 Scaling upper limit value' (Un\G506): 12000
- 'CH1 Scaling lower limit value' (Un\G508): 2000
- 'CH1 Conversion value shift amount' (Un\G472): 2000
- 'CH1 Digital clipping enable/disable setting' (Un\G510): Enable (0)

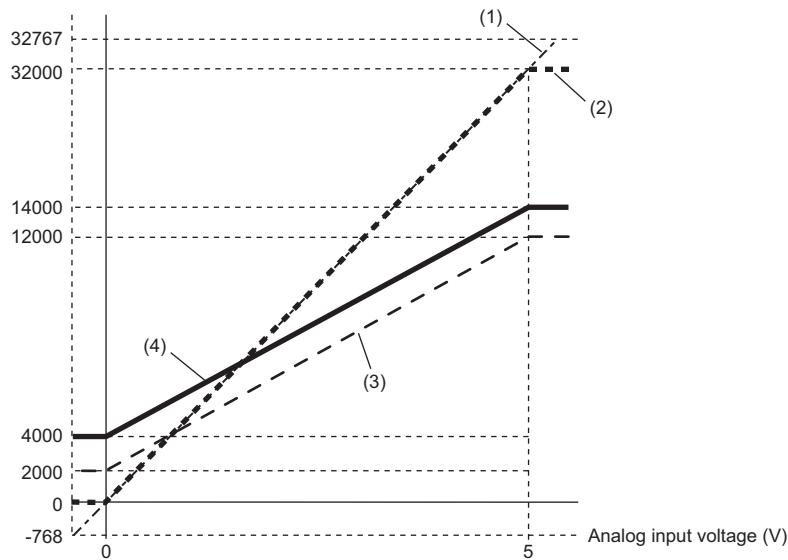

(1) 'CH1 Digital output value' (Un\G400)

Digital clipping

-768 to 32767

↓

0 to 32000

(2) Value after digital clipping

Scaling

0 to 32000

↓

2000 to 12000

(3) Value after scaling

'CH1 Conversion value shift amount' (Un\G472) "+2000"

↓

4000 to 14000

(4) 'CH1 Digital operation value' (Un\G402)

Input voltage (V)	Digital output value*1	Digital operation value
-0.12	-768	4000
0	0	4000
1	6400	6000
2	12800	8000
3	19200	10000
4	25600	12000
5	32000	14000
5.096	32767	14000

*1 These values are also applied to the case of digital output values (32 bits).

Point

When the digital clipping function is used with the scaling function, shift function, and difference conversion function, scale conversion, shift-and-add, and difference conversion are performed on the value obtained after digital clipping.

1.10 Difference Conversion Function

This function subtracts a difference conversion reference value from a digital operation value and stores the acquired value in the buffer memory area.

The digital operation value at the start of this function is treated as 0 (reference value). Thereafter, values that increased or decreased from the reference value are stored in the buffer memory.

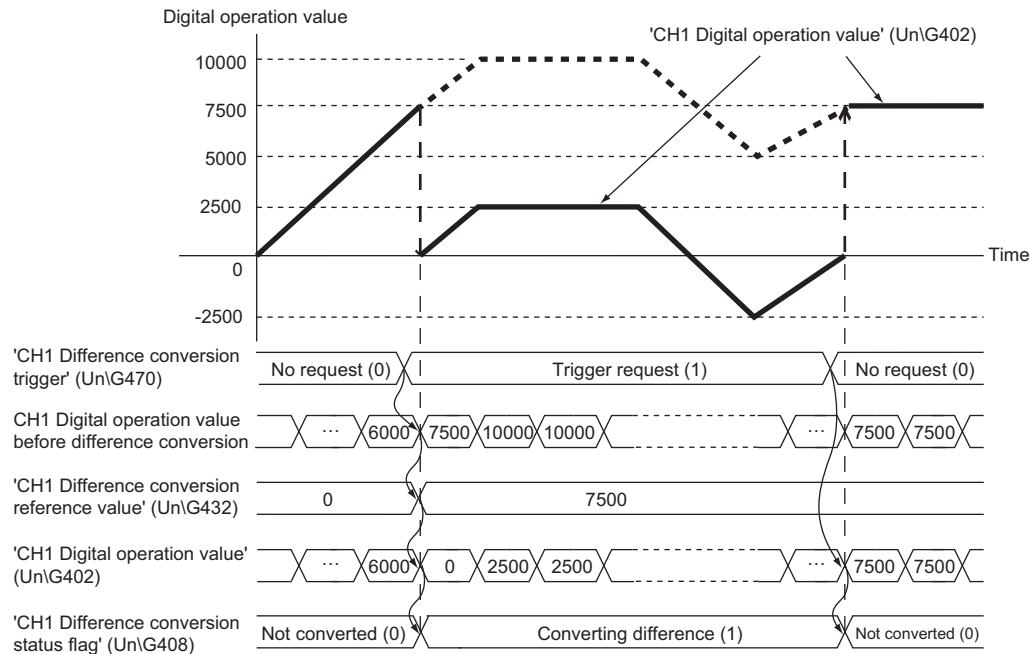

Operation

The digital operation value at the start of the difference conversion (the data stored inside the A/D converter module before the difference conversion starts) is determined as a difference conversion reference value. The value acquired by subtracting the difference conversion reference value from the digital operation value is stored in 'CH1 Digital operation value' (UnG402). At the start of this function, the digital operation value is 0 (because the digital operation value and the difference conversion reference value have the same value at the start).

- Digital operation value after difference conversion = Digital operation value - Difference conversion reference value

Starting the difference conversion

1. Change 'CH1 Difference conversion trigger' (UnG470) from No request (0) to Trigger request (1).

The rise of No request (0) → Trigger request (1) is detected as a trigger. When the trigger is detected, the digital operation value at the start is output to the difference conversion reference value. The value acquired by subtracting the difference conversion reference value from the digital operation value is stored in 'CH1 Digital operation value' (UnG402). After the value is stored, 'CH1 Difference conversion status flag' (UnG408) turns to Converting difference (1).

Stopping the difference conversion

1. Change 'CH1 Difference conversion trigger' (UnG470) from Trigger request (1) to No request (0).

The fall of Trigger request (1) → No request (0) is detected as a trigger. When the trigger is detected, the difference conversion stops, and 'CH1 Difference conversion status flag' (UnG408) turns to Not converted (0). Thereafter, the digital operation value is stored as it is in 'CH1 Digital operation value' (UnG402).

Operations of when an input signal error occurs

When an input signal error occurs, even if 'CH1 Difference conversion trigger' (Un\G470) changes from No request (0) to Trigger request (1), the difference conversion does not start. After the input signal error returns to the normal value, change 'CH1 Difference conversion trigger' (Un\G470) from No request (0) to Trigger request (1) again. If an input signal error occurs in the status of Trigger request (1), the difference conversion starts at the timing when the input signal error returns to the normal value, treating the digital operation value as the difference conversion reference value.

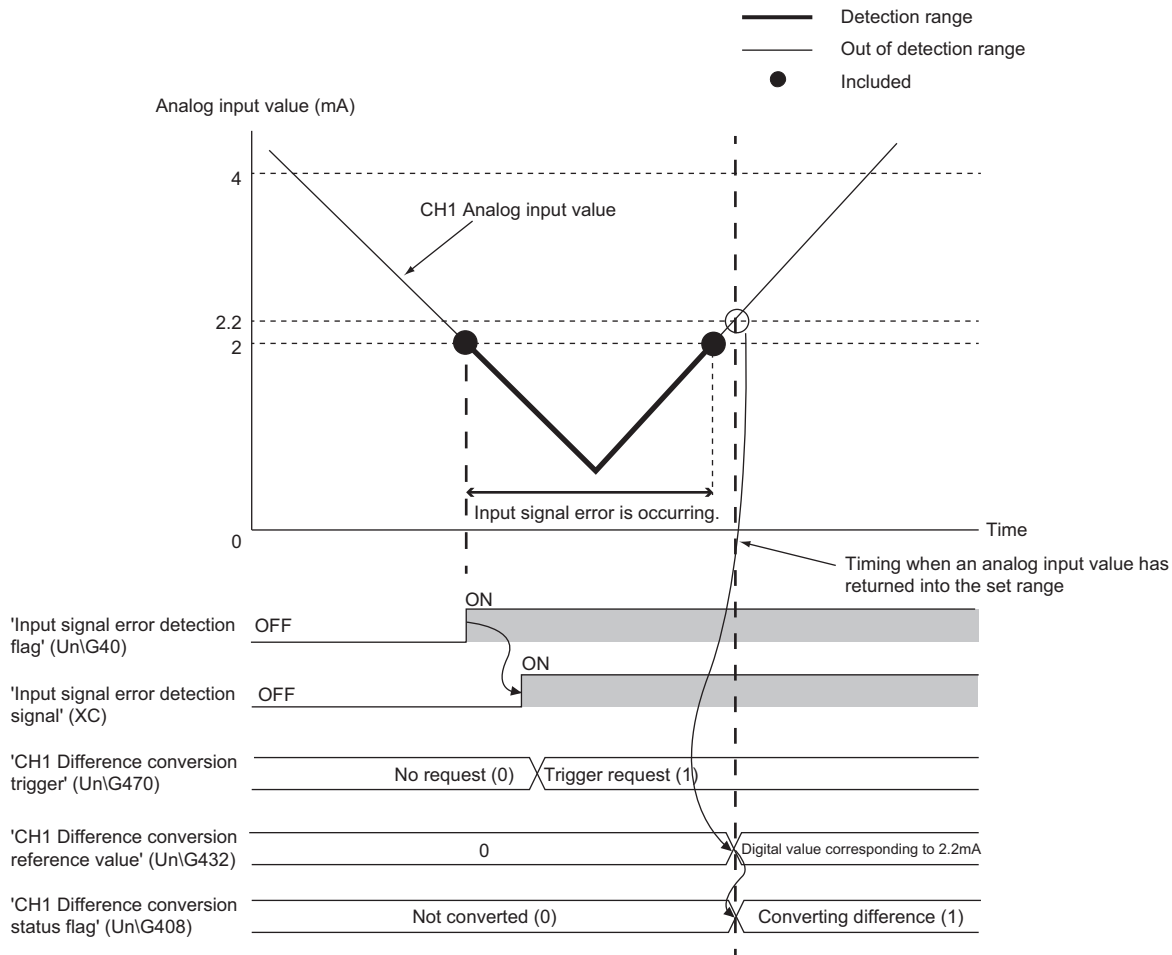

■ Operations of when 'Operating condition setting request' (Y9) is turned on and off

- During the difference conversion, even when 'Operating condition setting request' (Y9) is turned on and off, the difference conversion continues without updating the difference conversion reference value. To updating the difference conversion reference value, restart the difference conversion by changing CH1 Difference conversion trigger (Un\G470) from Trigger request (1) to No request (0), and Trigger request (1) again.
- CH1 Difference conversion trigger (Un\G470) does not become valid even when the trigger changes from No request (0) to Trigger request (1) when 'Operating condition setting request' (Y9) is turned off and on. After turning on and off 'Operating condition setting request' (Y9), change CH1 Difference conversion trigger (Un\G470) from No request (0) to Trigger request (1) again.

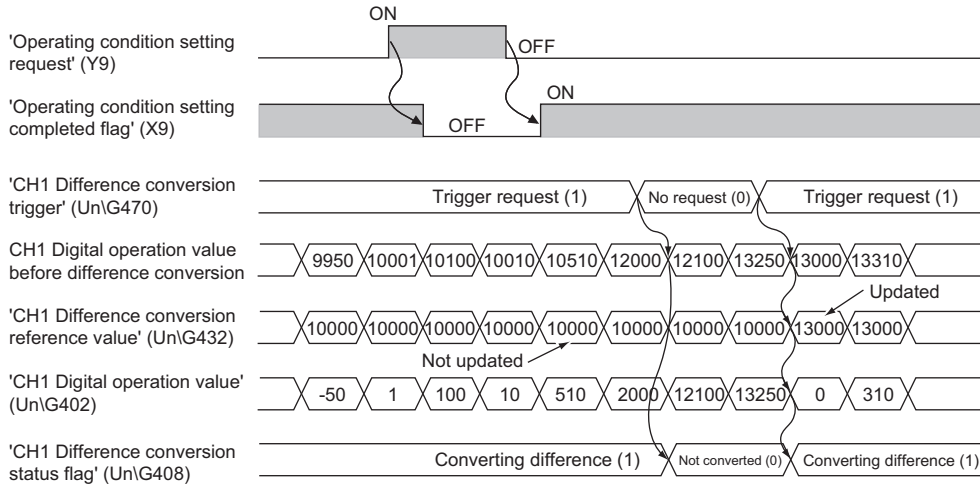

■ Operations of CH1 Maximum value (Un\G404) and CH1 Minimum value (Un\G406)

When the difference conversion starts, the maximum value and the minimum value of the values acquired by the difference conversion are stored in 'CH1 Maximum value' (Un\G404) and 'CH1 Minimum value' (Un\G406). By turning on 'Maximum value/minimum value reset request' (YD), the maximum value and the minimum value after the start of the difference conversion can be checked.

When 'Maximum value/minimum value reset request' (YD) is not turned on, the maximum values and minimum values before and after difference conversion are mixed.

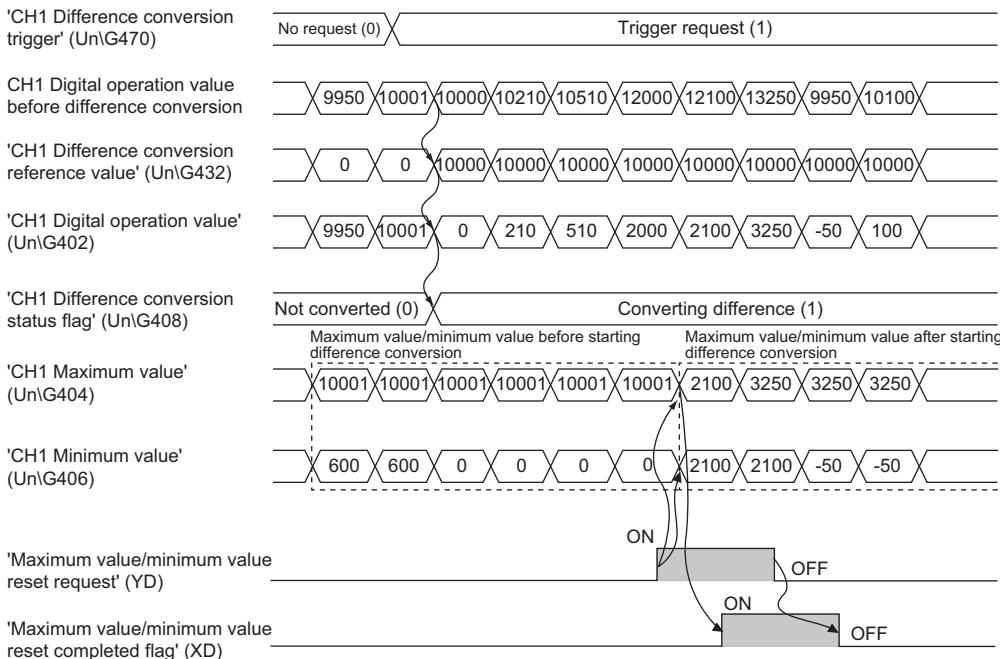

■ Operation of when the averaging processing is set

If the difference conversion starts after the averaging processing is set, the digital operation value at the completion of the averaging processing is determined as 'CH1 Difference conversion reference value' (Un\G432). 'CH1 Difference conversion status flag' (Un\G408) turns to Converting difference (1).

Point

- The difference conversion function can be started at any timing.
 - When the difference conversion function is used with the digital clipping function, scaling function, and shift function, each digital operation value is determined as a difference conversion reference value and used for the difference conversion.
 - Even though the digital clipping function, scaling function, and shift function are enabled during the difference conversion, the value in 'CH1 Difference conversion reference value' (Un\G432) is not updated. To update the value in 'CH1 Difference conversion reference value' (Un\G432), stop the difference conversion and restart it again.
-

1.11 Maximum Value/Minimum Value Hold Function

This function stores the maximum and minimum values of digital operation values in the buffer memory area for each channel. Time average and count average are processed on the averaging process cycle. The values of the sampling processing, moving average, and primary delay filter are updated on the sampling cycle.

Resetting the maximum value and the minimum value

Turn on and off 'Maximum value/minimum value reset request' (YD) or 'Operating condition setting request' (Y9) to update the maximum value and minimum value with the current value.

Turning on and off 'Maximum value/minimum value reset request' (YD) turns on 'Maximum value/minimum value reset completed flag' (XD).

Values to be the maximum value and the minimum value

The maximum and minimum values of digital operation values are stored in the buffer memory.

When the digital clipping function, scaling function, shift function, or difference conversion function is used, the maximum value and minimum value of each function are stored.

1.12 Logging Function

This function logs (records) digital output values or digital operation values. Data of 1000 points can be logged for each channel. Logging data are stored in the buffer memory area. In addition, the data collection can be stopped by using the status change of the data as a trigger. This function also helps the error analysis since the data before and after the occurrence of an error is held.

Using function blocks (FBs) enables saving the data stored in the buffer memory as a CSV file.

Logging function

Collecting logging data

Logging data is collected as follows.

- 1000 points of the latest digital output values or digital operation values can be always collected for each channel.
- The data can be collected at intervals of 10ms at a minimum and of 3600s at a maximum.

An address where the latest/oldest data is stored can be checked with the latest/head pointer.

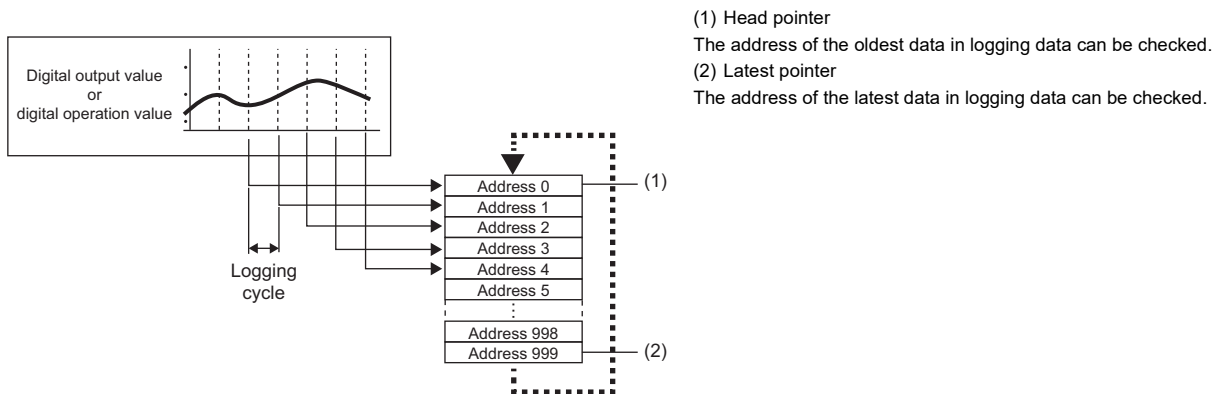

Logging data are stored in the buffer memory area. When the number of stored data points is 1001 or greater, data is sequentially overwritten from address 0 with new data.

Stopping the logging operation

The logging data is refreshed at high speed during logging. Stop logging when the logging data needs to be referred without paying attention to the refreshing cycle.

Logging can be stopped by the hold trigger.

- A hold trigger allows two options: Logging hold request or Level trigger.
- The number of data points to be collected after a hold trigger occurs can be set.

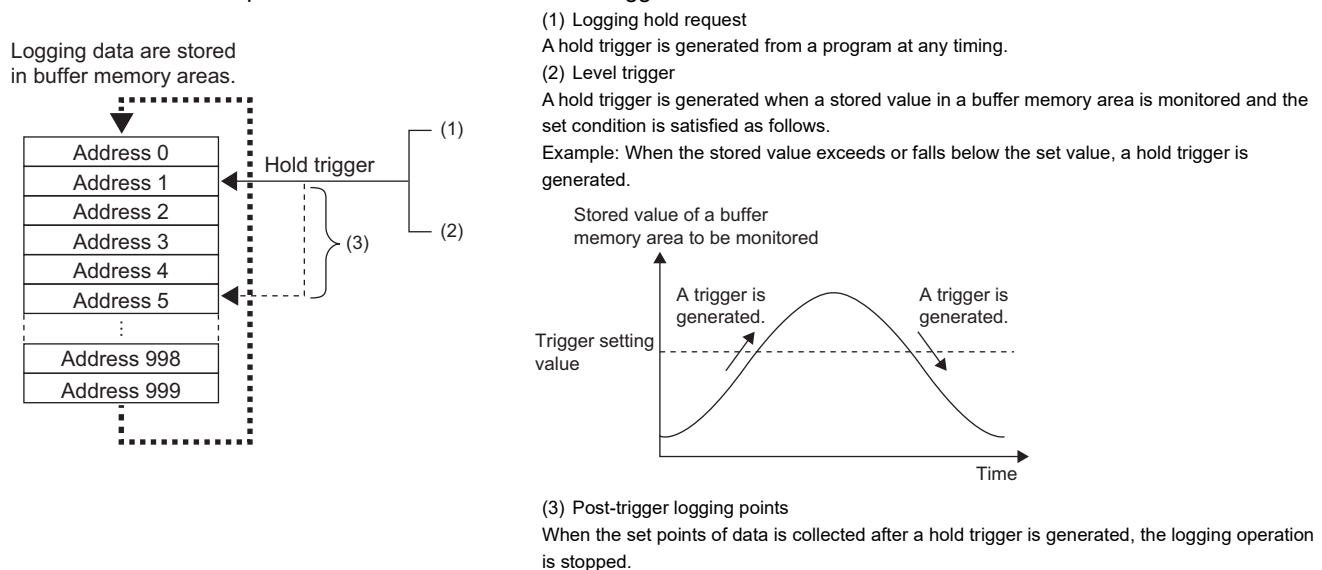

■Saving logging data into a CSV file

The data in 'CH1 Logging data' (Un\G10000 to Un\G10999) disappears when the module is powered off. However, the data can be saved in a CSV file by using function blocks (FBs).

Operation of logging

■Starting logging data collection

Logging data collection starts when 'CH1 Logging enable/disable setting' (Un\G535) is set to Enable (0) and 'Operating condition setting request' (Y9) is turned on and off.

The data in 'CH1 Digital output value' (Un\G400) or 'CH1 Digital operation value' (Un\G402) is stored in 'CH1 Logging data' (Un\G10000 to Un\G10999) on the set logging cycle. The data in 'CH1 Digital output value (32 bits)' (Un\G410, Un\G411) cannot be logged.

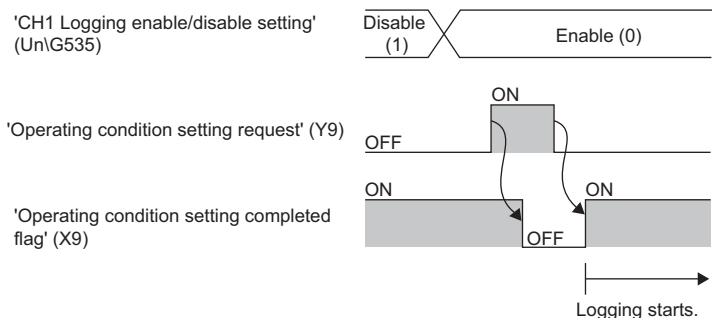

■Logging data

Logging data are stored in the following buffer memory areas.

When the number of stored data points is 10001 or greater, the data is overwritten with new data from the head of the storage area of the corresponding channel.

Channel*1	Storage area for logging data
CH1	Un\G10000 to Un\G10999
CH2	Un\G11000 to Un\G11999
CH3	Un\G12000 to Un\G12999
CH4	Un\G13000 to Un\G13999
CH5	Un\G14000 to Un\G14999
CH6	Un\G15000 to Un\G15999
CH7	Un\G16000 to Un\G16999
CH8	Un\G17000 to Un\G17999
CH9	Un\G18000 to Un\G18999
CH10	Un\G19000 to Un\G19999
CH11	Un\G20000 to Un\G20999
CH12	Un\G21000 to Un\G21999
CH13	Un\G22000 to Un\G22999
CH14	Un\G23000 to Un\G23999
CH15	Un\G24000 to Un\G24999
CH16	Un\G25000 to Un\G25999

*1 When the R60AD8-G is used, data is stored in CH1 to CH8.

If logging has been performed even once, all the logging data above are cleared to 0 at the timing when 'Operating condition setting request' (Y9) is turned off and on.

Logging data setting

Select a data type to be collected with 'CH1 Logging data setting' (Un\G536).

- Digital output value (0)
- Digital operation value (1)

Logging cycle

■Logging cycle setting

Set the logging cycle with 'CH1 Logging cycle setting value' (Un\G537) and 'CH1 Logging cycle unit setting' (Un\G538).

The following table lists the setting range for each cycle.

Setting value of CH1 Logging cycle unit setting	Setting range of CH1 Logging cycle setting value
ms (1)	10 to 32767
s (2)	1 to 3600

The logging cycle must be an integral multiple of the conversion cycle. Even if the setting is not an integral multiple, the actual logging cycle is adjusted to the integral multiple of the conversion cycle within a limit of the set logging cycle.

The following table lists the conversion cycle for each A/D conversion method.

Conversion method	Conversion cycle
Sampling processing	Number of conversion enabled channels × Conversion speed
Time average	$\left(\frac{\text{Time set in Time average/Count average/} \\ \text{Moving average/Primary delay filter constant setting}}{\text{Number of conversion enabled channels} \times \text{Conversion speed}} \right)^{*1} \times \text{Number of conversion enabled channels} \times \text{Conversion speed}$
Count average	(The count set to CH1 Time average/Count average/Moving average/Primary delay filter constant setting (Un\G502)) × (Number of conversion enabled channels × Conversion speed)
Moving average	Number of conversion enabled channels × Conversion speed
Primary delay filter	Number of conversion enabled channels × Conversion speed

*1 Values after the decimal point are omitted.

Ex.

With the following settings, the conversion cycle is 80ms and the actual logging cycle is every 6960ms (integral multiple of 80ms).

- Conversion enabled channel: CH1 to CH8
- Conversion process specification: Sampling processing
- 'CH1 Logging cycle setting value' (Un\G537): 7000
- Logging cycle unit setting: ms

The following values are stored in 'CH1 Logging cycle monitor value' (Un\G441, Un\G442).

Address	Item	Stored value
441	CH1 Logging cycle monitor value	s
442		ms
		6
		960

■When the logging function becomes disabled

The logging is not performed when even one of the following errors occurs after the logging function is enabled and 'Operating condition setting request' (Y9) is turned on and off.

- Error code (192□H to 195□H): Setting errors of 'CH1 Time average/Count average/Moving average/Primary delay filter constant setting' (Un\G502)
- Error code (1D0□H to 1D6□H): Setting errors of the logging function
- Error code (1D8□H to 1D9□H): Setting errors of the logging read function

Point

When 'Operating condition setting request' (Y9) is turned on and off on the condition that the logging cycle determined by 'CH1 Logging cycle setting value' (Un\G537) and 'CH1 Logging cycle unit setting' (Un\G538) is shorter than the conversion cycle, an error occurs and logging does not start. A logging cycle setting disable error (error code: 1D2□H) is stored in 'Latest error code' (Un\G0) to turn on 'Error flag' (XF) and the ERR LED.

Number of logging data

With 'CH1 Number of logging data' (Un\G436), the number of valid data points in 'CH1 Logging data' (Un\G10000 to Un\G10999) can be checked.

When the number of collected data points is less than 1000

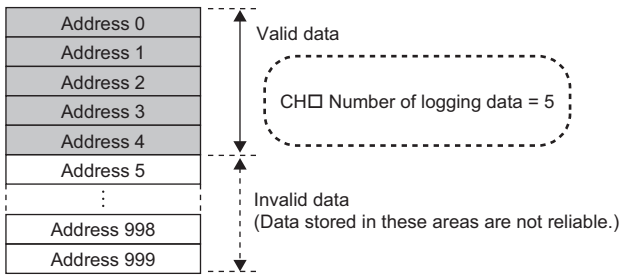

When the number of collected data points is 1001 or greater

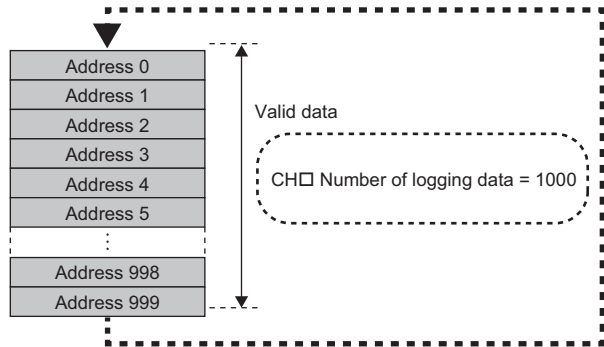

The number of logging data increases by one each time new data is stored.

When 'CH1 Logging data' (Un\G10000 to Un\G10999) becomes full (Number of logging data = 1000), the next data is stored in the start address of 'CH1 Logging data' (Un\G10000 to Un\G10999), and the logging operation continues overwriting the existing data. In this case, the number of logging data is fixed to 1000.

Head pointer and latest pointer

The storage locations of the oldest data and the latest data in 'CH1 Logging data' (Un\G10000 to Un\G10999) can be checked with the following buffer memory areas.

Buffer memory area	Description
'CH1 Head pointer' (Un\G434)	The buffer memory address of the oldest data in 'CH1 Logging data' (Un\G10000 to Un\G10999) can be checked with this buffer memory area. The offset value (0 to 999) counted from the start address of 'CH1 Logging data' (Un\G10000 to Un\G10999) is stored.
'CH1 Latest pointer' (Un\G435)	The buffer memory address of the latest data in 'CH1 Logging data' (Un\G10000 to Un\G10999) can be checked with this buffer memory area. The offset value (0 to 999) counted from the start address of 'CH1 Logging data' (Un\G10000 to Un\G10999) is stored.

When the number of collected data points is less than 1000

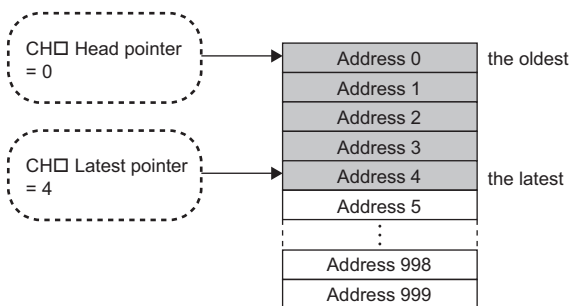

When the number of collected data points is 1001 or greater

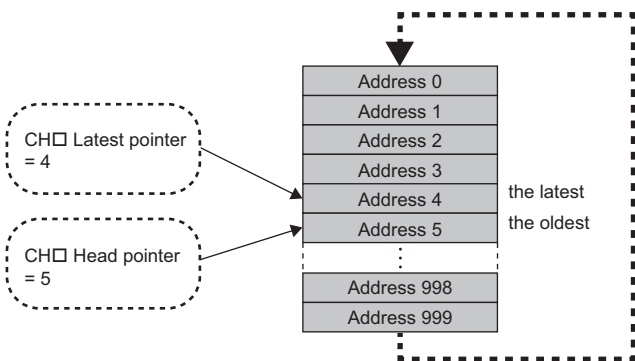

'CH1 Head pointer' (Un\G434) does not change (fixed to 0) until 'CH1 Logging data' (Un\G10000 to Un\G10999) becomes full after the logging start.

'CH1 Head pointer' (Un\G434) moves by one point when 'CH1 Logging data' (Un\G10000 to Un\G10999) becomes full and overwriting the data starts from the start address.

■Checking logging data without stopping the logging operation

Logging data can be checked during the logging operation with 'CH1 Head pointer' (Un\G434), 'CH1 Latest pointer' (Un\G435), and 'CH1 Number of logging data' (Un\G436).

To check logging data during logging operation, follow the precautions below because logging data may be refreshed while data is being read out.

- Set the cycle to 'CH1 Logging cycle setting value' (Un\G537) so that data checking and reading surely complete before logging data is refreshed. If the logging cycle is short, logging data may be refreshed during data checking and reading.
- After obtaining the logging data which needs to be checked, monitor the variation of 'CH1 Head pointer' (Un\G434) or 'CH1 Number of logging data' (Un\G436), and obtain logging data just after the stored value has changed.
- If the data refreshed and the data being checked do not synchronize due to the relationship between the logging cycle and the scan time of the CPU module, adjust the logging cycle.

Stop the logging operation when the logging data needs to be checked without paying attention to the logging cycle.

( Page 65 Stopping the logging operation)

Stopping the logging operation

Logging operation stops (holds) when the preset trigger condition is satisfied and the set points of the data are collected.

A trigger that is generated when the condition is satisfied is called a hold trigger.

To generate a hold trigger, the following two methods are available.

☞ Page 68 Logging hold request

☞ Page 69 Level trigger

When a hold trigger is detected during data collection, the logging operation stops after the points of the data set in 'CH1 Post-trigger logging points' (Un\G539) are collected.

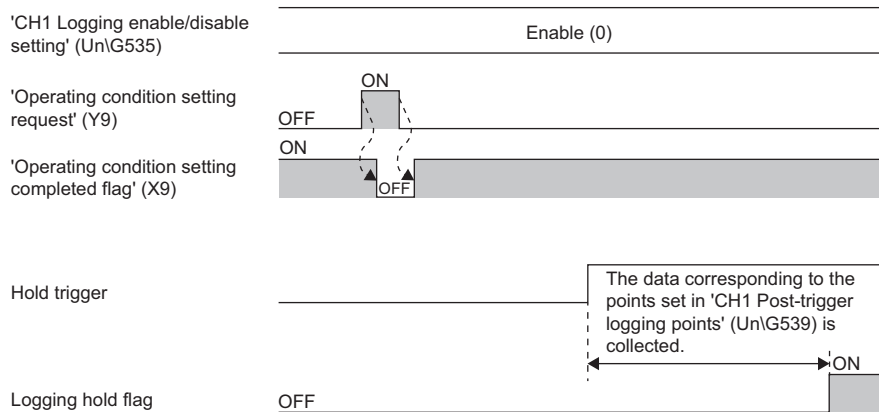

Post-trigger logging points

Set the number of data collected in the period from the detection of a hold trigger to logging operation stop to 'CH1 Post-trigger logging points' (Un\G539).

Checking that the logging has stopped

Check that 'CH1 Logging hold flag' (Un\G409) is ON (1).

Checking data when a hold trigger has occurred

The storage location of the data when a hold trigger has occurred can be checked with 'CH1 Trigger pointer' (Un\G437).

The offset value counted from the start address of 'CH1 Logging data' (Un\G10000 to Un\G10999) is stored in 'CH1 Trigger pointer' (Un\G437).

Ex.

The value stored in 'CH1 Trigger pointer' (Un\G437) when the logging operation stops under the following conditions

- 'CH1 Post-trigger logging points' (Un\G539): 655 points
- The data location where a hold trigger has occurred: 350th data

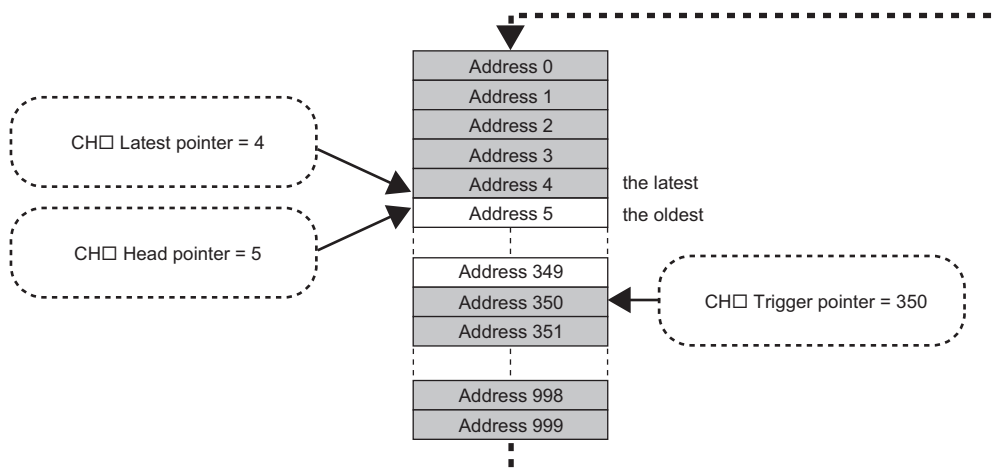

■Checking the trigger generation time

The trigger generation time can be checked with 'CH1 Trigger generation time' (Un\G444 to Un\G448).

Ex.

When 'CH1 Trigger generation time' (Un\G444 to Un\G448) is monitored

	b15	to	b8 b7	to	b0
'CH1 Trigger generation time (First/Last two digits of the year)' (Un\G444)	First two digits of the year			Last two digits of the year	
'CH1 Trigger generation time (Month/Day)' (Un\G445)	Month			Day	
'CH1 Trigger generation time (Hour/Minute)' (Un\G446)	Hour			Minute	
'CH1 Trigger generation time (Second/Day of the week)' (Un\G447)	Second			Day of the week	
'CH1 Trigger generation time (Millisecond)' (Un\G448)	Millisecond (higher-order digits)			Millisecond (lower-order digits)	

- First two digits of the year, last two digits of the year, month, day, hour, minute, second, and millisecond are all stored in the BCD code.
- In the day of the week segment, one of the following values in the BCD code indicating the corresponding day is stored. Sunday: 00H, Monday: 01H, Tuesday: 02H, Wednesday: 03H, Thursday: 04H, Friday: 05H, Saturday: 06H

Resuming the logging

It may take time until ON (1) is stored in 'CH1 Logging hold flag' (Un\G409) after 'CH1 Logging hold request' (Un\G471) is changed from off to on.

To resume logging, check that ON (1) is stored in 'CH1 Logging hold flag' (Un\G409) and 'CH1 Logging hold request' (Un\G471) is changed from on to off. After logging resumes, the value is stored from the head buffer memory area of 'CH1 Logging data' (Un\G10000 to Un\G10999).

In addition, OFF (0) is stored in 'CH1 Logging hold flag' (Un\G409).

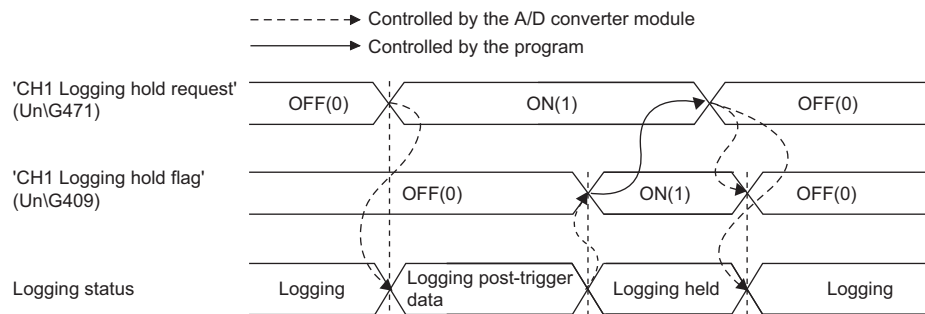

Logging does not stop when 'CH1 Logging hold request' (Un\G471) is changed from on to off before ON (1) is stored in 'CH1 Logging hold flag' (Un\G409).

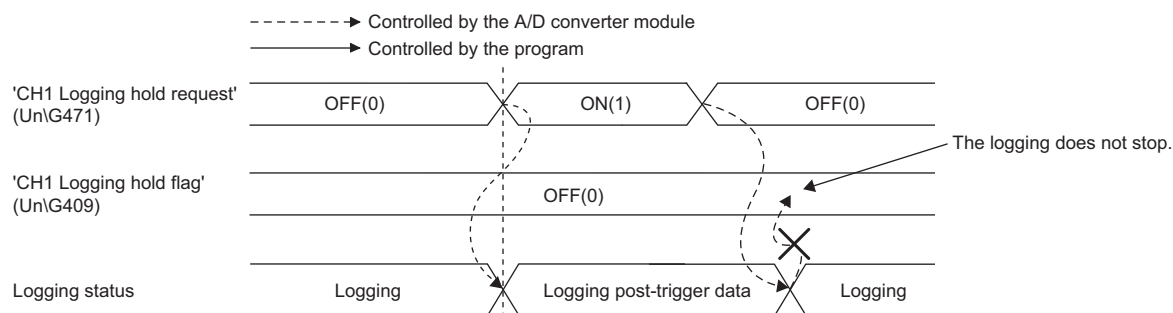

■ Buffer memory area status when logging resumes

The following table shows the buffer memory area status when logging resumes.

Buffer memory area	Value status
'CH1 Head pointer' (Un\G434)	Values are initialized.
'CH1 Latest pointer' (Un\G435)	
'CH1 Number of logging data' (Un\G436)	
'CH1 Trigger pointer' (Un\G437)	
'CH1 Trigger generation time' (Un\G444 to Un\G448)	The values before logging resumes are not initialized. After logging resumes, values are stored from the start address of 'CH1 Logging data' (Un\G10000 to Un\G10999). To refer to the logging data, check which area has valid data with 'CH1 Number of logging data' (Un\G436).
'CH1 Logging data' (Un\G10000 to Un\G10999)	

Logging hold request

A hold trigger is generated from a program at any timing.

Logging starts when ON (1) is set to 'CH1 Logging hold request' (Un\G471) and stops after a preset number of the data is collected.

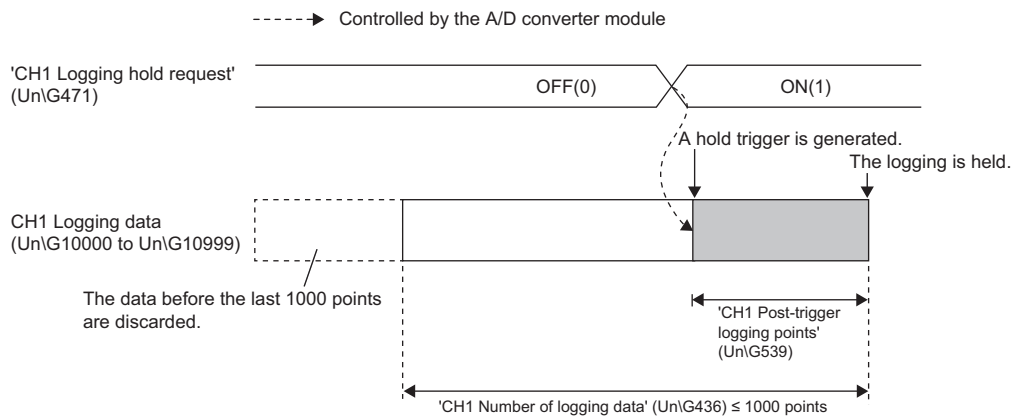

Point

- The following delay time occurs until the A/D converter module receives a hold trigger after the value in 'CH1 Logging hold request' (Un\G471) is changed from OFF (0) to ON (1).
Trigger delay = Logging cycle (Cycle at which logging is actually performed) + Scan time of the CPU module
- When 'CH1 Logging hold request' (Un\G471) is changed from ON (1) to OFF (0) before 'CH1 Logging hold flag' (Un\G409) turns to ON (1), the data set in 'CH1 Post-trigger logging points' (Un\G539) is not held after logging, and logging resumes soon.
- If a value other than OFF (0) and ON (1) is set to 'CH1 Logging hold request' (Un\G471), an error occurs. A logging hold request range error (error code: 1D7□H) is stored in 'Latest error code' (Un\G0) to turn on 'Error flag' (XF) and the ERR LED.

Checking that the logging has stopped

Check that 'CH1 Logging hold flag' (Un\G409) is ON (1).

Point

To refer to the logging data from the CPU module, hold (stop) the logging operation and check that ON (1) is stored in 'CH1 Logging hold flag' (Un\G409).

Level trigger

When a value in the monitored buffer memory area of the A/D converter module satisfies a preset condition, a hold trigger is generated.

A level trigger is monitored on the refreshing cycle of the digital output value or the digital operation value.

Initial setting of a level trigger

■ Setting a target to be monitored

As a condition to generate a hold trigger, set the buffer memory address to be monitored to 'CH1 Trigger data' (Un\G541).

Item	Setting range
CH1 Trigger data (Un\G541)	0 to 9999

To monitor a device value of a module other than the A/D converter module such as a device of the CPU module, set as follows.

- Set a value between 90 and 99 (Level data□ (Un\G90 to Un\G99)) to 'CH1 Trigger data' (Un\G541).
- Write a value of the monitored device to Level data□ (Un\G90 to Un\G99) by using the MOV instruction.

Item	Setting range
Level data□ (Un\G90 to Un\G99)	-32768 to 32767

Ex.

Application example of Level data□ (Un\G90 to Un\G99)

To monitor the data register D100 in the CPU module and operate the level trigger in CH1, create a program as follows.

1. Set 91 (buffer memory address of Level data 1) to 'CH1 Trigger data' (Un\G541) (when Level data 1 is used).
2. Store the storage data of D100 in 'Level data 1' (Un\G91) by the program continuously.

Point

Specify an appropriate data such as 'CH1 Digital output value' (Un\G400), 'CH1 Digital operation value' (Un\G402), or Level data□ (Un\G90 to Un\G99) to 'CH1 Trigger data' (Un\G541). When a setting area or a system area is specified, the normal operation is not guaranteed.

■Setting the monitoring condition

Set a condition to generate a hold trigger in 'CH1 Level trigger condition setting' (Un\G540).

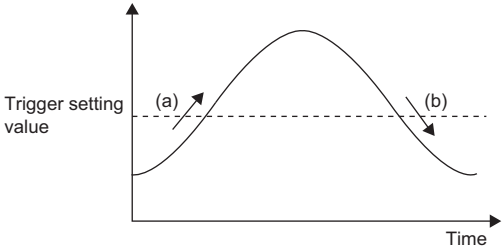
Setting value	Description	
Rise (1)	<p>Stored value of a buffer memory area to be monitored</p>  <p>Trigger setting value</p> <p>Time</p> <p>(a) A hold trigger is generated when the relation between the values changes from "Stored value of a buffer memory area to be monitored \leq Trigger setting value" to "Stored value of a buffer memory area to be monitored $>$ Trigger setting value".</p> <p>(b) A hold trigger is generated when the relation between the values changes from "Stored value of a buffer memory area to be monitored \geq Trigger setting value" to "Stored value of a buffer memory area to be monitored $<$ Trigger setting value".</p>	A hold trigger is generated under the condition (a).
Fall (2)		A hold trigger is generated under the condition (b).
Rise and fall (3)		A hold trigger is generated under the condition (a) or (b).

- Set a value where a hold trigger is generated to 'CH1 Trigger setting value' (Un\G542).

Item	Setting range
CH1 Trigger setting value (Un\G542)	-32768 to 32767

Point

The following figure shows the relation between setting items to be configured for the initial setting of a level trigger.

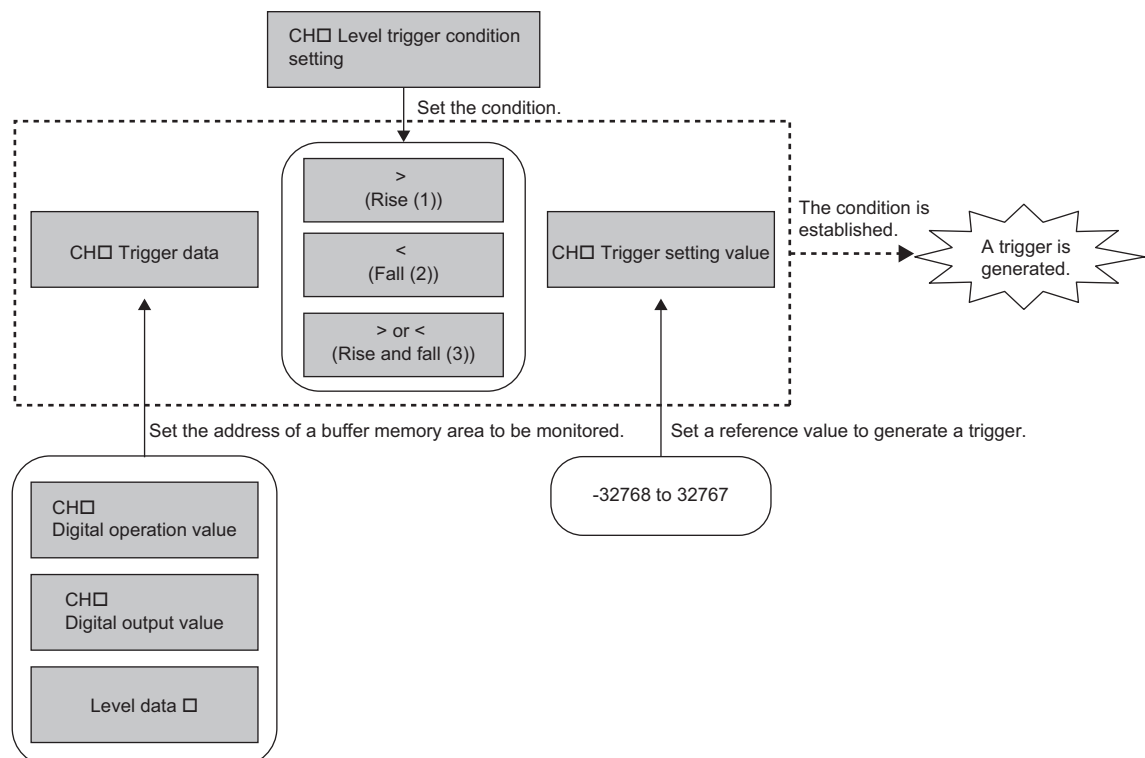

To generate a hold trigger when a value in 'CH1 Digital output value' (Un\G400) is greater than 10000, set as follows.

- 'CH1 Level trigger condition setting' (Un\G540): Rise (1)
- 'CH1 Trigger data' (Un\G541): 400
- 'CH1 Trigger setting value' (Un\G542): 10000

Operation of a level trigger

To use a level trigger, set ON (1) to 'CH1 Logging hold request' (Un\G471) in advance. At the point where ON (1) has been set to 'CH1 Logging hold request' (Un\G471), the module becomes the trigger condition wait status.

Data collection starts when the trigger condition has been satisfied, and stops when the set points of the data have been collected.

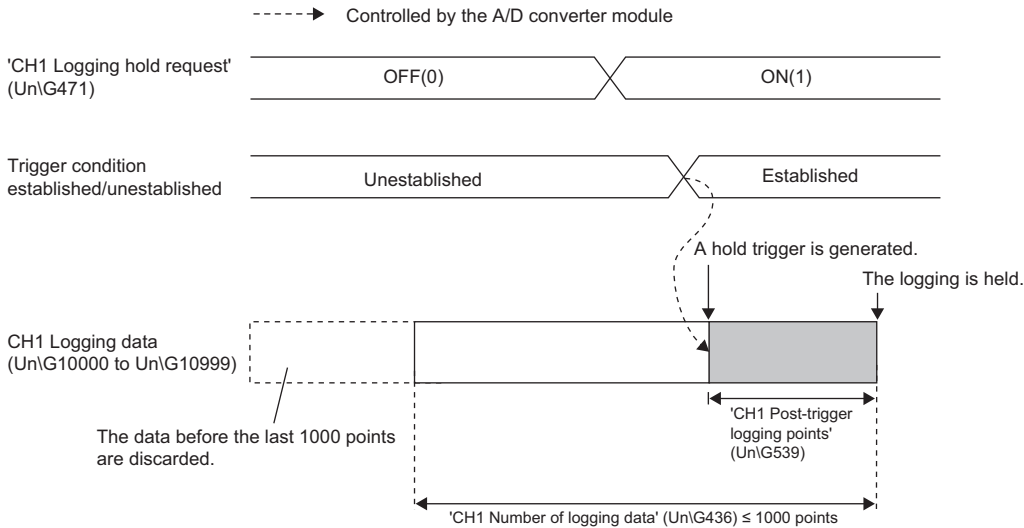

Point

A level trigger is detected on the refreshing cycle of the digital output value or the digital operation value. Therefore, the data when a hold trigger is generated may not be stored in 'CH1 Logging data' (Un\G10000 to Un\G10999) depending on the setting of the logging cycle. To store the data at the timing when a hold trigger is generated in 'CH1 Logging data' (Un\G10000 to Un\G10999), arrange related settings so that the conversion cycle of the monitoring target value (trigger data) and the logging cycle (actual logging cycle) have the same time period.

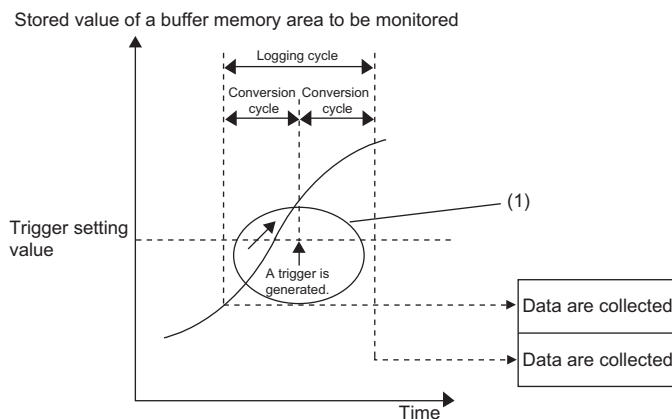

(1) The data at the timing when a trigger is generated is not stored in the buffer memory area.

- To refer to the logging data from the CPU module, hold (stop) the logging operation and check that ON (1) is stored in 'CH1 Logging hold flag' (Un\G409).



■Checking that the logging has stopped

Check that 'CH1 Logging hold flag' (Un\G409) is ON (1).

Initial settings of the logging function

The following describes the initial setting procedure to use the logging function.

Setting procedure

1. Set "A/D conversion enable/disable setting" to "A/D conversion enable".
 [Navigation window] ⇒ [Parameter] ⇒ [Module Information] ⇒ Module model name ⇒ [Basic setting] ⇒ [A/D conversion enable/disable setting]
2. Set "Logging enable/disable setting" to "Enable".
 [Navigation window] ⇒ [Parameter] ⇒ [Module Information] ⇒ Module model name ⇒ [Application setting] ⇒ [Logging function]
3. Set the target data to be logged in "Logging data setting". Set either of "Digital output value" or "Digital operation value" for each channel.
4. Set the cycle to store the logging data to "Logging cycle setting value".
5. Select a unit of the logging cycle setting value in "Logging cycle unit setting".
6. Set a condition to generate a hold trigger in "Level trigger condition setting". To use 'CH1 Logging hold request' (Un\G471), set "Disable". To use the level trigger, set either of "Level trigger (condition: Rise)", "Level trigger (condition: Fall)", or "Level trigger (condition: Rise and fall)".
7. Set a number of the data points to be collected for the time period from the occurrence of a hold trigger to logging stop in "Post-trigger logging points".
8. Set a buffer memory address to be monitored with a level trigger to "Trigger data".
9. Set whether to enable or disable the logging read function in "Read interrupt enable/disable setting"
10. Set a level where a level trigger operates for "Trigger setting value".

Logging read function

This function makes it possible to store more than 1000 points of logging data without stopping logging by transferring the device data to the file register of the CPU module during logging. This function reduces the takt time in a test demanding high-speed conversion.

Overview of the logging read function

After logging starts, an interrupt request is sent to the CPU module and an interrupt program is executed every time the preset number of data to be read is logged.

The A/D converter module has 16 points of the interrupt factor (SI) corresponding to the logging reading of each channel. For the setting of interrupt pointers, refer to the following.

☞ Page 73 Setting interrupt pointers

Setting interrupt pointers

Assign the interrupt factors (SI) of the A/D converter module and interrupt pointers of the CPU module using the interrupt pointer setting of the engineering tool.

The interrupt function must be set when the logging read function is used.

Starting the logging read function

To use the logging read function, set 'CH1 Loading interrupt enable/disable setting' (Un\G544) to Enable (0) and set a number of logging points to generate an interrupt in 'CH1 Logging read points setting value' (Un\G545). This function starts when 'Operating condition setting request' (Y9) is turned on and off.

■The number of logging read points

Set a value whose integral multiple is 1000 in 'CH1 Logging read points setting value' (Un\G545). The setting range is from 1 to 1000.

When a value whose integral multiple is not 1000 is set, the number of the actual logging read points is forced to become a maximum value whose integral multiple is 1000 within the set value. The value of the number of logging read points is stored in 'CH1 Logging read points monitor value' (Un\G440).

Logging read points setting value	Logging read points monitor value
100	100
90	50
110	100
650	500
400	250

Data checking method

■Current logging read pointer

- The head pointer read from 'CH1 Logging data' (Un\G10000 to Un\G10999) with the interrupt processing is stored in 'CH1 Current logging read pointer' (Un\G438).
- The default value of 'CH1 Current logging read pointer' (Un\G438) is -1.
- Every time the same number of data as the value stored in 'CH1 Logging read points monitor value' (Un\G440) is logged, a value calculated by the following formula is stored in 'CH1 Current logging read pointer' (Un\G438).

CH1 Current logging read pointer = CH1 Latest pointer - CH1 Logging read points monitor value + 1

■Previous logging read pointer

- 'CH1 Current logging read pointer' (Un\G438) at the timing when the previous read pointer detection interrupt occurs is stored in 'CH1 Previous logging read pointer' (Un\G439).
- The default value of 'CH1 Previous logging read pointer' (Un\G439) is -1.
- 'CH1 Previous logging read pointer' (Un\G439) is used to detect the overlap of the logging read pointer detection interrupt processing.

Ex.

The values to be stored in each pointer at every detection interrupt when the logging read detection starts with 'CH1 Logging read points setting value' (Un\G545) being set to 100

Occurrence of read pointer detection interrupts	Previous logging read pointer	Current logging read pointer	Latest pointer	Relative address	Buffer memory area
Default value	-1	-1	0	0	1st data
First time	-1	0	99	99	100th data
Second time	0	100	199	199	200th data
Third time	100	200	299	299	300th data
⋮	⋮	⋮	⋮	⋮	⋮
10th time	800	900	999	999	1000th data
11th time	900	0	99	99	100th data
12th time	0	100	199	199	200th data

Operation

The logging read function starts by setting interrupt pointers and turning on and off 'Operating condition setting request' (Y9). This function repeats its operation every time the same number of data as the logging read points monitor value is logged.

Ex.

The following figure shows the operation when the logging read function is used under the following conditions.

- A/D conversion-enabled channel: CH1
- 'CH1 Logging read points setting value' (Un\G545): 100 points

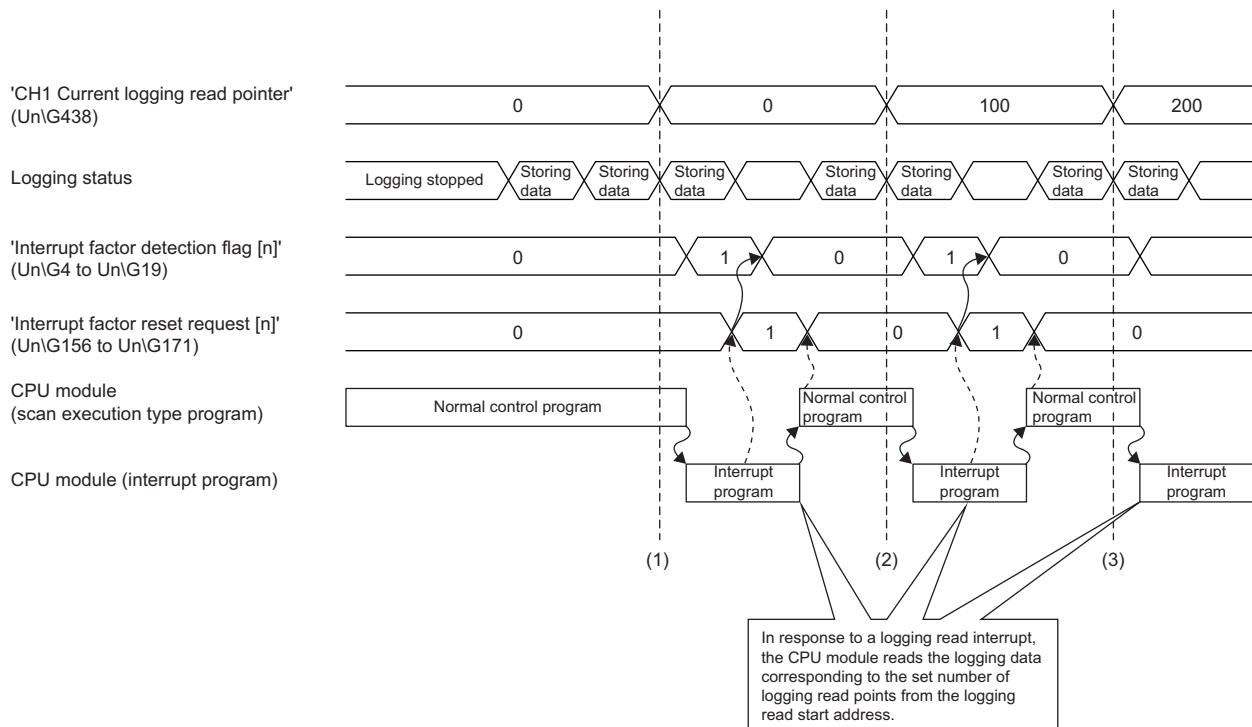

- (1) The timing that the first interrupt processing occurs
- (2) The timing that the second interrupt processing occurs
- (3) The timing that the third interrupt processing occurs

Setting procedure

To use the logging read function, both the logging read function and the interrupt setting must be set.

1. Set "Condition target setting" to "Logging read".

 [Navigation window] ⇒ [Parameter] ⇒ [Module Information] ⇒ Module model name ⇒ [Interrupt setting]

2. Set "A/D conversion enable/disable setting" to "A/D conversion enable".

 [Navigation window] ⇒ [Parameter] ⇒ [Module Information] ⇒ Module model name ⇒ [Basic setting] ⇒ [A/D conversion enable/disable setting]

3. Set "Logging enable/disable setting" to "Enable".

 [Navigation window] ⇒ [Parameter] ⇒ [Module Information] ⇒ Module model name ⇒ [Application setting] ⇒ [Logging function]

4. Set the target data to be logged in "Logging data setting".

5. Set the cycle to store the logging data to "Logging cycle setting value".

6. Set "Read interrupt enable/disable setting" to "Enable".

7. Set the number of logging points that generate a read interrupt in "Logging read points setting value".

Setting example

Ex.

When an interrupt program that is executed when the data of 'CH1 Logging read points monitor value' (U0\G440) is logged is assigned to the interrupt pointer I50

- Label settings

Classification	Label name	Description	Device																																													
Module Label	RCPU.stSM.bAfter_RUN1_Scan_ON	ON for one scan after RUN	SM402																																													
	R60ADG_1.unInterruptFactorMask_D[0].0	Interrupt factor mask	U0\G124																																													
	R60ADG_1.unInterruptFactorDetectionFlag_D[0].0	Interrupt factor detection flag?	U0\G4																																													
	R60ADG_1.unInterruptFactorResetRequest_D[0].0	Interrupt factor reset request	U0\G156																																													
	R60ADG_1.stnMonitor_D[0].wThisLoggingLoadPointer_D	CH1 Current logging read pointer	U0\G438																																													
	R60ADG_1.stnMonitor_D[0].uLoggingLoadPointsMonitorValue_D	CH1 Logging read points monitor value	U0\G440																																													
Labels to be defined	Define global labels as shown below:																																															
	<table border="1"> <thead> <tr> <th></th> <th>Label Name</th> <th>Data Type</th> <th>Class</th> <th>Assign</th> </tr> </thead> <tbody> <tr> <td>1</td> <td>G_uLoggingReadPoints</td> <td>Word [Unsigned]/Bit String [16-bit]</td> <td>VAR_GLOBAL</td> <td>D10</td> </tr> <tr> <td>2</td> <td>G_udLoggingReadPointsTemporary</td> <td>Double Word [Unsigned]/Bit String [32-bit]</td> <td>VAR_GLOBAL</td> <td>D12</td> </tr> <tr> <td>3</td> <td>G_udWritePosition</td> <td>Double Word [Unsigned]/Bit String [32-bit]</td> <td>VAR_GLOBAL</td> <td>D20</td> </tr> <tr> <td>4</td> <td>G_udSaveFileRegisterMaxValue</td> <td>Double Word [Unsigned]/Bit String [32-bit]</td> <td>VAR_GLOBAL</td> <td>D30</td> </tr> <tr> <td>5</td> <td>G_wThisTimeLoggingReadPointIndex</td> <td>Word [Signed]</td> <td>VAR_GLOBAL</td> <td>Z0</td> </tr> <tr> <td>6</td> <td>G_udWritePositionIndex</td> <td>Double Word [Unsigned]/Bit String [32-bit]</td> <td>VAR_GLOBAL</td> <td>Z4</td> </tr> <tr> <td>7</td> <td>G_wLoggingReadMonitorValuePlusIndex</td> <td>Word [Signed]</td> <td>VAR_GLOBAL</td> <td>U0\G10000Z0</td> </tr> <tr> <td>8</td> <td>G_wSaveFileRegisterPlusIndex</td> <td>Word [Signed]</td> <td>VAR_GLOBAL</td> <td>ZR0ZZ4</td> </tr> </tbody> </table>		Label Name	Data Type	Class	Assign	1	G_uLoggingReadPoints	Word [Unsigned]/Bit String [16-bit]	VAR_GLOBAL	D10	2	G_udLoggingReadPointsTemporary	Double Word [Unsigned]/Bit String [32-bit]	VAR_GLOBAL	D12	3	G_udWritePosition	Double Word [Unsigned]/Bit String [32-bit]	VAR_GLOBAL	D20	4	G_udSaveFileRegisterMaxValue	Double Word [Unsigned]/Bit String [32-bit]	VAR_GLOBAL	D30	5	G_wThisTimeLoggingReadPointIndex	Word [Signed]	VAR_GLOBAL	Z0	6	G_udWritePositionIndex	Double Word [Unsigned]/Bit String [32-bit]	VAR_GLOBAL	Z4	7	G_wLoggingReadMonitorValuePlusIndex	Word [Signed]	VAR_GLOBAL	U0\G10000Z0	8	G_wSaveFileRegisterPlusIndex	Word [Signed]	VAR_GLOBAL	ZR0ZZ4		
	Label Name	Data Type	Class	Assign																																												
1	G_uLoggingReadPoints	Word [Unsigned]/Bit String [16-bit]	VAR_GLOBAL	D10																																												
2	G_udLoggingReadPointsTemporary	Double Word [Unsigned]/Bit String [32-bit]	VAR_GLOBAL	D12																																												
3	G_udWritePosition	Double Word [Unsigned]/Bit String [32-bit]	VAR_GLOBAL	D20																																												
4	G_udSaveFileRegisterMaxValue	Double Word [Unsigned]/Bit String [32-bit]	VAR_GLOBAL	D30																																												
5	G_wThisTimeLoggingReadPointIndex	Word [Signed]	VAR_GLOBAL	Z0																																												
6	G_udWritePositionIndex	Double Word [Unsigned]/Bit String [32-bit]	VAR_GLOBAL	Z4																																												
7	G_wLoggingReadMonitorValuePlusIndex	Word [Signed]	VAR_GLOBAL	U0\G10000Z0																																												
8	G_wSaveFileRegisterPlusIndex	Word [Signed]	VAR_GLOBAL	ZR0ZZ4																																												

• Program Example

(0)	RCPJ.stSM.bAfter _RUN1_Scan_ON SM402					SI	I50	K1
								EI
						MOV	K0	G_uLoggingReadPoints D10
						DMOV	K0	G_udWritePosition D20
						DMOV	K50000	G_udSaveFileRegisterMaxVal ue D30
						SET		R60ADG_1_unInterruptFactor Mask_D[0].0 U0/G124.0
(16)								FEND

(18)	D+_U	G_udSaveFileRegi sterMaxValue D30	G_udWritePosition D20			MOV	R60ADG_1_stnMonitor_D [0].wThisLoggingLoadPoi nter_D U0/G438	G_wThisTimeLoggingReadPo intIndex Z0	
						MOV	R60ADG_1_stnMonitor_D [0].uLoggingLoadPointsM onitorValue_D U0/G440	G_uLoggingReadPoints D10	
						DMOV	G_udWritePosition D20	G_udWritePositionIndex Z4	
						BMOV	G_wLoggingReadMo nitorValuePlusIndex U0/G1000Z0	G_wSaveFileRegisterPlus sIndex ZR0Z24	G_uLoggingReadPoints D10
						UINT2UDINT	G_uLoggingReadPoints D10	G_udLoggingReadPointsTem porary D12	
						D+_U	G_udLoggingReadPoints Temporary D12	G_udWritePosition D20	
(45)	R60ADG_1_unInter ruptFactorDetectio nFlag_D[0].0 U0/G4.0							RST	R60ADG_1_unInterruptFactor DetectionFlag_D[0].0 U0/G4.0
								SET	R60ADG_1_unInterruptFactor ResetRequest_D[0].0 U0/G156.0
(54)								IRET	
(55)								{END }	

- (0) Enable only the interrupt pointer I50.
Initialize 'CH1 Logging read points monitor value' (U0/G440) and the write position of the save destination file register.
Set the maximum number of stored save destination file registers.
Clear Interrupt factor mask [0].

- (18) Store 'CH1 Current logging read pointer' (U0\G438) in the index register.
Store 'CH1 Logging read points monitor value' (U0\G440) in the register.
Store the write position of the save destination file register in the index register.
Store 'CH1 Logging data' (Un\G10000 to Un\G10999) for the logging read points monitor value in the save destination file register.
Add the points of the logging read points monitor value to the write position of the save destination file register and store the obtained value as the write position for the next logging.
- (45) Turn off Interrupt factor mask [0] when Interrupt factor detection flag turns on.
Turn on Interrupt factor reset request [0].

Saving to a CSV file

The logging data stored in the buffer memory areas can be saved to a CSV file by using function blocks (FBs). The save data is sorted in a time series, where the logging data can be easily checked.

However, function blocks (FBs) can be executed only when the logging operation is stopped. During the logging operation, the execution of function blocks (FBs) is disabled.

Saving a CSV file

To save a CSV file, an SD memory card is required.

CSV files are saved in an SD memory card installed in the CPU module. CSV files cannot be saved in the built-in memory of the CPU module.

Saving procedure

1. Check that ON (1) is stored in 'CH1 Logging hold flag' (Un\G409).
2. Execute the function block (FB).

Point

If the execution state of the function block (FB) is maintained, logging data can be saved in the CSV file every time logging stops.

Data to be saved in a CSV file

The logging data stored in the buffer memory areas is saved.

For how to check the logging data, refer to the following.

☞ Page 65 Checking data when a hold trigger has occurred

CSV file name

CSV files saved with the function block (FB) are named as follows.

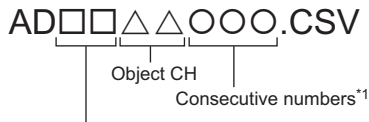

First two digits of the start I/O number of the A/D converter module (expressed in four hexadecimal digits)

*1 The maximum number of the consecutive numbers can be set with the input label i_Max_Number (maximum number of saving files) of the function block (FB).

Ex.

The file name under the following condition is AD4516006.CSV.

- Start I/O number of the A/D converter module: 0450H
- Target channel: 16
- Saving to a CSV file: 6th time.

Displaying logging data

The CSV file output with the logging function can be displayed graphically by reading the file through GX LogViewer. For how to display the logging data with GX LogViewer, refer to the following.

 GX LogViewer Version 1 Operating Manual

1.13 Interrupt Function

This function executes an interrupt program of the CPU module when an interrupt factor such as an input signal error or alert output is detected.

For the A/D converter module, the maximum number of interrupt pointers available is 16 per module.

Operation

■Detecting an interrupt factor

When an interrupt factor occurs, an interrupt request is sent to the CPU module at the same time as 'Interrupt factor detection flag [n]' (Un\G4 to Un\G19) is turned to Interrupt factor (1).

■How to reset an interrupt factor

When Reset request (1) is set to 'Interrupt factor reset request [n]' (Un\G156 to Un\G171) corresponding to the interrupt factor, the specified interrupt factor is reset and 'Interrupt factor detection flag [n]' (Un\G4 to Un\G19) changes to No interrupt factor (0).

Setting procedure

To use the interrupt function, set "Condition target setting", "Condition target channel setting", "Interrupt factor transaction setting", and "Interrupt pointer" in the engineering tool. After completing the settings, write the project to enable the settings.

 [Navigation window] ⇨ [Parameter] ⇨ [Module Information] ⇨ Module model name ⇨ [Interrupt setting]

The following table shows the setting items on the interrupt setting window.

Item	Description
Condition target setting	Select a factor of the target for the interrupt detection.
Condition target channel setting	Select a target channel when the condition target setting for the interrupt detection is channel specification.
Interrupt factor transaction setting	Set an interrupt request for when the same interrupt factor occurs during the interrupt factor detection.
Interrupt pointer	Specify the number of an interrupt pointer that is initiated at the detection of an interrupt factor.

■Condition target setting

Select a factor of the condition target setting for the interrupt detection.

For details on the factors to be detected, refer to the following.

 Page 151 Condition target setting [n]

■Condition target channel setting

Select a target channel when the condition target setting for the interrupt detection is channel specification.

For details on the settings, refer to the following.

 Page 152 Condition target channel setting [n]

■Interrupt factor transaction setting

Set an interrupt request for when the same interrupt factor occurs during the interrupt factor detection.

- With "Interrupt reissue requests (0)", if the same interrupt factor occurs during the interrupt factor detection, an interrupt request is sent to the CPU module again.
- With "No interrupt reissue request (1)", if the same interrupt factor occurs during the interrupt factor detection, an interrupt request is not sent to the CPU module.

■Interrupt pointer

Specify the number of an interrupt pointer that is initiated at the detection of an interrupt factor. For details on the interrupt pointers, refer to the following.

 MELSEC iQ-R CPU Module User's Manual (Application)

- If 'Condition target setting [n]' (Un\G232 to Un\G247) is Disable (0), an interrupt request is not sent to the CPU module.
- To reset the interrupt factor, set Reset request (1) until 'Interrupt factor detection flag [n]' (Un\G4 to Un\G19) changes to No interrupt factor (0).
- Resetting interrupt factors is executed only when 'Interrupt factor reset request [n]' (Un\G156 to Un\G171) changes from No reset request (0) to Reset request (1).
- Multiple interrupt pointers can also share the same setting of 'Condition target setting [n]' (Un\G232 to Un\G247). When interrupts with the same settings occur in 'Condition target setting [n]' (Un\G232 to Un\G247), the interrupt program is executed in order of the priority of the interrupt pointers. For the priority of the interrupt pointers, refer to the following.

 MELSEC iQ-R CPU Module User's Manual (Application)

- When All channels (0) is set for 'Condition target channel setting [n]' (Un\G264 to Un\G279) and an interrupt detection target is set for each channel of 'Condition target setting [n]' (Un\G232 to Un\G247), the interrupt requests that have the same interrupt factor are sent to the CPU module if alerts are issued in multiple channels. In this case, the CPU module executes multiple interrupt programs and judges that the program cannot be normally finished due to the scan monitoring function, and a CPU module error may occur. When a CPU error occurs, refer to the following.

 MELSEC iQ-R CPU Module User's Manual (Application)

Setting example

Ex.

If the interrupt program (I51) is executed when an error occurs in any channel

- Parameter setting

Set "Interrupt setting" of the module parameter as follows.

No.	Condition target setting	Condition target channel setting	Interrupt pointer
2	Error flag	All channels	I51

- Label settings

Classification	Label name	Description	Device
Module Label	RCPU.stSM.bAlways_ON	Always ON	SM400
	RCPU.stSM.bAfter_RUN1_Scan_ON	ON for one scan after RUN	SM402
	R60ADG_1.unInterruptFactorMask_D[1].0	Interrupt factor mask	U0\G125.0
	R60ADG_1.unInterruptFactorResetRequest_D[1].0	Interrupt factor reset request	U0\G157.0

Labels to be defined

Define global labels as shown below:

	Label Name	Data Type	Class	Assign (Device/Label)
1	G_bErrorDetection	Bit	VAR_GLOBAL	F0

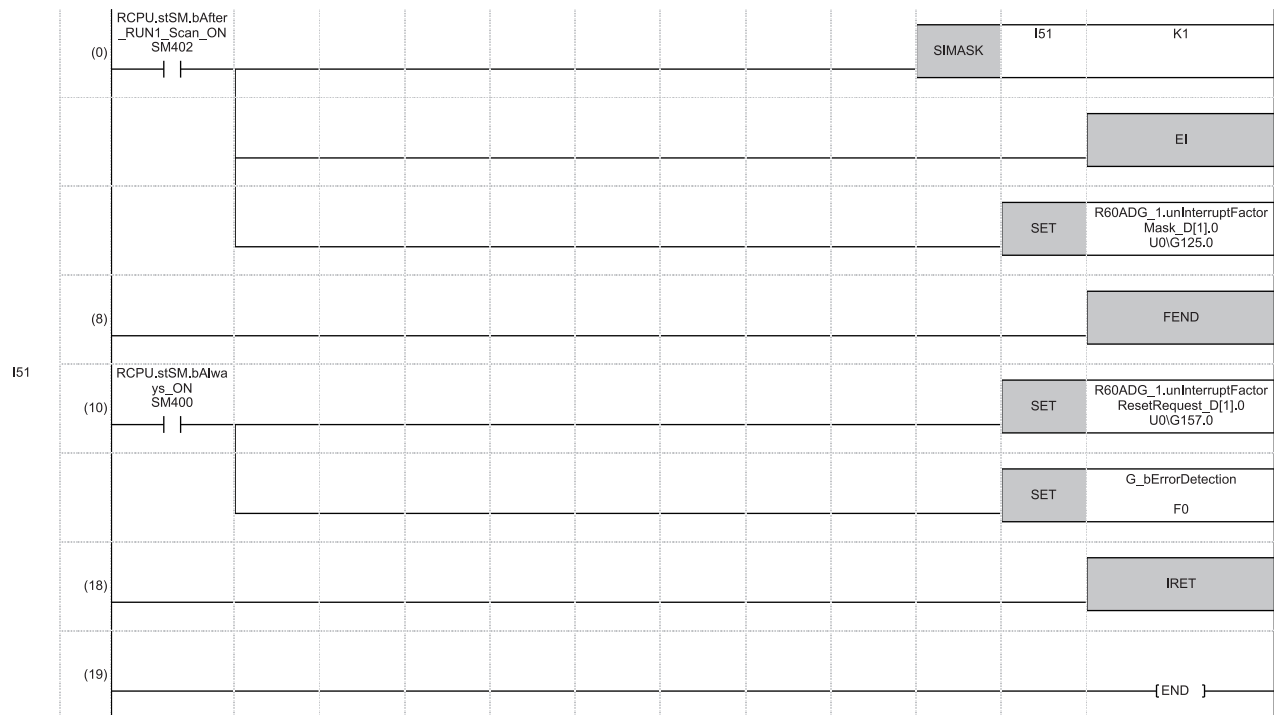

(0) Enable only the interrupt pointer I51.

(10) Turn on 'Interrupt factor reset request [1]' (U0\G157).

Performs the processing of when an error is detected.

1.14 Error History Function

This function records errors and alarms that occurred in the A/D converter module to store them into the buffer memory area. Up to 16 errors and alarms are stored.

Operation

When an error occurs, the error code and the error time are stored from Error history 1 (Un\G3600 to Un\G3609) in order.

When an alarm occurs, the alarm code and the alarm time are stored from Alarm history 1 (Un\G3760 to Un\G3769) in order.

- Detail of the error code assignment

	b15	to	b8 b7	to	b0
Un\G3600	Error code				
Un\G3601	First two digits of the year		Last two digits of the year		
Un\G3602	Month		Day		
Un\G3603	Hour		Minute		
Un\G3604	Second		Day of the week		
Un\G3605	Millisecond (higher-order digits)		Millisecond (lower-order digits)		
Un\G3606	System area				
⋮					
Un\G3609					

- Detail of the alarm code assignment

	b15	to	b8 b7	to	b0
Un\G3760	Alarm code				
Un\G3761	First two digits of the year		Last two digits of the year		
Un\G3762	Month		Day		
Un\G3763	Hour		Minute		
Un\G3764	Second		Day of the week		
Un\G3765	Millisecond (higher-order digits)		Millisecond (lower-order digits)		
Un\G3766	System area				
⋮					
Un\G3769					

Ex.

Storing example of error history and alarm history

Item	Storage contents	Storage example*1
First two digits of the year/Last two digits of the year	Stored in BCD code.	2015H
Month/Day		131H
Hour/Minute		1234H
Second		56H
Day of the week	One of the following values is stored in BCD code. Sunday: 0, Monday: 1, Tuesday: 2, Wednesday: 3 Thursday: 4, Friday: 5, Saturday: 6	6H
Millisecond (upper)	Stored in BCD code.	7H
Millisecond (lower)		89H

*1 Values stored when an error occurs at 12:34:56.789 on Saturday, January 31st, 2015.

The start address of Error history where the latest error is stored can be checked in 'Latest address of error history' (Un\G1).

The start address of Alarm history where the latest alarm is stored can be checked in 'Latest address of alarm history'

(Un\G3).

Ex.

When the third error occurs:

The third error is stored in Error history 3, and the value 3620 (start address of Error history 3) is stored to 'Latest address of error history' (Un\G1).

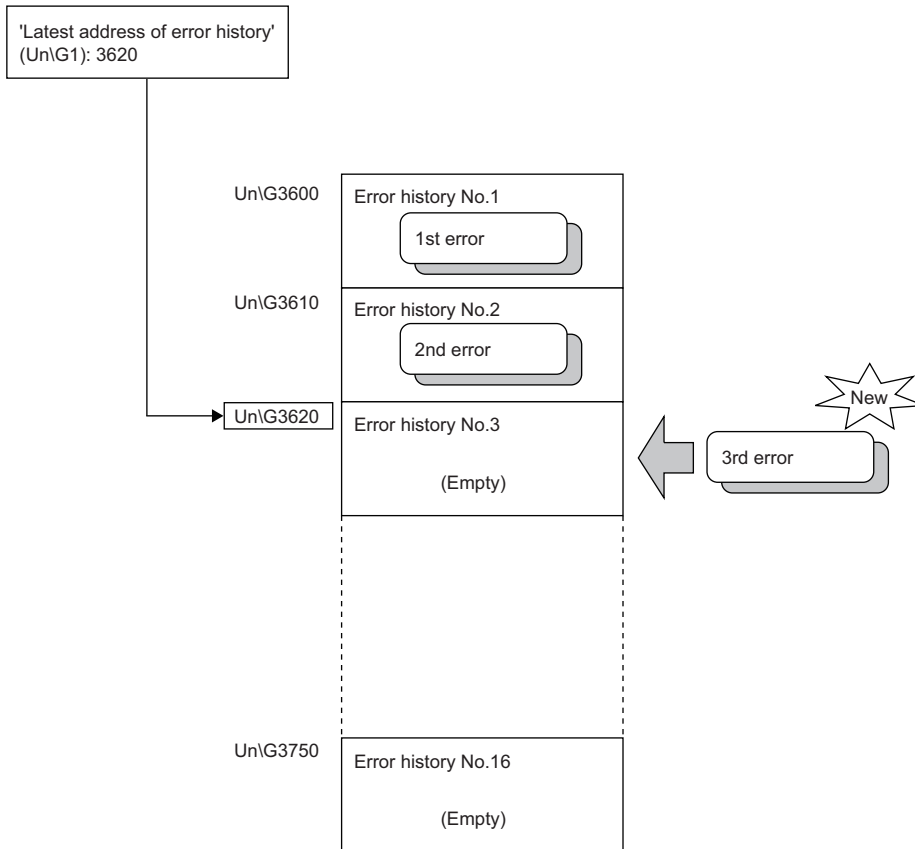

Ex.

When the 17th error occurs:

The 17th error is stored in Error history 1, and the value 3600 (start address of Error history 1) is stored to 'Latest address of error history' (Un\G1).

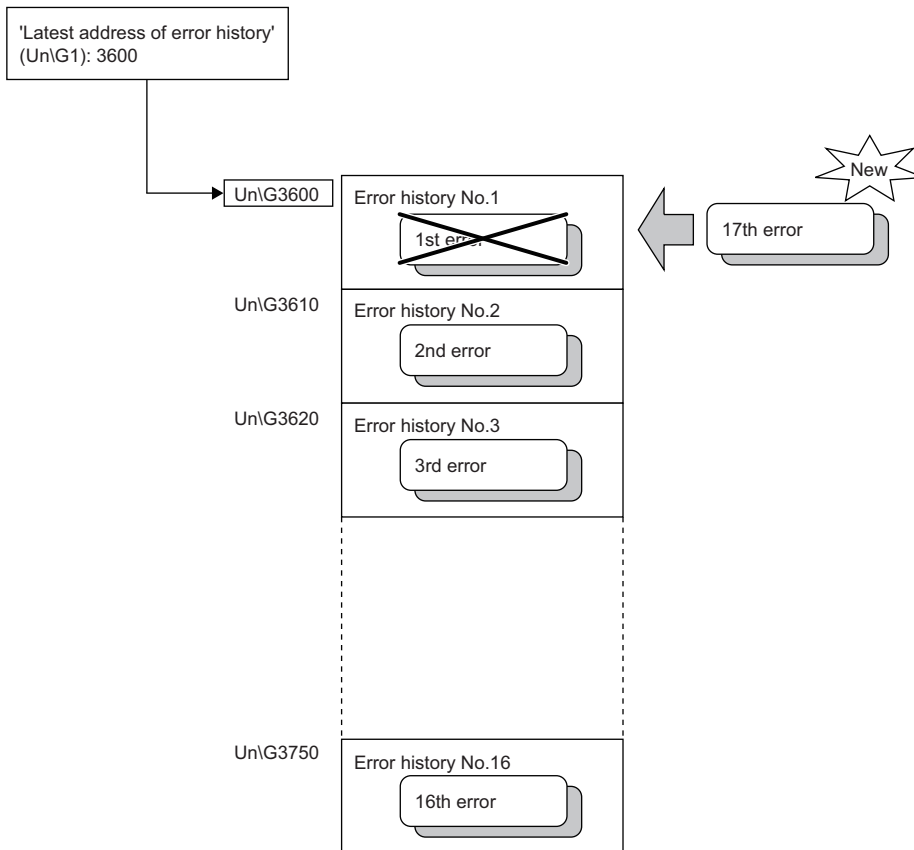
**Point**

- Once the error history storage area becomes full, subsequent error information will overwrite the existing data, starting from Error history 1 (Un\G3600 to Un\G3609), and continues sequentially thereafter. The overwritten history is deleted.
- The same processing is performed for Alarm history when an alarm occurs.
- The stored error history is cleared when the A/D converter module is powered off, or when the CPU module is reset.

1.15 Event History Function

This function collects generated errors, alarms or executed operations in the A/D converter module as event information in the CPU module.

The CPU module collects the event information caused in the A/D converter module and keeps them in the data memory inside of the CPU module or an SD memory card.

The event information collected by the CPU module can be displayed on an engineering tool to check the occurrence history in a time series.

Event type	Classification	Description
System	Error	An error detected by the self diagnostics in each module.
	Warning	A warning (alarm) detected in each module.
	Information	The operation by the normal detection of the system that is not classified as Error or Warning, or the operation performed automatically by the system.
Security	Warning	Operation that is judged as an unauthorized access to each module.
	Information	Operation that is hard to be judged as the success of unlocking passwords or an unauthorized access.
Operation	Warning	Deleting (data clear) operations that may change the action. (These operations are not judged as errors by the self diagnostics.)
	Information	Operations performed by users to change the system operation or configuration in the offset/gain setting.

Setting procedure

The event history function can be set from the event history setting window of the engineering tool. For the setting method, refer to the following.

 MELSEC iQ-R CPU Module User's Manual (Application)

Displaying event history

Access to the menu window of the engineering tool. For details on the operating procedure and how to view the contents, refer to the following.

 GX Works3 Operating Manual

List of event history data

The following table lists the events that would occur in the A/D converter module when the event type is set to "Operation"

Event code	Event class	Event name	Event detail	Additional information
20010	Information	Offset/gain setting execution	In the user range setting, offset/gain values has been set.	Total number of writes
20100	Information	Error clear	Error clear request has been issued.	—

1.16 Backing up, Saving, and Restoring Offset/Gain Values

The offset/gain values of the user range setting of the A/D converter module can be backed up, saved, and restored.

- Back up: Creates a module-specific backup parameter and saves offset/gain values.
- Save: Saves the offset/gain information, registered in this module by making the offset/gain setting, in the CPU module.
- Restoration: Writes the information backed up and saved in the CPU module to this module.

In the event that the A/D converter module fails and needs to be replaced, the offset/gain values of the failed A/D converter module can be restored onto the new A/D converter module.

However, if the offset/gain values are saved and restored, the accuracy after the restoration decreases by approximately three times compared to that before the restoration. Reconfigure the offset/gain setting when required.

Only when the model where the offset/gain values are to be saved and the model where the offset/gain values are to be restored are the same, the offset/gain values can be saved and restored.

Each procedure differs depending on whether a module-specific backup parameter is used or not.

When the module-specific backup parameter is used

Offset/gain values are automatically restored when the failed module is replaced with a new one using the online module change.

For details on the online module change, refer to the following.

 MELSEC iQ-R Online Module Change Manual

Details of the module-specific backup parameter

A module-specific backup parameter is a file created in an SD memory card or the data memory of the control CPU. The contents of the parameter are the offset/gain value of the user range stored in the non-volatile memory of the A/D converter module.

The file name of a module-specific backup parameter is determined as follows based on the start I/O number of the A/D converter module.

UBPmmmn.BPR

- mmm indicates a value calculated by dividing the module I/O No. by 10H (3 digits in hexadecimal).
- nn indicates a consecutive number of the module-specific backup parameters for each module and fixed to 00.

Creating and updating a module-specific backup parameter

A module-specific backup parameter is created or updated when the offset/gain values stored in the non-volatile memory of the A/D converter module are updated.

Timing when backup data is created or updated	Description
When the offset/gain setting is completed with "Offset/gain setting" of the engineering tool	A module-specific backup parameter is created or updated when the offset/gain setting is completed with "Offset/gain setting" of the engineering tool.
When 'User range write request' (YA) is turned on in the offset/gain setting mode	A module-specific backup parameter is created or updated when the offset/gain values of the user range are changed in the offset/gain setting mode.
When 'User range write request' (YA) is turned on in the normal mode	When 'User range write request' (YA) is turned on in the normal mode, the offset/gain values of the user range are restored based on the settings of the buffer memory areas (Save data type, CH1 Factory default setting offset value (L) to CH16 User range setting gain value (H)). At this timing, module-specific backup parameters are updated.
When the G(P).OGSTOR instruction is executed in the normal mode	When the G(P).OGSTOR instruction is executed in the normal mode, the offset/gain values of the user range are restored. At this timing, module-specific backup parameters are updated.
When a new module is recognized after the online module change	When a new module is mounted and recognized after the online module change, the offset/gain values of the user range are restored. At this timing, module-specific backup parameters are updated.

When no module-specific backup parameter exists in the data memory of the control CPU and a module-specific backup parameter needs to be created with the current setting, change the mode of the A/D converter module to the offset/gain setting mode and turn on 'User range write request' (YA). A module-specific backup parameter is created with the current setting of the flash memory.

■Precautions

If the creation of a module-specific backup parameter fails because the data memory of the control CPU does not have sufficient free space or the module-specific backup parameter is being used, a module-specific backup parameter creation error (error code: 17E1H) occurs.

Reading of module-specific backup parameters

To read a module-specific backup parameter and restore offset/gain values, set "Auto restore of Offset/gain setting with the module change" of the module parameter to "Enable" in advance.

 [Navigation window] ⇒ [Parameter] ⇒ [Module Information] ⇒ Module model name ⇒ [Application setting] ⇒ [Online module change]

■Reading timing

Module-specific backup parameters are read when a new module is mounted and recognized after the online module change. When the programmable controller is powered off and the module is replaced with a new one, module-specific backup parameters are not read.

■Precautions

When the module-specific backup parameter for the target slot does not exist in an SD memory card or the data memory of the control CPU, the subsequent restoration of the offset/gain values is not performed. If the offset/gain values cannot be restored even though the module-specific backup parameter exists, a module-specific backup parameter restore error (error code: 17E0H) occurs.

Restoration of the offset/gain values of the user range

When reading module-specific backup parameters are completed with no errors, the values are converted (restored) into the offset/gain values of the user range for the new module, and stored in the non-volatile memory. At the same timing, the module-specific backup parameter in the data memory of the control CPU is updated with the setting of the new module.

Restrictions on the module-specific backup parameter

Offset/gain values cannot be backed up or restored with a module-specific backup parameter in the following cases.

- When the control CPU is not the process CPU
- When the programmable controller is powered off and the A/D converter module is replaced with a new one
- When "Auto restore of Offset/gain setting with the module change" of the module parameter is set to "Disable"

In any of the cases above, back up or restore offset/gain values by the following method.

 Page 90 When the module-specific backup parameter is not used

When the module-specific backup parameter is not used

Back up or restore offset/gain values by one of the following methods.

- Saving and restoring by dedicated instructions
- Saving and restoring by reading from and writing to the buffer memory

With the method above, offset/gain values can be restored to a new module, or the offset/gain values set in one module can be applied to the other modules in the same system.

- To restore offset/gain values onto a new replaced module:

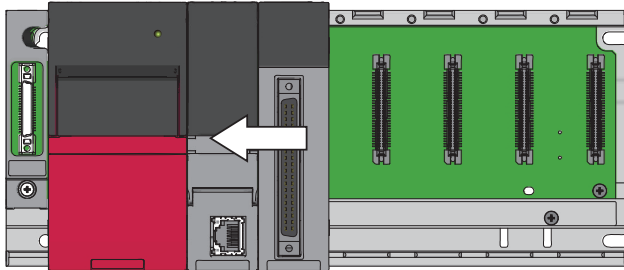

1. Save offset/gain values.

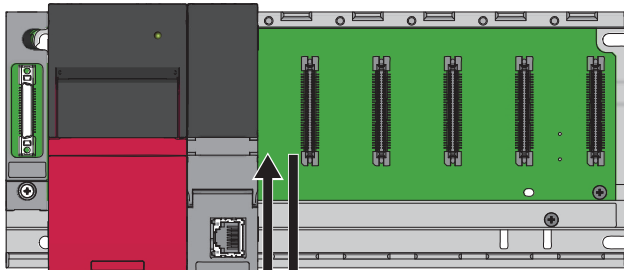

2. Power off the programmable controller, and replace the A/D converter module with a new one.

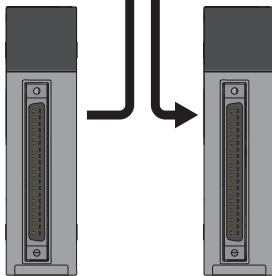

3. Restore the offset/gain values.

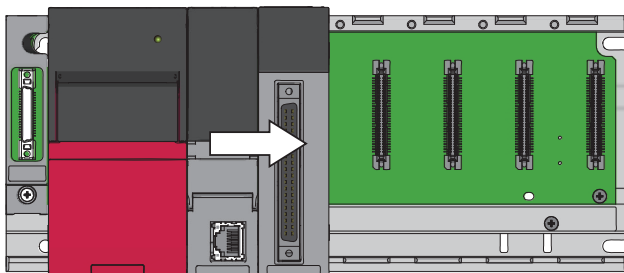

- To apply the offset/gain values set in one module to the other modules in the same system:

Ex.

When the offset/gain values in module No.1 are applied to modules No.2 to No.4

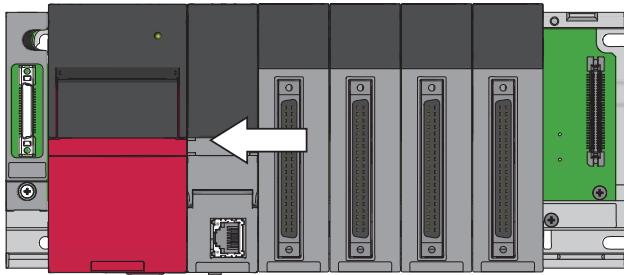

1. Save the offset/gain values in module No.1.

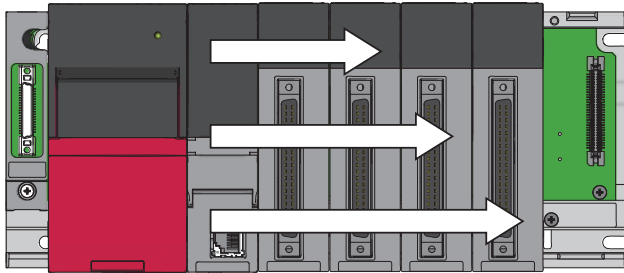

2. Apply the offset/gain values to modules No.2 to No.4

Saving and restoring by dedicated instructions

Use the dedicated instruction G(P).OGLOAD to temporarily save the offset/gain values of the source A/D converter module to the internal device of the CPU, then use G(P).OGSTOR to write the values to the destination A/D converter module.

Prevent the saved offset/gain setting data from being deleted, by one of the following methods before replacing the modules:

- Use latch settings for the internal device of the destination module.
- Save the data onto an SD memory card. (To write data: use the SP.FWRITE instruction. To read data: use the SP.FREAD instruction.)
- Store the saved data.

For use of dedicated instructions, refer to the following.

 MELSEC iQ-R Programming Manual (Module Dedicated Instructions)

Saving and restoring by reading from and writing to the buffer memory

Use Save data type setting, CH1 Factory default setting offset value (L) to CH16 User range setting gain value (H), and 'User range write request' (YA) to read the offset/gain values from the source A/D converter module. Use the buffer memory again to write the values to the destination A/D converter module.

The following describes the procedure for using the buffer memory.

■To restore offset/gain values onto a new replaced module:

- When restoring offset/gain values onto the source A/D converter module
1. Set Save data type setting.
 2. Turn on and off 'Operating condition setting request' (Y9).
 3. Save the stored values of Save data type setting and CH1 Factory default setting offset value (L) to CH16 User range setting gain value (H).
- When the power of the module is off
4. Replace the A/D converter module.
- When restoring offset/gain values onto the destination A/D converter module
5. Write the data saved in Save data type setting and CH1 Factory default setting offset value (L) to CH16 User range setting gain value (H).
 6. Turn on 'User range write request' (YA).
 7. Check that 'Offset/gain setting mode status flag' (XA) is on.
 8. Turn off 'User range write request (YA)'.
'User range write request (YA)'
 9. Check whether the destination A/D converter module operates with the offset/gain values that are restored.

Point

When replacing modules, prevent the saved offset/gain setting data from being deleted, by one of the following methods before powering off the module.

- Use latch settings for the internal device of the destination module.
- Save the data onto an SD memory card. (To write data: use the SP.FWRITE instruction. To read data: use the SP.FREAD instruction.)
- Store the saved data.

■To apply the offset/gain values set in one module to the other modules in the same system:

- When restoring offset/gain values onto the source A/D converter module
1. Set Save data type setting.
 2. Turn on and off 'Operating condition setting request' (Y9).
 3. Save the stored values of Save data type setting and CH1 Factory default setting offset value (L) to CH16 User range setting gain value (H).
- When restoring offset/gain values onto the destination A/D converter module
4. Write the data saved in Save data type setting and CH1 Factory default setting offset value (L) to CH16 User range setting gain value (H).
 5. Turn on 'User range write request' (YA).
 6. Check that 'Offset/gain setting mode status flag' (XA) is on.
 7. Turn off 'User range write request (YA)'.
'User range write request (YA)'
 8. Check whether the destination A/D converter module operates with the offset/gain values that are restored.

Range reference table

The following describes the range reference tables used for saving and restoring offset/gain values.

■ Factory default setting

The following describes the buffer memory addresses of the factory default setting.

R60AD8-G: CH1 Factory default setting offset value (L) (Un\G4004) to CH8 Factory default setting gain value (H) (Un\G4035)

R60AD16-G: CH1 Factory default setting offset value (L) (Un\G4004) to CH16 Factory default setting gain value (H) (Un\G4067)

- For the R60AD8-G

Address (decimal)								Description	Save data type setting ^{*1}	Analog value	Reference value (hexadecimal)
CH1	CH2	CH3	CH4	CH5	CH6	CH7	CH8				
4004	4008	4012	4016	4020	4024	4028	4032	Factory default setting offset value	Voltage specification	0V	800000H
4005	4009	4013	4017	4021	4025	4029	4033		Current specification	0mA	800000H
4006	4010	4014	4018	4022	4026	4030	4034	Factory default setting gain value	Voltage specification	10V	C92492H
4007	4011	4015	4019	4023	4027	4031	4035		Current specification	20mA	A4D6CDH

*1 The reference values differ depending on the setting of Save data type setting (Un\G4002) (voltage or current).

- For the R60AD16-G

Address (decimal)								Description	Save data type setting ^{*1}	Analog value	Reference value (hexadecimal)
CH1	CH2	CH3	CH4	CH5	CH6	CH7	CH8				
CH1	CH2	CH3	CH4	CH5	CH6	CH7	CH8	Factory default setting offset value	Voltage specification Current specification	0V 0mA	800000H
4004	4008	4012	4016	4020	4024	4028	4032				
4005	4009	4013	4017	4021	4025	4029	4033				
CH9	CH10	CH11	CH12	CH13	CH14	CH15	CH16				
4036	4040	4044	4048	4052	4056	4060	4064	Factory default setting gain value	Voltage specification Current specification	10V 20mA	C92492H A4D6CDH
4037	4041	4045	4049	4053	4057	4061	4065				
CH1	CH2	CH3	CH4	CH5	CH6	CH7	CH8				
4006	4010	4014	4018	4022	4026	4030	4034				
4007	4011	4015	4019	4023	4027	4031	4035	Factory default setting gain value	Voltage specification Current specification	10V 20mA	C92492H A4D6CDH
CH9	CH10	CH11	CH12	CH13	CH14	CH15	CH16				
4038	4042	4046	4050	4054	4058	4062	4066				
4039	4043	4047	4051	4055	4059	4063	4067				

*1 The reference values differ depending on the setting of Save data type setting (Un\G4002) (voltage or current).

■ User range setting

The following describes the buffer memory addresses of the user range setting.

R60AD8-G: CH1 User range setting offset value (L) (Un\G4036) to CH8 User range setting gain value (H) (Un\G4067)

R60AD16-G: CH1 User range setting offset value (L) (Un\G4068) to CH16 User range setting gain value (H) (Un\G4131)

Offset/gain value		Reference value (hexadecimal)
Current	4mA ^{*1}	875E29H
	20mA ^{*2}	A4D6CDH

*1 This value is stored in User range setting offset value by default of the R60AD8-G or R60ADI6-G.

*2 This value is stored in User range setting gain value by default of the R60AD8-G or R60ADI6-G.

1.17 Q Compatible Mode Function

This function allows setting the buffer memory addresses of the A/D converter module same as the buffer memory addresses of the MELSEC-Q series.

This compatibility makes it possible to reuse sequence programs that have exhibited high performance on the MELSEC-Q series modules.

The following table lists the compatible modules of the MELSEC-Q series.

A/D converter module of the MELSEC iQ-R series	Compatible A/D converter module
R60AD8-G	Q68AD-G

Point

The R60AD16-G does not support the Q compatible mode function.

Operation

Only the buffer memory assignment is changed in the Q compatible mode.

- The I/O signal assignment is the same as that of the R mode. Some signals have been changed. However, the signals that change the module operation maintain the compatibility. Therefore, when a MELSEC-Q series sequence program is diverted, a significant modification of the sequence program is not required. The following table shows a difference between the R60AD8-G and Q68AD-G.

Device number	R60AD8-G	Q68AD-G
X7	Use prohibited	High resolution mode status flag (ON: High resolution mode, OFF: Normal resolution mode)

Point

- When a MELSEC-Q series sequence program is diverted, check digital output values and the operation timing and modify the sequence program if necessary because the specifications such as the resolution and update timing are changed.
- When a MELSEC-Q series sequence program is diverted and an error code is set as the operating condition or interlock condition, the program does not operate normally.
- When the Q compatible mode function is enabled, a program that uses FB or labels cannot be created. When FB or labels is used, create a program in the R mode.

Setting procedure

1. When adding a new module, select the module whose module name has "(Q)" at the end.

 [Navigation window] ⇒ [Parameter] ⇒ [Module Information] ⇒ Right-click ⇒ [Add New Module]

2. Configure the same parameter setting as the one of when the R mode is used.
3. Restart the CPU module after the module parameter is written.

Point

- During the module operation, the mode cannot be switched between the R mode and Q compatible mode.
- The project of the compatible A/D converter module created by GX Works2 can be read with the other format read function of GX Works3. The read project keeps various settings of the compatible A/D converter module as the settings of the A/D converter module of the MELSEC iQ-R series. The settings to be kept are the switch setting, parameter setting, auto refresh setting, and I/O assignment setting.

2 PARAMETER SETTINGS

Set the parameters of each channel.

Setting parameters here eliminates the need to program them.

2

2.1 Basic Setting

Setting procedure

Open "Basic setting" of the engineering tool.

1. Start Module parameter.

[Navigation window] ⇒ [Parameter] ⇒ [Module Information] ⇒ Module model name ⇒ [Basic setting]

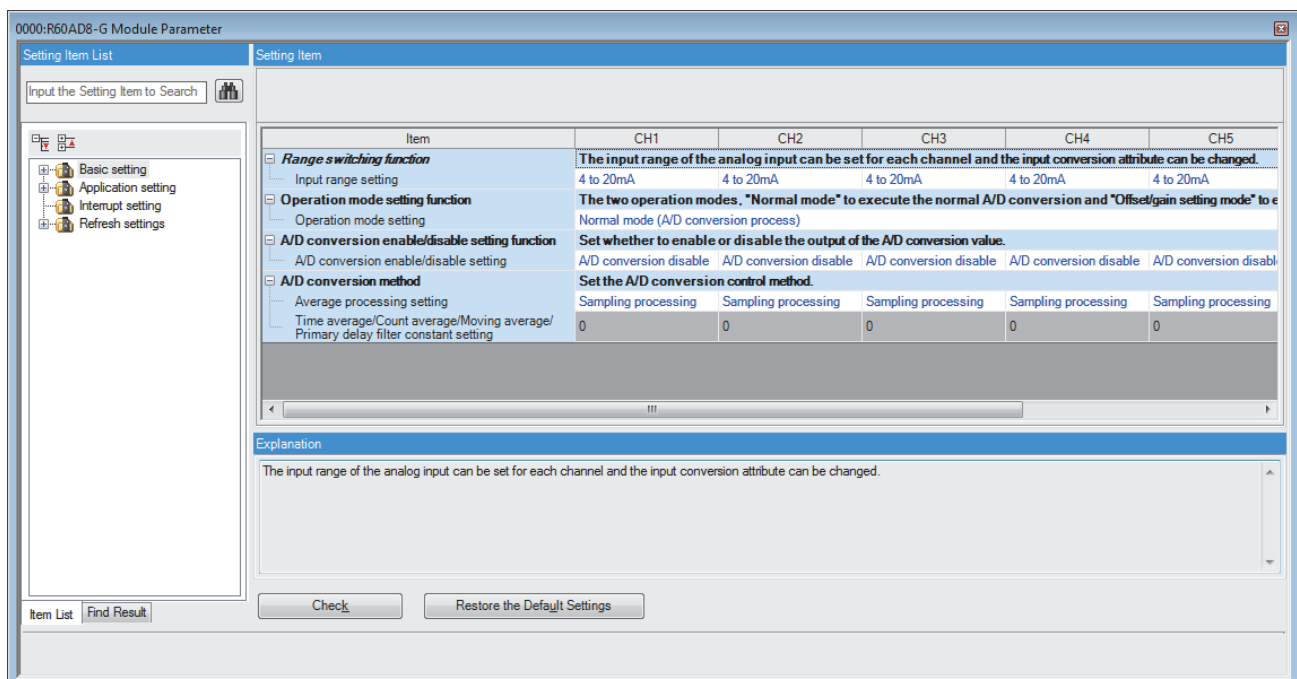

2. Click the item to be changed to enter the setting value.

- Item where a value is selected from the pull-down list

Click [▼] button of the item to be set, and from the pull-down list that appears, select the value.

- Item where a value is entered into the text box

Double-click the item to be set to enter the numeric value.

2.2 Application Setting

Setting procedure

Open "Application setting" of the engineering tool.

1. Start Module parameter.

[Navigation window] ⇒ [Parameter] ⇒ [Module Information] ⇒ Module model name ⇒ [Application setting]

Item	CH1	CH2	CH3	CH4	CH5
Scaling function					
Configure the setting for the scaling at the A/D conversion.					
Scaling enable/disable setting	Disable	Disable	Disable	Disable	Disable
Scaling upper limit value	0	0	0	0	0
Scaling lower limit value	0	0	0	0	0
Shift function					
Configure the setting for the shift function at the A/D conversion.					
Conversion value shift	0	0	0	0	0
Digital clipping function					
Configure the setting for the digital clipping function at the A/D conversion.					
Digitalclip enable/disable setting	Disable	Disable	Disable	Disable	Disable
Warning output function (Process alarm)					
Set an alert at the A/D conversion.					
Warning output setting (Process alarm)	Disable	Disable	Disable	Disable	Disable
Process alarm upper upper limit value	0	0	0	0	0
Process alarm upper lower limit value	0	0	0	0	0
Process alarm lower upper limit value	0	0	0	0	0
Process alarm lower lower limit value	0	0	0	0	0
Warning output function (Rate alarm)					
Set an alert at the A/D conversion.					
Warning output setting (Rate alarm)	Disable	Disable	Disable	Disable	Disable
Rate alarm detection cycle setting	0 times	0 times	0 times	0 times	0 times
Rate alarm upper limit value	0.0 %	0.0 %	0.0 %	0.0 %	0.0 %
Rate alarm lower limit value	0.0 %	0.0 %	0.0 %	0.0 %	0.0 %
Input signal error detection function					
Configure the setting for the input signal at the A/D conversion.					
Input signal error detection setting	Disable	Disable	Disable	Disable	Disable
Input signal error detection lower limit setting value	5.0 %	5.0 %	5.0 %	5.0 %	5.0 %
Input signal error detection upper limit setting value	5.0 %	5.0 %	5.0 %	5.0 %	5.0 %
Input signal error detection auto clear enable/disable setting	Disable	Disable	Disable	Disable	Disable
Logging function					
Configure the setting for the logging function at the A/D conversion.					
Logging enable/disable setting	Disable	Disable	Disable	Disable	Disable
Logging data setting	Digital operation value	Digital operation value	Digital operation value	Digital operation value	Digital operation value
Logging cycle setting value	160 ms	160 ms	160 ms	160 ms	160 ms
Logging cycle unit setting	ms	ms	ms	ms	ms
Level trigger condition setting	Disable	Disable	Disable	Disable	Disable
Logging points after trigger	500	500	500	500	500
Trigger data	402	602	802	1002	1202
Trigger setting value	0	0	0	0	0
Logging loading enable/disable setting	Disable	Disable	Disable	Disable	Disable
Logging read points setting value	100	100	100	100	100
Online module change					
The module can be changed without the system being stopped.					
Auto restore of Offset/gain setting with the module change	Enable	Enable	Enable	Enable	Enable

2. Click the item to be changed to enter the setting value.

- Item where a value is selected from the pull-down list

Click [▼] button of the item to be set, and from the pull-down list that appears, select the value.

- Item where a value is entered into the text box

Double-click the item to be set to enter the numeric value.

2.3 Interrupt Setting

Setting procedure

Open "Interrupt setting" of the engineering tool.

1. Start Module parameter.

[Navigation window] ⇒ [Parameter] ⇒ [Module Information] ⇒ Module model name ⇒ [Interrupt setting]

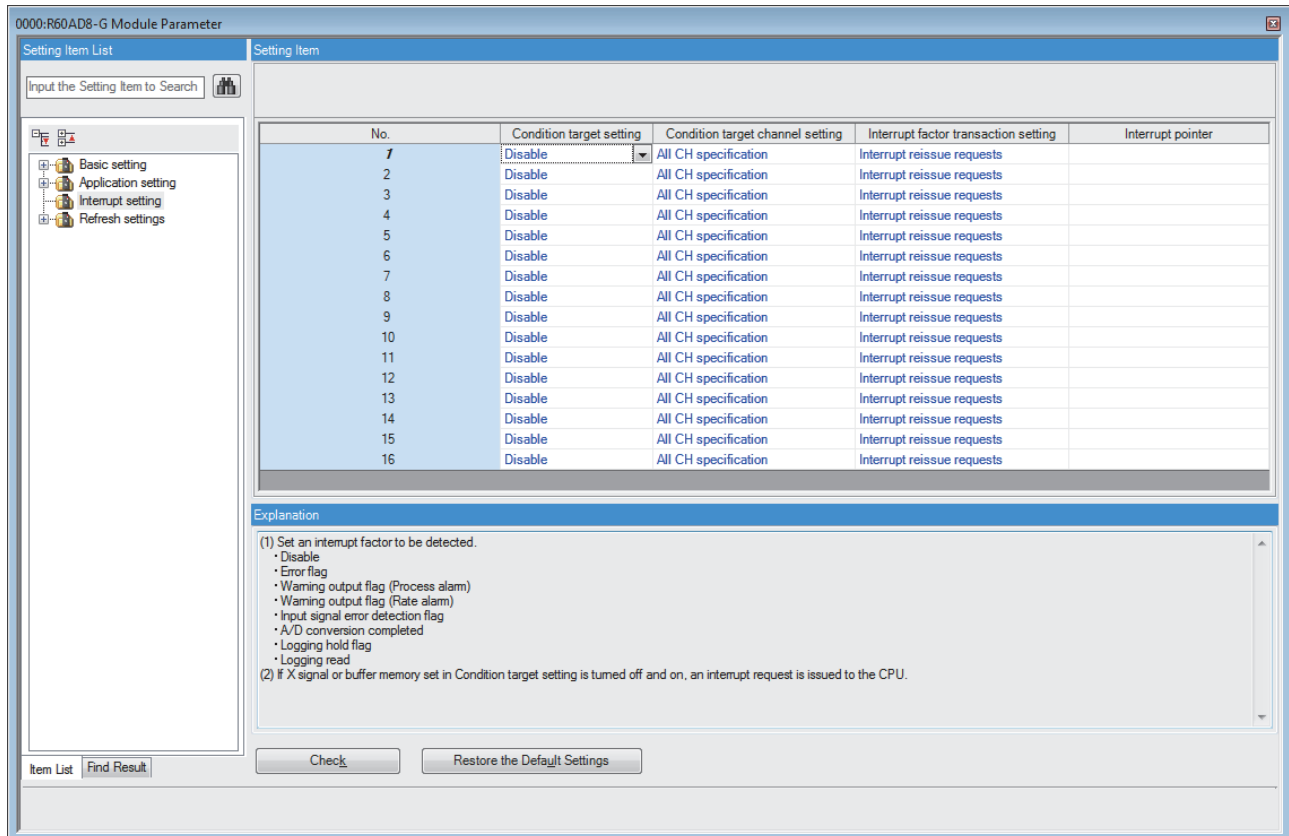

2. Click the interrupt setting number (No.1 to 16) to be changed to enter the setting value.

- Item where a value is selected from the pull-down list

Click [▼] button of the item to be set, and from the pull-down list that appears, select the value.

- Item where a value is entered into the text box

Double-click the item to be set to enter the numeric value.

2.4 Refresh Setting

Setting procedure

Set the buffer memory area of the A/D converter module to be refreshed.

This refresh setting eliminates the need for reading/writing data by programming.

1. Start Module parameter.

[Navigation window] ⇒ [Parameter] ⇒ [Module Information] ⇒ Module model name ⇒ [Refresh settings]

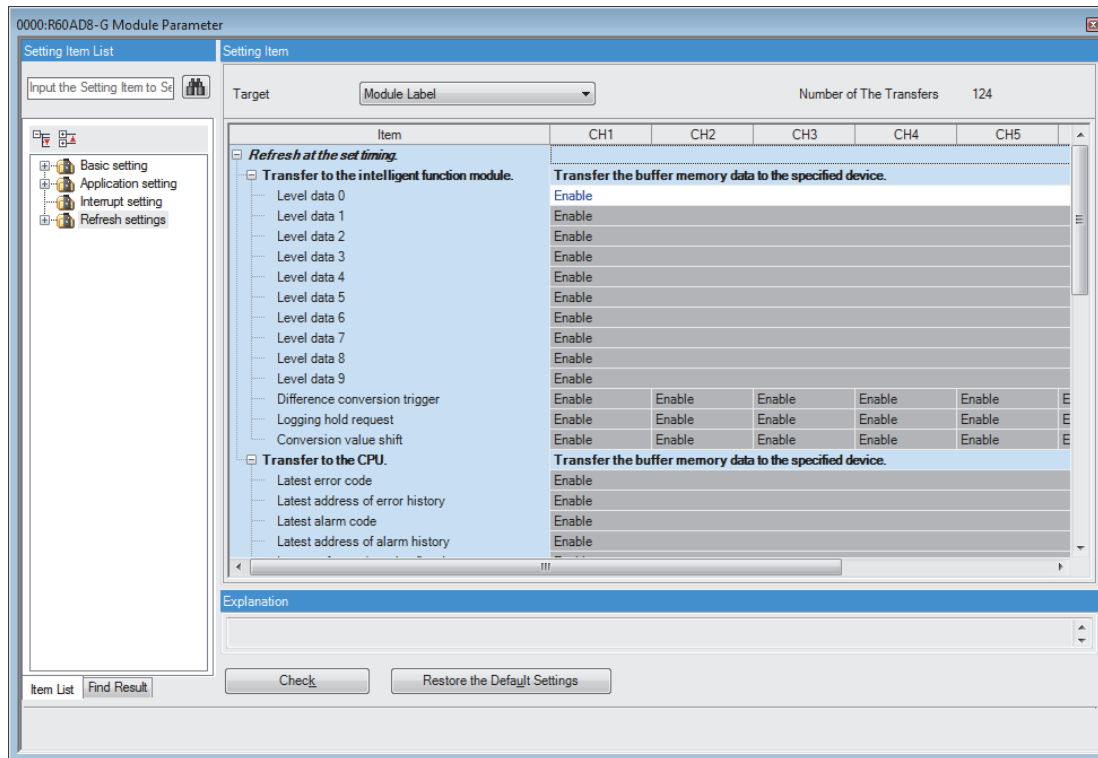

2. Click "Target", and set the auto refresh destination.

- When "Refresh Destination" is "Module Label"

Set whether to enable or disable the refresh by setting "Level data 0" to Valid or Invalid.

- When "Refresh Destination" is "Refresh Data Register (RD)"

The transfer destinations of all items are automatically set by setting the start device to "Top Device Name".

- When "Refresh Destination" is "Specified Device"

Double-click the item to be set to enter the refresh destination device.

3. Click "Refresh Group" to set the timing to refresh.

Set "Refresh Group" to "At the Execution Time of END Instruction" or "At the Execution Time of Specified Program".

When "At the Execution Time of Specified Program" is set, double-click "Group [n] (n: 1-64)" and set a value of 1 to 64.

Point

When the refresh is enabled, the values of the refresh destination are enabled at the refresh timing set with the engineering tool. At this time, the buffer memory areas are overwritten with the values of the refresh destination. To change the value in the refresh target buffer memory area, create a program to change the module label of the refresh destination and the device value.

Refresh processing time

The refresh processing time [μs] is a constituent of the scan time of the CPU module. For details on the scan time, refer to the following.

 MELSEC iQ-R CPU Module User's Manual (Application)

The refresh processing time [μs], which is taken for refresh, is given by:

- Refresh processing time [μs] = Refresh read time (time for transferring refresh data to the CPU module) + Refresh write time (time for transferring refresh data to the intelligent function module)

The refresh read time and refresh write time vary depending on the settings of "Target".

When "Target" is "Module Label" or "Refresh Data Register (RD)"

The following table shows the refresh read time and refresh write time with an R□CPU used.

Model	Classification	When using the refresh settings
R60AD8-G	Refresh read time	27.28 μs
	Refresh write time	23.94 μs
R60AD16-G	Refresh read time	39.92 μs
	Refresh write time	38.10 μs
R60AD8-G (Q compatible mode)	Refresh read time	24.70 μs
	Refresh write time	12.34 μs

When "Target" is "Device"

Calculate the refresh read time and refresh write time according to the number of items and the number of their transfer data (in units of word) that are set to be refreshed. For the calculation method, refer to the following.

 MELSEC iQ-R CPU Module User's Manual (Application)

3 TROUBLESHOOTING

This chapter describes errors that may occur in the use of the A/D converter module and those troubleshooting.

3.1 Troubleshooting with the LEDs

Check the state of the LEDs to narrow down the possible causes of the trouble. This step is the first diagnostics before using the engineering tool.

A state of the A/D converter module can be checked with the RUN LED, ERR LED, and ALM LED. The following table shows the correspondence of these LEDs and a state of the A/D converter module.

Name	Description
RUN LED	Indicates the operating status of the module. On: Normal operation Flashing (1s cycles): In offset/gain setting mode Flashing (400ms cycles): Selected as a module for the online module change Off: 5V power supply interrupted, watchdog timer error occurred, or exchanging the module is allowed in the process of the online module change.
ERR LED	Indicates the error status of the module.*1 On: Error occurred Off: Normal operation
ALM LED	Indicates the alarm status of the module.*2 Or indicates the wait-for-restart status after the safety module is disabled.*3 On: Alert (process alarm or rate alarm) issued Flashing (1s cycles): Input signal error detected Flashing (400ms cycles): Wait-for-restart Off: Normal operation

*1 For details, refer to the following.

☞ Page 107 List of Error Codes

*2 For details, refer to the following.

☞ Page 111 List of Alarm Codes

*3 For details, refer to the following.

☞ Page 215 Disabling the Safety Module

3.2 Checking the State of the Module

The following functions are available in the "Module Diagnostics" window of the A/D converter module.

FUNCTIONS	Application
Error Information	Displays the description of errors that have occurred. Clicking the [Event History] button displays the errors that have occurred on the network and the history of the errors detected and the operations executed on each module.
Module Information List	Displays each status information of the A/D converter module.

3

Error Information

Check the description and the actions of the errors that have occurred.

🖱️ [Diagnostics] ⇒ [System Monitor] ⇒ Right-click the module to be checked. ⇒ "Module Diagnostics"

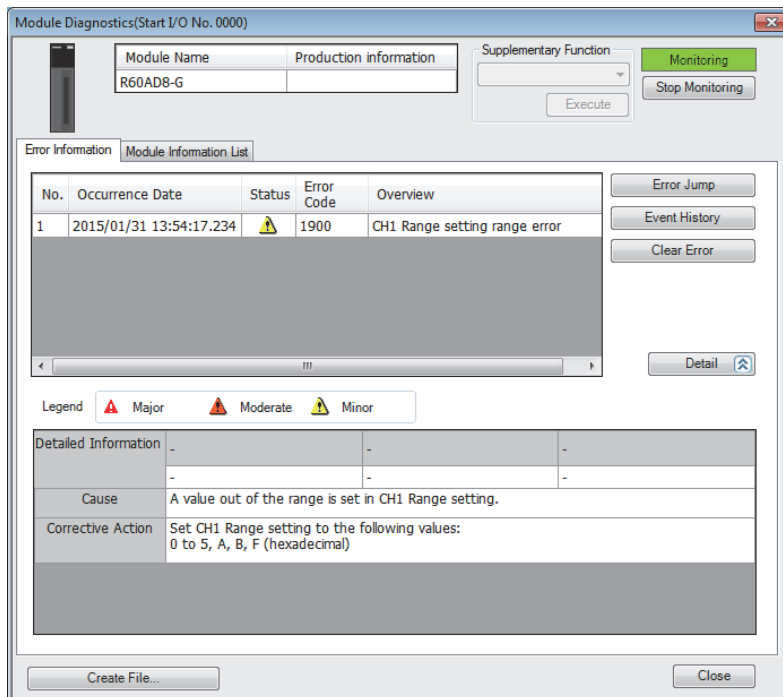

Item	Description
Status	Major: An error such as a hardware failure or memory failure. The module stops operating.
	Moderate: An error, such as a parameter error, which affects module operation. The module stops operating.
	Minor: An error such as a communication failure. The module continues operating.
Detailed Information	Displays detailed information about each error (maximum of 3 pieces).
Cause	Displays the detailed error causes.
Corrective Action	Displays the actions to eliminate the error causes.

Module Information List

Switch to the "Module Information List" tab to display each status information of the A/D converter module.

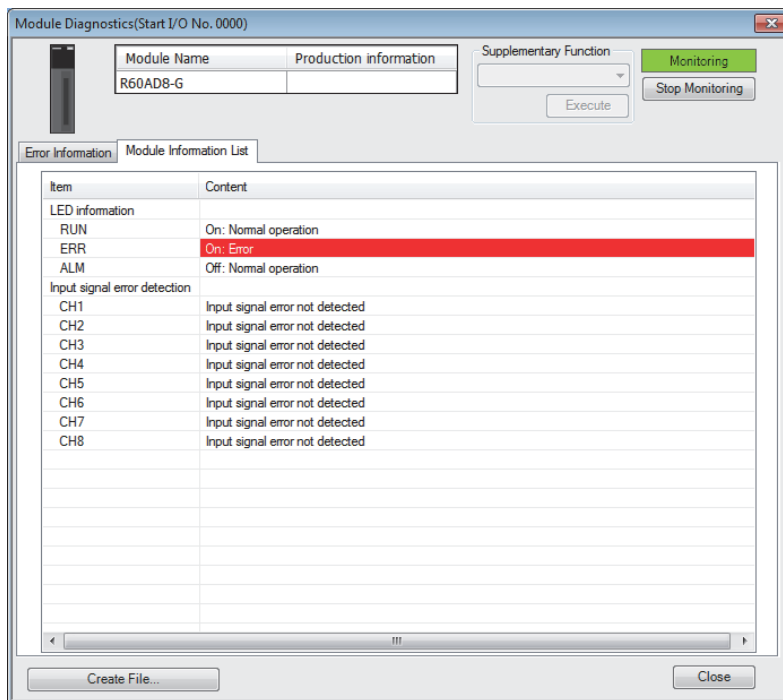

Item	Description
LED information	Displays the LED status of the A/D converter module.
Input signal error detection	Displays the detection status for the input signal errors of the A/D converter module for each channel.

3.3 Troubleshooting by Symptom

When the A/D converter module does not start up

Check item	Corrective action
Check that five seconds have passed since the power supply module is powered off.	After the power supply module is powered off, wait at least five seconds before turning on the input power supply to the power supply module.

When the RUN LED flashes or turns off

3

When flashing

Check item	Cause	Corrective Action
Check whether the module is in offset/gain setting mode.	In the module parameter setting of the engineering tool, the programmable controller power supply has been turned off and on, or the CPU module has been reset when "Operation mode setting" is "Offset/gain setting mode".	In the module parameter setting of the engineering tool, set "Operation mode setting" to "Normal mode (A/D conversion process)" and turn off and on the programmable controller power supply, or reset the CPU module.
	The G(P).OFFGAN instruction has been executed with the mode switched to offset/gain setting mode.	Review the program that uses the G(P).OFFGAN instruction to check whether the mode has been switched erroneously.
	The value in 'Mode switching setting' (Un\G296, Un\G297) has been changed and the mode has been switched to the offset/gain setting mode.	Review the program that uses 'Mode switching setting' (Un\G296, Un\G297) to check whether the mode has been switched erroneously.
Check whether the module is selected as a target module for the online module change.	The base number and slot number of the A/D converter module have been set in Module selection (base unit No.) (SD1600) or Module selection (slot No.) (SD1601).	Turn on Module selection cancel request flag (SM1615).

When turning off

Check item	Corrective Action
Check whether the power is supplied.	Check that the supply voltage of the power supply module is within the rated range.
Check whether the capacity of the power supply module is enough.	Calculate the current consumption of mounted modules, such as the CPU module, I/O modules, and intelligent function modules to check that the power capacity is enough.
Check whether the module is mounted properly.	Check the mounting state of the module.
Check whether the module is during online module change and is ready for the online module change.	Perform the online module change. For details, refer to the following manual.  MELSEC iQ-R Online Module Change Manual
Cases other than the above	Reset the CPU module, and check if the RUN LED turns on. If the RUN LED still remains off, the possible cause is a failure of the module. Please consult your local Mitsubishi representative.

When the ERR LED turns on

When turning on

Check item	Corrective Action
Check whether any error has occurred.	Check 'Latest error code' (Un\G0) and take actions described in the list of error codes.  Page 107 List of Error Codes

When the ALM LED turns on or flashes

When turning on

Check item	Corrective Action
Check whether any alert has been issued.	Check 'Alert output flag (process alarm upper limit)' (Un\G36), 'Alert output flag (process alarm lower limit)' (Un\G37), 'Alert output flag (rate alarm upper limit)' (Un\G38), and 'Alert output flag (rate alarm lower limit)' (Un\G39). Take actions described in the list of alarm codes.  Page 111 List of Alarm Codes

When flashing

Check item	Corrective Action
Check whether any input signal error has occurred.	Check 'Input signal error detection signal' (XC) or 'Input signal error detection flag' (Un\G40). Take actions described in the list of alarm codes.  Page 111 List of Alarm Codes

When a digital output value cannot be read

Check item	Corrective Action
Check whether there is any problem with the wiring, such as looseness or disconnection of analog signal lines.	Identify the faulty area of signal lines by a visual check and continuity check.
Check whether the CPU module is in the STOP state.	Change the state of the CPU module to RUN.
Check whether the offset/gain setting is correct.	If the input range setting is the user range setting, turn on and off 'Operating condition setting request' (Y9), and check CH□ User range setting offset value and CH□ User range setting gain value comparing with the range reference table. If the stored values are not desired offset/gain values, perform the offset/gain setting again. For the range reference table, refer to the following. ☞ Page 93 Range reference table
Check whether the input range setting is correct.	Check CH□ Range setting monitor using the engineering tool. If the input range is incorrect, correctly set the input range setting of the engineering tool and/or CH□ Range setting.
Check whether A/D conversion disable is set in A/D conversion enable/disable setting of the channel where a value is to be input.	Check CH□ A/D conversion enable/disable setting and set to A/D conversion enable using a program or the engineering tool.
Check whether 'Operating condition setting request' (Y9) has been executed.	Turn on and off*1 'Operating condition setting request' (Y9) and check that a digital output value is stored in CH□ Digital output value using the engineering tool. If the stored value is correct, further check if 'Operating condition setting request' (Y9) operates properly in the program.
Check whether the terminals (V+) and (I+) are connected at the current input.	For the current input, be sure to connect the terminals (V+) and (I+) by referring to the external wiring example. ☞ MELSEC iQ-R Channel Isolated Analog-Digital Converter Module User's Manual (Startup)
Check whether the setting value of the time average is correct when the time average is selected in Averaging process specification.	When the time average is selected for processing, set the time average value in CH□ Time average/Count average/Moving average/Primary delay filter constant setting so that the value satisfies the following condition: Time averaging setting value ≥ 4 (times) \times 10ms \times Number of conversion enabled channels If the condition above is not satisfied, the digital output value results in 0.
Check whether the program for reading digital output values has an error.	Check CH□ Digital output value using the engineering tool. If the digital output value is stored without being converted from the analog input value, review and correct the read program.
Check whether the refresh setting is correct.	If the refresh is set so that the value in CH□ Digital output value is transferred to the device of the CPU module, review and correct the auto refresh setting.
Check whether any input signal error has occurred.	The digital output value and digital operation value are not updated during the occurrence of an input signal error. If 'Input signal error detection flag' (UnG40) indicates an input signal error, check the values in CH□ Input signal error detection setting and CH□ Input signal error detection setting value to examine the validity of the input signal error detection upper limit value and the input signal error detection lower limit value. ☞ Page 38 Input Signal Error Detection Function If the values are valid, change the analog input value so that an input signal error does not occur.

*1 If 'Operating condition setting request' (Y9) is in an on state, A/D conversion does not start. In such a case, turn off and on it to check the off state of 'Operating condition setting completed flag' (X9), and be sure to turn on and off it.

Point

If digital output values cannot be read even after the above actions are taken, the possible cause is a failure of the module. Please consult your local Mitsubishi representative.

When the digital output value does not fall within the range of accuracy

Check item	Corrective Action
Check whether any measures have been taken to reduce noise.	To reduce noise, take measures such as the use of shielded cables for connection.

3.4 List of Error Codes

If an error occurs during operation, the A/D converter module stores the error code into 'Latest error code' (Un\G0) of the buffer memory. In addition, 'Error flag' (XF) turns on. Turning on 'Error clear request' (YF) clears the error code of 'Latest error code' (Un\G0), and 'Error flag' (XF) turns off.

Error codes of the A/D converter module are classified in minor errors or moderate errors.

- Minor error: This error is caused by the setting failure of programs and parameters. The A/D conversion continues with the parameter setting before the change. (1000H to 1FFFH)
- Moderate error: An error such as hardware failure. The A/D conversion does not continue. (2000H to 2FFFH, 3000H to 3FFFH)

The following table lists the error codes that may be stored.

□ in error codes: This symbol indicates the number of the channel where an error has occurred. A numerical value of 0 to F is used to correspond to CH1 to CH16.

(CH1: 0, CH2: 1, CH3: 2, CH4: 3, CH5: 4, CH6: 5, CH7: 6, CH8: 7, CH9: 8, CH10: 9, CH11: A, CH12: B, CH13: C, CH14: D, CH15: E, CH16: F)

△ in error codes: For what this symbol indicates, refer to Description and cause.

Error code	Error name	Description and cause	Corrective Action
0000H	—	There is no error.	—
1080H	Number of writes to offset/gain settings reach limit error	The number of the offset/gain settings has exceeded the guaranteed maximum number.	Any further setting of offset/gain values may not be reflected correctly.
1081H	Number of safety module status switching exceeding limit error	The number of times of enabling/disabling the safety module has exceeded the guaranteed maximum number.	Further executions of enabling/disabling the safety module will not guarantee the safety module to be enabled/disabled.
1302H	Failure of disabling safety module	Disabling the safety module function failed.	Disable the safety module function again. If the same error occurs again after re-registration, the possible cause is a module failure. Please consult your local Mitsubishi representative.
17E0H	Module-specific backup parameter restore error	Offset/gain values cannot be restored with the module-specific backup parameter.	The module-specific backup parameter file may be damaged. Readjust the user range.
17E1H	Module-specific backup parameter creation error	The module-specific backup parameter has not been created.	Check the free space on the data memory of the control CPU and the SD memory card, and recreate a module-specific backup parameter. For how to create module-specific backup parameters, refer to the following. ☞ Page 87 Backing up, Saving, and Restoring Offset/Gain Values
180△H	Interrupt factor generation setting range error	A value other than 0 to 1 is set in Interrupt factor generation setting [n]. △ indicates the interrupt setting related in the error as below: 0: Setting 1 to F: Setting 16	Set Interrupt factor generation setting [n] to 0 or 1.
181△H	Condition target setting range error	A value other than 0 to 7 is set in Condition target setting [n]. △ indicates the interrupt setting related in the error as below: 0: Setting 1 to F: Setting 16	Set Condition target setting [n] to 0 to 7.
182△H	Condition target channel setting range error	A value other than 0 to 16 is set in Condition target channel setting [n] (for the R60AD8-G, a value other than 0 to 8). △ indicates the interrupt setting related in the error as below: 0: Setting 1 to F: Setting 16	Set Condition target channel setting [n] to 0 to 16 (for the R60AD8-G, 0 to 8).
1860H	G(P).OGSTOR instruction execution error in offset/gain setting mode	The G(P).OGSTOR instruction has been executed in offset/gain setting mode.	Do not execute the G(P).OGSTOR instruction in the offset/gain setting mode.
1861H	Offset/gain setting continuous write occurrence error	The G(P).OGSTOR instruction has been executed continuously or a setting value has been continuously written to the flash memory 26 times or more in the offset/gain setting.	For the G(P).OGSTOR instruction, execute it only once per module. For the offset/gain setting, write the setting value only once per setting.

Error code	Error name	Description and cause	Corrective Action
1862H	Model mismatch error at the execution of OGSTOR	The G(P).OGSTOR instruction has been executed on a module different from the one on which the G(P).OGLOAD instruction was executed. The G(P).OGSTOR instruction has been executed ahead of the G(P).OGLOAD instruction.	Execute the G(P).OGLOAD and G(P).OGSTOR instructions on the same module. As the other way, execute the G(P).OGLOAD instruction on the module whose data is to be restored, and then execute the G(P).OGSTOR instruction on the module to which the data is to be restored.
190□H	Range setting range error	A value out of the range is set in CH□ Range setting.	Set CH□ Range setting to the following values: 0 to 5, A, B, F (hexadecimal)
191□H	Averaging process specification setting range error	A value other than 0 to 4 is set in CH□ Averaging process specification.	Set CH□ Averaging process specification to 0 to 4.
192□H	Time average setting range error	When the time average is selected in CH□ Averaging process specification, CH□ Time average/Count average/Moving average/Primary delay filter constant setting is set to the following value: A value other than 40 to 5000 A value smaller than "4 × Number of channels used × Conversion speed" (ms)	Set CH□ Time average/Count average/Moving average/Primary delay filter constant setting to the following value: 40 to 5000 A value equal to or larger than "4 × Number of channels used × Conversion speed" (ms)
193□H	Count average setting range error	When the count average is selected in CH□ Averaging process specification, a value other than 4 to 500 is set in CH□ Time average/Count average/Moving average/Primary delay filter constant setting.	Set CH□ Time average/Count average/Moving average/Primary delay filter constant setting to 4 to 500.
194□H	Moving average setting range error	When the moving average is selected in CH□ Averaging process specification, a value other than 2 to 200 is set in CH□ Time average/Count average/Moving average/Primary delay filter constant setting.	Set CH□ Time average/Count average/Moving average/Primary delay filter constant setting to 2 to 200.
195□H	Primary delay filter constant setting range error	When the primary delay filter is selected in CH□ Averaging process specification, a value other than 1 to 500 is set in CH□ Time average/Count average/Moving average/Primary delay filter constant setting.	Set CH□ Time average/Count average/Moving average/Primary delay filter constant setting to 1 to 500.
1A0□H	Scaling enable/disable setting range error	A value other than 0 and 1 is set in CH□ Scaling enable/disable setting.	Set CH□ Scaling enable/disable setting to 0 or 1.
1A1□H	Scaling setting range error	A value other than -32000 to 32000 is set in CH□ Scaling lower limit value and/or CH□ Scaling upper limit value.	Set CH□ Scaling lower limit value and CH□ Scaling upper limit value to -32000 to 32000.
1A2□H	Scaling upper/lower limit value setting error	CH□ Scaling upper limit value and CH□ Scaling lower limit value are set as the scaling upper limit value = the scaling lower limit value.	Set CH□ Scaling upper limit value and CH□ Scaling lower limit value as the scaling upper limit value ≠ the scaling lower limit value.
1A5□H	Digitalclip enable/disable setting range error	A value other than 0 and 1 is set in "CH□ Digitalclip enable/disable setting".	Set CH□ Digital clipping enable/disable setting to 0 or 1.
1A7□H	Difference conversion trigger setting range error	A value other than 0 and 1 is set in CH□ Difference conversion trigger.	Set CH□ Difference conversion trigger to 0 or 1.
1B0□H	Alert output setting (Process alarm) range error	A value other than 0 and 1 is set in CH□ Alert output setting (Process alarm).	Set CH□ Alert output setting (Process alarm) to 0 or 1.
1B△□H	Process alarm upper lower limit value setting range error	The values set in CH□ Process alarm upper upper limit value to CH□ Process alarm lower lower limit value do not satisfy the following condition: Upper upper limit value ≥ Upper lower limit value ≥ Lower upper limit value ≥ Lower lower limit value △ indicates that the set values are as follows: 1: Process alarm lower lower limit value > Process alarm lower upper limit value 2: Process alarm lower upper limit value > Process alarm upper lower limit value 3: Process alarm upper lower limit value > Process alarm upper upper limit value	Set CH□ Process alarm upper upper limit value to CH□ Process alarm lower lower limit value so that the values satisfy the following condition: Upper upper limit value ≥ Upper lower limit value ≥ Lower upper limit value ≥ Lower lower limit value
1B8□H	Alert output setting (rate alarm) range error	A value other than 0 and 1 is set in CH□ Alert output setting (Rate alarm).	Set CH□ Alert output setting (Rate alarm) to 0 or 1.
1B9□H	Rate alarm alert detection cycle setting range error	A value other than 1 to 32000 is set in CH□ Rate alarm alert detection cycle setting.	Set CH□ Rate alarm alert detection cycle setting to 1 to 32000.
1BA□H	Rate alarm upper/lower limit setting value inversion error	CH□ Rate alarm upper limit value and CH□ Rate alarm lower limit value are set as Lower limit value ≥ Upper limit value.	Set CH□ Rate alarm upper limit value and CH□ Rate alarm lower limit value as Lower limit value < Upper limit value.

Error code	Error name	Description and cause	Corrective Action
1C0□H	Input signal error detection setting range error	A value other than 0 to 4 is set in CH□ Input signal error detection setting.	Set CH□ Input signal error detection setting value to 0 to 4.
1C1□H	Input signal error detection setting value range error	A value other than 0 to 250 is set in CH□ Input signal error detection setting.	Set CH□ Input signal error detection setting value to 0 to 250.
1C6□H	Disconnection detection enabled range setting range error	Simple disconnection detection is set in CH□ Input signal error detection setting, and the value set in CH□ Input range setting is other than the following: • 4 to 20mA (extended mode) • 1 to 5V (extended mode)	For channels for simple disconnection detection using the input signal error detection function, set CH□ Input range setting to either of the following: • 4 to 20mA (extended mode) • 1 to 5V (extended mode)
1D0□H	Logging enable/disable setting range error	A value other than 0 and 1 is set in CH□ Logging enable/disable setting.	Set CH□ Logging enable/disable setting to 0 or 1.
1D1□H	Logging cycle setting value range error	A value out of the range is set in CH□ Logging cycle setting value and/or CH□ Logging cycle unit setting.	Set one or both of CH□ Logging cycle setting value and CH□ Logging cycle unit setting to the values within the range.
1D2□H	Logging cycle setting disable error	CH□ Logging cycle setting value and CH□ Logging cycle unit setting are set so that the set logging cycle falls below the conversion cycle.	Set CH□ Logging cycle setting value and CH□ Logging cycle unit setting so that the logging cycle is not less than the conversion cycle of the object to be logged.
1D3□H	Logging data setting range error	A value other than 0 and 1 is set in CH□ Logging data setting.	Set CH□ Logging data setting to 0 or 1.
1D4□H	Post-trigger logging points setting range error	A value other than 1 to 1000 is set in CH□ Post-trigger logging points.	Set CH□ Post-trigger logging points to 1 to 1000.
1D5□H	Level trigger condition setting range error	A value other than 0 to 3 is set in CH□ Level trigger condition setting.	Set CH□ Level trigger condition setting to 0 to 3.
1D6□H	Trigger data setting range error	A value other than 0 to 9999 is set in CH□ Trigger data.	Set CH□ Trigger data to 0 to 9999.
1D7□H	Logging hold request range error	A value other than 0 and 1 is set in CH□ Logging hold request.	Set CH□ Logging hold request to 0 or 1.
1D8□H	Loading interrupt enable/disable setting range error	A value other than 0 and 1 is set in CH□ Loading interrupt enable/disable setting.	Set CH□ Loading interrupt enable/disable setting to 0 or 1.
1D9□H	Logging read points setting value range error	A value other than 1 to 1000 is set in CH□ Logging read points setting value.	Set CH□ Logging read points setting value to 1 to 1000.
1E50H	Offset/gain setting channel specification error	In the offset/gain setting, "1: Setting channel" is set for both CH□ Offset/gain setting mode (offset specification) and CH□ Offset/gain setting mode (gain specification), or "0: Disable" is set.	Correctly set CH□ Offset/gain setting mode (offset specification) and CH□ Offset/gain setting mode (gain specification).
1E51H	User range data invalid (CH identification disabled)	An invalid value is set in the offset/gain setting. The number of the channel in which this error occurs cannot be identified.	Perform the offset/gain setting again for all channels where the user range is set. If the error occurs again, the possible cause is a failure of the module. Please consult your local Mitsubishi representative.
1E6□H	User range data invalid (CH identification allowed)	An invalid value is set in CH□ Offset/gain setting.	Perform the offset/gain setting again for the channels where the error has occurred. If the error occurs again, the possible cause is a failure of the module. Please consult your local Mitsubishi representative.
1E7□H	Offset/gain value inversion error	The offset value and gain value to be saved in the flash memory are as follows: Offset value ≥ Gain value	Perform the offset/gain setting again so that the following condition is satisfied: Offset value < Gain value
1E8□H	Offset/gain setting channel range error	A value other than 0 and 1 is set in CH□ Offset/gain setting mode (offset specification) and CH□ Offset/gain setting mode (gain specification).	Set CH□ Offset/gain setting mode (offset specification) and CH□ Offset/gain setting mode (gain specification) to 0 or 1.
1F00H	Hardware failure (minor)	A hardware failure (minor) has occurred in the module.	The module may be affected by noise. Review and adjust the cable wiring and the installation environment of the programmable controllers. After the adjustment, turn on and off 'Error clear request' (YF) to eliminate this error and resume the conversion. If the error occurs again, the possible cause is a failure of the module. Please consult your local Mitsubishi representative.

Error code	Error name	Description and cause	Corrective Action
3001H	Hardware failure (moderate)	A hardware failure (moderate) has occurred in the module.	Power off and on the module. If the error occurs again, the possible cause is a failure of the module. Please consult your local Mitsubishi representative.
3030H	Flash memory error	The data in the flash memory is abnormal.	Check the digital output values. If the values are abnormal, please consult your local Mitsubishi representative.
3040H	Start-up in standard mode with safety validated	The module whose function as the safety module was enabled was started up in standard mode.	To use the module in standard mode, disable the safety module function. For how to disable the safety module function, refer to the following.  Page 215 Disabling the Safety Module

3.5 List of Alarm Codes

If an alarm occurs during operation, the A/D converter module stores the alarm code into 'Latest alarm code' (Un\G2) of the buffer memory. Turning on 'Error clear request' (YF) clears the alarm code of 'Latest alarm code' (Un\G2).

□ in alarm codes: This symbol indicates the number of the channel where an alarm has occurred. A numerical value of 0 to F is used to correspond to CH1 to CH16.

(CH1: 0, CH2: 1, CH3: 2, CH4: 3, CH5: 4, CH6: 5, CH7: 6, CH8: 7, CH9: 8, CH10: 9, CH11: A, CH12: B, CH13: C, CH14: D, CH15: E, CH16: F)

Alarm code	Alarm name	Description and cause	Corrective Action
080□H	Process alarm (upper limit)	The process alarm (upper limit) has occurred in CH□.	Adjust CH□ Digital operation value to fall within the set range. As a result, the corresponding bit of CH□ Alert output flag (process alarm upper limit) or CH□ Alert output flag (process alarm lower limit) and 'Alert output signal' (X8) turn off.
081□H	Process alarm (lower limit)	The process alarm (lower limit) has occurred in CH□.	
082□H	Rate alarm (upper limit)	The rate alarm (upper limit) has occurred in CH□.	Adjust the change rate in CH□ Digital output value to fall within the set range. As a result, the corresponding bit of CH□ Alert output flag (rate alarm upper limit) or CH□ Alert output flag (rate alarm lower limit) and 'Alert output signal' (X8) turn off.
083□H	Rate alarm (lower limit)	The rate alarm (lower limit) has occurred in CH□.	
090□H	Input signal error detection (upper limit)	An input signal error (upper limit) has been detected in CH□.	The following operations are performed by turning on and off 'Error clear request' (YF) after the analog input value returns within the setting range. <ul style="list-style-type: none"> • All the bits of CH□ Input signal error detection flag are set to Normal (0). • 'Input signal error detection signal' (XC) turns off. • 'Latest alarm code' (Un\G2) is cleared.
091□H	Input signal error detection (lower limit)	An input signal error (lower limit) has been detected in CH□.	
0A0□H	Input signal error detection (disconnection)	An input signal error (disconnection) has been detected in CH□.	

APPENDICES (STANDARD MODE)

Appendix 1 Module Label

The functions of the A/D converter module can be set by using module labels.

Module labels of I/O signals

The module label name of an I/O signal is defined with the following structure:

"Module name"_"Module number".b"Label name" or "Module name"_"Module number".b"Label name"_D

Ex.

R60ADG_1.bModuleREADY_D

■Module name

The character string of a module model name is given.

■Module number

A number starting from 1 is added to identify modules that have the same module name.

■Label name

The label identifier unique to a module is given.

■_D

This string indicates that the module label is for the direct access input (DX) or direct access output (DY). A module label without the string is for the input (X) or output (Y) of the refresh processing.

Module labels of buffer memory areas

The module label name of a buffer memory area is defined with the following structure:

"Module name"_"Module number"."Data type"_D["(Channel)"]."Data format""Label name"_D

Ex.

R60ADG_1.stnMonitor_D[0].wDigitalOutputValue_D

■Module name

The character string of a module model name is given.

■Module number

A number starting from 1 is added to identify modules that have the same module name.

■Data type

The data type to sort a buffer memory area is given. Each data type is as follows:

Data type	Description
stnMonitor	Monitor
stnControl	Control
stnSetting	Setting

■Channel

The channel number corresponding to a module label is given. A numerical value of 0 to 15 is used to correspond to CH1 to CH16.

(CH1: 0, CH2: 1, CH3: 2, CH4: 3, CH5: 4, CH6: 5, CH7: 6, CH8: 7, CH9: 8, CH10: 9, CH11: 10, CH12: 11, CH13: 12, CH14: 13, CH15: 14, CH16: 15)

■Data format

The string that represents the data size of a buffer memory area is given. Each data format is as follows:

Data format	Description
u	Word [Unsigned]/Bit string [16-bit]
w	Word [Signed]
d	Double word [Signed]
z	System area

■Label name

The label identifier unique to a module is given.

■_D

This string indicates that the module label is for the direct access. A module label without the string is for the auto refresh. The following table shows the differences between the auto refresh and direct access.

Type	Description	Access timing	Example
Auto refresh	Values that are read from or written to the module label are reflected in the module collectively at the auto refresh. The run time of the program can be reduced. To use the auto refresh, set "Target" to "Module Label" in "Refresh settings" of "Module Parameter".	At auto refresh	R60ADG_1.stnMonitor[0].wDigitalOutputValue
Direct access	Values that are read from or written to the module label is reflected in the module instantly. Compared with the auto refresh, the run time of the program becomes longer. However, the responsiveness is high.	At reading/writing from/to the module label	R60ADG_1.stnMonitor_D[0].wDigitalOutputValue_D

Precautions

When using the R60AD8-G, do not use the module labels assigned to CH9 to CH16.

Doing so may cause malfunction.

Appendix 2 I/O Signals

List of I/O signals

The following table lists the I/O signals of the A/D converter module.

For details on the I/O signals, refer to the following.

☞ Page 115 Details of input signals

☞ Page 122 Details of output signals

Point

- The I/O number (X/Y) described below shows the case that the start I/O number of the A/D converter module is set to "0".
- Do not use the "Use prohibited" signals shown below because the system uses them. If users use (turn off and on) the signals, the functions of the A/D converter module cannot be guaranteed.

Input signal

Device number	Signal name
X0	Module READY
X1 to X7	Use prohibited
X8	Alert output signal
X9	Operating condition setting completed flag
XA	Offset/gain setting mode status flag
XB	Channel change completed flag
XC	Input signal error detection signal
XD	Maximum value/minimum value reset completed flag
XE	A/D conversion completed flag
XF	Error flag

Output signal

Device number	Signal name
Y0 to Y8	Use prohibited
Y9	Operating condition setting request
YA	User range write request
YB	Channel change request
YC	Use prohibited
YD	Maximum value/minimum value reset request
YE	Use prohibited
YF	Error clear request

Details of input signals

The following describes the details of the input signals for the A/D converter module which are assigned to the CPU module. The I/O numbers (X/Y) described in Appendix 2 are for the case when the start I/O number of the A/D converter module is set to 0.

Point

This section describes buffer memory addresses for CH1.

For details on the buffer memory addresses after CH2, refer to the following.

☞ Page 124 List of buffer memory addresses

Module READY

'Module READY' (X0) turns on to indicate the preparation for the A/D conversion is completed after the power-on or after the reset operation of the CPU module.

In the following cases, 'Module READY' (X0) turns off.

- In the offset/gain setting mode (In this case, the A/D conversion is performed.)
- When a watchdog timer error occurs in the A/D converter module (In this case, the A/D conversion is not performed.)

■Device number

The following shows the device number of this input signal.

Signal name	CH1 to CH16
Module READY	X0

Alert output signal

'Alert output signal' (X8) turns on when the process alarm or rate alarm has been detected. When the alert output function is disabled for all channels, 'Alert output signal' (X8) always turns off.

■Device number

The following shows the device number of this input signal.

Signal name	CH1 to CH16
Alert output signal	X8

■Process alarm

- 'Alert output signal' (X8) turns on when digital operation values of the A/D conversion enabled channels exceed the ranges set for 'CH1 Process alarm upper upper limit value' (Un\G514) to 'CH1 Process alarm lower lower limit value' (Un\G520) after 'CH1 Alert output setting (process alarm)' (Un\G512) is enabled. The ALM LED also turns on along with the on of the signal.
- Alert output signal (X8) turns off when the digital operation values fall within the setting range for all the A/D conversion enabled channels. The ALM LED also turns off along with the off of the signal.

■ Rate alarm

- 'Alert output signal' (X8) turns on when the change rate of the digital output values of the A/D conversion enabled channels exceed the ranges set for 'CH1 Rate alarm upper limit value' (Un\G524) to 'CH1 Rate alarm lower limit value' (Un\G526) after 'CH1 Alert output setting (rate alarm)' (Un\G513) is enabled. The ALM LED also turns on along with the on of the signal.
- Alert output signal (X8) turns off when the change rate of the digital output values falls within the setting range for all the A/D conversion enabled channels. The ALM LED also turns off along with the off of the signal.

-----▶ Controlled by the A/D converter module

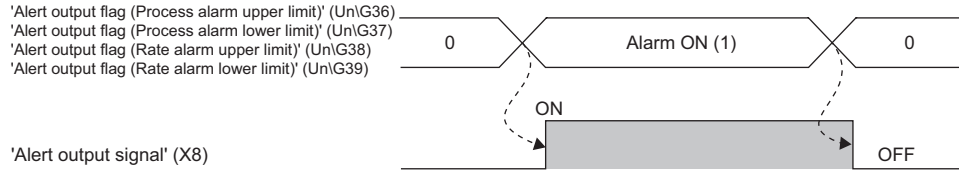

Operating condition setting completed flag

■ Device number

The following shows the device number of this input signal.

Signal name	CH1 to CH16
Operating condition setting completed flag	X9

When changing values of the buffer memory, use Operating condition setting completed flag (X9) as an interlock condition to turn on and off 'Operating condition setting request' (Y9). For the buffer memory addresses which require turning on and off of 'Operating condition setting request' (Y9) to enable the changed values, refer to the following.

☞ Page 124 List of buffer memory addresses

When 'Operating condition setting completed flag' (X9) is off, the A/D conversion is not performed.

When 'Operating condition setting request' (Y9) is on, 'Operating condition setting completed flag' (X9) turns off.

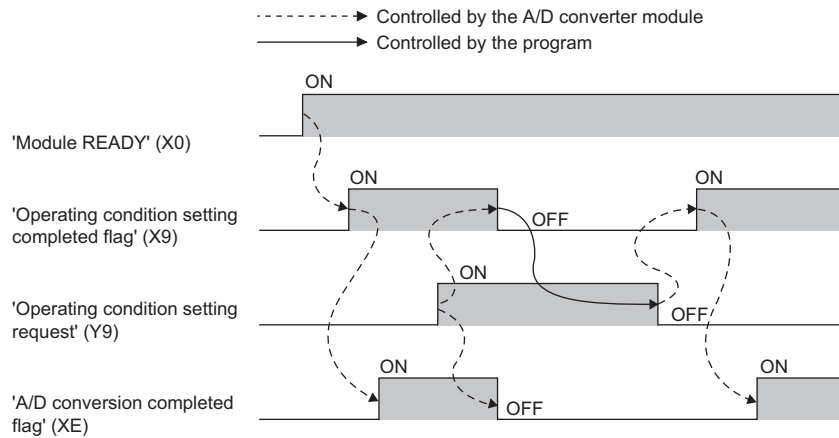

Offset/gain setting mode status flag

■Device number

The following shows the device number of this input signal.

Signal name	CH1 to CH16
Offset/gain setting mode status flag	XA

■In the offset/gain setting mode

When registering the value, which has been adjusted with the offset/gain setting, use Offset/gain setting mode status flag (XA) as an interlock condition to turn on and off 'User range write request' (YA).

When the offset/gain setting is configured from the offset/gain setting window of an engineering tool, the setting is performed properly on the window. Therefore, a program is not required to perform the setting.

When a sequence program used for the MELSEC-Q series A/D converter module is utilized to configure the offset/gain setting, check that this flag is used as an interlock.

For the sequence programs for the MELSEC-Q series A/D converter module, refer to the following.

 Channel Isolated Analog-Digital Converter Module/Channel Isolated Analog-Digital Converter Module (With Signal Conditioning Function) User's Manual

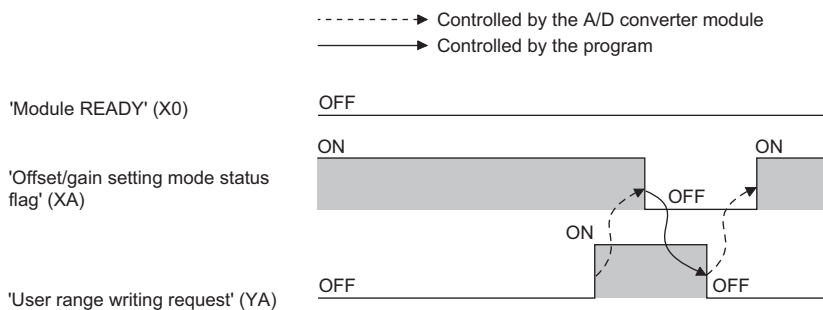

■In the normal mode

In the user range setting restoration, use Offset/gain setting mode status flag (XA) as an interlock condition to turn on and off 'User range write request' (YA).

For user range setting restoration, refer to the following.

 Page 87 Backing up, Saving, and Restoring Offset/Gain Values

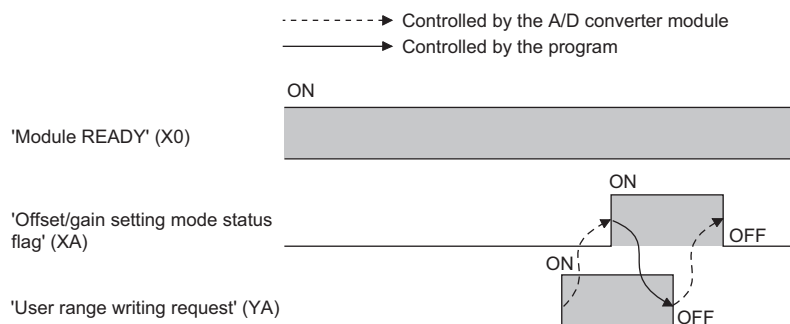

Channel change completed flag

When changing a channel to perform the offset/gain setting, use Channel change completed flag (XB) as an interlock condition to turn on and off 'Channel change request' (YB).

When the offset/gain setting is configured from the offset/gain setting window of an engineering tool, the setting is performed properly on the window. Therefore, a program is not required to perform the setting.

When a sequence program used for the MELSEC-Q series A/D converter module is utilized to configure the offset/gain setting, check that this flag is used as an interlock.

For the sequence programs for the MELSEC-Q series A/D converter module, refer to the following.

 Channel Isolated Analog-Digital Converter Module/Channel Isolated Analog-Digital Converter Module (With Signal Conditioning Function) User's Manual

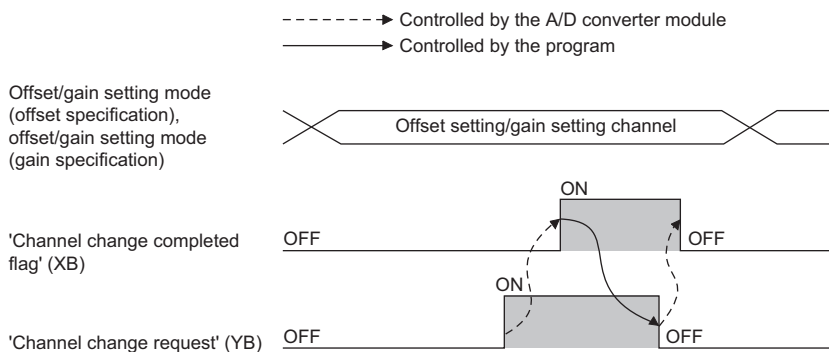

■Device number

The following shows the device number of this input signal.

Signal name	CH1 to CH16
Channel change completed flag	XB

Input signal error detection signal

■Device number

The following shows the device number of this input signal.

Signal name	CH1 to CH16
Input signal error detection signal	XC

■Turning on 'Input signal error detection signal' (XC)

Input signal error detection signal (XC) turns on when an analog input value exceeds the range set with 'CH1 Input signal error detection setting value' (Un\G529) in any channel which has been A/D conversion-enabled, after the detection condition is set in 'CH1 Input signal error detection setting' (Un\G528). When the simple disconnection detection is set, the signal ignores the setting for 'CH1 Input signal error detection setting value' (Un\G529) is ignored and turns on at the disconnection detection.

When 'Input signal error detection signal' (XC) turns on, the following operations are performed.

- 'CH1 Digital output value' (Un\G400) and 'CH1 Digital operation value' (Un\G402) hold the digital value just before the error was detected.
- The ALM LED flashes.
- In Q compatible mode, the corresponding bit of 'A/D conversion completed flag' (Un\G10) turns off. In R mode, the corresponding bit of 'A/D conversion completed flag' (Un\G42) remains on.

■Turning off 'Input signal error detection signal' (XC)

When 'Input signal error detection signal' (XC) turns off, the following operations are performed.

- The ALM LED turns off.
- 'Latest alarm code' (Un\G2) is cleared.

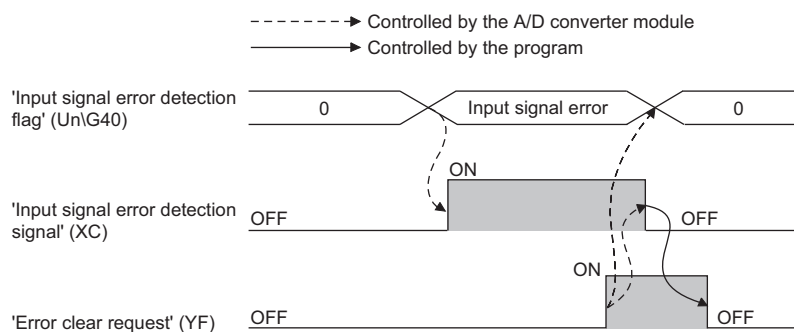

■'Input signal error detection auto-clear enable/disable setting' (Un\G302) is set to Disable (1)

The following operations are performed by turning on and off 'Error clear request' (YF) after the cause of the input signal error is eliminated and the analog input value returns within the setting range.

- 'Input signal error detection signal' (XC) turns off.
- 'Input signal error detection flag' (Un\G40) turns off.
- The ALM LED turns off.
- 'Latest alarm code' (Un\G2) is cleared.

■'Input signal error detection auto-clear enable/disable setting' (Un\G302) is set to Enable (0)

The following operations are performed after the cause of the input signal error is eliminated and the analog input value returns within the setting range.

- 'Input signal error detection signal' (XC) turns off.
- 'Input signal error detection flag' (Un\G40) turns off.
- The ALM LED turns off.

Point

- Averaging processing starts over after the A/D conversion resumes.
- 'Input signal error detection signal' (XC) operates only when the input signal error detection function is enabled. When the input signal error detection function is disabled, 'Input signal error detection signal' (XC) always turns off.

Maximum value/minimum value reset completed flag

Maximum value/minimum value reset completed flag (XD) turns on after the maximum and minimum values stored in 'CH1 Maximum value' (Un\G404) and 'CH1 Minimum value' (Un\G406) are reset by turning on and off 'Maximum value/minimum value reset request' (YD).

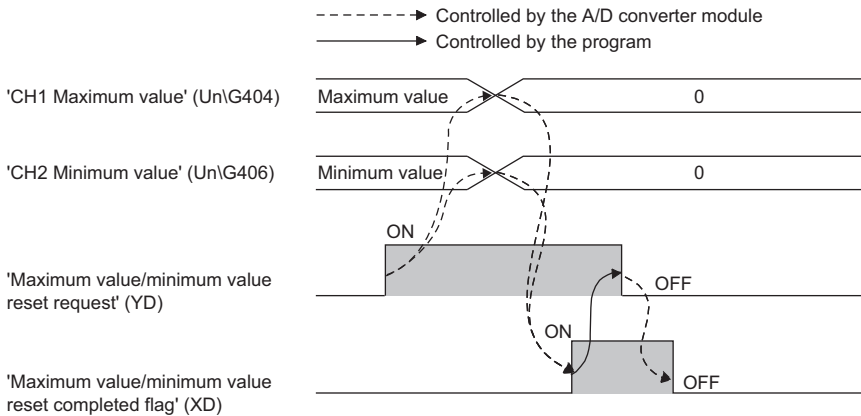

Device number

The following shows the device number of this input signal.

Signal name	CH1 to CH16
Maximum value/minimum value reset completed flag	XD

A/D conversion completed flag

A/D conversion completed flag (XE) turns on when all conversion enabled channels are converted.

Device number

The following shows the device number of this input signal.

Signal name	CH1 to CH16
A/D conversion completed flag	XE

Error flag

'Error flag' (XF) turns on when an error occurs.

Turn on and off 'Error clear request' (YF) to clear 'Latest error code' (Un\G0) and 'Latest alarm code' (Un\G2).

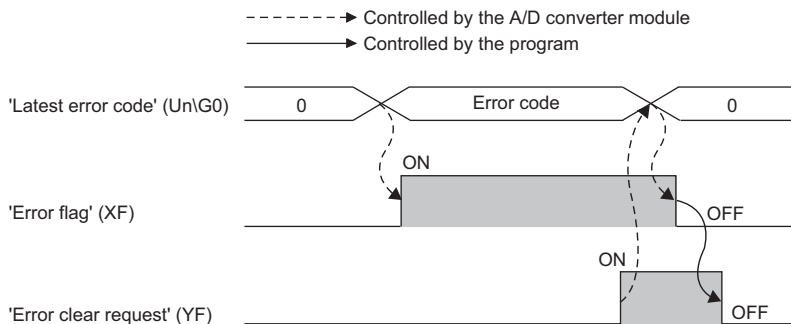

Device number

The following shows the device number of this input signal.

Signal name	CH1 to CH16
Error flag	XF

Details of output signals

The following describes the details of the output signals for the A/D converter module which are assigned to the CPU module. The I/O numbers (X/Y) described in Appendix 2 are for the case when the start I/O number of the A/D converter module is set to 0.

Point

This section describes buffer memory addresses for CH1.

For details on the buffer memory addresses after CH2, refer to the following.

☞ Page 124 List of buffer memory addresses

Operating condition setting request

Turn on and off Operating condition setting request (Y9) to enable the setting of the A/D converter module.

For the timing of turning the signal on and off, refer to the following.

☞ Page 117 Operating condition setting completed flag

For details on the buffer memory areas to be enabled, refer to the following.

☞ Page 124 List of buffer memory addresses

■Device number

The following shows the device number of this output signal.

Signal name	CH1 to CH16
Operating condition setting request	Y9

User range write request

■Device number

The following shows the device number of this output signal.

Signal name	CH1 to CH16
User range write request	YA

■In the offset/gain setting mode

Turn on and off User range write request (YA) to register values adjusted with the offset/gain setting in the A/D converter module. The data is written to the flash memory when this signal is turned off and on.

For the timing of turning the signal on and off, refer to the following.

☞ Page 118 In the offset/gain setting mode

■In the normal mode

Turn on and off User range write request (YA) to restore the user range.

For the timing of turning the signal on and off, refer to the following.

☞ Page 118 In the normal mode

Channel change request

Turn on and off Channel change request (YB) to change a channel to perform the offset/gain setting.

For the timing of turning the signal on and off, refer to the following.

☞ Page 119 Channel change completed flag

■Device number

The following shows the device number of this output signal.

Signal name	CH1 to CH16
Channel change request	YB

Maximum value/minimum value reset request

Turn on and off 'Maximum value/minimum value reset request' (YD) to clear the maximum and minimum values stored in 'CH1 Maximum value' (Un\G404) and 'CH1 Minimum value' (Un\G406).

For the timing of turning the signal on and off, refer to the following.

☞ Page 121 Maximum value/minimum value reset completed flag

■Device number

The following shows the device number of this output signal.

Signal name	CH1 to CH16
Maximum value/minimum value reset request	YD

Error clear request

Turn on and off Error clear request (YF) to clear 'Error flag' (XF), 'Input signal error detection signal' (XC), 'Latest error code' (Un\G0), and 'Latest alarm code' (Un\G2). For the timing of turning the signal on and off, refer to the following.

☞ Page 120 Input signal error detection signal

☞ Page 121 Error flag

■Device number

The following shows the device number of this output signal.

Signal name	CH1 to CH16
Error clear request	YF

Appendix 3 Buffer Memory Areas

List of buffer memory addresses

The following table lists the buffer memory addresses of the A/D converter module. For details on the buffer memory addresses, refer to the following.

 Page 144 Details of buffer memory addresses

The buffer memory areas of the A/D converter module are classified by the following data types.

Data type	Description	
Setting data	Description	Set this data according to the connected device and the use of the system.
	Write/read attribute	Data can be read and written from/to this area.
	Setting procedure	Set this data using an engineering tool or in a program.
	Setting timing	After changing the values, turn on and off 'Operating condition setting request' (Y9) to enable the set values.
Control data	Description	Use this data to control the A/D converter module.
	Write/read attribute	Data can be read and written from/to this area.
	Setting procedure	Set this data using an engineering tool or in a program.
	Setting timing	As soon as the values are changed, the set values become enabled.
Monitor data	Description	Use this data to monitor the status of the A/D converter module.
	Write/read attribute	Writing data is only allowed. Reading data is not allowed.
	Setting procedure	—
	Setting timing	—
User range setting data	Description	Use this data to update the user range setting of the A/D converter module.
	Write/read attribute	Data can be read and written from/to this area.
	Setting procedure	Set this data using an engineering tool or in a program.
	Setting timing	After changing the values, turn on and off 'User range write request' (YA) to enable the set values.

Point

- Do not write data to the system areas and areas whose data types are monitor in the buffer memory. Writing data into these areas can cause the malfunction of the module.
- When the R60AD8-G is used, the areas corresponding to CH9 to CH16 are used as system areas.

In R mode

■Un\G0 to Un\G399

Address (decimal)	Address (hexadecimal)	Name	Default value	Data type	Auto refresh
0	0H	Latest error code	0	Monitor	○
1	1H	Latest address of error history	0	Monitor	○
2	2H	Latest alarm code	0	Monitor	○
3	3H	Latest address of alarm history	0	Monitor	○
4 to 19	4H to 13H	Interrupt factor detection flag [n] ^{*1}	0	Monitor	○
20 to 35	14H to 23H	System area	—	—	—
36	24H	Alert output flag (Process alarm upper limit)	0000H	Monitor	○
37	25H	Alert output flag (Process alarm lower limit)	0000H	Monitor	○
38	26H	Alert output flag (Rate alarm upper limit)	0000H	Monitor	○
39	27H	Alert output flag (Rate alarm lower limit)	0000H	Monitor	○
40	28H	Input signal error detection flag	0000H	Monitor	○
41	29H	System area	—	—	—
42	2AH	A/D conversion completed flag	0000H	Monitor	○
43 to 89	2BH to 59H	System area	—	—	—
90	5AH	Level data 0	0	Control	○
91	5BH	Level data 1	0	Control	○

Address (decimal)	Address (hexadecimal)	Name	Default value	Data type	Auto refresh
92	5CH	Level data 2	0	Control	○
93	5DH	Level data 3	0	Control	○
94	5EH	Level data 4	0	Control	○
95	5FH	Level data 5	0	Control	○
96	60H	Level data 6	0	Control	○
97	61H	Level data 7	0	Control	○
98	62H	Level data 8	0	Control	○
99	63H	Level data 9	0	Control	○
100 to 123	64H to 7BH	System area	—	—	—
124 to 139	7CH to 8BH	Interrupt factor mask [n] ^{*1}	0	Control	×
140 to 155	8CH to 9BH	System area	—	—	—
156 to 171	9CH to ABH	Interrupt factor reset request [n] ^{*1}	0	Control	×
172 to 199	ACH to C7H	System area	—	—	—
200 to 215	C8H to D7H	Interrupt factor generation setting [n] ^{*1}	0	Setting	×
216 to 231	D8H to E7H	System area	—	—	—
232 to 247	E8H to F7H	Condition target setting [n] ^{*1}	0	Setting	×
248 to 263	F8H to 107H	System area	—	—	—
264 to 279	108H to 117H	Condition target channel setting [n] ^{*1}	0	Setting	×
280 to 295	118H to 127H	System area	—	—	—
296, 297	128H, 129H	Mode switching setting	0	Setting	×
298 to 301	12AH to 12DH	System area	—	—	—
302	12EH	Input signal error detection auto-clear enable/disable setting	1	Setting	×
303 to 399	12FH to 18FH	System area	—	—	—

*1 [n] in the table indicates an interrupt setting number. (n = 1 to 16)

■Un\G400 to Un\G3599

Address Decimal (hexadecimal)								Name	Default value	Data type	Auto refresh
CH1	CH2	CH3	CH4	CH5	CH6	CH7	CH8	CH□ Digital output value	0	Monitor	○
400 (190H)	600 (258H)	800 (320H)	1000 (3E8H)	1200 (4B0H)	1400 (578H)	1600 (640H)	1800 (708H)				
CH9	CH10	CH11	CH12	CH13	CH14	CH15	CH16				
2000 (7D0H)	2200 (898H)	2400 (960H)	2600 (A28H)	2800 (AF0H)	3000 (BB8H)	3200 (C80H)	3400 (D48H)	System area	—	—	—
CH1	CH2	CH3	CH4	CH5	CH6	CH7	CH8				
401 (191H)	601 (259H)	801 (321H)	1001 (3E9H)	1201 (4B1H)	1401 (579H)	1601 (641H)	1801 (709H)				
CH9	CH10	CH11	CH12	CH13	CH14	CH15	CH16	CH□ Digital operation value	0	Monitor	○
2001 (7D1H)	2201 (899H)	2401 (961H)	2601 (A29H)	2801 (AF1H)	3001 (BB9H)	3201 (C81H)	3401 (D49H)				
CH1	CH2	CH3	CH4	CH5	CH6	CH7	CH8				
402 (192H)	602 (25AH)	802 (322H)	1002 (3EAH)	1202 (4B2H)	1402 (57AH)	1602 (642H)	1802 (70AH)	System area	—	—	—
CH9	CH10	CH11	CH12	CH13	CH14	CH15	CH16				
2002 (7D2H)	2202 (89AH)	2402 (962H)	2602 (A2AH)	2802 (AF2H)	3002 (BBAH)	3202 (C82H)	3402 (D4AH)				
CH1	CH2	CH3	CH4	CH5	CH6	CH7	CH8	System area	—	—	—
403 (193H)	603 (25BH)	803 (323H)	1003 (3EBH)	1203 (4B3H)	1403 (57BH)	1603 (643H)	1803 (70BH)				
CH9	CH10	CH11	CH12	CH13	CH14	CH15	CH16				
2003 (7D3H)	2203 (89BH)	2403 (963H)	2603 (A2BH)	2803 (AF3H)	3003 (BBBH)	3203 (C83H)	3403 (D4BH)				

Address Decimal (hexadecimal)								Name	Default value	Data type	Auto refresh
CH1	CH2	CH3	CH4	CH5	CH6	CH7	CH8	CH□ Maximum value	0	Monitor	○
404 (194H)	604 (25CH)	804 (324H)	1004 (3ECH)	1204 (4B4H)	1404 (57CH)	1604 (644H)	1804 (70CH)				
CH9	CH10	CH11	CH12	CH13	CH14	CH15	CH16				
2004 (7D4H)	2204 (89CH)	2404 (964H)	2604 (A2CH)	2804 (AF4H)	3004 (BBCH)	3204 (C84H)	3404 (D4CH)				
CH1	CH2	CH3	CH4	CH5	CH6	CH7	CH8	System area	—	—	—
405 (195H)	605 (25DH)	805 (325H)	1005 (3EDH)	1205 (4B5H)	1405 (57DH)	1605 (645H)	1805 (70DH)				
CH9	CH10	CH11	CH12	CH13	CH14	CH15	CH16				
2005 (7D5H)	2205 (89DH)	2405 (965H)	2605 (A2DH)	2805 (AF5H)	3005 (BBDH)	3205 (C85H)	3405 (D4DH)				
CH1	CH2	CH3	CH4	CH5	CH6	CH7	CH8	CH□ Minimum value	0	Monitor	○
406 (196H)	606 (25EH)	806 (326H)	1006 (3EEH)	1206 (4B6H)	1406 (57EH)	1606 (646H)	1806 (70EH)				
CH9	CH10	CH11	CH12	CH13	CH14	CH15	CH16				
2006 (7D6H)	2206 (89EH)	2406 (966H)	2606 (A2EH)	2806 (AF6H)	3006 (BBEH)	3206 (C86H)	3406 (D4EH)				
CH1	CH2	CH3	CH4	CH5	CH6	CH7	CH8	System area	—	—	—
407 (197H)	607 (25FH)	807 (327H)	1007 (3EFH)	1207 (4B7H)	1407 (57FH)	1607 (647H)	1807 (70FH)				
CH9	CH10	CH11	CH12	CH13	CH14	CH15	CH16				
2007 (7D7H)	2207 (89FH)	2407 (967H)	2607 (A2FH)	2807 (AF7H)	3007 (BBFH)	3207 (C87H)	3407 (D4FH)				
CH1	CH2	CH3	CH4	CH5	CH6	CH7	CH8	CH□ Difference conversion status flag	0	Monitor	○
408 (198H)	608 (260H)	808 (328H)	1008 (3F0H)	1208 (4B8H)	1408 (580H)	1608 (648H)	1808 (710H)				
CH9	CH10	CH11	CH12	CH13	CH14	CH15	CH16				
2008 (7D8H)	2208 (8A0H)	2408 (968H)	2608 (A30H)	2808 (AF8H)	3008 (BC0H)	3208 (C88H)	3408 (D50H)				
CH1	CH2	CH3	CH4	CH5	CH6	CH7	CH8	CH□ Logging hold flag	0	Monitor	○
409 (199H)	609 (261H)	809 (329H)	1009 (3F1H)	1209 (4B9H)	1409 (581H)	1609 (649H)	1809 (711H)				
CH9	CH10	CH11	CH12	CH13	CH14	CH15	CH16				
2009 (7D9H)	2209 (8A1H)	2409 (969H)	2609 (A31H)	2809 (AF9H)	3009 (BC1H)	3209 (C89H)	3409 (D51H)				
CH1	CH2	CH3	CH4	CH5	CH6	CH7	CH8	CH□ Digital output value (32 bits) (L)	0	Monitor	○
410 (19AH)	610 (262H)	810 (32AH)	1010 (3F2H)	1210 (4BAH)	1410 (582H)	1610 (64AH)	1810 (712H)				
CH9	CH10	CH11	CH12	CH13	CH14	CH15	CH16				
2010 (7DAH)	2210 (8A2H)	2410 (96AH)	2610 (A32H)	2810 (AFAH)	3010 (BC2H)	3210 (C8AH)	3410 (D52H)				
CH1	CH2	CH3	CH4	CH5	CH6	CH7	CH8	CH□ Digital output value (32 bits) (H)	0	Monitor	○
411 (19BH)	611 (263H)	811 (32BH)	1011 (3F3H)	1211 (4BBH)	1411 (583H)	1611 (64BH)	1811 (713H)				
CH9	CH10	CH11	CH12	CH13	CH14	CH15	CH16				
2011 (7DBH)	2211 (8A3H)	2411 (96BH)	2611 (A33H)	2811 (AFBH)	3011 (BC3H)	3211 (C8BH)	3411 (D53H)				

Address Decimal (hexadecimal)								Name	Default value	Data type	Auto refresh
CH1	CH2	CH3	CH4	CH5	CH6	CH7	CH8	System area	—	—	—
412 to 429 (19CH to 1ADH)	612 to 629 (264H to 275H)	812 to 829 (32CH to 33DH)	1012 to 1029 (3F4H to 405H)	1212 to 1229 (4BCH to 4CDH)	1412 to 1429 (584H to 595H)	1612 to 1629 (64CH to 65DH)	1812 to 1829 (714H to 725H)				
CH9	CH10	CH11	CH12	CH13	CH14	CH15	CH16				
2012 to 2029 (7DCH to 7EDH)	2212 to 2229 (8A4H to 8B5H)	2412 to 2429 (96CH to 97DH)	2612 to 2629 (A34H to A45H)	2812 to 2829 (AFCH to B0DH)	3012 to 3029 (BC4H to BD5H)	3212 to 3229 (C8CH to C9DH)	3412 to 3429 (D54H to D65H)	CH□ Range setting monitor	0000H	Monitor	×
CH1	CH2	CH3	CH4	CH5	CH6	CH7	CH8				
430 (1AEH)	630 (276H)	830 (33EH)	1030 (406H)	1230 (4CEH)	1430 (596H)	1630 (65EH)	1830 (726H)				
CH9	CH10	CH11	CH12	CH13	CH14	CH15	CH16	System area	—	—	—
2030 (7EEH)	2230 (8B6H)	2430 (97EH)	2630 (A46H)	2830 (B0EH)	3030 (BD6H)	3230 (C9EH)	3430 (D66H)				
CH1	CH2	CH3	CH4	CH5	CH6	CH7	CH8				
431 (1AFH)	631 (277H)	831 (33FH)	1031 (407H)	1231 (4CFH)	1431 (597H)	1631 (65FH)	1831 (727H)	CH□ Difference conversion reference value	0000H	Monitor	×
CH9	CH10	CH11	CH12	CH13	CH14	CH15	CH16				
2031 (7EFH)	2231 (8B7H)	2431 (97FH)	2631 (A47H)	2831 (B0FH)	3031 (BD7H)	3231 (C9FH)	3431 (D67H)				
CH1	CH2	CH3	CH4	CH5	CH6	CH7	CH8	System area	—	—	—
433 (1B1H)	633 (279H)	833 (341H)	1033 (409H)	1233 (4D1H)	1433 (599H)	1633 (661H)	1833 (729H)				
CH9	CH10	CH11	CH12	CH13	CH14	CH15	CH16				
2033 (7F1H)	2233 (8B9H)	2433 (981H)	2633 (A49H)	2833 (B11H)	3033 (BD9H)	3233 (CA1H)	3433 (D69H)	CH□ Head pointer	0	Monitor	×
CH1	CH2	CH3	CH4	CH5	CH6	CH7	CH8				
434 (1B2H)	634 (27AH)	834 (342H)	1034 (40AH)	1234 (4D2H)	1434 (59AH)	1634 (662H)	1834 (72AH)				
CH9	CH10	CH11	CH12	CH13	CH14	CH15	CH16	CH□ Latest pointer	0	Monitor	×
2034 (7F2H)	2234 (8BAH)	2434 (982H)	2634 (A4AH)	2834 (B12H)	3034 (BDAH)	3234 (CA2H)	3434 (D6AH)				
CH1	CH2	CH3	CH4	CH5	CH6	CH7	CH8				
435 (1B3H)	635 (27BH)	835 (343H)	1035 (40BH)	1235 (4D3H)	1435 (59BH)	1635 (663H)	1835 (72BH)	CH□ Number of logging data	0	Monitor	×
CH9	CH10	CH11	CH12	CH13	CH14	CH15	CH16				
2035 (7F3H)	2235 (8BBH)	2435 (983H)	2635 (A4BH)	2835 (B13H)	3035 (BDBH)	3235 (CA3H)	3435 (D6BH)				
CH1	CH2	CH3	CH4	CH5	CH6	CH7	CH8	CH□ Number of logging data	0	Monitor	×
436 (1B4H)	636 (27CH)	836 (344H)	1036 (40CH)	1236 (4D4H)	1436 (59CH)	1636 (664H)	1836 (72CH)				
CH9	CH10	CH11	CH12	CH13	CH14	CH15	CH16				
2036 (7F4H)	2236 (8BCH)	2436 (984H)	2636 (A4CH)	2836 (B14H)	3036 (BDCH)	3236 (CA4H)	3436 (D6CH)				



Address Decimal (hexadecimal)								Name	Default value	Data type	Auto refresh
CH1	CH2	CH3	CH4	CH5	CH6	CH7	CH8	CH□ Trigger pointer	0	Monitor	×
437 (1B5H)	637 (27DH)	837 (345H)	1037 (40DH)	1237 (4D5H)	1437 (59DH)	1637 (665H)	1837 (72DH)				
CH9	CH10	CH11	CH12	CH13	CH14	CH15	CH16				
2037 (7F5H)	2237 (8BDH)	2437 (985H)	2637 (A4DH)	2837 (B15H)	3037 (BDDH)	3237 (CA5H)	3437 (D6DH)	CH□ Current logging read pointer	-1	Monitor	×
CH1	CH2	CH3	CH4	CH5	CH6	CH7	CH8				
438 (1B6H)	638 (27EH)	838 (346H)	1038 (40EH)	1238 (4D6H)	1438 (59EH)	1638 (666H)	1838 (72EH)				
CH9	CH10	CH11	CH12	CH13	CH14	CH15	CH16	CH□ Previous logging read pointer	-1	Monitor	×
2038 (7F6H)	2238 (8BEH)	2438 (986H)	2638 (A4EH)	2838 (B16H)	3038 (BDEH)	3238 (CA6H)	3438 (D6EH)				
CH1	CH2	CH3	CH4	CH5	CH6	CH7	CH8				
439 (1B7H)	639 (27FH)	839 (347H)	1039 (40FH)	1239 (4D7H)	1439 (59FH)	1639 (667H)	1839 (72FH)	CH□ Logging read points monitor value	0	Monitor	×
CH9	CH10	CH11	CH12	CH13	CH14	CH15	CH16				
2039 (7F7H)	2239 (8BFH)	2439 (987H)	2639 (A4FH)	2839 (B17H)	3039 (BDFH)	3239 (CA7H)	3439 (D6FH)				
CH1	CH2	CH3	CH4	CH5	CH6	CH7	CH8	CH□ Logging cycle monitor value (s)	0	Monitor	×
440 (1B8H)	640 (280H)	840 (348H)	1040 (410H)	1240 (4D8H)	1440 (5A0H)	1640 (668H)	1840 (730H)				
CH9	CH10	CH11	CH12	CH13	CH14	CH15	CH16				
2040 (7F8H)	2240 (8C0H)	2440 (988H)	2640 (A50H)	2840 (B18H)	3040 (BE0H)	3240 (CA8H)	3440 (D70H)	CH□ Logging cycle monitor value (ms)	0	Monitor	×
CH1	CH2	CH3	CH4	CH5	CH6	CH7	CH8				
441 (1B9H)	641 (281H)	841 (349H)	1041 (411H)	1241 (4D9H)	1441 (5A1H)	1641 (669H)	1841 (731H)				
CH9	CH10	CH11	CH12	CH13	CH14	CH15	CH16	System area	—	—	—
2041 (7F9H)	2241 (8C1H)	2441 (989H)	2641 (A51H)	2841 (B19H)	3041 (BE1H)	3241 (CA9H)	3441 (D71H)				
CH1	CH2	CH3	CH4	CH5	CH6	CH7	CH8				
442 (1BAH)	642 (282H)	842 (34AH)	1042 (412H)	1242 (4DAH)	1442 (5A2H)	1642 (66AH)	1842 (732H)	CH□ Trigger generation time (First/ Last two digits of the year)	0	Monitor	×
CH9	CH10	CH11	CH12	CH13	CH14	CH15	CH16				
2042 (7FAH)	2242 (8C2H)	2442 (98AH)	2642 (A52H)	2842 (B1AH)	3042 (BE2H)	3242 (CAAH)	3442 (D72H)				
CH1	CH2	CH3	CH4	CH5	CH6	CH7	CH8	CH□ Trigger generation time (Month/Day)	0	Monitor	×
443 (1BBH)	643 (283H)	843 (34BH)	1043 (413H)	1243 (4DBH)	1443 (5A3H)	1643 (66BH)	1843 (733H)				
CH9	CH10	CH11	CH12	CH13	CH14	CH15	CH16				
2043 (7FBH)	2243 (8C3H)	2443 (98BH)	2643 (A53H)	2843 (B1BH)	3043 (BE3H)	3243 (CABH)	3443 (D73H)	CH□ Trigger generation time (First/ Last two digits of the year)	0	Monitor	×
CH1	CH2	CH3	CH4	CH5	CH6	CH7	CH8				
444 (1BCH)	644 (284H)	844 (34CH)	1044 (414H)	1244 (4DCH)	1444 (5A4H)	1644 (66CH)	1844 (734H)				
CH9	CH10	CH11	CH12	CH13	CH14	CH15	CH16	CH□ Trigger generation time (Month/Day)	0	Monitor	×
2044 (7FCH)	2244 (8C4H)	2444 (98CH)	2644 (A54H)	2844 (B1CH)	3044 (BE4H)	3244 (CACH)	3444 (D74H)				
CH1	CH2	CH3	CH4	CH5	CH6	CH7	CH8				
445 (1BDH)	645 (285H)	845 (34DH)	1045 (415H)	1245 (4DDH)	1445 (5A5H)	1645 (66DH)	1845 (735H)	CH□ Trigger generation time (Month/Day)	0	Monitor	×
CH9	CH10	CH11	CH12	CH13	CH14	CH15	CH16				
2045 (7FDH)	2245 (8C5H)	2445 (98DH)	2645 (A55H)	2845 (B1DH)	3045 (BE5H)	3245 (CADH)	3445 (D75H)				

Address Decimal (hexadecimal)								Name	Default value	Data type	Auto refresh
CH1	CH2	CH3	CH4	CH5	CH6	CH7	CH8	CH□ Trigger generation time (Hour/Minute)	0	Monitor	×
446 (1BEH)	646 (286H)	846 (34EH)	1046 (416H)	1246 (4DEH)	1446 (5A6H)	1646 (66EH)	1846 (736H)				
CH9	CH10	CH11	CH12	CH13	CH14	CH15	CH16				
2046 (7FEH)	2246 (8C6H)	2446 (98EH)	2646 (A56H)	2846 (B1EH)	3046 (BE6H)	3246 (CAEH)	3446 (D76H)				
CH1	CH2	CH3	CH4	CH5	CH6	CH7	CH8	CH□ Trigger generation time (Second/Day of the week)	0	Monitor	×
447 (1BFH)	647 (287H)	847 (34FH)	1047 (417H)	1247 (4DFH)	1447 (5A7H)	1647 (66FH)	1847 (737H)				
CH9	CH10	CH11	CH12	CH13	CH14	CH15	CH16				
2047 (7FFH)	2247 (8C7H)	2447 (98FH)	2647 (A57H)	2847 (B1FH)	3047 (BE7H)	3247 (CAFH)	3447 (D77H)				
CH1	CH2	CH3	CH4	CH5	CH6	CH7	CH8	CH□ Trigger generation time (Millisecond)	0	Monitor	×
448 (1C0H)	648 (288H)	848 (350H)	1048 (418H)	1248 (4E0H)	1448 (5A8H)	1648 (670H)	1848 (738H)				
CH9	CH10	CH11	CH12	CH13	CH14	CH15	CH16				
2048 (800H)	2248 (8C8H)	2448 (990H)	2648 (A58H)	2848 (B20H)	3048 (BE8H)	3248 (CB0H)	3448 (D78H)				
CH1	CH2	CH3	CH4	CH5	CH6	CH7	CH8	System area	—	—	—
449 to 469 (1C1H to 1D5H)	649 to 669 (289H to 29DH)	849 to 869 (351H to 365H)	1049 to 1069 (419H to 42DH)	1249 to 1269 (4E1H to 4F5H)	1449 to 1469 (5A9H to 5BDH)	1649 to 1669 (671H to 685H)	1849 to 1869 (739H to 74DH)				
CH9	CH10	CH11	CH12	CH13	CH14	CH15	CH16				
2049 to 2069 (801H to 815H)	2249 to 2269 (BC9H to 8DDH)	2449 to 2469 (991H to 9A5H)	2649 to 2669 (A59H to A6DH)	2849 to 2869 (B21H to B35H)	3049 to 3069 (BE9H to BFDH)	3249 to 3269 (CB1H to CC5H)	3449 to 3469 (D79H to D8DH)				
CH1	CH2	CH3	CH4	CH5	CH6	CH7	CH8	CH□ Difference conversion trigger	0	Control	○
470 (1D6H)	670 (29EH)	870 (366H)	1070 (42EH)	1270 (4F6H)	1470 (5BEH)	1670 (686H)	1870 (74EH)				
CH9	CH10	CH11	CH12	CH13	CH14	CH15	CH16				
2070 (816H)	2270 (8DEH)	2470 (9A6H)	2670 (A6EH)	2870 (B36H)	3070 (BFEH)	3270 (CC6H)	3470 (D8EH)				
CH1	CH2	CH3	CH4	CH5	CH6	CH7	CH8	CH□ Logging hold request	0	Control	○
471 (1D7H)	671 (29FH)	871 (367H)	1071 (42FH)	1271 (4F7H)	1471 (5BFH)	1671 (687H)	1871 (74FH)				
CH9	CH10	CH11	CH12	CH13	CH14	CH15	CH16				
2071 (817H)	2271 (8DFH)	2471 (9A7H)	2671 (A6FH)	2871 (B37H)	3071 (BFFH)	3271 (CC7H)	3471 (D8FH)				
CH1	CH2	CH3	CH4	CH5	CH6	CH7	CH8	CH□ Conversion value shift amount	0	Control	○
472 (1D8H)	672 (2A0H)	872 (368H)	1072 (430H)	1272 (4F8H)	1472 (5C0H)	1672 (688H)	1872 (750H)				
CH9	CH10	CH11	CH12	CH13	CH14	CH15	CH16				
2072 (818H)	2272 (8E0H)	2472 (9A8H)	2672 (A70H)	2872 (B38H)	3072 (C00H)	3272 (CC8H)	3472 (D90H)				



Address Decimal (hexadecimal)								Name	Default value	Data type	Auto refresh
CH1	CH2	CH3	CH4	CH5	CH6	CH7	CH8	System area	—	—	—
473 to 499 (1D9H to 1F3H)	673 to 699 (2A1H to 2BBH)	873 to 899 (369H to 383H)	1073 to 1099 (431H to 44BH)	1273 to 1299 (4F9H to 513H)	1473 to 1499 (5C1H to 5DBH)	1673 to 1699 (689H to 6A3H)	1873 to 1899 (751H to 76BH)				
CH9	CH10	CH11	CH12	CH13	CH14	CH15	CH16				
2073 to 2099 (819H to 833H)	2273 to 2299 (8E1H to 8FBH)	2473 to 2499 (9A9H to 9C3H)	2673 to 2699 (A71H to A8BH)	2873 to 2899 (B39H to B53H)	3073 to 3099 (C01H to C1BH)	3273 to 3299 (CC9H to CE3H)	3473 to 3499 (D91H to DABH)				
CH1	CH2	CH3	CH4	CH5	CH6	CH7	CH8	CH□ A/D conversion enable/ disable setting	1	Setting	×
500 (1F4H)	700 (2BCH)	900 (384H)	1100 (44CH)	1300 (514H)	1500 (5DCH)	1700 (6A4H)	1900 (76CH)				
CH9	CH10	CH11	CH12	CH13	CH14	CH15	CH16				
2100 (834H)	2300 (8FCH)	2500 (9C4H)	2700 (A8CH)	2900 (B54H)	3100 (C1CH)	3300 (CE4H)	3500 (DACH)				
CH1	CH2	CH3	CH4	CH5	CH6	CH7	CH8	CH□ Averaging process specification	0	Setting	×
501 (1F5H)	701 (2BDH)	901 (385H)	1101 (44DH)	1301 (515H)	1501 (5DDH)	1701 (6A5H)	1901 (76DH)				
CH9	CH10	CH11	CH12	CH13	CH14	CH15	CH16				
2101 (835H)	2301 (8FDH)	2501 (9C5H)	2701 (A8DH)	2901 (B55H)	3101 (C1DH)	3301 (CE5H)	3501 (DADH)				
CH1	CH2	CH3	CH4	CH5	CH6	CH7	CH8	CH□ Time average/Count average/ Moving average/Primary delay filter constant setting	0	Setting	×
502 (1F6H)	702 (2BEH)	902 (386H)	1102 (44EH)	1302 (516H)	1502 (5DEH)	1702 (6A6H)	1902 (76EH)				
CH9	CH10	CH11	CH12	CH13	CH14	CH15	CH16				
2102 (836H)	2302 (8FEH)	2502 (9C6H)	2702 (A8EH)	2902 (B56H)	3102 (C1EH)	3302 (CE6H)	3502 (DAEH)				
CH1	CH2	CH3	CH4	CH5	CH6	CH7	CH8	System area	—	—	—
503 (1F7H)	703 (2BFH)	903 (387H)	1103 (44FH)	1303 (517H)	1503 (5DFH)	1703 (6A7H)	1903 (76FH)				
CH9	CH10	CH11	CH12	CH13	CH14	CH15	CH16				
2103 (837H)	2303 (8FFH)	2503 (9C7H)	2703 (A8FH)	2903 (B57H)	3103 (C1FH)	3303 (CE7H)	3503 (DAFH)				
CH1	CH2	CH3	CH4	CH5	CH6	CH7	CH8	CH□ Scaling enable/disable setting	1	Setting	×
504 (1F8H)	704 (2C0H)	904 (388H)	1104 (450H)	1304 (518H)	1504 (5E0H)	1704 (6A8H)	1904 (770H)				
CH9	CH10	CH11	CH12	CH13	CH14	CH15	CH16				
2104 (838H)	2304 (900H)	2504 (9C8H)	2704 (A90H)	2904 (B58H)	3104 (C20H)	3304 (CE8H)	3504 (DB0H)				
CH1	CH2	CH3	CH4	CH5	CH6	CH7	CH8	System area	—	—	—
505 (1F9H)	705 (2C1H)	905 (389H)	1105 (451H)	1305 (519H)	1505 (5E1H)	1705 (6A9H)	1905 (771H)				
CH9	CH10	CH11	CH12	CH13	CH14	CH15	CH16				
2105 (839H)	2305 (901H)	2505 (9C9H)	2705 (A91H)	2905 (B59H)	3105 (C21H)	3305 (CE9H)	3505 (DB1H)				
CH1	CH2	CH3	CH4	CH5	CH6	CH7	CH8	CH□ Scaling upper limit value	0	Setting	×
506 (1FAH)	706 (2C2H)	906 (38AH)	1106 (452H)	1306 (51AH)	1506 (5E2H)	1706 (6AAH)	1906 (772H)				
CH9	CH10	CH11	CH12	CH13	CH14	CH15	CH16				
2106 (83AH)	2306 (902H)	2506 (9CAH)	2706 (A92H)	2906 (B5AH)	3106 (C22H)	3306 (CEAH)	3506 (DB2H)				

Address Decimal (hexadecimal)								Name	Default value	Data type	Auto refresh
CH1	CH2	CH3	CH4	CH5	CH6	CH7	CH8	System area	—	—	—
507 (1FBH)	707 (2C3H)	907 (38BH)	1107 (453H)	1307 (51BH)	1507 (5E3H)	1707 (6ABH)	1907 (773H)				
CH9	CH10	CH11	CH12	CH13	CH14	CH15	CH16				
2107 (83BH)	2307 (903H)	2507 (9CBH)	2707 (A93H)	2907 (B5BH)	3107 (C23H)	3307 (CEBH)	3507 (DB3H)				
CH1	CH2	CH3	CH4	CH5	CH6	CH7	CH8	CH□ Scaling lower limit value	0	Setting	×
508 (1FCH)	708 (2C4H)	908 (38CH)	1108 (454H)	1308 (51CH)	1508 (5E4H)	1708 (6ACH)	1908 (774H)				
CH9	CH10	CH11	CH12	CH13	CH14	CH15	CH16				
2108 (83CH)	2308 (904H)	2508 (9CCH)	2708 (A94H)	2908 (B5CH)	3108 (C24H)	3308 (CECH)	3508 (DB4H)				
CH1	CH2	CH3	CH4	CH5	CH6	CH7	CH8				
509 (1FDH)	709 (2C5H)	909 (38DH)	1109 (455H)	1309 (51DH)	1509 (5E5H)	1709 (6ADH)	1909 (775H)	System area	—	—	—
CH9	CH10	CH11	CH12	CH13	CH14	CH15	CH16				
2109 (83DH)	2309 (905H)	2509 (9CDH)	2709 (A95H)	2909 (B5DH)	3109 (C25H)	3309 (CEDH)	3509 (DB5H)				
CH1	CH2	CH3	CH4	CH5	CH6	CH7	CH8				
510 (1FEH)	710 (2C6H)	910 (38EH)	1110 (456H)	1310 (51EH)	1510 (5E6H)	1710 (6AEH)	1910 (776H)	CH□ Digital clipping enable/disable setting	1	Setting	×
CH9	CH10	CH11	CH12	CH13	CH14	CH15	CH16				
2110 (83EH)	2310 (906H)	2510 (9CEH)	2710 (A96H)	2910 (B5EH)	3110 (C26H)	3310 (CEEH)	3510 (DB6H)				
CH1	CH2	CH3	CH4	CH5	CH6	CH7	CH8				
511 (1FFH)	711 (2C7H)	911 (38FH)	1111 (457H)	1311 (51FH)	1511 (5E7H)	1711 (6AFH)	1911 (777H)				
CH9	CH10	CH11	CH12	CH13	CH14	CH15	CH16	System area	—	—	—
2111 (83FH)	2311 (907H)	2511 (9CFH)	2711 (A97H)	2911 (B5FH)	3111 (C27H)	3311 (CEFH)	3511 (DB7H)				
CH1	CH2	CH3	CH4	CH5	CH6	CH7	CH8				
512 (200H)	712 (2C8H)	912 (390H)	1112 (458H)	1312 (520H)	1512 (5E8H)	1712 (6B0H)	1912 (778H)				
CH9	CH10	CH11	CH12	CH13	CH14	CH15	CH16	CH□ Alert output setting (Process alarm)	1	Setting	×
2112 (840H)	2312 (908H)	2512 (9D0H)	2712 (A98H)	2912 (B60H)	3112 (C28H)	3312 (CF0H)	3512 (DB8H)				
CH1	CH2	CH3	CH4	CH5	CH6	CH7	CH8				
513 (201H)	713 (2C9H)	913 (391H)	1113 (459H)	1313 (521H)	1513 (5E9H)	1713 (6B1H)	1913 (779H)				
CH9	CH10	CH11	CH12	CH13	CH14	CH15	CH16				
2113 (841H)	2313 (909H)	2513 (9D1H)	2713 (A99H)	2913 (B61H)	3113 (C29H)	3313 (CF1H)	3513 (DB9H)	CH□ Alert output setting (Rate alarm)	1	Setting	×
CH1	CH2	CH3	CH4	CH5	CH6	CH7	CH8	CH□ Process alarm upper upper limit value	0	Setting	×
514 (202H)	714 (2CAH)	914 (392H)	1114 (45AH)	1314 (522H)	1514 (5EAH)	1714 (6B2H)	1914 (77AH)				
CH9	CH10	CH11	CH12	CH13	CH14	CH15	CH16				
2114 (842H)	2314 (90AH)	2514 (9D2H)	2714 (A9AH)	2914 (B62H)	3114 (C2AH)	3314 (CF2H)	3514 (DBAH)				
CH1	CH2	CH3	CH4	CH5	CH6	CH7	CH8	System area	—	—	—
515 (203H)	715 (2CBH)	915 (393H)	1115 (45BH)	1315 (523H)	1515 (5EBH)	1715 (6B3H)	1915 (77BH)				
CH9	CH10	CH11	CH12	CH13	CH14	CH15	CH16				
2115 (843H)	2315 (90BH)	2515 (9D3H)	2715 (A9BH)	2915 (B63H)	3115 (C2BH)	3315 (CF3H)	3515 (DBBH)				



Address Decimal (hexadecimal)								Name	Default value	Data type	Auto refresh
CH1	CH2	CH3	CH4	CH5	CH6	CH7	CH8	CH□ Process alarm upper lower limit value	0	Setting	×
516 (204H)	716 (2CCH)	916 (394H)	1116 (45CH)	1316 (524H)	1516 (5ECH)	1716 (6B4H)	1916 (77CH)				
CH9	CH10	CH11	CH12	CH13	CH14	CH15	CH16				
2116 (844H)	2316 (90CH)	2516 (9D4H)	2716 (A9CH)	2916 (B64H)	3116 (C2CH)	3316 (CF4H)	3516 (DBCH)				
CH1	CH2	CH3	CH4	CH5	CH6	CH7	CH8	System area	—	—	—
517 (205H)	717 (2CDH)	917 (395H)	1117 (45DH)	1317 (525H)	1517 (5EDH)	1717 (6B5H)	1917 (77DH)				
CH9	CH10	CH11	CH12	CH13	CH14	CH15	CH16				
2117 (845H)	2317 (90DH)	2517 (9D5H)	2717 (A9DH)	2917 (B65H)	3117 (C2DH)	3317 (CF5H)	3517 (DBDH)				
CH1	CH2	CH3	CH4	CH5	CH6	CH7	CH8	CH□ Process alarm lower upper limit value	0	Setting	×
518 (206H)	718 (2CEH)	918 (396H)	1118 (45EH)	1318 (526H)	1518 (5EEH)	1718 (6B6H)	1918 (77EH)				
CH9	CH10	CH11	CH12	CH13	CH14	CH15	CH16				
2118 (846H)	2318 (90EH)	2518 (9D6H)	2718 (A9EH)	2918 (B66H)	3118 (C2EH)	3318 (CF6H)	3518 (DBEH)				
CH1	CH2	CH3	CH4	CH5	CH6	CH7	CH8	System area	—	—	—
519 (207H)	719 (2CFH)	919 (397H)	1119 (45FH)	1319 (527H)	1519 (5EFH)	1719 (6B7H)	1919 (77FH)				
CH9	CH10	CH11	CH12	CH13	CH14	CH15	CH16				
2119 (847H)	2319 (90FH)	2519 (9D7H)	2719 (A9FH)	2919 (B67H)	3119 (C2FH)	3319 (CF7H)	3519 (DBFH)				
CH1	CH2	CH3	CH4	CH5	CH6	CH7	CH8	CH□ Process alarm lower lower limit value	0	Setting	×
520 (208H)	720 (2D0H)	920 (398H)	1120 (460H)	1320 (528H)	1520 (5F0H)	1720 (6B8H)	1920 (780H)				
CH9	CH10	CH11	CH12	CH13	CH14	CH15	CH16				
2120 (848H)	2320 (910H)	2520 (9D8H)	2720 (AA0H)	2920 (B68H)	3120 (C30H)	3320 (CF8H)	3520 (DC0H)				
CH1	CH2	CH3	CH4	CH5	CH6	CH7	CH8	System area	—	—	—
521 (209H)	721 (2D1H)	921 (399H)	1121 (461H)	1321 (529H)	1521 (5F1H)	1721 (6B9H)	1921 (781H)				
CH9	CH10	CH11	CH12	CH13	CH14	CH15	CH16				
2121 (849H)	2321 (911H)	2521 (9D9H)	2721 (AA1H)	2921 (B69H)	3121 (C31H)	3321 (CF9H)	3521 (DC1H)				
CH1	CH2	CH3	CH4	CH5	CH6	CH7	CH8	CH□ Rate alarm alert detection cycle setting	0	Setting	×
522 (20AH)	722 (2D2H)	922 (39AH)	1122 (462H)	1322 (52AH)	1522 (5F2H)	1722 (6BAH)	1922 (782H)				
CH9	CH10	CH11	CH12	CH13	CH14	CH15	CH16				
2122 (84AH)	2322 (912H)	2522 (9DAH)	2722 (AA2H)	2922 (B6AH)	3122 (C32H)	3322 (CFAH)	3522 (DC2H)				
CH1	CH2	CH3	CH4	CH5	CH6	CH7	CH8	System area	—	—	—
523 (20BH)	723 (2D3H)	923 (39BH)	1123 (463H)	1323 (52BH)	1523 (5F3H)	1723 (6BBH)	1923 (783H)				
CH9	CH10	CH11	CH12	CH13	CH14	CH15	CH16				
2123 (84BH)	2323 (913H)	2523 (9DBH)	2723 (AA3H)	2923 (B6BH)	3123 (C33H)	3323 (CFBH)	3523 (DC3H)				
CH1	CH2	CH3	CH4	CH5	CH6	CH7	CH8	CH□ Rate alarm upper limit value	0	Setting	×
524 (20CH)	724 (2D4H)	924 (39CH)	1124 (464H)	1324 (52CH)	1524 (5F4H)	1724 (6BCH)	1924 (784H)				
CH9	CH10	CH11	CH12	CH13	CH14	CH15	CH16				
2124 (84CH)	2324 (914H)	2524 (9DCH)	2724 (AA4H)	2924 (B6CH)	3124 (C34H)	3324 (CFCH)	3524 (DC4H)				

Address Decimal (hexadecimal)								Name	Default value	Data type	Auto refresh
CH1	CH2	CH3	CH4	CH5	CH6	CH7	CH8	System area	—	—	—
525 (20DH)	725 (2D5H)	925 (39DH)	1125 (465H)	1325 (52DH)	1525 (5F5H)	1725 (6BDH)	1925 (785H)				
CH9	CH10	CH11	CH12	CH13	CH14	CH15	CH16				
2125 (84DH)	2325 (915H)	2525 (9DDH)	2725 (AA5H)	2925 (B6DH)	3125 (C35H)	3325 (CFDH)	3525 (DC5H)				
CH1	CH2	CH3	CH4	CH5	CH6	CH7	CH8	CH□ Rate alarm lower limit value	0	Setting	×
526 (20EH)	726 (2D6H)	926 (39EH)	1126 (466H)	1326 (52EH)	1526 (5F6H)	1726 (6BEH)	1926 (786H)				
CH9	CH10	CH11	CH12	CH13	CH14	CH15	CH16				
2126 (84EH)	2326 (916H)	2526 (9DEH)	2726 (AA6H)	2926 (B6EH)	3126 (C36H)	3326 (CFEH)	3526 (DC6H)				
CH1	CH2	CH3	CH4	CH5	CH6	CH7	CH8				
527 (20FH)	727 (2D7H)	927 (39FH)	1127 (467H)	1327 (52FH)	1527 (5F7H)	1727 (6BFH)	1927 (787H)				
CH9	CH10	CH11	CH12	CH13	CH14	CH15	CH16				
2127 (84FH)	2327 (917H)	2527 (9DFH)	2727 (AA7H)	2927 (B6FH)	3127 (C37H)	3327 (CFFH)	3527 (DC7H)				
CH1	CH2	CH3	CH4	CH5	CH6	CH7	CH8	CH□ Input signal error detection setting	0	Setting	×
528 (210H)	728 (2D8H)	928 (3A0H)	1128 (468H)	1328 (530H)	1528 (5F8H)	1728 (6C0H)	1928 (788H)				
CH9	CH10	CH11	CH12	CH13	CH14	CH15	CH16				
2128 (850H)	2328 (918H)	2528 (9E0H)	2728 (AA8H)	2928 (B70H)	3128 (C38H)	3328 (D00H)	3528 (DC8H)				
CH1	CH2	CH3	CH4	CH5	CH6	CH7	CH8	CH□ Input signal error detection lower limit set value	50	Setting	×
529 (211H)	729 (2D9H)	929 (3A1H)	1129 (469H)	1329 (531H)	1529 (5F9H)	1729 (6C1H)	1929 (789H)				
CH9	CH10	CH11	CH12	CH13	CH14	CH15	CH16				
2129 (851H)	2329 (919H)	2529 (9E1H)	2729 (AA9H)	2929 (B71H)	3129 (C39H)	3329 (D01H)	3529 (DC9H)				
CH1	CH2	CH3	CH4	CH5	CH6	CH7	CH8	CH□ Input signal error detection upper limit set value	50	Setting	×
530 (212H)	730 (2DAH)	930 (3A2H)	1130 (46AH)	1330 (532H)	1530 (5FAH)	1730 (6C2H)	1930 (78AH)				
CH9	CH10	CH11	CH12	CH13	CH14	CH15	CH16				
2130 (852H)	2330 (91AH)	2530 (9E2H)	2730 (AAAH)	2930 (B72H)	3130 (C3AH)	3330 (D02H)	3530 (DCAH)				
CH1	CH2	CH3	CH4	CH5	CH6	CH7	CH8	System area	—	—	—
531 to 534 (213H to 216H)	731 to 734 (2DBH to 2DEH)	931 to 934 (3A3H to 3A6H)	1131 to 1134 (46BH to 46EH)	1331 to 1334 (533H to 536H)	1531 to 1534 (5FBH to 5FEH)	1731 to 1734 (6C3H to 6C6H)	1931 to 1934 (78BH to 78EH)				
CH9	CH10	CH11	CH12	CH13	CH14	CH15	CH16				
2131 to 2134 (853H to 856H)	2331 to 2334 (91BH to 91EH)	2531 to 2534 (9E3H to 9E6H)	2731 to 2734 (AABH to AAEH)	2931 to 2934 (B73H to B76H)	3131 to 3134 (C3BH to C3EH)	3331 to 3334 (D03H to D06H)	3531 to 3534 (DCBH to DCEH)				
CH1	CH2	CH3	CH4	CH5	CH6	CH7	CH8	CH□ Logging enable/disable setting	1	Setting	×
535 (217H)	735 (2DFH)	935 (3A7H)	1135 (46FH)	1335 (537H)	1535 (5FFH)	1735 (6C7H)	1935 (78FH)				
CH9	CH10	CH11	CH12	CH13	CH14	CH15	CH16				
2135 (857H)	2335 (91FH)	2535 (9E7H)	2735 (AAFH)	2935 (B77H)	3135 (C3FH)	3335 (D07H)	3535 (DCFH)				



Address Decimal (hexadecimal)								Name	Default value	Data type	Auto refresh				
CH1	CH2	CH3	CH4	CH5	CH6	CH7	CH8	CH□ Logging data setting	1	Setting	×				
536 (218H)	736 (2E0H)	936 (3A8H)	1136 (470H)	1336 (538H)	1536 (600H)	1736 (6C8H)	1936 (790H)								
CH9	CH10	CH11	CH12	CH13	CH14	CH15	CH16								
2136 (858H)	2336 (920H)	2536 (9E8H)	2736 (AB0H)	2936 (B78H)	3136 (C40H)	3336 (D08H)	3536 (DD0H)	CH□ Logging cycle setting value	160	Setting	×				
CH1	CH2	CH3	CH4	CH5	CH6	CH7	CH8								
537 (219H)	737 (2E1H)	937 (3A9H)	1137 (471H)	1337 (539H)	1537 (601H)	1737 (6C9H)	1937 (791H)								
CH9	CH10	CH11	CH12	CH13	CH14	CH15	CH16	CH□ Logging cycle unit setting	1	Setting	×				
2137 (859H)	2337 (921H)	2537 (9E9H)	2737 (AB1H)	2937 (B79H)	3137 (C41H)	3337 (D09H)	3537 (DD1H)								
CH1	CH2	CH3	CH4	CH5	CH6	CH7	CH8								
538 (21AH)	738 (2E2H)	938 (3AAH)	1138 (472H)	1338 (53AH)	1538 (602H)	1738 (6CAH)	1938 (792H)	CH□ Post-trigger logging points	500	Setting	×				
CH9	CH10	CH11	CH12	CH13	CH14	CH15	CH16								
2138 (85AH)	2338 (922H)	2538 (9EAH)	2738 (AB2H)	2938 (B7AH)	3138 (C42H)	3338 (D0AH)	3538 (DD2H)								
CH1	CH2	CH3	CH4	CH5	CH6	CH7	CH8	CH□ Level trigger condition setting	0	Setting	×				
540 (21CH)	740 (2E4H)	940 (3ACH)	1140 (474H)	1340 (53CH)	1540 (604H)	1740 (6CCH)	1940 (794H)								
CH9	CH10	CH11	CH12	CH13	CH14	CH15	CH16								
2140 (85CH)	2340 (924H)	2540 (9ECH)	2740 (AB4H)	2940 (B7CH)	3140 (C44H)	3340 (D0CH)	3540 (DD4H)	CH□ Trigger data	*1	Setting	×				
CH1	CH2	CH3	CH4	CH5	CH6	CH7	CH8								
541 (21DH)	741 (2E5H)	941 (3ADH)	1141 (475H)	1341 (53DH)	1541 (605H)	1741 (6CDH)	1941 (795H)								
CH9	CH10	CH11	CH12	CH13	CH14	CH15	CH16	CH□ Trigger setting value	0	Setting	×				
2141 (85DH)	2341 (925H)	2541 (9EDH)	2741 (AB5H)	2941 (B7DH)	3141 (C45H)	3341 (D0DH)	3541 (DD5H)								
CH1	CH2	CH3	CH4	CH5	CH6	CH7	CH8								
542 (21EH)	742 (2E6H)	942 (3AEH)	1142 (476H)	1342 (53EH)	1542 (606H)	1742 (6CEH)	1942 (796H)	System area	—	—	—				
CH9	CH10	CH11	CH12	CH13	CH14	CH15	CH16								
2142 (85EH)	2342 (926H)	2542 (9EEH)	2742 (AB6H)	2942 (B7EH)	3142 (C46H)	3342 (D0EH)	3542 (DD6H)								
CH1	CH2	CH3	CH4	CH5	CH6	CH7	CH8	CH□ Loading interrupt enable/ disable setting	1	Setting	×				
543 (21FH)	743 (2E7H)	943 (3AFH)	1143 (477H)	1343 (53FH)	1543 (607H)	1743 (6CFH)	1943 (797H)								
CH9	CH10	CH11	CH12	CH13	CH14	CH15	CH16								
2143 (85FH)	2343 (927H)	2543 (9EFH)	2743 (AB7H)	2943 (B7FH)	3143 (C47H)	3343 (D0FH)	3543 (DD7H)	CH1	CH2	CH3	CH4	CH5	CH6	CH7	CH8
544 (220H)	744 (2E8H)	944 (3B0H)	1144 (478H)	1344 (540H)	1544 (608H)	1744 (6D0H)	1944 (798H)								
CH9	CH10	CH11	CH12	CH13	CH14	CH15	CH16								
2144 (860H)	2344 (928H)	2544 (9F0H)	2744 (AB8H)	2944 (B80H)	3144 (C48H)	3344 (D10H)	3544 (DD8H)								

Address Decimal (hexadecimal)								Name	Default value	Data type	Auto refresh
CH1	CH2	CH3	CH4	CH5	CH6	CH7	CH8	CH□ Logging read points setting value	100	Setting	×
545 (221H)	745 (2E9H)	945 (3B1H)	1145 (479H)	1345 (541H)	1545 (609H)	1745 (6D1H)	1945 (799H)				
CH9	CH10	CH11	CH12	CH13	CH14	CH15	CH16				
2145 (861H)	2345 (929H)	2545 (9F1H)	2745 (AB9H)	2945 (B81H)	3145 (C49H)	3345 (D11H)	3545 (DD9H)				
CH1	CH2	CH3	CH4	CH5	CH6	CH7	CH8	System area	—	—	—
546 to 597 (222H to 255H)	746 to 797 (2EAH to 31DH)	946 to 997 (3B2H to 3E5H)	1146 to 1197 (47AH to 4ADH)	1346 to 1397 (542H to 575H)	1546 to 1597 (60AH to 63DH)	1746 to 1797 (6D2 to 705H)	1946 to 1997 (79AH to 7CDH)				
CH9	CH10	CH11	CH12	CH13	CH14	CH15	CH16				
2146 to 2197 (862H to 895H)	2346 to 2397 (92AH to 95DH)	2546 to 2597 (9F2H to A25H)	2746 to 2797 (ABAH to AEDH)	2946 to 2997 (B82H to BB5H)	3146 to 3197 (C4AH to C7DH)	3346 to 3397 (D12H to D45H)	3546 to 3597 (DDAH to E0DH)				
CH1	CH2	CH3	CH4	CH5	CH6	CH7	CH8	CH□ Range setting	0	Setting	×
598 (256H)	798 (31EH)	998 (3E6H)	1198 (4AEH)	1398 (576H)	1598 (63EH)	1798 (706H)	1998 (7CEH)				
CH9	CH10	CH11	CH12	CH13	CH14	CH15	CH16				
2198 (896H)	2398 (95EH)	2598 (A26H)	2798 (AEEH)	2998 (BB6H)	3198 (C7EH)	3398 (D46H)	3598 (E0EH)				
CH1	CH2	CH3	CH4	CH5	CH6	CH7	CH8	System area	—	—	—
599 (257H)	799 (31FH)	999 (3E7H)	1199 (4AFH)	1399 (577H)	1599 (63FH)	1799 (707H)	1999 (7CFH)				
CH9	CH10	CH11	CH12	CH13	CH14	CH15	CH16				
2199 (897H)	2399 (95FH)	2599 (A27H)	2799 (AEFH)	2999 (BB7H)	3199 (C7FH)	3399 (D47H)	3599 (E0FH)				

*1 The following shows the default values.

CH1: 402, CH2: 602, CH3: 802, CH4: 1002, CH5: 1202, CH6: 1402, CH7: 1602, CH8: 1802, CH9: 2002, CH10: 2202, CH11: 2402, CH12: 2602, CH13: 2802, CH14: 3002, CH15: 3202, CH16: 3402

■Error history (Un\G3600 to Un\G3759)

Address (decimal)	Address (hexadecimal)	Name			Default value	Data type	Auto refresh	
3600	E10H	Error history 1	Error code			0	Monitor	×
3601	E11H		Error time	First two digits of the year	Last two digits of the year			
3602	E12H			Month	Day			
3603	E13H		Hour	Minute				
3604	E14H		Second	Day of the week				
3605	E15H		Millisecond					
3606 to 3609	E16H to E19H	System area			—	—	—	
3610 to 3615	E1AH to E1FH	Error history 2	Same as error history 1			0	Monitor	×
3616 to 3619	E20H to E23H	System area			—	—	—	
3620 to 3625	E24H to E29H	Error history 3	Same as error history 1			0	Monitor	×
3626 to 3629	E2AH to E2DH	System area			—	—	—	
3630 to 3635	E2EH to E33H	Error history 4	Same as error history 1			0	Monitor	×
3636 to 3639	E34H to E37H	System area			—	—	—	
3640 to 3645	E38H to E3DH	Error history 5	Same as error history 1			0	Monitor	×
3646 to 3649	E3EH to E41H	System area			—	—	—	
3650 to 3655	E42H to E47H	Error history 6	Same as error history 1			0	Monitor	×
3656 to 3659	E48H to E4BH	System area			—	—	—	
3660 to 3665	E4CH to E51H	Error history 7	Same as error history 1			0	Monitor	×

Address (decimal)	Address (hexadecimal)	Name	Default value	Data type	Auto refresh	
3666 to 3669	E52H to E55H	System area	—	—	—	
3670 to 3675	E56H to E5BH	Error history 8	Same as error history 1	0	Monitor	×
3676 to 3679	E5CH to E5FH	System area	—	—	—	
3680 to 3685	E60H to E65H	Error history 9	Same as error history 1	0	Monitor	×
3686 to 3689	E66H to E69H	System area	—	—	—	
3690 to 3695	E6AH to E6FH	Error history 10	Same as error history 1	0	Monitor	×
3696 to 3699	E70H to E73H	System area	—	—	—	
3700 to 3705	E74H to E79H	Error history 11	Same as error history 1	0	Monitor	×
3706 to 3709	E7AH to E7DH	System area	—	—	—	
3710 to 3715	E7EH to E83H	Error history 12	Same as error history 1	0	Monitor	×
3716 to 3719	E84H to E87H	System area	—	—	—	
3720 to 3725	E88H to E8DH	Error history 13	Same as error history 1	0	Monitor	×
3726 to 3729	E8EH to E91H	System area	—	—	—	
3730 to 3735	E92H to E97H	Error history 14	Same as error history 1	0	Monitor	×
3736 to 3739	E98H to E9BH	System area	—	—	—	
3740 to 3745	E9CH to EA1H	Error history 15	Same as error history 1	0	Monitor	×
3746 to 3749	EA2H to EA5H	System area	—	—	—	
3750 to 3755	EA6H to EABH	Error history 16	Same as error history 1	0	Monitor	×
3756 to 3759	EACH to EAFH	System area	—	—	—	

■ Alarm history (Un\G3760 to Un\G3999)

Address (decimal)	Address (hexadecimal)	Name	Default value	Data type	Auto refresh			
3760	EB0H	Alarm history 1	0	Monitor	×			
3761	EB1H					Alarm time	First two digits of the year	Last two digits of the year
3762	EB2H						Month	Day
3763	EB3H					Hour	Minute	
3764	EB4H					Second	Day of the week	
3765	EB5H					Millisecond		
3766 to 3769	EB6H to EB9H	System area	—	—	—			
3770 to 3775	EBAH to EBFH	Alarm history 2	Same as alarm history 1	0	Monitor	×		
3776 to 3779	EC1H to EC3H	System area	—	—	—			
3780 to 3785	EC4H to EC9H	Alarm history 3	Same as alarm history 1	0	Monitor	×		
3786 to 3789	ECAH to ECDH	System area	—	—	—			
3790 to 3795	ECEH to ED3H	Alarm history 4	Same as alarm history 1	0	Monitor	×		
3796 to 3799	ED4H to ED7H	System area	—	—	—			
3800 to 3805	ED8H to EDDH	Alarm history 5	Same as alarm history 1	0	Monitor	×		
3806 to 3809	EDEH to EE1H	System area	—	—	—			
3810 to 3815	EE2H to EE7H	Alarm history 6	Same as alarm history 1	0	Monitor	×		
3816 to 3819	EE8H to EEBH	System area	—	—	—			
3820 to 3825	EECH to EF1H	Alarm history 7	Same as alarm history 1	0	Monitor	×		
3826 to 3829	EF2H to EF5H	System area	—	—	—			
3830 to 3835	EF6H to EFBH	Alarm history 8	Same as alarm history 1	0	Monitor	×		
3836 to 3839	EFCH to EFFH	System area	—	—	—			
3840 to 3845	F00H to F05H	Alarm history 9	Same as alarm history 1	0	Monitor	×		
3846 to 3849	F06H to F09H	System area	—	—	—			
3850 to 3855	F0AH to F0FH	Alarm history 10	Same as alarm history 1	0	Monitor	×		
3856 to 3859	F10H to F13H	System area	—	—	—			
3860 to 3865	F14H to F19H	Alarm history 11	Same as alarm history 1	0	Monitor	×		
3866 to 3869	F1AH to F1DH	System area	—	—	—			

Address (decimal)	Address (hexadecimal)	Name	Default value	Data type	Auto refresh	
3870 to 3875	F1EH to F23H	Alarm history 12	Same as alarm history 1	0	Monitor	×
3876 to 3879	F24H to F27H	System area		—	—	—
3880 to 3885	F28H to F2DH	Alarm history 13	Same as alarm history 1	0	Monitor	×
3886 to 3889	F2EH to F31H	System area		—	—	—
3890 to 3895	F32H to F37H	Alarm history 14	Same as alarm history 1	0	Monitor	×
3896 to 3899	F38H to F3BH	System area		—	—	—
3900 to 3905	F3CH to F41H	Alarm history 15	Same as alarm history 1	0	Monitor	×
3906 to 3909	F42H to F45H	System area		—	—	—
3910 to 3915	F46H to F4BH	Alarm history 16	Same as alarm history 1	0	Monitor	×
3916 to 3999	F4CH to F9FH	System area		—	—	—

■ Offset/gain setting (for the R60AD8-G) (Un\G4000 to Un\G4131)

Address Decimal (hexadecimal)								Name	Default value	Data type	Auto refresh
CH1	CH2	CH3	CH4	CH5	CH6	CH7	CH8				
4000 to 4001 (FA0H to FA1H)								System area	—	—	—
4002 (FA2H)								Save data type setting	0000H	User range setting	×
4003 (FA3H)								System area	—	—	—
4004 (FA4H)	4008 (FA8H)	4012 (FACH)	4016 (FB0H)	4020 (FB4H)	4024 (FB8H)	4028 (FBCH)	4032 (FC0H)	CH□ Factory default setting offset value (L)	0	User range setting	×
4005 (FA5H)	4009 (FA9H)	4013 (FADH)	4017 (FB1H)	4021 (FB5H)	4025 (FB9H)	4029 (FBDH)	4033 (FC1H)	CH□ Factory default setting offset value (H)	0	User range setting	×
4006 (FA6H)	4010 (FAAH)	4014 (FAEH)	4018 (FB2H)	4022 (FB6H)	4026 (FBAH)	4030 (FBEH)	4034 (FC2H)	CH□ Factory default setting gain value (L)	0	User range setting	×
4007 (FA7H)	4011 (FABH)	4015 (FAFH)	4019 (FB3H)	4023 (FB7H)	4027 (FBBH)	4031 (FBFH)	4035 (FC3H)	CH□ Factory default setting gain value (H)	0	User range setting	×
4036 (FC4H)	4040 (FC8H)	4044 (FCCH)	4048 (FD0H)	4052 (FD4H)	4056 (FD8H)	4060 (FDCH)	4064 (FE0H)	CH□ User range setting offset value (L)	0	User range setting	×
4037 (FC5H)	4041 (FC9H)	4045 (FCDH)	4049 (FD1H)	4053 (FD5H)	4057 (FD9H)	4061 (FDDH)	4065 (FE1H)	CH□ User range setting offset value (H)	0	User range setting	×
4038 (FC6H)	4042 (FCAH)	4046 (FCEH)	4050 (FD2H)	4054 (FD6H)	4058 (FDAH)	4062 (FDEH)	4066 (FE2H)	CH□ User range setting gain value (L)	0	User range setting	×
4039 (FC7H)	4043 (FCBH)	4047 (FCFH)	4051 (FD3H)	4055 (FD7H)	4059 (FDBH)	4063 (FDFH)	4067 (FE3H)	CH□ User range setting gain value (H)	0	User range setting	×
4068 to 4131 (FE4H to 1023H)								System area	—	—	—

■Offset/gain setting (for the R60AD16-G) (Un\G4000 to Un\G4131)

Address Decimal (hexadecimal)								Name	Default value	Data type	Auto refresh
CH1 to CH16 4000, 4001 (FA0H, FA1H)								System area	—	—	—
CH1 to CH16 4002 (FA2H)								Save data type setting	0000H	User range setting	×
CH1 to CH16 4003 (FA3H)								System area	—	—	—
CH1	CH2	CH3	CH4	CH5	CH6	CH7	CH8	CH□ Factory default setting offset value (L)	0	User range setting	×
4004 (FA4H)	4008 (FA8H)	4012 (FACH)	4016 (FB0H)	4020 (FB4H)	4024 (FB8H)	4028 (FBCH)	4032 (FC0H)				
CH9	CH10	CH11	CH12	CH13	CH14	CH15	CH16				
4036 (FC4H)	4040 (FC8H)	4044 (FCCH)	4048 (FD0H)	4052 (FD4H)	4056 (FD8H)	4060 (FDCH)	4064 (FE0H)				
CH1	CH2	CH3	CH4	CH5	CH6	CH7	CH8	CH□ Factory default setting offset value (H)	0	User range setting	×
4005 (FA5H)	4009 (FA9H)	4013 (FADH)	4017 (FB1H)	4021 (FB5H)	4025 (FB9H)	4029 (FBDH)	4033 (FC1H)				
CH9	CH10	CH11	CH12	CH13	CH14	CH15	CH16				
4037 (FC5H)	4041 (FC9H)	4045 (FCDH)	4049 (FD1H)	4053 (FD5H)	4057 (FD9H)	4061 (FDDH)	4065 (FE1H)				
CH1	CH2	CH3	CH4	CH5	CH6	CH7	CH8	CH□ Factory default setting gain value (L)	0	User range setting	×
4006 (FA6H)	4010 (FAAH)	4014 (FAEH)	4018 (FB2H)	4022 (FB6H)	4026 (FBAH)	4030 (FBEH)	4034 (FC2H)				
CH9	CH10	CH11	CH12	CH13	CH14	CH15	CH16				
4038 (FC6H)	4042 (FAAH)	4046 (FCEH)	4050 (FD2H)	4054 (FD6H)	4058 (FDAH)	4062 (FDEH)	4066 (FE2H)				
CH1	CH2	CH3	CH4	CH5	CH6	CH7	CH8	CH□ Factory default setting gain value (H)	0	User range setting	×
4007 (FA7H)	4011 (FABH)	4015 (FAFH)	4019 (FB3H)	4023 (FB7H)	4027 (FBBH)	4031 (FBFH)	4035 (FC3H)				
CH9	CH10	CH11	CH12	CH13	CH14	CH15	CH16				
4039 (FC7H)	4043 (FCBH)	4047 (FCFH)	4051 (FD3H)	4055 (FD7H)	4059 (FDBH)	4063 (FDFH)	4067 (FE3H)				
CH1	CH2	CH3	CH4	CH5	CH6	CH7	CH8	CH□ User range setting offset value (L)	0	User range setting	×
4068 (FE4H)	4072 (FE8H)	4076 (FECH)	4080 (FF0H)	4084 (FF4H)	4088 (FF8H)	4092 (FFCH)	4096 (1000H)				
CH9	CH10	CH11	CH12	CH13	CH14	CH15	CH16				
4100 (1004H)	4104 (1008H)	4108 (100CH)	4112 (1010H)	4116 (1014H)	4120 (1018H)	4124 (101CH)	4128 (1020H)				
CH1	CH2	CH3	CH4	CH5	CH6	CH7	CH8	CH□ User range setting offset value (H)	0	User range setting	×
4069 (FE5H)	4073 (FE9H)	4077 (FEDH)	4081 (FF1H)	4085 (FF5H)	4089 (FF9H)	4093 (FFDH)	4097 (1001H)				
CH9	CH10	CH11	CH12	CH13	CH14	CH15	CH16				
4101 (1005H)	4105 (1009H)	4109 (100DH)	4113 (1011H)	4117 (1015H)	4121 (1019H)	4125 (101DH)	4129 (1021H)				
CH1	CH2	CH3	CH4	CH5	CH6	CH7	CH8	CH□ User range setting gain value (L)	0	User range setting	×
4070 (FE6H)	4074 (FEAH)	4078 (FEEH)	4082 (FF2H)	4086 (FF6H)	4090 (FFAH)	4094 (FFEH)	4098 (1002H)				
CH9	CH10	CH11	CH12	CH13	CH14	CH15	CH16				
4102 (1006H)	4106 (100AH)	4110 (100EH)	4114 (1012H)	4118 (1016H)	4122 (101AH)	4126 (101EH)	4130 (1022H)				
CH1	CH2	CH3	CH4	CH5	CH6	CH7	CH8	CH□ User range setting gain value (H)	0	User range setting	×
4071 (FE7H)	4075 (FEBH)	4079 (FEFH)	4083 (FF3H)	4087 (FF7H)	4091 (FFBH)	4095 (FFFH)	4099 (1003H)				
CH9	CH10	CH11	CH12	CH13	CH14	CH15	CH16				
4103 (1007H)	4107 (100BH)	4111 (100FH)	4115 (1013H)	4119 (1017H)	4123 (101BH)	4127 (101FH)	4131 (1023H)				

■Un\G4132 to Un\G4199

Address Decimal (hexadecimal)								Name	Default value	Data type	Auto refresh
CH1	CH2	CH3	CH4	CH5	CH6	CH7	CH8	CH□ Offset/gain setting mode (offset specification)	0	Setting	×
4132 (1024H)	4134 (1026H)	4136 (1028H)	4138 (102AH)	4140 (102CH)	4142 (102EH)	4144 (1030H)	4146 (1032H)				
CH9	CH10	CH11	CH12	CH13	CH14	CH15	CH16				
4148 (1034H)	4150 (1036H)	4152 (1038H)	4154 (103AH)	4156 (103CH)	4158 (103EH)	4160 (1040H)	4162 (1042H)	CH□ Offset/gain setting mode (gain specification)	0	Setting	×
CH1	CH2	CH3	CH4	CH5	CH6	CH7	CH8				
4133 (1025H)	4135 (1027H)	4137 (1029H)	4139 (102BH)	4141 (102DH)	4143 (102FH)	4145 (1031H)	4147 (1033H)				
CH9	CH10	CH11	CH12	CH13	CH14	CH15	CH16	CH□ Offset/gain setting mode (range specification)	0	Setting	×
4149 (1035H)	4151 (1037H)	4153 (1039H)	4155 (103BH)	4157 (103DH)	4159 (103FH)	4161 (1041H)	4163 (1043H)				
CH1	CH2	CH3	CH4	CH5	CH6	CH7	CH8				
4164 (1044H)	4165 (1045H)	4166 (1046H)	4167 (1047H)	4168 (1048H)	4169 (1049H)	4170 (104AH)	4171 (104BH)	System area	—	—	—
CH9	CH10	CH11	CH12	CH13	CH14	CH15	CH16				
4172 (104CH)	4173 (104DH)	4174 (104EH)	4175 (104FH)	4176 (1050H)	4177 (1051H)	4178 (1052H)	4179 (1053H)				
CH1 to CH16								System area	—	—	—
4180 to 4199 (1054H to 1067H)											

■Un\G4200 to Un\G9999 (for the R60AD8-G)

Address Decimal (hexadecimal)	Name	Default value	Data type	Auto refresh
4200 (1068H)	Command area for module invalidation	0	Setting	×
4201 (1069H)	Validation status area	0	Monitor	×
4202 to 9999 (106AH to 270FH)	System area	—	—	—

■Un\G4200 to Un\G9999 (for the R60AD16-G)

Address Decimal (hexadecimal)	Name	Default value	Data type	Auto refresh
4200 to 9999 (1068H to 270FH)	System area	—	—	—

■Logging data (Un\G10000 to Un\G25999)

Address Decimal (hexadecimal)								Name	Default value	Data type	Auto refresh
CH1	CH2	CH3	CH4	CH5	CH6	CH7	CH8	CH□ Logging data	0	Monitor	×
10000 to 10999 (2710H to 2AF7H)	11000 to 11999 (2AF8H to 2EDFH)	12000 to 12999 (2EE0H to 32C7H)	13000 to 13999 (32C8H to 36AFH)	14000 to 14999 (36B0H to 3A97H)	15000 to 15999 (3A98H to 3E7FH)	16000 to 16999 (3E80H to 4267H)	17000 to 17999 (4268H to 464FH)				
CH9	CH10	CH11	CH12	CH13	CH14	CH15	CH16				
18000 to 18999 (4650H to 4A37H)	19000 to 19999 (4A38H to 4E1FH)	20000 to 20999 (4E20H to 5207H)	21000 to 21999 (5208H to 55EFH)	22000 to 22999 (55F0H to 59D7H)	23000 to 23999 (59D8H to 5DBFH)	24000 to 24999 (5DC0H to 61A7H)	25000 to 25999 (61A8H to 658FH)	System area	—	—	—
26000 to 29999 (6590H to 752FH)											

■Un\G26000 to Un\G29999

Address Decimal (hexadecimal)	Name	Default value	Data type	Auto refresh
CH1 to CH16	System area	—	—	—
26000 to 29999 (6590H to 752FH)				

In Q compatible mode

■Un\G0 to Un\G199

Address Decimal (hexadecimal)								Name	Default value	Data type	Auto refresh
CH1	CH2	CH3	CH4	CH5	CH6	CH7	CH8				
0 (0H)								A/D conversion enable/disable setting	00FFH	Setting	×
1 (1H)	2 (2H)	3 (3H)	4 (4H)	5 (5H)	6 (6H)	7 (7H)	8 (8H)	CH□ Time average/Count average/ Moving average/Primary delay filter constant setting	0	Setting	×
9 (9H)								System area	—	—	—
10 (AH)								A/D conversion completed flag	0000H	Monitor	○
11 (BH)	12 (CH)	13 (DH)	14 (EH)	15 (FH)	16 (10H)	17 (11H)	18 (12H)	CH□ Digital output value	0	Monitor	○
19 (13H)								Latest error code	0	Monitor	○
20 (14H)				21 (15H)				Range setting monitor	0000H	Monitor	×
22 (16H)								Offset/gain setting mode (offset specification)	0000H	Setting	×
23 (17H)								Offset/gain setting mode (gain specification)	0000H	Setting	×
24 (18H)				25 (19H)				Averaging process setting	0	Setting	×
26 (1AH)								Offset/gain setting mode (range specification)	0	Setting	×
27 (1BH)				28 (1CH)				System area	—	—	—
29 (1DH)								Digital clipping enable/disable setting	00FFH	Setting	×
30 (1EH)	32 (20H)	34 (22H)	36 (24H)	38 (26H)	40 (28H)	42 (2AH)	44 (2CH)	CH□ Maximum value	0	Monitor	○
31 (1FH)	33 (21H)	35 (23H)	37 (25H)	39 (27H)	41 (29H)	43 (2BH)	45 (2DH)	CH□ Minimum value	0	Monitor	○
46(2EH)								System area	—	—	—
47(2FH)								Input signal error detection extension/ input signal error detection setting	00FFH	Setting	×
48 (30H) (b15 to b8: Rate alarm/b7 to b0: Process alarm)								Alert output setting (Process alarm) Alert output setting (Rate alarm)	FFFFH	Setting	×
49 (31H)								Input signal error detection flag	0000H	Monitor	○
50 (32H)								Alert output flag (Process alarm)	0000H	Monitor	○
51 (33H)								Alert output flag (Rate alarm)	0000H	Monitor	○
52 (34H)								System area	—	—	—
53 (35H)								Scaling enable/disable setting	00FFH	Setting	×
54 (36H)	55 (37H)	56 (38H)	57 (39H)	58 (3AH)	59 (3BH)	60 (3CH)	61 (3DH)	CH□ Digital operation value	0	Monitor	○
62 (3EH)	64 (40H)	66 (42H)	68 (44H)	70 (46H)	72 (48H)	74 (4AH)	76 (4CH)	CH□ Scaling lower limit value	0	Setting	×
63 (3FH)	65 (41H)	67 (43H)	69 (45H)	71 (47H)	73 (49H)	75 (4BH)	77 (4DH)	CH□ Scaling upper limit value	0	Setting	×
78 to 85 (4EH to 55H)								System area	—	—	—
86 (56H)	90 (5AH)	94 (5EH)	98 (62H)	102 (66H)	106 (6AH)	110 (6EH)	114 (72H)	CH□ Process alarm lower lower limit value	0	Setting	×
87 (57H)	91 (5BH)	95 (5FH)	99 (63H)	103 (67H)	107 (6BH)	111 (6FH)	115 (73H)	CH□ Process alarm lower upper limit value	0	Setting	×
88 (58H)	92 (5CH)	96 (60H)	100 (64H)	104 (68H)	108 (6CH)	112 (70H)	116 (74H)	CH□ Process alarm upper lower limit value	0	Setting	×
89 (59H)	93 (5DH)	97 (61H)	101 (65H)	105 (69H)	109 (6DH)	113 (71H)	117 (75H)	CH□ Process alarm upper upper limit value	0	Setting	×
118 (76H)	119 (77H)	120 (78H)	121 (79H)	122 (7AH)	123 (7BH)	124 (7CH)	125 (7DH)	CH□ Rate alarm alert detection cycle setting	0	Setting	×
126 (7EH)	128 (80H)	130 (82H)	132 (84H)	134 (86H)	136 (88H)	138 (8AH)	140 (8CH)	CH□ Rate alarm upper limit value	0	Setting	×

Address Decimal (hexadecimal)								Name	Default value	Data type	Auto refresh
CH1	CH2	CH3	CH4	CH5	CH6	CH7	CH8				
127 (7FH)	129 (81H)	131 (83H)	133 (85H)	135 (87H)	137 (89H)	139 (8BH)	141 (8DH)	CH□ Rate alarm lower limit value	0	Setting	×
142 (8EH)	143 (8FH)	144 (90H)	145 (91H)	146 (92H)	147 (93H)	148 (94H)	149 (95H)	CH□ Input signal error detection setting value/CH□ Input signal error detection lower limit set value	50	Setting	×
150 (96H)	151 (97H)	152 (98H)	153 (99H)	154 (9AH)	155 (9BH)	156 (9CH)	157 (9DH)	CH□ Input signal error detection upper limit set value	50	Setting	×
158, 159 (9EH, 9FH)								Mode switching setting	0	Setting	×
160, 161 (A0H, A1H)								System area	—	—	—
162(A2H)								Input signal error detection auto-clear enable/disable setting	1	Setting	×
163(A3H)								System area	—	—	—
164 (A4H)	165 (A5H)	166 (A6H)	167 (A7H)	168 (A8H)	169 (A9H)	170 (AAH)	171 (ABH)	CH□ Conversion value shift amount	0	Control	○
172 (ACH)	173 (ADH)	174 (AEH)	175 (AFH)	176 (B0H)	177 (B1H)	178 (B2H)	179 (B3H)	CH□ Difference conversion trigger	0	Control	○
180 (B4H)	181 (B5H)	182 (B6H)	183 (B7H)	184 (B8H)	185 (B9H)	186 (BAH)	187 (BBH)	CH□ Difference conversion reference value	0	Monitor	×
188, 189 (BCH, BDH)								System area	—	—	—
190 (BEH)	191 (BFH)	192 (C0H)	193 (C1H)	194 (C2H)	195 (C3H)	196 (C4H)	197 (C5H)	CH□ Difference conversion status flag	0	Monitor	○
198, 199 (C6H, C7H)								System area	—	—	—

■Un\G200 to Un\G399

Address Decimal (hexadecimal)								Name	Default value	Data type	Auto refresh
CH1	CH2	CH3	CH4	CH5	CH6	CH7	CH8				
200 (C8H)								Save data type setting	0000H	User range setting	×
201 (C9H)								System area	—	—	—
202 (CAH)	206 (CEH)	210 (D2H)	214 (D6H)	218 (DAH)	222 (DEH)	226 (E2H)	230 (E6H)	CH□ Factory default setting offset value (L)	0	User range setting	×
203 (CBH)	207 (CFH)	211 (D3H)	215 (D7H)	219 (DBH)	223 (DFH)	227 (E3H)	231 (E7H)	CH□ Factory default setting offset value (H)	0	User range setting	×
204 (CCH)	208 (D0H)	212 (D4H)	216 (D8H)	220 (DCH)	224 (E0H)	228 (E4H)	232 (E8H)	CH□ Factory default setting gain value (L)	0	User range setting	×
205 (CDH)	209 (D1H)	213 (D5H)	217 (D9H)	221 (DDH)	225 (E1H)	229 (E5H)	233 (E9H)	CH□ Factory default setting gain value (H)	0	User range setting	×
234 (EAH)	238 (EEH)	242 (F2H)	246 (F6H)	250 (FAH)	254 (FEH)	258 (102H)	262 (106H)	CH□ User range setting offset value (L)	0	User range setting	×
235 (EBH)	239 (EFH)	243 (F3H)	247 (F7H)	251 (FBH)	255 (FFH)	259 (103H)	263 (107H)	CH□ User range setting offset value (H)	0	User range setting	×
236 (ECH)	240 (F0H)	244 (F4H)	248 (F8H)	252 (FCH)	256 (100H)	260 (104H)	264 (108H)	CH□ User range setting gain value (L)	0	User range setting	×
237 (EDH)	241 (F1H)	245 (F5H)	249 (F9H)	253 (FDH)	257 (101H)	261 (105H)	265 (109H)	CH□ User range setting gain value (H)	0	User range setting	×
266 to 299 (10AH to 12BH)								System area	—	—	—
300 (12CH)	302 (12EH)	304 (130H)	306 (132H)	308 (134H)	310 (136H)	312 (138H)	314 (13AH)	CH□ Digital output value (32 bits) (L)	0	Monitor	○

Address Decimal (hexadecimal)								Name	Default value	Data type	Auto refresh
CH1	CH2	CH3	CH4	CH5	CH6	CH7	CH8				
301 (12DH)	303 (12FH)	305 (131H)	307 (133H)	309 (135H)	311 (137H)	313 (139H)	315 (13BH)	CH0 Digital output value (32 bits) (H)	0	Monitor	○
316 to 399 (13CH to 18FH)								System area	—	—	—

■Un\G400 to Un\G4999

Address Decimal (hexadecimal)								Name	Default value	Data type	Auto refresh
CH1	CH2	CH3	CH4	CH5	CH6	CH7	CH8				
400, 401 (190H, 191H)								System area	—	—	—
402 (192H)				403 (193H)				Range setting	0	Setting	×
404 to 999 (194H to 3E7H)								System area	—	—	—
1000 (3E8H)	1001 (3E9H)	1002 (3EAH)	1003 (3EBH)	1004 (3ECH)	1005 (3EDH)	1006 (3EEH)	1007 (3EFH)	CH0 Logging enable/disable setting	1	Setting	×
1008 (3F0H)	1009 (3F1H)	1010 (3F2H)	1011 (3F3H)	1012 (3F4H)	1013 (3F5H)	1014 (3F6H)	1015 (3F7H)	CH0 Logging hold request	0	Control	○
1016 (3F8H)	1017 (3F9H)	1018 (3FAH)	1019 (3FBH)	1020 (3FCH)	1021 (3FDH)	1022 (3FEH)	1023 (3FFH)	CH0 Logging hold flag	0	Monitor	○
1024 (400H)	1025 (401H)	1026 (402H)	1027 (403H)	1028 (404H)	1029 (405H)	1030 (406H)	1031 (407H)	CH0 Logging data setting	1	Setting	×
1032 (408H)	1033 (409H)	1034 (40AH)	1035 (40BH)	1036 (40CH)	1037 (40DH)	1038 (40EH)	1039 (40FH)	CH0 Logging cycle setting value	160	Setting	×
1040 (410H)	1041 (411H)	1042 (412H)	1043 (413H)	1044 (414H)	1045 (415H)	1046 (416H)	1047 (417H)	CH0 Logging cycle unit setting	1	Setting	×
1048 (418H)	1049 (419H)	1050 (41AH)	1051 (41BH)	1052 (41CH)	1053 (41DH)	1054 (41EH)	1055 (41FH)	CH0 Post-trigger logging points	500	Setting	×
1056 (420H)	1057 (421H)	1058 (422H)	1059 (423H)	1060 (424H)	1061 (425H)	1062 (426H)	1063 (427H)	CH0 Level trigger condition setting	0	Setting	×
1064 (428H)	1065 (429H)	1066 (42AH)	1067 (42BH)	1068 (42CH)	1069 (42DH)	1070 (42EH)	1071 (42FH)	CH0 Trigger data	*1	Setting	×
1072 to 1081 (430H to 439H)								Level data 0 to 9	0	Control	○
1082 (43AH)	1083 (43BH)	1084 (43CH)	1085 (43DH)	1086 (43EH)	1087 (43FH)	1088 (440H)	1089 (441H)	CH0 Trigger setting value	0	Setting	×
1090 (442H)	1091 (443H)	1092 (444H)	1093 (445H)	1094 (446H)	1095 (447H)	1096 (448H)	1097 (449H)	CH0 Head pointer	0	Monitor	×
1098 (44AH)	1099 (44BH)	1100 (44CH)	1101 (44DH)	1102 (44EH)	1103 (44FH)	1104 (450H)	1105 (451H)	CH0 Latest pointer	0	Monitor	×
1106 (452H)	1107 (453H)	1108 (454H)	1109 (455H)	1110 (456H)	1111 (457H)	1112 (458H)	1113 (459H)	CH0 Number of logging data	0	Monitor	×
1114 (45AH)	1115 (45BH)	1116 (45CH)	1117 (45DH)	1118 (45EH)	1119 (45FH)	1120 (460H)	1121 (461H)	CH0 Trigger pointer	0	Monitor	×
1122 (462H)	1125 (465H)	1128 (468H)	1131 (46BH)	1134 (46EH)	1137 (471H)	1140 (474H)	1143 (477H)	CH0 Logging cycle monitor value (s)	0	Monitor	×
1123 (463H)	1126 (466H)	1129 (469H)	1132 (46CH)	1135 (46FH)	1138 (472H)	1141 (475H)	1144 (478H)	CH0 Logging cycle monitor value (ms)	0	Monitor	×
1124 (464H)	1127 (467H)	1130 (46AH)	1133 (46DH)	1136 (470H)	1139 (473H)	1142 (476H)	1145 (479H)	System area	—	—	—
1146 to 1153 (47AH to 481H)								System area	—	—	—
1154 (482H)	1158 (486H)	1162 (48AH)	1166 (48EH)	1170 (492H)	1174 (496H)	1178 (49AH)	1182 (49EH)	CH0 Trigger generation time (First/Last two digits of the year)	0	Monitor	×
1155 (483H)	1159 (487H)	1163 (48BH)	1167 (48FH)	1171 (493H)	1175 (497H)	1179 (49BH)	1183 (49FH)	CH0 Trigger generation time (Month/Day)	0	Monitor	×
1156 (484H)	1160 (488H)	1164 (48CH)	1168 (490H)	1172 (494H)	1176 (498H)	1180 (49CH)	1184 (4A0H)	CH0 Trigger generation time (Hour/Minute)	0	Monitor	×
1157 (485H)	1161 (489H)	1165 (48DH)	1169 (491H)	1173 (495H)	1177 (499H)	1181 (49DH)	1185 (4A1H)	CH0 Trigger generation time (Second/Day of the week)	0	Monitor	×
1186 (4A2H)	1187 (4A3H)	1188 (4A4H)	1189 (4A5H)	1190 (4A6H)	1191 (4A7H)	1192 (4A8H)	1193 (4A9H)	CH0 Trigger generation time (Millisecond)	0	Monitor	×

Address Decimal (hexadecimal)								Name	Default value	Data type	Auto refresh
CH1	CH2	CH3	CH4	CH5	CH6	CH7	CH8				
1194 to 1199 (4AAH to 4AFH)								System area	—	—	—
1200 (4B0H)	1201 (4B1H)	1202 (4B2H)	1203 (4B3H)	1204 (4B4H)	1205 (4B5H)	1206 (4B6H)	1207 (4B7H)	CH□ Loading interrupt enable/disable setting	1	Setting	×
1208 (4B8H)	1209 (4B9H)	1210 (4BAH)	1211 (4BBH)	1212 (4BCH)	1213 (4BDH)	1214 (4BEH)	1215 (4BFH)	CH□ Logging read points setting value	100	Setting	×
1216 (4C0H)	1217 (4C1H)	1218 (4C2H)	1219 (4C3H)	1220 (4C4H)	1221 (4C5H)	1222 (4C6H)	1223 (4C7H)	CH□ Current logging read pointer	-1	Monitor	×
1224 (4C8H)	1225 (4C9H)	1226 (4CAH)	1227 (4CBH)	1228 (4CCH)	1229 (4CDH)	1230 (4CEH)	1231 (4CFH)	CH□ Previous logging read pointer	-1	Monitor	×
1232 (4D0H)	1233 (4D1H)	1234 (4D2H)	1235 (4D3H)	1236 (4D4H)	1237 (4D5H)	1238 (4D6H)	1239 (4D7H)	CH□ Logging read points monitor value	0	Monitor	×
1240 to 1799 (4D8H to 707H)								System area	—	—	—
1800 (708H)								Latest address of error history	0	Monitor	○
1801 to 1809 (709H to 711H)								System area	—	—	×
1810 to 1969 (712H to 7B1H)								Error history 1 to 16	0	Monitor	×
1970 to 3749 (7B2H to EA5H)								System area	—	—	—
3750 (EA6H)								Latest alarm code	0	Monitor	○
3751 (EA7H)								Latest address of alarm history	0	Monitor	○
3752 to 3759 (EA8H to EAFH)								System area	—	—	—
3760 to 3919 (EB0H to F4FH)								Alarm history 1 to 16	0	Monitor	×
3920 to 3999 (F50H to F9FH)								System area	—	—	—
4000 to 4015 (FA0H to FAFH)								Interrupt factor detection flag [n] ²	0	Monitor	○
4016 to 4031 (FB0H to FBFH)								System area	—	—	—
4032 to 4047 (FC0H to FCFH)								Interrupt factor mask [n] ²	0	Control	×
4048 to 4063 (FD0H to FDFH)								System area	—	—	—
4064 to 4079 (FE0H to FEFH)								Interrupt factor reset request [n] ²	0	Control	×
4080 to 4095 (FF0H to FFFH)								System area	—	—	—
4096 to 4111 (1000H to 100FH)								Interrupt factor generation setting [n] ²	0	Setting	×
4112 to 4127 (1010H to 101FH)								System area	—	—	—
4128 to 4143 (1020H to 102FH)								Condition target setting [n] ²	0	Setting	×
4144 to 4159 (1030H to 103FH)								System area	—	—	—
4160 to 4175 (1040H to 104FH)								Condition target channel setting [n] ²	0	Setting	×
4176 to 4199 (1050H to 1067H)								System area	—	—	—
4200 (1068H)								Command area for module invalidation	0	Setting	×
4201 (1069H)								Validation status area	0	Monitor	×
4202 to 4999 (106AH to 1387H)								System area	—	—	—

*1 The following shows the default values.

CH1: 54, CH2: 55, CH3: 56, CH4: 57, CH5: 58, CH6: 59, CH7: 60, CH8: 61

*2 [n] in the table indicates an interrupt setting number. (n = 1 to 16)

■ Logging data (Un\G5000 to Un\G75999)

Address Decimal (hexadecimal)	Name	Default value	Data type	Auto refresh
5000 to 5999 (1388H to 176FH)	CH1 Logging data	0	Monitor	×
15000 to 15999 (3A98H to 3E7FH)	CH2 Logging data	0	Monitor	×
25000 to 25999 (61A8H to 658FH)	CH3 Logging data	0	Monitor	×
35000 to 35999 (88B8H to 8C9FH)	CH4 Logging data	0	Monitor	×
45000 to 45999 (AFC8H to B3AFH)	CH5 Logging data	0	Monitor	×
55000 to 55999 (D6D8H to DABFH)	CH6 Logging data	0	Monitor	×
65000 to 65999 (FDE8H to 101CFH)	CH7 Logging data	0	Monitor	×
75000 to 75999 (124F8H to 128DFH)	CH8 Logging data	0	Monitor	×

Details of buffer memory addresses

The following describes the details of the buffer memory addresses of the A/D converter module.



This section describes buffer memory addresses for CH1.

Latest error code

The latest error code detected in the A/D converter module is stored. For details, refer to the following.

Page 107 List of Error Codes

■Buffer memory address

The following shows the buffer memory address of this area.

Buffer memory name	CH 1	CH 2	CH 3	CH 4	CH 5	CH 6	CH 7	CH 8	CH 9	CH 10	CH 11	CH 12	CH 13	CH 14	CH 15	CH 16
Latest error code	0															
Latest error code (in Q compatible mode)	19															—

■Clearing an error

Turn on and off 'Error clear request' (YF).

Latest address of error history

Among Error history □ (Un\G3600 to Un\G3759), a buffer memory address which stores the latest error code is stored. In the Q compatible mode, the error history is stored in Un\G1810 to Un\G1969.

■Buffer memory address

The following shows the buffer memory address of this area.

Buffer memory name	CH 1	CH 2	CH 3	CH 4	CH 5	CH 6	CH 7	CH 8	CH 9	CH 10	CH 11	CH 12	CH 13	CH 14	CH 15	CH 16
Latest address of error history	1															
Latest address of error history (in Q compatible mode)	1800															—

Latest alarm code

The latest alarm code detected in the A/D converter module is stored. For details, refer to the following.

Page 111 List of Alarm Codes

■Buffer memory address

The following shows the buffer memory address of this area.

Buffer memory name	CH 1	CH 2	CH 3	CH 4	CH 5	CH 6	CH 7	CH 8	CH 9	CH 10	CH 11	CH 12	CH 13	CH 14	CH 15	CH 16
Latest alarm code	2															
Latest alarm code (in Q compatible mode)	3750															—

■Clearing an alarm

Turn on and off 'Error clear request' (YF).

Latest address of alarm history

Among Alarm history □ (Un\G3760 to Un\G3999), a buffer memory address which stores the latest alarm code is stored.

■Buffer memory address

The following shows the buffer memory address of this area.

Buffer memory name	CH 1	CH 2	CH 3	CH 4	CH 5	CH 6	CH 7	CH 8	CH 9	CH 10	CH 11	CH 12	CH 13	CH 14	CH 15	CH 16
Latest address of alarm history	3															
Latest address of alarm history (in Q compatible mode)	3751															—

Interrupt factor detection flag [n]

The detection status of the interrupt factor is stored.

Monitor value	Description
0	No interrupt factor
1	Interrupt factor

When an interrupt factor occurs, an interrupt request is sent to the CPU module at the same time as 'Interrupt factor detection flag [n]' (Un\G4 to Un\G19) is turned to Interrupt factor (1).

"n" indicates an interrupt setting number. (n = 1 to 16)

■Buffer memory address

The following shows the buffer memory address of this area.

Buffer memory name	1	2	3	4	5	6	7	8	9	10	11	12	13	14	15	16
Interrupt factor detection flag [n]	4	5	6	7	8	9	10	11	12	13	14	15	16	17	18	19
Interrupt factor detection flag [n] (in Q compatible mode)	4000	4001	4002	4003	4004	4005	4006	4007	4008	4009	4010	4011	4012	4013	4014	4015

Alert output flag (Process alarm upper limit)

The upper limit alarm of the process alarm can be checked for each channel.

b15	b14	b13	b12	b11	b10	b9	b8	b7	b6	b5	b4	b3	b2	b1	b0
CH16	CH15	CH14	CH13	CH12	CH11	CH10	CH9	CH8	CH7	CH6	CH5	CH4	CH3	CH2	CH1

- 0: Normal, 1: Alarm ON
- b8 to b15 of the R60AD8-G are fixed to 0.

■Buffer memory address

The following shows the buffer memory address of this area.

Buffer memory name	CH 1	CH 2	CH 3	CH 4	CH 5	CH 6	CH 7	CH 8	CH 9	CH 10	CH 11	CH 12	CH 13	CH 14	CH 15	CH 16
Alert output flag (Process alarm upper limit)	36															

■Alert output flag status

- When the value is out of the range specified in the process alarm upper upper limit value, Alarm ON (1) is stored in 'Alert output flag (Process alarm upper limit)' (Un\G36) corresponding to each channel.
- When an alert is detected in any channel where the A/D conversion and the alert output setting (Process alarm) are enabled, 'Alert output signal' (X8) also turns on.

■Clearing Alert output flag

- When the digital operation value returns within the setting range, the flag is automatically cleared.
- When 'Operating condition setting request' (Y9) is turned on and off, the flag is cleared.

Alert output flag (Process alarm lower limit)

The lower limit alarm of the process alarm can be checked for each channel.

b15	b14	b13	b12	b11	b10	b9	b8	b7	b6	b5	b4	b3	b2	b1	b0
CH16	CH15	CH14	CH13	CH12	CH11	CH10	CH9	CH8	CH7	CH6	CH5	CH4	CH3	CH2	CH1

- 0: Normal, 1: Alarm ON
- b8 to b15 of the R60AD8-G are fixed to 0.

■Buffer memory address

The following shows the buffer memory address of this area.

Buffer memory name	CH 1	CH 2	CH 3	CH 4	CH 5	CH 6	CH 7	CH 8	CH 9	CH 10	CH 11	CH 12	CH 13	CH 14	CH 15	CH 16
Alert output flag (Process alarm lower limit)	37															

■Alert output flag status

- When the value is out of the range specified in the process alarm lower limit value, Alarm ON (1) is stored in 'Alert output flag (Process alarm lower limit)' (Un\G37) corresponding to each channel.
- When an alert is detected in any channel where the A/D conversion and the alert output setting (Process alarm) are enabled, 'Alert output signal' (X8) also turns on.

■Clearing Alert output flag

- When the digital operation value returns within the setting range, the flag is automatically cleared.
- When 'Operating condition setting request' (Y9) is turned on and off, the flag is cleared.

Alert output flag (Process alarm) [Q compatible mode]

When the Q compatible mode function is used, the upper/lower limit alarm of the process alarm can be checked.

b15	b14	b13	b12	b11	b10	b9	b8	b7	b6	b5	b4	b3	b2	b1	b0
CH8	CH8	CH7	CH7	CH6	CH6	CH5	CH5	CH4	CH4	CH3	CH3	CH2	CH2	CH1	CH1
Lower limit value	Upper limit value	Lower limit value	Upper limit value	Lower limit value	Upper limit value	Lower limit value	Upper limit value	Lower limit value	Upper limit value	Lower limit value	Upper limit value	Lower limit value	Upper limit value	Lower limit value	Upper limit value

0: Normal, 1: Alarm ON

■Buffer memory address

The following shows the buffer memory address of this area.

Only the R60AD8-G can use this area.

Buffer memory name	CH1	CH2	CH3	CH4	CH5	CH6	CH7	CH8
Alert output flag (Process alarm) (in Q compatible mode)	50							

■Alert output flag status

- When the value is out of the range specified in the process alarm upper limit value or process alarm lower limit value, Alarm ON (1) is stored in 'Alert output flag (Process alarm)' (Un\G50) corresponding to each channel.
- When an alert is detected in any channel where the A/D conversion and the alert output setting (Process alarm) are enabled, 'Alert output signal' (X8) also turns on.

■Clearing Alert output flag

- When the digital operation value returns within the setting range, the flag is automatically cleared.
- When 'Operating condition setting request' (Y9) is turned on and off, the flag is cleared.

Alert output flag (Rate alarm upper limit)

The upper limit alarm of the rate alarm can be checked for each channel.

b15	b14	b13	b12	b11	b10	b9	b8	b7	b6	b5	b4	b3	b2	b1	b0
CH16	CH15	CH14	CH13	CH12	CH11	CH10	CH9	CH8	CH7	CH6	CH5	CH4	CH3	CH2	CH1

- 0: Normal, 1: Alarm ON
- b8 to b15 of the R60AD8-G are fixed to 0.

■Buffer memory address

The following shows the buffer memory address of this area.

Buffer memory name	CH 1	CH 2	CH 3	CH 4	CH 5	CH 6	CH 7	CH 8	CH 9	CH 10	CH 11	CH 12	CH 13	CH 14	CH 15	CH 16
Alert output flag (Rate alarm upper limit)	38															

■Alert output flag status

- When the value is out of the range specified in the rate alarm upper limit value, Alarm ON (1) is stored in 'Alert output flag (Rate alarm upper limit)' (Un\G38) corresponding to each channel.
- When an alert is detected in any channel where the A/D conversion and the alert output setting (Rate alarm) are enabled, 'Alert output signal' (X8) also turns on.

■Clearing Alert output flag

- When the change rate of the digital output value returns within the setting range, the flag is automatically cleared.
- When 'Operating condition setting request' (Y9) is turned on and off, the flag is cleared.

Alert output flag (Rate alarm lower limit)

The lower limit alarm of the rate alarm can be checked for each channel.

b15	b14	b13	b12	b11	b10	b9	b8	b7	b6	b5	b4	b3	b2	b1	b0
CH16	CH15	CH14	CH13	CH12	CH11	CH10	CH9	CH8	CH7	CH6	CH5	CH4	CH3	CH2	CH1

- 0: Normal, 1: Alarm ON
- b8 to b15 of the R60AD8-G are fixed to 0.

■Buffer memory address

The following shows the buffer memory address of this area.

Buffer memory name	CH 1	CH 2	CH 3	CH 4	CH 5	CH 6	CH 7	CH 8	CH 9	CH 10	CH 11	CH 12	CH 13	CH 14	CH 15	CH 16
Alert output flag (Rate alarm lower limit)	39															

■Alert output flag status

- When the value is out of the range specified in the rate alarm lower limit value, Alarm ON (1) is stored in 'Alert output flag (Rate alarm lower limit)' (Un\G39) corresponding to each channel.
- When an alert is detected in any channel where the A/D conversion and the alert output setting (Rate alarm) are enabled, 'Alert output signal' (X8) also turns on.

■Clearing Alert output flag

- When the change rate of the digital output value returns within the setting range, the flag is automatically cleared.
- When 'Operating condition setting request' (Y9) is turned on and off, the flag is cleared.

Alert output flag (Rate alarm) [Q compatible mode]

When the Q compatible mode function is used, the upper/lower limit alarm of the rate alarm can be checked.

b15	b14	b13	b12	b11	b10	b9	b8	b7	b6	b5	b4	b3	b2	b1	b0
CH8	CH8	CH7	CH7	CH6	CH6	CH5	CH5	CH4	CH4	CH3	CH3	CH2	CH2	CH1	CH1
Lower limit value	Upper limit value	Lower limit value	Upper limit value	Lower limit value	Upper limit value	Lower limit value	Upper limit value	Lower limit value	Upper limit value	Lower limit value	Upper limit value	Lower limit value	Upper limit value	Lower limit value	Upper limit value

0: Normal, 1: Alarm ON

■Buffer memory address

The following shows the buffer memory address of this area.

Only the R60AD8-G can use this area.

Buffer memory name	CH1	CH2	CH3	CH4	CH5	CH6	CH7	CH8
Alert output flag (Rate alarm) (in Q compatible mode)	51							

■Alert output flag status

- When the value is out of the range specified in the rate alarm upper limit value or rate alarm lower limit value, Alarm ON (1) is stored in Alert output flag (Rate alarm) corresponding to each channel.
- When an alert is detected in any channel where the A/D conversion and the alert output setting (Rate alarm) are enabled, 'Alert output signal' (X8) also turns on.

■Clearing Alert output flag

- When the change rate of the digital output value returns within the setting range, the flag is automatically cleared.
- When 'Operating condition setting request' (Y9) is turned on and off, the flag is cleared.

Input signal error detection flag

The status of an input signal can be checked for each channel.

b15	b14	b13	b12	b11	b10	b9	b8	b7	b6	b5	b4	b3	b2	b1	b0
CH16	CH15	CH14	CH13	CH12	CH11	CH10	CH9	CH8	CH7	CH6	CH5	CH4	CH3	CH2	CH1

- 0: Normal, 1: Input signal error
- b8 to b15 of the R60AD8-G are fixed to 0.

■Buffer memory address

The following shows the buffer memory address of this area.

Buffer memory name	CH 1	CH 2	CH 3	CH 4	CH 5	CH 6	CH 7	CH 8	CH 9	CH 10	CH 11	CH 12	CH 13	CH 14	CH 15	CH 16
Input signal error detection flag	40															
Input signal error detection flag (in Q compatible mode)	49															

■Input signal error detection flag status

- When an analog input value out of the range specified in Input signal error detection setting value is detected, Input signal error (1) is stored in 'Input signal error detection flag' (Un\G40) corresponding to each channel.
- When an error is detected in any channel where the A/D conversion and the input signal error detection are enabled, 'Input signal error detection signal' (XC) turns on.

■Clearing Input signal error detection flag

'Input signal error detection flag' (Un\G40) is turned off by turning on and off 'Error clear request' (YF) after the analog input value returns within the setting range.

When 'Operating condition setting request' (Y9) is turned on and off, 'Input signal error detection flag' (Un\G40) is also cleared.

A/D conversion completed flag

The A/D conversion status can be checked.

b15	b14	b13	b12	b11	b10	b9	b8	b7	b6	b5	b4	b3	b2	b1	b0
CH16	CH15	CH14	CH13	CH12	CH11	CH10	CH9	CH8	CH7	CH6	CH5	CH4	CH3	CH2	CH1

- 0: During A/D conversion or not used, 1: A/D conversion completed
- b8 to b15 of the R60AD8-G are fixed to 0.

■Buffer memory address

The following shows the buffer memory address of this area.

Buffer memory name	CH 1	CH 2	CH 3	CH 4	CH 5	CH 6	CH 7	CH 8	CH 9	CH 10	CH 11	CH 12	CH 13	CH 14	CH 15	CH 16
A/D conversion completed flag	42															
A/D conversion completed flag (in Q compatible mode)	10															

■A/D conversion completed flag status

When the first A/D conversion is completed in the channel where the A/D conversion is enabled, the flag turns to A/D conversion completed (1). 'A/D conversion completed flag' (XE) turns on when the conversion of all the channels where the A/D conversion is enabled is completed.

■Clearing A/D conversion completed flag

Turning on and off 'Operating condition setting request' (Y9) turns the flag back to the default (During A/D conversion or unused (0)), and when the first A/D conversion has completed, the flag turns to A/D conversion completed (1) again.

Level data 0 to 9

This area stores data to be monitored when a level trigger of the logging function is used. Ten types of data are available: 'Level data 0' (Un\G90) to 'Level data 9' (Un\G99). Use the area to generate triggers while monitoring the values of devices other than the A/D converter module.

For details on the logging function, refer to the following.

☞ Page 60 Logging Function

■Buffer memory address

The following shows the buffer memory address of this area.

Buffer memory name	0	1	2	3	4	5	6	7	8	9
Level data□	90	91	92	93	94	95	96	97	98	99
Level data□ (in Q compatible mode)	1072	1073	1074	1075	1076	1077	1078	1079	1080	1081

■Setting range

The setting range is from -32768 to 32767.

■Default value

The default value is 0 for all channels.

Interrupt factor mask [n]

Set Interrupt factor mask to be used.

Setting value	Setting content
0	Mask (Interrupt unused)
1	Mask clear (Interrupt used)

When 'Interrupt factor mask [n]' (Un\G124 to Un\G139) is changed to Mask clear (Interrupt used) (1) and an interrupt factor occurs, an interrupt request is sent to the CPU module. When the set value is two or larger, the setting is regarded as Mask clear (Interrupt used) (1).

"n" indicates an interrupt setting number. (n = 1 to 16)

■Buffer memory address

The following shows the buffer memory address of this area.

Buffer memory name	1	2	3	4	5	6	7	8	9	10	11	12	13	14	15	16
Interrupt factor mask [n]	124	125	126	127	128	129	130	131	132	133	134	135	136	137	138	139
Interrupt factor mask [n] (in Q compatible mode)	4032	4033	4034	4035	4036	4037	4038	4039	4040	4041	4042	4043	4044	4045	4046	4047

■Default value

The default value is set to Mask (Interrupt unused) (0) for all channels.

Interrupt factor reset request [n]

An interrupt factor reset request is sent.

Setting value	Setting content
0	No reset request
1	Reset request

When Reset request (1) is set to 'Interrupt factor reset request [n]' (Un\G156 to Un\G171) corresponding to the interrupt factor, the interrupt factor corresponding to the specified interrupt is reset. After that, 'Interrupt factor reset request [n]' (Un\G156 to Un\G171) turns to No reset request (0). When the set value is two or larger, the setting is regarded as Reset request (1).

Interrupt factors can be reset by turning on and off 'Operating condition setting request' (Y9).

"n" indicates an interrupt setting number. (n = 1 to 16)

■Buffer memory address

The following shows the buffer memory address of this area.

Buffer memory name	1	2	3	4	5	6	7	8	9	10	11	12	13	14	15	16
Interrupt factor reset request [n]	156	157	158	159	160	161	162	163	164	165	166	167	168	169	170	171
Interrupt factor reset request [n] (in Q compatible mode)	4064	4065	4066	4067	4068	4069	4070	4071	4072	4073	4074	4075	4076	4077	4078	4079

■Default value

The default value is No reset request (0) for all channels.

Interrupt factor generation setting [n]

Set an interrupt request for when the same interrupt factor occurs during the interrupt factor detection.

Setting value	Setting content
0	Interrupt resend request
1	No interrupt resend request

When 'Interrupt factor generation setting [n]' (Un\G200 to Un\G215) is Interrupt resend request (0) and the same interrupt factor occurs during the interrupt factor detection, an interrupt request is sent to the CPU module again.

If a value other than the above is set, an interrupt factor generation setting range error (error code: 180△H) occurs.

"n" indicates an interrupt setting number. (n = 1 to 16)

■Buffer memory address

The following shows the buffer memory address of this area.

Buffer memory name	1	2	3	4	5	6	7	8	9	10	11	12	13	14	15	16
Interrupt factor generation setting [n]	200	201	202	203	204	205	206	207	208	209	210	211	212	213	214	215
Interrupt factor generation setting [n] (in Q compatible mode)	4096	4097	4098	4099	4100	4101	4102	4103	4104	4105	4106	4107	4108	4109	4110	4111

■Enabling the setting

Turn on and off 'Operating condition setting request' (Y9).

■Default value

The default value is Interrupt resend request (0) for all channels.

Condition target setting [n]

Set an interrupt factor to be detected.

Setting value	Setting content
0	Disable
1	Error flag (XF)
2	Alert output flag (Process alarm)
3	Alert output flag (Rate alarm)
4	Input signal error detection flag
5	A/D conversion completed
6	Logging hold flag
7	Logging read

If a value other than the above is set, a condition target setting range error (error code: 181△H) occurs.

When an input signal (X) or a buffer memory area set to 'Condition target setting [n]' (Un\G232 to Un\G247) turns off and on, an interrupt request is sent to the CPU module. When A/D conversion completed (5) is set, an interrupt request is sent with 'A/D conversion completed flag' (Un\G42) on.

"n" indicates an interrupt setting number. (n = 1 to 16)

■Buffer memory address

The following shows the buffer memory address of this area.

Buffer memory name	1	2	3	4	5	6	7	8	9	10	11	12	13	14	15	16
Condition target setting [n]	232	233	234	235	236	237	238	239	240	241	242	243	244	245	246	247
Condition target setting [n] (in Q compatible mode)	4128	4129	4130	4131	4132	4133	4134	4135	4136	4137	4138	4139	4140	4141	4142	4143

■Enabling the setting

Turn on and off 'Operating condition setting request' (Y9).

■Default value

The default value is Disable (0) for all channels.

Condition target channel setting [n]

Set a channel where an interrupt is detected.

Setting value ^{*1}	Setting content
0	All channels
1	CH1
2	CH2
3	CH3
4	CH4
5	CH5
6	CH6
7	CH7
8	CH8
9	CH9
10	CH10
11	CH11
12	CH12
13	CH13
14	CH14
15	CH15
16	CH16

*1 When the R60AD8-G is used, only 0 to 8 can be set.

When a factor for the channel specification is set to 'Condition target setting [n]' (Un\G232 to Un\G247), an interrupt factor in the channel set by this area is monitored. When a factor of the input signal (X) is set, the setting in this area is ignored.

If a value other than the above is set, a condition target channel setting range error (error code: 182△H) occurs.

"n" indicates an interrupt setting number. (n = 1 to 16)

■Buffer memory address

The following shows the buffer memory address of this area.

Buffer memory name	1	2	3	4	5	6	7	8	9	10	11	12	13	14	15	16
Condition target channel setting [n]	264	265	266	267	268	269	270	271	272	273	274	275	276	277	278	279
Condition target channel setting [n] (in Q compatible mode)	4160	4161	4162	4163	4164	4165	4166	4167	4168	4169	4170	4171	4172	4173	4174	4175

■Enabling the setting

Turn on and off 'Operating condition setting request' (Y9).

■Default value

The default value is All channels (0) for all channels.

Mode switching setting

Set a setting value for the mode to be switched.

Switching mode	Setting value	
Buffer memory address	296	297
Normal mode	5260H	4144H
Offset/gain setting mode	4144H	5260H

■Buffer memory address

The following shows the buffer memory address of this area.

Buffer memory name	CH	CH	CH	CH	CH	CH	CH	CH	CH	CH	CH	CH	CH	CH	CH	CH
	1	2	3	4	5	6	7	8	9	10	11	12	13	14	15	16
Mode switching setting	296, 297															
Mode switching setting (in Q compatible mode)	158, 159															—

■Enabling the setting

Turn on and off 'Operating condition setting request' (Y9).

■After the mode is switched

When the mode is switched, this area is cleared to 0 and 'Operating condition setting completed flag' (X9) turns off.

After checking that 'Operating condition setting completed flag' (X9) is off, turn off 'Operating condition setting request' (Y9).



If a value other than the above is set, the mode is not switched and only the operating condition is changed.

Input signal error detection auto-clear enable/disable setting

Set whether to enable or disable auto-clearing of input signal errors by using the input signal error detection function.

For details on the input signal error detection function, refer to the following.

Page 38 Input Signal Error Detection Function

Setting value	Setting content
0	Enable
1	Disable

If a value other than the above is set, the value is regarded as Disable (1).

■Buffer memory address

The following shows the buffer memory address of this area.

Buffer memory name	CH	CH	CH	CH	CH	CH	CH	CH	CH	CH	CH	CH	CH	CH	CH	CH
	1	2	3	4	5	6	7	8	9	10	11	12	13	14	15	16
Input signal error detection auto-clear enable/disable setting	302															
Input signal error detection auto-clear enable/disable setting (in Q compatible mode)	162															—

■Enabling the setting

Turn on and off 'Operating condition setting request' (Y9).

■Default value

The default value is Disable (1).

CH1 Digital output value

The A/D-converted digital output value is stored in 16-bit signed binary value.

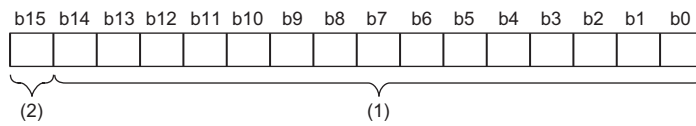

(1) Data section

(2) Sign bit 0: Positive, 1: Negative

■Buffer memory address

The following shows the buffer memory address of this area.

- CH□ Digital output value

CH1	CH2	CH3	CH4	CH5	CH6	CH7	CH8	CH9	CH10	CH11	CH12	CH13	CH14	CH15	CH16
400	600	800	1000	1200	1400	1600	1800	2000	2200	2400	2600	2800	3000	3200	3400

- CH□ Digital output value (in Q compatible mode)

CH1	CH2	CH3	CH4	CH5	CH6	CH7	CH8	CH9	CH10	CH11	CH12	CH13	CH14	CH15	CH16
11	12	13	14	15	16	17	18	—							

■Refreshing cycle

If averaging processing is performed, values are updated at every averaging process cycle, but if not performed, values are updated at every sampling cycle.

CH1 Digital operation value

A digital operation value obtained by the scaling function, shift function, digital clipping function, or difference conversion function is stored in 16-bit signed binary value.

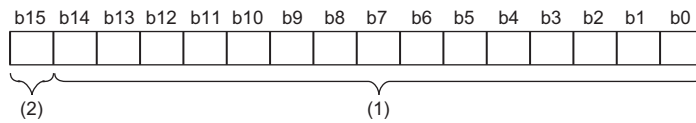

(1) Data section

(2) Sign bit 0: Positive, 1: Negative

■Buffer memory address

The following shows the buffer memory address of this area.

- CH□ Digital operation value

CH1	CH2	CH3	CH4	CH5	CH6	CH7	CH8	CH9	CH10	CH11	CH12	CH13	CH14	CH15	CH16
402	602	802	1002	1202	1402	1602	1802	2002	2202	2402	2602	2802	3002	3202	3402

- CH□ Digital operation value (in Q compatible mode)

CH1	CH2	CH3	CH4	CH5	CH6	CH7	CH8	CH9	CH10	CH11	CH12	CH13	CH14	CH15	CH16
54	55	56	57	58	59	60	61	—							

Point

When the scaling function, shift function, digital clipping function, or difference conversion function is not used, a value which is the same as the one in 'CH1 Digital output value' (UnG400) is stored.

CH1 Maximum value

The maximum value of the digital operation value is stored in 16-bit signed binary value.

In the following cases, 'CH1 Maximum value' (Un\G404) is updated with the current value.

- When 'Operating condition setting request' (Y9) is turned on and off and the setting is changed
- When 'Maximum value/minimum value reset request' (YD) is turned on and off

■Buffer memory address

The following shows the buffer memory address of this area.

- CH□ Maximum value

CH1	CH2	CH3	CH4	CH5	CH6	CH7	CH8	CH9	CH10	CH11	CH12	CH13	CH14	CH15	CH16
404	604	804	1004	1204	1404	1604	1804	2004	2204	2404	2604	2804	3004	3204	3404

- CH□ Maximum value (in Q compatible mode)

CH1	CH2	CH3	CH4	CH5	CH6	CH7	CH8	CH9	CH10	CH11	CH12	CH13	CH14	CH15	CH16
30	32	34	36	38	40	42	44	—							

CH1 Minimum value

The minimum value of the digital operation value is stored in 16-bit signed binary value.

In the following cases, 'CH1 Minimum value' (Un\G406) is updated with the current value.

- When 'Operating condition setting request' (Y9) is turned on and off and the setting is changed
- When 'Maximum value/minimum value reset request' (YD) is turned on and off

■Buffer memory address

The following shows the buffer memory address of this area.

- CH□ Minimum value

CH1	CH2	CH3	CH4	CH5	CH6	CH7	CH8	CH9	CH10	CH11	CH12	CH13	CH14	CH15	CH16
406	606	806	1006	1206	1406	1606	1806	2006	2206	2406	2606	2806	3006	3206	3406

- CH□ Minimum value (in Q compatible mode)

CH1	CH2	CH3	CH4	CH5	CH6	CH7	CH8	CH9	CH10	CH11	CH12	CH13	CH14	CH15	CH16
31	33	35	37	39	41	43	45	—							



- For the channel to which the averaging processing is specified, the maximum and minimum values are stored at every averaging processing time.
- When the scaling function, shift function, digital clipping function, or difference conversion function is used, values calculated by each function are stored in Maximum value and Minimum value.

CH1 Difference conversion status flag

The difference conversion status can be checked.

Monitor value	Description
0	Not converted
1	Converting difference

When the difference conversion starts after 'CH1 Difference conversion trigger' (Un\G470) is changed from No request (0) to Trigger request (1), 'CH1 Difference conversion status flag' (Un\G408) corresponding to the channel turns to Converting difference (1).

When 'CH1 Difference conversion trigger' (Un\G470) is changed from Trigger request (1) to No request (0), 'CH1 Difference conversion status flag' (Un\G408) is changed from Converting difference (1) to Not converted (0).

'CH1 Difference conversion status flag' (Un\G408) is Converting difference (1) during the difference conversion; Not converted (0) if not during the difference conversion.

■Buffer memory address

The following shows the buffer memory address of this area.

- CH□ Difference conversion status flag

CH1	CH2	CH3	CH4	CH5	CH6	CH7	CH8	CH9	CH10	CH11	CH12	CH13	CH14	CH15	CH16
408	608	808	1008	1208	1408	1608	1808	2008	2208	2408	2608	2808	3008	3208	3408

- CH□ Difference conversion status flag (in Q compatible mode)

CH1	CH2	CH3	CH4	CH5	CH6	CH7	CH8	CH9	CH10	CH11	CH12	CH13	CH14	CH15	CH16
190	191	192	193	194	195	196	197	—							

CH1 Logging hold flag

The logging holding status can be checked.

For details on the logging function, refer to the following.

 Page 60 Logging Function

Monitor value	Description
0	OFF
1	ON

When a state in which data is collected in 'CH1 Logging data' (Un\G10000 to Un\G10999) changes to the stop state, 'CH1 Logging hold flag' (Un\G409) is turned to ON (1).

When logging restarts by changing 'CH1 Logging hold request' (Un\G471) from ON (1) to OFF (0), 'CH1 Logging hold flag' (Un\G409) is turned to OFF (0).

■Buffer memory address

The following shows the buffer memory address of this area.

- CH□ Logging hold flag

CH1	CH2	CH3	CH4	CH5	CH6	CH7	CH8	CH9	CH10	CH11	CH12	CH13	CH14	CH15	CH16
409	609	809	1009	1209	1409	1609	1809	2009	2209	2409	2609	2809	3009	3209	3409

- CH□ Logging hold flag (in Q compatible mode)

CH1	CH2	CH3	CH4	CH5	CH6	CH7	CH8	CH9	CH10	CH11	CH12	CH13	CH14	CH15	CH16
1016	1017	1018	1019	1020	1021	1022	1023	—							

CH1 Digital output value (32 bits)

The A/D-converted digital output value is stored in 32-bit signed binary value.

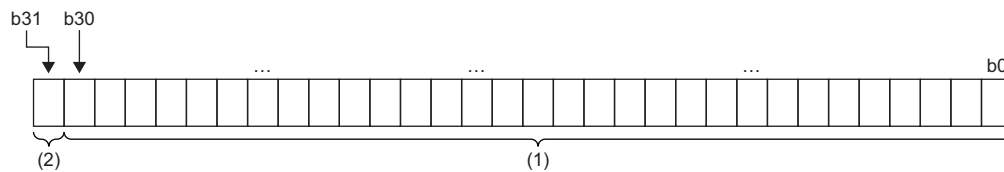

(1) Data section

(2) Sign bit 0: Positive, 1: Negative

■Buffer memory address

The following shows the buffer memory address of this area.

- CH□ Digital output value (32 bits)

CH1	CH2	CH3	CH4	CH5	CH6	CH7	CH8	CH9	CH10	CH11	CH12	CH13	CH14	CH15	CH16
410 to 411	610 to 611	810 to 811	1010 to 1011	1210 to 1211	1410 to 1411	1610 to 1611	1810 to 1811	2010 to 2011	2210 to 2211	2410 to 2411	2610 to 2611	2810 to 2811	3010 to 3011	3210 to 3211	3410 to 3411

- CH□ Digital output value (32 bits) (in Q compatible mode)

CH1	CH2	CH3	CH4	CH5	CH6	CH7	CH8	CH9	CH10	CH11	CH12	CH13	CH14	CH15	CH16
300 to 301	302 to 303	304 to 305	306 to 307	308 to 309	310 to 311	312 to 313	314 to 315	—							

■Refreshing cycle

If averaging processing is performed, values are updated at every averaging process cycle, but if not performed, values are updated at every sampling cycle.

CH1 Range setting monitor

The input range value set to the input range setting or 'CH1 Range setting' (Un\G598) can be checked.

Monitor value	Description
0H	4 to 20mA
1H	0 to 20mA
2H	1 to 5V
3H	0 to 5V
4H	-10 to 10V
5H	0 to 10V
AH	4 to 20mA (extended mode)
BH	1 to 5V (extended mode)
FH	User range setting

■Buffer memory address

The following shows the buffer memory address of this area.

- CH□ Range setting monitor

CH1	CH2	CH3	CH4	CH5	CH6	CH7	CH8	CH9	CH10	CH11	CH12	CH13	CH14	CH15	CH16
430	630	830	1030	1230	1430	1630	1830	2030	2230	2430	2630	2830	3030	3230	3430

Restriction

Values stored in this area will not be updated because the input range cannot be changed for channels with A/D conversion disabled. For details, refer to the following.

☞ Page 20 Range Switching Function

Range setting monitor [Q compatible mode]

When the Q compatible mode function is used, the input range value set in the input range setting can be checked.

	b15	...	b12	b11	...	b8	b7	...	b4	b3	...	b0
Range setting monitor (Un\G20) (setting range CH1 to CH4)	CH4			CH3			CH2			CH1		

	b15	...	b12	b11	...	b8	b7	...	b4	b3	...	b0
Range setting monitor (Un\G21) (setting range CH5 to CH8)	CH8			CH7			CH6			CH5		

■Buffer memory address

The following shows the buffer memory address of this area.

Only the R60AD8-G can use this area.

Buffer memory name	CH1	CH2	CH3	CH4	CH5	CH6	CH7	CH8
Range setting monitor	20				21			

The monitor value of the input range is the same as the one for the R mode.

Restriction

Bits corresponding to the channels with A/D conversion disabled in this area will not be updated because the input range cannot be changed for channels with A/D conversion disabled. For details, refer to the following.

 Page 20 Range Switching Function

CH1 Difference conversion reference value

This area stores 'CH1 Digital operation value' (Un\G402) at the start of the difference conversion as the difference conversion reference value.

The difference conversion reference value is updated when 'CH1 Difference conversion trigger' (Un\G470) is turned from No request (0) to Trigger request (1).

■Buffer memory address

The following shows the buffer memory address of this area.

- CH□ Difference conversion reference value

CH1	CH2	CH3	CH4	CH5	CH6	CH7	CH8	CH9	CH10	CH11	CH12	CH13	CH14	CH15	CH16
432	632	832	1032	1232	1432	1632	1832	2032	2232	2432	2632	2832	3032	3232	3432

- CH□ Difference conversion reference value (in Q compatible mode)

CH1	CH2	CH3	CH4	CH5	CH6	CH7	CH8	CH9	CH10	CH11	CH12	CH13	CH14	CH15	CH16
180	181	182	183	184	185	186	187	—							

■Setting range

The setting range is from -32768 to 32767.

Point

Even if 'CH1 Difference conversion status flag' (Un\G408) is turned from Converting difference (1) to Not converted (0), 'CH1 Difference conversion reference value' (Un\G432) is not cleared.

CH1 Head pointer

The buffer memory address of the oldest data in 'CH1 Logging data' (Un\G10000 to Un\G10999) can be checked with this buffer memory area.

The offset value counted from the start address of 'CH1 Logging data' (Un\G10000 to Un\G10999) is stored.

■ Buffer memory address

The following shows the buffer memory address of this area.

- CH□ Head pointer

CH1	CH2	CH3	CH4	CH5	CH6	CH7	CH8	CH9	CH10	CH11	CH12	CH13	CH14	CH15	CH16
434	634	834	1034	1234	1434	1634	1834	2034	2234	2434	2634	2834	3034	3234	3434

- CH□ Head pointer (in Q compatible mode)

CH1	CH2	CH3	CH4	CH5	CH6	CH7	CH8	CH9	CH10	CH11	CH12	CH13	CH14	CH15	CH16
1090	1091	1092	1093	1094	1095	1096	1097	—							

Ex.

When the value of 'CH2 Head pointer' (Un\G634) is 550

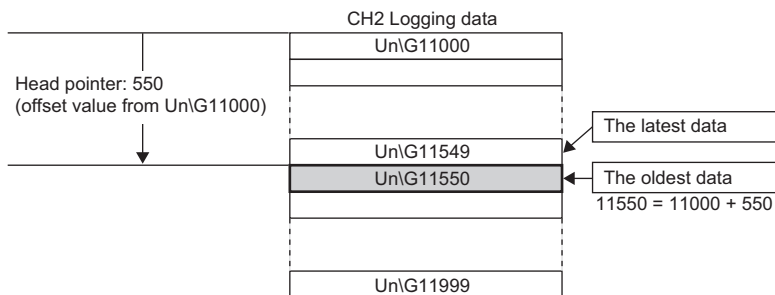

Point

- The value in 'CH1 Head pointer' (Un\G434) is fixed to 0 since the oldest data is stored in the start address of 'CH1 Logging data' (Un\G10000 to Un\G10999) while the data of the first 1000 points is being logged from the beginning of the logging. On and after the 1001st data, 'CH1 Head pointer' (Un\G434) increases one by one each time data is stored.
- When 'CH1 Logging hold request' (Un\G471) is turned on and off, 'CH1 Head pointer' (Un\G434) is cleared to 0.

A

CH1 Latest pointer

The buffer memory address of the latest data in 'CH1 Logging data' (Un\G10000 to Un\G10999) can be checked with this buffer memory area.

The offset value counted from the start address of 'CH1 Logging data' (Un\G10000 to Un\G10999) is stored.

■ Buffer memory address

The following shows the buffer memory address of this area.

- CH□ Latest pointer

CH1	CH2	CH3	CH4	CH5	CH6	CH7	CH8	CH9	CH10	CH11	CH12	CH13	CH14	CH15	CH16
435	635	835	1035	1235	1435	1635	1835	2035	2235	2435	2635	2835	3035	3235	3435

- CH□ Latest pointer (in Q compatible mode)

CH1	CH2	CH3	CH4	CH5	CH6	CH7	CH8	CH9	CH10	CH11	CH12	CH13	CH14	CH15	CH16
1098	1099	1100	1101	1102	1103	1104	1105	—							

Ex.

When the value of CH2 Latest pointer (Un\G635) is 549

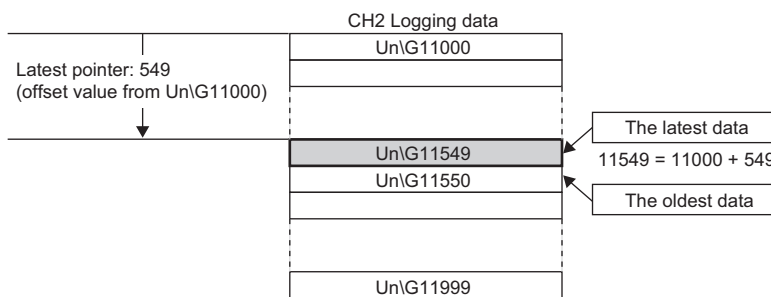

Point

- 'CH1 Latest pointer' (Un\G435) increases one by one each time data is stored from beginning of the logging.
- When 'CH1 Logging hold request' (Un\G471) is turned on and off, 'CH1 Latest pointer' (Un\G435) is cleared to 0.

CH1 Number of logging data

The number of data stored in the logging data storage area can be checked during the logging.

'CH1 Number of logging data' (Un\G436) increases one by one each time data is stored from beginning of the logging.

When the value in the logging data storage area reaches 1000, 'CH1 Number of logging data' (Un\G436) is fixed to 1000 since the value is overwritten from the head again.

For details on the logging function, refer to the following.

☞ Page 60 Logging Function

■ Buffer memory address

The following shows the buffer memory address of this area.

- CH□ Number of logging data

CH1	CH2	CH3	CH4	CH5	CH6	CH7	CH8	CH9	CH10	CH11	CH12	CH13	CH14	CH15	CH16
436	636	836	1036	1236	1436	1636	1836	2036	2236	2436	2636	2836	3036	3236	3436

- CH□ Number of logging data (in Q compatible mode)

CH1	CH2	CH3	CH4	CH5	CH6	CH7	CH8	CH9	CH10	CH11	CH12	CH13	CH14	CH15	CH16
1106	1107	1108	1109	1110	1111	1112	1113	—							

Point

When 'CH1 Logging hold request' (Un\G471) is turned on and off, 'CH1 Number of logging data' (Un\G436) is cleared to 0.

CH1 Trigger pointer

The buffer memory address of the data of when a hold trigger is executed in 'CH1 Logging data' (Un\G10000 to Un\G10999) can be checked with this buffer memory area.

The difference between the address of the buffer memory which stores the data of when a hold trigger is executed and the start address in 'CH1 Logging data' (Un\G10000 to Un\G10999) is stored.

For details on the logging function, refer to the following.

 Page 60 Logging Function

■ Buffer memory address

The following shows the buffer memory address of this area.

- CH□ Trigger pointer

CH1	CH2	CH3	CH4	CH5	CH6	CH7	CH8	CH9	CH10	CH11	CH12	CH13	CH14	CH15	CH16
437	637	837	1037	1237	1437	1637	1837	2037	2237	2437	2637	2837	3037	3237	3437

- CH□ Trigger pointer (in Q compatible mode)

CH1	CH2	CH3	CH4	CH5	CH6	CH7	CH8	CH9	CH10	CH11	CH12	CH13	CH14	CH15	CH16
1114	1115	1116	1117	1118	1119	1120	1121	—							

Point

When 'CH1 Logging hold request' (Un\G471) is turned on and off, 'CH1 Trigger pointer' (Un\G437) is cleared to 0.

CH1 Current logging read pointer

Each time an amount equivalent to the logging read points monitor value is logged, a value calculated by the following formula is stored.

CH1 Current logging read pointer = CH1 Latest pointer - CH1 Logging read points monitor value + 1

For details on the logging function, refer to the following.

 Page 60 Logging Function

■ Buffer memory address

The following shows the buffer memory address of this area.

- CH□ Current logging read pointer

CH1	CH2	CH3	CH4	CH5	CH6	CH7	CH8	CH9	CH10	CH11	CH12	CH13	CH14	CH15	CH16
438	638	838	1038	1238	1438	1638	1838	2038	2238	2438	2638	2838	3038	3238	3438

- CH□ Current logging read pointer (in Q compatible mode)

CH1	CH2	CH3	CH4	CH5	CH6	CH7	CH8	CH9	CH10	CH11	CH12	CH13	CH14	CH15	CH16
1216	1217	1218	1219	1220	1221	1222	1223	—							

CH1 Previous logging read pointer

A before-update current logging read pointer is stored just before an interrupt to the CPU module causes the update.

For details on the logging function, refer to the following.

☞ Page 60 Logging Function

■ Buffer memory address

The following shows the buffer memory address of this area.

- CH□ Previous logging read pointer

CH1	CH2	CH3	CH4	CH5	CH6	CH7	CH8	CH9	CH10	CH11	CH12	CH13	CH14	CH15	CH16
439	639	839	1039	1239	1439	1639	1839	2039	2239	2439	2639	2839	3039	3239	3439

- CH□ Previous logging read pointer (in Q compatible mode)

CH1	CH2	CH3	CH4	CH5	CH6	CH7	CH8	CH9	CH10	CH11	CH12	CH13	CH14	CH15	CH16
1224	1225	1226	1227	1228	1229	1230	1231	—							

CH1 Logging read points monitor value

The number of the actual logging read points is stored.

When 'Operating condition setting request' (Y9) is turned on and off, a value is not stored in the channel where the logging read function is disabled.

For details on the logging function, refer to the following.

☞ Page 60 Logging Function

■ Buffer memory address

The following shows the buffer memory address of this area.

- CH□ Logging read points monitor value

CH1	CH2	CH3	CH4	CH5	CH6	CH7	CH8	CH9	CH10	CH11	CH12	CH13	CH14	CH15	CH16
440	640	840	1040	1240	1440	1640	1840	2040	2240	2440	2640	2840	3040	3240	3440

- CH□ Logging read points monitor value (in Q compatible mode)

CH1	CH2	CH3	CH4	CH5	CH6	CH7	CH8	CH9	CH10	CH11	CH12	CH13	CH14	CH15	CH16
1232	1233	1234	1235	1236	1237	1238	1239	—							

CH1 Logging cycle monitor value

This area stores the actual logging cycle which is calculated from the refreshing cycle of data to be logged.

When 'Operating condition setting request' (Y9) is turned on and off, the actual logging cycle is stored in Logging cycle monitor value in the corresponding channel where the logging function is enabled.

For details on the logging function, refer to the following.

☞ Page 60 Logging Function

The following values are stored in 'CH1 Logging cycle monitor value' (Un\G441, Un\G442).

	b15	to	b0
'CH1 Logging cycle monitor value (s)' (Un\G441)	s		
'CH1 Logging cycle monitor value (ms)' (Un\G442)	ms		

■ Buffer memory address

The following shows the buffer memory address of this area.

- CH□ Logging cycle monitor value (s)

CH1	CH2	CH3	CH4	CH5	CH6	CH7	CH8	CH9	CH10	CH11	CH12	CH13	CH14	CH15	CH16
441	641	841	1041	1241	1441	1641	1841	2041	2241	2441	2641	2841	3041	3241	3441

- CH□ Logging cycle monitor value (ms)

CH1	CH2	CH3	CH4	CH5	CH6	CH7	CH8	CH9	CH10	CH11	CH12	CH13	CH14	CH15	CH16
442	642	842	1042	1242	1442	1642	1842	2042	2242	2442	2642	2842	3042	3242	3442

- CH□ Logging cycle monitor value (s) (in Q compatible mode)

CH1	CH2	CH3	CH4	CH5	CH6	CH7	CH8	CH9	CH10	CH11	CH12	CH13	CH14	CH15	CH16
1122	1125	1128	1131	1134	1137	1140	1143	—							

- CH□ Logging cycle monitor value (ms) (in Q compatible mode)

CH1	CH2	CH3	CH4	CH5	CH6	CH7	CH8	CH9	CH10	CH11	CH12	CH13	CH14	CH15	CH16
1123	1126	1129	1132	1135	1138	1141	1144	—							

CH1 Trigger generation time

The time when a trigger is generated is recorded.

For details on the logging function, refer to the following.

☞ Page 60 Logging Function

	b15	to	b8 b7	to	b0
'CH1 Trigger generation time (First/Last two digits of the year)' (Un\G444)	First two digits of the year		Last two digits of the year		
'CH1 Trigger generation time (Month/Day)' (Un\G445)	Month		Day		
'CH1 Trigger generation time (Hour/Minute)' (Un\G446)	Hour		Minute		
'CH1 Trigger generation time (Second/Day of the week)' (Un\G447)	Second		Day of the week		
'CH1 Trigger generation time (Millisecond)' (Un\G448)	Millisecond (higher-order digits)		Millisecond (lower-order digits)		

Item	Storage contents	Storage example*1
First two digits of the year/Last two digits of the year	Stored in BCD code.	2015H
Month/Day		131H
Hour/Minute		1234H
Second		56H
Day of the week	One of the following values is stored in BCD code. Sunday: 0, Monday: 1, Tuesday: 2, Wednesday: 3 Thursday: 4, Friday: 5, Saturday: 6	6H
Millisecond (upper)	Stored in BCD code.	7H
Millisecond (lower)		89H

*1 Values stored when an error occurs at 12:34:56.789 on Saturday, January 31st, 2015.

■ Buffer memory address

The following shows the buffer memory address of this area.

- CH□ Trigger generation time (First/Last two digits of the year)

CH1	CH2	CH3	CH4	CH5	CH6	CH7	CH8	CH9	CH10	CH11	CH12	CH13	CH14	CH15	CH16
444	644	844	1044	1244	1444	1644	1844	2044	2244	2444	2644	2844	3044	3244	3444

- CH□ Trigger generation time (Month/Day)

CH1	CH2	CH3	CH4	CH5	CH6	CH7	CH8	CH9	CH10	CH11	CH12	CH13	CH14	CH15	CH16
445	645	845	1045	1245	1445	1645	1845	2045	2245	2445	2645	2845	3045	3245	3445

- CH□ Trigger generation time (Hour/Minute)

CH1	CH2	CH3	CH4	CH5	CH6	CH7	CH8	CH9	CH10	CH11	CH12	CH13	CH14	CH15	CH16
446	646	846	1046	1246	1446	1646	1846	2046	2246	2446	2646	2846	3046	3246	3446

- CH□ Trigger generation time (Second/Day of the week)

CH1	CH2	CH3	CH4	CH5	CH6	CH7	CH8	CH9	CH10	CH11	CH12	CH13	CH14	CH15	CH16
447	647	847	1047	1247	1447	1647	1847	2047	2247	2447	2647	2847	3047	3247	3447

- CH□ Trigger generation time (Millisecond)

CH1	CH2	CH3	CH4	CH5	CH6	CH7	CH8	CH9	CH10	CH11	CH12	CH13	CH14	CH15	CH16
448	648	848	1048	1248	1448	1648	1848	2048	2248	2448	2648	2848	3048	3248	3448

- CH□ Trigger generation time (First/Last two digits of the year) (in Q compatible mode)

CH1	CH2	CH3	CH4	CH5	CH6	CH7	CH8	CH9	CH10	CH11	CH12	CH13	CH14	CH15	CH16
1154	1158	1162	1166	1170	1174	1178	1182	—							

- CH□ Trigger generation time (Month/Day) (in Q compatible mode)

CH1	CH2	CH3	CH4	CH5	CH6	CH7	CH8	CH9	CH10	CH11	CH12	CH13	CH14	CH15	CH16
1155	1159	1163	1167	1171	1175	1179	1183	—							

- CH□ Trigger generation time (Hour/Minute) (in Q compatible mode)

CH1	CH2	CH3	CH4	CH5	CH6	CH7	CH8	CH9	CH10	CH11	CH12	CH13	CH14	CH15	CH16
1156	1160	1164	1168	1172	1176	1180	1184	—							

- CH□ Trigger generation time (Second/Day of the week) (in Q compatible mode)

CH1	CH2	CH3	CH4	CH5	CH6	CH7	CH8	CH9	CH10	CH11	CH12	CH13	CH14	CH15	CH16
1157	1161	1165	1169	1173	1177	1181	1185	—							

- CH□ Trigger generation time (Millisecond) (in Q compatible mode)

CH1	CH2	CH3	CH4	CH5	CH6	CH7	CH8	CH9	CH10	CH11	CH12	CH13	CH14	CH15	CH16
1186	1187	1188	1189	1190	1191	1192	1193	—							

Point

- Time units shorter than one millisecond are not recorded.
- When 'CH1 Logging hold request' (Un\G471) is turned on and off, 'CH1 Trigger generation time' (Un\G444 to Un\G448) is cleared to 0.

CH1 Difference conversion trigger

Use this buffer memory area as a trigger to start or stop the difference conversion.

For details on the difference conversion function, refer to the following.

 Page 55 Difference Conversion Function

Setting value	Setting content
0	No request
1	Trigger request

If a value other than the above is set, a difference conversion trigger setting range error (error code: 1A7□H) occurs.

■ Buffer memory address

The following shows the buffer memory address of this area.

- CH□ Difference conversion trigger

CH1	CH2	CH3	CH4	CH5	CH6	CH7	CH8	CH9	CH10	CH11	CH12	CH13	CH14	CH15	CH16
470	670	870	1070	1270	1470	1670	1870	2070	2270	2470	2670	2870	3070	3270	3470

- CH□ Difference conversion trigger (in Q compatible mode)

CH1	CH2	CH3	CH4	CH5	CH6	CH7	CH8	CH9	CH10	CH11	CH12	CH13	CH14	CH15	CH16
172	173	174	175	176	177	178	179	—							

■ Starting and stopping the difference conversion

- The difference conversion starts when 'CH1 Difference conversion trigger' (Un\G470) is changed from No request (0) to Trigger request (1).
- The difference conversion stops when 'CH1 Difference conversion trigger' (Un\G470) is changed from Trigger request (1) to No request (0).

■ Default value

The default value is No request (0) for all channels.

CH1 Logging hold request

Use this buffer memory area as a trigger to hold (stop) logging at any timing during the logging.

For details on the logging function, refer to the following.

 Page 60 Logging Function

Setting value	Setting content
0	OFF
1	ON

If a value other than the above is set, a logging hold request range error (error code: 1D7□H) occurs.

When 'CH1 Logging enable/disable setting' (Un\G535) is set to Disable (1), the setting for 'CH1 Logging hold request' (Un\G471) is ignored.

■Buffer memory address

The following shows the buffer memory address of this area.

- CH□ Logging hold request

CH1	CH2	CH3	CH4	CH5	CH6	CH7	CH8	CH9	CH10	CH11	CH12	CH13	CH14	CH15	CH16
471	671	871	1071	1271	1471	1671	1871	2071	2271	2471	2671	2871	3071	3271	3471

- CH□ Logging hold request (in Q compatible mode)

CH1	CH2	CH3	CH4	CH5	CH6	CH7	CH8	CH9	CH10	CH11	CH12	CH13	CH14	CH15	CH16
1008	1009	1010	1011	1012	1013	1014	1015	—							

■Operation of the logging hold processing

- When Disable (0) is set to 'CH1 Level trigger condition setting' (Un\G540), the logging hold processing starts by turning off and on 'CH1 Logging hold request' (Un\G471).
- When a value other than Disable (0) is set to 'CH1 Hold trigger condition setting' (Un\G540), the logging hold processing starts after 'CH1 Logging hold request' (Un\G471) is turned off and on and the set trigger condition is satisfied. When the level trigger is enabled, use this buffer memory area as an interlock condition to operate the level trigger.
- If 'CH1 Logging hold request' (Un\G471) is turned on and off during the logging hold processing, the hold (stop) status is cleared and the logging restarts.

■Default value

The default value is OFF (0) for all channels.

Point

The stop status of the logging can be checked with 'CH1 Logging hold flag' (Un\G409).

CH1 Conversion value shift amount

Set 'CH1 Conversion value shift amount' (Un\G472) used for the shift function.

The digital operation value to which the conversion value shift amount is applied is stored in 'CH1 Digital operation value' (Un\G402).

For details on the shift function, refer to the following.

☞ Page 50 Shift Function

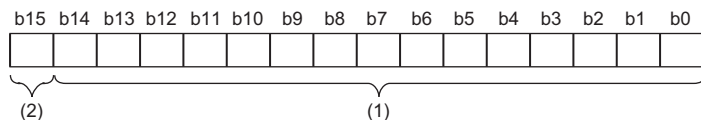

(1) Data section

(2) Sign bit 0: Positive, 1: Negative

■Buffer memory address

The following shows the buffer memory address of this area.

- CH□ Conversion value shift amount

CH1	CH2	CH3	CH4	CH5	CH6	CH7	CH8	CH9	CH10	CH11	CH12	CH13	CH14	CH15	CH16
472	672	872	1072	1272	1472	1672	1872	2072	2272	2472	2672	2872	3072	3272	3472

- CH□ Conversion value shift amount (in Q compatible mode)

CH1	CH2	CH3	CH4	CH5	CH6	CH7	CH8	CH9	CH10	CH11	CH12	CH13	CH14	CH15	CH16
164	165	166	167	168	169	170	171	—							

■Setting range

The setting range is from -32768 to 32767.

■Enabling the setting

Regardless of turning on and off 'Operating condition setting request' (Y9), the set conversion value shift amount takes effect.

■Default value

The default value is 0 for all channels.

CH1 A/D conversion enable/disable setting

Set whether to enable or disable the A/D conversion.

For details on the A/D conversion enable/disable setting function, refer to the following.

☞ Page 21 A/D Conversion Enable/Disable Setting Function

Setting value	Setting content
0	A/D conversion enable
1	A/D conversion disable

When a value other than the ones above is set, CH1 A/D conversion enable/disable setting (Un\G500) is turned to A/D conversion disable (1).

■Buffer memory address

The following shows the buffer memory address of this area.

- CH□ A/D conversion enable/disable setting

CH1	CH2	CH3	CH4	CH5	CH6	CH7	CH8	CH9	CH10	CH11	CH12	CH13	CH14	CH15	CH16
500	700	900	1100	1300	1500	1700	1900	2100	2300	2500	2700	2900	3100	3300	3500

■Enabling the setting

Turn on and off 'Operating condition setting request' (Y9).

■Default value

The default value is A/D conversion disable (1) for all channels.

A/D conversion enable/disable setting [Q compatible mode]

When the Q compatible mode function is used, set whether to enable or disable the A/D conversion.

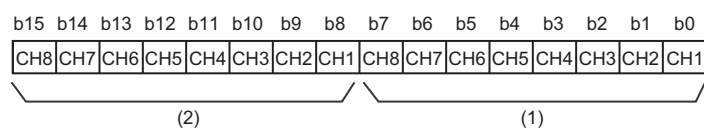

(1) 0: A/D conversion enabled, 1: A/D conversion disabled

(2) b8 to b15 are fixed to 0.

■Buffer memory address

The following shows the buffer memory address of this area.

Only the R60AD8-G can use this area.

Buffer memory name	CH1	CH2	CH3	CH4	CH5	CH6	CH7	CH8
A/D conversion enable/disable setting (in Q compatible mode)	0							

■Enabling the setting

Turn on and off 'Operating condition setting request' (Y9).

■Default value

The default value is A/D conversion disabled (1).

CH1 Averaging process specification

Select processing to be performed among the sampling processing, averaging processing, and filter processing.

Averaging processing consists of time average, count average, and moving average.

Setting value	Setting content
0	Sampling processing
1	Time average
2	Count average
3	Moving average
4	Primary delay filter

If a value other than the above is set, an averaging process specification setting range error (error code: 191□H) occurs.

■Buffer memory address

The following shows the buffer memory address of this area.

- CH□ Averaging process specification

CH1	CH2	CH3	CH4	CH5	CH6	CH7	CH8	CH9	CH10	CH11	CH12	CH13	CH14	CH15	CH16
501	701	901	1101	1301	1501	1701	1901	2101	2301	2501	2701	2901	3101	3301	3501

■Enabling the setting

Turn on and off 'Operating condition setting request' (Y9).

■Default value

The default value is Sampling processing (0) for all channels.

Averaging process specification [Q compatible mode]

In the Q compatible mode, set which processing is to be used, sampling processing, averaging processing, or filter processing.

Averaging process specification (Un\G24) (setting range: CH1 to CH4)	b15	...	b12	b11	...	b8	b7	...	b4	b3	...	b0
	CH4			CH3			CH2			CH1		

Averaging process specification (Un\G25) (setting range: CH5 to CH8)	b15	...	b12	b11	...	b8	b7	...	b4	b3	...	b0
	CH8			CH7			CH6			CH5		

The setting value of the averaging process specification is the same as the one for the R mode.

■Buffer memory address

The following shows the buffer memory address of this area.

Only the R60AD8-G can use this area.

Buffer memory name	CH1	CH2	CH3	CH4	CH5	CH6	CH7	CH8
Averaging process setting	24				25			

■Enabling the setting

Turn on and off 'Operating condition setting request' (Y9).

■Default value

The default value is Sampling processing (0).

CH1 Time average/Count average/Moving average/Primary delay filter constant setting

Configure the time (for averaging), count (for averaging), moving average count, and primary delay filter constant when values other than Sampling processing (0) is set for 'CH1 Averaging process specification' (Un\G501).

The following table lists the setting ranges.

Setting value	Setting content
40 to 5000 (ms)	Time average
4 to 500 (times)	Count average
2 to 200 (times)	Moving average
1 to 500 (times)	Primary delay filter constant

If a value other than the above is set, any of a time average setting range error (error code: 192□H), count average setting range error (error code: 193□H), moving average setting range error (error code: 194□H), or primary delay filter constant setting range error (error code: 195□H) occurs, and the A/D conversion process is performed with the setting before the occurrence of the error.

■Buffer memory address

The following shows the buffer memory address of this area.

- CH□ Time average/Count average/Moving average/Primary delay filter constant setting

CH1	CH2	CH3	CH4	CH5	CH6	CH7	CH8	CH9	CH10	CH11	CH12	CH13	CH14	CH15	CH16
502	702	902	1102	1302	1502	1702	1902	2102	2302	2502	2702	2902	3102	3302	3502

- CH□ Time average/Count average/Moving average/Primary delay filter constant setting (in Q compatible mode)

CH1	CH2	CH3	CH4	CH5	CH6	CH7	CH8	CH9	CH10	CH11	CH12	CH13	CH14	CH15	CH16
1	2	3	4	5	6	7	8	—							

■Enabling the setting

Turn on and off 'Operating condition setting request' (Y9).

■Default value

The default value is 0 for all channels.



- Set a primary delay filter constant for the primary delay filter. The value of the time constant (ms) is the product of the primary delay filter constant and the sampling cycle.
- Since the default value is 0, change the setting value according to the processing method.
- The setting for this area is ignored in the channel where Sampling processing (0) is set to 'CH1 Averaging process specification' (Un\G501).

CH1 Scaling enable/disable setting

Set whether to enable or disable the scaling.

For details on the scaling function, refer to the following.

☞ Page 26 Scaling Function

Setting value	Setting content
0	Enable
1	Disable

If a value other than the above is set, a scaling enable/disable setting range error (error code: 1A0□H) occurs.

■Buffer memory address

The following shows the buffer memory address of this area.

- CH□ Scaling enable/disable setting

CH1	CH2	CH3	CH4	CH5	CH6	CH7	CH8	CH9	CH10	CH11	CH12	CH13	CH14	CH15	CH16
504	704	904	1104	1304	1504	1704	1904	2104	2304	2504	2704	2904	3104	3304	3504

■Enabling the setting

Turn on and off 'Operating condition setting request' (Y9).

■Default value

The default value is Disable (1) for all channels.

Scaling enable/disable setting [Q compatible mode]

When the Q compatible mode function is used, set whether to enable or disable the scaling.

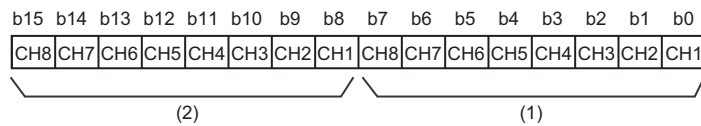

(1) 0: Enable, 1: Disable

(2) b8 to b15 are fixed to 0.

■Buffer memory address

The following shows the buffer memory address of this area.

Only the R60AD8-G can use this area.

Buffer memory name	CH1	CH2	CH3	CH4	CH5	CH6	CH7	CH8
Scaling enable/disable setting (in Q compatible mode)	53							

■Enabling the setting

Turn on and off 'Operating condition setting request' (Y9).

■Default value

The default value is Disable (1).

CH1 Scaling upper limit value

Set an upper limit value for the range of the scale conversion.

For details on the scaling function, refer to the following.

☞ Page 26 Scaling Function

■Buffer memory address

The following shows the buffer memory address of this area.

- CH□ Scaling upper limit value

CH1	CH2	CH3	CH4	CH5	CH6	CH7	CH8	CH9	CH10	CH11	CH12	CH13	CH14	CH15	CH16
506	706	906	1106	1306	1506	1706	1906	2106	2306	2506	2706	2906	3106	3306	3506

- CH□ Scaling upper limit value (in Q compatible mode)

CH1	CH2	CH3	CH4	CH5	CH6	CH7	CH8	CH9	CH10	CH11	CH12	CH13	CH14	CH15	CH16
63	65	67	69	71	73	75	77	—							

■Setting range

The setting range is from -32000 to 32000.

In the channel where a value out of the range is set, a scaling setting range error (error code: 1A1□H) occurs.

In the channel where a set value does not satisfy the condition "the scaling upper limit value ≠ the scaling lower limit value", a scaling upper/lower limit value setting error (error code: 1A2□H) occurs.

When 'CH1 Scaling enable/disable setting' (Un\G504) is set to Disable (1), the setting for 'CH1 Scaling upper limit value' (Un\G506) is ignored.

■Enabling the setting

Turn on and off 'Operating condition setting request' (Y9).

■Default value

The default value is 0 for all channels.

CH1 Scaling lower limit value

Set a lower limit value for the range of the scale conversion.

For details on the scaling function, refer to the following.

☞ Page 26 Scaling Function

■Buffer memory address

The following shows the buffer memory address of this area.

- CH□ Scaling lower limit value

CH1	CH2	CH3	CH4	CH5	CH6	CH7	CH8	CH9	CH10	CH11	CH12	CH13	CH14	CH15	CH16
508	708	908	1108	1308	1508	1708	1908	2108	2308	2508	2708	2908	3108	3308	3508

- CH□ Scaling lower limit value (in Q compatible mode)

CH1	CH2	CH3	CH4	CH5	CH6	CH7	CH8	CH9	CH10	CH11	CH12	CH13	CH14	CH15	CH16
62	64	66	68	70	72	74	76	—							

■Setting range

The setting range is from -32000 to 32000.

In the channel where a value out of the range is set, a scaling setting range error (error code: 1A1□H) occurs.

In the channel where a set value does not satisfy the condition "the scaling upper limit value ≠ the scaling lower limit value", a scaling upper/lower limit value setting error (error code: 1A2□H) occurs.

When 'CH1 Scaling enable/disable setting' (Un\G504) is set to Disable (1), the setting for 'CH1 Scaling lower limit value' (Un\G508) is ignored.

■Enabling the setting

Turn on and off 'Operating condition setting request' (Y9).

■Default value

The default value is 0 for all channels.

CH1 Digital clipping enable/disable setting

Set whether to enable or disable the digital clipping function.

For details on the digital clipping function, refer to the following.

☞ Page 53 Digital Clipping Function

Setting value	Setting content
0	Enable
1	Disable

If a value other than the above is set, a digital clipping enable/disable setting range error (error code: 1A5□H) occurs.

■Buffer memory address

The following shows the buffer memory address of this area.

- CH□ Digital clipping enable/disable setting

CH1	CH2	CH3	CH4	CH5	CH6	CH7	CH8	CH9	CH10	CH11	CH12	CH13	CH14	CH15	CH16
510	710	910	1110	1310	1510	1710	1910	2110	2310	2510	2710	2910	3110	3310	3510

■Enabling the setting

Turn on and off 'Operating condition setting request' (Y9).

■Default value

The default value is Disable (1) for all channels.

Digital clipping enable/disable setting [Q compatible mode]

When the Q compatible mode function is used, set whether to enable or disable the digital clipping function.

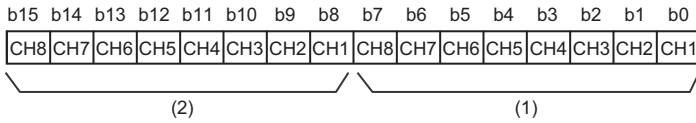

(1) 0: Enable, 1: Disable

(2) b8 to b15 are fixed to 0.

■Buffer memory address

The following shows the buffer memory address of this area.

Only the R60AD8-G can use this area.

Buffer memory name	CH1	CH2	CH3	CH4	CH5	CH6	CH7	CH8
Digital clipping enable/disable setting (in Q compatible mode)	29							

■Enabling the setting

Turn on and off 'Operating condition setting request' (Y9).

■Default value

The default value is Disable (1).

CH1 Alert output setting (Process alarm)

Set whether to enable or disable the alert output of the process alarm.

For details on the alert output function, refer to the following.

 Page 30 Alert Output Function

Setting value	Setting content
0	Enable
1	Disable

If a value other than the above is set, an alert output setting (Process alarm) range error (error code: 1B0□H) occurs.

■Buffer memory address

The following shows the buffer memory address of this area.

- CH□ Alert output setting (Process alarm)

CH1	CH2	CH3	CH4	CH5	CH6	CH7	CH8	CH9	CH10	CH11	CH12	CH13	CH14	CH15	CH16
512	712	912	1112	1312	1512	1712	1912	2112	2312	2512	2712	2912	3112	3312	3512

■Enabling the setting

Turn on and off 'Operating condition setting request' (Y9).

■Default value

The default value is Disable (1) for all channels.

CH1 Alert output setting (Rate alarm)

Set whether to enable or disable the alert output of the rate alarm.

For details on the alert output function, refer to the following.

☞ Page 30 Alert Output Function

Setting value	Setting content
0	Enable
1	Disable

If a value other than the above is set, an alert output setting (Rate alarm) range error (error code: 1B8□H) occurs.

■Buffer memory address

The following shows the buffer memory address of this area.

- CH□ Alert output setting (Rate alarm)

CH1	CH2	CH3	CH4	CH5	CH6	CH7	CH8	CH9	CH10	CH11	CH12	CH13	CH14	CH15	CH16
513	713	913	1113	1313	1513	1713	1913	2113	2313	2513	2713	2913	3113	3313	3513

■Enabling the setting

Turn on and off 'Operating condition setting request' (Y9).

■Default value

The default value is Disable (1) for all channels.

Alert output setting [Q compatible mode]

When the Q compatible mode function is used, set whether to enable or disable the alert output of process alarms and rate alarms.

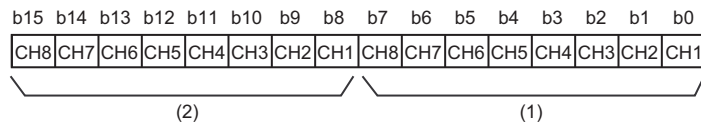

(1) 0: Process alarm enabled, 1: Process alarm disabled

(2) 0: Rate alarm enabled, 1: Rate alarm disabled

■Buffer memory address

The following shows the buffer memory address of this area.

Only the R60AD8-G can use this area.

Buffer memory name	CH1	CH2	CH3	CH4	CH5	CH6	CH7	CH8
Alert output setting (Process alarm)/Alert output setting (Rate alarm)	48							

■Enabling the setting

Turn on and off 'Operating condition setting request' (Y9).

■Default value

- b0 to b7: The default value is Process alarm disabled (1).
- b8 to b15: The default value is Rate alarm disabled (1).

CH1 Process alarm upper upper limit value

Set an upper upper limit value of the alert output function (Process alarm).

For details on the alert output function, refer to the following.

☞ Page 30 Alert Output Function

■Buffer memory address

The following shows the buffer memory address of this area.

- CH□ Process alarm upper upper limit value

CH1	CH2	CH3	CH4	CH5	CH6	CH7	CH8	CH9	CH10	CH11	CH12	CH13	CH14	CH15	CH16
514	714	914	1114	1314	1514	1714	1914	2114	2314	2514	2714	2914	3114	3314	3514

- CH□ Process alarm upper upper limit value (in Q compatible mode)

CH1	CH2	CH3	CH4	CH5	CH6	CH7	CH8	CH9	CH10	CH11	CH12	CH13	CH14	CH15	CH16
89	93	97	101	105	109	113	117	—							

■Setting range

The setting range is from -32768 to 32767.

■Enabling the setting

Turn on and off 'Operating condition setting request' (Y9).

■Default value

The default value is 0 for all channels.

CH1 Process alarm upper lower limit value

Set an upper lower limit value of the alert output function (Process alarm).

For details on the alert output function, refer to the following.

☞ Page 30 Alert Output Function

■Buffer memory address

The following shows the buffer memory address of this area.

- CH□ Process alarm upper lower limit value

CH1	CH2	CH3	CH4	CH5	CH6	CH7	CH8	CH9	CH10	CH11	CH12	CH13	CH14	CH15	CH16
516	716	916	1116	1316	1516	1716	1916	2116	2316	2516	2716	2916	3116	3316	3516

- CH□ Process alarm upper lower limit value (in Q compatible mode)

CH1	CH2	CH3	CH4	CH5	CH6	CH7	CH8	CH9	CH10	CH11	CH12	CH13	CH14	CH15	CH16
88	92	96	100	104	108	112	116	—							

■Setting range

The setting range is from -32768 to 32767.

■Enabling the setting

Turn on and off 'Operating condition setting request' (Y9).

■Default value

The default value is 0 for all channels.

CH1 Process alarm lower upper limit value

Set a lower upper limit value of the alert output function (Process alarm).

For details on the alert output function, refer to the following.

☞ Page 30 Alert Output Function

■Buffer memory address

The following shows the buffer memory address of this area.

- CH□ Process alarm lower upper limit value

CH1	CH2	CH3	CH4	CH5	CH6	CH7	CH8	CH9	CH10	CH11	CH12	CH13	CH14	CH15	CH16
518	718	918	1118	1318	1518	1718	1918	2118	2318	2518	2718	2918	3118	3318	3518

- CH□ Process alarm lower upper limit value (in Q compatible mode)

CH1	CH2	CH3	CH4	CH5	CH6	CH7	CH8	CH9	CH10	CH11	CH12	CH13	CH14	CH15	CH16
87	91	95	99	103	107	111	115	—							

■Setting range

The setting range is from -32768 to 32767.

■Enabling the setting

Turn on and off 'Operating condition setting request' (Y9).

■Default value

The default value is 0 for all channels.

CH1 Process alarm lower lower limit value

Set a lower lower limit value of the alert output function (Process alarm).

For details on the alert output function, refer to the following.

☞ Page 30 Alert Output Function

■Buffer memory address

The following shows the buffer memory address of this area.

- CH□ Process alarm lower lower limit value

CH1	CH2	CH3	CH4	CH5	CH6	CH7	CH8	CH9	CH10	CH11	CH12	CH13	CH14	CH15	CH16
520	720	920	1120	1320	1520	1720	1920	2120	2320	2520	2720	2920	3120	3320	3520

- CH□ Process alarm lower lower limit value (in Q compatible mode)

CH1	CH2	CH3	CH4	CH5	CH6	CH7	CH8	CH9	CH10	CH11	CH12	CH13	CH14	CH15	CH16
86	90	94	98	102	106	110	114	—							

■Setting range

The setting range is from -32768 to 32767.

■Enabling the setting

Turn on and off 'Operating condition setting request' (Y9).

■Default value

The default value is 0 for all channels.

Point

- When using the process alarm, configure the 4-step settings for the process alarm upper upper limit value, upper lower limit value, lower upper limit value, and lower lower value.
- In the channel where a set value does not satisfy the condition "the upper upper limit value \geq the upper lower limit value \geq the lower upper limit value \geq the lower lower limit value", a process alarm upper lower limit value setting range error (error code: 1B△□H) occurs.
- Since the default value is 0, change the setting value.
- When the scaling function, shift function, digital clipping function, or difference conversion function is used, alert targets are digital operation values to which the operation of each function is reflected. Be sure to consider operation results of each function to set values.

CH1 Rate alarm alert detection cycle setting

Set the cycle to check the change rate of digital output values.

The value of the cycle to detect a rate alarm alert is the product of the value in 'CH1 Rate alarm alert detection cycle setting' (Un\G522) and the conversion cycle.

■Buffer memory address

The following shows the buffer memory address of this area.

- CH□ Rate alarm alert detection cycle setting

CH1	CH2	CH3	CH4	CH5	CH6	CH7	CH8	CH9	CH10	CH11	CH12	CH13	CH14	CH15	CH16
522	722	922	1122	1322	1522	1722	1922	2122	2322	2522	2722	2922	3122	3322	3522

- CH□ Rate alarm alert detection cycle setting (in Q compatible mode)

CH1	CH2	CH3	CH4	CH5	CH6	CH7	CH8	CH9	CH10	CH11	CH12	CH13	CH14	CH15	CH16
118	119	120	121	122	123	124	125	—							

■Setting range

The setting range is from 1 to 32000 (times).

■Enabling the setting

Turn on and off 'Operating condition setting request' (Y9).

■Default value

The default value is 0 for all channels.

Point

- In the channel where a value out of the range is set, a rate alarm detection cycle setting range error (error code: 1B9□H) occurs.
- Since the default value is 0, change the setting value when setting the rate alarm function.

CH1 Rate alarm upper limit value

Set an upper limit value of the change rate of digital output values to detect a rate alarm.

For details on the alert output function, refer to the following.

☞ Page 30 Alert Output Function

■Buffer memory address

The following shows the buffer memory address of this area.

- CH□ Rate alarm upper limit value

CH1	CH2	CH3	CH4	CH5	CH6	CH7	CH8	CH9	CH10	CH11	CH12	CH13	CH14	CH15	CH16
524	724	924	1124	1324	1524	1724	1924	2124	2324	2524	2724	2924	3124	3324	3524

- CH□ Rate alarm upper limit value (in Q compatible mode)

CH1	CH2	CH3	CH4	CH5	CH6	CH7	CH8	CH9	CH10	CH11	CH12	CH13	CH14	CH15	CH16
126	128	130	132	134	136	138	140	—							

■Setting range

The setting range is from -32768 to 32767 (-3276.8 to 3276.7%). (Set it in a unit of 0.1%.)

■Enabling the setting

Turn on and off 'Operating condition setting request' (Y9).

■Default value

The default value is 0 for all channels.

CH1 Rate alarm lower limit value

Set a lower limit value of the change rate of digital output values to detect a rate alarm.

For details on the alert output function, refer to the following.

 Page 30 Alert Output Function

■Buffer memory address

The following shows the buffer memory address of this area.

- CH□ Rate alarm lower limit value

CH1	CH2	CH3	CH4	CH5	CH6	CH7	CH8	CH9	CH10	CH11	CH12	CH13	CH14	CH15	CH16
526	726	926	1126	1326	1526	1726	1926	2126	2326	2526	2726	2926	3126	3326	3526

- CH□ Rate alarm lower limit value (in Q compatible mode)

CH1	CH2	CH3	CH4	CH5	CH6	CH7	CH8	CH9	CH10	CH11	CH12	CH13	CH14	CH15	CH16
127	129	131	133	135	137	139	141	—							

■Setting range

The setting range is from -32768 to 32767 (-3276.8 to 3276.7%). (Set it in a unit of 0.1%.)

■Enabling the setting

Turn on and off 'Operating condition setting request' (Y9).

■Default value

The default value is 0 for all channels.

Point

- When using the rate alarm, configure the 2-step settings for the rate alarm upper limit value and lower limit value.
- In the channel where a set value does not satisfy the condition "the rate alarm lower limit value \geq the rate alarm upper limit value", a rate alarm upper/lower limit setting value inversion error (error code: 1BA□H) occurs.
- Since the default value is 0, change the setting value.

CH1 Input signal error detection setting

Set a condition for detecting an input signal error.

For details on the input signal error detection function, refer to the following.

 Page 38 Input Signal Error Detection Function

Setting value	Setting content
0	Disable
1	Upper and lower limit detection
2	Lower limit detection
3	Upper limit detection
4	Simple disconnection detection

If a value other than the above is set, an input signal error detection setting range error (error code: 1C0□H) occurs.

If Simple disconnection detection (4) is selected for the channel where the input range setting is other than the extended mode, a disconnection detection enabled range setting range error (error code: 1C6□H) occurs.

■Buffer memory address

The following shows the buffer memory address of this area.

- CH□ Input signal error detection setting

CH1	CH2	CH3	CH4	CH5	CH6	CH7	CH8	CH9	CH10	CH11	CH12	CH13	CH14	CH15	CH16
528	728	928	1128	1328	1528	1728	1928	2128	2328	2528	2728	2928	3128	3328	3528

■Enabling the setting

Turn on and off 'Operating condition setting request' (Y9).

■Default value

The default value is Disable (0) for all channels.

Input signal error detection extension setting/setting [Q compatible mode]

When the Q compatible mode function is used, set a condition for detecting an input signal error.

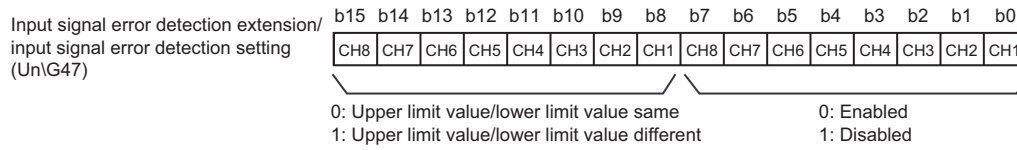

- When Upper limit value/lower limit value same (0) is set

The input signal error detection upper limit value and the input signal error detection lower limit value are calculated by using CH1 Input signal error detection setting value/CH1 Input signal error detection lower limit set value (Un\G142). In that case, CH1 Input signal error detection upper limit set value (Un\G150) is ignored.

- When Upper limit value/lower limit value different (1) is set

The input signal error detection upper limit value is calculated by using CH1 Input signal error detection upper limit set value (Un\G150).

The input signal error detection lower limit value is calculated by using CH1 Input signal error detection setting value/CH1 Input signal error detection lower limit set value (Un\G142).

■Buffer memory address

The following shows the buffer memory address of this area.

Only the R60AD8-G can use this area.

Buffer memory name	CH1	CH2	CH3	CH4	CH5	CH6	CH7	CH8
Input signal error detection extension/input signal error detection setting (in Q compatible mode)	47							

■Enabling the setting

Turn on and off 'Operating condition setting request' (Y9).

■Default value

- b0 to b7: The default value is Disabled (1).
- b8 to b15: The default value is Upper limit value/lower limit value same (0).

CH1 Input signal error detection lower limit set value

Set a lower limit value to detect an error for the input analog value.

For details on the input signal error detection function, refer to the following.

☞ Page 38 Input Signal Error Detection Function

■Buffer memory address

The following shows the buffer memory address of this area.

- CH□ Input signal error detection lower limit set value

CH1	CH2	CH3	CH4	CH5	CH6	CH7	CH8	CH9	CH10	CH11	CH12	CH13	CH14	CH15	CH16
529	729	929	1129	1329	1529	1729	1929	2129	2329	2529	2729	2929	3129	3329	3529

■Setting range

The setting range is from 0 to 250 (0 to 25.0%). Set it in a unit of 1 (0.1%).

For example, set 150 in the buffer memory area to set 15%.

In the channel where a value out of the range is set, an input signal error detection setting value range error (error code: 1C1□H) occurs.

The input signal error detection lower limit value is calculated by using the input signal error detection lower limit set value as follows. The input signal error detection lower limit value to be calculated varies depending on the input range used.

Input signal error detection lower limit value = Lower limit value of each range - (Gain value of each range - Offset value of each range) × (Input signal error detection lower limit set value/1000)

Ex.

When 'CH1 Input signal error detection lower limit set value' (Un\G529) is set to 100 (10%)

Range used: 4 to 20mA

The input signal error detection lower limit value is calculated as follows:

$$\text{Input signal error detection lower limit value} = 4 - (20 - 4) \times \frac{100}{1000} = 2.4\text{mA}$$

Detection conditions vary depending on the setting of 'CH1 Input signal error detection setting' (Un\G528) as follows:

- When 'CH1 Input signal error detection setting' (Un\G528) is set to Upper and lower limit detection (1), the detection is performed with both the input signal error detection upper limit value and the input signal error detection lower limit value.
- When 'CH1 Input signal error detection setting' (Un\G528) is set to Lower limit detection (2), the detection is performed only with the input signal error detection lower limit value.
- When 'CH1 Input signal error detection setting' (Un\G528) is set to Upper limit detection (3), the value set in this area is ignored.
- When 'CH1 Input signal error detection setting' (Un\G528) is set to Simple disconnection detection (4), the value set in this area is ignored.

■Enabling the setting

Turn on and off 'Operating condition setting request' (Y9).

■Default value

The default value is 50 for all channels.

CH1 Input signal error detection setting value/lower limit set value [Q compatible mode]

In the Q compatible mode, set a value to detect an error for the input analog value.

The operation varies depending on the value set in 'CH1 Input signal error detection extension/input signal error detection setting' (Un\G47).

■Buffer memory address

The following shows the buffer memory address of this area.

Only the R60AD8-G can use this area.

Buffer memory name	CH1	CH2	CH3	CH4	CH5	CH6	CH7	CH8
CH□ Input signal error detection setting value/CH□ Input signal error detection lower limit set value (in Q compatible mode)	142	143	144	145	146	147	148	149

■Setting range

The setting range is from 0 to 250 (0 to 25.0%). Set it in a unit of 1 (0.1%).

For example, set 150 in the buffer memory area to set 15%.

In the channel where a value out of the range is set, an input signal error detection setting value range error (error code: 1C1□H) occurs.

- When 'CH1 Input signal error detection extension/input signal error detection setting' (Un\G47) is set to Upper limit value/lower limit value same (0).

The area is used to set the input signal error detection setting value.

The input signal error detection upper limit value and the input signal error detection lower limit value are calculated as follows: The calculated values vary depending on the input range used.

Input signal error detection upper limit value =

Gain value of each range + (Gain value of each range - Offset value of each range) × (Input signal error detection set value^{*1}/1000)

Input signal error detection lower limit value =

Lower limit value of each range - (Gain value of each range - Offset value of each range) × (Input signal error detection set value^{*1}/1000)

*1 The input signal error detection setting value is set in this area.

- When 'CH1 Input signal error detection extension/input signal error detection setting' (Un\G47) is set to Upper limit value/lower limit value different (1)

The area is used to set the input signal error detection lower limit set value.

Setting 251 disables the input signal error detection.

The input signal error detection upper limit value and the input signal error detection lower limit value are calculated as follows: The calculated values vary depending on the input range used.

Input signal error detection upper limit value =

Gain value of each range + (Gain value of each range - Offset value of each range) × (Upper limit set value^{*1}/1000)

Input signal error detection lower limit value =

Lower limit value of each range - (Gain value of each range - Offset value of each range) × (Lower limit set value^{*2}/1000)

*1 The upper limit set value is the value set in 'CH1 Input signal error detection upper limit set value' (Un\G150).

*2 The lower limit set value is the value set in this area.

■Enabling the setting

Turn on and off 'Operating condition setting request' (Y9).

■Default value

The default value is 50 for all channels.

CH1 Input signal error detection upper limit set value

Set an upper limit value to detect an error for the input analog value.

For details on the input signal error detection function, refer to the following.

☞ Page 38 Input Signal Error Detection Function

■ Buffer memory address

The following shows the buffer memory address of this area.

- CH□ Input signal error detection upper limit set value

CH1	CH2	CH3	CH4	CH5	CH6	CH7	CH8	CH9	CH10	CH11	CH12	CH13	CH14	CH15	CH16
530	730	930	1130	1330	1530	1730	1930	2130	2330	2530	2730	2930	3130	3330	3530

■ Setting range

The setting range is from 0 to 250 (0 to 25.0%). Set it in a unit of 1 (0.1%).

For example, set 150 in the buffer memory area to set 15%.

In the channel where a value out of the range is set, an input signal error detection setting value range error (error code: 1C1□H) occurs.

The input signal error detection upper limit value is calculated by using the input signal error detection upper limit set value as follows. The input signal error detection upper limit value to be calculated varies depending on the input range used.

Input signal error detection upper limit value = Gain value of each range + (Gain value of each range - Offset value of each range) × (Input signal error detection upper limit set value/1000)

Ex.

When 'CH1 Input signal error detection upper limit set value' (Un\G530) is set to 100 (10%)

Range used: 4 to 20mA

The input signal error detection upper limit value is calculated as follows:

$$\text{Input signal error detection upper limit value} = 20 + (20 - 4) \times \frac{100}{1000} = 21.6\text{mA}$$

Detection conditions vary depending on the setting of 'CH1 Input signal error detection setting' (Un\G528) as follows:

- When 'CH1 Input signal error detection setting' (Un\G528) is set to Upper and lower limit detection (1), the detection is performed with both the input signal error detection upper limit value and the input signal error detection lower limit value.
- When 'CH1 Input signal error detection setting' (Un\G528) is set to Lower limit detection (2), the value set in this area is ignored.
- When 'CH1 Input signal error detection setting' (Un\G528) is set to Upper limit detection (3), the detection is performed only with the input signal error detection upper limit value.
- When 'CH1 Input signal error detection setting' (Un\G528) is set to Simple disconnection detection (4), the value set in this area is ignored.

■ Enabling the setting

Turn on and off 'Operating condition setting request' (Y9).

■ Default value

The default value is 50 for all channels.

CH1 Input signal error detection upper limit set value [Q compatible mode]

In the Q compatible mode, set an upper limit value to detect an input signal error.

The operation varies depending on the value set in 'CH1 Input signal error detection extension/input signal error detection setting' (Un\G47).

- When Upper limit value/lower limit value same (0) is set

The value set in this area is ignored.

- When Upper limit value/lower limit value different (1) is set

Set an upper limit value to detect an input signal error.

■Buffer memory address

The following shows the buffer memory address of this area.

Only the R60AD8-G can use this area.

Buffer memory name	CH1	CH2	CH3	CH4	CH5	CH6	CH7	CH8
CH□ Input signal error detection upper limit set value (in Q compatible mode)	150	151	152	153	154	155	156	157

■Setting range

The setting range is from 0 to 250 (0 to 25.0%). Set it in a unit of 1 (0.1%).

In the channel where a value out of the above range is set, an input signal error detection setting value range error (error code: 1C1□H) occurs.

However, setting 251 disables the input signal error detection.

For the setting method, refer to the following.

☞ Page 183 CH1 Input signal error detection setting value/lower limit set value [Q compatible mode]

■Enabling the setting

Turn on and off 'Operating condition setting request' (Y9).

■Default value

The default value is 50 for all channels.

A

CH1 Logging enable/disable setting

Set whether to enable or disable the logging function.

For details on the logging function, refer to the following.

☞ Page 60 Logging Function

Setting value	Setting content
0	Enable
1	Disable

If a value other than the above is set, a logging enable/disable setting range error (error code: 1D0□H) occurs.

■Buffer memory address

The following shows the buffer memory address of this area.

- CH□ Logging enable/disable setting

CH1	CH2	CH3	CH4	CH5	CH6	CH7	CH8	CH9	CH10	CH11	CH12	CH13	CH14	CH15	CH16
535	735	935	1135	1335	1535	1735	1935	2135	2335	2535	2735	2935	3135	3335	3535

- CH□ Logging enable/disable setting (in Q compatible mode)

CH1	CH2	CH3	CH4	CH5	CH6	CH7	CH8	CH9	CH10	CH11	CH12	CH13	CH14	CH15	CH16
1000	1001	1002	1003	1004	1005	1006	1007	—							

■Enabling the setting

Turn on and off 'Operating condition setting request' (Y9).

■Default value

The default value is Disable (1) for all channels.

CH1 Logging data setting

Determine the target to be collected: digital output value or digital operation value.

For details on the logging function, refer to the following.

☞ Page 60 Logging Function

Setting value	Setting content
0	Digital output value
1	Digital operation value

If a value other than the above is set, a logging data setting range error (error code: 1D3□H) occurs.

When 'CH1 Logging enable/disable setting' (Un\G535) is set to Disable (1), the setting for 'CH1 Logging data setting' (Un\G536) is ignored.

■Buffer memory address

The following shows the buffer memory address of this area.

- CH□ Logging data setting

CH1	CH2	CH3	CH4	CH5	CH6	CH7	CH8	CH9	CH10	CH11	CH12	CH13	CH14	CH15	CH16
536	736	936	1136	1336	1536	1736	1936	2136	2336	2536	2736	2936	3136	3336	3536

- CH□ Logging data setting (in Q compatible mode)

CH1	CH2	CH3	CH4	CH5	CH6	CH7	CH8	CH9	CH10	CH11	CH12	CH13	CH14	CH15	CH16
1024	1025	1026	1027	1028	1029	1030	1031	—							

■Enabling the setting

Turn on and off 'Operating condition setting request' (Y9).

■Default value

The default value is Digital operation value (1) for all channels.

CH1 Logging cycle setting value

Set a cycle for storing the logging data.

For details on the logging function, refer to the following.

☞ Page 60 Logging Function

■Buffer memory address

The following shows the buffer memory address of this area.

- CH□ Logging cycle setting value

CH1	CH2	CH3	CH4	CH5	CH6	CH7	CH8	CH9	CH10	CH11	CH12	CH13	CH14	CH15	CH16
537	737	937	1137	1337	1537	1737	1937	2137	2337	2537	2737	2937	3137	3337	3537

- CH□ Logging cycle setting value (in Q compatible mode)

CH1	CH2	CH3	CH4	CH5	CH6	CH7	CH8	CH9	CH10	CH11	CH12	CH13	CH14	CH15	CH16
1032	1033	1034	1035	1036	1037	1038	1039	—							

■Setting range

The setting range varies depending on the setting in 'CH1 Logging cycle unit setting' (Un\G538).

CH1 Logging cycle unit setting (Un\G538)	Setting range
ms (1)	10 to 32767
s (2)	1 to 3600

- If a value out of the range is set, a logging cycle setting value range error (error code: 1D1□H) occurs. Logging cannot be performed.
- If the set logging cycle is below the update cycle of data to be logged, a logging cycle setting disable error (error code: 1D2□H) occurs. Logging cannot be performed.

■Enabling the setting

Turn on and off 'Operating condition setting request' (Y9).

■Default value

The default value is 160 for all channels.

CH1 Logging cycle unit setting

Set a cycle unit for storing the logging data.

For details on the logging function, refer to the following.

☞ Page 60 Logging Function

Setting value	Setting content
1	ms
2	s

- If a value out of the range is set, a logging cycle setting value range error (error code: 1D1□H) occurs. Logging cannot be performed.
- If the set logging cycle is below the update cycle of data to be logged, a logging cycle setting disable error (error code: 1D2□H) occurs. Logging cannot be performed.

■Buffer memory address

The following shows the buffer memory address of this area.

- CH□ Logging cycle unit setting

CH1	CH2	CH3	CH4	CH5	CH6	CH7	CH8	CH9	CH10	CH11	CH12	CH13	CH14	CH15	CH16
538	738	938	1138	1338	1538	1738	1938	2138	2338	2538	2738	2938	3138	3338	3538

- CH□ Logging cycle unit setting (in Q compatible mode)

CH1	CH2	CH3	CH4	CH5	CH6	CH7	CH8	CH9	CH10	CH11	CH12	CH13	CH14	CH15	CH16
1040	1041	1042	1043	1044	1045	1046	1047	—							

■Enabling the setting

Turn on and off 'Operating condition setting request' (Y9).

■Default value

The default is ms (1) for all channels.

CH1 Post-trigger logging points

Set a number of data points collected for the time period from the occurrence of a hold trigger to the logging stop.

For details on the logging function, refer to the following.

☞ Page 60 Logging Function

■Buffer memory address

The following shows the buffer memory address of this area.

- CH□ Post-trigger logging points

CH1	CH2	CH3	CH4	CH5	CH6	CH7	CH8	CH9	CH10	CH11	CH12	CH13	CH14	CH15	CH16
539	739	939	1139	1339	1539	1739	1939	2139	2339	2539	2739	2939	3139	3339	3539

- CH□ Post-trigger logging points (in Q compatible mode)

CH1	CH2	CH3	CH4	CH5	CH6	CH7	CH8	CH9	CH10	CH11	CH12	CH13	CH14	CH15	CH16
1048	1049	1050	1051	1052	1053	1054	1055	—							

■Setting range

The setting range is from 1 to 1000.

If a value out of the range is set, a post-trigger logging points setting range error (error code: 1D4□H) occurs. Logging cannot be performed.

When 'CH1 Logging enable/disable setting' (Un\G535) is set to Disable (1), the setting for 'CH1 Post-trigger logging points' (Un\G539) is ignored.

■Enabling the setting

Turn on and off 'Operating condition setting request' (Y9).

■Default value

The default value is 500 for all channels.

CH1 Level trigger condition setting

Set the condition for the occurrence of a hold trigger when using the level trigger in the logging function.

To use the level trigger, set Level trigger condition setting to any of Level trigger (condition: Rise) (1), Level trigger (condition: Fall) (2), or Level trigger (condition: Rise and fall) (3).

For details on the logging function, refer to the following.

☞ Page 60 Logging Function

Setting value	Setting content
0	Disable
1	Level trigger (condition: Rise)
2	Level trigger (condition: Fall)
3	Level trigger (condition: Rise and fall)

If a value other than the above is set, a level trigger condition setting range error (error code: 1D5□H) occurs.

■Buffer memory address

The following shows the buffer memory address of this area.

- CH□ Level trigger condition setting

CH1	CH2	CH3	CH4	CH5	CH6	CH7	CH8	CH9	CH10	CH11	CH12	CH13	CH14	CH15	CH16
540	740	940	1140	1340	1540	1740	1940	2140	2340	2540	2740	2940	3140	3340	3540

- CH□ Level trigger condition setting (in Q compatible mode)

CH1	CH2	CH3	CH4	CH5	CH6	CH7	CH8	CH9	CH10	CH11	CH12	CH13	CH14	CH15	CH16
1056	1057	1058	1059	1060	1061	1062	1063	—							

■Enabling the setting

Turn on and off 'Operating condition setting request' (Y9).

■Default value

The default value is Disable (0) for all channels.

CH1 Trigger data

Set a buffer memory address to be monitored using a level trigger.

Set the buffer memory address where the target data for monitoring is stored.

For details on the logging function, refer to the following.

 Page 60 Logging Function

■Buffer memory address

The following shows the buffer memory address of this area.

- CH□ Trigger data

CH1	CH2	CH3	CH4	CH5	CH6	CH7	CH8	CH9	CH10	CH11	CH12	CH13	CH14	CH15	CH16
541	741	941	1141	1341	1541	1741	1941	2141	2341	2541	2741	2941	3141	3341	3541

■Setting range

The setting range is from 0 to 9999.

If a value out of the range is set, a trigger data setting range error (error code: 1D6□H) occurs. Logging cannot be performed.

When 'CH1 Logging enable/disable setting' (Un\G535) is set to Disable (1), the setting for 'CH1 Trigger data' (Un\G541) is ignored.

■Enabling the setting

Turn on and off 'Operating condition setting request' (Y9).

■Default value

The default values are set as shown below.

Channel	Default value	Buffer memory area to be monitored
CH1	402	'CH1 Digital operation value' (Un\G402)
CH2	602	'CH2 Digital operation value' (Un\G602)
CH3	802	'CH3 Digital operation value' (Un\G802)
CH4	1002	'CH4 Digital operation value' (Un\G1002)
CH5	1202	'CH5 Digital operation value' (Un\G1202)
CH6	1402	'CH6 Digital operation value' (Un\G1402)
CH7	1602	'CH7 Digital operation value' (Un\G1602)
CH8	1802	'CH8 Digital operation value' (Un\G1802)
CH9	2002	'CH9 Digital operation value' (Un\G2002)
CH10	2202	'CH10 Digital operation value' (Un\G2202)
CH11	2402	'CH11 Digital operation value' (Un\G2402)
CH12	2602	'CH12 Digital operation value' (Un\G2602)
CH13	2802	'CH13 Digital operation value' (Un\G2802)
CH14	3002	'CH14 Digital operation value' (Un\G3002)
CH15	3202	'CH15 Digital operation value' (Un\G3202)
CH16	3402	'CH16 Digital operation value' (Un\G3402)

CH1 Trigger data [Q compatible mode]

In the Q compatible mode, set a buffer memory address to be monitored using a level trigger.

Set the buffer memory address where the target data for monitoring is stored.

■Buffer memory address

The following shows the buffer memory address of this area.

Only the R60AD8-G can use this area.

Buffer memory name	CH1	CH2	CH3	CH4	CH5	CH6	CH7	CH8
CH1 Trigger data (in Q compatible mode)	1064	1065	1066	1067	1068	1069	1070	1071

■Setting range

The setting range is from 0 to 9999.

If a value out of the range is set, a trigger data setting range error (error code: 1D6□H) occurs. Logging cannot be performed.

When 'CH1 Logging enable/disable setting' (Un\G1000) is set to Disable (1), the setting for 'CH1 Trigger data' (Un\G1064) is ignored.

■Enabling the setting

Turn on and off 'Operating condition setting request' (Y9).

■Default value

The default values are set as shown below.

Channel	Default value	Buffer memory area to be monitored
CH1	54	CH1 Digital operation value (Un\G54)
CH2	55	CH2 Digital operation value (Un\G55)
CH3	56	CH3 Digital operation value (Un\G56)
CH4	57	CH4 Digital operation value (Un\G57)
CH5	58	CH5 Digital operation value (Un\G58)
CH6	59	CH6 Digital operation value (Un\G59)
CH7	60	CH7 Digital operation value (Un\G60)
CH8	61	CH8 Digital operation value (Un\G61)

A

CH1 Trigger setting value

Set a level to generate a level trigger.

For details on the logging function, refer to the following.

☞ Page 60 Logging Function

■Buffer memory address

The following shows the buffer memory address of this area.

- CH□ Trigger setting value

CH1	CH2	CH3	CH4	CH5	CH6	CH7	CH8	CH9	CH10	CH11	CH12	CH13	CH14	CH15	CH16
542	742	942	1142	1342	1542	1742	1942	2142	2342	2542	2742	2942	3142	3342	3542

- CH□ Trigger setting value (in Q compatible mode)

CH1	CH2	CH3	CH4	CH5	CH6	CH7	CH8	CH9	CH10	CH11	CH12	CH13	CH14	CH15	CH16
1082	1083	1084	1085	1086	1087	1088	1089	—							

■Setting range

The setting range is from -32768 to 32767.

■Enabling the setting

Turn on and off 'Operating condition setting request' (Y9).

■Default value

The default value is 0 for all channels.

CH1 Loading interrupt enable/disable setting

Set whether to enable or disable the logging read function.

For details on the logging function, refer to the following.

 Page 60 Logging Function

Setting value	Setting content
0	Enable
1	Disable

- If a value other than the above is set, a read interrupt enable/disable setting range error (error code: 1D8□H) occurs. Logging cannot be performed.
- When CH1 Logging read enable/disable setting (Un\G544) is set to Enable (0), an interrupt is generated and sent to the CPU module by setting a read pointer each time an amount equivalent to the logging read points setting value is logged.

■Buffer memory address

The following shows the buffer memory address of this area.

- CH□ Loading interrupt enable/disable setting

CH1	CH2	CH3	CH4	CH5	CH6	CH7	CH8	CH9	CH10	CH11	CH12	CH13	CH14	CH15	CH16
544	744	944	1144	1344	1544	1744	1944	2144	2344	2544	2744	2944	3144	3344	3544

- CH□ Loading interrupt enable/disable setting (in Q compatible mode)

CH1	CH2	CH3	CH4	CH5	CH6	CH7	CH8	CH9	CH10	CH11	CH12	CH13	CH14	CH15	CH16
1200	1201	1202	1203	1204	1205	1206	1207	—							

■Enabling the setting

Turn on and off 'Operating condition setting request' (Y9).

■Default value

The default value is Disable (1) for all channels.

Point

The interrupt pointer to be used is preset but can be changed. To change the interrupt pointer, set the corresponding interrupt pointer with the engineering tool.

CH1 Logging read points setting value

An interrupt is generated to the CPU module each time data is logged for the set number of data points.

For details on the logging function, refer to the following.

☞ Page 60 Logging Function

■Buffer memory address

The following shows the buffer memory address of this area.

- CH□ Logging read points setting value

CH1	CH2	CH3	CH4	CH5	CH6	CH7	CH8	CH9	CH10	CH11	CH12	CH13	CH14	CH15	CH16
545	745	945	1145	1345	1545	1745	1945	2145	2345	2545	2745	2945	3145	3345	3545

- CH□ Logging read points setting value (in Q compatible mode)

CH1	CH2	CH3	CH4	CH5	CH6	CH7	CH8	CH9	CH10	CH11	CH12	CH13	CH14	CH15	CH16
1208	1209	1210	1211	1212	1213	1214	1215	—							

■Setting range

The setting range is from 1 to 1000.

If a value out of the range is set, a logging read points setting value range error (error code: 1D9□H) occurs. Logging cannot be performed.

■Enabling the setting

Turn on and off 'Operating condition setting request' (Y9).

■Default value

The default value is 100 for all channels.

CH1 Range setting

This area is for setting an input range.

Input range	Setting value
4 to 20mA	0H
0 to 20mA	1H
1 to 5V	2H
0 to 5V	3H
-10 to 10V	4H
0 to 10V	5H
4 to 20mA (extended mode)	AH
1 to 5V (extended mode)	BH
User range setting	FH

- If a value other than the above is set, a range setting range error (error code: 190□H) occurs.
- The input range cannot be changed for channels with A/D conversion disabled. To change the input range, set 'CH1 A/D conversion enable/disable setting' (Un\G500) to A/D conversion enable (0), and turn on and off 'Operating condition setting request' (Y9).

■Buffer memory address

The following shows the buffer memory address of this area.

- CH□ Range setting

CH1	CH2	CH3	CH4	CH5	CH6	CH7	CH8	CH9	CH10	CH11	CH12	CH13	CH14	CH15	CH16
598	798	998	1198	1398	1598	1798	1998	2198	2398	2598	2798	2998	3198	3398	3598

■Enabling the setting

Turn on and off 'Operating condition setting request' (Y9).

■Default value

The default value is 4 to 20mA (0H) for all channels.

Range setting [Q compatible mode]

When the Q compatible mode function is used, this area is for setting an input range.

	b15	...	b12	b11	...	b8	b7	...	b4	b3	...	b0
Range setting (Un\G402) (setting range: CH1 to CH4)	CH4			CH3			CH2			CH1		

	b15	...	b12	b11	...	b8	b7	...	b4	b3	...	b0
Range setting (Un\G403) (setting range: CH5 to CH8)	CH8			CH7			CH6			CH5		

■Buffer memory address

The following shows the buffer memory address of this area.

Only the R60AD8-G can use this area.

Buffer memory name	CH1	CH2	CH3	CH4	CH5	CH6	CH7	CH8
Range setting (in Q compatible mode)	402				403			

The input range setting value is the same as the one for the R mode.

The input range cannot be changed for channels with A/D conversion disabled. To change the input range, set the bit corresponding to the channel of 'A/D conversion enable/disable setting [Q compatible mode]' (Un\G0) to A/D conversion enable (0), and turn on and off 'Operating condition setting request' (Y9).

■Enabling the setting

Turn on and off 'Operating condition setting request' (Y9).

■Default value

The default value is 4 to 20mA (0H).

Error history

Up to 16 errors that occurred in the module are recorded.

	b15	to	b8	b7	to	b0
Un\G3600	Error code					
Un\G3601	First two digits of the year			Last two digits of the year		
Un\G3602	Month			Day		
Un\G3603	Hour			Minute		
Un\G3604	Second			Day of the week		
Un\G3605	Millisecond (higher-order digits)			Millisecond (lower-order digits)		
Un\G3606	System area					
⋮						
Un\G3609						

Item	Storage contents	Storage example *1
First two digits of the year/Last two digits of the year	Stored in BCD code.	2015H
Month/Day		131H
Hour/Minute		1234H
Second		56H
Day of the week	One of the following values is stored in BCD code. Sunday: 0, Monday: 1, Tuesday: 2, Wednesday: 3 Thursday: 4, Friday: 5, Saturday: 6	6H
Millisecond (upper)	Stored in BCD code.	7H
Millisecond (lower)		89H

*1 Values stored when an error occurs at 12:34:56.789 on Saturday, January 31st, 2015.

■Buffer memory address

The following shows the buffer memory address of this area.

Buffer memory name	No.1 to No.16
Error history	3600 to 3759
Error history (in Q compatible mode)	1810 to 1969

Alarm history

Up to 16 alarms that occurred in the module are recorded.

	b15	to	b8 b7	to	b0
Un\G3760	Alarm code				
Un\G3761	First two digits of the year		Last two digits of the year		
Un\G3762	Month		Day		
Un\G3763	Hour		Minute		
Un\G3764	Second		Day of the week		
Un\G3765	Millisecond (higher-order digits)		Millisecond (lower-order digits)		
Un\G3766	System area				
⋮					
Un\G3769					

Item	Storage contents	Storage example*1
First two digits of the year/Last two digits of the year	Stored in BCD code.	2015H
Month/Day		131H
Hour/Minute		1234H
Second		56H
Day of the week	One of the following values is stored in BCD code. Sunday: 0, Monday: 1, Tuesday: 2, Wednesday: 3 Thursday: 4, Friday: 5, Saturday: 6	6H
Millisecond (upper)	Stored in BCD code.	7H
Millisecond (lower)		89H

*1 Values stored when an alarm occurs at 12:34:56.789 on Saturday, January 31st, 2015.

■ Buffer memory address

The following shows the buffer memory address of this area.

Buffer memory name	No.1 to No.16
Alarm history	3760 to 3919
Alarm history (in Q compatible mode)	3760 to 3919

Save data type setting

This area saves and restores the offset/gain setting value in user range setting.

Specify the data type of the offset/gain value to be saved and restored: voltage or current.

b15	b14	b13	b12	b11	b10	b9	b8	b7	b6	b5	b4	b3	b2	b1	b0
CH16	CH15	CH14	CH13	CH12	CH11	CH10	CH9	CH8	CH7	CH6	CH5	CH4	CH3	CH2	CH1

- 0: Voltage, 1: Current
- b8 to b15 of the R60AD8-G are fixed to 0.

■ Buffer memory address

The following shows the buffer memory address of this area.

Buffer memory name	CH 1	CH 2	CH 3	CH 4	CH 5	CH 6	CH 7	CH 8	CH 9	CH 10	CH 11	CH 12	CH 13	CH 14	CH 15	CH 16
Save data type setting	4002															
Save data type setting (in Q compatible mode)	200															

■ Default value

The default value is Voltage (0).

A

CH1 Factory default setting

This area restores the offset/gain setting value in user range setting. For details, refer to the following.

☞ Page 196 CH1 User range setting

CH1 User range setting

This area restores the offset/gain setting value in user range setting.

■ Buffer memory address

The following shows the buffer memory address of this area.

- For the R60AD8-G

Buffer memory name	CH1	CH2	CH3	CH4	CH5	CH6	CH7	CH8
CH□ Factory default setting offset value (L) (H)	4004	4008	4012	4016	4020	4024	4028	4032
	4005	4009	4013	4017	4021	4025	4029	4033
CH□ Factory default setting gain value (L) (H)	4006	4010	4014	4018	4022	4026	4030	4034
	4007	4011	4015	4019	4023	4027	4031	4035
CH□ User range setting offset value (L) (H)	4036	4040	4044	4048	4052	4056	4060	4064
	4037	4041	4045	4049	4053	4057	4061	4065
CH□ User range setting gain value (L) (H)	4038	4042	4046	4050	4054	4058	4062	4066
	4039	4043	4047	4051	4055	4059	4063	4067
CH□ Factory default setting offset value (L) (H) (in Q compatible mode)	202	206	210	214	218	222	226	230
	203	207	211	215	219	223	227	231
CH□ Factory default setting gain value (L) (H) (in Q compatible mode)	204	208	212	216	220	224	228	232
	205	209	213	217	221	225	229	233
CH□ User range setting offset value (L) (H) (in Q compatible mode)	234	238	242	246	250	254	258	262
	235	239	243	247	251	255	259	263
CH□ User range setting gain value (L) (H) (in Q compatible mode)	236	240	244	248	252	256	260	264
	237	241	245	249	253	257	261	265

- For the R60AD16-G

Buffer memory name	Address							
CH□ Factory default setting offset value (L)	CH1	CH2	CH3	CH4	CH5	CH6	CH7	CH8
	4004	4008	4012	4016	4020	4024	4028	4032
	CH9	CH10	CH11	CH12	CH13	CH14	CH15	CH16
	4036	4040	4044	4048	4052	4056	4060	4064
CH□ Factory default setting offset value (H)	CH1	CH2	CH3	CH4	CH5	CH6	CH7	CH8
	4005	4009	4013	4017	4021	4025	4029	4033
	CH9	CH10	CH11	CH12	CH13	CH14	CH15	CH16
	4037	4041	4045	4049	4053	4057	4061	4065
CH□ Factory default setting gain value (L)	CH1	CH2	CH3	CH4	CH5	CH6	CH7	CH8
	4006	4010	4014	4018	4022	4026	4030	4034
	CH9	CH10	CH11	CH12	CH13	CH14	CH15	CH16
	4038	4042	4046	4050	4054	4058	4062	4066
CH□ Factory default setting gain value (H)	CH1	CH2	CH3	CH4	CH5	CH6	CH7	CH8
	4007	4011	4015	4019	4023	4027	4031	4035
	CH9	CH10	CH11	CH12	CH13	CH14	CH15	CH16
	4039	4043	4047	4051	4055	4059	4063	4067
CH□ User range setting offset value (L)	CH1	CH2	CH3	CH4	CH5	CH6	CH7	CH8
	4068	4072	4076	4080	4084	4088	4092	4096
	CH9	CH10	CH11	CH12	CH13	CH14	CH15	CH16
	4100	4104	4108	4112	4116	4120	4124	4128
CH□ User range setting offset value (H)	CH1	CH2	CH3	CH4	CH5	CH6	CH7	CH8
	4069	4073	4077	4081	4085	4089	4093	4097
	CH9	CH10	CH11	CH12	CH13	CH14	CH15	CH16
	4101	4105	4109	4113	4117	4121	4125	4129
CH□ User range setting gain value (L)	CH1	CH2	CH3	CH4	CH5	CH6	CH7	CH8
	4070	4074	4078	4082	4086	4090	4094	4098
	CH9	CH10	CH11	CH12	CH13	CH14	CH15	CH16
	4102	4106	4110	4114	4118	4122	4126	4130
CH□ User range setting gain value (H)	CH1	CH2	CH3	CH4	CH5	CH6	CH7	CH8
	4071	4075	4079	4083	4087	4091	4095	4099
	CH9	CH10	CH11	CH12	CH13	CH14	CH15	CH16
	4103	4107	4111	4115	4119	4123	4127	4131

When the following operations are performed, the data to be used is stored (saved).

- Writing the initial setting by engineering tool
- Turning off and on 'Operating condition setting request' (Y9) (Data is not saved when the mode is switched from the normal mode to the offset/gain setting mode by 'Mode switching setting' (Un\G296, Un\G297).)
- Writing an offset/gain value in the offset/gain setting mode (When 'User range write request' (YA) is turned off and on)

When restoring the offset/gain setting value in user range setting, set the same data as the saved data in this area to the corresponding area of the A/D converter module that is the restoration destination.

For the offset/gain setting, refer to the following.

 MELSEC iQ-R Channel Isolated Analog-Digital Converter Module User's Manual (Startup)

■ Default value

The default value is 0 for all channels.



CH1 Offset/gain setting mode

Specify the channel where the offset/gain setting is adjusted.

- Offset/gain setting mode (offset specification): Channel to adjust the offset
- Offset/gain setting mode (gain specification): Channel to adjust the gain

Setting	Setting content
0	Disable
1	Setting channel

Set one of the offset specification or gain specification to the Setting channel (1), and the other to Disable (0). When a value other than 0 and 1 is set, an offset/gain setting channel range error (error code: 1E8□H) occurs.

Multiple channels can be set at the same time. In that case, set the offset specification and gain specification separately. The offset specification and gain specification cannot be set at the same time.

In the following cases, an offset/gain setting channel specification error (error code: 1E50H) occurs.

- When both the offset specification and gain specification of the same channel are set to Setting channel (1)
- When Disable (0) is set for all channels
- When both the offset specification and gain specification of multiple channels are set to Setting channel (1) at the same time

■Buffer memory address

The following shows the buffer memory address of this area.

- CH□ Offset/gain setting mode (offset specification)

CH1	CH2	CH3	CH4	CH5	CH6	CH7	CH8	CH9	CH10	CH11	CH12	CH13	CH14	CH15	CH16
4132	4134	4136	4138	4140	4142	4144	4146	4148	4150	4152	4154	4156	4158	4160	4162

- CH□ Offset/gain setting mode (gain specification)

CH1	CH2	CH3	CH4	CH5	CH6	CH7	CH8	CH9	CH10	CH11	CH12	CH13	CH14	CH15	CH16
4133	4135	4137	4139	4141	4143	4145	4147	4149	4151	4153	4155	4157	4159	4161	4163

■Enabling the setting

Turn off and on 'Channel change request' (YB).

■Default value

The default value is Disable (0) for all channels.

Offset/gain setting mode [Q compatible mode]

When the Q compatible mode function is used, specify the channel where the offset/gain setting is adjusted.

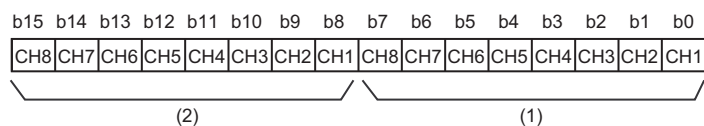

(1) 0: Disable, 1: Setting channel

(2) b8 to b15 are fixed to 0.

■Buffer memory address

The following shows the buffer memory address of this area.

Only the R60AD8-G can use this area.

Buffer memory name	CH1	CH2	CH3	CH4	CH5	CH6	CH7	CH8
Offset/gain setting mode (offset specification) (in Q compatible mode)	22							
Offset/gain setting mode (gain specification) (in Q compatible mode)	23							

■Enabling the setting

Turn off and on 'Channel change request' (YB).

■Default value

The default value is Disable (0).

Point

When the offset/gain setting is configured from the offset/gain setting window of an engineering tool, the setting is performed properly on the window. Therefore, a program is not required to perform the setting. When a sequence program used for the MELSEC-Q series A/D converter module is utilized to configure the offset/gain setting, check that an appropriate value has been set in this area.

For the sequence programs for the MELSEC-Q series A/D converter module, refer to the following.

Channel Isolated Analog-Digital Converter Module/Channel Isolated Analog-Digital Converter Module (With Signal Conditioning Function) User's Manual

CH1 Offset/gain setting mode (range specification)

In the offset/gain setting, specify the current input or voltage input for each channel.

Setting	Setting content
0	Voltage
1	Current

- When a value other than 0 and 1 is set, the setting is regarded as Current (1).
- When an offset/gain value is written in the offset/gain setting mode (When 'User range write request' (YA) is turned off and on), this setting is written to a flash memory.
- This setting is saved in the module-specific backup parameter at the online module change. After the module replacement, the factory default setting to be referred to is determined according to this setting when the offset/gain setting is restored.

■Buffer memory address

The following shows the buffer memory address of this area.

- CH□ Offset/gain setting mode (range specification)

CH1	CH2	CH3	CH4	CH5	CH6	CH7	CH8	CH9	CH10	CH11	CH12	CH13	CH14	CH15	CH16
4164	4165	4166	4167	4168	4169	4170	4171	4172	4173	4174	4175	4176	4177	4178	4179

■Default value

The default value is Voltage (0) for all channels.

At the following timings, the value saved in the flash memory is set.

- When 'Operating condition setting request' (Y9) is turned off and on
- When the operation mode is switched to the offset/gain setting mode

Offset/gain setting mode (range specification) [Q compatible mode]

In the offset/gain setting of the Q compatible mode, specify the current input or voltage input for each channel.

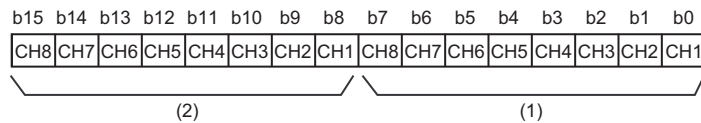

(1) 0: Voltage, 1: Current

(2) b8 to b15 are fixed to 0.

■Buffer memory address

The following shows the buffer memory address of this area.

Only the R60AD8-G can use this area.

Buffer memory name	CH1	CH2	CH3	CH4	CH5	CH6	CH7	CH8
Offset/gain setting mode (range specification) (in Q compatible mode)	26							

■Default value

The default value is Voltage (0).

Command area for module invalidation

For the R60AD8-G with the safety module function enabled, set this area to 1234H to disable the safety module function in standard mode.

■Buffer memory address

The following shows the buffer memory address of this area.

Only the R60AD8-G can use this area.

Buffer memory name	CH1	CH2	CH3	CH4	CH5	CH6	CH7	CH8
Command area for module invalidation	4200							

■Enabling the setting

Turn on and off 'Operating condition setting request' (Y9) to enable the setting.



If this area is set to a value other than 1234H and 'Operating condition setting request' (Y9) is turned on and off, the safety module function will not be disabled.

■Default value

The default value is set to 0000H.

■Procedure for disabling the safety module

For details, refer to the following.

Page 215 Disabling the Safety Module

Validation status area

Whether the safety module function is enabled or disabled is stored.

Stored value	Description	Remarks
0	Disable	Indicates that the safety module function of the R60AD8-G is disabled.
1	Enable	Indicates that the safety module function of the R60AD8-G is enabled.

If the R60AD8-G is started up in standard mode while the stored value of this area is Enable (1), an error (start-up in standard mode with safety validated (error code: 3040H)) occurs.

■Buffer memory address

The following shows the buffer memory address of this area.

Only the R60AD8-G can use this area.

Buffer memory name	CH1	CH2	CH3	CH4	CH5	CH6	CH7	CH8
Validation status area	4201							

CH1 Logging data

This area stores the data logged by the logging function.

Up to 1000 points of data can be stored per channel. When the number of stored data points is 1001 or greater, data is continuously collected overwriting the data from the head.

For details on the logging function, refer to the following.

 Page 60 Logging Function

■ Buffer memory address

The following shows the buffer memory address of this area.

- CH□ Logging data

CH1	CH2	CH3	CH4	CH5	CH6	CH7	CH8	CH9	CH10	CH11	CH12	CH13	CH14	CH15	CH16
10000 to 10999	11000 to 11999	12000 to 12999	13000 to 13999	14000 to 14999	15000 to 15999	16000 to 16999	17000 to 17999	18000 to 18999	19000 to 19999	20000 to 20999	21000 to 21999	22000 to 22999	23000 to 23999	24000 to 24999	25000 to 25999

- CH□ Logging data (in Q compatible mode)

CH1	CH2	CH3	CH4	CH5	CH6	CH7	CH8	CH9	CH10	CH11	CH12	CH13	CH14	CH15	CH16
5000 to 5999	15000 to 15999	25000 to 25999	35000 to 35999	45000 to 45999	55000 to 55999	65000 to 65999	75000 to 75999	—							

Point

- When 'Operating condition setting request' (Y9) is turned off and on, the logging data in all the channels are cleared.
- When Logging hold request is turned on and off while 'CH1 Logging hold flag' (Un\G409) is on, data logging resumes. In this case, the logged data is not cleared.

Appendix 4 Dedicated Instructions

Instruction list

The following table lists the dedicated instructions that can be used in the A/D converter module.

Instruction	Description
G(P).OFFGAN	Switches normal mode to offset/gain setting mode. Switches offset/gain setting mode to normal mode.
G(P).OGLOAD	Reads out the offset/gain setting value in the user range setting to write it into the CPU module.
G(P).OGSTOR	Restores the offset/gain setting value in the user range setting stored in the CPU module into the A/D converter module.

For details on the dedicated instructions, refer to the following.

 MELSEC iQ-R Programming Manual (Module Dedicated Instructions)

Appendix 5 Operation Examples of When the Remote Head Module Is Mounted

This section describes operation examples of when the remote head module is mounted.

System configuration example

The following system configuration is used to explain an example of operation.

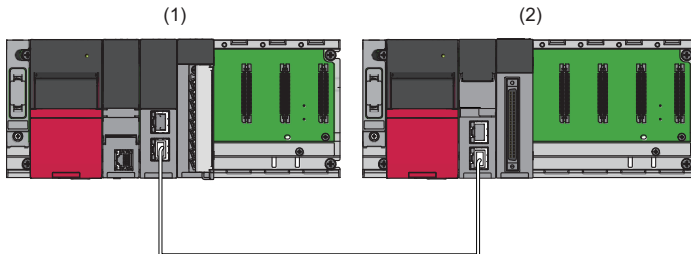

(1) Master station (Network number 1, station number 0)

- Power supply module: R61P
- CPU module: R04CPU
- Master/local module: RJ71GF11-T2 (Start I/O number: 0000H to 001FH)
- Input module: RX10 (Start I/O number: 0020H to 002FH)

(2) Intelligent device station (Network number 1, station number 1)

- Power supply module: R61P
- Remote head module: RJ72GF15-T2
- A/D converter module: R60AD8-G (Start I/O number: 0000H to 000FH^{*1})

*1 In the RX/RX setting of the master station, set 1000H to 100FH as the start I/O number of the A/D converter module.

Setting in the master station

Connect the engineering tool to the CPU module of the master station and set parameters.

1. Create the project with the following settings.

 [Project] ⇒ [New]

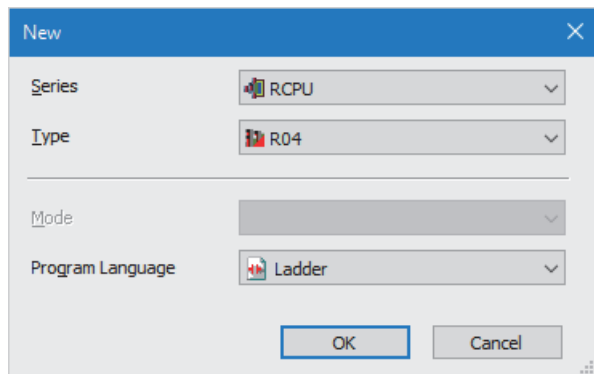

2. Click the [Setting Change] button and set the module to use the module label.
3. Click the [OK] button in the following window to add the module labels of the CPU module.

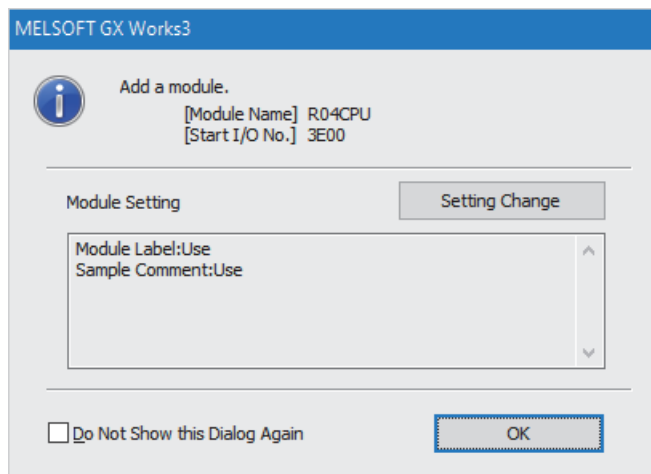

A

4. Add the master/local module with the following settings.

[Navigation window] ⇒ [Parameter] ⇒ [Module Information] ⇒ Right-click ⇒ [Add New Module]

5. Click the [OK] button in the following window to add the module labels of the master/local module.

6. Set "Required Settings" of the module parameter of the master/local module as shown below.

[Navigation window] ⇒ [Parameter] ⇒ [Module Information] ⇒ [RJ71GF11-T2] ⇒ [Required Settings]

Item	Setting
Station Type	
Station Type	Master Station
Network Number	
Network Number	1
Station Number	
Setting Method	Parameter Editor
Station No.	0
Parameter Setting Method	
Setting Method of Basic/Application Settings	Parameter Editor

7. Set "Network Configuration Settings" of the module parameter of the master/local module as shown below.

[Navigation window] ⇒ [Parameter] ⇒ [Module Information] ⇒ [RJ71GF11-T2] ⇒ [Basic Settings] ⇒ [Network Configuration Settings]

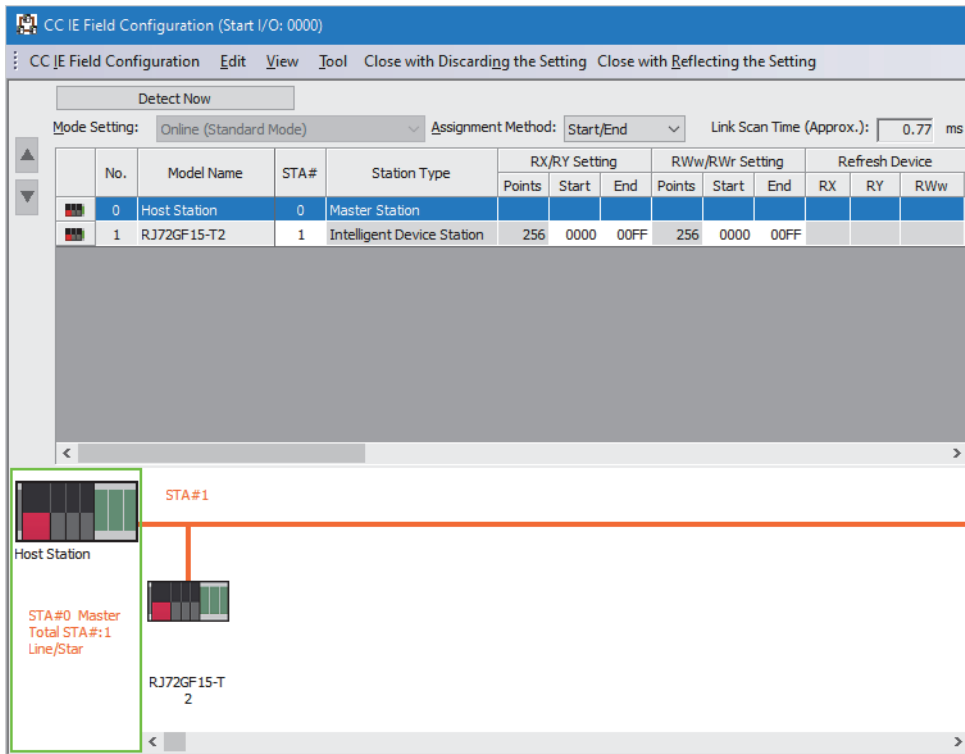

8. Set "Refresh Setting" of the module parameter of the master/local module as shown below.

[Navigation window] ⇒ [Parameter] ⇒ [Module Information] ⇒ [RJ71GF11-T2] ⇒ [Basic Settings] ⇒ [Refresh Setting]

No.	Link Side					CPU Side				
	Device Name	Points	Start	End		Target	Device Name	Points	Start	End
-	SB	512	00000	001FF	↔	Module Label				
-	SW	512	00000	001FF	↔	Module Label				
1	RX	256	00000	000FF	↔	Specify Device	X	256	01000	010FF
2	RY	256	00000	000FF	↔	Specify Device	Y	256	01000	010FF
3	RWw	256	00000	000FF	↔	Specify Device	W	256	00000	000FF
4	RWr	256	00000	000FF	↔	Specify Device	W	256	01000	010FF
5					↔					

9. Write the set parameters to the CPU module on the master station. Then reset the CPU module or power off and on the system.

[Online] ⇒ [Write to PLC]



Point

For parameters of the master/local module which are not described in this procedure, set default values. For details on parameters of the master/local module, refer to the following.

📖 MELSEC iQ-R CC-Link IE Field Network User's Manual (Application)

Setting in the intelligent device station

Connect the engineering tool to the remote head module of the intelligent device station and set parameters.

1. Create the project with the following settings.

[Project] ⇒ [New]

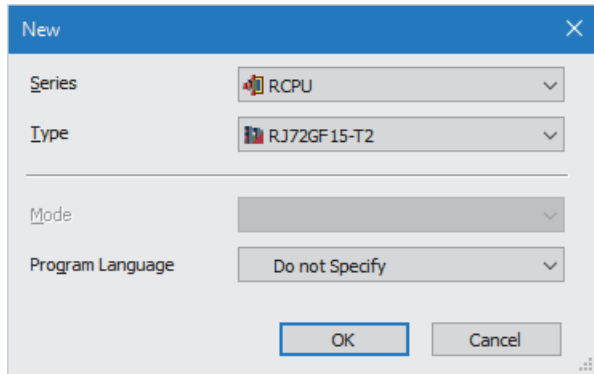

2. Set "Network Required Setting" of "CPU Parameter" of the remote head module as shown below.

[Navigation window] ⇒ [Parameter] ⇒ [RJ72GF15-T2] ⇒ [CPU Parameter] ⇒ [Network Required Setting]

Item	Setting
Network Number	
Network Number	1
Station Number	
Station No.	1

3. Add the A/D converter module with the following settings.

[Navigation window] ⇒ [Parameter] ⇒ [Module Information] ⇒ Right-click ⇒ [Add New Module]

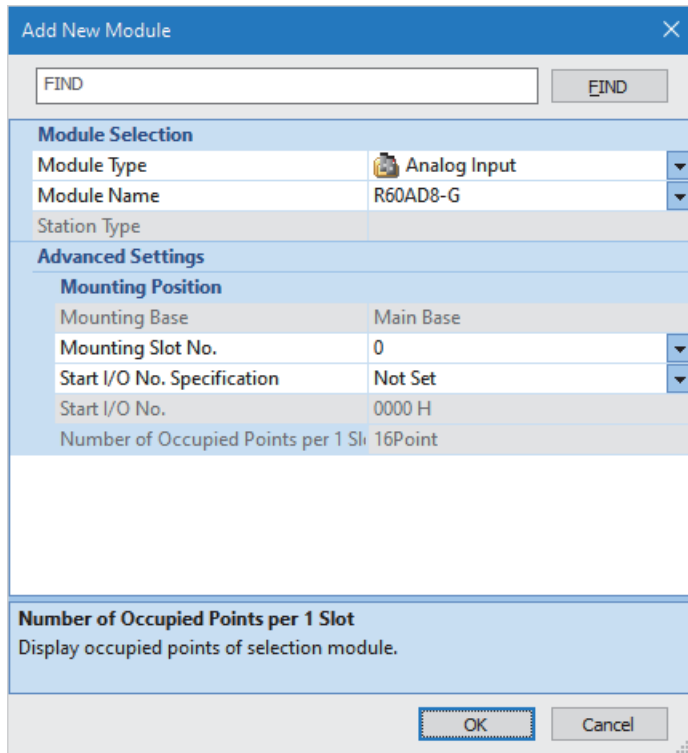

4. Configure the setting not to use the module labels.

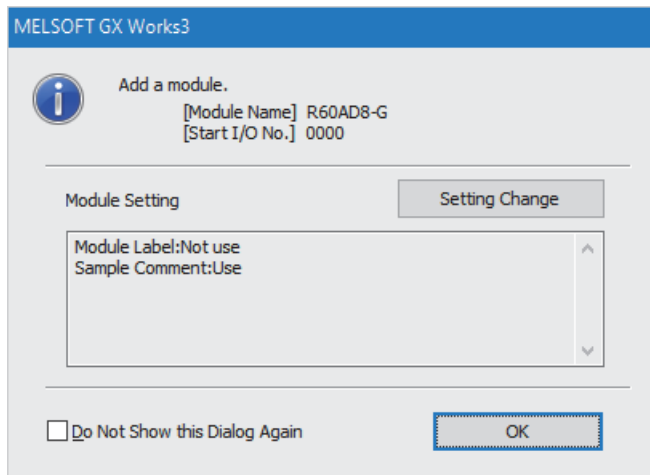

5. Set "Basic setting" of the module parameter of the A/D converter module as shown below.

[Navigation window] ⇒ [Parameter] ⇒ [Module Information] ⇒ [R60AD8-G] ⇒ [Basic setting]

Item	CH1	CH2	CH3	CH4	CH5	CH6	CH7	CH8
Range switching function	The input range of the analog input can be set for each channel and the input conversion attribute can be changed.							
Input range setting	0 to 10V	4 to 20mA	0 to 10V	4 to 20mA	0 to 20mA	4 to 20mA	4 to 20mA	4 to 20mA
Operation mode setting function	The two operation modes, "Normal mode" to execute the normal A/D conversion and "Offset/gain setting mode" to execute the offset/gain setting, can be set.							
Operation mode setting	Normal mode (A/D conversion process)							
A/D conversion enable/disable setting function	Set whether to enable or disable the output of the A/D conversion value.							
A/D conversion enable/disable setting	A/D conversion enable A/D conversion disable A/D conversion enable A/D conversion disable A/D conversion enable A/D conversion enable A/D conversion enable A/D conversion disable							
A/D conversion method	Set the A/D conversion control method.							
Average processing setting	Sampling processing	Sampling processing	Count average	Sampling processing	Moving average	Sampling processing	Sampling processing	Sampling processing
Time average/Count average/Moving average/Primary delay filter constant setting	0	0	50 times	0	10 times	0	0	0



6. Set "Application setting" of the module parameter of the A/D converter module as shown below.

[Navigation window] ⇒ [Parameter] ⇒ [Module Information] ⇒ [R60AD8-G] ⇒ [Application setting]

Item	CH1	CH2	CH3	CH4	CH5	CH6	CH7	CH8
Scaling function	Configure the setting for the scaling at the A/D conversion.							
Scaling enable/disable setting	Disable	Disable	Disable	Disable	Enable	Disable	Disable	Disable
Scaling upper limit value	0	0	0	0	16000	0	0	0
Scaling lower limit value	0	0	0	0	2000	0	0	0
Shift function	Configure the setting for the shift function at the A/D conversion.							
Conversion value shift	0	0	0	0	2000	0	0	0
Digital clipping function	Configure the setting for the digital clipping function at the A/D conversion.							
Digitalclip enable/disable setting	Disable	Disable	Disable	Disable	Enable	Disable	Disable	Disable
Warning output function (Process alarm)	Set an alert at the A/D conversion.							
Warning output setting (Process alarm)	Disable	Disable	Enable	Disable	Disable	Disable	Disable	Disable
Process alarm upper upper limit value	0	0	32000	0	0	0	0	0
Process alarm upper lower limit value	0	0	28000	0	0	0	0	0
Process alarm lower upper limit value	0	0	4000	0	0	0	0	0
Process alarm lower lower limit value	0	0	0	0	0	0	0	0
Warning output function (Rate alarm)	Set an alert at the A/D conversion.							
Warning output setting (Rate alarm)	Enable	Disable	Disable	Disable	Disable	Disable	Disable	Disable
Rate alarm detection cycle setting	400 times	0 times	0 times	0 times	0 times	0 times	0 times	0 times
Rate alarm upper limit value	25.0 %	0.0 %	0.0 %	0.0 %	0.0 %	0.0 %	0.0 %	0.0 %
Rate alarm lower limit value	-5.0 %	0.0 %	0.0 %	0.0 %	0.0 %	0.0 %	0.0 %	0.0 %
Input signal error detection function	Configure the setting for the input signal at the A/D conversion.							
Input signal error detection setting	Upper limit detection	Disable	Disable	Disable	Disable	Disable	Disable	Disable
Input signal error detection lower limit setting value	5.0 %	5.0 %	5.0 %	5.0 %	5.0 %	5.0 %	5.0 %	5.0 %
Input signal error detection upper limit setting value	8.0 %	5.0 %	5.0 %	5.0 %	5.0 %	5.0 %	5.0 %	5.0 %
Input signal error detection auto clear enable/disable setting	Disable							
Logging function	Configure the setting for the logging function at the A/D conversion.							
Logging enable/disable setting	Disable	Disable	Disable	Disable	Disable	Disable	Disable	Disable
Logging data setting	Digital operation value	Digital operation value	Digital operation value	Digital operation value	Digital operation value	Digital operation value	Digital operation value	Digital operation value
Logging cycle setting value	160 ms	160 ms	160 ms	160 ms	160 ms	160 ms	160 ms	160 ms
Logging cycle unit setting	ms	ms	ms	ms	ms	ms	ms	ms
Level trigger condition setting	Disable	Disable	Disable	Disable	Disable	Disable	Disable	Disable
Logging points after triaser	500	500	500	500	500	500	500	500
Triaser data	402	602	802	1002	1202	1402	1602	1802
Triaser setting value	0	0	0	0	0	0	0	0
Logging loading enable/disable setting	Disable	Disable	Disable	Disable	Disable	Disable	Disable	Disable
Logging read points setting value	100	100	100	100	100	100	100	100
Online module change	The module can be changed without the system being stopped.							
Auto restore of Offset/ gain setting with the module change	Enable							

7. Set "Refresh settings" of the module parameter of the A/D converter module as shown below.

 [Navigation window] ⇒ [Parameter] ⇒ [Module Information] ⇒ [R60AD8-G] ⇒ [Refresh settings]

Item	CH1	CH2	CH3	CH4	CH5	CH6	CH7	CH8
<input type="checkbox"/> Refresh at the set timing.								
<input type="checkbox"/> Transfer to the intelligent function module.	Transfer the buffer memory data to the specified device.							
<input type="checkbox"/> Transfer to the CPU.	Transfer the buffer memory data to the specified device.							
Latest error code	W1020							
Latest address of error history								
Latest alarm code								
Latest address of alarm history								
Interrupt factor detection flag 1								
Interrupt factor detection flag 2								
Interrupt factor detection flag 3								
Interrupt factor detection flag 4								
Interrupt factor detection flag 5								
Interrupt factor detection flag 6								
Interrupt factor detection flag 7								
Interrupt factor detection flag 8								
Interrupt factor detection flag 9								
Interrupt factor detection flag 10								
Interrupt factor detection flag 11								
Interrupt factor detection flag 12								
Interrupt factor detection flag 13								
Interrupt factor detection flag 14								
Interrupt factor detection flag 15								
Interrupt factor detection flag 16								
Warning output flag (Process alarm upper limit)	W1010							
Warning output flag (Process alarm lower limit)	W1011							
Warning output flag (Rate alarm upper limit)	W1012							
Warning output flag (Rate alarm lower limit)	W1013							
Input signal error detection flag	W1014							
A/D conversion completed flag	W1000							
Digital output value	W1001		W1002				W1004	
Digital operation value					W1003			
Maximum value					W1005			
Minimum value					W1006			
Difference conversion state flag								
Logging hold flag								
Digital output value(32bit)								

8. Write the set parameters to the remote head module on the intelligent device station. Then reset the remote head module or power off and on the system.

 [Online] ⇒ [Write to PLC]



Point 

For parameters of the remote head module which are not described in this procedure, set default values. For details on parameters of the remote head module, refer to the following.

-  MELSEC iQ-R CC-Link IE Field Network Remote Head Module User's Manual (Application)

Checking the network status

After setting parameters to the master station and the intelligent device station, check whether data link is normally performed between the master station and the intelligent device station. Check the network status using the CC-Link IE Field Network diagnostics of the engineering tool.

For how to perform the CC-Link IE Field Network diagnostics from the master station, refer to the following.

 MELSEC iQ-R CC-Link IE Field Network User's Manual (Application)

Program examples

For the program examples, the module labels of the master/local module are used.

Write the programs to the CPU module on the master station.

Classification	Label name	Description	Device																																																																																																																																																																
Module label	GF11_1.bSts_DataLinkError	Data link error status of own station	SB0049																																																																																																																																																																
	GF11_1.bnSts_DataLinkError_Station[1]	Data link status of each station (station number 1)	SW00B0.0																																																																																																																																																																
Label to be defined	Define global labels as shown below:																																																																																																																																																																		
	<table border="1"> <thead> <tr> <th>Label Name</th> <th>Data Type</th> <th>Class</th> <th>Assign (Device/)</th> </tr> </thead> <tbody> <tr><td>CH1_DigOutValTempArea</td><td>Word [Signed]</td><td>VAR_GLOBAL</td><td>D1 1</td></tr> <tr><td>CH3_DigOutValTempArea</td><td>Word [Signed]</td><td>VAR_GLOBAL</td><td>D1 2</td></tr> <tr><td>CH5_DigCalcValTempArea</td><td>Word [Signed]</td><td>VAR_GLOBAL</td><td>D1 3</td></tr> <tr><td>CH7_DigOutValTempArea</td><td>Word [Signed]</td><td>VAR_GLOBAL</td><td>D1 4</td></tr> <tr><td>CH5_DigMaxValTempArea</td><td>Word [Signed]</td><td>VAR_GLOBAL</td><td>D1 5</td></tr> <tr><td>CH5_DigMinValTempArea</td><td>Word [Signed]</td><td>VAR_GLOBAL</td><td>D1 6</td></tr> <tr><td>CH1_DigOutVal</td><td>Word [Signed]</td><td>VAR_GLOBAL</td><td>W1 001</td></tr> <tr><td>CH3_DigOutVal</td><td>Word [Signed]</td><td>VAR_GLOBAL</td><td>W1 002</td></tr> <tr><td>CH5_DigCalcVal</td><td>Word [Signed]</td><td>VAR_GLOBAL</td><td>W1 003</td></tr> <tr><td>CH7_DigOutVal</td><td>Word [Signed]</td><td>VAR_GLOBAL</td><td>W1 004</td></tr> <tr><td>CH5_DigMaxVal</td><td>Word [Signed]</td><td>VAR_GLOBAL</td><td>W1 005</td></tr> <tr><td>CH5_DigMinVal</td><td>Word [Signed]</td><td>VAR_GLOBAL</td><td>W1 006</td></tr> <tr><td>CH1_AD_conversionCompleteFlag</td><td>Bit</td><td>VAR_GLOBAL</td><td>W1 000.0</td></tr> <tr><td>CH3_AD_conversionCompleteFlag</td><td>Bit</td><td>VAR_GLOBAL</td><td>W1 000.2</td></tr> <tr><td>CH5_AD_conversionCompleteFlag</td><td>Bit</td><td>VAR_GLOBAL</td><td>W1 000.4</td></tr> <tr><td>CH7_AD_conversionCompleteFlag</td><td>Bit</td><td>VAR_GLOBAL</td><td>W1 000.6</td></tr> <tr><td>CH3_WarningOutputFlagProcessAlarmUpperLimit</td><td>Bit</td><td>VAR_GLOBAL</td><td>W1 01 0.2</td></tr> <tr><td>CH3_WarningOutputFlagProcessAlarmLowerLimit</td><td>Bit</td><td>VAR_GLOBAL</td><td>W1 01 1.2</td></tr> <tr><td>CH1_WarningOutputFlagRateAlarmUpperLimit</td><td>Bit</td><td>VAR_GLOBAL</td><td>W1 01 2.0</td></tr> <tr><td>CH1_WarningOutputFlagRateAlarmLowerLimit</td><td>Bit</td><td>VAR_GLOBAL</td><td>W1 01 3.0</td></tr> <tr><td>CH1_InputSignalErrorDetectionFlag</td><td>Bit</td><td>VAR_GLOBAL</td><td>W1 01 4.0</td></tr> <tr><td>CH3_ProcAlmUpLimit</td><td>Bit</td><td>VAR_GLOBAL</td><td>F0</td></tr> <tr><td>CH3_ProcAlmLowLimit</td><td>Bit</td><td>VAR_GLOBAL</td><td>F1</td></tr> <tr><td>CH1_RateAlmUpLimit</td><td>Bit</td><td>VAR_GLOBAL</td><td>F2</td></tr> <tr><td>CH1_RateAlmLowLimit</td><td>Bit</td><td>VAR_GLOBAL</td><td>F3</td></tr> <tr><td>CH1_InputSigErr</td><td>Bit</td><td>VAR_GLOBAL</td><td>F4</td></tr> <tr><td>DigitOutValSig</td><td>Bit</td><td>VAR_GLOBAL</td><td>X20</td></tr> <tr><td>MaxMinReadSig</td><td>Bit</td><td>VAR_GLOBAL</td><td>X21</td></tr> <tr><td>MaxMinResetSig</td><td>Bit</td><td>VAR_GLOBAL</td><td>X22</td></tr> <tr><td>ErrResetSig</td><td>Bit</td><td>VAR_GLOBAL</td><td>X23</td></tr> <tr><td>ModuleREADY</td><td>Bit</td><td>VAR_GLOBAL</td><td>X1 000</td></tr> <tr><td>InputSignalErrorDetectionSignal</td><td>Bit</td><td>VAR_GLOBAL</td><td>X1 00C</td></tr> <tr><td>MaxValueMinValueResetCompleteFlag</td><td>Bit</td><td>VAR_GLOBAL</td><td>X1 00D</td></tr> <tr><td>AD_conversionCompleteFlag</td><td>Bit</td><td>VAR_GLOBAL</td><td>X1 00E</td></tr> <tr><td>ErrorFlag</td><td>Bit</td><td>VAR_GLOBAL</td><td>X1 00F</td></tr> <tr><td>OperatingConditionSettingRequest</td><td>Bit</td><td>VAR_GLOBAL</td><td>Y1 003</td></tr> <tr><td>MaxValueMinValueResetRequest</td><td>Bit</td><td>VAR_GLOBAL</td><td>Y1 00D</td></tr> <tr><td>ErrorClearRequest</td><td>Bit</td><td>VAR_GLOBAL</td><td>Y1 00F</td></tr> <tr><td>Connect_FormationFlag_St1</td><td>Bit</td><td>VAR_GLOBAL</td><td>M0</td></tr> </tbody> </table>	Label Name	Data Type	Class	Assign (Device/)	CH1_DigOutValTempArea	Word [Signed]	VAR_GLOBAL	D1 1	CH3_DigOutValTempArea	Word [Signed]	VAR_GLOBAL	D1 2	CH5_DigCalcValTempArea	Word [Signed]	VAR_GLOBAL	D1 3	CH7_DigOutValTempArea	Word [Signed]	VAR_GLOBAL	D1 4	CH5_DigMaxValTempArea	Word [Signed]	VAR_GLOBAL	D1 5	CH5_DigMinValTempArea	Word [Signed]	VAR_GLOBAL	D1 6	CH1_DigOutVal	Word [Signed]	VAR_GLOBAL	W1 001	CH3_DigOutVal	Word [Signed]	VAR_GLOBAL	W1 002	CH5_DigCalcVal	Word [Signed]	VAR_GLOBAL	W1 003	CH7_DigOutVal	Word [Signed]	VAR_GLOBAL	W1 004	CH5_DigMaxVal	Word [Signed]	VAR_GLOBAL	W1 005	CH5_DigMinVal	Word [Signed]	VAR_GLOBAL	W1 006	CH1_AD_conversionCompleteFlag	Bit	VAR_GLOBAL	W1 000.0	CH3_AD_conversionCompleteFlag	Bit	VAR_GLOBAL	W1 000.2	CH5_AD_conversionCompleteFlag	Bit	VAR_GLOBAL	W1 000.4	CH7_AD_conversionCompleteFlag	Bit	VAR_GLOBAL	W1 000.6	CH3_WarningOutputFlagProcessAlarmUpperLimit	Bit	VAR_GLOBAL	W1 01 0.2	CH3_WarningOutputFlagProcessAlarmLowerLimit	Bit	VAR_GLOBAL	W1 01 1.2	CH1_WarningOutputFlagRateAlarmUpperLimit	Bit	VAR_GLOBAL	W1 01 2.0	CH1_WarningOutputFlagRateAlarmLowerLimit	Bit	VAR_GLOBAL	W1 01 3.0	CH1_InputSignalErrorDetectionFlag	Bit	VAR_GLOBAL	W1 01 4.0	CH3_ProcAlmUpLimit	Bit	VAR_GLOBAL	F0	CH3_ProcAlmLowLimit	Bit	VAR_GLOBAL	F1	CH1_RateAlmUpLimit	Bit	VAR_GLOBAL	F2	CH1_RateAlmLowLimit	Bit	VAR_GLOBAL	F3	CH1_InputSigErr	Bit	VAR_GLOBAL	F4	DigitOutValSig	Bit	VAR_GLOBAL	X20	MaxMinReadSig	Bit	VAR_GLOBAL	X21	MaxMinResetSig	Bit	VAR_GLOBAL	X22	ErrResetSig	Bit	VAR_GLOBAL	X23	ModuleREADY	Bit	VAR_GLOBAL	X1 000	InputSignalErrorDetectionSignal	Bit	VAR_GLOBAL	X1 00C	MaxValueMinValueResetCompleteFlag	Bit	VAR_GLOBAL	X1 00D	AD_conversionCompleteFlag	Bit	VAR_GLOBAL	X1 00E	ErrorFlag	Bit	VAR_GLOBAL	X1 00F	OperatingConditionSettingRequest	Bit	VAR_GLOBAL	Y1 003	MaxValueMinValueResetRequest	Bit	VAR_GLOBAL	Y1 00D	ErrorClearRequest	Bit	VAR_GLOBAL	Y1 00F	Connect_FormationFlag_St1	Bit	VAR_GLOBAL	M0		
Label Name	Data Type	Class	Assign (Device/)																																																																																																																																																																
CH1_DigOutValTempArea	Word [Signed]	VAR_GLOBAL	D1 1																																																																																																																																																																
CH3_DigOutValTempArea	Word [Signed]	VAR_GLOBAL	D1 2																																																																																																																																																																
CH5_DigCalcValTempArea	Word [Signed]	VAR_GLOBAL	D1 3																																																																																																																																																																
CH7_DigOutValTempArea	Word [Signed]	VAR_GLOBAL	D1 4																																																																																																																																																																
CH5_DigMaxValTempArea	Word [Signed]	VAR_GLOBAL	D1 5																																																																																																																																																																
CH5_DigMinValTempArea	Word [Signed]	VAR_GLOBAL	D1 6																																																																																																																																																																
CH1_DigOutVal	Word [Signed]	VAR_GLOBAL	W1 001																																																																																																																																																																
CH3_DigOutVal	Word [Signed]	VAR_GLOBAL	W1 002																																																																																																																																																																
CH5_DigCalcVal	Word [Signed]	VAR_GLOBAL	W1 003																																																																																																																																																																
CH7_DigOutVal	Word [Signed]	VAR_GLOBAL	W1 004																																																																																																																																																																
CH5_DigMaxVal	Word [Signed]	VAR_GLOBAL	W1 005																																																																																																																																																																
CH5_DigMinVal	Word [Signed]	VAR_GLOBAL	W1 006																																																																																																																																																																
CH1_AD_conversionCompleteFlag	Bit	VAR_GLOBAL	W1 000.0																																																																																																																																																																
CH3_AD_conversionCompleteFlag	Bit	VAR_GLOBAL	W1 000.2																																																																																																																																																																
CH5_AD_conversionCompleteFlag	Bit	VAR_GLOBAL	W1 000.4																																																																																																																																																																
CH7_AD_conversionCompleteFlag	Bit	VAR_GLOBAL	W1 000.6																																																																																																																																																																
CH3_WarningOutputFlagProcessAlarmUpperLimit	Bit	VAR_GLOBAL	W1 01 0.2																																																																																																																																																																
CH3_WarningOutputFlagProcessAlarmLowerLimit	Bit	VAR_GLOBAL	W1 01 1.2																																																																																																																																																																
CH1_WarningOutputFlagRateAlarmUpperLimit	Bit	VAR_GLOBAL	W1 01 2.0																																																																																																																																																																
CH1_WarningOutputFlagRateAlarmLowerLimit	Bit	VAR_GLOBAL	W1 01 3.0																																																																																																																																																																
CH1_InputSignalErrorDetectionFlag	Bit	VAR_GLOBAL	W1 01 4.0																																																																																																																																																																
CH3_ProcAlmUpLimit	Bit	VAR_GLOBAL	F0																																																																																																																																																																
CH3_ProcAlmLowLimit	Bit	VAR_GLOBAL	F1																																																																																																																																																																
CH1_RateAlmUpLimit	Bit	VAR_GLOBAL	F2																																																																																																																																																																
CH1_RateAlmLowLimit	Bit	VAR_GLOBAL	F3																																																																																																																																																																
CH1_InputSigErr	Bit	VAR_GLOBAL	F4																																																																																																																																																																
DigitOutValSig	Bit	VAR_GLOBAL	X20																																																																																																																																																																
MaxMinReadSig	Bit	VAR_GLOBAL	X21																																																																																																																																																																
MaxMinResetSig	Bit	VAR_GLOBAL	X22																																																																																																																																																																
ErrResetSig	Bit	VAR_GLOBAL	X23																																																																																																																																																																
ModuleREADY	Bit	VAR_GLOBAL	X1 000																																																																																																																																																																
InputSignalErrorDetectionSignal	Bit	VAR_GLOBAL	X1 00C																																																																																																																																																																
MaxValueMinValueResetCompleteFlag	Bit	VAR_GLOBAL	X1 00D																																																																																																																																																																
AD_conversionCompleteFlag	Bit	VAR_GLOBAL	X1 00E																																																																																																																																																																
ErrorFlag	Bit	VAR_GLOBAL	X1 00F																																																																																																																																																																
OperatingConditionSettingRequest	Bit	VAR_GLOBAL	Y1 003																																																																																																																																																																
MaxValueMinValueResetRequest	Bit	VAR_GLOBAL	Y1 00D																																																																																																																																																																
ErrorClearRequest	Bit	VAR_GLOBAL	Y1 00F																																																																																																																																																																
Connect_FormationFlag_St1	Bit	VAR_GLOBAL	M0																																																																																																																																																																

Common program

The following figure shows an example of the program to check the data link status of the remote head module (station number 1).

(0)	GF11_1.bnSts_DataLinkError	GF11_1.bnSts_DataLinkError_Station[1]								MC	NO	Connect_FormationFlg_St1 M0
	Connect_FormationFlg_St1 M0											
	NO	M0										

(0) Checks the data link status of the remote head module (station number 1).

Add the MCR instruction shown below to the last of the program.

(175)											MCR	NO
-------	--	--	--	--	--	--	--	--	--	--	-----	----

Program example 1

The following figure shows an example of the program to read digital output values of CH1, CH3, and CH7 and digital operation values of CH5 and save them.

(32)	DigitOutValSig X20	ModuleREADY X1000	A_D_conversionCompletedFlag X100E	OperatingConditionSettingRequest Y1009	CH1_AD_conversionCompletedFlag W1000.0						MOV	CH1_DigOutputVal W1001	CH1_DigOutputValTempArea D11
	CH3_AD_conversionCompletedFlag W1000.2												
	CH3_DigOutputVal W1002												
	CH3_DigOutputValTempArea D12												
	CH5_AD_conversionCompletedFlag W1000.4												
	CH5_DigCalcVal W1003												
	CH5_DigCalcValTempArea D13												
	CH7_AD_conversionCompletedFlag W1000.6												
	CH7_DigOutputVal W1004												
	CH7_DigOutputValTempArea D14												

(32) Reads values of CH1 Digital output value, CH3 Digital output value, CH5 Digital operation value, and CH7 Digital output value.

Program example 2

The following figure shows an example of the program to read a maximum value and a minimum value of CH5 and clear the values after reading out them.

(66)	MaxMinReadSig X21	ModuleREADY X1000	A_D_conversionCompletedFlag X100E	OperatingConditionSettingRequest Y1009	MaxValueMinValueResetCompletedFlag X100D							MOV	CH5_DigMaxVal W1005	CH5_DigMaxValTempArea D15
	CH5_DigMinVal W1006													
	CH5_DigMinValTempArea D16													
(88)	MaxMinResetSig X22											SET	MaxValueMinValueResetRequest Y100D	
(91)	MaxValueMinValueResetRequest Y100D	MaxValueMinValueResetCompletedFlag X100D											RST	MaxValueMinValueResetRequest Y100D

(66) Reads values of CH5 Maximum value and CH5 Minimum value.

(88) Turns on 'Maximum value/minimum value reset request' (Y100D).

(91) Turns off 'Maximum value/minimum value reset request' (Y100D).

A

Program example 3

The following figure shows an example of the program to perform operations reacting to an alert if an alert (process alarm upper/lower limit) occurs in CH3.

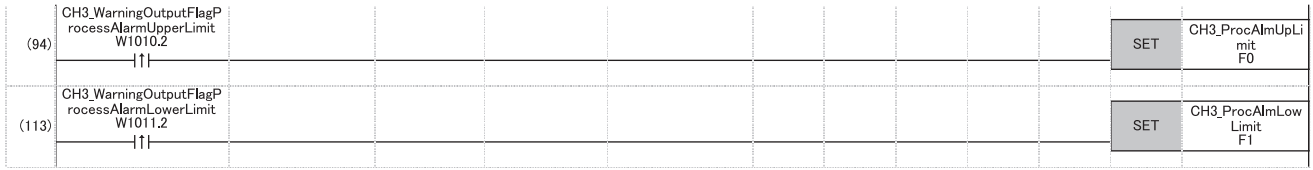

- (94) Performs a processing of when an alert (process alarm upper limit) has occurred in CH3.
- (113) Performs a processing of when an alert (process alarm lower limit) has occurred in CH3.

Program example 4

The following figure shows an example of the program to perform operations reacting to an alert if an alert (rate alarm upper/lower limit) occurs in CH1.

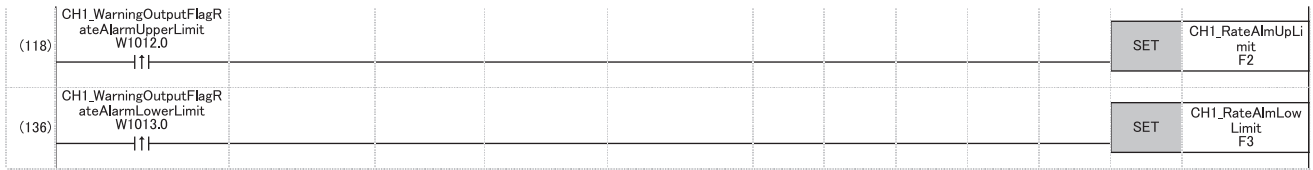

- (118) Performs a processing of when an alert (rate alarm upper limit) has occurred in CH1.
- (136) Performs a processing of when an alert (rate alarm lower limit) has occurred in CH1.

Program example 5

The following figure shows an example of the program to clear Input signal error detection flag, Error flag, and Latest error code if an input signal error is detected in CH1 or an error occurs in any of the channels.

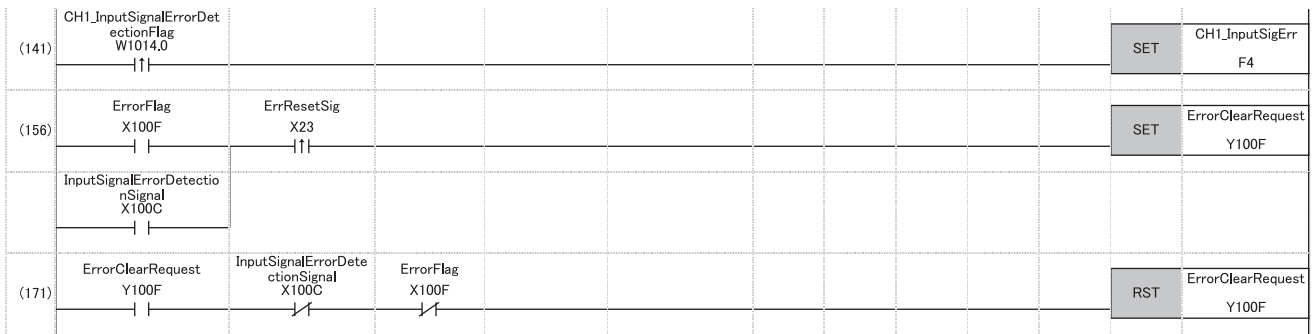

- (141) Performs a processing of when an input signal error was detected in CH1.
- (156) Turns on 'Error clear request' (Y100F).
- (171) Turns off 'Error clear request' (Y100F).

Appendix 6 Disabling the Safety Module

For the R60AD8-G whose safety module for SIL2 mode was enabled in a different system, to use this module in standard mode, disabling its safety module function is required. If the R60AD8-G with the safety module function enabled is started up in standard mode, an error (start-up in standard mode with safety validated (error code: 3040H)) occurs. The R60AD8-G does not operate normally until its safety module function becomes disabled.

Safety module validity status check

Whether the safety module function is enabled or not can be checked with Validation status area (Un\G4201).

- The R60AD8-G does not operate normally in standard mode while Enable (1) is stored in Validation status area (Un\G4201). In such a case, disabling the safety module function is required. Note that for the R60AD8-G operating in standard mode, its safety module function cannot be disabled through "Safety Module Operation" of GX Works3.
- The R60AD8-G operates normally in standard mode when Disable (0) is stored in Validation status area (Un\G4201). In this case, disabling the safety module function is not required.

Procedure for disabling the safety module

1. Set Command area for module invalidation (Un\G4200) to 1234H and turn on and off 'Operating condition setting request' (Y9). This operation disables the safety module function of the R60AD8-G.
2. To check whether the safety module function becomes disabled or not, refer to the table below.

Disabling the safety module	Description
Succeeded	<ul style="list-style-type: none"> • Disable (0) is stored in Validation status area (Un\G4201). • The ALM LED flashes (400ms cycle). (R60AD8-G waiting for restart)
Failed	<ul style="list-style-type: none"> • Enable (1) remains in Validation status area (Un\G4201). • The ALM LED does not flash (400ms cycle). • Failure of disabling safety module (error code: 1302H) is stored in 'Latest error code' (Un\G0).

3. If disabling the safety module fails, check that a set value in Command area for module invalidation (Un\G4200) is correct, and once again, turn on and off 'Operating condition setting request' (Y9) and check whether the safety module function is disabled.
4. When 'Operating condition setting request' (Y9) is turned on, 'Operating condition setting completed flag' (X9) turns off regardless of the result (succeed or fail) of disabling the safety module function.
3. After checking that the disabling has succeeded, reset the CPU module, or turn off and on the programmable controller's power to restart the R60AD8-G.
4. Check that the ALM LED is off. (The R60AD8-G is operating normally in standard mode.) If the ALM LED is on or flashing (1s cycles), it indicates that an alarm occurred, even though the R60AD8-G is operating in standard mode. Check 'Latest alarm code' (Un\G2), and take actions described in the list of alarm codes. (Page 111 List of Alarm Codes)



Point

When the safety module is disabled, the enabled/disabled state is saved in the flash memory in the module, but note that the number of rewrite operations is limited. The enabled and disabled states can be written up to 250000 times in total. If the number of write operations exceeds 250000, a number of safety module status switching exceeding limit error (error code: 1081H) occurs. In this case, a write operation of the enabled/disabled state is executed, but the result is not guaranteed.

Appendix 7 Using the Module in the Redundant System with Redundant Extension Base Unit

This chapter describes restrictions and precautions for using the A/D converter module that is mounted on the extension base unit in the redundant system.

Restrictions on functions and specifications

Functions

Function	Restriction
Logging function	Cannot be used. When the function is used, proper operation cannot be guaranteed.
Interrupt function	The interrupt program cannot be executed.
Backing up, saving, and restoring offset/gain values	The function cannot be used for either of the following cases. <ul style="list-style-type: none">• When using the module-specific backup parameter• When saving and restoring the values using the dedicated instruction instead of the module-specific backup parameter

Dedicated instructions

Any dedicated instructions of the A/D converter module cannot be used.

Module FBs

Name	Availability
M+R60ADG_SetLoggingParam	Cannot be used.
M+R60ADG_SaveLogging	When the FB is used, proper operation cannot be guaranteed.

Module parameter

■Application setting

Set "Auto restore of Offset/gain setting with the module change" to "Disable".

Precautions

When configuring the offset/gain setting

Connect the engineering tool to the CPU module of the control system.

The engineering tool cannot recognize the A/D converter module if it is connected to the CPU module of the standby system.

Program examples

Unless otherwise specified, program examples provided in this manual and the following manual are for when the module is used in the single CPU system or in the multiple CPU system.

 MELSEC iQ-R Channel Isolated Analog-Digital Converter Module User's Manual (Startup)

When using the module in the redundant system, refer to the following manual and observe the precautions on programming for when using the Process CPU (redundant mode).

 MELSEC iQ-R CPU Module User's Manual (Application)

Signal flow tracking setting

When using the module FBs and applying the program examples to an actual system, set "Signal Flow Memory Tracking Setting" to "Transfer". If not, the module FBs and programs may not work properly when system switching occurs.

 [CPU Parameter] ⇒ [Redundant System Settings] ⇒ [Tracking Setting]

Appendix 8 Added or Modified Function

This section describes the function added to or modified for the A/D converter module.

Addition/modification	Firmware version	Reference
Disabling the safety module (R60AD8-G only)	"02" or later	Page 215 Disabling the Safety Module



MEMO

PART 2 SIL2 MODE

This part consists of the following chapters. These chapters describe the details on using the R60AD8-G in SIL2 mode.

4 OVERVIEW

5 PART NAMES

6 SPECIFICATIONS

7 PROCEDURES BEFORE OPERATION

8 SYSTEM CONFIGURATION

9 INSTALLATION AND WIRING

10 FUNCTIONS

11 PARAMETER SETTINGS

12 EXAMPLE OF OPERATION

13 MAINTENANCE AND INSPECTION

14 TROUBLESHOOTING

APPENDICES (SIL2 MODE)

4 OVERVIEW

The R60AD8-G is equipped with the SIL2 mode certified according to the safety requirements of IEC61508: 2010 SIL2 and IEC61511: 2015 SIL2. This mode is used when a customer builds a SIL2 system using products compliant with IEC61508: 2010 SIL2 or IEC61511: 2015 SIL2.

The R60AD8-G in SIL2 mode can be used to build safety functions for general industry machinery.

Module set

To use the R60AD8-G in SIL2 mode, it is necessary to use the following four modules in combination: two R60AD8-G modules (SIL2 mode), one R60DA8-G module (normal mode), and one RY40PT5B module (normal mode). In addition, configure the settings of R60AD8-G modules using GX Works3 so that a module near the remote head module is handled as Main and another as Sub.

In this manual, these four module structure is referred to as the module set. Also, a system using the module set is referred to as a SIL2 analog input system.

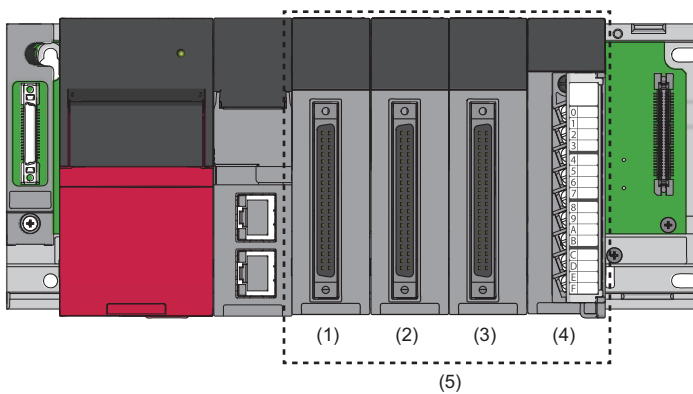

- (1) R60AD8-G set to SIL2 mode and Main
- (2) R60AD8-G set to SIL2 mode and Sub
- (3) R60DA8-G set to normal mode
- (4) RY40PT5B set to normal mode
- (5) Module set

In addition, to use the R60AD8-G in SIL2 mode, a redundant system must be configured based on a redundant master station or redundant line. The module set needs to be mounted with the remote head module.

For details, refer to the following.

➤ Page 235 SYSTEM CONFIGURATION

■R60AD8-G set to SIL2 mode

A/D conversion is performed in both the R60AD8-G (Main) and R60AD8-G (Sub), and the values from the A/D conversion are mutually referenced by the R60AD8-G (Main) and R60AD8-G (Sub). This dual A/D conversion ensures safe A/D conversion. Set the model names as shown in the following table on the module configuration diagram of GX Works3 so that the R60AD8-G module near the remote head module is Main and the other is Sub.

Module	Model name in GX Works3
R60AD8-G (Main)	R60AD8-G(S2M)
R60AD8-G (Sub)	R60AD8-G(S2S)

■R60DA8-G

As the process of the A/D conversion circuit diagnostic function, the R60DA8-G outputs voltage or current for internal diagnostics of the A/D conversion circuit of the R60AD8-G.

In this manual, the R60DA8-G in the module set is referred to as the R60DA8-G for diagnostics.

For details on the A/D conversion circuit diagnostic function, refer to the following.

 Page 285 A/D conversion circuit diagnostic function

■RY40PT5B

Relay is used to switch the analog input source to the R60AD8-G.

- Analog input from the external device
- Analog input from the R60DA8-G for diagnostics

A/D conversion circuit diagnostics is executed by switching to the analog input from the R60DA8-G for diagnostics.

SIL2 diagnostic FB library

To use the R60AD8-G in SIL2 mode, the SIL2 diagnostic FB library is required.

The SIL2 diagnostic FB library consists of SIL2 safety program FB running on the safety program and SIL2 standard program FB running on the standard program.

The SIL2 diagnostic FB library obtained the safety approval and allows building safety application compliant with the IEC61508: 2010 SIL2 and IEC61511: 2015 SIL2.

FB type	FB name	Description
SIL2 safety program FB (Safety program)	M+SIL2ADG_ADConv_R	Double input discrepancy detection and A/D conversion circuit diagnostics are conducted for two R60AD8-G modules.
SIL2 standard program FB (Standard program)	M+SIL2ADG-IEF_WriteDAVal_R	Digital value is set to the R60DA8-G for diagnostics. Also, relay switching is conducted using the RY40PT5B.

For details on the SIL2 diagnostic FB library, refer to the following.

 MELSEC iQ-R Channel Isolated Analog-Digital Converter Module SIL2 Diagnostic Function Block Library Reference

Safety communications

When the R60AD8-G is used in SIL2 mode, safety communications are carried out between the R60AD8-G (Main) and SIL2 Process CPU for data communication.

Safety communications are possible only through the paths with an arrow described as safety connections in the following figure.

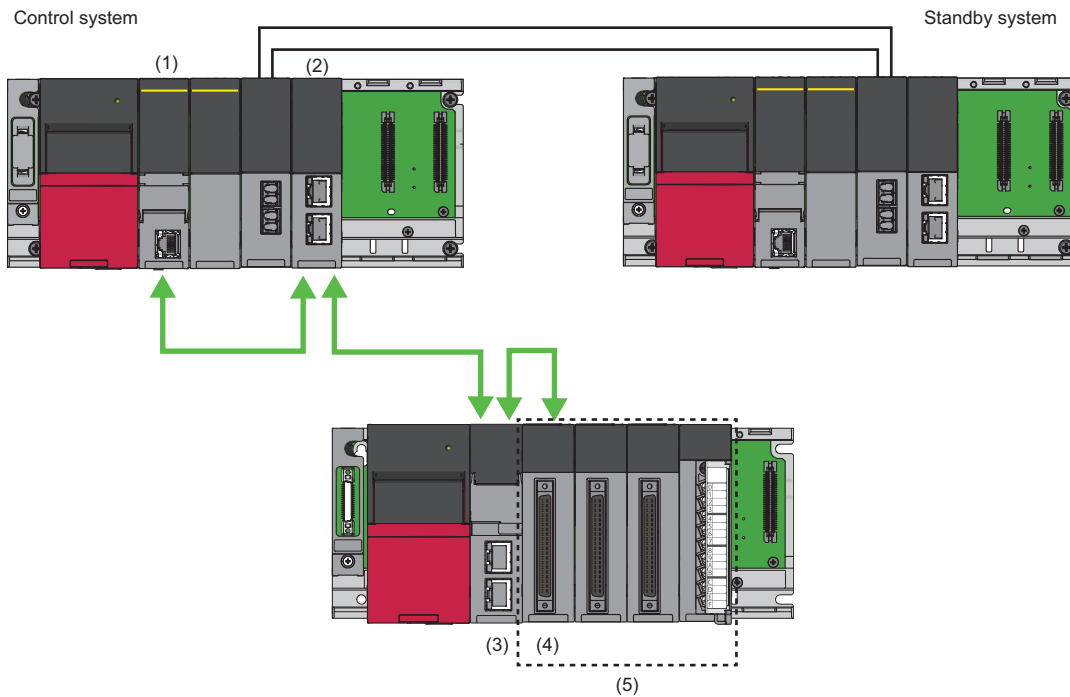

←→ Safety connection (each arrow direction indicates the direction in which a safety connection is possible)

- (1) SIL2 Process CPU
- (2) Master/local module
- (3) Remote head module
- (4) R60AD8-G (Main)
- (5) Module set

5 PART NAMES

Part names of the R60AD8-G are as follows.

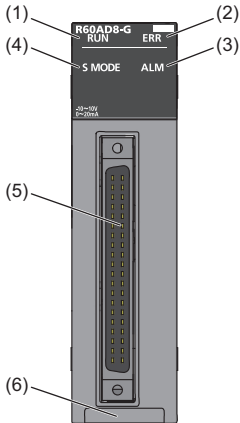

No.	Name	Description
(1)	RUN LED	Indicates the operating status of the module. On: Normal operation Off: 5V power off or a watchdog timer error occurred.
(2)	ERR LED	Indicates the error status of the module.*1 On: An error occurred (minor error). Flashing: An error occurred (moderate error). Off: Normal operation
(3)	ALM LED	Indicates the wait-for-restart status after the safety module is enabled. Flashing (400ms cycles): Wait-for-restart Off: Normal operation
(4)	S MODE LED*2	Indicates the operating status of the module (SIL2 mode). On: SIL2 A/D conversion is ongoing. Flashing (1s cycles): SIL2 A/D conversion is stopped. Flashing (400ms cycles): Executing the module position check*3 Off: Operating in standard mode
(5)	Connector for external devices	Connectors to connect input signal lines for external devices For details on signal layout, refer to the following. ☞ Page 242 Signal layout for the connector for external devices
(6)	Production information marking	Shows the production information (16 digits) of the module.

*1 For details, refer to the following.

☞ Page 319 List of Error Codes

*2 The LED is added to the module with production information (first four digits) of "0207" or later.

*3 For details, refer to the following.

☞ Page 258 Safety module operation

ERR LED behavioral difference from standard mode

In standard mode, the ERR LED turns on if a minor or moderate error occurs. In SIL2 mode, the ERR LED turns on if a minor error occurs and flashes if a moderate error occurs.

MEMO



6 SPECIFICATIONS

This chapter describes the performance specifications and function list of the R60AD8-G in SIL2 mode.

6.1 Performance Specifications

Performance specifications of the R60AD8-G in SIL2 mode are as follows.

Item	Specifications			
Number of analog input channels	8 channels			
Analog input voltage	-10 to 10VDC (Input resistance: 1MΩ)			
Analog input current	0 to 20mADC (input resistance 250Ω)			
Digital output	16-bit signed binary value (-32768 to 32767)			
I/O conversion characteristics, resolution ^{*1}	Analog input range		Digital output value	
	Voltage	0 to 10V	0 to 32000	312.5μV
		0 to 5V		156.3μV
		1 to 5V		125.0μV
		1 to 5V (extended mode)	-8000 to 32767	125.0μV
		-10 to 10V	-32000 to 32000	312.5μV
		User range setting (voltage)		50.0μV ^{*2}
	Current	0 to 20mA	0 to 32000	625.0nA
		4 to 20mA		500.0nA
		4 to 20mA (extended mode)	-8000 to 32767	500.0nA
		User range setting (current)	-32000 to 32000	190.6nA ^{*2}
	Accuracy (Accuracy of the maximum digital output value) ^{*3}	Reference accuracy: Within ±0.1% (±32 digit) ^{*4} Temperature coefficient: ±35ppm/°C (0.0035%/°C) ^{*5}		
Accuracy of double input discrepancy detection	0.5 to 5.0% ^{*10}			
Common mode characteristics	Common mode voltage between input and common ground (input voltage 0V): 500VAC			
	Common mode voltage rejection ratio (VCM < 500V): 60Hz 107dB, 50Hz 106dB			
Conversion speed ^{*6}	12ms/CH			
Response time ^{*7}	20ms			
SIL2 A/D conversion cycle setting	700 to 32767ms ^{*8}			
Control cycle time	12ms			
Absolute maximum input	Voltage: ±15V, Current: 30mA ^{*9}			
Isolation method	Between I/O terminals and programmable controller power supply: Transformer Between analog input channels: Transformer			
Withstand voltage	Between I/O terminals and programmable controller power supply: 500VACrms for 1 minute Between analog input channels: 1000VACrms for 1 minute			
Isolation resistance	Between I/O terminals and programmable controller power supply: 10MΩ or higher, at 500VDC Between analog input channels: 10MΩ or higher, at 500VDC			
Number of occupied I/O points	16 points, 1 slot (I/O assignment: Intelligent 16 points)			
External interface	40-pin connector			
Applicable wire size	When A6CON1 and A6CON4 are used	0.088 to 0.3mm ² (28 to 22 AWG) (stranded wire)		
	When A6CON2 is used	0.088 to 0.24mm ² (28 to 24 AWG) (stranded wire)		
Connector for external devices	A6CON1, A6CON2, A6CON4 (sold separately)			
Internal current consumption (5VDC)	0.33A			
External dimensions	Height	106mm (Base unit mounting side: 98mm)		
	Width	27.8mm		
	Depth	110mm		
Weight	0.19kg			

- *1 For details on the I/O conversion characteristics, refer to the following.
 Page 324 I/O Conversion Characteristics
- *2 A maximum resolution in the user range setting.
- *3 Excluded when the wiring is influenced by noise.
- *4 Accuracy in the ambient temperature when the offset/gain is set
- *5 Accuracy per 1°C temperature change
- *6 Cycle with which the digital output value which is A/D-converted in the module is updated.
- *7 Time until the analog input signal reaches the AD converter in the module
- *8 SIL2 A/D conversion cycle setting can be changed. Set "SIL2 A/D conversion cycle setting". ( Page 274 SIL2 A/D Conversion Function)
- *9 Instantaneous voltage and current values that do not cause any damage to internal resistance of the module.
- *10 The accuracy in a SIL2 analog input system is calculated by the following calculation formula.
 Accuracy of double input discrepancy detection + Accuracy of the R60AD8-G (Main) + Accuracy of the R60AD8-G (Sub)
 Set the accuracy of double input discrepancy detection using "Duplex input error range setting". For details, refer to the following.
 Page 281 Double input discrepancy detection function
 Example) The following example is a formula to calculate the accuracy in a SIL2 analog input system when a temperature change is 5°C (from 25°C to 30°C) and "Duplex input error range setting" is set to 0.5%.
 Accuracy of double input discrepancy detection + Accuracy of the R60AD8-G (Main) + Accuracy of the R60AD8-G (Sub)
 = $(\pm 0.5\%) + ((\pm 0.1\%) + (\pm 0.0035\%/^{\circ}\text{C} \times 5^{\circ}\text{C})) + ((\pm 0.1\%) + (\pm 0.0035\%/^{\circ}\text{C} \times 5^{\circ}\text{C}))$
 = $\pm 0.735\%$ (± 236 digit)

Restriction





When the input power supply to the power supply module is turned on immediately after the power supply module is powered off, the R60AD8-G may not start up. After the power supply module is powered off, wait at least five seconds before turning on the input power supply to the power supply module.

Input response time

The input response time of the R60AD8-G is the time needed to apply a value to the safety device after the analog value is input to the R60AD8-G, as defined by the following formula.

- $\text{SCmst} + (\text{S2cycin} \times 2) + \text{RMin} + \text{SRin} + (\text{nin} \times 2)$

Symbol	Description
SCmst	Safety cycle time of the master station (safety station) ^{*1}
S2cycin	Control cycle time of the R60AD8-G (Main) ^{*2}
RMin	Safety refresh monitoring time for the input connection of the master station (safety station) ^{*3} + Safety I/O HOLD time ^{*5}
SRin	Response time of the R60AD8-G (Main) (20ms)
nin	$\text{RMin} - (\text{TMrmtin} \div 2) - \text{TMrmtin} + c$
c	$\text{TMrmtin} - d$ (This value is effective only if a station set to Passive is the RJ71GF11-T2, or RJ72GF15-T2 to which the R60AD8-G (Main) is mounted. In other cases, the value is 0.)
d	The calculation result of $\text{TMrmtin} \div 2$, which is rounded up to a multiple of the safety cycle time (control cycle time of the R60AD8-G (Main)). ^{*4}
TMmstin	Transmission interval monitoring time for the input connection of the master station (safety station) ^{*3}
TMrmtin	Transmission interval monitoring time of the R60AD8-G (Main) ^{*2}

- *1 For details on the safety cycle time, refer to the following.
 MELSEC iQ-R CPU Module User's Manual (Application)
- *2 For details, refer to the following.
 Page 225 Performance Specifications
- *3 For details, refer to the following.
 MELSEC iQ-R CC-Link IE Field Network User's Manual (Application)
- *4 Calculation example of d:
 When the transmission interval monitoring time is 24ms and safety cycle time is 10ms, the calculation formula is $24 \div 2 = 12$, and the result is rounded up to 20, a multiple of 10.
- *5 For details on the safety I/O HOLD time, refer to the following.
 MELSEC iQ-R CPU Module User's Manual (Application)

6.2 Function List

The function list of the R60AD8-G in SIL2 mode is as follows.

Item		Description	Reference	
Range switching function		This function allows the input range of analog input to be switched for each channel. Switching the range makes it possible to change the I/O conversion characteristics.	Page 265 Range Switching Function	
A/D conversion enable/disable setting function		This function controls whether to enable or disable the A/D conversion for each channel. Disabling the A/D conversion for unused channels reduces the conversion cycles.	Page 266 A/D Conversion Enable/Disable Setting Function	
A/D conversion method	Sampling processing	This function converts analog input values to digital operation values at every sampling period.	Page 266 Sampling processing	
	Averaging processing	Count average	The A/D converter module executes the A/D conversion for a set number of times, and performs the averaging processing on the total value excluding the maximum and the minimum values. The time to complete averaging processing with a set number of times depends on the number of channels where the A/D conversion is enabled.	Page 267 Count average
		Moving average	The A/D converter module averages digital operation values taken at every sampling period for a specified number of times.	Page 268 Moving average
Scaling function		This function performs the scale conversion on digital operation values. The values are converted within a specified range between a scaling upper limit value and scaling lower limit value. This function helps reduce the time taken for creating a scale conversion program.	Page 269 Scaling Function	
Digital clipping function		This function fixes the digital operation value with the maximum digital output value and the minimum digital output value when the corresponding current or voltage exceeds the input range.	Page 272 Digital Clipping Function	
SIL2 A/D conversion function	Double input discrepancy detection function	An error is detected by mutually referencing digital operation values of two R60AD8-G modules.	Page 281 Double input discrepancy detection function	
	A/D conversion circuit diagnostic function	The R60DA8-G for diagnostics regularly inputs an analog value to the R60AD8-G set to SIL2 mode to internally diagnose the A/D conversion circuit of the R60AD8-G.	Page 285 A/D conversion circuit diagnostic function	
	Input HOLD function	This function holds the digital operation value for the specified time after safety refresh data receiving has an interrupt.	Page 288 Input HOLD function	
Self-diagnostic function		This function periodically monitors the operating status of the R60AD8-G, such as the MPU (operation processing unit) operating status, power supply voltage status (overvoltage and undervoltage), safety communications status, and built-in programs operating status, for any errors.	Page 289 Self-diagnostic Function	
Error history function		A maximum of 16 errors of the R60AD8-G error history can be checked with the engineering tool.	Page 290 Error History Function	
Event history function		This function collects errors and operations in the R60AD8-G as event information in the remote head module.	Page 291 Event History Function	



The following function is not available for the R60AD8-G in SIL2 mode.

- Online module change function

7 PROCEDURES BEFORE OPERATION

This chapter describes the procedures before operation to use the R60AD8-G in SIL2 mode.

Offset/gain setting

In SIL2 mode, the user range setting is available but the offset/gain setting is not available.

To use the user range setting, configure the offset/gain setting in a different system in standard mode. (📖 MELSEC iQ-R Channel Isolated Analog-Digital Converter Module User's Manual (Startup))

Record the setting of "Current / Voltage selection" when the offset/gain setting is configured in standard mode. This setting is necessary for setting module parameters of the R60AD8-G set to SIL2 mode. (👉 Page 265 When the user range setting is used)

Installation procedure

1. Installing the battery

Install the battery on the SIL2 Process CPU in both systems. (📖 MELSEC iQ-R CPU Module User's Manual (Startup))

2. Installing an extended SRAM cassette and SD memory card

As necessary, install an extended SRAM cassette and SD memory card on the CPU module in both systems. (📖 MELSEC iQ-R CPU Module User's Manual (Startup))

While accessing the SD memory card, do not power off, reset, or remove the SD memory card. (📖 MELSEC iQ-R CPU Module User's Manual (Application))

3. Installing module

Install each module on the base unit. (👉 Page 235 SYSTEM CONFIGURATION)

Wiring procedure

1. Wiring

Wire each module and external device.

Wiring location	Reference
Wiring the power supply	<ul style="list-style-type: none"> 📖 MELSEC iQ-R Module Configuration Manual
Wiring the redundant function module	<ul style="list-style-type: none"> 👉 Page 235 SYSTEM CONFIGURATION 📖 MELSEC iQ-R CPU Module User's Manual (Application)
Wiring from the master/local module to the remote head module	<ul style="list-style-type: none"> 👉 Page 235 SYSTEM CONFIGURATION 📖 MELSEC iQ-R Ethernet/CC-Link IE User's Manual (Startup) 📖 MELSEC iQ-R CC-Link IE Field Network Remote Head Module User's Manual (Startup)
Wiring the R60AD8-G, R60DA8-G for diagnostics, and RY40PT5B	<ul style="list-style-type: none"> 👉 Page 235 SYSTEM CONFIGURATION 👉 Page 241 INSTALLATION AND WIRING

Procedure on the remote head module side

1. Powering on the system

Check the following items and then power on the system.

- The power supply is wired correctly.
- The power supply voltage satisfies the specifications.
- The remote head module is in STOP state.

2. Creating a project

Start the engineering tool and create a project. (☞ Page 250 Creating a new project (remote head module side))

3. Connecting the personal computer and remote head module

Connect the personal computer with the engineering tool installed, and the remote head module. (📖 MELSEC iQ-R CC-Link IE Field Network Remote Head Module User's Manual (Startup))

4. Initializing the remote head module

Use the engineering tool to initialize the remote head module. (📖 MELSEC iQ-R CC-Link IE Field Network Remote Head Module User's Manual (Startup))

5. Setting parameters on the remote head module side

Set the system parameters, CPU parameters, and module parameters of each module.

- System parameter and CPU parameter setting (☞ Page 250 Creating a new project (remote head module side), Page 250 Setting parameters on the remote head module side)
- Module parameter setting of each module (☞ Page 250 Setting parameters on the remote head module side)

6. Writing to the remote head module

Write the configured parameters to the remote head module using the engineering tool. (📖 MELSEC iQ-R CC-Link IE Field Network Remote Head Module User's Manual (Startup))

7. Resetting the remote head module

Use either of the following methods to restart the system on the remote head module side.

- Turning off and on the power
- Resetting the remote head module (📖 MELSEC iQ-R CC-Link IE Field Network Remote Head Module User's Manual (Startup))

Procedure on the SIL2 Process CPU side

1. Powering on the system

In both systems, check the following items and then power on the system.

- The power supply is wired correctly.
- The power supply voltage satisfies the specifications.
- The SIL2 Process CPU is in STOP state.

Power on the system and ensure that the following LEDs turn on.

- Power supply module: POWER LED
- SIL2 Process CPU: READY LED
- SIL2 function module: READY LED
- Redundant function module: RUN LED

Although the LED status of each module is as follows after this first step, proceed to the next step.

- SIL2 Process CPU: ERROR LED flashing
- SIL2 function module: ERROR LED flashing
- Redundant function module: ERR LED On
- Master/local module: ERR LED On

2. Creating a project

Start the engineering tool and create a project. (📖 Page 252 Creating a new project (SIL2 Process CPU side))

3. Connecting the personal computer and SIL2 Process CPU

On the personal computer on which the engineering tool is installed, start the engineering tool. (📖 Page 252 Creating a new project (SIL2 Process CPU side))

Connect the personal computer with the engineering tool installed, and the SIL2 Process CPU. (📖 MELSEC iQ-R CPU Module User's Manual (Application))

4. Initializing the CPU module

Use the engineering tool to initialize the SIL2 Process CPU. (📖 MELSEC iQ-R CPU Module User's Manual (Startup))
Initialize one CPU module and then connect the other SIL2 Process CPU to the personal computer.
Then, initialize the SIL2 Process CPU in the same way. (📖 MELSEC iQ-R CPU Module User's Manual (Application))

5. Parameter setting on the SIL2 Process CPU side

Set the system parameters, CPU parameters, and module parameters of each module. (👉 Page 252 Creating a new project (SIL2 Process CPU side), 👉 Page 253 Setting parameters on the SIL2 Process CPU side)

Point

Load the actual system configuration into the module configuration diagram on the engineering tool to set the system parameters.

6. Safety communication setting

Configure the safety communication setting. (👉 Page 254 Safety communication setting)

7. Writing the system A/B setting

Configure the system A/B setting using the engineering tool. (👉 Page 255 Writing the system A/B setting, 📖 MELSEC iQ-R CPU Module User's Manual (Application))

8. Setting user information

Set user information in the SIL2 Process CPU in both systems and projects. (📖 GX Works3 Operating Manual)

9. Creating programs

Create a safety program and a standard program using the SIL2 diagnostic FB library. (👉 Page 296 EXAMPLE OF OPERATION)

10. Writing to the programmable controller

Write the configured parameters and created programs to the both systems using the engineering tool. (👉 Page 255 Writing the system A/B setting, 📖 MELSEC iQ-R CPU Module User's Manual (Application))

11. Resetting the SIL2 Process CPU

Use either of the following methods to restart the both systems.

- Turning off and on the power
- Resetting the SIL2 Process CPU

12. Checking LEDs on the SIL2 Process CPU side

Check that the LED status of each module is as follows. The CARD READY LED turns on or off depending on whether the SD memory card is installed.

- Control system

R08PSFCPU	R6PSFM	R6RFM	RJ71GF11-T2
READY	READY	RUN ERR	RUN ERR
ERROR	ERROR		
PROGRAM RUN	PROGRAM RUN	SYS [A] [CTRL	MST
USER	SAFETY COM RUN	[B] [SBY	D LINK
BATTERY	SAFETY COM ERR	[BACKUP	SD/RD
CARD READY	TEST	[SEPARATE	L ERR
CARD ACCESS		MEMORY COPY	
FUNCTION		LINK	
		L ERR	

- Standby system*¹

R08PSFCPU	R6PSFM	R6RFM	RJ71GF11-T2
READY	READY	RUN ERR	RUN ERR
ERROR	ERROR		
PROGRAM RUN	PROGRAM RUN	SYS [A] [CTRL	MST
USER	SAFETY COM RUN	[B] [SBY	D LINK
BATTERY	SAFETY COM ERR	[BACKUP	SD/RD
CARD READY	TEST	[SEPARATE	L ERR
CARD ACCESS		MEMORY COPY	
FUNCTION		LINK	
		L ERR	

*1 For the redundant master station system, the MST LED of the standby system master/local module flashes.

The following LEDs turn on when an error occurs. Use the engineering tool to check details of the error and remove the error cause.

- SIL2 Process CPU: ERROR LED (📖 MELSEC iQ-R CPU Module User's Manual (Startup))
- SIL2 function module: ERROR LED (📖 MELSEC iQ-R CPU Module User's Manual (Application))
- Redundant function module: ERR LED, L ERR LED (📖 MELSEC iQ-R CPU Module User's Manual (Application))
- Master/local module: ERR LED, L ERR LED (📖 MELSEC iQ-R Ethernet/CC-Link IE User's Manual (Startup))

Enabling modules

1. Safety module operation

Check that the system is powered on the SIL2 Process CPU side and the remote head module side, and use "Safety Module Operation" of the engineering tool to enable the modules set to SIL2 mode. (👉 Page 258 Safety module operation)

2. Powering off the system

After enabling the modules, power off the system on the SIL2 Process CPU side and the remote head module side.

3. Restarting the system

Set the RUN/STOP/RESET switch for the SIL2 Process CPU in both systems and for the remote head module to RUN, and turn the power of the systems on.

Operation check procedure

1. Checking

Check the status of each module used in the systems and program behaviors.

- Check each module to see whether an error occurred.
- Check that the LED status of each module is as follows.
- Control system

R08PSFCPU	R6PSFM	R6RFM	RJ71GF11-T2
READY <input checked="" type="checkbox"/>	READY <input checked="" type="checkbox"/>	RUN <input checked="" type="checkbox"/>	RUN <input checked="" type="checkbox"/>
ERROR <input type="checkbox"/>	ERROR <input type="checkbox"/>	ERR <input type="checkbox"/>	ERR <input type="checkbox"/>
PROGRAM RUN <input checked="" type="checkbox"/>	PROGRAM RUN <input checked="" type="checkbox"/>	SYS [A <input checked="" type="checkbox"/> B <input checked="" type="checkbox"/>	MST <input type="checkbox"/>
USER <input type="checkbox"/>	SAFETY COM RUN <input checked="" type="checkbox"/>	[CTRL <input checked="" type="checkbox"/> SBY <input checked="" type="checkbox"/>	D LINK <input checked="" type="checkbox"/>
BATTERY <input type="checkbox"/>	SAFETY COM ERR <input type="checkbox"/>	BACKUP <input checked="" type="checkbox"/>	SD/RD <input checked="" type="checkbox"/>
CARD READY <input type="checkbox"/>	TEST <input checked="" type="checkbox"/>	SEPARATE <input type="checkbox"/>	L ERR <input type="checkbox"/>
CARD ACCESS <input type="checkbox"/>		MEMORY COPY <input type="checkbox"/>	
FUNCTION <input type="checkbox"/>		LINK <input checked="" type="checkbox"/>	
		L ERR <input type="checkbox"/>	

- Standby system*1

R08PSFCPU	R6PSFM	R6RFM	RJ71GF11-T2
READY <input checked="" type="checkbox"/>	READY <input checked="" type="checkbox"/>	RUN <input checked="" type="checkbox"/>	RUN <input checked="" type="checkbox"/>
ERROR <input type="checkbox"/>	ERROR <input type="checkbox"/>	ERR <input type="checkbox"/>	ERR <input type="checkbox"/>
PROGRAM RUN <input type="checkbox"/>	PROGRAM RUN <input type="checkbox"/>	SYS [A <input type="checkbox"/> B <input type="checkbox"/>	MST <input type="checkbox"/>
USER <input type="checkbox"/>	SAFETY COM RUN <input type="checkbox"/>	[CTRL <input type="checkbox"/> SBY <input type="checkbox"/>	D LINK <input checked="" type="checkbox"/>
BATTERY <input type="checkbox"/>	SAFETY COM ERR <input type="checkbox"/>	BACKUP <input checked="" type="checkbox"/>	SD/RD <input checked="" type="checkbox"/>
CARD READY <input type="checkbox"/>	TEST <input checked="" type="checkbox"/>	SEPARATE <input type="checkbox"/>	L ERR <input type="checkbox"/>
CARD ACCESS <input type="checkbox"/>		MEMORY COPY <input type="checkbox"/>	
FUNCTION <input type="checkbox"/>		LINK <input checked="" type="checkbox"/>	
		L ERR <input type="checkbox"/>	

- Remote head module side*2

RJ72GF15-T2	RJ72GF15-T2	R60AD8-G	R60AD8-G	R60DA8-G	RY40PT5B
RUN <input checked="" type="checkbox"/>	RUN <input checked="" type="checkbox"/>	RUN <input checked="" type="checkbox"/>	RUN <input checked="" type="checkbox"/>	RUN <input checked="" type="checkbox"/>	RUN <input checked="" type="checkbox"/>
ERR <input type="checkbox"/>	ERR <input type="checkbox"/>	ERR <input type="checkbox"/>	ERR <input type="checkbox"/>	ERR <input type="checkbox"/>	ERR <input type="checkbox"/>
BUS RUN <input checked="" type="checkbox"/>	BUS RUN <input checked="" type="checkbox"/>	S MODE <input checked="" type="checkbox"/>	S MODE <input checked="" type="checkbox"/>	S MODE <input checked="" type="checkbox"/>	ALM <input type="checkbox"/>
D LINK <input checked="" type="checkbox"/>	D LINK <input checked="" type="checkbox"/>	ALM <input type="checkbox"/>	ALM <input type="checkbox"/>	ALM <input type="checkbox"/>	S MODE <input type="checkbox"/>
CTRL <input checked="" type="checkbox"/>	CTRL <input checked="" type="checkbox"/>				0 1 2 3 4 5 6 7
SD/RD <input checked="" type="checkbox"/>	SD/RD <input checked="" type="checkbox"/>				8 9 A B C D E F
SBY <input checked="" type="checkbox"/>	SBY <input checked="" type="checkbox"/>				
L ERR <input type="checkbox"/>	L ERR <input type="checkbox"/>				
		-10~10V 0~20mA	-10~10V 0~20mA	-12~12V 0~22mA	24VDC 0.5A
CC-Link IE <input checked="" type="checkbox"/>	CC-Link IE <input checked="" type="checkbox"/>				

*1 For the redundant master station system, the MST LED of the standby system master/local module flashes.

*2 Because the remote head module is not in a redundancy configuration for the redundant master station system, the following LEDs are always turned off.

· CTRL LED · SBY LED

- Check whether an error occurred in CC-Link IE Field Network diagnostics. (MELSEC iQ-R CC-Link IE Field Network User's Manual (Application))
- Check that the safety program and standard program behave normally.

2. Switching the safety operation mode

For normal operation as a safety control system via the SIL2 Process CPU, switch the safety operation mode to SAFETY MODE. Before switching the safety operation mode, set the SIL2 Process CPU to STOP state. (Page 263 Switching the safety operation mode, MELSEC iQ-R CPU Module User's Manual (Application))

Point

When the SIL2 Process CPU is in STOP state, a continuation error of operating status mismatch is detected in the standby system.

3. Program execution

Power off the SIL2 Process CPU in both systems and the remote head module. Then, set the RUN/STOP/RESET switch for the SIL2 Process CPU in both systems and for the remote head module to RUN, and turn the power of the systems on. Check that the PROGRAM RUN LED of the control system CPU module is on.

Point

If the RUN/STOP/RESET switch is set to RUN in power-on state, a continuation error of operating status mismatch is detected in the standby system.

4. Program monitoring

Use the engineering tool to check that programs run normally.

8 SYSTEM CONFIGURATION

This chapter describes the system configurations for using the R60AD8-G in SIL2 mode. For application in SIL2 mode, a redundant system must be configured based on a redundant master station or redundant line. In such a case, mount the R60AD8-G with a remote head module.

8.1 Redundant Master Station

The following diagram shows the system configuration with a redundant master station.

- System configuration diagram

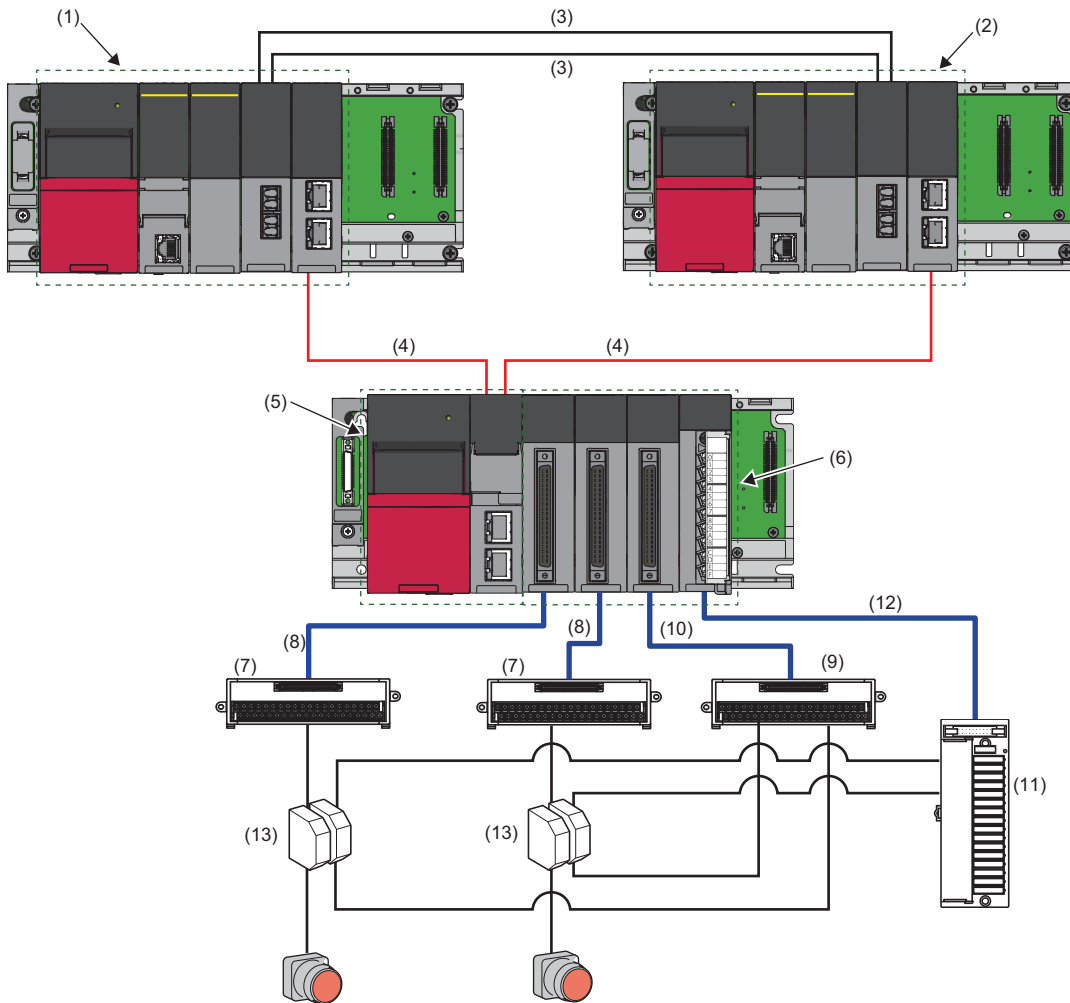

- List of components

No.	Name	Description
(1)	System A system	<p>Composed of the following modules:</p> <ul style="list-style-type: none"> • RnPSFCPU • R6PSFM • R6RFM • RJ71GF11-T2 <p>■Precautions</p> <ul style="list-style-type: none"> • Each module has restrictions on use in a system on the system configuration diagram. For details, refer to the User's Manual (Application) for each module. • Mount the above modules on the same base unit. Mount the modules so that they are arranged in the following order: RnPSFCPU → R6PSFM → R6RFM → RJ71GF11-T2, starting from the right side of the power supply module.
(2)	System B system	<p>Composed of the following modules:</p> <ul style="list-style-type: none"> • RnPSFCPU • R6PSFM • R6RFM • RJ71GF11-T2 <p>■Precautions</p> <ul style="list-style-type: none"> • Each module has restrictions on use in a system on the system configuration diagram. For details, refer to the User's Manual (Application) for each module. • Mount the above modules on the same base unit. Mount the modules so that they are arranged in the following order: RnPSFCPU → R6PSFM → R6RFM → RJ71GF11-T2, starting from the right side of the power supply module.
(3)	Tracking cable	Use cables designed for use by the R6RFM. (MELSEC iQ-R CPU Module User's Manual (Startup))

No.	Name	Description
(4)	CC-Link IE Field Network supporting cable	Use cables supporting CC-Link IE Field Network. (📖 MELSEC iQ-R Ethernet/CC-Link IE User's Manual (Startup))
(5)	Remote head module	Use the RJ72GF15-T2. Note that the module has restrictions on use in a system on the system configuration diagram. For details, refer to the MELSEC iQ-R CC-Link IE Field Network Remote Head Module User's Manual (Application).
(6)	Module set	<p>Composed of the following modules:</p> <ul style="list-style-type: none"> • R60AD8-G (Main) • R60AD8-G (Sub) • R60DA8-G for diagnostics • RY40PT5B <p>■Precautions</p> <ul style="list-style-type: none"> • When using the R60AD8-G in SIL2 mode, there is a restriction on the version. For details, refer to Page 240 Firmware Version for SIL2 Mode. • Mount the above modules on the same base unit. Mount the modules so that they are arranged in the following order: R60AD8-G (Main) → R60AD8-G (Sub) → R60DA8-G for diagnostics → RY40PT5B, starting from the right side of the remote head module.
(7)	Connector/terminal block converter module for the R60AD8-G	<p>Use the following products.</p> <p>📖 Page 240 Connector/terminal block converter module for the R60AD8-G</p>
(8)	Connector/terminal block converter module connection cable for the R60AD8-G	<p>This cable is a special cable for connecting the R60AD8-G and the connector/terminal block converter module. Use the following products.</p> <p>📖 Page 240 Connector/terminal block converter module for the R60AD8-G</p>
(9)	Connector/terminal block converter module for the R60DA8-G for diagnostics	<p>Use the following products.</p> <p>📖 Page 240 Connector/terminal block converter module for the R60DA8-G for diagnostics</p>
(10)	Connector/terminal block converter module connection cable for the R60DA8-G for diagnostics	<p>This cable is a special cable for connecting the R60DA8-G for diagnostics and the connector/terminal block converter module. Use the following products.</p> <p>📖 Page 240 Connector/terminal block converter module for the R60DA8-G for diagnostics</p>
(11)	Terminal module for the RY40PT5B	<p>This module is used to connect the relay switching RY40PT5B to relays. Use the following products.</p> <p>📖 Page 240 Terminal module for the RY40PT5B</p>
(12)	Terminal module connection cable for the RY40PT5B	<p>This cable is a special cable for connecting the RY40PT5B and the terminal module. Use the following products.</p> <p>📖 Page 240 Terminal module for the RY40PT5B</p>
(13)	Relay	<p>Use the following products.</p> <p>📖 Page 240 Relay</p>

8.2 Redundant Line

The following diagram shows the system configuration with a redundant line.

- System configuration diagram

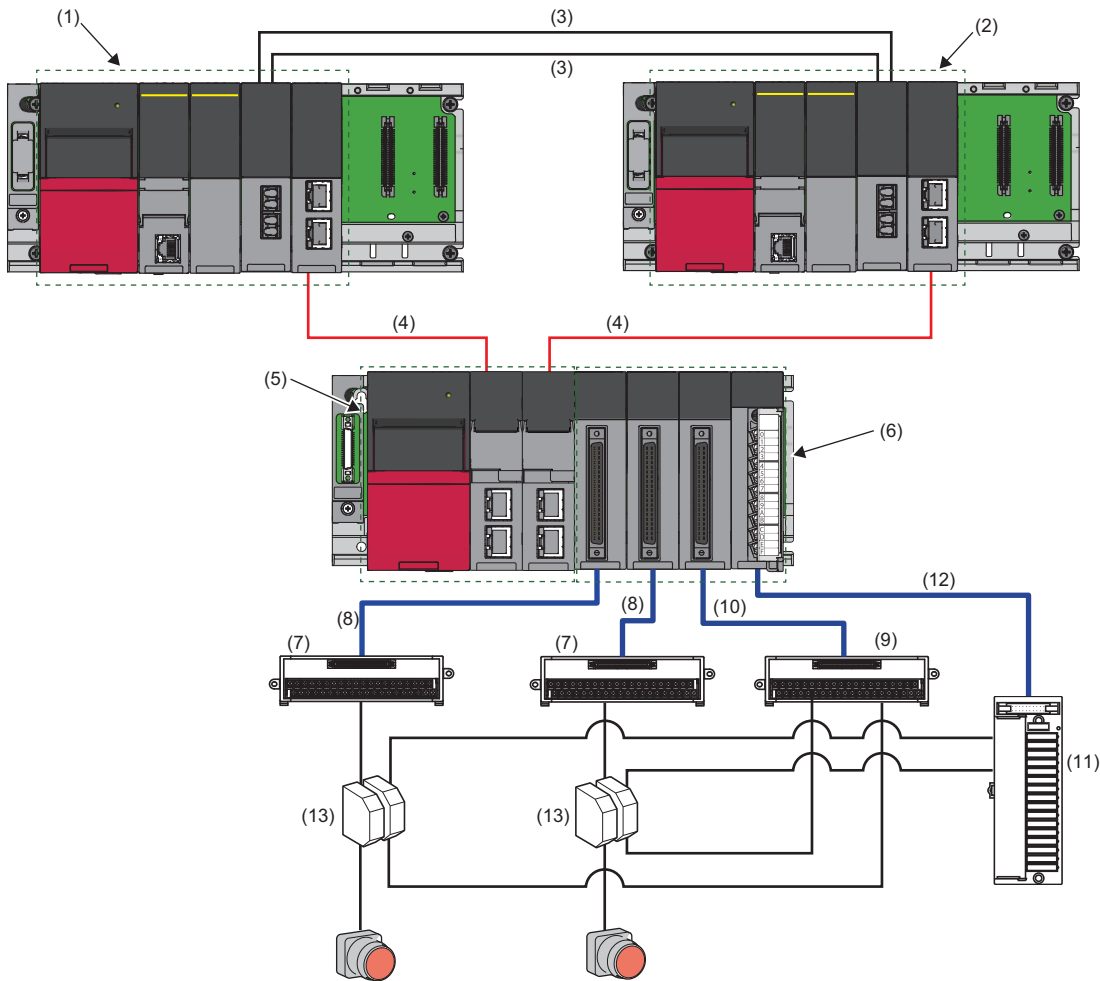

- List of components

No.	Name	Description
(1)	System A system	<p>Composed of the following modules:</p> <ul style="list-style-type: none"> • RnPSFCPU • R6PSFM • R6RFM • RJ71GF11-T2 <p>■Precautions</p> <ul style="list-style-type: none"> • Each module has restrictions on use in a system on the system configuration diagram. For details, refer to the User's Manual (Application) for each module. • Mount the above modules on the same base unit. Mount the modules so that they are arranged in the following order: RnPSFCPU → R6PSFM → R6RFM → RJ71GF11-T2, starting from the right side of the power supply module.
(2)	System B system	<p>Composed of the following modules:</p> <ul style="list-style-type: none"> • RnPSFCPU • R6PSFM • R6RFM • RJ71GF11-T2 <p>■Precautions</p> <ul style="list-style-type: none"> • Each module has restrictions on use in a system on the system configuration diagram. For details, refer to the User's Manual (Application) for each module. • Mount the above modules on the same base unit. Mount the modules so that they are arranged in the following order: RnPSFCPU → R6PSFM → R6RFM → RJ71GF11-T2, starting from the right side of the power supply module.
(3)	Tracking cable	Use cables designed for use by the R6RFM. ( MELSEC iQ-R CPU Module User's Manual (Startup))

No.	Name	Description
(4)	CC-Link IE Field Network supporting cable	Use cables supporting CC-Link IE Field Network. (📖 MELSEC iQ-R Ethernet/CC-Link IE User's Manual (Startup))
(5)	Remote head module	Use two sets of the RJ72GF15-T2 to build a redundant configuration. Note that the module has restrictions on use in a system on the system configuration diagram. For details, refer to the MELSEC iQ-R CC-Link IE Field Network Remote Head Module User's Manual (Application).
(6)	Module set	Composed of the following modules: <ul style="list-style-type: none"> • R60AD8-G (Main) • R60AD8-G (Sub) • R60DA8-G for diagnostics • RY40PT5B ■Precautions <ul style="list-style-type: none"> • When using the R60AD8-G in SIL2 mode, there is a restriction on the version. For details, refer to Page 240 Firmware Version for SIL2 Mode. • Mount the above modules on the same base unit. Mount the modules so that they are arranged in the following order: R60AD8-G (Main) → R60AD8-G (Sub) → R60DA8-G for diagnostics → RY40PT5B, starting from the right side of the remote head module.
(7)	Connector/terminal block converter module for the R60AD8-G	Use the following products. 📖 Page 240 Connector/terminal block converter module for the R60AD8-G
(8)	Connector/terminal block converter module connection cable for the R60AD8-G	This cable is a special cable for connecting the R60AD8-G and the connector/terminal block converter module. Use the following products. 📖 Page 240 Connector/terminal block converter module for the R60AD8-G
(9)	Connector/terminal block converter module for the R60DA8-G for diagnostics	Use the following products. 📖 Page 240 Connector/terminal block converter module for the R60DA8-G for diagnostics
(10)	Connector/terminal block converter module connection cable for the R60DA8-G for diagnostics	This cable is a special cable for connecting the R60DA8-G for diagnostics and the connector/terminal block converter module. Use the following products. 📖 Page 240 Connector/terminal block converter module for the R60DA8-G for diagnostics
(11)	Terminal module for the RY40PT5B	This module is used to connect the relay switching RY40PT5B to relays. Use the following products. 📖 Page 240 Terminal module for the RY40PT5B
(12)	Terminal module connection cable for the RY40PT5B	This cable is a special cable for connecting the RY40PT5B and the terminal module. Use the following products. 📖 Page 240 Terminal module for the RY40PT5B
(13)	Relay	Use the following products. 📖 Page 240 Relay

8.3 Firmware Version for SIL2 Mode

For application in SIL2 mode, use the R60AD8-G with the following conditions.

- Use a module with firmware version 02 or later.
- Use a module with production information (first four digits) of 0207 or later.

For how to check the firmware version and production information, refer to the MELSEC iQ-R Module Configuration Manual.

8.4 Reference Product

Connector/terminal block converter module for the R60AD8-G

Product	Model	Remarks	Contact
Connector/terminal block converter module	FA1-TBS40ADGN	—	Mitsubishi Electric Engineering Co., Ltd.
	FA-LTB40ADGN	—	
Special cable	FA-CBL05Q68ADGN	Cable length: 0.5m	
	FA-CBL10Q68ADGN	Cable length: 1.0m	
	FA-CBL20Q68ADGN	Cable length: 2.0m	
	FA-CBL30Q68ADGN	Cable length: 3.0m	

Connector/terminal block converter module for the R60DA8-G for diagnostics

Product	Model	Remarks	Contact
Connector/terminal block converter module	FA1-TBS40DAG	—	Mitsubishi Electric Engineering Co., Ltd.
	FA-LTB40DAG	—	
Special cable	FA1-CBL05R60DA8G	Cable length: 0.5m	
	FA1-CBL10R60DA8G	Cable length: 1.0m	
	FA1-CBL20R60DA8G	Cable length: 2.0m	
	FA1-CBL30R60DA8G	Cable length: 3.0m	

Terminal module for the RY40PT5B

Product	Model	Remarks	Contact
Terminal module	FA-THE16YTR20S	—	Mitsubishi Electric Engineering Co., Ltd.
Special cable	FA-CBL06TMV20	Cable length: 0.6m	
	FA-CBL10TMV20	Cable length: 1.0m	
	FA-CBL20TMV20	Cable length: 2.0m	
	FA-CBL30TMV20	Cable length: 3.0m	

Relay

Product	Model	Remarks	Contact
Analog switching module	M2MNV-13-R/CE-X: Special Product No.36111	—	M-System Co., Ltd.

9 INSTALLATION AND WIRING

This chapter describes wiring for the R60AD8-G.

9.1 Wiring Precautions

- Check the signal layout before wiring the R60AD8-G, and connect the cables correctly. For details on the signal layout, refer to the following.

 Page 241 Connector for external devices

- Use a single-point ground for the shield of shield wires and shielded cables.

Connector for external devices

Precautions

Tighten connector screws within the specified torque range.

Screw	Tightening torque range
Connector screw (M2.6)	0.20 to 0.29N·m

- Use copper wire with a temperature rating of 75°C or higher for the connector.
- Use UL listed connectors if necessary for UL compliance.

Applicable connectors

Connectors for external devices used for the R60AD8-G should be ordered by the customers.

The type of applicable connectors and a reference product of crimping tool are as follows.

■40-pin connector

Type	Model	Applicable wire size
Soldering type connector (straight type)	A6CON1* ¹	0.088 to 0.3mm ² (28 to 22 AWG) (stranded wire)
Crimping type connector (straight type)	A6CON2	0.088 to 0.24mm ² (28 to 24 AWG) (stranded wire)
Soldering type connector (dual purpose (straight/oblique) type)	A6CON4* ¹	0.088 to 0.3mm ² (28 to 22 AWG) (stranded wire)

*1 For application with 40 wires, use a wire with its sheath outside diameter at 1.3mm or less.
Select an adequate wire for your current value.

Point

A6CON3 (IDC type connector (straight type)) cannot be used.

■40-pin connector crimping tool

Type	Model	Contact
Crimping tool	FCN-363T-T005/H	FUJITSU COMPONENT LIMITED

For how to wire the connectors or use the crimping tool, contact FUJITSU COMPONENT LIMITED.

Connector wiring, installation procedure, disconnection procedure

For connector wiring, installation procedure, and disconnection procedure, refer to the following.

 MELSEC iQ-R Module Configuration Manual

9.2 External Wiring

Signal layout for the connector for external devices

The signal layout for connector for external devices of the R60AD8-G is as follows.

Pin layout (front module view)	Pin number	Signal name	Pin number	Signal name
A1	A1	CH1 V+	B1	CH1 V-/I-
A2	A2	CH1 I+	B2	—
A3	A3	—	B3	CH2 V+
A4	A4	CH2 V-/I-	B4	CH2 I+
A5	A5	—	B5	—
A6	A6	CH3 V+	B6	CH3 V-/I-
A7	A7	CH3 I+	B7	—
A8	A8	—	B8	CH4 V+
A9	A9	CH4 V-/I-	B9	CH4 I+
A10	A10	—	B10	—
A11	A11	CH5 V+	B11	CH5 V-/I-
A12	A12	CH5 I+	B12	—
A13	A13	—	B13	CH6 V+
A14	A14	CH6 V-/I-	B14	CH6 I+
A15	A15	—	B15	—
A16	A16	CH7 V+	B16	CH7 V-/I-
A17	A17	CH7 I+	B17	—
A18	A18	—	B18	CH8 V+
A19	A19	CH8 V-/I-	B19	CH8 I+
A20	A20	—	B20	—

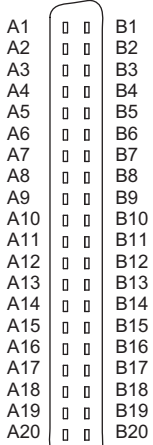

Examples of external wiring

Examples of external wiring are as follows.

Point 

For wiring for the R60DA8-G for diagnostics, refer to the following.

 MELSEC iQ-R Channel Isolated Digital-Analog Converter Module User's Manual (Startup)

For wiring for the RY40PT5B, refer to the following.

 MELSEC iQ-R I/O Module (With Diagnostic Functions) User's Manual (Startup)

Voltage input

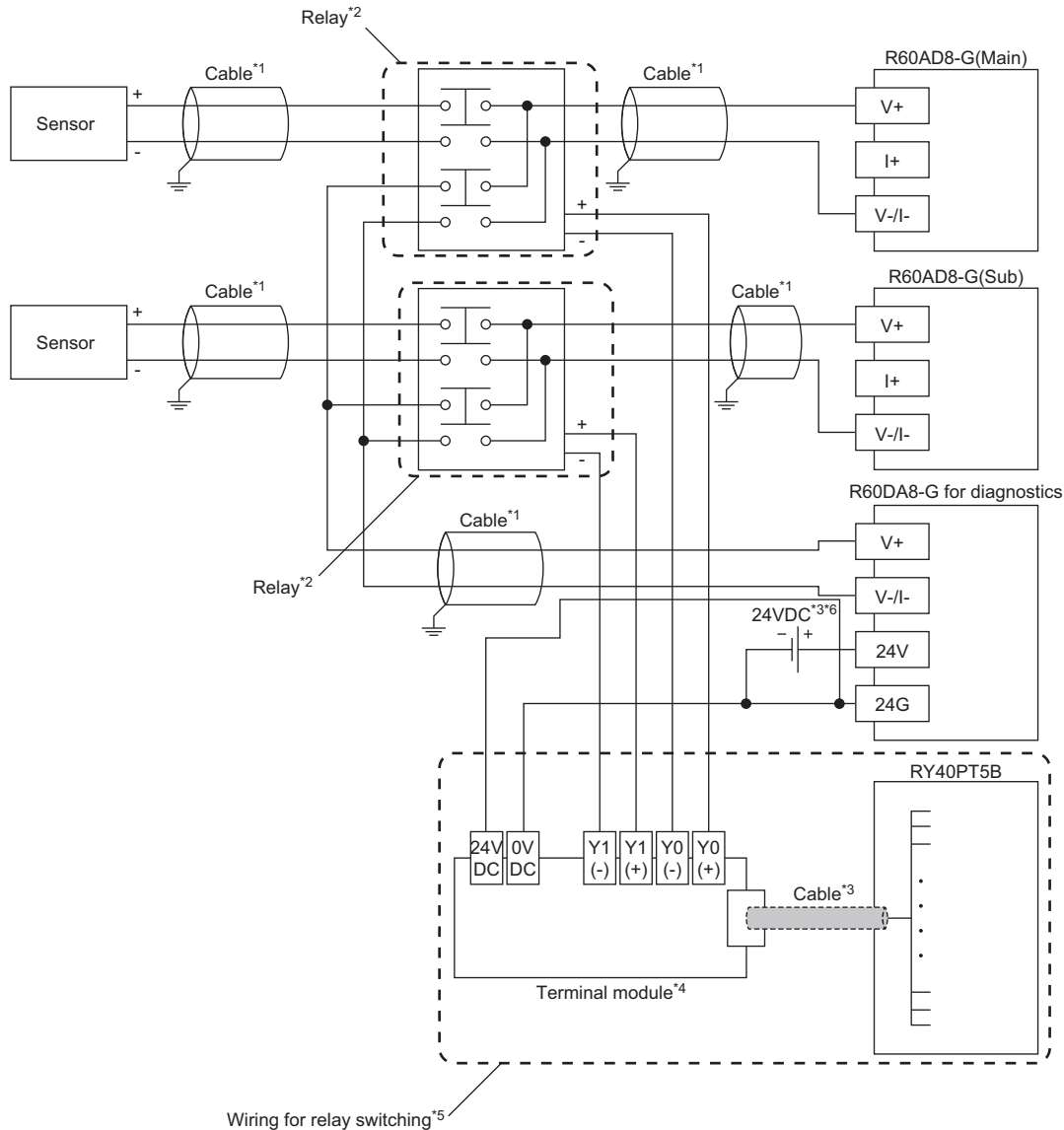

*1 For the application below, use shielded cables and single point grounding for the shield.

- Between the sensor and relay
- Between the R60AD8-G and relay
- Between the R60DA8-G for diagnostics and relay

*2 Install the relay and programmable controller within the same panel.

*3 When it is necessary to make the R60AD8-G compliant with EMC and Low Voltage Directives, refer to one of the following manuals.

- 📖 MELSEC iQ-R Module Configuration Manual
- 📖 Safety Guidelines (This manual is included with the base unit.)

*4 Relay cannot receive 24V output signals and therefore cannot be directly connected to the RY40PT5B.

*5 For details on wiring for relay switching, refer to the following.

- 📖 Page 247 Relay switching wiring

*6 Use an external power supply that satisfies the following conditions.

- The overvoltage protection function is available.
- The output voltage does not exceed 35VDC in single fault state.

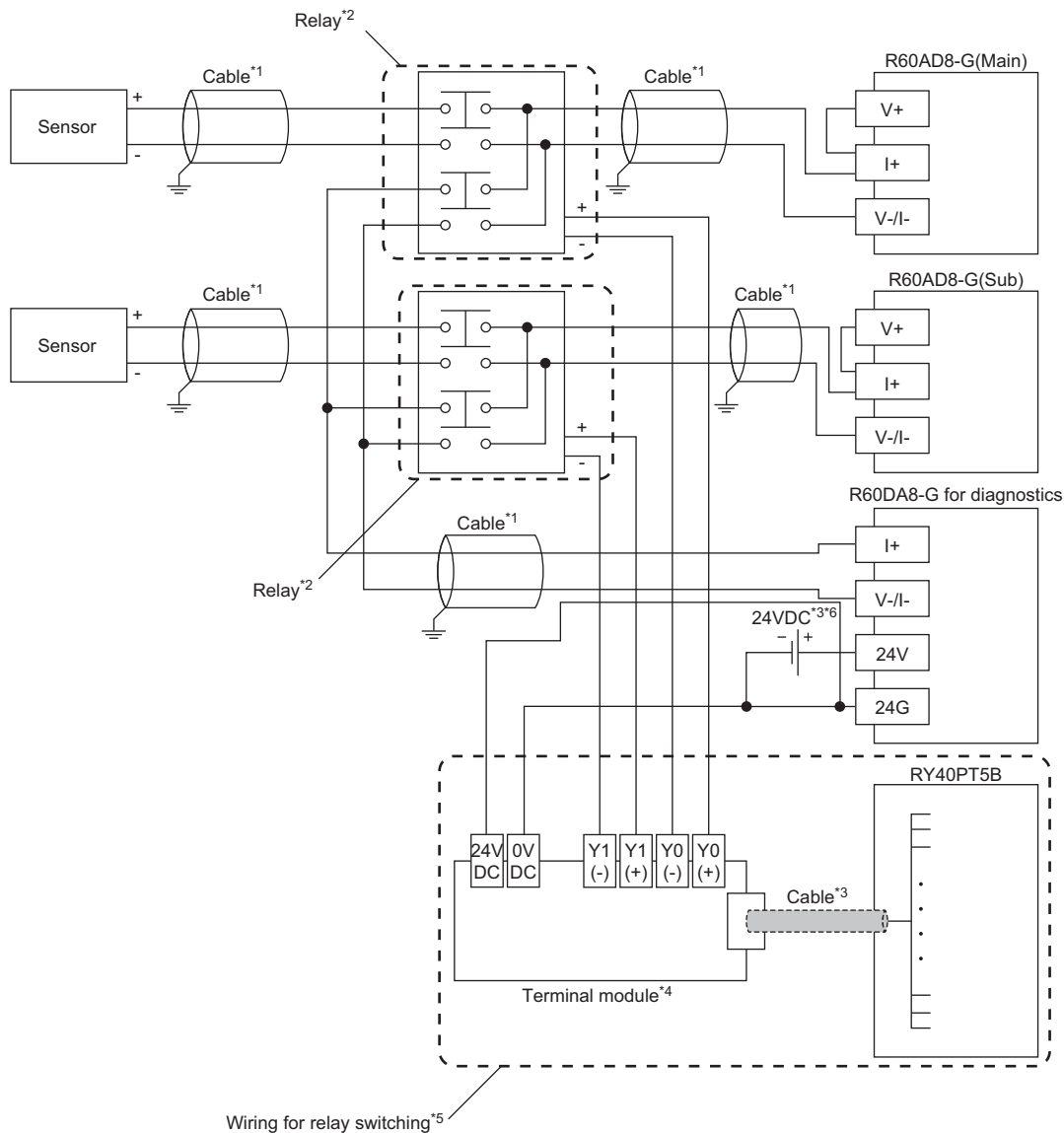

- *1 For the application below, use shielded cables and single point grounding for the shield.
 - Between the sensor and relay
 - Between the R60AD8-G and relay
 - Between the R60DA8-G for diagnostics and relay
- *2 Install the relay and programmable controller within the same panel.
- *3 When it is necessary to make the R60AD8-G compliant with EMC and Low Voltage Directives, refer to one of the following manuals.
 - 📖 MELSEC iQ-R Module Configuration Manual
 - 📖 Safety Guidelines (This manual is included with the base unit.)
- *4 Relay cannot receive 24V output signals and therefore cannot be directly connected to the RY40PT5B.
- *5 For details on wiring for relay switching, refer to the following.
 - 📖 Page 247 Relay switching wiring
- *6 Use an external power supply that satisfies the following conditions.
 - The overvoltage protection function is available.
 - The output voltage does not exceed 35VDC in single fault state.

When the connector/terminal block converter module is used

The connector/terminal block converter module and special cable for the R60AD8-G can be used for wiring. When the connector/terminal block converter module is used, the wiring should be as follows.

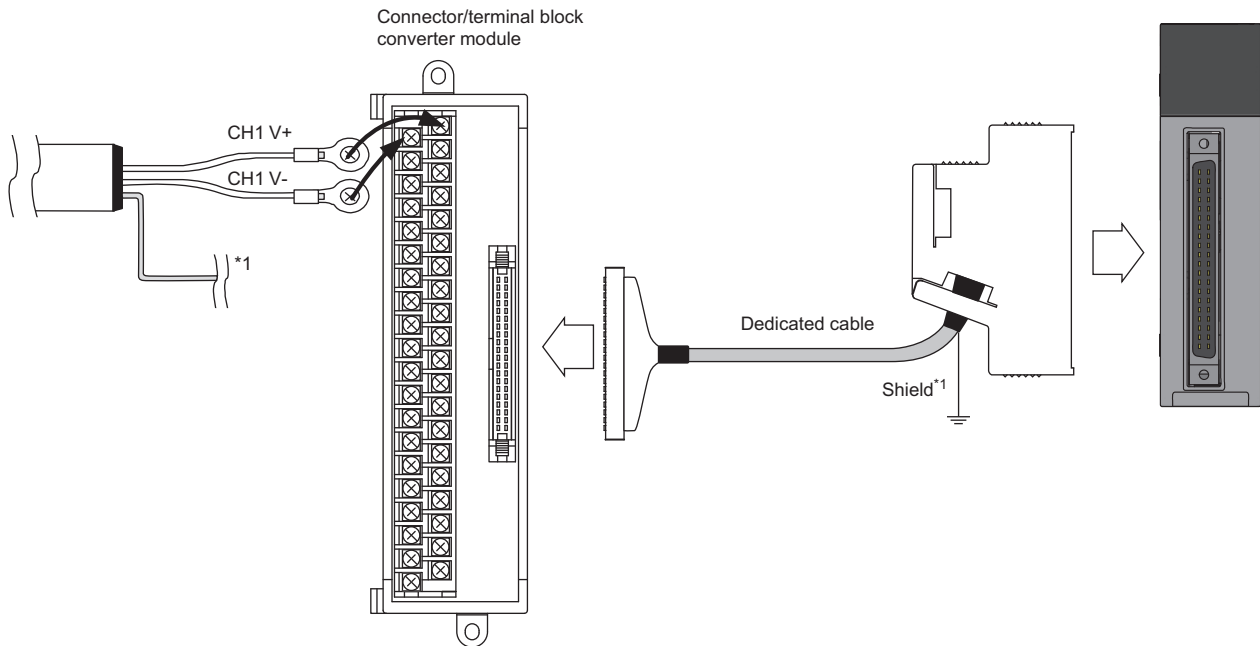

*1 Be sure to use a shielded cable. And be sure to ground the shield.

For available connector/terminal block converter modules and special cables, refer to the following.

☞ Page 240 Connector/terminal block converter module for the R60AD8-G

Point

Factory default setting of the R60AD8-G uses the offset/gain setting adjusted per module.

If a connector/terminal block converter module and a special cable are used, they may cause an error on the conversion characteristics due to effect of conductor resistance.

If the effect of conductor resistance is a problem, set offset and gain values and use the user range setting.

For the offset/gain setting, refer to the following.

📖 MELSEC iQ-R Channel Isolated Analog-Digital Converter Module User's Manual (Startup)

Relay switching wiring

Relay switching wiring is as follows.

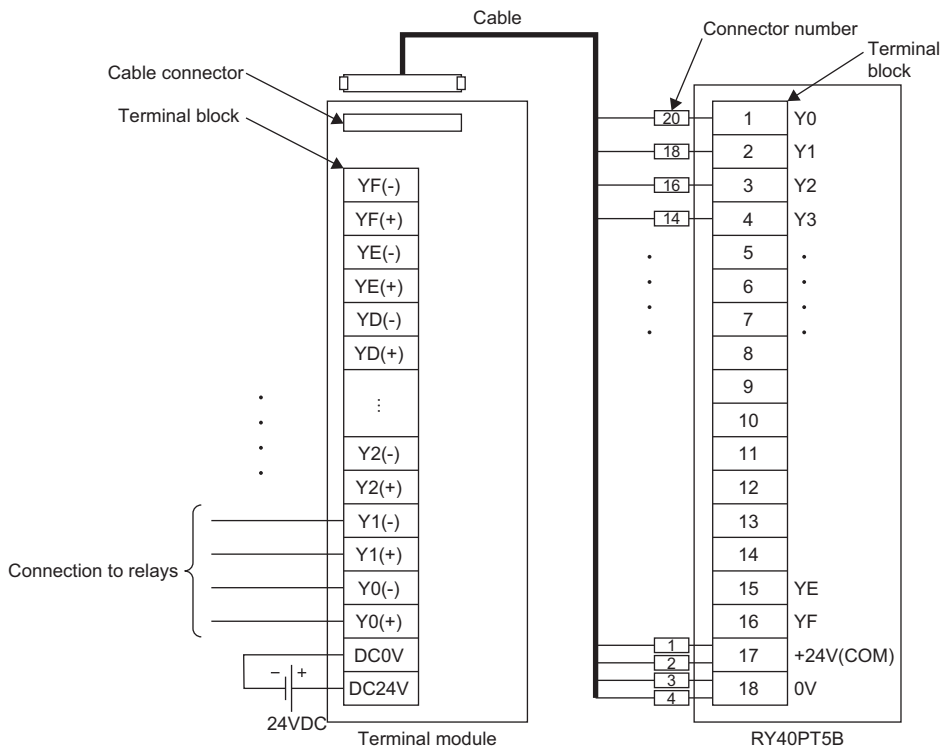

For available terminal modules and special cables, refer to the following.

☞ Page 240 Terminal module for the RY40PT5B

Use an external power supply (24VDC) that satisfies the following conditions.

- The overvoltage protection function is available.
- The output voltage does not exceed 35VDC in single fault state.

Precautions for channel number and output signal

Before wiring for SIL2 mode, pay attention to the following points.

Precautions for channel number

All the channels used for the R60AD8-G (Main), R60AD8-G (Sub), and R60DA8-G for diagnostics should use the same channel number.

Ex.

When the R60AD8-G (Main) and R60AD8-G (Sub) use CH1 to make A/D conversion, the R60DA8-G for diagnostics must use CH1.

Precautions for output signal

When a relay is wired with the RY40PT5B, the output signals used for the RY40PT5B should be wired as follows.

Output signals used for the RY40PT5B	Channel used by the R60AD8-G							
	CH1	CH2	CH3	CH4	CH5	CH6	CH7	CH8
R60AD8-G (Main) side	Y0	Y2	Y4	Y6	Y8	YA	YC	YE
R60AD8-G (Sub) side	Y1	Y3	Y5	Y7	Y9	YB	YD	YF

Ex.

When the R60AD8-G (Main) and R60AD8-G (Sub) use CH1, wire the R60AD8-G (Main) to Y0 of the RY40PT5B and wire the R60AD8-G (Sub) to Y1 of the RY40PT5B.

10 FUNCTIONS

This chapter describes details of functions that can be used by the R60AD8-G in SIL2 mode and their setting procedures.

Point

Numerical values corresponding to the channel where an error has occurred fit in the □ of an error code described in this chapter. For details on the numerical values, refer to the following.

 Page 319 List of Error Codes

10.1 SIL2 Mode

This section describes the settings necessary for operating the R60AD8-G in SIL2 mode.

Creating a new project (remote head module side)

Create a new project with the remote head module, and add necessary modules.

1. Create a project with the remote head module. Depending on the system configuration, specify the RJ72GF15-T2 or RJ72GF15-T2 (LR).
2. Depending on the system configuration, add "R60AD8-G(S2M)", "R60AD8-G(S2S)", "R60DA8-G", and "RY40PT5B".

Setting parameters on the remote head module side

With the created project, set the parameters.

1. Configure "Network Required Setting" in "CPU Parameter" for the remote head module.
2. Set the module parameters for "R60AD8-G(S2M)" and "R60DA8-G".
 - ☞ Page 251 Module parameters for "R60AD8-G(S2M)"
 - ☞ Page 251 Module parameters for "R60DA8-G"
 - There is no need to set module parameters for "R60AD8-G(S2S)" because the module parameters for "R60AD8-G(S2M)" are used automatically.
 - Do not change the default module parameters for "RY40PT5B".
3. Write the set parameters to the remote head module on the intelligent device station. Then reset the remote head module or turn off and on the power.
4. Save the project.

Point

The project on the remote head module side is used for configuring the safety communication setting in a project on the SIL2 Process CPU side. For details, refer to the following.

☞ Page 254 Safety communication setting

■Module parameters for "R60AD8-G(S2M)"

For details on each parameter, refer to the section of each function.

Module parameter		Reference
Basic settings	A/D conversion enable/disable setting	Page 266 A/D Conversion Enable/Disable Setting Function
	Input range setting	Page 265 Range Switching Function
	Averaging process setting	Page 266 A/D Conversion Method
	Count average/Moving average setting	
	Transmission interval monitoring time	Page 274 SIL2 A/D Conversion Function
Application settings	Scaling enable/disable setting	Page 269 Scaling Function
	Scaling upper limit value	
	Scaling lower limit value	
	Digital clipping enable/disable setting	Page 272 Digital Clipping Function
	SIL2 A/D conversion cycle setting	Page 274 SIL2 A/D Conversion Function
	Duplex input error range setting	Page 281 Double input discrepancy detection function
	Duplicated input mismatch detection count	
	Duplicated input mismatch automatic recovery setting	
	Duplicated input mismatch automatic return count	
	A/D conversion circuit diagnostic cycle setting	Page 285 A/D conversion circuit diagnostic function

■Module parameters for "R60DA8-G"

Set the following module parameters so that the module operates as the R60DA8-G for diagnostics. For parameters other than the following, use the default values.

Module parameter		Description
Basic settings	Output range setting	Set the following value depending on "Input range setting" of "R60AD8-G(S2M)". <ul style="list-style-type: none"> • For the voltage input range: "-10 to 10V" • For the current input range: "4 to 20mA (Extension)"
	D/A conversion enable/disable setting	Set "D/A conversion enable" to the same channel number as the A/D conversion enabled channel number of "R60AD8-G(S2M)".
Application settings	Input value shift amount	Set the following value depending on "Input range setting" of "R60AD8-G(S2M)". <ul style="list-style-type: none"> • For the voltage input range: 0 • For the current input range: 4000
	Auto restore of Offset/ gain setting with the module change	Do not change the default value. Note that in a SIL2 analog input system, it operates as "Disable".
Refresh settings	Digital value	Set W0 to W7 to CH1 to CH8 in ascending order. Example) CH1: W0, CH2: W1 ... CH7: W6, CH8: W7

Creating a new project (SIL2 Process CPU side)

Create a new project with the SIL2 Process CPU, and add necessary modules.

1. Create a project with the SIL2 Process CPU.

 [Project] ⇒ [New]

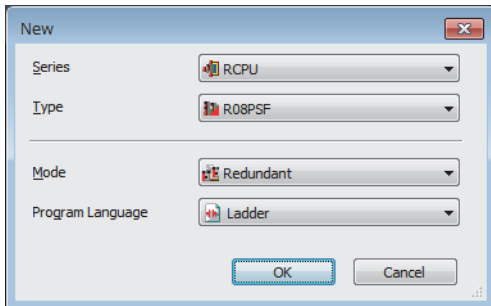

2. Add the user "Administrators" to the project and log on to the system.
3. Initialize the SIL2 Process CPU (built-in memory and user information) of the both systems.
4. Depending on the system configuration, add the R6PSFM and R6RFM.

 [Navigation window] ⇒ [Module Configuration] ⇒ [Element Selection window] ⇒ [CPU Extension]

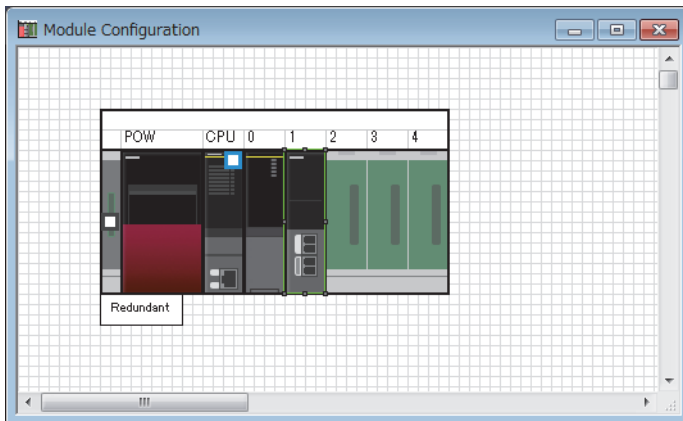

5. Depending on the system configuration, add the RJ71GF11-T2(MR) or RJ71GF11-T2(LR) as a master station.

 [Navigation window] ⇒ [Parameter] ⇒ [Module Information] ⇒ Right-click ⇒ [Add New Module]

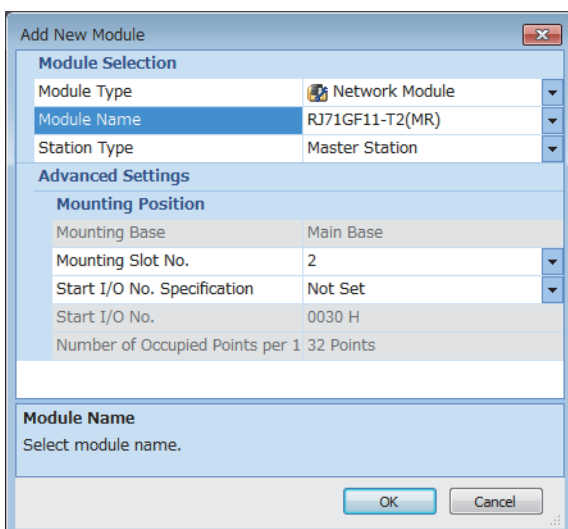

Setting parameters on the SIL2 Process CPU side

With the created project, set the parameters.

1. Set "CPU Parameter" according to the system configuration.

For details on item and setting procedure, refer to MELSEC iQ-R CPU Module User's Manual (Application).

2. Set "Required Settings" of the module parameter for the master/local module.

[Navigation window] ⇒ [Parameter] ⇒ [Module Information] ⇒ Target module ⇒ [Required Setting]

3. By using "Network Configuration Settings" of the module parameter for the master/local module, set the intelligent device station. For the intelligent device station, set RJ72GF15-T2 or RJ72GF15-T2 (LR) depending on the system configuration.

[Navigation window] ⇒ [Parameter] ⇒ [Module Information] ⇒ Target module ⇒ [Basic Settings] ⇒ [Network Configuration Settings]

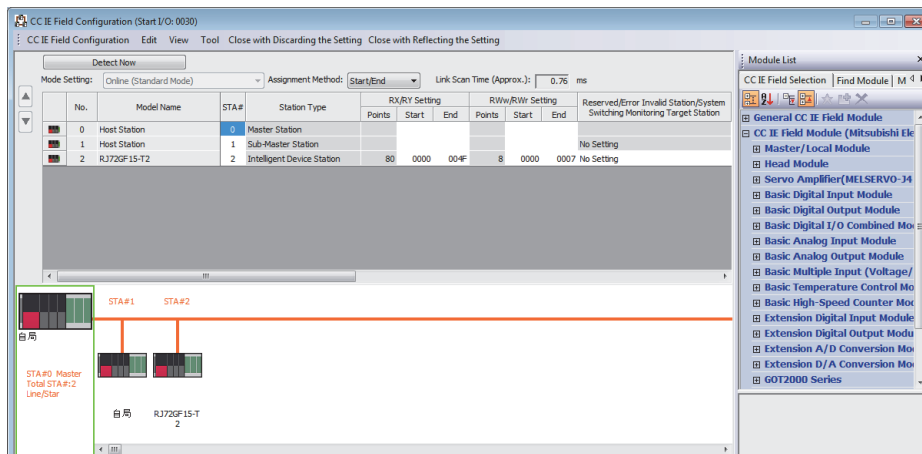

4. Set "Refresh Setting" of the module parameter for the master/local module as shown below.

[Navigation window] ⇒ [Parameter] ⇒ [Module Information] ⇒ [RJ71GF11-T2] ⇒ [Basic setting] ⇒ [Refresh settings]

No.	Link Side					CPU Side				
	Device Name	Points	Start	End		Target	Device Name	Points	Start	End
-	SB				↔					
-	SW				↔					
1	RY	16	00020	0002F	↔	Specify Device	Y	16	01000	0100F
2	RWw	8	00000	00007	↔	Specify Device	W	8	00000	00007
3	RY	16	00030	0003F	↔	Specify Device	Y	16	01010	0101F
4					↔					
5					↔					
6					↔					
7					↔					
8					↔					
9					↔					

5. Save the project.

Safety communication setting

Configure the safety communication setting using the project on the remote head module side. For details on safety communications, refer to the MELSEC iQ-R CC-Link IE Field Network User's Manual (Application).

1. Open a project on the SIL2 Process CPU side.
2. Set "To Use or Not to Use the Safety Communication Setting" of the module parameter for the master/local module to "Use".

 [Navigation window] ⇒ [Parameter] ⇒ [Module Information] ⇒ Target module ⇒ [Application setting] ⇒ [Safety Communication Setting]

3. Double-click "Safety Communication Setting" of the module parameter for the master/local module, and display the "Safety Communication Setting" window.

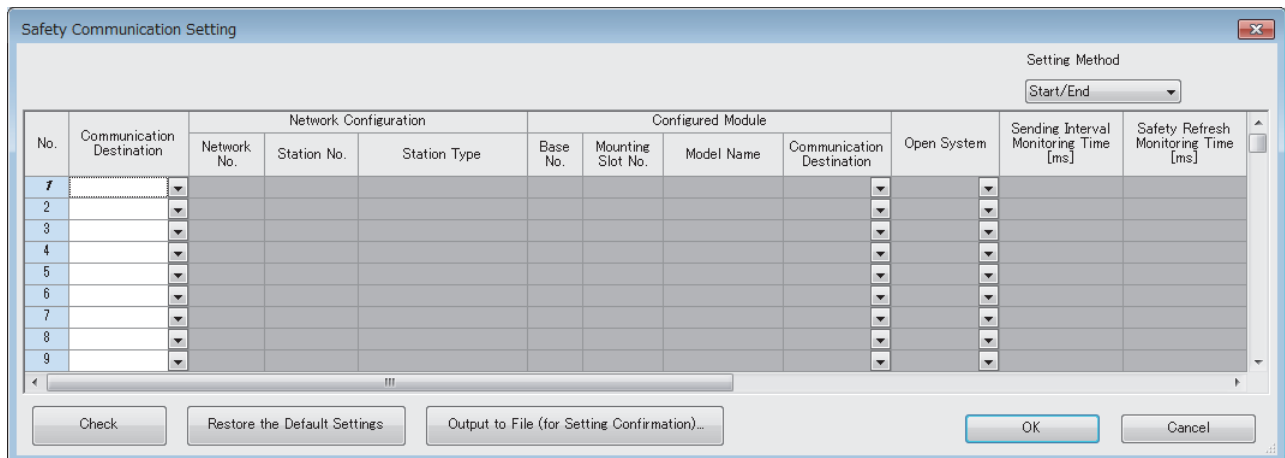

No.	Communication Destination	Network Configuration			Configured Module			Communication Destination	Open System	Sending Interval Monitoring Time [ms]	Safety Refresh Monitoring Time [ms]
		Network No.	Station No.	Station Type	Base No.	Mounting Slot No.	Model Name				
1											
2											
3											
4											
5											
6											
7											
8											
9											

4. Select "Local Network" for "Communication Destination", and display the "Select the target module for the Safety Communication Setting" window.

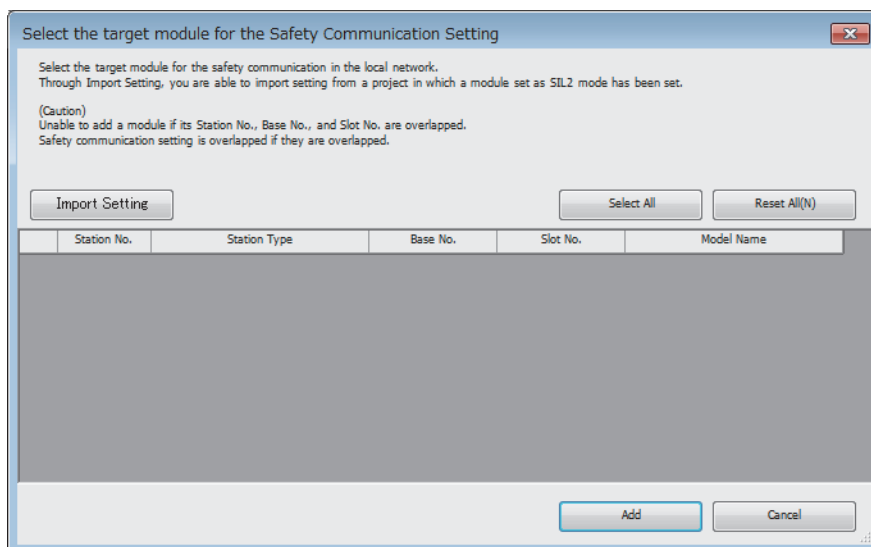

Select the target module for the safety communication in the local network.
Through Import Setting, you are able to import setting from a project in which a module set as SIL2 mode has been set.

(Caution)
Unable to add a module if its Station No., Base No., and Slot No. are overlapped.
Safety communication setting is overlapped if they are overlapped.

Import Setting Select All Reset All(N)

Station No.	Station Type	Base No.	Slot No.	Model Name

Add Cancel

5. Click the [Import Setting] button, and select the SIL2 system (remote head module side) project.

6. Select the check box for the safety communication setting target module, and click the [Add] button.

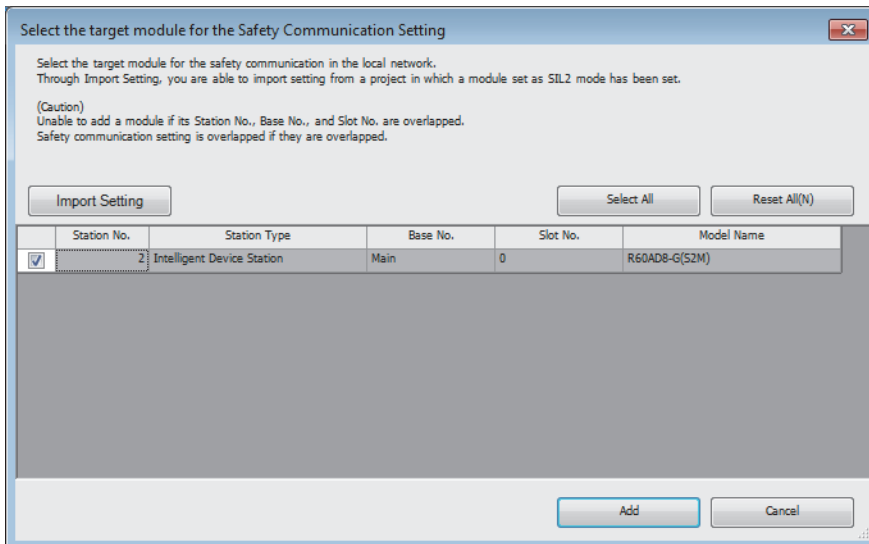

7. On the "Safety Communication Setting" window, configure the safety communication setting for the module added.

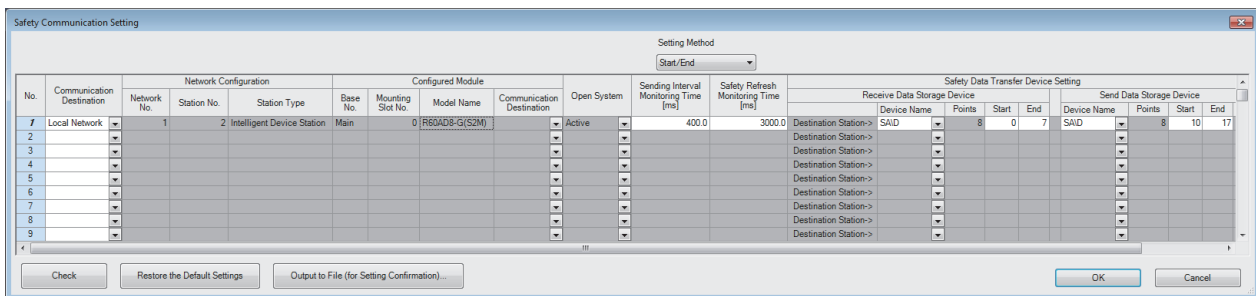

Item	Description
Sending Interval Monitoring Time [ms]	Refer to the following manual and set a value appropriate to your system. MELSEC iQ-R CC-Link IE Field Network User's Manual (Application) Set the time satisfying both of the following conditions. <ul style="list-style-type: none"> • $TM \geq S2cyc \times 3$ • $TM \geq (SCmst \times 2) + (LS \times 2)$ TM: Sending Interval Monitoring Time S2cyc: Control cycle time of the R60AD8-G (Page 225 Performance Specifications) SCmst: Safety cycle time of the master station (MELSEC iQ-R CPU Module User's Manual (Application)) LS: Link scan time (MELSEC iQ-R CC-Link IE Field Network User's Manual (Application))
Safety Refresh Monitoring Time [ms]	Refer to the following manual and set a value appropriate to your system. MELSEC iQ-R CC-Link IE Field Network User's Manual (Application)
Receive Data Storage Device	Select "SAID" or "SAIW" for "Device Name" to set the device for 8 points.
Send Data Storage Device	Select "SAID" or "SAIW" for "Device Name" to set the device for 8 points.

8. Write the set parameters to the SIL2 Process CPU and then reset the SIL2 Process CPU or turn off and on the power.

Writing the system A/B setting

Set system A/B to the SIL2 Process CPU in both systems. For details on setting procedure, refer to MELSEC iQ-R CPU Module User's Manual (Application). After the setting, both systems need to be restarted.

Setting user information

Set user information to set up access restrictions on the SIL2 Process CPU in both systems and projects. For details on setting procedure, refer to GX Works3 Operating Manual.

The set user information must be written into the SIL2 Process CPU in both systems.

Creating programs

Create a safety program and a standard program using the SIL2 diagnostic FB library. Refer to the following to create programs.

☞ Page 296 EXAMPLE OF OPERATION

■Attaching the SIL2 diagnostic FB library to programs

- Attach the SIL2 safety program FB to the safety program of the fixed scan execution type program.
- Attach the SIL2 standard program FB to the standard program of the scan execution type program.

Point

When more than one SIL2 safety program FB and SIL2 standard program FB are used, ensure that each FB has different instance name. If there is more than one FB with the same instance name, the target FB does not operate normally.

■Standard/safety shared label definition

Use the following procedure to define the standard/safety shared label.

The defined standard/safety shared label is used in the SIL2 safety program FB and SIL2 standard program FB.

1. Open the "New Data" window.

☞ [Navigation window] ⇒ [Label] ⇒ Right-click ⇒ [Add New Data]

2. Set the following and click the [OK] button. Set any name in "Data Name" but it must not be duplicated with any other "Data Name".

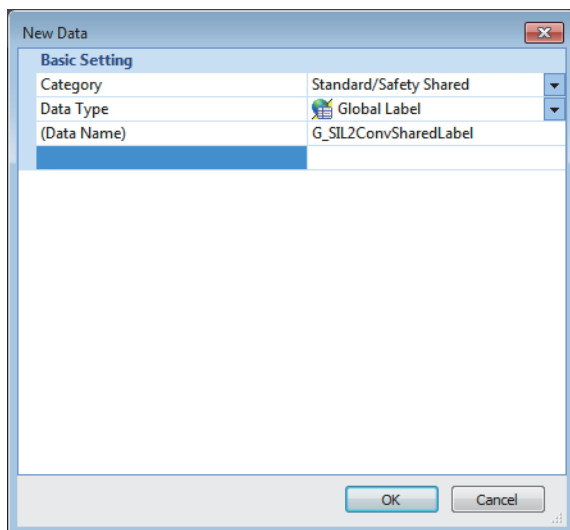

3. Set "Label Name". Set any name in "Label Name" but it must not be duplicated with any other "Label Name".

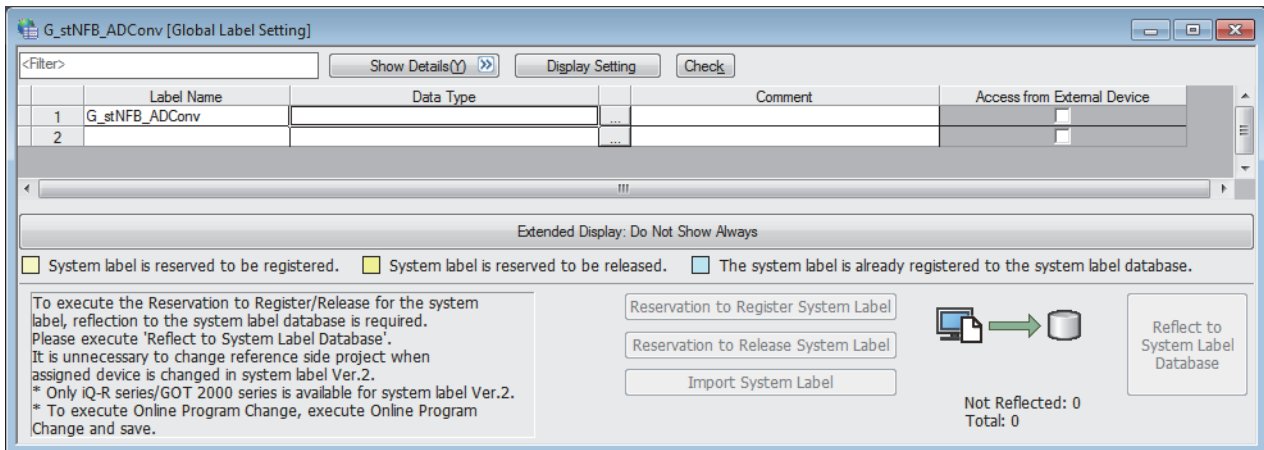

4. Click the [...] button to display the "Data Type Selection" window.
5. Set the following and click the [OK] button.

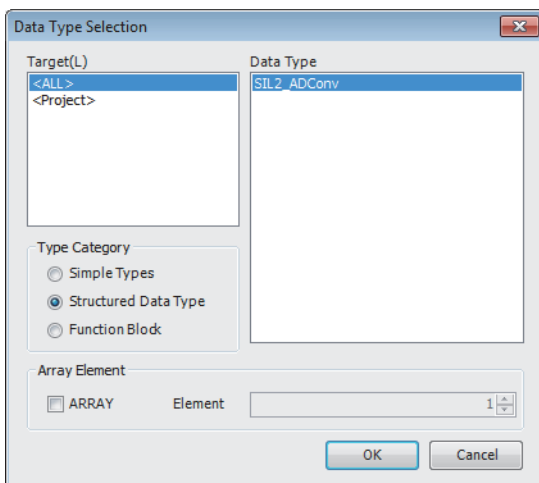

Point

When more than one SIL2 diagnostic FB library (SIL2 safety program FB and SIL2 standard program FB) are used, use each SIL2 diagnostic FB library as a single set. In addition, use a different standard/safety shared label for each set.



Safety module operation

With "Safety Module Operation" in the engineering tool, enable the R60AD8-G (Main) so that it can be used in SIL2 mode.

Point

Before performing safety module operation, pay attention to the following points.

- Ensure that the engineering tool is directly connected to the SIL2 Process CPU in the control system (specify "No Specification" for the engineering tool connection destination setting) before starting "Safety Module Operation". Do not connect the engineering tool directly to the SIL2 Process CPU in the standby system. Depending on the system configuration, performing the safety module operation with the engineering tool directly connected to the SIL2 Process CPU in the standby system may cause a timeout. A time that triggers a timeout is Set time in "Check at Communication Time" (second) × 3. (The default value for "Check at Communication Time" is 30 seconds.) For details on "Check at Communication Time", refer to the GX Works3 Operating Manual.
- Safety module operation is available only when the safety operation mode of the SIL2 Process CPU is set to TEST MODE. Ensure that the safety operation mode of the SIL2 Process CPU is set to TEST MODE before performing safety module operation. For details on the TEST MODE, refer to the MELSEC iQ-R CPU Module User's Manual (Application).

1. Open a project on the SIL2 Process CPU side.
2. Check that the safety operation mode of the SIL2 Process CPU is set to TEST MODE.
 [Diagnostics] ⇒ [Module Diagnostics (CPU Diagnostics)]
3. If the safety operation mode is SAFETY MODE, change it to TEST MODE.
 [Online] ⇒ [Safety PLC Operation] ⇒ [Switch Safety Operation Mode]
4. Start the "Safety Module Operation" window.
 [Online] ⇒ [Safety PLC Operation] ⇒ [Safety Module Operation]
5. Select the master/local module in the network where safety module operation is performed. The R60AD8-G (Main) to be enabled is displayed.

6. Select the check box for the R60AD8-G (Main) to be enabled, and click the [Update] button. The current enabled/ disabled status of the SIL2 analog input system is displayed for "Module Status".

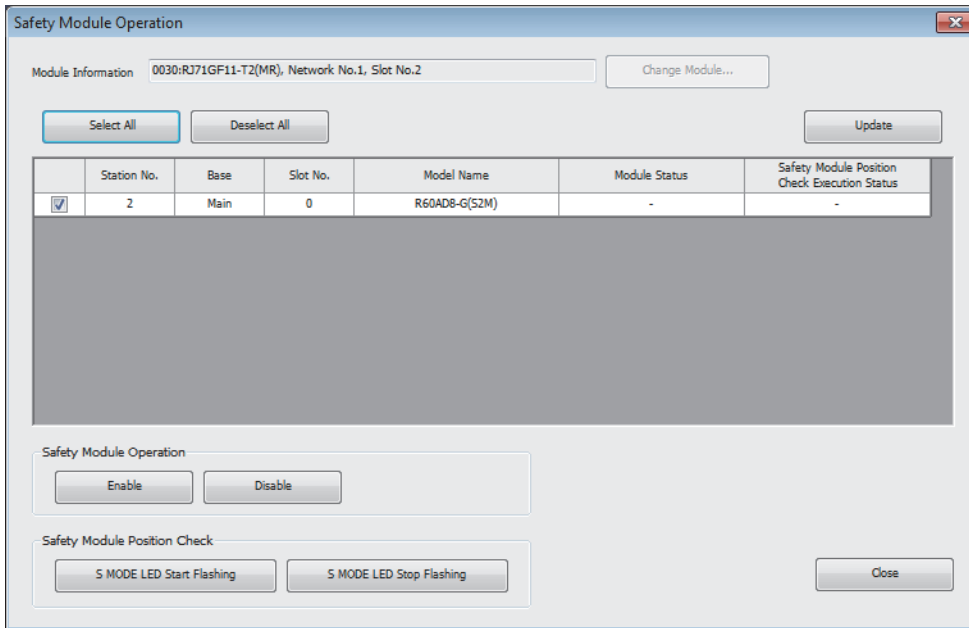

Module Status	Description
—	The information is not acquired.
Valid	The safety module is enabled and the configured parameters are valid.
Invalid	The safety module is not enabled and the configured parameters are not valid.
Valid (Reset Wait)	The safety module has just been enabled. In this state, the R60AD8-G needs to be reset, and the module status will be enabled after the reset. At this time, the ALM LED flashes every 0.4 seconds.
Invalid (Reset Wait)	The safety module has just been disabled. In this state, the R60AD8-G needs to be reset, and the module status will be disabled after the reset. At this time, the ALM LED flashes every 0.4 seconds.
Timeout	A timeout occurred because no response was returned from the target module. Check the settings or status of the target module. (☞ Page 313 When "Timeout" is displayed for "Module Status") <ul style="list-style-type: none"> • Is the module set to SIL2 mode? • Has an error occurred?

7. Select the check box for the R60AD8-G (Main) to be enabled, and click the [S MODE LED Start Flashing] button. Check that the S MODE LED for the R60AD8-G (Main and Sub) to be enabled is flashing (0.4s cycle). This operation makes it possible to check that there is no error on the operation target module before enabling it. In this case, the position checking status is displayed for "Safety Module Position Check Execution Status".

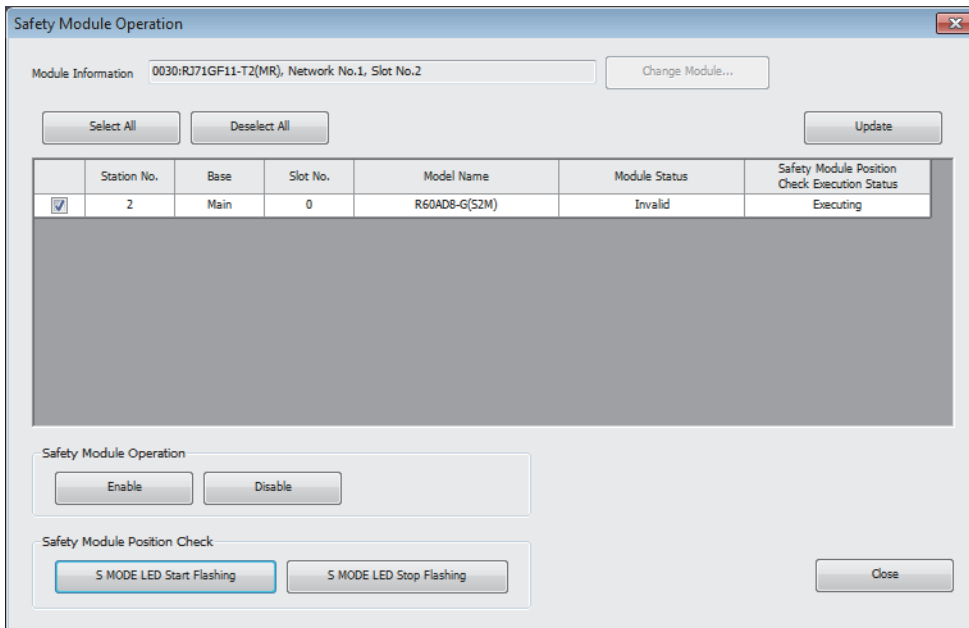

Safety Module Position Check Execution Status	Description
—	The information is not acquired.
Executing	The safety module position check is in process.
Stopping	The safety module position check is not executed.
Timeout	A timeout occurred because no response was returned from the target module. Check the settings or status of the target module. <ul style="list-style-type: none"> • Is the module set to SIL2 mode? • Has an error occurred?

8. After checking that the S MODE LED of the R60AD8-G (Main and Sub) to be enabled is flashing (0.4s cycle), click the [S MODE LED Stop Flashing] button to stop S MODE LED flashing.

Point

The S MODE LED of the R60AD8-G continues to flash (0.4s cycle) after the [S MODE LED Start Flashing] button is clicked and until the [S MODE LED Stop Flashing] button is clicked. Therefore, the S MODE LED of the R60AD8-G continues to flash (0.4s cycle) when the "Safety Module Operation" window is closed with the S MODE LED flashing (0.4s cycle).

To stop the flashing (0.4s cycle) of the S MODE LED of the R60AD8-G, open the "Safety Module Operation" window and click the [S MODE LED Stop Flashing] button.

9. Click the [Enable] button. In this case, the current enabled/disabled status of the safety module is displayed for "Module Status".

Module Status	Description
—	The information is not acquired.
Valid (Reset Wait)	The safety module has just been enabled. In this state, the R60AD8-G needs to be reset, and the module status will be enabled after the reset. At this time, the ALM LED flashes every 0.4 seconds.
Verification Failed	The module parameters are different between the SIL2 Process CPU project and the remote head module project. Check that the module parameters are consistent.
Enabling Failed (Module Error)	The safety module failed to be enabled. Check wiring or other items and retry it. If the error occurs again, the possible cause is a failure of the module.
Enabling Failed (Data Error)	
Timeout	A timeout occurred because no response was returned from the target module. Check the settings or status of the target module. (Page 313 When "Timeout" is displayed for "Module Status") <ul style="list-style-type: none"> • Is the module set to SIL2 mode? • Has an error occurred?

10. Check that "Valid (Reset Wait)" is displayed for "Module Status". The enabling and disabling operations are reflected to the R60AD8-G after the remote head module is reset or after the power is turned off and on.

11. Reset the remote head module or turn off and on the power, and click the [Update] button.

12. Check that "Valid" is displayed for "Module Status".

Point

- If a module that is already enabled is attempted to be enabled, the status does not change to "Valid (Reset Wait)" while the status is in "Valid".
- When changing a module parameter of the R60AD8-G, the safety module needs to be enabled again.
- When the safety module is enabled or disabled, the enabled/disabled state is saved in the flash memory in the module, but note that the number of rewrite operations is limited. The enabled and disabled states can be written up to 250000 times in total. If the number of write operations exceeds 250000, a number of safety module status switching exceeding limit error (error code: 1081H) occurs. In this case, a write operation of the enabled/disabled state is executed, but the result is not guaranteed.

■Disabling the safety module

Modules enabled by "Safety Module Operation" can be disabled. Modules need to be disabled when checking the module status after stopping the safety I/O or using them in standard mode.

1. In the "Safety Module Operation" window, select the check box for the R60AD8-G (Main) to be disabled, and click the [Disable] button. In this case, the current enabled/disabled status of the safety module is displayed for "Module Status".

Module Status	Description
—	The information is not acquired.
Invalid (Reset Wait)	The safety module has just been disabled. In this state, the R60AD8-G needs to be reset, and the module status will be disabled after the reset. At this time, the ALM LED flashes every 0.4 seconds.
Enabling Failed (Module Error)	The safety module failed to be enabled. Check wiring or other items and retry it. If the error occurs again, the possible cause is a failure of the module.
Enabling Failed (Data Error)	
Timeout	A timeout occurred because no response was returned from the target module. Check the settings or status of the target module. (☞ Page 313 When "Timeout" is displayed for "Module Status") <ul style="list-style-type: none"> • Is the module set to SIL2 mode? • Has an error occurred?

2. Check that "Invalid (Reset Wait)" is displayed for "Module Status" in the "Safety Module Operation" window. The enabling and disabling operations are reflected to the R60AD8-G (Main) after the remote head module is reset or after the power is turned off and on.

Operation check

Check the status of each module used in the systems and program behaviors. For details on the check procedure, refer to the following.

☞ Page 228 PROCEDURES BEFORE OPERATION

1. Power off the SIL2 Process CPU in both systems and the remote head module.
2. Set the RUN/STOP/RESET switch for the SIL2 Process CPU in both systems and for the remote head module to RUN, and turn the power of the systems on.
3. Check each module to see if an error did not occur.
4. Check the LED on/off status of each module.

• Control system

R08PSFCPU READY <input checked="" type="checkbox"/> ERROR <input type="checkbox"/> PROGRAM RUN <input checked="" type="checkbox"/> USER <input type="checkbox"/> BATTERY <input type="checkbox"/> CARD READY <input type="checkbox"/> CARD ACCESS <input type="checkbox"/> FUNCTION <input type="checkbox"/>	R6PSFM READY <input checked="" type="checkbox"/> ERROR <input type="checkbox"/> PROGRAM RUN <input checked="" type="checkbox"/> SAFETY COM RUN <input checked="" type="checkbox"/> SAFETY COM ERR <input type="checkbox"/> TEST <input checked="" type="checkbox"/>	R6RFM RUN <input checked="" type="checkbox"/> ERR <input type="checkbox"/> SYS [A <input checked="" type="checkbox"/> CTRL <input type="checkbox"/> [B <input checked="" type="checkbox"/> SBY <input type="checkbox"/> [BACKUP <input checked="" type="checkbox"/> [SEPARATE <input type="checkbox"/> MEMORY COPY <input type="checkbox"/> LINK <input checked="" type="checkbox"/> L ERR <input type="checkbox"/>	RJ71GF11-T2 RUN <input checked="" type="checkbox"/> ERR <input type="checkbox"/> MST <input checked="" type="checkbox"/> D LINK <input checked="" type="checkbox"/> SD/RD <input checked="" type="checkbox"/> L ERR <input type="checkbox"/>
---	--	--	--

• Standby system

R08PSFCPU READY <input checked="" type="checkbox"/> ERROR <input type="checkbox"/> PROGRAM RUN <input checked="" type="checkbox"/> USER <input type="checkbox"/> BATTERY <input type="checkbox"/> CARD READY <input type="checkbox"/> CARD ACCESS <input type="checkbox"/> FUNCTION <input type="checkbox"/>	R6PSFM READY <input checked="" type="checkbox"/> ERROR <input type="checkbox"/> PROGRAM RUN <input checked="" type="checkbox"/> SAFETY COM RUN <input checked="" type="checkbox"/> SAFETY COM ERR <input type="checkbox"/> TEST <input checked="" type="checkbox"/>	R6RFM RUN <input checked="" type="checkbox"/> ERR <input type="checkbox"/> SYS [A <input checked="" type="checkbox"/> CTRL <input type="checkbox"/> [B <input checked="" type="checkbox"/> SBY <input type="checkbox"/> [BACKUP <input checked="" type="checkbox"/> [SEPARATE <input type="checkbox"/> MEMORY COPY <input type="checkbox"/> LINK <input checked="" type="checkbox"/> L ERR <input type="checkbox"/>	RJ71GF11-T2 RUN <input checked="" type="checkbox"/> ERR <input type="checkbox"/> MST <input checked="" type="checkbox"/> D LINK <input checked="" type="checkbox"/> SD/RD <input checked="" type="checkbox"/> L ERR <input type="checkbox"/>
---	--	--	--

• Remote head module side*1

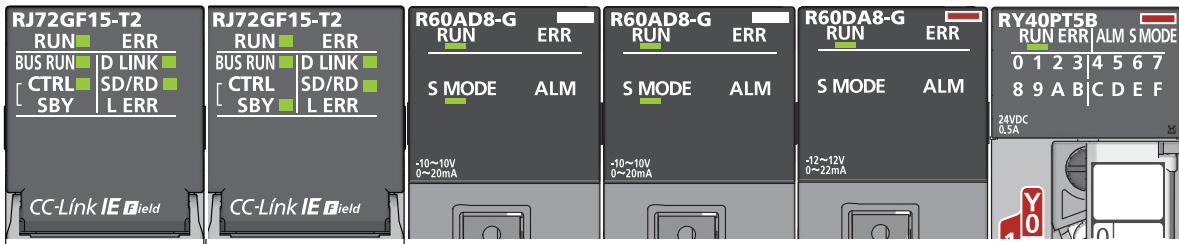

*1 Because the remote head module is not in a redundancy configuration for the redundant master station system, the following LEDs are always turned off.

·CTRL LED ·SBY LED

5. Check that no error occurred in CC-Link IE Field Network diagnostics.

(MELSEC iQ-R CC-Link IE Field Network User's Manual (Application))

6. Check the behaviors of the safety program and standard program.

Switching the safety operation mode

For normal operation as a SIL2 analog input system, switch the safety operation mode.

1. Power off the SIL2 Process CPU in both systems.

2. Set the RUN/STOP/RESET switch for the SIL2 Process CPU in both systems to STOP, and turn on the power.

3. With "Switch Safety Operation Mode" in the engineering tool, switch to the SAFETY MODE.

[Online] ⇒ [Safety PLC Operation] ⇒ [Switch Safety Operation Mode]

4. Power off the SIL2 Process CPU in both systems and the remote head module.

5. Set the RUN/STOP/RESET switch for the SIL2 Process CPU in both systems and for the remote head module to RUN, and turn the power of the systems on.

6. Check that the TEST LED for the R6PSFM is off.

10.2 Processing of Each Function

The functions are processed in the order shown below. If multiple functions are enabled, the output of the first processed function is used as the input of the next function.

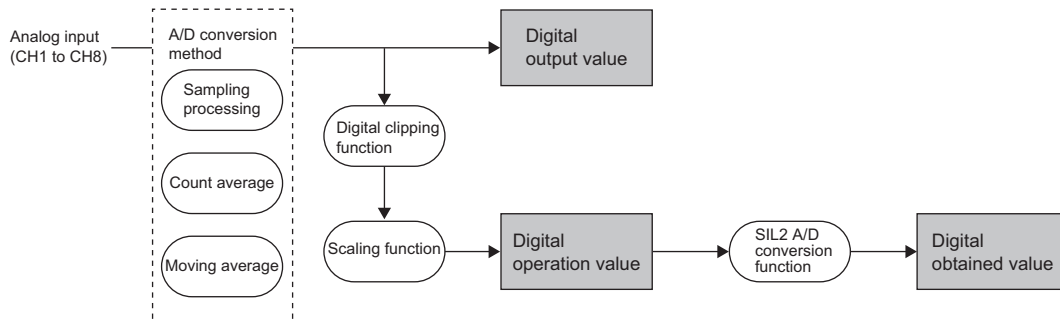

Digital output value

These values are the digital values after the sampling processing or each averaging processing has been performed.

These values are stored in the R60AD8-G (Main) and R60AD8-G (Sub) each.

Note that digital output values cannot be read from the R60AD8-G modules set to SIL2 mode because these modules handle digital output values as internal values.

Digital operation value

These values are obtained by operating a digital output value using the digital clipping function and scaling function. When each function is not used, the value is the same as the digital output value.

These values are stored in the R60AD8-G (Main) and R60AD8-G (Sub) each.

Note that digital output values cannot be read from the R60AD8-G modules set to SIL2 mode because these modules handle digital output values as internal values.

Digital obtained value

The average value of digital operation values of the R60AD8-G (Main) and R60AD8-G (Sub) is stored as a digital obtained value in the safety device specified by the SIL2 diagnostic FB library.

10.3 Range Switching Function

This function allows the input range of analog input to be switched for each channel. Switching the range makes it possible to change the I/O conversion characteristics.

Setting procedure

Set the input range to be used in the "Input range setting".

 [Navigation window] ⇒ [Parameter] ⇒ [Module Information] ⇒ Module model name ⇒ [Basic setting] ⇒ [Range switching function]

Input range setting	Digital operation value
4 to 20mA	0 to 32000
0 to 20mA	
1 to 5V	
0 to 5V	
-10 to 10V	-32000 to 32000
0 to 10V	0 to 32000
4 to 20mA (extended mode)	-8000 to 32767
1 to 5V (extended mode)	
User range setting	-32000 to 32000

After the data is written, the input range is switched when the programmable controller power supply is turned off and on or when the CPU module is reset.

When the user range setting is used

In SIL2 mode, the user range setting is available but the offset/gain setting is not available. To use the user range setting in SIL2 mode, configure the offset/gain setting in standard mode in advance. (MELSEC iQ-R Channel Isolated Analog-Digital Converter Module User's Manual (Startup))

In addition, refer to the descriptions below and set "Input range setting" according to the setting of "Current / Voltage selection" that was used for the offset/gain setting configured in standard mode.

- For channels for which the offset/gain setting was configured with "Voltage" selected, select "User Range Setting (Voltage)" for "Input range setting".
- For channels for which the offset/gain setting was configured with "Current" selected, select "User Range Setting (Current)" for "Input range setting".

If "Input range setting" is inconsistent with the setting of "Current / Voltage selection" used for the offset/gain setting configured in standard mode, A/D conversion circuit diagnostics does not work properly and an A/D conversion circuit diagnostic error (error code: 1EF□H) may occur.

Digital output upper limit value of the extended mode range

The digital output range in SIL2 mode is 16-bit signed binary data, and therefore the digital output upper limit with the input range of 4 to 20mA (extended mode) or 1 to 5V (extended mode) is 32767.

10.4 A/D Conversion Enable/Disable Setting Function

This function controls whether to enable or disable the A/D conversion for each channel. Disabling the A/D conversion for unused channels reduces the conversion cycles.

Setting procedure

Set "A/D conversion enable/disable setting" to "A/D conversion enable" or "A/D conversion disable".

 [Navigation window] ⇒ [Parameter] ⇒ [Module Information] ⇒ Module model name ⇒ [Basic setting] ⇒ [A/D conversion enable/disable setting function]

10.5 A/D Conversion Method

An A/D conversion method can be set for each channel.

Sampling processing

This function converts analog input values to digital operation values at every sampling period.

Point

The sampling period is "Conversion speed (12ms) × Number of conversion enabled channels".

Whether to enable or disable the A/D conversion can be set for each channel. Disabling the A/D conversion for unused channels reduces the conversion cycles.

Conversion cycle that applies when CH1 to CH3 is set to A/D conversion enabled

- $12 \times 3 = 36$ (ms)

The conversion cycle is 36 (ms).

Analog input values are converted to digital operation values of CH1 to CH3 every 36ms.

Averaging processing

The A/D converter module performs the averaging processing on digital operation values for each channel.

The following two types of averaging processing are provided.

- Count average
- Moving average

■Count average

The A/D converter module executes the A/D conversion for a set number of times, and performs the averaging processing on the total value excluding the maximum and the minimum values. The time to complete averaging processing with a set number of times depends on the number of channels where the A/D conversion is enabled.

The time taken for the mean value calculated through the count average to be stored in the buffer memory changes depending on the number of channels where the A/D conversion is enabled.

Processing time = Set number of times × (Number of conversion enabled channels × Conversion speed)

Ex.

The processing time calculated with the settings in the table is shown below.

Item	Setting
Number of channels where the A/D conversion is enabled	Four channels (CH1 to CH4)
Set number of times	Five times

$5 \text{ (times)} \times 4 \text{ (CH)} \times 12 \text{ (ms)} = 240 \text{ (ms)}$

A mean value is output every 240ms.

Point

Because the count average requires a sum of at least two counts excluding the maximum and minimum values, the set number of times should be four or more.

■ Moving average

The A/D converter module averages digital operation values taken at every sampling period for a specified number of times. The following figure shows the moving average processing of when the set number of times is five.

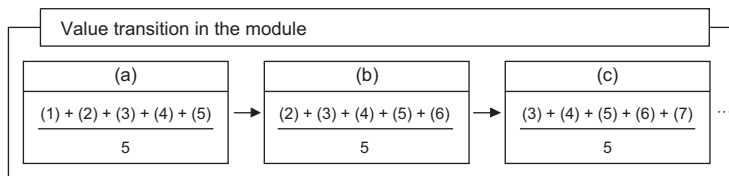
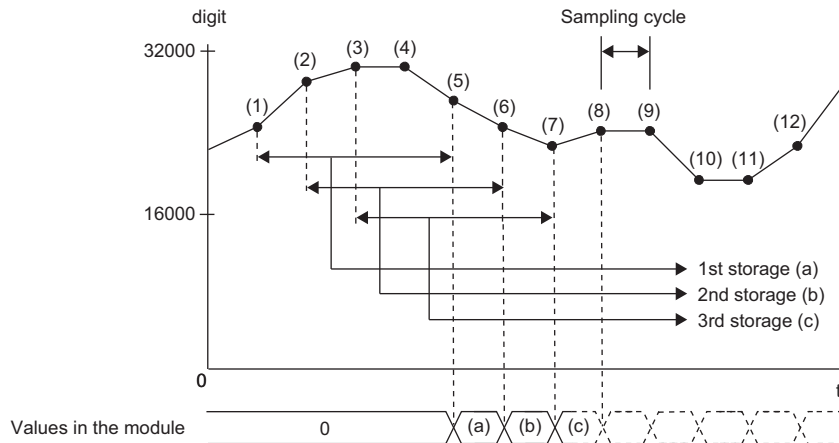

digit: Digital operation value
t: Time (ms)

Setting procedure

■ Sampling processing

Set "Averaging process specification" to "Sampling processing".

[Navigation window] ⇒ [Parameter] ⇒ [Module Information] ⇒ Module model name ⇒ [Basic setting] ⇒ [A/D conversion method]

■ Averaging processing

1. Set "Averaging process specification" to "Count average" or "Moving average".

[Navigation window] ⇒ [Parameter] ⇒ [Module Information] ⇒ Module model name ⇒ [Basic setting] ⇒ [A/D conversion method]

2. Set a value for "Count average/Moving average setting".

Item	Setting range
Count average	4 to 500 (times)
Moving average	2 to 200 (times)

10.6 Scaling Function

This function performs the scale conversion on digital operation values. The values are converted within a specified range between a scaling upper limit value and scaling lower limit value. This function helps reduce the time taken for creating a scale conversion program.

Concept of scaling setting

Ex.

When the input range is set to -10 to 10V:

For the scaling lower limit value, set a value corresponding to the lower limit value of the input range (-32000).

For the scaling upper limit value, set a value corresponding to the upper limit value of the input range (32000).

Calculating the scaling value

The scale conversion is based on the following formula. (In scale conversion, values are rounded to the nearest whole number.)

Current: 0 to 20mA, 4 to 20mA, 4 to 20mA (extended mode)*1, user range setting (current)

Voltage: 0 to 10V, 0 to 5V, 1 to 5V, 1 to 5V (extended mode)*1, user range setting (voltage)

$$D_Y = \frac{D_X \times (S_H - S_L)}{D_{Max}} + S_L$$

Voltage: -10 to 10V

$$D_Y = \frac{D_X \times (S_H - S_L)}{D_{Max} - D_{Min}} + \frac{(S_H + S_L)}{2}$$

D_X: Digital operation value before scaling

D_Y: Scaling value (Digital operation value)

D_{Max}: Maximum digital output value of the input range in use

D_{Min}: Minimum digital output value of the input range in use

S_H: Scaling upper limit value

S_L: Scaling lower limit value

*1 Although the range of the digital operation value in the extended mode is -8000 to 32767, this function performs the scale conversion for digital operation values within the range of 0 to 32000.

Point

When the calculated digital operation value exceeds 32767, the value 32767 is stored as the digital operation value. When the calculated digital operation value falls below -32768, the value -32768 is stored.

Setting procedure

1. Set "Scaling enable/disable setting" to "Enable".

[Navigation window] ⇒ [Parameter] ⇒ [Module Information] ⇒ Module model name ⇒ [Application setting] ⇒ [Scaling setting]

2. Set values for "Scaling upper limit value" and "Scaling lower limit value".

Item	Setting range
Scaling upper limit value	-32000 to 32000
Scaling lower limit value	

Point

- Even when the scaling upper limit value and the scaling lower limit value are set so that the change is greater than the resolution, the resolution will not increase.
- If the relation between the values is the scaling lower limit value > the scaling upper limit value, the scale conversion can be performed according to a negative slope.
- Set the scaling with the condition "Scaling upper limit value ≠ Scaling lower limit value".

Setting example

Ex.

When 20000 is set to the scaling upper limit value and 4000 is set to the scaling lower limit value for the R60AD8-G with the input range of 0 to 5V

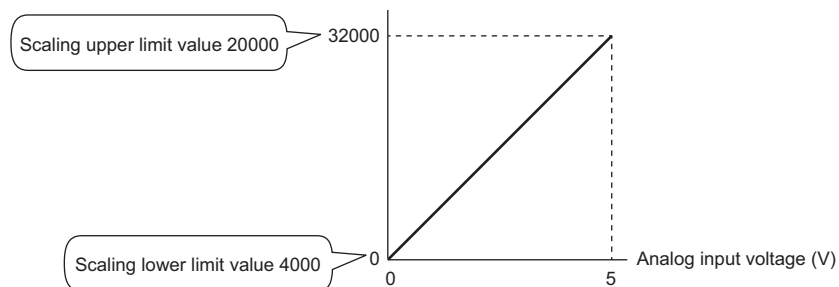

Voltage input (V)	Digital operation value before scaling	Digital operation value (scaling value)
0	0	4000
1	6400	7200
2	12800	10400
3	19200	13600
4	25600	16800
5	32000	20000

Ex.

When 20000 is set to the scaling upper limit value and 4000 is set to the scaling lower limit value for the R60AD8-G with the input range of -10 to 10V

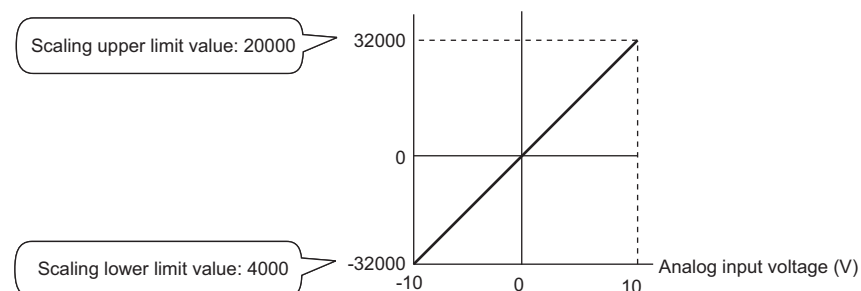

Voltage input (V)	Digital operation value before scaling	Digital operation value (scaling value)
-10	-32000	4000
-5	-16000	8000
0	0	12000
5	16000	16000
10	32000	20000

Ex.

When 20000 is set to the scaling upper limit value and 4000 is set to the scaling lower limit value for the R60AD8-G with the input range of 1 to 5V (extended mode)

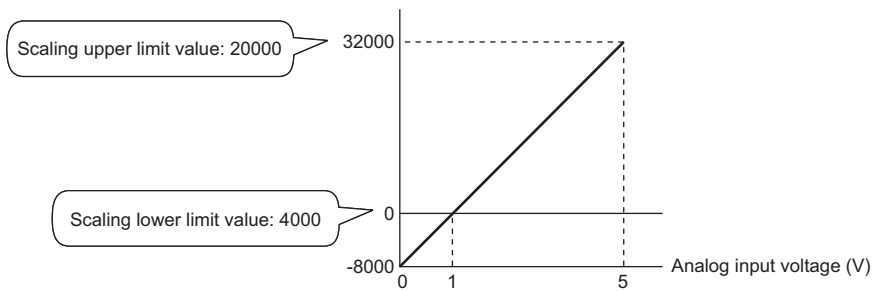

Voltage input (V)	Digital operation value before scaling	Digital operation value (scaling value)
0	-8000	0
1	0	4000
2	8000	8000
3	16000	12000
4	24000	16000
5	32000	20000

Ex.

When 32000 is set to the scaling upper limit value and -32000 is set to the scaling lower limit value for the R60AD8-G with the input range of 4 to 20mA (extended mode)

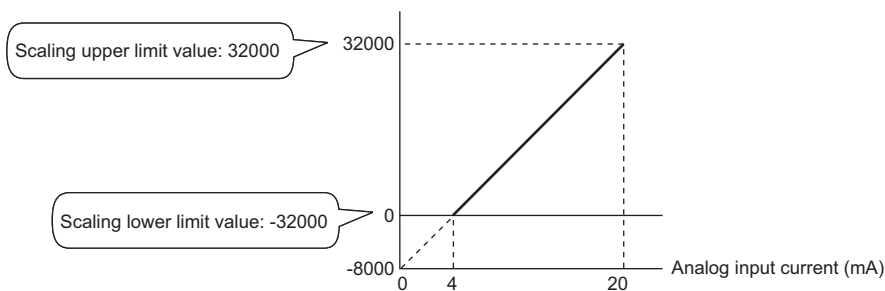

Current input (mA)	Digital operation value before scaling	Digital operation value (scaling value)
0	-8000	-32768 ^{*1}
4	0	-32000
8	8000	-16000
12	16000	0
16	24000	16000
20	32000	32000
20.24	32480	32767 ^{*2}

*1 Because the value falls below the range of -32768 to 32767, the value is fixed to -32768 (the lower limit value).

*2 Because the value exceeds the range of -32768 to 32767, the value is fixed to 32767 (the upper limit value).

Point

When the scaling function is used with the digital clipping function, the scale conversion is performed on the digital operation values after digital clipping.

10.7 Digital Clipping Function

This function fixes the digital operation value with the maximum digital output value and the minimum digital output value when the corresponding current or voltage exceeds the input range.

List of output ranges

The following table lists the output ranges of the digital operation values when the digital clipping function is enabled with each input range.

Input range	Output range of digital operation values	
	Digital clipping function is enabled	Digital clipping function is disabled
4 to 20mA	0 to 32000	-768 to 32767
0 to 20mA		
1 to 5V		
0 to 5V		
0 to 10V		
-10 to 10V	-32000 to 32000	-32768 to 32767
User range setting		
4 to 20mA (extended mode)	-8000 to 32767	-8768 to 32767
1 to 5V (extended mode)		

Point

When the determined digital operation value is out of the range of -32768 to 32767, the digital clipping function is performed to the following values.

- When the digital operation value is 32767 or greater: 32767
- When the digital operation value is -32768 or smaller: -32768

Setting procedure

Set "Digital clipping enable/disable setting" to "Enable".

 [Navigation window] ⇒ [Parameter] ⇒ [Module Information] ⇒ Module model name ⇒ [Application setting] ⇒ [Digital clipping function]

Setting example

Ex.

When the following values are used for the R60AD8-G with the input range of 0 to 5V

- "Scaling enable/disable setting": "Enable"
- "Scaling upper limit value": 12000
- "Scaling lower limit value": 2000
- "Digitalclip enable/disable setting": "Enable"

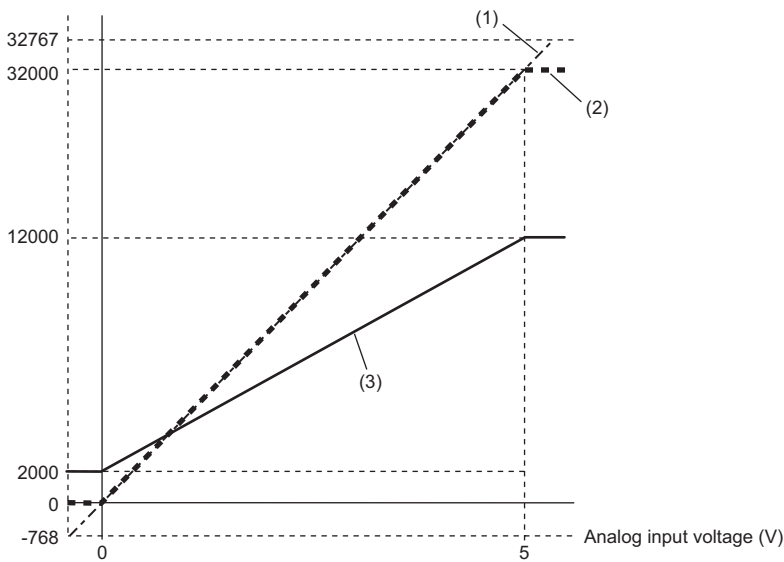

(1) Digital operation value before processing
 Digital clipping
 -768 to 32767
 ↓
 0 to 32000
 (2) Value after digital clipping
 Scaling
 0 to 32000
 ↓
 2000 to 12000
 (3) Digital operation value to be output

Input voltage (V)	Digital operation value before processing	Digital operation value to be output
-0.12	-768	2000
0	0	2000
1	6400	4000
2	12800	6000
3	19200	8000
4	25600	10000
5	32000	12000
5.096	32767	12000

Point

When the digital clipping function is used with the scaling function, scale conversion is performed on the value obtained after digital clipping.

10.8 SIL2 A/D Conversion Function

The R60AD8-G (Main) and R60AD8-G (Sub) use this function based on the time set in "SIL2 A/D conversion cycle setting" to execute A/D conversion that satisfies the safety level defined by IEC61508: 2010 SIL2 and IEC61511: 2015 SIL2 while executing error detection functions, such as double input discrepancy detection, and regular diagnostics for failure, such as A/D conversion circuit diagnostics. The SIL2 diagnostic FB library is required for this function.

The following table describes each function executed by the SIL2 A/D conversion function, corresponding SIL2 diagnostic FB library used, and the module status at the time of error detection.

Function name	SIL2 diagnostic FB library used	Module status at the time of error detection		
		Error description	Safety input status	Relay connection
Double input discrepancy detection function	SIL2 safety program FB (M+SIL2ADG_ADConv_R)	Double input discrepancy detection error (error code: 1ED□H)	Input of a channel with an error turns off.	Does not disconnect sensors.
A/D conversion circuit diagnostic function	<ul style="list-style-type: none"> SIL2 safety program FB (M+SIL2ADG_ADConv_R) SIL2 standard program FB (M+SIL2ADG-IEF_WriteDAVal_R) 	A/D conversion circuit diagnostic error (error code: 1EF□H)		Disconnect sensors.
Input HOLD function	—	Safety I/O HOLD time exceeded error (error code: 1500H)	Previous values are maintained for input of all channels.	The relay is not changed.

SIL2 diagnostic FB library

Safety devices specified by the SIL2 diagnostic FB library and corresponding I/O labels are as follows.

■SIL2 safety program FB (M+SIL2ADG_ADConv_R)

- Symbol

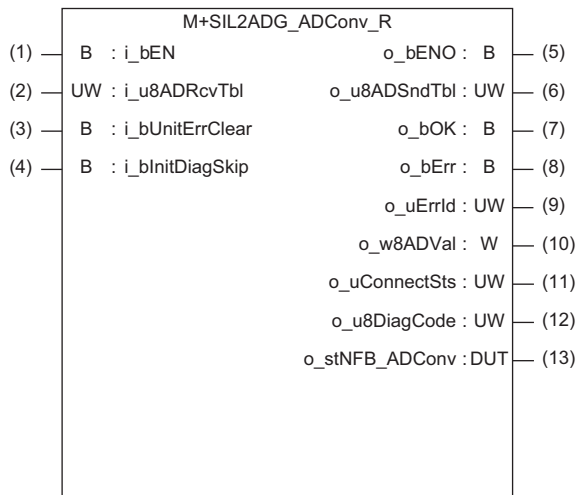

- Input labels

No.	Variable name	Name	Data type	Scope	Description
(1)	i_bEN	Execution command	Bit	On or off	<p>On: The FB is activated. Off: The FB is not activated.</p> <p>Set 'Safety refresh communication status of each safety connection (1st module)' (SA\SD1008 to SA\SD1015)^{*1} for the intelligent device station where the R60AD8-G (Main) is mounted.</p> <p>For details on the safety special register, refer to the following.</p> <p>📖 MELSEC iQ-R CPU Module User's Manual (Application)</p> <p>For a setting example of this input label, refer to the following.</p> <p>📄 Page 296 EXAMPLE OF OPERATION</p>

No.	Variable name	Name	Data type	Scope	Description
(2)	i_u8ADRCvTbl	Safety communications receive area	Word [unsigned]	Valid device range	The label sets the start device of the receive data storage device (8 words) for the safety communication setting.
(3)	i_bUnitErrClear	Module error clear	Bit	On or off	Turn it on to clear the error that is currently occurring. Turn it off after the error is cleared.
(4)	i_bInitDiagSkip	Start-up diagnostics skip request	Bit	On or off	The label selects whether start-up diagnostics is to be performed or not. This setting is valid only when the safety operation mode of the SIL2 Process CPU is TEST MODE. When the mode is other than TEST MODE, the diagnostics is performed independent of this setting. <ul style="list-style-type: none"> • On: Start-up diagnostics is not performed. • Off: Start-up diagnostics is performed.

*1 For details on the safety special register (2nd module or later), refer to the following.

📖 MELSEC iQ-R CPU Module User's Manual (Application)

• Output labels

No.	Variable name	Name	Data type	Default value	Description																						
(5)	o_bENO	Execution status	Bit	Off	On: The execution command is on. Off: The execution command is off.																						
(6)	o_u8ADSndTbl	Safety communications send area	Word [unsigned]	0	The label sets the start device of the send data storage device (8 words) for the safety communication setting.																						
(7)	o_bOK	Normal completion	Bit	Off	The on state indicates that the FB processing has been completed successfully.																						
(8)	o_bErr	Error completion	Bit	Off	The on state indicates that the FB processing has been completed with an error.																						
(9)	o_uErrId	Error code	Word [unsigned]	0	The error code is stored at error completion.																						
(10)	o_w8ADVal	Digital obtained value	Word [signed]	0	Digital operation values obtained from the R60AD8-G (Main) and the R60AD8-G (Sub) are averaged and output. This label specifies a safety device area for the CH1 output destination. For CH2 and subsequent channels, 7 words of safety device areas are assigned and numbered sequentially starting from the next area of that specified for CH1. Areas of 8 words are required as the output destination regardless of the number of A/D conversion enabled channels.																						
(11)	o_uConnectSts	External device connection status	Word [unsigned]	0	The label indicates the connection status between the R60AD8-G and a sensor. b0 to b7 correspond to CH1 to CH8. b8 to b15 are not used. <table style="margin-left: auto; margin-right: auto;"> <tr> <td style="text-align: center;">b15</td> <td style="text-align: center;">...</td> <td style="text-align: center;">b8</td> <td style="text-align: center;">b7</td> <td style="text-align: center;">b6</td> <td style="text-align: center;">b5</td> <td style="text-align: center;">b4</td> <td style="text-align: center;">b3</td> <td style="text-align: center;">b2</td> <td style="text-align: center;">b1</td> <td style="text-align: center;">b0</td> </tr> <tr> <td style="border: 1px solid black; width: 20px; height: 15px;"></td> <td></td> <td style="border: 1px solid black; width: 20px; height: 15px;"></td> <td style="border: 1px solid black; width: 20px; height: 15px;"></td> <td style="border: 1px solid black; width: 20px; height: 15px;"></td> <td style="border: 1px solid black; width: 20px; height: 15px;"></td> <td style="border: 1px solid black; width: 20px; height: 15px;"></td> <td style="border: 1px solid black; width: 20px; height: 15px;"></td> <td style="border: 1px solid black; width: 20px; height: 15px;"></td> <td style="border: 1px solid black; width: 20px; height: 15px;"></td> <td style="border: 1px solid black; width: 20px; height: 15px;"></td> </tr> </table> <ul style="list-style-type: none"> • On: Connected • Off: Disconnected 	b15	...	b8	b7	b6	b5	b4	b3	b2	b1	b0											
b15	...	b8	b7	b6	b5	b4	b3	b2	b1	b0																	
(12)	o_u8DiagCode	Status code	Word [unsigned]	0	A status code for each channel is stored. This label specifies a safety device area for the CH1 storage location. For CH2 and subsequent channels, safety device areas are assigned and numbered sequentially starting from the next area of that specified for CH1. Areas of 8 words are required as the storage location regardless of the number of A/D conversion enabled channels.																						
(13)	o_stNFB_ADConv	Standard/safety shared output data	Structure	—	Data from a SIL2 safety program FB to a SIL2 standard program FB is stored. For labels to be specified, refer to the following. 📖 Page 256 Standard/safety shared label definition																						

■ SIL2 standard program FB (M+SIL2ADG-IEF_WriteDAVal_R)

• Symbol

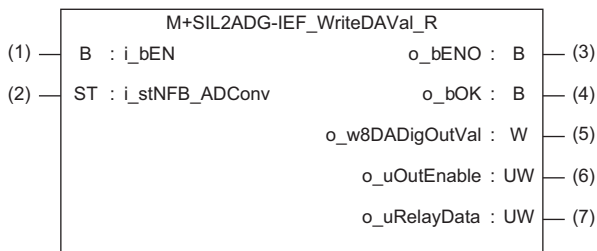

• Input labels

No.	Variable name	Name	Data type	Scope	Description
(1)	i_bEN	Execution command	Bit	On or off	On: The FB is activated. Off: The FB is not activated.
(2)	i_stNFB_ADConv	Standard/safety shared input data	Structure	—	The label specifies standard/safety shared data defined as follows.  Page 256 Standard/safety shared label definition

• Output labels

No.	Variable name	Name	Data type	Default value	Description
(3)	o_bENO	Execution status	Bit	Off	On: The execution command is on. Off: The execution command is off.
(4)	o_bOK	Normal completion	Bit	Off	The on state indicates that the FB processing has been completed successfully.
(5)	o_w8DADigOutVal	Digital value	Word [signed]	0	The label sets the device assigned to CH1 to CH8 Digital value of the R60DA8-G for diagnostics. Areas of 8 words are required regardless of the number of D/A conversion enabled channels.
(6)	o_uOutEnable	D/A output enable/disable setting	Word [unsigned]	0	The label sets the device assigned to Y00 to Y0F of the R60DA8-G for diagnostics in a word type.*1
(7)	o_uRelayData	Relay control signal	Word [unsigned]	0	The label sets the device assigned to Y00 to Y0F of the RY40PT5B in a word type.*1

*1 If the assigned device is a type of bit, it must be set up as a word-type device.

Setting procedure

To use the SIL2 A/D conversion function, the following module parameter settings and a program by the SIL2 diagnostic FB library are required.

- "SIL2 A/D conversion cycle setting"
- "Transmission interval monitoring time"

■ "SIL2 A/D conversion cycle setting"

Set the time required for conducting the following: match the digital operation values from the A/D conversion by the R60AD8-G (Main) and R60AD8-G (Sub) by double input discrepancy detection function; store the mean value in a safety device specified by the SIL2 diagnostic FB library.

 [Navigation window] ⇒ [Parameter] ⇒ [Module Information] ⇒ [R60AD8-G(S2M)] ⇒ [Application setting] ⇒ [SIL2 A/D conversion cycle setting]

Item	Setting range
SIL2 A/D conversion cycle setting	700 to 32767 (ms)

Use the following formula to calculate the setting value. Set the calculated value or a higher value.

- $(SCmst \times 10) + (RM \times 3) + (LS \times 16) + 372ms + (12ms \times CHad) + (SM \times 2)$

The following table lists symbols.

Symbol	Description
SCmst	Safety cycle time of the master station (safety station) ^{*1}
RM	Safety refresh monitoring time ^{*2}
LS	Link scan time
CHad	Number of A/D conversion enabled channels
SM	Sequence scan time of the master station (safety station)

*1 For details on the safety cycle time, refer to the following.

 MELSEC iQ-R CPU Module User's Manual (Application)

*2 For details on the safety refresh monitoring time, refer to the following.

 MELSEC iQ-R CC-Link IE Field Network User's Manual (Application)

Ex.

Calculation example with the following conditions:

- SCmst: 50ms
- RM: 400ms
- LS: 2ms
- CHad: 8 (A/D conversion enabled for all channels)
- SM: 2ms

$$\begin{aligned} & (SCmst \times 10) + (RM \times 3) + (LS \times 16) + 372ms + (12ms \times CHad) + (SM \times 2) \\ &= (50ms \times 10) + (400ms \times 3) + (2ms \times 16) + 372ms + (12ms \times 8) + (2ms \times 2) \\ &= 2204ms \end{aligned}$$

With the above conditions, set "SIL2 A/D conversion cycle setting" to 2204(ms) or higher.

■"Transmission interval monitoring time"

"Transmission interval monitoring time" of the R60AD8-G is the time used for monitoring where the master station detects an error on safety communications (data transmission from the R60AD8-G to the master station). If the interval of safety communications from the R60AD8-G exceeds the time set in "Transmission interval monitoring time", the master station detects it as disconnection.

 [Navigation window] ⇒ [Parameter] ⇒ [Module Information] ⇒ [R60AD8-G(S2M)] ⇒ [Basic setting] ⇒ [Transmission interval monitoring time]

Item	Setting range
Transmission interval monitoring time	30 to 3000(ms)

Set "Transmission interval monitoring time" of the R60AD8-G to the value same as the one set in "Sending Interval Monitoring Time [ms]" on the "Safety Communication Setting" window. ( Page 254 Safety communication setting)

■Program by the SIL2 diagnostic FB library

With a project on the SIL2 Process CPU side, create a safety program and standard program and define the I/O of the SIL2 diagnostic FB library. Refer to the following to create programs.

 Page 296 EXAMPLE OF OPERATION

Timing chart of the SIL2 A/D conversion function

The function behavior differs between the normal state and when the A/D conversion circuit diagnostic function is executed.

Normal state

Odd number channel double input discrepancy detection and even number channel double input discrepancy detection are repeated alternately for each SIL2 A/D conversion cycle.

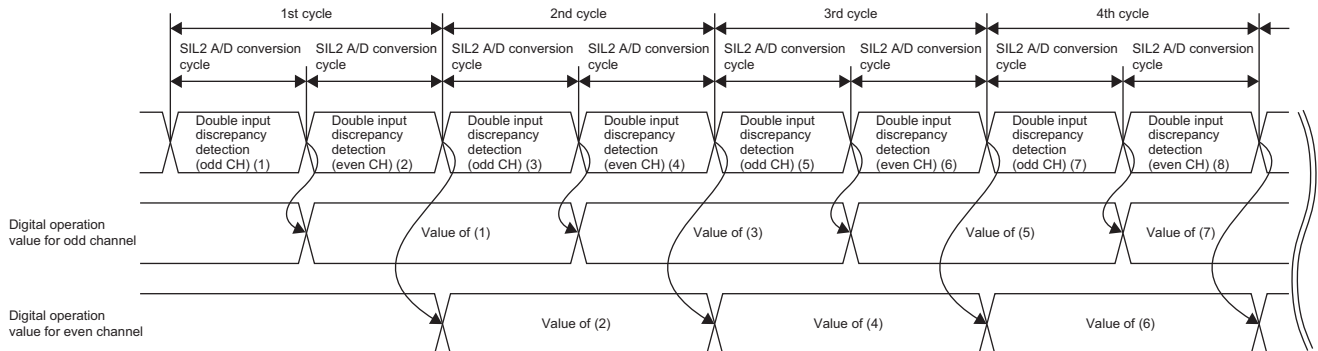

When the A/D conversion circuit diagnostic function is executed

When the A/D conversion circuit diagnostic function is executed, the double input discrepancy detection function and A/D conversion circuit diagnostic function are repeated alternately for each A/D conversion circuit diagnostic cycle. (The double input discrepancy detection function is not executed for start-up A/D conversion circuit diagnostics.) A/D conversion circuit diagnostics consists of two patterns of digital values for diagnostics, and up to six retries are attempted for each pattern. Each digital value for diagnostics consists of four cycles. Therefore, the A/D conversion circuit diagnostic function will be executed for 8 (minimum) to 56 (maximum) cycles. The following figure shows the entire timing chart of the A/D conversion circuit diagnostics.

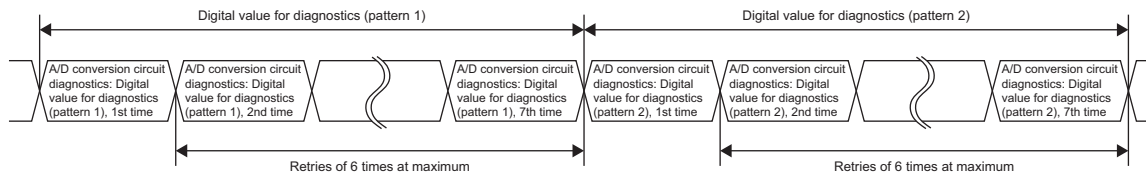

The following figure shows the timing chart of one digital value for diagnostics.

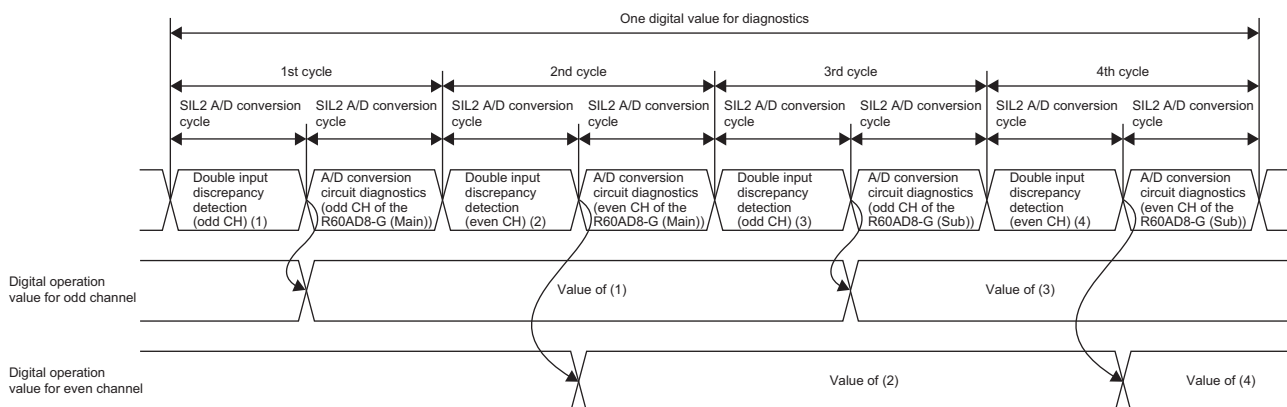

Cycle with which the digital operation value (safety device) is updated

The cycle with which the digital operation value (safety device specified by the SIL2 diagnostic FB library) is updated is determined by the following formula.

- SIL2 A/D conversion cycle setting × N

N is determined by the following rules.

A/D conversion enabled channels	N	
	Normal state	When the A/D conversion circuit diagnostic function is executed
Odd number channel only, or even number channel only	1	2
Enabled on odd and even number channels	2	4

Point

If change of the cycle with which the digital operation value (safety device specified by the SIL2 diagnostic FB library) is updated needs to be considered, build a system with the cycle calculated with N = 4.

Digital operation value at the time of error detection

If an error is detected with the double input discrepancy detection function or A/D conversion circuit diagnostic function, the digital operation value of the error-detected channel will be the OFF value (equivalent to 0V/0mA).

Input range		Digital operation value at the time of error detection
Voltage	0 to 10V	0
	0 to 5V	0
	1 to 5V	-768
	1 to 5V (extended mode)	-8000
	-10 to 10V	0
	User range setting (voltage)	0
Current	0 to 20mA	0
	4 to 20mA	-768
	4 to 20mA (extended mode)	-8000
	User range setting (current)	0

When "Scaling enable/disable setting" is "Enable", scale conversion is also applied to the digital operation value of the OFF value above (equivalent to 0V/0mA).

Relay switching behavior

The SIL2 standard program FB controls the RY40PT5B to switch the connected relay.

- While the double input discrepancy detection function is being executed, the voltage or current from the sensor is input to the R60AD8-G by switching the relay.
- While the A/D conversion circuit diagnostic function is being executed, the voltage or current from the sensor is cut off by switching the relay.

Double input discrepancy detection function

This function detects an error by mutually referencing digital operation values of two R60AD8-G modules.

The verification result is sent to the SIL2 diagnostic FB library.

- If the verification result is abnormal, the SIL2 diagnostic FB library counts the number of errors that continuously occur from the first error, and generates a double input discrepancy detection error (error code: 1ED□H) when the number of errors reaches a specified value.
- If the verification result is normal, the mean value from the A/D conversion by the R60AD8-G (Main) and R60AD8-G (Sub) is stored as a digital operation value in the safety device specified by the SIL2 diagnostic FB library, and the number of errors counted by the SIL2 diagnostic FB library is cleared at this point.

This function uses the SIL2 safety program FB (M+SIL2ADG_ADConv_R) to operate.

Setting procedure

To use the double input discrepancy detection function, the following parameter settings and a program by the SIL2 diagnostic FB library are required.

- "Duplex input error range setting"
- "Duplicated input mismatch detection count"
- "Duplicated input mismatch automatic recovery setting"
- "Duplicated input mismatch automatic return count"

■ "Duplex input error range setting"

For the R60AD8-G (Main) and R60AD8-G (Sub), set for each channel the allowable error range for verifying digital operation values obtained from each module.

 [Navigation window] ⇒ [Parameter] ⇒ [Module Information] ⇒ [R60AD8-G(S2M)] ⇒ [Application setting] ⇒ [Double input error range setting]

Item	Setting range
Double input error range setting	±0.5 to ±5.0%

Note that the allowable digit value varies depending on the "Scaling enable/disable setting" and range setting.

"Scaling enable/disable setting"	Range setting	Allowable digit value
"Disable"	—	Maximum digital output value × "Duplex input error range setting" Example) When "Duplex input error range setting" = 1.0%, the value is as follows. $32000 \times 0.010 = \pm 320$ digit
"Enable"	0 to 10V, 0 to 5V, 1 to 5V, 0 to 20mA, 4 to 20mA, 1 to 5V (extended mode), 4 to 20mA (extended mode)	$(\text{"Scaling upper limit value"} - \text{"Scaling lower limit value"}) \times \text{"Duplex input error range setting"}$ Example) When "Scaling upper limit value" = 8000, "Scaling lower limit value" = -4000, "Duplex input error range setting" = 1.0%, the value is as follows. $((8000 - (-4000)) \times 0.010 = \pm 120$ digit
	-10 to 10V, user range setting (voltage), user range setting (current)	$(\text{"Scaling upper limit value"} - \text{"Scaling lower limit value"}) \times \text{"Duplex input error range setting"} \div 2$ Example) When "Scaling upper limit value" = 8000, "Scaling lower limit value" = -4000, "Duplex input error range setting" = 1.0%, the value is as follows. $((8000 - (-4000)) \times 0.010) \div 2 = \pm 60$ digit

Point

- Adjust this setting if a double input discrepancy detection error (error code: 1ED□H) occurs frequently due to a noise affecting the digital operation value in noisy electrical environment.
- The setting of "Duplex input error range setting" is also applied to the error range of A/D conversion circuit diagnostics. ( Page 285 A/D conversion circuit diagnostic function)

■ "Duplicated input mismatch detection count"

For each channel, set the detection count to determine a double input discrepancy detection error when the verification result of digital operation values of the R60AD8-G (Main) and R60AD8-G (Sub) is out of the allowable error range.

 [Navigation window] ⇒ [Parameter] ⇒ [Module Information] ⇒ [R60AD8-G(S2M)] ⇒ [Application setting] ⇒ [Duplicated input mismatch detection count]

Item	Setting range
Duplicated input mismatch detection count	1 to 100 times

■ "Duplicated input mismatch automatic recovery setting"

The default value of this setting is "Disable". With this setting set to "Enable", it is determined that the error cause has been cleared for a channel for which the double input discrepancy detection verification results have been continuously within the allowable error range for the number of times specified in "Duplicated input mismatch automatic return count" after a double input discrepancy detection error (error code: 1ED□H) occurred, and the double input discrepancy detection error (error code: 1ED□H) will be cleared automatically.

 [Navigation window] ⇒ [Parameter] ⇒ [Module Information] ⇒ [R60AD8-G(S2M)] ⇒ [Application setting] ⇒ [Duplicated input mismatch automatic recovery setting]

Restriction

With "Duplicated input mismatch automatic recovery setting" set to "Enable", a channel, where a double input discrepancy detection error (error code: 1ED□H) has occurred and thus stops, may start operation immediately after the error state is eliminated. When "Duplicated input mismatch automatic recovery setting" is set to "Enable", the safety requirements of the system is not satisfied.

Point

With "Duplicated input mismatch automatic recovery setting" set to "Enable", whether a double input discrepancy detection error (error code: 1ED□H) has occurred cannot be checked via program after auto recovery. Check whether a double input discrepancy detection error (error code: 1ED□H) has occurred from the Module Diagnostics window. To check whether a double input discrepancy detection error (error code: 1ED□H) has occurred via program, set "Duplicated input mismatch automatic recovery setting" to "Disable".

■ "Duplicated input mismatch automatic return count"

With "Duplicated input mismatch automatic recovery setting" set to "Enable", set for each channel how many times the double input discrepancy detection verification results must be within the error range before the double input discrepancy detection error (error code: 1ED□H) is automatically cleared.

[Navigation window] ⇒ [Parameter] ⇒ [Module Information] ⇒ [R60AD8-G (S2M)] ⇒ [Application setting] ⇒ [Duplicated input mismatch automatic return count]

Point

- With "Duplicated input mismatch automatic return count" set to 0, the setting value of "Duplicated input mismatch detection count" is used instead as "Duplicated input mismatch automatic return count".
- Parameter settings of "Duplex input error range setting", "Duplicated input mismatch detection count", and "Duplicated input mismatch automatic return count" need to be set to allow the customer's system error range. If these settings do not allow the customer's system error range, a double input discrepancy detection error (error code: 1ED□H) may occur consecutively.

Ex.

The following figure shows auto recovery timing under the following conditions.

- "Duplicated input mismatch detection count": 3
- "Duplicated input mismatch automatic return count": 4

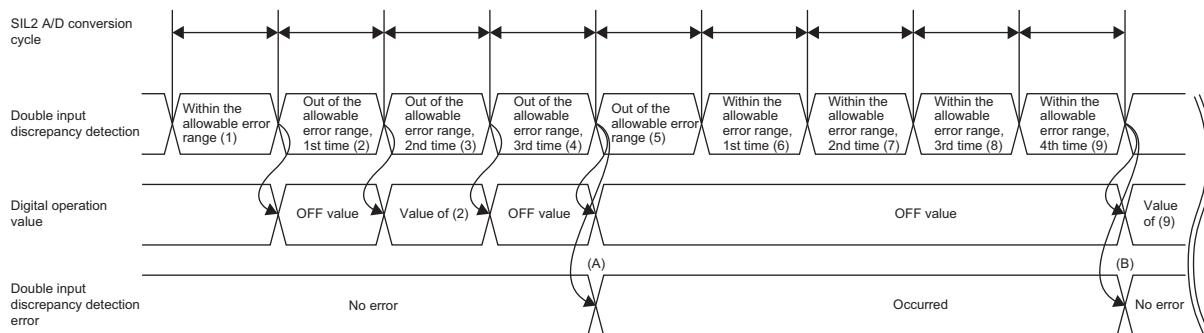

(A) A double input discrepancy detection error (error code: 1ED□H) occurs.

(B) When the verification results are within the error range for four times, a double input discrepancy detection error (error code: 1ED□H) is cleared.

■ Program by the SIL2 diagnostic FB library

With a project on the SIL2 Process CPU side, create a safety program and standard program and define the I/O of the SIL2 diagnostic FB library. Refer to the following to create programs.

Page 296 EXAMPLE OF OPERATION

Operation

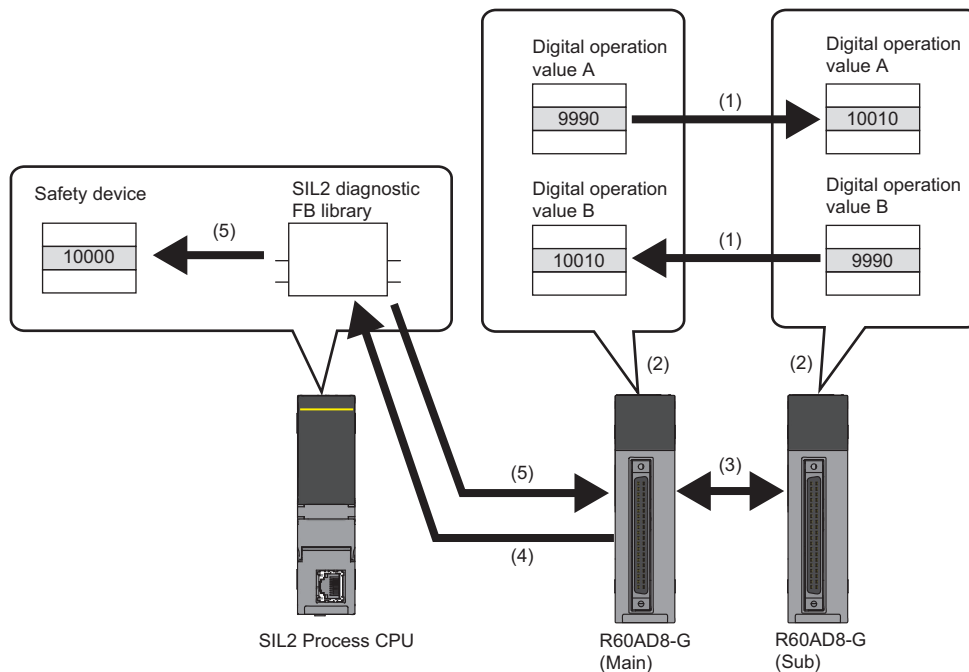

No.	Description
(1)	The R60AD8-G (Main) and R60AD8-G (Sub) mutually exchange digital operation values obtained from each module.
(2)	Whether the digital operation values are within the allowable error range set in "Duplex input error range setting" is verified, and the mean value of the digital operation values A and B is calculated. If the verification result is double input discrepancy, the mean value of the digital operation values A and B becomes the OFF value (equivalent to 0V/0mA).
(3)	The verification results of (2) in R60AD8-G (Main) and R60AD8-G (Sub) are mutually verified. If an error is detected by mutual verification, a hardware failure (error code: 3001H) occurs. Also, a safety communication timeout (error code: 1A63H) occurs in the SIL2 Process CPU.
(4)	The R60AD8-G (Main) sends the verification result and the mean value of the digital operation values A and B to the SIL2 diagnostic FB library.
(5)	The SIL2 diagnostic FB library stores the mean value of the digital operation values A and B to the safety device specified by the SIL2 diagnostic FB library. For channels where a discrepancy (allowable error range exceeded) was detected the specified times or more (the times set in "Duplicated input mismatch detection count" or more), a double input discrepancy detection error (error code: 1ED□H) occurs.

Point

If disconnection occurs in wiring of the R60AD8-G (Main) or R60AD8-G (Sub), a double input discrepancy detection error (error code: 1ED□H) occurs.

A/D conversion circuit diagnostic function

The R60DA8-G for diagnostics regularly inputs an analog value to the R60AD8-G set to SIL2 mode to internally diagnose the A/D conversion circuit of the R60AD8-G.

Internal diagnostics is executed at the following timing.

- When the entire system starts operating normally after power-on (at start-up)
- In the cycle specified by "A/D conversion circuit diagnostic cycle setting" (during operation)

This function uses the SIL2 safety program FB (M+SIL2ADG_ADConv_R) and SIL2 standard program FB (M+SIL2ADG-IEF_WriteDAVal_R).

Point

- During operation, A/D conversion circuit diagnostics is executed paired with the double input discrepancy detection function.
- If system switching occurs during A/D conversion circuit diagnostics, the A/D conversion circuit diagnostics is suspended, and after the system switching is complete, the diagnostics is resumed at the point where it was suspended.
- When the safety operation mode of SIL2 Process CPU is TEST MODE, the start-up A/D conversion circuit diagnostics can be skipped by turning on `i_bInItDiagSkip` (start-up diagnostics skip request) of the SIL2 safety program FB (M+SIL2ADG_ADConv_R).

Setting procedure

To use the A/D conversion circuit diagnostic function, the following module parameter setting and a program by the SIL2 diagnostic FB library are required.

- "A/D conversion circuit diagnostic cycle setting"

■ "A/D conversion circuit diagnostic cycle setting"

Set a cycle to perform A/D conversion circuit diagnostics.

 [Navigation window] ⇒ [Parameter] ⇒ [Module Information] ⇒ [R60AD8-G(S2M)] ⇒ [Application setting] ⇒ [A/D conversion circuit diagnostic cycle setting]

Item	Setting range
A/D conversion circuit diagnostic cycle setting	60 to 480min

■ Program by the SIL2 diagnostic FB library

With a project on the SIL2 Process CPU side, create a safety program and standard program and define the I/O of the SIL2 diagnostic FB library. Refer to the following to create programs.

 Page 296 EXAMPLE OF OPERATION

Operation

The following figure shows operation with one time of A/D conversion circuit diagnostics.

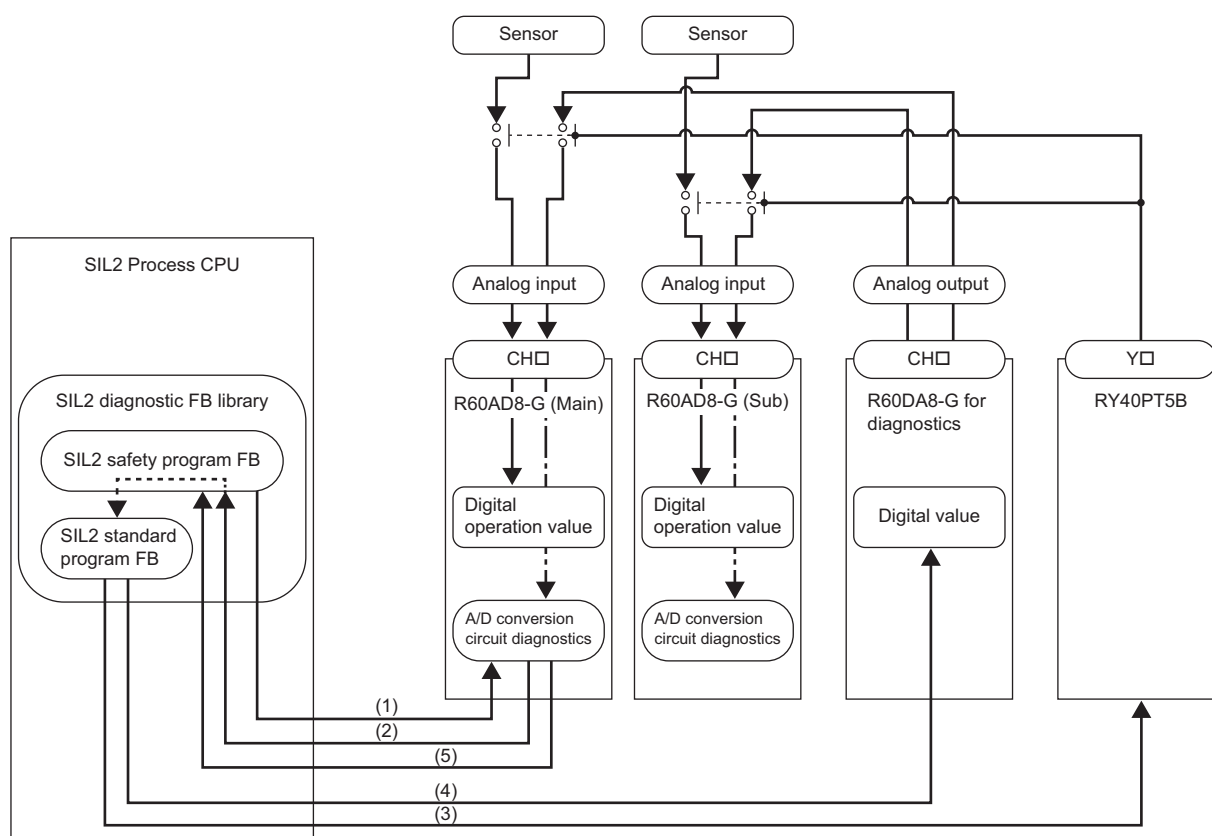

No.	Description
(1)	The SIL2 safety program FB sends a diagnostics start notification to the R60AD8-G.
(2)	The R60AD8-G sends a digital value for diagnostics to the SIL2 safety program FB.
(3)	The SIL2 standard program FB receives a request from the SIL2 safety program FB, and switches a device that inputs signals to the R60AD8-G from an input device (such as a sensor) to the R60DA8-G for diagnostics. The switching is performed for each channel used, by using a relay.
(4)	The SIL2 standard program FB receives a request from the SIL2 safety program FB, sets a digital value for diagnostics in the R60DA8-G for diagnostics, performs digital-analog converting for the digital value, and inputs the value to the R60AD8-G.
(5)	The R60AD8-G compares two values: a digital value obtained from A/D conversion on the analog value input from the R60DA8-G for diagnostics; the digital value for diagnostics. The R60AD8-G verifies whether the error (comparison result) is within the allowable error range set in "Duplex input error range setting", and sends the verification result to the SIL2 safety program FB. For channels determined to have an error as a result of verification, an A/D conversion circuit diagnostic error (error code: 1EF□H) occurs.

Point

- For verification, the setting value of "Duplex input error range setting" is automatically applied as the allowable error range. If A/D conversion circuit diagnostic errors occur frequently, adjust the setting of "Duplex input error range setting".
- When i_bEN (execution command) of the SIL2 safety program FB is turned off, A/D conversion circuit diagnostics is not executed even when the cycle of A/D conversion circuit diagnostics has elapsed. A/D conversion circuit diagnostics is executed when i_bEN (execution command) is turned on.
- During A/D conversion circuit diagnostics, the external connection is switched from the sensor to the R60DA8-G for diagnostics by controlling relay. Digital operation values are not updated and in the safety I/O HOLD state during A/D conversion circuit diagnostics.

■ Diagnostic processing time of A/D conversion circuit diagnostics

A/D conversion circuit diagnostics consisting of steps (1) to (5) is executed for the number of times corresponding to the following combination.

- Two patterns of digital values for diagnostics
- Two modules of R60AD8-G (Main) and R60AD8-G (Sub)
- Odd and even number channels

In addition, if the verification result is abnormal, A/D conversion circuit diagnostics is retried up to six times.

Therefore, when "SIL2 A/D conversion cycle setting" is 1000ms (default value), the maximum and maximum values of the number of times of A/D conversion circuit diagnostics and the diagnostics processing time are as follows.

Number of retries	Number of times of diagnostics	Diagnostics processing time	
		At start-up	During operation
6 (maximum)	56	56s	112s
0 (minimum)	8	8s	16s

Input HOLD function

This function holds the digital operation value for the specified time after safety refresh data receiving has an interrupt.

Input HOLD occurrence

When the R60AD8-G detects that safety refresh data receiving has an interrupt, the R60AD8-G holds the digital operation value immediately before the interrupt. The module also holds the previous digital obtained value of the safety device specified by the SIL2 diagnostic FB library.

Input HOLD release

After the input HOLD (safety refresh data receiving has an interrupt), when safety refresh data is successfully received within the time set in the "Safety I/O Hold Time" of the "CPU Parameter", the HOLD for the digital operation value is cleared. Updating of the digital obtained value of the safety device specified by the SIL2 diagnostic FB library is resumed.

Safety I/O HOLD time exceeded error

When the time of holding digital operation value exceeds the time set with "Safety I/O Hold Time" in "CPU Parameter", a safety I/O HOLD time exceeded error (error code: 1500H) will occur. The R60AD8-G holds the previous digital obtained value of the safety device specified by the SIL2 diagnostic FB library, but updating is restarted when it receives safety refresh data again.

The safety I/O HOLD time exceeded error (error code: 1500H) can be cleared by any of the following methods.

- `i_bUnitErrClear` (module error clear) of the SIL2 safety program FB
- [Clear Error] button on the "Module Diagnostics" window

10.9 Self-diagnostic Function

This function periodically monitors the operating status of the R60AD8-G, such as the MPU (operation processing unit) operating status, power supply voltage status (overvoltage and undervoltage), safety communications status, and built-in programs operating status, for any errors.

If an error is detected by the self-diagnostic function, digital operation values of all channels become the OFF value (equivalent to 0V/0mA) and safety communications are stopped in the safety layer. If hardware failure (error code: 3001H) is detected by the self-diagnostic function in the R60AD8-G (Main), a safety mutual monitoring error (error code: 3020H) occurs in the R60AD8-G (Sub). If hardware failure is detected in the R60AD8-G (Sub), a safety mutual monitoring error (error code: 3020H) occurs in the R60AD8-G (Main).

List of self-diagnostic functions

Diagnostics name	Diagnostics	Diagnostic timing ^{*1}		Error to be generated after error detection	Diagnostic cycle
		At start-up ^{*2}	During operation ^{*3}		
H/W diagnostic function	Verifies whether the MPU (operation processing unit) in the R60AD8-G operates normally.	○	○	Hardware failure (error code: 3001H)	8 hours or less
Power supply diagnostic function	Monitors the power supply voltage in the R60AD8-G, and when it detects an error, stops the MPU operation and shuts down the system. ^{*5}	○	○	Hardware failure (error code: 3001H)	8 hours or less
Safety layer diagnostic function	Monitors the status of safety communications between the R60AD8-G (Main) and SIL2 Process CPU.	×	○	^{*4}	Every 12ms
F/W operation monitoring function	Monitors program operating status in the R60AD8-G.	○	○	Hardware failure (error code: 3001H)	Every 12ms

*1 ○ indicates that the function is applicable, and × indicates that the function is not applicable.

*2 The diagnostic function is executed immediately after power-on. For SIL2 analog input systems, it starts after start-up diagnostics is complete. Due to the time needed for diagnostic functions, SIL2 analog input systems take more time to start up than normal systems.

*3 The diagnostic function is executed periodically after the SIL2 analog input system starts operating normally.

*4 An error code to be generated varies depending on the detection.

- If an error is detected in the send/receive data of the module, hardware failure (error code 3001H) is generated.
- If an error is detected in data link, no error code is generated. The error is logged in the event history.

*5 The power is not supplied to circuits such as microcomputers and the system is in the safety state.

- The module is in the following state at system shutdown.
- On the GX Works3 system monitor, it is indicated that the module is not mounted.
 - The RUN LED, ERR LED, ALM LED, and S MODE LED of the module turn off.

10.10 Error History Function

For the errors that occurred in the R60AD8-G, a maximum of 16 error histories can be checked using the engineering tool.

[Diagnostics] ⇒ [System Monitor] ⇒ Right-click the target module. ⇒ [Module Diagnostics]

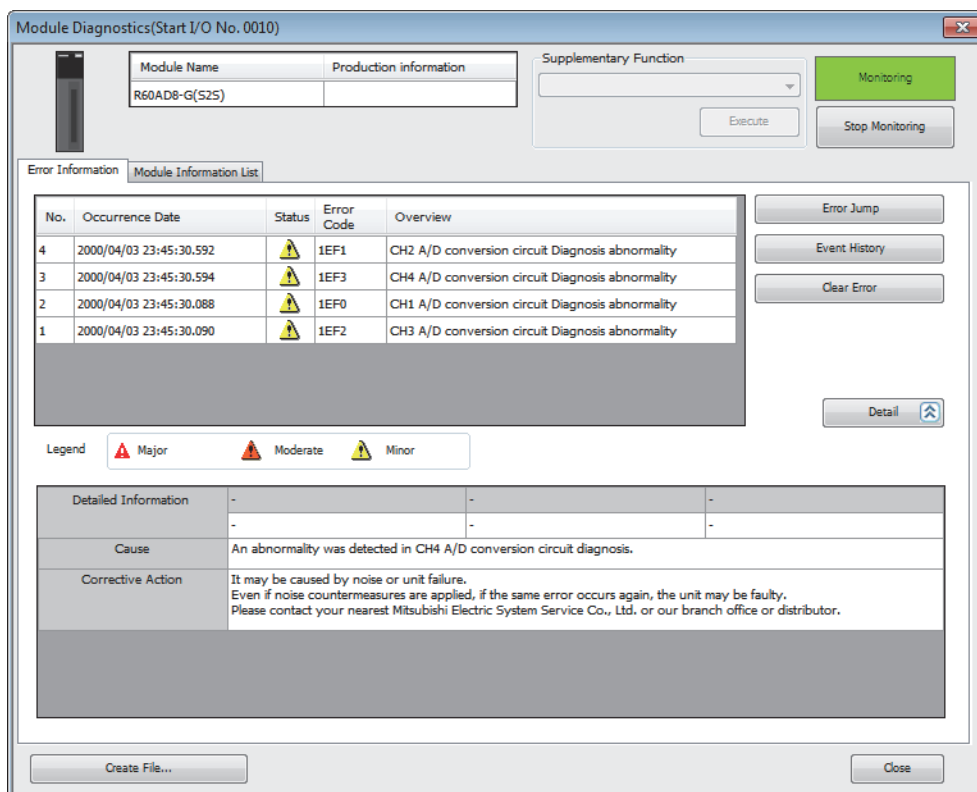

Point

When the number of error histories exceeds 16, the histories are overwritten sequentially from the first one, and error histories are continued to be recorded. The histories to be overwritten are deleted.

How to clear error histories using the error history function

Error histories can be cleared by either of the following methods.

- Turn the programmable controller's power off.
- Reset the remote head module.

10.11 Event History Function

This function collects errors that occurred in the R60AD8-G and executed operations as event information in the remote head module.

Information of an event that occurred in the R60AD8-G is collected by the remote head module and held inside the data memory in the remote head module.

Event information collected by the remote head module can be displayed using the engineering tool, and occurrence histories can be checked in chronological order.

Event type	Classification	Description
System	Error	Self-diagnostics error detected in each module
	Warning	Warning (alarm) detected in each module
	Information	Operation normally detected by the system not classified as an error or a warning, or operation performed automatically by the system.
Security	Warning	Operation that is judged as an unauthorized access to each module.
	Information	Operation that could not be judged as a successful unlock of a password or unauthorized access
Operation	Warning	Among operations performed on modules, delete operation (data clear) that is not judged as an error by self-diagnostics but likely to change the behavior
	Information	Operations performed by users including operation which changes system behavior and the structure

Details on the event history function

Refer to the following.

 MELSEC iQ-R CC-Link IE Field Network Remote Head Module User's Manual (Application)

Display of the event history

Display the event history from the menu of the engineering tool. For details on the operating procedure and how to view the contents, refer to the following.

 GX Works3 Operating Manual

List of event history data

The following table lists the events that would occur in the R60AD8-G.

Event code	Event classification	Event name	Description	Additional information
00150	Information	Safety communication start	Safety communications were started.	—
00151	Information	Safety communication stop	Safety communications were stopped.	—
00A00* ¹	Warning	Safety communication error	A safety communication error was detected.	—
00A02* ¹	Warning	Response monitoring timeout with safety communication connection being established	A response timeout occurred while a safety communication connection was being established.	—
00A03* ¹	Warning	Response monitoring timeout during safety communication refresh	A response timeout occurred during safety communication refresh.	—
00A04* ¹	Warning	Response monitoring timeout during safety communication error processing	A timeout occurred during the safety communication error response.	—
00A05* ¹	Warning	Safety communication reception interval monitoring timeout	No response was returned within the specified safety refresh monitoring time.	—
00A06* ¹	Warning	Safety communication receive data delay detection	Consecutive receive data is not complete.	—
00A07* ¹	Warning	Safety communication receive data loss detection	A loss of consecutive receive data was detected.	—
00A08* ¹	Warning	Application data error	A safety communication data frame error was detected.	—
00A10	Warning	Safety module validation match failure	An error was detected at the verification of safety parameter.	—
00A13	Warning	Disabling the safety module (parameter error)	The system switched to the safety module disabled state because a module parameter error was detected.	—
00A14	Warning	Disabling the safety module (safety-disabled module detection)	The system switched to the safety module disabled state because a module with the safety module disabled was detected in the module set.	—
00A15	Warning	Disabling the safety module (parameter mismatch when enabling the safety module)	The system switched to the safety module disabled state because the parameter information saved in the non-volatile memory and the module parameters do not match when enabling the safety module.	—
20100	Information	Error release (error clear)	An error clear request was executed.	—

*1 This event may occur when switching the SIL2 Process CPU system, but the digital operation value will be held for the time when the input HOLD function is enabled (time set in "Safety I/O Hold Time" in "CPU Parameter").

11 PARAMETER SETTINGS

Set the parameters of the R60AD8-G.

11.1 Basic Settings

Setting procedure

Open "Basic setting" of the engineering tool.

1. Start Module Parameter.

[Navigation window] ⇨ [Parameter] ⇨ [Module Information] ⇨ Target module ⇨ [Basic setting]

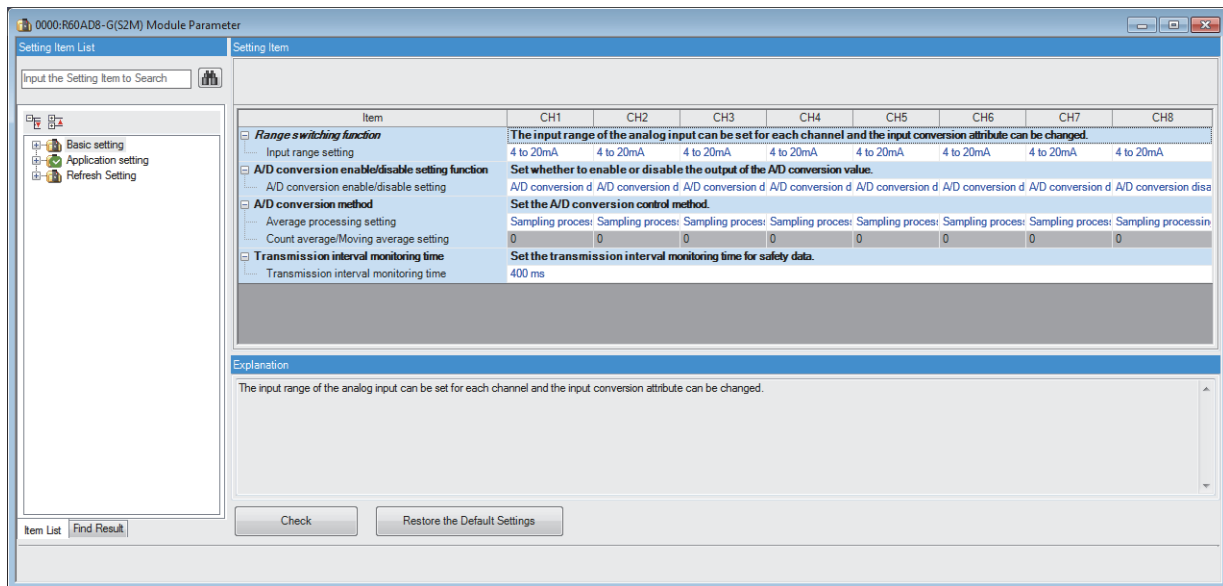

2. Double-click on an item to be changed and enter a setting value.

- Item where a value is selected from a drop-down list

Click the [▼] button of the item to be set to display a drop-down list. Select an item.

- Item where a value is entered into a text box

Double-click on the item to be set and enter a numerical value.

11.2 Application Settings

Setting procedure

Open "Application setting" of the engineering tool.

1. Start Module Parameter.

[Navigation window] ⇒ [Parameter] ⇒ [Module Information] ⇒ Target module ⇒ [Application setting]

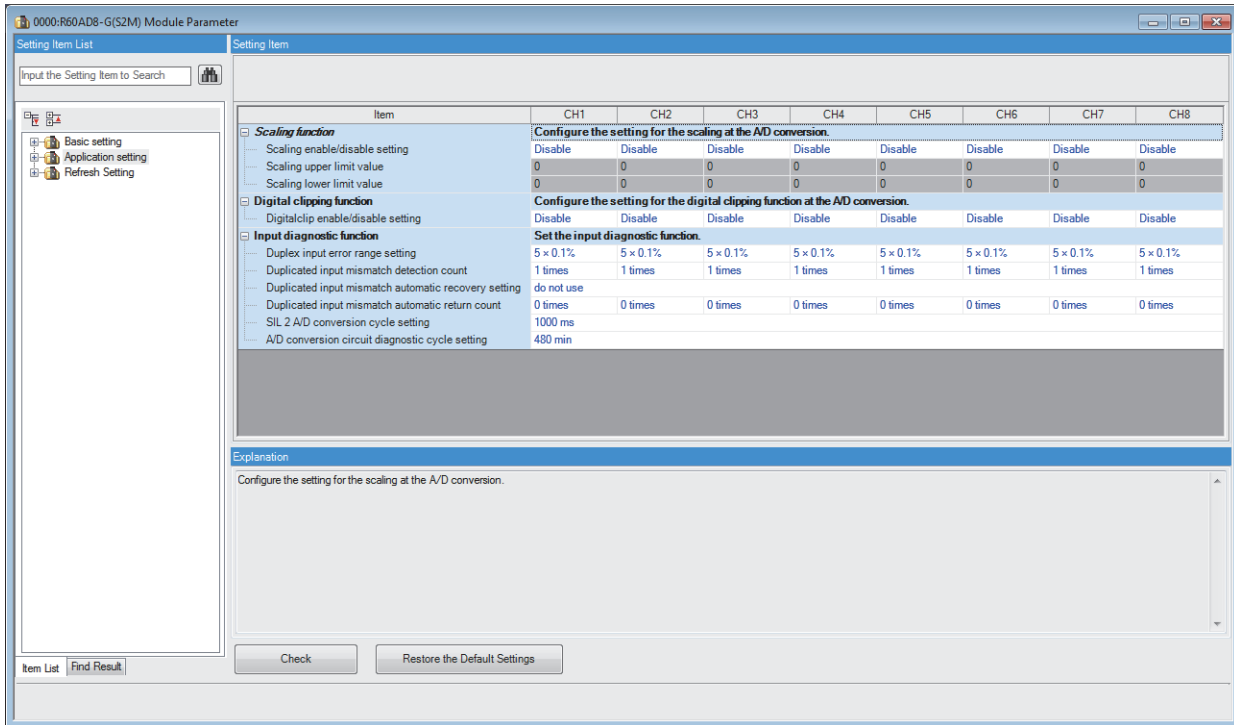

2. Double-click on an item to be changed and enter a setting value.

- Item where a value is selected from a drop-down list

Click the [▼] button of the item to be set to display a drop-down list. Select an item.

- Item where a value is entered into a text box

Double-click on the item to be set and enter a numerical value.

11.3 Refresh Settings

Module parameter refresh settings are not available for the R60AD8-G that is set to SIL2 mode.

12 EXAMPLE OF OPERATION

This chapter provides a program example to operate the R60AD8-G in SIL2 mode.

System configuration

The following system configuration is used to explain an example of operation.

☞ Page 236 Redundant Master Station

Program conditions

- A/D conversion enabled channels are CH1, CH2, CH3, and CH4.
- The input range for each channel is as follows: 0 to 10V for CH1 and CH2, 0 to 20mA for CH3, and 4 to 20mA for CH4.
- The A/D conversion method for each channel is as follows: sampling processing for CH1 to CH4.

Procedures before operation

Build a system and set parameters according to the following procedure.

☞ Page 228 PROCEDURES BEFORE OPERATION

In addition, set the parameters as follows on each parameter setting window so that the system can operate with the system configuration and program conditions of this example.

■ "CPU Parameter" for the SIL2 Process CPU

Item	Description
Safety cycle time	50.0ms

■ "Basic setting" of the master/local module

Item	Description																																																																																	
Network configuration setting	<table border="1"> <thead> <tr> <th rowspan="2">No.</th> <th rowspan="2">Model Name</th> <th rowspan="2">STA#</th> <th rowspan="2">Station Type</th> <th colspan="3">RX/RX Setting</th> <th colspan="3">RWw/RWr Setting</th> <th rowspan="2">Reserved/Error Invalid Station/System Switching Monitoring Target Station</th> </tr> <tr> <th>Points</th> <th>Start</th> <th>End</th> <th>Points</th> <th>Start</th> <th>End</th> </tr> </thead> <tbody> <tr> <td>0</td> <td>Host Station</td> <td>0</td> <td>Master Station</td> <td></td> <td></td> <td></td> <td></td> <td></td> <td></td> <td></td> </tr> <tr> <td>1</td> <td>Host Station</td> <td>1</td> <td>Sub-Master Station</td> <td></td> <td></td> <td></td> <td></td> <td></td> <td></td> <td>No Setting</td> </tr> <tr> <td>2</td> <td>RJ72GF15-T2</td> <td>2</td> <td>Intelligent Device Station</td> <td>80</td> <td>0000</td> <td>004F</td> <td>8</td> <td>0000</td> <td>0007</td> <td>No Setting</td> </tr> </tbody> </table>	No.	Model Name	STA#	Station Type	RX/RX Setting			RWw/RWr Setting			Reserved/Error Invalid Station/System Switching Monitoring Target Station	Points	Start	End	Points	Start	End	0	Host Station	0	Master Station								1	Host Station	1	Sub-Master Station							No Setting	2	RJ72GF15-T2	2	Intelligent Device Station	80	0000	004F	8	0000	0007	No Setting																															
No.	Model Name					STA#	Station Type	RX/RX Setting			RWw/RWr Setting			Reserved/Error Invalid Station/System Switching Monitoring Target Station																																																																				
		Points	Start	End	Points			Start	End																																																																									
0	Host Station	0	Master Station																																																																															
1	Host Station	1	Sub-Master Station							No Setting																																																																								
2	RJ72GF15-T2	2	Intelligent Device Station	80	0000	004F	8	0000	0007	No Setting																																																																								
Refresh settings	<table border="1"> <thead> <tr> <th rowspan="2">No.</th> <th colspan="5">Link Side</th> <th rowspan="2"></th> <th colspan="5">CPU Side</th> </tr> <tr> <th>Device Name</th> <th>Points</th> <th>Start</th> <th>End</th> <th>Target</th> <th>Device Name</th> <th>Points</th> <th>Start</th> <th>End</th> </tr> </thead> <tbody> <tr> <td>-</td> <td>SB</td> <td></td> <td></td> <td></td> <td></td> <td>↔</td> <td></td> <td></td> <td></td> <td></td> <td></td> </tr> <tr> <td>-</td> <td>SW</td> <td></td> <td></td> <td></td> <td></td> <td>↔</td> <td></td> <td></td> <td></td> <td></td> <td></td> </tr> <tr> <td>1</td> <td>RY</td> <td>16</td> <td>00020</td> <td>0002F</td> <td></td> <td>↔</td> <td>Specify Device</td> <td>Y</td> <td>16</td> <td>01000</td> <td>0100F</td> </tr> <tr> <td>2</td> <td>RWw</td> <td>8</td> <td>00000</td> <td>00007</td> <td></td> <td>↔</td> <td>Specify Device</td> <td>W</td> <td>8</td> <td>00000</td> <td>00007</td> </tr> <tr> <td>3</td> <td>RY</td> <td>16</td> <td>00030</td> <td>0003F</td> <td></td> <td>↔</td> <td>Specify Device</td> <td>Y</td> <td>16</td> <td>01010</td> <td>0101F</td> </tr> </tbody> </table>	No.	Link Side						CPU Side					Device Name	Points	Start	End	Target	Device Name	Points	Start	End	-	SB					↔						-	SW					↔						1	RY	16	00020	0002F		↔	Specify Device	Y	16	01000	0100F	2	RWw	8	00000	00007		↔	Specify Device	W	8	00000	00007	3	RY	16	00030	0003F		↔	Specify Device	Y	16	01010	0101F
No.	Link Side						CPU Side																																																																											
	Device Name	Points	Start	End	Target		Device Name	Points	Start	End																																																																								
-	SB					↔																																																																												
-	SW					↔																																																																												
1	RY	16	00020	0002F		↔	Specify Device	Y	16	01000	0100F																																																																							
2	RWw	8	00000	00007		↔	Specify Device	W	8	00000	00007																																																																							
3	RY	16	00030	0003F		↔	Specify Device	Y	16	01010	0101F																																																																							

■ "Application setting" of the master/local module

Item	Description																																												
Safety communication setting	<table border="1"> <thead> <tr> <th colspan="11">Safety Data Transfer Device Setting</th> </tr> <tr> <th colspan="5">Receive Data Storage Device</th> <th colspan="6">Send Data Storage Device</th> </tr> <tr> <th></th> <th>Device Name</th> <th>Points</th> <th>Start</th> <th>End</th> <th>Device Name</th> <th>Points</th> <th>Start</th> <th>End</th> <th></th> <th></th> </tr> </thead> <tbody> <tr> <td>Destination Station-></td> <td>SAID</td> <td>8</td> <td>0</td> <td>7</td> <td>SAID</td> <td>8</td> <td>10</td> <td>17</td> <td>-></td> <td>Destination Station</td> </tr> </tbody> </table>	Safety Data Transfer Device Setting											Receive Data Storage Device					Send Data Storage Device							Device Name	Points	Start	End	Device Name	Points	Start	End			Destination Station->	SAID	8	0	7	SAID	8	10	17	->	Destination Station
Safety Data Transfer Device Setting																																													
Receive Data Storage Device					Send Data Storage Device																																								
	Device Name	Points	Start	End	Device Name	Points	Start	End																																					
Destination Station->	SAID	8	0	7	SAID	8	10	17	->	Destination Station																																			

■Module parameters for "R60AD8-G(S2M)"

Configure the following settings. For parameters other than the following, use the default values.

Module parameter		Description
Basic settings	A/D conversion enable/disable setting	CH1 to CH4: A/D conversion enabled
	Input range setting	CH1: 0 to 10V CH2: 0 to 10V CH3: 0 to 20mA CH4: 4 to 20mA
Application settings	SIL2 A/D conversion cycle setting	2300ms

■Module parameters for "R60DA8-G"

Configure the following settings. For parameters other than the following, use the default values.

Module parameter		Description
Basic settings	D/A conversion enable/disable setting	CH1 to CH4: D/A conversion enabled
	Output range setting	CH1: -10 to 10V CH2: -10 to 10V CH3: 4 to 20mA (Extension) CH4: 4 to 20mA (Extension)
Application settings	Input value shift amount	CH3: 4000 CH4: 4000
Refresh settings	Digital value	Set W0 to W7 to CH1 to CH8 in ascending order. Example) CH1: W0, CH2: W1 ... CH7: W6, CH8: W7

Devices used

■SIL2 safety program FB

Device	Description
SAISD1008.0	Execution command Sets the safety refresh communication status of connection number 1 for slot 1 of the remote head module.
SAM1001	Module error clear
SAM1002	Start-up diagnostics skip request
SAM1003	Execution status
SAM1004	Normal completion
SAM1005	Error completion
SAM1010	System error
SAM1011 to SAM1014	Channel error: CH1 to CH4
SAID0000 to SAID0007	Safety communications receive area
SAID0010 to SAID0017	Safety communications send area
SAID1020	Error code
SAID1030 to SAID1037* ¹	Digital obtained value: CH1 to CH8
SAID1040	External device connection status
SAID1050 to SAID1057* ¹	Status code: CH1 to CH8

*1 Consecutive eight word areas are required independent of number of A/D conversion enabled channels.

■SIL2 standard program FB

Device	Description
SM400	Execution command (always ON)
M1001	Execution status
M1002	Normal completion
W0	Digital value
Y1000 to Y1007* ¹	CH1 to CH8 Output enable/disable flag
Y1008 to Y100F* ¹	Use prohibited
Y1010 to Y101F* ¹	Relay control data

*1 Consecutive 16-bit areas are required independent of number of A/D conversion enabled channels.

The function block used

The following function block is used in this program example.

■SIL2 safety program FB

- M+SIL2ADG_ADConv_R_00A

■SIL2 standard program FB

- M+SIL2ADG-IEF_WriteDAVal_R_00A

Program example

- When the safety refresh communication status is normal, digital operation values are obtained from CH1 to CH4 of the R60AD8-G and output to Digital obtained value (SA\D1030 to SA\D1033).
- To skip the start-up diagnostics, turn on Start-up diagnostics skip request (SA\M1002).
- When Execution status (SA\M1003) and Normal completion (SA\M1004) of the SIL2 safety program FB are on, processing runs according to Status code (SA\D1050 to SA\D1053) of each channel. For channels whose Status code is Double input discrepancy detection function completed (8004H), processing for normal state runs. For channels whose Status code indicates an error (C001H or larger), Channel error (SA\M1011 to SA\M1014) turns on.
- Execution status (SA\M1003) and Error completion (SA\M1005) of the SIL2 safety program FB are on, System error (SA\M1010) turns on.
- To clear the errors currently occurring, turn on Module error clear (SA\M1001). Turn off Module error clear (SA\M1001) after checking the error reset.

■ SIL2 safety program FB

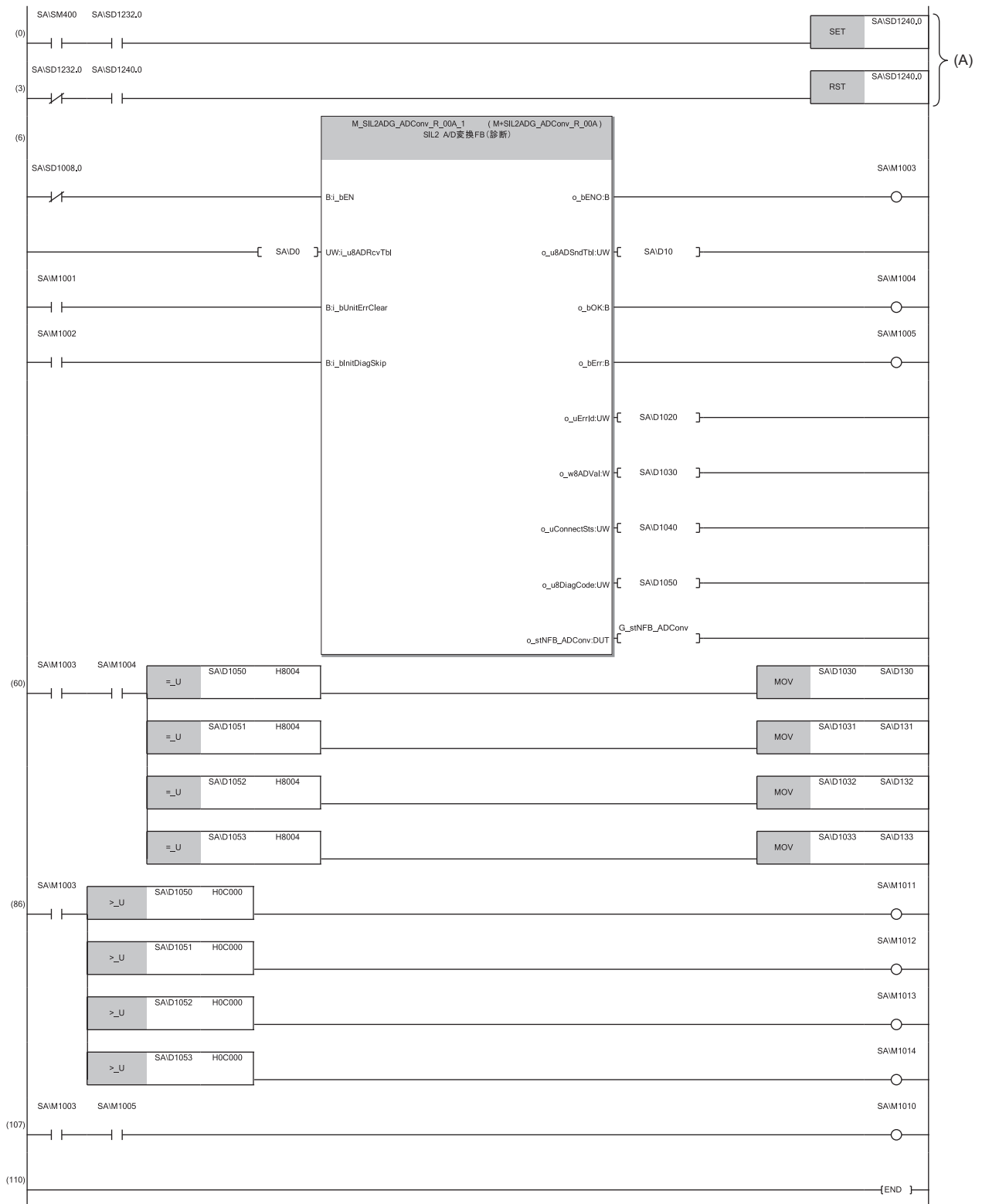

Point

The program (A) is required to continue safety communications after system switching. When using the SIL2 safety program FB, include the program (A).

■ SIL2 standard program FB

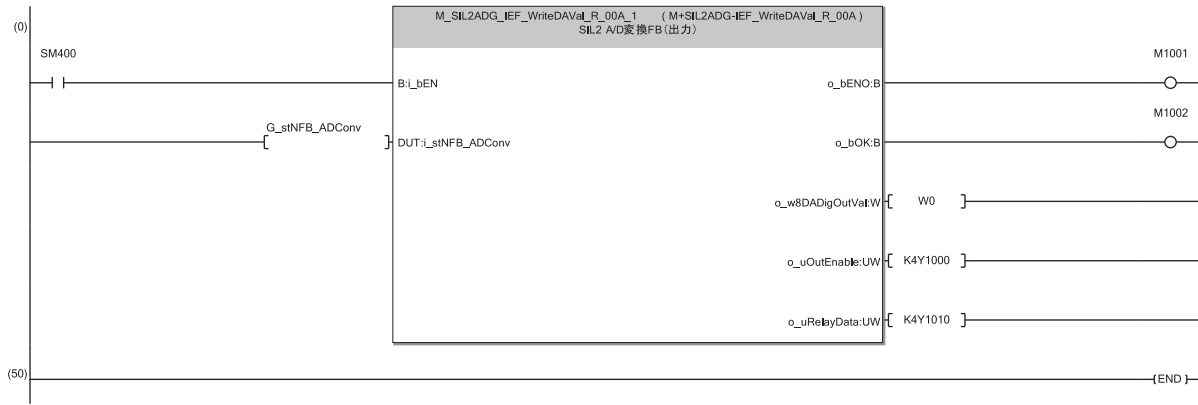

13 MAINTENANCE AND INSPECTION

This chapter describes inspection to be performed for using the R60AD8-G in SIL2 mode.

Periodic inspection

Perform the following inspection one or two times in 6 months to a year. Perform it as well after equipment is transferred or modified, or wiring is changed.

- Check that the relay switching is properly performed by a continuity check for relays.

For other inspection items, refer to the following.

 MELSEC iQ-R Module Configuration Manual

MEMO

14 TROUBLESHOOTING

This chapter describes errors that may occur in the use of the R60AD8-G and those troubleshooting.

14.1 Troubleshooting with the LEDs

By checking the LED indicator status, primary diagnostics without the engineering tool can be performed to narrow down the range of causes of error occurrences.

A state of the R60AD8-G can be checked with the RUN LED, ERR LED, ALM LED, and S MODE LED. The following table shows the correspondence of these LEDs and a state of the R60AD8-G.

Name	Description
RUN LED	Indicates the operating status of the module. On: Normal operation Off: 5V power off or a watchdog timer error occurred.
ERR LED	Indicates the error status of the module.*1 On: An error occurred (minor error). Flashing: An error occurred (moderate error). Off: Normal operation
ALM LED	Indicates the wait-for-restart status after the safety module is enabled. Flashing (400ms cycles): Wait-for-restart Off: Normal operation
S MODE LED	Indicates the operating status of the module (SIL2 mode). On: SIL2 A/D conversion is ongoing. Flashing (1s cycles): SIL2 A/D conversion is stopped. Flashing (400ms cycles): Executing the module position check*2 Off: Operating in standard mode

*1 For details, refer to the following.

 Page 319 List of Error Codes

*2 For details, refer to the following.

 Page 258 Safety module operation

14.2 Checking the State of the Module

The following functions are available in the "Module Diagnostics" window of the R60AD8-G.

Function	Application
Error Information	Displays the details of the currently occurring error. Clicking the [Event History] button displays the errors that have occurred on the network and the history of the errors detected and the operations executed on each module.
Module Information List	Displays each status information of the R60AD8-G.

Error Information

Check the description and the actions of the errors that have occurred.

🖱️ [Diagnostics] ⇒ [System Monitor] ⇒ Right-click the target module. ⇒ [Module Diagnostics]

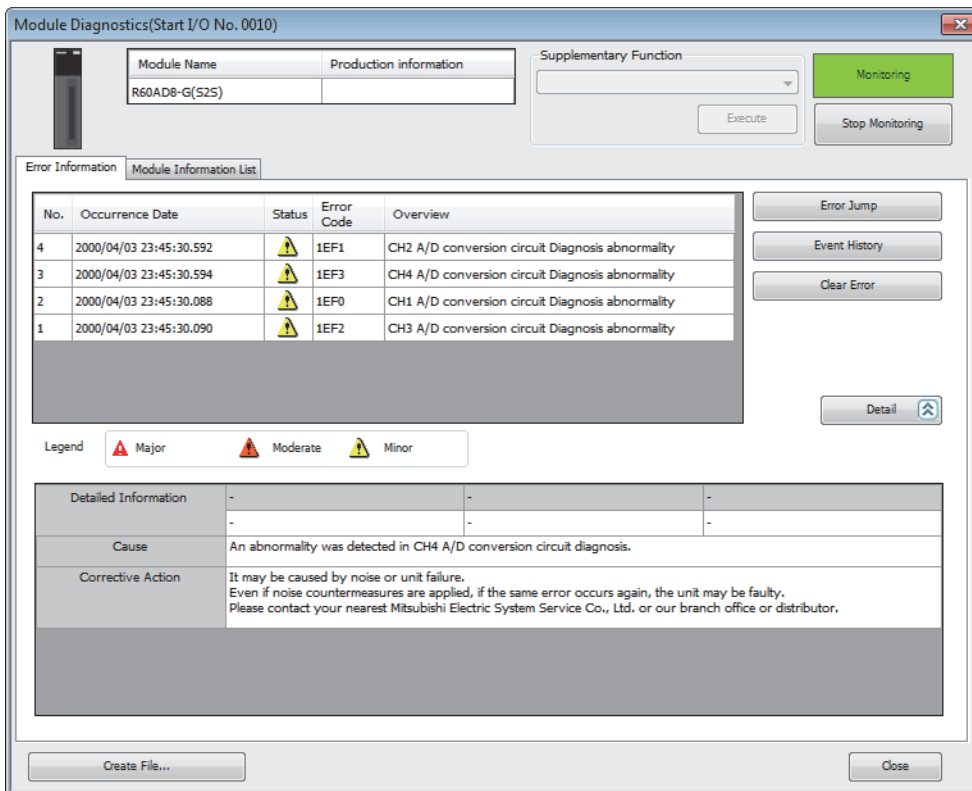

Item	Description
Status	Major: An error such as a hardware failure or memory failure. The module stops operating.
	Moderate: An error, such as a parameter error, which affects module operation. The module stops operating.
	Minor: An error such as a communication failure. The module continues operating.
Detailed Information	Displays detailed information about each error (maximum of 3 pieces).
Cause	Displays the details of the cause of each error.
Corrective Action	Displays actions against the error.

Module Information List

Switch to the "Module Information List" tab to display each status information of the R60AD8-G.

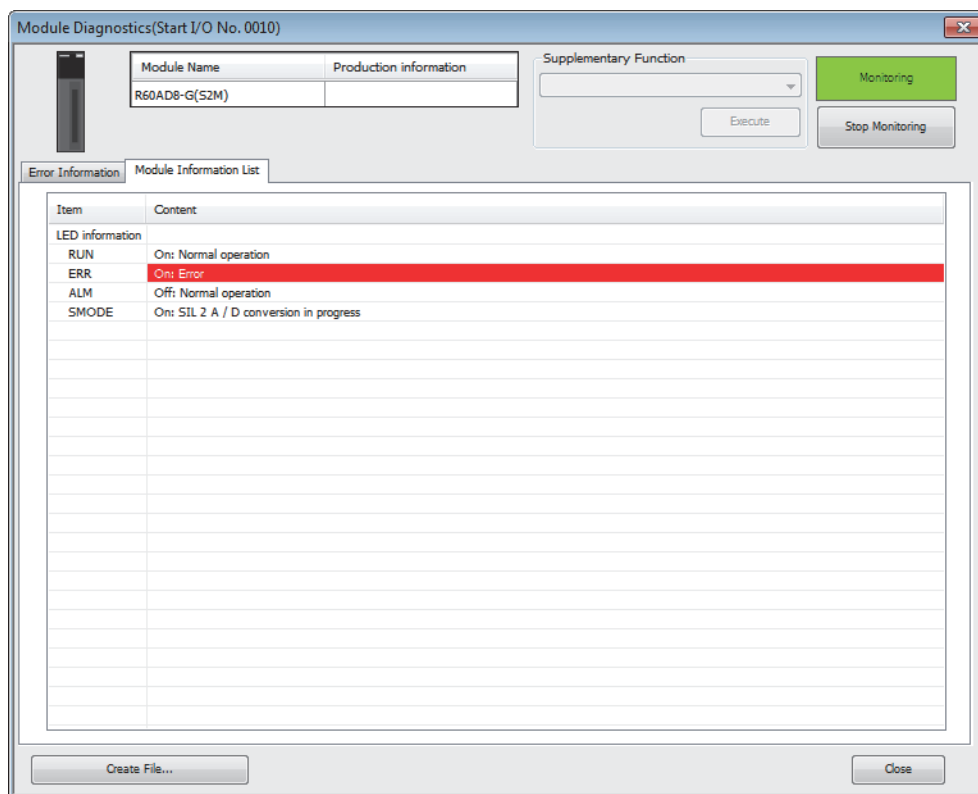

Item	Description
LED information	Displays the LED status of the R60AD8-G.

14.3 Troubleshooting by Symptom

When the R60AD8-G does not start up

Check item	Corrective action
Check that five seconds have passed since the power supply module is powered off.	After the power supply module is powered off, wait at least five seconds before turning on the input power supply to the power supply module.

When the RUN LED flashes or turns off

When flashing

Check item	Corrective action
Check whether the R60AD8-G is in standard mode and in offset/gain setting mode.	Check the module configuration diagram of GX Works3. When the module configuration diagram of GX Works3 is "R60AD8-G", the R60AD8-G is operating in standard mode and in offset/gain setting mode. Change the two R60AD8-G modules to those in SIL2 mode ("R60AD8-G (S2M)" and "R60AD8-G (S2S)").

When turning off



Check item	Corrective action
Check whether the power is supplied.	Check that the supply voltage of the power supply module is within the rated range.
Check whether the capacity of the power supply module is enough.	Calculate the current consumption of the mounted modules, such as the remote head module, I/O modules, and intelligent function modules, to check that the power capacity is enough.
Check whether the modules are mounted properly.	Check the mounting state of each module.
Cases other than the above	Reset the remote head module and check that the RUN LED turns on. If the RUN LED still remains off, the possible cause is a failure of the module. Please consult your local Mitsubishi representative.

When the ERR LED flashes or turns on

When flashing









Check item	Corrective action
Check whether a moderate error has occurred.	Check the error code in the "Module Diagnostics" window and take the action described in the list of error codes.  Page 319 List of Error Codes

When turning on

Check item	Corrective action
Check whether a minor error has occurred.	Check the error code in the "Module Diagnostics" window and take the action described in the list of error codes.  Page 319 List of Error Codes If a double input discrepancy detection error (error code: 1ED□H) or A/D conversion circuit diagnostic error (error code: 1EF□H) has occurred, take actions described as follows.  Page 309 When a double input discrepancy detection error occurs  Page 310 When an A/D conversion circuit diagnostic error occurs

When the S MODE LED flashes or turns off

When flashing (1s cycles)

Check item	Corrective action
Check whether the remote head module is in the STOP state.	Check the RUN/STOP/RESET switch for the remote head module and if it is set to STOP, change it to RUN.
Check whether [Import Setting] was performed to the project written to the remote head module, by using "Safety Communication Setting" of the SIL2 Process CPU project.	Save the project that was written to the remote head module. In addition, follow the steps below again starting from "Safety communication setting".  Page 230 Procedure on the SIL2 Process CPU side
Check whether the status is in "Safety station interlock status".	Monitor the 'Interlock status of each safety connection (1st module)' (SA\SD1232 to SA\SD1239) ^{*1} , and check the interlock status of the R60AD8-G. When the interlock status is in "Interlocked", use the 'Interlock release request for each safety connection (1st module)' (SA\SD1240 to SA\SD1247) ^{*1} corresponding to the R60AD8-G to clear the interlock status of the R60AD8-G. For details on the safety special register, refer to the following.  MELSEC iQ-R CPU Module User's Manual (Application)
Check whether the R60AD8-G is in safety module disabled state.	Enable the safety module. If enabling the safety module fails, follow the steps below again starting from "Safety communication setting".  Page 230 Procedure on the SIL2 Process CPU side
Check whether the wiring between the master station and the remote head module is correct.	Check the wiring between the master station and the remote head module.
Check whether momentary power failure has occurred in the remote head module. (Check whether power failure (error code: 1000H) has occurred in the remote head module. ( MELSEC iQ-R CC-Link IE Field Network Remote Head Module User's Manual (Application)))	When momentary power failure occurs in the remote head module, safety communications may stop if the value of "Transmission interval monitoring time" of the master station or the R60AD8-G is smaller than the value stated in the precautions regarding momentary power failure of the remote head module. Follow the procedure below as necessary. <ul style="list-style-type: none"> • Take measures against momentary power failure. ( MELSEC iQ-R Module Configuration Manual) • Check "Transmission interval monitoring time" of the R60AD8-G. ( Page 278 "Transmission interval monitoring time") • Check "Transmission interval monitoring time" of the master station. ( MELSEC iQ-R CC-Link IE Field Network User's Manual (Application)) For precautions regarding momentary power failure of the remote head module, refer to the following.  MELSEC iQ-R CC-Link IE Field Network Remote Head Module User's Manual (Application)

*1 For details on the safety special register (2nd module or later), refer to the following.
 MELSEC iQ-R CPU Module User's Manual (Application)

Point

Changing the module parameter of the R60AD8-G and writing it to the remote head module causes a change in the safety parameter, and thus the R60AD8-G automatically shifts to the safety module disabled state. To set the R60AD8-G to the safety module enabled state again, it is required to perform [Import Setting] to the changed project of the remote head module by using "Safety Communication Setting" of the CPU module project, and then to enable the safety module.

When flashing (400ms cycles)

Check item	Corrective action
Check whether the module position check has been executed.	With "Safety Module Operation" in the engineering tool, select the relevant module and click [S MODE LED Stop Flashing] button.



When turning off

Check item	Corrective action
Check whether the R60AD8-G in the module configuration diagram is SIL2 mode.	In the module configuration diagram of GX Works3, check that the two R60AD8-G modules are "R60AD8-G (S2M)" and "R60AD8-G (S2S)".
Check whether the project was written to the remote head module.	If no project was written to the remote head module, follow the steps below again starting from "Writing to the remote head module".  Page 229 Procedure on the remote head module side

When the ALM LED flashes

Check item	Corrective action
Check whether the system was restarted after enabling or disabling the safety module.	Restart the system when the safety module is enabled or disabled.

When a module parameter error is displayed in the "Module Diagnostics" window

Check item	Corrective action
Check whether the module configuration is correct.	Check that the module configuration diagram set in GX Works3 is correct. For details, refer to the following.  Page 235 SYSTEM CONFIGURATION
Check whether a module incompatible with the SIL2 mode is used.	Check that modules whose firmware version and production information are compatible with the SIL2 mode are used. Incompatible modules do not operate normally in SIL2 mode. For details, refer to the following.  Page 240 Firmware Version for SIL2 Mode







When a double input discrepancy detection error occurs

Check item	Corrective action
Check whether there is any problem with analog signal lines for modules and relay, such as looseness or disconnection.	<ul style="list-style-type: none"> Identify the faulty area by a visual check and continuity check for analog signal lines and relay of the channel where an error occurred. Check whether sensors are connected to different channels for the R60AD8-G (Main) and R60AD8-G (Sub).
Check whether any measures have been taken to reduce noise.	To reduce noise, take measures such as the use of shielded cables for connection.
Check "Duplex input error range setting" and "Duplicated input mismatch detection count".	Set "Duplex input error range setting" and "Duplicated input mismatch detection count" with GX Works3 so that the customer's system error range is allowed. If "Duplicated input mismatch detection count" needs to be increased considering noise effect, review and adjust "Duplex input error range setting".

Point 

If operation is not performed normally even after the actions described above are taken, the possible cause is a module failure. Please consult your local Mitsubishi representative.

When an A/D conversion circuit diagnostic error occurs

Check item	Corrective action
Check whether the R60DA8-G for diagnostics operates normally.	Check the error code of the R60DA8-G for diagnostics on the "Module Diagnostics" window. Refer to the following manual and take actions described in the list of error codes.  MELSEC iQ-R Channel Isolated Digital-Analog Converter Module User's Manual (Application)
Check whether the module parameters of the R60DA8-G for diagnostics are set correctly.	Check that the module parameters of the R60DA8-G for diagnostics are correct. For details, refer to the following.  Page 251 Module parameters for "R60DA8-G"
Check whether the 24VDC external power supply is applied to the R60DA8-G for diagnostics.	Check that the 24VDC external power supply is applied to the R60DA8-G for diagnostics. For details on how to check, refer to the following.  MELSEC iQ-R Channel Isolated Digital-Analog Converter Module User's Manual (Application) If the 24VDC external power supply is not applied, turn off and on the power supply to the entire system using SIL2 Process CPUs.
Check whether the RY40PT5B operates normally.	Check the error code of the RY40PT5B on the "Module Diagnostics" window. Refer to the following manual and take actions described in the list of error codes.  MELSEC iQ-R I/O Module (With Diagnostic Functions) User's Manual (Application)
Check whether the module parameters of the RY40PT5B have been changed.	If the module parameters of the RY40PT5B have been changed, reset them to the default values.
Check whether the 24VDC external power supply is applied to the RY40PT5B.	Check that the 24VDC external power supply is applied to the RY40PT5B. For details on how to check, refer to the following.  MELSEC iQ-R I/O Module (With Diagnostic Functions) User's Manual (Application) If the 24VDC external power supply is not applied, turn off and on the power supply to the entire system using SIL2 Process CPUs.
Check whether there is any problem with analog signal lines for modules and relay, such as looseness or disconnection.	Identify the faulty area by a visual check and continuity check for analog signal lines and relay of the channel where an error occurred.
Check whether any measures have been taken to reduce noise.	To reduce noise, take measures such as the use of shielded cables for connection.
Check "Duplex input error range setting".	The allowable error range for A/D conversion circuit diagnostics is automatically set according to "Duplex input error range setting". If A/D conversion circuit diagnostic errors occur frequently, adjust the setting of "Duplex input error range setting" to allow the customer's system error range including the effect of noise. For details, refer to the following.  Page 285 A/D conversion circuit diagnostic function







Point

If operation is not performed normally even after the actions described above are taken, the possible cause is a failure of a module in the module set. Please consult your local Mitsubishi representative.

When it takes time for the SIL2 analog input system to start up

Check item	Corrective action
Check whether the start-up diagnostics is being executed.	The start-up diagnostics is the function executed when a SIL2 analog input system starts up, and takes a maximum of SIL2 A/D conversion cycle (1000ms by default) × 56. To reduce the start-up diagnostic time, adjust "SIL2 A/D conversion cycle setting". To temporarily skip the start-up diagnostics when starting up the SIL2 analog input system, set the safety operation mode of the SIL2 Process CPU to TEST MODE. For details on the start-up diagnostics, refer to the following.  Page 285 A/D conversion circuit diagnostic function

When the safety device value is the OFF value (equivalent to 0V/0mA)

Check item	Corrective action
Check whether the R60DA8-G for diagnostics operates normally.	Check the error code of the R60DA8-G for diagnostics on the "Module Diagnostics" window. Refer to the following manual and take actions described in the list of error codes.  MELSEC iQ-R Channel Isolated Digital-Analog Converter Module User's Manual (Application)
Check whether the module parameters of the R60DA8-G for diagnostics are set correctly.	Check that the module parameters of the R60DA8-G for diagnostics are correct. For details, refer to the following.  Page 251 Module parameters for "R60DA8-G"
Check whether the 24VDC external power supply is applied to the R60DA8-G for diagnostics.	Check that the 24VDC external power supply is applied to the R60DA8-G for diagnostics. For details on how to check, refer to the following.  MELSEC iQ-R Channel Isolated Digital-Analog Converter Module User's Manual (Application) If the 24VDC external power supply is not applied, turn off and on the power supply to the entire system using SIL2 Process CPUs.
Check whether the RY40PT5B operates normally.	Check the error code of the RY40PT5B on the "Module Diagnostics" window. Refer to the following manual and take actions described in the list of error codes.  MELSEC iQ-R I/O Module (With Diagnostic Functions) User's Manual (Application)
Check whether the module parameters of the RY40PT5B have been changed.	If the module parameters of the RY40PT5B have been changed, reset them to the default values.
Check whether the 24VDC external power supply is applied to the RY40PT5B.	Check that the 24VDC external power supply is applied to the RY40PT5B. For details on how to check, refer to the following.  MELSEC iQ-R I/O Module (With Diagnostic Functions) User's Manual (Application) If the 24VDC external power supply is not applied, turn off and on the power supply to the entire system using SIL2 Process CPUs.
Check whether there is any problem with analog signal lines for modules and relay, such as looseness or disconnection.	Identify the faulty area by a visual check and continuity check for analog signal lines and relay of the channel where an error occurred.
Check whether the safety device being read is correct.	If a safety device different from the safety device assigned by the refresh device setting is referred to, digital operation values cannot be read correctly. Check the refresh device setting, and modify the program so that the safety device of the channel wanting to be read is referred to. For details on the refresh device setting, refer to the following.  MELSEC iQ-R CPU Module User's Manual (Application)
Check whether "A/D conversion disable" is set in "A/D conversion enable/disable setting" of the channel to be used.	Set "A/D conversion enable" in "A/D conversion enable/disable setting" of the channel to be used.
Check whether the SIL2 diagnostic FB library in use is correct.	Use a correct SIL2 diagnostic FB library. For details on the SIL2 diagnostic FB library used, refer to the following.  Page 274 SIL2 A/D Conversion Function

When the safety device does not fall within the range of accuracy

Check item	Corrective action
Check whether any measures have been taken to reduce noise.	To reduce noise, take measures such as the use of shielded cables for connection.

When the module shuts down

Check item	Corrective action
Check whether any measures have been taken to reduce noise.	To reduce noise, take measures such as the use of shielded cables for connection.

Point 

If operation is not performed normally even after the actions described above are taken, the possible cause is a module failure. Please consult your local Mitsubishi representative.

14.4 Troubleshooting While Proceeding Procedures Before Operation

When the module parameter write to the remote head module fails

Refer to the following.

 MELSEC iQ-R CC-Link IE Field Network Remote Head Module User's Manual (Application)

Troubleshooting on the "Safety Communication Setting" window

When [Import Setting] cannot be performed to the project of the remote head module

Check item	Corrective action
Check whether the module configuration of the remote head module project targeted for [Import Setting] operation is correct.	Review the module configuration of the remote head module project targeted for [Import Setting] operation.
Check whether the network number setting of the master/local module and the network number setting and station number setting of the remote head module are correct.	In the remote head module project for which [Import Setting] is executed, select "CPU Parameter" ⇒ "Network Required Setting" ⇒ "Network No." and set the same network number as the master/local module where [Import Setting] is executed.

Troubleshooting on the "Safety Module Operation" window

When the "Safety Module Operation" window cannot be opened

Check item	Corrective action
Check whether "To Use or Not to Use the Safety Communication Setting" is set to "Use" in the project of the SIL2 Process CPU.	Check "To Use or Not to Use the Safety Communication Setting" in the project of the SIL2 Process CPU and if "Not Use" is set, change it to "Use". In addition, follow the steps below again starting from "Safety communication setting".  Page 229 Procedure on the remote head module side

When the system is operated when the safety operation mode is not TEST MODE

Check item	Corrective action
Check whether the safety operation mode of the SIL2 Process CPU is set to SAFETY MODE.	When the safety operation mode of the SIL2 Process CPU is SAFETY MODE, enabling or disabling the safety module is not possible. The safety operation mode cannot be checked on the "Safety Module Operation" window. Select [Diagnostics] ⇒ [Module Diagnostics (CPU Diagnostics)] to check the safety operation mode. If the safety operation mode is SAFETY MODE, change the safety operation mode of the SIL2 Process CPU to TEST MODE. For details on the procedure, refer to the following.  Page 258 Safety module operation

When "Verification Failed" is displayed for "Module Status"

Check the following items in order of No.

No.	Check item	Corrective action
1	Check whether the project was written to the remote head module.	Follow the steps below again starting from "Writing to the remote head module". ☞ Page 229 Procedure on the remote head module side
2	Check whether the remote head module was reset after the write of the project to the remote head module.	The project is not valid unless the remote head module is reset after the write of the project to the remote head module. Follow the steps below again starting from "Resetting the remote head module". ☞ Page 229 Procedure on the remote head module side
3	Check whether [Import Setting] was performed to the project written to the remote head module, by using "Safety Communication Setting" of the SIL2 Process CPU project.	Save the project that was written to the remote head module. In addition, follow the steps below again starting from "Safety communication setting". ☞ Page 230 Procedure on the SIL2 Process CPU side
4	Check whether the module for which to enable the safety module is correct.	Press the [S MODE LED Start Flashing] button while selecting the module for which to enable the safety module on the "Safety Module Operation" window. Check that the S MODE LED for the module for which to enable the safety module is flashing (400ms cycle).

Point

- The setting of module parameter of the R60AD8-G that was written to the project of the remote head module is not reflected unless the [Import Setting] operation targeted for the remote head module project is completed by using "Safety Communication Setting" of the SIL2 Process CPU project. Thus, if the safety module operation is performed after a module parameter of the R60AD8-G is changed in the project of the remote head module without subsequent operation of [Import Setting] to the remote head module project, "Verification Failed" is displayed for "Module Status". When changing a module parameter of the R60AD8-G, perform the necessary operation again starting from the write of project to the remote head module.
- If operation is not performed normally even after the actions described above are taken, the possible cause is a module failure. Please consult your local Mitsubishi representative.

When "Timeout" is displayed for "Module Status"

Check the following items in order of No.

No.	Check item	Corrective action
1	Check whether LEDs of the R60AD8-G are in the following states. <ul style="list-style-type: none"> • The ERR LED is flashing. • The S MODE LED is flashing (1s cycle). 	A moderate error has occurred in the R60AD8-G. The safety module operation cannot be performed for the R60AD8-G with a moderate error. Check the error code in the "Module Diagnostics" window and take the action described in the list of error codes. ☞ Page 319 List of Error Codes
2	Check whether the safety module operation was performed with the personal computer connected to the SIL2 Process CPU in the standby system.	If the CPU redundant system with remote I/O modules is configured based on a redundant line, the safety module operation cannot be performed from the SIL2 Process CPU in the standby system. Perform the safety module operation again from the personal computer on which GX Works3 is open and to which the SIL2 Process CPU in the control system is connected.
3	Check whether the S MODE LED of the R60AD8-G is off.	The R60AD8-G is set to standard mode. Set the parameters for SIL2 mode by following the steps below again starting from "Setting parameters on the remote head module side". ☞ Page 229 Procedure on the remote head module side

Point

- If the safety module operation is performed while communications with the R60AD8-G are disabled, the time taken until "Timeout" is displayed for "Module Status" is set time in "Check at Communication Time" (second) × 3. (The default value for "Check at Communication Time" is 30 seconds.) For details on "Check at Communication Time", refer to the GX Works3 Operating Manual.
- If operation is not performed normally even after the actions described above are taken, the possible cause is a module failure. Please consult your local Mitsubishi representative.

When "Enabling Failed (Module Error)" is displayed for "Module Status"

Check item	Corrective action
Perform the safety module operation again, and check whether "Enabling Failed (Module Error)" is still displayed for "Module Status".	If this phenomenon persists, the possible cause is a module failure. Please consult your local Mitsubishi representative.

Point

If operation is not performed normally even after the actions described above are taken, the possible cause is a module failure. Please consult your local Mitsubishi representative.

When "Enabling Failed (Data Error)" is displayed for "Module Status"

Check item	Corrective action
Check whether measures have been properly taken against noise.	Take measures to reduce noise since the system may be affected by noise. If measures to reduce noise do not eliminate this symptom, the possible cause is a failure of the module. Please consult your local Mitsubishi representative.

Point

If operation is not performed normally even after the actions described above are taken, the possible cause is a module failure. Please consult your local Mitsubishi representative.

When "—" is displayed for "Module Status"

Check the following items in order of No.

No.	Check item	Corrective action
1	Check whether the R60AD8-G is mounted properly.	Check the "System Monitor" of GX Works3 and the actual base unit to check whether the R60AD8-G is mounted properly.
2	Check whether there are no problems on connections between the personal computer where GX Works3 is installed and the remote head module.	Inspect the connection path between the SIL2 Process CPU and the remote head module to eliminate the error cause if found.
3	Check whether there are no problems on the power supply of the remote head module.	Inspect the power supply environment of the remote head module again and eliminate the error cause if found.

Point



If operation is not performed normally even after the actions described above are taken, the possible cause is a module failure. Please consult your local Mitsubishi representative.

14.5 Troubleshooting SIL2 Diagnostic FB Library

When the SIL2 diagnostic FB library is not registered as a product option

Check item	Corrective action
Check whether the SIL2 diagnostic FB library is registered to GX Works3.	Register the SIL2 diagnostic FB library to the library list of GX Works3. For the FB library, please consult your local Mitsubishi representative. For details on the FB library registration method, refer to the GX Works3 Operating Manual.

When a program conversion error occurs in GX Works3

Check item	Corrective action
Check whether the correct SIL2 safety program FB is used.	Check that the SIL2 safety program FB (M+SIL2ADG_ADConv_R) has been attached to the safety program. For details, refer to the following.  Page 256 Creating programs If it is not attached correctly, the SIL2 analog input system does not operate normally.
Check whether the correct SIL2 standard program FB is used.	Check that the SIL2 standard program FB (M+SIL2ADG-IEF_WriteDAVal_R) has been attached to the standard program. For details, refer to the following.  Page 256 Creating programs If it is not attached correctly, the SIL2 analog input system does not operate normally.

When the execution status of the SIL2 diagnostic FB library is off

Check item	Corrective action
Check whether the SIL2 Process CPU is in STOP state.	Set the SIL2 Process CPU to RUN state.
Check whether i_bEN (execution command) of the SIL2 safety program FB is turned on.	Turn on i_bEN (execution command) of the SIL2 safety program FB.
Check whether i_bEN (execution command) of the SIL2 standard program FB is turned on.	Turn on i_bEN (execution command) of the SIL2 standard program FB.

Checking by status code of the SIL2 safety program FB

For 0000H

Check item	Corrective action
Check whether the SIL2 Process CPU is in STOP state.	Set the SIL2 Process CPU to RUN state.
Check whether i_bEN (execution command) of the SIL2 safety program FB is turned on.	Turn on i_bEN (execution command) of the SIL2 safety program FB.

For 8002H

Check item	Corrective action
Check whether "A/D conversion enable/disable setting" of the R60AD8-G is set to "A/D conversion disable".	Set "A/D conversion enable" to "A/D conversion enable/disable setting" of the R60AD8-G.

For C001H

Check item	Corrective action
Check whether the setting values of standard/safety shared labels used in the SIL2 safety program FB and SIL2 standard program FB are correct.	Check that the standard/safety shared labels used in the SIL2 safety program FB and the SIL2 standard program FB match.
Check whether the module parameter "SIL2 A/D conversion cycle setting" of the R60AD8-G is correct.	Check that "SIL2 A/D conversion cycle setting" is within the setting range. Also check that the parameter satisfies the setting value calculation formula. For details, refer to the following.  Page 277 "SIL2 A/D conversion cycle setting"

Point

If a double input discrepancy detection error (error code: 1ED□H) occurs in the R60AD8-G (Main), take actions described as follows.

 When a double input discrepancy detection error occurs

For C002H

Check item	Corrective action
Check whether the setting values of standard/safety shared labels used in the SIL2 safety program FB and SIL2 standard program FB are correct.	Check that the standard/safety shared labels used in the SIL2 safety program FB and the SIL2 standard program FB match.
Check whether the module parameter "SIL2 A/D conversion cycle setting" of the R60AD8-G is correct.	Check that "SIL2 A/D conversion cycle setting" is within the setting range. Also check that the parameter satisfies the setting value calculation formula. For details, refer to the following.  Page 277 "SIL2 A/D conversion cycle setting"
Check whether i_bEN (execution command) of the SIL2 standard program FB is turned on.	Turn on i_bEN (execution command) of the SIL2 standard program FB.

Point

If an A/D conversion circuit diagnostic error (error code: 1EF□H) occurs in the R60AD8-G (Main), take actions described as follows.

 When an A/D conversion circuit diagnostic error occurs



For C010H to C021H

Check item	Corrective action
Check whether the module parameters of the R60AD8-G are correct.	Check that the module parameters of the R60AD8-G indicated by status code are set within the setting range and the setting values are correct.

For C030H

Check item	Corrective action
Check whether the correct SIL2 safety program FB is used.	Check that the SIL2 safety program FB (M+SIL2ADG_ADConv_R) has been attached to the safety program. For details, refer to the following.  Page 256 Creating programs If it is not attached correctly, the SIL2 analog input system does not operate normally.

For C031H

Check item	Corrective action
Check whether setting values of i_u8ADRCvTbl (safety communications receive area) and o_u8ADSndTbl (safety communications send area) of the SIL2 safety program FB are correct.	Check that setting values of i_u8ADRCvTbl (safety communications receive area) and o_u8ADSndTbl (safety communications send area) of the SIL2 safety program FB are identical to those set in "Safety Communication Setting" of GX Works3.
Check whether the setting values of standard/safety shared labels used in the SIL2 safety program FB and SIL2 standard program FB are correct.	Check that the standard/safety shared labels used in the SIL2 safety program FB and the SIL2 standard program FB match.
Check whether the correct SIL2 safety program FB is used.	Check that the SIL2 safety program FB (M+SIL2ADG_ADConv_R) has been attached to the safety program. For details, refer to the following.  Page 256 Creating programs If it is not attached correctly, the SIL2 analog input system does not operate normally.
Check whether an error has occurred in any module of the SIL2 analog input system.	Check that there is no error in any module of the SIL2 analog input system.
Check whether the network settings and safety communication settings of the master station are correct, and whether the refresh settings of the master station and remote station are correct.	Check that the network settings and safety communication settings of the master station are correct, and that the refresh settings of the master station and remote station are correct.
Check that the R60AD8-G (Main) is in the safety module enabled state.	If the R60AD8-G (Main) is in the safety module disabled state, enable the safety module.
Check whether the module parameter "SIL2 A/D conversion cycle setting" of the R60AD8-G is correct.	Check that "SIL2 A/D conversion cycle setting" is within the setting range. Also check that the parameter satisfies the setting value calculation formula. For details, refer to the following.  Page 277 "SIL2 A/D conversion cycle setting"

For *1**H

Check item	Corrective action
Check whether i_bEN (execution command) of the SIL2 safety program FB is turned off.	Turn on i_bEN (execution command) of the SIL2 safety program FB.

Checking by error code of the SIL2 safety program FB

For 0201H

Check item	Corrective action
Check whether the setting values of standard/safety shared labels used in the SIL2 safety program FB and SIL2 standard program FB are correct.	Check that the standard/safety shared labels used in the SIL2 safety program FB and the SIL2 standard program FB match.
Check whether the module parameters of the R60AD8-G are correct.	Check that the module parameters of the R60AD8-G indicated by status code are set within the setting range and the setting values are correct.
Check whether the connection with the external devices is correct.	Check that each module is connected properly in the SIL2 analog input system. For details, refer to the following.  Page 242 External Wiring
Check whether i_bEN (execution command) of the SIL2 standard program FB is turned on.	Turn on i_bEN (execution command) of the SIL2 standard program FB.

14.6 List of Error Codes

If an error occurs while the R60AD8-G is running, the error code can be checked on the module diagnostics window of GX Works3.

Error codes of the R60AD8-G are classified in minor errors or moderate errors.

- Minor error: Errors that occur due to an incorrect parameter setting or by the SIL2 A/D conversion function (Number in the 1000s + H). Depending on the error type, a portion that stops operation differs.
- Moderate error: Errors that occur due to a hardware failure, self-diagnostics error, and module configuration error (Number in the 3000s + H). In this case, digital operation values of all channels become the OFF value (equivalent to 0V/0mA), and safety communications are stopped in the safety layer.

If an error has occurred, take actions against the error, such as reviewing connected devices, wiring, and voltage and replacing connected external devices. When the error cause is eliminated and if error clear is possible, turn on `i_bUnitErrClear` (module error clear) of the SIL2 safety program FB to clear the error. If a moderate error occurs, the module remains in safety stop state until the remote head module is reset or the power is turned off and on.

The following table lists error codes to be stored.

□ in error codes: This symbol indicates the number of the channel where an error has occurred. A numerical value of 0 to 7 is used to correspond to CH1 to CH8.

(CH1: 0, CH2: 1, CH3: 2, CH4: 3, CH5: 4, CH6: 5, CH7: 6, CH8: 7)

Error code	Error name	Error description and cause	Action
0000H	—	There is no error.	—
1081H	Number of safety module status switching exceeding limit error	The number of times of enabling/disabling the safety module has exceeded the guaranteed maximum number.	Further executions of enabling/disabling the safety module will not guarantee the safety module to be enabled/disabled.
1100H	Transmission interval monitoring time range error	A value other than 30 to 3000 is set in "Transmission interval monitoring time".	Set "Transmission interval monitoring time" within the range from 30 to 3000. If an error occurs even if a value in the range from 30 to 3000 is set, write the module parameter again. If the same error occurs again even after the parameter has been written again, the module may be in failure. Please consult your local Mitsubishi representative.
1110H	SIL2 A/D conversion cycle setting range error	A value other than 700 to 32767 is set in "SIL2 A/D conversion cycle setting".	Set "SIL2 A/D conversion cycle setting" within the range from 700 to 32767. If an error occurs even if a value in the range from 700 to 32767 is set, write the module parameter again. If the same error occurs again even after the parameter has been written again, the module may be in failure. Please consult your local Mitsubishi representative.
112□H	CH□ Double input error range setting range error	A value other than 5 to 50 is set in "CH□ Double input error range setting".	Set "CH□ Double input error range setting" within the range from 5 to 50. If an error occurs even if a value in the range from 5 to 50 is set, write the module parameter again. If the same error occurs again even after the parameter has been written again, the module may be in failure. Please consult your local Mitsubishi representative.
113□H	CH□ Number of double input discrepancy detection range error	A value other than 1 to 100 is set in "CH□ Number of double input discrepancy detection".	Set "CH□ Number of double input discrepancy detection" within the range from 1 to 100. If an error occurs even if a value in the range from 1 to 100 is set, write the module parameter again. If the same error occurs again even after the parameter has been written again, the module may be in failure. Please consult your local Mitsubishi representative.
1150H	A/D conversion circuit diagnostic cycle setting range error	A value other than 60 to 480 is set in "A/D conversion circuit diagnostic cycle setting".	Set "A/D conversion circuit diagnostic cycle setting" within the range from 60 to 480. If an error occurs even if a value in the range from 60 to 480 is set, write the module parameter again. If the same error occurs again even after the parameter has been written again, the module may be in failure. Please consult your local Mitsubishi representative.

Error code	Error name	Error description and cause	Action
1160H	Auto recovery settings after double input discrepancy range error	A value other than 0 to 1 is set in "Auto recovery settings after double input discrepancy".	Set "Auto recovery settings after double input discrepancy" within the range from 0 to 1. If an error occurs even if a value in the range from 0 to 1 is set, write the module parameter again. If the same error occurs again even after the parameter has been written again, the module may be in failure. Please consult your local Mitsubishi representative.
1170H	CH□ Necessary number for double input discrepancy auto recovery range error	A value other than 0 to 100 is set in "CH□ Necessary number for double input discrepancy auto recovery".	Set "CH□ Necessary number for double input discrepancy auto recovery" within the range from 0 to 100. If an error occurs even if a value in the range from 0 to 100 is set, write the module parameter again. If the same error occurs again even after the parameter has been written again, the module may be in failure. Please consult your local Mitsubishi representative.
1500H	Safety I/O HOLD time exceeded error*1	Duration of safety I/O HOLD state exceeded safety I/O HOLD time.	<ul style="list-style-type: none"> Check whether an error occurred on the switching of systems incorporating SIL2 Process CPUs. Check whether an error occurred in communications with a SIL2 Process CPU.
1900H	Range setting range error	A value out of the range is set in CH□ Range setting.	A parameter error has occurred. If the same error occurs again even after the module parameter has been written again, the module may be in failure. Please consult your local Mitsubishi representative.
1910H	Averaging process specification setting range error	A value other than 0, 2, and 3 is set in "CH□ Averaging process specification".	A parameter error has occurred. If the same error occurs again even after the module parameter has been written again, the module may be in failure. Please consult your local Mitsubishi representative.
1930H	Count average setting range error	When "Count average" is selected in "CH□ Averaging process specification", a value other than 4 to 500 is set in "CH□ Count average/Moving average setting".	A parameter error has occurred. If the same error occurs again even after the module parameter has been written again, the module may be in failure. Please consult your local Mitsubishi representative.
1940H	Moving average setting range error	When "Moving average" is selected in "CH□ Averaging process specification", a value other than 2 to 200 is set in "CH□ Count average/Moving average setting".	A parameter error has occurred. If the same error occurs again even after the module parameter has been written again, the module may be in failure. Please consult your local Mitsubishi representative.
1A00H	Scaling enable/disable setting range error	A value other than 0 and 1 is set in "CH□ Scaling enable/disable setting".	A parameter error has occurred. If the same error occurs again even after the module parameter has been written again, the module may be in failure. Please consult your local Mitsubishi representative.
1A10H	Scaling setting range error	A value other than -32000 to 32000 is set in "CH□ Scaling lower limit value" and/or "CH□ Scaling upper limit value".	A parameter error has occurred. If the same error occurs again even after the module parameter has been written again, the module may be in failure. Please consult your local Mitsubishi representative.
1A20H	Scaling upper/lower limit value setting error	"CH□ Scaling upper limit value" and "CH□ Scaling lower limit value" are set as the scaling upper limit value = the scaling lower limit value.	Set "CH□ Scaling upper limit value" or "CH□ Scaling lower limit value" as the scaling upper limit value ≠ the scaling lower limit value.
1A50H	Digitalclip enable/disable setting range error	A value other than 0 and 1 is set in "CH□ Digitalclip enable/disable setting".	A parameter error has occurred. If the same error occurs again even after the module parameter has been written again, the module may be in failure. Please consult your local Mitsubishi representative.
1E51H	User range data invalid (CH identification disabled)	An invalid value is set in the offset/gain setting. The number of the channel in which this error occurs cannot be identified.	If this error occurs in the safety module enabled state, the safety module will be disabled. Perform the offset/gain setting again for all channels where the user range is set. If the error occurs again, the possible cause is a module failure. Please consult your local Mitsubishi representative.
1E60H	User range data invalid (CH identification allowed)	An invalid value is set in CH□ Offset/gain setting.	If this error occurs on any channel in the safety module enabled state, the safety module will be disabled. Perform the offset/gain setting again for the channels where the error has occurred. If the error occurs again, the possible cause is a module failure. Please consult your local Mitsubishi representative.

Error code	Error name	Error description and cause	Action
1ED□H	Double input discrepancy detection error ^{*1}	The discrepancy of double input was detected.	Identify the channel with an error by the status code of the SIL2 diagnostic FB library, and check the connected devices and wiring. If connected devices and wiring are correct, there may be an influence from noise or module failure. If measures to reduce noise do not eliminate this error, the possible cause is module failure. Please consult your local Mitsubishi representative.
1EF□H	A/D conversion circuit diagnostic error	An error was detected with the A/D conversion circuit diagnostics.	There may be an influence from noise or module failure. If measures to reduce noise do not eliminate this error, the possible cause is module failure. Please consult your local Mitsubishi representative.
3001H	Hardware failure	A module hardware failure was detected.	Turn off and on the power supply of the module. If the same error occurs again, the possible cause is module failure. Please consult your local Mitsubishi representative.
3020H	Safety mutual monitoring error	An error was detected in the counterpart device that is mutually monitored.	A moderate error was detected in the counterpart device that is mutually monitored. Check the error code on the counterpart device side, and take an action corresponding to the error code. If a safety mutual monitoring error occurs in both modules, this indicates that either module is in failure but the failed module cannot be identified. Identify the module in failure by replacing each module one by one with a normally operating module, and consult your local Mitsubishi representative.
3050H	Safety parameter error	An error of safety parameter was detected at the startup of the system.	The possible cause is a failure of safety parameter write. Write the safety parameter to the module again with GX Works3. If the same error occurs again even after the parameter has been set again, the module may be in failure. Please consult your local Mitsubishi representative.
3060H	Module configuration error	An error was detected with the configuration check for operating the R60AD8-G in SIL2 mode.	Review the configuration for operating the R60AD8-G in SIL2 mode. If the same error occurs again even after the module configuration review, the module may be in failure. Please consult your local Mitsubishi representative.

*1 The error can be cleared by i_bUnitErrClear (module error clear) of the SIL2 safety program FB. If an error is displayed, change the module parameter and enable the safety module again.

APPENDICES (SIL2 MODE)

Appendix 9 I/O Signals

List of I/O signals

The following tables are lists of I/O signals for the R60AD8-G in SIL2 mode.

Point 

- The I/O signals (X/Y) described below show the case that the start I/O number of the R60AD8-G is set to "0".
- Do not use the "use prohibited" signals in the following tables since they are used by the system. If users use (turn on) the signals, the functions of the R60AD8-G cannot be guaranteed.

Input signal

Device number	Signal name
X0 to XF	Use prohibited

Output signal

Device number	Signal name
Y0 to YF	Use prohibited

Appendix 10 Buffer Memory

List of buffer memory addresses

The following table lists the buffer memory addresses of the R60AD8-G. For details on the buffer memory area, refer to the following.

☞ Page 323 Details of buffer memory area

The buffer memory area of the R60AD8-G is intended only for monitor data (data used for referring to the status of the R60AD8-G). Reading data is only allowed. Writing data is not allowed.



Do not write data into buffer memory areas. Writing data into these areas can cause a module malfunction.

Address (decimal)	Address (hexadecimal)	Name	Default value
0 to 4202	0H to 106AH	System area	—
4203	106BH	Safety module validation status	0001H
4204 to 80999	106CH to 13C67H	System area	—

Details of buffer memory area

This section describes details of buffer memory area of the R60AD8-G.

Safety module validation status

Whether the safety module function is enabled in SIL2 mode is stored. Whether the safety module function is enabled in the module set including the R60AD8-G (Sub) is stored in this area of the R60AD8-G (Main). Note that whether the safety module function is enabled is not stored in the R60AD8-G (Sub).

Stored value	Description
0001H	Disabled state
0002H	Disabled state (reset waiting)
0003H	Enabled state
0004H	Enabled state (reset waiting)

For how to enable the safety module function, refer to the following.

☞ Page 258 Safety module operation

■ Buffer memory address

The following shows the buffer memory address of this area.

Buffer memory name	X/Y00 to X/Y0F
Safety module validation status	4203

Appendix 11 I/O Conversion Characteristics

I/O conversion characteristics of A/D conversion shows the slope of a line between the offset value and gain value when an analog signal (voltage or current) from outside of the programmable controller is converted to a digital value.

Offset value

Analog input value (voltage or current) equivalent to the digital output value of 0

Gain value

Analog input value (voltage or current) equivalent to the digital output value of 32000

Voltage input characteristics

The following are list of analog input ranges for voltage input and graphs of each voltage input characteristics.

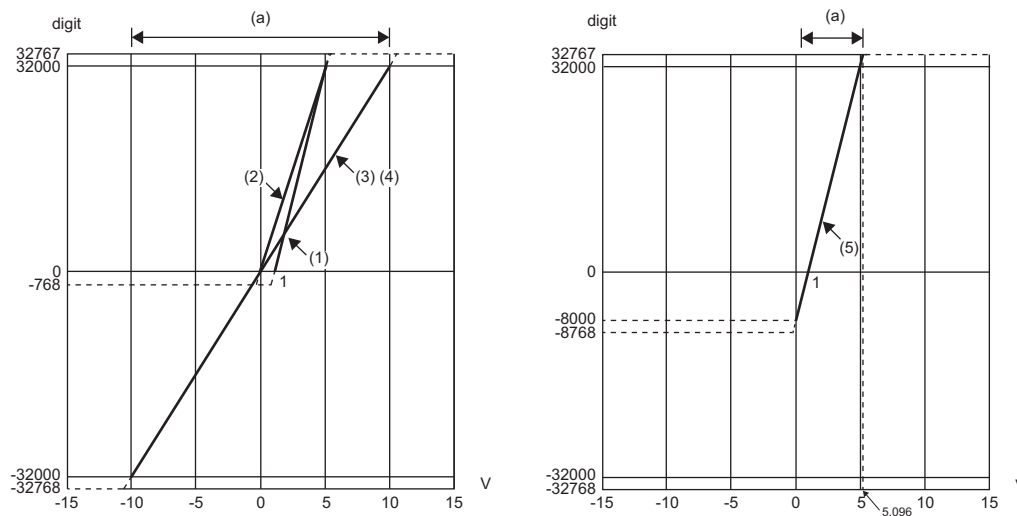

digit: Digital operation value

V: Analog input voltage (V)

(a): Practical analog input range

No.	Input range setting	Offset value	Gain value	Digital operation value ^{*3}	Resolution
(1)	1 to 5V	1V	5V	0 to 32000	125.0 μ V
(2)	0 to 5V	0V	5V		156.3 μ V
(3)	-10 to 10V	0V	10V	-32000 to 32000	312.5 μ V
(4)	0 to 10V	0V	10V	0 to 32000	
(5)	1 to 5V (extended mode)	1V	5V	-8000 to 32767	125.0 μ V
—	User range setting	*1	*1	-32000 to 32000	50.0 μ V ^{*2}

*1 Set the user range setting offset value and gain value in a range meeting the following conditions. If one of the following conditions is not met, A/D conversion may not be achieved correctly.

Setting range of offset value and gain value: -10 to 10V

$((\text{Gain value}) - (\text{Offset value})) \geq 1.6\text{V}$

*2 A maximum resolution in the user range setting

*3 When an analog input exceeds the digital operation value range, its digital operation value is fixed to the maximum or minimum.

Input range setting	Digital operation value	
	Minimum	Maximum
1 to 5V	-768	32767
0 to 5V		
-10 to 10V	-32768	
0 to 10V	-768	
1 to 5V (extended mode)	-8768	32767
User range setting	-32768	32767

Point

- Use the input range within the practical analog input range and practical digital output range. If the input range exceeds the ranges above, the resolution and accuracy may not meet the performance specifications. (Avoid using the range within the dotted lines on the voltage input characteristics graphs.)
- Do not input a value $\pm 15\text{V}$ or higher. Doing so may damage the elements.

Current input characteristics

The following are list of analog input ranges for current input and graphs for each current input characteristics.

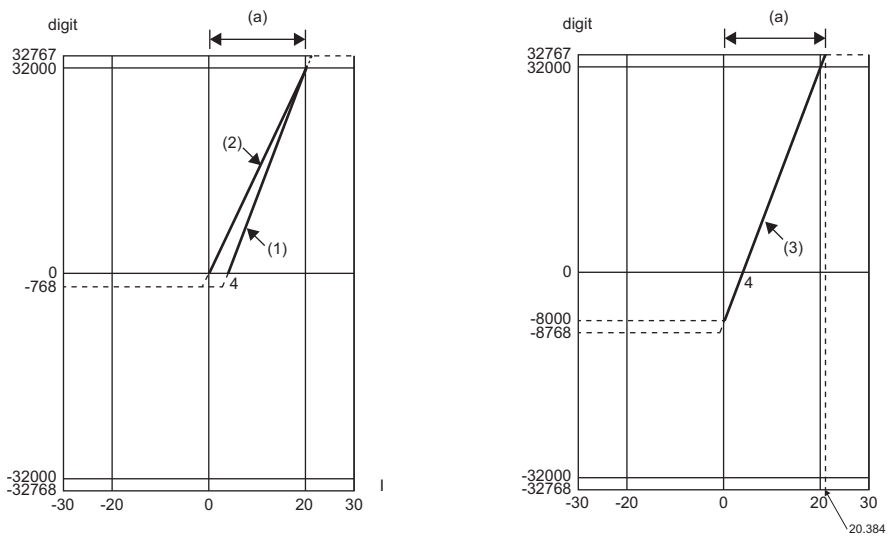

digit: Digital operation value

I: Analog input current (mA)

(a): Practical analog input range

No.	Input range setting	Offset value	Gain value	Digital operation value ^{*3}	Resolution
(1)	4 to 20mA	4mA	20mA	0 to 32000	500.0nA
(2)	0 to 20mA	0mA	20mA		625.0nA
(3)	4 to 20mA (extended mode)	4mA	20mA	-8000 to 32767	500.0nA
—	User range setting	*1	*1	-32000 to 32000	190.6nA ^{*2}

*1 Set the user range setting offset value and gain value in a range meeting the following conditions. If one of the following conditions is not met, A/D conversion may not be achieved correctly.

Gain value \leq 20mA, Offset value \geq 0mA

$((\text{Gain value}) - (\text{Offset value})) \geq 12.2\text{mA}$

*2 A maximum resolution in the user range setting

*3 When an analog input exceeds the digital operation value range, its digital operation value is fixed to the maximum or minimum.

Input range setting	Digital operation value	
	Minimum	Maximum
4 to 20mA	-768	32767
0 to 20mA		
4 to 20mA (extended mode)	-8768	32767
User range setting	-32768	32767

Point

- Use the input range within the practical analog input range and practical digital output range. If the input range exceeds the ranges above, the resolution and accuracy may not meet the performance specifications. (Avoid using the range within the dotted lines on the current input characteristics graphs.)
- Do not input a value $\pm 30\text{mA}$ or higher. Doing so may damage the elements.

Appendix 12 Accuracy

A/D conversion accuracy

A/D conversion accuracy is the accuracy of the maximum digital operation value. The accuracy is calculated by the following calculation formula.

Accuracy = (Reference accuracy) + (Temperature coefficient) × (Temperature change amount)

- Reference accuracy: Accuracy in the ambient temperature when the offset/gain value is set ($\pm 0.1\%$ (± 32 digit))
- Temperature coefficient: Accuracy per 1°C temperature change ($0.0035\%/^\circ\text{C}$ (± 1.12 digit))

Even when the offset/gain setting and analog input range are changed and the output characteristics are changed, the reference accuracy and temperature coefficient are not changed and the performance specifications are still satisfied.

(Excluded when the wiring is influenced by noise.)

Ex.

Accuracy when the temperature changes by 5°C (from 25°C to 30°C)

$(\pm 0.1\%) + (\pm 0.0035\%/^\circ\text{C} \times 5^\circ\text{C}) = \pm 0.1175\%$ (± 38 digit)

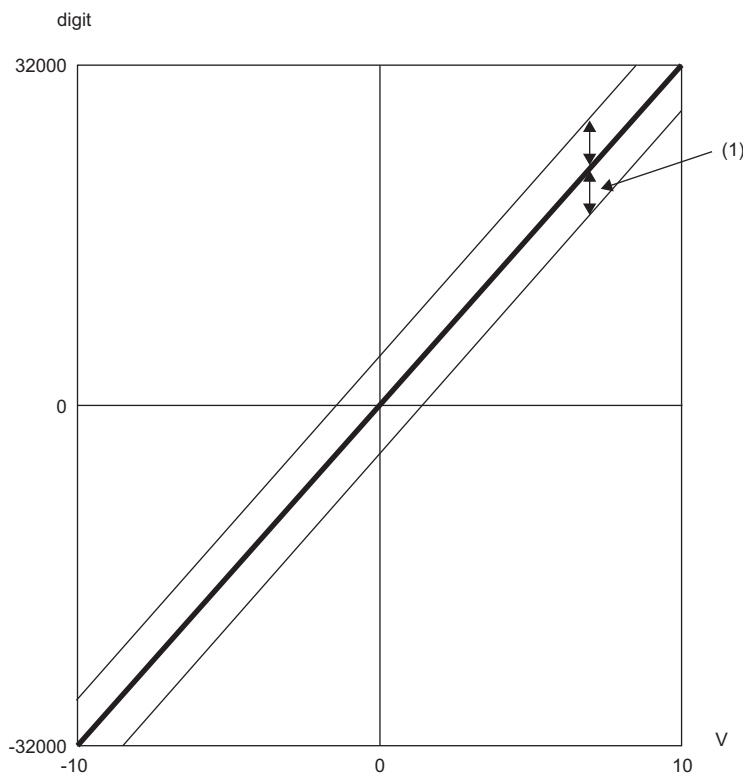

digit: Digital operation value

V: Analog input value (V)

(1) Fluctuation range

Accuracy in a SIL2 analog input system

When the R60AD8-G is used in SIL2 mode, the R60AD8-G (Main) and R60AD8-G (Sub) are configured, and digital operation values obtained from these two modules are compared for evaluation. An allowable error in this evaluation is the accuracy in a SIL2 analog input system.

An allowable error in evaluation can be set in the range of 0.5 to 5.0% in "Duplex input error range setting" in "Application setting". (Page 281 Double input discrepancy detection function)

Appendix 13 Calculation Method of Safety Response Time (Maximum Value)

The safety response time is the maximum time taken from when a value satisfying a certain condition is detected in the safety analog input of the R60AD8-G set in SIL2 mode (intelligent device station (safety station)) until the safety output of the RY40PT5B set in SIL2 mode (intelligent device station (safety station)) turns off. The time includes an error detection time. This maximum time is calculated by the following formula.

Intelligent device station (safety station) on the input side → Master station (safety station) → Intelligent device station (safety station) on the output side

$$(S2cycad \times 5) + (SCmst \times 2) + (S2cycout \times 2.5) + RMout + RMholdout + (nout \times 2) + SRout$$

Symbol	Description
S2cycad	SIL2 A/D conversion cycle
SCmst	Safety cycle time of the master station (safety station) ^{*1}
S2cycout	Control cycle time of the output side (RY40PT5B set in SIL2 mode) ^{*2}
RMout	Safety refresh monitoring time for the output connection of the master station (safety station) ^{*3}
RMholdout	Safety I/O HOLD time of the master station (safety station) ^{*5}
SRout	Safety output response time of the RY40PT5B set in SIL2 mode ^{*2}
nout	$RMout - TMrmtout - (TMrmtout \div 2) + a$
a	$TMrmtout - b$ (This value is effective only if a station set to Active is the RJ71GF11-T2. In other cases, the value is 0.)
b	The calculation result of $TMrmtout \div 2$, which is rounded up to a multiple of the safety cycle time ^{*4}
TMrmtout	Transmission interval monitoring time for the output connection of the master station (safety station) ^{*3}
TMrmtout	Transmission interval monitoring time of the output side (RY40PT5B set in SIL2 mode) ^{*2}

*1 For Safety cycle time, refer to the following.

 MELSEC iQ-R CPU Module User's Manual (Application)

*2 For details, refer to the following.

 MELSEC iQ-R I/O Module (With Diagnostic Functions) User's Manual (Application)

*3 For details, refer to the following.

 MELSEC iQ-R CC-Link IE Field Network User's Manual (Application)

*4 Calculation example of b:

When Transmission interval monitoring time is 24ms and Safety cycle time is 10ms, the calculation formula is $24 \div 2 = 12$, and the result is rounded up to 20, a multiple of 10.

*5 For Safety I/O HOLD time, refer to the following.

 MELSEC iQ-R CPU Module User's Manual (Application)

Appendix 14 Added or Modified Function

This section describes the function added to or modified for the R60AD8-G.

Addition/modification	Firmware version	Reference
SIL2 mode	"02" or later	Page 220 OVERVIEW

Appendix 15 External Dimensions

The following figure shows the external dimensions of the R60AD8-G.

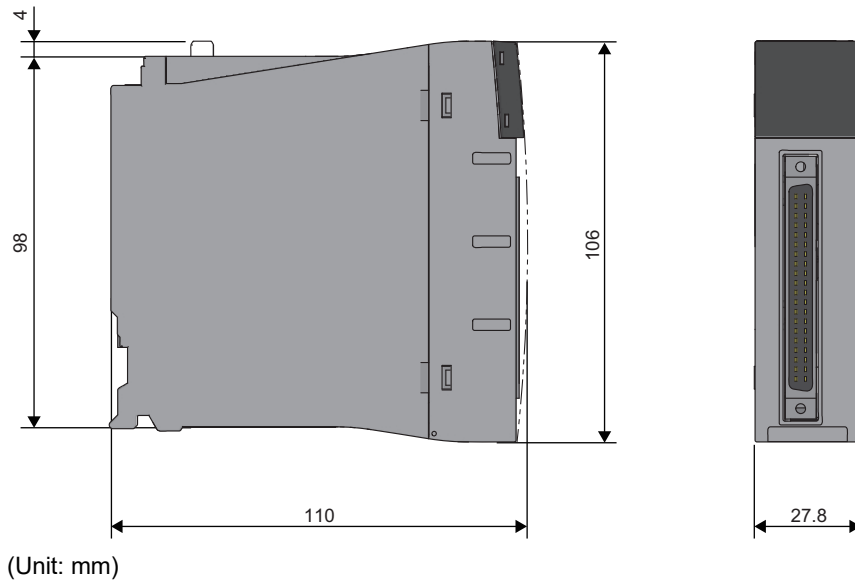

MEMO

A

INDEX

A

A/D conversion accuracy	327
A/D conversion circuit diagnostic function	285
A/D conversion completed flag	121,149
A/D conversion enable/disable setting function	21,266
A/D conversion method	22,266
Alarm history	195
Alert output flag (Process alarm lower limit)	146
Alert output flag (Process alarm upper limit)	145
Alert output flag (Rate alarm lower limit)	147
Alert output flag (Rate alarm upper limit)	147
Alert output function	30
Alert output signal	115
ALM LED	223
Analog switching module	240
Application setting	96,294
Averaging processing	22,267

B

Backing up, saving, and restoring offset/gain values	87
Basic setting	95,293

C

CH1 A/D conversion enable/disable setting	167
CH1 Alert output setting (process alarm)	174
CH1 Alert output setting (rate alarm)	175
CH1 Averaging process specification	168
CH1 Conversion value shift amount	167
CH1 Current logging read pointer	161
CH1 Difference conversion reference value	158
CH1 Difference conversion status flag	156
CH1 Difference conversion trigger	165
CH1 Digital clipping enable/disable setting	173
CH1 Digital operation value	154
CH1 Digital output value	154
CH1 Digital output value (32 bits)	157
CH1 Factory default setting	196
CH1 Head pointer	159
CH1 Input signal error detection lower limit set value	182
CH1 Input signal error detection setting	180
CH1 Input signal error detection upper limit set value	184
CH1 Latest pointer	160
CH1 Level trigger condition setting	189
CH1 Loading interrupt enable/disable setting	192
CH1 Logging cycle monitor value	163
CH1 Logging cycle setting value	187
CH1 Logging cycle unit setting	188
CH1 Logging data	202
CH1 Logging data setting	186
CH1 Logging enable/disable setting	185
CH1 Logging hold flag	156
CH1 Logging hold request	166
CH1 Logging read points monitor value	162
CH1 Logging read points setting value	193
CH1 Maximum value	155

CH1 Minimum value	155
CH1 Number of logging data	160
CH1 Offset/gain setting mode	198
CH1 Offset/gain setting mode (range specification)	200
CH1 Post-trigger logging points	188
CH1 Previous logging read pointer	162
CH1 Process alarm lower lower limit value	178
CH1 Process alarm lower upper limit value	177
CH1 Process alarm upper lower limit value	176
CH1 Process alarm upper upper limit value	176
CH1 Range setting	193
CH1 Range setting monitor	157
CH1 Rate alarm alert detection cycle setting	179
CH1 Rate alarm lower limit value	180
CH1 Rate alarm upper limit value	179
CH1 Scaling enable/disable setting	171
CH1 Scaling lower limit value	173
CH1 Scaling upper limit value	172
CH1 Time average/Count average/Moving average/Primary delay filter constant setting	170
CH1 Trigger data	190
CH1 Trigger generation time	164
CH1 Trigger pointer	161
CH1 Trigger setting value	191
CH1 User range setting	196
Channel change completed flag	119
Channel change request	122
Command area for module invalidation	201
Condition target channel setting	152
Condition target setting	151
Connector for external devices	223,241
Connector/terminal block converter module	240
Count average	23,267
Current input characteristics	326

D

Difference conversion function	55
Digital clipping function	53,272
Digital operation value	19,264
Digital output value	19,264
Double input discrepancy detection function	281

E

ERR LED	223
Error clear request	123
Error flag	121
Error history	194
Error history function	83,290
Event history function	86,291
External wiring	242

G

Gain value	324
----------------------	-----

I	
Input HOLD function	288
Input signal error detection auto-clear enable/disable setting	153
Input signal error detection extension/input signal error detection setting	181
Input signal error detection flag	148
Input signal error detection function	38
Input signal error detection signal	120
Interrupt factor detection flag	145
Interrupt factor generation setting	151
Interrupt factor mask	150
Interrupt factor reset request	150
Interrupt function	80
Interrupt setting	97
L	
Latest address of alarm history	145
Latest address of error history	144
Latest alarm code	144
Latest error code	144
Level data 0 to 9	149
Logging data	19
Logging function	60
Logging read function	73
M	
Maximum and minimum value	19
Maximum value/minimum value hold function	59
Maximum value/minimum value reset completed flag	121
Maximum value/minimum value reset request	123
Mode switching setting	153
Module label	112
Module READY	115
Module set	220
Moving average	23,268
O	
Offset value	324
Offset/gain setting mode status flag	118
Operating condition setting completed flag	117
Operating condition setting request	122
P	
Parameter setting	95,293
Primary delay filter	24
Process alarm	30
Production information marking	223
Q	
CH1 Input signal error detection setting value/CH1 Input signal error detection lower limit set value	183
Q Compatible mode function	94
R	
Range reference table	93
Range switching function	20,265
Rate alarm	33
Refresh processing time	99
Refresh settings	98,295
RUN LED	223
S	
S MODE LED	223
Safety module validation status	323
Sampling processing	22
Save data type setting	195
Scaling function	26,269
Self-diagnostic function	289
Shift function	50
SIL2 A/D conversion function	274
SIL2 analog input system	220
SIL2 diagnostic FB library	221
Simple disconnection detection	40
Special cable	240
T	
Terminal module	240
Time average	22
U	
User range write request	122
V	
Validation status area	201
Voltage input characteristics	325

REVISIONS

*The manual number is given on the bottom left of the back cover.

Revision date	*Manual number	Description
January 2015	SH(NA)-081487ENG-A	First edition
May 2016	SH(NA)-081487ENG-B	■Added or modified parts RELEVANT MANUALS, TERMS, Chapter 1, Section 1.2 to 1.9, 1.12, 1.13, 1.16, 1.17, 2.1 to 2.4, Appendix 3, 5
June 2018	SH(NA)-081487ENG-C	■Added or modified parts SAFETY PRECAUTIONS, INTRODUCTION, RELEVANT MANUALS, TERMS, Section 1.15, 1.16, 3.1, 3.4, Appendix 3, 4, 6, 7, PART2
December 2018	SH(NA)-081487ENG-D	■Added or modified parts PART2
August 2020	SH(NA)-081487ENG-E	■Added or modified part Appendix 14
October 2020	SH(NA)-081487ENG-F	■Added or modified parts SAFETY PRECAUTIONS, CONDITIONS OF USE FOR THE PRODUCT, RELEVANT MANUALS, TERMS, GENERIC TERMS AND ABBREVIATIONS, Chapter 12, Appendix 7

Japanese manual number: SH-081486-F

This manual confers no industrial property rights or any rights of any other kind, nor does it confer any patent licenses. Mitsubishi Electric Corporation cannot be held responsible for any problems involving industrial property rights which may occur as a result of using the contents noted in this manual.

© 2015 MITSUBISHI ELECTRIC CORPORATION

WARRANTY

Please confirm the following product warranty details before using this product.

1. Gratis Warranty Term and Gratis Warranty Range

If any faults or defects (hereinafter "Failure") found to be the responsibility of Mitsubishi occurs during use of the product within the gratis warranty term, the product shall be repaired at no cost via the sales representative or Mitsubishi Service Company.

However, if repairs are required onsite at domestic or overseas location, expenses to send an engineer will be solely at the customer's discretion. Mitsubishi shall not be held responsible for any re-commissioning, maintenance, or testing on-site that involves replacement of the failed module.

[Gratis Warranty Term]

The gratis warranty term of the product shall be for one year after the date of purchase or delivery to a designated place. Note that after manufacture and shipment from Mitsubishi, the maximum distribution period shall be six (6) months, and the longest gratis warranty term after manufacturing shall be eighteen (18) months. The gratis warranty term of repair parts shall not exceed the gratis warranty term before repairs.

[Gratis Warranty Range]

- (1) The range shall be limited to normal use within the usage state, usage methods and usage environment, etc., which follow the conditions and precautions, etc., given in the instruction manual, user's manual and caution labels on the product.
- (2) Even within the gratis warranty term, repairs shall be charged for in the following cases.
 1. Failure occurring from inappropriate storage or handling, carelessness or negligence by the user. Failure caused by the user's hardware or software design.
 2. Failure caused by unapproved modifications, etc., to the product by the user.
 3. When the Mitsubishi product is assembled into a user's device, Failure that could have been avoided if functions or structures, judged as necessary in the legal safety measures the user's device is subject to or as necessary by industry standards, had been provided.
 4. Failure that could have been avoided if consumable parts (battery, backlight, fuse, etc.) designated in the instruction manual had been correctly serviced or replaced.
 5. Failure caused by external irresistible forces such as fires or abnormal voltages, and Failure caused by force majeure such as earthquakes, lightning, wind and water damage.
 6. Failure caused by reasons unpredictable by scientific technology standards at time of shipment from Mitsubishi.
 7. Any other failure found not to be the responsibility of Mitsubishi or that admitted not to be so by the user.

2. Onerous repair term after discontinuation of production

- (1) Mitsubishi shall accept onerous product repairs for seven (7) years after production of the product is discontinued. Discontinuation of production shall be notified with Mitsubishi Technical Bulletins, etc.
- (2) Product supply (including repair parts) is not available after production is discontinued.

3. Overseas service

Overseas, repairs shall be accepted by Mitsubishi's local overseas FA Center. Note that the repair conditions at each FA Center may differ.

4. Exclusion of loss in opportunity and secondary loss from warranty liability

Regardless of the gratis warranty term, Mitsubishi shall not be liable for compensation to:

- (1) Damages caused by any cause found not to be the responsibility of Mitsubishi.
- (2) Loss in opportunity, lost profits incurred to the user by Failures of Mitsubishi products.
- (3) Special damages and secondary damages whether foreseeable or not, compensation for accidents, and compensation for damages to products other than Mitsubishi products.
- (4) Replacement by the user, maintenance of on-site equipment, start-up test run and other tasks.

5. Changes in product specifications

The specifications given in the catalogs, manuals or technical documents are subject to change without prior notice.

· When SIL2 mode is set

Please confirm the following product warranty details before using this product.

1. Limited Warranty and Product Support.

- a. Mitsubishi Electric Company ("MELCO") warrants that for a period of eighteen (18) months after date of delivery from the point of manufacture or one year from date of Customer's purchase, whichever is less, Mitsubishi programmable logic controllers (the "Products") will be free from defects in material and workmanship.
- b. At MELCO's option, for those Products MELCO determines are not as warranted, MELCO shall either repair or replace them or issue a credit or return the purchase price paid for them.
- c. For this warranty to apply:
 - (1) Customer shall give MELCO (i) notice of a warranty claim to MELCO and the authorized dealer or distributor from whom the Products were purchased, (ii) the notice shall describe in reasonable details the warranty problem, (iii) the notice shall be provided promptly and in no event later than thirty (30) days after the Customer knows or has reason to believe that Products are not as warranted, and (iv) in any event, the notice must be given within the warranty period;
 - (2) Customer shall cooperate with MELCO and MELCO's representatives in MELCO's investigation of the warranty claim, including preserving evidence of the claim and its causes, meaningfully responding to MELCO's questions and investigation of the problem, grant MELCO access to witnesses, personnel, documents, physical evidence and records concerning the warranty problem, and allow MELCO to examine and test the Products in question offsite or at the premises where they are installed or used; and
 - (3) If MELCO requests, Customer shall remove Products it claims are defective and ship them to MELCO or MELCO's authorized representative for examination and, if found defective, for repair or replacement. The costs of removal, shipment to and from MELCO's designated examination point, and reinstallation of repaired or replaced Products shall be at Customer's expense.
 - (4) If Customer requests and MELCO agrees to effect repairs onsite at any domestic or overseas location, the Customer will pay for the costs of sending repair personnel and shipping parts. MELCO is not responsible for any re-commissioning, maintenance, or testing on-site that involves repairs or replacing of the Products.
- d. Repairs of Products located outside of Japan are accepted by MELCO's local authorized service facility centers ("FA Centers"). Terms and conditions on which each FA Center offers repair services for Products that are out of warranty or not covered by MELCO's limited warranty may vary.
- e. Subject to availability of spare parts, MELCO will offer Product repair services for (7) years after each Product model or line is discontinued, at MELCO's or its FA Centers' rates and charges and standard terms in effect at the time of repair. MELCO usually produces and retains sufficient spare parts for repairs of its Products for a period of seven (7) years after production is discontinued.
- f. MELCO generally announces discontinuation of Products through MELCO's Technical Bulletins. Products discontinued and repair parts for them may not be available after their production is discontinued.

2. Limits of Warranties.

- a. MELCO does not warrant or guarantee the design, specify, manufacture, construction or installation of the materials, construction criteria, functionality, use, properties or other characteristics of the equipment, systems, or production lines into which the Products may be incorporated, including any safety, fail-safe and shut down systems using the Products.
- b. MELCO is not responsible for determining the suitability of the Products for their intended purpose and use, including determining if the Products provide appropriate safety margins and redundancies for the applications, equipment or systems into which they are incorporated.
- c. Customer acknowledges that qualified and experienced personnel are required to determine the suitability, application, design, construction and proper installation and integration of the Products. MELCO does not supply such personnel.
- d. MELCO is not responsible for designing and conducting tests to determine that the Product functions appropriately and meets application standards and requirements as installed or incorporated into the end-user's equipment, production lines or systems.
- e. MELCO does not warrant any Product:
 - (1) repaired or altered by persons other than MELCO or its authorized engineers or FA Centers;
 - (2) subjected to negligence, carelessness, accident, misuse, or damage;
 - (3) improperly stored, handled, installed or maintained;
 - (4) integrated or used in connection with improperly designed, incompatible or defective hardware or software;
 - (5) that fails because consumable parts such as batteries, backlights, or fuses were not tested, serviced or replaced;
 - (6) operated or used with equipment, production lines or systems that do not meet applicable and commensurate legal, safety and industry-accepted standards;
 - (7) operated or used in abnormal applications;
 - (8) installed, operated or used in contravention of instructions, precautions or warnings contained in MELCO's user, instruction and/or safety manuals, technical bulletins and guidelines for the Products;
 - (9) used with obsolete technologies or technologies not fully tested and widely accepted and in use at the time of the Product's manufacture;
 - (10) subjected to excessive heat or moisture, abnormal voltages, shock, excessive vibration, physical damage or other improper environment; or
 - (11) damaged or malfunctioning due to Acts of God, fires, acts of vandals, criminals or terrorists, communication or power failures, or any other cause or failure that results from circumstances beyond MELCO's control.
- f. All Product information and specifications contained on MELCO's website and in catalogs, manuals, or technical information materials provided by MELCO are subject to change without prior notice.

- g. The Product information and statements contained on MELCO's website and in catalogs, manuals, technical bulletins or other materials provided by MELCO are provided as a guide for Customer's use. They do not constitute warranties and are not incorporated in the contract of sale for the Products.
- h. These terms and conditions constitute the entire agreement between Customer and MELCO with respect to warranties, remedies and damages and supersede any other understandings, whether written or oral, between the parties. Customer expressly acknowledges that any representations or statements made by MELCO or others concerning the Products outside these terms are not part of the basis of the bargain between the parties and are not factored into the pricing of the Products.
- i. THE WARRANTIES AND REMEDIES SET FORTH IN THESE TERMS ARE THE EXCLUSIVE AND ONLY WARRANTIES AND REMEDIES THAT APPLY TO THE PRODUCTS.
- j. MELCO DISCLAIMS THE IMPLIED WARRANTIES OF MERCHANTABILITY AND FITNESS FOR A PARTICULAR PURPOSE.

3. Limits on Damages.

- a. MELCO'S MAXIMUM CUMULATIVE LIABILITY BASED ON ANY CLAIMS FOR BREACH OF WARRANTY OR CONTRACT, NEGLIGENCE, STRICT TORT LIABILITY OR OTHER THEORIES OF RECOVERY REGARDING THE SALE, REPAIR, REPLACEMENT, DELIVERY, PERFORMANCE, CONDITION, SUITABILITY, COMPLIANCE, OR OTHER ASPECTS OF THE PRODUCTS OR THEIR SALE, INSTALLATION OR USE SHALL BE LIMITED TO THE PRICE PAID FOR PRODUCTS NOT AS WARRANTED.
- b. Although MELCO has obtained the certification for Product's compliance to the international safety standards IEC61508 and IEC61511 from TUV Rheinland, this fact does not guarantee that Product will be free from any malfunction or failure. The user of this Product shall comply with any and all applicable safety standard, regulation or law and take appropriate safety measures for the system in which the Product is installed or used and shall take the second or third safety measures other than the Product. MELCO is not liable for damages that could have been prevented by compliance with any applicable safety standard, regulation or law.
- c. MELCO prohibits the use of Products with or in any application involving power plants, trains, railway systems, airplanes, airline operations, other transportation systems, amusement equipments, hospitals, medical care, dialysis and life support facilities or equipment, incineration and fuel devices, handling of nuclear or hazardous materials or chemicals, mining and drilling, and other applications where the level of risk to human life, health or property are elevated.
- d. MELCO SHALL NOT BE LIABLE FOR SPECIAL, INCIDENTAL, CONSEQUENTIAL, INDIRECT OR PUNITIVE DAMAGES, FOR LOSS OF PROFITS, SALES, OR REVENUE, FOR INCREASED LABOR OR OVERHEAD COSTS, FOR DOWNTIME OR LOSS OF PRODUCTION, FOR COST OVERRUNS, OR FOR ENVIRONMENTAL OR POLLUTION DAMAGES OR CLEAN-UP COSTS, WHETHER THE LOSS IS BASED ON CLAIMS FOR BREACH OF CONTRACT OR WARRANTY, VIOLATION OF STATUTE, NEGLIGENCE OR OTHER TORT, STRICT LIABILITY OR OTHERWISE.
- e. In the event that any damages which are asserted against MELCO arising out of or relating to the Products or defects in them, consist of personal injury, wrongful death and/or physical property damages as well as damages of a pecuniary nature, the disclaimers and limitations contained in these terms shall apply to all three types of damages to the fullest extent permitted by law. If, however, the personal injury, wrongful death and/or physical property damages cannot be disclaimed or limited by law or public policy to the extent provided by these terms, then in any such event the disclaimer of and limitations on pecuniary or economic consequential and incidental damages shall nevertheless be enforceable to the fullest extent allowed by law.
- f. In no event shall any cause of action arising out of breach of warranty or otherwise concerning the Products be brought by Customer more than one year after the cause of action accrues.
- g. Each of the limitations on remedies and damages set forth in these terms is separate and independently enforceable, notwithstanding the unenforceability or failure of essential purpose of any warranty, undertaking, damage limitation, other provision of these terms or other terms comprising the contract of sale between Customer and MELCO.

4. Delivery/Force Majeure.

- a. Any delivery date for the Products acknowledged by MELCO is an estimated and not a promised date. MELCO will make all reasonable efforts to meet the delivery schedule set forth in Customer's order or the purchase contract but shall not be liable for failure to do so.
- b. Products stored at the request of Customer or because Customer refuses or delays shipment shall be at the risk and expense of Customer.
- c. MELCO shall not be liable for any damage to or loss of the Products or any delay in or failure to deliver, service, repair or replace the Products arising from shortage of raw materials, failure of suppliers to make timely delivery, labor difficulties of any kind, earthquake, fire, windstorm, flood, theft, criminal or terrorist acts, war, embargoes, governmental acts or rulings, loss or damage or delays in carriage, acts of God, vandals or any other circumstances reasonably beyond MELCO's control.

5. Choice of Law/Jurisdiction.

These terms and any agreement or contract between Customer and MELCO shall be governed by the laws of the State of New York without regard to conflicts of laws. To the extent any action or dispute is not arbitrated, the parties consent to the exclusive jurisdiction and venue of the federal and state courts located in the Southern District of the State of New York. Any judgment there obtained may be enforced in any court of competent jurisdiction.

6. Arbitration.

Any controversy or claim arising out of, or relating to or in connection with the Products, their sale or use or these terms, shall be settled by arbitration conducted in accordance with the Center for Public Resources (CPR) Rules for Non-Administered Arbitration of International Disputes, by a sole arbitrator chosen from the CPR's panels of distinguished neutrals. Judgment upon the award rendered by the Arbitrator shall be final and binding and may be entered by any court having jurisdiction thereof. The place of the arbitration shall be New York City, New York. The language of the arbitration shall be English. The neutral organization designated to perform the functions specified in Rule 6 and Rules 7.7(b), 7.8 and 7.9 shall be the CPR.

TRADEMARKS

The company names, system names and product names mentioned in this manual are either registered trademarks or trademarks of their respective companies.

In some cases, trademark symbols such as [™] or [®] are not specified in this manual.

SH(NA)-081487ENG-F(2010)MEE

MODEL: R-AD-G-U-OU-E

MODEL CODE: 13JX30

mitsubishi electric corporation

HEAD OFFICE : TOKYO BUILDING, 2-7-3 MARUNOUCHI, CHIYODA-KU, TOKYO 100-8310, JAPAN
NAGOYA WORKS : 1-14, YADA-MINAMI 5-CHOME, HIGASHI-KU, NAGOYA, JAPAN

When exported from Japan, this manual does not require application to the
Ministry of Economy, Trade and Industry for service transaction permission.

Specifications subject to change without notice.