



Programmable Controller

MELSEC iQ-R
series

MELSEC iQ-R Motion Controller Programming Manual (G-Code Control)

-R16MTCPU
-R32MTCPU
-R64MTCPU



SAFETY PRECAUTIONS

(Read these precautions before using this product.)

Before using this product, please read this manual and the relevant manuals carefully and pay full attention to safety to handle the product correctly.

The precautions given in this manual are concerned with this product only. Refer to MELSEC iQ-R Module Configuration Manual for a description of the PLC system safety precautions.

In this manual, the safety precautions are classified into two levels: "  WARNING" and "  CAUTION".

 WARNING	Indicates that incorrect handling may cause hazardous conditions, resulting in death or severe injury.
 CAUTION	Indicates that incorrect handling may cause hazardous conditions, resulting in minor or moderate injury or property damage.

Under some circumstances, failure to observe the precautions given under "  CAUTION" may lead to serious consequences.

Observe the precautions of both levels because they are important for personal and system safety.

Make sure that the end users read this manual and then keep the manual in a safe place for future reference.

[Design Precautions]

WARNING

- Configure safety circuits external to the programmable controller to ensure that the entire system operates safely even when a fault occurs in the external power supply or the programmable controller. Failure to do so may result in an accident due to an incorrect output or malfunction.
 - (1) Emergency stop circuits, protection circuits, and protective interlock circuits for conflicting operations (such as forward/reverse rotations or upper/lower limit positioning) must be configured external to the programmable controller.
 - (2) When the programmable controller detects an abnormal condition, it stops the operation and all outputs are:
 - Turned off if the overcurrent or overvoltage protection of the power supply module is activated.
 - Held or turned off according to the parameter setting if the self-diagnostic function of the CPU module detects an error such as a watchdog timer error.
 - (3) All outputs may be turned on if an error occurs in a part, such as an I/O control part, where the CPU module cannot detect any error. To ensure safety operation in such a case, provide a safety mechanism or a fail-safe circuit external to the programmable controller. For a fail-safe circuit example, refer to "General Safety Requirements" in the MELSEC iQ-R Module Configuration Manual.
 - (4) Outputs may remain on or off due to a failure of a component such as a relay and transistor in an output circuit. Configure an external circuit for monitoring output signals that could cause a serious accident.
 - In an output circuit, when a load current exceeding the rated current or an overcurrent caused by a load short-circuit flows for a long time, it may cause smoke and fire. To prevent this, configure an external safety circuit, such as a fuse.
 - Configure a circuit so that the programmable controller is turned on first and then the external power supply. If the external power supply is turned on first, an accident may occur due to an incorrect output or malfunction.
-

[Design Precautions]

WARNING

- For the operating status of each station after a communication failure, refer to manuals relevant to the network. Incorrect output or malfunction due to a communication failure may result in an accident.
 - When connecting an external device with a CPU module or intelligent function module to modify data of a running programmable controller, configure an interlock circuit in the program to ensure that the entire system will always operate safely. For other forms of control (such as program modification, parameter change, forced output, or operating status change) of a running programmable controller, read the relevant manuals carefully and ensure that the operation is safe before proceeding. Improper operation may damage machines or cause accidents.
 - Especially, when a remote programmable controller is controlled by an external device, immediate action cannot be taken if a problem occurs in the programmable controller due to a communication failure. To prevent this, configure an interlock circuit in the program, and determine corrective actions to be taken between the external device and CPU module in case of a communication failure.
 - Do not write any data to the "system area" and "write-protect area" of the buffer memory in the module. Also, do not use any "use prohibited" signals as an output signal from the CPU module to each module. Doing so may cause malfunction of the programmable controller system. For the "system area", "write-protect area", and the "use prohibited" signals, refer to the user's manual for the module used.
 - If a communication cable is disconnected, the network may be unstable, resulting in a communication failure of multiple stations. Configure an interlock circuit in the program to ensure that the entire system will always operate safely even if communications fail. Failure to do so may result in an accident due to an incorrect output or malfunction.
 - To maintain the safety of the programmable controller system against unauthorized access from external devices via the network, take appropriate measures. To maintain the safety against unauthorized access via the Internet, take measures such as installing a firewall.
 - Configure safety circuits external to the programmable controller to ensure that the entire system operates safely even when a fault occurs in the external power supply or the programmable controller. Failure to do so may result in an accident due to an incorrect output or malfunction.
 - If safety standards (ex., robot safety rules, etc.) apply to the system using the module, servo amplifier and servo motor, make sure that the safety standards are satisfied.
 - Construct a safety circuit externally of the module or servo amplifier if the abnormal operation of the module or servo amplifier differs from the safety directive operation in the system.
 - Do not remove the SSCNETIII cable while turning on the control circuit power supply of modules and servo amplifier. Do not see directly the light generated from SSCNETIII connector of the module or servo amplifier and the end of SSCNETIII cable. When the light gets into eyes, you may feel something wrong with eyes. (The light source of SSCNETIII complies with class 1 defined in JISC6802 or IEC60825-1.)
-

[Design Precautions]

CAUTION

- Do not install the control lines or communication cables together with the main circuit lines or power cables. Keep a distance of 100mm or more between them. Failure to do so may result in malfunction due to noise.
 - During control of an inductive load such as a lamp, heater, or solenoid valve, a large current (approximately ten times greater than normal) may flow when the output is turned from off to on. Therefore, use a module that has a sufficient current rating.
 - After the CPU module is powered on or is reset, the time taken to enter the RUN status varies depending on the system configuration, parameter settings, and/or program size. Design circuits so that the entire system will always operate safely, regardless of the time.
 - Do not power off the programmable controller or reset the CPU module while the settings are being written. Doing so will make the data in the flash ROM and SD memory card undefined. The values need to be set in the buffer memory and written to the flash ROM and SD memory card again. Doing so also may cause malfunction or failure of the module.
 - When changing the operating status of the CPU module from external devices (such as the remote RUN/STOP functions), select "Do Not Open by Program" for "Opening Method" of "Module Parameter". If "Open by Program" is selected, an execution of the remote STOP function causes the communication line to close. Consequently, the CPU module cannot reopen the line, and external devices cannot execute the remote RUN function.
-

[Installation Precautions]

WARNING

- Shut off the external power supply (all phases) used in the system before mounting or removing the module. Failure to do so may result in electric shock or cause the module to fail or malfunction.
-

[Installation Precautions]

CAUTION

- Use the programmable controller in an environment that meets the general specifications in the Safety Guidelines included with the base unit. Failure to do so may result in electric shock, fire, malfunction, or damage to or deterioration of the product.
 - To mount a module, place the concave part(s) located at the bottom onto the guide(s) of the base unit, and push in the module until the hook(s) located at the top snaps into place. Incorrect interconnection may cause malfunction, failure, or drop of the module.
 - To mount a module with no module fixing hook, place the concave part(s) located at the bottom onto the guide(s) of the base unit, push in the module, and fix it with screw(s). Incorrect interconnection may cause malfunction, failure, or drop of the module.
 - When using the programmable controller in an environment of frequent vibrations, fix the module with a screw.
 - Tighten the screws within the specified torque range. Undertightening can cause drop of the screw, short circuit, or malfunction. Overtightening can damage the screw and/or module, resulting in drop, short circuit, or malfunction.
 - When using an extension cable, connect it to the extension cable connector of the base unit securely. Check the connection for looseness. Poor contact may cause malfunction.
 - When using an SD memory card, fully insert it into the SD memory card slot. Check that it is inserted completely. Poor contact may cause malfunction.
 - Securely insert an extended SRAM cassette or a battery-less option cassette into the cassette connector of the CPU module. After insertion, close the cassette cover and check that the cassette is inserted completely. Poor contact may cause malfunction.
 - Do not directly touch any conductive parts and electronic components of the module, SD memory card, extended SRAM cassette, battery-less option cassette, or connector. Doing so can cause malfunction or failure of the module.
-

[Wiring Precautions]

WARNING

- Shut off the external power supply (all phases) used in the system before installation and wiring. Failure to do so may result in electric shock or cause the module to fail or malfunction.
 - After installation and wiring, attach a blank cover module (RG60) to each empty slot and an included extension connector protective cover to the unused extension cable connector before powering on the system for operation. Failure to do so may result in electric shock.
-

[Wiring Precautions]

CAUTION

- Individually ground the FG and LG terminals of the programmable controller with a ground resistance of 100 ohms or less. Failure to do so may result in electric shock or malfunction.
 - Use applicable solderless terminals and tighten them within the specified torque range. If any spade solderless terminal is used, it may be disconnected when the terminal screw comes loose, resulting in failure.
 - Check the rated voltage and signal layout before wiring to the module, and connect the cables correctly. Connecting a power supply with a different voltage rating or incorrect wiring may cause fire or failure.
 - Connectors for external devices must be crimped or pressed with the tool specified by the manufacturer, or must be correctly soldered. Incomplete connections may cause short circuit, fire, or malfunction.
 - Securely connect the connector to the module. Poor contact may cause malfunction.
 - Do not install the control lines or communication cables together with the main circuit lines or power cables. Keep a distance of 100mm or more between them. Failure to do so may result in malfunction due to noise.
 - Place the cables in a duct or clamp them. If not, dangling cable may swing or inadvertently be pulled, resulting in damage to the module or cables or malfunction due to poor contact. Do not clamp the extension cables with the jacket stripped. Doing so may change the characteristics of the cables, resulting in malfunction.
 - Check the interface type and correctly connect the cable. Incorrect wiring (connecting the cable to an incorrect interface) may cause failure of the module and external device.
 - Tighten the terminal screws or connector screws within the specified torque range. Undertightening can cause drop of the screw, short circuit, fire, or malfunction. Overtightening can damage the screw and/or module, resulting in drop, short circuit, fire, or malfunction.
 - When disconnecting the cable from the module, do not pull the cable by the cable part. For the cable with connector, hold the connector part of the cable. For the cable connected to the terminal block, loosen the terminal screw. Pulling the cable connected to the module may result in malfunction or damage to the module or cable.
 - Prevent foreign matter such as dust or wire chips from entering the module. Such foreign matter can cause a fire, failure, or malfunction.
 - A protective film is attached to the top of the module to prevent foreign matter, such as wire chips, from entering the module during wiring. Do not remove the film during wiring. Remove it for heat dissipation before system operation.
 - Programmable controllers must be installed in control panels. Connect the main power supply to the power supply module in the control panel through a relay terminal block. Wiring and replacement of a power supply module must be performed by qualified maintenance personnel with knowledge of protection against electric shock. For wiring, refer to the MELSEC iQ-R Module Configuration Manual.
 - For Ethernet cables to be used in the system, select the ones that meet the specifications in the user's manual for the module used. If not, normal data transmission is not guaranteed.
-

[Startup and Maintenance Precautions]

WARNING

- Do not touch any terminal while power is on. Doing so will cause electric shock or malfunction.
 - Correctly connect the battery connector. Do not charge, disassemble, heat, short-circuit, solder, or throw the battery into the fire. Also, do not expose it to liquid or strong shock. Doing so will cause the battery to produce heat, explode, ignite, or leak, resulting in injury and fire.
 - Shut off the external power supply (all phases) used in the system before cleaning the module or retightening the terminal screws, connector screws, or module fixing screws. Failure to do so may result in electric shock.
-

[Startup and Maintenance Precautions]

CAUTION

- When connecting an external device with a CPU module or intelligent function module to modify data of a running programmable controller, configure an interlock circuit in the program to ensure that the entire system will always operate safely. For other forms of control (such as program modification, parameter change, forced output, or operating status change) of a running programmable controller, read the relevant manuals carefully and ensure that the operation is safe before proceeding. Improper operation may damage machines or cause accidents.
 - Especially, when a remote programmable controller is controlled by an external device, immediate action cannot be taken if a problem occurs in the programmable controller due to a communication failure. To prevent this, configure an interlock circuit in the program, and determine corrective actions to be taken between the external device and CPU module in case of a communication failure.
 - Do not disassemble or modify the modules. Doing so may cause failure, malfunction, injury, or a fire.
 - Use any radio communication device such as a cellular phone or PHS (Personal Handy-phone System) more than 25cm away in all directions from the programmable controller. Failure to do so may cause malfunction.
 - Shut off the external power supply (all phases) used in the system before mounting or removing the module. Failure to do so may cause the module to fail or malfunction.
 - Tighten the screws within the specified torque range. Undertightening can cause drop of the component or wire, short circuit, or malfunction. Overtightening can damage the screw and/or module, resulting in drop, short circuit, or malfunction.
 - After the first use of the product, do not perform each of the following operations more than 50 times (IEC 61131-2/JIS B 3502 compliant).
Exceeding the limit may cause malfunction.
 - Mounting/removing the module to/from the base unit
 - Inserting/removing the extended SRAM cassette or battery-less option cassette to/from the CPU module
 - Mounting/removing the terminal block to/from the module
 - After the first use of the product, do not insert/remove the SD memory card to/from the CPU module more than 500 times. Exceeding the limit may cause malfunction.
 - Do not touch the metal terminals on the back side of the SD memory card. Doing so may cause malfunction or failure of the module.
 - Do not touch the integrated circuits on the circuit board of an extended SRAM cassette or a battery-less option cassette. Doing so may cause malfunction or failure of the module.
-

[Startup and Maintenance Precautions]

CAUTION

- Do not drop or apply shock to the battery to be installed in the module. Doing so may damage the battery, causing the battery fluid to leak inside the battery. If the battery is dropped or any shock is applied to it, dispose of it without using.
 - Startup and maintenance of a control panel must be performed by qualified maintenance personnel with knowledge of protection against electric shock. Lock the control panel so that only qualified maintenance personnel can operate it.
 - Before handling the module, touch a conducting object such as a grounded metal to discharge the static electricity from the human body. Failure to do so may cause the module to fail or malfunction.
 - Before testing the operation, set a low speed value for the speed limit parameter so that the operation can be stopped immediately upon occurrence of a hazardous condition.
 - Confirm and adjust the program and each parameter before operation. Unpredictable movements may occur depending on the machine.
 - When using the absolute position system function, on starting up, and when the module or absolute position motor has been replaced, always perform a home position return.
 - Before starting the operation, confirm the brake function.
 - Do not perform a megger test (insulation resistance measurement) during inspection.
 - After maintenance and inspections are completed, confirm that the position detection of the absolute position detection function is correct.
 - Lock the control panel and prevent access to those who are not certified to handle or install electric equipment.
-

[Operating Precautions]

CAUTION

- When changing data and operating status, and modifying program of the running programmable controller from an external device such as a personal computer connected to an intelligent function module, read relevant manuals carefully and ensure the safety before operation. Incorrect change or modification may cause system malfunction, damage to the machines, or accidents.
 - Do not power off the programmable controller or reset the CPU module while the setting values in the buffer memory are being written to the flash ROM in the module. Doing so will make the data in the flash ROM and SD memory card undefined. The values need to be set in the buffer memory and written to the flash ROM and SD memory card again. Doing so also may cause malfunction or failure of the module.
 - Note that when the reference axis speed is specified for interpolation operation, the speed of the partner axis (2nd, 3rd, or 4th axis) may exceed the speed limit value.
 - Do not go near the machine during test operations or during operations such as teaching. Doing so may lead to injuries.
-

[Disposal Precautions]

CAUTION

- When disposing of this product, treat it as industrial waste.
 - When disposing of batteries, separate them from other wastes according to the local regulations. For details on battery regulations in EU member states, refer to the MELSEC iQ-R Module Configuration Manual.
-

[Transportation Precautions]

CAUTION

- When transporting lithium batteries, follow the transportation regulations. For details on the regulated models, refer to the MELSEC iQ-R Module Configuration Manual.
 - The halogens (such as fluorine, chlorine, bromine, and iodine), which are contained in a fumigant used for disinfection and pest control of wood packaging materials, may cause failure of the product. Prevent the entry of fumigant residues into the product or consider other methods (such as heat treatment) instead of fumigation. The disinfection and pest control measures must be applied to unprocessed raw wood.
-

CONDITIONS OF USE FOR THE PRODUCT

(1) Mitsubishi programmable controller ("the PRODUCT") shall be used in conditions;

- i) where any problem, fault or failure occurring in the PRODUCT, if any, shall not lead to any major or serious accident; and
- ii) where the backup and fail-safe function are systematically or automatically provided outside of the PRODUCT for the case of any problem, fault or failure occurring in the PRODUCT.

(2) The PRODUCT has been designed and manufactured for the purpose of being used in general industries.

MITSUBISHI SHALL HAVE NO RESPONSIBILITY OR LIABILITY (INCLUDING, BUT NOT LIMITED TO ANY AND ALL RESPONSIBILITY OR LIABILITY BASED ON CONTRACT, WARRANTY, TORT, PRODUCT LIABILITY) FOR ANY INJURY OR DEATH TO PERSONS OR LOSS OR DAMAGE TO PROPERTY CAUSED BY the PRODUCT THAT ARE OPERATED OR USED IN APPLICATION NOT INTENDED OR EXCLUDED BY INSTRUCTIONS, PRECAUTIONS, OR WARNING CONTAINED IN MITSUBISHI'S USER, INSTRUCTION AND/OR SAFETY MANUALS, TECHNICAL BULLETINS AND GUIDELINES FOR the PRODUCT.

("Prohibited Application")

Prohibited Applications include, but not limited to, the use of the PRODUCT in;

- Nuclear Power Plants and any other power plants operated by Power companies, and/or any other cases in which the public could be affected if any problem or fault occurs in the PRODUCT.
- Railway companies or Public service purposes, and/or any other cases in which establishment of a special quality assurance system is required by the Purchaser or End User.
- Aircraft or Aerospace, Medical applications, Train equipment, transport equipment such as Elevator and Escalator, Incineration and Fuel devices, Vehicles, Manned transportation, Equipment for Recreation and Amusement, and Safety devices, handling of Nuclear or Hazardous Materials or Chemicals, Mining and Drilling, and/or other applications where there is a significant risk of injury to the public or property.

Notwithstanding the above restrictions, Mitsubishi may in its sole discretion, authorize use of the PRODUCT in one or more of the Prohibited Applications, provided that the usage of the PRODUCT is limited only for the specific applications agreed to by Mitsubishi and provided further that no special quality assurance or fail-safe, redundant or other safety features which exceed the general specifications of the PRODUCTS are required. For details, please contact the Mitsubishi representative in your region.

INTRODUCTION

Thank you for purchasing the Mitsubishi Electric MELSEC iQ-R series programmable controllers.

This manual describes the dedicated signals, parameters, data, and functions required for performing G-code control of the relevant products listed below.

Before using this product, please read this manual and the relevant manuals carefully and develop familiarity with the functions and performance of the MELSEC iQ-R series programmable controller to handle the product correctly.

When applying the program examples provided in this manual to an actual system, ensure the applicability and confirm that it will not cause system control problems.

Please make sure that the end users read this manual.

Relevant products

R16MTCPU, R32MTCPU, R64MTCPU

CONTENTS

SAFETY PRECAUTIONS	1
CONDITIONS OF USE FOR THE PRODUCT	9
INTRODUCTION	9
RELEVANT MANUALS	14
TERMS	15
MANUAL PAGE ORGANIZATION	16
CHAPTER 1 OVERVIEW	19
1.1 G-Code Control Overview	19
1.2 Performance Specifications	20
1.3 G-Code Control Add-On Library Configuration	21
G-code control add-on library	21
Files size/Memory usage	21
1.4 Restrictions by the Software's Version	21
CHAPTER 2 STARTING UP THE SYSTEM	22
2.1 Starting Up the G-Code Control System	22
2.2 License Authentication of G-Code Control Add-On Library	24
2.3 Control Cycle of G-Code Control	24
2.4 G-Code Control System Device Assignment Method	25
2.5 G-Code Control System Start/End	25
2.6 G-Code Control System Stop Operation	26
Immediate stop	27
Deceleration stop	27
CHAPTER 3 G-CODE CONTROL DEDICATED SIGNALS	28
3.1 G-Code Control Common Command Signal	29
3.2 G-Code Control Common Control Device	30
3.3 G-Code Control Common Status	31
3.4 G-Code Control Common Monitor Device	32
3.5 G-Code Control Line Command Signal	34
3.6 G-Code Control Line Control Device	38
3.7 G-Code Control Line Status	39
3.8 G-Code Control Line Monitor Device	46
3.9 G-Code Control Line Monitor Device (Expansion)	57
3.10 G-Code Control Axis Status	64
3.11 G-Code Control Axis Monitor Device	66
3.12 Internal Relay (M)/Data Register (D) Availability	70
Internal relays	70
Data registers	73
CHAPTER 4 G-CODE CONTROL PARAMETERS	75
4.1 G-Code Control System Parameter	76
Line basic setting	79
Modal initial setting	79
Control setting	79
Override setting	81
Plane composition	82

Normal line control	82
Auxiliary function	83
Polar coordinate interpolation	83
High-accuracy control	84
Macro control	85
4.2 G-Code Control Axis Parameter	86
Line axis information	87
Stored stroke limit	88
Speed/time constant	89
Rotation axis information	90
Tandem function	91
High-accuracy control	92
4.3 G-Code Control Work Parameter	93
Tool radius compensation	93
Tool compensation data	94
Workpiece coordinate offset	94
Program coordinate rotation	94

CHAPTER 5 G-CODE CONTROL PROGRAMS 95

5.1 G-Code Control Program Composition	95
G-code program format	96
5.2 Fetching G-Code Program Files	98
Fetching G-code program file during operation	98
5.3 Pre-read Buffer	99
5.4 Decimal Point Input	100
5.5 Coordinate System	102
Basic machine coordinate system	102
Work coordinate system	102
Local coordinate system	103
Automatic coordinate system setting	103
Coordinate system for rotation axes	103
5.6 G-Code	104
G-code list	104
Modal/Unmodal	105
G-code priority	105
G00: Positioning (Fast forward)	108
G01: Linear interpolation	109
G02: Circular interpolation CW (center specified)	110
G03: Circular interpolation CCW (center specified)	112
G02: Circular interpolation CW (R-specified)	114
G03: Circular interpolation CCW (R-specified)	116
G04: Dwell (time specified)	118
G09: Exact stop check	119
G12.1: Polar coordinate interpolation mode start	120
G13.1: Polar coordinate interpolation mode cancel	125
G17 to G19: Plane selection	126
G38: Tool radius compensation vector setting	127
G39: Tool radius compensation corner arc	129
G40: Tool radius compensation cancel	131
G41: Tool radius compensation - Left	132

G42: Tool radius compensation - Right	133
G40.1: Normal line control cancel	134
G41.1: Normal line control - Left ON	135
G42.1: Normal line control - Right ON	136
G43: Tool length compensation (+)	137
G44: Tool length compensation (-)	139
G49: Tool length compensation cancel	141
G52: Local coordinate system setting	142
G53: Basic machine coordinate system selection	146
G54 to G59: Work coordinate system 1 selection to work coordinate system 6 selection	147
G61: Exact stop check mode	150
G61.1: High-accuracy control mode	151
G62: Automatic corner override	152
G64: Cutting mode	155
G65: Macro call	156
G68: Program coordinate rotation mode start	162
G69: Program coordinate rotation mode cancel	169
G90: Absolute value command	170
G91: Incremental value command	172
G94: Feed per minute (non-synchronized feed)	174
5.7 M-Code	175
M00: Program stop	176
M01: Program stop	177
M02: Program end	178
M30: Program end	179
M98: Subprogram call	180
M99: Sub/macro program return	182
5.8 Variable Commands	183
Writing variables	185
Quoting variables	186
Applying variables	187
Reading/writing timing of variables (devices)	187
Common variables	191
Local variables	192
5.9 Operation Commands	194
Order of priority for operations	195
Definition/Replacement(=)	196
Additive Operations (+, -)	197
Multiplicative Operations (*, /, MOD)	198
Logical Operations (OR, XOR, AND)	199
Trigonometric Functions (SIN, COS, TAN, ASIN, ACOS, ATAN)	200
Functions (SQRT, ABS, BIN, BCD, ROUND, FIX, FUP, LN, EXP, POW)	201
5.10 Control Commands	203
Branch (IF, GOTO)	203
Branch (IF, THEN, ELSE, ENDIF)	205
Repeat (WHILE, DO, END)	208
CHAPTER 6 AUXILIARY AND APPLIED FUNCTIONS	211
6.1 Relationship between G-Code Control and Each Function	211
6.2 Auxiliary Function (M Function)	213

M-code output	213
Auxiliary function complete	216
6.3 Feed Function	218
Fast forward speed	218
Cutting feed speed	219
Feed speed specification and the effects on each control axis	220
Deceleration check	223
6.4 Tool Compensation Function	227
Tool compensation	227
Tool length compensation	228
Tool radius compensation	228
6.5 Operation Supporting Functions	252
Automatic operation start (cycle start)	252
Automatic operation hold (feed hold)	253
Reset	254
Single block	255
6.6 Normal Line Control Function	256
6.7 High-Accuracy Control	269
Acceleration/deceleration before interpolation	271
Optimum speed control	274
Vector accuracy interpolation	281
Arc entrance/exit speed control	281
6.8 Tandem Function	282
6.9 G-Code Program Operation by GOT	283
GOT program input/output function	284
GOT program edit function	284
6.10 Functions Regarding Macro	285
Precautions when using macro commands	285
Example of using a macro command	286
APPENDICES	287
<hr/>	
Appendix 1 G-Code Control Error Details Codes	287
G-code control error details codes	287
Add-on license error details codes	293
Appendix 2 G-code Control Event Details Codes	294
G-code control event details codes	294
REVISIONS	296
WARRANTY	297
TRADEMARKS	298

RELEVANT MANUALS

Manual Name [Manual Number]	Description	Available form
MELSEC iQ-R Motion Controller Programming Manual (G-Code Control) [IB-0300371] (This manual)	This manual explains the dedicated instructions to use G-code control by G-code control parameters and G-code programs.	Print book e-Manual PDF
MELSEC iQ-R Motion Controller User's Manual [IB-0300235]	This manual explains specifications of the Motion CPU modules, SSCNETⅢ cables, synchronous encoder, troubleshooting, etc.	Print book e-Manual PDF
MELSEC iQ-R Motion Controller Programming Manual (Common) [IB-0300237]	This manual explains the Multiple CPU system configuration, performance specifications, common parameters, auxiliary/applied functions, error lists, etc.	Print book e-Manual PDF
MELSEC iQ-R Motion Controller Programming Manual (Program Design) [IB-0300239]	This manual explains the functions, programming, debugging for Motion SFC, etc.	Print book e-Manual PDF
MELSEC iQ-R Motion Controller Programming Manual (Positioning Control) [IB-0300241]	This manual explains the servo parameters, positioning instructions, device lists, etc.	Print book e-Manual PDF
MELSEC iQ-R Motion Controller Programming Manual (Advanced Synchronous Control) [IB-0300243]	This manual explains the dedicated instructions to use synchronous control by synchronous control parameters, device lists, etc.	Print book e-Manual PDF
MELSEC iQ-R Motion Controller Programming Manual (Machine Control) [IB-0300309]	This manual explains the dedicated instructions to use machine control by machine control parameters, machine positioning data, device lists, etc.	Print book e-Manual PDF

Point

e-Manual refers to the Mitsubishi Electric FA electronic book manuals that can be browsed using a dedicated tool.

e-Manual has the following features:

- Required information can be cross-searched in multiple manuals.
- Other manuals can be accessed from the links in the manual.
- The hardware specifications of each part can be found from the product figures.
- Pages that users often browse can be bookmarked.

TERMS

Unless otherwise specified, this manual uses the following terms.

Term	Description
R64MTCPU/R32MTCPU/R16MTCPU or Motion CPU (module)	Abbreviation for MELSEC iQ-R series Motion controller
MR-J4(W)-□B	Servo amplifier model MR-J4-□B/MR-J4W-□B
MR-J3(W)-□B	Servo amplifier model MR-J3-□B/MR-J3W-□B
AMP or Servo amplifier	General name for "Servo amplifier model MR-J4-□B/MR-J4W-□B/MR-J3-□B/MR-J3W-□B"
RnCPU, PLC CPU or PLC CPU module	Abbreviation for MELSEC iQ-R series CPU module
Multiple CPU system or Motion system	Abbreviation for "Multiple PLC system of the R series"
CPU _n	Abbreviation for "CPU No.n (n = 1 to 4) of the CPU module for the Multiple CPU system"
Operating system software	General name for "SW10DNC-RMTFW"
Engineering software package	General name for MT Developer2/GX Works3
MELSOFT MT Works2	General product name for the Motion controller engineering software "SW1DND-MTW2"
MT Developer2	Abbreviation for the programming software included in the "MELSOFT MT Works2" Motion controller engineering software
GX Works3	General product name for the MELSEC PLC software package "SW1DND-GXW3"
Serial absolute synchronous encoder or Q171ENC-W8	Abbreviation for "Serial absolute synchronous encoder (Q171ENC-W8)"
SSCNETⅢ/H* ¹	High speed synchronous network between Motion controller and servo amplifier
SSCNETⅢ* ¹	
SSCNETⅢ(/H)	General name for SSCNETⅢ/H, SSCNETⅢ
Absolute position system	General name for "system using the servo motor and servo amplifier for absolute position"
Intelligent function module	General name for module that has a function other than input or output such as A/D converter module and D/A converter module.
SSCNETⅢ/H head module* ¹	Abbreviation for "MELSEC-L series SSCNETⅢ/H head module (LJ72MS15)"
Optical hub unit or MR-MV200	Abbreviation for SSCNETⅢ/H Compatible Optical Hub Unit (MR-MV200)
Sensing module	General name for SSCNETⅢ/H compatible sensing module MR-MT2000 series
Sensing SSCNETⅢ/H head module* ¹ or MR-MT2010	Abbreviation for SSCNETⅢ/H head module (MR-MT2010)
Sensing extension module	General name for I/O module (MR-MT2100), pulse I/O module (MR-MT2200), analog I/O module (MR-MT2300), encoder I/F module (MR-MT2400)
Sensing I/O module or MR-MT2100	Abbreviation for I/O module (MR-MT2100)
Sensing pulse I/O module or MR-MT2200	Abbreviation for pulse I/O module (MR-MT2200)
Sensing analog I/O module or MR-MT2300	Abbreviation for analog I/O module (MR-MT2300)
Sensing encoder I/F module or MR-MT2400	Abbreviation for encoder I/F module (MR-MT2400)

*1 SSCNET: Servo System Controller NETwork

MANUAL PAGE ORGANIZATION

Representation of numerical values used in this manual

■ Axis No. representation

In the positioning dedicated signals, "n" in "M3200+20n", etc. indicates a value corresponding to axis No. as shown in the following table.

Axis No.	n	Axis No.	n	Axis No.	n	Axis No.	n	Axis No.	n	Axis No.	n	Axis No.	n	Axis No.	n
1	0	9	8	17	16	25	24	33	32	41	40	49	48	57	56
2	1	10	9	18	17	26	25	34	33	42	41	50	49	58	57
3	2	11	10	19	18	27	26	35	34	43	42	51	50	59	58
4	3	12	11	20	19	28	27	36	35	44	43	52	51	60	59
5	4	13	12	21	20	29	28	37	36	45	44	53	52	61	60
6	5	14	13	22	21	30	29	38	37	46	45	54	53	62	61
7	6	15	14	23	22	31	30	39	38	47	46	55	54	63	62
8	7	16	15	24	23	32	31	40	39	48	47	56	55	64	63

- The range of axis No.1 to 16 (n=0 to 15) is valid in the R16MTCPU. The range of axis No.1 to 32 (n=0 to 31) is valid in the R32MTCPU.
- Calculate as follows for the device No. corresponding to each axis.

Ex.

For axis No. 32 in Q series Motion compatible device assignment

M3200+20n ([Rq.1140] Stop command)=M3200+20×31=M3820

M3215+20n ([Rq.1155] Servo OFF command)=M3215+20×31=M3835

In the positioning dedicated signals, "n" in "M10440+10n", etc. of the "Synchronous encoder axis status", "Synchronous encoder axis command signal", "Synchronous encoder axis monitor device" and "Synchronous encoder axis control device" indicates a value corresponding to synchronous encoder axis No. as shown in the following table.

Synchronous encoder axis No.	n	Synchronous encoder axis No.	n	Synchronous encoder axis No.	n
1	0	5	4	9	8
2	1	6	5	10	9
3	2	7	6	11	10
4	3	8	7	12	11

- Calculate as follows for the device No. corresponding to each synchronous encoder.

Ex.

For synchronous encoder axis No.12 in Q series Motion compatible device assignment

M10440+10n ([St.320] Synchronous encoder axis setting valid flag)=M10440+10×11=M10550

D13240+20n ([Md.320] Synchronous encoder axis current value)=D13240+20×11=D13460

■ Machine No. representation

In the positioning dedicated signals, "m" in "M43904+32m", etc. indicates a value corresponding to machine No. as shown in the following table.

Machine No.	m	Machine No.	m
1	0	5	4
2	1	6	5
3	2	7	6
4	3	8	7

- Calculate as follows for the device No. corresponding to each machine.

Ex.

For machine No.8 in MELSEC iQ-R Motion device assignment

M43904+32m ([St.2120] Machine error detection) $M43904+32 \times 7 = M44128$

D53168+128m ([Md.2020] Machine type) $= M53168+28 \times 7 = D54064$

■ Line No. representation in G-code control

In the positioning dedicated signals, "s" in "D54496+128s", etc. indicates a value corresponding to line No. as shown in the following table.

Line No.	s
1	0
2	1

- Calculate as follows for the device No. corresponding to each line.

Ex.

For line No.2 in MELSEC iQ-R Motion device assignment

D54440.0+4s ([St.3208] During G-code control) $= D54440.0+4 \times 1 = D54444.0$

D54496+128s ([Md.3016] Number of axes on line) $= D54496+128 \times 1 = D54624$

■ Line No. and axis No. representation in G-code control

In the positioning dedicated signals, "sn" in "D54278+16sn", etc. indicates a value corresponding to line No. and axis No. as shown in the following table.

Line No.	Axis No.	sn	Line No.	Axis No.	sn
1	1	0	2	1	8
	2	1		2	9
	3	2		3	10
	4	3		4	11
	5	4		5	12
	6	5		6	13
	7	6		7	14
	8	7		8	15

- Calculate as follows for the device No. corresponding to each line.

Ex.

For line No.2, axis No. 8 in MELSEC iQ-R Motion device assignment

D54448.0+2sn ([St.3076] Smoothing zero) $= D54448.0+2 \times 15 = D54478.0$

D54754+32sn ([Md.3146] Rotating axis setting status) $= D54754+32 \times 15 = D55234$

Representation of device No. used in this manual

The "R" and "Q" beside the device No. of positioning dedicated signals such as "[Rq.1140] Stop command (R: M34480+32n/ Q: M3200+20n)" indicate the device No. for the device assignment methods shown below. When "R" and "Q" are not beside the device No., the device No. is the same for both device assignment methods.

Symbol	Device assignment method
R	MELSEC iQ-R Motion device assignment
Q	Q series Motion compatible device assignment

1 OVERVIEW

1.1 G-Code Control Overview

- G-code control uses the Motion CPU to analyze G-code programs for control. G-code control is applied on a wide range of manufacturing tools such as cutters.
- To use G-code control, the G-code add-on library must be installed.
- By setting the parameters required for control, a system of up to 2 lines can be configured. Up to 8 axes can be configured per line, and up to 4 axes can be configured as synchronous control axes. Program control can be separated between lines with each program operating independently at the same time. (Lines are the groups of axes configured to execute G-code control and is not the same as the term used for the servo networks.)
- G-code programs are created in text format on a personal computer. The program file is used by MT Developer2 for writing/reading to/from the Motion CPU. The G-code program can also be transmitted from the SD memory card in the Motion CPU using the file transmission at boot function.
- Use the G-code control devices from a sequence program or Motion SFC program to transfer to G-code control mode (each line), and automatically start/stop programs, or control using auxiliary functions such as M-code etc. For axis control, use the alphabet characters (X, Y, Z, A, B, C, U, V, W) allocated to each axis by the parameters in the instructions in the G-code programs.

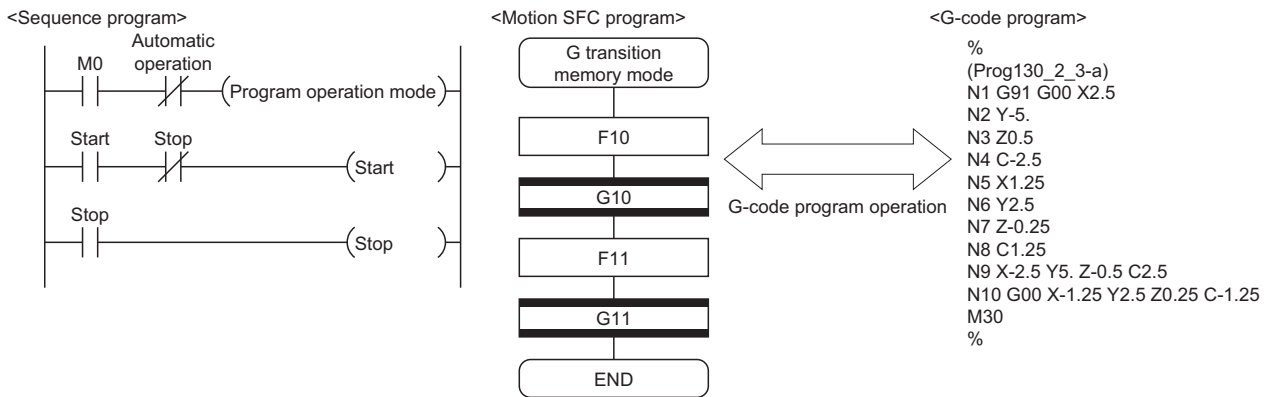

- G-code control can also be combined with other functions in the Motion CPU. For example, using advanced synchronous control to send the same command to another control axis enables highly accurate operations such as multiple axis synchronization. By combining G-code control with other functions, not only manufacturing control is possible, but a wide array of systems can also be built.

1.2 Performance Specifications

G-code control specifications

Item		Specifications
Number of G-code control configured axes (in a line)		Up to 8 axes
Number of contouring control axes		Up to 4 axes
Number of lines		Up to 2 lines
Operation mode		Memory operation
Program size/1 program		Up to 512k bytes
Number of programs		Up to 256 (O001 to O256)
Total program size		Up to 2M bytes
G-code		G00, G01, G02, G03, G04, G09, G12.1, G13.1, G17, G18, G19, G38, G39, G40, G40.1, G41, G41.1, G42, G42.1, G43, G44, G49, G52, G53, G54, G55, G56, G57, G58, G59, G61, G61.1, G62, G64, G65, G68, G69, G90, G91, G94
M-code		M-99999999 to M99999999 (Up to 4 groups can be commanded per block)
Special M-code		M00, M01, M02, M30, M98, M99
Operation command	Operators	+, -, *, /, =, OR, XOR, MOD, AND
	Functions	SIN, COS, TAN, ASIN, ACOS, ATAN, SQRT, ABS, BIN, BCD, ROUND, FIX, FUP, LN, EXP, POW
Control command		IF - GOTO, IF - THEN - ELSE - ENDIF, WHILE - DO - END
Control units of G-code control		Linear axis: mm, pulse Rotating axis: degree, pulse
Data units	Minimum command unit	Linear axis: 0.0001[mm] Rotating axis: 0.0001[degree]
Interpolation functions		Linear interpolation, circular interpolation, polar coordinate interpolation
Feed function		Rapid speed, cutting speed, deceleration check
Override function		Rapid override, cutting feed rate override, override cancel, automatic corner override
G-code auxiliary functions	M-code output	M00, M01, M02, M30
	Auxiliary function complete	Auxiliary function complete 1 (FIN1), Auxiliary function complete 2 (FIN2)
Tool compensation function	Compensation memory	Tool length compensation, tool radius compensation
	Number of compensation groups	Up to 40 groups
Coordinate systems		Basic machine coordinate system, work coordinate system, local coordinate system, automatic coordinate system, rotating axis coordinate system
Supporting functions		Automatic operation start, automatic operation hold, single block, G-code control reset, program coordinate rotation, normal line control
High-accuracy control		Acceleration/deceleration before interpolation, optimum speed control, vector accuracy interpolation, arc entrance/exit speed control
Tandem function		Provided

1.3 G-Code Control Add-On Library Configuration

G-code control add-on library

The add-on library used for G-code control is shown below.

Application	Model* ¹	Add-on library name
G-code control	SW10DND-GCD□	Gcode_Ctrl.adm

*1 □ indicates the number of licenses. (01, 05, 10, 15, 20)

Files size/Memory usage

The file size and memory usage of the add-on library is shown below.

Add-on library name	File size [byte]	Memory usage [byte]
Gcode_Ctrl.adm	193818 (approximately 189k bytes)	5697152 (approximately 5.4M bytes)

1.4 Restrictions by the Software's Version

There are restrictions in the function that can be used by the version of the add-on library, operating system software, and engineering software. The combination of each version and a function is shown below.

Function	Add-on library version		Operating system software version	Engineering software
	Major version	Minor version		MELSOFT MT Works2
Local coordinate system setting	01	02	14	1.140W
Polar coordinate interpolation	01	02	14	1.140W
High-accuracy control mode	01	02	14	1.140W
Program coordinate rotation	01	02	14	1.140W
Tandem control	01	02	14	1.140W
Parameter change function for G-code control parameters	01	02	14	1.140W
Add-on library license authentication function	01	02	14	1.140W
Subprogram control function	01	03	15	1.145B
Variable command	01	03	15	1.145B
Operation command	01	03	15	1.145B
Control command	01	03	15	1.145B
Macro call function	01	04	16	1.150G

2 STARTING UP THE SYSTEM

The procedure for G-code control is shown below.

2.1 Starting Up the G-Code Control System

The procedure to start up for G-code control system is shown below.

Preparation

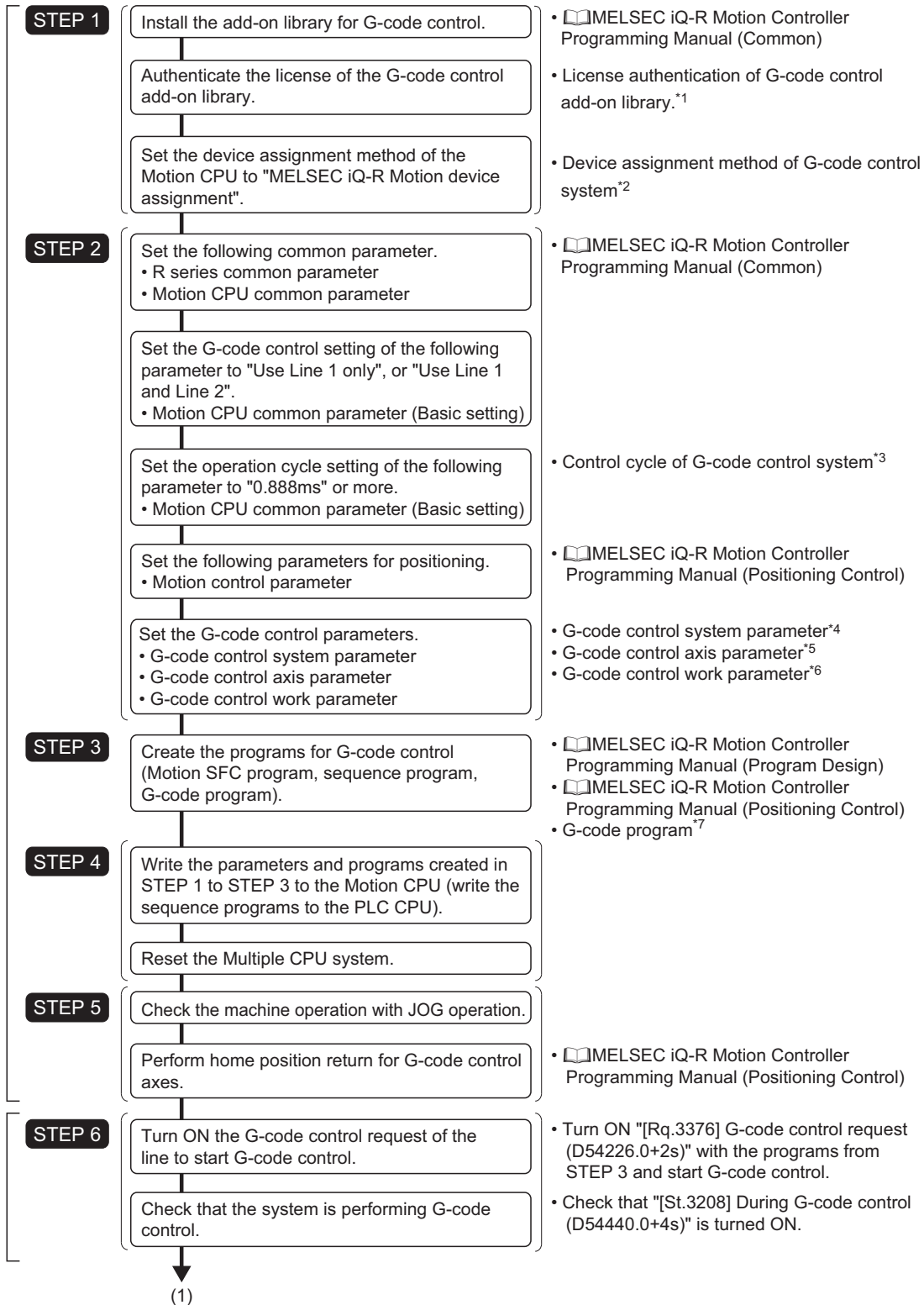

Start G-code control

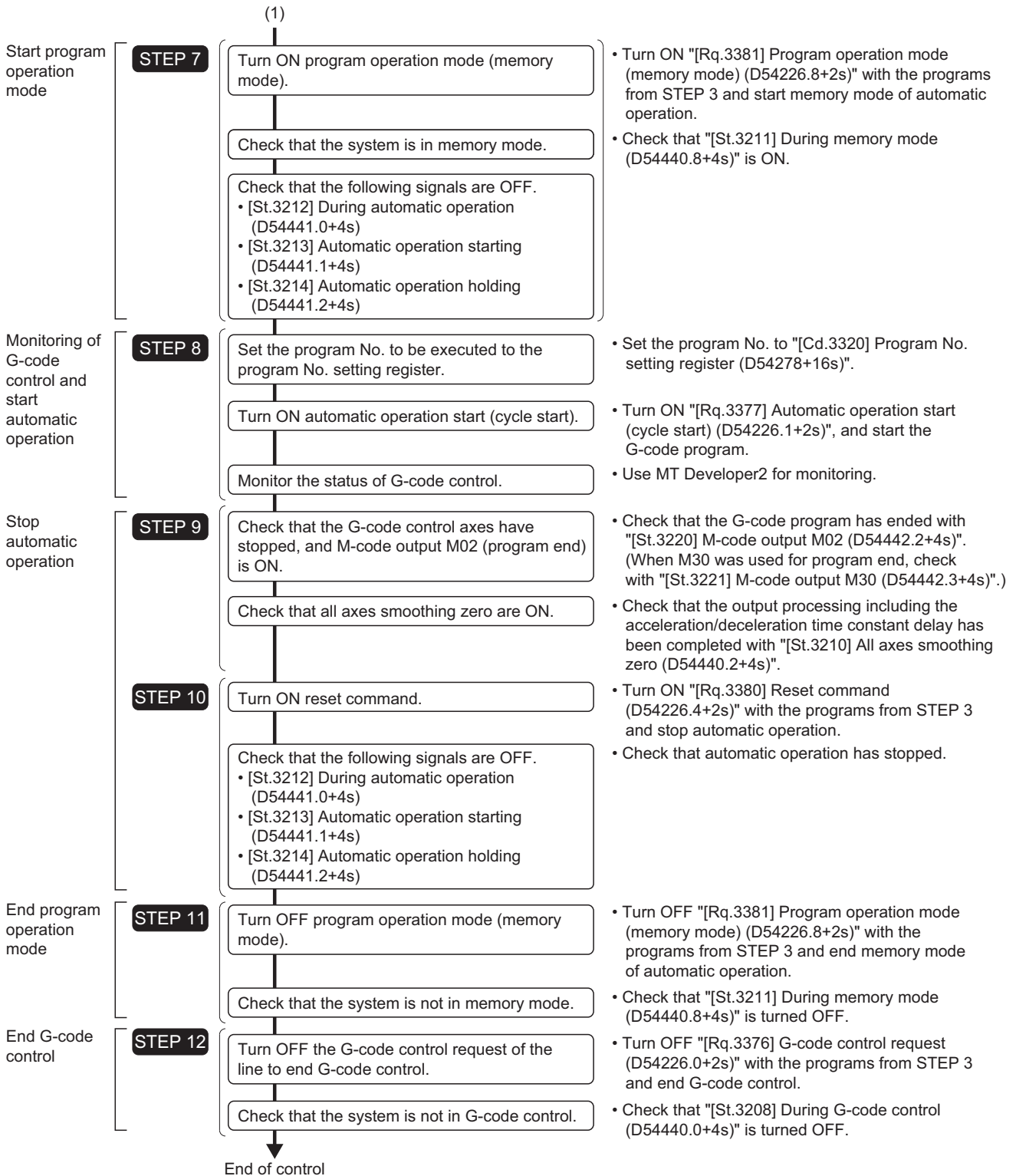

*1 License authentication is required for G-code control add-on libraries. (☞ Page 24 License Authentication of G-Code Control Add-On Library)

*2 G-code control system device assignment method (☞ Page 25 G-Code Control System Device Assignment Method)

*3 Control cycle of G-code control (☞ Page 24 Control Cycle of G-Code Control)

*4 G-code control system parameter (☞ Page 76 G-Code Control System Parameter)

*5 G-code control axis parameter (☞ Page 86 G-Code Control Axis Parameter)

*6 G-code control work parameter (☞ Page 93 G-Code Control Work Parameter)

*7 G-code program (☞ Page 95 G-CODE CONTROL PROGRAMS)

2.2 License Authentication of G-Code Control Add-On Library

The G-code control add-on library requires authentication. When a G-code add-on library is installed without purchasing a license, a license period is set. When the license period is exceeded, a moderate error (error code: 3081H) occurs, and the G-code add-on library can no longer be used.

Refer to the following for license authentication.

📖 MELSEC iQ-R Motion Controller Programming Manual (Common)

License period

The license period for when a G-code add-on library is installed is shown below.

License period	Remarks
1500 hours	The license period (remaining time until license authentication is required) decreases with the time in operation (the time when the Multiple CPU system power supply is ON). The time when the Multiple CPU system power supply is OFF is not counted.

2.3 Control Cycle of G-Code Control

- Set the operation cycle to "0.888ms" or more in [Motion CPU Common Parameter]⇒[Basic Setting]⇒"Operation Cycle". G-code control operates at the following cycles when "Motion setting operation cycle (SD523)" is 0.888[ms] or more. This cycle is stored in "[Md.3000] G-code control setting operation cycle (D54480)". (For functions other than G-code control, the operation cycle is "Motion setting operation cycle (SD523)".). When "Motion setting operation cycle (SD523)" is shorter than 0.888[ms], a moderate error (error code: 30FEH) occurs, and G-code control cannot be used.

Motion setting operation cycle (SD523)	[Md.3000] G-code control setting operation cycle (D54480)	Remarks
0.888[ms]	3.555[ms]	G-code control operates at intervals 4 times the Motion setting operation cycle.
1.777[ms]	7.111[ms]	
3.555[ms]	14.222[ms]	
7.111[ms]	28.444[ms]	

- Set the low speed operation cycle ratio to "Not Used" in [Motion CPU Common Parameter]⇒[Basic Setting]⇒"Low Speed Operation Cycle Magnification Setting". If low speed operation cycle ratio setting is set, a moderate error (error code: 30F9H) occurs.
- The time from the start of G-code control until completion is stored in "[Md.3001] G-code control operation cycle (D54481)" every G-code setting operation cycle. The largest of the stored values is stored in "[Md.3002] G-code control maximum operation cycle (D54482)".
- If the time in "[Md.3001] G-code control operation cycle (D54481)" exceeds that of "[Md.3000] G-code control setting operation cycle (D54480)", "[St.3272] G-code control operation cycle over flag (D54438.0)" turns ON. Also, even with time left over in "[Md.3001] G-code control operation cycle (D54481)", when the total time taken for Motion operation (Motion operation cycle (SD522)) exceeds "Motion setting operation cycle (SD523)", "[St.1046] Operation cycle over flag (R: M30054/Q: M2054)" turns ON.
- When "[St.3272] G-code control operation cycle over flag (D54438.0)" or "[St.1046] Operation cycle over flag (R: M30054/Q: M2054)" have turned ON, perform the following.
 - Change the operation cycle to a larger value in [Motion CPU Common Parameter]⇒[Basic Setting]⇒"Operation Cycle".
 - Reduce the number of event tasks and NMI task instructions being executed by the Motion SFC program.

2.4 G-Code Control System Device Assignment Method

"MELSEC iQ-R Motion device assignment" is the recommended device assignment method when using G-code control.

Refer to the following for details of device assignment methods.

📖 MELSEC iQ-R Motion Controller Programming Manual (Common)

Refer to G-code control dedicated signals for devices used by G-code control. (👉 Page 28 G-CODE CONTROL DEDICATED SIGNALS)

Cautions

When performing G-code control with R32MTCPU/R16MTCPU in "Q series Motion compatible device assignment", set the data register(D) to the points below or more in [R Series Common Parameter] ⇒ [Motion CPU Module] ⇒ [CPU Parameter] ⇒ "Device Related Setting" ⇒ "Device Points/Latch Setting". If the add-on library is installed with the default device points a moderate error (error code: 308FH (details code: 0500H)) occurs and G-code control cannot be used.

Device	Minimum points setting when using G-code control
Data register (D)	56320 points (55k)

Refer to the following for details on device points/latch setting.

📖 MELSEC iQ-R Motion Controller Programming Manual (Common)

2.5 G-Code Control System Start/End

The axes set by G-code control axis parameter are controlled with G-code programs.

G-code control is started/ended by turning ON/OFF "[Rq.3376] G-code control request (D54226.0+2s)" of each line. The status of G-code control can be checked with "[St.3208] During G-code control (D54440.0+4s)".

Memory mode of automatic operation can be selected by turning ON "[Rq.3381] Program operation mode (memory mode) (D54226.8+2s)". Memory mode can be cancelled by turning OFF "[Rq.3381] Program operation mode (memory mode) (D54226.8+2s)".

Turn OFF "[Rq.3376] G-code control request (D54226.0+2s)" after cancelling memory mode. By setting the program No. to be started to "[Cd.3320] Program No. setting register (D54278+16s)" and turning ON "[Rq.3377] Automatic operation start (cycle start) (D54226.1+2s)", memory operation is started. During memory operation "[St.3212] During automatic operation (D54441.0+4s)" turns ON.

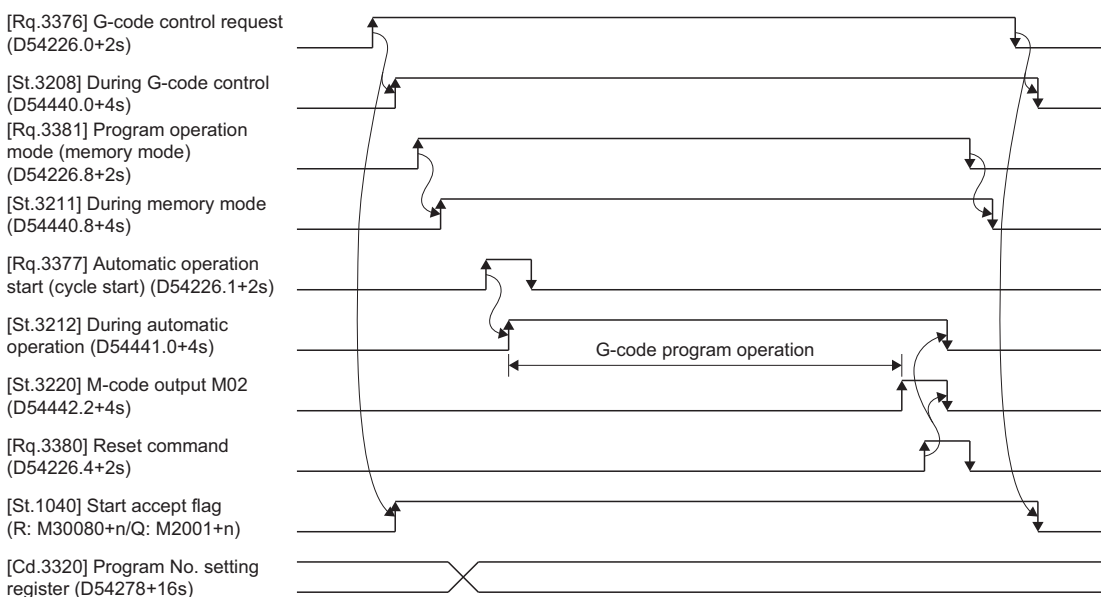

2.6 G-Code Control System Stop Operation

When one of the following stop causes occurs in a G-code control axis during G-code control, "[St.3215] G-code control finishing (D54441.3+4s)" turns ON, and after the stop processing of all axes in the line, "[St.3208] During G-code control (D54440.0+4s)", "[St.3215] G-code control finishing (D54441.3+4s)", and "[St.1040] Start accept flag (R: M30080+n/Q: M2001+n)" turn OFF, and G-code control ends. After ending, the updating of G-code control related devices is stopped.

Stop cause	Stop processing
Multiple CPU system reset operation	Immediate stop
Multiple CPU system power supply OFF	
Motion CPU WDT error	
Forced stop (forced stop by Motion controller (device))	
Forced stop (servo amplifier forced stop input terminal)	
Servo error occurrence	
Servo amplifier control circuit power supply ON→OFF	
Input from external input signals (STOP/FLS/RLS)	Deceleration stop
Motion CPU RUN→STOP	
"[Rq.3376] G-code control request (D54226.0+2s)" ON→OFF	

Point

- A check for stop causes is performed every operation cycle, but stop processing is executed at the G-code control operation cycle.
 - During G-code control, parameter block settings are disabled.
 - At a stop cause occurrence, the following signals turn OFF when "[St.3215] G-code control finishing (D54441.3+4s)" turns ON.
 - [St.3211] During memory mode (D54440.8+4s)
 - [St.3212] During automatic operation (D54441.0+4s)
 - [St.3213] Automatic operation starting (D54441.1+4s)
 - [St.3214] Automatic operation holding (D54441.2+4s)
 - [St.3216] Resetting (D54441.8+4s)
 - [St.3217] Reset completion (D54441.9+4s)
 - After a stop cause occurrence, turn "[Rq.3380] Reset command (D54226.4+2s)" OFF→ON before starting a G-code program.
-
- When one of the following stop causes occurs during G-code control, the stop processing is disabled and stop is not performed. Also, an error does not occur.
 - Software stroke limit detection for each axis
 - Input of stop command
 - Input of rapid stop command
 - Servo motor maximum speed check

Immediate stop

There is no deceleration processing for this stop. The Motion CPU stops commands immediately but the servo amplifier coasts for the amount of droop pulses in the deviation counter. The timing chart for immediate stop is shown below.

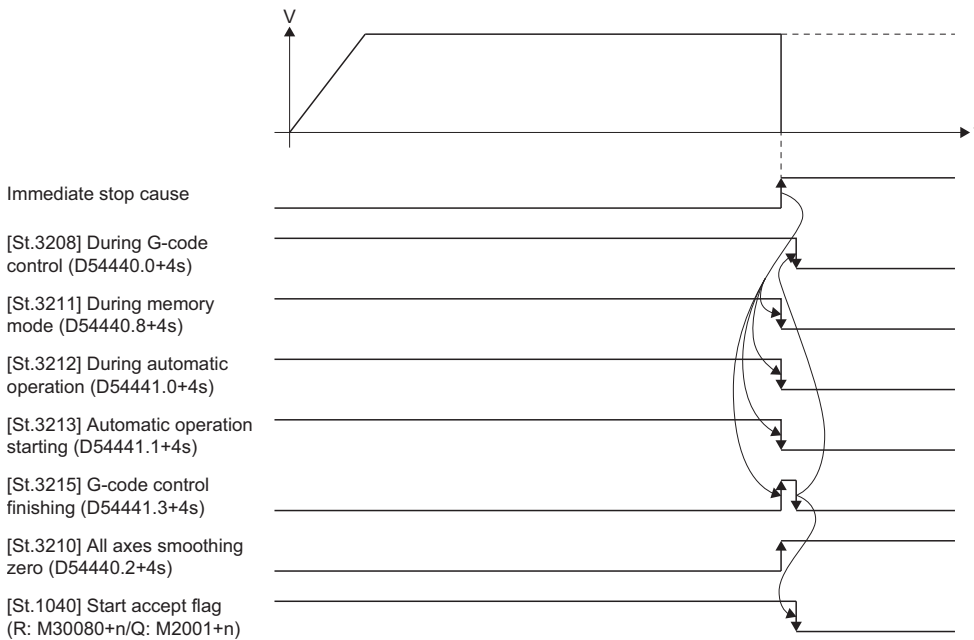

Deceleration stop

All axes within the line decelerate according to the acceleration/deceleration time constant in the G-code control parameter, and G-code control ends after coming to a stop.

The timing chart for a deceleration stop is shown below.

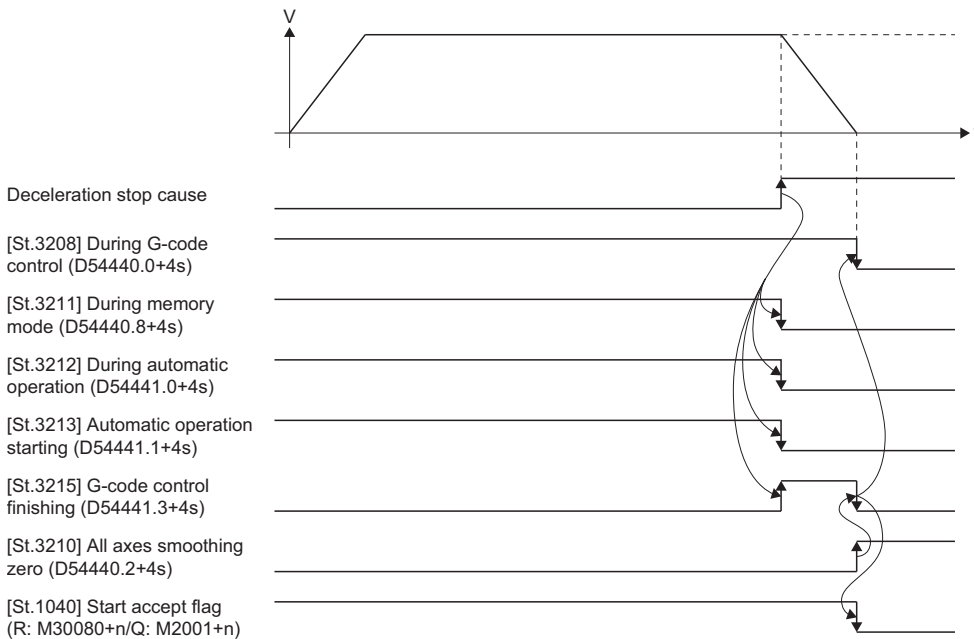

3 G-CODE CONTROL DEDICATED SIGNALS

G-code control devices used for G-code control are shown below.

Device	Device range	
	MELSEC iQ-R Motion device assignment	Q series Motion compatible device assignment
Data register (D)	D54192 to D55583 (1392 points)	

Point

- When using R32MTCPU/R16MTCPU in Q series Motion compatible device assignment, the device range must be changed in device points/latch setting so that it is the minimum setting range or more for using G-code control. If the add-on library is installed with the default device points, a moderate error (error code: 308FH (details code: 0500H)) occurs. (➔ Page 25 G-Code Control System Device Assignment Method)
- This manual only explains the internal relays and data registers used for G-code control. Refer to the following for the devices that are not explained in this manual.
 - 📖 MELSEC iQ-R Motion Controller Programming Manual (Positioning Control)
- G-code control devices are only valid during G-code control. (There are some G-code control devices that are valid when not in G-code control.)

Data register list

■ MELSEC iQ-R Motion device assignment/Q series Motion compatible device assignment

Device No.	Symbol	Purpose	Reference
D54192 to	—	Unusable (32 points)	—
D54224 to	[Rq.3344]	G-code control common command signal (2 points)	➔ Page 29 G-Code Control Common Command Signal
D54226 to	[Rq.3376] to [Rq.3385]	G-code control line command signal (4 points)	➔ Page 34 G-Code Control Line Command Signal
D54230 to	—	Unusable (32 points)	—
D54262 to	[Cd.3305]	G-code control common control device (16 points)	➔ Page 30 G-Code Control Common Control Device
D54278 to	[Cd.3320] to [Cd.3322]	G-code control line control device (32 points)	➔ Page 38 G-Code Control Line Control Device
D54310 to	—	Unusable (128 points)	—
D54438 to	[St.3272]	G-code control common status (2 points)	➔ Page 31 G-Code Control Common Status
D54440 to	[St.3208] to [St.3225], [St.3234]	G-code control line status (8 points)	➔ Page 39 G-Code Control Line Status
D54448 to	[St.3076]	G-code control axis status (32 points)	➔ Page 64 G-Code Control Axis Status
D54480 to	[Md.3000] to [Md.3004]	G-code control common monitor device (16 points)	➔ Page 32 G-Code Control Common Monitor Device
D54496 to	[Md.3016] to [Md.3070], [Md.3074]	G-code control line monitor device (256 points)	➔ Page 46 G-Code Control Line Monitor Device
D54752 to	[Md.3144] to [Md.3150], [Md.3152] to [Md.3154]	G-code control axis monitor device (512 points)	➔ Page 66 G-Code Control Axis Monitor Device
D55264 to D55583	[Md.3178] to [Md.3180]	G-code control line monitor device (expansion) (320 points)	➔ Page 57 G-Code Control Line Monitor Device (Expansion)

3.1 G-Code Control Common Command Signal

Device No.	Symbol	Signal name	Refresh cycle	Fetch cycle	Signal type
MELSEC iQ-R Motion device assignment	Q series Motion compatible device assignment				
D54224.0	—	Unusable	—	—	—
D54224.1					
D54224.2					
D54224.3					
D54224.4					
D54224.5					
D54224.6					
D54224.7					
D54224.8					
D54224.9					
D54224.A					
D54224.B					
D54224.C					
D54224.D					
D54224.E					
D54224.F					
D54225.0	Rq.3344	Program load request while running	—	Main cycle	Command signal
D54225.1	—	Unusable	—	—	—
D54225.2					
D54225.3					
D54225.4					
D54225.5					
D54225.6					
D54225.7					
D54225.8					
D54225.9					
D54225.A					
D54225.B					
D54225.C					
D54225.D					
D54225.E					
D54225.F					

[Rq.3344] Program load request while running (D54225.0)

This signal is for requesting the load of a G-code program file while executing a program.

Setting value	Description
ON	Request load
OFF	Do not request load

3.2 G-Code Control Common Control Device

Device No.		Symbol	Signal name	Refresh cycle	Fetch cycle	Signal type
MELSEC iQ-R Motion device assignment	Q series Motion compatible device assignment					
D54262		—	Unusable	—	—	—
D54263						
D54264		Cd.3305	Program No. for loading while running	—	At running program load request ON	Command device
D54265		—	Unusable	—	—	—
D54266						
D54267						
D54268						
D54269						
D54270						
D54271						
D54272						
D54273						
D54274						
D54275						
D54276						
D54277						

[Cd.3305] Program No. for loading while running (D54264)

This register is for loading the G-code program of the program No. specified in "[Rq.3344] Program load request while running (D54225.0)".

Item	Setting range
Program No.	1 to 256

3.3 G-Code Control Common Status

Device No.	Symbol	Signal name	Refresh cycle	Fetch cycle	Signal type
MELSEC iQ-R Motion device assignment	Q series Motion compatible device assignment				
D54438.0	St.3272	G-code control operation cycle over flag	G-code control operation cycle	—	Status signal
D54438.1	—	Unusable	—	—	—
D54438.2					
D54438.3					
D54438.4					
D54438.5					
D54438.6					
D54438.7					
D54438.8					
D54438.9					
D54438.A					
D54438.B					
D54438.C					
D54438.D					
D54438.E					
D54438.F					
D54439.0					
D54439.1					
D54439.2					
D54439.3					
D54439.4					
D54439.5					
D54439.6					
D54439.7					
D54439.8					
D54439.9					
D54439.A					
D54439.B					
D54439.C					
D54439.D					
D54439.E					
D54439.F					

[St.3272] G-code control operation cycle over flag (D54438.0)

This signal turns ON when G-code control operation processing is not completed within the G-code control operation cycle. To turn OFF, perform the following operations.

- Turn the Multiple CPU system power supply OFF→ON
- Reset the Multiple CPU system

■ Countermeasures for operation cycle over

- Change the operation cycle to a larger value in [Motion CPU Common Parameter]⇒[Basic Setting]⇒"Operation Cycle".
- Reduce the number of executions of event task and NMI task instructions in the Motion SFC program.

3.4 G-Code Control Common Monitor Device

Device No.		Symbol	Signal name	Refresh cycle	Fetch cycle	Signal type
MELSEC iQ-R Motion device assignment	Q series Motion compatible device assignment					
D54480		Md.3000	G-code control setting operation cycle	STOP→RUN	—	Monitor device
D54481		Md.3001	G-code control operation cycle	G-code control operation cycle	—	
D54482		Md.3002	G-code control maximum operation cycle			
D54483		—	Unusable	—	—	—
D54484						
D54485						
D54486						
D54487						
D54488						
D54489						
D54490						
D54491						
D54492		Md.3003	Program load status while running	Main cycle	—	Monitor device
D54493		Md.3004	Program load error information while running			
D54494		—	Unusable	—	—	—
D54495						

[Md.3000] G-code control setting operation cycle (D54480)

The G-code control operation cycle is stored in [μ s] units.

The control cycle for G-code control operates at the following cycles according to "Motion setting operation cycle (SD523)".

When "Motion setting operation cycle (SD523)" is shorter than 0.888[ms], a moderate error (error code: 30FEH) occurs, and G-code control cannot be used.

Motion setting operation cycle (SD523)	[Md.3000] G-code control setting operation cycle (D54480)
0.888[ms]	3.555[ms]
1.777[ms]	7.111[ms]
3.555[ms]	14.222[ms]
7.111[ms]	28.444[ms]

[Md.3001] G-code control operation cycle (D54481)

The time taken for G-code control operation processing is stored in [μ s] units every G-code control operation cycle.

[Md.3002] G-code control maximum operation cycle (D54482)

After Multiple CPU system power supply ON, the maximum time taken for G-code control operation processing is stored in [μ s] units every G-code control operation cycle.

[Md.3003] Program load status while running (D54492)

The status of the program load while running is stored.

Monitor values	Description
0	No request
1	Executing
2	Successfully completed
3	Failed

[Md.3004] Program load error information while running (D54493)

Stores the error information when "[Md.3003] Program load status while running (D54492)" is failed.

Monitor values	Description
0	No error
1	Applicable program running
2	No program file
3	File format error
4	Load area size exceeded
5	Program No. outside of range
6	Load request during STOP
7	System failure

3.5 G-Code Control Line Command Signal

Device No.		Signal name
MELSEC iQ-R Motion device assignment	Q series Motion compatible device assignment	
D54226 to D54227		Line 1 G-code control line command signal
D54228 to D54229		Line 2 G-code control line command signal

• Details for each line

Device No.		Symbol	Signal name	Refresh cycle	Fetch cycle	Signal type
MELSEC iQ-R Motion device assignment	Q series Motion compatible device assignment					
D54226.0+2s		Rq.3376	G-code control request	—	Main cycle/ G-code control operation cycle	Command signal
D54226.1+2s		Rq.3377	Automatic operation start (cycle start)	—	G-code control operation cycle	—
D54226.2+2s		Rq.3378	Automatic operation hold (feed hold)			
D54226.3+2s		Rq.3379	Single block			
D54226.4+2s		Rq.3380	Reset command			
D54226.5+2s		—	Unusable	—	—	—
D54226.6+2s		—	Unusable	—	—	—
D54226.7+2s						
D54226.8+2s						
D54226.8+2s		Rq.3381	Program operation mode (memory mode)	—	G-code control operation cycle	Command signal
D54226.9+2s		—	Unusable	—	—	—
D54226.A+2s						
D54226.B+2s						
D54226.C+2s		Rq.3384	Macro single	—	At G-code program start	Command signal
D54226.D+2s		—	Unusable	—	—	—
D54226.E+2s						
D54226.F+2s						
D54227.0+2s		Rq.3382	Auxiliary function complete1 (FIN1)	—	G-code control operation cycle	Command signal
D54227.1+2s		Rq.3383	Auxiliary function complete2 (FIN2)			
D54227.2+2s		—	Unusable	—	—	—
D54227.3+2s						
D54227.4+2s						
D54227.4+2s		Rq.3385	G65 argument initialization	—	At G-code program start	Command signal
D54227.5+2s		—	Unusable	—	—	—
D54227.6+2s						
D54227.7+2s						
D54227.8+2s						
D54227.9+2s						
D54227.A+2s						
D54227.B+2s						
D54227.C+2s						
D54227.D+2s						
D54227.E+2s						
D54227.F+2s						

[Rq.3376] G-code control request (D54226.0+2s)

This signal starts G-code control on a line by turning ON "[Rq.3376] G-code control request (D54226.0+2s)" of the applicable line. Turning OFF "[Rq.3376] G-code control request (D54226.0+2s)" when "[St.3208] During G-code control (D54440.0+4s)" is ON, ends G-code control. Refer to G-code control system start/end for details. (Page 25 G-Code Control System Start/End)

Setting value	Description	Fetch cycle
ON	G-code control request	Main cycle
OFF	G-code control finish	G-code control operation cycle

[Rq.3377] Automatic operation start (cycle start) (D54226.1+2s)

- This command is used for starting G-code program start, restarting after automatic operation hold, and restarting a block stop.
- "[St.3213] Automatic operation starting (D54441.1+4s)" is turned ON with the leading edge (OFF→ON) of "[Rq.3377] Automatic operation start (cycle start) (D54226.1+2s)" until "[Rq.3378] Automatic operation hold (feed hold) (D54226.2+2s)" turns ON, or the block is stopped with "[Rq.3379] Single block (D54226.3+2s)" turned ON.
- In the following cases, "[Rq.3377] Automatic operation start (cycle start) (D54226.1+2s)" is disabled even when turned ON.
 - When "[St.3213] Automatic operation starting (D54441.1+4s)" is already ON.
 - When "[Rq.3378] Automatic operation hold (feed hold) (D54226.2+2s)" is ON.
 - When "[St.3216] Resetting (D54441.8+4s)" is ON.
 - When an error is occurring.
- In the following cases, automatic operation hold or stop, and block stop occurs.
 - When "[Rq.3378] Automatic operation hold (feed hold) (D54226.2+2s)" is turned OFF→ON.
 - When "[Rq.3380] Reset command (D54226.4+2s)" was turned ON.
 - When no longer in program operation mode.
 - When the block being executed ends after "[Rq.3379] Single block (D54226.3+2s)" has turned ON.

[Rq.3378] Automatic operation hold (feed hold) (D54226.2+2s)

- This command is used for performing a deceleration stop while moving by automatic operation.
- After turning OFF "[Rq.3378] Automatic operation hold (feed hold) (D54226.2+2s)", the command restarts at the leading edge (OFF→ON) of "[Rq.3377] Automatic operation start (cycle start) (D54226.1+2s)". If "[Rq.3377] Automatic operation start (cycle start) (D54226.1+2s)" is turned ON when "[Rq.3378] Automatic operation hold (feed hold) (D54226.2+2s)" is ON, a minor error (error code: 1FC2H (details code: 0202H)) occurs.
- When "[St.3213] Automatic operation starting (D54441.1+4s)" is turned ON by the leading edge (OFF→ON) of "[Rq.3378] Automatic operation hold (feed hold) (D54226.2+2s)", automatic operation hold occurs and "[St.3214] Automatic operation holding (D54441.2+4s)" turns ON.

[Rq.3379] Single block (D54226.3+2s)

- This command is used for executing the G-code programs of automatic operation one block at a time.
- When automatic operation is being executed, it stops after the block being executed ends. To execute commands for the next block, turn ON "[Rq.3377] Automatic operation start (cycle start) (D54226.1+2s)" again.
- Operation stops after one block. Therefore it is possible to execute a G-code program one block at a time.

[Rq.3380] Reset command (D54226.4+2s)

This command is used to reset G-code control. When "[Rq.3380] Reset command (D54226.4+2s)" is turned OFF→ON, the following operations are executed.

- "[St.3216] Resetting (D54441.8+4s)" is turned ON, and moving control axes decelerate to a stop.
- After stopping, when reset ends, "[St.3216] Resetting (D54441.8+4s)" turns OFF, and "[St.3217] Reset complete (D54441.9+4s)" turns ON.
- Modal status is initialized.
- Tool compensation data is cancelled. (No axis operation.)
- The following error devices for G-code control are cleared. However, the LED display, error display on GX Works3 and MT Developer2, and errors on special relays and special registers are not cancelled. Refer to the following for the method for cancelling.

 MELSEC iQ-R Motion Controller Programming Manual (Common)

- [St.3209] G-code control error detection (D54440.1+4s)
- [Md.3019] G-code control error code (D54504+128s)
- [Md.3020] G-code control error details code 1 (D54505+128s)
- [Md.3021] G-code control error details code 2 (D54506+128s)
- M-code output is held. (Strobe signal is turned OFF.)
- M-code output (M00, M01, M02, M30) is turned OFF.

[Rq.3381] Program operation mode (memory mode) (D54226.8+2s)

- This command is used for memory mode of automatic operation.
- If "[Rq.3381] Program operation mode (memory mode) (D54226.8+2s)" is turned ON, memory mode of automatic operation is selected, and automatic operation of the specified G-code program is performed. (The G-code program is started with "[Rq.3377] Automatic operation start (cycle start) (D54226.1+2s)")
- Turn OFF "[Rq.3381] Program operation mode (memory mode) (D54226.8+2s)" to cancel memory mode. However, if turned OFF while the program is running, a minor error (error code: 1FC2H (details code: 0222H)) occurs and the block stops.
- Turn OFF "[Rq.3376] G-code control request (D54226.0+2s)" after turning OFF "[Rq.3381] Program operation mode (memory mode) (D54226.8+2s)" and cancelling memory mode.

[Rq.3384] Macro single (D54226.C+2s)

- When "[Rq.3384] Macro single (D54226.C+2s)" is turned ON during G-code control and "[Rq.3379] Single block (D54226.3+2s)" is ON, this command is used to execute operation command and control command G-code programs one block at a time.
- "[Rq.3384] Macro single (D54226.C+2s)" is enabled when operation is in a reset state*¹ and "[Rq.3377] Automatic operation start (cycle start) (D54226.1+2s)" is turned OFF→ON. When not using G-code control, or when operation is not in a reset state, reading from "[Rq.3384] Macro single (D54226.C+2s)" is ignored.
- To disable macro single, turn ON "[Rq.3380] Reset command (D54226.4+2s)" during automatic operation, and reset G-code control. When using macro single again, turn "[Rq.3384] Macro single (D54226.C+2s)" OFF→ON after resetting.

*¹ A reset state is when all of the following devices are turned OFF.

- [St.3212] During automatic operation (D54441.0+4s)
- [St.3213] Automatic operation starting (D54441.1+4s)
- [St.3214] Automatic operation holding (D54441.2+4s)

[Rq.3382] Auxiliary function complete 1 (FIN1) (D54227.0+2s)

This signal commands an auxiliary function (M function), and creates a process and completion sequence in the Motion SFC program and sequence program, and proceeds to the next block after waiting for a completion signal. At the trailing edge of "[Rq.3382] Auxiliary function complete 1 (FIN1) (D54227.0+2s)", operation proceeds to the next block. Refer to auxiliary function complete for details. ( Page 216 Auxiliary function complete)

[Rq.3383] Auxiliary function complete 2 (FIN2) (D54227.1+2s)

This signal commands an auxiliary function (M function), and creates a process and completion sequence in the Motion SFC program and sequence program, and proceeds to the next block after waiting for a completion signal. At the trailing edge of "[Rq.3383] Auxiliary function complete 2 (FIN2) (D54227.1+2s)", operation proceeds to the next block. Refer to auxiliary function complete for details. (☞ Page 216 Auxiliary function complete)

[Rq.3385] G65 argument initialization (D54227.4+2s)

- This command is used to operate "[Rq.3385] G65 argument initialization (D54227.4+2s)" and to initialize (0 clear) arguments not specified in a macro call.
- The initialization (0 clear) targets are the arguments on the layer that performs a macro call.
- "[Rq.3385] G65 argument initialization (D54227.4+2s)" is enabled when operation is in a reset state*1 and "[Rq.3377] Automatic operation start (cycle start) (D54226.1+2s)" is turned OFF→ON.
- The range that can be specified is shown below.

Setting value	Description
ON	During a macro call, keeps arguments that are not specified.
OFF	During a macro call, initializes (0 clears) arguments that are not specified.

- When a macro call is performed while the status of "[Rq.3385] G65 argument initialization (D54227.4+2s)" is OFF, arguments not specified in the macro call are initialized (0 cleared).

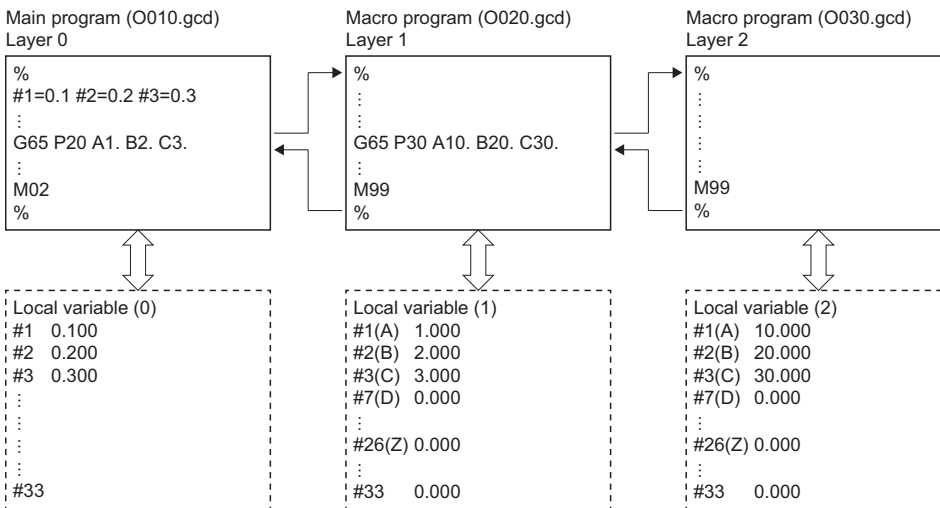

*1 A reset state is when all of the following devices are turned OFF.

- [St.3212] During automatic operation (D54441.0+4s)
- [St.3213] Automatic operation starting (D54441.1+4s)
- [St.3214] Automatic operation holding (D54441.2+4s)

3.6 G-Code Control Line Control Device

Device No.		Signal name
MELSEC iQ-R Motion device assignment	Q series Motion compatible device assignment	
D54278 to D54293		Line 1 G-code control line control device
D54294 to D54309		Line 2 G-code control line control device

• Details for each line

Device No.		Symbol	Signal name	Refresh cycle	Fetch cycle	Signal type
MELSEC iQ-R Motion device assignment	Q series Motion compatible device assignment					
D54278+16s		Cd.3320	Program No. setting register	—	G-code control operation cycle	Command signal
D54279+16s		—	Unusable	—	—	—
D54280+16s		Cd.3321	Sequence No. setting register	—	G-code control operation cycle	Command signal
D54281+16s						
D54282+16s		Cd.3322	Block No. setting register	—	—	—
D54283+16s						
D54284+16s		—	Unusable	—	—	—
D54285+16s						
D54286+16s						
D54287+16s						
D54288+16s						
D54289+16s						
D54290+16s						
D54291+16s						
D54292+16s						
D54293+16s						

[Cd.3320] Program No. setting register (D54278+16s)

This setting register is for starting the G-code program of the specified program No.

Refer to automatic operation start (cycle start) for details. (☞ Page 252 Automatic operation start (cycle start))

Item	Setting range
Program No.	1 to 256

[Cd.3321] Sequence No. setting register (D54280+16s, D54281+16s)

This setting register is for starting a G-code program from the block of the specified sequence No.

Refer to automatic operation start (cycle start) for details. (☞ Page 252 Automatic operation start (cycle start))

Item	Program No.
Sequence No.	0 to 99999

[Cd.3322] Block No. setting register (D54282+16s, D54283+16s)

This setting register is for starting a G-code program from the block of the specified block No.

Refer to automatic operation start (cycle start) for details. (☞ Page 252 Automatic operation start (cycle start))

Item	Setting range
Block No.	0 to 99999

3.7 G-Code Control Line Status

Device No.		Signal name
MELSEC iQ-R Motion device assignment	Q series Motion compatible device assignment	
D54440 to D54443		Line 1 G-code control line status
D54444 to D54447		Line 2 G-code control line status

• Details for each line

Device No.		Symbol	Signal name	Refresh cycle	Fetch cycle	Signal type
MELSEC iQ-R Motion device assignment	Q series Motion compatible device assignment					
D54440.0+4s		St.3208	During G-code control	Main cycle	—	Status signal
D54440.1+4s		St.3209	G-code control error detection	Immediate		
D54440.2+4s		St.3210	All axes smoothing zero	G-code control operation cycle		
D54440.3+4s		—	Unusable	—	—	—
D54440.4+4s						
D54440.5+4s						
D54440.6+4s						
D54440.7+4s						
D54440.8+4s						
D54440.8+4s		St.3211	During memory mode	G-code control operation cycle	—	Status signal
D54440.9+4s		—	Unusable	—	—	—
D54440.A+4s						
D54440.B+4s						
D54440.C+4s						
D54440.D+4s						
D54440.E+4s						
D54440.F+4s						
D54441.0+4s		St.3212	During automatic operation	G-code control operation cycle	—	Status signal
D54441.1+4s		St.3213	Automatic operation starting			
D54441.2+4s		St.3214	Automatic operation holding			
D54441.3+4s		St.3215	G-code control finishing			
D54441.4+4s		—	Unusable	—	—	—
D54441.5+4s						
D54441.6+4s						
D54441.7+4s						
D54441.8+4s		St.3216	Resetting	G-code control operation cycle	—	Status signal
D54441.9+4s		St.3217	Reset complete			
D54441.A+4s		—	Unusable	—	—	—
D54441.B+4s						
D54441.C+4s						
D54441.D+4s						
D54441.E+4s						

Device No.		Symbol	Signal name	Refresh cycle	Fetch cycle	Signal type
MELSEC iQ-R Motion device assignment	Q series Motion compatible device assignment					
D54441.F+4s		St.3234	Macro single enabled	G-code control operation cycle	—	Status signal
D54442.0+4s		St.3218	M-code output M00			
D54442.1+4s		St.3219	M-code output M01			
D54442.2+4s		St.3220	M-code output M02			
D54442.3+4s		St.3221	M-code output M30			
D54442.4+4s		St.3222	Auxiliary function strobe 1			
D54442.5+4s		St.3223	Auxiliary function strobe 2			
D54442.6+4s		St.3224	Auxiliary function strobe 3			
D54442.7+4s		St.3225	Auxiliary function strobe 4			
D54442.8+4s		—	Unusable	—	—	—
D54442.9+4s						
D54442.A+4s						
D54442.B+4s						
D54442.C+4s						
D54442.D+4s						
D54442.E+4s						
D54442.F+4s						
D54443.0+4s						
D54443.1+4s						
D54443.2+4s						
D54443.3+4s						
D54443.4+4s						
D54443.5+4s						
D54443.6+4s						
D54443.7+4s						
D54443.8+4s						
D54443.9+4s						
D54443.A+4s						
D54443.B+4s						
D54443.C+4s						
D54443.D+4s						
D54443.E+4s						
D54443.F+4s						

[St.3208] During G-code control (D54440.0+4s)

This signal turns ON during G-code control.

[St.3209] G-code control error detection (D54440.1+4s)

- This signal turns ON with detection of a G-code control related error, and can be used to judge whether there is an error or not. The applicable error code is stored in "[Md.3019] G-code control error code (D54504+128s)", "[Md.3020] G-code control error details code 1 (D54505+128s)", and "[St.3021] G-code control error details code 2 (D54506+128s)". Refer to the following for details of error codes.

 MELSEC iQ-R Motion Controller Programming Manual (Common)

- The signal turns OFF when "[Rq.3380] Reset command (D54226.4+2s)" turns ON.

[St.3210] All axes smoothing zero (D54440.2+4s)

This signal turns ON when the delay (delay by acceleration/deceleration time constant) for all control axes is zero. When the commanded movement by automatic operation, including the acceleration/deceleration time constant delay, completes all output processing this signal turns ON. The signal turns OFF while the movement command is being executed, and if there is an acceleration/deceleration time constant delay.

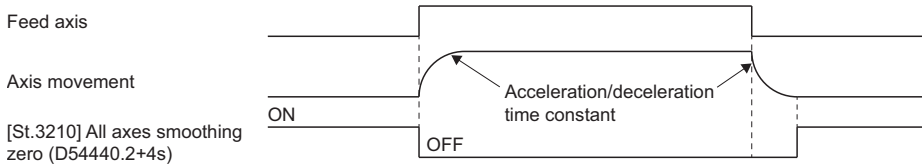

Point

When moving at extremely low speed, "[St.3210] All axes smoothing zero (D54440.2+4s)" may turn ON even while moving.

[St.3211] During memory mode (D54440.8+4s)

This signal turns ON during memory mode.

[St.3212] During automatic operation (D54441.0+4s)

This signal turns ON during automatic operation and stays ON from automatic operation start until reset by "[Rq.3377] Automatic operation start (cycle start) (D54226.1+2s)" turning ON.

The status of automatic operation according to the ON/OFF status of "[St.3212] During automatic operation (D54441.0+4s)", "[St.3213] Automatic operation starting (D54441.1+4s)", and "[St.3214] Automatic operation holding (D54441.2+4s)" is as follows.

Status	[St.3212] During automatic operation (D54441.0+4s)	[St.3213] Automatic operation starting (D54441.1+4s)	[St.3214] Automatic operation holding (D54441.2+4s)
Reset	OFF	OFF	OFF
Automatic operation stopped	ON	OFF	OFF
Automatic operation hold	ON	OFF	ON
Automatic operation running	ON	ON	OFF

The following is a description for each status.

- Reset
When automatic operation is stopped, including after reset. Any status where automatic operation is not being performed is a reset status.
- Automatic operation stopped
When the execution of a block has ended and automatic operation is stopped. When stopped by turning ON "[Rq.3379] Single block (D54226.3+2s)", the status is automatic operation stopped.
- Automatic operation hold
When automatic operation is stopped with a block still being executed. Automatic operation hold status is when "[Rq.3378] Automatic operation hold (feed hold) (D54226.2+2s)" is turned ON.
- Automatic operation running
When automatic operation is being executed.

[St.3213] Automatic operation starting (D54441.1+4s)

This signal turns ON when automatic operation is running and stays ON from automatic operation start until automatic operation hold, block stop, or reset by "[Rq.3377] Automatic operation start (cycle start) (D54226.1+2s)" turning ON. This can be used to check if a movement command or auxiliary function (M function) is being executed.

[St.3214] Automatic operation holding (D54441.2+4s)

- This signal turns ON when automatic operation is on hold, and can be used to check for a holding cause such as "[Rq.3378] Automatic operation hold (feed hold) (D54226.2+2s)" ON when executing a movement command or auxiliary function command.
- This signal turns ON when "[Rq.3378] Automatic operation hold (feed hold) (D54226.2+2s)" turns ON. It also turns ON during an auxiliary function (M function) command.
- This signal turns OFF at a reset, or when "[Rq.3377] Automatic operation start (cycle start) (D54226.1+2s)" is turned ON. However, when "[Rq.3378] Automatic operation hold (feed hold) (D54226.2+2s)" is not returned to OFF status, or when not in memory mode, this signal is disabled.

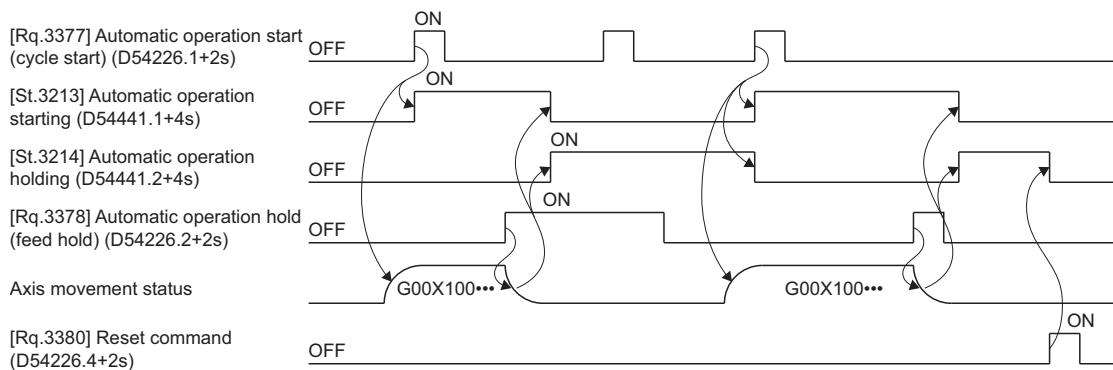

[St.3215] G-code control finishing (D54441.3+4s)

This signal turns ON when a G-code control stop cause occurs. "[St.3215] G-code control finishing (D54441.3+4s)" turns OFF after stop processing. Refer to G-code control system stop operation for details of stop causes. (Page 26 G-Code Control System Stop Operation)

[St.3216] Resetting (D54441.8+4s)

Turns ON during reset processing by "[Rq.3380] Reset command (D54226.4+2s)". When reset is completed immediately, the resetting status may not be detected.

[St.3217] Reset complete (D54441.9+4s)

- This signal turns ON when reset by "[Rq.3380] Reset command (D54226.4+2s)" is complete and can be used to check that reset is completed.
- "[St.3217] Reset complete (D54441.9+4s)" does not turn OFF automatically. To check if reset is complete when resetting again, turn ON "[Rq.3380] Reset command (D54226.4+2s)" after turning OFF "[St.3217] Reset complete (D54441.9+4s)".

[St.3234] Macro single enabled (D54441.F+4s)

- This signal turns ON when macro single can be used.
- Macro single is enabled when "[Rq.3379] Single block (D54226.3+2s)" is turned ON while "[St.3234] Macro single enabled (D54441.F+4s)" is turned ON.
- "[St.3234] Macro single enabled (D54441.F+4s)" turns ON/OFF in the following cases.

Status	Details
ON	<ul style="list-style-type: none"> • When "[Rq.3377] Automatic operation start (cycle start) (D54226.1+2s)" is turned OFF→ON after turning ON "[Rq.3384] Macro single (D54226.C+2s)" with operation in a reset state^{*1}.
OFF	<ul style="list-style-type: none"> • When G-code control reset is completed by turning ON "[Rq.3380] Reset command (D54226.4+2s)" during automatic operation. • When a G-code control stop case^{*2} occurs.

*1 A reset state is when all of the following devices are turned OFF.

- [St.3212] During automatic operation (D54441.0+4s)
- [St.3213] Automatic operation starting (D54441.1+4s)
- [St.3214] Automatic operation holding (D54441.2+4s)

*2 Refer to G-code control system stop operation for G-code control stop case. (Page 26 G-Code Control System Stop Operation)

[St.3218] M-code output M00 (D54442.0+4s)

- This signal turns ON when the special auxiliary function M00 is output. Although it is a special auxiliary function M00, the normal signals "[St.3222] Auxiliary function strobe 1 (D54442.4+4s)" to "[St.3225] Auxiliary function strobe 4 (D54442.7+4s)" and "[Md.3058] M-code data 1 (D54554+128s, D54555+128s)" to "[Md.3061] M-code data 4 (D54560+128s, D54561+128s)" are output.
- The signal turns ON when M00 is output during automatic operation, and is turned OFF with "[Rq.3382] Auxiliary function complete 1 (FIN1) (D54227.0+2s)", "[Rq.3383] Auxiliary function complete 2 (FIN2) (D54227.1+2s)", or "[Rq.3380] Reset command (D54226.4+2s)". Refer to M-code output for details. (☞ Page 213 M-code output)

[St.3219] M-code output M01 (D54442.1+4s)

- This signal turns ON when the special auxiliary function M01 is output. Although it is a special auxiliary function M01, the normal signals "[St.3222] Auxiliary function strobe 1 (D54442.4+4s)" to "[St.3225] Auxiliary function strobe 4 (D54442.7+4s)" and "[Md.3058] M-code data 1 (D54554+128s, D54555+128s)" to "[Md.3061] M-code data 4 (D54560+128s, D54561+128s)" are output.
- The signal turns ON when M01 is output during automatic operation, and is turned OFF with "[Rq.3382] Auxiliary function complete 1 (FIN1) (D54227.0+2s)", "[Rq.3383] Auxiliary function complete 2 (FIN2) (D54227.1+2s)", or "[Rq.3380] Reset command (D54226.4+2s)". Refer to M-code output for details. (☞ Page 213 M-code output)

[St.3220] M-code output M02 (D54442.2+4s)

- This signal turns ON when the special auxiliary function M02 is output. Although it is a special auxiliary function M02, the normal signals "[St.3222] Auxiliary function strobe 1 (D54442.4+4s)" to "[St.3225] Auxiliary function strobe 4 (D54442.7+4s)" and "[Md.3058] M-code data 1 (D54554+128s, D54555+128s)" to "[Md.3061] M-code data 4 (D54560+128s, D54561+128s)" are output.
- The signal turns ON when M02 is output during automatic operation, and is turned OFF with "[Rq.3382] Auxiliary function complete 1 (FIN1) (D54227.0+2s)", "[Rq.3383] Auxiliary function complete 2 (FIN2) (D54227.1+2s)", or "[Rq.3380] Reset command (D54226.4+2s)". Refer to M-code output for details. (☞ Page 213 M-code output)

[St.3221] M-code output M30 (D54442.3+4s)

- This signal turns ON when the special auxiliary function M30 is output. Although it is a special auxiliary function M30, the normal signals "[St.3222] Auxiliary function strobe 1 (D54442.4+4s)" to "[St.3225] Auxiliary function strobe 4 (D54442.7+4s)" and "[Md.3058] M-code data 1 (D54554+128s, D54555+128s)" to "[Md.3061] M-code data 4 (D54560+128s, D54561+128s)" are output.
- The signal turns ON when M30 is output during automatic operation, and is turned OFF with "[Rq.3382] Auxiliary function complete 1 (FIN1) (D54227.0+2s)", "[Rq.3383] Auxiliary function complete 2 (FIN2) (D54227.1+2s)", or "[Rq.3380] Reset command (D54226.4+2s)". Refer to M-code output for details. (☞ Page 213 M-code output)

[St.3222] Auxiliary function strobe 1 (D54442.4+4s)

- This signal turns ON when the first group of auxiliary function (M function) is commanded.
- This signal turns ON when the first group of auxiliary function (M function) is commanded by the G-code program of automatic operation.
- This signal turns OFF in the following cases.
 - When "[Rq.3382] Auxiliary function complete 1 (FIN1) (D54227.0+2s)" and "[Rq.3383] Auxiliary function complete 2 (FIN2) (D54227.1+2s)" have turned ON.
 - When in a reset status.

■ Operation

- Up to four auxiliary functions (M functions) can be commanded simultaneously in one block.

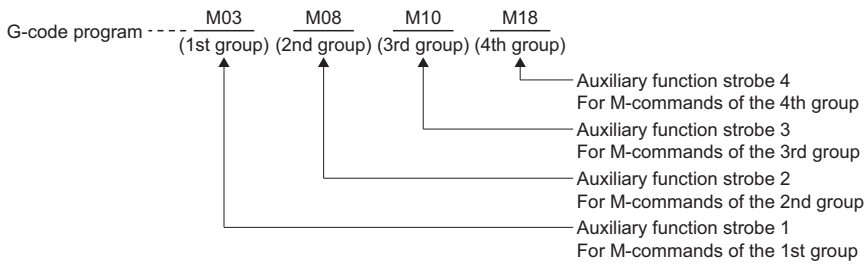

*1 The following M-code data does not output auxiliary function strobe.

- M98 (subprogram call)
- M99 (sub/macro program return)

- While "[Rq.3382] Auxiliary function complete 1 (FIN1) (D54227.0+2s)" or "[Rq.3383] Auxiliary function complete 2 (FIN2) (D54227.1+2s)" are turned ON, "[St.3222] Auxiliary function strobe 1 (D54442.4+4s)" to "[St.3225] Auxiliary function strobe 4 (D54442.7+4s)" do not turn ON when M function is executed.

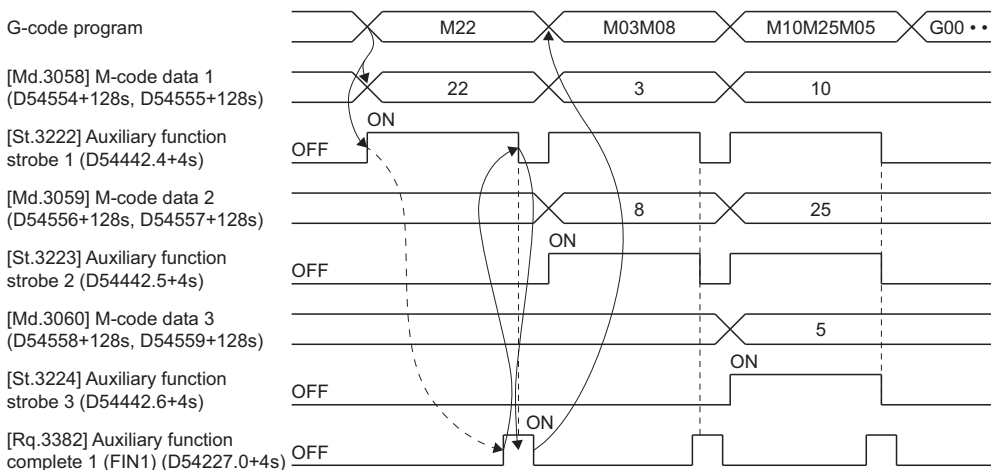

- The Motion SFC program and sequence program processing is as follows.
 - When auxiliary function (M function) is commanded, "[St.3222] Auxiliary function strobe 1 (D54442.4+4s)" to "[St.3225] Auxiliary function strobe 4 (D54442.7+4s)" and "[Md.3058] M-code data 1 (D54554+128s, D54555+128s)" to "[Md.3061] M-code data 4 (D54560+128s, D54561+128s)" are output.
 - In the Motion SFC program or sequence program, "[St.3222] Auxiliary function strobe 1 (D54442.4+4s)" to "[St.3225] Auxiliary function strobe 4 (D54442.7+4s)" are always triggers for starting the auxiliary function (M function) processing.
 - When auxiliary function (M function) processing is complete, "[Rq.3382] Auxiliary function complete 1 (FIN1) (D54227.0+2s)" or "[Rq.3383] Auxiliary function complete 2 (FIN2) (D54227.1+2s)" turn ON.
 - The Motion CPU recognizes the leading edge of "[Rq.3382] Auxiliary function complete 1 (FIN1) (D54227.0+2s)" or "[Rq.3383] Auxiliary function complete 2 (FIN2) (D54227.1+2s)", and turns OFF "[St.3222] Auxiliary function strobe 1 (D54442.4+4s)" to "[St.3225] Auxiliary function strobe 4 (D54442.7+4s)".
 - In the Motion SFC program or sequence program, "[St.3222] Auxiliary function strobe 1 (D54442.4+4s)" to "[St.3225] Auxiliary function strobe 4 (D54442.7+4s)" turning OFF is confirmed, and "[Rq.3382] Auxiliary function complete 1 (FIN1) (D54227.0+2s)" or "[Rq.3383] Auxiliary function complete 2 (FIN2) (D54227.1+2s)" are turned OFF.

[St.3223] Auxiliary function strobe 2 (D54442.5+4s)

- This signal turns ON when the second group of auxiliary function (M function) is commanded.
- This signal turns ON when two or more auxiliary functions (M functions) in the same block are commanded by automatic operation.
- The operation details are the same as "[St.3222] Auxiliary function strobe 1 (D54442.4+4s)". (Page 44 [St.3222] Auxiliary function strobe 1 (D54442.4+4s))

[St.3224] Auxiliary function strobe 3 (D54442.6+4s)

- This signal turns ON when the third group of auxiliary function (M function) is commanded.
- This signal turns ON when three or more auxiliary functions (M functions) in the same block are commanded by automatic operation.
- The operation details are the same as "[St.3222] Auxiliary function strobe 1 (D54442.4+4s)". ( Page 44 [St.3222] Auxiliary function strobe 1 (D54442.4+4s))

[St.3225] Auxiliary function strobe 4 (D54442.7+4s)

- This signal turns ON when the fourth group of auxiliary function (M function) is commanded.
- This signal turns ON when three or more auxiliary functions (M functions) in the same block are commanded by automatic operation.
- The operation details are the same as "[St.3222] Auxiliary function strobe 1 (D54442.4+4s)". ( Page 44 [St.3222] Auxiliary function strobe 1 (D54442.4+4s))

3.8 G-Code Control Line Monitor Device

Device No.		Signal name
MELSEC iQ-R Motion device assignment	Q series Motion compatible device assignment	
D54496 to D54623		Line 1 G-code control line monitor device
D54624 to D54751		Line 2 G-code control line monitor device

• Details for each line

Device No.		Symbol	Signal name	Refresh cycle	Fetch cycle	Signal type
MELSEC iQ-R Motion device assignment	Q series Motion compatible device assignment					
D54496+128s		Md.3016	Number of axes on line	STOP→RUN	—	Monitor device
D54497+128s		—	Unusable	—	—	—
D54498+128s		Md.3017	G-code control axis configuration	STOP→RUN	—	Monitor device
D54499+128s						
D54500+128s						
D54501+128s						
D54502+128s		Md.3018	Speed	G-code control operation cycle	—	Monitor device
D54503+128s						
D54504+128s		Md.3019	G-code control error code	Immediate	—	Monitor device
D54505+128s		Md.3020	G-code control error details code 1			
D54506+128s		Md.3021	G-code control error details code 2			
D54507+128s		—	Unusable	—	—	—
D54508+128s		Md.3022	Program No. being executed (main)	At G-code program start	—	Monitor device
D54509+128s		—	Unusable	—	—	—
D54510+128s		Md.3023	Sequence No. being executed (main)	G-code control operation cycle	—	Monitor device
D54511+128s						
D54512+128s		Md.3024	Block No. being executed (main)	—	—	Monitor device
D54513+128s						
D54514+128s		Md.3025	Program No. being executed (sub/macro)	—	—	Monitor device
D54515+128s		—	Unusable	—	—	—
D54516+128s		Md.3026	Sequence No. being executed (sub/macro)	G-code control operation cycle	—	Monitor device
D54517+128s						
D54518+128s		Md.3027	Block No. being executed (sub/macro)	—	—	Monitor device
D54519+128s						
D54520+128s		Md.3028	Group 01 modal status	G-code control operation cycle	—	Monitor device
D54521+128s		Md.3029	Group 02 modal status			
D54522+128s		Md.3030	Group 03 modal status			
D54523+128s		—	Unusable			
D54524+128s		Md.3034	Group 07 modal status	G-code control operation cycle	—	Monitor device
D54525+128s						
D54526+128s						
D54527+128s		Md.3035	Tool radius compensation No.	G-code control operation cycle	—	Monitor device
D54528+128s		Md.3036	Tool radius compensation amount			
D54529+128s						
D54530+128s		—	Unusable	—	—	—
D54531+128s		—	Unusable	—	—	—

Device No.		Symbol	Signal name	Refresh cycle	Fetch cycle	Signal type
MELSEC iQ-R Motion device assignment	Q series Motion compatible device assignment					
D54532+128s		Md.3038	Group 08 modal status	G-code control operation cycle	—	Monitor device
D54533+128s		Md.3039	Tool length compensation No.			
D54534+128s		Md.3040	Tool length compensation amount			
D54535+128s						
D54536+128s		—	Unusable	—	—	—
D54537+128s						
D54538+128s		Md.3042	Tool length compensation axis No.	G-code control operation cycle	—	Monitor device
D54539+128s		—	Unusable	—	—	—
D54540+128s						
D54541+128s						
D54542+128s		Md.3046	Group 12 modal status	G-code control operation cycle	—	Monitor device
D54543+128s		Md.3047	Group 13 modal status			
D54544+128s		—	Unusable	—	—	—
D54545+128s		Md.3049	Group 15 modal status	G-code control operation cycle	—	Monitor device
D54546+128s		Md.3050	Group 16 modal status			
D54547+128s		—	Unusable	—	—	—
D54548+128s						
D54549+128s						
D54550+128s						
D54551+128s		Md.3055	Group 21 modal status	G-code control operation cycle	—	Monitor device
D54552+128s		—	Unusable	—	—	—
D54553+128s						
D54554+128s		Md.3058	M-code data 1	G-code control operation cycle	—	Monitor device
D54555+128s						
D54556+128s	Md.3059	M-code data 2				
D54557+128s						
D54558+128s	Md.3060	M-code data 3				
D54559+128s						
D54560+128s	Md.3061	M-code data 4				
D54561+128s						

Device No.		Symbol	Signal name	Refresh cycle	Fetch cycle	Signal type
MELSEC iQ-R Motion device assignment	Q series Motion compatible device assignment					
D54562+128s		—	Unusable	—	—	—
D54563+128s						
D54564+128s						
D54565+128s						
D54566+128s						
D54567+128s						
D54568+128s						
D54569+128s						
D54570+128s						
D54571+128s						
D54572+128s						
D54573+128s						
D54574+128s						
D54575+128s						
D54576+128s						
D54577+128s						
D54578+128s						
D54579+128s						
D54580+128s						
D54581+128s						
D54582+128s		Md.3074	Local variable depth	G-code control operation cycle	—	Monitor device
D54583+128s		—	Unusable	—	—	—
D54584+128s						
D54585+128s						
D54586+128s						
D54587+128s						
D54588+128s		Md.3070	Program comment being executed	At G-code program start	—	Monitor device
D54589+128s						
D54590+128s						
D54591+128s						
D54592+128s						
D54593+128s						
D54594+128s						
D54595+128s						

Device No.		Symbol	Signal name	Refresh cycle	Fetch cycle	Signal type
MELSEC iQ-R Motion device assignment	Q series Motion compatible device assignment					
D54596+128s		—	Unusable	—	—	—
D54597+128s						
D54598+128s						
D54599+128s						
D54600+128s						
D54601+128s						
D54602+128s						
D54603+128s						
D54604+128s						
D54605+128s						
D54606+128s						
D54607+128s						
D54608+128s						
D54609+128s						
D54610+128s						
D54611+128s						
D54612+128s						
D54613+128s						
D54614+128s						
D54615+128s						
D54616+128s						
D54617+128s						
D54618+128s						
D54619+128s						
D54620+128s						
D54621+128s						
D54622+128s						
D54623+128s						

[Md.3016] Number of axes on line (D54496+128s)

The number of axes set in [Motion Control Parameter]⇒[G-code Control Parameter]⇒[G-code Control System Parameter]⇒"Line Basic Setting"⇒"Number of Axes on Line" is stored.

[Md.3017] G-code control axis configuration (D54498+128s to D54501+128s)

The axis No. set in [Motion Control Parameter]⇒[G-code Control Parameter]⇒[G-code Control Axis Parameter]⇒"Line Axis Information"⇒"Axis No." is stored as bit data. This can be used to check what axis No. allocated by the servo network setting is set for the axes on a line.

		b15	b14	b13	b12	b11	b10	b9	b8	b7	b6	b5	b4	b3	b2	b1	b0
[Md.3017] G-code control axis configuration	D54498+128s	Axis 16	Axis 15	Axis 14	Axis 13	Axis 12	Axis 11	Axis 10	Axis 9	Axis 8	Axis 7	Axis 6	Axis 5	Axis 4	Axis 3	Axis 2	Axis 1
	D54499+128s	Axis 32	Axis 31	Axis 30	Axis 29	Axis 28	Axis 27	Axis 26	Axis 25	Axis 24	Axis 23	Axis 22	Axis 21	Axis 20	Axis 19	Axis 18	Axis 17
	D54500+128s	Axis 48	Axis 47	Axis 46	Axis 45	Axis 44	Axis 43	Axis 42	Axis 41	Axis 40	Axis 39	Axis 38	Axis 37	Axis 36	Axis 35	Axis 34	Axis 33
	D54501+128s	Axis 64	Axis 63	Axis 62	Axis 61	Axis 60	Axis 59	Axis 58	Axis 57	Axis 56	Axis 55	Axis 54	Axis 53	Axis 52	Axis 51	Axis 50	Axis 49

*1: G-code control configuration axes store 0/1.
 0: Non-configuration axis
 1: Configuration axis
 *2: The following range is valid.
 R16MTCPU: Axis No. 1 to 16, R32MTCPU: Axis No. 1 to 32

[Md.3018] Speed (D54502+128s, D54503+128s)

The speed ($\times 0.01$ [mm/min]) during interpolation operation or non-interpolation operation is stored.

Item	Description
During interpolation operation	Stores the speed of the vector direction currently moving.
During non-interpolation operation	Stores the speed of the axis that has the highest speed of all axes currently moving.

[Md.3019] G-code control error code (D54504+128s)

- The corresponding error code at an error occurrence related to G-code control is stored. If another error occurs after error code storing, the previous error code is overwritten by the new error code.
- G-code control error codes can be cleared by "[Rq.3380] Reset command (D54226.4+2s)" or "Error reset (SM50)".

Point

Refer to the following for details of the error codes.

 MELSEC iQ-R Motion Controller Programming Manual (Common)

[Md.3020] G-code control error details code 1 (D54505+128s)

- The corresponding error details code 1 at an error occurrence related to G-code control is stored. If another error occurs after error code storing, the previous error code is overwritten by the new error code.
- G-code control error codes can be cleared by "[Rq.3380] Reset command (D54226.4+2s)" or "Error reset (SM50)".

Point

Refer to G-code control error details codes for details of error details codes. ( Page 287 G-code control error details codes)

[Md.3021] G-code control error details code 2 (D54506+128s)

- The corresponding error details code 2 at an error occurrence related to G-code control is stored. If another error occurs after error code storing, the previous error code is overwritten by the new error code.
- G-code control error codes can be cleared by "[Rq.3380] Reset command (D54226.4+2s)" or "Error reset (SM50)".

Point

Refer to G-code control error details codes for details of error details codes. ( Page 287 G-code control error details codes)

[Md.3022] Program No. being executed (main) (D54508+128s)

The corresponding program No. is stored when G-code program operation is being executed.

[Md.3023] Sequence No. being executed (main) (D54510+128s, D54511+128s)

The sequence No. being executed is stored during G-code program operation.

[Md.3024] Block No. being executed (main) (D54512+128s, D54513+128s)

The block No. being executed is stored during G-code program operation.

When the sequence No. is changed, the block No. starts from "0".

The block No. increases by 1 for every block executed.

■ Operation example

- When G-code program No.12 is executed.

Program	[Md.3022] Program No. being executed (main) (D54508+128s)	[Md.3023] Sequence No. being executed (main) (D54510+128s, D54511+128s)	[Md.3024] Block No. being executed (main) (D54512+128s, D54513+128s)
G90 G00 X0. Y0.	12	0	1
G91 X100. Y100.	12	0	2
N100 X-50. Y-25.	12	100	0
N110 G01 X250. F300.	12	110	0
Y-225.	12	110	1
X-50.	12	110	2
Y-25.	12	110	3
N120 Y-125.	12	120	0
N130 G00 X-100.	12	130	0
N140 G01 X-200.	12	140	0
Y-175.	12	140	1
X-100.	12	140	2
Y-75.	12	140	3
N150 G90 G00 X0. Y0.	12	150	0
N160 M02	12	160	0

- When a branch (IF, THEN, ELSE, ENDIF) instruction is executed

Blocks that are not executed as a result of the branch condition are not counted as block Nos.

Program	[Md.3023] Sequence No. being executed (main) (D54510+128s, D54511+128s)	[Md.3024] Block No. being executed (main) (D54512+128s, D54513+128s)	
		#100=0, #101=0	#100≠0, #101≠0
G90 G00 X0. Y0.	0	1	1
G91 G01 X100. Y100. F2000.	0	2	2
X200. Y200.	0	3	3
IF [#100 EQ 0] THEN	0	4	4
G01 Y300. F1500.	0	5	—
X300.	0	6	—
ENDIF	0	7	5
G02 X50. Y50. I0. J50. F800.	0	8	6
G01 X100. Y500. F2000.	0	9	7
IF [#101 EQ 0] THEN	0	10	8
G00 X10. Y100.	0	11	—
ELSE	0	12	9
G90 G00 X0 Y0.	0	—	10
ENDIF	0	13	11
M02	0	14	12

- When a repeat (WHILE, DO, END) instruction is executed

Block Nos. are counted for as many blocks (from WHILE to DO blocks until the END block) that are executed while the conditional expression expression is satisfied

Program	[Md.3023] Sequence No. being executed (main) (D54510+128s, D54511+128s)	[Md.3024] Block No. being executed (main) (D54512+128s, D54513+128s)			
		#100=0	#100=1	#100=2	#100=3
G90 G00 X0. Y0.	0	1			
#100=0	0	2			
G91 G00 X25. Y50.	0	3			
WHILE [#100 LT 3] DO1	0	4	8	12	16
G03 X0. Y0. I50. J0. F100.	0	5	9	13	—
#100=#100+1	0	6	10	14	—
END1	0	7	11	15	—
G90 G00 X0 Y0.	0	17			
M02	0	18			

[Md.3025] Program No. being executed (sub/macro) (D54514+128s)

The program No. of the subprogram or the macro program being executed is stored during G-code program operation. When a subprogram or a macro program is not being executed, "0" is stored.

[Md.3026] Sequence No. being executed (sub/macro) (D54516+128s, D54517+128s)

The sequence No. of the subprogram or the macro program being executed is stored during G-code program operation. When a subprogram or a macro program is not being executed, "0" is stored.

[Md.3027] Block No. being executed (sub/macro) (D54518+128s, D54519+128s)

The block No. of the subprogram or the macro program being executed is stored during G-code program operation. When a subprogram or a macro program is not being executed, "0" is stored. Also, when the sequence No. is changed, the block No. starts from "0".

The block No. increases by 1 for every block executed.

[Md.3028] Group 01 modal status (D54520+128s)

Modal status of group 01 is stored.

G-code modal status	Stored value
G00 Positioning	0
G01 Linear interpolation	10
G02 Circular interpolation CW	20
G03 Circular interpolation CCW	30

[Md.3029] Group 02 modal status (D54521+128s)

Modal status of group 02 is stored.

G-code modal status	Stored value
G17 X-Y plane selection	170
G18 Z-X plane selection	180
G19 Y-Z plane selection	190

[Md.3030] Group 03 modal status (D54522+128s)

Modal status of group 03 is stored.

G-code modal status	Stored value
G90 Absolute value command	900
G91 Incremental value command	910

[Md.3034] Group 07 modal status (D54526+128s)

Modal status of group 07 is stored.

G-code modal status	Stored value
G40 Tool radius compensation cancel	400
G41 Tool radius compensation left	410
G42 Tool radius compensation right	420

[Md.3035] Tool radius compensation No. (D54527+128s)

The tool radius compensation No. is stored.

[Md.3036] Tool radius compensation amount (D54528+128s, D54529+128s)

The tool radius compensation amount is stored.

[Md.3038] Group 08 modal status (D54532+128s)

Modal status of group 08 is stored.

G-code modal status	Stored value
G43 Tool length compensation (+)	430
G44 Tool length compensation (-)	440
G49 Tool length compensation cancel	490

[Md.3039] Tool length compensation No. (D54533+128s)

The tool length compensation No. is stored. Because the last commanded compensation No. is stored, when compensating for multiple axes, only the value of the axis last commanded is stored.

[Md.3040] Tool length compensation amount (D54534+128s, D54535+128s)

The tool length compensation amount is stored. Because the last commanded compensation amount is stored, when compensating for multiple axes, only the value of the axis last commanded is stored.

[Md.3042] Tool length compensation axis No. (D54538+128s)

The axis No. in the line that is executing tool length compensation is stored as bit data.

	b15	b14	b13	b12	b11	b10	b9	b8	b7	b6	b5	b4	b3	b2	b1	b0
[Md.3042] Tool length compensation axis No. (D54538+128s)	Not used								Axis	Axis	Axis	Axis	Axis	Axis	Axis	Axis
									8	7	6	5	4	3	2	1

*1: The axis being executed stores 0/1.
 0: Not being executed
 1: Being executed

[Md.3046] Group 12 modal status (D54542+128s)

Modal status of group 12 is stored.

G-code modal status	Stored value
G54 Work coordinate system 1 selection	540
G55 Work coordinate system 2 selection	550
G56 Work coordinate system 3 selection	560
G57 Work coordinate system 4 selection	570
G58 Work coordinate system 5 selection	580
G59 Work coordinate system 6 selection	590

[Md.3047] Group 13 modal status (D54543+128s)

Modal status of group 13 is stored.

G-code modal status	Stored value
G61 Exact stop check mode	610
G61.1 High-accuracy control mode	611
G62 Automatic corner override	620
G64 Cutting mode	640

[Md.3049] Group 15 modal status (D54545+128s)

Modal status of group 15 is stored.

G-code modal status	Stored value
G40.1 Normal line control cancel	401
G41.1 Normal line control left	411
G42.1 Normal line control right	421

[Md.3050] Group 16 modal status (D54546+128s)

Modal status of group 16 is stored.

G-code modal status	Stored value
G68 Program coordinate rotation mode start	680
G69 Program coordinate rotation mode cancel	690

[Md.3055] Group 21 modal status (D54551+128s)

Modal status of group 21 is stored.

G-code modal status	Stored value
G12.1 Polar coordinate interpolation mode start	121
G13.1 Polar coordinate interpolation mode cancel	131

[Md.3058] M-code data 1 (D54554+128s, D54555+128s)

- The value that follows after the auxiliary function address M is stored when auxiliary function (M function) is commanded. "8-digit BCD code", "Unsigned 32-bit binary data", and "Signed 32-bit binary data" can be selected for the output M-code data from G-code control system parameter "M Binary".
- When auxiliary function (M function) is commanded by automatic operation, "[Md.3058] M-code data 1 (D54554+128s, D54555+128s)" is updated. Data is not updated when "[Rq.3382] Auxiliary function complete 1 (FIN1) (D54227.0+2s)" or "[Rq.3383] Auxiliary function complete 2 (FIN2) (D54227.1+2s)" are turned ON. Data is not cleared when "[Rq.3380] Reset command (D54226.4+2s)" is turned ON.

Point

- Up to four groups of values that follow after address M can be commanded per block. When multiple Ms are programmed in one block, the interface that is output is determined by the programmed order.

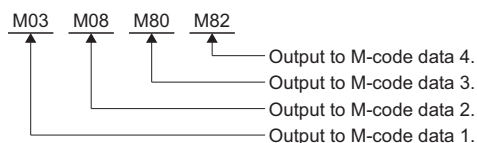

- M98 (subprogram call) and M99 (sub/macro program return) are processed in the Motion CPU and are not output as M-code data.

[Md.3059] M-code data 2 (D54556+128s, D54557+128s)

- The value that follows after the auxiliary function address M is stored when auxiliary function (M function) is commanded. "8-digit BCD code", "Unsigned 32-bit binary data", and "Signed 32-bit binary data" can be selected for the output M-code data from G-code control system parameter "M Binary".
- When two or more auxiliary functions (M function) are commanded in the same block by automatic operation, "[Md.3059] M-code data 2 (D54554+128s, D54555+128s)" is updated. Data is not updated when "[Rq.3382] Auxiliary function complete 1 (FIN1) (D54227.0+2s)" or "[Rq.3383] Auxiliary function complete 2 (FIN2) (D54227.1+2s)" are turned ON. Data is not cleared when "[Rq.3380] Reset command (D54226.4+2s)" is turned ON.

Point

- Up to four groups of values that follow after address M can be commanded per block. When multiple Ms are programmed in one block, the interface that is output is determined by the programmed order.



- M98 (subprogram call) and M99 (sub/macro program return) are processed in the Motion CPU and are not output as M-code data.

[Md.3060] M-code data 3 (D54558+128s, D54559+128s)

- The value that follows after the auxiliary function address M is stored when auxiliary function (M function) is commanded. "8-digit BCD code", "Unsigned 32-bit binary data", and "Signed 32-bit binary data" can be selected for the output M-code data from G-code control system parameter "M Binary".
- When three or more auxiliary functions (M function) are commanded in the same block by automatic operation, "[Md.3060] M-code data 3 (D54554+128s, D54555+128s)" is updated. Data is not updated when "[Rq.3382] Auxiliary function complete 1 (FIN1) (D54227.0+2s)" or "[Rq.3383] Auxiliary function complete 2 (FIN2) (D54227.1+2s)" are turned ON. Data is not cleared when "[Rq.3380] Reset command (D54226.4+2s)" is turned ON.

Point

- Up to four groups of values that follow after address M can be commanded per block. When multiple Ms are programmed in one block, the interface that is output is determined by the programmed order.

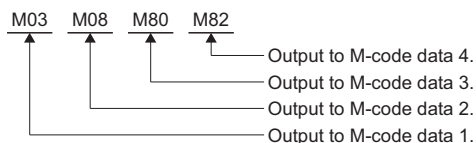

- M98 (subprogram call) and M99 (sub/macro program return) are processed in the Motion CPU and are not output as M-code data.

[Md.3061] M-code data 4 (D54560+128s, D54561+128s)

- The value that follows after the auxiliary function address M is stored when auxiliary function (M function) is commanded. "8-digit BCD code", "Unsigned 32-bit binary data", and "Signed 32-bit binary data" can be selected for the output M-code data from G-code control system parameter "M Binary".
- When four or more auxiliary functions (M function) are commanded in the same block by automatic operation, "[Md.3061] M-code data 4 (D54554+128s, D54555+128s)" is updated. Data is not updated when "[Rq.3382] Auxiliary function complete 1 (FIN1) (D54227.0+2s)" or "[Rq.3383] Auxiliary function complete 2 (FIN2) (D54227.1+2s)" are turned ON. Data is not cleared when "[Rq.3380] Reset command (D54226.4+2s)" is turned ON.

Point

- Up to four groups of values that follow after address M can be commanded per block. When multiple Ms are programmed in one block, the interface that is output is determined by the programmed order.



- M98 (subprogram call) and M99 (sub/macro program return) are processed in the Motion CPU and are not output as M-code data.

[Md.3074] Local variable depth (D54582+128s)

The local variable depth (0 to 4) during the macro call (G65) is stored. "[Md.3074] Local variable depth (D54582+128s)" is updated in the following cases.

- When a macro program is called from the main program or a subprogram.
- When returning to the main program or a subprogram from a macro program.

In addition, "[Md.3074] Local variable depth (D54582+128s)" is 0 cleared if the reset command is performed.

[Md.3070] Program comment being executed (D54588+128s to D54595+128s)

The program comment of the program being executed is stored as 8-words of ASCII code.

15 characters + 1 NULL character of the comment (the character string from "(" to ")") of the block following the end of record (%) set to the program start are stored.

3.9 G-Code Control Line Monitor Device (Expansion)

Device No.		Signal name
MELSEC iQ-R Motion device assignment	Q series Motion compatible device assignment	
D55264 to D55423		Line 1 G-code control line monitor device (expansion)
D55424 to D55583		Line 2 G-code control line monitor device (expansion)

• Details for each line

Device No.		Symbol	Signal name	Refresh cycle	Fetch cycle	Signal type
MELSEC iQ-R Motion device assignment	Q series Motion compatible device assignment					
D55264+160s		Md.3178	Program monitor being executed (1st line)	At block change	—	Monitor device
D55265+160s						
D55266+160s						
D55267+160s						
D55268+160s						
D55269+160s						
D55270+160s						
D55271+160s						
D55272+160s						
D55273+160s						
D55274+160s						
D55275+160s						
D55276+160s						
D55277+160s						
D55278+160s						
D55279+160s						
D55280+160s						
D55281+160s						
D55282+160s						
D55283+160s						
D55284+160s						
D55285+160s						
D55286+160s						
D55287+160s						
D55288+160s						
D55289+160s						
D55290+160s						
D55291+160s						
D55292+160s						
D55293+160s						
D55294+160s						
D55295+160s						

Device No.		Symbol	Signal name	Refresh cycle	Fetch cycle	Signal type
MELSEC iQ-R Motion device assignment	Q series Motion compatible device assignment					
D55296+160s		Md.3179	Program monitor being executed (2nd line)	At block change	—	Monitor device
D55297+160s						
D55298+160s						
D55299+160s						
D55300+160s						
D55301+160s						
D55302+160s						
D55303+160s						
D55304+160s						
D55305+160s						
D55306+160s						
D55307+160s						
D55308+160s						
D55309+160s						
D55310+160s						
D55311+160s						
D55312+160s						
D55313+160s						
D55314+160s						
D55315+160s						
D55316+160s						
D55317+160s						
D55318+160s						
D55319+160s						
D55320+160s						
D55321+160s						
D55322+160s						
D55323+160s						
D55324+160s						
D55325+160s						
D55326+160s						
D55327+160s						

Device No.		Symbol	Signal name	Refresh cycle	Fetch cycle	Signal type
MELSEC iQ-R Motion device assignment	Q series Motion compatible device assignment					
D55328+160s		Md.3180	Program monitor being executed (3rd line)	At block change	—	Monitor device
D55329+160s						
D55330+160s						
D55331+160s						
D55332+160s						
D55333+160s						
D55334+160s						
D55335+160s						
D55336+160s						
D55337+160s						
D55338+160s						
D55339+160s						
D55340+160s						
D55341+160s						
D55342+160s						
D55343+160s						
D55344+160s						
D55345+160s						
D55346+160s						
D55347+160s						
D55348+160s						
D55349+160s						
D55350+160s						
D55351+160s						
D55352+160s						
D55353+160s						
D55354+160s						
D55355+160s						
D55356+160s						
D55357+160s						
D55358+160s						
D55359+160s						
D55360+160s		—	Unusable	—	—	—
D55361+160s						
D55362+160s						
D55363+160s						
D55364+160s						
D55365+160s						
D55366+160s						
D55367+160s						
D55368+160s						
D55369+160s						
D55370+160s						
D55371+160s						
D55372+160s						
D55373+160s						
D55374+160s						
D55375+160s						
D55376+160s						

Device No.		Symbol	Signal name	Refresh cycle	Fetch cycle	Signal type
MELSEC iQ-R Motion device assignment	Q series Motion compatible device assignment					
D55377+160s		—	Unusable	—	—	—
D55378+160s						
D55379+160s						
D55380+160s						
D55381+160s						
D55382+160s						
D55383+160s						
D55384+160s						
D55385+160s						
D55386+160s						
D55387+160s						
D55388+160s						
D55389+160s						
D55390+160s						
D55391+160s						
D55392+160s						
D55393+160s						
D55394+160s						
D55395+160s						
D55396+160s						
D55397+160s						
D55398+160s						
D55399+160s						
D55400+160s						
D55401+160s						
D55402+160s						
D55403+160s						
D55404+160s						
D55405+160s						
D55406+160s						
D55407+160s						
D55408+160s						
D55409+160s						
D55410+160s						
D55411+160s						
D55412+160s						
D55413+160s						
D55414+160s						
D55415+160s						
D55416+160s						
D55417+160s						
D55418+160s						
D55419+160s						
D55420+160s						
D55421+160s						
D55422+160s						
D55423+160s						

[Md.3178] Program monitor being executed (1st line) (D55264+160s to D55295+160s)

Stores one block of the block being executed (first line) of the G-code program that is running as an ASCII character string. A maximum of 64 characters (63 characters + \0) are stored in a block.

Ex.

For a G-code program being executed on line 1

Program block	Program
First line (executing)	G91 G00 X100. Y100. Z100. C50.
Second line	G90 G94 G17 G00 X1000.0000 Y1000.0000 Z1000.0000 C180.0000 F10000.00 M100 M200 M300
Third line	G04 P1

- Device values stored in [Md.3178] Program monitor being executed (1st line)

Item	Device No.											
	D55264		D55265		D55266		D55267		D55268		D55269	
	Lower	Upper	Lower	Upper	Lower	Upper	Lower	Upper	Lower	Upper	Lower	Upper
ASCII character string	G	9	1	G	0	0	X	1	0	0	.	Y

Item	Device No.											
	D55270		D55271		D55272		D55273		D55274		D55275	
	Lower	Upper	Lower	Upper	Lower	Upper	Lower	Upper	Lower	Upper	Lower	Upper
ASCII character string	1	0	0	.	Z	1	0	0	.	C	5	0

Item	Device No.											
	D55276		D55277		D55278		D55279		D55280		D55281	
	Lower	Upper	Lower	Upper	Lower	Upper	Lower	Upper	Lower	Upper	Lower	Upper
ASCII character string	.	\0	\0	\0	\0	\0	\0	\0	\0	\0	\0	\0

Item	Device No.											
	D55282		D55283		D55284		D55285		D55286		D55287	
	Lower	Upper	Lower	Upper	Lower	Upper	Lower	Upper	Lower	Upper	Lower	Upper
ASCII character string	\0	\0	\0	\0	\0	\0	\0	\0	\0	\0	\0	\0

Item	Device No.											
	D55288		D55289		D55290		D55291		D55292		D55293	
	Lower	Upper	Lower	Upper	Lower	Upper	Lower	Upper	Lower	Upper	Lower	Upper
ASCII character string	\0	\0	\0	\0	\0	\0	\0	\0	\0	\0	\0	\0

Item	Device No.			
	D55294		D55295	
	Lower	Upper	Lower	Upper
ASCII character string	\0	\0	\0	\0

- Device values stored in [Md.3179] Program monitor being executed (2nd line)

Item	Device No.											
	D55296		D55297		D55298		D55299		D55300		D55301	
	Lower	Upper	Lower	Upper	Lower	Upper	Lower	Upper	Lower	Upper	Lower	Upper
ASCII character string	G	9	0	G	9	4	G	1	7	G	0	0

Item	Device No.											
	D55302		D55303		D55304		D55305		D55306		D55307	
	Lower	Upper	Lower	Upper	Lower	Upper	Lower	Upper	Lower	Upper	Lower	Upper
ASCII character string	X	1	0	0	0	.	0	0	0	0	Y	1

Item	Device No.											
	D55308		D55309		D55310		D55311		D55312		D55313	
	Lower	Upper	Lower	Upper	Lower	Upper	Lower	Upper	Lower	Upper	Lower	Upper
ASCII character string	0	0	0	.	0	0	0	0	Z	1	0	0

Item	Device No.											
	D55314		D55315		D55316		D55317		D55318		D55319	
	Lower	Upper	Lower	Upper	Lower	Upper	Lower	Upper	Lower	Upper	Lower	Upper
ASCII character string	0	.	0	0	0	0	C	1	8	0	.	0

Item	Device No.											
	D55320		D55321		D55322		D55323		D55324		D55325	
	Lower	Upper	Lower	Upper	Lower	Upper	Lower	Upper	Lower	Upper	Lower	Upper
ASCII character string	0	0	0	F	1	0	0	0	0	.	0	0

Item	Device No.			
	D55326		D55327	
	Lower	Upper	Lower	Upper
ASCII character string	M	1	0	\0

- Device values stored in [Md.3180] Program monitor being executed (3rd line)

Item	Device No.											
	D55328		D55329		D55330		D55331		D55332		D55333	
	Lower	Upper	Lower	Upper	Lower	Upper	Lower	Upper	Lower	Upper	Lower	Upper
ASCII character string	G	0	4	P	1	\0	\0	\0	\0	\0	\0	\0

Item	Device No.											
	D55334		D55335		D55336		D55337		D55338		D55339	
	Lower	Upper	Lower	Upper	Lower	Upper	Lower	Upper	Lower	Upper	Lower	Upper
ASCII character string	\0	\0	\0	\0	\0	\0	\0	\0	\0	\0	\0	\0

Item	Device No.											
	D55340		D55341		D55342		D55343		D55344		D55345	
	Lower	Upper	Lower	Upper	Lower	Upper	Lower	Upper	Lower	Upper	Lower	Upper
ASCII character string	\0	\0	\0	\0	\0	\0	\0	\0	\0	\0	\0	\0

Item	Device No.											
	D55346		D55347		D55348		D55349		D55350		D55351	
	Lower	Upper	Lower	Upper	Lower	Upper	Lower	Upper	Lower	Upper	Lower	Upper
ASCII character string	\0	\0	\0	\0	\0	\0	\0	\0	\0	\0	\0	\0

Item	Device No.											
	D55352		D55353		D55354		D55355		D55356		D55357	
	Lower	Upper	Lower	Upper	Lower	Upper	Lower	Upper	Lower	Upper	Lower	Upper
ASCII character string	\0	\0	\0	\0	\0	\0	\0	\0	\0	\0	\0	\0

Item	Device No.			
	D55358		D55359	
	Lower	Upper	Lower	Upper
ASCII character string	\0	\0	\0	\0

■ Cautions

- Spaces in a G-code program are not stored because they are deleted when displaying a block.
- Comment lines are not stored.
- When a block is 64 characters or more, up to the 63rd character is stored and the 64th character is "\0".

[Md.3179] Program monitor being executed (2nd line) (D55296+160s to D55327+160s)

Stores one block of the second line from the block being executed (first line) of the G-code program that is running as an ASCII character string.

A maximum of 64 characters (63 characters + \0) are stored in a block.

Refer to "[Md.3178] Program monitor being executed (1st line) (D55264+160s to D55295+160s)" for an example of the program stored. (☞ Page 61 [Md.3178] Program monitor being executed (1st line) (D55264+160s to D55295+160s))

[Md.3180] Program monitor being executed (3rd line) (D55328+160s to D55359+160s)

Stores one block of the third line from the block being executed (first line) of the G-code program that is running as an ASCII character string.

A maximum of 64 characters (63 characters + \0) are stored in a block.

Refer to "[Md.3178] Program monitor being executed (1st line) (D55264+160s to D55295+160s)" for an example of the program stored. ( Page 61 [Md.3178] Program monitor being executed (1st line) (D55264+160s to D55295+160s))

3.10 G-Code Control Axis Status

Device No.		Signal name
MELSEC iQ-R Motion device assignment	Q series Motion compatible device assignment	
D54448, D54449		Line 1 G-code control axis status of axis 1
D54450, D54451		Line 1 G-code control axis status of axis 2
D54452, D54453		Line 1 G-code control axis status of axis 3
D54454, D54455		Line 1 G-code control axis status of axis 4
D54456, D54457		Line 1 G-code control axis status of axis 5
D54458, D54459		Line 1 G-code control axis status of axis 6
D54460, D54461		Line 1 G-code control axis status of axis 7
D54462, D54463		Line 1 G-code control axis status of axis 8
D54464, D54465		Line 2 G-code control axis status of axis 1
D54466, D54467		Line 2 G-code control axis status of axis 2
D54468, D54469		Line 2 G-code control axis status of axis 3
D54470, D54471		Line 2 G-code control axis status of axis 4
D54472, D54473		Line 2 G-code control axis status of axis 5
D54474, D54475		Line 2 G-code control axis status of axis 6
D54476, D54477		Line 2 G-code control axis status of axis 7
D54478, D54479		Line 2 G-code control axis status of axis 8

• Details for each line

Device No.		Symbol	Signal name	Refresh cycle	Fetch cycle	Signal type
MELSEC iQ-R Motion device assignment	Q series Motion compatible device assignment					
D54448.0+2sn		St.3076	Smoothing zero	G-code control operation cycle	—	Status signal
D54448.1+2sn		—	Unusable	—	—	—
D54448.2+2sn						
D54448.3+2sn						
D54448.4+2sn						
D54448.5+2sn						
D54448.6+2sn						
D54448.7+2sn						
D54448.8+2sn						
D54448.9+2sn						
D54448.A+2sn						
D54448.B+2sn						
D54448.C+2sn						
D54448.D+2sn						
D54448.E+2sn						
D54448.F+2sn						
D54449.0+2sn						
D54449.1+2sn						
D54449.2+2sn						
D54449.3+2sn						
D54449.4+2sn						
D54449.5+2sn						
D54449.6+2sn						
D54449.7+2sn						

Device No.		Symbol	Signal name	Refresh cycle	Fetch cycle	Signal type
MELSEC iQ-R Motion device assignment	Q series Motion compatible device assignment					
D54449.8+2sn		—	Unusable	—	—	—
D54449.9+2sn						
D54449.A+2sn						
D54449.B+2sn						
D54449.C+2sn						
D54449.D+2sn						
D54449.E+2sn						
D54449.F+2sn						

[St.3076] Smoothing zero (D54448.0+2sn)

- This signal turns ON when acceleration/deceleration processing ends, and there are no remaining commands.
- This signal turns ON when all output processing for the movement amount commanded by automatic operation, including the delay in acceleration/deceleration, is complete.
- The signal turns OFF while executing the movement command, or when there is a delay in acceleration/deceleration.

Point 

When moving at extremely low speed, "[St.3076] Smoothing zero (D54448.0+2sn)" may turn ON even while moving.

3.11 G-Code Control Axis Monitor Device

Device No.		Signal name
MELSEC iQ-R Motion device assignment	Q series Motion compatible device assignment	
D54752 to D54783		Line 1 G-code control axis monitor device of axis 1
D54784 to D54815		Line 1 G-code control axis monitor device of axis 2
D54816 to D54847		Line 1 G-code control axis monitor device of axis 3
D54848 to D54879		Line 1 G-code control axis monitor device of axis 4
D54880 to D54911		Line 1 G-code control axis monitor device of axis 5
D54912 to D54943		Line 1 G-code control axis monitor device of axis 6
D54944 to D54975		Line 1 G-code control axis monitor device of axis 7
D54976 to D55007		Line 1 G-code control axis monitor device of axis 8
D55008 to D55039		Line 2 G-code control axis monitor device of axis 1
D55040 to D55071		Line 2 G-code control axis monitor device of axis 2
D55072 to D55103		Line 2 G-code control axis monitor device of axis 3
D55104 to D55135		Line 2 G-code control axis monitor device of axis 4
D55136 to D55167		Line 2 G-code control axis monitor device of axis 5
D55168 to D55199		Line 2 G-code control axis monitor device of axis 6
D55200 to D55231		Line 2 G-code control axis monitor device of axis 7
D55232 to D55263		Line 2 G-code control axis monitor device of axis 8

• Details of each line

Device No.		Symbol	Signal name	Refresh cycle	Fetch cycle	Signal type
MELSEC iQ-R Motion device assignment	Q series Motion compatible device assignment					
D54752+32sn		Md.3144	Axis No.	STOP→RUN	—	Monitor device
D54753+32sn		Md.3145	Axis name			
D54754+32sn		Md.3146	Rotating axis setting status			
D54755+32sn		Md.3153	Tandem function enabled information			
D54756+32sn		Md.3154	Local coordinate offset	Transition to G-code control/ G52 instruction execution/G54 to G59 instruction execution		
D54757+32sn						
D54758+32sn		—	Unusable	—	—	—
D54759+32sn						
D54760+32sn						
D54761+32sn						
D54762+32sn						
D54763+32sn						
D54764+32sn						
D54765+32sn						
D54766+32sn						
D54767+32sn						

Device No.		Symbol	Signal name	Refresh cycle	Fetch cycle	Signal type
MELSEC iQ-R Motion device assignment	Q series Motion compatible device assignment					
D54768+32sn		Md.3147	Machine position	Operation cycle	—	Monitor device
D54769+32sn						
D54770+32sn		Md.3148	Machine target position	G-code control operation cycle		
D54771+32sn						
D54772+32sn		Md.3149	Relative position	Operation cycle		
D54773+32sn						
D54774+32sn		Md.3150	Relative target position	G-code control operation cycle		
D54775+32sn						
D54776+32sn		—	Unusable	—	—	—
D54777+32sn						
D54778+32sn		Md.3152	Program target position	G-code control operation cycle	—	Monitor device
D54779+32sn						
D54780+32sn		—	Unusable	—	—	—
D54781+32sn						
D54782+32sn						
D54783+32sn						

Point

- The G-code control device address is stored as a value rounded to four decimal places or less, regardless of the fixed parameter unit setting. The number of decimal places for the device monitor values of "[Md.20] Feed current value (R: D32000+48n, D32001+48n/Q: D0+20n, D1+20n)", and "[Md.101] Real current value (R: D32002+48n, D32003+48n/Q: D2+20n, D3+20n)" differ. Therefore, care must be taken when comparing the address with the monitor value of "[Md.3147] Machine position (D54768+32n, D54769+32n)" established at OFF→ON of "[Rq.3376] G-code control request (D54226.0+2s)".
- When "Rotation axis" is set to G-code control axis parameters, and "shortcut valid" or "shortcut invalid" are set to rotation axis type, the G-code control device address is stored in the range of 0 to 359.9999[degree] regardless of "unit setting" of fixed parameters. The recommended unit setting when using a rotating axis is "degree".

[Md.3144] Axis No. (D54752+32sn)

The axis No. set by [Motion Control Parameter]⇒[G-code Control Parameter]⇒[G-code Control Axis Parameter]⇒"Line Axis Information"⇒"Axis No." is stored.

[Md.3145] Axis name (D54753+32sn)

The number of the axis name set by [Motion Control Parameter]⇒[G-code Control Parameter]⇒[G-code Control Axis Parameter]⇒"Line Axis Information"⇒"Axis Name" is stored.

The following values are stored for each axis name number.

Monitor value	Axis name
0	No setting
1	X
2	Y
3	Z
4	A
5	B
6	C
7	U
8	V
9	W

[Md.3146] Rotating axis setting status (D54754+32sn)

The information set by [Motion Control Parameter]⇒[G-code Control Parameter]⇒[G-code Control Axis Parameter]⇒"Line Axis Information"⇒"Rotation Axis" is stored.

Monitor value	Description
0	Linear axis
1	Rotation axis

[Md.3153] Tandem function enabled information (D54755+32sn)

Stores the master axis No. in tandem function.

Monitor value	Description
0	Tandem function not used (master control axis is 0)
1	Master axis No. when tandem function is used

[Md.3154] Local coordinate offset (D54756+32sn, D54757+32sn)

Stores the setting value of the local coordinate system in the coordinate system currently selected.

[Md.3147] Machine position (D54768+32sn, D54769+32sn)

With "[St.3208] During G-code control (D54440.0+4s)" turned ON, the machine position of the control axis is stored.

The machine position is established by the position of "[Md.20] Feed current value (R: D32000+48n, D32001+48n/Q: D0+20n, D1+20n)" at OFF→ON of "[Rq.3376] G-code control request (D54226.0+2s)".

[Md.3148] Machine target position (D54770+32sn, D54771+32sn)

The end point of the machine position in the block being executed is stored.

[Md.3149] Relative position (D54772+32sn, D54773+32sn)

The current value of work coordinate system selection (G54 to G59) is stored.

Ex.

When 1000. is set to G54

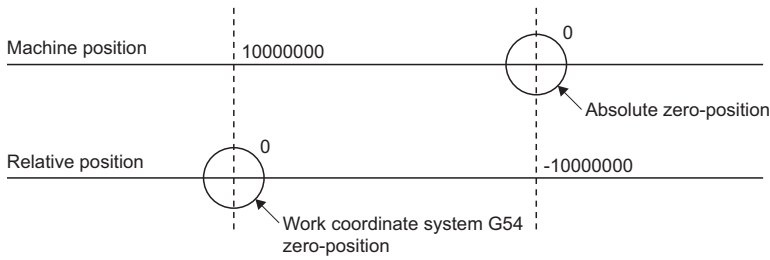

When in the 10000000 machine position, "relative position=0".

The relative position shifts according to the work coordinate system selection (G54 to G59) or the local coordinate system setting (G52).

[Md.3150] Relative target position (D54774+32sn, D54775+32sn)

The end point of the relative position in the block being executed is stored.

[Md.3152] Program target position (D54778+32sn, D54779+32sn)

The end point of the program position in the block being executed is stored.

3.12 Internal Relay (M)/Data Register (D) Availability

The availability of common devices such as internal relays (M) and data registers (D), and devices on each axis during G-code control is shown below.

Internal relays

Common device

○: Available ×: Not available

Device No.		Symbol	Signal name	During G-code control	Remarks
MELSEC iQ-R Motion device assignment	Q series Motion compatible device assignment				
M30000	M2000	Rq.1120	PLC ready flag	○	
M30001 to M30037	—	—	Unusable	—	
M30038	M2038	St.1041	Motion SFC debugging flag	○	
M30039	M2039	—	Unusable	—	
M30040	M2040	Rq.1122	Speed switching point specified flag	×	
M30041	M2041	—	Unusable	—	
M30042	M2042	Rq.1123	All axes servo ON command	×	No servo OFF during G-code control. (G-code control does not end.) When G-code control ends, the command status at that time becomes valid.
M30043 to M30047	M2043 to M2047	—	Unusable	—	
M30048	M2048	Rq.1124	JOG operation simultaneous start command	×	
M30049	M2049	St.1045	All axes servo ON accept flag	○	
M30050	M2050	—	Unusable	—	
M30051	M2051	Rq.1125	Manual pulse generator 1 enable flag	×	
M30052	M2052	Rq.1126	Manual pulse generator 2 enable flag	×	
M30053	M2053	Rq.1127	Manual pulse generator 3 enable flag	×	
M30054	M2054	St.1046	Operation cycle over flag	○	
M30055 to M30079	—	—	Unusable	—	
M30080 to M30143	M2001 to M2032	St.1040	Start accept flag	○	Turns ON at G-code control start. Turns OFF at G-code control end.
M30144 to M30207	M2061 to M2092	St.1047	Speed change accepting flag	×	
M30208 to M30271	M2128 to M2159	St.1048	Automatic decelerating flag	×	Turns OFF at G-code control start.
M30272 to M30335	M2240 to M2271	St.1049	Speed change "0" accepting flag	×	
M30336 to M30399	M2272 to M2303	St.1050	Control loop monitor status	○	
M30400 to M30639	—	—	Unusable	—	

Axis status

○: Available ×: Not available

Device No.		Symbol	Signal name	During G-code control	Remarks
MELSEC iQ-R Motion device assignment	Q series Motion compatible device assignment				
M32400+32n	M2400+20n	St.1060	Positioning start complete	×	Turns OFF at G-code control start.
M32401+32n	M2401+20n	St.1061	Positioning complete	×	
M32402+32n	M2402+20n	St.1062	In-position	○	Updated every operation cycle.
M32403+32n	M2403+20n	St.1063	Command in-position	×	Turns OFF at G-code control start.
M32404+32n	M2404+20n	St.1064	Speed controlling	×	
M32405+32n	M2405+20n	St.1065	Speed/position switching latch	×	
M32406+32n	M2406+20n	St.1066	Zero pass	○	
M32407+32n	M2407+20n	St.1067	Error detection	○	Errors detected by G-code control are not updated. Errors detected by other than G-code control are updated.
M32408+32n	M2408+20n	St.1068	Servo error detection	○	
M32409+32n	M2409+20n	St.1069	Home position return request	○	When turned ON, a minor error (error code: 19A6H) occurs at G-code control request.
M32410+32n	M2410+20n	St.1070	Home position return complete	○	When turned ON, it turns OFF at G-code control start.
M32411+32n	M2411+20n	St.1071	External signals	FLS	○
M32412+32n	M2412+20n	St.1072		RLS	○
M32413+32n	M2413+20n	St.1073		STOP	○
M32414+32n	M2414+20n	St.1074		DOG/CHANGE	○
M32415+32n	M2415+20n	St.1075	Servo ready	○	
M32416+32n	M2416+20n	St.1076	Torque limiting	○	
M32417+32n	M2417+20n	—	Unusable	—	
M32418+32n	M2418+20n				
M32419+32n	M2419+20n	St.1079	M-code outputting	×	
M32420+32n to M32431+32n		—	Unusable	—	

Axis command signals

○: Available ×: Not available

Device No.		Symbol	Signal name	During G-code control	Remarks
MELSEC iQ-R Motion device assignment	Q series Motion compatible device assignment				
M34480+32n	M3200+20n	Rq.1140	Stop command	×	
M34481+32n	M3201+20n	Rq.1141	Rapid stop command	×	
M34482+32n	M3202+20n	Rq.1142	Forward rotation JOG start command	×	
M34483+32n	M3203+20n	Rq.1143	Reverse rotation JOG start command	×	
M34484+32n	M3204+20n	Rq.1144	Complete signal OFF command	×	
M34485+32n	M3205+20n	Rq.1145	Speed/position switching enable command	×	
M34486+32n	M3206+20n	—	Unusable	—	
M34487+32n	M3207+20n	Rq.1147	Error reset command	○	Errors related to G-code control are not reset. Valid at axes with errors occurring by other than G-code control.
M34488+32n	M3208+20n	Rq.1148	Servo error reset command	○	
M34489+32n	M3209+20n	Rq.1149	External stop input disable at start command	×	
M34490+32n	M3210+20n	—	Unusable	—	
M34491+32n	M3211+20n				
M34492+32n	M3212+20n	Rq.1152	Feed current value update command	×	
M34493+32n	M3213+20n	—	Unusable	—	
M34494+32n	M3214+20n				
M34495+32n	M3215+20n	Rq.1155	Servo OFF command	×	No servo OFF during G-code control. (G-code control does not end.) When G-code control ends, the command status at that time becomes valid.
M34496+32n	M3216+20n	Rq.1156	Gain changing command	○	
M34497+32n	M3217+20n	Rq.1157	PI-PID switching command	○	
M34498+32n	M3218+20n	Rq.1158	Control loop changing command	○	
M34499+32n	M3219+20n	Rq.1159	FIN signal	×	
M34500+32n to M34511+32n		—	Unusable	—	

Data registers

Axis monitor devices

○: Available ×: Not available

Device No.		Symbol	Signal name	During G-code control	Remarks
MELSEC iQ-R Motion device assignment	Q series Motion compatible device assignment				
D32000+48n	D0+20n	Md.20	Feed current value	○	Updated every operation cycle.
D32001+48n	D1+20n				
D32002+48n	D2+20n				
D32003+48n	D3+20n	Md.101	Real current value	○	
D32004+48n	D4+20n				
D32005+48n	D5+20n	Md.102	Deviation counter value	○	
D32006+48n	D6+20n				
D32007+48n	D7+20n	Md.1003	Warning code	○	Errors detected by G-code control are not updated. Errors detected by other than G-code control are updated.
		Md.1004	Error code	○	
D32008+48n	D8+20n	Md.1005	Servo error code	○	
D32009+48n	D9+20n	Md.1006	Home position return re-travel value	×	
D32010+48n	D10+20n	Md.34	Travel value after proximity dog ON	×	
D32011+48n	D11+20n				
D32012+48n	D12+20n	Md.1008	Execute program No.	×	Clears at the G-code control start. The G-code program No. being executed is not stored.
D32013+48n	D13+20n	Md.25	M-code	×	
D32014+48n	D14+20n	Md.35	Torque limit value	○	
D32015+48n	D15+20n	Md.1011	Data set pointer for continuous trajectory control	×	
D32016+48n	D16+20n	—	Unusable	—	
D32017+48n	D17+20n				
D32018+48n	D18+20n	Md.1012	Real current value at stop input	×	
D32019+48n	D19+20n				
D32020+48n	#8001+20n	Md.104	Motor current value	○	
D32021+48n	#8017+20n	—	Unusable	—	
D32022+48n	#8002+20n	Md.103	Motor speed	○	
D32023+48n	#8003+20n				
D32024+48n	#8004+20n	Md.28	Command speed	○	
D32025+48n	#8005+20n				
D32026+48n	#8006+20n	Md.100	Home position return re-travel value	×	
D32027+48n	#8007+20n				
D32028+48n	#8008+20n	Md.1019	Servo amplifier display servo error code	○	
D32029+48n	#8009+20n	Md.107	Parameter error No.	○	
D32030+48n	#8000+20n	Md.1014	Servo amplifier type	○	
D32031+48n	#8016+20n	Md.1027	Servo amplifier vendor ID	○	
D32032+48n	#8010+20n	Md.108	Servo status1	○	
D32033+48n	#8011+20n	Md.1022	Servo status2	○	
D32034+48n	#8012+20n	Md.125	Servo status3	○	
D32035+48n	#8013+20n	—	Unusable	—	
D32036+48n	#8014+20n				
D32037+48n	#8015+20n				
D32038+48n	#8018+20n	Md.500	Servo status7	○	

Device No.		Symbol	Signal name	During G-code control	Remarks
MELSEC iQ-R Motion device assignment	Q series Motion compatible device assignment				
D32039+48n	#8019+20n	—	Unusable	—	
D32040+48n to D32047+48n					

4 G-CODE CONTROL PARAMETERS

This chapter describes the parameters used for G-code control.

Refer to the following for R series common parameters, and Motion CPU common parameters.

📖 MELSEC iQ-R Motion Controller Programming Manual (Common)

Refer to the following for Motion control parameters.

📖 MELSEC iQ-R Motion Controller Programming Manual (Positioning Control)

Point













When using G-code control set the following. If the following settings are not made G-code control cannot be performed.

- Set "0.888ms" or more in [Motion CPU Common Parameter]⇒[Basic Setting]⇒"Operation Cycle".
(📖 Page 24 Control Cycle of G-Code Control)
 - According to the lines being used, set "Use Line 1 only" or "Use Line 1 and Line 2" in [Motion CPU Common Parameter]⇒[Basic Setting]⇒"G-code Control Setting"
-

4.1 G-Code Control System Parameter

Parameters for setting the number of axes used on a line etc., for each G-code control line.

 [Motion Control Parameter]⇒[G-code Control Parameter]⇒[G-code Control System Parameter]

No.	Item		Default value	Setting range	Direct setting ^{*1}	Indirect setting ^{*2}		Reference section
					Valid/invalid	Valid/invalid (Required size)	Fetch cycle	
1	Line basic setting	Number of axes on line	1	1 to 8: Axes on line	○	×	—	 Page 79
2	Modal initial setting	Interpolation mode ^{*3}	0	0: Linear interpolation (G01 command status) 1: Positioning (G00 command status)	○	×	—	 Page 79
3		Plane selection ^{*3}	0	0: X-Y plane (G17 command status) 1: X-Y plane (G17 command status) 2: Z-X plane (G18 command status) 3: Y-Z plane (G19 command status)	○	×	—	 Page 79
4		Absolute setting ^{*3}	0	0: Increment setting (G91 command status) 1: Absolute setting (G90 command status)	○	×	—	 Page 79
5	Control setting	G00 Non-interpolation ^{*3}	0	0: Move to the end point in a straight line (Interpolation) 1: Move to the end point of each axis, at the fast-forward speed of each axis. (Non-interpolation)	○	×	—	 Page 79
6		Deceleration check ^{*3}	0000H	H 0 0 <input type="checkbox"/> <input type="checkbox"/> <ul style="list-style-type: none"> → G00 deceleration check method 0: Command deceleration method 1: In-position check method 2: Smoothing check method → G01 deceleration check method 0: Command deceleration method 1: In-position check method 2: Smoothing check method 	○	×	—	 Page 80
7		G1→G1 Deceleration check ^{*3}	1	0: Do not execute deceleration check 1: Execute deceleration check	○	×	—	 Page 80
8		Arc deviation ^{*3}	100(×10 ⁻⁴ [mm])	1 to 1000(×10 ⁻⁴ [mm])	○	×	—	 Page 80
9		Permissible compensation value of arc center deviation ^{*3}	0(×10 ⁻⁴ [mm])	-1000 to 100(×10 ⁻⁴ [mm])	○	×	—	 Page 81
10	Override setting	Automatic corner override ^{*3}	0[%]	0 to 100[%]	○	×	—	 Page 81
11		Automatic corner override maximum angle ^{*3}	0[degree]	0 to 180[degree]	○	×	—	 Page 81
12		Length before automatic corner override corner ^{*3}	0(×10 ⁻⁴ [mm])	0 to 99999999(×10 ⁻⁴ [mm])	○	×	—	 Page 81
13	Fast forward rate override ^{*3}	—	—	×	○ (1 word)	G-code control operation cycle	 Page 81	
14	Cutting feed rate override ^{*3}	—	—	×	○ (1 word)		 Page 81	
15	Override cancel ^{*3}	—	—	×	○ (1 bit)		 Page 81	

No.	Item	Default value	Setting range	Direct setting ^{*1}	Indirect setting ^{*2}		Reference section		
				Valid/invalid	Valid/invalid (Required size)	Fetch cycle			
16	Plane composition	Base axis I ^{*3}	1	0: No setting 1: X 2: Y 3: Z 4: A 5: B 6: C 7: U 8: V 9: W	<input type="radio"/>	×	—	Page 82	
17		Base axis J ^{*3}	2						<input type="radio"/>
18		Base axis K ^{*3}	3						<input type="radio"/>
19	Normal line control	Normal line control axis ^{*3}	0	0: No normal line control 1: X 2: Y 3: Z 4: A 5: B 6: C 7: U 8: V 9: W	<input type="radio"/>	×	—	Page 82	
20		Normal line control type ^{*3}	0	0: Normal line control type I 1: Normal line control type II	<input type="radio"/>	×	—	Page 82	
21		Minimum rotating angle ^{*3}	0	0 to 3600000($\times 10^{-4}$ [degree])	<input type="radio"/>	×	—	Page 82	
22		Normal line control axis rotating speed ^{*3}	2000	1 to 100000[degree/min]	<input type="radio"/>	×	—	Page 82	
23		Minimum rotating movement amount ^{*3}	0	0 to 99999999($\times 10^{-4}$ [mm])	<input type="radio"/>	×	—	Page 83	
24		Normal line control axis rotating radius ^{*3}	0	0 to 99999999($\times 10^{-4}$ [mm])	<input type="radio"/>	×	—	Page 83	
25		Normal line control axis insert radius ^{*3}	0	0 to 99999999($\times 10^{-4}$ [mm])	<input type="radio"/>	×	—	Page 83	
26		Auxiliary function	M binary ^{*3}	0	0: BCD 1: Unsigned binary -1: Signed binary	<input type="radio"/>	×	—	Page 83
27	Polar coordinate interpolation	Polar coordinate interpolation linear axis ^{*3}	0	0: No setting 1: X 2: Y 3: Z 4: A 5: B 6: C 7: U 8: V 9: W	<input type="radio"/>	×	—	Page 83	
28		Polar coordinate interpolation rotating axis ^{*3}	0						<input type="radio"/>

No.	Item	Default value	Setting range	Direct setting ^{*1}	Indirect setting ^{*2}		Reference section		
				Valid/invalid	Valid/invalid (Required size)	Fetch cycle			
29	High-accuracy control	Acceleration/ deceleration before interpolation - maximum speed ^{*3}	2000[mm/min]	1 to 999999[mm/min]	○	×	—	☞ Page 84	
30		Acceleration/ deceleration before interpolation - time constant ^{*3}	100[ms]	1 to 5000[ms]	○	×	—	☞ Page 84	
31		Tolerable acceleration control for each axis ON ^{*3}	0	0: Optimum corner deceleration 1: Tolerable acceleration control for each axis	○	×	—	☞ Page 84	
32		Corner deceleration angle ^{*3}	5[degree]	1 to 89[degree]	○	×	—	☞ Page 84	
33		Corner accuracy coefficient ^{*3}	0[%]	-1000 to 99[%]	○	×	—	☞ Page 84	
34		Curve accuracy coefficient ^{*3}	0[%]	-1000 to 99[%]	○	×	—	☞ Page 84	
35		Arc deceleration speed change ^{*3}	0	0: Do not decelerate 1: Decelerate	○	×	—	☞ Page 84	
36		Arc deceleration speed ^{*3}	1[mm/min]	1 to 999999[mm/min]	○	×	—	☞ Page 85	
37		Macro control	Common variable points for all systems	0	0 to 900: Common variable points for all systems ^{*4}	○	×	—	☞ Page 85
38			Common variable points for each system	0	0 to 900: Common variable points for each system ^{*4}	○	×	—	☞ Page 85
39	Start device No. of common variable for all systems		—	Word device (D, W, #, U3E□\G ^{*5} , U3E□\HG ^{*5}) ^{*6*7*8}	○	×	—	☞ Page 85	
40	Start device No. of common variable for each system		—	Word device (D, W, #, U3E□\G ^{*5} , U3E□\HG ^{*5}) ^{*6*7*8}	○	×	—	☞ Page 85	
41	Start device No. of local variable		—	Word device (D, W, #, U3E□\G ^{*5} , U3E□\HG ^{*5}) ^{*6*7*8}	○	×	—	☞ Page 85	

*1 For direct setting using MT Developer2, use the decimal format instead of the exponential format.

*2 Refer to the following for the range of devices used for indirect setting.

☞ MELSEC iQ-R Motion Controller Programming Manual (Common)

*3 This setting can be omitted.

*4 A combined total of 900 points can be set between common variable points for all systems and common variable points for each system.

*5 Only a device of the self-CPU can be set. If a device of an other CPU is set, a moderate error (error code: 2221H) occurs.

*6 Set an even number for the device No.

*7 Refer to the following for the setting range of the usable devices.

☞ MELSEC iQ-R Motion Controller Programming Manual (Common)

*8 "Module access device (U□\G)" cannot be set for word devices. If "Module access device (U□\G)" is set, a moderate error (error code: 2221H) occurs.

Line basic setting

Number of axes on line

Set the number of G-code control axes to be used on a line.

In G-code control axis parameter, provide settings for the number of axes set here in order from axis No.1.

Ex.

When the number of axes on line 1 is "4"

Axis No.1, No.2, No.3, and No.4 are allocated in order on line 1 of G-code control. Because axis No.1 to No.4 are used, settings for axis No.1 to No.4 must be made in G-code control axis parameter.

Modal initial setting

Interpolation mode

Select the linear command mode at Multiple CPU system power supply ON, or reset.

Plane selection

Select the plane at Multiple CPU system power supply ON, or reset.

When "0" is set, it is the same as if "1: X-Y plane (G17 command status)" has been set.

Absolute setting

Select the absolute setting/incremental setting mode at Multiple CPU system power supply ON, or reset.

Control setting

G00 Non-interpolation

Select the type of operation path of G00.

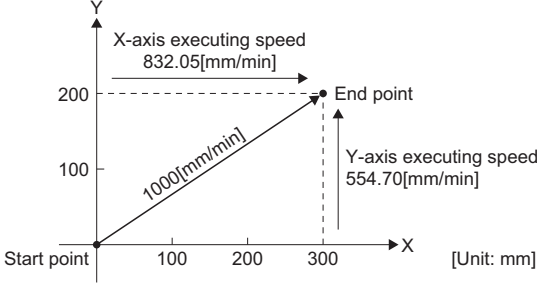
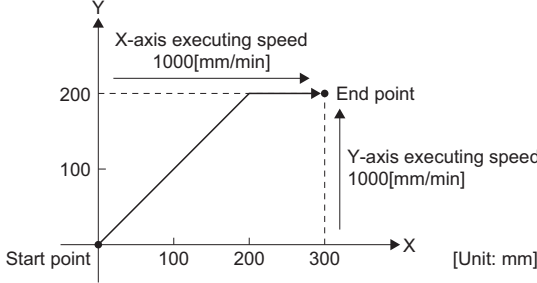
0: Move to the end point in a straight line. (Interpolation type)	1: Move to the end point of each axis, at the fast forward speed of each axis (Non-interpolation type)
<ul style="list-style-type: none"> • Uses the interpolation speed. • The movement path of the tool in positioning is the shortest path connecting the start point and end point. The positioning speed is automatically calculated so that the fastest time distribution is obtained without exceeding the fast forward speed of the commanded speed of each axis. <p>(Example) When the fast forward speed of X-axis and Y-axis are both 1000[mm/min] G91 G00 X300. Y200. ,F1000</p>  <p>[Unit: mm]</p>	<ul style="list-style-type: none"> • Uses the command speed for each axis. • The movement path of the tool in positioning is determined by the fast forward speed of each axis from the start point to the end point. <p>(Example) When the fast forward speed of X-axis and Y-axis are both 1000[mm/min] G91 G00 X300. Y200. ,F1000</p>  <p>[Unit: mm]</p>

Deceleration check

The execution block selects the deceleration check method of fast forward command (G00) and cutting command (G01, G02, G03). There are three deceleration check methods. Set the following values with the fast forward command (G00) and cutting command (G01, G02, G03).

Setting value	Deceleration check method	Description
0	Command deceleration check method	<p>The block is complete when the deceleration check time^{*1} has elapsed after interpolation is completed.</p> <p>*: Arrival at the target position of the position command is not checked.</p>
1	Smoothing check method	<p>The block is complete when the deceleration check time^{*1} elapses after interpolation is completed, and all axes on the line satisfy the following conditions.</p> <ul style="list-style-type: none"> The command position has arrived at the target position. <p>*: Arrival at the target position of the position command is checked.</p>
2	In-position check method	<p>The block is complete when the deceleration check time^{*1} elapses after interpolation ends, and all axes on the line satisfy the following conditions.</p> <ul style="list-style-type: none"> The command position has arrived at the target position. The actual motor position is within the in-position width.

*1 The deceleration check time is calculated automatically from the acceleration/deceleration mode and acceleration/deceleration time constant.

G1->G1 deceleration check

When G1→G1 movement direction is reversed, select whether to execute deceleration check, or not execute deceleration check.

G1->G1 deceleration check	Description
0: Do not execute deceleration check	After interpolation is complete, start movement of the next block without executing deceleration check.
1: Execute deceleration check	After interpolation is complete, start the movement of the next block after executing deceleration check.

Arc deviation

For an arc command, set the permissible deviation range when there is a difference between the end point and center coordinate.

Permissible compensation value of arc center deviation

Set the permissible compensation value for deviation of the center coordinate value of R-specified circular interpolation. When the deviation between "line connecting the start point and end point" and "command radius $\times 2$ " is less than or equal to the permissible value, a correction is made so that the mid point of the line connecting the start point and end point becomes the arc center.

- When setting value <0 : 0 (No compensation of center deviation)
- When setting value $=0$: $2 \times$ minimum setting unit (0.0001)
- When setting value >0 : Set value

Override setting

Automatic corner override

Set the override value of automatic corner override.

Setting "0[%]", or "100[%]" disables automatic corner override.

Automatic corner override maximum angle

Set the maximum angle of the corner for automatic deceleration by automatic corner override.

Setting "0[degree]" or "180[degree]" disables automatic corner override.

Length before automatic corner override corner

Set the position for starting deceleration for the corner of automatic corner override.

Set the distance from the corner to the point where deceleration starts.

Fast forward rate override

Set the device for setting the ratio of fast forward rate override. Override can be applied in 1[%] increments against the fast forward speed.

Set the following value to the specified device.

Setting range

0 to 100[%]

Cutting feed rate override

Set the device for setting the ratio of cutting feed rate override. Override can be applied in 1[%] increments against the feed speed command set in the G-code program.

Set the following value to the specified device.

Setting range

0 to 327[%]

Override cancel

Set the device for cancelling override.

By turning ON the set device, the override applied to the cutting feed rate override in automatic operation becomes "100[%]".

This device is "disabled" for automatic corner override, and fast forward rate override.

Plane composition

Base axis I/Base axis J/Base axis K

Set the axis names of the base axes for which the plane is composed.

Set the axis names set here to [Motion Control Parameter]⇒[G-code Control Parameter]⇒[G-code Control Axis Parameter]⇒"Line Axis Information"⇒"Axis name" also.

When using two axes etc., set "0" to items that are not used (Base axis I, Base axis J, Base axis K).

Normally, by setting X, Y, and Z to "Base axis I", "Base axis J", and "Base axis K", the following relationships are established.

When setting axis names other than the following, set any given axis name.

- G17: X-Y
- G18: Z-X
- G19: Y-Z

When the axis names set to "Base axis I", "Base axis J", and "Base axis K" are the same, or the set axis names have not been set in [Motion Control Parameter]⇒[G-code Control Parameter]⇒[G-code Control Axis Parameter]⇒"Line Axis Information"⇒"Axis name", a moderate error (error code: 30FDH (details code: 0010H)) occurs.

Normal line control

Normal line control axis

Set the axis names of the axes performing normal line control.

When the axes of the specified names have not been set, a moderate error (error code: 30FDH (details code: 0011H)) occurs.

Set the axis name of a rotating axis for normal line control axes. When an axis name of a linear axis is set, a moderate error (error code: 30FDH (details code: 0012H)) occurs.

The axis names of axes set to "Base axis I", "Base axis J", "Base axis K" cannot be set to normal line control axes. When set to normal line control axes, a moderate error (error code: 30FDH (details code: 0012H)) occurs.

Normal line control type

Set the normal line control type.

Normal line control type	Details		
	Rotating direction	Rotating speed for block joint	Rotating speed for circular interpolation
0: Normal line control type I	Direction for which there is less than 180[degree] (shortest way)	Parameter speed setting	The speed at which the program path follows the command speed.
1: Normal line control type II	■At start Direction for which there is less than 180[degree] (shortest way) ■Other than start Command direction	The speed at which the blade of the tool follows the command speed.	

Minimum rotating angle

Set the minimum rotating angle of a normal line control axis at a block joint during normal line control.

Normal line control axis rotating speed

Set the normal line control axis rotating speed of the block joint during normal line control.

Normal line control axis rotating speed is enabled for normal line control type I.

When the value set in normal line control axis rotating speed exceeds the normal line control axis value set in [G-code Control Axis Parameter]⇒"Speed/Time Constant"⇒"Cutting Feed Clamp Speed", a moderate error (error code: 30FDH(details code: 012H)) occurs.

Minimum rotating movement amount

Set the minimum movement amount of the block that performs a rotation operation at the joint directly before, during normal line control.

Normal line control axis rotating radius

Set the length from the center of the normal line control axis to the tip of the tool.
Used to calculate the rotating speed of the block joint, and during circular interpolation.
Normal line control axis rotating radius is enabled for normal line control type II.

Normal line control axis insert radius

Set the radius of the arc to be automatically inserted in the corner during normal line control. Normal line control axis insert radius is enabled for normal line control type I.

Auxiliary function

M binary

Set whether to output auxiliary function (M function) in BCD, or binary (signed or unsigned).

Polar coordinate interpolation

Polar coordinate interpolation linear axis

Set the name of the linear axis performing polar coordinate interpolation.
When the axis of the specified name has not been set, a moderate error (error code: 30FDH (details code:0013H)) occurs.
For polar coordinate interpolation linear axis, set the axis name of the linear axis. When an axis name of a rotating axis is set, a moderate error (error code: 30FDH (details code: 0014H)) occurs.
Set the axis names set to "Base axis I", "Base axis J", and "Base axis K". When the set axis name is not set to "Base axis I", "Base axis J", and "Base axis K", a moderate error (error code: 30FDH (details code: 0014H)) occurs.
Set both the polar coordinate interpolation linear axis and polar coordinate interpolation rotating axis. When only one is set, a moderate error (error code: 30FDH (details code: 0013H)) occurs.

Polar coordinate interpolation rotating axis

Set the name of the rotating axis performing polar coordinate interpolation.
When the axis of the specified name has not been set, a moderate error (error code: 30FDH (details code:0013H)) occurs.
For polar coordinate interpolation rotating axis, set the axis name of the rotating axis. When an axis name of a linear axis is set, a moderate error (error code: 30FDH (details code: 0014H)) occurs.
Set the axis names not set in the following. When the set axis name is set in the following, a moderate error (error code: 30FDH (details code: 0014H)) occurs.

- Base axis I, Base axis J, and Base axis K
- Normal line control axis

Set both the polar coordinate interpolation linear axis and polar coordinate interpolation rotating axis. When only one is set, a moderate error (error code: 30FDH (details code: 0013H)) occurs.

High-accuracy control

Acceleration/deceleration before interpolation - maximum speed

Set the cutting feed speed for acceleration/deceleration before interpolation.

When the value set to G-code control system parameter "Acceleration/deceleration before interpolation - maximum speed" is smaller than the value set to G-code control axis parameter "Cutting feed clamp speed" or G-code control axis parameter "Cutting feed clamp speed for high-accuracy control mode", a moderate error (error code: 30FDH (details code: 0015H)) occurs.

Acceleration/deceleration before interpolation - time constant

Set the cutting feed time constant for acceleration/deceleration before interpolation.

The relationship between the vector speed waveform and "acceleration/deceleration before interpolation - maximum speed" and "Acceleration/deceleration before interpolation - time constant" is shown below.

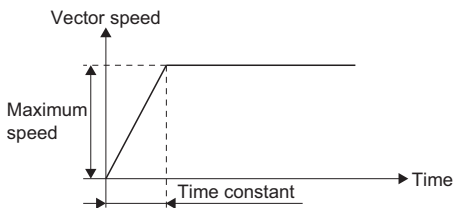

Tolerable acceleration control for each axis ON

Select the calculation method for corner deceleration speed between blocks when high-accuracy control is enabled.

Setting value	Description
0: Optimum corner deceleration	The deceleration speed is calculated using a common tolerable acceleration for all axes determined from the G-code control system parameters "Acceleration/deceleration before interpolation - maximum speed" and "Acceleration/deceleration before interpolation - time constant".
1: Tolerable acceleration control for each axis	The deceleration speed is calculated using the tolerable acceleration for each axis determined from the G-code control axis parameters "Cutting feed for each axis before interpolation - maximum speed" and "Cutting feed for each axis before interpolation - time constant".

Corner deceleration angle

Set the minimum value of the angle (outside angle) to be deemed as a corner.

When the angle (outside angle) between blocks during high-accuracy mode is larger than the setting value, it is deemed as a corner and decelerates in order to produce an edge.

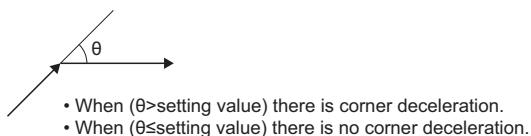

Corner accuracy coefficient

Set the compensation coefficient when making the rounded curve on corners smaller or larger during high-accuracy control mode. In theory, the larger the setting value, the smaller the path deviation. However, because the corner deceleration speed becomes lower, the cycle time increases.

Curve accuracy coefficient

Set the compensation coefficient when making the radius reduction in a curve (arc) smaller or larger during high-accuracy control mode. In theory, the larger the setting value, the smaller the path deviation. However, because the arc clamp speed becomes lower, the cycle time increases.

Arc deceleration speed change

Select whether to decelerate or not decelerate when entering the start and end of an arc during high-accuracy control mode.

Arc deceleration speed

Set the deceleration speed when entering the start and end of an arc.

Macro control

Common variable points for all systems

Set the points for common variables for all systems. When "0" is set, common variables for all systems cannot be used. A combined total of 900 points can be set between common variable points for all systems and common variable points for each system.

Common variable points for each system

Set the points for common variables for each system. When "0" is set, common variables for each system cannot be used. A combined total of 900 points can be set between common variable points for all systems and common variable points for each system.

Start device No. of common variable for all systems

Set the start device No. of common variables for all systems. Devices are assigned in 4-word units for each point of common variable for all systems. The data is 64-bit floating-point type.

Set an even number for the device No.

When the common variable points for all systems is "0", this setting can be omitted.

Refer to the following for the setting range of the usable word devices.

 MELSEC iQ-R Motion Controller Programming Manual (Common)

Start device No. of common variable for each system

Set the start device No. of common variables for each system. Devices are assigned in 4-word units for each point of common variable for each system. The data is 64-bit floating-point type.

Set an even number for the device No.

When the common variable points for each system is "0", this setting can be omitted.

Refer to the following for the setting range of the usable word devices.

 MELSEC iQ-R Motion Controller Programming Manual (Common)

Start device No. of local variable

Set the start device No. of local variables. Devices are assigned in 4-word units for each point of local variable. The data is 64-bit floating-point type.

Set an even number for the device No.

Local variables use up to 33 points from points #1 to #33 for each macro call depth level (0 to 4), so 165 points are used for each system. As such, local variables are assigned in 4-word units for each point, and the number of words each system uses for word devices is fixed to 660.

When local variables are not used in G-code control programs, this setting can be omitted.

Refer to local variables for details of local variables. ( Page 192 Local variables)











Refer to the following for the setting range of the usable word devices.

 MELSEC iQ-R Motion Controller Programming Manual (Common)

4.2 G-Code Control Axis Parameter

Set the parameters for the axis information of each axis on each line for G-code control.

 [Motion Control Parameter]⇒[G-code Control Parameter]⇒[G-code Control Axis Parameter]

No.	Item	Default value	Setting range	Direct setting ^{*1}	Indirect setting		Reference section	
				Valid/invalid	Valid/invalid (Required size)	Fetch cycle		
1	Line axis information	Axis No.	1	0: No setting 1 to 64: Axis No.	○	×	—	 Page 87
2		Axis name	0	0: No setting 1: X 2: Y 3: Z 4: A 5: B 6: C 7: U 8: V 9: W	○	×	—	 Page 87
3		Rotation axis ^{*2}	0	0: Linear axis 1: Rotation axis	○	×	—	 Page 87
4	Stored stroke limit	Software limit -	-99999999(×10 ⁻⁴ [mm])	■When linear axis is set -99999999 to 99999999(×10 ⁻⁴ [mm]) ■When rotation axis is set -99999999 to 99999999(×10 ⁻⁴ [degree])	○	×	—	 Page 88
5		Software limit +	99999999(×10 ⁻⁴ [mm])		○	×	—	
6	Speed/time constant	Fast forward speed	2000[mm/min]	■When linear axis is set 1 to 1000000[mm/min] ■When rotation axis is set 1 to 1000000[degree/min]	○	×	—	 Page 89
7		Cutting feed clamp speed	2000[mm/min]	■When linear axis is set 1 to 1000000[mm/min] ■When rotation axis is set 1 to 1000000[degree/min]	○	×	—	 Page 89
8		G0 time constant (linear)	1000[ms]	1 to 4000[ms]	○	×	—	 Page 89
9		G1 time constant (linear)	1000[ms]	1 to 4000[ms]	○	×	—	 Page 89
10	Rotation axis information	Rotation axis type ^{*2}	0	0: Shortcut invalid 1: Shortcut valid 3: All linear coordinates	○	×	—	 Page 90
11	Tandem function	Master control axis name ^{*2}	0	0: No setting 1: X 2: Y 3: Z 4: A 5: B 6: C 7: U 8: V 9: W	○	×	—	 Page 91

No.	Item	Default value	Setting range	Direct setting ^{*1}	Indirect setting		Reference section	
				Valid/invalid	Valid/invalid (Required size)	Fetch cycle		
12	High-accuracy control	Rapid traverse rate during high-accuracy control mode ^{*2}	0[mm/min]	<ul style="list-style-type: none"> ■Linear axis setting 0 to 1000000[mm/min] ■Rotation axis setting 0 to 1000000[degree/min] 	○	×	—	Page 92
13		Cutting feed clamp speed for high-accuracy control mode ^{*2}	0[mm/min]	<ul style="list-style-type: none"> ■Linear axis setting 0 to 999999[mm/min] ■Rotation axis setting 0 to 999999[degree/min] 	○	×	—	Page 92
14		Cutting feed for each axis before interpolation - maximum speed ^{*2}	0[mm/min]	<ul style="list-style-type: none"> ■Linear axis setting 0 to 999999[mm/min] ■Rotation axis setting 0 to 999999[degree/min] 	○	×	—	Page 92
15		Cutting feed for each axis before interpolation - time constant ^{*2}	0[ms]	0 to 5000[ms]	○	×	—	Page 92
16		Accuracy coefficient for each axis ^{*2}	0[%]	-1000 to 99[%]	○	×	—	Page 92

*1 For direct setting using MT Developer2, use the decimal format instead of the exponential format.

*2 This setting can be omitted.

Line axis information

Axis No.

Set the axis No. to be controlled by G-code control.

Set the axis No. that was set in the servo network setting. Duplicate axis Nos. cannot be set.

When an axis No. not set in the servo network setting or duplicate axis Nos. are set, a moderate error (error code: 30FDH (details code: 0020H)) occurs.

Axis name

Set the name of each axis with the following letters: X, Y, Z, A, B, C, U, V, W.

The same axis name cannot be set more than once in the same line. When the same axis name is set more than once in the same line, a moderate error (error code: 30FDH (details code: 0021H)) occurs. However, the same axis name being set in another line can be set.

Rotation axis

Set whether the axis to be controlled is a linear axis or rotation axis.

When a rotation axis is set, the axis is controlled by a rotation coordinate system.

Rotation axis type is set with "rotation axis type". (Page 90 Rotation axis type)

Depending on the rotation axis type that is set, set the units of the axis set in axis No. to the following units in [Motion Control Parameter]⇒[Axis Setting Parameter]⇒"Fixed Parameter"⇒"Unit Setting". When units other than the following are set, a moderate error (error code: 30FDH (details code: 0022H)) occurs.

Rotation axis	Unit setting
0: Linear axis	mm, pulse
1: Rotation axis	degree, pulse

Stored stroke limit

Software limit -/Software limit +

Set the movement range in the + direction (upper limit value) and - direction (lower limit value) of the stored stroke limit. In the following cases, a moderate error (error code: 30FDH (details code: 0024H)) occurs.

Rotation axis	Rotation axis type	Store stroke limit Valid/invalid	Error conditions
0: Linear axis	—	Valid	(Software limit -) ≥ (Software limit +)
1: Rotation axis	0: Shortcut invalid	Invalid	(Software limit -) != (Software limit +)
	1: Shortcut valid	Invalid	(Software limit -) != (Software limit +)
	3: All linear coordinates	Valid	(Software limit -) ≥ (Software limit +)

The following types of stored stroke limit are available.

■ Stored stroke limit I

Going outside of the set perimeter is prohibited.

The stroke limit is not valid immediately after turning ON the power supply of controlling equipment. Instead, it becomes valid after transition to G-code control. During G-code control, the fixed parameter stroke limit settings become invalid. When transitioning to G-code control, if there is an axis outside of the valid range for machine movement, there is no transition to G-code control, and a minor error (error code: 1FC1H (details code: 0101H)) occurs.

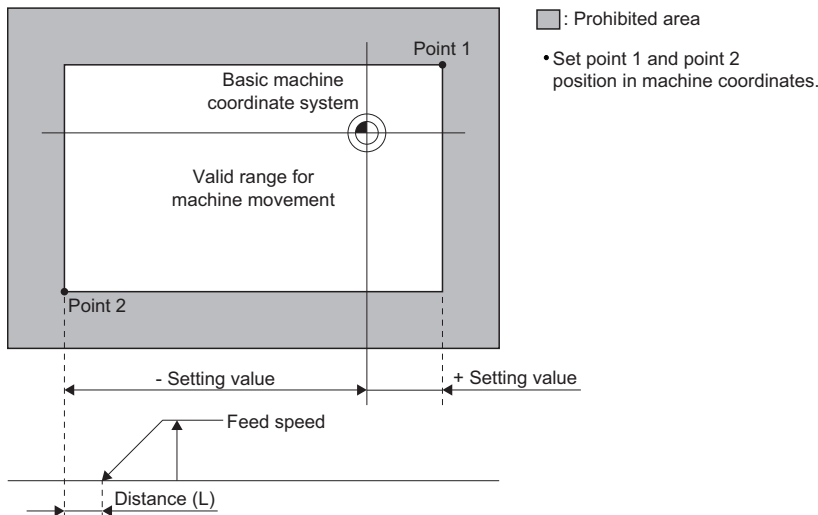

In automatic operation, a minor error (error code: 1FC2H (details code: 0221H)) occurs to avoid going into the prohibited area. When an error occurs on one axis, all axes decelerate to a stop. The stopping position is always before the prohibited area. The distance (L) between the prohibited area and stop position differs according to the feed speed.

Point

Before transition to G-code control, check that there are no problems with the current machine position using "[Md.20] Feed current value (R: D32000+48n, D32001+48n/Q: D0+20n, D1+20n)". When the axis unit setting is [degree], "[Md.20] Feed current value (R: D32000+48n, D32001+48n/Q: D0+20n, D1+20n)" is the rotating range (0 to 359.99999[degree]), but to check the machine position in the linear range (-2147483648 to 2147483647), set the "cumulative current value" data type in the optional data monitor setting. It can then be checked in the set storage device.

Speed/time constant

Fast forward speed

Set the fast forward speed for each axis. Refer to fast forward speed for details. ( Page 218 Fast forward speed)

Cutting feed clamp speed

Set the maximum speed for cutting feed rate on each axis. When the feed rate in G01 is commanding a value that exceeds the cutting feed clamp speed, the speed is clamped at the cutting feed clamp speed that has been set. Refer to cutting feed speed for details. ( Page 219 Cutting feed speed)

G0 time constant (linear)

Set the time constant of linear control in fast forward acceleration/deceleration. Refer to fast forward speed for details.

( Page 218 Fast forward speed)

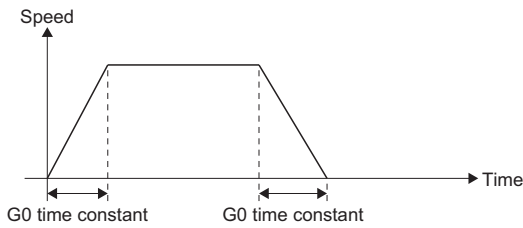

G1 time constant (linear)

Set the time constant of linear control in cutting feed acceleration/deceleration. Refer to cutting feed speed for details.

( Page 219 Cutting feed speed)

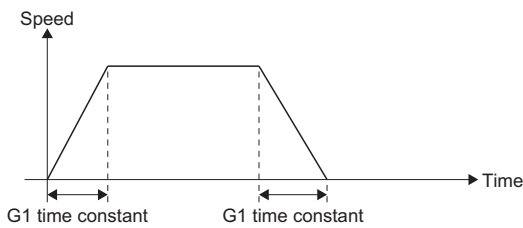

Rotation axis information

Rotation axis type

Set the rotation axis type to rotation (shortcut valid/invalid), or linear.

The setting is valid when rotation axis is set to "1: Rotation axis".

The method of movement differs according to the rotation axis type that is set.

■ Rotation type (0: Shortcut invalid)

- The machine position, work coordinate position, and relative position all have a range of 0 to 359.9999[degree].
- For an absolute value command, the movement follows the sign for the remainder only, after dividing by 360.0000[degree].

Ex.

When the following G-code program is executed with "0: Shortcut invalid"

Operation	Program	[Md.3149] Relative position (D54772+32sn, D54773+32sn)[degree]	[Md.3147] Machine position (D54768+32sn, D54769+32sn)[degree]
(1)	G90 C0.	0.0000	0.0000
(2)	G90 C-270.	90.0000	90.0000
(3)	C405.	45.0000	45.0000
(4)	G91 C180.	225.000	225.000

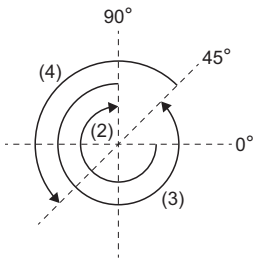

■ Rotation type (1: Shortcut valid)

- The machine position, work coordinate position, and relative position all have a range of 0 to 359.9999[degree].
- For an absolute value command, movement is in the direction with the least movement amount to the end point. However, when movement amounts are the same (180.0000[degree]) in both the positive and negative direction, movement is in the positive direction.

Ex.

When the following G-code program is executed with "1: Shortcut valid"

Operation	Program	[Md.3149] Relative position (D54772+32sn, D54773+32sn)[degree]	[Md.3147] Machine position (D54768+32sn, D54769+32sn)[degree]
(1)	G90 C0.	0.0000	0.0000
(2)	G90 C-270.	90.0000	90.0000
(3)	C405.	45.0000	45.0000
(4)	G91 C180.	225.000	225.000

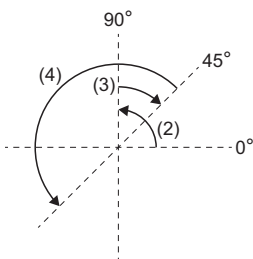

■ Linear type (3: All linear coordinates)

- All linear coordinates have a range of -9999.9999 to 9999.9999[degree].
- Same operation as a linear axis.
- After ending G-code control once and then transitioning to G-code control again, the work coordinate position is set based on the machine coordinate position.

Ex.

When the following G-code program is executed with "3: All linear coordinates"

Operation	Program	[Md.3149] Relative position (D54772+32sn, D54773+32sn)[degree]	[Md.3147] Machine position (D54768+32sn, D54769+32sn)[degree]
(1)	G90 C0.	0.0000	0.0000
(2)	G90 C-270.	-270.0000	-270.0000
(3)	C405.	405.0000	405.0000
(4)	G91 C180.	585.0000	585.0000

- The coordinate position when transitioning to G-code control again, after ending G-code control once.

Work [degree]	Machine position [degree]
585.0000	585.0000

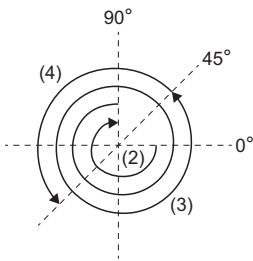

Tandem function

Master control axis name

Set the master control axis name for using tandem function.

In the follow cases, a moderate error (error code: 30FDH (details code: 0023H)) occurs.

- When this setting was used with an axis set to the following G-code control system parameters.
 - Base axis I, Base axis J, Base axis K
 - Normal line control
 - Polar coordinate interpolation linear axis, polar coordinate interpolation rotating axis
- When this setting was used with axes with G-code control axis parameter "axis name" other than "U", "V", "W".
- When the axis of the specified axis name has not been set.
- When the axis of the specified axis name is set as a slave control axis.
- When the axis of the specified axis name and the following parameters do not match.
 - G-code control axis parameter "Rotation axis"
 - G-code control axis parameter "Rotating axis type"

High-accuracy control

Rapid traverse rate during high-accuracy control mode

Set the fast forward speed during high-accuracy control mode for each axis.

When set to "0", the G-code control axis parameter "fast forward speed" is used.

Cutting feed clamp speed for high-accuracy control mode

Set the cutting feed maximum speed during high-accuracy control for each axis.

When set to "0", the G-code control axis parameter "cutting feed clamp speed" is used.

Cutting feed for each axis before interpolation - maximum speed

Set the maximum speed for calculating the tolerable acceleration of each axis when tolerable acceleration control for each axis is enabled.

When set to "0", the G-code control axis parameter "fast forward speed" is used.

Cutting feed for each axis before interpolation - time constant

Set the time constant (the time it takes to reach the maximum speed) for calculating the tolerable acceleration of each axis when tolerable acceleration control for each axis is enabled.

When set to "0", the G-code control axis parameter "G0 time constant (linear)" is used.

Accuracy coefficient for each axis







Set the compensation coefficient for adjusting the path deviation on corners and the clamp speed on each axis during high-accuracy control mode, when tolerable acceleration control for each axis is enabled.

The larger the setting value, the more accurate the edges become. However, because speed is reduced at corners, the cycle time increases.

4.3 G-Code Control Work Parameter

Set the parameters of the tool used for processing in G-code control.

 [Motion Control Parameter]⇒[G-code Control Parameter]⇒[G-code Control Work Parameter]

No.	Item		Default value	Setting range	Direct setting ^{*1}	Indirect setting		Reference section	
					Valid/invalid	Valid/invalid (Required size)	Fetch cycle		
1	Tool radius compensation	Tool radius compensation type ^{*2}	0	0: Type A 1: Type B	<input type="radio"/>	×	—	 Page 93	
2		Interference check ^{*2}	0	0: Interference check alarm 1: Interference check invalid 2: Interference check avoid	<input type="radio"/>	×	—	 Page 93	
3		Select tool radius or diameter compensation ^{*2}	0	0: Radius compensation amount 1: Diameter compensation amount	<input type="radio"/>	×	—	 Page 94	
4	Tool compensation data	Tool radius compensation amount ^{*2}	0($\times 10^{-4}$ [mm])	-99999999 to 99999999($\times 10^{-4}$ [mm])	<input type="radio"/>	×	—	 Page 94	
5		Tool length compensation amount ^{*2}	0($\times 10^{-4}$ [mm])	-99999999 to 99999999($\times 10^{-4}$ [mm])	<input type="radio"/>	×	—	 Page 94	
6	Workpiece coordinate offset	Coordinate offset ^{*2}	X	0	■When linear axis is set -99999999 to 99999999($\times 10^{-4}$ [mm]) ■When rotation axis is set -99999999 to 99999999($\times 10^{-4}$ [degree])	<input type="radio"/>	×	—	 Page 94
7			Y	0		<input type="radio"/>	×	—	
8			Z	0		<input type="radio"/>	×	—	
9			A	0		<input type="radio"/>	×	—	
10			B	0		<input type="radio"/>	×	—	
11			C	0		<input type="radio"/>	×	—	
12			U	0		<input type="radio"/>	×	—	
13			V	0		<input type="radio"/>	×	—	
14	W	0	<input type="radio"/>	×	—				
15	Program coordinate rotation	Coordinate rotation type ^{*2}	0	0: Coordinate rotation type 0 1: Coordinate rotation type 1	<input type="radio"/>	×	—	 Page 94	

*1 For direct setting using MT Developer2, use the decimal format instead of the exponential format.

*2 This setting can be omitted.

Tool radius compensation

Tool radius compensation type

Set the intersection operation processing method at startup and cancel command operations in tool radius compensation.

Tool radius compensation type	Description
0: Type A	Does not perform intersection operation processing for startup and cancel blocks, and performs an offset vector at a right angle to the command.
1: Type B	Performs the intersection operation processing for the command block and the next command block.

Interference check

Set the interference (loss) control to the work caused by the tool radius in tool radius compensation.

Interference check	Description
0: Interference check alarm	An alarm stops operation when it is determined that there will be interference.
1: Interference check invalid	No interference check.
2: Interference check avoid	Change the path so there is no interference.

Select tool radius or diameter compensation

Set tool compensation amount specified by radius or diameter.

Tool compensation data

Tool radius compensation amount

Set the compensation amount for the tool radius.

Up to 40 can be set for both lines.

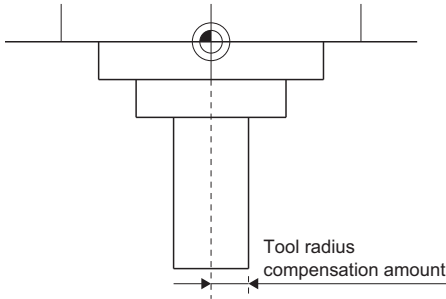

Tool length compensation amount

Set the compensation amount for the tool length.

Up to 40 can be set for both lines.

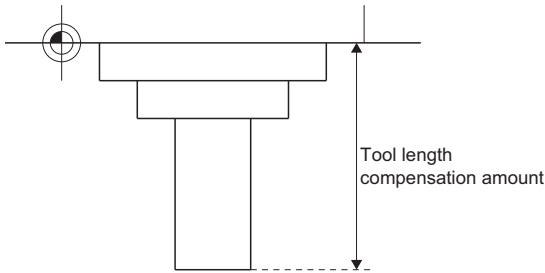

Workpiece coordinate offset

Coordinate offset (X to W)

Set an offset from the machine coordinate system to set the base point of the workpiece to be processed as the home position.

Set the offset amounts for each axis name to No. 1 to 6 of the workpiece coordinate system.

Program coordinate rotation

Coordinate rotation type

Select the start point in the first movement command after a program coordinate rotation command.

Coordinate rotation type	Description
0: Coordinate rotation type 0	The start point does not rotate with the coordinate rotation. The end position is calculated from the current position on the local coordinate system before rotation.
1: Coordinate rotation type 1	The end position is calculated assuming that the start point rotates with the coordinate rotation.

5 G-CODE CONTROL PROGRAMS

5.1 G-Code Control Program Composition

The files of the G-code program are created in text format. One G-code program is created per file. Multiple G-code programs cannot be created in one file.

Refer to the following for the storage destination of G-code program files.

📖 MELSEC iQ-R Motion Controller Programming Manual (Common)

G-code programs are created and written to the Motion CPU by the following methods.

G-code program operations with MT Developer2

Text files created on a personal computer can be written to/read from/verified with/deleted from the Motion CPU using MT Developer2. Refer to the following for details of operation.

📖 Help of MT Developer2

G-code program operations with GOT

G-code programs can be created on GOT and written to/read from the Motion CPU.

Refer to G-code program operation by GOT for details. (📖 Page 283 G-Code Program Operation by GOT)

Operations to the Motion CPU with file transmission via FTP server

Text files created on a personal computer can be written to/read from the Motion CPU using the file transmission via FTP server. Refer to the following for details of the file transmission via FTP server.

📖 MELSEC iQ-R Motion Controller Programming Manual (Common)

G-code program format

The file format of a G-code program is shown below.

Item	Description
File name	O***.gcd* ¹
Extension	.gcd
Line feed code	CRLF(0x0D, 0x0A)
Character code	ASCII code
File size	Up to 512k bytes

*1 ***= Program No. (001 to 256)

G-code program

A G-code program is a collection of units called "blocks" which command a single operation (sequence) of a machine. These blocks describe the actual order in which the tool moves.

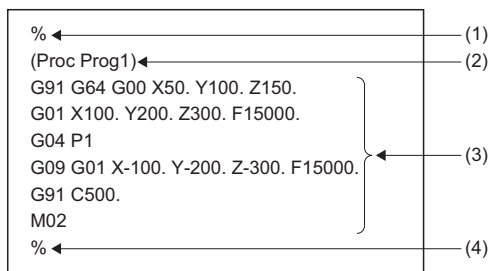

No.	Name	Description
(1)	Program start	End of record (%) is always written on the first line of the G-code program. The lines from end of record (%) to the end of record of program end (%) are read as one program.
(2)	Comment	When control out "(" is at the start of a block, that block is ignored and recognized as a comment. Information such as program names and comments (ASCII code) can be written. Also, for comments that are written on the line following end of record (%) in (1), 15 characters (excluding spaces) of that comment are stored in "[Md.3070] Program comment being executed (D54588+128s to D54595+128s)" while the program is being executed.
(3)	Program block	The program block is required for operation, and is made up of multiple blocks in the order of which control is performed. A line break at the end of the program block is recognized as the end of the block.
(4)	Program end	End of record (%) is always written on the last line of the G-code program. When end of record (%) is not written at the end of a G-code program, a minor error (error code: 1FC3H (details code: 0309H)) occurs.

Point

- Write the program start and program end at the start of the block. When "%" is written at a place other than the start of a block, it is not recognized as program start or program end.
- Write control out "(" at the start of the block. When "(" is written at a place other than the start of a block, it is not recognized as a comment, and a minor error (error code: 1FC3H (details code: 0306H)) occurs when the program is executed.
- When the start of the program block is not a "character from (A to Z)", "#", or "[" a minor error (error code: 1FC0H (details code: 0042H)) occurs. However, when the block is a line break only, that program is ignored and the block No. is not counted.
- Use upper case characters for writing addresses in G-code programs. When lower case letters are used, a minor error (error code: 1FC3H (details code: 0305H)) occurs.

Block

A block is a collection of units called "words" which include instructions for a single operation. A block includes the information required to perform specific operations on a machine, and is a complete command. With a line break, the line feed code is recognized as the end of the block.

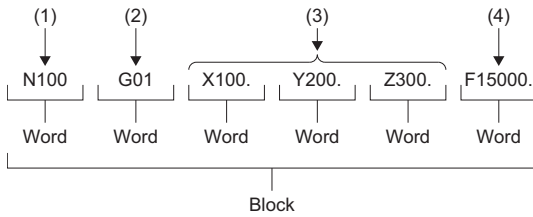

No.	Name	Description
(1)	Sequence No.	Comprises an address N and the numbers (up to 5 digits) that follow it. Used as an index (destination at program branches etc.) for searching for the required block on a program. It has no influence on operation.
(2)	Prepared functions (G-code, G-function)	Comprises an address G and the 2 digits, or 3 digits (includes 2 digit numbers with 1 decimal place) that follow it. G-code is used for specifying functions such as moving an axis and setting a coordinate system.
(3)	Coordinate language	Specifies the coordinate position and movement amount for each axis. Comprises the address that indicates each axis and the values (plus/minus sign and a number) that follow it. The letters X, Y, Z, A, B, C, U, V, W are used for the address.
(4)	Feed function (F-function)	Specifies the relative speed of the tool to the workpiece. Comprises an address F and the numbers that follow it.

■ Cautions

When the same address is written multiple times on the same block, the command of the address written last is valid.

Ex.

When the block "G01 X10. X1. F1000." is written
The valid address for X is X1, thus the X-address is 1[mm].

Word

A word is a collection of instruction code, numbers and symbols in a specific order. A word comprises a letter called an address and numbers (numerical values). The meaning of the numerical values and the valid number of digits differs according to the address.

For numbers, the leading zeros (zeros preceding the actual number) can be omitted.

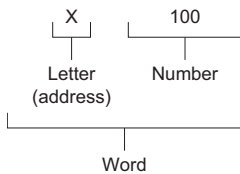

5.2 Fetching G-Code Program Files

The G-code program is stored in the standard ROM on the Motion CPU as a G-code program file. Refer to the following for storage destinations in the standard ROM.

 MELSEC iQ-R Motion Controller Programming Manual (Common)



The timing for fetching files is shown below.

- Multiple CPU system power supply ON
- Multiple CPU system reset
- STOP→RUN

Fetching G-code program file during operation

During G-code program operation, programs can be updated (fetch G-code program file) without stopping the Motion CPU by RUN→STOP. Fetch the program that is transferred to the fetching area during program operation in the Motion CPU.

Fetching G-code program files during operation can be executed using the following methods.

- G-code program operation in MT Developer2. ( Page 95 G-code program operations with MT Developer2)
- GOT program input/output and GOT program editing. ( Page 283 G-Code Program Operation by GOT)
- G-code program transmission by file transmission via FTP server. ( Page 99 Fetching program file during operation using file transmission via FTP server)

Cautions

- In the following cases, G-code program fetch fails. The causes and corrective action are shown below.

Error details and cause	Corrective action
When there was a G-code program fetch request during the operation of the applicable program.	Check that the applicable G-code program is not in operation.
When there is an error in the G-code program file format.	Correct the G-code program file format.
When the G-code program size exceeds the size of the fetching area during program operation.	End G-code control, RUN→STOP, and fetch the G-code program again.
When the specified program No. is outside of the range.	<ul style="list-style-type: none"> • Check "[Cd.3305] Program No. for loading while running (D54264)" • Check the applicable program is stored in the "\$MMTPRJ\$/gcode/prog/temp" folder in the standard ROM.
When program fetch during operation is requested during STOP.	Do not request program fetch during operation during STOP. The program will be fetched at STOP→RUN by storing the program in the folder as usual.
When subprogram or macro program fetch is requested during analysis of a M98 (subprogram call) or a G65 (macro call) block.	Stop the M98 (subprogram call) or the G65 (macro call) block by executing M00 (program stop) or M01 (program stop) at the block before the M98 (subprogram call) or the G65 (macro call).

- While executing program fetch, when the applicable G-code program is started, a minor error (error code: 1FC3H (details code: 031FH)) occurs.

Fetching program file during operation using file transmission via FTP server

The following describes the procedure for fetching program file during operation using the file transmission via FTP server. Refer to the following for details of file transmission via FTP server.

📖 MELSEC iQ-R Motion Controller Programming Manual (Common)

Operating procedure

1. Store the G-code program file in storage folder for the G-code program file (\$MMTPRJ\$/gcode/prog/temp).
2. Set the program No. (1 to 256) of the G-code program to be fetched in "[Cd.3305] Program No. for loading while running (D54264)".
3. Turn ON "[Rq.3344] Program load request while running (D54225.0)".
4. When completed successfully, "2: Successfully completed" is stored in "[Md.3003] Program load status while running (D54492)". When failed "3: Failed" is stored.
5. When fetching program files consecutively, turn OFF "[Rq.3344] Program load request while running (D54225.0)", then repeat steps 2. to 4.

■ Used devices

The following devices are used in the transmission of G-code programs by file transmission via FTP server.

Refer to G-code control dedicated signals for details of the devices. (📖 Page 28 G-CODE CONTROL DEDICATED SIGNALS)

Device No.	Name	Set side
D54225.0	[Rq.3344] Program load request while running	User
D54264	[Cd.3305] Program No. for loading while running	User
D54492*1	[Md.3003] Program load status while running	System/User
D54493*1	[Md.3004] Program load error information while running	System/User

*1 Execute device clears from the user side.

5.3 Pre-read Buffer

Normally, in automatic operation one block is read in advance to facilitate smooth program analyzing. Also, during tool radius compensation, three blocks of movement commands (up to five blocks if there are not three blocks of movement commands) are read in advance in order to calculate the intersection that includes interference check.

The details of pre-read are described below.

- Pre-read saves the data of one block.
- Comments are not loaded to the pre-read buffer.
- The pre-read buffer is cleared by turning ON "[Rq.3380] Reset command (D54226.4+2s)".
- During continuous operation, when "[Rq.3379] Single block (D54226.3+2s)" is turned ON, the pre-read buffer saves the data of the next block and stops.

5.4 Decimal Point Input

In the G-code program input information which defines the path, distance, and speed of the tool, a decimal point that commands the zero point in [mm] units can be input. For commands that do not use a decimal point, the minimum digit is the minimum input command unit.

- Decimal point command is valid for distance, angle, time and speed in the G-code program.
- The command units of position commands, speed commands, and time commands are shown in the chart below according to input method and whether there are arithmetic operations or not.

Input method	Arithmetic operation	Position command	Speed command	Time command
Constant	Invalid	0.0001[mm]	1.00[mm/min]	0.001[s]
	Valid*1	1.0000[mm]	1.00[mm/min]	1.000[s]
Variable	—	1.0000[mm]	1.00[mm/min]	1.000[s]

*1 When arithmetic operators are used, refer to operation commands. ( Page 194 Operation Commands)

- The valid command value range for decimal point commands is shown below. Do not execute commands with G-code programs that exceed the valid command value range.

Command	Valid command value range
Movement command (linear)	-9999.9999 to 9999.9999[mm]
Movement command (rotation)	-9999.9999 to 9999.9999[degree]
Feed speed	0.01 to 1000000.00[mm/min]
Dwell	0 to 99999.999[s]
Rotation angle/radius of R-specified arcs	-99999.9999 to 99999.9999[degree]

- Decimal point commands are also valid as defining commands for the variable data used by subprograms, macro programs, etc.

Decimal point command list

The list for decimal point commands is shown below. A minor error (error code: 1FC3H (details code: 031AH)) occurs for decimal point commands for addresses where decimal point commands are invalid. However, in variable commands all data is treated as having decimal points. When a variable with a decimal point is used at an address where decimal points are invalid, the variable is rounded up/down to the nearest integer.

○: Valid, ×: Invalid

Address	Decimal point command	Application	Remark
A	○	Coordinate position data	
B	○	Coordinate position data	
C	○	Coordinate position data	
D	×	Tool radius compensation No.	
F	○	Cutting feed rate	
	○	Fast forward speed	Specified as ,F
G	○	Prepared function code	
H	×	Tool length compensation No.	
	×	Subprogram call sequence No.	
I	○	Arc center	
	○	Vector component of tool radius compensation	
J	○	Arc center	
	○	Vector component of tool radius compensation	
K	○	Arc center	
	○	Vector component of tool radius compensation	
L	×	Number of subprogram repeats	
	×	Number of macro program repeats	
M	×	Auxiliary function code	
N	×	Sequence No.	
O	×	Program No.	
P	×	Dwell time	
	×	Subprogram call program No.	
	×	Macro program call program No.	
	×	Return destination sequence No.	
R	○	Radius of R-specified arc	
	○	Rotation angle	
U	○	Coordinate position data	
V	○	Coordinate position data	
W	○	Coordinate position data	
X	○	Coordinate position data	
	○	Dwell time	
Y	○	Coordinate position data	
Z	○	Coordinate position data	



- When a decimal point is not used at an address where decimal point commands are valid, the last digit of the command data matches with the command unit.
(Example) When "X1" is specified, the command is equivalent to "X0.0001".
- All of the decimal points in arguments used in macro calls are valid. Refer to macro call (G65) for details.
(Page 156 G65: Macro call)

5.5 Coordinate System

This section describes the coordinate systems.

The coordinate home position symbols that indicate the coordinate systems are shown below.

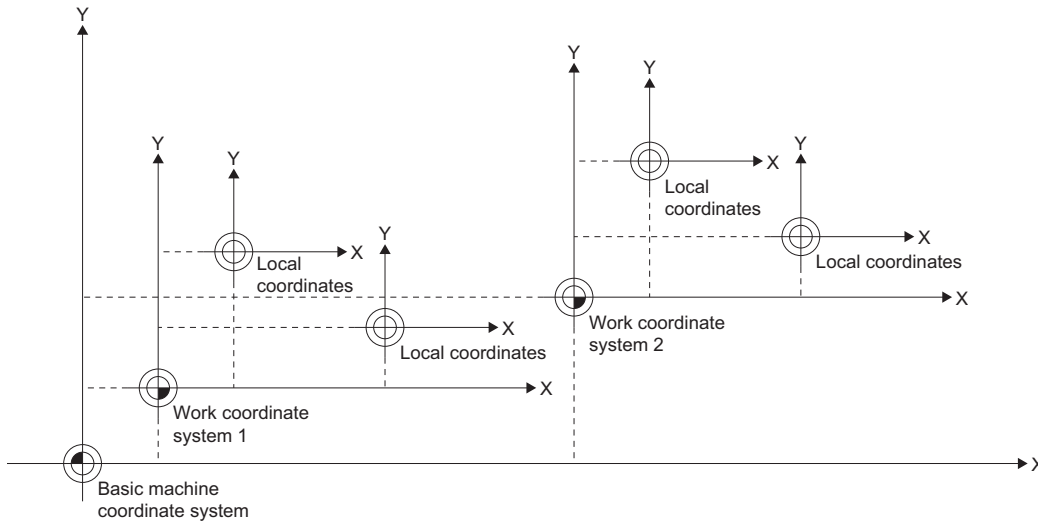

Coordinate home position symbol	Name	Description
	Machine coordinate home position	Position specifically determined by the machine
	Work coordinate home position	Home position of the coordinate system used for processing work
	Local coordinate home position	Home position of the coordinate system when the work coordinate system is temporarily changed.

Basic machine coordinate system

This is a coordinate system specific to the machine, and is used to indicate positions specifically determined by the machine (tool exchange position, stroke end position etc.).

The tool is moved to the command position on the machine coordinate system by the G53 command and the coordinate command that follows.

Only the G53 command and coordinate commands in the same block are commands to the machine coordinate system.

Work coordinate system

The work coordinate system is used when creating a G-code program and sets the base point on the work as the coordinate home position. The work coordinate system specifies positions with an offset amount from the basic machine coordinate system. The set offset amount is the distance from the machine coordinate system home position (0). Up to six work coordinate systems (work coordinate 1 to 6) can be set. They are set in the G-code control work parameter "Workpiece coordinate offset", or work coordinate system 1 selection (G54) to work coordinate system 6 selection (G59).

Local coordinate system

This coordinate system is for specifying a coordinate system within the work coordinate system currently selected. With this, the work coordinate system can be temporarily changed. Local coordinate systems can be independently specified on each work coordinate system, for work coordinate system 1 to 6 (G54 to G59).

The home position of a local coordinate system is commanded by the distance from the home position of the specified work coordinate system.

When in incremental value mode, the local coordinate home position is the position with the specified local coordinate offset amount added to it.

When a work coordinate system has not been specified, the local coordinate system is created on the work coordinate system currently selected.

Automatic coordinate system setting

When transitioning to G-code control, the basic machine coordinate system, and work coordinate system are automatically set according to parameters set beforehand.

The coordinate systems created by automatic coordinate system setting are as follows.

- Basic machine coordinate system
- Work coordinate system (G54 to G59)
- Local coordinate systems (G52) that are created under the work coordinate system (G54 to G59)

Parameters related to coordinates are all set by the distance from the home position of basic machine coordinate system.

When automatic coordinate system setting is executed, local coordinate system setting by G52 command is cancelled.

Coordinate system for rotation axes

Axes with the G-code control axis parameter "Rotation axis" set to "1: Rotation axis" are controlled with the coordinate system for rotation axes.

The types of rotation axes are rotation type (shortcut valid/invalid), and linear type. Set each axis type in [Motion Control Parameter]⇒[G-code Control Parameter]⇒[G-code Control Axis Parameter]⇒"Rotation Axis Information"⇒"Rotation Axis Type".

The machine position and relative position differs according to the parameter.

Rotation axes are commanded in [degree] units.

When restricting the movement range, set the G-code control axis parameter "Rotation axis type" to "3: All linear coordinates", and set the stored stroke limit. When not restricting the movement range, set the G-code control axis parameter "Rotation axis type" to "0: Shortcut invalid" or "1: Shortcut valid", and set the stored stroke limit upper value and lower value to the same value. Refer to stored stroke limit for details of stored stroke limit. (☞ Page 88 Stored stroke limit)

	Rotation axis			Linear axis
	Rotation axis type		Linear type	
	Shortcut invalid	Shortcut valid	All linear coordinates	
Work coordinate position	0 to 359.9999[degree]		-9999.9999 to 9999.9999 [degree]	-9999.9999 to 9999.9999[mm]
Machine position/Relative position	0 to 359.9999[degree]		-9999.9999 to 9999.9999 [degree]	-9999.9999 to 9999.9999[mm]
ABS command	Moves in direction of the sign for the remainder of the movement amount of the end point minus the current position divided by 360[degree].	Moves the shortest way to the end point.	Same as a normal linear axis. Moves in the direction of the sign for the movement amount of the end point minus the current position without rounding to 360[degree].	
INC command	Moves in the direction of the sign for the incremental amount commanded with the current position as the origin.			
Stored stroke limit setting range	Set the upper limit value and lower limit value to the same value.		-9999.9999 to 9999.9999 [degree]	-9999.9999 to 9999.9999[mm]

5.6 G-Code

G-code is commands that specify the operation modes in each block of the program.

G-code list

The G-code used in G-code programs are listed below.

G-code	Group	Description	Reference
G00 ^{*1}	01	Positioning (fast forward)	☞ Page 108 G00: Positioning (Fast forward)
G01 ^{*1}		Linear interpolation	☞ Page 109 G01: Linear interpolation
G02		Circular interpolation CW (center specified)	☞ Page 110 G02: Circular interpolation CW (center specified)
		Circular interpolation CW (R-specified)	☞ Page 114 G02: Circular interpolation CW (R-specified)
G03		Circular interpolation CCW (center specified)	☞ Page 112 G03: Circular interpolation CCW (center specified)
		Circular interpolation CCW (R-specified)	☞ Page 116 G03: Circular interpolation CCW (R-specified)
G04	00	Dwell (time specified)	☞ Page 118 G04: Dwell (time specified)
G09		Exact stop check	☞ Page 119 G09: Exact stop check
G12.1	21	Polar coordinate interpolation mode start	☞ Page 120 G12.1: Polar coordinate interpolation mode start
G13.1 ^{*2}		Polar coordinate interpolation mode cancel	☞ Page 125 G13.1: Polar coordinate interpolation mode cancel
G17 ^{*1}	02	Plane selection X-Y	☞ Page 126 G17 to G19: Plane selection
G18 ^{*1}		Plane selection Z-X	
G19 ^{*1}		Plane selection Y-Z	
G38	00	Tool radius compensation vector setting	☞ Page 127 G38: Tool radius compensation vector setting
G39		Tool radius compensation corner arc	☞ Page 129 G39: Tool radius compensation corner arc
G40 ^{*2}	07	Tool radius compensation cancel	☞ Page 131 G40: Tool radius compensation cancel
G41		Tool radius compensation left	☞ Page 132 G41: Tool radius compensation - Left
G42		Tool radius compensation right	☞ Page 133 G42: Tool radius compensation - Right
G40.1 ^{*2}	15	Normal line control cancel	☞ Page 134 G40.1: Normal line control cancel
G41.1		Normal line control left	☞ Page 135 G41.1: Normal line control - Left ON
G42.1		Normal line control right	☞ Page 136 G42.1: Normal line control - Right ON
G43	08	Tool length compensation (+)	☞ Page 137 G43: Tool length compensation (+)
G44		Tool length compensation (-)	☞ Page 139 G44: Tool length compensation (-)
G49 ^{*2}		Tool length compensation cancel	☞ Page 141 G49: Tool length compensation cancel
G52	00	Local coordinate system setting	☞ Page 142 G52: Local coordinate system setting
G53		Basic machine coordinate system selection	☞ Page 146 G53: Basic machine coordinate system selection
G54 ^{*2}	12	Work coordinate system 1 selection	☞ Page 147 G54 to G59: Work coordinate system 1 selection to work coordinate system 6 selection
G55		Work coordinate system 2 selection	
G56		Work coordinate system 3 selection	
G57		Work coordinate system 4 selection	
G58		Work coordinate system 5 selection	
G59		Work coordinate system 6 selection	
G61	13	Exact stop check mode	☞ Page 150 G61: Exact stop check mode
G61.1		High-accuracy control mode	☞ Page 151 G61.1: High-accuracy control mode
G62		Automatic corner override	☞ Page 152 G62: Automatic corner override
G64 ^{*2}		Cutting mode	☞ Page 155 G64: Cutting mode
G65	00	Macro call	☞ Page 156 G65: Macro call
G68	16	Program coordinate rotation mode start	☞ Page 162 G68: Program coordinate rotation mode start
G69 ^{*2}		Program coordinate rotation mode cancel	☞ Page 169 G69: Program coordinate rotation mode cancel
G90 ^{*1}	03	Absolute value command	☞ Page 170 G90: Absolute value command
G91 ^{*1}		Incremental value command	☞ Page 172 G91: Incremental value command
G94 ^{*1}	05	Feed per minute (Non-synchronized feedrate)	☞ Page 174 G94: Feed per minute (non-synchronized feed)

*1 Indicates code that is to be selected, or has been selected by parameters in their initial state.

*2 Indicates code that is to be selected, or has been selected in their initial state.

- When two or more G-code of the same group are commanded, the last G-code is valid.
- When G-code control request is cancelled or reset is input, modal is initialized.

Modal/Unmodal

In G-code, there are modal commands and unmodal commands.

Classification	Group	Description
Modal G-code	01, 02, 03, 05, 07, 08, 12, 13, 15, 16, 21	One of the G-code commands in the group is always specified as the operation mode. The operation mode continues until another G-code from the group is commanded, or a cancel command is made.
Unmodal G-code	00	The command operation mode is only valid for the block where it was commanded. The command is invalid for the next block.

G-code priority

The operation for when G commands are combined (when commanded in the same block, or when commanded in each modal) is shown below.

Commanded in the same block

○: Both commands are executed simultaneously, △: The last command is valid, ×: Command not possible

Group	G-code	Group										
		01	02	03	07	08	12	13	15	16	21	
00	G04	○ ^{*1}	○	○	× ^{*2}	× ^{*2}	○ ^{*1}	○	○ ^{*1}	○ ^{*2}	× ^{*3}	
	G09	○	○	○	○	○	○	○	○	○	× ^{*3}	
	G38	○ ^{*4}	× ^{*5}	○	○	○	○	○	○	○	× ^{*3}	
	G39	○	× ^{*5}	○	○	○	○	○	○	○	× ^{*3}	
	G52	○	○	○	× ^{*2}	× ^{*2}	○	○	○	○ ^{*2}	× ^{*3}	
	G53	○ ^{*6}	○	○	× ^{*2}	× ^{*2}	○	○	○	○ ^{*2}	× ^{*3}	
	G65	○ ^{*7}	○ ^{*7}	○ ^{*7}	○ ^{*7}	○ ^{*7}	○ ^{*7}	○ ^{*7}	○ ^{*7}	○ ^{*7}	○ ^{*7}	
01	G00	△	○	○	○	○	○	○	× ^{*8}	○	× ^{*3}	
	G01	△	○	○	○	○	○	○	○	○	× ^{*3}	
	G02	△	○	○	× ^{*9}	○	○	○	○	○	× ^{*3}	
	G03	△	○	○	× ^{*9}	○	○	○	○	○	× ^{*3}	
02	G17	○	△	○	○	○	○	○	○	○ ^{*10}	× ^{*3}	
	G18	○	△	○	○	○	○	○	○	○ ^{*10}	× ^{*3}	
	G19	○	△	○	○	○	○	○	○	○ ^{*10}	× ^{*3}	
03	G90	○	○	○	○	○	○	○	○	○	× ^{*3}	
	G91	○	○	○	○	○	○	○	○	○ ^{*11}	× ^{*3}	
05	G94	○	○	○	○	○	○	○	○	○	× ^{*3}	
07	G40	○ ^{*9}	○	○	△	○	○	○	○	○	× ^{*12}	
	G41	○ ^{*9}	○	○	△	○	○	○	○	○	× ^{*12}	
	G42	○ ^{*9}	○	○	△	○	○	○	○	○	× ^{*12}	
08	G43	○	○	○	○	△	○	○	○	○	× ^{*3}	
	G44	○	○	○	○	△	○	○	○	○	× ^{*3}	
	G49	○	○	○	○	△	○	○	○	○	× ^{*3}	
12	G54	○	○	○	○	○	△	○	○	○	× ^{*3}	
	G55	○	○	○	○	○	△	○	○	○	× ^{*3}	
	G56	○	○	○	○	○	△	○	○	○	× ^{*3}	
	G57	○	○	○	○	○	△	○	○	○	× ^{*3}	
	G58	○	○	○	○	○	△	○	○	○	× ^{*3}	
	G59	○	○	○	○	○	△	○	○	○	× ^{*3}	

Group	G-code	Group									
		01	02	03	07	08	12	13	15	16	21
13	G61	○	○	○	○	○	○	△	○	○	× ^{*3}
	G62	○	○	○	○	○	○	△	○	○	× ^{*3}
	G64	○	○	○	○	○	○	△	○	○	× ^{*3}
15	G40.1	○ ^{*13}	○	○	○	○	○	○	△	○	× ^{*12}
	G41.1	○ ^{*13}	○	○	○	○	○	○	△	○	× ^{*12}
	G42.1	○ ^{*13}	○	○	○	○	○	○	△	○	× ^{*12}
16	G68	○	○	○	○	○	○	○	○	△	× ^{*3}
	G69	○	× ^{*14}	○	○	○	○	○	○	△	× ^{*3}
21	G12.1	× ^{*3}	× ^{*3}	× ^{*3}	× ^{*12}	× ^{*3}	× ^{*3}	× ^{*3}	× ^{*3}	× ^{*15}	△
	G13.1	× ^{*3}	× ^{*3}	× ^{*3}	× ^{*12}	× ^{*3}	× ^{*3}	× ^{*3}	× ^{*3}	× ^{*15}	△

- *1 Modal is updated and G04 is executed.
- *2 A minor error (error code: 1FC3H (details code: 030FH)) occurs.
- *3 A minor error (error code: 1FC3H (details code: 0306H)) occurs.
- *4 A minor error (error code: 1FC3H (details code: 0306H)) occurs when the arc and G38 are commanded.
- *5 A minor error (error code: 1FC3H (details code: 0316H)) occurs.
- *6 The arc operates as a straight line.
- *7 Modal is updated and G65 is executed.
- *8 No rotating operation in G00 (non-interpolation).
- *9 A minor error (error code: 1FC3H (details code: 0315H)) occurs when the arc and G40, G41, and G42 are commanded.
- *10 A minor error (error code: 1FC3H (details code: 0326H)) occurs when G69 is commanded.
- *11 A minor error (error code: 1FC3H (details code: 0327H)) occurs when the movement command immediately after the command is G91.
- *12 A minor error (error code: 1FC3H (details code: 0306H or 0324H)) occurs.
- *13 Does not start in G00 (non-interpolation).
- *14 A minor error (error code: 1FC3H (details code: 0326H)) occurs during program coordinate rotation mode.
- *15 A minor error (error code: 1FC3H (details code: 0324H)) occurs when G68 is commanded, and a minor error (error code: 1FC3H (details code: 0306H)) occurs when G69 is commanded.

Commanded in each modal

○: Both commands are executed simultaneously, △: The last command is valid, ×: Command not possible

Group	G-code	Group in modal									
		01	02	03	07	08	12	13	15	16	21
00	G04	○	○	○	○	○	○	○	○	○	○
	G09	○	○	○	○	○	○	○	○	○	○
	G38	○ ^{*1}	× ^{*2}	○	○	○	○	○	○	○	○
	G39	○	× ^{*2}	○	○	○	○	○	○	○	○
	G52	○	○	○	○	○	○	○	× ^{*3}	○	× ^{*4}
	G53	○ ^{*5}	○	○	○	○	○	○	○	○	× ^{*4}
	G65	○	○	○	○	○	○	○	○	○	○
01	G00	○	○	○	○	○	○	○	× ^{*6}	○	○
	G01	○	○	○	○	○	○	○	○	○	○
	G02	○	○	○	○	○ ^{*7}	○	○	○	○	○
	G03	○	○	○	○	○ ^{*7}	○	○	○	○	○
02	G17	○	○	○	× ^{*2}	○	○	○	× ^{*8}	○ ^{*9}	× ^{*4}
	G18	○	○	○	× ^{*2}	○	○	○	× ^{*8}	○ ^{*9}	× ^{*4}
	G19	○	○	○	× ^{*2}	○	○	○	× ^{*8}	○ ^{*9}	× ^{*4}
03	G90	○	○	○	○	○	○	○	○	○	○
	G91	○	○	○	○	○	○	○	○	○ ^{*10}	○
05	G94	○	○	○	○	○	○	○	○	○	○
07	G40	○ ^{*11}	○	○	○	○	○	○	○	○	○
	G41	○ ^{*11}	○	○	○	○	○	○	○	○	○
	G42	○ ^{*11}	○	○	○	○	○	○	○	○	○
08	G43	○	○	○	○	○	○	○	○	○	× ^{*4}
	G44	○	○	○	○	○	○	○	○	○	× ^{*4}
	G49	○	○	○	○	○	○	○	○	○	× ^{*4}

Group	G-code	Group in modal												
		01	02	03	07	08	12	13	15	16	21			
12	G54	○	○	○	○	○	○	○	○	× ^{*3}	○	× ^{*4}		
	G55	○	○	○	○	○	○	○	○	× ^{*3}	○	× ^{*4}		
	G56	○	○	○	○	○	○	○	○	× ^{*3}	○	× ^{*4}		
	G57	○	○	○	○	○	○	○	○	× ^{*3}	○	× ^{*4}		
	G58	○	○	○	○	○	○	○	○	× ^{*3}	○	× ^{*4}		
	G59	○	○	○	○	○	○	○	○	× ^{*3}	○	× ^{*4}		
13	G61	○	○	○	○	○	○	○	○	○	○	○		
	G61.1	○	○	○	○	○	○	○	○	○	○	× ^{*4*12}		
	G62	○	○	○	○	○	○	○	○	○	○	× ^{*4}		
	G64	○	○	○	○	○	○	○	○	○	○	○		
15	G40.1	○ ^{*6}	○	○	○	○	○	× ^{*3}	○	○	○	○	× ^{*4}	
	G41.1	○ ^{*6}	○	○	○	○	○	× ^{*3}	○	○	○	○	× ^{*4}	
	G42.1	○ ^{*6}	○	○	○	○	○	× ^{*3}	○	○	○	○	× ^{*4}	
16	G68	○	○	○	○	○	○	○	○	○	○	○	× ^{*4}	
	G69	○	○	○	○	○	○	○	○	○	○	○	○	
21	G12.1	○	○	○	○	× ^{*13}	○	○	○	○ ^{*12*14}	× ^{*13}	× ^{*13}	○	× ^{*4}
	G13.1	○	○	○	○	× ^{*13}	○	○	○	○ ^{*12*14}	× ^{*13}	× ^{*13}	○	○

*1 A minor error (error code: 1FC3H (details code: 0306H)) occurs with the arc and G38.

*2 A minor error (error code: 1FC3H (details code: 0316H)) occurs.

*3 A minor error (error code: 1FC3H (details code: 0304H)) occurs.

*4 A minor error (error code: 1FC3H (details code: 0322H)) occurs.

*5 The arc operates as a straight line.

*6 No rotating operation in G00 (non-interpolation).

*7 The operation of G49 during the arc modal is performed by G01.

*8 A minor error (error code: 1FC3H (details code: 031CH)) occurs.

*9 A minor error (error code: 1FC3H (details code: 0326H)) occurs when G68 is commanded.

*10 A minor error (error code: 1FC3H (details code: 0327H)) occurs when the movement command immediately after the command is G91.

*11 A minor error (error code: 1FC3H (details code: 0315H)) occurs with G40, G41, and G42 during circular interpolation.

*12 For G61.1, set the G-code control system parameter "Tolerable acceleration control for each axis ON" to "1: Tolerable acceleration control for each axis".

*13 A minor error (error code: 1FC3H (details code: 0324H)) occurs.

*14 A minor error (error code: 1FC3H (details code: 0324H)) occurs when commanded during G62.

G00: Positioning (Fast forward)

Performs high-speed positioning to the commanded end point with the current point as the starting point.

Code	Format
G00	$G00 _X _x _Y _y _Z _z _ \square _ \square _, F _ f$

Processing details

- The G00 command is modal. It remains in effect until another G-code from the same group is used. When G00 is continuous, from the next block and after, it can only be commanded by coordinate language.
- ",F" command is only valid in the block specified. When an ",F" command is in the same block as G00 command, positioning is performed at the ",F" command speed. When there is no ",F" command, positioning is performed at the speed set in [Motion Control Parameter]⇒[G-code Control Parameter]⇒[G-code Control Axis Parameter]⇒"Speed/Time Constant"⇒"Fast Forward Speed".
- When there is no ",F" command during high-accuracy control mode, positioning is performed at the speed set in [Motion Control Parameter]⇒[G-code Control Parameter]⇒[G-code Control Axis Parameter]⇒"High-accuracy control"⇒"Rapid traverse rate during high-accuracy control mode". However, when the setting value of rapid traverse rate during high-accuracy control mode is "0", positioning is performed at the speed set in [Motion Control Parameter]⇒[G-code Control Parameter]⇒[G-code Control Axis Parameter]⇒"Speed/Time Constant"⇒"Fast Forward Speed".
- The setting of the movement path (linear, or non-linear) to the specified coordinate axis position is made in [Motion Control Parameter]⇒[G-code Control Parameter]⇒[G-code Control System Parameter]⇒"Control Setting"⇒"G00 Non-Interpolation". The positioning time of linear path and non-linear path are the same.
- In a G00 command, acceleration and deceleration are always performed at the start point and end point. A deceleration check is performed at the end point, and all moving axes in each line are checked for completion before moving to the next block.
- There are three methods for deceleration check. They are command deceleration check method, smoothing check method, and in-position check method. Set the deceleration check method to be used in fast forward/cutting in [Motion Control Parameter]⇒[G-code Control Parameter]⇒[G-code Control System Parameter]⇒"Control Setting"⇒"Deceleration Check". Refer to deceleration check for deceleration check. (Page 223 Deceleration check)

Program example

■ Positioning program for P0→P1→P2→P3→P4→P5 (absolute value command)

Operation	Program	Remarks
(1)	G00 X100. Y100.	Moving by G00
(2)	X200.	
(3)	Y200.	
(4)	G01 Y300. F100.	Moving by G01
(5)	X300.	

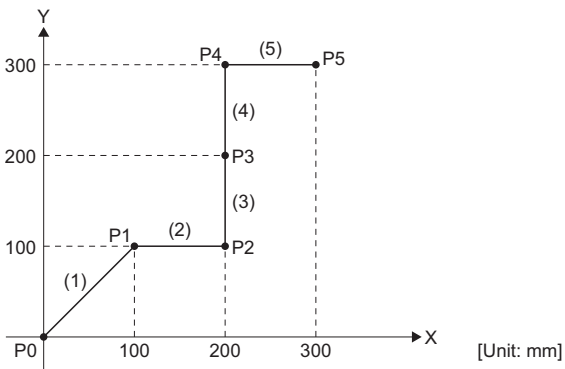

G01: Linear interpolation

Performs linear interpolation to the commanded end point from the current position at the commanded speed. The commanded feed speed is specified as the linear speed (composite speed) for the direction of movement.

Code	Format
G01	$G01 _X \ x \ _Y \ y \ _Z \ z \ _ \square \ \square \ _F \ f$ <div style="margin-left: 200px;"> Feed speed Coordinate commands *: \square is an additional axis </div>

Processing details

- The G01 command is modal. It remains in effect until another G-code from the same group is used. When G01 is continuous, from the next block and after, it can only be commanded by coordinate language.
- When an F command is not set in the first G01 command, a minor error (error code: 1FC3H (details code: 0311H)) occurs.
- The feed speed of the rotating axis is commanded as [degree/min](unit of the decimal point position). (F300=300[degree/min])
- When performing G01 command continuously, deceleration check is not performed. For the G01 command, deceleration check is valid in the following cases.
 - When G09 (exact stop check) is commanded in the same block.
 - When G61 (exact stop check mode) is selected.
- There are three methods for deceleration check. They are command deceleration check method, smoothing check method, and in-position check method. Set the deceleration check method to be used in fast forward/cutting in [Motion Control Parameter]⇒[G-code Control Parameter]⇒[G-code Control System Parameter]⇒"Control Setting"⇒"Deceleration Check". Refer to deceleration check for deceleration check. (☞ Page 223 Deceleration check)

Program example

■ Positioning program for P0→P1→P2→P3→P4→P1 (incremental value command)

Operation	Program	Remarks
(1)	G91 G00 X20. Y20.	Moving by G00 (tool positioning)
(2)	G01 X20. Y30. F300.	Moving by G01 (Moving at feed speed of 300[mm/min])
(3)	X30.	
(4)	X-20. Y-30.	
(5)	X-30.	

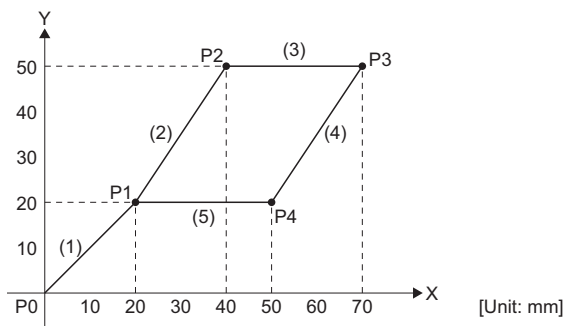

G02: Circular interpolation CW (center specified)

Moves along an arc (CW) to the specified coordinate position (end point) from the current position (start point).
The moving speed is the commanded feed speed.

Code	Format
G02	$G02_X\ x\ _Y\ y\ _I\ i\ _J\ j\ _F\ f$ <div style="margin-left: 150px;"> └─ Feed speed └─ Arc center coordinates └─ Coordinate command </div>

Processing details

- G02 (CW) gives the end point coordinates of the arc an X, Y, (and Z) address, and specifies the center coordinates of the arc as an I, J, (and K) address. The end point coordinates of the arc can be given as an absolute value or incremental value, but the center coordinates of the arc must be commanded as an incremental value from the start point.
- The base axis of the center coordinates is the axis name set in [Motion Control Parameter]⇒[G-code Control Parameter]⇒[G-code Control System Parameter]⇒"Plane Composition"⇒"Base Axis I to K".
- The G02 command is modal. It remains in effect until another G-code from the same group is used. When G02 is continuous, from the next block and after, it can only be commanded by coordinate language. The direction of rotation of the arc is CW (clockwise).

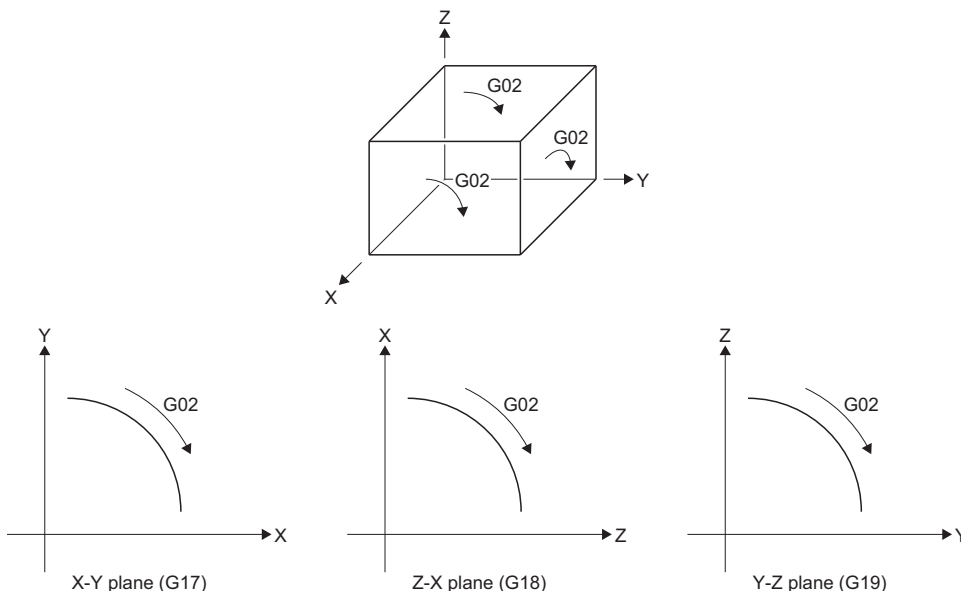

- Arcs that span over multiple quadrants can be executed with one block command.
- The following plane selections are available for an arc, and are selected by using G-code. When an axis without a plane selection is specified, a minor error (error code: 1FC3H (details code: 030AH)) occurs.

Plane selection	G-code
X-Y plane	G17
Z-X plane	G18
Y-Z plane	G19

- When commanding circular interpolation, if the center is not specified a minor error (error code: 1FC3H (details code: 0306H)) occurs.
- There are three methods for deceleration check. They are command deceleration check method, smoothing check method, and in-position check method. Set the deceleration check method to be used in fast forward/cutting in [Motion Control Parameter]⇒[G-code Control Parameter]⇒[G-code Control System Parameter]⇒"Control Setting"⇒"Deceleration Check". Refer to deceleration check for deceleration check. (Page 223 Deceleration check)

Precautions

- A 360° arc (perfect circle) is created in the following cases.
 - The end point coordinates are completely omitted, and I, J, K addresses are used to specify the center
 - The end point and start point are the same position
- The following is when the radius of the start point and end point do not match in an arc command.
 - When the difference ΔR is larger than the value set in [Motion Control Parameter]⇒[G-code Control Parameter]⇒[G-code Control System Parameter]⇒"Control Setting"⇒"Arc Deviation", a minor error (error code: 1FC3H (details code: 0313H)) occurs at the arc start point.

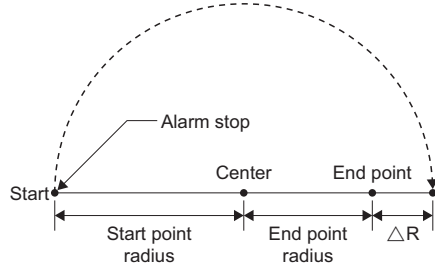

- When the difference ΔR is in the range of the value set in [Motion Control Parameter]⇒[G-code Control Parameter]⇒[G-code Control System Parameter]⇒"Control Setting"⇒"Arc Deviation", the movement to the commanded end point becomes a spiral shaped interpolation.

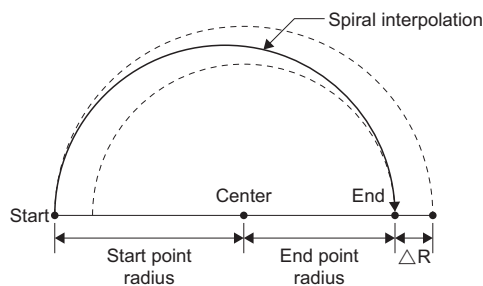

Program example

■ Program that draws a perfect circle by circular interpolation from the current position

Program	Remarks
G02 J50. F500.	Perfect circle command

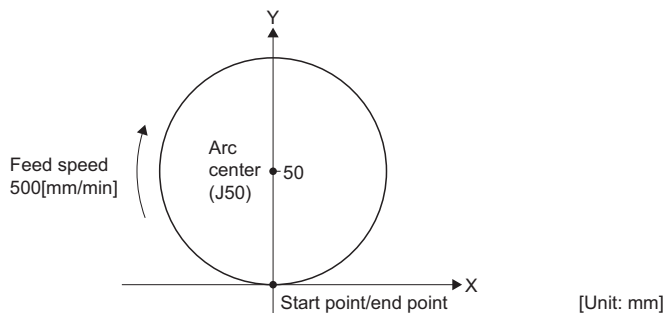

■ Program that draws a semi-circle by circular interpolation from the current position

Program	Remarks
G91 G02 X0. Y100. J50. F500.	—

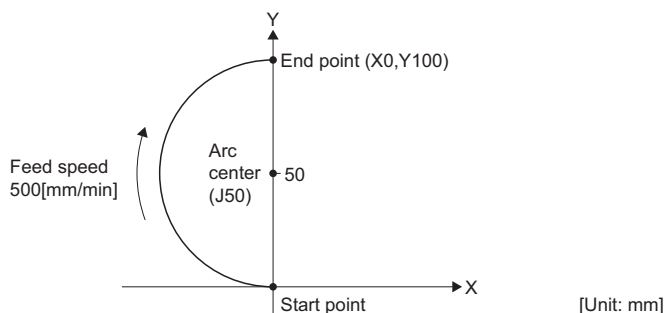

G03: Circular interpolation CCW (center specified)

Moves along an arc (CCW) to the specified coordinate position (end point) from the current position (start point).
The moving speed is the commanded feed speed.

Code	Format
G03	$G03_X\ x\ _Y\ y\ _I\ i\ _J\ j\ _F\ f$ <div style="margin-left: 150px;"> Feed speed Arc center coordinates Coordinate command </div>

Processing details

- G03 (CCW) gives the end point coordinates of the arc an X, Y, (and Z) address, and specifies the center coordinates of the arc as an I, J, (and K) address. The end point coordinates of the arc can be given as an absolute value or incremental value, but the center coordinates of the arc must be commanded as an incremental value from the start point.
- The base axis of the center coordinates is the axis name set in [Motion Control Parameter]⇒[G-code Control Parameter]⇒[G-code Control System Parameter]⇒"Plane Composition"⇒"Base Axis I to K".
- The G03 command is modal. It remains in effect until another G-code from the same group is used. When G03 is continuous, from the next block and after, it can only be commanded by coordinate language. The direction of rotation of the arc is CCW (counterclockwise).

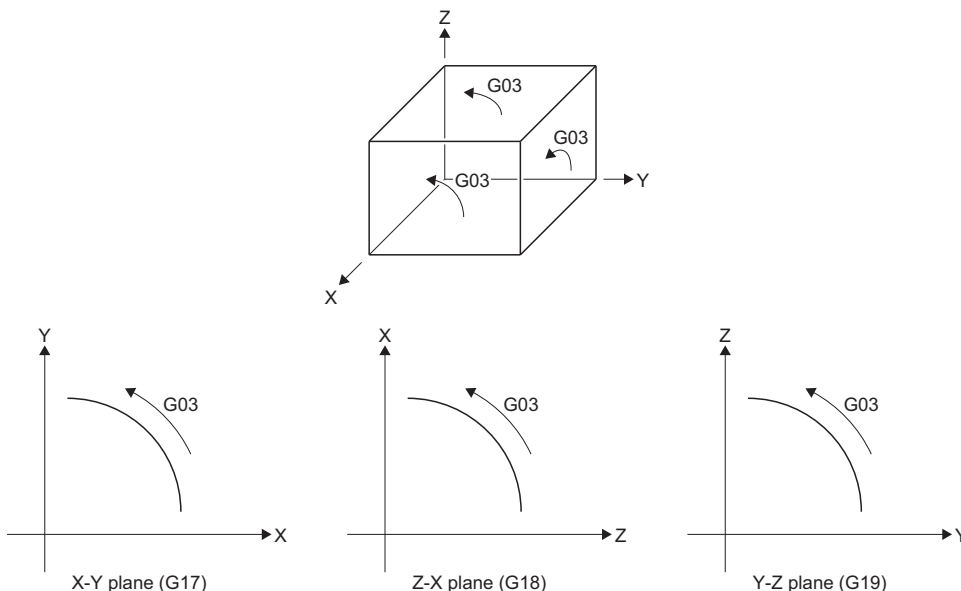

- Arcs that span over multiple quadrants can be executed with one block command.
- The following plane selections are available for an arc, and are selected by using G-code. When an axis without a plane selection is specified, a minor error (error code: 1FC3H (details code: 030AH)) occurs.

Plane selection	G-code
X-Y plane	G17
Z-X plane	G18
Y-Z plane	G19

- When commanding circular interpolation, if the center is not specified a minor error (error code: 1FC3H (details code: 0306H)) occurs.
- There are three methods for deceleration check. They are command deceleration check method, smoothing check method, and in-position check method. Set the deceleration check method to be used in fast forward/cutting in [Motion Control Parameter]⇒[G-code Control Parameter]⇒[G-code Control System Parameter]⇒"Control Setting"⇒"Deceleration Check". Refer to deceleration check for deceleration check. (Page 223 Deceleration check)

Precautions

- A 360° arc (perfect circle) is created in the following cases.
 - The end point coordinates are completely omitted, and I, J, K addresses are used to specify the center
 - The end point and start point are the same position
- The following is when the radius of the start point and end point do not match in an arc command.
 - When the difference ΔR is larger than the value set in [Motion Control Parameter]⇒[G-code Control Parameter]⇒[G-code Control System Parameter]⇒"Control Setting"⇒"Arc Deviation", a minor error (error code: 1FC3H (details code: 0313H)) occurs at the arc start point.

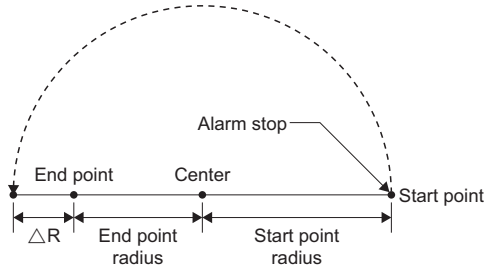

- When the difference ΔR is in the range of the value set in [Motion Control Parameter]⇒[G-code Control Parameter]⇒[G-code Control System Parameter]⇒"Control Setting"⇒"Arc Deviation", the movement to the commanded end point becomes a spiral shaped interpolation.

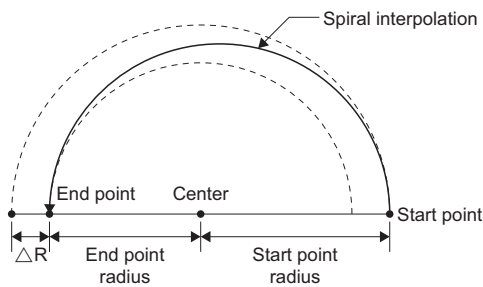

Program example

■ Program that draws a perfect circle by circular interpolation from the current position

Program	Remarks
G03 J50. F500.	Perfect circle command

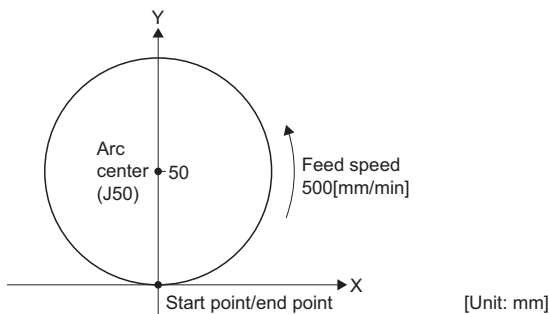

■ Program that draws a semi-circle by circular interpolation from the current position

Program	Remarks
G91 G03 X0. Y100. J50. F500.	—

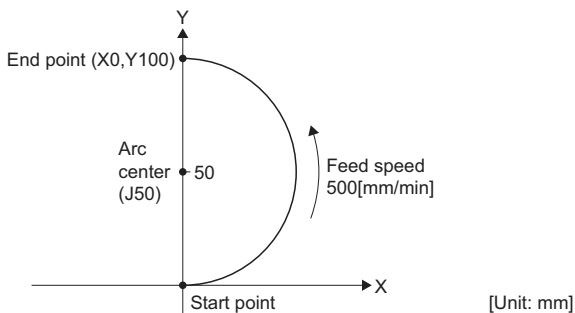

G02: Circular interpolation CW (R-specified)

Moves along an arc (CW) with a specified radius, to the specified coordinate position (end point) from the current position (start point).

The moving speed is the commanded feed speed.

Code	Format
G02	$G02 _X _x _Y _y _R _r _F _f$

Processing details

- The arc center lies on the perpendicular bisector of the straight line that joins the start point and end point. The center coordinates of the arc are where the arc with the specified radius and the start point as the center intersects with the perpendicular bisector.
- When the arc radius (R) value is positive, the arc is 180° or less, when negative, the arc is 180° or more.

<When radius is positive (R>0)>

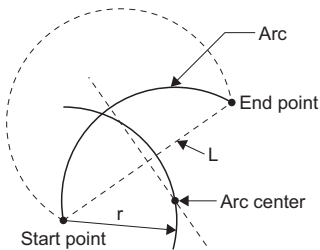

<When radius is negative (R<0)>

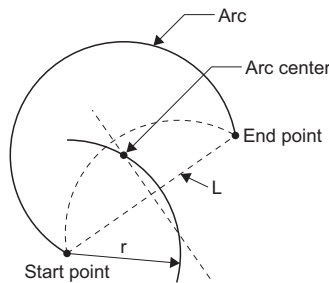

- For R-specified circular interpolation commands, make sure the formula below is satisfied. When "Straight line joining start and end points (L)/2×Arc radius (r)>Arc deviation (parameter value)", a minor error (error code: 1FC3H (details code: 0313H)) occurs.

$$\frac{\text{Straight line joining start and end points (L)}}{2 \times \text{Arc radius (r)}} \leq 1$$

- When an arc is not formed due to miscalculation, if the deviation of "straight line joining start and end points (L)" and "2× arc radius (r)" are less than or equal to the set values, compensation is performed so that the arc center becomes the mid point of the straight line joining the start and end points.

Set the arc deviation value in [Motion Control Parameter]⇒[G-code Control Parameter]⇒[G-code Control System Parameter]⇒"Control Setting"⇒"Permissible Compensation Value of Arc Center Deviation".

Permissible compensation value of arc center deviation setting value	Permissible compensation value of arc center deviation
Setting value<0	0 (No compensation of center deviation)
Setting value=0	2×Minimum setting unit (0.0001)
Setting value>0	Set value

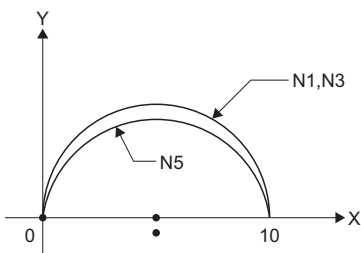

```

G90 X0. Y0.
N1 G02 X10. R5.0000
N2 G00 X0.
N3 G02 X10. R5.0001 ..... (a)
N4 G00 X0.
N5 G02 X10. R5.0002 ..... (b)
N6 G00 X0.
M02
    
```

- (a) "Compensate center coordinates"=passes over the same trajectory as N1.
- (b) "No compensation on center coordinates"=passes over a trajectory slightly inside N1.

Permissible compensation value of arc center deviation: 0.0002mm

Line from start point to end point : 10.0000

- N3: Radius×2=10.0002 "Deviation 0.0002 → below or equal to permissible value, therefore compensate"
- N5: Radius×2=10.0004 "Deviation 0.0004 → exceeding permissible value, therefore do not compensate"

- For G02 (CW), when both R-specified and center specified (I, J, K) are specified in the same block at the same time, the R-specified arc command takes priority.
- If a perfect circle command (start point and end point the same) is specified in R-specified circular interpolation, the R-specified arc command ends immediately, and there is no operation.
- There are three methods for deceleration check. They are command deceleration check method, smoothing check method, and in-position check method. Set the deceleration check method to be used in fast forward/cutting in [Motion Control Parameter]⇒[G-code Control Parameter]⇒[G-code Control System Parameter]⇒"Control Setting"⇒"Deceleration Check". Refer to deceleration check for deceleration check. (☞ Page 223 Deceleration check)

Program example

■ Program that draws an arc less than 180° when the arc radius value is positive

Program	Remarks
G91 G02 X50. Y50. R50. F500.	—

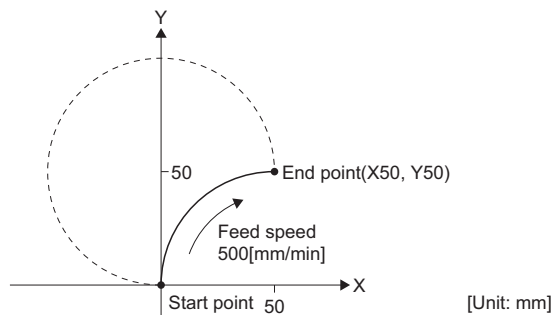

■ Program that draws an arc more than 180° when the arc radius value is negative

Program	Remarks
G91 G02 X50. Y50. R-50. F500.	—

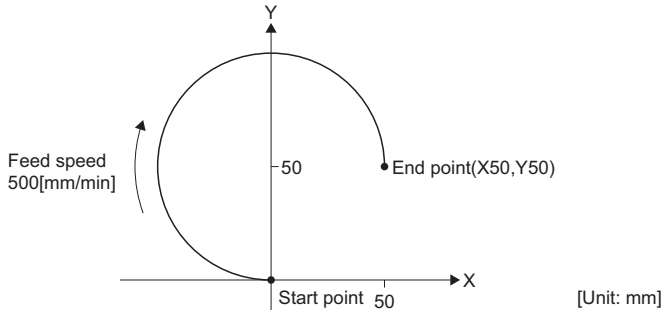

G03: Circular interpolation CCW (R-specified)

Moves along an arc (CCW) with a specified radius, to the specified coordinate position (end point) from the current position (start point).

The moving speed is the commanded feed speed.

Code	Format
G03	$G03 _X _x _Y _y _R _r _F _f$ <div style="margin-left: 150px;"> Coordinate command Arc radius Feed speed </div>

Processing details

- The arc center lies on the perpendicular bisector of the straight line that joins the start point and end point. The center coordinates of the arc are where the arc with the specified radius and the start point as the center intersects with the perpendicular bisector.
- When the arc radius (R) value is positive, the arc is 180° or less, when negative, the arc is 180° or more.

<When radius is positive (R>0)>

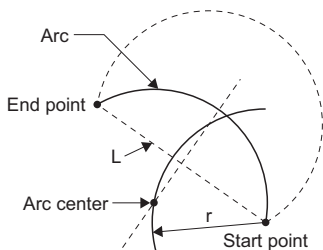

<When radius is negative (R<0)>

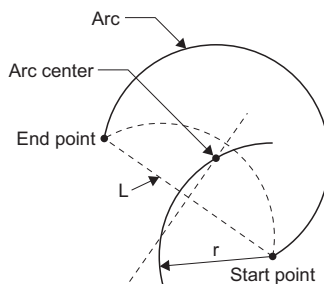

- For R-specified circular interpolation commands, make sure the formula below is satisfied. When "Straight line joining start and end points (L)/2×Arc radius (r)>Arc deviation (parameter value)", a minor error (error code: 1FC3H (details code: 0313H)) occurs.

$$\frac{\text{Straight line joining start and end points (L)}}{2 \times \text{Arc radius (r)}} \leq 1$$

- When an arc is not formed due to miscalculation, if the deviation of "straight line joining start and end points (L)" and "2× arc radius (r)" are less than or equal to the set values, compensation is performed so that the arc center becomes the mid point of the straight line joining the start and end points.

Set the arc deviation value in [Motion Control Parameter]⇒[G-code Control Parameter]⇒[G-code Control System Parameter]⇒"Control Setting"⇒"Permissible Compensation Value of Arc Center Deviation".

Permissible compensation value of arc center deviation setting value	Permissible compensation value of arc center deviation
Setting value<0	0 (No compensation of center deviation)
Setting value=0	2×Minimum setting unit (0.0001)
Setting value>0	Set value

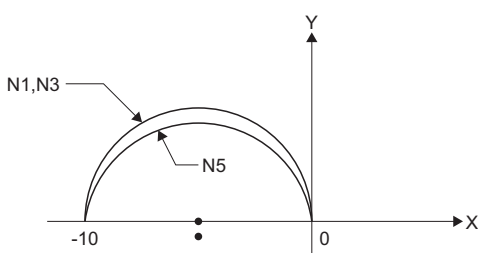

```
G90 X0. Y0.
N1 G03 X-10. R5.0000
N2 G00 X0.
N3 G03 X-10. R5.0001 ..... (a)
N4 G00 X0.
N5 G03 X-10. R5.0002 ..... (b)
N6 G00 X0.
M02
```

- (a) "Compensate center coordinates"=passes over the same trajectory as N1.
- (b) "No compensation on center coordinates"=passes over a trajectory slightly inside N1.

Permissible compensation value of arc center deviation: 0.0002mm
 Line from start point to end point : 10.0000

- N3: Radius×2=10.0002 "Deviation 0.0002 → below or equal to permissible value, therefore compensate"
- N5: Radius×2=10.0004 "Deviation 0.0004 → exceeding permissible value, therefore do not compensate"

- For G03 (CCW), when both R-specified and center specified (I, J, K) are specified in the same block at the same time, the R-specified arc command takes priority.
- If a perfect circle command (start point and end point the same) is specified in R-specified circular interpolation, the R-specified arc command ends immediately, and there is no operation.
- There are three methods for deceleration check. They are command deceleration check method, smoothing check method, and in-position check method. Set the deceleration check method to be used in fast forward/cutting in [Motion Control Parameter]⇒[G-code Control Parameter]⇒[G-code Control System Parameter]⇒"Control Setting"⇒"Deceleration Check". Refer to deceleration check for deceleration check. (☞ Page 223 Deceleration check)

Program example

■ Program that draws an arc less than 180° when the arc radius value is positive

Program	Remarks
G91 G03 X-50. Y50. R50. F500.	—

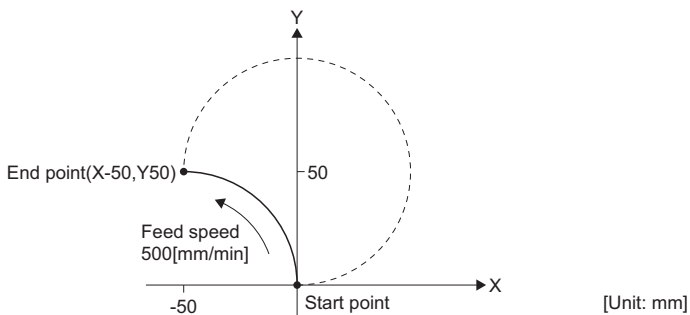

■ Program that draws an arc more than 180° when the arc radius value is negative

Program	Remarks
G91 G03 X50. Y50. R-50. F500	—

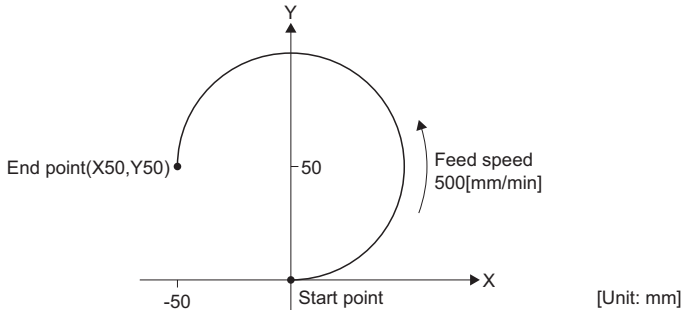

G04: Dwell (time specified)

Waits the specified time to execute the next block.

Code	Format
G04	<p>■X specification</p> <p>G04_ X x <small>└ Dwell time (0 to 99999.999[s])</small></p> <p>■P specification</p> <p>G04_ P p <small>└ Dwell time (0 to 99999999[ms])</small></p>

Processing details

- The setting range for dwell time by X is "0 to 99999.999" and decimal point commands are valid. When the decimal point is omitted, the dwell time is 0.001[s] units.
- The setting range for dwell time by P is "0 to 99999999[ms]" and decimal point commands are invalid. When a decimal value is commanded by P, a minor error (error code: 1FC3H (details code: 031AH)) occurs.
- Dwell commands start calculating the dwell time after the completion of a deceleration stop when there is a cutting command in the block before. However, when an M command is in the same block as a dwell command, they start simultaneously.
- When a feed hold signal is input while executing dwell, the dwell command is stopped, and after restarting the dwell command waits for the remaining time before executing the next block.

Point

Do not specify a movement command and dwell command in the same block. Only the G04 command is executed, and the movement command is not executed.

Program example

■ Program with dwell time in between positioning instructions

Operation	Program	Remarks
(1)	G01 X100. F10.	Positioning
(2)	See table below	Dwell time
(3)	G01 X200.	Positioning

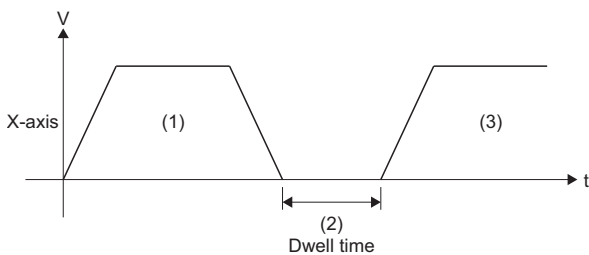

Command in (2)	Dwell time[s]
G04 X500	0.5
G04 X5000	5
G04 X5.	5
G04 P5000	5
G04 P12.345	Minor error (error code: 1FC3H (details code: 031AH))

G09: Exact stop check

Performs deceleration check for the specified block only.

Code	Format
G09	G09_ G01_ X x _ F f <small>Can only be used with G01, G02, G03 commands</small>

Processing details

- The G09 command performs deceleration check in the specified block only.
- The G09 command executes the next block after deceleration check at the specified coordinate position.
- The G09 command is unmodal. It is only valid for the specified block.
- Refer to deceleration check for details of deceleration check. (📖 Page 223 Deceleration check)

■ When exact stop check is used

G09 G01 X100. F300.
X200.

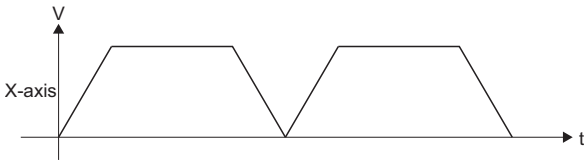

■ When exact stop check is not used

G01 X100. F300.
X200.

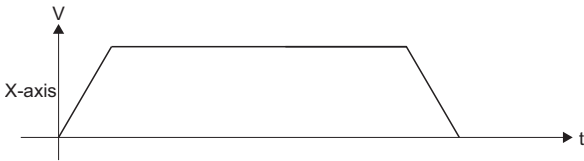

Program example

■ Program that is positioning by exact stop check

Operation	Program	Remarks
(1)	G09 G01 X100. F500.	Positioning by exact stop check
(2)	X200.	Positioning
(3)	X300.	Positioning
(4)	G09 G01 X400.	Positioning by exact stop check

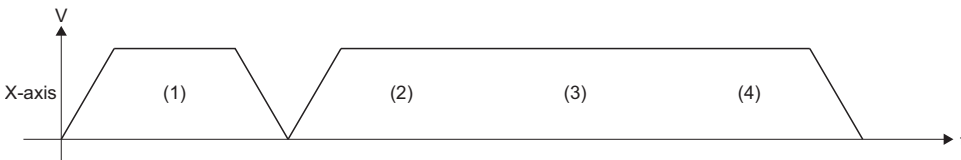

G12.1: Polar coordinate interpolation mode start

Starts polar coordinate interpolation mode which transforms linear axis movement (tool movement) and rotating axis movement (work rotation) for contouring control.

This is effective when cutting out a linear notch from the outer diameter of a workpiece, grinding a camshaft etc.

Code	Format
G12.1	G12.1

Processing details

- The G12.1 command performs polar coordinate interpolation on a selected polar coordinate interpolation plane which uses the linear axis as the first axis of the plane and a perpendicular virtual axis (polar coordinate interpolation rotating axis) as the second axis of the plane. In polar coordinate interpolation, the home position of the local coordinate system is the home position.

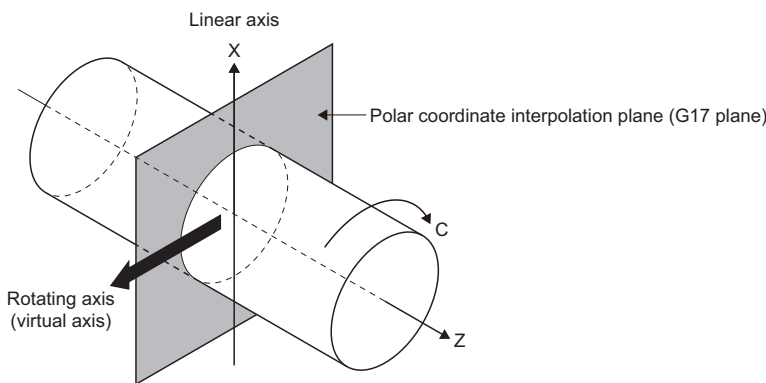

- The G12.1 command is modal. Polar coordinate interpolation mode continues until polar coordinate interpolation mode cancel (G13.1) is commanded.
- Use the G12.1 command in an independent block. When other commands are used in the same block, a minor error (error code: 1FC3H (details code: 0306H or 0324H)) occurs. Note that sequence No. (N), and speed (F, ,F) can be specified in the same block.
- Set linear axis and rotating axis for polar coordinate interpolation in [Motion Control Parameter]⇒[G-code Control Parameter]⇒[G-code Control System Parameter]⇒"Polar Coordinate Interpolation"⇒"Polar Coordinate Interpolation Linear Axis" or "Polar Coordinate Interpolation Rotating Axis". When G12.1 is commanded without setting "Polar Coordinate Interpolation Linear Axis" or "Polar Coordinate Interpolation Rotating Axis", a minor error (error code: 1FC3H (details code: 0325H)) occurs.
- When transitioning to G-code control or resetting, polar coordinate interpolation is cancelled.
- Deceleration check is performed in a polar coordinate interpolation mode start command block (G12.1).
- During polar coordinate interpolation, the area which the linear axis can move is determined by the position of the linear axis when polar coordinate interpolation is commanded. To use the plus side of the area which the linear axis can move during polar coordinate interpolation, the linear axis must be moving in the plus area (0 or more) before polar coordinate interpolation is commanded. Conversely, to use the minus side of the area which the linear axis can move, the linear axis must be moving in the minus area (not including 0) before polar coordinate interpolation is commanded.

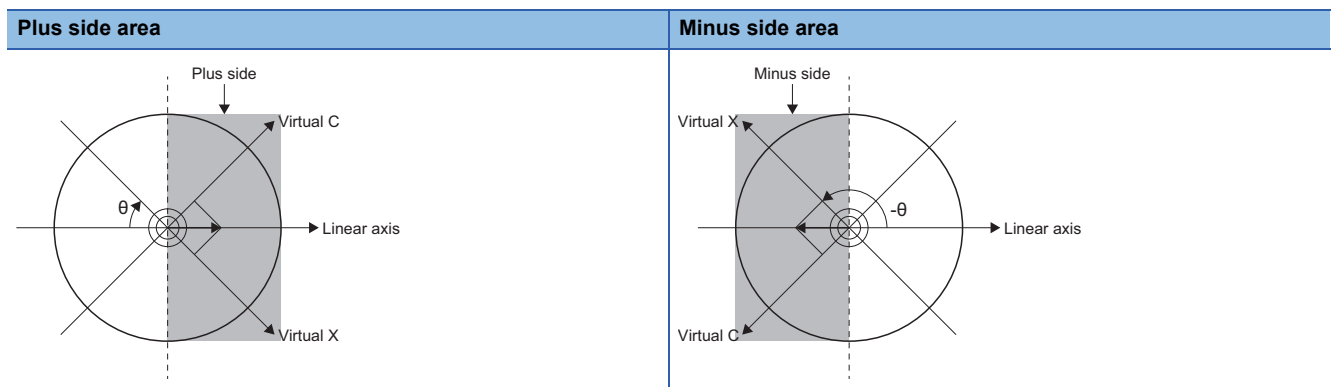

■ Polar coordinate interpolation mode operation when combined with each function

The polar coordinate interpolation mode operation for each function is shown below.

Function	Polar coordinate interpolation mode operation																					
Program commands in polar coordinate interpolation	<ul style="list-style-type: none"> Program commands during polar coordinate interpolation control are commanded using the Cartesian coordinate values of the linear axis and rotating axis (virtual axis) on the polar coordinate interpolation plane. The axis addresses of the polar coordinate interpolation rotating axis is used for commanding the second axis of the plane (virtual axis). At this time, the command units are not [degree], but the same as the units of the first axis (linear axis) ([mm]). Program commands can only command the two polar coordinate interpolation plane axes (polar coordinate interpolation linear axis and polar coordinate interpolation rotating axis), and the height axis only. If any other axes are commanded, a minor error (error code: 1FC3H (details code: 0323H)) occurs. The axis address for indicating the height axis is as follows according to the axis name set in G-code control system parameter "polar coordinate interpolation linear axis". (When "1: X" is set to "Base axis I", "2: Y" is set to "Base axis J", and "3: Z" is set to "Base axis K") <table border="1"> <thead> <tr> <th>Setting value of polar coordinate interpolation linear axis</th> <th>Plane</th> <th>Height</th> </tr> </thead> <tbody> <tr> <td>1: X</td> <td>G17(X-Y plane)</td> <td>Z</td> </tr> <tr> <td>2: Y</td> <td>G18(Y-Z plane)</td> <td>X</td> </tr> <tr> <td>3: Z</td> <td>G19(Z-X plane)</td> <td>Y</td> </tr> </tbody> </table> <ul style="list-style-type: none"> The rotating direction of the rotating axis during polar coordinate interpolation mode is the shortest way regardless of the G-code control axis parameter "rotating axis type" setting. The virtual axis coordinate value when the polar coordinate interpolation mode start command (G12.1) is commanded is "0". This means the position where G12.1 was commanded is deemed as "angle=0", and polar coordinate interpolation starts. The following are the monitor devices during polar coordinate interpolation start command (G12.1) and polar coordinate interpolation cancel command (G13.1). <table border="1"> <thead> <tr> <th>Monitor device</th> <th>Description</th> </tr> </thead> <tbody> <tr> <td>[Md.3147] Machine position (D54768+32sn, D54769+32sn)</td> <td rowspan="4">No change.</td> </tr> <tr> <td>[Md.3148] Machine target position (D54770+32sn, D54771+32sn)</td> </tr> <tr> <td>[Md.3149] Relative position (D54772+32sn, D54773+32sn)</td> </tr> <tr> <td>[Md.3150] Relative target position (D54774+32sn, D54775+32sn)</td> </tr> <tr> <td>[Md.3152] Program target position (D54778+32sn, D54779+32sn)</td> <td>"0" at polar coordinate interpolation mode start command (G12.1). No change at polar coordinate interpolation cancel command (G13.1).</td> </tr> </tbody> </table>	Setting value of polar coordinate interpolation linear axis	Plane	Height	1: X	G17(X-Y plane)	Z	2: Y	G18(Y-Z plane)	X	3: Z	G19(Z-X plane)	Y	Monitor device	Description	[Md.3147] Machine position (D54768+32sn, D54769+32sn)	No change.	[Md.3148] Machine target position (D54770+32sn, D54771+32sn)	[Md.3149] Relative position (D54772+32sn, D54773+32sn)	[Md.3150] Relative target position (D54774+32sn, D54775+32sn)	[Md.3152] Program target position (D54778+32sn, D54779+32sn)	"0" at polar coordinate interpolation mode start command (G12.1). No change at polar coordinate interpolation cancel command (G13.1).
Setting value of polar coordinate interpolation linear axis	Plane	Height																				
1: X	G17(X-Y plane)	Z																				
2: Y	G18(Y-Z plane)	X																				
3: Z	G19(Z-X plane)	Y																				
Monitor device	Description																					
[Md.3147] Machine position (D54768+32sn, D54769+32sn)	No change.																					
[Md.3148] Machine target position (D54770+32sn, D54771+32sn)																						
[Md.3149] Relative position (D54772+32sn, D54773+32sn)																						
[Md.3150] Relative target position (D54774+32sn, D54775+32sn)																						
[Md.3152] Program target position (D54778+32sn, D54779+32sn)	"0" at polar coordinate interpolation mode start command (G12.1). No change at polar coordinate interpolation cancel command (G13.1).																					
Positioning (G00)	<p>Can be commanded during polar coordinate interpolation mode.</p> <p>It is still an interpolation operation even when "Non-interpolation" is set in the G-code control system parameter "G00 non-interpolation".</p> <p>During polar coordinate interpolation, deceleration check when G1→G1 movement direction is reversed (G-code control system parameter "Deceleration check from G1 to G1") is disabled.</p>																					
Linear interpolation (G01)	<p>Can be commanded during polar coordinate interpolation mode.</p> <p>During polar coordinate interpolation, deceleration check when G1→G1 movement direction is reversed (G-code control system parameter "Deceleration check from G1 to G1") is disabled.</p>																					
Circular interpolation (G02, G03)	<p>Can be commanded during polar coordinate interpolation mode. Central point specification and radius specification can be used.</p> <p>The address for specifying the central point during central point specified circular interpolation is as follows according to the axis name set in G-code control system parameter "polar coordinate interpolation linear axis". (When "1: X" is set to "Base axis I", "2: Y" is set to "Base axis J", and "3: Z" is set to "Base axis K")</p> <table border="1"> <thead> <tr> <th>Setting value of polar coordinate interpolation linear axis</th> <th>Central point specification command</th> </tr> </thead> <tbody> <tr> <td>1: X</td> <td>I, J (polar coordinate plane is deemed as the X-Y plane)</td> </tr> <tr> <td>2: Y</td> <td>J, K (polar coordinate plane is deemed as the Y-Z plane)</td> </tr> <tr> <td>3: Z</td> <td>K, I (polar coordinate plane is deemed as the Z-X plane)</td> </tr> </tbody> </table> <p>During polar coordinate interpolation mode, deceleration check when G1→G1 movement direction is reversed (G-code control system parameter "Deceleration check from G1 to G1") is disabled.</p>	Setting value of polar coordinate interpolation linear axis	Central point specification command	1: X	I, J (polar coordinate plane is deemed as the X-Y plane)	2: Y	J, K (polar coordinate plane is deemed as the Y-Z plane)	3: Z	K, I (polar coordinate plane is deemed as the Z-X plane)													
Setting value of polar coordinate interpolation linear axis	Central point specification command																					
1: X	I, J (polar coordinate plane is deemed as the X-Y plane)																					
2: Y	J, K (polar coordinate plane is deemed as the Y-Z plane)																					
3: Z	K, I (polar coordinate plane is deemed as the Z-X plane)																					

Function	Polar coordinate interpolation mode operation								
Dwell (G04) Exact stop check (G09) Tool radius compensation vector setting (G38) Tool radius compensation corner arc (G39) Macro call (G65)	Can be commanded during polar coordinate interpolation mode.								
Plane selection	<p>With a polar coordinate interpolation mode start command (G12.1), the plane (polar coordinate interpolation plane) for polar coordinate interpolation is determined according to the axis name set in G-code control parameter "polar coordinate interpolation linear axis" as shown below.</p> <p>With a polar coordinate interpolation mode cancel command (G13.1), the plane returns to the plane selected before polar coordinate interpolation start. (When "1: X" is set to "Base axis I", "2: Y" is set to "Base axis J", and "3: Z" is set to "Base axis K")</p> <table border="1" data-bbox="497 584 1394 757"> <thead> <tr> <th data-bbox="497 584 868 645">Setting value of polar coordinate interpolation linear axis</th> <th data-bbox="868 584 1394 645">Plane</th> </tr> </thead> <tbody> <tr> <td data-bbox="497 645 868 683">1: X</td> <td data-bbox="868 645 1394 683">G17 (X-Y plane)</td> </tr> <tr> <td data-bbox="497 683 868 721">2: Y</td> <td data-bbox="868 683 1394 721">G18 (Y-Z plane)</td> </tr> <tr> <td data-bbox="497 721 868 757">3: Z</td> <td data-bbox="868 721 1394 757">G19 (Z-X plane)</td> </tr> </tbody> </table> <p>When plane selection command (G17 to G19) is made during polar coordinate interpolation mode, a minor error (error code: 1FC3H (details code: 0322H)) occurs.</p>	Setting value of polar coordinate interpolation linear axis	Plane	1: X	G17 (X-Y plane)	2: Y	G18 (Y-Z plane)	3: Z	G19 (Z-X plane)
Setting value of polar coordinate interpolation linear axis	Plane								
1: X	G17 (X-Y plane)								
2: Y	G18 (Y-Z plane)								
3: Z	G19 (Z-X plane)								
Absolute value command/Incremental value command	Both absolute value commands and incremental value commands can be used for coordinate commands.								
Speed command	<p>The feed speed is the interpolation speed on the polar coordinate interpolation plane (Cartesian coordinate system) therefore use "F" to command the tangential speed on the polar coordinate interpolation plane. (The relative speed with the tool changes by polar coordinate transformation.)</p> <p>The units for F are [mm/min].</p> <p>When not specifying an F command during polar coordinate interpolation mode, the feed speed of the F command immediately before is used. The F command modal value after polar coordinate interpolation mode cancel is the feed speed of the F command at the start of polar coordinate interpolation or the F command last set during polar coordinate interpolation mode.</p> <p>When passing through the proximity of the center of the rotating axis on the polar coordinate interpolation plane (Cartesian coordinate system), the feed speed on the rotating axis side after polar coordinate interpolation becomes extremely large. When the feed speed of the rotation axis becomes large due to the cutting feed clamp speed, clamp the speed of the rotating axis and linear axis so that the rotating axis does not exceed the cutting feed clamp speed.</p>								
Tool radius compensation	<ul style="list-style-type: none"> • Tool radius compensation can be used for program commands during polar coordinate interpolation mode. Polar coordinate interpolation is performed on the path after tool radius compensation. • Tool radius compensation can be used for the polar coordinate interpolation plane. When performing tool radius compensation, perform startup and cancel in polar coordinate interpolation mode. When polar coordinate interpolation mode start command (G12.1) or polar coordinate interpolation mode cancel command (G13.1) are performed during tool radius compensation, a minor error (error code: 1FC3H (details code: 0324H)) occurs. • When a G12.1 command or G13.1 command is commanded without a movement command made after tool radius compensation is cancelled by a G40 independent command, the position of the axis of the G12.1 command block or G13.1 command block is deemed as the position after tool radius compensation cancel, and the operation from then onwards is made. 								

Function	Polar coordinate interpolation mode operation
Tool length compensation	<ul style="list-style-type: none"> When tool length compensation is performed during polar coordinate interpolation mode, a minor error (error code: 1FC3H (details code: 0322H)) occurs. <p><Example></p> <pre> : G43 H12Tool length compensation before polar coordinate interpolation: Enabled G00 X100. Z0. G12.1 : G43 H11Tool length compensation during polar coordinate interpolation: Minor error : G13.1 </pre> <ul style="list-style-type: none"> Complete the tool compensation operation (movement by the tool length compensation amount) before polar coordinate interpolation mode starts. When tool compensation operation is incomplete at the time of polar coordinate interpolation mode start command the following occurs. <ul style="list-style-type: none"> The machine coordinates do not change even when G12.1 command is executed. When G12.1 command is executed, the work coordinates are the values after tool length compensation. Also, the tool length compensation amount is not updated during polar coordinate interpolation mode. Therefore when changing to polar coordinate interpolation during temporary cancel of tool length compensation, the tool length compensation amount stays cancelled, and tool length compensation is applied again from the movement commands after polar coordinate interpolation mode cancel. <p><Example></p> <pre> : G43 H1 Y0.....Make Y-axis the compensation axis : G53 X0. Y0. Z0.Temporarily cancel the tool length compensation G12.1(With tool length compensation cancelled) : : G13.1(With tool length compensation cancelled) Y10.....Tool length compensation restarts : </pre>
Local coordinate system setting (G52)	When commanded during polar coordinate interpolation mode, a minor error (error code: 1FC3H (details code: 0322H)) occurs.
Basic machine coordinate system selection (G53)	
Work coordinate system selection	<p>Before polar coordinate interpolation is commanded, set the work coordinate system so that the center of the rotating axis is the home position of the coordinate system.</p> <p>When commanded during polar coordinate interpolation mode, a minor error (error code: 1FC3H (details code: 0322H)) occurs.</p>
Exact stop check mode	<p>Switch to exact stop check mode is available during polar coordinate interpolation mode.</p> <p>Polar coordinate interpolation mode start command (G12.1) is available during exact stop check mode.</p>
Automatic corner override	<p>When polar coordinate interpolation mode start command (G12.1) is made during automatic corner override, a minor error (error code: 1FC3H (details code: 0324H)) occurs.</p> <p>When automatic corner override is commanded during polar coordinate interpolation mode, a minor error (error code: 1FC3H (details code: 0322H)) occurs.</p>
High-accuracy control mode	<p>High-accuracy control mode is available during polar coordinate interpolation mode.</p> <p>Polar coordinate interpolation mode start command (G12.1) is available during high-accuracy control mode.</p> <p>When used in combination with high-accuracy control mode, set the parameters so that the tolerable acceleration control for each axis is enabled.</p> <p>When tolerable acceleration control for each axis is disabled, and high-accuracy control mode (G61.1) is commanded during polar coordinate interpolation, a minor error (error code: 1FC3H (details code: 0322H)) occurs. Also, when polar coordinate interpolation mode start command (G12.1) is commanded during high-accuracy control mode, a minor error (error code: 1FC3H (details code: 0324H)) occurs.</p> <p>Arc entrance/exit speed control is not enabled during polar coordinate interpolation mode.</p> <p>Refer to high-accuracy control for details of high-accuracy control. ( Page 269 High-Accuracy Control)</p> <p>■Cautions</p> <p>When used in combination with high-accuracy control mode and a program that passes through the proximity of the center of the polar coordinate interpolation plane is operated, the speed may become inconsistent. There is no effect on the path accuracy. To restrict speed fluctuations, command a small value for speed.</p>
Cutting mode	<p>Switch to cutting mode is available during polar coordinate interpolation mode.</p> <p>Polar coordinate interpolation mode start command (G12.1) is available during cutting mode.</p>
Normal line control	<ul style="list-style-type: none"> Polar coordinate interpolation mode and normal line control cannot be used at the same time. When a polar coordinate interpolation start command (G12.1) is performed during normal line control, a minor error (error code: 1FC3H (details code: 0324H)) occurs. When a normal line control command (G41.1, G42.1) is performed during polar coordinate interpolation, a minor error (error code: 1FC3H (details code: 0322H)) occurs.

Function	Polar coordinate interpolation mode operation
Program coordinate rotation	<ul style="list-style-type: none"> • Polar coordinate interpolation mode and program coordinate rotation mode cannot be used at the same time. • When a polar coordinate interpolation start command (G12.1) is performed during program coordinate rotation mode, a minor error (error code: 1FC3H (details code: 0324H)) occurs. • When a program coordinate rotation mode command (G68) is performed during polar coordinate interpolation, a minor error (error code: 1FC3H (details code: 0322H)) occurs.

Program example

■ Program that positions by polar coordinate interpolation mode

Operation	Program	Remarks
(1)	G17 G90 G00 X40.0 C0 Z0	Determining the start position
(2)	G12.1	Polar coordinate interpolation mode: Start
(3)	G01 G42 X20.0 F2000	Actual start of working
(4)	C10.0	Shape program (By Cartesian coordinate values on the X-C plane.)
(5)	G03 X10.0 C20.0 R10.0	
(6)	G01 X-20.0	
(7)	C-10.0	
(8)	G03 X-10.0 C-20.0 I10.0 J0	
(9)	G01 X20.0	
(10)	C00	Actual end of working
(11)	G40 X40.0	Move to end position

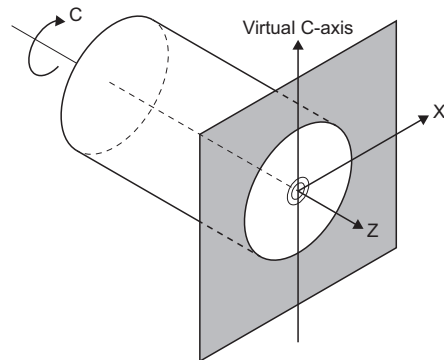
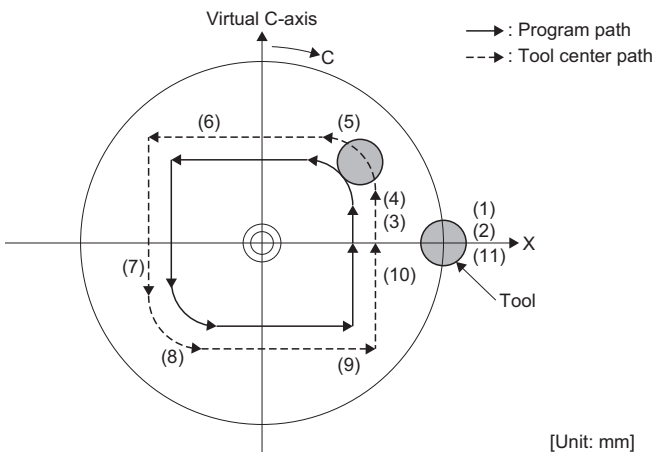

G13.1: Polar coordinate interpolation mode cancel

Ends polar coordinate interpolation mode.

Code	Format
G13.1	G13.1

Processing details

- The G13.1 command cancels the set polar coordinate interpolation mode start (G12.1), and ends polar coordinate interpolation mode.
- Use the G13.1 command in an independent block. When another command is used on the same block, a minor error (error code: 1FC3H (details code: 0306H, or 0324H)) occurs. However, sequence No. (N), and speed (F, ,F) can be specified in the same block.
- Deceleration check is performed in a polar coordinate interpolation mode cancel command block (G13.1).

Program example

■ Program that cancels polar coordinate interpolation mode

Operation	Program	Remarks
(1)	G17 G90 G00 X40.0 C0 Z0	Determining the start position
(2)	G12.1	Polar coordinate interpolation mode: Start
(3)	G01 G42 X20.0 F2000	Actual start of working
(4)	C10.0	Shape program
(5)	G03 X10.0 C20.0 R10.0	(By Cartesian coordinate values on the X-C plane.)
(6)	G01 X-20.0	
(7)	C-10.0	
(8)	G03 X-10.0 C-20.0 I10.0 J0	
(9)	G01 X20.0	
(10)	C00	Actual end of working
(11)	G40 X40.0	Move to end position
(12)	G13.1	Polar coordinate interpolation mode: Cancel
(13)	M30	Program end

G17 to G19: Plane selection

Specify the plane for circular interpolation and the plane for tool radius compensation.

Code	Format
G17, G18, G19	G17 G18 G19

Processing details

- Plane selection specifies the plane for performing circular interpolation or tool radius compensation.

G-code	Description
G17	X-Y plane selection
G18	Z-X plane selection
G19	Y-Z plane selection

- Set the base axes that make up the plane in [Motion Control Parameter]⇒[G-code Control Parameter]⇒[G-code Control System Parameter]⇒"Plane Composition"⇒"Base Axis I to K". Refer to Base axis I/base axis J/base axis K for details. (☞ Page 82 Base axis I/Base axis J/Base axis K)
- The plane selection command (G17, G18, G19) is modal. It remains in effect until another G-code from the same group is used, and planes cannot be switched at blocks that are not commanded.
- When an axis address is commanded in the same block as a plane selection command (G17, G18, G19), the commanded axis moves.
- Axis commands that do not exist on the plane determined by plane selection command (G17, G18, G19) have no effect on plane selection.

Ex.

When registered as the table below, and G17 X100. Z100. is commanded.

The XY plane is selected, and Z moves with no relation to the plane.

Base axis	Setting
I	1: X
J	2: Y
K	3: Z

Point

At G-code control start and reset, the plane set in [Motion Control Parameter]⇒[G-code Control Parameter]⇒[G-code Control System Parameter]⇒"Modal Initial Setting"⇒"Plane Selection" is specified.

Program example

■ Program that selects the X-Y plane, and draws an arc

Operation	Program	Remarks
(1)	G17	X-Y plane selection
(2)	G91 G02 X50. Y50. R50. F500.	Circular interpolation positioning

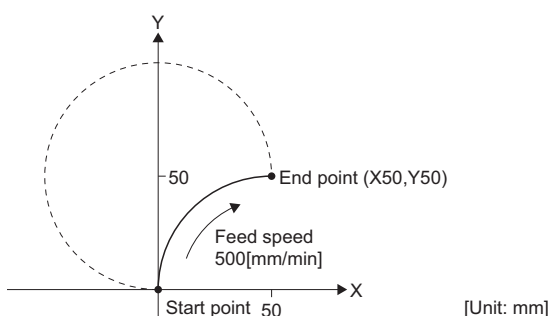

G38: Tool radius compensation vector setting

Change or keep the compensation vector during tool radius compensation.

Code	Format
G38	G38_ <u>l</u> <u>i</u> <u>J</u> <u>j</u> <div style="margin-left: 150px;"> Compensation vector direction </div>

Processing details

- When G38 command is executed, the compensation vector can be changed or kept during tool radius compensation.
- The G38 command is unmodal. It is valid for the specified block only.
- Refer to tool radius compensation for details of tool radius compensation. (👉 Page 228 Tool radius compensation)

■ Keeping the compensation vector

- When G38 is commanded in a block for a movement command, an intersection point calculation is not made at the end point of that block, and the vector of the previous block is kept.
- The operation for keeping compensation vector is shown below.
 - Keeping vector for inside compensation

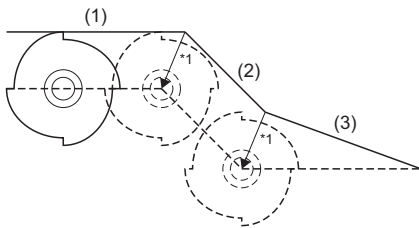

- (1) G01 Xx1
- (2) G38 Xx2 Yy2
- (3) G40 Xx3

*1: Vector of the intersection point calculation of block (1)-(2)

- Keeping acute angle vector for outside compensation

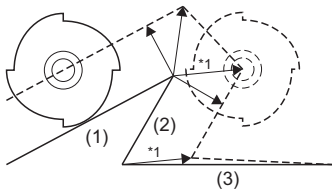

- (1) G01 Xx1 Yy1
- (2) G38 Xx2 Yy2
- (3) G40 Xx3

*1: Vector of the intersection point calculation of block (1)-(2)

- Keeping obtuse angle vector for outside compensation

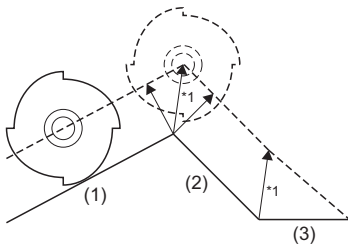

- (1) G01 Xx1 Yy1
- (2) G38 Xx2 Yy2
- (3) G40 Xx3

*1: Vector of the intersection point calculation of block (1)-(2)

■ Changing the compensation vector

- A new compensation vector direction "I, J, K", can be specified with the compensation amount "D".
- Command can be made in the same block as the movement command.
- The valid addresses in "I, J, K" differ depending on the selected plane.
- When G38 command is in the same block as the "I, J" arc command, "I, J" is treated as the G38 command vector direction, and therefore a minor error (error code: 1FC3H (details code: 0306H)) occurs.
- The operation for changing compensation vector is shown below.
 - Changing the vector

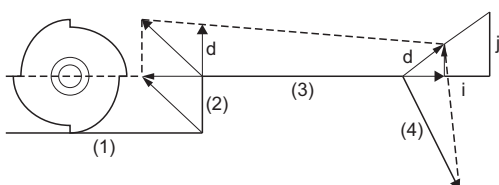

- (1) G01 Xx1
- (2) Yy2
- (3) G38 Xx3 Ii Jj Dd
- (4) G40 Xx4 Yy4

Program example

■ Program that keeps the compensation vector for positioning

Tool radius compensation amount is "compensation No.: 01", "compensation amount: 5[mm]"

Operation	Program	Remarks *1
(1)	G90 X0. Y0.	Move to "X0,Y0" by absolute value command
(2)	G91 G01 G41 X20. Y20. D01 F500.	Move to "X20,Y20" by tool radius compensation start operation
(3)	G01 X30.	Move by straight line "X50"
(4)	G01 G38 X-30. Y30.	Move by straight line to "X20,Y50"
(5)	X10.	Move by straight line to "X30"
(6)	X30. Y-30.	Move by straight line to "X60,Y20"

*1 Describes the program position.

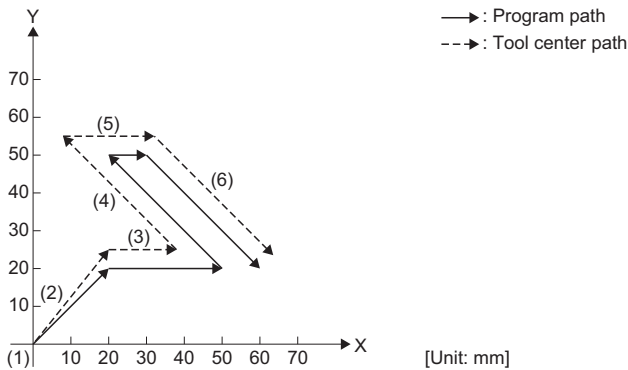

■ Program that changes the compensation vector for positioning

Tool radius compensation amount is "compensation No.: 01", "compensation amount: 5[mm]"

Operation	Program	Remarks *1
(1)	G90 X0. Y0.	Move to "X0,Y0" by absolute value command
(2)	G91 G01 G41 X20. Y20. D01 F500.	Move to "X20,Y20" by tool radius compensation start operation
(3)	G01 X30.	Move by straight line "X50"
(4)	G01 G38 X-30. Y30. I-2. J2.	Move by straight line to "X20,Y50"
(5)	X10.	Move by straight line to "X30"
(6)	X30. Y-30.	Move by straight line to "X60,Y20"

*1 Describes the program position.

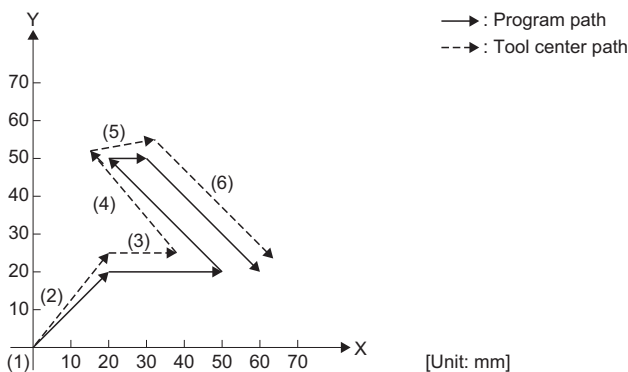

G39: Tool radius compensation corner arc

Inserts an arc with the compensation amount as the radius without an intersection point calculation at the workpiece corner.

Code	Format
G39	G39_ X x _Y y <div style="margin-left: 100px;"> Coordinate command </div>

Processing details

- When the G39 command is executed, an arc with the compensation amount as the radius is inserted without an intersection point calculation.

Compensation	With G39 command	Without G39 compensation
Outside compensation		
Inside compensation		

- The G39 command is unmodal. It is only valid for the specified block.
- Refer to tool radius compensation for details of tool radius compensation. (👉 Page 228 Tool radius compensation)

Program example

■ Program that uses the radius as the compensation amount in the command position

Tool radius compensation amount is "compensation No.: 01", "compensation amount: 5[mm]"

Operation	Program	Remarks *1
(1)	G90 X0. Y0.	Move to "X0,Y0" by absolute value command
(2)	G91 G01 G42 X20. Y20. D01 F100.	Move to "X20,Y15" by tool radius compensation start operation
(3)	G39 X40.	After moving to "X60,Y15" by straight line, move to "X65,Y20" by circular interpolation
(4)	G39 Y40.	After moving to "X60,Y60" by straight line, move to "X60,Y65" by circular interpolation
(5)	G39 X-40.	After moving to "X20,Y65" by straight line, move to "X15,Y60" by circular interpolation
(6)	Y-40.	Move to "X15,Y20" by straight line
(7)	G40 X-20. Y-20.	Move to "X0,Y0" by tool radius cancel operation
(8)	M02	Program end

*1 Describes the tool center position.

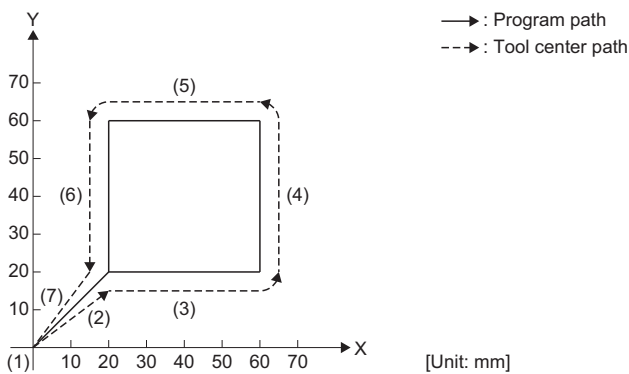

G40: Tool radius compensation cancel

Cancels the set tool radius compensation amount (G41, G42).

Code	Format
G40	G40_ X x _Y y <div style="margin-left: 100px;">└─── Coordinate command</div>

Processing details

- The G40 command cancels the set tool radius compensation amount (G41, G42) and performs positioning.
- Refer to tool radius compensation for details of tool radius compensation. (📖 Page 228 Tool radius compensation)

Program example

■ Program that cancels tool radius compensation (left)

Tool radius compensation amount is "compensation No.: 10", "compensation amount: 10[mm]"

Operation	Program	Remarks*1
(1)	G90 X0. Y0.	Move to "X0,Y0" by absolute position command
(2)	G91 G01 G41 X40. Y40. D10 F500.	Move to "X40,Y50" by tool radius compensation start operation
(3)	G01 X30.	Move to "X70" by straight line
(4)	G40 X30. Y-40.	Cancel tool radius compensation, move to "X0,Y0"

*1 Describes the tool center position.

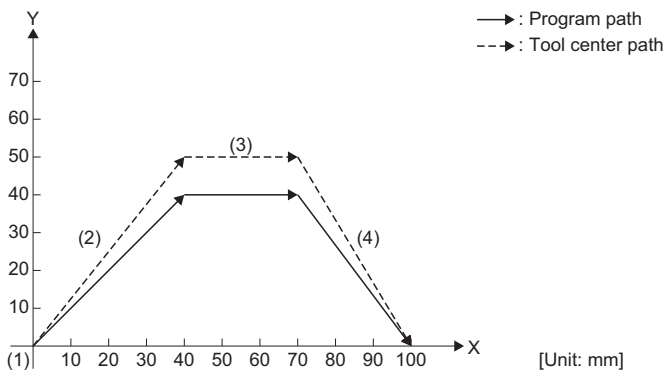

G41: Tool radius compensation - Left

The actual path of the tool center for the programmed path is compensated by an amount of the tool radius. The path is calculated by intersection operation method therefore the overcutting of inside corners can be prevented.

Code	Format
G41	G41_ X x _Y y _D d <div style="margin-left: 100px;"> Tool No. Coordinate command </div>

Processing details

- When G41 command is executed, the tool radius compensation amount set in [Motion Control Parameter]⇒[G-code Control Parameter]⇒[G-code Control Work Parameter]⇒"Tool Compensation Data"⇒"Tool Compensation Data" is added to the end position of the movement command, and outside or inside compensation is performed for movement.
- The G41 command is modal. The compensation amount is kept until tool radius compensation cancel (G40) is commanded.
- In tool radius compensation, H commands are ignored and only D commands are valid.
- When "0" is specified as the tool No., the tool radius compensation command is cancelled.
G41 D0 (With tool No. as 0, tool radius compensation is cancelled)
- Tool radius compensation is performed on the plane selected in [Motion Control Parameter]⇒[G-code Control Parameter]⇒[G-code Control System Parameter]⇒"Modal Initial Setting"⇒"Plane Selection". Compensation is not performed on axes that are not included in the specified plane.
- The operation for when compensation amount is set as a positive value (+), and negative value (-) is shown below.

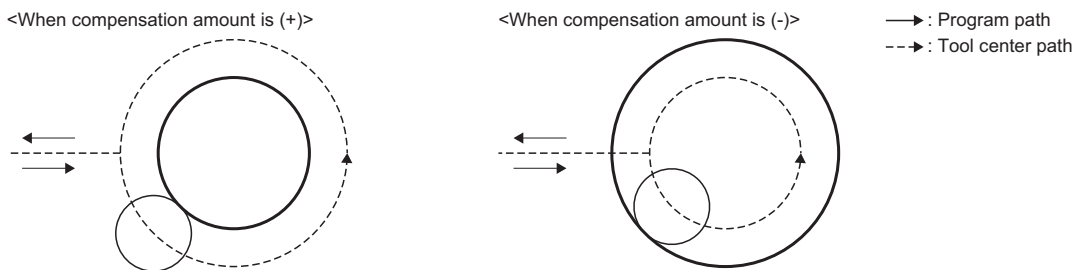

- Refer to tool radius compensation for details of tool radius compensation. (📖 Page 228 Tool radius compensation)

Program example

■ Program that starts tool radius compensation (left) and performs positioning

Tool radius compensation amount is "compensation No.: 10", "compensation amount: 10[mm]"

Operation	Program	Remarks ^{*1}
(1)	G90 X0. Y0.	Move to "X0,Y0" by absolute position command
(2)	G91 G01 G41 X40. Y40. D10 F500.	Move to "X40,Y50" by tool radius compensation start operation
(3)	G01 X30.	Move to "X70" by straight line

*1 Describes the tool center position.

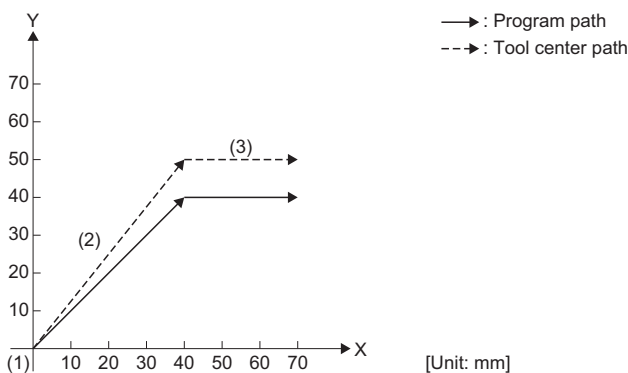

G42: Tool radius compensation - Right

The actual path of the tool center for the programmed path is compensated by an amount of the tool radius. The path is calculated by intersection operation method therefore the overcutting of inside corners can be prevented.

Code	Format
G42	G42_X x _Y y _D d <div style="margin-left: 100px;"> Tool No. Coordinate command </div>

Processing details

- When G42 command is executed, the tool radius compensation amount set in [Motion Control Parameter]⇒[G-code Control Parameter]⇒[G-code Control Work Parameter]⇒"Tool Compensation Data"⇒"Tool Compensation Data" is added to the end position of the movement command, and outside or inside compensation is performed for movement.
- The G42 command is modal. The compensation amount is kept until tool radius compensation cancel (G40) is commanded.
- In tool radius compensation, H commands are ignored and only D commands are valid.
- When "0" is specified as the tool No., the tool radius compensation command is cancelled.
G42 D0 (With tool No. as 0, tool radius compensation is cancelled)
- Tool radius compensation is performed on the plane selected in [Motion Control Parameter]⇒[G-code Control Parameter]⇒[G-code Control System Parameter]⇒"Modal Initial Setting"⇒"Plane Selection". Compensation is not performed on axes that are not included in the specified plane.
- The operation for when compensation amount is set as a positive value (+), and negative value (-) is shown below.

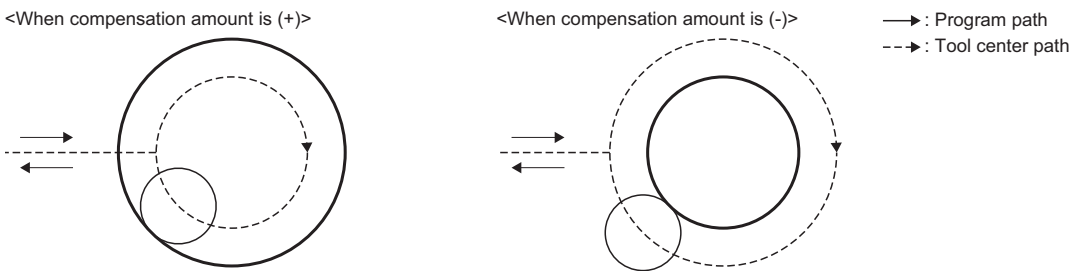

Refer to tool radius compensation for details of tool radius compensation. (📖 Page 228 Tool radius compensation)

Program example

■ Program that starts tool radius compensation (right) and performs positioning

Tool radius compensation amount is "compensation No.: 10", "compensation amount: 10[mm]"

Operation	Program	Remarks*1
(1)	G90 X0. Y0.	Move to "X0,Y0" by absolute position command
(2)	G91 G01 G42 X40. Y40. D10 F500.	Move to "X40,Y30" by tool radius compensation start operation
(3)	G01 X30.	Move to "X70" by straight line

*1 Describes the tool center position.

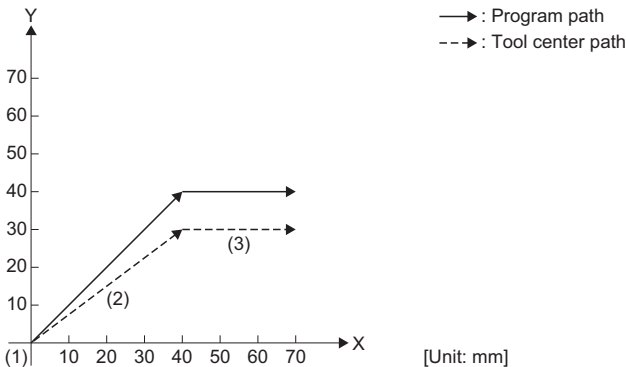

G40.1: Normal line control cancel

Cancels the set normal line control (G41.1, G42.1).

Code	Format
G40.1	G40.1 X x Y y F f

Processing details

- The G40.1 command cancels the set normal line control (G41.1, G42.1) and performs the specified positioning.
- Refer to normal line control function for details of normal line control. (Page 256 Normal Line Control Function)

Program example

Program that cancels normal line control

Operation	Program	Remarks
(1)	G41.1	Normal line control - left ON
(2)	G91 G01 X100. Y50. F500.	Move to "X100,Y50" by straight line after rotating axis rotates
(3)	G40.1	Cancel normal line control
(4)	X50. Y50.	Keep the position of the rotating axis, and move to "X50,Y50" by straight line

G41.1: Normal line control - Left ON

Controls the rotation of a rotating axis so that the tool is always in the normal direction for a movement axis selecting a plane.

Code	Format
G41.1	G41.1 X x Y y F f <div style="margin-left: 150px;"> Coordinate command Feed speed </div>

Processing details

- Performs normal line control for an axis selecting a plane. (G17: Plane X-Y axis, G18: Plane Z-X axis, G19: Plane Y-Z axis)

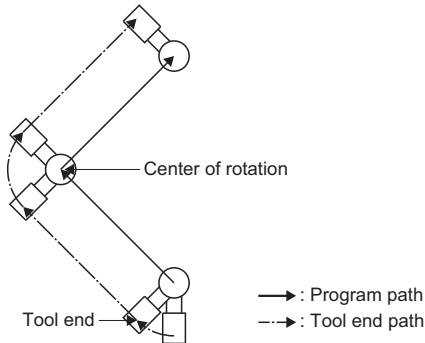

- The G41.1 command is modal. Normal line control continues until normal line control cancel (G40.1) is commanded.
- Set the axis name of the axis for normal line control in [Motion Control Parameter]⇒[G-code Control Parameter]⇒[G-code Control System Parameter]⇒"Normal Line Control"⇒"Normal Line Control Axis". When a normal line control axis is set to "0: No Normal Line Control" and G41.1 command is executed, a minor error (error code: 1FC3H (details code: 031BH)) occurs, and normal line control is not performed.
- There are two types of rotation methods for a normal line control axis. They are normal line control type I, and normal line control type II. Set the normal line control type in [Motion Control Parameter]⇒[G-code Control Parameter]⇒[G-code Control System Parameter]⇒"Normal Line Control"⇒"Normal Line Control Type".
- Refer to normal line control function for details of normal line control. (📖 Page 256 Normal Line Control Function)

Program example

■ Program that performs normal line control (left)

Operation	Program	Remarks
(1)	G41.1	Normal line control - Left ON
(2)	G91 G01 X-50. Y50. F500.	Move to "X-50,Y50" by straight line after rotating axis rotates
(3)	X50. Y50.	Move to "X50,Y50" by straight line after rotating axis rotates

G42.1: Normal line control - Right ON

Controls the rotation of a rotating axis so that the tool is always in the normal direction for a movement axis selecting a plane.

Code	Format
G42.1	$G42.1 _X _x _Y _y _F _f$

Processing details

- Performs normal line control for an axis selecting a plane. (G17: Plane X-Y axis, G18: Plane Z-X axis, G19: Plane Y-Z axis)

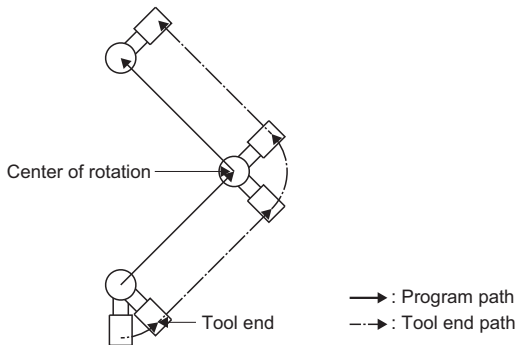

- The G42.1 command is modal. Normal line control continues until normal line control cancel (G40.1) is commanded.
- Set the axis name of the axis for normal line control in [Motion Control Parameter]⇒[G-code Control Parameter]⇒[G-code Control System Parameter]⇒"Normal Line Control"⇒"Normal Line Control Axis". When a normal line control axis is set to "0: No Normal Line Control" and G42.1 command is executed, a minor error (error code: 1FC3H (details code: 031BH)) occurs, and normal line control is not performed.
- There are two types of rotation methods for a normal line control axis. They are normal line control type I, and normal line control type II. Set the normal line control type in [Motion Control Parameter]⇒[G-code Control Parameter]⇒[G-code Control System Parameter]⇒"Normal Line Control"⇒"Normal Line Control Type".
- Refer to normal line control function for details of normal line control. (📖 Page 256 Normal Line Control Function)

Program example

■ Program that performs normal line control (right)

Operation	Program	Remarks
(1)	G42.1	Normal line control - Right ON
(2)	G91 G01 X50. Y50. F500.	Move to "X50,Y50" by straight line after rotating axis rotates
(3)	X-50. Y50.	Move to "X-50,Y50" by straight line after rotating axis rotates

G43: Tool length compensation (+)

Adds the set compensation amount to the movement command. By setting actual difference from the tool length as the compensation amount, programs can be created without having to remember the tool length.

Code	Format
G43	$G43_Z\ z\ _H\ h$

Processing details

- When G43 command is executed, the compensation amount set in [Motion Control Parameter]⇒[G-code Control Parameter]⇒[G-code Control Work Parameter]⇒"Tool Compensation Data"⇒"Tool Length Compensation Amount" is added to the end position of the movement command.
- The G43 command is modal. Compensation continues until tool length compensation cancel (G49) is commanded.
- When "0" is specified as the tool No., the tool length compensation command is cancelled. However, when an axis address is specified in the same block, tool length compensation is only performed for that specified axis address.
G43 H0 (With tool No. as 0, tool length compensation is cancelled)
- The G43 command calculates the movement amount by the following calculation.

Program	Z-axis movement amount	Operation
G43 Z10. H01	10+(Tool length compensation amount of tool No. 01)	Compensation in the + direction for the tool compensation amount only

- When G43 is commanded again during tool length compensation, only the difference between the compensation amounts of the compensation Nos. is compensated.

Program	Z-axis movement amount
G43 Z10. H01	10+(Tool length compensation amount of tool No. 01)
⋮	⋮
G43 Z10. H02	10-(Tool length compensation amount of tool No. 02-Tool length compensation amount of tool No. 01)

- For movement commands to the machine coordinate system (G53 command), movement to the machine position is made with tool compensation amount cancelled. When returning to work coordinate system (G54 to G59), the tool compensation amount is added to the position again.
- When transitioning to G-code control, or after resetting, the mode changes to G49 (tool length compensation cancel).
- Tool length compensation is valid for the axis addresses commanded in the same block as G43. The valid axis addresses are those set in [Motion Control Parameter]⇒[G-code Control Parameter]⇒[G-code Control System Parameter]⇒"Plane Composition"⇒"Base Axis I to K" only. (The details below are based on the following address settings: Base axis I="X", base axis J="Y", and base axis K="Z".)
- When there is no axis address specified in the same block as G43, tool length compensation is valid for the Z-axis. However, when base axis K has not been set tool length compensation is not performed.
- Tool length compensation is a command only valid for one axis. When two or more axes are commanded at the same time, the order of priority is "Z > Y > X".

Ex.

The following shows the valid axis for compensation for the following programs

Program	Axis for compensation
G43 X10. H01	X-axis is valid
G43 X10. Y10. Z10. H01	Z-axis is valid
G43 H01	Z-axis is valid

Program example

■ Program that adds the compensation amount to the command position (absolute value command)

Tool length compensation amount is "compensation No.: 01", "compensation amount: 100"

Operation	Program	Remarks
(1)	G90 G53 Z0.	Move to the Z-axis "0" position of the machine coordinate system
(2)	G90	Absolute value command
(3)	G43 Z5. H01	Use the tool length compensation amount of tool No. 01 and move to the "5" position on Z-axis
(4)	G01 Z-50. F500	Move to the "-50" position on Z-axis

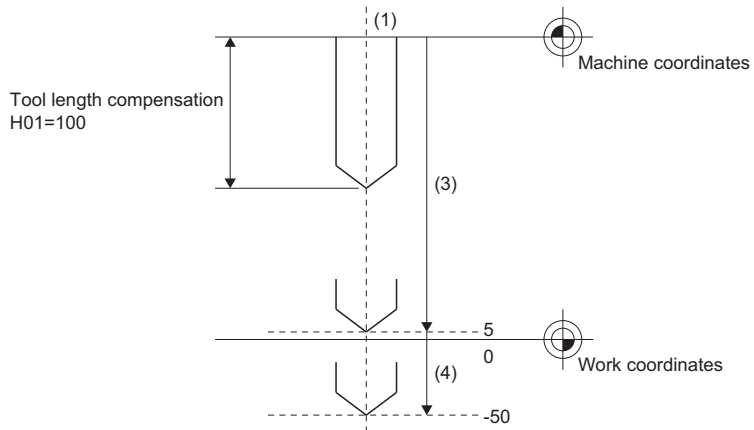

G44: Tool length compensation (-)

Subtracts the set compensation amount from the movement command. By setting the actual difference from the tool length as the compensation amount, programs can be created without having to remember the tool length.

Code	Format
G44	$G44_{_}Z z_{_}H h$

Processing details

- When G44 command is executed, the compensation amount set in [Motion Control Parameter]⇒[G-code Control Parameter]⇒[G-code Control Work Parameter]⇒"Tool Compensation Data"⇒"Tool Length Compensation Amount" is subtracted from the end position of the movement command.
- The G44 command is modal. Compensation continues until tool length compensation cancel (G49) is commanded.
- When "0" is specified as the tool No., the tool length compensation command is cancelled. However, when an axis address is specified in the same block, tool length compensation is only performed for that specified axis address.
G44 H0 (With tool No. as 0, tool length compensation is cancelled)
- The G44 command calculates the movement amount by the following calculation.

Program	Z-axis movement amount	Operation
G44 Z10. H01	10-(Tool length compensation amount of tool No. 01)	Compensation in the - direction for the tool compensation amount only

- When G44 is commanded again during tool length compensation, only the difference between the compensation amounts of the compensation Nos. is compensated.

Program	Z-axis movement amount
G44 Z10. H01	10-(Tool length compensation amount of tool No. 01)
:	:
G44 Z10. H02	10+(Tool length compensation amount of tool No. 02-Tool length compensation amount of tool No. 01)

- For movement commands to the machine coordinate system (G53 command), movement to the machine position is made with tool compensation amount cancelled. When returning to work coordinate system (G54 to G59), the tool compensation amount is subtracted from the position again.
- When transitioning to G-code control, or after resetting, the mode changes to G49 (tool length compensation cancel).
- Tool length compensation is valid for the axis addresses commanded in the same block as G44. The valid axis addresses are those set in [Motion Control Parameter]⇒[G-code Control Parameter]⇒[G-code Control System Parameter]⇒"Plane Composition"⇒"Base Axis I to K" only. (The details below are based on the following address settings: Base axis I="X", base axis J="Y", and base axis K="Z".)
- When there is no axis address specified in the same block as G44, tool length compensation is valid for the Z-axis. However, when base axis K has not been set tool length compensation is not performed.
- Tool length compensation is a command only valid for one axis. When two or more axes are commanded at the same time, the order of priority is "Z > Y > X".

Ex.

The following shows the valid axis for compensation for the following programs

Program	Axis for compensation
G44 X10. H01	X-axis is valid
G44 X10. Y10. Z10. H01	Z-axis is valid
G44 H01	Z-axis is valid

Program example

■ Program that subtracts the compensation amount from the command position (absolute value command)

Tool length compensation amount is "compensation No.: 01", "compensation amount: 100"

Operation	Program	Remarks
(1)	G90 G53 Z0.	Move to the Z-axis "0" position of the machine coordinate system
(2)	G90	Absolute value command
(3)	G44 Z5. H01	Use the tool length compensation amount of tool No. 01 and move to the "5" position on Z-axis
(4)	G01 Z-50. F500	Move to the "-50" position on Z-axis

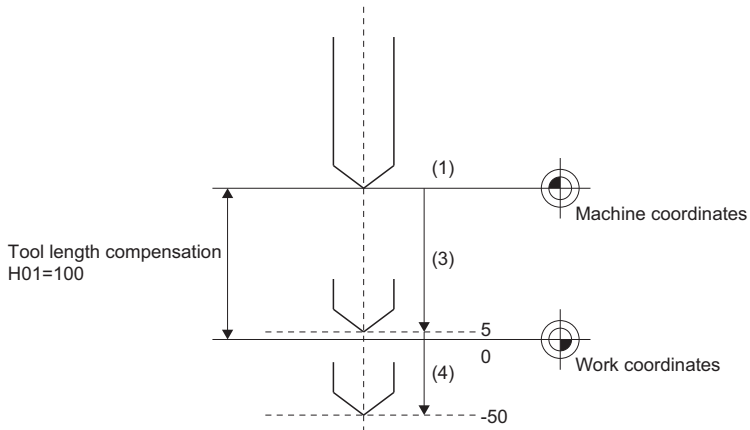

G49: Tool length compensation cancel

Cancels the set tool length compensation amount (G43, G44).

Code	Format
G49	G49_ <u>Z</u> <u>z</u> <div style="margin-left: 100px;">└── Coordinate command</div>

Processing details

- The G49 command cancels the set tool length compensation amount (G43, G44) and performs positioning.
- The G49 command calculates the movement amount by the following calculation.

Program	Z-axis movement amount	Operation
G49 Z10.	10-(+)(tool length compensation amount of tool No. 01)	Tool compensation cancel

Program example

■ Program that cancels compensation and performs positioning after the execution of positioning by tool length compensation (absolute value command)

The tool length compensation amount is "compensation No.: 01", "compensation amount: 100"

Operation	Program	Remarks
(1)	G90 G53 Z0.	Move to the Z-axis "0" position of the machine coordinate system
(2)	G90	Absolute value command
(3)	G43 Z5. H01	Use the tool length compensation amount of tool No. 01 and move to the "5" position on Z-axis
(4)	G01 Z-50. F500	Move to the "-50" position on Z-axis
(5)	G49 Z40.	Move to the "60" position on Z-axis

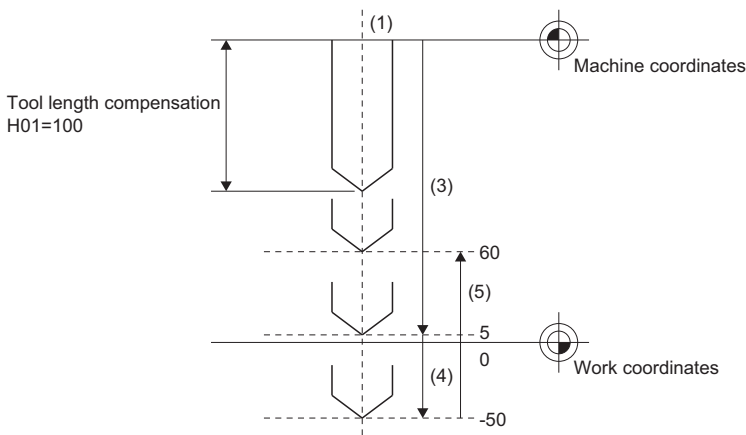

G52: Local coordinate system setting

Set the position of the local coordinate system offset on the selected work coordinate system.

Code	Format
G52	G54 X x Y y Z z to _____ Local coordinate offset position on the work coordinate system G59

Processing details

- The local coordinate system can be set so that the position commanded on the work coordinate system (G54 to G59) is the program home position. This can be used to change the difference between processing program home position and the workpiece home position.
- The G52 command is unmodal. It is effective until the next G52 command is executed.
- The G52 command does not move the coordinate system. A separate coordinate system can be used without changing the home position of the work coordinate system (G54 to G59).
- The local coordinate system is cancelled when transferring to G-code control, resetting, or when an absolute value command of "0" is commanded for axes that have had a local coordinate system set.

Ex.

When an absolute value command of "0" is commanded in work coordinate system 1 (G54)

```
G90 G54 G52 X0 Y0 Z0
```

- When in absolute value command mode (G90), the G52 command sets the local coordinate system at an absolute position from the home position of the currently selected work coordinate system. When in incremental value command mode (G91), the G52 command sets a new local coordinate system at a relative position from the home position of the current local coordinate system.

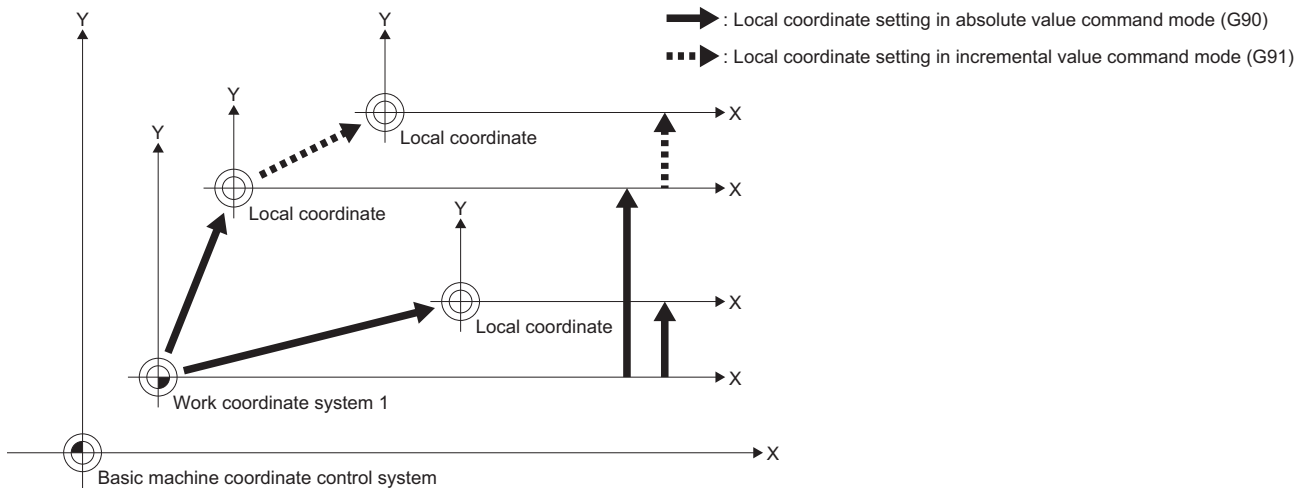

- An axis is not moved with a G52 command.
- Coordinate commands for absolute value commands (G90), move to positions on the local coordinate system.
- The position on the local coordinate system is the position of "[Md.3149] Relative position (D54772+32sn, D54773+32sn)" less "[Md.3154] Local coordinate offset (D54756+32sn, D54757+32sn)".
- The operations when local coordinate system is combined with each function is shown below.

Function	Operation
Tool radius compensation	When G52 is commanded in the same block as tool radius compensation command (G41, G42) and tool radius compensation cancel command (G40), a minor error (error code: 1FC3H (details code: 030FH)) occurs.
Tool length compensation	When G52 is commanded in the same block as tool length compensation command (G43, G44) and tool length compensation cancel command (G49), a minor error (error code: 1FC3H (details code: 030FH)) occurs.
Normal line control	Local coordinate system cannot be changed during normal line control. When changed, a minor error (error code: 1FC3H (details code: 0304H)) occurs.

Program example

■ Program that positions to a specified position from the position of the local coordinate system offset of the work coordinate system in absolute value mode

- Work coordinate system offset setting amount

Address	Offset setting amount
	Work coordinate system 1 (G54)
X	500
Y	500

Operation	Program	Remarks
(1)	G90 G54 X0. Y0. F100.	Move to "X0, Y0" of the work coordinate system 1 by absolute value command
(2)	G52 X1000. Y500.	Set the local coordinate system offset "X1000, Y500" (no axis movement)
(3)	G00 X0. Y0.	Move to "X0, Y0" on the local coordinate system
(4)	G01 X500.	Move to "X500, Y0" on the local coordinate system
(5)	Y500.	Move to "X500, Y500" on the local coordinate system
(6)	G52 X0. Y0.	Cancel the local coordinate system offset (no axis movement)
(7)	G00 X0. Y0.	Move to "X0, Y0" on the work coordinate system 1

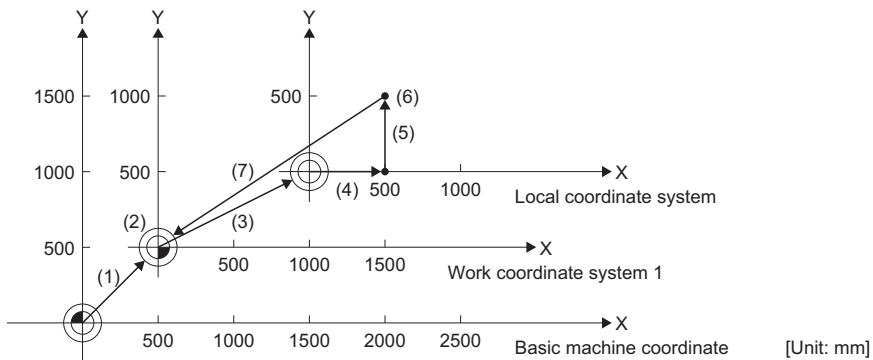

- The local coordinates are created by (2).
- Local coordinates are cancelled by (6), and the coordinates match the coordinate system of (1).

■ Program that positions to a specified position from the position of the local coordinate system offset of the work coordinate system in incremental value mode

- Work coordinate system offset setting amount

Address	Offset setting amount
	Work coordinate system 1 (G54)
X	500
Y	500

Operation	Program	Remarks
(1)	G90 G54 X0. Y0. F100.	Move to "X0, Y0" of the work coordinate system 1 by absolute value command
(2)	G91 G52 X1000. Y500.	Set the local coordinate system offset "X1000, Y500" by incremental value command (no axis movement)
(3)	G90 G00 X0. Y0.	Move to "X0, Y0" on the local coordinate system by absolute value command
(4)	G01 X500.	Move to "X500, Y0" on the local coordinate system
(5)	Y500.	Move to "X500, Y500" on the local coordinate system
(6)	G91 G52 X1000. Y1000.	Set the local coordinate system offset "X1000, Y1000" by incremental value command (no axis movement)
(7)	G90 G00 X0. Y0.	Move to "X0, Y0" on the local coordinate system by absolute value command
(8)	G01 X500.	Move to "X500, Y0" on the local coordinate system
(9)	Y500.	Move to "X500, Y500" on the local coordinate system
(10)	G91 G52 X-2000. Y-2000.	Set the local coordinate system offset "X-2000, Y-2000" by incremental value command (no axis movement)
(11)	G90 G00 X0. Y0.	Move to "X0, Y0" on the local coordinate system (work coordinate system 1) by absolute value command

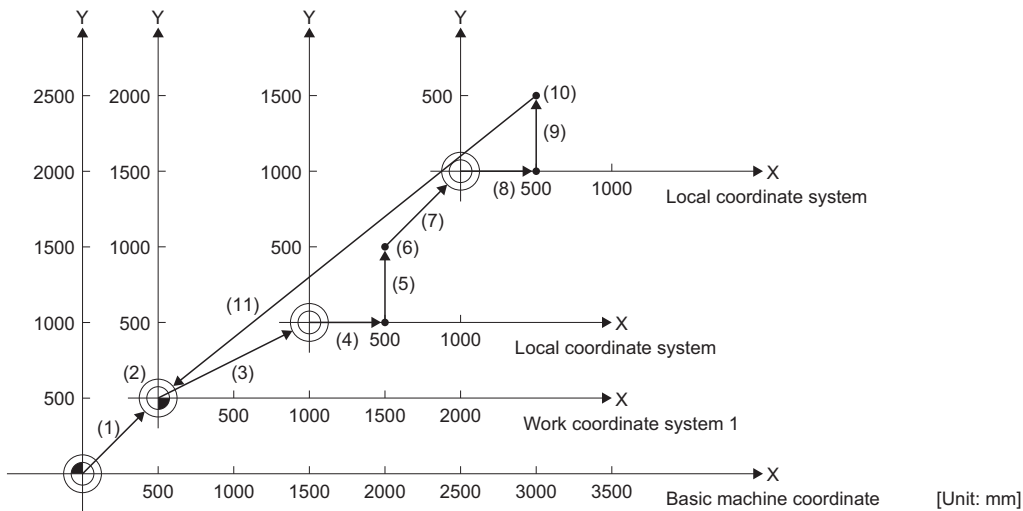

- Work coordinate system 1 is created by (1) at the position of "500, 500".
- Local coordinate system is created by (2) at the position of "X1000, Y500".
- Local coordinate system is created by (6) at the position of "X2000, Y1500".
- Local coordinate system is created by (10) at the position of "X500, Y500". (The local coordinate system and work coordinate system 1 match, and the local coordinate system is cancelled.)

■ Program that positions to a specified position from the position of the local coordinate system offset of multiple work coordinate systems

- Work coordinate system offset setting amount

Address	Offset setting amount	
	Work coordinate system 1 (G54)	Work coordinate system 2 (G55)
X	1000	1000
Y	500	2500

Operation	Program	Remarks
(1)	G90 G54 X0. Y0. F100.	Move to "X0, Y0" of the work coordinate system 1 by absolute value command
(2)	G52 X1500. Y500.	Set the local coordinate system offset "X1500, Y500" (no axis movement)
(3)	G00 X0. Y0.	Move to "X0, Y0" on the local coordinate system
(4)	G01 X500.	Move to "X500, Y0" on the local coordinate system
(5)	Y500.	Move to "X500, Y500" on the local coordinate system
(6)	G55 G00 X0. Y0.	Move to "X0, Y0" on the work coordinate system 2
(7)	G01 X500.	Move to "X500, Y0" on the work coordinate system 2
(8)	Y500.	Move to "X500, Y500" on the work coordinate system 2
(9)	G54 G00 X0. Y0.	Move to "X0, Y0" on the local coordinate system of work coordinate system 1
(10)	G52 X0. Y0.	Cancel the local coordinate system offset (no axis movement)
(11)	G00 X0. Y0.	Move to "X0, Y0" on the work coordinate system 1

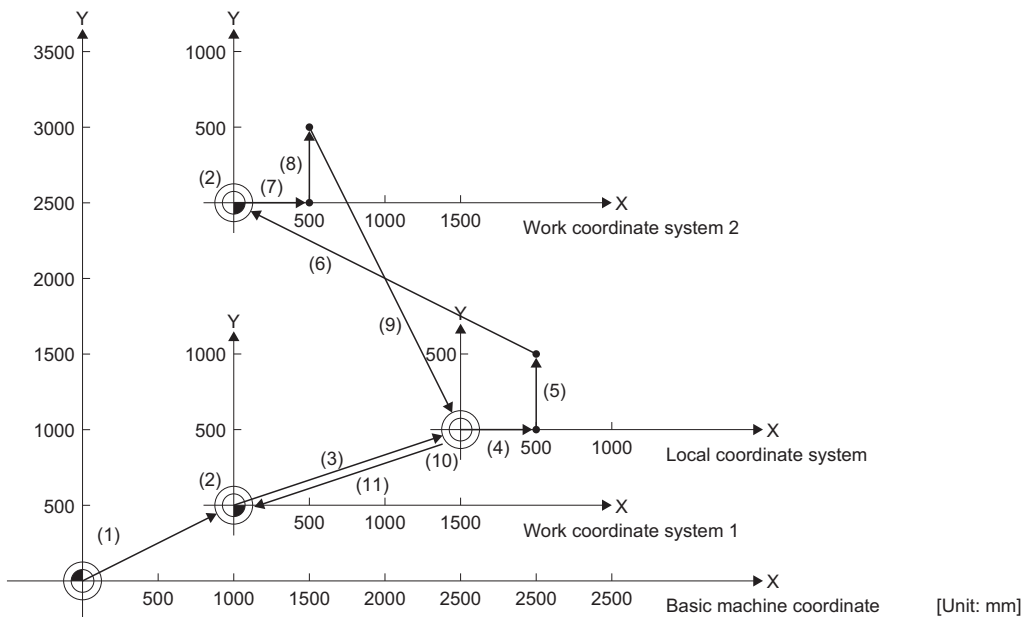

- Local coordinate system is created by (2) at the position of "X1500, Y500" of work coordinate system 1. (Local coordinate system is not created in work coordinate system 2)
- Move to "X0, Y0" of local coordinate system of work coordinate system 1 by (9).
- Local coordinate offset is cancelled by (10), and the coordinates match the coordinate system of (1).

G53: Basic machine coordinate system selection

Moves to command positions on the basic machine coordinate system.

Code	Format
G53	G53_ X x _ Y y _ Z z <div style="text-align: center; margin-top: -10px;"> Coordinate on basic machine coordinate system </div>

Processing details

- The basic machine coordinate system is used to indicate positions specifically determined by the machine.
- The G53 command is unmodal. It is only valid for the specified block.
- The G53 command moves by an incremental value based on the selected coordinate system when in incremental value command mode (G91). To move to a position on the basic machine coordinate system, use the G53 command in absolute value command mode (G90). When operating in incremental value command mode (G91) up until the block before, set absolute value command mode (G90) before the G53 command.
- The G53 command moves by cutting feed or fast forward in accordance with command modal (G00, G01). When the G53 command and circular interpolation command (G02, G03) are commanded in the same block, linear interpolation is performed to the end point coordinates but the modal is a circular modal.
- When the G53 command is executed, the compensation vector of the tool radius in the applicable block is cancelled. However, the compensation amount for the tool radius at axes commanded from the next point onwards is not cancelled.

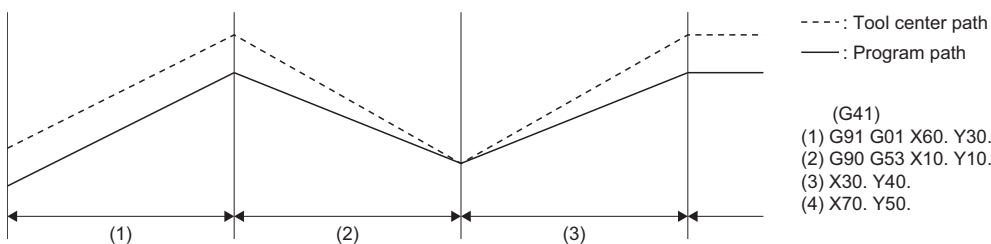

- Movement to the coordinate command of the G53 command block starts after the completion of deceleration stop at the previous block.
- The tool length compensation amount set by tool length compensation (G43, G44), is temporarily cancelled.

Program example

■ Program that performs positioning to the specified position of the work coordinate system after positioning to the specified position of the basic machine coordinate system in absolute value mode

Operation	Program	Remarks
(1)	G90	Absolute position command
(2)	G53 X10. Y10.	Move to basic machine coordinates X10,Y10
(3)	G01 X10. Y10. F20.	Move to work coordinates X10,Y10

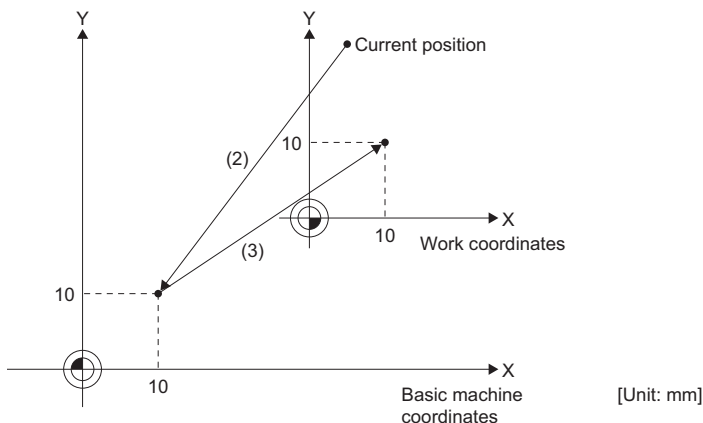

G54 to G59: Work coordinate system 1 selection to work coordinate system 6 selection

Selects the work coordinate system and moves to the specified position of the work coordinate system at the specified feed speed.

Code	Format
G54, G55, G56, G57, G58, G59	G54_ X x _ Y y _ Z z to _____ G59 _____ Position where work coordinate position is determined

Processing details

- The work coordinate system is the coordinate system used when programming and there are six available (work coordinate system 1 to 6(G54 to G59)). Work coordinate systems 1 to 6 reset the work coordinate systems so that the current position of the tool in the currently selected work coordinate system is that of the commanded coordinate value. (The current position of the tool includes compensation for the tool radius, tool length, and tool position.)
- When transitioning to G-code control, work coordinate system 1 (G54) is selected.
- The work coordinate system (1 to 6) selection command is modal. The command is valid until the next work coordinate system (1 to 6) selection is commanded.
- The offset setting of the work coordinate system is set by the distance from the basic machine coordinate system. Set the work coordinate system offset setting in [Motion Control Parameter]⇒[G-code Control Parameter]⇒[G-code Control Work Parameter]⇒"Workpiece Coordinate Offset".
- When transitioning to G-code control, the basic machine coordinate system and work coordinate system are set automatically by automatic coordinate system settings according to the parameter settings.

Program example

■ Program that performs positioning to specified positions of multiple work coordinate systems

- Offset settings for work coordinate systems

Address	Offset setting	
	Work coordinate system 1 (G54)	Work coordinate system 2 (G55)
X	500	2000
Y	500	1000

Operation	Program	Remarks
(1)	G90 G00 G53 X0. Y0.	Move to "X0,Y0" of the basic machine coordinate system by absolute value command
(2)	G54 X500. Y500. ,F100.	Move to "X500,Y500" of work coordinate system 1
(3)	G01 G91 X500. F100	Move "X500" from the current position by incremental value command
(4)	Y500.	Move "Y500" from the current position by incremental value command
(5)	G90 G00 G55 X0. Y0.	Move to "X0,Y0" of work coordinate system 2 by absolute value command
(6)	G01 X500.	Move to "X500,Y0" of work coordinate system 2
(7)	X0. Y500.	Move to "X0,Y500" of work coordinate system 2

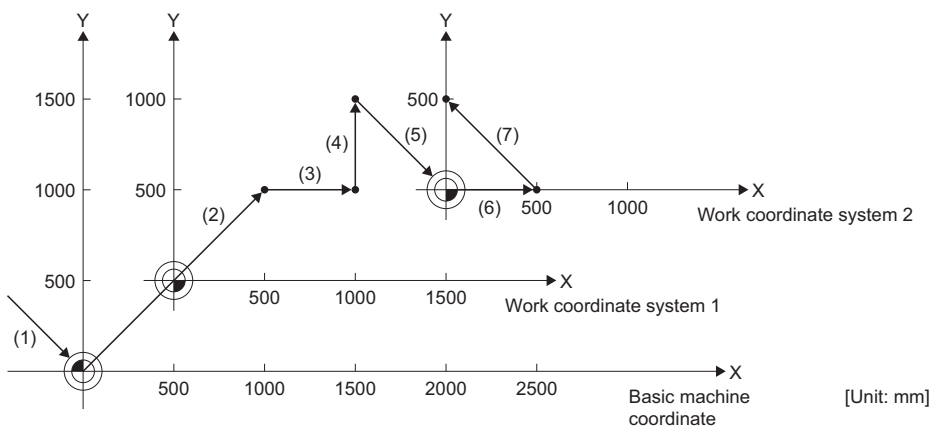

■ Program that puts three of the same workpieces on the G54 to G56 coordinate systems and performs positioning

- Offset settings for work coordinate systems

Address	Offset setting		
	Work coordinate system 1 (G54)	Work coordinate system 2 (G55)	Work coordinate system 3 (G56)
X	200	600	1000
Y	200	200	200

Operation	Program	Remarks
(1)	G90 G00 G53 X0. Y0.	Move to "X0,Y0" of the basic machine coordinate system by absolute value command
(2)	G90 G54 X0. Y0. F50.	Move to "X0,Y0" of work coordinate system 1
(3)	G90 G01 X50. Y50. F50.	Move to "X50,Y50" from the current position by absolute value command
(4)	X200.	Move to "X200,Y50"
(5)	Y200.	Move to "X200,Y200"
(6)	X50.	Move to "X50,Y200"
(7)	Y50.	Move to "X50,Y50"
(8)	X0. Y0.	Move to "X0,Y0"
(9)	G90 G00 G55 X0. Y0.	Move to "X0,Y0" of work coordinate system 2
(10)	G90 G01 X50. Y50. F50.	Move to "X50,Y50" from the current position by absolute value command
(11)	X200.	Move to "X200,Y50"
(12)	Y200.	Move to "X200,Y200"
(13)	X50.	Move to "X50,Y200"
(14)	Y50.	Move to "X50,Y50"
(15)	X0. Y0.	Move to "X0,Y0"
(16)	G90 G00 G56 X0. Y0.	Move to "X0,Y0" of work coordinate system 3
(17)	G90 G01 X50. Y50. F50.	Move to "X50,Y50" from the current position by absolute value command
(18)	X200.	Move to "X200,Y50"
(19)	Y200.	Move to "X200,Y200"
(20)	X50.	Move to "X50,Y200"
(21)	Y50.	Move to "X50,Y50"
(22)	X0. Y0.	Move to "X0,Y0"

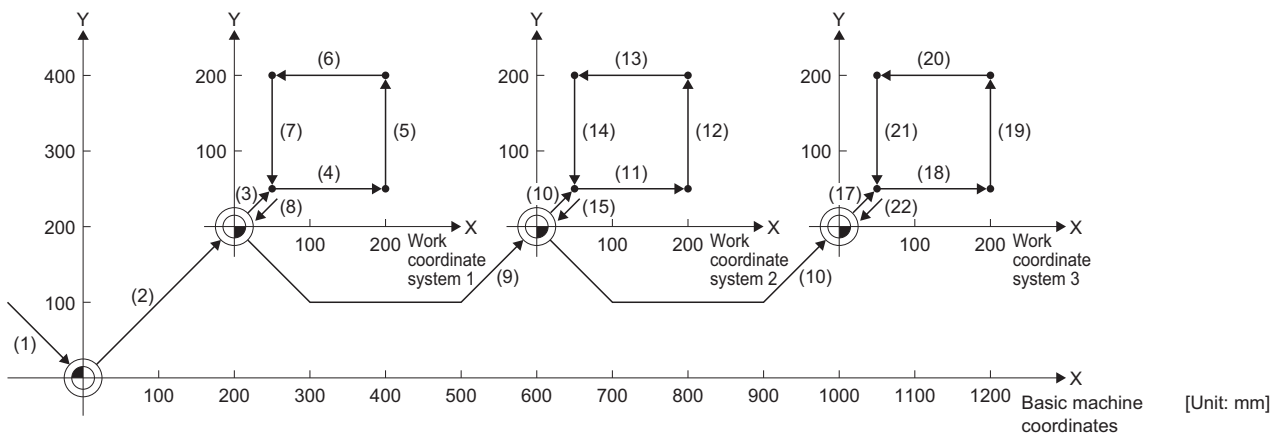

G61: Exact stop check mode

Performs a deceleration check.

Code	Format
G61	G61

Processing details

- The G61 command performs a deceleration check at all the end points of in blocks for cutting commands.
- The G61 command performs a deceleration check for each specified coordinate before executing the next block.
- The G61 command is modal. It remains in effect until any of high-accuracy control mode (G61.1), automatic corner override (G62), and cutting mode (G64) command from the same group are commanded.
- Refer to deceleration check for details of deceleration check. ( Page 223 Deceleration check)

■ In exact stop check mode

G61 G01 X100. F500.
X200.

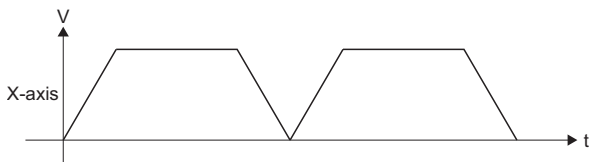

■ Not in exact stop mode check

G01 X100. F500.
X200.

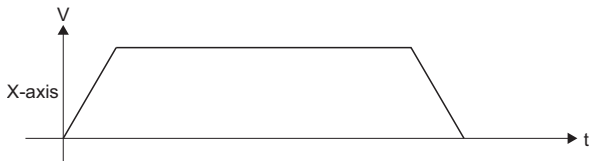

Program example

■ Program that performs positioning by exact stop check mode

Operation	Program	Remarks
(1)	G61 G01 X100. F500.	Positioning by exact stop check mode
(2)	X200.	Positioning by exact stop check mode
(3)	X300.	Positioning by exact stop check mode

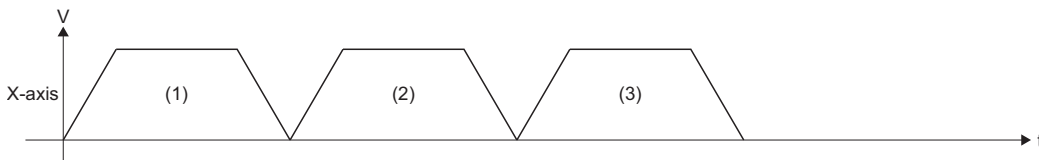

G61.1: High-accuracy control mode

Controls the deviation in processing that is caused by the delay in the control system.

Code	Format
G61.1	G61.1

Processing details

- The G61 command is modal. It remains in effect until any of exact stop check mode (G61), automatic corner override (G62), and cutting mode (G64) command from the same group are commanded.
- The fast forward speed set in [Motion Control Parameter]⇒[G-code Control Parameter]⇒[G-code Control Axis Parameter]⇒"High-accuracy Control"⇒"Rapid Traverse Rate During High-accuracy Control Mode" is enabled during high-accuracy control mode. When rapid traverse rate during high-accuracy control mode is set to "0", the fast forward speed set in [Motion Control Parameter]⇒[G-code Control Parameter]⇒[G-code Control Axis Parameter]⇒"Speed/Time Constant"⇒"Fast Forward Speed" is enabled.
During high-accuracy control mode, the G00 command processes acceleration/deceleration by the time constant acceleration/deceleration method.
- Feed speed commands (F) during high-accuracy control mode are clamped by the feed speed set in [Motion Control Parameter]⇒[G-code Control Parameter]⇒[G-code Control Axis Parameter]⇒"High-accuracy Control"⇒"Cutting Feed Clamp Speed For High-accuracy Control Mode". When cutting feed clamp speed for high-accuracy control mode is set to "0", feed speed commands (F) during high-accuracy control mode are clamped by the feed speed set in [Motion Control Parameter]⇒[G-code Control Parameter]⇒[G-code Control Axis Parameter]⇒"Speed/Time Constant"⇒"Cutting Feed Clamp Speed". During high-accuracy control mode, G01, G02, and G03 commands are processed with constant inclination acceleration/deceleration method (acceleration/deceleration before interpolation).
- When changing from another mode in the same group (G61, G62, G64) to high-accuracy control (G61.1), or when changing from high-accuracy control (G61.1) to another mode in the same group (G61, G62, G64), a deceleration check is performed.
- When transitioning to G-code control or resetting, the mode changes to cutting mode (G64).
- Refer to high-accuracy control for details of high-accuracy control. (📖 Page 269 High-Accuracy Control)

Program example

■ Program that performs positioning by switching between cutting mode and high-accuracy mode

Operation	Program	Remarks
(1)	G64 G91 G01 X100. F1000.	Positioning by cutting mode
(2)	G61.1 X100.	Positioning by high-accuracy control mode
(3)	Y100.	Positioning by high-accuracy control mode
(4)	G64 X100.	Positioning by cutting mode

G62: Automatic corner override

Applies the override to the feed speed automatically, and reduces the load on the tool during inside corner cutting or automatic corner R inside cutting in tool radius compensation.

Code	Format
G62	G62

Processing details

- When the G62 command is executed in conjunction with an interpolation command, automatic corner override is performed. The interpolation command codes that can be used with the G62 command are G01, G02, and G03 only. When G00 is specified it is invalid. Also, when changing from G00 to G01/G02/G03, or from G01/G02/G03 to G00 on a corner, automatic corner override is not applied to the G00 block at that corner.
- The G62 command is modal. It remains in effect until any of exact stop check mode (G61), high-accuracy control mode (G61.1), and cutting mode (G64) from the same group are commanded.
- In the following cases, automatic corner override is not applied.
 - When in automatic corner override mode, but not in tool radius compensation mode.
 - On a corner where tool radius compensation starts, or cancels.
 - On a corner where there are tool radius compensation I and J vectors.
 - When an intersection operation cannot be performed. (When movement command blocks are discontinuous for four times or more)
- The deceleration area at an arc command is the length of the arc.
- The angle of an inside corner is the angle of the program path set by the G-code control system parameter settings. When the parameters are set as follows, automatic corner override becomes invalid.
 - When the G-code control system parameter "Automatic Corner Override" setting is "0" or "100".
 - When the G-code control system parameter "Automatic Corner Override Maximum Angle" setting is "0" or "180".
 - When the G-code control system parameter "Length Before Automatic Corner Override Corner" setting is "0".

■ Inside corner

When cutting an inside corner, the machining allowance is large and the load applied on the tool increases. Therefore, to maintain a good cut, override is automatically applied over the setting range of the corner to reduce feed speed and control the increase in load on the tool.

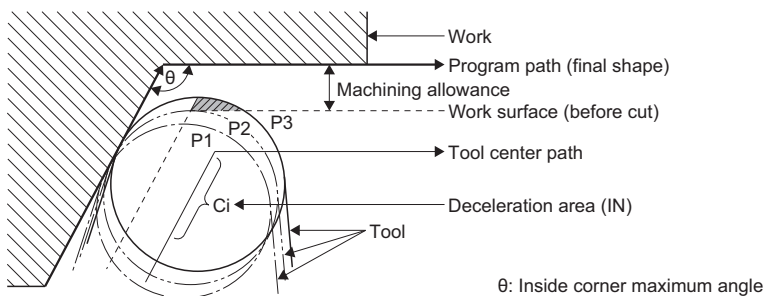

- With no G62 command

When the tool moves in the order of P1→P2→P3 in the illustration above, the machining allowance increases by the surface area indicated by when moving from P2 to P3, thus the load on the tool increases.
- With G62 command

When the angle θ of the inside corner in the illustration above is less than or equal to the angle set in the parameter, the override set in the parameter is applied automatically over the deceleration area Ci.

Automatic corner R

For inside compensation at automatic corner R, the override set in the parameter is applied automatically over the deceleration area (Ci), and the corner R section. (The angle is not checked.)

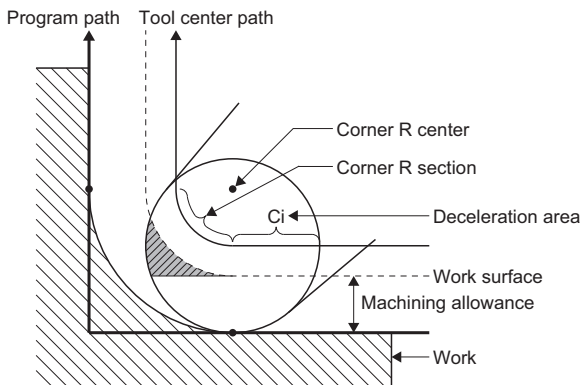

Examples

Examples of automatic corner override are shown below. The override set in the parameter is applied over the deceleration area.

- Line→line corner

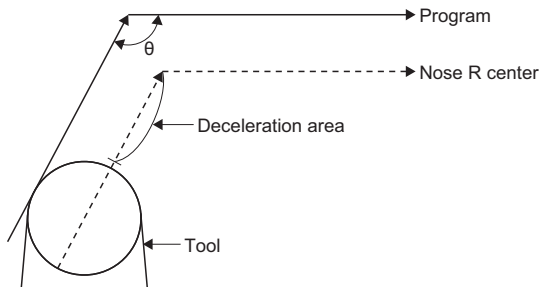

- Line→arc corner (outside compensation)

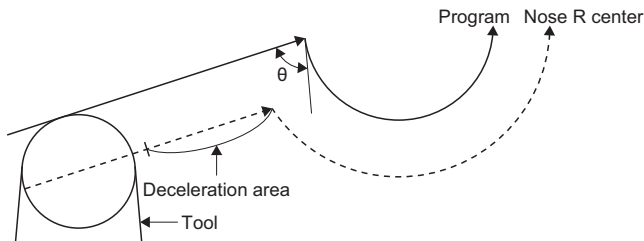

- Arc (outside compensation)→line corner

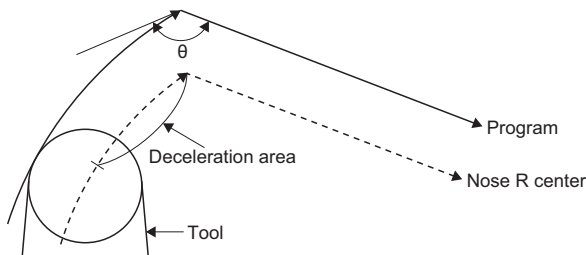

*: The deceleration area where override is applied is the length of the arc for an arc command.

- Arc (inside compensation)→arc (outside compensation) corner

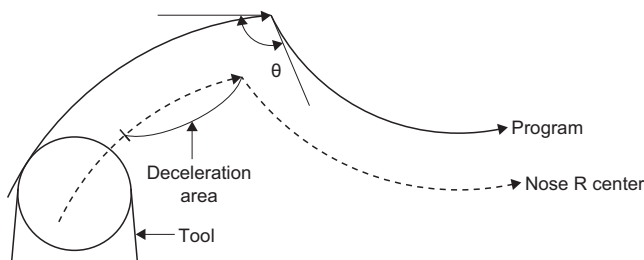

*: The deceleration area where override is applied is the length of the arc for an arc command.

■ Automatic corner override operations with each function

The operations for automatic corner override are shown below.

Function	Automatic corner override operation
Positioning (G00)	Automatic corner override is not applied at a positioning command.
Linear interpolation (G01)	Automatic corner override is applied for linear interpolation.
Circular interpolation (G02, G03)	Automatic corner override is applied for circular interpolation.
Cutting feed override	Cutting feed override is applied to automatic corner override.
Override cancel	Automatic corner override is not cancelled at override cancel.
Speed clamp	After automatic corner override is applied to cutting feed speed, clamp speed is applied.
Tool radius compensation	Automatic corner override is not applied until tool radius compensation mode.

Program example

■ Program that performs automatic corner override

Operation	Program	Remarks
(1)	G91 G01 G42 X10. Y10. D10 F2000.	Positioning
(2)	G62	Automatic corner override mode
(3)	G01 X20. Y40.	Positioning
(4)	X50.	Positioning

G64: Cutting mode

Executes the next block without deceleration stops between cutting feed blocks.

Code	Format
G64	G64

Processing details

- The G64 command is the opposite of the exact stop check mode (G61). The G64 command continuously executes blocks without performing a deceleration check between cutting feed blocks. The interpolation command codes that can be used with the G64 command are G01, G02, and G03 only.
- Cutting mode is in effect when the power supply of the Multiple CPU system is turned ON.
- The G64 command is modal. It remains in effect until any of exact stop check mode (G61), high-accuracy control mode (G61.1), and automatic corner override (G62) from the same group are commanded.

■ In cutting mode

```
G64 G01 X100. F500.
X200.
```

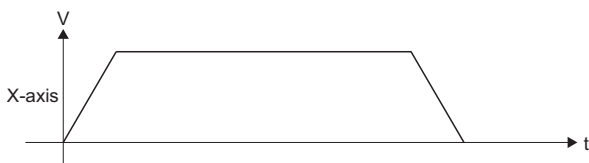

■ Not in cutting mode

```
G61 G01 X100. F500.
X200.
```

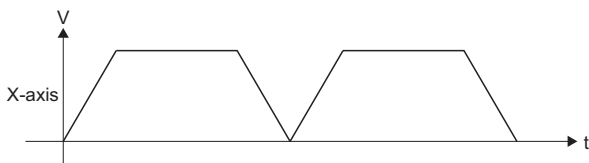

Program example

■ Program that performs positioning by cutting mode

Operation	Program	Remarks
(1)	G64 G01 X100. F500.	Positioning by cutting mode
(2)	X200.	Positioning by cutting mode
(3)	X300.	Positioning by cutting mode



G65: Macro call

Calls the specified macro program.

Code	Format
G65	$G65_P _p _L _I _A _a$ <div style="margin-left: 150px;"> <p>Argument(variable data specification)</p> <p>Number of macro program repeats(0 to 9999)</p> <p>Macro program call program No.(1 to 256)</p> </div>

Processing details

- If products are the same shape and the only difference between them is their dimensions, a macro program can be created separately from the main program and then that same macro program can be diverted and called.
- When required, a macro program can be called from the main program or a subprogram and used.
- Arguments can be used as local variables in each macro program that is called.
- Returns from a macro program are performed through the M99 command.
- Macro program call program Nos., number of macro program repeats, and argument operations are shown below.

Item	Operation
Macro program call program No.	<ul style="list-style-type: none"> • If the program No. is omitted or a program using the specified No. does not exist, a minor error (error code: 1FC3H (details code: 031FH)) occurs.
Number of macro program repeats	<ul style="list-style-type: none"> • If the number of macro program repeats is omitted, the program will repeat 1 time (commands L1). • If the number of macro program repeats is specified as "0", the macro program is not executed. • If the value set is outside the range, a minor error (error code: 1FC3H (details code: 0328H)) occurs.
Argument (variable data specified)	<ul style="list-style-type: none"> • If an argument passes on a local variable (#1 to #33) to a macro program, specify the actual value after the address. • An argument can use signs and decimal points regardless of the address. • The following 2 types of specification methods are available for arguments. <ul style="list-style-type: none"> · Argument specification I (Page 157 Argument specification I) · Argument specification II (Page 159 Argument specification II) • If arguments are not specified, "[Rq.3385] G65 argument initialization (D54227.4+2s)" can set them to either initialize (0 clear) or keep. • If the local variable start device is not set, a minor error (error code: 1FC3H (details code: 032AH)) occurs. If local variables are not used, this setting can be omitted. • Local variables can use "#1 to #33" for each macro call depth level (0 to 4). • Refer to local variables for details of local variables. (Page 192 Local variables)

- A macro program can be called from another macro program. This is called nesting. The maximum depth for macro calling (nesting depth) is 4.

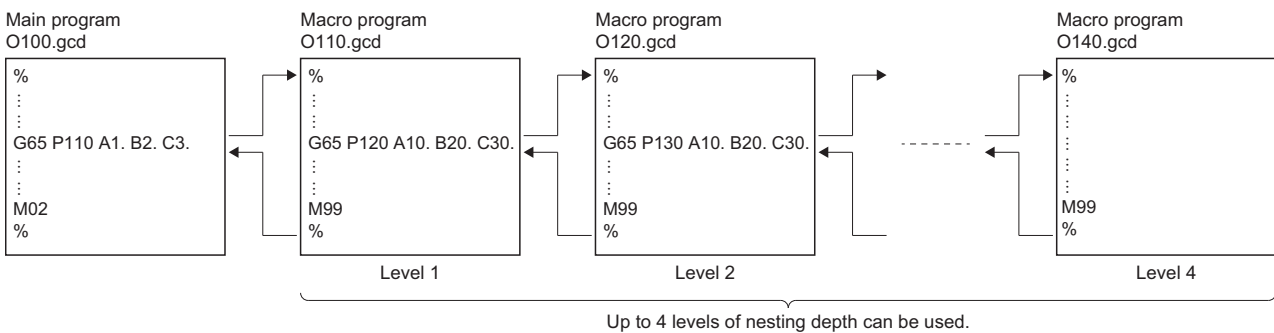

- When nesting, make sure the number of G65 commands and M99 commands specified are equal.
- The program No., sequence No., and block No. of the macro program being executed can be monitored with the following devices.
 - [Md.3025] Program No. being executed (sub/macro) (D54514+128s)
 - [Md.3026] Sequence No. being executed (sub/macro) (D54516+128s, D54517+128s)
 - [Md.3027] Block No. being executed (sub/macro) (D54518+128s, D54519+128s)

■ Argument specification I

- Correspondence between addresses that are usable by argument specification I and the variable No. of the macro program is shown below.

○: Usable, ×: Unusable, —: No address.

Argument specification I address	Variable No. in the macro program	Macro calls usable/unusable
A	#1	○
B	#2	○
C	#3	○
D	#7	○
E	#8	○
F	#9	○
—	#10	×
H	#11	○
I	#4	○
J	#5	○
K	#6	○
—	#12	×
M	#13	○
—	#14	×
—	#15	×
—	#16	×
Q	#17	○
R	#18	○
S	#19	○
T	#20	○
U	#21	○
V	#22	○
W	#23	○
X	#24	○
Y	#25	○
Z	#26	○

Ex.

For a program specified to argument specification I

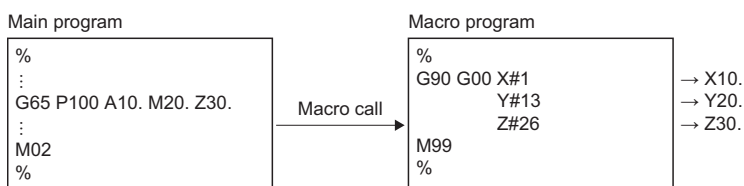

- Argument specification I can specify addresses "A to Z" to arguments; however, addresses "G, L, N, O, P" are used for the following purposes, so arguments cannot be specified to them.

Address	Details
G	G-code command
L	G65 command format
N	Sequence No.
O	If commanded, it is ignored
P	G65 command format

- Specify addresses "I, J, K" in alphabetical order. Addresses other than "I, J, K" do not require specification in alphabetical order.

Ex.

When specified to the following programs

Program	Variable data		Details
	Local variable (address)	Transferred data	
G65 P100 I40. J50. K60.	#4(I)	40.	Used as addresses for argument specification I.
	#5(J)	50.	
	#6(K)	60.	
G65 P100 A10. I40. B20. J50. C30. K60.	#1(A)	10.	
	#4(I)	40.	
	#2(B)	20.	
	#5(J)	50.	
	#3(C)	30.	
	#6(K)	60.	
G65 P100 J50. I40. K60.	#5(J)	50.	These are used as addresses for the first group (J) and the second group (I, K) in argument specification II, so their values are not set to the target variable.
	#7(I)	40.	
	#9(K)	60.	
G65 P100 A10. J50. B20. I40. C30. K60.	#1(A)	10.	
	#5(J)	50.	
	#2(B)	20.	
	#7(I)	40.	
	#3(C)	30.	
	#9(K)	60.	

- Addresses that are not specified can be omitted.
- In addition to numbers, variables can be used for the value specified after the address. Refer to variable commands for details of variables. (📖 Page 183 Variable Commands)

■ Argument specification II

- Correspondence between addresses that are usable by argument specification II and the variable No. of the macro program is shown below.

Argument specification II address		Variable No. of the macro program
A		#1
B		#2
C		#3
I	First group	#4
J		#5
K		#6
I	Second group	#7
J		#8
K		#9
I	Third group	#10
J		#11
K		#12
I	Fourth group	#13
J		#14
K		#15
I	Fifth group	#16
J		#17
K		#18
I	Sixth group	#19
J		#20
K		#21
I	Seventh group	#22
J		#23
K		#24
I	Eighth group	#25
J		#26
K		#27
I	Ninth group	#28
J		#29
K		#30
I	Tenth group	#31
J		#32
K		#33

Ex.

For a program specified to argument specification II

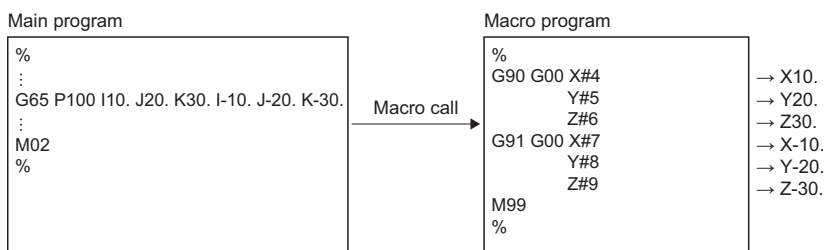

- Argument specification II can set up to 10 groups using groups of arguments each made up of the addresses "A, B, C" and "I, J, K". If the number of argument groups exceeds 10, a minor error (error code: 1FC3H (details code: 0336H)) occurs.

- When the same addresses (I, J, K) are duplicated, specify them in the predetermined order. If they are not set in order, argument group numbers will deviate and values will not be set to the target variable.

Ex.

If specified to the following programs

Program	Variable data		Details
	Local variable (address)	Transferred data	
G65 P100 I10. J20. K30. I40. J50. K60.	#4(I)	10.	Used as addresses for the first group (I, J, K) and the second group (I, J, K).
	#5(J)	20.	
	#6(K)	30.	
	#7(I)	40.	
	#8(J)	50.	
	#9(K)	60.	
G65 P100 I10. J20. K30. I40. K60. J50.	#4(I)	10.	Used as addresses for the first group (I, J, K), the second group (I, K), and the third group (J).
	#5(J)	20.	
	#6(K)	30.	
	#7(I)	40.	
	#9(K)	60.	
	#11(J)	50.	

- In addition to numbers, variables can be used for the value specified after the address. Refer to variable commands for details of variables. (Page 183 Variable Commands)

■ Differences between G65 (macro call) and M98 (subprogram call)

Differences between the G65 and M98 commands are shown below.

Item	G65 (macro call)	M98 (subprogram call)
Call depth (nesting)	Up to 4 levels	Up to 10 levels ^{*1}
Argument specification	Can be specified	Cannot be specified
Sequence No. specification	Cannot be specified	Can be specified
When an address not using the command format exists in a block	Single block	Stop
	Address command	Executes the address before the G65 command and then calls the macro program
Local variable depth	Variation (depending on call depth) ^{*2}	Fixed

*1 Up to 10 levels in combination with the G65 command.

*2 If a macro call is performed, the call depth is considered to be level 1 and the local variable depth is increased by 1.

Precautions

- Modal information is overwritten in the order of execution without any distinction between the main program, subprograms, and macro programs. After a macro call is executed, pay attention to the status of the modal data when programming.
- When the M02 command or the M30 command are executed in the macro program, the main program, subprogram, and macro program all end program execution.
- G65 command blocks can be stopped with a single block.
- Arguments in a macro call are regarded as having the decimal point at the end.

Ex.

For G65 P110 X100

When "100." is the local variable (#24) value for "X".

- If the same address is specified more than once in a macro call argument, the most recently written address command is valid.

Ex.

For G65 P110 A1. A2.

For Address A, "A2." is valid as an argument.

- When specifying an argument in a macro call, command the address after the G65 command.

Ex.

For X100. G65 P110

After the X-axis moves to position 100., a macro call is executed.

- If an address that corresponds to the same variable is specified while argument specification I and argument specification II are specified to the same block, the most recently written address command is valid.

Ex.

For G65 P100 A10. B20. D30. I40. I70.

If arguments "D30." and "I70." are specified to variable #7, the "I70." at the end is valid.

Address	Variable	Specification method
A10.	#1	Argument specification I
B20.	#2	
D30.	#7	
I40.	#4	
I70.	#7	Argument specification II

- The local variable is initialized (0 cleared) when "[Rq.3376]G-code control request (D54226.0+2s)" turns ON.

Program example

■ A program that executes the specified macro program, returns to the main program, and then ends operation

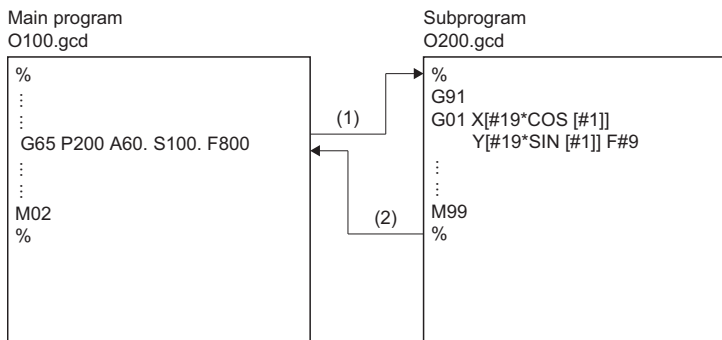

*: Local variable
 #1(A) =60.000
 #9(F) =800
 #19(S)=100.000

G68: Program coordinate rotation mode start

Specifies a rotation angle for the coordinate system and performs positioning on the rotated shape.

Code	Format
G68	$G68_X\ x\ _Y\ y\ _R\ r$ <div style="margin-left: 150px;"> </div> <div style="margin-left: 150px;"> Rotation angle </div> <div style="margin-left: 150px;"> Coordinate command </div>

Processing details

- The G68 command specifies a rotation angle for the local coordinate system, and performs positioning on the rotated shape.

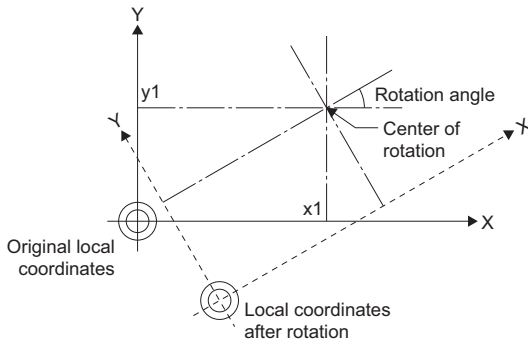

- When G68 command is executed, the mode changes to program coordinate rotation mode.
- The G68 command is modal. It remains in effect until program coordinate rotation mode cancel (G69) is commanded.
- When transitioning to G-code control or resetting, program coordinate rotation is cancelled.
- In the plane selection command (G17, G18, G19), select the command plane. Plane selection cannot be commanded in the same block as G69 command. When commanded in the same block, a minor error (error code: 1FC3H (details code: 0326H)) occurs. Also, plane selection cannot be commanded during program coordinate rotation mode. When commanded during program coordinate rotation mode, a minor error (error code: 1FC3H (details code: 0326H)) occurs.
- Program coordinate rotation is enabled on the local coordinate system. The relationship between the rotated coordinate system and the work coordinate system and basic machine coordinate system is shown below.

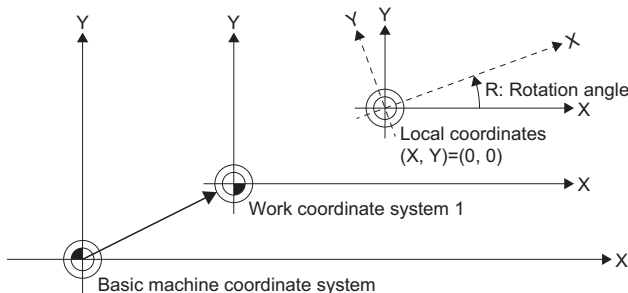

- The center of rotation coordinates are always commanded in absolute values based on the local coordinate system. Incremental value command mode (G91) is regarded as absolute values. When the center of rotation coordinates are omitted, the position where the G68 command was made becomes the center of rotation.
- The coordinates are rotated counterclockwise by the specified rotation angle. The command value for the rotation angle is in line with the absolute value command mode (G90)/incremental value command mode (G91) modal.
- The setting range for the rotation angle is -359.9999 to 359.9999[degree]. When commands exceed the setting range, the command is the remainder after dividing the command by 360.0000[degree].
- The rotation angle is modal data. It remains in effect until a new rotation angle is commanded.
- The rotation angle command can be omitted. However, if omitting the rotation angle when using the G68 command for the first time after transitioning to G-code control, the rotation angle operates at 0[degree].
- When coordinate rotation mode command (G68) is commanded during program coordinate rotation mode, it is processed as a change for center of rotation coordinates and rotation angle.

- Movement commands immediately after a G68 command must be made in absolute value command mode. When made in incremental value mode, a minor error (error code: 1FC3H (details code: 0327H)) occurs.
- In general, use an absolute value to command the two axes on the rotated plane after a G68 command. When the first movement command after coordinate rotation is for one axis only, the operation differs according to the G-code control work parameter "Coordinate rotation type".

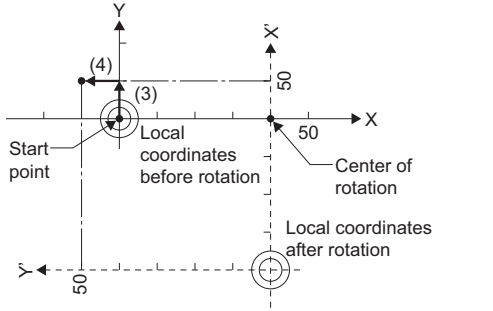
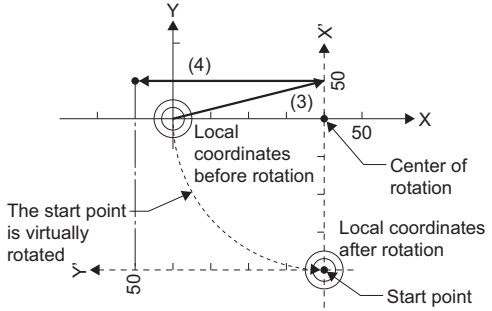
G-code program	0: Coordinate rotation type 0	1: Coordinate rotation type 1
(1) G90 G53 X0. Y0. (2) G68 X40. Y0. R90. (3) X50. (4) Y50. (5) G69 (6) M02	<p>Only the commanded axis in (3) (X-axis) moves. The start point does not rotate with coordinate rotation, and the end position is calculated from the current position on the local coordinate system before rotation.</p> 	<p>Operation in (3) is the same as a "X50. Y0." command. The end position is calculated on the assumption that the start point rotates with coordinate rotation.</p> 

- In general, use positioning/linear interpolation by absolute value to command the two axes on the rotated plane after a G68 command. When the first movement command after coordinate rotation is a circular interpolation command, make a movement command to the position of the start point by positioning/linear interpolation, even when the circular interpolation command does not result in any movement. When a circular interpolation command is made immediately after coordinate rotation, the operation differs according to the G-code control work parameter "Coordinate rotation type".

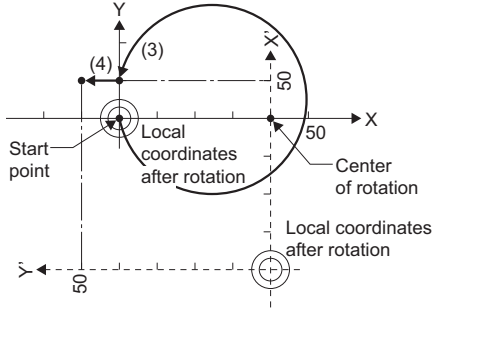
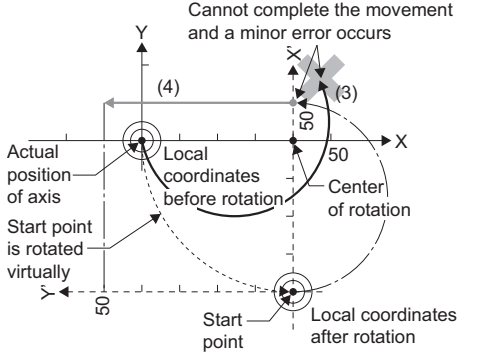
G-code program	0: Coordinate rotation type 0	1: Coordinate rotation type 1
(1) G90 G53 X0. Y0. (2) G68 X40. Y0. R90. (3) G03 X50. R-25. F500 (4) G00 Y50. (5) G69 (6) M02	<p>The starting point of circular interpolation does not rotate with coordinate rotation and is the same position before coordinate rotation when viewed from the basic machine coordinate system. Thus circular interpolation is performed from this start point to the end point.</p> 	<p>When rotated with coordinate rotation, the position of the virtually rotated start point and the actual position of the axis are different when viewed from the basic machine coordinate system. Therefore the axis cannot move along the path of circular interpolation from the start point to the end point, and a minor error (error code: 1FC3H (details code: 0313H)) occurs.</p> <p>Cannot complete the movement and a minor error occurs</p> 

- The operation for the machine coordinate system selection during program coordinate rotation can be selected by setting the G-code work parameter "coordinate rotation type".

G-code program	0: Coordinate rotation type 0	1: Coordinate rotation type 1
(1) G90 G53 X0. Y0. (2) G68 X20. Y0. R90. (3) G53 X20. Y20 (4) M02	<p>The operation moves to the position (X20, Y20) on the basic machine coordinate system by the G53 command. The program coordinates are the position on the basic machine coordinate system after coordinate rotation (X'40, Y'0) (local coordinate system after rotation).</p>	<p>Coordinate rotation is temporarily cancelled by the G53 command, and the operation moves to the position (X20, Y20) on the basic machine coordinate system. The program coordinates are the same position (X20, Y20) as the basic machine coordinate system because the coordinate rotation is temporarily cancelled.</p>

- The operation for the local coordinate system setting during program coordinate rotation can be selected by setting the G-code work parameter "coordinate rotation type".

Coordinate rotation type	Operation
Coordinate rotation type 0	The local coordinate home position becomes the position on the coordinate system after program coordinate rotation. However, the direction of shift is based on the coordinate system before rotation.
Coordinate rotation type 1	<ul style="list-style-type: none"> When there is no movement command of the plane selection axis between the G68 command and the G52 command The local coordinate home position becomes the position on the coordinate system before program coordinate rotation and that coordinate system is rotated. However, the direction of shift is based on the coordinate system before rotation. When there is a movement command of the plane selection axis between the G68 command and the G52 command The local coordinate home position becomes the position on the coordinate system after program coordinate rotation and that coordinate system is rotated. However, the direction of shift is based on the coordinate system before rotation.

Ex.

When coordinate rotation type 0 and coordinate rotation type 1 are selected (when there is no movement command of the plane selection axis between the G68 command and the G52 command).

Operation	Program	0: Coordinate rotation type 0	1: Coordinate rotation type 1 (when there is no movement command of the plane selection axis between the G68 command and the G52 command)
(1)	G90 G53 X0. Y0.	—	—
(2)	G68 X20. Y0. R90.	<p>The start point does not rotate with coordinate rotation and calculations are made from the current position on the local coordinate system before rotation.</p>	<p>The local coordinate system is not rotated.</p>

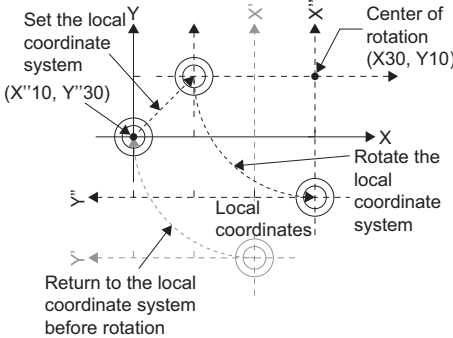
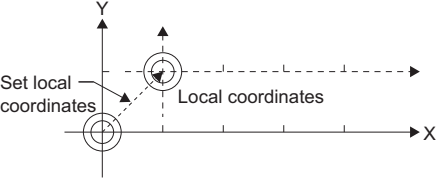
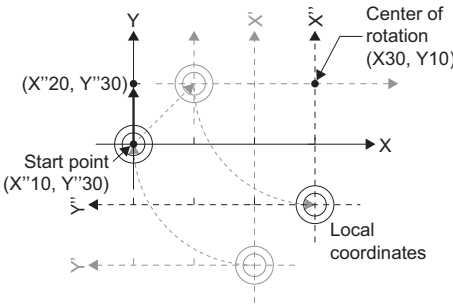
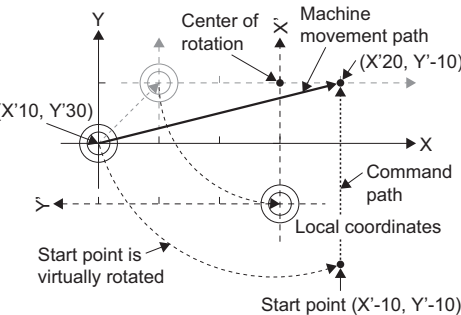
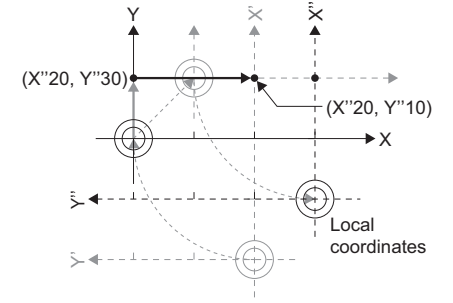
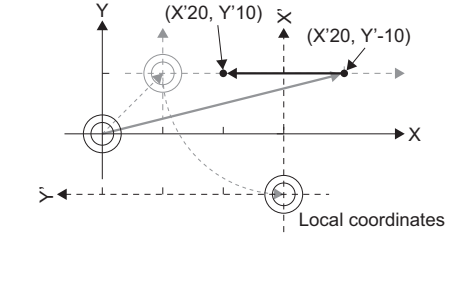
Operation	Program	0: Coordinate rotation type 0	1: Coordinate rotation type 1 (when there is no movement command of the plane selection axis between the G68 command and the G52 command)
(3)	G52 X10. Y10.	 <p>Set the local coordinate system ($X''10, Y''30$)</p> <p>Center of rotation ($X30, Y10$)</p> <p>Rotate the local coordinate system</p> <p>Local coordinates</p> <p>Return to the local coordinate system before rotation</p> <ol style="list-style-type: none"> The coordinates return to the local coordinate system before coordinate rotation. The local coordinate system is set on the work coordinate system. The local coordinate home position is the position shifted 10 in the X direction and 10 in the Y direction. The local coordinate system is rotated. The center of rotation coordinates are those set on the local coordinate system set in 2. 	 <p>Set local coordinates</p> <p>Local coordinates</p> <p>Local coordinate system is set on the work coordinate system.</p> <p>*: The direction of shift is based on the coordinate system before rotation.</p>
(4)	X20.	 <p>Center of rotation ($X30, Y10$)</p> <p>Start point ($X''10, Y''30$)</p> <p>Local coordinates</p> <p>The commanded X-axis moves on the rotated coordinate system.</p> <p>*: Axes with no movement command do not move.</p>	 <p>Center of rotation</p> <p>Machine movement path</p> <p>Command path</p> <p>Local coordinates</p> <p>Start point is virtually rotated</p> <p>Start point ($X'-10, Y'-10$)</p> <p>After virtually rotating the start point according to the coordinate rotation, the commanded X-axis moves on the rotated coordinate system.</p> <p>*: Axes with no movement command move to the position on the rotated coordinate system.</p>
(5)	Y10.	 <p>Center of rotation ($X30, Y10$)</p> <p>Start point ($X''20, Y''30$)</p> <p>Local coordinates</p> <p>The commanded Y-axis moves on the rotated coordinate system.</p> <p>*: Axes with no movement command do not move.</p>	 <p>Center of rotation</p> <p>Machine movement path</p> <p>Command path</p> <p>Local coordinates</p> <p>Start point is virtually rotated</p> <p>Start point ($X'-20, Y'-10$)</p> <p>The commanded Y-axis moves on the rotated coordinate system.</p> <p>*: Axes with no movement command do not move.</p>
(6)	G69	—	—
(7)	M02	—	—

Ex.

When coordinate rotation type 1 is selected (when there is a movement command of the plane selection axis between the G68 command and the G52 command)

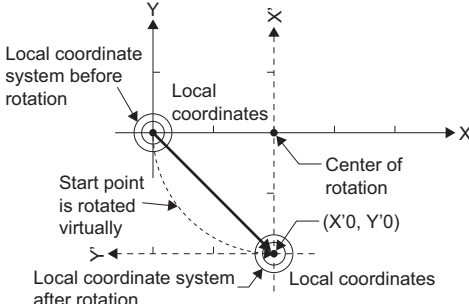
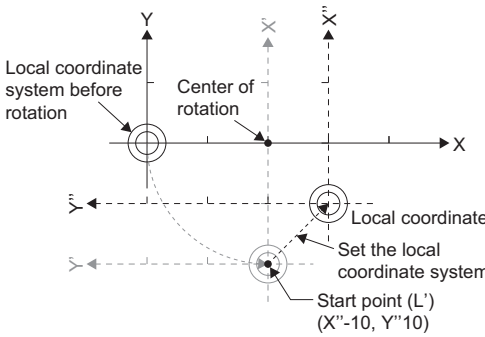
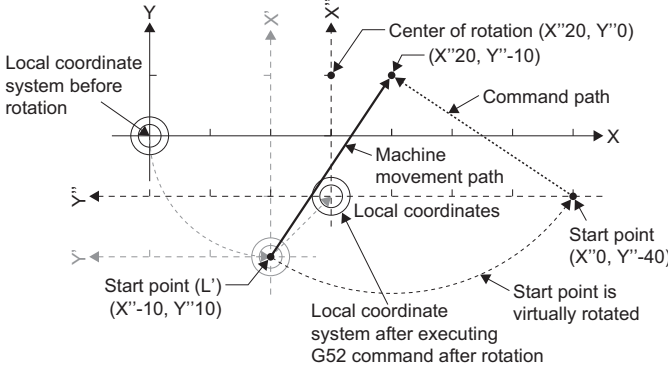
Operation	Program	1: Coordinate rotation type 1 (when there is a movement command of the plane selection axis between the G68 command and the G52 command)
(1)	G90 G53 X0. Y0.	—
(2)	G68 X20. Y0. R90. X0. Y0.	 <p>The start point is rotated virtually according to the coordinate rotation, and movement to the end position occurs.</p>
(3)	G52 X10. Y10.	 <p>A new local coordinate system is set from home position on the local coordinate system after rotation.</p> <p>*1: The direction of shift is based on the coordinate system before rotation.</p> <p>*2: The coordinates of start point (L') are on the coordinate system (XY plane) before rotation, and are found from the home position of the local coordinate system on the newly set coordinate system (X''Y'' plane).</p>
(4)	X20.	 <p>After virtually rotating the start point according to the coordinate rotation, the commanded X-axis moves on the rotated coordinate system.</p> <p>*: Axes with no movement command move to the position on the rotated coordinate system.</p>

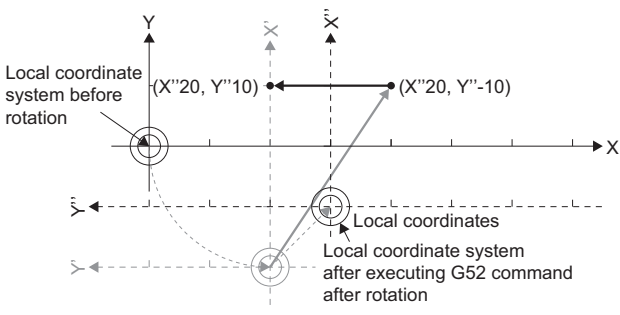
Operation	Program	1: Coordinate rotation type 1 (when there is a movement command of the plane selection axis between the G68 command and the G52 command)
(5)	Y10.	 <p>The commanded Y-axis moves on the rotated coordinate system. *: Axes with no movement command do not move.</p>
(6)	G69	—
(7)	M02	—

■ Program coordinate rotation mode operation when combined with each function

The program coordinate rotation mode operation for each function is shown below.

Function	Operation
Rotating axis	Coordinate rotation can also be performed on rotating axes. In this case the angle [degree] is processed as the length [mm] of rotation.
Positioning (fast forward)	When coordinate rotation is performed for a G00 command for one axis only, two axes are moved. If the G00 non-interpolation setting is "Non-interpolation" at this time, each axis moves independently at their respective fast forward speed. When moving from the start point to the end point in a straight line (interpolation), be sure to use the "Interpolation" setting of G00 non-interpolation. The feed speed at this time is the composite speed of the fast forward speed of each axis, therefore movement speeds become faster than moving only one axis (before coordinate rotation).
Work coordinate system selection	When the work coordinates are changed (such as change from G54 to G55) during coordinate rotation mode, the center of rotation of program coordinate rotation is the position on the coordinate system where the command was made. (The same position when viewed from the basic machine coordinate system.)
Program target position	All positions displayed are the positions after coordinate rotation based on the local coordinate system before coordinate rotation.
Tool length compensation	During program coordinate rotation, the tool length compensation amount is compensated for machine coordinates.

Program example

■ Program that performs positioning by program coordinate rotation mode

- Work coordinate system offset setting amount

Address	Offset setting amount
	Work coordinate system 1 (G54)
X	500
Y	500

Operation	Program	Remarks
(1)	G90 G54 X0. Y0. F100.	Move to "X0, Y0" of the work coordinate system 1 by absolute value command
(2)	G52 X1500. Y1000.	Set the local coordinate system offset "X1500, Y1000" (no axis movement)
(3)	G68 X-500. Y0. R-60.	Set "X-500, Y0" of the local coordinate system as the center of rotation, and rotate coordinates counterclockwise by -60[degree]
(4)	G01 X-500. Y0.	Move to "X-500, Y0" on the local coordinate system after rotation performed in (3)
(5)	Y250.	Move to "X-500, Y250" on the local coordinate system after rotation performed in (3)
(6)	X-1000.	Move to "X-1000, Y250" on the local coordinate system after rotation performed in (3)
(7)	Y-250.	Move to "X-1000, Y-250" on the local coordinate system after rotation performed in (3)
(8)	X-500.	Move to "X-500, Y-250" on the local coordinate system after rotation performed in (3)
(9)	Y0.	Move to "X-500, Y0" on the local coordinate system after rotation performed in (3)

- Paths for when the local coordinates (2), and program coordinate rotation (3) are set

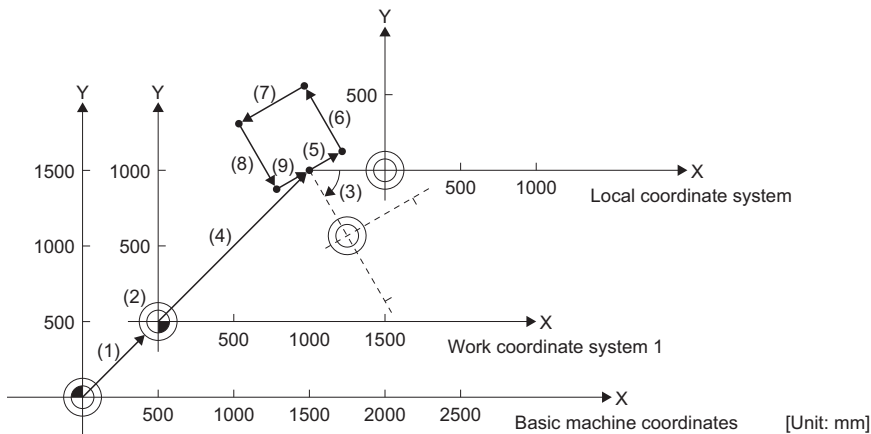

- Paths for when the local coordinates (2), and program coordinate rotation (3) are not set

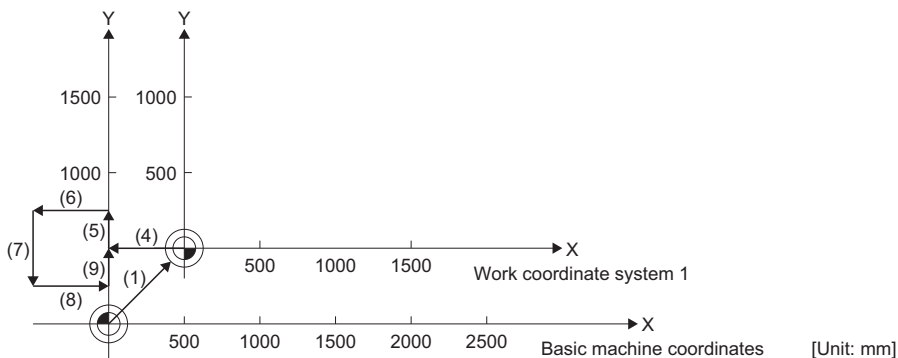

G69: Program coordinate rotation mode cancel

Cancels the set program coordinate rotation offset.

Code	Format
G69	G69

Processing details

- The G69 command cancels the set program coordinate rotation mode start (G68) and ends program coordinate rotation mode.
- Movement commands immediately after G69 command must be made in absolute value command mode. When made in incremental value mode, a minor error (error code: 1FC3H (details code: 0327H)) occurs.

Program example

■ Program that cancels program coordinate rotation mode

- Work coordinate system offset setting amount

Address	Offset setting amount
	Work coordinate system 1 (G54)
X	500
Y	500

Operation	Program	Remarks
(1)	G90 G54 X0. Y0. F100.	Move to "X0, Y0" of the work coordinate system 1 by absolute value command
(2)	G52 X1500. Y1000.	Set the local coordinate system offset "X1500, Y1000" (no axis movement)
(3)	G68 X-500. Y0. R-60.	Set "X-500, Y0" of the local coordinate system as the center of rotation, and rotate coordinates counterclockwise by -60[degree]
(4)	G01 X-500. Y0.	Move to "X-500, Y0" on the local coordinate system after rotation performed in (3)
(5)	Y250.	Move to "X-500, Y250" on the local coordinate system after rotation performed in (3)
(6)	X-1000.	Move to "X-1000, Y250" on the local coordinate system after rotation performed in (3)
(7)	Y-250.	Move to "X-1000, Y-250" on the local coordinate system after rotation performed in (3)
(8)	X-500.	Move to "X-500, Y-250" on the local coordinate system after rotation performed in (3)
(9)	Y0.	Move to "X-500, Y0" on the local coordinate system after rotation performed in (3)
(10)	G69	Cancel program coordinate rotation mode
(11)	G54 G52 X0. Y0.	Cancel the local coordinate system offset (no axis movement)

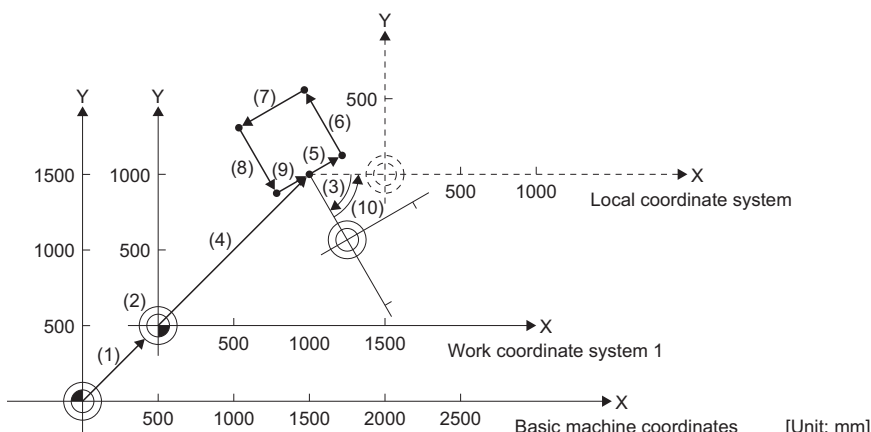

G90: Absolute value command

The coordinate command is executed as an absolute value command.

Code	Format
G90	G90_ X x _Y y _Z z <div style="text-align: center; margin-left: 150px;"> Coordinate command </div>

Processing details

- In absolute value mode, positioning to the position commanded by the program is performed with no regard to the current position. Positioning commands set after the execution of the G90 command use the absolute value from the home position.

Ex.

G90 X100. Y100.

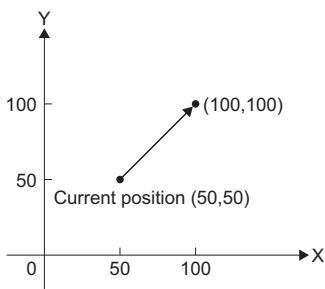

When current position coordinates are X50,Y50

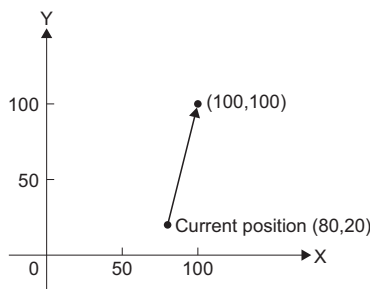

When current position coordinates are X80,Y20 [Unit: mm]

- Within the same block, a specific address only as an absolute value, or an incremental value can be commanded. The last executed command in the block remains valid as a modal command.

Ex.

G90 X100. G91 Y100.

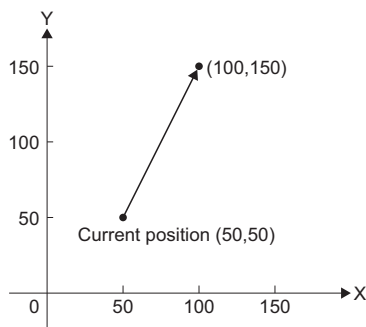

When current position coordinates are X50,Y50 [Unit: mm]

- The G90 command is modal. It remains in effect until incremental value command mode (G91) is commanded.
- The mode at the G-code control start, or reset can be set in [Motion Control Parameter]⇒[G-code Control Parameter]⇒[G-code Control System Parameter]⇒"Modal Initial Setting"⇒"Absolute Setting".

Program example

■ Example for comparing absolute value command and incremental value command

- Absolute value command

Program	Remarks
G90 X70. Y70.	Move to "X70,Y70" by absolute value command.

- Incremental value command

Program	Remarks
G91 X70. Y70.	Move to "X100,Y100" by incremental value command.

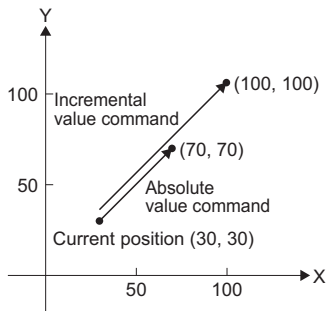

[Unit: mm]

G91: Incremental value command

The coordinate command is executed as an incremental value command.

Code	Format
G91	G91 <u>X x</u> <u>Y y</u> <u>Z z</u> <div style="text-align: center; margin-left: 150px;"> Coordinate command </div>

Processing details

- In incremental value mode, the movement is made for the specified value only, with the current position as the start point (0). Positioning commands set after the execution of the G91 command use the incremental value from the current position.

Ex.

G91 X100. Y100.

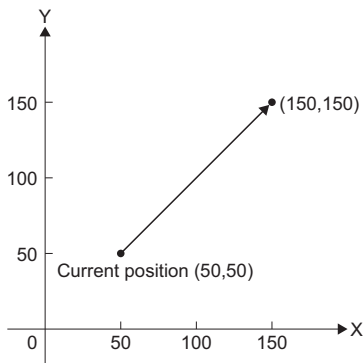

When current position coordinates are X50,Y50

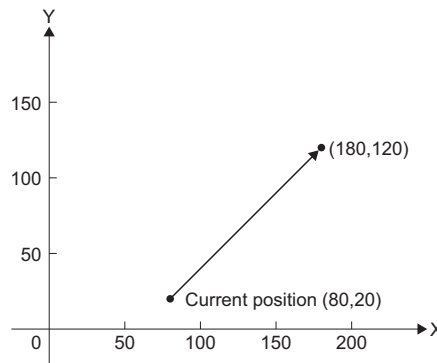

When current position coordinates are X80,Y20

[Unit: mm]

- Within the same block, a specific address only as an absolute value, or an incremental value can be commanded. The last executed command in the block remains valid as a modal command.

Ex.

G91 X100. G90 Y100.

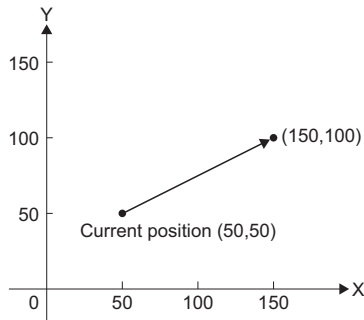

When current position coordinates are X50,Y50

[Unit: mm]

- The G91 command is modal. It remains in effect until absolute value command mode (G90) is commanded.
- The mode at the G-code control start, or reset can be set in [Motion Control Parameter]⇒[G-code Control Parameter]⇒[G-code Control System Parameter]⇒"Modal Initial Setting"⇒"Absolute Setting".

Program example

■ Example for comparing absolute value command and incremental value command

- Incremental value command

Program	Remarks
G91 X70. Y70.	Move to "X100,Y100" by incremental value command.

- Absolute value command

Program	Remarks
G90 X70. Y70.	Move to "X70,Y70" by absolute value command.

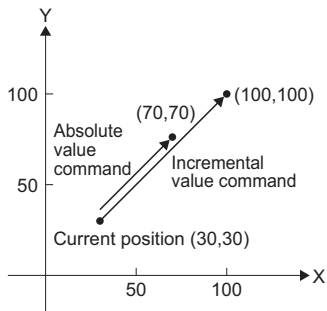

[Unit: mm]

G94: Feed per minute (non-synchronized feed)

The commands from the block are commanded at a feed speed of one minute [mm/min].

Code	Program
G94	G94

Processing details

- By commanding G94, the values that follow F can be commanded at a feed speed of one minute [mm/min].
- The G94 command is modal. G94 mode is valid when transitioning to G-code control or after reset.

5.7 M-Code

M-codes are specified by 8 digits (M-99999999 to M99999999) that follow an address M, and up to four can be commanded in a block. When M-code data is commanded "[Md.3058] M-code data 1 (D54554+128s, D54555+128s)" to "[Md.3061] M-code data 4 (D54560+128s, D54561+128s)" and "[St.3222] Auxiliary function strobe 1 (D54442.4+4s)" to "[St.3225] Auxiliary function strobe 4 (D54442.7+4s)" are output.

The following three types of output methods for M-code data are available.

Set the output method in [Motion Control Parameter]⇒[G-code Control Parameter]⇒[G-code Control System Parameter]⇒"Auxiliary Function"⇒"M Binary"







- BCD code
- Unsigned 32-bit binary data
- Signed 32-bit binary data



Point 

When five or more M-codes are commanded in one block, the last four are valid.

Specific auxiliary function (M function)

The M-code data in the table below is used for a specific purpose therefore it is not designated as a general auxiliary function (M function).

Auxiliary function (M function)	Description	Remarks
M00	Program stop	 Page 176 M00: Program stop
M01	Program stop	 Page 177 M01: Program stop
M02	Program end	 Page 178 M02: Program end
M30	Program end	 Page 179 M30: Program end
M98	Subprogram call	 Page 180 M98: Subprogram call
M99	Sub/macro program return	 Page 182 M99: Sub/macro program return

- Apart from the M98 command and M99 command, M commands output "[Md.3058] M-code data 1 (D54554+128s, D54555+128s)" to "[Md.3061] M-code data 4 (D54560+128s, D54561+128s)" and "[St.3222] Auxiliary function strobe 1 (D54442.4+4s)" to "[St.3225] Auxiliary function strobe 4 (D54442.7+4s)", as well as the independent signals "[St.3218] M-code output M00 (D54442.0+4s)" to "[St.3221] M-code output M30 (D54442.3+4s)". Refer to M-code output for details. ( Page 213 M-code output)
- Apart from the M98 command and M99 command, the processing and completion sequences need to be created with Motion SFC programs and sequence programs for all auxiliary functions (M functions). Refer to auxiliary function complete for details. ( Page 216 Auxiliary function complete)
- Because pre-reading is not permitted for the M00 command, M01 command, M02 command, and M30 command, the next block is not read to the pre-read buffer.

M00: Program stop

Stops the execution of the program.

Code	Format
M00	M00

Processing details

- When the M00 command is executed, the program stops without executing the next block. After stopping, the execution of the next block is started by turning ON "[Rq.3382] Auxiliary function complete 1 (FIN1) (D54227.0+2s)".
- When program stop is read, G-code programs can continue being executed by Motion SFC programs or sequence programs without stopping the block. Refer to M-code output for details. (☞ Page 213 M-code output)

Point

M00 and M01 have the same function.

Program example

■ Program that stops during positioning, and restarts

Operation	Program	Remarks
(1)	G01 X100. F10.	Positioning
(2)	M00	Program stop
(3)	G01 X200.	Restart positioning by auxiliary function complete 1 (FIN1)

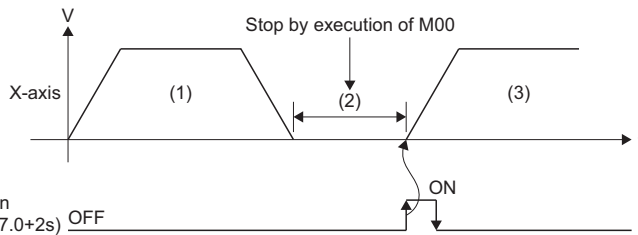

[Rq.3382] Auxiliary function complete 1 (FIN1) (D54227.0+2s) OFF

M01: Program stop

Stops the execution of programs.

Code	Format
M01	M01

Processing details

- When the M01 command is executed, the program stops without executing the next block. After stopping, the execution of the next block is started by turning ON "[Rq.3382] Auxiliary function complete 1 (FIN1) (D54227.0+2s)".
- When program stop is read, G-code programs can continue being executed by Motion SFC programs or sequence programs without stopping the block. Refer to M-code output for details. (📖 Page 213 M-code output)

Point

M01 and M00 have the same function.

Program example

■ Program that stops the program during positioning, and starts positioning again

Operation	Program	Remarks
(1)	G01 X100. F10.	Positioning
(2)	M01	Program stop
(3)	G01 X200.	Positioning starts again with auxiliary function complete 1 (FIN1)

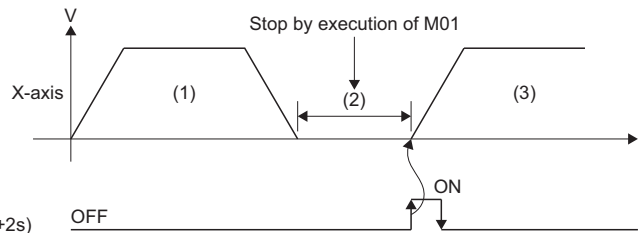

[Rq.3382] Auxiliary function complete 1 (FIN1) (D54227.0+2s)

M02: Program end

Ends the program.

Code	Format
M02	M02

Processing details

When the M02 command is executed, the program execution ends.

An M02 command (or M30 command) is required in the last block of a program.

Point

M02 and M30 have the same function.

Program example

■ Ending the program after positioning completion

Program	Remarks
G90	Absolute position command
G01 X100. Y200. F100.	Positioning
X200. Y300.	Positioning
G00 X0. Y0.	Positioning
M02	Program end
%	

M30: Program end

Ends the program.

Code	Format
M30	M30

Processing details

When the M30 command is executed, the program execution ends.

An M30 command (or M02 command) is required in the last block of a program.

Point

M30 and M02 have the same function.

Program example

■ Ending the program after positioning completion

Program	Remarks
G90	Absolute position command
G01 X100. Y200. F100.	Positioning
X200. Y300.	Positioning
G00 X0. Y0.	Positioning
M30	Program end
%	

Precautions

- Modal information is overwritten in the order of execution without any distinction between the main program and subprograms. After a subprogram call is executed, pay attention to the status of the modal data when programming.
- Blocks with "M98 P□" do not stop with single block. However, blocks with addresses other than N, P, L, and H can be stopped with single block.

Ex.

For the block "X100. M98 P100"

After executing "X100.", the program calls the program No. "100".

- When the M02 command or the M30 command are executed in the subprogram, the main program and subprogram both end program execution.
- Addresses (P, H, and L) on the same block as the M98 command are regarded as being specified by the M98 command.

Ex.

For the block "G04 P5 M98 H1"

"P5" is not regarded as the dwell time for the G04 command. It is regarded as the program No. for the M98 command. The program is equivalent to "G04 M98 P5 H1".

Program example

■ After executing the specified subprogram with two repetitions, the program returns to the main program and completes operation

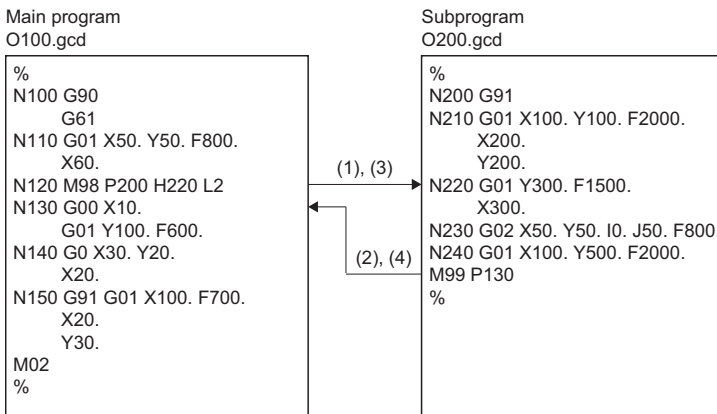

■ Calling a subprogram from a subprogram

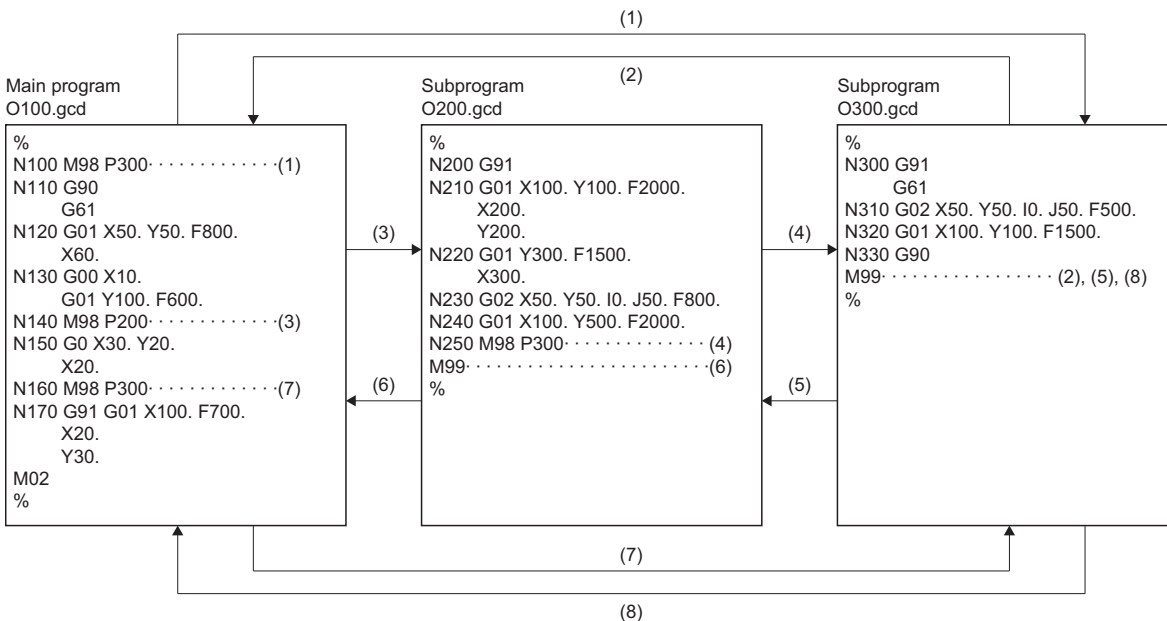

M99: Sub/macro program return

Returns from the subprogram or the macro program to the main program.

Code	Format
M99	M99 <u> </u> P <u> </u> p <div style="margin-left: 100px;">└── Return destination sequence No. (0 to 99999)</div>

Processing details

- Returns from the subprogram called with the M98 command or the macro program called with the G65 command to the next block after the call block in the main program.
- The operation for the return destination sequence No. is shown in the table below.

Item	Operation
Return destination sequence No.	<ul style="list-style-type: none"> • When the sequence No. is omitted, or "0" is specified, the program returns to the next block after the calling block. • When the specified sequence No. does not exist in the program, a minor error (error code: 1FC3H (details code: 0320H)) occurs.

- When nesting, make sure to specify the number of M98 commands or G65 commands so that they are equal to the number of M99 commands.
- Commands that can be nesting targets are shown below.
 - M98 (subprogram call)
 - G65 (macro call)

Precautions

- Blocks with "M99" do not stop with single block. However, blocks with addresses other than N, P, L, and H can be stopped with single block.

Ex.

For the block "X100. M99"

After executing "X100.", the program returns to the next block after the call block.

- When the M99 command is executed in the main program, the program returns to the start. However, when a sequence No. is specified, it searches for the specified sequence No. from the next block after the M98 command or the G65 command.
- For sequence Nos. specified by "M98 P□", the program searches from the next block after the M98 command or the G65 command to the program end. If the specified sequence No. does not exist, the program searches from the start of the program to the block before the M98 command or the G65 command. Therefore, when the sequence No. is in the opposite direction of the program order, the execution of a program can take time.

Program example

■ When there is a sequence No. specified after returning from the subprogram

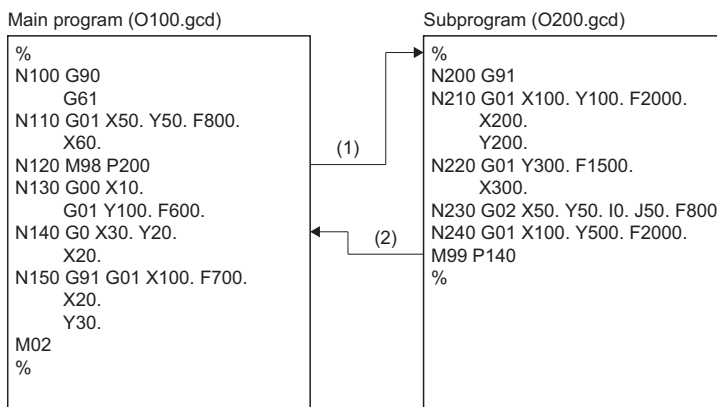

5.8 Variable Commands

Instead of allocating constants to addresses, allocating variables gives programs versatility.

When using constants, the values cannot be changed while the program is being executed, therefore a separate program for every operation pattern is required. However, when variables are used, the values can be changed while the program is being executed, allowing one program to support multiple operation patterns. The following types of variables are available.

Type	Function
Common variables for all systems	Can be used commonly across the main programs, subprograms, and macro programs in all systems.
Common variables for each system	Can be used commonly across the main programs, subprograms, and macro programs in each system.
Local variables	Can only be used in the main programs, subprograms, and macro programs in each system. Initializes (sets to 0) when "[Rq.3376] G-code control request (D54226.0+2s)" turns ON.

Common variables for all systems/common variables for each system/local variables

When using variables, set the following parameters in [Motion Control Parameters]⇒[G-code Control System Parameters]⇒[Macro Control]. Refer to G-code control system parameter for details of the parameters. (Page 76 G-Code Control System Parameter)

- Common variable points for all systems
- Common variable points for each system
- Start device No. of common variable for all systems
- Start device No. of common variable for each system
- Start device No. of local variable

■ Variable No. setting

The setting of variable numbers is shown below by using the settings of common variable points for all systems and common variable points for each system.

The setting of common variables for each system starts from #100 and continues consecutively for the number of points set to common variable points for each system.

The setting of common variables for all systems starts from the last number of the common variables for each system setting, and continues consecutively for the number of points set to common variable points for all systems.

Item	Variable No.		Remarks
	System 1	System 2	
Common variables for each system	#100	#100	The number of points set to common variable points for each system
	#101	#101	
	to	to	
	#i	#i	
Common variables for all systems	#(i+1)		The number of points set to common variable points for all systems
	to		
	#j		

Ex.

When "100 points" is set to common variables for all systems, "400 points" is set to common variables for each system, and "165 points" is set to local variables

Parameter	System 1	System 2
Common variable points for all systems	100	
Common variable points for each system	400	
Start device No. of common variable for all systems	D6000	
Start device No. of common variable for each system	D2000	D4000
Start device No. of local variable	D7000	D8000

*1 Allocate each start device to the user device.

*2 The area of the local variable cannot be rewritten from a sequence program or a motion SFC program. To perform writing, use common variables.

When setting common variables and local variables, the devices are allocated as follows.

Item	Variable			Device	
Common variables for all systems	#500 to #599			D6000 to D6399	
Common variables for each system	System 1	#100 to #499		D2000 to D3599	
	System 2	#100 to #499		D4000 to D5599	
Local variables	System 1	Macro call depth	Level 0	#1 to #33	D7000 to D7131
			Level 1	#1 to #33	D7132 to D7263
			Level 2	#1 to #33	D7264 to D7395
			Level 3	#1 to #33	D7396 to D7527
			Level 4	#1 to #33	D7528 to D7659
	System 2	Macro call depth	Level 0	#1 to #33	D8000 to D8131
			Level 1	#1 to #33	D8132 to D8263
			Level 2	#1 to #33	D8264 to D8395
			Level 3	#1 to #33	D8396 to D8527
			Level 4	#1 to #33	D8528 to D8659

Point

Devices are assigned in 4-word units for each point of a variable. The data is 64-bit floating-point type.

Writing variables

Variables are written in G-code programs as follows.

Format

#i_□ = □ <expression>

- The "i" in a variable (#i) indicates a given expression that follows #. "i" can be written as follows.

i	Writing example
Value	#123
Variable	#[#543]
Expression operator expression	#[#110 + #119]
-(minus) expression	#[-#120]
[Expression]	#[[#119]]
Function [expression]	#[ACOS[#110]]

- When written as follows, the variable is not recognized correctly.

Writing example		Explanation
Incorrect	Correct	
#206/2	#[206/2]	"#206/2" is not interpreted correctly. It is incorrectly interpreted as "[#206]/2".
#--105	#[[-105]]	For "#--105", a minor error (error code: 1FC3H (details code: 0306H)) occurs.
#[-#100]	#[-#100]	For "#-[#100]", a minor error (error code: 1FC3H (details code: 032AH)) occurs.

- An <expression> is a collection of constants, variables, functions, or operators. Refer to operating commands for functions and operators. (📖 Page 194 Operation Commands)

Cautions

- The variable (#i) is different to the Motion register (#).
- The four types of standard operators are +, -, *, and /.
- If any variable No. is specified to a number that is outside the range, a minor error (error code: 1FC3H (details code: 032AH)) occurs.
- Variable values are 64-bit floating-point (double-precision real number) values. The number of valid digits for 64-bit floating-point values is approximately 15. If this is exceeded, the operation may not be calculated correctly.
- When transferring common variables for all systems between systems, use the M00 and M01 commands to insert an interlock condition between systems.

Quoting variables

Variables can be used for all addresses excluding O (program No.) and N (sequence No.).

Examples of variable usage are shown below.

Item	Variable	Description
When using the value of the variable directly	#100 = 10 X#100	Using the value of #100 (10) as the value for X.
When using the complement of the value of the variable	X-#102	Using the value of #102 and changing the sign, as the value for X.
When defining the variable	#103 = #105	Using the value of the variable #105 that is an equivalent value to variable #103, as the value of #103.
	#101 = 1000	Using "1000" as the value of #101
When defining a variable operation expression	#101 = #103 + #102 - 100	Using the value of the result of the operation "#103 + #102 - 100", as the value of #101.
	X[#101 + #103 + 1000]	Using the value of the result of the operation "#103 + #102 + 1000", as the value of X.

Cautions

- Variables cannot be defined in the same block as the address. Separate the address and variable into different blocks. When a variable is defined in the same block as the address, a minor error (error code: 1FC3H (details code: 0305H)) occurs.

Ex.

Using "X#101"

Incorrect	Correct
X#101 = #103 + 100	#101 = #103 + 100 X#101

- "[" and "]" can be used for up to five levels. When used for six levels or more, a minor error (error code: 1FC3H (details code: 032DH)) occurs.

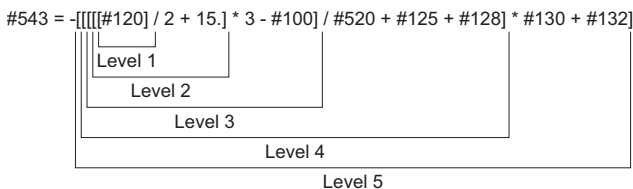

- Use "[" and "]" in pairs. When the number of "[" and "]" do not match, a minor error (error code: 1FC3H (details code: 032EH)) occurs.
- When defining a variable, if there is no "=" sign, a minor error (error code: 1FC3H (details code: 032BH)) occurs.
- For variable quotations, the variables are regarded as having the decimal point at the end.

Ex.

For "#100=10"

"X#100" is regarded as "X10."

- When defining variables, if a decimal is set to the variable No. on the left, a minor error (error code: 1FC3H (details code: 032AH)) occurs. However, when variable values and results of operation expressions that are quoted to a variable No. are a decimal, or when a decimal is set to the variable No. on the right, the decimals are rounded down to the nearest integer.
- Do not define variables in the same block and executable statements or control commands (IF - GOTO, WHILE - DO - END).

Applying variables

Multiplexing of variables

Variables make variable Nos. changeable (multiplexing), allowing them to be replaced in <expressions>. The following shows some examples of how variables are used.

Item	Variable	Description
Multiplexing variables	#101 = 110 #110 = 120 #120 = 30 #105 = #[#[101]]	#101 = 110, therefore #[#[101]] = #[110] #110 = 120, therefore #[110] = #120 Therefore #105 = #120. Thus #105 = 30.
	#101 = 110 #110 = 120 #120 = 30 #105 = 1000 #[#[101]] = #105	#101 = 110, therefore #[#[101]] = #[110]. #110 = 120, therefore #[110] = #120. Therefore #120 = #105. Thus #120 = 1000.
	#110 = 105 ##110 = 100	The <expression> ##110 = 100 is regarded as the same as #[110] = 100 Therefore #105 = 100.
Replacing variable Nos. with an <expression>	#110 = 210 #[#110 + 1] = 1000 #[#110 - 1] = -1000 #[#110 * 3] = 100 #[#110 / 2] = -100* ¹	#211 = 1000 #209 = -1000 #630 = 100 #105 = -100

*1 When the operation result is a decimal, the decimals are rounded down to the nearest integer.
(Example) When "#110 = 201", "#[110/2]" is regarded as the same as "#100".

Reading/writing timing of variables (devices)

The reading and writing of variable values are performed at the following timings.

Access timing of system devices

- : Device values are read by the system
- △: Output by the device system
- : No access

Operation/timing	Common variable	Local variable
G-code control request ON	—	△* ¹
At the start of the G-code program	○	—
At the automatic start-up of single block operation	○	—
At the restart after M00 and M01 commands	○	—
At the changing of blocks (excluding variable command, operation command, and control command blocks during continuous operation)	△	△
At reset	△	△

*1 Initialize (0 clear).

Transferring variables between G-code programs and Motion SFC programs

When transferring variables between G-code programs and Motion SFC programs, use the M00 and M01 commands, and execute the next block by turning OFF "[Rq.3382] Auxiliary function complete 1 (FIN1) (D54227.0+2s)", or turning ON "[Rq.3383] Auxiliary function complete 2 (FIN2) (D54227.1+2s)".

Examples of when a G-code program refers to the values of variables which were rewritten in a Motion SFC program, and when a Motion SFC program refers to the values of variables which were rewritten in a G-code program are shown below.

■ G-code program refers to the value of variable #100 (allocated to D2000) which was rewritten in a Motion SFC program (using system 1)

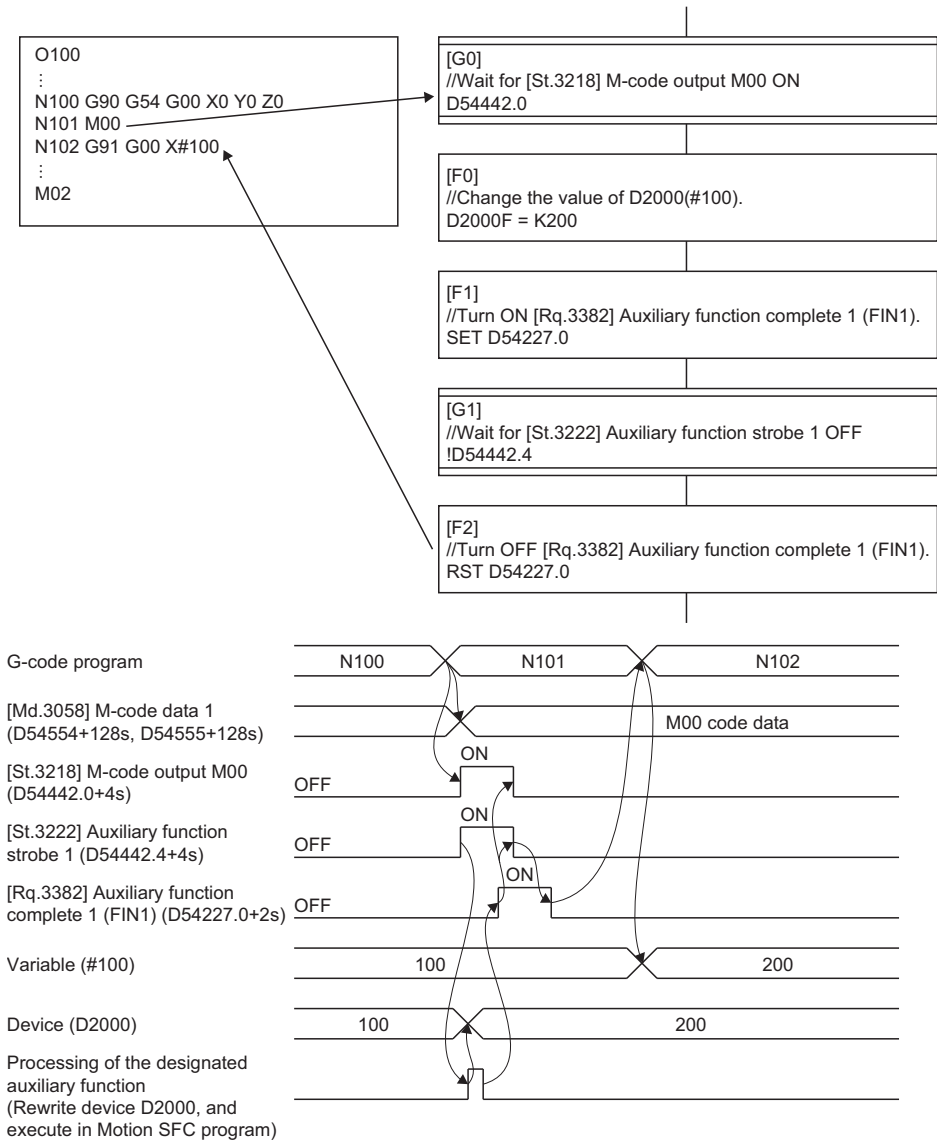

■ Motion SFC program refers to the value of variable #100 (allocated to D2000) which was rewritten in a G-code program (using system 1)

```

O101
:
N100 G90 G54 G00 X0 Y0 Z0
N101 #100 = 200
N102 M00
N103 IF [#100 EQ 200] GOTO200
:
N200 X#122
#101 = #101 + 1
:
M02
    
```

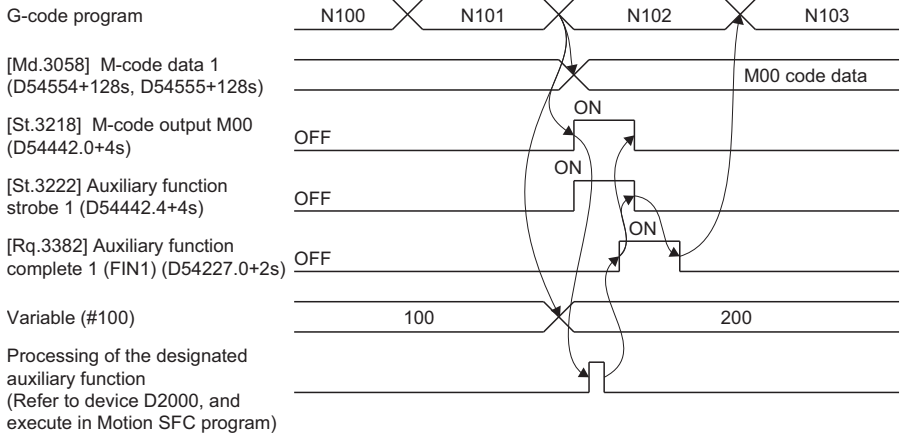
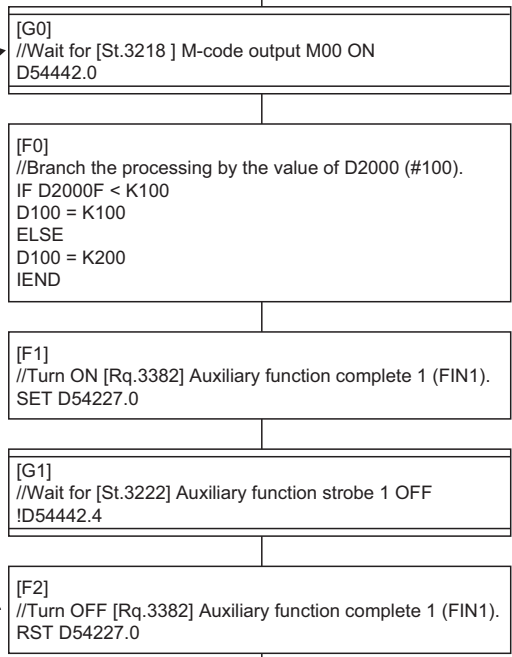

Transferring variables between the Motion CPU and other CPUs

When transferring variables between the Motion CPU and other CPUs, use the M00 and M01 commands, and execute the next block by turning OFF "[Rq.3382] Auxiliary function complete 1 (FIN1) (D54227.0+2s)", or turning ON "[Rq.3383] Auxiliary function complete 2 (FIN2) (D54227.1+2s)" after writing/reading the device allocated to a variable using the DDWR/DDRD instruction.

Examples of when a G-code program refers to the device data of other CPUs, and when another CPU refers to the values of variables which were rewritten in a G-code program are shown below.

■ G-code program refers to other CPU device data (variable: #100) (using system 1)

```
O101
:
:
N100 G90 G54 G00 X0 Y0 Z0
N101 M00
N102 G91 G00 X#100
:
:
M02
```

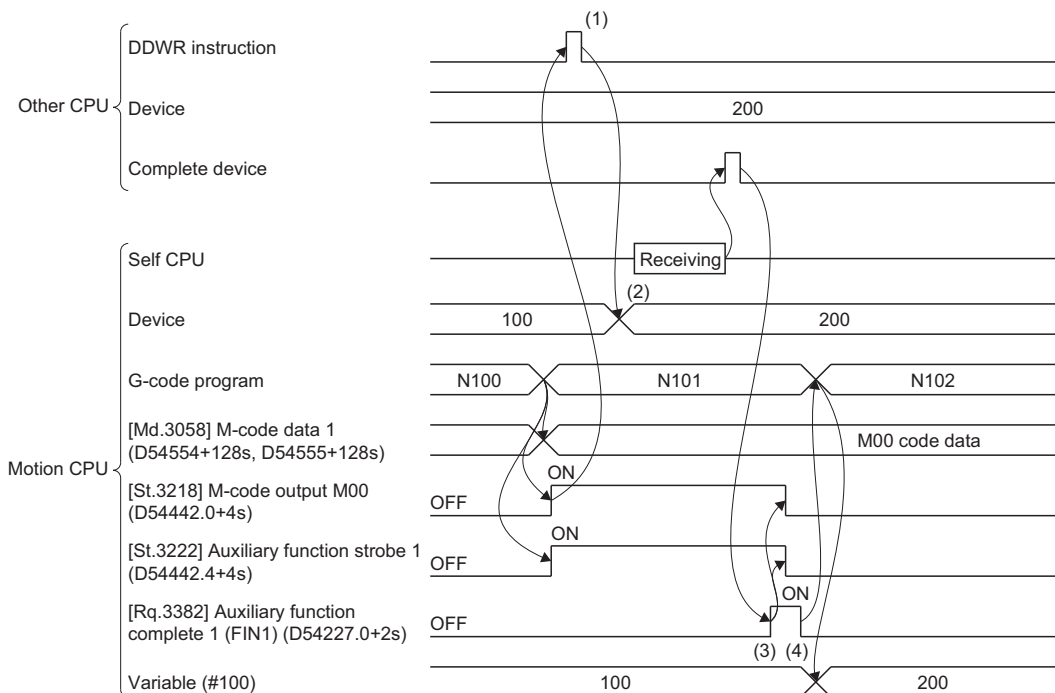

- (1) Execute the DDWR instruction after confirming that "[St.3218] M-code output M00 (D54442.0+4s)" is turned ON.
- (2) Write the device data of the other CPU to the device with the self CPU common variables allocated.
- (3) After confirming that the DDWR instruction is complete, turn ON "[Rq.3382] Auxiliary function complete 1 (FIN1) (D54227.0+2s)".
- (4) After confirming that "[St.3222] Auxiliary function strobe 1 (D54442.4+4s)" is turned OFF, turn OFF "[Rq.3382] Auxiliary function complete 1 (FIN1) (D54227.0+2s)", and move to the next block.

■ Other CPU refers to the value of variable #100 which was rewritten in a G-code program (using system 1)

```

O101
:
:
N100 G90 G54 G00 X0 Y0 Z0
N101 #100 = 200
N102 M00
N103 IF [#100 EQ 200] GOTO200
:
:
N200 X#122
#101 = #101 + 1
:
:
M02
    
```

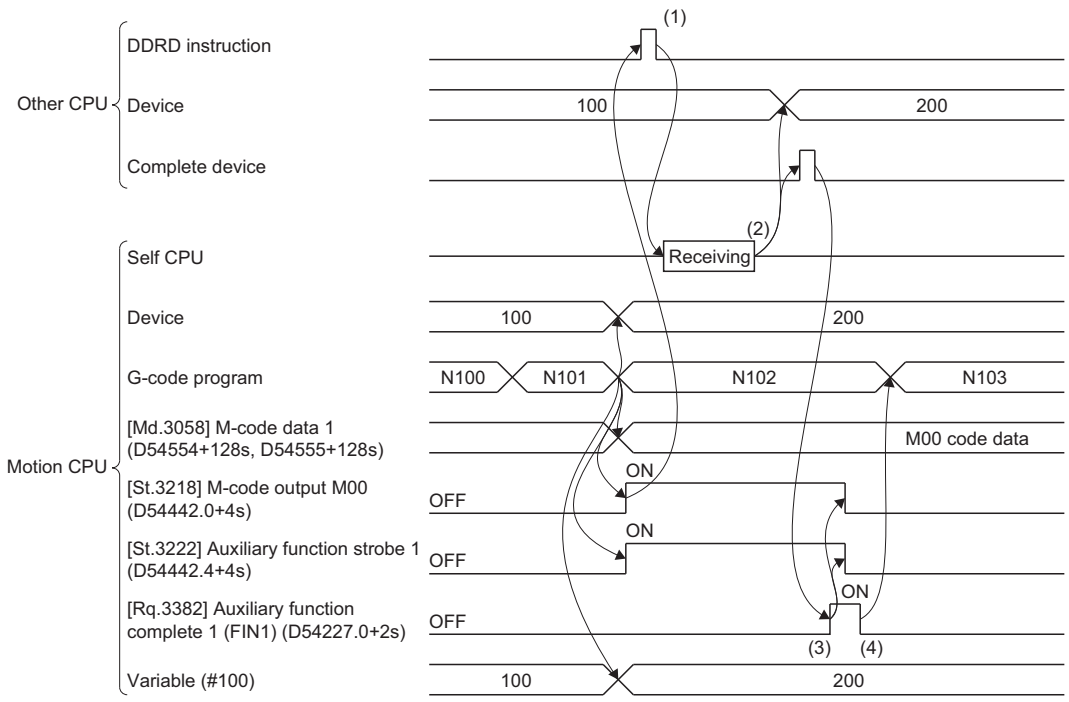

- (1) Execute the DDRD instruction after confirming that "[St.3218] M-code output M00 (D54442.0+4s)" is turned ON.
- (2) Read the device with the self CPU common variables allocated to the device of the other CPU.
- (3) After confirming that the DDRD instruction is complete, turn ON "[Rq.3382] Auxiliary function complete 1 (FIN1) (D54227.0+2s)".
- (4) After confirming that "[St.3222] Auxiliary function strobe 1 (D54442.4+4s)" is turned OFF, turn OFF "[Rq.3382] Auxiliary function complete 1 (FIN1) (D54227.0+2s)", and move to the next block.

Common variables

Variables that are used commonly starting from a position chosen by the user. Refer to variable commands for details.

(📖 Page 183 Variable Commands)

Local variables

These variables can only be used in the main program, subprograms, and macro programs at the macro call, but can be defined as an argument. Up to 4 levels can be duplicated regardless of macro program. If duplication exceeds 4 levels, a minor error (error code: 1FC3H (details code: 0335H)) occurs.

If specified without the start device No. of the local variable set, a minor error (error code: 1FC3H (details code: 032AH)) occurs. If local variables are not used, this setting can be omitted.

Refer to macro call (G65) for details of macro call. (Page 156 G65: Macro call)

- Local variables can be used independently on each depth level of a macro call (4 levels). Local variables are also used independently for the main program (local depth level 0). The local variable depth level being executed can be monitored with "[Md.3074] Local variable depth (D54582+128s)".

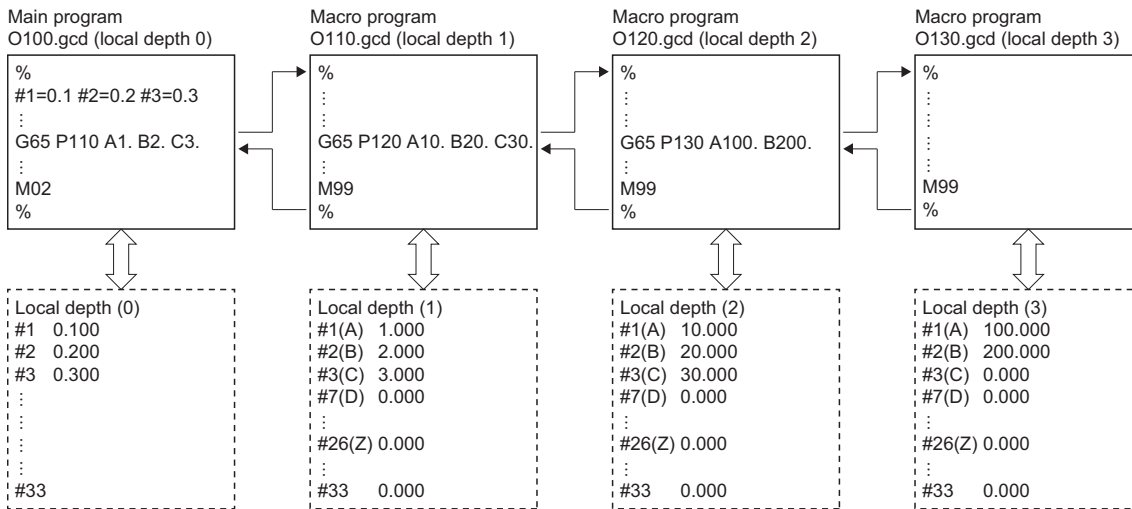

- Local variables for a macro program can be defined at the macro call by using argument specification.

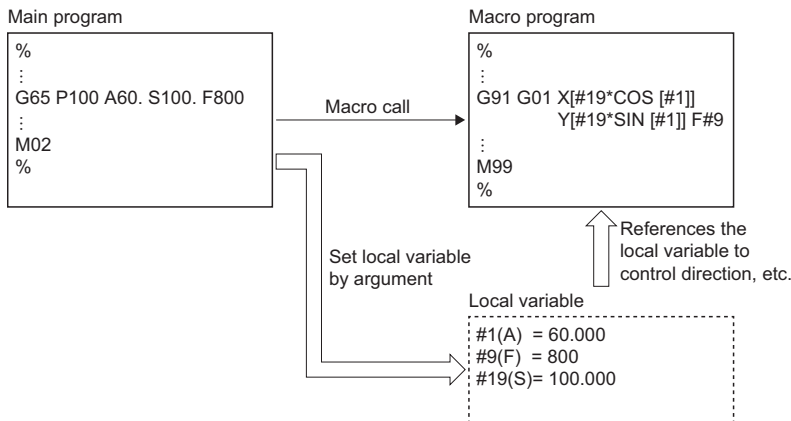

- Local variables can be used freely in macro programs.

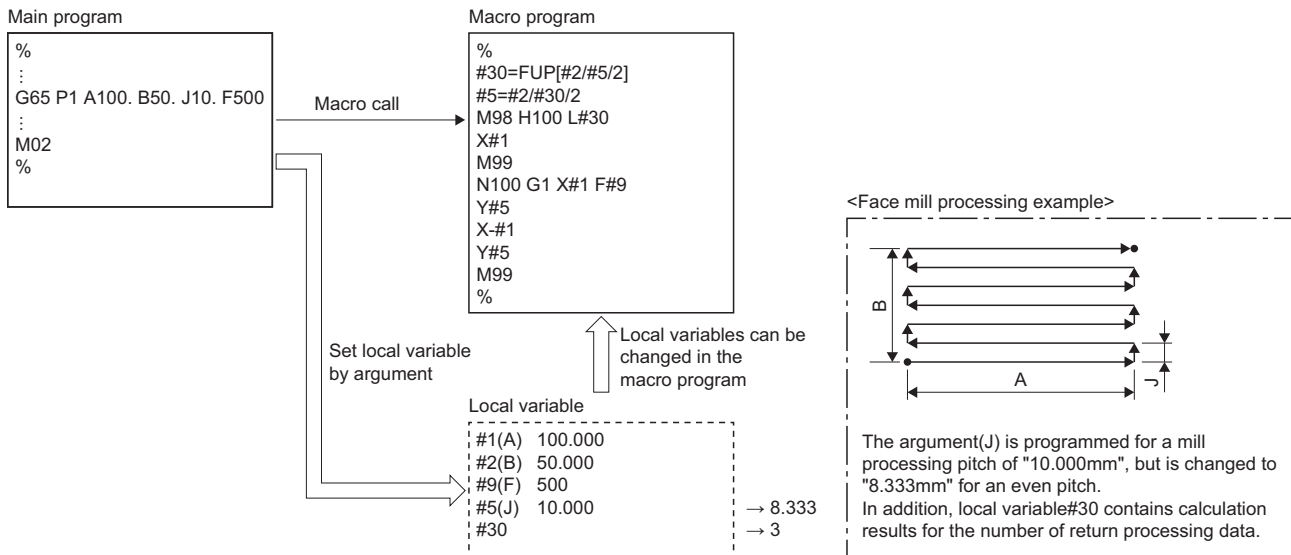

- Local variable depth when using the M98 command and the G65 command together is shown below.

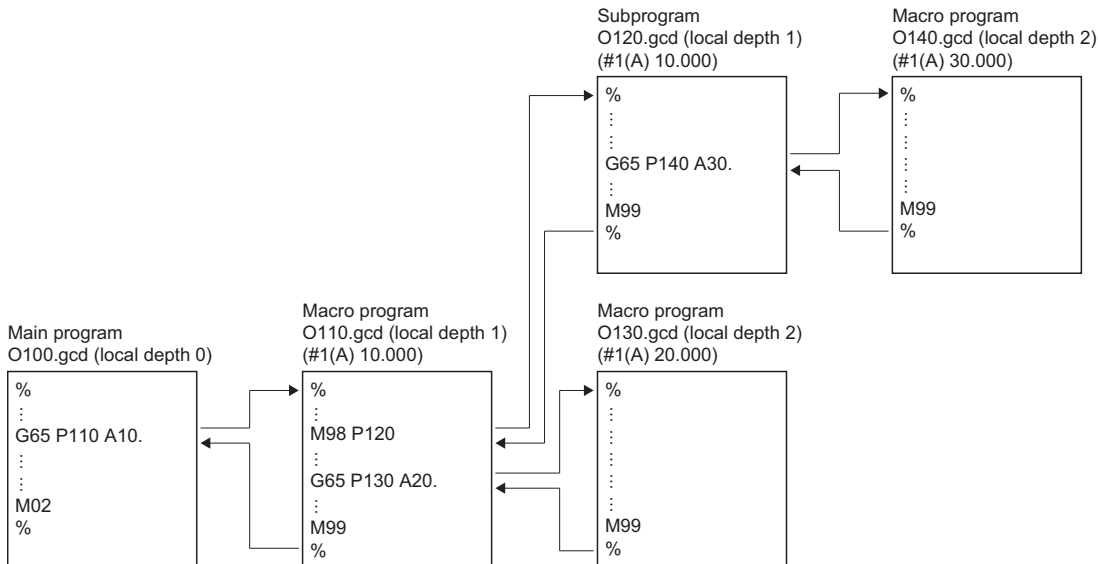

- At the macro call, devices allocated using G-code control system parameter "Start device No. of the local variable" settings and local variables with no specification in the argument use the values shown below based on "[Rq.3385] G65 argument initialization (D54227.4+2s)" settings. When repeatedly returning to local depth by macro call during G-code program operation, operation for each macro call conforms to "[Rq.3385] G65 argument initialization (D54227.4+2s)" settings

Setting value	Details
ON	At the macro call, keeps arguments that are not specified.
OFF	At the macro call, initializes (0 clears) arguments that are not specified.

5.9 Operation Commands

An operation command can perform various operations between variables. The supported operation commands are shown below.

Type	Operation command	Expression ^{*1*2}	Details	Reference
Variable definition, replacement	=	#i = #j	Constant, replacement	☞ Page 196 Definition/ Replacement(=)
Additive operations	+	#i = #j + #k	Addition	☞ Page 197 Additive Operations (+, -)
	-	#i = #j - #k	Subtractions	
Multiplicative operations	*	#i = #j * #k	Multiplication	☞ Page 198 Multiplicative Operations (*, /, MOD)
	/	#i = #j / #k	Division	
	MOD	#i = #j MOD #k	Remainder	
Logical operations	OR	#i = #j OR #k	Logical sum (each bit of 32 bits, round down to the nearest integer)	☞ Page 199 Logical Operations (OR, XOR, AND)
	XOR	#i = #j XOR #k	Exclusive logical sum (each bit of 32 bits, round down to the nearest integer)	
	AND	#i = #j AND #k	Logical multiply (each bit of 32 bits, round down to the nearest integer)	
Functions	SIN	#i = SIN[#k]	Sine (Unit of #k: degree)	☞ Page 200 Trigonometric Functions (SIN, COS, TAN, ASIN, ACOS, ATAN)
	COS	#i = COS[#k]	Cosine (Unit of #k: degree)	
	TAN	#i = TAN[#k]	Tangent (Unit of #k: degree)	
	ASIN	#i = ASIN[#k]	Arcsine	
	ACOS	#i = ACOS[#k]	Arccosine	
	ATAN	#i = ATAN[#k]	Arctangent	
	SQRT	#i = SQRT[#k]	Square root	
	ABS	#i = ABS[#k]	Absolute value	
	BIN	#i = BIN[#k]	Conversion from BCD to BIN (value of #k: BCD, round down to the nearest integer)	
	BCD	#i = BCD[#k]	Conversion from BIN to BCD (value of #k: BIN, round down to the nearest integer)	
	ROUND	#i = ROUND[#k]	Round-off	
	FIX	#i = FIX[#k]	Round-down	
	FUP	#i = FUP[#k]	Round-up	
	LN	#i = LN[#k]	Natural logarithm	
	EXP	#i = EXP[#k]	Quotient with a base of e(=2.718.....)	
POW	#i = POW[#j, #k]	Exponentiation (#j to the power of #k)		

*1 #i, #j, and #k indicate a variable.

*2 A constant can be used instead of #j, and #k.

Cautions.

- Values without a decimal are regarded as having a decimal at the end of the value.

Ex.

For "100"

The written value is regarded as "100."

- The expression that follows the end of a function must be enclosed between "[" and "]". If it is not enclosed, a minor error (error code: 1FC3H (details code: 0306H)) occurs.
- When arithmetic operators (+, -, *, /) are written, they are regarded as having a decimal point.

Ex.

For "G00 X123 + 0"

The X-axis command is "123mm". Not "12.3μm".

- A round-off error may be produced in operation. Especially when using a comparison operation, note that a round-off error may cause an unintended operation.

Ex.

When the value of #200 after a comparison operation is not true due to a round-off error

```
#100 = SQRT[#200]
```

```
#300 = #100 * #100
```

```
IF [#200 EQ #300]
```

- When a minor error occurs, the value is not updated by the operation.

Order of priority for operations

- The order of priority for operations is functions, multiplicative operations, additive operations, then logical operations.

Ex.

```
#101 = #111 + #112 * SIN[#113]
```

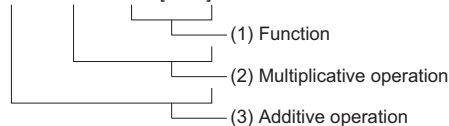

(1) Calculate "SIN[#113]".

(2) Calculate "#112 * [Result of calculation in (1)]".

(3) Calculate "#111 + [Result of calculation in (2)]".

- Enclosing parts in "[" and "]" gives them priority for operation. Up to five levels of "[" and "]", including the "[" and "]" of the expression, can be used. If six or more levels of "[" and "]" are used, a minor error (error code: 1FC3H (details code: 032DH)) occurs.

```
#101 = SQRT[[[#111 + #112] * SIN[#113] + #114] * #115]
```

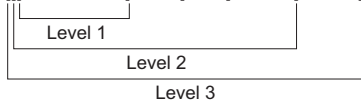

Definition/Replacement(=)

Used for definition/replacement (=).

Code	Format
=	$n1 _ Operator _ n2$ <p>Variable or constant Operator (=) Variable</p>

Processing details

- The calculation of the specified operator is performed.
- Values without a decimal are regarded as having a decimal at the end of the value.

Program example

Operator	Program	Result
=	#201 = 1000 #202 = 1000.	#201 = 1000.0000 #202 = 1000.0000
	#101 = 100 #102 = 200 #203 = #101 #204 = #102	#203 = 100.0000 #204 = 200.0000

Additive Operations (+, -)

Used for addition (+), and subtraction (-).

Code	Format
+, -	$n1 _ Operator _ n2$ <p>Variable or constant</p> <p>Operator (+, -)</p> <p>Variable or constant</p>

Processing details

- The calculation of the specified operator is performed.
- When arithmetic operators (+, -) are written, they are regarded as having a decimal point.
- Values without a decimal are regarded as having a decimal at the end of the value.

Program example

Operator	Program	Result
+	<pre>#201 = 100 #202 = 1000 #211 = #201 + 1000 #213 = #201 + #202</pre>	<pre>#211 = 1100.0000 #213 = 1100.0000</pre>
-	<pre>#201 = 100 #202 = 1000 #212 = #202 - 50. #213 = #201 - #202</pre>	<pre>#212 = 950.0000 #213 = -900.0000</pre>

Multiplicative Operations (*, /, MOD)

Used for multiplication (*), division (/), and remainder (MOD).

Code	Format
*, /, MOD	$n1 _ Operator _ n2$

Processing details

- The calculation of the specified operator is performed.
- When arithmetic operators (*, /) are written, they are regarded as having a decimal point.
- Values without a decimal are regarded as having a decimal at the end of the value.

Program example

Function	Program	Result
*	#221 = 100 * 100	#221 = 10000.0000
	#222 = 100. * 100	#222 = 10000.0000
	#223 = 100 * 100.	#223 = 10000.0000
	#224 = 100. * 100.	#224 = 10000.0000
	#101 = 100 #102 = 200 #225 = #101 * #102	#225 = 20000.0000
/	#226 = 100 / 100	#226 = 1.0000
	#227 = 100. / 100	#227 = 1.0000
	#228 = 100 / 100.	#228 = 1.0000
	#229 = 100. / 100.	#229 = 1.0000
	#101 = 100 #102 = 200 #230 = #101 / #102	#230 = 0.5000
	#231 = 100 / 0	Minor error (error code: 1FC3H(details code: 0319H))
MOD	#219 = 48 #220 = 9 #231 = #219 MOD #220	#219/#220 = 48/9 = 5 with remainder of 3 #231 = 3
	#232 = 100 MOD 0	Minor error (error code: 1FC3H(details code: 0319H))

Logical Operations (OR, XOR, AND)

Used for logical sum (OR), exclusive logical sum (XOR), and logical multiply (AND).

Code	Format
OR, XOR, AND	$n1 \text{ _ Logical operator _ } n2$

Processing details

- The calculation of the specified operator is performed.
- Values without a decimal are regarded as having a decimal at the end of the value.
- Perform the logical sum (OR), exclusive logical sum (XOR), and logical multiply (AND) operations within the 32-bit integer range. When the data for operation is outside the 32-bit integer range, the operation results are different to what would normally be expected.

5

Program example

Operator	Program	Result
OR*1	#203 = 100 #204 = #203 OR 14	#203 = 64H 14 = 0EH #204 = 6EH = 110
	#205 = 100.1234 OR 14	100.1234 = 64H 14 = 0EH #205 = 6EH = 110
	#206 = -100 OR 14	-100 = 9CH 14 = 0EH #206 = 9EH = -98
XOR*1	#203 = 100 #204 = #203 XOR 14	#203 = 64H 14 = 0EH #204 = 6AH = 106
	#205 = 100.1234 XOR 14	100.1234 = 64H 14 = 0EH #205 = 6AH = 106
	#206 = -100 XOR 14	-100 = 9CH 14 = 0EH #206 = 92H = -110
AND*1	#209 = 100 #210 = #209 AND 15	#209 = 64H 15 = 0FH #210 = 04H = 4
	#211 = 100.1234 AND 15	100.1234 = 64H 15 = 0FH #211 = 04H = 4
	#212 = -100 AND 15	-100 = 9CH 15 = 0FH #212 = 0CH = 12

*1 The decimals are rounded down to the nearest integer.

Trigonometric Functions (SIN, COS, TAN, ASIN, ACOS, ATAN)

Used for SIN (sine), COS (cosine), TAN (tangent), ASIN (arcsine), ACOS (arccosine), ATAN (arctangent) operations.

Code	Format
SIN, COS, TAN, ASIN, ACOS, ATAN	$\text{function } _ [n]$

Processing details

- The calculation of the specified operator is performed.
- Values without a decimal are regarded as having a decimal at the end of the value.
- The expression that follows the end of a function must be enclosed between "[" and "]". If it is not enclosed, a minor error (error code: 1FC3H (details code: 0306H)) occurs.
- When a number is set that makes $\cos\theta$ "0" in the argument of a TAN (tangent) operation, a minor error (error code: 1FC3H (details code: 0318H)) occurs.

Program example

Function	Program	Result
SIN ^{*1}	#501 = SIN [60]	#501 = 0.8660
	#502 = SIN [60.]	#502 = 0.8660
	#503 = 1000 * SIN [60]	#503 = 866.0254
	#504 = 1000. * SIN [60.]	#506 = 866.0254
COS ^{*1}	#541 = COS [45]	#541 = 0.7071
	#542 = COS [45.]	#542 = 0.7071
	#543 = 1000 * COS [45]	#543 = 707.1068
	#544 = 1000. * COS [45.]	#546 = 707.1068
TAN ^{*1}	#551 = TAN [60]	#551 = 1.7321
	#552 = TAN [60.]	#552 = 1.7321
	#553 = 1000 * TAN [60]	#553 = 1732.0508
	#554 = 1000. * TAN [60.]	#556 = 1732.0508
	#555 = TAN [90.]	Minor error (error code: 1FC3H (details code: 0318H))
ASIN ^{*2}	#531 = ASIN [100.5000 / 201.]	#531 = 30.0000
	#532 = ASIN [100.5000 / 201]	#532 = 30.0000
	#533 = ASIN [0.5000]	#533 = 30.0000
	#534 = ASIN [-0.5000]	#534 = -30.0000
	#535 = ASIN [1.1000]	Minor error (error code: 1FC3H (details code: 0318H))
ACOS ^{*2}	#521 = ACOS [100 / 141.4210]	#521 = 45.0000
	#522 = ACOS [100. / 141.4210]	#522 = 45.0000
	#523 = ACOS [1.1000]	Minor error (error code: 1FC3H (details code: 0318H))
ATAN	#561 = ATAN [173205 / 100000]	#561 = 60.0000
	#562 = ATAN [173205 / 100000.]	#562 = 60.0000
	#563 = ATAN [173.2050 / 100]	#563 = 60.0000
	#565 = ATAN [1.732050]	#565 = 60.0000

*1 Specify arguments within the range of "-360. to 360.".

*2 Specify arguments within the range of "-1 to 1".

Functions (SQRT, ABS, BIN, BCD, ROUND, FIX, FUP, LN, EXP, POW)

Used for SQRT (square root), ABS (absolute value), BIN (conversion from BCD to BIN), BCD (conversion from BIN to BCD), ROUND (round-off), FIX (round-down), FUP (round-up), LN (natural logarithm), EXP (quotient with a base of e), and POW (exponentiation) operations.

Code	Format
SQRT, ABS, BIN, BCD, ROUND, FIX, FUP, LN, EXP, POW	$\text{function } _ [n]$

Processing details

- The calculation of the specified operator is performed.
- Values without a decimal are regarded as having a decimal at the end of the value.
- The expression that follows the end of a function must be enclosed between "[" and "]". If it is not enclosed, a minor error (error code: 1FC3H (details code: 0306H)) occurs.
- A minor error (error code: 1FC3H (details code: 0318H)) occurs in the following cases.
 - When a negative number is set to the argument in a square root command (SQRT).
 - When a negative number is set to the argument in a natural logarithm command (LN).
 - When "0" is set to argument 1 and "0" or less is set to argument 2 of an exponentiation command (POW).
 - When negative number is set to argument 1 and a number that is not an integer is set to argument 2 of an exponentiation command (POW).
- When the result of EXP (quotient with a base of e), POW (exponentiation) operations exceeds the range of 64-bit floating-point data an overflow occurs, but a minor error does not occur.
- Specify an argument for BIN (conversion from BCD to BIN) and BCD (Conversion from BIN to BCD) within the range of "0 to 99999999". When the argument is outside the range of "0 to 99999999", the operation results are different to what would normally be expected.
- The following are the operations when a negative number is set to the argument in FIX (round-down), and FUP (round-up). The operation result is different to the result of a Motion SFC program (operation control program).

Function	Operation	
	G-code control	Motion SFC program
FIX	The absolute value gets smaller.	The absolute value gets bigger.
FUP	The absolute value gets bigger.	The absolute value gets smaller.

Program example

Function	Program	Result
SQRT ^{*1}	#571 = SQRT [1000]	#571 = 31.6228
	#572 = SQRT [1000.]	#572 = 31.6228
	#573 = SQRT [10. * 10. + 20. * 20]	#573 = 22.3607
	#574 = SQRT [-1.0000]	Minor error (error code: 1FC3H (details code: 0318H))
ABS	#576 = -1000	#576 = -1000.0000
	#577 = ABS [#576]	#577 = 1000.0000
	#203 = 70. #204 = -50. #580 = ABS [#204 - #203]	#580 = 120.0000
BIN ^{*2*3}	#201 = 100 #211 = BIN [#201]	#211 = 64
	#213 = BIN [100.5]	#213 = 64
	#215 = BIN [99999999]	#215 = 6564165
BCD ^{*2}	#201 = 100 #212 = BCD [#201]	#212 = 256
	#214 = BCD [100.5]	#214 = 256

Function	Program	Result
ROUND	#221 = ROUND [14 / 3]	#221 = 5
	#222 = ROUND [14. / 3]	#222 = 5
	#223 = ROUND [14. / 3.]	#224 = 5
	#224 = ROUND [-14 / 3]	#225 = -5
	#225 = ROUND [-14 / 3.]	#226 = -5
	#226 = ROUND [14 / 6]	#229 = 2
FIX	#221 = FIX [14 / 3]	#221 = 4.0000
	#222 = FIX [14. / 3]	#222 = 4.0000
	#223 = FIX [14. / 3.]	#224 = 4.0000
	#224 = FIX [-14 / 3]	#225 = -4.0000
	#225 = FIX [-14 / 3.]	#227 = -4.0000
	#226 = FIX [14 / 6]	#229 = 2.0000
FUP	#221 = FUP [14 / 3]	#221 = 5.0000
	#222 = FUP [14. / 3]	#222 = 5.0000
	#223 = FUP [14. / 3.]	#224 = 5.0000
	#224 = FUP [-14 / 3]	#225 = -5.0000
	#225 = FUP [-14 / 3.]	#227 = -5.0000
	#226 = FUP [14 / 6]	#229 = 3.0000
LN	#101 = LN [5]	#101 = 1.6094
	#102 = LN [0.5]	#102 = -0.6931
	#103 = LN [-5]	Minor error (error code: 1FC3H (details code: 0318H))
EXP	#104 = EXP [2]	#104 = 7.3891
	#105 = EXP [1]	#105 = 2.7183
	#106 = EXP [-2]	#106 = 0.1353
POW	#107 = POW [2, 3]	#107 = 8.0000
	#108 = POW [2, -3]	#108 = 0.1250
	#109 = POW [2.5, 3.5]	#109 = 24.7053
	#110 = POW [0, -1]	Minor error (error code: 1FC3H (details code: 0318H))
	#111 = POW [-2, 2.5]	

*1 Performing the operation within the brackets improves the operation accuracy. Perform operations in brackets when possible.

*2 The decimals are rounded down to the nearest integer.

*3 The BIN conversion result is converted to decimal and set to variables.

(Example) For BIN [99999999] = 5F5E0FFH

$$(5*1000000)+(15*100000)+(5*10000)+(14*1000)+(0*100)+(15*10)+(15*1)=6564165$$

5.10 Control Commands

The flow of a program can be controlled with control commands. The supported control commands are shown below.

Command	Control command	Reference
Branch	IF, GOTO	☞ Page 203 Branch (IF, GOTO)
	IF, THEN, ELSE, ENDIF	☞ Page 205 Branch (IF, THEN, ELSE, ENDIF)
Repeat	WHILE, DO, END	☞ Page 208 Repeat (WHILE, DO, END)

Branch (IF, GOTO)

This command is used to control the flow of a program being executed with the set conditions.

Code	Format
IF, GOTO	IF_ <u>[Conditional expression]</u> _GOTO <u>n</u> └─ Sequence No.

Processing details

- When the condition is met, the program branches to the sequence No. specified by GOTO. When the condition is not met, the next block is executed.
- The following types of conditional expressions are available.

Instruction	Conditional expression *1	Details
EQ	#i EQ #j	When #i and #j are equal (=)
NE	#i NE #j	When #i and #j are not equal (≠)
GT	#i GT #j	When #i is greater than #j (>)
LT	#i LT #j	When #i is less than #j (<)
GE	#i GE #j	When #i is greater than or equal to #j (≥)
LE	#i LE #j	When #i is less than or equal to #j (≤)

*1 #i, and #j represent a variable.

- An expression or variable can be used instead of a conditional expression using #i, #j, and n (sequence No.).
- A conditional expression must be enclosed between "[" and "]".
- The sequence No. specified by GOTO must be in the same program. If the specified sequence No. is not in the same program, a minor error (error code: 1FC3H (details code: 0320H)).
- When only GOTO is specified, the program branches to the specified sequence No. without a conditional expression.

Precautions

- When searching for the sequence No. to branch to, the program searches from the next block after the IF statement to the program end. If the specified sequence No. does not exist, the program searches from the start of the program to the block before the IF statement. When the sequence No. to branch to is in the opposite direction of the program order, the execution of the program can be longer compared to when the sequence No. is in the same direction of the program order.

• Searching in the order of the program

• Searching in the opposite direction of the program

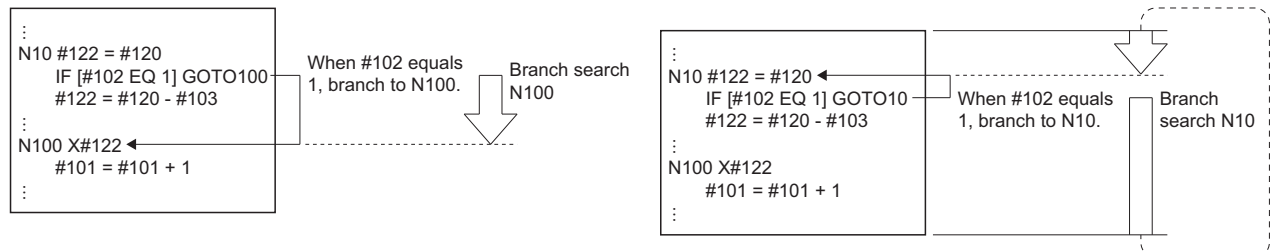

- As the pre-reading of one block is performed, when a value is changed while the block before the IF statement is being processed, the value before the change is used. In this case, use the M00 and M01 commands to stop pre-reading.

```
#102 = 0
:
N10 #122 = #120
  #102 = 1
  M100 ←
  IF [#102 EQ 1] GOTO 100
  #122 = #120 - #103
:
N100 X#122
  #101 = #101 + 1
:
```

Even though the value of #102 is changed by Motion SFC program while M100 is being executed, the program still jumps to N100 as the pre-reading of one block is performed.

- Only integers can be used in the "EQ" and "NE" conditional expressions. Use the "GT", "LT", "GE", and "LE" conditional expressions for decimal values.

Program example

■ Program that jumps to the specified sequence No. when conditions are met

Operation	Program	Remarks
(1)	N200 G91	
(2)	N210 G01 X100. Y100. F2000.	
(3)	X200.	
(4)	Y200.	
(5)	IF [#100 GT #102] GOTO230	When #100 exceeds #102, jump to N230 (jump to (8))
(6)	N220 G01 Y300. F1500.	
(7)	X300.	
(8)	N230 G02 X50. Y50. I0. J50. F800.	
(9)	N240 G01 X100. Y500. F2000.	
(10)	IF [#110 EQ 180] GOTO260	When #110 equals 180, jump to N260 (jump to (13))
(11)	N250 G00 X10.	
(12)	Y100.	
(13)	N260 G00 X0. Y0.	

Branch (IF, THEN, ELSE, ENDIF)

This command is used to control the flow of the program being executed with conditions.

Code	Format
IF, THEN, ELSE, ENDIF	IF [Conditional expression] THEN : ELSE : ENDIF

Processing details

- When conditions are met, the THEN instructions (the blocks up to ELSE) are executed. When conditions are not met, the ELSE instructions (the blocks up to ENDIF) are executed.
- The following types of conditional expressions are available.

Instruction	Conditional expression ^{*1}	Details
EQ	#i EQ #j	When #i and #j are equal (=)
NE	#i NE #j	When #i and #j are not equal (≠)
GT	#i GT #j	When #i is greater than #j (>)
LT	#i LT #j	When #i is less than #j (<)
GE	#i GE #j	When #i is greater than or equal to #j (≥)
LE	#i LE #j	When #i is less than or equal to #j (≤)

*1 #i, and #j represent a variable.

- An expression or variable can be used instead of a conditional expression using #i, and #j.
- A conditional expression must be enclosed between "[" and "]".
- The IF/THEN/ELSE/ENDIF instructions can be written in the following formats.

	Format	Details
(1)	IF [conditional expression] THEN Macro statement, or executable statement : ELSE Macro statement, or executable statement : ENDIF	<ul style="list-style-type: none"> • When there is an executable statement in the instruction being executed, or there are multiple instructions, enclose them in blocks of IF/THEN/ELSE/ENDIF instructions. • A minor error (error code: 1FC3H (details code: 0330H)) occurs when there is no ENDIF instruction. • A combination of formats (1) and (2) can be used. (Example) IF [#100 EQ 0] THEN #101 = 2 G00 X#101 ELSE #110 = 10 ENDIF
(2)	IF [conditional expression] THEN operation command ELSE operation command	<ul style="list-style-type: none"> • When the instruction being executed is an operation instruction, the instruction can be written after a THEN/ELSE instruction. • An ENDIF instruction can also be written.
(3)	IF [conditional expression] THEN operation command ELSE operation command	<ul style="list-style-type: none"> • When using an IF statement for nesting, write the ENDIF instruction. (Example) IF [#100 EQ 0] THEN(a) IF [#110 EQ 1] THEN #120=10(b) ENDIF(c) ELSE #120 = 20 ENDIF When there is an ENDIF instruction (c): ELSE is executed when the IF condition in (a) is false. When there is no ENDIF instruction (c): ELSE is executed when the IF condition in (b) is false.

- The THEN instructions (the blocks up until ELSE), or the ELSE instructions (the blocks up until ENDIF) can be omitted.

Instruction	Program
When omitting the process of the ELSE statement	IF[#100 EQ 0] THEN #101 = 2 G00 X#101 ENDIF
When omitting the process of the THEN statement	IF [#100 EQ 0] ELSE #101 = 10

- When the THEN/ELSE/ENDIF instructions are commanded without an IF instruction, a minor error (error code: 1FC3H (details code: 0330H)) occurs.
- When the IF instruction is not accompanied by THEN/ELSE instructions (an IF statement is commanded on it's own), a minor error (error code: 1FC3H (details code: 0331H)) occurs.
- The maximum depth of an IF statement is up to 10 levels. If the depth of an IF statement exceeds 10 levels, a minor error (error code: 1FC3H (details code: 032FH)) occurs.

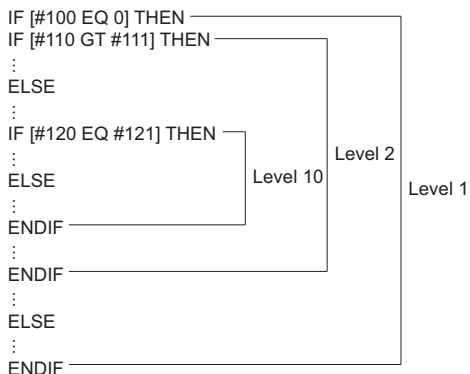

- Branching from a block in between the IF and ENDIF statements to a block outside the range between the IF and ENDIF statements is possible. However, do not branch from outside the range between the IF and ENDIF statements to a block in between the IF and ENDIF statements. Doing so skips the IF instruction, meaning it is disabled, thus all the the commands that apply to IF up until ENDIF are executed.

• Branching from a block in between the IF and ENDIF statements

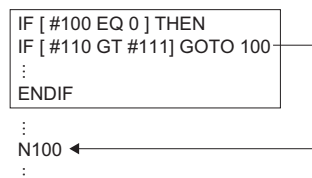

• Branching to a block between the IF and ENDIF statements

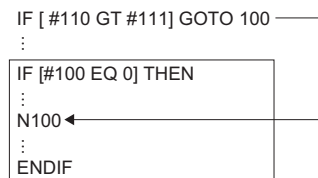

- A subprogram call (M98) or a macro call (G65) can be made from in between the IF and ENDIF statements. Additionally, an IF/THEN/ELSE/ENDIF instruction can be made within a subprogram or a macro program. The maximum depth of an IF statement in a subprogram or a macro program is 10 levels. (up to 10 levels of IF statements can be commanded in each program.)
- End the IF to ENDIF statements within the same program. When the IF to ENDIF statements are not ended in the same program (there is no ENDIF instruction), a minor error (error code: 1FC3H (details code: 0330H)) occurs.

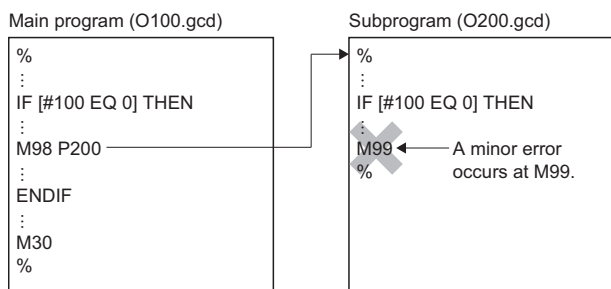

- The IF to ENDIF statements and WHILE to END statements cannot be used in a way that they overlap each other.

• When the WHILE to END statements overlap with the IF to ENDIF statements

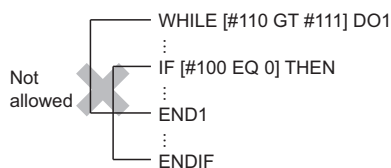

• When the IF to ENDIF statements overlap with the WHILE to END statements

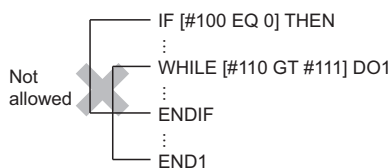

- To divide processing with the G-code program according to the status of the Motion register (M100), perform settings as shown below.

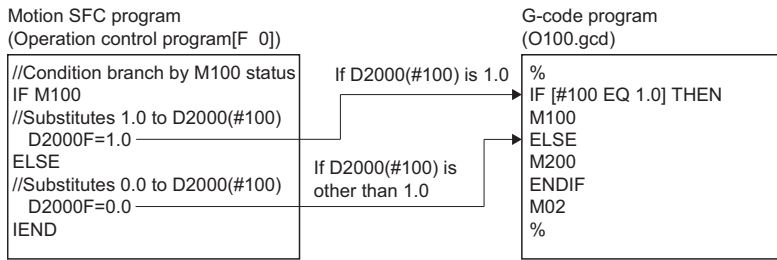

Program example

■ A program that executes the THEN or ELSE instructions when conditions are met

Operation	Program	Remarks
(1)	G91	
(2)	G01 X100. Y100. F2000.	
(3)	X200.	
(4)	Y200.	
(5)	IF [#100 EQ 0] THEN	When #100 is 0, execute THEN to ENDIF ((5) to (8))
(6)	G01 Y300. F1500.	
(7)	X300.	
(8)	ENDIF	
(9)	G02 X50. Y50. I0. J50. F800.	
(10)	G01 X100. Y500. F2000.	
(11)	IF [#110 GT #120] THEN	When #110 exceeds #120, execute THEN to ELSE ((11) to (14))
(12)	G00 X10.	
(13)	Y100.	
(14)	ELSE	When #110 less than or equal to #120, execute ELSE to ENDIF ((14) to (16))
(15)	G28 X0. Y0.	
(16)	ENDIF	

Repeat (WHILE, DO, END)

This command is used to control the flow of the program being executed with conditions.

Code	Format
WHILE, DO, END	<pre> WHILE _ [Conditional expression] _ DOm : : ENDm </pre> <p style="text-align: right;">Repeat identification No. (1 to 127)</p>

Processing details

- While conditions are met, the next block to the end block are repeatedly executed. When conditions are not met, the next block after the END block is executed.
- Use WHILE to DO, and END in pairs. When WHILE to DO, and END are not paired within the same program, a minor error (error code: 1FC3H (details code: 0334H)) occurs.
- END cannot be specified before WHILE to DO. When END is specified before WHILE to DO, a minor error (error code: 1FC3H (details code: 0334H)) occurs.
- When WHILE [Conditional expression] are omitted, DOm to ENDm are repeated indefinitely.
- The range of the repeat identification No. m is "1 to 127". When a value outside of the range is specified to the repeat identification No. m, a minor error (error code: 1FC3H (details code: 0332H)) occurs.
- A repeat identification No. can be used any amount of times. Also, repeat identification Nos. do not need to be used in any order.

```

WHILE [#110 GT #111] DO1 ←
:
:
END1
:
:
WHILE [#120 EQ #121] DO3 ←
:
:
END3
:
:
WHILE [#130 GT #131] DO1 ←
:
:
END1
    
```

- The maximum depth of a WHILE statement is up to 27 levels. If the depth of a WHILE statement exceeds 27 levels, a minor error (error code: 1FC3H (details code: 0333H)) occurs. When nesting, a repeat identification No. that has already been used in nesting cannot be used again.

```

WHILE[#120 GT #121] DO1 ←
:
:
WHILE[#120 LT #121] DO2 ←
:
:
:
WHILE[#120 EQ #121] DO27 ←
:
:
END27
:
:
END2
:
:
END1
    
```

Level 27 Level 2 Level 1

- Branching from a block in between the WHILE and END statements to a block outside the range between the WHILE and END statements is possible. However, branching from outside the range between the WHILE and END statements to a block in between the WHILE and END statements is not possible. When branching from outside the range between the WHILE and END statements to a block in between the WHILE and END statements, a minor error (error code: 1FC3H (details code: 0306H)) occurs.

- Branching from a block in between the WHILE and END statements

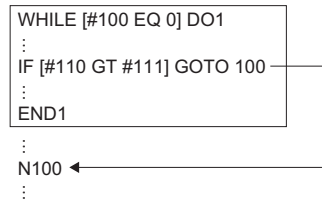

- Branching to a block between the WHILE and END statements

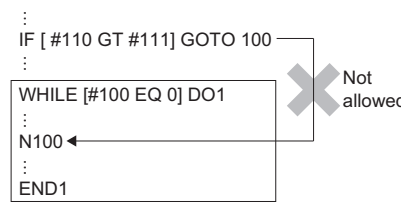

- Branching to a block between the WHILE and END statements from a block between the WHILE and END statements

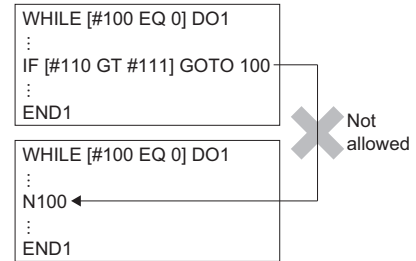

- A subprogram call (M98) or a macro call (G65) can be made from in between the WHILE and END statements. Additionally, a WHILE/DO/END instruction can be made within a subprogram or a macro program. The maximum depth of a WHILE statement is 27 levels (including the main program, subprogram, and macro program).
- When the WHILE and END statements are not used in pairs in a subprogram or a macro program, a minor error (error code: 1FC3H (details code: 0334H)) occurs when M99 is executed.

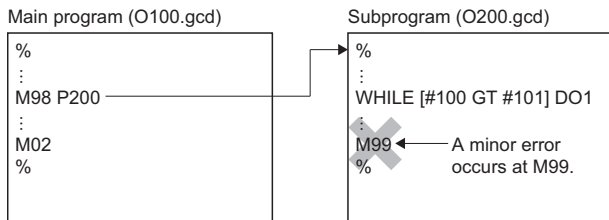

- WHILE to END statements cannot be used in a way that they overlap each other. Also, IF to ENDIF statements and WHILE to END statements cannot overlap each other. If overlapping occurs, a minor error (error code: 1FC3H (details code: 0334H)) occurs.

- When the WHILE to END statements overlap with each other

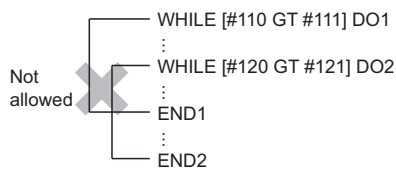

- When the WHILE to END statements overlap with the IF to ENDIF statements

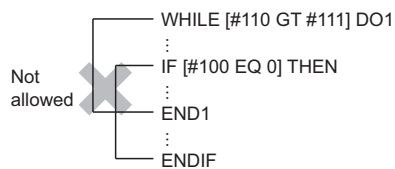

- When the IF to ENDIF statements overlap with the WHILE to END statements

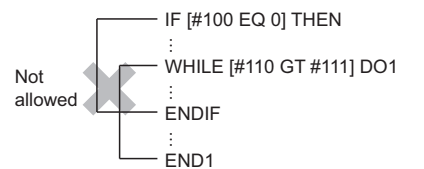

Program example

■ A program that repeats the specified block when conditions are met

Operation	Program	Remarks
(1)	#100 = 0	
(2)	G91 G00 X25. Y50.	
(3)	WHILE [#100 LT 3] DO1	When #100 is less than or equal to 3, repeat (3) to (6)
(4)	G03 X0. Y0. I50. J0. F100.	
(5)	#100 = #100 + 1	Add 1 to #100 each time (5) is executed
(6)	END1	
(7)	G00 X0. Y0.	

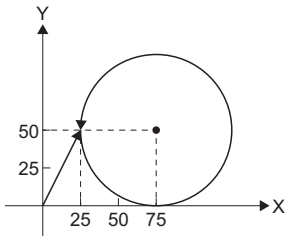

*1 The G-code program above draws a circle three times.

6 AUXILIARY AND APPLIED FUNCTIONS

6.1 Relationship between G-Code Control and Each Function

The relationship between G-code control and each function is shown below.

○: Valid, —: Invalid

Function	G-code control	Details
Torque limit function	○	Torque limit value can be changed by torque limit value change instruction (M(P).CHGT/D(P).CHGT, CHGT).
External input signal (STOP/FLS/RLS) input	○	The same as positioning control. However, when the "Deceleration process on STOP" parameter block is set to "Rapid stop" the deceleration process is a deceleration stop. The "Real current value at stop input" is not stored.
Forced stop	○	The same as other positioning methods.
Stop command	—	Ignored.
Rapid stop command	—	Ignored.
Stroke limit for each axis	—	Ignored.
Control change	Current value change	—
	Speed change	—
	Torque limit value change	○
	Target position change	—
Absolute position system	○	The same as other positioning methods.
M-code output function	—	The M-code for G-code control axes is not stored.
Backlash compensation function	○	The same as other positioning methods.
Skip function in which disregards stop command	—	Ignored.
Speed-torque control	—	<ul style="list-style-type: none"> During G-code control, speed-torque control cannot be started. A minor error (error code: 192AH) occurs. During speed-torque control, G-code control cannot be started. A minor error (error code: 1FC1H (details code: 0117H)) occurs.
Pressure control	—	<ul style="list-style-type: none"> During G-code control, pressure control cannot be started. A minor error (error code: 192AH) occurs. During pressure control, G-code control cannot be started. A minor error (error code: 1FC1H (details code: 0117H)) occurs. During pressure control, G-code control cannot be started. A minor error (error code: 1FC1H (details code: 0117H)) occurs.
File transmission at boot function	○	File transmission at boot for G-code control system parameters, G-code control axis parameters, G-code control work parameters, and G-code programs is available.
Parameter change function	○	Parameter change for G-code control system parameters, G-code control axis parameters, G-code control work parameters is available.
Override function	—	Override for G-code control axes is ignored. The override for G-code control is used.
Vibration suppression command filter	○	The same as other positioning methods.
Servo motor maximum speed check	—	Ignored.
ABS direction in degrees	—	Ignored.
Positioning control by servo program	—	<ul style="list-style-type: none"> During G-code control, other positioning controls cannot be started. A minor error (error code: 192AH) occurs. During other positioning controls, G-code control cannot be started. A minor error (error code: 1FC1H (details code: 0117H)) occurs.
Direct positioning control by Motion dedicated PLC instruction (M(P).SVSTD/D(P).SVSTD)	—	
JOG operation	—	
Manual pulse generator operation	—	
Advanced synchronous control	—	
Machine program operation	—	
Machine JOG operation	—	
Limit switch function	○	

Function	G-code control	Details
Mark detection function	○	The same as other positioning methods.
Mixed operation cycle function	—	Cannot be used. When G-code control and mixed operation cycle are both set to be used, a moderate error (error code: 30F9H) occurs when the Multiple CPU system power supply is turned ON.
Functions that use SSCNET communication	○	The same as other positioning methods.
Digital oscilloscope	○	G-code control devices are available.
Axis monitor	○	Monitors the positioning dedicated signals during G-code control. However, target speed and command address are not monitored.
Motion CPU error batch monitor	○	Registers the errors detected at G-code control.
Scroll monitor	—	Does not register the history during G-code control.
Current value history monitor	○	The same as other positioning methods.
Test mode	—	G-code control by test mode is not possible.

6.2 Auxiliary Function (M Function)

Auxiliary function, also called M function, is used to command G-code control auxiliary functions.

M-code output

When M00, M01, M02, and M30 are commanded, "[St.3218] M-code output M00 (D54442.0+4s)" to "[St.3221] M-code output M30 (D54442.3+4s)" are output in addition to "[Md.3058] M-code data 1 (D54554+128s, D54555+128s)" to "[Md.3061] M-code data 4 (D54560+128s, D54561+128s)" and "[St.3222] Auxiliary function strobe 1 (D54442.4+4s)" to "[St.3225] Auxiliary function strobe 4 (D54442.7+4s)".

When using M-code output, G-code control only outputs "[St.3218] M-code output M00 (D54442.0+4s)" to "[St.3221] M-code output M30 (D54442.3+4s)". The processing of operations and completion signals must be created by the user.

"[St.3218] M-code output M00 (D54442.0+4s)" to "[St.3221] M-code output M30 (D54442.3+4s)" turn OFF by after completion of auxiliary functions or by "[Rq.3380] Reset command (D54226.4+2s)" OFF→ON. When a movement command or dwell are in the same block, the M-code is output when the movement command and dwell are completed. Also, when the M-code output command is commanded on its own, the M-code is output after the axis movement of the previous command block is complete. However, when "[Rq.3382] Auxiliary function complete 1 (FIN1) (D54227.0+2s)" or "[Rq.3383] Auxiliary function complete 2 (FIN2) (D54227.1+2s)" are turned ON before the completion of the movement command and dwell, M-code is not output.

M-code	M-code output signal	Operation
M00	[St.3218] M-code output M00 (D54442.0+4s)	"[Rq.3382] Auxiliary function complete 1 (FIN1) (D54227.0+2s)" or "[Rq.3383] Auxiliary function complete 2 (FIN2) (D54227.1+2s)" OFF→ON
M01	[St.3219] M-code output M01 (D54442.1+4s)	"[Rq.3382] Auxiliary function complete 1 (FIN1) (D54227.0+2s)" or "[Rq.3383] Auxiliary function complete 2 (FIN2) (D54227.1+2s)" OFF→ON
M02	[St.3220] M-code output M02 (D54442.2+4s)	"[Rq.3380] Reset command (D54226.4+2s)" OFF→ON (Do not turn ON "[Rq.3382] Auxiliary function complete 1 (FIN1) (D54227.0+2s)" or "[Rq.3383] Auxiliary function complete 2 (FIN2) (D54227.1+2s)")
M30	[St.3221] M-code output M30 (D54442.3+4s)	"[Rq.3380] Reset command (D54226.4+2s)" OFF→ON (Do not turn ON "[Rq.3382] Auxiliary function complete 1 (FIN1) (D54227.0+2s)" or "[Rq.3383] Auxiliary function complete 2 (FIN2) (D54227.1+2s)")

Point

"[Md.3058] M-code data 1 (D54554+128s, D54555+128s)" to "[Md.3061] M-code data 4 (D54560+128s, D54561+128s)" and "[St.3222] Auxiliary function strobe 1 (D54442.4+4s)" to "[St.3225] Auxiliary function strobe 4 (D54442.7+4s)" are also output for specific auxiliary functions (M00, M01, M02, M30).

Example

■ Changing between block stop/continue execution with the status of the M00 command

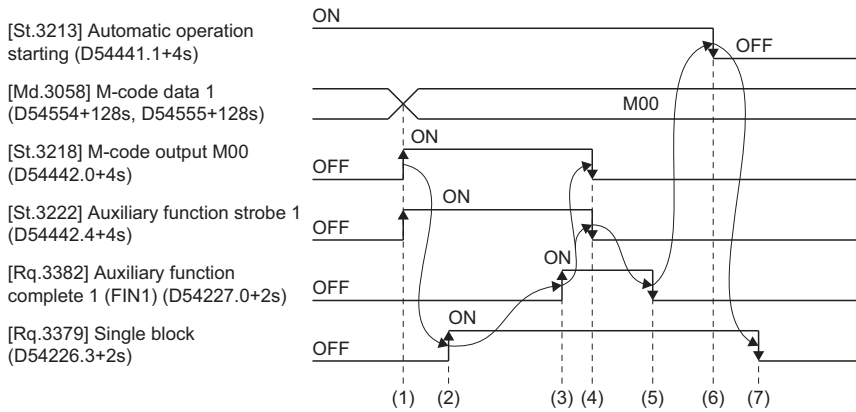

[Operation]

- (1) Output "[Md.3058] M-code data 1 (D54554+128s, D54555+128s)", "[St.3218] M-code output M00 (D54442.0+4s)" and "[St.3222] Auxiliary function strobe 1 (D54442.4+4s)" with the Motion CPU.
- (2) The user checks that "[St.3218] M-code output M00 (D54442.0+4s)" is turned ON, and turns ON "[Rq.3379] Single block (D54226.3+2s)".
- (3) When the processing in (2) is complete, the user turns ON "[Rq.3382] Auxiliary function complete 1 (FIN1) (D54227.0+2s)".
- (4) Check that "[Rq.3382] Auxiliary function complete 1 (FIN1) (D54227.0+2s)" is turned ON with the Motion CPU, and turn OFF "[St.3218] M-code output M00 (D54442.0+4s)", and "[St.3222] Auxiliary function strobe 1 (D54442.4+4s)".
- (5) The user checks that "[St.3222] Auxiliary function strobe 1 (D54442.4+4s)" is OFF, and turns OFF "[Rq.3382] Auxiliary function complete 1 (FIN1) (D54227.0+2s)".
- (6) Check that "[Rq.3382] Auxiliary function complete 1 (FIN1) (D54227.0+2s)" is turned OFF, the status of "[Rq.3379] Single block (D54226.3+2s)", the completion of the current block, and turn OFF "[St.3213] Automatic operation starting (D54441.1+4s)".
- (7) The user checks that "[St.3213] Automatic operation starting (D54441.1+4s)" is OFF, and turns OFF "[Rq.3379] Single block (D54226.3+2s)" before the next automatic operation starts.

■ Resetting with M02 command

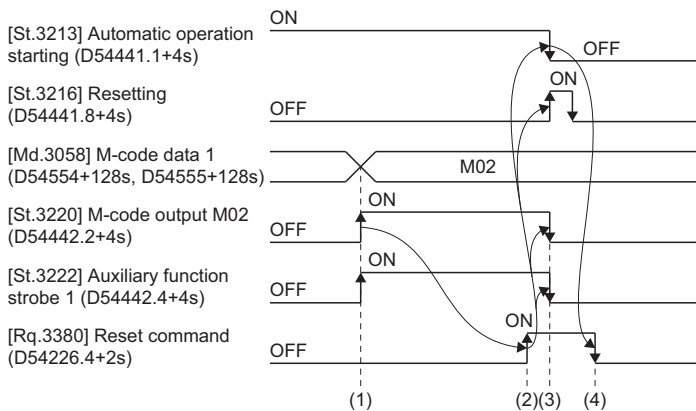

[Operation]

- (1) Output "[Md.3058] M-code data 1 (D54554+128s, D54555+128s)", "[St.3220] M-code output M02 (D54442.2+4s)" and "[St.3222] Auxiliary function strobe 1 (D54442.4+4s)" with the Motion CPU.
- (2) The user checks that "[St.3220] M-code output M02 (D54442.2+4s)" has turned ON, and performs the operation. After the operation is completed, "[Rq.3380] Reset command (D54226.4+2s)" is turned OFF→ON.
- (3) Check that "[Rq.3380] Reset command (D54226.4+2s)" is turned ON with the Motion CPU, and turn OFF "[St.3220] M-code output M02 (D54442.2+4s)", and "[St.3222] Auxiliary function strobe 1 (D54442.4+4s)".
- (4) The user checks that "[St.3213] Automatic operation starting (D54441.1+4s)" is OFF, and turns OFF "[Rq.3380] Reset command (D54226.4+2s)".

■ Outputting M02 command after axis operation completes

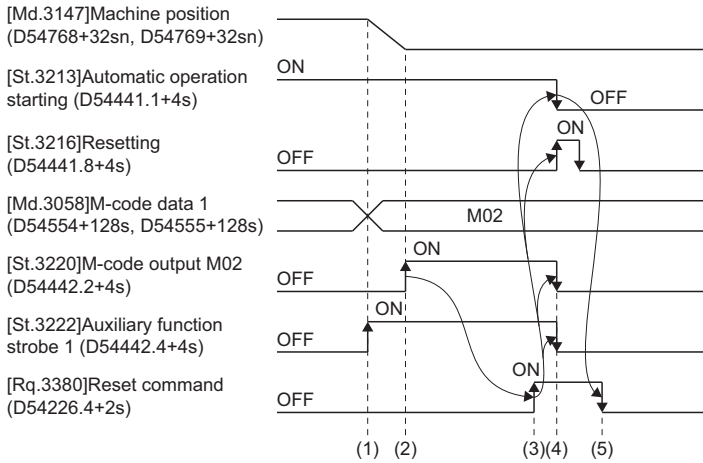

[Operation]

- (1) Output "[Md.3058] M-code data 1 (D54554+128s, D54555+128s)" and "[St.3222] Auxiliary function strobe 1 (D54442.4+4s)" with the Motion CPU.
- (2) After axis operation completes, output "[St.3220] M-code output M02 (D54442.2+4s)" with the Motion CPU.
- (3) The user checks that "[St.3220] M-code output M02 (D54442.2+4s)" has turned ON, and performs the operation. After the operation is completed, "[Rq.3380] Reset command (D54226.4+2s)" is turned OFF→ON.
- (4) Check that "[Rq.3380] Reset command (D54226.4+2s)" is turned ON with the Motion CPU, and turn OFF "[St.3220] M-code output M02 (D54442.2+4s)", and "[St.3222] Auxiliary function strobe 1 (D54442.4+4s)".
- (5) The user checks that "[St.3213] Automatic operation starting (D54441.1+4s)" is OFF, and turns OFF "[Rq.3380] Reset command (D54226.4+2s)".

Auxiliary function complete

When an auxiliary function (M function) is commanded, the completion signal is waited for before proceeding to the next block by creating the processing and completion sequences in a Motion SFC program or sequence program. There are two types of completion signals available. Use them according to the operation to be performed.

Auxiliary function completion signal	Operation
[Rq.3382] Auxiliary function complete 1 (FIN1) (D54227.0+2s)	At the trailing edge of completion signal (FIN1), proceed to the next block
[Rq.3383] Auxiliary function complete 2 (FIN2) (D54227.1+2s)	At the leading edge of completion signal (FIN2), proceed to the next block

Auxiliary function complete 1 (FIN1)

The operation for when the FIN1 signal is used is shown below. For Motion SFC programs and sequence programs, use a process that checks that the auxiliary function strobe signal is OFF before turning OFF "[Rq.3382] Auxiliary function complete 1 (FIN1) (D54227.0+2s)".

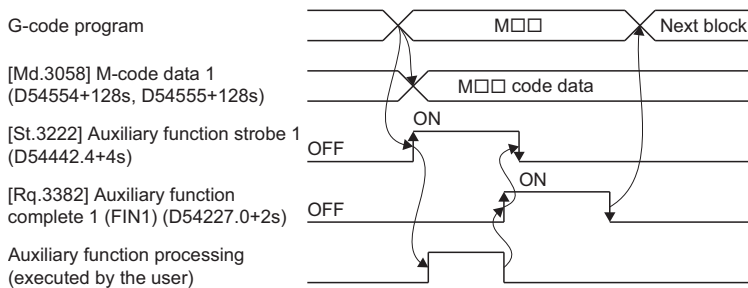

Points

- "[Rq.3382] Auxiliary function complete 1 (FIN1) (D54227.0+2s)" is used for all auxiliary functions (M functions), therefore turn it ON with the condition that all operations are complete.
- When "[Rq.3382] Auxiliary function complete 1 (FIN1) (D54227.0+2s)" is turned ON before an auxiliary function (M function) command, the auxiliary function (M function) data is not output.
- When using an M02 command or M30 command, turn ON "[Rq.3380] Reset command (D54226.4+2s)", not "[Rq.3382] Auxiliary function complete 1 (FIN1) (D54227.0+2s)". When "[Rq.3382] Auxiliary function complete 1 (FIN1) (D54227.0+2s)" is turned ON at the M02 command or M30 command at the end of a G-code program, a minor error (error code: 1FC3H (details code: 0309H)) occurs.
- When an M command is used in the block following a cutter command, M-code data is output before the cutter deceleration is completed. When executing an M command after axis movement is completed, insert a block (G04 without extended time) in between the cutter command and M command.

Program example

- Executing an M command after axis movement is completed

Program

```

:
G01 X10. F100.
G04 P0 M□□
Y10.
:

```

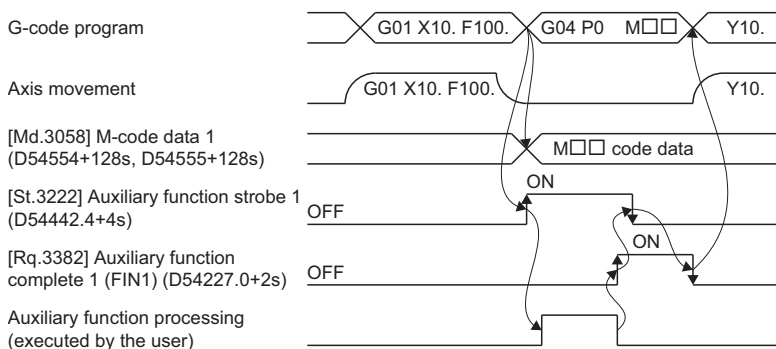

Auxiliary function complete 2 (FIN2)

The operation for when the FIN2 signal is used is shown below. For Motion SFC programs and sequence programs, use a process that checks that the auxiliary function strobe signal is OFF before turning OFF "[Rq.3383] Auxiliary function complete 2 (FIN2) (D54227.1+2s)".

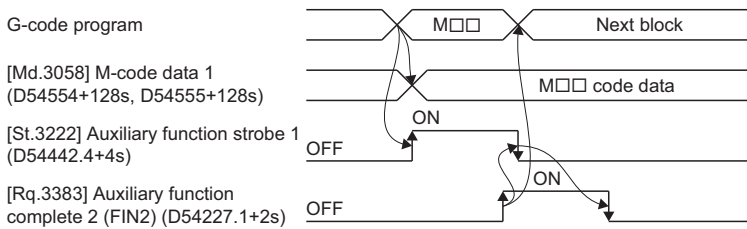

Points

- "[Rq.3383] Auxiliary function complete 2 (FIN2) (D54227.1+2s)" is used for all auxiliary functions (M functions), therefore turn it ON with the condition that all operations are complete.
- When "[Rq.3383] Auxiliary function complete 2 (FIN2) (D54227.1+2s)" is turned ON before an auxiliary function (M function) command, the auxiliary function (M function) data is not output.

Ex.

When M commands are continuous

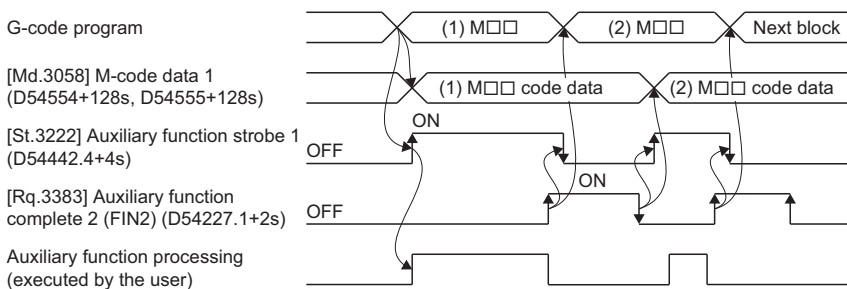

- After switching blocks, "[Md.3058] M-code data 1 (D54554+128s, D54555+128s)" to "[Md.3061] M-code data 4 (D545560+128s, D545561+128s)" and "[St.3222] Auxiliary function strobe 1 (D54442.4+4s)" to "[St.3225] Auxiliary function strobe 4 (D54442.7+4s)" are output when "[Rq.3383] Auxiliary function complete 2 (FIN2) (D54227.7+2s)" turns OFF.
- When using an M02 command or M30 command, turn ON "[Rq.3380] Reset command (D54226.4+2s)", not "[Rq.3383] Auxiliary function complete 2 (FIN2) (D54227.1+2s)". When "[Rq.3383] Auxiliary function complete 2 (FIN2) (D54227.1+2s)" is turned ON at the M02 command or M30 command at the end of a G-code program, a minor error (error code: 1FC3H (details code: 0309H)) occurs.

6.3 Feed Function

Fast forward speed

Fast forward speed is the positioning speed when positioning by the G00 command.

Set the fast forward speed in [Motion Control Parameter]⇒[G-code Control Parameter]⇒[G-code Control Axis Parameter]⇒"Speed/Time Constant"⇒"Fast Forward Speed".

For the path when positioning, there is the "interpolation type" which is a straight line from the start to the end point, and the "non-interpolation type" which moves at the fast forward speed for each axis. Set the interpolation type/non-interpolation type in [Motion Control Parameter]⇒[G-code Control Parameter]⇒[G-code Control System Parameter]⇒"Control Setting"⇒"G00 Non-Interpolation". The positioning time is the same regardless of which type is set.

Set the acceleration/deceleration time constant in [Motion Control Parameter]⇒[G-code Control Parameter]⇒[G-code Control Axis Parameter]⇒"Speed/Time Constant"⇒"G0 Time Constant (Linear)".

During fast forward, the speed stored in "[Md.3018] Speed (D54502+128s, D54503+128s)" differs depending on the setting of the G-code system parameter "G00 Non-Interpolation".

G00 Non-interpolation	[Md.3018] Speed (D54502+128s, D54503+128s)
0: Move to the end point in a straight line. (Interpolation type)	Stores the speed of the vector direction currently moving.
1: Move to the end point of each axis, at the fast forward speed of each axis. (Non-interpolation type)	Stores the speed of the axis that has the highest speed of all axes currently moving.

The feed speed during high-accuracy control mode is set in [Motion Control Parameter]⇒[G-code Control Parameter]⇒[G-code Control Axis Parameter]⇒"High-accuracy Control"⇒"Rapid Traverse Rate During High-accuracy Control Mode".

However, when rapid traverse rate during high-accuracy control mode is set to "0", the speed set in [Motion Control Parameter]⇒[G-code Control Parameter]⇒[G-code Control Axis Parameter]⇒"Speed/Time Constant"⇒"Fast Forward Speed" is used for movement.

The rapid traverse rate during high-accuracy control mode can be set for each axis.

The G00 command processes acceleration/deceleration by the time constant acceleration/deceleration method regardless of whether in cutting mode/high-accuracy control mode.

When interpolation distance is long, and speed reaches the fast forward speed

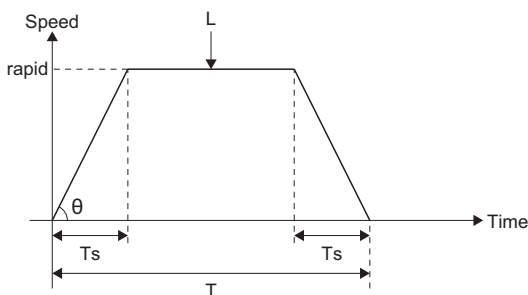

$$T = L + \text{rapid} + Ts$$

$$\theta = \tan^{-1}(\text{rapid} + Ts)$$

rapid : Fast forward speed
 Ts : Acceleration/deceleration time constant
 T : Interpolation time
 L : Interpolation distance
 θ : Acceleration/deceleration angle

When interpolation distance is short, and speed does not reach fast forward speed

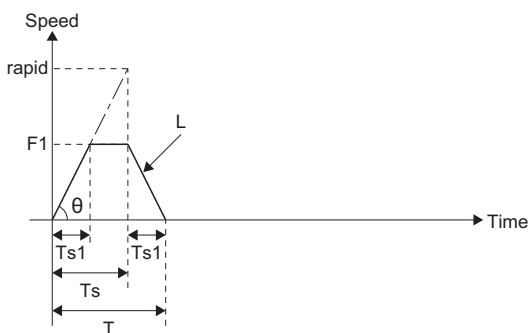

$$F1 = L + Ts$$

$$Ts1 = Ts \times F1 + \text{rapid}$$

$$Ts1 = L + \text{rapid}$$

$$T = Ts1 + Ts$$

$$T = L + \text{rapid} + Ts$$

$$\theta = \tan^{-1}(\text{rapid} + Ts)$$

rapid : Fast forward speed
 F1 : Actual speed
 Ts : Acceleration/deceleration time constant
 Ts1 : Acceleration/deceleration time taken to reach actual feed speed
 T : Interpolation time
 L : Interpolation distance
 θ : Acceleration/deceleration angle

Cutting feed speed

For the cutting feed speed, set feed speed[mm/min] per minute and an address F.

The cutting feed speed is valid for G01 commands, G02 commands, G03 commands.

The cutting feed speed is clamped by the value set in [Motion Control Parameter]⇒[G-code Control Parameter]⇒[G-code Control Axis Parameter]⇒"Speed/Time Constant"⇒"Cutting Feed Clamp Speed".

The cutting feed speed during high-accuracy control mode is clamped by the value set in [Motion Control Parameter]⇒[G-code Control Parameter]⇒[G-code Control Axis Parameter]⇒"High-accuracy Control"⇒"Cutting Feed Clamp Speed for High-accuracy Control Mode". However, when cutting feed clamp speed for high-accuracy control mode is set to "0", the value set in [Motion Control Parameter]⇒[G-code Control Parameter]⇒[G-code Control Axis Parameter]⇒"Speed/Time Constant"⇒"Cutting Feed Clamp Speed" is used for clamping.

During cutting feed, the composite speed of the interpolation axis is stored in "[Md.3018] Speed (D54502+128s, D54503+128s)".

Acceleration/deceleration processing during exact stop check mode/automatic corner override/cutting mode

G00, G01, and G03 commands during exact stop mode/automatic corner override/cutting mode use the time constant acceleration/deceleration method to process acceleration/deceleration.

The acceleration/deceleration time constant is set in [Motion Control Parameter]⇒[G-code Control Parameter]⇒[G-code Control Axis Parameter]⇒"Speed/Time Constant"⇒"G1 Time Constant (Linear)".

■ When interpolation distance is long, and speed reaches the cutting feed speed

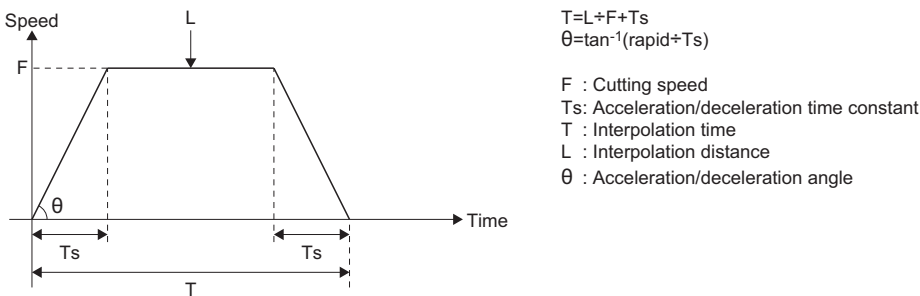

■ When interpolation distance is short, and speed does not reach cutting feed speed

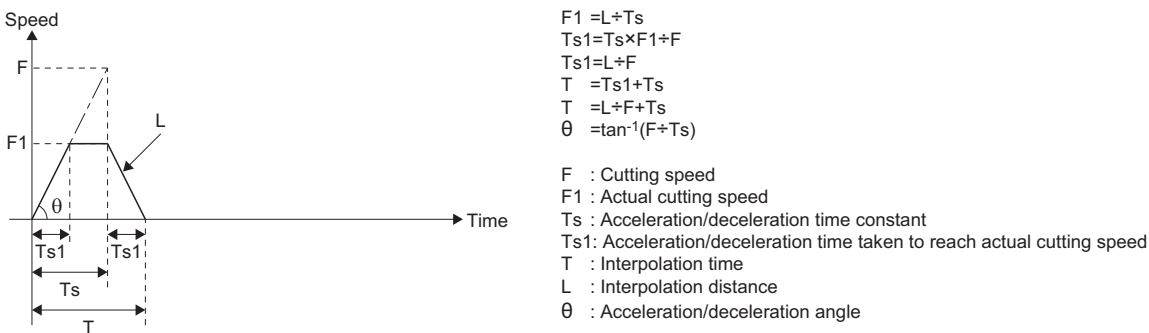

Acceleration/deceleration processing during high-accuracy control mode

G00, G01, and G03 commands during high-accuracy control mode use the constant inclination acceleration/deceleration method to process acceleration/deceleration.

Refer to acceleration/deceleration before interpolation for details on cutting feed acceleration/deceleration processing during high-accuracy control mode. (Page 271 Acceleration/deceleration before interpolation)

Feed speed specification and the effects on each control axis

Control axes are divided into linear axes which control linear movement, and rotating axes which control rotational movement. The feed speed is used to specify the displacement speed of these axes, and has different effects on the tool movement speed when cutting depending on if controlling a linear axis or rotating axis. Also, although the displacement amount is specified on each axis, feed speed is specified by a single value, and not specified on each axis. The following describes the effects on each axis when interpolating two axes or more.

Controlling a linear axis

When controlling one axis only, or two or more control axes simultaneously, the feed speed specified by F is applied to the vector speed of the tool advance direction.

■ Controlling linear axis only

Ex.

Specifying the feed speed as "f", and controlling linear axes (X-axis and Y-axis)

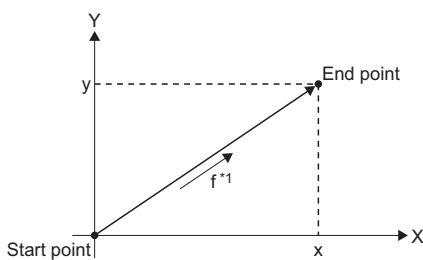

$$f_x = f \times \frac{x}{\sqrt{x^2 + y^2}} \dots \dots \text{X-axis feed speed}$$

$$f_y = f \times \frac{y}{\sqrt{x^2 + y^2}} \dots \dots \text{Y-axis feed speed}$$

*1: The speed of this direction is "f".

When controlling linear axes only, specify the cutting speed in the program. The feed speed of each axis is the result of an analysis of the specified feed speed in terms of movement amount.

■ Controlling linear axes using circular interpolation

Ex.

Specifying the feed speed as "f", and using circular interpolation to control linear axes (X-axis and Y-axis)

The speed of the tool advance direction (tangential direction) is the feed speed specified in the program.

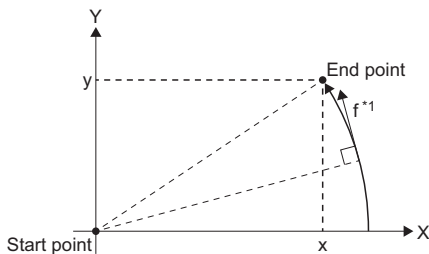

*1: The speed of this direction is "f".

In this case, the feed speed of the X-axis and Y-axis changes with the movement of the tool. However, the composite speed is always fixed at the value "f".

Controlling a rotating axis

When controlling a rotating axis, the specified feed speed acts as the rotation speed (angular speed) of the rotating axis. Thus, the cutting speed (vector speed) for the tool advance direction changes according to the distance between the center of rotation and the tool. The speed specified in the program must take this distance into account.

Ex.

Specifying the feed speed as "f", and controlling rotation axes (C-axis) (unit of f: [degree/min])

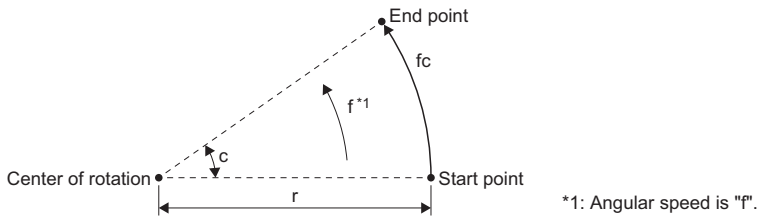

In this case, the formula to make "fc" as the cutting speed (vector speed) of the tool advance direction is:

$$fc = f \times \frac{\pi \times r}{180}$$

Thus, feed speed specified in the program is as follows.

$$f = fc \times \frac{180}{\pi \times r}$$

Controlling linear axes and rotating axes at the same time

Whether the controlling equipment controls linear axes or rotating axes, they are all treated the same way. When controlling a rotating axis, the values given by coordinate language (A, B, C) are the angles, and the value given by the feed speed (F) is used as the vector speed for all axes. In other words, 1[degree] for a rotation axis is equivalent to 1[mm] for a linear axis. Therefore, when linear axes and rotation axes are controlled at the same time, the way in which every axis treats the value given by "F" is the same as "when controlling a linear axis". In this case, the size of the speed component and direction for linear axis control do not change, but for rotating axis control the direction of the speed component changes with the movement of the tool (size does not change), and as a result, the composite feed speed of the tool advance direction changes with the movement of the tool.

Ex.

Specifying the feed speed as "f", and controlling a linear axis (X-axis) and rotation axis (C-axis) at the same time

When the X-axis incremental command value is "x", and C-axis incremental command value is "c"

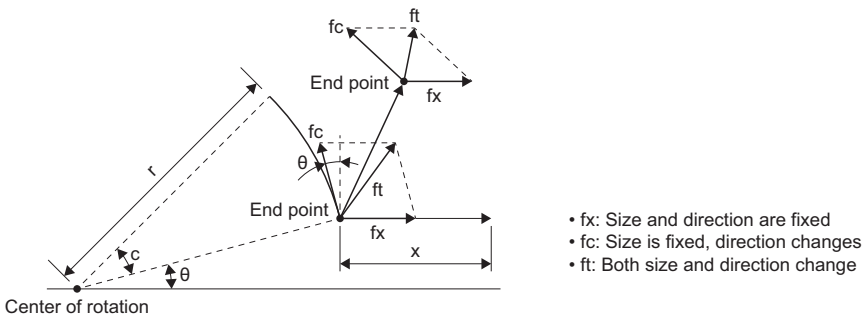

Center of rotation

The X-axis feed speed (vector speed) "fx", and C-axis feed speed (angular speed) "ω" are as follows:

$$f_x = f \times \frac{x}{\sqrt{x^2 + c^2}} \dots \dots (1)$$

$$\omega = f \times \frac{c}{\sqrt{x^2 + c^2}} \dots \dots (2)$$

The vector speed "fc" for C-axis control is:

$$f_c = \omega \times \frac{\pi \times r}{180} \dots \dots (3)$$

When the speed of the tool advance direction at the start point is "ft", the speed of the X-axis is "ftx" and the speed of the Y-axis is "fty", the following formula applies.

$$f_{tx} = -r \sin\left(\frac{\pi}{180} \theta\right) \times \frac{\pi}{180} \omega + f_x \dots \dots (4)$$

$$f_{ty} = -r \cos\left(\frac{\pi}{180} \theta\right) \times \frac{\pi}{180} \omega \dots \dots (5)$$

"r" is the distance between the center of rotation and the tool (unit: [mm]), and "θ" is the angle (unit: [degree]) made with the start point and X-axis from the center of rotation.

From the formulas (1) to (5), the composite speed "ft" is:

$$f_t = \sqrt{f_{tx}^2 + f_{ty}^2}$$

$$= f \times \frac{\sqrt{x^2 - x \times c \times r \sin\left(\frac{\pi}{180} \theta\right) \frac{\pi}{90} + \left(\frac{\pi \times r \times c}{180}\right)^2}}{\sqrt{x^2 + c^2}} \dots \dots (6)$$

Thus, the feed speed "f" to specify in the program is:

$$f = f_t \times \frac{x^2 + c^2}{\sqrt{x^2 - x \times c \times r \sin\left(\frac{\pi}{180} \theta\right) \frac{\pi}{90} + \left(\frac{\pi \times r \times c}{180}\right)^2}} \dots \dots (7)$$

Note that "ft" in formula (6) is the speed at the start point, and as the C-axis rotates the value for θ changes and thus the value for "ft" also changes. Therefore in order to keep the cutting speed (ft) fixed as much as possible, keep the rotating angle specified in a block as small as possible to keep the extent of the change in θ small.

Deceleration check

The deceleration check function reduces the impact on machinery when the feed speed of the control axis changes abruptly, and can also prevent the rounding of corners when cutting corners by decelerating to a stop at the block joint, before executing the next block.

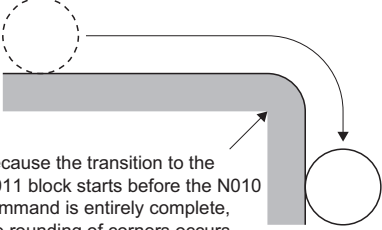
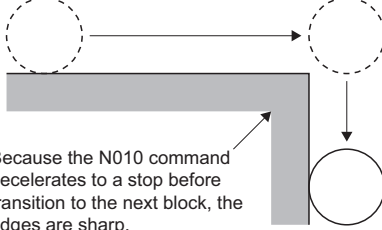
No deceleration check	Deceleration check
<p>N010 G01 X100. N011 G01 Y-50.</p>  <p>Because the transition to the N011 block starts before the N010 command is entirely complete, the rounding of corners occurs.</p>	<p>N010 G09 G01 X100. N011 G01 Y-50.</p>  <p>Because the N010 command decelerates to a stop before transition to the next block, the edges are sharp.</p>

Conditions for execution of deceleration check

Deceleration check during fast forward

For fast forward mode, when the movement for the block is complete a deceleration check is always performed before executing the next block.

Deceleration check during cutting feed

For cutting feed mode, when one of the following conditions is satisfied, a deceleration check is executed and movement for the next block starts after the deceleration check is completed.

- When G61 (exact stop check mode) is selected.
- When G09 (exact stop check) is commanded in the same block.
- When there is an axis in the current block which moves in the reverse direction in the next block, and the conditions for the combination of movement commands is satisfied. (Refer to deceleration check when movement changes to the reverse direction for details. (Page 225 Deceleration check when movement changes to the reverse direction))

Deceleration check methods

There are three methods for deceleration check: Command deceleration check method, smoothing check method, and in-position check method.

Set the deceleration check method in [Motion Control Parameter]⇒[G-code Control Parameter]⇒[G-code Control System Parameter]⇒"Control Setting"⇒"Deceleration Check".

Command deceleration check method

After interpolation of a block is completed, and checking that the commanded deceleration is completed, the execution of the next block starts. The following explains the transition from a block executing fast forward to the next block using examples. The time required for deceleration check is the longest of the deceleration check times of each axis, which are determined by the acceleration/deceleration modes and acceleration/deceleration time constants of each axis commanded at the same time.

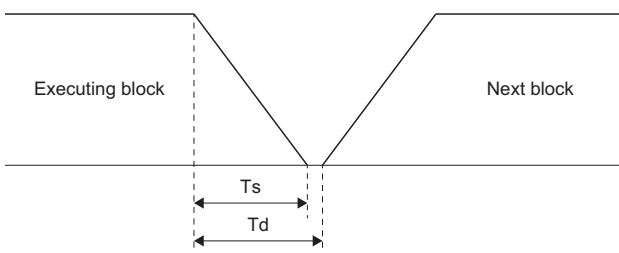

Ts : Acceleration/deceleration time
Td: Deceleration check time
 $Td = Ts + \alpha (0 \text{ to } 4 \text{ms}^{-1})$

*1: When the operation cycle is 1.777ms or more, the deceleration check time is a maximum of "operation cycle×4".

■ Smoothing check method

After a deceleration check and checking that the position commands of all axes on the line have reached their target position, the execution of the next block starts.

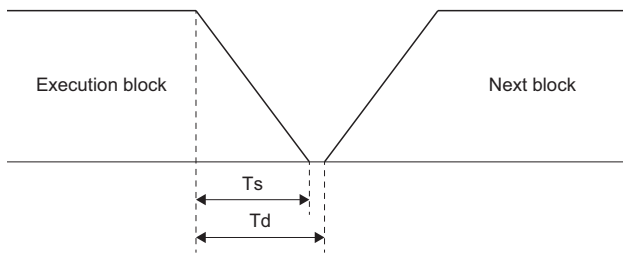

Ts : Acceleration/deceleration time
 Td: Deceleration check time
 $Td = Ts + \alpha (0 \text{ to } 4 \text{ms}^{-1})$

*1: When the operation cycle is 1.777ms or more, the deceleration check time is a maximum of "operation cycle×4".

■ In-position check method

After a deceleration check and checking that the remaining distance of the actual motor position on every axis in the line is equal to or below the fixed value, the execution of the next block starts. The checking of the remaining distance is performed by the in-position width. The in-position width is the servo parameter "In-position range (PA10)".

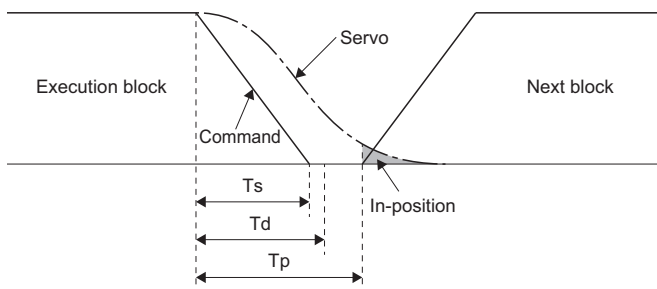

Ts : Acceleration/deceleration time
 Td: Deceleration check time
 Tp: Waiting time for block completion

The in-position width is illustrated above as the remaining distance of the previous block when the execution of the next block starts. (the area)

The purpose of the deceleration check is to reduce positioning time. If the in-position width setting value is made larger, the time reduction also becomes larger. However, the remaining distance of the previous block when the execution of the next block starts also becomes larger which may adversely affect the quality of the work.

The remaining distance is checked every G-code control operation cycle. Therefore, the intended positioning time reduction for the value set to the in-position width may not always occur.

Deceleration check when movement changes to the reverse direction

When the direction of movement is reversed in the cutting feed, the deceleration check is as follows.

○: Deceleration check, ×: No deceleration check

Current block	Next block		
	G00	G01	Other than G00/G01
G01	○	○/×*1	×
G02	×	×	×
G03	×	×	×

*1 Differs according to parameter settings. Refer to reverse of the direction of movement for G1→G1 for details. (Page 226 Reverse of the direction of movement for G1→G1)

Reverse of the direction of movement for G1→G0

When direction of movement is reversed for G1→G0, movement of the next block starts after interpolation and deceleration check is completed. The deceleration check avoids the overlapping of speed commands and excessive acceleration. For interpolation of multiple axes, if movement is reversed for one axis, a deceleration check is performed.

Same direction	Reverse direction

Ex.

Program examples for moving multiple axes are shown below.

Movement direction	Program	Description
X-axis(Forward→Reverse) Y-axis(Forward→Forward)	G91 G01 X100. Y100. F4000 G00 X-100. Y120.	The X-axis moves in the reverse direction, therefore deceleration check is performed.
X-axis(Forward→Forward) Y-axis(Reverse→Forward)	G91 G01 X100. Y-100. F4000 G00 X80. Y100.	The Y-axis moves in the reverse direction, therefore deceleration check is performed.
X-axis(Forward→Reverse) Y-axis(Forward→Forward)	G90 G01 X100. Y100. F4000 G00 X80. Y120.	The X-axis moves in the reverse direction, therefore deceleration check is performed. (When program start position is X0, Y0)
X-axis(Forward→Forward) Y-axis(Forward→Forward)	G91 G01 X100. Y100. F4000 G00 X100. Y100.	Both the X-axis and Y-axis move in the same direction, therefore deceleration check is not performed.
X-axis(Forward→Forward) Y-axis(Forward→No movement)	G91 G01 X100. Y80. F4000 G00 X80.	X-axis moves in the same direction, and Y-axis does not have a movement command, therefore deceleration check is not performed.

■ Reverse of the direction of movement for G1->G1

Set whether to perform deceleration check or not for reverse of the direction of movement for G1->G1 in [Motion Control Parameter]⇒[G-code Control Parameter]⇒[G-code Control System Parameter]⇒"Control Setting"⇒"G1→G1 Deceleration Check".

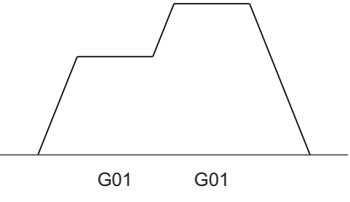
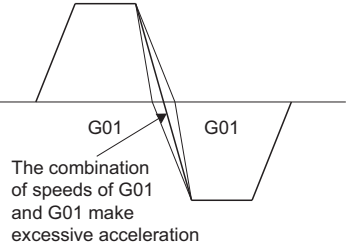
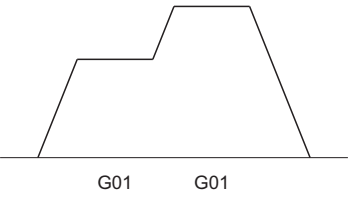
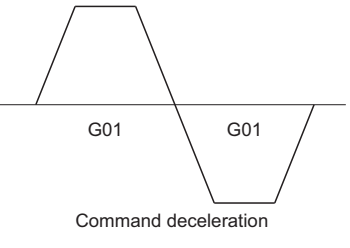
G1->G1 deceleration check	Description	Same direction	Reverse direction
0: Do not execute deceleration check	When direction of movement is reversed, after completion of interpolation a deceleration check is not performed and movement of the next block starts. Speed commands may overlap, and excessive acceleration may occur.		
1: Execute deceleration check	When direction of movement is reversed, after completion of interpolation a deceleration check is performed before movement of the next block starts. Speed commands do not overlap, and excessive acceleration is avoided. For interpolation of multiple axes, if movement is reversed for one axis, a deceleration check is performed.		

Ex.

Program examples for moving multiple axes when "1: Execute deceleration check" is set are shown below.

Movement direction	Program	Description
X-axis(Forward→Reverse) Y-axis(Forward→Forward)	G91 G01 X100. Y100. F4000 G01 X-100. Y120.	The X-axis moves in the reverse direction, therefore deceleration check is performed.
X-axis(Forward→Forward) Y-axis(Reverse→Forward)	G91 G01 X100. Y-100. F4000 G01 X80. Y100.	The Y-axis moves in the reverse direction, therefore deceleration check is performed.
X-axis(Forward→Reverse) Y-axis(Forward→Forward)	G90 G01 X100. Y100. F4000 G01 X80. Y120.	The X-axis moves in the reverse direction, therefore deceleration check is performed. (When program start position is X0, Y0)
X-axis(Forward→Forward) Y-axis(Forward→Forward)	G91 G01 X100. Y100. F4000 G01 X100. Y100.	Both the X-axis and Y-axis move in the same direction, therefore deceleration check is not performed.
X-axis(Forward→Forward) Y-axis(Forward→No movement)	G91 G01 X100. Y80. F4000 G01 X80.	X-axis moves in the same direction, and Y-axis does not have a movement command, therefore deceleration check is not performed.

6.4 Tool Compensation Function

Tool compensation

There are two types of tool compensation functions as illustrated below: Tool length compensation, and tool radius compensation. Set the tool compensation amounts in [Motion Control Parameter]⇒[G-code Control Parameter]⇒[G-code Control Work Parameter]⇒"Tool Compensation Data". When using tool compensation, specify the tool compensation No.

- Tool length compensation

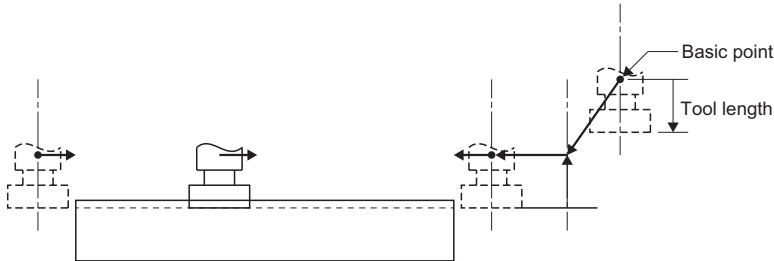

- Tool radius compensation

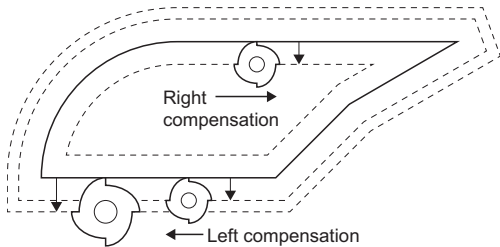

Tool compensation memory

In tool compensation amount, the shape compensation amount is set. For one compensation No. the tool length and tool radius can be set independently. In G-code programs, "H" is the compensation amount for tool length, and "D" is the compensation amount for tool radius.

■ Tool compensation amount

The locations for the shape compensation amount of the tool length and tool radius are illustrated below.

The setting range of the compensation amount is "-9999.9999 to 9999.9999[mm]".

Tool length compensation	Tool radius compensation

Tool compensation No. (H/D)

"H" and "D" are used as addresses for specifying tool compensation Nos.

A maximum of 40 groups can be used between lines.

H is used for tool length compensation, and D is used for tool radius compensation.

Tool compensation	Setting range
Tool length compensation	H01 to H40
Tool radius compensation	D01 to D40

■ Points

- Tool compensation No. is modal data. Once specified, it remains in effect until a new "H" or "D" is commanded.
- A tool compensation No. can only be commanded once in a block. When commanded more than once in a block, the last commanded tool compensation No. is valid.
- When the tool compensation No. is outside of range, a minor error (error code: 1FC3H (details code: 030DH)) occurs.
- When H0 or D0 is specified, tool length compensation or tool radius compensation is cancelled.

Tool length compensation

Controls movement so that the position of the end point of the movement command of each axis can be changed to a position that considers the compensation amount set in tool compensation. By using the G43 command, G44 command, and G49 command, the difference between the position of the program coordinates and the tool tip position on the machine, which is the tool length, is compensated.

Tool radius compensation

With tool radius compensation, the program path can be compensated for the compensation amount set in tool compensation in a selected vector direction, using G-code commands or D commands.

There are two starting operations and ending operations for tool radius compensation: Type A and type B. Set the type of tool radius compensation in [Motion Control Parameter]⇒[G-code Control Parameter]⇒[G-code Control Work Parameter]⇒"Tool Radius Compensation"⇒"Tool Radius Compensation Type".

Tool radius compensation start operation

With compensation cancelled, and all the conditions below satisfied, tool radius compensation starts. When starting compensation, regardless of whether in single block operation or not, three blocks of movement command, or if there are not three blocks of movement command, a maximum of five blocks are pre-read before execution. Also, during compensation, a maximum of five blocks are pre-read.

- When compensation commands (G41, G42) are commanded.
- When the compensation No. for tool radius compensation is within the range.
- When the movement command is positioning (G00), or linear interpolation (G01).

Point

When there is no movement command in the same block as a compensation command (G41, G42), compensation operation is performed perpendicular to the direction of the next movement block.

■ Inside corner ($\theta \leq 180^\circ$)

—→ : Program path, - - - -> : Tool center path, ——— : Tangent to the arc at intersection, - - - - : Parallel line to program path

Linear→Linear	Linear→Arc

■ Outside corner (obtuse angle)($90^\circ \leq \theta < 180^\circ$)

—→ : Program path, - - - -> : Tool center path, ——— : Tangent to the arc at intersection, - - - - : Parallel line to program path

Tool radius compensation type	Linear→Linear	Linear→Arc
Type A		
Type B		

■ Outside corner (acute angle)($\theta < 90^\circ$)

→ : Program path, - - - -> : Tool center path, — — — : Tangent to the arc at intersection, - - - - : Parallel line to program path

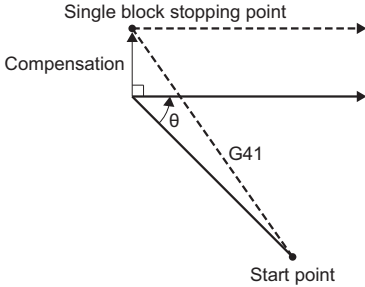
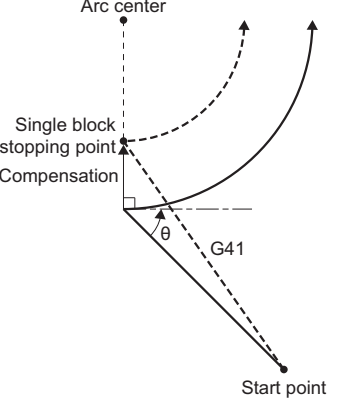
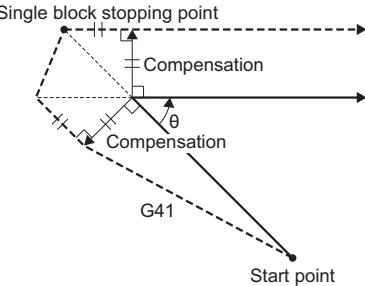
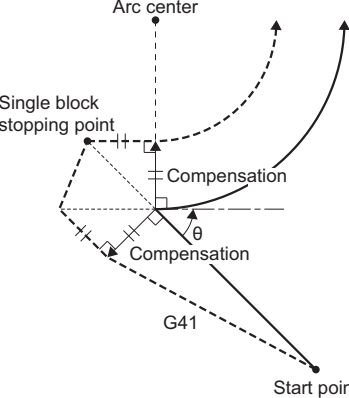
Tool radius compensation type	Linear→Linear	Linear→Arc
Type A		
Type B		

Operation during compensation mode

Program paths commanded by movement commands (G00, G01, G02, G03) are compensated to get the tool center path from a line/arc.

Point

- If the same compensation command (G41/G42) is commanded during compensation mode it is ignored.
- If four blocks or more that do not command movement are consecutively commanded during compensation mode, overcutting or undercutting occurs.
- During compensation mode, if M00 or M01 are commanded, pre-read becomes prohibited.

■ Inside corner (obtuse angle) ($90^\circ \leq \theta < 180^\circ$)

→ : Program path, - - - - - : Tool center path, ——— : Tangent to the arc at intersection, - - - - - : Parallel line to program path

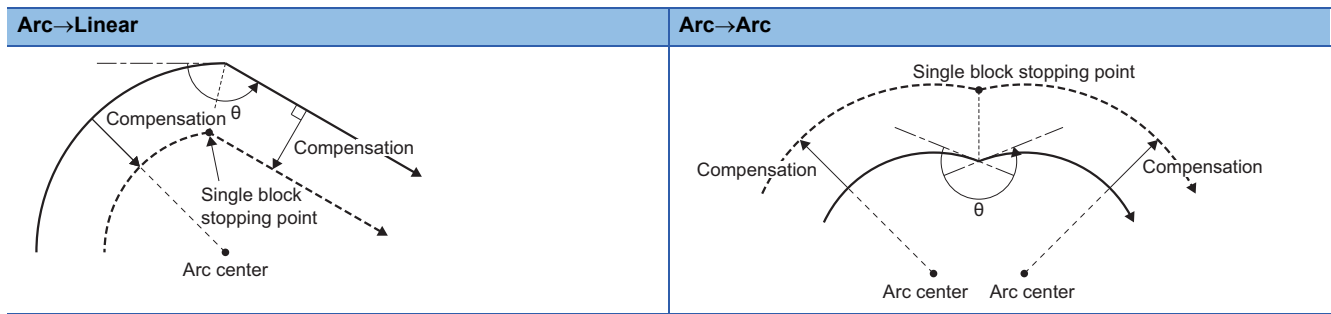
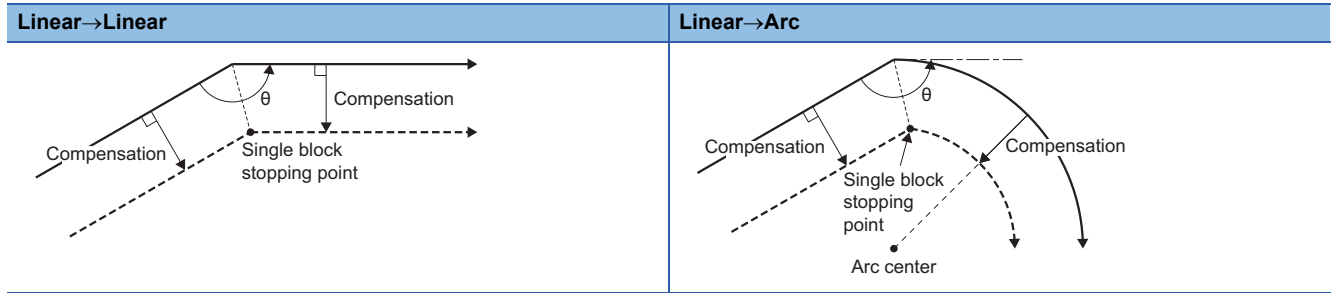

■ Inside corner (acute angle) ($\theta < 90^\circ$)

→ : Program path, - - - - - : Tool center path, ——— : Tangent to the arc at intersection, - - - - - : Parallel line to program path

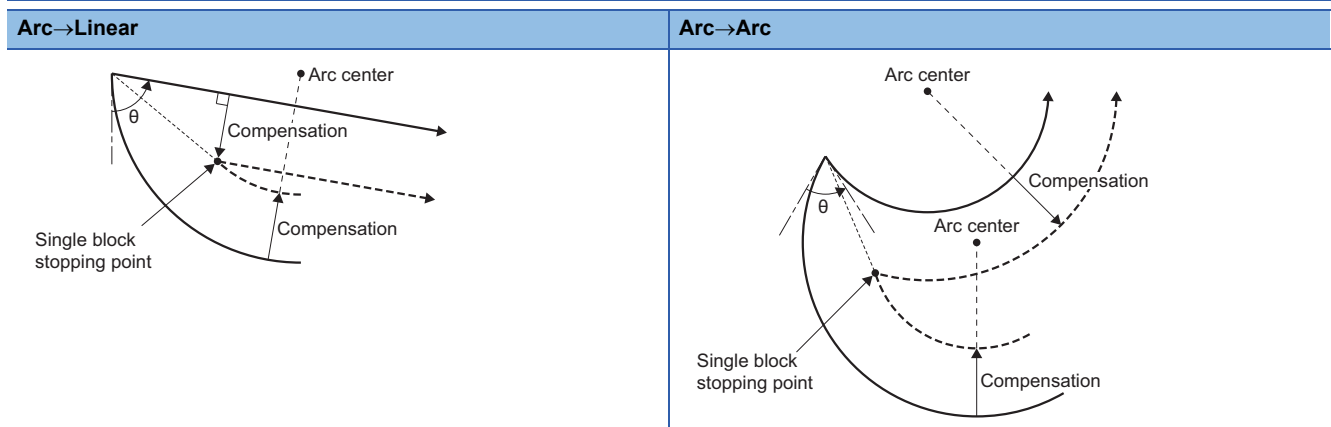
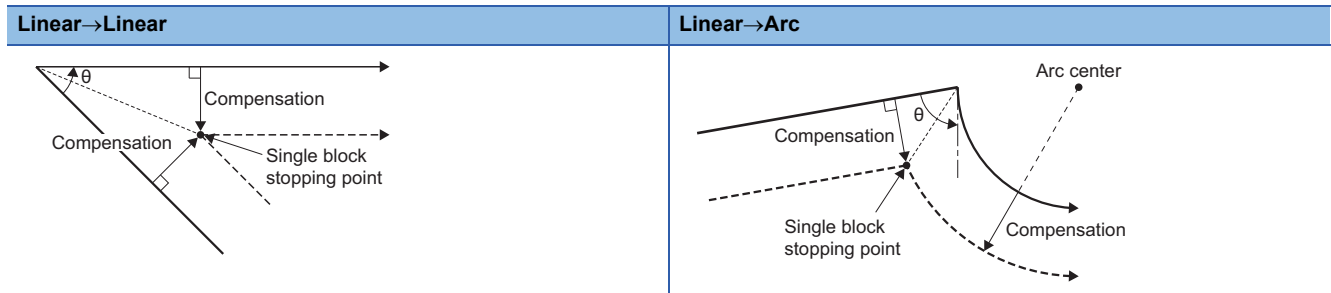

■ Outside corner (obtuse angle) ($90^\circ \leq \theta < 180^\circ$)

—→ : Program path, - - - - -> : Tool center path, ——— : Tangent to the arc at intersection, - - - - - : Parallel line to program path

Linear→Linear	Linear→Arc
Arc→Linear	Arc→Arc

■ Outside corner (acute angle) ($\theta < 90^\circ$)

—→ : Program path, - - - - -> : Tool center path, ——— : Tangent to the arc at intersection, - - - - - : Parallel line to program path

Linear→Linear	Linear→Arc
Arc→Linear	Arc→Arc

■ When the end point of arc is not on the arc

When the difference between the start point radius and the end point radius is within range, circular interpolation connects to the commanded end point in the shape of a spiral. When outside the range for arc deviation, a minor error (error code: 1FC3H (details code: 0313H)) occurs.

—→ : Program path, - - - -> : Tool center path, ——— : Tangent to the arc at intersection, - - - - : Parallel line to program path

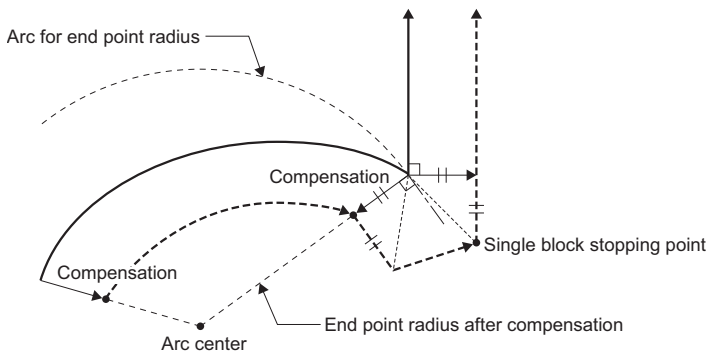

■ When an inside intersection does not exist

Depending on the compensation amount, an intersection between arc A and arc B may not exist. (Example 2 below)

In this case, at the end of the previous block, a minor error (error code: 1FC3H (details code: 031DH)) occurs.

In example 1 below, the compensation amount is small, thus an intersection exists and the work can be processed. However, example 2 has a large compensation amount thus an intersection does not exist, and work cannot be processed.

—→ : Program path, - - - -> : Tool center path

<Example 1>

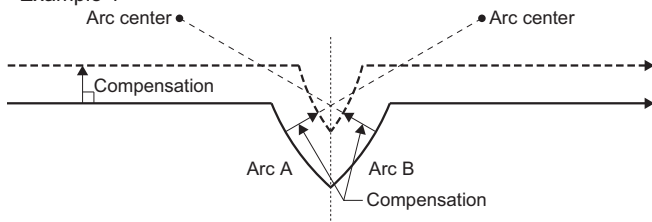

<Example 2>

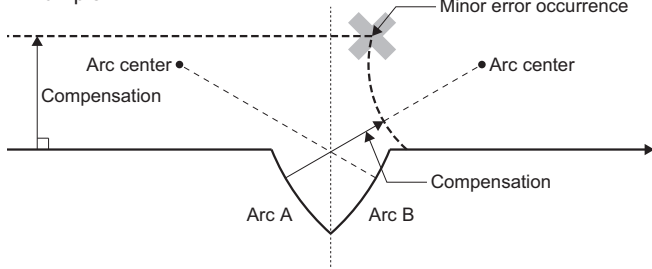

Tool radius compensation cancel operation

Under the following conditions, tool radius compensation changes to compensation cancel mode. In compensation cancel mode the compensation vector is "0", and the tool center path matches the program path. For G-code programs that include tool compensation, always end the program in the compensation cancel state.

- After transitioning to G-code control.
- When reset (including M02 and M30 with reset function) is performed.
- When tool radius compensation cancel command (G40) is commanded.
- When D00 is specified to the compensation No.

Point

- When cancelling tool radius compensation, cancel for a movement command other than an arc command. If compensation cancel is commanded at an arc command, a minor error (error code: 1FC3H (details code: 0315H)) occurs.
- After compensation cancel command is read, compensation cancel mode starts, the pre-read of five blocks is cancelled and one block is pre-read.

Inside corner

—→: Program path, - - - ->: Tool center path, ———: Tangent to the arc at intersection, - - - - : Parallel line to program path

Linear→Linear	Linear→Arc

Inside corner (obtuse angle) ($90^\circ \leq \theta < 180^\circ$)

—→: Program path, - - - ->: Tool center path, ———: Tangent to the arc at intersection, - - - - : Parallel line to program path

Tool radius compensation type	Linear→Linear	Linear→Arc
Type A		
Type B		

■ Outside corner (acute angle) ($\theta < 90^\circ$)

—→ : Program path, - - - -> : Tool center path, ——— : Tangent to the arc at intersection, - - - - : Parallel line to program path

Tool radius compensation type	Linear→Linear	Linear→Arc
Type A		
Type B		

Tool radius compensation (G41, G42) and I, J, K command (I, J type vector command)

By commanding tool radius compensation (G41, G42) and "I, J, K" in the same block, the direction of compensation can be changed at will. An example using "I, J type vector (G17 plane)" is used to describe the vector created by tool radius compensation commands (G41, G42).

"I, J type vector" does not calculate the intersection of the programmed path. Instead, the compensation vector is found by compensating the compensation amount perpendicular to the direction specified by "I, J". The I, J vector can be commanded at the start of compensation or during compensation mode. The compensation amount is determined by the compensation No. (modal data) of the block where I, J are specified.

■ Commanding "I, J" at compensation start

—→: Program path, - - - ->: Tool center path

- With a movement command

I, J type vector	Program	Operation
When "I, J" is commanded	<pre>(G40) : N100 G91 G41 X100 Y100 I100 J150 D01 N110 G04 P1000 N120 G01 F1000 N130 X150</pre>	
When "I, J" is not commanded (type A)	<pre>(G40) : N100 G91 G41 X100 Y100 D01 N110 G04 P1000 N120 G01 F1000 N130 X150</pre>	

- No movement command

I, J type vector	Program	Operation
When "I, J" is commanded	<pre>(G40) : N1 G41 I150 D01 N2 G91 X100 Y100 N3 X150</pre>	
When "I, J" is not commanded (type A)	<pre>(G40) : N1 G41 D01 N2 G91 X100 Y100 N3 X150</pre>	

■ Commanding "I, J" during compensation mode

→ : Program path, ----→ : Tool center path

- With a movement command

I, J type vector	Program	Operation
When "I, J" is commanded	<pre>(G17 G41 G91) : N100 G41 G00 X150 J50 D01 N110 G02 I50 N120 G00 X-150</pre>	
When "I, J" is not commanded (type A)	<pre>(G17 G41 G91) : N100 G41 G00 X150 D01 N110 G02 I50 N120 G00 X-150</pre>	

- No movement command

I, J type vector	Program	Operation
When "I, J" is commanded	<pre>N1 G41 D01 G01 F1000 N2 G91 X100 Y100 N3 G41 I50 N4 X150 N5 G40</pre>	
When "I, J" is not commanded (type A)	<pre>N1 G41 D01 G01 F1000 N2 G91 X100 Y100 N3 G41 N4 X150 N5 G40</pre>	

Points

- Command I, J type vectors in linear mode (G00, G01). If in arc mode at the start of compensation, a minor error (error code: 1FC3H (details code: 0315H)) occurs. I, J commands in arc mode during compensation mode will specify the center of the arc.
- When I, J type vector is specified, the vector is not erased (avoid interference) even if there is interference. Thus, overcutting may occur as illustrated below. (The  area)

—→: Program path, - - - ->: Tool center path

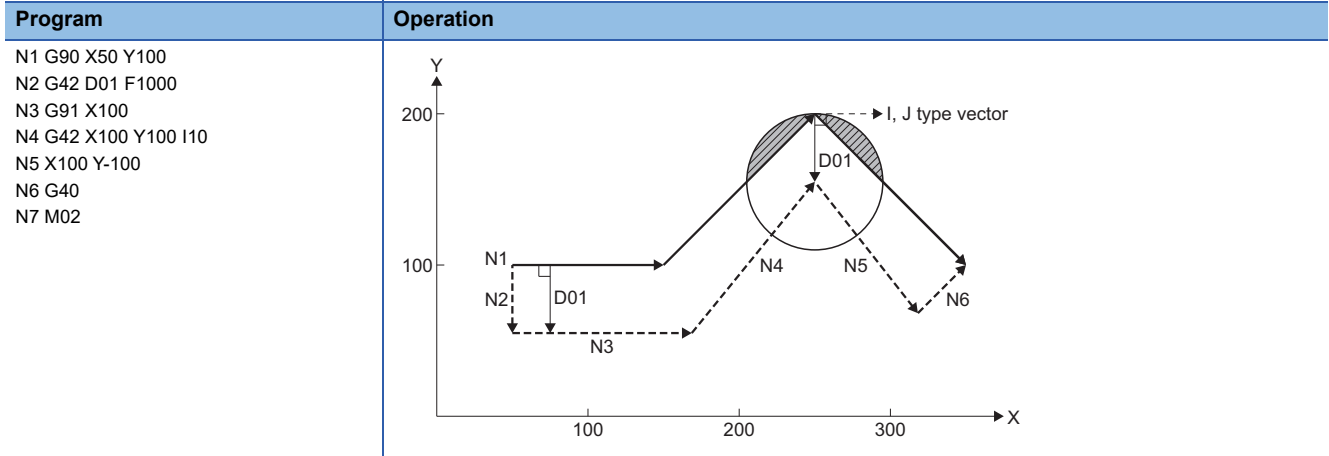

- The vector for compensation for the G38 command and the G41/G42 command is different.

—→: Program path, - - - ->: Tool center path

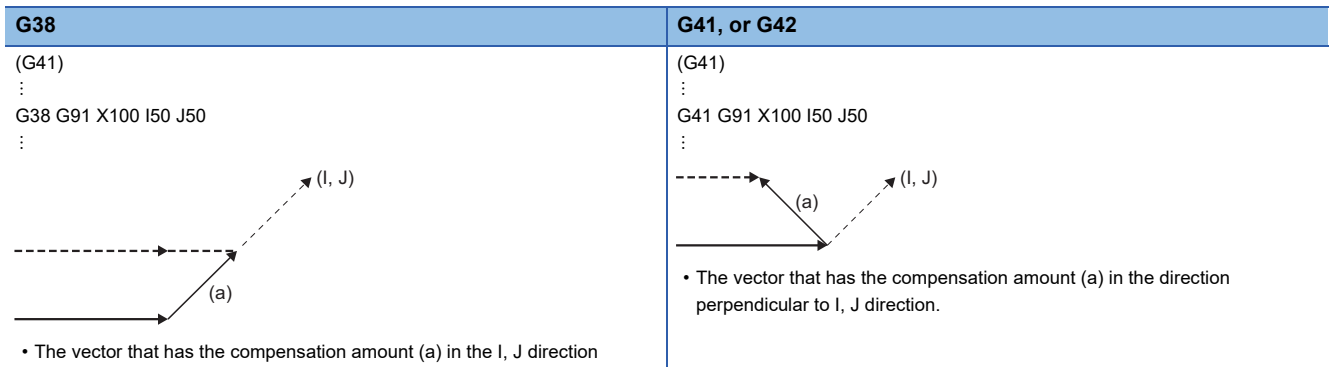

- The compensation method for each combination the G41/G42 command and I, J commands is shown below.

○: Command, ×: No command

G41/G42 command	I, J command	Compensation method
×	×	Intersection operation type vector
×	○	
○	×	
○	○	I, J type vector*1

*1 For the I, J type vector, there is no insertion block.

Direction of compensation vector

The directions of the compensation vector for the I, J type vector in tool radius compensation mode are shown below.

- Tool radius compensation (left) mode (G41)

Rotate the direction specified by I, J 90° to the left when looking at the home position from the positive direction of the Z-axis (third axis)

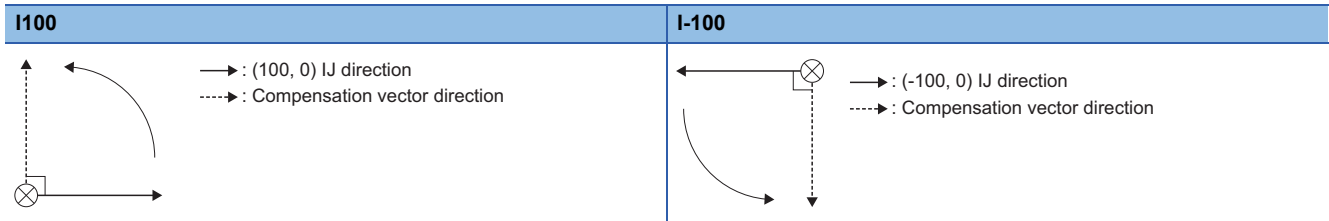

- Tool radius compensation (right) mode (G42)

Rotate the direction specified by I, J 90° to the right when looking at the home position from the positive direction of the Z-axis (third axis)

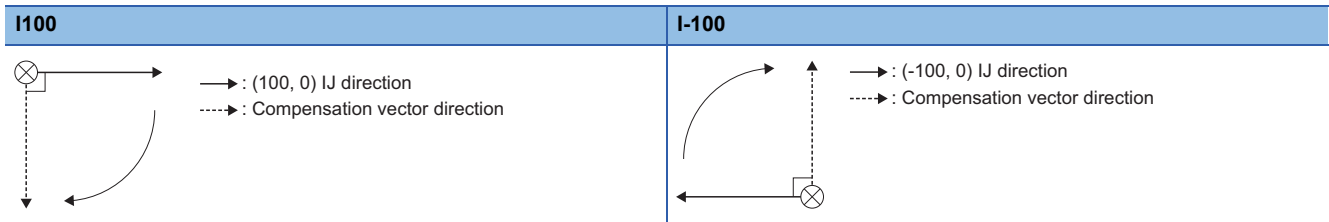

Changing the modal of compensation

The compensation direction (G41/G42 command modal) can be changed during compensation mode.

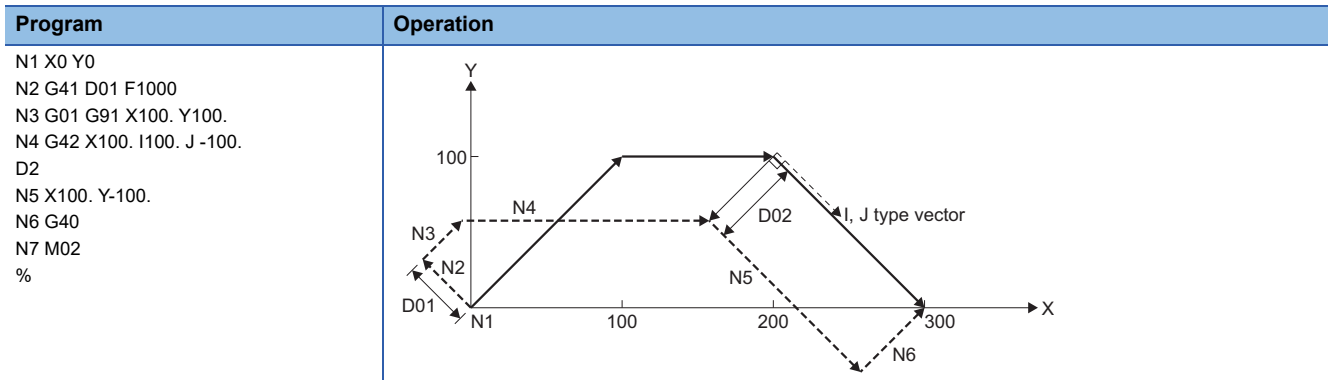

Interference check

Interference check prevents the tool compensated by tool radius compensation from cutting into the material (interference) when the tool radius is big for the program path. There are three types of interference check which are set in [Motion Control Parameter]⇒[G-code Control Parameter]⇒[G-code Control Work Parameter]⇒"Tool Radius Compensation"⇒"Interference Check"

Interference check	Operation
Interference check alarm	Before executing the block where cutting (interference) occurs, a minor error (error code: 1FC3H (details code: 031EH)) occurs and operation is stopped.
Interference check invalid	Even when cutting (interference) occurs, the operation proceeds with cutting. (Used for fine segment programs)
Interference check avoid	The path is changed so that cutting (interference) does not occur. When a path cannot be changed, a minor error (error code: 1FC3H (details code: 031EH)) occurs and operation is stopped.

■ Interference check conditions

When there are three blocks with movement commands out of the five pre-read blocks, when the compensation vectors made from the settings of each movement command intersect, it is considered as interference.

—→ : Program path, - - - - -→ : Tool center path, ·····→ : Compensation vector

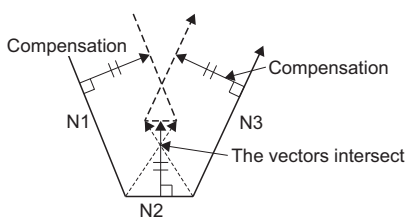

Ex.

When a tool with a large radius is used to process a program with a short line

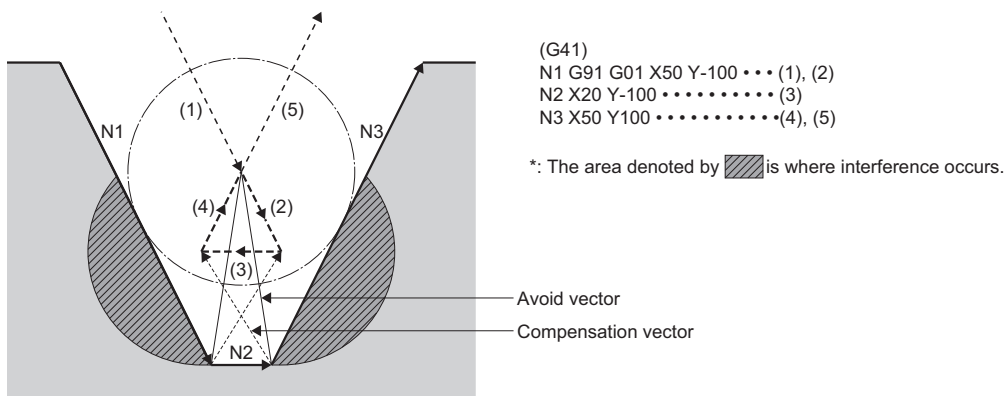

The operation for each interference check setting is shown below.

Interference check	Operation
Interference check alarm	Before execution of N1, an alarm occurs.
Interference check invalid	Operation proceeds by cutting the lines N1 and N3 as they are. The tool center path is (1)→(2)→(3)→(4)→(5).
Interference check avoid	The intersection of line N1 and N3 is calculated, and an avoiding vector is created. The tool center path is (1)→(5).

■ Conditions for no interference check

In the following cases, interference check cannot be performed and cutting (interference) occurs.

- When three movement command blocks cannot be pre-read. (There are three blocks or more out of the five pre-read blocks which do not have movement)
- When interference occurs at the fourth movement block or after.

→ : Program path, - - - - -> : Tool center path, ·····> : Compensation vector

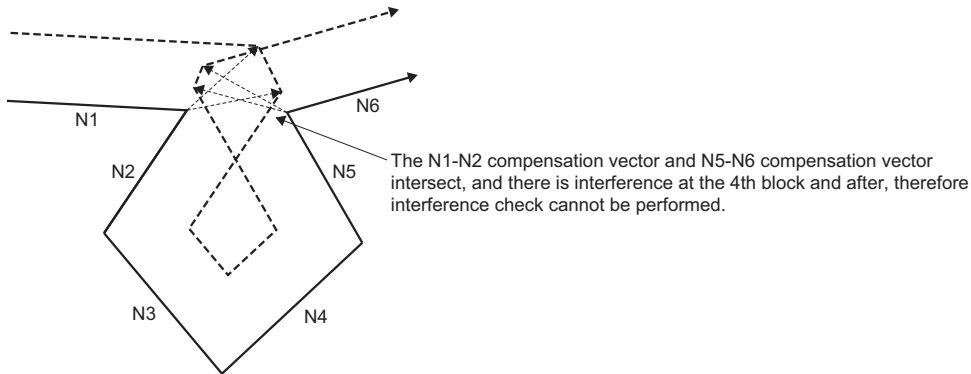

■ Interference check alarm

In the following cases, an interference check alarm occurs.

- When all vectors are erased at the end point of the current block

When vectors 1 to 4 are all erased at the end point of N1 block, a minor error (error code: 1FC3H (details code: 031EH)) occurs before the execution of N1.

→ : Program path, - - - - -> : Tool center path, ·····> : Compensation vector

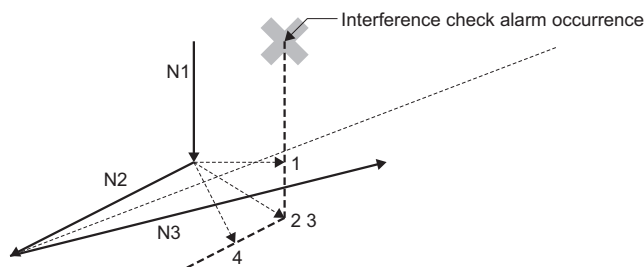

Point

Although the interference check alarm typically generates a minor error (error code: 1FC3H (details code: 031EH)) before the execution of a block where interference occurs and stops operation, in the following cases, an interference alarm does not occur and the interference avoid operation occurs.

- When start point of the arc and the compensation vector of the end point do not completely erase.

(Example)

When a program with an arc with a small radius is processed by a tool with a large diameter.

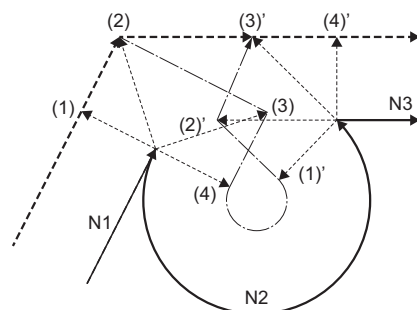

<Operation>

- Interference check process

1. Vector (1)(4)' check → No interference
2. Vector (2)(3)' check → No interference
3. Vector (3)(2)' check → Interference, erase vector (3)(2)'
4. Erase vector (4)(1)'

1. For interference check alarm function

(1), (2), (3)', (4)' remain as valid vectors by the interference check process above.

The tool center path is (1)→(2)→(3)'→(4)'.
(The path denoted by - - - - ->)

In this case, a interference check alarm does not occur.

2. For interference check avoid function

(1), (2), (3)', (4)' remain as valid vectors, by the interference check process above.

The tool center path is (1)→(2)→(3)'→(4)'.
(The path denoted by - - - - ->)

3. For interference check invalid function

The tool center path is (1)→(2)→(3)→(4)→(1)'→(2)'→(3)'→(4)'.
(The path denoted by →>)

■ Interference check avoid

The following is the operation for when interference check avoid is valid.

<Example 1>

- The tool center path is (1)→(3).

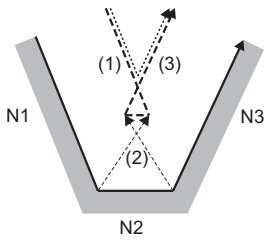

- > : Program path
- -> : Tool center path without interference check
-> : Tool center path with interference check avoid
- · - ·> : Compensation vector

<Example 2>

- The tool center path is (1)→(5)→(6).

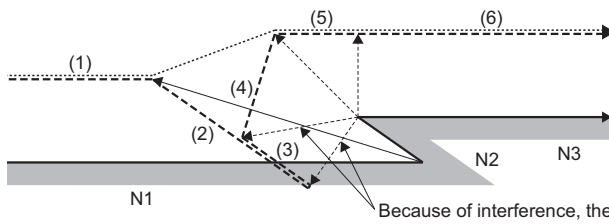

- > : Program path
- -> : Tool center path without interference check
-> : Tool center path with interference check avoid
- > : N1-N2 compensation vector
- · - ·> : N2-N3 compensation vector

When all line vectors of interference check are erased, a new avoid vector is created as shown below, and interference is avoided.

<Example 1>

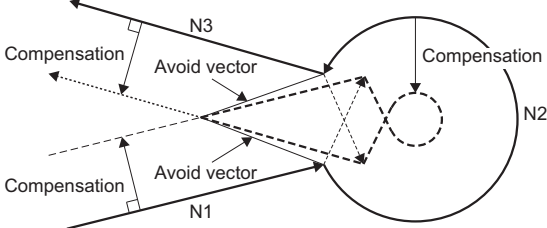

- > : Program path
- -> : Tool center path without interference check
-> : Tool center path with interference avoid
- · - ·> : Compensation vector

<Example 2>

- For compensation 1

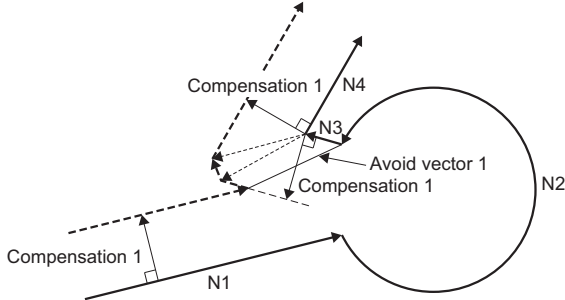

- For compensation 2

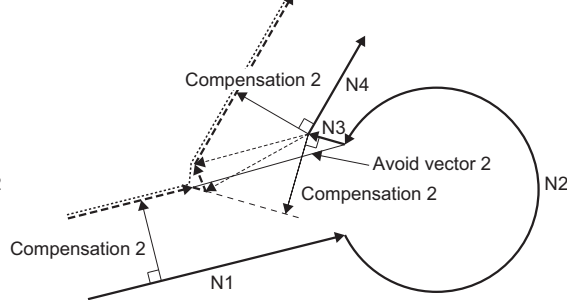

In the following case, there is an uncut section.

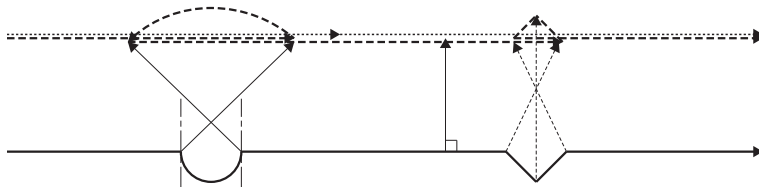

- > : Program path
- -> : Tool center path without interference check
-> : Tool center path with interference avoid
- · - ·> : Compensation vector

In the following cases, the path cannot be changed, and an interference check alarm occurs.

- When there is a valid end point vector in the next block even when all end point vectors are erased in the current block
Interference check is performed for N2 and all end point vectors are erased but the N3 end point vector is treated as valid.
In this case, a minor error (error code: 1FC3H (details code: 031EH)) occurs at the end point of N1.

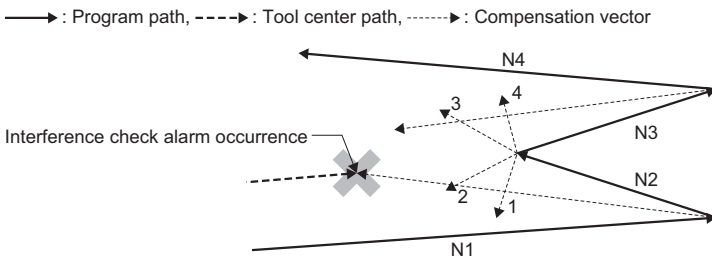

- When avoid vector cannot be created

Even when the conditions for creating an avoid vector are satisfied, an avoid vector is unable to be created, or the avoid vector interferes in N3.

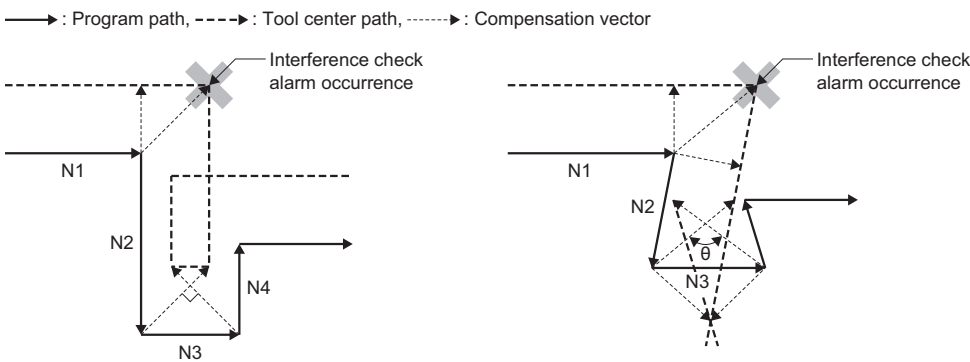

- When the advancing direction in the program and the advancing direction after compensation are reversed
When programming a groove that is narrower than the tool diameter, and parallel or widening at the bottom, while there is no actual interference, it may be treated as interference.

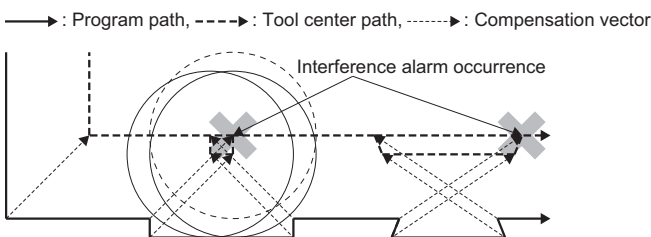

- When the end point vector of the block immediately before the command that temporarily loses the compensation vector interferes

Even at a block immediately before the command that temporarily loses the compensation vector, an interference check is performed at the end point vector in the same way as if the compensation vector is not lost. For this reason, even if there is no actual interference, it may be treated as interference, and when interference occurs a minor error (error code: 1FC3H (details code: 031EH)) occurs.

Select tool radius or diameter compensation

The tool radius compensation can be specified as tool diameter in [Motion Control Parameter]⇒[G-code Control Parameter]⇒[G-code Control Work Parameter]⇒"Tool Radius Compensation"⇒"Select Tool Radius or Diameter Compensation". When diameter compensation is set, the compensation amount set to the commanded tool number is recognized as diameter compensation, and this is converted to a radius compensation amount when compensating.

Precautions for the commands and operations of tool radius compensation

Changing compensation direction during tool radius compensation

- The compensation direction is determined by the tool radius compensation command (G41, G42) and the sign of the compensation amount. The compensation direction can be changed if, during compensation mode, the tool radius compensation cancel command is not made and the tool radius compensation command is changed.

Tool radius compensation command	Compensation amount	
	Sign(+)	Sign(-)
G41	Left compensation	Right compensation
G42	Right compensation	Left compensation

- Changes in the compensation amount are typically made in the tool radius compensation cancel mode when selecting a different tool. However, when change is made during compensation mode, the vector at the end point of the block uses the compensation amount specified in that block for calculations.

→: Program path, - - - - -: Tool center path

Linear→Linear

- When there is intersection (A) at the change of compensation direction

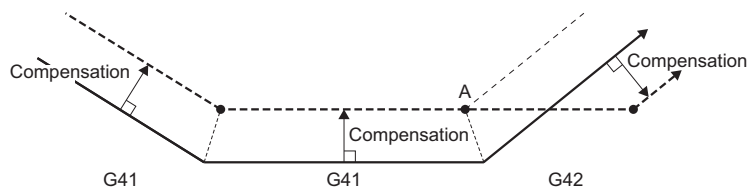

- When there is no intersection at the change of compensation direction

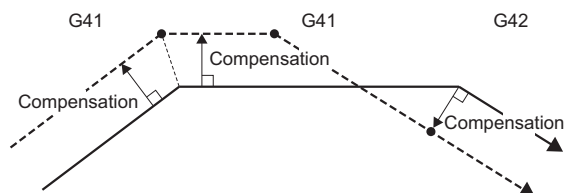

Linear→Arc

- When there is intersection (A) at the change of compensation direction

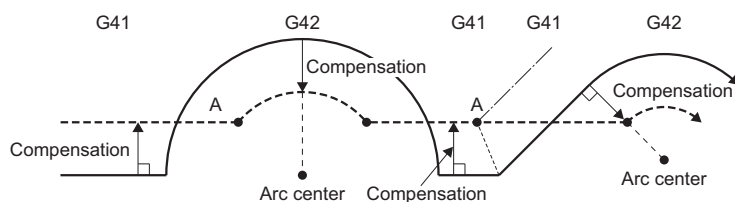

- When there is no intersection at the change of compensation direction

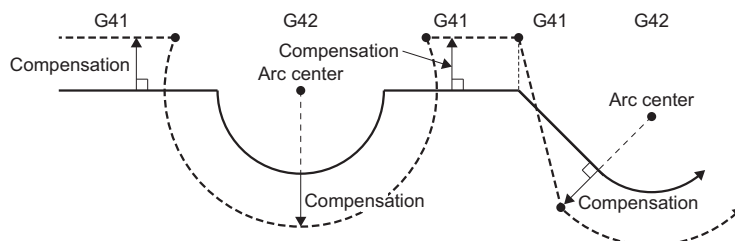

• Arc→Arc

• When there is intersection (A) at the change of compensation direction

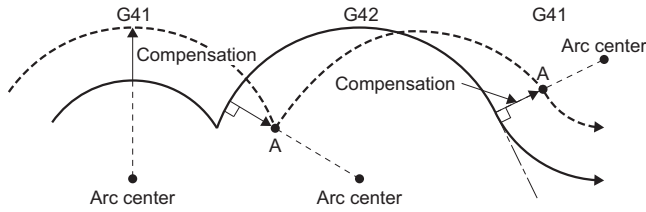

• When there is no intersection at the change of compensation direction

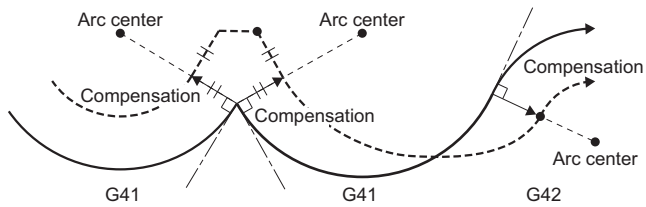

• When returning by linear operation

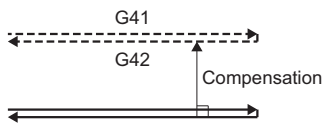

• When the arc is 360° or more due to the G41 and G42 changing.
Compensation is as follows, and there are uncut sections that remain.

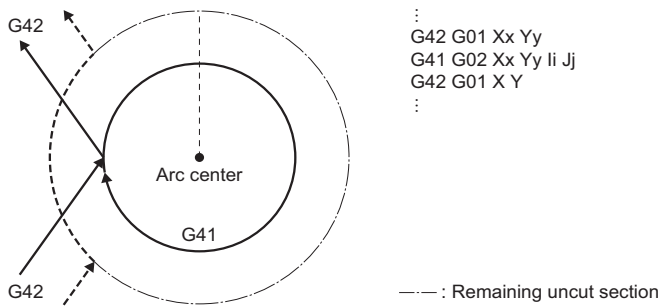

■ Changing the compensation No. during tool radius compensation

Do not change the compensation No. during compensation mode. The following is the operation when the compensation No. is changed during compensation mode.

Program

```
G41 G01 ..... D01
(α=0, 1, 2, 3)
N101 G0α Xx1 Yy1
N102 G0α Xx2 Yy2 D02
```

—→: Program path, - - - ->: Tool center path

• Linear→Linear

<Example 1>

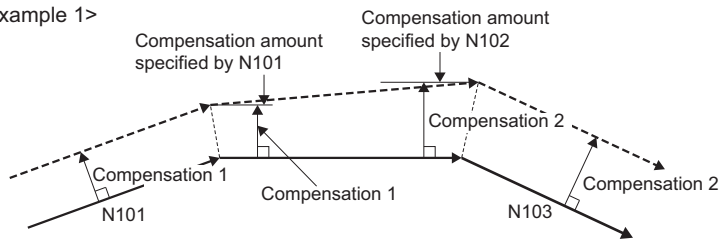

<Example 2>

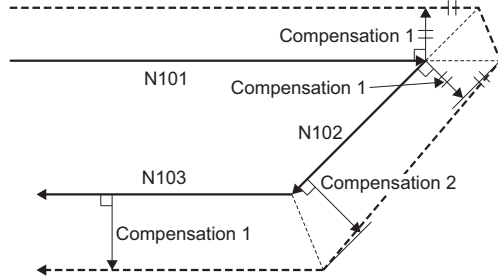

• Linear→Arc

<Example 1>

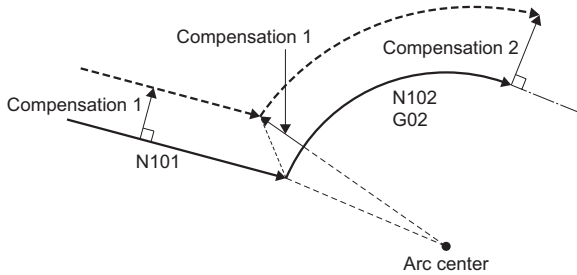

<Example 2>

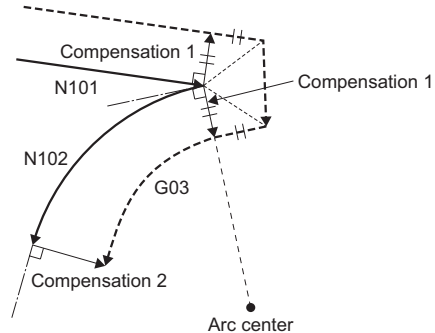

• Arc→Arc

<Example 1>

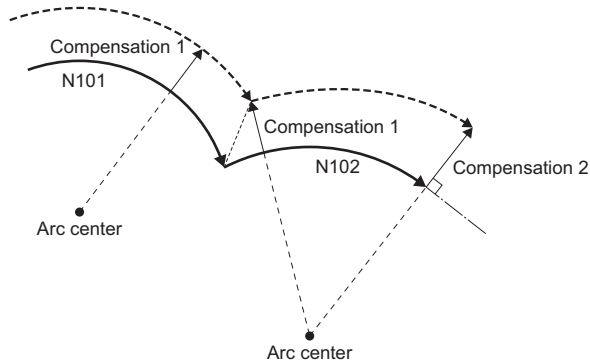

<Example 2>

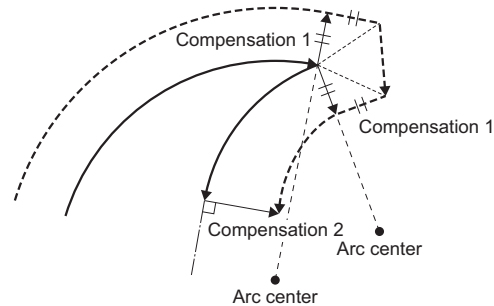

■ Command for temporarily erasing compensation vectors

When basic machine coordinate system selection (G53) is commanded during compensation mode, compensation vectors are temporarily erased, and compensation mode returns automatically afterwards. In this case, compensation cancel operation is not performed, and immediately after the intersection vector the tool moves to a point without a vector (point commanded by program). When returning to compensation mode, the tool moves directly to the intersection point.

■ Blocks with no movement

—→ : Program path, - - - - -→ : Tool center path

- When commanded at compensation start

When there are four or more consecutive blocks with no movement, and when there are M commands that are prohibited from being pre-read, compensation vector cannot be created.

Program	Operation
N1 G91 X50. Y130. N2 G41 D10 N3 G04 X1000 N4 F100 N5 M500 N6 M3 N7 X50. Y-80. N8 X100. Y-30.	
*: N2 to N6 are blocks with no movement	

- When commanded during compensation mode (less than four blocks without movement)

When there are less than four consecutive blocks with no movement during compensation mode, or there are no M commands that are prohibited from being pre-read, an intersection vector is created as normal.

Program	Operation
N6 G91 X50. Y100. N7 G04 P1000 N8 X200.	
*: N7 is a block with no movement	

- When commanded during compensation mode (there are four or more blocks with no movement)

When there are four or more consecutive blocks with no movement, and when there are M commands that are prohibited from being pre-read, a compensation vector perpendicular to the end point of the previous block is created. In this case, overcutting can occur.

Program	Operation
N6 G91 X50. Y100. N7 G04 X1000 N8 F100 N9 M500 N10 M4 N11 X200.	
*: N7 to N10 are blocks with no movement	

- When commanded with tool radius compensation cancel

When a block without movement is commanded together with G40, only the compensation vector is cancelled.

Program	Operation
N6 G91 X50. Y100. N7 G40 M5 N8 X150. Y30.	

■ When "I, J, K" are commanded to tool radius compensation cancel (G40)

When "I, J, K" are commanded together with tool radius compensation cancel (G40), the operation is as follows.

—→: Program path, - - - ->: Tool center path, ·····: Hypothetical tool center path

- When the last of the four blocks before G40 block is tool radius compensation (G41, G42) mode, it is processed as a movement command in the direction of the vector (I, J, K) from the end point of the last movement command, and tool radius compensation is cancelled after compensating up until the intersection of the movement in the direction of vector (I, J, K) and a hypothetical tool center path for that vector. At this time, compensation direction does not change.

Program	Operation
<p><Example 1> (G41) : N1 G91 G01 X200. N2 G40 X-100. Y100. I100. J50.</p>	<p><Example 1></p> <p>It should be noted that in this case, regardless of the compensation direction, even if the command vector is incorrect like example 2, an intersection is always requested.</p>
<p><Example 2> (G41) : N1 G91 G01 X200. N2 G40 X-100. Y100. I-100. J50.</p>	<p><Example 2> When the signs of I, J are incorrect</p>
<p><Example 3> (G41) : N1 G91 G01 X200. N2 G40 X-100. Y100. I100. J50.</p>	<p><Example 3></p>

- Take note that uncut sections remain when an arc is more than 360° as a result of the details of "I, J, K" by G40 after an arc command.

Program	Operation
<pre> (G42, G91) : N1 G01 X200. N2 G03 J50. N3 G40 G01 X100. Y-100. I-100. J100. </pre>	

■ Movement on a corner

When multiple compensation vectors are created at the joint of a movement command block, movement between those vectors is by straight line.

When vectors do not match, movement for going around the corner is performed.

For single block operation, the previous block and movement for the corner are executed as one block and at the next startup, the remaining movement and the next block are executed as one block.

—→ : Program path, - - - - -→ : Tool center path

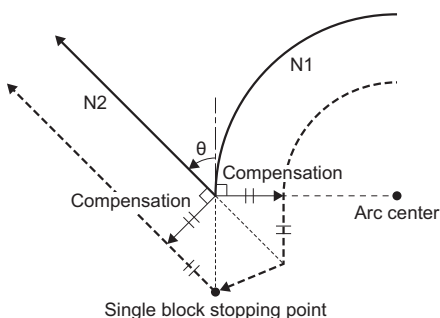

■ Tool radius compensation start and Z-axis cutting operation

At the start of cutting, normally radius compensation is applied beforehand at a location away from the work (normally the X-Y plane), followed by cutting by the Z-axis. When the Z-axis operation is divided into two stages, a fast forward stage and cutting after making contact with the work, take caution with the following when programming.

For the following G-code program (program 1), at the start of N1 compensation up to N6 block can be read, thus the relationship between N1 and N6 is determined and compensation is correctly performed as illustrated below.

→ : Program path, - - - -> : Tool center path

Program 1	Operation
<pre> N1 G91 G00 G41 X500. Y500. D01 N2 M1000 N3 M3 N4 G01 Z-150. F1 N6 Y100. F2 </pre>	

When the N4 block of the G-code program (program 1) above is divided into two, there are four blocks without a command from N2 to N5 and on the X-Y plane, therefore at the start of N1 compensation, up to N6 block cannot be read. Consequently, compensation is performed based on the information of N1 block only, and at the start of compensation a compensation vector cannot be created, and overcutting occurs.

→ : Program path, - - - -> : Tool center path

Program 2	Operation
<pre> N1 G91 G00 G41 X500. Y500. D01 N2 M1000 N3 M3 N4 Z-100. N5 G01 Z-50. F1 N6 Y200. F2 </pre>	

For the G-code program (program 2), by taking into account the internal calculation and commanding in the same direction as the direction after the Z-axis has dropped as shown in the G-code program below (program 3), immediately before Z-axis cutting, overcutting can be prevented. N2 is commanding in the same direction as N6 therefore compensation is performed correctly.

—→ : Program path, - - - -> : Tool center path

Program 3	Operation
<pre> N1 G91 G00 G41 X500. Y400. D01 N2 Y100. M1000 N3 M3 N4 Z-100. N5 G01 Z-50. F1 N6 Y200. F2 </pre>	<p>The diagrams illustrate the tool compensation function for Program 3. The top-left diagram shows a tool moving from N1 to N2, with a dashed line for the tool center path and a solid line for the program path. The top-right diagram shows the tool moving from N1 to N2, with a dashed line for the tool center path and a solid line for the program path. The bottom diagram shows the tool moving from N1 to N2, with a dashed line for the tool center path and a solid line for the program path.</p>

6.5 Operation Supporting Functions

Automatic operation start (cycle start)

By specifying the program No., sequence No., and block No. of the G-code program for automatic operation, the specified block is cued and a program can be started with the leading edge of "[Rq.3377] Automatic operation start (cycle start) (D54226.1+2s)". An automatic operation holding and block stopping G-code program can also be restarted. Automatic operation start is executed for each line.

G-code program priority

The level of priority for the specified program No., sequence No., and block No. is shown below.

Condition			Operation
[Cd.3320] Program No. setting register (D54278+16s)	[Cd.3321] Sequence No. setting register (D54280+16s, D54281+16s)	[Cd.3322] Block No. setting register (D54282+16s, D54283+16s)	
No setting (=0)	—	—	A minor error (error code: 1FC3H (details code: 031FH)) occurs.
Set	No setting (=0)	No setting (=0)	Starts from the start of the G-code program.
Set	No setting (=0)	Set	Starts from the position of the specified block of the blocks from the start of the G-code program up until to the sequence No. command.
Set	Set	No setting (=0)	Starts from the position of the sequence No. specified by the G-code program.
Set	Set	Set	Starts from the position of the specified block of the blocks from the sequence No. in the specified G-code program up until the next sequence No. command.

G-code program start conditions

The conditions for operation of a G-code program specified by program No., sequence No., and block No. in "[Rq.3377] Automatic operation start (cycle start) (D54226.1+2s)" are shown below.

Condition			Operation
[St.3212] During automatic operation (D54441.0+4s)	[St.3213] Automatic operation starting (D54441.1+4s)	[St.3214] Automatic operation holding (D54441.2+4s)	
OFF	OFF*1	OFF*1	Starts the G-code program specified by program No., sequence No., and block No.
ON	OFF	OFF	Restarts the G-code program in the automatic operation holding state.
	OFF	ON	Restarts the G-code program in the automatic operation holding state.
	ON	OFF	During automatic operating start, therefore the automatic operation starting signal is ignored.
	ON	ON	No such state exists.

*1 When "[St.3212] During automatic operation (D54441.0+4s)" is OFF, it will not turn ON.

Cautions

- When a sequence No., or block No. are specified for program startup, time is needed to search for the startup block thus it may take time for the block to actually start.
- When the same sequence No. is specified multiple times in one program, the program is started from the position of the sequence No. found first from the start of the program.
- When the G-code program of the specified program No. does not exist, a minor error (error code: 1FC3H (details code: 031FH)) occurs.
- When the corresponding sequence No. is not in the G-code program, a minor error (error code: 1FC3H (details code: 0320H)) occurs.
- When the corresponding block No. is not in the G-code program, a minor error (error code: 1FC3H (details code: 0321H)) occurs.
- When the specified block is cued and G-program started in the middle of a G-code program such as a program performing polar coordinate interpolation, program coordinate rotation mode, normal line control, etc., an unintended operation can occur therefore do not specify a block in the middle of a G-code program.
- When sequence No., block No. is specified for the startup of a G-code program that specifies the search sequence No. multiple times, the search for startup block is performed from the first sequence No. found from the program start, until the next different sequence No. is specified. If the corresponding block No. is not found before the next different sequence No., a minor error (error code: 1FC3H (details code: 0321H)) occurs.

Automatic operation hold (feed hold)

During automatic operation, an axis can be decelerated to a stop in the middle of operation by turning ON "[Rq.3378] Automatic operation hold (feed hold) (D54226.2+2s)". Restart the axis with "[Rq.3377] Automatic operation start (cycle start) (D54226.1+2s)".

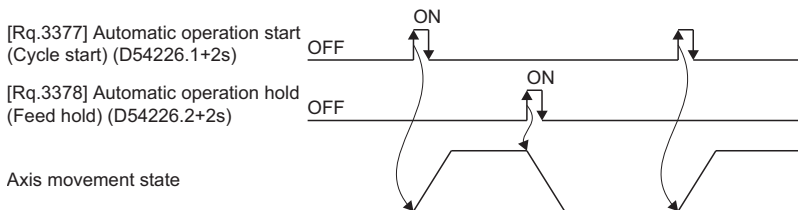

Point

For feed hold during automatic operation, the feed decelerates to a stop immediately but the M commands in the same block continue as they are.

Reset

G-code control operation can be reset by the leading edge of "[Rq.3380] Reset command (D54226.4+2s)". The operation for each function when reset is performed is shown below.

Function	Operation	Related devices	
G-code modal	Initialization	<ul style="list-style-type: none"> • [Md.3028] Group 01 modal status (D54520+128s) • [Md.3029] Group 02 modal status (D54521+128s) • [Md.3030] Group 03 modal status (D54522+128s) • [Md.3034] Group 07 modal status (D54526+128s) • [Md.3038] Group 08 modal status (D54532+128s) • [Md.3046] Group 12 modal status (D54542+128s) • [Md.3047] Group 13 modal status (D54543+128s) • [Md.3049] Group 15 modal status (D54545+128s) • [Md.3050] Group 16 modal status (D54546+128s) • [Md.3055] Group 21 modal status (D54551+128s) 	Set according to the initial status of each group
Tool compensation data	Cancel	<ul style="list-style-type: none"> • [Md.3035] Tool radius compensation No. (D54527+128s) • [Md.3036] Tool radius compensation amount (D54528+128s, D54529+128s) • [Md.3039] Tool length compensation No. (D54533+128s) • [Md.3040] Tool length compensation amount (D54534+128s, D54535+128s) • [Md.3042] Tool length compensation axis No. (D54538+128s) 	0 clear
Program	Stop	<ul style="list-style-type: none"> • [Md.3022] Program No. being executed (main) (D54508+128s) • [Md.3023] Sequence No. being executed (main) (D54510+128s, D54511+128s) • [Md.3024] Block No. being executed (main) (D54512+128s, D54513+128s) • [Md.3070] Program comment being executed (D54588+128s, D54595+128s) 	Hold
		<ul style="list-style-type: none"> • [Md.3025] Program No. being executed (sub/macro) (D54514+128s) • [Md.3026] Sequence No. being executed (sub/macro) (D54516+128s, D54517+128s) • [Md.3027] Block No. being executed (sub/macro) (D54518+128s, D54519+128s) 	0 clear
Error	Reset*1	<ul style="list-style-type: none"> • [St.3209] G-code control error detection (D54440.1+4s) 	OFF
		<ul style="list-style-type: none"> • [Md.3019] G-code control error code (D54504+128s) • [Md.3020] G-code control error details code 1 (D54505+128s) • [Md.3021] G-code control error details code 2 (D54506+128s) 	0 clear
Auxiliary function	Hold	<ul style="list-style-type: none"> • [Md.3058] M-code data 1 (D54554+128s, D54555+128s) • [Md.3059] M-code data 2 (D54556+128s, D54557+128s) • [Md.3060] M-code data 3 (D54558+128s, D54559+128s) • [Md.3061] M-code data 4 (D54560+128s, D54561+128s) 	Hold
	OFF	<ul style="list-style-type: none"> • [St.3218] M-code output M00 (D54442.0+4s) • [St.3219] M-code output M01 (D54442.1+4s) • [St.3220] M-code output M02 (D54442.2+4s) • [St.3221] M-code output M30 (D54442.3+4s) • [St.3222] Auxiliary function strobe 1 (D54442.4+4s) • [St.3223] Auxiliary function strobe 2 (D54443.5+4s) • [St.3224] Auxiliary function strobe 3 (D54444.6+4s) • [St.3225] Auxiliary function strobe 4 (D54445.7+4s) 	OFF
Macro single	Reset	<ul style="list-style-type: none"> • [St.3234] Macro single enabled (D54441.F+4s) 	OFF
Control axis movement	Deceleration stop	—	—
Output signal	ON	<ul style="list-style-type: none"> • [St.3216] Resetting (D54441.8+4s) 	ON
Local variable depth	Reset	<ul style="list-style-type: none"> • [Md.3074] Local variable depth (D54582+128s) 	0 clear

*1 When an error occurs, the G-code control status is reset by turning ON "[Rq.3380] Reset command (D54226.4+2s)", and the related devices are cleared. However, the error status of the LED display, GX Works3 and MT Developer2 display, special relays, and special registers are not cancelled. Refer to the following for the error cancelling method.

 MELSEC iQ-R Motion Controller Programming Manual (Common)

- While resetting, "[St.3216] Resetting (D54441.8+4s)" turns ON and controlling axes start to decelerate to a stop. When resetting is completed "[St.3217] Reset complete (D54441.9+4s)" turns ON. The automatic operation status changes to a reset status, and "[St.3212] During automatic operation (D54441.0+4s)" turns OFF. The operation when reset is executed while the axis is moving is shown below.

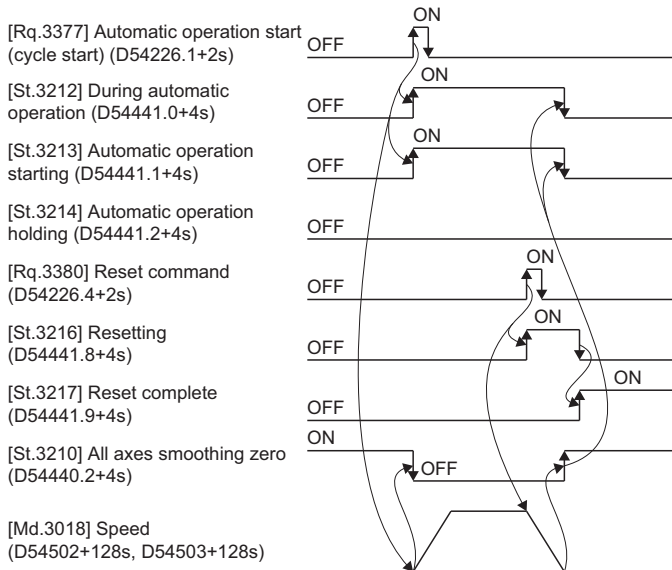

Single block

By turning ON "[Rq.3379] Single block (D54226.3+2s)", automatic operation executes commands one block at a time (block stop). Also, when "[Rq.3379] Single block (D54226.3+2s)" is turned ON during continuous operation, operation stops after the execution of the current block.

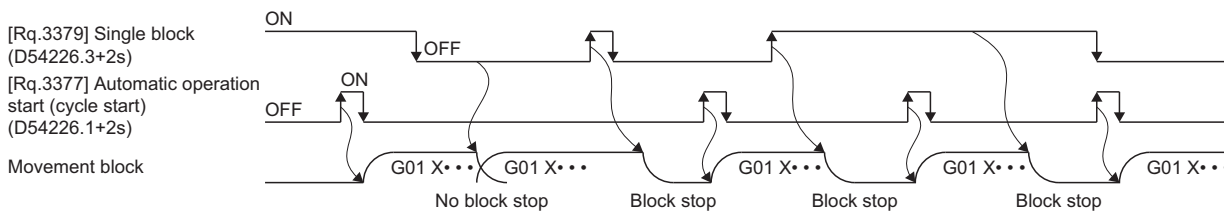

Point

- During the execution of automatic operation, when "[Rq.3379] Single block (D54226.3+2s)" is turned ON, operation stops after the block being executed ends. To execute the next block, turn ON "[Rq.3377] Automatic operation start (cycle start) (D54226.1+2s)" again.
- When automatic operation is started with "[Rq.3379] Single block (D54226.3+2s)" turned ON, operation stops after operation of one block. Therefore, a G-code program can be executed one block at a time.

6.6 Normal Line Control Function

In program operation the normal line control function controls the rotation of a rotating axis (C-axis) so that the tool is always in the normal direction for a movement axis currently selecting a plane.

- At a block joint, the rotation of a rotating axis (C-axis) is controlled so that the tool is always in the normal direction at the start point of the next block.

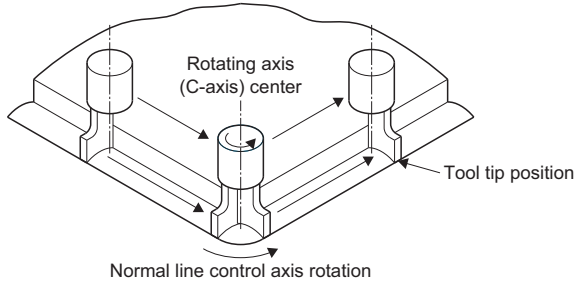

- During circular interpolation, the rotating axis is controlled in synchronization with the circular interpolation operation.

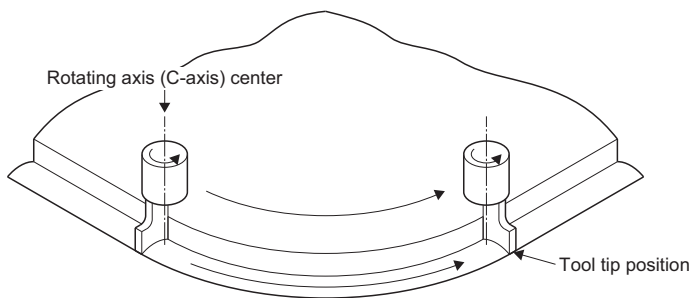

Angle of normal line control

The angle of normal line control is 0[degree] when the tool is facing the horizontal (+ direction) direction. Counter clockwise rotation is + (plus), and clockwise rotation is - (minus).

Plane selection	Description	Operation
G17 plane (I-axis - J-axis)	0[degree] when the tool is facing the + direction of the I-axis.	
G18 plane (K-axis - I-axis)	0[degree] when the tool is facing the + direction of the K-axis.	
G19 plane (J-axis - K-axis)	0[degree] when the tool is facing the + direction of the J-axis.	

Normal line control rotation operation for movement commands

Normal line control start

The movement of axes selecting planes is performed after the rotation of a normal line control axis to keep it at a right angle to the advancing direction at the start point of the normal line control command block. In both normal line control type I and type II, the rotating direction of the normal line control axis at startup is the direction that is 180[degree] or less (shortcut). However, in blocks for a G00 command with no interpolation, normal line control is not performed. Normal line control starts from the next block onwards.

→ : Program path, — : Tool end path

Block	Program	Operation
Independent block	<pre> : N1 G01 Xx1 Yy1 Ff1 N2 G41.1 N3 Xx2 Yy2 : *: No movement in N2 </pre>	
Same block	<pre> : N1 G01 Xx1 Yy1 Ff1 N2 G41.1 Xx2 Yy2 : </pre>	

During normal line control mode

- Operation in the block

For a linear command, the angle of the normal line control rotating axis is kept constant, and the normal line control axis does not rotate. For an arc command, the rotating axis for normal line control rotates in synchronization with the circular interpolation operation. However, when synchronizing with circular interpolation where there is a deviation within the circular interpolation tolerable deviation, the rotation angle during normal line control may deviate from normal line direction for as much as the tolerable deviation.

→ : Program path, — : Tool end path

Program	Operation
<pre> : G41.1 N1 G02 Xx1 Yy1 Ii1 Jj1 : </pre>	

• Block joint

—→: Program path, - - -→: Tool radius compensation path, - - -→: Tool end path

Tool radius compensation	Description	Operation		
		Linear→Linear	Linear→Arc	Arc→Arc
Without	Move the block after rotating the normal line control axis so that is at a right angle to the movement direction of the plane selecting axis of the next block*1			
With	When tool radius compensation is applied, normal line control is performed along the path with tool radius compensation applied.*1			

*1 When the block immediately after the joint is a G00 command with no interpolation, the normal line control axis does not rotate.

■ Normal line control end

At blocks after the G40.1 command, the rotating operation for normal line control is not performed. The normal line control axis (C-axis) moves according to the command.

After completion of a deceleration stop in a G40.1 command block, the coordinate commands of the next block start movement.

—→: Program path, ———: Tool end path

Block	Program	Operation
Independent block	⋮ N1 G01 Xx1 Yy1 Ff1 N2 G40.1 N3 Xx2 Yy2 ⋮ *: No movement in N2	
Same block	⋮ N1 G01 Xx1 Yy1 Ff1 N2 G40.1 Xx2 Yy2 ⋮	

Normal line control temporary cancel

During normal line control, the rotating operation for normal line control is not performed at a block, and it's joint to the previous block, where the movement amount is smaller than the movement amount set in [Motion Control Parameter]⇒[G-code Control Parameter]⇒[G-code Control System Parameter]⇒"Normal Line Control"⇒"Minimum Rotating Movement Amount".

■ Linear block

When the movement amount of N2 block is smaller than the G-code control system parameter "minimum rotating movement amount", normal line control axis rotating operation is not performed at the joint between N1 block and N2 block. The operation continues in the same direction of N1 block.

- N2 block movement amount < Minimum rotating movement amount

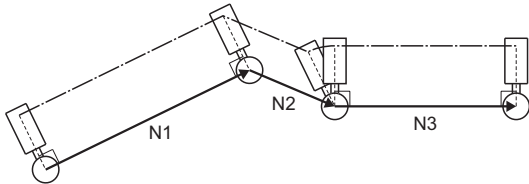

■ Arc block

When the diameter of N2 block is smaller than the G-code control system parameter "minimum rotating movement amount", normal line control axis rotating operation is not performed at the joint between N1 block and N2 block. The operation continues in the same direction of N1 block. Also, during circular interpolation in N2 block, the rotating operation for normal line control is not synchronized with the circular interpolation operation.

- N2 block diameter < Minimum rotating movement amount

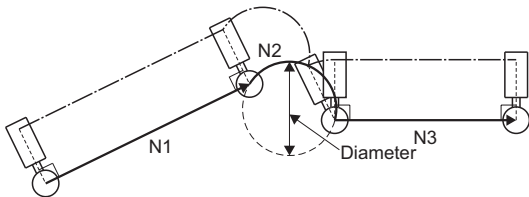

Point

During tool radius compensation, operation fractioning occurs with the intersection point calculation of two lines and therefore when the length of the line is equivalent to the G-code control system parameter "minimum rotating movement amount", the axis may or may not rotate.

Rotating direction of a normal line control axis at block joints

The rotating direction of normal line control axes at block joints differs according to normal line control type I and normal line control type II. There are also limitations on the rotating angle depending on the angle ϵ set in [Motion Control Parameter]⇒[G-code Control Parameter]⇒[G-code Control System Parameter]⇒"Normal Line Control"⇒"Minimum Rotating Angle"

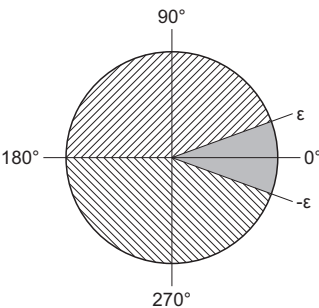
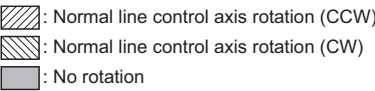
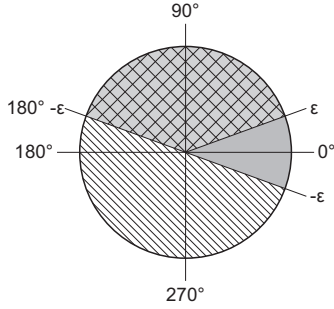
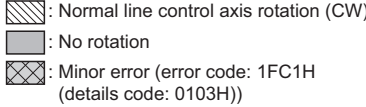
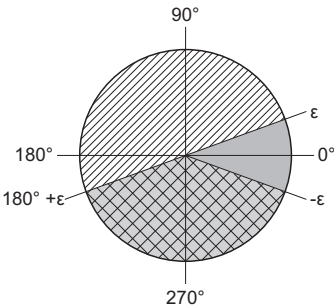
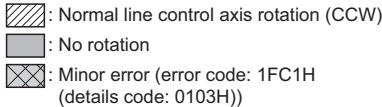
Item	Normal line control type I	Normal line control type II
Normal line control axis rotating direction for block joint	Direction which is 180° or less (shortcut)	<ul style="list-style-type: none"> • G41.1: - direction(CW) • G42.1: + direction(CCW)
Normal line control axis rotating angle for block joint	<p>When "$\theta < \epsilon$", there is no rotation.</p> <p>θ: Rotating angle ϵ: Minimum rotating angle</p> <p>When rotating angle=180°, the rotating direction is not fixed, regardless of the command mode.</p> <p><When the G41.1/G42.1 normal line control axis is at 0°></p>  <p>  </p>	<p>When "$\theta < \epsilon$", there is no rotation.</p> <p>θ: Rotating angle ϵ: Minimum rotating angle</p> <p>In the following cases, a minor error (error code: 1FC1H (details code: 0103H)) occurs.</p> <ul style="list-style-type: none"> • G41.1 $\epsilon \leq \theta < 180^\circ - \epsilon$ • G42.1 $180^\circ + \epsilon < \theta \leq 360^\circ - \epsilon$ <p><When G41.1 normal line control axis is at 0°></p>  <p>  </p> <p><When G42.1 normal line control axis is at 0°></p>  <p>  </p>

Normal line control type I

→ : Program path, — : Tool end path

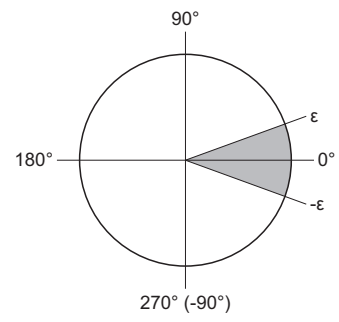
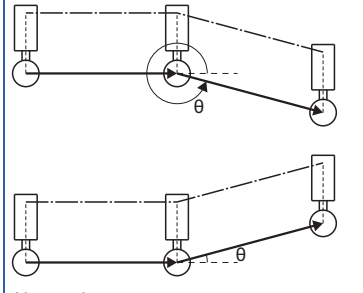
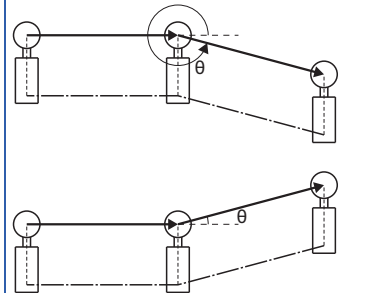
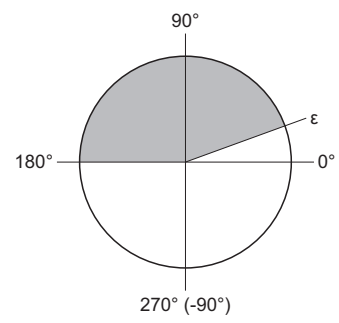
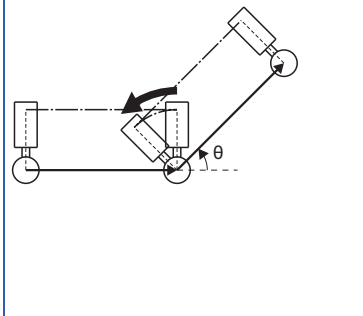
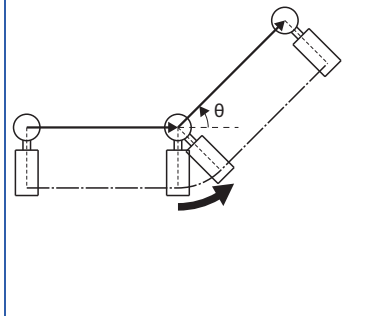
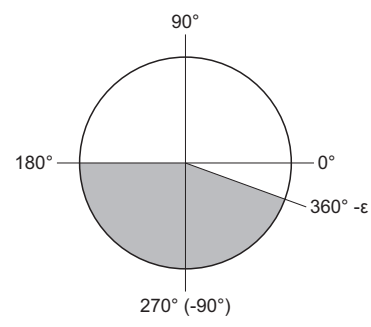
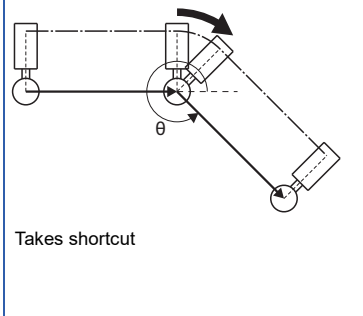
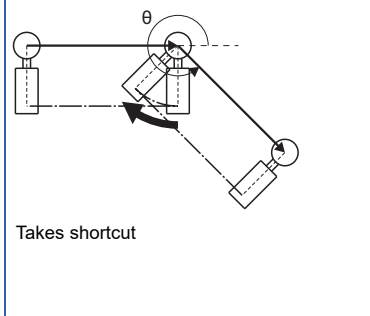
Normal line control axis rotating angle for block joint: θ	G41.1	G42.1
<p>$-\epsilon < \theta < \epsilon$</p> 	 <p>No rotation</p>	 <p>No rotation</p>
<p>$\epsilon \leq \theta < 180^\circ$</p> 		
<p>$180^\circ \leq \theta \leq 360^\circ - \epsilon$</p> 	 <p>Takes shortcut</p>	 <p>Takes shortcut</p>

Normal line control type II

— : Program path, - - - : Tool end path

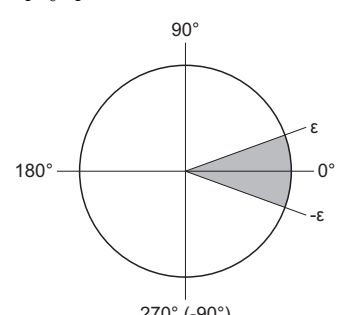
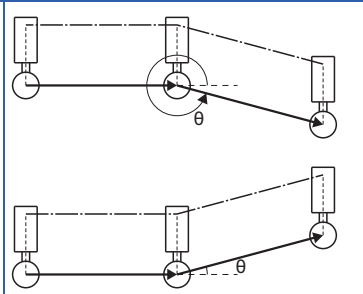
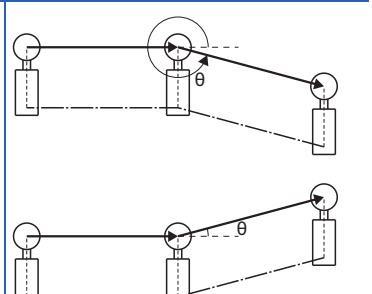
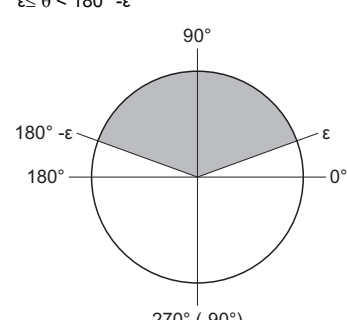
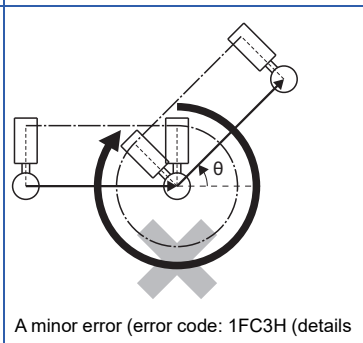
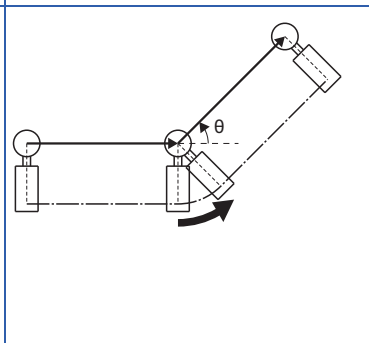
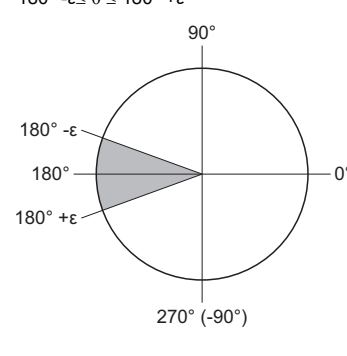
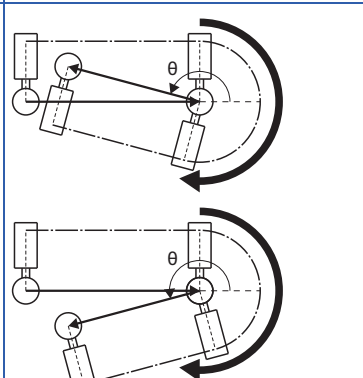
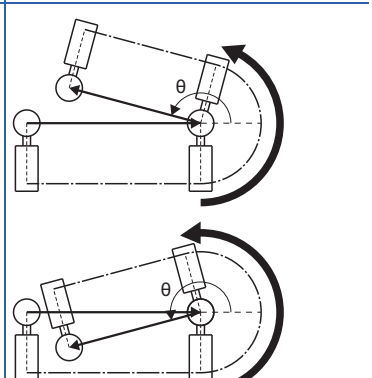
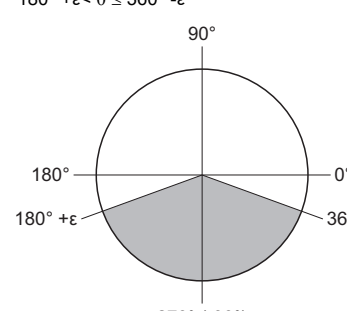
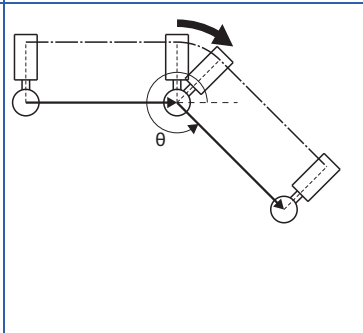
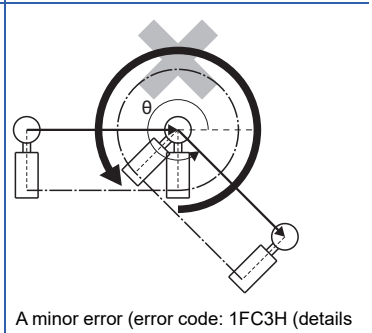
Normal line control axis rotating angle for block joint: θ	G41.1	G42.1
<p>$-\epsilon < \theta < \epsilon$</p>  <p>90° 180° 270° (-90°) ϵ $-\epsilon$</p>	 <p>No rotation</p>	 <p>No rotation</p>
<p>$\epsilon \leq \theta < 180^\circ - \epsilon$</p>  <p>90° 180° - ϵ 180° 270° (-90°) ϵ $-\epsilon$</p>	 <p>A minor error (error code: 1FC3H (details code: 0103H)) occurs.</p>	
<p>$180^\circ - \epsilon \leq \theta \leq 180^\circ + \epsilon$</p>  <p>90° 180° - ϵ 180° 180° + ϵ 270° (-90°) ϵ $-\epsilon$</p>		
<p>$180^\circ + \epsilon < \theta \leq 360^\circ - \epsilon$</p>  <p>90° 180° 180° + ϵ 360° - ϵ 270° (-90°) ϵ $-\epsilon$</p>		 <p>A minor error (error code: 1FC3H (details code: 0103H)) occurs.</p>

Operation when the rotating angle is less than the minimum rotating angle

During normal line control, when the rotating angle of the block joint is less than the minimum rotating angle, a rotating operation is not inserted. For the rotating angle where rotating operation is not inserted, there is no interpolation immediately after the block joint.

- Linear interpolation immediately after the block joint
Rotating angle is not interpolated.
- Circular interpolation immediately after the block joint
No interpolation where rotating operation is not inserted until the end point of the arc.

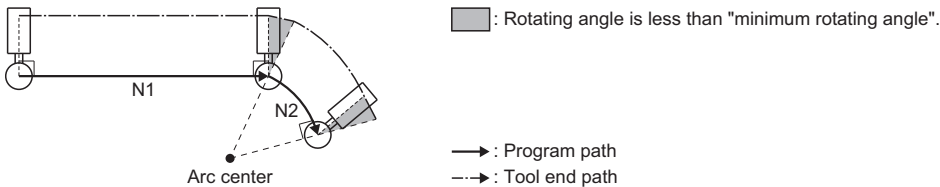

Speed of normal line control rotating axis

The speed of the normal line control rotating axis differs according to normal line control type I, and normal line control type II.

Normal line control rotating speed for block joint

- Fast forward immediately after block joint

— : Program path, - - - : Tool end path

Normal line control type	Speed of normal line control rotating axis
Normal line control type I	<p>The normal line control axis rotating speed set in [Motion Control Parameter]⇒[G-code Control Parameter]⇒[G-code Control Axis Parameter]⇒"Speed/Time Constant"⇒"Fast Forward Speed".</p> <p>Normal line control axis rotating speed $f = \text{fast forward speed} \times (\text{fast forward rate override})[\text{degree}/\text{min}]$</p>
Normal line control type II	<p>The feed speed of the end of the blade of the tool is the fast forward speed. The normal line control axis rotating speed is a normal line control axis speed in based on this fast forward speed.</p> <p>$f = F \times 180 \div (\pi \times R)$</p> <p>Normal line control axis rotating speed $f = F \times 180 \div (\pi \times R) \times (\text{fast forward rate override})[\text{degree}/\text{min}]$</p> <p>The following formula applies when $R=0$. Normal line control axis rotating speed $f = F \times (\text{fast forward rate override})[\text{degree}/\text{min}]$</p> <p>F: G-code control axis parameter "Fast forward speed"[mm/min] R: G-code control system parameter "Normal line control axis rotating radius"[mm] (length from the normal line control axis center to the end of the blade of the tool)</p> <p>*: When the normal line control axis rotating speed exceeds the fast forward speed, the speed is the fast forward speed.</p>

- Cutting immediately after block joint

→ : Program path, — : Tool end path

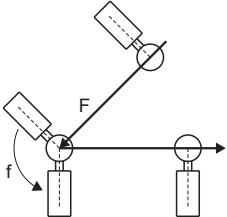
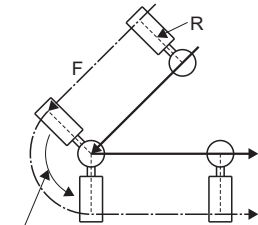
Normal line control type	Speed of normal line control rotating axis
Normal line control type I	<p>The normal line control axis rotating speed set in [Motion Control Parameter]⇒[G-code Control Parameter]⇒[G-code Control System Parameter]⇒"Normal Line Control"⇒"Normal Line Control Axis Rotating Speed".</p>  <p>Normal line control axis rotating speed $f = \text{Normal line control axis rotating speed} \times (\text{cutting feed rate override})[\text{degree}/\text{min}]$</p> <p>*: Set the G-code control system parameter "Normal line control axis rotating speed" equal to or less than the value set in [Motion Control Parameter]⇒[G-code Control Parameter]⇒[G-code Control Axis Parameter]⇒"Speed/Time Constant"⇒"Cutting Feed Clamp Speed". When a speed higher than the cutting feed clamp speed of the normal line control axis is set, a moderate error (error code: 30FDH (details code: 0012H)) occurs at the Multiple CPU system power supply ON, or STOP→RUN.</p>
Normal line control type II	<p>The feed speed of the end of the blade of the tool is the F command. The normal line control axis rotating speed is a normal line control axis speed based on this F command.</p>  <p>$f = F \times 180 \div (\pi \times R)$</p> <p>Normal line control axis rotating speed $f = F \times 180 \div (\pi \times R) \times (\text{cutting feed rate override})[\text{degree}/\text{min}]$</p> <p>The following formula applies when $R=0$. Normal line control axis rotating speed $f = F \times (\text{cutting feed rate override})[\text{degree}/\text{min}]$</p> <p>F: Feed speed command[mm/min] R: G-code control system parameter "Normal line control axis rotating radius"[mm] (length from the normal line control axis center to the end of the blade of the tool)</p> <p>*: When the normal line control axis rotating speed exceeds the cutting feed clamp speed, the speed is the cutting feed clamp speed.</p>

Normal line control rotating speed during circular interpolation

→ : Program path, — : Tool end path

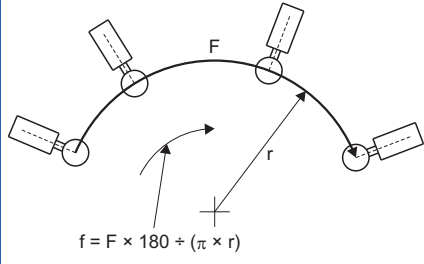
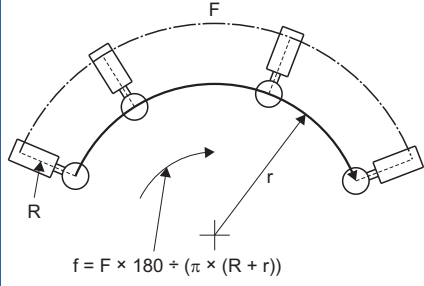
Normal line control type	Speed of normal line control rotating axis
Normal line control type I	<p>The normal line control axis rotating speed is a rotating speed based on the feed speed F.</p>  $f = F \times 180 \div (\pi \times r)$ <p>Normal line control axis rotating speed $f = F \times 180 \div (\pi \times r) \times (\text{cutting feed rate override})[\text{degree}/\text{min}]$</p> <p>F: Feed speed command[mm/min] r: Arc radius[mm]</p>
Normal line control type II	<p>The feed speed of the end of the blade of the tool is the F command. The normal line control axis rotating speed is a rotating speed based on this F command.</p>  $f = F \times 180 \div (\pi \times (R + r))$ <p>Normal line control axis rotating speed $f = F \times 180 \div (\pi \times (R + r)) \times (\text{cutting feed rate override})[\text{degree}/\text{min}]$</p> <p>F: Feed speed command[mm/min] R: G-code control system parameter "Normal line control axis rotating radius"[mm] (length from the normal line control axis center to the end of the blade of the tool) r: Arc radius[mm]</p>

Point

When the normal line control axis rotating speed exceeds the G-code control axis parameter "Cutting feed clamp speed", the following applies.

- Normal line control axis rotating speed = cutting feed clamp speed
- Movement speed of the axis during circular interpolation = Speed in accordance with rotating speed of normal line control axis

Automatic arc insertion at corner

During normal line control, an arc is automatically inserted to the corner of an axis movement selecting a plane. Automatic arc insertion at corner is performed with normal line control type I. Set the radius of the insertion arc in [Motion Control Parameter]⇒[G-code Control Parameter]⇒[G-code Control System Parameter]⇒"Normal Line Control"⇒"Normal Line Control Axis Insert Radius". When the G-code control system parameter "Normal Line Control Axis" is set to "0: No Normal Line Control", automatic arc insertion at corner is disabled.

Normal line control is also performed during interpolation of the insertion arc.

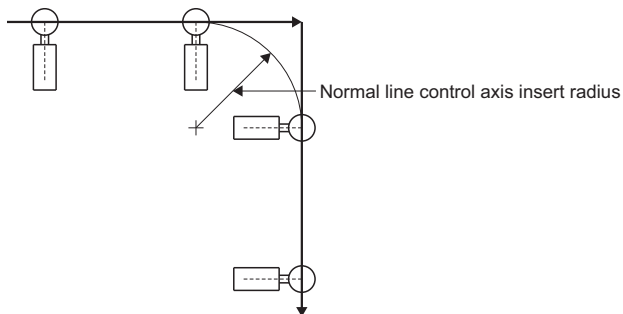

- An arc is not inserted at corners for "linear→arc", "arc→arc", "linear→block with no movement", "block with no movement→linear, or line shorter than radius of insertion arc".

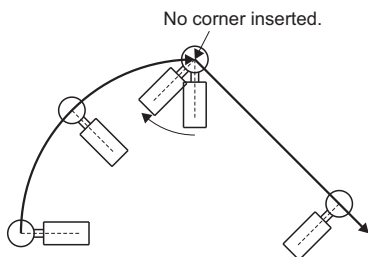

- During radius compensation, radius compensation is applied to the path where corner arc is inserted.

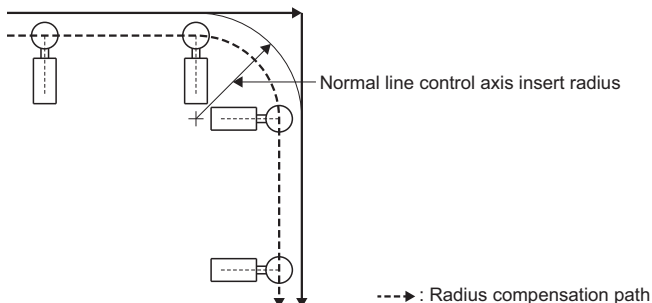

- The stopping point of single block is as follows.

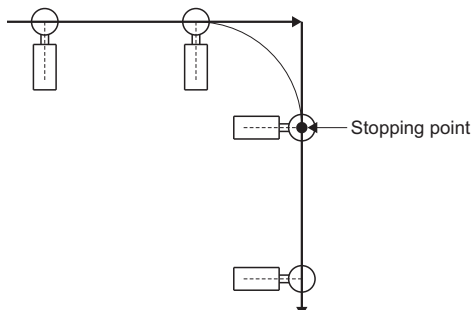

Program example

- Normal line control type I (when processing continuous circular interpolation by normal line control)

Program	Operation
<pre> N101 G90 G53 G00 X0. Y0. C0. N102 X25. Y-10. N103 G17 N104 G41.1 G03 X35. Y0. R10. F10. N105 G03 X8. Y9. R15. N106 G02 X-8. R10. N107 G03 Y-9. R-15. N108 G02 X8. R10. N109 G03 X35. Y0. R15. N110 G03 X25. Y10. R10. N111 G40.1 N112 G00 X0. Y0. C0. M02 </pre>	

- Normal line control type II (when processing on the right side of the program path by normal line control, with normal line control axis rotating radius=15.)

Program	Operation
<pre> N101 G90 G01 G54 X0. Y0. C90. Z3. F150. N102 G17 N103 G42.1 N104 G91 X-30. Z-3.01 N105 X60. N106 X-60. N107 G40.1 M02 </pre>	

Normal line control operation when combined with each function

The normal line control operation for each function is shown below.

Function	Normal line control operation
Exact stop check	No deceleration stop in the rotating operation of the normal line control axis.
Override	Override is also applied to the rotating operation in normal line control.
Program coordinate rotation	Normal line control is performed on the shape after coordinate rotation.
Work coordinate system offset	Work coordinate system cannot be changed during normal line control. A minor error (error code: 1FC3H (details code: 0304H)) occurs.
Local coordinate system offset	Local coordinate system cannot be changed during normal line control. A minor error (error code: 1FC3H (details code: 0304H)) occurs.
G00 non-interpolation	No normal line control.
Polar coordinate interpolation	Cannot be commanded during normal line control. A minor error (error code: 1FC3H (details code: 0324H)) occurs. Normal line control cannot be commanded during polar coordinate interpolation. A minor error (error code: 1FC3H (details code: 0322H)) occurs.
Plane selection	Cannot be commanded during normal line control. A minor error (error code: 1FC3H (details code: 031CH)) occurs.

Cautions

- During normal line control, the program coordinates are updated according to the movement of the normal line axis. Therefore program normal line control by the program coordinate system.
- For single block, the normal line control axis stops at the position of the start of rotating.
- During normal line control, movement commands to the normal line control axis (C-axis) are ignored.
- During normal line control, the following devices regarding the target position of the normal line control axis (C-axis) are not updated. They are updated when normal line control ends.
 - [Md.3148] Machine target position (D54770+32sn, D54771+32sn)
 - [Md.3150] Relative target position (D54774+32sn, D54775+32sn)
 - [Md.3152] Program target position (D54778+32sn, D54779+32sn)
- Set the axis name set in [Motion Control Parameter]⇒[G-code Control Parameter]⇒[G-code Control Axis Parameter]⇒"Line Axis Information"⇒"Axis Name" to the G-code control system parameter "normal line control axis". When the set axis name is not set in the G-code control axis parameter "axis name", a moderate error (error code: 30FDH (details code: 0011H)) occurs at the Multiple CPU system power supply ON, or STOP→RUN.
- Specify a rotating axis that does not overlap with the base axis to the G-code control system parameter "normal line control axis". When an incorrect axis, which cannot perform normal line control is specified, a moderate error (error code: 30FDH (details code: 0012H)) occurs at the Multiple CPU system power supply ON, or STOP→RUN.
- The movement of the normal line control axis is also counted as one axis of the number of contouring control axes. When the specified number of contouring control axes is exceeded due to the movement of the normal line control axis, a minor error (error code: 1FC3H (details code: 0302H)) occurs.

6.7 High-Accuracy Control

In high-accuracy control, the deviation in work that is caused by the delay in the control system is controlled. High-accuracy control is effective in work that requires sharp edges at corners and work that requires the deviation on curves to be minimized. By pre-reading several blocks ahead, acceleration/deceleration that does not cause deviations in work can be applied, and deceleration control that suits the workpiece shape is automatically applied so that extended working time is kept to a minimum while controlling deviations in work.

Shape	High-accuracy control	
	Disabled	Enabled
Corner		
Curve		

The following functions are available in high-accuracy control mode.

- Acceleration/deceleration before interpolation (Page 271 Acceleration/deceleration before interpolation)
- Optimum speed control (Page 274 Optimum speed control)
- Vector accuracy interpolation (Page 281 Vector accuracy interpolation)
- Arc entrance/exit speed control (Page 281 Arc entrance/exit speed control)

Point

During high-accuracy control mode, do not command a block with no movement as an independent block. When a block with no movement is commanded as an independent block, the switching of blocks can take time.

High-accuracy control operation when combined with each function

The high-accuracy control operation for each function is shown below.

Function	Operation
Normal line control	<ul style="list-style-type: none"> When normal line control and high-accuracy control mode are used together, set the parameters so that tolerable acceleration control for each axis is enabled. When tolerable acceleration control for each axis is disabled, and a G61.1 command is made during normal line control, a minor error (error code: 1FC3H (details code: 0304H)) occurs. Also, when normal line control is started by a G41.1 of G42.1 command, a minor error (error code: 1FC3H (details code: 0304H)) occurs. During normal line control, the independent operation of a rotating axis uses acceleration/deceleration after interpolation. When the rotating axis operates at the joints in between blocks, it switches between acceleration/deceleration before interpolation and acceleration/deceleration after interpolation therefore a deceleration check is performed. When the rotating axis operation between blocks does not do an independent operation^{*1}, the rotating axis is synchronized with the circular interpolation operation. Therefore calculate the optimum deceleration speed so that the acceleration speed at block joints is equal to or lower than the tolerable acceleration for the rotating axis, and decelerate to that speed in advance. After switching blocks, accelerate to the command speed once again. <p>[Operation example]</p> <p><Program> (G61.1) : N1 G41.1 G90 G01 X10. F3000 N2 G02 X20. Y-10. I0. J-10.</p> <p><Operation></p> <p><Speed pattern></p> <p>Composite speed</p> <p>Speed command (F)</p> <p>Deceleration speed (Fc) calculated from normal line control axis deceleration speed (fc)</p> <p>Time</p> <p>Normal line control axis speed</p> <p>Rotating speed of normal line control axis (f)</p> <p>Deceleration speed (fc) calculated from tolerable acceleration speed</p> <p>Control so that acceleration of the normal line control axis is equal to or less than the tolerable acceleration of the normal line control axis</p> <p>Time</p> <p>■Caution</p> <p>Because the speed is not clamped by the tolerable acceleration speed of the rotating axis at circular interpolation during normal line control, if the radius of the arc is small, the acceleration of the rotating axis may become larger than the tolerable acceleration of the rotating axis. When the radius of the arc is small, make the settings so that the tolerable acceleration for all axes is a smaller value compared to the tolerable acceleration of the rotating axis.</p>
Polar coordinate interpolation	<ul style="list-style-type: none"> When polar coordinate interpolation mode and high-accuracy control mode are used together, set the parameters so that tolerable acceleration control for each axis is enabled. When tolerable acceleration control for each axis is disabled, and a high-accuracy control mode command (G61.1) is made during polar coordinate control, a minor error (error code: 1FC3H (details code: 0322H)) occurs. Also, when polar coordinate mode start command (G12.1) is commanded during high-accuracy control mode, a minor error (error code: 1FC3H (details code: 0324H)) occurs. Arc entrance/exit speed control is not enabled during polar coordinate interpolation mode.

*1 Any of the following cases

- When the rotating angle of the block joint is less than or equal to the G-code control system parameter "minimum rotating angle".
- When the block afterwards is linear interpolation and the movement amount is less than the G-code control system parameter "minimum rotating movement amount".
- When the block afterwards is circular interpolation and the diameter value is less than the G-code control system parameter "minimum rotating movement amount".

Acceleration/deceleration before interpolation

In order to control the impact on the machine when starting/stopping, acceleration/deceleration control is performed for movement commands and the speed curve is smoothed. However, because the acceleration/deceleration processing when high-accuracy control is disabled is performed after interpolation, corners at block joints become rounded and deviations from the commanded shape occur. In high-accuracy control mode, these problems are solved by acceleration/deceleration control before interpolation. With acceleration/deceleration before interpolation, a working path that is consistent with the commanded shape in the G-code program is possible. Moreover, because acceleration/deceleration before interpolation uses the constant inclination acceleration/deceleration method, the acceleration/deceleration time can be shortened.

Basic patterns for acceleration/deceleration control in linear interpolation commands

Control mode	Acceleration/deceleration curve pattern	Operation
Normal mode (Acceleration/ deceleration after interpolation)	<p>clamp:Cutting feed clamp speed G1tL: G1 time constant (linear)</p>	<ul style="list-style-type: none"> • Because the acceleration time to reach the command speed is fixed (time constant acceleration/deceleration), the slower the command speed, the more gradual the acceleration/deceleration becomes (acceleration/deceleration time does not change). • The time to reach the command speed (G1 time constant (linear)) is set for each axis. However, when the time constant for the base axis is different, arcs can become warped.

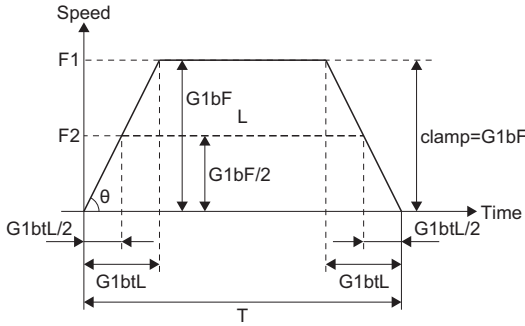
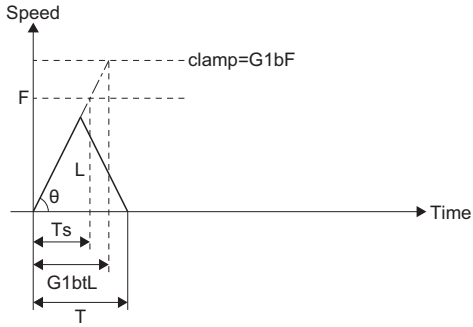
Control mode	Acceleration/deceleration curve pattern	Operation
High-accuracy control mode (Acceleration/deceleration before interpolation)	<p>• When interpolation distance is long and the speed reaches the feed speed</p>  $T = \frac{L}{F1} + \frac{T_s \times F1}{G1bF} \quad \theta = \tan^{-1} \left(\frac{G1bF}{T_s} \right)$ <p>*: T_s is always $G1btL$</p> <p>• When interpolation distance is short and the speed does not reach the feed speed</p>  $T = 2 \times \sqrt{T_s \times L/F} \quad T_s = \frac{F \times G1btL}{2R} \quad \theta = \tan^{-1} \left(\frac{G1bF}{G1btL} \right)$ <p>F: Feed speed T: Interpolation time Ts: Acceleration/deceleration time to reach the feed speed L: Interpolation distance θ: Acceleration/deceleration inclination clamp: Cutting feed clamp speed for high-accuracy control mode G1bF: Acceleration/deceleration before interpolation - maximum speed G1btL: Acceleration/deceleration before interpolation - time constant</p>	<ul style="list-style-type: none"> • Because the acceleration time until the maximum speed set in the parameters (acceleration/deceleration before interpolation) is fixed (constant inclination acceleration/deceleration), the slower the command speed, the shorter the acceleration/deceleration time. • There is one value (common value for all axes) for the acceleration/deceleration time constant for a line. <p>*: Acceleration/deceleration before interpolation - maximum speed and acceleration/deceleration before interpolation - time constant are for defining the inclination of acceleration/deceleration. The actual cutting feed maximum speed is clamped by the G-code control axis parameter "cutting feed clamp speed for high-accuracy control mode".</p>

Path control in circular interpolation commands

For circular interpolation commands, with the conventional acceleration/deceleration control method after interpolation, the acceleration/deceleration smoothing process is affected and the path output from the Motion CPU to the servo amplifier is deviated inwards from the actual commanded path, and the radius of the arc becomes smaller. With acceleration/deceleration control method before interpolation, interpolation is performed after acceleration/deceleration control therefore the path output from the Motion CPU to the servo amplifier is the same as the commanded path. A comparison between the reduction of the arc radius for control methods in acceleration/deceleration control after interpolation and acceleration/deceleration control before interpolation in high-accuracy control mode is shown below.

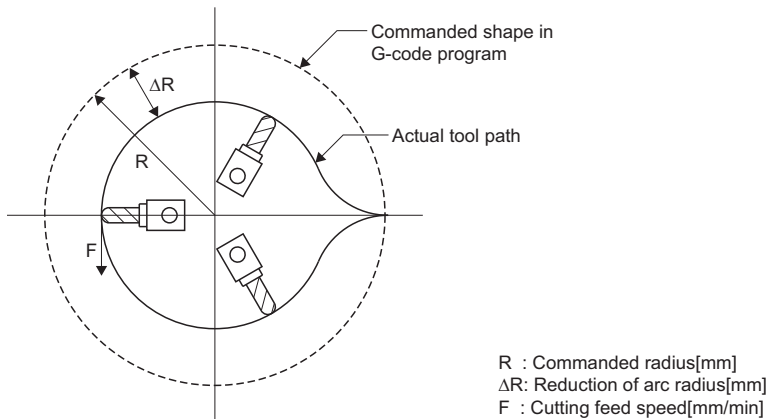

As shown in the figure above, when the commanded shape in the G-code program is an arc, there is a deviation ΔR between the commanded shape in the G-code program and the actual path of the tool. In normal mode (acceleration/deceleration after interpolation), ΔR occurs from the acceleration/deceleration of the Motion CPU, and the delays of the servo system. However, in high-accuracy control mode (acceleration/deceleration before interpolation), the deviation from the Motion CPU acceleration/deceleration is 0, and by using feed forward control, deviation from the delays of the servo system can be reduced. ΔR occurs from delays of the servo system.

Delays of the servo system, are expressed as a position loop time constant (T_p [s]) of the servo system. T_p is the inverse ($T_p=1/PG1$) of the number of the servo parameter "Model loop gain (PB07)".

Feed forward control is expressed as a feed forward coefficient (K_f). K_f is the servo parameter "Feed forward gain (PB04)".

The arc radius reduction ΔR is calculated as shown in the chart below.

Control mode	Calculation
Acceleration/deceleration control after interpolation (Normal mode)	$\Delta R = \frac{1}{2R} \left(\frac{1}{12} T_s^2 + T_p^2 \left(1 - \left(\frac{K_f}{100} \right)^2 \right) \right) \left(\frac{F}{60} \right)^2$
Acceleration/deceleration control before interpolation (High-accuracy control mode)	$\Delta R = \frac{1}{2R} T_p^2 \left(1 - \left(\frac{K_f}{100} \right)^2 \right) \left(\frac{F}{60} \right)^2$

*1 T_s : G-code control axis parameter "G1 time constant (linear)"

*2 T_p : Servo system position loop time constant [s] (servo parameter "Model loop gain (PB07)")

*3 K_f : Feed forward coefficient (servo parameter "Feed forward gain (PB04)")

*4 F : Cutting feed speed [mm/min]

To reduce the arc radius reduction ΔR , the cutting feed speed F must be reduced.

Optimum speed control

When movement direction changes at corners and arcs, the acceleration that corresponds to the change in direction and feed speed is generated. If that acceleration is large, the machine vibrates and traces from working are left on the working surface. In high-accuracy control mode, deceleration control (optimum speed control) is performed to keep the generated acceleration equal to or less than the tolerable acceleration set in the parameters. With optimum speed control, cycle time increases are kept to a minimum while controlling machine vibration, making highly accurate work possible.

The following functions are available in optimum speed control.

Function		Operation	Details
Corner deceleration	Optimum corner deceleration	<p>Deceleration control keeps the composite acceleration from exceeding the common tolerable acceleration for each axis</p>	<p>The composite acceleration that is generated at the joints between blocks is kept equal to or lower than the common tolerable acceleration for each axis by deceleration control. This allows edges to be cut with high precision.</p> <p>To perform optimum corner deceleration, set the G-code control system parameter "tolerable acceleration control for each axis ON" to "0: Optimum corner deceleration".</p>
	Tolerable acceleration control for each axis	<p>Deceleration control keeps the acceleration for each axis from exceeding the tolerable acceleration for each axis</p>	<p>The acceleration generated for each axis at the joints between blocks is kept equal to or lower than the tolerable acceleration set to each axis by deceleration control.</p> <p>Tolerable acceleration control for each axis is effective when the characteristics (acceleration) of each axis are different. If the characteristics of each axis are the same, the deceleration control is the same as optimum corner deceleration.</p> <p>To perform tolerable acceleration control for each axis, set the G-code control system parameter "tolerable acceleration control for each axis ON" to "1: Tolerable acceleration control for each axis".</p>
Arc speed clamp		<p>Deceleration control keeps the composite acceleration generated at an arc from exceeding the common tolerable acceleration for each axis</p>	<p>The composite acceleration that is generated at an arc is kept equal to or lower than the common tolerable acceleration for each axis by deceleration control. This keeps the path deviation (arc radius reduction) from exceeding a fixed value.</p>

Optimum corner deceleration

When the composite speed that is generated at the joints between blocks is kept equal to or lower than the common tolerable acceleration for each axis determined by the G-code control system parameters "acceleration/deceleration before interpolation - maximum speed", "acceleration/deceleration before interpolation - time constant", and the accuracy coefficient by deceleration control, highly precise edges can be cut. When entering a corner, the optimum speed (optimum corner speed) is calculated from the angle with the next block (corner angle), and the common tolerable acceleration for all axes. The system decelerates to this speed in advance, and after passing the corner, returns to the command speed.

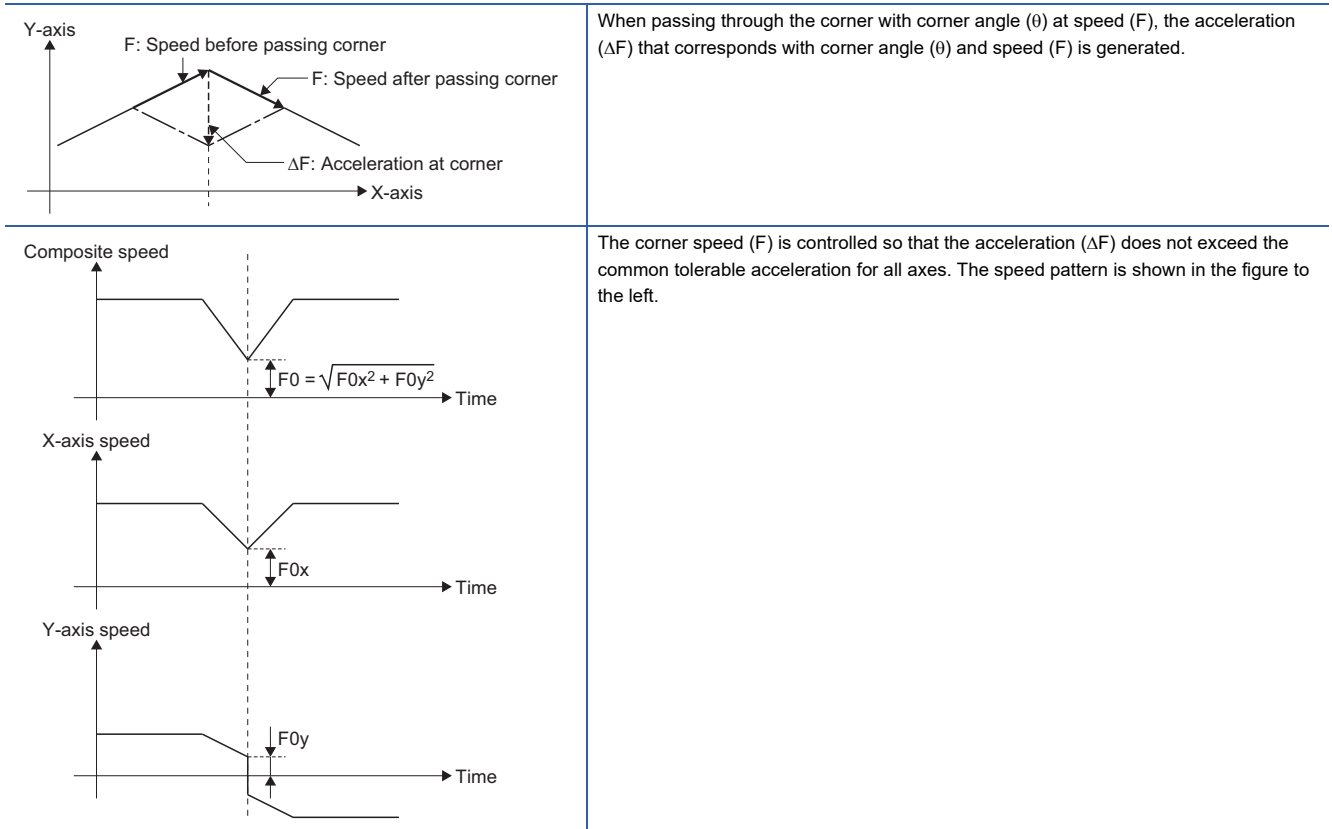

When blocks are joined smoothly, deceleration is not required therefore optimum corner deceleration is not performed. The basis of whether blocks are joined smoothly or not is set in [Motion Control Parameter]⇒[G-code Control Parameter]⇒[G-code Control System Parameter]⇒"High-accuracy Control"⇒"Corner Deceleration Angle". When the corner angle is equal to or less than the set corner deceleration angle, it is deemed to be a smooth corner and optimum corner deceleration is not performed. Also, when improving the precision of edges, set the accuracy coefficient in [Motion Control Parameter]⇒[G-code Control Parameter]⇒[G-code Control System Parameter]⇒"High-accuracy Control"⇒"Corner Accuracy Coefficient".

When a value close to the upper limit of the accuracy coefficient is set, the edge precision improves, but the cycle time increases due to the slower optimum corner speed. When a negative value is set to the accuracy coefficient, the optimum corner speed increases and the cycle time shortens, but the edge precision is reduced.

The common tolerable acceleration for all axes can be calculated with the following formula.

$$\text{Common tolerable acceleration for all axes}[\text{mm/s}^2] = \frac{\text{Acceleration/deceleration before interpolation - maximum speed}[\text{mm/min}] \div 60}{\text{Acceleration/deceleration before interpolation - time constant}[\text{ms}] \div 1000} \times \frac{100 - \text{Corner accuracy coefficient}}{100}$$

Tolerable acceleration control for each axis (optimum acceleration control)

The acceleration that occurs at the joint between blocks is evaluated by each axis and deceleration control for passing block joints at the optimum speed is performed. This enables the cutting of highly precise edges. The optimum speed is calculated so that the acceleration that occurs at each axis at the block joints is equal to or less than the tolerable acceleration for each axis. The system decelerates to this speed in advance, and after passing the corner, returns to the command speed. When blocks are joined smoothly (when the acceleration that occurs at each axis is equal to or less than the tolerable acceleration of each axis), there is no deceleration. By using tolerable acceleration control for each axis, even when a specific axis (rotating axis) has a low tolerable acceleration and vibrations on the machine occur easily, deceleration is made at deceleration speeds that correspond to the characteristics of each axis. Thus at corners where acceleration occurs, the deceleration speed can be set high on axes whose tolerable acceleration is high, reducing the cycle time.

For a corner when acceleration occurs in both the X-axis (linear axis) and C-axis (rotating axis) such as the corner in the chart below, the corner speed (F) of each axis is controlled so that the acceleration that occurs at the X-axis does not exceed the X-axis tolerable acceleration, and the acceleration that occurs at the C-axis does not exceed the C-axis tolerable acceleration. When the X-axis tolerable acceleration is higher than the C-axis tolerable acceleration, the deceleration speed on paths where acceleration occurs only on the X-axis can be set higher than the deceleration speed on paths where acceleration occurs only on the C-axis, resulting in the following speed patterns.

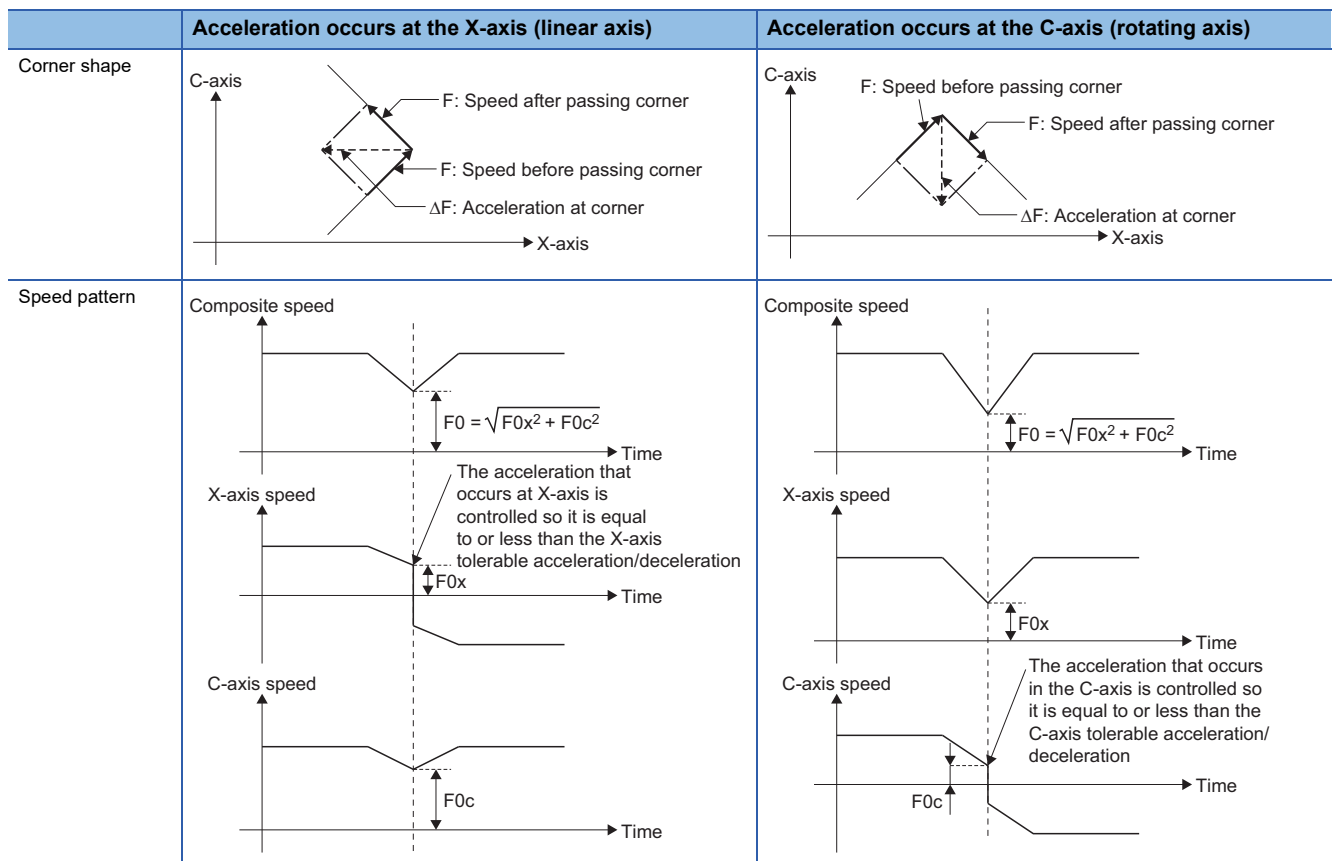

To improve edge precision further, make the accuracy coefficient larger. However, when the accuracy coefficient is made larger, the optimum corner speed is reduced, making the cycle time longer.

When a negative value is set to the accuracy coefficient, the optimum corner speed increases and the cycle time shortens. However, the edge precision is reduced.

The tolerable speed can be adjusted for each axis and is calculated with the following formula.

$$\text{Common tolerable acceleration for each axis [mm/s}^2\text{]} = \frac{\text{Cutting feed for each axis before interpolation - maximum speed [mm/min]}^{-1} + 60}{\text{Cutting feed for each axis before interpolation - time constant [ms]}^2 + 1000} \times \frac{100 - \text{Corner accuracy coefficient}}{100} \times \frac{100 - \text{Accuracy coefficient for each axis}}{100}$$

*1 When set to "0", the speed of the G-code control axis parameter "fast forward speed" is used.

*2 When set to "0", the time constant of the G-code control axis parameter "G0 time constant (linear)" is used.

■ Cautions

- When the G-code control axis parameters "cutting feed for each axis before interpolation - maximum speed" and "cutting feed for each axis before interpolation - time constant" of the three axes set as base axis I, base axis J, and base axis K are all "0", the tolerable acceleration for each axis of base axis I, base axis J, and base axis K is set as the lowest tolerable acceleration of base axis I, base axis J, and base axis K.

Ex.

When the values in the table below are set

The tolerable acceleration for each axis of the three axes (X, Y, and Z) set as base axis I to K is tolerable acceleration of the Z-axis (8.3333[mm/s²]), which is the lowest of base axes I to K.

The tolerable acceleration for each axis of the axis (C-axis) not set as base axis I to K is the tolerable acceleration (83.3333[mm/s²]) calculated from the G-code control axis parameters "cutting feed for each axis before interpolation - maximum speed" and "cutting feed for each axis before interpolation - time constant". (It is not set as the lowest tolerable acceleration of base axis I to K)

Item	X-axis (base axis I)	Y-axis (base axis J)	Z-axis (base axis K)	C-axis
Fast forward speed	2000[mm/min]	2000[mm/min]	1000[mm/min]	2000[degree/min]
G0 time constant (linear)	1000[ms]	1000[ms]	2000[ms]	1000[ms]
Cutting feed for each axis before interpolation - maximum speed	0 (not set)	0 (not set)	0 (not set)	1000[degree/min]
Cutting feed for each axis before interpolation - time constant	0 (not set)	0 (not set)	0 (not set)	200[ms]
Accuracy coefficient for each axis	0 (not set)	0 (not set)	0 (not set)	0 (not set)

- When the tolerable acceleration varies between base axes I to K, arcs are warped. Set so that the tolerable acceleration for base axis I to K is the same value.

Arc speed clamp

In circular interpolation, even when moving at a fixed speed, acceleration occurs because the advancing direction is constantly changing. When the arc radius is large enough for the commanded speed, the speed is controlled at the commanded speed. But when the arc radius is comparatively small, the speed is clamped so that the generated acceleration does not exceed acceleration/deceleration before interpolation - tolerable acceleration calculated from the parameters. Because of this, cutting arcs at the correct feed speed for the arc radius is possible.

In the figure below, the acceleration (ΔF)[mm/s²] is shown when moving by a fixed speed (F)[mm/min] on an arc of radius (R)[mm]. The arc clamp speed (F')[mm/min] that has an acceleration (ΔF) smaller than the common tolerable acceleration for all axes (A_c)[mm/s²] can be found with the following formula.

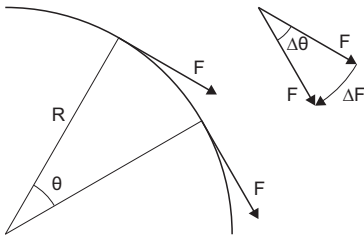

F : Command speed[mm/min]
 R : Command arc radius[mm]
 $\Delta\theta$: Change in angle per interpolation unit
 ΔF : Change in speed per interpolation unit

The arc clamp speed is fed to keep F from exceeding common tolerable acceleration for all axes[mm/s²].

$$F' \leq \sqrt{R \times A_c} \times 60 \dots \dots \dots (1)$$

$$\Delta F' = \frac{\text{Acceleration/deceleration before interpolation - maximum speed[mm/min]}}{\text{Acceleration/deceleration before interpolation - time constant[ms]}} \dots \dots \dots (2)$$

When formula (1) is substituted for F of the formula that shows the largest theoretical arc radius reduction (ΔR) for acceleration/deceleration before interpolation (Page 273 Path control in circular interpolation commands), the command radius (R) is eliminated, and ΔR is no longer dependent on R .

The servo system position loop time constant (T_p [s]) is the inverse ($T_p=1/PG1$) of the number of the servo parameter "Model loop gain (PB07)".

The feed forward coefficient (K_f) is the servo parameter "Feed forward gain (PB04)".

$$\Delta R = \frac{1}{2R} T_p^2 \left(1 - \left(\frac{K_f}{100} \right)^2 \right) \left(\frac{F}{60} \right)^2 \implies \Delta R = \frac{A_c}{2} T_p^2 \left(1 - \left(\frac{K_f}{100} \right)^2 \right)$$

Therefore, in arc commands that are clamped by the arc clamp speed, regardless of the commanded radius (R), work can be executed with an arc radius reduction (ΔR) that is always within a fixed value. Also, to improve the roundness, make the accuracy coefficient larger. However, when the accuracy coefficient is made larger, the arc clamp speed is reduced, making the cycle time longer.

When a negative value is set to the accuracy coefficient, the arc clamp speed increases and the cycle time shortens. However, the roundness is reduced.

The common tolerable acceleration for all axes can be found with the following formula.

$$\text{Common tolerable acceleration for all axes[mm/s}^2\text{]} = \frac{\text{Acceleration/deceleration before interpolation - maximum speed[mm/min]} \div 60}{\text{Acceleration/deceleration before interpolation - time constant[ms]} \div 1000} \times \frac{100 - \text{Curve accuracy coefficient}}{100}$$

High-accuracy control parameters and the relationship with speed/acceleration

The following shows the relationship between each of the high-accuracy control parameters and speed/acceleration.

Item	Details	Parameter used	
Cutting feed acceleration [m/s ²]	Calculated based on the data of the parameter used.	<ul style="list-style-type: none"> ■G-code control system parameter <ul style="list-style-type: none"> • Acceleration/deceleration before interpolation - maximum speed • Acceleration/deceleration before interpolation - time constant 	
Cutting feed acceleration for each axis [m/s ²]	Calculated based on the data of the parameter used.	<ul style="list-style-type: none"> ■G-code control axis parameter <ul style="list-style-type: none"> • Cutting feed for each axis before interpolation - maximum speed • Cutting feed for each axis before interpolation - time constant 	
Tolerable corner acceleration for each axis [m/s ²]	Calculated based on the data of the parameter used.	<ul style="list-style-type: none"> ■G-code control system parameter <ul style="list-style-type: none"> • Corner accuracy coefficient ■G-code control axis parameter <ul style="list-style-type: none"> • Cutting feed for each axis before interpolation - maximum speed • Cutting feed for each axis before interpolation - time constant • Accuracy coefficient for each axis 	
Tolerable curve acceleration for each axis [m/s ²]	Calculated based on the data of the parameter used.	<ul style="list-style-type: none"> ■G-code control system parameter <ul style="list-style-type: none"> • Curve accuracy coefficient ■G-code control axis parameter <ul style="list-style-type: none"> • Cutting feed for each axis before interpolation - maximum speed • Cutting feed for each axis before interpolation - time constant • Accuracy coefficient for each axis 	
Corner deceleration speed [mm/min]	The corner deceleration speed for the corner with angle (outside angle) of θ [degree] is calculated based on the data of the parameter used.	<Optimum corner deceleration> <ul style="list-style-type: none"> ■G-code control system parameter <ul style="list-style-type: none"> • Acceleration/deceleration before interpolation - maximum speed • Acceleration/deceleration before interpolation - time constant • Corner deceleration angle • Corner accuracy coefficient 	<Tolerable acceleration control for each axis> <ul style="list-style-type: none"> ■G-code control system parameter <ul style="list-style-type: none"> • Corner deceleration angle • Corner accuracy coefficient ■G-code control axis parameter <ul style="list-style-type: none"> • Cutting feed for each axis before interpolation - maximum speed • Cutting feed for each axis before interpolation - time constant • Accuracy coefficient for each axis
Corner deceleration speed at a right angle [mm/min]	The corner deceleration speed for the corner with angle (outside angle) of 90[degree] is calculated based on the data of the parameter used.	<Optimum corner deceleration> <ul style="list-style-type: none"> ■G-code control system parameter <ul style="list-style-type: none"> • Acceleration/deceleration before interpolation - maximum speed • Acceleration/deceleration before interpolation - time constant • Corner accuracy coefficient 	<Tolerable acceleration control for each axis> <ul style="list-style-type: none"> ■G-code control system parameter <ul style="list-style-type: none"> • Corner accuracy coefficient ■G-code control axis parameter <ul style="list-style-type: none"> • Cutting feed for each axis before interpolation - maximum speed • Cutting feed for each axis before interpolation - time constant • Accuracy coefficient for each axis
Theoretical corner shear drop amount [mm]	The corner shear drop amount[mm] for the corner with angle (outside angle) of θ [degree] is calculated based on the data of the parameter used.	<Optimum corner deceleration> <ul style="list-style-type: none"> ■G-code control system parameter <ul style="list-style-type: none"> • Acceleration/deceleration before interpolation - maximum speed • Acceleration/deceleration before interpolation - time constant • Corner deceleration angle • Corner accuracy coefficient ■Servo parameter (value of control axis 1) <ul style="list-style-type: none"> • Feed forward gain (PB04) • Model loop gain (PB07) 	<Tolerable acceleration control for each axis> <ul style="list-style-type: none"> ■G-code control system parameter <ul style="list-style-type: none"> • Corner deceleration angle • Corner accuracy coefficient ■G-code control axis parameter <ul style="list-style-type: none"> • Cutting feed for each axis before interpolation - maximum speed • Cutting feed for each axis before interpolation - time constant • Accuracy coefficient for each axis ■Servo parameter (value of control axis 1) <ul style="list-style-type: none"> • Feed forward gain (PB04) • Model loop gain (PB07)
Theoretical right angle shear drop amount [mm]	The corner shear drop amount[mm] for the corner with angle (outside angle) of 90[degree] is calculated based on the data of the parameter used.	<Optimum corner deceleration> <ul style="list-style-type: none"> ■G-code control system parameter <ul style="list-style-type: none"> • Acceleration/deceleration before interpolation - maximum speed • Acceleration/deceleration before interpolation - time constant • Corner deceleration angle • Corner accuracy coefficient ■Servo parameter (value of control axis 1) <ul style="list-style-type: none"> • Feed forward gain (PB04) • Model loop gain (PB07) 	<Tolerable acceleration control for each axis> <ul style="list-style-type: none"> ■G-code control system parameter <ul style="list-style-type: none"> • Corner deceleration angle • Corner accuracy coefficient ■G-code control axis parameter <ul style="list-style-type: none"> • Cutting feed for each axis before interpolation - maximum speed • Cutting feed for each axis before interpolation - time constant • Accuracy coefficient for each axis ■Servo parameter (value of control axis 1) <ul style="list-style-type: none"> • Feed forward gain (PB04) • Model loop gain (PB07)

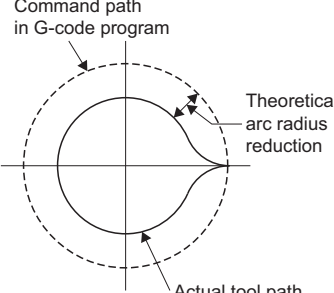
Item	Details	Parameter used	
Theoretical radius reducing difference [mm]	<p>The theoretical arc radius reduction[mm] for an arc with radius R is calculated based on the data of the parameter used.</p> 	<p><Optimum corner deceleration></p> <ul style="list-style-type: none"> ■G-code control system parameter • Acceleration/deceleration before interpolation - maximum speed • Acceleration/deceleration before interpolation - time constant • Curve accuracy coefficient ■Servo parameter (value of control axis 1) • Feed forward gain (PB04) • Model loop gain (PB07) 	<p><Tolerable acceleration control for each axis></p> <ul style="list-style-type: none"> ■G-code control system parameter • Curve accuracy coefficient ■G-code control axis parameter • Cutting feed for each axis before interpolation - maximum speed • Cutting feed for each axis before interpolation - time constant • Accuracy coefficient for each axis ■Servo parameter (value of control axis 1) • Feed forward gain (PB04) • Model loop gain (PB07)
R5mm arc clamp speed [mm/min]	<p>The arc deceleration speed[mm/min] for an arc with radius of 5mm is calculated based on the data of the parameter used.</p>	<p><Optimum corner deceleration></p> <ul style="list-style-type: none"> ■G-code control system parameter • Acceleration/deceleration before interpolation - maximum speed • Acceleration/deceleration before interpolation - time constant • Curve accuracy coefficient 	<p><Tolerable acceleration control for each axis></p> <ul style="list-style-type: none"> ■G-code control system parameter • Curve accuracy coefficient ■G-code control axis parameter • Cutting feed for each axis before interpolation - maximum speed • Cutting feed for each axis before interpolation - time constant • Accuracy coefficient for each axis
R1mm arc clamp speed [mm/min]	<p>The arc deceleration speed for an arc with radius of 1mm is calculated based on the data of the parameter used.</p>	<p><Optimum corner deceleration></p> <ul style="list-style-type: none"> ■G-code control system parameter • Acceleration/deceleration before interpolation - maximum speed • Acceleration/deceleration before interpolation - time constant • Curve accuracy coefficient 	<p><Tolerable acceleration control for each axis></p> <ul style="list-style-type: none"> ■G-code control system parameter • Curve accuracy coefficient ■G-code control axis parameter • Cutting feed for each axis before interpolation - maximum speed • Cutting feed for each axis before interpolation - time constant • Accuracy coefficient for each axis

Vector accuracy interpolation

During fine segment commands, when joints between blocks have extremely small angles, and are smooth (no optimum corner deceleration), vector accuracy interpolation function makes the joints even smoother.

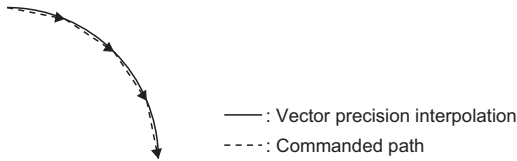

Arc entrance/exit speed control

At joints where changes from line to arc or arc to line occur, a change in acceleration can occur causing the machine to vibrate. Arc entrance/exit speed control decelerates to the deceleration speed before entering an arc and when exiting an arc to reduce machine vibration. However, when used with optimum corner deceleration or tolerable acceleration control for each axis (optimum acceleration control), the function with the lower deceleration speed is effective. Enabling/disabling arc entrance/exit speed control is set in the G-code control system parameter "Arc deceleration speed change". Also, the deceleration speed is set in G-code system parameter "arc deceleration speed".

Operation example

■No corner deceleration

Program	Operation	Speed pattern
<pre>(G61.1) : N1 G01 X-10. F3000. N2 G02 X-5. Y-5. J-2.5 N3 G01 Y10. :</pre>		

■Corner deceleration

Program	Operation	Speed pattern
<pre>(G61.1) : N1 G01 X-10. F3000. N2 G02 X-5. Y-5. J-2.5 N3 G01 X10. :</pre>		

6.8 Tandem Function

The tandem function outputs the same movement command of a specified axis (master axis) to another axis (slave axis) during G-code control. The axes used for tandem function are set in [Motion Control Parameter]⇒[G-code Control Parameter]⇒[G-code Control Axis Parameter]⇒"Tandem Function"⇒"Master Control Axis Name". The tandem function enable information can be checked with "[Md.3153] Tandem function enabled information (D54755+32sn)".

Cautions

- The axis address set to the slave axis cannot be specified in the G-code program. When the axis address set to the slave axis is specified, the command is ignored.
- Contents for the status and monitor devices of the slave control axis when enabled/disabled are shown below.

Device	Contents when enabled/disabled
[St.3076] Smoothing zero (D54448.0+2sn)	Remains ON.
[Md.3153] Tandem function enabled information (D54755+32sn)	Stores the master control axis No. *: Updated only when tandem function settings are made.
[Md.3147] Machine position (D54768+32sn, D54769+32sn)	Updated
[Md.3148] Machine target position (D54770+32sn, D54771+32sn)	Not updated
[Md.3149] Relative position (D54772+32sn, D54773+32sn)	Updated
[Md.3150] Relative target position (D54774+32sn, D54775+32sn)	Not updated
[Md.3152] Program target position (D54778+32sn, D54779+32sn)	Not updated

- When using tandem function, before turning ON G-code control request, match the reference positions of the master control axis and slave control axis.
- For G-code control axis parameters "fast forward speed", "cutting feed clamp speed", "G0 time constant (linear)", and "G1 time constant (linear)", the values set to the slave control axis No. are ignored and the values set to the master control axis No. are used.
- Note that the stored stroke limit operation for slave control axes is as follows.

G-code control	Operation
At G-code control request	Executes error check based on the slave axis settings
During G-code control	Disabled

- Set the same units to the axes set as master axes and slave axes in [Motion Control Parameter]⇒[Axis Setting Parameter]⇒"Fixed Parameter"⇒"Unit Setting".

6.9 G-Code Program Operation by GOT

G-code programs can be input/output and edited on a GOT screen by connecting the GOT and Motion CPU. The GOT models and engineering software versions that support G-code program operation are shown below.

Compatible models

Product	Model
GOT2000 series	SVGA, XGA, and WXGA resolution GT25 and GT27 <ul style="list-style-type: none"> • GT25□□-S • GT25□□-WX • GT27□□-S • GT27□□-X

Engineering software

■Display screen designer software

Product	Model	Device used	Engineering software version
MELSOFT GT Works3 • GT Designer3 Version1(GOT2000)	SW1DND-GTWK3-E	If not using the following devices	1.185T or later
		If using the following CPU modules <ul style="list-style-type: none"> • PLC CPU (R00CPU, R01CPU, R02CPU) • Process CPU (R□PCPU) • Safety CPU (R□SFCPU) • C Controller module (R12CCPU-V) 	1.215Z or later
		If using GT25□□-WX	1.230Q or later

■System application (expansion functions)

Product	Function
System application	Motion program input/output
	Motion program edit

GOT program input/output function

The input/output of G-code programs between a Motion CPU connected to a GOT, and a memory card can be done on the GOT screen.

- Motion G-code programs can be input/output individually in text file format from the GOT.
- G-code programs can be deleted individually or by batch.

Refer to the following for details on program input/output.

 GOT2000 Series User's Manual (Monitor)

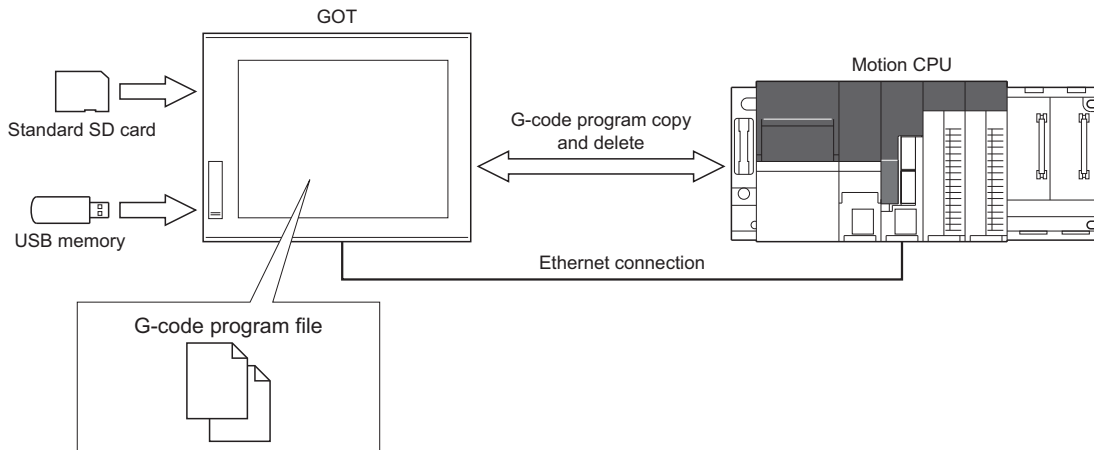

GOT program edit function

The G-code programs of a Motion CPU connected to a GOT can be edited on the GOT screen.

- G-code programs in the Motion CPU can be selected from program list on the screen and edited. However, new G-code programs cannot be created and existing programs cannot be deleted.
- G-code programs can be displayed, edited, and have lines inserted/deleted. Also, searches for character threads can be made.

Refer to the following for details on program editing.

 GOT2000 Series User's Manual (Monitor)

6.10 Functions Regarding Macro

A macro command program can be made by using variable commands, operation commands, and control commands. Refer to the following for variable commands, operation commands, and control commands.

- Variable commands (☞ Page 183 Variable Commands)
- Operation commands (☞ Page 194 Operation Commands)
- Control commands (☞ Page 203 Control Commands)

Precautions when using macro commands

When using a user-macro command, conventional control commands such as movement commands and M commands can be combined with macro commands such as operations, conditions, and branching to create a machining program. Conventional control commands such as movement commands and M commands are written as macro commands such as executable statements, operations, conditions, and branching to make a macro statement. The processing of the macro statements is not directly related to controlling the machine, thus when machining the macro statements are processed in a batch, reducing machining time. To execute macro statements one block at a time, turn ON "[Rq.3384] Macro single (D54226.C+2s)". By executing each macro block one at a time, checking the operation of macro statements becomes easier. When the macro single setting is enabled, "[St.3234] Macro single enabled (D54441.F+4s)" turns ON.

Point

- Macro statements refer to the following commands.
 - Operation commands (blocks that include =)
 - Control commands (blocks that include GOTO, DO to END, etc.)
 - Macro call command (G65)
- Executable statements refer to anything other than macro statements.

Example program

The processing by the program is shown below.

Operation	Program	Remarks
(1)	N1 G91 G28 X0 Y0	Executable statement
(2)	N2 G00 X-100. Y-100.	Executable statement
(3)	N3 #101 = 100. * COS[210.]	Macro statement
(4)	N4 #103 = 100. * SIN[210.]	Macro statement
(5)	N5 G01 X#101 Y#103 F800	Executable statement

■ Macro single OFF

N3, N4, and N5 are processed concurrently with N2 control. If the analyzing of N3, N4, and N5 finishes during N2 control, machine control operates consecutively.

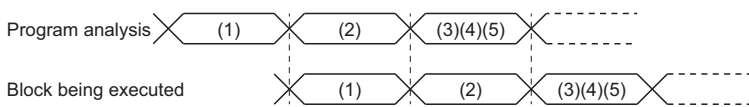

■ Macro single ON

N3 is processed concurrently with N2 control. After N2 control finishes, N4 and N5 are analyzed and N5 is executed, thus machine control is in a standby state for the analysis time of N4 and N5 only.

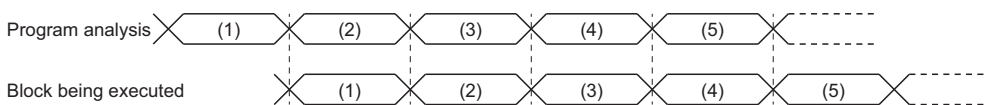

Example of using a macro command

An example program for changing the stroke with the angle is shown below.

Main program (O102.gcd)

```
%  
:  
#101=0  
#102=360  
#103=100  
#109=100  
M98 P103  
:  
M02  
%
```

Subprogram (O103.gcd)

```
%  
WHILE [#101 LE #102] DO1  
#104=#103*SIN [#101]  
IF [#101 GT 180] THEN #104=#104/2  
G90 G01 X#101 Y#104 F#109  
#101=#101+10  
END1  
M99  
%
```

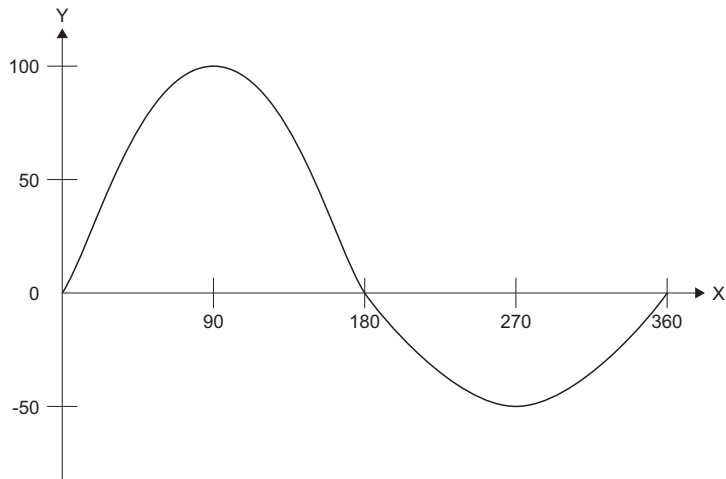

*1 The trajectory above is for illustrative purposes only. This program uses 10[degree] units, thus the actual trajectory is rougher than the trajectory above.

APPENDICES

Appendix 1 G-Code Control Error Details Codes

G-code control error details codes

The detail codes when a G-code control error is detected are shown below.

Detailed information 1

■ G-code control parameter error (minor error (error code: 1FC0H)), G-code control configuration error (moderate error (error code: 30FDH))

The details codes for when G-code control parameter error (minor error (error code: 1FC0H)), and G-code control configuration error (moderate error (error code: 30FDH)) are detected are shown below.

Details code	Description	Error details and cause	Corrective action
0010H	Base axis setting error	<ul style="list-style-type: none"> Axis names are duplicated in base axis I, base axis J, and base axis K. The specified axis name is not in the G-code control line. 	<ul style="list-style-type: none"> Set the axis names so that base axis I, base axis J, and base axis K are not duplicated. Set the axis name set in the G-code control axis parameter "axis name".
0011H	Normal line control axis name error	The axis of the axis name set to the normal line control axis name has not been set.	Specify the axis name set to the G-code axis parameter "axis name".
0012H	Normal line control axis setting error	<ul style="list-style-type: none"> The normal line control axis is not a rotating axis. The normal line control axis is set to base axis I, base axis J, and base axis K. The normal line control axis rotating speed is higher than the cutting feed clamp speed. 	<ul style="list-style-type: none"> Set a rotating axis to be used by the normal line control axis. Review the settings so that base axis I, base axis J, and base axis K are not set to the axis to be used by the normal line control axis. Set the normal line control axis rotating speed to a value less than or equal to the cutting feed clamp speed.
0013H	Polar coordinate interpolation axis name error	<ul style="list-style-type: none"> The axis of the axis name set to the polar coordinate interpolation linear axis has not been set. The axis of the axis name set to the polar coordinate interpolation rotating axis has not been set. Only one of either polar coordinate interpolation linear axis or polar coordinate interpolation rotating axis has been set. 	<ul style="list-style-type: none"> Set the axis name set to the G-code axis parameter "axis name". When using polar coordinate interpolation, set both polar coordinate interpolation linear axis and polar coordinate interpolation rotating axis .
0014H	Polar coordinate interpolation axis setting error	<ul style="list-style-type: none"> The polar coordinate interpolation linear axis is not a linear axis. The polar coordinate interpolation rotating axis is not a rotating axis. The polar coordinate interpolation linear axis is not set to base axis I, base axis J, and base axis K. The polar coordinate interpolation rotating axis is set to base axis I, base axis J, and base axis K. The polar coordinate interpolation rotating axis is set to a normal line control axis. 	<ul style="list-style-type: none"> Set a linear axis to be used by the polar coordinate interpolation linear axis. Set a rotating axis to be used by the polar coordinate interpolation rotating axis. Use an axis set to base axis I, base axis J, and base axis K for the axis to be used by the polar coordinate interpolation linear axis. Review the settings so that the axis to be used by the polar coordinate interpolation rotating axis is not set to base axis I, base axis J, and base axis K. Review the settings so that the axis to be used by the polar coordinate interpolation rotating axis is not set to a normal line control axis.
0015H	High-accuracy control setting error	<ul style="list-style-type: none"> Acceleration/deceleration before interpolation - maximum speed is smaller than cutting feed clamp speed. Acceleration/deceleration before interpolation - maximum speed is smaller than cutting feed clamp speed for high-accuracy control mode. 	<ul style="list-style-type: none"> Set the acceleration/deceleration before interpolation - maximum speed so it is equal to or larger than cutting feed clamp speed. Set the acceleration/deceleration before interpolation - maximum speed so it is equal to or larger than cutting feed clamp speed or high-accuracy control mode.

Details code	Description	Error details and cause	Corrective action
0016H	Macro control setting error	<ul style="list-style-type: none"> The total points of the common variable points for all systems and common variable points for each system exceeds 900 points. The start device No. of common variable for all systems has not been set when the common variable points for all systems is set. The start device No. of common variable for each system has not been set when the common variable points for each system is set. There are devices being used for both the common variables for all systems and common variables for each system at the same time. There are devices being used for common variables for each system in more than one system. The start device No. of local variable+(660-1) exceeds the device point setting range. The device Nos. used for local variables and common variables for all systems are duplicated. The device Nos. used for local variables and common variables for each systems are duplicated. There are device Nos. being used for local variables in more than one system. 	<ul style="list-style-type: none"> Set the the common variable points for all systems and common variable points for each system so that the total points are equal to or less than 900 points. When using common variable points for all systems, set the start device No. of common variable for all systems. When using common variable points for each system, set the start device No. of common variable for each system. Set the devices so that they are not used for both the common variables for all systems and the common variables for each system. Set the devices used for common variables for each system so that they are not used in more than one system. Set the start device No. of local variable+(660-1) so that it does not exceed the device point setting range. Set the device Nos. used for local variables and common variables for all systems so that they are not duplicated. Set the device Nos. used for local variables and common variables for each systems so that they are not duplicated. Set the device Nos. used for local variables so that they are not used in more than one system.
0020H	Axis No. setting error	<ul style="list-style-type: none"> An axis not in the servo network settings has been set. Axis Nos. are duplicated within the G-code control line. 	<ul style="list-style-type: none"> Set an axis No. that has been set in the servo network settings. Set the axis Nos. so that they are not duplicated.
0021H	Axis name error	Axis names are duplicated within the G-code control line.	Set the axis names so that they are not duplicated.
0022H	Control unit error	<ul style="list-style-type: none"> With a rotating axis set, the unit settings of the axis specified by axis No. are [mm], and [inch]. With a linear axis set, the unit settings of the axis specified by axis No. are [inch], and [degree]. 	<ul style="list-style-type: none"> When setting a rotating axis, set the unit settings of the fixed parameter to a unit other than [mm] and [inch]. When setting a linear axis, set the unit settings of the fixed parameter to a unit other than [inch] and [degree].
0023H	Tandem function setting error	<ul style="list-style-type: none"> An axis allocated to base axis I, base axis J, and base axis K was set as a slave control axis. An axis allocated to a normal line control axis was set as a slave control axis. An axis allocated to a polar coordinate interpolation linear axis or polar coordinate interpolation rotating axis was set as a slave control axis. An axis with axis name other than "U", "V", and "W" was set as a slave control axis. The axis of the axis name set to the master control axis name has not been set. The master control axis is set to a slave control axis. The following parameters for the master control axis and slave control axis do not match. G-code control axis parameter "rotation axis" G-code control axis parameter "rotating axis type" 	<ul style="list-style-type: none"> Set the "axis name" that is set to G-code control axis parameter "axis name". Review the settings so that the axis to be used by the slave control axis is not set to base axis I, base axis J, and base axis K. Review the settings so that the axis to be used by the slave control axis is not set to a normal line control axis. Review the settings so that the axis to be used by the slave control axis is not set to a polar coordinate interpolation linear axis or polar coordinate interpolation rotating axis. Set the axis name to be used by the slave control axis to "U", "V", or "W". Review the settings so that master control axis is not a slave control axis. Review the settings so that "rotation axis" and "rotating axis type" for master control axis and slave control axis match.
0024H	Software limit setting error	<ul style="list-style-type: none"> Software limit - is larger than software limit +. When the rotating axis type is shortcut valid or shortcut invalid, the software limit - and software limit + do not match. 	<ul style="list-style-type: none"> Review the setting values so that software limit - is smaller than software limit +. When rotating axis type is shortcut valid or shortcut invalid, make the software limit + and software limit - setting match.
0040H	G-code program file error	There was an error in G-code program file.	<p>Rewrite the G-code program file.</p> <p>If the same error occurs, the possible cause is a hardware failure of the Motion controller. Please consult your local Mitsubishi Electric representative.</p>

Details code	Description	Error details and cause	Corrective action
0041H	G-code program capacity over	<ul style="list-style-type: none"> The G-code program exceeds the maximum file size. The total size of the G-code program exceeds the program capacity. 	<ul style="list-style-type: none"> Edit the G-code program so the file size is within the maximum file size. Edit the G-code program so the total size is within the program capacity. (Refer to performance specifications for maximum file size and program capacity. (Page 20 Performance Specifications))
0042H	G-code program format error	End of record (%) is not at the program start or program end.	Set end of record (%) to the program start and program end.



■ G-code control operation error (minor error (error code: 1FC1H))

The details codes for when G-code operation error (minor error (error code: 1FC1H)) is detected are shown below.

Details code	Description	Error details and cause	Corrective action
0101H	Stored stroke limit over	The operation went outside of the stored stroke limit.	<ul style="list-style-type: none"> With G-code control OFF, move the machine inside the limit range. Review the G-code control axis parameter "stored stroke limit".
0102H	No operation mode	Operation mode is not specified.	Set the operation mode.
0103H	Block joint rotating stop during normal line control	<ul style="list-style-type: none"> The rotating angle of the block joint during normal line control exceeded the limit. When rotating on the inside of an arc with normal line control type II, the setting value of G-code control system parameter "normal line control axis rotating radius" is larger than the arc radius. 	<ul style="list-style-type: none"> Review the setting value of the G-code control system parameter "minimum rotating angle" or the rotating angle. Review the setting value of G-code system parameter "normal line control axis rotating radius". When starting operation with "[St.3208] During G-code control" turned ON, OFF→ON "[Rq.3380] Reset command".
0104H	Reset processing	With "[St.3216] Resetting" ON, "[Rq.3377] Automatic operation start (cycle start)" was turned ON.	Turn ON "[Rq.3377] Automatic operation start (cycle start)" after waiting for "[Rq.3217] Reset complete" to turn ON.
0111H	External stop signal ON	<ul style="list-style-type: none"> External stop signal was ON at G-code control request. External stop signal turned ON during G-code control. 	Turn ON "[Rq.3376] G-code control request" with the external stop signal turned OFF.
0112H	Hardware stroke limit +	<ul style="list-style-type: none"> External signal FLS (upper stroke limit) was OFF at G-code control request. External signal FLS (upper stroke limit) turned OFF during G-code control. 	Move in the reverse direction to within the external limit range, and turn ON "[Rq.3376] G-code control request".
0113H	Hardware stroke limit -	<ul style="list-style-type: none"> External signal RLS (lower stroke limit) was OFF at G-code control request. External signal RLS (lower stroke limit) turned OFF during G-code control. 	Move in the forward direction to within the external limit range, and turn ON "[Rq.3376] G-code control request".
0114H	PLC ready OFF	<ul style="list-style-type: none"> "[Rq.1120] PLC ready flag" or "PCPU preparation completion flag" was OFF at G-code control request. "[Rq.1120] PLC ready flag" or "PCPU preparation completion flag" turned OFF during G-code control. 	<ul style="list-style-type: none"> Change the Motion CPU mode to RUN. Turn ON "[Rq.1120] PLC ready flag". After the above, turn ON "[Rq.3376] G-code control request".
0115H	Start acceptance ON	"[St.1040] Start accept flag" was ON.	With "[St.1040] Start accept flag" turned OFF, turn ON "[Rq.3376] G-code control request".
0116H	Home position return incomplete	"[St.1069] Home position return request" was ON.	Turn ON "[Rq.3376] G-code control request" after executing home position return.
0117H	Servo error detection signal ON	<ul style="list-style-type: none"> "[St.1068] Servo error detection" was ON at G-code control request. "[St.1068] Servo error detection" turned ON during G-code control. 	Remove the error on the servo side, and turn ON "[Rq.3376] G-code control request" after resetting "[St.1068] Servo error detection" by "[Rq.1148] Servo error reset command".
0118H	Servo ready OFF	<ul style="list-style-type: none"> "[St.1075] Servo ready" was OFF at G-code control request. (1) Servo amplifier power supply OFF (2) Initial processing by servo amplifier power supply ON (3) Servo amplifier not installed (4) Servo error occurrence (5) Cable failure (6) "[Rq.1155] Servo OFF command" is ON During G-code control, the servo amplifier power supply turned OFF. (not installed detection, cable failure etc.) 	<ul style="list-style-type: none"> Turn ON servo amplifier power supply or check the cable connected to the servo amplifier. Turn ON "[Rq.3376] G-code control request" with "[St.1075] Servo ready" turned ON.
0119H	PLC ready ON at G-code control end	While ending G-code control, "[Rq.1120] PLC ready flag" turned OFF→ON again.	After "[St.3208] During G-code control" of all lines turns OFF, turn ON "[Rq.3376] G-control request" with "[Rq.1120] PLC ready flag" turned ON.

■ G-code control stop error (minor error (error code: 1FC2H))

The details codes for when G-code control stop error (minor error (error code: 1FC2H)) is detected are shown below.

Details code	Description	Error details and cause	Corrective action
0201H	Reset command ON	Automatic operation start (cycle start) is not possible because "[Rq.3380] Reset command" is ON.	Check that "[Rq.3380] Reset command" is OFF, and start the operation.
0202H	Automatically operation pause (feed hold) ON	"[Rq.3378] Automatic operation hold (feed hold)" is ON.	Turn OFF "[Rq.3378] Automatic operation hold (feed hold)".
0203H	No operation mode	An operation mode is not selected.	Turn ON "[Rq.3381] Program operation mode (memory mode)".
0221H	Stored stroke limit	The stored stroke limit was reached.	<ul style="list-style-type: none"> • Correct the program. • Review the G-code axis parameter "stored stroke limit". • When starting operation with "[St.3208] During G-code control" turned ON, turn "[Rq.3380] Reset command" OFF→ON.
0222H	Operation mode change	<ul style="list-style-type: none"> • During automatic operation, the operation mode was cancelled. • During automatic operation, the operation was changed to another program operation mode. 	Cancel the operation mode after ending automatic operation.

■ G-code control program error (minor error (error code: 1FC3H))

The details codes for when G-code control program error (minor error (error code: 1FC3H)) is detected are shown below.

Details code	Description	Error details and cause	Corrective action
0301H	Cannot be pre-calculated	The number of pre-read blocks exceeds the limit due to the combination of instructions which require pre-read.	Reduce or eliminate the instructions which require pre-read.
0302H	Number of synchronization axis over	The number of axis addresses commanded to the same block is more than the system specifications.	<ul style="list-style-type: none"> • Divide the commands of the blocks where error is occurring into two. • Check the specifications for number of axes.
0303H	Axis name setting error	The axis address name in the program command and parameter setting are different.	Review the axis name in the program.
0304H	Command disabled status	<ul style="list-style-type: none"> • A normal line control command (G40.1, G41.1, G42.1) was commanded in a modal which cannot perform normal line control. • During normal line control, an attempt to change a modal that cannot be changed was made. 	Correct the program.
0305H	Incorrect address	An address outside of the specifications was used.	Check the specifications and correct the program address.
0306H	Format error	The command format on the program is incorrect.	Correct the program.
0307H	Incorrect G-code	A G-code outside of the specifications was used.	Correct the program G-code address.
0308H	Command value over	The setting range of each address was exceeded.	Correct the program.
0309H	Program end error	"EOF" was read during program operation.	Enter M02 or M30 at the end of the program.
030AH	Helical operation disabled	An axis not selecting a plane is commanded by a circular interpolation command.	When specifying an axis that is not selecting a plane by a circular interpolation command, move the command to the next block.
030DH	No compensation number	When using a compensation command (G41, G42, G43, G44), there is no compensation No. (D□□, H□□) command. Or the compensation No. is larger than the group specifications.	<ul style="list-style-type: none"> • Add the command of the compensation No. to the compensation command block. • Check the number of compensation No. groups, and correct the command to a compensation No. within the number of compensation groups.
030EH	Calculation error	An axis command where the axis units cannot be calculated was performed.	Correct the program.
030FH	G-code combination error	A G-code that cannot be commanded in the same block was commanded.	Separate the G-code that cannot be commanded in the same block to another block.
0310H	Interpolation length over	The command movement distance is large. (exceeding 2^{-31})	Correct the command range of the axis address.
0311H	No F-command	There is no F-command in the first cutting command (G01, G02, G03).	Command the feed speed by F-command.
0312H	F-command value over	The F-command, or ,F-command exceeds the command range.	Correct the F-command or ,F-command so that it is within the command range.

Details code	Description	Error details and cause	Corrective action
0313H	Arc radius difference over	The arc start point, end point or arc center is incorrect.	<ul style="list-style-type: none"> Correct the values of the specified addresses of the program start point, end point, arc center and radius. Review the G-code control system parameter "arc deviation".
0314H	Arc center calculation disabled	During R specified circular interpolation, the center of the arc is not found.	Correct the values of the addresses in the program.
0315H	Tool radius compensation in arc modal	A compensation command (G40, G41, G42) was commanded in an arc modal (G02, G03).	Command a linear command (G01) or fast forward command (G00) in the tool radius compensation command block or cancel block. (Change the modal to linear interpolation.)
0316H	Plane selection in tool radius compensation	Plane selection command (G17, G18, G19) was commanded during tool radius compensation (G41, G42).	Execute the plane selection command after tool radius compensation command is completed (command the axis movement command after the cancel command of G40).
0317H	Plane selection error	The arc command axis and plane selection are incorrect.	Perform the arc command with the correct plane selection.
0318H	Operation invalid	The operation calculation is incorrect.	Correct the program.
0319H	Zero ratio	The denominator of the dividing calculation is zero.	Correct the program, so the denominator of the dividing calculation for operation is not zero.
031AH	Decimal point command disabled	The decimal point command was performed at an address that cannot be used.	Correct the program.
031BH	Normal line control axis error	The normal line control axis is not set.	Correct the normal line control axis.
031CH	Plane selection in normal line control	A plane selection command (G17, G18, G19) was commanded during normal line control.	Delete the plane selection commands (G17, G18, G19) from the normal line control program.
031DH	No intersection	During the execution of tool radius compensation (G41, G42), the intersection cannot be calculated in the interference block processing.	<ul style="list-style-type: none"> Correct the program. Review the G-code control work parameter "interference check".
031EH	Compensation interference error	During the execution of tool radius compensation (G41, G42), an interference error occurred.	Correct the program.
031FH	No program No.	<ul style="list-style-type: none"> G-code program is not registered. "[Rq.3377] Automatic operation start (cycle start)" turned ON during the loading of the G-code program. 	<ul style="list-style-type: none"> Correct the program No. Write the G-code program of the applicable program No. Turn ON "[Rq.3377] Automatic operation start (cycle start)" after completing the loading of the G-code program.
0320H	No sequence No.	The specified sequence No. is not set in the program.	<ul style="list-style-type: none"> Correct the sequence No. Set the sequence No. to an appropriate block.
0321H	No block No.	The specified block No. is not in the program.	Correct the block No.
0322H	Incorrect G-code (polar coordinate interpolation)	During polar coordinate interpolation, G-code that cannot be combined with polar coordinate interpolation was used.	Correct the program.
0323H	Incorrect axis command (polar coordinate interpolation)	An axis command that cannot be commanded during polar coordinate interpolation was made.	Correct the program.
0324H	Incorrect modal (polar coordinate interpolation)	<ul style="list-style-type: none"> Polar coordinate interpolation mode start command was made during normal line control. Polar coordinate interpolation mode start command was made during tool radius compensation. Polar coordinate interpolation mode start command was made during program coordinate rotation mode. Polar coordinate interpolation mode start command was made during high-accuracy control mode. (When tolerable acceleration control for each axis is disabled) During polar coordinate interpolation, an automatic corner override was commanded during tool radius compensation. 	<ul style="list-style-type: none"> Start polar coordinate interpolation mode after ending normal line control. Start polar coordinate interpolation mode with tool radius compensation cancelled. Start polar coordinate interpolation mode with program coordinate rotation cancelled. Start polar coordinate interpolation mode after ending high-accuracy control. Enable tolerable acceleration control for each axis. During polar coordinate interpolation, do not command automatic corner override during tool radius compensation.
0325H	Polar coordinate interpolation axis error	Polar coordinate interpolation mode start command was made without a polar coordinate interpolation axis set.	Set a polar coordinate interpolation axis.

Details code	Description	Error details and cause	Corrective action
0326H	Plane selection in coordinate rotation	A plane selection command (G17, G18, G19) was commanded during a coordinate rotation command.	After coordinate rotation command, be sure to execute a coordinate rotation cancel command before making a plane selection command (G17, G18, G19).
0327H	Incremental value command after coordinate rotation	The movement command immediately after program coordinate rotation mode start command (G68), and program coordinate rotation mode cancel command (G69) was an incremental value command.	Make absolute value commands immediately after program coordinate rotation mode start command (G68), and program coordinate rotation mode cancel command (G69).
0328H	Number of sub/macro program repetitions over	A value outside of the range was set to the number of sub/macro program repeats.	Correct the number of sub/macro program repeats.
0329H	Sub/macro program depth over	The number of times a sub/macro program is successively called from a subprogram exceeds 10.	Correct the program so that the number of times a sub/macro program is called from a subprogram does not exceed 10.
032AH	No variable number	A variable number outside of the range was specified.	Correct the variable number.
032BH	No = in variable definition	An "=" is not commanded when defining a variable.	Set an "=" when defining a variable of a program.
032CH	Operation command/control command format error	An operation command (a block with =) or a control command (branch, repeat) is mixed with another command (such as a movement command) in the same block.	Correct the program by writing the operation command (a block with =) or the control command (branch, repeat) in a block separate from the other command (such as a movement command).
032DH	Bracket depth over	The number of brackets in one block exceeded 5 levels.	Correct the program so that the number of brackets is 5 levels or less.
032EH	Bracket number unmatched	The number of brackets commanded in a block do not match (not in pairs).	Correct the program so that the number of brackets match (are in pairs).
032FH	IF depth over	The depth of IF statements exceeds 10.	Correct the program so that the depth of IF statements does not exceed 10.
0330H	IF statement unmatched	<ul style="list-style-type: none"> IF and ENDIF are not in pairs. THEN/ELSE is commanded without a IF instruction. 	<ul style="list-style-type: none"> Correct the program so that IF and ENDIF are in pairs. Insert a IF command before the THEN/ELSE command.
0331H	IF statement error	<ul style="list-style-type: none"> The conditional expression is not enclosed in brackets. THEN or ELSE is not commanded. 	<ul style="list-style-type: none"> Enclose the conditional expression in brackets. Insert a THEN or ELSE command.
0332H	WHILE statement error	<ul style="list-style-type: none"> The conditional expression is not enclosed in brackets. A value outside of the range was specified to the repeat identification No. 	<ul style="list-style-type: none"> Enclose the conditional expression in brackets. Correct the repeat identification No.
0333H	DO-END depth over	The depth of the WHILE [conditional expression] DO□ to END□ statement exceeds 27.	Correct the program so that the depth of DO to END statements does not exceed 27.
0334H	DO-END unmatched	DO and END are not in pairs.	Correct the program so that DO to END are in pairs.
0335H	Macro call - depth over	The number of times a macro program is successively called exceeds 4.	Correct the program so that the number of macro calls does not exceed 4.
0336H	Macro argument - number of groups over	When using argument specification II in a macro call, the number of argument groups exceeds 10.	Correct the program so that the number of macro call argument specification II groups does not exceed 10.



Add-on license error details codes

The detail codes when an add-on license error is detected in G-code control are shown below.

Detailed information 1

■ Add-on license warning (warning (error code: 0EF1H)), add-on license minor error (minor error (error code: 1FF1H)), add-on license moderate error (moderate error (error code: 3081H))

Refer to the following for the details codes for when add-on license warning (warning (error code: 0EF1H)), add-on license minor error (minor error (error code: 1FF1H)), and add-on license moderate error (moderate error (error code: 3081H)) are detected.

📖 MELSEC iQ-R Motion Controller Programming Manual (Common)

Appendix 2 G-code Control Event Details Codes

G-code control event details codes

The detail codes when a G-code control event is detected are shown below.

Detailed information 1

■ G-code control system information (information (event code: 07FAH))

The details codes for when G-code control system information (information (event code: 07FAH)) is detected are shown below.

Details code	Description	Details
0401H	G-code control request ON	Turned OFF→ON "[Rq.3376] G-code control request"
0402H	G-code control request OFF	Turned ON→OFF "[Rq.3376] G-code control request"
0403H	Reset command ON during program start	Turned OFF→ON "[Rq.3380] Reset command" during program starting.
0404H	Automatically operation pause (feed hold) ON	"[Rq.3378] Automatic operation hold (feed hold)" turned ON. (Automatic operation can be restarted by turning OFF→ON "[Rq.3377] Automatic operation start (cycle start)".)
0405H	Single block stop	Operation was stopped by single block. (Automatic operation can be restarted by turning OFF→ON "[Rq.3377] Automatic operation start (cycle start)".)
0406H	Cutting override zero	Cutting feed rate override is set to "0", or a value outside the setting range was set.
0407H	Fast forward override zero	Fast forward rate override is set to "0", or a value outside the setting range was set.

MEMO

A

REVISIONS

* The manual number is given on the bottom left of the back cover

Revision date	*Manual number	Description
July 2017	IB(NA)-0300371-A	First edition
December 2017	IB(NA)-0300371-B	<p>■Added functions Polar coordinate interpolation mode (G12.1, G13.1), Local coordinate system setting (G52), High-accuracy control mode (G61.1), Program coordinate rotation mode (G68, G69), Tandem function, G-code program operation by GOT</p> <p>■Added or modified parts Section 2.1, 2.2, Chapter 3, Section 3.1, 3.2, 3.4, 3.8, 3.9, 3.11, 4.1, 4.2, 4.3, 5.1, 5.2, 5.4, 5.5, 5.6, 6.3, 6.5, 6.7, 6.8, 6.9, Appendix 1, Appendix 2</p>
June 2018	IB(NA)-0300371-C	<p>■Added functions Subprogram call (M98), Subprogram return (M99), Variable command, Operation command, Control command</p> <p>■Added or modified parts SAFETY PRECAUTIONS, Section 1.1, 1.2, 1.4, 3.5, 3.7, 3.8, 3.12, 4.1, 4.2, 5.1, 5.2, 5.4, 5.5, 5.6, 5.7, 5.8, 5.9, 5.10, 6.1, 6.5, 6.6, 6.7, 6.8, 6.10, Appendix 1</p>
December 2018	IB(NA)-0300371-D	<p>■Added functions Macro call (G65)</p> <p>■Added or modified parts SAFETY PRECAUTIONS, Section 1.2, 1.3, Chapter 3, Section 3.5, 3.7, 3.8, 4.1, 5.2, 5.4, 5.6, 5.7, 5.8, 5.10, 6.5, 6.10, Appendix 1</p>
February 2020	IB(NA)-0300371-E	<p>■Added or modified parts Section 2.6, 4.1, 5.2, 5.10, 6.2, 6.9</p>

Japanese manual number: IB-0300370-E

This manual confers no industrial property rights of any other kind, nor does it confer any patent licenses. Mitsubishi Electric Corporation cannot be held responsible for any problems involving industrial property rights which may occur as a result of using the contents noted in this manual.

©2017 MITSUBISHI ELECTRIC CORPORATION

WARRANTY

Please confirm the following product warranty details before using this product.

1. Gratis Warranty Term and Gratis Warranty Range

If any faults or defects (hereinafter "Failure") found to be the responsibility of Mitsubishi occurs during use of the product within the gratis warranty term, the product shall be repaired at no cost via the sales representative or Mitsubishi Service Company.

However, if repairs are required onsite at domestic or overseas location, expenses to send an engineer will be solely at the customer's discretion. Mitsubishi shall not be held responsible for any re-commissioning, maintenance, or testing on-site that involves replacement of the failed module.

[Gratis Warranty Term]

The gratis warranty term of the product shall be for one year after the date of purchase or delivery to a designated place. Note that after manufacture and shipment from Mitsubishi, the maximum distribution period shall be six (6) months, and the longest gratis warranty term after manufacturing shall be eighteen (18) months. The gratis warranty term of repair parts shall not exceed the gratis warranty term before repairs.

[Gratis Warranty Range]

- (1) The range shall be limited to normal use within the usage state, usage methods and usage environment, etc., which follow the conditions and precautions, etc., given in the instruction manual, user's manual and caution labels on the product.
- (2) Even within the gratis warranty term, repairs shall be charged for in the following cases.
 1. Failure occurring from inappropriate storage or handling, carelessness or negligence by the user. Failure caused by the user's hardware or software design.
 2. Failure caused by unapproved modifications, etc., to the product by the user.
 3. When the Mitsubishi product is assembled into a user's device, Failure that could have been avoided if functions or structures, judged as necessary in the legal safety measures the user's device is subject to or as necessary by industry standards, had been provided.
 4. Failure that could have been avoided if consumable parts (battery, backlight, fuse, etc.) designated in the instruction manual had been correctly serviced or replaced.
 5. Failure caused by external irresistible forces such as fires or abnormal voltages, and Failure caused by force majeure such as earthquakes, lightning, wind and water damage.
 6. Failure caused by reasons unpredictable by scientific technology standards at time of shipment from Mitsubishi.
 7. Any other failure found not to be the responsibility of Mitsubishi or that admitted not to be so by the user.

2. Onerous repair term after discontinuation of production

- (1) Mitsubishi shall accept onerous product repairs for seven (7) years after production of the product is discontinued. Discontinuation of production shall be notified with Mitsubishi Technical Bulletins, etc.
- (2) Product supply (including repair parts) is not available after production is discontinued.

3. Overseas service

Overseas, repairs shall be accepted by Mitsubishi's local overseas FA Center. Note that the repair conditions at each FA Center may differ.

4. Exclusion of loss in opportunity and secondary loss from warranty liability

Regardless of the gratis warranty term, Mitsubishi shall not be liable for compensation to:

- (1) Damages caused by any cause found not to be the responsibility of Mitsubishi.
- (2) Loss in opportunity, lost profits incurred to the user by Failures of Mitsubishi products.
- (3) Special damages and secondary damages whether foreseeable or not, compensation for accidents, and compensation for damages to products other than Mitsubishi products.
- (4) Replacement by the user, maintenance of on-site equipment, start-up test run and other tasks.

5. Changes in product specifications

The specifications given in the catalogs, manuals or technical documents are subject to change without prior notice.

TRADEMARKS

Microsoft, Microsoft Access, Excel, SQL Server, Visual Basic, Visual C++, Visual Studio, Windows, Windows NT, Windows Server, Windows Vista, and Windows XP are either registered trademarks or trademarks of Microsoft Corporation in the United States and/or other countries.

The company names, system names and product names mentioned in this manual are either registered trademarks or trademarks of their respective companies.

In some cases, trademark symbols such as [™] or [®] are not specified in this manual.

IB(NA)-0300371-E(2002)MEE

MODEL: RMT-P-GCD-E

mitsubishi electric corporation

HEAD OFFICE : TOKYO BUILDING, 2-7-3 MARUNOUCHI, CHIYODA-KU, TOKYO 100-8310, JAPAN
NAGOYA WORKS : 1-14, YADA-MINAMI 5-CHOME, HIGASHI-KU, NAGOYA, JAPAN

When exported from Japan, this manual does not require application to the
Ministry of Economy, Trade and Industry for service transaction permission.

Specifications subject to change without notice.