



Programmable Controller

**MELSEC iQ-R**  
series

MELSEC iQ-R Inter-Module Synchronization  
Function  
Reference Manual

---



# SAFETY PRECAUTIONS

---

(Read these precautions before using this product.)

Before using MELSEC iQ-R series programmable controllers, please read the manuals for the product and the relevant manuals introduced in those manuals carefully, and pay full attention to safety to handle the product correctly. Make sure that the end users read this manual and then keep the manual in a safe place for future reference.

## CONDITIONS OF USE FOR THE PRODUCT

---

(1) MELSEC programmable controller ("the PRODUCT") shall be used in conditions;

- i) where any problem, fault or failure occurring in the PRODUCT, if any, shall not lead to any major or serious accident; and
- ii) where the backup and fail-safe function are systematically or automatically provided outside of the PRODUCT for the case of any problem, fault or failure occurring in the PRODUCT.

(2) The PRODUCT has been designed and manufactured for the purpose of being used in general industries.

MITSUBISHI ELECTRIC SHALL HAVE NO RESPONSIBILITY OR LIABILITY (INCLUDING, BUT NOT LIMITED TO ANY AND ALL RESPONSIBILITY OR LIABILITY BASED ON CONTRACT, WARRANTY, TORT, PRODUCT LIABILITY) FOR ANY INJURY OR DEATH TO PERSONS OR LOSS OR DAMAGE TO PROPERTY CAUSED BY THE PRODUCT THAT ARE OPERATED OR USED IN APPLICATION NOT INTENDED OR EXCLUDED BY INSTRUCTIONS, PRECAUTIONS, OR WARNING CONTAINED IN MITSUBISHI ELECTRIC USER'S, INSTRUCTION AND/OR SAFETY MANUALS, TECHNICAL BULLETINS AND GUIDELINES FOR the PRODUCT.

("Prohibited Application")

Prohibited Applications include, but not limited to, the use of the PRODUCT in;

- Nuclear Power Plants and any other power plants operated by Power companies, and/or any other cases in which the public could be affected if any problem or fault occurs in the PRODUCT.
- Railway companies or Public service purposes, and/or any other cases in which establishment of a special quality assurance system is required by the Purchaser or End User.
- Aircraft or Aerospace, Medical applications, Train equipment, transport equipment such as Elevator and Escalator, Incineration and Fuel devices, Vehicles, Manned transportation, Equipment for Recreation and Amusement, and Safety devices, handling of Nuclear or Hazardous Materials or Chemicals, Mining and Drilling, and/or other applications where there is a significant risk of injury to the public or property.

Notwithstanding the above restrictions, Mitsubishi Electric may in its sole discretion, authorize use of the PRODUCT in one or more of the Prohibited Applications, provided that the usage of the PRODUCT is limited only for the specific applications agreed to by Mitsubishi Electric and provided further that no special quality assurance or fail-safe, redundant or other safety features which exceed the general specifications of the PRODUCTS are required. For details, please contact the Mitsubishi Electric representative in your region.

(3) Mitsubishi Electric shall have no responsibility or liability for any problems involving programmable controller trouble and system trouble caused by DoS attacks, unauthorized access, computer viruses, and other cyberattacks.

# INTRODUCTION

---

Thank you for purchasing the Mitsubishi Electric MELSEC iQ-R series programmable controllers.

This manual describes the inter-module synchronization function, which controls multiple modules synchronously.

Before using this product, please read this manual and the relevant manuals carefully and develop familiarity with the functions and performance of the MELSEC iQ-R series programmable controller to handle the product correctly.



When applying the program examples provided in this manual to an actual system, ensure the applicability and confirm that it will not cause system control problems.

Please make sure that the end users read this manual.

---

## **Point**

For using a C Controller module, when a reference to the GX Works3 Operating Manual or the MELSEC iQ-R CPU Module User's Manual (Startup or Application) is given, the reference should be made to the following instead:

-  CW Configurator Operating Manual
  -  MELSEC iQ-R C Controller Module User's Manual (Startup)
  -  MELSEC iQ-R C Controller Module User's Manual (Application)
-

# CONTENTS

SAFETY PRECAUTIONS .....	1
CONDITIONS OF USE FOR THE PRODUCT .....	1
INTRODUCTION .....	2
RELEVANT MANUALS .....	5
TERMS .....	6
GENERIC TERMS AND ABBREVIATIONS .....	6
<b>CHAPTER 1 OVERVIEW</b> .....	<b>7</b>
<b>CHAPTER 2 SYSTEM CONFIGURATION</b> .....	<b>9</b>
2.1 Precautions for System Configuration .....	9
2.2 Inter-module Synchronous Master .....	11
If the network module is not targeted for inter-module synchronization .....	12
If CC-Link IE TSN is targeted for inter-module synchronization .....	12
If CC-Link IE Field Network is targeted for inter-module synchronization .....	13
If CC-Link IE TSN and CC-Link IE Field Network are targeted for inter-module synchronization .....	14
2.3 Configuration Devices .....	16
<b>CHAPTER 3 SPECIFICATIONS</b> .....	<b>18</b>
3.1 Performance Specifications .....	18
Inter-module synchronization accuracy .....	18
<b>CHAPTER 4 PROCEDURES BEFORE OPERATION</b> .....	<b>20</b>
<b>CHAPTER 5 FUNCTION</b> .....	<b>23</b>
5.1 Fixed Cycle Synchronization Function .....	23
Timing for synchronizing CPU modules .....	23
Timing to synchronize each module .....	25
Coordination with multiple CPU system function's fixed scan communication cycle .....	34
Network synchronous communication function .....	39
<b>CHAPTER 6 PARAMETER SETTINGS</b> .....	<b>44</b>
6.1 Inter-module Synchronization Setting .....	44
Setting the mounting slot No. ....	46
6.2 Multiple CPU Settings .....	47
6.3 Module Parameter Settings .....	48
<b>CHAPTER 7 PROGRAM EXAMPLES</b> .....	<b>51</b>
7.1 For Single CPU System Configuration .....	51
System configuration .....	51
Programming condition .....	51
Parameter setting .....	51
Applicable labels .....	52
Program .....	53
7.2 For CC-Link IE Field Network Configuration .....	54
System configuration .....	54
Parameter setting .....	54
Applicable labels .....	56

Applicable function blocks . . . . .	57
Program . . . . .	57
<b>7.3 For CC-Link IE TSN Configuration . . . . .</b>	<b>60</b>
System configuration . . . . .	60
Parameter settings . . . . .	61
Applicable labels . . . . .	63
Applicable function blocks . . . . .	64
Program . . . . .	64
<b>CHAPTER 8 TROUBLESHOOTING . . . . .</b>	<b>67</b>
<hr/>	
<b>8.1 Error Processing and Recovery Methods . . . . .</b>	<b>67</b>
Inter-module synchronous interrupt program does not run . . . . .	68
A specific module is not synchronized. . . . .	68
<b>8.2 RAS Function. . . . .</b>	<b>69</b>
Inter-module synchronous interrupt program execution time monitor . . . . .	69
Inter-module synchronization signal error monitoring . . . . .	69
Monitor of output exceeding inter-module synchronization cycle . . . . .	69
Cyclic monitor . . . . .	69
<b>APPENDIX . . . . .</b>	<b>70</b>
<hr/>	
<b>Appendix 1 Processing Time . . . . .</b>	<b>70</b>
Overhead time for executing interrupt program. . . . .	70
Refresh processing time . . . . .	70
Instruction processing time in interrupt program . . . . .	70
<b>INDEX . . . . .</b>	<b>72</b>
<hr/>	
REVISIONS . . . . .	73
WARRANTY . . . . .	75
TRADEMARKS . . . . .	76

# RELEVANT MANUALS

Manual name [manual number]	Description	Available form
MELSEC iQ-R Inter-Module Synchronization Function Reference Manual [SH-081401ENG] (this manual)	Inter-module synchronization function, which controls multiple modules synchronously	e-Manual PDF
MELSEC iQ-R CPU Module User's Manual (Startup) [SH-081263ENG]	Specifications, procedures before operation, and troubleshooting of the CPU module	Print book e-Manual PDF
MELSEC iQ-R CC-Link IE Field Network Remote Head Module User's Manual (Startup) [SH-081614ENG]	Specifications, procedures before operation, system configuration, wiring, and communication examples of the CC-Link IE Field Network remote head module	Print book e-Manual PDF
MELSEC iQ-R C Controller Module User's Manual (Application) [SH-081369ENG]	Functions, devices, and parameters of C Controller module	Print book e-Manual PDF

## Point

e-Manual refers to the Mitsubishi Electric FA electronic book manuals that can be browsed using a dedicated tool. e-Manual has the following features:

- Required information can be cross-searched in multiple manuals.
- Other manuals can be accessed from the links in the manual.
- The hardware specifications of each part can be found from the product figures.
- Pages that users often browse can be bookmarked.
- Sample programs can be copied to an engineering tool.

# TERMS

Unless otherwise specified, this manual uses the following terms.

Term	Description
Control CPU	A CPU module that controls connected I/O modules and intelligent function modules. In a multiple CPU system, there are multiple CPU modules and each connected module can be controlled by a control CPU.
Cyclic transmission	A function by which data are periodically exchanged among stations on the same network using link devices
Device	A memory of a CPU module to store data. Devices such as X, Y, M, D, and others are provided depending on the intended use.
Engineering tool	A tool used for setting up programmable controllers, programming, debugging, and maintenance
Global label	A label that is valid for all the program data when multiple program data are created in the project. There are two types of global label: a module specific label (module label), which is generated automatically by GX Works3, and an optional label, which can be created for any specified device.
Intelligent function module	A module that has functions other than an input or output, such as an A/D converter module and D/A converter module
Module label	A label that represents one of memory areas (I/O signals and buffer memory areas) specific to each module in a given character string. For the module used, GX Works3 automatically generates this label, which can be used as a global label.

# GENERIC TERMS AND ABBREVIATIONS

Unless otherwise specified, this manual uses the following generic terms and abbreviations.

Generic term/abbreviation	Description
A/D converter module	A MELSEC iQ-R series analog-digital converter module and high speed analog-digital converter module
C Controller module	A MELSEC iQ-R series C Controller module
CC-Link IE Field Network-equipped master/local module	An RJ71GF11-T2 CC-Link IE Field Network master/local module and the following modules when the CC-Link IE Field Network function is used: <ul style="list-style-type: none"> <li>• RJ71EN71</li> <li>• RnENCPU</li> </ul>
CC-Link IE TSN master/local module	RJ71GN11-T2 and RJ71GN11-EIP (CC-Link IE TSN part)
CPU module	A MELSEC iQ-R series CPU module
D/A converter module	A MELSEC iQ-R series digital-analog converter module and high speed digital-analog converter module
Motion module	RD78G(H)
Network module	A generic term for the following modules: <ul style="list-style-type: none"> <li>• CC-Link IE TSN master/local module</li> <li>• CC-Link IE Field Network-equipped master/local module</li> </ul>
RAS	Reliability, Availability, Serviceability. This term refers to the overall usability of automated equipment.
Remote head module	An RJ72GF15-T2 CC-Link IE Field Network remote head module
RJ71GN11-EIP (CC-Link IE TSN part)	An RJ71GN11-EIP when it performs communications on CC-Link IE TSN



# 1 OVERVIEW

The inter-module synchronization function adjusts the control timing for the signals between multiple modules. When this function is used, the synchronization target module can match the input or output timing to the inter-module synchronization cycle. The inter-module synchronization cycle is a fixed scan interval for the inter-module synchronization function. The multiple CPU system function's fixed scan communication cycle, CC-Link IE TSN network synchronous communication function, and the CC-Link IE Field Network synchronous communication function can be coordinated with the inter-module synchronization cycle.

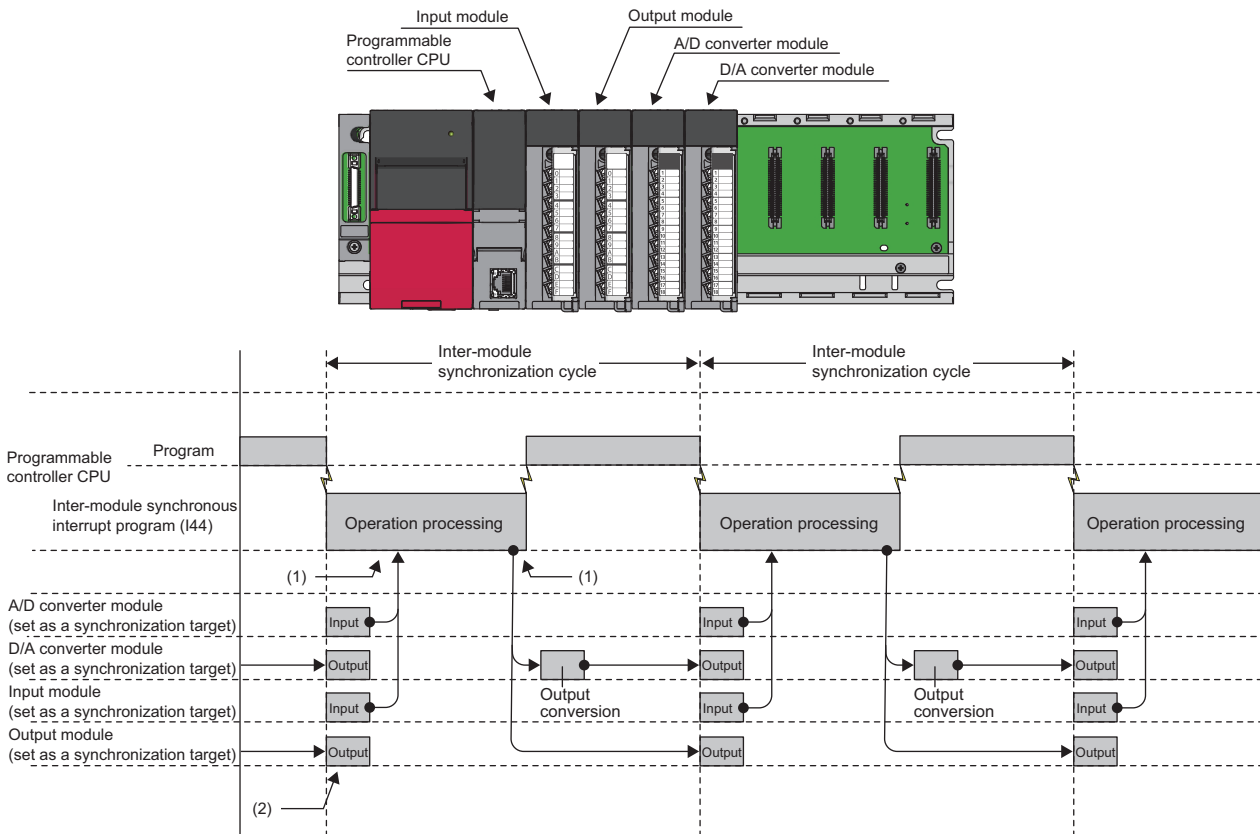

- (1) Refreshing is executed before and after the inter-module synchronous interrupt program (I44).
- (2) The input process and output process are performed at the timing of the inter-module synchronization cycle.

## Point

When using the inter-module synchronization function, be sure to execute the EI instruction by the CPU module and set I44 (inter-module synchronous interrupt) to be interrupt-enabled. To prioritize the fixed scan interval of the inter-module synchronization function, consider the following.

- Not switching the enabled/disabled of I44 during inter-module synchronization
- Using the multiple interrupt function

For details on I44 and multiple interrupt function, refer to the following.

📖 MELSEC iQ-R CPU Module User's Manual (Application)

# MEMO

---

# 2 SYSTEM CONFIGURATION

This chapter describes the system configuration for the inter-module synchronization function.

## 2.1 Precautions for System Configuration

This section lists precautions for configuring the inter-module synchronization function system.

Item	Description	
Modules targeted for inter-module synchronization function*1	This function can be used only with the MELSEC iQ-R Series modules. (Page 16 Configuration Devices)	
For configuration that uses the network module as the synchronization target module.	Network compatible with inter-module synchronization function	<ul style="list-style-type: none"> <li>CC-Link IE TSN*7*8*10</li> <li>CC-Link IE Field Network*8</li> </ul>
	Number of network modules that can be specified as target module for inter-module synchronization function (Per station including those on extension base unit.)*2*3	<ul style="list-style-type: none"> <li>Master station modules: 8 modules*9</li> <li>Local station modules: 1 module*6</li> </ul>
	Network transmission path format compatible with inter-module synchronization function	Only the following network topology can be used. <ul style="list-style-type: none"> <li>Line topology</li> <li>Star topology*4</li> <li>Line topology and star topology combination*4</li> </ul>
	Mounting position of master station module in synchronization target network module	<ul style="list-style-type: none"> <li>On main base unit</li> <li>On extension base unit (Mounting of CC-Link IE TSN master/local module and Motion module is not possible.)</li> </ul>
	Mounting position of local station module in synchronization target network module	<ul style="list-style-type: none"> <li>On main base unit</li> <li>Mounting on extension base unit is not possible.</li> </ul>
	Types of stations supported with inter-module synchronization function*5	Only master station and local station
	Time required for inter-module synchronization function to start (rising edge)	<ul style="list-style-type: none"> <li>CC-Link IE TSN: 50s maximum.</li> <li>CC-Link IE Field Network: 20s maximum.</li> </ul>

- \*1 This is not restricted by the module mounting position, maximum number of mountable modules, or the number of CPU modules when using a multiple CPU system configuration. (Same as when not using the inter-module synchronization function.) (MELSEC iQ-R Module Configuration Manual)
- \*2 In the multiple CPU system, the inter-module synchronization function can be used only by the network module controlled by the CPU No. 1.
- \*3 If the local station is specified as the module targeted for the inter-module synchronization function, the master station on the same base unit as the local station cannot be set as a module targeted for the inter-module synchronization function.

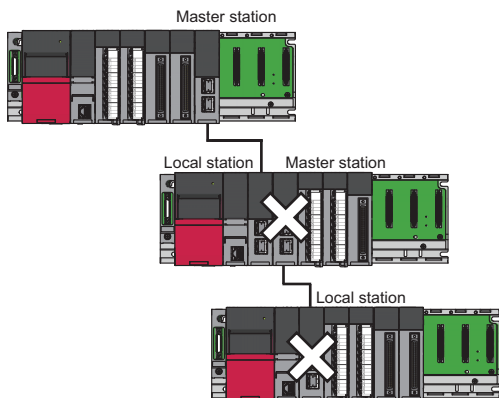

- \*4 A hub compatible with the inter-module synchronization function must be used. (MELSEC iQ-R Ethernet/CC-Link IE User's Manual (Startup))
- \*5 The type of station that can be selected with the station type setting is indicated. (MELSEC iQ-R CC-Link IE Field Network User's Manual (Application))

- \*6 To use the module on the local station as the synchronization target module, Inter-module Synchronization Master Setting is required. (☞ Page 11 Inter-module Synchronous Master, ☞ Page 44 Inter-module Synchronization Setting)
- \*7 If the CC-Link IE TSN network synchronous communication function is used, some devices cannot be synchronized depending on the CC-Link IE TSN authentication Class. (📖 MELSEC iQ-R CC-Link IE TSN User's Manual (Startup), 📖 MELSEC iQ-R CC-Link IE TSN Plus Master/Local Module User's Manual, 📖 MELSEC iQ-R Motion Module User's Manual (Application), 📖 MELSEC iQ-R Motion Module User's Manual (Application for Simple Motion Mode))
- \*8 When mixing modules on CC-Link IE TSN and CC-Link IE Field Network-equipped master/local modules on the same base unit, refer to the following. (☞ Page 15 Restrictions)
- \*9 When the RJ71GN11-T2 with the firmware version "10" is used, only one CC-Link IE TSN master/local module (master station) can be connected.
- \*10 To use the inter-module synchronization function via CC-Link IE TSN on the Motion module, the following versions are supported:  
PLCopen motion controller FB mode: "Ver.1.16 or later" of add-on baseSystem version  
Simple Motion mode: "Ver.1.20 or later" of add-on baseSystem version

## 2.2 Inter-module Synchronous Master

The inter-module synchronous master is a module that issues the inter-module synchronization command. If the inter-module synchronization function is used, set one module on the base unit as the inter-module synchronous master.

The modules that can be set as the inter-module synchronous master are listed below.

- CPU module
- CC-Link IE TSN master/local module (master station), Motion module
- CC-Link IE TSN master/local module (local station)
- CC-Link IE Field Network-equipped master/local module (local station)
- Remote head module

(Default: CPU module)

The modules that can be set as the inter-module synchronous master differ depending on the modules installed on the same base unit or the "Select Inter-module Synchronization Target Module" setting. The modules that can be set as the inter-module synchronous master are listed.

The modules listed in the table are indicated by the following symbols.

- No.1: CPU module
- No.2: CC-Link IE TSN master/local module (master station), Motion module
- No.3: CC-Link IE TSN master/local module (local station)
- No.4: CC-Link IE Field Network-equipped master/local module (local station)
- No.5: Remote head module
- : Set "Synchronize" in "Select Inter-module Synchronization Target Module".
- ×: Set "Do Not Synchronize" in "Select Inter-module Synchronization Target Module".

Network module installation status	"Select Inter-module Synchronization Target Module" setting status			Modules that can be set as inter-module synchronous master
	No.2 <sup>*1*2*3</sup>	No.3 <sup>*4</sup>	No.4 <sup>*4</sup> , No.5	
Not installed	×	×	×	No.1
Installed	×	×	×	No.1
	○	×	×	No.2
	×	○	×	No.3
	×	×	○	No.4, No.5

\*1 When the RJ71GN11-T2 with the firmware version "10" is used, only one master station can be set as the target module for synchronization.

\*2 When the RJ71GN11-T2 with the firmware version "11" or later is used, multiple master stations can be set as the target modules for synchronization. However, if one master module is set as the target module for synchronization, local stations cannot be set as the target modules.

\*3 When two or more CC-Link IE TSN master stations are mounted on the same base unit, set the leftmost one as the inter-module synchronous master.

\*4 Only one local station of the network module can be set as the target module for synchronization. When a local station of the network module is set as the target module for synchronization, the master station cannot be set as the target module.

## If the network module is not targeted for inter-module synchronization

In a system configuration in which the network module is not set as an inter-module synchronization target, the CPU module becomes the inter-module synchronous master and issues the inter-module synchronization command. (For the multiple CPU system configuration, the CPU module on the extreme left, for which "Use" is set in "Use Inter-module Synchronization Function in System" of "Inter-module Synchronization Setting", becomes the inter-module synchronous master.)

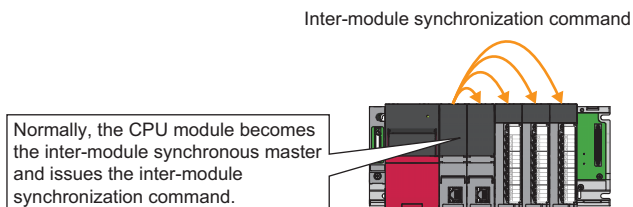

## If CC-Link IE TSN is targeted for inter-module synchronization

If CC-Link IE TSN is targeted for inter-module synchronization, the master station becomes the inter-module synchronous master and issues the inter-module synchronization command. The local station adjusts the start timing of the inter-module synchronization cycle (communication cycle start timing) through time synchronization with the master station. The time-synchronized local station issues the inter-module synchronization command as the inter-module synchronous master. (Note that a Motion module cannot be connected to the local station.)

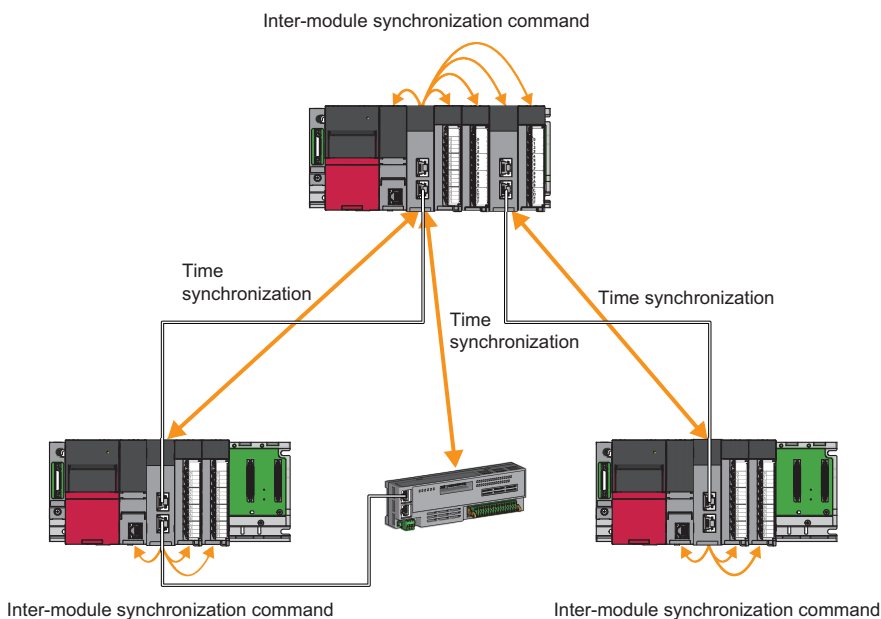

When two or more master stations targeted for inter-module synchronization are mounted on the same base unit, set the leftmost one as the inter-module synchronous master.

# If CC-Link IE Field Network is targeted for inter-module synchronization

If CC-Link IE Field Network is targeted for inter-module synchronization, the CPU module becomes the inter-module synchronous master and issues the inter-module synchronization command. Upon receiving the inter-module synchronization command, the master station sends the inter-module synchronization command to each station. Upon receiving the inter-module synchronization command, each local station sends the inter-module synchronization command as the inter-module synchronous master.

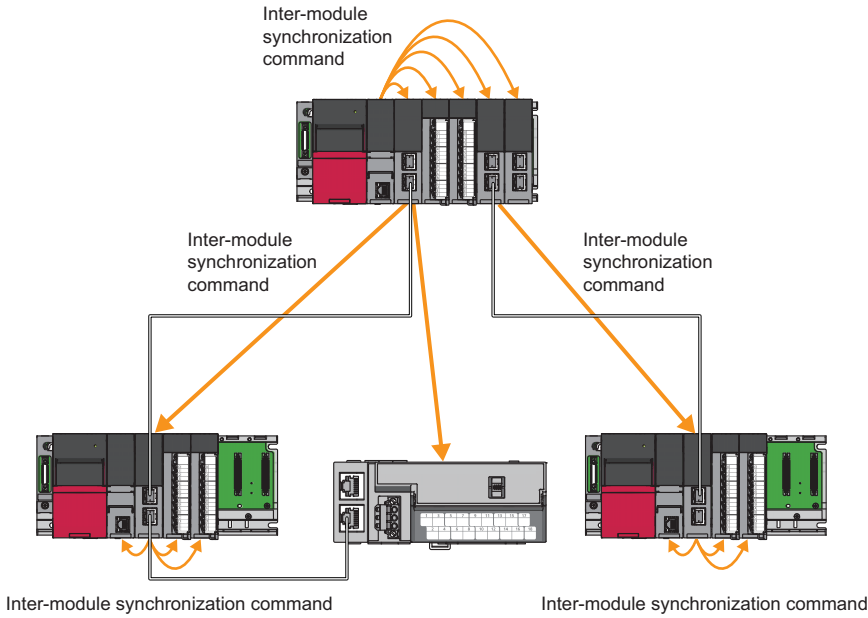

# If CC-Link IE TSN and CC-Link IE Field Network are targeted for inter-module synchronization

If CC-Link IE TSN and CC-Link IE Field Network are targeted for inter-module synchronization, the CC-Link IE TSN master station becomes the inter-module synchronous master and issues the inter-module synchronization command.

## Operation of network module

### ■CC-Link IE TSN

Because the local station is time-synchronized with the master station, at the start timing of the inter-module synchronization cycle (communication cycle start timing), it issues the inter-module synchronization command as the inter-module synchronous master. (Note that a Motion module cannot be connected to the local station.)

### ■CC-Link IE Field Network

Upon receiving the inter-module synchronization command, the CC-Link IE Field Network-equipped master/local module (master station) sends the inter-module synchronization command to each station. Upon receiving the inter-module synchronization command, each CC-Link IE Field Network-equipped master/local module (local station) sends the inter-module synchronization command as the inter-module synchronous master.

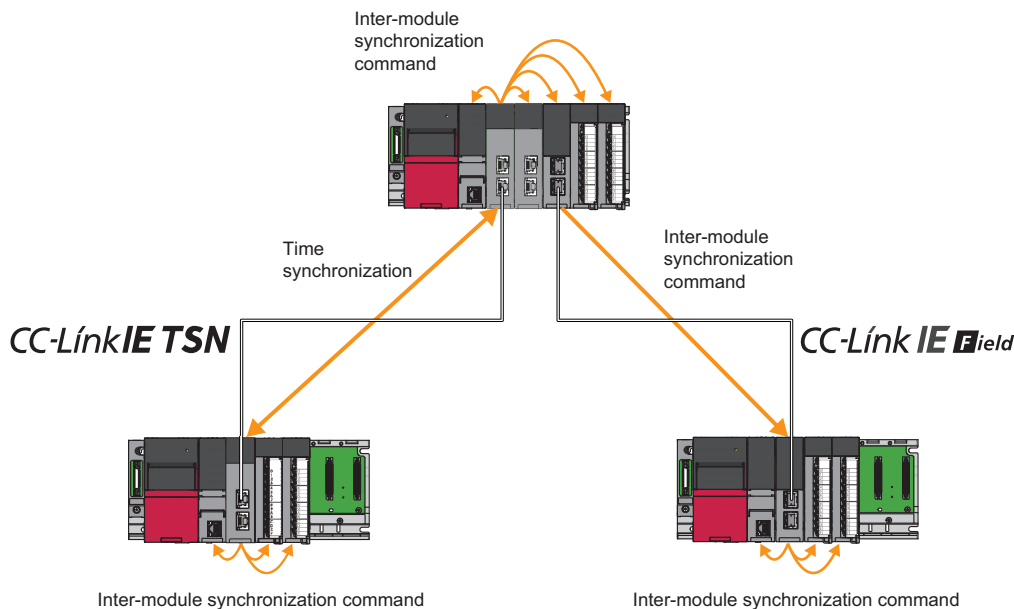



## Restrictions

### ■ Setting of inter-module synchronization target module

- Only the master station or a local station on the same base unit can be set as the inter-module synchronization target module.
- Multiple local stations on the same base unit cannot be set as the inter-module synchronization target modules.

### ■ Network module combinations

The possible combinations of network modules installed on the same base unit are shown below, along with restrictions.

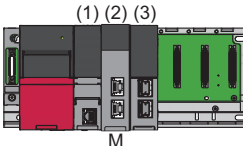
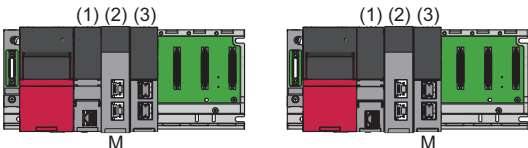
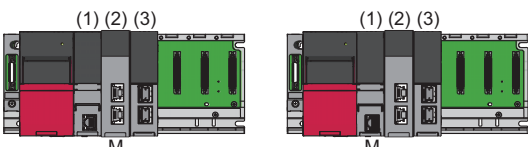
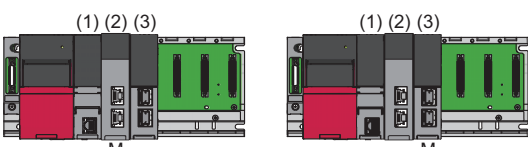
Installation module 1	Installation module 2	Restrictions when setting inter-module synchronization target modules
CC-Link IE TSN master/local module (master station), Motion module	CC-Link IE Field Network-equipped master/local module (master station)	<p>There are no restrictions. Both modules can be set as the inter-module synchronization target module.</p>  <p>M: Inter-module synchronous master            (1) CPU module (CPU #1)            (2) CC-Link IE TSN master/local module (master station)            (3) CC-Link IE Field Network-equipped master/local module (master station)</p>
	CC-Link IE Field Network-equipped master/local module (local station)	<p>Either module can be set as the inter-module synchronization target module.</p>  <p>M: Inter-module synchronous master            (1) CPU module (CPU #1)            (2) CC-Link IE TSN master/local module (master station)            (3) CC-Link IE Field Network-equipped master/local module (local station)</p>
CC-Link IE TSN master/local module (local station)	CC-Link IE Field Network-equipped master/local module (master station)	<p>Either module can be set as the inter-module synchronization target module.</p>  <p>M: Inter-module synchronous master            (1) CPU module (CPU #1)            (2) CC-Link IE TSN master/local module (local station)            (3) CC-Link IE Field Network-equipped master/local module (master station)</p>
	CC-Link IE Field Network-equipped master/local module (local station)	<p>Either module can be set as the inter-module synchronization target module.</p>  <p>M: Inter-module synchronous master            (1) CPU module (CPU #1)            (2) CC-Link IE TSN master/local module (local station)            (3) CC-Link IE Field Network-equipped master/local module (local station)</p>

## 2.3 Configuration Devices

This section lists the modules that can be synchronously controlled with the inter-module synchronization function.

Part name		Model name	
CPU module	Programmable controller CPU	<ul style="list-style-type: none"> <li>• R00CPU</li> <li>• R01CPU</li> <li>• R02CPU</li> <li>• R04CPU</li> <li>• R04ENCPU</li> <li>• R08CPU</li> <li>• R08ENCPU</li> <li>• R16CPU</li> <li>• R16ENCPU</li> <li>• R32CPU</li> <li>• R32ENCPU</li> <li>• R120CPU</li> <li>• R120ENCPU</li> </ul>	
	Process CPU (process mode)	<ul style="list-style-type: none"> <li>• R08PCPU</li> <li>• R16PCPU</li> <li>• R32PCPU</li> <li>• R120PCPU</li> </ul>	
	Safety CPU* <sup>2</sup>	<ul style="list-style-type: none"> <li>• R08SFCPU</li> <li>• R16SFCPU</li> <li>• R32SFCPU</li> <li>• R120SFCPU</li> </ul>	
	Motion CPU	<ul style="list-style-type: none"> <li>• R16MTCPU</li> <li>• R32MTCPU</li> </ul>	
	C Controller module	R12CCPU-V	
Remote head module		RJ72GF15-T2	
Network module	Master/local module	CC-Link IE TSN master/local module	RJ71GN11-T2 <sup>3,4</sup>
		CC-Link IE Field Network-equipped master/local module	RJ71GN11-EIP <sup>3,4</sup>
			<ul style="list-style-type: none"> <li>• RJ71GF11-T2</li> <li>• RJ71EN71<sup>1</sup></li> </ul>
I/O module	AC input module	<ul style="list-style-type: none"> <li>• RX10</li> <li>• RX10-TS</li> <li>• RX28</li> </ul>	
	DC input module	<ul style="list-style-type: none"> <li>• RX40C7</li> <li>• RX40C7-TS</li> <li>• RX41C4</li> <li>• RX41C4-TS</li> <li>• RX70C4</li> <li>• RX71C4</li> </ul>	
	DC high-speed input module	<ul style="list-style-type: none"> <li>• RX40PC6H</li> <li>• RX40NC6H</li> <li>• RX41C6HS</li> <li>• RX61C6HS</li> </ul>	
	Input module with diagnostic functions	RX40NC6B	
	Contact output module	<ul style="list-style-type: none"> <li>• RY10R2</li> <li>• RY10R2-TS</li> <li>• RY18R2A</li> </ul>	
	Triac output module	RY20S6	
	Transistor output module	<ul style="list-style-type: none"> <li>• RY40NT5P</li> <li>• RY40NT5P-TS</li> <li>• RY41NT2P</li> <li>• RY41NT2P-TS</li> <li>• RY40PT5P</li> <li>• RY40PT5P-TS</li> <li>• RY41PT1P</li> <li>• RY41PT1P-TS</li> </ul>	
	Transistor high-speed output module	<ul style="list-style-type: none"> <li>• RY41NT2H</li> <li>• RY41PT2H</li> </ul>	
	Output module with diagnostic functions	RY40PT5B	

Part name		Model name
Intelligent function module	A/D converter module	<ul style="list-style-type: none"> <li>• R60AD4</li> <li>• R60ADI8</li> <li>• R60ADV8</li> <li>• R60ADH4</li> </ul>
	D/A converter module	<ul style="list-style-type: none"> <li>• R60DA4</li> <li>• R60DAI8</li> <li>• R60DAV8</li> <li>• R60DAH4</li> </ul>
	Simple motion module	<ul style="list-style-type: none"> <li>• RD77MS2</li> <li>• RD77MS4</li> <li>• RD77MS8</li> <li>• RD77MS16</li> <li>• RD77GF4</li> <li>• RD77GF8</li> <li>• RD77GF16</li> </ul>
	Motion module	<ul style="list-style-type: none"> <li>• RD78G4</li> <li>• RD78G8</li> <li>• RD78G16</li> <li>• RD78G32</li> <li>• RD78G64</li> <li>• RD78GHV</li> <li>• RD78GHW</li> </ul>
	High-speed counter module	<ul style="list-style-type: none"> <li>• RD62P2</li> <li>• RD62D2</li> <li>• RD62P2E</li> </ul>
	Flexible high-speed I/O control module	RD40PD01
	Positioning module	<ul style="list-style-type: none"> <li>• RD75P2</li> <li>• RD75P4</li> <li>• RD75D2</li> <li>• RD75D4</li> </ul>

\*1 Usable only when operating as the CC-Link IE Field Network

\*2 The inter-module synchronization function cannot be used for the multiple CPU system configured with a combination of a Safety CPU and a Motion CPU or with a combination of a Safety CPU and a C Controller module.

\*3 The SSCNET III/H compatible Simple Motion module and Motion CPU cannot be synchronized with the inter-module synchronization function.

\*4 There are restrictions on the CPU module to be used. For details, refer to the following.

 MELSEC iQ-R CPU Module User's Manual (Application)

### Point

A module other than those listed in the table can be mounted on the system as long as it is not a module that is synchronously controlled with the inter-module synchronization function.

# 3 SPECIFICATIONS

This chapter describes the specifications for the inter-module synchronization function.

## 3.1 Performance Specifications

This section describes the performance specifications for the inter-module synchronization function.

Item	Performance value
Inter-module synchronization cycle	<ul style="list-style-type: none"> <li>• R00CPU, R01CPU, R02CPU: 0.50 to 10.00ms</li> <li>• Safety CPU: 1.00 to 10.00ms</li> <li>• CPU modules other than the above: 0.10 to 10.00ms</li> </ul>
Inter-module synchronization accuracy	Calculate the accuracy with the inter-module synchronization accuracy formula. (Page 19 Inter-module synchronization accuracy calculation formula)

**Point**

Set the inter-module synchronization cycle to satisfy the following condition.

- Inter-module synchronization cycle > inter-module synchronous interrupt program execution time + output preparation process time of the output module

When using a Safety CPU, set the inter-module synchronization cycle considering the safety cycle process time since the safety cycle process is prioritized over the inter-module synchronization in the Safety CPU.

- Inter-module synchronization cycle > inter-module synchronous interrupt program execution time + output preparation process time of the output module + safety cycle process time

### Inter-module synchronization accuracy

The accuracy is the difference that each module recognizes the synchronization point and the time of the synchronization point. For the following output module, the inter-module synchronization accuracy is  $T_{max} - T_0$  in the positive direction, and  $T_0 - T_{min}$  in the negative direction.

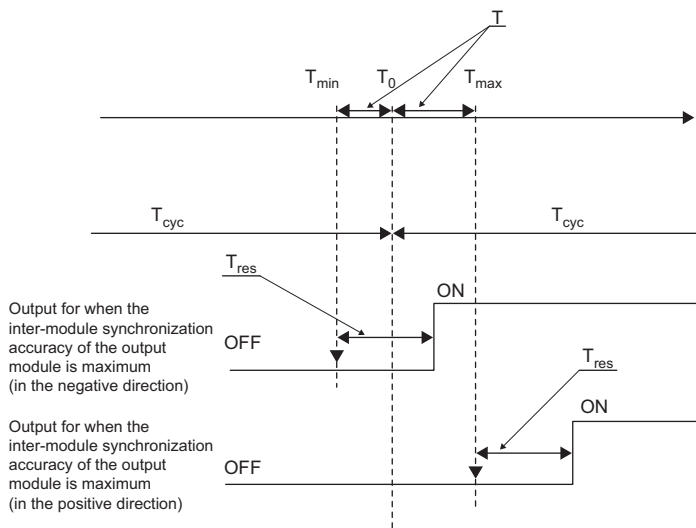

- T: Inter-module synchronization accuracy
- $T_0$ : Synchronization point time
- $T_{min}$ : Time that an output module recognizes synchronization point (Min.)
- $T_{max}$ : Time that an output module recognizes synchronization point (Max.)
- $T_{cyc}$ : Inter-module synchronization cycle
- $T_{res}$ : Output module response time

The actual external output is output with the following time lag.

Inter-module synchronization accuracy + output module response time ( $T_{res}$ )

**Point**

- Each module starts the process at the inter-module synchronization functions' start timing, so the input or output is made after the response time from that inter-module synchronization function's start timing.
- For details on each module's response time ( $T_{res}$ ), refer to each module's manual.

## Inter-module synchronization accuracy calculation formula

This section shows the calculation formula for the inter-module synchronization accuracy. Use as a guide to set the inter-module synchronization cycle.

### ■When not going through a network module

$$T = T_{cyc} \times 2.4 \times 10^{-4} + N_r \times 80 + 150$$

The variables are listed below.

Variable	Description
T	Inter-module synchronization accuracy (ns)
$T_{cyc}$	Inter-module synchronization cycle (ns)
$N_r$	Number of stages in extension base unit in which the module for calculating the inter-module synchronization accuracy is mounted <sup>*1</sup>

\*1 The number of stages is 0 for the main base unit.

### ■When going through a network module

- For inter-module synchronization via CC-Link IE TSN

The inter-module synchronization accuracy between the local station and the modules installed on the same base unit is shown below.

$$T = T_{cyc} \times 2.4 \times 10^{-4} + N_r \times 80 + 150 + 1000$$

- For inter-module synchronization via CC-Link IE Field Network

The inter-module synchronization accuracy between the CC-Link IE Field Network-equipped master/local module (local station) and the modules installed on the same base unit is shown below.

$$T = T_{cyc} \times 2.4 \times 10^{-4} + N_r \times 80 + N_s \times 12 + 700$$

The variables are listed below.

Variable	Description
T	Inter-module synchronization accuracy (ns)
$T_{cyc}$	Inter-module synchronization cycle (ns)
$N_r$	Number of stages in extension base unit in which the module for calculating the inter-module synchronization accuracy is mounted <sup>*1</sup>
$N_s$	Number of transit stations from the master station in which the module for calculating the inter-module synchronization accuracy is mounted +1 <sup>*2</sup>

\*1 The number of stations is 0 for the main base unit.

\*2 The number of relay stations from the master station refers to the number of stations physically related from the master station to the relevant station when using the following type of line topology or line topology/star topology combination.

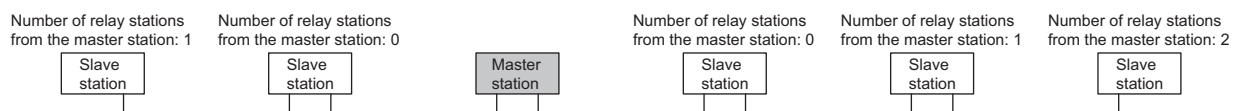

### Point

Obtain the inter-module synchronization accuracy for the module mounted in the master station with the "When not going through network module" method.

# 4 PROCEDURES BEFORE OPERATION

This chapter describes the procedures for using the inter-module synchronization function.

## 1. Starting up the engineering tool

Connect the personal computer in which the engineering tool is installed to the CPU module or remote head module, and start up the engineering tool. (📖 GX Works3 Operating Manual)

### Point

For details on the preparations for starting up the engineering tool (mounting the modules, wiring each device, powering on the system, or other preparations), refer to the following.

📖 MELSEC iQ-R CPU Module User's Manual (Startup)

📖 MELSEC iQ-R CC-Link IE Field Network Remote Head Module User's Manual (Startup)

## 2. Setting the applicable system

Set the system to be used in the module configuration drawing. (📖 GX Works3 Operating Manual) When using the multiple CPU system configuration, set the system parameters for all CPU modules. (📖 MELSEC iQ-R CPU Module User's Manual (Application))

## 3. Setting the inter-module synchronization function

Set the parameters required for using the inter-module synchronization function.

- Inter-module synchronization setting (👉 Page 44 Inter-module Synchronization Setting)
- If necessary, set the CPU parameters and module parameters. (📖 Manual for each module)
- To coordinate the multiple CPU system function's fixed scan communication cycle with the inter-module synchronization cycle, set the fixed scan communication setting of the multiple CPU settings. (👉 Page 47 Multiple CPU Settings)
- To coordinate the network synchronous communication function with the inter-module synchronization cycle, make the required settings on the master station of the network module. (👉 Page 48 Module Parameter Settings)

## 4. Programming

Create the following programs.

- Inter-module synchronous interrupt program (I44)
- Program to set I44 to be interrupt-enabled using the EI instruction

In addition, to exchange the data used with the inter-module synchronization function between the multiple CPU systems, create a program for exchanging data.

## 5. RAS setting

If necessary, set to monitor the inter-module synchronous interrupt program's execution time. (👉 Page 69 Inter-module synchronous interrupt program execution time monitor)

## 6. Writing the parameters and programs

Write the parameters set with the engineering tool and the created program into the CPU module or remote head module\*1. (📖 GX Works3 Operating Manual) When using the multiple CPU system configuration, the parameter settings and program must be written into each CPU module for CPU No.2 to 4.

\*1 Programs cannot be written into the remote head module. Write programs to the CPU module on the master station.

## 7. Restarting the system

Restart the system with one of the following methods.

- Power OFF → ON → RUN
- Reset the CPU module or remote head module → RUN

### Point

---

To restart the system for coordinating the network synchronous communication function with the inter-module synchronous communication function, check the following:

- The cable is connected between the master station and local stations.
  - Start the master station and local stations simultaneously or start the master station before starting local stations.
- 

## 8. Monitoring and diagnosis

If necessary, check the operation of the inter-module synchronization function with the system monitor or the interrupt program monitor list for each CPU module. (☞ Page 67 Error Processing and Recovery Methods)

# MEMO

---



# 5 FUNCTION

This chapter describes the details of the inter-module synchronization function.

## 5.1 Fixed Cycle Synchronization Function

Multiple modules are synchronized at the inter-module synchronization cycle timing set with the parameters. The data is exchanged and the input/output is control at a fixed cycle. By using this function, the encoder input can be collected at a fixed-time so data is retrieved at an accurate speed. In addition, the input/output timing is accurately known so highly accurate model prediction control is possible.

### Timing for synchronizing CPU modules

The CPU modules execute an inter-module synchronous interrupt program at each inter-module synchronization cycle. (Page 24 Inter-module synchronous interrupt) The CPU module and each module are synchronized by refreshing. The refreshing is performed before or after the inter-module synchronous interrupt program. With this, the input data can be retrieved and the output data can be written at the inter-module synchronization cycle timing.

When using C Controller module, refer to the following manual.

 MELSEC iQ-R C Controller Module User's Manual (Application)

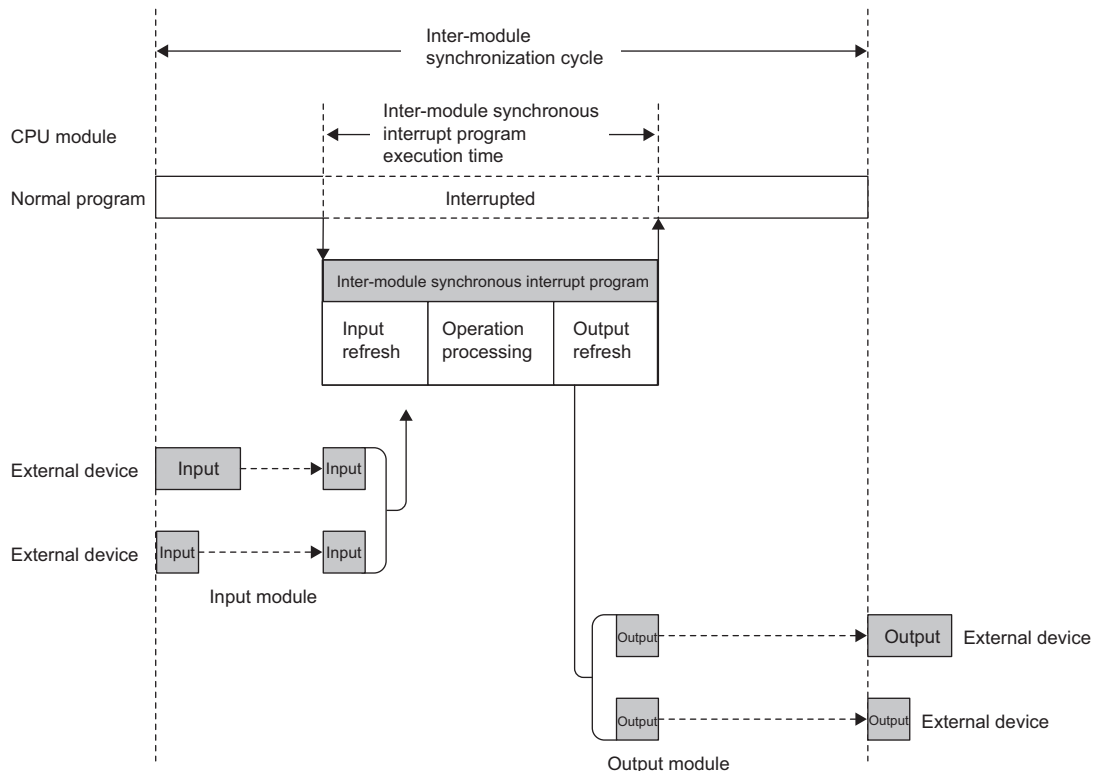

#### Point

- The input signals (X) and output signals (Y) of the CC-Link IE TSN master/local module, Motion module, and CC-Link IE Field Network module are refreshed at the END processing.
- The link devices (LB, LW) of the CC-Link IE TSN master/local module are refreshed at the END processing.
- For details on the refresh operation and settings, refer to each module's manual.

## Inter-module synchronous interrupt

The interrupt program is executed at the inter-module synchronization cycle timing set in the parameters. The interrupt program executed at each inter-module synchronization cycle is called the inter-module synchronous interrupt program. For details on the inter-module synchronous interrupt program, refer to the manual for each CPU module.

### Point

- Write the program for controlling the synchronization target in the inter-module synchronous interrupt program.
- The operation when an interrupt cause occurs and the methods such as creating the program are the same as a normal interrupt program.

### ■Execution timing

The inter-module synchronous interrupt program is executed at the inter-module synchronization cycle timing. The inter-module synchronization cycle can be changed with the parameter settings. ( Page 44 Inter-module Synchronization Setting)

### ■Multiple interrupt

For details on the inter-module synchronization (I44) multiple interrupt function, refer to the following.

 MELSEC iQ-R CPU Module User's Manual (Application)

## Refresh timing according to CPU module operation status

This section shows the refresh timing according to the CPU module operation status.

### Point

For C Controller module, the refresh timing is before and after an inter-module synchronous interrupt program since an inter-module synchronous interrupt program is executed even when the operating status of C Controller module is STOP. For more details, refer to the following manual.

 MELSEC iQ-R C Controller Module User's Manual (Application)

### ■Operation at STOP (RUN → STOP)

At STOP<sup>\*1</sup>, the CPU module stops the execution of the inter-module synchronous interrupt program, and turns the output OFF. Refreshing is executed even during STOP. Note that refreshing will not be executed the specified inter-module synchronization cycle (fixed cycle), but will be executed at the END process.

\*1 This includes CPU module stop errors.

### ■STOP → RUN operation<sup>\*1</sup>

The CPU module issues the inter-module synchronization start instruction to each module at the inter-module synchronization cycle after STOP → RUN. The inter-module synchronous interrupt program execution starts at the next inter-module synchronization cycle. The refresh timing changes from the END process to before and after the inter-module synchronous interrupt program.

\*1 The operation is the same at power-on → RUN.

# Timing to synchronize each module

This section shows the timing to synchronize each module.

## Input module

The input module retrieves the input module at the inter-module synchronization cycle start timing, and holds the input value during the inter-module synchronization cycle. (The input value is retrieved only once during the inter-module synchronization cycle.) By reading the input value (input signal) from the inter-module synchronous interrupt program, multiple modules can read the retrieved value at the same timing.

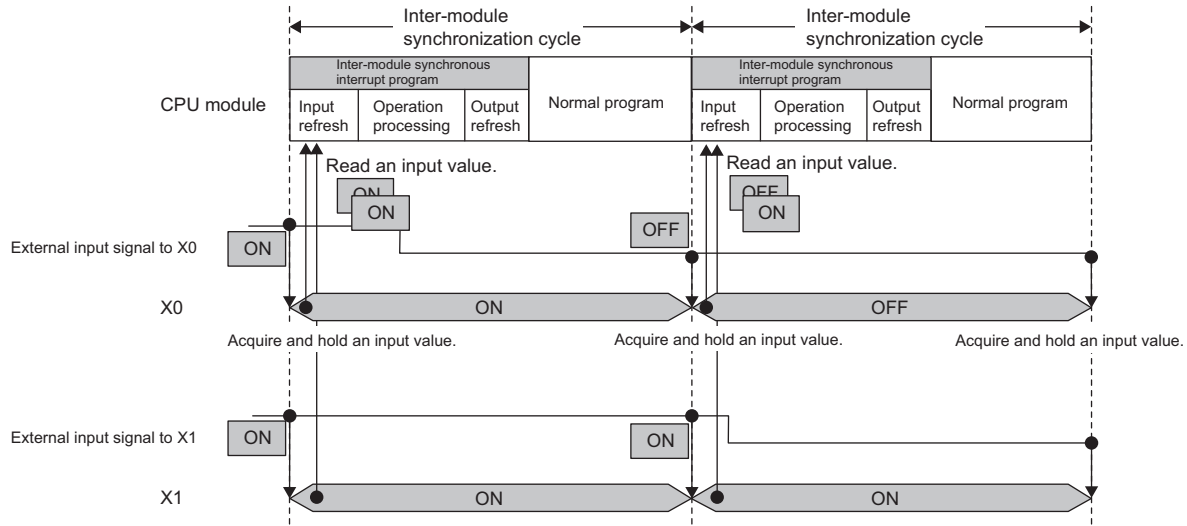

## A/D converter module

During the interval from the inter-module synchronization cycle start timing to execution of the inter-module synchronous interrupt program, the latest A/D conversion value is retrieved and stored in the synchronization latch digital operation value or synchronization digital output value. The synchronization latch digital operation value and synchronization digital output value are held during the inter-module synchronization cycle. By reading the synchronization latch digital operation value or synchronization digital output value from the inter-module synchronous interrupt program, multiple modules can read the A/D conversion value at the same timing.

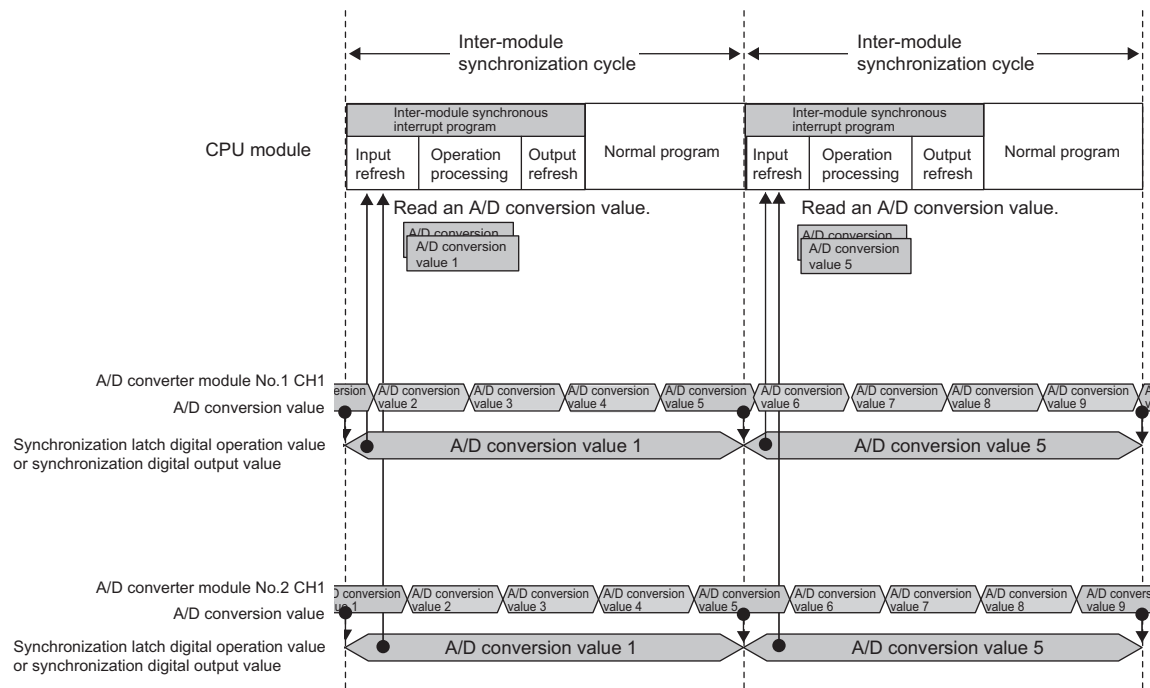

For details on the inter-module synchronization function in the A/D converter module, refer to the following.

Each A/D converter module manual

## High-speed counter module

The value is latched in synchronization with the falling edge of the inter-module synchronization control signal. The latched value is stored in the buffer memory. The normal count operation is executed even when using the inter-module synchronization signal. The latch target and storage destination buffer memory differ according to the operation mode.

Operation mode	Latch timing	Latch target	Storage location buffer memory name <sup>*1</sup>
Pulse count mode	Falling edge of inter-module synchronization control signal	Current counter value	Synchronization latch count value
Pulse measurement mode	Falling edge of inter-module synchronization control signal	Measured pulse value	Synchronization measured pulse value

\*1 The value is updated only at the falling edge of the inter-module synchronization control signal regardless of the ON/OFF state of the count enable instruction pulse measurement instruction.

### ■Pulse count mode (Synchronization latch counter function)

The latest current counter value is retrieved at the inter-module synchronization cycle start timing, and is held during the inter-module synchronization cycle. By reading the synchronization latch counter value from the inter-module synchronous interrupt program, multiple modules can read the retrieved current count value at the same timing.

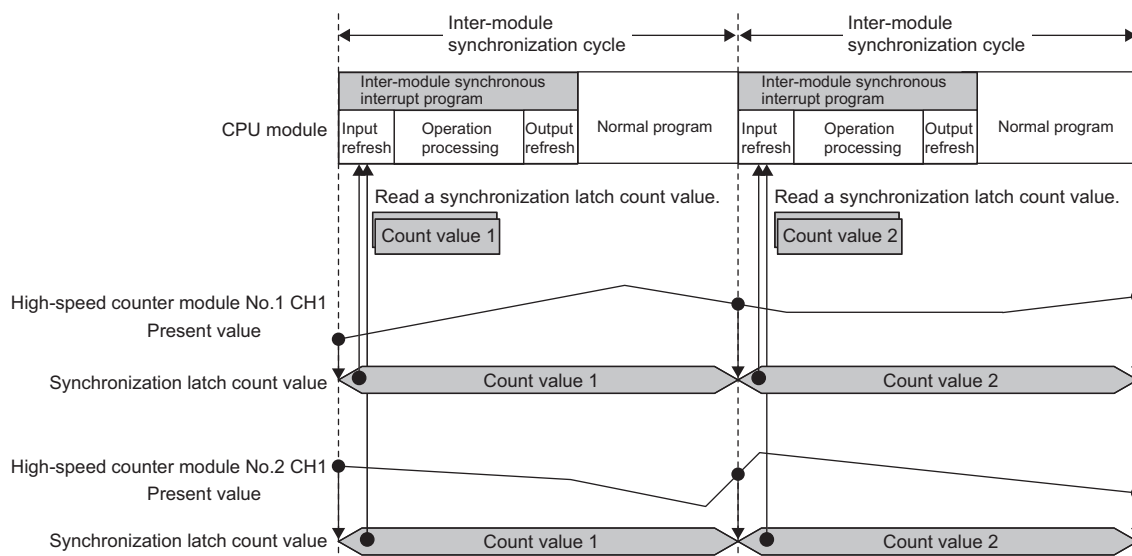

## ■ Pulse measurement mode (Synchronous pulse measurement function)

The pulse measurement value of the function input terminal's input pulse is retrieved at the inter-module synchronization cycle start timing. The pulse measurement interval can be selected from four patterns: ON width, OFF width, rising edge to rising edge, or falling edge to falling edge. (The synchronization latch pulse measurement value is updated only once during the inter-module synchronization cycle.) By reading the synchronization latch pulse measurement value from the inter-module synchronous interrupt program, the pulse measurement value of the input pulse just before the inter-module synchronization cycle is started can be read out.

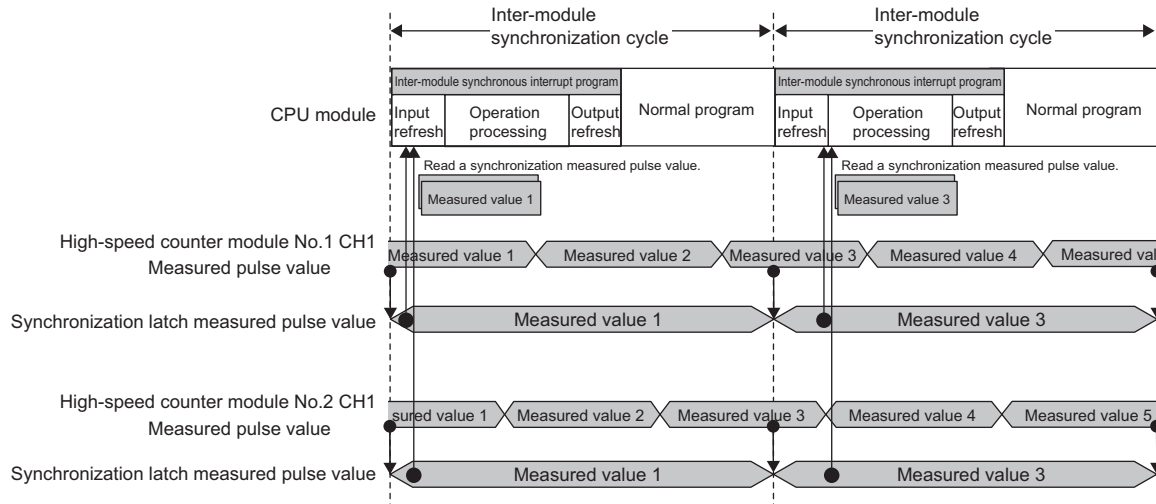

## Flexible high-speed I/O control module

The flexible high-speed I/O control module can synchronize external output timings by using the inter-module synchronization signal as a trigger. With this, command timings to external devices that are connected to more than one flexible high-speed I/O control module can be synchronized with each other, enabling simultaneous control of outputs more than the number that one module can use.

In addition, the count value and the High/Low status of external input signal at the latest synchronization cycle can be referred to in the inter-module synchronous interrupt program because a count value and an I/O status are refreshed to the CPU module by using the inter-module synchronization signal as a trigger.

The inter-module synchronization signal also can be output from an external output terminal. Using this output signal expands the targets of synchronization control to external devices that do not have the inter-module synchronization function.

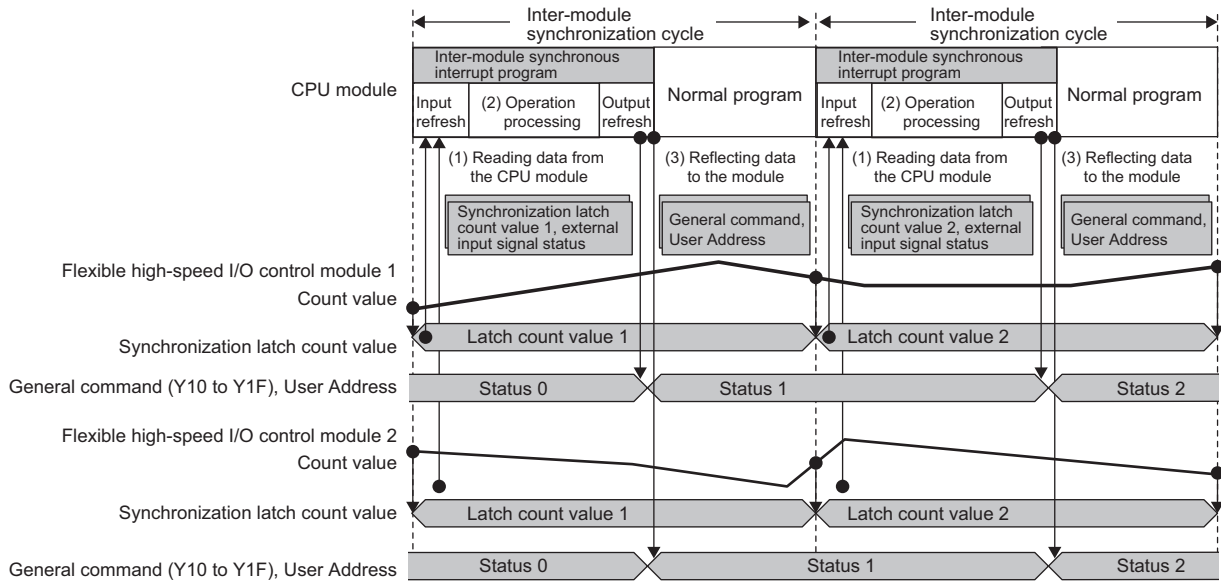

### Point

For details on the inter-module synchronization function in the flexible high-speed I/O control module, refer to the following.

Manual for each flexible high-speed I/O control module

## Output module

The output module's external output value (ON/OFF) is updated at the inter-module synchronization cycle start timing. (The output value is updated only once during the inter-module synchronization cycle.) By setting the output value from the inter-module synchronous interrupt program, several modules can output the setting value externally at the same value. The external output value is updated at the start timing of the inter-module synchronization cycle after the output that is set in the inter-module synchronous interrupt program.

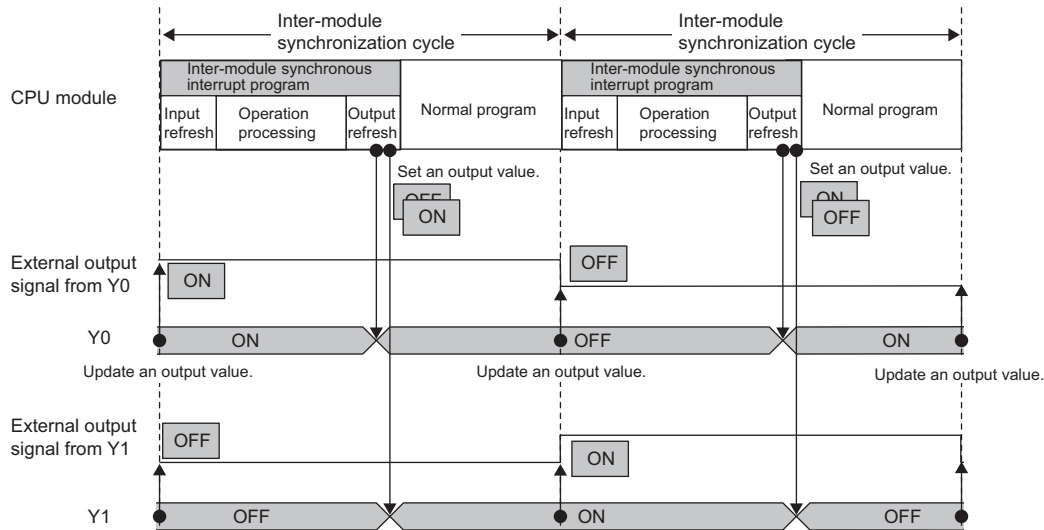

## D/A converter module

After execution of the inter-module synchronous interrupt program is completed, the output preparation process is executed using the digital value set in the D/A converter module. The analog signal is output at the start timing of the next inter-module synchronization cycle after the inter-module synchronization cycle. (The output preparation process is executed only once during the inter-module synchronization cycle.) By writing the digital value from the inter-module synchronous interrupt program to multiple D/A converter modules, multiple modules can output the analog signal at the same timing.

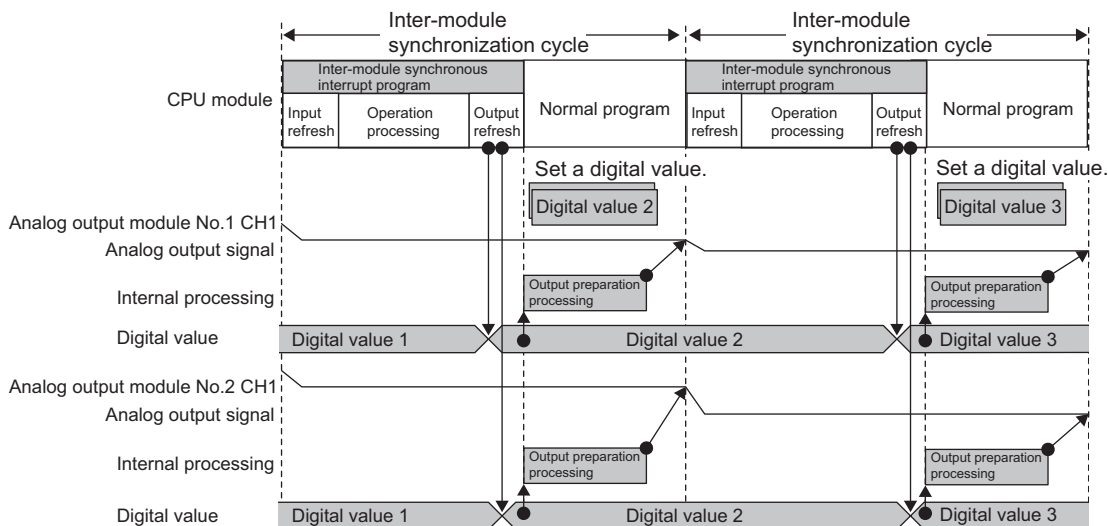

### Point

For details on the inter-module synchronization function in the D/A converter module, refer to the following.  
 Manual for each D/A converter module

### Precaution

If the inter-module synchronization cycle is too short and the output preparation process has not been completed by the start timing of the next inter-module synchronization cycle, the D/A converter module outputs an error.



## Positioning module, Simple Motion module, Motion module

The positioning starts at the start timing of inter-module synchronization cycle. Just after the positioning start command (either Positioning start signal or External command signal) turns on, the positioning data analysis starts. After the data analysis has been completed, the positioning starts at the next start timing of inter-module synchronization cycle.

**Ex.**

For the case when Positioning start signal turns on in the positioning module

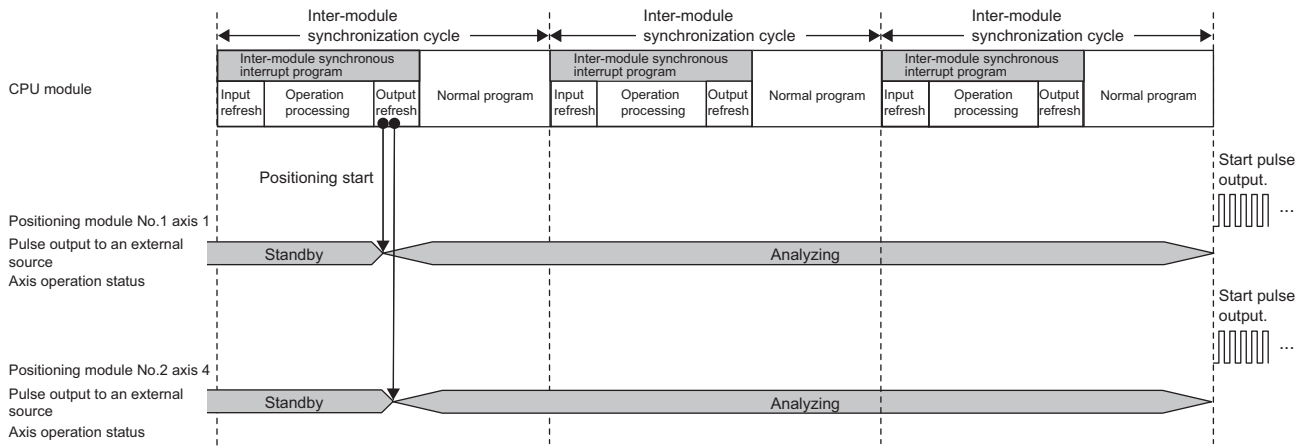

5

### Point

For details on the inter-module synchronization function of each module, refer to the following.

- 📖 MELSEC iQ-R Positioning Module User's Manual (Application)
- 📖 MELSEC iQ-R Simple Motion Module User's Manual (Application)
- 📖 MELSEC iQ-R Motion Module User's Manual (Application)
- 📖 MELSEC iQ-R Motion Module User's Manual (Application for Simple Motion Mode)

### Simple Motion module

For the RD77MS, there is no need to match the inter-module synchronization cycle to the simple motion operation cycle. Note that the buffer memory values are updated and referred to at the simple motion operation cycle. (Buffer memory values referred to are the values at the timing of read execution, not the values at the timing of refresh.)

Condition	Operation
When the inter-module synchronization cycle is shorter than the simple motion operation cycle	The monitor data is updated each simple motion operation cycle. For data such as the control data, if the data has turned on only for one scan of the inter-module synchronization cycle, this turning on may not be processed.
When the inter-module synchronization cycle is longer than the simple motion operation cycle	If the monitor data has changed for one simple motion operation cycle only, this data change may be omitted. For the RD77GF, the inter-module synchronization cycle is equal to the simple motion operation cycle.

Update timing of buffer memory values slightly vary depending on data types of the buffer memory areas.

For details on the update timing for each data type, refer to the following.

- 📖 MELSEC iQ-R Simple Motion Module User's Manual (Application)

### Motion module

The buffer memory values are updated and referred to at the buffer memory refresh cycle.

Condition	Operation
When the inter-module synchronization cycle is shorter than the buffer memory refresh cycle	The monitor data is updated each buffer memory refresh cycle. For data such as the control data, if the data has turned on only for one scan of the inter-module synchronization cycle, this turning on may not be processed.
When the inter-module synchronization cycle is longer than the buffer memory refresh cycle	If the monitor data has changed for one buffer memory refresh cycle only, this data change may be omitted.

## Remote head module

The remote head module receives the inter-module synchronization timing from the master station to perform each refreshing according to the inter-module synchronization cycle and transfer the timing to the mounted modules.

With this, the input data can be retrieved and the output data can be written at the same inter-module synchronization cycle timing as that of the system of the master station.

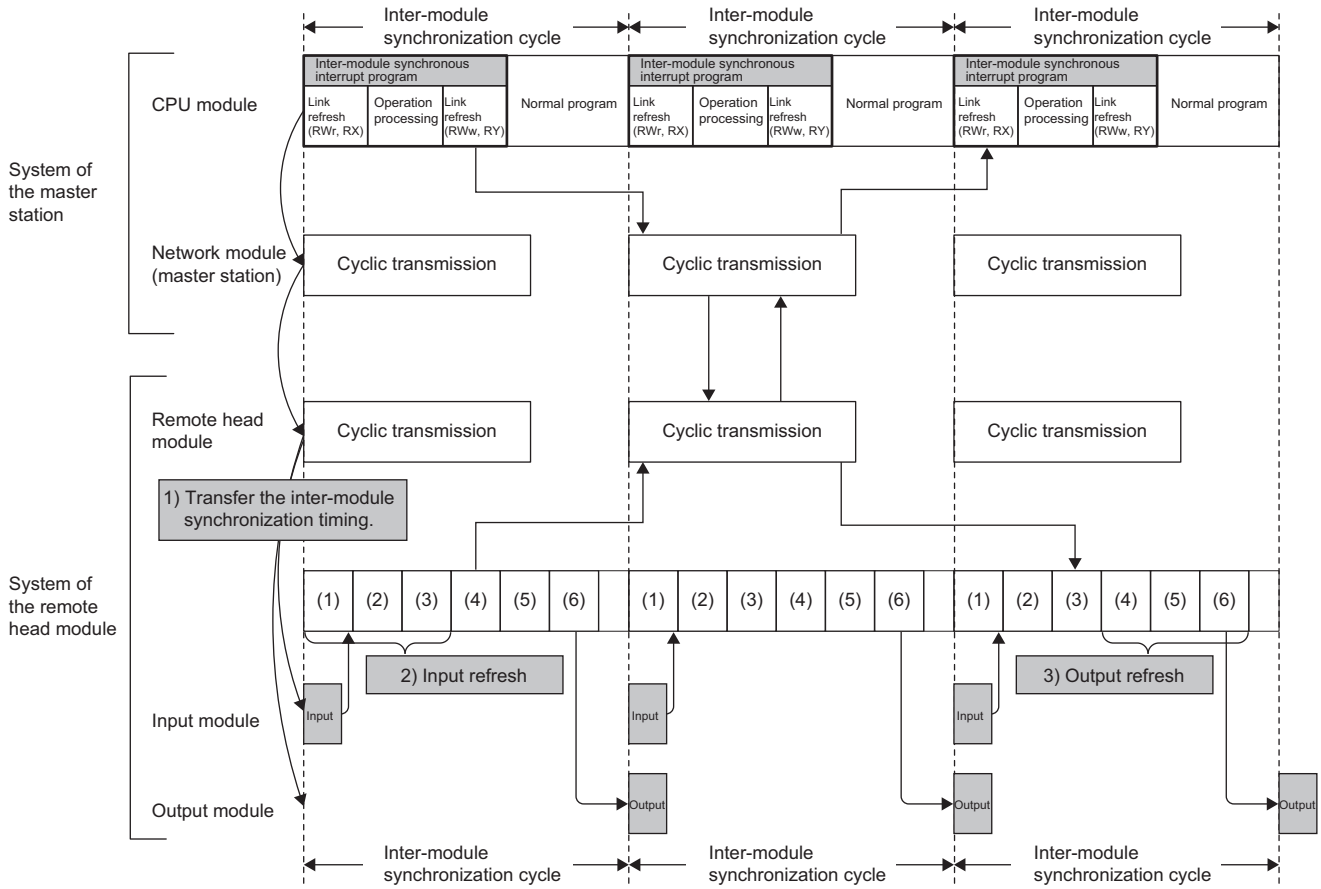



- (1) Input refresh
- (2) Intelligent function module refresh (transfer to the CPU module)
- (3) Link refresh (RW<sub>w</sub>, RY)
- (4) Link refresh (RW<sub>r</sub>, RX)
- (5) Intelligent function module refresh (transfer to the intelligent function module)
- (6) Output refresh

The following table shows details of the data refreshed according to the inter-module synchronization.

Item	Refresh operation	Device	Remarks
Input	Input refresh	X	Refreshes only the items assigned to the target modules of the inter-module synchronization.
	Intelligent function module refresh	Buffer memory (transfer to the CPU module)	Refreshes only the items of the inter-module synchronization function.
	Link refresh	RW <sub>r</sub> , RX	Refreshes all the signals set on the master station.
Output	Output refresh	Y	Refreshes only the items assigned to the target modules of the inter-module synchronization.
	Intelligent function module refresh	Buffer memory (transfer to the intelligent function module)	Refreshes only the items of the inter-module synchronization function.
	Link refresh	RW <sub>w</sub> , RY	Refreshes all the signals set on the master station.

**Point** 



- The inter-module synchronization timing is adjusted to the inter-module synchronization timing of the master station by coordinating the inter-module synchronization function with the CC-Link IE Field Network synchronous communication function. Therefore, the CC-Link IE Field Network synchronous communication function must be set to use the inter-module synchronization function. ( Page 48 Module Parameter Settings)
- If the remote head module is disconnected, it cannot receive synchronous signals from the master station. This state generates an error in the remote head module and stops the cyclic transmission, inter-module synchronization, and CC-Link IE Field Network synchronous communication. After the remote head module is returned, reset the module. ( Page 57 Program)

**■Cyclic transmission in master station and remote head module**

It takes two inter-module synchronization cycles for the remote head module's input/output refreshing state to be sent.

To synchronize the input/output refreshing between the master station and remote head module, the master station's input/output refreshing must be delayed by two inter-module synchronization cycles.

**Point** 

An inter-module synchronization function FB is provided to absorb the two-cycle input/output difference. Use the inter-module synchronization function FBs to create a program to delay the master station's input/output refreshing by two inter-module synchronization cycles. ( Page 53 Program,  MELSEC iQ-R CPU Module Function Block Reference)

# Coordination with multiple CPU system function's fixed scan communication cycle

The fixed scan communication cycle for the multiple CPU system function can be set to the inter-module synchronization cycle.

When using C Controller module, refer to the following manual.

 MELSEC iQ-R C Controller Module User's Manual (Application)

## Programmable controller CPU

By setting the fixed scan communication cycle for the multiple CPU system function to the inter-module synchronization cycle, modules with different control CPUs can input and output in synchronization. Coordination with the fixed scan communication cycle for the multiple CPU system function is set with the parameters. ( Page 47 Multiple CPU Settings)

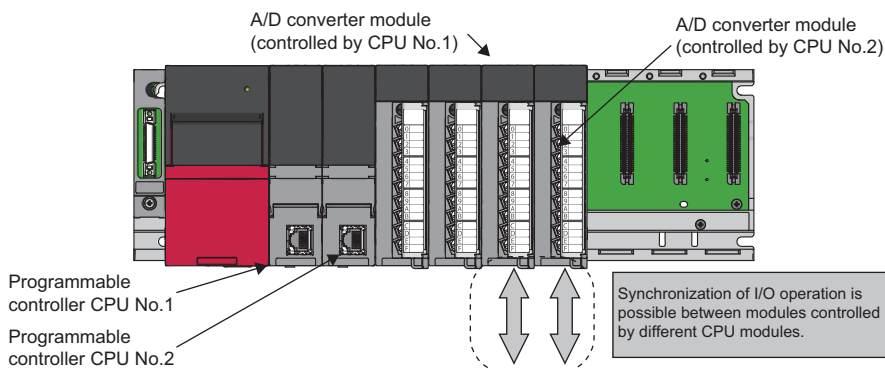

### Point

For details on the multiple CPU system function, refer to the following.

 MELSEC iQ-R CPU Module User's Manual (Application)

## Program operation

When the inter-module synchronization cycle is coordinated with the fixed scan communication cycle for the multiple CPU system function, the multiple CPU synchronous interrupt program (I45) and inter-module synchronous interrupt program (I44) are executed between the inter-module synchronization cycles. The programs are executed in the order of multiple CPU synchronous interrupt program (I45) and inter-module synchronous interrupt program (I44). It takes two inter-module synchronization cycles for the host CPU module's retrieval data to reach another CPU module. To synchronize the output between the CPU modules, the output timing from the host's control module must be delayed by two inter-module synchronization cycles.

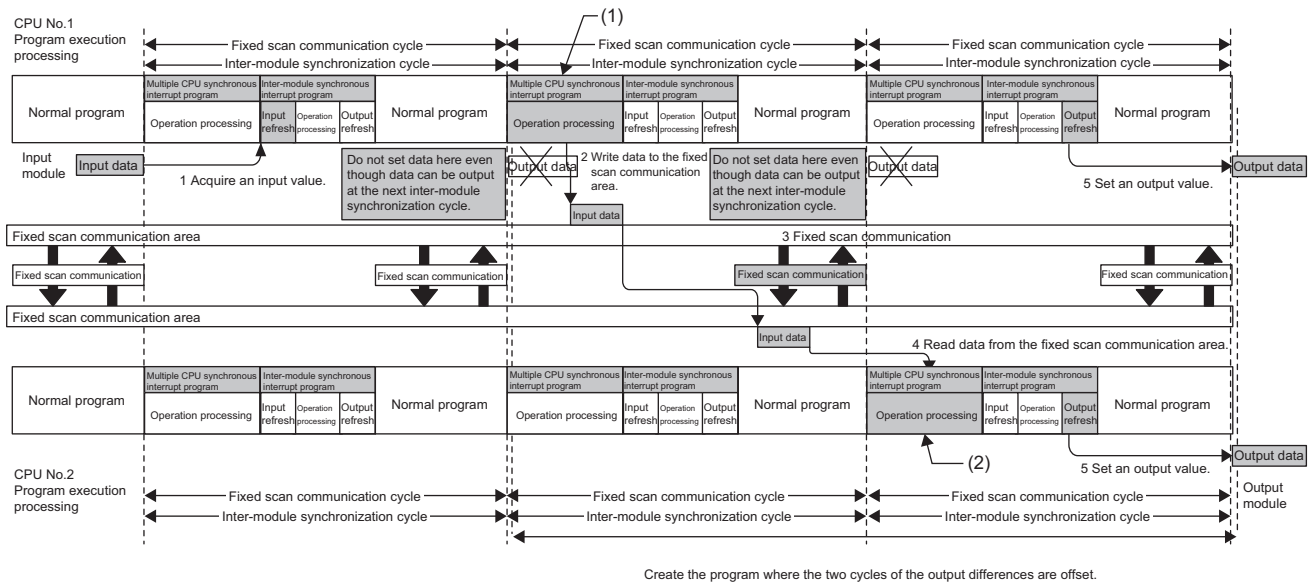

Create the program where the two cycles of the output differences are offset.

- (1) Write the input value into the CPU No.1's fixed scan communication area.
- (2) Read the CPU No.1's fixed scan communication area, and set the output value.

**Point**

An inter-module synchronization function FB is provided to absorb the two-cycle output difference. To delay the output timing of the host's control module by two inter-module synchronization cycles, create a program using the inter-module synchronization function's FB. (MELSEC iQ-R CPU Module Function Block Reference)

## ■Precautions

This section describes the precautions for coordinating with the multiple CPU system function's fixed scan communication cycle.

- Even if the input/output settings for other than the group are enabled with another CPU module's program, the input or output cannot be retrieved from the synchronization target's module. Data can be read with direct specifications such as the DX, DY, Un\Gn or FROM instructions, but the data might be inconsistent.
- To synchronize the start timings of inter-module synchronization function for all CPU modules and all stations, set the CPU parameter to synchronize the rising of each module, and set the system parameter to synchronize the rising of all CPU modules.
- By setting "Fixed Scan Communication Function and Inter-module Synchronization Function" to "Cooperate" in multiple CPU setting of system parameter, the fixed scan communication cycle of multiple CPU system function operates according to the inter-module synchronization cycle of the inter-module synchronization function, and the both functions are controlled to operate at the same timing. (In this case, the fixed scan communication cycle of multiple CPU system function cannot be set.) Note that the number of program executions is different even though "Cooperate" is set in multiple CPU setting of system parameter, because the start timings of interrupt program executions are different between the inter-module synchronous interrupt (I44) and the multiple CPU synchronous interrupt (I45). For details on the start timings, refer to Page 24 Refresh timing according to CPU module operation status. For details on the operations of interrupt programs (such as during interrupt disabled time), refer to the MELSEC iQ-R CPU Module User's Manual (Application).
- Control with synchronized timing is not possible without synchronizing with the inter-module synchronization function even if the same value is set for the multiple CPU system function's fixed scan communication cycle and the inter-module synchronization cycle.

## Motion CPU

The execution timing for the motion operation or motion SFC event task (fixed cycle task) is as follows when the multiple CPU system function's fixed scan communication cycle or inter-module synchronization cycle is used.

Item	Inter-module synchronization cycle				
	Disable		Enable		
			Do not synchronize with the selected inter-module synchronization target module	Synchronize with the selected inter-module synchronization target module	
Fixed scan communication cycle for multiple CPU system function	Disable		Cycle unique to Motion CPU		Synchronization with inter-module synchronization cycle*1
	Enable	Do not synchronize with inter-module synchronization cycle	Fixed scan communication cycle for multiple CPU system function*1 (☞ Page 37 Timing example 1)		Error occurs
		Synchronize with inter-module synchronization cycle	Setting not possible	Multiple CPU system function's fixed scan communication cycle = synchronization with inter-module synchronization cycle*1 (☞ Page 38 Timing example 2, ☞ Page 38 Timing example 3)	

\*1 When the motion operation cycle and the multiple CPU system function's fixed scan communication cycle or inter-module synchronization cycle differ, the start timing of the longer cycle is always synchronized with the start timing of the shorter cycle.

### Ex.

When using the following setting with programmable controller CPU (CPU No.1) and Motion CPU (CPU No.2)

- Inter-module synchronization cycle = 1.00ms, multiple CPU system function's fixed scan communication cycle = 0.888ms
- Set the Motion CPU (CPU No.2) to "Do Not Synchronize" in the inter-module synchronization target module selection

The communication cycle of the programmable controller CPU (CPU No.1) and Motion CPU (CPU No.2) multiple CPU synchronous interrupt program (I45) and CPU buffer memory access device (U3En\HGn) is a 0.888ms cycle.

The programmable controller CPU (CPU No.1) inter-module synchronous interrupt program (I44) has a 1.00ms cycle.

The Motion CPU operation cycle is a cycle synchronized to 0.888ms.

### ■Timing example 1

Synchronization with multiple CPU system function's fixed scan communication cycle

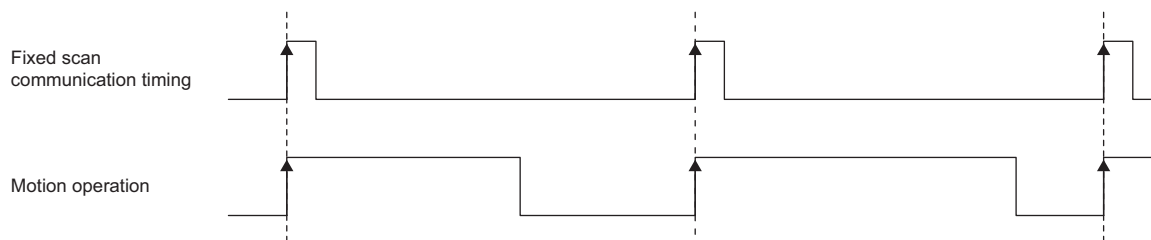

## ■Timing example 2

When motion operation cycle and inter-module synchronization cycle are equal

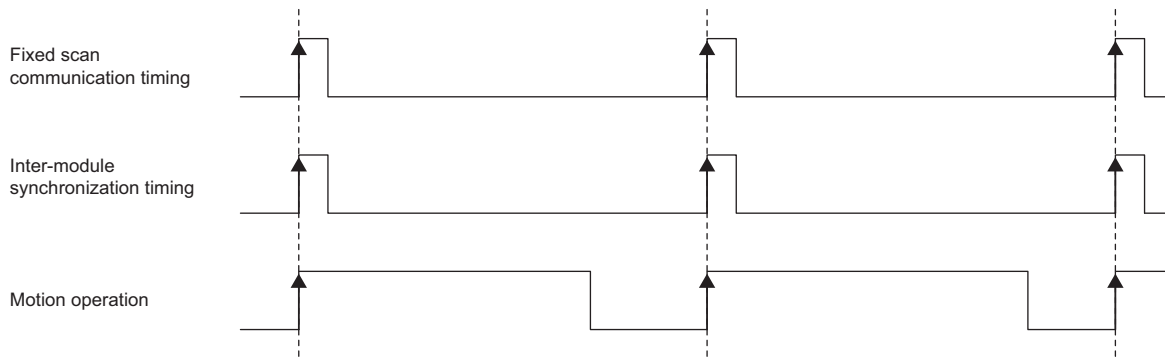

## ■Timing example 3

When motion operation cycle is double the inter-module synchronization cycle

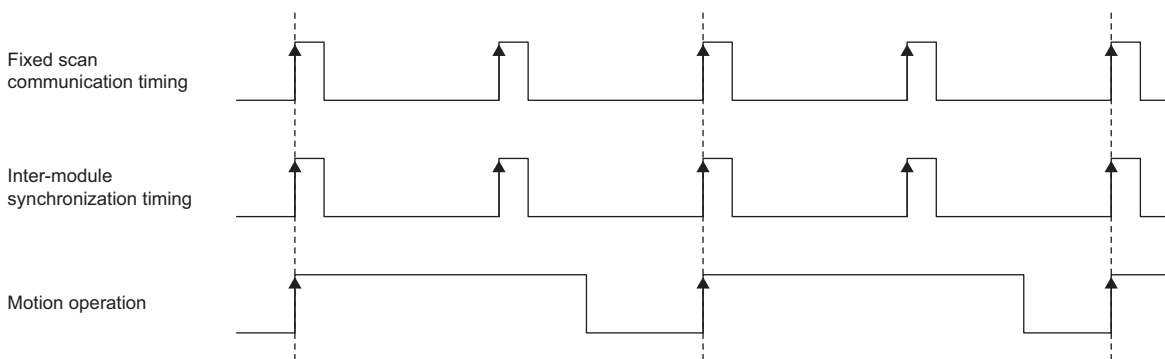



For details on the inter-module synchronization function in the Motion CPU, refer to the following.  
📖 Manual for Motion CPU



## Network synchronous communication function

---

For synchronization with the inter-module synchronization cycle using the following network synchronous communication functions, the parameters of the master station must be set.

- CC-Link IE TSN network synchronous communication function (  Page 49 Settings for CC-Link IE TSN)
- CC-Link IE Field Network synchronous communication function (  Page 50 Settings in CC-Link IE Field Network)

### **Restriction**

---

The CC-Link IE Field Network synchronous communication function cannot be used with a redundant system station.

---

### **Point**

- When the system is powered off and on or the CPU module or the remote head module on the local station is reset and set in RUN state, if these modules cannot receive the synchronous signal from the master station, they become a waiting state for synchronization.
  - These modules cannot perform the network communications or communications with external devices because they are in the initial processing state until they receive the synchronous signal from the master station or the waiting state for synchronization times out.
  - If an error caused by a parameter mismatch (inter-module synchronization cycle mismatch (error code: 3600H) or inter-module synchronization target mismatch (error code: 3601H)) has been detected between the master station and a local station on CC-Link IE TSN, it may take longer for the CPU module on the local station to start up.
-

## Master station and local station network synchronous communication

### ■When using the CC-Link IE TSN network synchronous communication function

The CC-Link IE TSN network synchronous communication function performs time synchronization by synchronizing between the master station and the local station. The local station sends the inter-module synchronization cycle timing to each module in its own station based on the synchronized time.

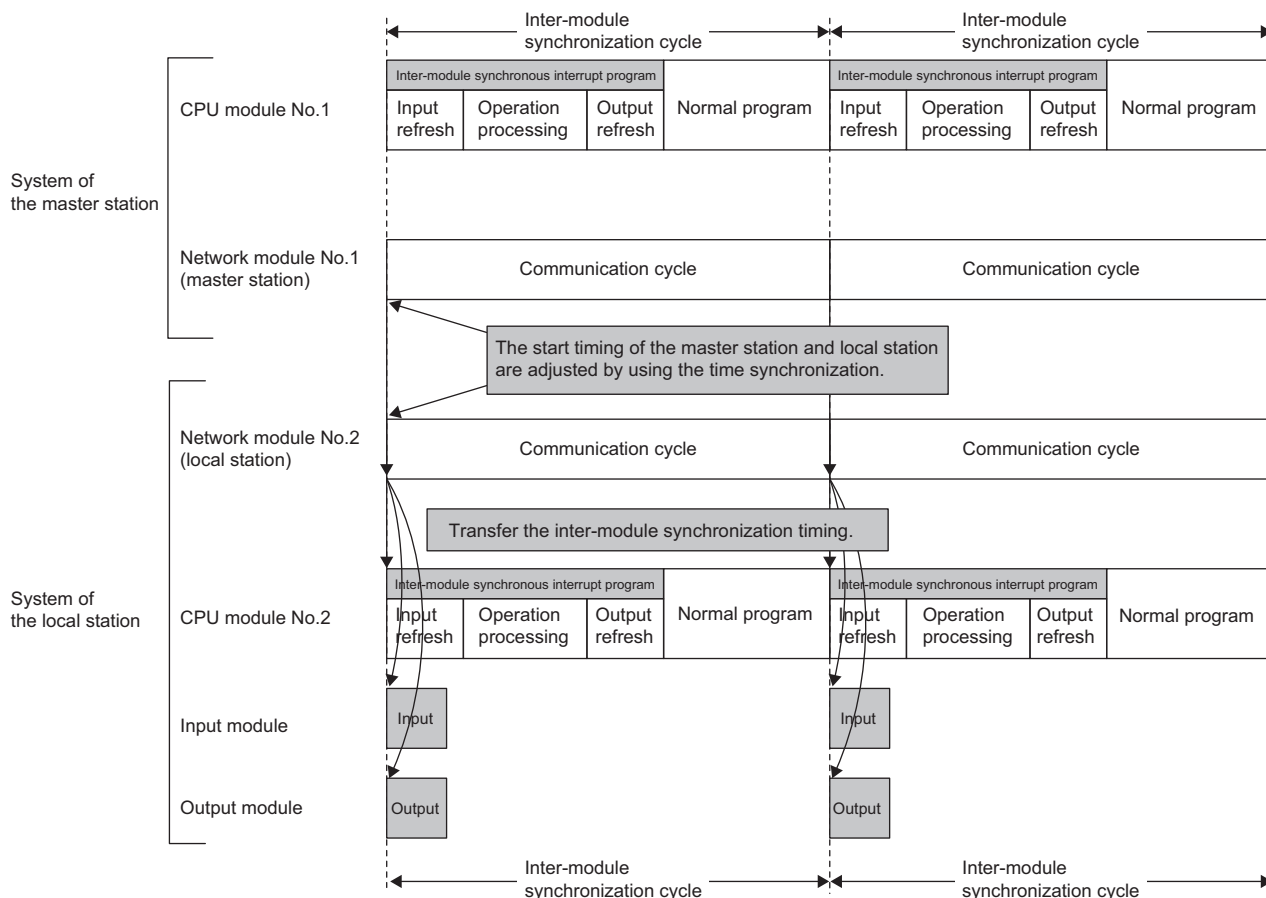

#### Point

If the local station is disconnected, time synchronization with the master station becomes impossible and this causes an error at the local station.

When the error is detected, the CPU module either continues or stops the operation according to the "Synchronous Interrupt Execution Interval Error (CPU Module)" setting.

If the CPU module continues to operate, the inter-module synchronization in the local station continues.

However, the CC-Link IE TSN network synchronous communication stops. If the CPU module stops operating, both the CC-Link IE TSN network synchronous communication and the inter-module synchronization in the local station stop. Regardless of whether the CPU module continues or stops the operation, reset the CPU module of the local station to perform normal synchronization with the master station after the local station is returned. (🔧 Page 64 Program)

### ■When using the CC-Link IE Field Network synchronous communication function

With the CC-Link IE Field Network synchronous communication function, the inter-module synchronization timing for the system in the master station is sent to the slave station via the network. The local station sends the inter-module synchronization cycle timing to each module in its own station.

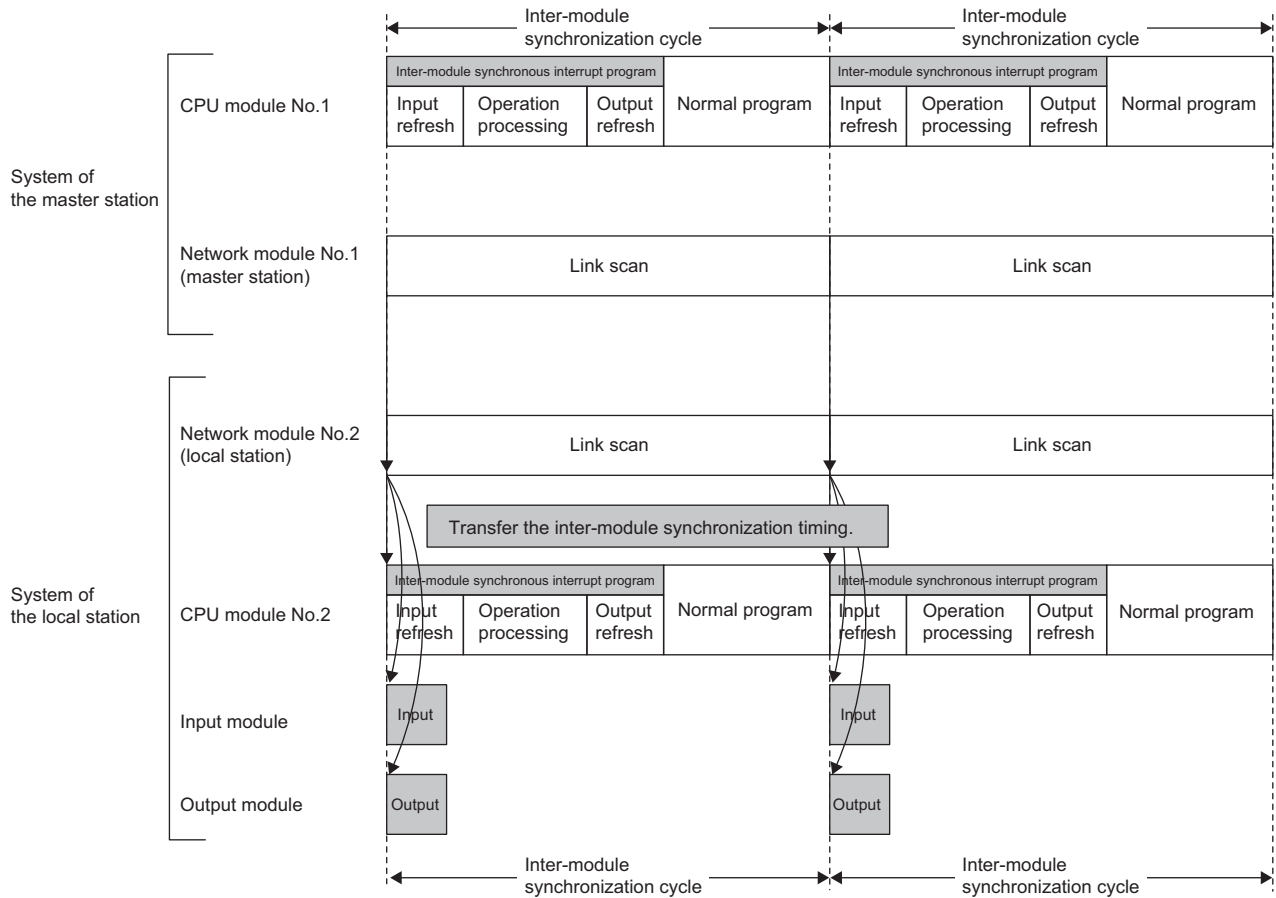

**Point**

If the local station is disconnected, the disconnected station cannot receive synchronous signals from the master station and this causes an error at the local station. When the error is detected, the CPU module either continues or stops the operation according to the "Synchronous Interrupt Execution Interval Error (CPU Module)" setting.

When the CPU module continues to operate, the inter-module synchronization in the local station continues. However, the CC-Link IE Field Network synchronous communication stops. When the CPU module stops operating, both the CC-Link IE Field Network synchronous communication and the inter-module synchronization in the local station stop. Regardless of whether the CPU module continues or stops the operation, reset the CPU module of the local station to perform normal synchronization with the master station after the local station is returned. ( Page 57 Program)

## ■Cyclic transmission in master station and local station

It takes two inter-module synchronization cycles for the local station's input/output refreshing state to be sent. To synchronize the input/output refreshing between the master station and local station, the master station's input/output refreshing must be delayed by two inter-module synchronization cycles.

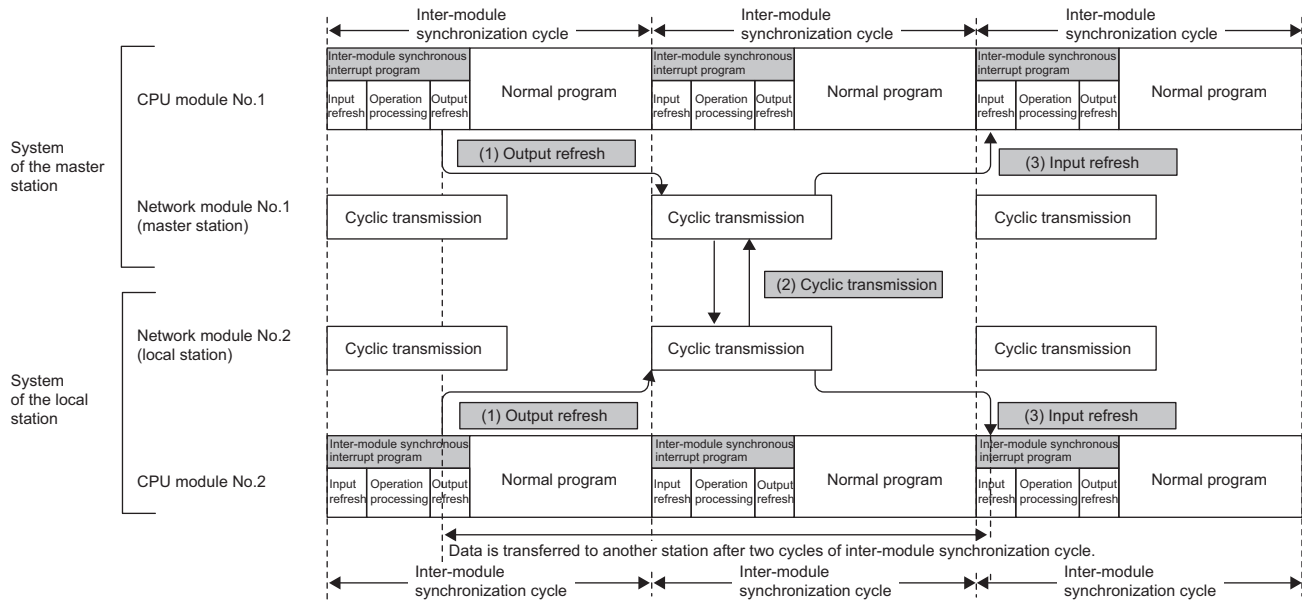

- (1) Data refreshing is executed from the CPU module to network module 1 with the output refresh processing of the inter-module synchronous interrupt program.
- (2) In the next inter-module synchronization cycle following step (1) above, the data refreshed in (1) is transferred to other stations by cyclic transmission.
- (3) The data transferred in step (2) above during the input refresh processing of the inter-module synchronous interrupt program of the next inter-module synchronization cycle following step (2) is refreshed from network module 2 to the CPU module.

### Point

An inter-module synchronization function FB is provided to absorb the two-cycle input/output difference. Use the inter-module synchronization function FBs to create a program to delay the master station's input/output refreshing by two inter-module synchronization cycles. (👉 Page 53 Program, 📖 MELSEC iQ-R CPU Module Function Block Reference)

## Network synchronous communication with slave station

Using the network synchronous communication function, other slave stations connected in the same network can be operated in synchronization with the inter-module synchronization cycle.

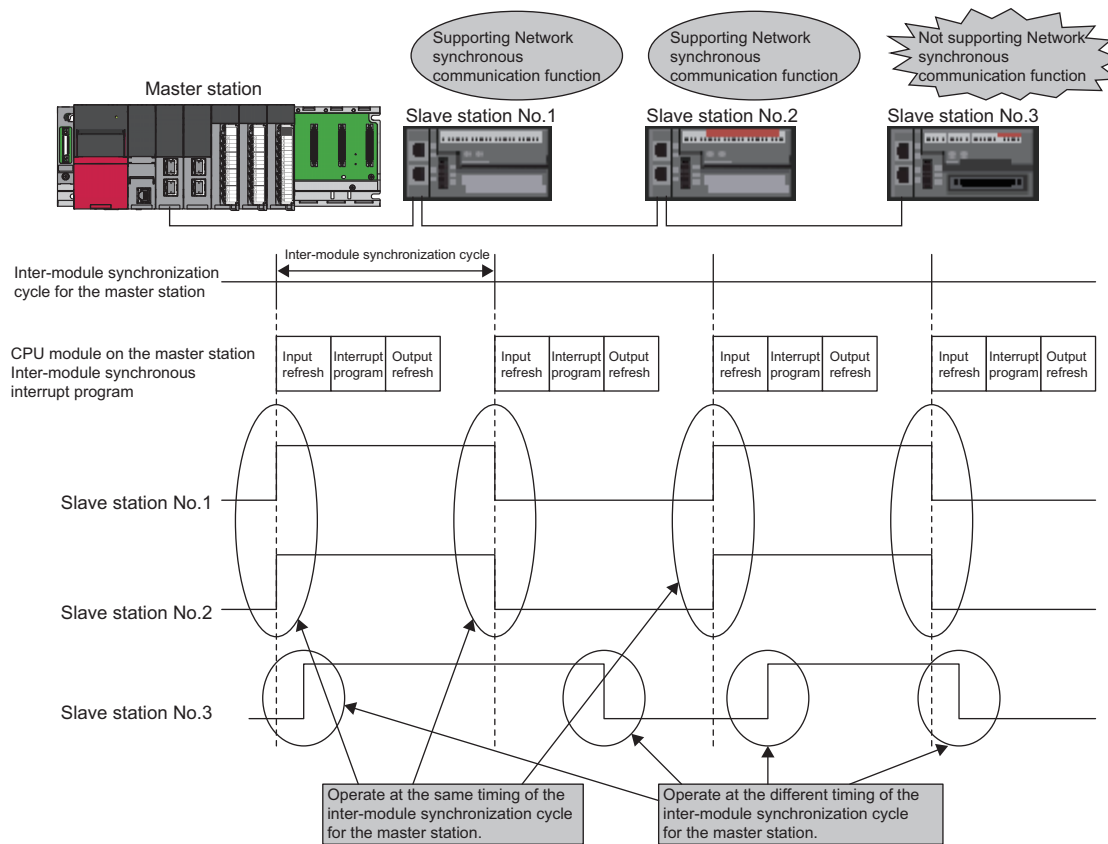

### Point

- For details on the network synchronous communication function with the local station, refer to the following.  
 📖 Page 40 Master station and local station network synchronous communication
- For details on the network synchronous communication function with the slave station, refer to the following.  
 📖 Manual for each slave station
- For details on the CC-Link IE Field Network synchronous communication function with the remote head module, refer to the following.  
 📖 Page 32 Remote head module
- If a local station and a slave station other than the remote head module is disconnected, the synchronous signal cannot be received from the master station and the slave station waits for synchronization. After that, when the slave station is returned, the synchronization automatically restarts.

# 6 PARAMETER SETTINGS

This chapter describes the parameter settings required to use the inter-module synchronization function.

## 6.1 Inter-module Synchronization Setting

Set the module configuration diagram with the engineering tool, and set the inter-module synchronization settings.

 [System Parameter] ⇨ "Inter-module Synchronization Setting" ⇨ "Inter-module Synchronization Setting"

### Operating procedure

"Inter-module Synchronization Setting" window

Item	Setting
Inter-module Synchronization Setting	
Use Inter-module Synchronization Function in System	Use
Select Inter-module Synchronization Target Module	<Detailed Setting>

"Select the Synchronous Target Module" window

Slot	Module Name	Management	Master/Local	Setting
<b>Main</b>				
CPU	R04CPU(Host Station)	1PLC controlled		Synchronize
CPU	R08CPU	2PLC No.		Synchronize
1(0-1)	RX10	1PLC controlled		Synchronize
2(0-2)	RY10R2	1PLC controlled		Synchronize
3(0-3)	RD77MS2	1PLC controlled		Synchronize

"Inter-module Synchronization Setting" window

Item	Setting
Fixed Scan Interval Setting of Inter-module Synchronization	
0.05ms Unit Setting	Set
Fixed Scan Interval Setting (Not set in 0.05ms unit)	0.888ms
Fixed Scan Interval Setting (Set in 0.05ms unit)	0.50 ms

"Inter-module Synchronization Setting" window

Item	Setting
Inter-module Synchronization Master Setting	
Synchronization Master Settings of CC IE TSN/CC IE Field	Set
Mounting Slot No.	0

1. Select "Use" for "Use Inter-module Synchronization Function in System".
2. Click "Detailed Setting" at "Select Inter-module Synchronization Target Module".
3. The modules set in the module configuration diagram appear. Set "Synchronize" in the setting field for the synchronization target module.
4. Set the inter-module synchronization cycle at "Fixed Scan Interval Setting of Inter-module Synchronization".
5. When writing the parameters, write in both the system parameters and module parameters.
6. To use one of the following module as the synchronization target module, set the inter-module synchronous master.\*2
  - CC-Link IE TSN master/local module (master station/local station)
  - Motion module
  - CC-Link IE Field Network-equipped master/local module (local station)\*1

\*1 When a project is created with the remote head module, the setting is not available.

\*2 For the modules to be set as inter-module synchronous master, refer to the following.

 Page 11 Inter-module Synchronous Master

## Displayed items

Item	Description	Setting range	Default	
Use Inter-module Synchronization Function in System	Sets whether to use the inter-module synchronization function.	<ul style="list-style-type: none"> <li>• Not Use</li> <li>• Use</li> </ul>	Not Use	
Select Inter-module Synchronization Target Module	Detailed Setting Sets the module to be synchronized. <ul style="list-style-type: none"> <li>• Only one local station of the network module can be set for synchronization.</li> <li>• When a local station of the network module is set for synchronization, the master station of the network module cannot be set for synchronization. (☞ Page 15 Restrictions)</li> <li>• For the devices that can be set for synchronization, refer to the following. (☞ Page 16 Configuration Devices)</li> </ul>	<ul style="list-style-type: none"> <li>• Do Not Synchronize</li> <li>• Synchronize</li> </ul>	Do Not Synchronize	
Fixed Scan Interval Setting of Inter-module Synchronization	0.05ms Unit Setting	Sets whether to set the inter-module synchronization cycle in 0.05ms units.	<ul style="list-style-type: none"> <li>• Not Set</li> <li>• Set</li> </ul>	Set
	Fixed Scan Interval Setting (Not set in 0.05ms unit)	When not setting in 0.05ms units, select the inter-module synchronization cycle from the options.*3	<ul style="list-style-type: none"> <li>• 0.222ms<sup>*5*6</sup></li> <li>• 0.444ms<sup>*5*6</sup></li> <li>• 0.888ms<sup>*6</sup></li> <li>• 1.777ms</li> <li>• 3.555ms</li> <li>• 7.111ms</li> </ul>	<ul style="list-style-type: none"> <li>• Safety CPU: 7.111ms</li> <li>• CPU modules other than the above: 0.888ms</li> </ul>
	Fixed Scan Interval Setting (Set in 0.05ms unit)	When setting in 0.05ms units, set the inter-module synchronization cycle.*3*7	<ul style="list-style-type: none"> <li>• R00CPU, R01CPU, R02CPU: 0.50 to 10.00ms</li> <li>• Safety CPU: 1.00 to 10.00ms</li> <li>• CPU modules other than the above: 0.10 to 10.00ms</li> </ul>	<ul style="list-style-type: none"> <li>• Safety CPU: 5.00ms</li> <li>• CPU modules other than the above: 0.50ms</li> </ul>
Inter-module Synchronization Master Setting*4	Synchronization Master Settings of CC IE TSN/CC IE Field	<p>■When "Set" is selected Select this to set the network module as the inter-module synchronous master. Select this if one of the following module is set as the inter-module synchronization target module.</p> <ul style="list-style-type: none"> <li>• CC-Link IE TSN master/local module (master station/local station)</li> <li>• Motion module</li> <li>• CC-Link IE Field Network-equipped master/local module (local station)</li> </ul> <p>■When "Not Set" is selected Select this if not setting the network module as the inter-module synchronous master. When this setting is selected, the CPU module (the leftmost CPU module in a multi-CPU system configuration) becomes the inter-module synchronous master.</p>	<ul style="list-style-type: none"> <li>• Not Set</li> <li>• Set</li> </ul>	Not Set
	Mounting Slot No.	<ul style="list-style-type: none"> <li>• This setting is enabled when "Set" is selected for "Synchronization Master Settings of CC IE TSN/CC IE Field".</li> <li>• Set the mounting slot No. for the network module to be set as the inter-module synchronous master. (☞ Page 11 Inter-module Synchronous Master)</li> </ul>	0 to 11	0

\*3 The inter-module synchronization cycle setting range differs according to the module. (☞ Manual for each module)

\*4 When a project is created with the remote head module, the setting is not available.

\*5 This item is not displayed for the R00CPU, R01CPU, and R02CPU.

\*6 This item cannot be specified for the Safety CPU.

\*7 For CC-Link IE TSN, set this setting value and the "Communication Period Setting" in "Basic Settings" in the module parameters to the same cycle.

## Setting the mounting slot No.

The setting of the mounting slot No. differs depending on which module becomes the inter-module synchronization master. Check which module will become the inter-module synchronous master. (  Page 11 Inter-module Synchronous Master) The settings of the mounting slot No. are shown below.

Module to become the inter-module synchronous master	Synchronous master setting of CC IE TSN/CC IE Field	Mounting slot No.
CPU module	"Not Set"	Cannot be set.
CC-Link IE TSN master/local module (master station), Motion module	"Set"	Set the mounting slot No. for the module to become the inter-module synchronous master.
CC-Link IE TSN master/local module (local station)		
CC-Link IE Field Network-equipped master/local module (local station)		

### Point

If a network module that can be set as the inter-module synchronous master is not mounted on the same base unit, the CPU module will become the synchronous master and therefore the setting of the mounting slot No. is not required.



## 6.2 Multiple CPU Settings

Set when coordinating the inter-module synchronization cycle to the multiple CPU system function's fixed scan communication cycle.

 [System Parameter] ⇒ [Multiple CPU Setting] ⇒ [Communication Setting between CPUs] ⇒ [Fixed Scan Communication Setting]

### Window

Item	Setting
Fixed Scan Interval Setting of Fixed Scan Communication	
0.05ms Unit Setting	Not Set
Fixed Scan Interval Setting (Not set in 0.05ms unit)	-----
Fixed Scan Interval Setting (Set in 0.05ms unit)	-----
Fixed Scan Communication Function and Inter-module Synchron	Cooperate

### Displayed items

Item	Description	Setting range	Default
Fixed Scan Interval Setting of Fixed Scan Communication	Fixed Scan Communication Function and Inter-module Synchronization Function	<ul style="list-style-type: none"> <li>Cooperate</li> <li>Not Cooperated</li> </ul>	Not Cooperated

6

### Point

When set to "Cooperate", the fixed scan communication cycle of multiple CPU system function operates according to the inter-module synchronization cycle. (The fixed scan interval setting in the fixed scan communication setting cannot be set.)

## 6.3 Module Parameter Settings

By setting the module parameters, the modules compatible with the network synchronous communication function can be synchronized with the inter-module synchronization cycle.

 [Module Parameter] ⇒ "Basic Settings" ⇒ "Network Configuration Settings" ⇒ "Detailed Setting"

### Point

- Set the link device assignments to be made in the network configuration settings so the network synchronous communication target station and non-target station are in succession. If not, the time for the refreshing process at the inter-module synchronization interrupt will take longer.

No.	RX/RX Setting		RWw/RWr Setting		Network Synchronous Communication
	Start	End	Start	End	
0					
1	0000	00FF	0000	00FF	Synchronous
2	0100	01FF	0100	01FF	Asynchronous
3	0200	02FF	0200	02FF	Synchronous
4	0300	03FF	0300	03FF	Asynchronous
5	0400	04FF	0400	04FF	Synchronous

Refresh takes longer because a synchronous area and an asynchronous area comes alternately.

No.	RX/RX Setting		RWw/RWr Setting		Network Synchronous Communication
	Start	End	Start	End	
0					
1	0000	00FF	0000	00FF	Synchronous
2	0100	01FF	0100	01FF	Synchronous
3	0200	02FF	0200	02FF	Synchronous
4	0300	03FF	0300	03FF	Asynchronous
5	0400	04FF	0400	04FF	Asynchronous

Refresh takes shorter because the same areas (synchronous or asynchronous) come continuously.

- For local stations and slave stations other than the remote head module, parameters must be set individually. Refer to the manual for each slave station for details.

## Settings for CC-Link IE TSN

Set this to synchronize with the inter-module synchronization cycle using the CC-Link IE TSN network synchronous communication function. This setting is made in the master station.

### Window

No.	Model Name	STA#	Station Type	RX Setting Points	RY Setting Points	RWr Setting Points	RWw Setting Points	Parameter Automatic Setting	PDO Mapping Setting	IP Address	Subnet Mask	Default Gateway	Reserved/Error Invalid Station	Network Synchronous Communication
0	Host Station	0	Master Station							192.168.3.253				
1	RJ71GN11-T2	1	Local Station	32	32	16	16			192.168.3.1			No Setting	Synchronous
2	RJ71GN11-T2	2	Local Station	32	32	16	16			192.168.3.2			No Setting	Synchronous
3	NZ2GN2S1-32T	3	Remote Station	32	32	4	4			192.168.3.3			No Setting	Synchronous
4	NZ2GN2S1-32T	4	Remote Station	32	32	4	4			192.168.3.4			No Setting	Synchronous
5	NZ2GN2S1-32D	5	Remote Station	32	32	4	4			192.168.3.5			No Setting	Synchronous
6	NZ2GN2S1-32D	6	Remote Station	32	32	4	4			192.168.3.6			No Setting	Synchronous

STA#0 Master Station  
Total STA#:6  
Line/Star

RJ71GN11-T2 RJ71GN11-T2 NZ2GN2S1-32T NZ2GN2S1-32T NZ2GN2S1-32D NZ2GN2S1-32D

### Displayed items

Item	Description	Setting range	Default
Network Synchronous Communication	Sets whether to coordinate (synchronize) the inter-module synchronization cycle with the CC-Link IE TSN network synchronous communication function.	<ul style="list-style-type: none"> <li>Asynchronous</li> <li>Synchronize</li> </ul>	Asynchronous

## Settings in CC-Link IE Field Network

Set this to synchronize with the inter-module synchronization cycle using the CC-Link IE Field Network synchronous communication function. This setting is made in the master station.

### Window

No.	Model Name	STA#	Station Type	RX/RX Setting			RWw/RWr Setting			Reserved/Error Invalid Station/System Switching Monitoring Target Station	Pairing	Network Synchronous Communication
				Points	Start	End	Points	Start	End			
0	Host Station	0	Master Station									
1	RJ71GF11-T2	1	Local Station	32	0000	001F	16	0000	000F	No Setting		Synchronous
2	NZ2GF2B1-16D	2	Remote Device Station	16	0020	002F	20	0010	0023	No Setting		Synchronous
3	NZ2GFCE3-16D	3	Remote Device Station	16	0030	003F	20	0024	0037	No Setting		Synchronous
4	NZ2GF2B1-16T	4	Remote Device Station	16	0040	004F	20	0038	004B	No Setting		Synchronous
5	NZ2GFCE3-16T	5	Remote Device Station	16	0050	005F	20	004C	005F	No Setting		Synchronous

STA#0 Master  
Total STA#:5  
Line/Star

RJ71GF11-T 2    NZ2GF2B1-1 6D    NZ2GFCE3-16D    NZ2GF2B1-1 6T    NZ2GFCE3-16T

### Displayed items

Item	Description	Setting range	Default
Network Synchronous Communication	Sets whether to coordinate (synchronize) the inter-module synchronization cycle with the CC-Link IE Field Network synchronous communication function.	<ul style="list-style-type: none"> <li>Asynchronous</li> <li>Synchronize</li> </ul>	Asynchronous

# 7 PROGRAM EXAMPLES

This chapter shows examples of the inter-module synchronization function.

## 7.1 For Single CPU System Configuration

An example of the program that starts at the inter-module synchronization cycle for multiple positioning modules is shown below. (This program starts axis 1 of each positioning module simultaneously.)

### System configuration

The following system configuration is used.

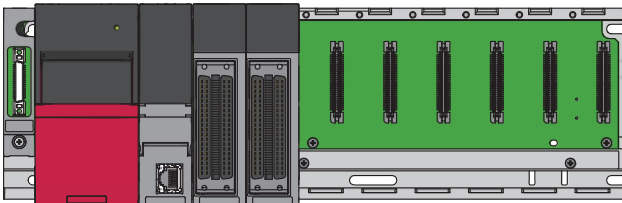

- CPU module: R08CPU
- Positioning module: RD75D4, RD75P4

### Programming condition

It is assumed that there are no errors in the positioning module settings.

### Parameter setting

This table shows the details of the inter-module synchronization settings.

Item	Description
Use Inter-module Synchronization Function in System	Select "Use".
Select Inter-module Synchronization Target Module	Select "Synchronize" for all.
Fixed Scan Interval Setting of Inter-module Synchronization	0.888ms (Select "Not Set" in "0.05ms Unit Setting".)

The default setting is used for each module's refresh setting.

# Applicable labels

This table shows the labels used in this program example.

Classification	Label name	Description	Device																	
Module label	RD75_1.bPLCReady	RW: Programmable controller ready	Y0																	
	RD75_2.bPLCReady	RW: Programmable controller ready	Y20																	
	RD75_1.bnBusy_Axis[0]	R: BUSY	X0C																	
	RD75_2.bnBusy_Axis[0]	R: BUSY	X2C																	
	RD75_1.stnAxisControlData_Axis_D[0].uPositioningStartNo_D	RW: Positioning start number (direct)	U0\G1500																	
	RD75_2.stnAxisControlData_Axis_D[0].uPositioningStartNo_D	RW: Positioning start number (direct)	U2\G1500																	
	RD75_1.stnAxisControlData_Axis_D[0].uAnalysisModeSetting_D	RW: Analysis mode setting (direct)	U0\G1590																	
	RD75_2.stnAxisControlData_Axis_D[0].uAnalysisModeSetting_D	RW: Analysis mode setting (direct)	U2\G1590																	
	RD75_1.stnAxisMonitorData_Axis_D[0].uAnalysisMode_D	R: Analysis mode (direct)	U0\G857																	
	RD75_2.stnAxisMonitorData_Axis_D[0].uAnalysisMode_D	R: Analysis mode (direct)	U2\G857																	
	RD75_1.stSynchronousRefreshArea.unAnalysisCompleteFlag_Axis[0]	R: Analysis complete flag	—																	
	RD75_2.stSynchronousRefreshArea.unAnalysisCompleteFlag_Axis[0]	R: Analysis complete flag	—																	
	RD75_1.bnPositioningStart_Axis[0]	RW: Positioning start	Y10																	
	RD75_2.bnPositioningStart_Axis[0]	RW: Positioning start	Y30																	
	RD75_1.bnStartComplete_Axis[0]	R: Start complete	X10																	
	RD75_1.bnErrorDetection_Axis[0]	R: Error detection	X8																	
	RD75_1.bnBusy_Axis_D[0]	R: BUSY (direct)	DX0C																	
	RD75_2.bnStartComplete_Axis[0]	R: Start complete	X30																	
	RD75_2.bnErrorDetection_Axis[0]	R: Error detection	X28																	
	RD75_2.bnBusy_Axis_D[0]	R: BUSY (direct)	DX2C																	
Defined labels	Define the global labels the following manner.																			
	<table border="1"> <thead> <tr> <th>Label Name</th> <th>Data Type</th> <th>Class</th> </tr> </thead> <tbody> <tr> <td>bInputSimultaneousMultipleUnitStartReq</td> <td>Bit</td> <td>VAR_GLOBAL</td> </tr> </tbody> </table>			Label Name	Data Type	Class	bInputSimultaneousMultipleUnitStartReq	Bit	VAR_GLOBAL											
Label Name	Data Type	Class																		
bInputSimultaneousMultipleUnitStartReq	Bit	VAR_GLOBAL																		
Define the local labels in the following manner.																				
<table border="1"> <thead> <tr> <th>Label Name</th> <th>Data Type</th> <th>Class</th> </tr> </thead> <tbody> <tr> <td>bSimultaneousMultipleUnitStartReq</td> <td>Bit</td> <td>VAR</td> </tr> <tr> <td>bPreAnalysisModeFlag</td> <td>Bit</td> <td>VAR</td> </tr> <tr> <td>bAnalysisCompFlag</td> <td>Bit</td> <td>VAR</td> </tr> <tr> <td>bInputPositioningStartReq</td> <td>Bit</td> <td>VAR</td> </tr> <tr> <td>bSimultaneousMultipleUnitStartReq</td> <td>Bit</td> <td>VAR</td> </tr> </tbody> </table>			Label Name	Data Type	Class	bSimultaneousMultipleUnitStartReq	Bit	VAR	bPreAnalysisModeFlag	Bit	VAR	bAnalysisCompFlag	Bit	VAR	bInputPositioningStartReq	Bit	VAR	bSimultaneousMultipleUnitStartReq	Bit	VAR
Label Name	Data Type	Class																		
bSimultaneousMultipleUnitStartReq	Bit	VAR																		
bPreAnalysisModeFlag	Bit	VAR																		
bAnalysisCompFlag	Bit	VAR																		
bInputPositioningStartReq	Bit	VAR																		
bSimultaneousMultipleUnitStartReq	Bit	VAR																		

# Program

To shorten the inter-module synchronous interrupt program's processing time, perform the positioning start processing with the inter-module synchronous interrupt program, and perform the other processing with the normal program.

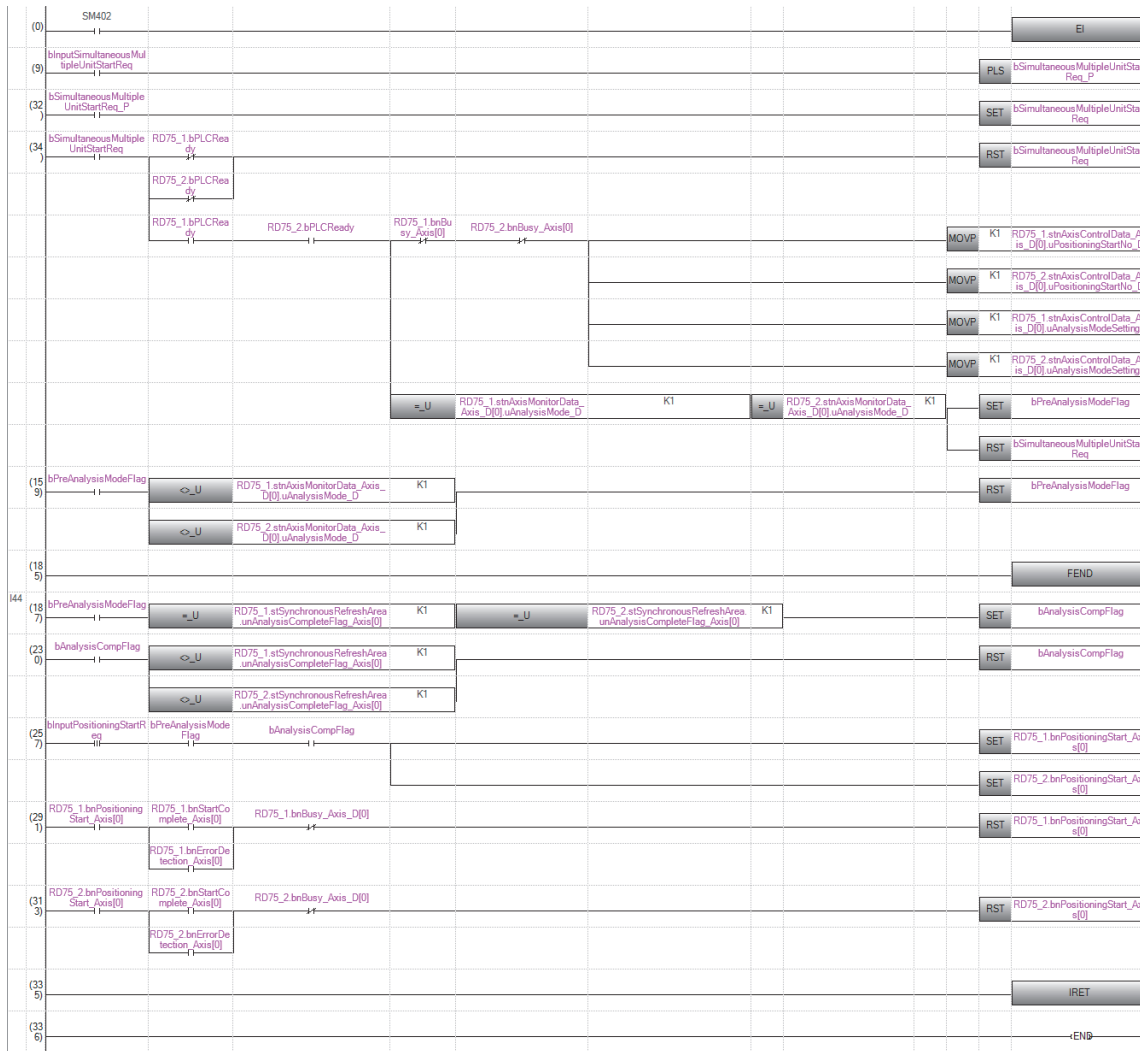

## 7.2 For CC-Link IE Field Network Configuration

The following is an example of a program that outputs to the adjacent output module and multiple output modules via the network at the inter-module synchronization cycle timing.

### System configuration

The following system configuration is used.

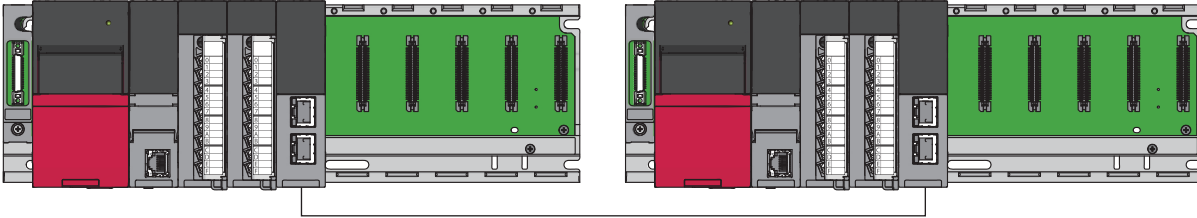

#### Master station side

- CPU module: R120CPU
- Each module: RX10, RY40NT5P, RJ71GF11-T2

#### Local station side

- CPU module: R04CPU
- Each module: RY40NT5P, RY40NT5P, RJ71GF11-T2

### Parameter setting

This section shows the details of each parameter setting.

#### Master station side

This section shows the details of the master station side parameter settings.

##### ■Inter-module synchronization setting

This table shows the details of the inter-module synchronization settings.

Item	Description
Use Inter-module Synchronization Function in System	Select "Use".
Select Inter-module Synchronization Target Module	Select "Synchronize" for all.
Fixed Scan Interval Setting of Inter-module Synchronization	1.00ms (Select "Set" in "0.05ms Unit Setting".)

##### ■Network configuration setting

Add the local station with the network configuration settings.

Set "Network Synchronous Communication" to "Synchronous".

##### ■Refresh settings

Set the transmission range between the RJ71GF11-T2 and the CPU module devices.

[Module Parameter] ⇒ [Basic Settings] ⇒ [Refresh Settings] ⇒ [Detailed Setting]

No.	Link Side					CPU Side				
	Device Name	Points	Start	End		Target	Device Name	Points	Start	End
-	SB	512	00000	001FF	↔	Module Label				
-	SW	512	00000	001FF	↔	Module Label				
1	RX	32	00000	0001F	↔	Specify Device	X	32	01000	0101F
2	RY	32	00000	0001F	↔	Specify Device	Y	32	01000	0101F
3	Rw/r	16	00000	0000F	↔	Specify Device	W	16	00000	0000F
4	Rw/w	16	00000	0000F	↔	Specify Device	W	16	01000	0100F



## Local station side

The table shows the details of the local station side parameters.

### ■Inter-module synchronization setting

This table shows the details of the inter-module synchronization settings. Set the same details as the master station side.

Item	Description
Use Inter-module Synchronization Function in System	Select "Use".
Select Inter-module Synchronization Target Module	Select "Synchronize" for all.
Fixed Scan Interval Setting of Inter-module Synchronization	1.00ms (Select "Set" in "0.05ms Unit Setting".)
Inter-module Synchronization Master Setting	Synchronization Master Setting of CC IE TSN/CC IE Field: "Set", Mounting Slot No.: 2

### ■Operation related setting







This table shows the details of the operation related setting in the CPU parameter.

Item	Description
Remote Reset Setting	Select "Enable".

### ■Refresh settings

Set the transmission range between the RJ71GF11-T2 and the CPU module devices. Set the same value as the master station side.

 [Module Parameter] ⇒ [Basic Settings] ⇒ [Refresh Settings] ⇒ [Detailed Setting]

No.	Link Side					CPU Side				
	Device Name	Points	Start	End		Target	Device Name	Points	Start	End
-	SB	512	00000	001FF		Module Label				
-	SW	512	00000	001FF		Module Label				
1	RX	32	00000	0001F		Specify Device	X	32	01000	0101F
2	RY	32	00000	0001F		Specify Device	Y	32	01000	0101F
3	Rwr	16	00000	0000F		Specify Device	W	16	00000	0000F
4	RWw	16	00000	0000F		Specify Device	W	16	01000	0100F

# Applicable labels

This table shows the labels used in this program example.

## Master station side

This section shows the labels used by the master station.

Classification	Label name	Description	Device																																								
Module label	GF11_1.bSts_BatonPassError	Own station baton pass status	SB0047																																								
	GF11_1.bnOp_Synchronous_Station[1]	Each station synchronous/asynchronous operation status information (station No.1)	SW01C8.0																																								
Defined labels	Define the global labels the following manner.																																										
	<table border="1"> <thead> <tr> <th>Label Name</th> <th>Data Type</th> <th>Class</th> <th>Assign (Device/Label)</th> </tr> </thead> <tbody> <tr> <td>bnInput1</td> <td>Bit(0..15)</td> <td>VAR_GLOBAL</td> <td>X0</td> </tr> <tr> <td>bnOutput1</td> <td>Bit(0..15)</td> <td>VAR_GLOBAL</td> <td>Y10</td> </tr> <tr> <td>bnStation1_Output1</td> <td>Bit(0..15)</td> <td>VAR_GLOBAL</td> <td>Y1000</td> </tr> <tr> <td>bnStation1_Output2</td> <td>Bit(0..15)</td> <td>VAR_GLOBAL</td> <td>Y1010</td> </tr> <tr> <td>bStation1_Reset</td> <td>Bit</td> <td>VAR_GLOBAL</td> <td>M0</td> </tr> <tr> <td>bRunRemoteReset</td> <td>Bit</td> <td>VAR_GLOBAL</td> <td>M1</td> </tr> <tr> <td>bReset_OK</td> <td>Bit</td> <td>VAR_GLOBAL</td> <td>M2</td> </tr> <tr> <td>bReset_NG</td> <td>Bit</td> <td>VAR_GLOBAL</td> <td>M3</td> </tr> <tr> <td>uResetErrID</td> <td>Word [Unsigned]/Bit String [16-bit]</td> <td>VAR_GLOBAL</td> <td>D0</td> </tr> </tbody> </table>	Label Name	Data Type	Class	Assign (Device/Label)	bnInput1	Bit(0..15)	VAR_GLOBAL	X0	bnOutput1	Bit(0..15)	VAR_GLOBAL	Y10	bnStation1_Output1	Bit(0..15)	VAR_GLOBAL	Y1000	bnStation1_Output2	Bit(0..15)	VAR_GLOBAL	Y1010	bStation1_Reset	Bit	VAR_GLOBAL	M0	bRunRemoteReset	Bit	VAR_GLOBAL	M1	bReset_OK	Bit	VAR_GLOBAL	M2	bReset_NG	Bit	VAR_GLOBAL	M3	uResetErrID	Word [Unsigned]/Bit String [16-bit]	VAR_GLOBAL	D0		
Label Name	Data Type	Class	Assign (Device/Label)																																								
bnInput1	Bit(0..15)	VAR_GLOBAL	X0																																								
bnOutput1	Bit(0..15)	VAR_GLOBAL	Y10																																								
bnStation1_Output1	Bit(0..15)	VAR_GLOBAL	Y1000																																								
bnStation1_Output2	Bit(0..15)	VAR_GLOBAL	Y1010																																								
bStation1_Reset	Bit	VAR_GLOBAL	M0																																								
bRunRemoteReset	Bit	VAR_GLOBAL	M1																																								
bReset_OK	Bit	VAR_GLOBAL	M2																																								
bReset_NG	Bit	VAR_GLOBAL	M3																																								
uResetErrID	Word [Unsigned]/Bit String [16-bit]	VAR_GLOBAL	D0																																								

## Local station side

This section shows the labels used on the local station side.

Classification	Label name	Description	Device																				
Defined labels	Define the global labels the following manner.																						
	<table border="1"> <thead> <tr> <th>Label Name</th> <th>Data Type</th> <th>Class</th> <th>Assign (Device/Label)</th> </tr> </thead> <tbody> <tr> <td>bnStation1_Output1</td> <td>Bit(0..15)</td> <td>VAR_GLOBAL</td> <td>X1000</td> </tr> <tr> <td>bnStation1_Output2</td> <td>Bit(0..15)</td> <td>VAR_GLOBAL</td> <td>X1010</td> </tr> <tr> <td>bnOutput1</td> <td>Bit(0..15)</td> <td>VAR_GLOBAL</td> <td>Y0</td> </tr> <tr> <td>bnOutput2</td> <td>Bit(0..15)</td> <td>VAR_GLOBAL</td> <td>Y10</td> </tr> </tbody> </table>	Label Name	Data Type	Class	Assign (Device/Label)	bnStation1_Output1	Bit(0..15)	VAR_GLOBAL	X1000	bnStation1_Output2	Bit(0..15)	VAR_GLOBAL	X1010	bnOutput1	Bit(0..15)	VAR_GLOBAL	Y0	bnOutput2	Bit(0..15)	VAR_GLOBAL	Y10		
Label Name	Data Type	Class	Assign (Device/Label)																				
bnStation1_Output1	Bit(0..15)	VAR_GLOBAL	X1000																				
bnStation1_Output2	Bit(0..15)	VAR_GLOBAL	X1010																				
bnOutput1	Bit(0..15)	VAR_GLOBAL	Y0																				
bnOutput2	Bit(0..15)	VAR_GLOBAL	Y10																				

# Applicable function blocks

---

The following are the function blocks used in this program example.

## Master station side

- M+RJ71GF11\_RemoteReset\_00A
- M+RCPU\_Msynchronization\_Delay2OUT\_00A

## Program

---

The master station CPU module instructs the local station system output, and with this instruction, the master station system output and local station system output are performed at the same inter-module synchronization cycle timing. It takes two inter-module synchronization cycles from when the master station CPU module instructs the local station CPU module until output is performed from the local station system. Thus, to perform output from a module nearest the master station, start it using the inter-module synchronization function FB after two inter-module synchronization cycles. (📖 MELSEC iQ-R CPU Module Function Block Reference) When the CC-Link IE Field Network synchronous communication stops due to disconnection of the local station, reset the local station from the master station using the remote reset FB after the local station is returned. (📖 MELSEC iQ-R Ethernet, CC-Link IE, and MELSECNET/H Function Block Reference)

# Master station side

This section shows the master station side program.

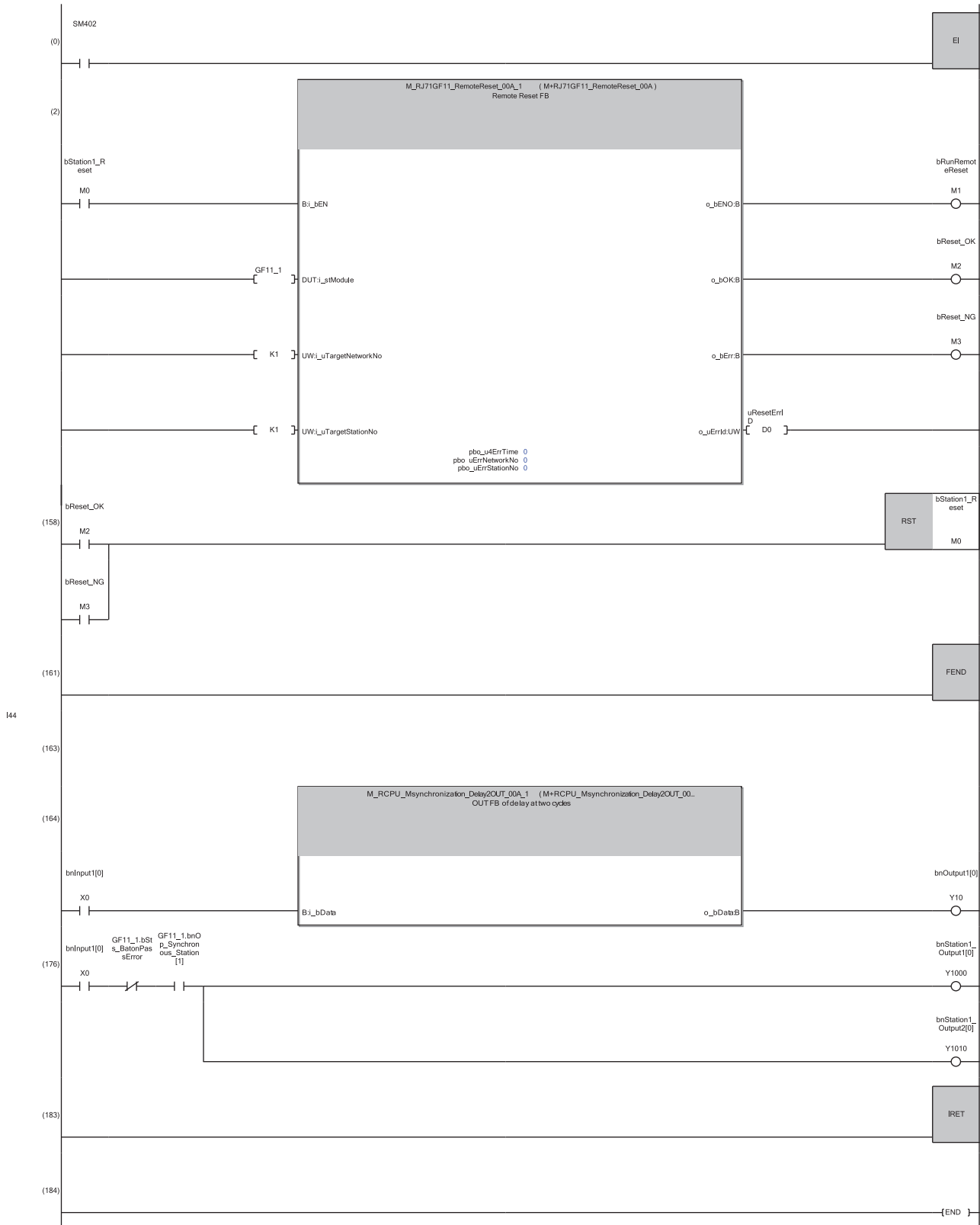

## Local station side

This section shows the local station side program.



## 7.3 For CC-Link IE TSN Configuration

The following is an example of a program that outputs to the adjacent output module and multiple output modules via the network at the inter-module synchronization cycle timing.

### System configuration

The following system configuration is used.

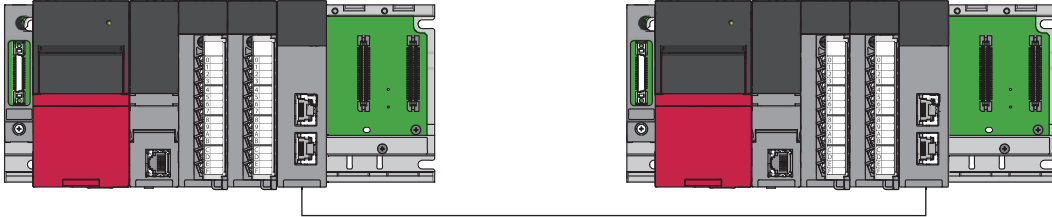

#### Master station side

- CPU module: R04CPU
- Each module: RX40C7, RY40NT5P, RJ71GN11-T2

#### Local station side

- CPU module: R04CPU
- Each module: RY40NT5P, RY40NT5P, RJ71GN11-T2

# Parameter settings

This section shows the details of each parameter setting.

## Master station side

This section shows the details of the master station side parameter settings.

### Inter-module Synchronization Setting

This table shows the details of the inter-module synchronization settings.

Item	Description
Use Inter-module Synchronization Function in System	Select "Use".
Select Inter-module Synchronization Target Module	Select "Synchronize" for all.
Fixed Scan Interval Setting of Inter-module Synchronization	1.00ms (Select "Set" in "0.05ms Unit Setting".)
Inter-module Synchronization Master Setting	Synchronization Master Setting of CC IE TSN/CC IE Field: "Set", Mounting Slot No.: 2

### Link direct device setting

This table shows the details of the "Link Direct Device Setting" setting in "Memory/Device Setting" in the CPU parameters.

Item	Description
Link Direct Device Setting	Extended mode (iQ-R Series Mode)

### IP Address

This table shows the details of the "IP Address" setting in "Required Settings" in the RJ71GN11-T2 module parameters.

Item	Description
IP Address	192.168.3.253

### Network Configuration Settings







Add the local station with the network configuration settings.

Set "Network Synchronous Communication" to "Synchronous". All other settings are default values.

### Refresh Settings

Set the transmission range between the RJ71GN11-T2 and the CPU module devices.

 [Module Parameter] ⇒ [Basic Settings] ⇒ [Refresh Settings] ⇒ [Detailed Setting]

No.	Link Side					CPU Side				
	Device Name	Points	Start	End		Target	Device Name	Points	Start	End
-	SB	4096	00000	00FFF		Module Label				
-	SW	4096	00000	00FFF		Module Label				
1	RX	32	00000	0001F		Specify Device	X	32	01000	0101F
2	RY	32	00000	0001F		Specify Device	Y	32	01000	0101F
3	RWr	16	00000	0000F		Specify Device	W	16	00000	0000F
4	RWw	16	00000	0000F		Specify Device	W	16	01000	0100F

### Communication Period Setting

This table shows the details of the "Communication Period Setting" settings in "Basic Settings" in the RJ71GN11-T2 module parameters.

Item	Description	
Communication Period Setting	Setting in Units of 1μs	Not Set
	Communication Period Interval Setting (Do Not Set it in Units of 1μs)	1000.00μs
	System Reservation Time	20.00μs
	Cyclic Transmission Time	500.00μs

## Local station side

The table shows the details of the local station side parameters.

### ■Inter-module synchronization setting

Make the inter-module synchronization settings the same as those of the master station side. (☞ Page 61 Inter-module Synchronization Setting)

### ■Operation Related Setting

This table shows the details of the operation related setting in the CPU parameter.

Item	Description
Remote Reset Setting	Select "Enable".

### ■Link Direct Device Setting

Make the "Link Direct Device Setting" setting in "Memory/Device Setting" in the CPU parameters the same as that of the master station side. (☞ Page 61 Link direct device setting)

### ■IP Address

This table shows the details of the "IP Address" setting in "Required Settings" in the RJ71GN11-T2 module parameters.

Item	Description
IP Address	192.168.3.1

### ■Refresh Settings

Make the transmission range between the RJ71GN11-T2 and the CPU module devices the same as that of the master station side. (☞ Page 61 Refresh Settings)



# Applicable labels

This table shows the labels used in this program example.

## Master station side

This section shows the labels used by the master station.

Classification	Label name	Description	Device																																																
Module label	GN11_1.bSts_DataLinkError_System	Data link error status of each station	SB00B0																																																
	GN11_1.bnOp_Synchronous_Station[1]	Each station synchronous/asynchronous operation status information (station No.1)	SW01C8.0																																																
Defined labels	Define the global labels the following manner.																																																		
	<table border="1"> <thead> <tr> <th>Label Name</th> <th>Data Type</th> <th>Class</th> <th>Assign (Device/Label)</th> </tr> </thead> <tbody> <tr> <td>bnInput1</td> <td>Bit(0..15)</td> <td>VAR_GLOBAL</td> <td>X0</td> </tr> <tr> <td>bnOutput1</td> <td>Bit(0..15)</td> <td>VAR_GLOBAL</td> <td>Y10</td> </tr> <tr> <td>bnStation1_Output1</td> <td>Bit(0..15)</td> <td>VAR_GLOBAL</td> <td>Y1000</td> </tr> <tr> <td>bnStation1_Output2</td> <td>Bit(0..15)</td> <td>VAR_GLOBAL</td> <td>Y1010</td> </tr> <tr> <td>bStation1_Reset</td> <td>Bit</td> <td>VAR_GLOBAL</td> <td>M0</td> </tr> <tr> <td>bRunRemoteReset</td> <td>Bit</td> <td>VAR_GLOBAL</td> <td>M1</td> </tr> <tr> <td>bReset_OK</td> <td>Bit</td> <td>VAR_GLOBAL</td> <td>M2</td> </tr> <tr> <td>bReset_NG</td> <td>Bit</td> <td>VAR_GLOBAL</td> <td>M3</td> </tr> <tr> <td>uResetErrID</td> <td>Word [Unsigned]/Bit String [16-bit]</td> <td>VAR_GLOBAL</td> <td>D0</td> </tr> <tr> <td>uTargetAddress</td> <td>Word [Unsigned]/Bit String [16-bit](0..1)</td> <td>VAR_GLOBAL</td> <td>D1</td> </tr> <tr> <td>uTargetPortNo</td> <td>Word [Unsigned]/Bit String [16-bit]</td> <td>VAR_GLOBAL</td> <td>D3</td> </tr> </tbody> </table>	Label Name	Data Type	Class	Assign (Device/Label)	bnInput1	Bit(0..15)	VAR_GLOBAL	X0	bnOutput1	Bit(0..15)	VAR_GLOBAL	Y10	bnStation1_Output1	Bit(0..15)	VAR_GLOBAL	Y1000	bnStation1_Output2	Bit(0..15)	VAR_GLOBAL	Y1010	bStation1_Reset	Bit	VAR_GLOBAL	M0	bRunRemoteReset	Bit	VAR_GLOBAL	M1	bReset_OK	Bit	VAR_GLOBAL	M2	bReset_NG	Bit	VAR_GLOBAL	M3	uResetErrID	Word [Unsigned]/Bit String [16-bit]	VAR_GLOBAL	D0	uTargetAddress	Word [Unsigned]/Bit String [16-bit](0..1)	VAR_GLOBAL	D1	uTargetPortNo	Word [Unsigned]/Bit String [16-bit]	VAR_GLOBAL	D3		
Label Name	Data Type	Class	Assign (Device/Label)																																																
bnInput1	Bit(0..15)	VAR_GLOBAL	X0																																																
bnOutput1	Bit(0..15)	VAR_GLOBAL	Y10																																																
bnStation1_Output1	Bit(0..15)	VAR_GLOBAL	Y1000																																																
bnStation1_Output2	Bit(0..15)	VAR_GLOBAL	Y1010																																																
bStation1_Reset	Bit	VAR_GLOBAL	M0																																																
bRunRemoteReset	Bit	VAR_GLOBAL	M1																																																
bReset_OK	Bit	VAR_GLOBAL	M2																																																
bReset_NG	Bit	VAR_GLOBAL	M3																																																
uResetErrID	Word [Unsigned]/Bit String [16-bit]	VAR_GLOBAL	D0																																																
uTargetAddress	Word [Unsigned]/Bit String [16-bit](0..1)	VAR_GLOBAL	D1																																																
uTargetPortNo	Word [Unsigned]/Bit String [16-bit]	VAR_GLOBAL	D3																																																

## Local station side

This section shows the labels used on the local station side.

Classification	Label name	Description	Device																				
Defined labels	Define the global labels the following manner.																						
	<table border="1"> <thead> <tr> <th>Label Name</th> <th>Data Type</th> <th>Class</th> <th>Assign (Device/Label)</th> </tr> </thead> <tbody> <tr> <td>bnStation1_Output1</td> <td>Bit(0..15)</td> <td>VAR_GLOBAL</td> <td>X1000</td> </tr> <tr> <td>bnStation1_Output2</td> <td>Bit(0..15)</td> <td>VAR_GLOBAL</td> <td>X1010</td> </tr> <tr> <td>bnOutput1</td> <td>Bit(0..15)</td> <td>VAR_GLOBAL</td> <td>Y0</td> </tr> <tr> <td>bnOutput2</td> <td>Bit(0..15)</td> <td>VAR_GLOBAL</td> <td>Y10</td> </tr> </tbody> </table>	Label Name	Data Type	Class	Assign (Device/Label)	bnStation1_Output1	Bit(0..15)	VAR_GLOBAL	X1000	bnStation1_Output2	Bit(0..15)	VAR_GLOBAL	X1010	bnOutput1	Bit(0..15)	VAR_GLOBAL	Y0	bnOutput2	Bit(0..15)	VAR_GLOBAL	Y10		
Label Name	Data Type	Class	Assign (Device/Label)																				
bnStation1_Output1	Bit(0..15)	VAR_GLOBAL	X1000																				
bnStation1_Output2	Bit(0..15)	VAR_GLOBAL	X1010																				
bnOutput1	Bit(0..15)	VAR_GLOBAL	Y0																				
bnOutput2	Bit(0..15)	VAR_GLOBAL	Y10																				

# Applicable function blocks

---

The following are the function blocks used in this program example.

## Master station side

- M+RJ71GN11\_RemoteReset\_IP\_00C
- M+RCPU\_Msynchronization\_Delay2OUT\_00A

## Program

---

After "bnInput1" is turned on, the master station system output and local station system output are performed at the same inter-module synchronization cycle timing. It takes two inter-module synchronization cycles to perform output from the local station system according to the output from the master station system. Thus, the master station system output is performed using the inter-module synchronization function FB after two inter-module synchronization cycles. When the CC-Link IE TSN network synchronous communication stops due to disconnection of the local station, reset the local station from the master station using the remote reset FB after the local station is returned by setting "bStation1\_Reset" to "ON". After that, synchronous communication can be started again. (📖 MELSEC iQ-R Ethernet, CC-Link IE, and MELSECNET/H Function Block Reference)

## Master station side

This section shows the master station side program.

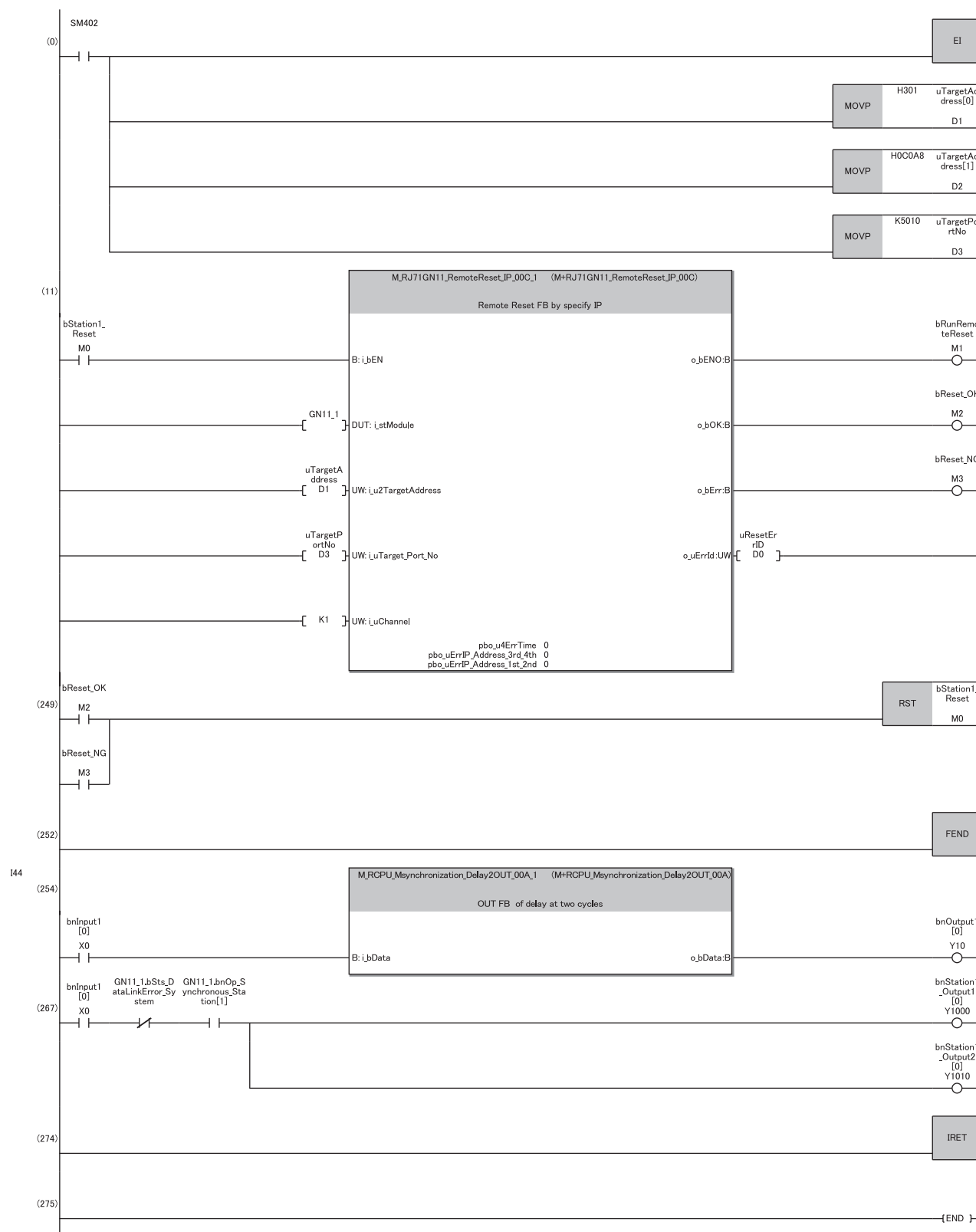

## Local station side

This section shows the local station side program.

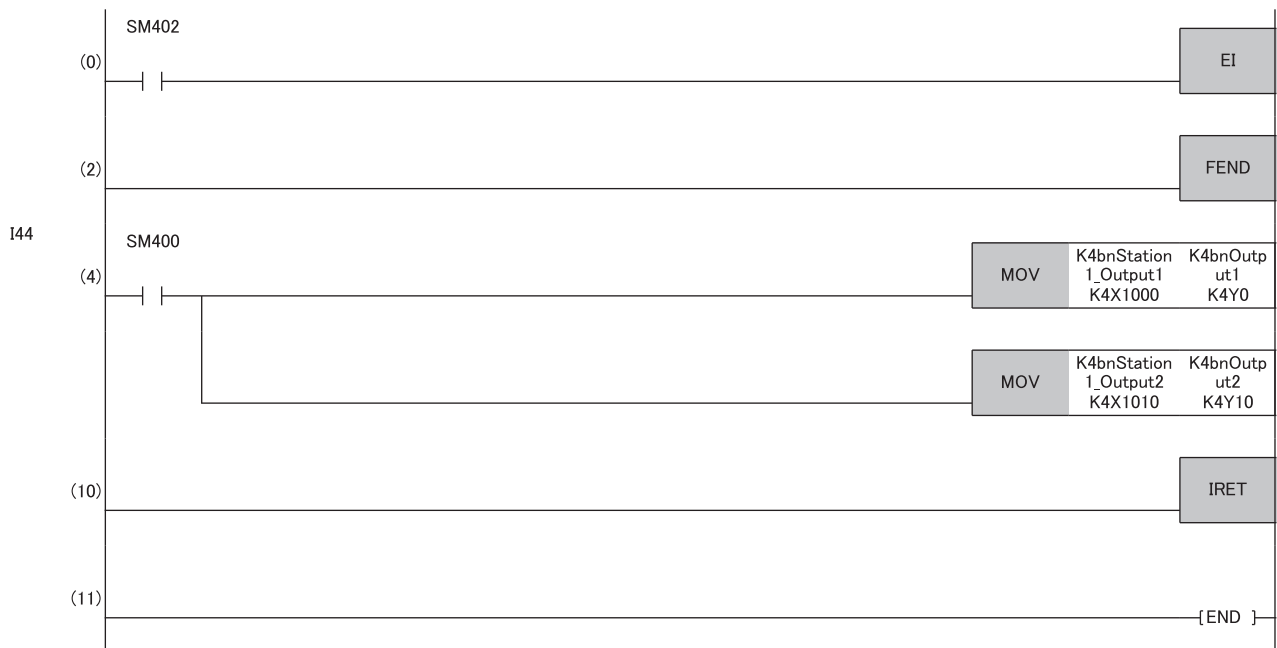

# 8 TROUBLESHOOTING

This chapter describes troubleshooting for the inter-module synchronization function.

## 8.1 Error Processing and Recovery Methods

This section shows the abnormal process detection and recovery methods used when an error occurs with the inter-module synchronization function. The inter-module synchronization function's synchronization state can be checked on the system monitor.

[Diagnostics] ⇒ [System Monitor]

### Window

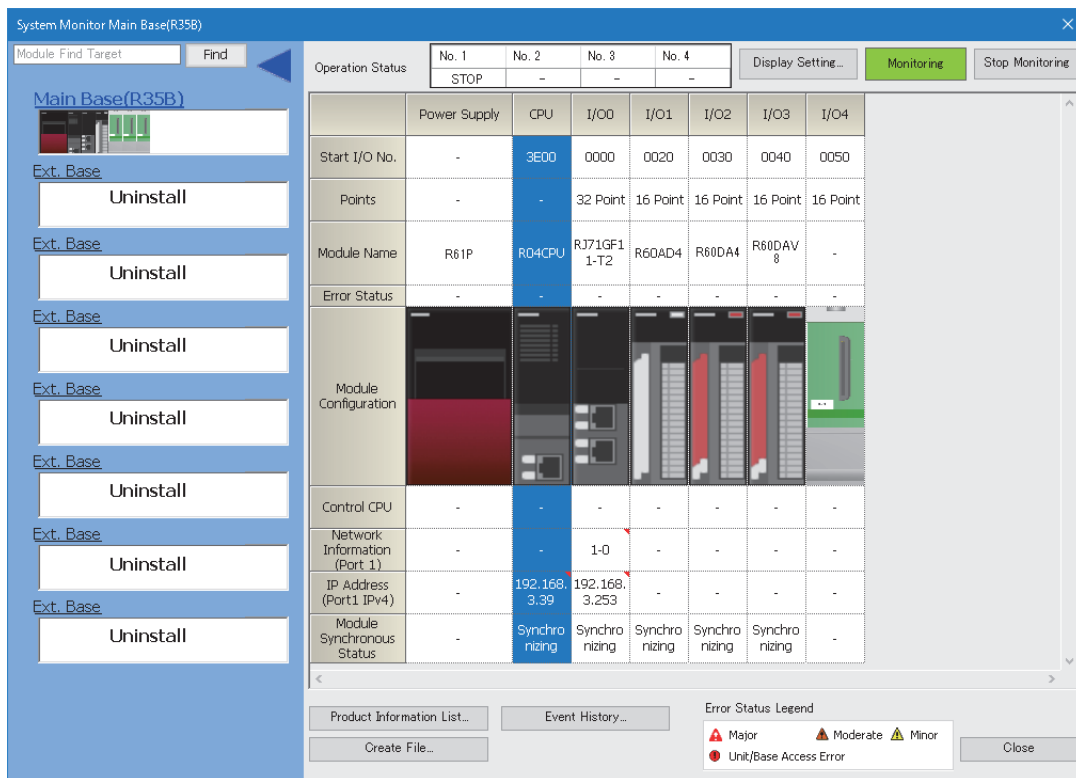

### Displayed items

Item	Description	Setting range	Default
Inter-module synchronization state	<p>Shows the synchronization state of the inter-module synchronization function.</p> <ul style="list-style-type: none"> <li>Synchronizing: Shows that the inter-module synchronization function is operating.</li> <li>Preparing: Shows that the inter-module synchronization function is in the pre-operation preparation stage.</li> <li>Error: Appears when an error occurs with the inter-module synchronization function.</li> <li>—: Appears when the inter-module synchronization function is disabled or when the module is not supported.</li> </ul>	—	—

## Inter-module synchronous interrupt program does not run

Check the following if the inter-module synchronous interrupt program does not run.

Confirmation items	Action
Is the inter-module synchronization setting enabled?	Enable the inter-module synchronization setting if it is not enabled. (☞ Page 44 Inter-module Synchronization Setting)
Does an inter-module synchronous interrupt program present?	If the inter-module synchronous interrupt program is not present, add one.
Is the CPU module set to RUN?	Set the CPU module to RUN if it is not already set.
Is interrupt permitted?	Execute the EI instruction if it hasn't been executed yet.
Has the inter-module synchronous interrupt program been registered?	When C Controller module is used, register and enable the inter-module synchronous interrupt program using the C Controller module dedicated function. (📖 MELSEC iQ-R C Controller Module User's Manual (Application))
When the modules on CC-Link IE TSN are set as the inter-module synchronization target module, are the CPU module and the modules on CC-Link IE TSN versions compatible?	Use versions of the modules that support the following. <ul style="list-style-type: none"><li>• CPU module: Supports inter-module synchronization with the modules on CC-Link IE TSN.</li><li>• Modules on CC-Link IE TSN: Supports inter-module synchronization (network synchronous communication).</li></ul>

### Point

The inter-module synchronous interrupt program operating status can be checked with the interrupt program monitor list. (📖 GX Works3 Operating Manual)

## A specific module is not synchronized

Check the following if a specific module does not run.

Confirmation items	Action
Is the inter-module synchronization function target module set?	Set the inter-module synchronization target module if it is not set yet. (☞ Page 44 Inter-module Synchronization Setting)
Is refresh set?	<ul style="list-style-type: none"><li>• Check whether a module label is used in the inter-module synchronization function and whether the refresh destination device is used in the inter-module synchronous interrupt program.</li><li>• Review the refresh settings.</li></ul>

### Point

Synchronization of an arbitrary module can be checked with the system monitor. (☞ Page 67 Error Processing and Recovery Methods)

## 8.2 RAS Function

This section describes the RAS functions related to the inter-module synchronization function.

### Inter-module synchronous interrupt program execution time monitor

The error detection setting is used to monitor the inter-module synchronous interrupt program's execution time. Set whether to detect an error related to the inter-module synchronous interrupt program's execution time. When an error is detected, the number of cycle overs is stored in SD480. For details on the setting method of error detection setting and special register, refer to the following.

 MELSEC iQ-R CPU Module User's Manual (Application)

#### Point

When synchronizing via a network module, even if an error is detected at the master station's CPU module is still not be detected at the local station. Therefore, to stop the local station when an error occurs, prepare a program to monitor the master station status using the network module's link special register areas or others.

### Inter-module synchronization signal error monitoring

Each module monitors for errors in the inter-module signal cycle, and generates a moderate error if an error is detected. The CPU module can monitor for errors in the inter-module synchronization signal with SM488.

### Monitor of output exceeding inter-module synchronization cycle

The D/A converter module monitors whether the output preparation process is completed before the next inter-module synchronization cycle. If the inter-module synchronous interrupt program does not complete before the next inter-module synchronization cycle starts, an error will occur even if the output preparation process has not started. If the output preparation process is constantly delayed, a cycle over will always occur. Set the inter-module synchronization cycle to a value at which the D/A converter module's output conversion can accurately finish.

### Cyclic monitor

The CC-Link IE TSN master/local module (master station), Motion module, or CC-Link IE Field Network-equipped master/local module (master station) monitors whether cyclic transmission has been completed by the next inter-module synchronization cycle. If the inter-module synchronous interrupt program has not been completed by the start of next inter-module synchronization cycle and thus cyclic transmission has not started yet, an error occurs as well.

#### Precautions

If the cyclic transmission process is constantly delayed, a cycle over will always occur. In that case, the inter-module synchronization function does not operate.

##### ■For CC-Link IE TSN

For each setting value, set a value that is greater than or equal to the calculation value of the link special register (SW) below (for CC-Link IE TSN master/local module)

- Inter-module synchronization cycle, communication cycle: 'Communication cycle interval (calculation value)' (SW0072)
- Cyclic transmission time: 'Cyclic transmission time (calculation value)' (SW0073)
- Transient transmission time: 'Transient transmission time (calculation value)' (SW0078)

Set the inter-module synchronization cycle and CC-Link IE TSN communication cycle to values that are longer than the total combined time of the execution time of the inter-module synchronous interrupt program (144) and the cyclic transmission processing time (cyclic data transfer processing time).

##### ■For CC-Link IE Field Network

Set a value longer than the cyclic transmission processing time (link scan time) for the inter-module synchronization cycle.

# APPENDIX

---

## Appendix 1 Processing Time

---

This section describes the processing time.

### Overhead time for executing interrupt program

---

The overhead time for executing the inter-module synchronous interrupt program between modules differs according to each CPU module.

 Manual for each CPU module

### Refresh processing time

---

For details on the refresh processing time, refer to the following.

 Manual for each module

### Instruction processing time in interrupt program

---

For details on the instruction processing time in the interrupt program, refer to the following.

 MELSEC iQ-R Programming Manual (CPU Module Instructions, Standard Functions/Function Blocks)



# MEMO

---

A

# INDEX

---

## A

---

A/D converter module . . . . . 6

## C

---

C Controller module . . . . . 6  
CC-Link IE Field Network synchronous communication  
function . . . . . 41  
CC-Link IE TSN network synchronous communication  
function . . . . . 40  
Control CPU . . . . . 6  
CPU module . . . . . 6  
CPU module's operation status . . . . . 24  
Cyclic transmission . . . . . 6

## D

---

D/A converter module . . . . . 6  
Device . . . . . 6

## E

---

Engineering tool . . . . . 6

## F

---

Fixed cycle synchronization function . . . . . 23  
Fixed scan communication cycle . . . . . 34

## G

---

Global label . . . . . 6

## I

---

Instruction processing time . . . . . 70  
Intelligent function module . . . . . 6  
Inter-module synchronization accuracy . . . . . 18  
Inter-module synchronization cycle . . . . . 7  
Inter-module synchronization setting . . . . . 44  
Inter-module synchronization signal . . . . . 69  
Inter-module synchronous interrupt . . . . . 24

## M

---

Module label . . . . . 6  
Multiple CPU settings . . . . . 47  
Multiple CPU synchronous interrupt program . . . . . 35  
Multiple CPU system function . . . . . 34  
Multiple interrupt . . . . . 24

## N

---

Network configuration settings . . . . . 48  
Network synchronous communication . . . . . 49,50  
Number of relay stations . . . . . 19

## O

---

Overhead time . . . . . 70

## P

---

Program examples . . . . . 51  
Pulse measurement mode . . . . . 28

## R

---

RAS . . . . . 6  
RAS function . . . . . 69  
Refresh . . . . . 23  
Refresh processing time . . . . . 70  
Remote head module . . . . . 6

## S

---

System monitor . . . . . 67

# REVISIONS

\*The manual number is given on the bottom left of the back cover.

Revision date	*Manual number	Description
June 2014	SH(NA)-081401ENG-A	First edition
July 2014	SH(NA)-081401ENG-B	■Added or modified parts Section 2.1, 6.1
February 2015	SH(NA)-081401ENG-C	■Added model R12CCPU-V
April 2015	SH(NA)-081401ENG-D	■Added models RX40PC6H, RX40NC6H
July 2015	SH(NA)-081401ENG-E	■Added models R04ENCPU, R08ENCPU, R16ENCPU, R32ENCPU, R120ENCPU, R08PCPU, R16PCPU, R32PCPU, R120PCPU ■Added or modified parts Section 2.2
January 2016	SH(NA)-081401ENG-F	■Added models RY41NT2H, RY41PT2H, R60ADH4, RD77GF4, RD77GF8, RD77GF16 ■Added or modified parts Section 2.2, 5.1
May 2016	SH(NA)-081401ENG-G	■Added models RJ72GF15-T2, RX41C6HS, RX61C6HS, RX40NC6B, RY40PT5B ■Added or modified parts TERMS, Section 2.1, 2.2, Chapter 4, Section 5.1, Section 6.1
October 2016	SH(NA)-081401ENG-H	■Added models RY20S6, RD40PD01 ■Added or modified parts Section 2.2, 5.1
February 2017	SH(NA)-081401ENG-I	■Added models RX28, RY18R2A, R60DAH4 ■Added or modified parts TERMS, Section 2.2
April 2017	SH(NA)-081401ENG-J	■Added or modified parts RELEVANT MANUALS, Section 5.1, 7.2
October 2017	SH(NA)-081401ENG-K	■Added or modified parts Section 2.2, 3.1, 6.1
April 2018	SH(NA)-081401ENG-L	■Added models RX10-TS, RX40C7-TS, RX41C4-TS, RX70C4, RX71C4, RY10R2-TS, RY40NT5P-TS, RY41NT2P-TS, RY40PT5P-TS, RY41PT1P-TS ■Added or modified parts Section 2.2, Appendix 1
April 2019	SH(NA)-081401ENG-M	■Added models R08SFPCPU, R16SFPCPU, R32SFPCPU, R120SFPCPU ■Added or modified parts TERMS, GENERIC TERMS AND ABBREVIATIONS, Section 2.2, 3.1, 5.1, 6.1
May 2020	SH(NA)-081401ENG-N	■Added model RJ71GN11-T2 ■Added or modified parts GENERIC TERMS AND ABBREVIATIONS, Chapter 1, Section 2.1, 2.2, 2.3, 3.1, Chapter 4, Section 5.1, 6.1, 6.3, 7.3, 8.1, 8.2
July 2020	SH(NA)-081401ENG-O	■Added or modified parts Section 2.1, 2.2, Chapter 4, Section 6.1
June 2021	SH(NA)-081401ENG-P	■Added or modified parts Chapter 2, 5
October 2021	SH(NA)-081401ENG-Q	■Added or modified parts Section 5.1

Revision date	*Manual number	Description
January 2022	SH(NA)-081401ENG-R	■Added model RJ71GN11-EIP ■Added or modified parts GENERIC TERMS AND ABBREVIATIONS, Section 2.1, 2.3, 5.1, 6.1, 8.1

Japanese manual number: SH-081400-R

This manual confers no industrial property rights or any rights of any other kind, nor does it confer any patent licenses. Mitsubishi Electric Corporation cannot be held responsible for any problems involving industrial property rights which may occur as a result of using the contents noted in this manual.

© 2014 MITSUBISHI ELECTRIC CORPORATION

# WARRANTY

---

Please confirm the following product warranty details before using this product.

## **1. Gratis Warranty Term and Gratis Warranty Range**

If any faults or defects (hereinafter "Failure") found to be the responsibility of Mitsubishi occurs during use of the product within the gratis warranty term, the product shall be repaired at no cost via the sales representative or Mitsubishi Service Company.

However, if repairs are required onsite at domestic or overseas location, expenses to send an engineer will be solely at the customer's discretion. Mitsubishi shall not be held responsible for any re-commissioning, maintenance, or testing on-site that involves replacement of the failed module.

[Gratis Warranty Term]

The gratis warranty term of the product shall be for one year after the date of purchase or delivery to a designated place. Note that after manufacture and shipment from Mitsubishi, the maximum distribution period shall be six (6) months, and the longest gratis warranty term after manufacturing shall be eighteen (18) months. The gratis warranty term of repair parts shall not exceed the gratis warranty term before repairs.

[Gratis Warranty Range]

- (1) The range shall be limited to normal use within the usage state, usage methods and usage environment, etc., which follow the conditions and precautions, etc., given in the instruction manual, user's manual and caution labels on the product.
- (2) Even within the gratis warranty term, repairs shall be charged for in the following cases.
  1. Failure occurring from inappropriate storage or handling, carelessness or negligence by the user. Failure caused by the user's hardware or software design.
  2. Failure caused by unapproved modifications, etc., to the product by the user.
  3. When the Mitsubishi product is assembled into a user's device, Failure that could have been avoided if functions or structures, judged as necessary in the legal safety measures the user's device is subject to or as necessary by industry standards, had been provided.
  4. Failure that could have been avoided if consumable parts (battery, backlight, fuse, etc.) designated in the instruction manual had been correctly serviced or replaced.
  5. Failure caused by external irresistible forces such as fires or abnormal voltages, and Failure caused by force majeure such as earthquakes, lightning, wind and water damage.
  6. Failure caused by reasons unpredictable by scientific technology standards at time of shipment from Mitsubishi.
  7. Any other failure found not to be the responsibility of Mitsubishi or that admitted not to be so by the user.

## **2. Onerous repair term after discontinuation of production**

- (1) Mitsubishi shall accept onerous product repairs for seven (7) years after production of the product is discontinued. Discontinuation of production shall be notified with Mitsubishi Technical Bulletins, etc.
- (2) Product supply (including repair parts) is not available after production is discontinued.

## **3. Overseas service**

Overseas, repairs shall be accepted by Mitsubishi's local overseas FA Center. Note that the repair conditions at each FA Center may differ.

## **4. Exclusion of loss in opportunity and secondary loss from warranty liability**

Regardless of the gratis warranty term, Mitsubishi shall not be liable for compensation to:

- (1) Damages caused by any cause found not to be the responsibility of Mitsubishi.
- (2) Loss in opportunity, lost profits incurred to the user by Failures of Mitsubishi products.
- (3) Special damages and secondary damages whether foreseeable or not, compensation for accidents, and compensation for damages to products other than Mitsubishi products.
- (4) Replacement by the user, maintenance of on-site equipment, start-up test run and other tasks.

## **5. Changes in product specifications**

The specifications given in the catalogs, manuals or technical documents are subject to change without prior notice.

# TRADEMARKS

---

The company names, system names and product names mentioned in this manual are either registered trademarks or trademarks of their respective companies.

In some cases, trademark symbols such as <sup>™</sup> or <sup>®</sup> are not specified in this manual.



SH(NA)-081401ENG-R(2201)

MODEL: IMSF-R-E

## **mitsubishi electric corporation**

HEAD OFFICE : TOKYO BUILDING, 2-7-3 MARUNOUCHI, CHIYODA-KU, TOKYO 100-8310, JAPAN  
NAGOYA WORKS : 1-14, YADA-MINAMI 5-CHOME, HIGASHI-KU, NAGOYA, JAPAN

When exported from Japan, this manual does not require application to the  
Ministry of Economy, Trade and Industry for service transaction permission.

Specifications subject to change without notice.