

Programmable Controllers
MELSEC-L series



Little on size, Large on performance

The new L series has a small footprint and is loaded with features

MELSEC *L* series

Simple!

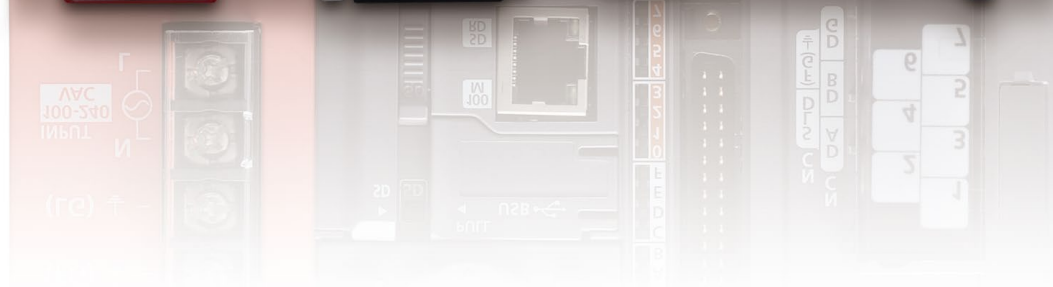

GLOBAL IMPACT OF MITSUBISHI ELECTRIC



Through Mitsubishi Electric's vision, "Changes for the Better" are possible for a brighter future.

Changes for the Better

"Changes for the Better" represents the Mitsubishi Electric Group's attitude to "always strive to achieve something better", as we continue to change and grow. Each one of us shares a strong will and passion to continuously aim for change, reinforcing our commitment to creating "an even better tomorrow".

Mitsubishi Electric is involved in many areas including the following:

Energy and Electric Systems

A wide range of power and electrical products from generators to large-scale displays.

Electronic Devices

A wide portfolio of cutting-edge semiconductor devices for systems and products.

Home Appliance

Dependable consumer products like air conditioners and home entertainment systems.

Information and Communication Systems

Commercial and consumer-centric equipment, products and systems.

Industrial Automation Systems

Maximizing productivity and efficiency with cutting-edge automation technology.

Our advances in AI and IoT are adding new value to society in diverse areas from automation to information systems. The creation of game-changing solutions is helping to transform the world, which is why we are honored to be recognized in the 2019 "Forbes Digital 100" as one of world's most influential digital corporations.



L Series Features P.4

CPU P.14

I/O P.22

Analog/
Temperature Control P.26

Simple Motion/
Positioning P.44

Flexible I/O/
High-Speed Counter P.49

Network P.52

Software P.64

Simple

Convenience that fits in the palm of your hand

The L Series is a compact-class controller, part of the MELSEC products renowned for exceptional cost verses performance and strong reliability. It provides the performance, functions, and capabilities required for today's demanding applications in a small package.

MELSEC-L Series greatly expands the range of functionality traditionally associated with compact programmable controllers and through user-centric design, pushes the limits of ease of use.

Flexible

Ideally configured to satisfy the applications requirements

MELSEC L Series has been designed with three key concepts in mind.

Reliability

Robust and trusted MELSEC product quality.

Ease-of-use

Enabling engineers and programmers to do their job as efficiently as possible to reduce costs.

Flexibility

L Series is a cost-efficient control system flexible to various applications, enabling an ideal system design.



MELSEC *L* series

*1: Option (sold separately). Does not support L02SCPU(-P).

*2: Included with L26CPU(-P)BT

*3: Included with L02CPU(-P), L06CPU(-P), L26CPU(-P), L26CPU(-P)BT

L Series Built-in I/O Features

Every L Series CPU comes with 24 points of built-in I/O standard. These I/O points are capable of many functions usually reserved for separate modules. Save on system costs by using the built-in functions rather than relying exclusively on additional modules.

The built-in I/O*1 comes in sink or source type format and may be chosen based on the application.

L Series CPU Built-in I/O Functions

Positioning (Built-in control of 2 axes)	High-Speed Counter (Two channels built-in)	Pulse Catch	Interrupt Input	General-purpose Input/Output
Function		Features		
Positioning*2	Number of axes: Maximum 2 axes	Maximum speed: 200K pulses/s High-speed activation: 30 μs (Shortest activation time) S-curve acceleration and deceleration are supported.		
High-Speed Counter*2	Number of channels: Maximum 2 channels	Maximum counting speed: 200K pulses/s Open collector, Differential line driver input High accuracy ON/OFF measurements with a resolution of 5 μs High precision PWM control up to 200 kHz (High speed pulse output)		
Pulse Catch	Number of input points: 16 points	Minimum input response time: 10 μs Pulse signals whose ON time is shorter than the scan time can be detected.		
Interrupt Input	Number of interrupt points: 16 points	Built-in CPU provides high-speed processing. All input points support interrupt inputs.		
General-purpose Input	Number of high-speed inputs: 6 points Number of standard inputs: 10 points	Minimum input response time of high-speed input: 10 μs Minimum input response time of standard input: 100 μs		
General-purpose Output	Number of output points: 8 points	Output response time: 1 μs or less		

*1: The L02SCPU, L02CPU, L06CPU, L26CPU and L26CPU-BT are sink type, and the L02SCPU-P, L02CPU-P, L06CPU-P, L26CPU-P and L26CPU-PBT are source type.

*2: Points used by the positioning and high speed counting functions are fixed (as in A phase, B phase, near-point dog). Custom points for these functions may not be assigned.



Easy setup of built-in I/O functions

Configuring built-in I/O functions can be done easily by setting parameters using the programming tool.

Input Signal Function Selection	Input Response Time	Interrupt Processing Condition
In0: Pulse Catch	0.0 ms	Rising
In1: Pulse Catch	0.0 ms	Rising
In2: Interrupt Input	1 ms	Rising
In3: Interrupt Input	1 ms	Falling
In4: Interrupt Input	1 ms	Rising
In5: Interrupt Input	1 ms	Falling
In6: General Input	10 ms	Rising
In7: General Input	10 ms	Rising
In8: General Input	10 ms	Rising
In9: General Input	10 ms	Rising
InA: General Input	10 ms	Rising
InB: General Input	10 ms	Rising
InC: General Input	10 ms	Rising
InD: General Input	10 ms	Rising
InE: General Input	10 ms	Rising
InF: General Input	10 ms	Rising

Built-in I/O function example parameter settings
Pulse Catch: 0.01 ms (response time)
Interrupt Input: 1 ms (response time)

Pulse Output Mode	CW/CCW Mode
Rotation Direction Setting	Current Value Increment with Forward Run Pulse Output
S/W Stroke Upper Limit (pulse)	2147483647
S/W Stroke Lower Limit (pulse)	-2147483648
Speed Limit Value (pulses/s)	20000
Base Speed at Start (pulses/s)	0
Acceleration/Deceleration System Selection	Trapezoid Acceleration/Deceleration

Positioning function example parameter settings
Pulse Output Mode: CW/CCW mode
Rotation Direction Setting:
Current Value Increment with Forward Run Pulse Output

Operation Mode Setting	Normal Mode
Count Source Selection	A Phase/B Phase
Pulse Input Mode	1-Phase Multiple of 1
Counting Speed Setting	100kpps
Z Phase (Preset) Trigger Setting	Rising
External Preset (Z Phase) Request Detection Setting	ON at detection
Counter Format	Linear Counter
Function Input Logic Setting	Positive Logic
Counter Function Selection	Count Disabling Function
Coincidence Output Time Preset Setting	Not preset
Coincidence Detection Interrupt Setting (Counter Value Coincidence No.1)	Not used
Coincidence Detection Interrupt Setting (Counter Value Coincidence No.2)	Not used
Sampling Time Setting (ms)	
Frequency Movement Averaging Processing Count	
Rotation Speed Measurement Unit Time Setting	
Rotation Speed Measurement Unit Time Setting	
Number of Pulses per Rotation (pulse)	
Pulse Measurement Target Setting	

High-speed counter function example parameter settings
Pulse Input Mode: 1-Phase Multiple of 1
Counting Speed Setting: 100 kpps

Built-in CPU positioning control function

Positioning function

The built-in positioning function has a start time of just 30 μs with a maximum high speed output of 200K pulses per second.

Furthermore, it supports S-curve acceleration and deceleration for applications that require minimal machine vibration.

High-speed counter function

Two channels support the high speed counting function. The differential line driver inputs support counting speeds up to 200K pulses per second.

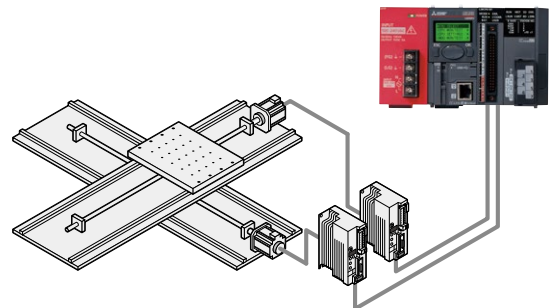

Positioning

High-Speed Counter

Make highly accurate measurements with a resolution of 5 μs

High-Speed Counter

Using pulse measurement mode, where the input signal ON/OFF time is 200 μs or greater, highly accurate measurements in units of 5 μs or greater are possible.

For example it is possible to calculate length by knowing the "work object passing speed" and measuring the ON time of the sensor.

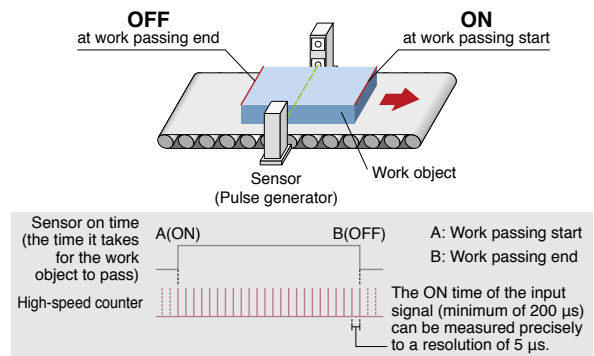

High precision PWM control up to 200 kHz

High-Speed Counter

Using the pulse width modulation control function of the high speed outputs, cycle times as fast as 5 μs can be created. Simply input the ON time and cycle time to drive a wide range of devices from lighting dimmer control, motors, and heaters to precision inspection equipment requiring high resolution performance.

Setting item	Setting range	Description
PWM output ON time*1	0 or 10... 10000000*1 (0.1 μs)	Set the ON time of output pulse
PWM output cycle time*1	50...10000000*1 (0.1 μs)	Set the cycle time of output pulse

*1: The PWM output ON time must be ≤ than PWM output cycle time.

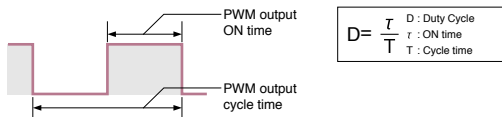

Lighting dimmer control using PWM output

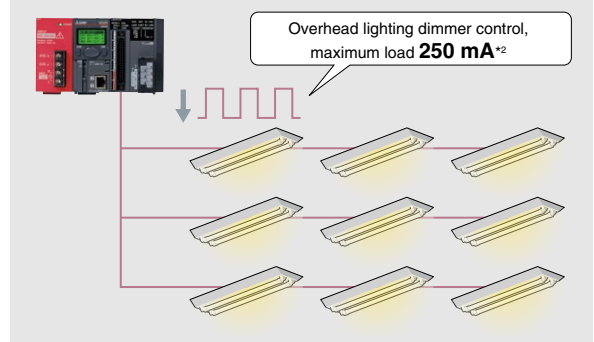

*2: In cases where the first six digits of the serial number are "120722" or later. Previous serial numbers of the CPU module are applied to 100 mA.

Guaranteed input pulse detection

Pulse Catch

Typical programmable controller input devices are unable to detect pulse signals whose ON time is shorter than the scan time or do not occur during I/O refresh periods. The pulse catch function allows these signals to be reliably detected and passed to the sequence program. This function is different from the interrupt input function in that it does not require any special programming. Pulse catch inputs may be used in programs exactly the same as traditional input (X) signals.

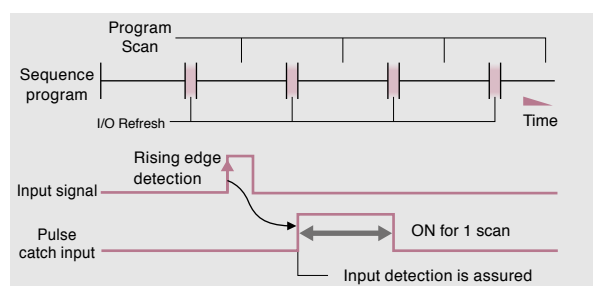

CPU with built-in CC-Link network connectivity

L26CPU-(P)BT

L Series CC-Link ready CPUs are compatible with the latest generation of CC-Link devices and support connections with over 1,000 different product types. Without adding a module, these CPUs can perform high-speed communication with a maximum of 128 words*3 between a master station and a local station. CC-Link is the dominate FA network standard in Asia and continues to gain support worldwide.

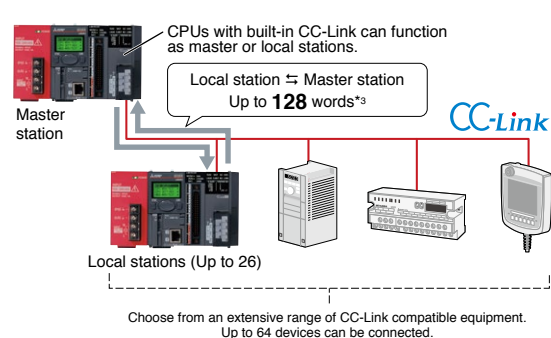

*3: When the number of occupied stations is 4 and the extended cyclic setting is octuple in the Remote net Ver.2 mode.

L Series Features

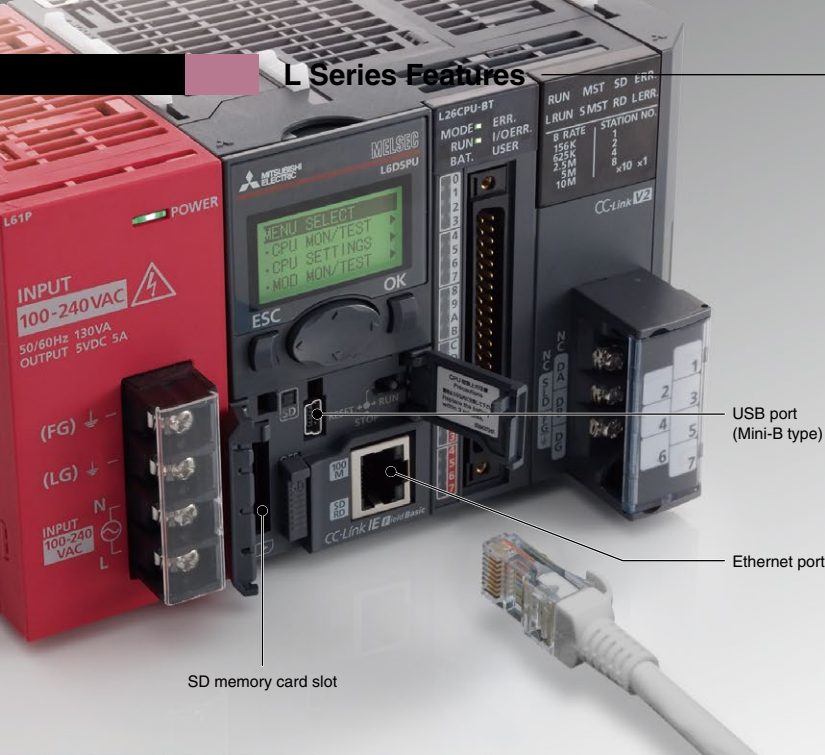

Convenient communication and storage options come as standard

Program, configure, and perform diagnostics on L Series systems using either the USB 2.0 or Ethernet connections. The SD Memory Card slot has many uses including the easy backup and restore of programs and parameters.

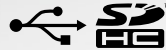

L02CPU(-P) L06CPU(-P) L26CPU(-P) L26CPU(-P)BT

USB and Ethernet connections standard

Use the USB 2.0 interface or Ethernet to connect directly at the installation site. The Ethernet interface supports direct connection with either a cross or straight LAN cable and does not require any configuration of the programmable controller or PC to operate.

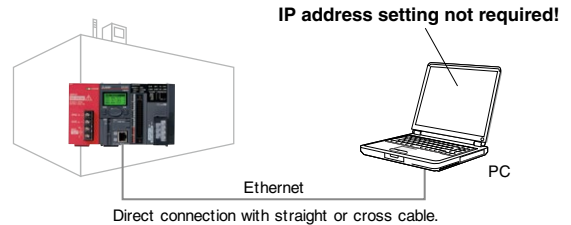

CC-Link IE Field Network Basic does not require network module **Improved functionality!**

Programmable controller CPUs with an embedded Ethernet port can be used as a master station*1, eliminating the need for an additional network module. The network can be configured with a minimum number of modules reducing space and hardware cost.

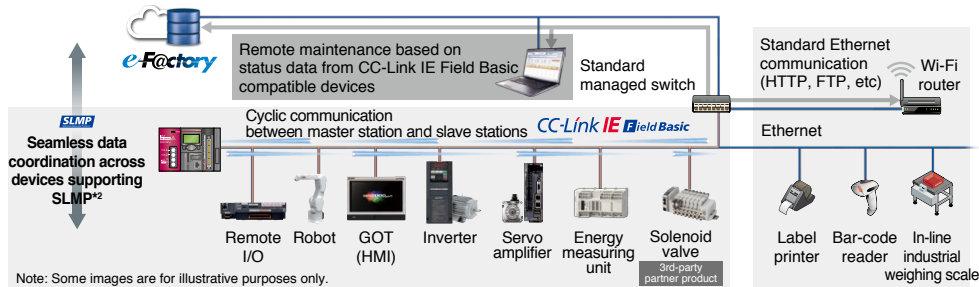

Note: Some images are for illustrative purposes only.

*1: Only LnCPU(-P/-BT/-PBT) are compatible.

*2: SLMP: Seamless Message Protocol

Easily connect to BACnet® and MODBUS®/TCP **Improved functionality!**

Ethernet realizes a high-speed connection, such as communication with external devices.

By using the predefined protocol support function, various devices that require open network protocol support, such as BACnet® and MODBUS®/TCP are supported.

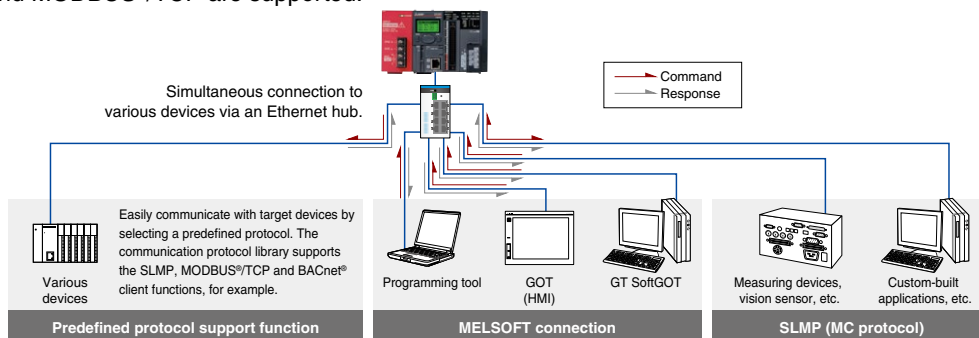

Network timestamp

Synchronize systems on an Ethernet network using an SNTP*1 server. Time synchronization can be achieved to enable simultaneous operations, quality control, or error tracking.

*1: SNTP: Simple Network Time Protocol

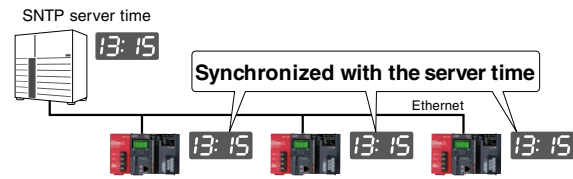

Program-less device data transfer

Simple PLC communication function*2

Using the programming tool, a simple parameter setting is all that is needed to transfer device data such as production information with no programming required.

This function makes it possible to easily establish communications not only with L Series, but also MELSEC iQ-R Series, iQ-F Series, Q Series and QnA/A Series controllers.

*2: CPU module whose first five serial number digits are "13042" or later is required.

Simple PLC Communication Setting

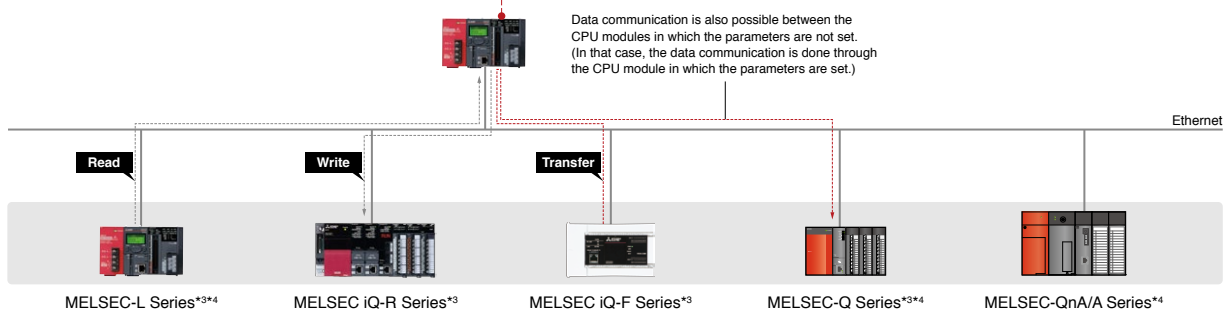
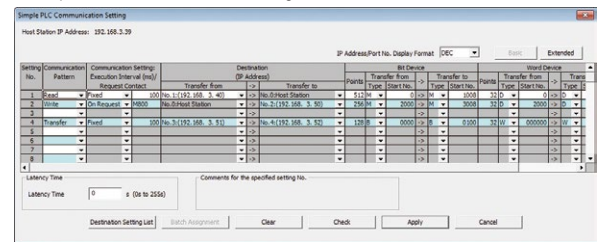

*3: Built-in Ethernet port CPU is supported.

*4: CPU module and Ethernet interface module are supported.

SD memory card special features

Use the SD/SDHC compatible memory card to quickly and easily back-up the CPU programs and parameters. The backups can then be just as easily restored or used to program other CPUs. The memory card can also be used to hold data captured with the data logging function*5.

*5: For details about the data logging function, please refer to page 10.

Save/load programs directly into the Programmable Controller

Multiple project save/load function*6

Parameters, program files, etc., can be saved/read onto an SD memory card by simply using the onboard display unit, without having to connect to a separate PC. Once saved on the SD memory card, files can be sent via e-mail, for example, when requiring off-site editing of the files.

*6: Supported by CPU module whose first five serial number digits are "14042" or later.

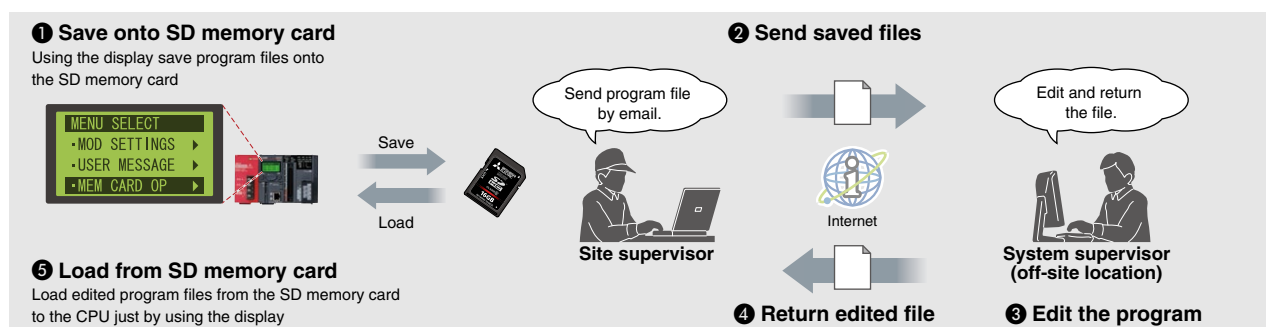

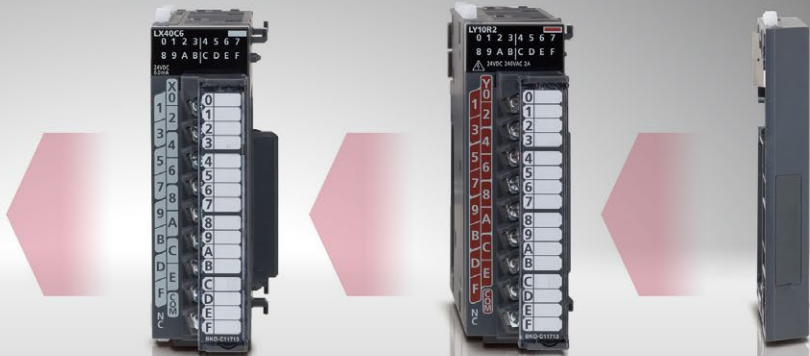

Gain more flexibility with an integrated system bus structure

Save space in control panels by utilizing the integrated system bus structure. Flexibility in system design is made possible by choosing only the required expansion modules for the application.

Expand L Series systems with no base unit restrictions

L Series modules do not require a base unit. The installation space is not restricted by base size, and the system can be installed with minimal required space.

Furthermore, the addition of modules to the system is not restricted by the number of available base unit slots and costs may be reduced due to the elimination of extension base units.

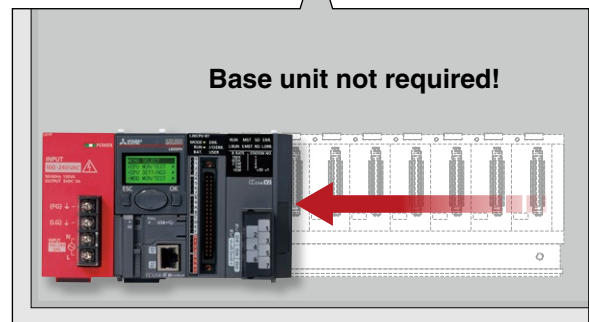
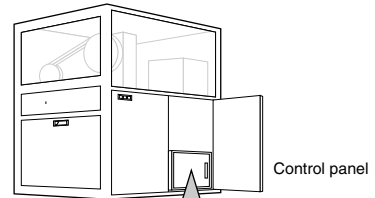

Installation space is reduced in the control panel

Identify important information easily

Every L Series module has the serial number printed on the front surface of the module to allow viewing even during system operation (modules do not need to be removed).

*: Serial numbers can also be checked using GX Works2.



Function version

A serial number is printed on the front surface.

System expandable according to production equipment scale

Up to three extension blocks connectable to the main block using branch and extension modules. A maximum of 40 modules*1 caters a wide range of production equipment and line scale.

CPU module*2	Number of extension blocks	Number of connectable modules*3
L02SCPU(-P) L02CPU(-P)	Up to 2 blocks	Main block: 10 modules Extension block: 11 modules
L06CPU(-P) L26CPU(-P)	Up to 3 blocks	
L26CPU(-P)		
L26CPU(-P)BT		

*1: In the case of L06CPU(-P), L26CPU(-P), and L26CPU(-P)BT.

*2: CPU modules whose first five serial number digits are 13072 or later.

*3: Total number of I/O modules, intelligent function modules, network modules and branch modules.

This does not include the following: Power supply, CPU, display units, extension modules, RS-232 adapter, RS-422/485 adapter, and END covers.

When adding a branch module to a fully occupied block, relocate one of the other modules to a new block to give way to the branch module.

Example of largest system configuration of L26CPU-BT

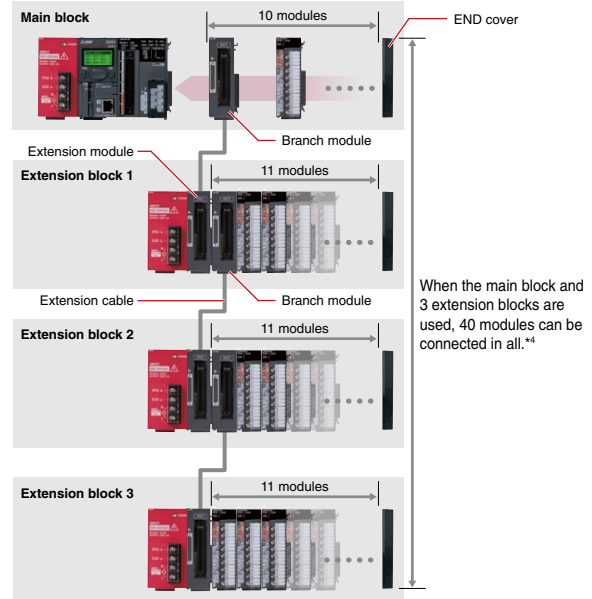

*4: Total number of I/O modules, intelligent function modules and network modules, excluding branch modules.

Well-organized control panel with minimum wiring

Branch module can be strategically placed in a block to minimize wiring space. Extension cables are available in 0.6-, 1.0- and 3.0-m. The maximum extension length is 3.0 m*5.

The extension cable is a one-touch type which can be easily connected and disconnected.

*5: The total length of extension cables should be within 3.0 m.

Example of vertical system configuration

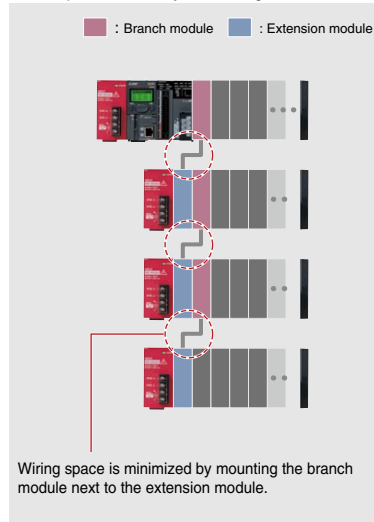

Example of horizontal system configuration

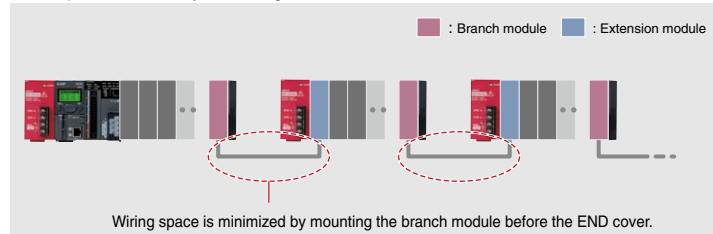

Example of vertical and horizontal mixed system

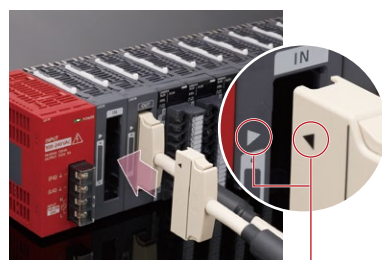
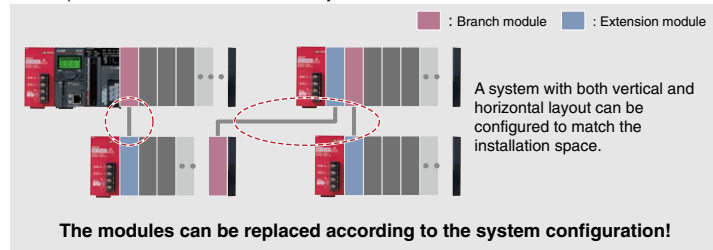

Matching marks on the slot and the cable

Installation position when branch or extension module is used

Modules	Installed block	Possible installation position
Branch module	Main block	Right side of CPU module or left side of END cover
	Extension block	Right side of extension module or left side of END cover
Extension module	Main block	Not applicable
	Extension block	Right side of power supply module

Historical trend and live feeds of production

The data logging function*1 embedded in the CPU module allows collected data to be saved in CSV format on an SD memory card simply by using the dedicated setting tool wizard. Additionally, the real-time feature enables live feeds of production data with setup options enabling adjustment of data capture timings.

*1: Not equipped in L02SCPU(-P).

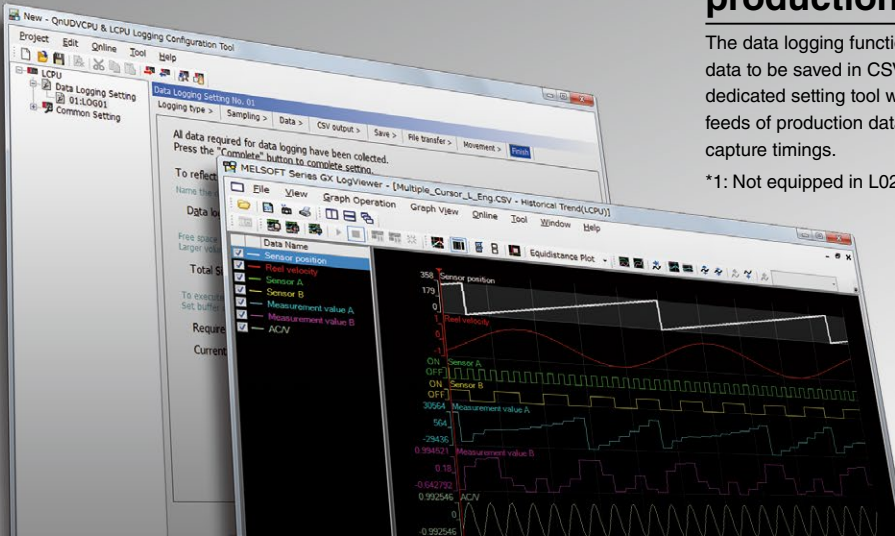

Easily collect production data

Utilizing the installed SD memory card or a direct live connection to the CPU module, logging data can be easily realized just by simply registering parameters. Logged data can be saved in CSV format and utilized in a number of ways, such as for using on third-party spreadsheet software or as a real-time feed data for analyzing various manufacturing processes. The real-time feature of GX LogViewer also enables live feeds showing device status changes, helping to improve traceability, smooth startup, and debugging.

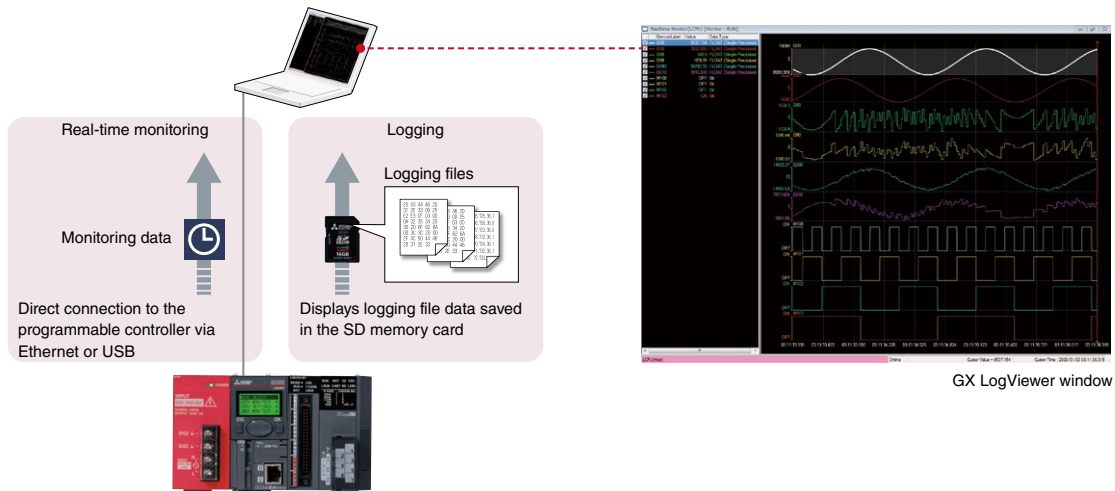

Logging of control data variances

Data is collected during each scan or within millisecond intervals allowing detection of control deviation even at very high speeds. Therefore, identification of errors can be conducted faster and in more detail.

- Generic sample data from a PC or external device at 100 ms intervals
- L Series data logging function is capable of sampling data at much higher intervals as to detect fast changing values.

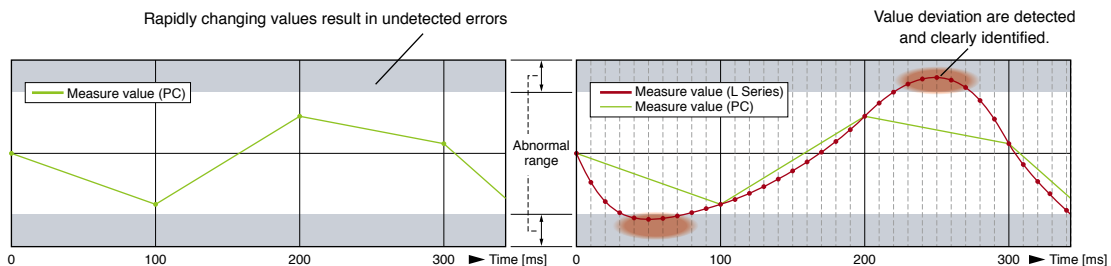

Auto logging function

Automatic data logging realized just by inserting the SD memory card into the CPU, which is achieved as the memory card includes the logging configuration file. Instructing data logging remotely is also realized just by sending the configuration file by e-mail and copying onto the SD memory card.

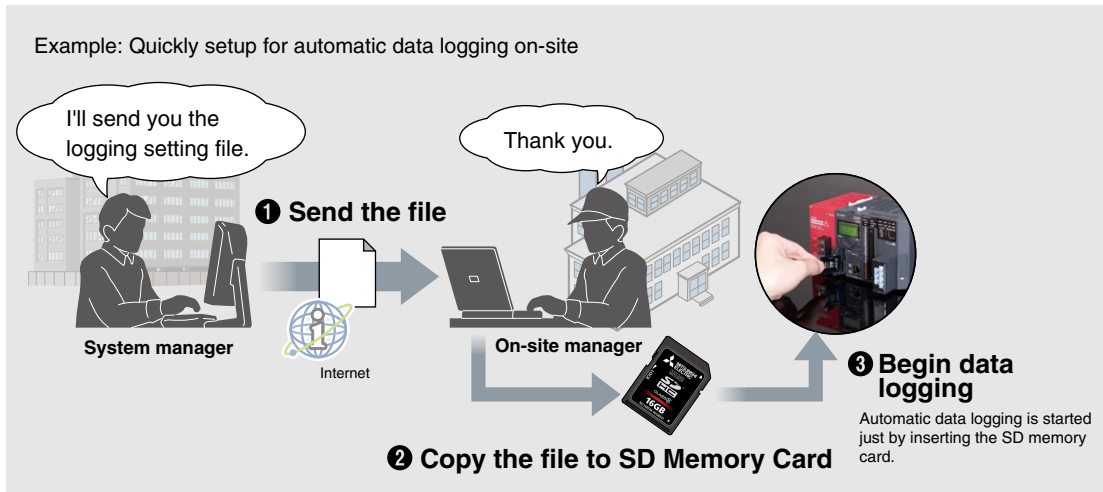

Automatically send logging files to FTP server

Data logging files saved on the SD memory card can be sent to the FTP server just by making a simple setting with the logging configuration tool. As the logging server can handle multiple files, management and maintenance tasks can be reduced.

■ File transfer feature*1

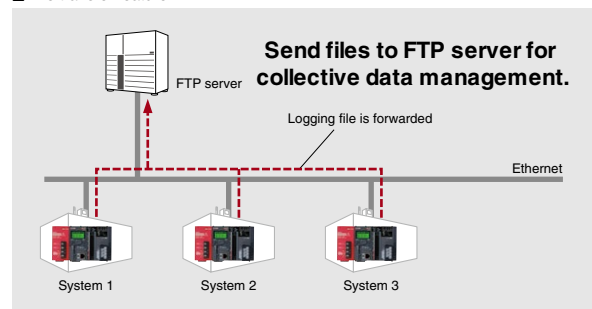

*1: Using a CPU module with the first 5 digits of the serial number "12112" or later.

Trigger logging function

Error causes and solutions can be quickly done as only the required data related to the problem is extracted, without having to spend time on filtering large volumes of diagnostic data.

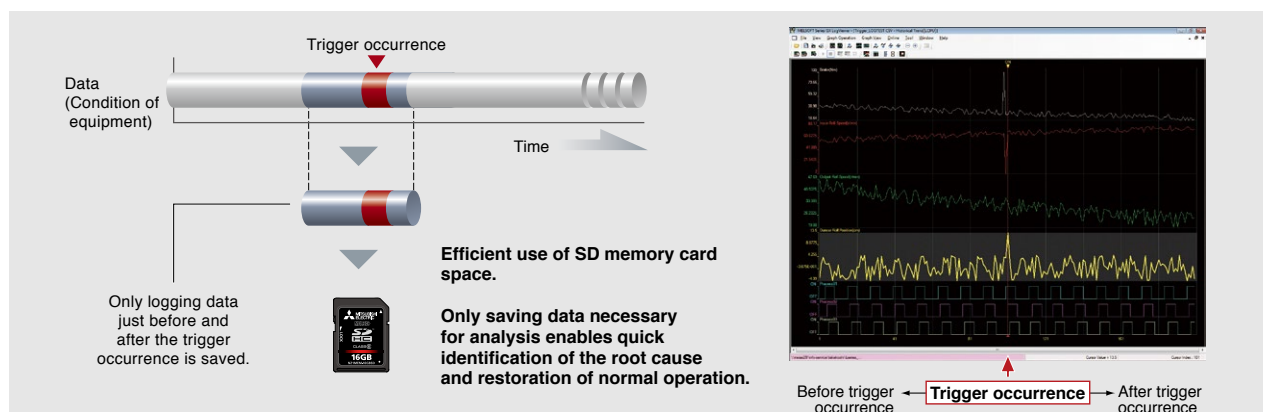

To receive a copy of GX LogViewer, contact your local Mitsubishi Electric representative.

L Series Features

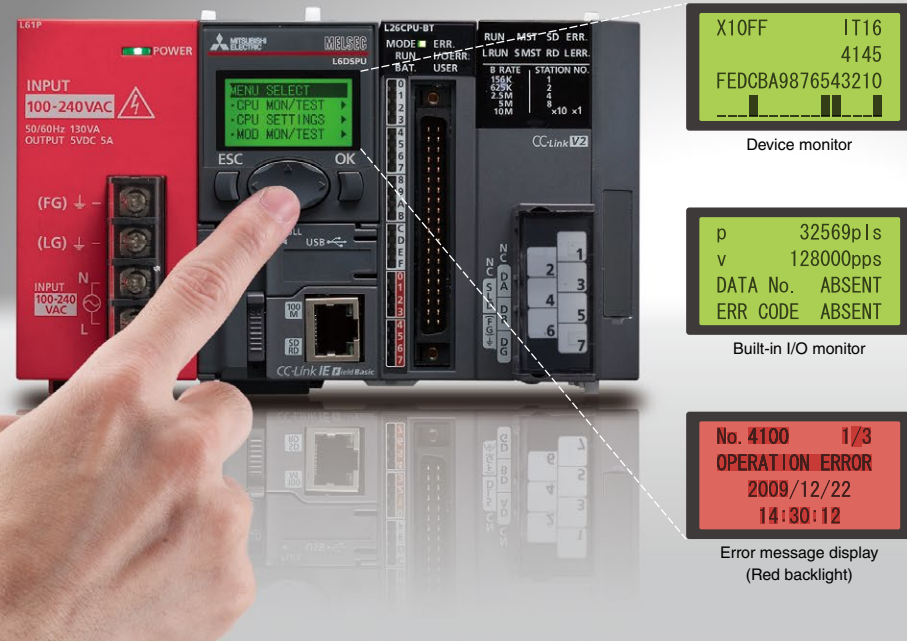

X10FF IT16
4145
FEDCBA9876543210

Device monitor

p 32569pIs
v 128000pps
DATA No. ABSENT
ERR CODE ABSENT

Built-in I/O monitor

No. 4100 1/3
OPERATION ERROR
2009/12/22
14:30:12

Error message display
(Red backlight)

Feature rich and easy to use display

Check the system status and make setting changes directly from the display. Error status is clearly identified and troubleshooting and error investigation can be performed all without the need for any connections or engineering software.

*: Not available for L02SCPU(-P).

L02CPU(-P) L06CPU(-P) L26CPU(-P) L26CPU(-P)BT

Instant error information check

Error history and detailed error information are available directly from the display unit.

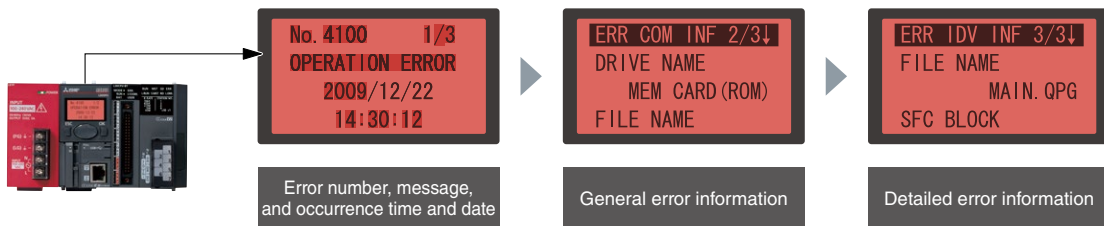

Intuitive menu navigation

The menu navigation guide shows the current menu tree location and an arrow to indicate the scroll direction at the top of the display.

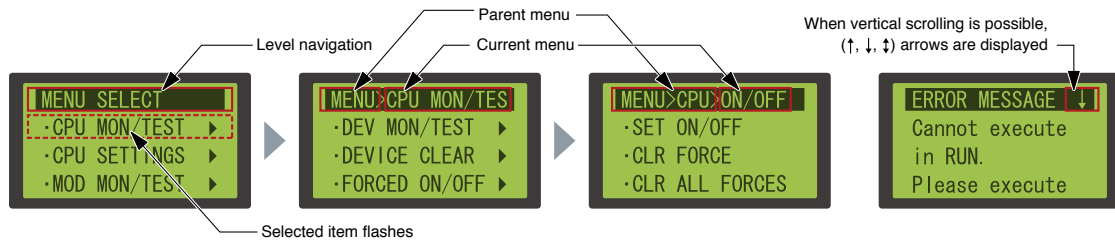

Multilingual operation

The display unit language can be selected (Japanese or English).

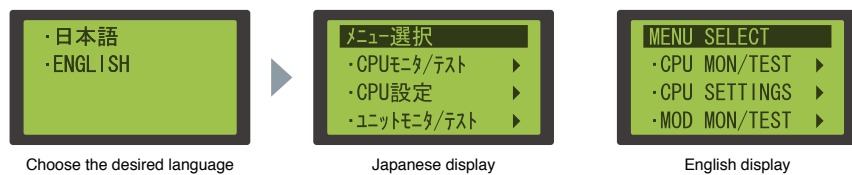



Universal Design

An easy-to-use modular design

The L Series module labeling design has been created to ensure clear legibility and identification of information at a glance to avoid mistakes.

L Series Features

CPU

I/O

Universal design

Adopting a universal font

A high visibility font has been chosen for characters printed on system modules.

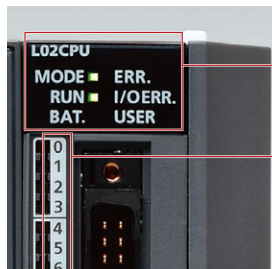

Regular Gothic font

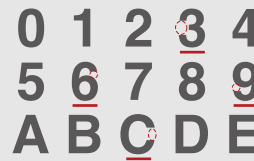

The characters are thick enough, however the numbers "3, 6, 8, 9" and the alphabet "C" are not clearly distinguishable because the spacing indicated with a red circle is not large enough.

Font for L Series

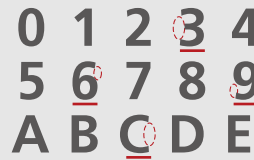

The space indicated with a red circle has been enlarged. The numbers "3, 6, 8, 9" and the alphabet "C" are clearly distinguishable. Characters are legible even in small print.

Module design

White and red are used to distinguish inputs from outputs respectively to allow for easy identification of terminal connection type.

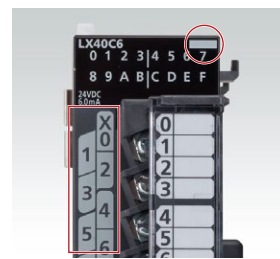

White for input module

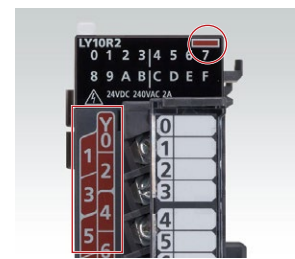

Red for output module

Analog/
Temperature Control

Simple Motion/
Positioning

Flexible I/O/
High-Speed Counter

Easily identify module status

LEDs display the current status of modules including run and error states.



LEDs are located on the top front surface of the modules.

Network

Software

CPU Modules

Communication interface: RS-232		<p>L02SCPU</p> <p>General-purpose output: Sink type Program capacity: 20K steps Basic operation processing speed: 60 ns</p> <p>*: End cover is enclosed. Cannot be mounted on display unit (L6DSPU), RS-232 adapter, RS-422/485 adapter.</p>	<p>L02SCPU-P</p> <p>General-purpose output: Source type Program capacity: 20K steps Basic operation processing speed: 60 ns</p>
Communication interface: Ethernet		<p>L02CPU</p> <p>General-purpose output: Sink type Program capacity: 20K steps Basic operation processing speed: 40 ns</p> <p>*: END cover is included.</p>	<p>L02CPU-P</p> <p>General-purpose output: Source type Program capacity: 20K steps Basic operation processing speed: 40 ns</p>
		<p>L06CPU</p> <p>General-purpose output: Sink type Program capacity: 60K steps Basic operation processing speed: 9.5 ns</p> <p>*: END cover is included.</p>	<p>L06CPU-P</p> <p>General-purpose output: Source type Program capacity: 60K steps Basic operation processing speed: 9.5 ns</p>
		<p>L26CPU</p> <p>General-purpose output: Sink type Program capacity: 260K steps Basic operation processing speed: 9.5 ns</p> <p>*: END cover is included.</p>	<p>L26CPU-P</p> <p>General-purpose output: Source type Program capacity: 260K steps Basic operation processing speed: 9.5 ns</p>
Communication interface: Ethernet port and a built-in CC-Link interface		<p>L26CPU-BT</p> <p>General-purpose output: Sink type Program capacity: 260K steps Basic operation processing speed: 9.5 ns</p> <p>*: END cover is included.</p>	<p>L26CPU-PBT</p> <p>General-purpose output: Source type Program capacity: 260K steps Basic operation processing speed: 9.5 ns</p>

Model	General-purpose output	Number of I/O points	Program capacity	Basic operation processing speed (LD instruction)	Peripheral connection ports	Built-in network
L02SCPU	Sink type	1024 points	20K steps	60 ns	USB/RS-232	—
L02CPU				40 ns		—
L06CPU		4096 points	60K steps	9.5 ns	USB/Ethernet	—
L26CPU						—
L26CPU-BT						CC-Link
L02SCPU-P	Source type	1024 points	20K steps	60 ns	USB/RS-232	—
L02CPU-P				40 ns		—
L06CPU-P		4096 points	60K steps	9.5 ns	USB/Ethernet	—
L26CPU-P						—
L26CPU-PBT						CC-Link

CPU packages

- **L02CPU-SET**
Includes CPU (L02CPU), power supply module (L61P), and display unit (L6DSPU).
- **L02CPU-P-SET**
Includes CPU (L02CPU-P), power supply module (L61P), and display unit (L6DSPU).



- **L06CPU-SET**
Includes CPU (L06CPU), power supply module (L61P), and display unit (L6DSPU).
- **L06CPU-P-SET**
Includes CPU (L06CPU-P), power supply module (L61P), and display unit (L6DSPU).



- **L26CPU-SET**
Includes CPU (L26CPU), power supply module (L61P), and display unit (L6DSPU).
- **L26CPU-P-SET**
Includes CPU (L26CPU-P), power supply module (L61P), and display unit (L6DSPU).



- **L26CPU-BT-SET**
Includes CPU (L26CPU-BT), power supply module (L61P), and display unit (L6DSPU).
- **L26CPU-PBT-SET**
Includes CPU (L26CPU-PBT), power supply module (L61P), and display unit (L6DSPU).



General specifications

General specifications indicate the environmental specifications in which this product can be installed and operated. Unless otherwise specified, these general specifications apply to all L Series products.
*: General specifications of jointly developed products are different from those of MELSEC products. For more information, please refer to the product manuals or contact your local Mitsubishi Electric representative.

Item	Specification					
Operating ambient temperature	0...55°C					
Storage ambient temperature	-25...75°C					
Operating ambient humidity	5...95%RH, non-condensing					
Storage ambient humidity						
Vibration resistance	Compliant with JIS B 3502 and IEC 61131-2	Under intermittent vibration	Frequency	Constant acceleration	Half amplitude	Sweep count 10 times each in X, Y, Z directions
			5...8.4 Hz	—	3.5 mm	
		Under continuous vibration	8.4...150 Hz	9.8 m/s ²	—	—
			5...8.4 Hz	—	1.75 mm	
8.4...150 Hz	4.9 m/s ²	—	—			
Shock resistance	Compliant with JIS B 3502 and IEC 61131-2 (147 m/s ² , 3 times each in directions X, Y, Z)					
Operating atmosphere	No corrosive gases					
Operating altitude*1	0...2000 m					
Installation location	Inside a control panel					
Overvoltage category*2	≤ II					
Pollution degree*3	≤ 2					
Equipment class	Class 1					

*1: Do not use or store the programmable controller under pressure higher than the atmospheric pressure of altitude 0 m.

Doing so may cause malfunction. When using the programmable controller under pressure, please consult your local Mitsubishi Electric representative.

*2: This indicates the section of the power supply to which the equipment is assumed to be connected between the public electrical power distribution network and the machinery within premises.

Category II applies to equipment for which electrical power is supplied from fixed facilities. The surge voltage withstand level for up to the rated voltage of 300 V is 2500 V.

*3: This index indicates the degree to which conductive material is generated in terms of the environment in which the equipment is used.

Pollution level 2 is when only non-conductive pollution occurs. A temporary conductivity caused by condensing must be expected occasionally.

CPU module specifications

Item	L02SCPU L02SCPU-P	L02CPU L02CPU-P	L06CPU L06CPU-P	L26CPU L26CPU-P	L26CPU-BT L26CPU-PBT	
Control method	Stored program cyclic operation					
I/O control mode	Refresh mode (The direct access input/output is available by specifying the direct access input/output (DX, DY).)					
Programming language (sequence control language)	Function block, relay symbol language, MELSAP3 (SFC), MELSAP-L, structured text (ST), logic symbolic language					
Processing speed*4 (sequence instruction)	LD instruction	60 ns	40 ns	9.5 ns		
	MOV instruction	120 ns	80 ns	19 ns		
Constant scan	0.5...2000 ms (Setting is available in increments of 0.5 ms by parameter.)					
Program capacity	20K steps (80K bytes)		60K steps (240K bytes)	260K steps (1040K bytes)		
Memory capacity	Program memory (drive 0)	80K bytes		240K bytes	1040K bytes	
	Memory card (RAM) (drive 1)	—				
	Memory card (ROM) (drive 2)	Depends on the SD/SDHC memory card used.*5				
	Standard RAM (drive 3)	128K bytes		768K bytes		
Standard ROM (drive 4)	512K bytes		1024K bytes	2048K bytes		
Maximum number of files stored	Program memory	64 files		124 files	252 files	
	Memory card (RAM)	—				
	Memory card (ROM)	SD	—			
		SDHC	—			
Standard RAM	4 files (each one of the following files: file register file, local device file, sampling trace file, and module error collection file)					
Maximum number of intelligent function module parameters	Initial setting	2048 parameters		4096 parameters		
	Refresh	1024 parameters		2048 parameters		
Maximum number of installable modules*6	30		40			
Built-in I/O function	Refer to the built-in I/O specifications ➡ P.17 to P.19					
Data logging function	—		Refer to the data logging function specifications ➡ P.18			
Built-in Ethernet function	—		Refer to the built-in Ethernet specifications ➡ P.19			
Built-in serial communication function	Refer to the built-in serial communication specifications ➡ P.19		—			
Built-in CC-Link function	—				Refer to the CC-Link Master/Local Module specifications. ➡ P.56	
Clock function	Displayed information	Year, month, date, hour, minute, second, and day of the week (automatic leap year detection)				
	Accuracy	0°C: -2.96...+3.74 s (TYP. +1.42 s) per day 25°C: -3.18...+3.74 s (TYP. +1.50 s) per day 55°C: -13.20...+2.12 s (TYP. -3.54 s) per day				
5 V DC internal current consumption	CPU	With display unit	—	1.00 A	1.06 A	1.43 A
		Without display unit	0.75 A	0.94 A	1.00 A	1.37 A
	END cover (Accessory)*7	0.04 A				
Weight	CPU	With display unit	—		0.40 kg	0.50 kg
		Without display unit	0.32 kg		0.37 kg	0.47 kg
	END cover (Accessory)*7	0.06 kg				

*4: Indexing devices does not delay processing time.

*5: The operation of devices that are not manufactured or recommended as compatible products by Mitsubishi Electric cannot be guaranteed.

*6: The total number of modules that can be installed onto a CPU module. Also refer to the "Module size allocation" for each module.

(Power supply modules, CPU module, Display unit, Extension module, RS-232 adapter, RS-422/485 adapter, END cover, and END cover with error terminal are not included. Note that only one CPU per system is possible.)

*7: The END cover is included with the CPU module and must be placed on the right end of the last module in the system.

■ CPU module device specifications

Item	L02SCPU L02SCPU-P	L02CPU L02CPU-P	L06CPU L06CPU-P	L26CPU L26CPU-P	L26CPU-BT L26CPU-PBT
Number of I/O device points (number of points available on a program)	8192 points (X/Y0...X/Y1FFF)				
Number of I/O points	1024 points (X/Y0...X/Y3FF)		4096 points (X/Y0...X/YFFF)		
Internal relay (M)	8192 points (M0...M8191) by default (changeable)				
Latch relay (L)	8192 points (L0...L8191) by default (changeable)				
Link relay (B)	8192 points (B0...B1FFF) by default (changeable)				
Timer (T)	2048 points (T0...T2047) by default (changeable) (Low-speed and high-speed timers available) (Low-speed timer: 1...1000 ms (in increments of 1 ms), default: 100 ms) (High-speed timer: 0.1...100 ms (in increments of 0.1 ms), default: 10 ms)				
Retentive timer (ST)	0 point by default (changeable)(Low-speed and high-speed retentive timers available) (Low-speed retentive timer: 1...1000 ms (in increments of 1 ms), default: 100 ms) (High-speed retentive timer: 0.1...100 ms (in increments of 0.1 ms), default: 10 ms)				
Counter (C)	Normal counter 1024 points (C0...C1023) by default (changeable)				
Data register (D)	12288 points (D0...D12287) by default (changeable)				
Extended data register (D)	32768 points (D12288...D45055) by default (changeable)		131072 points (D12288...D143359) by default (changeable)		
Link register (W)	8192 points (W0...W1FFF) by default (changeable)				
Extended link register (W)	0 point by default (changeable)				
Annunciator (F)	2048 points (F0...F2047) by default (changeable)				
Edge relay (V)	2048 points (V0...V2047) by default (changeable)				
Link special relay (SB)	2048 points (SB0...SB7FF) by default (changeable)				
Link special register (SW)	2048 points (SW0...SW7FF) by default (changeable)				
File register	(R)	32768 points (R0...R32767) (Maximum 65536 points are available by switching blocks.)		32768 points (R0...R32767) (Maximum 393216 points are available by switching blocks.)	
	(ZR)	65536 points (ZR0...ZR65535) (Blocks do not need to be switched.)		393216 points (ZR0...ZR393215) (Blocks do not need to be switched.)	
Step relay (S)	8192 points (S0...S8191) by default				
Index register/standard device register (Z)	20 point (Z0...Z19) (maximum)				
Index register (Z) (32-bit index modification of ZR device)	10 point (Z0...Z18) (maximum) (The index register is used as a double-word device.)				
Pointer (P)	4096 points (P0...P4095) (The local pointer range and the common pointer range can be set by parameter.)				
Interrupt pointer (I)	256 points (I0...I255) (The fixed scan interval for the system interrupt pointer I28...I31 can be set by parameter.) 0.5...1000 ms (in increments of 0.5 ms) Default I28: 100 ms, I29: 40 ms, I30: 20 ms, I31: 10 ms				
Special relay (SM)	2048 points (SM0...SM2047) (The number of device points is fixed.)				
Special register (SD)	2048 points (SD0...SD2047) (The number of device points is fixed.)				
Function input (FX)	16 points (FX0...FX F) (The number of device points is fixed.)				
Function output (FY)	16 points (FY0...FY F) (The number of device points is fixed.)				
Function register (FD)	5 points (FD0...FD4) (The number of device points is fixed.)				
Intelligent function module device	Device that directly accesses the buffer memory of an intelligent function module Specification format: U□□/G□□				
Latch (data retention during power failure) range	8192 points (L0...L8191) by default (The latch range can be set for the devices, B, F, V, T, ST, C, D, W, and R by parameter.)				

■ CPU built-in I/O function – input specifications (general-purpose input/interrupt input/pulse catch function)

Item		Description	
Standard input	Points	10	
	Input voltage/current	24 V DC 4.1 mA (TYP.)	
	Minimum input response time	100 μ s	
	Input response time setting	0.1 ms, 1 ms, 5 ms, 10 ms, 20 ms, 70 ms	
	Common terminal arrangement	10 points/common (Positive or negative common)	
High-speed input	Points	6	
	Input voltage/current	DC input	24 V DC 6.0 mA (TYP.)
		Differential input	EIA Standard RS-422-A Differential line driver level AM26L31 (manufactured by Texas Instruments Incorporated) or equivalent
	Minimum input response time	10 μ s	
	Input response time setting	0.01 ms/0.1 ms/0.2 ms/0.4 ms/0.6 ms/1 ms	
Common terminal arrangement	Independent		

■ CPU built-in I/O function – output specifications (general-purpose output function)

Item		Description
Points		8
Output voltage/current		5...24 V DC 0.1 A
Response time	OFF to ON	$\leq 1 \mu$ s (rated load, resistance load)
	ON to OFF	
Common terminal arrangement		L02SCPU, L02CPU, L06CPU, L26CPU, L26CPU-BT: 8 points/common (Sink type) L02SCPU-P, L02CPU-P, L06CPU-P, L26CPU-P, L26CPU-PBT: 8 points/common (Source type)

■ CPU built-in I/O function – positioning function specifications

Item		Description	
Number of controlled axes		2	
Control unit		pulse	
Operation pattern	PTP*1 control	Available	
	Path control	Not usable	
Number of positioning data		10 data/axis	
Positioning control	Positioning control method	PTP*1 control	ABS/INC
		Speed/position switching control	INC
	Positioning range	PTP*1 control	-2147483648...2147483647 pulses
		Speed/position switching control	0...2147483647 pulses
	Speed command	0...200k pulses/s	
Acceleration/deceleration system selection	Automatic trapezoid acceleration/deceleration and S-curve acceleration/deceleration		
Acceleration/deceleration time		0...32767 ms	
OPR method		6 types	
Starting time (1-axis linear control)		Trapezoid acceleration/deceleration (single-axis start): 30 μ s/axis S-curve acceleration/deceleration (single-axis start): 35 μ s/axis	
Command pulse output	Pulse output method	L02SCPU, L02CPU, L06CPU, L26CPU, L26CPU-BT: 5...24V DC (Sink type) L02SCPU-P, L02CPU-P, L06CPU-P, L26CPU-P, L26CPU-PBT: 5...24V DC (Source type)	
	Pulse output mode	4 types	
	Maximum output pulse	200k pulses/s	
	Maximum connection distance with drive unit	2 m	
External input	Zero signal	DC input	24 V DC 6.0 mA (TYP.)
		Differential input	EIA RS-422-A differential line driver level AM26L31 (manufactured by Texas Instruments Incorporated) or equivalent
	Speed/position switching signal	24 V DC 4.1 mA (TYP.)	
	Near-point dog signal		
	Upper and lower limit signal		
Drive unit ready signal			
Input response time	Zero signal: 10 μ s Speed/position switching control, near-point dog signal: 100 μ s Upper and lower limit signal, drive unit ready signal: 2 ms		
External output	Deviation counter clear signal	L02SCPU, L02CPU, L06CPU, L26CPU, L26CPU-BT: 5...24 V DC 0.1A (Sink type) L02SCPU-P, L02CPU-P, L06CPU-P, L26CPU-P, L26CPU-PBT: 5...24 V DC 0.1A (Source type)	
	Response time	OFF to ON ON to OFF	$\leq 1 \mu$ s (rated load, resistive load)

*1: Abbreviation for "Point to Point." This is a type of position control.

■ CPU built-in I/O function – high-speed counter specifications

Item		Description
Number of channels		2
Count input signal	Phase	1-phase input (1 multiple/2 multiples) CW/CCW, 2-phase input (1 multiple/2 multiples/4 multiples)
	Signal level	DC input 24 V DC 6.0 mA (TYP.) Differential input EIA Standard RS-422-A Differential line driver level AM26L31 (manufactured by Texas Instruments Incorporated) or equivalent
Counter	Maximum counting speed	200k pulses/s (for 2 multiples of 1 phase and 4 multiples of 2 phases)
	Counting range	-2147483648...2147483647
	Model	UP/DOWN preset counter (with ring counter function)
	Minimum count pulse width (Duty ratio 50%)	1 phase: 5 μs 2 phases: 10 μs
Min. phase differential for 2-phase input		5 μs
External input	Phase Z (preset)	DC input 24 V DC 6.0 mA (TYP.) Differential input EIA Standard RS-422-A Differential line driver level AM26L31 (manufactured by Texas Instruments Incorporated) or equivalent
	Function start	24 V DC 4.1 mA (TYP.)
	Latch	
	Input response time	Phase Z: 10 μs Function start, latch: 100 μs
External output	Output format	L02SCPU, L02CPU, L06CPU, L26CPU, L26CPU-BT: Sink type L02SCPU-P, L02CPU-P, L06CPU-P, L26CPU-P, L26CPU-PBT: Source type
	Output voltage/current	Coincidence output No. 1 / PWM output: 5...24 V DC/0.25 A*1 Coincidence output No. 2: 5...24 V DC/0.1 A
	Response time	OFF to ON: ≤ 1 μs (Rated load, resistance load) ON to OFF: ≤ 1 μs (Rated load, resistance load)
	Comparison range	-2147483648...2147483647
Coincidence output	Comparison result	Set value < Counted value Set value = Counted value Set value > Counted value
	Output points	2 points/channel
PWM output	Output frequency range	DC...200 kHz
	ON width	1 μs
	Duty ratio	On width can be set in increments of 0.1 μs.
Pulse width measurement	Output points	1 point/channel
	Measurement item	Pulse width (On width: ≥ 200 μs, Off width: ≥ 200 μs)
	Measurement resolution	5 μs
Measurement points		1 point/channel

*1: For units where the first six digits of the serial number are "120722" or later. The specification for previous serial numbers is 5 to 24 V DC/0.1 A.

■ CPU data logging function specifications

Item		L02CPU L02CPU-P	L06CPU L06CPU-P	L26CPU L26CPU-P	L26CPU-BT L26CPU-PBT
Number of data logging settings		10			
Data logging buffer capacity		For each setting, any of 32 to 4832K bytes (in units of 1K byte) can be specified. The total value of settings No.1 to No.10 is up to 5120K bytes.			
Data storage location		Standard ROM (configuration files only), SD Memory Card			
Logging type		<ul style="list-style-type: none"> Continuous logging Trigger logging Each scanning cycle Time specification Condition specification (Device specification, Step No. specification) 			
Data sampling	Sampling interval	Up to 1280 (128 points per setting)			
	No. of data sampling points	In the Sampling interval setting, Device and Step No. under "Condition specification" can be specified in combination (AND conjunction).			
Data processing	AND conjunction	In the Trigger setting, Device data change and Step No. under "Condition specification" can be specified in combination (AND conjunction).			
	Trigger logging	Trigger condition	<ul style="list-style-type: none"> Condition specification (Device change specification, Step No. specification) When trigger instruction executed When data logging trigger activated 		
		AND conjunction	In the Trigger setting, Device data change and Step No. under "Condition specification" can be specified in combination (AND conjunction).		
		Trigger logging range	Data of the specified number of records are logged before and after a trigger.		
	Number of triggers	1			
	Number of trigger logging records	Up to 1000000			
File output	File name	Up to 48 one-byte characters can be used for the following. • File number (serial number)*2 • Character string (name)*3 • Date and time*3			
	File format	CSV file			
	Data type	<ul style="list-style-type: none"> Bit Double word (unsigned) FLOAT (double precision) 	<ul style="list-style-type: none"> Word (unsigned) Double word (signed) Character string: 1...256 characters 	<ul style="list-style-type: none"> Word (signed) FLOAT (single precision) Numeric string: 1...256 bytes 	
	Data output format (CSV file)	<ul style="list-style-type: none"> Decimal format 	<ul style="list-style-type: none"> Hexadecimal format 	<ul style="list-style-type: none"> Exponential format 	
Handling of output files	File switching	File switching timing	No. of records	File size	
		Number of saved files	1...65535		

*2: Part of the saved file name, this number is automatically assigned.

*3: Optional data to be appended to the saved file name.

■ CPU built-in Ethernet function specifications

Item		L02CPU L02CPU-P	L06CPU L06CPU-P	L26CPU L26CPU-P	L26CPU-BT L26CPU-PBT
Transmission specifications	Data transfer speed	100 or 10 Mbps			
	Communication mode	Full-duplex or half-duplex			
	Transmission method	Base band			
	Maximum distance between hub and node	100 m			
	Maximum number of nodes/connection	10BASE-T	Cascade connection: Up to four		
	100BASE-TX	Cascade connection: Up to two			
Number of connections	TCP/IP	Total of 16 for socket communications, MELSOFT connections, and MC protocol.*1			
	UDP/IP	One for FTP			
Connection cable*2	10BASE-T	Ethernet cable of category 3 or higher (STP/UTP cable)*3			
	100BASE-TX	Ethernet cable of category 5 or higher (STP cable)			

*1: Only the QnA-compatible 3E frame may be used.

*2: Standard (straight type) cable. Also, when the CPU is connected directly with a GOT(HMI), a cross cable (category 5e or less) may be used.

*3: The use of STP (Shielded Twisted Pair) cables is recommended in noisy environments.

■ Communication performance comparison (Comparison of LCPU with built-in Ethernet port and Ethernet interface module)

Function/performance	LCPU with built-in Ethernet port	Ethernet interface module
Communication speed	100 Mbps	100 Mbps
MC protocol communication	●*4	●
Socket communication	●*5	● (Fixed buffer communication)
Communications using a random access buffer	—	●
E-mail function	—	●
Communications using data link instructions	—	●
File transfer (FTP server) function	●*6	●
Web function	—	●
MELSOFT products and GOT(HMI) connection	●	●

*4: QnA compatible 3E frame device memory access commands only. Refer to the relevant manual for details.

*5: There are some differences regarding the fixed buffer communications function. Refer to the relevant manual for details.

*6: The "quote cpuchg" command is not supported.

■ CPU built-in serial communication function specifications

Item	L02SCPU L02SCPU-P
Communication mode	Full duplex
Synchronization method	Asynchronous method
Transmission speed	9.6 kbps, 19.2 kbps, 38.4 kbps, 57.6 kbps, 115.2 kbps
Data format	<ul style="list-style-type: none"> Start bits: 1 Data bits: 8 Parity bits: Odd number Stop bits: 1
MC protocol format*7 (automatic judgment)	<ul style="list-style-type: none"> Formats 4 (ASCII) Formats 5 (Binary)
Frame*7	<ul style="list-style-type: none"> QnA compatible 3C frame QnA compatible 4C frame
Transmission control	DTR/DSR control
Transmission distance (Overall distance)	Maximum 15 m

*7: Information relevant to the MC protocol format and frame are shown below.

Function		Formats 4	Formats 5
Communication with ASCII code	QnA compatible 3C frame	●	—
	QnA compatible 4C frame	●	—
Communication with binary code	QnA compatible 4C frame	●	●

■ How to read the product code

L 26 □ CPU - P BT - SET

① ② ③ ④ ⑤ ⑥

Number	Item	Code	Specification
①	Program memory capacity	02	20K steps
		06	60K steps
		26	260K steps
②	Communication interface	Blank	Built-in Ethernet model
		S	Built-in RS-232 model
③	Type of module	CPU	CPU module
④	Built-in I/O output format	Blank	Sink type
		P	Source type
⑤	Built-in CC-Link function	Blank	—
		BT	●
		SET	●
⑥	Product set	Blank	—
		SET	Set includes a power supply module (L61P) and display unit (L6DSPU)

Branch/Extension Modules



Branch and extension module specifications

Item	L6EXB [Branch module]	L6EXE [Extension module]
5 V DC internal current consumption	0.08 A	0.08 A
Weight	0.12 kg	0.13 kg

Extension cable specifications

Item	LC06E	LC10E	LC30E
Cable length	0.6 m	1.0 m	3.0 m
Weight	0.19 kg	0.23 kg	0.45 kg

Power Supply Modules

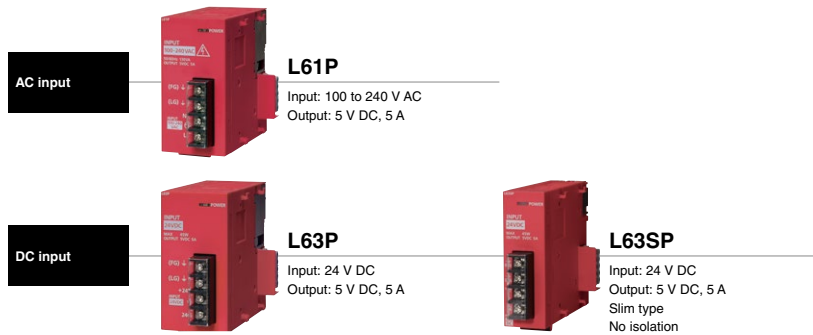

Power supply module specifications

Item	L61P	L63P	L63SP
Input power supply	100...240 V AC (-15%...+10%)	24 V DC (-35%...+30%)	
Input frequency	50/60 Hz (-5%...+5%)	—	
Input voltage distortion	≤ 5%	—	
Maximum input apparent power	130 VA	—	
Maximum input power	—	45 W	
Inrush current	20 A, ≤ 8 ms	100 A, ≤ 1 ms (24 V DC input)	
Rated output current (5 V DC)	5 A		
Overcurrent protection (5 V DC)	≥ 5.5 A		
Overvoltage protection	5.5...6.5 V		
Efficiency	≥ 70%		
Allowable momentary power failure time	≤ 10 ms (24 V DC input)		
Withstand voltage	2300 V AC per minute (altitude 0...2000 m) Between the combined "line input/LG terminals" and the "FG terminal and output".	510 V AC per minute (altitude 0...2000 m) Between the combined "line input/LG terminals" and the "FG terminal and output".	—*1
Insulation resistance	10 MΩ or higher by 500 V DC insulation resistance tester • Between the combined "line input/LG terminals" and the "FG terminal and output". • The line input and LG terminals. • The FG terminal and output.		—*1
Weight	0.32 kg	0.29 kg	0.19 kg

*1: There is no isolation between the primary side 24 V DC and secondary side 5 V DC.

RS-232 Adapter

RS-232
adapter



L6ADP-R2

Transmission speed: 115.2 kbps
GOT(HMI) connection
MELSOFTTM connection

Predefined protocol support function
Serial communication function

MODBUS®

*1: Please refer to each MELSOFT product manual for details on the supported software.

■ RS-232 adapter specifications

Item	Specification
Maximum data transmission speed	115.2 kbps
5 V DC internal current consumption	0.02 A
Weight	0.10 kg

RS-422/485 Adapter

RS-422/485
adapter



L6ADP-R4

Transmission speed: 115.2 kbps
GOT(HMI) connection

Predefined protocol support function
Serial Communication function

MODBUS®

■ RS-422/485 adapter specifications

Item	Specification
Maximum data transmission speed	115.2 kbps
5 V DC internal current consumption	0.15 A
Weight	0.12 kg

END Cover with Error Terminal

END cover with
error terminal



L6EC-ET

Error output relay

■ END cover with error terminal specifications

Item	Specification		
ERR. terminal	Rated switching voltage, current	24 V DC 0.5 A	
	Minimum switching load	5 V DC, 1 mA	
	Response time	OFF to ON	≤ 10 ms
		ON to OFF	≤ 12 ms
	Life	Mechanical	≥ 20 million times
		Electrical	Rated switching voltage/current: 10 million times or more
Surge suppressor	—		
Fuse	—		
Applicable wire size	0.3...2.0 mm ² (AWG22...14) (Twisted wire/Solid wire)		
External interface	Spring clamp terminal block		
5 V DC internal current consumption	0.06 A		
Weight	0.11 kg		

Display Unit

Display unit







L6DSPU



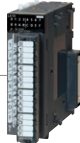





■ Display Unit specifications

Item	Specification
Number of displayed characters	16 one-byte characters × 4 lines
Displayed characters	<ul style="list-style-type: none"> Alphanumeric (two-byte/one-byte character) Japanese character Katakana (two-byte/one-byte character) Japanese character Hiragana (two-byte character) Chinese character (two-byte character) Symbol (two-byte/one-byte character)
Language	Japanese/English
Backlight	Green (normal), red (error)
Weight	0.03 kg



Input Modules

AC input		LX10 Number of inputs: 16 points 100 to 120 V AC 18-point terminal block		LX28 Number of inputs: 8 points 100 to 240 V AC 18-point terminal block
DC input		LX40C6 Number of inputs: 16 points 24 V DC 18-point terminal block		LX41C4 Number of inputs: 32 points 24 V DC 40-pin connector
				LX42C4 Number of inputs: 64 points 24 V DC 40-pin connector x2

Output Modules

Contact output		LY10R2 Number of outputs: 16 points 24 V DC/240 V AC Rated switching current: 2 A/point 18-point terminal block		LY18R2A Number of outputs: 8 points (all points independent) 24 V DC/240 V AC Rated switching current: 2 A/point 18-point terminal block
Triac output		LY20S6 Number of outputs: 16 points 100 to 240 V AC Max. load current: 0.6 A/point 18-point terminal block		LY28S1A Number of outputs: 8 points (all points independent) 100 to 240 V AC Max. load current: 1 A/point 18-point terminal block
Transistor output (Sink type)		LY40NT5P Number of outputs: 16 points 12 to 24 V DC Max. load current: 0.5 A/point Protection function 18-point terminal block		LY41NT1P Number of outputs: 32 points 12 to 24 V DC Max. load current: 0.1 A/point Protection function 40-pin connector
Transistor output (Source type)		LY40PT5P Number of outputs: 16 points 12 to 24 V DC Max. load current: 0.5 A/point Protection function 18-point terminal block		LY41PT1P Number of outputs: 32 points 12 to 24 V DC Max. load current: 0.1 A/point Protection function 40-pin connector
				LY42NT1P Number of outputs: 64 points 12 to 24 V DC Max. load current: 0.1 A/point Protection function 40-pin connector x2
				LY42PT1P Number of outputs: 64 points 12 to 24 V DC Max. load current: 0.1 A/point Protection function 40-pin connector x2

I/O Combined Modules

DC input / Transistor output (Sink type)		LH42C4NT1P Input specifications Number of inputs: 32 points 24 V DC 40-pin connector	Output specifications Number of outputs: 32 points 12 to 24 V DC Max. load current: 0.1 A/point Protection function 40-pin connector	DC input / Transistor output (Source type)		LH42C4PT1P Input specifications Number of inputs: 32 points 24 V DC 40-pin connector	Output specifications Number of outputs: 32 points 12 to 24 V DC Max. load current: 0.1 A/point Protection function 40-pin connector
--	---	---	---	--	---	---	---

Spring clamp terminal block (push-in type): L6TE-18S

The screw terminal block of installed modules can be replaced with a push-in type spring clamp terminal block. This terminal block type helps to reduce the amount of wiring and maintenance time.

- Push-in type for reduced wiring
Easier to wire just by inserting into the terminal block.

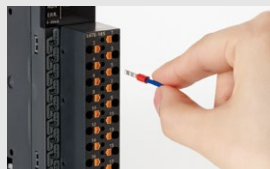

- Simple to confirm signal integrity
Includes dedicated terminals for insertion of a test probe, for example.

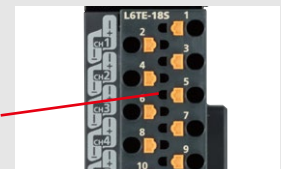

Input module specifications

AC input module

Item		LX10	LX28
Number of input points		16 points	8 points
Rated input voltage, frequency		100...120 V AC (+10%/-15%), 50/60Hz (±3 Hz)	100...240 V AC (+10%/-15%), 50/60 Hz(±3 Hz)
Input voltage distortion		≤ 5%	
Rated input current		8.2 mA (100 V AC, 60 Hz), 6.8 mA (100 V AC, 50 Hz)	16.4 mA (200 V AC, 60 Hz), 13.7 mA (200 V AC, 50 Hz), 8.2 mA (100 V AC, 60 Hz), 6.8 mA (100 V AC, 50 Hz)
Inrush current		Max. 200 mA ≤ 1 ms	Max. 950 mA ≤ 1 ms
ON voltage/ON current		≥ 80 V AC / ≥ 5 mA (50 Hz, 60 Hz)	
OFF voltage/OFF current		≤ 30 V AC / ≤ 1.7 mA (50 Hz, 60 Hz)	
Input resistance		12.2 kΩ (60 Hz), 14.6 kΩ (50 Hz)	
Response time	OFF to ON	≤ 15 ms (100 V AC 50 Hz, 60 Hz)	≤ 15 ms (100 V AC 50 Hz, 60 Hz) ≤ 10 ms (200 V AC 50 Hz, 60 Hz)
	ON to OFF	≤ 20 ms (100 V AC 50 Hz, 60 Hz)	≤ 20 ms (100/200 V AC 50 Hz, 60 Hz)
Common terminal arrangement		16 points/common	8 points/common
Module size allocation		1	
Number of occupied I/O points		16 points (I/O assignment: input 16 points)	
External interface		18-point terminal block	
5 V DC internal current consumption		90 mA (TYP. all points ON)	80 mA (TYP. all points ON)
Weight		0.17 kg	0.15 kg

DC input module

Item		LX40C6	LX41C4	LX42C4
Number of input points		16 points	32 points	64 points
Rated input voltage		24 V DC (ripple rate: ≤ 5%) (allowable voltage range: 20.4...28.8 V DC)		
Rated input current		6.0 mA TYP. (at 24 V DC)	4.0 mA TYP. (at 24 V DC)	
ON voltage/ON current		≥ 15 V DC / ≥ 4 mA	≥ 19 V DC / ≥ 3 mA	
OFF voltage/OFF current		≤ 8 V DC / ≤ 2 mA	≤ 9 V DC / ≤ 1.7 mA	
Input resistance		3.8 kΩ	5.7 kΩ	
Response time	OFF to ON	1 ms, 5 ms, 10 ms, 20 ms, 70 ms or less Initial setting is 10 ms.		
	ON to OFF			
Common terminal arrangement		16 points/common	32 points/common	
Module size allocation		1		
Number of occupied I/O points		16 points (I/O allocation: input 16 points)	32 points (I/O assignment: input 32 points)	64 points (I/O allocation: input 64 points)
External interface		18-point terminal block	40-pin connector	40-pin connector × 2
5 V DC internal current consumption		90 mA (TYP. all points ON)	100 mA (TYP. all points ON)	120 mA (TYP. all points ON)
Weight		0.15 kg	0.11 kg	0.12 kg

Output module specifications

Contact output module

Item		LY10R2	LY18R2A
Number of output points		16 points	8 points
Rated switching voltage, current		24 V DC 2 A (resistive load)/point, 8 A/common 240 V AC 2 A (COSφ=1)/point, 8 A/common	24 V DC 2 A (resistive load)/point, 8 A/module 240 V AC 2 A (COSφ=1)/point, 8 A/module
Minimum switching load		5 V DC 1 mA	
Maximum switching load		264 V AC 125 V DC	
Response time	OFF to ON	≤ 10 ms	
	ON to OFF	≤ 12 ms	
Life	Electrical	Mechanical	
		≥ 20 million times	
		Usage environment	
		Switching life	
		Rated switching voltage/current, rated load	
		200 V AC 1.5 A, 240 V AC 1 A (COSφ = 0.7)	
		200 V AC 0.4 A, 240 V AC 0.3 A (COSφ = 0.7)	
200 V AC 1 A, 240 V AC 0.5 A (COSφ = 0.35)			
200 V AC 0.3 A, 240 V AC 0.15 A (COSφ = 0.35)			
24 V DC 1 A, 100 V DC 0.1 A (L/R = 7 ms)			
24 V DC 0.3 A, 100 V DC 0.03 A (L/R = 7 ms)			
Maximum switching frequency		3600 times/hour	
Surge suppressor		—	
Fuse		—	(a fuse is recommended to be installed for each external wiring point)
Common terminal arrangement		16 points/common	No common (all points independent)
Module size allocation		1	
Number of occupied I/O points		16 points (I/O assignment: 16 output points)	
External interface		18-point terminal block	
5 V DC internal current consumption		460 mA (TYP. all points ON)	260 mA (TYP. all points ON)
Weight		0.21 kg	0.18 kg

Output module specifications

Triac output

Item	LY20S6	LY28S1A
Number of output points	16 points	8 points
Rated load voltage, frequency	100...240 V AC (+10%/-15%), 50/60 Hz(±3 Hz)	
Maximum load current	0.6 A/point, 4.8 A/common	1 A/point, 8 A/module
Load voltage distortion ratio	≤ 5%	
Maximum load voltage	264 V AC	
Minimum load voltage/current	24 V AC/100 mA, 100 V AC/25 mA, 240 V AC/25 mA	
Maximum inrush current	≤ 20 A/cycle	
Leakage current at OFF	≤ 3 mA (at 240 V, 60 Hz), ≤ 1.5 mA (at 120 V, 60 Hz)	
Maximum voltage drop at ON	≤ 1.5 V (at load current of 0.6 A)	
Response time	OFF to ON	Total of 1 ms and 0.5 cycles or less
	ON to OFF	Total of 1 ms and 0.5 cycles or less (rated load, resistive load)
Surge suppressor	CR absorber	
Fuse	None (Attaching a fuse to each external wiring is recommended.)	
Common terminal arrangement	16 points/common	No common (all points independent)
Module size allocation	1	
Number of occupied I/O points	16 points (I/O assignment: output 16 points)	
External interface	18-point terminal block	
5 V DC internal current consumption	300 mA (TYP. all points ON)	200 mA (TYP. all points ON)
Weight	0.22 kg	0.19 kg

Transistor output (Sink type)

Item	LY40NT5P	LY41NT1P	LY42NT1P
Number of output points	16 points	32 points	64 points
Rated load voltage	10.2...28.8 V DC		
Maximum load current	0.5 A/point, 5 A/common	0.1 A/point, 2 A/common	
Maximum inrush current	Current is limited by the overload protection function.		
Leakage current at OFF	≤ 0.1 mA		
Maximum voltage drop at ON	0.2 V DC(TYP.) 0.5 A, 0.3 V DC(MAX.) 0.5 A	0.1 V DC (TYP.) 0.1 A, 0.2 V DC (MAX.) 0.1 A	
Response time	OFF to ON	≤ 0.5 ms	
	ON to OFF	≤ 1 ms (rated load, resistance load)	
Surge suppressor	Zener diode		
Fuse	—		
External power supply	Voltage	12/24 V DC (ripple rate: ≤ 5%) (allowable voltage range: 10.2...28.8 V DC)	
	Current	9 mA (at 24 V DC)/common	13 mA (at 24 V DC)/common
			9 mA (at 24 V DC)/common
Common terminal arrangement	16 points/common	32 points/common	
Module size allocation	1		
Number of occupied I/O points	16 points (I/O assignment: 16 output points)	32 points (I/O assignment: 32 output points)	64 points (I/O assignment: 64 output points)
Protection function	Overload protection	Limited current when detecting overcurrent (overload protection): 1.5...3.5 A/point. Activated in increments of 1 point.	
	Overheat protection	Activated in increments of 1 point	
External interface	18-point terminal block	40-pin connector	40-pin connector x2
5 V DC internal current consumption	100 mA (TYP. all points ON)	140 mA (TYP. all points ON)	190 mA (TYP. all points ON)
Weight	0.15 kg	0.11 kg	0.12 kg

Transistor output (Source type)

Item	LY40PT5P	LY41PT1P	LY42PT1P
Number of output points	16 points	32 points	64 points
Rated load voltage	10.2...28.8 V DC		
Maximum load current	0.5 A/point, 5 A/common	0.1 A/point, 2 A/common	
Maximum inrush current	Current is limited by the overload protection function.		
Leakage current at OFF	≤ 0.1 mA		
Maximum voltage drop at ON	0.2 V DC(TYP.)0.5 A, 0.3 V DC(MAX.)0.5 A	0.1 V DC (TYP.) 0.1 A, 0.2 V DC (MAX.) 0.1 A	
Response time	OFF to ON	≤ 0.5 ms	
	ON to OFF	≤ 1 ms (rated load, resistance load)	
Surge suppressor	Zener diode		
Fuse	—		
External power supply	Voltage	12/24 V DC (ripple rate: ≤ 5%) (allowable voltage range: 10.2...28.8 V DC)	
	Current	17 mA (at 24 V DC)/common	20 mA (at 24 V DC)/common
Common terminal arrangement	16 points/common	32 points/common	
Module size allocation	1		
Number of occupied I/O points	16 points (I/O assignment: 16 output points)	32 points (I/O assignment: 32 output points)	64 points (I/O assignment: 64 output points)
Protection function	Overload protection	Overcurrent detection: ≥ 1.5 A/point. Activated in increments of 1 point.	
	Overheat protection	Activated in increments of 1 point.	
External interface	18-point terminal block	40-pin connector	40-pin connector x2
5 V DC internal current consumption	100 mA (TYP. all points ON)	140 mA (TYP. all points ON)	190 mA (TYP. all points ON)
Weight	0.15 kg	0.11 kg	0.12 kg

I/O combined module specifications DC input/transistor output combined module

Item	LH42C4NT1P	LH42C4PT1P
■ Input specifications		
Number of input points	32 points	
Rated input voltage	24 V DC (ripple rate: ≤ 5%) (allowable voltage range: 20.4...28.8 V DC)	
Rated input current	4.0 mA TYP. (at 24 V DC)	
Input ON voltage/ON current	≥ 19 V DC/≥ 3 mA	
Input OFF voltage/OFF current	≤ 9 V DC/≤ 1.7 mA	
Input resistance	5.7 kΩ	
Input response time	1 ms, 5 ms, 10 ms, 20 ms, 70 ms or less (Initial setting is 10 ms)	
Input common terminal arrangement	32 points/common	
■ Output specifications		
Output format	Transistor output combined module (Sink type)	Transistor output combined module (Source type)
Number of output points	32 points	
Rated load voltage	10.2...28.8 V DC	
Maximum load current	0.1 A/point, 2 A/common	
Maximum inrush current	Current is limited by the overload protection function.	
Leakage current at OFF	≤ 0.1 mA	
Maximum voltage drop at ON	0.1 V DC (TYP.) 0.1 A, 0.2 V DC (MAX.) 0.1 A	
Output response time	≤ 0.5 ms	
Surge suppressor	Zener diode	
Fuse	—	
Protection function	Overload protection	Limited current when detecting overcurrent (overload protection): 1...3 A/point, activated in increments of 1 point
	Overheat protection	Activated in increments of 1 point
Output common terminal arrangement	32 points/common	
■ Common specifications		
External power supply	12/24 V DC (ripple rate: ≤ 5%) (allowable voltage range: 10.2...28.8 V DC)	
	Voltage	
	Current	9 mA (at 24 V DC)/common
Module size allocation	1	
Number of occupied I/O points	32 points (I/O assignment: input/output 32 points)	
External interface	40-pin connector x2	
5 V DC internal current consumption	160 mA (TYP. all points ON)	150 mA (TYP. all points ON)
Weight	0.12 kg	

How to read the product code

• For input module or output module

• For I/O combined module

L Y 4 0 NT 5 P

L H 4 2 C4 NT1 P

① ② ③ ④ ⑤ ⑥
① ② ③
Input type
Output type
④ ⑤ ⑥

Number	Item	Code	Specification					
①	Module type	X	Input					
		Y	Output					
		H	I/O combined					
②	Voltage specification	Code	Input specifications		Output specifications			
			AC input	DC input	Contact output	Triac output	Transistor output	
		1	100...120 V AC	—	24 V DC/240 V AC	—	—	
		2	100...240 V AC	—	—	100...240 V AC	—	
4	—	24 V DC	—	—	12...24 V DC			
③	I/O points	Code	Specification					
			0	16 points				
			1	32 points				
			2	64 points				
8	8 points							
④	I/O type	Code	Specification					
			Blank	AC input				
			C	DC input (positive/negative shared common)				
			NT	Transistor output module (Sink type)				
			PT	Transistor output module (Source type)				
			R	Contact output				
S	Triac output							
⑤	Current specification	Code	Input specifications		Output specifications			
			AC input	DC input	Contact output	Triac output	Transistor output	
			1	—	—	—	1 A	0.1 A
			2	—	—	2 A	—	—
			4	—	4 mA	—	—	—
			5	—	—	—	—	0.5 A
6	—	6 mA	—	0.6 A	—			
⑥	Extra specifications	Code	Specification					
			P	Includes protection function				
A	Independent common							

Multiple Input (Voltage/Current/Temperature) Module

Channel isolated multiple input



L60MD4-G

Number of inputs: 4 channels
 Input voltage: -10 to 10 V DC
 Input current: 0 to 20 mA DC
 Input micro voltage: -100 to 100 mV
 Input thermocouple: K, J, T, E, N, R, S, B, U, L, PL II, W5Re/W26Re
 Input RTD: Pt1000, Pt100, JPt100, Pt50
 Conversion speed: 50 ms/channel
 Resolution
 Voltage/Current/micro voltage: 1/20000
 Thermocouple: B, R, S, N, PL II, W5Re/W26Re: 0.3°C,
 K, E, J, T, U, L: 0.1°C
 RTD: Pt100, JPt100: 0.03°C/0.1°C,
 Pt1000, Pt50: 0.1°C

Analog Input Modules

Analog Input



L60AD4

Number of inputs: 4 channels
 Input voltage: -10 to 10 V DC
 Input current: 0 to 20 mA DC
 Conversion speed: 20 µs/channel
 Resolution: 1/20000



L60ADVL8

Number of inputs: 8 channels
 Input voltage: -10 to 10 V DC
 Conversion speed: 1 ms/channel
 Resolution: 1/16000



L60ADIL8

Number of inputs: 8 channels
 Input current: 0 to 20 mA DC
 Conversion speed: 1 ms/channel
 Resolution: 1/8000

Dual channel Isolation Analog Input



L60AD4-2GH

Number of inputs: 4 channels
 Input voltage: -10 to 10 V DC
 Input current: 0 to 20 mA DC
 Conversion speed: 40 µs/2 channels
 Resolution: 1/32000

Analog Output Modules

Analog Output



L60DA4

Number of outputs: 4 channels
 Output voltage: -10 to 10 V DC
 Output current: 0 to 20 mA DC
 Conversion speed: 20 µs/channel
 Resolution: 1/20000



L60DAVL8

Number of outputs: 8 channels
 Output voltage: -10 to 10 V DC
 Conversion speed: 200 µs/channel
 Resolution: 1/16000



L60DAIL8

Number of outputs: 8 channels
 Output current: 0 to 20 mA DC
 Conversion speed: 200 µs/channel
 Resolution: 1/8000

Analog I/O Module

Analog I/O



L60AD2DA2

Analog input specifications
 Number of inputs: 2 channels
 Input voltage: -10 to 10 V DC
 Input current: 0 to 20 mA DC
 Conversion speed: 80 µs/channel
 Resolution: 1/12000

Analog output specifications
 Number of outputs: 2 channels
 Output voltage: -10 to 10 V DC
 Output current: 0 to 20 mA DC
 Conversion speed: 80 µs/channel
 Resolution: 1/12000

Temperature Input Module

RTD input



L60RD8

Number of inputs: 8 channels
 Input RTD: Pt1000, Pt100 (JIS C 1604–2013), JPt100 (JIS C 1604–1981), Pt50 (JIS C 1604–1981), Ni500 (DIN 43760 1987), Ni120 (DIN 43760 1987), Ni100 (DIN 43760 1987), Cu100 (GOST 6651-2009, $\alpha=0.00428$), Cu50 (GOST 6651-2009, $\alpha=0.00428$)
 Conversion speed: 40 ms/ch
 Resolution: 0.1°C

Multiple/analog/temperature input features

Function	Multiple input (voltage/current/temperature) module	Analog input module				Analog I/O module	Temperature input module	
		L60MD4-G	L60AD4	L60ADVL8	L60ADIL8			L60AD4-2GH
Channel isolation	●	—	—	—	—	● ^{*1}	—	
AD conversion method	Sampling processing	●	●	●	●	●	●	
	Averaging processing	Time average	●	●	●	●	●	●
		Count average	●	●	●	●	●	●
		Moving average	●	●	●	●	●	●
Time lag filter function	—	—	—	—	●	—	—	
Digital filtering function	—	—	—	—	●	—	—	
Conversion speed switch function	—	●	—	—	—	—	—	
Input range extended mode function	●	● ^{*2}	●	●	●	●	—	
Maximum value/minimum value hold function	●	●	●	●	●	●	●	
Disconnection detection function	●	—	—	—	—	—	●	
Input signal error detection function	●	●	●	●	●	●	—	
Input signal error detection extension function	—	● ^{*2}	●	●	—	—	—	
Warning output function	Process alarm	●	●	●	●	—	●	
	Rate alarm	●	—	—	—	—	●	
Scaling function	●	●	●	●	●	●	●	
2-point sensor compensation function	—	—	—	—	—	—	●	
Shift function	— ^{*3}	● ^{*2}	— ^{*3}	— ^{*3}	— ^{*3}	— ^{*3}	●	
Digital clipping function	— ^{*3}	●	— ^{*3}	— ^{*3}	— ^{*3}	— ^{*3}	—	
Difference conversion function	— ^{*3}	● ^{*2}	— ^{*3}	— ^{*3}	— ^{*3}	— ^{*3}	—	
Logging function	— ^{*4}	● ^{*2}	— ^{*4}	— ^{*4}	— ^{*4}	— ^{*4}	— ^{*4}	
Flow amount integration function	—	● ^{*2}	—	—	—	—	—	
Trigger conversion function	—	—	—	—	—	●	—	
Variable arithmetic function	—	—	—	—	—	● ^{*5}	—	
Variable conversion characteristics function	—	—	—	—	—	● ^{*5}	—	
Variable conversion characteristics function + variable arithmetic function	—	—	—	—	—	● ^{*5}	—	

Analog output features

Function	Analog output module			Analog I/O module
	L60DA4	L60DAVL8	L60DAIL8	
Analog output HOLD/CLEAR function	●	●	●	●
Scaling function	●	●	●	●
Warning output function	Process alarm	●	●	●
	Wave output function	● ^{*6}	●	●
Wave output step action function	Wave output step action function	● ^{*6}	●	●
	Variable arithmetic function	—	—	—
Variable conversion characteristics function	—	—	—	● ^{*5}
Variable conversion characteristics function + variable arithmetic function	—	—	—	● ^{*5}

*1: Every two channels are isolated. (CH1 and CH2 are isolated from CH3 and CH4).

*2: Supported by models whose first five serial number digits are "13041" or later.

*3: Please use function blocks (FB) for the shift function, digital clipping function, and difference conversion function. The function blocks (FB) can be downloaded for free from the MELSOFT Library on the Mitsubishi Electric FA site.

*4: For logging, please use the data logging function of the CPU module.

*5: Supported by models whose first five serial number digits are "17042" or later.

*6: Supported by models whose first five serial number digits are "14041" or later.

Easily and finely adjust the system startup time with the shift function

Shift function

Using this function, the set shifting amount to conversion value can be added (shifted) to the digital output value. When the shifting amount to conversion value is changed, it is reflected to the scaling value (digital operation value) in real time. Therefore, fine adjustment can be easily performed when the system starts.

For L60AD4

■ Before adjustment	
Input voltage (V)	Digital output value
0	-10
5	19990

▼ Shifting amount to conversion value: +10

■ After adjustment	
Input voltage (V)	Scaling value (digital operation value)
0	0
5	20000

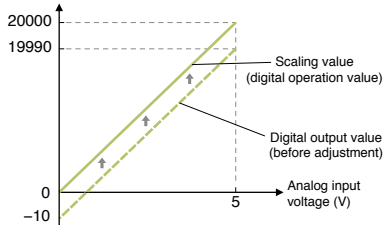
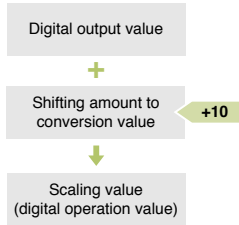

Reduce the time taken for programming

Scaling function

The scaling function converts values directly to easy-to-understand units without requiring any programming. Since a separate conversion program is not required, the number of overall programming steps can be reduced.

Scaling settings example (L60AD4)

Normally an analog input of 4 to 20 mA is converted to a digital value from 0 to 20000. Using the scaling feature, the same input can result in a digital value of ±20000.

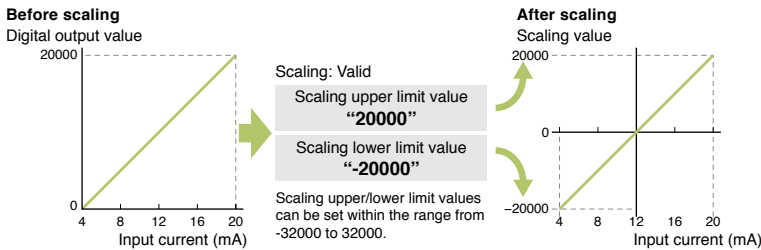

Input current (mA)	Digital output value	Scaling value
4	0	-20000
8	5000	-10000
12	10000	0
16	15000	10000
20	20000	20000

Digital filtering function

This function eliminates unnecessary frequency elements with simple parameter settings. Select from low pass filter, high pass filter or band pass filter.

Programming steps can be further reduced as extra ladder code is not required to achieve the filter processing. The filtered A/D conversion program is available at the same time as conversion completion, reducing the overall conversion to filter process time.

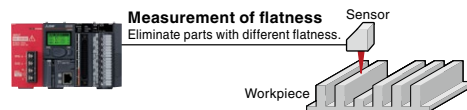
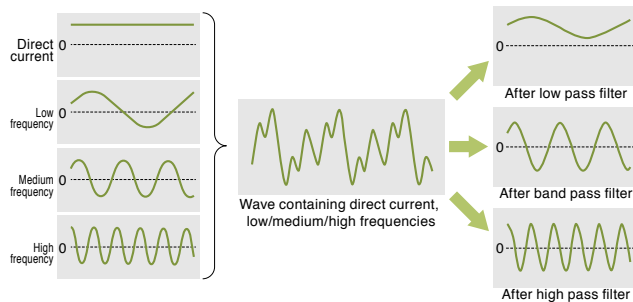

■ When low pass is processed with ladder
When requiring a filter processing program, more than 300 lines are necessary.

Not required when using digital filter function

■ Total time when processing digital filter with ladder

Processing time is reduced by using the digital filter function

A/D conversion time Program processing time (filter process)

First-delay filter function

The first-delay filter function constant outputs a digital value which filters out (smooths) the excessive noise.

Log data for up to 10,000 points

Logging function

Data is continuously collected at the set cycle and stored in the buffer memory.

Data stored in the buffer memory can be used for debugging, and to periodically confirm data variations.

Item	Description		
	L60AD4	L60AD4-2GH	L60AD2DA2
Collectable points	10000 points/channel		
Collectable data	Digital output value or scaling value (digital operation value)		
Logging cycle*1	80...32767 μs	40...32767 μs	80...32767 μs
	1...32767 ms	1...32767 ms	1...32767 ms
	1...3600 s	1...3600 s	1...3600 s
Conversion speed	80 μs, or 1 ms	40 μs/2 channels	80 μs
Level trigger condition	Above, Below, Pass Through		
Logging points after trigger	1...10000		

*1: The actual logging cycle is "an integral multiple of the conversion cycle of each A/D conversion method".
 Ex.) When using the sampling processing: Conversion cycle = conversion speed x number of channels in use.

The logging data can be analyzed with the GX LogViewer.

When an error is detected in the digital value:

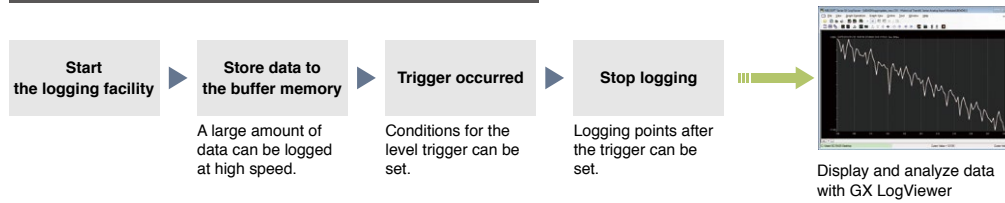

Logging data can be transferred to the CPU device memory while still logging.

Logging and data transmission can be executed simultaneously so the next logging session can be started right away.

Logging for 10,000 points and greater

When logging of 1001 - 2000 points of data commences, the first 1000 points (1 - 1000) are stored into the CPU device memory. By storing every 1000 points of data in the CPU, overall logging of total data larger than 1000 points can be logged.

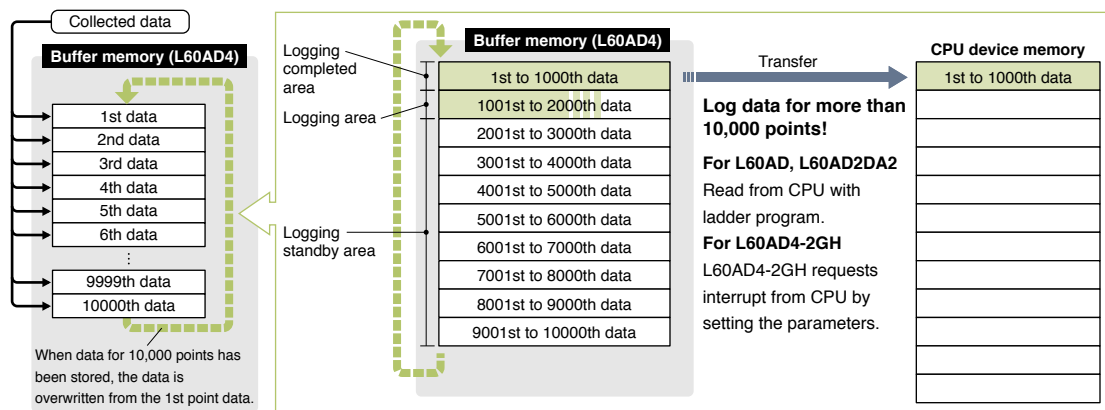

Easily measure part thicknesses!

Difference conversion function

When the difference conversion starts, the scaling value (digital operation value) at that time is determined as the difference conversion reference value. The value acquired by subtracting the difference conversion reference value from the scaling value (digital operation value) is stored as the scaling value (digital operation value) after difference conversion.

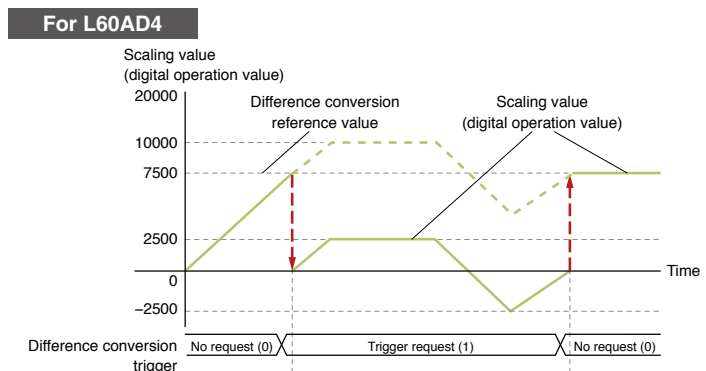

$$\text{Scaling value (digital operation value) after difference conversion} = \text{Scaling value (digital operation value)} - \text{Difference conversion reference value}$$

Extend the detection method according to applications

Input signal error detection extension function

Using this function, the detection method of the input signal error detection function can be extended. Use this function to detect an input signal error only at the lower or upper limit, or to execute the disconnection detection.

Input range extension function

The input range can be extended. By combining this function with the input signal error detection function, simple disconnection detection can be executed.

Connected devices monitoring alarm

Warning output function

■ **Process alarm**

Outputs an alarm when the digital output value enters a preset alarm range.

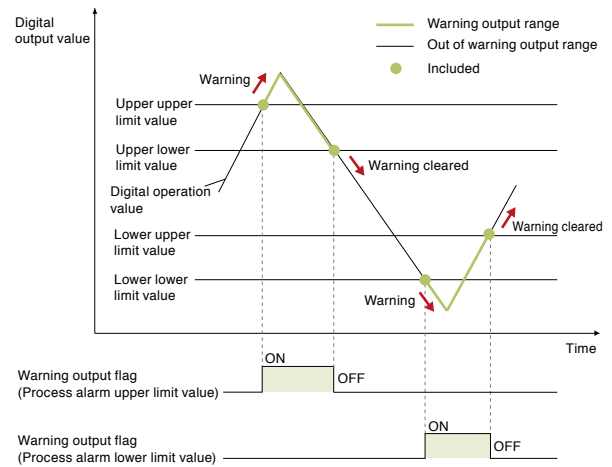

■ **Rate alarm**

An alarm is generated if the digital output value's variation rate is larger than the rate alarm upper limit value, or if it is smaller than the rate alarm lower limit value.

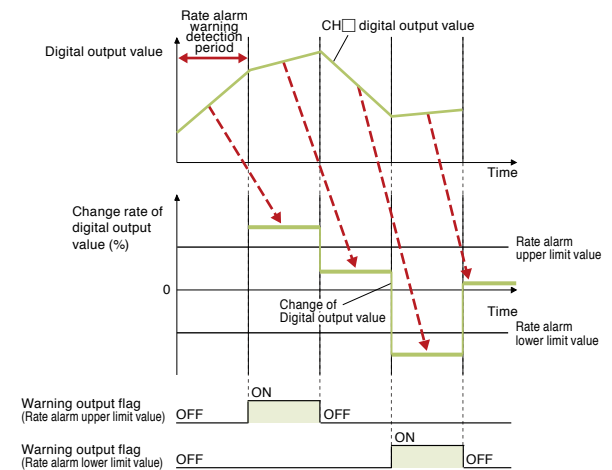

Noise isolation for smoother system operation

L60AD4-2GH

Channel isolation

Each channel is isolated preventing any noise interference between channels resulting in more stable measurements.

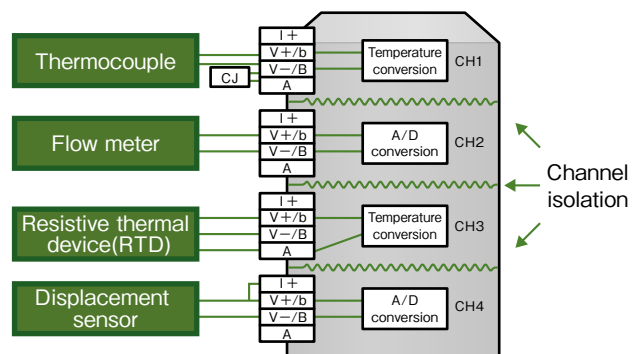

A/D variable conversion timing

Trigger conversion function

A/D conversion is processed at the rising edge of the trigger position timing.

This function enables easier use of the converter and enhances the overall program performance.

There are two types of trigger conversion request: “External trigger conversion request (external input terminal)” or “internal trigger conversion request (buffer memory)”.

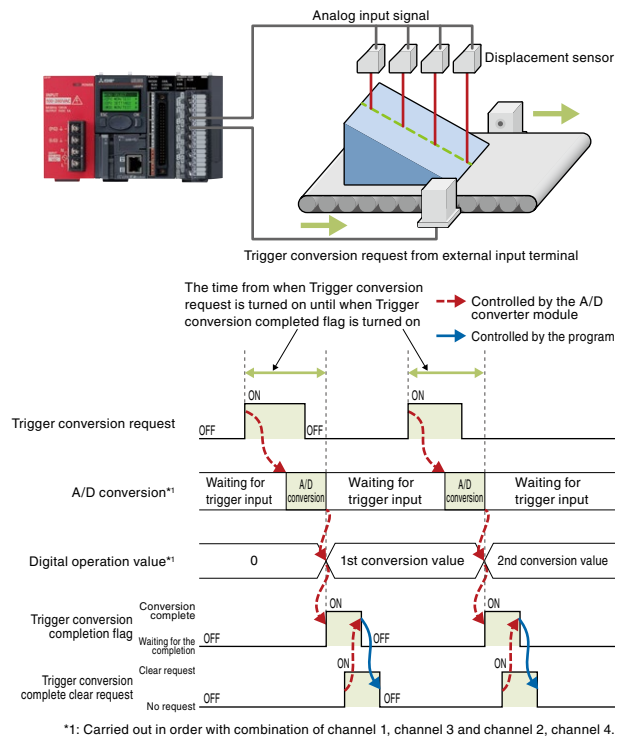

Quickly calculate and record flow amount

Flow amount integration function

This function performs the A/D conversion of analog input value (voltage or current) from a flow meter and others, and integrates the scaling value (digital operation value) by every integration cycle. In this function, integral processing is performed regarding the scaling value (digital operation value) as the instantaneous flow amount.

■ Concept of integral processing

With this function, integral processing is performed using the following formula.

$$\text{Integrated flow amount} = \left(\text{Instantaneous flow amount} \times \frac{\Delta T}{T} \times \text{Unit scaling} \right) + \text{Previous amount}$$

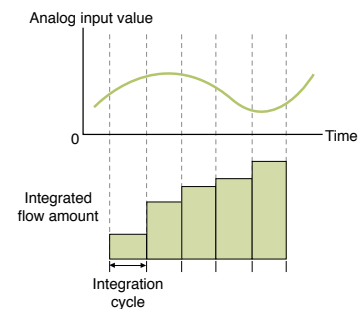

Item	Description												
Integrated flow amount	Result of integral processing												
Instantaneous flow amount	Instantaneous flow amount value output in analog from flow meter												
ΔT	Integration cycle (ms)												
T	Conversion value to convert time unit of instantaneous flow amount to ms unit												
	<table border="1"> <thead> <tr> <th>Range of flow meter</th> <th>Setting value to specify flow amount time unit</th> <th>T (ms)</th> </tr> </thead> <tbody> <tr> <td>/s</td> <td>0</td> <td>1000</td> </tr> <tr> <td>/min</td> <td>1</td> <td>60000</td> </tr> <tr> <td>/h</td> <td>2</td> <td>3600000</td> </tr> </tbody> </table>	Range of flow meter	Setting value to specify flow amount time unit	T (ms)	/s	0	1000	/min	1	60000	/h	2	3600000
	Range of flow meter	Setting value to specify flow amount time unit	T (ms)										
	/s	0	1000										
/min	1	60000											
/h	2	3600000											
Unit scaling for integrated flow amount													
Unit scaling	This is used when the value of instantaneous flow amount $\times \Delta T/T$ is 0 to 1.												
	<table border="1"> <thead> <tr> <th>Setting value to specify unit scaling</th> <th>Unit scaling</th> </tr> </thead> <tbody> <tr> <td>0</td> <td>1</td> </tr> <tr> <td>1</td> <td>10</td> </tr> <tr> <td>2</td> <td>100</td> </tr> <tr> <td>3</td> <td>1000</td> </tr> <tr> <td>4</td> <td>10000</td> </tr> </tbody> </table>	Setting value to specify unit scaling	Unit scaling	0	1	1	10	2	100	3	1000	4	10000
	Setting value to specify unit scaling	Unit scaling											
	0	1											
	1	10											
2	100												
3	1000												
4	10000												
Previous amount	Stored integrated flow amount value before integral processing												

Realize fast and smooth continuous analog output

Wave output function

The industry's first*1 waveform output function is included.

This function enables control wave data that is faster than the program control to be directly registered in the D/A converter module and output the data at a set conversion cycle.

Therefore, the analog output value is not affected by the scan time of the CPU module resulting in faster and smoother analog control.

*1: Mitsubishi Electric survey dated April 2012.

Analog output from sequence program

Analog values are output at each scan time.

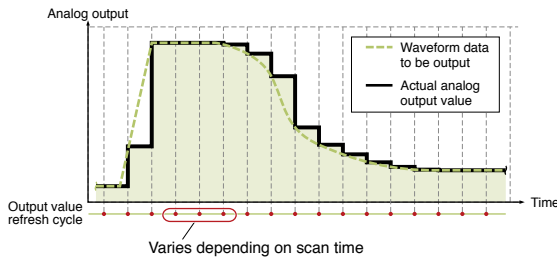

The actual waveform and the output waveform deviate.

Analog output with waveform output function

Analog values are output at set interval.

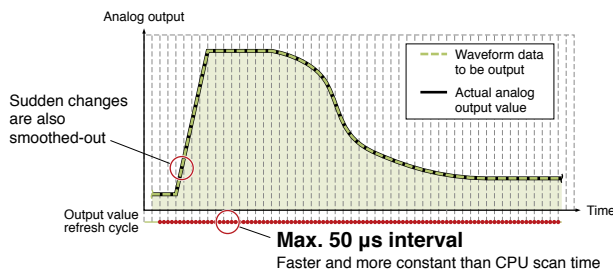

The output waveform is closer to the actual waveform (less deviation).

Register up to 50000 points of waveform output data

① Using GX Works2 to create the waveform output data to be analog output

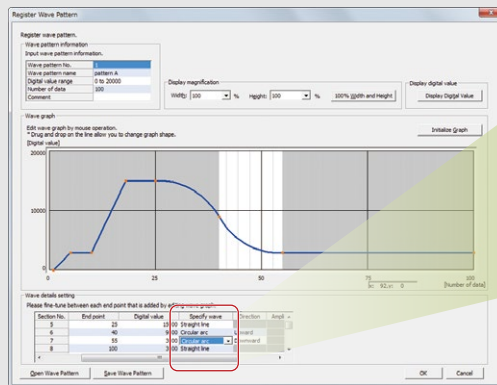

Designate waveform

- Circular arc
- (Do not specify)
- Circular arc
- Straight line
- Exponential function
- Logarithmic function
- Sine function
- Cosine function

By registering the waveform patterns (multiple), they can be combined freely with the tool.

② Save waveform output data into CPU module's file resister (or SD memory card)

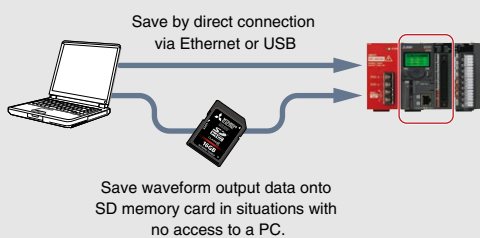

③ Execute the function block (FB)*2 and register into analog output module

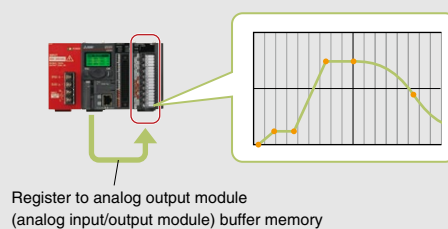

Register to analog output module (analog input/output module) buffer memory

*2: Contact your local Mitsubishi Electric sales office or representative.

More flexible calculation and conversion reduce programming time

L60AD2DA2

Conversion by polynomial expressions

The variable arithmetic function enables the analog I/O module to perform polynomial calculations, eliminating the need of such calculations programmed by ladder. With the calculations performed on the analog I/O module side, advanced calculations are possible without being restricted by the scan time.

Make polynomial expressions using brackets, operators, constants, and data saved in buffer memory.

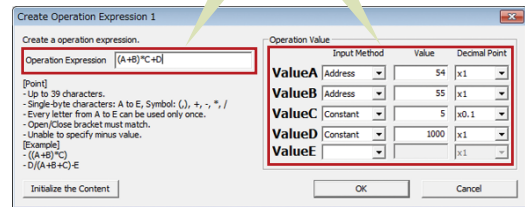

Graph-form conversion characteristics

The variable conversion characteristics function enables conversion characteristics for analog input, analog output, and analog I/O to be easily set on graphs. This means that conversion characteristics do not need to be programmed by ladder, which leads to reduced programming time.

Item	Description
Analog input	Conversion characteristics can be easily set for the A-D conversion channels (CH1, CH2).
Analog output	Conversion characteristics can be easily set for the D-A conversion channels (CH3, CH4).
Analog I/O	Conversion characteristics for the analog input-output conversion can be easily set in simple steps, eliminating the need of creating ladder programs.

Previous control method

Ex.) Analog output module

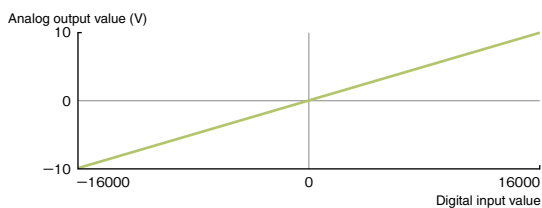

Straight line between the offset and gain values was the conversion characteristics

Control using graph-form conversion characteristics

Ex.) Analog I/O module

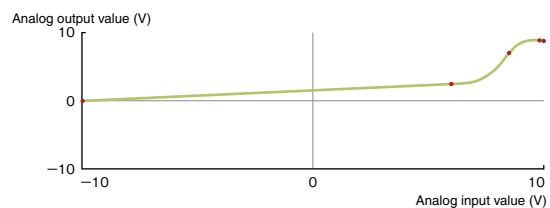

Conversion characteristics can be easily set

Conversion by graph-form conversion characteristics plus polynomial expressions

The two functions described above can also be combined; the digital values are first converted according to graph-form conversion characteristics and then by polynomial expressions. These two levels of conversion realize full adjustment of analog values at the time of output rather than adjusting them post-conversion.

Ex.) Obtaining intended analog output using the conversion by graph-form conversion characteristics plus polynomial expressions

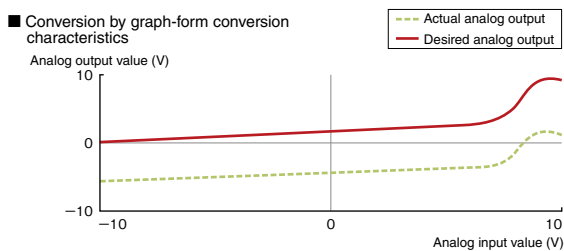

Gap still exists between desired and actual analog outputs

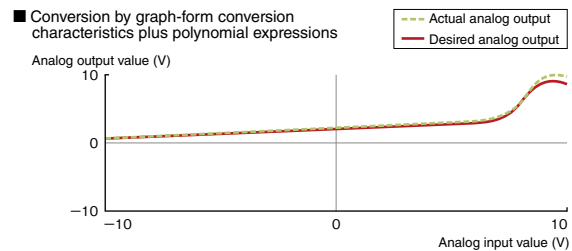

Analog output values are adjusted towards the desired output

One module covering voltage, current, micro-voltage, thermocouples and RTD

For each channel, it is possible to select from voltage, current, micro-voltage, thermocouples or RTD. As a result, dedicated modules required for each type of sensor can now be integrated into a single module.

Example System with up to four channels (including analog and temperature input channels)

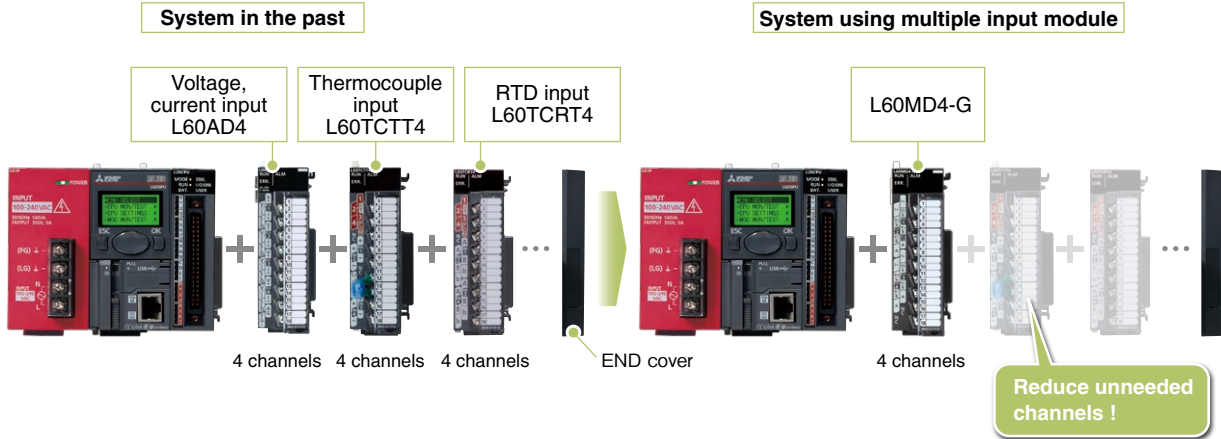

The multiple input module also supports the Pt50 and JPt100 sensors, which are compatible with the former JIS standards. Modules can be replaced without altering the already existing sensor equipment.

Thermocouple	K, J, T, E, N, R, S, B, U, L, PL II, W5Re/W26Re
RTD	Pt1000, Pt100, JPt100, Pt50

8 input channels with wider input ranges

L60RD8

Single L60RD8 can measure temperatures of up to 8 channels. With the number of supported channels doubled compared to before (L60MD4-G), space and cost savings can be realized. The input range is expanded to meet the DIN standards, GOST standards, and Pt1000 range in addition to Pt100, JPt100, and Pt50, bringing new application possibilities.

RTD	Pt1000, Pt100, JPt100, Pt50, Ni (DIN standards), Cu (GOST standards)
-----	--

Reduced wiring time with no screw tightening

L60RD8

The module is equipped with a spring clamp terminal block, which does not require screw tightening. This push-in type terminal block does not require any dedicated wiring tool and significantly reduces the installation time.

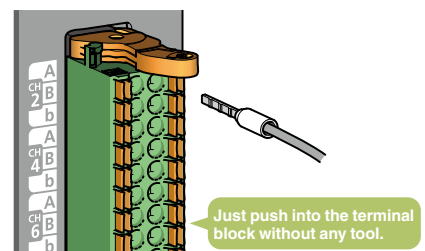

Easier calibration

L60RD8

Measured temperatures can be easily calibrated towards the actual temperature using the sensor calibration function (shift function, 2-point sensor compensation function).

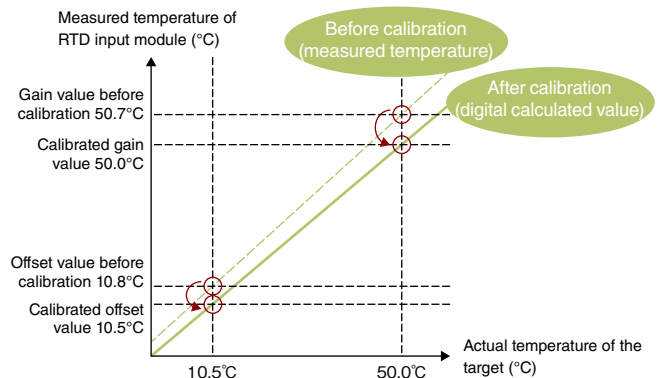

The measured temperature of 10.8 to 50.7 (°C) is calibrated to be 10.5 to 50.0 (°C) by digital calculation. A temperature closer to the one input to RTD is obtained.

Multiple input (voltage/current/temperature) module specifications

Item		L60MD4-G		
Number of analog input channels		4 channels		
Analog input	Voltage	-10...10 V DC (Input resistance value 1 MΩ)		
	Current	0...20 mA DC (Input resistance value 250 Ω)		
	micro voltage	-100...100 mV DC		
	Thermocouple	Available type	K, J, T, E, N, R, S, B, U, L, PL II, W5Re/W26Re	
		Cold junction compensation resistor	Use the included cold junction compensation resistor (CJ)	
Resistive thermal device	Available type	Pt1000, Pt100, JPt100, Pt50		
	Measurement method	3-wire system		
Digital output	Voltage, Current, micro voltage	-20480...20479		
	Resistive thermal device Pt100 (-20...120°C), JPt100 (-20...120°C)	-2000...20000: Value rounded off to two decimal places × 100 times		
	Thermocouple, Resistive thermal device (other than the above)	-4000...32000: Value rounded off to one decimal place × 10 times		
	When using the scaling function	-32768...32767		
I/O characteristics, resolution	Voltage	0...10 V	0...20000	500 μV
		0...5 V	0...20000	250 μV
		1...5 V	0...20000	200 μV
		-10...10 V	-20000...20000	500 μV
		1...5 V (Extended mode)	-5000...22500	200 μV
	Current	0...20 mA	0...20000	1000 nA
		4...20 mA		800 nA
		4...20 mA (Extended mode)	-5000...22500	800 nA
	micro voltage	-100...100 mV	-20000...20000	5 μV
	Thermocouple	B, R, S, N, PL II, W5Re/W26Re: 0.3°C K, E, J, T, U, L: 0.1°C		
Resistive thermal device (RTD)	Pt100 (-20...120°C): JPt100 (-20...120°C): 0.03°C Pt100 (-200...850°C), JPt100 (-200...600°C), Pt1000, Pt50: 0.1°C			
Accuracy ^{1,2}	Voltage/Current/ micro voltage	Ambient temperature 25 ± 5°C	Maximum value of the measurement range × (± 0.3%)	
		Ambient temperature 0...55°C	Maximum value of the measurement range × (± 0.9%)	
	Thermocouple	Ambient temperature 25 ± 5°C	Full scale × (± 0.15%)	
		Ambient temperature 0...55°C	Full scale × (± 0.3%) ³	
	Cold junction compensation resistor ⁴	Temperature measured value: 0°C or higher	≤ ± 1.0°C	
		Temperature measured value: -150°C...-100°C	≤ ± 2.0°C	
		Temperature measured value: -200°C...-150°C	≤ ± 3.0°C	
Resistive thermal device	(Accuracy) ⁵ = (Conversion accuracy) + (Temperature characteristics) × (Operating ambient temperature change) + (Allowable difference of resistance temperature detector used)			
Conversion speed	50 ms/ch			
Output current for temperature detection	Pt100, JPt100, Pt50: 1 mA, Pt1000: 0.2 mA			
Absolute maximum input	Voltage: ±15 V, Current: 30 mA ⁶			
Isolation method	Between I/O terminals and programmable controller power supply: photocoupler isolation Between input channels: transformer isolation			
Module size allocation	1			
Number of occupied I/O points	16 points (I/O assignment: 16 points for intelligent)			
External interface	18-point terminal block			
5 V DC internal current consumption	0.49 A			
Weight	0.19 kg			

*1: Except when influenced by noise.

*2: To acquire sufficient accuracy, a warm-up (conduction) for 15 minutes is required.

*3: The accuracy for when the measured temperature of the type W5Re/W26Re thermocouple is 2000°C or higher is ±0.5%.

*4: The following table shows the accuracy of the cold junction compensation for when the type "T" thermocouple or type "U" thermocouple is used.

Measured temperature	T Thermocouple	U Thermocouple
0°C or higher	± 1.0°C	
-100°C...0°C	± 2.0°C	
-150°C...-100°C	± 3.0°C	
-200°C...-150°C	± 5.0°C	± 4.0°C

*5: The following table shows RTD types and values for each item.

RTD type	Celsius			Fahrenheit		
	Measured temperature range	Conversion accuracy (operating ambient temperature: 25±5°C)	Temperature characteristics (for a change of 1°C in the operating ambient temperature)	Measured temperature range	Conversion accuracy (operating ambient temperature: 25±5°C)	Temperature characteristics (for a change of 1°C in the operating ambient temperature)
Pt100	-20...-120°C	1°C	0.1°C	0...200°F	1°F	0.1°F
	-200...850°C	2°C	0.2°C	-300...1500°F	3°F	0.3°F
JPt100	-20...-120°C	1°C	0.1°C	0...200°F	1°F	0.1°F
	-200...600°C	2°C	0.2°C	-300...1100°F	3°F	0.3°F
Pt1000	-200...850°C	2°C	0.2°C	-300...1500°F	3°F	0.3°F
Pt50	-200...650°C	2°C	0.2°C	-300...1200°F	3°F	0.2°F

*6: A momentary current value which does not cause damage to internal resistors of the module, although the maximum continuous input current is 24 mA.

Analog input module specifications

L60AD4

Item		L60AD4																																	
Number of analog input channels		4 channels																																	
Analog input	Voltage	-10...10 V DC (Input resistance value 1 MΩ)																																	
	Current	0...20 mA DC (Input resistance value 250 Ω)																																	
Digital output		-20480...20479																																	
When using the scaling function		-32768...32767																																	
I/O characteristics, resolution																																			
<table border="1"> <thead> <tr> <th colspan="2">Analog input range</th> <th>Digital output value</th> <th>Resolution</th> </tr> </thead> <tbody> <tr> <td rowspan="6">Voltage</td> <td>0...10 V</td> <td rowspan="3">0...20000</td> <td>500 μV</td> </tr> <tr> <td>0...5 V</td> <td>250 μV</td> </tr> <tr> <td>1...5 V</td> <td>200 μV</td> </tr> <tr> <td>-10...10 V</td> <td>-20000...20000</td> <td>500 μV</td> </tr> <tr> <td>1...5 V (Extended mode)</td> <td>-5000...22500</td> <td>200 μV</td> </tr> <tr> <td>Users range setting</td> <td>-20000...20000</td> <td>307 μV^{*1}</td> </tr> <tr> <td rowspan="4">Current</td> <td>0...20 mA</td> <td rowspan="2">0...20000</td> <td>1000 nA</td> </tr> <tr> <td>4...20 mA</td> <td>800 nA</td> </tr> <tr> <td>4...20 mA (Extended mode)</td> <td>-5000...22500</td> <td>800 nA</td> </tr> <tr> <td>Users range setting</td> <td>-20000...20000</td> <td>1230 nA^{*1}</td> </tr> </tbody> </table>			Analog input range		Digital output value	Resolution	Voltage	0...10 V	0...20000	500 μV	0...5 V	250 μV	1...5 V	200 μV	-10...10 V	-20000...20000	500 μV	1...5 V (Extended mode)	-5000...22500	200 μV	Users range setting	-20000...20000	307 μV ^{*1}	Current	0...20 mA	0...20000	1000 nA	4...20 mA	800 nA	4...20 mA (Extended mode)	-5000...22500	800 nA	Users range setting	-20000...20000	1230 nA ^{*1}
Analog input range		Digital output value	Resolution																																
Voltage	0...10 V	0...20000	500 μV																																
	0...5 V		250 μV																																
	1...5 V		200 μV																																
	-10...10 V	-20000...20000	500 μV																																
	1...5 V (Extended mode)	-5000...22500	200 μV																																
	Users range setting	-20000...20000	307 μV ^{*1}																																
Current	0...20 mA	0...20000	1000 nA																																
	4...20 mA		800 nA																																
	4...20 mA (Extended mode)	-5000...22500	800 nA																																
	Users range setting	-20000...20000	1230 nA ^{*1}																																
Accuracy ^{*2}	Ambient temperature 25 ± 5°C	≤ ± 0.1% (± 20 digit)																																	
	Ambient temperature 0...55°C	≤ ± 0.2% (± 40 digit)																																	
Conversion speed ^{*3,*4,*5}		High speed: 20 μs/channel Medium speed: 80 μs/channel Low speed: 1 ms/channel																																	
Absolute maximum input		Voltage: ± 15 V, Current: 30 mA ^{*6}																																	
Isolation method		Between I/O terminals and programmable controller power supply: photocoupler isolation Between input channels: no isolation																																	
Module size allocation		1																																	
Number of occupied I/O points		16 points (I/O assignment: 16 points for intelligent)																																	
External interface		18-point terminal block																																	
5 V DC internal current consumption		0.52 A																																	
Weight		0.19 kg																																	

L60ADVL8

Item		L60ADVL8																						
Number of analog input channels		8 channels																						
Analog input	Voltage	-10...10 V DC (Input resistance value 1 MΩ)																						
	Current	0...20 mA DC (Input resistance value 250 Ω)																						
Digital output		-16384...16383																						
When using the scaling function		-32768...32767																						
I/O characteristics, resolution																								
<table border="1"> <thead> <tr> <th colspan="2">Analog input range</th> <th>Digital output value</th> <th>Resolution</th> </tr> </thead> <tbody> <tr> <td rowspan="6">Voltage</td> <td>0...10 V</td> <td>0...16000</td> <td>625 μV</td> </tr> <tr> <td>0...5 V</td> <td rowspan="2">0...8000</td> <td>625 μV</td> </tr> <tr> <td>1...5 V</td> <td>500 μV</td> </tr> <tr> <td>-10...10 V</td> <td>-16000...16000</td> <td>625 μV</td> </tr> <tr> <td>1...5 V (Extended mode)</td> <td>-2000...9000</td> <td>500 μV</td> </tr> <tr> <td>Users range setting</td> <td>-8000...8000</td> <td>414 μV^{*1}</td> </tr> </tbody> </table>			Analog input range		Digital output value	Resolution	Voltage	0...10 V	0...16000	625 μV	0...5 V	0...8000	625 μV	1...5 V	500 μV	-10...10 V	-16000...16000	625 μV	1...5 V (Extended mode)	-2000...9000	500 μV	Users range setting	-8000...8000	414 μV ^{*1}
Analog input range		Digital output value	Resolution																					
Voltage	0...10 V	0...16000	625 μV																					
	0...5 V	0...8000	625 μV																					
	1...5 V		500 μV																					
	-10...10 V	-16000...16000	625 μV																					
	1...5 V (Extended mode)	-2000...9000	500 μV																					
	Users range setting	-8000...8000	414 μV ^{*1}																					
Accuracy ^{*2}	Ambient temperature 25 ± 5°C	≤ ± 0.2%																						
	Ambient temperature 0...55°C	≤ ± 1%																						
Conversion speed		1 ms/ch																						
Absolute maximum input		Voltage ± 15 V																						
Isolation method		Between I/O terminals and programmable controller power supply: photocoupler isolation Between input channels: no isolation																						
Module size allocation		1																						
Number of occupied I/O points		16 points (I/O assignment: 16 points for intelligent)																						
External interface		18-point terminal block																						
5 V DC internal current consumption		0.20 A																						
Weight		0.19 kg																						

L60ADIL8

Item		L60ADIL8																
Number of analog input channels		8 channels																
Analog input	Current	0...20 mA DC (Input resistance value 250 Ω)																
	Voltage	0...10 V DC (Input resistance value 1 MΩ)																
Digital output		-8192...8192																
When using the scaling function		-32768...32767																
I/O characteristics, resolution																		
<table border="1"> <thead> <tr> <th colspan="2">Analog input range</th> <th>Digital output value</th> <th>Resolution</th> </tr> </thead> <tbody> <tr> <td rowspan="4">Current</td> <td>0...20 mA</td> <td rowspan="2">0...8000</td> <td>2500 nA</td> </tr> <tr> <td>4...20 mA</td> <td>2000 nA</td> </tr> <tr> <td>4...20 mA (Extended mode)</td> <td>-2000...9000</td> <td>2000 nA</td> </tr> <tr> <td>Users range setting</td> <td>-8000...8000</td> <td>1660 nA^{*1}</td> </tr> </tbody> </table>			Analog input range		Digital output value	Resolution	Current	0...20 mA	0...8000	2500 nA	4...20 mA	2000 nA	4...20 mA (Extended mode)	-2000...9000	2000 nA	Users range setting	-8000...8000	1660 nA ^{*1}
Analog input range		Digital output value	Resolution															
Current	0...20 mA	0...8000	2500 nA															
	4...20 mA		2000 nA															
	4...20 mA (Extended mode)	-2000...9000	2000 nA															
	Users range setting	-8000...8000	1660 nA ^{*1}															
Accuracy ^{*2}	Ambient temperature 25 ± 5°C	≤ ± 0.2%																
	Ambient temperature 0...55°C	≤ ± 1%																
Conversion speed		1 ms/ch																
Absolute maximum input		Current 30 mA ^{*6}																
Isolation method		Between I/O terminals and programmable controller power supply: photocoupler isolation Between input channels: no isolation																
Module size allocation		1																
Number of occupied I/O points		16 points (I/O assignment: 16 points for intelligent)																
External interface		18-point terminal block																
5 V DC internal current consumption		0.21 A																
Weight		0.19 kg																

*1: Maximum resolution in the user range setting.

*2: Accuracy for the maximum value of the digital output value. Except when influenced by noise.

*3: The default value is 80 μs/channel.

*4: The logging function can be used only in the middle speed (80 μs/channel) or low speed (1 ms/channel).

*5: The flow amount integration function can be used only in the low speed (1 ms/channel).

*6: A momentary current value which does not cause damage to internal resistors of the module, although the maximum continuous input current is 24 mA.

Dual channel isolation analog input module specifications

Item		L60AD4-2GH																															
Number of analog input channels		4 channels																															
Analog input	Voltage	-10...10 V DC (Input resistance value 1 MΩ)																															
	Current	0...20 mA DC (Input resistance value 250 Ω)																															
Digital output		-32000...32000																															
When using the scaling function		-32768...32767																															
I/O characteristics, resolution		<table border="1"> <thead> <tr> <th>Analog input range</th> <th>Digital output value</th> <th>Resolution</th> </tr> </thead> <tbody> <tr> <td>0...10 V</td> <td rowspan="3">0...32000</td> <td>312.5 μV</td> </tr> <tr> <td>0...5 V</td> <td>156 μV</td> </tr> <tr> <td>1...5 V</td> <td>125 μV</td> </tr> <tr> <td>-10...10 V</td> <td>-32000...32000</td> <td>312.5 μV</td> </tr> <tr> <td>1...5 V (Extended mode)</td> <td>-8000...32000</td> <td>125 μV</td> </tr> <tr> <td>Users range setting (Bipolar: voltage)</td> <td>-32000...32000</td> <td>200 μV*1</td> </tr> <tr> <td rowspan="4">Current</td> <td>0...20 mA</td> <td rowspan="2">0...32000</td> <td>625 nA</td> </tr> <tr> <td>4...20 mA</td> <td>500 nA</td> </tr> <tr> <td>4...20 mA (Extended mode)</td> <td>-8000...32000</td> <td>500 nA</td> </tr> <tr> <td>Users range setting (Unipolar: Current)</td> <td>0...32000</td> <td>400 nA*1</td> </tr> </tbody> </table>	Analog input range	Digital output value	Resolution	0...10 V	0...32000	312.5 μV	0...5 V	156 μV	1...5 V	125 μV	-10...10 V	-32000...32000	312.5 μV	1...5 V (Extended mode)	-8000...32000	125 μV	Users range setting (Bipolar: voltage)	-32000...32000	200 μV*1	Current	0...20 mA	0...32000	625 nA	4...20 mA	500 nA	4...20 mA (Extended mode)	-8000...32000	500 nA	Users range setting (Unipolar: Current)	0...32000	400 nA*1
		Analog input range	Digital output value	Resolution																													
		0...10 V	0...32000	312.5 μV																													
		0...5 V		156 μV																													
		1...5 V		125 μV																													
		-10...10 V	-32000...32000	312.5 μV																													
		1...5 V (Extended mode)	-8000...32000	125 μV																													
		Users range setting (Bipolar: voltage)	-32000...32000	200 μV*1																													
		Current	0...20 mA	0...32000	625 nA																												
			4...20 mA		500 nA																												
4...20 mA (Extended mode)	-8000...32000		500 nA																														
Users range setting (Unipolar: Current)	0...32000		400 nA*1																														
Accuracy*2	Reference accuracy*3	≤ ± 0.05% (± 16 digit)																															
	Temperature coefficient*4	≤ ± 40.1 ppm/°C																															
Conversion speed		40 μs/2 channel																															
Absolute maximum input		Voltage: ± 15 V, Current: 30 mA*5																															
Isolation method		Between I/O terminals and programmable controller power supply: photocoupler isolation Between analog input channels: dual channel transformer isolation																															
Module size allocation		1																															
Number of occupied I/O points		16 points (I/O assignment: 16 points for intelligent)																															
External interface		18-point terminal block																															
5 V DC internal current consumption		0.76 A																															
Weight		0.20 kg																															
External trigger input	Input points		1 point																														
	Rated input voltage		24 V DC (+ 20%/-15%, ripple ratio: ≤ 5%)																														
	Rated input current		6.0 mA TYP. (at 24 V DC)																														
	ON voltage/ON current		≥ 13 V, ≥ 3 mA																														
	OFF voltage/OFF current		≤ 8 V, ≤ 1.6 mA																														
	Input resistance		3.9 kΩ																														
	Response time	OFF to ON	40 μs																														
	ON to OFF	40 μs																															

*1: Maximum resolution in the user range setting.

*2: Accuracy for the maximum value of the digital output value. Except when influenced by noise.

*3: Accuracy under the ambient temperature when the offset/gain setting is performed.

*4: Accuracy when the temperature changes 1°C.

Example: Accuracy when the temperature changes from 25°C to 30°C

$$0.05\% + 0.00401\%/^{\circ}\text{C} (\text{temperature coefficient}) \times 5^{\circ}\text{C} (\text{temperature change}) = 0.070\%$$

*5: A momentary input current value which does not cause damage to internal resistors of the module. The maximum input current value for constant application is 24 mA.

Analog output module specifications

L60DA4

Item		L60DA4																						
Number of analog output channels		4 channels																						
Digital input		-20480...20479																						
When using the scaling function		-32768...32767																						
Analog output	Voltage	-10...10 V DC (External load resistance value 1 kΩ...1 MΩ)																						
	Current	0...20 mA DC (External load resistance value 0 Ω...600 Ω)																						
I/O characteristics, resolution		<table border="1"> <thead> <tr> <th>Analog output range</th> <th>Digital value</th> <th>Resolution</th> </tr> </thead> <tbody> <tr> <td>0...5 V</td> <td rowspan="3">0...20000</td> <td>250 μV</td> </tr> <tr> <td>1...5 V</td> <td>200 μV</td> </tr> <tr> <td>-10...10 V</td> <td>500 μV</td> </tr> <tr> <td>Users range setting</td> <td>-20000...20000</td> <td>333 μV*6</td> </tr> <tr> <td rowspan="4">Current</td> <td>0...20 mA</td> <td rowspan="2">0...20000</td> <td>1000 nA</td> </tr> <tr> <td>4...20 mA</td> <td>800 nA</td> </tr> <tr> <td>Users range setting</td> <td>-20000...20000</td> <td>700 nA*6</td> </tr> </tbody> </table>	Analog output range	Digital value	Resolution	0...5 V	0...20000	250 μV	1...5 V	200 μV	-10...10 V	500 μV	Users range setting	-20000...20000	333 μV*6	Current	0...20 mA	0...20000	1000 nA	4...20 mA	800 nA	Users range setting	-20000...20000	700 nA*6
		Analog output range	Digital value	Resolution																				
		0...5 V	0...20000	250 μV																				
		1...5 V		200 μV																				
		-10...10 V		500 μV																				
		Users range setting	-20000...20000	333 μV*6																				
		Current	0...20 mA	0...20000	1000 nA																			
			4...20 mA		800 nA																			
			Users range setting	-20000...20000	700 nA*6																			
			Accuracy*7	Ambient temperature 25 ± 5°C	≤ ± 0.1%																			
Ambient temperature 0...55°C	≤ ± 0.3%																							
Conversion speed	Normal output mode	20 μs/channel																						
	Wave output mode	50 μs/channel 80 μs/channel																						
Output short protection		Protected																						
Isolation method		Between I/O terminals and programmable controller power supply: photocoupler isolation Between output channels: no isolation Between external power supply and analog output: transformer isolation																						
Module size allocation		1																						
Number of occupied I/O points		16 points (I/O assignment: 16 points for intelligent)																						
External interface		18-point terminal block																						
External power supply		24 V DC (+20%, -15%)																						
		Ripple, spike 500 mV _{P-P} or lower																						
		Inrush current: 4.3 A, 1000 μs or shorter																						
		Current consumption: 0.18 A																						
5 V DC internal current consumption		0.16 A																						
Weight		0.20 kg																						

*6: Maximum resolution in the user range setting.

*7: Accuracy for the maximum value of analog output value. Except when influenced by noise. Warm up (power on) the module for 30 minutes to satisfy the accuracy shown in the table.

■ Analog output module specifications

L60DAVL8

Item		L60DAVL8																
Number of analog output channels		8 channels																
Digital input		-16384...16383																
When using the scaling function		-32768...32767																
Analog output	Voltage	-10...10 V DC (External load resistance value 1 kΩ...1 MΩ)																
I/O characteristics, resolution		<table border="1"> <thead> <tr> <th colspan="2">Analog output range</th> <th>Digital value</th> <th>Resolution</th> </tr> </thead> <tbody> <tr> <td rowspan="4">Voltage</td> <td>0...5 V</td> <td rowspan="2">0...8000</td> <td>625 μV</td> </tr> <tr> <td>1...5 V</td> <td>500 μV</td> </tr> <tr> <td>-10...10 V</td> <td>-16000...16000</td> <td>625 μV</td> </tr> <tr> <td>Users range setting</td> <td>-8000...8000</td> <td>320 μV*1</td> </tr> </tbody> </table>	Analog output range		Digital value	Resolution	Voltage	0...5 V	0...8000	625 μV	1...5 V	500 μV	-10...10 V	-16000...16000	625 μV	Users range setting	-8000...8000	320 μV*1
		Analog output range		Digital value	Resolution													
		Voltage	0...5 V	0...8000	625 μV													
			1...5 V		500 μV													
			-10...10 V	-16000...16000	625 μV													
Users range setting	-8000...8000		320 μV*1															
Accuracy ²	Ambient temperature 25 ± 5°C	≤ ± 0.3%																
	Ambient temperature 0...55°C	≤ ± 0.5%																
Conversion speed	Normal output mode	200 μs/channel																
	Wave output mode	200 μs/channel																
Output short protection		Protected																
Isolation method		Between I/O terminals and programmable controller power supply: photocoupler isolation Between output channels: no isolation Between external power supply and analog output: transformer isolation																
Module size allocation		2																
Number of occupied I/O points		16 points (I/O assignment: 16 points for intelligent)																
External interface		18-point terminal block																
External power supply		24 V DC (+20%, -15%)																
		Ripple, spike 500 mV _{P-P} or lower																
		Inrush current: 3.9 A, 2.0 ms or shorter																
		Current consumption: 0.13 A																
5 V DC internal current consumption		0.15 A																
Weight		0.22 kg																

L60DAIL8

Item		L60DAIL8													
Number of analog output channels		8 channels													
Digital input		-8192...8191													
When using the scaling function		-32768...32767													
Analog output	Current	0...20 mA DC (External load resistance value 0 Ω...600 Ω)													
I/O characteristics, resolution		<table border="1"> <thead> <tr> <th colspan="2">Analog output range</th> <th>Digital value</th> <th>Resolution</th> </tr> </thead> <tbody> <tr> <td rowspan="4">Current</td> <td>0...20 mA</td> <td rowspan="2">0...8000</td> <td>2500 nA</td> </tr> <tr> <td>4...20 mA</td> <td>2000 nA</td> </tr> <tr> <td>Users range setting</td> <td>-8000...8000</td> <td>707 nA*1</td> </tr> </tbody> </table>	Analog output range		Digital value	Resolution	Current	0...20 mA	0...8000	2500 nA	4...20 mA	2000 nA	Users range setting	-8000...8000	707 nA*1
		Analog output range		Digital value	Resolution										
		Current	0...20 mA	0...8000	2500 nA										
			4...20 mA		2000 nA										
			Users range setting	-8000...8000	707 nA*1										
Accuracy ²	Ambient temperature 25 ± 5°C		≤ ± 0.3%												
	Ambient temperature 0...55°C	≤ ± 1.0%													
Conversion speed	Normal output mode	200 μs/channel													
	Wave output mode	200 μs/channel													
Output short protection		Protected													
Isolation method		Between I/O terminals and programmable controller power supply: photocoupler isolation Between output channels: no isolation Between external power supply and analog output: transformer isolation													
Module size allocation		2													
Number of occupied I/O points		16 points (I/O assignment: 16 points for intelligent)													
External interface		18-point terminal block													
External power supply		24 V DC (+20%, -15%)													
		Ripple, spike 500 mV _{P-P} or lower													
		Inrush current: 3.9 A, 2.0 ms or shorter													
		Current consumption: 0.25 A													
5 V DC internal current consumption		0.15 A													
Weight		0.22 kg													

*1: Maximum resolution in the user range setting.

*2: Accuracy for the maximum value of analog output value. Except when influenced by noise.

■ Analog input/output module specifications

Item		L60AD2DA2				
■ A/D conversion part						
Number of analog input channels		2 channels				
Analog input	Voltage	-10...10 V DC (Input resistance value 1 MΩ)				
	Current	0...20 mA DC (Input resistance value 250 Ω)				
Digital output		-16384...16383				
	When using the scaling function	-32768...32767				
I/O characteristics, resolution	Voltage	Analog input range		Resolution		
		0...10 V	0...16000	625 μV		
		0...5 V	0...12000	416 μV		
		1...5 V		333 μV		
		-10...10 V	-16000...16000	625 μV		
	1...5 V (Extended mode)	-3000...13500	333 μV			
	Current	Users range setting		321 μV*1		
		0...20 mA	0...12000	1666 nA		
		4...20 mA		1333 nA		
		4...20 mA (Extended mode)	-3000...13500	1333 nA		
Users range setting		-12000...12000	1287 nA*1			
Accuracy*2	Voltage	Analog input range		Ambient temperature		
				25 ± 5°C	0...55°C	
		0...10 V	≤ ± 0.2%	≤ ± 0.3%		
		-10...10 V				
		0...5 V				
	1...5 V					
	1...5 V (Extended mode)	≤ ± 0.3%				
	Current	0...20 mA				
		4...20 mA				
		4...20 mA (Extended mode)				
Conversion speed	Logging function	80 μs/channel				
	Wave output function	80 μs/channel				
	Variable conversion characteristics function	100 μs/channel				
	Variable arithmetic function	100 μs/channel				
	Variable conversion characteristics function + variable arithmetic function	160 μs/channel				
Absolute maximum input		Voltage: ± 15 V, Current: 30 mA*3				
■ D/A conversion part						
Number of analog output channels		2 channels				
Digital input		-16384...16383				
	When using the scaling function	-32768...32767				
Analog output	Voltage	-10...10 V DC (External load resistance value 1k to 1M Ω)				
	Current	0...20 mA DC (External load resistance value 0 to 600 Ω)				
I/O characteristics, resolution	Voltage	Analog output range		Digital value	Resolution	
		0...5 V	0...12000	416 μV		
		1...5 V		333 μV		
		-10...10 V	-16000...16000	625 μV		
		Users range setting		-12000...12000	319 μV*1	
	Current	0...20 mA		0...12000	1666 nA	
		4...20 mA			1333 nA	
		4...20 mA (Extended mode)		-12000...12000	696 nA*1	
Accuracy*2	Voltage	Analog output range		Ambient temperature		
				25 ± 5°C	0...55°C	
		0...5 V	≤ ± 0.2%	≤ ± 0.4%		
		1...5 V				
		-10...10 V				
	0...20 mA					
	4...20 mA	≤ ± 0.4%				
	Conversion speed	Normal output	80 μs/channel			
		Wave output function	80 μs/channel			
		Variable conversion characteristics function	100 μs/channel			
Variable arithmetic function		100 μs/channel				
Variable conversion characteristics function + variable arithmetic function		320 μs/2 channels*4				
Output short protection		Protected				
■ Common part						
Isolation method		Between I/O terminals and programmable controller power supply: photocoupler isolation Between output channels: no isolation Between external power supply and analog output: transformer isolation				
Module size allocation		1				
Number of occupied I/O points		16 points (I/O assignment: 16 points for intelligent)				
External interface		18-point terminal block 24 V DC (+20%/-15%)				
External power supply		Ripple, spike 500 mV _{P-P} or lower Inrush current: 3.5 A, 1000 μs or shorter Current consumption: 0.12 A				
5 V DC internal current consumption		0.17 A				
Weight		0.22 kg				

*1: Maximum resolution in the user range setting.

*2: Accuracy for the maximum value of the digital /analog output value. Except when influenced by noise.

*3: A momentary current value which does not cause damage to internal resistors of the module, although the maximum continuous input current 24 mA.

*4: When the variable arithmetic function or the variable conversion characteristics function + variable arithmetic function is used, the operation speed for polynomial expressions is 320 μs. Since each operation result of two polynomial expressions is output on each D/A conversion channel, D/A conversion is executed at intervals of 320 μs regardless of the number of conversion enabled channels.

Temperature input module specifications

Item		L60RD8	
Number of analog input channels		8 channels	
Output	Temperature measured value	-3280...15620	
	Digital operation value	-32768...32767	
Applicable RTD		9 types Pt1000, Pt100, JPt100, Pt50, Ni500, Ni120, Ni100, Cu100, Cu50	
Measured temperature range, accuracy*1		(Accuracy) = (Conversion accuracy) + (Allowable difference of RTD used)	
Temperature detecting output current*2	1 mA	Pt100, JPt100, Pt50, Ni120, Ni100, Cu100, Cu50	
	100 µA	Pt1000, Ni500	
Resolution*3		0.1°C	
Conversion speed		40 ms/ch	
Number of 2-point sensor compensation settings		10000 times maximum	
Isolation method		Between input terminals and programmable controller power supply: Photocoupler Between input channels: Non-isolation	
Module size allocation		1	
Number of occupied I/O points		16 points (I/O assignment: Intelligent 16 points)	
External interface		24-point spring clamp terminal block	
Applicable cable type*4		Solid wire, stranded wire, bar solderless terminal	
Applicable wire size	Core	0.5...1.5 mm ² (AWG24...16)	
	Terminal hole size	2.4 mm x 1.5 mm	
Applicable solderless terminal	AI 0.5-10WH [Applicable wire size: 0.5 mm ²]	PHOENIX CONTACT GmbH & Co. KG	
	AI 0.75-10GY [Applicable wire size: 0.75 mm ²]		
	A 1-10 [Applicable wire size: 1.0 mm ²]		
	A 1.5-10 [Applicable wire size: 1.5 mm ²]		
Wire strip length		10 mm	
5 V DC internal current consumption		0.22 A	
Weight		0.15 kg	

*1: The following table shows RTD types and values for each item.

RTD type	Measured temperature range	Celsius		Measured temperature range	Fahrenheit	
		Operating ambient temperature 25±5°C	Conversion accuracy Operating ambient temperature 0...55°C		Operating ambient temperature 25±5°C	Conversion accuracy Operating ambient temperature 0...55°C
Pt100	-20...120°C	±0.6°C	±2.0°C	-4...248°F	±1.1°F	±3.6°F
	-200...850°C	Specified temperature x±0.3% or ±0.8°C, whichever is greater	Specified temperature x±0.8% or ±2.7°C, whichever is greater	-328...1562°F	Specified temperature x±0.3% or ±1.5°F, whichever is greater	Specified temperature x±0.8% or ±4.9°F, whichever is greater
JPt100	-20...120°C	±0.6°C	±2.0°C	-4...248°F	±1.1°F	±3.6°F
	-200...600°C	Specified temperature x±0.3% or ±0.8°C, whichever is greater	Specified temperature x±0.8% or ±2.7°C, whichever is greater	-328...1112°F	Specified temperature x±0.3% or ±1.5°F, whichever is greater	Specified temperature x±0.8% or ±4.9°F, whichever is greater
Pt1000	-200...850°C	Specified temperature x±0.3% or ±0.8°C, whichever is greater	Specified temperature x±0.8% or ±2.7°C, whichever is greater	-328...1562°F	Specified temperature x±0.3% or ±1.5°F, whichever is greater	Specified temperature x±0.8% or ±4.9°F, whichever is greater
Pt50	-200...650°C	Specified temperature x±0.3% or ±0.8°C, whichever is greater	Specified temperature x±0.8% or ±4.1°C, whichever is greater	-328...1202°F	Specified temperature x±0.3% or ±1.5°F, whichever is greater	Specified temperature x±0.8% or ±7.4°F, whichever is greater
Ni100	-60...250°C	±0.6°C	Specified temperature x±0.8% or ±1.4°C, whichever is greater	-76...482°F	±1.1°F	Specified temperature x±0.8% or ±2.6°F, whichever is greater
Ni120	-60...250°C	±0.6°C	Specified temperature x±0.8% or ±1.4°C, whichever is greater	-76...482°F	±1.1°F	Specified temperature x±0.8% or ±2.6°F, whichever is greater
Ni500	-60...250°C	±0.6°C	Specified temperature x±0.8% or ±1.4°C, whichever is greater	-76...482°F	±1.1°F	Specified temperature x±0.8% or ±2.6°F, whichever is greater
Cu100	-180...200°C	±0.8°C	±2.7°C	-292...392°F	±1.5°F	±4.9°F
Cu50	-180...200°C	±0.8°C	±2.7°C	-292...392°F	±1.5°F	±4.9°F

*2: Current is output only on channels in which conversion is being performed.

*3: When the standard product (L60MD4-G) is replaced by this module, the resolution of Pt100 (-20 to 120°C) and JPt100 (-20 to 120°C) is different.

*4: When a stranded wire is used, attach a bar solderless terminal.

Temperature Control Modules

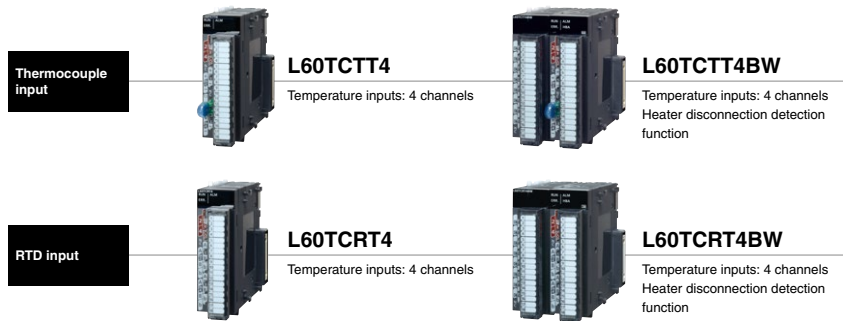

Function	L60TCTT4	L60TCTT4BW	L60TCRT4	L60TCRT4BW
	Thermocouple input		RTD input	
Standard control	●	●	●	●
Heating-cooling control	●	●	●	●
Self-tuning function	●	●	●	●
Peak current suppression function	●	●	●	●
Simultaneous temperature rise function	●	●	●	●
Selectable sampling cycle	●	●	●	●
Temperature input mode	●	●	●	●
Temperature control mode	●	●	●	●
Heater disconnection detection function	—	●	—	●

Highly stable temperature control

Standard control/heating and cooling control

Prevent overheating and overcooling in devices that require a high level of temperature stability, such as in an extrusion molding machine.

The following control methods can be selected according to the target device.

- Standard control (heating or cooling)
- Heating/cooling control (heating and cooling)
- Mix control (combination of standard control and heating-cooling control)

■ Example: Standard control (heating only)

The temperature of the object is controlled by adjusting the heater output based on the PID calculations resulting from the temperature sensor input.

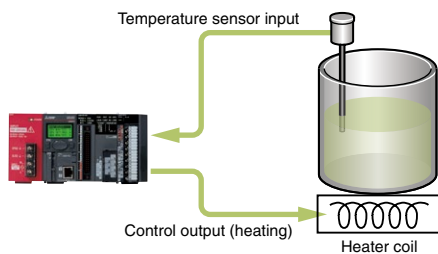

■ Example: Heating-cooling control (heating and cooling elements controlled simultaneously)

Heating is performed when the control object's temperature is lower than the target temperature, and cooling is performed when it is hotter or the humidity needs to be reduced.

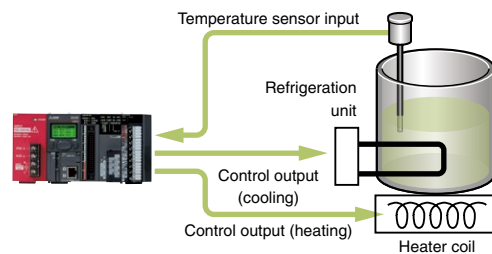

Reduce running costs by taking advantage of the energy-saving effect

Peak current control function

The peak current control function reduces the peak current by automatically changing the upper-output limit value for each channel, while dividing the transistor output timing*1. The energy conserved by reducing the peak current, such as a reduction in system power capacity and reduction in contracted power, can help to reduce running costs.

*1: The timing can be split between two to four outputs.

When two or more loads are being controlled, the peak current can be minimized by spreading the total load out over time.

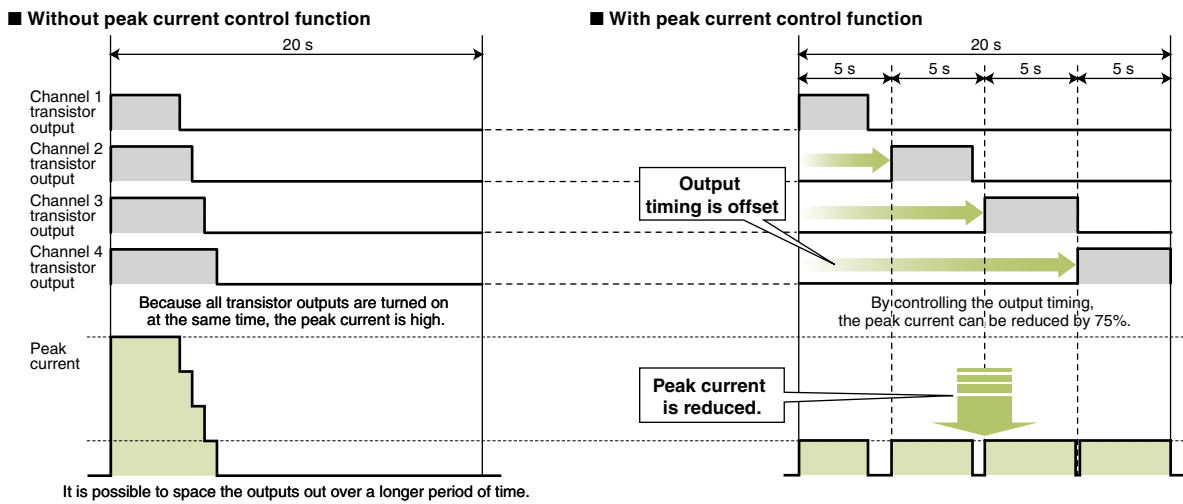

Ensures uniform temperature control

Simultaneous temperature rise function

Ensures uniform temperature control by synchronizing the temperature arrival times from multiple loops. Perform a uniform temperature rise using two or more control loops without going over temperature or resulting in unexpected thermal expansion.

A "no idling" format increases energy efficiency and reduces running costs.

■ Example: Temperature control of injection molding machine ■ Example: Wafer heating process for semiconductor manufacturing

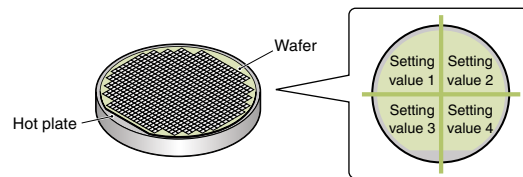
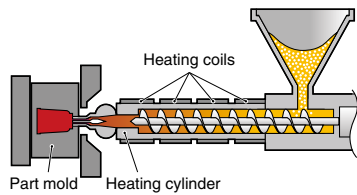

The running costs is reduced!

Without the simultaneous temperature rise function

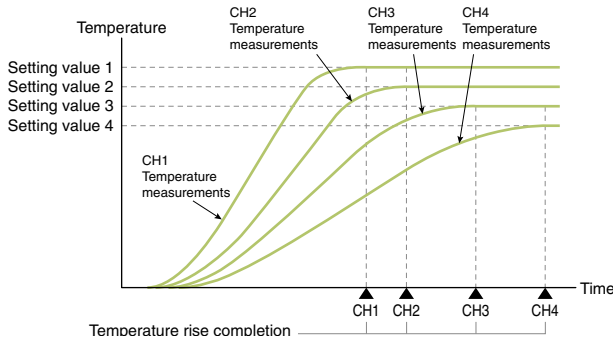

With the simultaneous temperature rise function

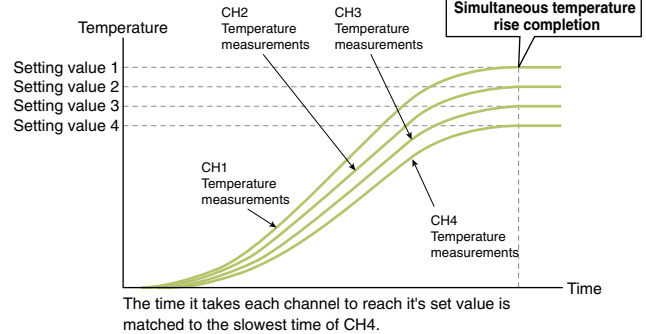

Using this function, it is possible to coordinate the control of two or more loops to reach their target values (SV) at the same time. Control the simultaneous rise in temperature of separate loops by setting a channel group (Max. 2 groups). This is an effective way to control applications where differing target temperature arrival times can result in undesirable temperature differentials.

Specifications

Item		L60TCTT4	L60TCTT4BW	L60TCRT4	L60TCRT4BW
Control output		Transistor output			
Number of temperature input channels		4 channels			
Applicable temperature sensors		Thermocouple		Resistive thermal device	
Accuracy*1	Indication accuracy	Ambient temperature: 25 ± 5°C		Full scale × (± 0.3%)	
		Ambient temperature: 0...55°C		Full scale × (± 0.7%)	
	Cold junction temperature compensation accuracy: (ambient temperature: 0...55°C)	Temperature process value (PV): -100°C or more		≤ ± 1.0°C	
		Temperature process value (PV): -150...-100°C		≤ ± 2.0°C	
		Temperature process value (PV): -200...-150°C		≤ ± 3.0°C	
Sampling cycle		250 ms/4 channels 500 ms/4 channels			
Control output cycle		0.5...100.0 s			
Input impedance		1 MΩ			
Input filter		0...100 s (0: Input filter OFF)			
Sensor correction value setting		-50.00...50.00%			
Operation at sensor input disconnection		Upscale processing			
Temperature control method		PID ON/OFF pulse or two-position control			
PID constants range	PID constants setting		Can be set by auto tuning.		
	Proportional band (P)		0.0...1000.0% (0: Two-position control)		
	Integral time (I)		0...3600 s (set 0 for P control and PD control.)		
	Derivative time (D)		0...3600 s (set 0 for P control and PI control.)		
Set value (SV) setting range		Within the temperature range set in the thermocouple/platinum resistance thermometer to be used			
Dead band setting range		0.1...10.0%			
Transistor output	Output signal		ON/OFF pulse		
	Rated load voltage		10...30 V DC		
	Max. load current		0.1 A/point, 0.4 A/common		
	Max. inrush current		0.4 A 10 ms		
	Leakage current at OFF		≤ 0.1 mA		
	Max. voltage drop at ON		1.0 V DC (TYP) at 0.1 A 2.5 V DC (MAX) at 0.1 A		
Response time		OFF→ON: ≤ 2 ms, ON→OFF: ≤ 2 ms			
Number of accesses to non-volatile memory		Max. 10 ¹² times			
Isolation method		Between input terminal and programmable controller power supply: Transformer isolation Between input channels: Transformer isolation			
Heater disconnection detection specifications	Current sensor	—		—	
		• CTL-12-S36-10 (0.0...100.0 A)*2 • CTL-12-S56-10 (0.0...100.0 A)*2 • CTL-6-P-H (0.00...20.00 A)*2		• CTL-12-S36-10 (0.0...100.0 A)*2 • CTL-12-S56-10 (0.0...100.0 A)*2 • CTL-6-P-H (0.00...20.00 A)*2	
	Input accuracy	Full scale × (± 1.0%)		Full scale × (± 1.0%)	
Number of alert delay		3...255		3...255	
Module size allocation		1	2	1	2
Number of occupied I/O points		16 points (I/O assignment: Intelligent 16 points)			
External interface		18-point terminal block	18-point terminal block × 2	18-point terminal block	18-point terminal block × 2
5 V DC internal current consumption		0.30 A	0.33 A	0.31 A	0.35 A
Weight		0.18 kg	0.33 kg	0.18 kg	0.33 kg

*1: Calculate the accuracy in the following method (only when it is not affected by noise).

Accuracy (°C) = full scale × indication accuracy + cold junction temperature compensation accuracy

Ex.) Accuracy at the input range of 38 (-200.0 to 400.0°C), the operating ambient temperature of 35°C, and the temperature process value (PV) of 300°C

(Full scale) × (indication accuracy) + cold junction temperature compensation accuracy

= (400.0°C - (-200.0°C)) × (±0.007) + (±1.0°C)

= ± 5.2°C

*2: U.R.D.Co., LTD. For more information, visit <http://www.u-rd.com>

Control mode

Control mode	Contents	Number of controllable loops
Standard control	Performs the standard control of four channels.	Standard control 4 loops
Heating-cooling control (normal mode)	Performs the heating-cooling control. CH3 and CH4 cannot be used.	Heating-cooling control 2 loops
Heating-cooling control (expanded mode)	Performs the heating-cooling control. The number of loops is expanded using an output module and others in the system.	Heating-cooling control 4 loops
Mix control (normal mode)	Performs the standard control and the heating-cooling control. CH2 cannot be used.	Standard control 2 loops Heating-cooling control 1 loop
Mix control (expanded mode)	Performs the standard control and the heating-cooling control. The number of loops is expanded using an output module and others in the system.	Standard control 2 loops Heating-cooling control 2 loops

Control for each channel is as follows.

Channel	Standard control	Heating-cooling control		Mix control	
		Normal mode	Expanded mode	Normal mode	Expanded mode
CH1	Standard control	Heating-cooling control	Heating-cooling control	Heating-cooling control	Heating-cooling control
CH2	Standard control	Heating-cooling control	Heating-cooling control	—*3	Heating-cooling control*4
CH3	Standard control	—*3	Heating-cooling control*4	Standard control	Standard control
CH4	Standard control	—*3	Heating-cooling control*4	Standard control	Standard control

*3: Only temperature measurement using a temperature input terminal can be performed.

*4: Heating-cooling control is performed using an output module in the system.

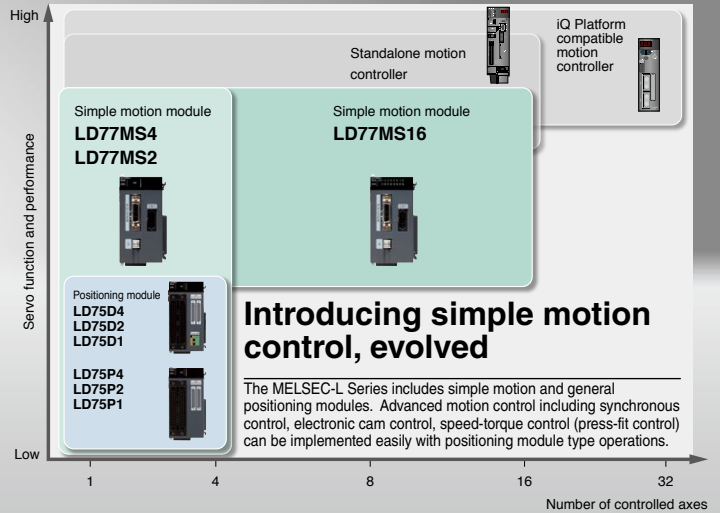

Simple Motion Modules

SSCNET III/H-compatible



LD77MS2

Number of control axes: 2 axes
Communication cycle: 150 Mbps
Positioning data: 600 data/axis
Max. connection distance: 100 m



LD77MS4

Number of control axes: 4 axes
Communication cycle: 150 Mbps
Positioning data: 600 data/axis
Max. connection distance: 100 m



LD77MS16

Number of control axes: 16 axes
Communication cycle: 150 Mbps
Positioning data: 600 data/axis
Max. connection distance: 100 m



*SSCNET (Servo System Controller NETwork)

Function	LD77MS2	LD77MS4	LD77MS16
Positioning control function	●	●	●
Speed/torque control function	●	●	●
Linear interpolation	2 axes	2/3/4 axes	2/3/4 axes
Circular interpolation	2 axes	2 axes	2 axes
Synchronous control function	External encoder	●	●
	Cam	●	●
	Phase compensation	●	●
Manual pulse generator operation function	●	●	●
OPR Control	●	●	●

Positioning Modules

Open collector output



LD75P1

Number of control axes: 1 axis
Max. output pulses: 200K pulses/s
Positioning data: 600 data/axis
Max. connection distance: 2 m



LD75P2

Number of control axes: 2 axes
Max. output pulses: 200K pulses/s
Positioning data: 600 data/axis
Max. connection distance: 2 m



LD75P4

Number of control axes: 4 axes
Max. output pulses: 200K pulses/s
Positioning data: 600 data/axis
Max. connection distance: 2 m

Differential output



LD75D1

Number of control axes: 1 axis
Max. output pulses: 4M pulse/s
Positioning data: 600 data/axis
Max. connection distance: 10 m



LD75D2

Number of control axes: 2 axes
Max. output pulses: 4M pulse/s
Positioning data: 600 data/axis
Max. connection distance: 10 m



LD75D4

Number of control axes: 4 axes
Max. output pulses: 4M pulse/s
Positioning data: 600 data/axis
Max. connection distance: 10 m

Function	LD75P1	LD75P2	LD75P4	LD75D1	LD75D2	LD75D4
	Open collector output			Differential output		
Positioning control function	●	●	●	●	●	●
Speed control function	●	●	●	●	●	●
Linear interpolation	—	2 axes	2/3/4 axes	—	2 axes	2/3/4 axes
Circular interpolation	—	2 axes	2 axes	—	2 axes	2 axes
Helical interpolation	—	—	3 axes	—	—	3 axes
OPR Control	●	●	●	●	●	●

Countless applications are possible

LD77MS□

A variety of control types including positioning control, speed-torque control, synchronous control and electronic cam control can be implemented easily with simple parameter settings and a sequence program.

Positioning control

- Support for a multitude of applications thanks to a wide variety of control formats including linear interpolation control (up to 4 axes), 2-axis circular interpolation control, fixed feed control and continuous orbit control.
- Use a sequence program to set the positioning address, speed, etc. for easy automatic operation.
- Quickly implement powerful auxiliary functions such as step operation, target position change, M codes, and the skip function.

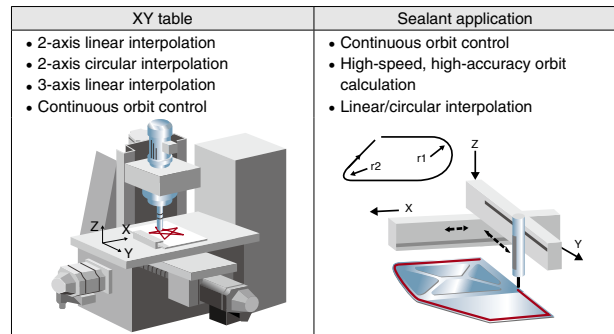

Speed-torque control

- Tension control applications such as winding and rewinding are supported.
- Switch from positioning control, to speed-torque control, and back to positioning control.
Because the present location is tracked even in speed-torque control mode, it is possible to maintain the current absolute position when returning to positioning control.

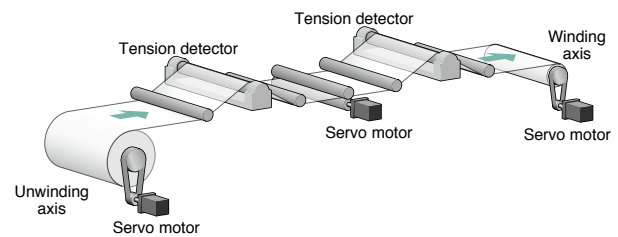

Synchronous control and electronic cam control

- Electronic cam control may be used alone or combined with synchronous control.

Example application for electronic cam control:

To create a movement path around a workpiece using positioning control, axis 2 waits for axis 1 to complete the move from P1 to P2 before it begins moving from P2 to P3. By using electronic cam control, axis 2 does not need to wait for axis 1 to complete its movement and the in position time can be shortened.

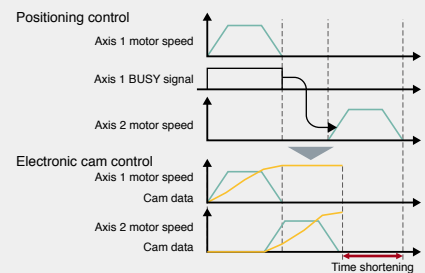
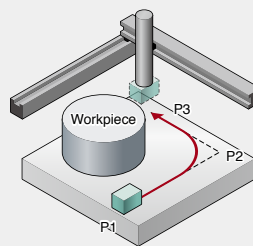

Many functions in a compact design

LD77MS□

Use a synchronous encoder with synchronous control

- Input pulses from a synchronous encoder can be used to perform synchronous control and electronic cam control.
- The incremental synchronous encoder can be used by using the LD77MS built-in interface. An option unit is not required.
- To further improve the synchronization accuracy, the phase compensation function, designed to compensate for synchronous encoder delays, can be used.

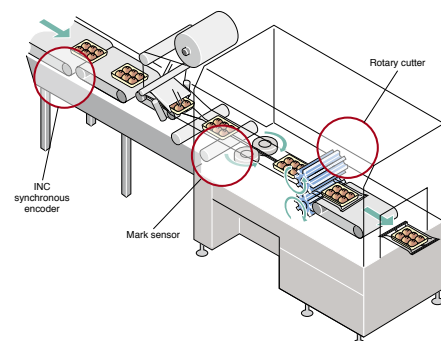

Standard mark detection function

- The built-in mark detection signal interface allows these units to be used in packaging systems for example, without additional option modules.

Automatic cam data generation for rotary cutter

- Complicated cam data for rotary cutters can be automatically generated just by specifying a few parameters like the sheet length and synchronization width.

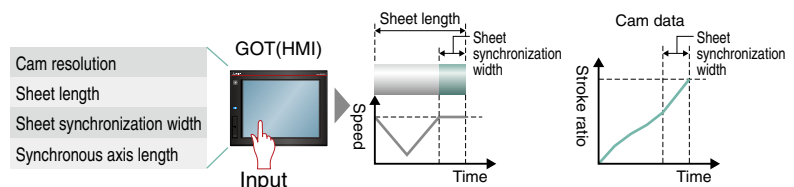

Perfect synchronous control is easy to achieve

LD77MS

Replace mechanical gears, shafts, speed change gears, cams, etc. and generate synchronous control operations using software.

- Complicated programs are unnecessary for synchronous control because it can be implemented easily using parameter settings.
- Start and stop synchronous control for each axis. Use the synchronous control axis and positioning control axis together.
- Convey the travel value of main shaft to the output axis via the clutch.

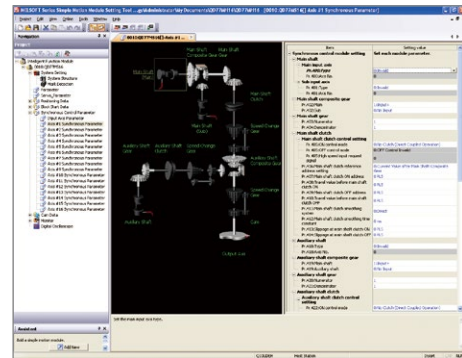

Synchronous Control Parameter Settings

Cam control made simple

LD77MS

Create cam data patterns easily.

- Create cam profiles unrestricted by existing concepts of electronic cam control.
- Change the acceleration, speed, stroke, and jerk while simultaneously seeing how it effects the profile.
- Easily check created cam data by viewing them as thumbnails.
- Import and export cam data in CSV format.

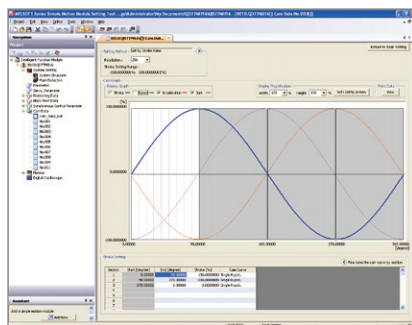

Cam Data

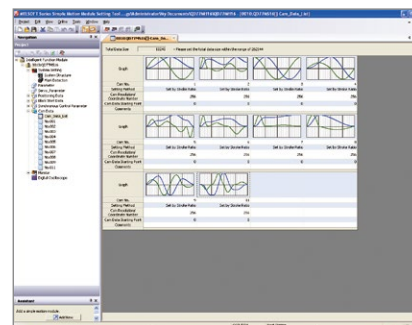

Cam Data List

Simplified debugging and commissioning

LD77MS

Digital oscilloscope function

- Collection of data from the simple motion module is synchronized with the operation cycle and waveform displays to facilitate an efficient start up.
- The assistant function explains each step.
- Use the purpose-based probe setting to easily set frequently-viewed data.
- Sample 16CH word and 16CH bit data and display 8CH words and 8CH bits in real time.

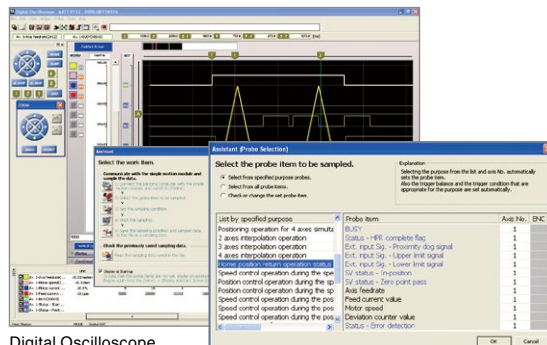

Digital Oscilloscope

Monitor and test functions

- Complete the system installation and perform operational checks easily using powerful monitor and test functions.
- Select items to be displayed on the monitor using a wealth of information monitoring options.
- The test function can be used to check basic operations without a sequence program.

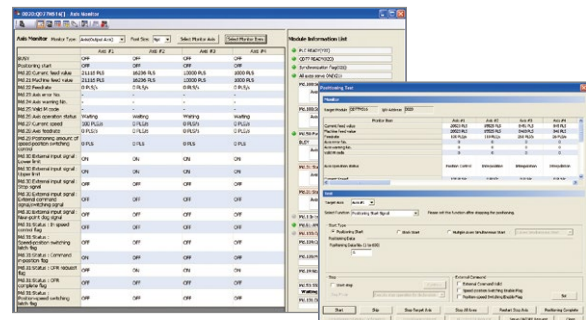

Axis Monitor

Positioning Test

Specifications

Item		LD77MS2	LD77MS4	LD77MS16
Number of control axes (Virtual servo amplifier axis included)		2 axes	4 axes	16 axes
Operation cycle (Operation cycle settings) *1		0.88 ms/1.77 ms		
Interpolation function		2-axis linear interpolation, 2-axis circular interpolation	2-axis/3-axis/4-axis linear interpolation, 2-axis circular interpolation	
Control modes		PTP (Point To Point) control, Trajectory control (both linear and arc can be set), Speed control, Speed-position switching control, Position-speed switching control, Speed-torque control		
Acceleration/deceleration process		Trapezoidal acceleration/deceleration, S-curve acceleration/deceleration		
Compensation function		Backlash compensation, Electronic gear, Near pass function		
Synchronous control		Synchronous encoder input, Cam, Phase Compensation, Cam auto-generation		
Control unit		mm, inch, degree, pulse		
Positioning data		600 data/axis (Can be set with MELSOFT GX Works2 or Sequence program.)		
Backup		Parameters, positioning data, and block start data can be saved on flash ROM (battery-less backup)		
OPR control	OPR method	Near-point dog method, Count method 1, Count method 2, Data set method, Scale home position signal detection method		
	Fast OPR control	●		
	Sub functions	OPR retry, OP shift		
Position control	Linear control	1-axis linear control, 2-axis linear interpolation control, 3-axis linear interpolation control, 4-axis linear interpolation control*2 (Composite speed, Reference axis speed)		
	Fixed-pitch feed control	1-axis fixed-pitch feed, 2-axis fixed-pitch feed, 3-axis fixed-pitch feed, 4-axis fixed-pitch feed		
	2-axis circular interpolation	Sub point designation, center point designation		
	Speed control	1-axis speed control, 2-axis speed control, 3-axis speed control, 4-axis speed control		
	Speed-position switching control	INC mode, ABS mode		
	Position-speed switching control	INC mode		
	Current value changing	Positioning data, Start No. for a current value changing		
	NOP instruction	●		
	JUMP instruction	Unconditional JUMP, Conditional JUMP		
	LOOP, LEND	●		
Manual control	High-level positioning control	Block start, Condition start, Wait start, Simultaneous start, Repeated start		
	JOG operation	●		
	Inching operation	●		
Expansion control	Manual pulse generator operation	Possible to connect 1 module (Incremental) Unit magnification (1...10000 times)		
	Speed-torque control	Speed control without positioning loops, Torque control, Tightening & press-fit control*3		
Absolute position system		Made compatible by setting battery to servo amplifier		
Synchronous encoder interface		Up to 4 channels (Total of the internal interface, via PLC CPU interface, and servo amplifier interface*3)		
Functions that limit control	Internal interface	1 channel (Incremental)		
	Speed limit function	Speed limit value, JOG speed limit value		
	Torque limit function	Torque limit value_same setting, torque limit value_individual setting		
	Forced stop	Valid/invalid setting		
	Software stroke limit function	Movable range check with current feed value, movable range check with machine feed value		
	Hardware stroke limit function	●		
Functions that change control details	Speed change function	●		
	Override function	●		
	Acceleration/deceleration time change function	●		
	Torque change function	●		
Other functions	Target position change function	Target position address and speed to target position are changeable		
	M code output function	●		
	Step function	Deceleration unit step, Data No. unit step		
	Skip function	Via PLC CPU, Via external command signal		
Mark detection function	Teaching function	●		
	Mark detection signal	2 points	4 points	
Optional data monitor function	Mark detection setting	4 settings	16 settings	
	Driver communication function	4 points/axis		
Amplifier-less operation function		●		
Digital oscilloscope function*4	Bit data	8 ch		16 ch
	Word data	4 ch		16 ch
Starting time*5	1-axis linear control	0.88 ms	0.88 ms	1.77 ms
	1-axis speed control			
	2-axis linear interpolation control (Composite speed)			
	2-axis linear interpolation control (Reference axis speed)			
	2-axis circular interpolation control			
	2-axis speed control			
	3-axis linear interpolation control (Composite speed)			
	3-axis linear interpolation control (Reference axis speed)			
	3-axis speed control			
	4-axis linear interpolation control			
4-axis speed control				
Maximum distance between stations [m (ft.)]		100 m		
Module size allocation		2		
Number of occupied I/O points		32 points (I/O assignment: Intelligent 32 points)		
Servo amplifier connection system		SSCNET III/H (1 system)		
5 V DC internal current consumption		0.55 A	0.7 A	
Weight		0.22 kg		

*1: Default value is 1.77 ms. If necessary, check the operation time and change to 0.88 ms.

*2: 4-axis linear interpolation control is enabled only at the reference axis speed.

*3: QD77MS and LD77MS only.

*4: 8CH word data and 8CH bit data can be displayed in real time.

*5: Time from accepting the positioning start signal until BUSY signal turns ON

Specifications

Item		LD75P1/LD75D1 ¹⁾	LD75P2/LD75D2 ¹⁾	LD75P4/LD75D4 ¹⁾	
Number of control axes		1 axis	2 axes	4 axes	
Interpolation function		—	2-axis linear interpolation, 2-axis circular interpolation	2-axis/3-axis/4-axis linear interpolation, 2-axis circular interpolation, 3-axis helical interpolation	
Control system		PTP (Point To Point) control, Path control (linear, arc and helical can be set), Speed control, Speed-position switching control, Position-speed switching control			
Control unit		mm, inch, degree, pulse			
Positioning data		600 data (positioning data No.1...600) /axis (Can be set with peripheral device or sequence program.)			
Backup		Parameters, positioning data, and block start data can be saved on flash ROM (battery-less backup)			
Positioning control	Positioning control system	PTP ^{*2} control		Increment system, absolute system	
		Speed-position switching control		Increment system, absolute system ^{*3}	
		Position-speed switching control		Increment system	
		Path control		Increment system, absolute system	
	Positioning control range	In absolute system	-214748364.8...214748364.7 (μm)		-21474.83648...21474.83647 (inch)
			0...359.99999 (degree)		-2147483648...2147483647 (pulse)
		In increment system	-214748364.8...214748364.7 (μm)		-21474.83648...21474.83647 (inch)
			-21474.83648...21474.83647 (degree)		-2147483648...2147483647 (pulse)
	In speed-position switching control (INC mode)/ position-speed switching control	0...214748364.7 (μm)		0...21474.83647 (inch)	
		0...21474.83647 (degree)		0...2147483647 (pulse)	
	In speed-position switching control (ABS mode) ^{*3}	0...359.99999 (degree)			
Speed command		0.01...20000000.00 (mm/min)		0.001...2000000.000 (inch/min)	
		0.001...2000000.000 (degree/min)		1...4000000 (pulse/s)	
Acceleration/deceleration system selection		Trapezoidal acceleration/deceleration, S-curve acceleration/deceleration			
Acceleration/deceleration time		1...8388608 ms			
Sudden stop deceleration time		Four patterns can be set for each of acceleration time and deceleration time			
		1...8388608 ms			
OPR method		6 types			
Starting time ^{*4}	1-axis linear control		1.5 ms		
	1-axis speed control		1.5 ms		
	2-axis linear interpolation control (Composite speed)		1.5 ms		
	2-axis linear interpolation control (Reference axis speed)		1.5 ms		
	2-axis circular interpolation control		2.0 ms		
	2-axis speed control		1.5 ms		
	3-axis linear interpolation control (Composite speed)		1.7 ms		
	3-axis linear interpolation control (Reference axis speed)		1.7 ms		
	3-axis helical interpolation control		2.6 ms		
	3-axis speed control		1.7 ms		
4-axis linear interpolation control		1.8 ms			
4-axis speed control		1.8 ms			
Maximum output pulse	LD75P□	200 kpulse/s			
	LD75D□	4 Mpulse/s			
Maximum connection distance between drive units	LD75P□	2 m			
	LD75D□	10 m			
Module size allocation		2			
Number of occupied I/O points		32 points (I/O assignment: Intelligent 32 points)			
External interface		40-pin connector		40-pin connector x2	
5 V DC internal current consumption	LD75P□	0.44 A	0.48 A	0.55 A	
	LD75D□	0.51 A	0.62 A	0.76 A	
Weight		0.18 kg			

*1: LD75P□ refers to the open collector output type, and LD75D□ refers to the differential driver output type.

*2: The abbreviation for Point To Point, referring to position control.

*3: In speed-position switching control (ABS mode), "degree" is the only control unit available.

*4: Using the pre-reading start function, the actual starting time can be shortened.

Flexible High-Speed I/O Control Module

I/O
(DC/differential)



LD40PD01

Input specifications

Number of inputs: 12 points (all for 5 V DC/24 V DC/differential)
Pulse input speed: Max. 8M pulse/s (2MHz)

Output specifications

Number of outputs: 8 points for 5 V DC to 24 V DC, 6 points for differential
Pulse output speed: Max. 8M pulse/s (2MHz)

Equipped with FPGA for high-speed I/O control

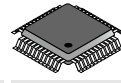

I/O response

1 μ s

Resolution

25 ns

Intuitive setting

Fast and stable I/O response

High-speed response is realized with the hardware performance asynchronous to the CPU and control bus.

- LD40PD01 is equipped with an external I/O interface and FPGA*1. This feature enables LD40PD01 to perform high-speed control, without being restricted by the CPU scan time and control bus performance. Dedicated configuration tool is also available to pre-check the product operation, further reducing the startup time.
- I/O response is stable as its processing speed only fluctuates in nanoseconds.

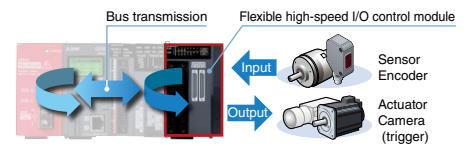

Flexible high-speed I/O control module

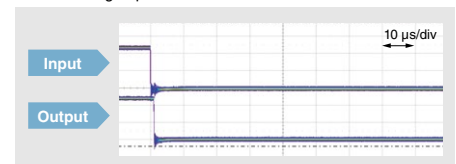

Existing programmable controller (LCPU embedded I/O + interrupts)

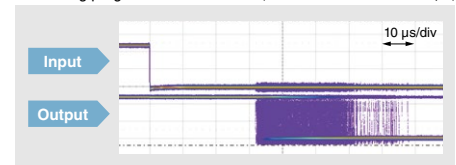

*1: Abbreviation of Field Programmable Gate Array. FPGA is an LSI that can be programmed after the manufacture.

Easy FPGA setup with dedicated configuration tool*2

The design process associated with FPGA (HDL programming, logic synthesis, timing analysis) is no longer required, drastically reducing the development time. The configuration tool is also useful to pre-check the product operation, further reducing the startup time.

Select	Connect	Parameter setup	Debug
<p>Drag & drop a block</p> <ul style="list-style-type: none"> Drag & drop a function block to the configuration window 	<p>Connect blocks</p> <ul style="list-style-type: none"> Click terminals to connect between blocks Identify connectable terminals by colors Branch connection to multiple terminals Multiple signals connectable to one terminal 	<p>Set up parameters of the block</p> <ul style="list-style-type: none"> Set function block operations by parameters Parameters assigned to buffer memories are accessible from CPU programs 	<p>Check the signal status on a waveform</p> <ul style="list-style-type: none"> Check the operation with virtual inputs Check the simulation result on GX LogViewer

*2: For further information on "Flexible High-Speed I/O Control Module Configuration Tool", please contact your local Mitsubishi sales representative.

L Series Features
CPU
I/O
Analog/ Temperature Control
Simple Motion/ Positioning
Flexible I/O/ High-Speed Counter
Network
Software

Supporting versatile applications

The flexible high-speed I/O control module realizes a wide range of controls including speed measurement, adjusted pulse output, ratio setting/distributed output, PWM control, and cam switch control.

Pulse adjustment

- ON/OFF timings are finely adjusted down to 25 ns by using trigger inputs.
- Fluctuation of ON/OFF operation is minimized down to nanoseconds, enabling highly precise control.

Speed measurement

- In addition to ON and OFF width, measurement in different conditions is possible, such as ON timing difference between sensors.
- The measurement increment of minimum 25 ns realizes highly accurate measurement.

Delay output

- Output timing delays are adjusted for each point, minimizing output variations.

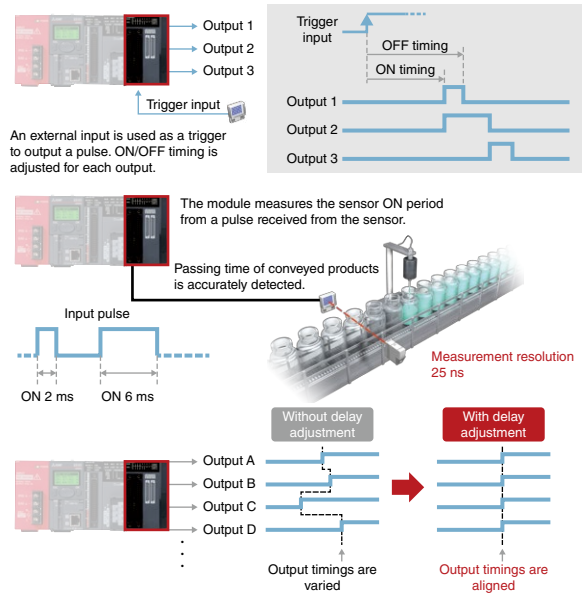

Specifications

Item	LD40PD01		
	DC	Differential	
Number of input points	12 points (5/24 V DC/differential)		
Number of output points	8 points (5...24 V DC, 0.1 A/point)	6 points	
Number of interrupts	8 interrupts		
Input response time	≤ 1 μs (pulse input speed: Max. 200 kpulse/s)	≤ 1 μs (pulse input speed: Max. 8 Mpulse/s)	
Output response time	≤ 1 μs (pulse input speed: Max. 200 kpulse/s)	≤ 1 μs (pulse input speed: Max. 8 Mpulse/s)	
Main blocks (included in the configuration tool)			
External input block	Logic select	Inverted, not inverted	
	Filter time	General input: 0 μs, 10 μs, 50 μs, 0.1 ms, 0.2 ms, 0.4 ms, 0.6 ms, 1 ms, 5 ms Pulse input: 10 kpulse/s, 100 kpulse/s, 200 kpulse/s, 500 kpulse/s, 1 Mpulse/s, 2 Mpulse/s, 4 Mpulse/s, 8 Mpulse/s	
Parallel encoder block	Input data type	Pure binary, gray code, BCD	
	Data length	1 bit...12 bits	
SSI encoder block	Input data type	Pure binary, gray code	
	Data length	1 bit...32 bits (Data length for single turn, multi-turn, and status can be set.)	
	Transmission speed	100 kHz, 200 kHz, 300 kHz, 400 kHz, 500 kHz, 1.0 MHz, 1.5 MHz, 2.0 MHz	
Multi function counter block	Counter timer block	Type	Addition, subtraction, linear counter mode, ring counter mode, addition mode, preset counter function, latch counter function, internal clock function
		Internal clock	25 ns, 50 ns, 0.1 μs, 1 μs, 10 μs, 100 μs, 1 ms
	Compare block	Counting range	32-bit signed binary (-2147483648...2147483647), 32-bit unsigned binary (0...4294967295) 16-bit signed binary (-32768...32767), 16-bit unsigned binary (0...65535)
		Compare value	Same as the counting range
	Cam switch block	Compare mode	=, >, <, ≥, ≤, <>, within the range, outside the range
Set/reset block	Cam switch block number of steps	Up to 16 steps	
Logical operation block	Logical operation type	AND, OR, XOR	
	Logic select	Inverted, not inverted	
External output block	Delay time	None, 12.5 ns, 25 ns, 50 ns, 0.1 μs, 1 μs, 10 μs, 100 μs, 1 ms Can be set up to 64 multiplies.	
	Delay time	None, 12.5 ns, 25 ns, 50 ns, 0.1 μs, 1 μs, 10 μs, 100 μs, 1 ms Can be set up to 64 multiplies.	
Main functions that can be performed with the combination of main blocks	Pulse count, coincidence detection, cam switch, highly-accurate pulse output, PWM output, ratio setting, pulse measurement, electrical interface conversion		
Processing time of the main hardware logic	Logic operation: Min. 87.5 ns, Coincidence output: Min. 137.5 ns, Cam switch: Min. 262.5 ns		
Module size allocation	2		
Number of occupied I/O points	32 points (I/O assignment: Intelligent 32 points)		
External interface	40-pin connector x2		
5 V DC internal current	0.66 A		
Weight	0.18 kg		

High-Speed Counter Modules

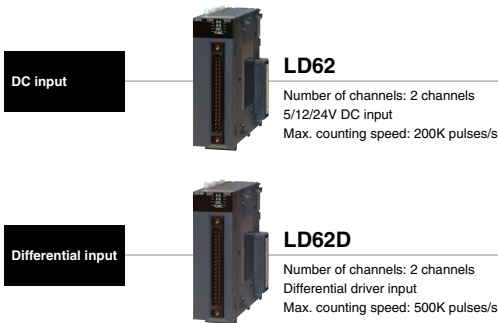

Function	LD62	LD62D
	DC input	Differential input
Linear counter function	●	●
Ring counter function	●	●
Coincidence output function	●	●
Preset function	●	●
Disable count function	●	●
Latch counter function	●	●
Sampling counter function	●	●
Periodic pulse counter function	●	●

Specifications

Item		LD62 [DC input]	LD62D [Differential input]	
Number of channels		2 channels		
Counting speed switch setting		10K pulses/s, 100K pulses/s, 200K pulses/s	10K pulses/s, 100K pulses/s, 200K pulses/s, 500K pulses/s	
Count input signal	Phase	1-phase input (multiple of 1/2), CW/CCW, 2-phase input (multiple of 1/2/4)		
	Signal level (A, B)	5/12/24 V DC 2...5 mA	EIA Standard RS-422-A differential type line driver level (Equivalent with AM26LS31 (manufactured by Texas Instruments Japan Limited))	
Counter	Maximum counting speed*1	200K pulses/s		
	Counting range	-2147483648...2147483647		
	Type	UP/DOWN preset counter and ring counter functions		
	Minimum count pulse width (Duty ratio 50%)	10K pulses/s	50 μs	10K pulses/s
		100K pulses/s	5 μs	100K pulses/s
200K pulses/s		2.5 μs	200K pulses/s	
Minimum phase differential for 2-phase input	10K pulses/s	25 μs	10K pulses/s	
	100K pulses/s	2.5 μs	100K pulses/s	
	200K pulses/s	1.25 μs	200K pulses/s	
Coincidence output	Comparison range	Binary with 32-bit code (-2147483648...2147483647)		
	Comparison result	Set value < Count value Set value = Count value Set value > Count value		
External input	Preset	5/12/24 V DC 2...5 mA		
	Function start	5/12/24 V DC 2...5 mA (Differential type line drivers conforming to EIA standard RS-422-A are also applicable.)		
External output	Minimum input response time	OFF to ON	Function start: 0.5 ms	
	Output voltage/current	ON to OFF	Function start: 1 ms	
External output	Coincidence output	2 points/channel		
	Output response time	OFF to ON	12...24 V DC 0.5 A	
External output	Output response time	ON to OFF	≤ 0.1 ms (rated load, resistive load)	
	Module size allocation	1		
Number of occupied I/O points		16 points (I/O assignment: Intelligent 16 points)		
External interface		40-pin connector		
5 V DC internal current consumption		0.31 A	0.36 A	
Weight		0.13 kg		

*1: The counting speed is affected by the rising/falling pulse speed. For details, refer to the corresponding manual.

Seamless communication

Seamless data communication through Ethernet, CC-Link IE, and CC-Link allow easy access to information, no matter where it resides on the network. Through this technology, it is possible to “drill down” from the Enterprise or IT layer through multiple networks accessing programming controllers using GX Works2 programming or other related software. In addition, many devices supporting SLMP*1 such as vision sensors and RFID controllers may be connected to the CC-Link IE.

*1: SLMP (SeamLess Message Protocol) is a protocol advocated by the CC-Link Partner Association.

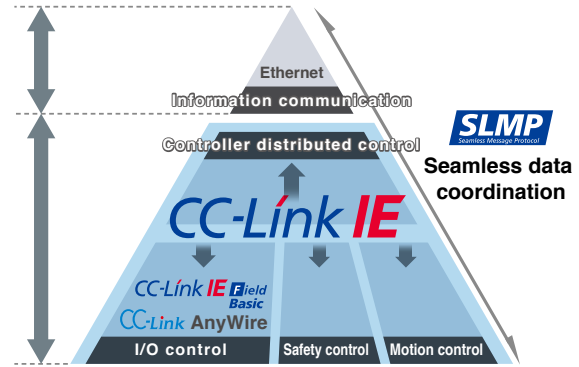

L Series Features

CPU

I/O

Analog/
Temperature Control

Simple Motion/
Positioning

Flexible I/O/
High-Speed Counter

Network

Software

CC-Link IE Control

CC-Link IE Control is a high-reliability distributed control network designed to handle very large data communications (128K word) over a high-speed (1 Gbps) dual-loop optical cable topology.
*: L Series does not support the CC-Link IE Control Network.

CC-Link IE Field

CC-Link IE Field is a versatile gigabit Ethernet-based network integrating controller, I/O control, safety control, and motion control in a flexible wiring topology supporting star, ring, and line configurations.
*: Compatible modules: LJ71GF11-T2, LJ72GF15-T2

CC-Link IE Field Basic

CC-Link IE Field Network Basic realizes easier network integration, as its cyclic communications stack is software-based, without requiring a dedicated ASIC helping to reduce implementation costs for device partners. CC-Link IE Field Network Basic, which is a part of CC-Link IE, realizes easier connection of Ethernet devices.
*: Compatible modules: LnCPU(-P/-BT/-PBT)

CC-Link

CC-Link is a high-speed and high-reliable deterministic I/O control network which realizes reduced wiring whilst offering multi-vendor compatible products. This open field network is a global standard originating from Japan and Asia.
*: Compatible modules: L26CPU-BT, L26CPU-PBT, LJ61BT11

CC-Link/LT

CC-Link/LT is a wire-saving sensor level network which is designed for use in panels between simple discrete devices. Its wiring system is based on reducing incorrect wiring and is based on CC-Link realizing high-speed and robust noise resistance features.
*: Compatible module: LJ61CL12

AnyWireASLINK

AnyWireASLINK makes it possible to centrally monitor (visibility) the state of all sensors from the programmable controller, by that improving productivity and reducing operation steps.
*: Module supporting AnyWireASLINK: LJ51AW12AL

SSCNET III/H

SSCNET III/H is a dedicated high-speed, high-performance, and highly reliable servo system control network that offers flexible long distance wiring capabilities based on optical fiber cable topology.
*: Compatible modules: LD77MS2, LD77MS4, LD77MS16, LJ72MS15

BACnet®

This network supports the communication protocol standard BACnet® client function. This network is mainly used to monitor and control air-conditioning, lighting and fire detection, etc. in building automation system applications.
*: Compatible modules: L02CPU(-P), L06CPU(-P), L26CPU(-P), L26CPU(-P)BT, LJ71E71-100 (client only)

MODBUS®

L-Series is now supporting the MODBUS® protocol network, realizing easy communication, with various MODBUS® slave devices compatible with Ethernet MODBUS®/TCP or RS-232/422/485 serial communication.
*: Modules supporting MODBUS®/TCP: L02CPU(-P), L06CPU(-P), L26CPU(-P), L26CPU(-P)BT, LJ71E71-100 (master only)
*: Modules supporting MODBUS®: L6ADP(-R2/R4), LJ71C24(-R2) (master only)

Network	Application	Enterprise level network		Device level network			Sensor level network
		Information communication	Control level network Controller distributed control	I/O control	Safety control	Motion control	Control
Ethernet		●					
CC-Link IE Control			●*2				
CC-Link IE Field			●	●	●*2	●*2	
CC-Link IE Field Network Basic				●			
CC-Link				●			
CC-Link/LT							●
AnyWireASLINK							●
SSCNET III/H						●	
BACnet®		●					
MODBUS®/TCP			●				
MODBUS®				●			

*2. MELSEC-L Series compatible products are not available.

CC-Link IE Field Network Master/Local Module



Easy to configure settings

Network parameters are configured using the engineering tool, GX Works2. Only the master station needs to be configured, thereby greatly simplifying the network setup. Updating the system configuration is a breeze.

Master station settings are all that is required!

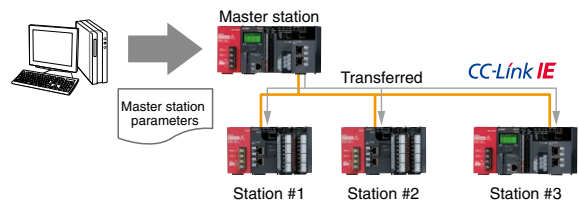

Flexible network topology

Various network topologies are supported including star, line, star and line combination, and ring. When hubs*1 are used, new equipment can be added and machine layouts can be changed easily.

*1: Hubs cannot be used in a ring configuration.

Examples of network topologies

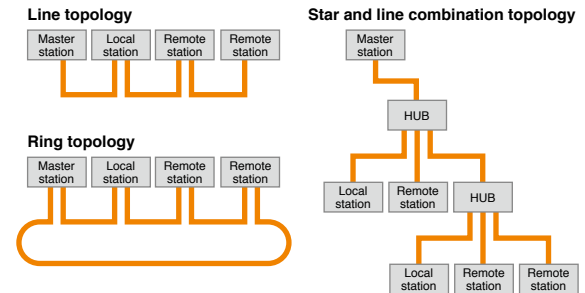

Specifications

Item		LJ71GF11-T2	
Transmission speed		1 Gbps	
Maximum overall cable distance (Maximum transmission distance)	Line topology	12000 m (when cables are connected to 1 master station and 120 slave stations)	
	Star topology	Depends on the system configuration	
	Ring topology	12100 m (when cables are connected to 1 master station and 120 slave stations)	
Maximum number of connected stations	Master station	1 station (Up to 120 slave stations can be connected to the master station)	
	Local station	120 stations	
Maximum link points per station	Remote register (RWw)	8192 points, 16 KB	
	Remote register (RWr)	8192 points, 16 KB	
	Remote input (RX)	16384 points, 2 KB	
	Remote output (RY)	16384 points, 2 KB	
Maximum link points per station	Master station	Remote register (RWw)	8192 points, 16 KB
		Remote register (RWr)	8192 points, 16 KB
		Remote input (RX)	16384 points, 2 KB
		Remote output (RY)	16384 points, 2 KB
	Local station	Remote register (RWw)	8192 points, 16 KB (also including the send range of own station)
		Remote register (RWr)	8192 points, 16 KB
		Remote input (RX)	16384 points, 2 KB
		Remote output (RY)	16384 points, 2 KB (also including the send range of own station)
Network topology		Line topology, star topology (Coexistence of line topology and star topology is possible.), and ring topology	
Communication method		Token passing method	
Communication port		CC-Link IE Field Network port x 2	
RAS function		Automatic return, Slave station disconnection, Loopback function	
Connection cable*2		Ethernet cable (Category 5e or higher, double shielded/STP)	
Module size allocation		2	
Number of occupied I/O points		32 points (I/O assignment: Intelligent 32 points)	
5 V DC internal current consumption		0.89 A	
Weight		0.27 kg	

*2: Standard (straight type) cable

CC-Link IE Field Network Head Module



CC-Link IE

CC-Link IE Field Network remote station

L Series I/O and intelligent function modules can be connected to the head module without a dedicated CPU. There are many benefits to using intelligent device stations including reduced CPU and wiring costs, great flexibility in selecting I/O and intelligent function modules, and compact unit size.

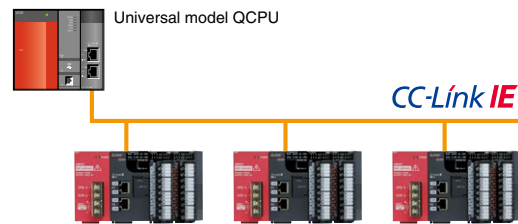

Modules compatible with the CC-Link IE Field Network head module

Item	
I/O module	Input, output, I/O combined
Multiple input module	Multiple input (voltage/current/temperature)
Analog module	Analog input, analog output, analog input/output
Temperature input module	RTD input
Temperature control module	
Simple motion module	
Positioning module	
High-speed counter module	
Network module	CC-Link, CC-Link/LT, AnyWireASLINK, serial communication

RAS (Reliability, Availability, Serviceability) functions

One feature of RAS is to store all remote station error histories in the master station's latched memory. This preserves the error information in one place in the event of power loss and allows for easy troubleshooting. Other RAS features include network event logging, unit error logging, and testing and monitoring capabilities.

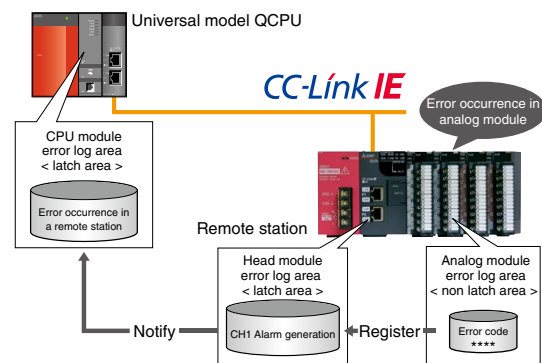

Specifications

Item	LJ72GF15-T2	
Transmission speed	1 Gbps	
Maximum overall cable distance (Maximum transmission distance)	Line network topology	12000 m (with 1 master and 120 slaves connected)
	Star network topology	Depends on the system configuration
	Ring network topology	12100 m (with 1 master and 120 slaves connected)
Transmission path	Line, star, line and star mixed, or ring topology	
Communication method	Deterministic (token passing)	
Maximum number of installable modules*1	10	
Communication port	CC-Link IE Field Network port x 2	
RAS function	Network event logging, unit error logging, testing, monitoring, and error history preservation function	
Connection cable*2	Ethernet cable (Category 5e or higher, double shielded/STP)	
5 V DC internal current consumption	1.00 A	
Weight	0.23 kg	

*1: The total number of modules that can be installed onto a CC-Link IE Field Network head module. (END cover and power supply module are not included.) Note that only one head module per system is possible.

*2: Standard (straight type) cable.

CC-Link Master/Local Module



Connect with a huge selection of device types using CC-Link

With such a large selection of CC-Link open network compatible devices, constructing a control system is easy.

Even applications requiring vast amounts of data transmissions can be satisfied because CC-Link Ver.2.0 is supported.

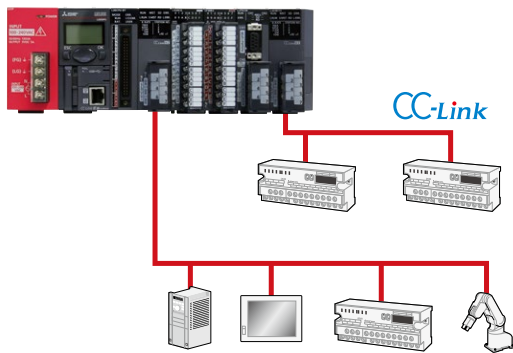

Local stations do not require transmission speed settings

Transmission speed auto-tracking function

When used as a local station, no transmission speed setting is required; the setting is made through automatic detection of the master station setting.

The current transmission speed is indicated by an LED on the front surface of the module.

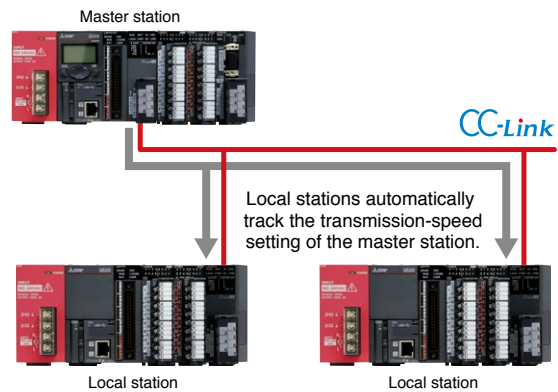

Specifications

Item	LJ61BT11	
Transmission speed	156 kbps/625 kbps/2.5 Mbps/5 Mbps/10 Mbps	
Maximum overall cable distance (Maximum transmission distance)	1200 m (without repeater, varies according to the transmission speed)	
Maximum number of connected stations (master station)	64	
Number of occupied stations (local station)	1...4 stations (The number of stations can be switched using the GX Works2 parameter setting)	
Maximum number of link points per system*2	Remote I/O (RX, RY)	2048 points
	Remote register (RWw)	256 points (master station → remote device station/local station/intelligent device station/standby master station)
	Remote register (RWr)	256 points (remote device station/local station/intelligent device station/standby master station → master station)
Number of link points per station*2	Remote I/O (RX, RY)	32 points (local station is 30 points)
	Remote register (RWw)	4 points (master station → remote device station/local station/intelligent device station/standby master station)
	Remote register (RWr)	4 points (remote device station/local station/intelligent device station/standby master station → master station)
Communication method	Broadcast polling method	
Synchronous method	Frame synchronization method	
Encoding method	NRZI method	
Transmission path	Bus (RS-485)	
Transmission format	Conforms to HDLC	
Error control system	CRC (X ¹⁶ +X ¹² +X ⁶ +1)	
RAS function	Automatic return function	
	Slave station cut-off function	
	Error detection via link special relay/register	
Connection cable	CC-Link dedicated cables compatible with Ver. 1.10	
Module size allocation	1	
Number of occupied I/O points	32 points (I/O assignment: Intelligent 32 points)	
5 V DC internal current consumption	0.46 A	
Weight	0.15 kg	

*2: Indicates the number of link points for Remote net Ver.1 mode.

CC-Link/LT Master Module



CC-Link/LT

LJ61CL12
 CC-Link/LT master station
 Max. communication speed: 2.5 Mbps
 Remote I/O: 1024 points*1
 *1: When in 16-point mode

High speed equipment response

CC-Link/LT has an excellent response time. With 64 stations and a transmission speed of 2.5 Mbps, the maximum link scan time is just 1.2 ms. According to the transmission distance required, it is possible to select speeds of 2.5 Mbps, 625 kbps, or 156 kbps.

■ CC-Link/LT link scan time (using a transmission speed of 2.5 Mbps)

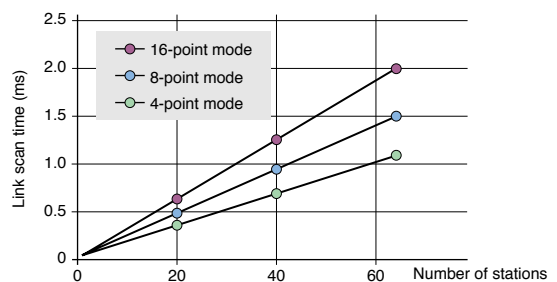

Simple networking that 'just works'

There are no confusing parameters settings to make, and with remote I/O, only the master station needs to set the transmission speed.

■ Specifications

Item		LJ61CL12				
Point mode		4-point mode	8-point mode	16-point mode		
Control specifications	Maximum link points (the same I/O address used)	256 points (512 points)	512 points (1024 points)	1024 points (2048 points)		
	Link points per station (the same I/O address used)	4 points (8 points)	8 points (16 points)	16 points (32 points)		
	Link scan time	32 stations connected	Points	128 points	256 points	512 points
			2.5 Mbps	0.7 ms	0.8 ms	1.0 ms
			625 kbps	2.2 ms	2.7 ms	3.8 ms
		64 stations connected	156 kbps	8.0 ms	10.0 ms	14.1 ms
			Points	256 points	512 points	1024 points
			2.5 Mbps	1.2 ms	1.5 ms	2.0 ms
625 kbps	4.3 ms	5.4 ms	7.4 ms			
156 kbps	15.6 ms	20.0 ms	27.8 ms			
Communication specifications	Transmission speed	2.5 Mbps/625 kbps/156 kbps				
	Communication method	BITR method (Broadcast polling + Interval Timed Response)				
	Network topology	T-branch type				
	Error control system	CRC				
	Number of connectable modules	64				
	Remote station number	1...64				
	Installation position of master station	End of a trunk line				
	RAS function	Network diagnostics, internal loopback diagnostics, slave station cutoff function, automatic return function				
Connection cable*2	Dedicated flat cable (0.75 mm ² × 4)*3, VCTF cable*4, flexible cable*3					
Module size allocation	1					
Number of occupied I/O points*5	16, 32, 48, 64, 128, 256, 512, or 1024 points (I/O assignment: Intelli.)					
5 V DC internal current consumption	0.16 A					
24 V DC power supply*6	Voltage	20.4...28.8 V DC				
	Current consumption	0.03 A				
	Current on startup	0.07 A				
Weight	0.12 kg					

*2: When the cables other than dedicated flat cables, VCTF cables, and flexible cables are used, performance of CC-Link/LT is not guaranteed.
 *3: Use the dedicated flat cables and flexible cables accredited by CC-Link Partner Association. CC-Link Partner Association website: <http://www.cc-link.org>
 *4: Refer to the manual for details regarding VCTF cable specifications.
 *5: Set the number of occupied I/O points using the operation setting switch. Refer to the manual for details.
 *6: 24 V DC power supply is supplied through the dedicated power supply or power supply adapter.

AnyWireASLINK Master Module

AnyWireASLINK



LJ51AW12AL DB

AnyWireASLINK master station
 Transmission distance: Max. 200 m
 Data I/O: Max. 512 points*1
 Number of connected stations: Max. 128 modules
 *1: 256 input points/256 output points

AnyWireASLINK

Linking the sensor I/O with the programmable controller

The AnyWireASLINK master module links the sensor inputs and outputs to the programmable controller.

The module enables flexible layout of miniature sensors with 512 I/O points.

The sensor power can be supplied to the AnyWireASLINK transmission line (2-wire) for communication, allowing sensors to be added easily.

With the MELSEC-L Series, faulty sensors can be detected and the slave module settings can be managed at once by GX Works2 engineering environment, further reducing the engineering time.

Basic configuration

Either the 2-wire type or 4-wire slave device can be selected according to the load current for AnyWireASLINK. In addition to the 2-wire type, a 4-wire type can also be used by supplying the local power.

2-wire type

If the load current is low, 2-wire type (non-insulated) slave devices can be used without an external power supply.

4-wire type

The 4-wire type (insulated) slave devices require an external 24 V DC power supply to satisfy large load current applications, for example.

Configuration with 2-wire type (with no local power feed)

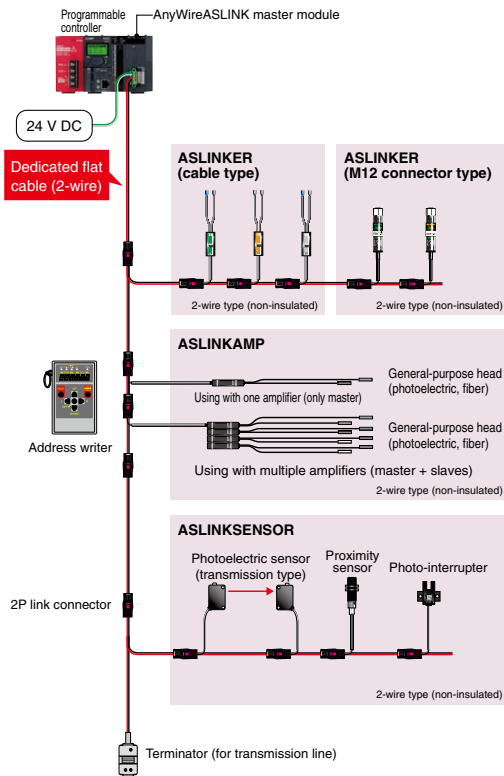

Configuration with 2-wire/4-wire type (with local power feed)

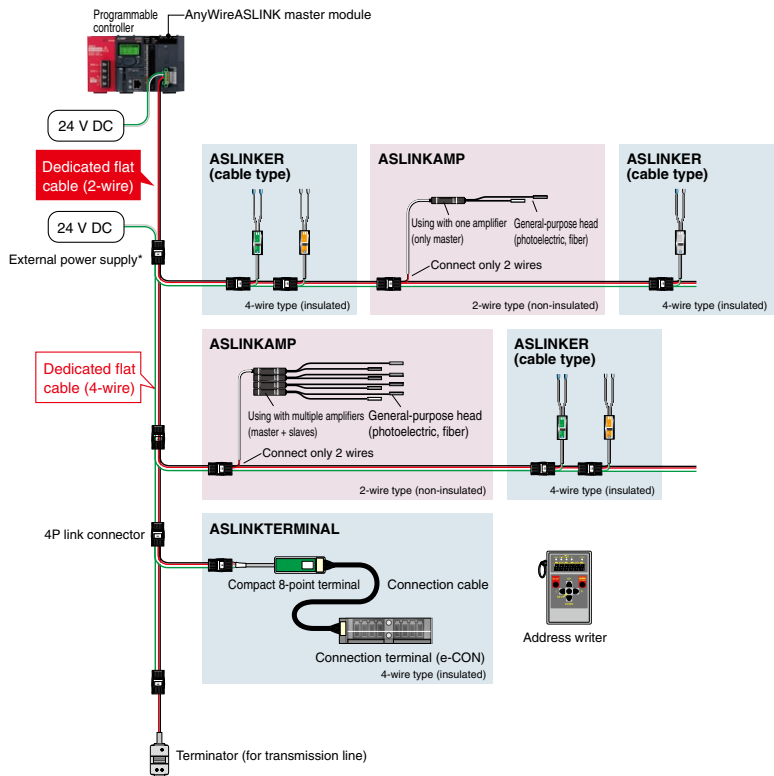

* External power for 4-wire type wiring.

Preventing intermittent operation stops

AnyWireASLINK can be used to monitor and save the sensor information within the programmable controller. Parameter settings of the AnyWireASLINK can also be changed via the programmable controller. Perform “preventive maintenance” with this function to prevent intermittent stops before they happen.

Prevent intermittent stops with preventive maintenance!

- Analyze the amount of incoming light.
- Sensitivity threshold can be adjusted to keep operation up to the maintenance cycle.

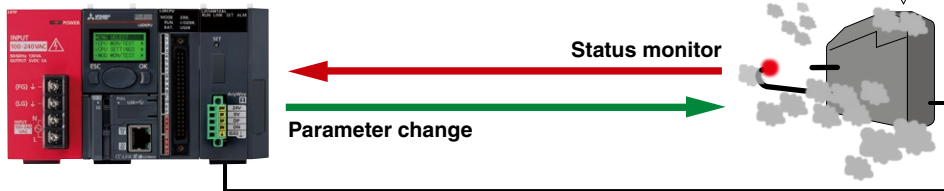
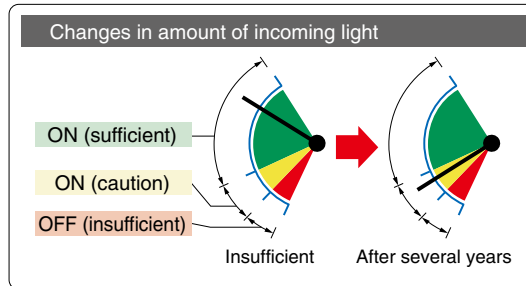

Reducing the setup time, and providing the traceability

AnyWireASLINK enables the set value to be registered at once to multiple sensors via a GOT (HMI) or personal computer. Also, the initial set values can be re-confirmed easily without having to read each sensor individually.

- Register set values to multiple sensors, and automatically read the initial set values.

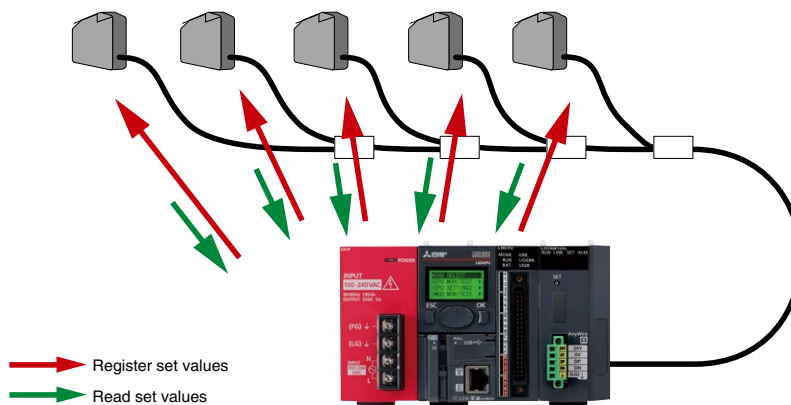

■ Specifications

Item	LJ51AW12AL DB
Transmission clock	27.0 kHz
Maximum transmission distance (overall length)	200 m ^{*1}
Transmission method	DC power superimposed total frame cyclic method
Connection style	Bus type (multi-drop method, T-branch method, tree branch method)
Transmission protocol	Dedicated protocol (AnyWireASLINK)
Error control	Checksum, double verification method
Number of connected I/O points	Max. 512 points (256 input points/256 output points)
Number of connected modules	Max. 128 modules (varies according to each slave module's current consumption)
RAS function	Transmission cable break position detection function, transmission cable short-circuit detection function, transmission power drop detection function
Transmission cable (DP, DN)	<ul style="list-style-type: none"> • UL compatible universal 2-wire cable (VCTF, VCT 1.25 mm², 0.75 mm², rated temperature 70°C or more) • UL compatible universal cable (1.25 mm², 0.75 mm², rated temperature 70°C or more) • Dedicated flat cable (1.25 mm², 0.75 mm², rated temperature 90°C)
Power cable (24 V, 0 V)	<ul style="list-style-type: none"> • UL compatible universal 2-wire cable (VCTF, VCT 0.75 mm²...2.0 mm², rated temperature 70°C or more) • UL compatible universal cable (0.75 mm²...2.0 mm², rated temperature 70°C or more) • Dedicated flat cable (1.25 mm², 0.75 mm², rated temperature 90°C)
Transmission cable supply current ^{*2}	Using 1.25 mm ² cable: Max. 2 A Using 0.75 mm ² cable: Max. 1 A
Module size allocation	1
Number of occupied I/O points	32 points (I/O assignment: 32 intelligent points)
External power supply	Voltage: 21.6...27.6 V DC (24 V DC -10...+15%), ripple voltage 0.5 Vp-p or less Recommended voltage: 26.4 V DC (24 V DC +10%) Module current consumption: 0.1 A Transmission cable current supply: Max. 2 A ^{*1}
5 V DC internal current consumption	Max. 0.2 A
Weight	0.2 kg

*1: With the slave module having an integrated transmission cable (DP, DN) and module, the length of the transmission cable (DP, DN) is included in the overall length.

*2: Refer to the manual for the relation of the overall length, transmission cable (DP, DN) wire diameter and transmission cable current supply. In some slave modules with cables, the wire diameter of the transmission cable (DP, DN) integrated with the module may be 0.75 mm² or less.

SSCNET III/H Head Module



SSCNET III/H remote station

The SSCNET III/H head module is used to connect the MELSEC-L Series I/O and intelligent function modules to the SSCNET III/H network.

Functioning as the motion controller's remote station, flexible system configuration can be achieved while realizing reduced system wiring and a smaller footprint.

In addition, modules installed on the SSCNET III/H head module can be used as a motion controller input/output using cyclic transmission.

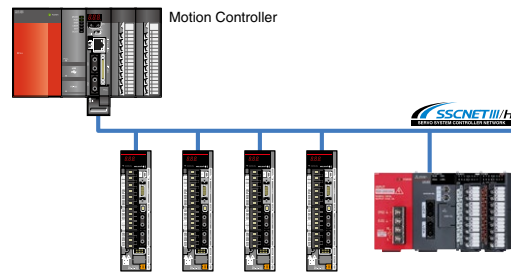

SSCNET III/H head module compatible modules

Product	
I/O module	Input, output, I/O combined
Multiple input module	Multiple input (voltage/current/temperature)
Analog module	Analog input, analog output, analog I/O combined
Temperature input module	RTD input
High-speed counter modules	

Compatible motion controller

Category	Model
Motion CPU	Q172DSCPU
	Q173DSCPU
Standalone motion controller	Q170MSCPU

Specifications

Item	LJ72MS15	
Maximum link points per network	RW _r , RX	256 bytes
	RW _w , RY	256 bytes
Maximum link points per station	RW _r , RX	64 bytes
	RW _w , RY	64 bytes
Communication speed	150 Mbps	
Maximum connectable stations per network*1	Communication cycle: 888 μs	4
	Communication cycle: 444 μs	2
	Communication cycle: 222 μs	1
Maximum station-to-station distance	POF type: 20 m, H-PCF type: 50 m	
Connection method	Daisy chain connection (Regenerative relay system with a servo amplifier)	
Synchronous method	Synchronization of the control cycle and communication cycle that synchronize with the data transmission of the motion controller	
Communication cycle	222 μs/444 μs/888 μs	
Maximum number of installable modules*2	10	
Communication port	SSCNET III/H port x2	
Connection cable	SSCNET III cable (optical fiber cable)	
5 V DC internal current consumption	0.55 A	
Weight	0.20 kg	

*1: This number includes only head modules. Servo amplifiers are not included.

*2: Total number of modules that can be installed onto a SSCNET III/H head module. (Does not include the END cover or power supply module.) Note that only one head module per system is possible.

Ethernet Interface Module

Ethernet



LJ71E71-100

Communication speed: 100 Mbps/10 Mbps
 MELSOFT connection
 SLMP communication (MC protocol)
 Predefined protocol support function
 E-mail function
 Web function

BACnet®
MODBUS®/TCP

Modify/collect CPU data from other devices

SLMP (MC protocol) communication*1

SLMP (Seamless Message Protocol) realizes seamless communication across devices on Ethernet that support the SLMP protocol.

*1: This function can be used with modules with first five serial number digits are "15042" or later.

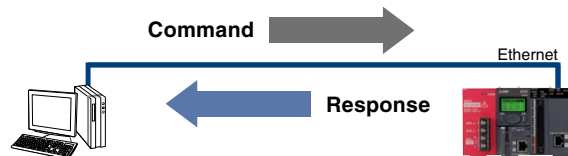

MELSOFT connection

The MELSOFT connection feature realizes the connection to various MELSOFT products including the GX Works2 programming tool. In addition, by using together with the MX Component communication support tool (optional product), custom communications programs can be created, without having to consider any dedicated protocol (send/receive procedure).

Easily connect to BACnet® and MODBUS®/TCP

Predefined Protocol support function

Use the GX Works2 Predefined Protocol support function to easily set the required protocol for communicating with other devices.

- ▶ Selecting from the communication protocol library
Easily communicate with target devices by selecting a prepared protocol. The communication protocol library supports the SLMP, MODBUS®/TCP and BACnet® client functions.
- ▶ Randomly preparing and editing a protocol

Write communication protocol

By creating a random protocol with the predefined protocol support function, data can be exchanged with a protocol that matches the target device.

Specifications

Item		LJ71E71-100	
Standard		100 BASE-TX	10 BASE-T
Transmission specifications	Data transmission speed	100 Mbps	10 Mbps
	Interface	RJ45 (Auto MDI/MDI-X)	
	Communication mode	Full duplex/Half duplex	Half duplex
	Transmission method	Base band	
	Maximum segment length	100 m (length between a hub and node)*2	
Sending/receiving data storage memory	Maximum number of cascade connections	Cascade connection (maximum of 2 levels)*3	Cascade connection (maximum of 4 levels)*3
	Number of simultaneous open connections	16 connections (Connections usable on a program)	
	Fixed buffer	1K word × 16	
Module size allocation	Random access buffer	6K words × 1	
	E-mail	Attachment	6K words × 1
		Main text	960 words × 1
Number of occupied I/O points	32 points (I/O assignment: Intelligent 32 points)		
5 V DC internal current consumption	0.60 A		
Weight	0.18 kg		

*2: For the maximum segment length (a length between hubs), consult with the manufacturer of the switching hub used.

*3: This applies when a repeater hub is used. For the number of levels that can be constructed when a switching hub is used, consult with the manufacturer of the switching hub used.

Serial Communication Modules

RS-232
RS-422/485



LJ71C24

Max. communication speed: 230.4 kbps^{*1}
MC protocol communications
Predefined protocol support function
^{*1}: Available for only channel 1

MODBUS®

RS-232



LJ71C24-R2

Max. communication speed: 230.4 kbps^{*2}
MC protocol communications
Predefined protocol support function
^{*2}: Available for only channel 1

MODBUS®

Quick connection using predefined protocols

The predefined protocol enables easy setup of protocols to communicate with external devices using GX Works2. Connections are quickly setup by selecting the target device from the communications protocol library.

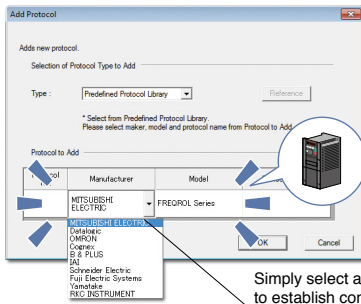

Easy to create/edit of predefined protocols

Easily create or edit predefined protocols from within the communications library. Even if the target device protocol is not listed, it can be added easily to the existing library.

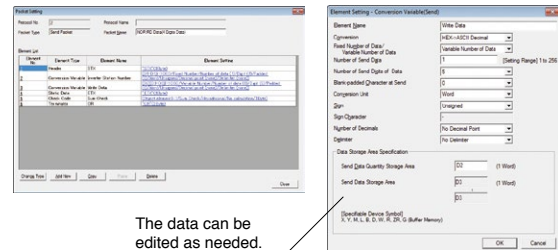

Specifications

Item		LJ71C24	LJ71C24-R2																		
Interface	CH 1	RS-232 compliant (D-Sub 9P female)	RS-232 compliant (D-Sub 9P female)																		
	CH 2	RS-422/485 compliant (2-piece terminal block)	RS-232 compliant (D-Sub 9P female)																		
Communication system	Line	Full-duplex/half-duplex communications																			
	MC protocol	Half-duplex communications																			
	Predefined protocol	Full-duplex/half-duplex communications																			
	Nonprocedural protocol	Full-duplex/half-duplex communications																			
Synchronization method		Asynchronous method																			
Transmission speed		50 bps/300 bps/600 bps/1200 bps/2400 bps/4800 bps/9600 bps/14.4 kbps/19.2 kbps/28.8 kbps/38.4 kbps/57.6 kbps/115.2 kbps/230.4 kbps Transmission speed 230.4 kbps is only available for channel 1. Total transmission speed of two interfaces is available up to 230.4 kbps. Total transmission speed of two interfaces is available up to 115.2 kbps when the communication data monitoring function is used.																			
Data format	Start bits	1																			
	Data bits	7 or 8																			
	Parity bits	1 (vertical parity) or none																			
	Stop bits	1 or 2																			
Error detection	Parity check	All protocols and when ODD/EVEN is selected by parameter.																			
	Sum check code	MC protocol/bidirectional protocol selected by parameter. For the predefined protocol, whether or not a sum check code is needed depends on the selected protocol. Nonprocedural protocol selected by user frame.																			
Transmission control	<table border="1"> <thead> <tr> <th></th> <th>RS-232</th> <th>RS-422/485</th> </tr> </thead> <tbody> <tr> <td>DTR/DSR (ER/DR) control</td> <td>●</td> <td>—</td> </tr> <tr> <td>RS/CS control</td> <td>●</td> <td>—</td> </tr> <tr> <td>CD signal control</td> <td>●</td> <td>—</td> </tr> <tr> <td>DC1/DC3 (Xon/Xoff) control</td> <td>●</td> <td>●</td> </tr> <tr> <td>DC2/DC4 control</td> <td>●</td> <td>●</td> </tr> </tbody> </table>				RS-232	RS-422/485	DTR/DSR (ER/DR) control	●	—	RS/CS control	●	—	CD signal control	●	—	DC1/DC3 (Xon/Xoff) control	●	●	DC2/DC4 control	●	●
		RS-232	RS-422/485																		
	DTR/DSR (ER/DR) control	●	—																		
	RS/CS control	●	—																		
	CD signal control	●	—																		
DC1/DC3 (Xon/Xoff) control	●	●																			
DC2/DC4 control	●	●																			
• DTR/DSR signal control and DC code control are selected by the user.																					
Module size allocation	1																				
Number of occupied I/O points	32 points (I/O assignment: Intelligent 32 points)																				
5 V DC internal current consumption	0.39 A	0.26 A																			
Weight	0.17 kg	0.14 kg																			

Increase productivity and lower the total cost of ownership

GX Works2

GX Works2 focuses on driving down total cost by including features that speed up commissioning, reduce downtime, improve programming productivity, and provide strong security.

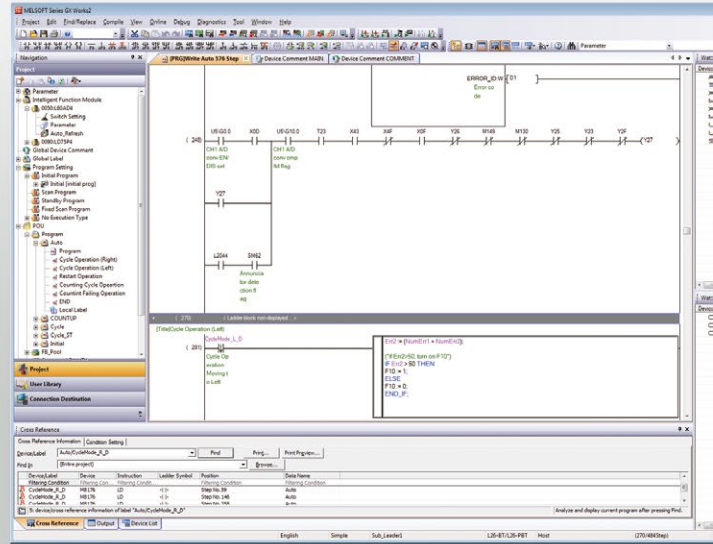

User interface that is "easy to use" by design

The programming tool GX Works2 has been developed from the ground up to be intuitive for all users and allow anyone to begin programming easily. The user interface and other functions provide a comfortable programming environment that enables improvements in design efficiency.

Fully integrated intelligent function module management tools.

Use tabs to easily switch between programs, parameters, and other screens.

Improve readability by hiding ladder rungs not relevant to the current operation.

Use "Watch windows" to conveniently monitor pertinent values.

Project tree gives compressive look at flow of information in program and structure.

Program titles help to identify the content of each program.

Cross reference devices and labels with ease.

Use the Inline-ST* feature to quickly write complex expressions in ladder programs.

*1: In-line ST can be only be created in projects that use labels.

Easily create circuits with few key inputs

The program can be easily modified using the keyboard shortcut [Alt] + [←] / [→] or [Alt] + [↑] / [↓] keys.

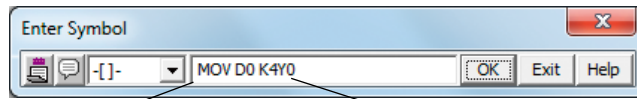

■ Editing the circuit
[Alt]+[→] ... MOV→D0→K4Y0
[Alt]+[←] ... K4Y0→D0→MOV



■ Changing the device No.
[Alt]+[↑] ... K4Y0→K4Y1→K4Y2
[Alt]+[↓] ... K4Y2→K4Y1→K4Y0

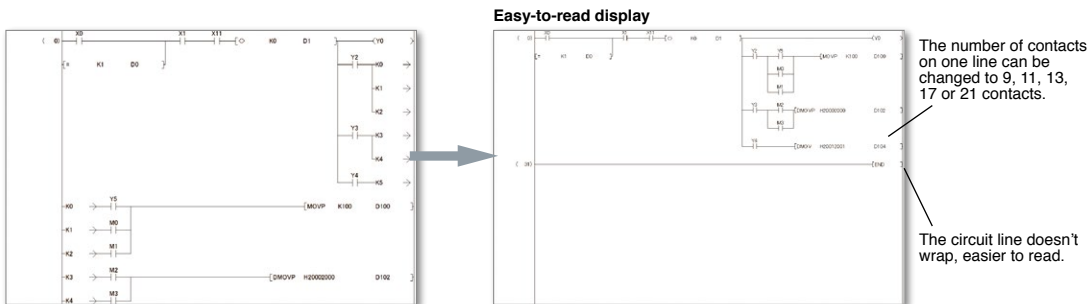
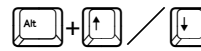

Click the Undo button.

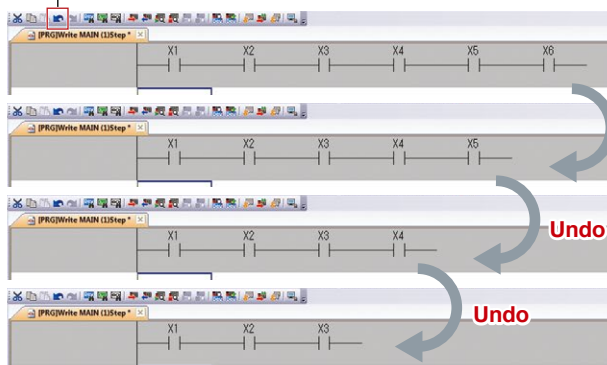

Undo
Use Undo ([Ctrl] + [z])
to go back to up to
30 previous input steps.

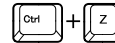

The device number is automatically incremented when repeatedly pasting a cut/copied ladder rung.

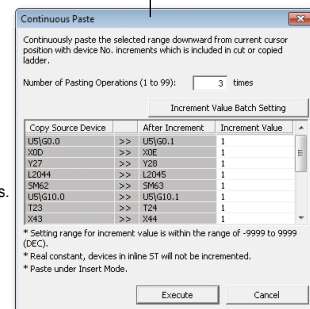

Efficiently edit lines with keyboard

Ladder rungs can be easily modified just by using the various keyboard shortcut keys, eliminating the need to switch to editing mode.

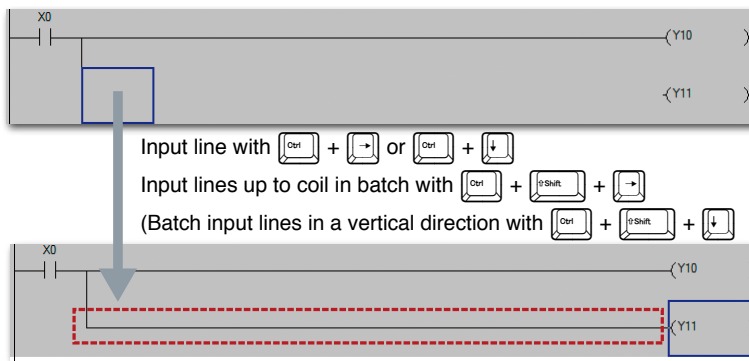

Use function blocks for common operations

Function blocks allow selections of commonly used code to be easily reused and shared among projects. Shared or created function blocks can be added to a program using simple drag and drop operation. Using function blocks effectively results in faster development times with fewer programming mistakes.

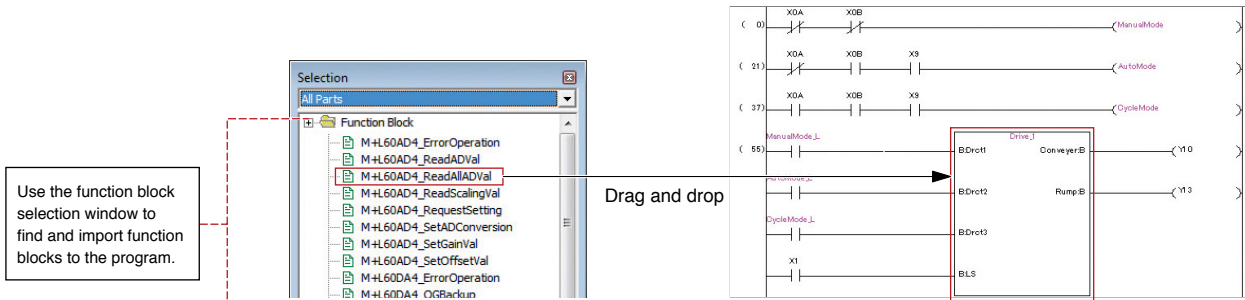

Use sample comments to eliminate the need to input comments

Sample comments are provided for the CPU's special relays/registers and the intelligent function module's buffer memory/XY signals. These can be copied into the project's comments thus greatly reducing the time required for entering device comments.

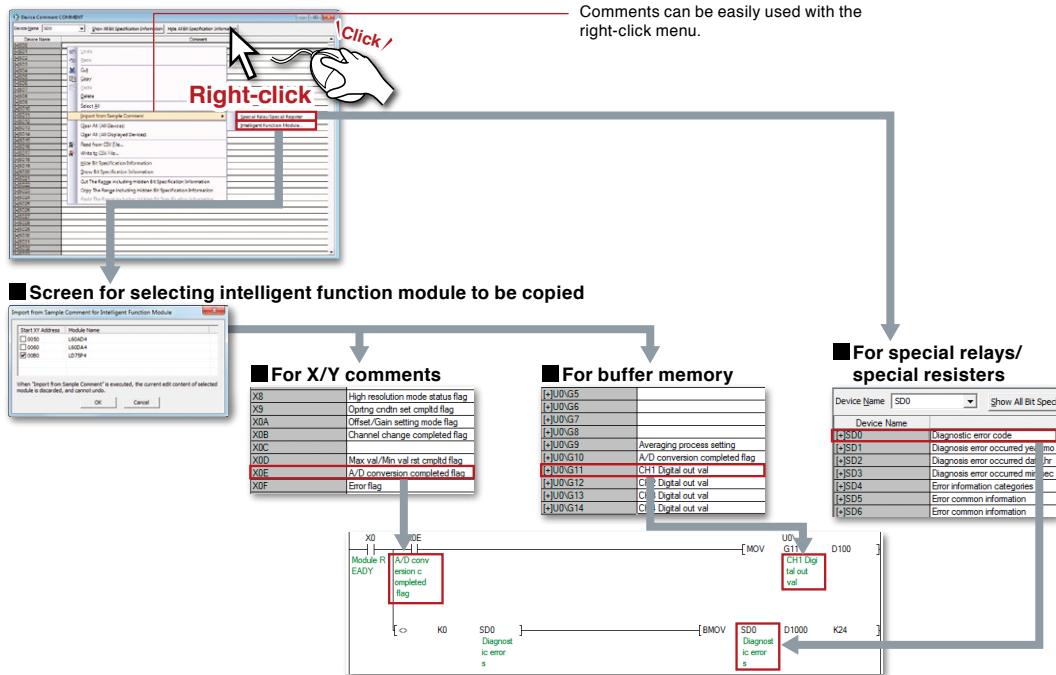

Quickly identify similar devices

Word device comments can be registered per bit with the contents displayed directly on the ladder rung.

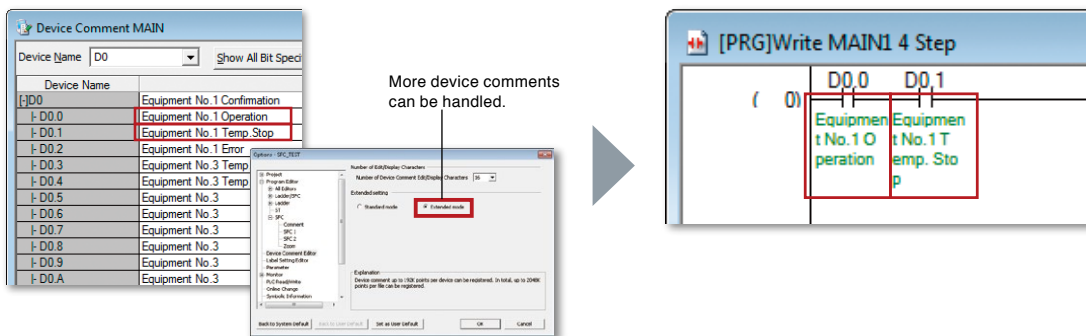

Cross referencing interlinked with circuit displays

Relevant devices and labels can be searched within the contents of the program by using the cross reference tool. The results are immediately displayed in the cross reference dialog box conveniently besides the actual program view screen. It is then very easy to check where the relevant device is actually used within the program, just by double clicking on the target device.

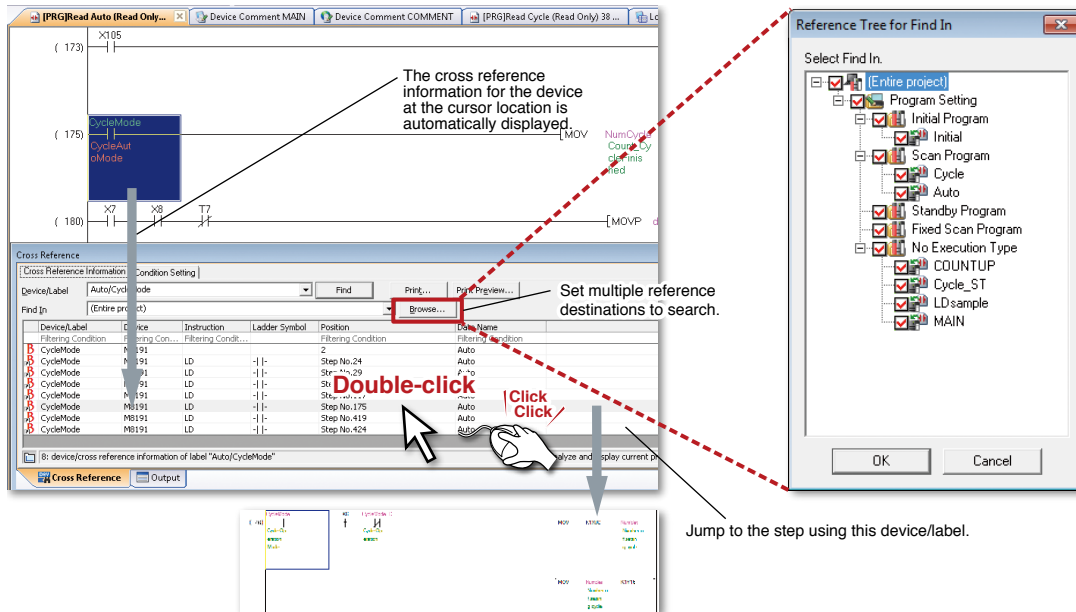

Offline debug without physical hardware

GX Simulator Function

The simulation function is now integrated. The program can be executed in a step-by-step method, finding program errors more easily.

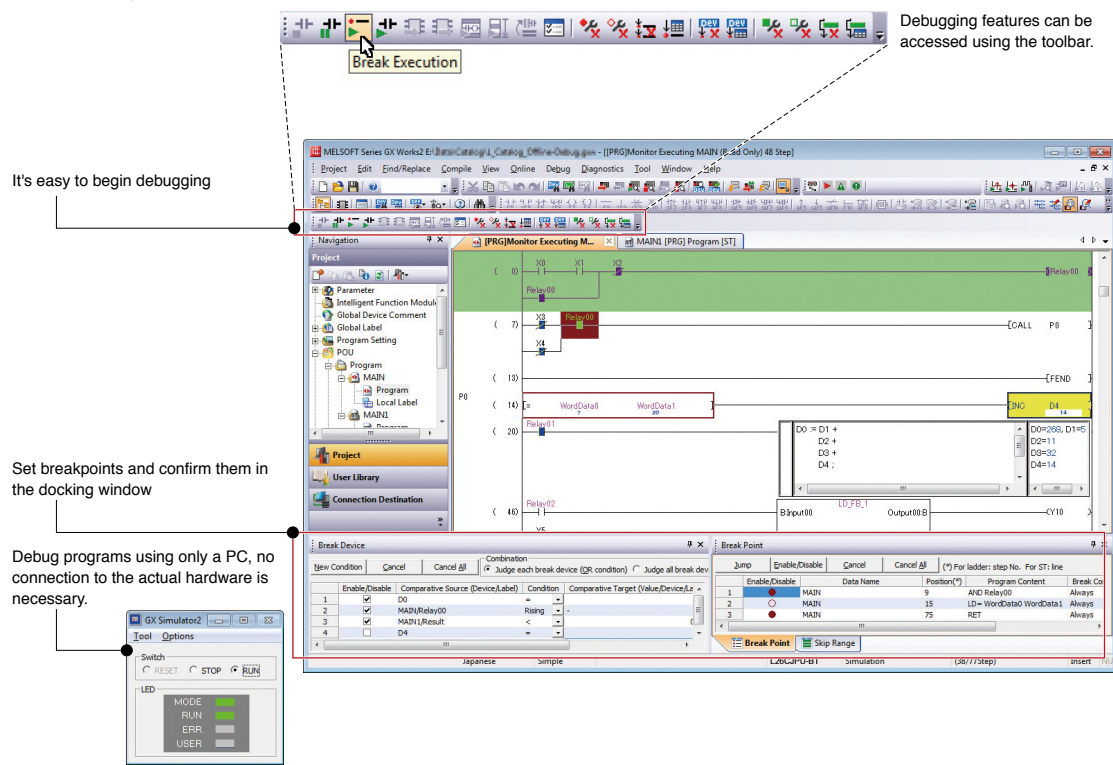

Integrating the intelligent function module setting tool (GX Configurator)

The intelligent function module's setting functions have been unified with GX Works2. Manage the intelligent function module's setting with a GX Works2 project.

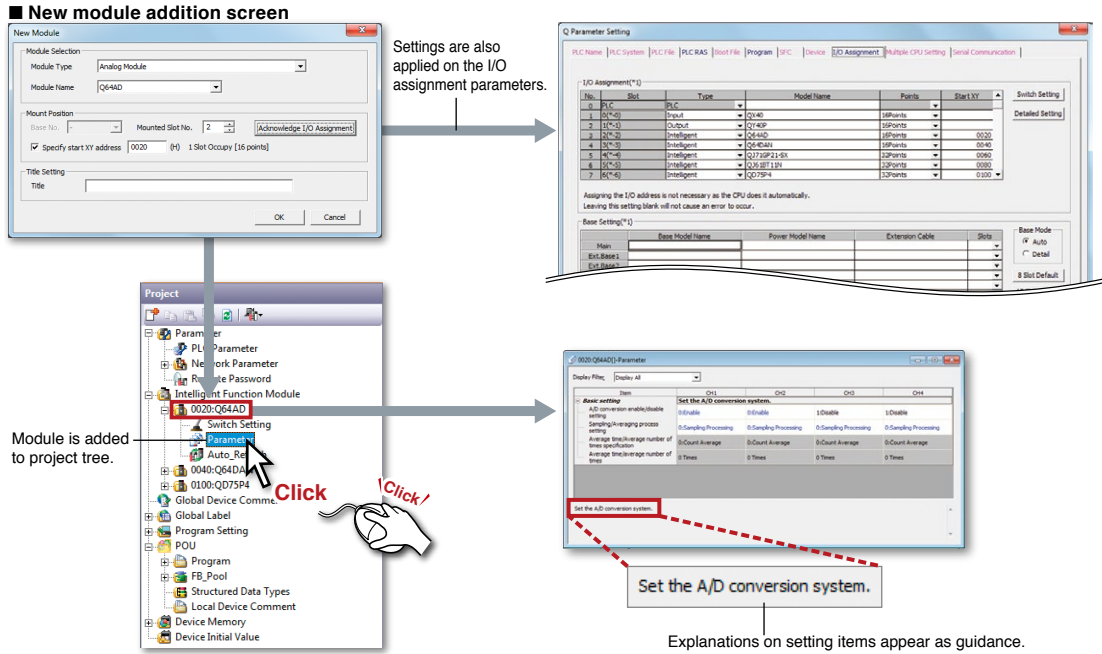

System monitor and PLC diagnostics

Operation status of the entire programmable controller system is clearly displayed. Each module's diagnosis and detailed information are displayed enabling faster troubleshooting.

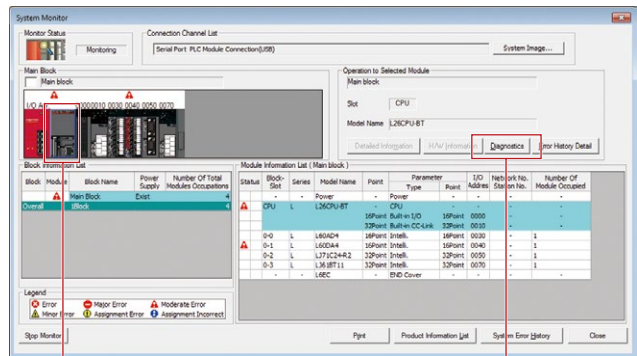

Jump to the module information screen

Jump to the PLC diagnostics screen

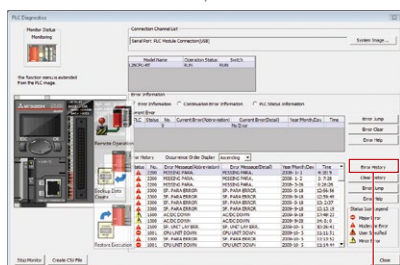

PLC diagnostics

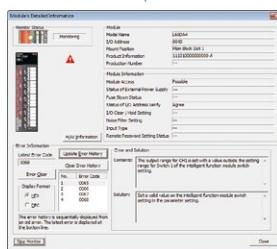

Module information

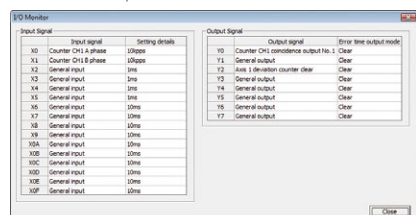

Built-in I/O monitor

Jump to the error history screen

Time-stamped error history list

Simplify troubleshooting with a combined, time-stamped, error history list for the CPU and all expansion modules. The details section provides explanations of error codes and suggested solutions.

No.	Error Code	Date and Time	Model Name	Start I/O
00050	5782	2009/10/08 18:14:17	LJ51BT11	0110
00059	7D13	2009/10/08 17:53:06	LJ71C24-R2	00F0
00058	7D16	2009/10/08 17:52:32	LJ71C24-R2	00F0
00057	05DC	2009/10/08 16:14:09	L26CPU-BT	----
00056	7D12	2009/10/08 16:00:53	LJ71C24-R2	00F0
00055	7D16	2009/10/08 15:50:40	LJ71C24-R2	00F0
00054	7D16	2009/10/08 14:43:27	LJ71C24-R2	00F0
00053	7D16	2009/10/08 14:59:03	LJ71C24-R2	00F0
00052	7D12	2009/10/08 14:35:02	LJ71C24-R2	00F0
00051	7D12	2009/10/08 14:35:53	LJ71C24-R2	00F0
00050	7FF2	2009/10/08 14:35:02	LJ71C24-R2	00F0
00049	1005	2009/10/08 14:03:44	L26CPU-BT	----
00048	7F42	2009/10/08 13:37:00	LJ71C24-R2	00F0
00047	0C21	2009/10/08 13:13:56	L26CPU-BT	----
00046	0834	2009/10/08 13:12:40	L26CPU-BT	----
00045	05DC	2009/10/08 13:11:51	L26CPU-BT	----
00044	7F42	2009/10/08 12:04:52	LJ71C24-R2	00F0
00043	0840	2009/10/08 11:43:17	L26CPU-BT	----
00042	0840	2009/10/08 11:43:17	L26CPU-BT	----

Quickly identify the error, its cause, and solution without the need to reference a manual.

Set parameters and monitor the sensor

Parameter settings and monitoring can be performed on the third-party partner products, which support the iQ Sensor Solution (iQSS). Sensor connection and current values can be checked visually, allowing the user to act faster in case of a trouble.

Right click

Parameters can be set.

Status can be monitored.

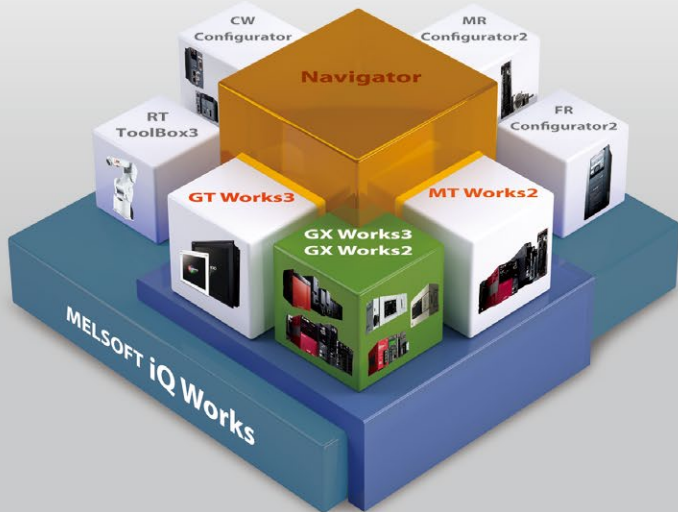

MELSOFT iQ Works

Next Generation Integrated Engineering Environment

MELSOFT iQ Works is an integrated software suite consisting of GX Works3, GX Works2, MT Works2, GT Works3, RT ToolBox3, FR Configurator2, CW Configurator and MR Configurator2. The advantages of this powerful integrated software suite are that system design is made much easier with a substantial reduction in repetitious tasks, cutting down on errors while helping to reduce the overall TCO.

Graphical project management

The entire control system is represented using the "Network Configuration", "Module Configuration" and field network configuration windows. System components are easily added using a drag & drop interface, and the validity of the system can be confirmed using the check function to ensure parameters are configured correctly, the power supply is sufficient, etc. Different programmable controller and GOT (HMI) projects can be grouped together (for example by factory, line, and cell) for central management.

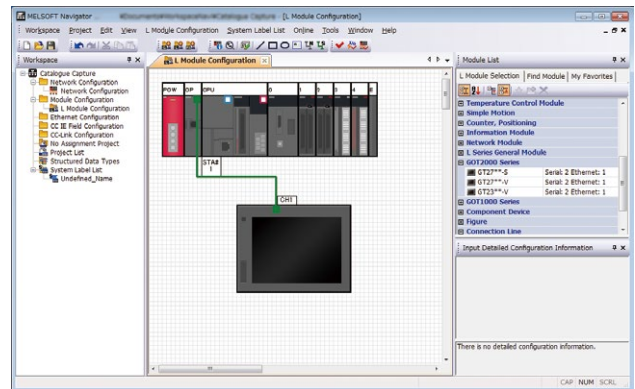

Read project data for multiple devices in a batch

Multiple projects can be read as a block just by having one connection to the programmable controller. If there are multiple devices such as other CPU or GOT(HMI) on the same network as the target master programmable controller, it is possible to upload all projects to each target device without having to individually connect to each device.

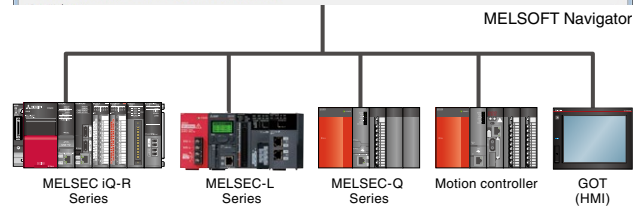
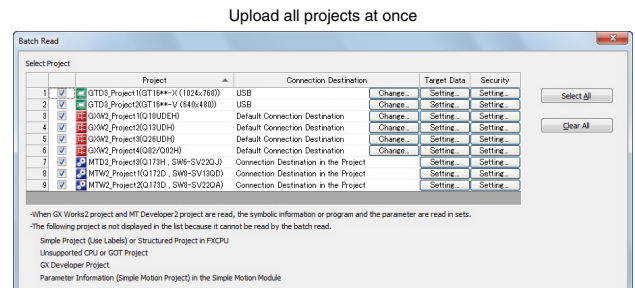

Automatically start up the relevant maintenance software with a single click

Just double-click on the corresponding project in the system configuration diagram or workspace tree to automatically startup the software relevant for that device. Maintenance can be efficiently performed without having to know and startup each relevant software manually.

Double-click on corresponding project in workspace tree

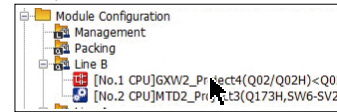

Double-click on corresponding device in system configuration diagram



Software for corresponding device automatically startup

- GX Works3
- GX Works2
- MT Works2
- GT Works3
- RT ToolBox3
- FR Configurator2
- CW Configurator
- MR Configurator2

Set up field network slave stations

There's no need to prepare a dedicated tool to check or change the parameter settings of a slave station on-site. The latest version of iQ Works includes slave station setting utility. Inverter parameters, for example, can be confirmed or changed for speed adjustment directly from the field network configuration window. In addition, error information can be read easily.

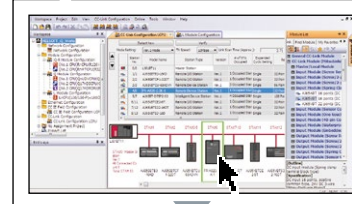

Right-click the slave station illustration and select the "slave station parameter process"

Open the slave station setting screen from the field network configuration window.

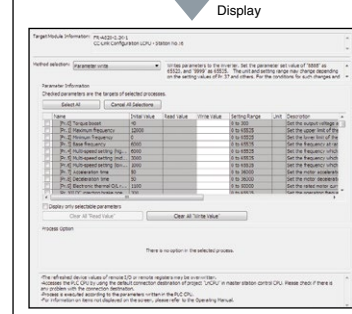

Slave station's parameter setting window opens

Set slave station parameters with GX Works3, GX Works2 and Navigator.

Get error information!

- CC-Link IE
- CC-Link
- Ethernet
- AnyWireASLINK

Prepare a device from the system configuration diagram with no manual inputs

A list of modules used can be exported as a CSV file from the system configuration diagram. This is particularly useful when utilizing data for creating a bill of materials (BOM) in Excel®, etc.

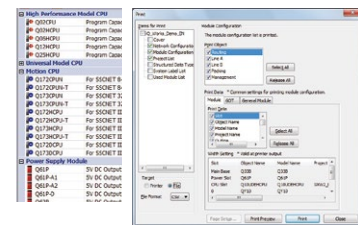

Export CSV file from list of modules

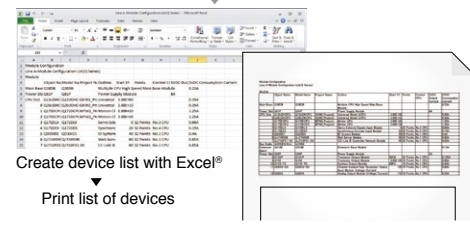

Create device list with Excel®
Print list of devices



GX LogViewer

Visualizing the production process

Within modern manufacturing needs, data collection has become more important for fully optimizing the production process. GX LogViewer is a software tool that realizes visualization of large amounts of production data in a simple to use format. Utilizing this functionality to identify root error causes and improving the production rate.

Easily display and analyze large amounts of collected logging data

This tool is used when large amounts of data need to be visualized and collected from the MELSEC-Q Series or MELSEC-L Series.

The connection settings and checking of log files are the same as GX Works2 enabling individual connections to each module.

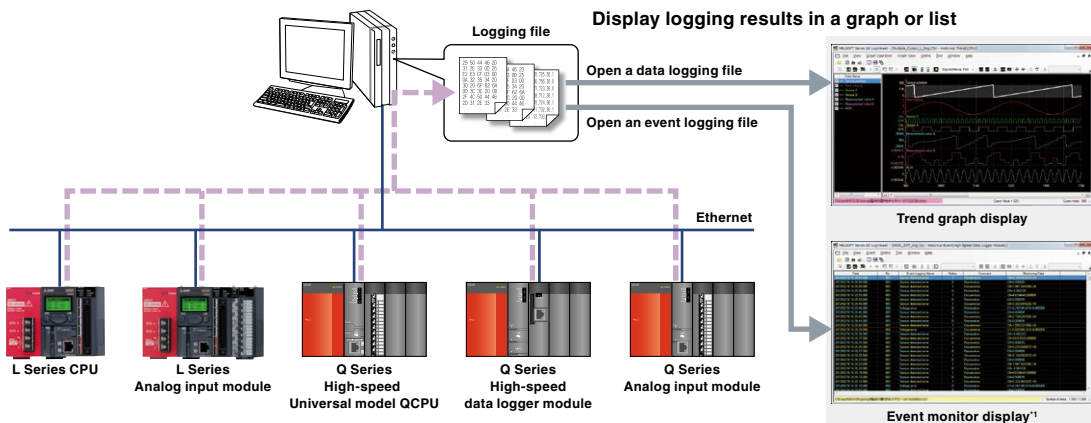

¹: The event monitor display is supported only with the Q Series high-speed logger module.

Easily adjust graphs without referring to the setup manual

Arranging graphs

Able to arrange each graph so as not to overlap each other. It is easier to display the graphs as each graph is evenly spaced out.

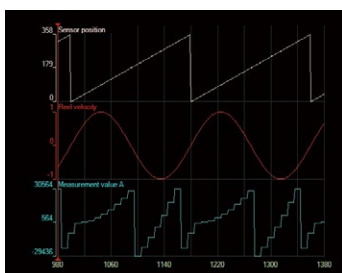

Overlapping graphs

With this it is possible to overlap each graph over one another. Multiple graphs can be compared enabling easier data analysis and comparison.

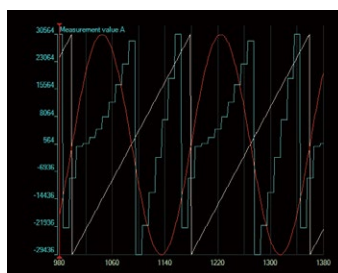

Automatically adjusting graphs

Various attributes of the graph are automatically adjusted (max/min values) as to display the upper and lower limit values better.

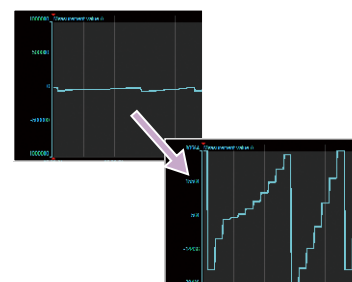

Easily confirm changes in data with dual cursors

Data changes within a designated time frame can be quickly checked with user-friendly dual cursors (multi-cursors). When the cursors are moved to the point at which changes are to be confirmed, the difference in time and value between those points will appear.

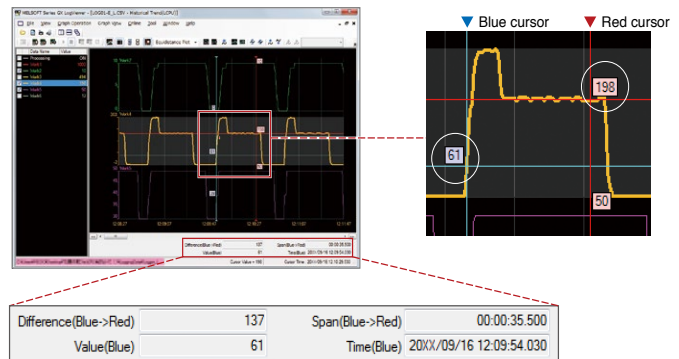

The difference in time and value between the cursors is automatically calculated and displayed.

Display data for multiple files within one graph area for easy comparison

Data for multiple files are displayed with the same time units in the same graph area. The display position within a file can be moved easily. This allows the differences of data within multiple files to be confirmed easily.

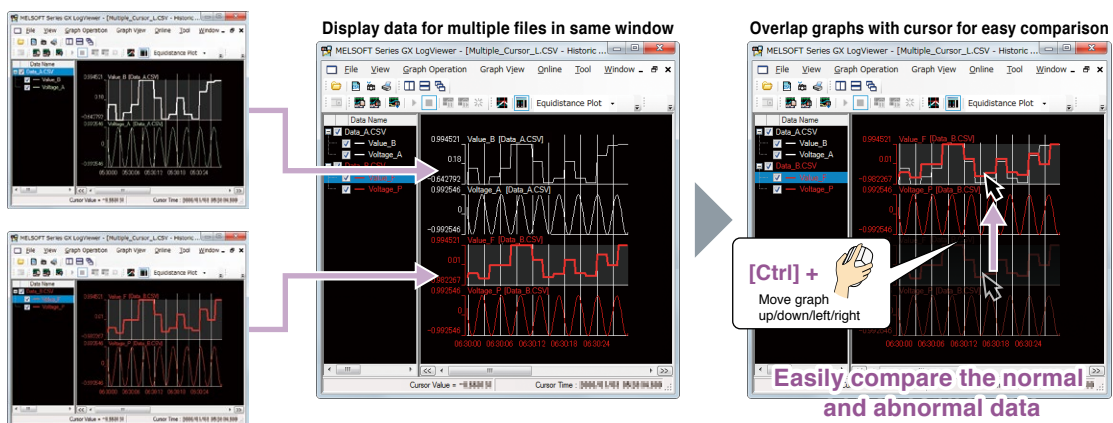

Quickly jump cursor to designated position

Cursor jump

Confirm data values by quickly moving the cursor to a designated value, time or index position in the trend graph.

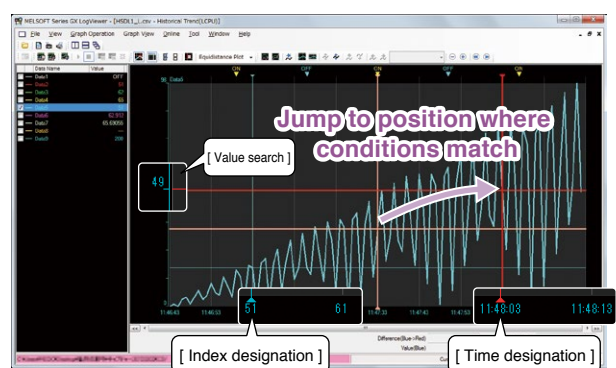

Jump Cursor

Select conditions for jump cursor.

File Name: HSD1_L.csv
Data Name: Data5
Classification: Conditional

Search the selecting data in specified condition.

Value Range: 0 to 4294967295

Select a cursor that jumps

Red Cursor Blue Cursor

Jump Previous Jump Next Close

Value search
Values are searched, and the cursor jumps to the position where the conditions match.

Jump Cursor

Select conditions for jump cursor.

File Name: HSD1_L.csv
Time Range: 2011/03/31 11:46:43 to 2011/03/31 11:48:22
Date and time to which the cursor jumps

Date
2011/03/31

Hour Minute Second

11 47 33

Select a cursor that jumps

Red Cursor Blue Cursor

Jump Previous Jump Next Close

Time designation
The cursor jumps to the designated time.

Jump Cursor

Select conditions for jump cursor.

File Name: HSD1_L.csv
Index Range: 1 to 100
Index to which the cursor jumps: 51

Select a cursor that jumps

Red Cursor Blue Cursor

Jump Previous Jump Next Close

Index designation
The cursor jumps to the designated index.

CPU modules

L02SCPU, L02SCPU-P

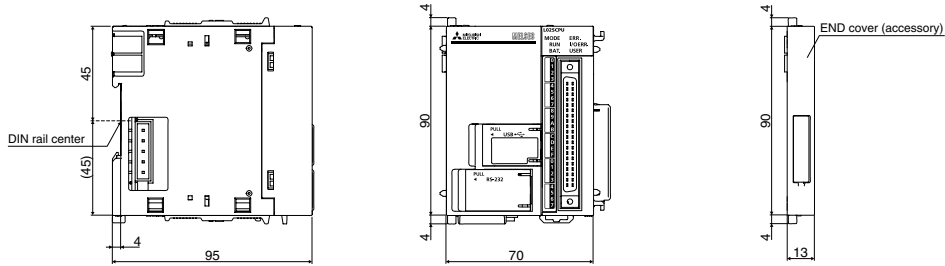

L02CPU, L02CPU-P, L06CPU, L06CPU-P, L26CPU, L26CPU-P

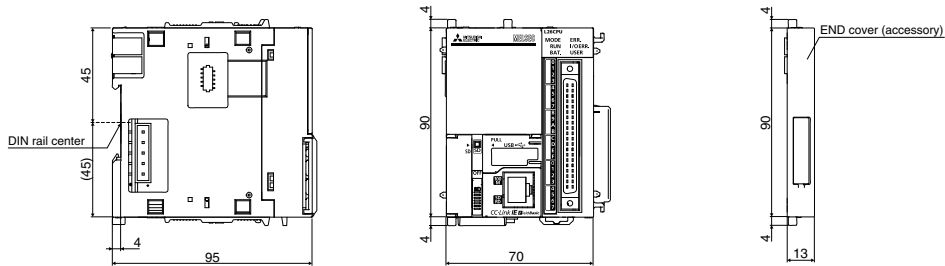

L26CPU-BT, L26CPU-PBT

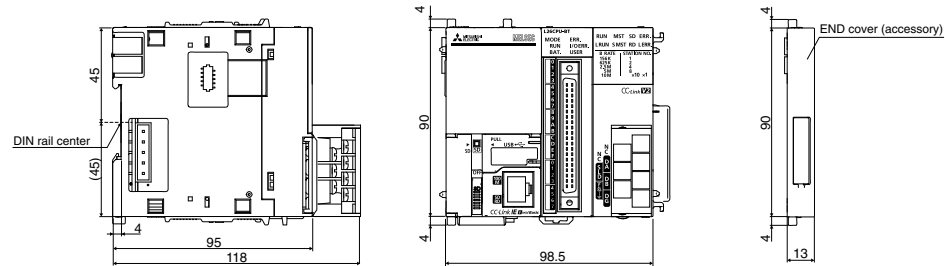

Display unit

L6DSPU

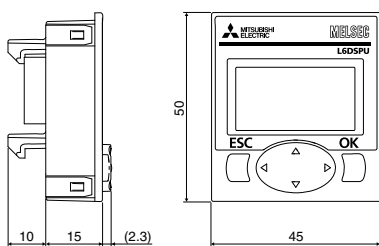

RS-232 adapter

L6ADP-R2

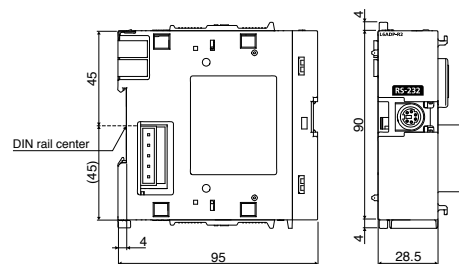

Unit: mm

RS-422/485 adapter

L6ADP-R4

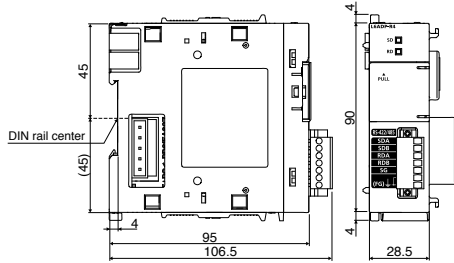

END cover with error terminal

L6EC-ET

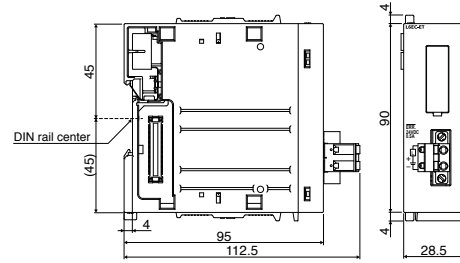

Power supply modules

L61P, L63P

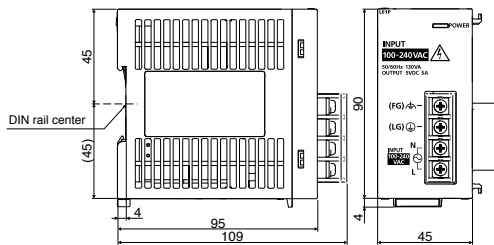

L63SP

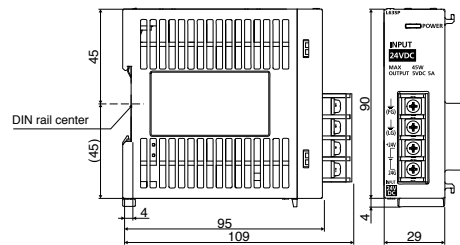

Branch module

L6EXB

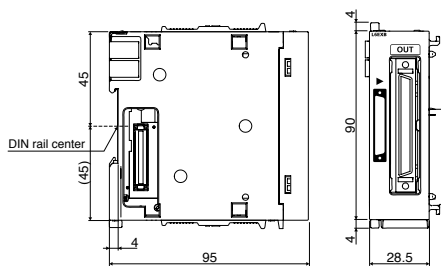

Extension module

L6EXE

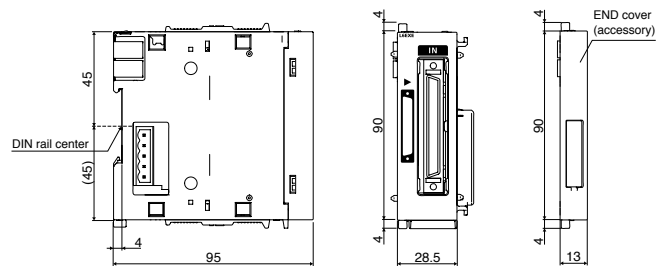

Extension cable

LC06E, LC10E, LC30E

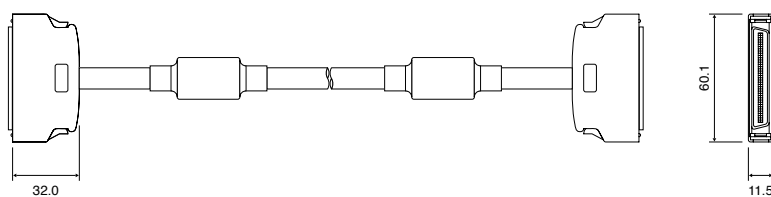

Unit: mm

Input/Output/I/O combined modules

LX10, LX28, LX40C6, LY10R2, LY18R2A
LY20S6, LY28S1A, LY40NT5P, LY40PT5P

LX41C4, LY41NT1P, LY41PT1P

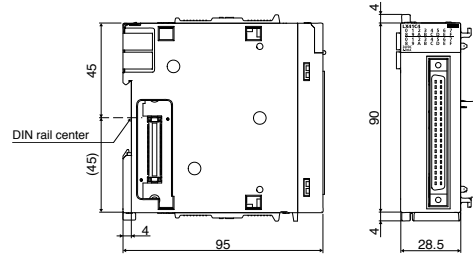
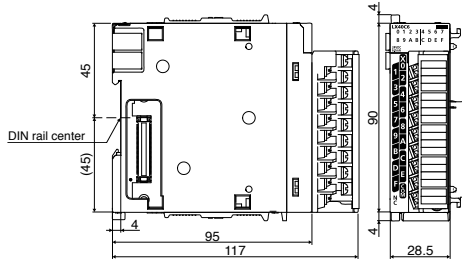

LX42C4, LY42NT1P, LY42PT1P
LH42C4NT1P, LH42C4PT1P

LG69

L6TE-18S

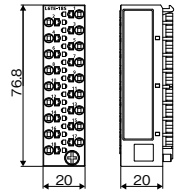
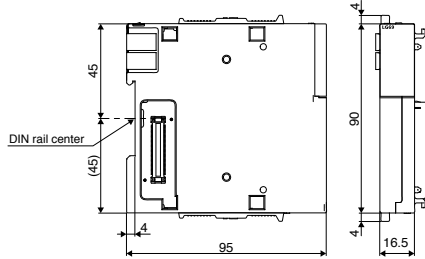
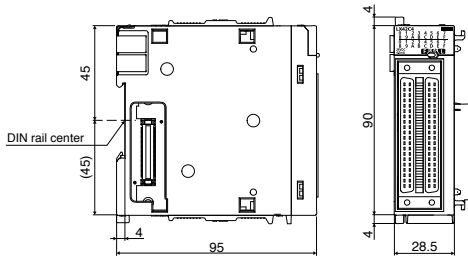

Multiple input (voltage/current/temperature)/Analog input/output/I/O module

L60MD4-G, L60AD4, L60DA4, L60ADVL8, L60ADIL8,
L60AD4-2GH, L60AD2DA2

L60DAVL8, L60DAIL8

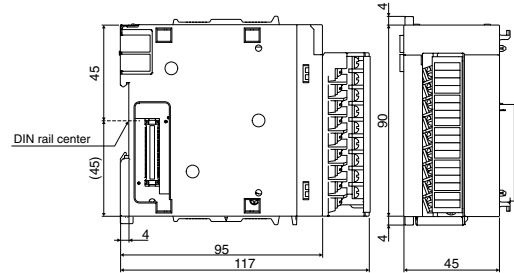
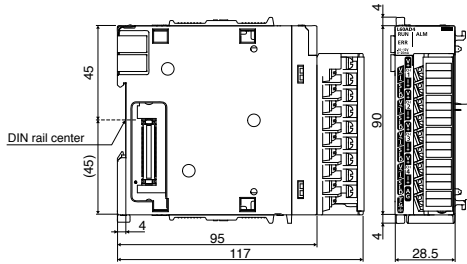

Temperature input module

L60RD8

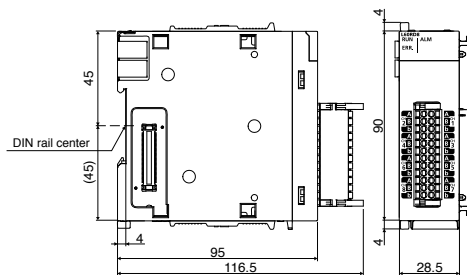

Unit: mm

Temperature control modules

L60TCTT4, L60TCRT4

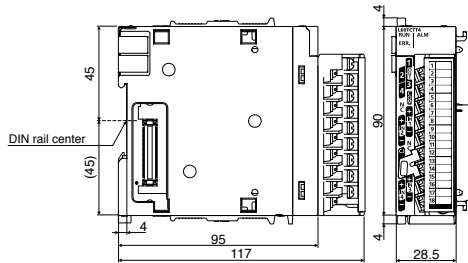

L60TCTT4BW, L60TCRT4BW

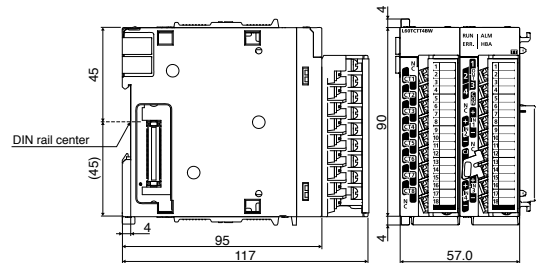

Simple motion modules

LD77MS2, LD77MS4, LD77MS16

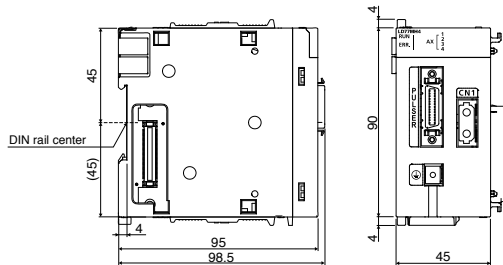

Positioning modules

LD75P1, LD75P2

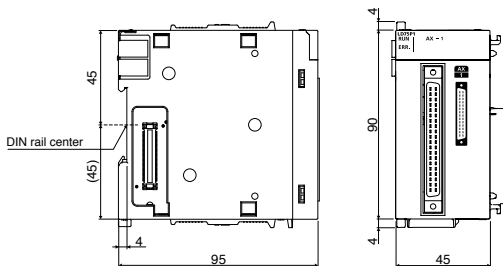

LD75D1, LD75D2

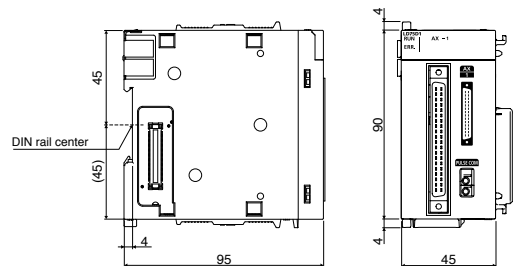

LD75P4

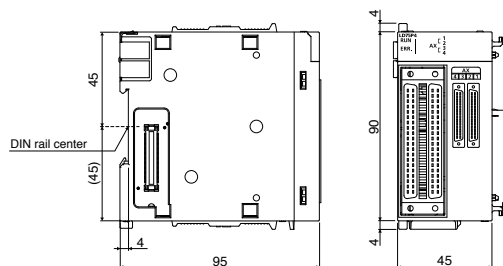

LD75D4

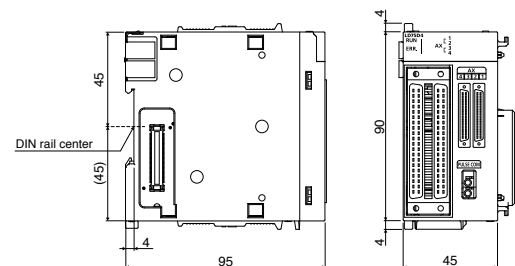

Unit: mm

Flexible high-speed I/O control module

LD40PD01

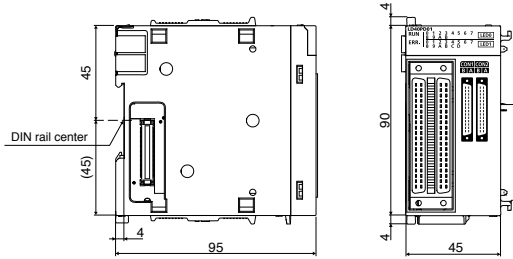

High-speed counter module

LD62, LD62D

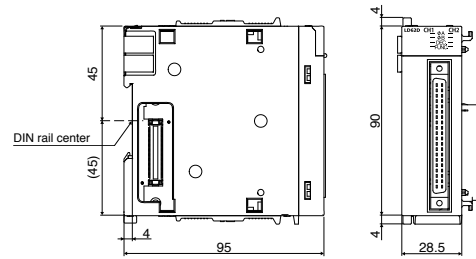

CC-Link IE Field Network master/local module

LJ71GF11-T2

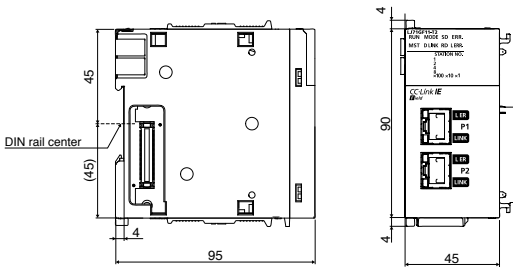

CC-Link IE Field Network head module

LJ72GF15-T2

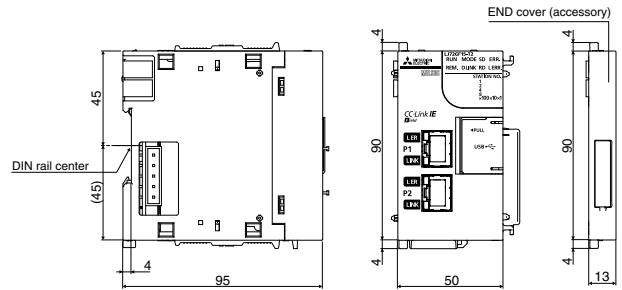

CC-Link master/local module

LJ61BT11

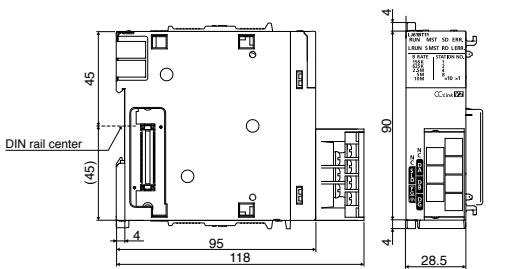

CC-Link/LT master module

LJ61CL12

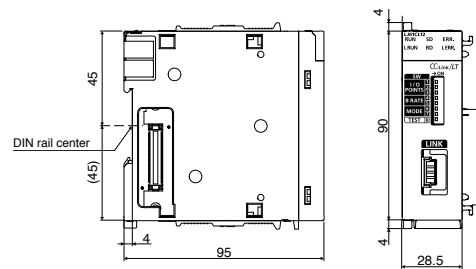

Unit: mm

AnyWireASLINK master module

LJ51AW12AL DB

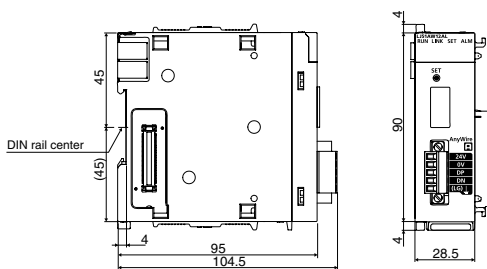

SSCNET III/H head module

LJ72MS15

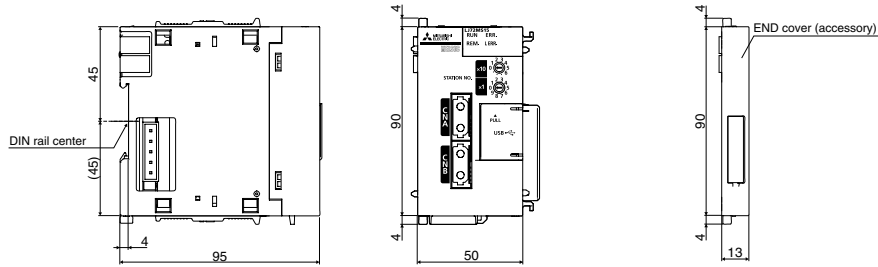

Ethernet interface module

LJ71E71-100

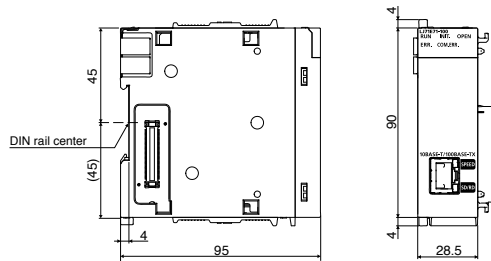

Serial communication modules

LJ71C24

LJ71C24-R2

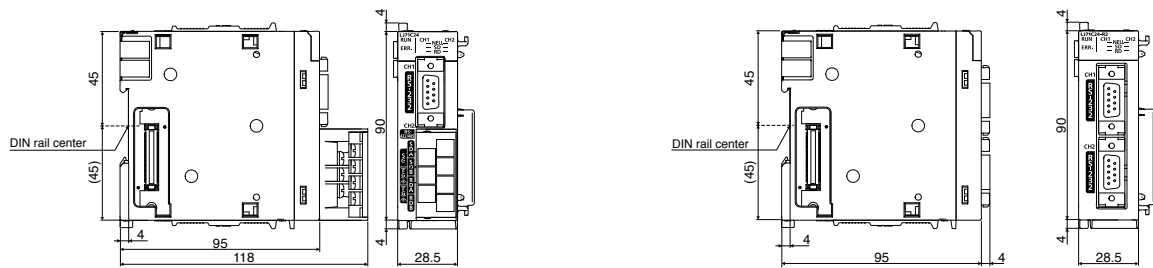

Unit: mm

Extensive global support coverage providing expert help whenever needed

■ Global FA centers

■ EMEA

Europe FA Center

MITSUBISHI ELECTRIC EUROPE B.V. Polish Branch
Tel: +48-12-347-65-81

Germany FA Center

MITSUBISHI ELECTRIC EUROPE B.V. German Branch
Tel: +49-2102-486-0 / Fax: +49-2102-486-1120

UK FA Center

MITSUBISHI ELECTRIC EUROPE B.V. UK Branch
Tel: +44-1707-27-8780 / Fax: +44-1707-27-8695

Czech Republic FA Center

MITSUBISHI ELECTRIC EUROPE B.V. Czech Branch
Tel: +420-255 719 200

Italy FA Center

MITSUBISHI ELECTRIC EUROPE B.V. Italian Branch
Tel: +39-039-60531 / Fax: +39-039-6053-312

Russia FA Center

MITSUBISHI ELECTRIC (RUSSIA) LLC ST.
Petersburg Branch
Tel: +7-812-633-3497 / Fax: +7-812-633-3499

Turkey FA Center

MITSUBISHI ELECTRIC TURKEY A.S. Umraniye Branch
Tel: +90-216-526-3990 / Fax: +90-216-526-3995

■ Asia-Pacific

China

Beijing FA Center

MITSUBISHI ELECTRIC AUTOMATION (CHINA) LTD.
Beijing FA Center
Tel: +86-10-6518-8830 / Fax: +86-10-6518-2938

Guangzhou FA Center

MITSUBISHI ELECTRIC AUTOMATION (CHINA) LTD.
Guangzhou FA Center
Tel: +86-20-8923-6730 / Fax: +86-20-8923-6715

Shanghai FA Center

MITSUBISHI ELECTRIC AUTOMATION (CHINA) LTD.
Shanghai FA Center
Tel: +86-21-2322-3030 / Fax: +86-21-2322-3000

Tianjin FA Center

MITSUBISHI ELECTRIC AUTOMATION (CHINA) LTD.
Tianjin FA Center
Tel: +86-22-2813-1015 / Fax: +86-22-2813-1017

Taiwan

Taipei FA Center

SETSUYO ENTERPRISE CO., LTD.
Tel: +886-2-2299-9917 / Fax: +886-2-2299-9963

Korea

Korea FA Center

MITSUBISHI ELECTRIC AUTOMATION KOREA CO., LTD.
Tel: +82-2-3660-9632 / Fax: +82-2-3664-0475

Thailand

Thailand FA Center

MITSUBISHI ELECTRIC FACTORY AUTOMATION
(THAILAND) CO., LTD.
Tel: +66-2682-6522-31 / Fax: +66-2682-6020

ASEAN

ASEAN FA Center

MITSUBISHI ELECTRIC ASIA PTE. LTD.
Tel: +65-6470-2480 / Fax: +65-6476-7439

Malaysia

Malaysia FA Center

Malaysia FA Center
Tel: +60-3-7626-5080 / Fax: +60-3-7658-3544

Indonesia

Indonesia FA Center

PT. MITSUBISHI ELECTRIC INDONESIA
Cikarang Office
Tel: +62-21-2961-7797 / Fax: +62-21-2961-7794

Vietnam

Hanoi FA Center

MITSUBISHI ELECTRIC VIETNAM COMPANY LIMITED
Hanoi Branch Office
Tel: +84-24-3937-8075 / Fax: +84-24-3937-8076

Ho Chi Minh FA Center

MITSUBISHI ELECTRIC VIETNAM COMPANY LIMITED
Tel: +84-28-3910-5945 / Fax: +84-28-3910-5947

Philippines

Philippines FA Center

MELCO Factory Automation Philippines Inc.
Tel: +63-(0)2-8256-8042

India

India Ahmedabad FA Center

MITSUBISHI ELECTRIC INDIA PVT. LTD.
Ahmedabad Branch
Tel: +91-7965120063

India Bangalore FA Center

MITSUBISHI ELECTRIC INDIA PVT. LTD.
Bangalore Branch
Tel: +91-80-4020-1600 / Fax: +91-80-4020-1699

India Chennai FA Center

MITSUBISHI ELECTRIC INDIA PVT. LTD.
Chennai Branch
Tel: +91-4445548772 / Fax: +91-4445548773

India Coimbatore FA Center

MITSUBISHI ELECTRIC INDIA PVT. LTD.
Coimbatore Branch
Tel: +91-422-438-5606

India Gurgaon FA Center

MITSUBISHI ELECTRIC INDIA PVT. LTD.
Gurgaon Head Office
Tel: +91-124-463-0300 / Fax: +91-124-463-0399

India Pune FA Center

MITSUBISHI ELECTRIC INDIA PVT. LTD.
Pune Branch
Tel: +91-20-2710-2000 / Fax: +91-20-2710-2100

■ Americas

USA

North America FA Center

MITSUBISHI ELECTRIC AUTOMATION, INC.
Tel: +1-847-478-2469 / Fax: +1-847-478-2253

Mexico

Mexico City FA Center

MITSUBISHI ELECTRIC AUTOMATION, INC.
Mexico Branch
Tel: +52-55-3067-7511

Mexico FA Center

MITSUBISHI ELECTRIC AUTOMATION, INC.
Queretaro Office
Tel: +52-442-153-6014

Mexico Monterrey FA Center

MITSUBISHI ELECTRIC AUTOMATION, INC.
Monterrey Office
Tel: +52-55-3067-7521

Brazil

Brazil FA Center

MITSUBISHI ELECTRIC DO BRASIL COMERCIO E
SERVICOS LTDA.
Tel: +55-11-4689-3000 / Fax: +55-11-4689-3016

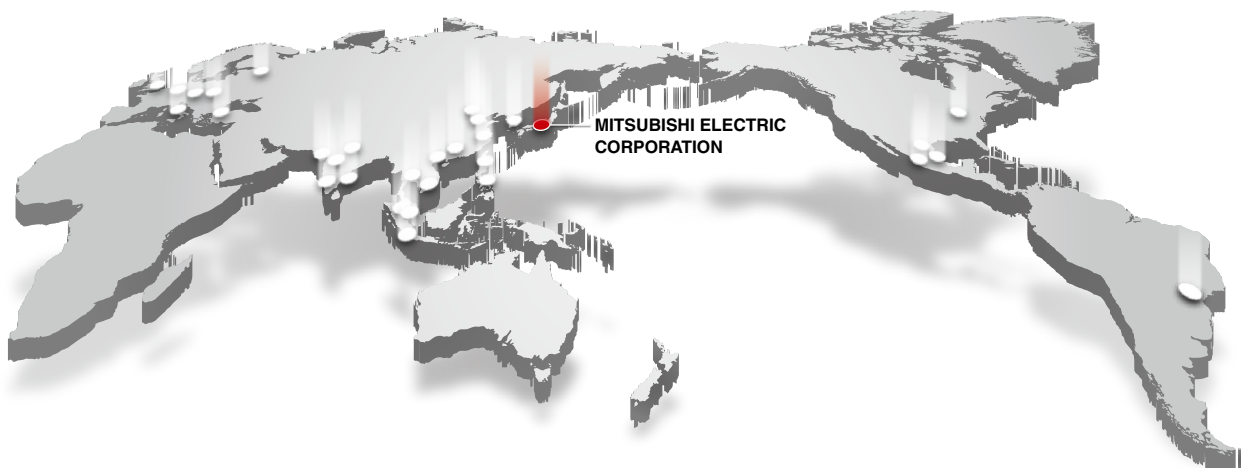

Factory Automation Global website

Mitsubishi Electric Factory Automation provides a mix of services to support its customers worldwide. A consolidated global website is the main portal, offering a selection of support tools and a window to its local Mitsubishi Electric sales and support network.

From here you can find:

- Overview of available factory automation products
- Library of downloadable literature
- Support tools such as online e-learning courses, terminology dictionary, etc.
- Global sales and service network portal
- Latest news related to Mitsubishi Electric factory automation



Mitsubishi Electric Factory Automation Global website:
www.MitsubishiElectric.com/fa

Mitsubishi Electric FA e-Learning

An extensive library of e-learning courses covering the factory automation product range. Courses from beginner to advanced levels of difficulty are available anytime anywhere.



- **Beginner level**
Designed for newcomers to Mitsubishi Electric Factory Automation products gaining a background of the fundamentals and an overview of various products related to the course.
- **Basic to Advanced levels**
Various different features are explained along with setup, programming, and network configuration.

Innovative next-generation e-Manual

A next-generation digital manual that consolidates factory automation products manuals into an easy-to-use package with various useful features.

- **e-Manual Viewer**
Multiple manuals can be cross-searched at once. Multiple users can share the latest manuals and knowhow with document sharing function.



Download on the
App Store

GET IT ON
Google Play

- **e-Manual Create**
Software for converting word files and chm files to e-Manual documents. User's customized machine manuals can be converted to e-Manual documents, allowing consolidated management of user's maintenance information and Mitsubishi Electric product information.

Product List

Please check the compatibility and restrictions of the product in the related manual before purchasing.

[Legend] **DB** : Double brand product ^(Note) **NEW** : Recently released product **SOON** : Product available soon

MELSEC-L series

Type	Model	Outline
CPU	L02SCPU	Number of I/O points: 1024 points, Number of I/O device points: 8192 points, Program capacity: 20K steps, Basic operation processing speed (LD instruction): 60 ns, Program memory capacity: 80 KB, Peripheral connection ports: USB and RS-232 (Predefined protocol support function), Memory card I/F: None, Built-in I/O functions (General-purpose input: 16 points, General purpose output (Sink type): 8 points, Interrupt input, Pulse catch, Positioning, High-speed counter), END cover included
	L02SCPU-P	Number of I/O points: 1024 points, Number of I/O device points: 8192 points, Program capacity: 20K steps, Basic operation processing speed (LD instruction): 60 ns, Program memory capacity: 80 KB, Peripheral connection ports: USB and RS-232 (Predefined protocol support function), Memory card I/F: None, Built-in I/O functions (General-purpose input: 16 points, General-purpose output (Source type): 8 points, Interrupt input, Pulse catch, Positioning, High-speed counter), END cover included
	L02CPU	Number of I/O points: 1024 points, Number of I/O device points: 8192 points, Program capacity: 20K steps, Basic operation processing speed (LD instruction): 40 ns, Program memory capacity: 80 KB, Peripheral connection ports: USB and Ethernet (Predefined protocol support function), Memory card I/F: SD Memory Card, Built-in I/O functions (General-purpose input: 16 points, General-purpose output (Sink type): 8 points, Interrupt input, Pulse catch, Positioning, High-speed counter), CC-Link IE Field Network Basic compatible, END cover included
	L02CPU-P	Number of I/O points: 1024 points, Number of I/O device points: 8192 points, Program capacity: 20K steps, Basic operation processing speed (LD instruction): 40 ns, Program memory capacity: 80 KB, Peripheral connection ports: USB and Ethernet (Predefined protocol support function), Memory card I/F: SD Memory Card, Built-in I/O functions (General-purpose input: 16 points, General-purpose output (Source type): 8 points, Interrupt input, Pulse catch, Positioning, High-speed counter), CC-Link IE Field Network Basic compatible, END cover included
	L06CPU	Number of I/O points: 4096 points, Number of I/O device points: 8192 points, Program capacity: 60K steps, Basic operation processing speed (LD instruction): 9.5 ns, Program memory capacity: 240 KB, Peripheral connection ports: USB and Ethernet (Predefined protocol support function), Memory card I/F: SD Memory Card, Built-in I/O functions (General-purpose input: 16 points, General-purpose output (Sink type): 8 points, Interrupt input, Pulse catch, Positioning, High-speed counter), CC-Link IE Field Network Basic compatible, END cover included
	L06CPU-P	Number of I/O points: 4096 points, Number of I/O device points: 8192 points, Program capacity: 60K steps, Basic operation processing speed (LD instruction): 9.5 ns, Program memory capacity: 240 KB, Peripheral connection ports: USB and Ethernet (Predefined protocol support function), Memory card I/F: SD Memory Card, Built-in I/O functions (General-purpose input: 16 points, General-purpose output (Source type): 8 points, Interrupt input, Pulse catch, Positioning, High-speed counter), CC-Link IE Field Network Basic compatible, END cover included
	L26CPU	Number of I/O points: 4096 points, Number of I/O device points: 8192 points, Program capacity: 260K steps, Basic operation processing speed (LD instruction): 9.5 ns, Program memory capacity: 1040 KB, Peripheral connection ports: USB and Ethernet (Predefined protocol support function), Memory card I/F: SD Memory Card, Built-in I/O functions (General-purpose input: 16 points, General-purpose output (Sink type): 8 points, Interrupt input, Pulse catch, Positioning, High-speed counter), CC-Link IE Field Network Basic compatible, END cover included
	L26CPU-P	Number of I/O points: 4096 points, Number of I/O device points: 8192 points, Program capacity: 260K steps, Basic operation processing speed (LD instruction): 9.5 ns, Program memory capacity: 1040 KB, Peripheral connection ports: USB and Ethernet (Predefined protocol support function), Memory card I/F: SD Memory Card, Built-in I/O functions (General-purpose input: 16 points, General-purpose output (Source type): 8 points, Interrupt input, Pulse catch, Positioning, High-speed counter), CC-Link IE Field Network Basic compatible, END cover included
	L26CPU-BT	Number of I/O points: 4096 points, Number of I/O device points: 8192 points, Program capacity: 260K steps, Basic operation processing speed (LD instruction): 9.5 ns, Program memory capacity: 1040 KB, Peripheral connection ports: USB and Ethernet (Predefined protocol support function), Memory card I/F: SD Memory Card, Built-in I/O functions (General-purpose input: 16 points, General-purpose output (Sink type): 8 points, Interrupt input, Pulse catch, Positioning, High-speed counter), CC-Link master/local station function, CC-Link IE Field Network Basic compatible, END cover included
	L26CPU-PBT	Number of I/O points: 4096 points, Number of I/O device points: 8192 points, Program capacity: 260K steps, Basic operation processing speed (LD instruction): 9.5 ns, Program memory capacity: 1040 KB, Peripheral connection ports: USB and Ethernet (Predefined protocol support function), Memory card I/F: SD Memory Card, Built-in I/O functions (General-purpose input: 16 points, General-purpose output (Source type): 8 points, Interrupt input, Pulse catch, Positioning, High-speed counter), CC-Link master/local station function, CC-Link IE Field Network Basic compatible, END cover included
CPU packages	L02CPU-SET	CPU module (L02CPU), Display unit (L6DSPU), and Power supply module (L61P) set
	L02CPU-P-SET	CPU module (L02CPU-P), Display unit (L6DSPU), and Power supply module (L61P) set
	L06CPU-SET	CPU module (L06CPU), Display unit (L6DSPU), and Power supply module (L61P) set
	L06CPU-P-SET	CPU module (L06CPU-P), Display unit (L6DSPU), and Power supply module (L61P) set
	L26CPU-SET	CPU module (L26CPU), Display unit (L6DSPU), and Power supply module (L61P) set
	L26CPU-P-SET	CPU module (L26CPU-P), Display unit (L6DSPU), and Power supply module (L61P) set
	L26CPU-BT-SET	CPU module (L26CPU-BT), Display unit (L6DSPU), and Power supply module (L61P) set
	L26CPU-PBT-SET	CPU module (L26CPU-PBT), Display unit (L6DSPU), and Power supply module (L61P) set

Note: General specifications and product guarantee conditions of jointly developed products are different from those of MELSEC products.
For more information, please refer to the product manuals or contact your local Mitsubishi representative for details.

MELSEC-L series

Type		Model	Outline	
CPU options	Display unit	L6DSPU	STN black-and-white LCD, 16 characters x4 lines	
	Battery	Q6BAT	Replacement battery	
		Q7BAT-SET	High capacity battery with a battery holder for CPU installation	
		Q7BAT	High capacity replacement battery	
	SD Memory Card	NZ1MEM-2GBSD*1	SD memory card, capacity: 2 GB	
		NZ1MEM-4GBSD*1	SDHC memory card, capacity: 4 GB	
		NZ1MEM-8GBSD*1	SDHC memory card, capacity: 8 GB	
NZ1MEM-16GBSD*1		SDHC memory card, capacity: 16 GB		
RS-232 adapter	L6ADP-R2	For GOT(HMI) connection, 1 x RS-232 channel, maximum transmission speed: 115.2Kpbs, MELSOFT connectable MODBUS® RTU master function (using predefined protocol support function)		
RS-422/485 adapter	L6ADP-R4	For GOT(HMI) connection, 1 x RS-422/485 channel, maximum transmission speed: 115.2Kpbs MODBUS® RTU master function (using predefined protocol support function)		
END cover with error terminal		L6EC-ET	END cover with error terminal	
Power supply		L61P	Input voltage: 100...240 V AC, Output voltage: 5 V DC, Output current: 5 A	
		L63P	Input voltage: 24 V DC, Output voltage: 5 V DC, Output current: 5 A	
	Slim type Power supply	L63SP	Input voltage: 24 V DC, Output voltage: 5 V DC, Output current: 5 A, No isolation	
Branch / Extension module		L6EXB	Branch module	
		L6EXE	Extension module with END cover	
Extension cable		LC06E	0.6-m cable for connecting branch and extension modules	
		LC10E	1.0-m cable for connecting branch and extension modules	
		LC30E	3.0-m cable for connecting branch and extension modules	
I/O module	Input	AC input	LX10	16 points, 100...120 V AC, Response time: 20 ms or less, 16 points/common, 18-point terminal block
			LX28	8 points, 100...240 V AC, Response time: 20 ms or less, 8 points/common, 18-point terminal block
		DC input	LX40C6	16 points, 24 V DC, Response time: 1/5/10/20/70 ms or less, 16 points/common, Positive/Negative common, 18-point terminal block
			LX41C4	32 points, 24 V DC, Response time: 1/5/10/20/70 ms or less, 32 points/common, Positive/Negative common, 40-pin connector
	LX42C4		64 points, 24 V DC, Response time: 1/5/10/20/70 ms or less, 32 points/common, Positive/Negative common, 40-pin connector x2	
	Output	Relay	LY10R2	16 points, 24 V DC/240 V AC, 2 A/point, 8 A/common, Response time: 12 ms or less, 16 points/common, 18-point terminal block
			LY18R2A	8 points, 24 V DC/240 V AC, 2 A/point, 8 A/module, Response time: 12 ms or less, No common (all points independent), 18-point terminal block
		Triac	LY20S6	16 points, 100...240 V AC, 0.6 A/point, 4.8 A/common, Response time: 1 ms + 0.5 cycles or less, 16 points/common, 18-point terminal block
			LY28S1A	8 points, 100...240 V DC, 1 A/point, 8 A/module, Response time: 1 ms + 0.5 cycles or less, No common (all points independent), 18-point terminal block
		Transistor (Sink)	LY40NT5P	16 points, 12...24 V DC, 0.5 A/point, 5 A/common, Response time: 1 ms or less, 16 points/common, 18-point terminal block, overload protection function, overheat protection function, surge suppression
			LY41NT1P	32 points, 12...24 V DC, 0.1 A/point, 2 A/common, Response time: 1 ms or less, 32 points/common, Sink type, 40-pin connector, overload protection function, overheat protection function, surge suppression
			LY42NT1P	64 points, 12...24 V DC, 0.1 A/point, 2 A/common, Response time: 1 ms or less, 32 points/common, Sink type, 40-pin connector x2, overload protection function, overheat protection function, surge suppression
		Transistor (Source)	LY40PT5P	16 points, 12...24 V DC, 0.5 A/point, 5 A/common, Response time: 1 ms or less, 16 points/common, 18-point terminal block, overload protection function, overheat protection function, surge suppression
	LY41PT1P		32 points, 12...24 V DC, 0.1 A/point, 2 A/common, Response time: 1 ms or less, 32 points/common, 40-pin connector, overload protection function, overheat protection function, surge suppression	
	LY42PT1P		64 points, 12...24 V DC, 0.1 A/point, 2 A/common, Response time: 1 ms or less, 32 points/common, 40-pin connector x2, overload protection function, overheat protection function, surge suppression	
	I/O combined	DC input/transistor output (sink)	LH42C4NT1P	Input specifications : 32 points, 24 V DC, Response time: 1/5/10/20/70 ms or less, 32 points/common, Positive/Negative common Output specifications : 32 points, 12...24 V DC, 0.1 A/point, 2 A/common, Response time: 1 ms or less, 32 points/common, overload protection function, overheat protection function, surge suppression 40-pin connector x2
		DC input/transistor output (source)	LH42C4PT1P	Input specifications : 32 points, 24 V DC, Response time: 1/5/10/20/70 ms or less, 32 points/common, Positive/Negative common Output specifications : 32 points, 12...24 V DC, 0.1 A/point, 2 A/common, Response time: 1 ms or less, 32 points/common, overload protection function, overheat protection function, surge suppression 40-pin connector x2
	Space module		LG69	Space module for AnS module replacement
	Spring clamp terminal block		L6TE-18S	Alternative to a 18-point screw terminal block, 0.3...1.0 mm ² (AWG22...18), push-in type

*1: Mitsubishi Electric does not guarantee the operation of non-Mitsubishi Electric products.

MELSEC-L series

Type		Model	Outline
Multiple input (voltage/current/temperature) modules		L60MD4-G	4 channels, Input: -10...10 V DC, 0...20 mA DC, micro voltage-100...100 mV DC, Thermocouple (K, J, T, E, N, R, S, B, U, L, PL II, W5Re/W26Re), RTD (Pt1000, Pt100, JPt100, Pt50), Output (resolution): 0...20000, -20000...20000, (with voltage, current, micro voltage input) Conversion speed: 50 ms/channels, 18-point terminal block, Channel isolated
Analog I/O module	Analog input	L60AD4	4 channels, Input: -10...10 V DC, 0...20 mA DC, Output (resolution): 0...20000, -20000...20000, Conversion speed: 20 μs, 80 μs, 1 ms/channel, 18-point terminal block
		L60ADVL8	8 channels, Input: -10...10 V, Output (resolution)-16000...16000, Conversion speed: 1 ms/channels 18-point terminal block
		L60ADIL8	8 channels, Input: 0...20 mA DC, Output (resolution): 0...8000, Conversion speed: 1 ms/channels 18-point terminal block
		L60AD4-2GH	4 channels, Input: -10...10 V DC, 0...20 mA DC, Output (resolution): 0...32000, -32000...32000, Conversion speed: 40 μs/2 channels, 18-point terminal block, Dual channel isolation
	Analog output	L60DA4	4 channels, Input (resolution): 0...20000, -20000...20000, Output: -10...10 V DC, 0...20 mA DC, Conversion speed: 20 μs/channel, 18-point terminal block
		L60DAVL8	8 channels, Input (resolution): -16000...16000, Output: -10...10 V DC, Conversion speed: 200 μs/channel, 18-point terminal block
		L60DAIL8	8 channels, Input (resolution): 0...8000, Output: 0...20 mA DC, Conversion speed: 200 μs/channel, 18-point terminal block
Analog I/O	L60AD2DA2	Input specifications : 2 channels, Input: -10...10 V DC, 0...20 mA DC, Output (resolution): 0...12000, -16000...16000, Conversion speed: 80 μs/channel, Output specifications : 2 channels, Input (resolution): 0...12000, -16000...16000, Output: -10...10 V DC, 0...20 mA DC, Conversion speed: 80 μs/channel, 18-point terminal block	
Temperature input module	RTD input	L60RD8	8 channels, RTD (Pt1000, Pt100, JPt100, Pt50, Ni500, Ni120, Ni100, Cu100, Cu50) Resolution: 0.1°C, Conversion speed: 40 ms/ch, 24-point spring clamp terminal block
Temperature control module	Thermocouple input	L60TCTT4	4 channels (normal mode) /2 channels (heating-cooling control), Thermocouple (K, J, T, B, S, E, R, N, U, L, PL II, W5Re/W26Re), No Heater disconnection detection function, sampling cycle: 250 ms/4 channels, 500 ms/4 channels, Channel isolated, 18 point terminal block
		L60TCTT4BW	4 channels (normal mode) /2 channels (heating-cooling control), Thermocouple (K, J, T, B, S, E, R, N, U, L, PL II, W5Re/W26Re), Heater disconnection detection function, Sampling cycle: 250 ms/4 channels, 500 ms/4 channels, Channel isolated, 18 point terminal block x2
	RTD input	L60TCRT4	4 channels (normal mode) /2 channels (heating-cooling control), Platinum type resistive temperature device(Pt100, JPt100), No Heater disconnection detection function, Sampling cycle: 250 ms/4 channels, 500 ms/4 channels, Channel isolated, 18 point terminal block
		L60TCRT4BW	4 channels (normal mode) /2 channels (heating-cooling control), Platinum type resistive temperature device (Pt100, JPt100), Heater disconnection detection function, Sampling cycle: 250 ms/4 channels, 500 ms/4 channels, Channel isolated, 18 point terminal block x2
Simple motion module	SSCNET III/H	LD77MS2*1	2 axes, 2-axis linear interpolation, 2-axis circular interpolation, synchronous control, Control unit: mm, inch, degree, pulse, Number of positioning data: 600 data/axis, SSCNET III/H connectivity
		LD77MS4*1	4 axes, 2-/3-/4-axis linear interpolation, 2-axis circular interpolation, synchronous control, Control unit: mm, inch, degree, pulse, Number of positioning data: 600 data/axis, SSCNET III/H connectivity
		LD77MS16*1	16 axes, 2-/3-/4-axis linear interpolation, 2-axis circular interpolation, synchronous control, Control unit: mm, inch, degree, pulse, Number of positioning data: 600 data/axis, SSCNET III/H connectivity
Positioning module	Open collector	LD75P1	1 axis, Control unit: mm, inch, degree, pulse, Number of positioning data: 600 data/axis, Maximum output pulse: 200 kpps, 40-pin connector
		LD75P2	2 axes, 2-axis linear interpolation, 2-axis circular interpolation, Control unit: mm, inch, degree, pulse, Number of positioning data: 600 data/axis, Maximum output pulse: 200 kpps, 40-pin connector
		LD75P4	4 axes, 2-/3-/4-axis linear interpolation, 2-axis circular interpolation, 3-axis helical interpolation, Control unit: mm, inch, degree, pulse, Number of positioning data: 600 data/axis, Maximum output pulse: 200 kpps, 40-pin connector x2
	Differential driver	LD75D1	1 axis, Control unit: mm, inch, degree, pulse, Number of positioning data: 600 data/axis, Maximum output pulse: 4 Mpps, 40-pin connector
		LD75D2	2 axes, 2-axis linear interpolation, 2-axis circular interpolation, Control unit: mm, inch, degree, pulse, Number of positioning data: 600 data/axis, Maximum output pulse: 4 Mpps, 40-pin connector
		LD75D4	4 axes, 2-/3-/4-axis linear interpolation, 2-axis circular interpolation, 3-axis helical interpolation, Control unit: mm, inch, degree, pulse, Number of positioning data: 600 data/axis, Maximum output pulse: 4 Mpps, 40-pin connector x2
Flexible high-speed I/O control module		LD40PD01	12 input points (all for 5 V DC/24 V DC/differential) 14 output points (8 points for DC (5 V DC...24 V), 6 points for differential)
High-speed counter module		LD62	2 channels, 200/100/10 kpps, Count input signal: 5/12/24 V DC, External input: 5/12/24 V DC, Coincidence output: transistor (sink), 12/24 V DC, 0.5 A/point, 2 A/common, 40-pin connector
		LD62D	2 channels, 500/200/100/10 kpps, Count input signal: EIA standards RS-422-A (Differential line driver level), External input: 5/12/24 V DC, Coincidence output: transistor (sink), 12/24 V DC, 0.5 A/point, 2 A/common, 40-pin connector

*1: The connector is not appended. Please obtain an LD77MHIOCON separately.

MELSEC-L series

Type	Model	Outline	
Network module	CC-Link IE Field Network	LJ71GF11-T2 LJ72GF15-T2*1	Master/Local station Remote station (Head module with END cover)
	CC-Link	LJ61BT11	Master/Local station, CC-Link Ver.2.0 compatible
	CC-Link/LT	LJ61CL12	Master station, CC-Link/LT system compatible
	AnyWireASLINK	LJ51AW12AL DB	Master station, AnyWireASLINK system compatible
	SSCNET III/H	LJ72MS15*2	Remote station (Head module with END cover)
	Ethernet interface	LJ71E71-100	10BASE-T/100BASE-TX BACnet® client function, MODBUS® TCP master function (using predefined protocol support function)
	Serial communication	LJ71C24	RS-232: 1 channel, RS-422/485: 1 channel, Total transmission speed of 2 channels: 230.4 kbps MODBUS® RTU master function (using predefined protocol support function)
		LJ71C24-R2	RS-232: 2 channels, Total transmission speed of 2 channels: 230.4 kbps MODBUS® RTU master function (using predefined protocol support function)

*1: The CPU module, branch and extension module, display unit, RS-232 adapter, CC-Link IE Field Network master/local module and Ethernet interface module cannot be mounted on a system using LJ72GF-T2.

*2: The CPU module, branch and extension module, display unit, RS-232 adapter, temperature control module, simple motion module, positioning module, CC-Link IE Field Network master/local module, CC-Link IE Field network head module, CC-Link master/local module, CC-Link/LT master module, AnyWireASLINK master module, Ethernet interface module, and serial communication module cannot be mounted on a system using LJ72MS15.

Compatible module for each protocol

Compatible protocol	Compatible module	Model	Outline
CC-Link IE Field Network Basic	CPU (Built-in Ethernet)	L02CPU(-P) L06CPU(-P) L26CPU(-P) L26CPU(-P)BT	CC-Link IE Field Network Basic master station function
SLMP (MC protocol)	CPU (Built-in Ethernet)	L02CPU(-P) L06CPU(-P) L26CPU(-P) L26CPU(-P)BT	SLMP server function (only MC protocol QnA compatible 3E frame) SLMP client function (using SLMP frame send Instruction, predefined protocol support function)
	Ethernet interface module	LJ71E71-100	SLMP server function (QnA compatible 3E and 4E frame of MC protocol) SLMP client function (using predefined protocol support function)
BACnet®	CPU (Built-in Ethernet)	L02CPU(-P) L06CPU(-P) L26CPU(-P) L26CPU(-P)BT	Compatible BACnet® object: Analog Input (AI), Binary Input (BI), Binary Output (BO), Accumulator (AC) (using predefined protocol support function)
	Ethernet interface module	LJ71E71-100	
MODBUS®/TCP	CPU (Built-in Ethernet)	L02CPU(-P) L06CPU(-P) L26CPU(-P) L26CPU(-P)BT	MODBUS®/TCP communication master function (using predefined protocol support function)
	Ethernet interface module	LJ71E71-100	
MODBUS®	CPU (Built-in RS-232)	L02SCPU(-P)	MODBUS®RTU communication master function (using predefined protocol support function)
	RS-232 adapter	L6ADP-R2	
	RS-422/485 adapter	L6ADP-R4	
	Serial Communication Modules	LJ71C24(-R2)	

Options

Type	Model	Outline
Connector	A6CON1*3*4	Soldering type 32-point connector (40-pin connector)
	A6CON2*3*4	Crimp contact type 32-point connector (40-pin connector)
	A6CON3*3*5	Flat cable pressure welding type 32-point connector (40-pin connector)
	A6CON4*3*4	Soldering type 32-point connector (40-pin connector, cable connectable in bidirection)
Connector/terminal block converter module	A6TBXY36*6*7*8	For positive common type input module and sink type output module (Standard type)
	A6TBXY54*6*7*8	For positive common type input module and sink type output module (2-wire type)
	A6TBX70*6*9	For positive common type input module (3-wire type)

*3: Available for the L Series CPU, LX41C4, LX42C4, LY41NT1P, LY42NT1P, LY41PT1P, LY42PT1P, LH42C4NT1P, and LH42C4PT1P.

*4: Available for LD75P1, LD75P2, LD75P4, LD75D1, LD75D2, LD75D4, LD40PD01, LD62 and LD62D.

*5: Available for the L Series CPU when using all the I/O signals for normal I/O output functions.

*6: Available for LX41C4 and LX42C4. (Positive common only)

*7: Available for LY41NT1P, LY42NT1P, LY41PT1P and LY42PT1P.

*8: Available for LH42C4NT1P and LH42C4PT1P. (Input side only when using plus common.)

*9: Available for LH42C4NT1P and LH42C4PT1P. (Input side only when using plus common. Output side is not usable.)

Ethernet related products

Type	Model	Outline
Industrial switching HUB	NZ2EHG-T8N DB	10 Mbps/100 Mbps/1 Gbps Auto MDI/MDI-X, DIN rail mountable, 8 ports
Intelligent HUB	NZ2MHG-T8F2	10 Mbps/100 Mbps/1 Gbps DIN rail mountable, 8 ports (2 ports support optical fiber cable), CC-Link IE and Ethernet devices are connectable, ERP- and LA- style topologies, VLAN and SNMP are supported

»For details on the software versions compatible with each module, refer to the manual for each product.
Please contact your local Mitsubishi Electric sales office or representative for the latest information about MELSOFT software versions and compatible operating systems.

MELSOFT – Programming Tool

Type	Model	Outline
MELSOFT iQ Works	SW2DND-IQWK-E	FA engineering software*1 <ul style="list-style-type: none"> • System Management Software: MELSOFT Navigator • Controller Programming Software: MELSOFT GX Works3*2, GX Works2, GX Developer • Motion Programming Software: MELSOFT MT Works2 • HMI Programming Software: MELSOFT GT Works3 • Robot Programming Software: MELSOFT RT ToolBox3*3 • Inverter Setup Software: MELSOFT FR Configurator2 • Servo setup software: MELSOFT MR Configurator2 • C Controller setting and monitoring tool: MELSOFT CW Configurator • MITSUBISHI ELECTRIC FA Library
MELSOFT GX Works3	SW1DND-GXW3-E	Controller Programming Software: MELSOFT GX Works3*2 MITSUBISHI ELECTRIC FA Library Comes with GX Works2, GX Developer and PX Developer*4
MELSOFT GX Works2	SW1DND-GXW2-E	Controller Programming Software Comes with GX Developer
MELSOFT MX Component	SW4DNC-ACT-E	ActiveX® library for communication
MELSOFT MX Sheet	SW2DNC-SHEET-E*5	Excel® communication support tool
MELSOFT MX Works	SW2DNC-SHEETSET-E	A set of two products: MELSOFT MX Component, MELSOFT MX Sheet
MELSOFT MX Component for iOS/Android™	SW1DNC-ACTAND-B	Library for communication (for Android application development) (Japanese/English version)
	SW1MIC-ACTIOS-B	Library for communication (for iOS application development) (Japanese/English version)

*1: For detailed information about supported modules, refer to the manuals of the relevant software package.

*2: The MELSOFT GX Works3 menu is switchable between Japanese, English, and simplified Chinese.

*3: RT ToolBox3 mini (simplified version) will be installed if iQ Works product ID is used. When RT ToolBox3 (with simulation function) is required, please purchase RT ToolBox3 product ID.

*4: Includes both programming tool and monitor tool for process control.

*5: To use MELSOFT MX Sheet, MELSOFT MX Component is required.

Android is trademark of Google Inc.
BACnet is a registered trademark of the American Society of Heating, Refrigerating and Air-Conditioning Engineers, Inc.
Ethernet is a trademark of Xerox Corporation.
Excel is registered trademark of Microsoft Corporation in the United States and other countries.
MODBUS is a registered trademark of Schneider Electric USA, Inc.
SD/SDHC logo is a trademark of SD-3C, LLC.
All other company names and product names used in this document are trademarks or registered trademarks of their respective companies.

Precautions before use

This publication explains the typical features and functions of the products herein and does not provide restrictions or other information related to usage and module combinations. Before using the products, always read the product user manuals. Mitsubishi Electric will not be held liable for damage caused by factors found not to be the cause of Mitsubishi Electric; opportunity loss or lost profits caused by faults in Mitsubishi Electric products; damage, secondary damage, or accident compensation, whether foreseeable or not, caused by special factors; damage to products other than Mitsubishi Electric products; or any other duties.

For safe use

- To use the products given in this publication properly, always read the relevant manuals before beginning operation.
- The products have been manufactured as general-purpose parts for general industries, and are not designed or manufactured to be incorporated in a device or system used in purposes related to human life.
- Before using the products for special purposes such as nuclear power, electric power, aerospace, medicine or passenger-carrying vehicles, consult with Mitsubishi Electric.
- The products have been manufactured under strict quality control. However, when installing the products where major accidents or losses could occur if the products fail, install appropriate backup or fail-safe functions in the system.

YOUR SOLUTION PARTNER

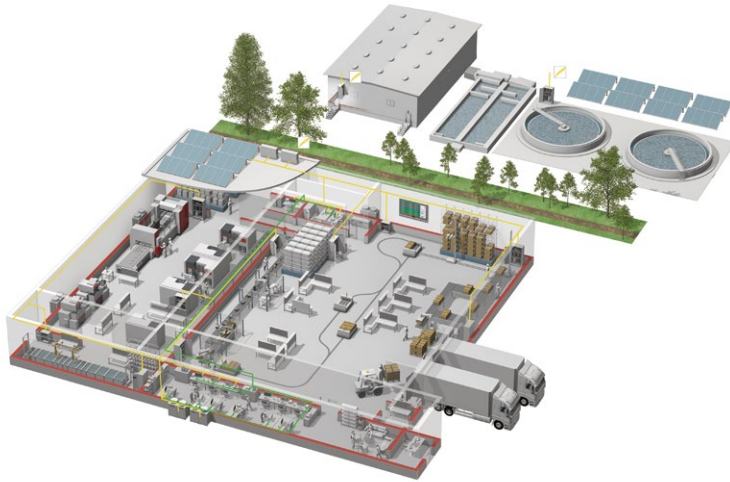

Mitsubishi Electric offers a wide range of automation equipment from PLCs and HMIs to CNC and EDM machines.

A NAME TO TRUST

Since its beginnings in 1870, some 45 companies use the Mitsubishi name, covering a spectrum of finance, commerce and industry.

The Mitsubishi brand name is recognized around the world as a symbol of premium quality.

Mitsubishi Electric Corporation, established in 1921, is active in space development, transportation, semi-conductors, energy systems, communications and information processing, audio visual equipment and home electronics, building and energy management and automation systems, and has 183 factories, laboratories and offices worldwide in over 140 countries.

This is why you can rely on Mitsubishi Electric automation solution - because we know first hand about the need for reliable, efficient, easy-to-use automation and control in our own factories.

As one of the world's leading companies with a global turnover of over 4 trillion Yen (over \$40 billion), employing over 146,000 people, Mitsubishi Electric has the resource and the commitment to deliver the ultimate in service and support as well as the best products.



Low-voltage Power Distribution Products



Transformers, Med-voltage Distribution Products



Power Monitoring and Energy Saving Products



Power (UPS) and Environmental Products



Compact and Modular Controllers



Servos, Motors and Inverters



Visualization: HMIs



Edge Computing Products



Numerical Control (NC)



Collaborative and Industrial Robots

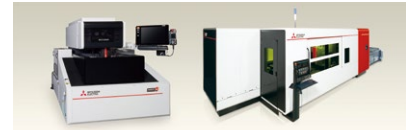

Processing machines: EDM, Lasers

* Not all products are available in all countries.

Country/Region	Sales office	Tel/Fax
USA	<p>MITSUBISHI ELECTRIC AUTOMATION, INC. 500 Corporate Woods Parkway, Vernon Hills, IL 60061, U.S.A.</p>	<p>Tel : +1-847-478-2100 Fax : +1-847-478-2253</p>
Mexico	<p>MITSUBISHI ELECTRIC AUTOMATION, INC. Mexico Branch Boulevard Miguel de Cervantes Saavedra 301, Torre Norte Piso 5, Ampliacion Granada, Miguel Hidalgo, Ciudad de Mexico, Mexico, C.P.115200</p>	<p>Tel : +52-55-3067-7512</p>
Brazil	<p>MITSUBISHI ELECTRIC DO BRASIL COMERCIO E SERVICOS LTDA. Avenida Adelino Cardana, 293, 21 andar, Bethaville, Barueri SP, Brasil</p>	<p>Tel : +55-11-4689-3000 Fax : +55-11-4689-3016</p>
Germany	<p>MITSUBISHI ELECTRIC EUROPE B.V. German Branch Mitsubishi-Electric-Platz 1, 40882 Ratingen, Germany</p>	<p>Tel : +49-2102-486-0 Fax : +49-2102-486-7780</p>
UK	<p>MITSUBISHI ELECTRIC EUROPE B.V. UK Branch Travellers Lane, UK-Hatfield, Hertfordshire, AL10 8XB, U.K.</p>	<p>Tel : +44-1707-28-8780 Fax : +44-1707-27-8695</p>
Ireland	<p>MITSUBISHI ELECTRIC EUROPE B.V. Irish Branch Westgate Business Park, Ballymount, Dublin 24, Ireland</p>	<p>Tel : +353-1-4198800 Fax : +353-1-4198890</p>
Italy	<p>MITSUBISHI ELECTRIC EUROPE B.V. Italian Branch Centro Direzionale Colleoni - Palazzo Sirio, Viale Colleoni 7, 20864 Agrate Brianza (MB), Italy</p>	<p>Tel : +39-039-60531 Fax : +39-039-6053-312</p>
Spain	<p>MITSUBISHI ELECTRIC EUROPE, B.V. Spanish Branch Carretera de Rubi, 76-80-Apdo. 420, E-08190 Sant Cugat del Valles (Barcelona), Spain</p>	<p>Tel : +34-935-65-3131 Fax : +34-935-89-1579</p>
France	<p>MITSUBISHI ELECTRIC EUROPE B.V. French Branch 25, Boulevard des Bouvets, 92741 Nanterre Cedex, France</p>	<p>Tel : +33-1-55-68-55-68 Fax : +33-1-55-68-57-57</p>
Czech Republic	<p>MITSUBISHI ELECTRIC EUROPE B.V. Czech Branch, Prague Office Pekarska 621/7, 155 00 Praha 5, Czech Republic</p>	<p>Tel : +420-255-719-200</p>
Poland	<p>MITSUBISHI ELECTRIC EUROPE B.V. Polish Branch ul. Krakowska 48, 32-083 Balice, Poland</p>	<p>Tel : +48-12-347-65-00</p>
Sweden	<p>MITSUBISHI ELECTRIC EUROPE B.V. (Scandinavia) Hedvig Mollersgata 6, 223 55 Lund, Sweden</p>	<p>Tel : +46-8-625-10-00 Fax : +46-46-39-70-18</p>
Russia	<p>MITSUBISHI ELECTRIC (RUSSIA) LLC St. Petersburg Branch Piskarevsky pr. 2, bld 2, lit "Sch", BC "Benua", office 720; 195027 St. Petersburg, Russia</p>	<p>Tel : +7-812-633-3497 Fax : +7-812-633-3499</p>
Turkey	<p>MITSUBISHI ELECTRIC TURKEY A.S. Umraniye Branch Serifali Mah. Kale Sok. No:41 34775 Umraniye - Istanbul, Turkey</p>	<p>Tel : +90-216-969-2500 Fax : +90-216-661-4447</p>
UAE	<p>MITSUBISHI ELECTRIC EUROPE B.V. Dubai Branch Dubai Silicon Oasis, P.O.BOX 341241, Dubai, U.A.E.</p>	<p>Tel : +971-4-3724716 Fax : +971-4-3724721</p>
South Africa	<p>ADROIT TECHNOLOGIES 20 Waterford Office Park, 189 Witkoppen Road, Fourways, South Africa</p>	<p>Tel : +27-11-658-8100 Fax : +27-11-658-8101</p>
China	<p>MITSUBISHI ELECTRIC AUTOMATION (CHINA) LTD. Mitsubishi Electric Automation Center, No.1386 Hongqiao Road, Shanghai, China</p>	<p>Tel : +86-21-2322-3030 Fax : +86-21-2322-3000</p>
Taiwan	<p>SETSUYO ENTERPRISE CO., LTD. 6F, No.105, Wugong 3rd Road, Wugu District, New Taipei City 24889, Taiwan</p>	<p>Tel : +886-2-2299-2499 Fax : +886-2-2299-2509</p>
Korea	<p>MITSUBISHI ELECTRIC AUTOMATION KOREA CO., LTD. 7F to 9F, Gangseo Hangang Xi-tower A, 401, Yangcheon-ro, Gangseo-Gu, Seoul 07528, Korea</p>	<p>Tel : +82-2-3660-9569 Fax : +82-2-3664-8372</p>
Singapore	<p>MITSUBISHI ELECTRIC ASIA PTE. LTD. 307 Alexandra Road, Mitsubishi Electric Building, Singapore 159943</p>	<p>Tel : +65-6473-2308 Fax : +65-6476-7439</p>
Thailand	<p>MITSUBISHI ELECTRIC FACTORY AUTOMATION (THAILAND) CO., LTD. 12th Floor, SV.City Building, Office Tower 1, No. 896/19 and 20 Rama 3 Road, Kwaeng Bangpongpan, Khet Yannawa, Bangkok 10120, Thailand</p>	<p>Tel : +66-2682-6522-31 Fax : +66-2682-6020</p>
Vietnam	<p>MITSUBISHI ELECTRIC VIETNAM COMPANY LIMITED Unit 01-04, 10th Floor, Vincom Center, 72 Le Thanh Ton Street, District 1, Ho Chi Minh City, Vietnam</p>	<p>Tel : +84-28-3910-5945 Fax : +84-28-3910-5947</p>
Indonesia	<p>PT. MITSUBISHI ELECTRIC INDONESIA Gedung Jaya 8th Floor, JL. MH. Thamrin No.12, Jakarta Pusat 10340, Indonesia</p>	<p>Tel : +62-21-31926461 Fax : +62-21-31923942</p>
India	<p>MITSUBISHI ELECTRIC INDIA PVT. LTD. Pune Branch Emerald House, EL-3, J Block, M.I.D.C., Bhosari, Pune-411026, Maharashtra, India</p>	<p>Tel : +91-20-2710-2000 Fax : +91-20-2710-2100</p>
Australia	<p>MITSUBISHI ELECTRIC AUSTRALIA PTY. LTD. 348 Victoria Road, P.O. Box 11, Rydalmere, N.S.W 2116, Australia</p>	<p>Tel : +61-2-9684-7777 Fax : +61-2-9684-7245</p>

MITSUBISHI ELECTRIC CORPORATION
 HEAD OFFICE: TOKYO BLDG., 2-7-3, MARUNOUCHI, CHIYODA-KU, TOKYO 100-8310, JAPAN
www.MitsubishiElectric.com