

FATEC

**Mitsubishi Programmable Controllers
Training Manual
QD77 Positioning (Simple Motion)**

● SAFETY PRECAUTION ●

(Always read these instructions before using the products.)

When designing the system, always read the relevant manuals and give sufficient consideration to safety.

During the exercise, pay full attention to the following points and handle the product correctly.

[EXERCISE PRECAUTIONS]

WARNING

- Do not touch the terminals while the power is on to prevent electric shock.
- Before opening the safety cover, make sure to turn off the power or ensure the safety.
- Do not touch the movable parts.

CAUTION

- Follow the instructor's directions during the exercise.
- Do not remove the module from the demonstration machine/kit or change wirings without permission. Doing so may cause failures, malfunctions, personal injuries and/or a fire.
- Turn off the power before installing or removing the module. Failure to do so may result in malfunctions of the module or electric shock.
- When the demonstration machine (such as X/Y table) emits abnormal odor/sound, press "Power switch" or "Emergency switch" to turn off the system.
- When a problem occurs, notify the instructor as soon as possible.

REVISIONS

*The textbook number is written at the bottom left of the back cover.

Print date	*Textbook number	Revision
Mar., 2015	SH-030228ENG-A	First edition

This textbook confers no industrial property rights or any rights of any other kind, nor does it confer any patent licenses. Mitsubishi Electric Corporation cannot be held responsible for any problems involving industrial property rights which may occur as a result of using the contents noted in this textbook.

CONTENTS

CHAPTER 1	About the demonstration machine used at this training	1- 1 to 1- 4
1.1	Device configuration of the demonstration machine	1- 1
1.1.1	Device configuration to perform positioning control with the SSCNET III/H method	1- 2
1.2	Device configuration of the X-Y table module	1- 3
CHAPTER 2	Purposes and applications of positioning control	2- 1 to 2-22
2.1	What is positioning control	2- 1
2.2	Mechanism of positioning control	2- 5
2.2.1	Outline design of positioning system	2- 6
2.3	Flow of system operation	2- 8
2.3.1	Flow of all processes	2- 8
2.3.2	Outline of starting	2-10
2.3.3	Outline of stopping	2-12
2.3.4	Outline for restarting	2-14
2.4	General image of system	2-16
2.5	Component list	2-19
2.6	Applicable system	2-21
CHAPTER 3	Specifications and functions	3- 1 to 3-32
3.1	Performance specifications	3- 1
3.2	Main features of the QD77MS simple motion module	3- 3
3.3	List of functions	3- 6
3.3.1	Control functions	3- 6
3.3.2	Main functions	3- 8
3.3.3	Sub functions, common functions	3-10
3.4	Specifications of input/output signals between the PLC CPU	3-13
3.4.1	Specifications for input/output signals between the PLC CPU	3-13
3.5	I/O interfaces with external devices	3-21
3.5.1	I/O interface signals	3-23
3.6	Buffer memory	3-26
3.6.1	Buffer memory configuration	3-26
3.6.2	Description of commonly used buffer memory areas	3-28

4.1	Parameters	4- 5
4.1.1	Basic parameters	4- 5
4.1.2	Detailed parameters	4-11
4.2	OPR parameters	4-24
4.2.1	OPR basic parameters	4-24
4.2.2	OPR detailed parameters	4-30
4.2.3	Expansion parameters	4-33
4.3	Servo parameters	4-34
4.3.1	Servo amplifier series	4-34
4.3.2	Basic setting	4-34
4.3.3	Gain/filter setting	4-40
4.3.4	Extension setting	4-51
4.3.5	I/O setting	4-56
4.3.6	Extension setting 2	4-59
4.3.7	Extension setting 3	4-61
4.4	Positioning data	4-63
4.4.1	Linear control	4-71
4.4.2	Fixed-feed	4-72
4.4.3	Circular interpolation with a specified sub point	4-73
4.4.4	Circular interpolation control with center point designation	4-74
4.4.5	Speed control	4-75
4.4.6	Speed-position switching control	4-76
4.4.7	Position-speed switching control	4-77
4.4.8	NOP instruction	4-78
4.4.9	Changing the current value	4-79
4.4.10	JUMP instruction	4-80
4.4.11	LEND control from LOOP	4-81

5.1	System configuration of the demonstration machine	5- 1
5.2	Assignment of devices used for training	5- 3
5.3	GX Works2 startup and shutdown Comparison Operation Instruction	5- 4
5.3.1	Startup operation	5- 4
5.3.2	Automatic refresh setting	5- 8
5.3.3	Shutdown operation	5-10
5.4	Specifying the connecting CPU Arithmetic Operation Instruction	5-11
5.5	Positioning training using the test operation function (QD77MS2)	5-14
5.5.1	Setting of the servo amplifier series, the basic parameters, and the basic parameters for the home position return	5-15
5.5.2	Setting the positioning data	5-19
5.5.3	Simulation	5-20
5.5.4	Saving the simple motion module project	5-20
5.5.5	Writing data to the QD77MS	5-22
5.5.6	Test operations and monitoring	5-23

**CHAPTER 6 Training (2) Single-axis positioning operation with the sequence program
(QD77MS2)**

6- 1 to 6-42

6.1	Positioning system used for training	6- 1
6.2	Opening the QD77MS project	6- 2
6.3	Writing data to the QD77MS	6- 6
6.4	Simple sequence program	6- 9
6.5	Exercise (4) JOG operation	6-11
6.6	Sample sequence program	6-12
6.6.1	PLC READY	6-13
6.6.2	Error code displays and resetting errors	6-13
6.6.3	Reading the current value of axis 1	6-14
6.6.4	Axis 1 JOG operation and manual pulser operation	6-15
6.6.5	Axis 1 home position return	6-17
6.6.6	Starting the positioning data	6-18
6.6.7	Multiple points continuous positioning	6-20
6.6.8	Multi-point positioning with speed switching	6-21
6.6.9	Stopping during operation	6-22
6.6.10	Restarting after stopping	6-23
6.6.11	Changing speed during the positioning operation	6-24
6.6.12	Setting addresses with digital switches	6-25
6.6.13	Teaching playback	6-26
6.6.14	Specifying the speed and movement amount with digital switch	6-28
6.6.15	Fixed-feed	6-30
6.6.16	Speed control	6-31
6.6.17	Positioning using M codes	6-33
6.6.18	Sequence program summary	6-37
6.7	Monitoring buffer memory with GX Works2	6-42

**CHAPTER 7 Training (3) 2-axis positioning operation with the sequence program
(QD77MS2)**

7- 1 to 7-41

7.1	Positioning operation system with XY axes control (SSCNET III/H)	7- 1
7.2	Axis 1 and axis 2 parameters and OPR parameters	7- 5
7.3	Sequence program for 2-axis control	7- 7
7.4	Positioning to the waiting point by independent operation of each axis	7-12
7.5	Interpolation operation (Axis 1/axis 2)	7-14
7.6	2-axis positioning operation using a path plate	7-16
7.6.1	Exercise (1) Continuous positioning to the waiting point by independent operation of each axis → Interpolation operation 1	7-17
7.6.2	Exercise (2) Interpolation operation 2	7-21
7.6.3	Exercise (3) Circular interpolation operation 1	7-24
7.6.4	Exercise (4) Circular interpolation operation 2	7-27
7.6.5	Exercise (5) Continuous positioning operation 1	7-34
7.6.6	Exercise (6) Continuous positioning operation 2	7-38

CHAPTER 8 Training (4) Synchronous operations with the sequence program
(QD77MS2)

8- 1 to 8-34

8.1	Outline of synchronous control	8- 1
8.1.1	Synchronous control module	8- 2
8.1.2	List of synchronous control module	8- 2
8.2	Synchronous operation system with an X-axis roller and a Y-axis cam	8-16
8.3	Creating cam data	8-17
8.4	Sequence program of the synchronous operation	8-23
8.4.1	Editing the servo input axis parameters	8-25
8.4.2	Editing synchronous control parameters	8-26
8.4.3	Writing data to the QD77MS2	8-28
8.5	Demonstration machine operations	8-31

APPENDIX

App.- 1 to App.- 49

Appendix 1	Precautions when performing maintenance of the QD75/QD77MS	App.- 1
Appendix 2	Intelligent function module device Special Relay	App.- 2
Appendix 3	Dedicated instructions Special Register	App.- 3
Appendix 3.1	PSTRT1,PSTRT2,PSTRT3,PSTRT4	App.- 6
Appendix 3.2	TEACH1,TEACH2,TEACH3,TEACH4	App.-10
Appendix 3.3	PFWRT	App.-13
Appendix 4	Pulse control	App.-16
Appendix 4.1	Positioning mechanism by the pulse control	App.-16
Appendix 4.2	General design of the positioning system using the pulse control	App.-18
Appendix 4.3	Comparison with the pulse control (QD75P□N/QD75D□N) and SSCNET III/H (QD77MS)	App.-20
Appendix 5	Specifications and functions of the QD75 positioning module	App.-21
Appendix 5.1	Performance specifications	App.-21
Appendix 5.2	Main features of the QD75 positioning module	App.-23
Appendix 6	Servomotor specifications	App.-26
Appendix 7	Parameter settings of the servo amplifier (MR-J4-A) used in this training	App.-27
Appendix 8	List of block start data	App.-28
Appendix 9	List of condition data	App.-33
Appendix 10	Precautions for the replacement of the QD75D□ with the QD75D□N	App.-41
Appendix 11	MELSEC Explanation of positioning terms	App.-43

INTRODUCTION

This is the training textbook to help you easily understand single-axis control and multi-axis control using the MELSEC-Q series positioning module and the simple motion unit.

Contents include information to help you understand the features of the positioning module and the simple motion unit as well as descriptions on how to configure data for positioning, create sequence programs, monitor, and test using the QD77MS2 simple motion module and GX Works2 demonstration machine.

However, advanced positioning controls (such as the block operation start) are not described, so please refer to the User's Manuals when using these controls.

The related manuals are shown below.

- (1) Simple Motion Module User's Manuals
 - MELSEC-Q QD77MS Simple Motion Module User's Manual
(Positioning Control)..... IB-0300185
 - MELSEC-Q/L QD77MS/QD77GF/LD77MS/LD77MH Simple Motion Module
User's Manual (Synchronous Control) IB-0300174
- (2) Operating Manuals
 - GX Works2 Version 1 Operating Manual (Common) SH-080779ENG
 - GX Works2 Version 1 Operating Manual (Simple Project)..... SH-080780ENG
 - GX Works2 Version 1 Operating Manual
(Intelligent Function Module)..... SH-080921ENG
- (3) QCPU User's Manual
 - QnUCPU User's Manual
(Function Explanation, Program Fundamentals) SH-080807ENG
- (4) Servo related Manual
 - MR-J4-_A(-RJ) SERVO AMPLIFIER INSTRUCTION MANUAL
..... SH-030107
 - MR-J4-_B(-RJ) SERVO AMPLIFIER INSTRUCTION MANUAL
..... SH-030106
 - MELSERVO-J4 Servo amplifier INSTRUCTION MANUAL
TROUBLE SHOOTING SH-030109
 - HG-MR/HG-KR/HG-SR/HG-JR/HG-RR/HG-UR SERVO MOTOR
INSTRUCTION MANUAL (Vol.3)..... SH-030113

How to read this manual

(1) Icons

Descriptions for the QD77MS simple motion module are used through this textbook.

Icons are used to illustrate specified functions and features of each axis control module.

*Icons are not used for common components.

QD77MS2: Functions/features for only the QD77MS simple motion module (2-axis module).

QD77MS4: Functions/features for only the QD77MS simple motion module (4-axis module).

QD77MS16: Functions/features for only the QD77MS simple motion module (16-axis module).

(2) Reference icons

Reference: Reference describing detailed content.

(3) Bookmarks

This textbook contains bookmarks for "Operation start summary", "Buffer memory", "Parameters", and "Positioning data".

This allows you to find the desired location without checking the table of contents when confirming details on content.

CHAPTER 1 About the demonstration machine used at this training

1.1 Device configuration of the demonstration machine

The following five modules make up the positioning control demonstration machine. Use a suitable combination in accordance with the control method.

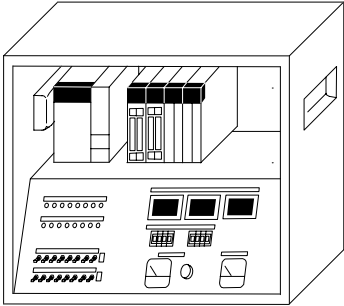
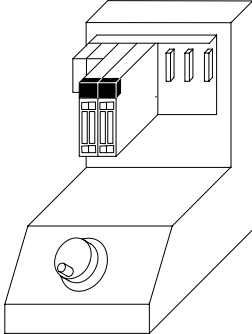
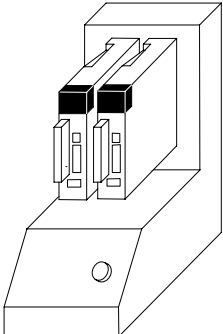
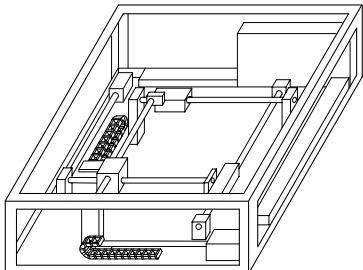
Module Name	External View	Overview
Q PLC demonstration machine		<p>This is the Q PLC demonstration machine equipped with the Q06UD(E)HCPU.</p> <p>An I/O panel, which is equipped with an input switch and an output lamp, is mounted on the bottom.</p>
QD77MS simple motion module		<p>This is an additional module equipped with the QD77MS simple motion module.</p> <ul style="list-style-type: none"> • QD77MS2: This is an additional module for controlling the servo amplifier by the SSCNET III/H method.
MR-J4-B servo module		<p>This is a module equipped with the "MR-J4-B" servo amplifier controlled by the SSCNET III/H communication method.</p>
X-Y table module		<p>This is an X-Y table module equipped with two "ball screw" axes.</p> <p>"Ball screw" is the typical mechanism used in the positioning control. At this training, trainees will learn the single-axis control and the interpolation control between two axes.</p>

1.1.1 Device configuration to perform positioning control with the SSCNET III/H method

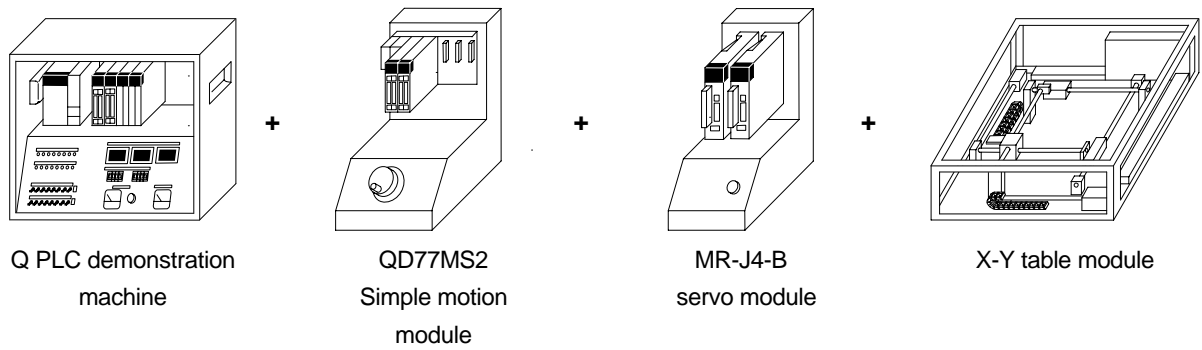

Chapter 5 through 8 describe about the training.

- SSCNET III/H method QD77MS2
 - Chapter 5: Test operations with GX Works2
 - Chapter 6: 1-axis positioning operations with a sequence program
 - Chapter 7: 2-axis positioning operations with a sequence program
 - Chapter 8: Synchronization operations with a sequence program

1.2 Device configuration of the X-Y table module

This section describes each part and function of the X-Y table module.

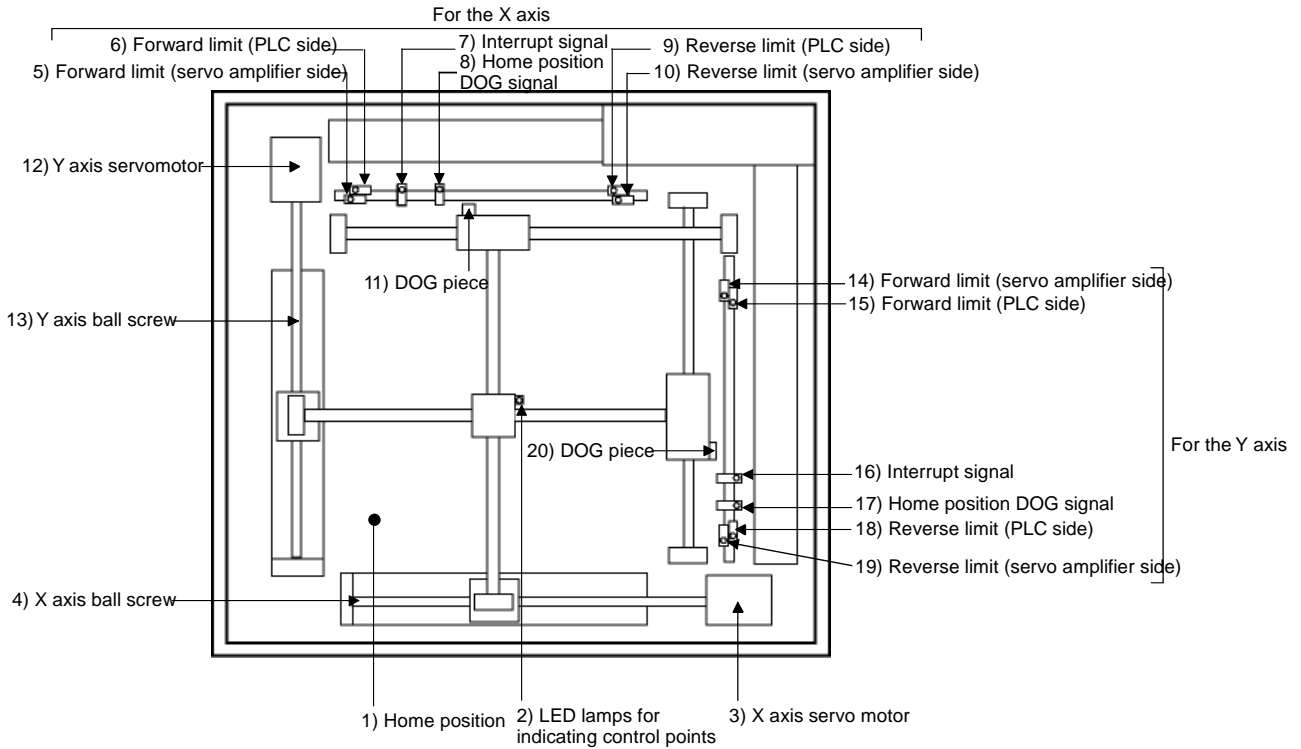

Operational checks are performed by installing the "track plate" according to the training object to the control frame on the front.

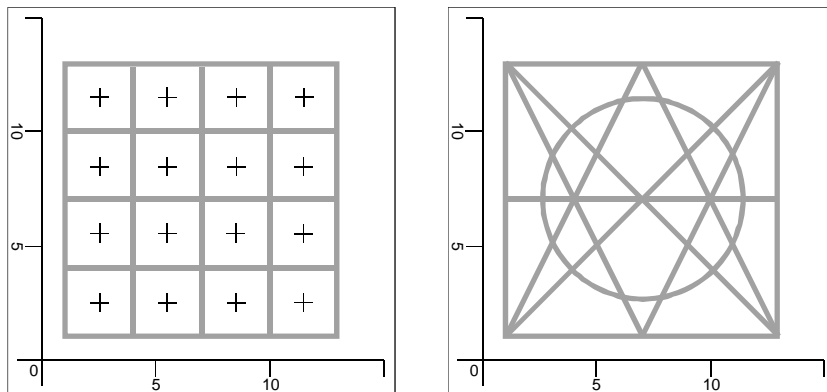

Name		Function
Common	1) Home position	The 0-point position for the X axis and Y axis when performing the home position return operation using a home position DOG signal.
	2) LED lamps indicating the control points	When performing the home position return operation, the position of this LED lamp will move to the 0 point, which is the home position. When performing positioning operations, the LED position is controlled to the target position.
X axis	3) X axis servo motor	This is the servo motor that drives the X axis (movement in the horizontal direction) ball screw, and it is connected to the MR-J4 servo amplifier.
	4) X axis ball screw	The ball screw that moves the LED lamp in the horizontal direction. When the servomotor rotates forward, it operates in the + direction (side with an address increment) moving the LED lamp 2 mm for every rotation of the motor.
	5) Forward limit (servo amplifier side)	This is a limit switch connected to the servo amplifier that prevents overrun when the PLC limit switch does not operate and damage to the mechanical system due to workpiece collisions.
	6) Forward limit (PLC side)	This is a limit switch connected to the PLC that controls the workpiece within the maximum travel range. Workpiece is forcibly stopped when the operation exceeds this control range.
	7) Interrupt signal	A signal used in the training of a positioning controller which has the interrupt operation function
	8) Home position DOG signal	A sensor for the target home position when performing the "home position return" operation for the X axis (movement in the horizontal direction). The position when the DOG sensor is off is the 0-point position.
	9) Reverse limit (PLC side)	Same as 6)
	10) Reverse limit (servo amplifier side)	Same as 5)
	11) DOG piece	A metal piece used to operate proximity switches such as the home position DOG signal and the limit switches.
Y axis	12) Y axis servomotor	This is the servo motor that drives the Y axis (movement in the vertical direction) ball screw, and it is connected to the MR-J4 servo amplifier.
	13) Y axis ball screw	The ball screw that moves the LED lamp in the horizontal direction. When the servomotor rotates forward, it operates in the + direction (side with an address increment) moving the LED lamp 2 mm for every rotation of the motor.
	14) Forward limit (servo amplifier side)	This is a limit switch connected to the servo amplifier that prevents overrun when the PLC limit switch does not operate and damage to the mechanical system due to workpiece collisions.
	15) Forward limit (PLC side)	This is a limit switch connected to the PLC that controls the workpiece within the maximum travel range. Workpiece is forcibly stopped when the operation exceeds this control range.
	16) Interrupt signal	A signal used in training of a positioning controller which has the interrupt operation function
	17) Home position DOG signal	Sensor for the target home position when performing the "home position return" operation for the Y axis (movement in the vertical direction). A position where the DOG sensor turns off is the 0-point position.
	18) Reverse limit (PLC side)	Same as 15)
	19) Reverse limit (servo amplifier side)	Same as 14)
20) DOG piece	A metal piece used to operate proximity switches such as the home position DOG signal and the limit switches.	

CHAPTER 2 Purposes and applications of positioning control

2.1 What is positioning control

The positioning control moves a moving body such as a workpiece or a tool (hereinafter referred to as "workpiece") at a specified rate and stops the movement precisely at the target position.

The control to move the workpiece to the target position stops according to the timer time and this can easily be accomplished by installing a sensor at the stop position. However, various problems may be encountered when calculating the stop position precisely or trying to stop the workpiece after moving it at high speed.

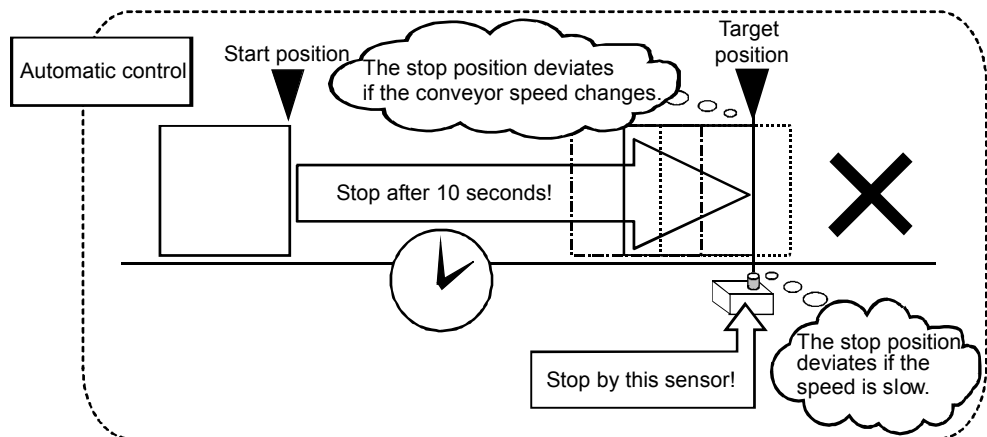
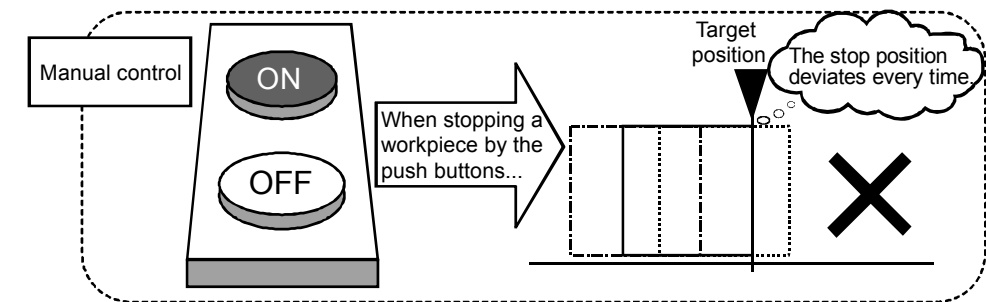

The "positioning", which trainees learn in this textbook to solve these problems, is **"moving the workpiece at high speed to the target position and stopping the workpiece precisely."**

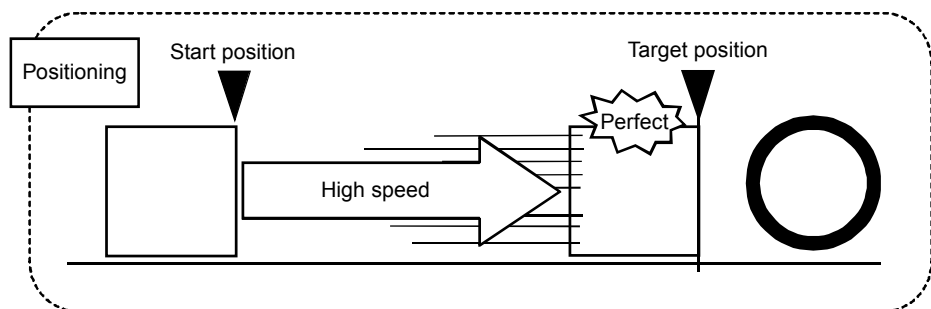

PLCs are often used for simple movement control that does not require stop precision such as those using timers and limit switches similar to that on the previous page.

By using the PLC's positioning function when high-precision stop control is required, the control of workpiece by moving it to the target position at high speed and stopping it precisely can be **precisely performed and repeated.**

Although it depends on the configuration of the device, this stopping precision can be controlled in units of micrometers.

- Applicable modules are necessary to perform the positioning control using the PLC's "positioning function." Outlines and roles of each module are as follows.
 1. Positioning controllers, which are responsible for the position control (PLC main units or positioning modules)
 2. Amplifier and drivers, which drive servomotors according to instructions received from a PLC
 3. Servomotors and stepping motors, which can precisely detect the rotation angle



1) Positioning controller

The positioning controller includes the PLC main units or additional modules with the positioning function for PLCs. These devices send necessary information for positioning to the servo amplifiers or the stepping motors driver.



2) Servo amplifiers or stepping motors driver

Based on the following instructions from the driver PLC:

- "which direction, forward or reverse" ... rotation direction instruction
- "how fast" ... speed instruction
- "until what position" ... position instruction

the rotation direction, the rotation speed, or the rotation amount is sent to the servomoto



3) Servomotor and stepping motors

These motors rotate in the target direction at the specified speed and stop at the specified position according to the details of the instructions from the servo amplifiers and the stepping motor drivers.

The following figures show the examples of typical applications.

■ Punch press (X, Y feed positioning)

- To punch insulation material or leather, etc., as the same shape at a high yield, positioning is carried out with the X axis and Y axis servos.
- After positioning the table with the X axis servo, the press head is positioned with the Y axis servo, and is then punched with the press.
- When the material type or shape changes, the press head die is changed, and the positioning pattern is changed.

■ Palletizer

- Using the servo for one axis, the palletizer is positioned at a high accuracy.
- The amount to lower the palletizer according to the material thickness is saved.

■ Compact machining center (ATC magazine positioning)

Rotation direction for calling 11, 12, 1, 2 or 3

Rotation direction for calling 17 to 20, 1 to 5

Rotation direction for calling 5, 6, 7, 8, 9 or 10

Rotation direction for calling 7 to 16

Current value retrieval position

Current value retrieval position

<Number of tools: 12> <Number of tools: 20>

- The ATC tool magazine for a compact machining center is positioned.
- The relation of the magazine's current value and target value is calculated, and positioning is carried out with forward run or reverse run to achieve the shortest access time.

■ Lifter

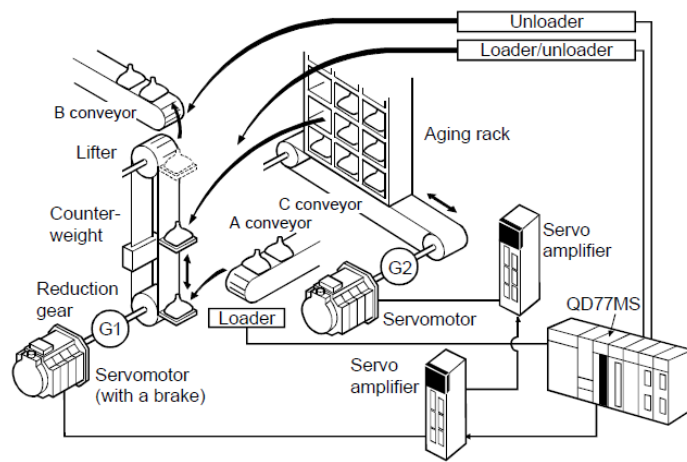

- During the aging process, storage onto the rack is carried out by positioning with the AC servo.
- The up/down positioning of the lifter is carried out with the 1-axis servo, and the horizontal position of the aging rack is positioned with the 2-axis servo.

■ Index table (High-accuracy indexing of angle)

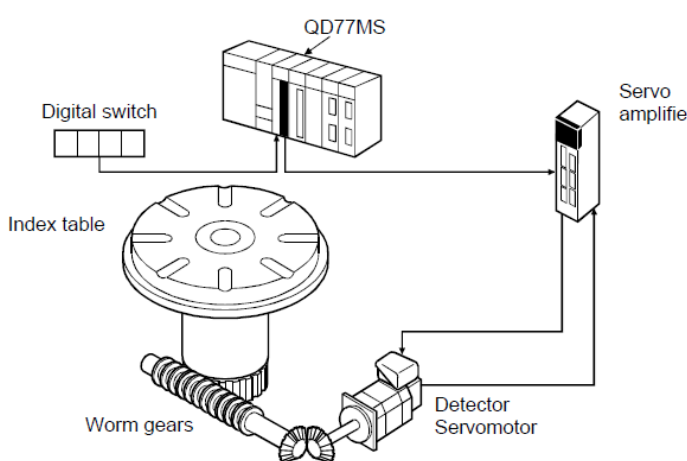

- The index table is positioned at a high accuracy using the 1-axis servo.

■ Inner surface grinder

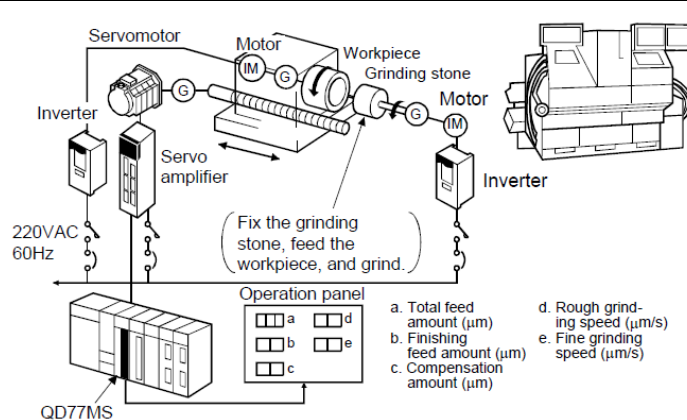

- The grinding of the workpiece's inner surface is controlled with the servo and inverter.
- The rotation of the workpiece is controlled with the 1-axis inverter, and the rotation of the grinding stone is controlled with the 2-axis inverter. The workpiece is fed and ground with the 3-axis servo.

2.2 Mechanism of positioning control

In the positioning system using QD77MS, various software and devices are used for the following roles.

QD77MS realizes complicated positioning control when it reads in various signals, parameters and data and is controlled with the PLC CPU.

(1) Positioning control using the QD77MS

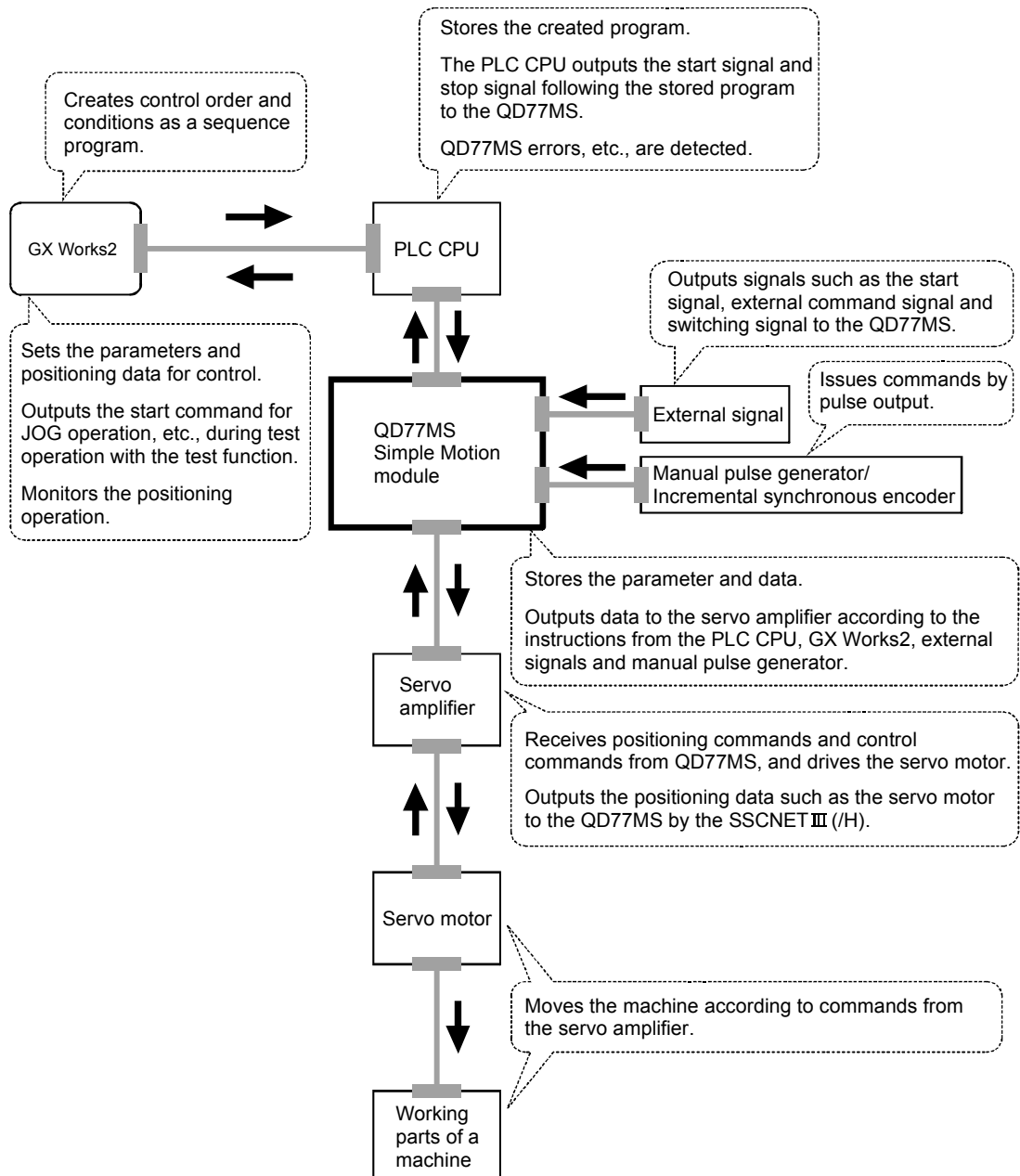

2.2.1 Outline design of positioning system

The following figure shows the overview of the design and operation of the positioning system.

(1) Movement amount and speed in a system using worm gears

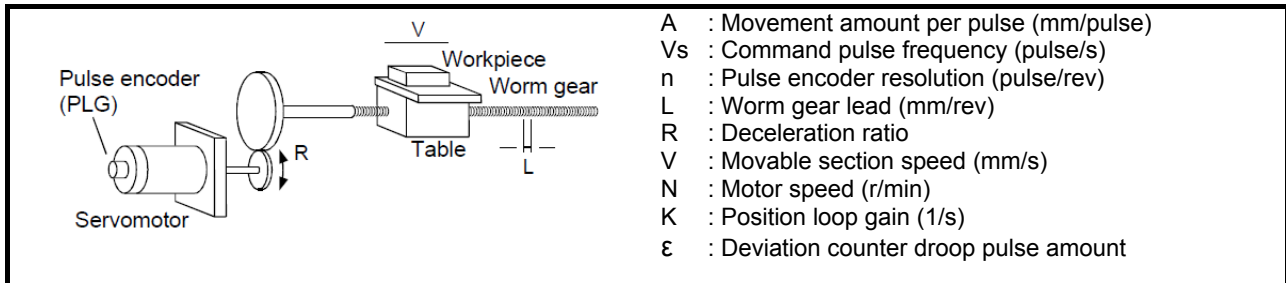

Fig. 1.1 System using worm gears

(a) In the system shown in Fig. 1.1, the movement amount per pulse, command pulse frequency, and the deviation counter droop pulse amount are determined as follows:

1) Movement amount per pulse

The movement amount per pulse is determined by the worm gear lead, deceleration ratio, and the pulse encoder resolution. The movement amount, therefore, is given as follows: (Number of pulses output) \times (Movement amount per pulse).

$$A = \frac{L}{R \times n} \text{ [mm/pulse]}$$

2) Command pulse frequency

The command pulse frequency is determined by the speed of the moving part and movement amount per pulse:

$$V_s = \frac{V}{A} \text{ [Pulse/s]}$$

3) Deviation counter droop pulse amount.

The deviation counter droop pulse amount is determined by the command pulse frequency and position loop gain.

$$\varepsilon = \frac{V_s}{K} \text{ [Pulse]}$$

(2) Positioning system using QD77MS

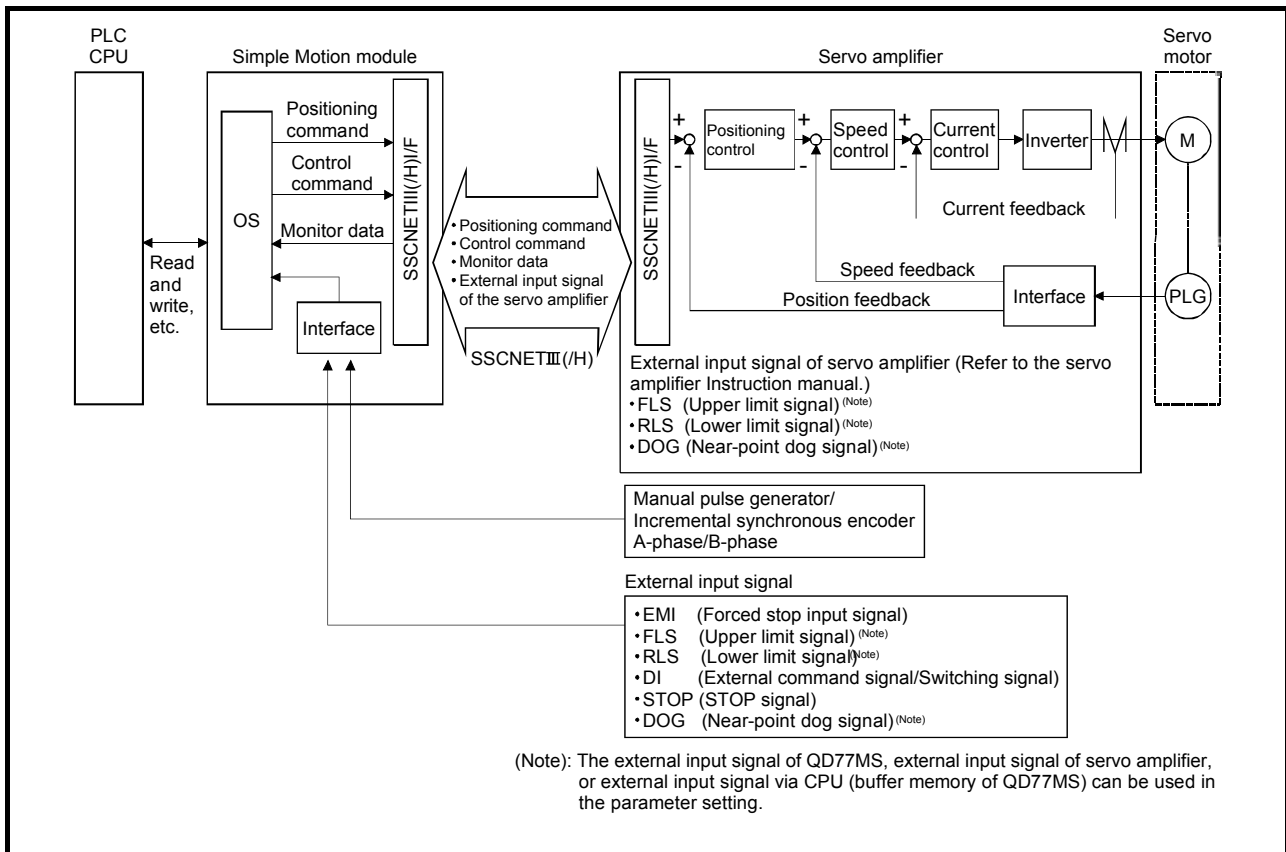
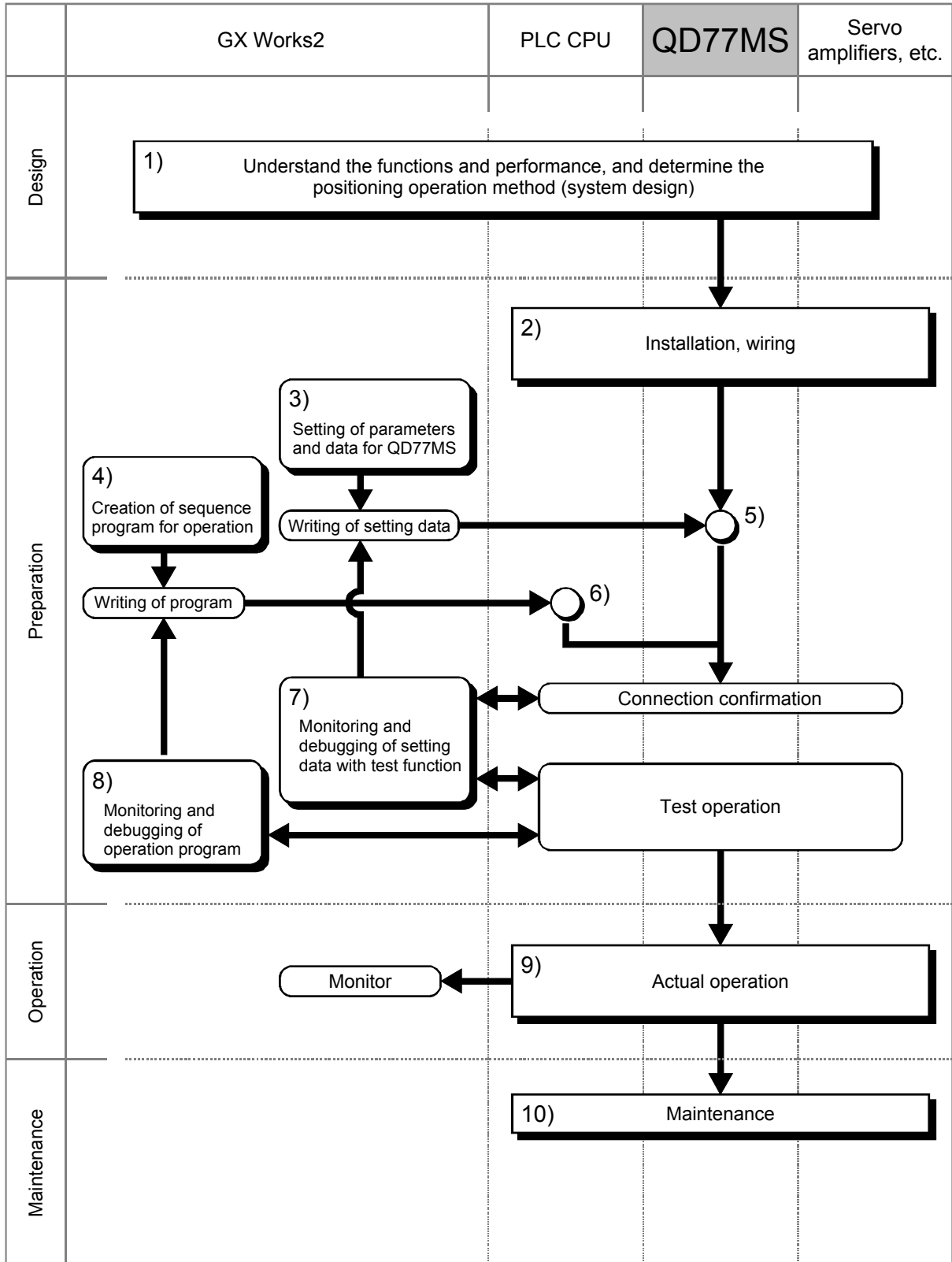

Fig. 1.2 Outline of the operation of positioning system using QD77MS

2.3 Flow of system operation

2.3.1 Flow of all processes

The positioning control processes, using QD77MS, are shown below.



The following works are performed at each process.

	Details	Reference
1)	Understand the product functions and usage methods, the configuration devices and specifications required for positioning control, and design the system.	<ul style="list-style-type: none"> ▪ QD77MS User's Manual
2)	Install QD77MS onto the base unit, wire QD77MS and external connection devices (servo amplifier, etc.) and wire the PLC CPU and peripheral devices.	<ul style="list-style-type: none"> ▪ QD77MS User's Manual
3)	Using GX Works2, set the servo parameters, parameter, positioning data, block start data and condition data required for the positioning control to be executed.	<ul style="list-style-type: none"> ▪ QD77MS User's Manual ▪ Simple Motion Module Setting Tool Help
4)	Using GX Works2, create the sequence program required for positioning operation.	<ul style="list-style-type: none"> ▪ QD77MS User's Manual ▪ GX Works2 Version1 Operating Manual (Common)
5)	Write the parameters and positioning data, etc., created with GX Works2 into QD77MS.	<ul style="list-style-type: none"> ▪ QD77MS User's Manual ▪ Simple Motion Module Setting Tool Help
6)	Using GX Works2, write the created sequence program into the PLC CPU.	<ul style="list-style-type: none"> ▪ QD77MS User's Manual ▪ GX Works2 Version1 Operating Manual (Common)
7)	Carry out test operation and adjustments in the test function of GX Works2 to check the connection with QD77MS and external connection device, and to confirm that the designated positioning operation is executed correctly. (Debug the set "parameters" and "positioning data", etc.)	<ul style="list-style-type: none"> ▪ QD77MS User's Manual ▪ Simple Motion Module Setting Tool Help
8)	Carry out test operation and adjustment to confirm that the designated positioning operation is executed correctly. (Debug the created sequence program.)	<ul style="list-style-type: none"> ▪ GX Works2 Version1 Operating Manual (Common)
9)	Actually operate the positioning operation. At this time, monitor the operation state as required. If an error or warning occurs, remedy.	<ul style="list-style-type: none"> ▪ QD77MS User's Manual ▪ Simple Motion Module Setting Tool Help ▪ GX Works2 Version1 Operating Manual (Common)
10)	Maintenance of QD77MS as required.	<ul style="list-style-type: none"> ▪ QD77MS User's Manual

2.3.2 Outline of starting

The outline for starting each control is shown with the following flowchart.

* It is assumed that each module is installed, and the required system configuration, etc., has been prepared.)

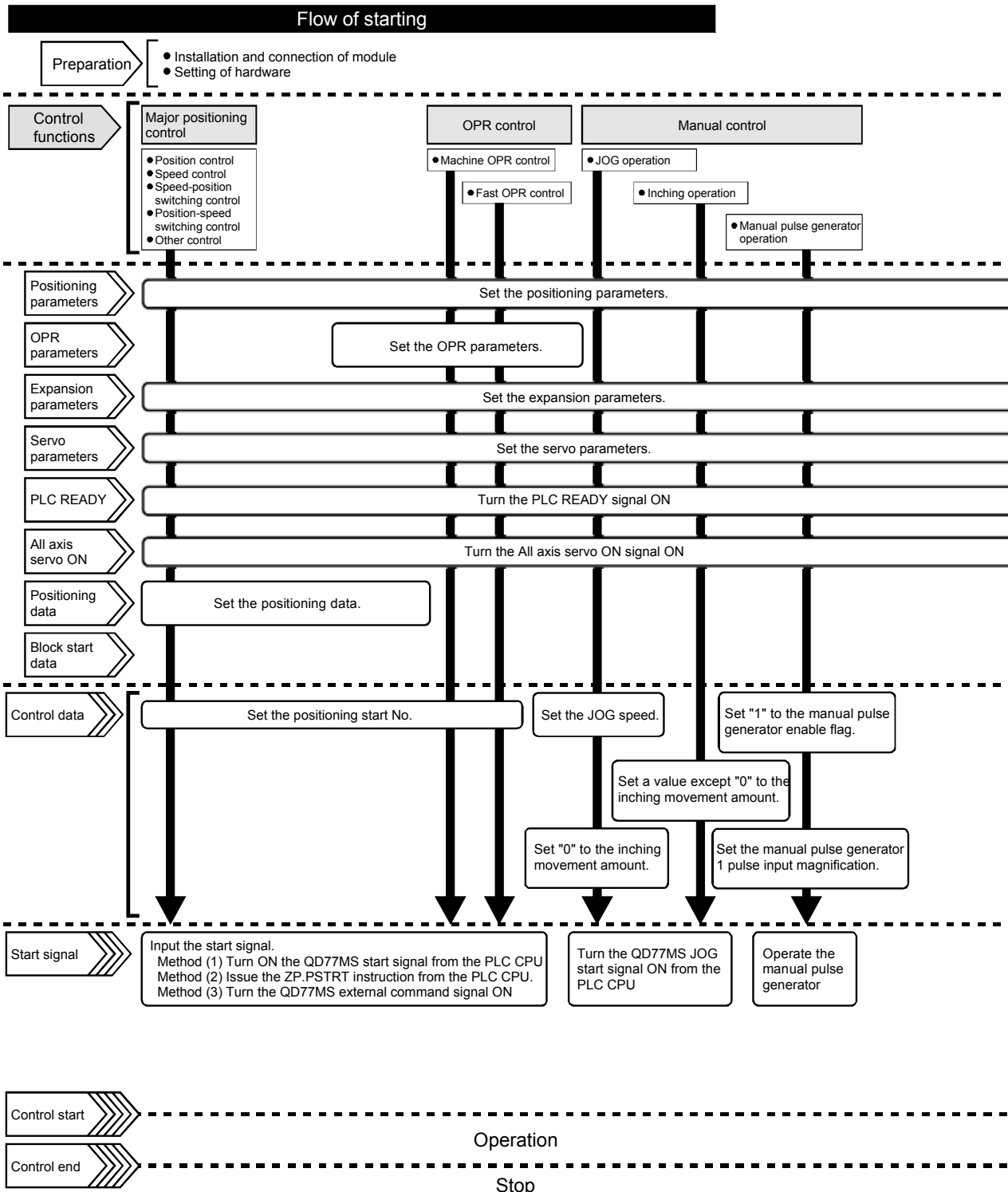

Setting method

 : Indicates the sequence program that must be created.

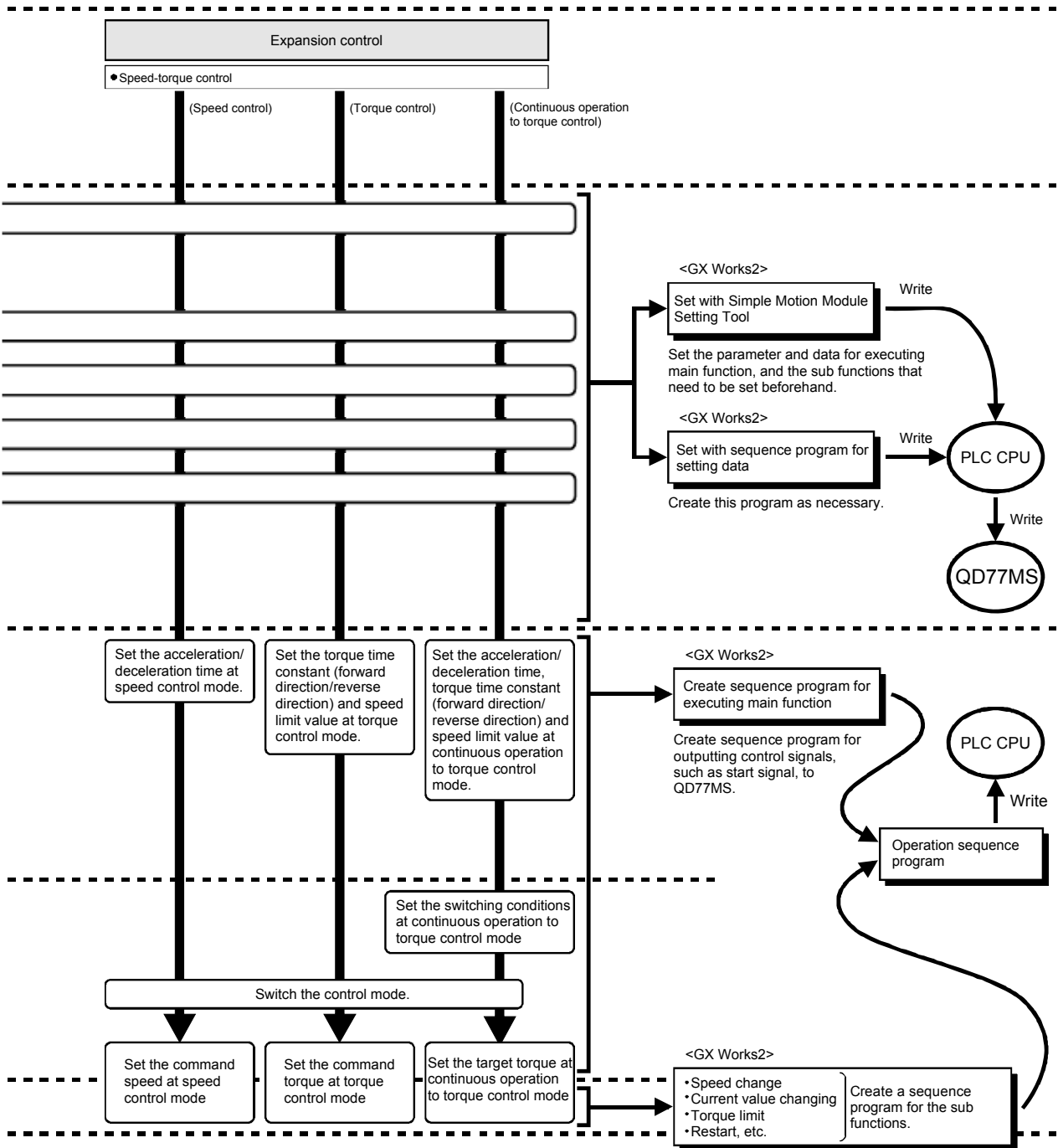

2.3.3 Outline of stopping

Each control is stopped in the following cases.

- (a) When each control is completed normally.
- (b) When the servo amplifier power supply OFF.
- (c) When a PLC CPU error occurs.
- (d) When the PLC READY signal is turned OFF.
- (e) When an error occurs in QD77MS.
- (f) When control is intentionally stopped (Stop signal from PLC CPU turned ON or Stop signal of external input signal turned ON, etc.).

The outline for the stopping process in these cases is shown below. (Excluding (a) for normal stopping.)

Stop cause		Stop axis	M code ON signal after stop	Axis operation status after stopping	Stop process					
					OPR control		Major positioning control	Positioning control	Manual control	
					Machine OPR control	Fast OPR control			JOG/inching operation	Manual pulse generator operation
Forced stop	"Forced stop input signal" OFF from an external device	All axes	No change	Servo OFF	Servo OFF or free run (The operation stops with dynamic brake.)					
	Servo READY OFF Servo amplifier power supply OFF	Each axis	No change	Servo amplifier has not been connected						
	Servo alarm			Error						
	Forced stop input to servo amplifier			Servo OFF						
Fatal stop (Stop group 1)	Hardware stroke limit upper/lower limit error occurrence	Each axis	No change	Error	Deceleration stop/sudden stop (Select with "Stop group 1 sudden stop selection".)				Deceleration stop	
Emergency stop (Stop group 2)	Error occurs in PLC CPU	All axes	No change	Error	Deceleration stop/sudden stop (Select with "Stop group 2 sudden stop selection".)				Deceleration stop	
	PLC READY signal OFF		Turns OFF							
	Error in test mode		No change							
Relatively safe stop (Stop group 3)	Axis error detection (Error other than stop group 1 or 2)* ¹	Each axis	No change	Error	Deceleration stop/sudden stop (Select with "Stop group 3 sudden stop selection".)				Deceleration stop	
	"Stop" input from GX Works2									
Intentional stop (Stop group 3)	"Axis stop signal" ON from PLC CPU	Each axis	No change	Stopped (Standby)						
	"Stop signal" of external input signal ON									

*1: If an error occurs in a positioning data due to an invalid setting value, when the continuous positioning control uses multiple positioning data successively, it automatically decelerates at the previous positioning data. It does not stop suddenly even the setting value is sudden stop in stop group 3. If any of the following error occurs, the operation is performed up to the positioning data immediately before the positioning data where an error occurred, and then stops immediately.

- No command speed (Error code 503)
- Outside linear movement amount range (Error code 504)
- Large arc error deviation (Error code 506)
- Software stroke limit + (Error code 507)
- Software stroke limit - (Error code 508)
- Sub point setting error (Error code 525)
- End point setting error (Error code 526)
- Center point setting error (Error code 527)
- Outside radius range (Error code 544)
- Illegal setting of ABS direction in unit of degree (Error code 546)

REMARK

Provide the emergency stop circuits outside the servo system to prevent cases where danger may result from abnormal operation of the overall system in the event of an external power supply fault or servo system failure.

2.3.4 Outline for restarting

When a stop cause has occurred during operation with position control causing the axis to stop, positioning to the end point of the positioning data can be restarted from the stopped position by using the "Restart command".

If issued during a continuous positioning or continuous path control operation, the restart command will cause the positioning to be re-executed using the current position (pointed by the positioning data No. associated with the moment when the movement was interrupted) as the start point.

■ When "Restart command" is ON

- (1) If the "Axis operation status" is stopped, positioning to the end point of the positioning data will be restarted from the stopped position regardless of the absolute system or incremental system.
- (2) When "Axis operation status" is not stopped, the warning "Restart not possible" (warning code: 104) will be applied, and the restart command will be ignored.

[Example for incremental system]

- (a) The restart operation when the axis 1 movement amount is 300 and the axis 2 movement amount is 600 is shown below.

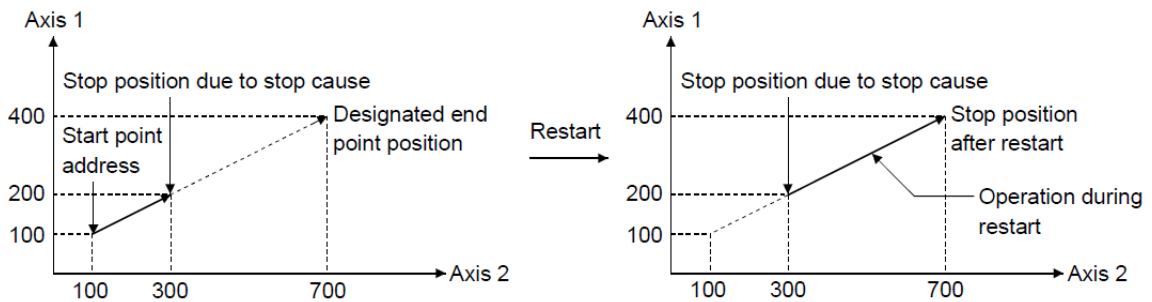

■ Reference

If the positioning start signal/external command signal is turned ON while the "Axis operation status" is standby or stopped, positioning will be restarted from the start of the positioning start data regardless of the absolute system or incremental system. (* When the external command signal is set to "External positioning start") (Same as normal positioning.)

[Example for incremental system]

- (a) The positioning start operation, which stops the positioning control while executing that the axis 1 movement amount is 300 and the axis 2 movement amount is 600, is shown below.

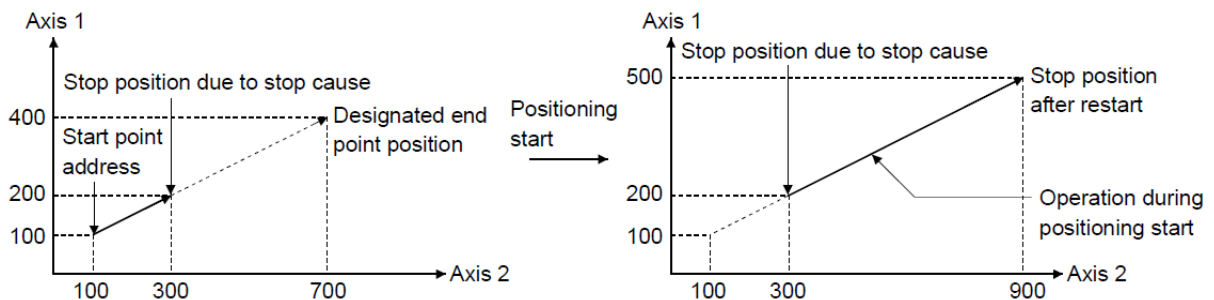

MEMO

2.4 General image of system

The general image of the system, including the QD77MS, CPU module and peripheral devices is shown below.

(The Numbers. in the illustration refers to the "No." in Section 2.5 "Component list".

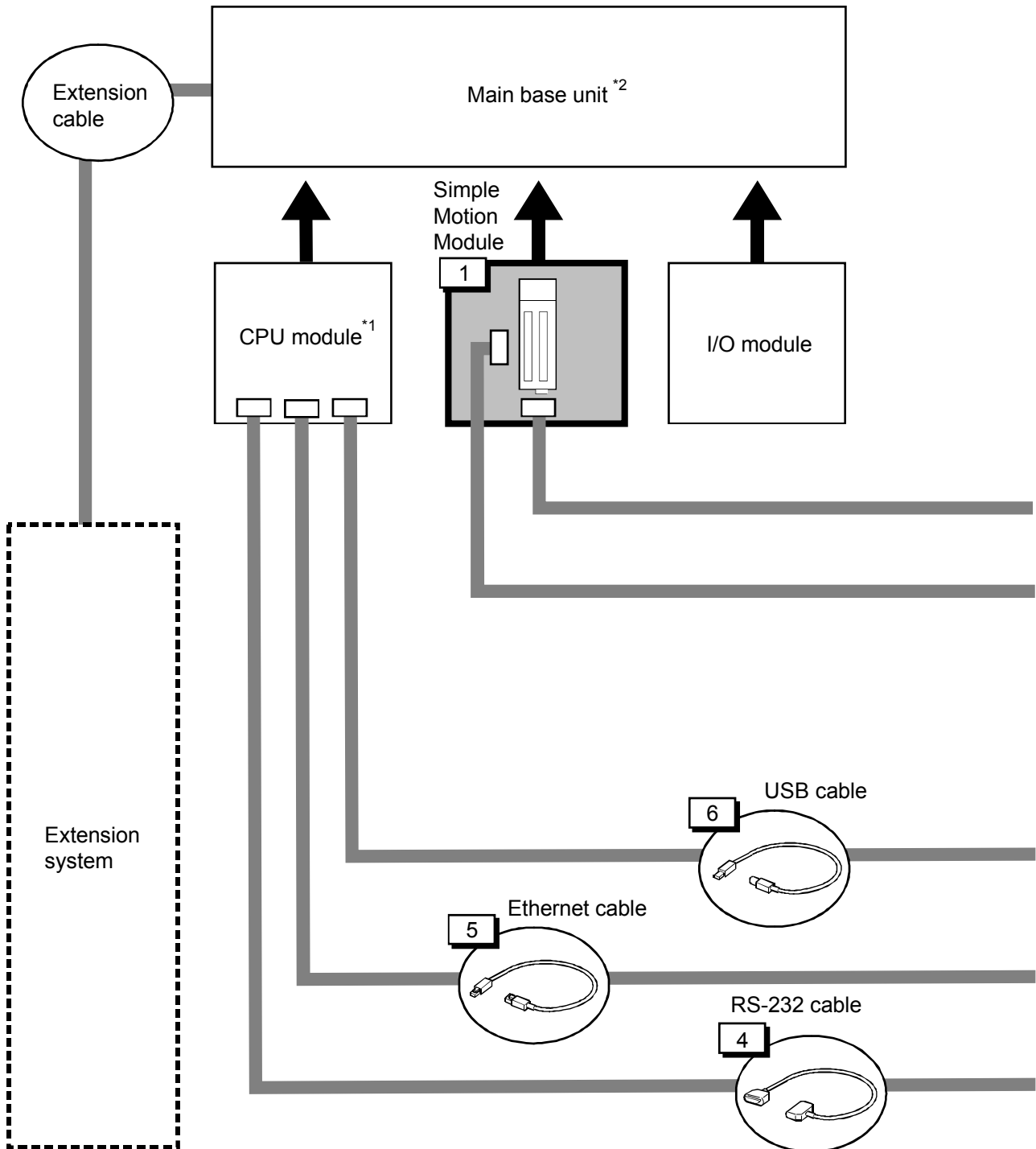

REMARK

*1: Refer to Section 2.6 "Applicable system" for the CPU modules that can be used.

*2: Refer to the CPU module User's Manual for the base units that can be used.

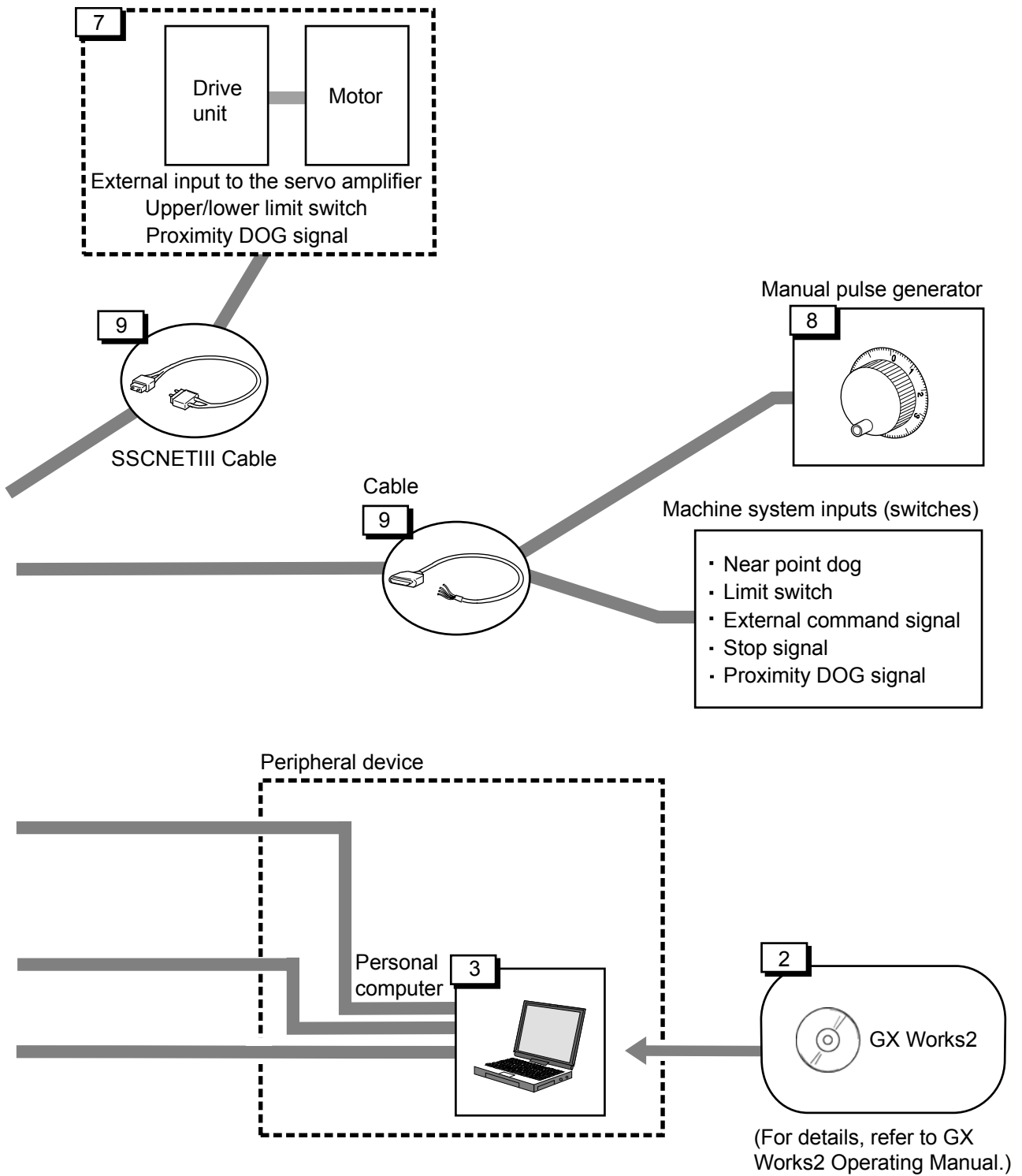

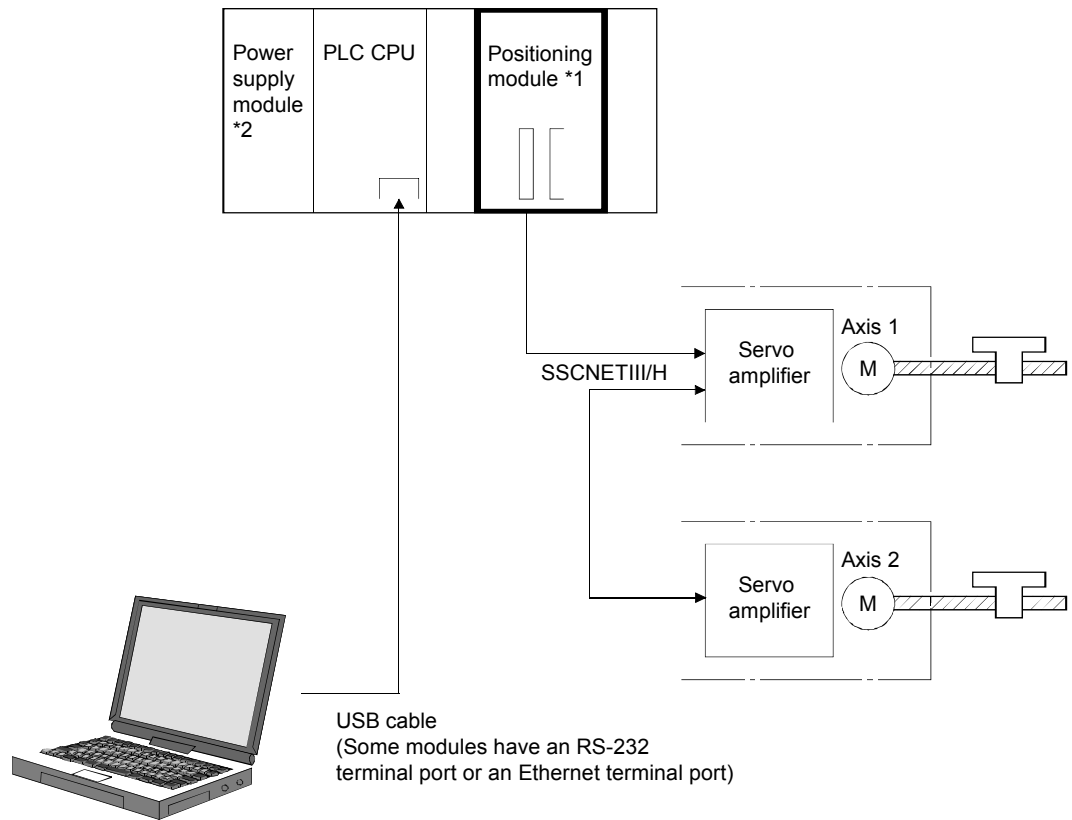

Peripheral device ... GX Works2
(Personal computer)

- *1: The illustration above shows an example of a 2-axis module (QD77MS2).
- *2: The capacity of the power supply module must be greater than the total power consumed internally by all the modules in the base unit and the additional base unit (without power supply).

2.5 Component list

The positioning system using the QD77MS is configured of the following devices.

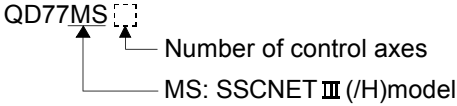
No.	Part name	Type	Remarks
1	Simple Motion module	QD77MS2 QD77MS4 QD77MS16	 <p>QD77MS□□</p> <p>Number of control axes</p> <p>MS: SSCNET III (H)model</p>
2	GX Works2	SW1DNC-GXW2-E	The software package for Windows 2000, Windows XP, Windows Vista, and Windows 7.
3	Personal computer	Personal computer which supports Windows®	Refer to the "GX Works2 Version1 Operating Manual" for details.
4	RS-232 cable	QC30R2	An RS-232 cable is needed for connecting the CPU module with a personal computer. Refer to the "GX Works2 Version1 Operating Manual" for details.
5	Ethernet cable	—	An Ethernet cable is needed for connecting the CPU module with a personal computer. Refer to the "GX Works2 Version1 Operating Manual (Common)" for details.
6	USB cable	—	A USB cable is needed for connecting the CPU module with a personal computer. Refer to the "GX Works2 Version1 Operating Manual" for details.
7	Drive unit	—	
8	Manual pulse generator	—	Recommended: MR-HDP01 (Mitsubishi Electric)
9	Cable*1,*2 (For the connection between the QD77 and the drive unit)	—	Cables are needed for connecting the QD77MS with an external device. (Prepare them referring to the manuals for the connected devices and information given in Section 3.4.)

*1: The SSCNETIII cable connecting the QD77MS and servo amplifier, or between servo amplifiers, external input signal connector has been prepared.

[SSCNETIII cable]

Model name		Cable length	Description
MR-J3BUS□M*3 (Standard cord for inside panel)	MR-J3BUS015M	0.15	<ul style="list-style-type: none"> ▪ QD77MS□MR-J4(W)-B/MR-J3(W)-B ▪ MR-J4(W)-B/MR-J3(W)-B□ MR-J4(W)-B/MR-J3(W)-B
	MR-J3BUS03M	0.3	
	MR-J3BUS05M	0.5	
	MR-J3BUS1M	1	
	MR-J3BUS3M	3	
MR-J3BUS□M-A*4 (Standard cable for outside panel)	MR-J3BUS5M-A	5	
	MR-J3BUS10M-A	10	
	MR-J3BUS20M-A	20	
MR-J3BUS□M-B*3 (Long distance cable)	MR-J3BUS30M-B	30	
	MR-J3BUS40M-B	40	
	MR-J3BUS50M-B	50	

*3: □ = Cable length

(015:0.15m, 03:0.3m, 05:0.5m, 1:1m, 3:3m, 5:5m, 10:10m, 20:20m, 30:30m, 40:40m, 50:50m)

[External input signal connect or]

Part name	Specification
Applicable connector	A6CON1, A6CON2, A6CON3, A6CON4 (Sold separately)
Applicable wire size	0.3mm ² (When A6CON1 and A6CON4 are used), AWG24 to AWG28 (When A6CON2 is used), AWG28 (twisted)/AWG30 (single wire) (When A6CON3 is used)

*2: Mitsubishi Electric System & Service Co., Ltd. provides the SSCNET III and SSCNET III/H cables to connect the QD77MS and the servo amplifier and among servo amplifiers.

[SSCNET III/H cable]

Model	Description
SC-J3BUS M-C	□ indicates the cable length. (in units of 1m) SSCNET III: Maximum of 50m SSCNET III/H: Maximum of 100m

Contact local sales office for the cables manufactured by Mitsubishi Electric System & Service Co., Ltd.

Refer to the following website for information about local Mitsubishi Electric System & Service Co., Ltd. sales office.

<http://www.melsc.co.jp/business/>

■ Specifications of recommended manual pulse generator

Item	Specification
Model name	MR-HDP01
Pulse resolution	25PLS/rev (100 PLS/rev after magnification by 4)
Output method	Voltage-output, Output current Max. 20mA
Power supply voltage	4.5 to 13.2VDC
Current consumption	60mA
Output level	"H" level : Power supply voltage*4 -1V or more (in no load) "L" level : 0.5V or less (with maximum leading-in)
Life time	1000000 revolutions (at 200r/min)
Permitted axial loads	Radial load: Max. 19.6N
	Thrust load: Max. 9.8N
Ambient temperature	-10 to 60°C
Weight	0.4kg
Number of max. revolution	Instantaneous Max. 600r/min. normal 200r/min
Pulse signal status	2 signals: A phase, B phase, 90° phase difference
Start friction torque	0.06N·m (20°C)

*4: When using separate power supplies for the QD77MS, use power supplies that provide a stable DC supply voltage of 5VDC ±0.25VDC.

2.6 Applicable system

The QD77MS can be used in the following system.

(1) Applicable modules and number of mountable modules

The following table shows the CPU modules and the network modules (for the remote I/O station), where the QD77MS can be mounted, and the number of mountable QD77MS modules.

(a) When mounted with a CPU module

Applicable CPU module		No. of modules *1	Base unit *2		
CPU type	CPU model		Main base unit	Extension base unit	
PLC CPU	Basic model QCPU	Q00JCPU	Up to 8 modules		
		Q00CPU	Up to 24 modules	○	○
		Q01CPU			
	High performance model QCPU	Q02CPU	Up to 64 modules	○	○
		Q02HCPU			
		Q06HCPU			
		Q12HCPU			
		Q25HCPU			
	Universal model QCPU	Q00UJCPU	Up to 16 modules	○	○
		Q00UCPU	Up to 24 modules	○	○
		Q01UCPU			
		Q02UCPU	Up to 36 modules		
		Q03UDCPU	Up to 64 modules		
		Q04UDHCPU			
		Q06UDHCPU			
		Q10UDHCPU			
		Q13UDHCPU			
		Q20UDHCPU			
		Q26UDHCPU			
		Q03UDECPU			
		Q04UDEHCPU			
		Q06UDEHCPU			
		Q10UDEHCPU			
		Q13UDEHCPU			
		Q20UDEHCPU			
		Q26UDEHCPU			
		Q50UDEHCPU			
	Q100UDEHCPU				
Safety PLC	QS001CPU	N/A		×	×

○: Applicable, ×: N/A

*1: Limited within the range of I/O points for the CPU module.

*2: Can be installed to any I/O slot of a base unit.

(b) Mounting to a MELSECNET/H remote I/O station

Applicable network module	No. of modules *1	Base unit *2	
		Main base unit of remote I/O station	Extension base unit of remote I/O station
QJ72LP25-25	Max. 64 modules	○	○
QJ72LP25G			
QJ72BR15			

○: Installation possible, ×: Installation not possible

*1: Within the I/O point range of network module only.

*2: It can be installed in any of the I/O slots of installable base unit.

REMARK

The basic model QCPU cannot configure the MELSECNET/H remote I/O network.

- (2) Compatibility with multiple PLC system
When using the QD77MS in a multiple PLC system, first refer to the QCPU User's Manual (multiple CPU system).
- (3) Programming tool compatible with the QD77MS
The applicable programming tool's versions of the QD77MS are shown below.
For the applicable programming tool's versions of the CPU module, refer to the "QCPU User's Manual (Hardware Design, Maintenance and Inspection)".

	Version	
	GX Works2	MR Configurator2
QD77MS2	Version 1.77F or later	Version 1.09K or later
QD77MS4		
QD77MS16		

REMARK

QD77MS cannot be supported with GX Developer, GX Configurator-QP and MR Configurator.
Use GX Works2 and MR Configurator2 to use QD77MS.

CHAPTER 3 Specifications and functions

3.1 Performance specifications

(1) QD77MS simple motion module



QD77MS2 QD77MS4 QD77MS16
SSCNETIII/H

Table 3.1 QD77MS Performance specifications

Model		QD77MS2	QD77MS4	QD77MS16
Item				
Number of control axes		2 axes	4 axes	16 axes
Interpolation function (Described in Chapter 7.)		2-axis linear interpolation, 2-axis circular interpolation	2-, 3-, or 4-axis linear interpolation, 2-axis circular interpolation	
Control system		PTP (Point To Point) control, path control (both linear and arc can be set), speed control, speed-position switching control, position-speed switching control, Speed-torque control		
Control unit		mm, inch, degree, PLS		
Positioning data		600 data/axis (Can be set with GX Works2 or sequence program.)		
Backup		Parameters, positioning data, and block start data can be saved on flash ROM (battery-less backup)		
Positioning	Positioning system	PTP control: Speed-position switching control: Position-speed switching control: Path control:	Incremental system/absolute system Incremental system/absolute system* ¹ Incremental system Incremental system/absolute system	
	Positioning range	<div style="border: 1px solid black; padding: 2px;">In absolute system</div> <ul style="list-style-type: none"> • -214748364.8 to 214748364.7 (μm) • -21474.83648 to 21474.83647 (inch) • 0 to 359.99999 (degree) • -2147483648 to 2147483647 (PLS) <div style="border: 1px solid black; padding: 2px;">In incremental system</div> <ul style="list-style-type: none"> • -214748364.8 to 214748364.7 (μm) • -21474.83648 to 21474.83647 (inch) • -21474.83648 to 21474.83647 (degree) • -2147483648 to 2147483647 (PLS) <div style="border: 1px solid black; padding: 2px;">In speed-position switching control (INC mode) / position-speed switching control</div> <ul style="list-style-type: none"> • 0 to 214748364.7 (μm) • 0 to 21474.83647 (inch) • 0 to 21474.83647 (degree) • 0 to 2147483647 (PLS) <div style="border: 1px solid black; padding: 2px;">In speed-position switching control (ABS mode)*¹</div> <ul style="list-style-type: none"> • 0 to 359.99999 (degree) 		
	Speed command	0.01 to 20000000.00(mm/min) 0.001 to 2000000.000(inch/min) 0.001 to 2000000.000(degree/min)* ² 1 to 1000000000(PLS/s)		
	Acceleration/ deceleration process	Trapezoidal acceleration/deceleration, S-curve acceleration/deceleration		

Table 3.1 QD77MS Performance specifications

Model		QD77MS2	QD77MS4	QD77MS16
Positioning	Acceleration/ deceleration time	1 to 8388608 (ms) Four patterns can be set for each of acceleration time and deceleration time		
	Sudden stop deceleration time	1 to 8388608 (ms)		
Starting time ^{*3}		0.88ms	0.88ms	0.88ms/1.77ms ^{*4}
1-axis linear control				
1-axis speed control				
2-axis linear interpolation control (Composite speed)				
2-axis linear interpolation control (Reference axis speed)				
2-axis circular interpolation control				
2-axis speed control				
3-axis linear interpolation control (Composite speed)				
3-axis linear interpolation control (Reference axis speed)				
3-axis speed control				
4-axis linear interpolation control				
4-axis speed control				
External wiring connection system		40-pin connector		
Applicable wire size		0.3mm ² (When A6CON1 and A6CON4 are used), AWG24 to AWG28 (When A6CON2 is used), AWG28 (twisted) /AWG30 (single wire) (When A6CON3 is used)		
Applicable connector for external input signal		A6CON1, A6CON2, A6CON3, A6CON4 (Sold separately)		
SSCNET III cable ^{*7}	MR-J3BUS□M ^{*5}	<ul style="list-style-type: none"> • QD77MS↔MR-J4(W)-B/MR-J3(W)-B/ MR-J4(W)-B/MR-J3(W)-B↔MR-J4(W)-B/MR-J3(W)-B • Standard cord for inside panel 0.15m, 0.3m, 0.5m, 1m, 3m 		
	MR-J3BUS□M-A ^{*5}	<ul style="list-style-type: none"> • QD77MS↔MR-J4(W)-B/MR-J3(W)-B/ MR-J4(W)-B/MR-J3(W)-B↔MR-J4(W)-B/MR-J3(W)-B • Standard cable for outside panel 5m, 10m, 20m 		
	MR-J3BUS□M-B ^{*5,*6}	<ul style="list-style-type: none"> • QD77MS↔MR-J4(W)-B/MR-J3(W)-B/ MR-J4(W)-B/MR-J3(W)-B↔MR-J4(W)-B/MR-J3(W)-B • Long distance cable 30m, 40m, 50m 		
5VDC internal current consumption		0.6A		0.75A
Number of occupied I/O points [points]		32 (I/O assignment: Intelligent function module 32 points)		
External dimensions [mm]		98(H)×27.4(W)×90(D)		
Mass [kg]		0.15		0.16

*1: In speed-position switching control (ABS mode), the control unit available is "degree" only.

*2: When "Speed control 10 x multiplier setting for degree axis function" is valid, this will be the setting range 0.01 to 20000000.00 (degree/min).

*3: Time from accepting the positioning start signal until BUSY signal turns ON.

*4: The initial value is 1.77ms. Confirm the calculation time as necessary and change to 0.88ms.

*5: □ = Cable length

(015:0.15m, 03:0.3m, 05:0.5m, 1:1m, 3:3m, 5:5m, 10:10m, 20:20m, 30:30m, 40:40m, 50:50m)

*6: For the cable of less than 30m, contact your nearest Mitsubishi sales representative.

*7: Contact local Mitsubishi Electric System & Service Co., Ltd. sales office for details of the ultra-long bending fiber optic cable up to 100m (Refer to Chapter 2.6).

3.2 Main features of the QD77MS simple motion module

- (1) High-speed starting time
High-speed starting time "0.88ms" (QD77MS4 use) during positioning control is achieved.
(QD77MS16 use: 0.88/1.77ms)
- (2) Wide variety of positioning control functions
The main functions (such as OPR control, positioning control and manual control) which are required for any positioning system and the sub functions which limit and add functions to those controls are supported.
 - (a) Enhanced OPR control
 - 1) Additional features of OPR control
Five machine OPR methods are provided: one near-point dog method, two count methods, one data set method and one scale origin signal detection method. Select an applicable method according to the system.
 - 2) OPR retry function
The OPR retry function is provided so that the machine OPR control can be performed from any position, regardless of the machine stop position when the system is powered on.
 - (b) Wide variety of control methods
Positioning controls, such as position control, speed control, speed-position switching control, position-speed switching control, and other controls, are provided.
 - 1) Independent control of each axis
Controls, such as position control and speed control, can be performed independently for each axis at any given timing.
 - 2) Interpolation control
Interpolation controls using multiple axes can be performed.
(2- to 4-axis linear interpolation control, 2-axis circular interpolation control, 2- to 4-axis speed control, etc.)
 - 3) Speed-torque control
Speed control and torque control not including position loop can be performed.
 - (c) Large amount of data
Up to 600 positioning data (combinations of data, such as control system, positioning address, and command speed) per axis can be set.
 - (d) Continuous processing of multiple positioning data
Multiple positioning data can be processed continuously within one positioning operation.
Continuous positioning control can be executed over multiple blocks, where each block consists of multiple positioning data.
This reduces the number of executions of positioning, management of execution status, and others.
 - (e) Acceleration/deceleration processing
Two acceleration/deceleration processing methods are provided: trapezoidal acceleration/deceleration and S-curve acceleration/deceleration.
The acceleration/deceleration curve can be selected according to the machine characteristic.
- (3) Synchronous control
The synchronous control and electronic cam control can be performed.
- (4) Mark detection function
The mark detection to latch any data by the external command signal [DI1 to DI4] can be performed.

- (5) High maintainability
Maintainability is enhanced in the QD77MS.
- (a) Data retention without battery
Data such as the positioning data and parameters can be stored in the flash ROM inside the QD77MS. This feature allows the module retain the data without a battery.
 - (b) Module error collection function
The QD77MS notifies error details to the PLC CPU when an error occurs. Storing the error information in the PLC CPU allows the user to check the error from the programming tool even after the module is powered off or reset.
- (6) Support of intelligent function module dedicated instructions
Dedicated instructions such as the positioning start instruction (Axis 1 to Axis 4) and teaching instruction (Axis 1 to Axis 4) are provided.
The use of such dedicated instructions simplifies programs.
The dedicated instructions are fully compatible with the LD77MH/LD77MS/QD75MH.
Reference Appendix 3 "Special instructions"
- (7) Setting, monitoring, and testing through GX Works2
Parameters and positioning data for the QD77MS can be set using GX Works2 (Simple Motion Module Setting).
Moreover, using the test function of GX Works2 (Simple Motion Module Setting), users can check the wiring status and the validity of the preset parameters and positioning data by performing test operation before creating a program for positioning control.
The control monitor function of GX Works2 allows user to debug programs efficiently.
The servo parameters can be set easily by using the GX Works2 in combination with the MR Configurator2.
Reference Chapter 8 "Test operations with GX Works2"
- (8) Compatibility with the LD77MH/LD77MS/QD75MH
The proven programs in LD77MH/LD77MS/QD75MH can be used because the QD77MS is compatible with the LD77MH/LD77MS/QD75MH.
- (9) Forced stop function
The batch forced stop is available for all axes of servo amplifier by the forced stop input signal of the external input.
"Valid/Invalid" of the forced stop input signal can be selected by the parameters.
Reference Chapter 4.1.2 "Detailed parameters"
- (10) Connection between the QD77MS and servo amplifier with high speed synchronous network by SSCNETIII(/H)
The QD77MS can be directly connected to the Mitsubishi servo amplifiers of MR-J4-B/MR-J3-B series using the SSCNETIII(/H).
- (a) Because the high speed synchronous network by SSCNETIII(/H) is used to connect the QD77MS and the servo amplifier, or servo amplifiers, saving wiring can be realized. The maximum distance between the QD77MS and servo amplifier, servo amplifier and servo amplifier of the SSCNETIII cable on the same bus was set to 50(164.04)[m(ft.)], and the flexibility will improve at the system design.
 - (b) By the use of SSCNETIII cable (Optical communication), influence of electromagnetic noise and others from servo amplifier, etc. are reduced.
 - (c) The servo parameters can be set on the QD77MS side to write or read them to/from the servo amplifier using the SSCNET communication.
 - (d) The actual current value and error description contained in the servo can be checked by the buffer memory of the QD77MS.
 - (e) The communication between the MR Configurator2 and servo amplifiers is possible via the PLC CPU.

- (11) Easy application to the absolute position system
- (a) The MR-J4-B/MR-J3-B series servo amplifiers and servo motors correspond to the absolute position system. It can be realized only at connecting the battery for absolute position system to the servo amplifier.
 - (b) Once the OP have been established, the OPR operation is unnecessary at the system's power supply ON.
 - (c) With the absolute position system, the data set method OPR is used to establish the OP. The wiring of near-point dog, etc. is unnecessary.
 - (d) When the setting unit is "degree", the absolute position system with unlimited length fed can be configured.

3.3 List of functions

3.3.1 Control functions

The QD77MS has several functions.

In this text, the QD77MS functions are categorized and explained as follows.

(1) Main functions

1) OPR control

"OPR control" is a function that established the start point for carrying out positioning control, and carries out positioning toward that start point.

This is used to return a workpiece, located at a position other than the OP when the power is turned ON or after positioning stop, to the OP.

2) Positioning control

This control is carried out using the "Positioning data" stored in the QD77MS.

Positioning control, such as position control and speed control, is executed by setting the required items in this "positioning data" and starting that positioning data.

3) Manual control

This control executes the random positioning operation by inputting a signal into the QD77MS from an external device.

Use this text control to move the workpiece to a random position (JOG operation), and to finely adjust the positioning (inching operation, manual pulse generator operation), etc.

4) High-level positioning control

This control executes the "positioning data" stored in the QD77MS using the "block start data".

The following types of applied positioning control can be carried out.

- Random blocks, handling several continuing positioning data items as "blocks", can be executed in the designated order.
- "Condition judgment" can be added to position control and speed control.
- The operation of the designated positioning data No. that is set for multiple axes can be started simultaneously. (Command is output simultaneously to multiple servo amplifiers.)
- The designated positioning data can be executed repeatedly, etc.

5) Expansion control

The following controls other than the positioning control can be executed.

- Speed control and torque control not including position loop for the command to servo amplifier (Speed-torque control).
- Synchronous control with gear, shaft, change gear and cam not by mechanical, but by software use "synchronous control parameter", and is synchronized with input axis (Synchronous control).

(2) Sub functions

Control compensation, limits and functions can be added.

(3) Common functions

Common control using the QD77MS for "parameter initialization" or "backup of execution data" can be carried out.

Fig. 3.1 QD77MS simple motion module control function

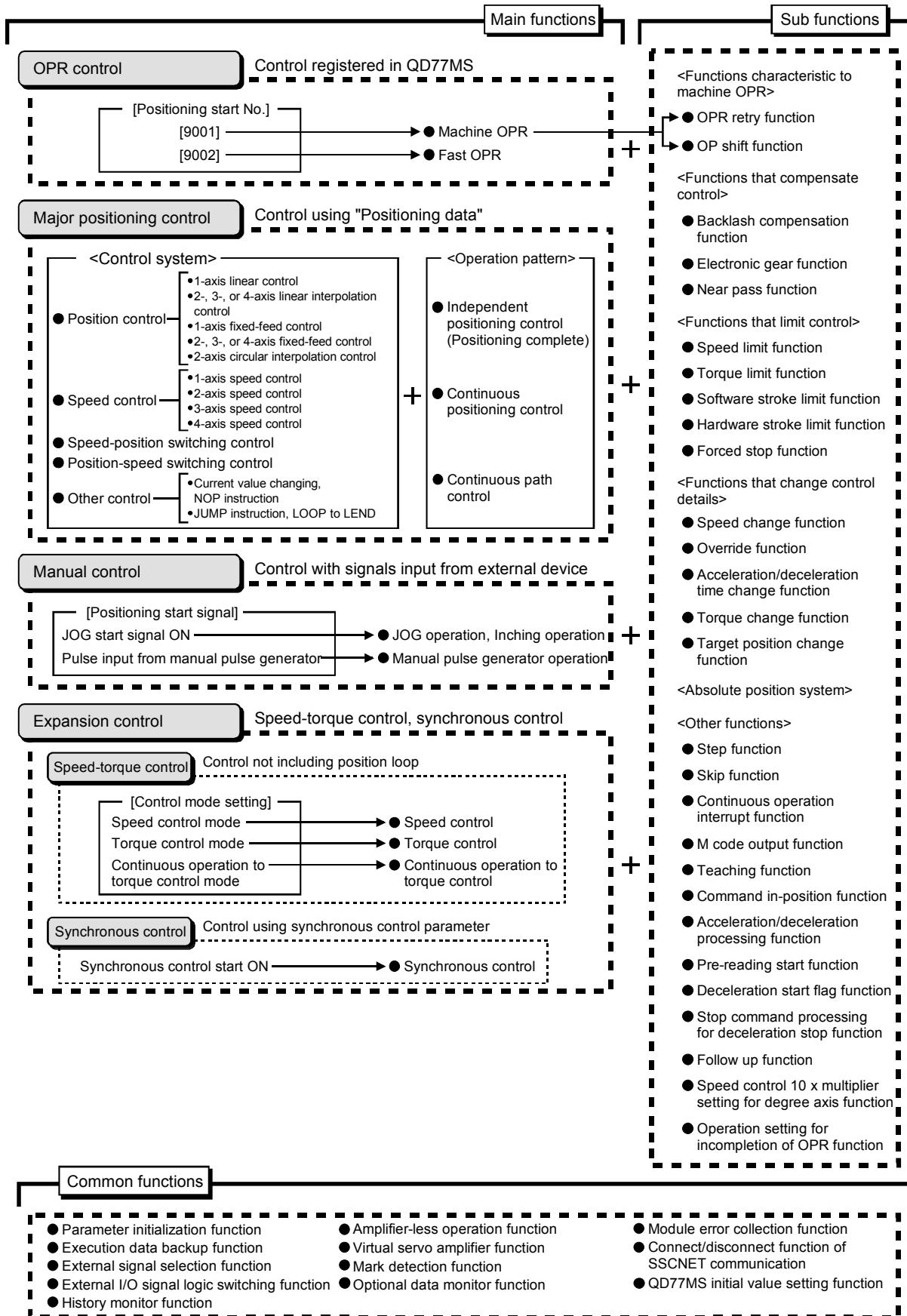

3.3.2 Main functions

The outline of the main functions for positioning control with the QD77MS is described below.

(For details of each function, refer to the user's manual (advanced) for each module.)

Main functions		Details	
OPR control	Machine OPR control	Determines a start position of the positioning automatically by the proximity DOG or a stopper. (Positioning start No. 9001)	
	Fast OPR control	Positions a target to the OP address (Machine feed value) stored in the QD77MS using machine OPR. (Positioning start No. 9002)	
Major positioning control	Position control	Linear control (1-axis linear control) (2-axis linear interpolation control) (3-axis linear interpolation control) (4-axis linear interpolation control)	Positions a target using a linear path to the address set in the positioning data or to the position designated with the movement amount.
		Fixed-feed control (1-axis fixed-feed control) (2-axis fixed-feed control) (3-axis fixed-feed control) (4-axis fixed-feed control)	Positions a target by the movement amount designated with the amount set in the positioning data. (With fixed-feed control, the "Current feed value" is set to "0" when the control is started. With 2-, 3-, or 4-axis fixed-feed control, the fixed-feed is fed along a linear path obtained by interpolation.)
		2-axis circular interpolation control	Positions a target using an arc path to the address set in the positioning data, or to the position designated with the movement amount, sub point or center point.
	Speed control	Speed control (1-axis speed control) (2-axis speed control) (3-axis speed control) (4-axis speed control)	Continuously outputs the command corresponding to the command speed set in the positioning data.
	Speed-position switching control	First, carries out speed control, and then carries out position control (positioning with movement amount) by turning the "speed-position switching signal" ON.	
	Position-speed switching control	First, carries out position control, and then carries out speed control (continuous output of the command corresponding to the designated command speed) by turning the "position-speed switching signal" ON.	
	Other control	Current value changing	Changes the current feed value to the address set in the positioning data. The following two methods can be used. (The machine feed value cannot be changed.) • Current value changing using positioning data • Current value changing using current value changing start No. (No.9003)
		NOP instruction	No execution control system. When NOP instruction is set, this instruction is not executed and the operation of the next data is started.
		JUMP instruction	Unconditionally or conditionally jumps to designated positioning data No.
		LOOP	Carries out loop control with repeated LOOP to LEND.
LEND		Returns to the beginning of the loop control with repeated LOOP to LEND.	

Main functions		Details
Manual control	JOG operation	Outputs pluses while the JOG start signal is ON.
	Inching operation	Outputs pluses corresponding to minute movement amount by manual operation to servo amplifier. (Performs fine adjustment with the JOG start signal.)
	Manual pulse generator operation	Outputs pulses commanded with the manual pulse generator to servo amplifier. (Performs fine adjustments with the pulse level.)
Expansion control	Speed-torque control	Carries out the speed control or torque control that does not include the position loop for the command to servo amplifier by switching control mode.
	Synchronous control	Carries out the synchronous control that synchronizes with input axis by setting the system such as gear, shaft, change gear and cam to the "synchronous control parameter".

Operation pattern	Details
Independent positioning control (positioning complete)	When "independent positioning control" is set for the operation pattern of the started positioning data, only the designated positioning data will be executed, and then the positioning will end.
Continuous positioning control	When "continuous positioning control" is set for the operation pattern of the started positioning data, after the designated positioning data is executed, the program will stop once, and then the next following positioning data will be executed.
Continuous path control	When "continuous path control" is set for the operation pattern of the started positioning data, the designated positioning data will be executed, and then without decelerating, the next following positioning data will be executed.

3.3.3 Sub functions, common functions

(1) Sub functions

The outline of the functions that assist positioning control using the QD77MS is described below.

(For details of each function, refer to the following user's manual.)

•MELSEC-Q QD77MS Simple Motion Module User's Manual (Positioning Control)

IB-0300185

Sub function		Details
Functions characteristic to machine OPR	OPR retry function	This function retries the machine OPR with the upper/lower limit switches during OPR. This allows machine OPR to be carried out even if the axis is not returned to before the near-point dog with JOG operation, etc.
	OP shift function	After returning to the machine OP, this function compensates the position by the designated distance from the machine OP position and sets that position as the OP address.
Functions that compensate control	Backlash compensation function	This function compensates the mechanical backlash amount. Feed commands equivalent to the set backlash amount are output each time the movement direction changes.
	Electronic gear function	By setting the movement amount per pulse, this function can freely change the machine movement amount per commanded pulse. When the movement amount per pulse is set, a flexible positioning system that matches the machine system can be structured.
	Near pass function* ¹	This function suppresses the machine vibration when the positioning data is switched during continuous path control in the interpolation control.
Functions that limit control	Speed limit function	If the command speed exceeds "Speed limit value" during control, this function limits the commanded speed to within the "Speed limit value" setting range.
	Torque limit function* ²	If the torque generated by the servomotor exceeds "Torque limit setting value" during control, this function limits the generated torque to within the "Torque limit setting value" setting range.
	Software stroke limit function	If a command outside of the upper/lower limit stroke limit setting range, set in the parameters, is issued, this function will not execute positioning for that command.
	Hardware stroke limit function	This function carries out deceleration stop with the hardware stroke limit switch of the QD77MS.
	Forced stop function	This function is stopped the all axis of the servo amplifier when the forced stop input signal of the QD77MS external input signal connector is turned ON.
Functions that change control details	Speed change function	This function changes the speed during positioning. Set the new speed in the speed change buffer memory (New speed value), and change the speed with the speed change request.
	Override function	This function changes the speed within a percentage of 1 to 300% during positioning. This is executed using "Positioning operation speed override".
	Acceleration/deceleration time change function	This function changes the acceleration/deceleration time during speed change.
	Torque change function	This function changes the "torque limit value" during control.
	Target position change function	This function changes the target position during positioning. Position and speed can be changed simultaneously.
Absolute position system* ³		This function restores the absolute position of designated axis. If the OPR is executed at the start of system, after that, it is unnecessary to carry out the OPR when the power is turned ON.

	Sub function	Details
Other functions	Step function	This function temporarily stops the operation to confirm the positioning operation during debugging, etc. The operation can be stopped at each "automatic deceleration" or "positioning data".
	Skip function	This function stops (decelerates to a stop) the positioning being executed when the skip signal is input, and carries out the next positioning.
	M code output function	This function issues a command for a sub work (clamp or drill stop, tool change, etc.) corresponding to the M code No. (0 to 65535) that can be set for each positioning data.
	Teaching function	This function stores the address positioned with manual control into the "Positioning address" having the designated positioning data No..
	Command in-position function	At each automatic deceleration, this function calculates the remaining distance for the QD77MS to reach the positioning stop position. When the value is less than the set value, the "command in-position flag" is set to "1". When using another auxiliary work before ending the control, use this function as a trigger for the sub work.
	Acceleration/deceleration processing function	This function adjusts the acceleration/deceleration.
	Continuous operation interrupt function	This function interrupts continuous operation. When this request is accepted, the operation stops when the execution of the current positioning data is completed.
	Deceleration start flag function	Function that turns ON the flag when the constant speed status or acceleration status switches to the deceleration status during position control, whose operation pattern is "Positioning complete", to make the stop timing known.
	Pre-reading start function	This function shortens the virtual start time.
	Stop command processing for deceleration stop function	Function that selects a deceleration curve when a stop cause occurs during deceleration stop processing to speed 0.
	Follow up function	This function monitors the motor rotation amount with the servo turned OFF, and reflects it on the current feed value.
	Speed control 10 x multiplier setting for degree axis function	This function multiplies the instruction speed's speed and the control value designated by the positioning data and parameters to 10 times.
Operation setting for incompleteness of OPR function	This function is provided to select whether positioning control is operated or not, when OPR request flag is ON.	

- *1: The near pass function is featured as standard and is valid only for position control. It cannot be set to be invalid with parameters.
- *2: To carry out "torque limit", the "D/A conversion module" and a "drive unit capable of the torque limit command with an analog voltage" must be prepared.
- *3: "The 16-point input module", "16-point output module", and "the drive unit capable of configuring an absolute position detection system (which is a Mitsubishi General-Purpose AC Servo and has an absolute position detection function (absolute position data transference protocol) equivalent to that of MR-J3- A)" are required to execute the "absolute position restoration function".

(2) Common functions

The outline of the functions executed as necessary is described below.

(For details of each function, refer to the following user's manual.)

•MELSEC-Q QD77MS Simple Motion Module User's Manual (Positioning Control)

IB-0300185

Common functions	Details
Parameter initialization function	This function returns the "parameters" stored in the buffer memory and flash ROM of QD77MS to the default values. The following two methods can be used. 1) Method using sequence program 2) Method using GX Works2
Execution data backup function	This function stores the "setting data", currently being executed, into the flash ROM. The following two methods can be used. 1) Method using sequence program 2) Method using GX Works2
External signal selection function	This function selects either the QD77MS external input signal, the servo amplifier external input signal, or the external input signal via the CPU (QD77MS buffer memory) when using upper/lower limit signal and a proximity DOG signal.
External I/O signal logic switching function	This function switches I/O signal logic according to externally connected devices. This function enables the use of the system that does not use b (N.C.)-contact signals, such as Upper/lower limit signal, by setting parameters to positive logic.
History monitor function	This function monitors errors, warnings, and start history of all axes.
Amplifier-less operation function	This function executes the positioning control of QD77MS without connecting to the servo amplifiers. It is used to debug the program at the start-up of the device or simulate the positioning operation.
Virtual servo amplifier function	This function executes the operation as the axis (virtual servo amplifier axis) that operates only command (instruction) virtually without servo amplifiers.
Mark detection function	This function is used to latch any data at the input timing of the mark detection signal (DI1 to DI4).
Optional data monitor function	This function is used to store the data selected by user up to 4 data per axis to buffer memory and monitor them.
Module error collection function	This function collects errors occurred in the QD77MS in the PLC CPU. Holding the error contents in the PLC CPU, this function enables to check the error history even after the PLC CPU in powered off or reset.
Connect/disconnect function of SSCNET communication	Temporarily connect/disconnect of SSCNET communication is executed during system's power supply ON. This function is used to exchange the servo amplifiers or SSCNETIII cables.
QD75MH initial value setting function	This function is used to set the factory-set initial value of QD75MH for the setting data set in the QD77MS buffer memory/internal memory and flash ROM/internal memory (nonvolatile).

3.4 Specifications of input/output signals between the PLC CPU

3.4.1 Specifications for input/output signals between the PLC CPU

(1) Communicating signals between QD77MS and each module

The outline of the signal communication between the Simple Motion module and PLC CPU, peripheral device and servo amplifier, etc., is shown below. (The peripheral device communicates with the Simple Motion module via the PLC CPU to which it is connected.)

* The following diagram shows an example of the QD77MS4.

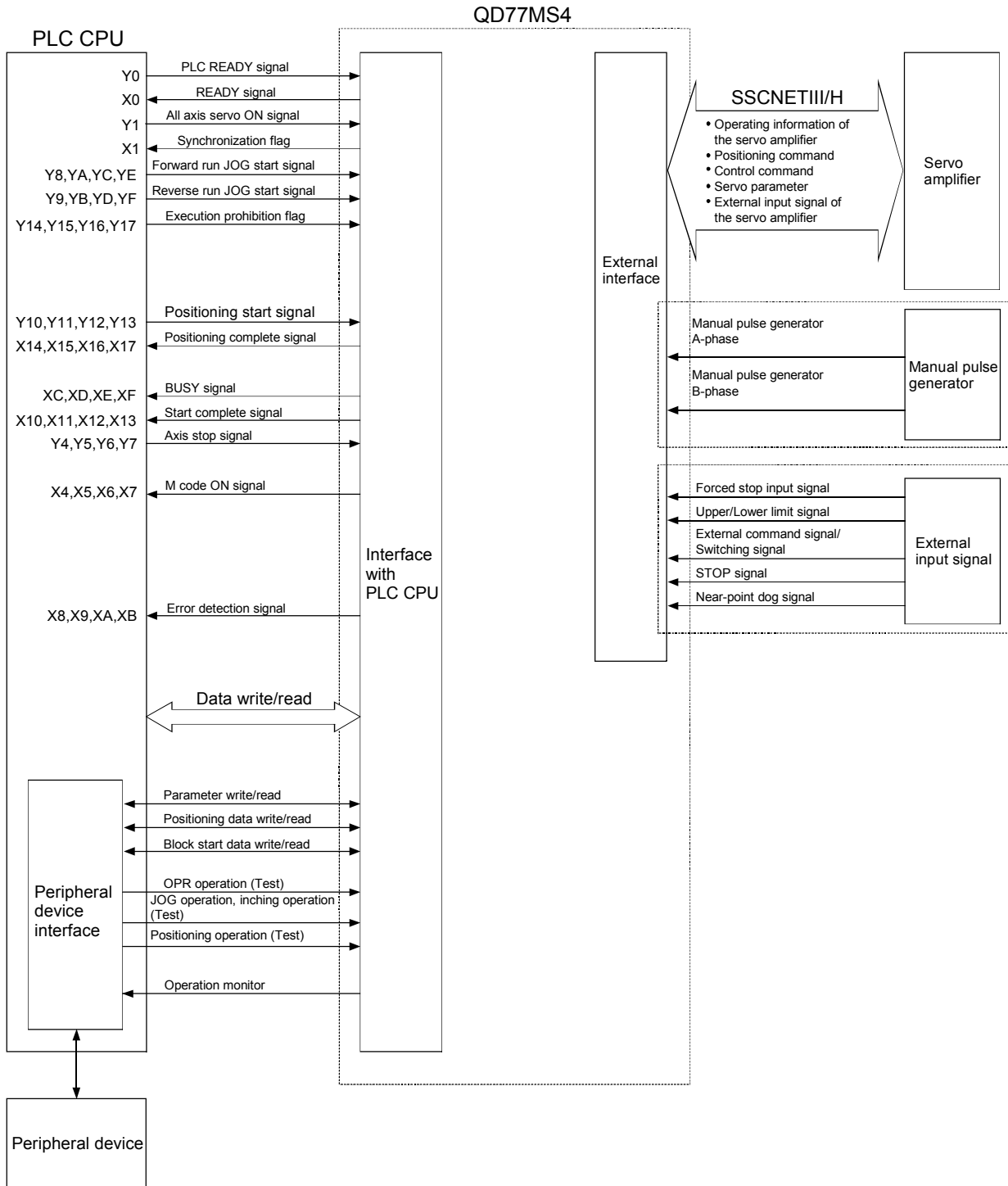

■ QD77MS ↔ PLC CPU

The QD77MS and PLC CPU communicate the following data.

Direction Communication	QD77MS → PLC CPU	PLC CPU → QD77MS
Control signal*	<ul style="list-style-type: none"> Signal indicating QD77MS state • READY signal • BUSY signal etc. 	<ul style="list-style-type: none"> Signal related to commands • PLC READY signal • All axis servo ON signal • Positioning start signal etc.
Data (read/write)	<ul style="list-style-type: none"> • Parameter • Positioning data • Block start data • Control data • Monitor data 	<ul style="list-style-type: none"> • Parameter • Positioning data • Block start data • Control data

*: Refer to Section 3.4 "Specifications of input/output signals with PLC CPU" for details.

■ QD77MS ↔ Peripheral device

The QD77MS and peripheral device communicate the following data via the PLC CPU.

Direction Communication	QD77MS → Peripheral device	Peripheral device → QD77MS
Data (read/write)	<ul style="list-style-type: none"> • Parameter • Positioning data 	<ul style="list-style-type: none"> • Parameter • Positioning data
Test operation	—	<ul style="list-style-type: none"> • OPR control start command • Positioning control start command • JOG/Inching operation start command • Teaching start command • Manual pulse generator operation enable/disable command
Operation monitor	<ul style="list-style-type: none"> • Monitor data 	—

■ QD77MS ↔ Servo amplifier

The QD77MS and servo amplifier communicate the following data via the SSCNETIII/H.

Direction Communication	QD77MS → Servo amplifier	Servo amplifier → QD77MS
SSCNETIII/H	<ul style="list-style-type: none"> • Positioning commands • Control commands • Servo parameter 	<ul style="list-style-type: none"> • Operating information of the servo amplifier • Servo parameter • External input signal of the servo amplifier

■ QD77MS ↔ Manual pulse generator

The QD77MS and manual pulse generator communicate the following data via the external input signal connector .

(Connect the manual pulse generator to a connector for external device connections for either axis 1 or both axis 1 and axis 2.)

Direction Communication	QD77MS → Manual pulse generator	Manual pulse generator → QD77MS
Pulse signal	—	<ul style="list-style-type: none"> • Manual pulse generator A-phase • Manual pulse generator B-phase

■ QD77MS ↔ External signal

The QD77MS and the external signals communicate via the connector for external device connections as shown below.

Direction Communication	QD77MS → External signal	External signal → QD77MS
Control signal	—	<ul style="list-style-type: none"> • Forced stop input signal • Upper/Lower limit signal • External command signal/switching signal • Stop signal • Near-point dog signal

(2) List of input/output signals with PLC CPU

The QD77MS uses 32 input points and 32 output points for exchanging data with the PLC CPU.

The table below shows the input/output signals when the QD77MS is mounted to slot No. 0 on the base unit.

Device X refers to the signals input from the QD77MS to the PLC CPU, and device Y refers to the signals output from the PLC CPU to the QD77MS.

(a) List of input/output signals for the QD77MS2/QD77MS4

Signal direction: QD77MS2/QD77MS4 → PLC CPU				Signal direction: PLC CPU → QD77MS2/QD77MS4			
Device No.	Signal name			Device No.	Signal name		
X0	QD77 READY		ON : READY OFF: Not READY/Watch dog timer error	Y0	PLC READY		OFF: PLC READY OFF ON: PLC READY ON
X1	Synchronization flag		OFF: Module access disabled ON: Module access enabled	Y1	All axis servo ON		OFF: Servo OFF ON: Servo ON
X2	Use prohibited			Y2	Use prohibited		
X3	Use prohibited			Y3	Use prohibited		
X4	Axis 1	M code ON	OFF: M code is not set ON: M code is set	Y4	Axis 1	Axis stop	OFF: Axis stop not requested ON: Axis stop requested
X5	Axis 2			Y5	Axis 2		
X6	Axis 3* ¹			Y6	Axis 3* ¹		
X7	Axis 4* ¹			Y7	Axis 4* ¹		
X8	Axis 1	Error detection	OFF: No error ON: Error occurrence	Y8	Axis 1	Forward run JOG start	OFF: JOG not started ON: JOG started
X9	Axis 2			Y9		Reverse run JOG start	
XA	Axis 3* ¹			YA	Axis 2	Forward run JOG start	
XB	Axis 4* ¹			YB		Reverse run JOG start	
XC	Axis 1	BUSY	OFF: Not BUSY ON: BUSY	YC	Axis 3* ¹	Forward run JOG start	
XD	Axis 2			YD		Reverse run JOG start	
XE	Axis 3* ¹			YE	Axis 4* ¹	Forward run JOG start	
XF	Axis 4* ¹			YF		Reverse run JOG start	
X10	Axis 1	Start complete	OFF: Start incomplete ON: Start complete	Y10	Axis 1	Positioning start	OFF: Positioning start not requested ON: Positioning start requested
X11	Axis 2			Y11	Axis 2		
X12	Axis 3* ¹			Y12	Axis 3* ¹		
X13	Axis 4* ¹			Y13	Axis 4* ¹		
X14	Axis 1	Positioning complete	OFF: Positioning incomplete ON: Positioning complete	Y14	Axis 1	Execution prohibition flag	OFF: Not during execution prohibition ON: During execution prohibition
X15	Axis 2			Y15	Axis 2		
X16	Axis 3* ¹			Y16	Axis 3* ¹		
X17	Axis 4* ¹			Y17	Axis 4* ¹		
X18	Use prohibited			Y18	Use prohibited		
X19	Use prohibited			Y19	Use prohibited		
X1A	Use prohibited			Y1A	Use prohibited		
X1B	Use prohibited			Y1B	Use prohibited		
X1C	Use prohibited			Y1C	Use prohibited		
X1D	Use prohibited			Y1D	Use prohibited		
X1E	Use prohibited			Y1E	Use prohibited		
X1F	Use prohibited			Y1F	Use prohibited		

*1: Use is prohibited in the QD77MS2.

Important

[Y2, Y3], [Y18 to Y1F], [X2, X3], and [X18 to X1F] are used by the system, and cannot be used by the user.

If these devices are used, the operation of the QD77MS4 will not be guaranteed.

(b) List of input/output signals for the QD77MS16

Signal direction: QD77MS16 → PLC CPU			Signal direction: PLC CPU → QD77MS16						
Device No.	Signal name		Device No.	Signal name					
X0	QD77 READY	ON: READY OFF: Not READY/Watch dog timer error	Y0	PLC READY	OFF: PLC READY OFF ON: PLC READY ON				
X1	Synchronization flag	OFF: Module access disabled ON: Module access enabled	Y1	All axis servo ON	OFF: Servo OFF ON: Servo ON				
X2	Use prohibited		Y2	Use prohibited					
X3									
X4									
X5									
X6									
X7									
X8									
X9									
XA									
XB									
XC									
XD									
XE									
XF									
X10			Axis 1			BUSY OFF: Not BUSY ON: BUSY	Y10	Axis 1	Positioning start OFF: Positioning start not requested ON: Positioning start requested
X11			Axis 2						
X12	Axis 3								
X13	Axis 4								
X14	Axis 5								
X15	Axis 6								
X16	Axis 7								
X17	Axis 8								
X18	Axis 9								
X19	Axis 10								
X1A	Axis 11								
X1B	Axis 12								
X1C	Axis 13								
X1D	Axis 14								
X1E	Axis 15								
X1F	Axis 16								

POINT

- (1) For QD77MS16, M code ON signal, error detection signal, start complete signal and positioning complete signal are assigned to the bit of "Status".
- (2) For QD77MS16, axis stop signal, forward run JOG start signal, reverse run JOG start signal, execution prohibition flag are assigned to the buffer memory [Cd.180] to [Cd.183].

Important

[Y2 to YF] and [X2 to XF] are used by the system, and cannot be used by the user.
If these devices are used, the operation of the QD77MS16 will not be guaranteed.

(3) ON/OFF timings for the input/output signals

The ON/OFF timings of the input/output signals during the home position return, the positioning operation, the JOG operation, and the manual pulse generator are shown below.

(a) ON/OFF timings for the input/output signals during the home position return

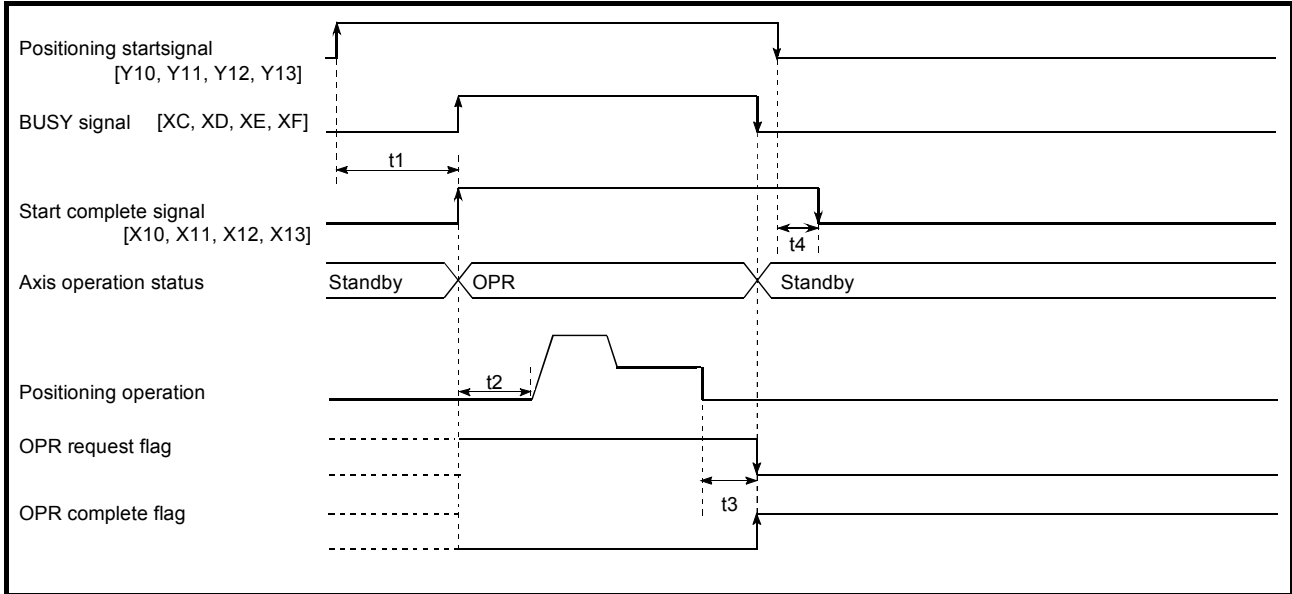

Normal timing time

	Operation cycle	t1	t2	t3	t4
QD77MS2	0.88ms	0.2 to 0.3ms	1.8 to 2.7ms	0 to 0.9ms	0 to 0.9ms
QD77MS4					
QD77MS16	0.88ms	0.3 to 1.4ms	1.8 to 2.7ms	0 to 0.9ms	0 to 0.9ms
	1.77ms	0.3 to 1.4ms	3.2 to 3.9ms	0 to 1.8ms	0 to 1.8ms

- The t1 timing time could be delayed depending on the operating conditions of the other axis.

(b) ON/OFF timings for the input/output signals during the positioning control

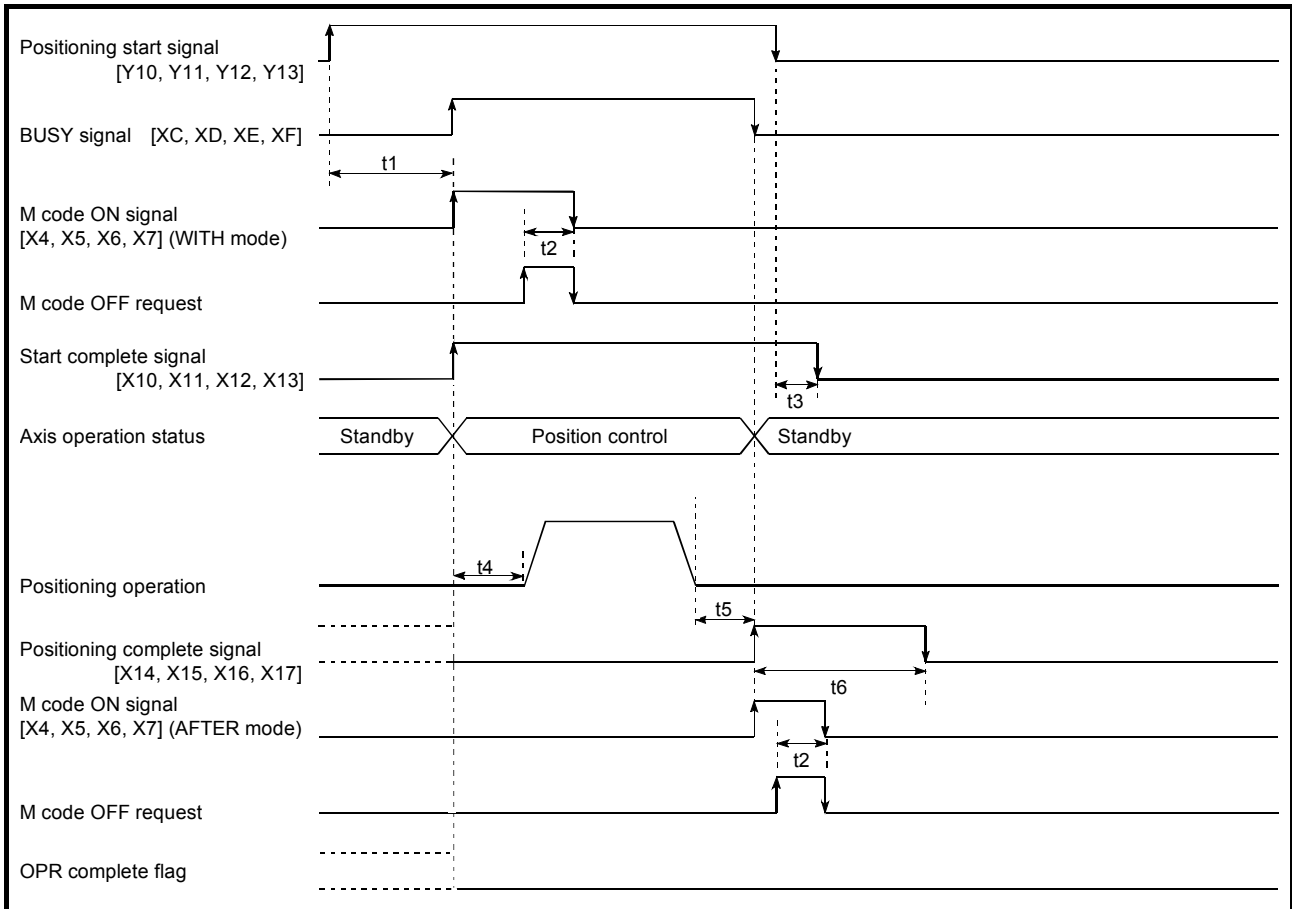

When the positioning start signal turns ON, if the "positioning complete signal" or "OPR complete flag" are already ON, the "positioning complete signal" or "OPR complete flag" will turn OFF when the positioning start signal turns ON.

Normal timing time

	Operation cycle	t1	t2	t3	t4	t5	t6
QD77MS2	0.88ms	0.2 to 0.3ms	0 to 0.9ms	0 to 0.9ms	1.8 to 2.7ms	0 to 0.9ms	Follows parameters
QD77MS4							
QD77MS16	0.88ms	0.3 to 1.4ms	0 to 0.9ms	0 to 0.9ms	1.8 to 2.7ms	0 to 0.9ms	Follows parameters
	1.77ms	0.3 to 1.4ms	0 to 1.8ms	0 to 1.8ms	3.2 to 3.9ms	0 to 1.8ms	Follows parameters

- The t1 timing time could be delayed depending on the operating conditions of the other axis.

(c) ON/OFF timings for the input/output signals during the JOG operation

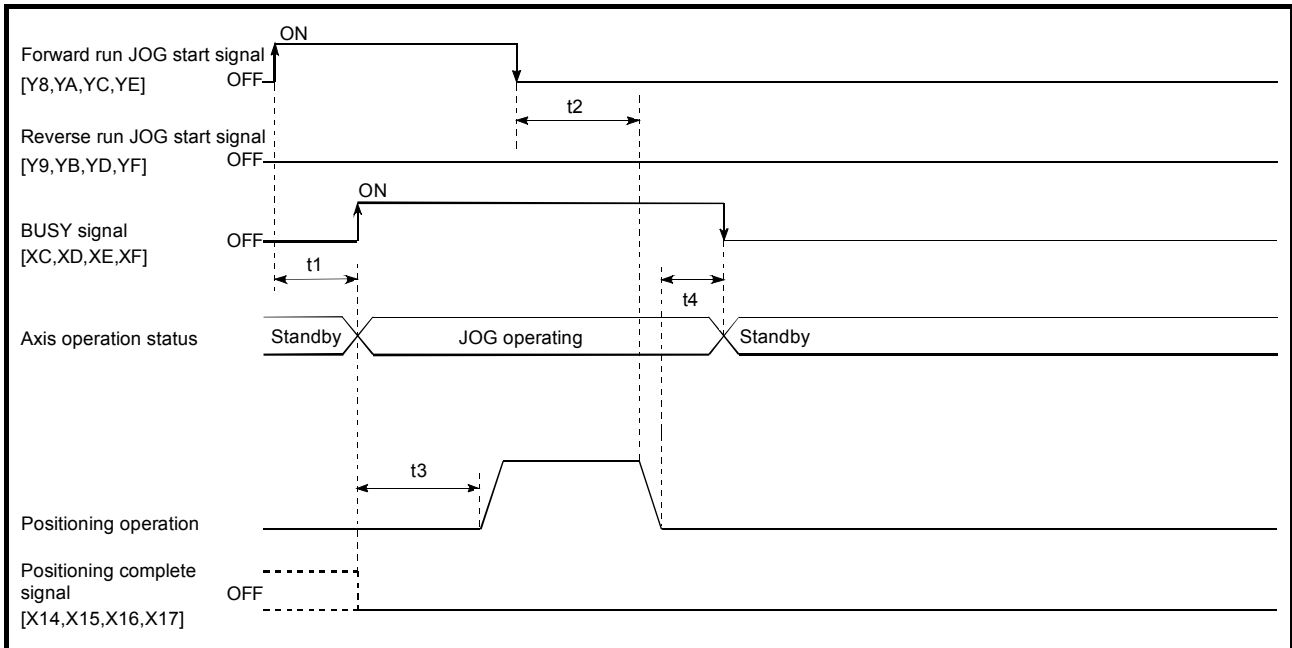

Normal timing time

	Operation cycle	t1	t2	t3	t4
QD77MS2	0.88ms	0.4 to 0.9ms	0 to 0.9ms	1.8 to 2.7ms	0 to 0.9ms
QD77MS4					
QD77MS16	0.88ms	0.4 to 0.9ms	0 to 0.9ms	1.8 to 2.7ms	0 to 0.9ms
	1.77ms	0.8 to 1.4ms	0 to 1.8ms	3.2 to 3.9ms	0 to 1.8ms

- The t1 timing time could be delayed depending on the operating conditions of the other axis.

3.5 I/O interfaces with external devices

(1) Signal layout of the connector for external device connections for the QD77MS

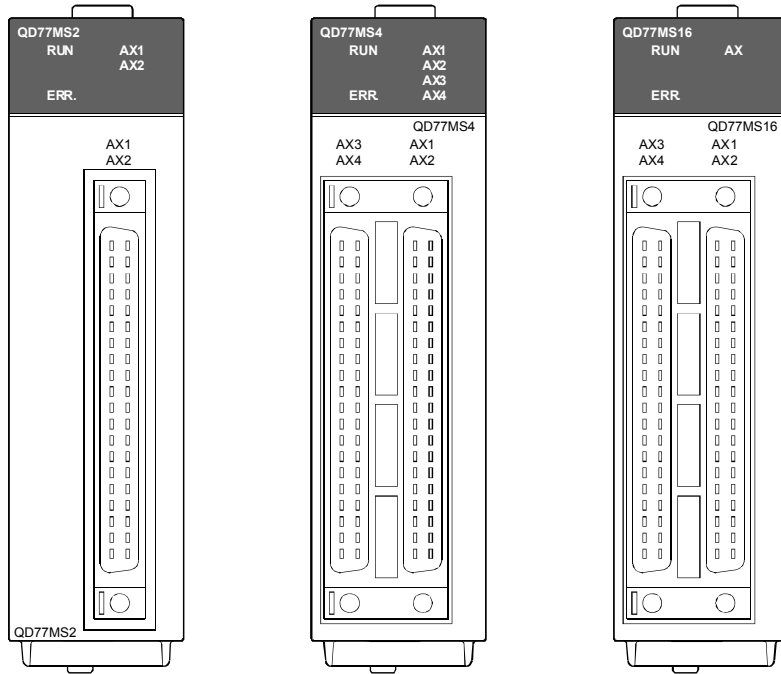

Table 3.2 Connector signal layout (QD77MS)

Pin layout	Axis 4 (AX4) (External input signal 4)		Axis 3 (AX3) (External input signal 3)		Axis 2 (AX2) (External input signal 2)		Axis 1 (AX1) (External input signal 1)	
	Pin No.	Signal name	Pin No.	Signal name	Pin No.	Signal name	Pin No.	Signal name
<p>Front view of the module</p>	2B20	No connect*7	2A20	No connect*7	1B20	HB*3,*4,*5	1A20	5V
	2B19		2A19		1B19	HA*3,*4,*5	1A19	5V
	2B18		2A18		1B18	HBL*3,*4,*6	1A18	HBH*3,*4,*6
	2B17		2A17		1B17	HAL*3,*4,*6	1A17	HAH*3,*4,*6
	2B16		2A16		1B16	No connect*7	1A16	No connect*7
	2B15		2A15		1B15	5V	1A15	5V
	2B14		2A14		1B14	SG	1A14	SG
	2B13		2A13		1B13	No connect*7	1A13	No connect*7
	2B12		2A12		1B12			
	2B11		2A11		1B11			
	2B10	2A10	1B10					
	2B9	2A9	1B9	1A9				
	2B8	2A8	1B8	EMI.COM	1A8	EMI		
	2B7	COM	2A7	COM	1B7	COM	1A7	COM
	2B6	COM	2A6	COM	1B6	COM	1A6	COM
	2B5	DI4*8	2A5	DI3*8	1B5	DI2*8	1A5	DI1*8
	2B4	STOP*8	2A4	STOP*8	1B4	STOP*8	1A4	STOP*8
	2B3	DOG*8	2A3	DOG*8	1B3	DOG*8	1A3	DOG*8
	2B2	RLS*8	2A2	RLS*8	1B2	RLS*8	1A2	RLS*8
	2B1	FLS*8	2A1	FLS*8	1B1	FLS*8	1A1	FLS*8

- *1: Pin No. "1□□□" indicates the pin No. for the right connector. Pin No. "2□□□" indicates the pin No. for the left connector.
- *2: For QD77MS2 does not have AX3 and AX4 connector of the left side.
- *3: Input type from manual pulse generator/incremental synchronous encoder is switched in "Pr.89 Manual pulse generator/Incremental synchronous encoder input type selection". (Only the value specified against the axis 1 is valid.)
 - 0: Differential-output type
 - 1: Voltage-output/open-collector type (Default value)
- *4: Set the signal input form in "Pr.24 Manual pulse generator/Incremental synchronous encoder input selection".
- *5: Voltage-output/open-collector type
Connect the A-phase/PLS signal to HA, and the B-phase/SIGN signal to HB.
- *6: Differential-output type
Connect the A-phase/PLS signal to HAH, and the A-phase/PLS inverse signal to HAL.
Connect the B-phase/SIGN signal to HBH, and the B-phase/SIGN inverse signal to HBL.
- *7: Do not connect to any of the terminal explained as "No connect".
- *8: Set the external command signal [DI, FLS, RLS, DOG, STOP] in "External input signal selection" and "External command signal selection" at QD77MS16 use.

3.5.1 I/O interface signals

(1) Internal circuit of the QD77MS interface

The diagram shows the internal circuit for the interface for external device connections for the QD77MS.

(a) Interface between external input signals/forced stop input signals

Input or Output	Signal name	Pin No.	Wiring example	Internal circuit	Description	
Input	Upper-limit signal ^{*1}	FLS	□□1 ^{*2}			Upper-limit signal, Lower-limit signal, Near-point dog signal, Stop signal, External command signal, Switching signal, Forced stop input signal
	Lower-limit signal ^{*1}	RLS	□□2 ^{*2}			
	Near-point dog signal ^{*1}	DOG	□□3 ^{*2}			
	Stop signal	STOP	□□4 ^{*2}			
	External command/ Switching	DI	□□5 ^{*2}			
	Common	COM	□□6 ^{*2} □□7 ^{*2}			
	Forced stop input signal	EMI	1A8			
EMI.COM		1B8				

*1: When using external input signal of servo amplifier, set "1" with "External signal selection".

*2: "□□" indicates "1A (AX1)", "1B (AX2)", "2A (AX3)", or "2B (AX4)".

*3: As for the 24VDC sign, both "+" and "-" are possible.

(b) Manual pulse generator/Incremental synchronous encoder input
 1) Interface between manual pulse generator/incremental synchronous encoder (Differential-output type)

Input or Output	Signal name	Pin No.	Wiring example	Internal circuit	Specification	Description
Input *1,*2	Manual pulse generator, phase A/ PLS	A+ HAH	1A17		<ul style="list-style-type: none"> Rated input voltage 5.5VDC or less HIGH level 2.0 to 5.25VDC LOW level 0.8VDC or less 26LS31 or equivalent 	For connection manual pulse generator/incremental synchronous encoder <ul style="list-style-type: none"> Pulse width Leading edge, Trailing edge time $\leq 0.25\mu\text{s}$ or less Phase difference (Phases A, B)
		A- HAL	1B17			
	Manual pulse generator, phase B/ SIGN	B+ HBH	1A18			
		B- HBL	1B18			
Power supply	5V ^{*3}	1A15 1B15	5V	Power supply 5VDC		
	SG	1A14 1B14	SG			

*1: Set "0: Differential-output type" in "Manual pulse generator/Incremental synchronous encoder input type selection" if the manual pulse generator/Incremental synchronous encoder of differential-output type is used.
 The default value is "1: Voltage-output/open-collector type".

*2: Set the signal input form in "Manual pulse generator/Incremental synchronous encoder input selection".

*3: The 5VDC power supply from the Simple Motion module must not be used if a separate power supply is applied to the manual pulse generator/incremental synchronous encoder.
 If a separate power supply is used, use a stabilized power supply of voltage 5VDC.
 Anything else may cause a failure.

2) Interface between manual pulse generator/Incremental synchronous encoder (Voltage-output/open-collector type)

Input or Output	Signal name	Pin No.	Wiring example	Internal circuit	Specification	Description
Input *1,*2	Manual pulse generator, phase A/PLS HA	1B19			<ul style="list-style-type: none"> Rated input voltage 5.5VDC or less HIGH level 3 to 5.25VDC/ 2mA or less LOW level 1VDC or less/ 5mA or more 	<p>For connection manual pulse generator/ incremental synchronous encoder</p> <ul style="list-style-type: none"> Pulse width Leading edge, Trailing edge time \dots 1.2µs or less Phase difference (Phases A, B) <p>(1) Positioning address increases if Phase A leads Phase B. (2) Positioning address decreases if Phase B leads Phase A.</p>
	Manual pulse generator, phase B/SIGN HB	1B20				
Power supply	5V ^{*3}	1A15 1B15		<p>Power supply 5VDC</p>		
	SG	1A14 1B14				

*1: Set "1: Voltage-output/open-collector type" in "Manual pulse generator/Incremental synchronous encoder input type selection" if the manual pulse generator/Incremental synchronous encoder of voltage output/open-collector type is used.
 The default value is "1: Voltage-output/open-collector type"

*2: Set the signal input form in "Manual pulse generator/Incremental synchronous encoder input selection".

*3: The 5VDC power supply from the Simple Motion module must not be used if a separate power supply is applied to the manual pulse generator/Incremental synchronous encoder.

If a separate power supply is used, use a stabilized power supply of voltage 5VDC.

Anything else may cause a failure.

3.6 Buffer memory

The QD77MS has buffer memory areas. A high level of control can be performed by reading or writing the buffer memory areas by sequence programs.

3.6.1 Buffer memory configuration

The following table shows the configuration of the buffer memory areas.

Table 3.3 Buffer memory configuration (QD77MS)

Buffer memory area configuration		Buffer memory address		Writing possibility
		QD77MS2, QD77MS4	QD77MS16	
Parameter area	Basic parameter area	0+150n to 15+150n		Possible
	Detailed parameter area	17+150n to 69+150n		
	OPR basic parameter area	70+150n to 78+150n		
	OPR detailed parameter area	79+150n to 91+150n		
	Expansion parameter area	100+150n to 149+150n		
	Mark detection setting parameter area	54000+20k to 54019+20k		
Monitor data area	System monitor area	1200 to 1499 31300 to 31549	4000 to 4299 31300 to 31549	Not possible
	Axis monitor area	800+100n to 899+100n	2400+100n to 2499+100n	
	Mark detection monitor data area	54960+80k to 55039+80k		
Control data area	System control data area	1900 to 1999	5900 to 5999	Possible
	Axis control data area	1500+100n to 1599+100n	4300+100n to 4399+100n	
	Expansion axis control data area		30100+10n to 30109+10n	
	Mark detection control data area	54640+10k to 54649+10k		
Positioning data area (No.1 to 100)	Positioning data area	2000+6000n to 2999+6000n	6000+1000n to 6999+1000n	Possible
Positioning data area (No.101 to 600)		3000+6000n to 7999+6000n	Set with GX Works2	
Block start data area (No.7000)	Block start data area	26000+1000n to 26049+1000n	22000+400n to 22049+400n	
		26050+1000n to 26099+1000n	22050+400n to 22099+400n	
Block start data area (No.7001)	Condition data area	26100+1000n to 26199+1000n	22100+400n to 22199+400n	
		26200+1000n to 26249+1000n	22200+400n to 22249+400n	
		26250+1000n to 26299+1000n	22250+400n to 22299+400n	
Block start data area (No.7002)	Condition data area	26300+1000n to 26399+1000n	22300+400n to 22399+400n	
		26400+1000n to 26449+1000n	Set with GX Works2	
		26450+1000n to 26499+1000n		
Block start data area (No.7003)	Condition data area	26500+1000n to 26599+1000n		
		26600+1000n to 26649+1000n		
Block start data area (No.7004)	Condition data area	26650+1000n to 26699+1000n		
		26700+1000n to 26799+1000n		
		26800+1000n to 26849+1000n		
Block start data area (No.7004)	Condition data area	26850+1000n to 26899+1000n		
		26900+1000n to 26999+1000n		
PLC CPU memo area	PLC CPU memo area	30000 to 30099		Possible

Table 3.3 Buffer memory configuration (QD77MS) (Continued)

Buffer memory area configuration			Buffer memory address		Writing possibility
			QD77MS2, QD77MS4	QD77MS16	
Servo parameter area	Servo series		30100+200n	28400+100n	Possible
	PA group	PA01 to PA18	30101+200n to 30118+200n	28401+100n to 28418+100n	
		PA19	30932+50n	Set with GX Works2	
		PA20 to PA32	64400+250n to 64412+250n	64400+70n to 64412+70n	
	PB group		30119+200n to 30163+200n	28419+100n to 28463+100n	
			64413+250n to 64431+250n	64413+70n to 64431+70n	
	PC group		30164+200n to 30195+200n	28464+100n to 28495+100n	
			64432+250n to 64463+250n	64432+70n to 64463+70n	
	PD group		30196+200n to 30227+200n	Set with GX Works2	
			64464+250n to 64479+250n		
	PE group		30228+200n to 30267+200n		
			64480+250n to 64503+250n		
	PS group		30268+200n to 30299+200n		
			64504+250n to 64535+250n		
PF group		30900+50n to 30915+50n			
		64504+250n to 64535+250n			
Option unit parameter area		30916+50n to 30931+50n			
Po group		64536+250n to 64551+250n			
PL group		64552+250n to 64599+250n			
PT group		64600+250n to 64647+250n			
Synchronous control area	Servo input axis parameter		32800+10n to 32805+10n		Possible
	Servo input axis monitor data		33120+10n to 33127+10n		Not possible
	Synchronous encoder axis parameter		34720+20j to 34735+20j	Possible	
	Synchronous encoder axis control data		35040+10j to 35047+10j	Possible	
	Synchronous encoder axis monitor data		35200+20j to 35212+20j	Not possible	
	Synchronous control system control data		36320,36322	Possible	
	Synchronous parameter		36400+200n to 36513+200n	Possible	
	Synchronous control monitor data		42800+40n to 42835+40n	Not possible	
	Control data for synchronous control		44080+20n to 44090+20n	Possible	
	Cam operation control data		45000 to 53791	Possible	
	Cam operation monitor data		53800 to 53801	Not possible	

n: Axis No.-1

k: Mark detection setting No.-1

j: Synchronous encoder axis No.-1

* Use of address Numbers. skipped above is prohibited. If used, the system may not operate correctly.

POINT
<p>When the parameter of the servo amplifier side is changed by the following method, the QD77MS reads parameters automatically, and the data is transmitted to the servo parameter area in the buffer memory/internal memory and internal memory (nonvolatile).</p> <p>(a) When changing the servo parameters by the auto tuning.</p> <p>(b) When the servo parameter is changing after the MR Configurator2 is connected directly with the servo amplifier.</p>

Buffer memory

3.6.2 Description of commonly used buffer memory areas

This section describes the buffer memory areas used for the programs in this training.

Refer to the help for GX Configurator-QP and the simple motion module setting tool for details on buffer memory areas that are not described here.

Table 3.4 Commonly used buffer memory areas

Buffer memory address		Item	Remarks/Setting range	Default value
QD77MS2 QD77MS4	QD77MS16			
27+150n		M code ON signal output timing	0: WITH mode 1: AFTER mode	0
62+150n		External command function selection	0: External positioning start 1: External speed change request 2: Speed-position, position-speed switching request 3: Skip request 4: High speed input request	0
800+100n 801+100n	2400+100n 2401+100n	Current feed value	The currently commanded address is stored. The current position address is stored. If "degree" is selected as the unit, the addresses will have a ring structure for values between 0 and 359.99999 degrees. • The OP address is stored when the machine OPR is completed. • When the current value is changed with the current value changing function, the changed value is stored.	0
802+100n 803+100n	2402+100n 2403+100n	Machine feed value	The address of the current position according to the machine coordinates will be stored. Note that the current value changing function will not change the machine feed value. Under the speed control mode, the machine feed value is constantly updated always, irrespective of the parameter setting. The value will not be cleared to "0" at the beginning of fixed-feed control. Ring addresses between 0 to 359.99999° cannot be used when the unit is "degree." • Machine coordinates: Characteristic coordinates determined with machine	0
804+100n 805+100n	2404+100n 2405+100n	Federate	The speed of the operating workpiece is stored. • During interpolation operation, the speed is stored in the following manner. Reference axis : Composite speed or reference axis speed (set with parameter 1 "Interpolation speed designation method" in the detailed parameters) Interpolation axis : 0	0
806+100n	2406+100n	Axis error No.	When an axis error is detected, the error code corresponding to the error details is stored. • The latest error code is always stored. (When a new axis error occurs, the error code is overwritten.) • When "Axis error reset" (axis control data) turns ON, the axis error No. is cleared (set to 0).	0
807+100n	2407+100n	Axis warning No.	Whenever an axis warning is reported, a related warning code is stored. • This area stores the latest warning code always. (Whenever an axis warning is reported, a new warning code replaces the stored warning code.) • When the "Axis error reset" (axis control data) is set to ON, the axis warning No. is cleared to "0".	0
808+100n	2408+100n	Valid M code	This area stores an M code that is currently active (i.e. set to the positioning data relating to the current operation). • Update timing: when the M code ON signal turns ON When the PLC READY signal [Y0] goes OFF, the value is set to "0".	0

n: Axis No.-1

Table 3.4 Commonly used buffer memory (continued)

Buffer memory address		Item	Remarks/Setting range	Default value								
QD77MS2	QD77MS4											
817+100n	2417+100n	Status	<ul style="list-style-type: none"> Indicates the ON/OFF status of each flag. 	0								
1500+100n	4300+100n	Positioning start No.	<ul style="list-style-type: none"> Set the positioning start No. <p>1 to 600 : Positioning data No. 7000 to 7004 : Block start designation 9001 : Machine OPR 9002 : Fast-OPR 9003 : Current value changing 9004: Simultaneous starting of multiple axes</p>	0								
1501+100n	4301+100n	Positioning starting point No.	Sets the point number for the block start data to be started.	0								
1502+100n	4302+100n	Axis error reset	<ul style="list-style-type: none"> Clears the axis error detection, axis error No., axis warning detection and axis warning No. When the axis operation state is "in error occurrence", the error is cleared and the Simple Motion module is returned to the "waiting" state. <p>0: Axis error reset request reception complete (set by the QD77MS) 1: Axis error reset request (Set by the sequence program)</p>	0								
1503+100n	4303+100n	Restart command	<ul style="list-style-type: none"> Setting "1" when the axis operation status is "Stopped", positioning is performed from the stopped position to the designated stop position. <p>0: Restart command reception complete (set by the QD77MS) 1: Restart command (Set by the sequence program)</p>	0								
1504+100n	4304+100n	M code OFF request	<ul style="list-style-type: none"> The M code ON signal turns OFF. <p>0: M code OFF request reception complete (set by the QD77MS) 1: M code OFF request (Set by the sequence program)</p>	0								
1505+100n	4305+100n	External command valid	<ul style="list-style-type: none"> Validates or invalidates external command signals. <p>0: Invalidates an external command. 1: Validates an external command.</p>	0								
1506+100n 1507+100n	4306+100n 4307+100n	New current value	<ul style="list-style-type: none"> When changing the "current feed value" using the start No. "9003", use this data item to specify a new feed value. <table border="1"> <tr> <td>-2147483648 to +2147483647 $\times 10^{-1}\mu\text{m}$</td> <td>-2147483648 to +2147483647 $\times 10^{-5}\text{inch}$</td> <td>0 to 35999999 $\times 10^{-5}\text{degree}$</td> <td>-2147483648 to +2147483647 pulse</td> </tr> <tr> <td colspan="4" style="text-align: center;">1 to 300%</td> </tr> </table>	-2147483648 to +2147483647 $\times 10^{-1}\mu\text{m}$	-2147483648 to +2147483647 $\times 10^{-5}\text{inch}$	0 to 35999999 $\times 10^{-5}\text{degree}$	-2147483648 to +2147483647 pulse	1 to 300%				0
-2147483648 to +2147483647 $\times 10^{-1}\mu\text{m}$	-2147483648 to +2147483647 $\times 10^{-5}\text{inch}$	0 to 35999999 $\times 10^{-5}\text{degree}$	-2147483648 to +2147483647 pulse									
1 to 300%												
1514+100n 1515+100n	4314+100n 4315+100n	New speed value	<ul style="list-style-type: none"> When changing the speed, use this data item to specify a new speed. The operation halts if you specify "0". <table border="1"> <tr> <td>0 to 2000000000 $\times 10^{-2}\text{mm/min}$</td> <td>0 to 2000000000 $\times 10^{-3}\text{inch/min}$</td> <td>0 to 2000000000 10^{-3}degree/min</td> <td>0 to 1000000000 pulse/s</td> </tr> </table>	0 to 2000000000 $\times 10^{-2}\text{mm/min}$	0 to 2000000000 $\times 10^{-3}\text{inch/min}$	0 to 2000000000 10^{-3}degree/min	0 to 1000000000 pulse/s	0				
0 to 2000000000 $\times 10^{-2}\text{mm/min}$	0 to 2000000000 $\times 10^{-3}\text{inch/min}$	0 to 2000000000 10^{-3}degree/min	0 to 1000000000 pulse/s									
1516+100n	4316+100n	Speed change request	<ul style="list-style-type: none"> When performing the speed change, set this to 1 after setting the speed change value. <p>0: Speed change request reception complete (set by the QD77MS) 1: Speed change request (Set by the sequence program)</p>	0								

n: Axis No.-1

Table 3.4 Commonly used buffer memory (continued)

Buffer memory address		Item	Remarks/Setting range	Default value								
QD77MS2 QD77MS4	QD77MS16											
1517+100n	4317+100n	Inching movement amount	<ul style="list-style-type: none"> Use this data item to set the amount of movement by inching. The machine performs a JOG operation if "0" is set. <table border="1"> <tr> <td>0 to 65535</td> <td>0 to 65535</td> <td>0 to 65535</td> <td>0 to 65535</td> </tr> <tr> <td>$\times 10^{-1} \mu\text{m}$</td> <td>$\times 10^{-5} \text{inch}$</td> <td>$\times 10^{-5} \text{degree}$</td> <td>pulse</td> </tr> </table>	0 to 65535	0 to 65535	0 to 65535	0 to 65535	$\times 10^{-1} \mu\text{m}$	$\times 10^{-5} \text{inch}$	$\times 10^{-5} \text{degree}$	pulse	0
0 to 65535	0 to 65535	0 to 65535	0 to 65535									
$\times 10^{-1} \mu\text{m}$	$\times 10^{-5} \text{inch}$	$\times 10^{-5} \text{degree}$	pulse									
1518+100n 1519+100n	4318+100n 4319+100n	JOG speed	<ul style="list-style-type: none"> Use this data item to set the JOG speed. Stores the changed speed value when changing the speed during the JOG operation. <table border="1"> <tr> <td>1 to 2000000000</td> <td>1 to 2000000000</td> <td>1 to 2000000000</td> <td>0 to 1000000000</td> </tr> <tr> <td>$\times 10^{-2} \text{mm/min}$</td> <td>$\times 10^{-3} \text{inch/min}$</td> <td>$\times 10^{-3} \text{degree/min}$</td> <td>pulse/s</td> </tr> </table>	1 to 2000000000	1 to 2000000000	1 to 2000000000	0 to 1000000000	$\times 10^{-2} \text{mm/min}$	$\times 10^{-3} \text{inch/min}$	$\times 10^{-3} \text{degree/min}$	pulse/s	0
1 to 2000000000	1 to 2000000000	1 to 2000000000	0 to 1000000000									
$\times 10^{-2} \text{mm/min}$	$\times 10^{-3} \text{inch/min}$	$\times 10^{-3} \text{degree/min}$	pulse/s									
1522+100n 1523+100n	4322+100n 4323+100n	Manual pulse generator 1 pulse input magnification	<ul style="list-style-type: none"> This data item determines the factor by which the number of pulses from the manual pulse generator is magnified. 	0								
1524+100n	4324+100n	Manual pulse generator enable flag	<ul style="list-style-type: none"> This data item enables or disables operations using a manual pulse generator. <p>0: Disable 1: Enable</p>	0								
1528+100n	4328+100n	Speed-position switching enable flag	<ul style="list-style-type: none"> When setting the external command function selection to the speed-position, position-speed switching request, sets whether the change is permitted or not depending on the control switching signal (external instruction signal "CHG") from the external device. <p>0: Disable 1: Enable</p>	0								
1900	5900	Flash ROM write request	<ul style="list-style-type: none"> Requests writing of data from the buffer memory to the flash ROM. Writing to the flash ROM is performed when the PLC READY signal "Y0" is OFF. <p>0: Flash ROM write complete (set by the QD77MS) 1: Requests write access to flash ROM.(set by the sequence program)</p>	0								
2004+6000n 2005+6000n	6004+1000n 6005+1000n	Command speed	<ul style="list-style-type: none"> -1: The command speed setting can be omitted (current speed) <table border="1"> <tr> <td>1 to 2000000000</td> <td>1 to 2000000000</td> <td>1 to 2000000000</td> <td>1 to 1000000</td> </tr> <tr> <td>$\times 10^{-2} \text{mm/min}$</td> <td>$\times 10^{-3} \text{inch/min}$</td> <td>$\times 10^{-3} \text{degree/min}$</td> <td>pulse/s</td> </tr> </table>	1 to 2000000000	1 to 2000000000	1 to 2000000000	1 to 1000000	$\times 10^{-2} \text{mm/min}$	$\times 10^{-3} \text{inch/min}$	$\times 10^{-3} \text{degree/min}$	pulse/s	0
1 to 2000000000	1 to 2000000000	1 to 2000000000	1 to 1000000									
$\times 10^{-2} \text{mm/min}$	$\times 10^{-3} \text{inch/min}$	$\times 10^{-3} \text{degree/min}$	pulse/s									
2006+6000n 2007+6000n	6006+1000n 6007+1000n	Positioning address/movement amount	<ul style="list-style-type: none"> Sets the movement amount or the address for the positioning. The setting range differs depending on the control method and the module used (refer to Chapter 4.3) 	0								
2008+6000n 2009+6000n	6008+1000n 6009+1000n	Arc address	<ul style="list-style-type: none"> When the control method is the ABS circular interpolation, sets the auxiliary point or the center point address. When the control method is the INC circular interpolation, sets the distance from the start point to the auxiliary point or the center point. 	0								

<Configuration of the positioning data area>

• QD77MS2/QD77MS4

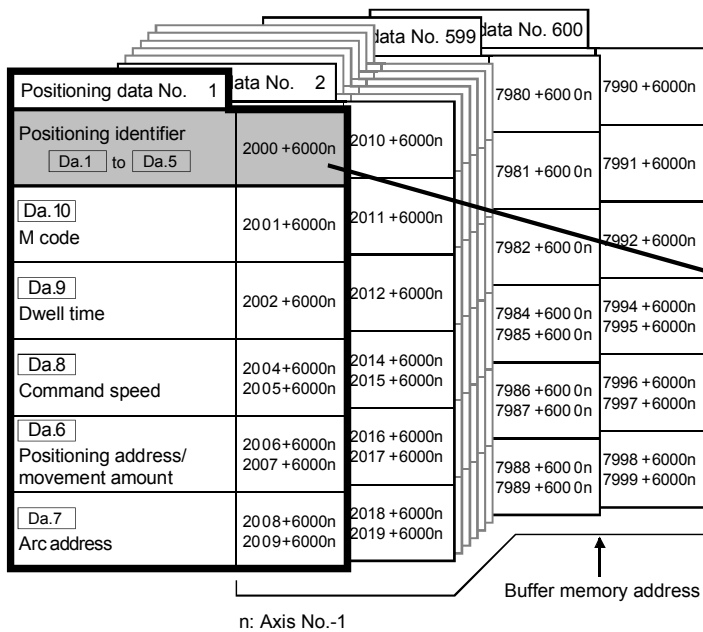

- Up to 600 positioning data items can be set (stored) for each axis in the buffer memory address shown on the left. Data is controlled as positioning data No. 1 to 600 for each axis.
- One positioning data item is configured of the items shown in the bold box.

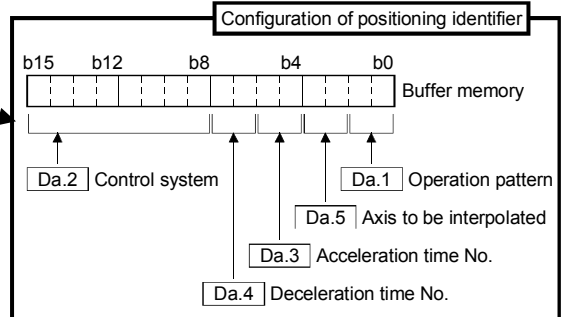

• QD77MS16

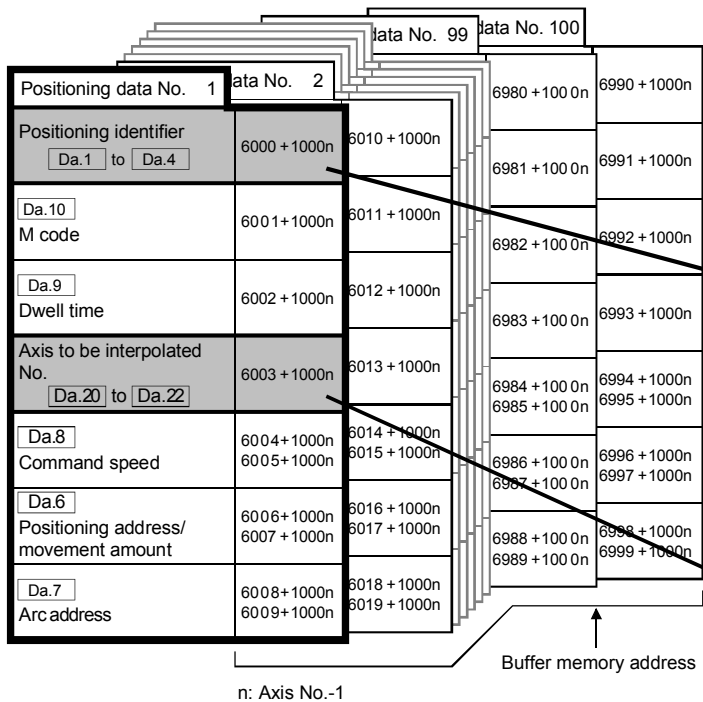

- Up to 100 positioning data items can be set (stored) for each axis in the buffer memory address shown on the left. No.101 to No.600 are not allocated to buffer memory. Set with GX Works2. Data is controlled as positioning data No. 1 to 600 for each axis.
- One positioning data item is configured of the items shown in the bold box.

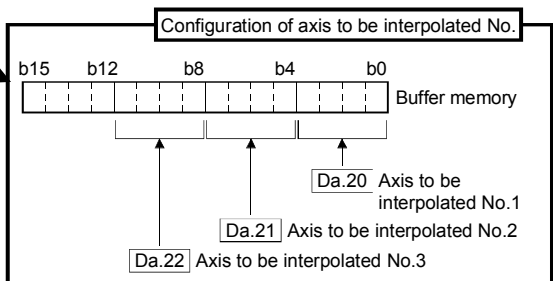
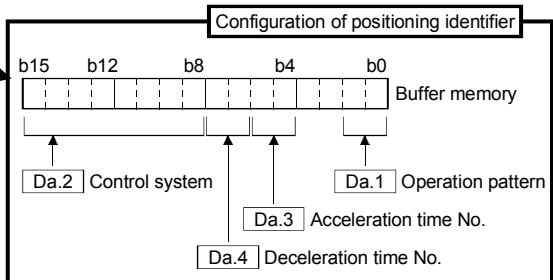

Refer to the help on the simple motion module setting tool for details on the buffer memory areas.

<Buffer memory list screen from the simple motion module setting tool help>

Positioning data		Axis No. 1			
		Positioning data(PD) No. 1			
Da.[]	Item	Buffer memory address Un[G[]]			
		QD77MS2	QD77MS4	QD77MS16	QD77GF16
Da.1	Operation pattern				
Da.2	Control method				
Da.3	Acceleration time No.	Un[G2000	Un[G2000	Un[G6000	Un[G6000
Da.4	Deceleration time No.				
Da.5	Axis to be interpolated				
Da.10	M code/Condition data/Number of LOOP to LEND repetitions	Un[G2001	Un[G2001	Un[G6001	Un[G6001
Da.9	Dwell time/JUMP destination positioning data No.	Un[G2002	Un[G2002	Un[G6002	Un[G6002
Da.20					
Da.21	Axis to be interpolated	-	-	Un[G6003	Un[G6003
Da.22					
Da.8	Command speed	Un[G2004 Un[G2005	Un[G2004 Un[G2005	Un[G6004 Un[G6005	Un[G6004 Un[G6005
Da.6	Positioning address/movement amount	Un[G2006 Un[G2007	Un[G2006 Un[G2007	Un[G6006 Un[G6007	Un[G6006 Un[G6007
Da.7	Arc address	Un[G2008 Un[G2009	Un[G2008 Un[G2009	Un[G6008 Un[G6009	Un[G6008 Un[G6009

POINT
Block start data list Refer to Appendix 8 for details of the Block start data list, which are used for the positioning control.

CHAPTER 4 Data types

The data points necessary for the QD77MS to perform the positioning control are called the "setting data". The data types are listed on the next page. (Refer to Appendix 9 for a list of the block start data.) Create this data for each axis, and store it in the buffer memory in the QD77MS.

Some of the setting data points can be changed only when the PLC READY (Yn0) is off. When writing the setting data from peripheral devices, the PLC CPU must be in the STOP status.

However, by unchecking the "Confirm PLC operation status when writing a Data" checkbox in the [Options] screen in GX Works2, writing operations can be performed in the RUN status.

Note) Changing parameters while the device is operating may lead to a dangerous situation depending on parameters. Pay full attention to safety.

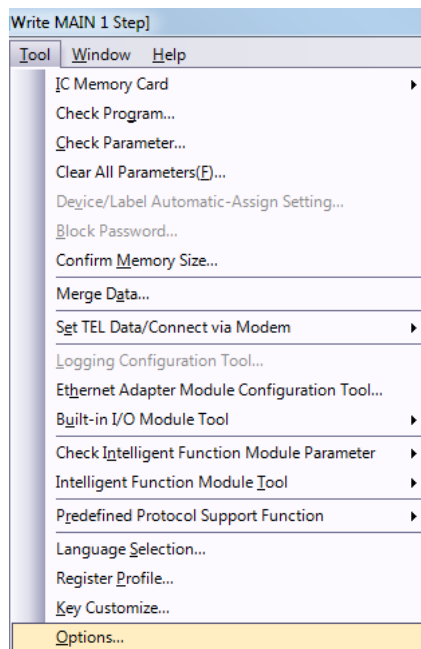

- 1) Click [Tool] → [Options], to display the "Options" dialog box.

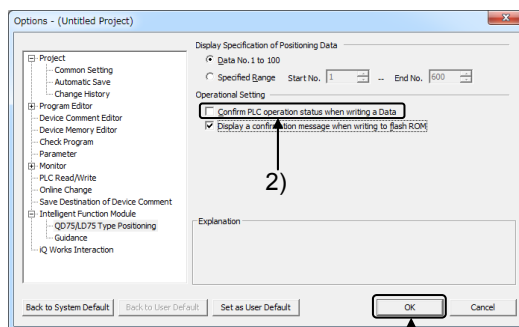

- 2) From the tree display, select [Intelligent Function Module] → [QD75/LD75 Type Positioning], and remove the check for the "Confirm PLC operation status when writing a Data" option under "Operational Setting".

- 3) Click the button.

The parameters and data required to carry out control with the Simple Motion module include the "setting data", "monitor data" and "control data" shown below.

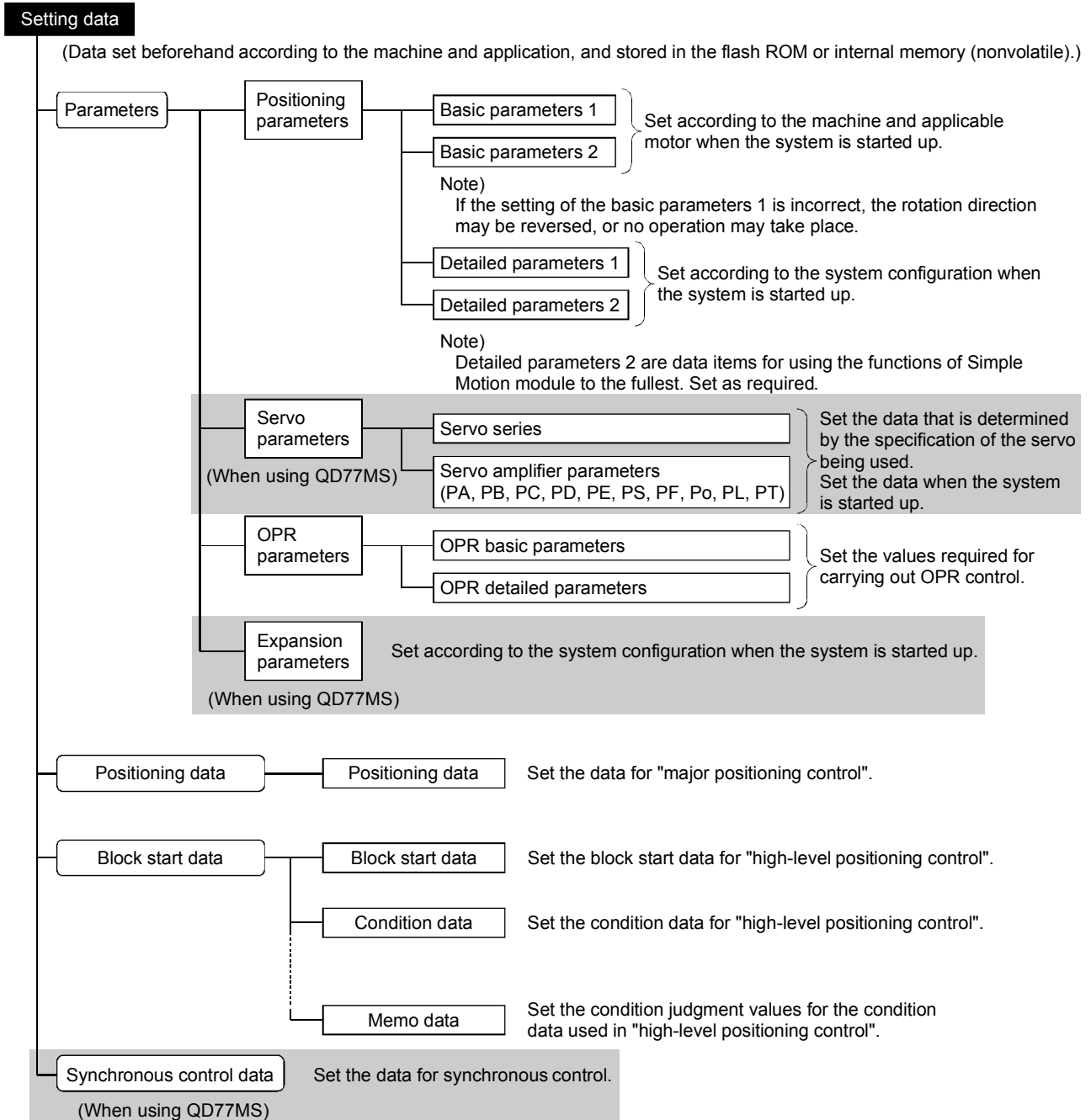

- Data settings are performed with the sequence program or a peripheral device. In this textbook, the methods using a peripheral device will be explained (Refer to page 4-4 "POINT").

- The basic parameters 1, detailed parameters 1, OPR parameters, "Speed control 10 x multiplier setting for degree axis", "Manual pulse generator/Incremental synchronous encoder input type selection", "Operation setting for speed-torque control mode" and "External command signal selection" become valid when the PLC READY signal [Y0] turns from OFF to ON.
- The basic parameters 2, detailed parameters 2 (Note that this excludes "Speed control 10 x multiplier setting for degree axis", "Manual pulse generator/Incremental synchronous encoder input type selection", "Operation setting for speed-torque control mode" and "External command signal selection".) become valid immediately when they are written to the buffer memory, regardless of the state of the PLC READY signal [Y0].
- Even when the PLC READY signal [Y0] is ON, the values or contents of the following can be changed: basic parameters 2, detailed parameters 2, positioning data, and block start data.
- The expansion parameter and servo parameter is transmitted from the QD77MS to the servo amplifier when the initialized communication carried out after the power supply is turned ON or the PLC CPU is reset.

The power supply is turned ON or the PLC CPU is reset after writing servo parameter in flash ROM of QD77MS if the servo parameter is transmitted to the servo amplifier.

The following servo parameter in the buffer memory is transmitted to the servo amplifier when the PLC READY [Y0] turns from OFF to ON.

- "Auto tuning mode (PA08)"
 - "Auto tuning response (PA09)"
 - "Feed forward gain (PB04)"
 - "Load to motor inertia ratio/load to motor mass ratio (PB06)"
 - "Model loop gain (PB07)"
 - "Position loop gain (PB08)"
 - "Speed loop gain (PB09)"
 - "Speed integral compensation (PB10)"
 - "Speed differential compensation (PB11)"
- The only valid data assigned to basic parameter 2, detailed parameter 2, positioning data or block start data are the data read at the moment when a positioning or JOG operation is started. Once the operation has started, any modification to the data is ignored.
Exceptionally, however, modifications to the following are valid even when they are made during a positioning operation: acceleration time 0 to 3, deceleration time 0 to 3, and external command function.
 - Acceleration time 0 to 3 and deceleration time 0 to 3:
Positioning data are pre-read and pre-analyzed. Modifications to the data four or more steps after the current step are valid.
 - External command function selection: The value at the time of detection is valid.

Monitor data (Data that indicates the control state. Stored in the buffer memory, and monitors as necessary.)

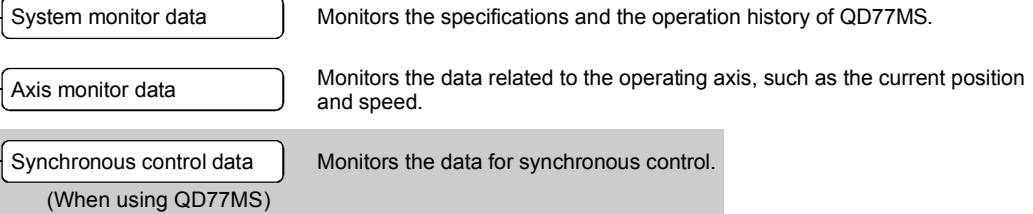

- Data settings are monitored with the sequence program or a peripheral device. In this textbook, the methods using a peripheral device will be explained.

Control data (Data for user to control positioning system.)

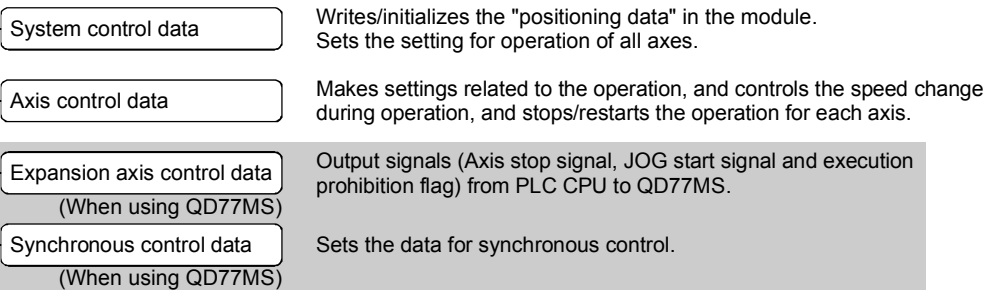

- Control using the control data is carried out with the sequence program. "Deceleration start flag valid" is valid for only the value at the time when the PLC READY signal [Y0] turns from OFF to ON.

POINT
(1) The "setting data" is created for each axis.
(2) The "setting data" parameters have determined default values, and are set to the default values before shipment from the factory. (Parameters related to axes that are not used are left at the default value.)
(3) The "setting data" can be initialized with GX Works2 or the sequence program.
(4) It is recommended to set the "setting data" with GX Works2. The sequence program for data setting is complicated and many devices must be used. This will increase the scan time.

4.1 Parameters

Parameters include basic parameters 1 and 2 and advanced parameters 1 and 2. These data points are the basic data points that determine how the QD77MS mechanically performs the positioning control.

4.1.1 Basic parameters

Basic parameters are classified into basic parameters 1 or basic parameters 2.

Table 4.1 List of basic parameters (QD77MS)

Unit Item		Setting range				Default value	
		mm	inch	degree	PLS		
Basic parameters 1	Unit setting	0:mm	1:inch	2:degree	3:pulse	3	
	Movement amount per pulse (A)	Number of pulses per rotation (AP)	1 to 200000000 pulse				20000
		Movement amount per rotation (AL)	1 to 200000000 ($\times 10^{-1}\mu\text{m}$)	1 to 200000000 ($\times 10^{-5}\text{inch}$)	1 to 200000000 ($\times 10^{-5}\text{degree}$)	1 to 20000000 (pulse)	20000
		Unit magnification (Am)	1 times 10 times 100 times 1000 times				1
	Bias speed at start	0 to 2000000000 ($\times 10^{-2}\text{mm/min}$)	0 to 2000000000 ($\times 10^{-3}\text{inch/min}$)	0 to 2000000000 ($\times 10^{-3}\text{degree/min}$)*	0 to 1000000000 (pulse/s)	0	
Basic parameters 2	Speed limit value	0 to 2000000000 ($\times 10^{-2}\text{mm/min}$)	0 to 2000000000 ($\times 10^{-3}\text{inch/min}$)	0 to 2000000000 ($\times 10^{-3}\text{degree/min}$)*	0 to 1000000000 (pulse/s)	20000	
	Acceleration time 0	1 to 8388608ms				1000	
	Deceleration time 0	1 to 8388608ms				1000	

- 1) Default values are common for axis 1 to axis 4.
- 2) Decimal point values cannot be used when setting with the sequence program.
- 3) Settable values for the acceleration time and the deceleration time are 0 to 3. Values 1 to 3 for the acceleration time and the deceleration time are described in the advanced parameters.

*: Range of speed limit value when "Speed control 10 x multiplier setting for degree axis" is set to valid: 1 to 2000000000 ($\times 10^{-2}\text{degree/min}$)

Unit setting

Set the unit used for defining positioning operations. Choose from the following units depending on the type of the control target: mm, inch, degree, or PLS.

(Example)

mm or inchX-Y table, conveyor (Select mm or inch depending on the machine specifications.)

degreeRotating body (360 degrees/rotation)

PLS.....X-Y table, conveyor

Different units can be defined for different axes.

Movement amount per pulse

1) Number of pulses per rotation (AP)

The number of pulse (n) for the manual pulse generator feedbacks to the servo amplifier MR-J4.

$$AP=n$$

2) Movement amount per rotation (AL)

The amount how the workpiece moves with one motor rotation is determined by the mechanical structure.

If the worm gear lead ($\mu\text{m}/\text{rev}$) is PB and the deceleration rate is $1/n$, then

$$AL=PB\times R$$

3) Unit magnification (Am)

The setting range of the movement amount movement per rotation is limited. However, the magnification can be adjusted when the movoment amout exceeds the setting range.

```

---Setting the movement amount per rotation and the unit magnification
<Conditions>
  • The ball screw lead is 10mm (10000 $\mu\text{m}$ ) and the gear ratio is  $\frac{1}{1}$ 
<Setting example>
  • The settable range for the movement amount per rotation is between 0.1 to 20000000.0 $\mu\text{m}$ , so set "10000.0".
  • Set "1" to the unit magnification.

```

<The method for compensating the error>

When the position control is carried out using the "Electronic gear" set in a parameter, this may produce an error between the command movement amount (L) and the actual movement amount (L'). With QD77MS, this error is compensated by adjusting the electronic gear. The "Error compensation amount", which is used for error compensation, is defined as follows:

$$\text{Error compensation amount} = \frac{\text{Command movement amount (L)}}{\text{Actual movement amount (L')}} \dots(2)$$

The electronic gear including an error compensation amount is shown below.

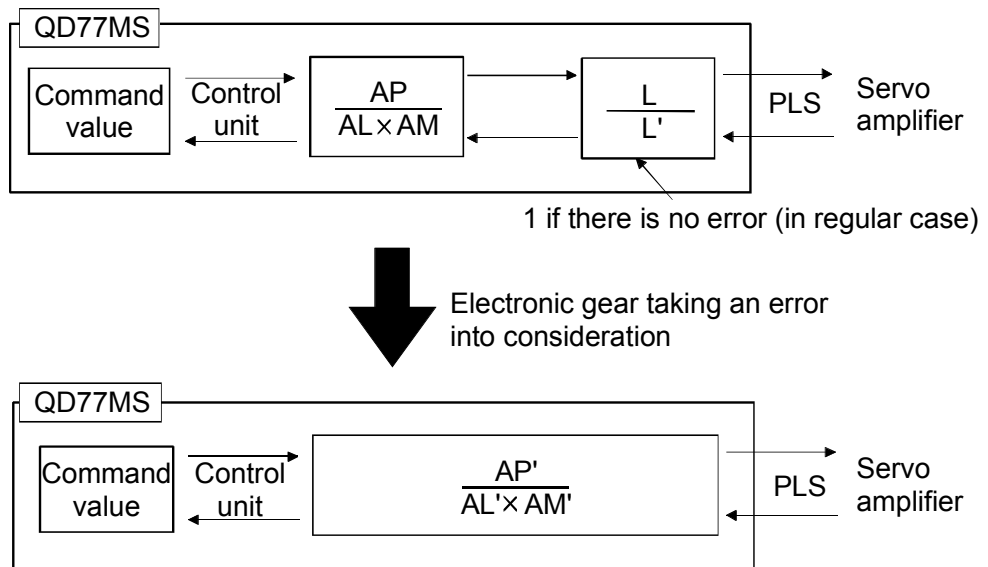

--- Calculation example ---

(Conditions)

Number of pulses per rotation (AP) : 4194304 [PLS]
 Movement amount per rotation(AL) : 5000.0 [μ m]
 Unit magnification (AM) : 1

(Positioning results)

Command movement amount (L) : 100 [mm]
 Actual movement amount (L') : 101 [mm]

(Compensation value)

$$\frac{AP}{AL \times AM} \times \frac{L}{L'} = \frac{4194304}{5000.0 \times 1} \times \frac{100}{101} = \frac{4194304 (AP)}{5050(AL') \times 1(AM')}$$

Number of pulses per rotation (AP') : 4194304 ... Pr.2
 Movement amount per rotation (AL') : 5050.0 Pr.3
 Unit magnification (AM') : 1 Pr.4

Set the post-compensation "Number of pulses per rotation (AP')", "Movement amount per rotation (AL')", and "Unit magnification (AM')" in the parameters, and write them to the QD77MS.

The set details are validated at the rising edge (OFF ON) of the PLC READY signal [Y0].

Bias speed at start

The bias speed at start is the minimum speed at the start of the operation to rotate the motor smoothly when using the stepping motor.

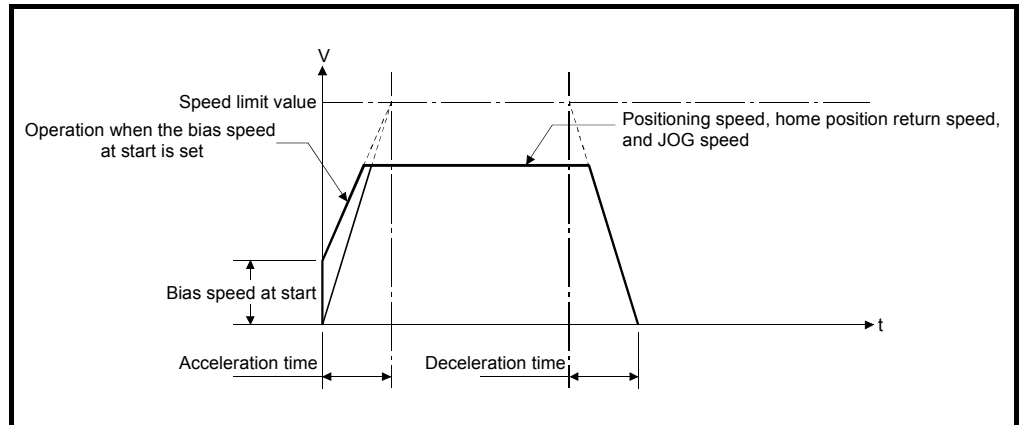

Fig 4.1 Bias speed at start

- 1) This speed is valid during the home position return, the positioning, and the JOG operation.
- 2) Do not set other than the default value "0" since this parameter is for the manufacturer setting.

Speed limit value

Set the upper limit speed for the positioning control and the home position return control. When a speed that exceeds the speed control value is set, the speed is limited to the speed control value.

Set the speed control value within the range of the following expression. When the value does not satisfy the following range, the error "Out of speed limit value range" (error code: 910) will occur.

The command pulse frequency converted from the speed limit value \leq Maximum output pulse

Acceleration/deceleration time

Set the period from the start of the operation to the speed control value set by the basic parameters (2).

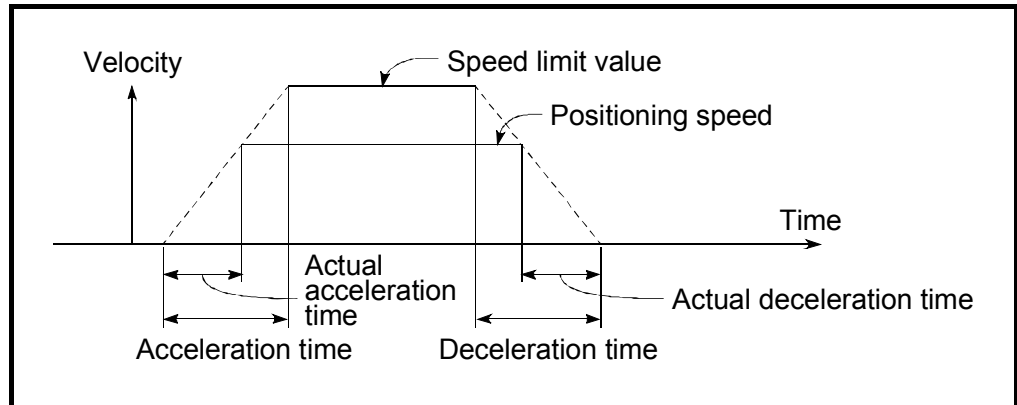

Fig 4.2 Acceleration/deceleration time

- 1) If the positioning speed is set lower than the parameter-defined speed limit value, the actual acceleration/deceleration time will be relatively short.
Thus, set the maximum positioning speed equal to or only a little lower than the parameter-defined speed limit value.
- 2) These settings are valid for OPR, positioning and JOG operations.
- 3) When the positioning involves interpolation, the acceleration/deceleration time defined for the reference axis is valid.

4.1.2 Detailed parameters

Advanced parameters are classified into the advanced parameters 1 or the advanced parameters 2.

Table 4.2 List of advanced parameters (QD77MS)

Unit	Setting range				Default value
	mm	inch	degree	PLS	
Backlash compensation amount	0 to 65535 ($\times 10^{-1}\mu\text{m}$)	0 to 65535 ($\times 10^{-5}\text{inch}$)	0 to 65535 ($\times 10^{-5}\text{degree}$)	0 to 65535(pulse)	0
Software stroke limit upper limit value	-2147483648 to 2147483647 ($\times 10^{-1}\mu\text{m}$)	-2147483648 to 2147483647 ($\times 10^{-5}\text{inch}$)	0 to 35999999 ($\times 10^{-5}\text{degree}$)	-2147483648 to 2147483647(pulse)	2147483647
Software stroke limit lower limit value	-2147483648 to 2147483647 ($\times 10^{-1}\mu\text{m}$)	-2147483648 to 2147483647 ($\times 10^{-5}\text{inch}$)	0 to 35999999 ($\times 10^{-5}\text{degree}$)	-2147483648 to 2147483647(pulse)	-2147483648
Software stroke limit selection	0: Apply software stroke limit on current feed value 1: Apply software stroke limit on machine feed value				0
Software stroke limit valid/invalid setting	0: Software stroke limit valid during JOG operation and manual pulse generator operation 1: Software stroke limit invalid during JOG operation and manual pulse generator operation				0
Command in-position width	1 to 2147483647 ($\times 10^{-1}\mu\text{m}$)	1 to 214783647 ($\times 10^{-5}\text{inch}$)	1 to 2147483647 ($\times 10^{-5}\text{degree}$)	1 to 2147483647 (pulse)	100
Torque limit setting value	1 to 1000%				300
M code ON signal output timing	0: WITH mode 1: AFTER mode				0
Speed switching mode	0: Standard speed switching mode Switch the speed when executing the next positioning data. 1: Front-loading speed switching mode The speed switches at the end of the positioning data currently being executed.				0
Interpolation speed designation method	0: Composite speed The movement speed for the control target is designated, and the speed for each axis is calculated by the QD77MS. 1: Reference axis speed The axis speed set for the reference axis is designated, and the speed for the other axis carrying out interpolation is calculated by the QD77MS.				0
Current feed value during speed control	0: Do not update current feed value The current feed value will not change. (The value at the beginning of the speed control will be kept.) 1: Update current feed value The current feed value will be updated. (The current feed value will change from the initial.) 2: Clear current feed value to zero The current feed value will be set initially to zero and change from zero while the speed control is in effect.				0
Input signal logic selection	Lower limit	0: Negative logic 1: Positive logic			0
	Upper limit				
	Stop signal				
	External command				
	Near-point dog signal				
Manual pulse generator input					
External input signal selection	0: External input signal of QD77MS QD77MS2 QD77MS4 1: External input signal of servo amplifier 2: Buffer memory of QD77MS 3: External input signal 1 of QD77MS QD77MS16 4: External input signal 2 of QD77MS QD77MS16 5: External input signal 3 of QD77MS QD77MS16 6: External input signal 4 of QD77MS QD77MS16				*1

Detailed parameters 1

Parameters

Table 4.2 List of advanced parameters (QD77MS) (continued)

Unit Item		Setting range				Default value
		mm	inch	degree	PLS	
Detailed parameters 1	Manual pulse generator synchronous encoder input selection	0: A-phase/B-phase multiplied by 4 1: A-phase/B-phase multiplied by 2 2: A-phase/B-phase multiplied by 1 3: PLS/SIGN				0
	Speed-position function selection	0: Speed-position switching control (INC mode) 2: Speed-position switching control (ABS mode)				0
	Forced stop valid/invalid selection	0: Valid...Forced stop is used 1: Invalid...Forced stop is not used				0
Detailed parameters 2	Acceleration time 1 to 3	1 to 8388608ms				1000
	Deceleration time 1 to 3	1 to 8388608ms				1000
	JOG speed limit value	1 to 2000000000 ($\times 10^{-2}$ mm/min)	1 to 2000000000 ($\times 10^{-3}$ inch/min)	1 to 2000000000 ($\times 10^{-3}$ degree/min)	1 to 1000000000 (PLS/s)	20000
	JOG operation acceleration time selection	0 to 3				0
	JOG operation deceleration time selection	0 to 3				0
	Acceleration/deceleration process selection	0 : Trapezoid acceleration/deceleration process 1 : S-curve acceleration/deceleration process				0
	S-curve ratio	1 to 100%				100
	Sudden stop deceleration time	1 to 8388608ms				1000
	Stop group 1 to 3 sudden stop selection	0 : Normal deceleration stop 1 : Sudden stop				0
	Positioning complete signal output time	0 to 65535ms				300
	Allowable circular interpolation error width	0 to 100000 ($\times 10^{-1}$ μ m)	0 to 100000 ($\times 10^{-5}$ inch)	0 to 100000 ($\times 10^{-5}$ degree)	0 to 100000 (pulse)	100
	External command function selection	0: External positioning start The external command signal input is used to start a positioning operation. 1: External speed change request The external command signal input is used to change the speed in the current positioning operation. The new speed should be set in the "New speed value" 2: Speed-position, positionspeed switching request The external command signal input is used to switch from the speed control to the position control while in the speed-position switching control mode, or from the position control to the speed control while in the position-speed switching control mode. To enable the speed-position switching control, set the "Speed-position switching enable flag" to "1". To enable the position-speed switching control, set the "26 Position-speed switching enable flag" to "1". 3: Skip request The external command signal input is used skip the current positioning operation. 4: High speed input request The external command signal input is used to execute the mark detection. And, also set to use the external command signal in the synchronous control.				0
	Speed control 10 x multiplier setting for degree axis	0: Invalid 1: Valid				0
	Restart allowable range when servo OFF to ON	0, 1 to 327680[PLS] 0: restart not allowed				0

*1: QD77MS2, QD77MS4: 0 QD77MS16: 1

Backlash compensation amount

The error that occurs due to backlash when moving the machine via gears can be compensated.

(When the backlash compensation amount is set, commands equivalent to the compensation amount will be output each time the direction changes during positioning.)

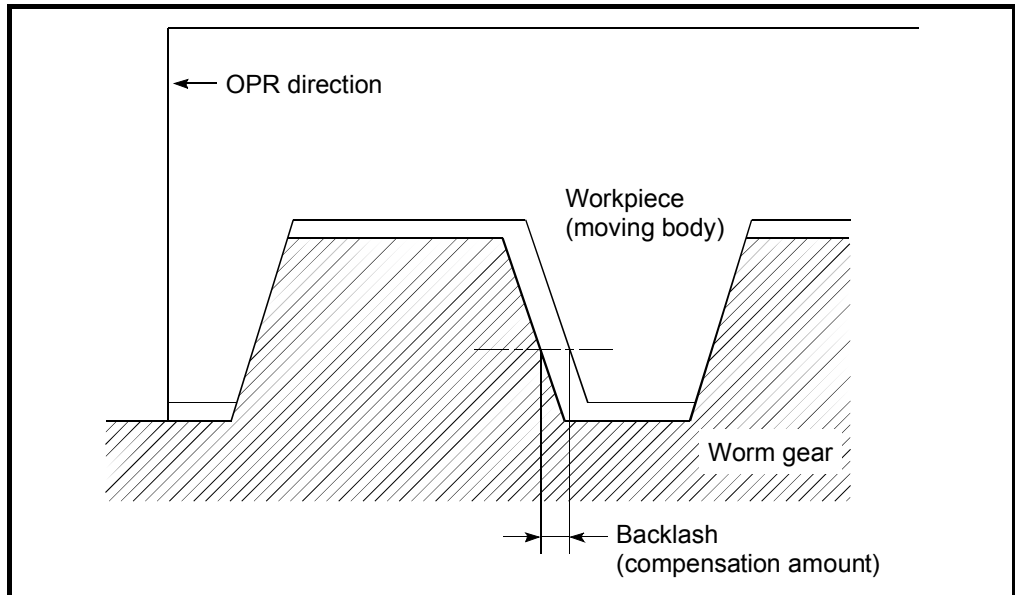

Fig 4.3 Backlash compensation amount

- 1) The backlash compensation is valid after machine OPR. Thus, if the backlash compensation amount is set or changed, always carry out machine OPR once.
- 2) The backlash compensation amount setting range is 0 to 65535, but it must be set to 255 or less by using the following expression.

$$0 \leq \frac{\text{Backlash compensation amount}}{\text{Movement amount per pulse}} \leq 255$$

Software stroke limit upper limit value

Set the upper limit for the machine's movement range during positioning control.

Software stroke limit lower limit value

Set the lower limit for the machine's movement range during positioning control.

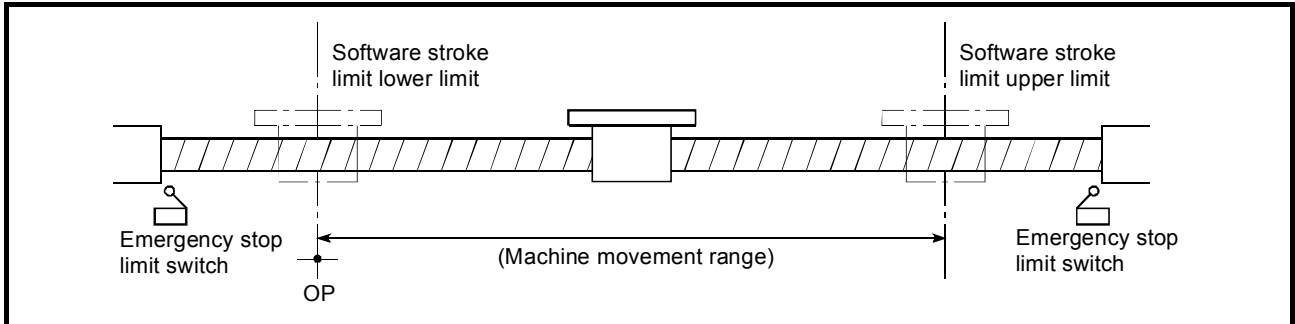
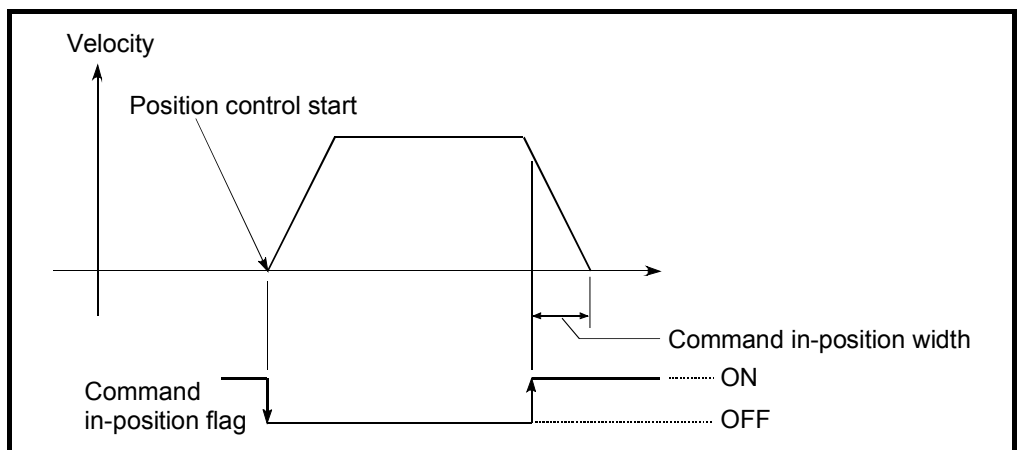

Fig 4.4 Software stroke limit upper/lower limit value

- 1) Generally, the OP is set at the lower limit or upper limit of the stroke limit.
- 2) By setting the upper limit value or lower limit value of the software stroke limit, overrun can be prevented in the software. However, an emergency stop limit switch must be installed nearby outside the range.
- 3) To invalidate the software stroke limit, set the setting value to "upper limit value = lower limit value". (If it is within the setting range, the setting value can be anything.)
- 4) When the unit is "degree", the software stroke limit check is invalid during speed control (including the speed control in speed-position and positionspeed switching control) or during manual control.

Command in-position width

Set the remaining distance that turns the command in-position ON. The command in-position signal is used as a front-loading signal of the positioning complete signal. When positioning control is started, the "Command in-position flag (Status: b2)" turns OFF, and the "command in-position flag" turns ON at the set position of the command in-position sigma I.



Torque limit setting value

The torque limit function limits the torque generated by the servomotor within the set range.

If the torque required for control exceeds the torque limit value, it is controlled with the set torque limit value.

USAGE CONDITION

(1) Limits for pulse train output type

- (a) The D/A conversion module and the D/A conversion module and a drive unit must be wired.
- (b) A drive unit that can issue a torque limit command with the analog voltage is required.
- (c) The "Torque limit setting value" setting is set to the buffer memory "Torque limit stored value", so transmit that "Torque limit stored value" to the D/A conversion module with the sequence program.

M code ON signal output timing

This parameter sets the M code ON signal output timing.

Choose either WITH mode or AFTER mode as the M code ON signal output timing.

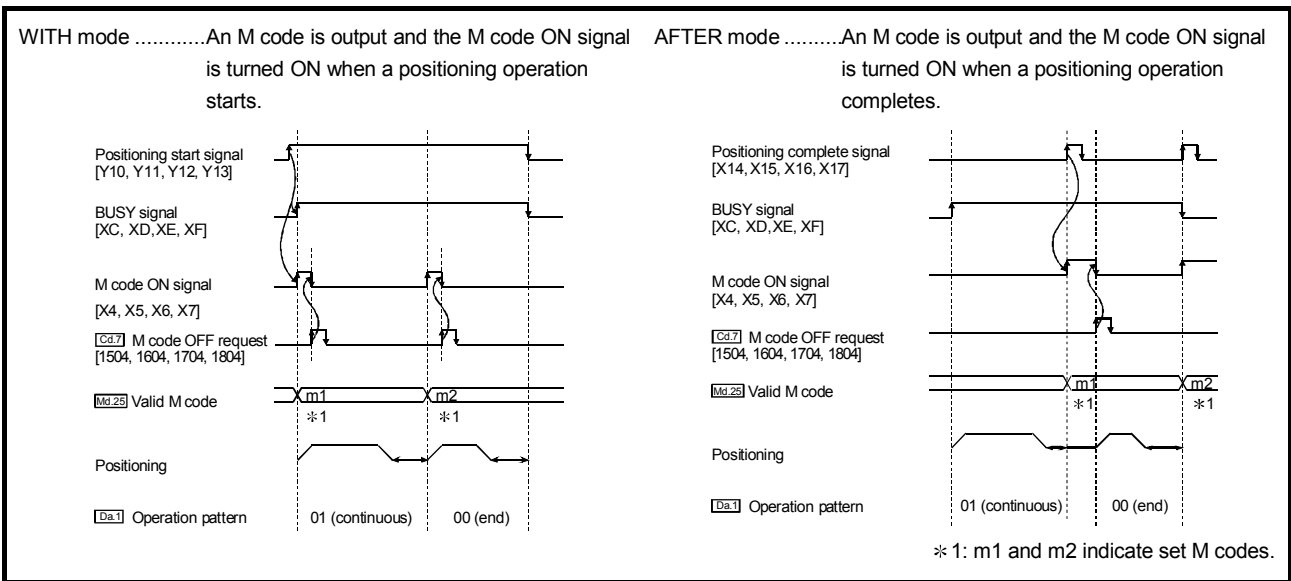

Note: If AFTER mode is used with speed control, an M code will not be output and the M code ON signal will not be turned ON.

Speed switching mode

Set whether to switch the speed switching mode with the standard switching or front-loading switching in mode.

- 0 : Standard switching Switch the speed when executing the next positioning data.
- 1 : Front-loading switching The speed switches at the end of the positioning data currently being executed.

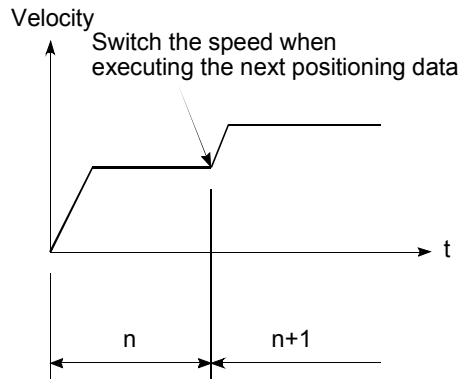

<For standard switching>

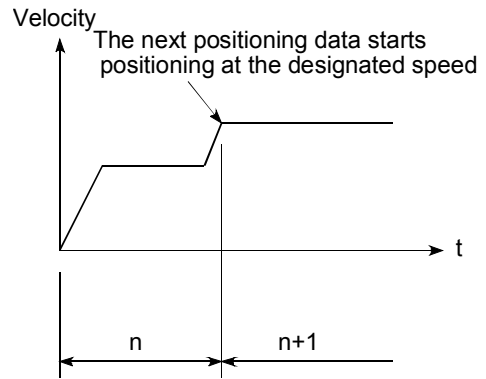

<For front-loading switching>

Interpolation speed designation method

When carrying out linear interpolation/circular interpolation, set whether to designate the composite speed or reference axis speed.

- 0: Composite speed The movement speed for the control target is designated, and the speed for each axis is calculated by the Q77MS.
- 1: Reference axis speed The axis speed set for the reference axis is designated, and the speed for the other axis carrying out interpolation is calculated by the Q77MS.

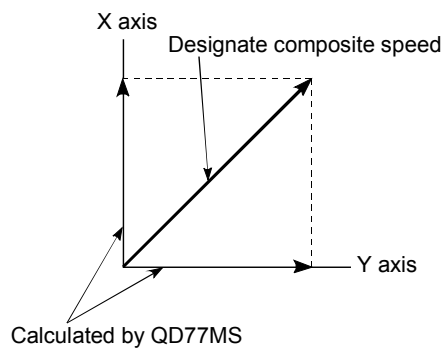

<When composite speed is designated>

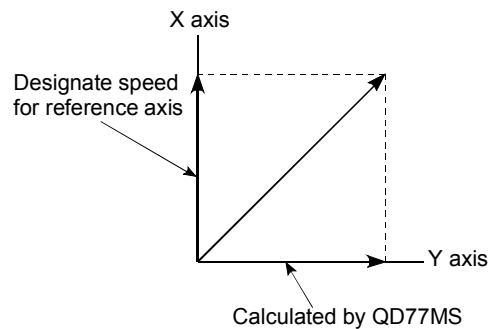

<When reference axis speed is designated>

Input/output signal logic selection

Set whether update the "Current feed value" or not while operations are performed under the speed control (including the speed-position and position-speed switching control).

0: The update of the current feed value is disabled The current feed value will not be changed. (The current feed value at the beginning of the speed control will be kept.)

1: The update of the current feed value is enabled The current feed value will be updated. (The current feed value will change from the initial.)

2: The current feed value is cleared to zero The current feed value will be reset to 0 and will not be updated.

Note 1) When performing the speed control for axis 2 to axis 4, the setting for the reference axis determines whether the current feed value for the interpolation axis is updated or not.

Note 2) Set "1" to perform the speed-position switching control (ABS mode).

Forced stop valid/invalid selection

Set the forced stop valid/invalid. (Only the value specified against the axis 1 is valid.) All axis of the servo amplifier are made to batch forced stop when the forced stop input signal is turned on.

But "Servo READY signal OFF during operation" (error code: 102) does not occur even if the forced input signal is turned on during operation.

0: Valid (Forced stop is used)

1: Invalid (Forced stop is not used)

Note1: If the setting is other than 0 and 1, "Forced stop valid/invalid setting error" (error code: 937) occurs.

Note2: The "Forced stop input" is stored "1" by setting "Forced stop valid/invalid selection" to invalid.

Acceleration/deceleration process selection

Set whether to use trapezoid acceleration/deceleration or S-curve acceleration/deceleration for the acceleration/deceleration process .

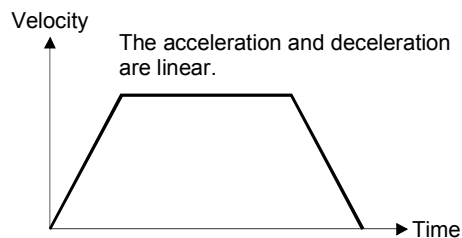

<Trapezoid acceleration/deceleration>

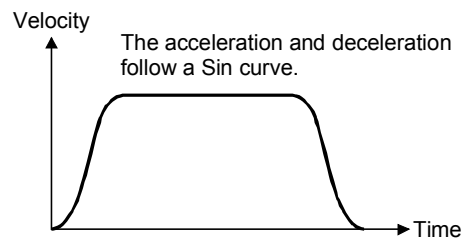

<S-curve acceleration/deceleration>

S-curve ratio

- (a) Set the S-curve ratio (1 to 100%) for carrying out the S-curve acceleration/deceleration process.
- (b) The S-curve ratio indicates where to draw the acceleration/deceleration curve using the Sin curve as shown below.

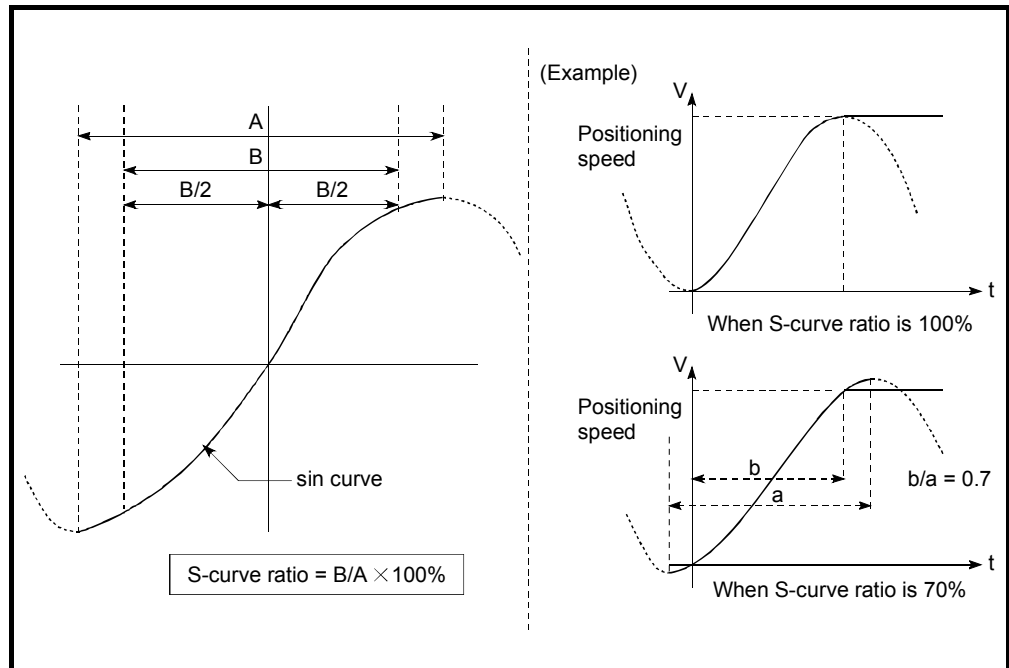

Sudden stop selection (Stop group 1 to 3)

Set the method to stop when the stop causes in the following stop groups occur.

- Stop group 1 Stop with hardware stroke limit
- Stop group 2 Error occurrence of the PLC CPU, PLC READY signal [Y0] OFF, Fault in test mode
- Stop group 3 Axis stop signal from PLC CPU
Stop signal from test function of GX Works2
Error occurrence (excludes errors in stop groups 1 and 2: includes only the software stroke limit errors during JOG operation, speed control, speed-position switching control, and position-speed switching control)

The methods of stopping include "0: Normal deceleration stop" and "1: Sudden stop".

If "1: Sudden stop" is selected, the axis will suddenly decelerate to a stop when the stop cause occurs.

Positioning complete signal output time

- (a) Set the output time of the positioning complete signal (X14, X15, X16, X17) output from the QD77MS.
 A positioning completes when the specified dwell time has passed after the QD77MS had terminated the command output.
 For the interpolation control, the positioning completed signal of interpolation axis is output only during the time set to the reference axis.

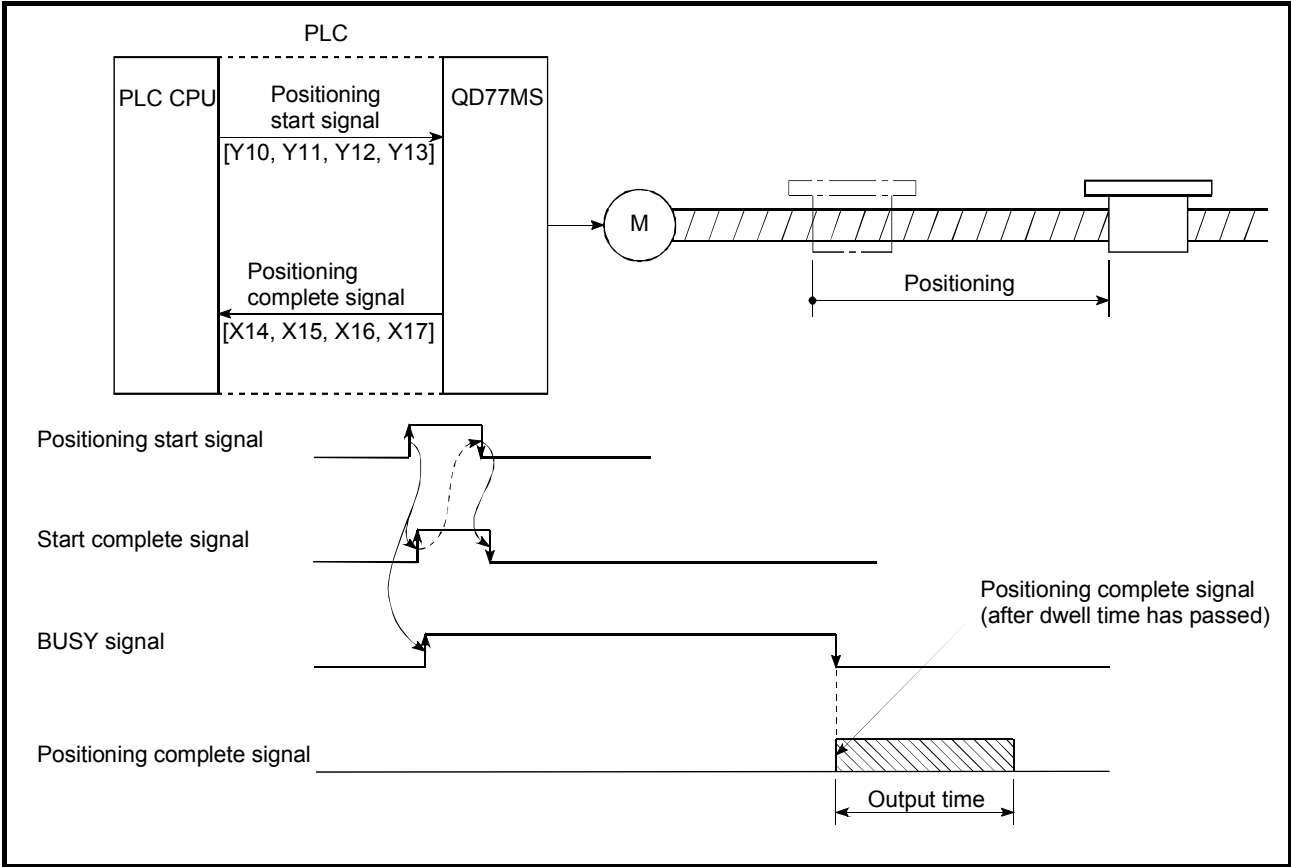
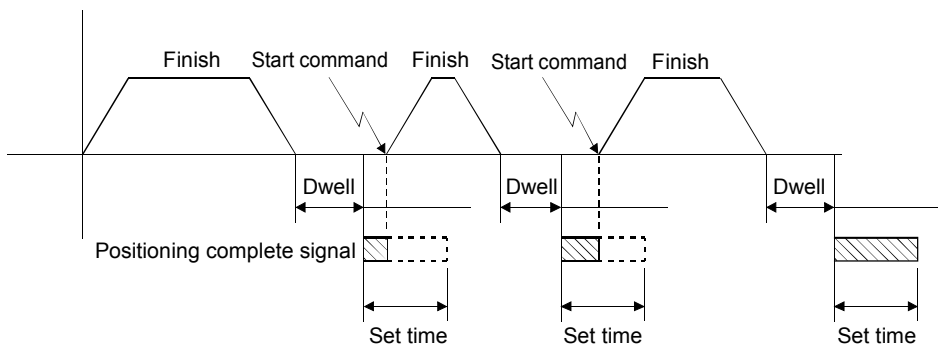
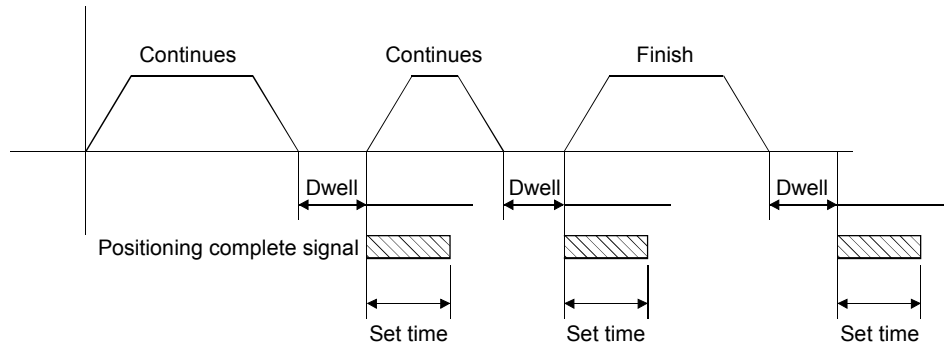

Fig 4.5 Positioning complete signal output time

- (b) The operations when the next positioning is started while the positioning complete signal is on are described. (Details on the positioning pattern are described in the section on the positioning data.)
 1) When the positioning pattern is the "Finish", the positioning complete signal turns off when the next data No. starts.



- 2) When the set time for the positioning complete signal is shorter than the next positioning operation time while the positioning pattern is the "continuous positioning control", the positioning complete signal turns on when the next data No. starts after the previous dwell time has passed. The positioning complete signal turns off after the set time has passed.



- 3) When the set time for the positioning complete signal is longer than the next positioning operation time while the positioning pattern is in the "continuous positioning", the positioning complete signal turns on when the next data No. starts after the previous dwell time has passed. When the next data No. starts, the positioning complete signal remains on until the set time has passed, the passed time up to this point is ignored, and measured again from 0. The positioning complete signal also turns off after the set time has passed.

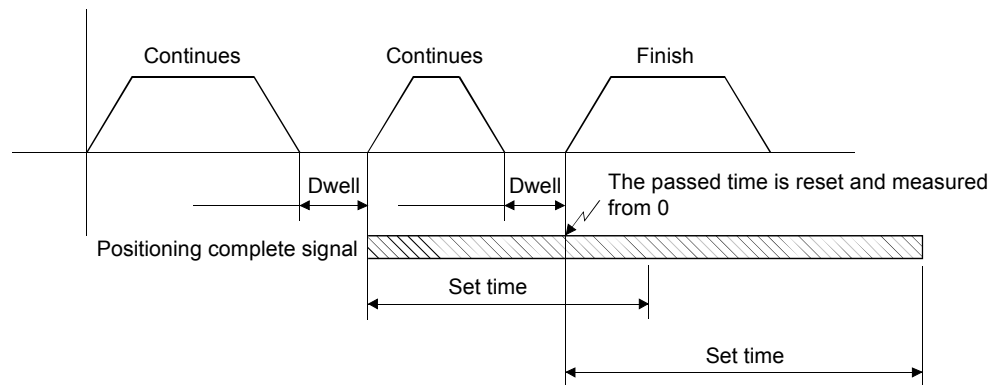

- 4) When the positioning pattern is in the "continuous path", the positioning complete signal turns on when the speed changes and the next positioning for the next data No. starts.

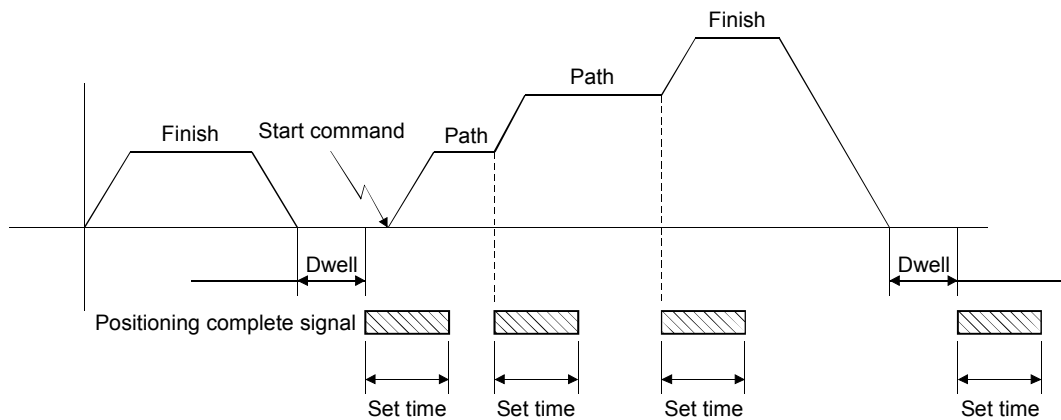

(Note) When the set time for the positioning complete signal is longer than the next positioning operation time while the positioning pattern is in the "continuous path", the operation will be the same as that described in section 3.

Allowable circular interpolation error width

The allowable error range of the calculated arc path and end point address is set.*1
If the error of the calculated arc path and end point address is within the set range, circular interpolation will be carried out to the set end point address while compensating the error with spiral interpolation.

The allowable circular interpolation error width is set in the following axis buffer memory addresses.

- If axis 1 is the reference axis, set in the axis 1 buffer memory address [60, 61].
- If axis 2 is the reference axis, set in the axis 2 buffer memory address [210, 211].
- If axis 3 is the reference axis, set in the axis 3 buffer memory address [360, 361].
- If axis 4 is the reference axis, set in the axis 4 buffer memory address [510, 511].

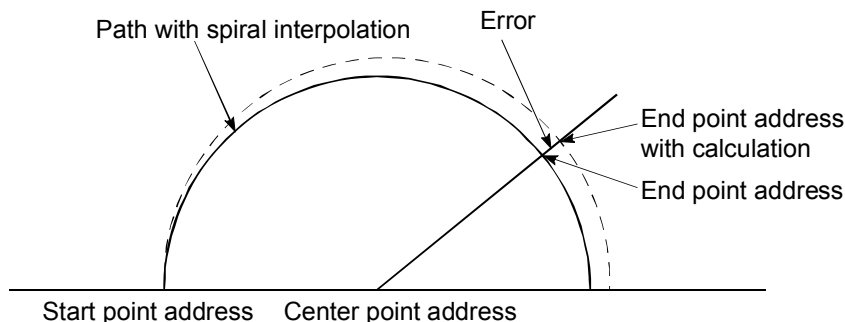

*1 With circular interpolation control using the center point designation, the arc path calculated with the start point address and center point address and the end point address may deviate.

External command function selection

Select a command with which the external command signal should be associated.

0: External positioning start

The external command signal input is used to start a positioning operation.

1: External speed change request

The external command signal input is used to change the speed in the current positioning operation. The new speed should be set in the "New speed value"

2: Speed-position, position-speed switching request

The external command signal input is used to switch from the speed control to the position control while in the speed-position switching control mode, or from the position control to the speed control while in the position-speed switching control mode. To enable the speed-position switching control, set the "Speed-position switching enable flag" to "1". To enable the position-speed switching control, set the "Position-speed switching enable flag" to "1".

3: Skip request

The external command signal input is used skip the current positioning operation.

POINT
To enable the external command signal, set the "External command valid" (1505,1605,1705,1805) to "1".

Speed control 10 x multiplier setting for degree axis

Set the speed control 10 x multiplier setting for degree axis when you use command speed and speed limit value set by the positioning data and the parameter at "Unit setting" setup degree by ten times at the speed.

Normally, the speed specification range is 0.001 to 2000000.000[degree/min], but it will be decupled and become 0.01 to 20000000.00[degree/min] by setting "Speed control 10 x multiplier setting for degree axis" to valid.

Note) The speed control 10 x multiplier setting for degree axis is included in detailed parameters 2, but it will be valid at the rising edge (OFF to ON) of the PLC READY signal [Y0].

*: Refer to section 13.7.10 "Speed control 10 x multiplier setting for degree axis function" in the MELSEC-Q QD77MS Simple Motion Module User's Manual (Positioning Control) for details on setting the 10 x multiplier setting for degree axis.

Restart allowable range when servo OFF to ON

The restart function at switching servo OFF to ON performs continuous positioning operation (positioning start, restart) when switching servo OFF to ON while the QD77MS is stopped (including forced stop, servo forced stop).

Restart at switching servo OFF to ON can be performed when the difference between the last command position of QD77MS at stop and the present value at switching servo OFF to ON is equal to or less than the value set in the buffer memory for the restart allowable range setting.

(1) Servo emergency stop processing

- (a) When operations stops due to the servo emergency stop signal, operation stops and operation can restart if the difference between the last command position of the QD77MS when the servo stop signal turns on and the current value when the servo stop signal turns off is less than or equal to the value set by the buffer memory for the restart allowable range setting.
- (b) When the difference between the last command position of the QD77MS when the servo stop signal turns on and the current value when the servo stop signal turns off is larger than the value set by the buffer memory for the restart allowable range setting, the positioning operation is judged as on-standby and cannot be restarted.

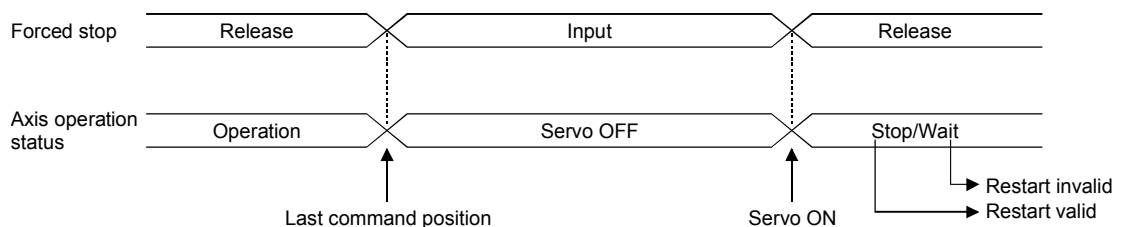

(2) Processing at switching the servo ON signal from OFF to ON

- (a) When the difference between the last command position of QD77MS at switching the servo ON signal from ON to OFF and the present value at switching the servo ON signal from OFF to ON is equal to or less than the value set in the buffer memory for the restart allowable range setting, the positioning operation is judged as stopped and can be restarted.
- (b) When the difference between the last command position of QD77MS at switching the servo ON signal from ON to OFF and the present value at switching the servo ON signal from OFF to ON is greater than the value set in the buffer memory for the restart allowable range setting, the positioning operation is judged as onstandby and cannot be restarted.

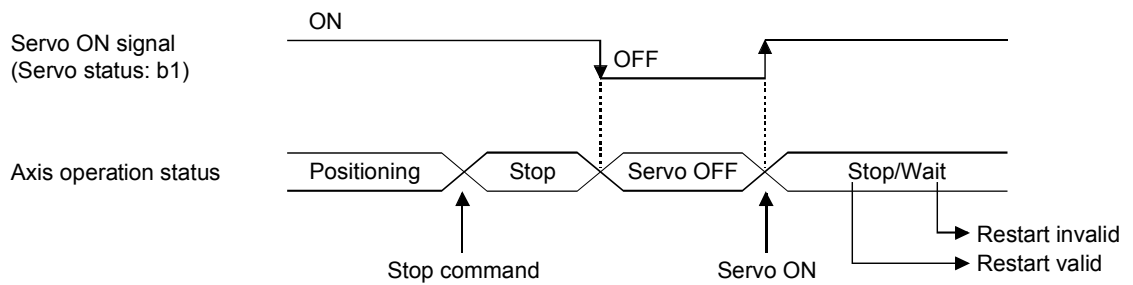

*: Refer to MELSEC-Q QD77MS Simple Motion Module User's Manual (Positioning Control) for details.

4.2 OPR parameters

Home position return parameters include the basic parameters and the advanced parameters.

4.2.1 OPR basic parameters

(These parameters cannot be changed during the PLC READY status)

Table 4.3 OPR basic parameters (QD77MS)

Item	Setting range				Default value
	mm	inch	degree	PLS	
OPR method	0 : Near-point dog method 4 : Count method 1) (the zero signal is used) 5 : Count method 2) (the zero signal is not used) 6 : Data set method 7 : Scale origin signal detection method				0
OPR direction	0 : Positive direction (address increment direction) 1 : Negative direction (address decrement direction)				0
OP address	-2147483648 to 2147483647 ($\times 10^{-1}\mu\text{m}$)	-2147483648 to 2147483647 ($\times 10^{-5}\text{inch}$)	0 to 35999999 ($\times 10^{-5}\text{degree}$)	-2147483648 to 2147483647(PLS)	0
OPR speed	1 to 2000000000 ($\times 10^{-2}\text{mm/min}$)	1 to 2000000000 ($\times 10^{-3}\text{inch/min}$)	1 to 2000000000 ($\times 10^{-3}\text{degree/min}$)*	1 to 1000000000 (PLS/s)	1
Creep speed	1 to 2000000000 ($\times 10^{-2}\text{mm/min}$)	1 to 2000000000 ($\times 10^{-3}\text{inch/min}$)	1 to 2000000000 ($\times 10^{-3}\text{degree/min}$)*	1 to 1000000000 (PLS/s)	1
OPR retry	0 : Do not retry OPR with limit switch 1 : Retry OPR with limit switch				0

*: The OPR speed setting range is 1 to 2000000000 ($\times 10^{-3}\text{degree/min}$), but it will be decupled and become 1 to 2000000000 ($\times 10^{-2}\text{degree/min}$) by setting "Speed control 10 x multiplier setting for degree axis" to valid.

OPR method

- (1) Near-point dog method
 - (a) Start machine OPR.
(Start movement at the "OPR speed" in the "OPR direction".)
 - (b) Detect the near-point dog ON, and start deceleration.
 - (c) Decelerate to "Creep speed", and move with the creep speed.
(At this time, the near-point dog must be ON. If the nearpoint dog is OFF, the axis will decelerate to a stop.)
 - (d) At the first zero signal after the near-point dog turned OFF, machine OPR is completed.

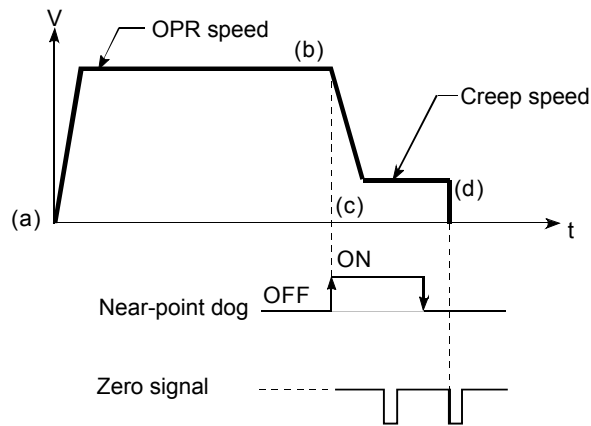

- (2) Count method 1
 - (a) Start machine OPR.
(Start movement at the "OPR speed" in the "OPR direction".)
 - (b) Detect the near-point dog ON, and start deceleration.
 - (c) Decelerate to "Creep speed", and move with the creep speed.
 - (d) After the near-point dog turns ON and the movement amount set in " Pr.50 Setting for the movement amount after near-point dog ON" has passed, the Simple Motion module stops with the first zero signal, and the machine OPR is completed.

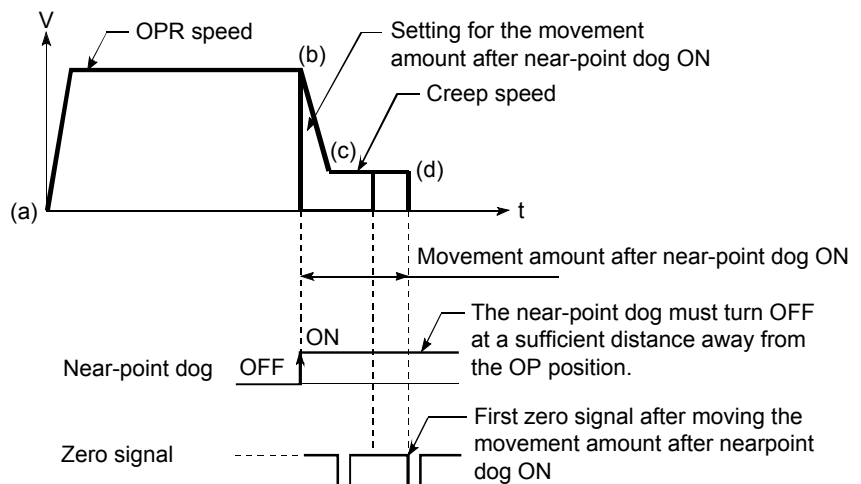

(3) Count method 2

- (a) Start machine OPR.
(Start movement at the "OPR speed" in the "OPR direction".)
- (b) Detect the near-point dog ON, and start deceleration.
- (c) Decelerate to "Creep speed", and move with the creep speed.
- (d) After the near-point dog turns ON and the movement amount set in "Setting for the movement amount after near-point dog ON" has passed, machine OPR is completed.

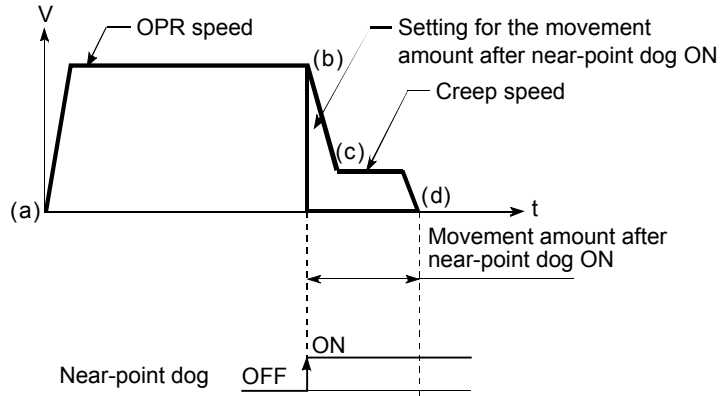

(4) Data set method

The position where the machine OPR has been made will be the OP.
(Perform after the servo amplifier has been turned ON and the servomotor has been rotated at least once using the JOG or similar operation. However, if selecting "1: Not need to pass servo motor Z-phase after power on" with "Function selection C-4 (PC17)", it is possible to carry out the home position return (OPR) without passing the zero point.)

(5) Scale origin signal detection method

- (a) Start machine OPR.
(Start movement at the "OPR speed" in the "OPR direction".)
- (b) Detect the near-point dog ON, and start deceleration.
- (c) After deceleration stop, it moves in the opposite direction against of OPR at the "OPR speed".
- (d) During movement, the machine begins decelerating when the first zero signal is detected.
- (e) After deceleration stop, it moves in direction of OPR at the speed set in "Creep speed", and stops at the detected nearest zero signal to complete the machine OPR.

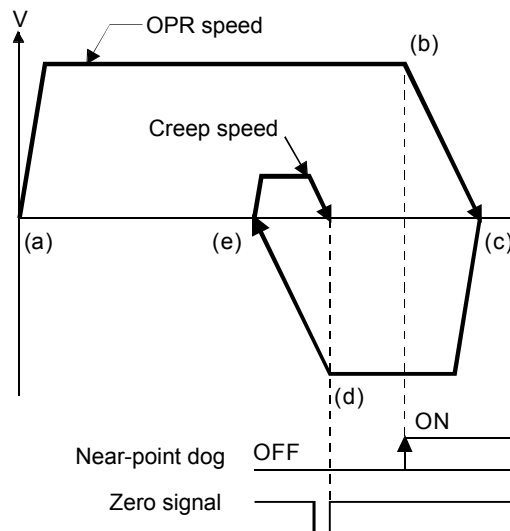

OPR direction

Set the direction to start movement when starting machine OPR.

0: Positive direction (address increment direction)

Moves in the direction that the address increments. (Arrow 2))

1: Negative direction (address decrement direction)

Moves in the direction that the address decrements. (Arrow 1))

Normally, the OP is set near the lower limit or the upper limit, so "OPR direction" is set as shown below.

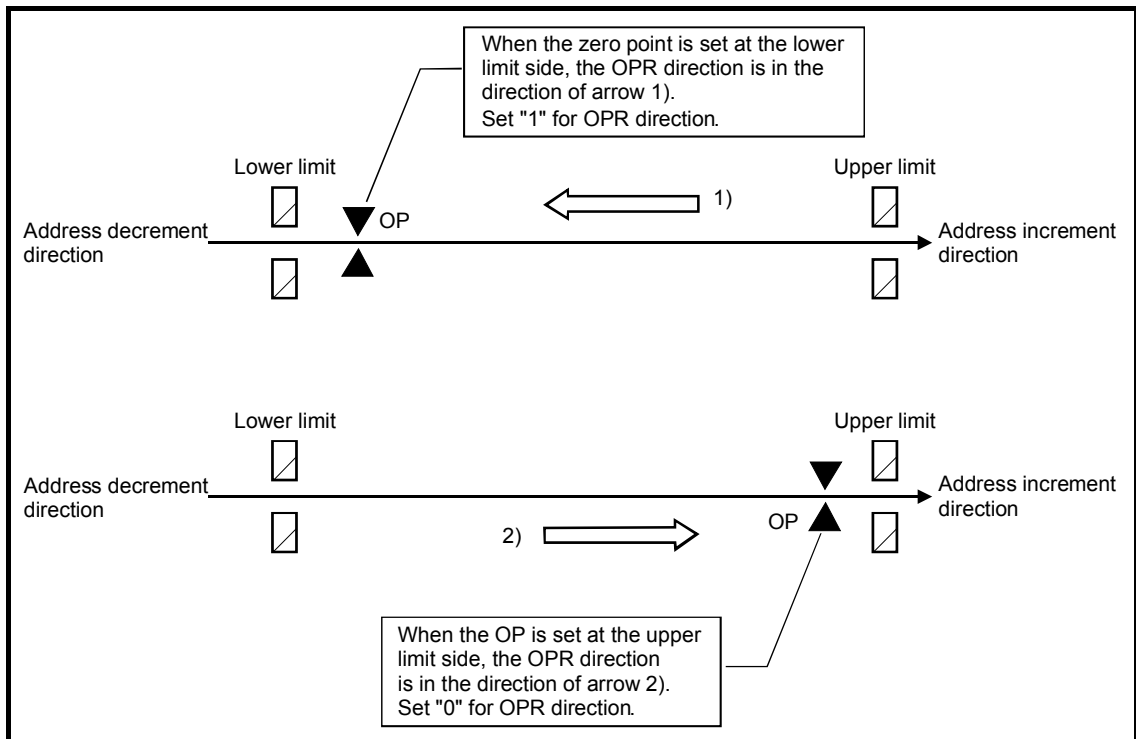

Fig 4.6 OPR direction

OP address

Set the address used as the reference point for positioning control (ABS system). (When the machine OPR is completed, the stop position address is changed to the address set in "OP address". At the same time, the "OP address" is stored in "Current feed value" and "Machine feed value".)

OPR speed

Set the speed for OPR.

Note) Set the "OPR speed" to less than "Speed limit value". If the "speed limit value" is exceeded, the error "outside speed limit value range" (error code: 910) will occur, and OPR will not be executed.

The "OPR speed" should be equal to or faster than the "Bias speed at start" and "Creep speed".

Creep speed

Set the creep speed after near-point dog ON (the low speed just before stopping after decelerating from the OPR speed).

The creep speed is set within the following range.

$OPR\ speed \geq Creep\ speed \geq Bias\ speed\ at\ start$

Note) The creep speed affects the detection difference when the home position return method is performed by the zero signal, and affects the magnitude of shock at collisions when the home position method is the stopper stop method.

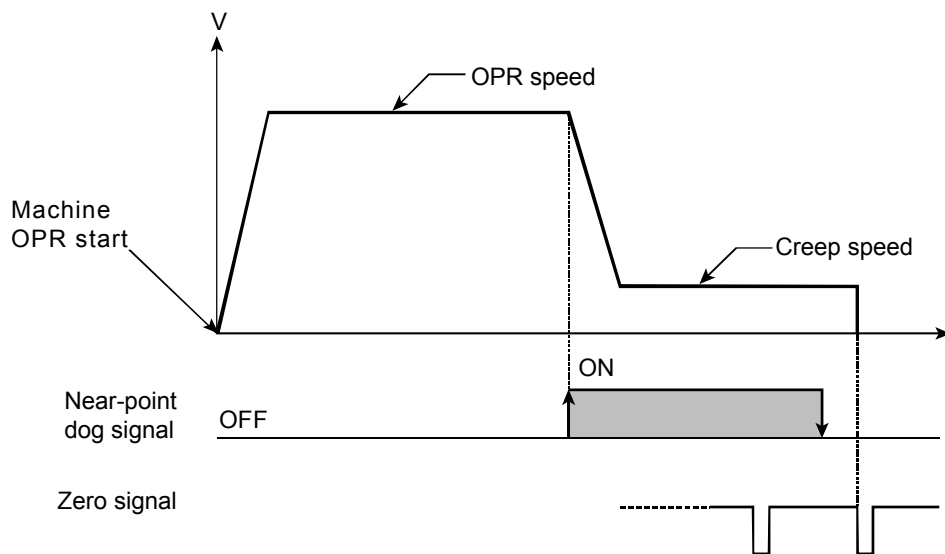

OPR retry

Set whether to perform the home position return retry or not.

When the machine home position return is started with valid home position return retry function, the workpiece moves to the home position return direction (1)). When the limit signal OFF is detected before the near-point dog signal turns on (2)), the workpiece moves to the reverse direction of the specified home position return after the deceleration stop (3)). When the near-point dog signal ON is detected during the reverse direction movement, the machine home position return is performed again after the deceleration stop (5), 6)).

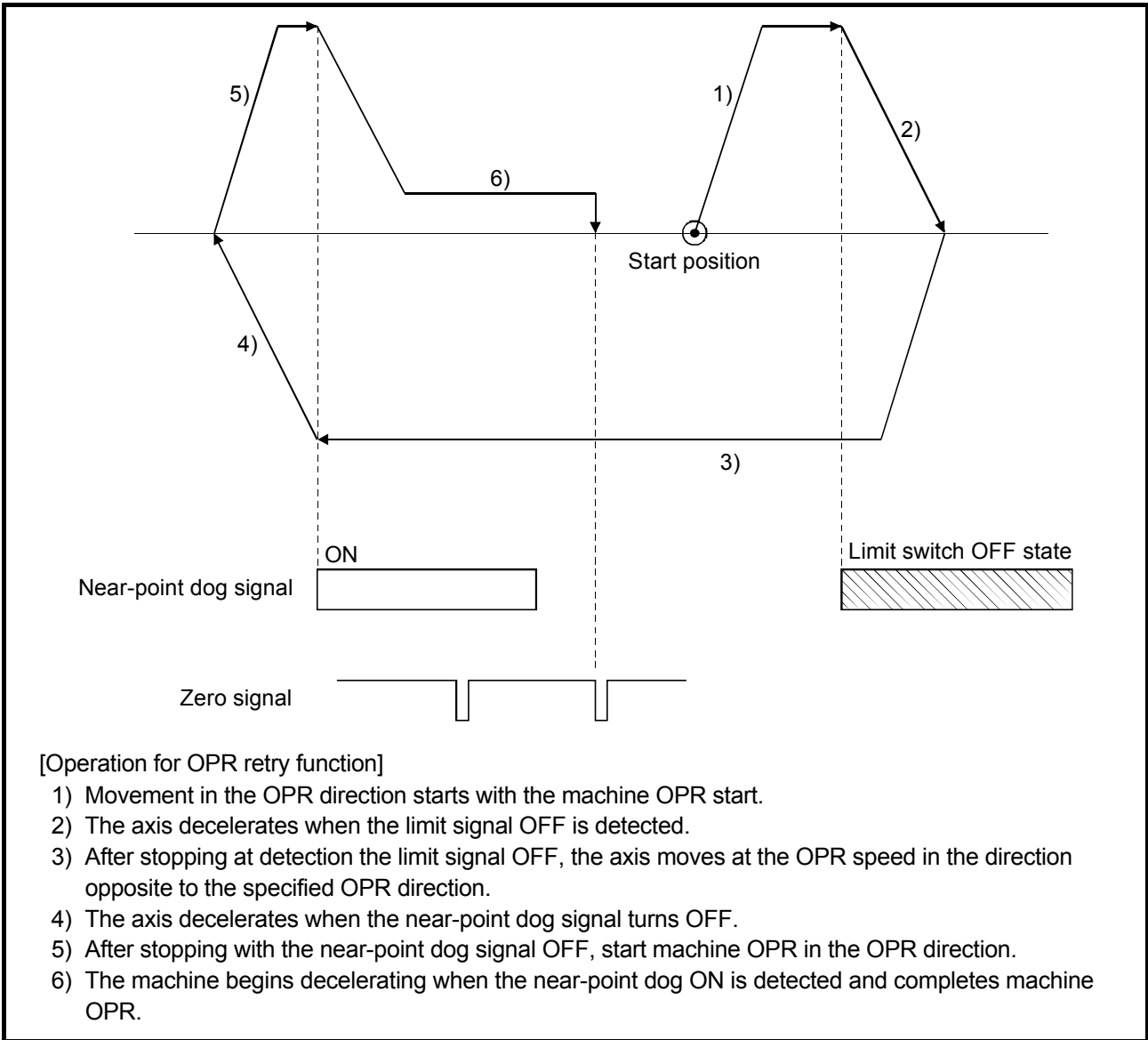

Fig. 4.7 Home position return retry by the limit switches

4.2.2 OPR detailed parameters

(These parameters cannot be changed during the PLC READY status)

Table 4.4 OPR detailed parameters (QD77MS)

Item	Setting range				Default value
	mm	inch	degree	PLS	
Setting for the movement amount after near-point dog ON	0 to 2147483647 ($\times 10^{-1}\mu\text{m}$)	0 to 2147483647 ($\times 10^{-5}\text{inch}$)	0 to 2147483647 ($\times 10^{-5}\text{degree}$)	0 to 2147483647 (pulse)	0
OPR acceleration time selection	Select the acceleration time 0 to 3 from the basic parameters 2 and the advanced parameters 2.				0
OPR deceleration time selection	Select the deceleration time 0 to 3 from the basic parameters 2 and the advanced parameters 2.				0
OP shift amount	-2147483648 to 2147483647 ($\times 10^{-1}\mu\text{m}$)	-2147483648 to 2147483647 ($\times 10^{-5}\text{inch}$)	-2147483648 to 2147483647 ($\times 10^{-5}\text{degree}$)	-2147483648 to 2147483647 (pulse)	0
OPR torque limit value	1 to 1000%				300
Operation setting for incompleteness of OPR	0 : Positioning control is not executed. 1 : Positioning control is executed.				0
Speed designation during OP shift	0 : OPR speed 1 : Creep speed				0
Dwell time during OPR retry	0 to 65535ms				0
Pulse conversion module home position return request setting*	0: Turn on the home position return request when the servo is off 1: Does not turn on the home position return request when the servo is off				0
Wait time after the clear signal is output for the pulse conversion unit*	1 to 1000ms				0

*: Only when using the pulse conversion module

Setting for the movement amount after near-point dog ON

When using the count method 1) or 2), set the movement amount to the OP after the near-point dog signal turns ON.

(The movement amount after near-point dog ON should be equal to or greater than the sum of the "distance covered by the deceleration from the OPR speed to the creep speed" and "distance of movement in 10 ms at the OPR speed".)

OP shift amount

Set the amount to shift (move) from the position stopped at with machine OPR.

* The OP shift function is used to compensate the OP position stopped at with machine OPR.

If there is a physical limit to the OP position, due to the relation of the near-point dog installation position, use this function to compensate the OP to an optimum position.

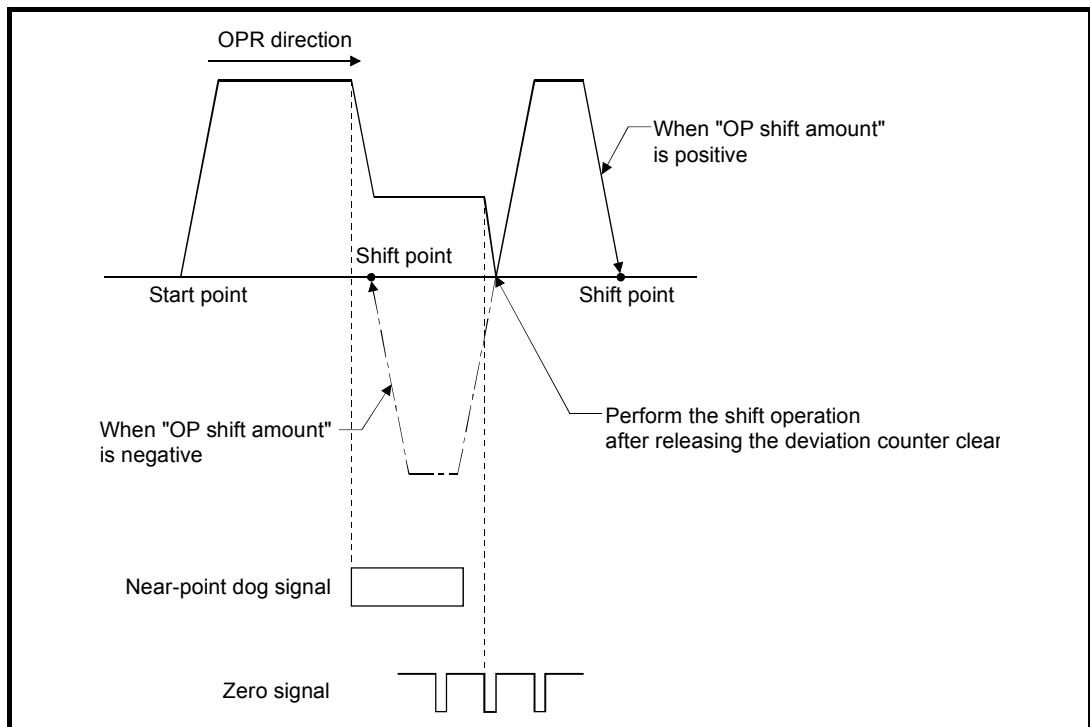

Fig. 4.8 Home position shifting

Operation setting for incompleteness of OPR

Set whether the positioning control is executed or not (When the OPR request flag is ON.).

(1) When OPR request flag is ON, selecting "0: Positioning control is not executed" will result in an "Operation starting at incompleteness of OPR" error (error code: 547), and positioning control will not be performed. At this time, operation with the manual control (JOG operation, inching operation, manual pulse generator operation) is available.

The positioning control can be executed even if the OPR request flag is ON when selecting "1: Positioning control is executed".

(2) The following shows whether the positioning control is possible to start/restart or not when selecting "0: Positioning control is not executed".

(a) Start possible

Machine OPR, JOG operation, inching operation, manual pulse generator operation, current value changing using current value changing start No. (9003).

(b) Start/restart impossible control

The positioning control is impossible to start/restart in the following case. 1-axis linear control, 2/3/4-axis linear interpolation control, 1/2/3/4-axis fixed-feed control, 2-axis circular interpolation control with sub point designation, 2-axis circular interpolation control with center point designation, 1/2/3/4-axis speed control, Speed-position switching control (INC mode/ ABS mode), Position-speed switching control, current value changing using current value changing (No.1 to 600).

(3) When OPR request flag is ON, starting Fast OPR will result in an "Home positioning return (OPR) request flag ON" error (error code: 207) despite the setting value of "Operation setting incompleteness of OPR", and Fast OPR will not be executed.

CAUTION

- Do not execute the positioning control in home position return request signal ON for the axis which uses in the positioning control.
Failure to observe this could lead to an accident such as a collision.

4.2.3 Expansion parameters

Table 4.5 Expansion parameters (QD77MS)

Item	Setting range	Default value
Optional data monitor: Data type setting 1	0 : No setting 1 : Effective load ratio 2 : Regenerative load ratio 3 : Peak load ratio 4 : Load inertia moment ratio 5 : Position loop gain 1	0
Optional data monitor: Data type setting 2	6 : Bus voltage 7 : Servo motor speed 8 : Absolute position encoder multiple revolution counter 9 : Unit power consumption 10 : Instantaneous torque 12 : Motor thermistor temperature 13 : Equivalent disturbance torque	0
Optional data monitor: Data type setting 3	14 : Overload alarm margin 15 : Error excessive alarm margin 16 : Settling time 17 : Overshoot amount 20 : Position feedback * ¹ 21 : Absolute position encoder single revolution position * ¹ 22 : Select droop pulses * ¹	0
Optional data monitor: Data type setting 4	23 : Unit integral power consumption * ¹ 24 : Load side encoder information 1 * ¹ 25 : Load side encoder information 2 * ¹ 26 : Z-phase counter * ¹ 27 : Motor-side/load-side position deviation * ¹ 28 : Motor-side/load-side speed deviation * ¹	0
Operation cycle setting QD77MS16	0: 0.88ms 1: 1.77ms	1
SSCNET setting	0: SSCNETIII 1: SSCNETIII/H	1

*1: Used point: 2 words

4.3 Servo parameters

Servo parameters include the servo amplifier series settings, the basic settings, the gain/filter settings, the extension settings, the I/O settings, the extension settings 2, and the extension settings 3.

4.3.1 Servo amplifier series

Set the servo amplifier series connected to the QD77MS (they cannot be changed during the PLC READY status).

32: MR-J4-B (Default value: 0)

POINT
Always set the servo amplifier series. Communication with the servo amplifier cannot be started under the default value from the factory shipment of 0. (The LED display on the servo amplifier displays "Ab".)

4.3.2 Basic setting

(These settings cannot be changed during the PLC READY status.)

Table 4.6 Basic setting

Item		Setting range	Default value
Operation mode **	Operation mode selection	0: Standard control mode 1: Fully closed loop control mode 4: Linear servo motor control mode 6: DD motor control mode Setting other than above will result in [AL. 37 Parameter error].	0
	Compatibility mode selection	0: J3 compatibility mode 1: J4 mode	1
Regenerative option **		00: Regenerative option is not used. ▪ For servo amplifier of 100 W, regenerative resistor is not used. ▪ For servo amplifier of 0.2 kW to 7 kW, built-in regenerative resistor is used. 01: FR-RC/FR-CV/FR-BU2 When you use FR-RC-(H), FR-CV-(H) or FR-BU2-(H), select "Mode 2 (_ _ _ 1)" of "Undervoltage alarm detection mode selection" in [Pr. PC20]. 02: MR-RB032 03: MR-RB12 04: MR-RB32 05: MR-RB30 06: MR-RB50 (Cooling fan is required.) 08: MR-RB31 09: MR-RB51 (Cooling fan is required.) 0B: MR-RB3N 0C: MR-RB5N (Cooling fan is required.)	0000h
Absolute position detection system *		0: Disabled (used in incremental system) 1: Enabled (used in absolute position detection system)	0
Function selection A-1 *	Servo forced stop selection	0: Enabled (The forced stop input EM2 or EM1 is used.) 1: Disabled (The forced stop input EM2 and EM1 are not used.)	0
	Forced stop deceleration function selection	0: Forced stop deceleration function disabled (EM1) 2: Forced stop deceleration function enabled (EM2)	2
Auto tuning mode		0: 2 gain adjustment mode 1 (interpolation mode) 1: Auto tuning mode 1 2: Auto tuning mode 2 3: Manual mode 4: 2 gain adjustment mode 2	1

*: After changing parameters (sending parameters from the QD77MS to the servo amplifier), the parameters become valid by either turning off the power of the servo amplifier and then on again, or performing a controller reset.

** : After changing parameters (sending parameters from the QD77MS to the servo amplifier), the parameters become valid by turning off the power of the servo amplifier and then on again.

Table 4.6 Basic setting (Continued)

Item	Setting range	Default value																																																																																									
Auto tuning response	<table border="1"> <thead> <tr> <th data-bbox="536 331 651 360">Setting value</th> <th colspan="2" data-bbox="651 331 1238 360">Machine characteristic</th> </tr> <tr> <th data-bbox="536 360 651 389"></th> <th data-bbox="651 360 770 389">Response</th> <th data-bbox="770 360 1238 389">Guideline for machine resonance frequency [Hz]</th> </tr> </thead> <tbody> <tr><td>1</td><td rowspan="10">Low response</td><td>2.7</td></tr> <tr><td>2</td><td>3.6</td></tr> <tr><td>3</td><td>4.9</td></tr> <tr><td>4</td><td>6.6</td></tr> <tr><td>5</td><td>10.0</td></tr> <tr><td>6</td><td>11.3</td></tr> <tr><td>7</td><td>12.7</td></tr> <tr><td>8</td><td>14.3</td></tr> <tr><td>9</td><td>16.1</td></tr> <tr><td>10</td><td>18.1</td></tr> <tr><td>11</td><td>20.4</td></tr> <tr><td>12</td><td>23.0</td></tr> <tr><td>13</td><td>25.9</td></tr> <tr><td>14</td><td>29.2</td></tr> <tr><td>15</td><td>32.9</td></tr> <tr><td>16</td><td>37.0</td></tr> <tr><td>17</td><td>41.7</td></tr> <tr><td>18</td><td>47.0</td></tr> <tr><td>19</td><td>52.9</td></tr> <tr><td>20</td><td rowspan="10">Middle response</td><td>59.6</td></tr> <tr><td>21</td><td>67.1</td></tr> <tr><td>22</td><td>75.6</td></tr> <tr><td>23</td><td>85.2</td></tr> <tr><td>24</td><td>95.9</td></tr> <tr><td>25</td><td>108.0</td></tr> <tr><td>26</td><td>121.7</td></tr> <tr><td>27</td><td>137.1</td></tr> <tr><td>28</td><td>154.4</td></tr> <tr><td>29</td><td>173.9</td></tr> <tr><td>30</td><td>195.9</td></tr> <tr><td>31</td><td>220.6</td></tr> <tr><td>32</td><td>248.5</td></tr> <tr><td>33</td><td>279.9</td></tr> <tr><td>34</td><td>315.3</td></tr> <tr><td>35</td><td>355.1</td></tr> <tr><td>36</td><td>400.0</td></tr> <tr><td>37</td><td>446.6</td></tr> <tr><td>38</td><td>501.2</td></tr> <tr><td>39</td><td rowspan="2">High response</td><td>571.5</td></tr> <tr><td>40</td><td>642.7</td></tr> </tbody> </table>	Setting value	Machine characteristic			Response	Guideline for machine resonance frequency [Hz]	1	Low response	2.7	2	3.6	3	4.9	4	6.6	5	10.0	6	11.3	7	12.7	8	14.3	9	16.1	10	18.1	11	20.4	12	23.0	13	25.9	14	29.2	15	32.9	16	37.0	17	41.7	18	47.0	19	52.9	20	Middle response	59.6	21	67.1	22	75.6	23	85.2	24	95.9	25	108.0	26	121.7	27	137.1	28	154.4	29	173.9	30	195.9	31	220.6	32	248.5	33	279.9	34	315.3	35	355.1	36	400.0	37	446.6	38	501.2	39	High response	571.5	40	642.7	16
	Setting value	Machine characteristic																																																																																									
		Response	Guideline for machine resonance frequency [Hz]																																																																																								
	1	Low response	2.7																																																																																								
	2		3.6																																																																																								
	3		4.9																																																																																								
	4		6.6																																																																																								
	5		10.0																																																																																								
	6		11.3																																																																																								
	7		12.7																																																																																								
	8		14.3																																																																																								
	9		16.1																																																																																								
	10		18.1																																																																																								
	11	20.4																																																																																									
	12	23.0																																																																																									
	13	25.9																																																																																									
	14	29.2																																																																																									
	15	32.9																																																																																									
	16	37.0																																																																																									
	17	41.7																																																																																									
	18	47.0																																																																																									
	19	52.9																																																																																									
	20	Middle response	59.6																																																																																								
	21		67.1																																																																																								
	22		75.6																																																																																								
	23		85.2																																																																																								
	24		95.9																																																																																								
	25		108.0																																																																																								
	26		121.7																																																																																								
	27		137.1																																																																																								
	28		154.4																																																																																								
	29		173.9																																																																																								
	30	195.9																																																																																									
	31	220.6																																																																																									
	32	248.5																																																																																									
	33	279.9																																																																																									
	34	315.3																																																																																									
	35	355.1																																																																																									
	36	400.0																																																																																									
	37	446.6																																																																																									
38	501.2																																																																																										
39	High response	571.5																																																																																									
40		642.7																																																																																									
In-position range	0 to 65535[PLS]	1600																																																																																									
Rotation direction selection *	0: CCW direction with the increase of the positioning address 1: CW direction with the increase of the positioning address	0																																																																																									
Encoder output pulses *	1 to 65535[PLS/rev]	4000																																																																																									
Encoder output pulses 2 *	1 to 65535	1																																																																																									

*: After changing parameters (sending parameters from the QD77MS to the servo amplifier), the parameters become valid by either turning off the power of the servo amplifier and then on again, or performing a controller reset.

** : After changing parameters (sending parameters from the QD77MS to the servo amplifier), the parameters become valid by turning off the power of the servo amplifier and then on again.

Table 4.6 Basic setting (Continued)

Item		Setting range								Default value		
		PA19	Setting operation	PA	PB	PC	PD	PE	PF	PL		
Parameter writing inhibit *		Other than below	Reading	○	/	/	/	/	/	/	00ABh	
			Writing	○	/	/	/	/	/	/		
		000Ah	Reading	Only 19	/	/	/	/	/	/		/
			Writing	Only 19	/	/	/	/	/	/		/
		000Bh	Reading	○	○	○	/	/	/	/		/
			Writing	○	○	○	/	/	/	/		/
		000Ch	Reading	○	○	○	○	/	/	/		/
			Writing	○	○	○	○	/	/	/		/
		000Fh	Reading	○	○	○	○	○	/	/		○
			Writing	○	○	○	○	○	○	/		○
		00AAh	Reading	○	○	○	○	○	○	○		/
			Writing	○	○	○	○	○	○	○		/
		00ABh (initial value)	Reading	○	○	○	○	○	○	○		○
			Writing	○	○	○	○	○	○	○		○
		100Bh	Reading	○	/	/	/	/	/	/		/
			Writing	Only 19	/	/	/	/	/	/		/
		100Ch	Reading	○	○	○	○	/	/	/		/
			Writing	Only 19	/	/	/	/	/	/		/
		100Fh	Reading	○	○	○	○	○	/	/		○
			Writing	Only 19	/	/	/	/	/	/		/
10AAh	Reading	○	○	○	○	○	○	○	/			
	Writing	Only 19	/	/	/	/	/	/	/			
10ABh	Reading	○	○	○	○	○	○	○	○			
	Writing	Only 19	/	/	/	/	/	/	/			
Tough drive setting *	Vibration tough drive selection	0: Disabled 1: Enabled								0		
	Instantaneous power failure tough drive selection	0: Disabled 1: Enabled								0		
Function selection A-3 *		0: Disabled 1: Enabled								1		
Drive recorder arbitrary alarm trigger setting	Alarm detail No. setting	Set the digits when you execute the trigger with arbitrary alarm detail No. for the drive recorder function. When these digits are "0 0", only the arbitrary alarm No. setting will be enabled.								00		
	Alarm No. setting	Set the digits when you execute the trigger with arbitrary alarm No. for the drive recorder function. When "0 0" are set, arbitrary alarm trigger of the drive recorder will be disabled.								00		
Function selection A-4 *		0: Standard mode 1: 3 inertia mode 2: Low response mode								0		

*: After changing parameters (sending parameters from the QD77MS to the servo amplifier), the parameters become valid by either turning off the power of the servo amplifier and then on again, or performing a controller reset.

** : After changing parameters (sending parameters from the QD77MS to the servo amplifier), the parameters become valid by turning off the power of the servo amplifier and then on again.

Operation mode

Select an operation mode.

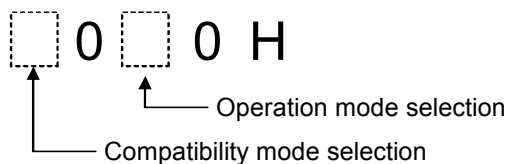

Regenerative option

Set whether to use the regeneration options or not.

0 0 H
 ↑
 Regenerative option settings

*1: Enter the setting value in
(hexadecimal value)

Absolute position detection system

Set whether to use the absolute position detection system or not. When using the absolute position detection system in the increment system, set "0: Disabled (Use in the increment system)". When using the the absolute position detection system in the absolute system, set "1: Enabled".

POINT

When setting "1: Enable (Use in the absolute system) with an increment synchronization encoder, a parameter error will occur.

Function selection A-1

Set whether to use the forced stop input (EM1) of the servo amplifier or not.

0 0 H
 ↑ ↑
 ↑ Servo forced stop selection
 Forced stop deceleration function selection

Auto tuning mode

Select the gain adjustment mode.

0 0 0 H
 ↑
 Gain adjustment mode selection

Auto tuning response

Set this parameter to increase the response of the servo amplifier. The applicable response can be selected according to the rigidity of the device (when the auto tuning mode is valid). The higher response can be set for higher rigidity device, improving reactions to commands and reducing the setting time.

In-position range

Set the range for output of the positioning complete signal in units of command pulses.

Rotation direction selection

Set the rotational direction as seen from the servo motor load.

Encoder output pulses

Set the encoder pulse (A-phase and B-phase) output by the servo amplifier by the number of pulses output per rotation or output dividing ratio (After multiplication by 4). Either "0: Output pulse setting" or "1: Output frequency ratio setting" can be selected for "Detector pulse output selection". The number of the output A-phase and the B-phase pulses is 1/4 time of the set value. The maximum output frequency is 4.6 [Mpps] (after multiplication by 4). Set the number of output pulses within these ranges.

Encoder output pulses 2

Set a denominator of the electronic gear for the A/B-phase pulse output. To set a denominator of the electronic gear, select "A-phase/B-phase pulse electronic gear setting (_ _ 3 _)" of "Encoder output pulse setting selection" in [Pr. PC03].

Parameter writing inhibit

Select a reference range and writing range of the parameter.

Tough drive setting

Alarms may not be avoided with the tough drive function depending on the situations of the power supply and load fluctuation.

You can assign MTTR (During tough drive) to pins CN3-9, CN3-13 and CN3-15 with [Pr. PD07] to [Pr. PD09].

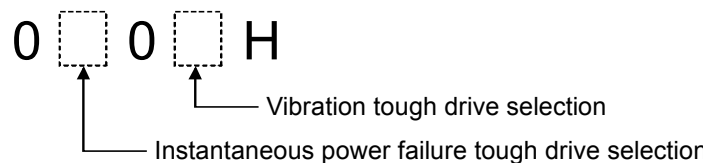

Function selection A-3



When the digit is "0", the one-touch tuning with MR Configurator2 will be disabled.

Drive recorder arbitrary alarm trigger setting

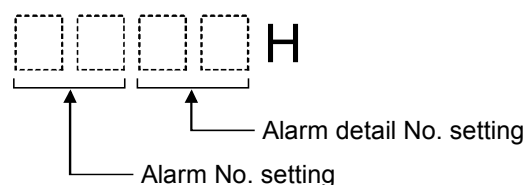

Setting example:

To activate the drive recorder when [AL. 50 Overload 1] occurs, set "5 0 0 0".

To activate the drive recorder when [AL. 50.3 Thermal overload error 4 during operation] occurs, set "5 0 0 3".

Function selection A-4

0 0 0 H

↑
Vibration suppression function selection

When two low resonance frequencies are generated, select "3 inertia mode (_ _ _ 1)". When the load to motor inertia ratio exceeds the recommended load to motor inertia ratio, select "Low response mode (_ _ _ 2)".

When you select the standard mode or low response mode, "Vibration suppression control 2" is not available.

When you select the 3 inertia mode, the feed forward gain is not available.

Before changing the control mode with the controller during the 3 inertia mode or low response mode, stop the motor.

4.3.3 Gain/filter setting

(These parameters cannot be changed during the PLC READY status)

Table 4.7 Gain/filter setting

Item		Setting range	Default value
Adaptive tuning mode (adaptive filter II)		0: Disabled 1: Automatic setting 2: Manual setting	0
Vibration suppression control tuning mode (advanced vibration suppression control II)	Vibration suppression control 1 tuning mode selection	0: Disabled 1: Automatic setting 2: Manual setting	0
	Vibration suppression control 2 tuning mode selection	0: Disabled 1: Automatic setting 2: Manual setting	0
Torque feedback loop gain		0 to 18000[rad/s]	18000
Feed forward gain		0 to 100[%]	0
Load to motor inertia ratio/load to motor mass ratio		0 to 300.0[Multiplier]	7.0
Model loop gain		1 to 2000[rad/s]	15
Position loop gain		1 to 2000[rad/s]	37
Speed loop gain		20 to 65535[rad/s]	823
Speed integral compensation		0.1 to 1000.0[ms]	33.7
Speed differential compensation		0 to 1000	980
Overshoot amount compensation		0 to 100[%]	0
Machine resonance suppression filter 1		100 to 4500[Hz]	4500
Notch shape selection 1	Notch depth selection	0: -40dB 1: -14dB 2: -8dB 3: -4dB	0
	Notch width selection	0: $\alpha = 2$ 1: $\alpha = 3$ 2: $\alpha = 4$ 3: $\alpha = 5$	0
Machine resonance suppression filter 2		100 to 4500[Hz]	4500
Notch shape selection 2	Machine resonance suppression filter 2 selection	0: Disabled 1: Enabled	0
	Notch depth selection	0: -40dB 1: -14dB 2: -8dB 3: -4dB	0
	Notch width selection	0: $\alpha = 2$ 1: $\alpha = 3$ 2: $\alpha = 4$ 3: $\alpha = 5$	0
Shaft resonance suppression filter	Shaft resonance suppression filter setting frequency selection	This is used for setting the shaft resonance suppression filter.	00
	Notch depth selection	0: -40dB 1: -14dB 2: -8dB 3: -4dB	0
Low-pass filter setting		100 to 18000[rad/s]	3141
Vibration suppression control 1 - Vibration frequency		0.1 to 300.0[Hz]	100.0
Vibration suppression control 1 - Resonance frequency		0.1 to 300.0[Hz]	100.0
Vibration suppression control 1 - Vibration frequency damping		0.0 to 0.3	0.0

Table 4.7 Gain/filter setting (Continued)

Item		Setting range	Default value
Vibration suppression control 1 - Resonance frequency damping		0.0 to 0.3	0.0
Low-pass filter selection	Shaft resonance suppression filter selection	0: Automatic setting 1: Manual setting 2: Disabled	0
	Low-pass filter selection	0: Automatic setting 1: Manual setting 2: Disabled	0
Slight vibration suppression control *	Slight vibration suppression control selection	0: Disabled 1: Enabled	0
	PI-PID switching control selection	0: PI control enabled 3: Continuous PID control enabled	0
Gain switching function *	Gain switching selection	0: Disabled 1: Control command from controller is enabled 2: Command frequency 3: Droop pulses 4: Servo motor speed/linear servo motor speed	0
	Gain switching condition selection	0: Gain after switching is enabled with gain switching condition or more 1: Gain after switching is enabled with gain switching condition or less	0
Gain switching condition		0 to 65535[kpps, PLS, r/min]	10
Gain switching time constant		0 to 100[ms]	1
Load to motor inertia ratio/load to motor mass ratio after gain switching		0.0 to 300.0[Multiplier]	7.0
Position loop gain after gain switching		0 to 2000[rad/s]	0
Speed loop gain after gain switching		0 to 65535[rad/s]	0
Speed integral compensation after gain switching		0.0 to 5000.0[ms]	0.0
Vibration suppression control 1 - Vibration frequency after gain switching		0.1 to 300.0[Hz]	0.0
Vibration suppression control 1 - Resonance frequency after gain switching		0.1 to 300.0[Hz]	0.0
Vibration suppression control 1 - Vibration frequency damping after gain switching		0.00 to 0.30	0.00
Vibration suppression control 1 - Resonance frequency damping after gain switching		0.00 to 0.30	0.00
Command notch filter	Command notch filter setting frequency selection	00 to 5F	00h
	Notch depth selection	0 to F	0h
Machine resonance suppression filter 3		10 to 4500[Hz]	4500
Notch shape selection 3	Machine resonance suppression filter 3 selection	0: Disabled 1: Enabled	0h
	Notch depth selection	0: -40dB 1: -14dB 2: -8dB 3: -4dB	0h
	Notch width selection	0: $\alpha = 2$ 1: $\alpha = 3$ 2: $\alpha = 4$ 3: $\alpha = 5$	0h
Machine resonance suppression filter 4		10 to 4500[Hz]	4500

*: After changing parameters (sending parameters from the QD77MS to the servo amplifier), the parameters become valid by either turning off the power of the servo amplifier and then on again, or performing a controller reset.

Table 4.7 Gain/filter setting (Continued)

Item		Setting range	Default value
Notch shape selection 4	Machine resonance suppression filter 4 selection	0: Disabled 1: Enabled	0h
	Notch depth selection	0: -40dB 1: -14dB 2: -8dB 3: -4dB	0h
	Notch width selection	0: $\alpha = 2$ 1: $\alpha = 3$ 2: $\alpha = 4$ 3: $\alpha = 5$	0h
Machine resonance suppression filter 5		10 to 4500[Hz]	4500
Notch shape selection 5	Machine resonance suppression filter 5 selection	0: Disabled 1: Enabled	0h
	Notch depth selection	0: -40dB 1: -14dB 2: -8dB 3: -4dB	0h
	Notch width selection	0: $\alpha = 2$ 1: $\alpha = 3$ 2: $\alpha = 4$ 3: $\alpha = 5$	0h
Vibration suppression control 2 - Vibration frequency		0.1 to 300.0[Hz]	100.0
Vibration suppression control 2 - Resonance frequency		0.1 to 300.0[Hz]	100.0
Vibration suppression control 2 - Vibration frequency damping		0.0 to 0.3	0.0
Vibration suppression control 2 - Resonance frequency damping		0.0 to 0.3	0.0
Vibration suppression control 2 - Vibration frequency after gain switching		0.0 to 300.0[Hz]	0.0
Vibration suppression control 2 - Resonance frequency after gain switching		0.0 to 300.0[Hz]	0.0
Vibration suppression control 2 - Vibration frequency damping after gain switching		0.0 to 0.3	0.0
Vibration suppression control 2 - Resonance frequency damping after gain switching		0.0 to 0.3	0.0
Model loop gain after gain switching		0.0 to 2000.0[rad/s]	0.0

Adaptive tuning mode (adaptive filter II)

- Set the adaptive filter tuning.
- When "1: Filter tuning mode" is selected, the "Machine resonance suppression filter 1" and the "Notch shape selection 1" are automatically set.
- When the "1: Filter tuning mode" is selected, tuning completes after the positioning is performed for specific times and during specific period, and then the mode automatically changes to the "2: Manual mode".
- When selecting the "0: Filter off", the "Machine resonance suppression filter 1" and the "Notch shape selection 1" are reset to the default values of the factory shipment. However, these parameters do not function when the servo is off.

Vibration suppression control tuning mode (advanced vibration suppression control II)

- This is used to set the vibration suppression control tuning.
- When selecting the "1: Vibration suppression control tuning mode", the "Vibration suppression control - Vibration frequency" and the "Vibration suppression control - Resonance frequency" are be automatically set.
- When selecting the "1: Vibration suppression control tuning mode", after the positioning for specific times and specific time, the mode automatically changes to "2: Manual mode".
- When selecting the "0: "Vibration suppression control - Vibration frequency" and the "Vibration suppression control - Resonance frequency" are reset to the default values of the factory shipment.

Torque feedback loop gain

- This is used to set a torque feedback loop gain in the continuous operation to torque control mode.
- Decreasing the setting value will also decrease a collision load during continuous operation to torque control mode.
- Setting a value less than 6 rad/s will be 6 rad/s.

Feed forward gain

- Set the feedback forward gain coefficient for the positioning control. When this is set to 100[%] during operation at a specific speed, droop pulses are not be generated. However, when sudden acceleration or deceleration occurs, the overshoot amount increases. (The objective acceleration and deceleration time at 100[%] is at least one second.)

Load to motor inertia ratio/load to motor mass ratio

- This is used to set the load to motor inertia ratio or load to motor mass ratio.
- When the auto tuning mode 1 or the interpolation mode is set, the load to motor inertia ratio or load to motor mass ratio are the result of the auto tuning automatically. When the autotuning mode is wither of the "2: Auto tuning mode 2" or the "3: Manual mode", this can be set manually.

Model loop gain

- Set the response gain up to the target position.
- Increasing the setting value will also increase the response level to the position command.
- When the auto tuning mode 1 or the auto tuning mode 2 is set, the model loop gain is the result of the auto tuning automatically. When the auto tuning mode is either of the "1: Auto tuning mode 1" or the "3: Manual mode", this can be set manually.

Position loop gain

- This is used to set the gain of the position loop.
- Set this parameter to increase the position response to level load disturbance. Increasing the setting value will also increase the response level to the load disturbance but will be liable to generate vibration and/or noise.
- When the auto tuning mode 1, the auto tuning mode 2, the manual mode, and the interpolation mode is set, the position loop gain is the result of the auto tuning manually. When the auto tuning mode is the "3: Auto tuning mode", this can be set manually.

Speed loop gain

- This is used to set the gain of the speed loop.
- Set this parameter when vibration occurs on machines of low rigidity or large backlash.
Increasing the setting value will also increase the response level but will be liable to generate vibration and/or noise.
- When the auto tuning mode 1, the auto tuning mode 2, and the interpolation mode are set, the gain of the speed loop is the result of the auto tuning automatically. When the auto tuning mode is the "3: Auto-tuning mode", this can be set manually.

Speed integral compensation

- This is used to set the integral time constant of the speed loop.
- Decreasing the setting value will increase the response level but will be liable to generate vibration and/or noise.
- The results of auto-tuning will be automatic during auto-tuning mode 1/2 and the interpolation mode setting. The auto-tuning mode is configured manually under the "3: Auto-tuning mode".

Speed differential compensation

- This is used to set the differential compensation.
- Turning on PID with the PI-PID switching validates this parameter.

Overshoot amount compensation

- This is used to set a viscous friction torque or thrust to rated torque in percentage unit at servo motor rated speed or linear servo motor rated speed.
When the response level is low or when the torque/thrust is limited, the efficiency of the parameter may be lower.

Machine resonance suppression filter 1

- Set the notch frequency of the machine resonance suppression filter 1. (Select the frequency that matches the mechanical resonance frequency.)
- This parameter is automatically set when "1: Filter tuning mode" is selected for the adaptive tuning mode.
- This parameter is invalid when the adaptive tuning mode is "0: Filter off".

Notch shape selection 1

- Set the shape of the machine resonance suppression filter 1 (Notch shape selection 1).
- This parameter is automatically set when "1 Filter tuning mode" is selected for the adaptive tuning mode.
- This parameter is invalid when the adaptive tuning mode is "0: Filter off".

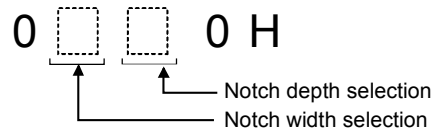

*1: [] Enter the setting value in (hexadecimal value)

Machine resonance suppression filter 2

- Set the notch frequency of the machine resonance suppression filter 2. (Select the frequency that matches the mechanical resonance frequency.)
- The mechanical resonance suppression filter 2 is invalid when the "Notch shape selection 2" is "0: Disabled".

Notch shape selection 2

- Set the shape of the machine resonance suppression filter 2 (Notch shape selection 2).

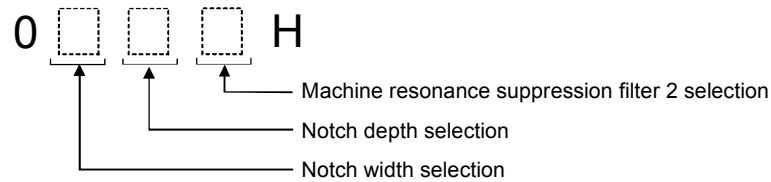

*1: [] Enter the setting value in (hexadecimal value)

Shaft resonance suppression filter

- This is used for setting the shaft resonance suppression filter.
- This is used to suppress a low-frequency machine vibration.

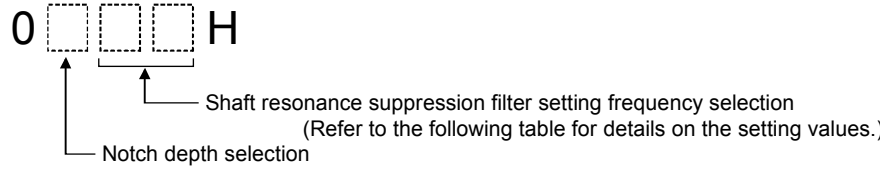

Shaft resonance suppression filter setting frequency selection

Setting value	Frequency [Hz]	Setting value	Frequency [Hz]
00	Disabled	10	562
01	Disabled	11	529
02	4500	12	500
03	3000	13	473
04	2250	14	450
05	1800	15	428
06	1500	16	409
07	1285	17	391
08	1125	18	375
09	1000	19	360
0A	900	1A	346
0B	818	1B	333
0C	750	1C	321
0D	692	1D	310
0E	642	1E	300
0F	600	1F	290

Low-pass filter setting

- Set the low-pass filter.
- The low-pass filter is automatically changed when the "Low pass filter selection" is set to the "0: Automatic setting".
- The low-pass filter can be set manually when the "Low pass filter selection" is set to the "1: Manual setting".

Vibration suppression control - Vibration frequency

- Set the vibration frequency for vibration suppression control to suppress low-frequency machine vibration.
- The vibration frequency is automatically changed when the "Vibration suppression control tuning mode" is set to the "1: Vibration suppression control tuning mode".
- The vibration frequency can be set manually when the "Vibration suppression control tuning mode" is set to the "2: Manual mode".
- This parameter is invalid when the "Vibration suppression control tuning mode" is set to the "0: Vibration suppression control off".

Vibration suppression control - Resonance frequency

- Set the resonance frequency for vibration suppression control to suppress low-frequency machine vibration.

Vibration suppression control - Vibration frequency damping

- Set a damping of the vibration frequency for vibration suppression control to suppress low frequency machine vibration.

Vibration suppression control - Resonance frequency damping

- Set a damping of the resonance frequency for vibration suppression control to suppress low frequency machine vibration.

Low-pass filter selection

- Select the shaft resonance suppression filter and low-pass filter.

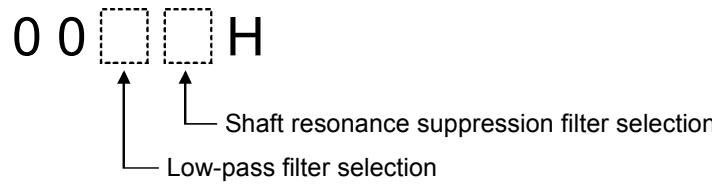

Slight vibration suppression control

- Select the slight vibration suppression control.
- This parameter is valid when the auto tuning mode is set to the "3: Manual mode".

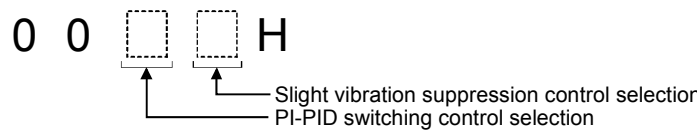

*1: Enter the setting value in (hexadecimal value)

Gain switching function

- Select the gain switching condition.

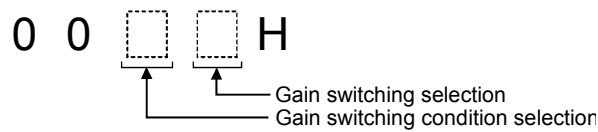

*1: Enter the setting value in (hexadecimal value)

Gain switching condition

- This is used to set the value of gain switching (command frequency, droop pulses, and servo motor speed/linear servo motor speed) selected in [Gain switching function].
- The set value unit differs depending on the switching condition item.

Gain switching time constant

- This is used to set the time constant at which the gains will change in response to the conditions set in [Gain switching condition] and [Gain switching condition].

Load to motor inertia ratio/load to motor mass ratio after gain switching

- This is used to set the load to motor inertia ratio/load to motor mass ratio when gain switching is enabled.
- This parameter is valid when the auto-tuning mode is valid when the "Auto tuning mode" is set to the "3: Manual mode".

Position loop gain after gain switching

- Set the position loop gain when the gain switching is enabled.
- This parameter is valid when the auto-tuning mode is valid when the "Auto tuning mode" is set to the "3: Manual mode".

Speed loop gain after gain switching

- Set the speed loop gain when the gain switching is enabled.
- This parameter is valid when the auto-tuning mode is valid when the "Auto tuning mode" is set to the "3: Manual mode".

Speed integral compensation after gain switching

- Set the speed integral compensation when the gain changing is enabled.
- This parameter is valid when the auto-tuning mode is valid when the "Auto tuning mode" is set to the "3: Manual mode".

Vibration suppression control - Vibration frequency after gain switching

- Set the vibration frequency for vibration suppression control when the gain switching is enabled.
- This parameter is valid when the gain adjustment mode is the "3: Manual mode", the "Vibration suppression control tuning mode" is set to the "2: Manual setting", and the "Gain switching" is set to the "1: Control command from controller is enabled".

Note) Be sure to switch them after the servo motor stops.

Vibration suppression control - Resonance frequency after gain switching

- Set the resonance frequency for vibration suppression control when the gain switching is enabled.
- This parameter is valid when the gain adjustment mode is the "3: Manual mode", the "Vibration suppression control tuning mode" is set to the "2: Manual setting", and the "Gain switching" is set to the "1: Control command from controller" is enabled.

Note) Be sure to switch them after the servo motor stops.

Vibration suppression control - Vibration frequency damping after gain switching

- Set a damping of the vibration frequency for vibration suppression control when the gain switching is enabled.
- This parameter is valid when the gain adjustment mode is the "3: Manual mode", the "Vibration suppression control tuning mode" is set to the "2: Manual setting", and the "Gain switching" is set to the "1: Control command from controller is enabled".

Note) Be sure to switch them after the servo motor stops.

Vibration suppression control - Resonance frequency damping after gain switching

- Set a damping of the resonance frequency for vibration suppression control when the gain switching is enabled.
- This parameter is valid when the gain adjustment mode is the "3: Manual mode", the "Vibration suppression control tuning mode" is set to the "2: Manual setting", and the "Gain switching" is set to the "1: Control command from controller is enabled".

Note) Be sure to switch them after the servo motor stops.

Command notch filter

- Set the command notch filter.

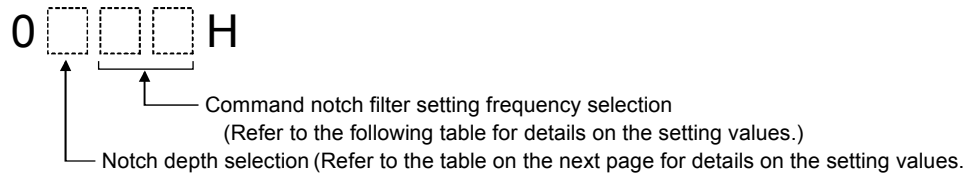

Command notch filter setting frequency selection

Setting value	Frequency [Hz]	Setting value	Frequency [Hz]	Setting value	Frequency [Hz]
00	Disabled	20	70	40	17.6
01	2250	21	66	41	16.5
02	1125	22	62	42	15.6
03	750	23	59	43	14.8
04	562	24	56	44	14.1
05	450	25	53	45	13.4
06	375	26	51	46	12.8
07	321	27	48	47	12.2
08	281	28	46	48	11.7
09	250	29	45	49	11.3
0A	225	2A	43	4A	10.8
0B	204	2B	41	4B	10.4
0C	187	2C	40	4C	10
0D	173	2D	38	4D	9.7
0E	160	2E	37	4E	9.4
0F	150	2F	36	4F	9.1
10	140	30	35.2	50	8.8
11	132	31	33.1	51	8.3
12	125	32	31.3	52	7.8
13	118	33	29.6	53	7.4
14	112	34	28.1	54	7.0
15	107	35	26.8	55	6.7
16	102	36	25.6	56	6.4
17	97	37	24.5	57	6.1
18	93	38	23.4	58	5.9
19	90	39	22.5	59	5.6
1A	86	3A	21.6	5A	5.4
1B	83	3B	20.8	5B	5.2
1C	80	3C	20.1	5C	5.0
1D	77	3D	19.4	5D	4.9
1E	75	3E	18.8	5E	4.7
1F	72	3F	18.2	5F	4.5

Notch depth selection

Setting value	Depth [dB]	Setting value	Depth [dB]
0	-40.0	8	-6.0
1	-24.1	9	-5.0
2	-18.1	A	-4.1
3	-14.5	B	-3.3
4	-12.0	C	-2.5
5	-10.1	D	-1.8
6	-8.5	E	-1.2
7	-7.2	F	-0.6

Machine resonance suppression filter 3

- Set the notch frequency of the machine resonance suppression filter 3.
- This parameter is valid when the "Machine resonance suppression filter 3" is set to the "1: Enabled".

Notch shape selection 3

- Set the shape of the machine resonance suppression filter 3.

Machine resonance suppression filter 4

- Set the notch frequency of the machine resonance suppression filter 4.
- This parameter is valid when the "Machine resonance suppression filter 4 selection" is set to the "1: Enabled".

Notch shape selection 4

- Set the shape of the machine resonance suppression filter 4.

Machine resonance suppression filter 5

- Set the notch frequency of the machine resonance suppression filter 5.
- This parameter is valid when the "Machine resonance suppression filter 5 selection" is set to "1: Enabled".

Notch shape selection 5

- Set the shape of the machine resonance suppression filter 5.
- When you select "1: Enabled" of "Robust filter selection", the machine resonance suppression filter 5 is not available.

Model loop gain after gain switching

- Set the model loop gain when the gain switching is enabled.
- This parameter is valid when the gain adjustment mode is the "3: Manual mode" and the "Gain switching" is set to the "1: Control command from controller is enabled".

Note) Be sure to switch them after the servo motor stops.

4.3.4 Extension setting

(These parameters cannot be changed during the PLC READY status)

Table 4.8 Extension setting

Item	Setting range	Default value
Error excessive alarm level	1 to 1000[rev]/[mm]	0
Electromagnetic brake sequence output	0 to 1000[ms]	0
Encoder output pulse selection *	Encoder output pulse phase selection 0: Increasing A-phase 90° in CCW or positive direction 1: Increasing A-phase 90° in CW or negative direction	0
	Encoder output pulse setting selection 0: Output pulse setting 1: Division ratio setting 3: A-phase/B-phase pulse electronic gear setting	0
	Selection of the encoders for encoder output pulse 0: Servo motor encoder 1: Load-side encoder	0
Function selection C-1 **	0: Two-wire type 1: Four-wire type	0
Function selection C-2 **	0: Disabled 1: Enabled	0
Function selection C-3 **	0: Per 1 rev or 1 mm 1: Per 0.1 rev or 0.1 mm 2: Per 0.01 rev or 0.01 mm 3: Per 0.001 rev or 0.001 mm	0
Zero speed	0 to 10000[r/min]/[mm/s]	50
Overspeed alarm detection level	0 to 20000[r/min]/[mm/s]	0
Analog monitor 1 output	00: (Linear) servo motor speed (±8 V/max. speed) 01: Torque or thrust (±8 V/max. torque or max. thrust) 02: (Linear) servo motor speed (+8V/max. speed) 03: Torque or thrust (+8 V/max. torque or max. thrust) 04: Current command (±8 V/max. current command) 05: Speed command (±8 V/max. speed) 06: Servo motor-side droop pulses (±10 V/100 pulses) 07: Servo motor-side droop pulses (±10V/1000pulse) 08: Servo motor-side droop pulses (±10V/10000pulse) 09: Servo motor-side droop pulses (±10V/100000pulse) 0A: Feedback position (±10V/1Mpulse) 0B: Feedback position (±10V/10Mpulse) 0C: Feedback position (±10V/100Mpulse) 0D: Bus voltage (+8V/400V, 200V amplifier) 0E: Speed command 2 (±8 V/max. speed) 10: Load-side droop pulses (±10V/100pulse) 11: Load-side droop pulses (±10V/1000pulse) 12: Load-side droop pulses (±10V/10000pulse) 13: Load-side droop pulses (±10V/100000pulse) 14: Load-side droop pulses (±10V/1Mpulse) 15: Servo motor-side/load-side position deviation (±10V/100000pulse) 16: Servo motor-side/load-side speed deviation (±8 V/max. speed) 17: Encoder inside temperature (±10 V/±128 °C)	00

*: After changing parameters (sending parameters from the QD77MS to the servo amplifier), the parameters are valid by either turning off the power of the servo amplifier and then on again, or performing a controller reset.

** : After changing parameters (sending parameters from the QD77MS to the servo amplifier), the parameters are valid by turning off the power of the servo amplifier and then on again.

Table 4.8 Extension setting (Continued)

Item	Setting range	Default value
Analog monitor 2 output	00: (Linear) servo motor speed (± 8 V/max. speed) 01: Torque or thrust (± 8 V/max. torque or max. thrust) 02: (Linear) servo motor speed (+8V/max. speed) 03: Torque or thrust (+8 V/max. torque or max. thrust) 04: Current command (± 8 V/max. current command) 05: Speed command (± 8 V/max. speed) 06: Servo motor-side droop pulses (± 10 V/100 pulses) 07: Servo motor-side droop pulses (± 10 V/1000pulse) 08: Servo motor-side droop pulses (± 10 V/10000pulse) 09: Servo motor-side droop pulses (± 10 V/100000pulse) 0A: Feedback position (± 10 V/1Mpulse) 0B: Feedback position (± 10 V/10Mpulse) 0C: Feedback position (± 10 V/100Mpulse) 0D: Bus voltage (+8V/400V, 200V amplifier) 0E: Speed command 2 (± 8 V/max. speed) 10: Load-side droop pulses (± 10 V/100pulse) 11: Load-side droop pulses (± 10 V/1000pulse) 12: Load-side droop pulses (± 10 V/10000pulse) 13: Load-side droop pulses (± 10 V/100000pulse) 14: Load-side droop pulses (± 10 V/1Mpulse) 15: Servo motor-side/load-side position deviation (± 10 V/100000pulse) 16: Servo motor-side/load-side speed deviation (± 8 V/max. speed) 17: Encoder inside temperature (± 10 V/ ± 128 °C)	01
Analog monitor 1 offset	-999 to 999[mV]	0
Analog monitor 2 offset	-999 to 999[mV]	0
Analog monitor - Feedback position output standard data - Low	-9999 to 9999[pulse]	0
Analog monitor - Feedback position output standard data - High	-9999 to 9999[pulse]	0
Function selection C-4 **	0: Need to pass servo motor Z-phase after power on 1: Not need to pass servo motor Z-phase after power on	0
Function selection C-5 *	0: Detection with ready-on and servo-on command 1: Detection with servo-on command	0
Function selection C-7 *	0: Method 1 1: Method 2	0
Alarm history clear *	0: Disabled 1: Enabled	0
Forced stop deceleration time constant	0 to 20000[ms]	100
Function selection C-9 **	0: Encoder pulse increasing direction in the servo motor CCW or positive direction 1: Encoder pulse decreasing direction in the servo motor CCW or positive direction	0
Function selection C-B *	0: Enabled 1: Disabled	0
Vertical axis freefall prevention compensation amount	-25000 to 25000[0.0001rev]/[0.01mm]	0

*: After changing parameters (sending parameters from the QD77MS to the servo amplifier), the parameters are valid by either turning off the power of the servo amplifier and then on again, or performing a controller reset.

** : After changing parameters (sending parameters from the QD77MS to the servo amplifier), the parameters are valid by turning off the power of the servo amplifier and then on again.

Error excessive alarm level

- The error excessive alarm level is set by the servomotor rotation amount.

Electromagnetic brake sequence output

- This is used to set the delay time between MBR (Electromagnetic brake interlock) and the base drive circuit is shut-off.

Encoder output pulse selection

- This is used to select the encoder pulse direction and encoder output pulse setting.

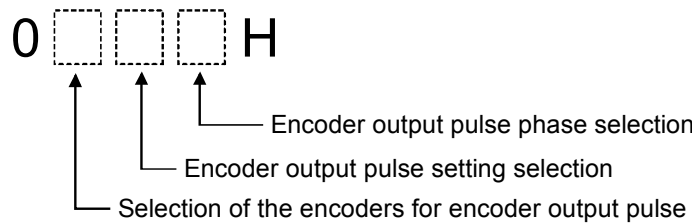

Function selection C-1

- Select the serial encoder cable to be used.
The following serial encoder cables are four-wire type.
 - MR-EKCBL30M-L
 - MR-EKCBL30M-H
 - MR-EKCBL40M-H
 - MR-EKCBL50M-H

Function selection C-2

- This is used to select the motor-less operation.

Function selection C-3

- Select the error excessive alarm level setting. The parameter is not available in the speed control mode and torque control mode.



Zero speed

- Used to set the output range of ZSP (Zero speed detection).
- ZSP (Zero speed detection) has hysteresis of 20 r/min or 20 mm/s.

Overspeed alarm detection level

- This is used to set an overspeed alarm detection level.
- When you set a value more than "servo motor maximum speed × 120%" or "linear servo motor maximum speed × 120%", the set value will be clamped.
When you set "0", the value of "(linear) servo motor maximum speed × 120%" will be set.

Analog monitor 1 output

- Select a signal to output to Analog monitor 1.
 - *A: Encoder pulse unit
 - *B: The maximum output torque is 8V.
 - *C: This can be used under the absolute (absolute position) system.

Analog monitor 2 output

- Select a signal to output to Analog monitor 2.
 - *A: Encoder pulse unit
 - *B: The maximum output torque is 8V.
 - *C: This can be used under the absolute (absolute position) system.

Analog monitor 1 offset

- This is used to set the offset voltage of MO1 (Analog monitor 1).

Analog monitor 2 offset

- This is used to set the offset voltage of MO2 (Analog monitor 2).

Analog monitor - Feedback position output standard data - Low

- Set a monitor output standard position (lower 4 digits) for the feedback position for when selecting "Feedback position" for MO1 (Analog monitor 1) and MO2 (Analog monitor 2).

Analog monitor - Feedback position output standard data - High

- Set a monitor output standard position (higher 4 digits) for the feedback position for when selecting "Feedback position" for MO1 (Analog monitor 1) and MO2 (Analog monitor 2).

Function selection C-4

- This is used to select a home position setting condition.
- Set this parameter when using the absolute position encoder.

Function selection C-5

- This is used to select an occurring condition of [Main circuit off warning].

Function selection C-7

- This is used to select an undervoltage alarm detection method.
- Select "Mode 2" when using FR-RC, FR-CV, or FR-BU2.

Alarm history clear

- Used to clear the alarm history.

0 0 0 H

↑ Alarm history clear selection

Forced stop deceleration time constant

- This is used to set deceleration time constant when you use the forced stop deceleration function.
- Set the time per ms from the rated speed to 0 r/min or 0 mm/s.

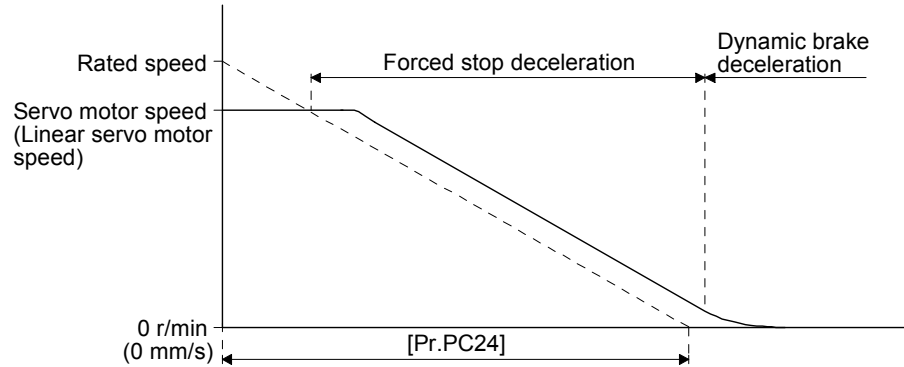

Function selection C-9

- This is used to select a polarity of the linear encoder or load-side encoder.

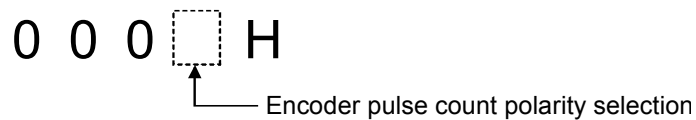

Function selection C-B

- This is used to select the POL reflection at torque control.

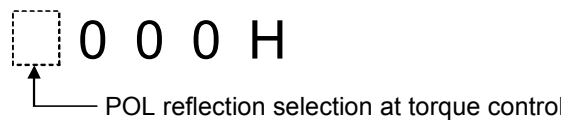

Vertical axis freefall prevention compensation amount

- Set the compensation amount of the vertical axis freefall prevention function.
- Set it per servo motor rotation amount.
- When a positive value is set, compensation is performed to the address increasing direction. When a negative value is set, compensation is performed to the address decreasing direction.
- The vertical axis freefall prevention function is performed when all of the following conditions are met.
 - 1) Position control mode
 - 2) The value of the parameter is other than "0".
 - 3) The forced stop deceleration function is enabled.
 - 4) Alarm occurs or EM2 turns off when the (linear) servo motor speed is zero speed or less.
 - 5) MBR (Electromagnetic brake interlock) was enabled in [Pr. PD07] to [Pr. PD09], and the base circuit shut-off delay time was set in [Pr. PC02].

4.3.5 I/O setting

(These parameters cannot be changed during the PLC READY status)

Table 4.9 I/O setting

Item		Setting range	Default value
Input signal automatic on selection 2 *	FLS (Upper stroke limit) selection	0: Disabled 1: Enabled	0
	RLS (Lower stroke limit) selection	0: Disabled 1: Enabled	0
Output device selection 1 *		00: Always off 02: RD (Ready) 03: ALM (Malfunction) 04: INP (In-position) 05: MBR (Electromagnetic brake interlock) 07: TLC (Limiting torque) 08: WNG (Warning) 09: BWNG (Battery warning) 0A: SA (Speed reached) 0C: ZSP (Zero speed detection) 0F: CDPS (Variable gain selection) 11: ABSV (Absolute position undetermined) 17: MTTR (During tough drive)	05
Output device selection 2 *		00: Always off 02: RD (Ready) 03: ALM (Malfunction) 04: INP (In-position) 05: MBR (Electromagnetic brake interlock) 07: TLC (Limiting torque) 08: WNG (Warning) 09: BWNG (Battery warning) 0A: SA (Speed reached) 0C: ZSP (Zero speed detection) 0F: CDPS (Variable gain selection) 11: ABSV (Absolute position undetermined) 17: MTTR (During tough drive)	04
Output device selection 3 *		00: Always off 02: RD (Ready) 03: ALM (Malfunction) 04: INP (In-position) 05: MBR (Electromagnetic brake interlock) 07: TLC (Limiting torque) 08: WNG (Warning) 09: BWNG (Battery warning) 0A: SA (Speed reached) 0C: ZSP (Zero speed detection) 0F: CDPS (Variable gain selection) 11: ABSV (Absolute position undetermined) 17: MTTR (During tough drive)	03
Function selection D-1 *		0: Enabled 1: Disabled	0
Function selection D-3 *		0: Off 1: On	0

*: After changing parameters (sending parameters from the QD77MS to the servo amplifier), the parameters are valid by either turning off the power of the servo amplifier and then on again, or performing a controller reset.

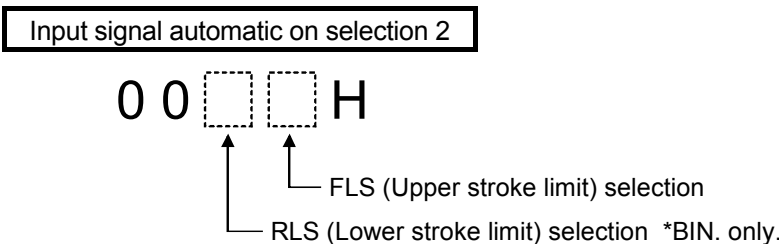

Output device selection 1

Set the signal output to the connector (CN3-13 pin) of the servo amplifier.

*A: Always off in the speed control mode.

*B: This will be SA (speed reached) in the speed control mode.

*C: Do not configure any of the manufacturer settings.

0 0 H
↑
Output device selection

*1: Enter the setting value in (hexadecimal value)

Output device selection 2

Set the signal output to the connector (CN3-9 pin) of the servo amplifier.

*A: Always off in the speed control mode.

*B: This will be SA (speed reached) in the speed control mode.

*C: Do not configure any of the manufacturer settings.

0 0 H
↑
Output device selection

*1: Enter the setting value in (hexadecimal value)

Output device selection 3

Set the signal output to the connector (CN3-15 pin) of the servo amplifier.

*A: Always off under the speed control mode.

*B: This will be SA (speed reached) in the speed control mode.

*C: Do not configure any of the manufacturer settings.

0 0 H
↑
Output device selection

*1: Enter the setting value in (hexadecimal value)

Function selection D-1

0 0 0 H
↑
Servo motor thermistor enabled/disabled selector

For servo motors without thermistor, the setting will be disabled.

Function selection D-3

Select WNG (Warning) and ALM (Malfunction) output status at warning occurrence.

Servo amplifier output

Setting value	Device status
0	<p>WNG 1 0</p> <p>ALM 1 0</p> <p>Warning occurrence</p>
1	<p>WNG 1 0</p> <p>ALM 1 0</p> <p>Warning occurrence (Note)</p>

(Note) Although ALM is turned off upon occurrence of the warning, the forced stop deceleration is performed.

4.3.6 Extension setting 2

(These parameters cannot be changed during the PLC READY status)

Table 4.10 Extension setting 2

Item	Setting range	Default value
Fully closed loop function selection 1 **	0: Always enabled 1: Switching with the control command of controller (switching semi./full.)	0
Fully closed loop function selection 2 *	Fully closed loop control error detection function selection 0: Disabled 1: Speed deviation error detection 2: Position deviation error detection 3: Speed deviation error/position deviation error detection	3
	Position deviation error detection system selection 0: Continuous detection system 1: Detection system at stop (detected with command set to "0")	0
	Fully closed loop control error reset selection 0: Reset disabled (reset by powering off/on enabled) 1: Reset enabled	0
Fully closed loop control - Feedback pulse electronic gear 1 - Numerator **	1 to 65535	1
Fully closed loop control - Feedback pulse electronic gear 1 - Denominator **	1 to 65535	1
Fully closed loop control - Speed deviation error detection level	1 to 50000[r/min]	400
Fully closed loop control - Position deviation error detection level	1 to 20000[kpulse]	100
Fully closed loop dual feedback filter	0 to 4500[rad/s]	10
Fully closed loop function selection 3	Fully closed loop control - Position deviation error detection level - Unit selection 0: 1 kpulse unit 1: 1 pulse unit	0
	Droop pulse monitor selection for controller display 0: Servo motor encoder 1: Load-side encoder 2: Deviation between the servo motor and load side	0
	Cumulative feedback pulses monitor selection for controller display 0: Servo motor encoder 1: Load-side encoder	0
Fully closed loop control - Feedback pulse electronic gear 2 - Numerator **	1 to 65535	1
Fully closed loop control - Feedback pulse electronic gear 2 - Denominator **	1 to 65535	1
Function selection E-3	0: Disabled 1: Enabled	0

*: After changing parameters (sending parameters from the QD77MS to the servo amplifier), the parameters are valid by either turning off the power of the servo amplifier and then on again, or performing a controller reset.

** : After changing parameters (sending parameters from the QD77MS to the servo amplifier), the parameters are valid by turning off the power of the servo amplifier and then on again.

Fully closed loop function selection 1

0 0 0 H

↑ Fully closed loop function selection

To enable the digit, select "Fully closed loop control mode (_ _ 1 _)" of "operation mode selection".

Fully closed loop function selection 2

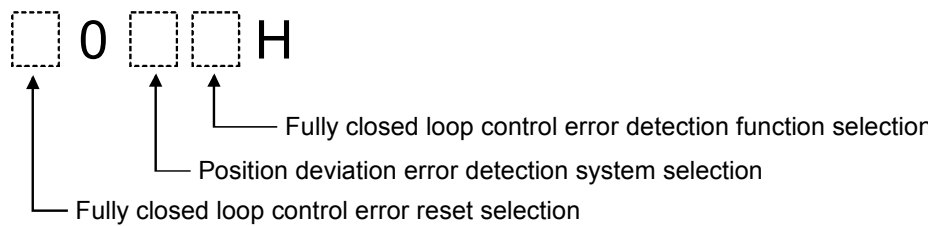

Fully closed loop control - Feedback pulse electronic gear - Numerator

- This is used to set a numerator of electronic gear for the servo motor encoder pulse at the fully closed loop control.
- Set the electronic gear so that the number of servo motor encoder pulses for one servo motor revolution is converted to the resolution of the load-side encoder.

Fully closed loop control - Feedback pulse electronic gear - Denominator

- This is used to set a denominator of electronic gear for the servo motor encoder pulse at the fully closed loop control.
- Set the electronic gear so that the number of servo motor encoder pulses for one servo motor revolution is converted to the resolution of the load-side encoder.

Fully closed loop control - Speed deviation error detection level

- This is used to set [AL. 42.9 Fully closed loop control error by speed deviation] of the fully closed loop control error detection.
- When the speed deviation between the servo motor encoder and load-side encoder becomes larger than the setting value, the alarm will occur.

Fully closed loop control - Position deviation error detection level

- This is used to set [AL. 42.8 Fully closed loop control error by position deviation] of the fully closed loop control error detection.
- When the position deviation between the servo motor encoder and load-side encoder becomes larger than the setting value, the alarm will occur.

Fully closed loop dual feedback filter

- This is used to set a dual feedback filter band.

Fully closed loop function selection 3

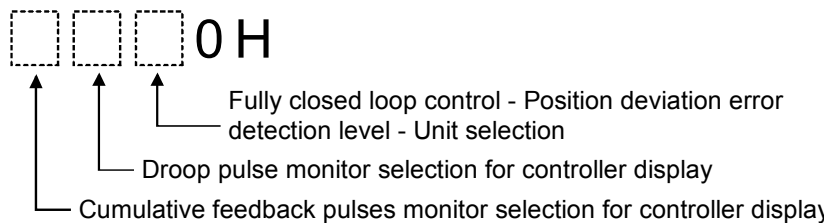

Function selection E-3

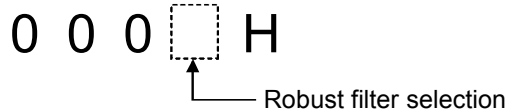

4.3.7 Extension setting 3

(These parameters cannot be changed during the PLC READY status)

Table 4.11 Extension setting 3

Item	Setting range	Default value
Drive recorder switching time setting	-1 to 32767[s]	0
Vibration tough drive - Oscillation detection level	0 to 100[%]	50
Vibration tough drive function selection *	0: [AL. 54 Oscillation detection] will occur at oscillation detection. 1: [AL. F3.1 Oscillation detection warning] will occur at oscillation detection. 2: Oscillation detection function disabled	0
SEMI-F47 function - Instantaneous power failure detection time	30 to 200[ms]	200
Machine diagnosis function - Friction judgement speed	0 to permissible speed [r/min]	0

*: After changing parameters (sending parameters from the QD77MS to the servo amplifier), the parameters are valid by either turning off the power of the servo amplifier and then on again, or performing a controller reset.

Drive recorder switching time setting

- This is used to set a drive recorder switching time.
- When a USB communication is cut during using a graph function, the function will be changed to the drive recorder function after the settling time of this parameter.
- When a value from "1" to "32767" is set, it will switch after the setting value. However, when "0" is set, it will switch after 600 s.
- When "-1" is set, the drive recorder function is disabled.

Vibration tough drive - Oscillation detection level

- This is used to set a filter readjustment sensitivity of [Machine resonance suppression filter 1] and [Machine resonance suppression filter 2] while the vibration tough drive is enabled.

Vibration tough drive function selection

- Select alarm or warning when a oscillation continues at a filter readjustment sensitivity level of [Vibration tough drive - Oscillation detection level].
- The digit is continuously enabled regardless of the vibration tough drive.

0 0 0 H

↑ Oscillation detection alarm selection

SEMI-F47 function - Instantaneous power failure detection time

- Set the time of the [AL. 10.1 Voltage drop in the control circuit power] occurrence.
- To disable the parameter, select "Disabled (_ 0 _)" of "SEMI-F47 function selection".

Machine diagnosis function - Friction judgement speed

- Set a (linear) servo motor speed to divide a friction estimation area into high and low for the friction estimation process of the machine diagnosis. However, setting "0" will be the value half of the rated speed.
- When your operation pattern is under rated speed, we recommend that you set half value to the maximum speed with this.

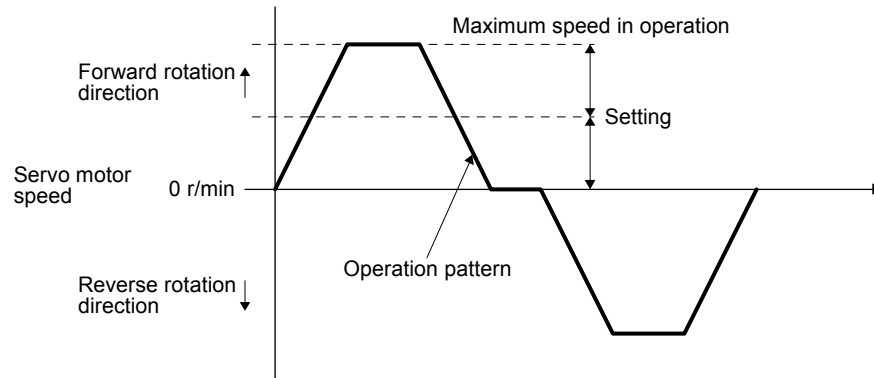

4.4 Positioning data

(These parameters can be changed during PLC READY status)

- (a) The positioning data points are used when performing the positioning operations (excluding the home position return, the JOG operation, and the manual pulser operation). The following table shows the positioning data types.
- (b) When performing 2-axis interpolation control such as the 2-axis linear interpolation control, the 2-axis fixed-feed control, and the 2-axis circular interpolation control, determine the reference axis and the interpolation axis from axis 1 to axis 4. Set all the positioning data types such as the operation pattern and the control method to the reference axis. Set only the positioning address and movement amount necessary for the interpolation to the interpolation axis.
- (c) Range checks for each set value of the positioning data are performed when each positioning is performed. (An error will occur when the set value is out of the range, and the positioning will not be performed.)

Table 4.12 Positioning data

Item	Setting range				Default value
	mm	inch	degree	PLS	
Control system	00: Positioning complete 01: Continuous positioning control 11: Continuous path control				0000H
Control system	01: 1-axis linear control (ABS) 02: 1-axis linear control (INC) 03: 1-axis fixed-feed control 04: 1-axis speed control (forward run) 05: 1-axis speed control (reverse run) 06: Speed-position switching control (forward run) 07: Speed-position switching control (reverse run) 08: Position-speed switching control (forward run) 09: Position-speed switching control (reverse run) 0A: 2-axis linear interpolation control (ABS) 0B: 2-axis linear interpolation control (INC) 0C: Fixed-feed control by 2-axis linear interpolation 0D: Circular interpolation control with sub point specified (ABS) 0E: Circular interpolation control with sub point specified (INC) 0F: Circular interpolation control with center point specified (ABS, CW) 10: Circular interpolation control with center point specified (ABS, CCW) 11: Circular interpolation control with center point specified (INC, CW) 12: Circular interpolation control with center point specified (INC, CCW) 13: 2-axis speed control (forward run) 14: 2-axis speed control (reverse run) 15: 3-axis linear interpolation control (ABS) 16: 3-axis linear interpolation control (INC) 17: Fixed-feed control by 3-axis linear interpolation control 18: 3-axis speed control (forward run) 19: 3-axis speed control (reverse run) 1A: 4-axis linear interpolation control (ABS) 1B: 4-axis linear interpolation control (INC) 1C: Fixed-feed control by 4-axis linear interpolation control 1D: 4-axis speed control (forward run) 1E: 4-axis speed control (reverse run) 80: NOP instruction 81: Current value changing 82: JUMP instruction 83: Declares the beginning of LOOP to LEND section 84: Declares the end of LOOP to LEND section				
Acceleration time No.	00: Acceleration time 0 01: Acceleration time 1 10: Acceleration time 2 11: Acceleration time 3				

Table 4.12 Positioning data (Continued)

Item	Unit	Setting range				Default value
		mm	inch	degree	PLS	
Deceleration time No.		00: Deceleration time 0 01: Deceleration time 1 10: Deceleration time 2 11: Deceleration time 3				0000H
Axis to be interpolated QD77MS2 QD77MS4		00: Axis 1 01: Axis 2 10: Axis 3 11: Axis 4				
Positioning address	Absolute	-214748364.8 to 214748364.7µm	-21474.83648 to 21474.83647inch	0 to 359.99999degree	-2147483648 to 2147483647pulse	0
Movement amount	Incremental	-214748364.8 to 214748364.7µm	-21474.83648 to 21474.83647inch	-21474.83648 to 21474.83647degree	-2147483648 to 2147483647pulse	0
	Speed-position switching control	0 to 214748364.7µm	0 to 21474.83647inch	0 to 21474.83647degree	0 to 2147483647pulse	0
Arc address (Sub point or center point)		-214748364.8 to 214748364.7µm	-21474.83648 to 21474.83647inch	—	-2147483648 to 2147483647pulse	0
Command speed		0.01 to 20000000.00 mm/min	0.001 to 2000000.000 inch/min	0.001 to 2000000.000 degree/min	1 to 1000000pulse/s	0
		-1: Current speed (Speed set for previous positioning data No.)				
Dwell time		When the control method is other than the JUMP instruction and LOOP: 0 to 6553 ms JUMP instruction: Jump destination data No. 1 to 600 LOOP instruction: Number of repetitions: 1 to 65535 times				0
M code		Other than JUMP instruction: 0 to 65535 JUMP instruction: Condition data No. 1 to 10 for condition JUMP				0
Axis to be interpolated	Axis to be interpolated No.1 QD77MS16	0: Axis 1 selected 1: Axis 2 selected 2: Axis 3 selected 3: Axis 4 selected 4: Axis 5 selected 5: Axis 6 selected				0000H
	Axis to be interpolated No.2 QD77MS16	6: Axis 7 selected 7: Axis 8 selected 8: Axis 9 selected 9: Axis 10 selected A: Axis 11 selected B: Axis 12 selected				
	Axis to be interpolated No.3 QD77MS16	C: Axis 13 selected D: Axis 14 selected E: Axis 15 selected F: Axis 16 selected				

(d) The following table shows the configuration of the positioning data setting screen.

<Setting example>

No.	Operation pattern	Control system	Axis to be interpolated	Acceleration time No.	Deceleration time No.	Positioning address [μm]	Arc address [μm]	Command speed [mm/min]	Dwell time [ms]	M code	Positioning data comments
1	00: Positioning complete	1:ABS1	—	0:100	0:100	50000.0	0.0	2000.00	0	0	
2	00: Positioning complete	1:ABS1	—	0:100	0:100	75000.0	0.0	2000.00	0	0	
3	00: Positioning complete	1:ABS1	—	0:100	0:100	100000.0	0.0	2000.00	0	0	
4	00: Positioning complete	1:ABS1	—	0:100	0:100	150000.0	0.0	2000.00	0	0	
5	00: Positioning complete	1:ABS1	—	0:100	0:100	200000.0	0.0	2000.00	0	0	
6	00: Positioning complete	1:ABS1	—	0:100	0:100	25000.0	0.0	2000.00	0	0	
7											
8											
9											
10											

The necessary parameters to be set for the positioning data differ depending on the control method.

For this reason, the intelligent function module setting screen of GX Works2 displays the setting column according to the setting necessities as follows.

Yellow: Setting these items are unavailable as they are used for the interpolation axis side of the interpolation control

Red: Setting these items is necessary the setting is not configured or an error occur

Gray: Setting these items are unavailable (setting is ignored)

Operation pattern

The operation pattern designates whether positioning of a certain data No. is to be ended with just that data, or whether the positioning for the next data No. is to be carried out in succession .

[Operation pattern]

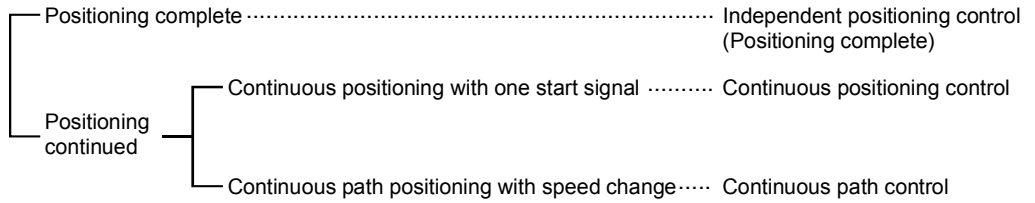

1) Positioning complete Set to execute positioning to the designated address, and then complete positioning.

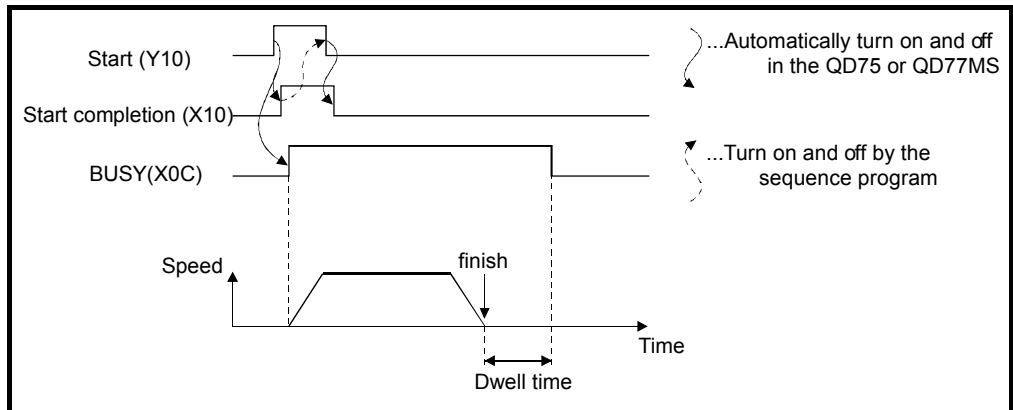

Fig. 4.9 [Complete] pattern

2) Continuous positioning controlPositioning is carried out successively in order of data Numbers. with one start signal. The operation halts at each position indicated by a positioning data.

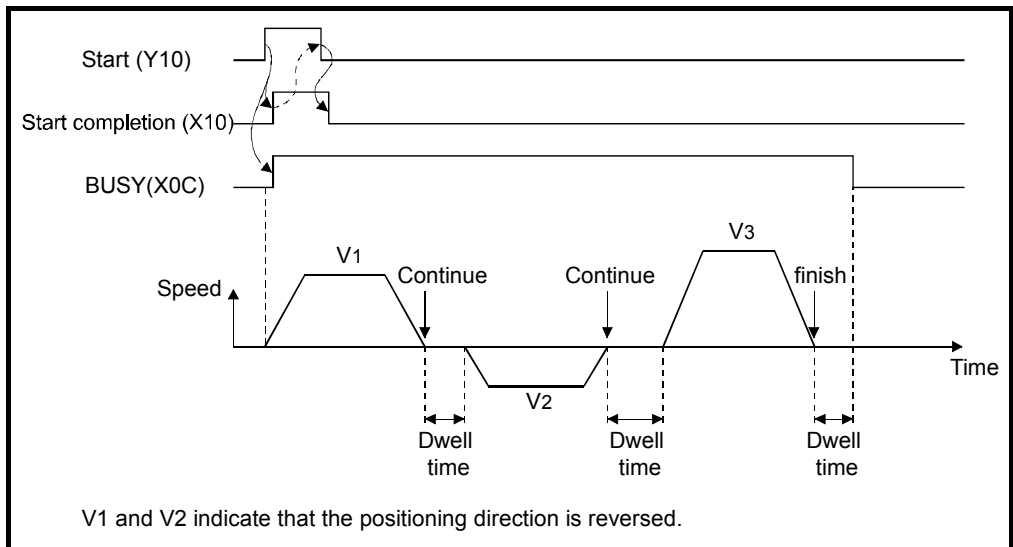

Fig. 4.10 [Continuous] pattern

- 3) Continuous path controlPositioning is carried out successively in order of data Numbers. with one start signal.
The operation does not stop at each positioning data.

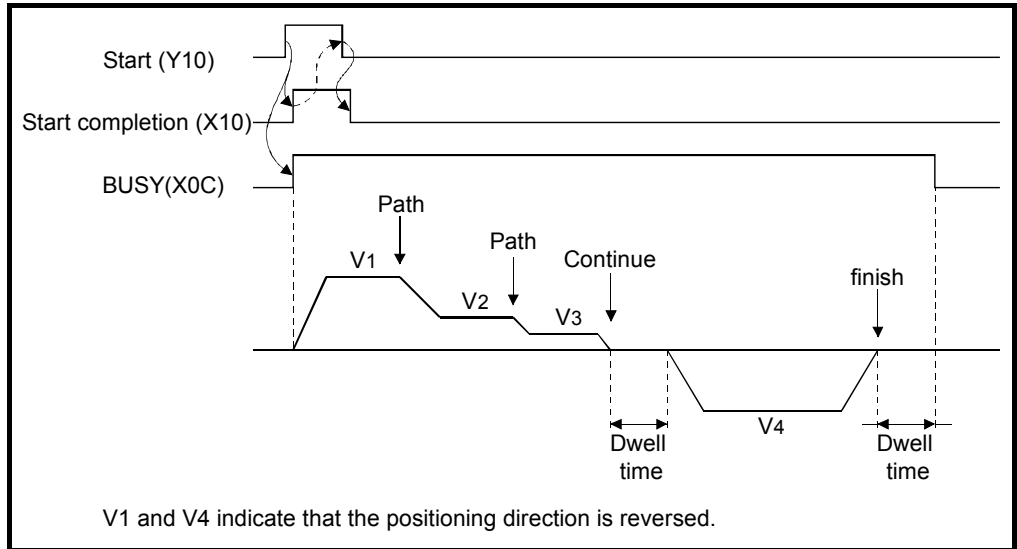

Fig. 4.11 [Path] pattern

Operation pattern

Set the "control system" for carrying out positioning control.

- When "JUMP instruction" is set for the control system, the "Dwell time" and "M code" setting details will differ.
- In case you selected "LOOP" as the control system, the "M code" should be set differently from other cases.
- Refer to Section 4.3.1 to 4.3.11 for details on the control systems.
- If "degree" is set for "Unit setting", circular interpolation control cannot be carried out. (The "Circular interpolation not possible error" will occur when executed (error code: 535).)

Axis to be interpolated QD77MS2 QD77MS4

Set the target axis (partner axis) for operations under the 2-axis interpolation control.

0: Selects the axis 1 as the target axis (partner axis).

1: Selects the axis 2 as the target axis (partner axis).

2: Selects the axis 3 as the target axis (partner axis).

3: Selects the axis 4 as the target axis (partner axis).

- 1) Do not specify the own axis number or any number except the above. (If you do, the "Illegal interpolation description command error" will occur during the program execution (error code: 521).)
- 2) This item does not need to be set in case 3 or 4-axis interpolation is selected.

Positioning address

- (a) Absolute (ABS) system, current value changing
 - The setting value (positioning address) for the ABS system and current value changing is set with an absolute address (address from OP).

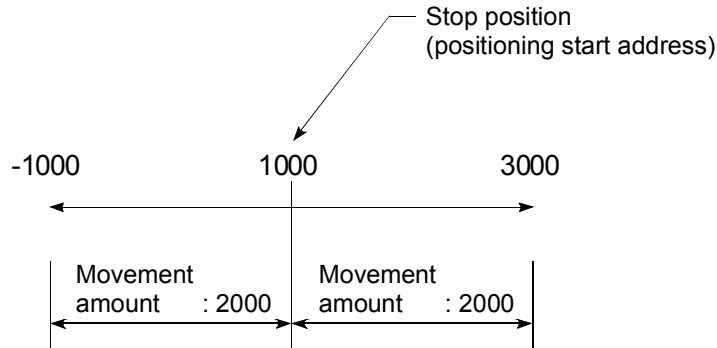

- (b) Incremental (INC) system, fixed-feed 1, fixed-feed 2, fixed-feed 3, fixed-feed 4
 - The setting value (movement amount) for the INC system is set as a movement amount with sign.
 - When movement amount is positive: Moves in the positive direction (address increment direction)
 - When movement amount is negative: Moves in the negative direction (address decrement direction)

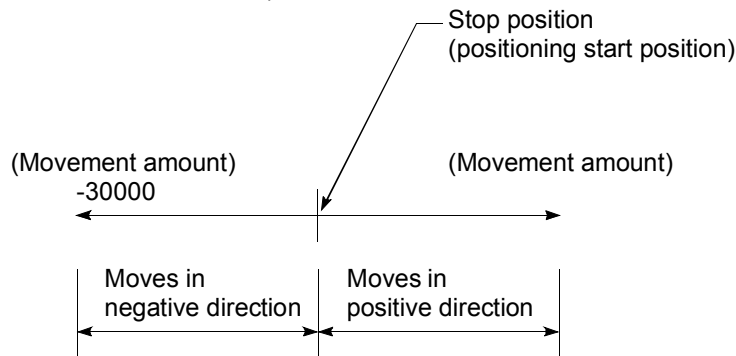

- (c) Speed-position switching control
 - INC mode: Set the amount of movement after the switching from speed control to position control.
 - ABS mode: Set the absolute address which will be the target value after speed control is switched to position control. (The unit is "degree" only)

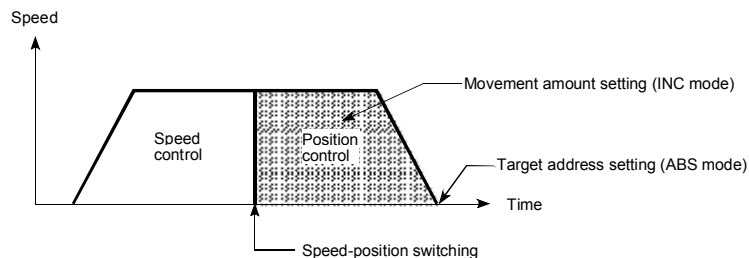

- (d) Position-speed switching control
 - Set the amount of movement before the switching from position control to speed control.

Arc address

The arc address is data required only when carrying out circular interpolation control.

- 1) When carrying out circular interpolation with sub point designation, set the sub point (passing point) address as the arc address.
- 2) When carrying out circular interpolation with center point designation, set the center point address of the arc as the arc address.

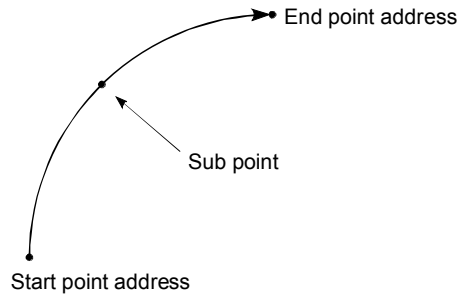

<Circular interpolation with sub point designation>

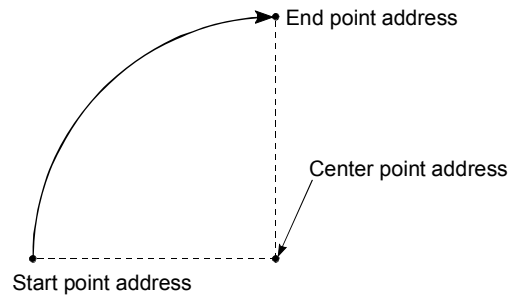

<Circular interpolation with center point designation>

Command speed

Set the command speed for positioning.

- 1) If the set command speed exceeds "Speed limit value", positioning will be carried out at the speed limit value.
- 2) If "-1" is set for the command speed, the current speed (speed set for previous positioning data No.) will be used for positioning control. Use the current speed for uniform speed control, etc. If "-1" is set for continuing positioning ate, and the speed is changed, the following speed will also change.

(Note that when starting positioning, if the "-1" speed is set for the positioning data that carries out positioning control first, the error "Command speed is to set"(error code: 503) will occur, and the positioning will not start.)

Dwell time/JUMP designation positioning data No.

Set the "dwell time" or "positioning data No." corresponding to the "Control system".

- When a method other than "JUMP instruction" is set for "Control system"
..... Set the "dwell time".
- When "JUMP instruction" is set for "Control system"
..... Set the "positioning data No." for the JUMP destination.

When the "dwell time" is set, the setting details of the "dwell time" will be as follows according to "Operation pattern".

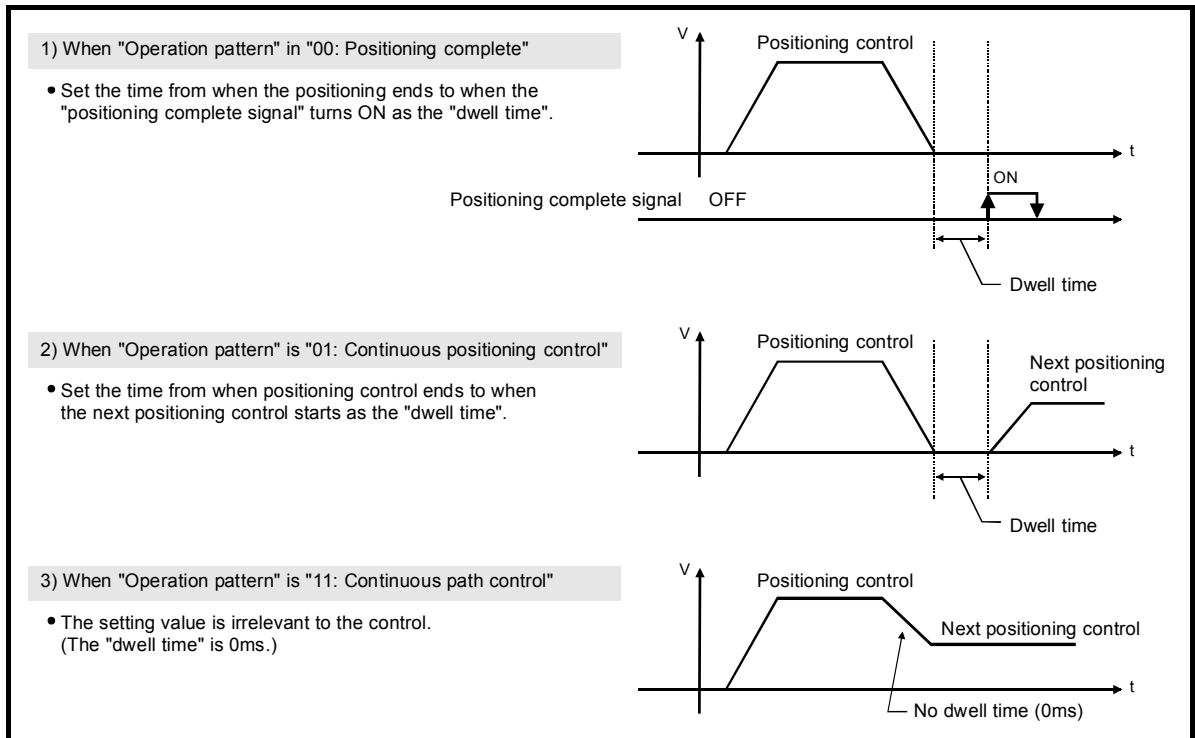

M code

Set an "M code", a "condition data No.", or the "Number of LOOP to LEND repetitions" depending on how the "Control system" is set.

- If a method other than "JUMP instruction" and "LOOP" is selected as the "Control system"
.....Set an "M code".
If no "M code" needs to be output, set "0" (default value).
- If "JUMP instruction" or "LOOP" is selected as the "Control system"
.....Set the "condition data No." for JUMP.
 - 0 : Unconditional JUMP to the positioning data specified by Da.9.
 - 1 to 10 : JUMP performed according to the condition data No. specified (a number between 1 and 10).

** The condition data specifies the condition for the JUMP instruction to be executed. (A JUMP will take place when the condition is satisfied.)

4.4.1 Linear control

Control with ABS linear 1 to 4 (absolute method)

- 1) The positioning control is performed from the current stop address having the home position as a reference (address before the positioning) to the specified address.
- 2) The movement direction is determined by the current stop address and the specified address.

Parameter	Necessity of setting during interpolation control	
	Reference axis	Interpolation axis
Operation pattern	○	-
Control method	"ABS linear 1" "ABS linear 2" "ABS linear 3" "ABS linear 4"	-
Interpolation axis	○*1	-
Acceleration time No.	○	-
Deceleration time No.	○	-
Positioning address	○	○
Arc address	-	-
Command speed	○	-
Dwell time	△	-
M code	△	-

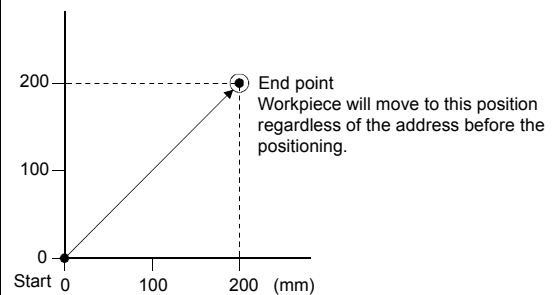

○: Necessary -: Unnecessary △: Necessary depending on conditions

*1: Necessary only when the control method is the ABS linear 2

Control with INC linear 1 to 4 (increment method)

- 1) The positioning control is performed from the current stop address for the specified movement amount.
- 2) The movement direction is determined by the encoding of the movement amount (+/-).
 - For positive movement direction Positive direction positioning (direction of address increase)
 - For negative movement direction Negative direction positioning (direction of address decrease)

Parameter	Necessity of setting during interpolation control	
	Reference axis	Interpolation axis
Operation pattern	○	-
Control method	"INC linear 1" "INC linear 2" "INC linear 3" "INC linear 4"	-
Interpolation axis	○*1	-
Acceleration time No.	○	-
Deceleration time No.	○	-
Positioning address	○	○
Arc address	-	-
Command speed	○	-
Dwell time	△	-
M code	△	-

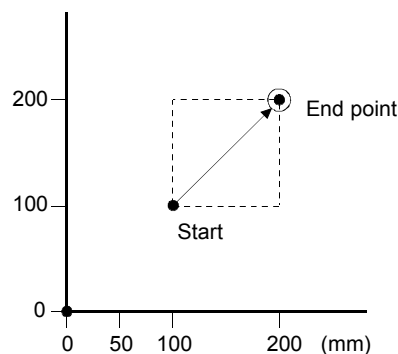

○: Necessary -: Unnecessary △: Necessary depending on conditions

*1: Necessary only when the control method is the ABS linear 2

4.4.2 Fixed-feed

Control with fixed-feed 1 to 4 (increment method)

- (1) The positioning control is performed for the specified movement amount by setting the current stop position as 0.
- (2) The movement direction is determined by the encoding of the movement amount.
 - For positive movement direction Positive direction positioning (direction of address increase)
 - For negative movement direction Negative direction positioning (direction of address decrease)
- (3) Fixed-feed 2 to 4 are the interpolation control.

Parameter	Necessity of setting during interpolation control	
	Reference axis	Interpolation axis
Operation pattern	○	-
Control method	"Constant-rate feed 1" "Constant-rate feed 2" "Constant-rate feed 3" "Constant-rate feed 4"	-
Interpolation axis	○*1	-
Acceleration time No.	○	-
Deceleration time No.	○	-
Positioning address	○	○
Arc address	-	-
Command speed	○	-
Dwell time	△	-
M code	△	-

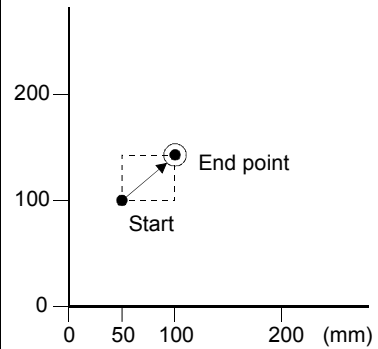

○: Necessary -: Unnecessary △: Necessary depending on conditions
 *1: Necessary only when the control method is the Fixed-feed 2

4.4.3 Circular interpolation with a specified sub point

2-axis control with ABS circular interpolation (absolute method)

- (1) The circular interpolation is performed from the current stop address (address before the positioning) having the home position as a reference by passing through the specified auxiliary point address to the final address.
- (2) The resulting control path is an arc having as its center the intersection point of perpendicular bisectors of a straight line between the start point address (current stop position) and sub point address, and a straight line between the sub point address and end point address.

Parameter	Necessity of setting during interpolation control	
	Reference axis	Interpolation axis
Operation pattern	○	-
Control method	Selection of "ABS circular interpolation"	-
Interpolation axis	○	-
Acceleration time No.	○	-
Deceleration time No.	○	-
Positioning address	○	○
Arc address	○ (Set the auxiliary point address)	○ (Set the auxiliary point address)
Command speed	○	-
Dwell time	△	-
M code	△	-

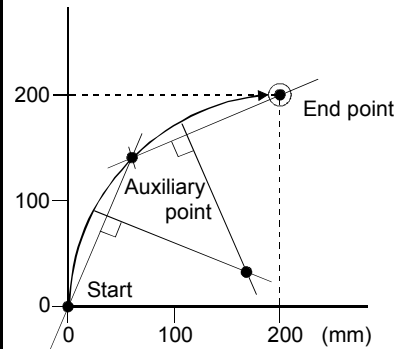

○: Necessary -: Unnecessary △ Necessary depending on conditions

2-axis control with INC circular interpolation (increment method)

- (1) The circular interpolation is performed from the current stop position address, passing through the specified auxiliary point to the final point.
- (2) The resulting control path is an arc having as its center the intersection point of perpendicular bisectors between the start point (current stop position) and sub point, and a straight line between the sub point and end point.

Parameter	Necessity of setting during interpolation control	
	Reference axis	Interpolation axis
Operation pattern	○	-
Control method	Selection of "INC circular interpolation"	-
Interpolation axis	○	-
Acceleration time No.	○	-
Deceleration time No.	○	-
Positioning address	○	○
Arc address	○ (Set the movement amount from the start point to the auxiliary point)	○ (Set the movement amount from the start point to the auxiliary point)
Command speed	○	-
Dwell time	△	-
M code	△	-

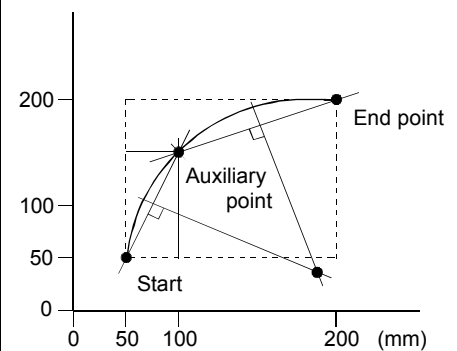

○: Necessary -: Unnecessary △ Necessary depending on conditions

4.4.4 Circular interpolation control with center point designation

2-axis control with ABS circular right and ABS circular left (absolute method)

- (1) The circular interpolation is performed from the current stop address (address before the positioning) having the home position as a reference with an arc whose radius is a distance from the start point to the center point.

Parameter	Necessity of setting during interpolation control	
	Reference axis	Interpolation axis
Operation pattern	○	-
Control method	"ABS circular right" "ABS circular left"	-
Interpolation axis	○	-
Acceleration time No.	○	-
Deceleration time No.	○	-
Positioning address	○	○
Arc address	○ (Set the center point address)	○ (Set the center point address)
Command speed	○	-
Dwell time	△	-
M code	△	-

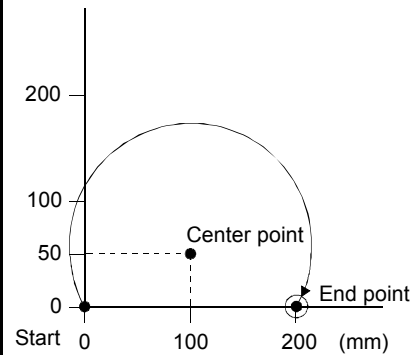

○: Necessary -: Unnecessary △: Necessary depending on conditions

2-axis control with INC circular right and INC circular left (increment method)

- (1) The circular interpolation is performed from the current stop address (0, 0) with an arc whose radius is a distance from the start point to the center point by the movement amount from the start point to the end point.

Parameter	Necessity of setting during interpolation control	
	Reference axis	Interpolation axis
Operation pattern	○	-
Control method	"INC circular right" "INC circular left"	-
Interpolation axis	○	-
Acceleration time No.	○	-
Deceleration time No.	○	-
Positioning address	○	○
Arc address	○ (Set the center point address)	○ (Set the center point address)
Command speed	○	-
Dwell time	△	-
M code	△	-

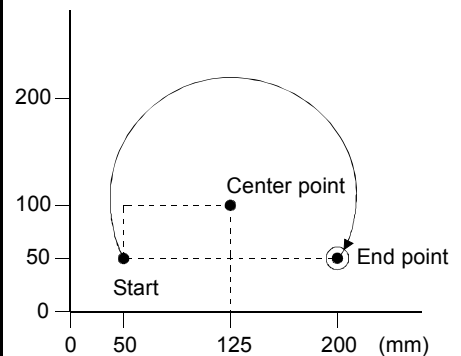

○: Necessary -: Unnecessary △: Necessary depending on conditions

4.4.5 Speed control

Control by the forward speed control and the reverse speed control

- (1) The control is performed from the start of the servomotor operation to the stop command input at the specified speed.
- (2) When the "Pr. 21 Current feed value during speed control" is set to the "2: Clear current feed value to zero", the current feed value remains 0. (The machine feed value is added.)

Parameter	Necessity of setting during interpolation control	
	Reference axis	Interpolation axis
Operation pattern	"Stops"	-
Control method	"Forward speed 1" "Forward speed 2" "Forward speed 3" "Forward speed 4" "Reverse speed 1" "Reverse speed 2" "Reverse speed 3" "Reverse speed 4"	-
Interpolation axis	○*1	-
Acceleration time No.	○	-
Deceleration time No.	○	-
Positioning address	-	-
Arc address	-	-
Command speed	○	○*1
Dwell time	-	-
M code	△*2	-

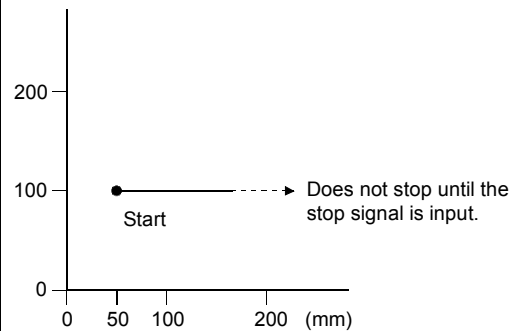

○: Necessary —: Unnecessary

△: Necessary depending on conditions

*1: Necessary when the control method is the forward speed 2 or the reverse speed 2

*2: Valid only when the M code is set to "WITH mode"

4.4.6 Speed-position switching control

Single axis control with the forward run speed/position control and the reverse run speed/position control (increment method)

- (1) The speed control is performed after the start of the operation. The control method switches to the positioning control when the speed-position switching enable flag is on (enabled) by the external command signal (selecting the "External command function selection" to "Speed-position, position-speed switching request") and the positioning is performed for the specified movement amount.
- (2) The current feed value at the start of operation and during the speed control varies depending on the setting of the "Current feed value during speed control". (The machine feed value is always added.)

Parameter	Necessity of setting
Operation pattern	"Stops"
Control method	"Forward speed/position" "Reverse speed/position"
Interpolation axis	-
Acceleration time No.	○
Deceleration time No.	○
Positioning address	○
Arc address	-
Command speed	○
Dwell time	△
M code	△

○: Necessary -: Unnecessary
 △: Necessary depending on conditions

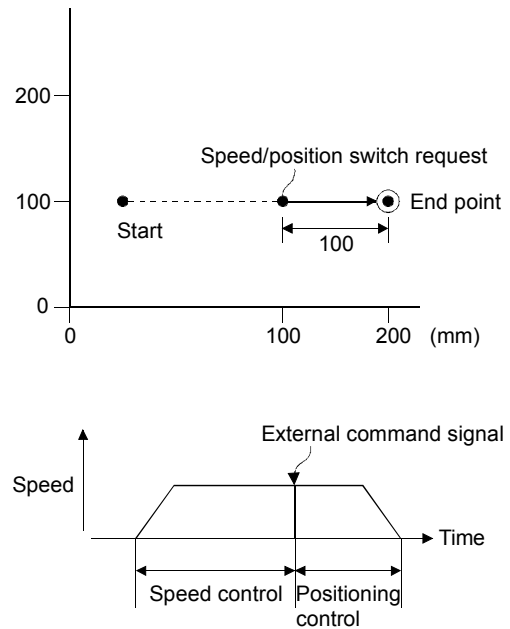

4.4.7 Position-speed switching control

Single axis control with forward run position/speed control and the reverse run position/speed control (increment method)

- (1) The positioning control is performed after the start of the operation. The control switches to the speed control by the external command signal (selecting the "External command function selection" to "Speed-position, position-speed switching request") when the position-speed switching enable flag is on (enabled) before the positioning end point has been reached. The speed control is performed until the stop signal is input.
- (2) The current feed value at the start of operation and during the speed control varies depending on the setting of the "Current feed value during speed control". (The machine feed value is always added.)

Parameter	Necessity of setting
Operation pattern	"Stop"
Control method	"Forward position/speed" "Reverse position/speed"
Interpolation axis	-
Acceleration time No.	○
Deceleration time No.	○
Positioning address	○
Arc address	-
Command speed	○
Dwell time	△
M code	△

○: Necessary -: Unnecessary
 △: Necessary depending on conditions

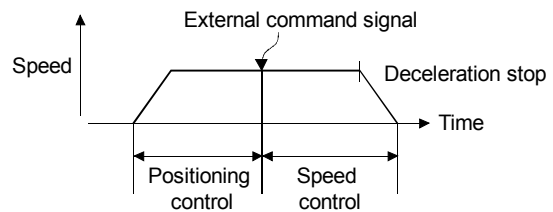
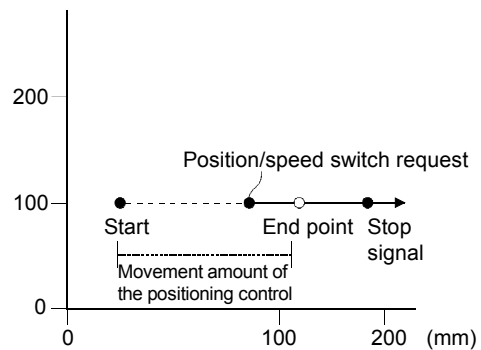

4.4.8 NOP instruction

Instructions that do not execute anything

- (1) The NOP instruction is used for the nonexecutable control system. When the control method is the NOP instruction, all the settings (such as the positioning address or the command speed) other than the control method are disabled.
- (2) The positioning data Numbers. where the NOP instructions are set are not processed, and the operation transitions to the next positioning data No. However, an error will occur when the NOP instruction is set to the positioning data No. 600.

REMARK

The NOP instructions are used to reserve data when there is a possibility that speed switches or temporary stops (automatic deceleration) may be performed at a point.

Data can be changed by replacing the identifier.

4.4.9 Changing the current value

Changing the current stop position value

- (1) The current feed value can be changed to the desired value by the current value change instruction when the workpiece stops or during continuous positioning control.
(The current value cannot be changed during the continuous path control.)
- (2) The change value is set in the [Positioning address] column.
- (3) The current feed value is changed after this instruction is executed, and the mechanical feed value is not changed.

Parameter	Necessity of setting
Operation pattern	○
Control method	"Change current value"
Interpolation axis	-
Acceleration time No.	-
Deceleration time No.	-
Positioning address	○
Arc address	-
Command speed	-
Dwell time	-
M code	△

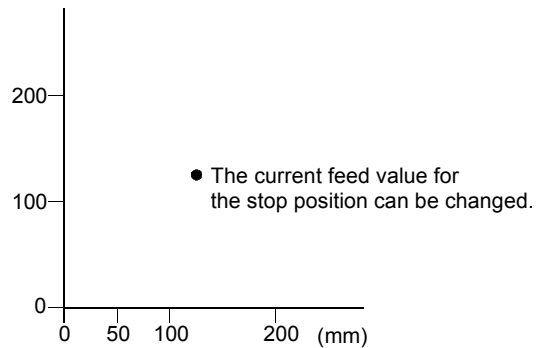

○: Necessary -: Unnecessary △: Necessary depending on conditions

REMARKS

The current feed value changes may also be performed by storing the change value in the buffer memory areas (1506, 1507/1606, 1607/1706, 1707/1806, and 1807) by the DTO instruction using the positioning data No. 9003.

4.4.10 JUMP instruction

Data No. jumps by the JUMP instruction during continuous path control

- (1) The unconditional jump or conditional jump to the specified positioning data No. is performed during the continuous path control or the continuous positioning control.
 - Unconditional jump: Executing this instruction performs the unconditional jump when the execution conditions (M code column) for the JUMP instruction are not set.
 - Conditional jump: Executing this instruction performs a jump when the conditions are satisfied or a transition to the next positioning data No. when the conditions are not satisfied when the execution conditions (M code column) 1 to 10 for the JUMP instruction are set.

- (2) Set the dwell time between 1 to 600 for the jump destination positioning data No.

- (3) The execution conditions are set by the block start condition data 1 to 10 in the M code column.

Parameter	Necessity of setting
Operation pattern	-
Control method	"JUMP instruction"
Interpolation axis	-
Acceleration time No.	-
Deceleration time No.	-
Positioning address	-
Arc address	-
Command speed	-
Dwell time	○ (jump destination data No.)
M code	△*1

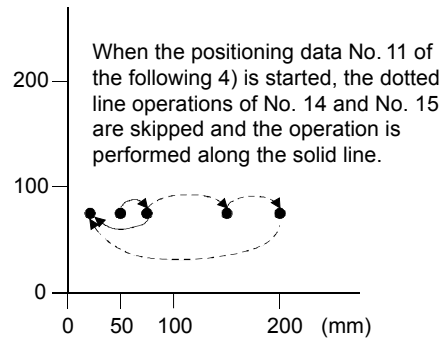

○: Necessary -: Unnecessary △: Necessary depending on conditions

*1 Set the condition data No. for the conditional jumps

- (4) The following table shows an example in which the JUMP instruction is input to the positioning data No. 13 and the condition data 1 is set to the M code column, and then the system jumps to the data No. 16 when the conditions are satisfied.

No.	Operation Pattern	Control method	Interpolation axis	Acceleration time No.	Deceleration time No.	Positioning Address [μm]	Arc address [μm]	Command speed [mm/min]	Dwell Time [ms]	M code	Positioning data Comments
11	1: Continuous	1: ABS linear 1	—	0:100	0:100	50000.0	0.0	2000.00	0	0	
12	1: Continuous	1: ABS linear 1	—	0:100	0:100	75000.0	0.0	2000.00	0	0	
13	1: Continuous	X: JUMP instruction	—	0:100	0:100	0.0	0.0	2000.00	16	1	
14	1: Continuous	1: ABS linear 1	—	0:100	0:100	150000.0	0.0	2000.00	0	0	
15	1: Continuous	1: ABS linear 1	—	0:100	0:100	200000.0	0.0	2000.00	0	0	
16	0: Finish	1: ABS linear 1	—	0:100	0:100	25000.0	0.0	2000.00	0	0	
17											

Note) Separate conditions must be created for the condition data No. 1.

JUMP destination data No. Condition data No.

4.4.11 LEND control from LOOP

Repetitious control by repetitions of LOOP to LEND

- (1) The LOOP to LEND loop is repeated for the specified number of repetitions.
- (2) The number of repetitions is set between 1 to 65535 in the M code column.
- (3) When the control method is LOOP, all the settings other than the number of repetitions (M code column) are disabled.
- (4) When the control method is LEND, settings for other parameters are disabled.
- (5) The loop ends when the number of repetitions specified by LOOP is 0, and then the next positioning data No. is processed. (The operation pattern is ignored.) When stopping the operation after executing the specified number of repetitions, set the next positioning data after LEND as a dummy (positioning with a movement amount of zero using the increment method).

Parameter	Necessity of setting	
	LOOP	LEND
Operation pattern	-	-
Control method	“LOOP”	“LEND”
Interpolation axis	-	-
Acceleration time No.	-	-
Deceleration time No.	-	-
Positioning address	-	-
Arc address	-	-
Command speed	-	-
Dwell time	-	-
M code	○ (Set the number of repetitions)	-

○: Necessary -: Unnecessary □: Necessary depending on conditions

- (6) The following table shows an example in which the LOOP is input to the positioning data No. 22, the number of repetitions 2 is set in the M code column, and then system jumps to positioning data No. 25.

No.	Operation Pattern	Control method	Interpolation axis	Acceleration time No.	Deceleration time No.	Positioning Address [μm]	Arc address [μm]	Command speed [mm/min]	Dwell Time [ms]	M code	Positioning data Comments
21	1: Continuous	1: ABS linear 1	—	0:100	0:100	50000.0	0.0	2000.00	0	0	
22	0: Finish	Y: LOOP	—	0:100	0:100	0.0	0.0	0.00	0	2	
23	1: Continuous	1: ABS linear 1	—	0:100	0:100	100000.0	0.0	2000.00	0	0	
24	1: Continuous	1: ABS linear 1	—	0:100	0:100	150000.0	0.0	2000.00	0	0	
25	0: Finish	Z: LEND	—	0:100	0:100	0.0	0.0	0.00	0	0	
26	0: Finish	1: ABS linear 1	—	0:100	0:100	25000.0	0.0	2000.00	0	0	
27											

Number of repetitions

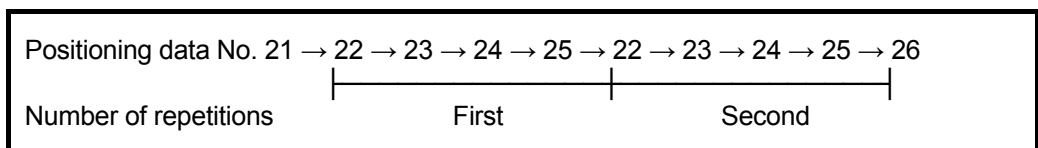

Positioning data

CHAPTER 5 Training (1) Test operations with GX Works2 (QD77MS2)

5.1 System configuration of the demonstration machine

(1) I/O number assignment

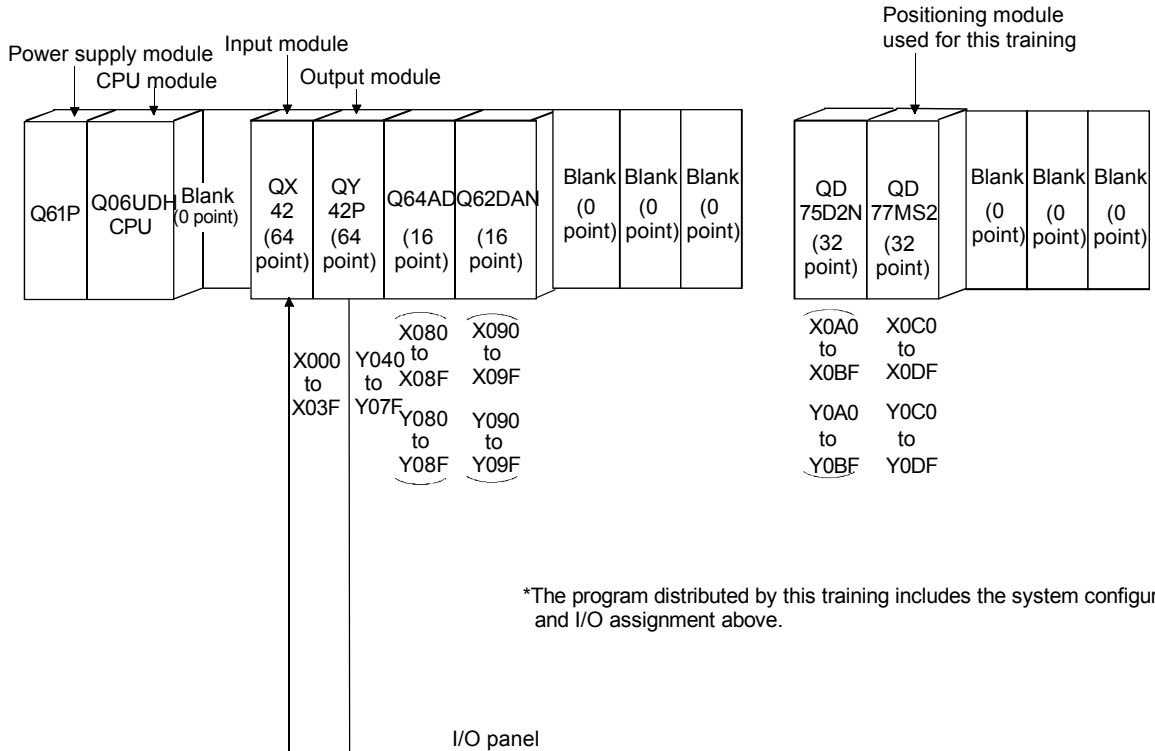

*The program distributed by this training includes the system configurat and I/O assignment above.

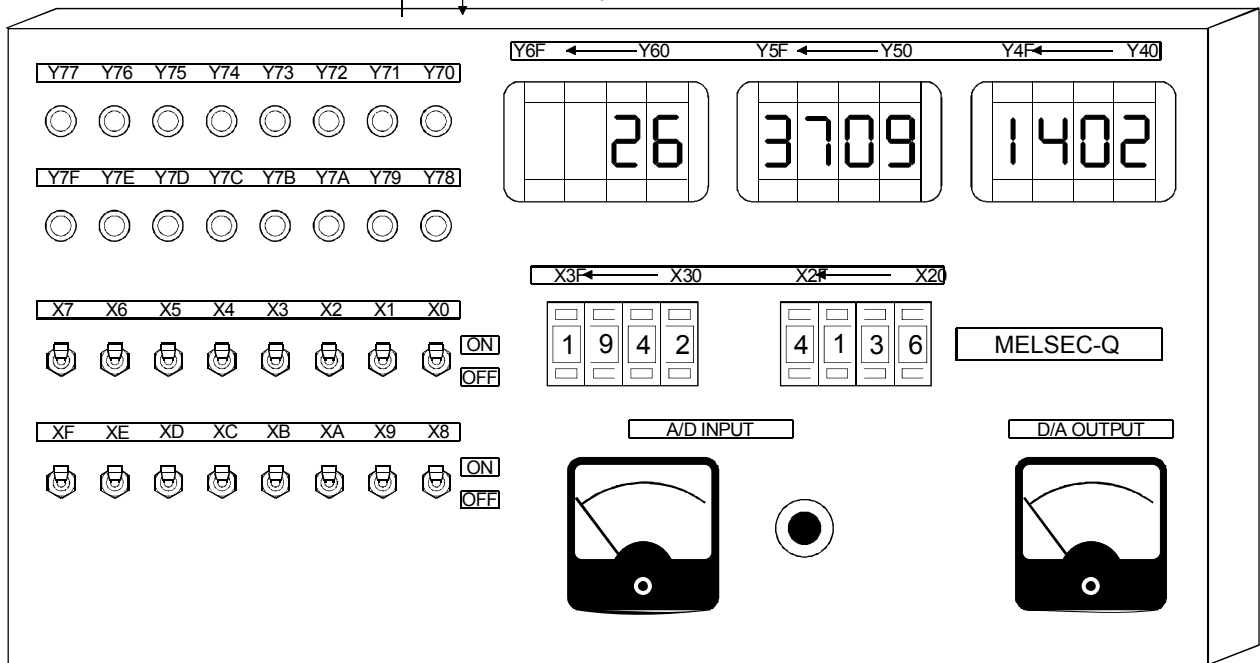

* Refer to the next section for more information on device assignment of the demonstration machine.

(2) Demonstration machine used

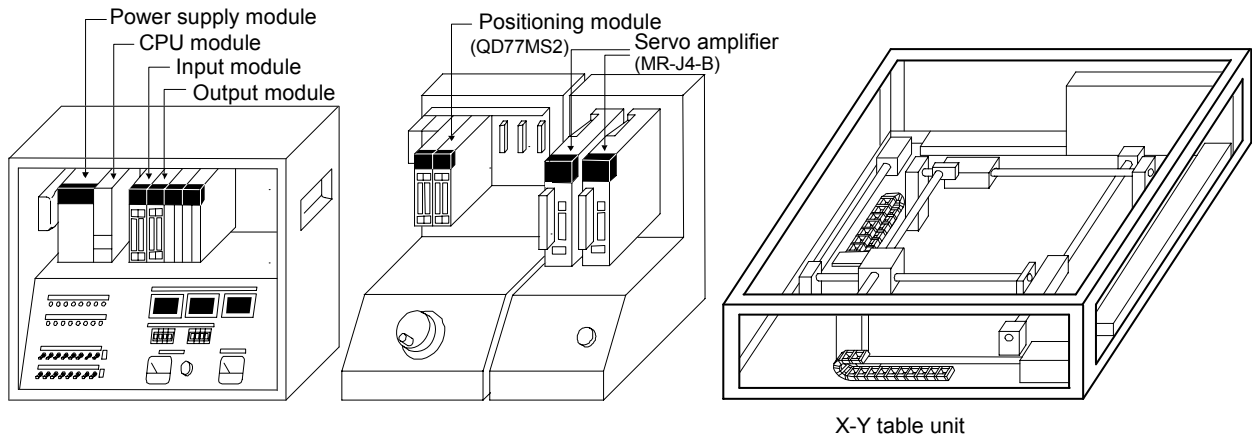

(Already installed in the personal computer used for this training)

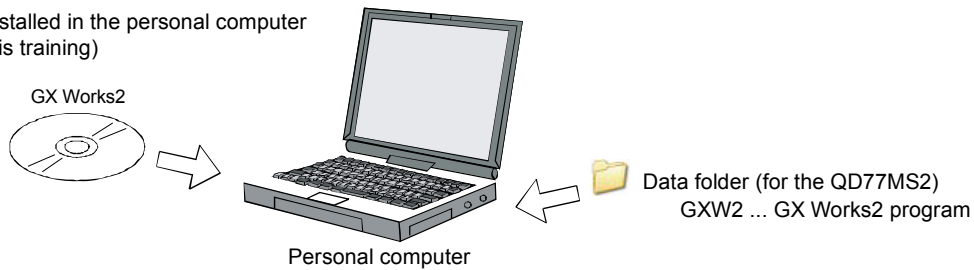

(3) Turning on the power supply

Turn on the power supply switch for the demonstration machine after stopping the Q06UDHCPU.

CAUTION

Instructors prepare the equipment. Do not connect or disconnect cables without instructions, and do not disassemble equipment.

Doing so may cause failure, malfunction, injury, or fire.

5.2 Assignment of devices used for training

- X0······ Home position return command
- X1······ Stop command
- X2······ Waiting point start
- X3······ Specified positioning data No. start
- X4······ Forward run JOG start
- X5······ Reverse run JOG start
- X6······ Inching operation
- X7······ Registering the setting data
- X8······ Data change target switch
- X9······ Restart command
- X0A····· PLC READY OFF command
- X0B····· Error reset
- X0C····· Manual pulser command

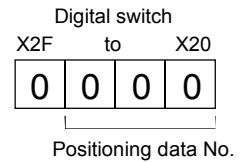
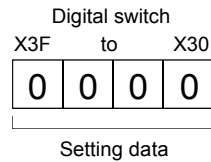

- Y70····· Home position return request
- Y71····· Stop
- Y73····· M code detection
- Y74····· Forward run JOG
- Y75····· Reverse run JOG
- Y77····· Error display

- D10····· For positioning data No. (X20 to X2B)
- D11····· For setting data (X30 to X3F)
- D13,14····· For operations
- D20····· For status signal reads

Automatic refresh setting

- D100,101···· Axis 1 current feed value
- D102,103···· Axis 1 feed device value
- D104,105···· Axis 1 feed speed
- D106······ Axis 1 error code
- D107······ Axis 1 warning code
- D108······ Axis 1 valid M code
- D109······ Axis 1 operation status

- M0······ Home position return command
- M2······ Waiting point start
- M3······ Specified positioning data No. start
- M7······ Registering the setting data
- M8······ External command signal disable 1
- M9······ Error reset, restart
- M10······ Interlock (flash ROM write)
- M11······ External command signal disable 2
- M20······ Master control

- T1······ M code 1 detection
- T2······ M code 3 detection
- T3······ M code 5 detection

*: Values in the QD77MS buffer memory areas are automatically updated by the automatic refresh setting for the operation of the intelligent function module in GX Works2. (Refer to Chapter 5.3.2)

M200 to M259····· Used for the QD77 special instructions
 D200 to D259·····

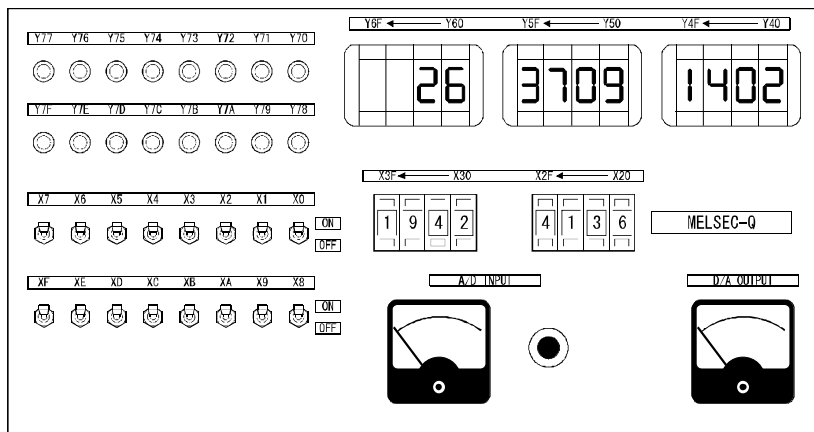

5.3 GX Works2 startup and shutdown

This section describes how to startup and shutdown GX Works2 with an example of using the QD77MS2 simple motion module.

5.3.1 Startup operation

In this training, trainees create a new project after starting up GX Works2, and add the intelligent function module.

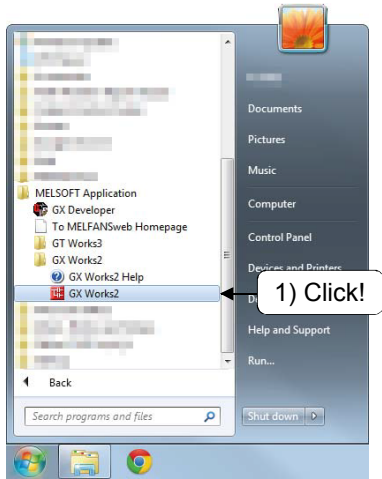

1. Select [Start] → [All Programs] → [MELSOFT Application] → [GX Works2] → [GX Works2].

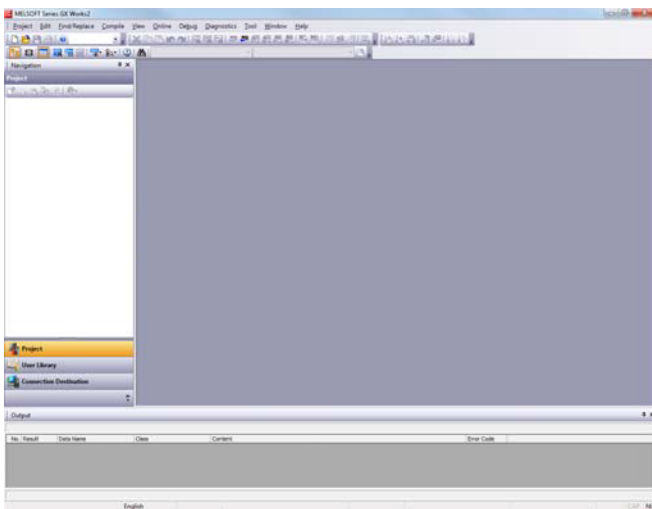

2. GX Works2 starts up.

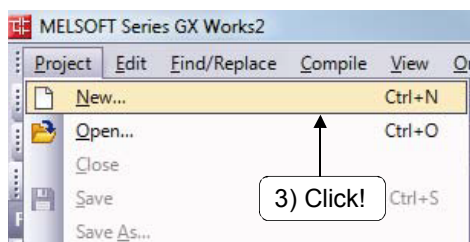

3. Select [Project] → [New...] from the menu.



To the next page

From the previous page

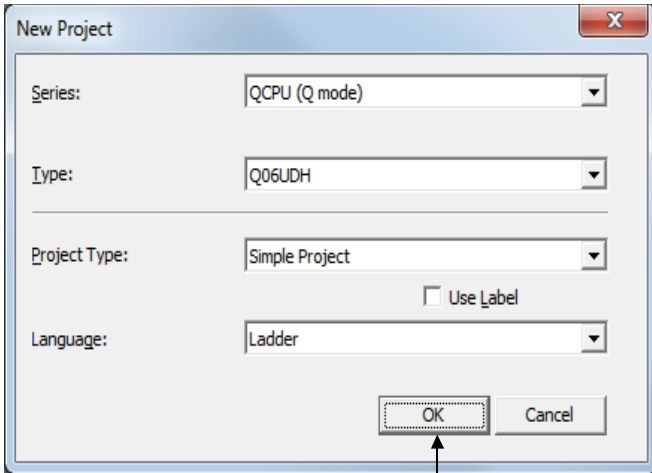

4. The [New Project] dialog box is displayed, enter the following setting and click the **OK** button.

Project Type: Simple Project
Series: QCPU (Q mode)
Type: Q06UDH

4) Click!

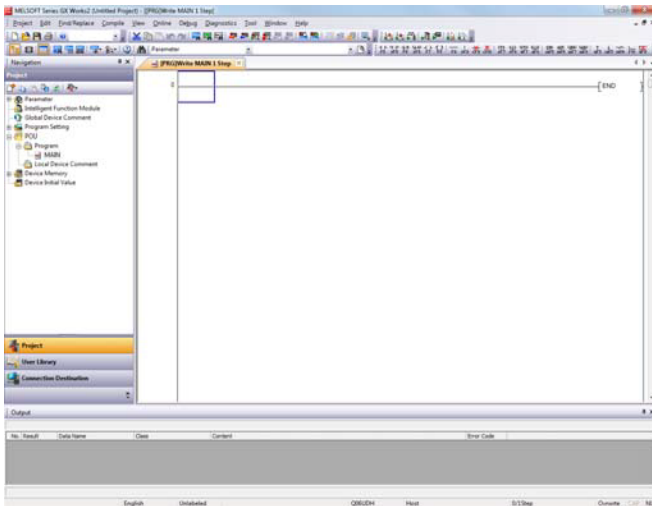

5. The new project will open.

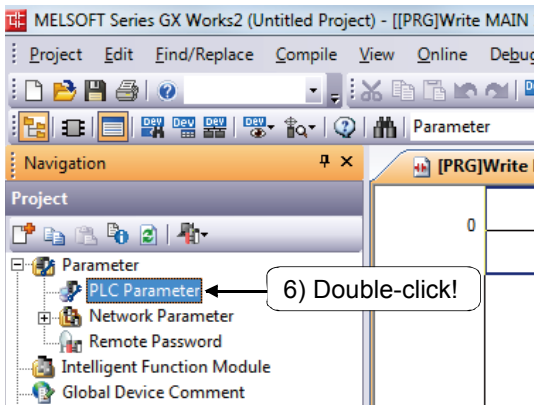

6. Double-click "PLC Parameter" from the project view to display the [Q Parameter Setting] dialog box.



To the next page

From the previous page



No.	Slot	Type	Model Name	Points	Start XY
0	PLC	PLC			
1	0(*-0)	Empty		0 Point	
2	1(*-1)	Input		6*Points	
3	2(*-2)	Output		6*Points	
4	3(*-3)	Intelligent		16Points	
5	4(*-4)	Intelligent		16Points	
6	5(*-5)	Empty		0 Point	
7	6(*-6)	Empty		0 Point	
8	7(0-7)	Empty		0 Point	
9	8(1-0)				
10	9(1-1)				

Assigning the I/O address is not necessary as the CPU does it automatically.
Leaving this setting blank will not cause an error to occur.

Base Setting(*1)		Power Model Name	Extension Cable	Slots
Main				8
Ext.Base 1				5

7) Set!



- Click the "I/O Assignment" tab, and set the I/O assignment and the slot number in the Base Settings.
- Click the **End** button.

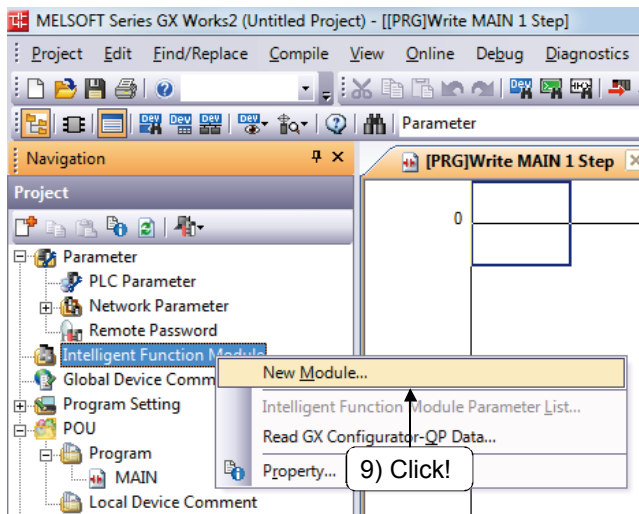

- Right-click on the "Intelligent Function Module" in the project view, and click "New Module".

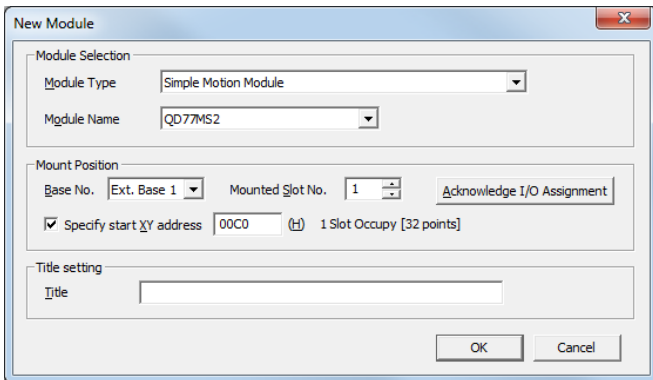

- The [New Module] dialog box is displayed, enter the following setting, and click the **OK** button.

Module Type: Simple Motion Module
 Module Name: QD77MS2
 Base No.: Ext. Base 1
 Mounted Slot No.: 1
 Start XY address: 00C0



To the next page

From the previous page

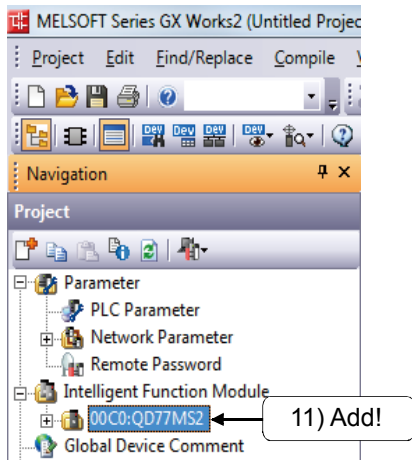

11. The data for the specified intelligent function module is added to the project view.

5.3.2 Automatic refresh setting

Configure the automatic refresh setting described in Chapter 5.2.

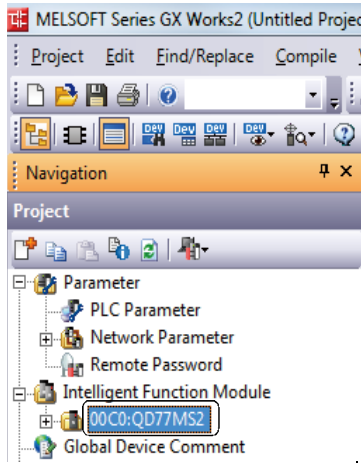

1. Double-click the "00C0:QD77MS2" icon in the project view.

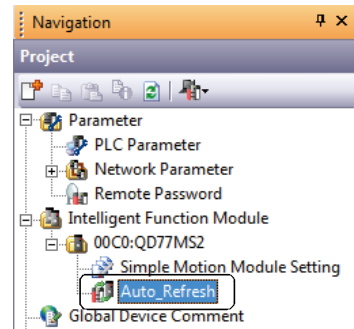

2. Double-click the "Auto_Refresh" icon.

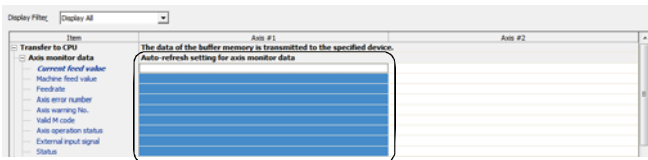

3. The automatic refresh configuration window is displayed.
Select items to which the devices are assigned by sequential numbers.

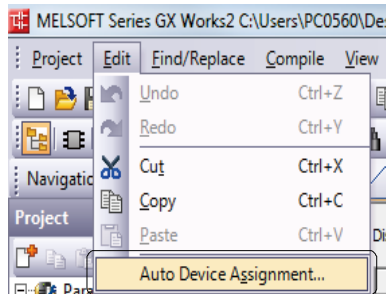

4. Select [Edit] → [Auto Device Assignment] from the menu.



To the next page

From the previous page

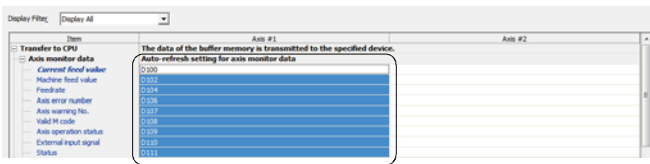
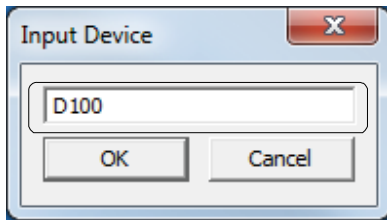

5. The [Input Device] screen is displayed, enter "D100", then click the button.

6. The automatic refresh settings are assigned in a sequential order.

5.3.3 Shutdown operation

This section describes the shutdown operation of GX Works2.

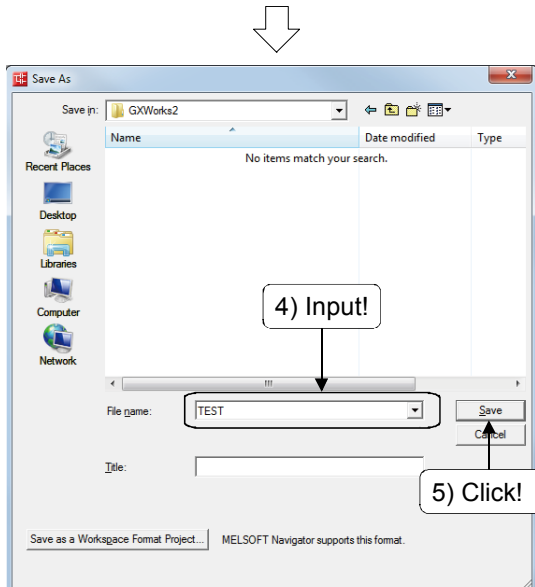
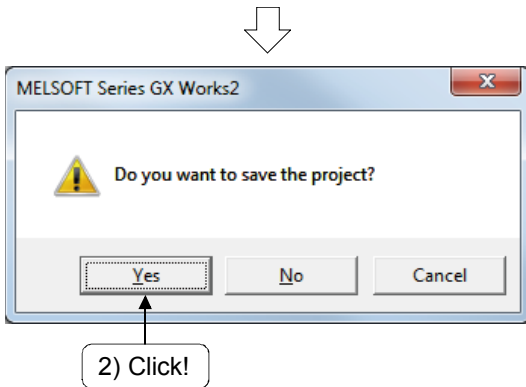
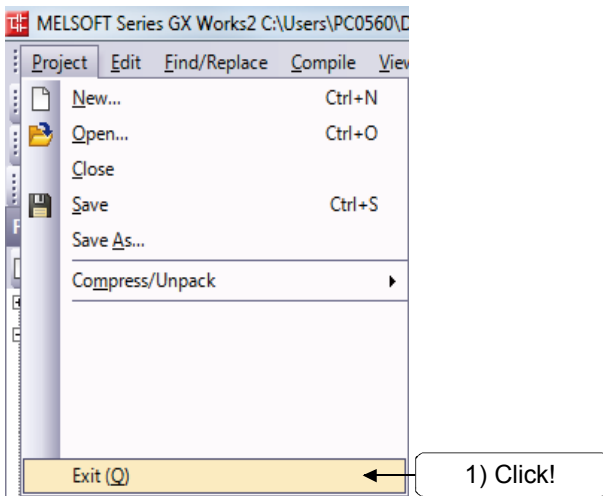

1. Select [Project] → [Exit] from the menu.
 - This will shutdown GX Works2 when there is no project open.
 - When there have been no changes made to the setting of an open project, click "Yes" button in the dialog box that confirms the closing of the project.
 - When changes have been made to the setting of an open project, proceed to step 2.
2. A dialog box that confirms the closing of the project is displayed. Click the button to overwrite and save the project and shutdown GX Works2.
3. When the project name has been set (unnamed), the [Save As] dialog box is displayed.
4. Enter the workspace name and the project name.
5. Click the button to save as a new project and shutdown GX Works2.

5.4 Specifying the connecting CPU

GX Works2 can access the QD77MS via the PLC CPU or a serial communication module.

Configure the settings for the interface on the peripheral device or other setting to perform online operations (such as writing/reading of data, monitoring, testing).

1. From the View selection area in the navigation window, click "Connection Destination".

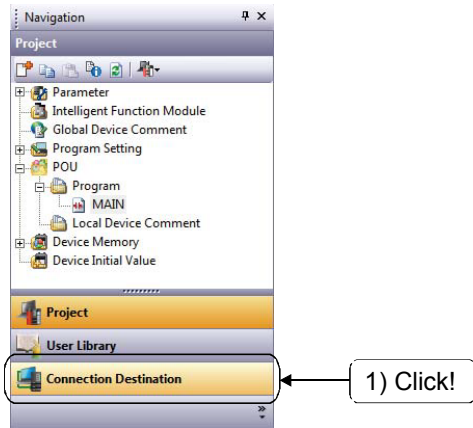

2. The Connection Destination view is displayed, double-click the current connection, "Connection1".

The [Transfer Setup] dialog box is displayed.

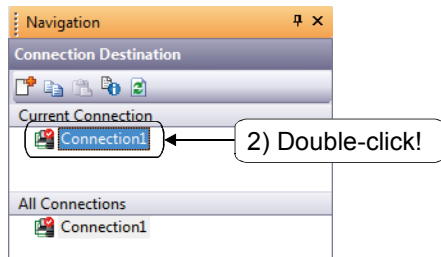

3. Double-click "Serial USB" of the "PC side I/F".

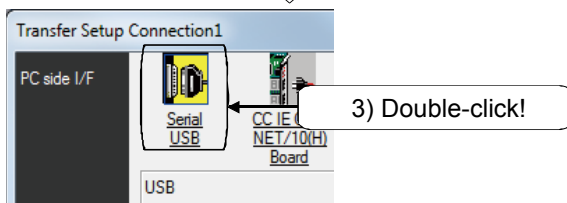

4. The [PC side I/F Serial setting] dialog box is displayed, place a check on "USB" checkbox, and click the button.

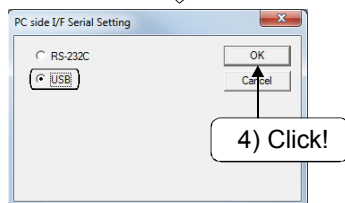

5. Double-click "PLC Module" for the PLC side I/F.

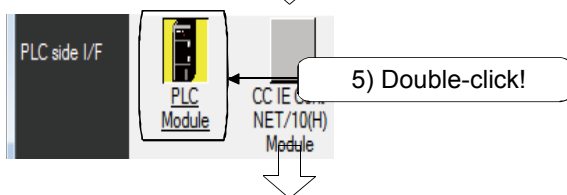

To the next page

From the previous page

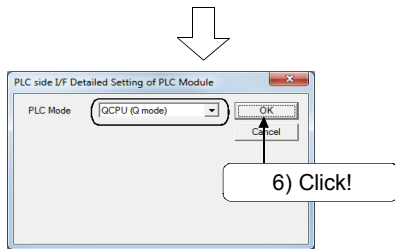

6. The [PLC side I/F Detailed Setting of PLC Module] dialog box is displayed, select "QCPU (Q mode)", and click the **OK** button.

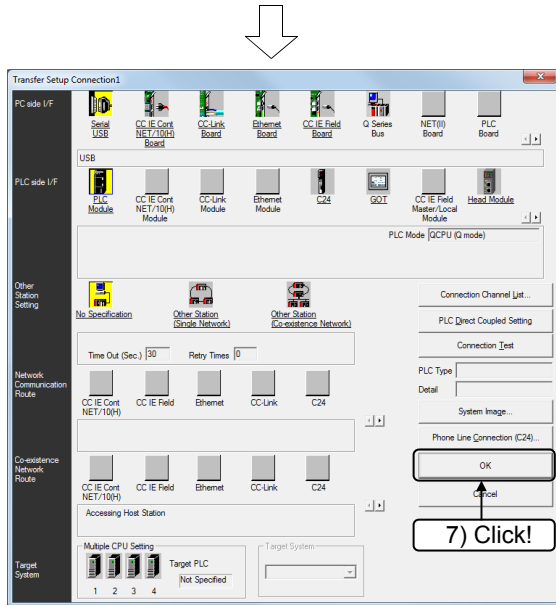

7. Click the **OK** button.

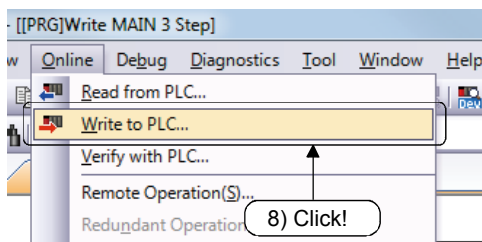

8. Click [Online] → [Write to PLC] from the menu.

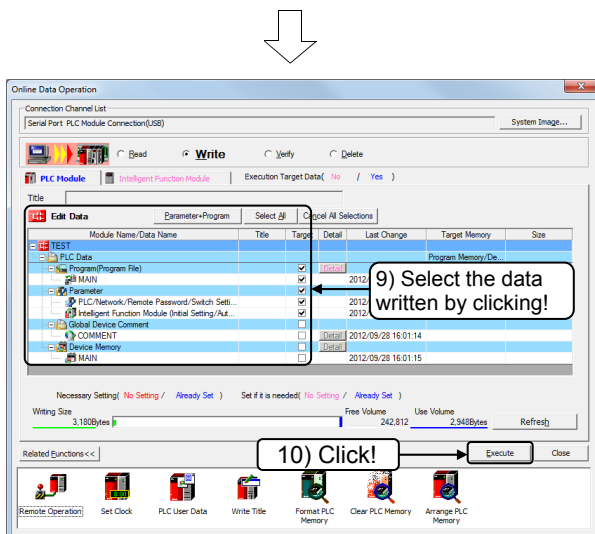

9. Click and select the program and parameters to write to the CPU on the PLC Module tab and click on **Parameter+Program**.

10. Click the **Execute** button.

To the next page

From the previous page

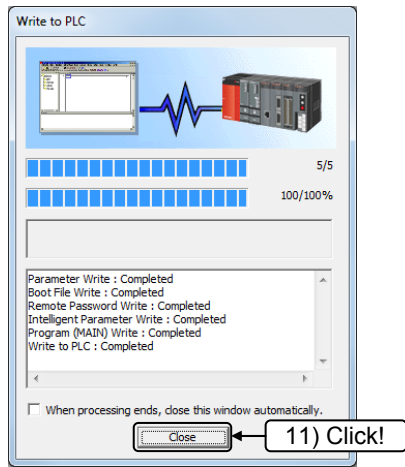

11. The write in progress dialog box is displayed.

Once the writing is completed, The message that indicates the writing has completed is displayed. Click the button.

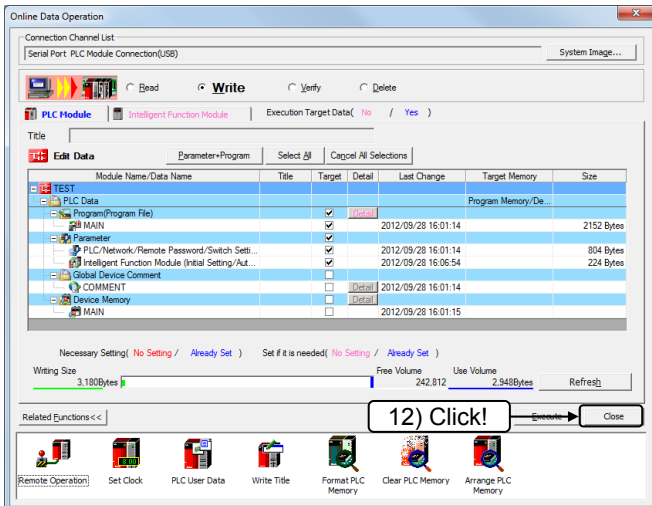

12. Click the button to close the dialog box.



13. Reset the PLC CPU.

5.5 Positioning training using the test operation function (QD77MS2)

Project name	TEST
--------------	------

Set the parameters, the home position return parameters, and the positioning parameters with GX Works2 and write them to the QD77MS. The test mode is used to perform the test operations and monitoring from the peripheral device.

Procedure

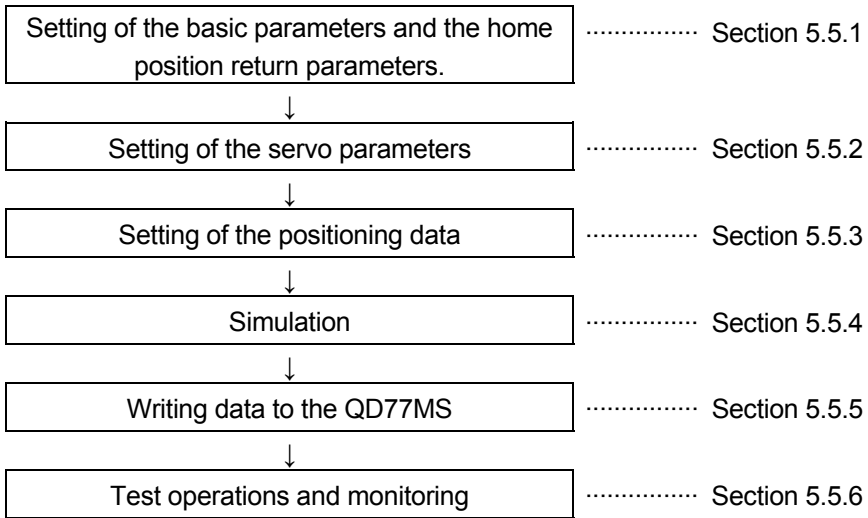

<Positioning example>

Linear control (Operation pattern: finish)

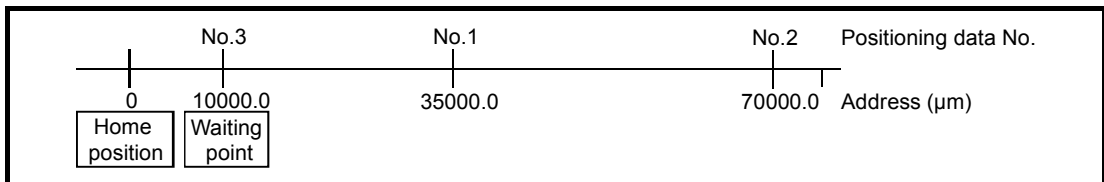

<Movement on the X-Y table unit>

The figure below shows the movement of the LED lamp.

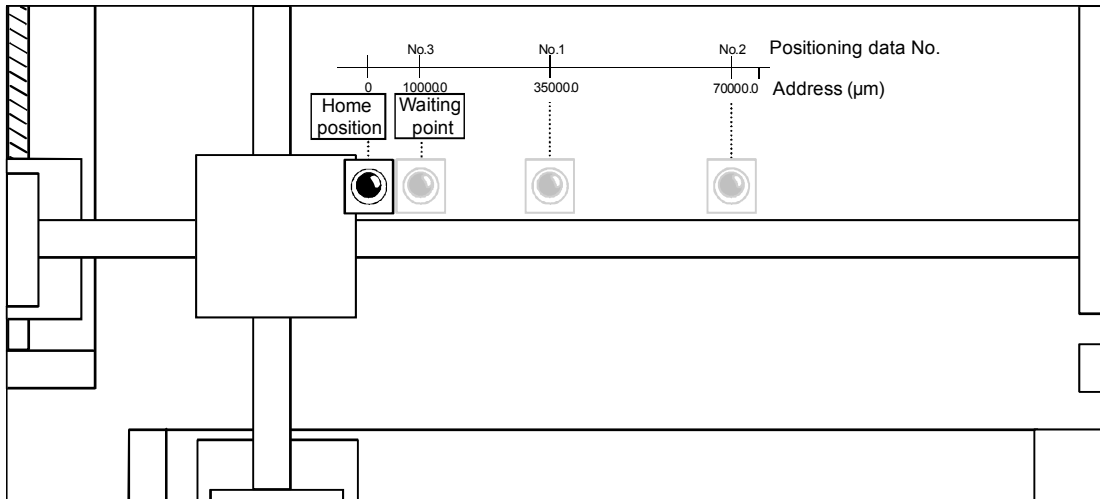

5.5.1 Setting of the servo amplifier series, the basic parameters, and the basic parameters for the home position return

Set parameters according to the devices used and control contents.

In this section, use the initial values (default values) except for some parameters.

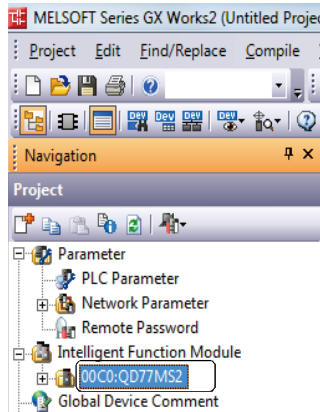

1. Double-click the "00C0:QD77MS2" icon in the project view.

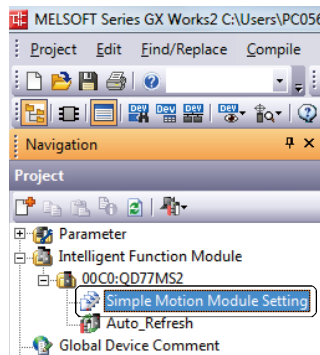

2. Double-click the "Simple Motion Module Setting" icon.

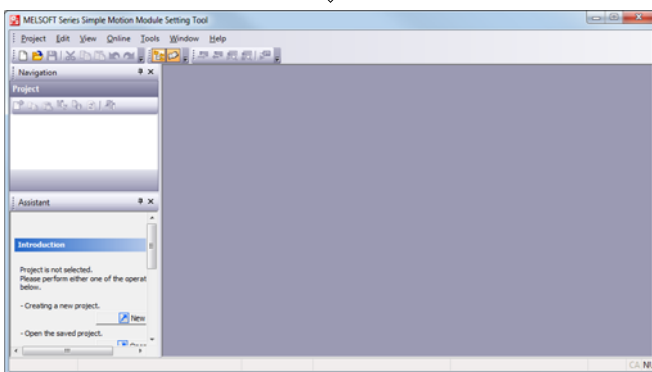

3. The Simple Motion Module Setting Tool starts up.
- * The following steps 4. to 17. are operations using the Simple Motion Module Setting Tool.

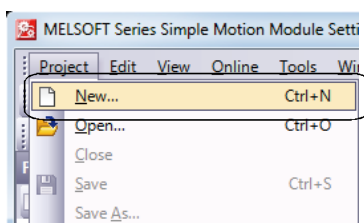

4. Select [Project] → [New] from the menu.

To the next page

From the previous page

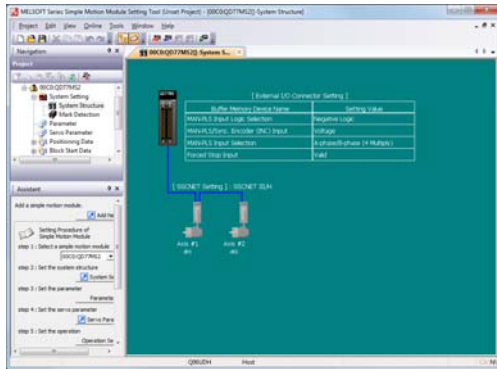
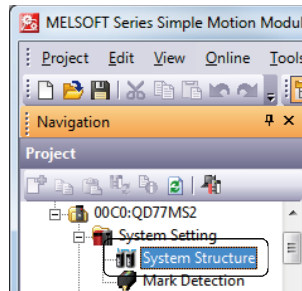
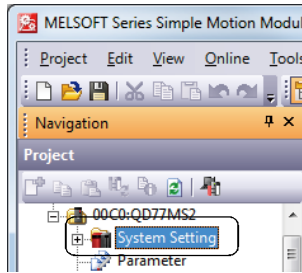
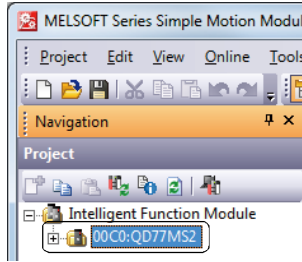
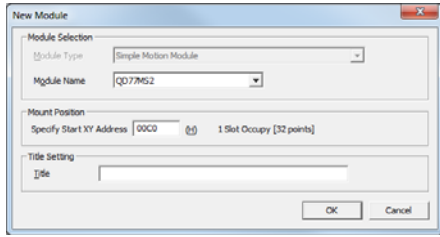

To the next page

5. The [New Module] dialog box is displayed, enter the following setting, and click the button.

Module Name: QD77MS2
Start XY Address: 00C0

6. The data for the specified intelligent function module is added to the project view.
7. Double-click the "00C0:QD77MS2" icon.

8. Double-click the "System Setting" icon.

9. Double-click the "System Structure" icon.

10. The system configuration screen is displayed.

From the previous page

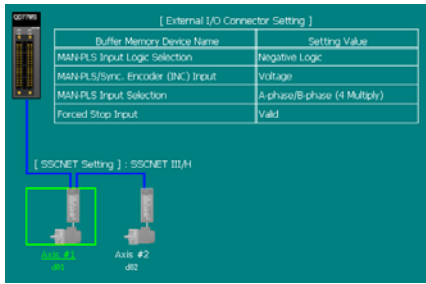

11. Double-click the servo amplifier (Axis #1) on the screen.

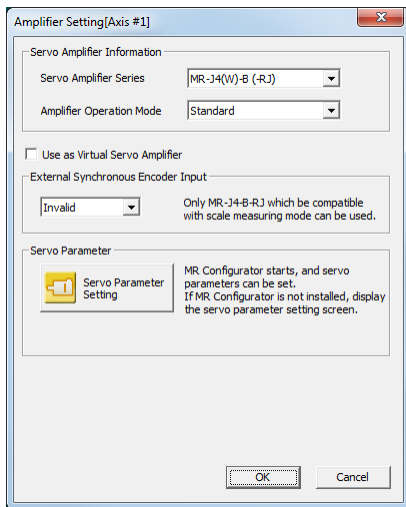

12. The [Amplifier Setting[Axis #1]] dialog box is displayed, enter the following setting, and click the **OK** button.

Servo Amplifier Series: MR-J4(W)-B
Amplifier Operation Mode: Standard

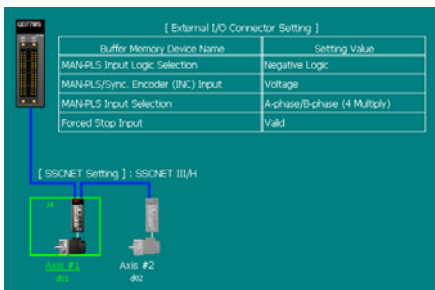

13. The set servo amplifier and servomotor are displayed.

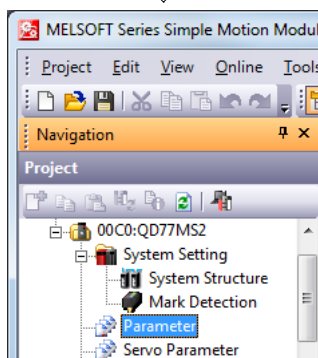

14. Double-click the "Parameter" icon again.



To the next page

From the previous page



Item	Axis #1
Basic parameters 1	Set according to the machine and applicable motor when system is started up.
Pr. 1:Unit setting	0:mm
Pr. 2:No. of pulses per rotation	4194304 PLS
Pr. 3:Movement amount per rotation	2000.0 μm
Pr. 4:Unit magnification	1:x1 Times
Pr. 7:Bias speed at start	0.00 mm/min
Basic parameters 2	Set according to the machine and applica...
Pr. 8:Speed limit value	6000.00 mm/min
Pr. 9:Acceleration time 0	100 ms
Pr. 10:Deceleration time 0	100 ms



Item	Axis #1
Detailed parameters 1	Set according to the system configuration when the system is started up. (This parameter become valid when the PLC READY signal [Y0])
Pr. 11:Backlash compensation amount	0.0 μm
Pr. 12:Software stroke limit upper limit value	214748364.7 μm
Pr. 13:Software stroke limit lower limit value	-214748364.8 μm
Pr. 14:Software stroke limit selection	0:Set Software Stroke Limit to Current Feed Value
Pr. 15:Software stroke limit valid/invalid setting	0:Valid
Pr. 16:Command in-position width	10.0 μm
Pr. 17:Torque limit setting value	300 %
Pr. 18:M code ON signal output timing	0:WITH Mode
Pr. 19:Speed switching mode	0:Standard Speed Switching Mode
Pr. 20:Interpolation speed designation method	0:Composite Speed
Pr. 21:Current feed value during speed control	0:Not Update of Current Feed Value
Pr. 22:Input signal logic selection : Lower limit	0:Negative Logic
Pr. 22:Input signal logic selection : Upper limit	0:Negative Logic
Pr. 22:Input signal logic selection : Stop signal	0:Negative Logic
Pr. 22:Input signal logic selection : External command/switching signal	0:Negative Logic
Pr. 22:Input signal logic selection : Near-point dog signal	0:Negative Logic
Pr. 22:Input signal logic selection : Manual pulse generator input	0:Negative Logic
Pr. 80:External input signal selection	0:Use External Input Signal of QD77MS
Pr. 24:Manual pulse generator/Incremental Sync. ENC input selection	0:A-phase/B-phase Mode (4 Multiply)
Pr. 81:Speed-position function selection	0:Speed-Position Switching Control (INC Mode)
Pr. 82:Forced stop valid/invalid selection	1:Invalid



Item	Axis #1
OPR basic parameters	Set the values required for carrying out OPR control. (This parameter become valid when the
Pr. 43:OPR method	0:Near-point Dog Method
Pr. 44:OPR direction	1:Reverse Direction (Address Decrease Direction)
Pr. 45:OP address	0.0 μm
Pr. 46:OPR speed	1000.00 mm/min
Pr. 47:Creep speed	300.00 mm/min
Pr. 48:OPR retry	0:Do not retry OPR with Limit Switch

15. The parameter edit window will be displayed. Configure the basic parameters for axis 1 as follows.

Unit setting 0:mm
 No. of pulses per rotation 4,194,304
 Speed limit value 6,000.00
 Acceleration time 0 100
 Deceleration time 0 100

Reference Chapter 4.1.1 Basic parameters

16. Scroll down the parameter edit window, and set the detailed parameter 1 for axis 1 as follows.

Forced stop valid/invalid selection...Invalid

Reference Chapter 4.1.2 Detailed parameters

17. Scroll down the parameter edit window, and set the basic parameters for the home position return for axis 1 as follows.

OPR direction 1: Reverse Direction (Address Decrease DIRECTION)

OPR speed 1000.00

Creep speed 300.00

Reference Chapter 4.2 OPR parameters

5.5.2 Setting the positioning data

Set the positioning data.

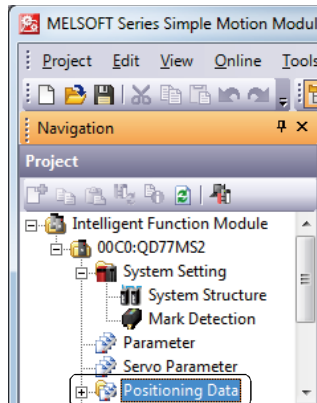

1. Double-click the "Positioning Data" icon in the Simple Motion Module Setting Tool.

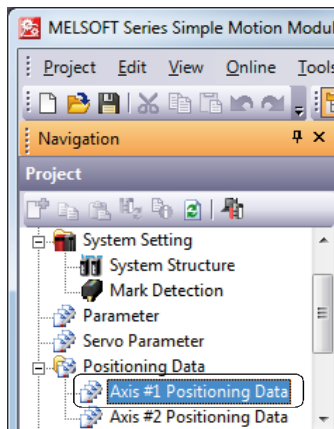

2. Double-click the "Axis#1 Positioning Data" icon.

No.	Operation pattern	Control system	Axis to be interpolated	Acceleration time No.	Deceleration time No.	Positioning address	Arc address	Command speed	Dwell time	M code	Positioning data comments
1	0: Finish	1: ABS linear 1	—	0:100	0:100	35000.0	0	400.00	0	0	
2	0: Finish	1: ABS linear 1	—	0:100	0:100	70000.0	0	400.00	0	0	
3	0: Finish	1: ABS linear 1	—	0:100	0:100	10000.0	0	500.00	0	0	

2. The [Axis#1 Positioning Data] window is displayed. Double-click and Operation pattern, the Control system, the Acceleration time No., and the Deceleration time No., to select applicable item from the list. Directly enter the setting values for other parameters.

Reference Chapter 4.4 Positioning data

<Example of the Axis 1 positioning data setting>

Operation pattern	Control system	Axis to be interpolated	Acceleration time No.	Deceleration time No.	Positioning address [μm]	Arc address [μm]	Command speed [mm/min]	Dwell time [ms]	M code	Positioning data comments
0: Finish	1: ABS linear 1	—	0:100	0:100	35000.0	0	400.00	0	0	
0: Finish	1: ABS linear 1	—	0:100	0:100	70000.0	0	400.00	0	0	
0: Finish	1: ABS linear 1	—	0:100	0:100	10000.0	0	500.00	0	0	

REMARKS

The dragged positioning data can be edited by selecting [Edit] → [Cut], [Copy] or [Paste] from the menu.

5.5.3 Simulation

Use the simulation function (virtual positioning) to confirm that the details of the settings configured for the positioning data such as the operation pattern, the control system, the axis to be interpolated, the address, the command speed, are correct.

No.	Operation pattern	Control system	Axis to be interpolated	Acceleration time No.	Deceleration time No.
1	0:END <Positioning Comment>	01h:ABS Linear 1	-	0:100	0:100
2	0:END <Positioning Comment>	01h:ABS Linear 1	-	0:100	0:100
3	0:END <Positioning Comment>	01h:ABS Linear 1	-	0:100	0:100

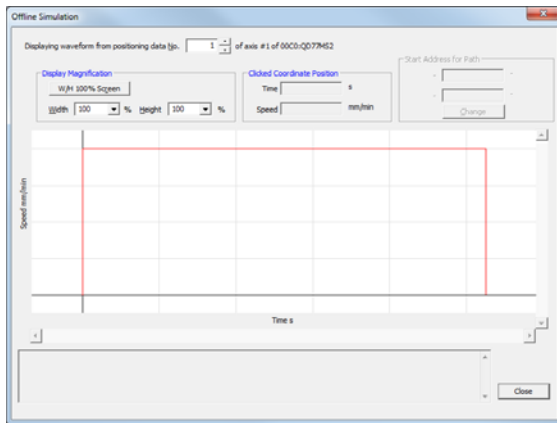

1. Click the **Offline Simulation** button in the [Axis#1 Positioning Data] window of the Simple Motion Module Setting Tool.
 2. The simulation window is displayed, enter "1" for the positioning start No.
 3. The simulation result for the positioning data No. 1 is displayed.
 4. Each positioning data can be simulated by changing the positioning data start No. to "2" or "3".
- Note) The simulation results are for cases in which the positioning starts from address 0.

5.5.4 Saving the simple motion module project

Save the contents set in Section 5.5.1 to Section 5.5.2.

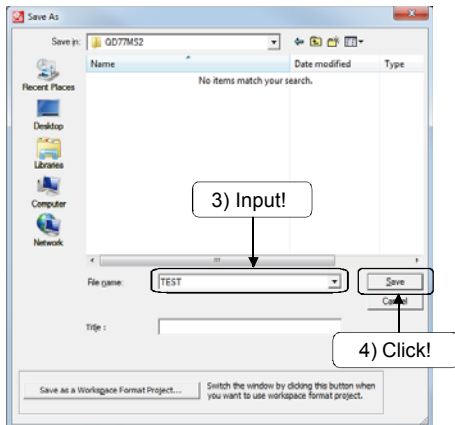
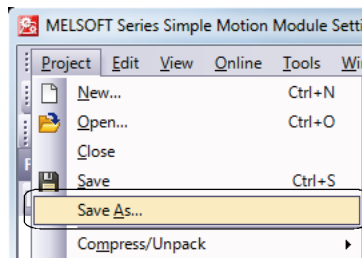

1. Select [Project] → [Save As] from the menu.
2. The [Save As] dialog box is displayed.
3. Enter a project name.
4. Click the **Save** button to save as a new project and shutdown GX Works2.

REMARKS

Use one of the following methods to initialize parameters and the positioning data.

- Perform with the sequence program
- Perform with the Simple Motion Module Setting Tool

Procedure for the initialization with the Simple Motion Module Setting Tool

1. Click Online → [Request of Parameter Initialization/Flash ROM Write].
2. Select the target module.
3. Confirm that a check is placed on [Request to Initialize Parameter], and click the button.
4. Confirm the displayed message, and click the [OK] button.

* Refer to the following manual for more information on the initialization method with the sequence program.

MELSEC-Q QD77MS Simple Motion Module User's Manual (Positioning Control)

5.5.5 Writing data to the QD77MS

Write the parameters, the home position return parameters, and the positioning data set with the Simple Motion Module Setting Tool to the QD77MS. (The data type and range can be specified by the units of axis.)

Note) Set the PLC CPU to the "STOP" status.

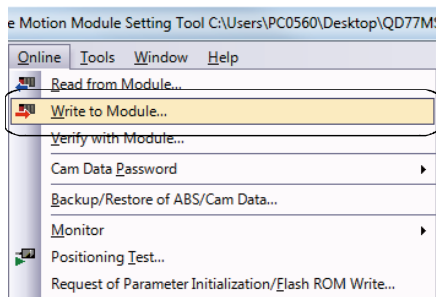
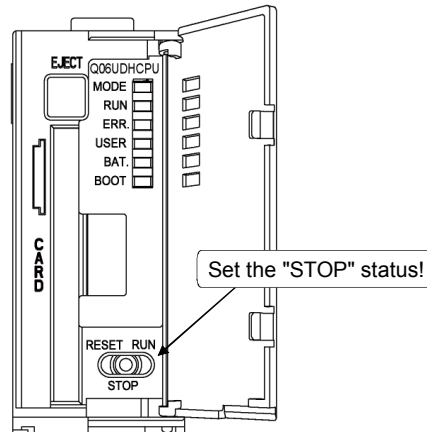

1. Select [Online] → [Write to Module] in the Simple Motion Module Setting Tool from the menu.

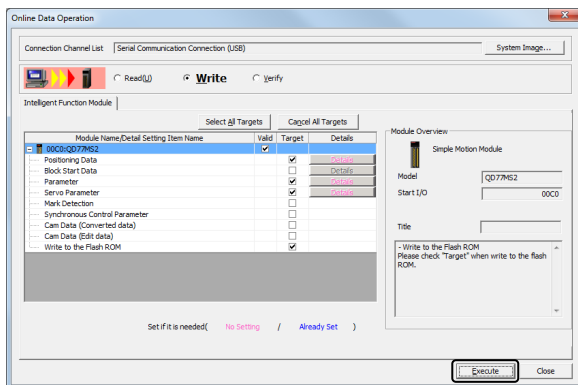

2. The online data operation dialog box is displayed.

Place a check on the check boxes for "Valid", "Positioning Data", "Parameter", "Servo Parameter", and "Write to the Flash ROM".

3. Click the **Execute** button to execute the write operation to the QD77MS.

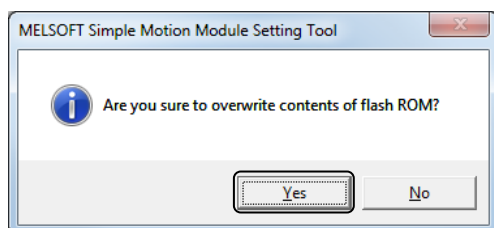

4. A dialog box to confirm the execution to the flash ROM write is displayed, click the **Yes** button.

5. Reset the PLC CPU.

5.5.6 Test operations and monitoring

Perform the home position return tests and the test operations with the written positioning data to confirm the QD77MS operation.

In addition, monitor the axis status during the operation and the setting contents.

[Home position return and positioning test operations]

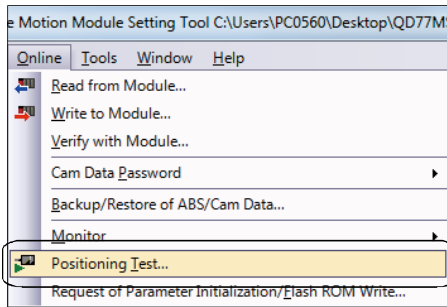

1. Select [Online] → [Positioning Test] in the Simple Motion Module Setting Tool.

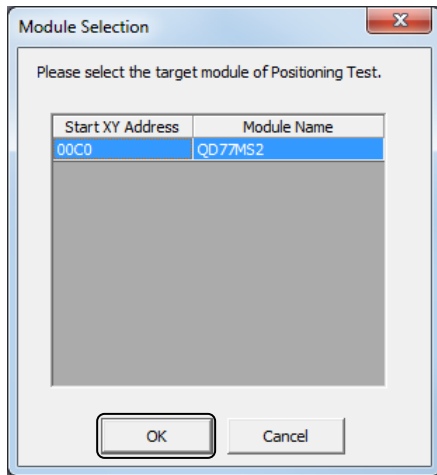

2. The [Module Selection] dialog box is displayed, select QD77MS2, and click the button.

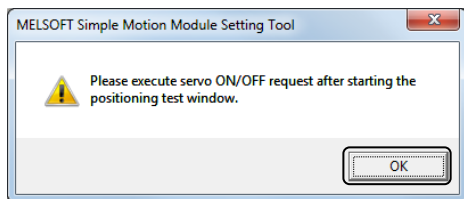

3. The message shown on the left is displayed, click the button.



To the next page

From the previous page

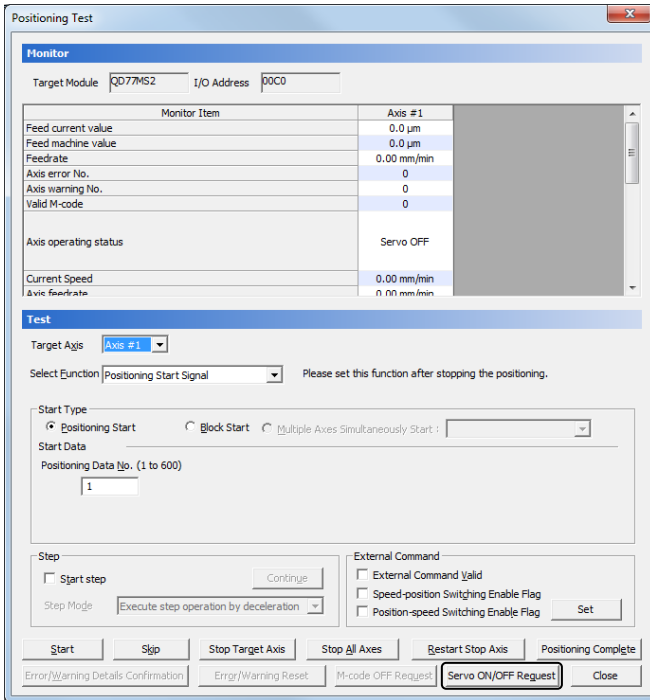

4. The [Positioning Test] dialog box is displayed.

Click the **Servo ON/OFF Request** button.

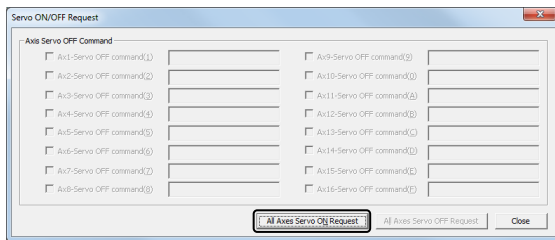

5. The [Servo ON/OFF Request] dialog box is displayed, click the **All Axis Servo ON Request** button.

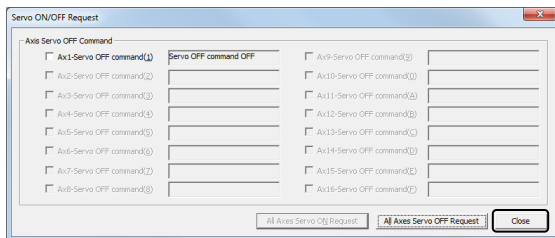

6. All the servos of all axes turn on.

Click the **Close** button.

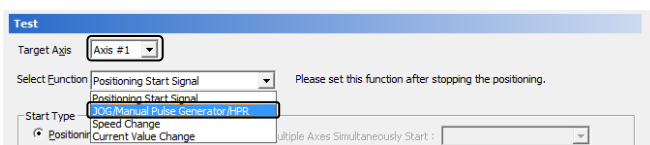

7. Select "Axis #1" for the "Target Axis", and select "JOG/Manual Pulse Generator/OPR" for the "Select Function".



To the next page

From the previous page

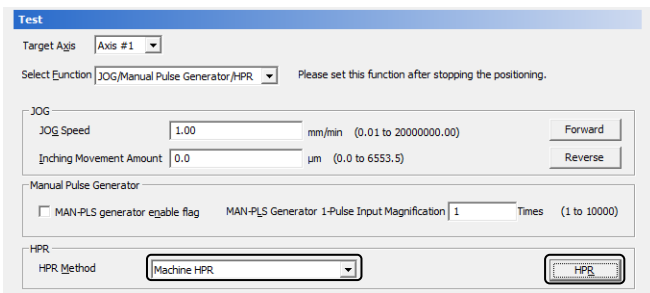
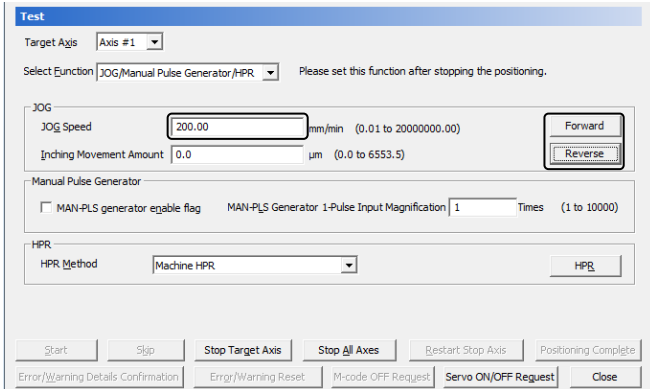

Item	Axis #1
HPR detailed parameters	
Pr. 50: Setting for the movement amount after proximity dog ON	0.0 μm
Pr. 51: HPR acceleration time selection	0:100
Pr. 52: HPR deceleration time selection	0:100
Pr. 53: HP shift amount	0.0 μm
Pr. 54: HPR torque limit value	300 %
Pr. 55: Operation setting for incompletion of HPR	0: Positioning Control is Not Executed

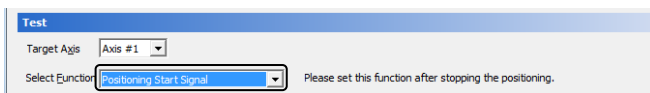

To the next page

8. Set the "JOG Speed" to 200.00mm/min, and then push and hold either the [Forward RUN] or the [Reverse RUN] button for a few seconds. Confirm that the JOG operation is executed for the time while the button was pushed.

9. Confirm that "Machine OPR" is selected for the "OPR Method", and click the **OPR** button.

10. The home position return test completes when the monitored current feed value parameter is "0".
<Movement on the XY table>

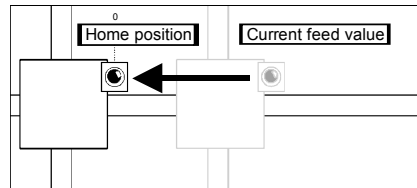

11. When the home position does not match the measure on the XY table, change the value for the "OP Shift Amount" in the detailed home position return parameters for axis 1 parameter data to correct the home position.

Reference Chapter 4.2.2 OPR detailed parameters

12. Perform the test operation of the positioning data. Select "Positioning Start Signal" for the "Select Function".

From the previous page

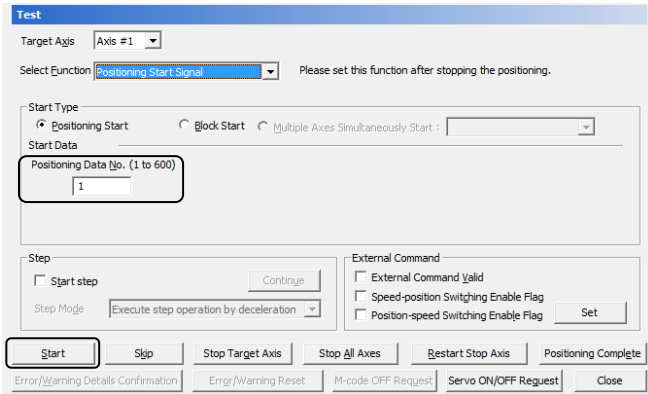

13. Confirm that a check is placed on "Positioning start signal" for the "Start type", and that the "Positioning data No." for the operation start data is set to "1", and click the **Start** button. The single-axis linear control test is completed when the monitored current feed value is "35000.0".

<Movement on the XY table>

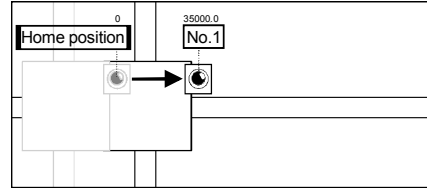

[Monitor operation]

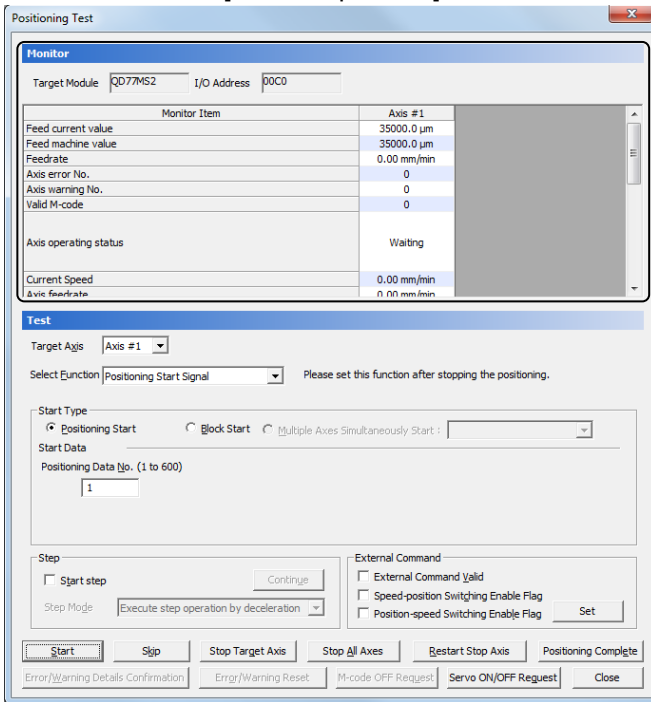

14. The monitoring screen is displayed in the top of the [Positioning Test] dialog box.

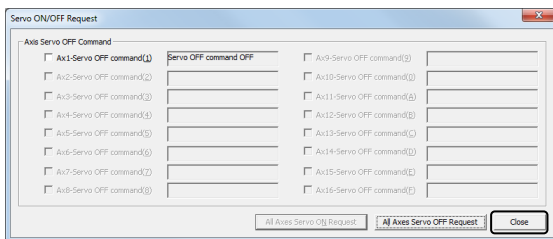

15. Click the **All Axis Servo OFF Request** button in the [Servo ON/OFF Request] dialog box, and turn off the servos of all axes. Click the **Close** button.

To the next page



From the previous page



Step

Start step Continue

Step Mode: Execute step operation by deceleration

External Command

External Command Valid

Speed-position Switching Enable Flag

Position-speed Switching Enable Flag Set

Start Skip Stop Target Axis Stop All Axes Restart Stop Axis Positioning Complete

Error/Warning Details Confirmation Error/Warning Reset M-code OFF Request Servo ON/OFF Request Close

16. Click the Close button in the dialog box to exit the test mode.

REMARKS

The operation of the upper/lower limit switches (FLS/RLS) can be confirmed with the JOG operation.

CHAPTER 6 Training (2) Single-axis positioning operation with the sequence program (QD77MS2)

Perform the home position return and the positioning operations with the sequence program for the PLC CPU.

6.1 Positioning system used for training

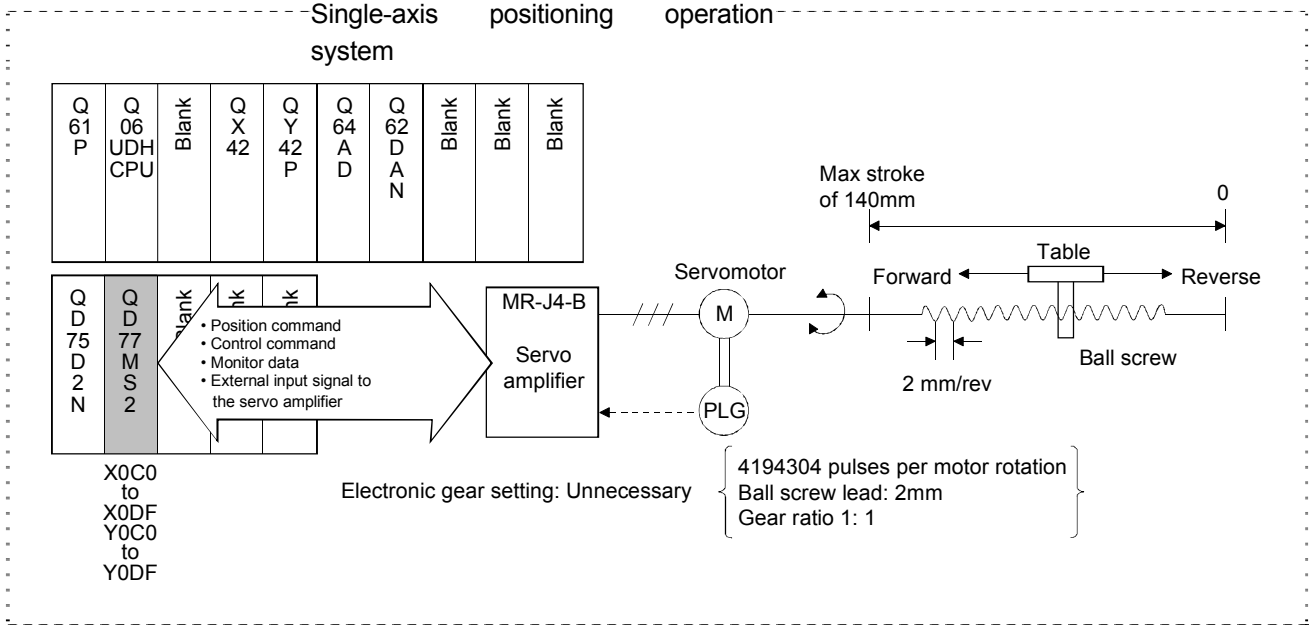

The QD77MS2 (SSCNET III/H control) used for the training in this chapter can transmit the position instructions and the speed instructions directly to the servo amplifier by using the SSCNET method.

For this reason, it is unnecessary to set the electronic gear on the servo amplifier. (In comparison with the pulse train method, this is equivalent to a maximum output pulse frequency of approximately 419Mpps.)

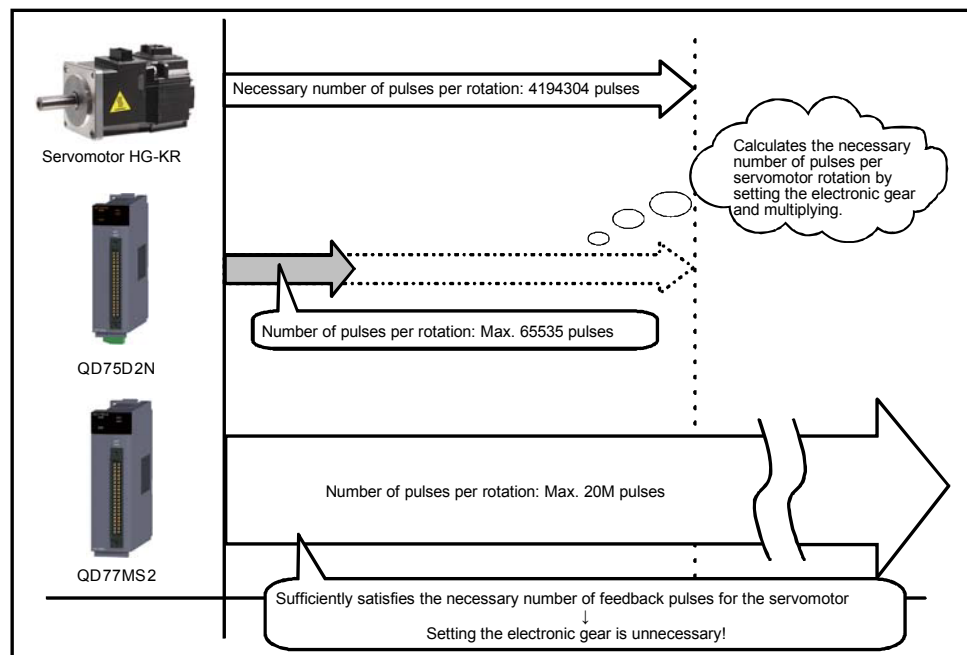

6.2 Opening the QD77MS project

Project name	X
--------------	---

Open the Simple Motion Module Setting Tool project stored in a folder on the desktop.

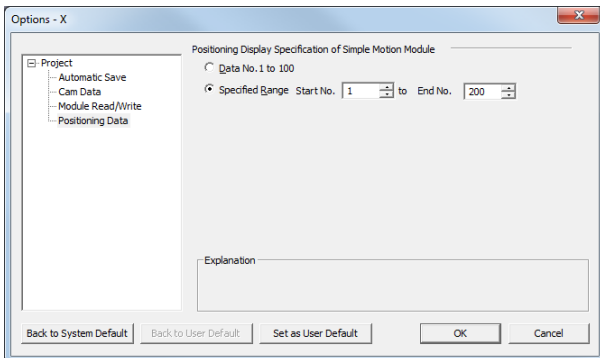
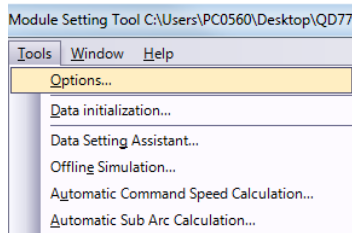
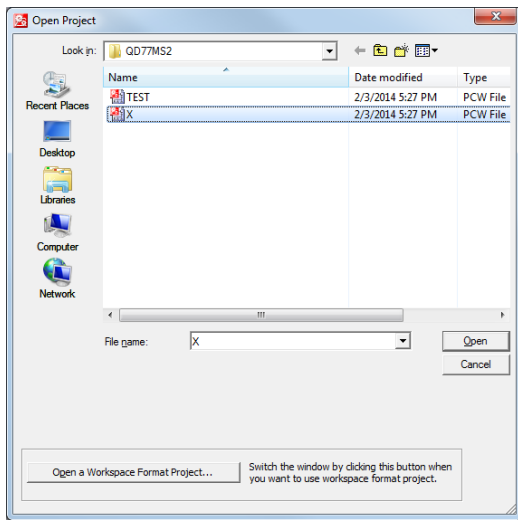
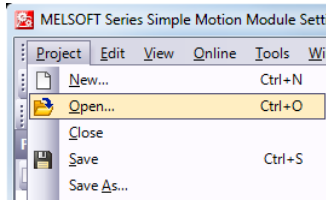

1. Select [Project] → [Open] from the menu in the Simple Motion Module Setting Tool.

2. The [Open Project] dialog box is displayed, select the project named "X".

3. Click the **Open** button.

4. The project "X" open.

5. To display the data No. 101 or later, click [Tools] → [Options]. The [Options] dialog box is displayed.

6. Select "Positioning Data" from the tree.

7. Place a check on "Specified Range" in the "Positioning Display Specification of Simple Motion Module", and set the range "1 to 200".

8. Click the **OK** button.

The parameters and the positioning data in the project "X" in the folder are already set. The figure below shows the parameters changed from the default values.

Double-click "Parameter" in the project view, and the parameter edit window is displayed.

The parameters and the home position return parameters that are different from the initial values (default) are displayed.

Reference Section 4.1 Parameters, Section 4.2 OPR parameters, Section 4.3 Servo parameters

<Basic parameter 1>

Item	Axis #1
Basic parameters 1	Set according to the machine and applicable motor when system is started up. (This parameter become valid when the PLC READY signal [Y0])
Pr. 1:Unit setting	0:mm
Pr. 2:No. of pulses per rotation	4194304 PLS
Pr. 3:Movement amount per rotation	2000.0 μm
Pr. 4:Unit magnification	1:x1 Times
Pr. 7:Bias speed at start	0.00 mm/min

Annotations for Basic parameter 1:

- Units of mm (points to Pr. 1)
- Command pulse (points to Pr. 2)
- Movement amount per motor rotation (points to Pr. 3)

<Basic parameter 2>

Item	Axis #1
Basic parameters 2	Set according to the machine and applicable motor when syst...
Pr. 8:Speed limit value	6000.00 mm/min
Pr. 9:Acceleration time 0	100 ms
Pr. 10:Deceleration time 0	100 ms

Annotations for Basic parameter 2:

- 3000r/min×2mm/rev (points to Pr. 8)
- 0.1 sec (points to Pr. 9 and Pr. 10)

<Detailed parameter 1>

Item	Axis #1
Detailed parameters 1	Set according to the system configuration when the system is started up. (This parameter become valid when the PLC READY signal [Y0])
Pr. 11:Backlash compensation amount	0.0 μm
Pr. 12:Software stroke limit upper limit value	214748364.7 μm
Pr. 13:Software stroke limit lower limit value	-214748364.8 μm
Pr. 14:Software stroke limit selection	0:Set Software Stroke Limit to Current Feed Value
Pr. 15:Software stroke limit valid/invalid setting	0:Valid
Pr. 16:Command in-position width	10.0 μm
Pr. 17:Torque limit setting value	300 %
Pr. 18:M code ON signal output timing	1:AFTER Mode
Pr. 19:Speed switching mode	0:Standard Speed Switching Mode
Pr. 20:Interpolation speed designation method	0:Composite Speed
Pr. 21:Current feed value during speed control	0:Not Update of Current Feed Value
Pr. 22:Input signal logic selection : Lower limit	0:Negative Logic
Pr. 22:Input signal logic selection : Upper limit	0:Negative Logic
Pr. 22:Input signal logic selection : Stop signal	0:Negative Logic
Pr. 22:Input signal logic selection : External command/switching signal	0:Negative Logic
Pr. 22:Input signal logic selection : Near-point dog signal	0:Negative Logic
Pr. 22:Input signal logic selection : Manual pulse generator input	0:Negative Logic
Pr. 80:External input signal selection	0:Use External Input Signal of QD77MS
Pr. 24:Manual pulse generator/Incremental Sync. ENC input selection	0:A-phase/B-phase Mode (4 Multiply)
Pr. 81:Speed-position function selection	0:Speed-Position Switching Control (INC Mode)
Pr. 82:Forced stop valid/invalid selection	1:Invalid

← M code turns on at the completion of the positioning

← The forced stop is disabled (because EMI is not connected)

<Detailed parameter 2>

Item	Axis #1
Detailed parameters 1	Set according to the system configuration when the system is started up. (This parameter become valid when the PLC READY signal [Y0])
Pr. 11:Backlash compensation amount	0.0 μm
Pr. 12:Software stroke limit upper limit value	214748364.7 μm
Pr. 13:Software stroke limit lower limit value	-214748364.8 μm
Pr. 14:Software stroke limit selection	0:Set Software Stroke Limit to Current Feed Value
Pr. 15:Software stroke limit valid/invalid setting	0:Valid
Pr. 16:Command in-position width	10.0 μm
Pr. 17:Torque limit setting value	300 %
Pr. 18:M code ON signal output timing	1:AFTER Mode
Pr. 19:Speed switching mode	0:Standard Speed Switching Mode
Pr. 20:Interpolation speed designation method	0:Composite Speed
Pr. 21:Current feed value during speed control	0:Not Update of Current Feed Value
Pr. 22:Input signal logic selection : Lower limit	0:Negative Logic
Pr. 22:Input signal logic selection : Upper limit	0:Negative Logic
Pr. 22:Input signal logic selection : Stop signal	0:Negative Logic
Pr. 22:Input signal logic selection : External command/switching signal	0:Negative Logic
Pr. 22:Input signal logic selection : Near-point dog signal	0:Negative Logic
Pr. 22:Input signal logic selection : Manual pulse generator input	0:Negative Logic
Pr. 80:External input signal selection	0:Use External Input Signal of QD77MS
Pr. 24:Manual pulse generator/Incremental Sync. ENC input selection	0:A-phase/B-phase Mode (4 Multiply)
Pr. 81:Speed-position function selection	0:Speed-Position Switching Control (INC Mode)
Pr. 82:Forced stop valid/invalid selection	1:Invalid

← 2000r/min×2mm/rev

<Home position return basic parameters/home position return detailed parameters>

Item	Axis #1
OPR basic parameters	Set the values required for carrying out OPR control. (This parameter become valid when the PLC READY signal [Y0] turns from OFF to ON)
Pr. 43:OPR method	0:Near-point Dog Method
Pr. 44:OPR direction	1:Reverse Direction (Address Decrease Direction)
Pr. 45:OP address	0.0 μm
Pr. 46:OPR speed	1000.00 mm/min
Pr. 47:Creep speed	300.00 mm/min
Pr. 48:OPR retry	1:Retry OPR with Limit Switch
OPR detailed parameters	Set the values required for carrying out OPR control. (This parameter become valid when the PLC READY signal [Y0] turns from OFF to ON)
Pr. 50:Setting for the movement amount after near-point dog ON	0.0 μm
Pr. 51:OPR acceleration time selection	0:100
Pr. 52:OPR deceleration time selection	0:100
Pr. 53:OP shift amount	0.0 μm
Pr. 54:OPR torque limit value	300 %
Pr. 55:Operation setting for incompletion of OPR	0:Positioning Control is Not Executed
Pr. 56:Speed designation during OP shift	0:OPR Speed
Pr. 57:Dwell time during OPR retry	0 ms
Pr. 86:Pulse conversion unit : OPR request setting	0:Turn OPR Request ON at Servo OFF
Pr. 87:Pulse conversion unit : Waiting time after clear signal output	0 ms

Address decrease direction
 1000mm/min
 300mm/min
 Home position return is possible even when the workpiece stops between the lower limit and the DOG

Double-clicking "Axis #1 Positioning Data" in the project view, displays the positioning data edit window (single-axis).

Reference Section 4.4 Positioning data

No.	Operation pattern	Control system	Axis to be interpolated	Acceleration time No.	Deceleration time No.	Positioning address	Arc address	Command speed	Dwell time	M code
1	0:END <Positioning Comment>	01h:ABS Linear 1	-	0:100	0:100	50000.0 μm	0.0 μm	2000.00 mm/min	0 ms	0
2	0:END <Positioning Comment>	01h:ABS Linear 1	-	0:100	0:100	75000.0 μm	0.0 μm	2000.00 mm/min	0 ms	0
3	0:END <Positioning Comment>	01h:ABS Linear 1	-	0:100	0:100	100000.0 μm	0.0 μm	2000.00 mm/min	0 ms	0
4	0:END <Positioning Comment>	01h:ABS Linear 1	-	0:100	0:100	130000.0 μm	0.0 μm	2000.00 mm/min	0 ms	0
5	0:END <Positioning Comment>	01h:ABS Linear 1	-	0:100	0:100	140000.0 μm	0.0 μm	2000.00 mm/min	0 ms	0
6	0:END <Positioning Comment>	01h:ABS Linear 1	-	0:100	0:100	25000.0 μm	0.0 μm	2000.00 mm/min	0 ms	0

Open the GX Works2 project "X", and double-click "Auto Refresh" in the project view to display the [Auto Refresh] window.

Item	Axis #1	Axis #2
Transfer to CPU	The data of the buffer memory is transmitted to the specified device.	
Axis monitor data	Auto-refresh setting for axis monitor data	
Current feed value	D100	
Machine feed value	D102	
Feedrate	D104	
Axis error number	D106	
Axis warning No.	D107	
Valid M code	D108	
Axis operation status	D109	

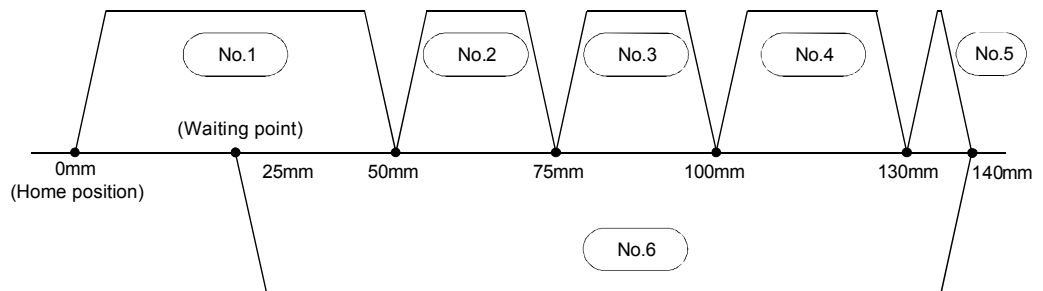

6.3 Writing data to the QD77MS

Write the project data read from the folder to the QD77MS.

Refer to Section 5.5.5 for the basic write operation to the QD77MS.

This section describes the method for writing only the necessary range of information.

1. Select [Online] → [Write to PLC] from the menu in the Simple Motion Module Setting Tool.

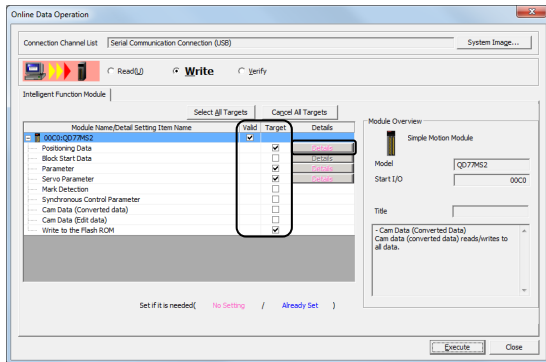

2. The online data operation dialog box is displayed. Place a check on the check boxes for "Valid", "Positioning Data", "Parameter", "Servo Parameter", and "Flash ROM Write".

3. Click the **Details** button of the "Positioning Data" to set a range of the positioning data No.

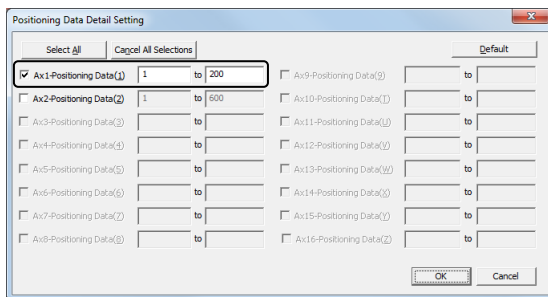

4. The positioning data detailed setting dialog box is displayed, specify the range to be written from the positioning data No. 1 to No. 200 for axis 1.

5. Click the **OK** button.

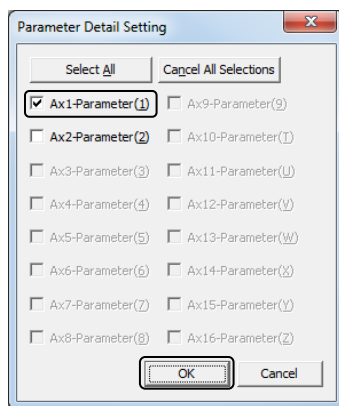

6. Click the **Details** button for "Parameter" to specify the target axis to write the parameters.

7. The parameter detailed setting dialog box is displayed, specify axis 1 as the write target.

8. Click the **OK** button.



To the next page

From the previous page

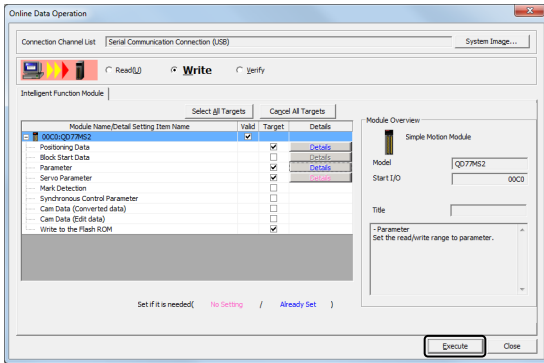

9. Click the **Execute** button to write the specified data and execute the flash ROM write operation.

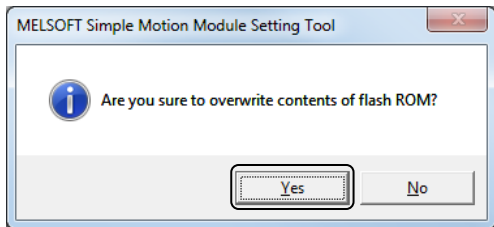

10. The message that confirms the overwriting the contents of the flash ROM is displayed. Click the **Yes** button.

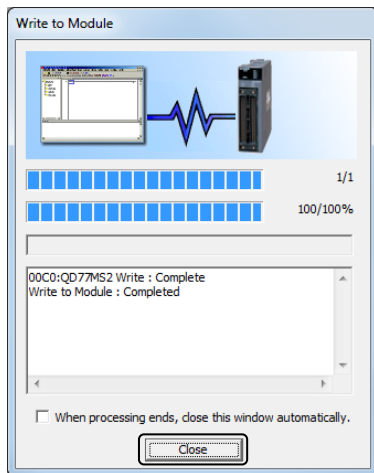

11. The PLC write operation complete message is displayed.

Click the **Close** button.

The following shows the operation method from GX Works2 to delete a program in the PLC CPU before writing the program to the PLC CPU.

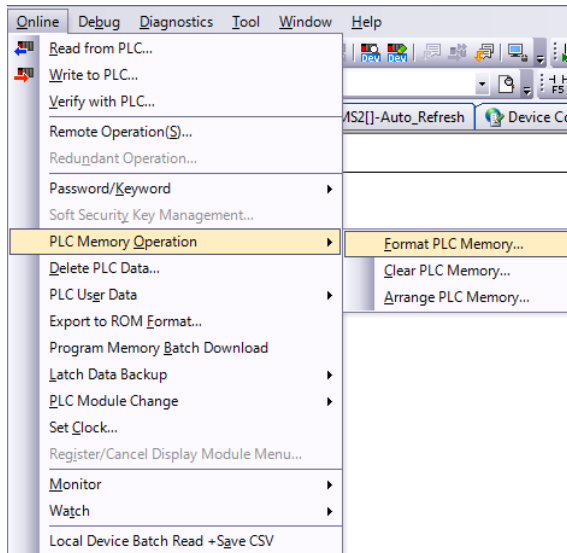

(1) Select [Online] → [PLC Memory Operation] → [Format PLC Memory] from the menu.

* Always perform this operation before writing a new program.

6.4 Simple sequence program

Project name	A
--------------	---

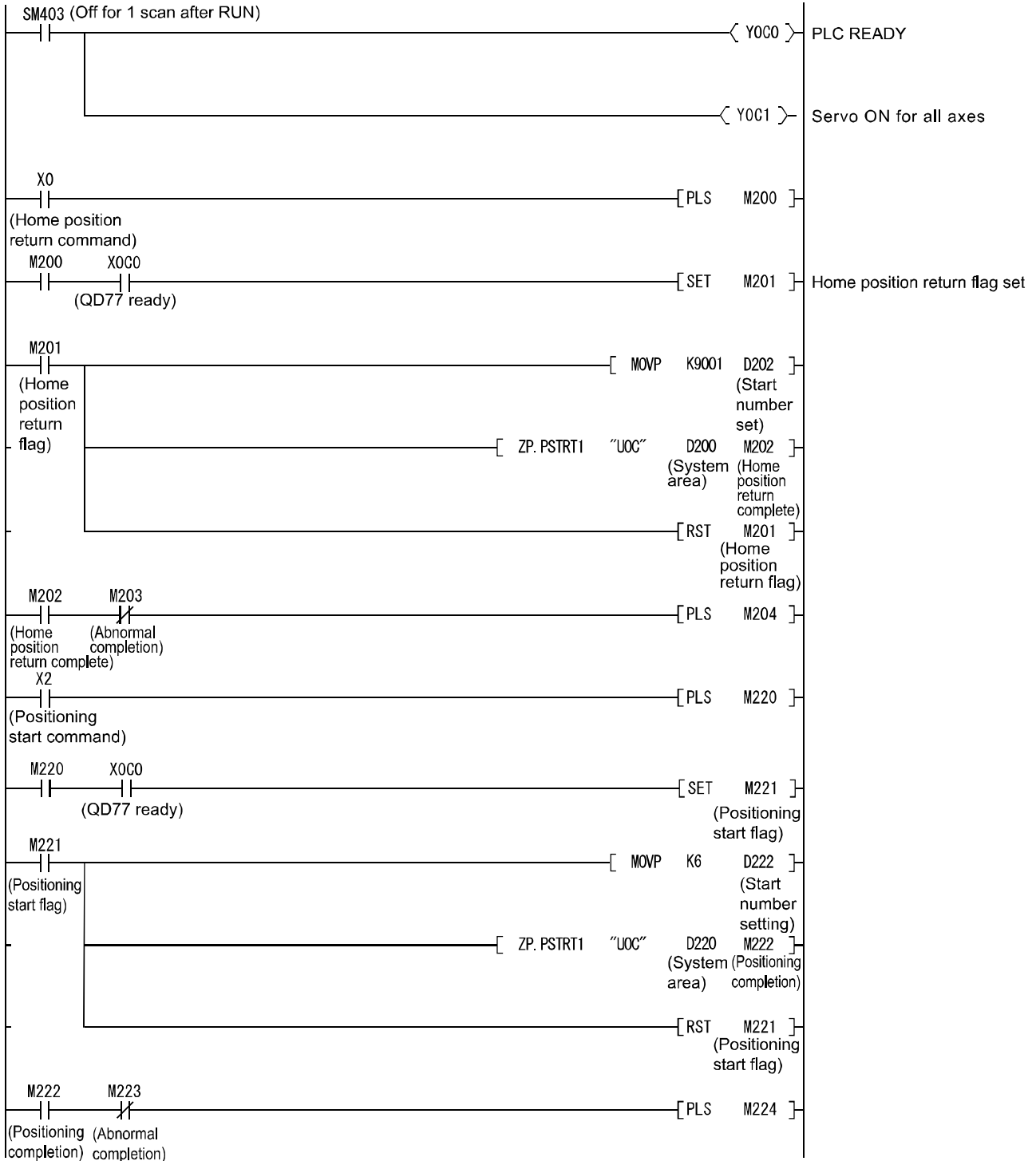

(The QD77-dedicated instruction "ZP.PSTRT1" is described in Appendix 3.)

Peripheral device operation

Create the sequence program previously described, and write it to the PLC CPU.

1. Start GX Works2.
2. Create a new circuit.
3. Convert the circuit by selecting [Compile] → [Build] from the menu.
4. Double-click "PLC Parameter" in the project view, and perform the I/O assignment setting.
5. Delete the program in the PLC CPU before writing the new program to the PLC CPU. (Select [Online] → [Delete PLC Data] from the menu.)
6. Write the parameters and the sequence program to the PLC CPU by selecting [Online] → [Write to PLC] from the menu.

PLC CPU is stopped.

(Click the **Parameter+Program** button, and click the **Execute** button in the online data operation dialog box.)

7. Reset and then run the PLC CPU.
8. Monitor the circuit in GX Works2.
Select [Online] → [Monitor] → [Start Monitoring] from the menu.
9. Monitor the operation of the simple motion module.
Select [Monitor] → [Module Monitor] from the project tree in the Simple Motion Module Setting Tool, and select each monitor or history.

Start operation

During the home position return, confirm the current feed value and the axis status in the test dialog box.

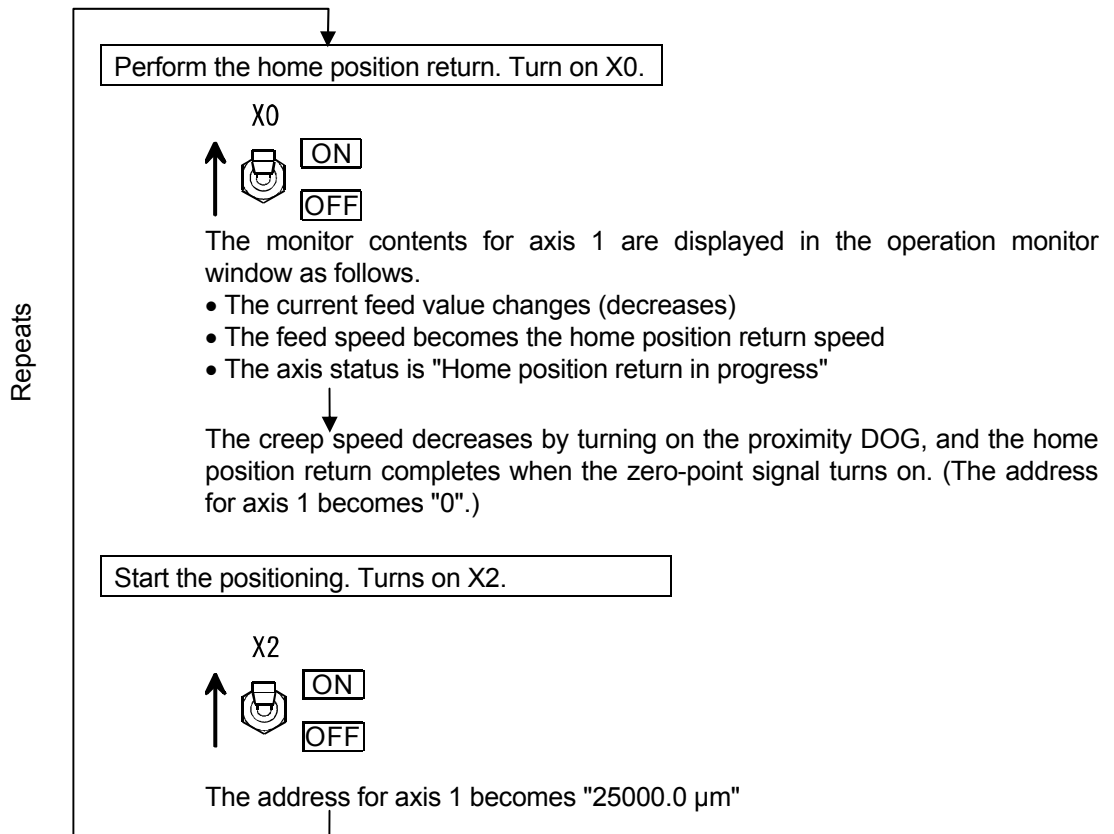

6.5 Exercise (4) JOG operation

- <Conditions>
- The axis 1 forward run JOG can be performed when X4 turns on.
 - The axis 1 forward run JOG can be performed when X5 turns on.
 - The JOG speed is 1000.00mm/min.

- <Hints>
- Send the JOG speed to the QD77MS buffer memory directly by using the DMOV instruction of the intelligent function module direct device.
 - Turn on the output Y of the JOG start.
 - Provide an interlock.

- <Details>
- Fill in the

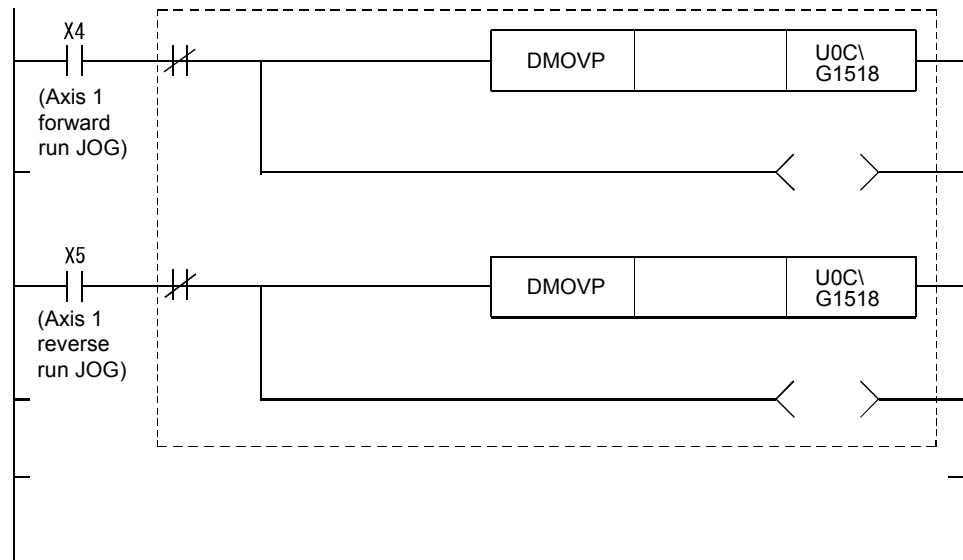

<Operation>

Add the answer to the sequence program created in Section 6.4, then write it to the PLC CPU, and confirm the operation.

(See P6-13 for the answer)

Exercise (4) Answer

Project name B

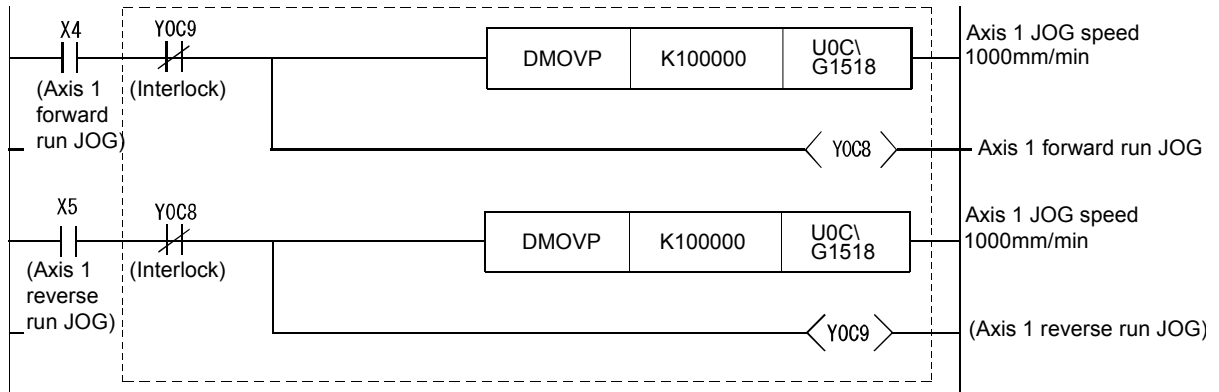

Reference: When specifying the JOG speed in the sequence program, specify a value 100 times of the actual value as the unit is $[\times 10^{-2} \text{ mm/min}]$.

6.6 Sample sequence program

Read the sequence program from the folder on the desktop, and write it to the PLC CPU with a sequence program that can be used as a sample.

Peripheral device operation

1. Start GX Works2.
2. Select [Project] → [Open] from the menu.
Open the project named "X" from the [Open Project] dialog box.
3. Write the parameters and sequence program to the PLC CPU by selecting [Online] → [Write to PLC] from the menu.

PLC CPU is stopped.

 (Click the Parameter+Program button, and click the Execute button in the online data operation dialog box.)
4. Reset and run the PLC CPU.
5. Perform monitoring on GX Works2.
Select [Online] → [Monitor] → [Start Monitoring] from the menu.

6.6.1 PLC READY

Project name	X
--------------	---

Always configure this program.

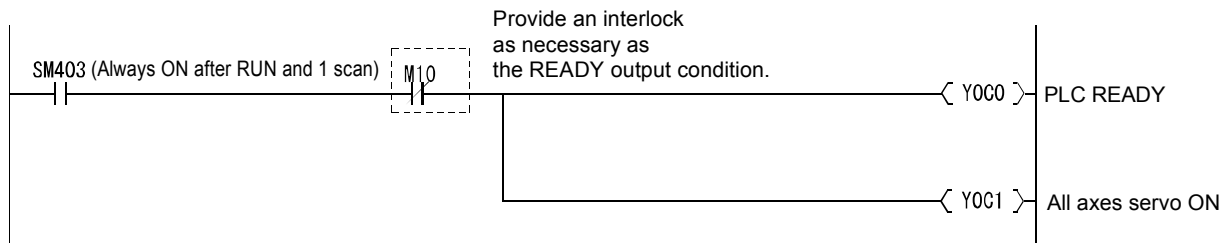

6.6.2 Error code displays and resetting errors

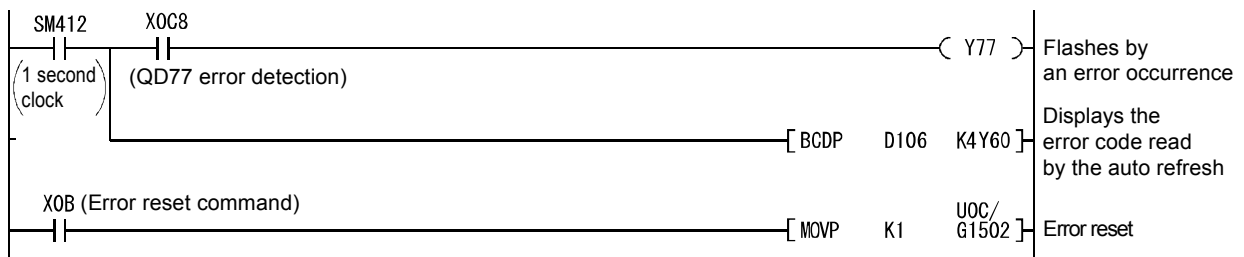

Demonstration machine operations

Error codes for the X axis read from the buffer memory "806" by the auto refresh are displayed by the BCD codes on a digital display device.

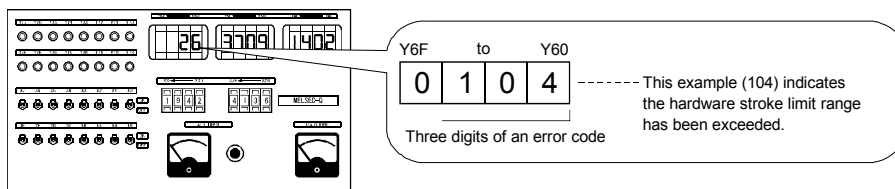

The error codes are categorized as follows.

Error code	Error classification
001 to 009	Fatal error
100 to 199	Common error
200 to 299	Error at OPR or absolute position restoration
300 to 399	Error during JOG operation or during inching operation
500 to 599	Error during positioning operation
800 to 899	I/F (Interface) error
900 to 999	Error during parameter setting range check

Refer to MELSEC-Q QD77MS Simple Motion Module User's Manual (Positioning Control) for details.

6.6.3 Reading the current value of axis 1

The pulse number output by the QD77MS is displayed as the current value.

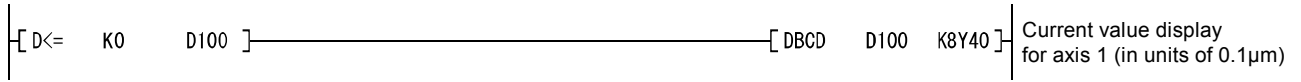

Demonstration machine operations

The current value of axis 1 read from the buffer memory "800" by the auto refresh is displayed by the BCD codes on a digital display device. The unit of the display is 0.1 µm.

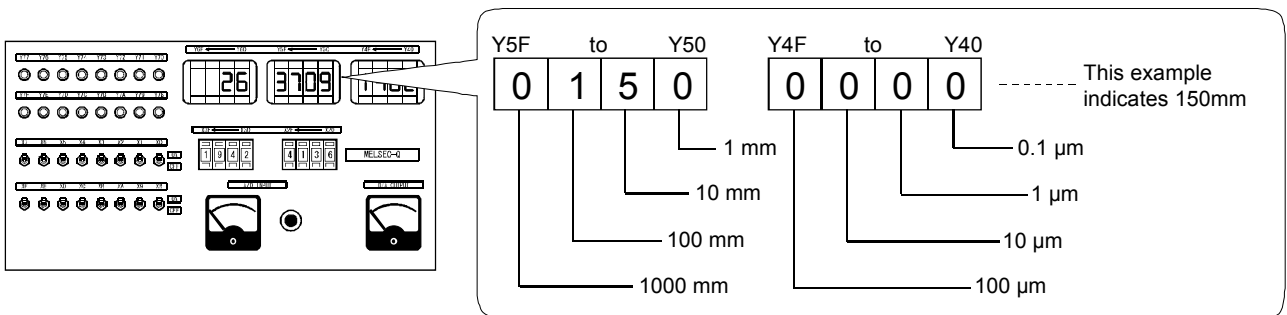

Reference

Control unit	mm	inch	degree	pulse
Minimum current feed value	0.1µm	0.00001inch	0.00001degree	1pulse

6.6.4 Axis 1 JOG operation and manual pulser operation

(1) JOG operation

Forward run JOG operates while X4 is on, and reverse run JOG operates while X5 is on.

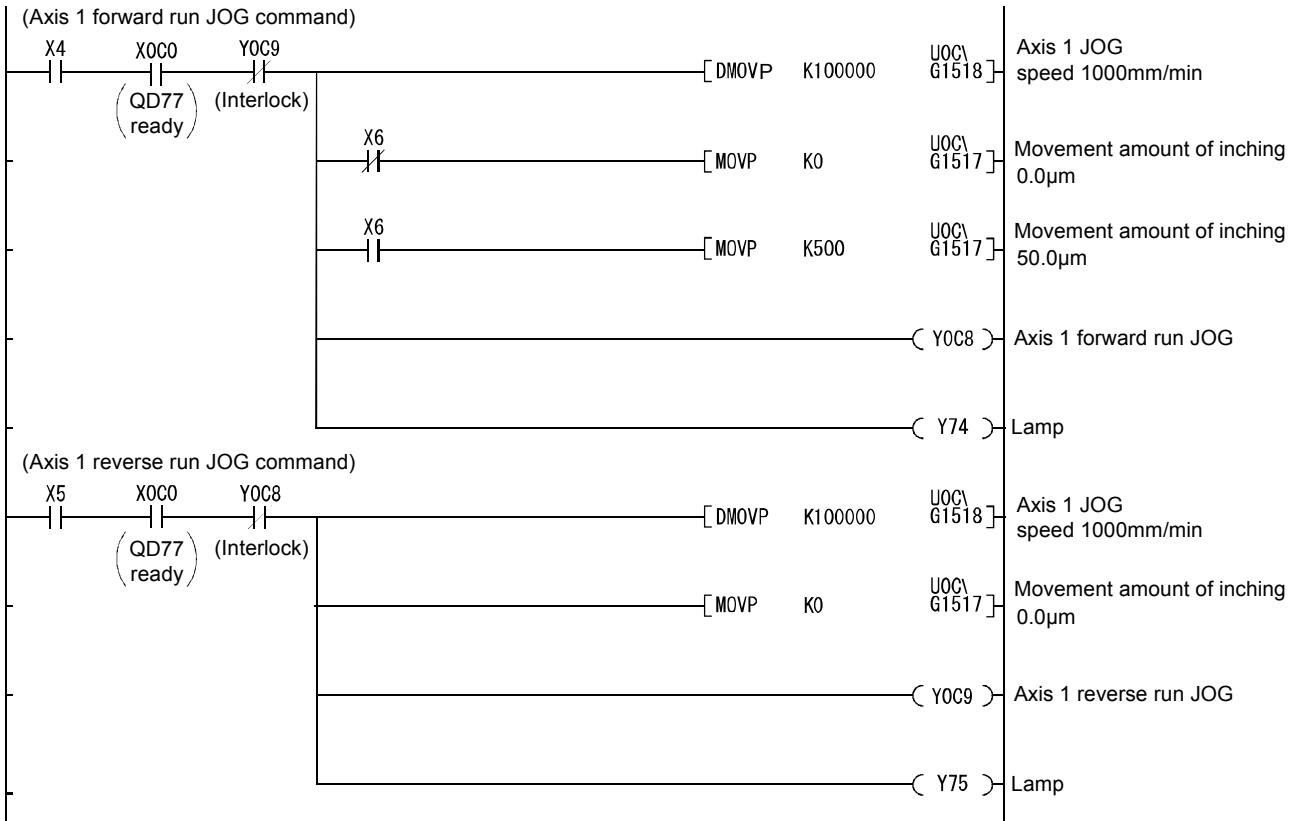

Demonstration machine operations

1. The forward operation starts when X4 turns on, and stops when X4 turns off.
2. The reverse operation starts when X5 turns on, and stops when X5 turns off.
3. The inching movement of 50.0m is performed for the forward direction for each ON of X4 while X6 is on.

<Movement of the X-Y table unit>

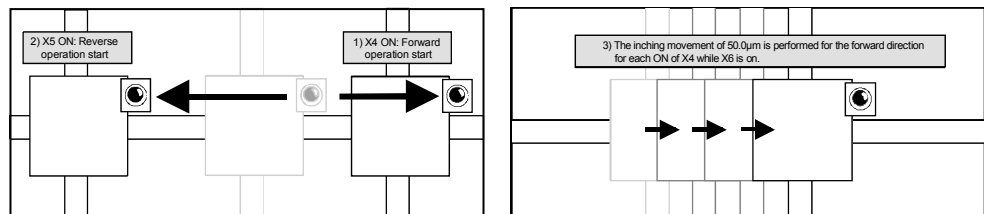

REFERENCE

The inching operation can be performed by setting the inching movement amount in the JOG operation program.

	Axis 1	Axis 2	Axis 3	Axis 4
Buffer memory for the inching movement amount	1517	1617	1717	1817

(2) Manual pulser operation

Use the manual pulser to move the X axis to the target position manually.

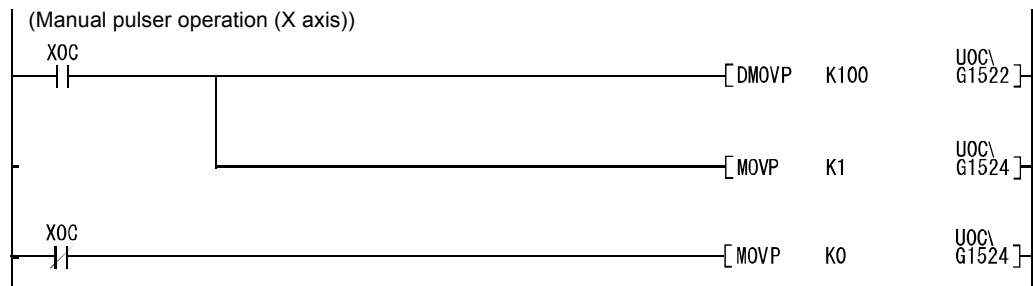

Demonstration machine operations

1. The positioning with the manual pulser can be performed by turning on XOC.
2. Rotating the manual pulser clockwise starts the forward operation and rotating it counter-clockwise starts the reverse operation.

<Manual pulser operation and movement of the X-Y table unit>

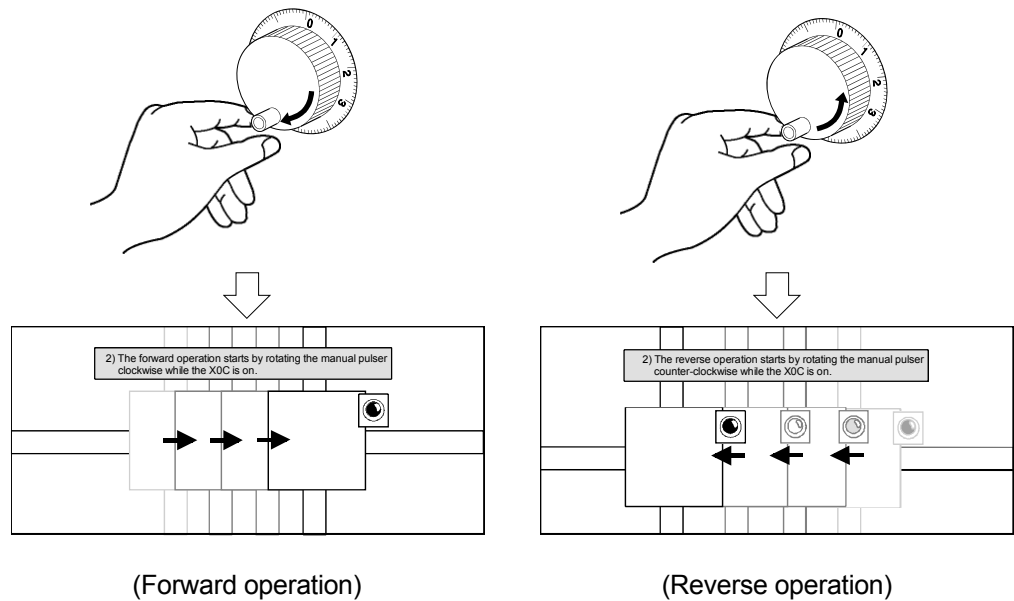

* Refer to Section 2.5 (P2-20) for information on the specifications for the manual pulser used in this training.

6.6.5 Axis 1 home position return

As the retry is set to perform in the home position return basic parameters, when the control point stops before the DOG, it will automatically move outside of the DOG, and the home position return operation will start again.

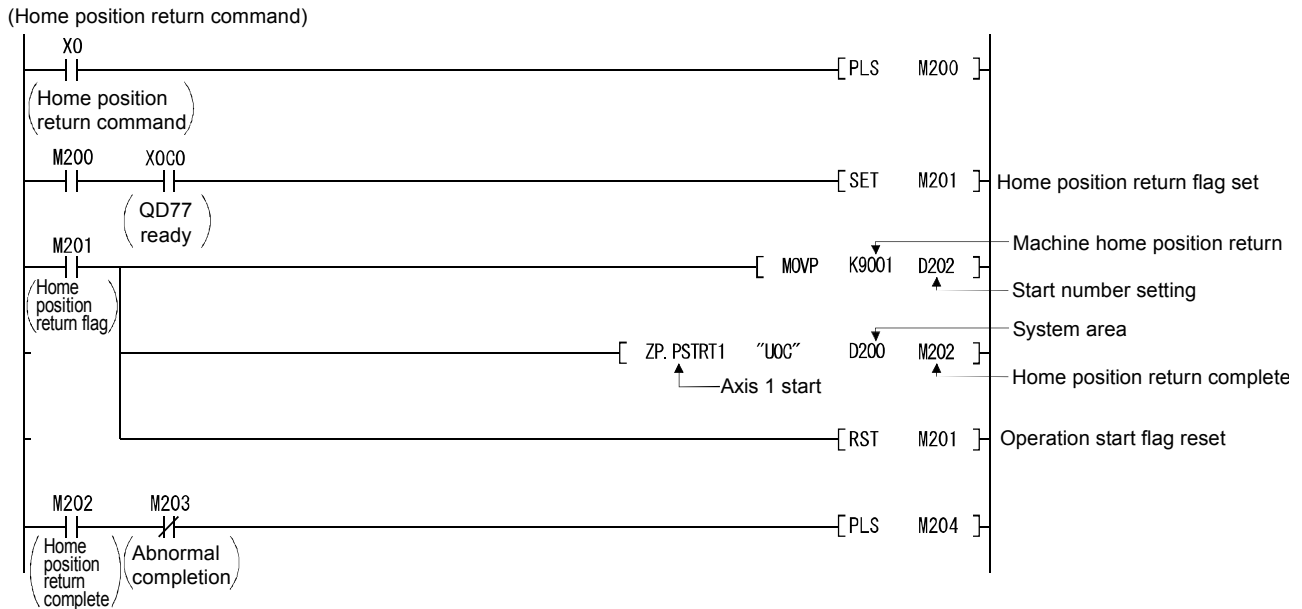

Demonstration machine operations

1. Start the home position return by turning on X0. (The current value becomes 0.)

<Movement of the X-Y table unit>

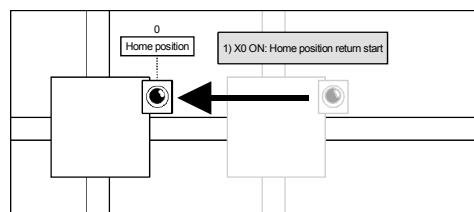

POINT

Starting the positioning control without performing the home position return may cause a stroke limit error. To avoid this, an interlock program by the home position return request flag is necessary.

Program example

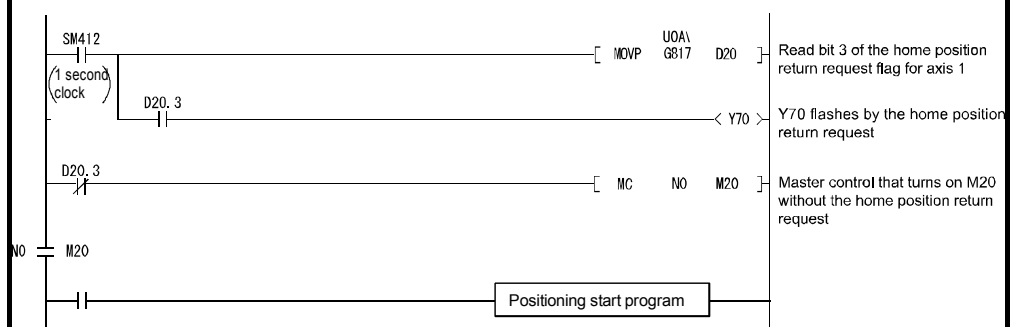

6.6.6 Starting the positioning data

Turning on X2 starts the data No. 6 directly.
 Turning on X3 starts the positioning data No. set by three digits of the digital switch X20 to X2E indirectly by using D232.

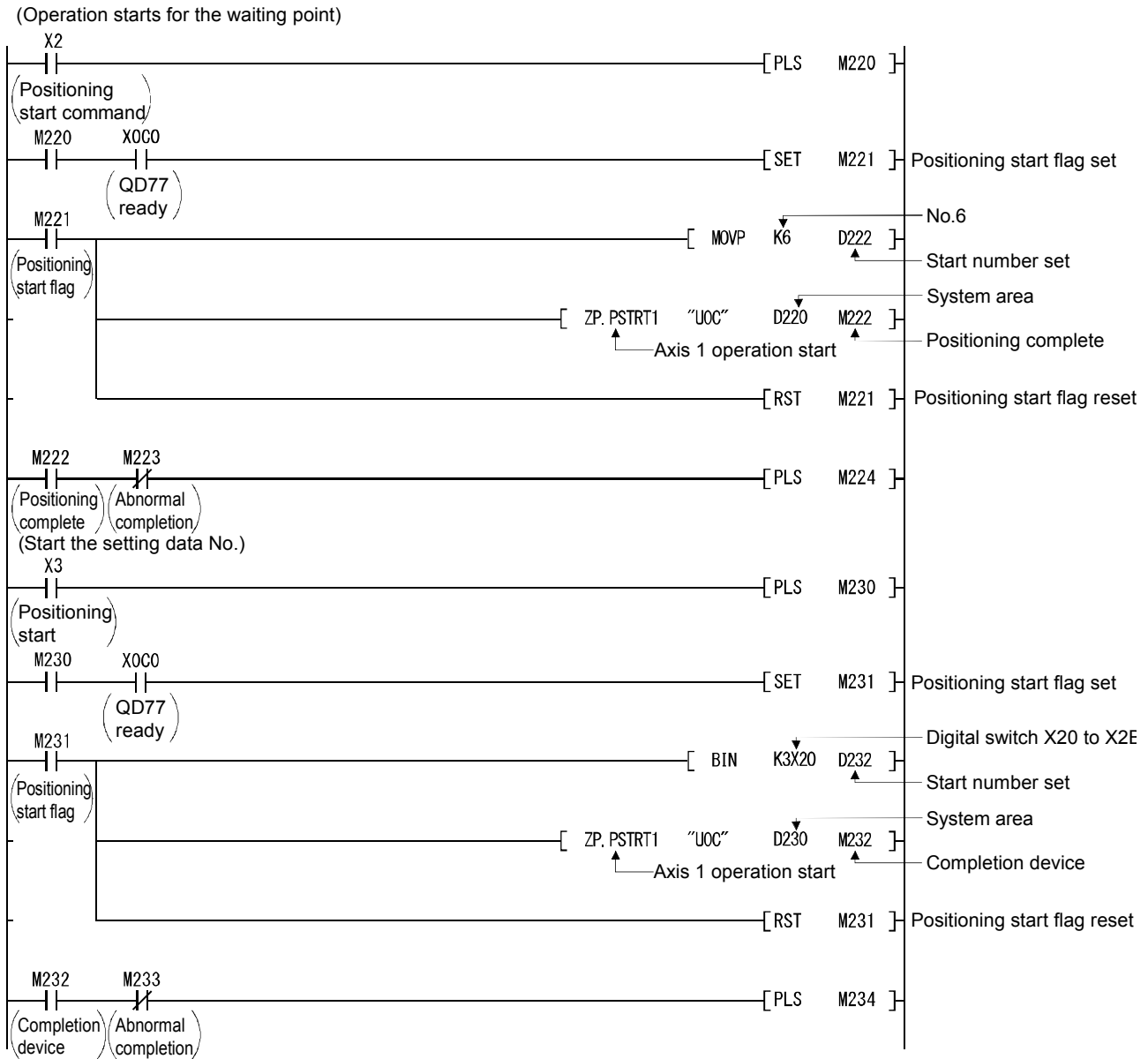

Transfer the indirect specification to the start number setting word device of the PSTRT instruction.
 The positioning data Numbers. are stored in the word device by the BIN instruction.

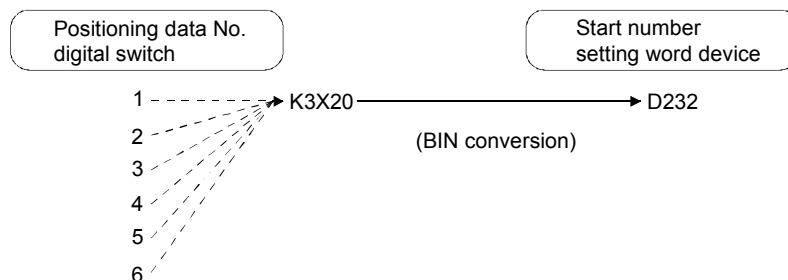

<Operation description>

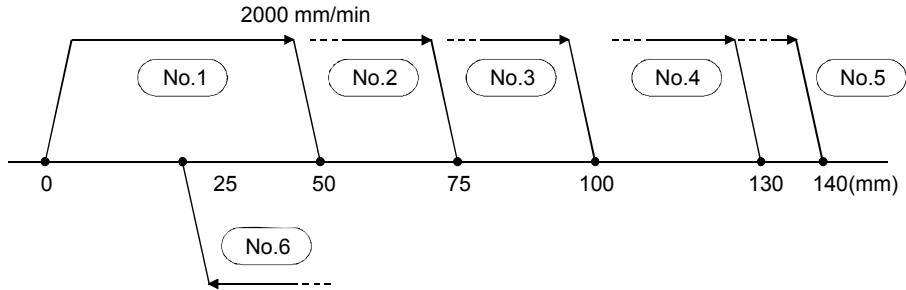

<Positioning data>

No.	Operation pattern	Control method	Interpolation axis	Acceleration time No.	Deceleration time No.	Positioning address [μ m]	Arc address [μ m]	Command speed [mm/min]	Dwell time [ms]	M code	Positioning data comments
1	0: Finish	1: ABS linear 1	—	0:100	0:100	50000.0	0.0	2000.00	0	0	
2	0: Finish	1: ABS linear 1	—	0:100	0:100	75000.0	0.0	2000.00	0	0	
3	0: Finish	1: ABS linear 1	—	0:100	0:100	100000.0	0.0	2000.00	0	0	
4	0: Finish	1: ABS linear 1	—	0:100	0:100	130000.0	0.0	2000.00	0	0	
5	0: Finish	1: ABS linear 1	—	0:100	0:100	140000.0	0.0	2000.00	0	0	
6	0: Finish	1: ABS linear 1	—	0:100	0:100	25000.0	0.0	2000.00	0	0	
7											
8											
9											
10											

Demonstration machine operations

- Turning on X2 performs the positioning for the wait point of the positioning data No. 6 (25mm) (The current value becomes 25000.0 μ m.)
- Specify the positioning data No. by a digital switch.

Repeat

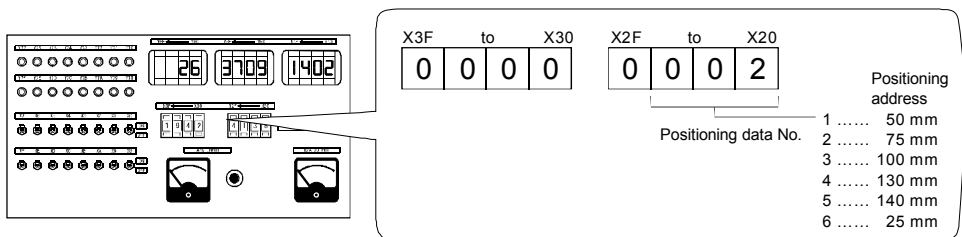

- Turning on X3 performs the specified positioning. (The current value becomes the specified data No. address)

<Movement of the X-Y table unit>

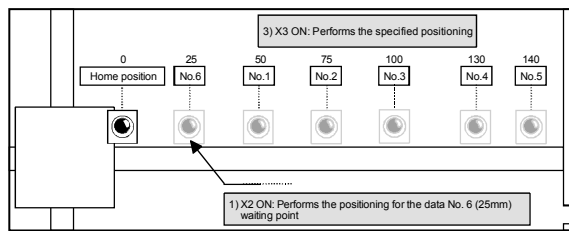

6.6.7 Multiple points continuous positioning

Starting one positioning data performs the positioning for the desired multiple points continuously.

Set the positioning data pattern to "1" (continuous positioning control).
(It is unnecessary to change the sequence program.)

<Operation description>

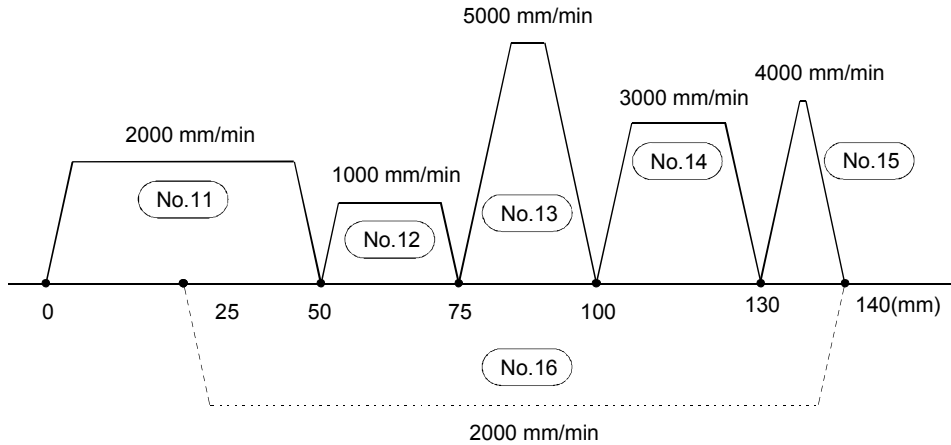

<Positioning data>

No.	Operation Pattern	Control method	Interpolation axis	Acceleration time No.	Deceleration time No.	Positioning address [μ m]	Arc address [μ m]	Command speed [mm/min]	Dwell time [ms]	M code	Positioning data comments
11	1: Continuous	1: ABS linear 1	—	0:100	0:100	50000.0	0.0	2000.00	500	0	
12	1: Continuous	1: ABS linear 1	—	0:100	0:100	75000.0	0.0	1000.00	500	0	
13	1: Continuous	1: ABS linear 1	—	0:100	0:100	100000.0	0.0	5000.00	500	0	
14	1: Continuous	1: ABS linear 1	—	0:100	0:100	130000.0	0.0	3000.00	500	0	
15	1: Continuous	1: ABS linear 1	—	0:100	0:100	140000.0	0.0	4000.00	500	0	
16	0: Finish	1: ABS linear 1	—	0:100	0:100	25000.0	0.0	2000.00	500	0	
17						20					
18											
19											
20											

Demonstration machine operations

1. Start the positioning data No. 11.

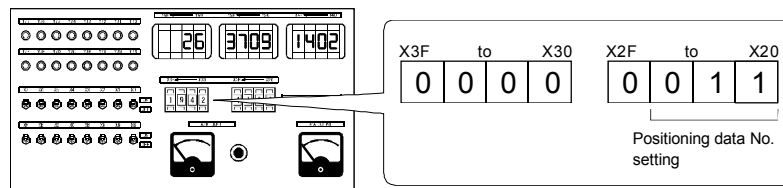

Turn on X3.

(Confirm with the axis monitor in the Simple Motion Module Setting Tool.)

<Movement of the X-Y table unit>

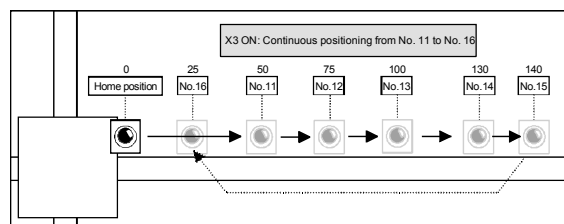

6.6.8 Multi-point positioning with speed switching

Starting one positioning data changes the speed automatically at the desired address to move multiple points continuously.

Set the positioning data pattern to "3" (continuous path control).

(It is unnecessary to change the sequence program.)

<Operation description>

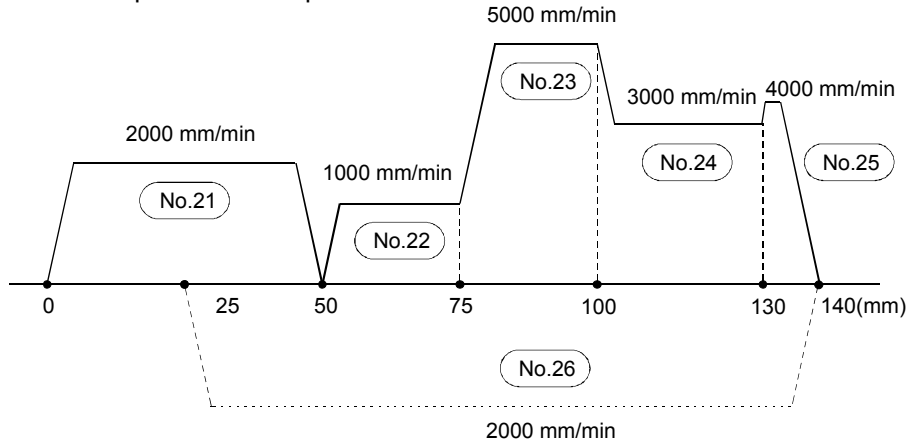

<Positioning data>

No.	Operation pattern	Control method	Interpolation axis	Acceleration time No.	Deceleration time No.	Positioning address [μm]	Arc address [μm]	Command speed [mm/min]	Dwell time [ms]	M code	Positioning data comments
21	1: Continuous	1: ABS linear 1	—	0:100	0:100	50000.0	0.0	2000.00	500	0	
22	3: Path	1: ABS linear 1	—	0:100	0:100	75000.0	0.0	1000.00	0	0	
23	3: Path	1: ABS linear 1	—	0:100	0:100	100000.0	0.0	5000.00	0	0	
24	3: Path	1: ABS linear 1	—	0:100	0:100	130000.0	0.0	3000.00	0	0	
25	1: Continuous	1: ABS linear 1	—	0:100	0:100	140000.0	0.0	4000.00	500	0	
26	0: Finish	1: ABS linear 1	—	0:100	0:100	25000.0	0.0	2000.00	0	0	
27											
28											
29											
30											

Demonstration machine operations

1. Start the positioning data No. 21.

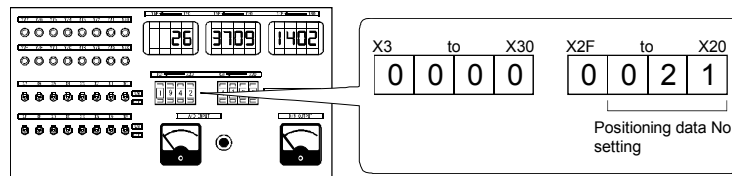

Turn X3 on.

(Confirm with the axis monitor in the Simple Motion Module Setting Tool)

<Movement of the X-Y table unit>

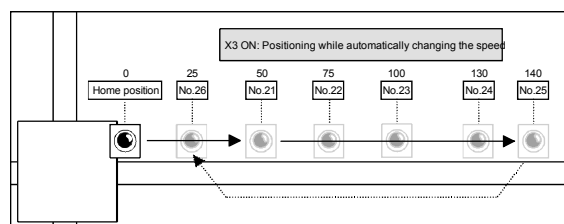

6.6.9 Stopping during operation

Turn on the Axis 1 stop (Y0C4) when to stop the control point in the BUSY status.

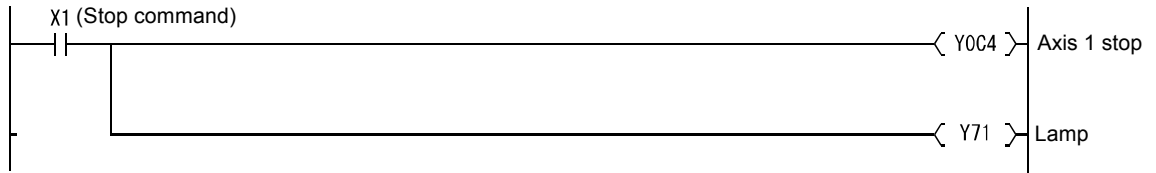

Demonstration machine operations

1. Turn on X1 during the operation.

<Movement of the X-Y table unit>

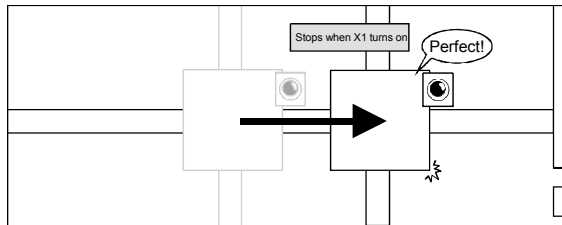

<Q PLC demonstration machine>

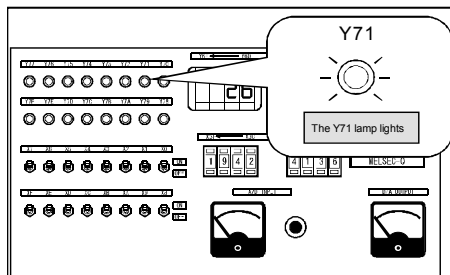

REMARKS

Wiring an external switch to the external stop signal can stop the control point during the operation as well. This can stop the control point quickly regardless of the scan time of the PLC CPU.

6.6.10 Restarting after stopping

To stop and restart operation when the Stop X1 turns on during the continuous positioning of data No. 11 to No. 16 and No. 21 to No. 26, write "1" to the buffer memory 1503 (restart instruction).

<Operation description>

This figure is the same as the operation description drawing in Section 6.8.7.

<Sequence program>

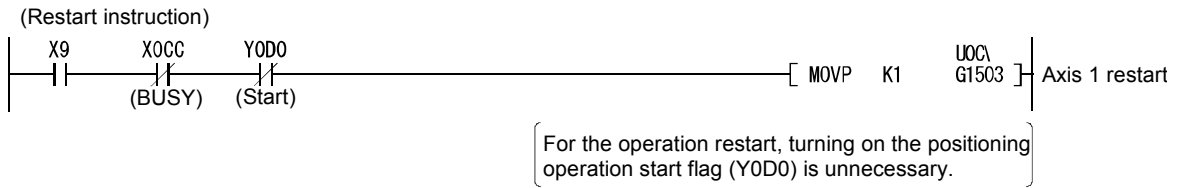

Demonstration machine operations

1. Start the positioning data No. 11.

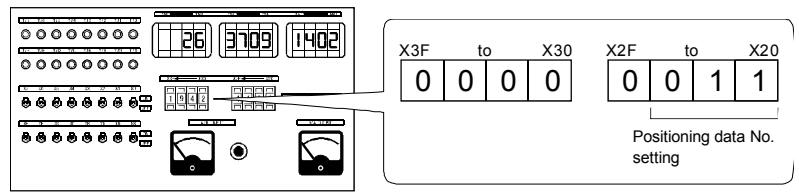

- Turn on X3.
2. Turn on the Stop X1 during the continuous positioning.
 3. Turn on the Restart X9.

<Movement of the X-Y table unit>

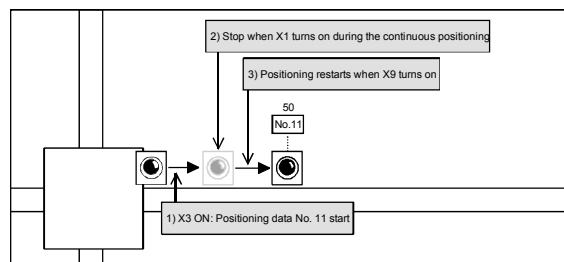

6.6.11 Changing speed during the positioning operation

The speed can be changed in the BUSY status.

The speed is written to axis 1 buffer memory 1514 and 1515 in units of 0.01mm/min. (Operation can be stopped by setting the speed to zero.)

Execute the speed change by writing "1" to the speed change request buffer memory 1516.

<Operation description drawing>

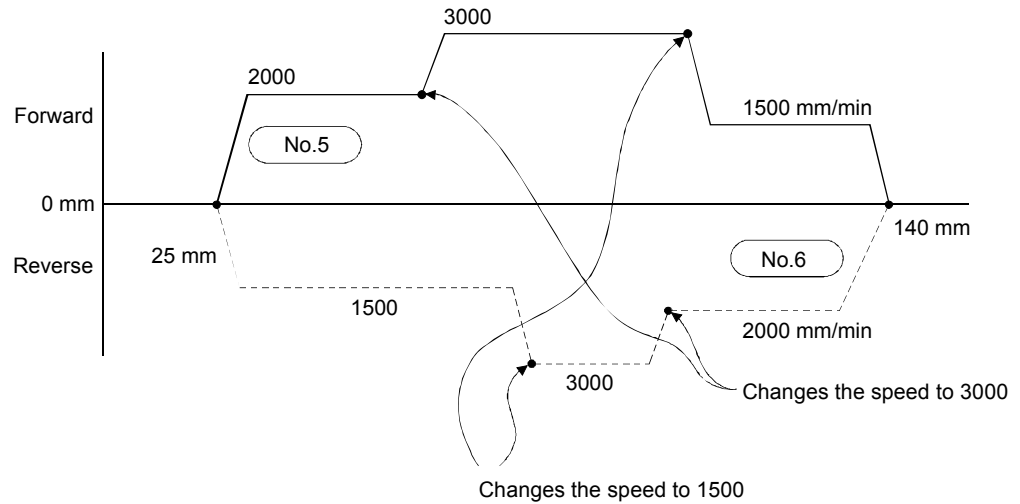

<Sequence program>

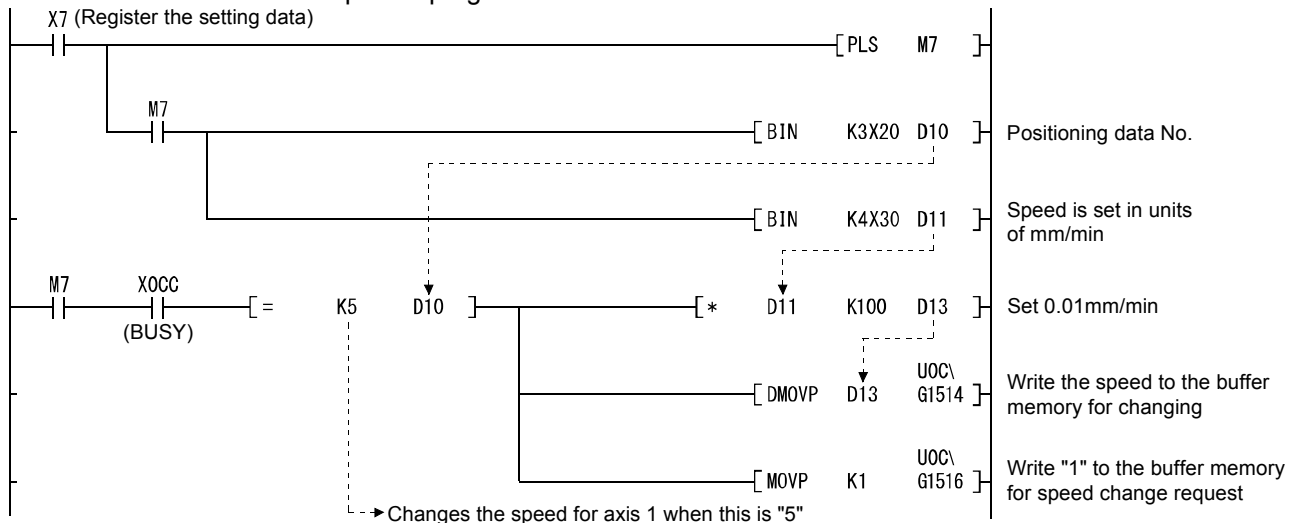

Demonstration machine operations

1. Set a digital switch.
- X3F to X30: 1 0 0 0 (Set the speed between 0 to 9999 (mm/min))

X2F to X20: 0 0 0 5 (Positioning data No. setting)

----- This example indicates 1000mm/min.
2. The speed changes when X7 turns on while X3 is on and the control point is moving to 150mm of the data No. 5.
 3. The speed changes when X7 turns on while X2 is on and control point is moving to 25mm of data No. 6.
- Repeat

6.6.12 Setting addresses with digital switches

Change the positioning data No. 31 (buffer memory 2306 and 2307) by specifying the positioning address in units of 1mm.

<Operation description>

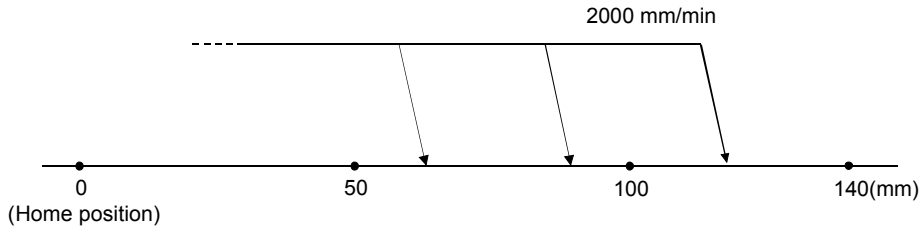

<Positioning data>

No.	Operation pattern	Control method	Interpolation axis	Acceleration time No.	Deceleration time No.	Positioning address [μ m]	Arc address [μ m]	Instruction speed [mm/min]	Dwell time [ms]	M code	Positioning data comments
31	0: Finish	1: ABS linear 1	—	0:100	0:100	0.0	0.0	2000.00	0	0	
32											
33											

Change this value.

(Refer to Section 3.6.2)

<Sequence program>

The portion in the dotted line was created in Section 6.6.11

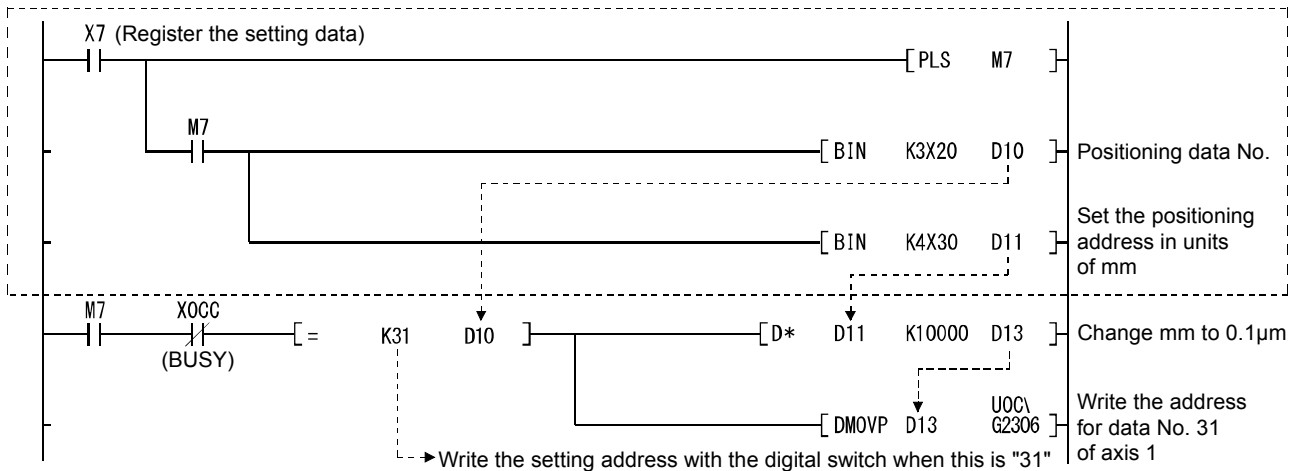

Demonstration machine operations

1. Set a digital switch.

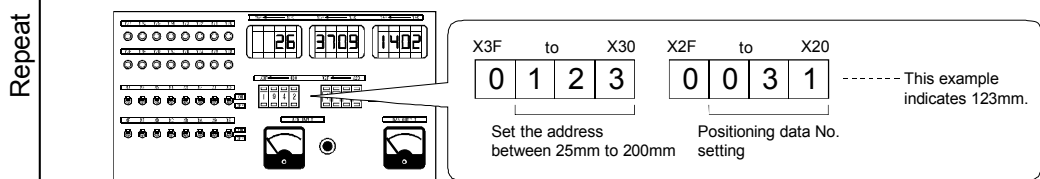

2. The value of multiplying the set value by 10000 (in units of 0.1 μ m) when X7 turns on becomes the address for data No. 31.
3. Turning on X3 starts the positioning for the set address.

6.6.13 Teaching playback

Move to a registering position with the JOG operation (or manual pulser), and register the operation. Once the position is registered, the positioning to the registered position for an unlimited number of times can be performed using the start switch.

<Positioning data>

No.	Operation pattern	Control method	Interpolation axis	Acceleration time No.	Deceleration time No.	Positioning address [μ m]	Arc address [μ m]	Instruction speed [mm/min]	Dwell time [ms]	M code	Positioning data comments
35	0: Finish	1: ABS linear 1	—	0:100	0:100	0.0	0.0	2000.00	0	0	
36											
37											

<Sequence program>

Change this value.

The portion in the dotted line was created in Section 6.6.11.

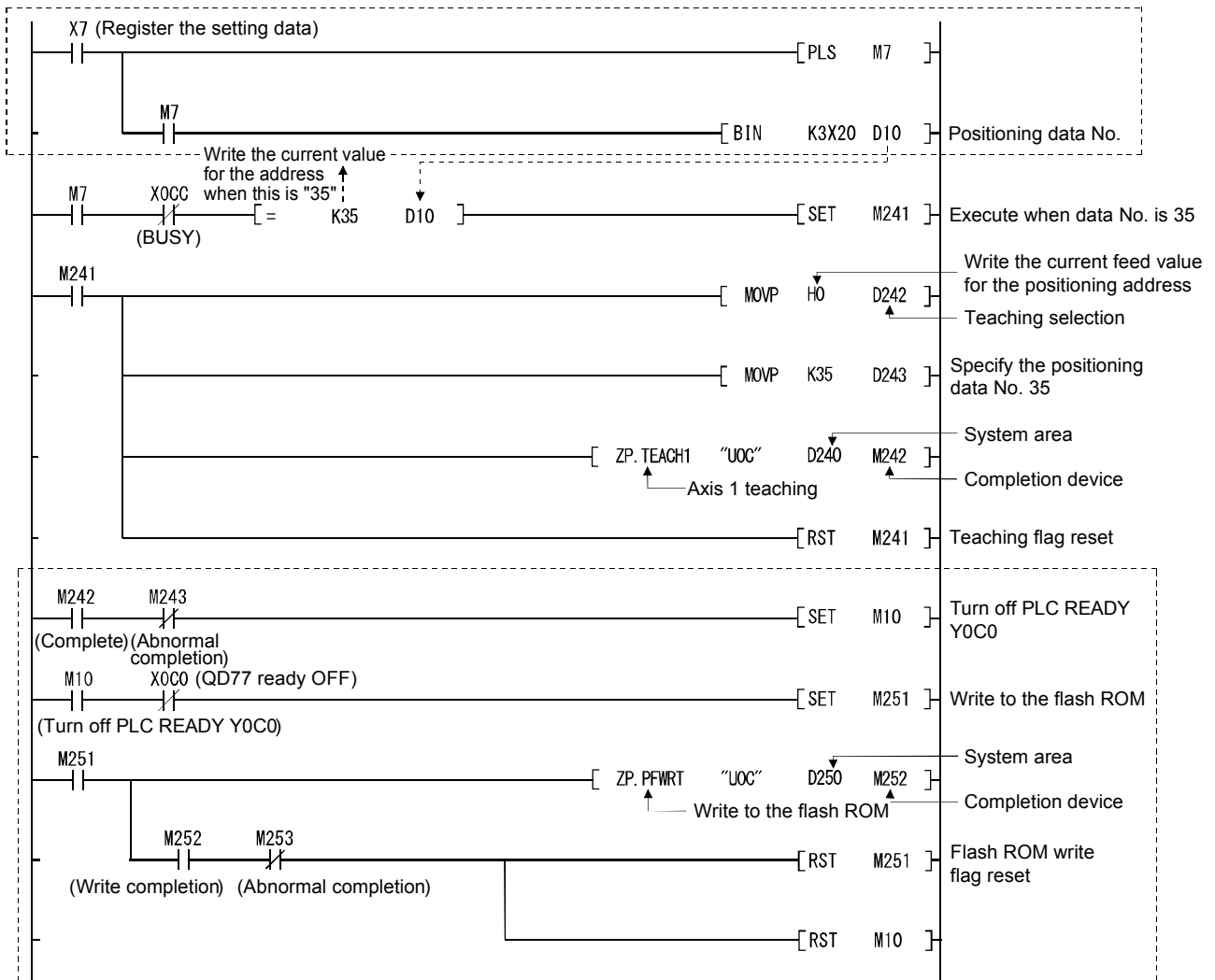

Configure the portion in the dotted line before writing to the flash ROM after the teaching.

Demonstration machine operations

Repeat → 1. Turn on X4, perform a forward run JOG and turn off X4 at the desired position.
 (Note the current value address

--	--	--	--	--	--	--	--

.)

2. Set a digital switch.

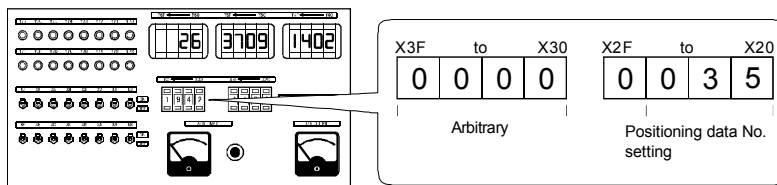

3. Turning on X7 teaches the current value to the data No. 35.

4. Perform the home position return.

5. Turning on X3 performs the data No. 35. (The control point stops at the noted address.)

6. Read the positioning data from the QD77MS.

7. Confirm that the address of the data No. 35 is taught.

6.6.14 Specifying the speed and movement amount with digital switch

Combine the absolute positioning method and the increment positioning method. Specify the speed and the movement amount for the increment method with a digital switch.

<Operation description>

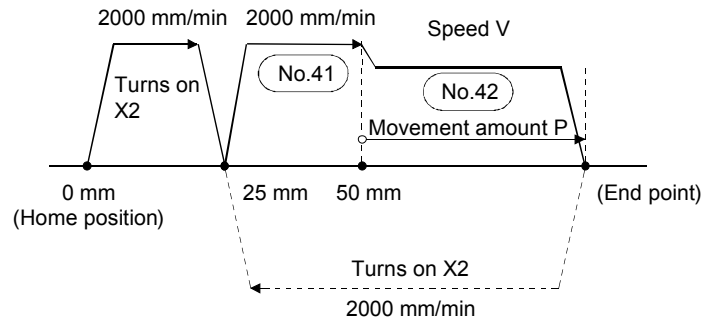

<Positioning data>

No.	Operation pattern	Control method	Interpolation axis	Acceleration time No.	Deceleration time No.	Positioning address [μ m]	Arc address [μ m]	Instruction speed [mm/min]	Dwell time [ms]	M code	Positioning data comments
41	3: Path	1: ABS linear 1	—	0:100	0:100	50000.0	0.0	2000.00	0	0	
42	0: Finish	2: INC linear 1	—	0:100	0:100	0.0	0.0	1.00	0	0	
43											
44											
45											

Set the speed V.
Set the address P.

<Sequence program>

The portion in the dotted line was created in Section 6.6.11

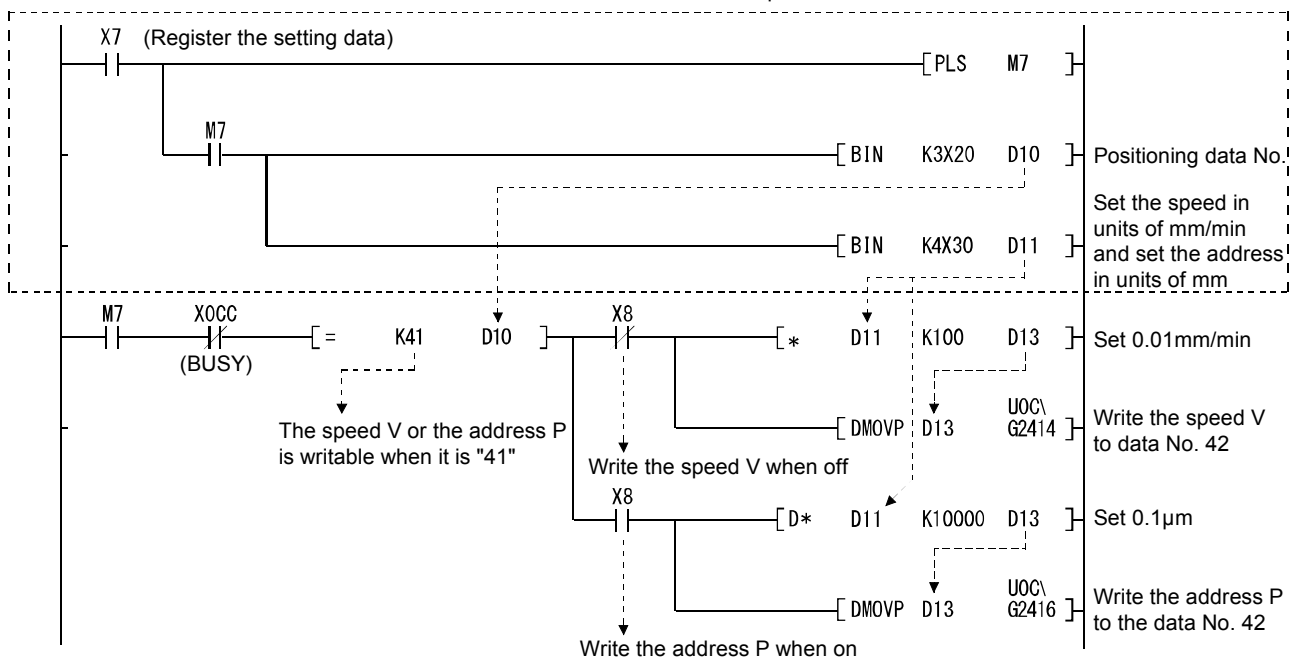

Demonstration machine operations

- Repeat
1. Turn on X2 and return the control point to the waiting point 25 mm.
 2. Set a digital switch, and write the speed V to the buffer memory by X7.

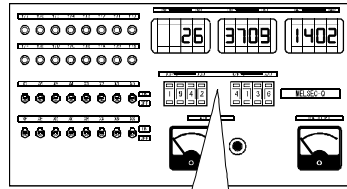

Speed V (2414, 2415)	X3F to X30	X2F to X20	→ Turn off X8 → Turn on X7
	0 4 4 4 mm/min Set this between 0044 to 9999	0 0 4 1 Positioning data No. setting	

3. Set a digital switch, and write the address P to the buffer memory by X8 and X7.

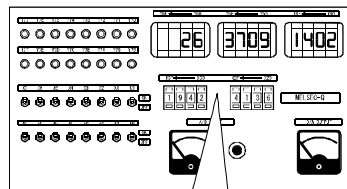

Movement amount P (2416, 2417)	X3F to X30	X2F to X20	→ Turn on X8 → Turn on X7
	0 0 4 4 mm Set this between 0001 to 0100	0 0 4 1 Positioning data No. setting	

Do not set values larger than 100mm for the movement amount.
 [This may cause a stroke limit exceeded error.]

4. Turn on X3.

The address of the data No. 41: 50mm	+	Movement amount of the data No. 42	=	End point
---	---	------------------------------------	---	-----------

6.6.15 Fixed-feed

After performing cutting or drilling for a constant amount by the increment method, perform feeding again.

<Operation description>

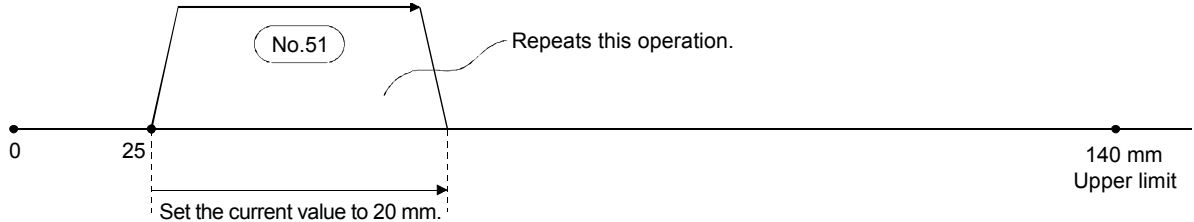

<Positioning data>

No.	Operation pattern	Control method	Interpolation axis	Acceleration time No.	Deceleration time No.	Positioning address [μm]	Arc address [μm]	Instruction speed [mm/min]	Dwell time [ms]	M code	Positioning data comments
51	0: Finish	3: Fixed-feed 1	—	0:100	0:100	20000.0	0.0	3000.00	0	0	
52											
53											

<Sequence program>

The program is a program that starts the positioning data No. 51 (Same as that in Section 6.6.6.).

Demonstration machine operations

1. Turn on X0 and perform the home position return.
2. Set a digital switch.

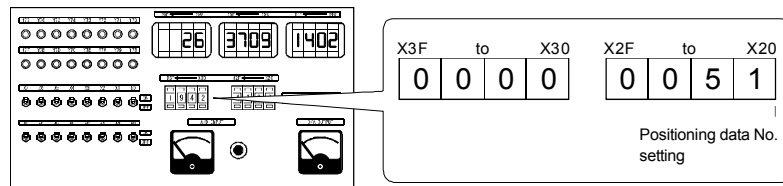

3. Turn on X3.

Confirm that the current value is 20000.0 μm .

[Do not turn on this for 10 times or more in the XY table. This will cause the upper limit to operate resulting in an error.]

6.6.16 Speed control

The speed control is a control used to operate the object (such as conveyors or transporters) in the same direction endlessly.

The current value for the speed control does not change regardless of the forward operation or the reverse operation, and does not stop until the stop instruction is input.

However, the current value can be increased or decreased by setting "1" to the current feed value update request command (buffer memory addresses 30, 180, 330, 480) for detailed parameter (1).

The demonstration machine in this textbook is equipped with upper and lower limit switches, and automatically stops at these positions.

<Operation description>

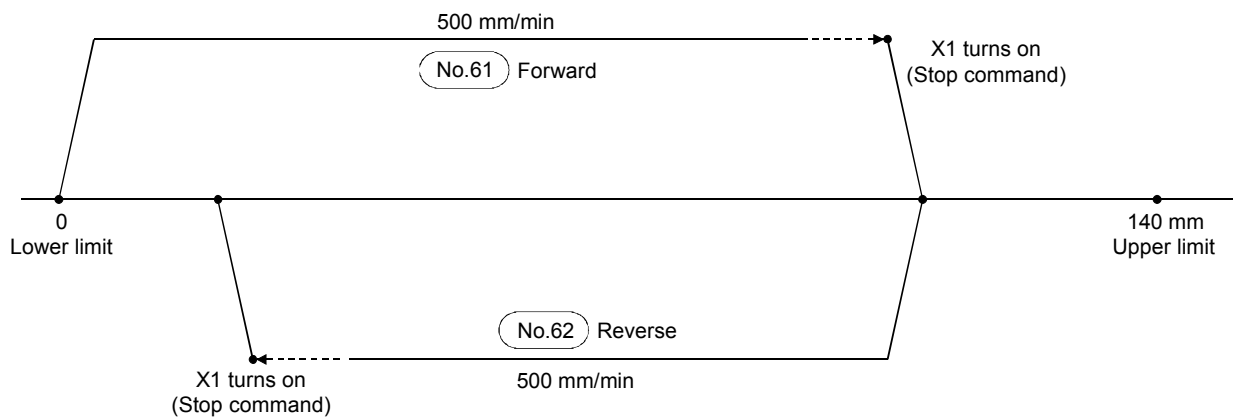

<Positioning data>

No.	Operation pattern	Control method	Interpolation axis	Acceleration time No.	Deceleration time No.	Positioning address [μ m]	Arc address [μ m]	Instruction speed [mm/min]	Dwell time [ms]	M code	Positioning data comments
61	0: Finish	4: Forward speed 1	—	0:100	0:100	0.0	0.0	500.00	0	0	
62	0: Finish	5: Reverse speed 1	—	0:100	0:100	0.0	0.0	500.00	0	0	
63											

<Sequence program>

The program is a program that starts the positioning data No. 61 and 62. (Same as that in Chapter 6.6.6.).

Demonstration machine operations

1. Turn on X0 and perform the home position return.
2. Set a digital switch to 61.

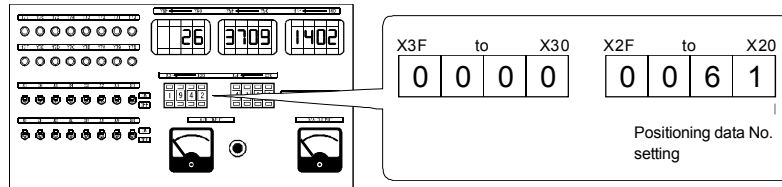

Forward run starts when X3 turns on.

The axis 1 current value in the positioning monitor/test screen in the Simple Motion Module Setting Tool remains "0" and not increased.
Confirm that the speed is displayed.

3. Change the digital switch to 62.

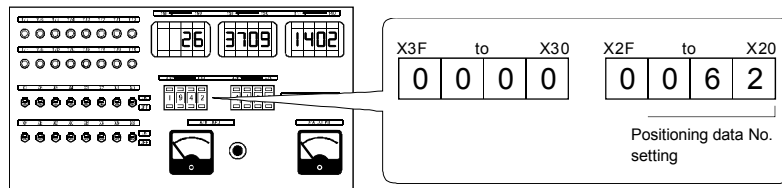

Reverse run starts when X3 turns on.

The axis 1 current value in the in the axis monitor of the Simple Motion Module Setting Tool remain "0" and not decreased.
Confirm that the speed is displayed.

Turn on X1 during operation to stop the reverse run.

REFERENCE

When an error occurs, use the JOG operation to move the control point to the center, and turn on the X0B Error reset.

6.6.17 Positioning using M codes

M codes are added to the positioning data and use numbers between 0 to 65535 for each axis.

Set whether to detect the M code at the startup of "WITH mode [0]" or at the operation "AFTER mode [1]" completion by the "M code ON signal output timing" (buffer memory areas 27, 177, 327, 477) in detailed parameter (1).

Change to "AFTER mode [1]" by the parameter.

After the M code detection signal (X0C4, X0C5, X0C6, X0C7) turns on in the sequence program, Valid M codes (buffer memory areas 808, 908, 1008, 1108) are read from the QD77MS buffer memory areas, and the sequence (work) corresponding to the M code number can be performed.

Comments (32 single-byte characters) can be added to M codes 1 to 50, and these M code comments (work details) can be monitored while peripheral devices are detecting the M code comments.

* When monitoring cannot be performed, open the Axis Monitor screen in the Simple Motion Module Setting Tool, and add "Md44: Positioning data No. being executed" from the monitor selection.

1) Detect the M code during execution of the following data No., and perform the work corresponding to the M code.

No. 91, 93M code "1"Comment "Weld for 6 seconds"

No. 92, 94, 95 ...M code "3"Comment "Weld for 4.4 seconds"

No. 96M code "5"Comment "Replace processed products"

<Operation description>

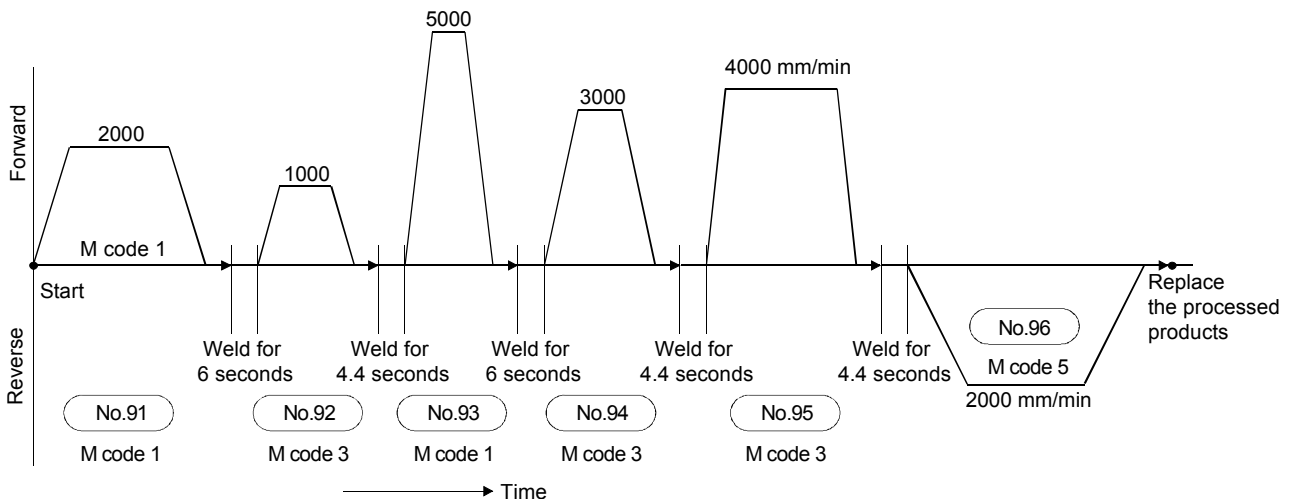

<Positioning data>

No.	Operation pattern	Control method	Interpolation axis	Acceleration time No.	Deceleration time No.	Positioning address [μm]	Circular address [μm]	Command speed [mm/min]	Dwell time [ms]	M code	Positioning data comments
91	1: Continuous	1: ABS linear 1	—	0:100	0:100	50000.0	0.0	2000.00	500	1	
92	1: Continuous	1: ABS linear 1	—	0:100	0:100	75000.0	0.0	1000.00	500	3	
93	1: Continuous	1: ABS linear 1	—	0:100	0:100	100000.0	0.0	5000.00	500	1	
94	1: Continuous	1: ABS linear 1	—	0:100	0:100	130000.0	0.0	3000.00	500	3	
95	1: Continuous	1: ABS linear 1	—	0:100	0:100	140000.0	0.0	4000.00	500	3	
96	0: Finish	1: ABS linear 1	—	0:100	0:100	25000.0	0.0	2000.00	500	5	
97											
98											
99											
100											

Select [Edit] → [M Code Comment Edit] from the menu

The screenshot shows a data table with columns: No., Operation pattern, Control method, Axis to be interpolated, Acceleration time No., Deceleration time No., Positioning address, Arc address, Command speed, Dwell time, and M-code. An 'M-code Comment Edit' dialog box is open, displaying a table with columns: No., M-code, and M-code Comment. The dialog box contains the following data:

No.	M-code	M-code Comment
1	1	Weld for 6 seconds
2	3	Weld for 4.4 seconds
3	5	Replace processed products
4		
5		
6		
7		
8		
9		

<Output M code in AFTER mode>

The screenshot shows the 'Detailed parameters 1' configuration window for Axis #1. The parameters are listed on the left, and their values are shown on the right. An arrow points to the 'Pr. 18: M code ON signal output timing' parameter, which is set to '1:AFTER Mode'. The text 'Confirm that it is set to the AFTER mode' is written next to the arrow.

Item	Axis #1
Detailed parameters 1	Set according to the system configuration when the system is started up. (This parameter become valid when the PLC READY)
Pr. 11: Backlash compensation amount	0.0 μm
Pr. 12: Software stroke limit upper limit value	214748364.7 μm
Pr. 13: Software stroke limit lower limit value	-214748364.8 μm
Pr. 14: Software stroke limit selection	0: Set Software Stroke Limit to Current Feed Value
Pr. 15: Software stroke limit valid/invalid setting	0: Valid
Pr. 16: Command in-position width	10.0 μm
Pr. 17: Torque limit setting value	300 %
Pr. 18: M code ON signal output timing	1: AFTER Mode
Pr. 19: Speed switching mode	0: Standard Speed Switching Mode

<Sequence program>

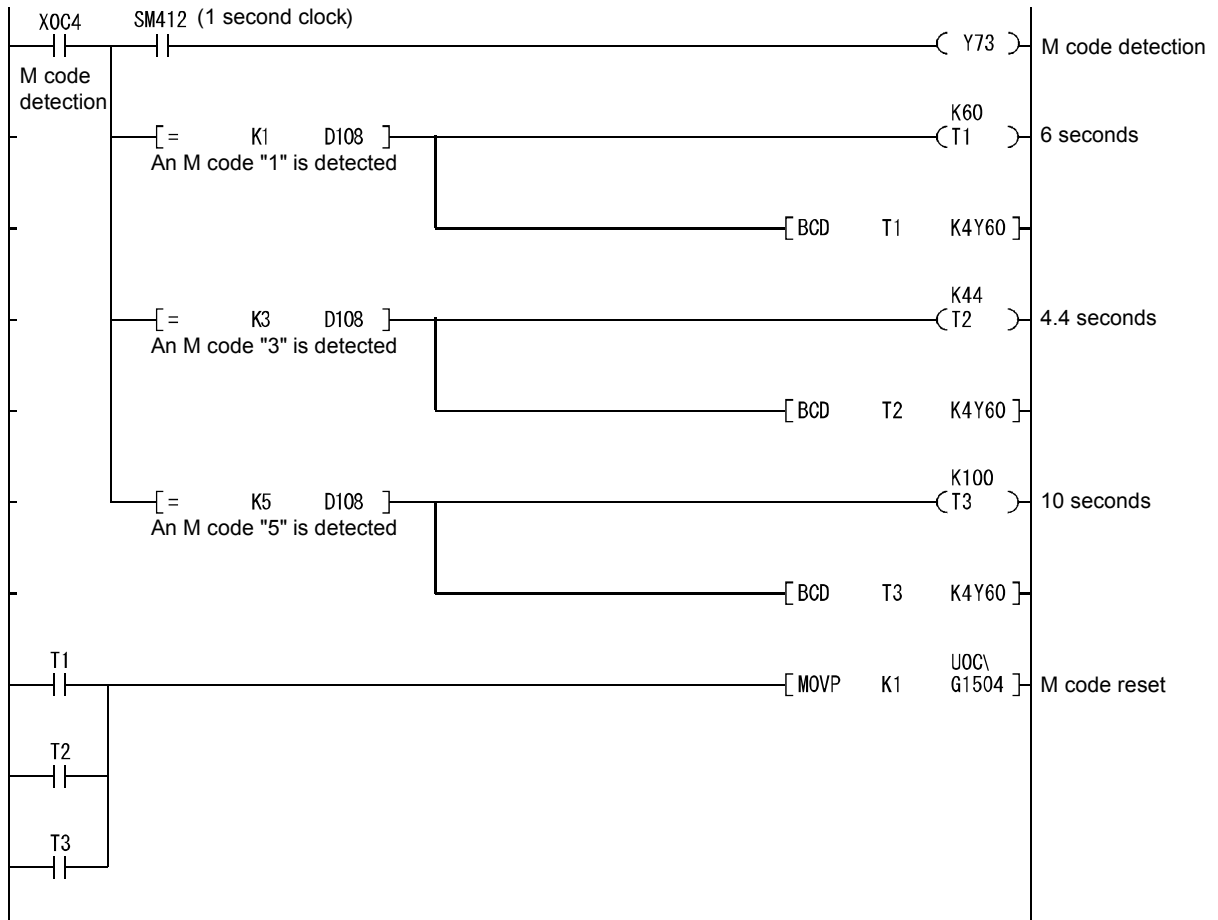

Demonstration machine operations

1. From the navigation window in the Simple Motion Module Setting Tool, select [Monitor] → [Module Monitor] → [Axis Monitor].
2. Monitor the circuit in GX Works2.
Select [Online] → [Monitor] → [Start Monitoring] from the menu.
3. Turn on X0 and perform the home position return.
4. Start the positioning data No. 91.

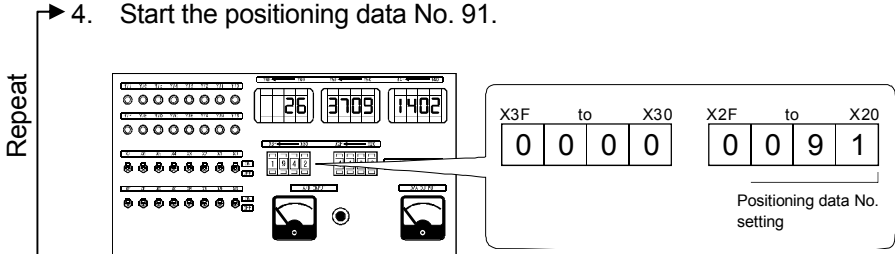

Turn on X3.

Operate continuously from data No. 91 to No. 96 and display the welding time on the digital display devices Y60 to Y6F.

6.6.18 Sequence program summary

The programs described in Section 6.6 are combined into one program.

Project name	X
--------------	---

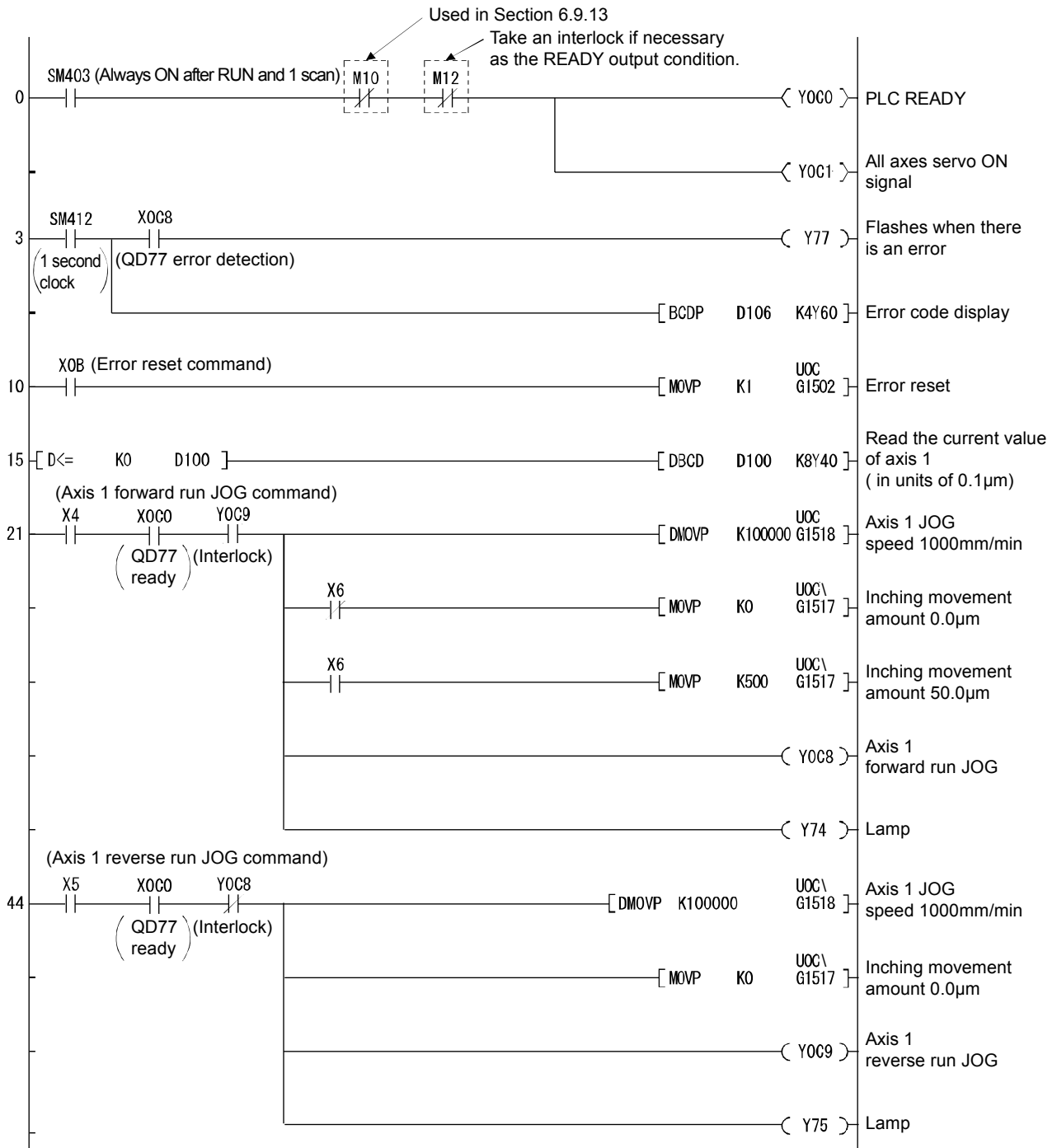

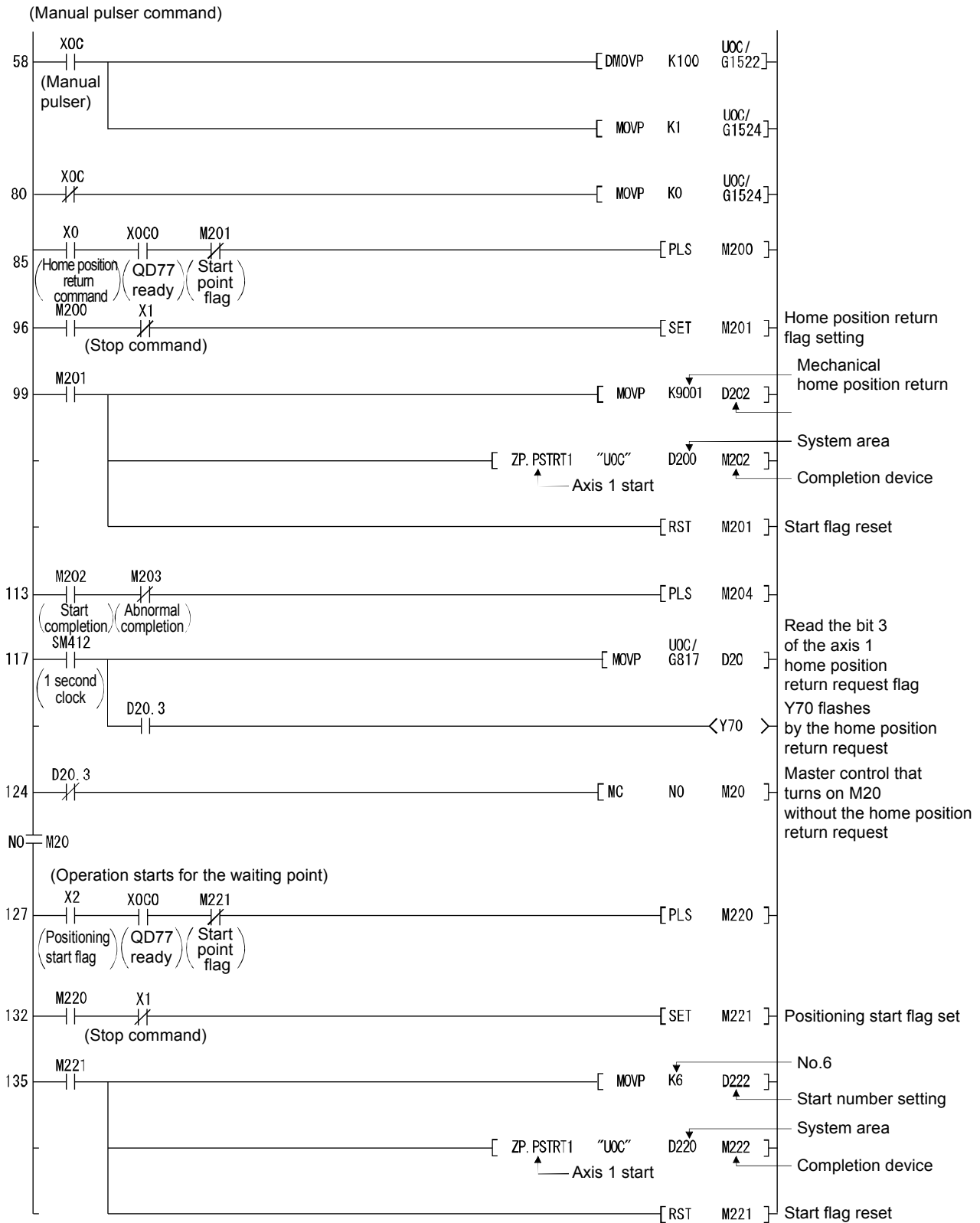

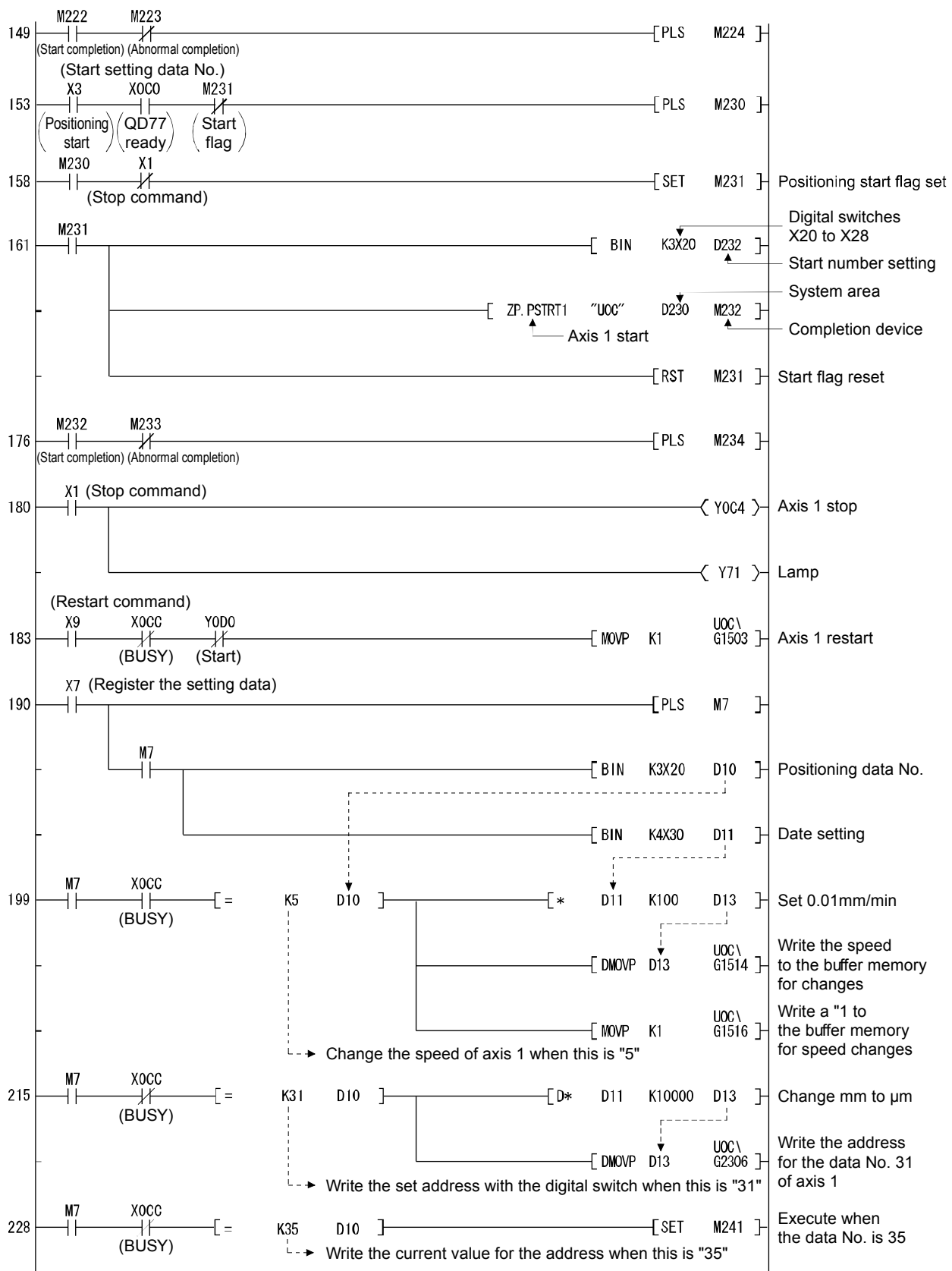

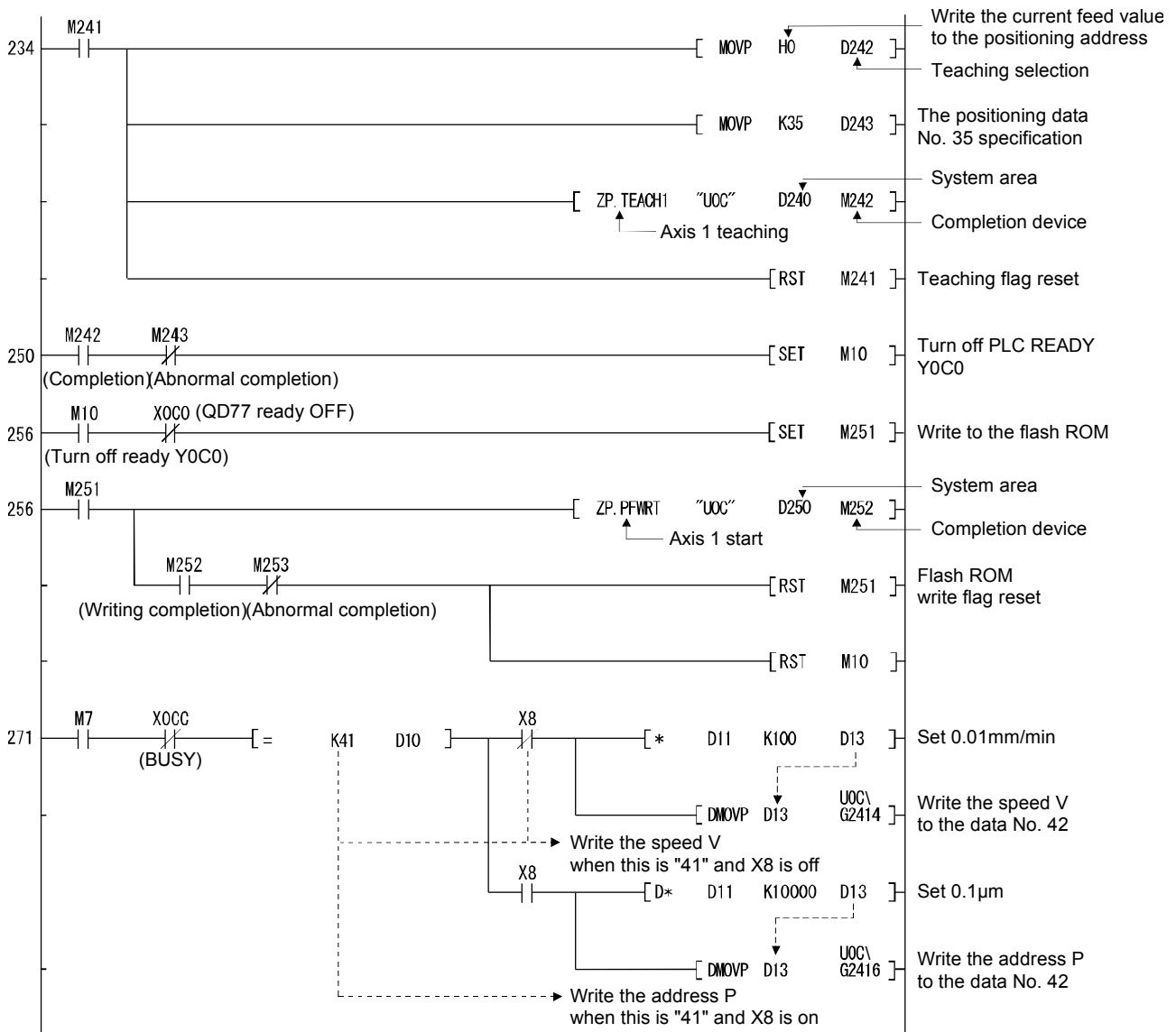

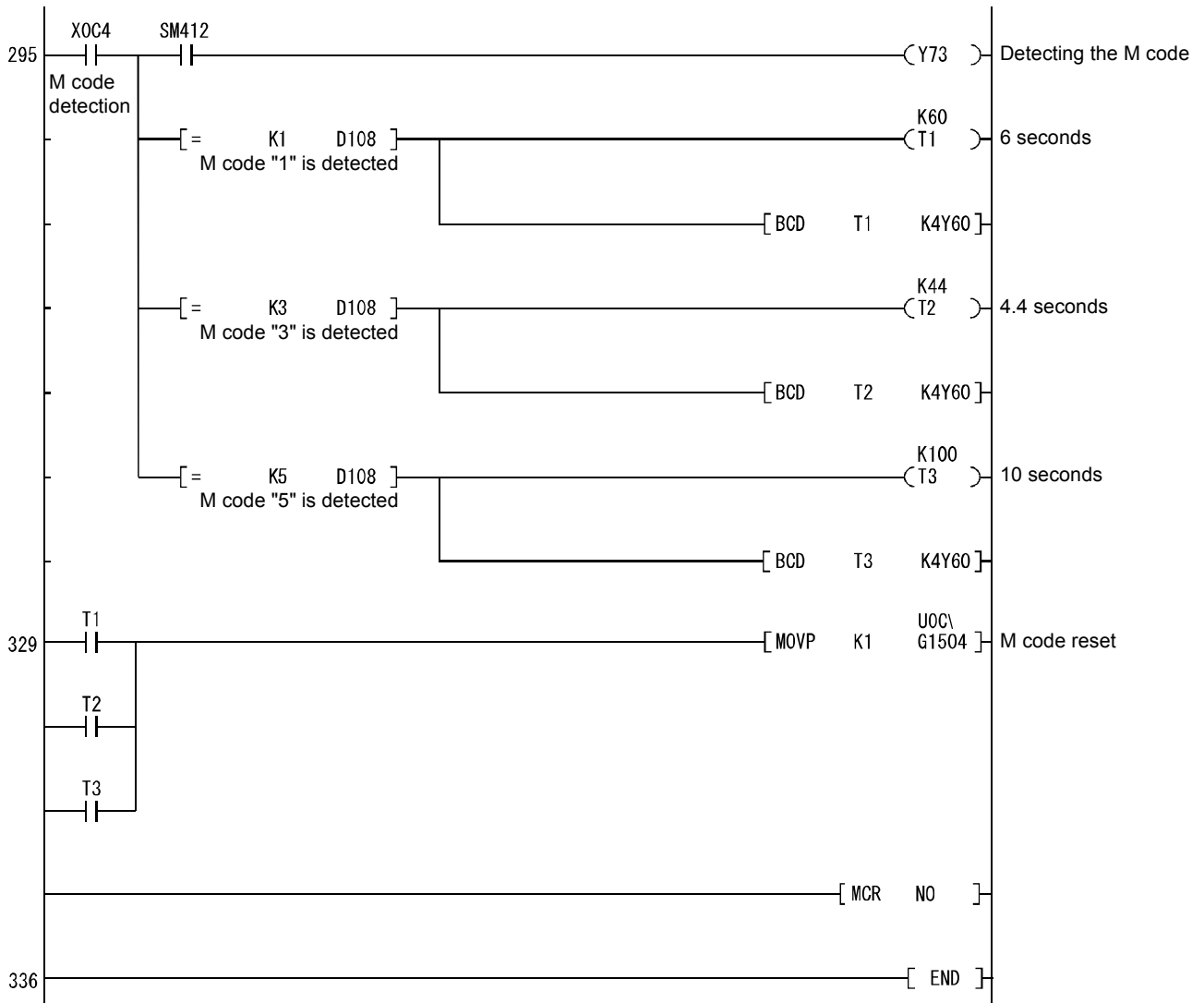

6.7 Monitoring buffer memory with GX Works2

QD77MS buffer memory areas can be monitored directly from GX Works2.

Demonstration machine operations

1. Select [Online] → [Monitor] → [Device/Buffer Memory Batch] from the menu of GX Works2.
2. The Device/Buffer Memory Batch Monitor dialog box is displayed.
3. Specify the buffer memory address.

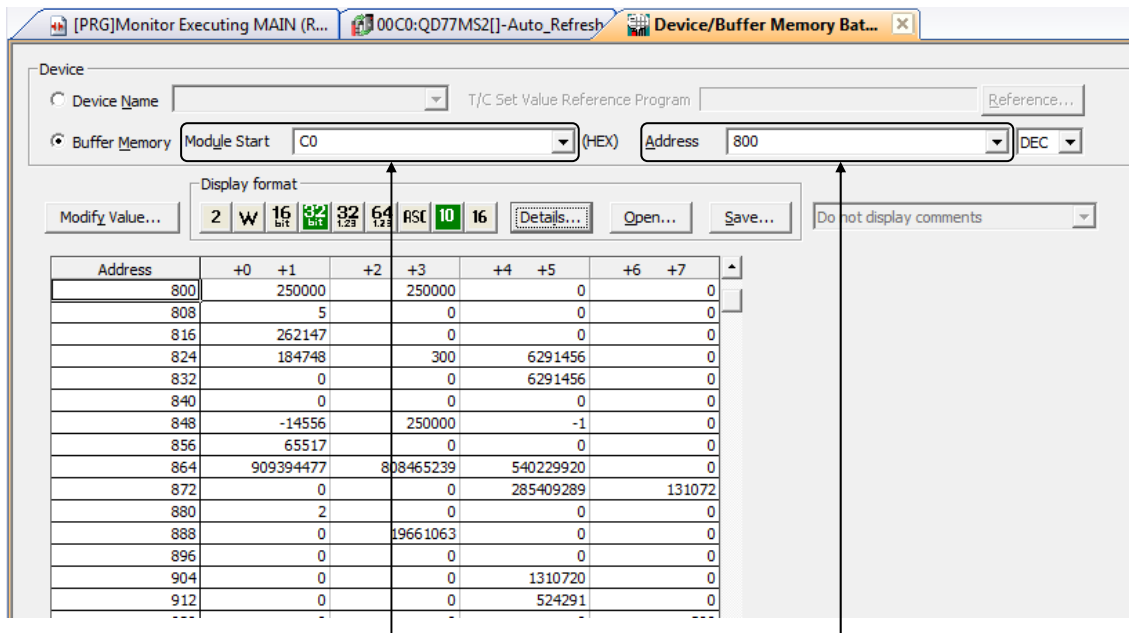

Set the module start I/O numbers of the destination monitor. Select "C0".

Set the buffer memory address to be monitored.

4. Click the **Details** button to change the display format.

Select the bit format or the word format depending on the buffer memory to be monitored.

Select "32-bit Integer" for the double-word format.

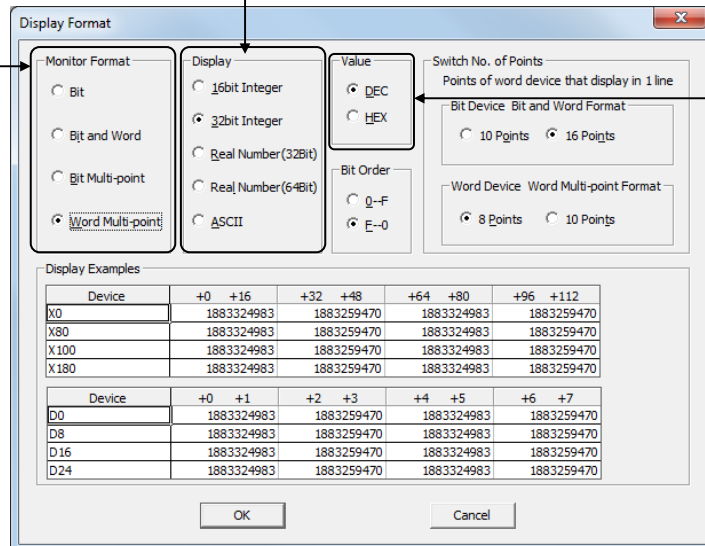

Select Dec for the word format.

CHAPTER 7 Training (3) 2-axis positioning operation with the sequence program (QD77MS2)

7.1 Positioning operation system with XY axes control (SSCNET III/H)

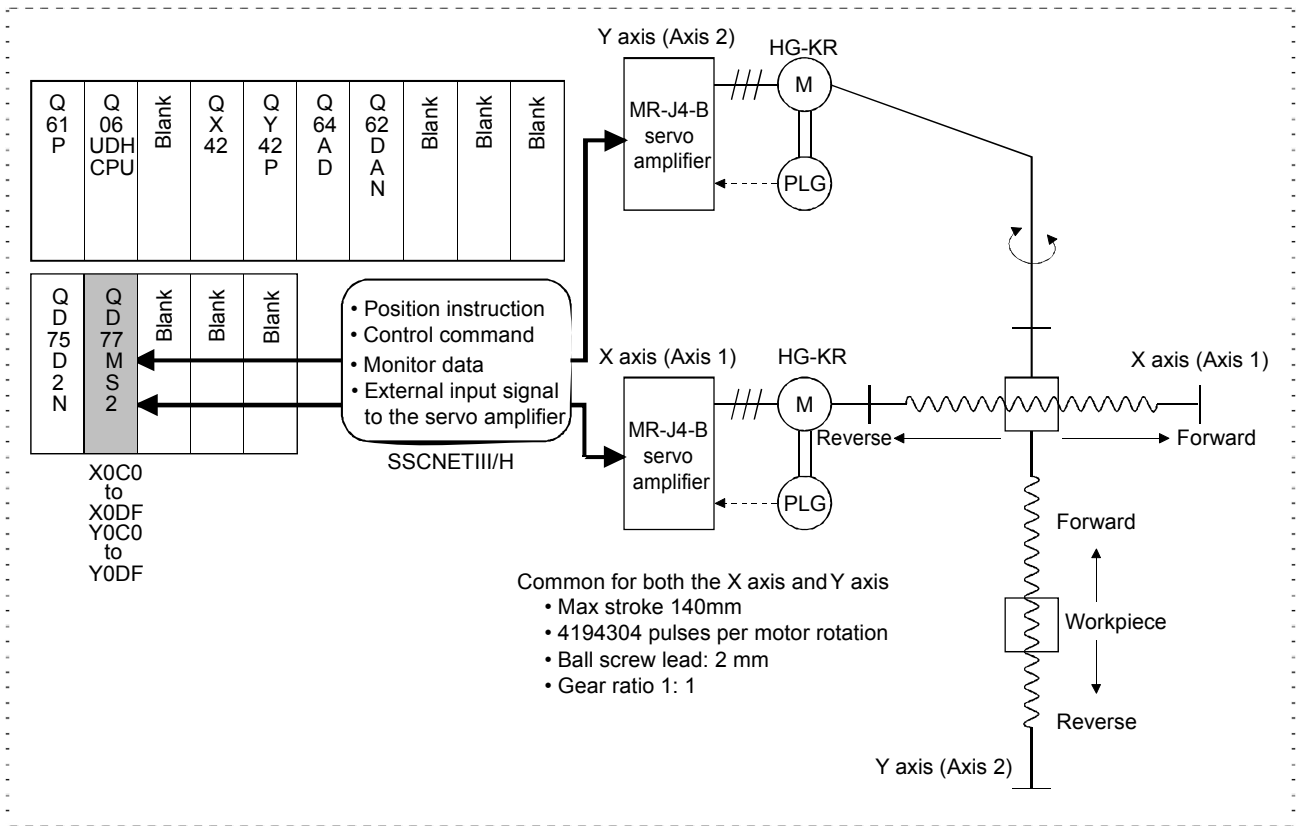

(1) Meaning of interpolation control

In "2-axis linear interpolation control", "3-axis linear interpolation control", "4-axis linear interpolation control", "2-axis fixed-feed control", "3-axis fixed-feed control", "4-axis fixed-feed control", "2-axis speed control", "3-axis speed control", "4-axis speed control", and "2-axis circular interpolation control", control is carried out so that linear and arc paths are drawn using a motor set in two to four axis directions. This kind of control is called "interpolation control".

In interpolation control, the axis in which the control system is set is defined as the "reference axis", and the other axis is defined as the "interpolation axis".

The Simple Motion module controls the "reference axis" following the positioning data set in the "reference axis", and controls the "interpolation axis" corresponding to the reference axis control so that a linear or arc path is drawn.

The following table shows the reference axis and interpolation axis combinations.

Interpolation of "Da.2 Control system"	Axis definition		QD77MS2		QD77MS4		QD77MS16		
	Reference axis	Interpolation axis	Reference axis	Interpolation axis	Reference axis	Interpolation axis	Reference axis	Interpolation axis	
2-axis linear interpolation control 2-axis fixed-feed control 2-axis circular interpolation control 2-axis speed control	Any of axes 1 to 2	"Axis to be interpolated" set in reference axis	Any of axes 1 to 4	"Axis to be interpolated" set in reference axis	Any of axes 1 to 16	"Axis to be interpolated No.1" set in reference axis			
3-axis linear interpolation control 3-axis fixed-feed control 3-axis speed control	—		Axis 1	Axis 2, Axis 3		"Axis to be interpolated No.1" and "Axis to be interpolated No.2" set in reference axis			
	—		Axis 2	Axis 3, Axis 4					
	—		Axis 3	Axis 4, Axis 1					
4-axis linear interpolation control 4-axis fixed-feed control 4-axis speed control	—		Axis 4	Axis 1, Axis 2					
	—		Axis 1	Axis 2, Axis 3, Axis 4					
	—		Axis 2	Axis 3, Axis 4, Axis 1					
	—		Axis 3	Axis 4, Axis 1, Axis 2					
—		Axis 4	Axis 1, Axis 2, Axis 3			"Axis to be interpolated No.1", "Axis to be interpolated No.2" and "Axis to be interpolated No.3" set in reference axis			

(2) Starting the interpolation control

The positioning data Numbers. of the reference axis (axis in which interpolation control was set in "[Da.2] Control system") are started when starting the interpolation control. (Starting of the interpolation axis is not required.)

The following errors or warnings will occur and the positioning will not start if both reference axis and the interpolation axis are started.

- Reference axis : Interpolation while interpolation axis BUSY (error code: 519)
- Interpolation axis : Control system setting error (error code: 524), start during operation (warning code: 100).

(3) Interpolation control continuous positioning

When carrying out interpolation control in which "continuous positioning control" and "continuous path control" are designated in the operation pattern, the positioning method for all positioning data from the started positioning data to the positioning data in which "positioning complete" is set must be set to interpolation control.

The number of the interpolation axes and axes to be interpolated cannot be changed from the intermediate positioning data. When the number of the interpolation axes and axes to be interpolated are changed, an error "Control system setting error" (error code: 524) will occur and the positioning will stop.

(4) Speed during interpolation control

Either the "composite speed" or "reference axis speed" can be designated as the speed during interpolation control.

([Pr.20] Interpolation speed designation method)

Only the "Reference axis speed" can be designated in the following interpolation control.

When a "composite speed" is set and positioning is started, the "Interpolation mode error (error code: 523)" occurs, and the system will not start.

- 4-axis linear interpolation
- 2-axis speed control
- 3-axis speed control
- 4-axis speed control

(5) Cautions in interpolation control

(a) If either of the axes exceeds the "[Pr.8] Speed limit value" in the 2- to 4-axes speed control, the axis which exceeded the speed limit value is controlled by the speed limit value.

For the other axes which perform interpolation, the speed can be suppressed by the ratio of a command speed.

If the reference axis exceeds "[Pr.8] Speed limit value" during 2- to 4-axis linear interpolation control, 2- to 4-axis fixed-feed control or 2-axis circular interpolation control, the reference axis is controlled at the speed limit value.

(The speed limit does not function on the interpolation axis side.)

(b) In 2-axis interpolation, you cannot change the combination of interpolated axes midway through operation.

POINT
When the "reference axis speed" is set during interpolation control, set so the major axis side becomes the reference axis. If the minor axis side is set as the reference axis, the major axis side speed may exceed the "[Pr.8] Speed limit value".

(6) Limits to interpolation control

There are limits to the interpolation control that can be executed and speed ([Pr.20] Interpolation speed designation method) that can be set, depending on the "[Pr.1] Unit setting" of the reference axis and interpolation axis. (For example, circular interpolation control cannot be executed if the reference axis and interpolation axis units differ.)

The following table shows the interpolation control and speed designation limits.

[Da.2] Control system" interpolation control	[Pr.20] Interpolation speed designation method	[Pr.1] Unit setting *1	
		Reference axis and interpolation axis units are the same, or a combination of "mm" and "inch". *3	Reference axis and interpolation axis units differ *3
Linear 2 (ABS, INC) Fixed-feed 2	Composite speed	○	×
	Reference axis speed	○	○
Circular sub (ABS, INC) Circular right (ABS, INC) Circular left (ABS, INC)	Composite speed	○ ^{*2}	×
	Reference axis speed	×	×
Linear 3 (ABS, INC) Fixed-feed 3	Composite speed	○	×
	Reference axis speed	○	○
Linear 4 (ABS, INC) Fixed-feed 4	Composite speed	×	×
	Reference axis speed	○	○

○ : Setting possible, × : Setting not possible.

*1 : "mm" and "inch" unit mix possible.

When "mm" and "inch" are mixed, convert as follows for the positioning.

- If interpolation control units are "mm", positioning is controlled by calculating position commands from the address, travel value, positioning speed and electronic gear, which have been converted to "mm" using the formula: inch setting value × 25.4 = mm setting value.
- If interpolation control units are "inch", positioning is controlled by calculating position commands from the address, travel value, positioning speed and electronic gear, which have been converted to "inch" using the formula: mm setting value ÷ 25.4 = inch setting value.

*2 : "degree" setting not possible. A "Circular interpolation not possible (error code: 535)" will occur and the positioning control does not start if circular interpolation control is set when the unit is "degree". The machine will immediately stop if "degree" is set during positioning control.

*3 : The unit set in the reference axis will be used for the speed unit during control if the units differ or if "mm" and "inch" are combined.

(7) Axis operation status during interpolation control

"Interpolation" will be stored in the "[Md.26] Axis operation status" during interpolation control. "Standby" will be stored when the interpolation operation is terminated.

Both the reference axis and interpolation axis will carry out a deceleration stop if an error occurs during control, and "Error" will be stored in the operation status.

7.2 Axis 1 and axis 2 parameters and OPR parameters

The interpolation speed is a composite speed from the initial value in detailed parameter 1.

Reference Section 4.1 "Parameters", Section 4.2 "OPR parameters", Section 4.3 "Servo parameters"

Project name	XY
--------------	----

<<Parameters>>

Item	Axis #1	Axis #2
Basic parameters 1	Set according to the machine and applicable motor when system is started up. (This parameter become valid when the PLC READY signal [Y0] turns from OFF to ON.)	
Pr. 1:Unit setting	0:mm	0:mm
Pr. 2:No. of pulses per rotation	4194304 PLS	4194304 PLS
Pr. 3:Movement amount per rotation	2000.0 μm	2000.0 μm
Pr. 4:Unit magnification	1:x1 Times	1:x1 Times
Pr. 7:Bias speed at start	0.00 mm/min	0.00 mm/min
Basic parameters 2	Set according to the machine and applicable motor when system is started up.	
Pr. 8:Speed limit value	6000.00 mm/min	6000.00 mm/min
Pr. 9:Acceleration time 0	100 ms	100 ms
Pr. 10:Deceleration time 0	100 ms	100 ms

Item	Axis #1	Axis #2
Detailed parameters 1	Set according to the system configuration when the system is started up. (This parameter become valid when the PLC READY signal [Y0] turns from OFF to ON)	
Pr. 11:Backlash compensation amount	0.0 μm	0.0 μm
Pr. 12:Software stroke limit upper limit value	214748364.7 μm	214748364.7 μm
Pr. 13:Software stroke limit lower limit value	-214748364.8 μm	-214748364.8 μm
Pr. 14:Software stroke limit selection	0:Set Software Stroke Limit to Current Feed Value	0:Set Software Stroke Limit to Current Feed Value
Pr. 15:Software stroke limit valid/invalid setting	0:Valid	0:Valid
Pr. 16:Command in-position width	10.0 μm	10.0 μm
Pr. 17:Torque limit setting value	300 %	300 %
Pr. 18:M code ON signal output timing	1:AFTER Mode	0:WITH Mode
Pr. 19:Speed switching mode	0:Standard Speed Switching Mode	0:Standard Speed Switching Mode
Pr. 20:Interpolation speed designation method	0:Composite Speed	0:Composite Speed
Pr. 21:Current feed value during speed control	0:Not Update of Current Feed Value	0:Not Update of Current Feed Value
Pr. 22:Input signal logic selection : Lower limit	0:Negative Logic	0:Negative Logic
Pr. 22:Input signal logic selection : Upper limit	0:Negative Logic	0:Negative Logic
Pr. 22:Input signal logic selection : Stop signal	0:Negative Logic	0:Negative Logic
Pr. 22:Input signal logic selection : External command/switching signal	0:Negative Logic	0:Negative Logic
Pr. 22:Input signal logic selection : Near-point dog signal	0:Negative Logic	0:Negative Logic
Pr. 22:Input signal logic selection : Manual pulse generator input	0:Negative Logic	
Pr. 80:External input signal selection	0:Use External Input Signal of QD77MS	0:Use External Input Signal of QD77MS
Pr. 24:Manual pulse generator/Incremental Sync. ENC input selection	0:A-phase/B-phase Mode (4 Multiply)	
Pr. 81:Speed-position function selection	0:Speed-Position Switching Control (INC Mode)	0:Speed-Position Switching Control (INC Mode)
Pr. 82:Forced stop valid/invalid selection	1:Invalid	

Item	Axis #1	Axis #2
Detailed parameters 2	Set according to the system configuration when the system is started up. (Set as required.)	
Pr.25:Acceleration time 1	1000 ms	1000 ms
Pr.26:Acceleration time 2	1000 ms	1000 ms
Pr.27:Acceleration time 3	1000 ms	1000 ms
Pr.28:Deceleration time 1	1000 ms	1000 ms
Pr.29:Deceleration time 2	1000 ms	1000 ms
Pr.30:Deceleration time 3	1000 ms	1000 ms
Pr.31:JOG speed limit value	4000.00 mm/min	4000.00 mm/min
Pr.32:JOG operation acceleration time selection	0:100	0:100
Pr.33:JOG operation deceleration time selection	0:100	0:100
Pr.34:Acceleration/deceleration process selection	0:Trapezoidal Acceleration/Deceleration Process	0:Trapezoidal Acceleration/Deceleration Process
Pr.35:S-curve ratio	100 %	100 %
Pr.36:Sudden stop deceleration time	1000 ms	1000 ms
Pr.37:Stop group 1 sudden stop selection	0:Normal Deceleration Stop	0:Normal Deceleration Stop
Pr.38:Stop group 2 sudden stop selection	0:Normal Deceleration Stop	0:Normal Deceleration Stop
Pr.39:Stop group 3 sudden stop selection	0:Normal Deceleration Stop	0:Normal Deceleration Stop
Pr.40:Positioning complete signal output time	300 ms	300 ms
Pr.41:Allowable circular interpolation error width	10.0 μm	10.0 μm
Pr.42:External command function selection	0:External Positioning Start	0:External Positioning Start
Pr.83:Speed control 10x multiplier setting for degree axis	0:Invalid	0:Invalid
Pr.84:Restart allowable range when servo OFF to ON	0 PLS	0 PLS
Pr.89:Manual pulse generator/Incremental Sync. ENC input type selection	1:Voltage Output/Open Collector Type	
Pr.90:Operation setting for SPD-TRQ Cont. mode : Torque initial value selection	0:Command Torque	0:Command Torque
Pr.90:Operation setting for SPD-TRQ Cont. mode : Speed initial value selection	0:Command Speed	0:Command Speed
Pr.90:Operation setting for SPD-TRQ Cont. mode : Condition selection at mode switching	0:Switching Conditions Valid at Mode Switching	0:Switching Conditions Valid at Mode Switching

Item	Axis #1	Axis #2
OPR basic parameters	Set the values required for carrying out OPR control. (This parameter become valid when the PLC READY signal [Y0] turns from OFF to ON)	
Pr.43:OPR method	0:Near-point Dog Method	0:Near-point Dog Method
Pr.44:OPR direction	1:Reverse Direction (Address Decrease Direction)	1:Reverse Direction (Address Decrease Direction)
Pr.45:OP address	0.0 μm	0.0 μm
Pr.46:OPR speed	1000.00 mm/min	1000.00 mm/min
Pr.47:Creep speed	300.00 mm/min	300.00 mm/min
Pr.48:OPR retry	1:Retry OPR with Limit Switch	1:Retry OPR with Limit Switch
OPR detailed parameters	Set the values required for carrying out OPR control. (This parameter become valid when the PLC READY signal [Y0] turns from OFF to ON)	
Pr.50:Setting for the movement amount after near-point dog ON	0.0 μm	0.0 μm
Pr.51:OPR acceleration time selection	0:100	0:100
Pr.52:OPR deceleration time selection	0:100	0:100
Pr.53:OP shift amount	0.0 μm	0.0 μm
Pr.54:OPR torque limit value	300 %	300 %
Pr.55:Operation setting for incompletion of OPR	0:Positioning Control is Not Executed	0:Positioning Control is Not Executed
Pr.56:Speed designation during OP shift	0:OPR Speed	0:OPR Speed
Pr.57:Dwell time during OPR retry	0 ms	0 ms
Pr.86:Pulse conversion unit : OPR request setting	0:Turn OPR Request ON at Servo OFF	0:Turn OPR Request ON at Servo OFF
Pr.87:Pulse conversion unit : Waiting time after clear signal output	0 ms	0 ms
Expansion parameters	Set according to the system configuration when the system is started up. (This parameter become valid after ...)	
Pr.91:Optional data monitor : Data type setting 1	0:No Setting	0:No Setting
Pr.92:Optional data monitor : Data type setting 2	0:No Setting	0:No Setting
Pr.93:Optional data monitor : Data type setting 3	0:No Setting	0:No Setting
Pr.94:Optional data monitor : Data type setting 4	0:No Setting	0:No Setting
Pr.96:Operation cycle setting	0:0.88ms	
Pr.97:SSCNET Setting	1:SSCNET III/H	
Pr.114:External command signal compensation valid/invalid setting	0:Invalid	

7.3 Sequence program for 2-axis control

The sequence program for controlling two axes including the PLC READY, error code reading/resetting, current value reading, JOG operation, home position return, and positioning data No. operation start is shown below.

Auto refresh setting		
Current feed value	Axis 1 D100	Axis 2 D110
X0: Home position return command		Y70: Home position return request
X1: Stop command		Y71: Commanding stop
X2: Movement to the waiting point		Y72: —
X3: Circular interpolation command		Y73: —
X4: Forward run JOG command		Y74: Forward running JOG
X5: Reverse run JOG command		Y75: Reverse running JOG
X6: 2-axis independent operation		Y76: —
X7: 2-axis interpolation operation		Y77: Error occurred
X8: 2-axis interpolation operation 2		
X9: Operation restart command	M300 to M389	} Used for QD77 dedicated commands
X0A: Circular interpolation command 2	D300 to D389	
X0B: Error reset command		

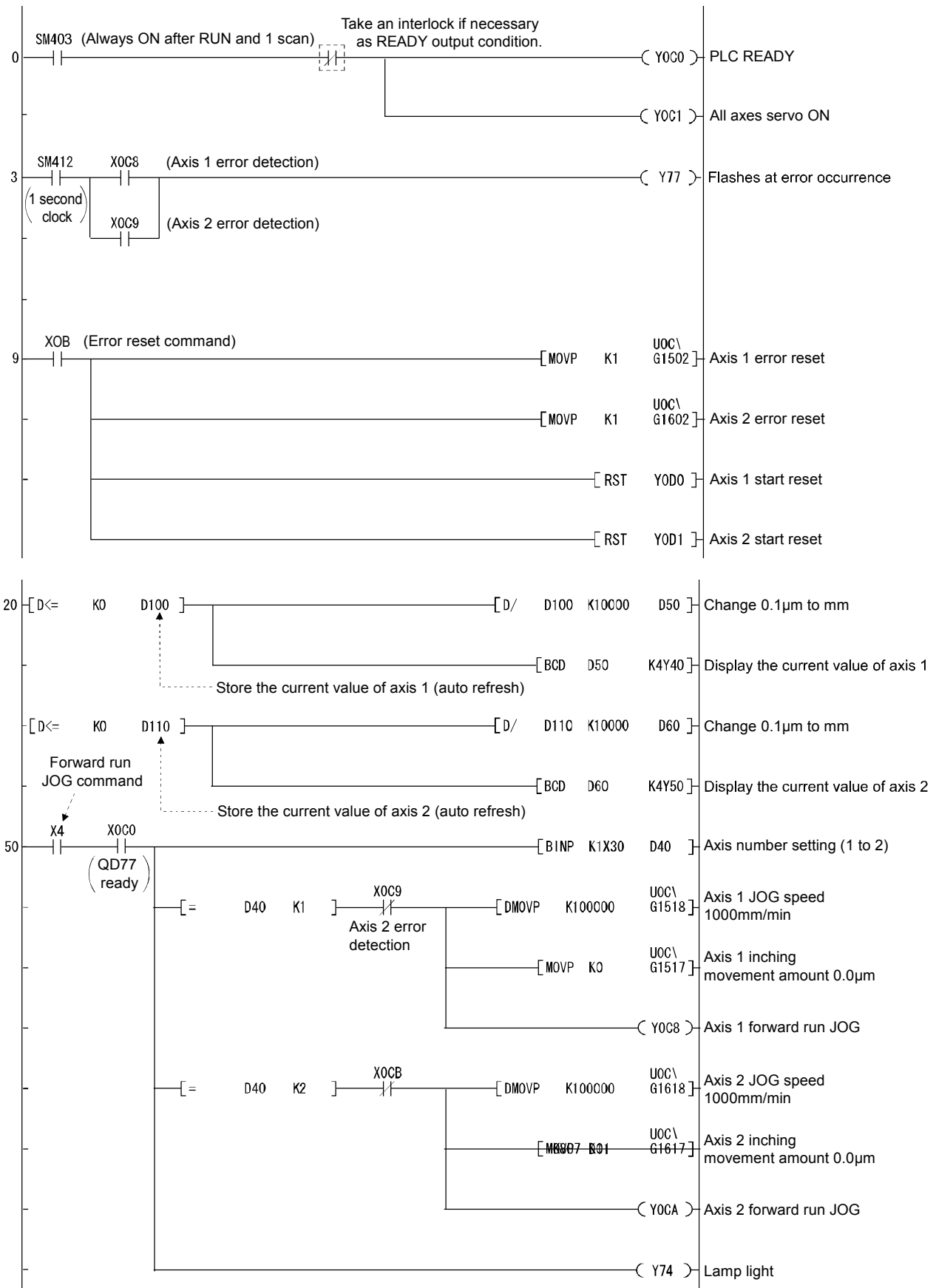

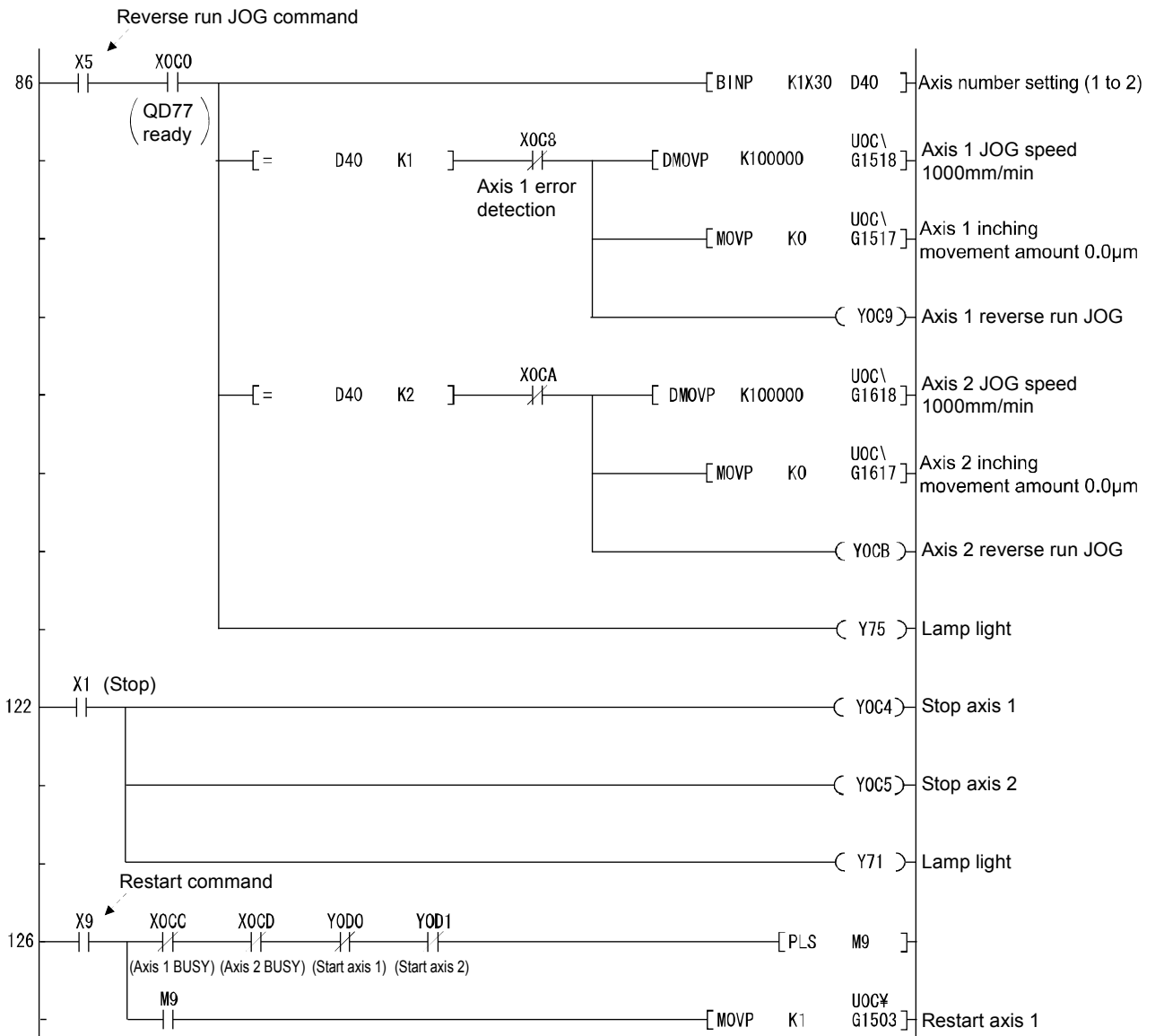

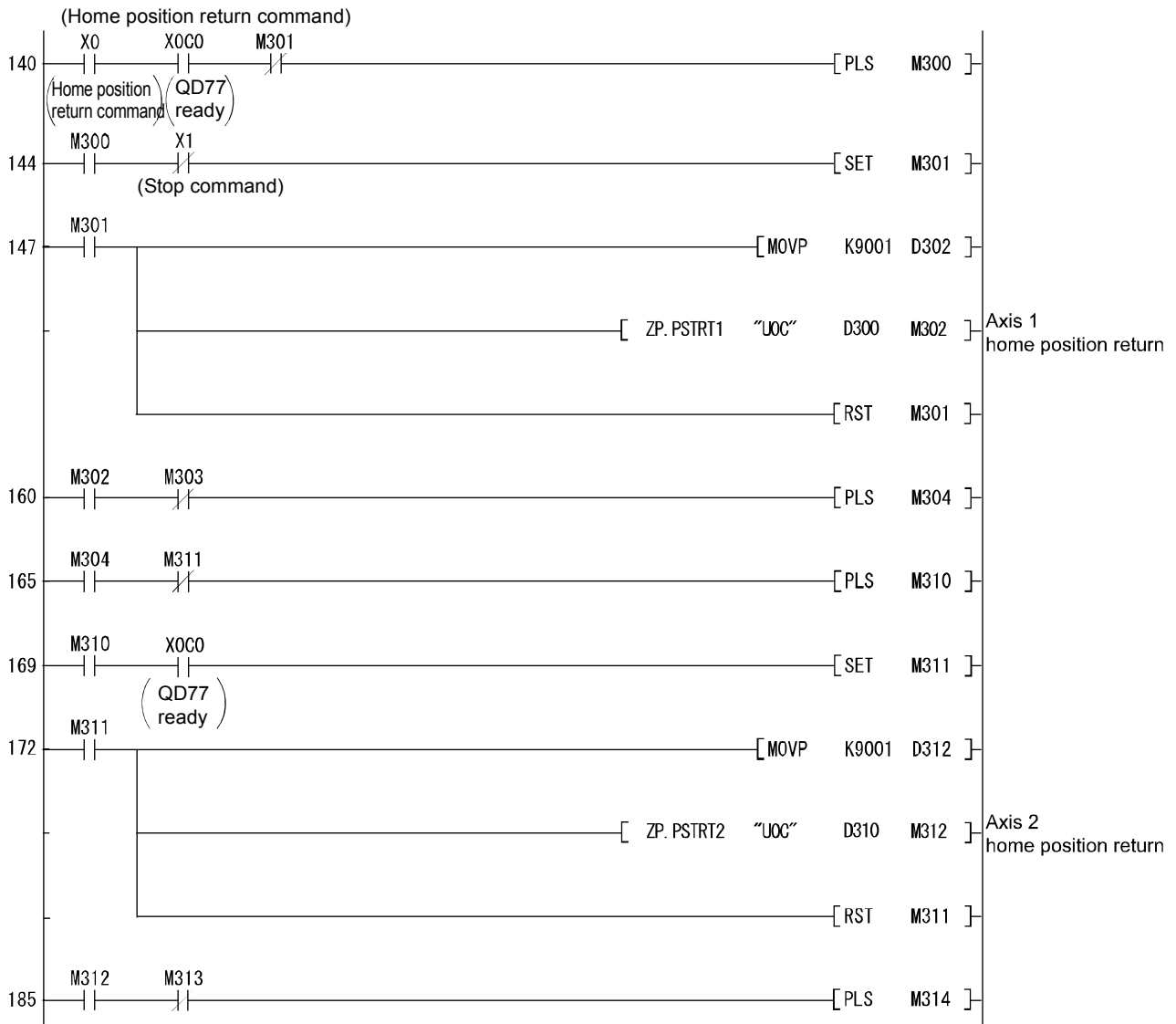

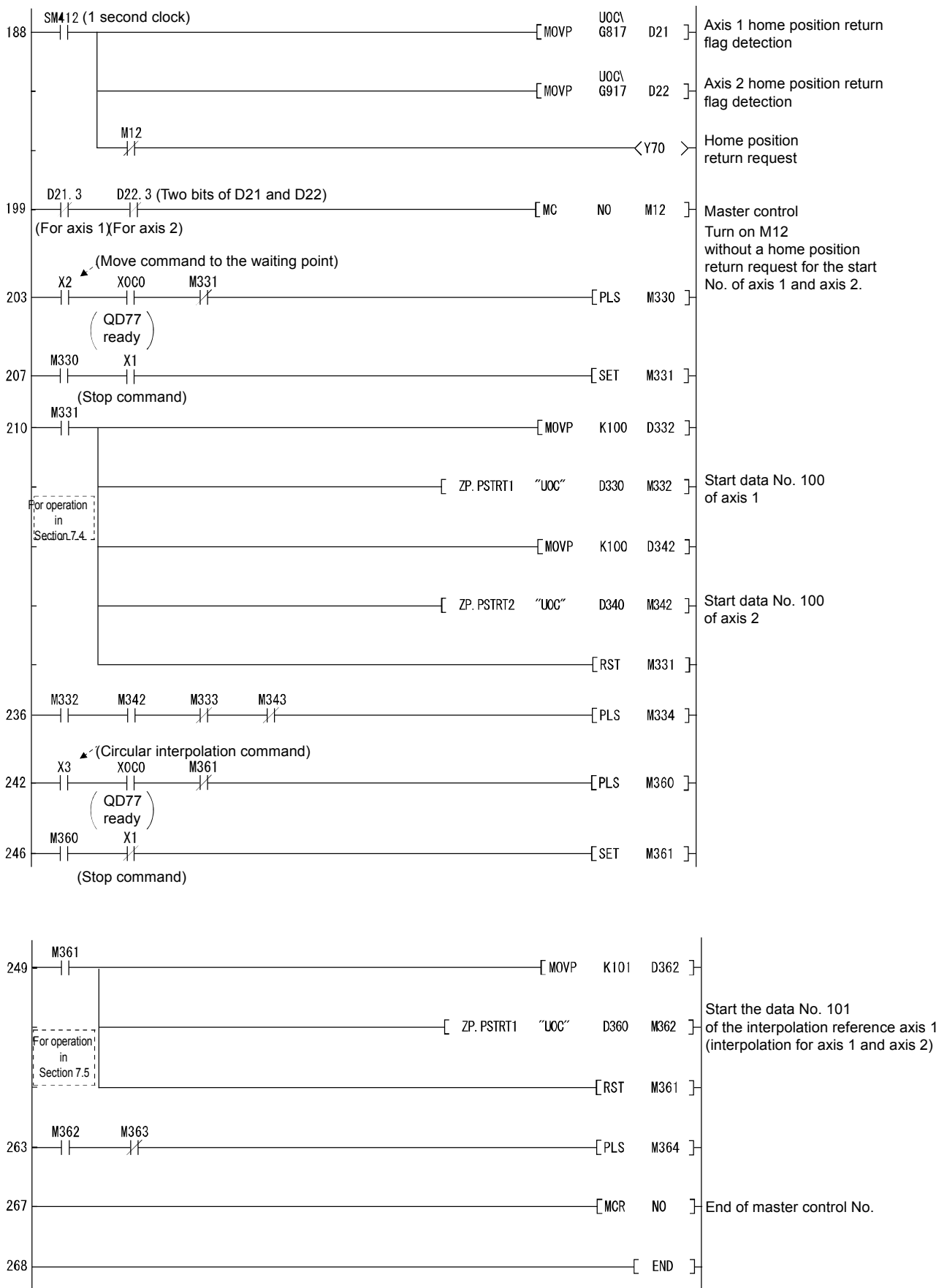

7.4 Positioning to the waiting point by independent operation of each axis

Axis 1 and axis 2 are independently operated by the ABS linear 1 control method.

<Operation description>

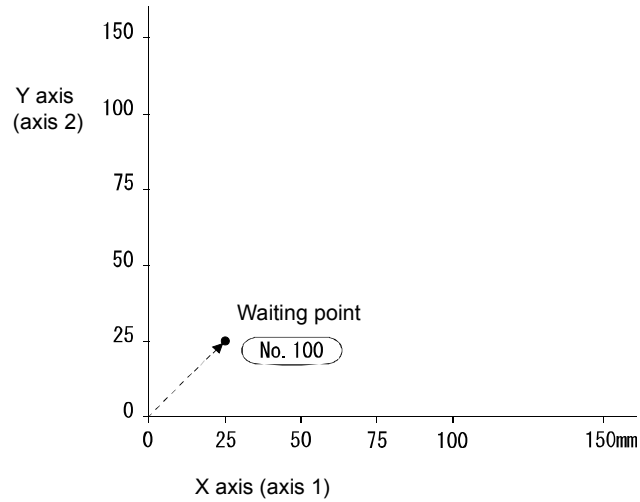

00C0:QD77MS2 → Axis 1 positioning data (independent axis)

No.	Operation pattern	Control method	Interpolation axis	Acceleration time No.	Deceleration time No.	Positioning address [μm]	Arc address [μm]	Command speed [mm/min]	Dwell time [ms]	M code	Positioning data comments
100	0: Finish	1: ABS linear 1	—	0:100	0:100	25000.0	0.0	2000.00	0	0	

00C0:QD77MS2 → Axis 2 positioning data (independent axis)

No.	Operation pattern	Control method	Interpolation axis	Acceleration time No.	Deceleration time No.	Positioning address [μm]	Arc address [μm]	Command speed [mm/min]	Dwell time [ms]	M code	Positioning data comments
100	0: Finish	1: ABS linear 1	—	0:100	0:100	25000.0	0.0	2000.00	0	0	

Demonstration machine operations

- 1) The data types (the sequence program, the parameters, and the positioning data) are

Project name	XY
--------------	----

Read from the folder and write to the QD77MS2.

- 2) Turning on X0 starts the home position return in order of axis 1 to axis 2.
- 3) Turning on X2 performs the positioning to the waiting point of the positioning data No. 100 (25mm) for both axis 1 and axis 2.
(The current value becomes 25000.0μm)

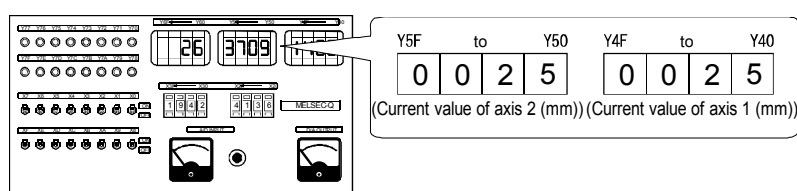

<Movement of the X-Y table unit>

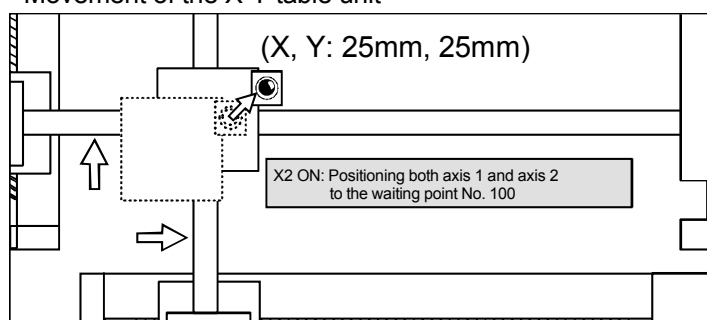

7.5 Interpolation operation (Axis 1/axis 2)

Perform the 2-axis linear interpolation between axis 1 and axis 2 and the 2-axis circular interpolation.

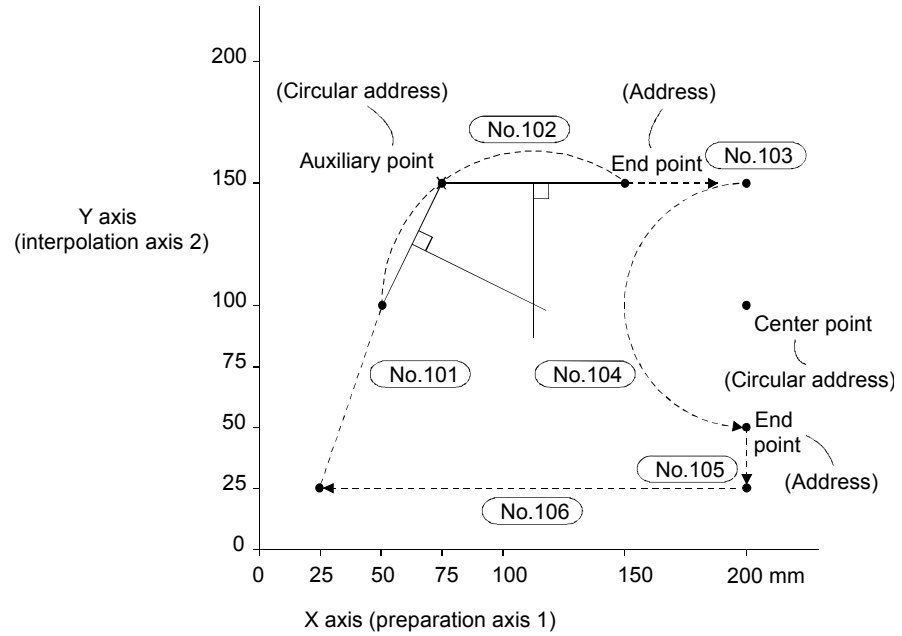

<Operation description>





Positioning data No. from 1 to 600 are supported, but the initial range of data No. to be displayed in the screen is set for No. 1 to 100.

Use the following procedure to select the range to display data No. 100 or later.

From the Simple Motion Module Setting Tool, select [Tools] → [Options] → [Positioning Data], and set the range selection.

 00C0:QD77MS2 →  Axis 1 positioning data (reference axis)

No.	Operation pattern	Control method	Interpolation axis	Acceleration time No.	Deceleration time No.	Positioning address [μm]	Arc address [μm]	Command speed [mm/min]	Dwell time [ms]	M code	Positioning data comments
101	1: Continuous	A: ABS linear 2	Axis 2	0:100	0:100	50000.0	0.0	5000.00	700	0	
102	1: Continuous	D: ABS circular interpolation	Axis 2	0:100	0:100	120000.0	60000.0	3000.00	700	0	
103	1: Continuous	A: ABS linear 2	Axis 2	0:100	0:100	140000.0	0.0	1000.00	700	0	
104	3: Path	10h: ABS circular left	Axis 2	0:100	0:100	140000.0	140000.0	4000.00	0	0	
105	3: Path	A: ABS linear 2	Axis 2	0:100	0:100	140000.0	0.0	2000.00	0	0	
106	0: Finish	A: ABS linear 2	Axis 2	0:100	0:100	25000.0	0.0	6000.00	0	0	

 00C0:QD77MS2 →  Axis 2 positioning data (interpolation axis)

No.	Operation pattern	Control method	Interpolation axis	Acceleration time No.	Deceleration time No.	Positioning address [μm]	Arc address [μm]	Command speed [mm/min]	Dwell time [ms]	M code	Positioning data comments
101						75000.0	0.0	0.00			
102						120000.0	120000.0	0.00			
103						120000.0	0.0	0.00			
104						40000.0	80000.0	0.00			
105						25000.0	0.0	0.00			
106						25000.0	0.0	0.00			

Demonstration machine operations

- 1) Turning X3 on will perform the interpolation operation between axis 1 and axis 2.
- 2) Turning on X1 during continuous operation stops the operation.
Turning on X9 restarts the operation.

<Movement of the X-Y table unit>

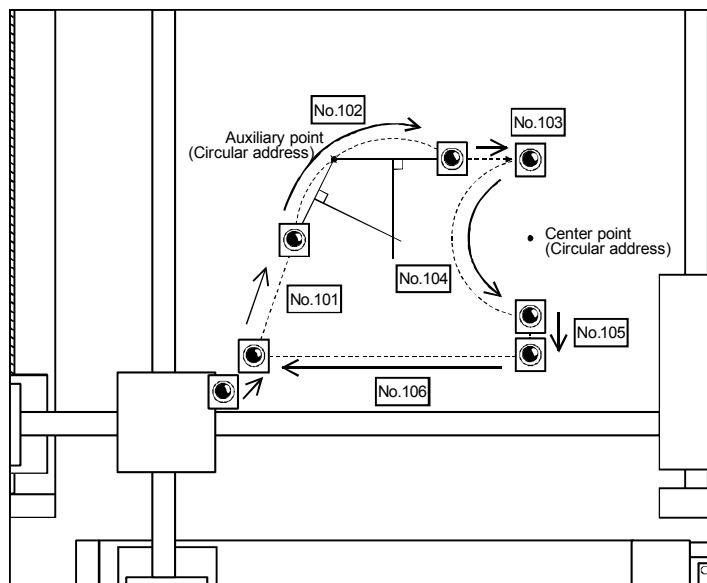

7.6 2-axis positioning operation using a path plate

Install a path plate to the control frame of the X-Y table unit, and confirm that the program performs the positioning correctly.

In this training, add the following program to the project "XY" to create the project "XY-2".

* Parameter settings are the same as those in Section 7.2.

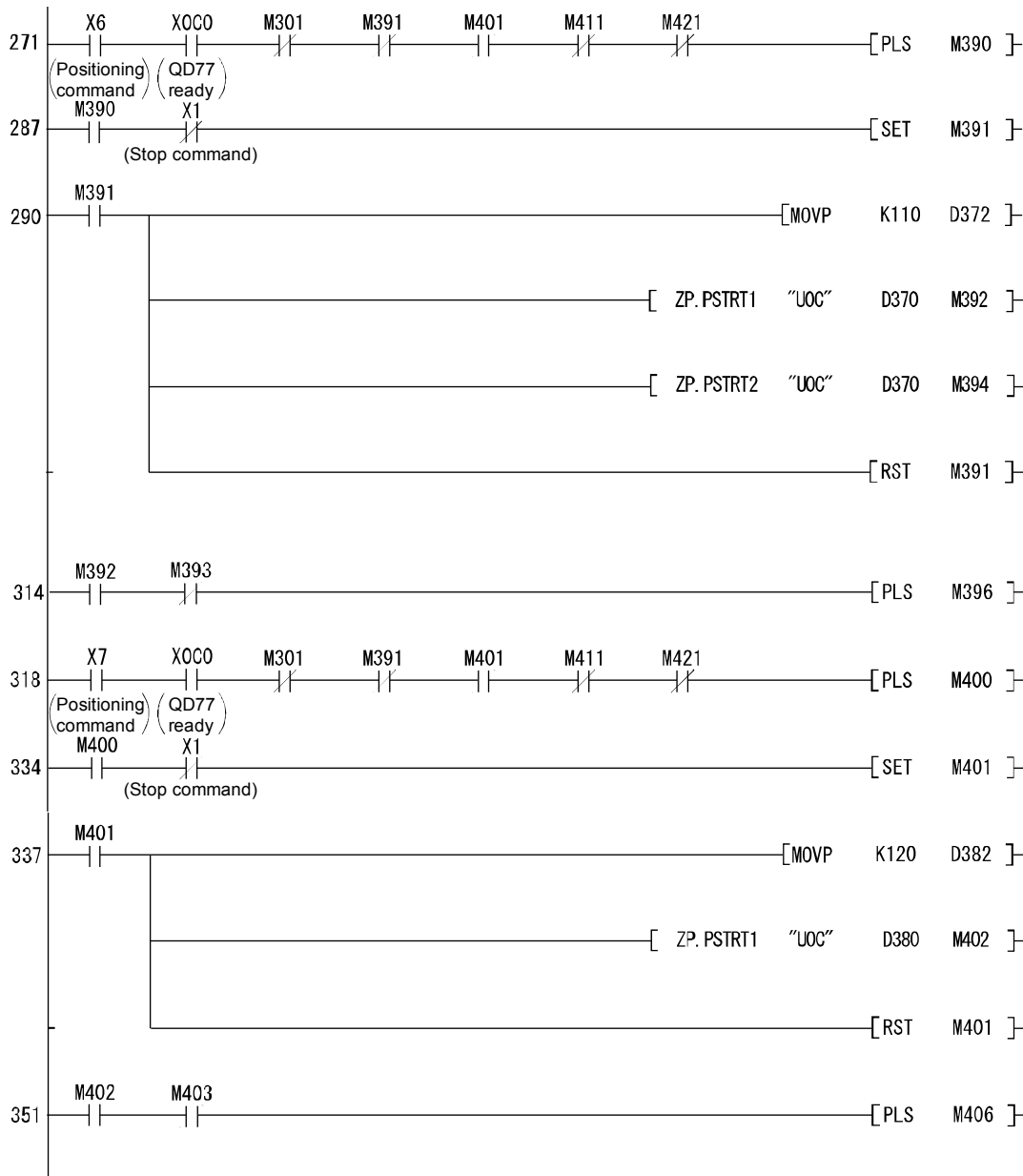

7.6.1 Exercise (1) Continuous positioning to the waiting point by independent operation of each axis → Interpolation operation 1

Axis 1 and axis 2 are independently and continuously operated by the ABS linear 1 control method.

<Operation description>

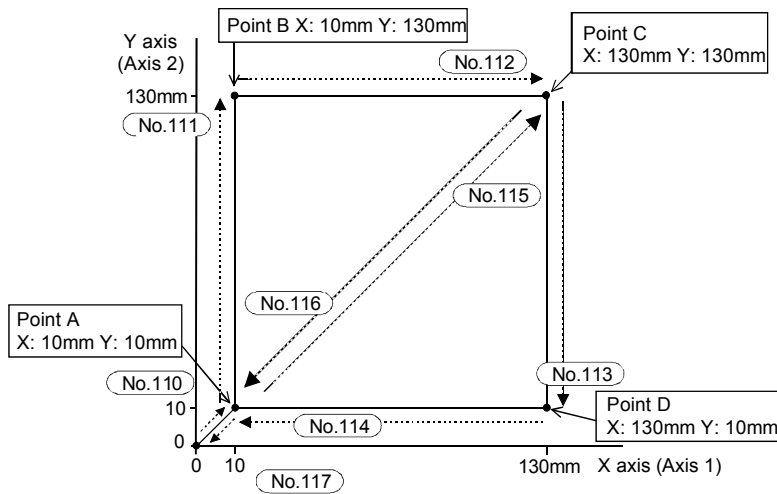

- [No. 110] The X axis and Y axis move simultaneously to the point A (Operation speed: 4000mm/min)
- [No. 111] Only the Y axis moves to the point B (Operation speed: 4000mm/min)
- [No. 112] Only the X axis moves to the point C (Operation speed: 4000mm/min)
- [No. 113] Only the Y axis moves to the point D (Operation speed: 4000mm/min)
- [No. 114] Only the X axis moves to the point A (Operation speed: 4000mm/min)
- [No. 115] The X axis and Y axis move simultaneously to the point C (Operation speed: 6000mm/min)
Stop for 3 seconds after positioning is completed
- [No. 116] The X axis and Y axis move simultaneously to the point A (Operation speed: 6000mm/min)
Stop for 3 seconds after positioning is completed
- [No. 117] The X and Y axes move simultaneously to the original point 0 (Operation speed: 0mm/min)

The positioning data for axis 1 and axis 2 used for this training are shown below.

00C0:QD77MS2 → Axis 1 positioning data (independent axis)

No.	Operation pattern	Control method	Interpolation axis	Acceleration time No.	Deceleration time No.	Positioning address [μm]	Arc address [μm]	Command speed [mm/min]	Dwell time [ms]	M code	Positioning data comments
110	1: Continuous	1: ABS linear 1	—	0:100	0:100	10000.0	0.0	4000.00	0	0	
111	1: Continuous	1: ABS linear 1	—	0:100	0:100	10000.0	0.0	4000.00	0	0	
112	1: Continuous	1: ABS linear 1	—	0:100	0:100	130000.0	0.0	4000.00	0	0	
113	1: Continuous	1: ABS linear 1	—	0:100	0:100	130000.0	0.0	4000.00	0	0	
114	1: Continuous	1: ABS linear 1	—	0:100	0:100	10000.0	0.0	4000.00	0	0	
115	1: Continuous	1: ABS linear 1	—	0:100	0:100	130000.0	0.0	6000.00	3000	0	
116	1: Continuous	1: ABS linear 1	—	0:100	0:100	10000.0	0.0	6000.00	3000	0	
117	0: Finish	1: ABS linear 1	—	0:100	0:100	0.0	0.0	2000.00	0	0	

00C0:QD77MS2 → Axis 1 positioning data (independent axis)

No.	Operation pattern	Control method	Interpolation axis	Acceleration time No.	Deceleration time No.	Positioning address [μm]	Arc address [μm]	Command speed [mm/min]	Dwell time [ms]	M code	Positioning data comments
110	1: Continuous	1: ABS linear 1	—	0:100	0:100	10000.0	0.0	4000.00	0	0	
111	1: Continuous	1: ABS linear 1	—	0:100	0:100	130000.0	0.0	4000.00	0	0	
112	1: Continuous	1: ABS linear 1	—	0:100	0:100	130000.0	0.0	4000.00	0	0	
113	1: Continuous	1: ABS linear 1	—	0:100	0:100	10000.0	0.0	4000.00	0	0	
114	1: Continuous	1: ABS linear 1	—	0:100	0:100	10000.0	0.0	4000.00	0	0	
115	1: Continuous	1: ABS linear 1	—	0:100	0:100	130000.0	0.0	6000.00	3000	0	
116	1: Continuous	1: ABS linear 1	—	0:100	0:100	10000.0	0.0	6000.00	3000	0	
117	0: Finish	1: ABS linear 1	—	0:100	0:100	0.0	0.0	2000.00	0	0	

Demonstration machine operations

- 1) The data types (the sequence program, the parameters, and the positioning data) are

Project name	XY-2
--------------	------

Read from the folder and write to the QD77MS2.

- 2) Turning on X0 starts the home position return in order of axis 1 to axis 2.
- 3) Turning on X6 does not perform the positioning for both axis 1 and axis 2 according to the operation description due to the positioning data Numbers. deviation caused by the continuous positioning of each axis.

Using the positioning data on the previous page as an example, the positioning address for No. 110 is the same, but for the positioning data No. 111, positioning of 130000.0 μ m is performed for only axis 2. However, axis 1 does not wait for the axis 2 positioning completion before starting the positioning for No. 112.

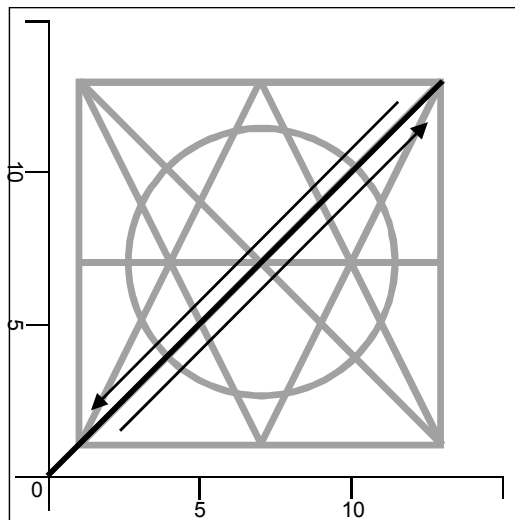

(Movement of the X-Y table when using the positioning data in P7-17)





The operation is repeatedly going back and forth in the same place as shown above.

To perform this positioning operation correctly, it is necessary to change from the independent operation of each axis to the interpolation operation.

4) Enter the positioning data below into the positioning data No. 120 to 127.

 00C0:QD77MS2 →  Axis 1 positioning data (reference axis)

No.	Operation pattern	Control method	Interpolation axis	Acceleration time No.	Deceleration time No.	Positioning address [μm]	Arc address [μm]	Command speed [mm/min]	Dwell time [ms]	M code	Positioning data comments
120	1: Continuous	A: ABS linear 2	Axis 2	0:100	0:100	10000.0	0.0	4000.00	0	0	
121	1: Continuous	A: ABS linear 2	Axis 2	0:100	0:100	10000.0	0.0	4000.00	0	0	
122	1: Continuous	A: ABS linear 2	Axis 2	0:100	0:100	130000.0	0.0	4000.00	0	0	
123	1: Continuous	A: ABS linear 2	Axis 2	0:100	0:100	130000.0	0.0	4000.00	0	0	
124	1: Continuous	A: ABS linear 2	Axis 2	0:100	0:100	10000.0	0.0	4000.00	0	0	
125	1: Continuous	A: ABS linear 2	Axis 2	0:100	0:100	130000.0	0.0	6000.00	3000	0	
126	1: Continuous	A: ABS linear 2	Axis 2	0:100	0:100	10000.0	0.0	6000.00	3000	0	
127	0: Finish	A: ABS linear 2	Axis 2	0:100	0:100	0.0	0.0	2000.00	0	0	

 00C0:QD77MS2 →  Axis 2 positioning data (interpolation axis)

No.	Operation pattern	Control method	Interpolation axis	Acceleration time No.	Deceleration time No.	Positioning address [μm]	Arc address [μm]	Command speed [mm/min]	Dwell time [ms]	M code	Positioning data comments
120						10000.0	0.0	0.00			
121						130000.0	0.0	0.00			
122						130000.0	0.0	0.00			
123						10000.0	0.0	0.00			
124						10000.0	0.0	0.00			
125						130000.0	0.0	0.00			
126						10000.0	0.0	0.00			
127						0.0	0.0	0.00			

5) After writing the data to the QD77MS2, turn on X0 and perform the home position return, then set the positioning data No. to 120 by the digital switch.

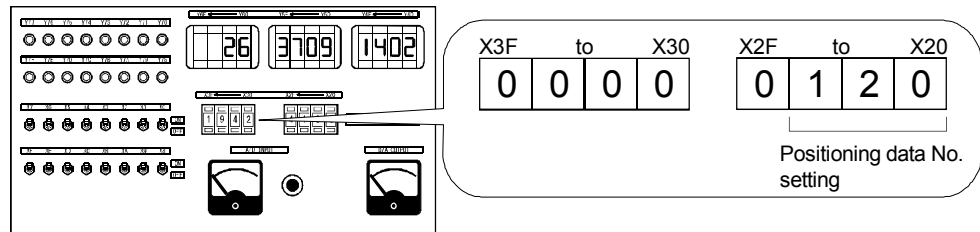

6) Turn on X7.

<Movement of the path plate on the XY table>

If the LED lamp traces the following path, then the setting is correct.

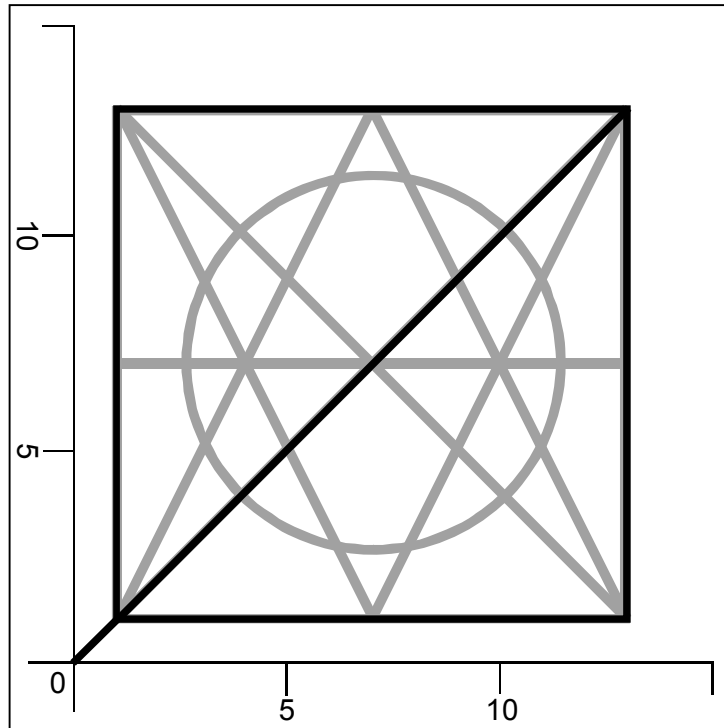

7.6.2 Exercise (2) Interpolation operation 2

2-axis linear interpolation will be performed between axis 1 and axis 2.

<Operation description>

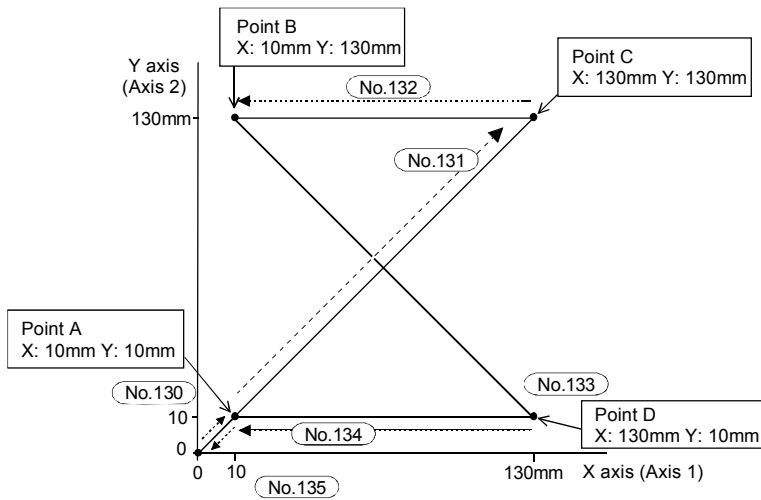

- [No. 130] The X axis and Y axis move simultaneously to the point A (Operation speed: 4000mm/min)
Stop for 0.5 seconds after positioning is completed
- [No. 131] The X axis and Y axis move simultaneously to the point C (Operation speed: 4000mm/min)
Stop for 0.5 seconds after positioning is completed
- [No. 132] Only the X axis moves to the point B (Operation speed: 4000mm/min)
Stop for 0.5 seconds after positioning is completed
- [No. 133] The X axis and Y axis move simultaneously to the point D (Operation speed: 4000mm/min)
Stop for 0.5 seconds after positioning is completed
- [No. 134] Only the X axis moves to the point A (operation speed: 4000mm/min)
Stop for 0.5 seconds after positioning is completed
- [No. 135] The X and Y axes move simultaneously to the original point 0 (Operation speed: 2000mm/mi)

Complete the positioning data for axis 1 and axis 2 that are used for the training.

(See P7-22 for the answer.)



00C0:QD77MS2 → Axis 1 positioning data (reference axis)

No.	Operation pattern	Control method	Interpolation axis	Acceleration time No.	Deceleration time No.	Positioning address [μm]	Arc address [μm]	Command speed [mm/min]	Dwell time [ms]	M code	Positioning data comments
130											
131											
132											
133											
134											
135											

00C0:QD77MS2 → Axis 2 positioning data (interpolation axis)

No.	Operation pattern	Control method	Interpolation axis	Acceleration time No.	Deceleration time No.	Positioning address [μm]	Arc address [μm]	Command speed [mm/min]	Dwell time [ms]	M code	Positioning data comments
130											
131											
132											
133											
134											
135											

Answer of exercise (2)

 00C0:QD77MS2 →  Axis 1 positioning data (reference axis)

No.	Operation pattern	Control method	Interpolation axis	Acceleration time No.	Deceleration time No.	Positioning address [μm]	Arc address [μm]	Command speed [mm/min]	Dwell time [ms]	M code	Positioning data comments
130	1: Continuous	A: ABS linear 2	Axis 2	0:100	0:100	10000.0	0.0	4000.00	500	0	
131	1: Continuous	A: ABS linear 2	Axis 2	0:100	0:100	130000.0	0.0	4000.00	500	0	
132	1: Continuous	A: ABS linear 2	Axis 2	0:100	0:100	10000.0	0.0	4000.00	500	0	
133	1: Continuous	A: ABS linear 2	Axis 2	0:100	0:100	130000.0	0.0	4000.00	500	0	
134	1: Continuous	A: ABS linear 2	Axis 2	0:100	0:100	10000.0	0.0	4000.00	500	0	
135	0: Finish	A: ABS linear 2	Axis 2	0:100	0:100	0.0	0.0	2000.00	0	0	

 00C0:QD77MS2 →  Axis 2 positioning data (interpolation axis)

No.	Operation pattern	Control method	Interpolation axis	Acceleration time No.	Deceleration time No.	Positioning address [μm]	Arc address [μm]	Command speed [mm/min]	Dwell time [ms]	M code	Positioning data comments
130						10000.0	0.0	0.00			
131						130000.0	0.0	0.00			
132						130000.0	0.0	0.00			
133						10000.0	0.0	0.00			
134						10000.0	0.0	0.00			
135						0.0	0.0	0.00			

Demonstration machine operations

- 1) The data types (the sequence program, the parameters, and the positioning data) are

Project name	XY-2
--------------	------

Read from the folder and write to the QD77MS2.

- 2) Turning on X0 starts the home position return in order of axis 1 to axis 2.

- 3) Set the positioning data No. to 130 by the digital switch.

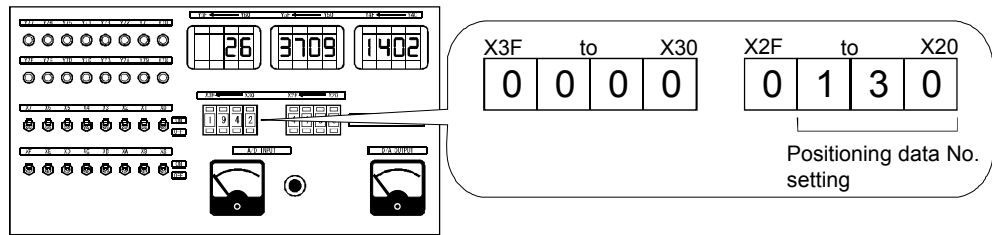

- 4) Turn on X8.

<Movement of the path plate on the XY table>

If the LED lamp traces the following path, the setting is correct.

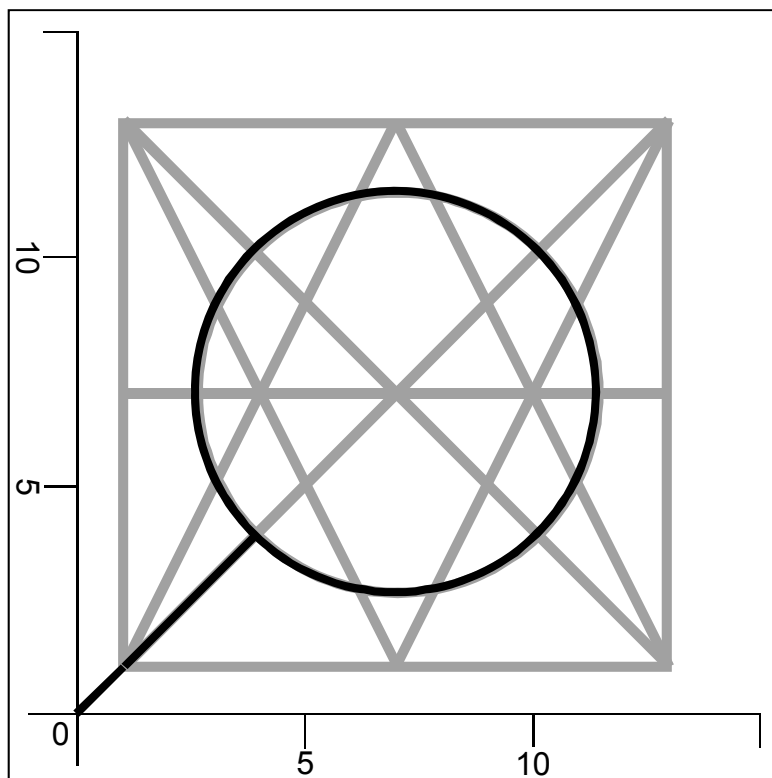

7.6.3 Exercise (3) Circular interpolation operation 1

Perform the 2-axis circular interpolation between axis 1 and axis 2.

<Operation description>

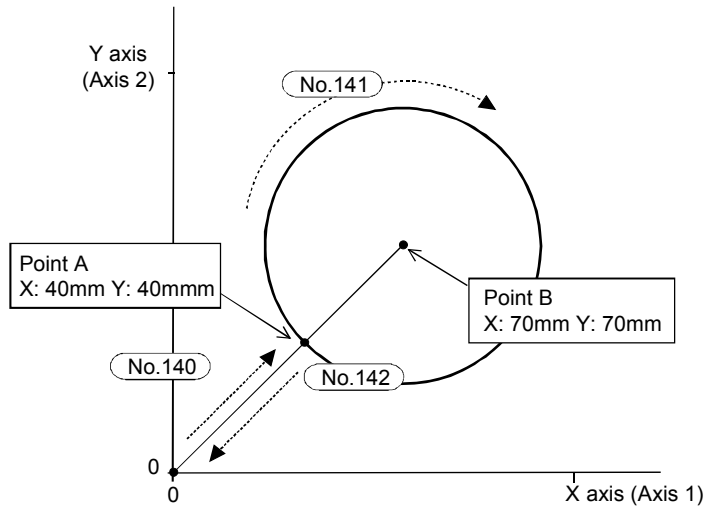

[No. 140] The X axis and Y axis move simultaneously to the point A (Operation speed: 4000mm/min)

[No. 141] Moves to the target position A, specifying the point B as the center in the circular interpolation (Operation speed: 4000mm/min)

[No. 142] The X axis and Y axis return simultaneously to the home position 0 (Operation speed: 4000mm/min)

Complete the positioning data for axis 1 and axis 2 that are used for the training.

(See P7-26 for the answer.)



00C0:QD77MS2 → Axis 1 positioning data (reference axis)

No.	Operation pattern	Control method	Interpolation axis	Acceleration time No.	Deceleration time No.	Positioning address [μm]	Arc address [μm]	Command speed [mm/min]	Dwell time [ms]	M code	Positioning data comments
140											
141											
142											



00C0:QD77MS2 → Axis 2 positioning data (interpolation axis)

No.	Operation pattern	Control method	Interpolation axis	Acceleration time No.	Deceleration time No.	Positioning address [μm]	Arc address [μm]	Command speed [mm/min]	Dwell time [ms]	M code	Positioning data comments
140											
141											
142											

Answer of exercise (3)

 00C0:QD77MS2 →  Axis 1 positioning data (independent axis)

No.	Operation pattern	Control method	Interpolation axis	Acceleration time No.	Deceleration time No.	Positioning address [μm]	Arc address [μm]	Command speed [mm/min]	Dwell time [ms]	M code	Positioning data comments
140	1: Continuous	A: ABS linear 2	Axis 2	0:100	0:100	40000.0	0.0	4000.00	0	0	
141	1: Continuous	F: ABS circular right	Axis 2	0:100	0:100	40000.0	70000.0	4000.00	0	0	
142	0: Finish	A: ABS linear 2	Axis 2	0:100	0:100	0.0	0.0	4000.00	0	0	

 00C0:QD77MS2 →  Axis 1 positioning data (interpolation axis)

No.	Operation pattern	Control method	Interpolation axis	Acceleration time No.	Deceleration time No.	Positioning address [μm]	Arc address [μm]	Command speed [mm/min]	Dwell time [ms]	M code	Positioning data comments
140						40000.0	0.0	0.00			
141						40000.0	70000.0	0.00			
142						0.0	0.0	0.00			

Demonstration machine operations

1) The data types (the sequence program, the parameters, and the positioning data) are

Project name XY-2 .

Read from the folder and write to the QD77MS2.

2) Turning on X0 starts the home position return in order of axis 1 to axis 2.

3) Set the positioning data No. to 140 by the digital switch.

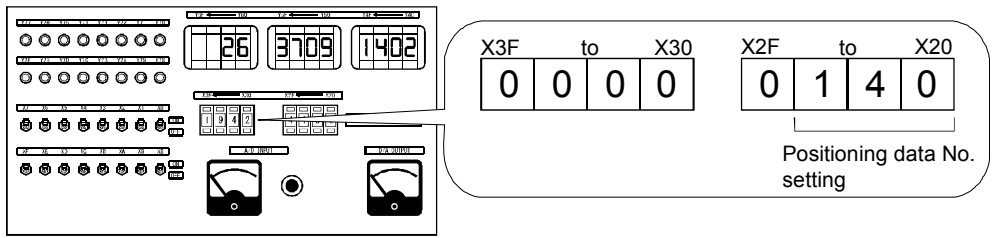

4) Turn on X04.

<Movement of the path plate on the XY table>

If the LED lamp traces the following path, the setting is correct.

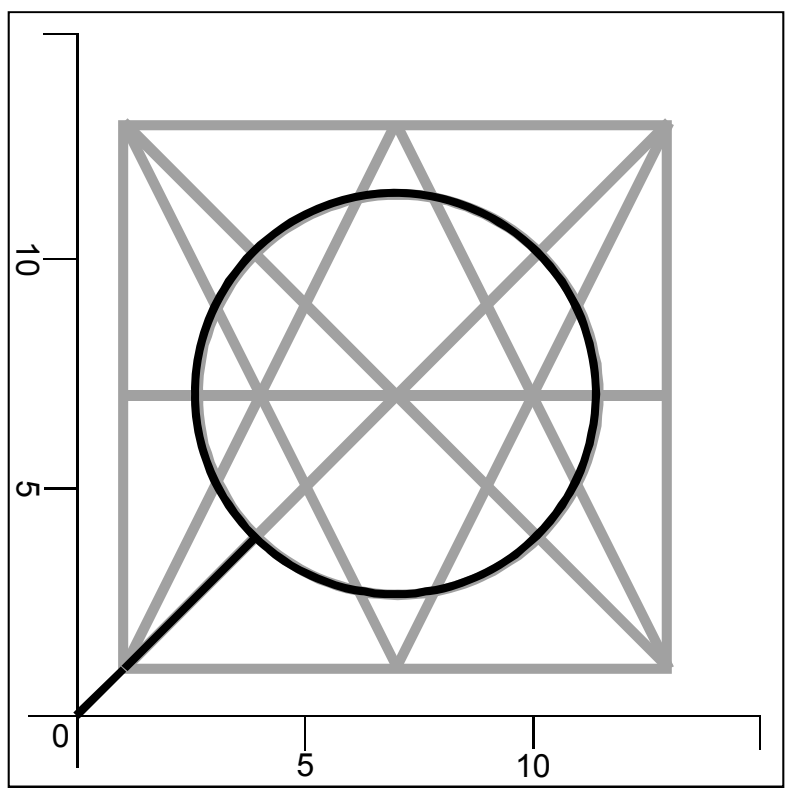

7.6.4 Exercise (4) Circular interpolation operation 2

Perform the 2-axis circular interpolation between axis 1 and axis 2.

For the following trainings, add the following program to the project "XY-2" to create "XY-3". * Parameter settings are the same as those in Section 7.2.

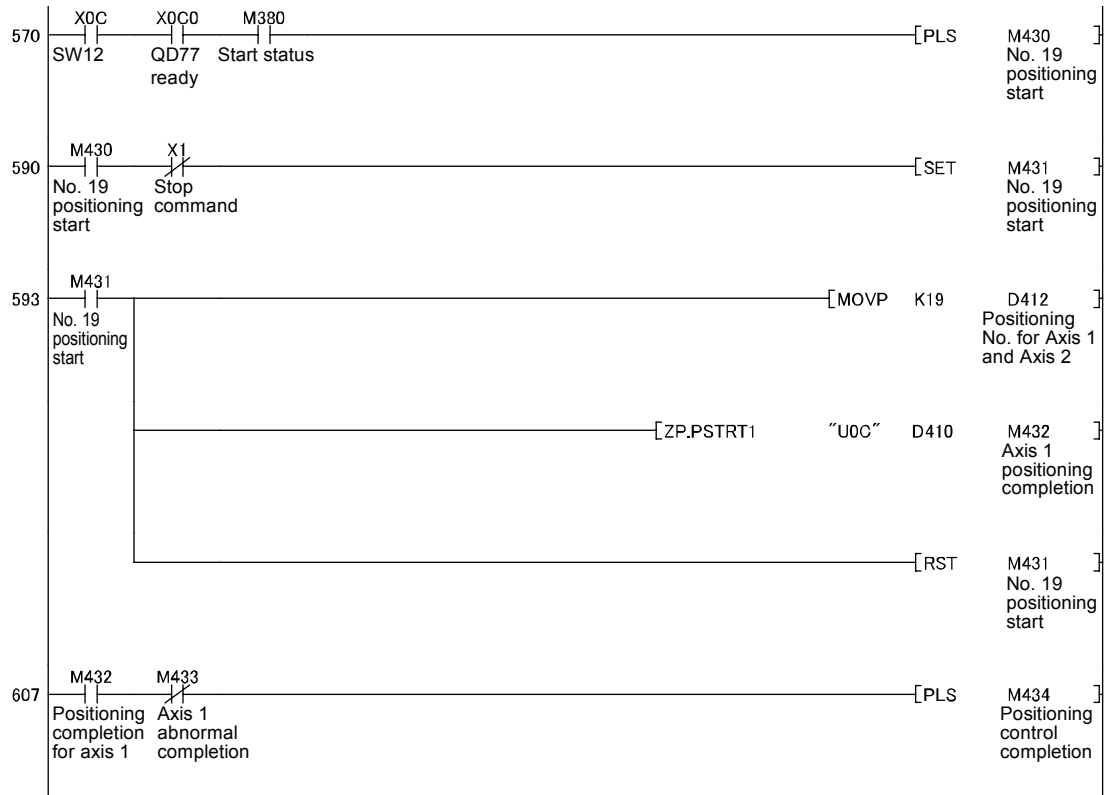

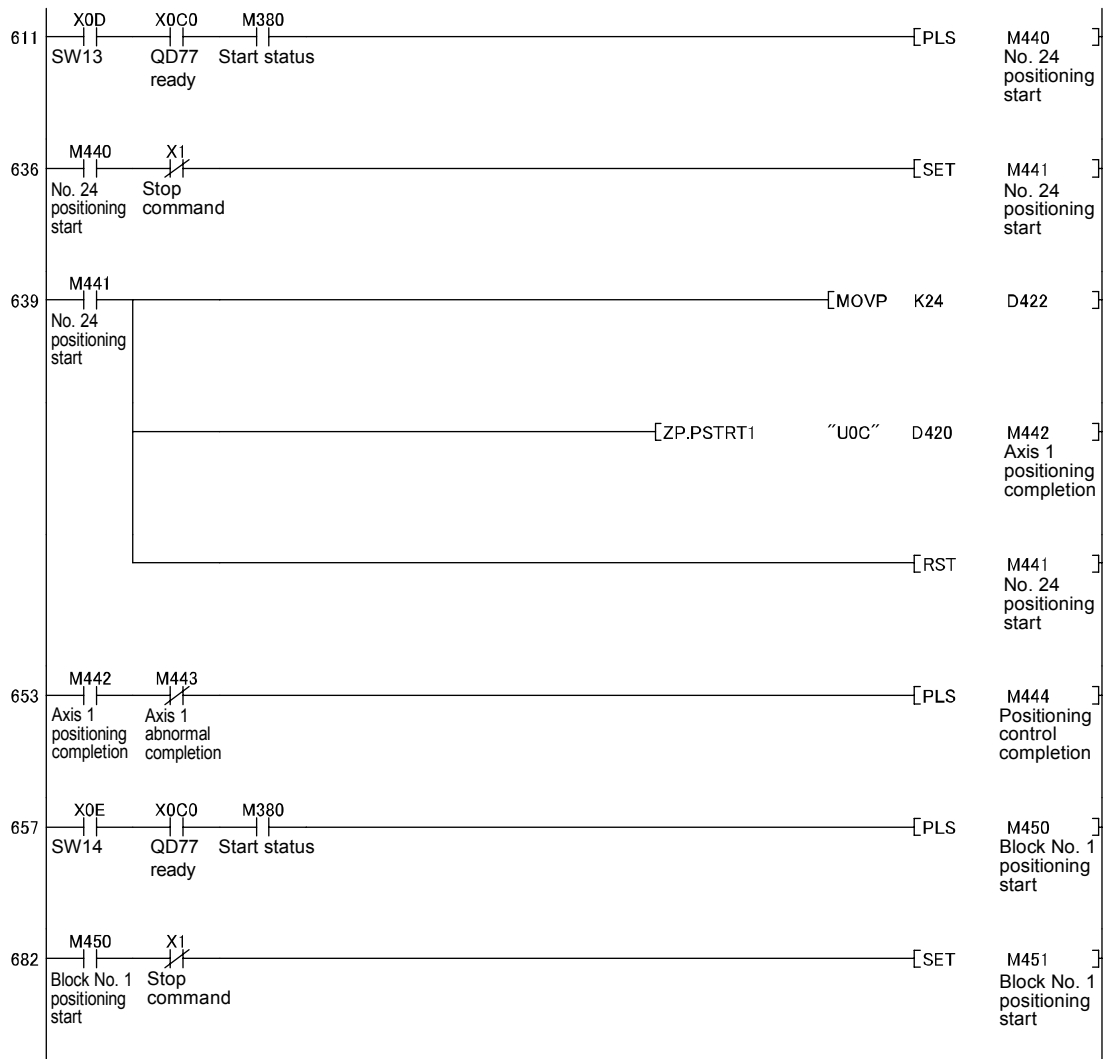

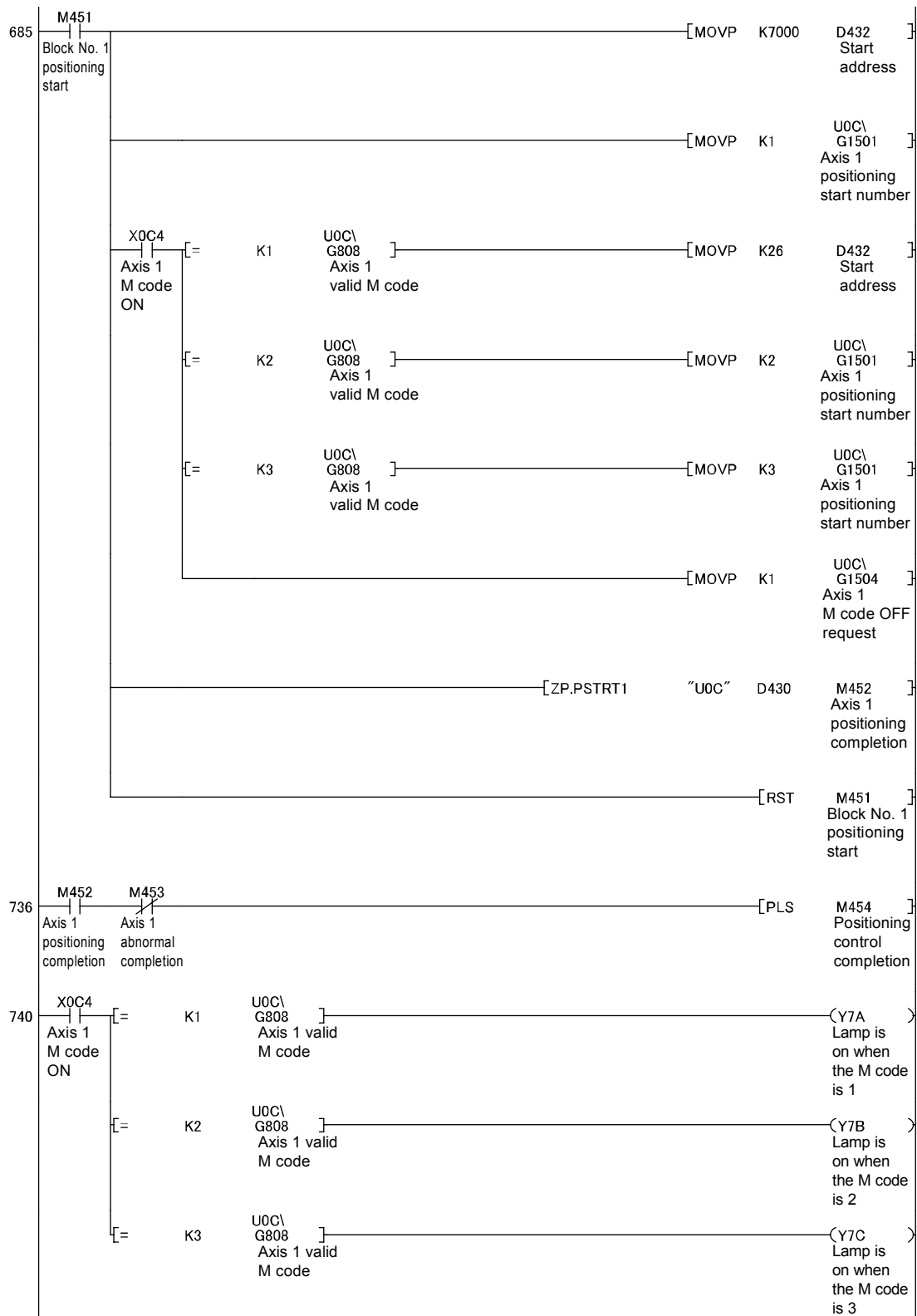

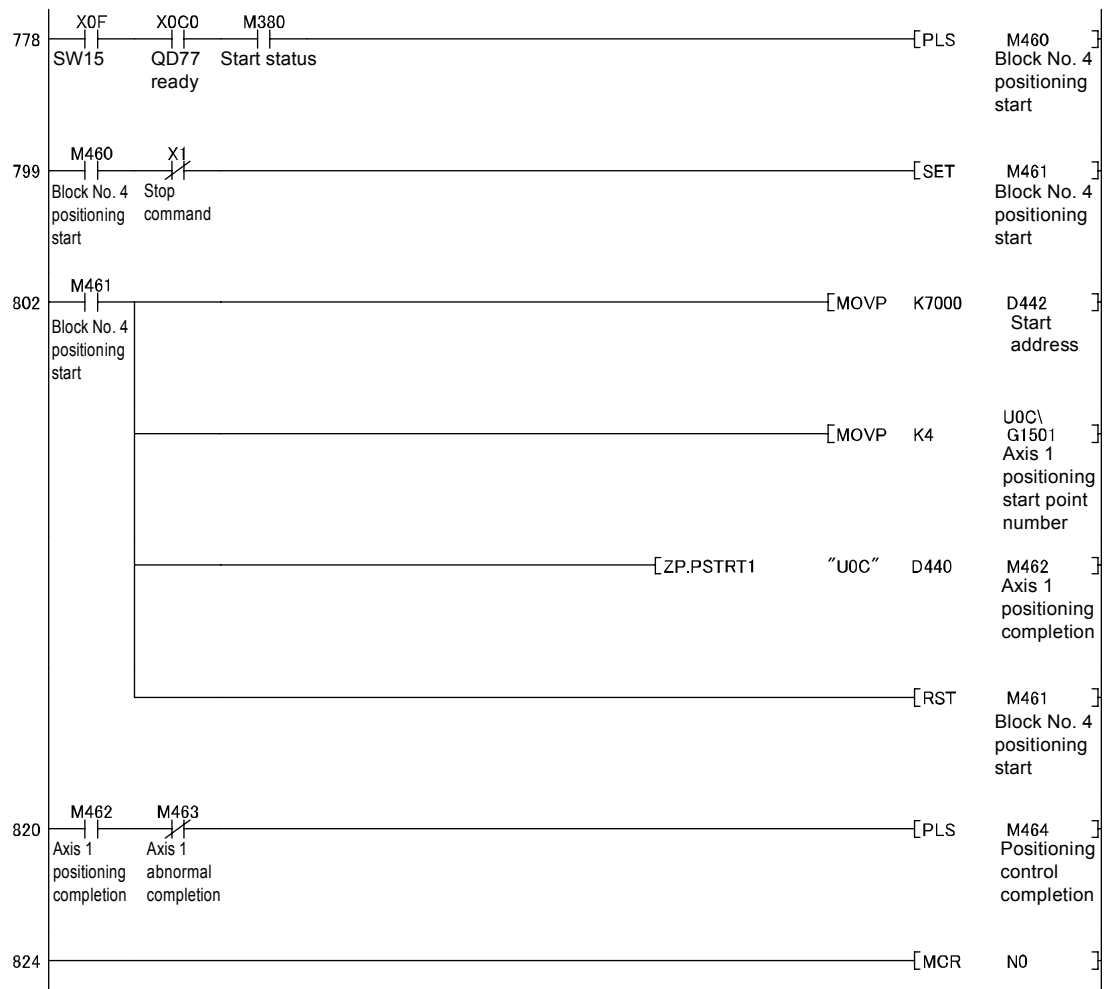

<Operation description>

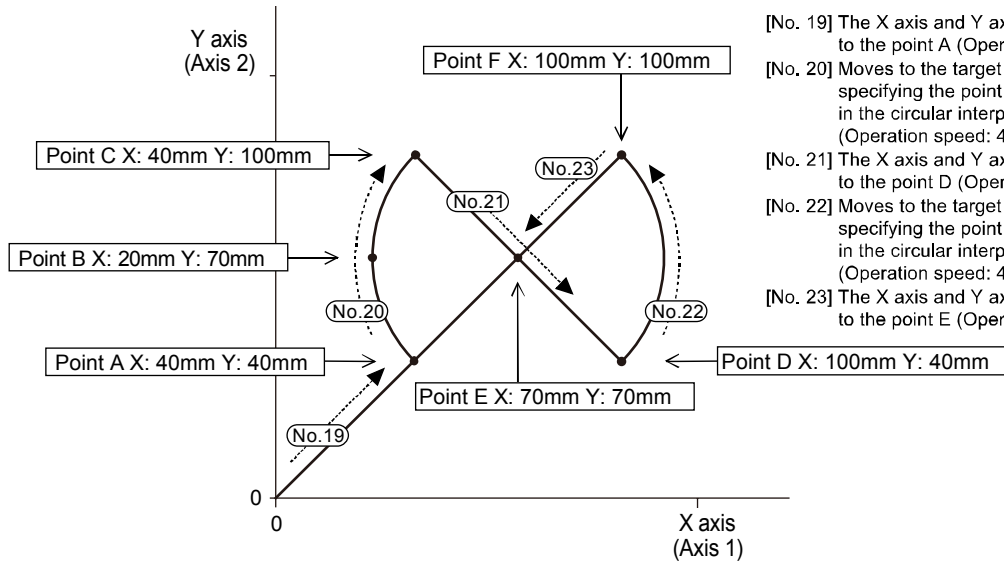

- [No. 19] The X axis and Y axis move simultaneously to the point A (Operation speed: 4000mm/min)
- [No. 20] Moves to the target position point C, specifying the point B as the auxiliary point in the circular interpolation (Operation speed: 4000mm/min)
- [No. 21] The X axis and Y axis move simultaneously to the point D (Operation speed: 4000mm/min)
- [No. 22] Moves to the target position point F, specifying the point E as the center in the circular interpolation (Operation speed: 4000mm/min)
- [No. 23] The X axis and Y axis move simultaneously to the point E (Operation speed: 4000mm/min)

Complete the positioning data for axis 1 and axis 2 that are used for the training.
(See P7-34 for the answer)

00C0:QD77MS2 → Axis 1 positioning data (reference axis)

No.	Operation pattern	Control method	Interpolation axis	Acceleration time No.	Deceleration time No.	Positioning address [μm]	Arc address [μm]	Command speed [mm/min]	Dwell time [ms]	M code	Positioning data comments
19											
20											
21											
22											
23											



00C0:QD77MS2 → Axis 2 positioning data (interpolation axis)

No.	Operation pattern	Control method	Interpolation axis	Acceleration time No.	Deceleration time No.	Positioning address [μm]	Arc address [μm]	Command speed [mm/min]	Dwell time [ms]	M code	Positioning data comments
19											
20											
21											
22											
23											

Answer of exercise (4)

 00C0:QD77MS2 →  Axis 1 positioning data (independent axis)

No.	Operation pattern	Control method	Interpolation axis	Acceleration time No.	Deceleration time No.	Positioning address [μm]	Arc address [μm]	Command speed [mm/min]	Dwell time [ms]	M code	Positioning data comments
19	3: Path	0Ah: ABS linear 2	Axis 2	0:100	0:100	40000.0	0.0	4000.00	0	0	
20	3: Path	0Dh: ABS circular interpolation	Axis 2	0:100	0:100	40000.0	20000.0	4000.00	0	0	
21	3: Path	0Ah: ABS linear 2	Axis 2	0:100	0:100	100000.0	0.0	4000.00	0	0	
22	3: Path	10h: ABS circular left	Axis 2	0:100	0:100	100000.0	70000.0	4000.00	0	0	
23	0: Finish	0Ah: ABS linear 2	Axis 2	0:100	0:100	70000.0	0.0	4000.00	0	0	

 00C0:QD77MS2 →  Axis 2 positioning data (interpolation axis)

No.	Operation pattern	Control method	Interpolation axis	Acceleration time No.	Deceleration time No.	Positioning address [μm]	Arc address [μm]	Command speed [mm/min]	Dwell time [ms]	M code	Positioning data comments
19						40000.0	0.0	0.00			
20						100000.0	70000.0	0.00			
21						40000.0	0.0	0.00			
22						100000.0	70000.0	0.00			
23						70000.0	0.0	0.00			

Demonstration machine operations

- 1) The data types (the sequence program, the parameters, and the positioning data) are

Project name	XY-3
--------------	------

Read from the folder and write to the QD77MS2.

- 2) Turning on X0 starts the home position return in order of axis 1 to axis 2.
- 3) Turn on XC.

<Movement of the path plate on the XY table>

If the LED lamp traces the following path, the setting is correct.

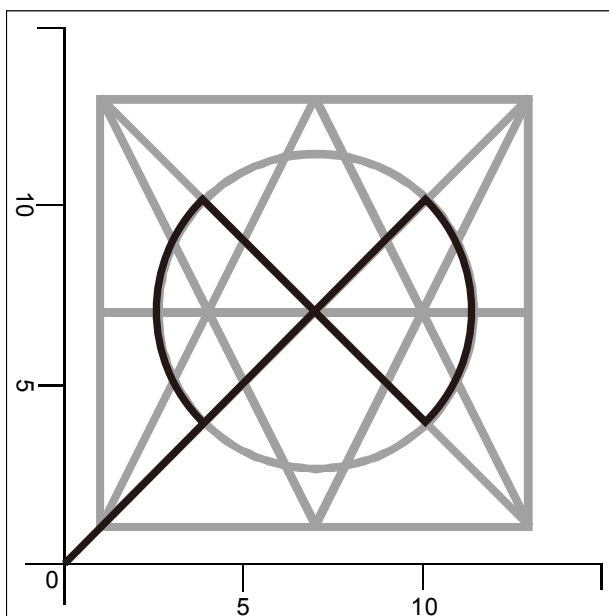

7.6.5 Exercise (5) Continuous positioning operation 1

Perform the 2-axis continuous positioning between axis 1 and axis 2. Select the positioning data No. by the M code, and use the simultaneous start of the block start data special start instruction for the X axis and Y axis.

<Operation description>

<Axis 1 positioning data>

- [No. 24] X: Moves to a point of 30 (+30)mm
(Operation speed: 1000mm/min)
- [No. 25] X: Moves to a point of 60 (+30)mm
(Operation speed: 2000mm/min)
- [No. 26] X: Moves to a point of 90 (+30)mm
(Operation speed: 3000mm/min)
- [No. 27] X: Moves to a point of 140 (+50)mm
(Operation speed: 500mm/min)
- [No. 28] X: Moves to a point of 0 (-140)mm
(Operation speed: 5000mm/min)

<Axis 2 positioning data>

- [No. 24] Y: Moves to a point of 60 (+60)mm
(Operation speed: 1000mm/min)
- [No. 25] Y: Moves to a point of 140 (+80)mm
(Operation speed: 2000mm/min)
- [No. 26] Y: Moves to a point of 0 (-140)mm
(Operation speed: 5000mm/min)

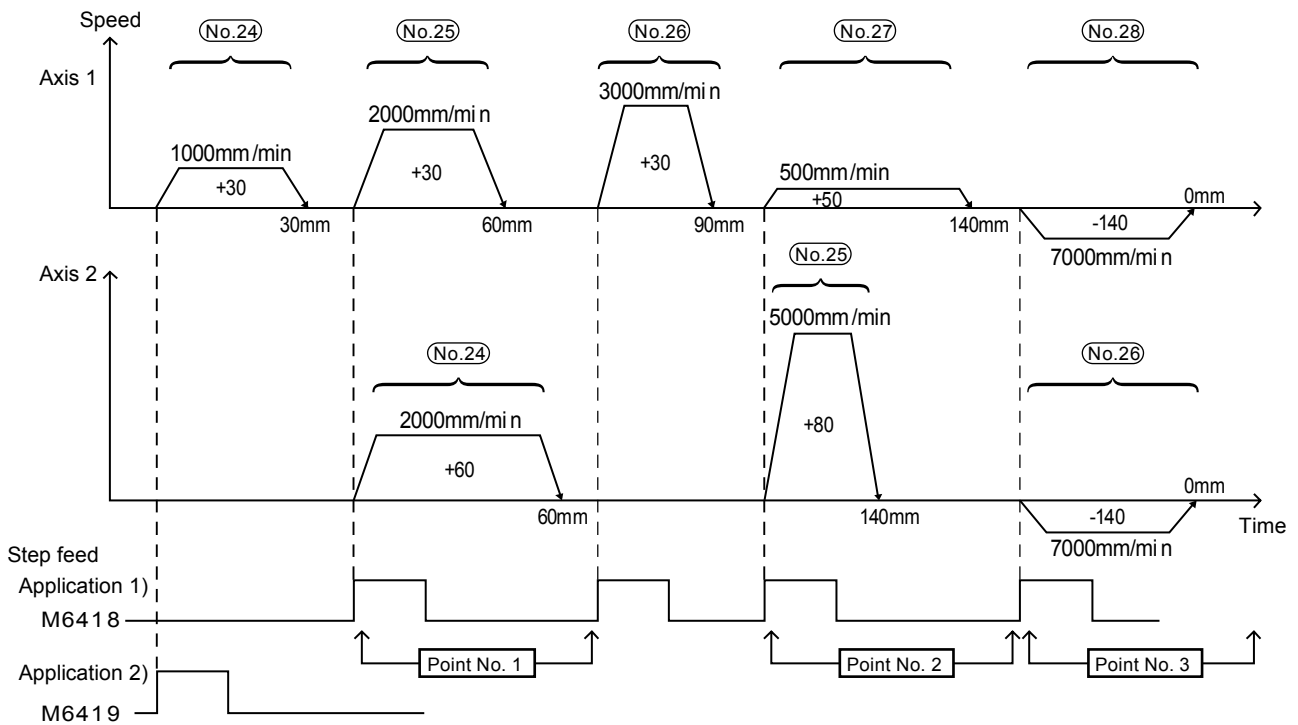

<Axis 1 positioning Block start data>

- [Point No. 1] Special start instruction that starts Axis 2 positioning data: No. 24 with Axis 1 positioning data: No. 25
- [Point No. 2] Special start instruction that starts Axis 2 positioning data: No. 25 with Axis 1 positioning data: No. 27
- [Point No. 3] Special start instruction that starts Axis 2 positioning data: No. 26 with Axis 1 positioning data: No. 28



Complete the positioning data for axis 1 and axis 2 and the block start data for axis 1 that are used for the training.

(See P7-38 for the answer)

 00C0:QD77MS2 →  Axis 1 positioning data (independent axis)

No.	Operation pattern	Control method	Interpolation axis	Acceleration time No.	Deceleration time No.	Positioning address [μm]	Arc address [μm]	Command speed [mm/min]	Dwell time [ms]	M code	Positioning data comments
24											
25											
26											
27											
28											



 00C0:QD77MS2 →  Axis 2 positioning data (independent axis)

No.	Operation pattern	Control method	Interpolation axis	Acceleration time No.	Deceleration time No.	Positioning address [μm]	Arc address [μm]	Command speed [mm/min]	Dwell time [ms]	M code	Positioning data comments
24											
25											
26											
27											
28											



 00C0:QD77MS2 → Positioning block start data for axis 1

Point No.	Form	Start data No.	Special start instruction	Parameter	Conditional data
1					
2					
3					

Answer of exercise (5)

 00C0:QD77MS2 →  Axis 1 positioning data (independent axis)

No.	Operation pattern	Control method	Interpolation axis	Acceleration time No.	Deceleration time No.	Positioning address [μm]	Circular address [μm]	Command speed [mm/min]	Dwell time [ms]	M code	Positioning data comments
24	0: Finish	01h: ABS linear 1	—	0:100	0:100	30000.0	0.0	1000.00	0	0	
25	0: Finish	01h: ABS linear 1	—	0:100	0:100	60000.0	0.0	2000.00	0	1	
26	0: Finish	01h: ABS linear 1	—	0:100	0:100	90000.0	0.0	3000.00	0	2	
27	0: Finish	01h: ABS linear 1	—	0:100	0:100	140000.0	0.0	500.00	0	3	
28	0: Finish	01h: ABS linear 1	—	0:100	0:100	0.0	0.0	5000.00	0	0	

 00C0:QD77MS2 →  Axis 1 positioning data (independent axis)

No.	Operation pattern	Control method	Interpolation axis	Acceleration time No.	Deceleration time No.	Positioning address [μm]	Circular address [μm]	Command speed [mm/min]	Dwell time [ms]	M code	Positioning data comments
24	0: Finish	01h: ABS linear 1	—	0:100	0:100	60000.0	0.0	2000.00	0	0	
25	0: Finish	01h: ABS linear 1	—	0:100	0:100	140000.0	0.0	5000.00	0	0	
26	0: Finish	01h: ABS linear 1	—	0:100	0:100	0.0	0.0	5000.00	0	0	

 00C0:QD77MS2 → Positioning block operation start data for axis 1

Point No.	Form	Start data No.	Special start instruction	Parameter	Conditional data
1	0: Finish	25	03h: Synchronization start	1	Axis 2 (No. 24)
2	0: Finish	27	03h: Synchronization start	2	Axis 2 (No. 25)
3	0: Finish	28	03h: Synchronization start	3	Axis 2 (No. 26)

Demonstration machine operations

- 1) The data types (the sequence program, the parameters, and the positioning data) are

Project name	XY-3
--------------	------

.

Read from the folder and write to the QD77MS2.

- 2) Turn on X0 to start the home position return in order of axis 1 to axis 2.
- 3) Turn on XD. (Axis 1: No. 24 operates)
- 4) Turn on XE. (Axis 1: No. 25 and Axis 2: No. 24 operate)
- 5) Turn on XE. (Axis 1: No. 26 operates)
- 6) Turn on XE. (Axis 1: No. 27 and Axis 2: No. 25 operate)
- 7) Turn on XE. (Axis 1: No. 28 and Axis 2: No. 26 operate)

7.6.6 Exercise (6) Continuous positioning operation 2

Perform the 2-axis continuous positioning for axis 1 and axis 2.

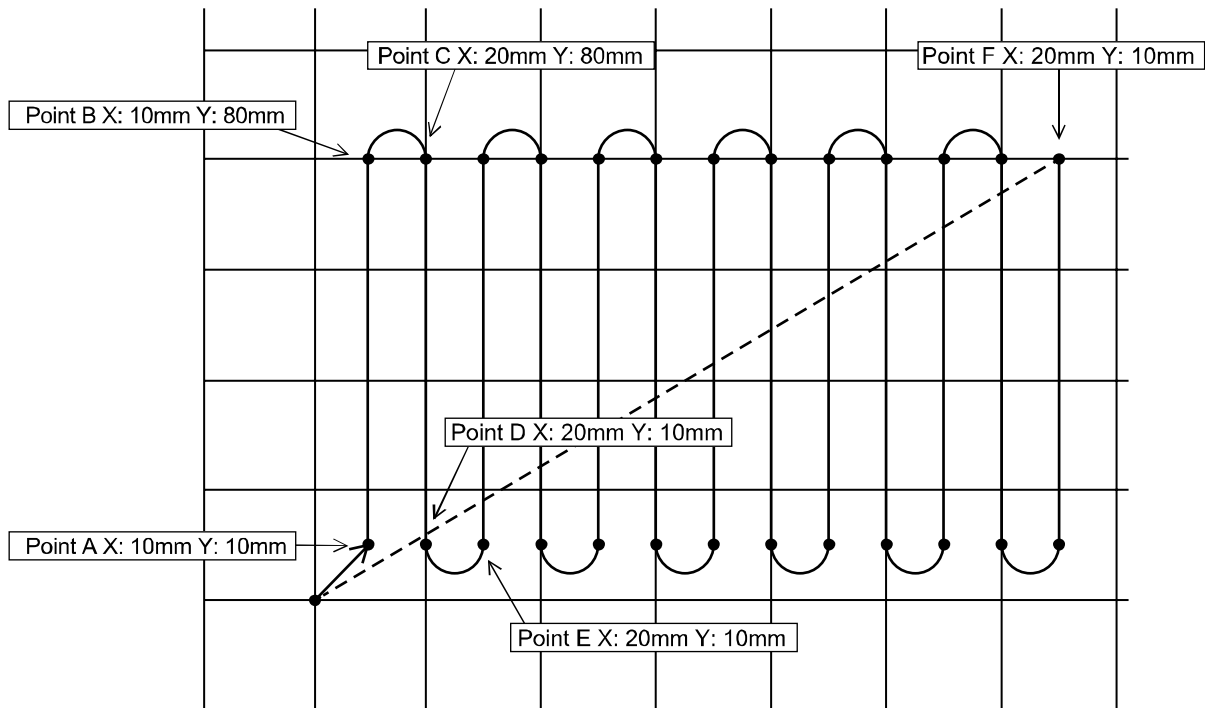

<Operation description>

- [No. 29] The X axis and Y axis move simultaneously to the point A
(Operation speed: 4000mm/min)
- [No. 30] Only the Y axis moves by the INC instruction to the point B
(Operation speed: 4000mm/min)
- [No. 31] The X axis and Y axis simultaneously by the INC instruction
to the point C (Operation speed: 4000mm/min)
- [No. 32] Only the Y axis moves by the INC instruction to the point D
(Operation speed: 4000mm/min)
- [No. 33] The X axis and Y axis move simultaneously by the INC instruction
to the point E (Operation speed: 4000mm/min)
- [No. 34] Hereafter, moves to the point F by specifying the INC linear
and the INC circular control as the block start data and the number
of repetition of the special start instruction as 6.
- [No. 35] The X axis and Y axis move simultaneously to the waiting point
(Operation speed: 4000 mm/min)





Complete the positioning data for axis 1 and axis 2 and the block start data for axis 1 that are used for the training.

(See P7-42 for the answer.)

 00C0:QD77MS2 →  Axis 1 positioning data (reference axis)

No.	Operation pattern	Control method	Interpolation axis	Acceleration time No.	Deceleration time No.	Positioning address [μm]	Arc address [μm]	Command speed [mm/min]	Dwell time [ms]	M code	Positioning data comments
29											
30											
31											
32											
33											
34											
35											



 00C0:QD77MS2 →  Axis 2 positioning data (interpolation axis)

No.	Operation pattern	Control method	Interpolation axis	Acceleration time No.	Deceleration time No.	Positioning address [μm]	Arc address [μm]	Command speed [mm/min]	Dwell time [ms]	M code	Positioning data comments
29											
30											
31											
32											
33											
34											
35											



 00C0:QD77MS2 → Positioning block operation start data for axis 1

Point No.	Form	Start data No.	Special start instruction	Parameter	Conditional data
4					
5					
6					
7					
8					
9					

Answer of exercise (6)

 00C0:QD77MS2 →  Axis 1 positioning data (independent axis)

No.	Operation pattern	Control method	Interpolation axis	Acceleration time No.	Deceleration time No.	Positioning address [μm]	Arc address [μm]	Command speed [mm/min]	Dwell time [ms]	M code	Positioning data comments
29	0: Finish	0Ah: ABS linear 2	Axis 2	0:100	0:100	10000.0	0.0	4000.00	0	0	
30	0: Finish	0Bh: INC linear 2	Axis 2	0:100	0:100	0.0	0.0	4000.00	0	0	
31	1: Continuous	0Eh: INC circular interpolation	Axis 2	0:100	0:100	10000.0	5000.0	4000.00	0	0	
32	0: Finish	0Bh: INC linear 2	Axis 2	0:100	0:100	0.0	0.0	4000.00	0	0	
33	0: Finish	0Eh: INC circular interpolation	Axis 2	0:100	0:100	10000.0	5000.0	4000.00	0	0	
34	0: Finish	0Bh: INC linear 2	Axis 2	0:100	0:100	0.0	0.0	4000.00	0	0	
35	0: Finish	0Ah: ABS linear 2	Axis 2	0:100	0:100	0.0	0.0	4000.00	0	0	

 00C0:QD77MS2 →  Axis 2 positioning data (interpolation axis)

No.	Operation pattern	Control method	Interpolation axis	Acceleration time No.	Deceleration time No.	Positioning address [μm]	Arc address [μm]	Command speed [mm/min]	Dwell time [ms]	M code	Positioning data comments
29						10000.0	0.0	4000.00			
30						70000.0	0.0	4000.00			
31						0.0	5000.0	4000.00			
32						-70000.0	0.0	4000.00			
33						0.0	-5000.0	4000.00			
34						70000.0	0.0	4000.00			
35						0.0	0.0	4000.00			

 00C0:QD77MS2 → Positioning block operation start data for axis 1

Point No.	Form	Start data No.	Special start instruction	Parameter	Conditional data
4	1: Continuous	29	00h: Normal start	0	
5	1: Continuous	30	04h: FOR loop	6	Number of repetitions
6	1: Continuous	31	00h: Normal start	0	
7	1: Continuous	33	06h: NEXT start	0	
8	1: Continuous	34	00h: Normal start	0	
9	0: Finish	35	00h: Normal start	0	

Demonstration machine operations

- 1) The data types (the sequence program, the parameters, and the positioning data) are

Project name	XY-3
--------------	------

.

Read from the folder and write to the QD77MS2.

- 2) Turn on X0 to start the home position return in order of axis 1 to axis 2.
- 3) Turn on XF.

CHAPTER 8 Training (4) Synchronous operations with the sequence program (QD77MS2)

8.1 Outline of synchronous control

"Synchronous control" can be achieved using software instead of controlling mechanically with gear, shaft, speed change gear or cam etc.

"Synchronous control" synchronizes movement with the input axis (servo input axis, synchronous encoder axis), by setting "the parameters for synchronous control" and starting synchronous control on each output axis.

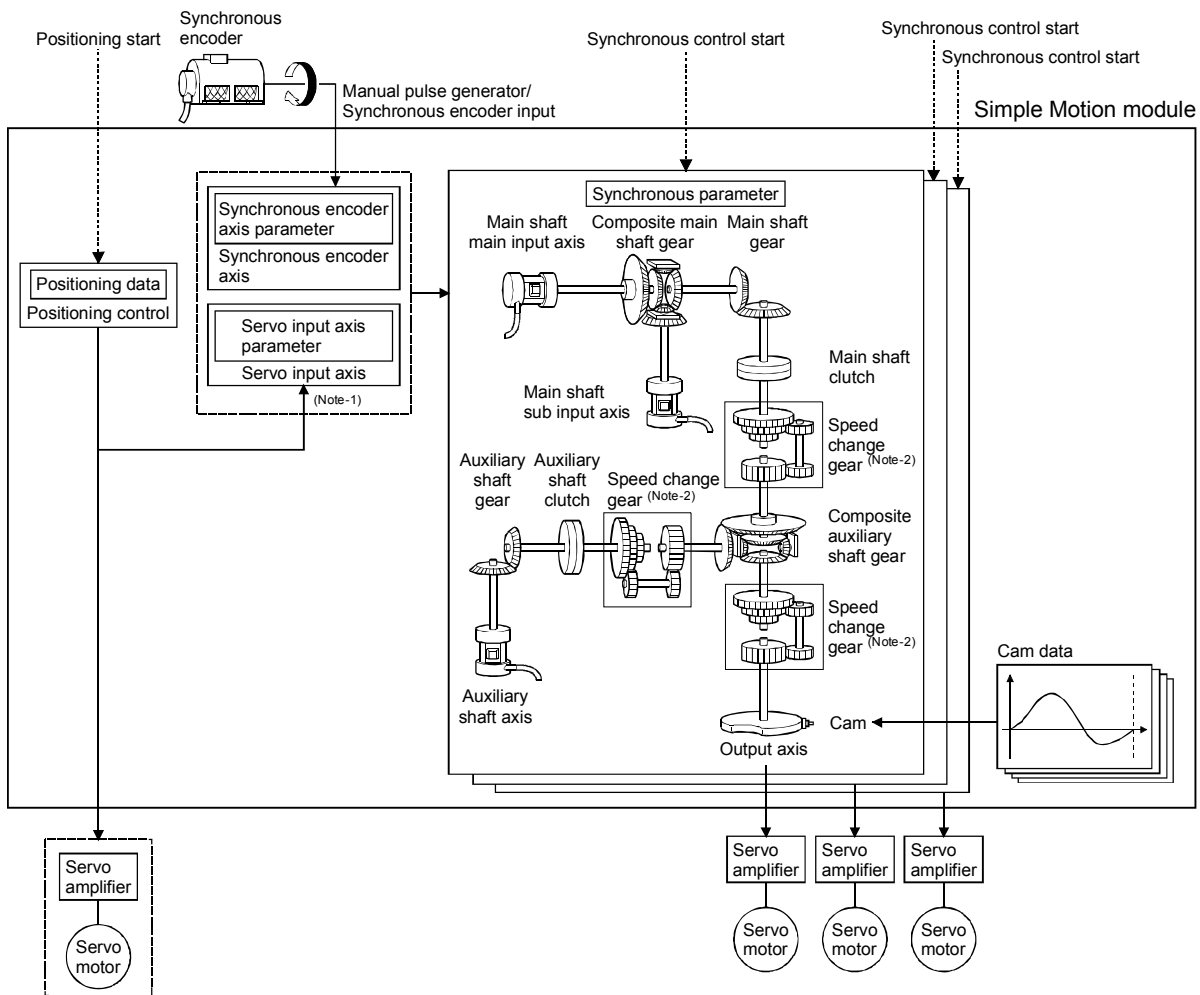
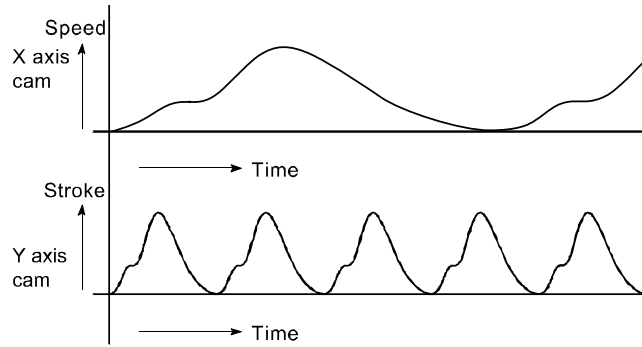

It is possible to control without amplifier by setting the virtual servo amplifier.

(Note-1): It is possible to drive the servo input axis except the positioning control (OPR, manual control, speed-torque control, synchronous control). Refer to the "User's Manual (Positioning control)" of each Simple Motion module for details on the positioning control, OPR, the manual control and the speed-torque control.





(Note-2): Speed change gear can be arranged on one of "Main shaft side", "Auxiliary shaft side" or "After composite auxiliary shaft gear".

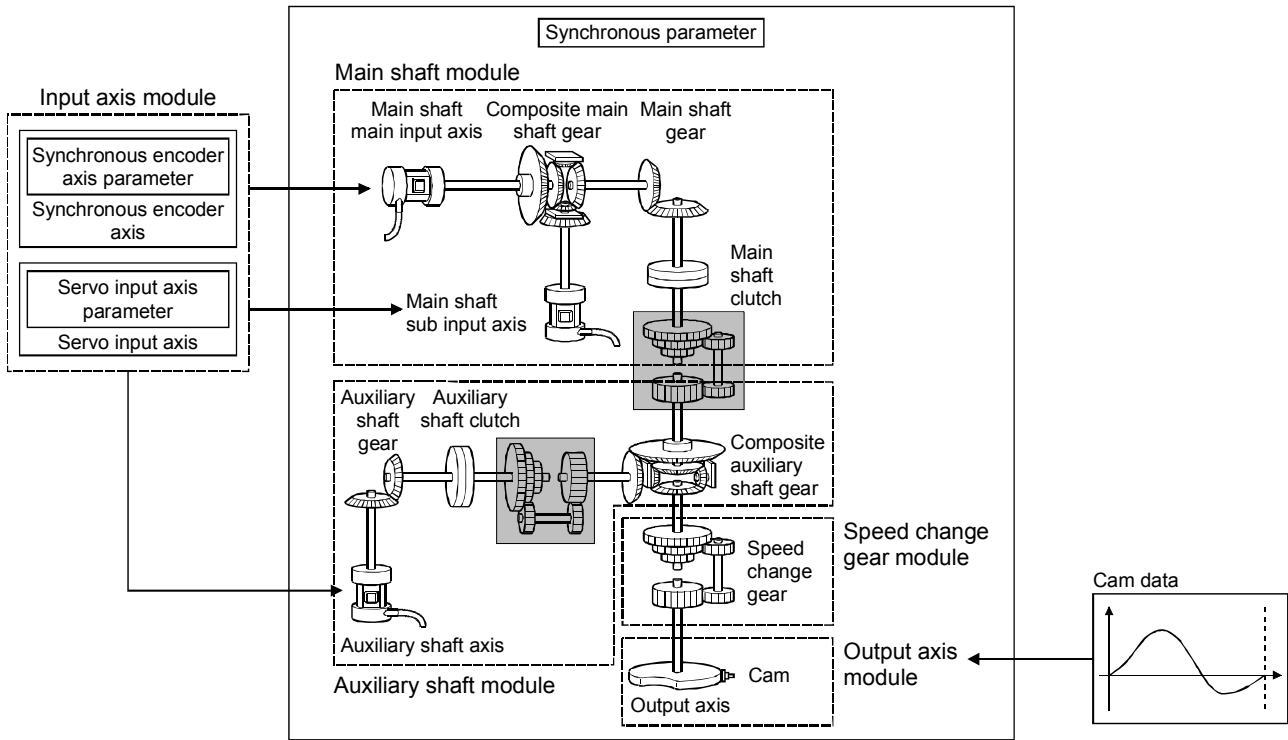



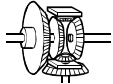

8.1.1 Synchronous control module

The module is used in synchronous control as follows.



8.1.2 List of synchronous control module

Classification	Name	Parts	Maximum number of usable	
			Number per module (2-axis module)	Number per axis
Input axis module	Servo input axis	—	2	—
	Synchronous encoder axis	—	4	—
Main shaft module	Main shaft main input axis		2	1
	Main shaft sub input axis		2	1
	Composite main shaft gear		2	1
	Main shaft gear		2	1
	Main shaft clutch		2	1

Classification	Name	Parts	Maximum number of usable	
			Number per module (2-axis module)	Number per axis
Auxiliary shaft module	Auxiliary shaft axis		2	1
	Auxiliary shaft gear		2	1
	Auxiliary shaft clutch		2	1
	Composite auxiliary shaft gear		2	1
Speed change gear module	Speed change gear		2	1
Output axis module	Output axis		2	1
Cam data	Cam data	—	Up to 256	—

(1) Servo input axis parameters

Used to drive the input axis with the position of the servomotor controlled by the Simple Motion module.

Symbol	Setting item	Setting details	Setting value	Fetch cycle	Default value	Buffer memory address
Pr.300	Servo input axis type	Set the current value type to be generated of the input value for the servo input axis.	<ul style="list-style-type: none"> • Set in decimal. 0 : Invalid 1 : Current feed value 2 : Real current value 3 : Servo command value 4 : Feedback value 	At power supply ON	0	32800+10n
Pr.301	Servo input axis smoothing time constant	Set to smooth the input value.	<ul style="list-style-type: none"> • Set in decimal. 0 to 5000[ms] 		0	32801+10n
Pr.302	Servo input axis phase compensation advance time	Set the time to advance or delay the phase.	<ul style="list-style-type: none"> • Set in decimal. -2147483648 to 2147483647[μs] 	Operation cycle	0	32802+10n 32803+10n
Pr.303	Servo input axis phase compensation time constant	Set the time constant to affect the phase compensation.	<ul style="list-style-type: none"> • Set in decimal. 0 to 65535 [ms]^{*1} 	At power supply ON	10	32804+10n
Pr.304	Servo input axis rotation direction restriction	Set this parameter to restrict the input travel value to one direction.	<ul style="list-style-type: none"> • Set in decimal. 0 : Without rotation direction restriction 1 : Enable only for current value increase direction 2 : Enable only for current value decrease direction 		0	32805+10n

n: Axis No.-1

*1 Set the value as follows in a sequence program.
0 to 767..... Set as a decimal.
32768 to 535 Convert into a hexadecimal and set.

(2) Synchronous encoder axis parameters

Used to drive the input axis by input pulses from the synchronous encoder connected externally.

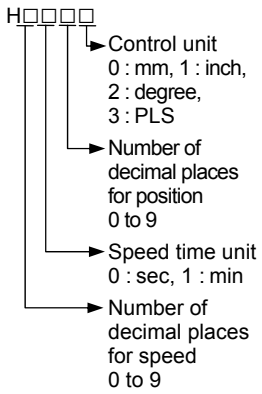
Symbol	Setting item	Setting details	Setting value	Fetch cycle	Default value	Buffer memory address
Pr.320	Synchronous encoder axis type	Set the synchronous encoder axis type to be used.	<ul style="list-style-type: none"> • Set in decimal. 0 : Invalid 1 : Incremental synchronous encoder 101 to 116 : Synchronous encoder via CPU servo amplifier (Connecting servo amplifier: Axes 1 to 16) 201 : Synchronous encoder via CPU 	At power supply ON	0	34720+20j
Pr.321	Synchronous encoder axis unit setting	<ul style="list-style-type: none"> • Set the unit of the synchronous encoder axis. • Set the position unit within the range from $\times 1$ to 10^{-9} [control unit]. • Set the speed unit within the range from $\times 1$ to 10^{-9} [control unit/s or control unit/min]. 	<ul style="list-style-type: none"> • Set in hexadecimal. 		0003h	34721+20j
Pr.322	Synchronous encoder axis unit conversion: Numerator	Set the numerator to convert the unit from the encoder pulse of the synchronous encoder axis into the synchronous encoder axis unit.	<ul style="list-style-type: none"> • Set in decimal. -2147483648 to 2147483647 [Synchronous encoder axis position units]^{*1} 		1	34722+20j 34723+20j
Pr.323	Synchronous encoder axis unit conversion: Denominator	Set the denominator to convert the unit from the encoder pulse of the synchronous encoder axis into the synchronous encoder axis unit.	<ul style="list-style-type: none"> • Set in decimal. 1 to 2147483647[PLS] 		1	34724+20j 34725+20j
Pr.324	Synchronous encoder axis length per cycle	Set the length per cycle of the synchronous encoder axis.	<ul style="list-style-type: none"> • Set in decimal. 1 to 2147483647 [Synchronous encoder axis position units]^{*1} 		4000	34726+20j 34727+20j
Pr.325	Synchronous encoder axis smoothing time constant	Set the time to smooth for the input value.	<ul style="list-style-type: none"> • Set in decimal. 0 to 5000[ms] 		0	34728+20j
Pr.326	Synchronous encoder axis phase compensation advance time	Set the time to advance or delay the phase.	<ul style="list-style-type: none"> • Set in decimal. -2147483648 to 2147483647[μs] 		Operation cycle	0

Symbol	Setting item	Setting details	Setting value	Fetch cycle	Default value	Buffer memory address
Pr.327	Synchronous encoder axis phase compensation time constant	Set the time constant to affect the phase compensation.	• Set in decimal. 0 to 65535[ms] *2	At power supply ON	10	34732+20j
Pr.328	Synchronous encoder axis rotation direction restriction	Set this parameter to restrict the input travel value to one direction.	• Set in decimal. 0 : Without rotation direction restriction 1 : Enable only for current value increase direction 2 : Enable only for current value decrease direction		0	34733+20j

j: Synchronous encoder axis No.-1

*1 : Synchronous encoder axis position units

*2 : Set the value as follows in a sequence program.

0 to 32767Set as a decimal

32768 to 65535Convert into a hexadecimal and set

(3) Main shaft parameters

This is the input axis on the main side of the main shaft module. The reference position on the main shaft.

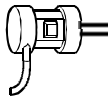

Symbol	Setting item	Setting details	Setting value	Fetch cycle	Default value	Buffer memory address
Pr.400	Main input axis No.	Set the input axis No. on the main input side for the main shaft.	• Set in decimal. 0 : Invalid 1 to 16 : Servo input axis*1 801 to 804 : Synchronous encoder axis	At start of synchronous control	0	36400+200n

n: Axis No.-1

*1 : The range from 1 to 2 is valid in the 2-axis module.

(4) Main shaft sub input axis

The input axis on the sum side of the main shaft module. This is used to compensate for the position of the main shaft main input axis.



Symbol	Setting item	Setting details	Setting value	Fetch cycle	Default value	Buffer memory address
Pr.401	Sub input axis No.	Set the input axis No. on the sub input side for the main shaft.	• Set in decimal. 0 : Invalid 1 to 16 : Servo input axis*1 801 to 804 : Synchronous encoder axis	At start of synchronous control	0	36401+200n

n: Axis No.-1

*1 : The range from 1 to 2 is valid in the 2-axis module.

(5) Composite main shaft gear

The composite travel value of the main shaft main input axis and the main shaft sub input axis are transmitted to the main shaft gear.

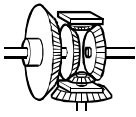

Symbol	Setting item	Setting details	Setting value	Fetch cycle	Default value	Buffer memory address
Pr.402	Composite main shaft gear	Select the composite method for input values from the main input axis and sub input axis.	<ul style="list-style-type: none"> • Set in hexadecimal. H□□□□ ├─ Main input method 0 : No input 1 : Input+ 2 : Input- └─ Sub input method 0 : No input 1 : Input+ 2 : Input- 	Operation cycle	0001h	36402+200n

n: Axis No.-1

(6) Main shaft gear

The converting travel value after composite main shaft gear is transmitted by the setting gear ratio.

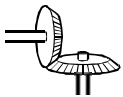

Symbol	Setting item	Setting details	Setting value	Fetch cycle	Default value	Buffer memory address
Pr.403	Main shaft gear: Numerator	Set the numerator for the main shaft gear.	<ul style="list-style-type: none"> • Set in decimal. -2147483648 to 147483647 	At start of synchronous control	1	36404+200n 36405+200n
Pr.404	Main shaft gear: Denominator	Set the denominator for the main shaft gear.	<ul style="list-style-type: none"> • Set in decimal. 1 to 2147483647 		1	36406+200n 36407+200n

n: Axis No.-1

(7) Main shaft clutch

The main shaft travel value is transmitted by the clutch ON/OFF.

This is used to transmit or disconnect instruction pulses from the main axis input to the output axis module, and control the operation and stopping of the servomotor.



Symbol	Setting item	Setting details	Setting value	Fetch cycle	Default value	Buffer memory address
Pr.405	Main shaft clutch control setting	Set the control method for the clutch.	<ul style="list-style-type: none"> • Set the control method for the clutch. H□□□□ → ON control mode <ul style="list-style-type: none"> 0 : No clutch 1 : Clutch command ON/OFF 2 : Clutch command leading edge 3 : Clutch command trailing edge 4 : Address mode 5 : High speed input request → OFF control mode <ul style="list-style-type: none"> 0 : OFF control invalid 1 : One-shot OFF 2 : Clutch command leading edge 3 : Clutch command trailing edge 4 : Address mode 5 : High speed input request → High speed input request signal <ul style="list-style-type: none"> 0 to F: High speed input request signal from axis 1 to axis 16*¹ 	Operation cycle	0000h	36408+200n
Pr.406	Main shaft clutch reference address setting	Set the reference address for the clutch.	<ul style="list-style-type: none"> • Set in decimal. 0 : Current value after composite main shaft gear 1 : Current value per cycle after main shaft gear 	At start of synchronous control	0	36409+200n
Pr.407	Main shaft clutch ON address	<ul style="list-style-type: none"> • Set the clutch ON address for address mode. (This setting is invalid except during address mode.) • If the address is out of the range from 0 to (Cam axis length per cycle - 1), the address is converted to a value within range. 	<ul style="list-style-type: none"> • Set in decimal. -2147483648 to 2147483647 [Main input axis position units*², or cam axis cycle units*³] 	Operation cycle	0	36410+200n 36411+200n

Symbol	Setting item	Setting details	Setting value	Fetch cycle	Default value	Buffer memory address
Pr.408	Travel value before main shaft clutch ON	<ul style="list-style-type: none"> Set the travel value for the distance between the clutch ON condition completing and the clutch closing. Set the travel value for the distance between the clutch ON condition completing and the clutch closing 	<ul style="list-style-type: none"> Set in decimal. -2147483648 to 2147483647 [Main input axis position units*², or cam axis cycle units*³] 	At completing clutch ON condition	0	36412+200n 36413+200n
Pr.409	Main shaft clutch OFF address	<ul style="list-style-type: none"> Set the clutch OFF address for the address mode. (This setting is invalid except during address mode.) If the address is out of the range from 0 to (Cam axis length per cycle - 1), the setting address is converted to a value within range. 	<ul style="list-style-type: none"> Set in dec -2147483648 to 2147483647 [Main input axis position units*², or cam axis cycle units*³] 	Operation cycle	0	36414+200n 36415+200n
Pr.410	Travel value before main shaft clutch OFF	<ul style="list-style-type: none"> Set the travel value for the distance between the clutch OFF condition completing and the clutch opening. Set the travel value for the distance between the clutch OFF condition completing and the clutch opening. 	<ul style="list-style-type: none"> Set in decimal. -2147483648 to 2147483647 [Main input axis position units*², or cam axis cycle units*³] 	At completing clutch OFF condition	0	36416+200n 36417+200n
Pr.411	Main shaft clutch smoothing method	Main shaft clutch smoothing method	<ul style="list-style-type: none"> Set in decimal. 0: Direct 1: Time constant method (Exponent) 2: Time constant method (Linear) 3: Slippage method (Exponent) 4: Slippage method (Linear) 	At start of synchronous control	0	36418+200n
Pr.412	Main shaft clutch smoothing time constant	For smoothing with a time constant method, set the smoothing time constant.	<ul style="list-style-type: none"> Set in decimal. 0 to 5000[ms] 		0	36419+200n
Pr.413	Slippage amount at main shaft clutch ON	For smoothing with a slippage method, set the slippage amount at clutch ON.	<ul style="list-style-type: none"> Set in decimal. 0 to 2147483647 [Main input axis position units*², or cam axis cycle units*³] 	At turning clutch ON.	0	36420+200n 36421+200n

Symbol	Setting item	Setting details	Setting value	Fetch cycle	Default value	Buffer memory address
Pr.414	Slippage amount at main shaft clutch OFF	For smoothing with a slippage method, set the slippage amount at clutch OFF.	<ul style="list-style-type: none"> Set in decimal. 0 to 2147483647 [Main input axis position units*2, or cam axis cycle units*3] 	At turning clutch OFF.	0	36422+200n 36423+200n

n: Axis No.-1

*1 : The range from 1 to 2 is valid in the 2-axis module.

*2 : Main input axis position units

*3 : Cam axis cycle units

(8) Auxiliary shaft parameters

This is the input axis for the auxiliary shaft module. For the auxiliary shaft module, the input value is generated from the auxiliary shaft. The input value can be converted by the auxiliary shaft gear that provides the deceleration ratio and the rotation direction for the machine system etc.



Symbol	Setting item	Setting details	Setting value	Fetch cycle	Default value	Buffer memory address
Pr.418	Auxiliary shaft axis No.	Set the input axis No. for the auxiliary shaft.	<ul style="list-style-type: none"> Set in decimal. 0 : Invalid 1 to 32 : Servo input axis*1 801 to 804 : Synchronous encoder axis 	At start of synchronous control	0	36430+200n

n: Axis No.-1

*1 : The range from 1 to 2 is valid in the 2-axis module.

(9) Auxiliary shaft gear

The converting auxiliary shaft travel value is transmitted by the setting gear ratio.

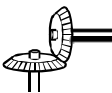

Symbol	Setting item	Setting details	Setting value	Fetch cycle	Default value	Buffer memory address
Pr.420	Auxiliary shaft gear: Numerator	Set the numerator for the auxiliary shaft gear.	<ul style="list-style-type: none"> Set in decimal. -2147483648 to 2147483647 	At start of synchronous control	1	36432+200n 36433+200n
Pr.421	Auxiliary shaft gear: Denominator	Set the denominator for the auxiliary shaft gear.	<ul style="list-style-type: none"> Set in decimal. 1 to 2147483647 		1	36434+200n 36435+200n

n: Axis No.-1

(10) Auxiliary shaft clutch

The auxiliary shaft travel value is transmitted by the clutch ON/OFF

This is used to transmit or disconnect instruction pulses from the auxiliary axis input to the output axis module, and control the operation and stopping of the servomotor.



Symbol	Setting item	Setting details	Setting value	Fetch cycle	Default value	Buffer memory address
Pr.422	Auxiliary shaft clutch control setting	Set the control method for the clutch.	<ul style="list-style-type: none"> • Set in hexadecimal. H□□□□ → ON control mode <ul style="list-style-type: none"> 0 : No clutch 1 : Clutch command ON/OFF 2 : Clutch command leading edge 3 : Clutch command trailing edge 4 : Address mode 5 : High speed input request → OFF control mode <ul style="list-style-type: none"> 0 : OFF control invalid 1 : One-shot OFF 2 : Clutch command leading edge 3 : Clutch command trailing edge 4 : Address mode 5 : High speed input request → High speed input request signal <ul style="list-style-type: none"> 0 to F: High speed input request signal from axis 1 to axis 16^{*1} 	Operation cycle	0000h	36436+200n
Pr.423	Auxiliary shaft clutch reference address setting	Set the reference address for the clutch.	<ul style="list-style-type: none"> • Set in decimal. 0 : Auxiliary shaft current value 1 : Current value per cycle after auxiliary shaft gear 	At start of synchronous control	0	36437+200n
Pr.424	Auxiliary shaft clutch ON address	<ul style="list-style-type: none"> • Set the clutch ON address for address mode. (This setting is invalid except during address mode.) • If the address is out of the range from 0 to (Cam axis length per cycle - 1), the address is converted to a value within range. 	<ul style="list-style-type: none"> • Set in decimal. -2147483648 to 2147483647 [Auxiliary shaft position units^{*2}, or cam axis cycle units^{*3}] 	Operation cycle	0	36438+200n 36439+200n

Symbol	Setting item	Setting details	Setting value	Fetch cycle	Default value	Buffer memory address
Pr.425	Travel value before auxiliary shaft clutch ON	<ul style="list-style-type: none"> Set the travel value for the distance between the clutch ON condition completing and the clutch closing. Set a positive value when the reference address is increasing, and a negative value when it is decreasing. 	<ul style="list-style-type: none"> Set in decimal. -2147483648 to 2147483647 [Auxiliary shaft position units*², or cam axis cycle units*³] 	At completing clutch ON condition	0	36440+200n 36441+200n
Pr.426	Auxiliary shaft clutch OFF address	<ul style="list-style-type: none"> Set the clutch OFF address for the address mode. (This setting is invalid except during address mode.) If the address is out of the range from 0 to (Cam axis length per cycle - 1), the setting address is converted to a value within range. 	<ul style="list-style-type: none"> Set in decimal. -2147483648 to 2147483647 [Auxiliary shaft position units*², or cam axis cycle units*³] 	Operation cycle	0	36442+200n 36443+200n
Pr.427	Travel value before auxiliary shaft clutch OFF	<ul style="list-style-type: none"> Set the travel value for the distance between the clutch OFF condition completing and the clutch opening. Set a positive value when the reference address is increasing, and a negative value when it is in decreasing. 	<ul style="list-style-type: none"> Set in decimal. -2147483648 to 2147483647 [Auxiliary shaft position units*², or cam axis cycle units*³] 	At completing clutch OFF condition	0	36444+200n 36445+200n
Pr.428	At completing clutch OFF condition	At completing clutch OFF condition	<ul style="list-style-type: none"> Set in decimal. 0: Direct 1: Time constant method (Exponent) 2: Time constant method (Linear) 3: Slippage method (Exponent) 4: Slippage method (Linear) 	At start of synchronous control	0	36446+200n
Pr.429	Auxiliary shaft clutch smoothing time constant	For smoothing with a time constant method, set the smoothing time constant.	<ul style="list-style-type: none"> Set in decimal. 0 to 5000[ms] 		0	36447+200n
Pr.430	At start of synchronous control	For smoothing with a slippage method, set the slippage amount at clutch ON.	<ul style="list-style-type: none"> Set in decimal. 0 to 2147483647 [Auxiliary shaft position units*², or cam axis cycle units*³] 	At turning clutch ON	0	36448+200n 36449+200n

Symbol	Setting item	Setting details	Setting value	Fetch cycle	Default value	Buffer memory address
Pr.431	At turning clutch ON	For smoothing with a slippage method, set the slippage amount at clutch OFF.	<ul style="list-style-type: none"> Set in decimal. 0 to 2147483647 [Auxiliary shaft position units*², or cam axis cycle units*³] 	At turning clutch OFF	0	36450+200n 36451+200n

n: Axis No.-1

*1 : The range from 1 to 2 is valid in the 2-axis module.

*2 : Auxiliary shaft position units

*3 : Cam axis cycle units

(11) Composite auxiliary shaft gear

The composite travel value of the main shaft and the auxiliary shaft are transmitted.

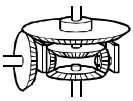

Symbol	Setting item	Setting details	Setting value	Fetch cycle	Default value	Buffer memory address
Pr.419	Composite auxiliary shaft gear	Select the composite method for input values from the main shaft and the auxiliary shaft.	<ul style="list-style-type: none"> Set in hexadecimal. <p>H□□□</p> <ul style="list-style-type: none"> Main shaft input method <ul style="list-style-type: none"> 0 : No input 1 : Input + 2 : Input - Auxiliary shaft input method <ul style="list-style-type: none"> 0 : No input 1 : Input + 2 : Input - 	Operation cycle	0001h	36431+200n

n: Axis No.-1

(12) Speed change gear

A speed change gear module is used to change the input speed from the main shaft/auxiliary shaft/composite auxiliary shaft gear during operation. Set the [Pr. 434] Speed change gear to "0: No speed change gear" when not using this.

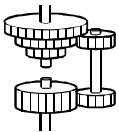

Symbol	Setting item	Setting details	Setting value	Fetch cycle	Default value	Buffer memory address
Pr.434	Speed change gear	Set the arrangement for the speed change gear.	<ul style="list-style-type: none"> Set in decimal. 0 : No speed change gear 1 : Main shaft side 2 : Auxiliary shaft side 3 : After composite auxiliary shaft gear 	At start of synchronous control	0	36460+200n
Pr.435	Speed change gear smoothing time constant	Set the smoothing time constant for the speed change gear.	<ul style="list-style-type: none"> Set in decimal. 0 to 5000[ms] 		0	36461+200n
Pr.436	Speed change ratio: Numerator	Set the numerator for the speed change ratio.	<ul style="list-style-type: none"> Set in decimal. -2147483648 to 2147483647 	Operation cycle	1	36462+200n 36463+200n
Pr.437	Speed change ratio: Denominator	Set the denominator for the speed change ratio.	<ul style="list-style-type: none"> Set in decimal. 1 to 2147483647 		1	36462+200n 36463+200n

n: Axis No.-1

(13) Output axis

The cam conversion is processed based on the input travel value and the setting cam data. The current feed value is output as the command to the servo amplifier.

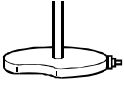

Symbol	Setting item	Setting details	Setting value	Fetch cycle	Default value	Buffer memory address
Pr.438	Cam axis cycle unit setting	<ul style="list-style-type: none"> Set the units for the cam axis length per cycle. There is no influence on the control for the parameter for monitor display. 	<ul style="list-style-type: none"> Set in hexadecimal. H□□□□ Control unit 0 : mm 1 : inch 2 : degree 3 : PLS Number of decimal places 0 to 9 Number of decimal places 0 : Use units of main input axis 1 : Use units of this setting 	At start of synchronous control	0000h	36470+200n
Pr.439	Cam axis length per cycle	Set the required input amount with the cam per cycle.	<ul style="list-style-type: none"> Set in decimal. 1 to 2147483647 [Cam axis cycle units]*¹ 		QD77MS/ QD77GF/ LD77MS: 4194304 LD77MH: 262144	36472+200n 36473+200n
Pr.440	Cam No.	Cam No.	<ul style="list-style-type: none"> Set in decimal number. 0 : Linear cam (preset) 1 : 256: user-created cam 	At start of synchronous control, At passing through the 0th point of cam data	0	36474+200n
Pr.441	Cam stroke amount	<ul style="list-style-type: none"> Set the cam stroke amount corresponding to the stroke ratio 100% for cam with stroke ratio data format. This is ignored for cams using the coordinate data format. 	<ul style="list-style-type: none"> Set in decimal. -2147483648 to 2147483647 [Output axis position units]*² 		QD77MS/ QD77GF/ LD77MS: 4194304 LD77MH: 262144	36476+200n 36477+200n
Pr.444	Cam axis phase compensation advance time	Set the time to advance or delay the phase of the cam axis.	<ul style="list-style-type: none"> Set in decimal. -2147483648 to 2147483647 [μs] 	Operation cycle	0	36482+200n 36483+200n
Pr.445	Cam axis phase compensation time constant	Set the time constant to affect the phase compensation of the cam axis.	<ul style="list-style-type: none"> Set in decimal. 0 to 65535[ms]*³ 	At start of synchronous control	10	36484+200n
Pr.446	Synchronous control deceleration time	Set the deceleration time for the synchronous control.	<ul style="list-style-type: none"> Set in decimal. 0 to 65535[ms]*³ 		0	36485+200n

Symbol	Setting item	Setting details	Setting value	Fetch cycle	Default value	Buffer memory address
Pr.447	Output axis smoothing time constant	Set to smooth the output axis.	• Set in decimal. 0 to 5000[ms] ^{*3}		0	36486+200n

n: Axis No.-1

*1 : Cam axis cycle units

*2 : Output axis position units

*3 : Set the value as follows in a sequence program.

0 to 32767Set as a decimal

32768 to 65535Convert into a hexadecimal and set

[Cam data]

The output axis for synchronous control is operated with a cam. With the cam data, register the operation pattern of the output axis (two-way operation and feed operation), which is corresponding to the input travel value of the output axis module.

Operation includes the following patterns.

- Two-way operation: Reciprocating operation with a constant cam strokes range

Two-way operation

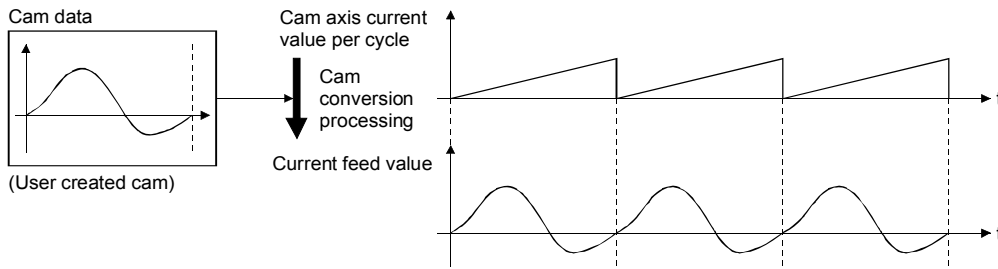

- Feed operation: Cam reference position is updated every cycle

Feed operation

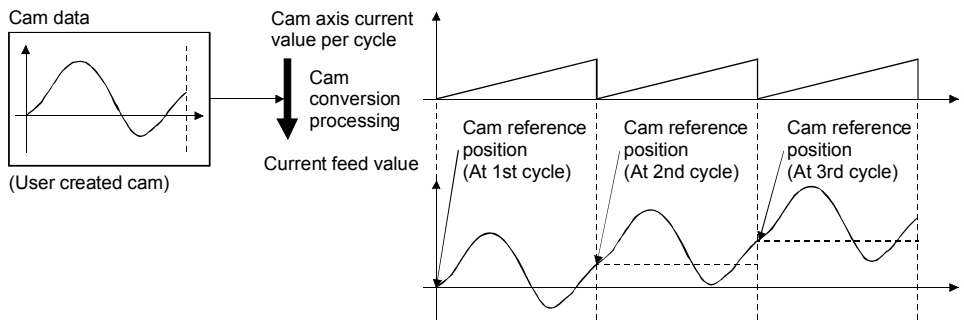

- Linear operation: Linear operation (cam No. 0) in the cycle as the stroke ratio is 100%

Linear operation

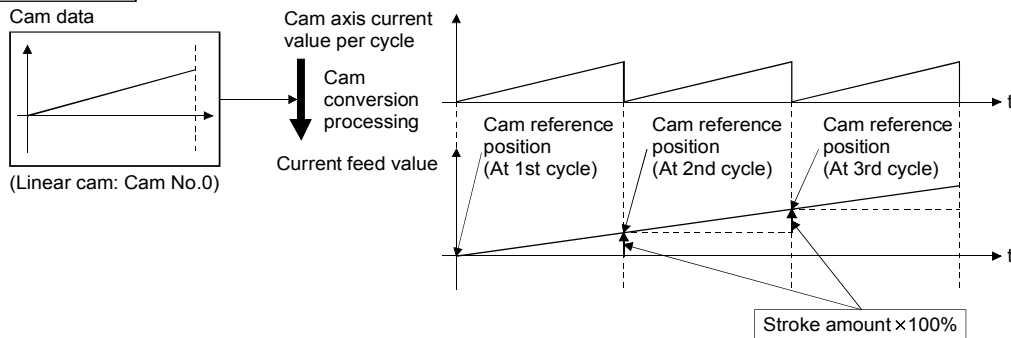

8.2 Synchronous operation system with an X-axis roller and a Y-axis cam

How to achieve the movement according to the path

- The X axis is set to rotate 2mm per rotation by the basic parameters, and the Y axis is the main axis.
- A the ball screw for the Y axis (axis 2) moves 2mm per rotation (4,194,304 pulses/rotation), set the axis 1 cam cycle length to 4,194,304 pulses (actually 30mm or 10mm) for the output axis parameter to make the operation confirmation easier.

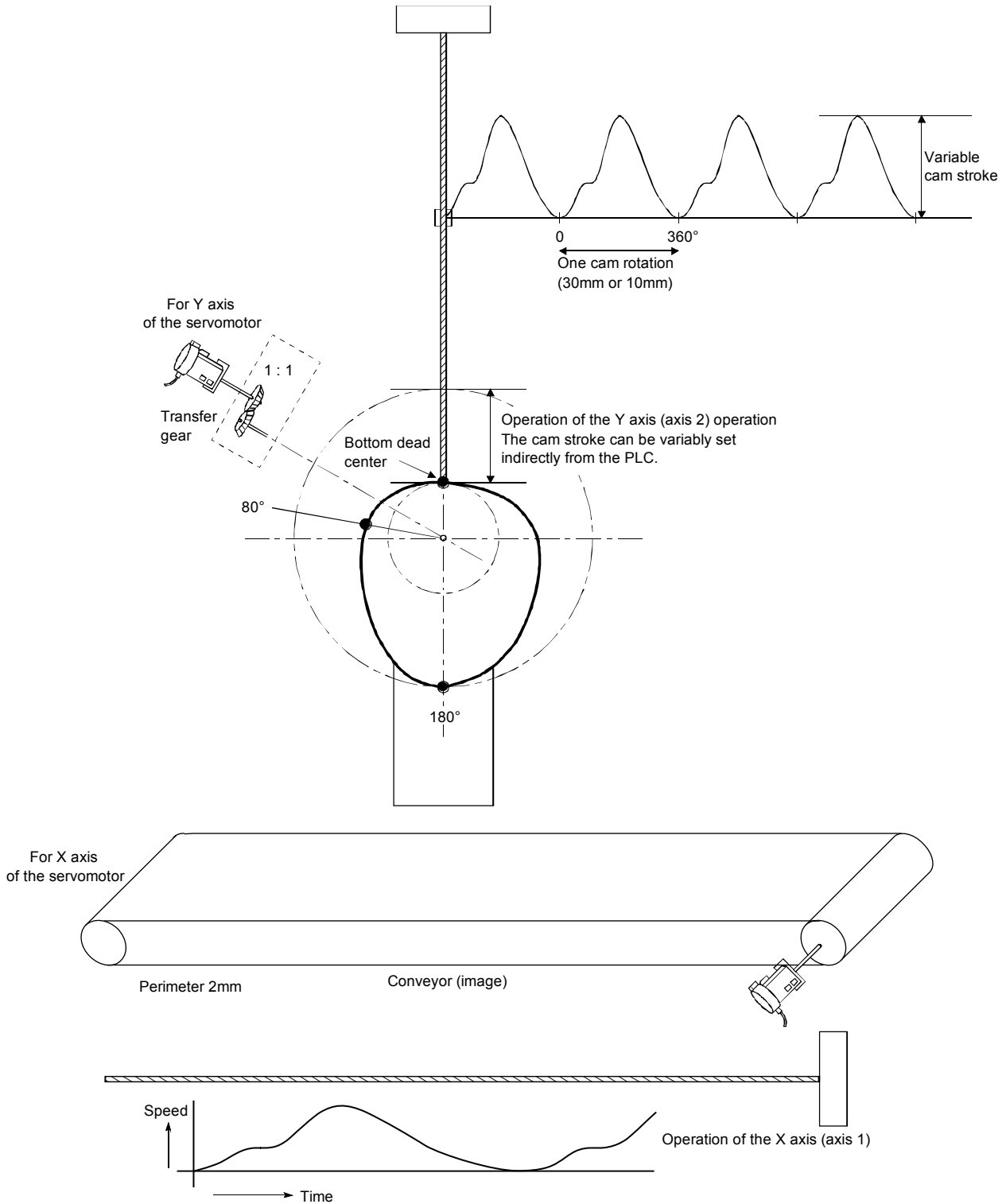

8.3 Creating cam data

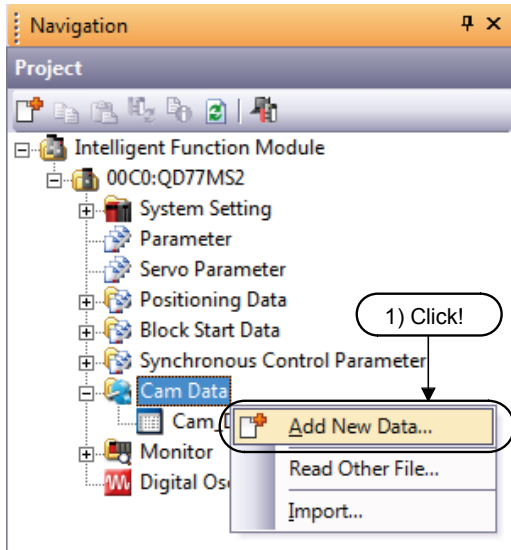

- 1) Right-click "Cam data" in the project window, and click [Add New Data].

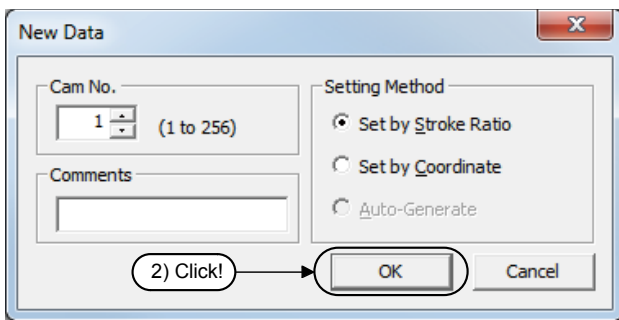

- 2) The New Data screen is displayed. Set the cam number, and click the **OK** button.

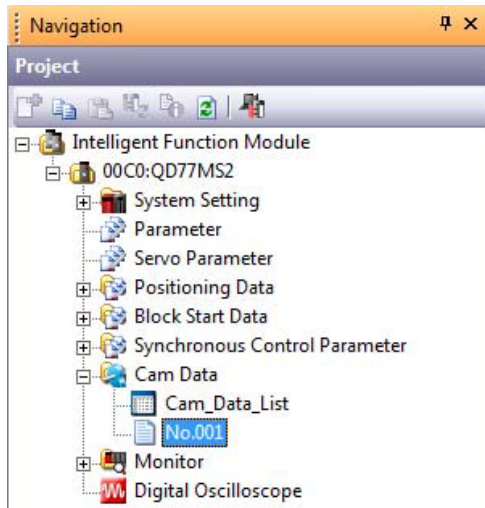

- 3) The cam data is crated, and the setting screen is displayed.

↓
To the next page

From the previous page

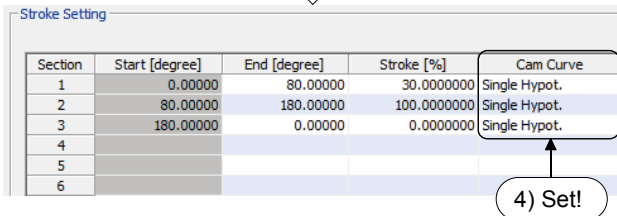
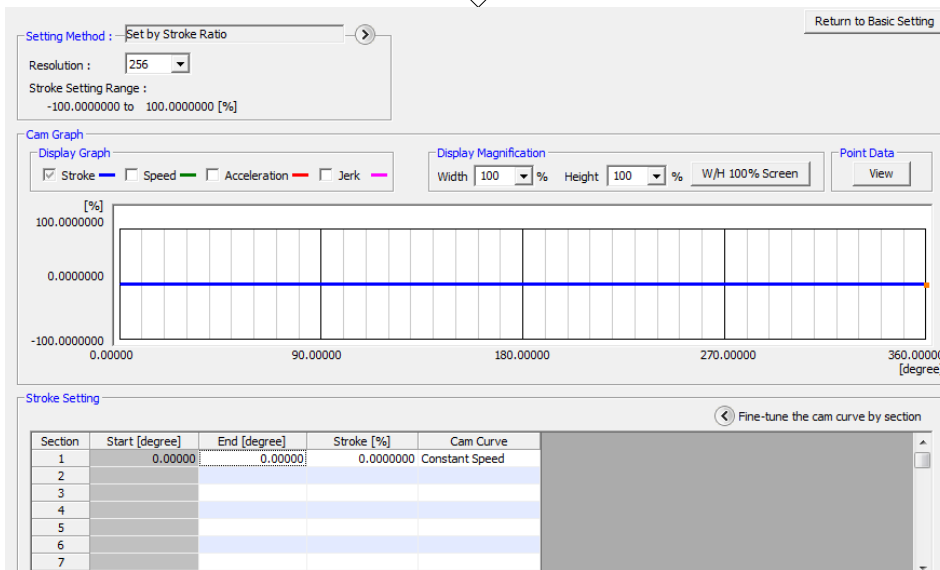

4) Configure the stroke setting on the setting screen as follows.

Section	Start [degree]	End [degree]	Stroke [%]
1	0.00000	80.00000	30.0000000
2		180.00000	100.0000000
3		0.00000	0.0000000

Stroke setting range

"Minimum value": 0.00000, "Maximum value": 100.0000000

Set the total stroke to "Single Hypot." in the Cam Curve.

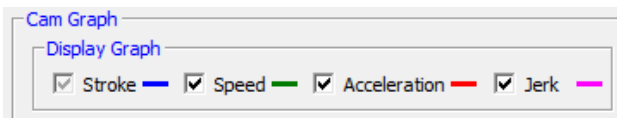

5) To see [Stroke], [Speed], [Acceleration], and [Jerk] corresponding to the operation angle in the table, change the selection of check boxes in Display Graph to change the graph displays.

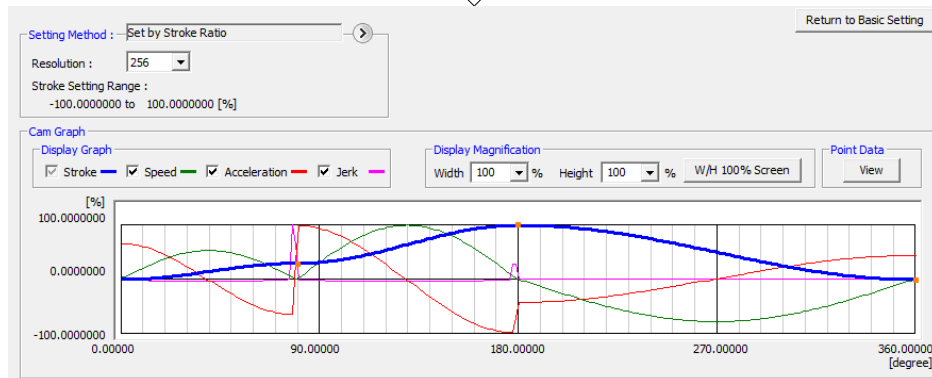

To the next page

From the previous page

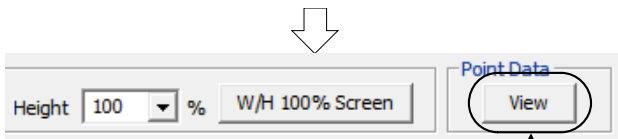

- 6) To see the stroke ratio, speed, acceleration, and jerk corresponding to the operation angle in numerical values, click the **View** button in Point Data.

Point Data Display - Cam Data No.001

Table No.	Length per Cycle [degree]	Stroke [%]	Speed	Acceleration	Jerk	Cam Curve	Cam Data
1	1.40625	0.0228663	0.07	3.29	-0.1	Single Hypot.	228662
2	2.81250	0.0913954	0.12	3.26	-0.1	Single Hypot.	913954
3	4.21875	0.2053785	0.16	3.23	-0.1	Single Hypot.	2053785
4	5.62500	0.3644680	0.21	3.18	-0.2	Single Hypot.	3644680
5	7.03125	0.5681789	0.25	3.13	-0.2	Single Hypot.	5681789
6	8.43750	0.8158901	0.30	3.06	-0.2	Single Hypot.	8158901
7	9.84375	1.1068464	0.34	2.99	-0.3	Single Hypot.	11068463
8	11.25000	1.4401606	0.38	2.91	-0.3	Single Hypot.	14401606
9	12.65625	1.8148166	0.42	2.82	-0.3	Single Hypot.	18148166
10	14.06250	2.2296721	0.46	2.72	-0.3	Single Hypot.	22296721
11	15.46875	2.6834623	0.50	2.61	-0.4	Single Hypot.	26834622
12	16.87500	3.1748036	0.54	2.49	-0.4	Single Hypot.	31748035
13	18.28125	3.7021980	0.57	2.37	-0.4	Single Hypot.	37021980
14	19.68750	4.2640376	0.60	2.24	-0.4	Single Hypot.	42640376
15	21.09375	4.8586094	0.64	2.10	-0.5	Single Hypot.	48586094
16	22.50000	5.4841007	0.66	1.95	-0.5	Single Hypot.	54841007
17	23.90625	6.1386045	0.69	1.80	-0.5	Single Hypot.	61386044
18	25.31250	6.8201252	0.72	1.65	-0.5	Single Hypot.	68201251

After confirmation, click the **Close** button.

The table contains No. 1 to 256. Scroll the screen to display.

Stroke Setting

Section	Start [degree]	End [degree]	Stroke [%]	Cam Curve
1	0.00000	80.00000	30.0000000	Constant Speed
2	80.00000	180.00000	100.0000000	Constant Speed
3	180.00000	0.00000	0.0000000	Constant Speed
4				
5				
6				

- 7) Create the cam data for cam No. 002 using the same procedure of cam No. 001. For cam No. 002, set all strokes to "Constant Speed" in the "Cam Curve". (Other than this setting, the settings are the same as cam No. 001.)

Stroke Setting

Section	Start [degree]	End [degree]	Stroke [%]	Cam Curve
1	0.00000	80.00000	30.0000000	Double Hypot.
2	80.00000	150.00000	100.0000000	Double Hypot.
3	150.00000	220.00000	100.0000000	Double Hypot.
4	220.00000	310.00000	0.0000000	Double Hypot.
5	310.00000	0.00000	0.0000000	Double Hypot.
6				

- 8) Set cam No. 003 using the same procedure. Configure the Stroke Setting as follows.

Section	Start [degree]	End [degree]	Stroke [%]
1	0.00000	80.00000	30.0000000
2		150.00000	100.0000000
3		220.00000	100.0000000
4		310.00000	0.0000000
5		0.00000	0.0000000

Stroke setting range
 "Minimum value": 0.00000, "Maximum value":
 100.0000000

Set all strokes to "Double Hypot." in the "Cam Curve".

To the next page

From the previous page



Stroke Setting

Section	Start [degree]	End [degree]	Stroke [%]	Cam Curve
1	0.00000	45.00000	0.0000000	Constant Speed
2	45.00000	90.00000	50.0000000	Constant Speed
3	90.00000	180.00000	50.0000000	Constant Speed
4	180.00000	225.00000	0.0000000	Constant Speed
5	225.00000	270.00000	0.0000000	Constant Speed
6	270.00000	300.00000	-60.0000000	Constant Speed
7	300.00000	330.00000	-60.0000000	Constant Speed

9) Set!

9) Set cam No. 004 using the same procedure. Configure the Stroke Setting as follows.

Section	Start [degree]	End [degree]	Stroke [%]
1	0.00000	45.00000	0.0000000
2		90.00000	50.0000000
3		180.00000	50.0000000
4		225.00000	0.0000000
5		270.00000	0.0000000
6		300.00000	-60.0000000
7		330.00000	-60.0000000
8		0.00000	0.0000000

Stroke setting range
 "Minimum value": -100.00000 "Maximum value":
 100.0000000

Set the total stroke to "Constant Speed" in the "Cam Curve".

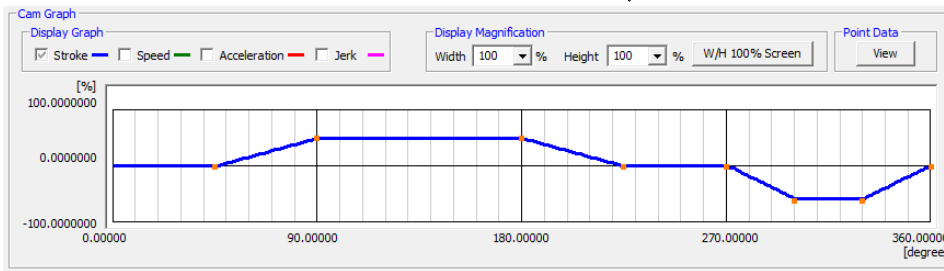

The stroke value of cam No. 004 may be negative value.

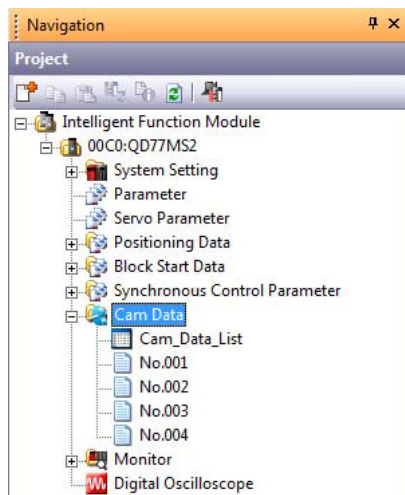

10) This completes the creation of cam data.

[Path of each created cam]

<Waveform of cam No. 001>

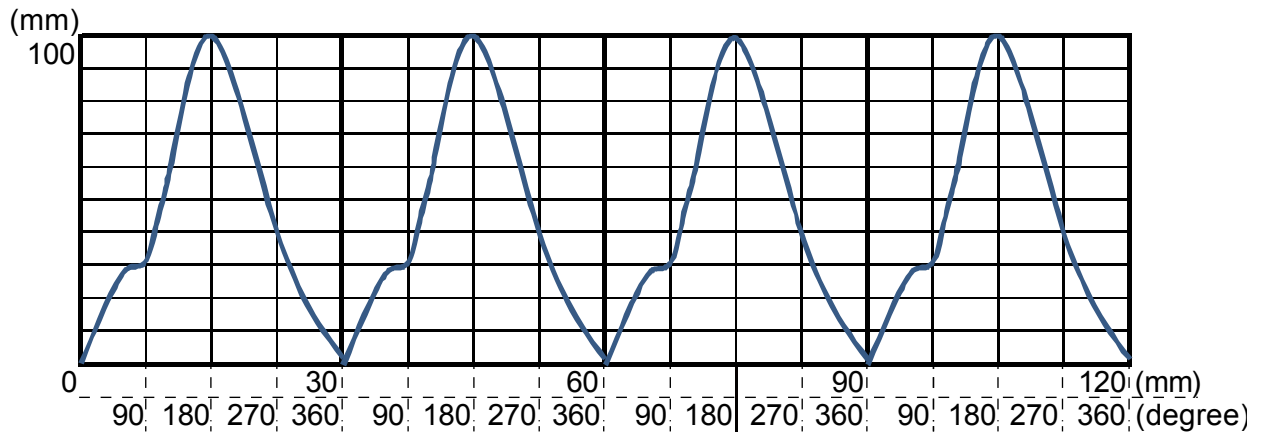

<Waveform of cam No. 002>

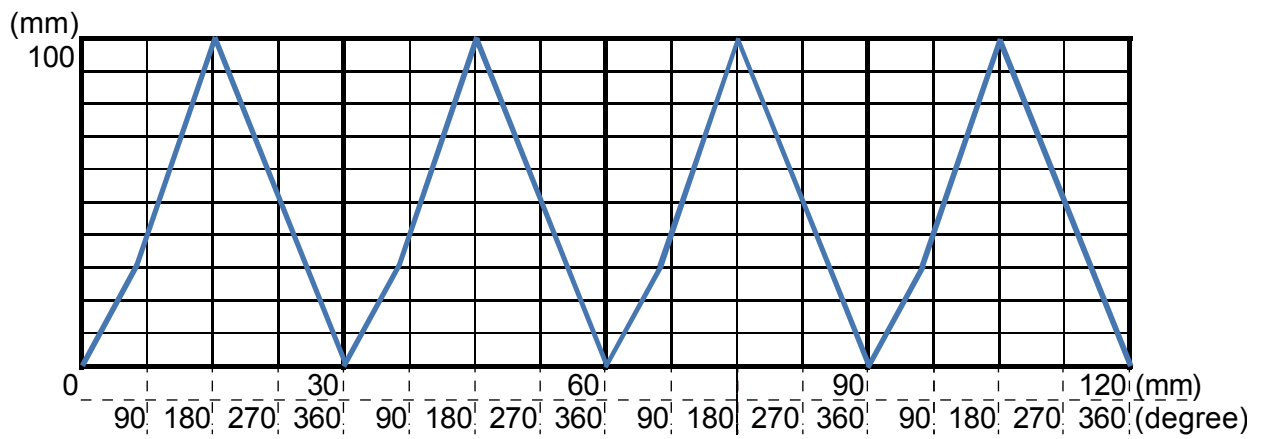

<Waveform of cam No. 003>

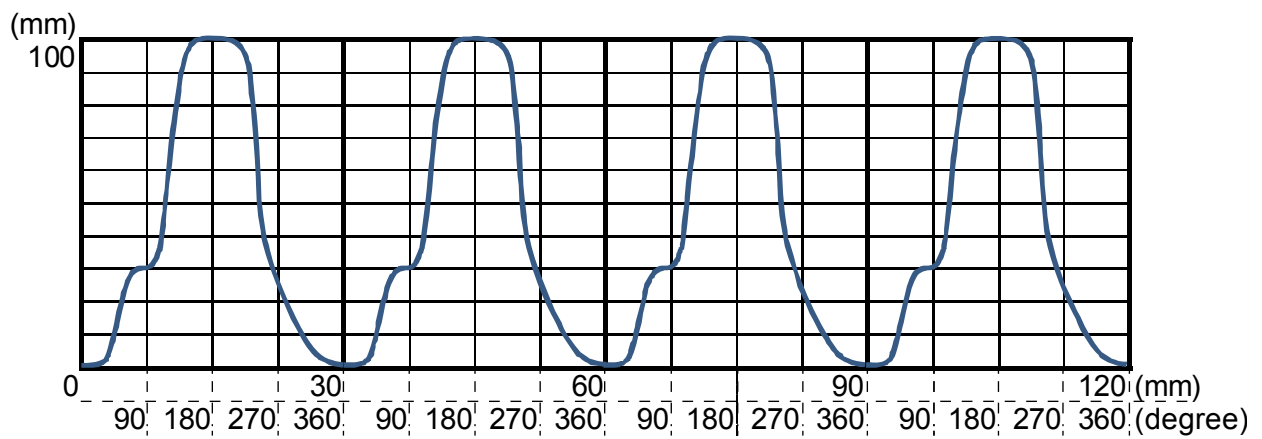

<Waveform of cam No. 004>

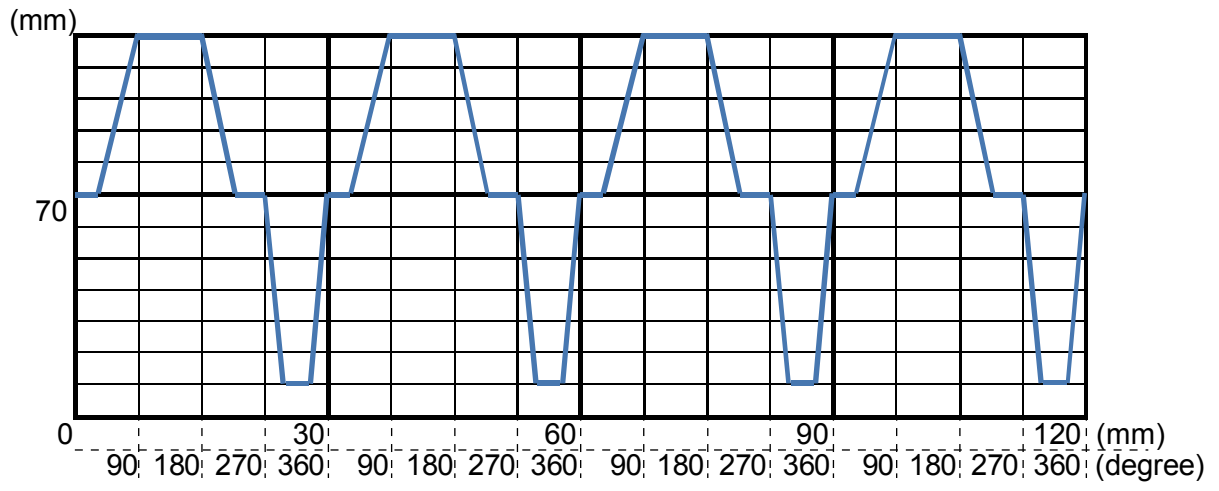

8.4 Sequence program of the synchronous operation

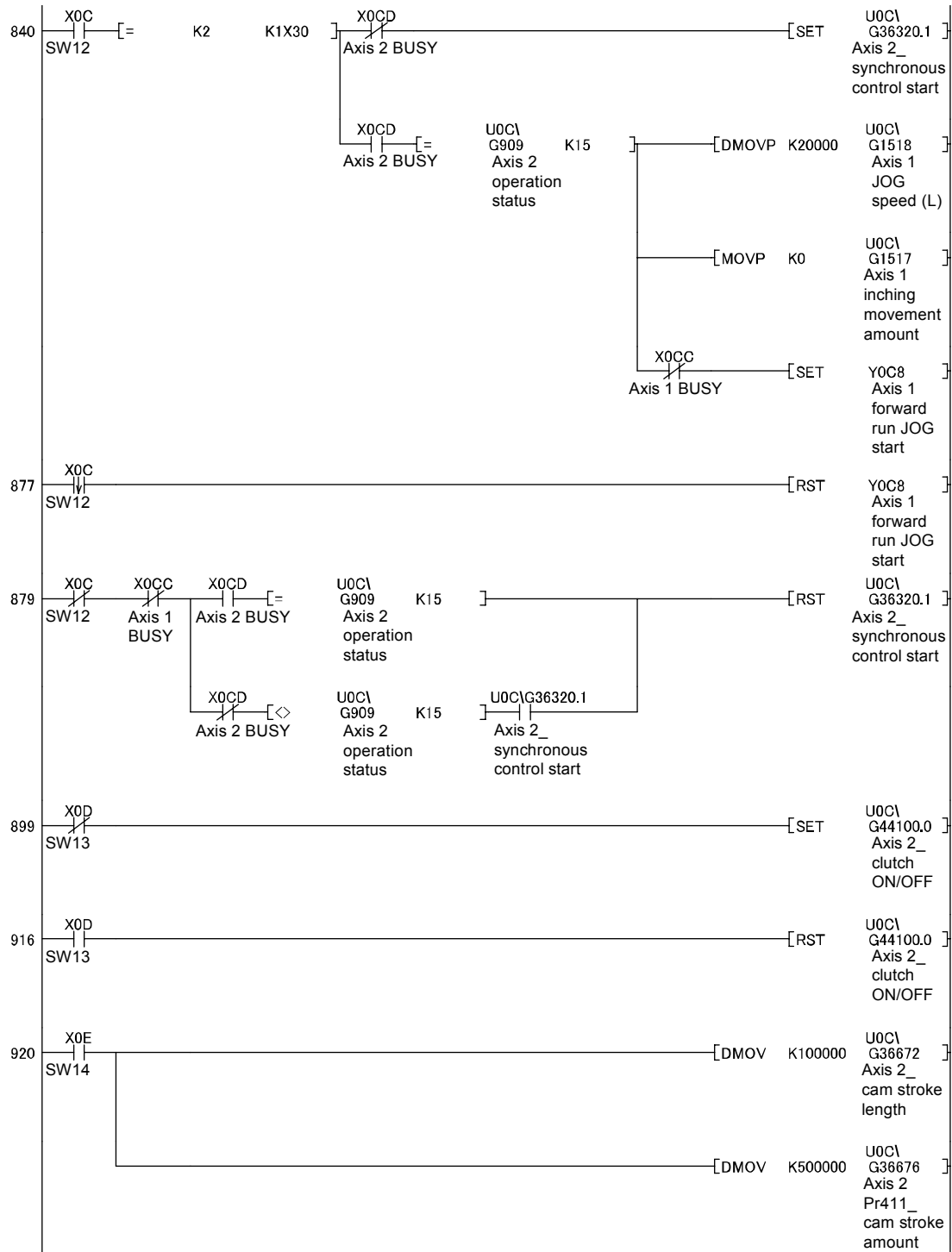

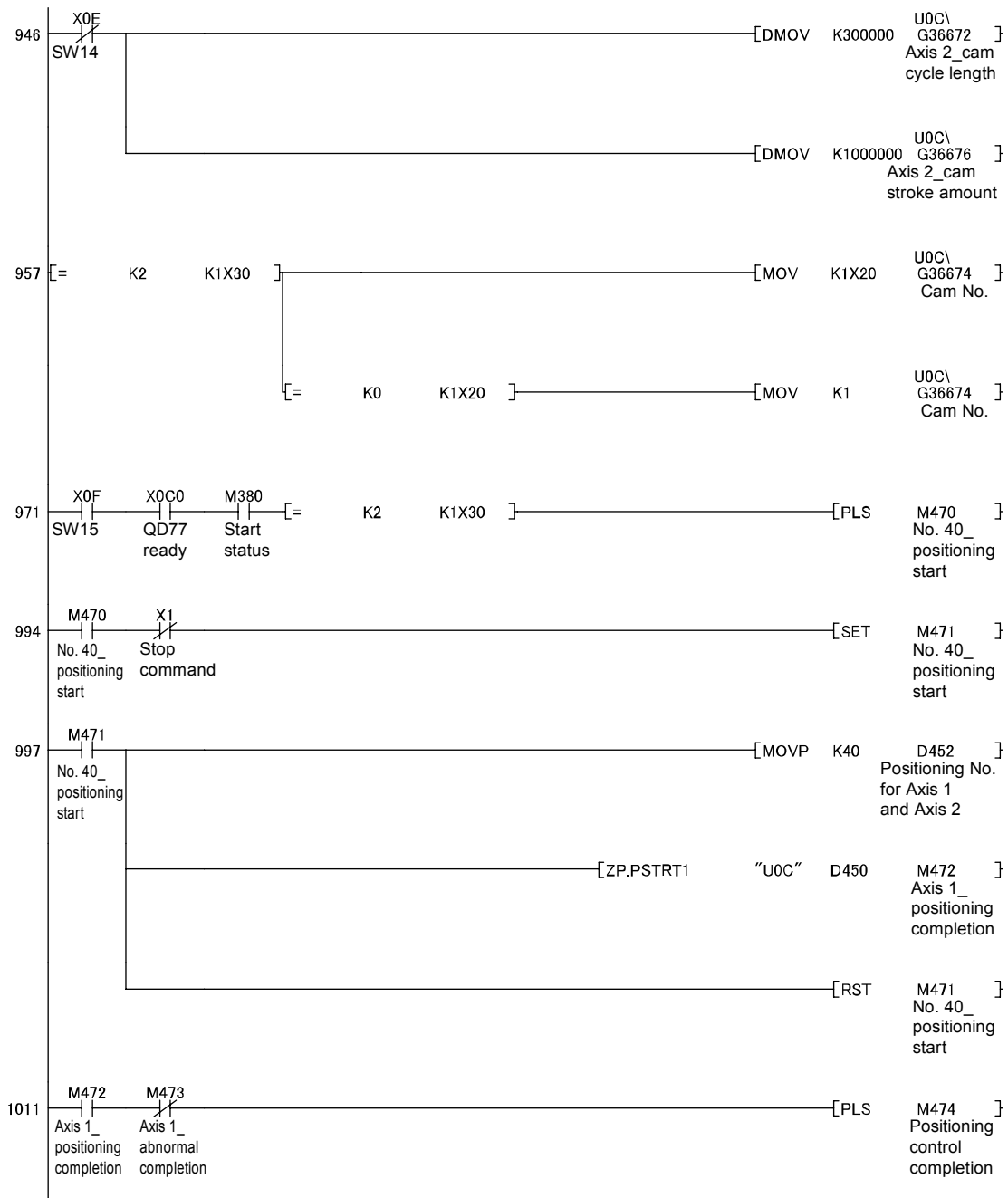

8.4.1 Editing the servo input axis parameters

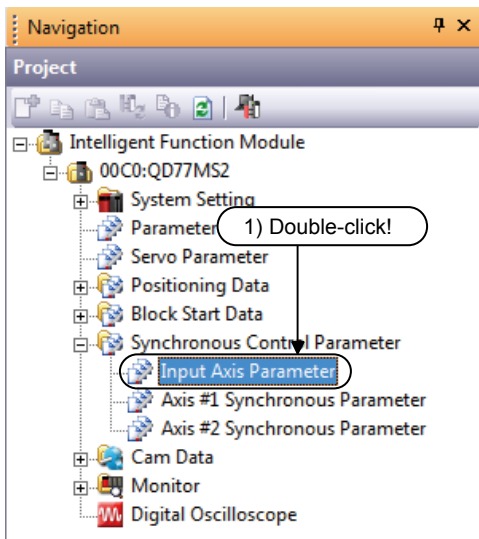

- 1) From [Synchronous Control Parameter] under the project window, double-click [Input Axis Parameter].

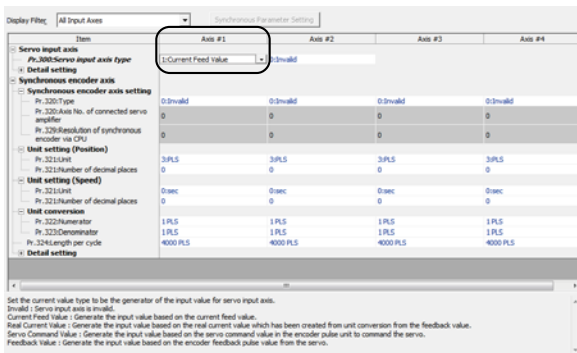

- 2) The Input Axis Parameter dialog box is displayed. Set the following to only axis 1.

Servo input axis type	1: Current Feed Value
-----------------------	-----------------------

8.4.2 Editing synchronous control parameters

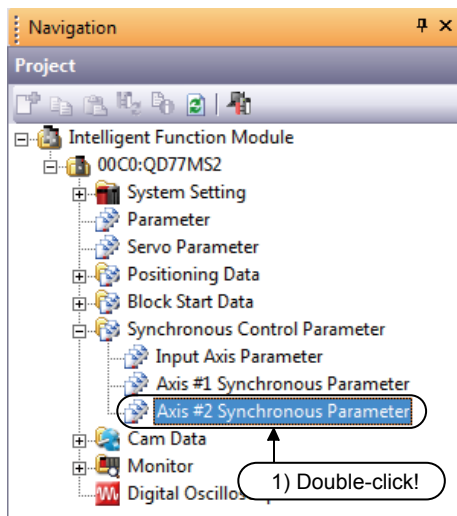

- 1) From [Synchronous Control Parameter] under the project window, double-click [Axis #2 Synchronous Parameter].



- 2) The Axis #2 Synchronous Parameter dialog box is displayed, and set "Pr. 400: Type" and "Pr. 400: Axis No." for the Main input axis as follows.

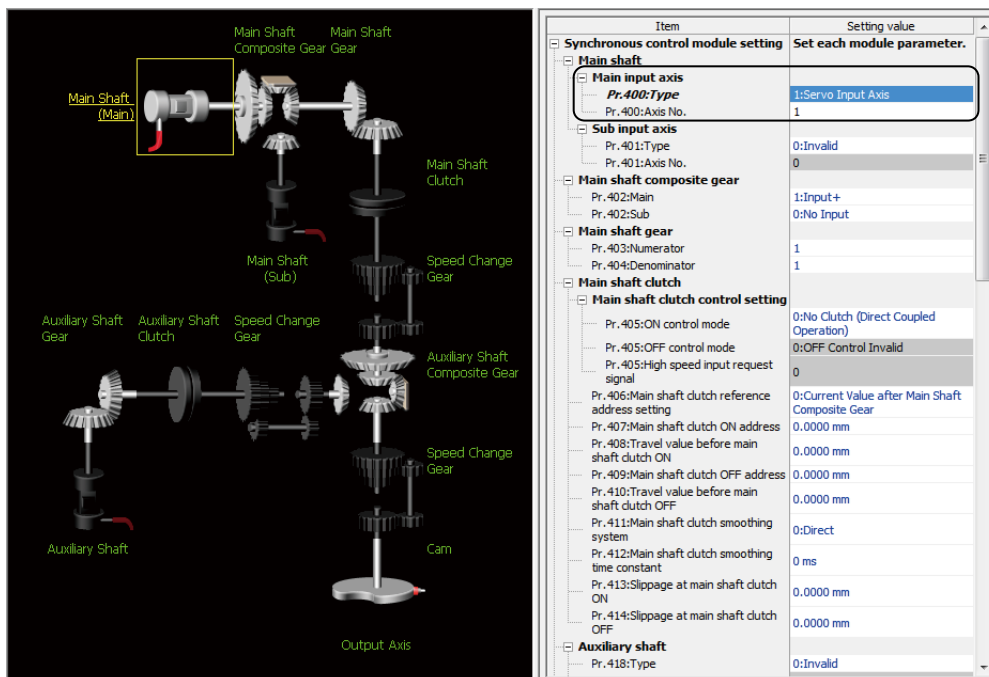

* "1: Servo Input Axis" indicates axis 1 of the input axis parameters.

For the axis 1 of the input axis parameters, change the setting of "Pr. 300: Servo input axis type" to "1: Current Feed Value".



To the next page

From the previous page



3) Set "Pr. 405: ON control mode" for Main shaft clutch control settings as follows.

Item	Setting value
Synchronous control module setting	
Main shaft	
Pr. 400:Type	1:Servo Input Axis
Pr. 400:Axis No.	1
Sub input axis	
Pr. 401:Type	0:Invalid
Pr. 401:Axis No.	0
Main shaft composite gear	
Pr. 402:Main	1:Input+
Pr. 402:Sub	0:No Input
Main shaft gear	
Pr. 403:Numerator	1
Pr. 404:Denominator	1
Main shaft clutch	
Main shaft clutch control setting	
Pr. 405:ON control mode	1:Clutch Command ON/OFF
Pr. 405:OFF control mode	0:OFF Control Invalid
Pr. 405:High speed input request signal	0
Pr. 406:Main shaft clutch reference address setting	0:Current Value after Main Shaft Composite Gear
Pr. 407:Main shaft clutch ON address	0.0000 mm
Pr. 408:Travel value before main shaft clutch ON	0.0000 mm
Pr. 409:Main shaft clutch OFF address	0.0000 mm
Pr. 410:Travel value before main shaft clutch OFF	0.0000 mm
Pr. 411:Main shaft clutch smoothing system	0:Direct
Pr. 412:Main shaft clutch smoothing time constant	0 ms
Pr. 413:Slippage at main shaft clutch ON	0.0000 mm
Pr. 414:Slippage at main shaft clutch OFF	0.0000 mm
Auxiliary shaft	
Pr. 418:Type	0:Invalid



4) Set the "Pr. 439: Cam axis length per cycle" and "Pr. 441: Cam stroke amount" as follows.

Item	Setting value
Pr. 426:Auxiliary shaft clutch OFF address	0 PLS
Pr. 427:Travel value before auxiliary shaft clutch OFF	0 PLS
Pr. 428:Auxiliary shaft clutch smoothing system	0:Direct
Pr. 429:Auxiliary shaft clutch smoothing time constant	0 ms
Pr. 430:Slippage at auxiliary shaft clutch ON	0 PLS
Pr. 431:Slippage at auxiliary shaft clutch OFF	0 PLS
Speed change gear	
Pr. 434:Speed change gear arrangement	0:No Speed Change Gear
Pr. 435:Speed change gear smoothing time constant	0 ms
Speed change ratio	
Pr. 436:Numerator	1
Pr. 437:Denominator	1
Output axis	
Cam axis cycle unit	
Pr. 438:Unit setting selection	0:Use Units of Main Input Axis
Pr. 438:Unit	0:mm
Pr. 438:Number of decimal places	0
Pr. 439:Cam axis length per cycle	30.0000 mm
Pr. 441:Cam stroke amount	100000 PLS
Pr. 440:Cam No.	0
Pr. 444:Cam axis phase compensation advance time	0 μs
Pr. 445:Cam axis phase compensation time constant	10 ms
Pr. 446:Synchronous control deceleration time	0 ms
Pr. 447:Output axis smoothing time constant	0 ms
Synchronous control initial position parameter	
Set the parameter for the initial alignment when starting the synchronous c...	

This completes the setting of the axis 2 synchronous parameters.

8.4.3 Writing data to the QD77MS2

Write the created data (the positioning data, the synchronization control parameters, and the cam data) to the QD77MS2.

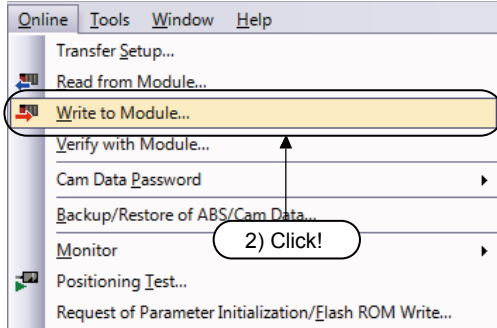

- 1) Stop the QD77MS2.
- 2) Select [Online] → [Write to Module] from the menu in the Simple Motion Module Setting Tool.

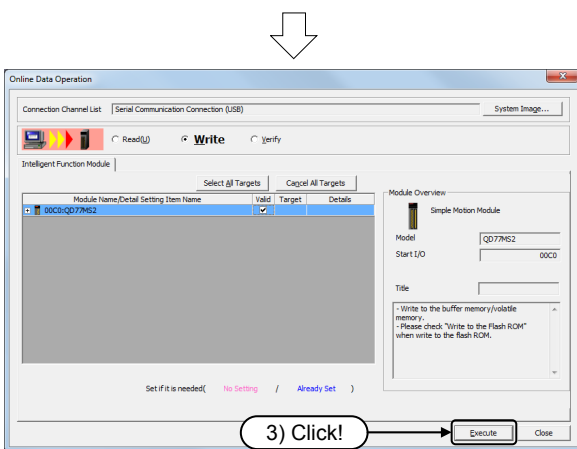

- 3) The online data operation dialog box is displayed.

Place a check in the "Valid", "Positioning Data", "Block Start Data", "Parameter", "Servo Parameter", "Synchronous Control Parameter", "Cam Data (Converted data)", "Cam data (Edit data)", and "Write" check boxes, and click the **Execute** button.

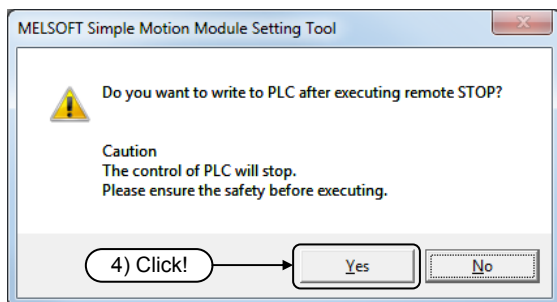

- 4) A dialog box to confirm the execution to the PLC write operation is displayed. Click the **Yes** button.

To the next page

From the previous page

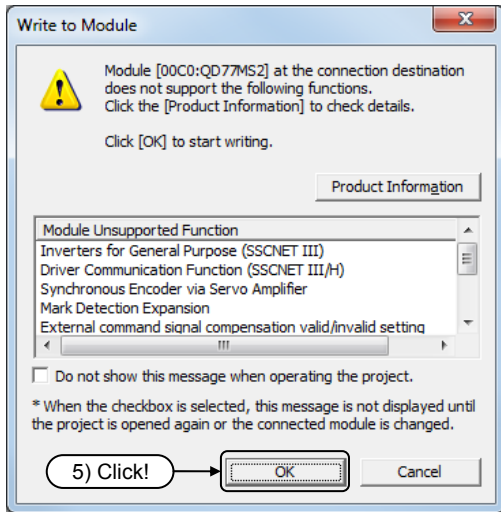

- 5) The Write to Module dialog box is displayed. Click the **OK** button.

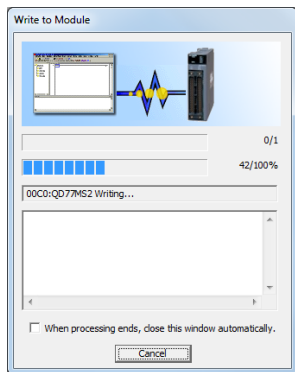

- 6) The module writing operation will start.

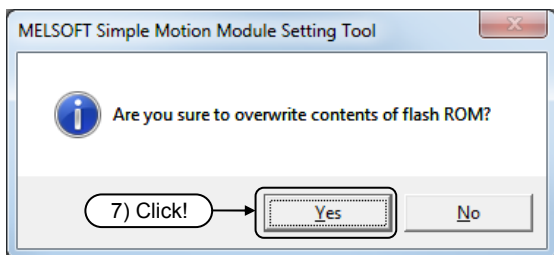

- 7) A dialog box to confirm the execution to the flash ROM overwrite is displayed. Click the **Yes** button.

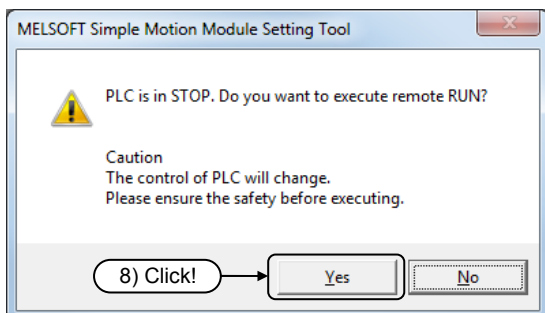

- 8) A dialog box to confirm the execution to the remote RUN operation is displayed. Click the **Yes** button.



To the next page

From the previous page

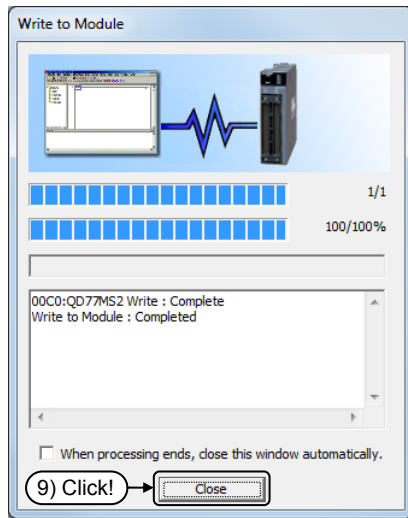

- 9) The message that indicates the writing to PLC operation completes is displayed. Click the **Close** button.

8.5 Demonstration machine operations

Operation confirmation

The data types (the sequence program, the parameters, and the positioning data) are

Project name	XY-4
--------------	------

Read from the folder and write to the QD77MS2.



[Confirm operation of cam No. 001]

- 1) Set "2" to the digital switches "X3F←X30". The operation switches to the synchronous operation.
- 2) Set "1" to the digital switches "X2F←X20". Cam No. 001 is called.
- 3) Turn on "X0" and perform the home position return.
- 4) Turn on "XC" and drive the cam No. 001. The cam path follows a waveform as shown below.

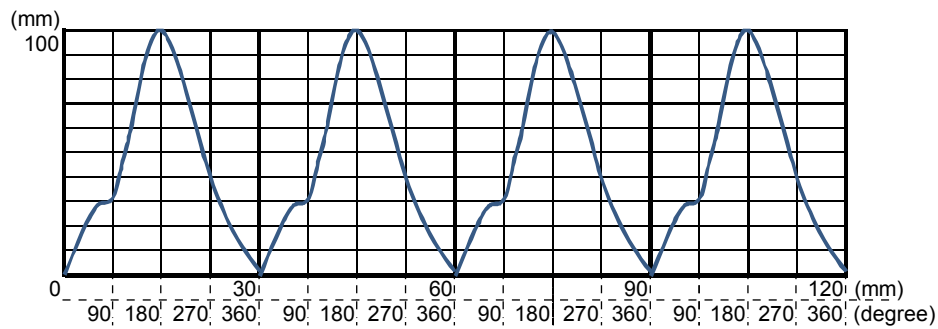

- 5) An error will occur if the path reaches the final end, so turn on "XB" to clear the error.
- 6) Turn on "X0" and perform the home position return.
- 7) Turn on "XE", then "XC" to change the cam stroke amount and the cam stroke length, and perform the driving. The cam path follows a waveform as shown below.

[When XE is on]

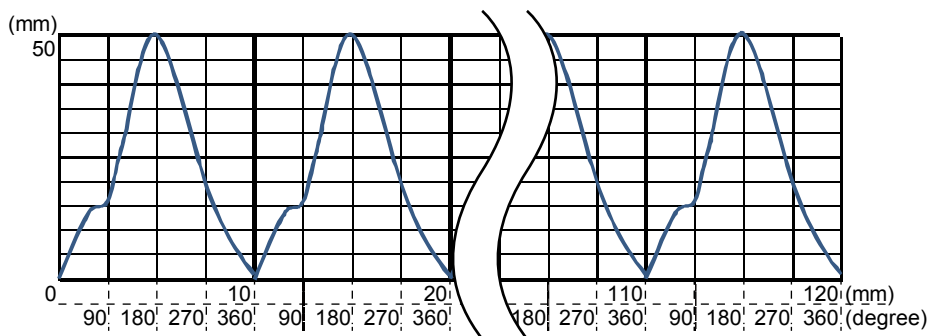

To the next page

From the previous page



- 8) Turn on "XD" during the driving, and confirm that the clutch turns off.
- 9) Turn off "XD", and confirm that the clutch turns on.
- 10) Turn off "XC" and stop the driving of cam No. 001. Perform the home position return after stopping.



[Confirm operation of cam No. 002]

- 1) Set "2" to the digital switches "X2F←X20. Cam No. 002 is called.
- 2) Perform the driving according to the same procedures as steps 3 to 10 from [Confirm operation of cam No. 001], and confirm the operation of cam No. 002. The path of cam No. 002 follows a waveform as shown below.

[When XE is off]

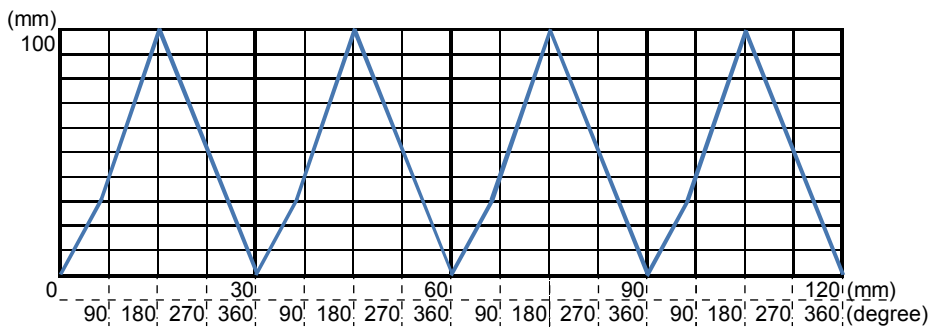

[When XE is on]

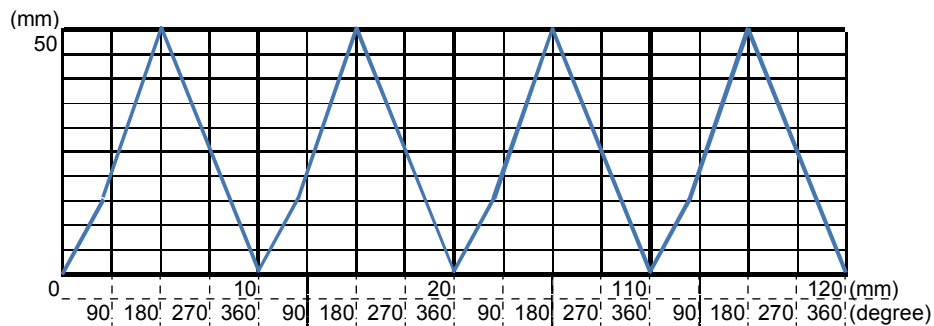

To the next page

From the
previous page



[Confirm operation of cam No. 003]

- 1) Set "3" to the digital switches "X2F←X20". Cam No. 003 is called.
- 2) Perform the driving according to the same procedures as steps 3 to 10 from <Confirm operation of cam No. 001>, and confirm the operation of cam No. 003. The path of cam No. 003 follows a waveform as shown below.

[When XE is off]

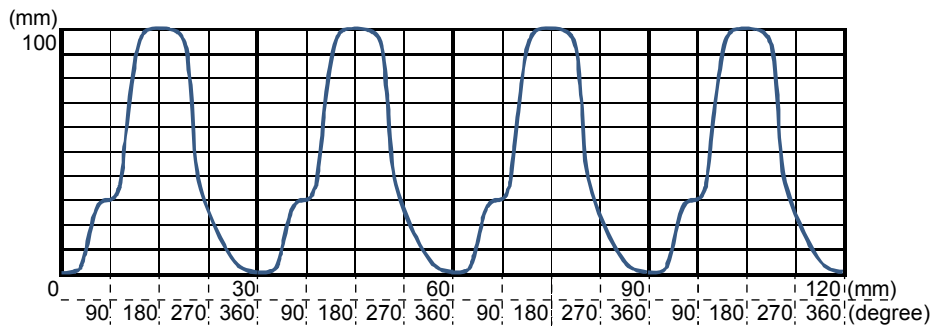

[When XE is on]

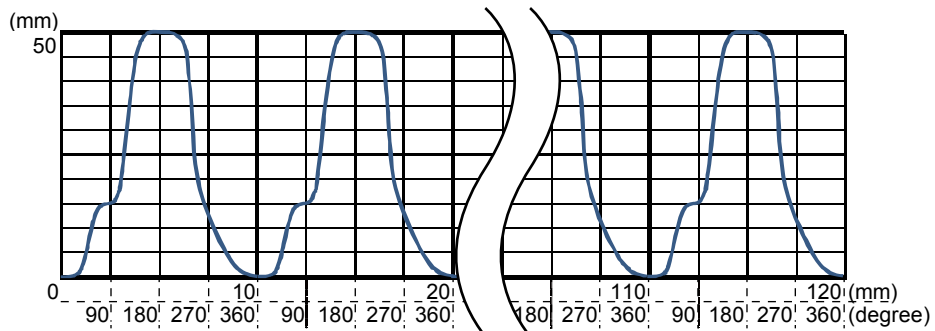

To the next page

From the
previous page



[Confirm operation of cam No. 004]

- 1) Set "4" to the digital switches "X2F←X20". Cam No. 004 is called.
- 2) Turn on "X0" and perform the home position return.
- 3) Turn on "XF", and move to the positioning data No. 40.
- 4) After moving to the positioning data No. 40 completes, turn on "XC", and drive cam No. 004. The path of cam No. 004 follows a waveform as shown below.

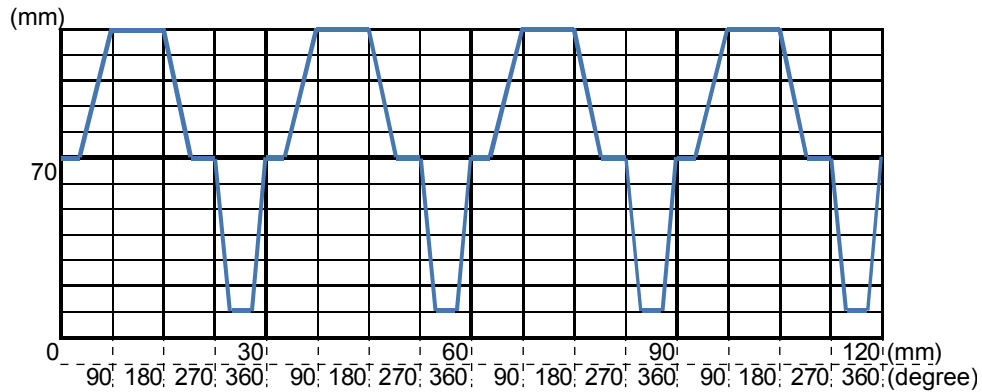

- 5) An error will occur if the path reaches the final end, so turn on "XB" to clear the error.
- 6) Turn on "X0" and perform the home position return.
- 7) Turn on "XF" again, and move to the positioning data No. 40.
- 8) After moving to the positioning data No. 40 completes, turn on "XE", then "XC" to change the cam stroke amount and the cam stroke length, and perform the driving. The path of cam No. 004 follows a waveform as shown below.

[When XE is on]

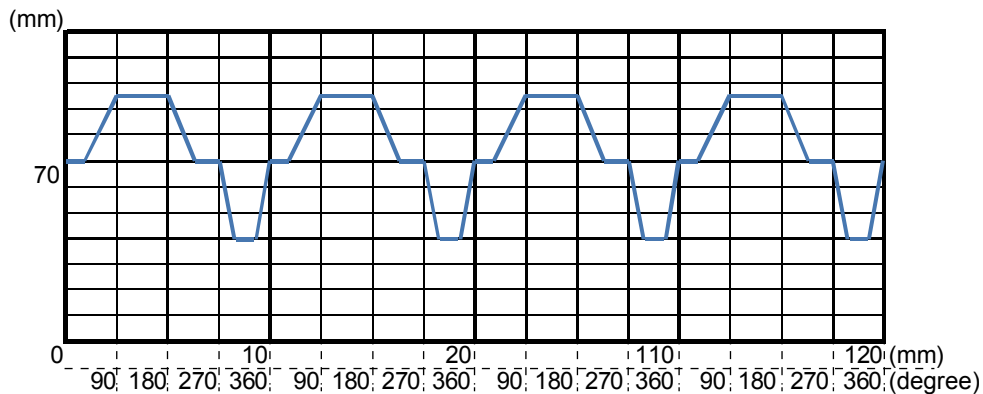

- 9) Turn off "XC" and stop the driving of cam No. 001. Perform the home position return after stopping.



When all these operations are completed, the operation confirmation is finished.

Appendix 1 Precautions when performing maintenance of the QD75/QD77MS

The replacement procedure for the QD75/QD77MS is shown below.
It is assumed that GX Works2 is installed to the personal computer.

1. Read the positioning data, the parameters, and the block start data from the buffer memory of the QD75/QD77MS to the peripheral device (personal computer).
2. Turn off the power supply of the PLC and disconnect the connector that is connected to the QD75/QD77MS module.
3. Disconnect the QD75/QD77MS from the base unit.
4. Attach a new QD75/QD77MS module to the base unit.
5. Attach the connector for connecting to the QD75/QD77MS module.
6. Turn on the power supply, and confirm the status of the QD75/QD77MS module and the connector connection status with the peripheral device in the System monitor of GX Works2.
7. Write the data to the QD75/QD77MS module from the personal computer.
8. Switch the PLC CPU to RUN, and confirm that it operates normally.

Appendix 2 Intelligent function module device

In this textbook, data is written or read by using the intelligent function module devices to simplify sequence programs and reduce the number of steps.

(1) What is the intelligent function module device

A device that accesses the buffer memory areas in the intelligent function module or the special function module directly from the QCPU.

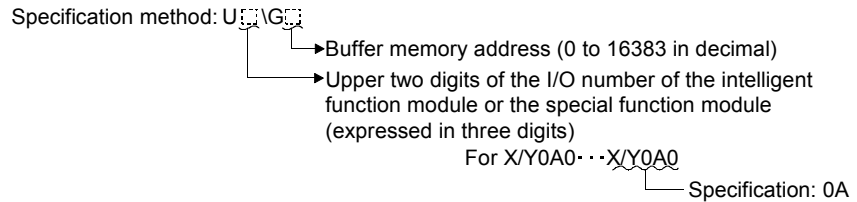

(2) Program example

The following shows program examples when using the intelligent function module device to read the axis 1 positioning error codes from the buffer memory (address: 806) of the QD75DN positioning module (X/YA0) and when using the FROM instruction.

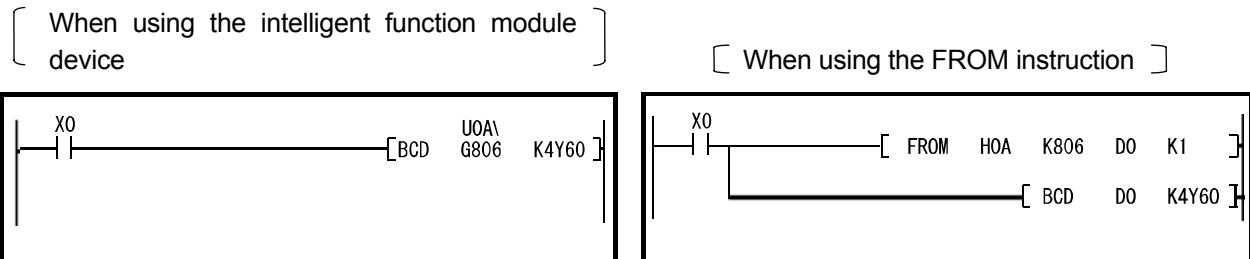

Fig. 2.1 Example of writing data to the buffer memory

(3) Processing speed

The processing speed of the intelligent function module device is as follows.

- (a) When performing writing or reading, the speed is the same as the processing speed using the FROM/TO instruction. (For example, the case of "DMOV U0A\G800 D0".)
- (b) To perform processing different from a reading operation with one instruction, the speed is the total of the processing speed with the FROM/TO instruction and the instruction processing speed. (For example, the case of "D/ U0A\G800 K10000 D10".)

Appendix 3 Dedicated instructions

This section describes the types of special instructions, the format, and the usages of each instruction.

(1) List of dedicated instructions

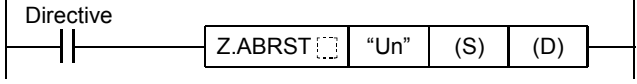
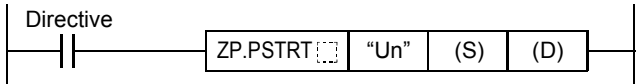
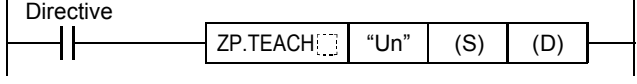
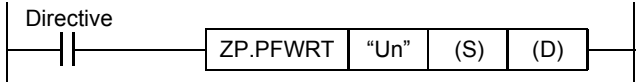
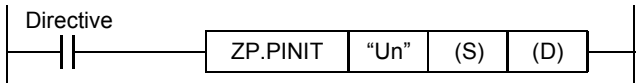
Application	Instruction symbol		Outline of functions
Absolute position restoration QD75P/D	Z.ABRST1	Directive 	This function restores the absolute position of the designated axis of the QD75. (Refer to Section 14.3 in Type QD75P/QD75D Positioning Module User's Manual)
	Z.ABRST2		
	Z.ABRST3		
	Z.ABRST4		
Positioning start	ZP.PSTRT1	Directive 	This function starts the positioning control of the designated axis of the QD75/QD77MS. (Refer to Appendix 3.1)
	ZP.PSTRT2		
	ZP.PSTRT3		
	ZP.PSTRT4		
Teaching	ZP.TEACH1	Directive 	This function carries out teaching the designated axis of the QD75/QD77MS. (Refer to Appendix 3.2)
	ZP.TEACH2		
	ZP.TEACH3		
	ZP.TEACH4		
Writing to flash ROM	ZP.PFWRT	Directive 	This function writes the buffer memory parameters, positioning data and block start data to the flash ROM. (Refer to Appendix 3.3)
Parameter initialization	ZP.PINIT	Directive 	This function initializes the buffer memory and flash ROM setting data to the factory-set data (initial values). (Refer to Section 14.7 in Type QD75P/QD75D Positioning Module User's Manual and Section 15.6 in the MELSEC-Q QD77MS Simple Motion Module User's Manual (Positioning Control))

*: If the originating station is a Basic model QCPU (function version B or later), universal model QCPU, or safety CPU, "" (double quotation) of the first argument can be omitted.

Setting data	Setting details	Setting side *1	Data type
"Un"	Head I/O number of QD75/QD77MS (00 to FE: High-order two digits of I/O number expressed in three digits)	User	BIN 16 bits
(S)	Head number of a device in which control data is stored	—	Word
(D)	Head number of a bit device which turns ON the operation by one scan at the time of completion of the instruction. If the instruction is completed abnormally, ((D) + 1) will also be turned ON.	System	Bit

Note) The file register of each of the local device and the program cannot be used as a device for setting data.

*1: The data on the setting side is as follows.

- User : Data before the execution of dedicated instructions is stored by user.
- System: Data after the execution of dedicated instruction is stored by PLC CPU.

POINT

The dedicated instructions of QD77MS16 can be used for only axis 1 to 4. They cannot be used for axis 5 to 16. If the ZP.PSTRT5 to ZP.PSTRT16 or ZP.TEACH5 to ZP.TEACH16 is executed, "Program code error" (error code: 4002) for PLC CPU and "PLC CPU error" (error code: 803) for QD77MS16 will occur and positioning cannot be started.

Refer to "QCPU User's Manual (Hardware Design, Maintenance and Inspection) for error of PLC CPU".

(2) Sequence program of dedicated instructions

The following shows examples when using a sequence program that uses the dedicated instruction PSTRT to start the positioning data No. 100 for axis 1 from X2, and when performing this by the direct device.

[When using the dedicated instruction PSTRT1]

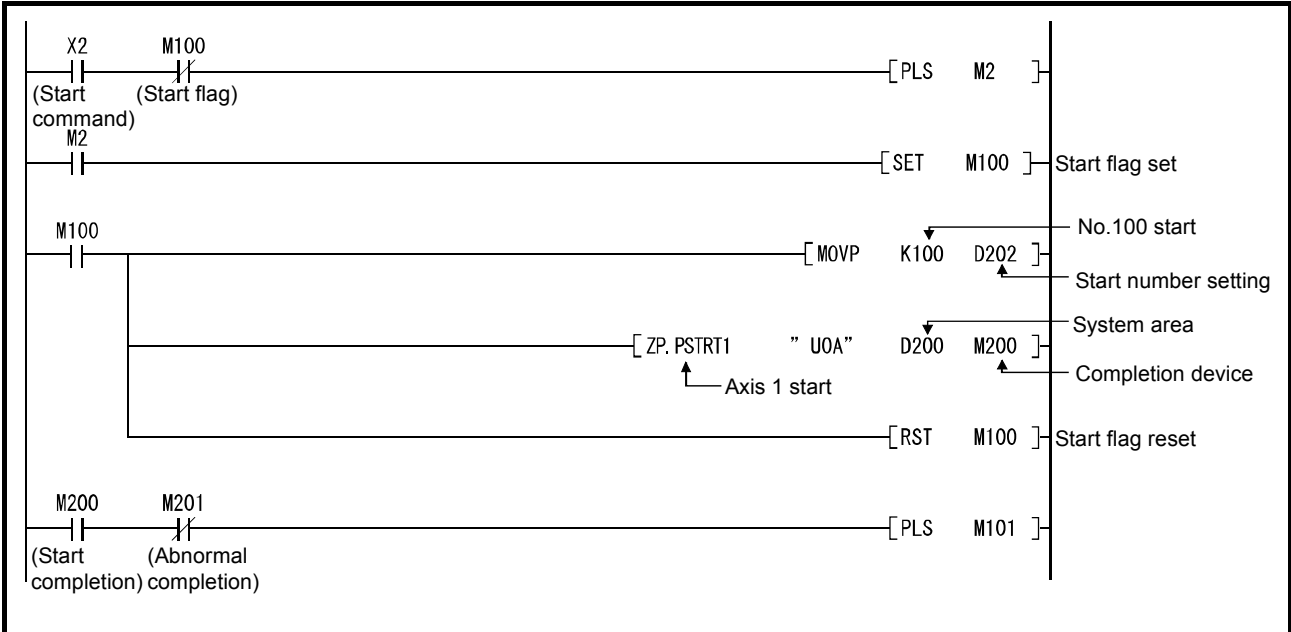

[When not using the special instruction]

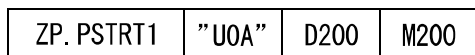
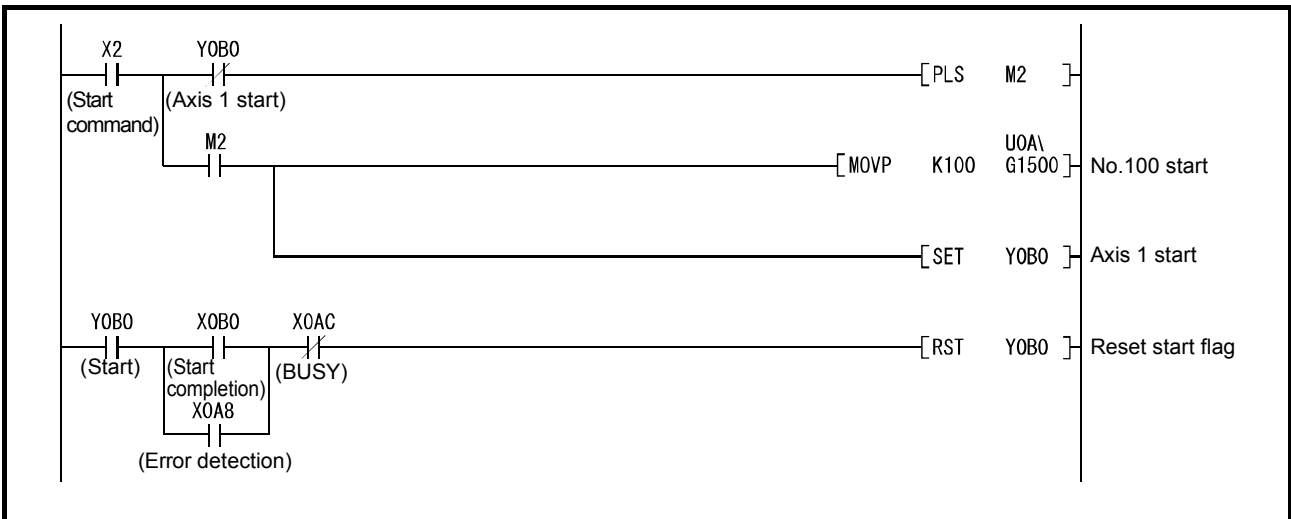

M200 Turns on by one scan after the operation start completes.
M201 Turns on by one scan after an abnormal completion.
D200 System area
D201 Error code is input after an abnormal completion.
D202 Set the start number.
Upper two digits of the I/O number of the attached QD75/QD77MS (X/Y0A0)

Appendix 3.1 PSTRT1,PSTRT2,PSTRT3,PSTRT4

These dedicated instructions are used to start the positioning of the designated axis.

Setting data	Usable device								
	Internal device		File register	Link direct device J□\□		Intelligent function module U□\G□	Index register Zn	Constant K,H,\$	Others
	Bit	Word		Bit	Word				
(S)	—	○	—	—	—	—	—	—	
(D)	○	○	—	—	—	—	—	—	

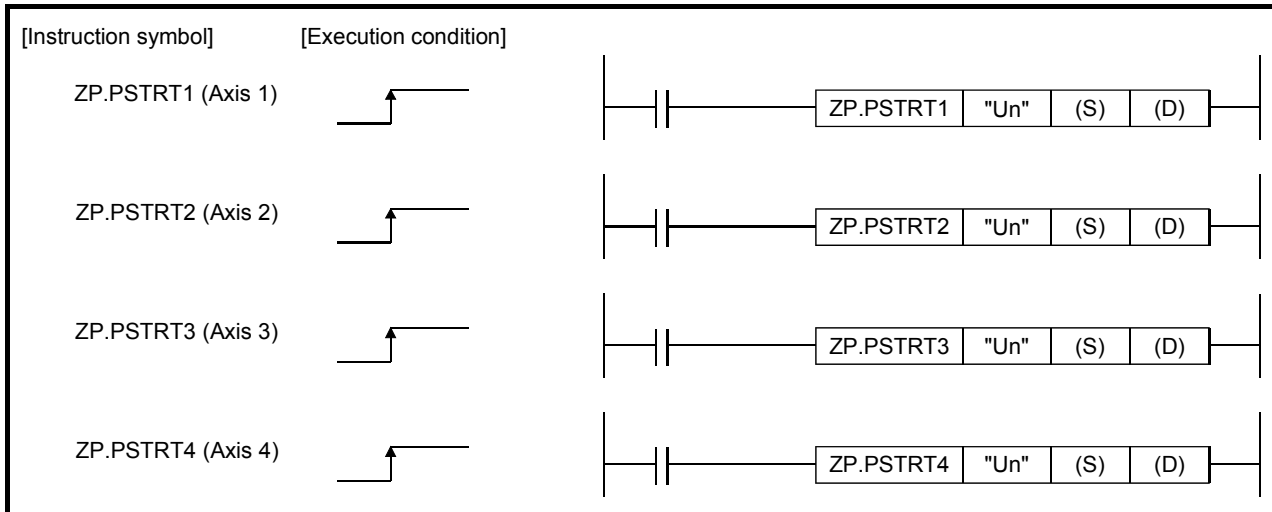

*: If the originating station is a Basic model QCPU (function version B or later), universal model QCPU, or safety CPU, "" (double quotation) of the first argument can be omitted. **QD75P/D**

When PSTRT1, PSTRT2, PSTRT3, and PSTRT4 are common to each other, they are designated as "PSTRT□".

[Setting data]

Setting data	Setting details	Setting side ^{*1}	Data type
"Un"	Head I/O number of QD75/QD77MS (00 to FE: High-order two digits of I/O number expressed in three digits)	User	BIN 16 bits
(S)	Head number of a device in which control data is stored	—	Word
(D)	Head number of a bit device which turns ON the operation by one scan at the time of completion of the instruction. If the instruction is completed abnormally, ((D) + 1) will also be turned ON.	System	Bit

[Control data]

Device	Item	Setting data	Setting range	Setting side *1
(S)+0	System area	—	—	—
(S)+1	Complete status	The state at the time of completion is stored. <ul style="list-style-type: none"> • 0 : Normal completion • Other than 0: Abnormal completion (error code) 	—	System
(S)+2	Start No.	The following data Numbers. to be started by the PSTRT□ instruction are designated. <ul style="list-style-type: none"> • Positioning data No. : 1 to 600 • Block start : 7000 to 7004 • Machine OPR : 9001 • Fast OPR : 9002 • Current value changing : 9003 • Multiple axes simultaneous start : 9004 	1 to 600 7000 to 7004 9000 to 9004	User

*1: The data on the setting side is as follows.

- User: Data before the execution of dedicated instructions is stored by user.
- System: Data after the execution of dedicated instruction is stored by PLC CPU.

[Functions]

- The positioning start of the axes to be processed (See below) is carried out.
 - PSTRT1: Axis 1
 - PSTRT2: Axis 2
 - PSTRT3: Axis 3
 - PSTRT4: Axis 4
- The block start, OPR start, current value changing, and multiple axes simultaneous start can be carried out by the setting of "start number" 7000 to 7004/9001 to 9004 in ((S)+2).
- The PSTRT instruction completion can be confirmed using the complete devices ((D)+0) and ((D)+1).
 - Complete device ((D)+0)
This device is turned ON by the END processing of the scan for which PSTRT□ instruction is completed, and turned OFF by the next END processing.
 - Complete state display device ((D)+1)
This device is turned ON and OFF according to the state in which PSTRT□ instruction is completed.
 - When completed normally : Kept unchanged at OFF.
 - When completed abnormally: This device is turned ON by the END processing of the scan for which PSTRT□ instruction is completed, and turned OFF by the next END processing. (Same ON/OFF operation as the complete device.)

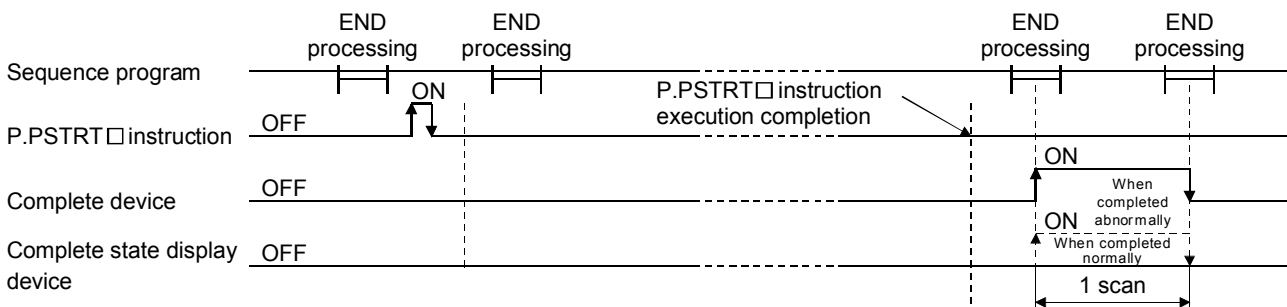

[Errors]

- When a PSTRT□ instruction is completed abnormally, the error complete signal ((D)+1) is turned ON, and the error code is stored in the complete status ((S)+1).

[Precautions]

- (1) When positioning is started by the PSTRT□ instruction, the positioning start signals (Y10 to Y13) will not turn ON.
To confirm that positioning control is being executed, use the PSTRT□ start command or start complete signal (X10 to X13).
- (2) The following dedicated instructions cannot be executed simultaneously for the same axis. (The instructions can be executed simultaneously for different axes.)
 - Positioning start instructions (PSTRT1 to PSTRT4)
 - Absolute position restoration instructions (ABRST1 to ABRST4)
 - Teaching instructions (TEACH1 to TEACH4)
- (3) The PSTRT□ instruction can only be executed when the READY signal [X0] is turned ON.
Even if the PSTRT□ instruction execution request is given when the READY signal [X0] is turned OFF, the PSTRT□ instruction will not be executed. (Not processed.)
Before executing the PSTRT□ instruction, turn ON the PLC READY signal [Y0], and turn ON the READY signal [X0].

[Program examples]

Program to execute the positioning of the positioning data No. 100 repeatedly and the positioning data No. 200 when X71 is on.

When X72 is on, the positioning finishes.

Use D90 to D92 as the control data devices of positioning data No. 100, and M32 and M33 as the completion devices.

Use D93 to D95 as the control data devices of positioning data No. 200, and M95 and M96 as the completion devices.

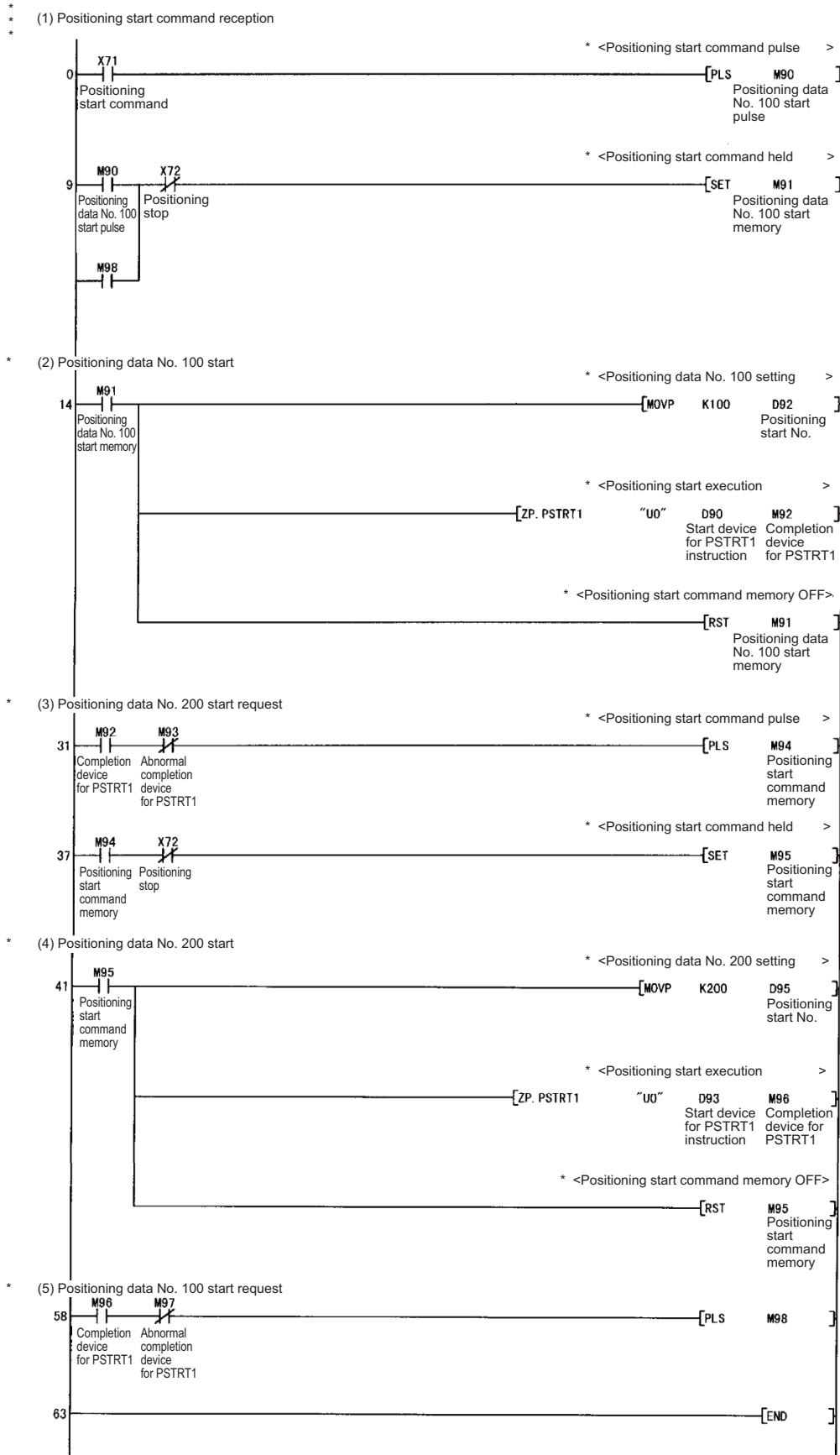

Appendix 3.2 TEACH1,TEACH2,TEACH3,TEACH4

These dedicated instructions are used to teach the designated axis .

Setting data	Usable device								
	Internal device		File register	Link direct device J□\□		Intelligent function module U□\G□	Index register Zn	Constant K,H,\$	Others
	Bit	Bit		Bit	Word				
(S)	—	○	—	—	—	—	—	—	
(D)	○	○	—	—	—	—	—	—	

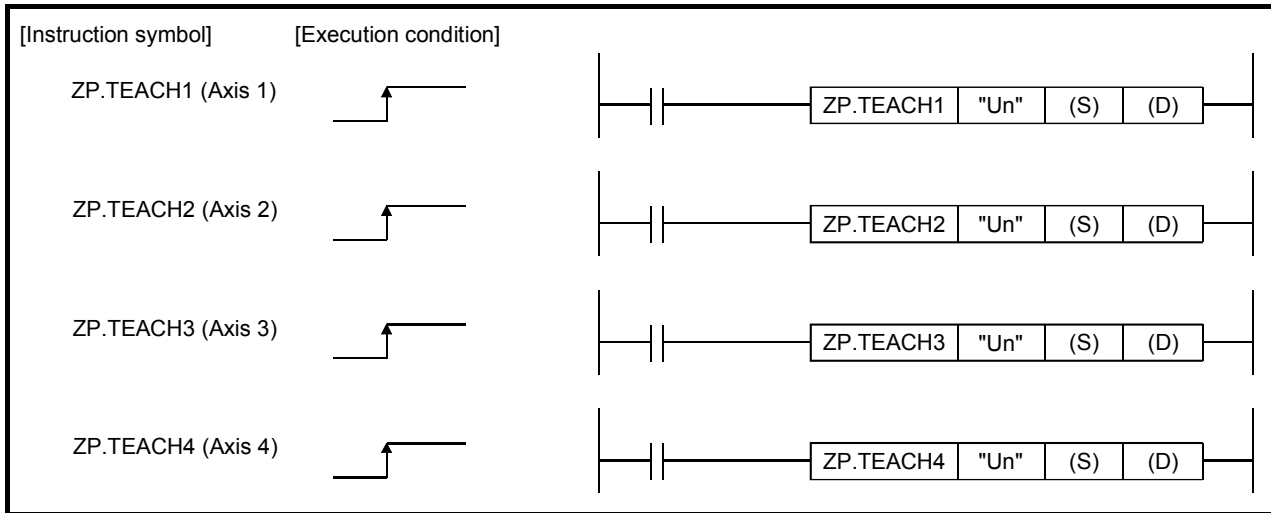

*: If the originating station is a Basic model QCPU (function version B or later), universal model QCPU, or safety CPU, "" (double quotation) of the first argument can be omitted. **QD75P/D**

When TEACH1, TEACH2, TEACH3, and TEACH4 are common to each other, they are designated as "TEACH□".

[Setting data]

Setting data	Setting details	Setting side *1	Data type
"Un"	Head I/O number of QD75/QD77MS (00 to FE: High-order two digits of I/O number expressed in three digits)	User	BIN 16 bits
(S)	Head number of a device in which control data is stored	—	Word
(D)	Head number of a bit device which turns ON the operation by one scan at the time of completion of the instruction. If the instruction is completed abnormally, ((D) + 1) will also be turned ON.	System	Bit

[Control data]

Device	Item	Setting data	Setting range	Setting side ^{*1}
(S)+0	System area	—	—	—
(S)+1	Complete status	The state at the time of completion is stored. 0: Normal completion Other than 0: Abnormal completion (error code)	—	System
(S)+2	Teaching data selection	The address (positioning address/arc address) to which the current feed value is written is set. 0: Current feed value is written to positioning address. 1: Current feed value is written to arc address.	0,1	User
(S)+3	Positioning data No.	The positioning data No. for which teaching is carried out is set.	1 to 600	User

*1: The data on the setting side is as follows.

- User: Data before the execution of dedicated instructions is stored by user.
- System: Data after the execution of dedicated instruction is stored by PLC CPU.

[Functions]

- The "current feed value" of the axes to be set (See below) is set in the positioning address or arc address.
The positioning data other than the positioning addresses and arc addresses are set by GX Works2 or using a sequence program.
 - TEACH1: Axis 1
 - TEACH2: Axis 2
 - TEACH3: Axis 3
 - TEACH4: Axis 4
- Teaching can be carried out for the positioning data No. 1 to 600.
- The movement of the machine to the address (position) set in the positioning address/arc address of the positioning data is carried out by the JOG operation, inching operation, or manual pulse generator operation.
- The TEACH□ instruction completion can be confirmed using the complete devices ((D)+0) and ((D)+1).
 - Complete device ((D)+0)
This device is turned ON by the END processing of the scan for which TEACH□ instruction is completed, and turned OFF by the next END processing.
 - Complete state display device ((D)+1)
This device is turned ON and OFF according to the state in which TEACH□ instruction is completed.
 - When completed normally : Kept unchanged at OFF.
 - When completed abnormally: This device is turned ON by the END processing of the scan for which TEACH□ instruction is completed, and turned OFF by the next END processing. (Same ON/OFF operation as the complete device.)

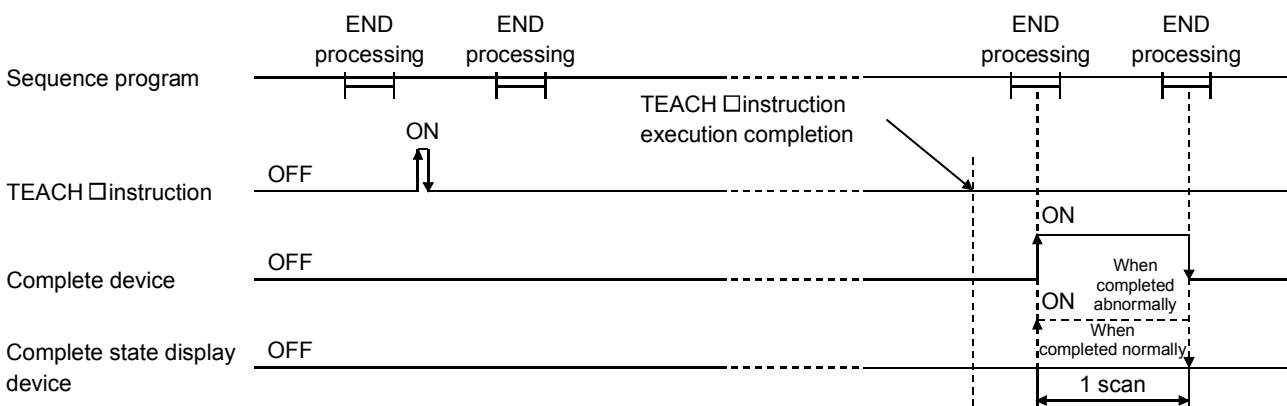

[Errors]

- (1) When a TEACH□ instruction is completed abnormally, the error complete signal ((D)+1) is turned ON, and the error code is stored in the complete status (S)+1.

[Precautions]

- (1) The following dedicated instructions cannot be executed simultaneously for the same axis. (The instructions can be executed simultaneously for different axes.)
 - Positioning start instructions (PSTRT1 to PSTRT4)
 - Absolute position restoration instructions (ABRST1 to ABRST4)
 - Teaching instructions (TEACH1 to TEACH4)
- (2) The TEACH□ instruction can only be executed when the BUSY signal (XC,XD,XE,XF) is turned OFF.
 When the BUSY signal is turned ON, the TEACH□ instruction will not be executed. (Not processed.)
 Before executing the TEACH□ instruction, make sure that the BUSY signal for the axis to be processed is turned OFF.

[Program example]

- (1) Program to execute the teaching of the positioning data No. 3 of the axis 1 when X39 is turned ON.

Teaching program

Positioned manually to target position.

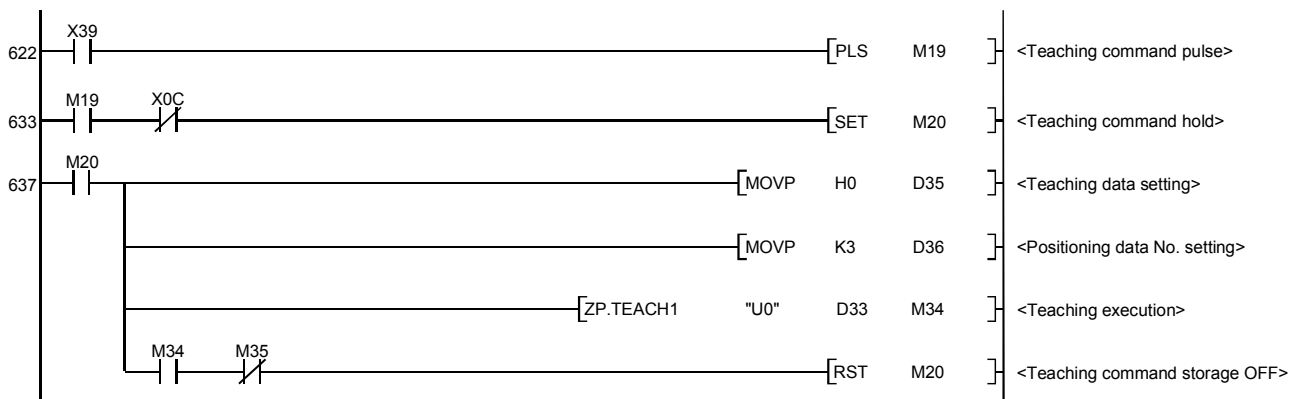

Appendix 3.3 PFWRT

These dedicated instructions are used to write the parameters, positioning data, and block start data of QD75/QD77MS to the flash ROM.

Setting data	Usable device								
	Internal device		File register	Link direct device J□\□		Intelligent function module U□\G□	Index register Zn	Constant K,H,\$	Others
	Bit	Word		Bit	Word				
(S)	—	○	—	—	—	—	—	—	
(D)	○	○	—	—	—	—	—	—	

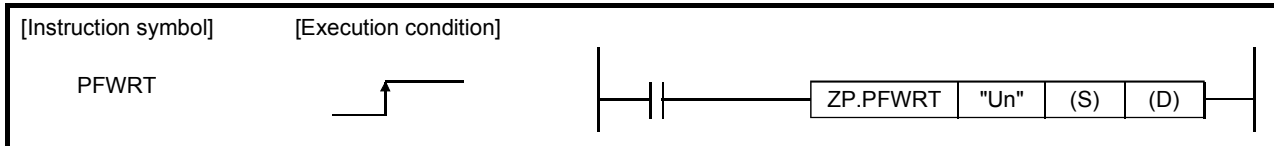

*: If the originating station is a Basic model QCPU (function version B or later), universal model QCPU, or safety CPU, "" (double quotation) of the first argument can be omitted. **QD75P/D**

[Setting data]

Setting data	Setting details	Setting side * ¹	Data type
"Un"	Head I/O number of QD75/QD77MS (00 to FE: High-order two digits of I/O number expressed in three digits)	User	BIN 16 bits
(S)	Head number of a device in which control data is stored	—	Word
(D)	Head number of a bit device which turns ON the operation by one scan at the time of completion of the instruction. If the instruction is completed abnormally, ((D) + 1) will also be turned ON.	System	Bit

[Control data]

Device	Item	Setting data	Setting range	Setting side * ¹
(S)+0	System area	—	—	—
(S)+1	Complete status	The state at the time of completion is stored. 0: Normal completion Other than 0: Abnormal completion (error code)	—	System

*1: The data on the setting side is as follows.

- User: Data before the execution of dedicated instructions is stored by user.
- System: Data after the execution of dedicated instruction is stored by PLC CPU.

[Functions]

- (1) The PFWRT instruction completion can be confirmed using the complete devices ((D)+0) and ((D)+1).
 - (a) Complete device ((D)+0)
This device is turned ON by the END processing of the scan for which PFWRT instruction is completed, and turned OFF by the next END processing.
 - (b) Complete state display device ((D)+1)
This device is turned ON and OFF according to the state in which PFWRT instruction is completed.
 - When completed normally : Kept unchanged at OFF.
 - When completed abnormally: This device is turned ON by the END processing of the scan for which PFWRT instruction is completed, and turned OFF by the next END processing. (Same ON/OFF operation as the complete device .)

[Instruction symbol]

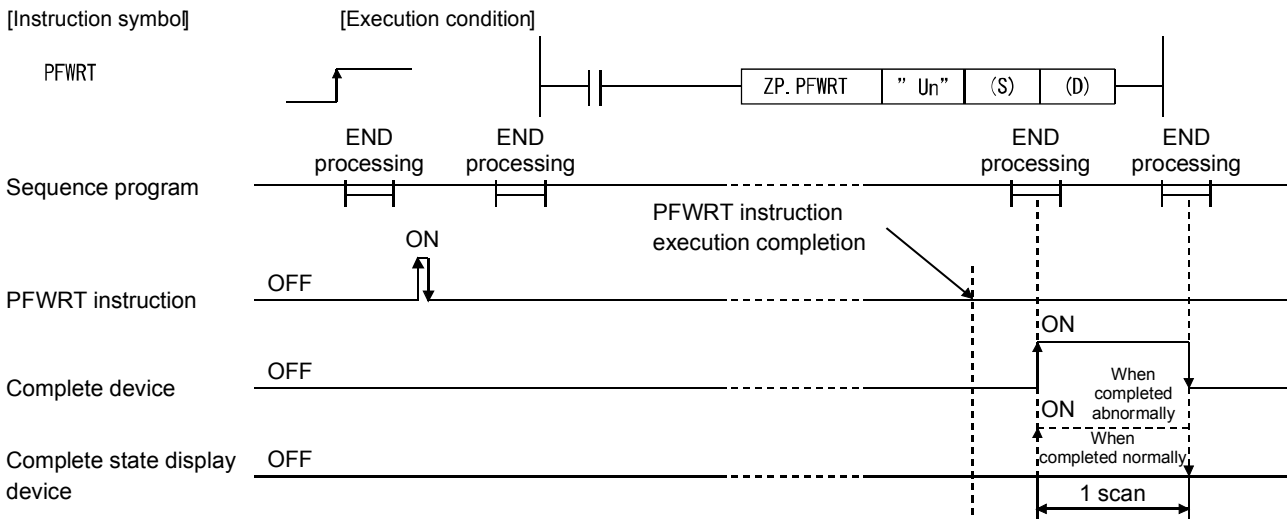

[Errors]

- (1) When a dedicated instruction is completed abnormally, the error complete signal ((D)+1) is turned ON, and the error code is stored in the complete status ((S)+1).

[Precautions]

- (1) Do not turn ON the power and reset the PLC CPU while parameters, positioning data and block start data are written to the flash ROM using the PFWRT instruction. A parameter error will occur or normal positioning start will become impossible because the parameters, positioning data and block start data are not written normally to the flash ROM. If this occurs, restart the operation by the method shown below.
 - For GX Works2, write the parameters, positioning data and block start data again to the flash ROM.
 - For a sequence program, write the parameters, positioning data and block start data to the QD75/QD77MS after initializing the parameters (PINIT instruction execution and others). Then execute the PFWRT instruction again.
- (2) Writing to the flash ROM is up to 100,000 times. If writing to the flash ROM exceeds 100,000 times, the writing to the flash ROM will become impossible.

- (3) After the power ON and PLC CPU reset operation, writing to the flash ROM using a sequence program is limited to up to 25 times. (Not limited to up to 25 times when writing to the flash ROM is carried out by GX Works2.)
 If the 26th or more writing is requested after the power ON/PLC CPU reset operation, a flash ROM exceed writing error (error code: 805) will occur, and the writing will be disabled. If a flash ROM write error occurs by one writing to the flash ROM, check and correct the flash ROM writing program. Then reset the error or turn ON the power and reset the PLC CPU again.
- (4) The PFWRT instruction can only be executed when the READY signal [X0] is turned OFF. When the READY signal [X0] is turned ON, the PFWRT instruction cannot be executed. Before executing the PFWRT instruction, turn OFF the PLC READY signal [Y0] and then turn OFF the READY signal [X0].

[Program example]

- (1) Program used to write the parameters and positioning data stored in the buffer memory to the flash ROM when X3D is turned ON.

Flash ROM write program

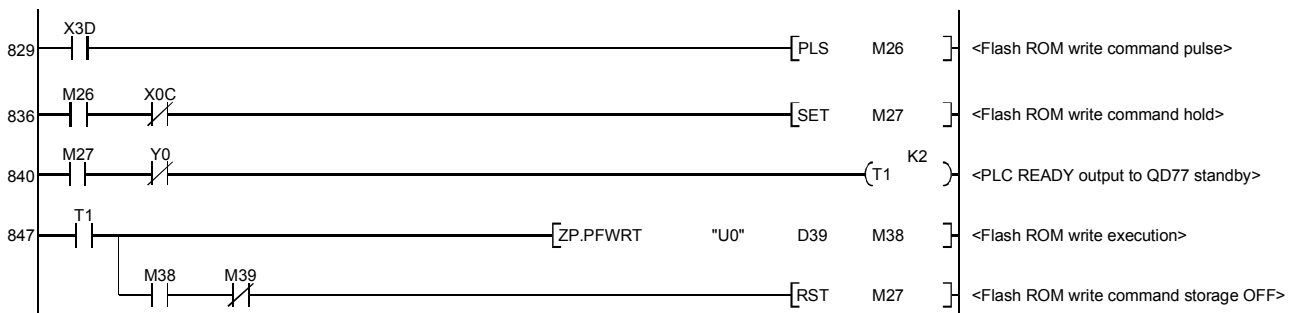

Appendix 4 Pulse control

Appendix 4.1 Positioning mechanism by the pulse control

Positioning control using the QD75 is carried out with "pulse signals". (The QD75 is a module that generates pulses). In the positioning system using the QD75, various software and devices are used for the following roles. The QD75 realizes complicated positioning control when it reads in various signals, parameters and data and is controlled with the CPU module.

(1) Positioning control using the QD75D **QD75D**

The positioning control using the QD75D is performed using the pulse signals. (The QD75D is a module that generates pulse.)

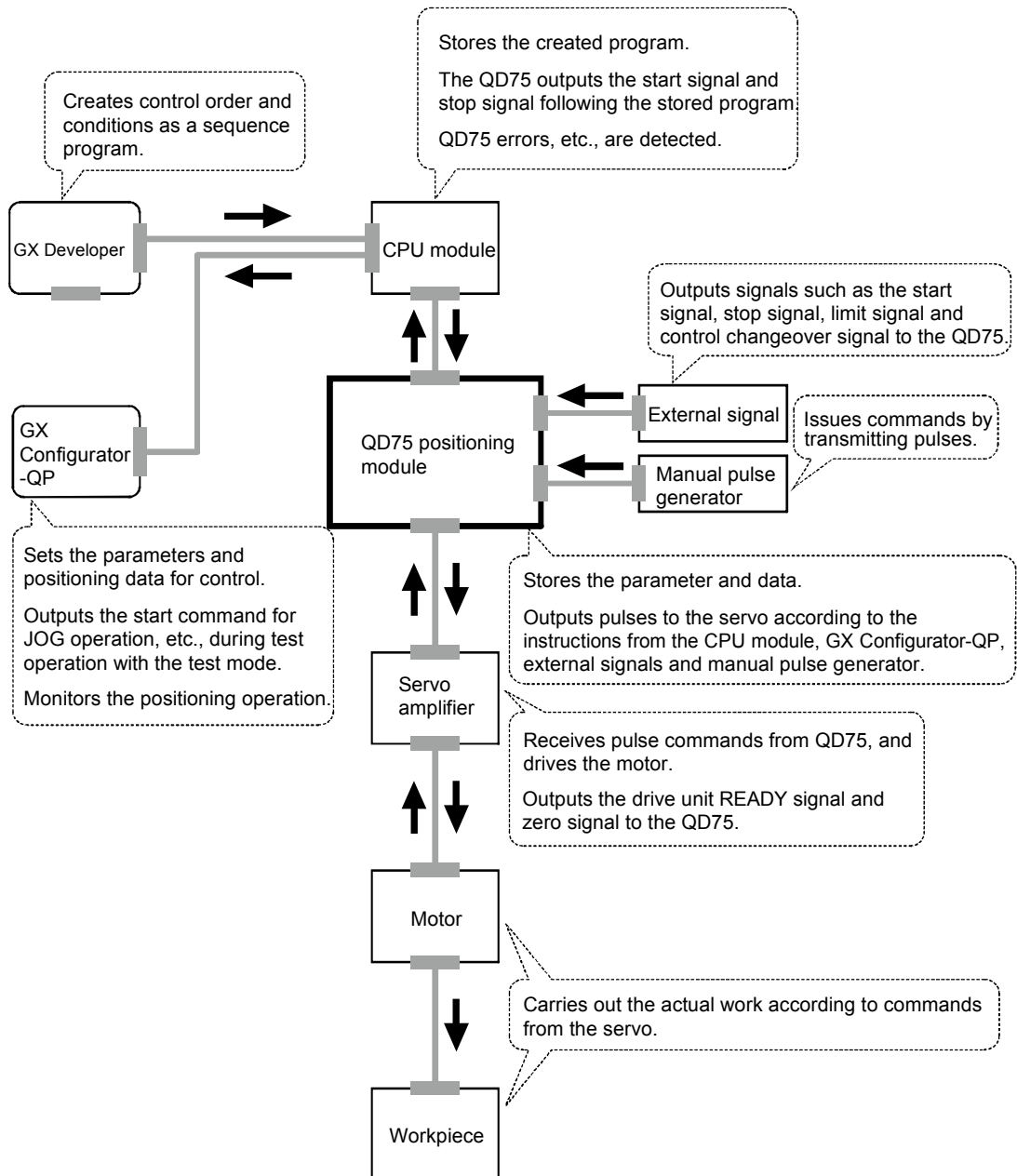

(a) Principle of "position control"

The total No. of pulses required to move the designated distance is obtained in the following manner.

$$\left[\begin{array}{l} \text{Total No. of pulses} \\ \text{required to move} \\ \text{designated distance} \end{array} \right] = \left[\begin{array}{l} \text{Designated distance} \\ \text{Movement amount of machine (load)} \\ \text{side when motor rotates once} \end{array} \right] \times \left[\begin{array}{l} \text{No. of pulses} \\ \text{required for motor to} \\ \text{rotate once} \end{array} \right]$$

*The No. of pulses required for the motor to rotate once is the "encoder resolution" described in the motor catalog specification list.

When this total No. of pulses is issued from the QD75 to the servo amplifier, control to move the designated distance can be executed.

The machine side movement amount when one pulse is issued to the servo amplifier is called the "movement amount per pulse". This value is the min. value for the workpiece to move, and is also the electrical positioning precision.

(b) Principle of "speed control"

The speed is determined by the frequency of pulses sent from the QD75 to the drive unit.

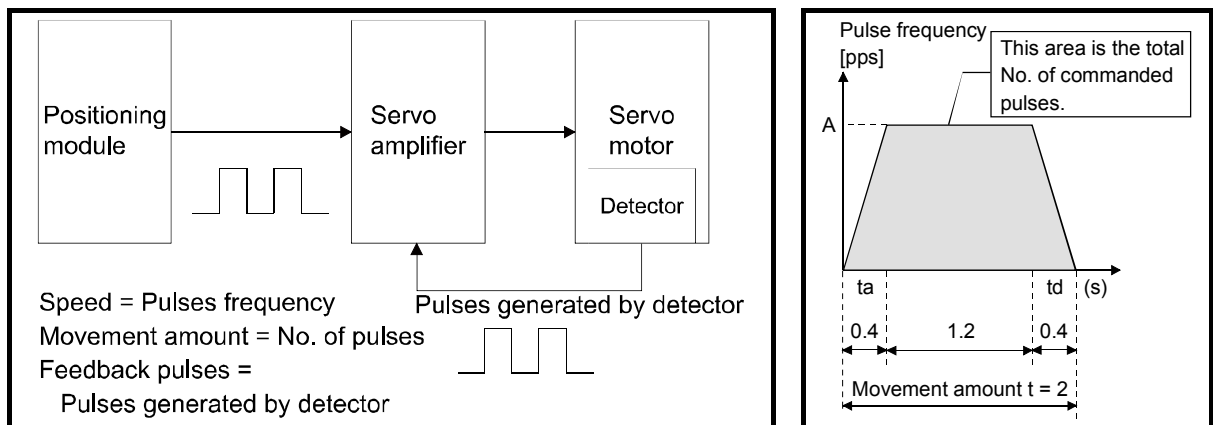

Fig Relationship between position control and speed control

POINT
The QD75 controls the position with the "total No. of pulses", and the speed with the "pulse frequency".

Appendix 4.2 General design of the positioning system using the pulse control

(1) Positioning system using QD75D QD75D

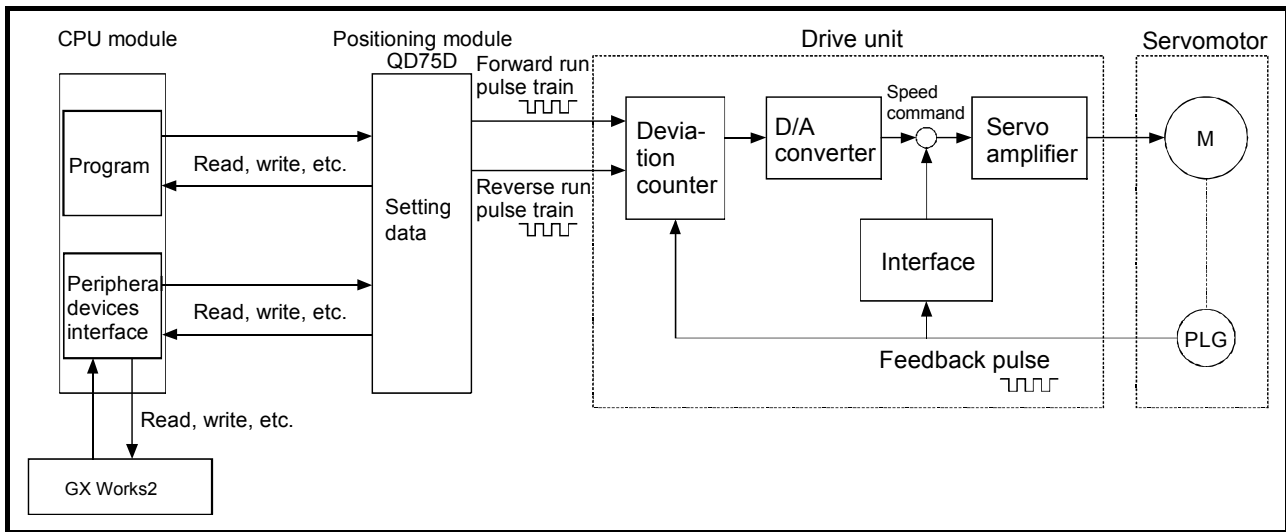

Fig Outline of the operation of positioning system using QD75D

(a) Positioning operation by the QD75D

1) The QD75D output is a pulse train.

The pulse train output by the QD75D is counted by and stored in the deviation counter in the drive unit.

The D/A converter outputs an analog DC current proportionate to the count maintained by the deviation counter (called "pulse droop"). The analog DC current serves as the servomotor speed control signal.

2) The motor rotation is controlled by the speed control signal from the drive unit.

As the motor rotates, the pulse encoder (PLG) attached to the motor generates feedback pulses, the frequency of which is proportionate to the rotation speed.

The feedback pulses are fed back to the drive unit and decrements the pulse droop, the pulse count maintained by the deviation counter.

The motor keeps on rotating as the pulse droop is maintained at a certain level.

3) When the QD75D terminates the output of a pulse train, the motor decelerates as the pulse droop decreases and stops when the count drops to zero.

Thus, the motor rotation speed is proportionate to the pulse frequency, while the overall motor rotation angle is proportionate to the total number of pulses output by the QD75D.

Therefore, when a movement amount per pulse is given, the overall movement amount can be determined by the number of pulses in the pulse train.

The pulse frequency, on the other hand, determines the motor rotation speed (feed speed).

(b) Pulse train output from the QD75

- 1) As shown in Fig. 1.3, the pulse frequency increases as the motor accelerates. The pulses are sparse when the motor starts and more frequent when the motor speed comes close to the target speed.
- 2) The pulse frequency stabilizes when the motor speed equals the target speed.
- 3) The QD75 decreases the pulse frequency (sparser pulses) to decelerate the motor before it finally stops the output.

There will be a little difference in timing between the decrease in the pulse frequency and the actual deceleration and stopping of the motor.

This difference, called "the stop settling time", is required for gaining a stopping accuracy.

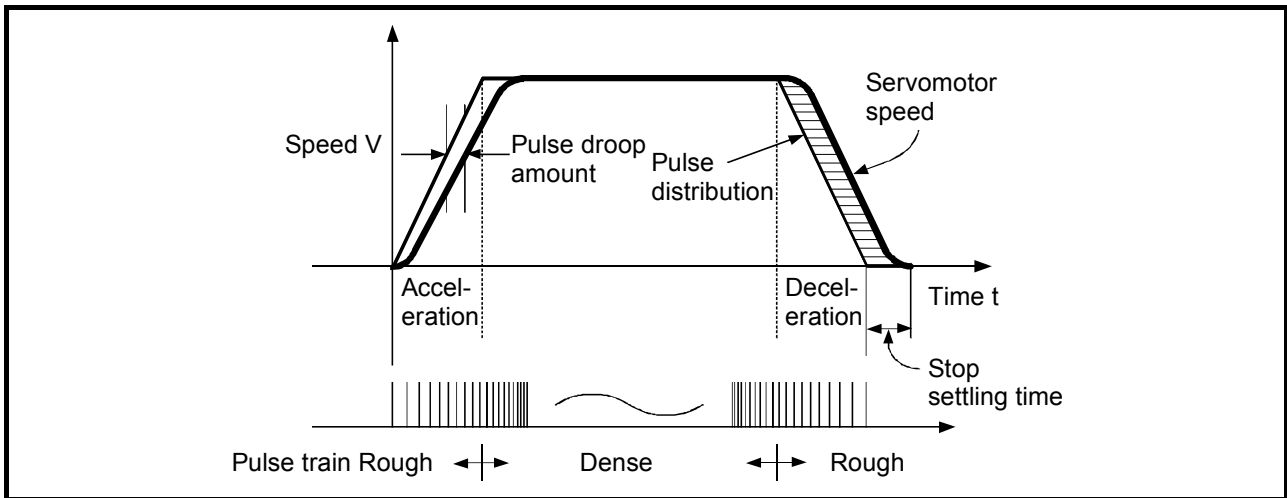

Fig. 1.3 QD75 output pulses

Appendix 4.3 Comparison with the pulse control (QD75P□N/QD75D□N) and SSCNET III/H (QD77MS)

Model		QD75P1N QD75D1N	QD75P2N QD75D2N	QD75P4N QD75D4N	QD77MS2	QD77MS4	QD77MS16
Item		1	2	4	2	4	16
Number of control axes		1	2	4	2	4	16
No. of positioning data items		600/axis					
Interpolation functions	2-axis linear interpolation	×	○	○	○	○	○
	3-axis linear interpolation	×	×	○	×	○	○
	4-axis linear interpolation	×	×	○	×	○	○
	2-axis circular interpolation	×	○	○	○	○	○
Positioning systems	Position control	○					
	Speed control	○					
	Speed-position switching control	○					
	Position-speed switching control	○					
OPR function		○ (6 types)			○ (5 types)		
JOG operation		○					
Inching operation		○					
Manual pulse generator function		○					
Acceleration/deceleration processing	Trapezoidal acceleration/deceleration	○					
	S-curve acceleration/deceleration	○					
Acceleration/deceleration time		Acceleration time and deceleration time setting possible (4 patterns each)					
Compensation		Electronic gears, backlash compensation			Electronic gears, backlash compensation, near pass function *1		
Error display		Error LED					
History data storage (Start, error, warning)		Provided (3 types, 16 items/axis)					
Data storage destination		Flash ROM (battery-less backup)					
Connection with servo amplifiers		Pulse signal Servo ON signal Servo READY signal Zero signal			SSCNETIII/H (Upper/lower limit signal, near-point dog signal)		
ABS function		—			Return of the present value function Follow up function		
Electronic gear width		Numerator/Denominator (16bit)			Numerator/Denominator (32bit)		
Absolute value guarantee for the degree limitless-feed		Not provided			Provided		
No. of I/O points		32					
No. of module occupied slots		1					

○: Possible, ×: Not possible

*1: The near pass function is a standard equipment and valid only for the positioning control. This cannot be disabled with a parameter.

Appendix 5 Specifications and functions of the QD75 positioning module

Appendix 5.1 Performance specifications

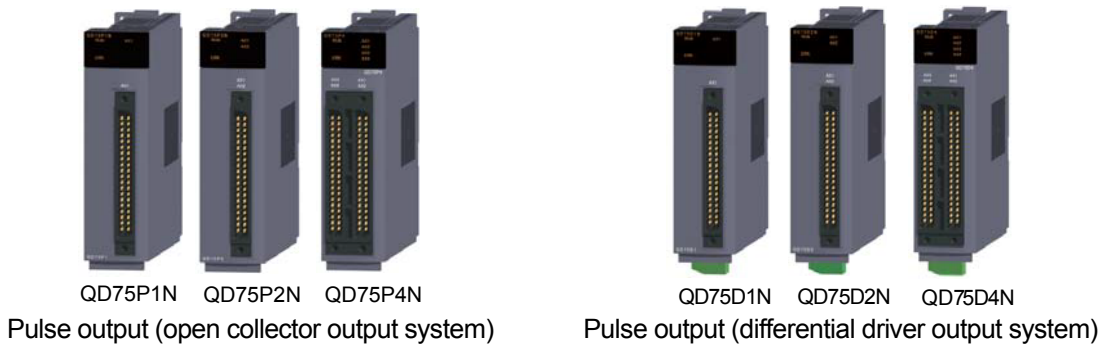

Table Performance specifications of QD75

Model		QD75P1N ^{*1} QD75D1N	QD75P2N ^{*1} QD75D2N	QD75P4N ^{*1} QD75D4N
Item				
No. of control axes		1 axis	2 axes	4 axes
Interpolation function (Described in Chapter 7.)		None	2-axis linear interpolation 2-axis circular interpolation	2-, 3-, or 4-axis linear interpolation 2-axis circular interpolation
Control system		PTP (Point To Point) control, path control (both linear and arc can be set), speed control, speed position, switching control, position-speed switching control		
Control unit		mm, inch, degree, pulse		
Positioning data		600 data /axis (Can be set with peripheral device or sequence program.)		
Backup		Parameters, positioning data, and block start data can be saved on flash ROM (battery-less backup)		
Positioning	Positioning system	PTP control: Speed-position switching control: Position-speed switching control: Path control:		Incremental system/absolute system Incremental system/absolute system ^{*2} Incremental system Incremental system/absolute system
	Positioning range	<div style="border: 1px solid black; padding: 2px;">In absolute system</div> <ul style="list-style-type: none"> • -214748364.8 to 214748364.7(μm) • -21474.83648 to 21474.83647(inch) • 0 to 359.99999(degree) • -2147483648 to 2147483647(pulse) <div style="border: 1px solid black; padding: 2px;">In incremental system</div> <ul style="list-style-type: none"> • -214748364.8 to 214748364.7(μm) • -21474.83648 to 21474.83647(inch) • -21474.83648 to 21474.83647(degree) • -2147483648 to 2147483647(pulse) <div style="border: 1px solid black; padding: 2px;">In speed-position switching control (INC mode)/position-speed switching control</div> <ul style="list-style-type: none"> • 0 to 214748364.7(μm) • 0 to 21474.83647(inch) • 0 to 21474.83647(degree) • 0 to 2147483647(pulse) <div style="border: 1px solid black; padding: 2px;">In speed-position switching control (ABS mode)^{*2}</div> <ul style="list-style-type: none"> • 0 to 359.99999(degree) 		
	Speed command	0.01 to 2000000.00(mm/min) 0.001 to 200000.000(inch/min) 0.001 to 200000.000(degree/min) 1 to 4000000(pulse/s)		
	Acceleration/deceleration process	Trapezoidal acceleration/deceleration, S-curve acceleration/deceleration		
	Acceleration/deceleration time	1 to 8388608(ms) Four patterns can be set for each of acceleration time and deceleration time		
	Sudden stop deceleration time	1 to 8388608(ms)		

Table Performance specifications of QD75

Model	QD75P1N ^{*1} QD75D1N	QD75P2N ^{*1} QD75D2N	QD75P4N ^{*1} QD75D4N
Item			
Starting time ^{*3}	1-axis linear control	1.5ms	Factors in starting time extension The following times will be added to the starting time in the described conditions: • S-curve acceleration/deceleration is selected: 0.1ms • Other axis is in operation: 0.5ms • During continuous positioning control: 0.3ms • During continuous path control: 0.3ms
	1-axis speed control	1.5ms	
	2-axis linear interpolation control (Composite speed)	1.5ms	
	2-axis linear interpolation control (Reference axis speed)	1.5ms	
	2-axis circular interpolation control	2.0ms	
	2-axis speed control	1.5ms	
	3-axis linear interpolation control (Composite speed)	1.7ms	
	3-axis linear interpolation control (Reference axis speed)	1.7ms	
	3-axis speed control	1.7ms	
	4-axis linear interpolation control	1.8ms	
	4-axis speed control	1.8ms	
External wiring connection system	40-pin connector		
Applicable wire size	0.3mm ² (AWG22) (for A6CON1 or A6CON4), 0.088 to 0.24mm ² (AWG28 to 24) (for A6CON2)		
Applicable connector for external device	A6CON1, A6CON2, A6CON4 (sold separately)		
Max. output pulse	QD75P1N,QD75P2N,QD75P4N: 200kpps QD75D1N,QD75D2N,QD75D4N: 4Mpps		
Max. connection distance between servos	QD75P1N,QD75P2N,QD75P4N: 2m QD75D1N,QD75D2N,QD75D4N: 10m		
Internal current consumption (5VDC)	QD75P1N: 0.29A QD75D1N: 0.43A	QD75P2N: 0.30A QD75D2N: 0.45A	QD75P4N: 0.36A QD75D4N: 0.66A
No. of occupied I/O points	32 points (I/O assignment: intelligent 32 points)		
Outline dimensions (mm)	98(H)×27.4(W)×90(D)		
Weight (kg)	QD75P1N: 0.14 QD75D1N: 0.15	QD75P2N: 0.14 QD75D2N: 0.15	QD75P4N: 0.16 QD75D4N: 0.16

*1: QD75P□N represents the open collector output system, and QD75D□N represents the differential driver output system.

*2: In speed-position switching control (ABS mode), the control unit available is "degree" only.

*3: Using the "Pre-reading start function", the virtual start time can be shortened.

Appendix 5.2 Main features of the QD75 positioning module

- (1) Availability of one, two, and four axis modules
 - (a) The pulse output types of the available modules are either the open collector output system or the differential driver output system. A module can be selected from the following depending on the drive unit type and the number of axes.
 - Open collector output system:
QD75P1N/QD75P2N/QD75P4N(QD75P1/QD75P2/QD75P4)
 - Differential driver output system:
QD75D1N/QD75D2N/QD75D4N(QD75D1/QD75D2/QD75D4)
 - (b) For connecting any of the QD75 modules to the base unit, a single slot and 32 dedicated I/O channels are required.
Within the limit imposed by the maximum number of inputs and outputs supported by the CPU module, up to 64 modules can be used.
- (2) Wide variety of positioning control functions
 - (a) A wide variety of positioning control functions essential to any positioning system are supported: positioning to an arbitrary position, fixed-feed control, equal-speed control, and so on.
 - 1) Up to 600 positioning data items, including such information as positioning addresses, control systems, and operation patterns, can be prepared for each axis.
Using the prepared positioning data, the positioning control is performed independently for each axis. (In addition, such controls as interpolation involving two to four axes and simultaneous startup of multiple axes are possible.)
 - 2) Independent control of each axis can be achieved in linear control mode (executable simultaneously over four axes).
Such control can either be the independent positioning control using a single positioning data or the continuous positioning control enabled by the continuous processing of multiple positioning data.
Reference Section 6.8.6 to section 6.8.8
 - 3) Coordinated control over multiple axes can take the form of either the linear interpolation through the speed or position control of two to four axes or the circular interpolation involving two axes.
Reference Section 7.5 "Interpolation operation (Axis 1/axis 2)"
Such control can either be the independent positioning control using a single positioning data or the continuous positioning control enabled by the continuous processing of multiple positioning data.
 - (b) For each positioning data, the user can specify any of the following control systems: position control, speed control, speed-position switching control, position-speed switching control, and so on.
Reference Chapter 6 "Single-axis positioning operation with the sequence program (QD77MS2)"
 - (c) Continuous positioning control using multiple positioning data can be executed in accordance with the operation patterns the user assigned to the positioning data.
Continuous positioning control can be executed over multiple blocks, where each block consists of multiple positioning data.

- (d) OPR control is given additional features
- 1) Six different machine OPR methods are provided: near point dog method (one method), stopper methods (three methods), and count methods (two methods).
Reference Section 4.2.1 "OPR basic parameters"
 - 2) OPR retry function facilitates the machine OPR control from an arbitrary position.
 (The machine OP a premier reference position for positioning control. The machine is set to the machine OP through one of the machine OPR methods mentioned in 1) above.)
Reference Section 4.2.1 "OPR basic parameters"
- (e) Two acceleration/deceleration control methods are provided: trapezoidal acceleration/deceleration and S-curve acceleration/deceleration.
 (The S-curve acceleration/deceleration cannot be performed when using the stepping motor.)
- (3) Quick startup
 The processing time to start the positioning operation is shortened.
 QD75P□N/QD75D□N: 1.5ms (QD75P□/QD75D□: 6ms)
 When operation using simultaneous start function or interpolation operation is executed, the axes start without delay.
- (Example) Axis 1 and Axis 3 are started by the simultaneous start function:
 No delay in Axis 1 and Axis 3 start
 Axis 2 and Axis 4 are started by the interpolation operation:
 No delay in Axis 2 and Axis 4 start
- (4) Faster pulse output and allowance of longer distance to drive unit
 The modules with a differential driver (QD75D□N (QD75D□)) incorporate the improvements in pulse output speed and maximum distance to the drive unit.
- QD75D□N: 4Mpulse/s, 10m max. (QD75D□: 1Mpulse/s, 10m max.)
 - QD75P□N: 200kpulse/s, 2m max. (QD75P□: 200kpulse/s, 2m max.)
- (5) Easy maintenance
 Each QD75 positioning module incorporates the following improvements in maintainability:
- (a) Data such as the positioning data and parameters can be stored on a flash ROM inside the QD75, eliminating the need of a battery for retaining data.
Reference Section 5.5.4 "Saving the simple motion module project"
 - (b) Error messages are classified in more detail to facilitate the initial troubleshooting procedure.
 - (c) The module retains 16 error messages and 16 warning messages recently output, offering more complete error and warning histories.
Reference Section 5.5.6 "Test operations and monitoring"
- (6) Support of intelligent function module dedicated instructions
 Dedicated instructions such as the absolute position restoration instruction, positioning start instruction, and teaching instruction are provided.
 The use of such dedicated instruction simplifies sequence programs.
Reference Appendix 3 "Dedicated instructions"

(7) Setups, monitoring, and testing through operations of intelligent function module of GX Works2

Using operations of intelligent function module of GX Works2, the user can control the QD75 parameters and positioning data without having to be conscious of the buffer memory addresses.

Moreover, positioning software package has a test function which allows the user to check the wiring before creating a sequence program for positioning control, or test operation the QD75 using created parameters and positioning data for checking their integrity.

The control monitor function of GX Works2 allows the user to debug programs efficiently.

Reference Chapter 5 "Test operations with GX Works2 (QD77MS2)"

Appendix 6 Servomotor specifications

The following shows the specifications of the servomotor mounted on the X-Y table unit.

Servomotor type		HG-KR053(B)	HG-KR13(B)	HG-KR23(B)	HG-KR43(B)	HG-KR73(B)
Corresponding servo amplifier type		MR-J4-10_		MR-J4-20_	MR-J4-40_	MR-J4-70_
Power supply capacity *1 (kVA)						
Continuous running duty	Rated output (kW)	0.05	0.1	0.2	0.4	0.75
	Rated torque (N•m)	0.16	0.32	0.64	1.3	2.4
Maximum torque (N•m)		0.56	1.1	2.2	4.5	8.4
Rated speed (r/min)		3000				
Maximum speed (r/min)		6000				
Instantaneous permissible speed (r/min)		6900				
Power rate at continuous rated torque	Standard (kW/s)	5.63	13.0	18.3	43.7	45.2
	With an electromagnetic brake (kW/s)	5.37	12.1	16.7	41.3	41.6
Rated current (A)		0.9	0.7	1.3	2.6	4.9
Maximum current (A)		3.2	2.5	4.6	9.1	17.2
Regenerative brake frequency*2 (r/min)		(*2-1)	(*2-2)	448	249	
Moment of inertia J	Standard ($\times 10^{-4}$ kg/m ²)	0.0450	0.0777	0.221	0.371	1.26
	With an electromagnetic brake ($\times 10^{-4}$ kg/m ²)	0.0472	0.0837	0.243	0.393	1.37
Recommended load to motor inertia ratio		35 times or less *3		24 times or less *3	22 times or less *3	15 times or less *3
Speed/position detector		22-bit encoder common to absolute position/incremental systems (resolution per servo motor revolution: 4194304 pulses/rev)				
Accessories						
Insulation class						
Structure		Totally-enclosed, natural-cooling (IP rating: IP65) *4				
Environment	Ambient temperature	0 °C to 40 °C (non-freezing), Storage: -15 °C to 70 °C (non-freezing)				
	Ambient humidity	80 %RH or less (non-condensing), Storage: 90 %RH or less (non-condensing)				
	Ambience	Indoors (no direct sunlight), free from corrosive gas, flammable gas, oil mist, dust, and dirt				
	Altitude/Vibration *5	Max. 1000 m above sea level/X,Y: 49m/s ²				
Mass	Standard (kg)	0.34	0.54	0.91	1.4	2.8
	With an electromagnetic brake (kg)	0.54	0.74	1.3	1.8	3.8

*1 The power supply capacity varies depending on the power supply impedance.

*2 The regenerative brake frequency indicates the allowable frequency when decelerating and stopping from the rated speed on a motor to stop without the regeneration option.

*2-1 When decelerating and stopping from the rated speed, there are no restrictions on the regeneration frequency if the effective torque is within the rated torque range. When decelerating and stopping from the maximum speed, there are no restrictions on the regeneration frequency if the load inertia moment is five times or less and the effective torque is within the rated torque range.

*2-2 When decelerating and stopping from the rated speed, there are no restrictions on the regeneration frequency if the effective torque is within the rated torque range. When decelerating and stopping from the maximum speed, there are no restrictions on the regeneration frequency if the load inertia moment is four times or less and the effective torque is within the rated torque range.

*3 Please contact us if the load moment of inertia ratio exceeds the described values.

*4 Except for the shaft-through portion.

*5 The following figure shows the vibration directions. The value is the one at the part that indicates the maximum value (normally the opposite to load-side bracket). When the servo motor stops, fretting is likely to occur at the bearing. Therefore, suppress the vibration to about half of the permissible value.

Appendix 7 Parameter settings of the servo amplifier (MR-J4-A) used in this training

The following settings of the parameters for the MR-J4-A servo amplifier (used in the training in Chapters 5 to 7) used in this training have been changed beforehand.

No.	Abbreviation	Name	Changed value
PA06	CMX	Electronic gear numerator (command pulse multiplication numerator)	128
PA07	CDV	Electronic gear denominator (command pulse multiplication denominator)	1
PA13	PLSS	Command pulse input form	0000h
PA19	BLK	Parameter writing inhibit	00Ch
PD25	DO3	Output device selection 3 (CN1-24)	002h

* All other values are default value.

Appendix 8 List of block start data

The illustrations below show the organization of the block start data stored in the buffer memory of QD77MS. The block start data setting items **Da.11** to **Da.14** are explained in the pages that follow.

• QD77MS2/QD77MS4

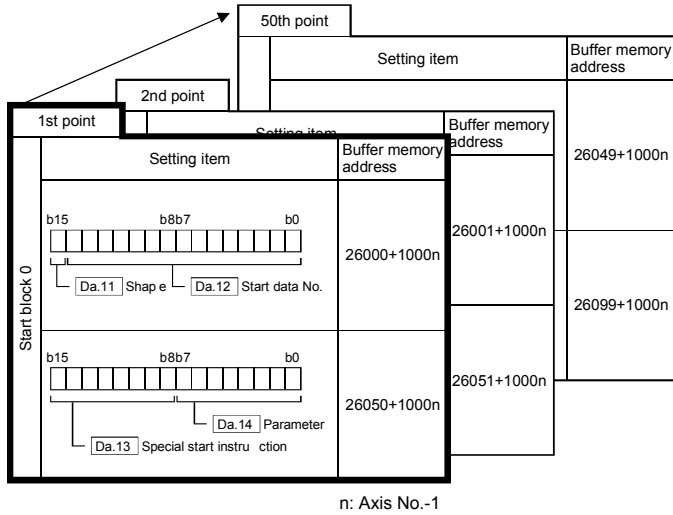

- Up to 50 block start data points can be set (stored) for each axis in the buffer memory addresses shown on the left.
- Items in a single unit of block start data are shown included in a bold frame.
- Each axis has five start blocks (block Numbers. 0 to 4).

• QD77MS16

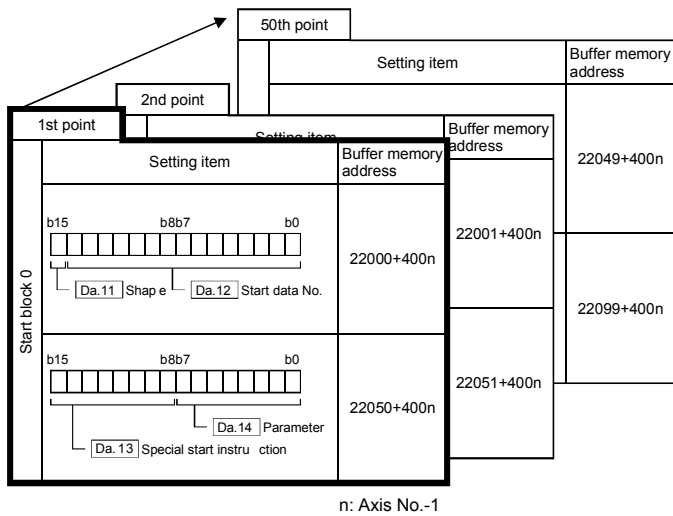

- Up to 50 block start data points can be set (stored) for each axis in the buffer memory addresses shown on the left.
- Items in a single unit of block start data are shown included in a bold frame.
- Each axis has five start blocks (block Numbers. 0 to 4). Start block 2 to 4 are not allocated to buffer memory. Set with GX Works2.

Hereinafter, the setting parameters for block start (Da.11 to Da.14) are described.

(Buffer memory addresses shown are those of the "1st point block start data (block No. 7000)" of axis 1 to axis 4.)

- Guide to buffer memory address

In the buffer memory address, "n" in "22000+400n", etc. indicates a value corresponding to axis No. such as the following table.

Axis No.	n	Axis No.	n	Axis No.	n	Axis No.	n
1	0	5	4	9	8	13	12
2	1	6	5	10	9	14	13
3	2	7	6	11	10	15	14
4	3	8	7	12	11	16	15

*: Calculate as follows for the buffer memory address corresponding to each axis.

(Example) For axis No. 16

$$22000 + 400n (\text{Da.16 Shape}) = 22000 + 400 \times 15 = 28000$$

*: The range from axis No.1 to 2 (n=0 to 1) is valid in the QD77MS2.

*: The range from axis No.1 to 4 (n=0 to 3) is valid in the QD77MS4.

REMARK

To perform a high-level positioning control using block start data, set a number between 7000 and 7004 to the "Cd.3 Positioning start No." and use the "Cd.4 Positioning starting point No." to specify a point number between 1 and 50, a position counted from the beginning of the block.

The number between 7000 and 7004 specified here is called the "block No.".

With the QD77MS, up to 50 "block start data" points and up to 10 "condition data" items can be assigned to each "block No.".

- QD77MS2

Block No.*1	Axis	Block start data	Condition	Buffer memory	GX Works2
7000	Axis 1	Start block 0	Condition data (1 to 10)	Supports the settings	Supports the settings
	Axis 2		Condition data (1 to 10)		
7001	Axis 1	Start block 1	Condition data (1 to 10)		
	Axis 2		Condition data (1 to 10)		
7002	Axis 1	Start block 2	Condition data (1 to 10)		
	Axis 2		Condition data (1 to 10)		
7003	Axis 1	Start block 3	Condition data (1 to 10)		
	Axis 2		Condition data (1 to 10)		
7004	Axis 1	Start block 4	Condition data (1 to 10)		
	Axis 2		Condition data (1 to 10)		

• QD77MS4

Block No.*1	Axis	Block start data	Condition	Buffer memory	GX Works2
7000	Axis 1	Start block 0	Condition data (1 to 10)	Supports the settings	Supports the settings
	Axis 2		Condition data (1 to 10)		
	Axis 3		Condition data (1 to 10)		
	Axis 4		Condition data (1 to 10)		
7001	Axis 1	Start block 1	Condition data (1 to 10)		
	Axis 2		Condition data (1 to 10)		
	Axis 3		Condition data (1 to 10)		
	Axis 4		Condition data (1 to 10)		
7002	Axis 1	Start block 2	Condition data (1 to 10)		
	Axis 2		Condition data (1 to 10)		
	Axis 3		Condition data (1 to 10)		
	Axis 4		Condition data (1 to 10)		
7003	Axis 1	Start block 3	Condition data (1 to 10)		
	Axis 2		Condition data (1 to 10)		
	Axis 3		Condition data (1 to 10)		
	Axis 4		Condition data (1 to 10)		
7004	Axis 1	Start block 4	Condition data (1 to 10)		
	Axis 2		Condition data (1 to 10)		
	Axis 3		Condition data (1 to 10)		
	Axis 4		Condition data (1 to 10)		

*1: Setting cannot be made when the "Pre-reading start function" is used. If you set any of Numbers. 7000 to 7004 and perform the Pre-reading start function, "Outside start No. range error (error code: 543)" will occur.

• QD77MS16

Block No.*1	Axis	Block start data	Condition	Buffer memory	GX Works2
7000	Axis 1	Start block 0	Condition data (1 to 10)	Supports the settings	Supports the settings
	to		to		
	Axis 16		Condition data (1 to 10)		
7001	Axis 1	Start block 1	Condition data (1 to 10)		
	to		to		
	Axis 16		Condition data (1 to 10)		
7002	Axis 1	Start block 2	Condition data (1 to 10)		
	to		to		
	Axis 16		Condition data (1 to 10)		
7003	Axis 1	Start block 3	Condition data (1 to 10)		
	to		to		
	Axis 16		Condition data (1 to 10)		
7004	Axis 1	Start block 4	Condition data (1 to 10)		
	to		to		
	Axis 16		Condition data (1 to 10)		

*1: Setting cannot be made when the "Pre-reading start function" is used. If you set any of Numbers. 7000 to 7004 and perform the Pre-reading start function, "Outside start No. range error (error code: 543)" will occur.

Item	Setting value		Default value	Buffer memory address	
	Value set with GX Works2	Value set with sequence program		QD77MS2 QD77MS4	QD77MS16
Da.11 Shape	0 : End 1 : Continue	0 1	0000H	26000+1000n	22000+400n
Da.12 Start data No.	Positioning data No.: 1 to 600 (01H to 258H)	01H to 258H			
Da.13 Special start instruction	0 : Block start (normal start) 1 : Condition start 2 : Wait start 3 : Simultaneous start 4 : FOR loop 5 : FOR condition 6 : NEXT start	00H 01H 02H 03H 04H 05H 06H	0000H	26050+1000n	22050+400n
Da.14 Parameter	Condition data No.: 1 to 10 (01H to 0AH) Number of repetitions: 0 to 255 (00H to FFH)	00H to FFH			

n: Axis No.-1

Da.11 Shape

Set whether to carry out only the local "block start data" and then end control, or to execute the "block start data" set in the next point.

Setting value	Setting details
0 : End	Execute the designated point's "block start data", and then complete the control.
1 : Continue	Execute the designated point's "block start data", and after completing control, execute the next point's "block start data".

Da.12 Start data No.

Set the "positioning data No." designated with the "block start data".

Da.13 Special start instruction

Set the "special start instruction" for using "high-level positioning control". (Set how to start the positioning data set in "**Da.12** Start data No.".)

Setting value	Setting details
00H: Block start (Normal start)	Execute the random block positioning data in the set order with one start.
01H: Condition start	Carry out the condition judgment set in "condition data" for the designated positioning data, and when the conditions are established, execute the "block start data". If not established, ignore that "block start data", and then execute the next point's "block start data".
02H: Wait start	Carry out the condition judgment set in "condition data" for the designated positioning data, and when the conditions are established, execute the "block start data". If not established, stop the control (wait) until the conditions are established.
03H: Simultaneous start	Simultaneous execute (output command at same timing) the positioning data with the No. designated for the axis designated in the "condition data". Up to four axes can start simultaneously.
04H: Repeated start (FOR loop)	Repeat the program from the block start data with the "FOR loop" to the block start data with "NEXT" for the designated number of times.
05H: Repeated start (FOR condition)	Repeat the program from the block start data with the "FOR condition" to the block start data with "NEXT" until the conditions set in the "condition data" are established.
06H: NEXT start	Set the end of the repetition when "04H: Repetition start (FOR loop)" or "05H: Repetition start (FOR condition)" is set.

Da.14 Parameter

Set the value as required for "**Da.13** Special start instruction".

Da.13 Special start instruction	Setting value	Special start instruction
Block start (Normal start)	—	Not used. (There is no need to set.)
Condition start	1 to 10	Set the condition data No. (Data No. of "condition data" is set up for the condition judgment.)
Wait start		
Simultaneous start		
Repeated start (FOR loop)	0 to 255	Set the number of repetitions.
Repeated start (FOR condition)	1 to 10	Set the condition data No. (Data No. of "condition data" is set up for the condition judgment.)

Appendix 9 List of condition data

The illustrations below show the organization of the condition data stored in the buffer memory of QD77MS. The condition data setting items **Da.15** to **Da.19** are explained in the pages that follow.

• QD77MS2/QD77MS4

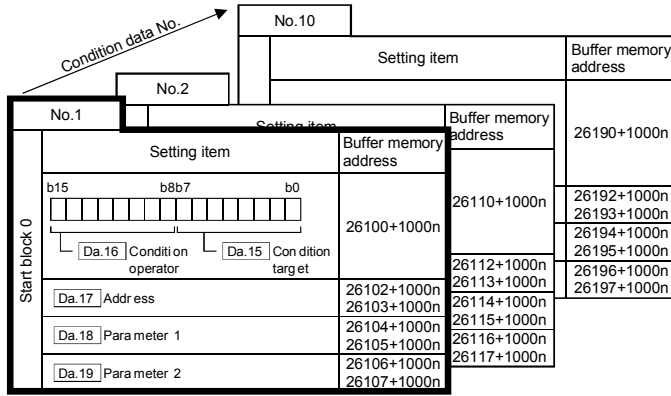

n: Axis No.-1

- Up to 10 condition data points can be set (stored) for each axis in the buffer memory addresses shown on the left.
- Items in a single unit of condition data are shown included in a bold frame.
- Each axis has five start blocks (block Numbers. 0 to 4).

• QD77MS16

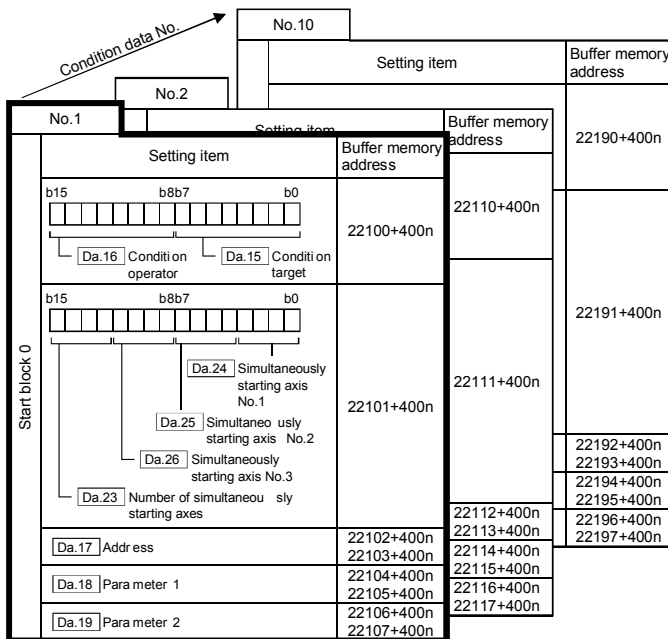

n: Axis No.-1

- Up to 10 condition data points can be set (stored) for each axis in the buffer memory addresses shown on the left.
- Items in a single unit of condition data are shown included in a bold frame.
- Each axis has five start blocks (block Numbers. 0 to 4). Start block 2 to 4 are not allocated to buffer memory. Set with GX Works2.

The pages that follow explain the condition data setting items Da.15 to Da.19.
 (Buffer memory addresses shown are those of the "Condition data No. 1 (block No. 7000)" of axes 1 to 4.)

- Guide to buffer memory address
 In the buffer memory address, "n" in "22000+400n", etc. indicates a value corresponding to axis No. such as the following table.

Axis No.	n	Axis No.	n	Axis No.	n	Axis No.	n
1	0	5	4	9	8	13	12
2	1	6	5	10	9	14	13
3	2	7	6	11	10	15	14
4	3	8	7	12	11	16	15

*: Calculate as follows for the buffer memory address corresponding to each axis.

(Example) For axis No. 16

$$22100 + 400n (\text{Da.16 Condition operator}) = 22100 + 400 \times 15 = 28100$$

$$22106 + 400n (\text{Da.19 Parameter 2}) = 22106 + 400 \times 15 = 28106$$

*: The range from axis No.1 to 2 (n=0 to 1) is valid in the QD77MS2.

*: The range from axis No.1 to 4 (n=0 to 3) is valid in the QD77MS4.

REMARK

To perform an high-level positioning control using block start data, set a number between 7000 and 7004 to the "Cd.3 Positioning start No." and use the "Cd.4 Positioning starting point No." to specify a point number between 1 and 50, a position counted from the beginning of the block.

The number between 7000 and 7004 specified here is called the "block No.".

With the QD77MS, up to 50 "block start data" points and up to 10 "condition data" items can be assigned to each "block No.".

• QD77MS2

Block No.*1	Axis	Block start data	Condition	Buffer memory	GX Works2
7000	Axis 1	Start block 0	Condition data (1 to 10)	Supports the settings	Supports the settings
	Axis 2		Condition data (1 to 10)		
7001	Axis 1	Start block 1	Condition data (1 to 10)		
	Axis 2		Condition data (1 to 10)		
7002	Axis 1	Start block 2	Condition data (1 to 10)		
	Axis 2		Condition data (1 to 10)		
7003	Axis 1	Start block 3	Condition data (1 to 10)		
	Axis 2		Condition data (1 to 10)		
7004	Axis 1	Start block 4	Condition data (1 to 10)		
	Axis 2		Condition data (1 to 10)		

• QD77MS4

Block No.*1	Axis	Block start data	Condition	Buffer memory	GX Works2
7000	Axis 1	Start block 0	Condition data (1 to 10)	Supports the settings	Supports the settings
	Axis 2		Condition data (1 to 10)		
	Axis 3		Condition data (1 to 10)		
	Axis 4		Condition data (1 to 10)		
7001	Axis 1	Start block 1	Condition data (1 to 10)		
	Axis 2		Condition data (1 to 10)		
	Axis 3		Condition data (1 to 10)		
	Axis 4		Condition data (1 to 10)		
7002	Axis 1	Start block 2	Condition data (1 to 10)		
	Axis 2		Condition data (1 to 10)		
	Axis 3		Condition data (1 to 10)		
	Axis 4		Condition data (1 to 10)		
7003	Axis 1	Start block 3	Condition data (1 to 10)		
	Axis 2		Condition data (1 to 10)		
	Axis 3		Condition data (1 to 10)		
	Axis 4		Condition data (1 to 10)		
7004	Axis 1	Start block 4	Condition data (1 to 10)		
	Axis 2		Condition data (1 to 10)		
	Axis 3		Condition data (1 to 10)		
	Axis 4		Condition data (1 to 10)		

*1: Setting cannot be made when the "Pre-reading start function" is used. If you set any of Numbers. 7000 to 7004 and perform the Pre-reading start function, "Outside start No. range error (error code: 543)" will occur.

• QD77MS16

Block No.*1	Axis	Block start data	Condition	Buffer memory	GX Works2
7000	Axis 1	Start block 0	Condition data (1 to 10)	Supports the settings	Supports the settings
	to		to		
	Axis 16		Condition data (1 to 10)		
7001	Axis 1	Start block 1	Condition data (1 to 10)		
	to		to		
	Axis 16		Condition data (1 to 10)		
7002	Axis 1	Start block 2	Condition data (1 to 10)		
	to		to		
	Axis 16		Condition data (1 to 10)		
7003	Axis 1	Start block 3	Condition data (1 to 10)		
	to		to		
	Axis 16		Condition data (1 to 10)		
7004	Axis 1	Start block 4	Condition data (1 to 10)		
	to		to		
	Axis 16		Condition data (1 to 10)		

*1: Setting cannot be made when the "Pre-reading start function" is used. If you set any of Numbers. 7000 to 7004 and perform the Pre-reading start function, "Outside start No. range error (error code: 543)" will occur.

Item	Setting value		Default value	Buffer memory address			
	Value set with GX Works2	Value set with sequence program		QD77MS2 QD77MS4	QD77MS16		
Condition identifier	Da.15 Condition target	01 : Device X	01H	0000H	26100+1000n	22100+400n	
		02 : Device Y	02H				
		03 : Buffer memory (1-word)	03H				
		04 : Buffer memory (2-word)	04H				
		05 : Positioning data No.	05H				
	Da.16 Condition operator	01 : *≠P1	01H				
		02 : *≠P1	02H				
		03 : *≠P1	03H				
		04 : *≠P1	04H				
		05 : P1≠P2	05H				
		06 : *≠P1, P2≠**	06H				
		07 : DEV=ON	07H				
		08 : DEV=OFF	08H				
		10 : Axis 1 selected	10H				
		20 : Axis 2 selected	20H				
		30 : Axis 1 and 2 selected	30H				
		40 : Axis 3 selected	40H				
		50 : Axis 1 and 3 selected	50H				
		60 : Axis 2 and 3 selected	60H				
		70 : Axis 1, 2, and 3 selected	70H				
80 : Axis 4 selected	80H						
90 : Axis 1 and 4 selected	90H						
A0 : Axis 2 and 4 selected	A0H						
B0 : Axis 1, 2, and 4 selected	B0H						
C0 : Axis 3 and 4 selected	C0H						
D0 : Axis 1, 3, and 4 selected	D0H						
E0 : Axis 2, 3, and 4 selected	E0H						
Da.17 Address	Buffer memory address	Example) 	0000H	26102+1000n 26103+1000n	22102+400n 22103+400n		
Da.18 Parameter 1	Value	Example) 	0000H	26104+1000n 26105+1000n	22104+400n 22105+400n		
Da.19 Parameter 2	Value	Example) 	0000H	26106+1000n 26107+1000n	22106+400n 22107+400n		

n: Axis No.-1

Item	Setting value		Default value	Buffer memory address	
	Value set with GX Works2	Value set with sequence program		QD77MS2 QD77MS4	QD77MS16
Simultaneously starting axis	Da.23 Number of simultaneously starting axes QD77MS16	2: 2 axes	2H	0000H	22101+400n
		3: 3 axes	3H		
		4: 4 axes	4H		
	Da.24 Simultaneously starting axis No.1 QD77MS16	0: Axis 1 selected	0H		
		1: Axis 2 selected	1H		
		2: Axis 3 selected	2H		
	Da.25 Simultaneously starting axis No.2 QD77MS16	3: Axis 4 selected	3H		
		4: Axis 5 selected	4H		
		5: Axis 6 selected	5H		
	Da.26 Simultaneously starting axis No.3 QD77MS16	6: Axis 7 selected	6H		
		7: Axis 8 selected	7H		
		8: Axis 9 selected	8H		
	9: Axis 10 selected	9H			
	A: Axis 11 selected	AH			
	B: Axis 12 selected	BH			
	C: Axis 13 selected	CH			
	D: Axis 14 selected	DH			
	E: Axis 15 selected	EH			
	F: Axis 16 selected	FH			

n: Axis No.-1

Da.15 Condition target

Set the condition target as required for each control.

Setting value	Setting details
01H : Device X	Set the input/output signal ON/OFF as the conditions.
02H : Device Y	
03H : Buffer memory (1-word)	Set the value stored in the buffer memory as the condition. 03H: The target buffer memory is "1-word (16 bits)" 03H: The target buffer memory is "1-word (16 bits)"
04H : Buffer memory (2-word)	
05H : Positioning data No.	Select only for "simultaneous start".

Da.16 Condition operator

Set the condition operator as required for the "**Da.15** Condition target".

Da.15 Condition target	Setting value	Setting details
01H: Device X 02H: Device Y	07H: DEV=ON 08H: DEV=OFF	The state (ON/OFF) of an I/O signal is defined as the condition. Select ON or OFF as the trigger.
03H: Buffer memory (1-word) 04H: Buffer memory (2-word)	01H: =P1 02H: ≠P1 03H: ≤P1 04H: ≥P1 05H: P1≤≤P2 06H: ≤P1,P2≤	Select how to use the value () in the buffer memory as a part of the condition.
05H: Positioning data No.	10H: Axis 1 selected 20H: Axis 2 selected 30H: Axis 1 and 2 selected 40H: Axis 3 selected 50H: Axis 1 and 3 selected 60H: Axis 2 and 3 selected 70H: Axis 1, 2, and 3 selected 80H: Axis 4 selected 90H: Axis 1 and 4 selected A0H: Axis 2 and 4 selected B0H: Axis 1, 2, and 4 selected C0H: Axis 3 and 4 selected D0H: Axis 1, 3, and 4 selected E0H: Axis 2, 3, and 4 selected	If "simultaneous start" is specified, select the axis (or axes) that should start simultaneously. QD77MS2 QD77MS4

Da.17 Address

Set the address as required for the "**Da.15** Condition target".

Da.15 Condition target.	Setting value	Setting details
01H: Device X 02H: Device Y	—	Not used. (There is no need to set.)
03H: Buffer memory (1-word) 04H: Buffer memory (2-word)	Value (Buffer memory address)	Set the target "buffer memory address". (For 2 word, set the low-order buffer memory 04H: Buffer memory (2-word) address.)
05H: Positioning data No.	—	Not used. (There is no need to set.)

Da.18 Parameter 1

• QD77MS2/QD77MS4

Set the parameters as required for the "**Da.16** Condition operator".

Da.16 Condition target.	Setting value	Setting details
01H: =P1	Value	The value of P1 should be equal to or smaller than the value of P2. (P1≤P2) If P1 is greater than P2 (P1>P2), the "condition data error" (error code 533) will occur.
02H: ≠P1		
03H: ≤P1		
04H: ≥P1		
05H: P1≤≤P2		
06H: ≤P1,P2≤		
07H: DEV=ON	Value (bit No.)	Set the device bit No. X: 0H, 1H, 4H to 17H Y: 0H, 1H, 4H to 17H
08H: DEV=OFF		
10H: Axis 1 selected	Value (positioning data No.)	Set the positioning data No. for starting axis 1 and/or axis 2. Low-order 16-bit : Axis 1 positioning data No. 1 to 600 (01H to 258H) High-order 16-bit : Axis 2 positioning data No. 1 to 600 (01H to 258H)
↓		
E0H: Axis 2, 3, and 4 selected		

• QD77MS16

Set the parameters as required for the "**Da.16** Condition operator" and "**Da.23** Number of simultaneously starting axes".

Da.16 Condition operator	Da.23 Number of simultaneously starting axes	Setting value	Setting details
01H: =P1	2 to 4	Value	The value of P1 should be equal to or smaller than the value of P2. (P1≤P2) If P1 is greater than P2 (P1>P2), the "condition data error" (error code 533) will occur.
02H: ≠P1			
03H: ≤P1			
04H: ≥P1			
05H: P1≤≤P2			
06H: ≤P1,P2≤			
07H: DEV=ON		Value (bit No.)	Set the device bit No. X: 0H to 1H, 10H to 1FH Y: 0H, 1H, 10H to 1FH
08H: DEV=OFF			
		Value (positioning data No.)	Set the positioning data No. for starting axis set in " Da.24 Simultaneously starting axis No.1" and/or " Da.25 Simultaneously starting axis No.2". Low-order 16-bit : Axis 1 positioning data No. 1 to 600 (01H to 258H) High-order 16-bit : Axis 2 positioning data No. 1 to 600 (01H to 258H)

Da.19 Parameter 2

• QD77MS2/QD77MS4

Set the parameters as required for the "Da.16 Condition operator".

Da.17 Condition target.	Setting value	Setting details
01H: =P1	—	Not used. (No need to be set.)
02H: ≠P1		
03H: ≤P1		
04H: ≥P1		
05H: P1≤P2	Value	The value of P2 should be equal to or greater than the value of P1. (P1≤P2) If P1 is greater than P2 (P1>P2), the "condition data error" (error code 533) will occur.
06H: ≤P1,P2≤		
07H: DEV=ON	—	Not used. (No need to be set.)
08H: DEV=OFF		
10H: Axis 1 selected		
20H: Axis 2 selected		
30H: Axis 1 and 2 selected		
40H: Axis 3 selected	Value (positioning data No.)	Set the positioning data No. for starting axis 3 and/or axis 4. Low-order 16-bit : Axis 3 positioning data No. 1 to 600 (01H to 258H) High-order 16-bit : Axis 4 positioning data No. 1 to 600 (01H to 258H)
50H: Axis 1 and 3 selected		
60H: Axis 2 and 3 selected		
70H: Axis 1, 2, and 3 selected		
80H: Axis 4 selected		
90H: Axis 1 and 4 selected		
A0H: Axis 2 and 4 selected		
B0H: Axis 1, 2, and 4 selected		
C0H: Axis 3 and 4 selected		
D0H: Axis 1, 3, and 4 selected		
E0H: Axis 2, 3, and 4 selected		

• QD77MS16

Set the parameters as required for the "Da.16 Condition operator" and "Da.23 Number of simultaneously starting axes".

Da.16 Condition operator	Da.23 Number of simultaneously starting axes	Setting value	Setting details	
01H: =P1	/	—	Not used. (No need to be set.)	
02H: ≠P1				
03H: ≤P1				
04H: ≥P1				
05H: P1≤P2		Value (bit No.)	The value of P2 should be equal to or greater than the value of P1. (P1≤P2) If P1 is greater than P2 (P1>P2), the "condition data error" (error code 533) will occur.	
06H: ≤P1,P2≤				
07H: DEV=ON		2 to 3	—	Not used. (No need to be set.)
08H: DEV=OFF				
/	4	Value (positioning data No.)	Set the positioning data No. for starting axis set in "Da.26 Simultaneously starting axis No.3" Low-order 16-bit: Simultaneously starting axis No.3 positioning data No. 1 to 600 (01H to 258H) High-order 16-bit : Not used (Set "0")	

Appendix 10 Precautions for the replacement of the QD75D□ with the QD75D□N

(1) Specification differences between the QD75D□N and the QD75D□

The following table shows the differences. The specifications not listed below are the same for the both models.

Item		QD75D□N	QD75D□
Max. output pulse		4Mpulse/s (QD75D□N)	1Mpulse/s (QD75D□)
Speed command (pulse unit)		1 to 4000000pulse/s	1 to 1000000pulse/s
Starting time (1-axis linear control)		Trapezoidal acceleration/ deceleration: 1.5ms S-curve acceleration/ deceleration: 1.6ms	Trapezoidal acceleration/ deceleration: 6ms S-curve acceleration/ deceleration: 6.5ms
Monitor data refreshing cycle	Current feed value	0.9ms	1.8ms
	Other axis monitors (except external I/O signals)	0.9ms	56.8ms
Manual pulse generator 1 pulse input magnification		1 to 1000	1 to 100
ON voltage/current of external input	External command signal	19VDC or more/2.7mA or more	17.5VDC or more/3.5mA or more
OFF voltage/current of external input	External command signal	7VDC or less/0.8mA or less	7VDC or less/1.7mA or less
Input resistance of external input	Zero signal (5VDC)	Approx. 620Ω	Approx. 300Ω
	Manual pulse generator A/B phase	Approx. 1.1kΩ	Approx. 1.5kΩ
	External command signal	Approx. 7.7kΩ	Approx. 4.3kΩ
Internal current consumption (5VDC)		QD75D1N: 0.43A QD75D2N: 0.45A QD75D4N: 0.66A	QD75D1: 0.52A QD75D2: 0.56A QD75D4: 0.82A
Weight		QD75D1N: 0.15kg QD75D2N: 0.15kg QD75D4N: 0.16kg	QD75D1: 0.15kg QD75D2: 0.15kg QD75D4: 0.16kg

(2) Precaution on the use of sequence programs

The QD75D□N is upgraded from the QD75D□. Therefore, the recognized sequence programs for the QD75D□ can be applied to the QD75D□N. Note that specifications such as time takes for startup and data update cycle are improved. When applying a sequence program to the QD75D□N, modify the sequence program if necessary, checking the processing timing.

(3) Transferring the set data of the QD75D□ using GX Works2

When GX Works2 is used, the set data of the QD75D□ can be transferred to the QD75D□N in the following procedure.

(a) Saving the set data of the QD75D□ from "Save the Positioning Module Data..."

- 1) In the project view, select the QD75D□ from where the set data is transferred.
- 2) Go to [Project] → [Intelligent Function Module]
→ [Save the Positioning Module Data...].
- 3) Input the file name, and save the set data.

(b) Reading the set data to the QD75D□N from "Read from the Positioning Module Data..."

- 1) In the project view, select the QD75D□N to where the saved data is transferred.
- 2) Go to [Project] → [Intelligent Function Module] → [Read from the Positioning Module Data...].
- 3) Select the name of the file saved in step (a), and open it. The following window opens.

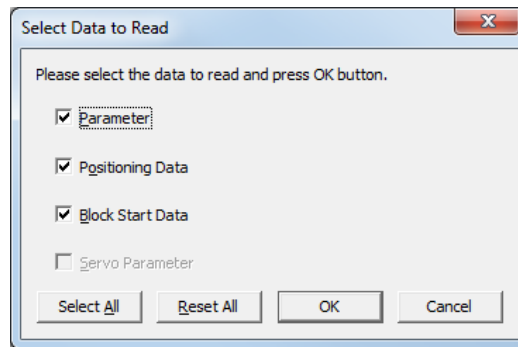

4) Check the data to read and click **OK**. The set data is read to the QD75D□N.

(4) Precaution on the use of GX Configurator-QP

To use the QD75D□N with GX Configurator-QP, select the QD75D□ in "Select module type". The QD75D□N can be used in the same manner as the QD75D□. Note that a speed exceeding 1000000pulse/s cannot be set in the following items when "Pulse" is set in "[Pr.1 Unit setting]"). To set a value outside a setting range in GX Configurator-QP, set it through a sequence program or GX Works2 of the version 1.64S or later.

Setting item	Setting range in GX Configurator-QP	Setting range in GX Works2 and sequence programs
[Pr.7] Bias speed at start	0 to 1000000(pulse/s)	0 to 4000000(pulse/s)
[Pr.8] Speed limit value	1 to 1000000(pulse/s)	1 to 4000000(pulse/s)
[Pr.31] JOG speed limit value		
[Pr.46] OPR speed	1 to 1000000(pulse/s)	
[Pr.47] Creep speed		
[Da.8] Command speed		

ABSOLUTE ENCODER

This is a detector that enables the angle data within 1 motor rotation to be output to an external destination. Absolute encoders are generally able to output 360° in 18 to 22 bits.

Incremental encoders have a disadvantage in that the axis position is lost when a power failure occurs. However, with absolute encoders, the axis position is not lost even when a power failure occurs.

Various codes such as a binary code and BCD code can be output.

Absolute encoders are more expensive, more accurate, and larger than incremental encoders.

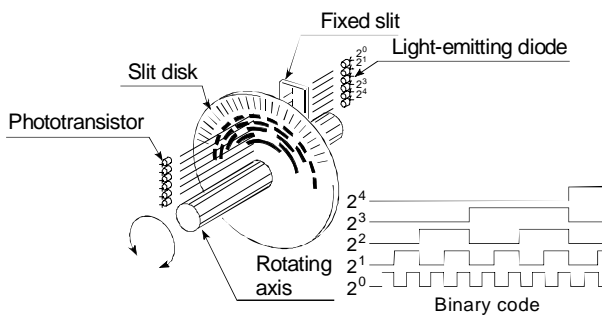

ABSOLUTE POSITION DETECTION SYSTEM

In the absolute position detection system, once an OPR is carried out at the system startup, the system stores the machine position in the memory and retains the current position even when the power is turned OFF. Mechanical deviation will be compensated, so that the OPR is not required after the power is turned ON next time. Configuring this system requires a motor with an absolute position detector and a servo amplifier and positioning module compatible with an absolute position detection system.

ABSOLUTE SYSTEM

This is one system for expressing a positioning address.

Absolute address system.

This system uses 0 as a reference, and expresses the address as the distance from 0.

The direction is automatically determined, even when it is not designated. The other address system is the increment system.

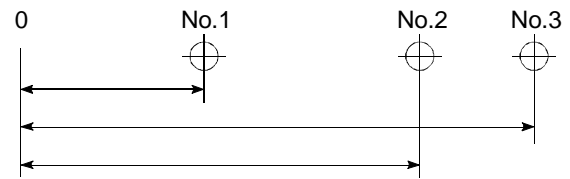

AUTOMATIC TRAPEZOIDAL ACCELERATION/DECELERATION

An operation in which a graph of the time and speed takes a trapezoidal shape.

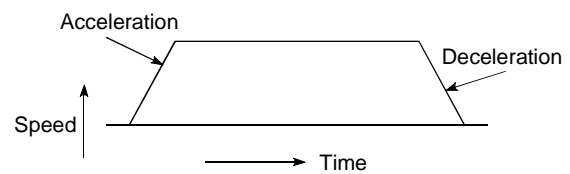

COMPOSITE SPEED

The movement speed for the target control during interpolation operations.

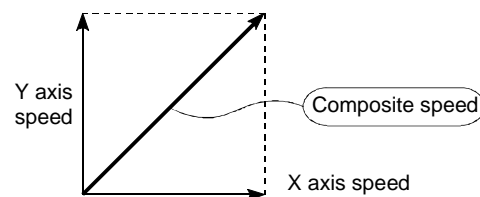

CREEP SPEED

A speed at which the machine moves very slowly. It is difficult for the machine to stop accurately when running at high speed, so the movement must first be changed to the creep speed before stopping.

CURRENT FEED VALUE

The OP address at the completion of the machine OPR is stored.

The position currently being executed is stored. This value changes when the current value is changed.

DEVIATION COUNTER

Deviation counters have the following two functions.

- 1) To count the command pulses issued from the QD75, and transmit the count value to the D/A converter.
- 2) To subtract the feedback pulses from the command pulses, and run the motor by the deviation value (droop pulse) of the command pulses and feedback pulses until the command pulses reaches 0.

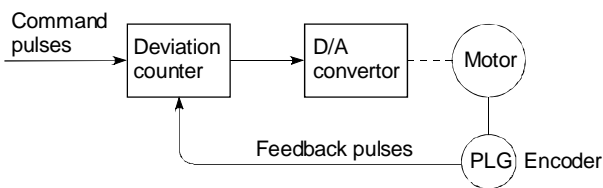

DIFFERENTIAL OUTPUT TYPE

When one signal is output with this method, a companion signal having the reverse polarity is simultaneously output. This method enables high-frequency transfer, and is resistant to noise, etc., so it is also used in high-speed signal transfer such as inputting and outputting of pulse trains. In general, the transmission side is called the driver, the reception side is called the receiver, and a dedicated IC is used.

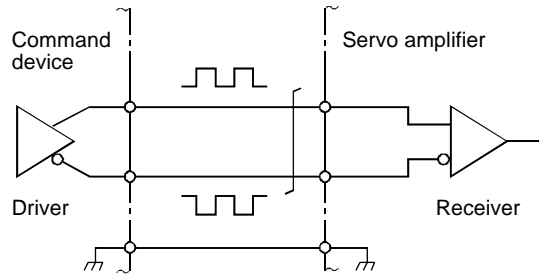

DRIVE UNIT

The commands output from the positioning module are low-voltage, low-current commands with insufficient energy to run the motor.

The drive unit increases the width of these commands so the motor can be run. It is an accessory on servomotors and stepping motors. Also called a servo amplifier.

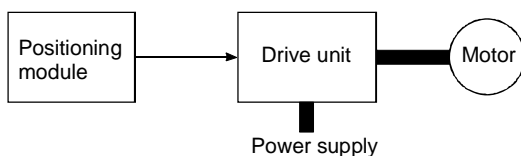

DRIVE UNIT READY

This signal is output when the drive unit for the motor is in a READY state.

This signal remains OFF when the drive unit power is OFF, or during faults, etc.

DROOP PULSE

Because of inertia (GD²) in the machine, it will lag behind and not be able to track if the positioning module speed commands are issued in their normal state.

Thus, for a servomotor, a method is used in which the speed command pulses are delayed by accumulation in a deviation counter. These accumulated pulses are called the droop pulse. The deviation counter emits all pulses and returns to 0 when the machine stops.

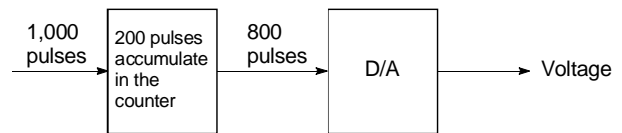

DYNAMIC BRAKE

When protection circuits operate due to power failures, emergency stops (EMG signal) etc., this function is used to short-circuit between servomotor terminals via a resistor, thermally consume the rotation energy, and cause a sudden stop without allowing coasting of the motor.

Braking power is generated by electromagnetic brakes only when running motors with which a large brake torque can be obtained. Because electromagnetic brakes have no holding power, they are used in combination with mechanical brakes to prevent dropping of the vertical axis.

ELECTRONIC GEAR

This is a function that amplifies the command pulses from the pulse command module electrically by factors between 1/10 to 4000 inside the servo amplifier.

Therefore, the positioning speed and the movement amount can be controlled by the electronic gear ratio factor.

FAST OPR

The axis returns to the machine OP at the OPR speed without detecting the near-point dog. (This is not validated unless a machine OPR has been carried out first.)

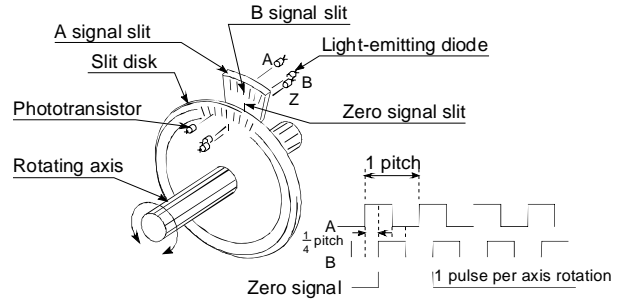
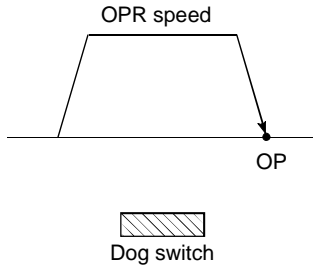

FEEDBACK PULSE

This is a method of using a returning pulse train to confirm whether the machine faithfully operated according to the commands issued in automatic control. If the machine did not faithfully operate according to the commands, a correction command is issued. For example, if a command is issued for 10,000 pulses, and a feedback pulse of 10,000 pulses is returned, then the balance becomes 0 and it can be judged that the command was faithfully followed.

INCREMENTAL SYSTEM

The current value is 0 in this system. Positions are expressed by the designated direction and distance of travel. Also called the relative address system. This system is used in fixedfeed, etc.

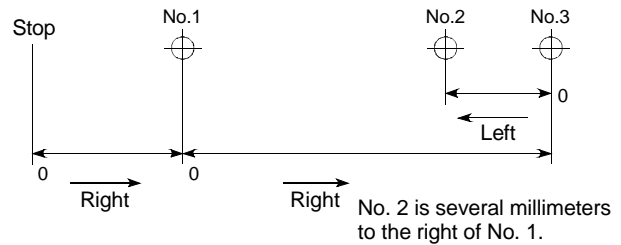

FLASH ROM

This battery-less memory can be used to store parameters and positioning data for backup. Because it is battery-less, battery maintenance is not required.

INTERLOCK

In this condition, the machine is blocked from moving to the next operation until the operation in progress is complete. This function is used to prevent damage to devices and malfunctioning.

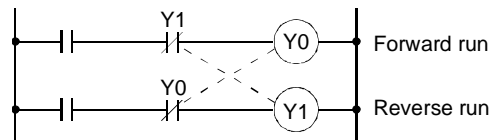

INCREMENTAL ENCODER

A device that simply outputs ON/OFF pulses by the rotation of the axis. 1-phase types output only A pulses, and do not indicate the axis rotation direction. 2-phase types output both A and B pulse trains, and can judge the rotation direction. The direction is judged to be forward if the B pulse train turns ON when A is ON, and judged to be reverse if A turns ON when B is ON. There is also another type of incremental encoder with a zero signal. The most commonly used incremental encoders output between 100 and 10,000 pulses per axis rotation. Refer to "ENCODER".

MACHINE FEED VALUE

The OP address at the completion of the machine OPR is stored. The current position of the machine coordinates determined by a machine having the OP address as a reference. Even if the current value is changed, this value will not change.

MANUAL PULSE GENERATOR

The handle of this device is manually rotated to generate pulses. This device is used when manually carrying out accurate positioning.

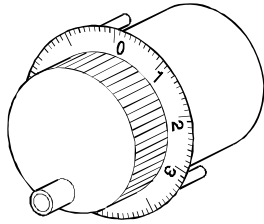

Made by Mitsubishi Electric Corp.
(model: MR-HDP01)

MASTER AXIS

When carrying out interpolation operations, this is the side on which the positioning data is executed in priority. For example, when positioning with the X axis and Y axis, the side with the largest movement distance will become the master axis, and the speed will follow that axis. The slave axis speed will be ignored..

NEAR-POINT DOG

This is a switch placed before the OP. When this switch turns ON, the feedrate is changed to the creep speed. Because of that, the time that this switch is ON must be long enough to allow for the time required for deceleration from the feedrate to the creep speed.

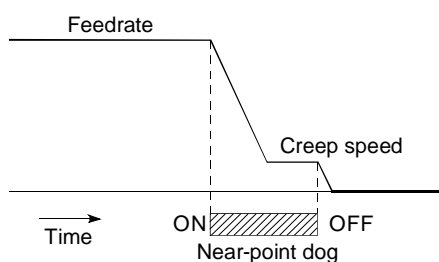

OP SHIFT FUNCTION

The OP position can be shifted in the positive or negative direction by executing a machine OPR and determining the shift amount from the machine OPR complete position.

An OP can be set at a position besides the OP position, or outside the dog switch.

OVERRIDE FUNCTION

With this function, the speed during positioning operations (current speed) can be varied between 1 and 300%.

The speed can also be changed by the same variable rate for continuous positioning with differing designated speeds.

PC READY

The signal when the PLC CPU is in the ready status. The positioning cannot be performed if the PLC CPU is not in this status.

POSITION CONTROL

This is mainly the control of position and dimension, such as in fixed-feed, positioning, numerical control, etc. This is always controlled with feed pulses. There is also speed control.

POSITIONING DATA

This is data for the user to carry out positioning. The No. of points to which positioning is carried out (the No. of addresses) is designated by the user. In the QD77, these are 600 points.

Data can be written (changed) by the program during the positioning.

POSITIONING PARAMETER

This is basic data for carrying out positioning control. Types of data include control unit, movement amount per pulse, speed limit value, upper and lower stroke limit values, acceleration/deceleration time, positioning system, etc.

Parameters have an initial value, so that value is changed to match the control conditions.

REFERENCE AXIS SPEED

This is the speed of the reference axis during interpolation operations.

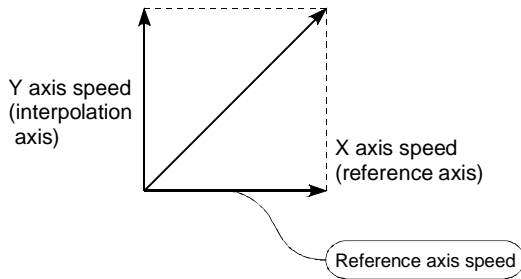

REGENERATIVE BRAKE OPTION

This function is an option. It is used when carrying out highly repetitive acceleration/deceleration.

Refer to "EXTERNAL REGENERATIVE RESISTOR".

RESOLVER

This device detects the angle by resolving the two voltages of the analog input. Also called a 2-phase synchro. For a 1-phase voltage input, the axis rotation angle is converted into a perpendicular 2-phase voltage (analog voltage) and output.

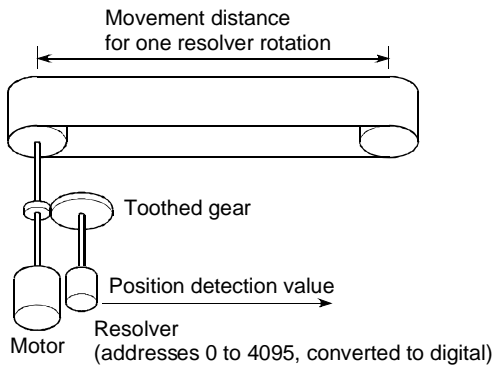

SERVO ON

The servo amplifier will not operate if the servo amplifier is in a normal state and this servo ON signal is OFF.

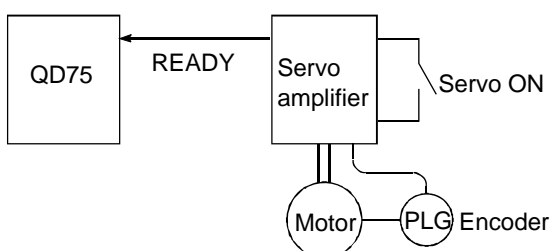

SKIP FUNCTION

When a SKIP signal is input, the positioning being executed is interrupted, the motor is deceleration stopped, and the next positioning is automatically carried out.

SPEED CONTROL

Speed control is mainly carried out with the servomotor. It is an application for grindstone rotation, welding speed, feedrate, etc. Speed control differs from position control in that the current position (address) is not controlled.

SPEED INTEGRAL COMPENSATION

This is one item in the parameters of the servo amplifier, and is used to raise the frequency response during speed control to improve transient characteristics.

When adjusting the speed loop gain, raising this value is effective if the overshooting during acceleration/deceleration remains large.

This compensation is set in ms units.

SPEED LIMIT VALUE

This is the max. speed for positioning. Even if other data is mistakenly set to a higher speed than this, the positioning will be carried out at this speed limit value when it is set in the parameters. The acceleration time becomes the time to accelerate from a stopped state to the speed limit value, and the deceleration time becomes the time to decelerate from the speed limit value to a stopped state.

SPEED LOOP GAIN

This is one item in the parameters of the servo amplifier, and expresses the speed of the control response during speed control. When the load inertia moment ratio increases, the control system speed response decreases and the operation may become unstable. If this happens, the operation can be improved by raising this setting value.

The overshoot will become larger if the speed loop gain is raised too far, and motor vibration noise will occur during operation and when stopped.

STEP FUNCTION

When the operation is designed so that several positioning data Numbers. are consecutively run, this function can be used to carry out a test operation for 1 data item at a time.

STROKE LIMIT

This is the range in which a positioning operation is possible, or the range in which the machine can be moved without damage occurring.

(Movement outside this range is possible in the manual operation.) For operations using a worm gear, the stroke limit is determined by the length of the screw. For operations using a fixed-feed, it is determined by the max. dimension to be cut. The upper and lower limits are set in the parameters, but a separate limit switch should be established and an emergency stop circuit outside the programmable controller should be created.

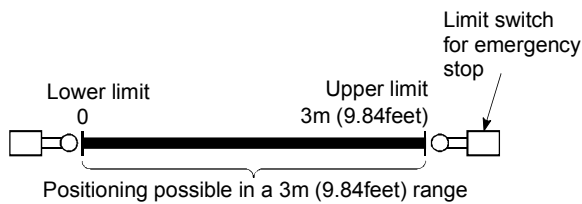

TEACHING

When the positioning address is uncertain, or gauging is required, this function is used by the user to search for and teach the position to the machine.

For example, complex addresses such as drawings can be taught by tracing a model, and the positioning operation can be reproduced.

TORQUE CONTROL

In this function, a limit is established for the resistance torque applied to the motor used for positioning. The power is turned OFF if torque exceeding that value is applied to the motor.

When excessive torque is applied to a motor, it causes the current to suddenly increase. Motor burning and other stress on the motor occurs, and the life of the motor is shortened.

This function utilizes the sudden increase in the torque when the machine OPR to issue a command to stop the motor.

TRACKING FUNCTION

In this function, positioning is carried out at a speed relative to a moving target object by inputting the movement amount from an external encoder and adding it to the servo command value.

TURNTABLE

A rotating table, which is turned using power. The table is used divided from one 360° rotation into the required locations for work.

The positioning control unit is "degree".

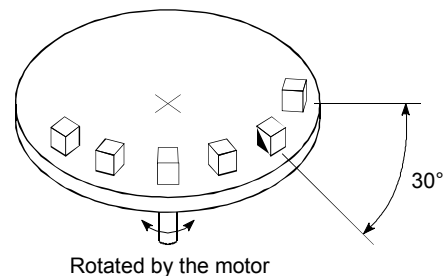

UNIT SETTING

This is the setting of the unit for the actual address to which positioning is required, or for the movement amount.

The following units can be set: mm, inch, degree and pulse. The initial value in the parameters is a pulse unit.

XY TABLE

This is a device that moves a table in the X (latitudinal) and Y (longitudinal) directions so that positioning can be carried out easily.

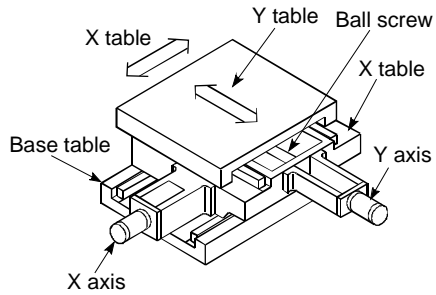

ZERO SIGNAL

Pulse(s) generated per rotation of the pulse generator axis.

Use this signal for the home position return of the positioning. It is also known as Z signal or PG0.

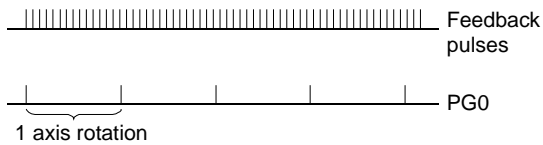

Mitsubishi Programmable Controllers Training Manual

QD77 Positioning (Simple Motion)

MODEL	
MODEL CODE	
SH-030228ENG-A (1503) MEE	

MITSUBISHI ELECTRIC CORPORATION

HEAD OFFICE: TOKYO BLDG., 2-7-3, MARUNOUCHI, CHIYODA-KU, TOKYO 100-8310, JAPAN
NAGOYA WORKS: 1-14, YADA-MINAMI 5-CHOME, HIGASHI-KU, NAGOYA 461-8670, JAPAN

When exported from Japan, this manual does not require application to the Ministry of Economy, Trade and Industry for service transaction permission.

Specifications subject to change without notice.