

Mitsubishi Programmable Controller

MELSEC **Q** series

Energy Measuring Module User's Manual (Details)

QE84WH

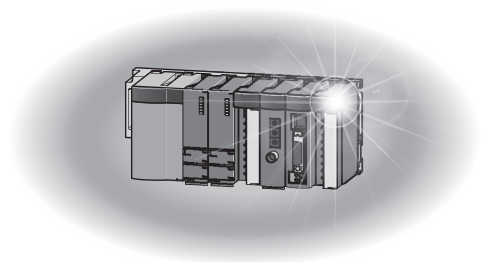

● SAFETY PRECAUTIONS ●

(Read these precautions before using this product.)

This manual contains important instructions for MELSEC-Q series QE84WH.

Before using this product, please read this manual and the relevant manuals carefully and pay full attention to safety to handle the product correctly.

The precautions given in this manual are concerned with this product only. For the safety precautions of the programmable controller system, refer to the user's manual of the CPU module used.

In this manual, the safety precautions are classified into two levels: "DANGER" and "CAUTION".



Indicates that incorrect handling may cause hazardous conditions, resulting in death or severe injury.



Indicates that incorrect handling may cause hazardous conditions, resulting in medium or slight personal injury or physical damage.

Under some circumstances, failure to observe the precautions given under “ CAUTION” may lead to serious consequences.

Observe the precautions of both levels because they are important for personal and system safety.

Keep this manual in an accessible place for future reference whenever needed, and make sure it is delivered to the end user.

[Precautions for Operating Environment and Conditions]

Caution

- Do not use this product in the places listed below. Failure to follow the instruction may cause malfunctions or decrease of product-life.
 - Places the Ambient temperature exceeds the range 0 to +55°C.
 - Places the Relative humidity exceeds the range 5 - 95% or condensation is observed.
 - Altitude exceeds 2000 m.
 - Places exposed to rain or water drop.
 - Dust, corrosive gas, saline and oil smoke exist.
 - Vibration and impact exceed the specifications.
 - Installation on excluding the control board

[Design Precautions]

Danger

- Do not write data into “System Area” in the buffer memory of the intelligent function module. Also, do not output (turn ON) the “use prohibited” signal in the output signal sent from the sequencer CPU to the intelligent function module. Doing so may cause a malfunction to the sequencer system.

Caution

Do not install the input signal wire together with the main circuit lines or power cables. Keep a distance as below. (Except for the terminal input part) Failure to do so may result in malfunction due to noise.

Conditions	Distance
Below 600V, or 600A power lines	300mm or more
Other power lines	600mm or more

[Installation Precautions]

Caution

- Any person who is involved in the installation and the wiring of this Sequencer should be fully competent to do the work.
- Use the programmable controller in an environment that meets the general specifications in the User's manual of the CPU module used.
Failure to do so may result in electric shock, fire, malfunction, or damage to or deterioration of the product.
- To mount the module, while pressing the module-mounting lever located in the lower part of the module, fully insert the module fixing projection(s) into the hole(s) in the base unit and press the module until it snaps into place.
Incorrect mounting may cause a malfunction, failure or a fall of the module.
When using the Sequencer in an environment of frequent vibrations, fix the module with a screw.
- Tighten the screws within the specified torque range.
Fixing-Module screw (arranged by user): M3 x 12mm
Tightening torque of the fixing-module screws 0.36 - 0.48 N•m
When the screw tightening is loose, it causes a fall, short-circuit, and a malfunction.
Over-tightening can damage the screws and the module, and it may cause a fall, short-circuit, or a malfunction.
- Shut off the external power supply for the system in all phases before mounting or removing the module. Failure to do so may result in damage to the product.
- Do not touch directly any conductive parts and electronic parts of the module.
Doing so can cause a malfunction or failure of the module.

[Wiring Precautions]

Danger

- For installation and wiring works, make sure that the power source is shut off for all outside phases. If all phases are not turned off, it may cause an electric shock or product damages.

Caution

- FG terminal must be grounded according to the D-type ground (Type 3) dedicated for sequencer. Failure to do so may result in electric shock or malfunction.
- When using this product, make sure to use it in combination with current sensor (EMU-CT***, EMU-CT***-A or EMU2-CT5). Please not to exceed the ratings of this product for input of current sensor. For further details, please refer to current sensor manual to maintain the functionality and the accuracy of this product .
- Current sensor (EMU-CT***, EMU-CT***-A (Excluding EMU-CT5-A)) is used only for low voltage circuit. It cannot be used with a high voltage circuit. Also, EMU2-CT5 and EMU-CT5-A should be used with the secondary side (5 A) of transformer transfixed. If it is connected with a high-voltage circuit by mistake, it may cause a burnout of the device and a fire. It is critically dangerous. For the Allowable maximum voltage, refer to Appendix 2 “Optional devices”.
- Current sensor has a polarity (directionality). Be careful about it when installing the module.
- Do not open the secondary side of current sensor.
- Take care not entering any foreign objects such as chips and wire pieces into the module. It may cause a fire, failure or a malfunction.
- In order to prevent the module from incoming foreign objects such as wire pieces during wiring work, a foreign-object preventive label is placed on the module. While a wiring work is performed, keep the label on the module. Before operating the system, peel off the label for heat release. If the foreign-object preventive label is not peeled and the system is in use, residual heat inside the module may reduce the product life.
- The wires to be connected to the module shall be put in a duct or fixed together by clamp. If not, the loosening and unstable wire or careless stretching results in poor contact of electric wires. That may cause a breakage of the module or wire or a malfunction.
- After wiring, confirm whether there is a wiring forgetting or a faulty wiring. They may cause a device malfunction, a fire, or an electric shock.
- If the wires connected to the module are strongly pulled off, it may cause a malfunction or a breakage to the module or the wire. (Tensile load: 22N or less)
- Ensure the wiring to the module properly, checking the rated voltage and current of the product and the terminal pin assignment. If the input voltage exceed the rated voltage or the wiring is improper, it may cause a fire or a breakage.
- Do not exceed the specified voltage when doing an insulation resistance test and a commercial frequency withstand voltage test.
- To protect persons who do not have adequate knowledge of electric equipment from electric shocks, any of the following measures should be taken for the panel.
 - (a) To lock the panel so that only trained persons having adequate knowledge of electric equipment can open it.
 - (b) To design the structure so that the power is automatically interrupted upon opening of the panel. The protection class of the panel should be IP2X or higher.
- Terminal screws must be tightened to the specified torque. Loose terminal screws may cause a short circuit or malfunction. If terminal screws are over-tightened, the screws or the module may be damaged, causing a short circuit or malfunction. For specified torque, refer to Section 8.1 Precautions for handling.
- Use an applicable solderless terminal for the current input line and tighten it to the specified torque. If a spade terminal is used, it may fall, causing a breakage of the module when the terminal screw is loosened.
- Use appropriate size of electric wires. If inappropriate size of electric wire is used, it may cause a fire due to generated heat. For appropriate size of electric wires, refer to Section 8.5.2 How to connect wires.
- In case using stranded wire, take measures so that the filament should not vary by processing the point twisted.
- To prevent persons with little knowledge about electric equipment from electric shock, panel must be taken either following measure. Lock the panel so that only those who get an education about electric equipment and have sufficient knowledge can unlock, or shut off power supply automatically by opening the panel. Cover the dangerous part of this unit.

[Start-up Precautions]

Caution

- Use the product within the ratings specified in this manual. When using it outside the ratings, it not only causes a malfunction or failure but also there is a fear of igniting and damaging by a fire.
- Before operating the product, check that active bare wire and so on does not exist around the product. If any bare wire exists, stop the operation immediately, and take an appropriate action such as isolation protection.
- Do not disassemble or modify the module. It may cause failure, a malfunction, an injury or a fire.
- Attaching and detaching the module must be performed after the power source is shut off for all outside phases. If not all phases are shut off, it may cause failure or a malfunction of the module.
- Do not touch the live terminal. It may cause a malfunction.

[Maintenance Precautions]

Caution

- Cleaning and additional tightening of screws must be performed after the input power source is shut off for all outside phases. If not all phases are shut off, it may cause failure or a malfunction of the module.
- Use a soft dry cloth to clean off dirt of the module surface.
- Do not let a chemical cloth remain on the surface for an extended period nor wipe the surface with thinner or benzene.
Check for the following items for using this product properly for long time.
<Daily maintenance>
(1) No damage on this product (2) No abnormality with LED indicators (3) No abnormal noise, smell or heat.
<Periodical maintenance> (Once every 6 months to 1 year)
(4) Confirm there is loosening in installation, wire connection to terminal blocks, and the connection of the connectors. (Check these items under the power failure condition.)

[Storage Precautions]

Caution

- To store this product, turn off the power and remove wires, and put it in a plastic bag.
For long-time storage, avoid the following places. Failure to follow the instruction may cause a failure and reduced life of the product.
 - Places the Ambient temperature exceeds the range -25 to +75°C.
 - Places the Relative humidity exceeds the range 5 - 95% or condensation is observed.
 - Dust, corrosive gas, saline and oil smoke exist, and vibration and frequent physical impact occur.
 - Places exposed to rain or water drop.

[Disposal Precautions]

Caution

- Dispose of the product as an industrial waste.

Revision history

* Instruction Manual Number is provided at the bottom of the cover page.

Printed date	*Instruction Manual #	Description of revisions
July, 2012	IB-63720	First edition
Jan, 2016	IB63720A	<u>Correction</u> Cover Section 2.1, Section 6.1, Section 6.2.12, Section 9.1, Section 9.2.1, Section 9.2.2, Section 9.3.1, Section 9.3.2, Appendix-2 Back cover
Jul, 2017	IB63720B	<u>Correction</u> SAFETY PRECAUTIONS, Compliance with the EMC and Low Voltage Directives, Section 2.1, Chapter 3, Chapter 4, Section 6.2, Section 6.3, Section 7.2, Section 7.7, Section 7.8, Section 7.9, Section 8.2, Section 8.5, Section 8.6, Chapter 9, Section 10.2, Section 10.3, Appendix 2, Back cover
Jan, 2021	IB63720C	<u>Correction</u> Compliance with the EMC and Low Voltage Directives, Section 3.2, Back cover

This manual does not guarantee to protect or does not give permission to any industrial property and any related rights. Also, our company shall not be held any responsible for any issues related to industrial properties due to product usage described in this manual.

© 2012 MITSUBISHI ELECTRIC CORPORATION

Table of Content

Safety precautions	A-1
Revision history	A-5
Table of content	A-6
Compliance with the EMC and Low Voltage Directives	A-8
Product configuration	A-8
Chapter 1: Overview	1-1
1.1 Features	1-1
Chapter 2: System Configuration	2-1 - 2-4
2.1 Applicable system	2-1
2.2 Precautions for system configuration	2-3
2.2 How to check the function version, serial number, and module version	2-3
Chapter 3: Specifications	3-1 - 3-3
3.1 General specifications	3-1
3.2 Electrical and mechanical specifications	3-2
Chapter 4: Functions	4-1 - 4-18
4.1 List of functions	4-1
4.2 Functions in detail	4-2
Chapter 5: I/O signal to CPU module	5-1 - 5-8
5.1 List of I/O signals	5-1
5.2 Details of I/O signals	5-2
Chapter 6: Buffer memory	6-1 - 6-33
6.1 Buffer memory assignment	6-1
6.2 Configurable sections (Un\G0 to Un\G99)	6-6
6.3 Measurement sections (Un\G100 to Un\G2999)	6-17
6.4 Common sections (Un\4500 to Un\G4999)	6-32
Chapter 7: Current measuring mode	7-1 - 7-18
7.1 Measuring functions in the current measuring mode	7-1
7.2 Selecting the current measuring mode	7-1
7.3 List of I/O signals	7-2
7.4 Buffer memory	7-3
7.5 Names and functions of LEDs	7-4
7.6 Names of signals of terminal block	7-5
7.7 Wiring	7-6
7.8 Setting from GX Works2	7-8
7.9 Setting from GX Developer	7-14

Chapter 8: Setting and procedure for operation	8-1 - 8-35
--	------------

8.1 Precautions for handling	8-1
8.2 Procedure for operation	8-2
8.3 Name and function of each part.....	8-3
8.4 Attaching and removing the module	8-6
8.5 Wiring	8-8
8.6 Setting from GX Works2	8-21
8.7 Setting from GX Developer	8-29

Chapter 9: Programming	9-1 - 9-22
------------------------	------------

9.1 Programming procedure	9-1
9.2 System configuration and usage conditions for sample program	9-2
9.3 System configuration and usage conditions for current measuring mode	9-11

Chapter 10: Troubleshooting	10-1 - 10-9
-----------------------------	-------------

10.1 List of error codes	10-1
10.2 Troubleshooting.....	10-3
10.3 Q&A	10-6

Appendix	Appendix 1 - 5
----------	----------------

Appendix 1: External dimensions	Appendix-1
Appendix 2: Optional devices.....	Appendix-2

Index	Index 1
-------	---------

Compliance with the EMC and Low Voltage Directives

(1) For programmable controller system

To configure a system meeting the requirements of the EMC and Low Voltage Directives when incorporating the Mitsubishi programmable controller (EMC and Low Voltage Directives compliant) into other machinery or equipment, refer to QCPU User's Manual (Hardware Design, Maintenance and Inspection).

The CE mark, indicating compliance with the EMC and Low Voltage Directives, is printed on the rating plate of the programmable controller.

(2) For the product

For the compliance of this product with the EMC and Low Voltage Directives, refer to Section 8.5 Wiring.

In addition, attach ferrite cores to power line of power supply module.

Ferrite cores used in our testing is below.

KITAGAWA INDUSTRIES CO.,LTD., RFC-10

(3) CE marking conformity combination module

This module conforms to CE marking standard in a condition to make combination use with following current sensor and cable.

(a)Current input

current sensor	EMU-CT50, EMU-CT100, EMU-CT250, EMU-CT400, EMU-CT600, EMU-CT400-A, EMU-CT600-A	EMU2-CT5
cable or current sensor cable	CE marking cable (twisted pair cable) Stranded wire: AWG20 – AWG18 (0.5 - 0.8 mm ²) Solderless terminal: R1.25-3 (No solderless terminal with insulation sleeve can be used.)	EMU2-CB-Q5B(indispensable) EMU2-CB-T1M, EMU2-CB-T5M EMU2-CB-T10M, EMU2-CB-T1MS EMU2-CB-T5MS, EMU2-CB-T10MS
Max. cable length	50m	11m(EMU2-CT5 include)

(b)Voltage input

cable	CE marking cable (twisted pair cable) Single wire: AWG24 – AWG16 (φ0.5 - 1.3mm) Stranded wire: AWG24 – AWG16 (0.2 – 1.3 mm ²)
Max. cable length	50m

Product configuration

The following describes the product configuration.

Model name	Product name	Quantity
QE84WH	Energy Measuring Module	1
	Voltage input terminals	1

Note

Chapter 1: Overview

This manual explains specifications, handling methods, and programming of Energy Measuring Module QE84WH (hereinafter, abbreviated as QE84WH) supporting MELSEC-Q series.

1.1 Features

- (1) This Energy Measuring Module can measure four channels of various types of electric quantity.
It can measure four channels of electric energy, reactive energy, current, voltage, electric power, reactive power, power factor, and frequency.
Both consumption and regeneration of the electric energy can be measured.
- (2) Extensive monitoring functions
In addition to memorizing the maximum and minimum values, two types of alarm monitoring for upper and lower limit can be performed for each channel.
- (3) It also can measure the electric energy for a certain period.
It can measure the electric energy for the duration of time for which the output device is on.
This feature enables to acquire the electric energy needed during device operation or energy per tact.
- (4) Equipped with the current measuring mode where eight channels of current can be measured.
By selecting the current measuring mode using the intelligent function module switch, you can measure only the current through eight channels.
Note that the input/output signals and buffer memory to be used in the current measuring mode are different from those used in the regular operation mode. For details, refer to Chapter 7.

Chapter 2: System Configuration

2.1 Applicable system

The following describes applicable systems.

(1) Applicable module and the quantity of attachable pieces

(a) When mounted with CPU module

CPU module to which QE84WH can be attached and the number of attachable pieces are shown below.

Depending on the combination of the attached module and the number of attached pieces, lack of power capacity may occur.

When attaching the module, please consider the power capacity.

If the power capacity is insufficient, reconsider the combination of modules to be attached.

Since the number of attachable modules are limited by the power module which used, please refer to the notes on the 2.2 precautions for system configuration.

Attachable CPU Module		Attachable quantity.	Remarks
CPU Type	CPU Model		
Programmable controller CPU	Basic model QCPU	Q00JCPU	8
		Q00CPU	24
		Q01CPU	
	High performance model QCPU	Q02CPU	64
		Q02HCPU	
		Q06HCPU	
		Q12HCPU	
		Q25HCPU	
	Process CPU	Q02PHCPU	64
		Q06PHCPU	
		Q12PHCPU	
		Q25PHCPU	
	Redundant CPU	Q12PRHCPU	53
		Q25PRHCPU	
	Universal model QCPU	Q00UJCPU	8
		Q00UCPU	24
		Q01UCPU	
		Q02UCPU	36
		Q03UDCPU	64
		Q04UDHCPU	
Q06UDHCPU			
Q10UDHCPU			
Q13UDHCPU			
Q20UDHCPU			
Q26UDHCPU			
Q03UDECPU			
Q04UDEHCPU			
Q06UDEHCPU			
Q10UDEHCPU			
Q13UDEHCPU			
Q20UDEHCPU			
Q26UDEHCPU			
Q50UDEHCPU			
Q100UDEHCPU			

Attachable CPU Module		Attachable quantity.	Remarks	
CPU Type	CPU Model			
Programmable controller CPU	High-speed Universal model QCPU	Q03UDVCPU	64	
		Q04UDVCPU		
		Q06UDVCPU		
		Q13UDVCPU		
		Q26UDVCPU		
		Q04UDPVCPU		
		Q06UDPVCPU		
		Q13UDPVCPU		
		Q26UDPVCPU		
C Controller module		Q06CCPU-V	64	
		Q06CCPU-V-B		
		Q12DCCPU-V		
		Q24DHCCPU-LS		
		Q26DHCCPU-LS		

(b) When mounted with MELSECNET/H remote I/O station

The table below shows the network modules applicable to the QE84WH and the number of network modules to be mounted.

Depending on the combination with other modules or the number of mounted modules, power supply capacity may be insufficient.

Pay attention to the power supply capacity before mounting modules, and if the power supply capacity is insufficient, change the combination of the modules.

Applicable Network Module	Number of modules	Remarks
QJ72LP25-25	64	
QJ72LP25G		
QJ72BR15		

(c) Attachable base unit

QE84WH can be attached to any I/O slot of the basic base unit and expansion base unit (*1) (*2).

*1 In the case of dual CPU, it can be attached only to an expansion base unit. It cannot be attached to the base unit.

*2 It has to be within the range of I/O slots of the CPU module.

(2) For multiple CPU system

The function version of the first released CT input module is C, and the CT input module supports multiple CPU systems.

When using the CT input module in a multiple CPU system, refer to the following.

*QCPU User's Manual (Multiple CPU system)

(3) Applicable software package

QE84WH supported software packages are as follows:

(a) Software package for sequencer

Product name	Model name	Remarks
GX Works2	SW1DNC-GXW2	iQ Platform compatible programmable controller engineering software
GX Developer	SWnD5C-GPPW	MELSEC sequencer programming software "n" in the model name is 4 or larger.

2.2 Precautions for system configuration

(1) When attaching it to an expansion base without a power module

If QE84WH is attached to an expansion base without a power module, refer to the user's manual of the sequencer CPU to be used in order to select the power module and expansion cable.

2.3 How to check the function version, serial number, and module version

(1) How to check the module version

It can be checked with the serial number label (placed on the right side of QE84WH).

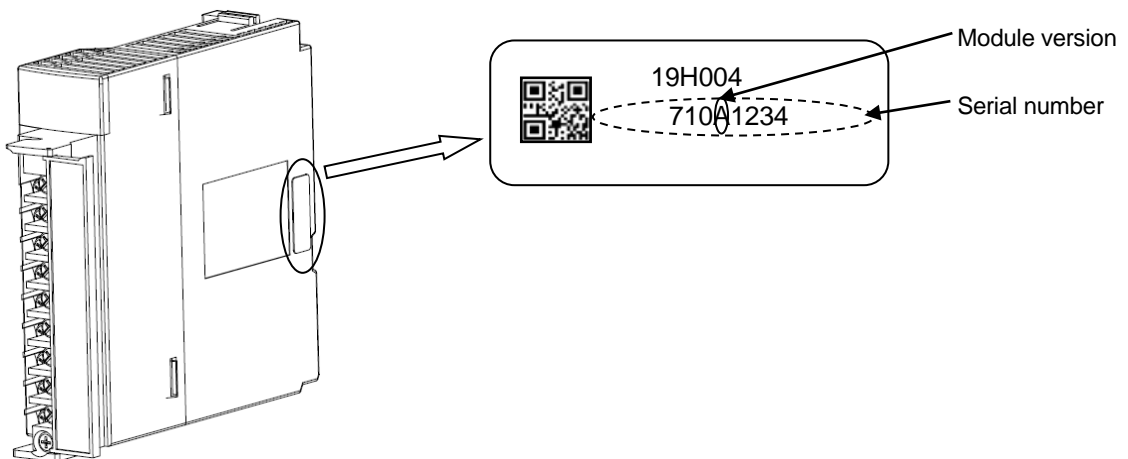

- (2) How to check the function version and serial number
 - (a) Checking on the front of the module

The serial number and function version on the rating plate is shown on the front (at the bottom) of the module.

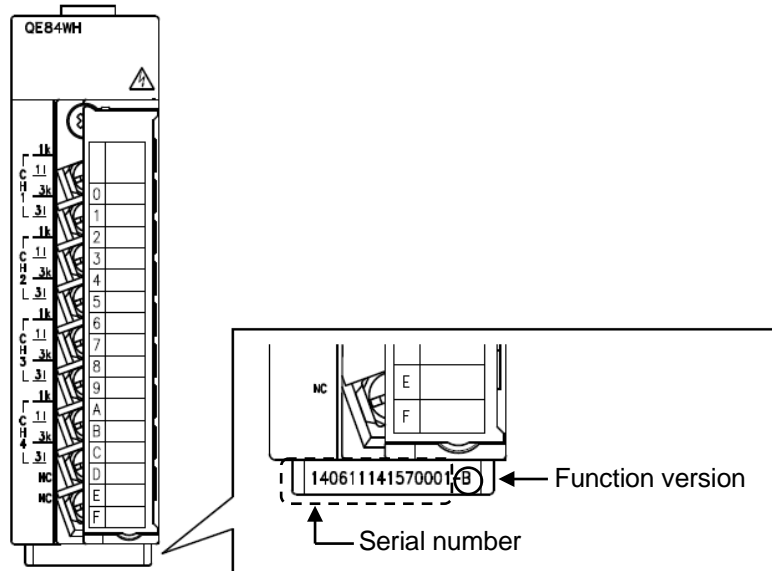

- (b) Checking on the System monitor dialog box (Product Information List)
- To display the system monitor, select [Diagnostics] → [System monitor] and click the Product Information List button of GX Developer.

Slot	Type	Series	Model name	Points	I/O No.	Master PLC	Serial No	Ver.	Product No.
PLC	PLC	Q	Q00UJCPU	-	-	-	1310200000000000	B	140115140218032-B
0-0	Intelli.	Q	QE84WH	32pt	0000	-	1406100000000000	B	-
0-1	-	-	None	-	-	-	-	-	-
0-2	-	-	None	-	-	-	-	-	-
0-3	-	-	None	-	-	-	-	-	-
0-4	-	-	None	-	-	-	-	-	-

Point

The serial number displayed on the Product Information List dialog box of GX Developer may differ from that on the rating plate and on the front of the module.

- The serial number on the rating plate and front part of the module indicates the management information of the product.
- The serial number displayed on the Product Information List dialog box of GX Developer indicates the function information of the product.

The function information of the product is updated when a new function is added.

Chapter 3: Specifications

3.1 General specifications

Item		Specifications	
Phase wire system		single-phase 2-wire / single-phase 3-wire / three-phase 3-wire	
Rating	Voltage circuit *1	single-phase 2-wire, three-phase 3-wire	100 – 220 V AC
		single-phase 3-wire	110V AC (1 - 2 line, 2 - 3 line) 220 V (1 - 3 line)
	Current circuit		50 A, 100 A, 250 A, 400 A, 600 A AC (Current sensor is used. Each value refers to the current at the primary side of current sensor.) 5 AAC (Current sensor is used together with current transformer (CT), and the primary-side current is configurable up to 6000 A.) *2
	Frequency		50-60 Hz
Allowable tolerance of main module (excluding current sensor) *3		Current, current demand *4 : $\pm 1.0\%$ (100% of the rating) Voltage : $\pm 1.0\%$ (100% of the rating) Electric power, electric power demand *4 : $\pm 1.0\%$ (100% of the rating) Reactive power : $\pm 1.0\%$ (100% of the rating) Frequency : $\pm 1.0\%$ (45 – 65 Hz range of the rating) Power factor : $\pm 3.0\%$ (against the electric angle 90°) Electric energy : $\pm 2.0\%$ (5 – 100% range of the rating, power factor = 1) Reactive energy : $\pm 2.5\%$ (10 – 100% range of the rating, power factor = 0)	
Measurable circuit count		4 circuits (4 channels) under the same voltage system, or 8 circuits (8 channels) in the current measuring mode	
Data update cycle		500 ms *5 (100 ms in the current measuring mode)	
Response time		2 seconds or less	
Backup for electric blackout		Backup is made using nonvolatile memory. (Stored items: settings, the max./min. values and time of occurrence, electric energy (consumption, regenerated), reactive energy (consumption lag), and periodic electric energy)	
I/O occupation		32 points (I/O assignment: intelligence 32 points)	

* 1 : 100 - 220V AC direct connection is possible. For the circuit over this voltage, transformer (VT) is necessary (Primary voltage of VT can be set up to 6600V, and secondary voltage of VT can be set up to 220V as optional setting). Star – delta connection and delta – star connection transformer instead of VT cannot measure definitely to be out of phase. Please use a transformer of the same connection.

* 2 : 5 A primary current can be set when using the current sensor is as follows.

5A, 6A, 7.5A, 8A, 10A, 12A, 15A, 20A, 25A, 30A, 40A, 50A, 60A, 75A, 80A, 100A, 120A, 150A, 200A, 250A, 300A, 400A, 500A, 600A, 750A, 800A, 1000A, 1200A, 1500A, 1600A, 2000A, 2500A, 3000A, 4000A, 5000A, 6000A (Primary current of CT can be set up to 6000A in any . However, secondary current of CT can not be set to other than 5A).

* 3 : The ratio error of the current sensor : $\pm 1.0\%$.(5 – 100% range of the rating)

* 4 : Demand shows the moving average of a set period.

* 5 : Always accumulating the integrated values of Wh and varh. It can capture short-cycled load fluctuation (500 ms or shorter).

3.2 Electrical and mechanical specifications

Item		Specifications					
Consumed VA	Voltage circuit	Each phase 0.1 VA (at 110 V AC), Each phase 0.2 VA (at 220 V AC)					
	Current circuit	Each phase 0.1 VA (secondary side of current sensor)					
Internal current consumption (5 V DC)		0.46 A					
Operating temperature		0 – +55°C (Average daily temperature 35°C or below)					
Operating humidity		5 – 95% RH (No condensation)					
Storage temperature		-25° – +75°C					
Storage humidity		5 – 95% RH (No condensation)					
Operating altitude		2000m or below					
Installation area		Inside a control panel					
Operating environment		No corrosive gas					
Vibration resistance		Conforms to JIS B 3502, IEC 61131-2		Frequency	Constant acceleration	Half amplitude	Sweep time
			Intermittent vibration	5 – 8.4 Hz	-	3.5 mm	XYZ each direction 10 times
				8.4 – 150 Hz	9.8 m/s ²	-	
			Continuous vibration	5 – 8.4 Hz	-	1.75 mm	-
8.4 – 150 Hz	4.9 m/s ²	-					
Impact resistance		Conforms to JIS B 3502, IEC 61131-2 (147m/s ² , XYZ each direction 3 times)					
Over voltage category *1		II or less					
Pollution degree *2		2 or less					
Equipment category		Class I					
Applicable wire (Usable electric wire)	Voltage input terminal	Single wire	AWG24 – AWG16 (φ0.5 - 1.3mm)		Tightening torque : 0.4 – 0.5 N · m		
		Stranded wire *4	AWG24 – AWG16 (0.2 – 1.3 mm ²)				
	Current input terminal *3	Stranded wire *5	AWG20 – AWG18 (0.5 - 0.8 mm ²)		Applicable solderless terminals : R1.25-3 (No solderless terminal with insulation sleeve can be used) Tightening torque : 0.42 – 0.58 N · m		
Tightening torque		Current input terminal block fixing screws (M3.5)			0.66 - 0.89 N•m		
		Module-fixing screws (M3 screw) *6			0.36 – 0.48 N•m		
Commercial frequency withstand voltage		Between voltage/current input terminals - FG terminal				2210 V AC	
		Between voltage/current input terminals - sequencer power source and GND terminals				5 sec	
Insulation resistance Standard*7		Between voltage/current input terminals - FG terminal				2210 V AC	
		Between voltage/current input terminals - sequencer power source and GND terminals				5 sec	
Insulation resistance		5 MΩ or more (500 V DC) at locations above					
Standard*7		EMC: EN61131-2:2007, EN61326-1:2013 LVD: EN61131-2:2007, EN61010-1:2010					
Dimensions		27.4 mm (W) x 98 mm (H) x 112 mm (D) excluding protruding portions					
Mass		0.19 kg					
Product life expectancy		10 years (used under the average daily temperature 35°C or less)					

- *1. This indicates the assumed area of electric distribution to which the device is connected, the area ranging from public distribution to factory machinery. The category II applies to the device power-supplied from fixed facility. The surge voltage of this product is 2500 V up to the rated voltage of 300 V.
- *2. The index indicates the level of conductive substance at the device's operating environment. Contamination level 2 means only non-conductive substance. However, occasional condensation may lead to temporary conduction.
- *3. At the connection between the secondary terminal of current sensor (k, l) and the main module terminal (1k, 1l, 3k, 3l), use twisted pair cable.
- *4. When using stranded wires for the voltage input terminals, strand the wire edges to prevent thin wires from loosening.
- *5. When using stranded wires for the current input terminals, use applicable solderless terminals. If any spade solderless terminal is used, it may be disconnected when the terminal screw comes loose, resulting in failure. In addition, no solderless terminal with insulation sleeve can be used.
- *6. The module can be fixed easily to the base unit, using the hook on top of the module. However, if it is used under a vibrating environment, we strongly recommend that the module be fixed with screws.
- *7. When combine this unit with a CT (Model: EMU2-CT5, EMU-CT50, EMU-CT100, EMU-CT250, EMU-CT400-A, EMU-CT600-A), it becomes UL standard.

Chapter 4: Functions

4.1 List of functions

Functions of QE84WH are provided in Table 4.1-1.

The “n” that is used in this and later chapters (for example: Xn0, Yn0, Un\G0, etc.) refers to the number that appears at the beginning of QE84WH.

Table 4.1-1 List of Functions

No.	Function	Descriptions	Reference section
1	Measurement	It measures current, current demand, voltage, electric power, electric power demand, reactive power, power factor, frequency, electric energy (consumption, regeneration), and reactive energy (consumption lag) and sequentially stores the records into the buffer memory.	Section 4.2.1
2	Periodic electric energy	The electric energy only for a period of time when a certain output signal is ON will be stored in the buffer memory. Periodic energy 1 and 2 can be measured independently.	Section 4.2.2
3	Hold max./min. values	For current demand, voltage, electric power demand, and power factor, each maximum/minimum values and date/time of occurrence are stored.	Section 4.2.3
4	Upper/lower limit alarm monitoring	Of current demand, voltage, electric power demand, and power factor, you can select two items for which their upper/lower limit can be monitored. If it exceeds the upper limit or goes below the lower limit, the specified input signal is turned on.	Section 4.2.4
5	Test	Selecting the test mode using the intelligent function module switch enables pseudo-storage of the specified value into the buffer memory, even with non-existence of input from voltage and current (sensor). Using this module, you can create a sequence, etc.	Section 4.2.5
6	Integrated value set	Set the integrated value (electric energy (consumption, regeneration), reactive energy (consumption lag)) to an arbitrary value. It is used to clear integrated value.	Section 4.2.6
7	Current measuring mode function	By selecting the current measuring mode using the intelligent function module switch, you can measure eight channels of current and sequentially store the records into the buffer memory.	Chapter 7

4.2 Functions in detail

4.2.1 Measuring functions

(1) Measured items

Measured items of each channel are described as follows:

Each measured item is stored in the buffer memory every 500 ms.

Measured items	
	Details
Current	1 - phase current
	2 - phase current* ¹
	3 - phase current* ¹
	average current
Current demand * The average of fluctuation for the set period of current demand time is indicated.	1 - phase current demand
	2 - phase current demand* ¹
	3 - phase current demand* ¹
	Max. value
	Min. value
	Date of max. value occurrence Date of min. value occurrence
Voltage	1 - 2 line voltage (voltage V12)
	2 - 3 line voltage* ¹ (voltage V23)
	3 - 1 line voltage* ¹ (voltage V31)
	average voltage
	Max. value
	Min. value
	Date/time of max. value occurrence Date/time of min. value occurrence
Electric power	Present value
Electric power demand * The average of fluctuation for the set period of electric power demand time is indicated.	Present value
	Max. value
	Min. value
	Date/time of max. value occurrence Date/time of min. value occurrence
Reactive power	Reactive power
Power factor	Present value
	Max. value
	Min. value
	Date/time of max. value occurrence Date/time of min. value occurrence
Frequency	Present value
Electric energy	Electric energy (consumption)
	Electric energy (regeneration)
Reactive energy	Reactive energy (consumption lag)
Periodic electric energy	Periodic electric energy 1
	Periodic electric energy 2

*1: If phase wire system is set to single-phase 2-wire, measurement will not be taken.

(2) Total, maximum, and minimum values

The following describes how to calculate the maximum, minimum, and total values.

Item	Phase wire system	Formula
Average current	single-phase 2-wire	Average current = 1-phase current
	single-phase 3-wire	Average current = (1-phase current + 3-phase current) / 2
	three-phase 3-wire	
Average voltage	single-phase 2-wire	Average voltage = voltage V12
	single-phase 3-wire	Average voltage = (voltage V12 + voltage V23) / 2
	three-phase 3-wire	
Maximum current demand	single-phase 2-wire	Maximum value of 1-phase current demand (The highest value after the max./min. value was reset.)
	single-phase 3-wire	Highest value of either 1-phase current demand or 3-phase current demand (The highest value after the max./min. value was reset.)
	three-phase 3-wire	Highest value among 1-phase current demand, 2-phase current demand, or 3-phase current demand (The highest value after the max./min. value was reset.)
Minimum current demand	single-phase 2-wire	Minimum value of 1-phase current demand (The lowest value after the max./min. value was reset.)
	single-phase 3-wire	Lowest value of either 1-phase current demand or 3-phase current demand (The lowest value after the max./min. value was reset.)
	three-phase 3-wire	Lowest value among 1-phase current demand, 2-phase current demand, or 3-phase current demand (The lowest value after the max./min. value was reset.)
Maximum voltage	single-phase 2-wire	Highest value of the 1 - 2 line voltage (The highest value after the max./min. value was reset.)
	single-phase 3-wire	Highest value of either the 1 - 2 line voltage or the 2 - 3 line voltage (The highest value after the max./min. value was reset.)
	three-phase 3-wire	Highest value among the 1 - 2 line voltage, the 2 - 3 line voltage, or 3 - 1 line voltage (The highest value after the max./min. value was reset.)
Minimum voltage	single-phase 2-wire	Lowest value of the 1 - 2 line voltage (The lowest value after the max./min. value was reset.)
	single-phase 3-wire	Lowest value of either the 1 - 2 line voltage or the 2 - 3 line voltage (The lowest value after the max./min. value was reset.)
	three-phase 3-wire	Lowest value among the 1 - 2 line voltage, the 2 - 3 line voltage, or 3 - 1 line voltage (The lowest value after the max./min. value was reset.)

(3) Resolution of measured data

Resolution of measured data according to the rating (phase wire system, primary voltage, and primary current) is described as follows.

1) Current, current demand

Rated primary current setting	Multiplier	Resolution*	
5 A to 30 A	-3	2 digits after the decimal point	0.01 A
40 A to 300 A	-3	1 digit after the decimal point	0.1 A
400 A to 3000 A	-3	Integer	1 A
4000 A to 6000 A	-3	×10	10 A

* Digits lower than the resolution are fixed to 0.

2) Voltage

Rated primary voltage setting	Multiplier	Resolution*	
110 V to 220 V	-3	1 digit after the decimal point	0.1 V
440 V to 2200 V	-3	Integer	1 V
3300 V to 6600 V	-3	×10	10 V

* Digits lower than the resolution are fixed to 0.

3) Electric power, electric power demand, reactive power

Full load power W ^{*1}	Multiplier	Resolution ^{*2*3}	
I. W < 12 kW	-3	3 digits after the decimal point	0.001 kW
II. 12 kW ≤ W < 120 kW	-3	2 digits after the decimal point	0.01 kW
III. 120 kW ≤ W < 1200 kW	-3	1 digit after the decimal point	0.1 kW
IV. 1200 kW ≤ W < 12000 kW	-3	Integer	1 kW
V. 12000 kW ≤ W < 120000 kW	-3	×10	10 kW

^{*1} For calculating full load power W, refer to Table 4.2.1-1.

^{*2} Digits lower than the resolution are fixed to 0.

^{*3} In the case of reactive power, the unit will be kvar.

4) Power factor

Power factor	Multiplier	Resolution*	
All setting ranges	-3	1 digit after the decimal point	0.1%

* Digits lower than the resolution are fixed to 0.

5) Frequency

Frequency	Multiplier	Resolution*	
All setting ranges	-3	1 digit after the decimal point	0.1 Hz

* Digits lower than the resolution are fixed to 0.

6) Electric energy, Reactive energy, periodic electric energy

Full load power W ^{*1}	Multiplier	Resolution ^{*2}		Range [kWh,kvarh]
I. W < 12 kW	-5	5 digits after the decimal point	0.00001 kWh, kvarh	0.00001 – 9999.99999
II. 12kW ≤ W < 120 kW	-4	4 digits after the decimal point	0.0001 kWh, kvarh	0.0001 – 99999.9999
III. 120kW ≤ W < 1200 kW	-3	3 digits after the decimal point	0.001 kWh, kvarh	0.001 – 999999.999
IV. 1200kW ≤ W < 12000 kW	-2	2 digits after the decimal point	0.01 kWh, kvarh	0.01 – 9999999.99
V. 12000kW ≤ W < 120000 kW	-1	1 digit after the decimal point	0.1 kWh, kvarh	0.1 – 99999999.9

*1 For calculating full load power W, refer to Table 4.2.1-1.

*2 Because the higher resolution than a typical watt-hour meter, the minimum digit values will change more than 2 at once update. According to setting value of input voltage, primary current, primary voltage of VT and the condition of load.

Table 4.2.1-1 How to calculate full load power

(a) single-phase 2-wire system

Primary current [A]	Primary voltage [V]							
	110	220	440	690	1100	2200	3300	6600
5								
6								
7.5								
8								
10								
12								
15								
20								
25								
30								
40								
50								
60								
75								
80								
100								
120								
150								
200								
250								
300								
400								
500								
600								
750								
800								
1000								
1200								
1500								
1600								
2000								
2500								
3000								
4000								
5000								
6000								

I

W,var :3 digits after the decimal point
Wh,varh :2 digits after the decimal point

II

W,var :2 digits after the decimal point
Wh,varh :1 digit after the decimal point

III

W,var : 1 digit after the decimal point
Wh,varh : Integer

IV

W,var :Intege
Wh,varh :x10

V

W,var :x10
Wh,varh :x100

(b) single-phase 3-wire system

		Primary voltage [V]	
		110	
Primary current [A]	5	I W,var :3 digits after the decimal point Wh,varh:2 digits after the decimal point	
	6		
	7.5		
	8		
	10		
	12		
	15		
	20		
	25		
	30		
	40		
	50		
		60	II W,var :2 digits after the decimal point Wh,varh :1 digit after the decimal point
	75		
	80		
	100		
	120		
	150		
	200		
	250		
	300		
	400		
	500		
	600		
	750	III W,var :1 digit after the decimal point Wh,varh :Integer	
800			
1000			
1200			
1500			
1600			
2000			
2500			
3000			
4000			
5000			
	6000		IV W,var :Integer Wh,varh :x 10

(c) three-phase 3-wire system

		Primary voltage[V]							
		110	220	440	690	1100	2200	3300	6600
Primary current[A]	5								
	6	I							
	7.5								
	8								
	10								
	12								
	15								
	20								
	25								
	30								
	40								
	50								
	60								
	75								
	80								
	100								
	120								
	150								
	200								
	250								
	300								
	400								
	500								
	600								
750									
800									
1000									
1200									
1500									
1600									
2000									
2500									
3000									
4000									
5000									
6000									

W,var :3 digits after the decimal point
Wh,varh :2 digits after the decimal point

W,var :2 digits after the decimal point
Wh,varh :1 digit after the decimal point

W,var :1 digit after the decimal point
Wh,varh :Integer

W,var :Integer
Wh,varh :x 10

W,var :x10
Wh,varh :x100

(4) Restrictions for measuring data

- Measurement cannot be performed immediately after the power loading to the sequencer system (Module ready signal is under the OFF condition).
After checking that Module ready (Xn0) is ON, obtain measuring data.
- Measurement cannot be performed immediately after operating conditions are set up to the module. After checking that Operating condition setting completion flag (Xn9) becomes ON, obtain measuring data.
- Behaviors during operation are as follows:

Measuring item	Behavior of the module
Current	When the input current is less than 0.4% of the rating current, it becomes 0A.
Current demand	Current demand is obtained by current moving average. Therefore, even if current is 0A, current demand may not be 0A.
Voltage	When the input voltage is less than 10% of the rating voltage, it becomes 0V.
Electric power, Reactive power	When current is 0A (at all phases are 0A) or when voltage is 0V (all in-between wires are 0V), it becomes 0kW.
Electric power demand	Electric power demand is obtained by electric power moving average. Therefore, even if electric power is 0kW, electric power demand may not be 0kW.
Electric energy	The electric energy is measured with a load that is about 0.4% or more of all load power. Even if the indicated value is "0", measurement value will increase.
Power factor	When current is 0A (at all phases are 0A) or when voltage is 0V (all in-between wires are 0V), it becomes 100%.
Frequency	Voltage condition When the input voltage is less than 10% of the rating voltage, it becomes 0Hz.
	Frequency condition When it is less than 44.5Hz, it is fixed to 44.5Hz.

4.2.2 Measuring function for periodic electric energy

This function is to measure electric energy for a certain period, and stores it into the buffer memory. It can be used to measure electric energy for a certain tact or energy (standby power) when the facility or equipment is not in operation.

(1) Overview

- 1) It can measure two periodic electric energy (periodic electric energy 1 and periodic electric energy 2) of each channel. Each of these can be measured independently.
- 2) During the time when Periodic electric energy 1 measurement flag/ Periodic electric energy 2 measurement flag is ON, periodic electric energy can be measured.
- 3) Periodic electric energy is stored in the nonvolatile memory, so that it can be retained even at a power source reset.
- 4) I/O signals and buffer memory corresponding to each periodic electric energy 1 and 2 are provided below.

		Buffer memory (Double words)	Periodic electric energy measurement flag	Periodic electric energy data completion flag	Periodic electric energy reset request	Periodic electric energy reset completion flag
CH1	Periodic electric energy 1	Un\G114, 115	Yn5	Xn5	Yn7	Xn7
	Periodic electric energy 2	Un\G116, 117	Yn6	Xn6	Yn8	Xn8
CH2	Periodic electric energy 1	Un\G1114, 1115	YnB	XnB	YnD	XnD
	Periodic electric energy 2	Un\G1116, 1117	YnC	XnC	YnE	XnE
CH3	Periodic electric energy 1	Un\G2114, 2115	Yn11	Xn11	Yn13	Xn13
	Periodic electric energy 2	Un\G2116, 2117	Yn12	Xn12	Yn14	Xn14
CH4	Periodic electric energy 1	Un\G3114, 3115	Yn17	Xn17	Yn19	Xn19
	Periodic electric energy 2	Un\G3116, 3117	Yn18	Xn18	Yn1A	Xn1A

Note

Measurement of periodic electric energy is performed every measuring cycle (500 ms). Therefore, if the time to turn ON the periodic electric energy measurement flag is set to 500 ms or less, measurement may not be taken.

(2) Basic procedure

1) Measuring periodic electric energy

- (a) Check that CH1 periodic electric energy 1 measurement flag (Yn5) is OFF.
- (b) Check CH1 periodic electric energy 1 (Un\G114, 115).
- (c) When starting measurement, set CH1 periodic electric energy 1 measurement flag (Yn5) to ON.

This module starts measuring the specified periodic electric energy, and CH1 periodic electric energy 1 data completion flag (Xn5) will be turned OFF

- (d) When stopping measurement, set CH1 periodic electric energy 1 measurement flag (Yn5) to OFF.

This module stops measuring the specified periodic electric energy, and CH1 periodic electric energy 1 data completion flag (Xn5) will be turned ON.

- (e) Check that CH1 periodic electric energy 1 data completion flag (Xn5) becomes ON, and obtain the value of periodic electric energy.

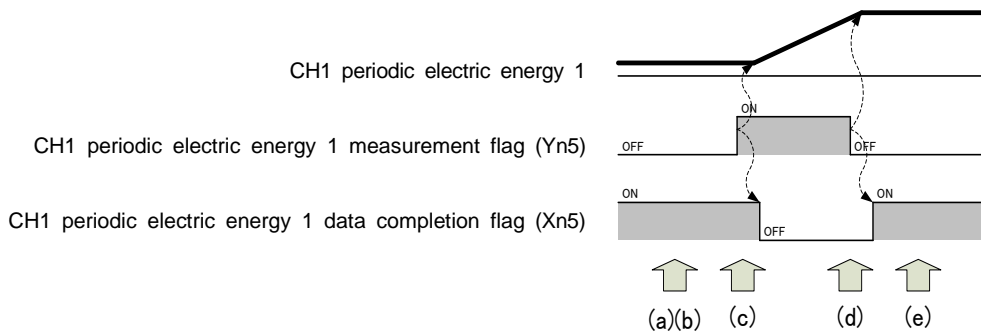

Figure 4.2.2-1 Basic procedure of measuring the periodic electric energy

2) Resetting periodic electric power

- (a) Check that CH1 periodic electric energy 1 measurement flag (Yn5) is OFF and CH1 periodic electric energy 1 reset request (Yn7) is OFF.
- (b) Set CH1 periodic electric energy 1 reset request (Yn7) to ON. The specified periodic electric energy is reset to 0 kWh, and CH1 periodic electric energy 1 reset completion flag (Xn7) will be turned ON.
- (c) Check that CH1 periodic electric energy 1 reset completion flag (Xn7) has become ON, and then set CH1 periodic electric energy 1 reset request (Yn7) to OFF. CH1 periodic electric energy 1 reset completion flag (Xn7) will be turned OFF.

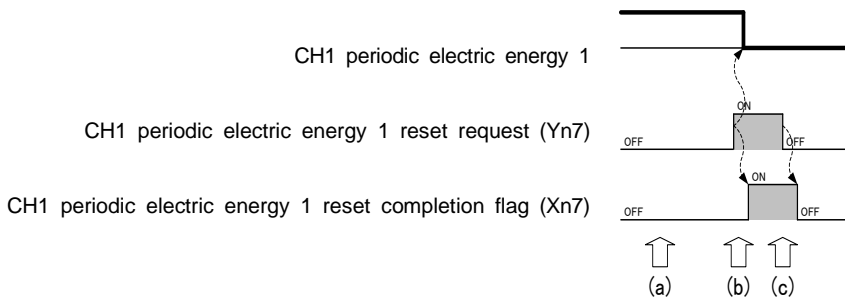

Figure 4.2.2-2 How to reset the periodic electric energy

(3) Sample use case

1) Procedure for continuously measuring periodic electric energy

If you turn CH1 periodic electric energy 1 measurement flag to ON only for the extent of time you want to measure, this module accumulates the power starting at the previously measured amount. Usage procedure is the same as 1) in (2).

An example is provided below.

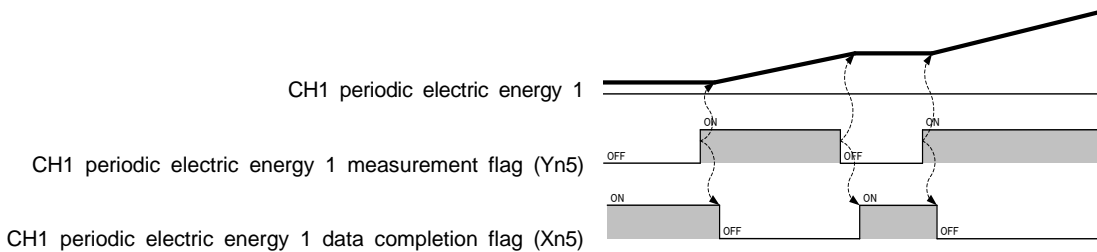

Figure 4.2.2-3 Example of continuous measurement of periodic electric energy

2) Procedure for measuring periodic electric energy after every reset

If you turn Periodic electric energy measurement flag (Yn1/Yn2) to ON only for the extent of time you want to measure, this module accumulates the power starting at the previously measured amount. The following describes the usage procedure.

- (a) Check that CH1 periodic electric energy 1 measurement flag (Yn5) is OFF and CH1 periodic electric energy 1 reset request (Yn7) is OFF.
- (b) Set CH1 periodic electric energy 1 reset request (Yn7) to ON.
The specified periodic electric energy is reset to 0 kWh, and CH1 periodic electric energy 1 reset completion flag (Xn7) will be turned ON.
- (c) Check that CH1 periodic electric energy 1 reset completion flag (Xn7) has become ON, and then set CH1 periodic electric energy 1 reset request (Yn7) to OFF.
CH1 periodic electric energy 1 reset completion flag (Xn7) will be turned OFF.
- (d) When starting measurement, set CH1 periodic electric energy 1 measurement flag (Yn5) to ON.
This module starts measuring the specified periodic electric energy, and CH1 periodic electric energy 1 data completion flag (Xn5) will be turned OFF.
- (e) When stopping measurement, set CH1 periodic electric energy 1 measurement flag (Yn5) to OFF.
This module stops measuring the specified periodic electric energy, and CH1 periodic electric energy 1 data completion flag (Xn5) will be turned ON.
- (f) Check that CH1 periodic electric energy 1 data completion flag (Xn5) becomes ON, and obtain the value of periodic electric energy.

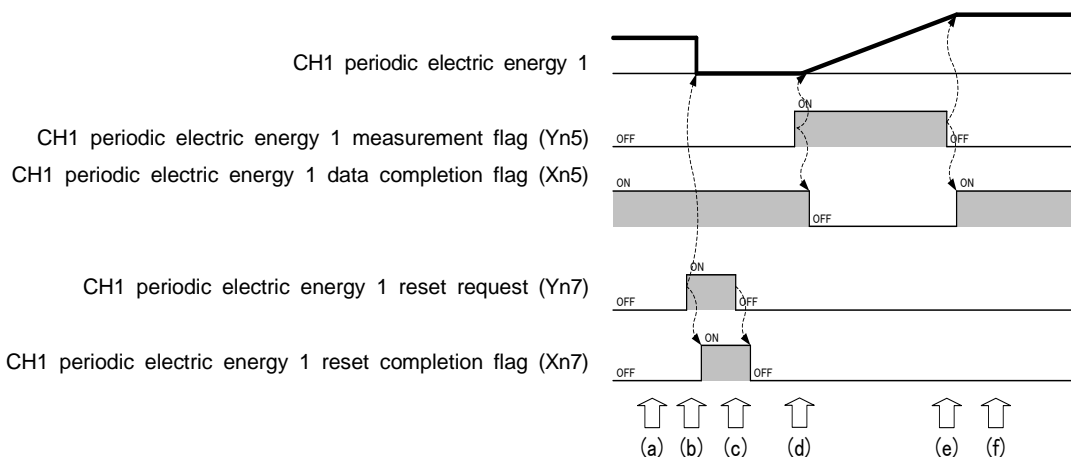

Figure 4.2.2-4 Example of measurement of periodic electric energy after every reset

4.2.3 Max./min. value hold function

It memorizes the max./min. value for each measured item, and retains it until the max./min. value clear is performed.

(1) Max./min. value memory

- 1) It memorizes the max. and min. values of the following measured items of each channel.
 - Current demand
 - Voltage
 - Electric power demand
 - Power factor
- 2) It memorizes the date and time of occurrence (year/month/day/hour/minute/second/day of the week) together with the max. and min. values.
- 3) The max. and min. values and the date of occurrence are stored in the nonvolatile memory, so that these values can be retained even at a power source reset.

(2) How to clear the max. and min. values

- 1) You can use the I/O signal to clear the max. and min. values.
- 2) The max. and min. values immediately after the clear will be the present values and the date of occurrence will be the present date and time.
- 3) The following describes how to clear the max. and min. values.
 - (a) Check that Max./min. values clear request (Yn4) is OFF.
 - (b) In the max./min. value clear target (Un\G56), set the measured items of the channel you want to clear.
 - (c) Set Max./min. values clear request (Yn4) to ON.
 This module clears the max./min. values of the measured items of the channel you selected in step (b) above and their date of occurrence and turns Max./min. values clear completion flag (Xn4) to ON.
 - (d) Check that Max./min. values clear completion flag (Xn4) is ON, and then set Max./min. values clear request (Yn4) to OFF. Max./min. values clear completion flag (Xn4) will be turned OFF.

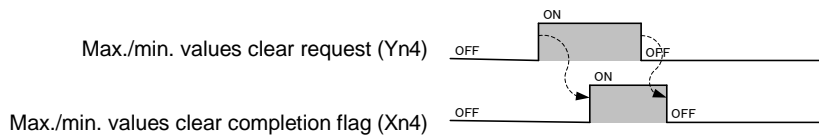

Figure 4.2.3-1 Procedure for clearing max./min. value

4.2.4 Upper/lower limit alarm monitoring function

You can set an upper and lower limit alarm for maximum two points for each channel and implement a monitoring function for them. During the alarm monitoring, it can monitor the input signal to check for the occurrence.

(1) Setting the upper/lower limit alarm monitoring

1) Setting items and setting range for the alarm monitoring are described below.

Items set in the buffer memory	Setting range	Description
Alarm item	0: No monitoring 1: Current demand upper limit 2: Current demand lower limit 3: Voltage upper limit 4: Voltage lower limit 5: Power demand upper limit 6: Power demand lower limit 7: Power factor upper limit 8: Power factor lower limit	For respective alarm 1 and alarm 2, set the measuring item and either upper or lower limit for monitoring target.
Alarm value	-2147483648 – 2147483647 [Unit] Current: $\times 10^{-3}$ A Voltage: $\times 10^{-3}$ V Power: $\times 10^{-3}$ kW PF: $\times 10^{-3}\%$	The value to be monitored for the alarm. Set the value according to the unit of the measuring item that is set as an alarm monitoring item. (Double words)
Alarm reset method	0: Self-retention 1: Auto reset	Set whether or not the alarm-occurrence condition should be retained if the value goes below the upper limit alarm value or goes over the lower limit alarm value after the upper/lower limit alarm occurred.
Alarm delay time	0 – 300 [Unit] second	If it exceeds the upper limit alarm value or if it goes below the lower limit alarm value, and the situation continues for the period of the alarm delay time, then it is considered as an alarm occurrence.

The table below shows I/O signals and buffer memory for alarm 1 and alarm 2.

		Alarm reset request	Alarm flag	Buffer memory (Double words)			
				Alarm item	Alarm value	Alarm reset method	Alarm delay time
CH1	Alarm 1	Yn9	Xn9	Un\G11	Un\G12, 13	Un\G14	Un\G15
	Alarm 2	YnA	XnA	Un\G21	Un\G22, 23	Un\G24	Un\G25
CH2	Alarm 1	YnF	XnF	Un\G1011	Un\G1012, 1013	Un\G1014	Un\G1015
	Alarm 2	Yn10	Xn10	Un\G1021	Un\G1022, 1023	Un\G1024	Un\G1025
CH3	Alarm 1	Yn15	Xn15	Un\G2011	Un\G2012, 2013	Un\G2014	Un\G2015
	Alarm 2	Yn16	Xn16	Un\G2021	Un\G2022, 2023	Un\G2024	Un\G2025
CH4	Alarm 1	Yn1B	Xn1B	Un\G3011	Un\G3012, 3013	Un\G3014	Un\G2015
	Alarm 2	Yn1C	Xn1C	Un\G3021	Un\G3022, 3023	Un\G3024	Un\G2025

2) Setting procedures are as follows:

- (a) Check that Operating condition setting request (Yn2) is OFF.
- (b) Set the alarm item, alarm value, alarm reset method, and alarm delay time in the buffer memory. For the address of buffer memory for alarm 1 and alarm 2, refer to Chapter 6.
- (c) Set Operating condition setting request (Yn2) to ON. Operation starts at each set value, and then Operating condition setting completion flag (Xn2) is turned ON.
- (d) Check that Operating condition setting completion flag (Xn2) becomes ON, and then set Operating condition setting request (Yn2) to OFF. Operating condition setting completion flag (Xn2) will be turned OFF.

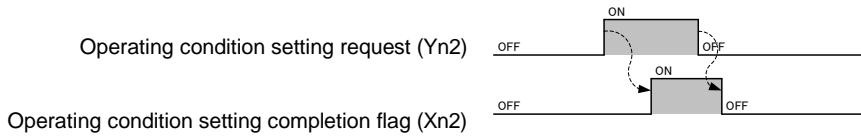

Figure 4.2.4-1 Time chart of alarm monitoring setting

3) Each item of the alarm monitoring is stored in the nonvolatile memory, so that values can be retained even at a power source reset.

(2) Behavior of the upper/lower limit alarm

1) When the alarm reset method is set to "0: self-retention" (example of the upper limit monitoring with CH1 alarm 1)

- (a) If the measured value that was set with the alarm 1 item exceeds the upper limit and the situation continues and remains for the alarm 1 delay time, CH1 alarm 1 flag (Xn9) will turn ON. At the same time, ALM1 LED flashes.
- (b) Even if the measured value goes below the upper limit, CH1 alarm 1 flag (Xn9) remains in the ON status (self-retention). During the self-retention, ALM1 LED is lit.
- (c) By turning CH1 alarm 1 reset request (Yn9) to ON, CH1 alarm 1 flag (Xn9) will turn OFF. At this time, ALM1 LED is turned off.
- (d) Check that CH1 alarm 1 flag (Xn9) becomes OFF, and then set CH1 alarm 1 reset request (Yn9) to OFF.

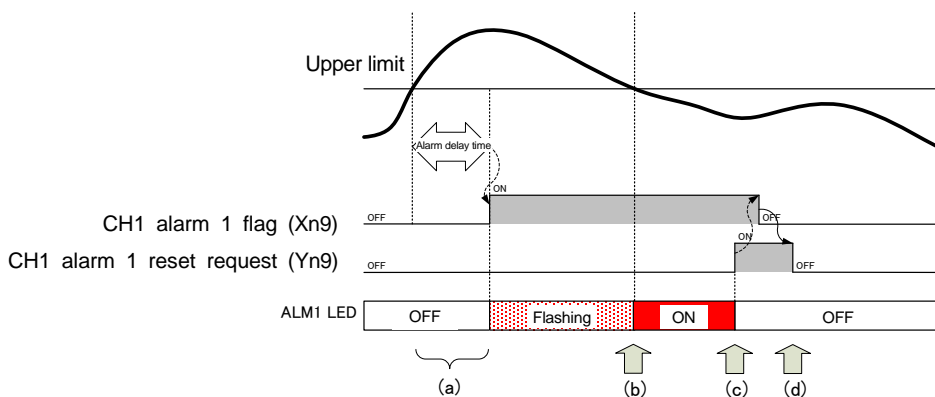

Figure 4.2.4-2 Time chart of the upper/lower limit alarm (alarm reset method = "self-retention")

- 2) When the alarm reset method is set to "1: auto reset" (example of the upper limit monitoring with CH1 alarm 1)
 - (a) If the measured value that was set with the alarm 1 item exceeds the upper limit and the situation continues and remains for the alarm 1 delay time, CH1 alarm 1 flag (Xn9) will turn ON. At the same time, ALM1 LED flashes.
 - (b) If the measured value goes below the upper limit, CH1 alarm 1 flag (Xn9) will turn OFF. At this time, ALM1 LED is turned off.
 - (c) If the measured value that was set with the alarm 1 item exceeds the upper limit but goes below the upper limit within the alarm 1 delay time, then CH1 alarm 1 flag (Xn9) will remain in the OFF status.

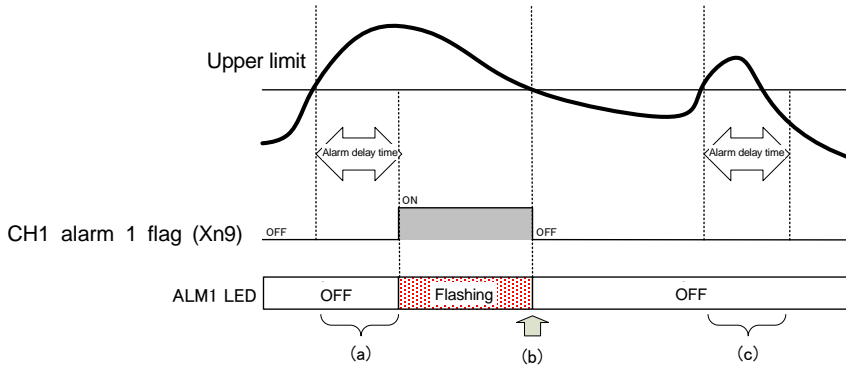

Figure 4.2.4-3 Time chart of the upper/lower limit alarm (alarm reset method = "auto-reset")

- 3) An example of the alarm 1 was indicated in 1) and 2) above. The alarm 2 will be in accordance with the same behavior. For the setting items for the buffer memory that corresponds to the alarm 2 and the I/O signals, refer to Chapters 5 and 6. The following describes a case with the alarm 2.

[When the alarm reset method is set to "1: auto reset" (example of the lower limit monitoring with CH1 alarm 2)]

- (a) If the measured value that was set with the alarm 2 item goes below the lower limit and the situation continues and remains for the alarm 2 delay time, CH1 alarm 2 flag (XnA) will turn ON. At the same time, ALM2 LED flashes.
- (b) If the measured value exceeds the lower limit, CH1 alarm 2 flag (XnA) will turn OFF. At this time, ALM2 LED is turned off.
- (c) If the measured value that was set with the alarm 2 item goes below the lower limit but exceeds the lower limit within the alarm 2 delay time, then CH1 alarm 2 flag (XnA) will remain in the OFF status.

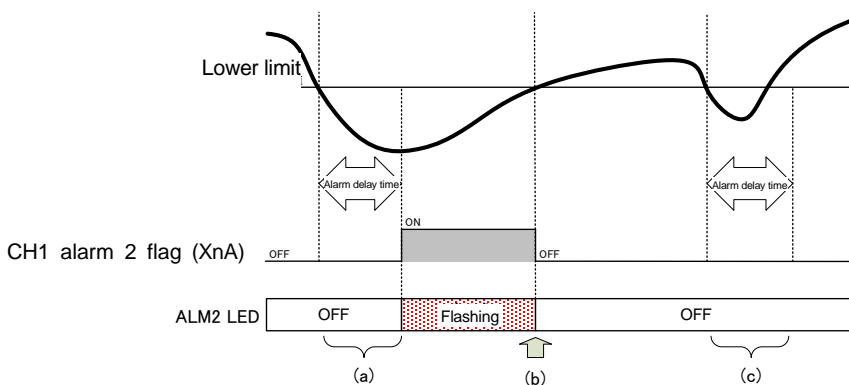

Figure 4.2.4-4 Time chart of the upper/lower limit alarm (alarm reset method = "auto-reset")

(3) How to reset Alarm flag

- 1) When Alarm flag is ON during the alarm occurrence or the self-retention (in the case of the alarm reset method = "self-retention"), Alarm flag can be reset (turned OFF) using Alarm reset request.
- 2) How to reset Alarm flag during alarm occurrence (example of the upper limit alarm monitoring with CH1 alarm 1)
 - (a) If the measured value that was set with the alarm 1 item exceeds the upper limit, CH1 alarm 1 flag (Xn9) will turn ON. At the same time, ALM1 LED flashes.
 - (b) By turning CH1 alarm 1 reset request (Yn9) to ON, CH1 alarm 1 flag (Xn9) will turn OFF. At this time, ALM1 LED will remain flashing (because ALM1 LED is synchronized with the alarm status, it will not turn off).
 - (c) Check that CH1 alarm 1 flag (Xn9) becomes OFF, and then set CH1 alarm 1 reset request (Yn9) to OFF.
 - (d) If the measured value goes below the upper limit, ALM1 LED will turn off.
 - (e) After that, if the measured value exceeds the upper limit, CH1 alarm 1 flag (Xn9) will turn ON again. At the same time, ALM1 LED flashes.

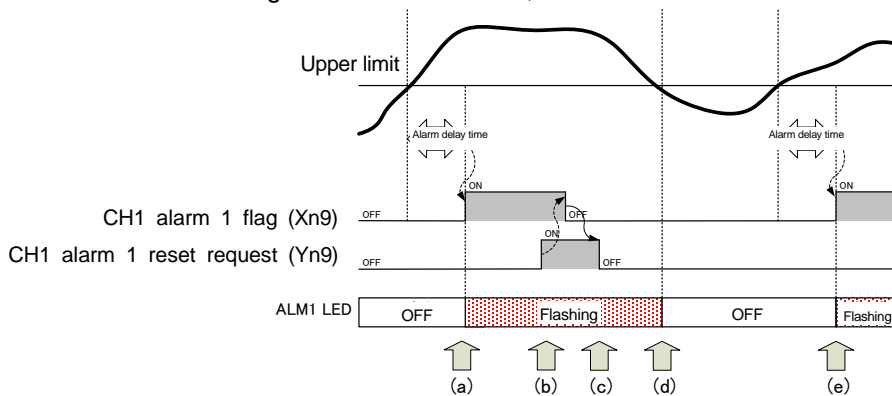

Figure 4.2.4-5 Procedure for resetting Alarm 1 flag (alarm reset method = "auto-reset")

- 3) How to reset Alarm flag during self-retention (in the case the alarm reset method = "self-retention" only)

Refer to the procedure described in (2) 1).

(4) Precautions during the alarm monitoring

- 1) When current demand time and electric power demand time are set to anytime except 0 second, current demand and electric power demand become lower than the actual values (closer to 0) immediately after the power source ON and the CPU reset. When current demand and electric power demand are being monitored for their lower limit, the alarm occurrence flag may turn ON. Thus, to avoid this from happening, follow the procedure below.
 - (a) Set the alarm monitoring target to "no monitoring" immediately after the power source ON and the CPU reset.
 - (b) After passing for a 3-times longer period than the demand time, set the alarm monitoring target again, and start the alarm monitoring.

4.2.5 Test function

This function is to output pseudo-fixed value to a buffer memory for debugging sequence program. The value can be output to the buffer memory without input of voltage and current.

(1) How to use the test function

- 1) Using the intelligent function module switch setting, you can start the test mode to output the fixed value.
- 2) For procedure for the intelligent function module switch setting, refer to the following.
For GX Works2, refer to 8.6.2.
For GX Developer, refer to 8.7.2.
- 3) To finish the test mode, the set value is returned by the intelligent function module switch setting, and after that, it enters to a measuring mode by resetting it.
(It resumes with the previous set value, electric energy and periodic electric energy.)

(2) Content of fixed-output

For the value to be output to the buffer memory, refer to Table 6.1-1 to 6.1-3 in 6.1 Buffer memory assignment.

(3) LED display when using the test function

All LED lights.

(4) I/O signals when using the test function

Unit READY (Xn0) only ON. Other input and output signals are all OFF.

(5) Precautions for using the test function

Because fixed-output is output to the buffer memory, isolate the actual device to avoid unexpected operation before running the sequence program.

4.2.6 Integrated value set function

This is a function that can set the integrated value (electric energy (consumption, regeneration), reactive energy (consumption lag)) to an arbitrary value.

It is used to clear integrated value.

(1) Setting procedure

- (a) Set integrated value setting target (Un\G51) in the buffer memory. Setting range is as follows:

Setting value					Description
CH1	CH2	CH3	CH4	All CHs	
0	0	0	0	0	No set
11	21	31	41	91	Electric energy (consumption)
12	22	32	42	92	Electric energy (regeneration)
13	23	33	43	93	Reactive energy (consumption lag)
19	29	39	49	99	Total integrated value

- (b) Set integrated value setting value (Un\G52, 53) in the buffer memory.
 - Configurable range: 0 to 999999999
 - The unit used for the setting value is the same as that used for the electric energy and reactive energy that are output to the buffer memory.
 For details, refer to section 6.3.2.
- (c) Turn Integrated value setting request (Yn3) from OFF to ON to enable* the setting. Integrated value set completion flag (Xn3) turns ON after Integrated value set request (Yn3) is set OFF to ON.
- (d) After checking that integrated value set completion flag (Xn3) turns ON and setting is completed, set the integrated value set request (Yn3) to OFF.

After detected that the integrated value set request (Yn3) turns OFF, the integrated value set completion flag (Xn3) turns OFF.

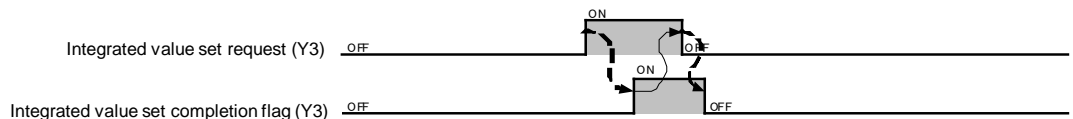

Figure 4.2.6 Integrated value setting procedure

(2) Default value

- integrated value setting target (Un\G51) is set to 0 (No set).
- integrated value setting value (Un\G52, Un\G53) is set to 0.

Chapter 5: I/O signals for the CPU module

5.1 List of I/O signals

I/O signals of QE84WH are listed in Table 5.1-1.

Table 5.1-1 List of I/O signals

Input signal (signal direction from QE84WH to CPU module)		Output signal (signal direction from CPU module to QE84WH)	
Device #	Signal name	Device #	Signal name
Xn0	Module ready	Yn0	Use prohibited *1
Xn1	Data acquisition clock	Yn1	Use prohibited *1
Xn2	Operating condition setting completion flag	Yn2	Operating condition setting request
Xn3	Integrated value set completion flag	Yn3	Integrated value set request
Xn4	Max./min. values clear completion flag	Yn4	Max./min. values clear request
Xn5	CH1 periodic electric energy 1 data completion flag	Yn5	CH1 periodic electric energy 1 measurement flag
Xn6	CH1 periodic electric energy 2 data completion flag	Yn6	CH1 periodic electric energy 2 measurement flag
Xn7	CH1 periodic electric energy 1 reset completion flag	Yn7	CH1 periodic electric energy 1 reset request
Xn8	CH1 periodic electric energy 2 reset completion flag	Yn8	CH1 periodic electric energy 2 reset request
Xn9	CH1 alarm 1 flag	Yn9	CH1 alarm 1 reset request
XnA	CH1 alarm 2 flag	YnA	CH1 alarm 2 reset request
XnB	CH2 periodic electric energy 1 data completion flag	YnB	CH2 periodic electric energy 1 measurement flag
XnC	CH2 periodic electric energy 2 data completion flag	YnC	CH2 periodic electric energy 2 measurement flag
XnD	CH2 periodic electric energy 1 reset completion flag	YnD	CH2 periodic electric energy 1 reset request
XnE	CH2 periodic electric energy 2 reset completion flag	YnE	CH2 periodic electric energy 2 reset request
XnF	CH2 alarm 1 flag	YnF	CH2 alarm 1 reset request
Xn10	CH2 alarm 2 flag	Yn10	CH2 alarm 2 reset request
Xn11	CH3 periodic electric energy 1 data completion flag	Yn11	CH3 periodic electric energy 1 measurement flag
Xn12	CH3 periodic electric energy 2 data completion flag	Yn12	CH3 periodic electric energy 2 measurement flag
Xn13	CH3 periodic electric energy 1 reset completion flag	Yn13	CH3 periodic electric energy 1 reset request
Xn14	CH3 periodic electric energy 2 reset completion flag	Yn14	CH3 periodic electric energy 2 reset request
Xn15	CH3 alarm 1 flag	Yn15	CH3 alarm 1 reset request
Xn16	CH3 alarm 2 flag	Yn16	CH3 alarm 2 reset request
Xn17	CH4 periodic electric energy 1 data completion flag	Yn17	CH4 periodic electric energy 1 measurement flag
Xn18	CH4 periodic electric energy 2 data completion flag	Yn18	CH4 periodic electric energy 2 measurement flag
Xn19	CH4 periodic electric energy 1 reset completion flag	Yn19	CH4 periodic electric energy 1 reset request
Xn1A	CH4 periodic electric energy 2 reset completion flag	Yn1A	CH4 periodic electric energy 2 reset request
Xn1B	CH4 alarm 1 flag	Yn1B	CH4 alarm 1 reset request
Xn1C	CH4 alarm 2 flag	Yn1C	CH4 alarm 2 reset request
Xn1D	Use prohibited *1	Yn1D	Use prohibited *1
Xn1E	Use prohibited *1	Yn1E	Use prohibited *1
Xn1F	Error flag	Yn1F	Error clear request

Point

*1 These signals cannot be used by the user since they are for system use only. If these are set to on or off by the sequence program, the performance of the QE84WH cannot be guaranteed.

5.2 Details of I/O signals

Detailed explanation about I/O signals of QE84WH is provided as follows:

5.2.1 Input signals

(1) Module ready (Xn0)

- (a) When the power of CPU module is turned on or the CPU module reset is performed, it will turn ON as soon as the measurement is ready.
- (b) This signal (Xn0) is turned OFF when energy measuring module displays a hardware error, and RUN LED is turned off.

(2) Data acquisition clock (Xn1)

- Regular operating mode

- (a) When the power is supplied to the CPU module and immediately after the initial computation is performed, this signal (Xn1) is turned ON and count of the output period of data acquisition clock is started. After that, this signal turns ON at the timing when the measurement data is completely written into the buffer memory after the elapse of the output period of data acquisition clock.

If the settings of the input voltage, primary current, primary voltage of VT, secondary voltage of VT, primary current of CT and output period of data acquisition clock are changed, this signal turns ON immediately after the change of the settings and count of the output period of data acquisition clock is started.

- (b) This signal (Xn1) turns OFF 150 ms after it turns ON.

- Current measuring mode

- (a) When the power is supplied to the CPU module and immediately after the initial computation is performed, this signal (Xn1) is turned ON and count of the output period of data acquisition clock is started. After that, this signal turns ON at the timing when the measurement data is completely written into the buffer memory after the elapse of the output period of data acquisition clock.

If the settings of the primary current, primary current of CT and output period of data acquisition clock are changed, this signal turns ON immediately after the change of the settings and count of the output period of data acquisition clock is started.

- (b) This signal (Xn1) turns OFF 150ms after it turns ON.

- When output period of data acquisition clock is 1 from 100, this signal (Xn1) turns OFF 50ms after it turns ON.
- When output period of data acquisition clock is 101 from 200, this signal (Xn1) turns OFF 100ms after it turns ON.
- When output period of data acquisition clock is more than 201, this signal (Xn1) turns OFF 150ms after it turns ON.

(3) Operating condition setting completion flag (Xn2)

(a) When Operating condition setting request (Yn2) is turned ON, the following settings are changed and this signal (Xn2) turns ON.

- Phase wire system (Un\G0)
- Primary voltage (Un\G1)
- Primary current (Un\G2/1002/2002/3002)
- Current demand time (Un\G3/1003/2003/3003)
- Electric power demand time (Un\G4/1004/2004/3004)
- Primary voltage of VT (Un\G5)
- Secondary voltage of VT (Un\G6)
- Primary current of CT (Un\G7/1007/2007/3007)
- Alarm 1 item (Un\G11/1011/2011/3011)
- Alarm 1 value (Un\G12, 13/1012, 1013/2012, 2013/3012, 3013)
- Alarm 1 reset method (Un\G14/1014/2014/3014)
- Alarm 1 delay time (Un\G15/1015/2015/3015)
- Alarm 2 item (Un\G21/1021/2021/3021)
- Alarm 2 value (Un\G22, 23/1022, 1023/2022, 2023/3022, 3023)
- Alarm 2 reset method (Un\G24/1024/2024/3024)
- Alarm 2 delay time (Un\G25/1025/2025/3025)
- Output period of data acquisition clock (Un\G60, 61/1060, 1061/2060, 2061/3060, 3061)

(b) When Operating condition setting request (Yn2) is turned OFF, this signal (Xn2) turns OFF.

- (4) Integrated value set completion flag (Xn3)
- (a) When Integrated value set request (Yn3) is turned ON and preset of each integrated value such as electric energy (consumption), electric energy (regeneration), and reactive energy (consumption delay) is completed, this signal (Xn3) turns ON.
 - (b) When Integrated value set request (Yn3) is turned OFF, this signal (Xn3) turns OFF.
- (5) Max./min. values clear completion flag (Xn4)
- (a) When Max./min. values clear request (Yn4) is turned ON and the data of max./min. value (maximum value, minimum value, and their date and time of occurrence) are cleared, this signal (Xn4) turns ON.
 - (b) When Max./min. values clear request (Yn4) is turned OFF, this signal (Xn4) turns OFF.
- (6) CH1 periodic electric energy 1 data completion flag (Xn5)
- (a) When CH1 periodic electric energy 1 measurement flag (Yn5) is turned OFF and calculation of CH1 periodic electric energy 1 is stopped, this signal (Xn5) turns ON.
 - (b) When CH1 periodic electric energy 1 measurement flag (Yn5) is turned ON and calculation of CH1 periodic electric energy 1 is started, this signal (Xn5) turns OFF.
 - (c) In order to acquire the data under the condition where CH1 periodic electric energy 1 is checked after the accumulation of the periodic electric energy is stopped, obtain the data while this signal (Xn5) is ON.
*For specific usage procedures, refer to Section 4.2.2.
- (7) CH1 periodic electric energy 2 data completion flag (Xn6)
- The usage procedure is the same as that of CH1 periodic electric energy 1 data completion flag (Xn5). Refer to (6).
- (8) CH1 periodic electric energy 1 reset completion flag (Xn7)
- (a) When CH1 periodic electric energy 1 reset request (Yn7) is turned ON and CH1 periodic electric energy 1 that is stored in the buffer memory is reset, this signal (Xn7) turns ON.
 - (b) When CH1 periodic electric energy 1 reset request (Yn7) is turned OFF, this signal (Xn7) turns OFF.
*For specific usage procedures, refer to Section 4.2.2.
- (9) CH1 periodic electric energy 2 reset completion flag (Xn8)
- The usage procedure is the same as that of CH1 periodic electric energy 1 reset completion flag (Xn7). Refer to (8).

(10)CH1 alarm 1 flag (Xn9)

- (a) If the measured value of CH1 alarm 1 item (Un\G11) exceeds the upper limit (or if it goes below the lower limit in the case of the lower alarm), after the elapse of CH1 alarm 1 delay time (Un\G15), this signal (Xn9) turns ON.
- (b) Operations after this signal (Xn9) is turned ON vary depending on the setting of CH1 alarm 1 reset method (Un\G14).

[When CH1 alarm 1 reset method (Un\G14) is "0: self-retention"]

Even if the measured value of CH1 alarm 1 monitoring target goes below the upper limit (or if it exceeds the lower limit in the case of lower limit alarm), this signal (Xn9) remains ON. When CH1 alarm 1 reset request (Yn9) is turned ON, this signal (Xn9) turns OFF.

[When CH1 alarm 1 reset method (Un\G14) is "1: auto reset"]

If the measured value of CH1 alarm 1 monitoring target goes below the upper limit (or it exceeds the lower limit in the case of lower limit alarm), this signal (Xn9) turns OFF.

- (c) When the measured value of the alarm 1 monitoring target is set to "not monitoring", this signal (Xn9) always turns OFF.

*For the actual behavior of alarm monitoring, refer to Section 4.2.4.

(11)CH1 alarm 2 flag (XnA)

The usage procedure is the same as that of CH1 alarm 1 flag (Xn9). Refer to (10).

(12)Error flag (Xn1F)

- (a) If an outside-set-value error occurs or a hardware error occurs, this signal (Xn1F) turns ON.
- (b) The description of the error can be checked with latest error code (Un\G4500).
*For description of error codes, refer to Section 10.1.
- (c) If an outside-set-value error occurs, this signal (Xn1F) is turned OFF by setting a value within the range again.

5.2.2 Output signals

- (1) Operating condition setting request (Yn2)
 - (a) When switching this request (Yn2) from the OFF status to the ON status, the following operating conditions will be set.
 - Phase wire system (Un\G0)
 - Primary voltage (Un\G1)
 - Primary current (Un\G2/1002/2002/3002)
 - Current demand time (Un\G3/1003/2003/3003)
 - Electric power demand time (Un\G4/1004/2004/3004)
 - Primary voltage of VT (Un\G5)
 - Secondary voltage of VT (Un\G6)
 - Primary current of CT (Un\G7/1007/2007/3007)
 - Alarm 1 item (Un\G11/1011/2011/3011)
 - Alarm 1 value (Un\G12, 13/1012, 1013/2012, 2013/3012, 3013)
 - Alarm 1 reset method (Un\G14/1014/2014/3014)
 - Alarm 1 delay time (Un\G15/1015/2015/3015)
 - Alarm 2 item (Un\G21/1021/2021/3021)
 - Alarm 2 value (Un\G22, 23/1022, 1023/2022, 2023/3022, 3023)
 - Alarm 2 reset method (Un\G24/1024/2024/3024)
 - Alarm 2 delay time (Un\G25/1025/2025/3025)
 - Output period of data acquisition clock (Un\G60, 61/1060, 1061/2060, 2061/3060, 3061)
 - (b) When the operating condition setting is completed, Operating condition setting completion flag (Xn2) turns ON.
 - (c) When this request (Yn2) is turned OFF, Operating condition setting completion flag (Xn2) turns OFF.
- (2) Integrated value set request (Yn3)
 - (a) If you want to set the electric energy (consumption and regeneration) and the reactive energy to an arbitrary value, write Integrated value setting target (Un\G51) and Integrated value setting value (Un\G52, 53) into it, and after that, turn this request (Yn3) to ON.
 - (b) When switching this request (Yn3) from the OFF status to the ON status, the integrated value setting value will be set. When the integrated value setting is completed, Integrated value set completion flag (Xn3) turns ON.
 - (c) When this request (Yn3) is set to OFF, Integrated value set completion flag (Xn3) turns OFF.
- (3) Max./min. values clear request (Yn4)
 - (a) When the max./min. value data (max./min. value and their date/time of occurrence) is reset, this request (Yn4) turns ON.
 - (b) After writing max./min. values clear item (Un\G56), switching this request (Yn4) from the OFF status to the ON status will clear the max./min. values. When clearing the max./min. data is completed, Max./min. values clear completion flag (Xn4) turns ON.
 - (c) When this request (Xn4) is set to OFF, Max./min. values clear completion flag (Xn4) turns OFF.

- (4) CH1 periodic electric energy 1 measurement flag (Yn5)
- (a) When switching this signal (Yn5) from the ON status to the OFF status, CH1 periodic electric energy 1 is measured and stored in the buffer memory.
 - (b) When this signal (Yn5) is turned OFF, CH1 periodic electric energy 1 data completion flag (Xn5) turns ON at the time that CH1 periodic electric energy 1 is checked for that period, and then CH1 periodic electric energy 1 is retained.
 - (c) In order to read the checked data of CH1 periodic electric energy 1 using the sequence program, use CH1 periodic electric energy 1 data completion flag (Xn5) as the interlock condition.
*For specific usage procedures, refer to Section 4.2.2.
- (5) CH1 periodic electric energy 2 measurement flag (Yn6)
- The usage procedure is the same as that of CH1 periodic electric energy 1 measurement flag (Yn5). Refer to (4).
- (6) CH1 periodic electric energy 1 reset request (Yn7)
- (a) When this request (Yn7) is turned ON from the OFF status, CH1 periodic electric energy 1 reset completion flag (Xn7) turns ON, and CH1 periodic electric energy 1 that has been stored in the buffer memory is reset.
 - (b) Regardless of the status of CH1 periodic electric energy 1 measurement flag (Yn5), either OFF or ON, the periodic electric energy 1 can be reset using this request (Yn7). When CH1 periodic electric energy 1 measurement flag (Yn5) is ON, and the measurement is taking place, the measurement will resume immediately after the reset.
 - (c) When this request (Yn7) is set to OFF, CH1 periodic electric energy 1 reset completion flag (Xn7) turns OFF.
*For specific usage procedures, refer to Section 4.2.2.
- (7) CH1 periodic electric energy 2 reset request (Yn8)
- The usage procedure is the same as that of CH1 periodic electric energy 1 reset request (Yn7). Refer to (6).
- (8) CH1 alarm 1 reset request (Yn9)
- (a) When CH1 alarm 1 flag (Xn9) is reset, this request (Yn9) turns ON. (b) When this request (Yn9) is switched from the OFF status to the ON status, CH1 alarm 1 flag (Xn9) will forcibly be turned OFF regardless of the present alarm occurrence status.
 - (b) Check that CH1 alarm 1 flag (Xn9) becomes OFF, and then set this request (Yn9) to OFF.
- (9) CH1 alarm 2 reset request (YnA)
- The usage procedure is the same as that of CH1 periodic electric energy 1 reset request (Yn9). Refer to (8).

(10) Error clear request (Yn1F)

- (a) When switching this request (Yn1F) from the OFF status to the ON status while an outside-set-value error is present, Error flag (Xn1F) turns OFF, and the latest error code in the buffer memory (Un\G4500) will be cleared.
- (b) At the same time as clearing the error above, the values that were set in the buffer memory below will be replaced with the previously set values, and integrated value setting target (Un\G51) and integrated value setting value (Un\G52, 53) will be reset to 0.
[Set values to be replaced with the previously set values]
- Phase wire system (Un\G0)
 - Primary voltage (Un\G1)
 - Primary current (Un\G2/1002/2002/3002)
 - Current demand time (Un\G3/1003/2003/3003)
 - Electric power demand time (Un\G4/1004/2004/3004)
 - Primary voltage of VT (Un\G5)
 - Secondary voltage of VT (Un\G6)
 - Primary current of CT (Un\G7/1007/2007/3007)
 - Alarm 1 item (Un\G11/1011/2011/3011)
 - Alarm 1 value (Un\G12, 13/1012, 1013/2012, 2013/3012, 3013)
 - Alarm 1 reset method (Un\G14/1014/2014/3014)
 - Alarm 1 delay time (Un\G15/1015/2015/3015)
 - Alarm 2 item (Un\G21/1021/2021/3021)
 - Alarm 2 value (Un\G22, 23/1022, 1023/2022, 2023/3022, 3023)
 - Alarm 2 reset method (Un\G24/1024/2024/3024)
 - Alarm 2 delay time (Un\G25/1025/2025/3025)
 - Output period of data acquisition clock (Un\G60, 61/1060, 1061/2060, 2061/3060, 3061)
- (c) While a hardware error is present (error code: 0000h to 0FFFh), it will not be cleared even if this signal (Yn1F) turns ON.

Chapter 6: Buffer memory

6.1 Buffer memory assignment

The following describes buffer memory assignment.

Point
In the buffer memory, do not write data to the "system area" or area where data writing data from sequence programs is disabled. Doing so may cause malfunction.

- (1) Configurable sections (CH1: Un\G0 to Un\G99, CH2: Un\G1000 to Un\G1099,
CH3: Un\G2000 to Un\G2099, CH4: Un\G3000 to Un\G3099)

Table 6.1-1 Configurable sections

Item	Address (decimal)				Data type	Description	Default value	R/W	Back up*1	Output value during the test mode*2				
	CH1	CH2	CH3	CH4						CH1	CH2	CH3	CH4	
Setting value	—	1000 § 1001	2000 § 2001	3000 § 3001	—	System area	—	—	—	—				
		0			Pr	Phase wire system	3	R/W	○	3				
		1			Pr	Primary voltage	2	R/W	○	2				
		2	1002	2002	3002	Pr	Primary current	2	R/W	○	2	3	4	5
		3	1003	2003	3003	Pr	Current demand time	120	R/W	○	100	200	300	400
		4	1004	2004	3004	Pr	Electric power demand time	120	R/W	○	150	250	350	450
			5			Pr	Primary voltage of VT	0	R/W	○	0			
			6			Pr	Secondary voltage of VT	0	R/W	○	0			
		7	1007	2007	3007	Pr	Primary current of CT	0	R/W	○	0	0	0	0
		8 § 10	1008 § 1010	2008 § 2010	3008 § 3010	—	System area	—	—	—	—			
		11	1011	2011	3011	Pr	Alarm 1 item	0	R/W	○	1	3	5	7
		12	1012	2012	3012	Pr	Alarm 1 value	0	R/W	○	1100	2100	3100	4100
		14	1014	2014	3014	Pr	Alarm 1 reset method	0	R/W	○	0	1	0	1
		15	1015	2015	3015	Pr	Alarm 1 delay time	0	R/W	○	110	120	130	140
		16 § 20	1016 § 1020	2016 § 2020	3016 § 3020	—	System area	—	—	—	—			
		21	1021	2021	3021	Pr	Alarm 2 item	0	R/W	○	2	4	6	8
		22	1022	2022	3022	Pr	Alarm 2 value	0	R/W	○	510	520	530	540
		23	1023	2023	3023	Pr	Alarm 2 reset method	0	R/W	○	1	0	1	0
		24	1024	2024	3024	Pr	Alarm 2 delay time	0	R/W	○	210	220	230	240
		26 § 50	1026 § 1053	2026 § 2053	3026 § 3053	—	System area	—	—	—	—			
			51			Pr	Integrated value setting target	0	W	—	0			
			52			Pr	Integrated value setting value	0	W	—	0			
			53											
		54 § 55	1054 § 1056	2054 § 2056	3054 § 3056	—	System area	—	—	—	—			
			56			Pr	Max./min values clear item	0	W	—	0			
		57 § 59	1057 § 1061	2057 § 2061	3057 § 3061	—	System area	—	—	—	—			
			60			Pr	output period of data acquisition clock	0	R/W	○	0			
			61											
		62 § 99	1062 § 1099	2062 § 2099	3062 § 3099	—	System area	—	—	—	—			

*1 Even if the power failure is restored, data is held because data is backed up by the nonvolatile memory.

*2 For the procedure for using the test mode, refer to section 4.2.5.

(2) Measurement sections (CH1: Un\G100 to Un\G999, CH2: Un\G1100 to Un\G1999,
CH3: Un\G2100 to Un\G2999, CH4: Un\G3100 to Un\G3999)

Table 6.1-2 Measurement sections 1/3

Item	Address(Decimal)				Data Type	Description	Default value	R/W	Back up*1	Output value during the test mode*2			
	CH1	CH2	CH3	CH4						CH1	CH2	CH3	CH4
Electric energy	100	1100	2100	3100	Md	Multiplier of Electric energy, reactive energy	-4	R	—	-4	-3	-2	-1
	101	1101	2101	3101	—	System area	—	—	—	—			
	102	1102	2102	3102	Md	Electric energy (consumption)	0	R	○	1101000	1201000	1301000	1401000
	103	1103	2103	3103	Md	Electric energy (regeneration)	0	R	○	1102000	1202000	1302000	1402000
	104	1104	2104	3104	Md	Electric energy (consumption lag)	0	R	○	1103000	1203000	1303000	1403000
	105	1105	2105	3105	Md	Electric energy (consumption lag)	0	R	○	1103000	1203000	1303000	1403000
	106	1106	2106	3106	Md	Electric energy (consumption lag)	0	R	○	1103000	1203000	1303000	1403000
	107	1107	2107	3107	—	System area	—	—	—	—			
	108	1108	2108	3108	§	§	§	§	—	—			
	113	1113	2113	3113	—	System area	—	—	—	—			
	114	1114	2114	3114	Md	Periodic electric energy1	0	R	○	1104000	1204000	1304000	1404000
	115	1115	2115	3115	Md	Periodic electric energy1	0	R	○	1104000	1204000	1304000	1404000
	116	1116	2116	3116	Md	Periodic electric energy2	0	R	○	1105000	1205000	1305000	1405000
	117	1117	2117	3117	Md	Periodic electric energy2	0	R	○	1105000	1205000	1305000	1405000
	118	1118	2118	3118	§	§	§	§	—	—			
	199	1199	2199	3199	—	System area	—	—	—	—			
	Current	200	1200	2200	3200	Md	Multiplier of current	-3	R	—	-3	-3	-3
201		1201	2201	3201	—	System area	—	—	—	—			
202		1202	2202	3202	Md	1-phase current	0	R	—	210100	220100	230100	240100
203		1203	2203	3203	Md	1-phase current	0	R	—	210100	220100	230100	240100
204		1204	2204	3204	Md	2-phase current	0	R	—	210200	220200	230200	240200
205		1205	2205	3205	Md	2-phase current	0	R	—	210200	220200	230200	240200
206		1206	2206	3206	Md	3-phase current	0	R	—	210300	220300	230300	240300
207		1207	2207	3207	Md	3-phase current	0	R	—	210300	220300	230300	240300
208		1208	2208	3208	§	§	§	§	—	—			
209		1209	2209	3209	—	System area	—	—	—	—			
210		1210	2210	3210	Md	1-phase current demand	0	R	—	210500	220500	230500	240500
211		1211	2211	3211	Md	1-phase current demand	0	R	—	210500	220500	230500	240500
212		1212	2212	3212	Md	2-phase current demand	0	R	—	210600	220600	230600	240600
213		1213	2213	3213	Md	2-phase current demand	0	R	—	210600	220600	230600	240600
214		1214	2214	3214	Md	3-phase current demand	0	R	—	210700	220700	230700	240700
215		1215	2215	3215	Md	3-phase current demand	0	R	—	210700	220700	230700	240700
216		1216	2216	3216	§	§	§	§	—	—			
217		1217	2217	3217	—	System area	—	—	—	—			
218		1218	2218	3218	Md	Average current	0	R	—	210900	220900	230900	240900
219		1219	2219	3219	Md	Average current	0	R	—	210900	220900	230900	240900
220		1220	2220	3220	Md	Maximum current demand	0	R	○	211000	221000	231000	241000
221		1221	2221	3221	Md	Maximum current demand	0	R	○	211000	221000	231000	241000
222		1222	2222	3222	Md	Year of time of max. current demand	0	R	○	2001h	2002h	2003h	2004h
223		1223	2223	3223	Md	month and day of time of max. current demand	0	R	○	0101h	0102h	0103h	0104h
224		1224	2224	3224	Md	Hour and minute of time of max. current demand	0	R	○	1331h	1332h	1333h	1334h
225		1225	2225	3225	Md	Second and day of the week of time of max. current demand	0	R	○	3000h	3001h	3002h	3003h
226		1226	2226	3226	Md	Second and day of the week of time of max. current demand	0	R	○	3000h	3001h	3002h	3003h
227		1227	2227	3227	Md	Minimum current demand	0	R	○	211100	221100	231100	241100
228		1228	2228	3228	Md	Year of time of min. current demand	0	R	○	2006h	2007h	2008h	2009h
229		1229	2229	3229	Md	month and day of time of min. current demand	0	R	○	0206h	0207h	0208h	0209h
230		1230	2230	3230	Md	Hour and minute of time of min. current demand	0	R	○	1436h	1437h	1438h	1439h
231		1231	2231	3231	Md	Second and day of the week of time of min. current demand	0	R	○	3503h	3504h	3505h	3506h
232	1232	2232	3232	§	§	§	§	—	—				
299	1299	2299	3299	—	System area	—	—	—	—				

*1 Even if the power failure is restored, data is held because data is backed up by the nonvolatile memory.

*2 For the procedure for using the test mode, refer to section 4.2.5.

Table 6.1-2 Measurement sections 2/3

Item	Address(Decimal)				Data Type	Description	Default value	R/W	Back up*1	Output value during the test mode*2				
	CH1	CH2	CH3	CH4						CH1	CH2	CH3	CH4	
Voltage	300	1300	2300	3300	Md	Multiplier of voltage	-3	R	—	-3	-3	-3	-3	
	301	1301	2301	3301	—	System area	—	—	—	—				
	302	1302	2302	3302	Md	1-2 line voltage	0	R	—	310100	320100	330100	340100	
	303	1303	2303	3303	Md	2-3 line voltage	0	R	—	310200	320200	330200	340200	
	304	1304	2304	3304	Md	3-1 line voltage	0	R	—	310300	320300	330300	340300	
	305	1305	2305	3305	Md	3-1 line voltage	0	R	—	310300	320300	330300	340300	
	306	1306	2306	3306	Md	3-1 line voltage	0	R	—	310300	320300	330300	340300	
	307	1307	2307	3307	Md	3-1 line voltage	0	R	—	310300	320300	330300	340300	
	308	1308	2308	3308	—	System area	—	—	—	—				
	313	1313	2313	3313	—	System area	—	—	—	—				
	314	1314	2314	3314	Md	Average voltage	0	R	—	310700	320700	330700	340700	
	315	1315	2315	3315	Md	Average voltage	0	R	—	310700	320700	330700	340700	
	316	1316	2316	3316	—	System area	—	—	—	—				
	319	1319	2319	3319	—	System area	—	—	—	—				
	320	1320	2320	3320	Md	Maximum voltage	0	R	○	310900	320900	330900	340900	
	321	1321	2321	3321	Md	Maximum voltage	0	R	○	310900	320900	330900	340900	
	322	1322	2322	3322	Md	Year of time of max.voltage	0	R	○	2011h	2012h	2013h	2014h	
	323	1323	2323	3323	Md	Month and day of time of max. voltage	0	R	○	0311h	0312h	0313h	0314h	
	324	1324	2324	3324	Md	Hour and minute of time of max. voltage	0	R	○	1541h	1542h	1543h	1544h	
	325	1325	2325	3325	Md	Second and day of the week of time of max. voltage	0	R	○	4000h	4001h	4002h	4003h	
	326	1326	2326	3326	Md	Minimum voltage	0	R	○	311000	321000	331000	341000	
	327	1327	2327	3327	Md	Minimum voltage	0	R	○	311000	321000	331000	341000	
	328	1328	2328	3328	Md	Year of time of min.voltage	0	R	○	2016h	2017h	2018h	2019h	
	329	1329	2329	3329	Md	Month and day of time of min. voltage	0	R	○	0416h	417h	418h	419h	
	330	1330	2330	3330	Md	Hour and minute of time of min. voltage	0	R	○	1646h	1647h	1648h	1649h	
	331	1331	2331	3331	Md	Second and day of the week of time of min. voltage	0	R	○	4503h	4504h	4505h	4506h	
	332	1332	2332	3332	—	System area	—	—	—	—				
	399	1399	2399	3399	—	System area	—	—	—	—				
	Electric power	400	1400	2400	3400	Md	Multiplier of electric power	-3	R	—	-3	-3	-3	-3
		401	1401	2401	3401	—	System area	—	—	—	—			
		402	1402	2402	3402	Md	Electric power	0	R	—	410100	420100	430100	440100
		403	1403	2403	3403	Md	Electric power	0	R	—	410100	420100	430100	440100
		404	1404	2404	3404	Md	Electric power demand	0	R	—	410200	420200	430200	440200
405		1405	2405	3405	Md	Electric power demand	0	R	—	410200	420200	430200	440200	
406		1406	2406	3406	—	System area	—	—	—	—				
419		1419	2419	3419	—	System area	—	—	—	—				
420		1420	2420	3420	Md	Maximum value of electric power demand	0	R	○	410300	420300	430300	440300	
421		1421	2421	3421	Md	Maximum value of electric power demand	0	R	○	410300	420300	430300	440300	
422		1422	2422	3422	Md	Year of time of max.electric power demand	0	R	○	2031h	2032h	2033h	2034h	
423		1423	2423	3423	Md	Month and day of time of max. electric power demand	0	R	○	0701h	0702h	0703h	0704h	
424		1424	2424	3424	Md	Hour and minute of time of max. electric power demand	0	R	○	1901h	1902h	1903h	1904h	
425		1425	2425	3425	Md	Second and day of the week of time of max. electric power demand	0	R	○	0000h	0001h	0002h	0003h	
426		1426	2426	3426	Md	Minimum value of electric power demand	0	R	○	410400	420400	430400	440400	
427		1427	2427	3427	Md	Minimum value of electric power demand	0	R	○	410400	420400	430400	440400	
428		1428	2428	3428	Md	Year of time of min.electric power demand	0	R	○	2036h	2037h	2038h	2039h	
429		1429	2429	3429	Md	Month and day of time of min. electric power demand	0	R	○	0806h	0807h	0808h	0809h	
430		1430	2430	3430	Md	Hour and minute of time of min. electric power demand	0	R	○	2106h	2107h	2108h	2109h	
431		1431	2431	3431	Md	Second and day of the week of time of min. electric power demand	0	R	○	0503h	0504h	0505h	0506h	
432	1432	2432	3432	—	System area	—	—	—	—					
499	1499	2499	3499	—	System area	—	—	—	—					

*1 Even if the power failure is restored, data is held because data is backed up by the nonvolatile memory.

*2 For the procedure for using the test mode, refer to section 4.2.5.

Table 6.1-2 Measurement sections 3/3

Item	Address(Decimal)				Data Type	Description	Default value	R/W	Back up*1	Output value during the test			
	CH1	CH2	CH3	CH4						CH1	CH2	CH3	CH4
Reactive power	500	1500	2500	3500	Md	Multiplier of reactive	-3	R	—	-3	-3	-3	-3
	501	1501	2501	3501	—	System area	—	—	—	—			
	502	1502	2502	3502	Md	Reactive power	0	R	—	510100	520100	530100	540100
	503	1503	2503	3503									
	504	1504	2504	3504	—	System area	—	—	—	—			
699	1699	2699	3699										
Power factor	700	1700	2700	3700	Md	Multiplier of power factor	-3	R	—	-3	-3	-3	-3
	701	1701	2701	3701	—	System area	—	—	—	—			
	702	1702	2702	3702	Md	Power factor	0	R	—	710100	720100	730100	740100
	703	1703	2703	3703									
	704	1704	2704	3704	—	System area	—	—	—	—			
	719	1719	2719	3719									
	720	1720	2720	3720	Md	Maximum power factor	0	R	○	710200	720200	730200	740200
	721	1721	2721	3721									
	722	1722	2722	3722	Md	Year of time of max. power factor	0	R	○	2041h	2042h	2043h	2044h
	723	1723	2723	3723	Md	Month and day of time of max. power factor	0	R	○	0911h	0912h	0913h	0914h
	724	1724	2724	3724	Md	Hour and minute of time of max. power factor	0	R	○	2211h	2212h	2213h	2214h
	725	1725	2725	3725	Md	Second and day of the week of time of max.	0	R	○	1000h	1001h	1002h	1003h
	726	1726	2726	3726	Md	Minimum power factor	0	R	○	710300	720300	730300	740300
	727	1727	2727	3727									
	728	1728	2728	3728	Md	Year of time of min. power factor	0	R	○	2046h	2047h	2048h	2049h
	729	1729	2729	3729	Md	Month and day of time of min. power factor	0	R	○	1016h	1017h	1018h	1019h
	730	1730	2730	3730	Md	Hour and minute of time of min. power factor	0	R	○	2316h	2317h	2318h	2319h
	731	1731	2731	3731	Md	Second and day of the week of time of min.	0	R	○	1503h	1504h	1505h	1506h
	732	1732	2732	3732	—	System area	—	—	—	—			
799	1799	2799	3799										
Frequency	800	1800	2800	3800	Md	Multiplier of frequency	-3	R	—	-3	-3	-3	-3
	801	1801	2801	3801	—	System area	—	—	—	—			
	802	1802	2802	3802	Md	Frequency	0	R	—	810100	820100	830100	840100
	803	1803	2803	3803									
	804	1804	2804	3804	—	System area	—	—	—	—			
999	1999	2999	3999										

*1 Even if the power failure is restored, data is held because data is backed up by the nonvolatile memory.

*2 For the procedure for using the test mode, refer to section 4.2.5.

(3) Common sections (Un\G4500 to Un\G4999)

Table 6.1-3 Common sections (Un\G4500 to Un\G4999)

Item	Address (Decimal)			Data Type	Description	Default value	R/W	Back up*1	Output value during the test mode*2		
	CH1	CH2	CH3						CH1	CH2	CH3
Error	4500			—	Latest error code	—	R	—	1		
	4501			—	Year of time of error	—	R	—	2051h		
	4502			—	Month and day of time of	—	R	—	1130h		
	4503			—	Hour and minute of time of	—	R	—	0059h		
	4504			—	Second and day of the week	—	R	—	5906h		
	4505~4549			—	System area	—	—	—	—		
	4550			—	State of measuring	—	R	—	—		
4551~4999			—	System area	—	—	—	—			

*1 Even if the power failure is restored, data is held because data is backed up by the nonvolatile memory.

*2 For the procedure for using the test mode, refer to section 4.2.5.

6.2 Configurable sections (CH1: Un\G0 to Un\G99, CH2: Un\G1000 to Un\G1099,
CH3: Un\G2000 to Un\G2099, CH4: Un\G3000 to Un\G3099)

6.2.1 Phase wire system (Un\G0)

Phase wire system for target electric circuits is configured below. This setting is common to all channels.

(1) Setting procedure

(a) Set the phase wire in the buffer memory. Setting range is as follows:

Setting value	Description
1	single-phase 2-wire
2	single-phase 3-wire
3	three-phase 3-wire

(b) Turn Operating condition setting request (Yn2) from OFF to ON to enable the setting. (Refer to 5.2.2 (1).)

(2) Default value

It is set to 0 (three-phase 3-wire).

6.2.2 Primary voltage (Un\G1), Primary voltage of VT (Un\G5), Secondary voltage of VT (Un\G6)

- Primary voltage (Un\G1): set the primary voltage of the target electric circuit. This setting is common to all channels.
- Primary voltage of VT (Un\G5): when use for primary voltage of voltage transformer that is not in the primary voltage (Un\G1) setting, set the voltage of the primary side of voltage transformer.
- Secondary voltage of VT (Un\G6): when use for primary voltage of voltage transformer that is not in the primary voltage (Un\G1) setting, set the voltage of the secondary side of voltage transformer.

(1) Setting procedure

- (a) Set the primary voltage, primary voltage of VT and secondary voltage of VT in the buffer memory. Setting range is as follows:

When set other than "1 to 9" the value of this setting, set to "0:any setting" this setting, and set primary / secondary voltage of VT (Un\G5 / Un\G6).

Please setup the primary voltage is 110V (Direct connection) in 1 phase 3 wire.

When the value of this setup is set as "1 to 9", primary/ secondary voltage of VT are disabled.

Primary voltage (Un\G1)		Primary voltage of VT (Un\G5)	Secondary voltage of VT (Un\G6)
Setting value	Description		
0	Any setting	1 - 6600	1 - 220
1	110 V (Direct connection)	0 – 6600 (However, this setting is disabled)	0 – 220 (However, this setting is disabled)
2	220 V (Direct connection)		
3	220/110 V		
4	440/110 V		
5	690/110 V		
6	1100/110 V		
7	2200/110 V		
8	3300/110 V		
9	6600/110 V		

- (b) Turn Operating condition setting request (Yn2) from OFF to ON to enable the setting. (Refer to 5.2.2 (1).)

(2) Default value

Primary voltage (Un\G1) is set to 220 V (2).

Primary voltage of VT (Un¥G5) is set to 0.

Secondary voltage of VT (Un¥G6) is set to 0.

6.2.3 CH1 primary current (Un\G2), CH1 primary current of CT (Un\G7)

- CH1 primary current (Un\G2): set the primary current of the target electric circuit.
- CH1 primary current of CT (Un\G7): when use for primary current of current transformer that is not in the CH1 primary current (Un\G2) setting, set the current of the primary side of current transformer.
Secondary current of CT cannot be set. Because secondary current of CT is fixed to 5A.

(1) Setting procedure

- (a) Set the primary current and primary current of CT in the buffer memory. Setting range is as follows: Please choose the settings to match the current sensor to be used.

When set other than "1 to 5, 501 to 536" the value of this setting, set to "0: any setting" this setting, and set primary current of CT (Un\G7).

When the value of this setup is set as "1 to 5, 501 to 536", primary current of CT is disabled.

CH1 primary current (Un\G2)		CH1 primary current of CT (Un\G7)	Current sensor
Setting value	Description		
0	Any setting	1 - 6000	EMU2-CT5, EMU-CT5-A
1	50A	0 – 6000 (However, this setting is disabled)	EMU-CT50, EMU-CT50-A
2	100A		EMU-CT100, EMU-CT100-A
3	250A		EMU-CT250, EMU-CT250-A
4	400A		EMU-CT400, EMU-CT400-A
5	600A		EMU-CT600, EMU-CT600-A
501	5/5A		EMU2-CT5, EMU-CT5-A
502	6/5A		
503	7.5/5A		
504	8/5A		
505	10/5A		
506	12/5A		
507	15/5A		
508	20/5A		
509	25/5A		
510	30/5A		
511	40/5A		
512	50/5A		
513	60/5A		
514	75/5A		
515	80/5A		

CH1 primary current (Un\G2)		CH1 primary current of CT (Un\G7)	Current sensor
Setting value	Description		
516	100/5A	0 – 6000 (However, this setting is disabled)	EMU2-CT5, EMU-CT5-A
517	120/5A		
518	150/5A		
519	200/5A		
520	250/5A		
521	300/5A		
522	400/5A		
523	500/5A		
524	600/5A		
525	750/5A		
526	800/5A		
527	1000/5A		
528	1200/5A		
529	1500/5A		
530	1600/5A		
531	2000/5A		
532	2500/5A		
533	3000/5A		
534	4000/5A		
535	5000/5A		
536	6000/5A		

(b) Turn Operating condition setting request (Yn2) from OFF to ON to enable the setting. (Refer to 5.2.2 (1).)

(2) Default value

CH1 Primary current (Un\G2) is set to 2 (100 A).

CH1 Primary current of CT (Un\G7) is set to 0.

6.2.4 CH1 current demand time (Un\G3)

Set a time duration for which the average fluctuation of current demand is measured from the measured current value.

If current demand time is set short, the response to change of current will be quick; however, the fluctuation range may be too large. Adjust the duration according to the load and purposes.

(1) Setting procedure

(a) Set current demand time in the buffer memory.

- Configurable range: 0 to 1800 (seconds)

- Set the value in seconds.

(b) Turn Operating condition setting request (Yn2) from OFF to ON to enable the setting. (Refer to 5.2.2 (1).)

(2) Default value

It is set to 120 (seconds).

6.2.5 CH1 electric power demand time (Un\G4)

Set a time duration for which the average fluctuation of electric power demand is measured from the measured power value.

If electric power demand time is set short, the response to change of power will be quick; however, the fluctuation range may be too large. Adjust the duration according to the load and purposes.

(1) Setting procedure

(a) Set electric power demand time in the buffer memory.

- Configurable range: 0 to 1800 (seconds)
- Set the value in seconds.

(b) Turn Operating condition setting request (Yn2) from OFF to ON to enable the setting. (Refer to 5.2.2 (1).)

(2) Default value

It is set to 120 (seconds).

6.2.6 CH1 alarm 1 item (Un\G11), CH1 alarm 2 item (Un\G21)

Set which measuring item will be monitored for the upper/lower limit alarm.
Alarm 1 and 2 operate independently.

(1) Setting procedure

(a) Set the item for alarm 1 and 2 in the buffer memory. Setting range is as follows:

Setting value	Description
0	No monitoring
1	Current demand upper limit
2	Current demand lower limit
3	Voltage upper limit
4	Voltage lower limit
5	Electric power demand upper limit
6	Electric power demand lower limit
7	Power factor upper limit
8	Power factor lower limit

(b) Measuring items for the monitoring target are as follows:

Description	Measuring item of monitoring target		
	single-phase 2-wire	single-phase 3-wire	three-phase 3-wire
Current demand upper limit Current demand lower limit	1-phase current demand	1-phase current demand 3-phase current demand *1	1-phase current demand 2-phase current demand 3-phase current demand *1
Voltage upper limit Voltage lower limit	1 - 2 line voltage	1 - 2 line voltage 2 - 3 line voltage *1	1 - 2 line voltage 2 - 3 line voltage 3 - 1 line voltage *1
Electric power demand upper limit Electric power demand lower limit	Electric power demand		
Power factor upper limit Power factor lower limit	Power factor *2		

*1 When multiple number of measuring items are targeted for monitoring, the alarm judgment condition will be as following.

Upper/lower limits	Alarm judgment conditions	
	Condition for occurrence	Condition for non-occurrence
Current demand upper limit Voltage upper limit	Any one of alarm item exceeds the alarm value.	All alarm item go below the alarm value.
Current demand lower limit Voltage lower limit	Any one of alarm item go below the alarm value	All alarm item exceeds the alarm value

*2 The idea of upper and lower for PF upper /lower limit judgment is shown below.

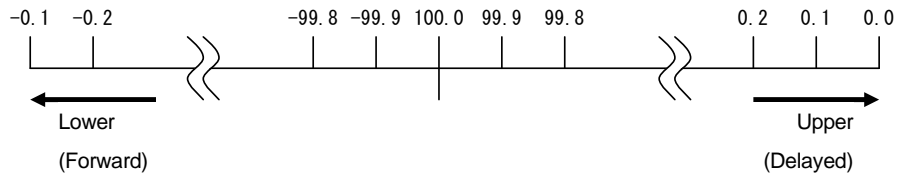

(c) Turn Operating condition setting request (Yn2) from OFF to ON to enable the setting. (Refer to 5.2.2 (1).)

(2) Default value

It is set to 0 (no monitoring).

6.2.7 CH1 alarm 1 value (Un\G12, 13), CH1 alarm 2 value (Un\G22, 23)

Set the upper/lower limit monitoring value for the target that was set in alarm 1 item and alarm 2 item.

(1) Setting procedure

(a) Set the monitoring values for alarm 1 and 2 in the buffer memory.

- Configurable range: -2147483648 to 2147483647
- The unit of the setting value is the same as below which was used for the measuring value of the monitored target configured in alarm 1 item and alarm 2 item.

Alarm 1 item Alarm 2 item	Unit of alarm 1 value and alarm 2 value
Current demand upper limit Current demand lower limit	$\times 10^{-3}$ A
Voltage upper limit Voltage lower limit	$\times 10^{-3}$ V
Electric power demand upper limit Electric power demand lower limit	W ($\times 10^{-3}$ kW)
Power factor upper limit Power factor lower limit	$\times 10^{-3}\%$

(b) Turn Operating condition setting request (Yn2) from OFF to ON to enable the setting.

(2) Default value

It is set to 0.

6.2.8 CH1 alarm 1 reset method (Un\G14), CH1 alarm 2 reset method (Un\G24)

Set the reset method of the alarm1 and alarm 2.

For differences in behavior of alarm monitoring for different reset methods, refer to 4.2.4 (2).

(1) Setting procedure

(a) Set the reset method for alarm 1 and 2 in the buffer memory. Setting range is as follows:

Setting value	Description
0	Self-retention
1	Auto reset

(b) Turn Operating condition setting request (Yn2) from OFF to ON to enable the setting.

(2) Default value

It is set to 0 (self retention).

6.2.9 CH1 alarm 1 delay time (Un\G15), CH1 alarm 2 delay time (Un\G25)

Set the alarm delay time for the alarm 1 and alarm 2.

Alarm delay time means a grace period that takes from the moment when it exceeds the upper limit or goes under the lower limit of the alarm 1 value or alarm 2 value until the alarm flag is turned ON. For detailed behavior, refer to 4.2.4 (2).

(1) Setting procedure

(a) Set the delay time for alarm 1 and alarm 2 in the buffer memory.

- Configurable range: 0 to 300 (seconds)
- Set the value in seconds.

(b) Turn Operating condition setting request (Yn2) from OFF to ON to enable the setting.

(2) Default value

It is set to 0 (seconds).

6.2.10 Integrated value setting target (Un\G51), integrated value setting value (Un\G52, 53)

(1) Setting procedure

(a) Set integrated value setting target (Un\G51) in the buffer memory. Setting range is as follows:

Setting value					Description
CH1	CH2	CH3	CH4	All CHs	
0	0	0	0	0	No set
11	21	31	41	91	Electric energy (consumption)
12	22	32	42	92	Electric energy (regeneration)
13	23	33	43	93	Reactive energy (consumption lag)
19	29	39	49	99	Total integrated value

(b) Set integrated value setting value (Un\G52, 53) in the buffer memory.

- Configurable range: 0 to 999999999
 - The unit used for the setting value is the same as that used for the electric energy and reactive energy that are output to the buffer memory.
- For details, refer to section 6.3.2.

(c) Turn Integrated value setting request (Yn3) from OFF to ON to enable* the setting.

(d) After checking that integrated value set completion flag (Xn3) turns ON and setting is completed, set the integrated value set request (Yn3) to OFF.

After detected that the integrated value set request (Yn3) turns OFF, the integrated value set completion flag (Xn3) turns OFF.

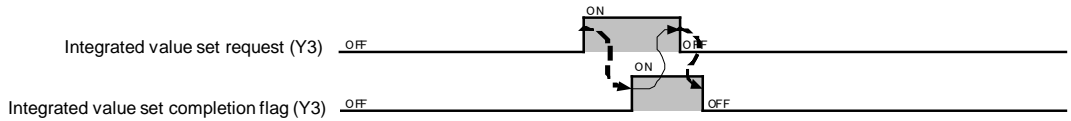

Figure 6.2.10 Integrated value setting procedure

(2) Default value

- integrated value setting target (Un\G51) is set to 0 (No set).
- integrated value setting value (Un\G52, Un\G53) is set to 0.

6.2.11 Max./min. values clear item (Un¥G56)

Select the max./min. values you want to clear.

- Regular operating mode

(1) Setting procedure

- (a) Set max./min values clear item (Un¥G56) in the buffer memory.

Setting range is as follows:

Setting value					Description
CH1	CH2	CH3	CH4	All CHs	
0	0	0	0	0	No clear
11	21	31	41	91	Current demand
12	22	32	42	92	Voltage
13	23	33	43	93	Electric power demand
14	24	34	44	94	Power factor
19	29	39	49	99	All items

- (b) Turn Max./min. values clear request (Yn4) from OFF to ON to enable the setting.

(2) Default value

It is set to 0 (No clear).

- Current measuring mode

(1) Setting procedure

- (a) Set max./min values clear item (Un¥G4002) in the buffer memory.

Setting range is as follows:

Setting value									Description
CH1	CH2	CH3	CH4	CH5	CH6	CH7	CH8	All CHs	
0	0	0	0	0	0	0	0	0	No clear
11	21	31	41	51	61	71	81	91	Current demand

- (b) Turn Max./min. values clear request (Yn4) from OFF to ON to enable the setting.

(2) Default value

It is set to 0 (No clear).

6.2.12 Output period of data acquisition clock (Un\G60, 61)

Set the output period of Data acquisition clock (Xn1). This setting is common to all channels.

- Data acquisition clock (Regular operating mode)

(1) Setting procedure

- (a) Set output period of data acquisition clock (Un\G60, 61) in the buffer memory.

- Configurable range: 0 to 86400000 (ms)

*When the output period of data acquisition clock is set to 0, Data acquisition clock (Xn1) is always OFF.

- (b) Because the data update interval is 500 ms, Data acquisition clock (Xn1) runs every 500 ms.

Note that the output period of data acquisition clock is not a multiple of 500 ms, Data acquisition clock turns ON at the time of the first data update after the elapse of the output period of data acquisition clock.

<Example> When the output period of data acquisition clock is 1600 ms:

Measurement data update count = $1600 \text{ ms} / 500 \text{ ms} = \text{quotient } 3 + \text{remainder } 100 \text{ ms}$

Thus, the input device (Xn1) turns ON once in every four times the measurement data is updated.

As a result, it is same as the case where the output period of data acquisition clock is 2000 ms.

- (c) Turn Operating condition setting request (Yn2) from OFF to ON to enable the setting.

(2) Default value

It is set to 0 (ms).

- Data acquisition clock (Current measuring mode)

(1) Setting procedure

- (a) Set output period of data acquisition clock (Un\G60, 61) in the buffer memory.

- Configurable range: 0 to 86400000 (ms)

*When the output period of data acquisition clock is set to 0, Data acquisition clock (Xn1) is always OFF.

- (b) Because the data update interval is 100 ms, Data acquisition clock (Xn1) runs every 100 ms.

Note that the output period of data acquisition clock is not a multiple of 100 ms, Data acquisition clock turns ON at the time of the first data update after the elapse of the output period of data acquisition clock.

<Example> When the output period of data acquisition clock is 250 ms:

Measurement data update count = $250 \text{ ms} / 100 \text{ ms} = \text{quotient } 2 + \text{remainder } 50 \text{ ms}$

Thus, the input device (Xn1) turns ON once in every three times the measurement data is updated.

As a result, it is same as the case where the output period of data acquisition clock is 300 ms.

- (c) Turn Operating condition setting request (Yn2) from OFF to ON to enable the setting.

(2) Default value

It is set to 0 (ms).

6.3 Measurement sections (CH1: Un\G100 to Un\G999, CH2: Un\G1100 to Un\G1999,
CH3: Un\G2100 to Un\G2999, CH4: Un\G3100 to Un\G3999)

This product divides the measuring data into the Data and Multiplier, and output them to Buffer memory. Actual measuring data is obtained by the following formula.

$$\text{Measuring data} = \text{Data} \times 10^n \text{ (Multiplier is } n\text{).}$$

(Example)

The values output to the Buffer memory are as follows when total current is measured 123.456A.

Data (Un\G218, 219): 123456

Multiplier (Un\G200): -3

The actual measuring data is obtained from the value of Buffer memory as follows.

$$\begin{aligned} \text{Measuring data} &= \text{Data} \times 10^{-3} \\ &= 123.456\text{A} \end{aligned}$$

6.3.1 Multiplier of CH1 electric energy (Un\G100)

Multiplier of electric energy are stored.

As to how the multiplier is determinate, refer to section 4.2.1 (3).

(1) Details of stored data

(a) Storage format

Data are stored as 16-bit signed binary in the buffer memory.

- Data range: -5 to -1

(b) Update timing

It will be updated when phase wire system (Un\G0), primary voltage (Un\G1), and CH1 primary current (Un\G2), primary voltage of VT(Un\G5), secondary voltage of VT(Un\G6), and CH1 primary current of CT(Un\G7) are set.

6.3.2 CH1 electric energy (consumption) (Un\G102, 103), CH1 electric energy (regeneration) (Un\G104,105)

Stores the electric energy of the consumption side and the regeneration side will be stored.

(1) Details of stored data

(a) Storage format

Data are stored as double-word 32-bit signed binary in the buffer memory.

- Data range: 0 to 999999999

When the stored data exceeds 999999999, stored data turns to 0 and continues measuring.

*Restrictions for measured data including resolution and measuring range, refer to section 4.2.1.

(b) Unit

Unit can be determined by multiplier of CH1 electric energy (Un\G100), as shown below.

Multiplier of CH1 electric energy (Un\G100)	Unit
-5	$\times 10^{-5}$ kWh
-4	$\times 10^{-4}$ kWh
-3	$\times 10^{-3}$ kWh
-2	$\times 10^{-2}$ kWh
-1	$\times 10^{-1}$ kWh

(c) Update timing

It will be updated every measuring cycle (500 ms).

6.3.3 CH1 reactive energy (consumption lag) (Un\G106, 107)

Delayed consumption of the reactive energy is stored.

(1) Details of stored data

(a) Storage format

Data are stored as double-word 32-bit signed binary in the buffer memory.

- Data range: 0 to 999999999

When the stored data exceeds 999999999, stored data turns to 0 and continues measuring.

*Restrictions for measured data including resolution and measuring range, refer to section 4.2.1.

(b) Unit

Unit can be determined by multiplier of CH1 electric energy (Un\G100), as shown below.

Multiplier of CH1 electric energy (Un\G100)	Unit
-5	$\times 10^{-5}$ kvarh
-4	$\times 10^{-4}$ kvarh
-3	$\times 10^{-3}$ kvarh
-2	$\times 10^{-2}$ kvarh
-1	$\times 10^{-1}$ kvarh

(c) Update timing

It will be updated every measuring cycle (500 ms).

6.3.4 CH1 periodic electric energy 1 (Un\G114, 115), CH1 periodic electric energy 2 (Un\G116, 117)

Stores the periodic electric energy 1 and periodic electric energy 2. The periodic electric energy of the consumption side is measured.

For specific usage procedures for the periodic electric energy, refer to section 4.2.2.

(1) Details of stored data

(a) Storage format

Data are stored as double-word 32-bit signed binary in the buffer memory.

- Data range: 0 to 999999999

When the stored data exceeds 999999999, stored data turns to 0 and continues measuring.

*Restrictions for measured data including resolution and measuring range, refer to section 4.2.1.

(b) Unit

Unit can be determined by multiplier of CH1 electric energy (Un\G100), as shown below.

Multiplier of CH1 electric energy (Un\G100)	Unit
-5	$\times 10^{-5}$ kWh
-4	$\times 10^{-4}$ kWh
-3	$\times 10^{-3}$ kWh
-2	$\times 10^{-2}$ kWh
-1	$\times 10^{-1}$ kWh

(c) Update timing

It will be updated every measuring cycle (500 ms).

6.3.5 Multiplier of CH1 electric current (Un\G200)

The multiplier of the electric current is stored.

(1) Details of stored data

(a) Storage format

Data are stored as 16-bit signed binary in the buffer memory.

- Data range: -3 (fixed)

(b) Update timing

Because it is fixed at -3, there is no update.

6.3.6 CH1 1-phase current (Un\G202, 203), CH1 2-phase current (Un\G204, 205),
CH1 3-phase current (Un\G206, 207)

The electric current (effective value) of each phase is stored.

(1) Details of stored data

(a) Storage format

Data are stored as double-word 32-bit signed binary in the buffer memory.

- Data range: 0 to 99999999 (0 to 99999.990A)

*Restrictions for measured data including resolution and measuring range, refer to section 4.2.1.

(b) Unit

$\times 10^{-3}$ A *Unit is fixed.

(c) Update timing

It will be updated every measuring cycle (500 ms).

6.3.7 CH1 1-phase current demand (Un\G210, 211), CH1 2-phase current demand (Un\G212, 213),
CH1 3-phase current demand (Un\G214, 215)

Stores the electric current (effective value) at each phase that is calculated based on the moving average for the duration of time configured in current demand time (Un\G3).

(1) Details of stored data

(a) Storage format

Data are stored as double-word 32-bit signed binary in the buffer memory.

- Data range: 0 to 99999999 (0 to 99999.990A)

*Restrictions for measured data including resolution and measuring range, refer to section 4.2.1.

(b) Unit

$\times 10^{-3}$ A *Unit is fixed.

(c) Update timing

It will be updated every measuring cycle (500 ms).

6.3.8 CH1 average current (Un\G218, 219)

Stores the average current.

For procedure for storing the average current using phase wire system, refer to section 4.2.1 (2).

(1) Details of stored data

(a) Storage format

Data are stored as double-word 32-bit signed binary in the buffer memory.

- Data range: 0 to 99999999 (0 to 99999.990A)

*Restrictions for measured data including resolution and measuring range, refer to section 4.2.1.

(b) Unit

$\times 10^{-3}$ A *Unit is fixed.

(c) Update timing

It will be updated every measuring cycle (500 ms).

6.3.9 CH1 maximum current demand (Un\G220, 221), CH1 minimum current demand (Un\G226,227)

Stores the max./min. values of the electric current demand among phases.

For procedure for storing the max./min. the electric current demand using phase wire system, refer to section 4.2.1 (2).

(1) Details of stored data

(a) Storage format

Data are stored as double-word 32-bit signed binary in the buffer memory.

- Data range: 0 to 99999999 (0 to 99999.990A)

*Restrictions for measured data including resolution and measuring range, refer to section 4.2.1.

(b) Unit

$\times 10^{-3}$ A *Unit is fixed.

(c) Update timing

It will be updated every measuring cycle (500ms) if it exceeds the current max. value or goes under the current min. value.

- 6.3.10 Year of time of CH1 max. current demand (Un\G222),
- month and day of time of CH1 max. current demand (Un\G223),
- hour and minute of time of CH1 max. current demand (Un\G224),
- second and day of the week of time of CH1 max. current demand (Un\G225),
- year of time of CH1 min. current demand (Un\G228),
- month and day of time of CH1 min. current demand (Un\G229),
- hour and minute of time of CH1 min. current demand (Un\G230),
- second and day of the week of time of CH1 min. current demand (Un\G231)

Stores year, month, day, hour, minute, second, and day of the week of time when CH1 max. current demand (Un\G220, 221) and CH1 min. current demand (Un\G226, 227) were updated.

(1) Details of stored data

(a) Storage format

As indicated below, data are stored as BCD code in the buffer memory.

Buffer memory address	Storage format																
Un\G222 /Un\G228	<p>e.g.) Year 2010h</p>																
Un\G223 /Un\G229	<p>e.g.) July 30 0730h</p>																
Un\G224 /Un\G230	<p>e.g.) 10:35 1035h</p>																
Un\G225 /Un\G231	<p>e.g.) 48 sec Friday 4805h</p> <table border="1" style="margin-left: auto; margin-right: 0;"> <thead> <tr> <th colspan="2">Day of the week</th> </tr> </thead> <tbody> <tr><td>0</td><td>Sunday</td></tr> <tr><td>1</td><td>Monday</td></tr> <tr><td>2</td><td>Tuesday</td></tr> <tr><td>3</td><td>Wednesday</td></tr> <tr><td>4</td><td>Thursday</td></tr> <tr><td>5</td><td>Friday</td></tr> <tr><td>6</td><td>Saturday</td></tr> </tbody> </table>	Day of the week		0	Sunday	1	Monday	2	Tuesday	3	Wednesday	4	Thursday	5	Friday	6	Saturday
Day of the week																	
0	Sunday																
1	Monday																
2	Tuesday																
3	Wednesday																
4	Thursday																
5	Friday																
6	Saturday																

(b) Update timing

It will be updated every measuring cycle (500 ms) if it exceeds the current max. value or goes under the current min. value.

6.3.11 Multiplier of CH1 the electric voltage (Un\G300)

The multiplier of the electric voltage is stored.

(1) Details of stored data

(a) Storage format

Data are stored as 16-bit signed binary in the buffer memory.

- Data range: -3 (fixed)

(b) Update timing

Because it is fixed at -3, there is no update.

6.3.12 CH1 1 - 2 line voltage (Un\G302, 303), CH1 2 - 3 line voltage (Un\G304, 305),
CH1 3 - 1 line voltage (Un\G306, 307)

The electric voltage between every combination of wires (effective value) is stored.

(1) Details of stored data

(a) Storage format

Data are stored as double-word 32-bit signed binary in the buffer memory.

- Data range: 0 to 99999900 (0 to 99,999.900 V)

*Restrictions for measured data including resolution and measuring range, refer to section 4.2.1.

(b) Unit

$\times 10^{-3}$ V *Unit is fixed.

(c) Update timing

It will be updated every measuring cycle (500 ms).

6.3.13 CH1 average voltage (Un\G314, 315)

Stores the average voltage.

For procedure for storing the average voltage using phase wire system, refer to 4.2.1 (2).

(1) Details of stored data

(a) Storage format

Data are stored as double-word 32-bit signed binary in the buffer memory.

- Data range: 0 to 99999900 (0 to 99,999.900 V)

*Restrictions for measured data including resolution and measuring range, refer to section 4.2.1.

(b) Unit

$\times 10^{-3}$ V *Unit is fixed.

(c) Update timing

It will be updated every measuring cycle (500 ms).

6.3.14 CH1 maximum voltage (Un\G320, 321), CH1 minimum voltage (Un\G326, 327)

Stores the max./min. values of the voltage among in-between wires.

For procedure for storing the max./min. voltage using phase wire system, refer to section 4.2.1 (2).

(1) Details of stored data

(a) Storage format

Data are stored as double-word 32-bit signed binary in the buffer memory.

- Data range: 0 to 99999900 (0 to 99,999.900 V)

*Restrictions for measured data including resolution and measuring range, refer to section 4.2.1.

(b) Unit

$\times 10^{-3}$ V *Unit is fixed.

(c) Update timing

It will be updated every measuring cycle (500 ms) if it exceeds the current max. value or goes under the current min. value.

- 6.3.15 Year of time of CH1 the max. voltage (Un\G322),
- month and day of time of CH1 max. voltage (Un\G323),
- hour and minute of time of CH1 max. voltage (Un\G324),
- second and day of the week of time of CH1 max. voltage (Un\G325),
- year of time of CH1 min. voltage (Un\G328),
- month and day of time of CH1 min. voltage (Un\G329),
- hour and minute of time of CH1 min. voltage (Un\G330),
- second and day of the week of time of CH1 min. voltage (Un\G331)

Stores year, month, day, hour, minute, and the day of the week of time of maximum voltage (Un\G320, 321) and minimum voltage (Un\G326, 327) were updated.

(1) Details of stored data

(a) Storage format

As indicated below, data are stored as BCD code in the buffer memory.

Buffer memory address	Storage format																
Un\G322 /Un\G328	<p>e.g.) Year 2010 2010h</p>																
Un\G323 /Un\G329	<p>e.g.) July 30 0730h</p>																
Un\G324 /Un\G330	<p>e.g.) 10:35 1035h</p>																
Un\G325 /Un\G331	<p>e.g.) 48sec Firday 4805h</p> <table border="1" style="margin-left: auto; margin-right: 0;"> <thead> <tr> <th colspan="2">Day of the week</th> </tr> </thead> <tbody> <tr><td>0</td><td>Sunday</td></tr> <tr><td>1</td><td>Monday</td></tr> <tr><td>2</td><td>Tuesday</td></tr> <tr><td>3</td><td>Wednesday</td></tr> <tr><td>4</td><td>Thursday</td></tr> <tr><td>5</td><td>Friday</td></tr> <tr><td>6</td><td>Saturday</td></tr> </tbody> </table>	Day of the week		0	Sunday	1	Monday	2	Tuesday	3	Wednesday	4	Thursday	5	Friday	6	Saturday
Day of the week																	
0	Sunday																
1	Monday																
2	Tuesday																
3	Wednesday																
4	Thursday																
5	Friday																
6	Saturday																

(b) Update timing

It will be updated every measuring cycle (500ms) and if it exceeds the max. value or goes under the min. value.

6.3.16 Multiplier of CH1 power (Un\G400)

The multiplier of power is stored.

(1) Details of stored data

(a) Storage format

Data are stored as 16-bit signed binary in the buffer memory.

- Data range: -3 (fixed)

(b) Update timing

Because it is fixed at -3, there is no update.

6.3.17 CH1 electric power (Un\G402,403)

The electric power (effective value) is stored.

(1) Details of stored data

(a) Storage format

Data are stored as double-word 32-bit signed binary in the buffer memory.

If the power is negative, represents the regenerative power.

- Data range: -999999999 to 999999999 (-999999.999 to 999999.999 kW)

*Restrictions for measured data including resolution and measuring range, refer to section 4.2.1.

*The sign of the data is as shown in the following figure.

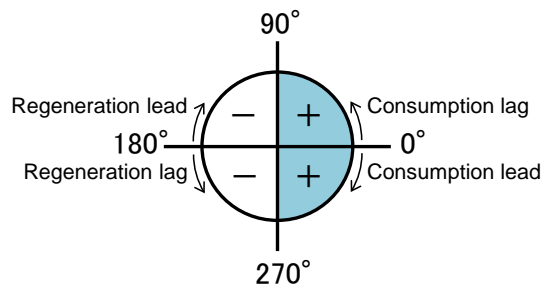

(b) Unit

$\times 10^{-3}$ kW *Unit is fixed.

(c) Update timing

It will be updated every measuring cycle (500 ms).

6.3.18 CH1 electric power demand (Un\G404,405)

Stores the electric power that is measured based on the moving average for the duration of time configured in CH1 electric power demand time (Un\G4).

(1) Details of stored data

(a) Storage format

Data are stored as double-word 32-bit signed binary in the buffer memory.

If the power is negative, represents the regenerative power.

- Data range: -999999999 to 999999999 (-999999.999 to 999999.999 kW)

*Restrictions for measured data including resolution and measuring range, refer to section 4.2.1.

(b) Unit

$\times 10^{-3}$ kW *Unit is fixed.

(c) Update timing

It will be updated every measuring cycle (500 ms).

6.3.19 CH1 maximum value of electric power demand (Un\G420, 421),

CH1 minimum value of electric power demand (Un\G426, 427)

Stores the max./min. values of the electric power demand.

(1) Details of stored data

(a) Storage format

Data are stored as double-word 32-bit signed binary in the buffer memory.

If the power is negative, represents the regenerative power.

- Data range: -999999999 to 999999999 (-999999.999 to 999999.999 kW)

*Restrictions for measured data including resolution and measuring range, refer to section 4.2.1.

(b) unit

$\times 10^{-3}$ kW *Unit is fixed.

(c) Update timing

It will be updated every measuring cycle (500 ms) if it exceeds the current max. value or goes under the current min. value.

- 6.3.20 Year of time of CH1 max. electric power demand (Un\G422),
- month and day of time of CH1 max. electric power demand (Un\G423),
- hour and minute of time of CH1 max. electric power demand (Un\G424),
- second and day of the week of time of CH1 max. electric power demand (Un\G425),
- year of time of CH1 min. electric power demand (Un\G428),
- month and day of time of CH1 min. electric power demand (Un\G429)
- hour and minute of time of CH1 min. electric power demand (Un\G430),
- second and day of the week of time of CH1 min. electric power demand (Un\G431)

Stores year, month, day, hour, minute, second, and day of the week of time when CH1 max. electric power demand (Un\G420, 421) and CH1 min. electric power demand (Un\G426, 427) were updated.

(1) Details of stored data

(a) Storage format

As indicated below, data are stored as BCD code in the buffer memory.

Buffer memory address	Storage format																
Un\G422 /Un\G428	<p>e.g.) Year 2010 2010h</p>																
Un\G423 /Un\G429	<p>e.g.) July 30 0730h</p>																
Un\G424 /Un\G430	<p>e.g.) 10:35 1035h</p>																
Un\G425 /Un\G431	<p>e.g.) 48sec Friday 4805h</p> <table border="1" style="margin-left: auto; margin-right: 0;"> <thead> <tr> <th colspan="2">Day of the week</th> </tr> </thead> <tbody> <tr><td>0</td><td>Sunday</td></tr> <tr><td>1</td><td>Monday</td></tr> <tr><td>2</td><td>Tuesday</td></tr> <tr><td>3</td><td>Wednesday</td></tr> <tr><td>4</td><td>Thursday</td></tr> <tr><td>5</td><td>Friday</td></tr> <tr><td>6</td><td>Saturday</td></tr> </tbody> </table>	Day of the week		0	Sunday	1	Monday	2	Tuesday	3	Wednesday	4	Thursday	5	Friday	6	Saturday
Day of the week																	
0	Sunday																
1	Monday																
2	Tuesday																
3	Wednesday																
4	Thursday																
5	Friday																
6	Saturday																

(b) Update timing

It will be updated every measuring cycle (500 ms) if it exceeds the current max. value or goes under the current min. value.

6.3.21 Multiplier of CH1 reactive power (Un\G500)

The multiplier of reactive power is stored.

(1) Details of stored data

(a) Storage format

Data are stored as 16-bit signed binary in the buffer memory.

- Data range: -3 (fixed)

(b) Update timing

Because it is fixed at -3, there is no update.

6.3.22 CH1 reactive power (Un\G502, 503)

The reactive power is stored.

(1) Details of stored data

(a) Storage format

Data are stored as double-word 32-bit signed binary in the buffer memory.

- Data range: -999999999 to 999999999 (-999999.999 to 999999.999 kvar)

*Restrictions for measured data including resolution and measuring range, refer to section 4.2.1.

*The sign of the data is as shown in the following figure.

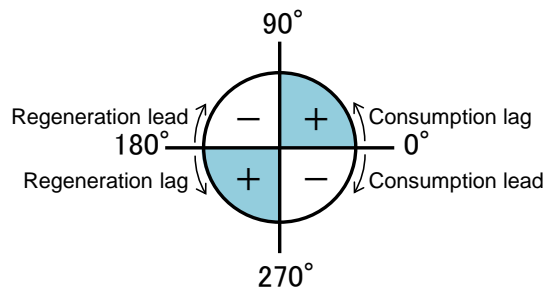

(b) Unit

$\times 10^{-3}$ kvar *Unit is fixed.

(c) Update timing

It will be updated every measuring cycle (500 ms).

6.3.23 Multiplier of CH1 power factor (Un\G700)

The multiplier of the power factor is stored.

(1) Details of stored data

(a) Storage format

Data are stored as 16-bit signed binary in the buffer memory.

- Data range: -3 (fixed)

(b) Update timing

Because it is fixed at -3, there is no update.

6.3.24 CH1 power factor (Un\G702, 703)

Stores the power factor.

(1) Details of stored data

(a) Storage format

Data are stored as double-word 32-bit signed binary in the buffer memory.

- Data range: -100000 to 100000 (-100.000 to 100.000%)

*Restrictions for measured data including resolution and measuring range, refer to section 4.2.1.

*The sign of the data is as shown in the following figure.

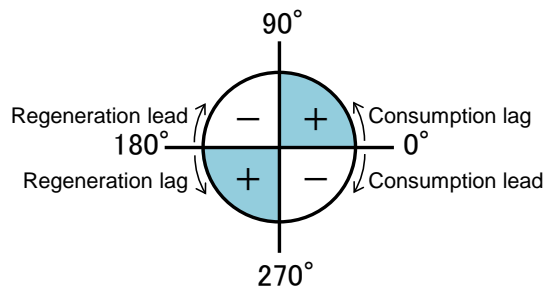

(b) Unit

$\times 10^{-3}\%$ *Unit is fixed.

(c) Update timing

It will be updated every measuring cycle (500 ms).

6.3.25 CH1 maximum power factor (Un\G720, 721), CH1 minimum power factor (Un\G726, 727)

The max./min. power factors are stored.

(1) Details of stored data

(a) Storage format

Data are stored as double-word 32-bit signed binary in the buffer memory.

- Data range: -100000 to 100000 (-100.000 to 100.000%)

*For the resolution, refer to Section 4.2.1.

(b) Unit

$\times 10^{-3}\%$ *Unit is fixed.

(c) Update timing

It will be updated every measuring cycle (500 ms).

- 6.3.26 Year of time of CH1 max. power factor (Un\G722),
- month and day of time of CH1 max. power factor (Un\G723),
- hour and minute of time of CH1 max. power factor (Un\G724),
- second and day of the week of time of CH1 max. power factor (Un\G725),
- year of time of CH1 min. power factor (Un\G728),
- month and day of time of CH1 min. power factor (Un\G729),
- hour and minute of time of CH1 min. power factor (Un\G730),
- second and day of the week of time of CH1 min. power factor (Un\G731)

Stores year, month, day, hour, minute, second, and day of the week of time when CH1 max. power factor (Un\G720, 721) and CH1 min. power factor (Un\G726, 727) were updated.

(1) Details of stored data

(a) Storage format

As indicated below, data are stored as BCD code in the buffer memory.

Buffer memory address	Storage format																
Un\G722 /Un\G728	<p>e.g.) Year 2010 2010h</p>																
Un\G723 /Un\G729	<p>e.g.) July 30 0730h</p>																
Un\G724 /Un\G730	<p>e.g.) 10:35 1035h</p>																
Un\G725 /Un\G731	<p>e.g.) 48sec Friday 4805h</p> <table border="1" style="margin-left: 20px;"> <thead> <tr> <th colspan="2">Day of the week</th> </tr> </thead> <tbody> <tr><td>0</td><td>Sunday</td></tr> <tr><td>1</td><td>Monday</td></tr> <tr><td>2</td><td>Tuesday</td></tr> <tr><td>3</td><td>Wednesday</td></tr> <tr><td>4</td><td>Thursday</td></tr> <tr><td>5</td><td>Friday</td></tr> <tr><td>6</td><td>Saturday</td></tr> </tbody> </table>	Day of the week		0	Sunday	1	Monday	2	Tuesday	3	Wednesday	4	Thursday	5	Friday	6	Saturday
Day of the week																	
0	Sunday																
1	Monday																
2	Tuesday																
3	Wednesday																
4	Thursday																
5	Friday																
6	Saturday																

(b) Update timing

It will be updated every measuring cycle (500 ms) if it exceeds the current max. value or goes under the current min. value.

6.3.27 Multiplier of CH1 frequency (Un\G800)

The multiplier of the frequency is stored.

(1) Details of stored data

(a) Storage format

Data are stored as 16-bit signed binary in the buffer memory.

- Data range: -3 (fixed)

(b) Update timing

Because it is fixed at -3, there is no update.

6.3.28 CH1 frequency (Un\G802, 803)

Stores the frequency.

(1) Details of stored data

(a) Storage format

Data are stored as double-word 32-bit signed binary in the buffer memory.

- Data range: 0 to 999999 (0 to 999.999 Hz)

*Restrictions for measured data including resolution and measuring range, refer to section 4.2.1.

(b) Unit

$\times 10^{-3}\%$ *Unit is fixed.

(c) Update timing

It will be updated every measuring cycle (500 ms).

6.4 Common sections (Un\G4500 to Un\G4999)

6.4.1 Latest error code (Un\G4500)

The latest error code that is detected with this module will be stored.
 *For the list of error codes, refer to section 10.1.

(1) Details of stored data

(a) Storage format

Data are stored as 16-bit signed binary in the buffer memory.
 - Data range: 0000h (normal), 0001h to FFFFh (error code)

(b) Update timing

It will be updated at the time of error occurrence and error recovery.

6.4.2 Year of time of the error (Un\G4501), month and day of time of the error (Un\G4502), hour and minute the error (Un\G4503), second and day of the week of time of the error (Un\G4504)

The year, month, day, hour, minute, and day of the week of time of the error will be stored.

(1) Details of stored data

(a) Storage format

As indicated below, data are stored as BCD code in the buffer memory.

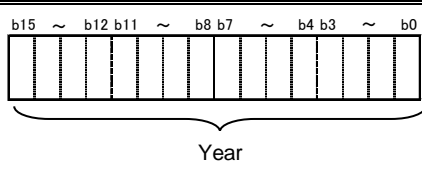
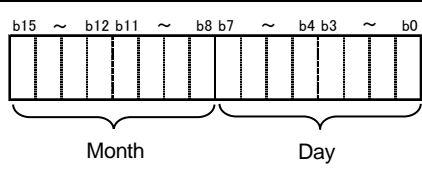
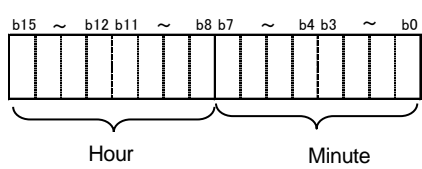
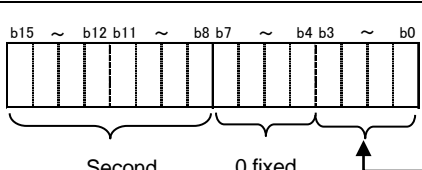
Buffer memory address	Storage format																
Un\G4501	 <p>e.g.) Year 2010 2010h</p>																
Un\G4502	 <p>e.g.) July 30 0730h</p>																
Un\G4503	 <p>e.g.) 10:35 1035h</p>																
Un\G4504	 <p>e.g.) 48sec Friday 4805h</p> <table border="1" data-bbox="1157 1803 1380 1982"> <thead> <tr> <th colspan="2">Day of the week</th> </tr> </thead> <tbody> <tr><td>0</td><td>Sunday</td></tr> <tr><td>1</td><td>Monday</td></tr> <tr><td>2</td><td>Tuesday</td></tr> <tr><td>3</td><td>Wednesday</td></tr> <tr><td>4</td><td>Thursday</td></tr> <tr><td>5</td><td>Friday</td></tr> <tr><td>6</td><td>Saturday</td></tr> </tbody> </table>	Day of the week		0	Sunday	1	Monday	2	Tuesday	3	Wednesday	4	Thursday	5	Friday	6	Saturday
Day of the week																	
0	Sunday																
1	Monday																
2	Tuesday																
3	Wednesday																
4	Thursday																
5	Friday																
6	Saturday																

(b) Update timing

It will be updated at the time of error occurrence and error recovery.

6.4.3 State of measuring mode (Un¥G4550)

Store the state of measuring mode.

(a) Storage format

Measuring mode :0

Current measuring mode :1

Test mode :2

(b) Update timing

It will be updated at the time of changing the setting the intelligent function of the module switch.

Chapter 7: Current measuring mode

7.1 Measuring functions in the current measuring mode

(1) Measured items

By activating the current measuring mode, you can measure only the current data shown below of up to eight circuits.

Each measured item is stored in the buffer memory every 100 ms.

Measured items	
Details	
Current	Current
Current demand	Current demand
	Maximum current demand
	Minimum current demand
	Date/time of the maximum current demand
	Date/time of the minimum current demand

(2) Maximum/minimum current demand

The maximum and minimum current demands are obtained as follows:

Maximum current demand: Maximum value obtained since the reset of the maximum and minimum values until now.

Minimum current demand: Minimum value obtained since the reset of the maximum and minimum values until now.

(3) Resolution of measured data

The resolution of the current value is same as those listed in 4.2.1 (3).

(4) Restrictions on measured data

The restrictions on the current value are same as those described in 4.2.1 (4).

7.2 Selecting the current measuring mode

1) How to use the current measuring mode

You can use the current measuring mode by the intelligent function module switch setting.

For GX Works 2, refer to 8.6.2.

For GX Developer, refer to 8.7.2.

7.3 List of I/O signals

I/O signals used in the current measuring mode are listed in Table 7.3-1.

Table 7.3-1 List of I/O signals

Input signal (signal direction from QE84WH to CPU module)		Output signal (signal direction from CPU module to QE84WH)	
Device #	Signal name	Device #	Signal name
Xn0	Module ready	Yn0	Use prohibited *1
Xn1	Data acquisition clock	Yn1	Use prohibited *1
Xn2	Operating condition setting completion flag	Yn2	Operating condition setting request
Xn3	Use prohibited *1	Yn3	Use prohibited *1
Xn4	Max./min. values clear completion flag	Yn4	Max./min. values clear request
Xn5	Use prohibited *1	Yn5	Use prohibited *1
Xn6	Use prohibited *1	Yn6	Use prohibited *1
Xn7	Use prohibited *1	Yn7	Use prohibited *1
Xn8	Use prohibited *1	Yn8	Use prohibited *1
Xn9	CH1 alarm 1 flag	Yn9	CH1 alarm 1 reset request
XnA	CH1 alarm 2 flag	YnA	CH1 alarm 2 reset request
XnB	CH2 alarm 1 flag	YnB	CH2 alarm 1 reset request
XnC	CH2 alarm 2 flag	YnC	CH2 alarm 2 reset request
XnD	CH3 alarm 1 flag	YnD	CH3 alarm 1 reset request
XnE	CH3 alarm 2 flag	YnE	CH3 alarm 2 reset request
XnF	CH4 alarm 1 flag	YnF	CH4 alarm 1 reset request
Xn10	CH4 alarm 2 flag	Yn10	CH4 alarm 2 reset request
Xn11	CH5 alarm 1 flag	Yn11	CH5 alarm 1 reset request
Xn12	CH5 alarm 2 flag	Yn12	CH5 alarm 2 reset request
Xn13	CH6 alarm 1 flag	Yn13	CH6 alarm 1 reset request
Xn14	CH6 alarm 2 flag	Yn14	CH6 alarm 2 reset request
Xn15	CH7 alarm 1 flag	Yn15	CH7 alarm 1 reset request
Xn16	CH7 alarm 2 flag	Yn16	CH7 alarm 2 reset request
Xn17	CH8 alarm 1 flag	Yn17	CH8 alarm 1 reset request
Xn18	CH8 alarm 2 flag	Yn18	CH8 alarm 2 reset request
Xn19	Use prohibited *1	Yn19	Use prohibited *1
Xn1A	Use prohibited *1	Yn1A	Use prohibited *1
Xn1B	Use prohibited *1	Yn1B	Use prohibited *1
Xn1C	Use prohibited *1	Yn1C	Use prohibited *1
Xn1D	Use prohibited *1	Yn1D	Use prohibited *1
Xn1E	Use prohibited *1	Yn1E	Use prohibited *1
Xn1F	Error flag	Yn1F	Error clear request

Point

*1 These signals cannot be used by the user since they are for system use only.

For details about each I/O signal, refer to Section 5.2.

7.4 Buffer memory

The following describes buffer memory assignment in the current measuring mode.

Table 7.4-1 Buffer memory

Item	Address(Decimal)								Data Type	Description	t value	R/W	Back up*2	Output value during the test mode*2								
	CH1	CH2	CH3	CH4	CH5	CH6	CH7	CH8						CH1	CH2	CH3	CH4	CH5	CH6	CH7	CH8	
Setting	—	4050	4100	4150	4200	4250	4300	4350	—	System area	—	—	—	—								
		4052	4102	4152	4202	4252	4302	4352	—													
		4000							Pr	Output period of data acquisition clock	0	R/W	○	0								
		4001							Pr	Max./min. value clear target	0	W	—	0								
		4003	4053	4103	4153	4203	4253	4303	4353	Pr	Primary current	2	R/W	○	521	522	523	524	525	526	527	528
		4004	4054	4104	4154	4204	4254	4304	4354	Pr	Current demand time	120	R/	○	1010	1020	1030	1040	1050	1060	1070	1080
		4005	4055	4105	4155	4205	4255	4305	4355	Pr	Primary current of CT	0	R/	○	0	0	0	0	0	0	0	0
		4004	4054	4104	4154	4204	4254	4304	4354	—	System area	—	—	—	—							
		4010	4060	4110	4160	4210	4260	4310	4360	—												
		4011	4061	4111	4161	4211	4261	4311	4361	Pr	Alarm 1 item	0	R/	○	1	2	1	2	1	2	1	2
		4012	4062	4112	4162	4212	4262	4312	4362	Pr	Alarm 1 value	0	R/W	○	2010	2020	2030	2040	2050	2060	2070	2080
		4013	4063	4113	4163	4213	4263	4313	4363	—												
		4014	4064	4114	4164	4214	4264	4314	4364	Pr	Alarm 1 reset method	0	R/	○	0	1	0	1	0	1	0	1
		4015	4065	4115	4165	4215	4265	4315	4365	Pr	Alarm 1 delay time	0	R/	○	101	102	103	104	105	106	107	108
		4016	4066	4116	4166	4216	4266	4316	4366	—	System area	—	—	—	—							
		4020	4070	4120	4170	4220	4270	4320	4370	—												
		4021	4071	4121	4171	4221	4271	4321	4371	Pr	Alarm 2 item	0	R/	○	2	1	2	1	2	1	2	1
		4022	4072	4122	4172	4222	4272	4322	4372	Pr	Alarm 2 value	0	R/W	○	3010	3020	3030	3040	3050	3060	3070	3080
		4023	4073	4123	4173	4223	4273	4323	4373	—												
		4024	4074	4124	4174	4224	4274	4324	4374	Pr	Alarm 2 reset method	0	R/	○	1	0	1	0	1	0	1	0
		4025	4075	4125	4175	4225	4275	4325	4375	Pr	Alarm 2 delay time	0	R/	○	201	202	203	204	205	206	207	208
		4026	4076	4126	4176	4226	4276	4326	4376	—	System area	—	—	—	—							
		4029	4079	4129	4179	4229	4279	4329	4379	—												
		4030	4080	4130	4180	4230	4280	4330	4380	Md	Multiplier of current	-3	R	—	-3	-3	-3	-3	-3	-3	-3	-3
		4031	4081	4131	4181	4231	4281	4331	4381	—	System area	—	—	—	—							
		4032	4082	4132	4182	4232	4282	4332	4382	Md	Current	0	R	—	91100	91200	91300	91400	91500	91600	91700	91800
		4033	4083	4133	4183	4233	4283	4333	4383	—												
		4034	4084	4134	4184	4234	4284	4334	4384	Md	Current demand	0	R	—	92100	92200	92300	92400	92500	92600	92700	92800
		4035	4085	4135	4185	4235	4285	4335	4385	—												
		4036	4086	4136	4186	4236	4286	4336	4386	Md	Maximum current demand	0	R	—	93100	93200	93300	93400	93500	93600	93700	93800
		4037	4087	4137	4187	4237	4287	4337	4387	—												
		4038	4088	4138	4188	4238	4288	4338	4388	Md	Year of time of max. current	0	R	—	2051h	2052h	2053h	2054h	2055h	2056h	2057h	2058h
		4039	4089	4139	4189	4239	4289	4339	4389	Md	Month and day of time of max. current demand	0	R	—	1121h	1122h	1123h	1124h	1125h	1126h	1127h	1128h
		4040	4090	4140	4190	4240	4290	4340	4390	Md	Hour and minute of time of max. current demand	0	R	—	2041h	2042h	2043h	2044h	2045h	2046h	2047h	2048h
		4041	4091	4141	4191	4241	4291	4341	4391	Md	Second and day of the week of time of max. current demand	0	R	—	2100h	2201h	2302h	2403h	2504h	2605h	2706h	2800h
		4042	4092	4142	4192	4242	4292	4342	4392	—												
		4043	4093	4143	4193	4243	4293	4343	4393	Md	Minimum current demand	0	R	—	94100	94200	94300	94400	94500	94600	94700	94800
		4044	4094	4144	4194	4244	4294	4344	4394	Md	Year of time of min. current	0	R	—	2061h	2062h	2063h	2064h	2065h	2066h	2067h	2068h
		4045	4095	4145	4195	4245	4295	4345	4395	Md	Month and day of time of min. current demand	0	R	—	1201h	1202h	1203h	1204h	1205h	1206h	1207h	1208h
		4046	4096	4146	4196	4246	4296	4346	4396	Md	Hour and minute of time of min. current demand	0	R	—	2151h	2152h	2153h	2154h	2155h	2156h	2157h	2158h
	4047	4097	4147	4197	4247	4297	4347	4397	Md	Second and day of the week of time of min. current demand	0	R	—	3101h	3202h	3303h	3404h	3505h	3606h	3700h	3801h	
	4048	4098	4148	4198	4248	4298	4348	4398	—	System area	—	—	—	—								
	4049	4099	4149	4199	4249	4299	4349	4399	—													

* Set the primary current to the same value between CH1 and CH2, between CH3 and CH4, between CH5 and CH6, and between CH7 and CH8. If you set the CH2 (or CH4, CH6, or CH8) address to any value that is inconsistent with the value of CH1 (or CH3, CH5, or CH7), the value you set becomes invalid and is replaced with the value of CH1 (or CH3, CH5, or CH7) after the operating conditions are set.

7.5 Names and functions of LEDs

The following describes names and functions of LEDs in the current measuring mode.

Table 7.5-1 Names and functions of LEDs (in the current measuring mode)

Name	Color	Role	ON/OFF condition
0 LED	Green	Displays the operation status of this module.	ON: Normal operation OFF: Internal power shut-off, hardware error *1
1 LED	Green	Displays CH1 current measurement status.	ON: CH1 current > 0 A OFF: CH1 current = 0 A
2 LED	Green	Displays CH2 current measurement status.	ON: CH2 current > 0 A OFF: CH2 current = 0 A
3 LED	Green	Displays CH3 current measurement status.	ON: CH3 current > 0 A OFF: CH3 current = 0 A
4 LED	Green	Displays CH4 current measurement status.	ON: CH4 current > 0 A OFF: CH4 current = 0 A
5 LED	Green	Displays CH5 current measurement status.	ON: CH5 current > 0 A OFF: CH5 current = 0 A
6 LED	Green	Displays CH6 current measurement status.	ON: CH6 current > 0 A OFF: CH6 current = 0 A
7 LED	-	-	Always OFF.
8 LED	Red	Displays errors and conditions of this module.	Flashing: Out-of-range error *1 ON: Hardware error *1 OFF: Normal operation
9 LED	Green	Displays CH7 current measurement status.	ON: CH7 current > 0 A OFF: CH7 current = 0 A
A LED	Green	Displays CH8 current measurement status.	ON: CH8 current > 0 A OFF: CH8 current = 0 A
B LED	-	-	Always OFF.
C LED	-	-	Always OFF.
D LED	-	-	Always OFF.
E LED	-	-	Always OFF.
F LED	-	-	Always OFF.

*1 For details, check with the list of error codes. (Refer to Section 10.1.)

7.6 Names of signals of terminal block

The following describes names of signals of terminal block in the current measuring mode.

Table 7.6-1 Names of signals of terminal block

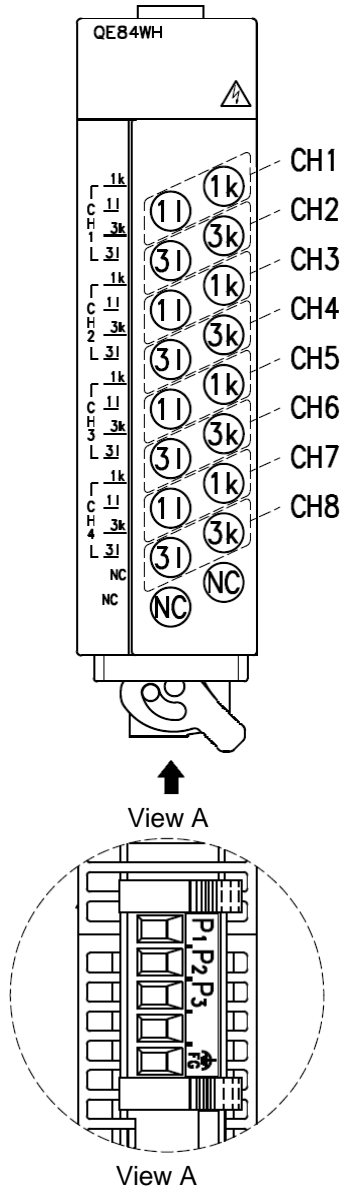

CH1	1k	CH1 current input terminal (power source side)
	1l	CH1 current input terminal (load side)
	3k	CH2 current input terminal (power source side)
	3l	CH2 current input terminal (load side)
CH2	1k	CH3 current input terminal (power source side)
	1l	CH3 current input terminal (load side)
	3k	CH4 current input terminal (power source side)
	3l	CH4 current input terminal (load side)
CH3	1k	CH5 current input terminal (power source side)
	1l	CH5 current input terminal (load side)
	3k	CH6 current input terminal (power source side)
	3l	CH6 current input terminal (load side)
CH4	1k	CH7 current input terminal (power source side)
	1l	CH7 current input terminal (load side)
	3k	CH8 current input terminal (power source side)
	3l	CH8 current input terminal (load side)
P1	-	
P2	-	
P3	-	
FG	-	

Figure 7.6-1 Placement of the terminal block

7.7 Wiring

Follow the wiring diagram for external connection in the current measuring mode.

(1) In the case using 5A current sensor.

(a) Case of using EMU2-CT5

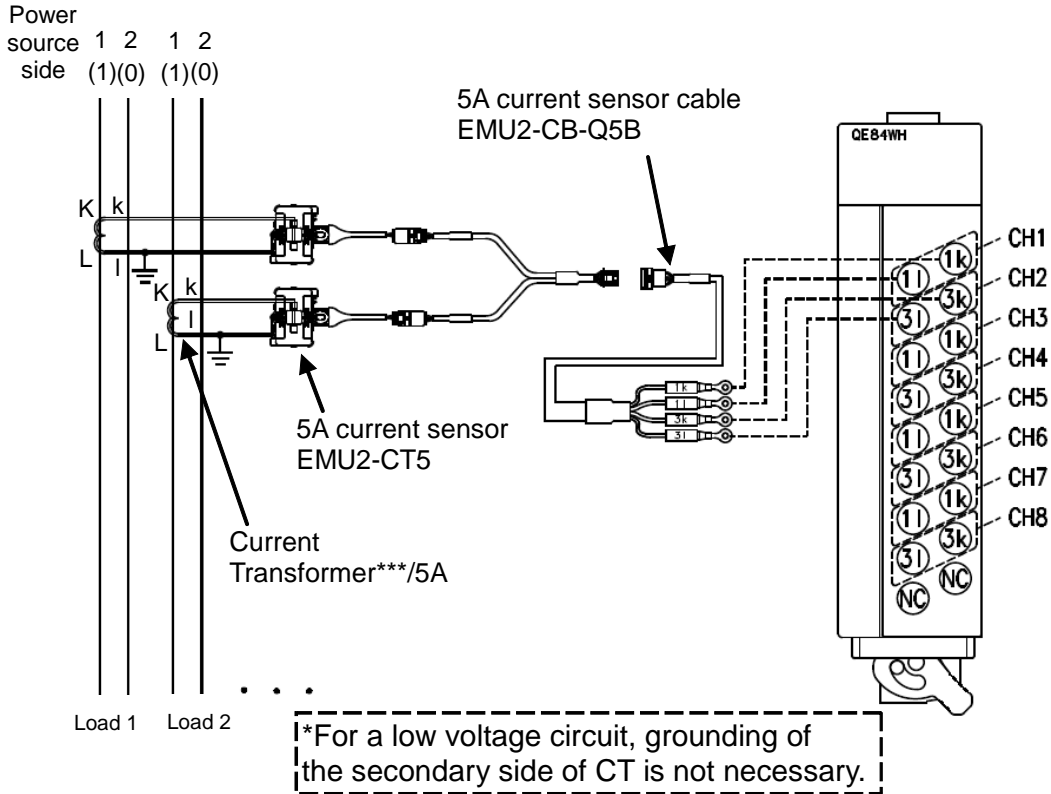

Figure 7.7(1)-(a) Wiring in the using EMU2-CT5 (with the current transformer)

(b) Case of using EMU-CT5-A

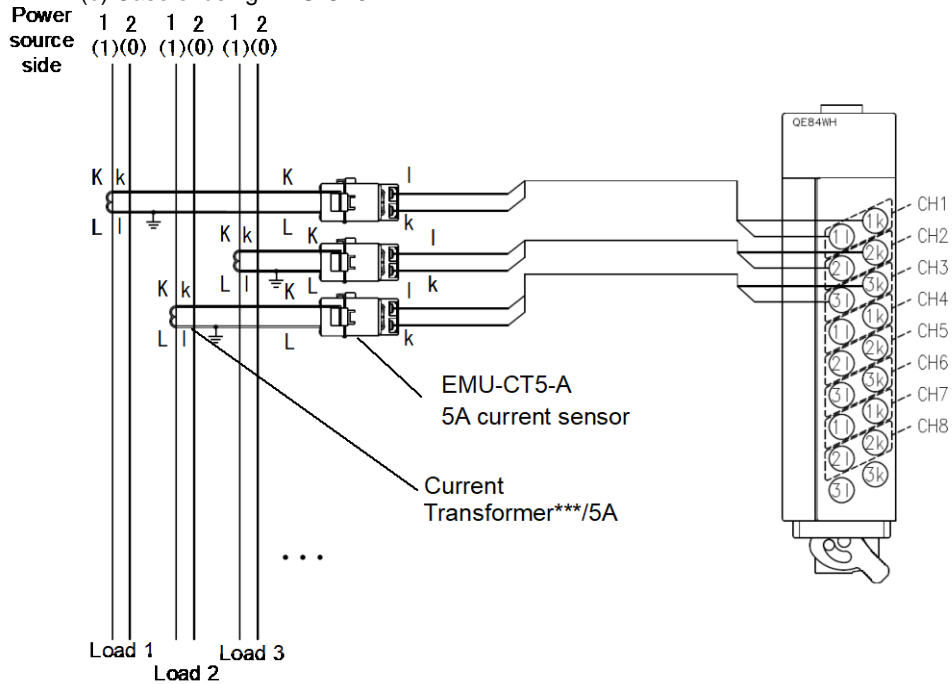

Figure 7.7(1)-(b) Wiring in the using EMU-CT5-A (with the current transformer)

(2) In the case using split-type current sensor.

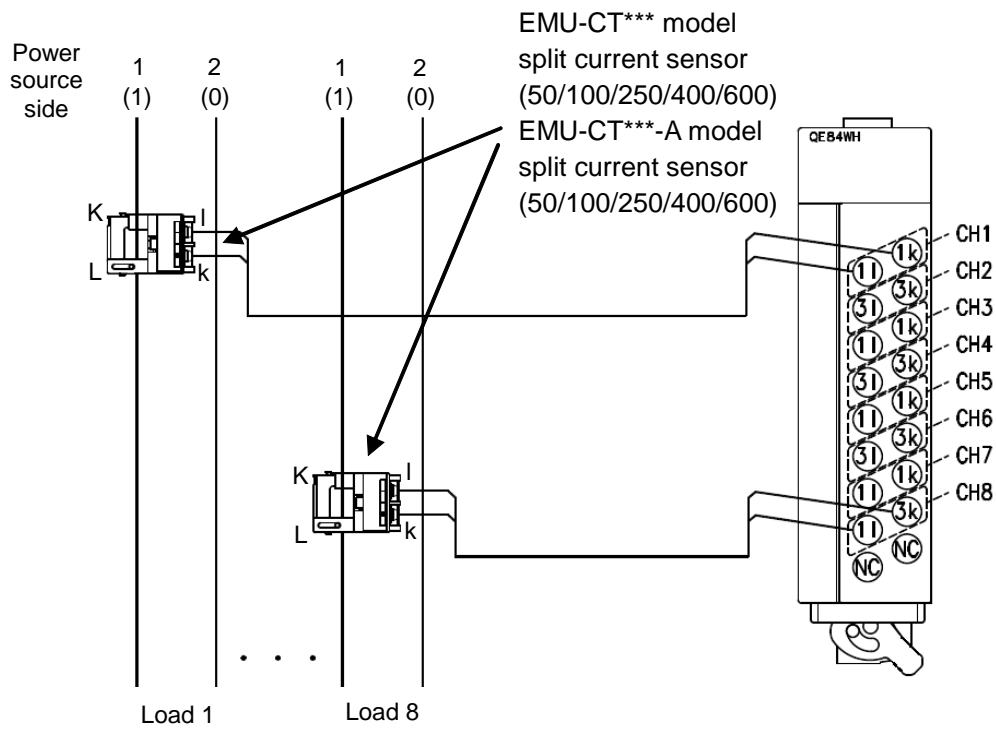

Figure7.7(2) Wiring in the using split current sensor

7.8 Setting from GX Works2

This section explains setting from GX Works2 necessary to use QE84WH. Before performing this setting, install GX Works2 and connect the Management CPU with the PC using a USB cable. For details, refer to the manual of CPU module.

Point

To addition the unit, enable the switch setting, parameter setting and auto refresh, write the settings to the CPU module, and reset the CPU module or power on the programmable controller again.

7.8.1 Addition the unit

Add the model name of the energy measuring module to use the project.

(1) Addition procedure

Open the “New Module” window.

Project window→[intelligent Function Module]→Right-click→[New Module...]

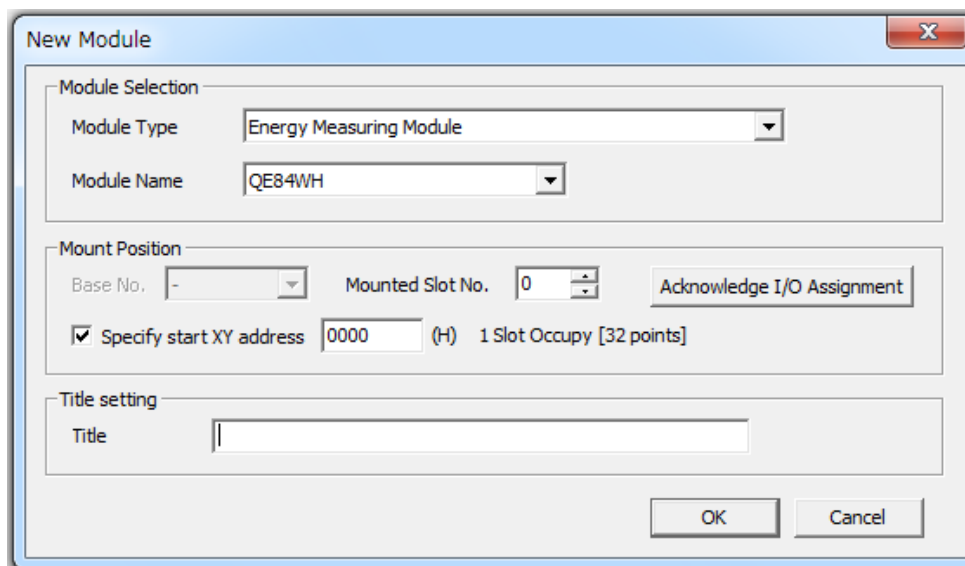

Figure 7.8.1-1 Dialog box of “I/O assignment”

Table 7.8.1-1 Setting items on the “I/O assignment” tab

Item		Description
Module Selection	Module Type	Set [Energy Measuring module].
	Module Name	Set the name of the module to mount.
Mount Position	Base No.	Set the base No. where the module is mounted.
	Mounted Slot No.	Set the slot No. where the module is mounted.
	Specify start XY address	The start I/O number (hexadecimal) of the target module is set, according to the mounted slot No. Any start I/O number can be set.
Title Setting	Title	Set any title.

7.8.2 Setting the intelligent function of the module switch

Set the operation mode.

(1)Setting procedure

Open the “Switch Setting” window.

Project window→[intelligent Function Module]→Module name→[Switch Setting]

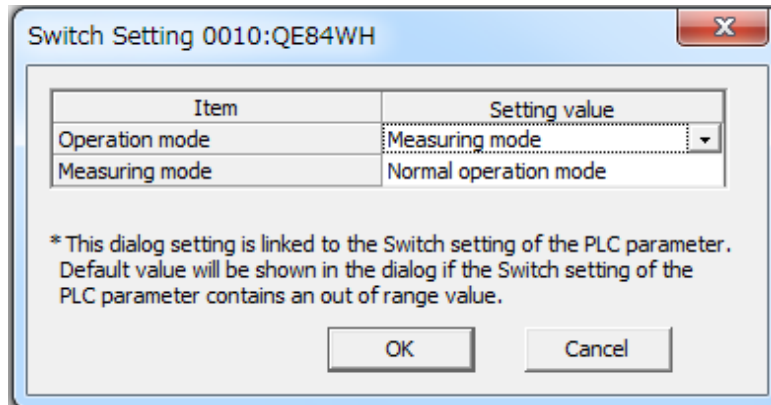

Figure 7.8.2-1 Dialog box to set the intelligent function of the module switch

Table 7.8.2-1 Setting the intelligent function of the module switch

Item	Description	Setting value
Operation mode	Measurement Mode and test mode are changed.	Measuring mode (default) Test mode
Measuring mode	When set measuring mode above setting, set the kind of measuring mode. When set test mode above setting, this setting disable.	Regular operating mode(default) Current measuring mode

7.8.3 Parameter Setting

Set the parameters.

Setting parameters on the screen omits the parameter setting in a program.

(1) Setting procedure

Open the "Parameter" window.

Project window → [intelligent Function Module] → Module name → [Parameter]

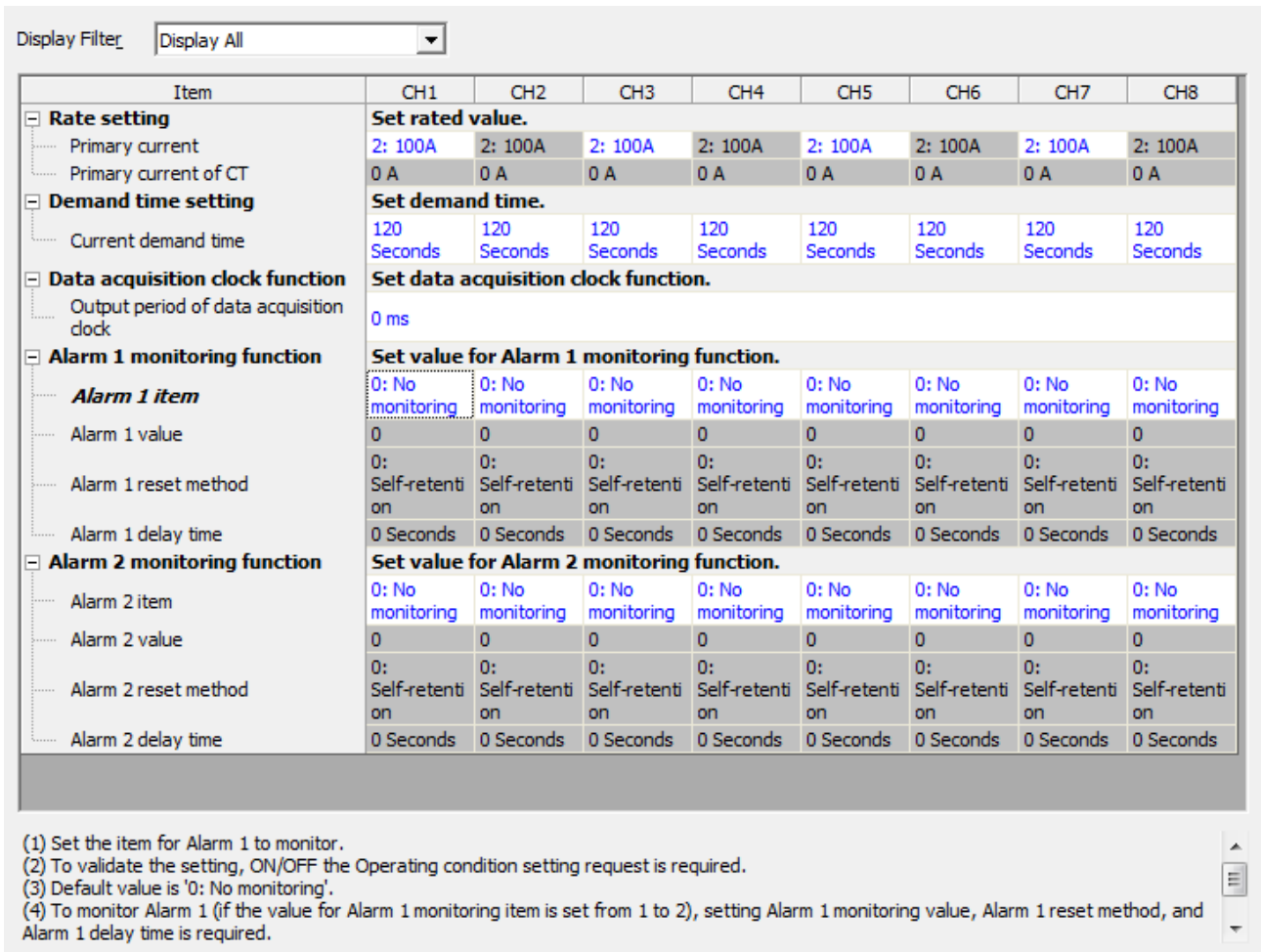

Figure 7.8.3-1 Dialog box to monitor all buffer memories (a case where the module is attached to the slot 0)

(2) Double-click the item to change the setting, and input the setting value.

- Items to input from the pull-down list
 Double-click the item to set to display the pull-down list. Select the item.
- Items to input from the text box
 Double-click the item to set, and input the setting value.

(3) Setup of CH2 to CH8 is performed by operation of Procedure (2).

Item	Setting value		Reference	
Rate setting	Primary current	0:Any setting	516:100/5A	Section 6.2.3
		1:50A	517:120/5A	
		2:100A	518:150/5A	
		3:250A	519:200/5A	
		4:400A	520:250/5A	
		5:600A	521:300/5A	
		501:5/5A	522:400/5A	
		502:6/5A	523:500/5A	
		503:7.5/5A	524:600/5A	
		504:8/5A	525:750/5A	
		505:10/5A	526:800/5A	
		506:12/5A	527:1000/5A	
		507:15/5A	528:1200/5A	
		508:20/5A	529:1500/5A	
		509:25/5A	530:1600/5A	
		510:30/5A	531:2000/5A	
511:40/5A	532:2500/5A			
512:50/5A	533:3000/5A			
513:60/5A	534:4000/5A			
514:75/5A	535:5000/5A			
515:80/5A	536:6000/5A			
	Primary current of CT	0~6000A	Section 6.2.3	
Demand time setting	Current demand time	0~1800seconds	Section 6.2.4	
Data acquisition clock function	Output period of data acquisition clock	flag non-use:0 flag use:1~8640000ms	Section 6.2.12	
Alarm 1 monitoring function	Alarm 1 item	0:No monitoring 1:Current demand upper limit 2:Current demand lower limit	Section 6.2.6	
	Alarm 1 value	-2147483648 to 2147483647	Section 6.2.7	
	Alarm 1 reset method	0:Self-retention 1:Auto reset	Section 6.2.8	
	Alarm 1 delay time	0 to 300seconds	Section 6.2.9	
Alarm 2 monitoring function	Alarm 2 item	0:No monitoring 1:Current demand upper limit 2:Current demand lower limit	Section 6.2.6	
	Alarm 2 value	-2147483648 to 2147483647	Section 6.2.7	
	Alarm 2 reset method	0:Self-retention 1:Auto reset	Section 6.2.8	
	Alarm 2 delay time	0 to 300 seconds	Section 6.2.9	

7.8.4 Auto Refresh

This function transfers data in the buffer memory to specified devices.
Programming of reading/writing data is unnecessary.

(1) Setting procedure

1) Start "Auto Refresh" .

Project window→[intelligent Function Module]→Module name→[Auto Refresh]

2) Start "Auto Refresh" .

Click the item to set, and input the destination device for auto refresh.

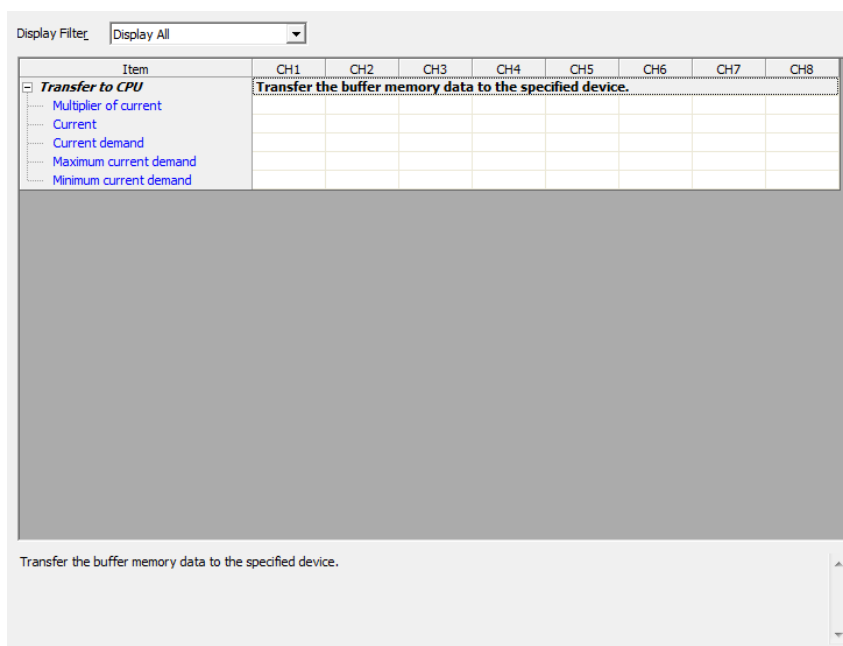

Point
Available devices are X, Y, M, L, B, T, C, ST, D, W, R, and ZR. When a bit device X, Y, M, L, or B is used, set a number that is divisible by 16 points (example: X10, Y120, M16). Data in the buffer memory are stored in 16 points of devices starting from the set device No. (Example: When X10 is set, the data are stored in X10 to X1F).

7.8.5 Debugging program

QE84WH provides a test function so that you can debug a program with no input of voltage or current. Pseudo-value can be stored into the buffer memory. For detailed explanation for the test function, refer to 4.2.5.

**Caution**

Test function stores pseudo-values for setting value and error information as well as measured value. If you use these data to control the sequence program that controls external devices, there is a chance that erroneous control may occur. For safety of external devices, use this function after disconnecting the device.

- (1) Setting intelligent function of the module switch
 - 1) Configure the operation mode in switch setting as shown below. (Refer to 8.6.2)
Test mode transition : Test mode
 - 2) From the "Online" menu, select "Write to PLC" to display the dialog box of Write to PLC, and then execute the writing to PLC parameter. After resetting the CPU module, the value will become effective.

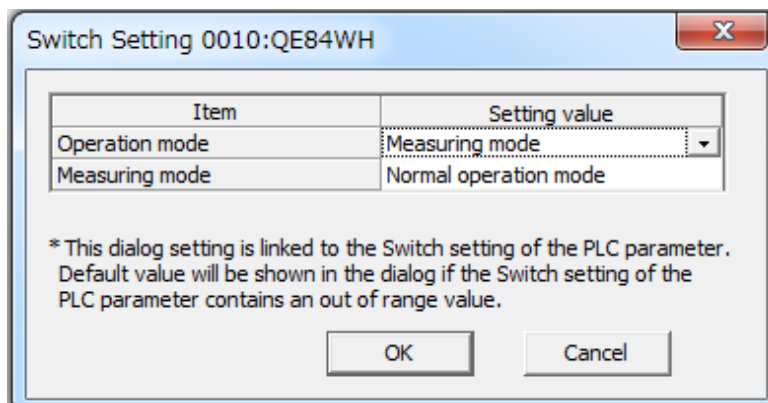

- (2) Starting the test function
 - 1) Reset the CPU module.
 - 2) QE84WH starts in the test function mode. All LEDs are turned on. Pseudo-values are stored in the buffer memory.
- (3) Finishing the test function (Move back to the measuring mode)
 - 1) Following 1) in step (1), Configure the operation mode in switch setting as shown below
Test mode transition : Test mode
 - 2) Following 2) in step (1), write the data into PLC.
 - 3) Reset the CPU module, then the operation goes back to the measuring mode.

7.9 Setting from GX Developer

This section explains setting from GX Developer necessary to use QE84WH. Before performing this setting, install GX Developer and connect the Management CPU with the PC using a USB cable. For details, refer to the manual of CPU module.

7.9.1 I/O assignment setting

- (1) Double-click the dialog box of “PLC Parameter” in the GX Developer Project.
- (2) Click “I/O assignment”.
- (3) Set the following item to the slot*1 to which QE84WH has been attached.

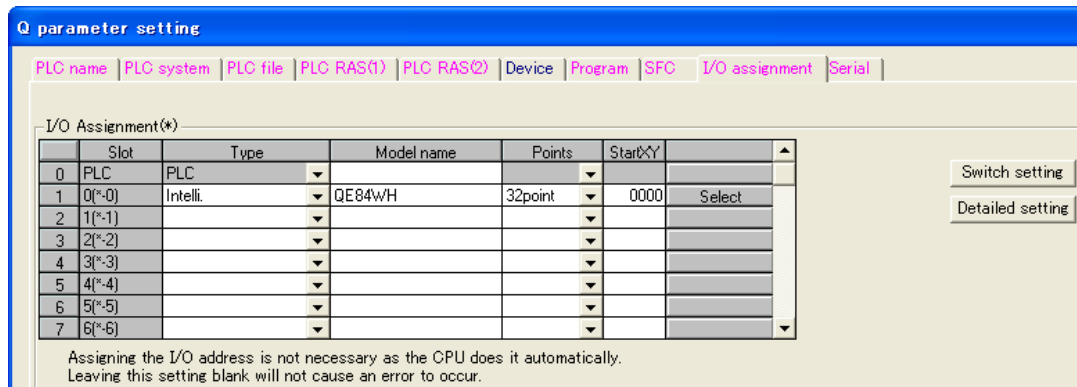

Figure 7.9.1-1 Dialog box of “I/O assignment”

Table 7.9.1-1 Setting items on the “I/O assignment” tab

Item	Descriptions
Type	Select “Intelli.”.
Model name	Enter the model name of the module.
Points	Select 32 points.
Start XY	Enter the initial I/O number of QE84WH.

*1 is a case where QE84WH is attached to the slot 0.

7.9.2 Setting the intelligent function of the module switch

- (1) In the “I/O assignment” of 7.9.1, click the **Switch setting** button to display the dialog box of “I/O module, intelligent function module switch setting”.
- (2) The intelligent function module switch setting displays switches 1 to 5; however, only switches 4 and 5 is used for this purpose. Switch setting is configured using 16-bit data. Settings are as shown in Table 7.9.2-1.

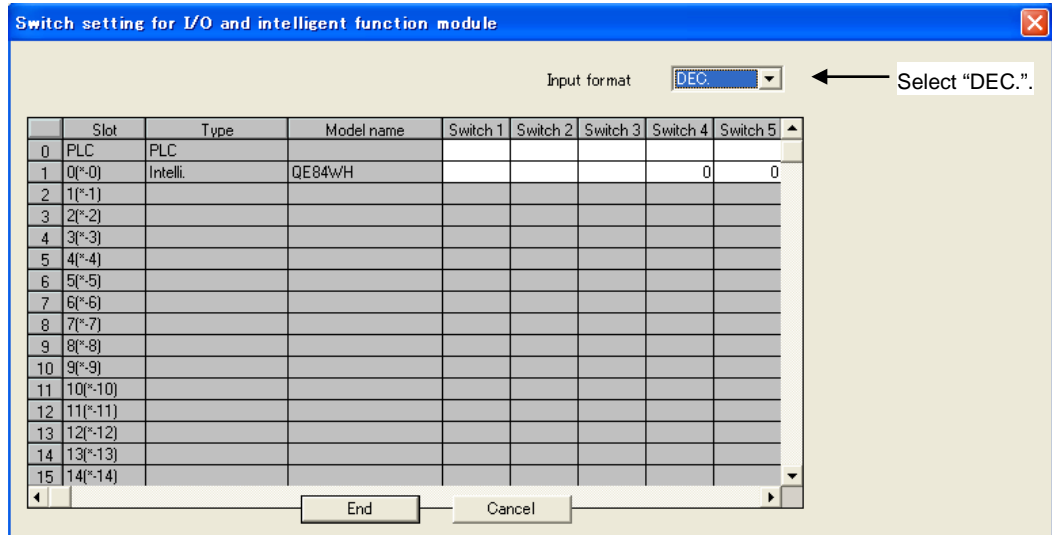

Figure 7.9.2-1 Dialog box to set the intelligent function of the module switch

Table 7.9.2-1 Setting the intelligent function of the module switch

Swith No.	Switch name	Description
1	Not used	-
2	Not used	-
3	Not used	-
4	Measuring mode selection	0: Regular operating mode 1: Current measuring mode *When switch 5 is set to "1", the test mode is selected.
5	Test mode transition	0: Measuring mode (Even when this switch is not set, the module runs in the measuring mode.) 1: Test mode * For details of test mode, refer to 4.2.5.

- (3) When the setting is completed, click the Complete setting button.
- (4) From the “Online” menu, select “Write to PLC” to display the dialog box of Write to PLC, and then execute the writing to PLC parameter. After resetting the CPU module, the value will become effective.

7.9.3 Initial setting

This section explains the setting of the operating condition for phase wire system, primary voltage, primary current, current demand time, voltage demand time, primary voltage of VT, secondary voltage of VT, and primary current of CT that are required for measurement. Once each value is set, these values will be stored in the nonvolatile memory of the module, so that reconfiguration is not needed. You can also perform the setting using sequence program. In this case, you need to create a program, as referring to Chapter 9.

Follow the procedure below for each setting.

- (1) Check the current setting
- (2) Set the Buffer memory

(1) Check the current setting

- 1) From the “Online” menu, select “Monitor” – “Buffer memory batch ...”.The dialog box to monitor all buffer memories. After setting the address as shown below, click the **Start monitoring** button to check the current buffer memory status.

Module initial address: Set the initial address of this module.

Buffer memory address: 0

(Display: 16-bit integer, numerical value: check the number in decimal)

- 2) Check each item. The following shows items for operating condition settings. For specific setting value, see the provided references.

Table 7.9.3-1 List of setting items

Buffer memory address								Item	Reference
CH1	CH2	CH3	CH4	CH5	CH6	CH7	CH8		
Un\ G4003	Un\ G4053	Un\ G4103	Un\ G4153	Un\ G4203	Un\ G4253	Un\ G4303	Un\ G4353	Primary current	Section 6.2.3
Un\ G4004	Un\ G4054	Un\ G4104	Un\ G4154	Un\ G4204	Un\ G4254	Un\ G4304	Un\ G4354	Current demand time	Section 6.2.4
Un\ G4005	Un\ G4055	Un\ G4105	Un\ G4155	Un\ G4205	Un\ G4255	Un\ G4305	Un\ G4355	Primary current of CT	Section 6.2.3

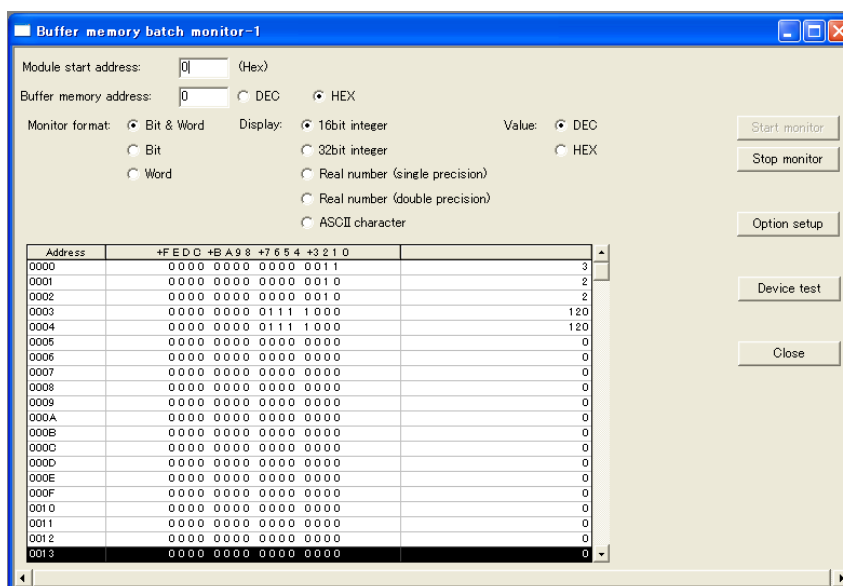

Figure 7.9.3-1 Dialog box to monitor all buffer memories (a case where the module is attached to the slot 0)

- (2) Set the Buffer memory
 - 1) In the dialog box to monitor all buffer memories, click the **Device test** button to display the Device test dialog box.
 - 2) In the Word device / buffer memory, specify the module initial address and buffer address, and click the **Set** button to apply the setting.

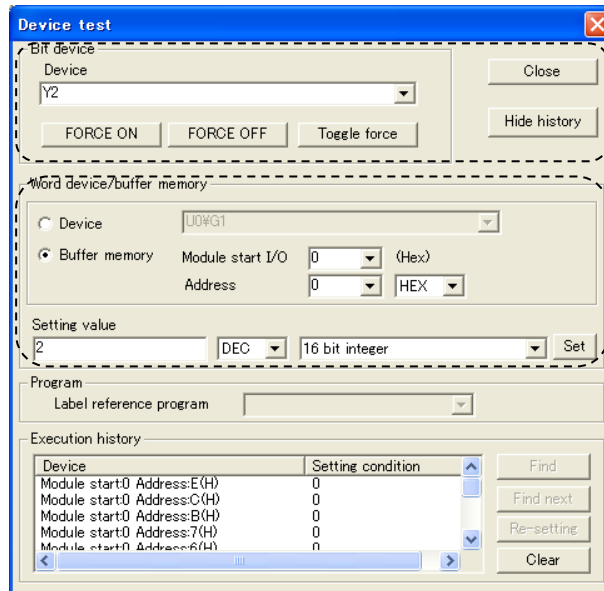

Figure 7.9.3-2 Device test dialog box (a case where this module is attached to the slot 0)

- 3) Change the setting in 2).
- 4) In the section of bit device setting in the device test dialog box, select "Y2"* and click the **FORCE ON** button.
- 5) When the setting is completed without any problem, the Device "X2"* changes to ON. Check this using the procedure as follows:
 - (a) From the "Online" menu, select "Monitor" – "Device batch ...". The dialog box to monitor all devices is displayed.
 - (b) Set "X0"* to the device, and click "Start monitor"
 - (c) Check that Device "X2"* is in the ON status.

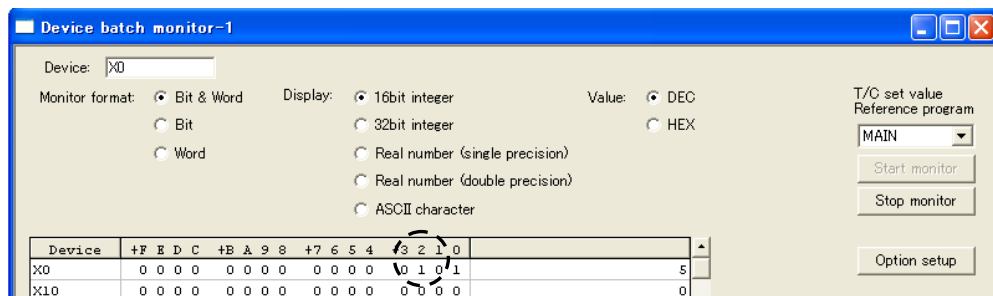

Figure 7.9.3-3 Checking the device "X2"* in the dialog box to monitor all devices

- 6) After checking that the device "X2"* is in the ON status, select "Device: "Y2"* in the dialog box of device test, and then click the **FORCE OFF** button. Setting is completed.
 - 7) If the Device "X2"* is not in the ON status, this means an error because the set value is out of range (ERR.LED is flashing). Modify the setting, and change the device "Y2" to the OFF status, then change it back to the ON status.
- * Indicates a number in the case where the initial I/O number (initial XY) is set to 0.

7.9.4 Debugging program

QE84WH provides a test function so that you can debug a program with no input of voltage or current. Pseudo-value can be stored into the buffer memory. For detailed explanation for the test function, refer to 4.2.5.

**Caution**

Test function stores pseudo-values for setting value and error information as well as measured value. If you use these data to control the sequence program that controls external devices, there is a chance that erroneous control may occur. For safety of external devices, use this function after disconnecting the device.

- (1) Setting intelligent function of the module switch
 - 1) In the "I/O assignment setting" of 7.9.1, click the **Switch setting** button to display the dialog box of "I/O module, intelligent function module switch setting". (Refer to 7.9.2)
 - 2) The intelligent function module switch setting displays switches 1 to 5; however, use switch 5 when using the test function. Switch setting is configured using 16-bit data.
Setting is as follows:
Switch 5: "1"
 - 3) When the setting is completed, click the **End** button.
 - 4) From the "Online" menu, select "Write to PLC" to display the dialog box of Write to PLC, and then execute the writing to PLC parameter. After resetting the CPU module, the value will become effective.
- (2) Starting the test function
 - 1) Reset the CPU module.
 - 2) QE84WH starts in the test function mode. All LEDs are turned on. Pseudo-values are stored in the buffer memory.
- (3) Finishing the test function (Move back to the measuring mode)
 - 1) Following 1) and 2) in step (1), configure the intelligent function switch setting as shown below.
Switch 5: "0"
 - 2) Following 3) and 4) in step (1), complete the setting and write the data into PLC.
 - 3) Reset the CPU module, then the operation goes back to the measuring mode.

Chapter 8: Setting and procedure for operation

8.1 Precautions for handling

- (1) Do not drop or apply strong shock to the module case.
- (2) Do not remove the printed-circuit board of the module from the case.
Doing so may cause failure.
- (3) Prevent foreign matter such as dust or wire chips from entering the module.
Such foreign matter can cause a fire, failure, or malfunction.
- (4) A protective film is attached to the top of the module to prevent foreign matter, such as wire chips, from entering the module during wiring.
Do not remove the film during wiring.
Remove it for heat dissipation before system operation.
- (5) Module fixing screws must be tightened within the specified range as described below.
Loose screws may cause short-circuit, failure, or malfunction.
*1 The module can be fixed easily to the base unit, using the hook on top of the module. However, if it is used under a vibrating environment, we strongly recommend that the module be fixed with screws.

Table 8.1-1 Tightening torque

Locations of screws	Torque range
Module fixing screws (M3 x 12 mm)	0.36 - 0.48 N•m
Terminal screws on the current input terminal block (M3)	0.42 - 0.58 N•m
Current input terminal block fixing screws (M3.5)	0.66 - 0.89 N•m
Terminal screws on the voltage input terminal block	0.4 - 0.5 N•m

- (6) To attach the module to the base unit, firmly insert the protruding portions for fixing the module into the holes on the base unit, and make sure the module is securely attached to the module holes as fulcrum points.
Insecure attachment of the module may cause malfunction, failure, and a falling.
- (7) Before touching the module, make sure that you need to discharge static electricity on your body by touching a metal that is grounded.
Otherwise, it may cause failure or malfunction to the module.

8.2 Procedure for operation

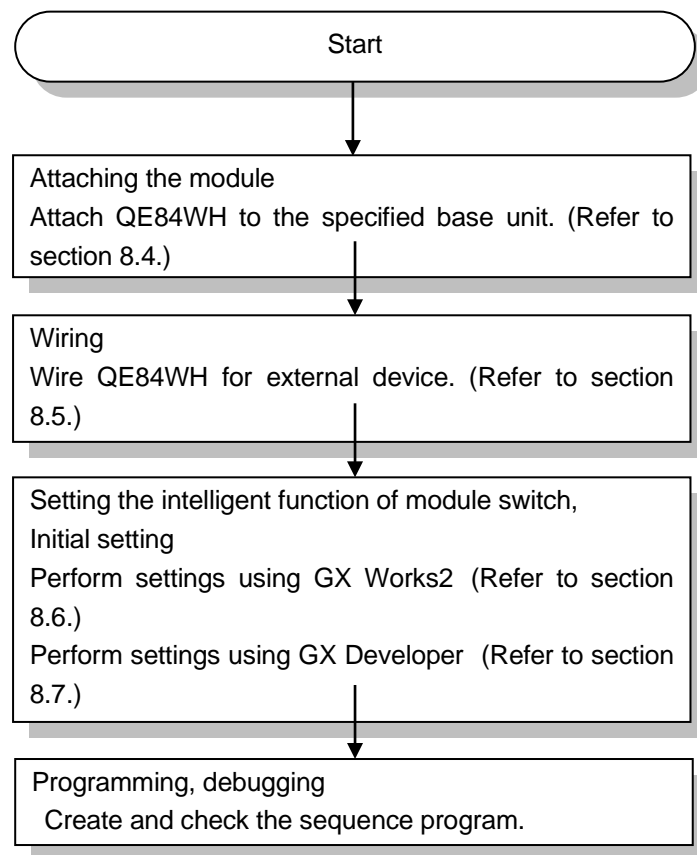

Figure 8.2-1 Procedure for operation

8.3 Name and function of each part

Names and functions of parts of QE84WH are provided below.

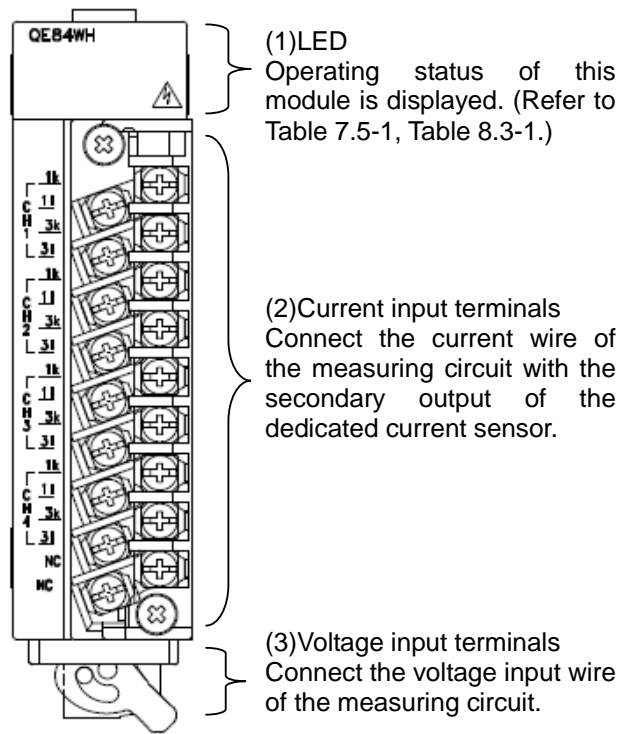

Figure 8.3-1 Appearance of the module

(1) Names and functions of LEDs

The following describes names and functions of LEDs.

Table 8.3-1 Names and functions of LEDs

Name	Color	Role	ON/OFF condition
0 LED	Green	Displays the operation status of this module.	ON: Normal operation OFF: Internal power shut-off, hardware error *1
1 LED	Green	Displays CH1 measurement status of this module.	Flashing: Measuring electric energy (regeneration) ON: Measuring electric energy (consumption) OFF: Not measuring (No measurement)
2 LED	Green	Displays CH2 measurement status of this module.	Flashing: Measuring electric energy (regeneration) ON: Measuring electric energy (consumption) OFF: Not measuring (No measurement)
3 LED	Green	Displays CH3 measurement status of this module.	Flashing: Measuring electric energy (regeneration) ON: Measuring electric energy (consumption) OFF: Not measuring (No measurement)
4 LED	Green	Displays CH4 measurement status of this module.	Flashing: Measuring electric energy (regeneration) ON: Measuring electric energy (consumption) OFF: Not measuring (No measurement)
5 LED	Green	Displays CH1 3-side measurement status (regeneration) of this module.	ON: Measuring electric energy (regeneration) on side 3 OFF: Other than the above
6 LED	Green	Displays CH2 3-side measurement status (regeneration) of this module.	ON: Measuring electric energy (regeneration) on side 3 OFF: Other than the above
7 LED	-	-	Always OFF.
8 LED	Red	Displays errors and conditions of this module.	Flashing: Out-of-range error *1 ON: Hardware error *1 OFF: Normal operation
9 LED	Green	Displays CH1 1-side measurement status (regeneration) of this module.	ON: Measuring electric energy (regeneration) on side 1 OFF: Other than the above
A LED	Green	Displays CH2 1-side measurement status (regeneration) of this module.	ON: Measuring electric energy (regeneration) on side 1 OFF: Other than the above
B LED	Green	Displays CH3 1-side measurement status (regeneration) of this module.	ON: Measuring electric energy (regeneration) on side 1 OFF: Other than the above
C LED	Green	Displays CH4 1-side measurement status (regeneration) of this module.	ON: Measuring electric energy (regeneration) on side 1 OFF: Other than the above
D LED	Green	Displays CH3 3-side measurement status (regeneration) of this module.	ON: Measuring electric energy (regeneration) on side 3 OFF: Other than the above
E LED	Green	Displays CH4 3-side measurement status (regeneration) of this module.	ON: Measuring electric energy (regeneration) on side 3 OFF: Other than the above
F LED	-	-	Always OFF.

*1 For details, check with the list of error codes. (Refer to section 10.1)

(2) Names of signals of terminal block
 The following describes names of signals of terminal block.

Table8.3-2 Names of signals of terminal block

Terminal symbol		Name of terminal
CH1	1k	1-phase current input terminal (power source side)
	1l	1-phase current input terminal (load side)
	3k	3-phase current input terminal (power source side)
	3l	3-phase current input terminal (load side)
CH2	1k	1-phase current input terminal (power source side)
	1l	1-phase current input terminal (load side)
	3k	3-phase current input terminal (power source side)
	3l	3-phase current input terminal (load side)
CH3	1k	1-phase current input terminal (power source side)
	1l	1-phase current input terminal (load side)
	3k	3-phase current input terminal (power source side)
	3l	3-phase current input terminal (load side)
CH4	1k	1-phase current input terminal (power source side)
	1l	1-phase current input terminal (load side)
	3k	3-phase current input terminal (power source side)
	3l	3-phase current input terminal (load side)
P1	1-phase voltage input terminal	
P2	2-phase voltage input terminal	
P3	3-phase voltage input terminal	
FG	Frame GND terminal	

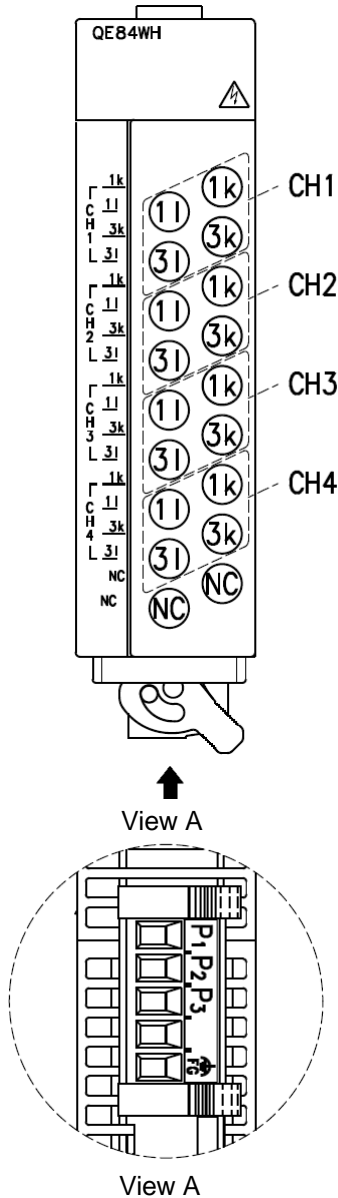
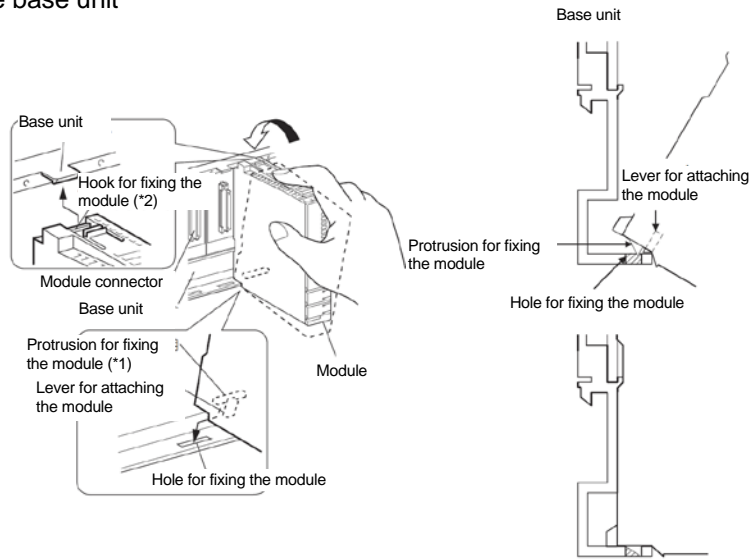
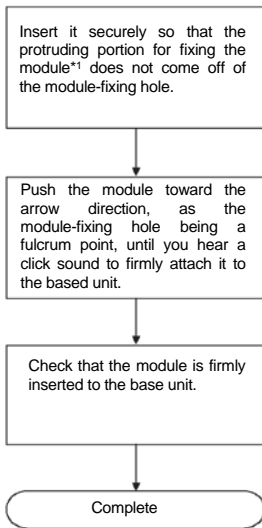

Figure8.3-2 Placement of the terminal block

8.4 Attaching and removing the module

8.4.1 How to attach to the base unit



! Caution

- Attach to the base of MELSEC-Q series.
- When attaching the module, make sure to insert the protruding portions for fixing the module into the holes on the base unit. In doing so, insert it securely so that the protruding portion of the module does not come off of the holes. Do not force to attach the module; otherwise the module may break.
- When installing the module at a vibrating area with strong impact, tighten the module to the base unit using screws. Module-fixing screws: M3 x 12 (Prepare them yourself.)

Locations of screws	Torque range
Module-fixing screws	0.36 - 0.48 N•m

- Attaching and detaching the module and the base unit should be performed 50 times or less (to conform to JIS B3502). If the count exceeds 50 times, it may cause a malfunction.

8.4.2 How to detach it from the base unit

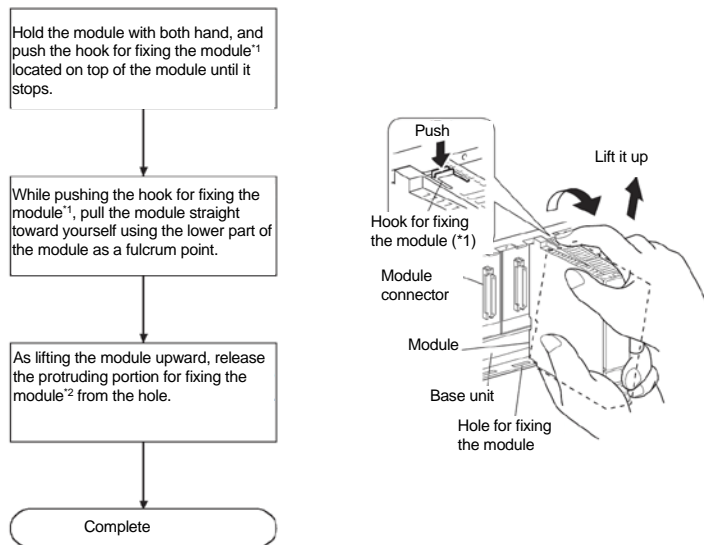

- When module-fixing screws are used, make sure to remove the screws for detaching the module first, and then remove the protruding portion for fixing the module from the holes. Do no force to remove the module; it may break the protruding portions for fixing the module.

8.5 Wiring

8.5.1 Precautions for wiring

- (1) Connect cables. For connecting voltage transformer and current transformer, refer to the corresponding wiring diagram.
- (2) For wiring, check with the wiring diagram and check phase wire system for the connecting circuit.
- (3) For the current circuit input, Mitsubishi's current sensor is required. (Refer to section 8.5.3)
- (4) If a current sensor is located in a strong magnetic field such as an area nearby a transformer or high-current cable bus bar, the voltage circuit input may be influenced, which in turn affects the measured value. Thus, please ensure sufficient distance between devices.

Condition	Distance
Power line carrying 600 V or lower and 600 A or lower	300 mm or longer
Other power lines	600 mm or longer

- (5) For input wiring of the measurement circuit, use separate cables from other external signals in order to prevent from AC surge and induction.
- (6) Keep any object off the cables.
- (7) Protect cable coating from scratch.
- (8) Cable length should be routed in length with a margin, please take care to avoid causing stress to pull the terminal block. (Tensile load: less than 22N)
- (9) For the actual usage, connect the FG terminal to ground. (D-type ground: Type 3) Connect it directly to the ground terminal.

8.5.2 How to connect wires

(1) Follow the wiring diagram for external connection to QE84WH.

(2) Use appropriate electric wires as described below.

<Voltage input terminals>

1) Stripping length of the wire to be used has to be 7 mm. Check the stripping length using the strip gauge of QE84WH main module.

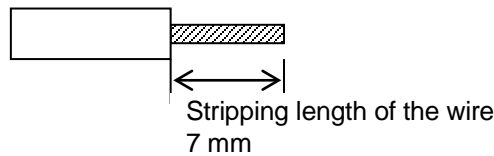

Applicable wire (Usable electric wire)	Single wire: AWG24 – AWG16 (φ0.5 - 1.3mm) Stranded wire: AWG24 – AWG16 (0.2 – 1.3 mm ²)
---	--

2) When using a stranded wire, strand the wire edges to prevent thin wires from loosening.

<Current input terminals>

1) For the connection between the secondary terminal of current sensor (EMU-CT***, EMU-CT***-A) and current input terminals, use twisted pair cable.

Applicable wire (Usable electric wire)	Stranded wire: AWG20 – AWG18 (0.5 - 0.8 mm ²)
---	---

2) Use a solderless terminal to prevent thin wires from loosening. No solderless terminal with insulation sleeve can be used.

Applicable solderless terminal	R1.25-3
--------------------------------	---------

3) It is recommended to cover the solderless terminals connecting electric cables with a mark tube or insulating tube.

8.5.3 How to wire

Follow the wiring diagram (Figure 8.5.3(1)-(a) to 8.5.3(2)-(b)) for external connection of QE84WH.

(1) In the case using 5A current sensor.

(a) Case of using EMU2-CT5

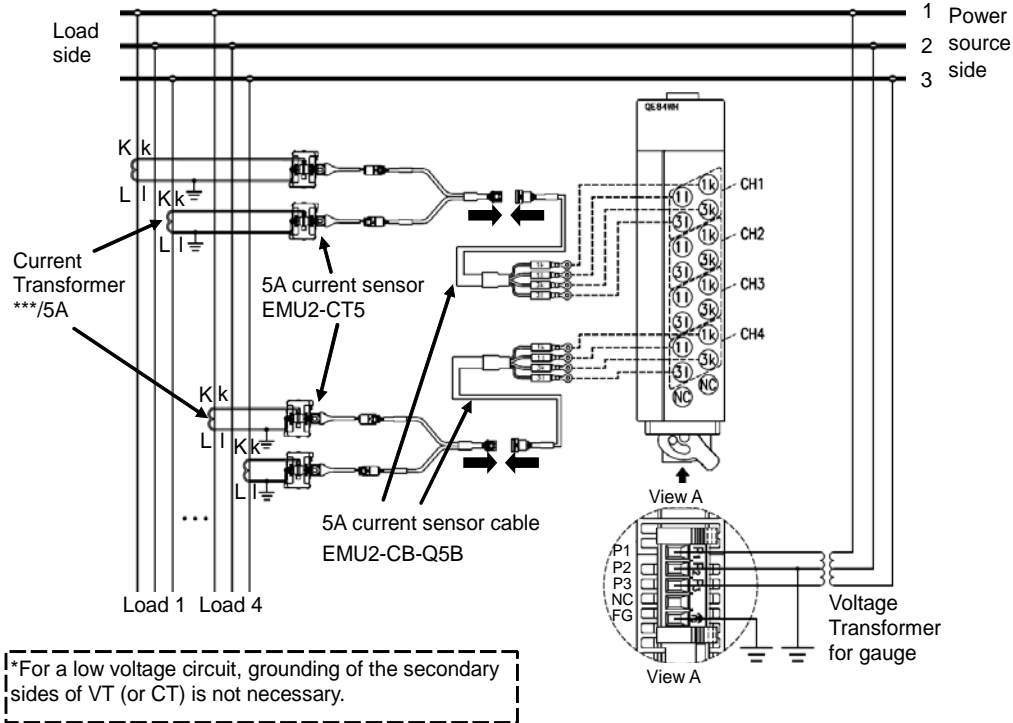

Figure 8.5.3(1)-(a) In the case of Three-Phase 3-wire system (with the voltage transformer for gauge/ current transformer)

(b) Case of using EMU-CT5-A

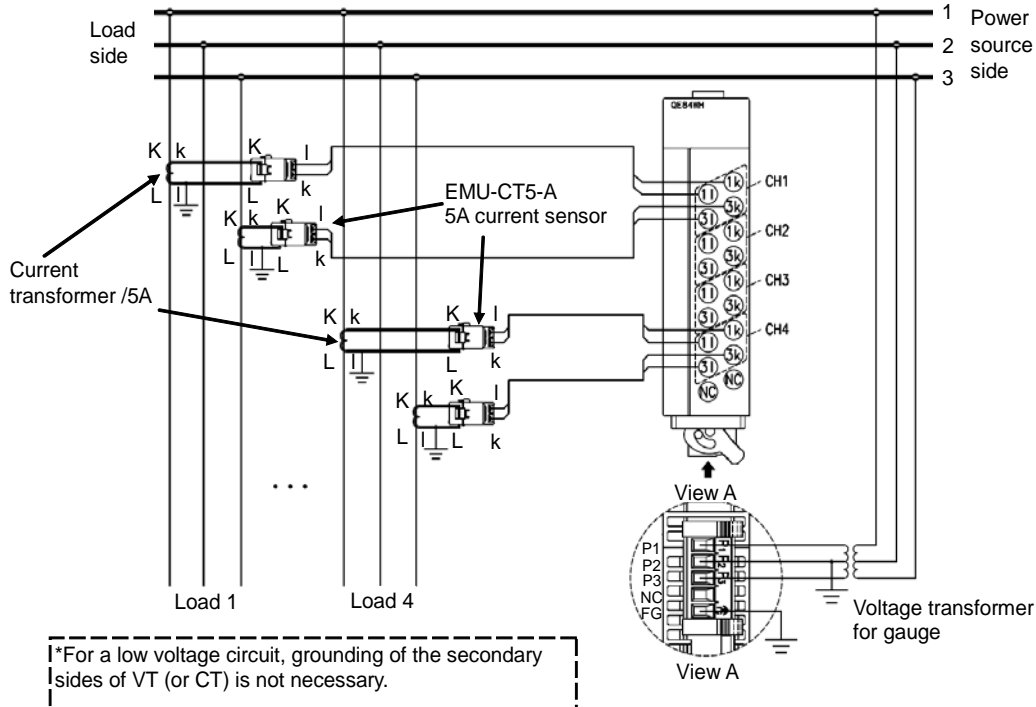

Figure 8.5.3(1)-(b) In the case of Three-phase 3-wire system (with the voltage transformer for gauge/current transformer)

- (2) In the case using split-type current sensor.
 - (a) Case of Three-phase 3-wire system

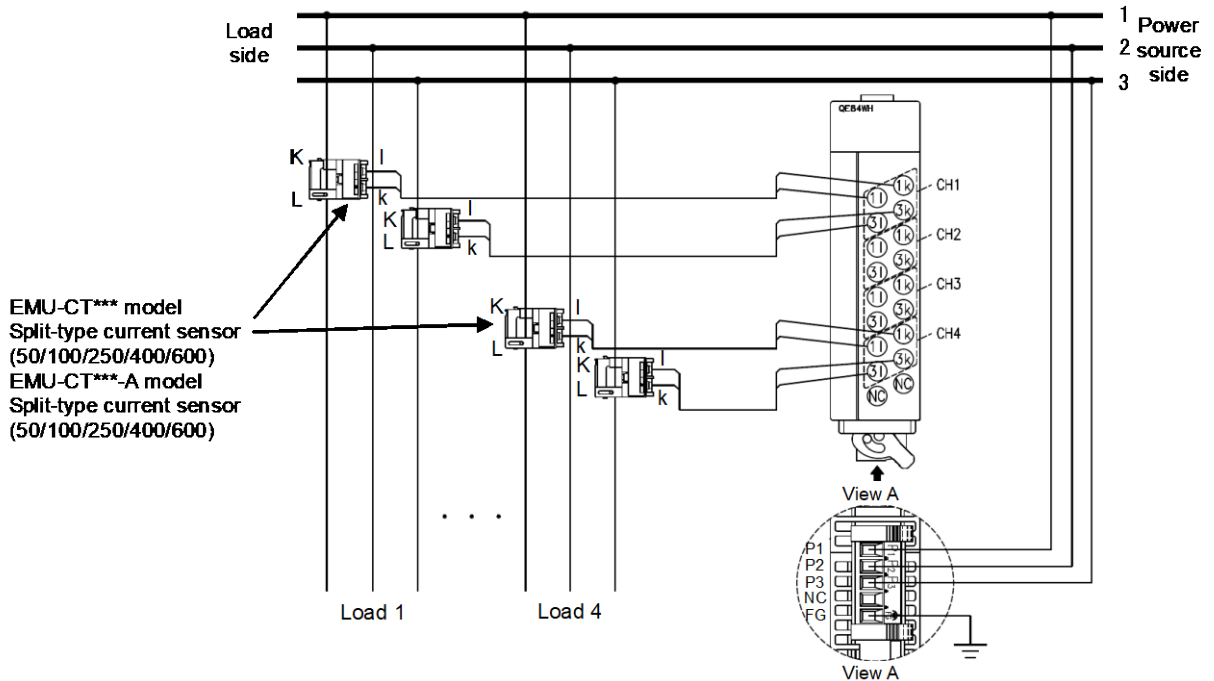

Figure 8.5.3(2)-(a) In the case of Three-Phase 3-wire system

- (b) Case of Single-phase 2-wire system

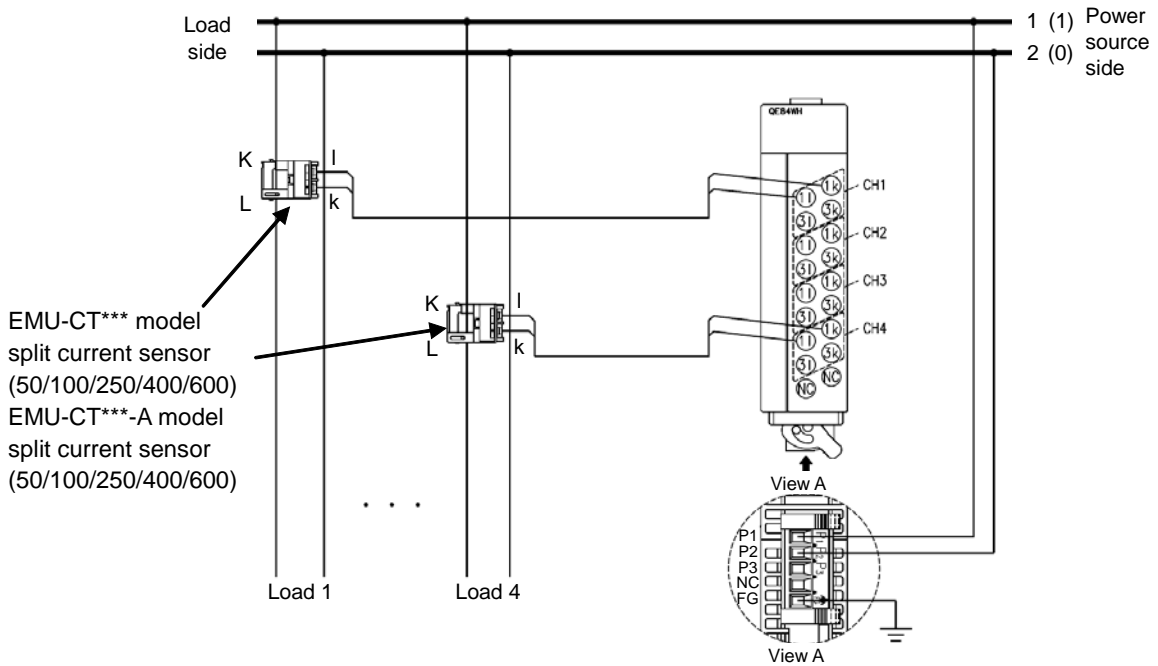

Figure 8.5.3(2)-(b) In the case of Single-phase 2-wire system

(c) Case of Single-phase 3-wire system

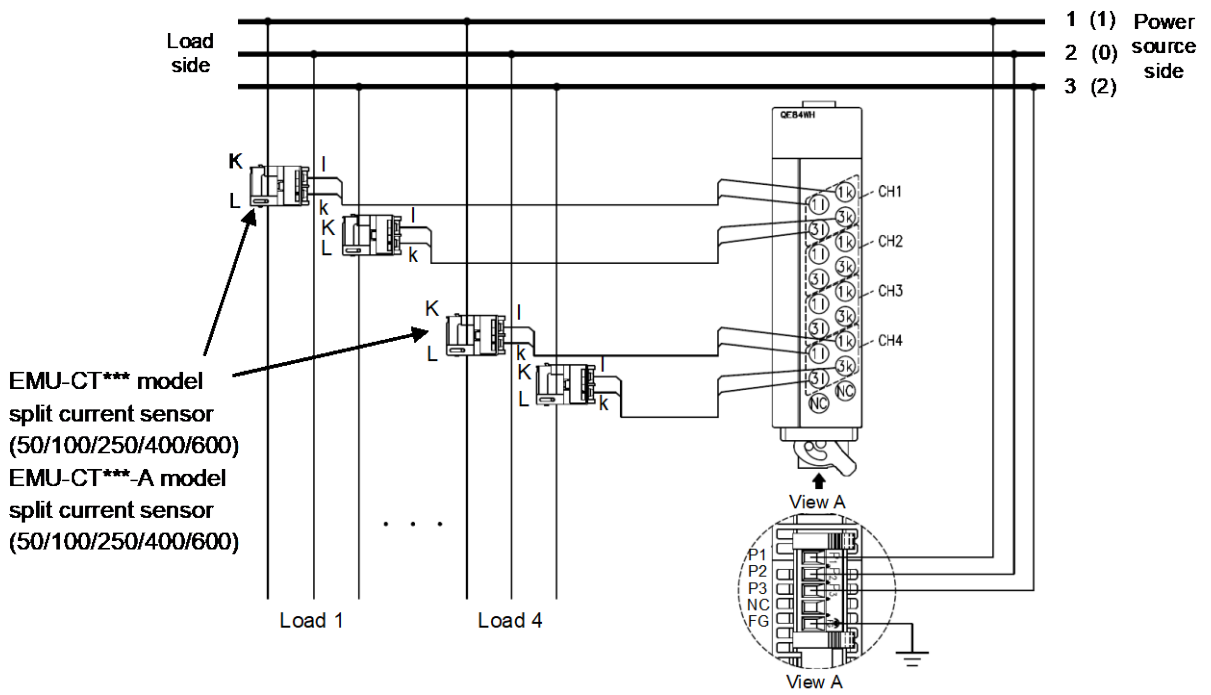

Figure 8.5.3(2)-(c) In the case of Single-phase 3-wire system

8.5.3.1 Current circuit connection

A dedicated current sensor (EMU-CT ***, EMU-CT ***-A, EMU2-CT5) is required to connect the current circuit.

■ How to attach EMU-CT5/CT50/CT100/CT250-A

- 1) Press the locking claw of the moving core, please open the moving core by removing the engagement (Figure 1). Before inserting the cable, check the symbols K and L to fit the current sensor in the correct direction. (The direction from the power supply side to the load side is indicated with →.) (Figure 3)
- 2) After checking that the core parting faces are free from dirt, close the moving core. Push down the moving core until the stoppers are securely locked. (Locking claw of the moving core is applied to the stopper, you hear click.) (Figure 2)
- 3) Pass the tying bands into the current sensor locking holes to secure the sensor with the cable. (Figure 3)

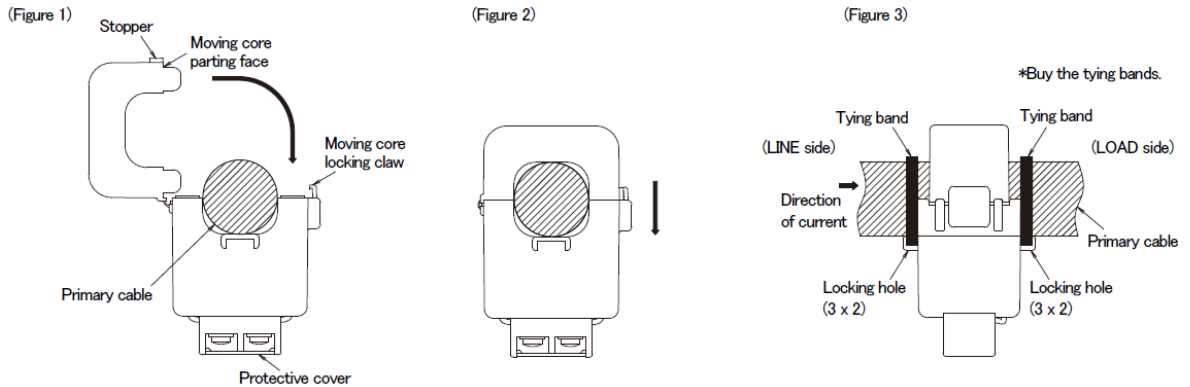

✓ **Supplementary**

- Make sure that before connecting the cable, the orientation of the current sensor is correct for attachment. K to L is the correct direction. K: power source side, L: load side.
- Do not bend the moving core in a direction other than the operation direction (shown in Fig. 1). The current sensor may be damaged.
- Refer to the table below for appropriate size of electric wires.

		EMU-CT5-A	EMU-CT50-A	EMU-CT100-A	EMU-CT250-A
Usable wires size (reference)	IV cable	38 mm ² or less	38 mm ² or less	60 mm ² or less	200 mm ² or less
	CV cable	22 mm ² or less	22 mm ² or less	60 mm ² or less	150 mm ² or less

Size of electric wires conforms to what is described in the catalog of general PVC insulated wires. Thickness of external PVC insulation is different for different wire. Check with the external dimension diagram of this product and make sure the wire can go through the given space.

■ How to attach EMU-CT400/CT600-A

- 1) Press the locking claw of the moving core, please open the moving core by removing the engagement (Figure 1). At this time, the hinge cover opens automatically. Before inserting the cable, check the symbols K and L to fit the current sensor in the correct direction. (The direction from the power supply side to the load side is indicated with →.) (Figure 3)
- 2) After checking that the core parting faces are free from dirt, close the moving core. Push down the moving core until the stoppers are securely locked. (Locking claw of the moving core is applied to the stopper, you hear click.) After the stopper is securely locked, close the hinge cover. (Figure 2)
- 3) Pass the tying bands into the current sensor locking holes to secure the sensor with the cable. (Figure 3)

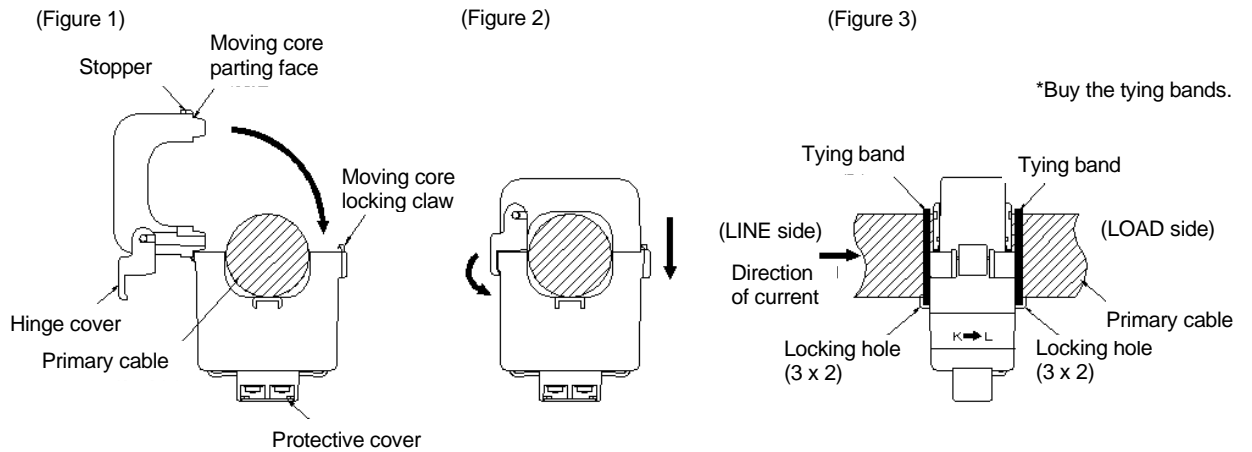

✓ **Supplementary**

- Make sure that before connecting the cable, the orientation of the current sensor is correct for attachment. K to L is the correct direction. K: power source side, L: load side.
- Do not bend the moving core in a direction other than the operation direction (shown in Fig. 1). The current sensor may be damaged.
- Refer to the table below for appropriate size of electric wires.

		EMU-CT400-A	EMU-CT600-A
Usable wires size (reference)	IV cable	500 mm ² or less	500 mm ² or less
	CV cable	400 mm ² or less	400 mm ² or less

Size of electric wires conforms to what is described in the catalog of general PVC insulated wires. Thickness of external PVC insulation is different for different wire. Check with the external dimension diagram of this product and make sure the wire can go through the given space.

■ How to attach EMU-CT50/CT100/CT250

Follow the procedure below to attach to the cable of the target circuit.

- 1) Open the movable core, as shown in the figure on the right.
Lift slowly the hooks located on both sides of the movable core, and detach them from the stopper. **Do not force to open it. You may break the hook.**
- 2) Do not let the cable touch on the core-split surface. Thus, carefully pass the cable from underneath. Before passing the cable, check the direction symbols of K and L, in order to attach the sensor in the correct orientation. (Direction from power source side (K) to load side (L) is indicated with the arrow.)
- 3) Make sure no dust or foreign object is attached on the split-core surface, and after that, close the movable core. Lift the movable core until the stoppers are firmly locked. (When the hooks on both side of movable core are locked to the stoppers, you will hear click sound twice.)
- 4) Put a binding cable through a hole for fixing the current sensor, and then tie it with the cable. Do not tie it too tightly. (Holes for fixing the current sensor are located on both side of the current sensor.)
- 5) Cut off the extra portion of binding cable, using a nipper, etc, to avoid interference of the cable.
- 6) Lift a protective cover of the secondary terminal, by holding the center portion of the protective cover, and remove it. And then, connect the given sensor cable. **Check the terminal symbols printed on the secondary terminal surface, so that connection is performed correctly.**

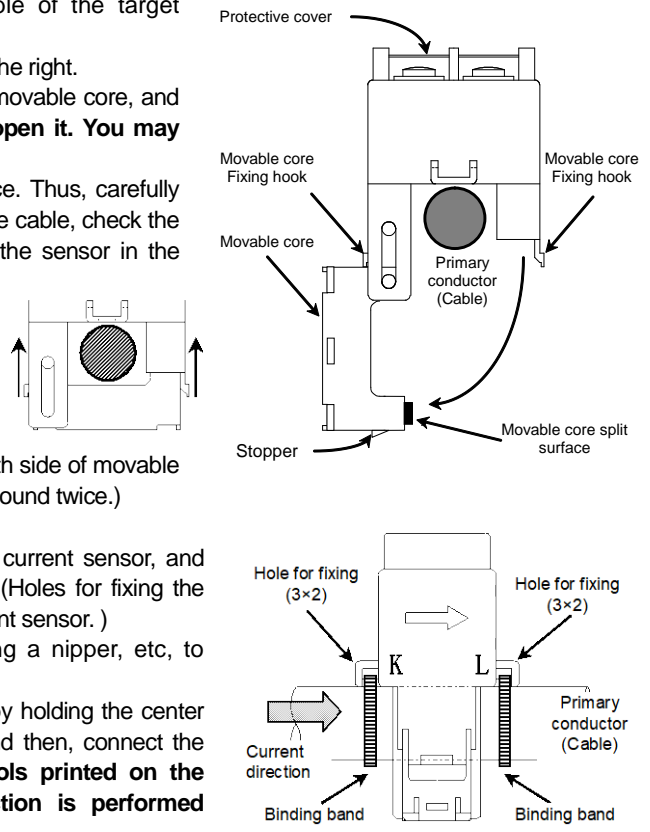

✓ **Supplementary** -----

- When opening the movable core on current sensor, **do not widen the hook for fixing the movable core too widely**. It may break the hook.
- Refer to the table below for appropriate size of electric wires.

		EMU-CT50	EMU-CT100	EMU-CT250
Usable wires size (reference)	IV cable	60 mm ² or less	60 mm ² or less	150 mm ² or less
	CV cable	38 mm ² or less	38 mm ² or less	150 mm ² or less

Size of electric wires conforms to what is described in the catalog of general PVC insulated wires. Thickness of external PVC insulation is different for different wire. Check with the external dimension diagram of this product and make sure the wire can go through the given space.

■ How to attach EMU-CT400/CT600

Follow the procedure below to attach the cable to the target circuit.

- 1) Release the band 1) to the arrow direction (top), and detach the core cover.
- 2) Remove the terminal cover, and shift the secondary short switch into "short".
- 3) Loosen the screw 2), and open the core band to remove the core. Make sure that no dust, etc attaches on the core.
- 4) Loosen the screw 3). Put this module onto the cable, and fix the module by tightening the screw 3) using the metal bracket that is directly attached to the cable. Tighten the screw as tightly as the metal bracket will not bend.
- 5) Align the symbol of "K" on the removed core and the "K" on the module to return the core as in the original location. And then, tighten the core band using the screw 2).
- 6) Attach the core cover and fix it with the band 1).
- 7) Connect the secondary terminal with multiple-circuit power measuring module, turn the secondary short switch into "open", and then attach the terminal cover.

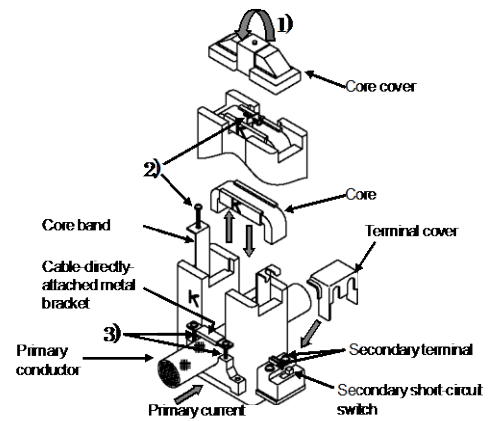

✓ Supplementary

- Refer to the table below for appropriate size of electric wires.

		EMU-CT400		EMU-CT600	
		1 wire	2 wire	1 wire	2 wire
Usable wires size (reference)	IV cable	500mm ²	325mm ²	500mm ²	325mm ²
	CV cable				

Size of electric wires conforms to what is described in the catalog of general PVC insulated wires. Thickness of external PVC insulation is different for different wire. Check with the external dimension diagram of this product and make sure the wire can go through the given space.

■ How to attach EMU2-CT5

- Transfix EMU2-CT5 current sensor to the secondary-side wire of current transformer (/5A rated). Make sure to use it in a correct combination with 5 A current sensor conversion cable: EMU2-CB-Q5B
- EMU2-CT5 has polarities. Make sure to connect to the right symbol on the terminal. Power source side: (k side), load side: (l side).

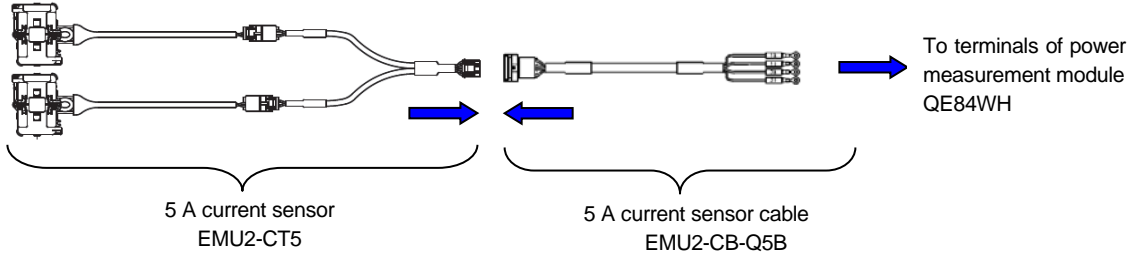

Follow the procedure below to attach the cable to the target circuit.

- 1) Slide the lock pin to the arrow direction.
- 2) Put the electric wire through the clamp, and close the clamp again.
- 3) Use your finger to hold the clamp in the full close position, and push the lock pin until it locks.

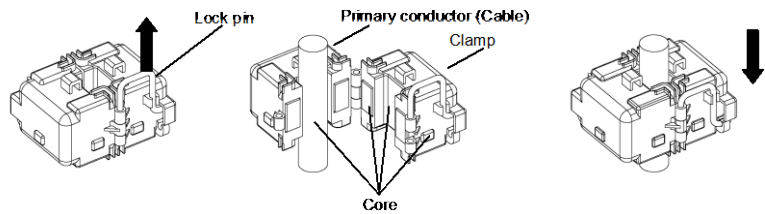

⚠ Caution

- The lock pin is made of metal. If you let it touch electrically charged portions, it may cause electric shock or device failure or fire. Be careful handling the lock pin.
- Physical impact to the core may cause breakage. It may directly influence the performance. Be careful handling the core.
- The mating surface on the core is very sensitive. Even a small foreign object on the surface may affect the measurement performance.
- Excessive force to the core during open clamp may cause breakage. Incorrect direction may cause inaccurate measurement.
- For both the transfixing wire and the binding band for fixing the sensor, use the size of $W=2.6$ mm or less. To fix them together Put a binding band through a hole for fixing the current sensor, and tie it with the cable. Do not tie it too tightly. (Total four holes for fixing the current sensor exist on both sides of the current sensor).

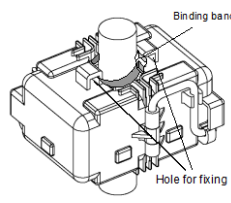

■ When wiring single-phase 2-wire circuit

5 A current sensor is not used L3. As shown below, L3 remove connector , and connector with insulating tape.

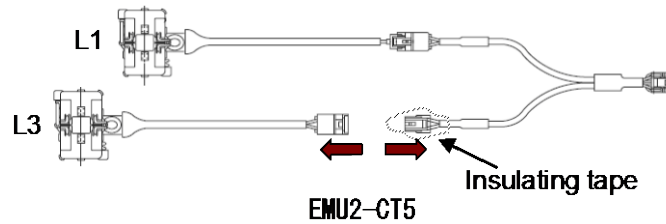

■ Extending the cable of 5 A current sensor

If the cable from current sensor is too short, you can extend it by using an extension cable as shown below.

Extension cable (standard)

Model name	EMU2-CB-T1M	EMU2-CB-T5M	EMU2-CB-T10M
Cable length	1 m	5 m	10 m

Extension cable (separate)

Model name	EMU2-CB-T1MS	EMU2-CB-T5MS	EMU2-CB-T10MS
Cable length	1 m	5 m	10 m

Connecting 5 A current sensor and the cable

◆ Connecting 5 A current sensor and extension cable (standard)

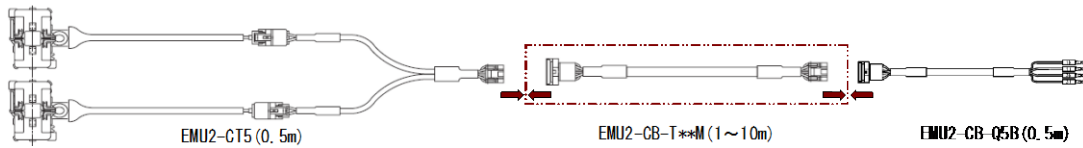

◆ Connecting 5 A current sensor and extension cable (separate)

1) Disconnect the connector

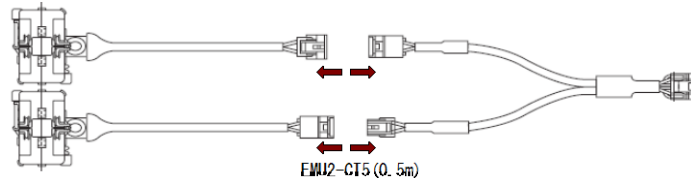

2) Connect the extension cable

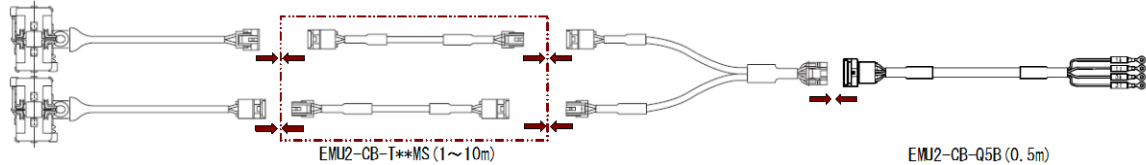

✓ **Supplementary** -----

- Cable extension for EMU2-CT5 is 10 m max. (Total cable length is 11m max.)
- Use extension cable (separate) when 1-phase and 3-phase are set apart.

8.5.3.2 Voltage circuit connection

- If more than 220 V circuit is used, make sure that use a transformer.
- The transformer which has primary voltage of VT less than 6600V and secondary voltage of VT not more than 220V can be used. For connection to P1 to P3 terminals on QE84WH, connect the secondary of transformer. Make sure that terminal symbols are correct.
- In order to perform maintenance work such as changing the wire layout and replacing equipment, we recommend that you connect protective device (breaker) for the voltage input circuit (P1, P2, and P3 terminals).

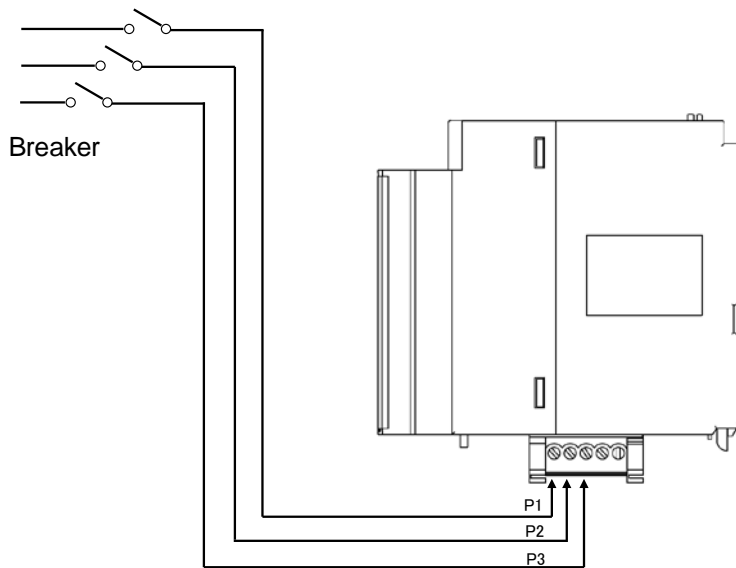

- Use the voltage input terminal block to enter the circuit voltage to QE84WH.
Fix the module by turning the lever until the clicks after inserting the voltage input terminal block.
- When removing a voltage input terminal block from the module, turn the lever in the opposite direction, hold the voltage input terminal part.

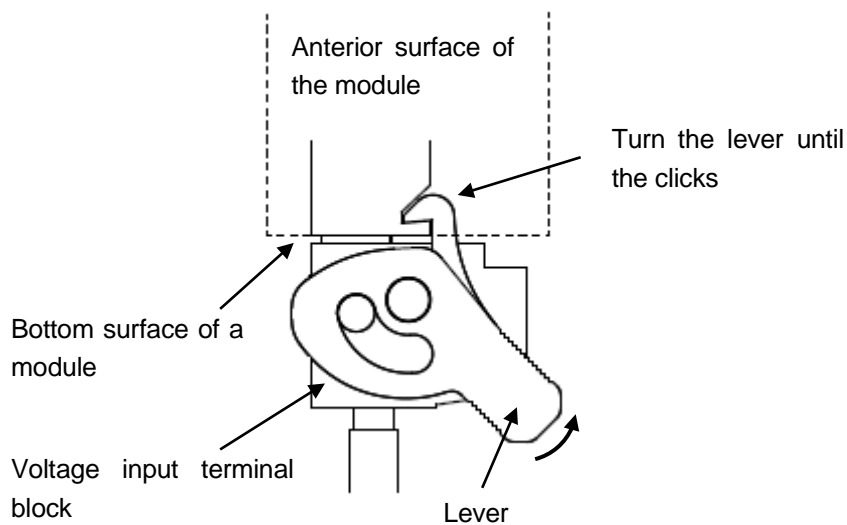

8.6 Setting from GX Works2

This section explains setting from GX Works2 necessary to use QE84WH. Before performing this setting, install GX Works2 and connect the Management CPU with the PC using a USB cable. For details, refer to the manual of CPU module.

Point

To addition the unit, enable the switch setting, parameter setting and auto refresh, write the settings to the CPU module, and reset the CPU module or power on the programmable controller again.

8.6.1 Addition the unit

Add the model name of the energy measuring module to use the project.

(1) Addition procedure

Open the “New Module” window.

Project window→[intelligent Function Module]→Right-click→[New Module...]

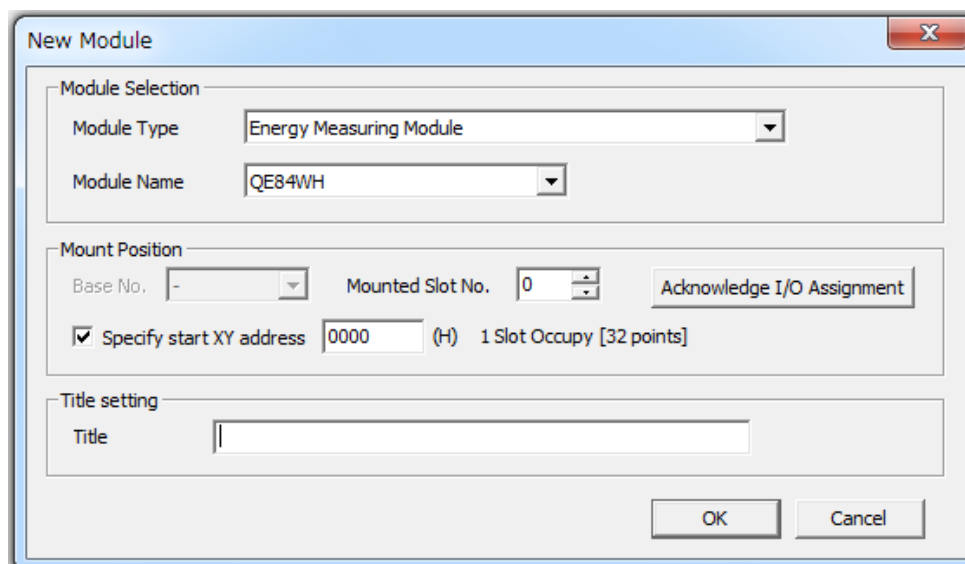

Figure 8.6.1-1 Dialog box of “I/O assignment”

Table 8.6.1-1 Setting items on the “I/O assignment” tab

Item		Description
Module Selection	Module Type	Set [Energy Measuring module].
	Module Name	Set the name of the module to mount.
Mount Position	Base No.	Set the base No. where the module is mounted.
	Mounted Slot No.	Set the slot No. where the module is mounted.
	Specify start XY address	The start I/O number (hexadecimal) of the target module is set, according to the mounted slot No. Any start I/O number can be set.
Title Setting	Title	Set any title.

8.6.2 Setting the intelligent function of the module switch

Set the operation mode.

(1)Setting procedure

Open the "Switch Setting" window.

Project window→[intelligent Function Module]→Module name→[Switch Setting]

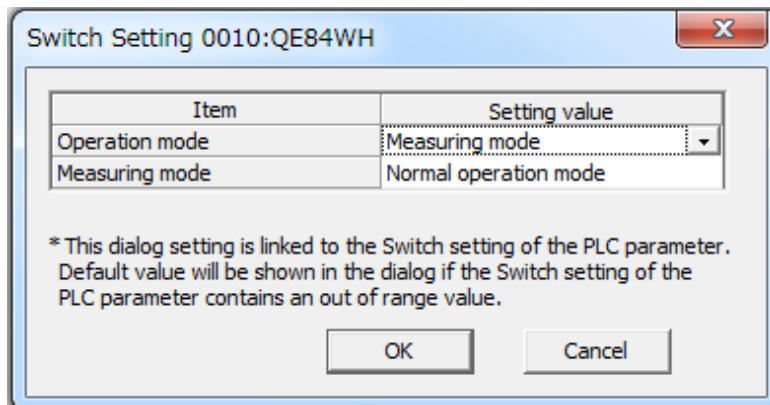

Figure 8.6.2-1 Dialog box to set the intelligent function of the module switch

Table 8.6.2-1 Setting the intelligent function of the module switch

Item	Description	Setting value
Operation mode	Measurement Mode and test mode are changed.	Measuring mode (default) Test mode
Measuring mode	When set measuring mode above setting, set the kind of measuring mode. When set test mode above setting, this setting disable.	Regular operating mode(default) Current measuring mode

8.6.3 Parameter Setting

Set the parameters.

Setting parameters on the screen omits the parameter setting in a program.

(1) Setting procedure

Open the "Parameter" window.

Project window → [intelligent Function Module] → Module name → [Parameter]

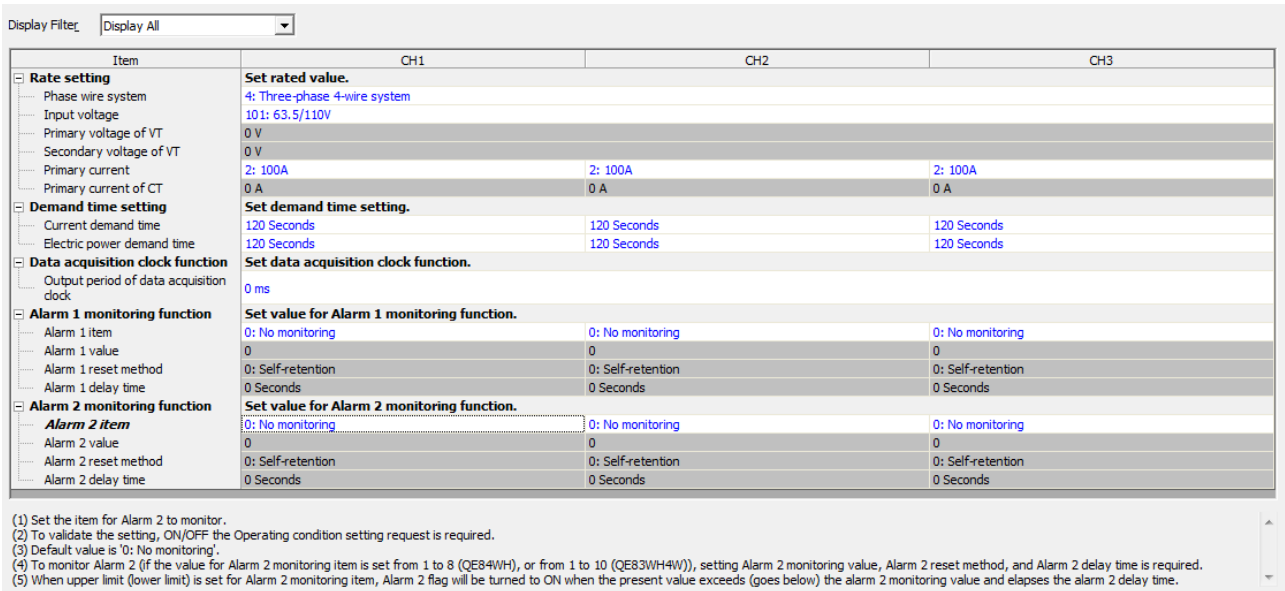

Figure 8.6.3-1 Dialog box to monitor all buffer memories (a case where the module is attached to the slot 0)

(2) Double-click the item to change the setting, and input the setting value.

- Items to input from the pull-down list
Double-click the item to set to display the pull-down list. Select the item.
- Items to input from the text box
Double-click the item to set, and input the setting value.

(3) Setup of CH2 to CH4 is performed by operation of Procedure (2).

Item	Setting value	Reference		
Rate setting	Phase wire system	1:single-phase 2-wire 2:single-phase 3-wire 3:three-phase 3-wire	Section 6.2.1	
	Primary voltage	0:Any setting 1:110V 2:220V 3:220/110V 4:440/110V 5:690/110V 6:1100/110V 7:2200/110V 8:3300/110V 9:6600/110V	Section 6.2.2	
	Primary voltage of VT	0 - 6600V	Section 6.2.2	
	Secondary voltage of VT	0 - 220V	Section 6.2.2	
	Primary current	0:Any setting 1:50A 2:100A 3:250A 4:400A 5:600A 501:5/5A 502:6/5A 503:7.5/5A 504:8/5A 505:10/5A 506:12/5A 507:15/5A 508:20/5A 509:25/5A 510:30/5A 511:40/5A 512:50/5A 513:60/5A 514:75/5A 515:80/5A	516:100/5A 517:120/5A 518:150/5A 519:200/5A 520:250/5A 521:300/5A 522:400/5A 523:500/5A 524:600/5A 525:750/5A 526:800/5A 527:1000/5A 528:1200/5A 529:1500/5A 530:1600/5A 531:2000/5A 532:2500/5A 533:3000/5A 534:4000/5A 535:5000/5A 536:6000/5A	Section 6.2.3
	Primary current of CT	0~6000A	Section 6.2.3	
	Demand time setting	Current demand time	0~1800seconds	Section 6.2.4
		Electric power demand time	0~1800seconds	Section 6.2.5
	Data acquisition clock function	Output period of data acquisition clock	flag non-use:0 flag use:1~8640000ms	Section 6.2.12
	Alarm 1 monitoring function	Alarm 1 item	0:No monitoring 1:Current demand upper limit 2:Current demand lower limit 3:Voltage upper limit 4:Voltage lower limit 5:Electric power demand upper limit 6:Electric power demand lower limit 7:Power factor upper limit 8:Power factor lower limit	Section 6.2.6
Alarm 1 value		-2147483648 to 2147483647	Section 6.2.7	
Alarm 1 reset method		0:Self-retention 1:Auto reset	Section 6.2.8	
Alarm 1 delay time		0 to 300seconds	Section 6.2.9	
Alarm 2 monitoring function	Alarm 2 item	0:No monitoring 1:Current demand upper limit 2:Current demand lower limit 3:Voltage upper limit 4:Voltage lower limit 5:Electric power demand upper limit 6:Electric power demand lower limit 7:Power factor upper limit 8:Power factor lower limit	Section 6.2.6	
	Alarm 2 value	-2147483648 to 2147483647	Section 6.2.7	
	Alarm 2 reset method	0:Self-retention 1:Auto reset	Section 6.2.8	
	Alarm 2 delay time	0 to 300 seconds	Section 6.2.9	

8.6.4 Auto Refresh

This function transfers data in the buffer memory to specified devices. Programming of reading/writing data is unnecessary.

(1) Setting procedure

- 1) Start "Auto Refresh" .
Project window → [Intelligent Function Module] → Module name → [Auto Refresh]
- 2) Start "Auto Refresh" .
Click the item to set, and input the destination device for auto refresh.

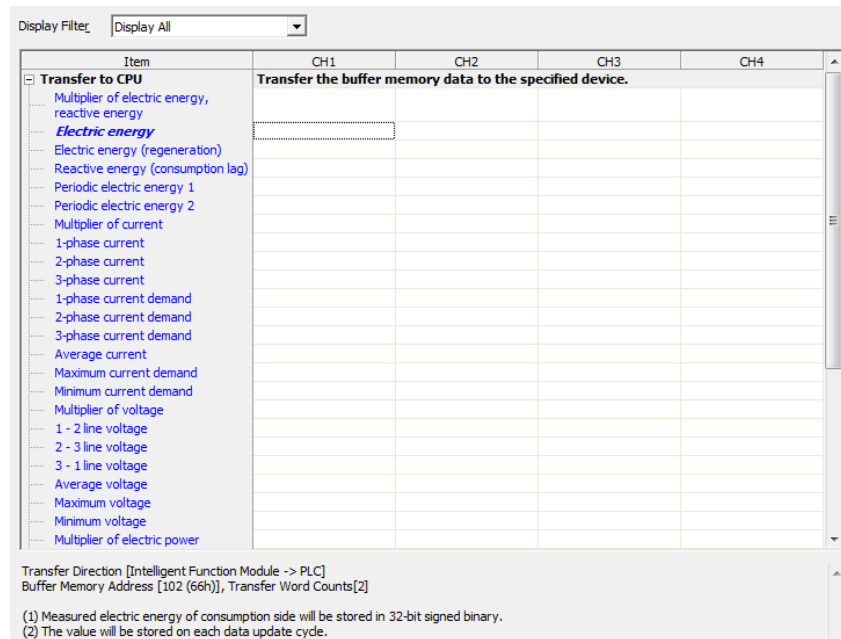

Point
Available devices are X, Y, M, L, B, T, C, ST, D, W, R, and ZR. When a bit device X, Y, M, L, or B is used, set a number that is divisible by 16 points (example: X10, Y120, M16). Data in the buffer memory are stored in 16 points of devices starting from the set device No. (Example: When X10 is set, the data are stored in X10 to X1F).

8.6.5 Setting function for integrated value

This function is to set integrated value (electric energy (consumption, regeneration) and reactive energy (consumption lag)) to any value. If you want to clear integrated value, set it to 0.

(1) Setting procedure

- 1) Start "Intelligent unit monitor"
 Project window → [intelligent Function Module] → Module name → Right-Click → [Intelligent monitor]
- 2) Set the integrated value setting target(Un#G51) and integrated value setting value (Un#G52,3)
- 3) Turn integrated value setting request (Yn3) from OFF to ON to enable the setting. (Refer to 5.2.2).

Unit monitor1 (0000:QE84WH) – normal measuring mode			
Items	Preset value	Device	
CH2 Periodic electric energy 1confirmation flag	ON	X0B	Bit
CH2 Periodic electric energy 2confirmation flag	ON	X0C	Bit
CH2 Periodic electric energy 1 reset completion flag	OFF	X0D	Bit
CH2 Periodic electric energy 2 reset completion flag	OFF	X0E	Bit
CH2 Alarm 1 flag	OFF	X0F	Bit
CH2 Alarm 2 flag	OFF	X10	Bit
CH3 Periodic electric energy 1confirmation flag	ON	X11	Bit
CH3 Periodic electric energy 2confirmation flag	ON	X12	Bit
CH3 Periodic electric energy 1 reset completion flag	OFF	X13	Bit
CH3 Periodic electric energy 2 reset completion flag	OFF	X14	Bit
CH3 Alarm 1 flag	OFF	X15	Bit
CH3 Alarm 2 flag	OFF	X16	Bit
CH4 Periodic electric energy 1confirmation flag	ON	X17	Bit
CH4 Periodic electric energy 2confirmation flag	ON	X18	Bit
CH4 Periodic electric energy 1 reset completion flag	OFF	X19	Bit
CH4 Periodic electric energy 2 reset completion flag	OFF	X1A	Bit
CH4 Alarm 1 flag	OFF	X1B	Bit
CH4 Alarm 2 flag	OFF	X1C	Bit
Error flag	OFF	X1F	Bit
<input type="checkbox"/> Output signal (Y):			
Operating condition setting request	OFF	Y2	Bit
Max and Min value clear request	OFF	Y3	Bit
CH1 Periodic electric energy 1 measurement flag	OFF	Y4	Bit
CH1 Periodic electric energy 2 measurement flag	OFF	Y5	Bit
CH1 Periodic electric energy 1 reset request	OFF	Y6	Bit
CH1 Periodic electric energy 2 reset request	OFF	Y7	Bit
CH1 Alarm 1 reset request	OFF	Y8	Bit
CH1 Alarm 2 reset request	OFF	Y9	Bit
CH2 Periodic electric energy 1 measurement flag	OFF	Y0A	Bit
CH2 Periodic electric energy 2 measurement flag	OFF	Y0B	Bit
CH2 Periodic electric energy 1 reset request	OFF	Y0C	Bit
CH2 Periodic electric energy 2 reset request	OFF	Y0D	Bit
CH2 Alarm 1 reset request	OFF	Y0E	Bit
CH2 Alarm 2 reset request	OFF	Y0F	Bit
CH2 Alarm 2 reset request	OFF	Y10	Bit
CH3 Periodic electric energy 1 measurement flag	OFF	Y11	Bit
CH3 Periodic electric energy 2 measurement flag	OFF	Y12	Bit
CH3 Periodic electric energy 1 reset request	OFF	Y13	Bit
CH3 Periodic electric energy 2 reset request	OFF	Y14	Bit
CH3 Alarm 1 reset request	OFF	Y15	Bit
CH3 Alarm 2 reset request	OFF	Y16	Bit
CH4 Periodic electric energy 1 measurement flag	OFF	Y17	Bit
CH4 Periodic electric energy 2 measurement flag	OFF	Y18	Bit
CH4 Periodic electric energy 1 reset request	OFF	Y19	Bit
CH4 Periodic electric energy 2 reset request	OFF	Y1A	Bit
CH4 Alarm 1 reset request	OFF	Y1B	Bit
CH4 Alarm 2 reset request	OFF	Y1C	Bit
Error clear request	OFF	Y1F	Bit
<input type="checkbox"/> Buffer memory monitor			
Integrated value setting target	Not set	U0#G51	Word
Integrated value setting value	0	U0#G52	Double word
Max and Min values clear target	Not clear	U0#G56	Word
<input type="checkbox"/> Latest error code	H00	U0#G4500	Error code
Error occurred	--	U0#G4501	Time
Measurement mode		U0#G4550	Word

- 4) After checking that the Integrated value setting completion flag (Xn3) is in the ON status, turn off the integrated value setting request (Yn3).
The integrated value setting completion flag (Xn3) is OFF, after detect the status is OFF.
After detecting Integrated value setting request (Yn3) is in the OFF status, Integrated value setting completion flag (Xn3) turns to OFF.

(2)Default value

- Integrated value setting target (Un#G51) is set to 0 (No set).
- Integrated value setting value (Un#G52,3) is set to 0.

8.6.6 Debugging program

QE84WH provides a test function so that you can debug a program with no input of voltage or current. Pseudo-value can be stored into the buffer memory. For detailed explanation for the test function, refer to 4.2.5.

 **Caution**

Test function stores pseudo-values for setting value and error information as well as measured value. If you use these data to control the sequence program that controls external devices, there is a chance that erroneous control may occur. For safety of external devices, use this function after disconnecting the device.

- (1) Setting intelligent function of the module switch
 - 1) Configure the operation mode in switch setting as shown below. (Refer to 8.6.2)
Test mode transition : Test mode
 - 2) From the "Online" menu, select "Write to PLC" to display the dialog box of Write to PLC, and then execute the writing to PLC parameter. After resetting the CPU module, the value will become effective.

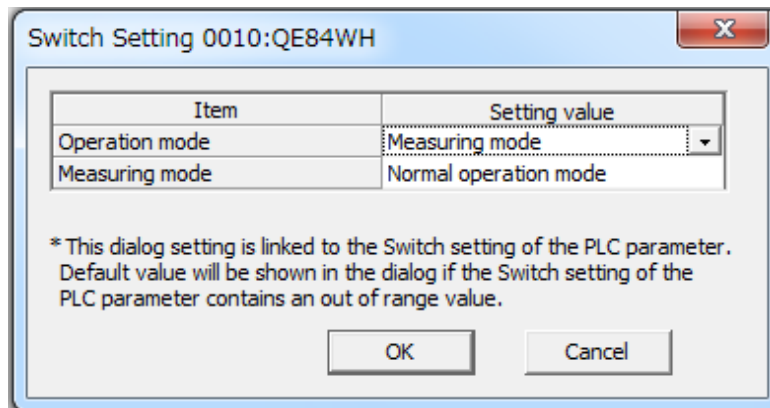

- (2) Starting the test function
 - 1) Reset the CPU module.
 - 2) QE84WH starts in the test function mode. All LEDs are turned on. Pseudo-values are stored in the buffer memory.
- (3) Finishing the test function (Move back to the measuring mode)
 - 1) Following 1) in step (1), Configure the operation mode in switch setting as shown below.
Test mode transition : Test mode
 - 2) Following 2) in step (1), write the data into PLC.
 - 3) Reset the CPU module, then the operation goes back to the measuring mode.

8.7 Setting from GX Developer

This section explains setting from GX Developer necessary to use QE84WH. Before performing this setting, install GX Developer and connect the Management CPU with the PC using a USB cable. For details, refer to the manual of CPU module.

8.7.1 I/O assignment setting

- (1) Double-click the dialog box of “PLC Parameter” in the GX Developer Project.
- (2) Click “I/O assignment”.
- (3) Set the following item to the slot*1 to which QE84WH has been attached.

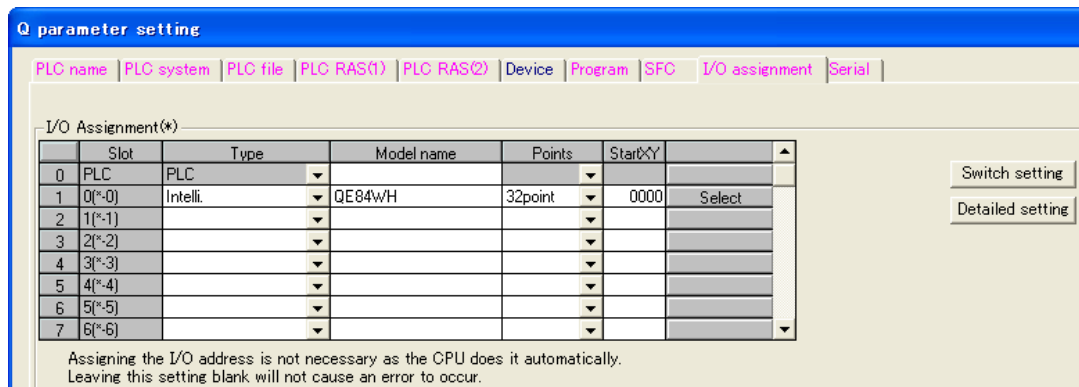

Figure 8.7.1-1 Dialog box of “I/O assignment”

Table 8.7.1-1 Setting items on the “I/O assignment” tab

Item	Descriptions
Type	Select “Intelli.”.
Model name	Enter the model name of the module.
Points	Select 32 points.
Start XY	Enter the initial I/O number of QE84WH.

*1 is a case where QE84WH is attached to the slot 0.

8.7.2 Setting the intelligent function of the module switch

- (1) In the "I/O assignment" of 8.7.1, click the **Switch setting** button to display the dialog box of "I/O module, intelligent function module switch setting".
- (2) The intelligent function module switch setting displays switches 1 to 5; however, only switches 4 and 5 is used for this purpose. Switch setting is configured using 16-bit data. Settings are as shown in Table 8.7.2-1.

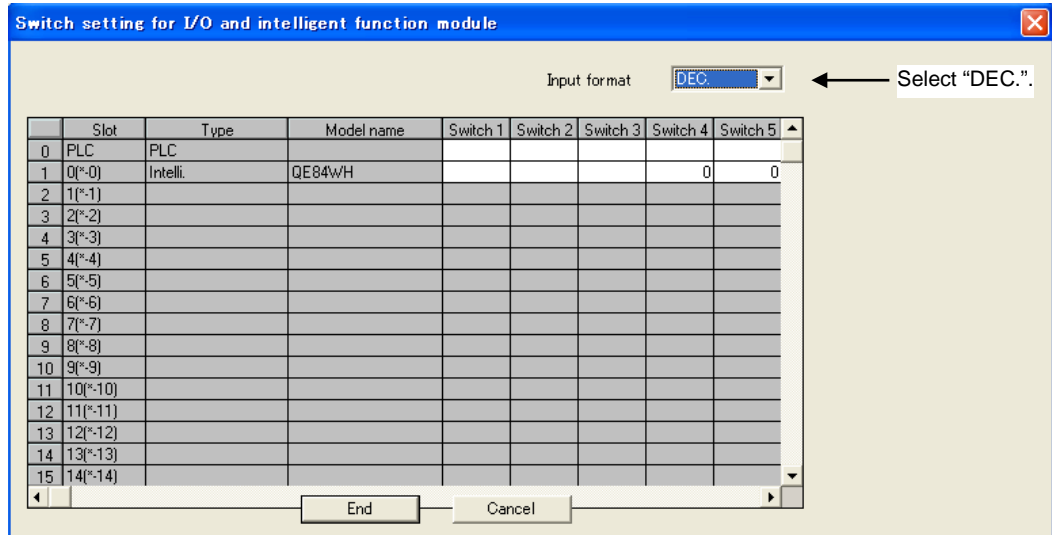

Figure 8.7.2-1 Dialog box to set the intelligent function of the module switch

Table 8.7.2-1 Setting the intelligent function of the module switch

Swith No.	Switch name	Description
1	Not used	-
2	Not used	-
3	Not used	-
4	Measuring mode selection	0: Regular operating mode 1: Current measuring mode *When switch 5 is set to "1", the test mode is selected.
5	Test mode transition	0: Measuring mode (Even when this switch is not set, the module runs in the measuring mode.) 1: Test mode * For details of test mode, refer to 4.2.5.

- (3) When the setting is completed, click the Complete setting button.
- (4) From the "Online" menu, select "Write to PLC" to display the dialog box of Write to PLC, and then execute the writing to PLC parameter. After resetting the CPU module, the value will become effective.

8.7.3 Initial setting

This section explains the setting of the operating condition for phase wire system, primary voltage, primary current, current demand time, and voltage demand time, primary voltage of VT, secondary voltage of VT, and primary current of CT that are required for measurement. Once each value is set, these values will be stored in the nonvolatile memory of the module, so that reconfiguration is not needed. You can also perform the setting using sequence program. In this case, you need to create a program, as referring to Chapter 9.

Follow the procedure below for each setting.

- (1) Check the current setting
- (2) Set the Buffer memory

- (1) Check the current setting

- 1) From the “Online” menu, select “Monitor” – “Buffer memory batch ...”.The dialog box to monitor all buffer memories. After setting the address as shown below, click the **Start monitoring** button to check the current buffer memory status.

Module initial address: Set the initial address of this module.
 Buffer memory address: 0

(Display: 16-bit integer, numerical value: check the number in decimal)

- 2) Check each item. The following shows items for operating condition settings. For specific setting value, see the provided references.

Table 8.7.3-1 List of setting items

Buffer memory address				Item	Reference
CH1	CH2	CH3	CH4		
Un\G0 (Common to all CHs)				Phase wire system	Section 6.2.1
Un\G1 (Common to all CHs)				Primary voltage	Section 6.2.2
Un\G2	Un\G1002	Un\G2002	Un\G3002	Primary current	Section 6.2.3
Un\G3	Un\G1003	Un\G2003	Un\G3003	Current demand time	Section 6.2.4
Un\G4	Un\G1004	Un\G2004	Un\G3004	Electric power demand time	Section 6.2.5
Un\G5 (Common to all CHs)				Primary voltage of VT	Section 6.2.2
Un\G6 (Common to all CHs)				Secondary voltage of VT	Section 6.2.2
Un\G7	Un\G1007	Un\G2007	Un\G3007	Primary current of CT	Section 6.2.3

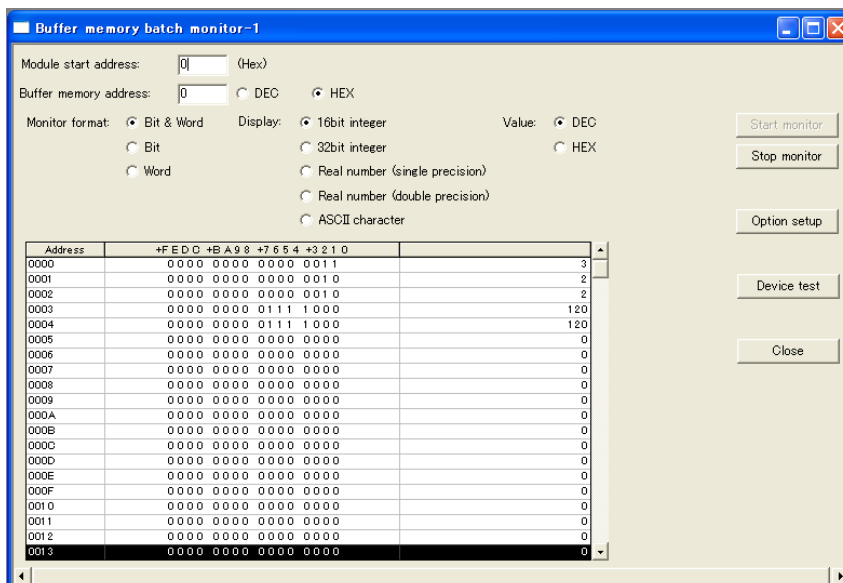

Figure 8.7.3-1 Dialog box to monitor all buffer memories (a case where the module is attached to the slot 0)

- (2) Set the Buffer memory
 - 1) In the dialog box to monitor all buffer memories, click the **Device test** button to display the Device test dialog box.
 - 2) In the Word device / buffer memory, specify the module initial address and buffer address, and click the **Set** button to apply the setting.

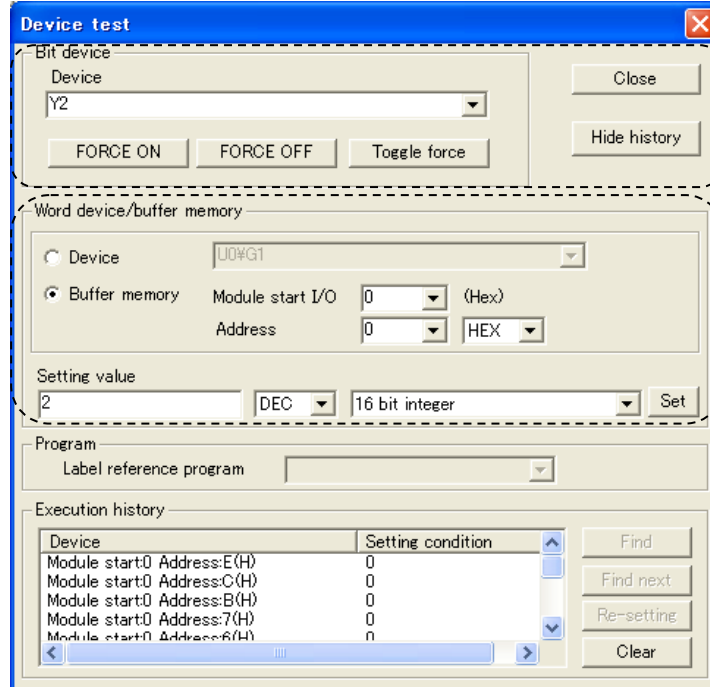

Figure 8.7.3-2 Device test dialog box (a case where this module is attached to the slot 0)

- 3) Change the setting in 2).
- 4) In the section of bit device setting in the device test dialog box, select "Y2"* and click the **FORCE ON** button.
- 5) When the setting is completed without any problem, the Device "X2"* changes to ON. Check this using the procedure as follows:
 - (a) From the "Online" menu, select "Monitor" – "Device batch ...". The dialog box to monitor all devices is displayed.
 - (b) Set "X0"* to the device, and click "Start monitor"
 - (c) Check that Device "X2"* is in the ON status.

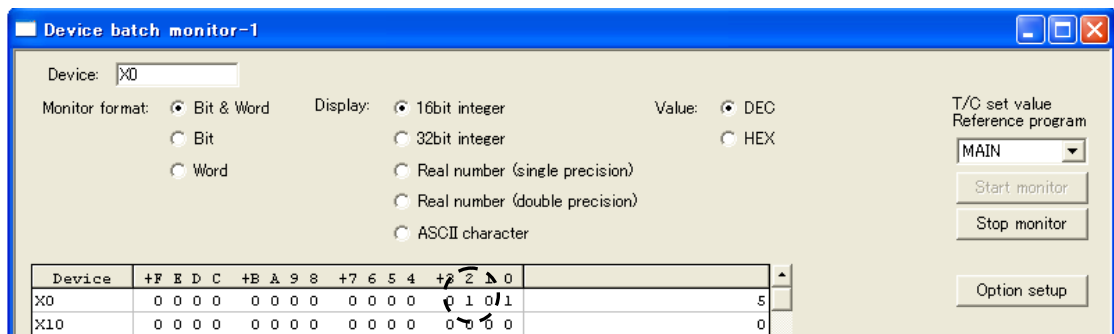

Figure 8.7.3-3 Checking the device "X2"* in the dialog box to monitor all devices

- 6) After checking that the device "X2"* is in the ON status, select "Device: "Y2"* in the dialog box of device test, and then click the **FORCE OFF** button. Setting is completes.
 - 7) If the Device "X2"* is not in the ON status, this means an error because the set value is out of range (ERR.LED is flashing). Modify the setting, and change the device "Y2" to the OFF status, then change it back to the ON status.
- * Indicates a number in the case where the initial I/O number (initial XY) is set to 0.

8.7.4 Integrated value setting

This function is to set integrated value (electric energy (consumption, regeneration) and reactive energy (consumption lag)) to any value. If you want to clear integrated value, set it to 0.

(1) Check the current setting

- 1) From the "Online" menu, select "Monitor" – "Entry data monitor". After registering the address as shown below, click the **Start monitoring** button to check the current buffer memory status.

Table 8.7.4-1 List of setting items

Items	Buffer memory	Display
Integrated value setting target	Un¥G51	16bit
Integrated value setting value	Un¥G52	32bit
Electric energy(consumption)	Un¥G102	16bit
Integrated value set request	YC	16bit
Integrated value set completion flag	XC	16bit

2) Check item.

- (a) Set integrated value setting target (Un¥G51) in the buffer memory. Setting range is as follows:

Table 8.7.4-2 List of setting items

Setting value	Description
0	No set
1	Electric energy (consumption)
2	Electric energy (regeneration)
3	Reactive energy (consumption lag)

- (b) Set integrated value setting value (Un¥G52, 53) in the buffer memory.

- Configurable range: 0 to 999999999

- The unit used for the setting value is the same as that used for the electric energy and reactive energy that are output to the buffer memory.

For details, refer to section 6.3.1.

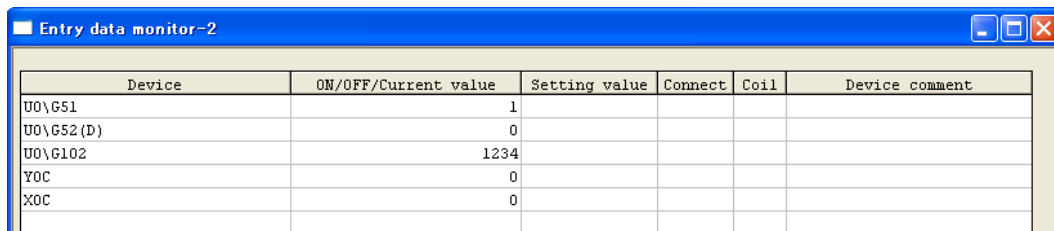

Figure 8.7.4-1 Dialog box to Entry data monitor (a case where the module is attached to the slot 0)

(2) Setting function for integrated value

This function is to set integrated value (electric energy (consumption, regeneration) and reactive energy (consumption lag)) to any value. If you want to clear integrated value, set it to 0.

- 1) In the dialog box to monitor all buffer memories, click the **Device test** button to display the Device test dialog box.
- 2) In the Word device / buffer memory, specify the module initial address and buffer address, and click the **Set** button to apply the setting.

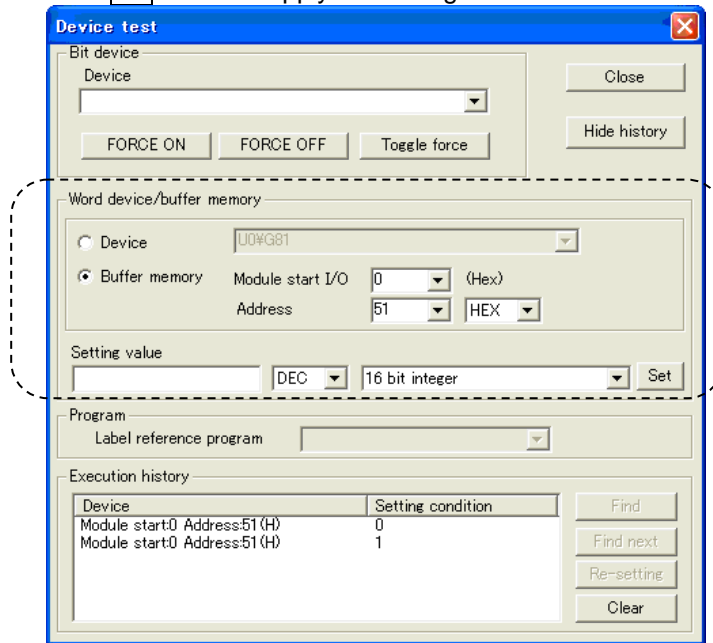

Figure 8.7.4-2 Device test dialog box (a case where this module is attached to the slot 0)

- 3) Change the setting in 2).
- 4) In the section of bit device setting in the device test dialog box, select “YC”^{*} and click the **FORCE ON** button.
- 5) When the setting is completed without any problem, the Device “XC”^{*} changes to ON.

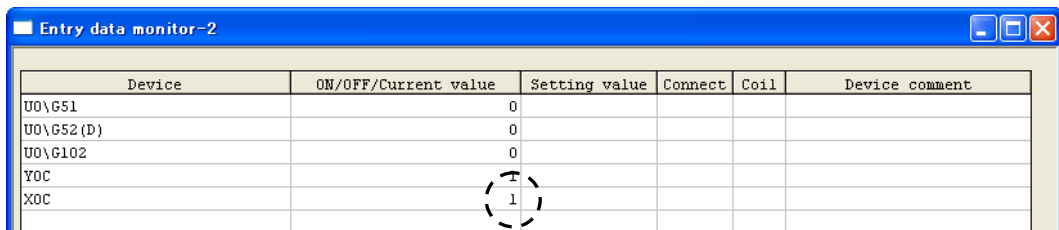

Figure 8.7.4-3 Checking the device “XC”^{*} in the dialog box to Entry data monitor

- 6) After checking that the device “XC”^{*} is in the ON status, select “Device: “YC”^{*} in the dialog box of device test, and then click the **FORCE OFF** button. Setting is completes.

^{*} Indicates a number in the case where the initial I/O number (initial XY) is set to 0.

8.7.5 Debugging program

QE84WH provides a test function so that you can debug a program with no input of voltage or current. Pseudo-value can be stored into the buffer memory. For detailed explanation for the test function, refer to 4.2.5.

**Caution**

Test function stores pseudo-values for setting value and error information as well as measured value. If you use these data to control the sequence program that controls external devices, there is a chance that erroneous control may occur. For safety of external devices, use this function after disconnecting the device.

- (1) Setting intelligent function of the module switch
 - 1) In the "I/O assignment setting" of 8.7.1, click the **Switch setting** button to display the dialog box of "I/O module, intelligent function module switch setting". (Refer to 8.7.2)
 - 2) The intelligent function module switch setting displays switches 1 to 5; however, use switch 5 when using the test function. Switch setting is configured using 16-bit data.
Setting is as follows:
Switch 5: "1"
 - 3) When the setting is completed, click the **End** button.
 - 4) From the "Online" menu, select "Write to PLC" to display the dialog box of Write to PLC, and then execute the writing to PLC parameter. After resetting the CPU module, the value will become effective.
- (2) Starting the test function
 - 1) Reset the CPU module.
 - 2) QE84WH starts in the test function mode. All LEDs are turned on. Pseudo-values are stored in the buffer memory.
- (3) Finishing the test function (Move back to the measuring mode)
 - 1) Following 1) and 2) in step (1), configure the intelligent function switch setting as shown below.
Switch 5: "0"
 - 2) Following 3) and 4) in step (1), complete the setting and write the data into PLC.
 - 3) Reset the CPU module, then the operation goes back to the measuring mode.

Chapter 9: Programming

This chapter explains about programming for QE84WH.

When you apply sample programs introduced in this chapter into the actual system, make sure to verify in advance that there is no problem with the target system control.

Follow the procedure in Figure 9.1-1 to create a sample program using QE84WH.

The default setting allows you to use either GX Works2 (Regular operating mode: refer to 8.6. Current measuring mode: refer to 7.8.), GX Developer (refer to 8.7) or the sequence program to make settings; however, if the setting is made for the first time by using GX Works2 or GX Developer, the program for initial setting can be eliminated, which will reduce time for scanning.

9.1 Programming procedure

Follow the procedure in Figure 9.1-1 to create a program for acquiring the measured data, alarm monitoring, calculating periodical electricity amount using QE84WH.

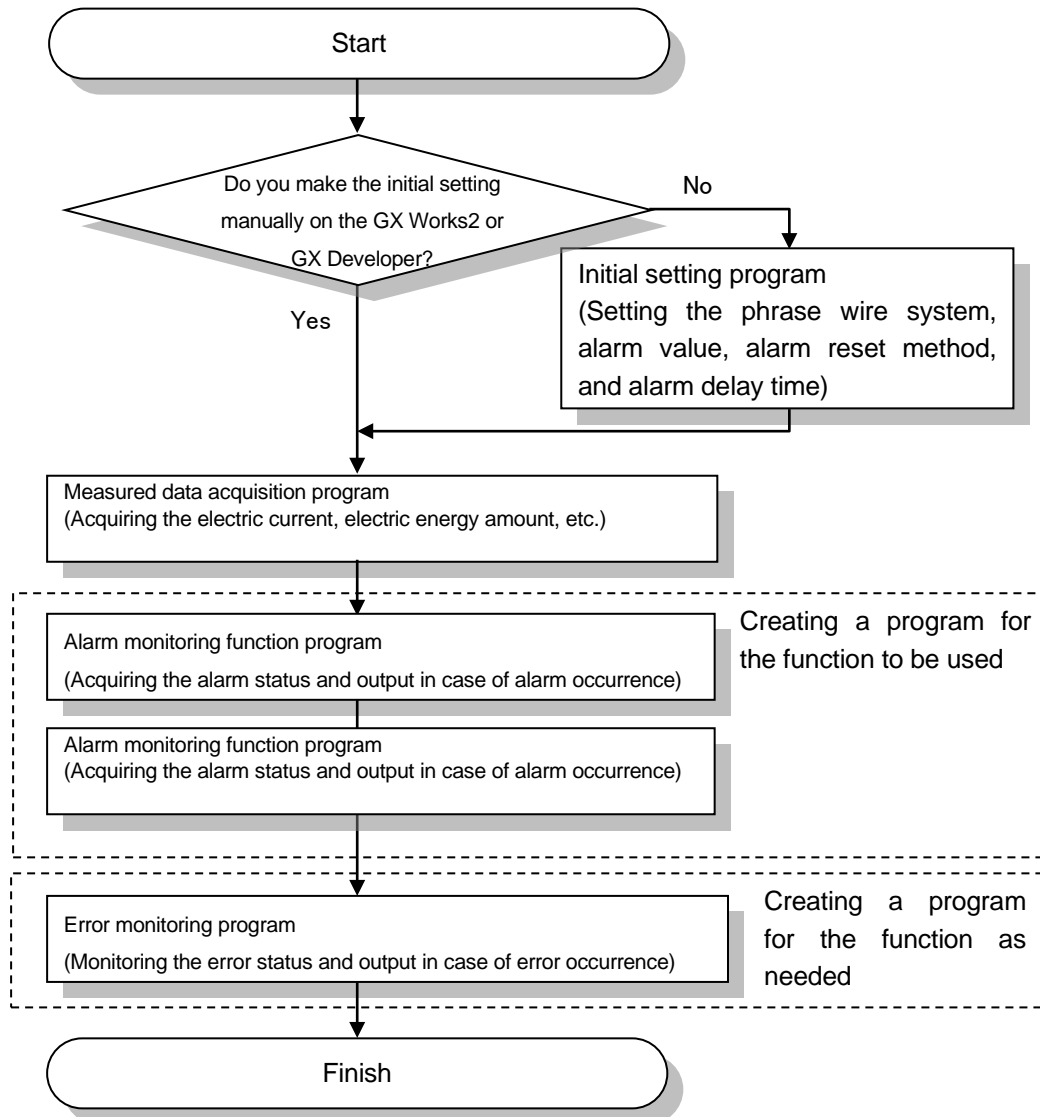

Figure 9.1-1 Programming chart

9.2 System configuration and usage conditions for sample program

A sample program under the following system and the usage condition is shown below.

(1) System configuration

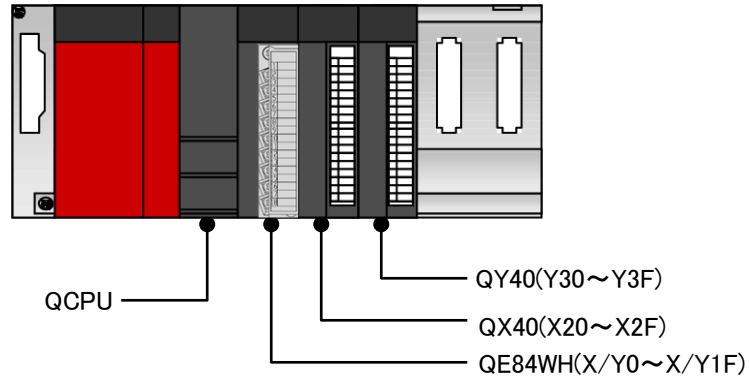

Figure 9.2-1 Sample system configuration using a sample program

(2) Setting conditions for the intelligent function of the module switch

Setting is as follows:

Table 9.2-1 Setting the intelligent function of the module switch

Switch No.	Switch name	Description
1	Not used	-
2	Not used	-
3	Not used	-
4	Measuring mode selection	0 (Regular measuring mode)
5	Operation mode	0 (Measuring mode)

(3) Programming conditions

(a) Setting the operating conditions

- Phase wire : Three-phase 3-wire
- Primary voltage : 220 V
- Primary current : 250 A
- Current demand time : 30 sec
- Electric power demand time : 30 sec
- Primary voltage of VT : 0
- Secondary voltage of VT : 0
- Primary current of CT : 0

(b) Alarm monitoring setting

- Alarm 1 item : Current demand upper limit
- Alarm 1 value : 100000 (100 A)
- Alarm 1 reset method : Auto reset
- Alarm 1 delay time : 5 sec
- Alarm 2 item : Current demand upper limit
- Alarm 2 value : 120000 (120 A)
- Alarm 2 reset method : Self-retention
- Alarm 2 delay time : 5 sec

(c) Data acquisition clock setting

- Output period of data acquisition clock : 1000 (1sec)

(4) Before creating a program

Before creating a program, attach QE84WH to the base unit, and connect it to external devices.

Electric current sensor: EMU-CT250

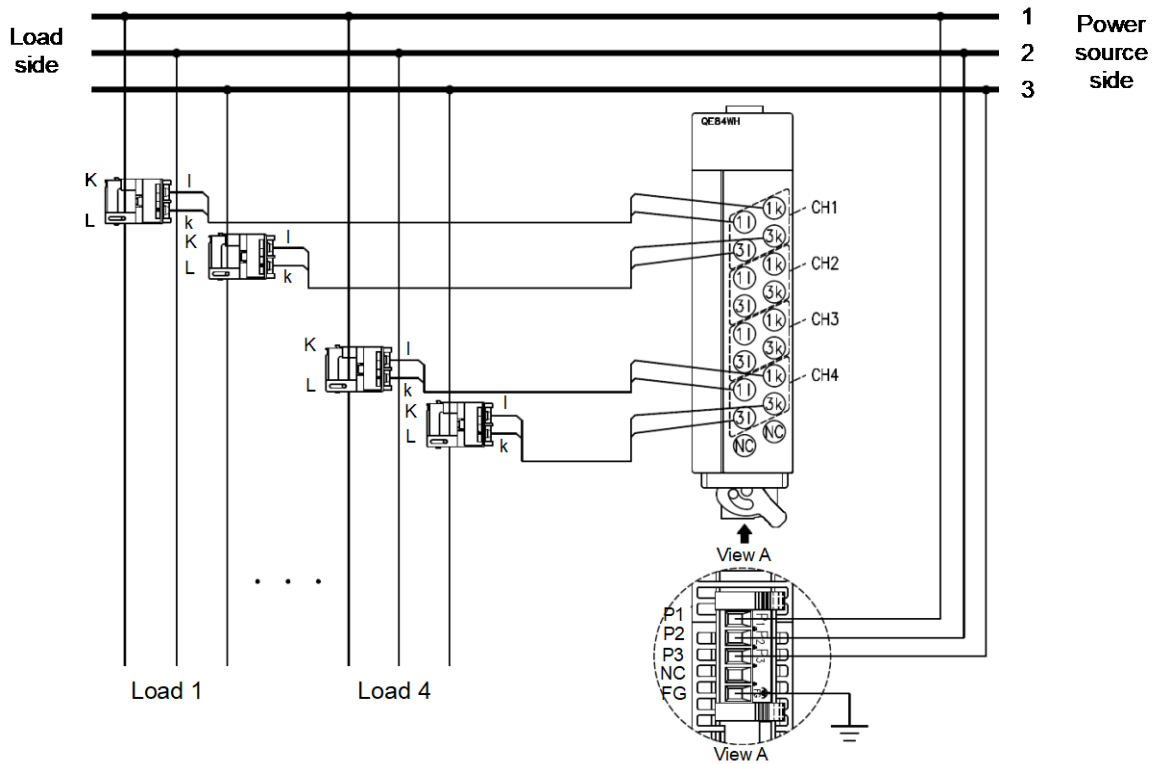

Figure 9.2-2 Example of wiring using a sample program

9.2.1 Sample program when make the initial setting using GX Works2 or GX Developer.

(1) List of devices

Table 9.2.1-1 List of devices

Device	Function	
D30	Device that stores latest error code	
X0	Module ready	QE84WH (X/Y0 to X/Y1F)
X2	Operating condition setting completion flag	
X9	CH1 Alarm 1 flag	
XA	CH1 Alarm 2 flag	
XB	CH2 Alarm 1 flag	
XC	CH2 Alarm 2 flag	
X1F	Error flag	
Y2	Operating condition setting request	
YA	CH1 Alarm 2 reset request	
YC	CH2 Alarm 2 reset request	
X21	Device that the user will turn ON in order to cancel error after CH1 alarm 2 occur	
X2E	Device that the user will turn ON in order to support measurement of CH1 periodic electric energy	
X2F	Device that the user will turn ON in order to reset integrated value of CH1	
Y30	Device that turns ON to send an output to the external device when the CH1 alarm 1 occurs	QY40 (Y30 to Y3F)
Y31	Device that turns ON to send an output to the external device when the CH1 alarm 2 occurs	
Y3F	Device that turns ON to send an output to the external device in the case of an error	

(2) List of buffer memories to be used

Table 9.2.1-2 List of buffer memories to be used

Device	Description	Setting value	Remarks
U0\G4500	Latest error code	-	Stores latest error code

(3) Sample program

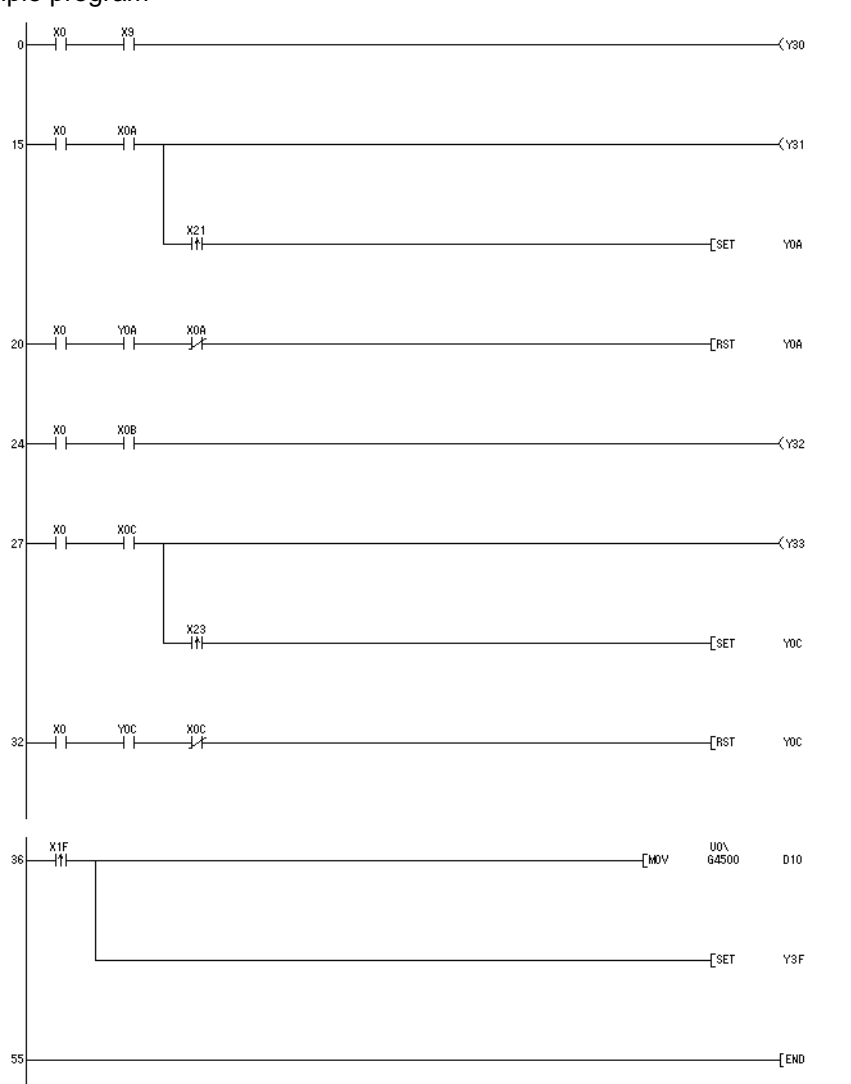

Figure 9.2.1-1 Example of a sample program

9.2.2 Sample program when make the initial setting using sequence program.

(1) List of devices

Table 9.2.2-1 List of devices

Device	Function	
D0, D1	Device that stores Multiplier of electric energy	
D2, D3	Device that stores electric energy (consumption)	
D4, D5	Periodic electric energy 1	
D6, D7	Periodic electric energy 2	
D8, D9	Device that stores average current	
D10, D11	Device that stores average voltage	
D12, D13	Device that stores electric power	
D14, D15	Device that stores reactive power	
D16, D17	Device that stores power factor	
D18, D19	Device that stores frequency	
D30	Device that stores latest error code	
X0	Module ready	QE84WH (X/Y0 to X/Y1F)
X1	Data acquisition clock	
X2	Operating condition setting completion flag	
X9	Alarm 1 flag	
XA	Alarm 2 flag	
X1F	Error flag	
Y2	Operating condition setting request	
Y5	Periodic electric energy 1 measurement flag	
Y6	Periodic electric energy 2 measurement flag	
Y0A	CH1 Alarm 2 reset request	
X21	Device that the user will turn ON in order to cancel error after CH1 alarm 2 occur	QX40 (X20 to X2F)
X2E	Device that the user will turn ON in order to support measurement of CH1 periodic electric energy	
X2F	Device that the user will turn ON in order to reset integrated value of CH1	
Y30	Device that turns ON to send an output to the external device when the CH1 alarm 1 occurs	QY40 (Y30 to Y3F)
Y31	Device that turns ON to send an output to the external device when the CH1 alarm 2 occurs	
Y3F	Device that turns ON to send an output to the external device in the case of an error	

(2) List of buffer memories to be used

Table 9.2.2-2 List of buffer memories to be used

Device	Description	Setting value	Remarks
U0\G0	Phase wire method	3	Three-phase 3-wire
U0\G1	Primary voltage	2	220 V
U0\G2	Primary current	3	250 A
U0\G3	Current demand time	30	30 sec
U0\G4	Electric power demand time	30	30 sec
U0\G5	Primary voltage of VT	0	When Primary voltage(U0\G1) is expect 0
U0\G6	Secondary voltage of VT	0	When Primary voltage(U0\G1) is expect 0
U0\G7	Primary current of CT	0	When Primary current (U0\G2) is expect 0
U0\G11	Alarm 1 item	1	Current demand upper limit
U0\G12, 13	Alarm 1 value	100000	100 A
U0\G14	Alarm 1 reset method	1	Auto reset
U0\G15	Alarm 1 delay time	5	5 sec
U0\G21	Alarm 2 item	1	Current demand upper limit
U0\G22, 23	Alarm 2 value	120000	120 A
U0\G24	Alarm 2 reset method	0	Self-retention
U0\G25	Alarm 2 delay time	5	5 sec
U0\G60,61	Output period of data acquisition clock	1000	1 sec
U0\G100	Multiplier of electric energy	-	Stores multiplier of electric energy
U0\G102, 103	Electric energy (consumption)	-	Stores electric energy
U0\G114,115	Periodic electric energy 1	-	Stores Periodic electric energy 1
U0\G116,117	Periodic electric energy 2	-	Stores Periodic electric energy 2
U0\G218, 219	Average current	-	Stores average current
U0\G314, 315	Average voltage	-	Stores average voltage
U0\G402, 403	Electric power	-	Stores Electric power
U0\G502, 503	Reactive power	-	Stores Reactive power
U0\G702, 703	Power factor	-	Stores power factor
U0\G802, 803	Frequency	-	Stores frequency
U0\G51	Integrated value setting target	19	CH1 Total integrated value
U0\G52,53	Integrated value setting value	0	0kWh(kvarh)
U0\G4500	Latest error code	-	Stores latest error code

(3) Sample program

1. Initial setting program for QE84WH

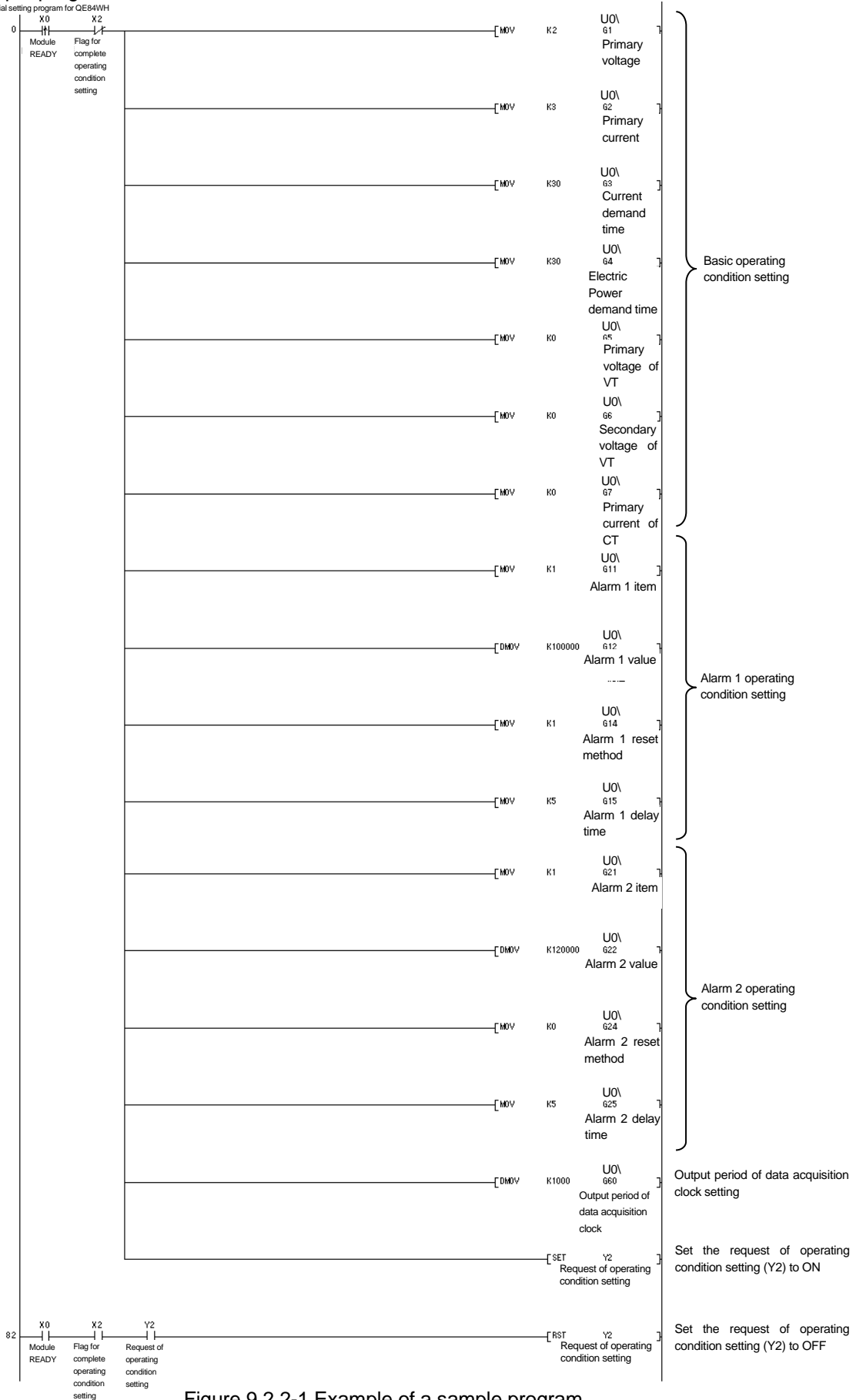

Figure 9.2.2-1 Example of a sample program

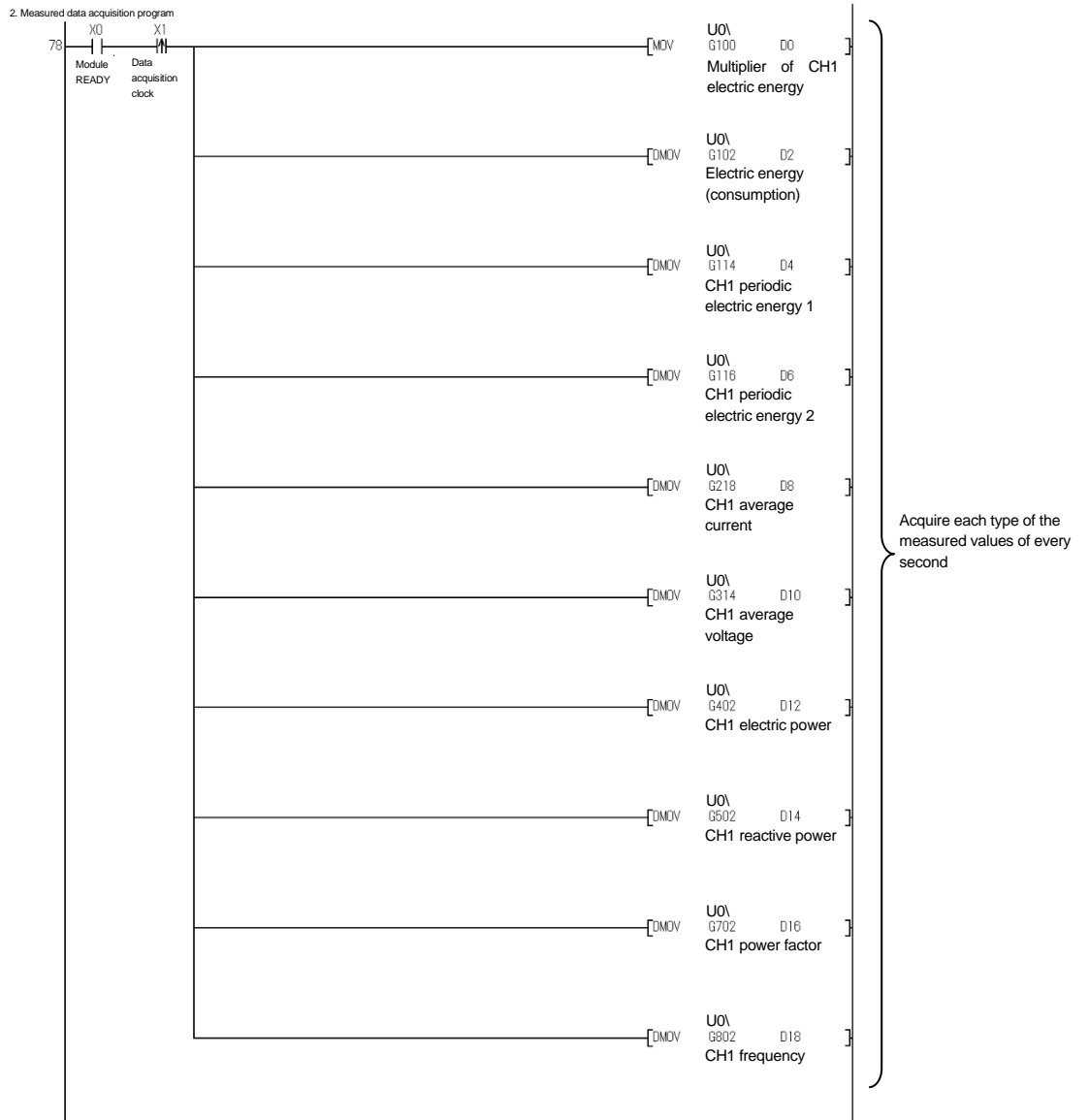

Figure 9.2.2-2 Example of a sample program (continued)

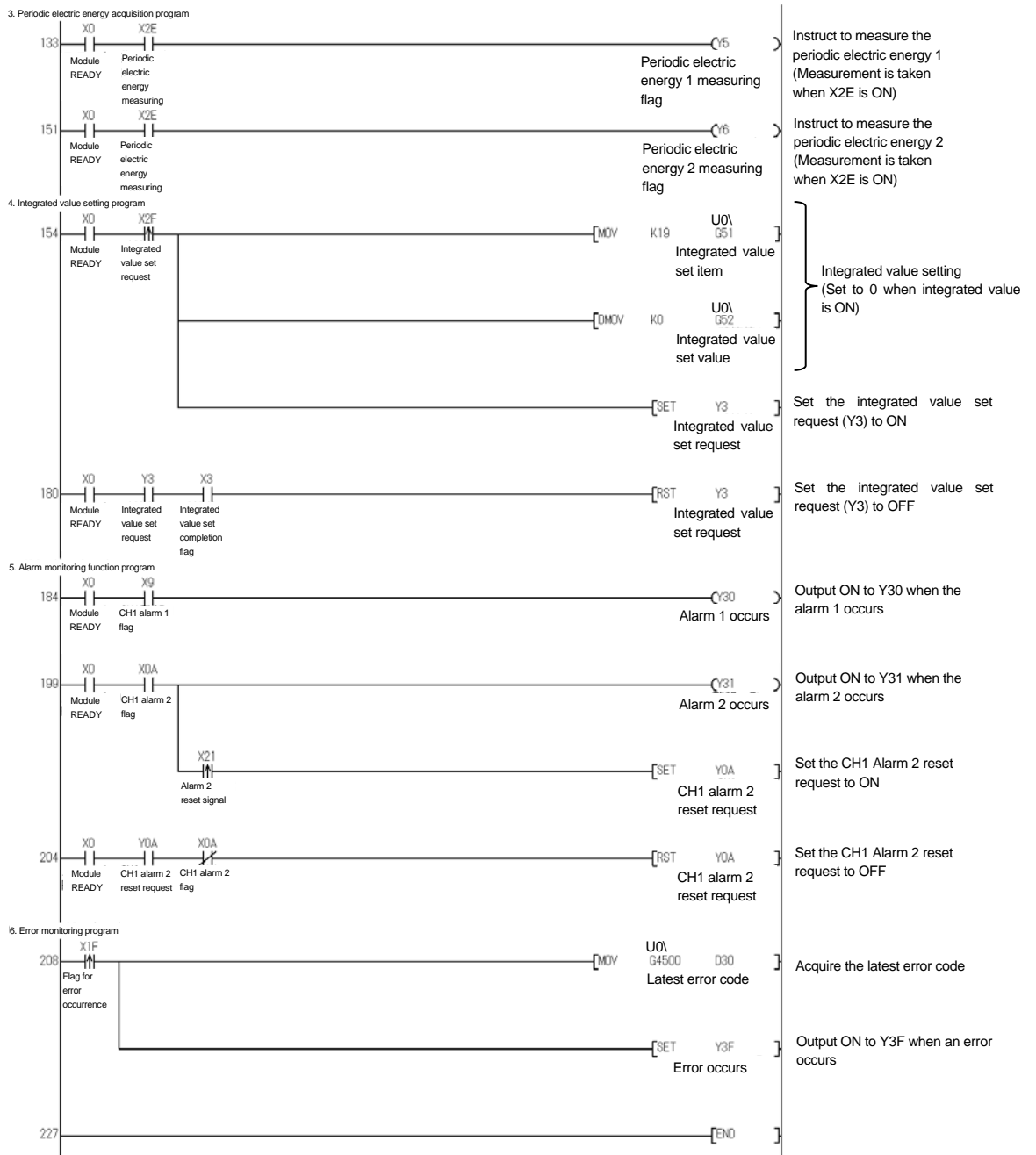

Figure 9.2.2-3 Example of a sample program (continued)

9.3 System configuration and usage conditions for current measuring mode

A sample program is shown below based on the following system and the usage condition.

(1) System configuration

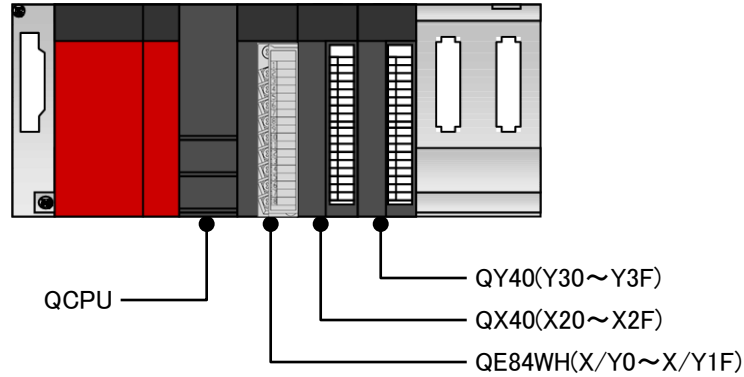

Figure 9.3-1 Sample system configuration using a sample program

(2) Setting conditions for the intelligent function module switch

Setting is as follows:

Table 9.3-1 Intelligent function module switch setting

Switch No.	Switch name	Description
1	Not used	-
2	Not used	-
3	Not used	-
4	Measuring mode selection	1 (Current measuring mode)
5	Operation mode	0 (Measuring mode)

(3) Programming conditions

(a) Operating condition setting

- Channel to be used : CH1, CH2
- Primary current : 250 A
- CH1 and CH2 current demand time : 30 sec. (Setting the operating conditions)
- Primary current of CT : 0 (When Primary current (U0\G4003) is aspect 0)

(b) Alarm monitoring setting

- CH1 and CH2 alarm 1 item : Maximum current demand
- CH1 and CH2 alarm 1 value : 100000 (100 A)
- CH1 and CH2 alarm 1 reset method : Auto reset
- CH1 and CH2 alarm 1 delay time : 5 sec.
- CH1 and CH2 alarm 2 item : Maximum current demand
- CH1 and CH2 alarm 2 value : 120000 (120 A)
- CH1 and CH2 alarm 2 reset method : Self-retention
- CH1 and CH2 alarm 2 delay time : 5 sec.

(c) Data acquisition clock setting

- Output period of data acquisition clock : 500 (0.5 sec.)

(4) Before creating a program

Before creating a program, attach QE84WH to the base unit, and connect it to external devices.

Electric current sensor: EMU-CT250 (Split type)

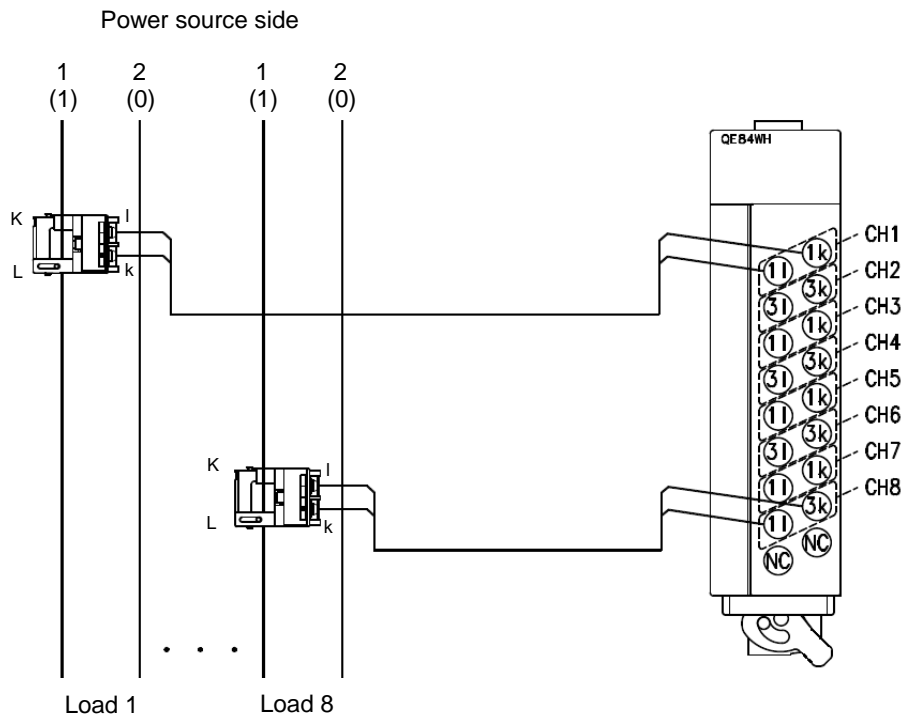

Figure 9.3-2 Example of wiring using a sample program

9.3.1 Sample program when make the initial setting using GX Works2 or GX Developer.
A sample program is shown below based on the following system and the usage condition.

(1) List of devices

Table 9.3.1-1 List of devices

Device	Function		
D0, D1	Device that stores CH1 current		
D4, D5	Device that stores CH2 current		
D10	Device that stores latest error code		
X0	Module ready	QE84WH (X/Y0 to X/Y1F)	
X1	Data acquisition clock		
X2	Operating condition setting completion flag		
X9	CH1 alarm 1 flag		
XA	CH1 alarm 2 flag		
XB	CH2 alarm 1 flag		
XC	CH2 alarm 2 flag		
X1F	Error flag		
Y2	Operating condition setting request		
YA	CH1 alarm2 reset request.		
YC	CH2 alarm2 reset request.		
X21	Device that the user will turn ON in order to cancel error after CH1 alarm 2 occur		QX40 (X20 to X2F)
X23	Device that the user will turn ON in order to cancel error after CH2 alarm 2 occur		
Y30	Device that turns ON to send an output to the external device when the CH1 alarm 1 occurs	QY40 (Y30 to Y3F)	
Y31	Device that turns ON to send an output to the external device when the CH1 alarm 2 occurs		
Y32	Device that turns ON to send an output to the external device when the CH2 alarm 1 occurs		
Y33	Device that turns ON to send an output to the external device when the CH2 alarm 2 occurs		
Y3F	Device that turns ON to send an output to the external device in the case of an error		

(2) List of buffer memories to be used

Table 9.3.1-2 List of buffer memories to be used

Device	Description		Setting value	Remarks
U0\G4003	CH1 and CH2	Primary current	3	250 A
U0\G4004	CH1	Current demand time	30	30 sec.
U0\G4054	CH2	Current demand time	30	30 sec.
U0\G4005	CH1	Primary current of CT	0	When Primary current (U0\G4003) is axpect 0
U0\G4011	CH1	Alarm 1 item	1	Maximum current demand
U0\G4012, 4013		Alarm 1 value	100000	100 A
U0\G4014		Alarm 1 reset method	1	Auto reset
U0\G4015		Alarm 1 delay time	5	5 sec.
U0\G4021		Alarm 2 item	1	Maximum current demand
U0\G4022, 4023		Alarm 2 value	120000	120 A
U0\G4024		Alarm 2 reset method	0	Self-retention
U0\G4025		Alarm 2 delay time	5	5 sec.
U0\G4061	CH2	Alarm 1 item	1	Maximum current demand
U0\G4062, 4063		Alarm 1 value	1000000	100 A
U0\G4064		Alarm 1 reset method	0	Auto reset
U0\G4065		Alarm 1 delay time	5	5 sec.
U0\G4071		Alarm 2 item	1	Maximum current demand
U0\G4072, 4073		Alarm 2 value	120000	120 A
U0\G4074		Alarm 2 reset method	0	Self-retention
U0\G4075		Alarm 2 delay time	5	5 sec.
U0\G4000, 4001	All CHs	Output period of data acquisition clock	500	0.5 sec.
U0\G4032, 4033	CH1	Current	-	Stores the current measurement.
U0\G4082, 4083	CH2	Current	-	Stores the current measurement.
U0\G4500	Latest error code		-	Stores the latest error code.

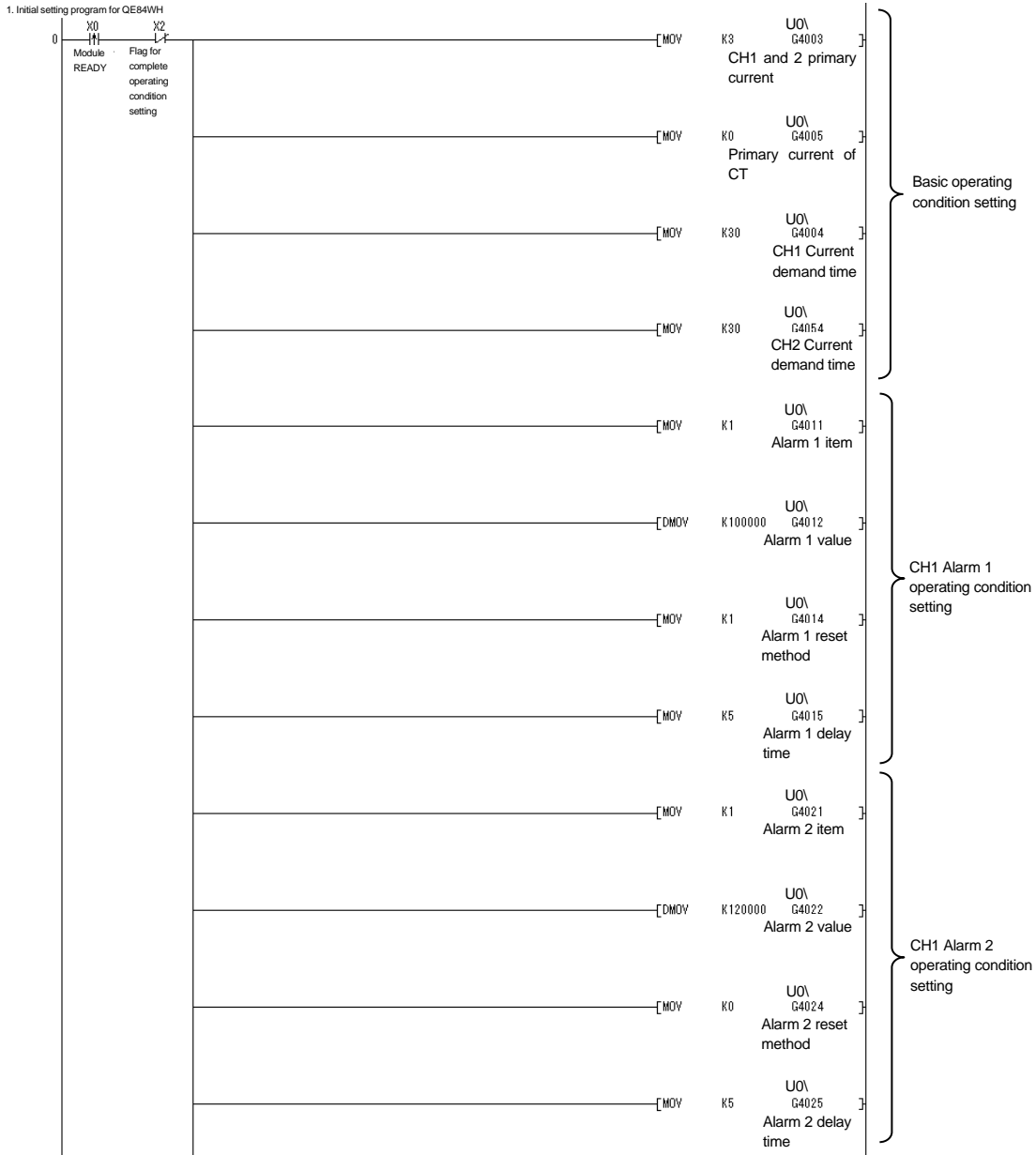

Figure 9.3.1-1 Example of a sample program

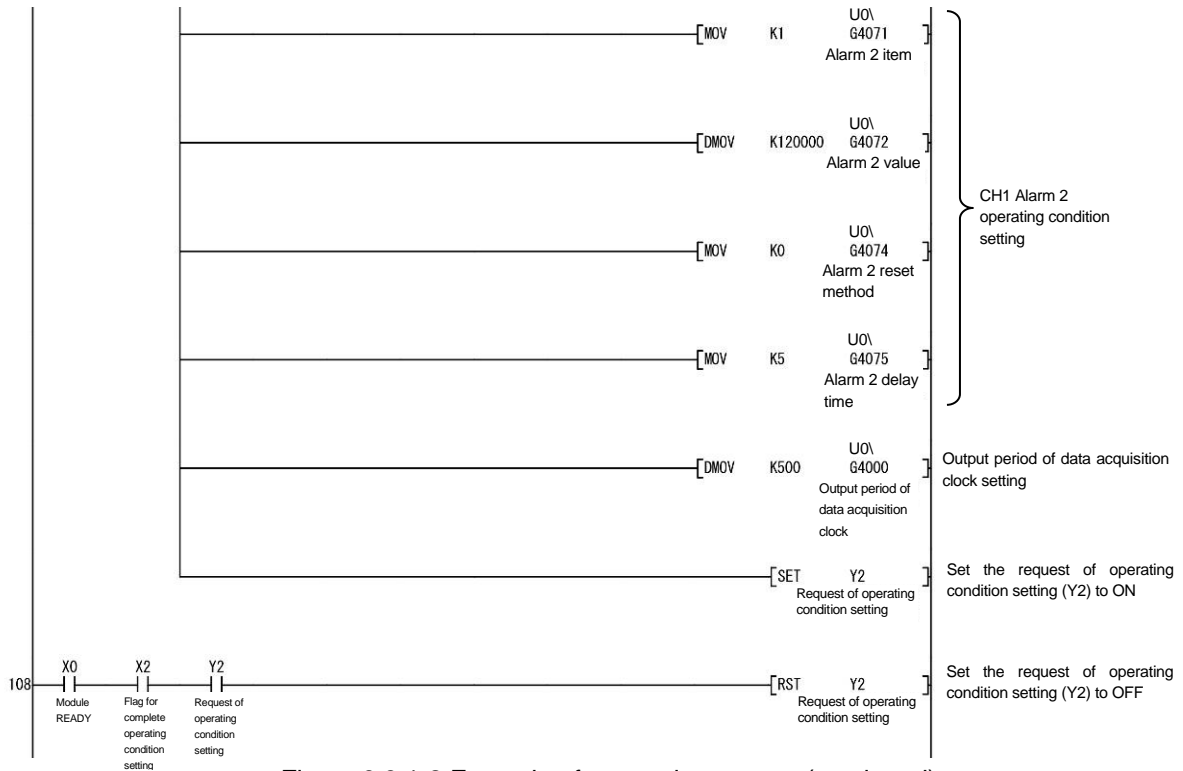

Figure 9.3.1-2 Example of a sample program (continued)

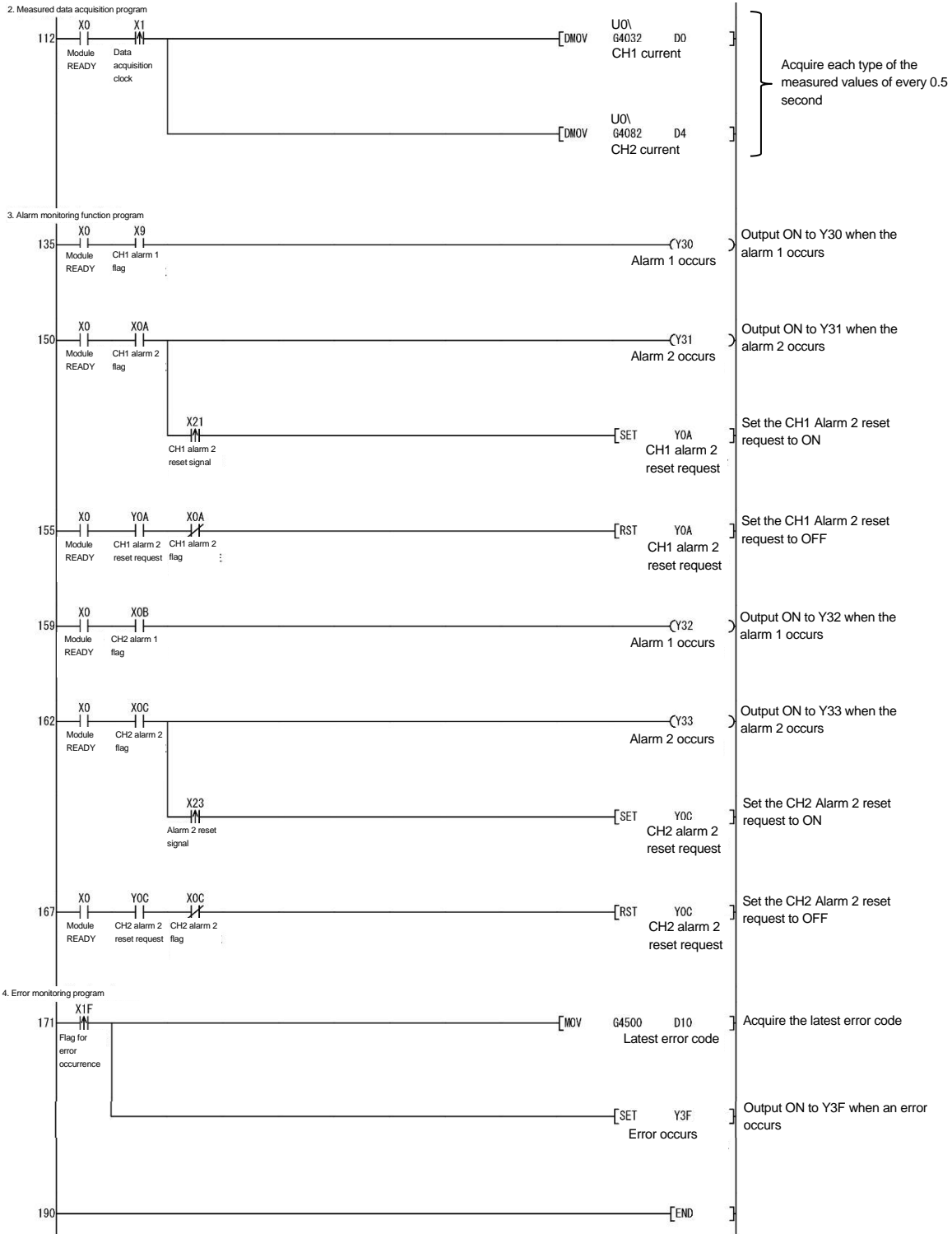

Figure 9.3.1-3 Example of a sample program (continued)

9.3.2 Sample program when make the initial setting using sequence program.

A sample program is shown below based on the following system and the usage condition.

(1) List of devices

Table 9.3.2-1 List of devices

Device	Function		
D0, D1	Device that stores CH1 current		
D4, D5	Device that stores CH2 current		
D10	Device that stores latest error code		
X0	Module ready	QE84WH (X/Y0 to X/Y1F)	
X1	Data acquisition clock		
X2	Operating condition setting completion flag		
X9	CH1 alarm 1 flag		
XA	CH1 alarm 2 flag		
XB	CH2 alarm 1 flag		
XC	CH2 alarm 2 flag		
X1F	Error flag		
Y2	Operating condition setting request		
YA	CH1 alarm2 reset request.		
YC	CH2 alarm2 reset request.		
X21	Device that the user will turn ON in order to cancel error after CH1 alarm 2 occur		QX40 (X20 to X2F)
X23	Device that the user will turn ON in order to cancel error after CH2 alarm 2 occur		
Y30	Device that turns ON to send an output to the external device when the CH1 alarm 1 occurs	QY40 (Y30 to Y3F)	
Y31	Device that turns ON to send an output to the external device when the CH1 alarm 2 occurs		
Y32	Device that turns ON to send an output to the external device when the CH2 alarm 1 occurs		
Y33	Device that turns ON to send an output to the external device when the CH2 alarm 2 occurs		
Y3F	Device that turns ON to send an output to the external device in the case of an error		

(2) List of buffer memories to be used

Table 9.3.2-2 List of buffer memories to be used

Device	Description	Setting value	Remarks	
U0\G4003	CH1 and CH2	Primary current	3	250 A
U0\G4004	CH1	Current demand time	30	30 sec.
U0\G4054	CH2	Current demand time	30	30 sec.
U0\G4005	CH1	Primary current of CT	0	When Primary current (U0\G4003) is aspect 0
U0\G4011	CH1	Alarm 1 item	1	Maximum current demand
U0\G4012, 4013		Alarm 1 value	100000	100 A
U0\G4014		Alarm 1 reset method	1	Auto reset
U0\G4015		Alarm 1 delay time	5	5 sec.
U0\G4021		Alarm 2 item	1	Maximum current demand
U0\G4022, 4023		Alarm 2 value	120000	120 A
U0\G4024		Alarm 2 reset method	0	Self-retention
U0\G4025		Alarm 2 delay time	5	5 sec.
U0\G4061	CH2	Alarm 1 item	1	Maximum current demand
U0\G4062, 4063		Alarm 1 value	1000000	100 A
U0\G4064		Alarm 1 reset method	0	Auto reset
U0\G4065		Alarm 1 delay time	5	5 sec.
U0\G4071		Alarm 2 item	1	Maximum current demand
U0\G4072, 4073		Alarm 2 value	120000	120 A
U0\G4074		Alarm 2 reset method	0	Self-retention
U0\G4075		Alarm 2 delay time	5	5 sec.
U0\G4000, 4001	All CHs	Output period of data acquisition clock	500	0.5 sec.
U0\G4032, 4033	CH1	Current	-	Stores the current measurement.
U0\G4082, 4083	CH2	Current	-	Stores the current measurement.
U0\G4500	Latest error code		-	Stores the latest error code.

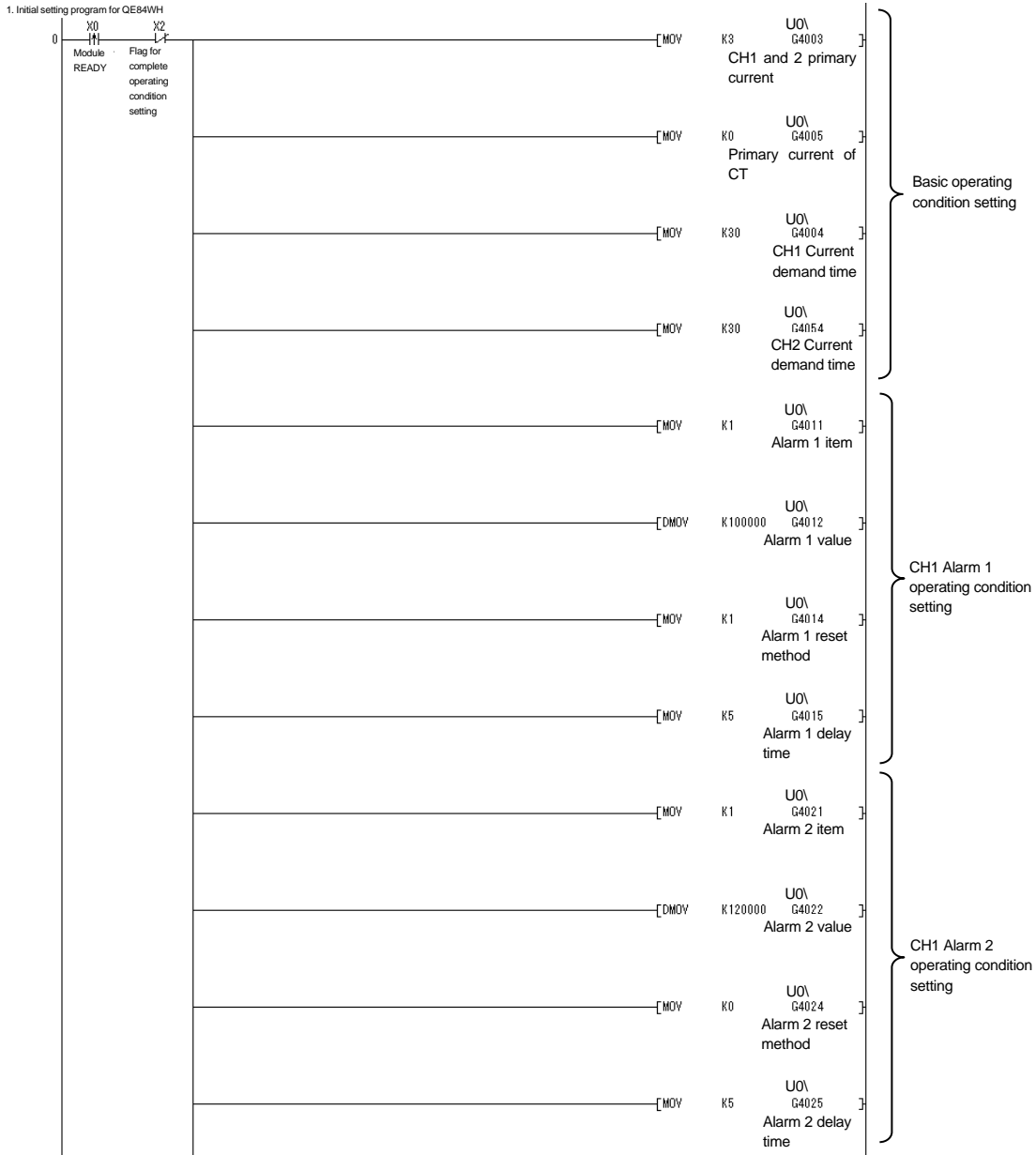

Figure 9.3.2-1 Example of a sample program

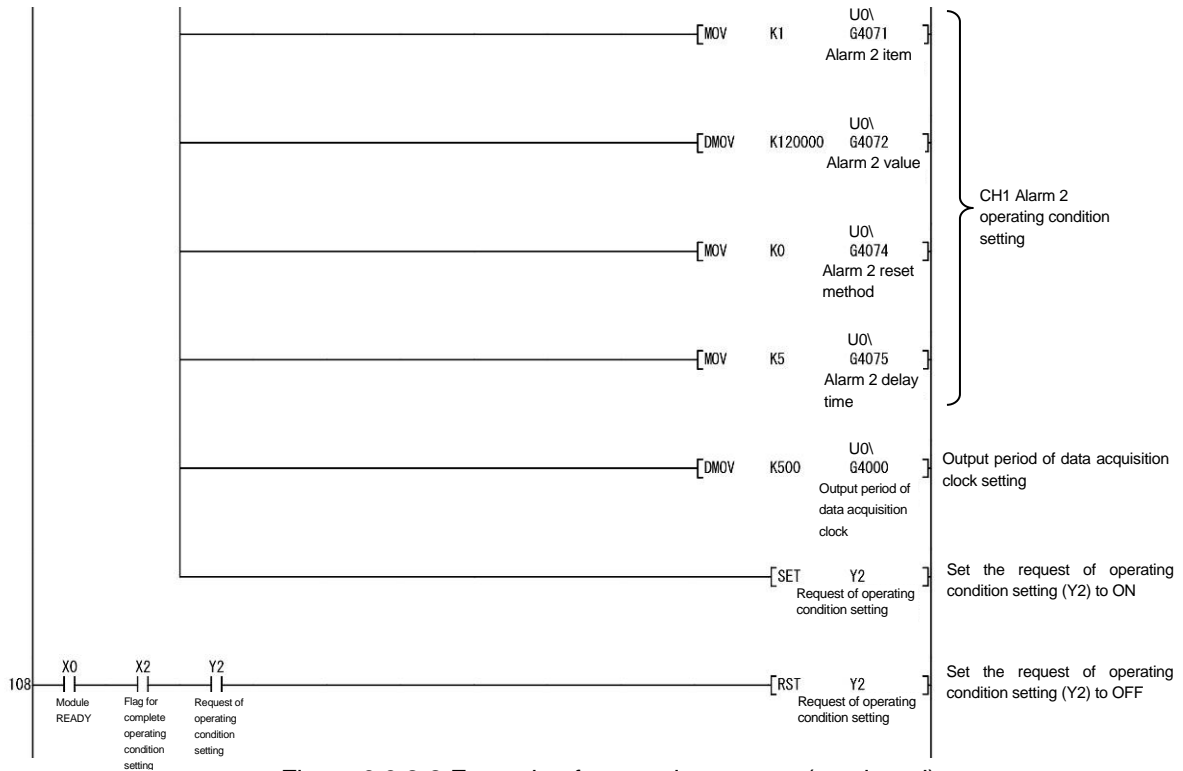

Figure 9.3.2-2 Example of a sample program (continued)

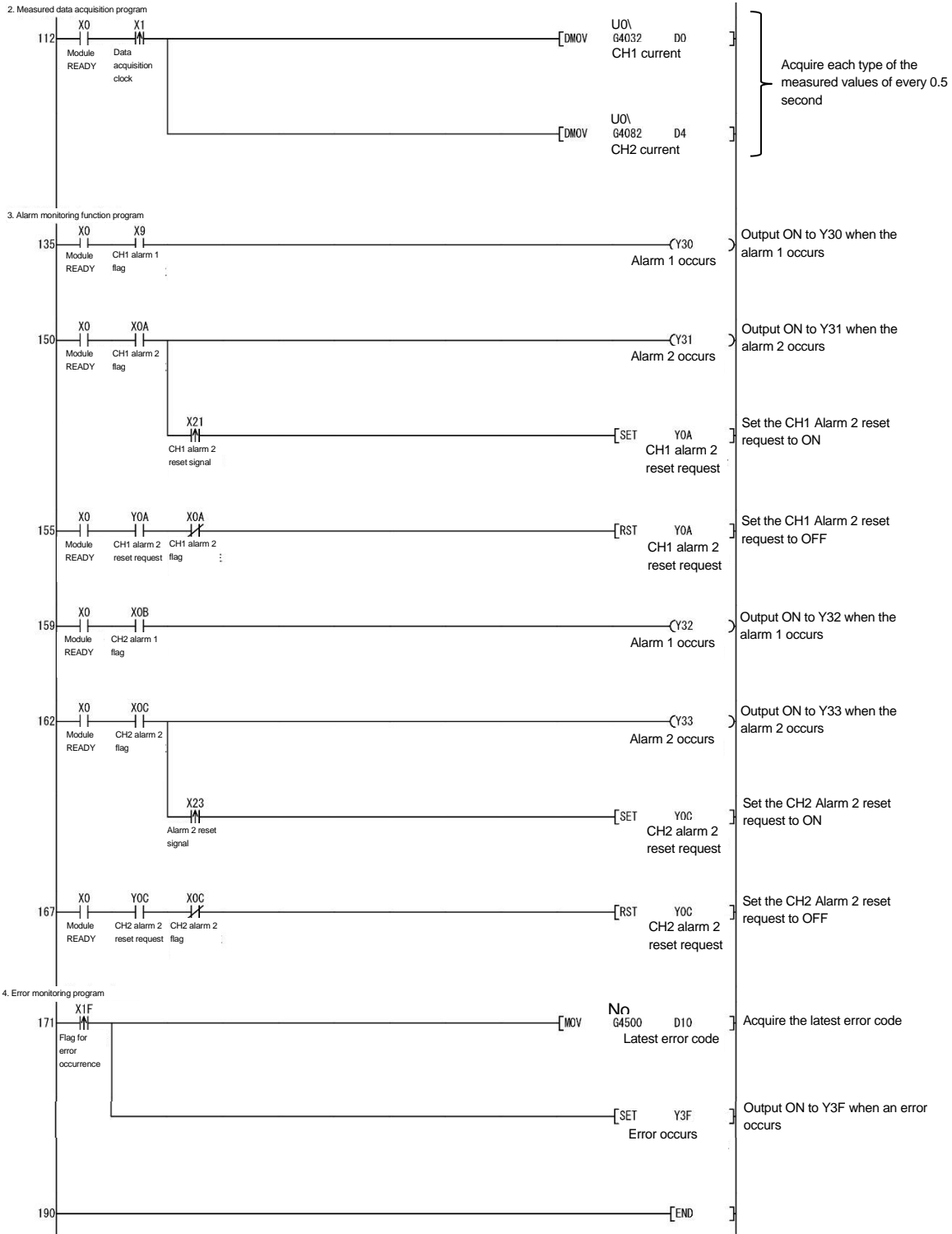

Figure 9.3.2-3 Example of a sample program (continued)

Chapter 10: Troubleshooting

⚠ CAUTION	If abnormal sound, a smell, smoke, and generation of heat occur from this apparatus, please turn off the power immediately and stop use.
------------------	--

10.1 List of error codes

When the data are written to the CPU module from this module or when a reading error occurs, error codes will be stored into the following buffer memory.

Table 10.1-1 Latest error code, storage destination upon error occurrence

Latest error code	Time of error occurrence
Un\G4500	Un\G4501 to Un\G4504

Table below shows error codes.

Table 10.1-2 List of error codes

Error code (HEX)	Error level	Measuring mode	Descriptions	Action	Reference
0001h 0002h 0003h	Mid	All modes	Hardware error with the module.	Turn the power OFF/ON. If the error recurs, the module may have a failure. Consult with a nearest sales agent or our company branch for the symptom of the failure.	-
1001h	Low	Regular operating	Phase wire method is set out of range.	Check phase wire method, and set it within 1-3.	Section 6.2.1
1002h	Low	Regular operating	Primary voltage is set out of range.	Set it within 0 to 9 according to the primary voltage.	Section 6.2.2
1003h (CH1), 1013h (CH2) 1023h (CH3), 1033h (CH4)	Low	Regular operating	Primary current is set out of range.	Set it within the range* of 0 to 5, 501 to 536 according to the primary current.	Section 6.2.3
1004h (CH1), 1014h (CH2) 1024h (CH3), 1034h (CH4)	Low	Regular operating	Current demand time is set out of range.	Set current demand time within the range* of 0 to 1800 (seconds).	Section 6.2.4
1005h (CH1), 1015h (CH2) 1025h (CH3), 1035h (CH4)	Low	Regular operating	Electric power demand time is set out of range.	Set electric power demand time within the range* of 0 to 1800 (seconds).	Section 6.2.5
100Dh	Low	Regular operating	Primary voltage of VT is set out of range.	Set primary voltage of VT within the range* of 0 to 6600 (V). However, this setting cannot set 0 (any setting) when primary voltage (Un\G1) is 0.	Section 6.2.2
100Eh	Low	Regular operating	Secondary voltage of VT is set out of range.	Set secondary voltage of VT within the range* of 0 to 220 (V). However, this setting cannot set 0 (any setting) when primary voltage (Un\G1) is 0.	Section 6.2.2
100Fh (CH1), 101Fh (CH2) 102Fh (CH3), 103Fh (CH4)	Low	Regular operating	Primary current of CT is set out of range.	Set primary current of CT within the range* of 0 to 6000 (A). However, this setting cannot set 0 (any setting) when primary current (Un\G2) is 0.	Section 6.2.3
1006h (CH1), 1016h (CH2) 1026h (CH3), 1036h (CH4)	Low	Regular operating	Alarm 1 item is set out of range.	Set alarm 1 item within 1 to 8.	Section 6.2.6
1007h (CH1), 1017h (CH2) 1027h (CH3), 1037h (CH4)	Low	Regular operating	Alarm 2 item is set out of range.	Set alarm 2 item within 1 to 8.	Section 6.2.6
1008h (CH1), 1018h (CH2) 1028h (CH3), 1038h (CH4)	Low	Regular operating	Alarm 1 reset method is set out of range.	Set alarm 1 reset method within 0 to 1.	Section 6.2.8
1009h (CH1), 1019h (CH2) 1029h (CH3), 1039h (CH4)	Low	Regular operating	Alarm 2 reset method is set out of range.	Set alarm 2 reset method within 0 to 1.	Section 6.2.8
100Ah (CH1), 101Ah (CH2) 102Ah (CH3), 103Ah (CH4)	Low	Regular operating	Alarm 1 delay time is set out of range.	Set alarm 1 delay time within the range* of 0 to 300 (seconds).	Section 6.2.9
100Bh (CH1), 101Bh (CH2) 102Bh (CH3), 103Bh (CH4)	Low	Regular operating	Alarm 2 delay time is set out of range.	Set alarm 2 delay time within the range* of 0 to 300 (seconds).	Section 6.2.9
100Ch	Low	Regular operating	Integrated value setting value is set out of range.	Set integrated value setting value within the range* of 0 to 999999999 in the double word format (32-bit integer).	Section 6.2.10
1041h	Low	Regular operating	Output period of data acquisition clock is set out of range.	Set the output period of data acquisition clock within the range* of 0 to 86400000 in the double word format (32-bit integer).	Section 6.2.12

Error code (HEX)	Error level	Measuring mode	Descriptions	Action	Reference
2000h	Low	Current measuring	Output period of data acquisition clock is set out of range.	Set the output period of data acquisition clock within the range* of 0 to 86400000 in the double word format (32-bit integer).	Section 6.2.12
2001h(CH1), 2021h(CH3) 2041h(CH5), 2061h(CH7)	Low	Current measuring	Primary current is set out of range.	Set it within the range* of 0 to 5 or 501 to 536 according to the primary current.	Section 6.2.3
2002h(CH1), 2012h(CH2) 2022h(CH3), 2032h(CH4) 2042h(CH5), 2052h(CH6) 2062h(CH7), 2072h(CH8)	Low	Current measuring	Current demand time is set out of range.	Set the current demand time within the range* of 0 to 1800 (seconds).	Section 6.2.4
2003h(CH1), 2013h(CH2) 2023h(CH3), 2033h(CH4) 2043h(CH5), 2053h(CH6) 2063h(CH7), 2073h(CH8)	Low	Current measuring	Alarm 1 item is set out of range.	Set the alarm 1 item within the range of 0 to 2.	Section 6.2.6
2004h(CH1), 2014h(CH2) 2024h(CH3), 2034h(CH4) 2044h(CH5), 2054h(CH6) 2064h(CH7), 2074h(CH8)	Low	Current measuring	Alarm 2 item is set out of range.	Set the alarm 2 item within the range of 0 to 2.	Section 6.2.6
2005h(CH1), 2015h(CH2) 2025h(CH3), 2035h(CH4) 2045h(CH5), 2055h(CH6) 2065h(CH7), 2075h(CH8)	Low	Current measuring	Alarm 1 reset method is set out of range.	Set the alarm 1 reset method within the range of 0 to 1.	Section 6.2.8
2006h(CH1), 2016h(CH2) 2026h(CH3), 2036h(CH4) 2046h(CH5), 2056h(CH6) 2066h(CH7), 2076h(CH8)	Low	Current measuring	Alarm 2 reset method is set out of range.	Set the alarm 2 reset method within the range of 0 to 1.	Section 6.2.8
2007h(CH1), 2017h(CH2) 2027h(CH3), 2037h(CH4) 2047h(CH5), 2057h(CH6) 2067h(CH7), 2077h(CH8)	Low	Current measuring	Alarm 1 delay time is set out of range.	Set the alarm 1 delay time within the range* of 0 to 300 (seconds).	Section 6.2.9
2008h(CH1), 2018h(CH2) 2028h(CH3), 2038h(CH4) 2048h(CH5), 2058h(CH6) 2068h(CH7), 2078h(CH8)	Low	Current measuring	Alarm 2 delay time is set out of range.	Set the alarm 2 delay time within the range* of 0 to 300 (seconds).	Section 6.2.9
2009h(CH1), 2029h(CH3), 2049h(CH5), 2069h(CH7),	Low	Current measuring	Primary current of CT is set out of range.	Set primary current of CT within the range* of 0 to 6000 (A). However, this setting cannot set 0 (any setting) when primary current (Un\G2) is 0	Section 6.2.3
0000h	-	All mode	Normal	-	-

* Also check that it is set in decimal.

10.2 Troubleshooting

10.2.1 When "0" LED (RUN) is turned off

Table 10.2.1-1 When "0" LED is turned off

Check item	Action	Reference
Is power source is supplied?	Check that supply voltage of the power source is within the rating.	-
Is capacity of the power source module sufficient?	Calculate the consumption current of CPU module, I/O module, and intelligent function module attached to the base unit, and check that the power capacity is sufficient.	-
Is the watchdog time an error?	Reset CPU module, and check whether it is turned on. If RUN LED is not turned on even after doing the above, the module may have a failure. Consult with a nearest sales agent or our company branch for the symptom of the failure.	-
Is the module properly attached to the base unit?	Check the module attachment status.	Section 8.4
Is the slot type set to "empty" in the I/O assignment setting of the PC parameter at GX Developer?	Set the slot type to "Intelligent".	Section 8.7.1

10.2.2 When "8" LED (ERR) is turned on or flashing

(1) If it is ON

Table 10.2.2-1 When "8" LED is turned on

Check item	Action	Reference
Did any error occur?	Check latest error code (Un\G4500), and take a corrective action as described in section 10.1. After that, reset CPU module, and check whether it is turned on. If "8" LED is turned on even after doing the above, the module may have a failure. Consult with a nearest sales agent or our company branch for the symptom of the failure.	Section 10.1

(2) If it is flashing

Table 10.2.2-2 When "8" LED is flashing

Check item	Action	Reference
Did any error occur?	The set value may be out of range. Check that the operating condition settings and the integrated value are correct. Correct configuration or turning Error clear request (Y1F*) ON will clear the error. When the error is cleared by Error clear request (Y1F*), the operation continues according to the previous settings. * In the case where the initial I/O number of this module is 0	Section 5.2.2 Chapter 6 Section 8.6.3 Section 8.7.3

10.2.3 If electric energy cannot be measured

The following check has to be performed while current is flowing from the power source side to the load side.

Note that electric energy is not measured in the current measuring mode.

Table 10.2.3-1 If electric energy cannot be measured

Check item				Action	Reference
CH1	"1" LED is OFF.	"9" LED is OFF.	"5" LED is OFF.	1) The type of current sensor may be incorrect. In addition, if the rating of the sensor in use is different from the primary current, measurement cannot be taken correctly. 2) Wiring is not done or wrong. Refer to Section 8.5 to check the wiring. 3) Voltage wiring may be incorrect. Check connection of P1, P2, and P3.	Section 8.5
CH2	"2" LED is OFF.	"A" LED is OFF.	"6" LED is OFF.		
CH3	"3" LED is OFF.	"B" LED is OFF.	"D" LED is OFF.		
CH4	"4" LED is OFF.	"C" LED is OFF.	"E" LED is OFF.		
CH1	"1" LED is flashing.	"9" LED is OFF.	"5" LED is ON.	1) Current sensors on side 1 and side 3 may be installed in the reverse order or current sensors on side 1 and side 3 may be swapped. Check the connection. 2) Voltage wiring may be incorrect. Check connection of P1, P2, and P3.	
CH2	"2" LED is flashing.	"A" LED is OFF.	"6" LED is ON.		
CH3	"3" LED is flashing.	"B" LED is OFF.	"D" LED is ON.		
CH4	"4" LED is flashing.	"C" LED is OFF.	"E" LED is ON.		
CH1	"1" LED is ON, flashing, or OFF.	"9" LED is ON.	"5" LED is OFF.	1) Current sensor on side 1 may be installed in the reverse order. Check the connection. 2) Voltage wiring may be incorrect. Check connection of P1, P2, and P3.	
CH2	"2" LED is ON, flashing, or OFF.	"A" LED is ON.	"6" LED is OFF.		
CH3	"3" LED is ON, flashing, or OFF.	"B" LED is ON.	"D" LED is OFF.		
CH4	"4" LED is ON, flashing, or OFF.	"C" LED is ON.	"E" LED is OFF.		
CH1	"1" LED is ON, flashing, or OFF.	"9" LED is ON.	"5" LED is ON.	1) Current sensor on side 3 may be installed in the reverse order. Check the connection. 2) Voltage wiring may be incorrect. Check connection of P1, P2, and P3.	
CH2	"2" LED is ON, flashing, or OFF.	"A" LED is ON.	"6" LED is ON.		
CH3	"3" LED is ON, flashing, or OFF.	"B" LED is ON.	"D" LED is ON.		
CH4	"4" LED is ON, flashing, or OFF.	"C" LED is ON.	"E" LED is ON.		
CH1	"1" LED is ON.	"9" LED is OFF.	"5" LED is OFF.	1) Measurement is taken normally. Check for the correct buffer memory address and data format (double word: 32-bit integer).	Chapter 6
CH2	"2" LED is ON.	"A" LED is OFF.	"6" LED is OFF.		
CH3	"3" LED is ON.	"B" LED is OFF.	"D" LED is OFF.		
CH4	"4" LED is ON.	"C" LED is OFF.	"E" LED is OFF.		

10.2.4 If the electric current and voltage that are measured using this module do not match with the ones measured with other gauge

Table 10.2.4-1 If current and voltage that are measured using this module do not match with the ones measured with other gauge

Check item	Action	Reference
Are phase wire method, primary current, and primary voltage correct?	Check the value in the buffer memory for checking the phase wire method, primary current and primary voltage. When the value in the buffer memory is changed, you need to turn the request for operating condition setting into ON. Otherwise, it will not be applied to the measurement.	Section 6.1
Does the compared gauge measure the effective value correctly?	This module stores the effective value into the buffer memory. If the compared device uses the average value instead of the effective value, the resulted value may largely differ when there is current distortion in the measurement circuit.	-
Is the secondary of CT short-circuited?	Make sure that the secondary of CT is not short-circuited. If it is connected to Mitsubishi's current transformer CW-5S(L), check that the secondary switch is not short-circuited.	-
Are you using other current sensor than recommended ones?	Only the dedicated current sensors can be connected to this module. Check that other company's sensor is not being used.	-

10.3 Q&A

10.3.1 General

Q	To what degree is the module durable against overvoltage and overcurrent? Is external protective circuit required?
A	<p>Momentary*: Up to 2 times as high as rated voltage and 20 times as high as rated current.</p> <p>Continuous : Up to 1.1 times as high as rated voltage and rated current.</p> <p>* Momentary means: Energizing 9 times for 0.5 seconds at 1-minute intervals, and then 1 time for 5 seconds.</p> <p>External protective circuit is not required.</p>
Q	Can the module be used as an electric energy meter?
A	<p>This module can be used to measure the electric energy and to manage the use of electric energy.</p> <p>However, it cannot be used for deal and proof of electric energy measurement stipulated in the measurement law.</p>
Q	Are errors in wiring verifiable easily?
A	<p>They are verifiable by the illuminating condition of the LEDs on the front of the module.</p> <p>Refer to Section 10.2.3 for details.</p>
Q	Is it OK to open the secondary terminals of the current sensor?
A	<p>The secondary side of the models EMU2-CT5, EMU-CT50, EMU-CT100, EMU-CT250, EMU-CT5-A, EMU-CT50-A, EMU-CT100-A, EMU-CT250-A, EMU-CT400-A, and EMU-CT600-A is equipped with the protective circuit against opening of secondary terminals. Opening them during the wiring work causes no problems. However, for safety, please do not continuously energize the module with the terminals open.</p> <p>The secondary side of the models EMU-CT400 and EMU-CT600 is equipped with the protective circuit against opening of secondary terminals. However, during the wiring work, be sure to turn the secondary side short-circuit switch to short. After completion of work, be sure to turn the secondary short-circuit switch to open. Note that failing to turn the switch open results in an inaccurate measurement.</p>
Q	Is measurement of inverter circuit possible?
A	<p>Measuring the secondary side of the inverter is impossible due to the large fluctuation of frequency.</p> <p>Make measurement on the primary side of the inverter. However, since a current waveform on the primary side of the inverter has a distortion containing the harmonic components, a slight error occurs.</p>

Q	If a load such as welding equipment exists, a current flows only for a short period (e.g. 2-cycle waveform of commercial frequency (50 Hz: 40 ms, 60 Hz: 33 ms)). Is accurate measurement possible?
A	<p>This module makes measurement with a sampling period of 4340 Hz (for both 50 Hz and 60 Hz). However, measuring part of buffer memory data is updated every 500 ms. The electrical amount such as current, voltage, electric power, power factor, and frequency is measured in a cycle of 500 ms period.</p> <p>The amount of electricity and reactive power amount are measured separately from the momentary data described above, using a sampling period of 4340 Hz continuously without intermittence. Therefore, measuring the load for a short period is possible.</p>

Q	Obtained values may be different from other measuring instruments. Why is it so?
A	<p>There are various possible causes. Check the following first, please:</p> <p>[1] Check for wiring errors (polarity of current sensors, connections of current circuits, and connections of voltage circuits, in particular).</p> <p>[2] On the split-type current sensor, check for the poor engagement or separation of fitting surfaces.</p> <p>[3] On the split-type current sensor, check for pinching of foreign object between fitting surfaces.</p> <p>[4] Check that the measuring instrument used for comparison indicates a correct RMS value.</p> <p>[5] If the measuring instrument used for comparison measures an average value instead of rms value, distortion in the current of the circuit to be measured causes a significant difference of values. This module measures an rms value.</p> <p>[6] Check for the short-circuit on the secondary side of the current transformer (CT).</p> <p>[7] Current sensor connectable to the module is the dedicated current sensor only. Check that the proper current sensor is connected or not.</p>

10.3.2 Q&A about Specifications

Q	What accuracy does “measuring accuracy” mean?
A	<p>In terms of the amount of electricity, it means a range of tolerances in reading values. For example, when the reading value is “10 kWh,” a tolerance is ± 0.2 kWh.</p> <p>In terms of measuring elements other than the amount of electricity, it means tolerance for the rated input. For a current, when a rated current is set to 250 A, $\pm 1\%$ of 250 A is a tolerance.</p>

Q	Is accuracy of a current sensor included?
A	<p>Accuracy of a current sensor is not included in accuracy of the module.</p> <p>A maximum value of tolerance is obtained by summing tolerance of the module and that of a current sensor.</p>

Q	To what degree an area of microcurrent is measured?
A	<p>A current value is measured from the area exceeding 0.4% of the rated current. In an area below 0.4%, measurement result is indicated as “0” (zero).</p> <p>However, in that case, still, the amount of electricity is being measured. Even if the indicated value is “0,” measurement value will increase in continuing measurement for a long time.</p> <p>The amount of electricity is measured with a load that is about 0.4% or more of all load power.</p>

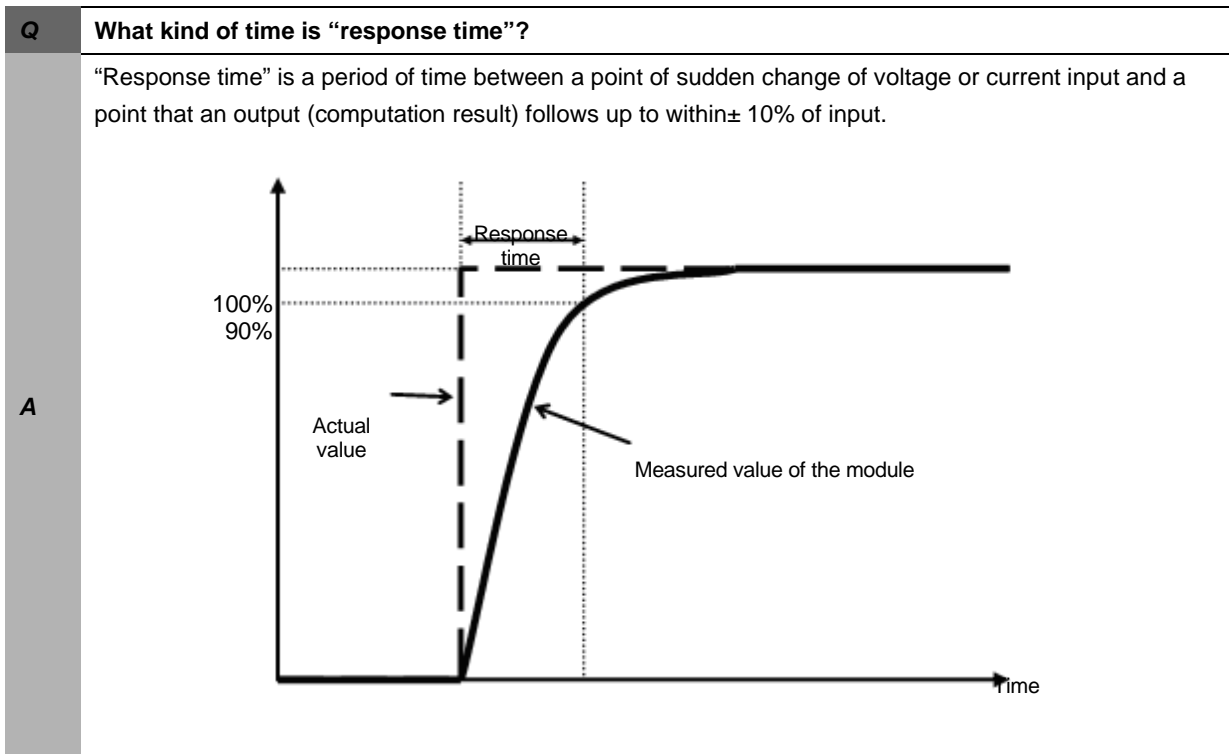

10.3.3 Q&A about Installing

Q	What is wire diameter that allows installing a current sensor?
A	<p>The following lists the nominal cross-sectional areas of the conductor of 600-V vinyl coated wires that can penetrate (values for reference).</p> <ul style="list-style-type: none"> ● IV wire (600-V vinyl insulated wire) <ul style="list-style-type: none"> 38 mm² (EMU-CT50-A), 60 mm² (EMU-CT50/CT100, EMU-CT100-A), 150 mm² (EMU-CT250), 200 mm² (EMU-CT250-A), 500 mm² × 1 wire, 325 mm² × 2 wires (EMU-CT400/CT600), 500 mm² (EMU-CT400/CT600-A) ● CV wire (600-V vinyl insulated wire) <ul style="list-style-type: none"> 22 mm² (EMU-CT50-A), 38 mm² (EMU-CT50/CT100), 60 mm² (EMU-CT100-A), 150 mm² (EMU-CT250 (100 mm² is recommended), EMU-CT250-A), 400 mm² (EMU-CT400/CT600-A), 500 mm² × 1 wire, 325 mm² × 2 wires (EMU-CT400/CT600) <p>The above shows the standard nominal cross-sectional areas. Due to the outer difference of finished vinyl insulation and deformation (bending) depending on manufacturers, a wire may not penetrate. Make verification on site.</p>
Q	What are the points when installing a current sensor?
A	<p>Models EMU2-CT5, EMU-CT*** and EMU-CT***-A are split-type. If split surfaces are not engaged sufficiently or a foreign object exists between the split surfaces, adequate performances are not obtained. Pay attention in installation.</p>

10.3.4 Q&A about Connection

Q	Does polarity exist in connection between a current sensor and the module?
A	Yes, it does. Make connections so that secondary terminals of current sensor (k, l) and terminal symbols of module agree with each other. If polarity is incorrect, the current value is measurable, but the electric power and the electrical energy can not be measured correctly.
Q	Are there any key points in avoiding errors in wiring?
A	Check polarity of current sensor on the primary current side. Power supply side of the circuit is indicated as "K," and the load is indicated as "L." An arrow indicates the direction from K to L. For a 3-wire circuit, check that the current sensor and the module are connected correctly for the 1-side circuit and 3-side circuit. Besides, check that voltage inputs are connected correctly among P1, P2, and P3.
Q	How do wires extend between a current sensor and the module?
A	Model EMU-CT***, EMU-CT***-A are extendable up to 50 m. Model EMU2-CT5 is extendable up to 11 m, using together with extension cable. To extend the wire further, use the current transformer CW-5S(L) for split-type instrument in combination, extending the secondary wiring on CW-5S(L) side.

10.3.5 Q&A about Setting

Q	Is the setting required?
A	At least, settings of phase wires, primary current and primary voltage are required. Specify settings in accordance with a circuit to be connected.
Q	If a primary current setting value is different from that of rated current on a connected current sensor, does it cause a breakdown?
A	It does not cause breakdown or burning. However, measurement values will be totally incorrect.

Appendix

Appendix 1: External dimensions

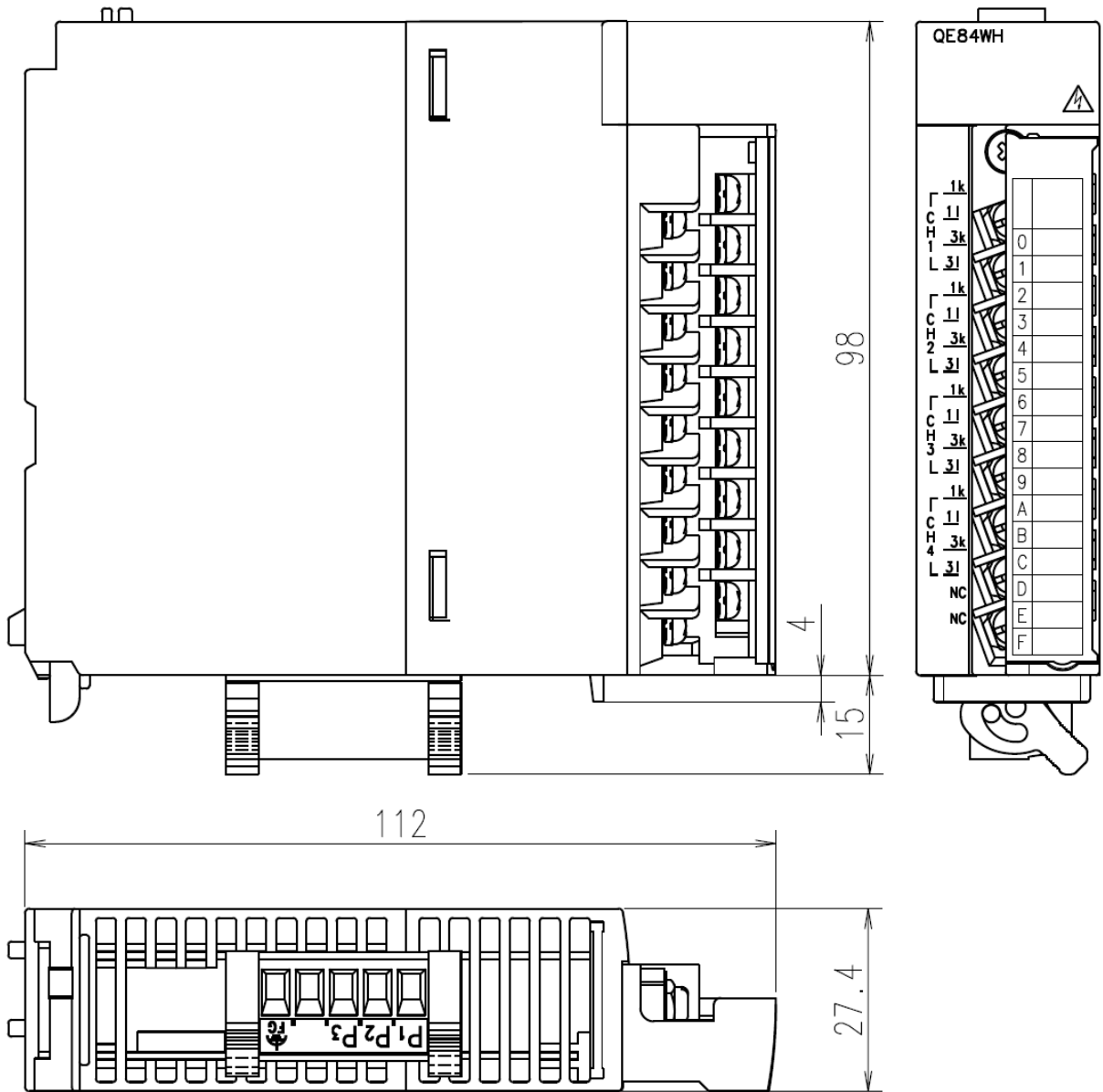

Unit [mm]

Appendix 2: Optional devices

■ Split type current sensor

Item	Specifications				
Model	EMU-CT50	EMU-CT100	EMU-CT250	EMU-CT400	EMU-CT600
Rated primary current	50A AC	100A AC	250A AC	400A AC	600A AC
Rated secondary current	16.66mA	33.33mA	66.66mA	66.66mA	66.66mA
Rated burden	0.1VA				
Maximum voltage (voltage to ground/line voltage)	460V AC				
Ratio error	±1% (5% to 100% of rating, $RL \leq 10\Omega$)				
Phase displacement	±0.9 c rad (5% to 100% of rating, $RL \leq 10\Omega$)				
Measurement(installation)category	III				
Pollution degree	2				
Working temperature range	-5°C to +55°C (daily mean temperature: 35°C or less)				
Working humidity range	5% to 95%RH (no condensation)				
CE marking conformity standard	EN61010-2-32				
CE marking conformity standard Maximum voltage (voltage to ground/line voltage)	460V AC				
Weight (per one)	0.1kg			0.7kg	

*Use an electric wire of the size of penetrating this current sensor for a primary side cable, do not use a non-insulation electric wire or a metal for a primary cable.

*EMU-CT400 and EMU-CT600 are stopped.

Item	Specifications				
Model	EMU-CT50-A	EMU-CT100-A	EMU-CT250-A	EMU-CT400-A	EMU-CT600-A
Rated primary current	50A AC	100A AC	250A AC	400A AC	600A AC
Rated secondary current	16.66mA	33.33mA	66.66mA	66.66mA	66.66mA
Rated burden	0.1VA				
Maximum voltage (voltage to ground/line voltage)	460V AC				
Ratio error	±1% (5% to 100% of rating, $RL \leq 10\Omega$)				
Phase displacement	±1.3 c rad (10% to 100% of rating, $RL=10\Omega$) ±1.8 c rad (5% of rating, $RL=10\Omega$)		±1.2 c rad (5% to 100% of rating, $RL=10\Omega$)	±1.2 c rad (5% to 100% of rating, $RL \leq 10\Omega$)	
Measurement(installation)category	-			III	
Pollution degree	-			2	
Working temperature range	-5°C to +55°C (daily mean temperature: 35°C or less)				
Working humidity range	30% to 85%RH (no condensation)				
CE marking conformity standard	-			EN61010-2-32	
CE marking conformity standard Maximum voltage (voltage to ground/line voltage)	-			460V AC	
Weight (per one)	0.05kg	0.1kg	0.2kg	0.3kg	0.4kg

*Use an electric wire of the size of penetrating this current sensor for a primary side cable, do not use a non-insulation electric wire or a metal for a primary cable.

■ 5A current sensor

Item	Specifications	
	EMU2-CT5	EMU-CT5-A
Model	EMU2-CT5	EMU-CT5-A
Rated primary current	5A AC	
Rated secondary current	1.66mA	
Rated burden	0.1VA	
Maximum voltage (voltage to ground/line voltage)	260V AC	460V AC
Ratio error	±1% (5% to 100% of rating, $R_L \leq 10\Omega$)	±1% (5% to 100% of rating, $R_L \leq 10\Omega$)
Phase displacement	±0.9 c rad (5% to 100% of rating, $R_L \leq 10\Omega$)	±1.3 c rad (10% to 100% of rating, $R_L = 10\Omega$) ±1.8 c rad (5% of rating, $R_L = 10\Omega$)
Measurement(installation)category	III	-
Pollution degree	II	-
Working temperature range	-5°C to +55°C (daily mean temperature: 35°C or less)	-5°C to +55°C (daily mean temperature: 35°C or less)
Working humidity range	5% to 95%RH (no condensation)	30% to 85%RH (no condensation)
CE marking conformity standard	EN61010-2-32	-
CE marking conformity standard Maximum voltage	260V AC	-
Weight (per one)	0.1kg	0.05kg

*Use an electric wire of the size of penetrating this current sensor for a primary side cable, do not use a non-insulation electric wire or a metal for a primary cable.

Appendix 3: Optional devices

■ Current sensor

◆ EMU-CT50, EMU-CT100, EMU-CT250

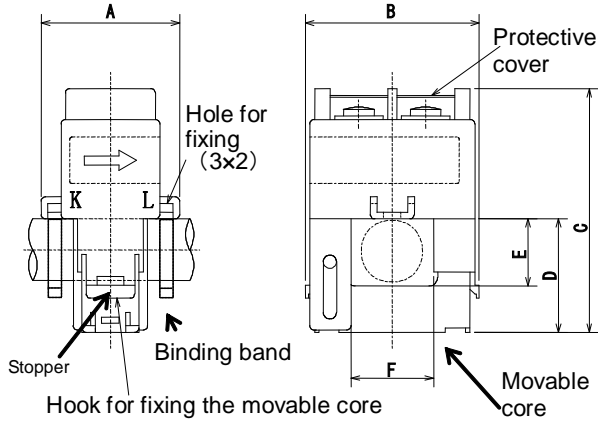

Model	A	B	C	D	E	F
EMU-CT50/CT100	31.5	39.6	55.2	25.7	15.2	18.8
EMU-CT250	36.5	44.8	66	32.5	22	24

◆ EMU-CT400, EMU-CT600

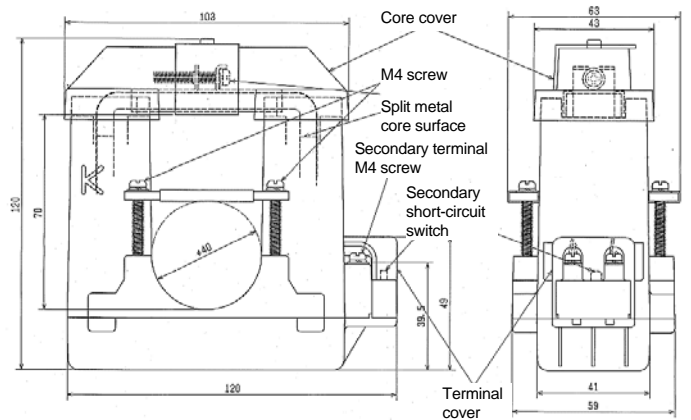

Unit [mm]

◆ EMU-CT5-A, EMU-CT50-A, EMU-CT100-A

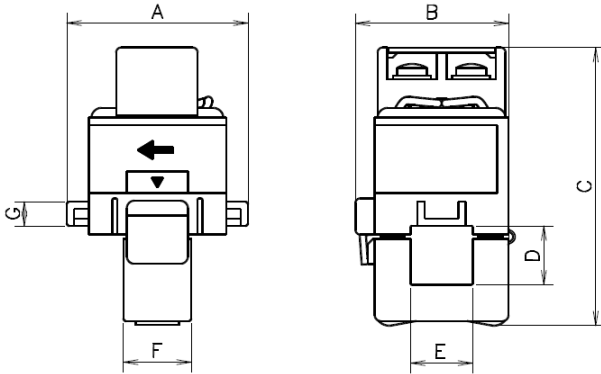

Model	A	B	C	D	E	F	G
EMU-CT5-A	37.4	31.6	57.5	12.2	12.8	14	5
EMU-CT50-A	43.6	33.6	65	16.2	16.2	19	5

Unit [mm]

◆ EMU-CT250-A, EMU-CT400-A, EMU-CT600-A

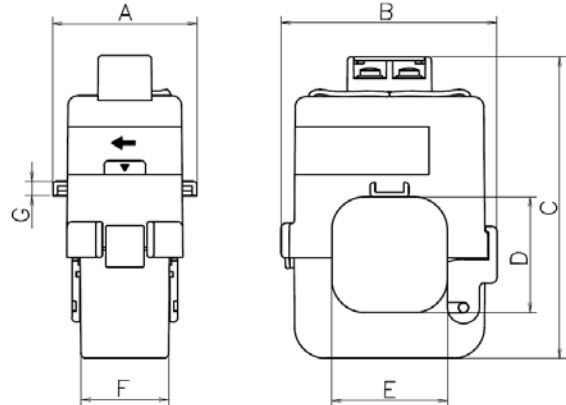

Model	A	B	C	D	E	F	G
EMU-CT250-A	42.6	49.4	74.5	24	24	25.2	4.5
EMU-CT400-A	44.9	67.2	94	36	36	27	4.5

Unit [mm]

◆ EMU2-CT5

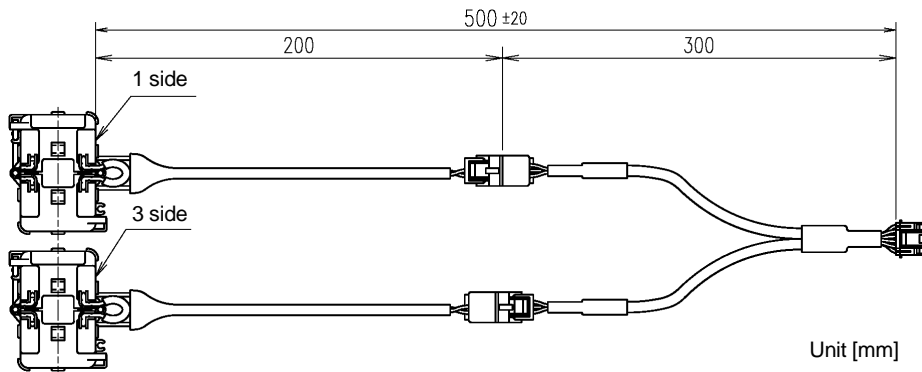

Unit [mm]

Sensor in detail

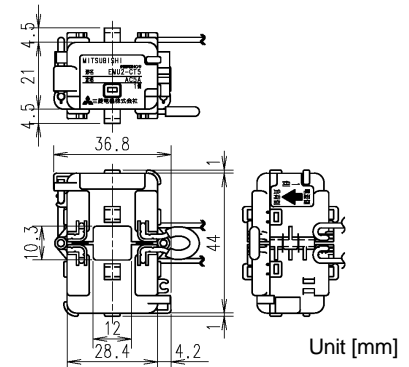

Unit [mm]

■ Dedicated cable

- ◆ 5A current sensor cable EMU2-CB-Q5B

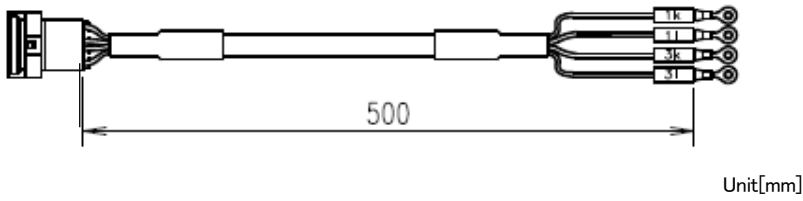

- ◆ Extension cable(standard) EMU2-CB-T**M

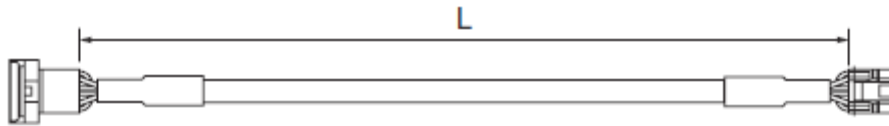

Model	EMU2-CB-T1M	EMU2-CB-T5M	EMU2-CB-T10M
Length	1000mm	5000mm	10000mm

- ◆ Extension cable(separate) EMU2-CB-T**MS

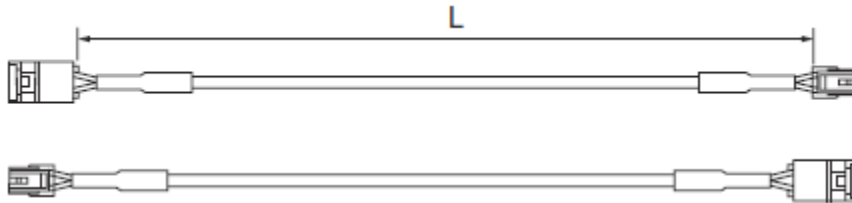

Model	EMU2-CB-T1MS	EMU2-CB-T5MS	EMU2-CB-T10MS
Length	1000mm	5000mm	10000mm

Index

【5】

5A current sensor cable 8-17

【A】

Alarm delay time 4-13

Alarm flag 4-16, 5-5

Alarm item 4-13

Alarm reset method..... 4-14

Alarm reset request..... 5-7

Applicable solderless terminal..... 8-9

Applicable wire..... 8-9

Average current 4-3

Average voltage 4-3

【C】

Current demand time 4-16, 6-9

Current measuring mode 7-1

【D】

Demand value 4-2, 4-3

【E】

Electric energy

(consumption, regeneration) 4-1, 4-2

Electric power demand time..... 4-16, 6-10

EMU2-CT5..... 8-17, Appendix-3

EMU-CT50/100/250/400/600 .. 8-15, Appendix-2

EMU-CT5/50/100/250/400/600-A

..... 8-13, Appendix-2

Error clear request..... 5-8

Error flag..... 5-5

External dimensions..... Appendix-1

【F】

Full load power 4-5

【G】

GX Developer 7-14, 8-28

GX Works2 7-8, 8-20

【I】

Integrated value set completion flag 5-4

Integrated value set function 4-18

Integrated value set request 5-6

【L】

List of functions 4-1

List of I/O signals..... 5-1

【M】

Max./min. value hold function..... 4-1, 4-12

Max./min. values clear completion

flag (Xn4)..... 4-12, 5-4

Max./min. values clear request (Yn4).... 4-12, 5-6

Measured items 4-2

Module ready..... 5-2

【N】

Name of each part 8-3

【O】

Operating condition setting completion flag... 5-3

Operating condition setting request 5-6

Output signal 5-5

【P】

Periodic electric energy..... 4-2, 4-9

Periodic electric energy data completion

flag (Xn5, Xn6)..... 4-10, 5-4

Periodic electric energy measurement flag

(Yn5, Yn6)..... 4-10, 5-7

Periodic electric energy reset completion

flag (Xn7, Xn8)..... 4-10, 5-4

Periodic electric energy reset request

(Yn7, Yn8)..... 4-10, 5-7

Phase wire system..... 3-1, 6-6

Programming..... 9-1

【R】

Rated primary current setting 4-4

Rated primary voltage setting..... 4-4

【S】

Split-type current sensor 8-13

【T】

Test function..... 4-17

Troubleshooting 10-1

【U】

Upper/lower limit alarm monitoring 4-1, 4-13

【W】

Wiring 8-8

Warranty

For using this product, please thoroughly read the following product warranty descriptions.

1. Gratis Warranty Period and Gratis Warranty Coverage

If any failure or defect (hereinafter collectively called "failures") for which our company is held responsible occurs on the product during the gratis warranty period, our company shall replace the product for free through the distributor at which you purchased the product or our service company.

However, if an international travel is required for replacement, or a travel to an isolated island or remote location equivalent is required for replacement, the actual cost incurred to send an engineer(s) shall be charged.

[Gratis Warranty Period]

The gratis warranty term of the product shall be for one year after the date of purchase or delivery to a designated place.

Note that after manufacture and shipment from Mitsubishi, the maximum distribution period shall be six (6) months, and the longest gratis warranty term after manufacturing shall be eighteen (18) months. The gratis warranty term of repair parts shall not exceed the gratis warranty term before repairs.

[Gratis Warranty Coverage]

- (1) The gratis warranty shall apply only if the product is being used properly in the conditions, with the methods and under the environments in accordance with the terms and precautions described in the instruction manual, user's manual, caution label on the product, etc.
- (2) Replacement shall be charged for the following cases even during the gratis warranty period.
 - 1) Failures occurring due to your improper storage or handling, carelessness or fault, and failures arising from the design contents of hardware or software you use.
 - 2) Failures arising from modification you performed on the product without prior consent of our company.
 - 3) Failures occurring in the event that the product is assembled into the device you use and that are acknowledged as avoidable if the device is equipped with a safety mechanism that comply with the legal regulations applicable to the device or with functions/architecture which are considered as necessary to be equipped under conventions of the industry.
 - 4) Failures due to accidental force such as a fire, abnormal voltage, etc. and force majeure such as an earthquake, thunderstorm, wind, flood, etc.
 - 5) Failures due to matters unpredictable based on the level of science technology at the time of product
 - 6) Other failures which are beyond responsibility of our company or which you admit that our company is not held responsible for.

2. Fare-Paying Repair Period after Production Discontinued

- (1) The period our company may accept product replacement with charge shall be seven (7) years after production of the product is discontinued.

Production stoppage shall be announced in the technical news, etc. of our company.
- (2) The product (including spare) cannot be supplied after production is discontinued.

3. Exemption of Compensation Liability for Opportunity Loss, Secondary Loss, etc.

Our company shall not be liable to compensate for any loss arising from events not attributable to our company, opportunity loss and lost earning of the customer due to failure of the product, and loss, secondary loss, accident compensation, damage to other products besides our products and other operations caused by a special reason regardless of our company's predictability in both within and beyond the gratis warranty period.

4. Change of Product Specifications

Please be advised in advance that the specifications described in catalogs, manuals or technical materials are subject to change without notice.

5. Application of Products

- (1) For use of our general-purpose sequencer MELSEC-Q series and Energy Measuring Unit QE84WH, they shall be used for a purpose which shall not lead to a material accident even when a failure or malfunction of the sequencer occurs, and a backup or fail-safe function shall be implemented systematically at external of the device in the event of a failure or malfunction.
- (2) Our general-purpose sequencers are designed and manufactured as general-purpose products which are targeted for general industry applications. Therefore, use of the sequencer for purposes in nuclear power plants and other power plants of each electric power company which greatly affect public, or for purposes in each JR company and the Defense Agency requiring a special quality assurance system shall be excluded from its applications.

However, the sequencer may be used for such purposes if the customer acknowledges that it should be used for limited purpose only and agrees not to require special quality.

Also, if you are considering to use this device for purposes that are expected to greatly affect human life or property and require high reliability especially in safety or control system such as aviation, medical care, railroad, combustion/fuel device, manned carrier device, entertainment machine, safety equipment, please consult with our service representative to exchange necessary specifications.

Energy Measuring Module

Service Network

Country/Region	Corporation Name	Address	Telephone
Australia	Mitsubishi Electric Australia Pty. Ltd.	348 Victoria Road, Rydalmere, N.S.W. 2116, Australia	+61-2-9684-7777
Algeria	Mec Casa	Rue I N 125 Hay-Es-Salem, 02000, W-Chlef, Algeria	+213-27798069
Bangladesh	PROGRESSIVE TRADING CORPORATION	HAQUE TOWER,2ND FLOOR,610/11,JUBILEE ROAD, CHITTAGONG, BANGLADESH	+880-31-624307
	ELECTRO MECH AUTOMATION & ENGINEERING LTD.	SHATABDI CENTER, 12TH FLOOR, SUITES:12-B, 292, INNER CIRCULAR ROAD, FAKIRA POOL, MOTIJHEEL, DHAKA-1000, BANGLADESH	+88-02-7192826
Belarus	Tehnikon	Oktyabrskaya 19, Off. 705, BY-220030 Minsk, Belarus	+375 (0)17 / 210 46 26
Belgium	Koning & Hartman B.V.	Woluwelaan 31, BE-1800 Vilvoorde, Belgium	+32 (0)2 / 2570240
Brazil	Mitsubishi Electric do Brasil Comércio e Serviços Ltda.	Avenida Adelino Cardana, 293 – 21º Andar, Bethaville, Barueri, SP, Brasil, CEP 06401-147	+55-11-4689-3000
Cambodia	DHINIMEX CO.,LTD	#245, St. Tep Phan, Phnom Penh, Cambodia	+855-23-997-725
Central America	Automation International LLC	7050 W. Palmetto Park Road Suite #15 PMB #555, Boca Raton, FL 33433	+1-561-237-5228
Chile	Rhona S.A. (Main office)	Vte. Agua Santa 4211 Casilla 30-D (P.O. Box) Vina del Mar, Chile	+56-32-2-320-600
China	Mitsubishi Electric Automation (China) Ltd.	Mitsubishi Electric Automation Building, No.1386 Hongqiao Road, Shanghai, China 200336	+86-21-2322-3030
	Mitsubishi Electric Automation (China) Ltd. BeiJing	5/F, ONE INDIGO,20 Jiuxianqiao Road Chaoyang District, Beijing, China 100016	+86-10-6518-8830
	Mitsubishi Electric Automation (China) Ltd. ShenZhen	Level 8, Galaxy World Tower B, 1 Yabao Road, Longgang District, Shenzhen, China 518129	+86-755-2399-8272
	Mitsubishi Electric Automation (China) Ltd. GuangZhou	Rm.1006, A1 Times E-Park, No.276-282, Hanxi Road East, Zhongcun Street, Panyu Distric, Guangzhou, China 510030	+86-20-8923-6730
	Mitsubishi Electric Automation (China) Ltd. ChengDu	1501-1503,15F, Guang-hua Centre Building-C, No.98 North Guang Hua 3th Rd Chengdu, China 610000	+86-28-8446-8030
Mitsubishi Electric Automation (Hong Kong) Ltd.	20/F., Cityplaza One, 1111 King's Road, Taikoo shing, Hong Kong	+852-2510-0555	
Colombia	Proelectrico Representaciones S.A.	Carrera 42 No 75 – 367 Bodega 109, Itagüí, Medellín, Antioquia, Colombia	+57-4-4441284
Czech Republic	AUTOCONT CONTROL SYSTEMS S.R.O	Technologická 374/6, CZ-708 00 Ostrava - Pustkovec	+420 595 691 150
Denmark	BEIJER ELECTRONICS A/S	LYKKEGARDSVEJ 17, DK-4000 ROSKILDE, Denmark	+45 (0)46 / 75 76 66
Egypt	Cairo Electrical Group	9, Rostoum St. Garden City P.O. Box 165-11516 Maglis El-Shaab,Cairo - Egypt	+20-2-27961337
France	Mitsubishi Electric Europe B.V. French Branch	FR-92741 Nanterre Cedex	+33 (0)1 55 68 57 01
Germany	Mitsubishi Electric Europe B.V.	Mitsubishi-Electric-Platz 1, 40882 Ratingen, Germany	+49 (0) 2102 4860
Greece	KALAMARAKIS - SAPOUNAS S.A.	IONIAS & NEROMILOU STR., CHAMOMILOS ACHARNES, ATHENS, 13678 Greece	+30-2102 406000
	UTECO	5, MAVROGENOUS STR., 18542 PIRAEUS, Greece	+30-211-1206-900
Hungary	Meltrade Ltd.	Fertő utca 14, HU-1107 Budapest, Hungary	+36 (0)1-431-9726
India	Mitsubishi Electric India Private Limited	2nd Floor, Tower A&B, Cyber Greens, DLF Cyber City, DLF Phase-III, Gurgaon - 122 022 Haryana, India	+91-124-4630300
	Mitsubishi Electric India Private Limited Pune Sales Office	ICC-Devi Gaurav Technology Park, Unit no. 402, Fourth Floor, Survey no. 191-192 (P), Opp. Vallabh Nagar Bus Depot, Pune – 411018, Maharashtra, India	+91-20-68192100
	Mitsubishi Electric India Private Limited FA Center	204-209, 2nd Floor, 31FIVE, Corporate Road, Prahladnagar, Ahmedabad 380015,Gujarat, India	+91-79677-77888
Indonesia	PT.Mitsubishi Electric Indonesia	Gedung Jaya 8th floor, J.L.MH. Thamrin No.12 Jakarta Pusat 10340, Indonesia	+62-21-3192-6461
	P.T. Sahabat Indonesia	P.O.Box 5045 Kawasan Industri Perumahan, Jakarta, Indonesia	+62-(0)21-6610651-9
Ireland	Mitsubishi Electric Europe B.V.	Westgate Business Park, Ballymount, IRL-Dublin 24, Ireland	+353 (0)1-4198800
Israel	Gino Industries Ltd.	26, Ophir Street IL-32235 Haifa, Israel	+972 (0)4-867-0656
Italy	Mitsubishi Electric Europe B.V.	Viale Colleoni 7, I-20041 Agrate Brianza (MI), Italy	+39 039-60531
Kazakhstan	Kazpromavtomatika	Ul. Zhambyla 28, KAZ - 100017 Karaganda	+7-7212-501000
Korea	Mitsubishi Electric Automation Korea Co., Ltd	9F Gangseo Hangang xi-tower A, 401 Yangcheon-ro, Gangseo-gu, Seoul 07528 Korea	+82-2-3660-9573
Laos	AROUNKIT CORPORATION IMPORT-EXPORT SOLE CO.,LTD	SAPHANMO VILLAGE. SAYSETHA DISTRICT, VIENTIANE CAPITAL, LAOS	+856-20-415899
Lebanon	Comptoir d'Electricite Generale-Liban	Cebaco Center - Block A Autostrade Dora, P.O. Box 11-2597 Beirut - Lebanon	+961-1-240445
Lithuania	Rifas UAB	Tinklu 29A, LT-5300 Panevezys, Lithuania	+370 (0)45-582-728
Malaysia	Mitric Sdn Bhd	No. 5 Jalan Pemberita U1/49, Temasya Industrial Park, Glenmarie 40150 Shah Alam,Selangor, Malaysia	+603-5569-3748
	Flexible Automation System Sdn Bhd	60, Jalan USJ 10/1B,UEP Subang Jaya,47620 Selangor Darul Ehsan,Malaysia	+603-5633-1280
Malta	ALFATRADE LTD	99 PAOLA HILL, PAOLA PLA 1702, Malta	+356 (0)21-697-816
Marocco	SCHIELE MAROC	KM 7.2 NOUVELLE ROUTE DE RABAT AIN SEBAA, 20600 Casablanca, Maroco	+212 661 45 15 96
Myanmar	Peace Myanmar Electric Co.,Ltd.	NO137/139 Botahtaung Pagoda Road, Botahtaung Town Ship 11161, Yangon, Myanmar	+95-(0)1-202589
Nepal	Watt&Volt House	KHA 2-65, Volt House Dillibazar Post Box:2108, Kathmandu, Nepal	+977-1-4411330
Netherlands	Imtech Marine & Offshore B.V.	Shuijesdijk 155, NL-3087 AG Rotterdam, Netherlands	+31 (0)10-487-19 11
North America	Mitsubishi Electric Automation, Inc.	500 Corporate Woods Parkway, Vernon Hills, IL 60061 USA	+847-478-2100
Norway	Scanelec AS	Leirvikasen 43B, NO-5179 Godvik, Norway	+47 (0)55-506000
Mexico	Mitsubishi Electric Automation, Inc. Mexico Branch	Bldv. Miguel de Cervantes Saavedra 301, Torre Norte Piso 5, Col. Ampliación Granada, Miguel Hidalgo, Ciudad de México, CP 11520, México	+52-55-3067-7511
Middle East Arab Countries & Cyprus	Comptoir d'Electricite Generale-International-S.A.L.	Cebaco Center - Block A Autostrade Dora P.O. Box 11-1314 Beirut - Lebanon	+961-1-240430
Pakistan	Prince Electric Co.	2-P GULBERG II, LAHORE, 54600, PAKISTAN	+92-42-575232, 5753373
Peru	Rhona S.A. (Branch office)	Avenida Argentina 2201, Cercado de Lima	+51-1-464-4459
Philippines	MELCO Factory Automation Philippines Inc.	128, Lopez Rizal St., Brgy. Highway Hills, Mandaluyong City, Metro Manila, Philippines	+63-(0)2-256-8042
	Edison Electric Integrated, Inc.	24th Fl. Galleria Corporate Center, Edsa Cr. Ortigas Ave., Quezon City Metro Manila, Philippines	+63-(0)2-634-8691
Poland	Mitsubishi Electric Europe B.V. Polish Branch	Krakowska 48, 32-083 Balice, Poland	+48 12 347 65 00
Republic of Moldova	Intehsis SRL	bld. Traian 23/1, MD-2060 Kishinev, Moldova	+373 (0)22-66-4242
Romania	Sirius Trading & Services SRL	RO-060841 Bucuresti, Sector 6 Aleea Lacul Morii Nr. 3	+40-(0)21-430-40-06
Russia	Mitsubishi Electric (Russia) LLC	2 bld.1, Letnikovskaya street, Moscow, 115114, Russia	+7 495 721-2070
Saudi Arabia	Center of Electrical Goods	Al-Shuwayer St. Side way of Salahuddin Al-Ayoubi St. P.O. Box 15955 Riyadh 11454 - Saudi Arabia	+966-1-4770149
Singapore	Mitsubishi Electric Asia Pte. Ltd.	307 Alexandra Road, Mitsubishi Electric Building, Singapore 159943	+65-6473-2308
Slovakia	PROCONT, Presov	Kupelna 1/, SK - 08001 Presov, Slovakia	+421 (0)51 - 7580 611
	SIMAP	Jana Derku 1671, SK - 91101 Trenčín, Slovakia	+421 (0)32 743 04 72
Slovenia	Inea RBT d.o.o.	Stegne 11, SI-1000 Ljubljana, Slovenia	+386 (0)1-513-8116
South Africa	CBI-electric: low voltage	Private Bag 2016, ZA-1600 Isando Gauteng, South Africa	+27-(0)11-9282000
Spain	Mitsubishi Electric Europe B.V. Spanish Branch	Carretera de Rubí 76-80, E-08190 Sant Cugat del Vallés (Barcelona), Spain	+34 (0)93-565-3131
Sweden	Mitsubishi Electric Europe B.V. (Scandinavia)	Hedvig Möllers gata 6, 223 55 Lund, Sweden	+46 (0)8-625-10-00
	Euro Energy Components AB	Järnvägsgatan 36, S-434 24 Kungälv, Sweden	+46 (0)300-690040
Switzerland	TriElec AG	Muehlentalstrasse 136, CH-8201 Schaffhausen, Switzerland	+41-(0)52-6258425
Taiwan	Setsuyo Enterprise Co., Ltd	5th Fl., No.105, Wu Kung 3rd, Wu-Ku Hsiang, Taipei, Taiwan, R.O.C.	+886-(0)2-2298-8889
	United Trading & Import Co., Ltd.	77/12 Bamrungmuang Road,Klong Mahanak Pomprab Bangkok Thailand	+66-223-4220-3
Thailand	MITSUBISHI ELECTRIC FACTORY AUTOMATION (THAILAND) CO.,LTD	101, True Digital Park Office, 5th Floor, Sukhumvit Road, Bangchak, Phara Khanong, Bangkok, 10260 Thailand	+662-092-8600
Tunisia	MOTRA Electric	3, Résidence Imen, Avenue des Martyrs Mourouj III, 2074 - El Mourouj III Ben Arous, Tunisia	+216-71 474 599
Turkey	Mitsubishi Electric Turkey A.S.	Şerifali Mahallesi Kale Sokak No: 41, 34775 Ümraniye, Istanbul, Turkey	+90-216-969-2666
United Kingdom	Mitsubishi Electric Europe B.V.	Travellers Lane, UK-Hatfield, Herts. AL10 8XB, United Kingdom	+44 (0)1707-276100
Uruguay	Fierro Vignoli S.A.	Avda. Uruguay 1274 Montevideo Uruguay	+598-2-902-0808
Vietnam	Mitsubishi Electric Vietnam Co.,Ltd. Head Office	11th & 12th Floor, Viettel Tower B, 285 Cach Mang Thang 8 Street, Ward 12, District 10, Ho Chi Minh City, Vietnam	+84-28-3910-5945
	Mitsubishi Electric Vietnam Co.,Ltd. Hanoi Branch	24th Floor, Handico Tower, Pham Hung Road, khu do thi moi Me Tri Ha, Nam Tu Liem District, Hanoi City, Vietnam	+84-24-3937-8075

MITSUBISHI ELECTRIC CORPORATION
HEAD OFFICE: TOKYO BUILDING, 2-7-3, MARUNOUCHI, CHIYODA-KU, TOKYO 100-8310, JAPAN