

Mitsubishi Programmable Controller

MELSEC **Q** series

Energy Measuring Module User's Manual (Details)

QE81WH4W

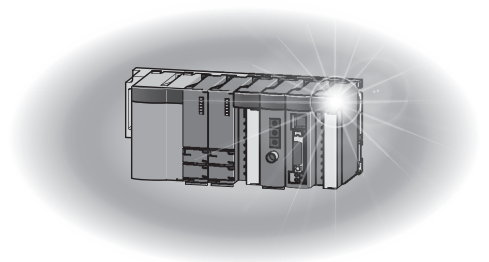

● SAFETY PRECAUTIONS ●

(Read these precautions before using this product.)

This manual contains important instructions for MELSEC-Q series QE81WH4W.

Before using this product, please read this manual and the relevant manuals carefully and pay full attention to safety to handle the product correctly.

The precautions given in this manual are concerned with this product only. For the safety precautions of the programmable controller system, refer to the user's manual of the CPU module used.

In this manual, the safety precautions are classified into two levels: "DANGER" and "CAUTION".



Indicates that incorrect handling may cause hazardous conditions, resulting in death or severe injury.



Indicates that incorrect handling may cause hazardous conditions, resulting in medium or slight personal injury or physical damage.

Under some circumstances, failure to observe the precautions given under “ CAUTION” may lead to serious consequences.

Observe the precautions of both levels because they are important for personal and system safety.

Keep this manual in an accessible place for future reference whenever needed, and make sure it is delivered to the end user.

[Precautions for Operating Environment and Conditions]

CAUTION

- Do not use this product in the places listed below. Failure to follow the instruction may cause malfunctions or decrease of product-life.
 - Places the Ambient temperature exceeds the range 0 - 55°C.
 - Places the Relative humidity exceeds the range 5 - 95% or condensation is observed.
 - Altitude exceeds 2000 m.
 - Places exposed to rain or water drop.
 - Dust, corrosive gas, saline and oil smoke exist.
 - Vibration and impact exceed the specifications.
 - Installation on excluding the control board

[Design Precautions]

DANGER

- Do not write data into “System Area” in the buffer memory of the intelligent function module. Also, do not output (turn ON) the “use prohibited” signal in the output signal sent from the sequencer CPU to the intelligent function module. Doing so may cause a malfunction to the sequencer system.

CAUTION

- Do not install the input signal wire together with the main circuit lines or power cables. Keep a distance as below. (Except for the terminal input part) Failure to do so may result in malfunction due to noise.

Conditions	Distance
Below 600V, or 600A power lines	300mm or more
Other power lines	600mm or more

[Installation Precautions]

CAUTION

- Any person who is involved in the installation and the wiring of this Sequencer should be fully competent to do the work.
- Use the programmable controller in an environment that meets the general specifications in the User's manual of the CPU module used.
Failure to do so may result in electric shock, fire, malfunction, or damage to or deterioration of the product.
- To mount the module, while pressing the module-mounting lever located in the lower part of the module, fully insert the module fixing projection(s) into the hole(s) in the base unit and press the module until it snaps into place.
Incorrect mounting may cause a malfunction, failure or a fall of the module.
When using the Sequencer in an environment of frequent vibrations, fix the module with a screw.
- Tighten the screws within the specified torque range.
Fixing-Module screw (arranged by user): M3 x 12mm
Tightening torque of the fixing-module screws 0.36 - 0.48 N•m
When the screw tightening is loose, it causes a fall, short-circuit, and a malfunction.
Over-tightening can damage the screws and the module, and it may cause a fall, short-circuit, or a malfunction.
- Shut off the external power supply for the system in all phases before mounting or removing the module. Failure to do so may result in damage to the product.
- Do not touch directly any conductive parts and electronic parts of the module.
Doing so can cause a malfunction or failure of the module.

[Wiring Precautions]

DANGER

- For installation and wiring works, make sure that the power source is shut off for all outside phases. If all phases are not turned off, it may cause an electric shock or product damages.
- When the input voltage of voltage transform module is 55V or less, voltage display will be 0V by cut-off. The voltage maybe still applied even if the display is 0V. Touching the active wire is strictly prohibited. Make sure shut off the switch, and check the voltage was not been applied.

CAUTION

- FG terminal must be grounded according to the D-type ground (Type 3) dedicated for sequencer. Failure to do so may result in electric shock or malfunction.
- When using this product, make sure to use it in combination with current sensor (EMU-CT***, EMU-CT***-A or EMU2-CT5-4W) and Voltage transform module (QE8WH4VT). Please not to exceed the ratings of this product for input of current sensor. For further details, please refer to current sensor manual to maintain the functionality and the accuracy of this product. The available range of the voltage transform module is from 63.5/110 to 277/480V AC. When used in a circuit more than 227/480V AC, voltage transformer is required.
- Current sensor (EMU-CT***, EMU-CT***-A (Excluding EMU-CT5-A)) is used only for low voltage circuit. It cannot be used with a high voltage circuit. Also, EMU2-CT5-4W and EMU-CT5-A should be used with the secondary side (5 A) of transformer transfixed. If it is connected with a high-voltage circuit by mistake, it may cause a burnout of the device and a fire. It is critically dangerous. For the Allowable maximum voltage, refer to Appendix 2 “Option devices”.
- Current sensor has a polarity (directionality). Be careful about it when installing the module.
- Do not open the secondary side of current sensor.
- Take care not entering any foreign objects such as chips and wire pieces into the module. It may cause a fire, failure or a malfunction.
- In order to prevent the module from incoming foreign objects such as wire pieces during wiring work, a foreign-object preventive label is placed on the module. While a wiring work is performed, keep the label on the module. Before operating the system, peel off the label for heat release. If the foreign-object preventive label is not peeled and the system is in use, residual heat inside the module may reduce the product life.
- The wires to be connected to the module shall be put in a duct or fixed together by clamp. If not, the loosening and unstable wire or careless stretching results in poor contact of electric wires. That may cause a breakage of the module or wire or a malfunction.
- Use appropriate size of electric wires. If inappropriate size of electric wire is used, it may cause a fire due to generated heat. For appropriate size of electric wires, refer to 7.5.2 How to connect wires.
- In case using stranded wire, take measures so that the filament should not vary by using a bar terminal or by processing the point twisted. Use the bar terminal appropriated for the size of electric wires. If using inappropriate bar terminals, a wire breakage or a contact failure may cause a device malfunction, failure, a burnout or a fire.
- After wiring, confirm whether there is a wiring forgetting or a faulty wiring. They may cause a device malfunction, a fire, or an electric shock.
- When removing the wires connected to the module, do not pull wires as holding on their electric wire portions. Push the buttons on the terminal, and then remove the wire.
- If the wires connected to the module are strongly pulled off, it may cause a malfunction or a breakage to the module or the wire. (Tensile load: 22N or less)
- Ensure the wiring to the module properly, checking the rated voltage and current of the product and the terminal pin assignment. If the input voltage exceed the rated voltage or the wiring is improper, it may cause a fire or a breakage.
- Do not exceed the specified voltage when doing an insulation resistance test and a commercial frequency withstand voltage test.
- To protect persons who do not have adequate knowledge of electric equipment from electric shocks, any of the following measures should be taken for the panel.
 - (a) To lock the panel so that only trained persons having adequate knowledge of electric equipment can open it.
 - (b) To design the structure so that the power is automatically interrupted upon opening of the panel. The protection class of the panel should be IP2X or higher.

[Start-up Precautions]

CAUTION

- Use the product within the ratings specified in this manual. When using it outside the ratings, it not only causes a malfunction or failure but also there is a fear of igniting and damaging by a fire.
- Before operating the product, check that active bare wire and so on does not exist around the product. If any bare wire exists, stop the operation immediately, and take an appropriate action such as isolation protection.
- Do not disassemble or modify the module. It may cause failure, a malfunction, an injury or a fire.
- Attaching and detaching the module must be performed after the power source is shut off for all outside phases. If not all phases are shut off, it may cause failure or a malfunction of the module.
- Do not touch the live terminal. It may cause a malfunction.

[Maintenance Precautions]

CAUTION

- Cleaning and additional tightening of module-fixing screws must be performed after the input power source is shut off for all outside phases. If not all phases are shut off, it may cause failure or a malfunction of the module.
- Use a soft dry cloth to clean off dirt of the module surface.
- Do not let a chemical cloth remain on the surface for an extended period nor wipe the surface with thinner or benzene.

Check for the following items for using this product properly for long time.

<Daily maintenance>

(1) No damage on this product (2) No abnormality with LED indicators (3) No abnormal noise, smell or heat.

<Periodical maintenance> (Once every 6 months to 1 year)

(4) Confirm there is loosening in installation, wire connection to terminal blocks, and the connection of the connectors. (Check these items under the power failure condition.)

[Storage Precautions]

CAUTION

- To store this product, turn off the power and remove wires, and put it in a plastic bag. For long-time storage, avoid the following places. Failure to follow the instruction may cause a failure and reduced life of the product.
 - Places the Ambient temperature exceeds the range -25 to +75°C.
 - Places the Relative humidity exceeds the range 5 - 95% or condensation is observed.
 - Dust, corrosive gas, saline and oil smoke exist, and vibration and frequent physical impact occur.
 - Places exposed to rain or water drop.

[Disposal Precautions]

CAUTION

- Dispose of the product as an industrial waste.

Revision history

* Instruction Manual Number is provided at the bottom of the cover page.

Printed date	*Instruction Manual #	Description of revisions
Mar, 2012	IB-63704	First edition
Aug, 2012	IB-63704-A	<p>Correction 2.3, 3.1, 5.2, 6.1, 6.2, 9.1</p> <p>Addition 3.1, 5.2, 6.1, 6.2, 7.6</p>
Jan. 2016	IB63704B	<p>Correction Cover, Section 2.1, Section 6.3, Section 8.3.1, Section 8.3.2, Section 9.2.3, Appendix-2, Appendix-3, Back cover</p>
Jul, 2017	IB63704C	<p>Correction SAFETY PRECAUTIONS, Compliance with the EMC and Low Voltage Directives, Section 2.1, Section 2.3, Chapter 3, Chapter 4, Section 6.2, Section 6.3, Section 7.2, Section 7.5, Section 7.6, Chapter 8, Section 9.1, Section 9.3, Appendix 2, Appendix 3, Back cover</p>
Jan, 2021	IB63704D	<p>Correction Compliance with the EMC and Low Voltage Directives, Section 3.2, Back cover</p>

This manual does not guarantee to protect or does not give permission to any industrial property and any related rights. Also, our company shall not be held any responsible for any issues related to industrial properties due to product usage described in this manual.

Table of Content

Safety precautions	A-1
Revision history	A-5
Table of content	A-6
Compliance with the EMC and Low Voltage Directives	A-8
Product configuration	A-8
Chapter 1: Overview	1-1
1.1 Features	1-1
Chapter 2: System Configuration	2-1 - 2-4
2.1 Applicable system	2-1
2.2 Precautions for system configuration	2-3
2.3 How to check the function version, serial number, and module version	2-3
Chapter 3: Specifications	3-1 - 3-2
3.1 General specifications	3-1
3.2 Electrical and mechanical specifications	3-2
Chapter 4: Functions	4-1 - 4-16
4.1 List of functions	4-1
4.2 Functions in detail	4-2
Chapter 5: I/O signal to CPU module	5-1 - 5-6
5.1 List of I/O signals	5-1
5.2 Details of I/O signals	5-2
Chapter 6: Buffer memory	6-1 - 6-31
6.1 Buffer memory assignment	6-1
6.2 Configurable sections (Un\G0 to Un\G99)	6-6
6.3 Measurement sections (Un\G100 to Un\G2999)	6-15
6.4 Common sections (Un\3000 to Un\G4999)	6-31
Chapter 7: Setting and procedure for operation	7-1 - 7-31
7.1 Precautions for handling	7-1
7.2 Procedure for operation	7-2
7.3 Name and function of each part	7-3
7.4 Attaching and removing the module	7-5
7.5 Wiring	7-6
7.6 Setting from GX Works2	7-18
7.7 Setting from GX Developer	7-25

Chapter 8: Programming	8-1 - 8-9
------------------------	-----------

8.1 Programming procedure	8-1
8.2 System configuration and usage conditions for sample program	8-2
8.3 Sample programming	8-4

Chapter 9: Troubleshooting	9-1 - 9-9
----------------------------	-----------

9.1 List of error codes	9-1
9.2 Troubleshooting	9-2
9.3 Q&A	9-6

Appendix	Appendix 1 - 8
----------	----------------

Appendix 1: External dimensions	Appendix-1
Appendix 2: Optional devices	Appendix-2
Appendix 3: Addition or change of functions	Appendix-8

Index	Index-1
-------	---------

Compliance with the EMC and Low Voltage Directives

(1) For programmable controller system

To configure a system meeting the requirements of the EMC and Low Voltage Directives when incorporating the Mitsubishi programmable controller (EMC and Low Voltage Directives compliant) into other machinery or equipment, refer to QCPU User's Manual (Hardware Design, Maintenance and Inspection).

The CE mark, indicating compliance with the EMC and Low Voltage Directives, is printed on the rating plate of the programmable controller.

(2) For the product

For the compliance of this product with the EMC and Low Voltage Directives, refer to Section 7.5 Wiring.

In addition, attach ferrite cores to power line of power supply module.

Ferrite cores used in our testing is below.

KITAGAWA INDUSTRIES CO.,LTD., RFC-10

(3) CE marking conformity combination module

This module conforms to CE marking standard in a condition to make combination use with following current sensor and cable.

current sensor	EMU-CT50, EMU-CT100, EMU-CT250, EMU-CT400, EMU-CT600, EMU-CT400-A, EMU-CT600-A	EMU2-CT5-4W
cable or current sensor cable	CE marking cable (twisted pair cable) Single wire: AWG24 – AWG18 (φ0.5 - 1.0mm) Stranded wire: AWG22 – AWG18 (0.3 - 0.8 mm ²)	EMU2-CB-Q5A-4W EMU2-CB-T1M, EMU2-CB-T5M EMU2-CB-T10M, EMU2-CB-T1MS EMU2-CB-T5MS, EMU2-CB-T10MS
Max. cable length	50m	11m

Product configuration

The following describes the product configuration.

Model name	Product name	Quantity
QE81WH4W	Energy Measuring Module (for three-phase 4-wire)	1

Note

Chapter 1: Overview

This manual explains specifications, handling methods, and programming of Energy Measuring Module QE81WH4W (hereinafter, abbreviated as QE81WH4W) supporting MELSEC-Q series.

1.1 Features

- (1) This Energy Measuring Module can measure various types of electric quantity.
It can measure electric energy, reactive energy, current, voltage, electric power, reactive power, apparent power, power factor, and frequency.
Both consumption and regeneration of the electric energy can be measured.
- (2) Extensive monitoring functions
In addition to memorizing the maximum and minimum values, two types of alarm monitoring for upper and lower limit can be performed.
- (3) It also can measure the electric energy for a certain period.
It can measure the electric energy for the duration of time for which the output device is on.
This feature enables to acquire the electric energy needed during device operation or energy per tact.

Chapter 2: System Configuration

2.1 Applicable system

The following describes applicable systems.

(1) Applicable module and the quantity of attachable pieces

(a)When mounted with CPU module

CPU module to which QE81WH4W can be attached and the number of attachable pieces are shown below.

Depending on the combination of the attached module and the number of attached pieces, lack of power capacity may occur.

When attaching the module, please consider the power capacity.

If the power capacity is insufficient, reconsider the combination of modules to be attached.

Since the number of attachable modules are limited by the power module which used, please refer to the notes on the 2.2 precautions for system configuration.

Attachable CPU Module			Attachable quantity.	Remarks
CPU Type	CPU Model			
Programmable controller CPU	Basic model QCPU	Q00JCPU	16	
		Q00CPU	24	
		Q01CPU		
	High performance model QCPU	Q02CPU	64	
		Q02HCPU		
		Q06HCPU		
		Q12HCPU		
		Q25HCPU		
	Process CPU	Q02PHCPU	64	
		Q06PHCPU		
		Q12PHCPU		
		Q25PHCPU		
	Redundant CPU	Q12PRHCPU	53	
		Q25PRHCPU		
	Universal model QCPU	Q00UJCPU	16	
		Q00UCPU	24	
		Q01UCPU		
		Q02UCPU	36	
		Q03UDCPU	64	
		Q04UDHCPU		
Q06UDHCPU				
Q10UDHCPU				
Q13UDHCPU				
Q20UDHCPU				
Q26UDHCPU				
Q03UDECPU				
Q04UDEHCPU				
Q06UDEHCPU				
Q10UDEHCPU				
Q13UDEHCPU				
Q20UDEHCPU				
Q26UDEHCPU				
Q50UDEHCPU				
Q100UDEHCPU				

Attachable CPU Module		Attachable quantity.	Remarks	
CPU Type	CPU Model			
Programmable controller CPU	High-Speed Universal model QCPU	64		
				Q03UDVCPU
				Q04UDVCPU
				Q06UDVCPU
				Q13UDVCPU
				Q26UDVCPU
				Q04UDPVCPU
				Q06UDPVCPU
				Q13UDPVCPU
	Q26UDPVCPU			
C Controller module		64		
				Q06CCPU-V
				Q06CCPU-V-B
				Q12DCCPU-V
				Q24DHCCPU-LS
				Q26DHCCPU-LS

(b) When mounted with MELSECNET/H remote I/O station

The table below shows the network modules applicable to the QE81WH4W and the number of network modules to be mounted.

Depending on the combination with other modules or the number of mounted modules, power supply capacity may be insufficient.

Pay attention to the power supply capacity before mounting modules, and if the power supply capacity is insufficient, change the combination of the modules.

Applicable Network Module	Number of modules	Remarks
QJ72LP25-25	64	
QJ72LP25G		
QJ72BR15		

(c) The base unit can be mounted

QE81WH4W can be installed to any I/O slot of main base unit and extension base unit.

*1 In case of redundant CPU, can be mounted to the extension base unit only. Mounted to the main base unit is not allowed.

*2 Limited within the range of I/O points for the CPU module.

(2) Attachable base unit

QE81WH4W can be attached to any I/O slot of the basic base unit and expansion base unit (*1) (*2).

*1 In the case of dual CPU, it can be attached only to an expansion base unit. It cannot be attached to the base unit.

*2 It has to be within the range of I/O slots of the CPU module.

(3) Applicable software package

QE81WH4W supported software packages are as follows:

(a) Software package for sequencer

Product name	Model name	Remarks
GX Works2	SW1DNC-GXW2	iQ Platform compatible programmable controller engineering software
GX Developer	SWnD5C-GPPW	MELSEC sequencer programming software "n" in the model name is 4 or larger.

2.2 Precautions for system configuration

(1) The number of attachable modules by the power module

The table below shows the number of modules by the power module.

Applicable Power Module	Number of modules	Remarks
Q61P	12	
Q62P	6	
Q63P	12	
Q64PN	12	
Q61P-D	12	
Q61SP	3	
Q63RP	12	
Q64RP	12	

(2) When mounted to the extension base

This module can not be mounted to the extension base without the power module. When extending, please use the power module mounted type extension base units.

2.3 How to check the function version, serial number, and module version

(1) How to check the serial number and module version

It can be checked with the serial number label (placed on the right side of QE81WH4W).

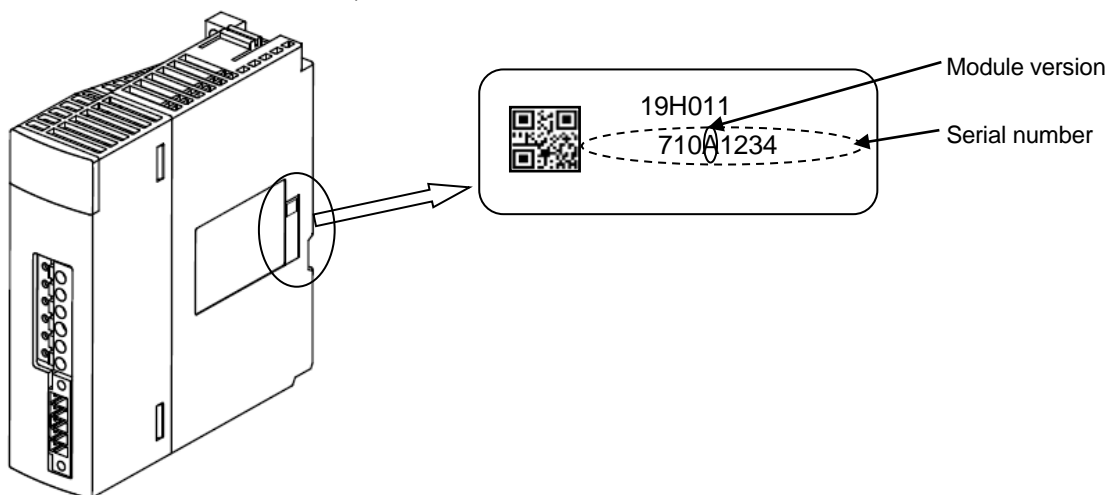

(2) How to check the function version and serial number

(a) Checking on the front of the module.

The serial number and function version on the rating plate is shown on the front (at the bottom) of the module.

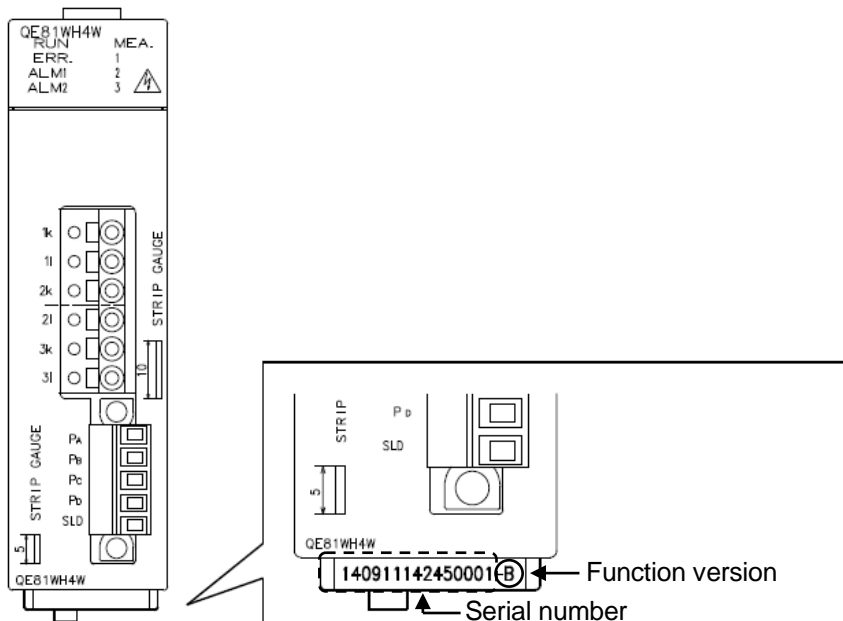

(b) Checking on the System monitor dialog box (Product Information List)

To display the system monitor, select [Diagnostics] → [System monitor] and click the Product Information List button of GX Developer.

Slot	Type	Series	Model name	Points	I/O No.	Master PLC	Serial No	Ver.	Product No.
PLC	PLC	Q	Q00UJCPU	-	-	-	1310200000000000	B	140115140218032-B
0-0	Intelli.	Q	QE81WH4W	16pt	0000	-	1407200000000000	B	-
0-1	-	-	None	-	-	-	-	-	-
0-2	-	-	None	-	-	-	-	-	-
0-3	-	-	None	-	-	-	-	-	-

Point

The serial number displayed on the Product Information List dialog box of GX Developer may differ from that on the rating plate and on the front of the module.

- The serial number on the rating plate and front part of the module indicates the management information of the product.
- The serial number displayed on the Product Information List dialog box of GX Developer indicates the function information of the product. The function information of the product is updated when a new function is added.

Chapter 3: Specifications

3.1 General specifications

Item	Specifications	
Phase wire system	three-phase 4-wire	
Rating	Voltage circuit *1	63.5/110 - 277/480V AC (Selected from: 63.5/110V, 100/173V, 105/182V, 110/190V, 115/199V, 120/208V, 127/220V, 200/346V, 220/380V, 230/400V, 240/415V, 242/420V, 250/430V, 254/440V, 265/460V, 277/480V AC. Each value refers to the primary voltage of voltage transform module.)
	Current circuit	50 A, 100 A, 250 A, 400 A, 600 A AC (Current sensor is used. Each value refers to the current at the primary side of current sensor.) 5 AAC (Current sensor is used together with current transformer (CT), and the primary-side current is configurable up to 6000 A.) *2
	Frequency	50-60 Hz
Allowable tolerance of main module (excluding current sensor) *3	Current *4 : ±1.0% (100% of the rating) Voltage : ±1.0% (100% of the rating) Electric power : ±1.0% (100% of the rating) Reactive power : ±1.0% (100% of the rating) Apparent power : ±1.0% (100% of the rating) Frequency : ±1.0% (45 – 65 Hz range of the rating) Power factor : ±3.0% (against the electric angle 90°) Electric energy : ±2.0% (5 – 100% range of the rating, power factor = 1) Reactive energy : ±2.5% (10 – 100% range of the rating, power factor = 0)	
Measurable circuit count	1 circuit	
Data update cycle	250 ms *5	
Response time	2 seconds or less	
Backup for electric blackout	Backup is made using nonvolatile memory. (Stored items: settings, the max./min. values and time of occurrence, electric energy (consumption, regenerated), reactive energy (consumption lag), and periodic electric energy)	
I/O occupation	16 points (I/O assignment: intelligence 16 points)	

* 1 : Above 277/480V, voltage transformer (VT) is required. For the circuit over this voltage, transformer (VT) is necessary (Primary voltage of VT can be set up to 6600V, and secondary voltage of VT can be set up to 220V as optional setting). Star – delta connection and delta – star connection transformer instead of VT cannot measure definitely to be out of phase. Please use a transformer of the same connection.

* 2 : 5 A primary current can be set when using the current sensor is as follows.

5A, 6A, 7.5A, 8A, 10A, 12A, 15A, 20A, 25A, 30A, 40A, 50A, 60A, 75A, 80A, 100A, 120A, 150A, 200A, 250A, 300A, 400A, 500A, 600A, 750A, 800A, 1000A, 1200A, 1500A, 1600A, 2000A, 2500A, 3000A, 4000A, 5000A, 6000A

* 3 : Please refer to 2 (1) as for the ratio error of the current sensor and the voltage transform module.

* 4 : Demand shows the moving average of a set period.

* 5 : Always accumulating the integrated values of Wh and varh. It can capture short-cycled load fluctuation.

3.2 Electrical and mechanical specifications

Item		Specifications					
Consumed VA	Voltage circuit	P1-P0: 2VA, P2-P0: 0.3VA, P3-P0: 0.3VA (primary side of voltage transform module)					
	Current circuit	Each phase 0.1 VA (secondary side of current sensor)					
Internal current consumption (5 V DC)		0.18 A					
Operating temperature		0 – 55°C (Average daily temperature 35°C or below)					
Operating humidity		5 – 95% RH (No condensation)					
Storage temperature		-25° – +75°C					
Storage humidity		5 – 95% RH (No condensation)					
Operating altitude		2000m or below					
Installation area		Inside a control panel					
Operating environment		No corrosive gas					
Vibration resistance		Conforms to JIS B 3502, IEC 61131-2	Intermittent vibration	Frequency	Constant acceleration	Half amplitude	Sweep time
				5 – 8.4 Hz	-	3.5 mm	XYZ each direction 10 times
			Continuous vibration	8.4 – 150 Hz	9.8 m/s ²	-	
				5 – 8.4 Hz	-	1.75 mm	
Impact resistance		Conforms to JIS B 3502, IEC 61131-2 (147m/s ² , XYZ each direction 3 times)					
Over voltage category * ¹		II or less					
Pollution degree * ²		2 or less					
Equipment category		Class I					
Applicable wire (Usable electric wire)	Voltage input terminal	Single wire	AWG24 – AWG16 (φ0.5 - 1.3mm)				
		Stranded wire * ⁴	AWG24 – AWG16 (0.2 – 1.3 mm ²)				
	Current input terminal * ³	Single wire	AWG24 – AWG18 (φ0.5 - 1.0mm)				
		Stranded wire * ⁴	AWG22 – AWG18 (0.3 - 0.8 mm ²)				
Tightening torque		Module-fixing screws (M3 screw) * ⁵	0.36 – 0.48 N•m				
Commercial frequency withstand voltage		Between voltage/current input terminals - SLD terminal				2210 V AC	
		Between voltage/current input terminals - sequencer power source and GND terminals				5 sec	
Insulation resistance		5 MΩ or more (500 V DC) at locations above					
Standard * ⁶		EMC: EN61131-2:2007, EN61326-1:2013 LVD: EN61131-2:2007, EN61010-1:2010					
Dimensions		27.4 mm (W) x 98 mm (H) x 90mm (D) excluding protruding portions					
Mass		0.1kg					
Product life expectancy		10 years (used under the average daily temperature 35°C or less)					

*1. This indicates the assumed area of electric distribution to which the device is connected, the area ranging from public distribution to factory machinery. The category II applies to the device power-supplied from fixed facility. The surge voltage of this product is 2500 V up to the rated voltage of 300 V.

*2. The index indicates the level of conductive substance at the device's operating environment. Contamination level 2 means only non-conductive substance. However, occasional condensation may lead to temporary conduction.

*3. At the connection between the secondary terminal of current sensor (k, l) and the main module terminal (1k, 1l, 2k, 2l, 3k, 3l), use twisted pair cable.

*4. If stranded wire is used for current input terminals, a bar terminal must be used. Recommended bar terminal: TGV TC-1.25-11T (Made by Nichifu)

*5. The module can be fixed easily to the base unit, using the hook on top of the module. However, if it is used under a vibrating environment, we strongly recommend that the module be fixed with screws.

*6. When combine this unit with a CT (Model: EMU2-CT5-4W, EMU-CT50, EMU-CT100, EMU-CT250, EMU-CT400-A, EMU-CT600-A), it becomes UL standard.

Chapter 4: Functions

4.1 List of functions

Functions of QE81WH4W are provided in Table 4.1.

The “n” that is used in this and later chapters (for example: Xn0, Yn0, Un\G0, etc.) refers to the number that appears at the beginning of QE81WH4W.

Table 4.1 List of Functions

No.	Function	Descriptions	Reference section
1	Measurement	It measures current, current demand, voltage (L-L), voltage (L-N), electric power, reactive power, apparent power, electric power demand, power factor, frequency, effective energy (consumption, regeneration), reactive energy (consumption lag), and sequentially stores the records into a buffer memory.	Section 4.2.1
2	Periodic electric energy	The electric energy only for a period of time when a certain output signal is ON will be stored in the buffer memory. Periodic energy 1 and 2 can be measured independently.	Section 4.2.2
3	Hold max./min. values	For current demand, line voltage, phase voltage, electric power demand, and power factor, each maximum /minimum values and date/time of occurrence are stored.	Section 4.2.3
4	Upper/lower limit alarm monitoring	Of current demand, line voltage, phase voltage, electric power demand, and power factor, you can select two items for which their upper/lower limit can be monitored. If it exceeds the upper limit or goes below the lower limit, the specified input signal is turned on.	Section 4.2.4
5	Test	The intelligent function module switch enables pseudo-storage of the specified value into the buffer memory, even with non-existence of input from voltage and current (sensor). Using this module, you can create a sequence, etc.	Section 4.2.5
6	Integrated value set	Set the integrated value (electric energy (consumption, regeneration), reactive energy (consumption lag)) to an arbitrary value. It is used to clear integrated value.	Section 4.2.6

4.2 Functions in detail

4.2.1 Measuring functions

(1) Measured items

Measured items and measured ranges are described as follows:

Each measured item is stored in the buffer memory every 250 ms.

	Measured items
	Details
Current	1 - phase current
	2 - phase current
	3 - phase current
	Neutral current
	Average value current
Current demand * The average of fluctuation for the set period of current demand time is indicated.	1 - phase current demand
	2 - phase current demand
	3 - phase current demand
	Neutral current demand
	Max. value
	Min. value
	Date of max. value occurrence
	Date of min. value occurrence
Voltage	Voltage V12
	Voltage V23
	Voltage V31
	average value voltage (L-L)
	Max. value of the voltage (L-L)
	Min. value of the voltage (L-L)
	Date/time of max. voltage value occurrence (L-L)
	Date/time of min. voltage value occurrence (L-L)
	Voltage V1N
	Voltage V2N
	Voltage V3N
	average value voltage (L-N)
	Max. value of the voltage (L-N)
	Min. value of the voltage (L-N)
	Date/time of max. voltage value occurrence (L-N)
	Date/time of min. voltage value occurrence (L-N)
Electric power	Present value

	Measured items
	Details
Electric power demand * The average of fluctuation for the set period of electric power demand time is indicated.	Present value
	Max. value
	Min. value
	Date/time of max. value occurrence
	Date/time of min. value occurrence
Reactive power	Reactive power
Apparent power	Apparent power
Power factor	Present value
	Max. value
	Min. value
	Date/time of max. value occurrence
	Date/time of min. value occurrence
Frequency	Present value
Electric energy	Electric energy (consumption)
	Electric energy (regeneration)
Reactive energy	Reactive energy (consumption lag)
Periodic electric energy	Periodic electric energy 1
	Periodic electric energy 2

(2) Total, maximum, and minimum values

The following describes how to calculate the maximum, minimum, and total values.

Item	Formula
Average value current	Average value current = (1-phase current + 2-phase current + 3-phase current) / 3
Average value voltage (L-L)	Average value voltage (L-L) = (voltage V12 + voltage V23 + voltage V31) / 3
Average value voltage (L-N)	Average value voltage (L-N) = (voltage V1N + voltage V2N + voltage V3N) / 3
Maximum current demand	Highest value among 1-phase current demand, 2-phase current demand, 3-phase current demand, or N-phase current demand (The highest value after the max./min. value was reset.)
Minimum current demand	Lowest value among 1-phase current demand, 2-phase current demand, or 3-phase current demand (The lowest value after the max./min. value was reset.)
Maximum value voltage (L-L)	Highest value among the voltage V12, the voltage V23, or the voltage V31 (The highest value after the max./min. value was reset.)
Minimum value voltage (L-L)	Lowest value among the voltage V12, the voltage V23, or the voltage V31 (The lowest value after the max./min. value was reset.)
Maximum value voltage (L-N)	Highest value among the voltage V1N, the voltage V2N, or the voltage V1N (The highest value after the max./min. value was reset.)
Minimum value voltage (L-N)	Lowest value among the voltage V1N, the voltage V2N, or the voltage V1N (The highest value after the max./min. value was reset.)

(3) Resolution of measured data

Resolution of measured data according to the rating (phase wire system, primary voltage, and primary current) is described as follows.

1) Current, current demand

Rated primary current setting	Multiplier	Resolution*	
5 A to 30 A	-3	2 digits after the decimal point	0.01 A
40 A to 300 A	-3	1 digit after the decimal point	0.1 A
400 A to 3000 A	-3	Integer	1 A
4000 A to 6000 A	-3	×10	10 A

* Digits lower than the resolution are fixed to 0.

2) Voltage

a. When not use voltage transformer

Input voltage setting	Multiplier	Resolution*	
63.5 / 110 V to 277 / 480 V	-3	1 digit after the decimal point	0.1 V

b. When use voltage transformer

Rated primary voltage setting	Multiplier	Resolution*	
1 V to 329 V	-3	1 digit after the decimal point	0.1 V
330 V to 2299 V	-3	Integer	1 V
3300 V to 6600 V	-3	×10	10 V

* Digits lower than the resolution are fixed to 0.

3) Electric power, electric power demand, reactive power, apparent power

Full load power W ^{1*3}	Multiplier	Resolution ^{*2*3}	
I. W < 12 kW	-3	3 digits after the decimal point	0.001 kW
II. 12 kW ≤ W < 120 kW	-3	2 digits after the decimal point	0.01 kW
III. 120 kW ≤ W < 1200 kW	-3	1 digit after the decimal point	0.1 kW
IV. 1200 kW ≤ W < 12000 kW	-3	Integer	1 kW
V. 12000 kW ≤ W < 120000 kW	-3	×10	10 kW

^{*1} Full load power W can be calculated by the following equation:

In addition, for calculating full load power W, refer to Table 4.2 (pages 4 to 5).

$$\text{Full load power } W \text{ [kW]} = 3 \times (\text{VT primary voltage}) \times (\text{CT primary current}) / 1000$$

Primary voltage = voltage (L-N) of input voltage (when not use voltage transformer)

= primary voltage of voltage transformer (when use voltage transformer)

^{*2} Digits lower than the resolution are fixed to 0.

^{*3} In the case of reactive power, the unit will be kvar.

In the case of apparent power, the unit will be kVA

4) Power factor

Power factor	Multiplier	Resolution*	
All setting ranges	-3	1 digit after the decimal point	0.1%

* Digits lower than the resolution are fixed to 0.

5) Frequency

Frequency	Multiplier	Resolution*	
All setting ranges	-3	1 digit after the decimal point	0.1 Hz

* Digits lower than the resolution are fixed to 0.

6) Electric energy, reactive energy, periodic electric energy

Full load power W ^{*1}	Multiplier	Resolution ^{*2*3}	Range [kWh,kvarh]
I. W < 12 kW	-5	5 digits after the decimal point	0.00001 – 9999.99999
II. 12kW ≤ W < 120 kW	-4	4 digits after the decimal point	0.0001 – 99999.9999
III. 120kW ≤ W < 1200 kW	-3	3 digits after the decimal point	0.001 – 999999.999
IV. 1200kW ≤ W < 12000 kW	-2	2 digits after the decimal point	0.01 – 9999999.99
V. 12000kW ≤ W < 120000 kW	-1	1 digit after the decimal point	0.1 – 99999999.9

^{*1} For calculating full load power W, refer to Table 4.2 (pages 4-5 to 4-7).

^{*2} Digits lower than the resolution are fixed to 0.

^{*3} Because the higher resolution than a typical watt-hour meter, the minimum digit values will change more than 2 at once update. According to setting value of input voltage, primary current, primary voltage of VT and the condition of load.

Table 4.2 How to calculate full load power

		Primary voltage[V]							
		110	220	440	690	1100	2200	3300	6600
Primary current[A]	5								
	6	I							
	7.5								
	8	W < 12kW							
	10								
	12								
	15								
	20		II						
	25								
	30								
	40		12kW ≤ W < 120kW						
	50								
	60								
	75								
	80			III					
	100								
	120			120kW ≤ W < 1200kW					
	150								
	200								
	250								
	300								
	400								
	500								
	600					IV			
	750								
	800					1200kW ≤ W < 12000kW			
	1000								
	1200								
1500									
1600									
2000								V	
2500									
3000									
4000								12000kW ≤ W < 120000kW	
5000									
6000									

(4) Restrictions for measuring data

- Measurement cannot be performed immediately after the power loading to the sequencer system (Module ready signal is under the OFF condition).
After checking that Module ready (Xn0) is ON, obtain measuring data.
- Measurement cannot be performed immediately after operating conditions are set up to the module. After checking that Operating condition setting completion flag (Xn9) becomes ON, obtain measuring data.
- Behaviors during operation are as follows:

Measuring item	Behavior of the module
Current	When the input current is less than 0.4% of the rating current, it becomes 0A.
Current demand	Current demand is obtained by current moving average. Therefore, even if current is 0A, current demand may not be 0A.
Voltage (L-N)	When the input voltage (L-N) is less than 55V, it becomes 0V. If there is no input at voltage V1N, all measurement cannot be done.
Voltage (L-L)	When the input voltage (L-L) is less than 95V, it becomes 0V.
Electric power Reactive power	When current is 0A (at all phases are 0A) or when voltage is 0V (all phases are 0V), it becomes 0kW.
Electric power demand	Electric power demand is obtained by electric power moving average. Therefore, even if electric power is 0kW, electric power demand may not be 0kW.
Electric energy	The electric energy is measured with a load that is about 0.4% or more of all load power. Even if the indicated value is "0", measurement value will increase.
Power factor	When current is 0A (at all phases are 0A) or when voltage is 0V (all phases are 0V), it becomes 100%.
Frequency	Voltage condition When the input voltage (L-N) is less than 55V, it becomes 0Hz.
	Frequency condition When it is less than 44.5Hz, it is fixed to 44.5Hz.

4.2.2 Measuring function for periodic electric energy

This function is to measure electric energy for a certain period, and stores it into the buffer memory. It can be used to measure electric energy for a certain tact or energy (standby power) when the facility or equipment is not in operation.

(1) Overview

- 1) It can measure two periodic electric energy (periodic electric energy 1, periodic electric energy 2). Each of these can be measured independently.
- 2) During the time when Periodic electric energy 1 measurement flag (Yn1)/ Periodic electric energy 2 measurement flag (Yn2) is ON, periodic electric energy can be measured.
- 3) Periodic electric energy is stored in the nonvolatile memory, so that it can be retained even at a power source reset.
- 4) I/O signals and buffer memory corresponding to each periodic electric energy 1 and 2 are provided below.

	Buffer memory (Double words)	Periodic electric energy measurement flag	Periodic electric energy data completion flag	Periodic electric energy reset request	Periodic electric energy reset completion flag
Periodic electric energy 1	Un\G114, 115	Yn1	Xn1	Yn3	Xn3
Periodic electric energy 2	Un\G116, 117	Yn2	Xn2	Yn4	Xn4

Note

Measurement of periodic electric energy is performed every measuring cycle (250 ms). Therefore, if the time to turn ON Periodic electric energy 1 measurement flag (Yn1) and Periodic electric energy 2 measurement flag (Yn2) is set to 250 ms or less, measurement may not be taken.

(2) Basic procedure

1) Measuring periodic electric energy

- (a) Check that Periodic electric energy measurement flag (Yn1/Yn2) is OFF.
- (b) Check periodic electric energy (Un\G114, 115/Un\G116, 117).
- (c) When starting measurement, set Periodic electric energy measurement flag (Yn1/Yn2) to ON.

This module starts measuring specified periodic electric energy, and Periodic electric energy data completion flag (Xn1/Xn2) will be turned OFF.

- (d) When stopping measurement, set Periodic electric energy measurement flag (Yn1/Yn2) to OFF.

This module stops measuring the specified periodic electric energy, and Periodic electric energy data completion flag (Xn1/Xn2) will be turned ON.

- (e) Check that Periodic electric energy data completion flag (Xn1/Xn2) becomes ON, and obtain the value of periodic electric energy.

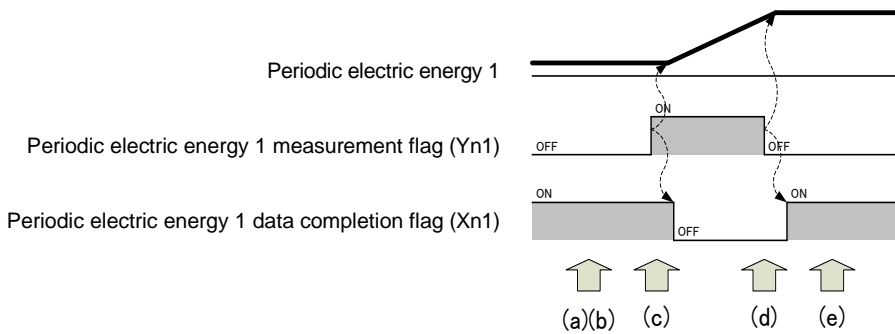

Figure 4.1 Basic procedure of measuring the periodic electric energy

2) Resetting periodic electric power

- (a) Check that Periodic electric energy measurement flag (Yn1/Yn2) is OFF and that Periodic electric energy reset request (Yn3/Yn4) is OFF.
- (b) Set Periodic electric energy reset request (Yn3/Yn4) to ON. The specified periodic electric energy is reset to 0 kWh, and Periodic electric energy reset completion flag (Xn3/Xn4) will be turned to ON.
- (c) Check that Periodic electric energy reset completion flag (Xn3/Xn4) has become ON, and then set Periodic electric energy reset request (Yn3/Yn4) to OFF. Periodic electric energy reset completion flag (Xn3/Xn4) will be turned OFF.

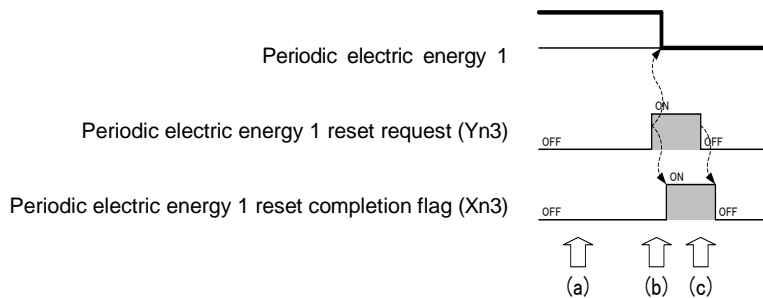

Figure 4.2 How to reset the periodic electric energy

(3) Sample use case

1) Procedure for continuously measuring periodic electric energy

If you turn Periodic electric energy measurement flag (Yn1/Yn2) to ON only for the extent of time you want to measure, this module accumulates the power starting at the previously measured amount. Usage procedure is the same as 1) in (2).

An example is provided below.

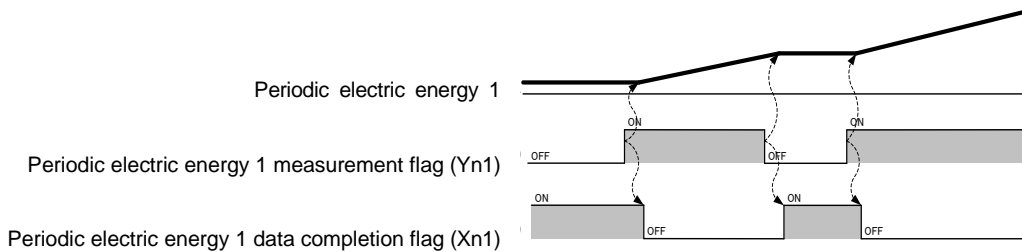

Figure 4.3 Example of continuous measurement of periodic electric energy

2) Procedure for measuring periodic electric energy after every reset

If you turn Periodic electric energy measurement flag (Yn1/Yn2) to ON only for the extent of time you want to measure, this module accumulates the power starting at the previously measured amount. The following describes the usage procedure.

- (a) Check that Periodic electric energy measurement flag (Yn1/Yn2) is OFF and that Periodic electric energy reset request (Yn3/Yn4) is OFF.
- (b) Set Periodic electric energy reset request (Yn3/Yn4) to ON.
The specified periodic electric energy is reset to 0 kWh, and Periodic electric energy reset completion flag (Xn3/Xn4) will be turned ON.
- (c) Check that Periodic electric energy reset completion flag (Xn3/Xn4) has become ON, and then set Periodic electric energy reset request (Yn3/Yn4) to OFF.
Periodic electric energy reset completion flag (Xn3/Xn4) will be turned OFF.
- (d) When starting measurement, set Periodic electric energy measurement flag (Yn1/Yn2) to ON.
This module starts measuring the specified periodic electric energy, and Periodic electric energy data completion flag (Xn1/Xn2) will be turned OFF.
- (e) When stopping measurement, set Periodic electric energy measurement flag (Yn1/Yn2) to OFF.
This module stops measuring the specified periodic electric energy, and Periodic electric energy data completion flag (Xn1/Xn2) will be turned ON.
- (f) Check that Periodic electric energy data completion flag (Xn1/Xn2) becomes ON, and obtain the value of periodic electric energy.

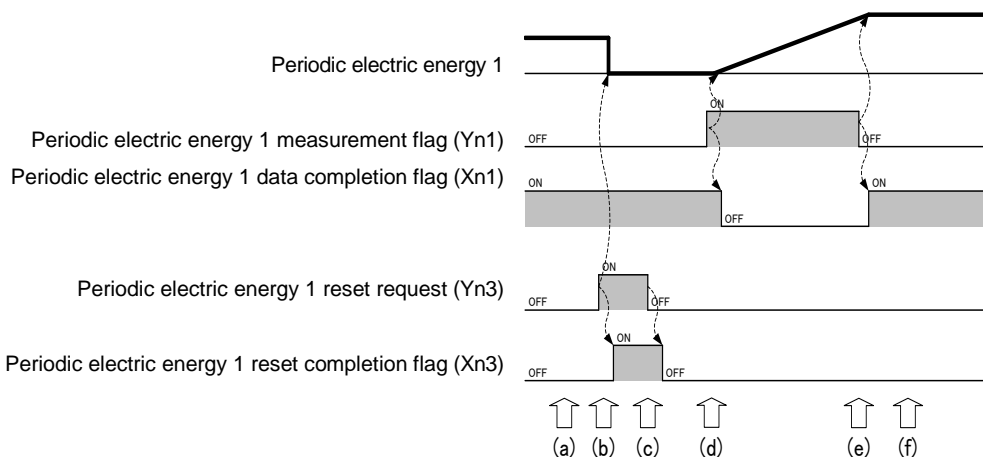

Figure 4.4 Example of measurement of periodic electric energy after every reset

4.2.3 Max./min. value hold function

It memorizes the max./min. value for each measured item, and retains it until the max./min. value clear is performed.

(1) Max./min. value memory

- 1) It memorizes the max. and min. values for the following measured item.
 - Current demand
 - Voltage (L-L)
 - Electric power demand
 - Power factor
 - Voltage (L-N)
- 2) It memorizes the date and time of occurrence (year/month/day/hour/minute/second/day of the week) together with the max. and min. values.
- 3) The max. and min. values and the date of occurrence are stored in the nonvolatile memory, so that these values can be retained even at a power source reset.

(2) How to clear the max. and min. values

- 1) You can use the I/O signal to clear the max. and min. values.
- 2) The max. and min. values immediately after the clear will be the present values and the date of occurrence will be the present date and time.
- 3) The following describes how to clear the max. and min. values.
 - (a) Check that Max./min. values clear request (YnD) is OFF.
 - (b) Set Max./min. values clear request (YnD) to ON.
This module clears all the max./min. values and the date of occurrence, and changes Max./min. values clear completion flag (XnD) to ON.
 - (c) Check that Max./min. values clear completion flag (XnD) is ON, and then set Max./min. values clear request (YnD) to OFF. Max./min. values clear completion flag (XnD) will be turned OFF.

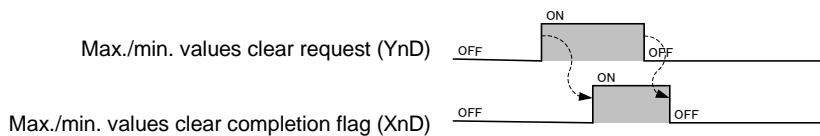

Figure 4.5 Procedure for clearing max./min. value

4.2.4 Upper/lower limit alarm monitoring function

You can set an upper and lower limit alarm for maximum two points and implement a monitoring function for them. During the alarm monitoring, it can monitor the input signal to check for the occurrence.

(1) Setting the upper/lower limit alarm monitoring

1) Setting items and setting range for the alarm monitoring are described below.

Items set in the buffer memory	Setting range	Description
Alarm item (Un\G11/Un\G21)	0: No monitoring 1: Current demand upper limit 2: Current demand lower limit 3: Voltage (L-L)upper limit 4: Voltage (L-L)lower limit 5: Power demand upper limit 6: Power demand lower limit 7: Power factor upper limit 8: Power factor lower limit 9: Voltage (L-N) upper limit 10: Voltage (L-N)lower limit	For respective alarm 1 and alarm 2, set the measuring item and either upper or lower limit for monitoring target.
Alarm value (Un\G12,13 /Un\G22,23)	-2147483648 – 2147483647 [Unit] Current: $\times 10^{-3}$ A Voltage: $\times 10^{-3}$ V Power: $\times 10^{-3}$ kW PF: $\times 10^{-3}\%$	The value to be monitored for the alarm. Set the value according to the unit of the measuring item that is set as an alarm monitoring item. (Double words)
Alarm reset method (Un\G14/Un\G24)	0: Self-retention 1: Auto reset	Set whether or not the alarm-occurrence condition should be retained if the value goes below the upper limit alarm value or goes over the lower limit alarm value after the upper/lower limit alarm occurred.
Alarm delay time (Un\G15/Un\G25)	0 – 300 [Unit] second	If it exceeds the upper limit alarm value or if it goes below the lower limit alarm value, and the situation continues for the period of the alarm delay time, then it is considered as an alarm occurrence.

2) Setting procedures are as follows:

- (a) Check that Operating condition setting request (Yn9) is OFF.
- (b) Set the alarm item in the buffer memory (Un\G11/Un\G21), alarm value (Un\G12,13 /Un\G22,23), alarm reset method (Un\G14/Un\G24), and alarm delay time (Un\G15/Un\G25). For the address of buffer memory corresponding the alarm1 and alarm2, refer to Chapter 6.
- (c) Set Operating condition setting request (Yn9) to ON. Operation starts at each set value, and then, Operating condition setting completion flag (Xn9) is turned ON.
- (d) Check that Operating condition setting completion flag (Xn9) becomes ON, and then set Operating condition setting request (Yn9) to OFF. Operating condition setting completion flag (Xn9) will be turned OFF.

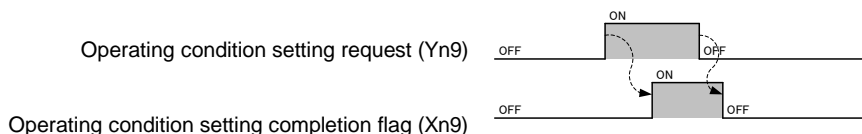

Figure 4.6 Time chart of alarm monitoring setting

3) Each item of the alarm monitoring is stored in the nonvolatile memory, so that values can be retained even at a power source reset.

(2) Behavior of the upper/lower limit alarm

- 1) When the alarm reset method is in the “self-retention” setting (example of an upper limit monitoring at alarm 1)
 - (a) If the measured value that was set with the alarm 1 monitoring item exceeds the upper limit and the situation continues and remains for the alarm 1 delay time, Alarm 1 flag (XnA) will turn ON. At the same time, ALM1 LED flashes.
 - (b) Even if the measured value goes below the upper limit, Alarm 1 flag (XnA) retains an ON status (self retention). During the self-retention, ALM1 LED is turned on.
 - (c) By turning Alarm 1 reset request (YnA) to ON, Alarm 1 flag (XnA) will turn OFF. At this time, ALM1 LED is turned off.
 - (d) Check that Alarm 1 flag (XnA) becomes OFF, and then set Alarm 1 reset request (YnA) to OFF.

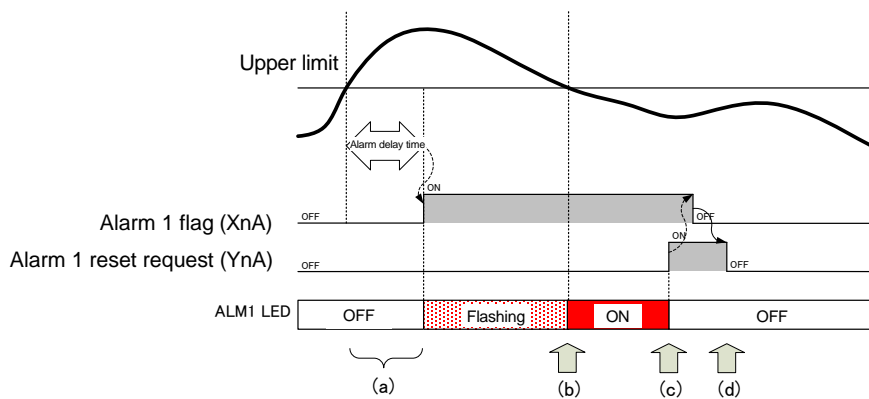

Figure 4.7 Time chart of the upper/lower limit alarm (alarm reset method = “self-retention”)

- 2) When the alarm reset method is in the “auto reset” setting (example of an upper limit monitoring at alarm 1)
 - (a) If the measured value that was set with the alarm 1 item exceeds the upper limit and the situation continues and remains for the alarm 1 delay time, Alarm 1 flag (XnA) will turn ON. At the same time, ALM1 LED flashes.
 - (b) If the measured value goes below the upper limit, Alarm 1 flag (XnA) will turn OFF. At this time, ALM1 LED is turned off.
 - (c) If the measured value that was set with the alarm 1 monitoring item exceeds the upper limit but goes below the upper limit within the alarm 1 delay time, then Alarm 1 flag (XnA) will remain in the OFF status.

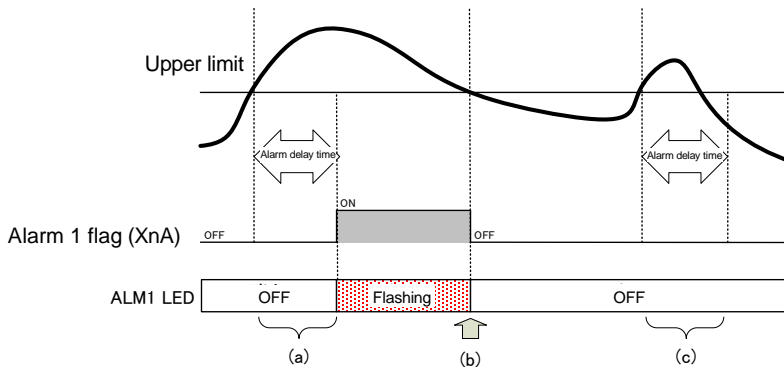

Figure 4.8 Time chart of the upper/lower limit alarm (alarm reset method = “auto-reset”)

3) An example of the alarm 1 was indicated in 1) and 2) above. The alarm 2 will be in accordance with the same behavior.

For the setting items for the buffer memory that corresponds to the alarm 2 and the I/O signals, refer to Chapters 5 and 6. The following describes a case with the alarm 2.

[When the alarm reset method is in the “auto reset” setting (Example of a lower limit monitoring at alarm 2)]

- (a) If the measured value that was set with the alarm 2 item goes below the lower limit and the situation continues and remains for the alarm 2 delay time, Alarm 2 flag (XnB) will turn ON. At the same time, ALM2 LED flashes.
- (b) If the measured value exceeds the lower limit, Alarm 2 flag (XnB) will turn OFF. At this time, ALM2 LED is turned off.
- (c) If the measured value that was set with the alarm 2 monitoring item goes below the lower limit but exceeds the lower limit within the alarm 2 delay time, then Alarm 2 flag (XnB) will remain in the OFF status.

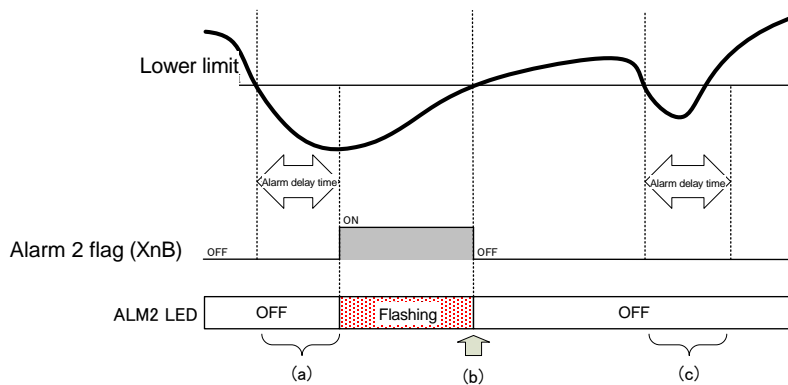

Figure 4.9 Time chart of the upper/lower limit alarm (alarm reset method = “auto-reset”)

(3) How to reset Alarm flag

1) When Alarm flag is ON during the alarm occurrence or the self-retention (in the case of the alarm reset method = "self-retention"), Alarm flag can be reset (turned OFF) using Alarm reset request.

2) How to reset Alarm flag during alarm occurrence (example of the upper limit alarm monitoring with the alarm 1)

- (a) If the measured value that was set with the alarm 1 item exceeds the upper limit, Alarm 1 flag (XnA) will turn ON. At the same time, ALM1 LED flashes.
- (b) By turning Alarm 1 reset request (YnA) to ON, Alarm 1 flag (XnA) will turn OFF. At this time, ALM1 LED will remain flashing (because ALM1 LED is synchronized with the alarm status, it will not turn off).
- (c) Check that Alarm 1 flag (XnA) becomes OFF, and then set Alarm 1 reset request (YnA) to OFF.
- (d) If the measured value goes below the upper limit, ALM1 LED will turn off.
- (e) After that, if the measured value exceeds the upper limit, Alarm 1 flag (XnA) will turn ON again. At the same time, ALM1 LED flashes.

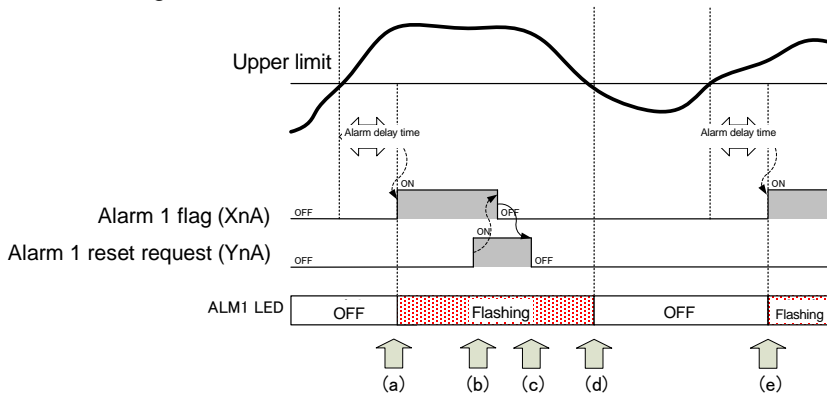

Figure 4.10 Procedure for resetting Alarm 1 flag (alarm reset method = "auto-reset")

3) How to reset Alarm flag during self-retention (in the case the alarm reset method = "self-retention" only)

Refer to the procedure described in (2) 1).

(4) Precautions during the alarm monitoring

- 1) When current demand time and electric power demand time are set to anytime except 0 second, current demand and electric power demand become lower than the actual values (closer to 0) immediately after the power source ON and the CPU reset. When current demand and electric power demand are being monitored for their lower limit, the alarm occurrence flag may turn ON. Thus, to avoid this from happening, follow the procedure below.
 - (a) Set the alarm monitoring target to "no monitoring" immediately after the power source ON and the CPU reset.
 - (b) After passing for a 3-times longer period than the demand time, set the alarm monitoring target again, and start the alarm monitoring.

4.2.5 Test function

This function is to output pseudo-fixed value to a buffer memory for debugging sequence program. The value can be output to the buffer memory without input of voltage and current.

(1) How to use the test function

- 1) Using the intelligent function module switch setting, you can start the test mode to output the fixed value.
- 2) For procedure for the intelligent function module switch setting.
For GX Works2, refer to 7.6.2.
For GX Developer, refer to 7.7.2.
- 3) To finish the test mode, the set value is returned by the intelligent function module switch setting, and after that, it enters to a normal operation by resetting it.
(It resumes with the previous set value, electric energy and periodic electric energy.)

(2) Content of fixed-output

For the value to be output to the buffer memory, refer to Table 6.1 to 6.3 in 6.1 Buffer memory assignment.

(3) LED display when using the test function

All LED lights.

(4) I/O signals when using the test function

Unit READY (Xn0) only ON. Other input and output signals are all OFF.

(5) Precautions for using the test function

Because fixed-output is output to the buffer memory, isolate the actual device to avoid unexpected operation before running the sequence program.

4.2.6 Integrated value set function

This is a function that can set the integrated value (electric energy (consumption, regeneration), reactive energy (consumption lag)) to an arbitrary value.

It is used to clear integrated value.

(1) Setting procedure

(a) Set the integrated value setting target in the buffer memory. Setting range is as follows:

Setting value	Description
0	No set
1	Electric energy (consumption)
2	Electric energy (regeneration)
3	Reactive energy (consumption lag)

(b) Set the integrated value setting value in the buffer memory.

- Configurable range: 0 to 999999999
 - The unit used for the setting value is the same as that used for the electric energy and reactive energy that are output to the buffer memory.
- For details, refer to section 6.3.2.

(c) Turn Integrated value set request (YnC) from OFF to ON to enable* the setting.

Integrated value set completion flag (XnC) turns ON after Integrated value set request (YnC) is set OFF to ON.

(d) After checking that integrated value set completion flag (XnC) turns ON and setting is completed, set the integrated value set request (YnC) to OFF.

After detected that the integrated value set request (YnC) turns OFF, the integrated value set completion flag (XnC) turns OFF.

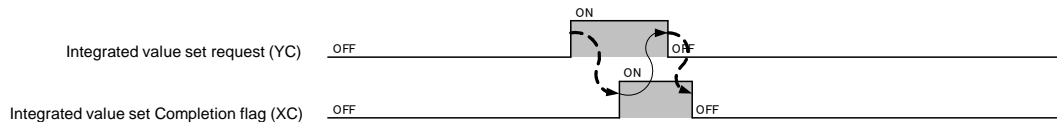

Figure 4.2.6 Integrated value setting procedure

(2) Default value

- Integrated value setting target (Un\G51) is set to 0 (No set).
- Integrated value setting value (Un\G52, Un\G53) is set to 0.

Chapter 5: I/O signals for the CPU module

5.1 List of I/O signals

I/O signals of QE81WH4W are listed in Table 5.1.

Table 5.1 List of I/O signals

Input signal (signal direction from QE81WH4W to CPU module)		Output signal (signal direction from CPU module to QE81WH4W)	
Device #	Signal name	Device #	Signal name
Xn0	Module ready	Yn0	Use prohibited *1
Xn1	Periodic electric energy 1 data completion flag	Yn1	Periodic electric energy 1 measurement flag
Xn2	Periodic electric energy 2 data completion flag	Yn2	Periodic electric energy 2 measurement flag
Xn3	Periodic electric energy 1 reset completion flag	Yn3	Periodic electric energy 1 reset request
Xn4	Periodic electric energy 2 reset completion flag	Yn4	Periodic electric energy 2 reset request
Xn5	Use prohibited *1	Yn5	Use prohibited *1
Xn6	Use prohibited *1	Yn6	Use prohibited *1
Xn7	Use prohibited *1	Yn7	Use prohibited *1
Xn8	Data acquisition clock	Yn8	Use prohibited *1
Xn9	Operating condition setting completion flag	Yn9	Operating condition setting request
XnA	Alarm 1 flag	YnA	Alarm 1 reset request
XnB	Alarm 2 flag	YnB	Alarm 2 reset request
XnC	Electric energy preset completion flag	YnC	Electric energy preset request
XnD	Max./min. values clear completion flag	YnD	Max./min. values clear request
XnE	Use prohibited *1	YnE	Use prohibited *1
XnF	Error flag	YnF	Error clear request

Point

*1 These signals cannot be used by the user since they are for system use only. If these are set to on or off by the sequence program, the performance of the QE81WH4W cannot be guaranteed.

5.2 Details of I/O signals

Detailed explanation about I/O signals of QE81WH4W is provided as follows:

5.2.1 Input signals

(1) Module ready (Xn0)

- (a) When the power of CPU module is turned on or the CPU module reset is performed, it will turn ON as soon as the measurement is ready.
- (b) This signal (Xn0) is turned OFF when energy measuring module displays a hardware error, and RUN LED is turned off.

(2) Periodic electric energy 1 data completion flag (Xn1)

- (a) When Periodic electric energy 1 measurement flag (Yn1) is turned OFF and calculation of the periodic electric energy 1 is stopped, then this signal (Xn1) turns ON. While calculating the periodic electric energy 1, this signal (Xn1) turns OFF.
- (b) In order to acquire the data under the condition where the periodic electric energy 1 is checked after the accumulation of the periodic electric energy is stopped, obtain the data while this signal (Xn1) is ON.

*For specific usage procedures, refer to section 4.2.2.

(3) Periodic electric energy 2 data completion flag (Xn2)

The usage procedure is the same as Periodic electric energy 1 data completion flag (Xn1). Refer to (2).

(4) Periodic electric energy 1 reset completion flag (Xn3)

- (a) When Periodic electric energy 1 reset request (Yn3) is turned ON, and the periodic electric energy 1 that is stored in the buffer memory is reset, then this signal (Xn3) turns ON.

*For specific usage procedures, refer to section 4.2.2.

(5) Periodic electric energy 2 reset completion flag (Xn4)

The usage procedure is the same as Periodic electric energy 1 reset completion flag (Xn3). Refer to (4).

(6) Data acquisition clock (Xn8)

- (a) After turning on the power of CPU module, the output period of data acquisition clock counting will start by turned on this signal (Xn8) immediately after the initial operation. Then the output period of data acquisition clock has completed writing the measurement data to the buffer memory and this signal would be turned on at this moment. Also, if the set of input voltage, primary current, primary voltage of VT and measurement data acquisition period are changed, immediately turn on and the output period of data acquisition clock counting will start.
- (b) This signal will be off after turned on for 150ms.

(7) Operating condition setting completion flag (Xn9)

(a) When turning Operating condition setting request (Yn9) to ON and changing the following settings, this signal (Xn9) turns ON.

- Phase wire system (Un\G0)
- Input voltage (Un\G1)
- Primary current (Un\G2)
- Current demand time (Un\G3)
- Electric power demand time (Un\G4)
- Primary voltage of VT (Un\G5)
- Alarm 1 item (Un\G11)
- Alarm 1 value (Un\G12, 13)
- Alarm 1 reset method (Un\G14)
- Alarm 1 delay time (Un\G15)
- Alarm 2 item (Un\G21)
- Alarm 2 value (Un\G22, 23)
- Alarm 2 reset method (Un\G24)
- Alarm 2 delay time (Un\G25)
- Output period of data acquisition clock (Un\G60, 61)

(b) When Operating condition setting request (Yn9) is OFF, this signal (Xn9) turns OFF.

(8) Alarm 1 flag (XnA)

(a) If the measured value of the alarm 1 item (Un\G11) exceeds the upper limit (in the case of the lower alarm, it goes under the lower limit), and if the situation continues and passes the alarm 1 delay time (Un\G15), then this signal (XnA) turns ON.

(b) Operations after this signal (XnA) is turned ON are different depending on the setting of the alarm 1 reset method (Un\G14).

[When the alarm 1 reset method (Un\G14) is “auto reset”]

If the measured value of the alarm 1 monitoring target becomes below the upper limit (in the case of lower limit alarm, it exceeds the lower limit), then this signal (XnA) turns OFF.

[When the alarm 1 reset method (Un\G14) is “self retention”]

Even if the measured value of the alarm 1 monitoring target becomes below the upper limit (in the case of lower limit alarm, it exceeds the lower limit), this signal (XnA) retains ON. Then, when Alarm 1 reset request (YnA) is turned to ON, this signal (XnA) turns OFF.

(c) When the measured value of the alarm 1 monitoring target is set to “not monitoring”, this signal (XnA) turns OFF.

*For the actual behavior of alarm monitoring, refer to 4.2.4.

(9) Alarm 2 flag (XnB)

The usage procedure is the same as Alarm 1 flag (XnA). Refer to (7).

(10) Electric energy preset completion flag (XnC)

- (a) When Electric energy preset request (YnC) is turned ON, and preset of each integrated value such as electric energy (consumption), electric energy (regeneration), reactive energy (consumption delay) is completed, this signal (XnC) turns ON.
- (b) When Electric energy preset request (YnC) is turned OFF, this signal (XnC) turns OFF.

(11) Max./min. values clear completion flag (XnD)

- (a) When Max./min. values clear request (YnD) is turned ON and the data of max./min. value (maximum value, minimum value and their date and time of occurrence) are cleared, this signal (XnD) turns ON.
- (b) When Max./min. values clear request (YnD) is turned OFF, this signal (XnD) turns OFF.

(12) Error flag (XnF)

- (a) If an outside-set-value error occurs, and if a hardware error occurs, this signal (XnF) turns ON.
- (b) The description of the occurred error can be checked with a latest error code (Un\G3000).
* For description of error codes, refer to section 9.1.
- (c) If an outside-set-value error occurs, this signal (XnF) is turned OFF by setting a value within the range again.

5.2.2 Output signals

(1) Periodic electric energy 1 measurement flag (Yn1)

- (a) When switching this signal (Yn1) from the ON status to the OFF status, the periodic electric energy 1 is measured, and will be stored into the buffer memory.
- (b) When this signal (Yn1) is turned OFF, Periodic electric energy 1 data completion flag (Xn1) is turns ON at the time that the periodic electric energy 1 is checked for that period, and then the periodic electric energy 1 is retained.
- (c) In order to read the checked data of the periodic electric energy 1, using the sequence program, use Periodic electric energy 1 data completion flag (Xn1) as the interlock condition.

*For specific usage procedures, refer to section 4.2.2.

(2) Periodic electric energy 2 measurement flag (Yn2)

The usage procedure is the same as that of Periodic electric energy 1 measurement flag (Yn1). Refer to (1).

(3) Periodic electric energy 1 reset request (Yn3)

- (a) When this request (Yn3) is turned ON from the OFF status, Periodic electric energy 1 reset completion flag (Xn3) turns ON, and the periodic electric energy 1 that has been stored in the buffer memory is reset.
- (b) Regardless of the status of Periodic electric energy 1 measurement flag (Yn1), either OFF or ON, the periodic electric energy can be reset using this request (Yn3). When Periodic electric energy 1 measurement flag (Yn1) is ON, and the measurement is taking place, the measurement will resume immediately after the reset.
- (c) When this request (Yn3) is set to OFF, Periodic electric energy 1 reset completion flag (Xn3) turns OFF.

*For specific usage procedures, refer to section 4.2.2.

(4) Periodic electric energy 2 reset request (Yn4)

The usage procedure is the same as that of Periodic electric energy 1 reset request (Yn3). Refer to (3).

(5) Operating condition setting request (Yn9)

- (a) When switching this request (Yn9) from the OFF status to the ON status, the following operating conditions will be set.
 - Phase wire system (Un\G0)
 - Input voltage (Un\G1)
 - Primary current (Un\G2)
 - Current demand time (Un\G3)
 - Electric power demand time (Un\G4)
 - Primary voltage of VT (Un\G5)
 - Alarm 1 item (Un\G11)
 - Alarm 1 value (Un\G12)
 - Alarm 1 reset method (Un\G14)
 - Alarm 1 delay time (Un\G15)
 - Alarm 2 item (Un\G21)
 - Alarm 2 value (Un\G22)
 - Alarm 2 reset method (Un\G24)
 - Alarm 2 delay time (Un\G25)
 - Output period of data acquisition clock (Un\G60, 61)

- (b) When the operating condition setting is completed, Operating condition setting completion flag (Xn9) turns ON.
 - (c) When this request (Yn9) is turned OFF, Operating condition setting completion flag (Xn9) turns OFF.
- (6) Alarm 1 reset request (YnA)
- (a) When Alarm 1 flag (XnA) is reset, this request (YnA) turns ON.
 - (b) When this request (XnA) is switched from the OFF status to the ON status, Alarm 1 flag (XnA) will forcibly be turned OFF regardless of the present alarm occurrence status.
- (7) Alarm 2 reset request (YnB)
- The usage procedure is the same as that of Alarm 1 reset request (YnA). Refer to (6).
- (8) Electric energy preset request (YnC)
- (a) If you want to set the energy (consumption and regeneration) and the reactive energy to an arbitrary value, write Electric energy preset item (Un\G51) and Electric energy preset value (Un\G52, 53) into it, and after that, turn this request (YnC) into ON.
 - (b) When switching this request (YnC) from the OFF status to the ON status, setting of the integrated value will be performed. When the integrated value setting is completed, Electric energy preset completion flag (XnC) turns ON.
 - (c) When this request (YnC) is set to OFF, Electric energy preset completion flag (XnC) turns OFF.
- (9) Max./min. values clear request (YnD)
- (a) When the max./min. value data (max./min. value and their date/time of occurrence) is reset, this request (YnD) turns ON.
 - (b) When switching this request (YnD) from the OFF status to the ON status, the max./min. value data will be cleared. When clearing the max./min. data is completed, Max./min. values clear completion flag (XnD) turns ON.
- (10) Error clear request (YnF)
- (a) When switching this request (YnF) from the OFF status to the ON status while an outside-set-value error is present, Error flag (XnF) turns OFF, and the latest error code in the buffer memory (Un\G3000) will be cleared.
 - (b) At the same time as clearing the error above, the value that was set in the buffer memory below will be replaced with the previously set value, and Electric energy preset item (Un\G51) and Electric energy preset value (Un\G52, 53) will be changed to 0.
 [Set value to be replaced with the previously set value]
 - Phase wire system (Un\G0)
 - Input voltage (Un\G1)
 - Primary current (Un\G2)
 - Current demand time (Un\G3)
 - Electric power demand time (Un\G4)
 - Primary voltage of VT (Un\G5)
 - Alarm 1 item (Un\G11)
 - Alarm 1 value (Un\G12, 13)
 - Alarm 1 reset method (Un\G14)
 - Alarm 1 delay time (Un\G15)
 - Alarm 2 item (Un\G21)
 - Alarm 2 value (Un\G22, 23)
 - Alarm 2 reset method (Un\G24)
 - Alarm 2 delay time (Un\G25)
 - Output period of data acquisition clock (Un\G60, 61)
 - (c) While a hardware error is present (error code: 0000H to 0FFFH), it will not be cleared even if this signal (YnF) turns ON.

Chapter 6: Buffer memory

6.1 Buffer memory assignment

The following describes buffer memory assignment.

Point
In the buffer memory, do not write data to the "system area" or area where data writing data from sequence programs is disabled. Doing so may cause malfunction.

(1) Configurable sections (Un\G0 to Un\G99)

Table 6.1 Configurable sections (Un\G0 to Un\G99)

Item	Address (Decimal)	Data Type	Description	Default value	R/W	Back up*1	Output value during the test mode*2	
Setting value	0	Pr	Phase wire system	3	R/W	○	3	
	1	Pr	Primary voltage	2	R/W	○	2	
	2	Pr	Primary current	2	R/W	○	2	
	3	Pr	Current demand time	120	R/W	○	120	
	4	Pr	Electric power demand time	120	R/W	○	120	
	5	Pr	Primary voltage of VT	0	R/W	○	0	
	6-10	-	-	System area	-	-	-	-
	11	Pr	Alarm 1 item	0	R/W	○	5	
	12	Pr	Alarm 1 value	0	R/W	○	1000	
	13							
	14	Pr	Alarm 1 reset method	0	R/W	○	0	
	15	Pr	Alarm 1 delay time	0	R/W	○	5	
	16-20	-	-	System area	-	-	-	-
	21	Pr	Alarm 2 item	0	R/W	○	6	
	22	Pr	Alarm 2 value	0	R/W	○	-1000	
	23							
	24	Pr	Alarm 2 reset method	0	R/W	○	1	
	25	Pr	Alarm 2 delay time	0	R/W	○	300	
	26-50	-	-	System area	-	-	-	-
	51	Pr	Electric energy preset item	0	W	×	0	
	52	Pr	Electric energy preset value	0	W	×	0	
	53							
	54-59	-	-	System area	-	-	-	-
	60	Pr	Output period of data acquisition clock	0	R/W	○	0	
	61							
	62-99	-	-	System area	-	-	-	-

*1 Even if the power failure is restored, data is held because data is backed up by the nonvolatile memory.

*2 For the procedure for using the test mode, refer to section 4.2.5.

(2) Measurement sections (Un\G100 to Un\G2999)

Table 6.2 Measurement sections (Un\G100 to Un\G2999) 1/3

Item	Address (Decimal)	Data Type	Description	Default value	R/W	Back up*1	Output value during the test mode*2
Electric energy	100	Md	Multiplier of electric energy	-4	R	x	-4
	101	-	System area	-	-	-	-
	102	Md	Electric energy (consumption)	0	R	o	123456789
	103						
	104	Md	Electric energy (regeneration)	0	R	o	234567890
	105						
	106	Md	Reactive energy (consumption lag)	0	R	o	345678901
	107						
	108 – 113	-	System area	-	-	-	-
	114	Md	Periodic electric energy 1	0	R	o	789012345
	115						
	116	Md	Periodic electric energy 2	0	R	o	890123456
	117						
	118 – 199	-	System area	-	-	-	-
Current	200	Md	Multiplier of current	-3	R	x	-3
	201	-	System area	-	-	-	-
	202	Md	1-phase current	0	R	x	10100
	203						
	204	Md	2-phase current	0	R	x	10200
	205						
	206	Md	3-phase current	0	R	x	10300
	207						
	208	Md	Neutral current	0	R	x	11000
	209						
	210	Md	1-phase current demand	0	R	x	11100
	211						
	212	Md	2-phase current demand	0	R	x	11200
	213						
	214	Md	3-phase current demand	0	R	x	11300
	215						
	216	Md	Neutral current demand	0	R	x	11400
	217						
	218	Md	Average current	0	R	x	10400
	219						
	220	Md	Maximum current demand	0	R	o	10500
	221						
	222	Md	Year of time of max. current demand	*3	R	o	2011H
	223	Md	Month and day of time of max. current demand	*3	R	o	0102H
	224	Md	Hour and minute of time of max. current demand	*3	R	o	0304H
	225	Md	Second and day of the week of time of max. current demand	*3	R	o	0501H
	226	Md	Minimum current demand	*3	R	o	10600
	227						
	228	Md	Year of time of min. current demand	*3	R	o	2012H
	229	Md	Month and day of time of min. current demand	*3	R	o	0203H
230	Md	Hour and minute of time of min. current demand	*3	R	o	0405H	
231	Md	Second and day of the week of time of min. current demand	*3	R	o	0602H	
232 – 299	-	System area	-	-	-	-	

*1 Even if the power failure is restored, data is held because data is backed up by the nonvolatile memory.

*2 For the procedure for using the test mode, refer to section 4.2.5.

*3 The data becomes value at power on.

Table 6.2 Measurement sections (Un#G100 to Un#G2999) 2/3

Item	Address (Decimal)	Data Type	Description	Default value	R/W	Back up*1	Output value during the test mode*2
Voltage	300	Md	Multiplier of voltage	-3	R	x	-3
	301	-	System area	-	-	-	-
	302	Md	Voltage V12	0	R	x	20100
	303						
	304	Md	Voltage V23	0	R	x	20200
	305						
	306	Md	Voltage V31	0	R	x	20300
	307						
	308	Md	Voltage V1N	0	R	x	20700
	309						
	310	Md	Voltage V2N	0	R	x	20800
	311						
	312	Md	Voltage V3N	0	R	x	20900
	313						
	314	Md	Average value voltage (L-L)	0	R	x	20400
	315						
	316	Md	Average value voltage (L-N)	0	R	x	21000
	317						
	318	-	System area	-	-	-	-
	319	-	System area	-	-	-	-
	320	Md	Maximum value voltage (L-L)	0	R	o	20500
	321						
	322	Md	Year of time of max. value voltage (L-L)	0	R	o	2013H
	323	Md	Month and day of time of max. value voltage (L-L)	0	R	o	0304H
	324	Md	Hour and minute of time of max. value voltage (L-L)	0	R	o	0506H
	325	Md	Second and day of the week of time of max. value voltage (L-L)	0	R	o	0703H
	326	Md	Minimum value voltage (L-L)	0	R	o	20600
	327						
	328	Md	Year of time of min. value voltage (L-L)	0	R	o	2014H
	329	Md	Month and day of time of min. value voltage (L-L)	0	R	o	0405H
	330	Md	Hour and minute of time of min. value voltage (L-L)	0	R	o	0607H
	331	Md	Second and day of the week of time of min. value voltage (L-L)	0	R	o	0804H
	332	Md	Maximum value voltage (L-N)	0	R	o	21100
	333						
334	Md	Year of time of max. value voltage (L-N)	0	R	o	2020H	
335	Md	Month and day of time of max. value voltage (L-N)	0	R	o	1011H	
336	Md	Hour and minute of time of max. value voltage (L-N)	0	R	o	1213H	
337	Md	Second and day of the week of time of max. value voltage (L-N)	0	R	o	1405H	
338	Md	Minimum value voltage (L-N)	0	R	o	21200	
339							
340	Md	Year of time of min. value voltage (L-N)	0	R	o	2021H	
341	Md	Month and day of time of min. value voltage (L-N)	0	R	o	1112H	
342	Md	Hour and minute of time of min. value voltage (L-N)	0	R	o	1314H	
343	Md	Second and day of the week of time of min. value voltage (L-N)	0	R	o	1506H	
344-399	-	System area	-	-	-	-	

*1 Even if the power failure is restored, data is held because data is backed up by the nonvolatile memory.

*2 For the procedure for using the test mode, refer to section 4.2.5.

*3 The data becomes value at power on.

Table 6.2 Measurement sections (Un\G100 to Un\G2999) 3/3

Item	Address (Decimal)	Data Type	Description	Default value	R/W	Back up*1	Output value during the test mode*2
Electric power	400	Md	Multiplier of electric power	-3	R	x	-3
	401	-	System area	-	-	-	-
	402	Md	Electric power	0	R	x	30100
	403						
	404	Md	Electric power demand	0	R	x	30200
	405						
	406 – 419	-	System area	-	-	-	-
	420	Md	Maximum value of electric power demand	0	R	o	30300
	421						
	422	Md	Year of time of max. electric power demand	*3	R	o	2014H
	423	Md	Month and day of time of max. electric power demand	*3	R	o	0506H
	424	Md	Hour and minute of time of max. electric power demand	*3	R	o	0708H
	425	Md	Second and day of the week of time of max. electric power demand	*3	R	o	0905H
	426	Md	Minimum value of electric power demand	*3	R	o	30400
	427						
	428	Md	Year of time of min. electric power demand	*3	R	o	2016H
	429	Md	Month and day of time of min. electric power demand	*3	R	o	0607H
	430	Md	Hour and minute of time of min. electric power demand	*3	R	o	0809H
	431	Md	Second and day of the week of time of min. electric power demand	*3	R	o	1005H
432 – 499	-	System area	-	-	-	-	
Reactive power	500	Md	Multiplier of reactive power	-3	R	-	-3
	501	-	System area	-	-	-	-
	502	Md	Total reactive power	0	R	-	40100
	503						
	504 – 599	-	System area	-	-	-	-
Apparent power	600	Md	Multiplier of apparent power	-3	R	-	-3
	601	-	System area	-	-	-	-
	602	Md	Total apparent power	0	R	-	40200
	603						
	604 – 699	-	System area	-	-	-	-
Power factor	700	Md	Multiplier of power factor	-3	R	x	-3
	701	-	System area	-	-	-	-
	702	Md	Power factor	0	R	x	50100
	703						
	704 – 719	-	System area	-	-	-	-
	720	Md	Maximum power factor	0	R	o	50200
	721						
	722	Md	Year of time of max. power factor	*3	R	o	2017H
	723	Md	Month and day of time of max. power factor	*3	R	o	0708H
	724	Md	Hour and minute of time of max. power factor	*3	R	o	0910H
	725	Md	Second and day of the week of time of max. power factor	*3	R	o	1106H
	726	Md	Minimum power factor	*3	R	o	50300
	727						
	728	Md	Year of time of min. power factor	*3	R	o	2018H
	729	Md	Month and day of time of min. power factor	*3	R	o	0809H
	730	Md	Hour and minute of time of min. power factor	*3	R	o	1011H
	731	Md	Second and day of the week of time of min. power factor	*3	R	o	1200H
732 – 799	-	System area	-	-	-	-	
Frequency	800	Md	Multiplier of frequency	-3	R	x	-3
	801	-	System area	-	-	-	-
	802	Md	Frequency	0	R	x	60100
	803						
	804 – 2999	-	System area	-	-	-	-

*1 Even if the power failure is restored, data is held because data is backed up by the nonvolatile memory.

*2 For the procedure for using the test mode, refer to section 4.2.5.

*3 The data becomes value at power on.

(3) Common sections (Un\G3000 to Un\G4999)

Table 6.3 Common sections (Un\G3000 to Un\G4999)

Item	Address (Decimal)	Data Type	Description	Default value	R/W	Back up*1	Output value during the test mode*2
Error	3000	-	Latest error code	0	R	○	1
	3001	-	Year of time of error	0	R	○	2019H
	3002	-	Month and day of time of error	0	R	○	0910H
	3003	-	Hour and minute of time of error	0	R	○	1112H
	3004	-	Second and day of the week of time of error	0	R	○	1301H
	3005-4999	-	System area	-	-	-	-

*1 Even if the power failure is restored, data is held because data is backed up by the nonvolatile memory.

*2 For the procedure for using the test mode, refer to section 4.2.5.

6.2 Configurable sections (Un\G0 to Un\G99)

6.2.1 Phase wire system (Un\G0)

Phase wire system for target electric circuits is configured.

Do not change the set value from the default value of 4. Because this product is a three-phase four-wire dedicated product.

6.2.2 Input voltage (Un\G1), Primary voltage of VT (Un\G5), Secondary voltage of VT (Un\G6)

- Primary voltage (Un\G1): set the primary voltage of the target electric circuit.
- Primary voltage of VT (Un\G5): when use for primary voltage of voltage transformer that is not in the primary voltage (Un\G1) setting, set the voltage of the primary side of voltage transformer.
- Secondary voltage of VT (Un\G6): when use for primary voltage of voltage transformer that is not in the primary voltage (Un\G1) setting, set the voltage of the secondary side of voltage transformer.

(1) Setting procedure

(a) Set the Input voltage in the buffer memory. Setting range is as follows:

When set other than "101 to 116" the value of this setting, set to "0:any set" this setting, and set primary / secondary voltage of VT (Un\G5 / Un\G6).

When the value of this setup is set as "101 to 116", primary/ secondary voltage of VT are disabled.

Input voltage (Un\G1)		Primary voltage of VT (Un\G5)	Secondary voltage of VT (Un\G6)
Setting value	Description		
0	Any setting	1 - 6600	1 - 220
101	63.5/110 V	0 – 6600 (However, this setting is disabled)	0 – 220 (However, this setting is disabled)
102	100/173 V		
103	105/182 V		
104	110/190 V		
105	115/199 V		
106	120/208 V		
107	127/220 V		
108	200/346 V		
109	220/380 V		
110	230/400 V		
111	240/415 V		
112	242/420 V		
113	250/430 V		
114	254/440 V		
115	265/460 V		
116	277/480 V		

(b) Turn Operating condition setting request (Yn9) from OFF to ON to enable the setting. (Refer to 5.2.2 (5).)

(2) Default value

It is set to 63.5/110 V (101).

6.2.3 Primary current (Un\G2), primary current of CT (Un\G7)

Set the primary current of the target electric circuit.

(1) Setting procedure

- (a) Set the primary current and primary current of CT in the buffer memory. Setting range is as follows: Please choose the settings to match the current sensor to be used.

When set other than "1 to 5, 501 to 536" the value of this setting, set to "0: any setting" this setting, and set primary current of CT (Un≠G7).

When the value of this setup is set as "1 to 5, 501 to 536", primary current of CT is disabled.

Primary current (Un\G2)		Primary current of CT (Un\G7)	Current sensor
Setting value	Description		
0	Any setting	1 - 6000	EMU2-CT5-4W, EMU-CT5-A
1	50A	0 – 6000 (However, this setting is disabled)	EMU-CT50, EMU-CT50-A
2	100A		EMU-CT100, EMU-CT100-A
3	250A		EMU-CT250, EMU-CT250-A
4	400A		EMU-CT400, EMU-CT400-A
5	600A		EMU-CT600, EMU-CT600-A
501	5/5A		EMU2-CT5-4W, EMU-CT5-A
502	6/5A		
503	7.5/5A		
504	8/5A		
505	10/5A		
506	12/5A		
507	15/5A		
508	20/5A		
509	25/5A		
510	30/5A		
511	40/5A		
512	50/5A		
513	60/5A		
514	75/5A		

Primary current (Un\G2)		Primary current of CT (Un\G7)	Current sensor
Setting value	Description		
515	80/5A	0 – 6000 (However, this setting is disabled)	EMU2-CT5-4W, EMU-CT5-A
516	100/5A		
517	120/5A		
518	150/5A		
519	200/5A		
520	250/5A		
521	300/5A		
522	400/5A		
523	500/5A		
524	600/5A		
525	750/5A		
526	800/5A		
527	1000/5A		
528	1200/5A		
529	1500/5A		
530	1600/5A		
531	2000/5A		
532	2500/5A		
533	3000/5A		
534	4000/5A		
535	5000/5A		
536	6000/5A		

(b) Turn Operating condition setting request (Yn9) from OFF to ON to enable the setting. (Refer to 5.2.2 (5).)

(2) Default value

Primary current (Un\G2) is set to 100 A (2).

Primary current of CT (Un¥G7) is set to 0.

6.2.4 Current demand time (Un\G3)

Set a time duration for which the average fluctuation of current demand is measured from the measured current value.

If current demand time is set short, the response to change of current will be quick; however, the fluctuation range may be too large. Adjust the duration according to the load and purposes.

(1) Setting procedure

(a) Set current demand time in the buffer memory.

- Configurable range: 0 to 1800 (seconds)
- Set the value in seconds.

(b) Turn Operating condition setting request (Yn9) from OFF to ON to enable the setting. (Refer to 5.2.2 (5).)

(2) Default value

It is set to 120 seconds.

6.2.5 Electric power demand time (Un\G4)

Set a time duration for which the average fluctuation of electric power demand is measured from the measured power value.

If electric power demand time is set short, the response to change of power will be quick; however, the fluctuation range may be too large. Adjust the duration according to the load and purposes.

(1) Setting procedure

(a) Set electric power demand time in the buffer memory.

- Configurable range: 0 to 1800 (seconds)
- Set the value in seconds.

(b) Turn Operating condition setting request (Yn9) from OFF to ON to enable the setting. (Refer to 5.2.2 (5).)

(2) Default value

It is set to 120 seconds.

6.2.6 Alarm 1 item (Un\G11), alarm 2 item (Un\G21)

Set which measuring item will be monitored for the upper/lower limit alarm.
Alarm 1 and 2 operate independently.

(1) Setting procedure

(a) Set the item for alarm 1 and 2 in the buffer memory. Setting range is as follows:

Setting value	Description
0	No monitoring
1	Current demand upper limit
2	Current demand lower limit
3	Voltage (L-L) upper limit
4	Voltage (L-L) lower limit
5	Electric power demand upper limit
6	Electric power demand lower limit
7	Power factor upper limit
8	Power factor lower limit
9	Voltage (L-N) upper limit
10	Voltage (L-N) lower limit

(b) Measuring items for the monitoring target are as follows:

Description	Measuring item of monitoring target
Current demand upper limit	1-phase current demand 2-phase current demand 3-phase current demand Neutral current demand *1
Current demand lower limit	1-phase current demand 2-phase current demand 3-phase current demand *1
Voltage (L-L) upper limit Voltage (L-L) lower limit	Voltage V12 Voltage V23 Voltage V31 *1
Electric power demand upper limit Electric power demand lower limit	Electric power demand
Power factor upper limit Power factor lower limit	Power factor *2
Voltage (L-N) upper limit Voltage (L-N) lower limit	Voltage V1N Voltage V2N Voltage V3N *1

*1 When multiple number of measuring items are targeted for monitoring, the alarm judgment condition will be as following.

Upper/lower limits	Alarm judgment conditions	
	Condition for occurrence	Condition for non-occurrence
Current demand upper limit Line voltage upper limit Voltage (L-N) upper limit	Any one of alarm item exceeds the alarm value.	All alarm item go below the alarm value.
Current demand lower limit Line voltage lower limit Voltage (L-N) lower limit	Any one of alarm item go below the alarm value	All alarm item exceeds the alarm value

*2 The idea of upper and lower for PF upper /lower limit judgment is shown below.

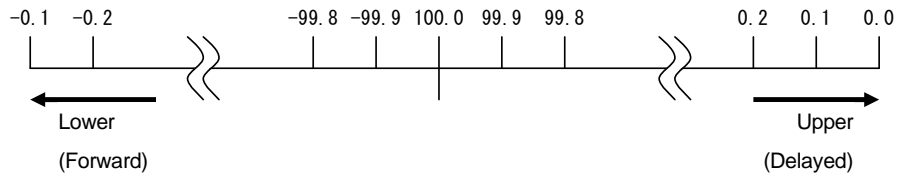

(c) Turn Operating condition setting request (Yn9) from OFF to ON to enable the setting. (Refer to 5.2.2 (5).)

(2) Default value

It is set to not monitoring (0).

6.2.7 Alarm 1 value (Un\G12,13), alarm 2 value (Un\G22, 23)

Set the upper/lower limit monitoring value for the target that was set in alarm 1 item and alarm 2 item.

(1) Setting procedure

(a) Set the monitoring values for alarm 1 and 2 in the buffer memory.

- Configurable range: -2147483648 to 2147483647
- The unit of the setting value is the same as below which was used for the measuring value of the monitored target configured in alarm 1 item and alarm 2 item.

Alarm 1 item Alarm 2 item	Unit of alarm 1 value and alarm 2 value
Current demand upper limit Current demand lower limit	$\times 10^{-3}$ A
Voltage (L-L) upper limit Voltage (L-L) lower limit	$\times 10^{-3}$ V
Electric power demand upper limit Electric power demand lower limit	W ($\times 10^{-3}$ kW)
Power factor upper limit Power factor lower limit	$\times 10^{-3}\%$
Voltage (L-N) upper limit Voltage (L-N) lower limit	$\times 10^{-3}$ V

(b) Turn Operating condition setting request (Yn9) from OFF to ON to enable the setting.

(2) Default value

It is set to 0.

6.2.8 Alarm 1 reset method (Un\G14), Alarm 2 reset method (Un\G24)

Set the reset method of the alarm1 and alarm 2.

For differences in behavior of alarm monitoring for different reset methods, refer to 4.2.4 (2).

(1) Setting procedure

(a) Set the reset method for alarm 1 and 2 in the buffer memory. Setting range is as follows:

Setting value	Description
0	Self-retention
1	Auto reset

(b) Turn Operating condition setting request (Yn9) from OFF to ON to enable the setting.

(2) Default value

It is set to self retention (0).

6.2.9 Alarm 1 delay time (Un\G15), alarm 2 delay time (Un\G25)

Set the alarm delay time for the alarm 1 and alarm 2.

Alarm delay time means a grace period that takes from the moment when it exceeds the upper limit or goes under the lower limit of the alarm 1 value or alarm 2 value until the alarm flag is turned ON. For detailed behavior, refer to 4.2.4 (2).

(1) Setting procedure

(a) Set the delay time for alarm 1 and alarm 2 in the buffer memory.

- Configurable range: 0 to 300 (seconds)
- Set the value in seconds.

(b) Turn Operating condition setting request (Yn9) from OFF to ON to and enable the setting.

(2) Default value

It is set to 0 seconds.

6.2.10 Set Electric energy preset item (Un\G51) and Electric energy preset value (Un\G52, 53)

(1) Setting procedure

(a) Set the integrated value setting target in the buffer memory. Setting range is as follows:

Setting value	Description
0	No set
1	Electric energy (consumption)
2	Electric energy (regeneration)
3	Reactive energy (consumption lag)

(b) Set the integrated value setting value in the buffer memory.

- Configurable range: 0 to 999999999
 - The unit used for the setting value is the same as that used for the electric energy and reactive energy that are output to the buffer memory.
- For details, refer to section 6.3.2.

(c) Turn Electric energy preset request (YnC) from OFF to ON to enable* the setting.

* When the setting is enabled, Electric energy preset completion flag (XnC) changes from OFF to ON.

(d) After checking that integrated value set completion flag (XnC) turns ON and setting is completed, set the integrated value set request (YnC) to OFF.

After detected that the integrated value set request (YnC) turns OFF, the integrated value set completion flag (XnC) turns OFF.

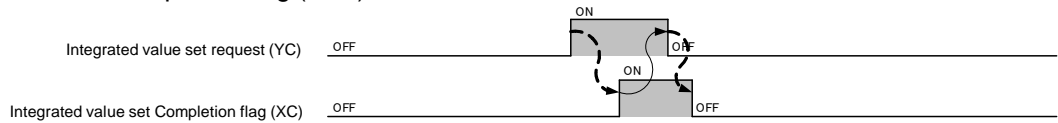

Figure 6.2.10 Integrated value setting procedure

(2) Default value

Integrated value setting target (Un\G51) is set to 0 (No set).

Integrated value setting value (Un\G52, Un\G53) is set to 0.

6.2.11 Output period of data acquisition clock (Un\G60, 61)

Set the period of the data acquisition clock (Xn8).

(1) Setting procedure

(a) Set the output period of data acquisition clock in the buffer memory. Setting range is as follows

- Configurable range: 0 to 86400000 (ms)

* If set the output period of data acquisition clock to 0, the data acquisition clock (Xn8) will be turned off all the time.

(b). Because the data update cycle is 250ms, data acquisition clock operate in unit of 250ms.

However, if the output period of data acquisition clock is not a multiple of 250ms, data acquisition clock will turn on at the timing of the first data update after the output period of data acquisition clock.

• For example

Output period of data acquisition clock : 800ms

Times of updating measurement data = quotient 3 + surplus 50ms

The input device (Xn8) will turn on once every four times of measurement data update.

As a result, the output period of data acquisition clock will be the same as the case of 1000ms

(c) Turn Operating condition setting request (Yn9) from OFF to ON to and enable the setting.

(2) Default value

It is set to 0 milliseconds.

6.3 Measurement sections (Un\G100 to Un\G2999)

This product divides the measuring data into the Data and Multiplier, and output them to Buffer memory. Actual measuring data is obtained by the following formula.

$$\text{Measuring data} = \text{Data} \times 10^n \text{ (Multiplier is } n\text{).}$$

(Example)

The values output to the Buffer memory are as follows when total current is measured 123.456A.

Data (Un\G218, 219): 123456

Multiplier (Un\G200): -3

The actual measuring data is obtained from the value of Buffer memory as follows.

$$\begin{aligned} \text{Measuring data} &= \text{Data} \times 10^{-3} \\ &= 123.456\text{A} \end{aligned}$$

6.3.1 Multiplier of electric energy (Un\G100)

Multiplier of electric energy are stored.

As to how the multiplier is determinate, refer to section 4.2.1 (3).

(1) Details of stored data

(a) Storage format

Data are stored as 16-bit signed binary in the buffer memory.

- Data range: -5 to -1

(b) Update timing

It will be updated when input voltage (Un\G1), primary current (Un\G2), and primary voltage of VT (Un\G5) are set.

6.3.2 Electric energy (consumption) (Un\G102,103), electric energy (regeneration) (Un\G104,105)

Stores the electric energy of the consumption side and the regeneration side will be stored.

(1) Details of stored data

(a) Storage format

Data are stored as double-word 32-bit signed binary in the buffer memory.

- Data range: 0 to 999999999

When the stored data exceeds 999999999, stored data turns to 0 and continues measuring.

*Restrictions for measured data including resolution and measuring range, refer to section 4.2.1.

(b) Unit

Unit can be determined by multiplier of electric energy (Un\G100), as shown below.

Electric energy, multiplier of the reactive energy (Un\G100)	Unit
-5	$\times 10^{-5}$ kWh
-4	$\times 10^{-4}$ kWh
-3	$\times 10^{-3}$ kWh
-2	$\times 10^{-2}$ kWh
-1	$\times 10^{-1}$ kWh

(c) Update timing

It will be updated every measuring cycle (250 ms).

6.3.3 Reactive energy (consumption lag) (Un\G106, 107)

Delayed consumption of the reactive energy is stored.

(1) Details of stored data

(a) Storage format

Data are stored as double-word 32-bit signed binary in the buffer memory.

- Data range: 0 to 999999999

When the stored data exceeds 999999999, stored data turns to 0 and continues measuring.

*Restrictions for measured data including resolution and measuring range, refer to section 4.2.1.

(b) Unit

Unit can be determined by the electric energy and the multiplier of the reactive energy (Un\G100), as shown below.

Electric energy, multiplier of the reactive energy (Un\G100)	Unit
-5	$\times 10^{-5}$ kvarh
-4	$\times 10^{-4}$ kvarh
-3	$\times 10^{-3}$ kvarh
-2	$\times 10^{-2}$ kvarh
-1	$\times 10^{-1}$ kvarh

(c) Update timing

It will be updated every measuring cycle (250 ms).

6.3.4 Periodic electric energy 1 (Un\G114, 115), periodic electric energy 2 (Un\G116, 117)

Stores the periodic electric energy 1 and periodic electric energy 2. The periodic electric energy of the consumption side is measured.

For specific usage procedures for the periodic electric energy, refer to section 4.2.2.

(1) Details of stored data

(a) Storage format

Data are stored as double-word 32-bit signed binary in the buffer memory.

- Data range: 0 to 999999999

When the stored data exceeds 999999999, stored data turns to 0 and continues measuring.

*Restrictions for measured data including resolution and measuring range, refer to section 4.2.1.

(b) Unit

Unit can be determined by the electric energy and the multiplier of the reactive energy (Un\G100), as shown below.

Electric energy, multiplier of the reactive energy (Un\G100)	Unit
-5	$\times 10^{-5}$ kWh
-4	$\times 10^{-4}$ kWh
-3	$\times 10^{-3}$ kWh
-2	$\times 10^{-2}$ kWh
-1	$\times 10^{-1}$ kWh

(c) Update timing

It will be updated every measuring cycle (250 ms).

6.3.5 Multiplier of the electric current (Un\G200)

The multiplier of the electric current is stored.

(1) Details of stored data

(a) Storage format

Data are stored as 16-bit signed binary in the buffer memory.

- Data range: -3 (fixed)

(b) Update timing

Because it is fixed at -3, there is no update.

6.3.6 1-phase current (Un\G202, 203), 2-phase current (Un\G204, 205), 3-phase current (Un\G206, 207)
Neutral current (Un\G208, 209)

The electric current (effective value) of each phase is stored.

(1) Details of stored data

(a) Storage format

Data are stored as double-word 32-bit signed binary in the buffer memory.

- Data range: 0 to 99999990 (0 to 99999.990 A)

*Restrictions for measured data including resolution and measuring range, refer to section 4.2.1.

(b) Unit

$\times 10^{-3}$ A *Unit is fixed.

(c) Update timing

It will be updated every measuring cycle (250 ms).

6.3.7 1-phase current demand (Un\G210, 211), 2-phase current demand (Un\G212, 213),
3-phase current demand (Un\G214, 215), Neutral current demand (Un\G216, 217)

Stores the electric current (effective value) at each phase that is measured based on the moving average for the duration of time configured in the electric current demand time (Un\G3).

(1) Details of stored data

(a) Storage format

Data are stored as double-word 32-bit signed binary in the buffer memory.

- Data range: 0 to 99999990 (0 to 99999.990 A)

*Restrictions for measured data including resolution and measuring range, refer to section 4.2.1.

(b) Unit

$\times 10^{-3}$ A *Unit is fixed.

(c) Update timing

It will be updated every measuring cycle (250 ms).

6.3.8 Average current (Un\G218, 219)

Stores the average current.

For procedure for storing the average current, refer to section 4.2.1 (2).

(1) Details of stored data

(a) Storage format

Data are stored as double-word 32-bit signed binary in the buffer memory.

- Data range: 0 to 99999990 (0 to 99999.990 A)

*Restrictions for measured data including resolution and measuring range, refer to section 4.2.1.

(b) Unit

$\times 10^{-3}$ A *Unit is fixed.

(c) Update timing

It will be updated every measuring cycle (250 ms).

6.3.9 Maximum value of electric current demand (Un\G220,221), minimum value of electric current demand (Un\G226,227)

Stores the max./min. values of the electric current demand among phases.

For procedure for storing the max./min. the electric current demand, refer to section 4.2.1 (2).

(1) Details of stored data

(a) Storage format

Data are stored as double-word 32-bit signed binary in the buffer memory.

- Data range: 0 to 99999990 (0 to 99999.990 A)

*Restrictions for measured data including resolution and measuring range, refer to section 4.2.1.

(b) Unit

$\times 10^{-3}$ A *Unit is fixed.

(c) Update timing

It will be updated every measuring cycle (250 ms) if it exceeds the current max. value or goes under the current min. value.

- 6.3.10 Year of time of the max. current demand (Un\G222),
- month and day of time of the max. current demand (Un\G223),
- hour and minute of time of the max. current demand (Un\G224),
- second and day of the week of time of the max. current demand (Un\G225),
- year of time of the min. current demand (Un\G228),
- month and day of time of the min. current demand (Un\G229),
- hour and minute of time of the min. current demand (Un\G230),
- second and day of the week of time of the min. current demand (Un\G231)

Stores year, month, day, hour, minute, and the day of the week of time of maximum value of electric current demand (Un\G220, 221) and minimum value of electric current demand (Un\G226, 227) were updated.

(1) Details of stored data

(a) Storage format

As indicated below, data are stored as BCD code in the buffer memory.

Buffer memory address	Storage format																
Un\G222 /Un\G228	<p>e.g.) Year 2010 2010h</p>																
Un\G223 /Un\G229	<p>e.g.) July 30 0730h</p>																
Un\G224 /Un\G230	<p>e.g.) 10:35 1035h</p>																
Un\G225 /Un\G231	<p>e.g.) 48 sec Friday 4805h</p> <table border="1" style="margin-left: 20px;"> <thead> <tr> <th colspan="2">Day of the week</th> </tr> </thead> <tbody> <tr><td>0</td><td>Sunday</td></tr> <tr><td>1</td><td>Monday</td></tr> <tr><td>2</td><td>Tuesday</td></tr> <tr><td>3</td><td>Wednesday</td></tr> <tr><td>4</td><td>Thursday</td></tr> <tr><td>5</td><td>Friday</td></tr> <tr><td>6</td><td>Saturday</td></tr> </tbody> </table>	Day of the week		0	Sunday	1	Monday	2	Tuesday	3	Wednesday	4	Thursday	5	Friday	6	Saturday
Day of the week																	
0	Sunday																
1	Monday																
2	Tuesday																
3	Wednesday																
4	Thursday																
5	Friday																
6	Saturday																

(b) Update timing

It will be updated every measuring cycle (250 ms) if it exceeds the current max. value or goes under the current min. value.

6.3.11 Multiplier of the electric voltage (Un\G300)

The multiplier of the electric voltage is stored.

(1) Details of stored data

(a) Storage format

Data are stored as 16-bit signed binary in the buffer memory.

- Data range: -3 (fixed)

(b) Update timing

Because it is fixed at -3, there is no update.

6.3.12 Voltage between 1 and 2 wires (Un\G302, 303), voltage between 2 and 3 wires (Un\G304, 305), voltage between 3 and 1 wires (Un\G306, 307)

The electric voltage between every combination of wires (effective value) is stored.

(1) Details of stored data

(a) Storage format

Data are stored as double-word 32-bit signed binary in the buffer memory.

- Data range: 0 to 99999900 (0 to 99,999.900 V)

*Restrictions for measured data including resolution and measuring range, refer to section 4.2.1.

(b) Unit

$\times 10^{-3}$ V *Unit is fixed.

(c) Update timing

It will be updated every measuring cycle (250 ms).

6.3.13 Voltage V1N (Un\G308, 309), Voltage V2N (Un\G310, 311), Voltage V3N (Un\G312, 313),

Stores the phase voltage.

(1) Details of stored data

(a) Storage format

Data are stored as double-word 32-bit signed binary in the buffer memory.

- Data range: 0 to 99999900 (0 to 99,999.900 V)

*Restrictions for measured data including resolution and measuring range, refer to section 4.2.1.

(b) Unit

$\times 10^{-3}$ V *Unit is fixed.

(c) Update timing

It will be updated every measuring cycle (250 ms).

6.3.14 Average value voltage (L-L) (Un\G314, 315), Average value voltage (L-N) (Un\G316, 317)

Stores the average line voltage and the average phase voltage.

For procedure for storing the average voltage using phase wire system, refer to 4.2.1 (2).

(1) Details of stored data

(a) Storage format

Data are stored as double-word 32-bit signed binary in the buffer memory.

- Data range: 0 to 99999900 (0 to 99,999.900 V)

*Restrictions for measured data including resolution and measuring range, refer to section 4.2.1.

(b) Unit

$\times 10^{-3}$ V *Unit is fixed.

(c) Update timing

It will be updated every measuring cycle (250 ms).

6.3.15 Maximum value voltage (L-L) (Un\G320, 321), minimum value voltage (L-L) (Un\G326, 327)

Maximum value voltage (L-N) (Un\G332, 333), minimum value voltage (L-N) (Un\G338, 339)

Stores the max./min. values of the voltage among in-between wires and phases.

For procedure for storing the max./min. voltage, refer to section 4.2.1 (2).

(1) Details of stored data

(a) Storage format

Data are stored as double-word 32-bit signed binary in the buffer memory.

- Data range: 0 to 99999900 (0 to 99,999.900 V)

*Restrictions for measured data including resolution and measuring range, refer to section 4.2.1.

(b) Unit

$\times 10^{-3}$ V *Unit is fixed.

(c) Update timing

It will be updated every measuring cycle (250 ms) if it exceeds the current max. value or goes under the current min. value.

6.3.16 Year of time of the max. voltage (L-L) (Un\G322), month and day of time of the max. voltage (L-L) (Un\G323), hour and minute of time of the max. voltage (L-L) (Un\G324), second and day of the week of time of the max. voltage (L-L) (Un\G325), year of time of the min. voltage (L-L) (Un\G328), month and day of time of the min. voltage (L-L) (Un\G329), hour and minute of time of the min. voltage (L-L) (Un\G330), second and day of the week of time of the min. voltage (L-L) (Un\G331) Year of time of the max. voltage (L-N) (Un\G334), month and day of time of the max. voltage (L-N) (Un\G335), hour and minute of time of the max. voltage (L-N) (Un\G336), second and day of the week of time of the max. voltage (L-N) (Un\G337), year of time of the min. voltage (L-N) (Un\G340), month and day of time of the min. voltage (L-N) (Un\G342), hour and minute of time of the min. voltage (L-N) (Un\G330), second and day of the week of time of the min. voltage (L-N) (Un\G343)

Stores year, month, day, hour, minute, and the day of the week of time of maximum voltage (L-N) (Un\G320, 321), minimum voltage (L-L) (Un\G326, 327), maximum voltage (L-N) (Un\G332, 333) and minimum voltage (L-N) (Un\G338, 339) were updated.

(1) Details of stored data

(a) Storage format

As indicated below, data are stored as BCD code in the buffer memory.

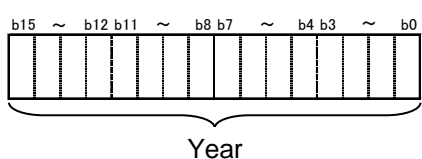
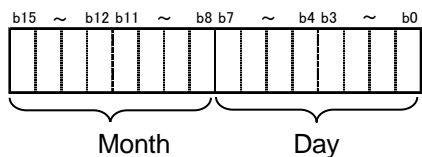
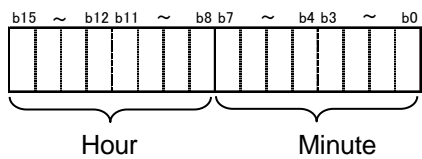
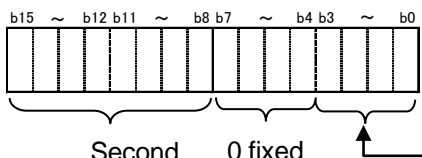
Buffer memory address	Storage format																
Un\G322 /Un\G328 /Un\G334 /Un\G340	 <p>e.g.) Year 2010 2010h</p>																
Un\G323 /Un\G329 /Un\G335 /Un\G341	 <p>e.g.) July 30 0730h</p>																
Un\G324 /Un\G330 /Un\G336 /Un\G342	 <p>e.g.) 10:35 1035h</p>																
Un\G325 /Un\G331 /Un\G337 /Un\G343	 <p>e.g.) 48sec Firday 4805h</p> <table border="1" data-bbox="1149 1724 1372 1915"> <thead> <tr> <th colspan="2">Day of the week</th> </tr> </thead> <tbody> <tr><td>0</td><td>Sunday</td></tr> <tr><td>1</td><td>Monday</td></tr> <tr><td>2</td><td>Tuesday</td></tr> <tr><td>3</td><td>Wednesday</td></tr> <tr><td>4</td><td>Thursday</td></tr> <tr><td>5</td><td>Friday</td></tr> <tr><td>6</td><td>Saturday</td></tr> </tbody> </table>	Day of the week		0	Sunday	1	Monday	2	Tuesday	3	Wednesday	4	Thursday	5	Friday	6	Saturday
Day of the week																	
0	Sunday																
1	Monday																
2	Tuesday																
3	Wednesday																
4	Thursday																
5	Friday																
6	Saturday																

(b) Update timing

It will be updated every measuring cycle (250ms) and if it exceeds the max. value or goes under the min. value.

6.3.17 Multiplier of power (Un\G400)

The multiplier of power is stored.

(1) Details of stored data

(a) Storage format

Data are stored as 16-bit signed binary in the buffer memory.

- Data range: -3 (fixed)

(b) Update timing

Because it is fixed at -3, there is no update.

6.3.18 Electric power (Un\G402,403)

The electric power (effective value) is stored.

(1) Details of stored data

(a) Storage format

Data are stored as double-word 32-bit signed binary in the buffer memory.

If the power is negative, represents the regenerative power.

- Data range: -999999999 to 999999999 (-999999.999 to 999999.999 kW)

*Restrictions for measured data including resolution and measuring range, refer to section 4.2.1.

*The sign of the data is as shown in the following figure.

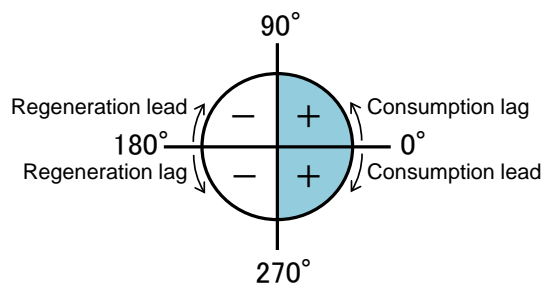

(b) Unit

$\times 10^{-3}$ kW *Unit is fixed.

(c) Update timing

It will be updated every measuring cycle (250 ms).

6.3.19 Electric power demand (Un\G404,405)

Stores the electric power that is measured based on the moving average for the duration of time configured in the electric power demand time (Un\G4).

(1) Details of stored data

(a) Storage format

Data are stored as double-word 32-bit signed binary in the buffer memory.

If the power is negative, represents the regenerative power.

- Data range: -999999999 to 999999999 (-999999.999 to 999999.999 kW)

*Restrictions for measured data including resolution and measuring range, refer to section 4.2.1.

(b) Unit

$\times 10^{-3}$ kW *Unit is fixed.

(c) Update timing

It will be updated every measuring cycle (250 ms).

6.3.20 Maximum value of electric power demand (Un\G420, 421), minimum value of electric power demand

(Un\G426, 427)

Stores the max./min. values of the electric power demand.

(1) Details of stored data

(a) Storage format

Data are stored as double-word 32-bit signed binary in the buffer memory.

If the power is negative, represents the regenerative power.

- Data range: -999999999 to 999999999 (-999999.999 to 999999.999 kW)

*Restrictions for measured data including resolution and measuring range, refer to section 4.2.1.

(b) unit

$\times 10^{-3}$ kW *Unit is fixed.

(c) Update timing

It will be updated every measuring cycle (250 ms) if it exceeds the current max. value or goes under the current min. value.

- 6.3.21 Year of time of the max. electric power demand (Un\G422),
- month and day of time of the max. electric power demand (Un\G423),
- hour and minute of time of the max. electric power demand (Un\G424),
- second and day of the week of time of the max. electric power demand (Un\G425),
- year of time of the min. electric power demand (Un\G428),
- month and day of time of the min. electric power demand (Un\G429),
- hour and minute of time of the min. electric power demand (Un\G430),
- second and day of the week of time of the min. electric power demand (Un\G431)

Stores year, month, day, hour, minute, and the day of the week of time of maximum value of electric power demand (Un\G420, 421) and minimum value of electric power demand (Un\G426, 427) were updated.

(1) Details of stored data

(a) Storage format

As indicated below, data are stored as BCD code in the buffer memory.

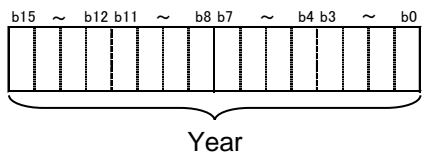
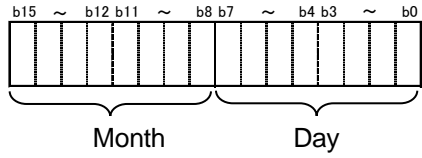
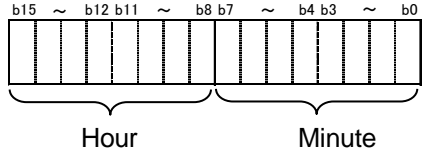
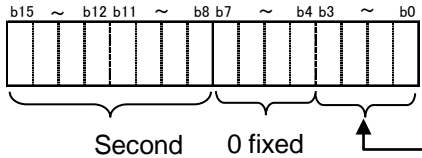
Buffer memory address	Storage format																
Un\G422 /Un\G428	 <p>e.g.) Year 2010 2010h</p>																
Un\G423 /Un\G429	 <p>e.g.) July 30 0730h</p>																
Un\G424 /Un\G430	 <p>e.g.) 10:35 1035h</p>																
Un\G425 /Un\G431	 <p>e.g.) 48sec Friday 4805h</p> <table border="1" data-bbox="1149 1624 1372 1814"> <thead> <tr> <th colspan="2">Day of the week</th> </tr> </thead> <tbody> <tr><td>0</td><td>Sunday</td></tr> <tr><td>1</td><td>Monday</td></tr> <tr><td>2</td><td>Tuesday</td></tr> <tr><td>3</td><td>Wednesday</td></tr> <tr><td>4</td><td>Thursday</td></tr> <tr><td>5</td><td>Friday</td></tr> <tr><td>6</td><td>Saturday</td></tr> </tbody> </table>	Day of the week		0	Sunday	1	Monday	2	Tuesday	3	Wednesday	4	Thursday	5	Friday	6	Saturday
Day of the week																	
0	Sunday																
1	Monday																
2	Tuesday																
3	Wednesday																
4	Thursday																
5	Friday																
6	Saturday																

(b) Update timing

It will be updated every measuring cycle (250 ms) if it exceeds the current max. value or goes under the current min. value.

6.3.22 Multiplier of reactive power (Un\G500),
Multiplier of apparent power (Un\G600)

The number of decimal places the reactive power and the apparent power are stored.

(1) Details of stored data

(a) Storage format

Data are stored as 16-bit signed binary in the buffer memory.

- Data range: -3 (fixed)

(b) Update timing

Because it is fixed at -3, there is no update.

6.3.23 Total reactive power(Un\G502, 503)

Stores the total reactive power.

(1) Details of stored data

(a) Storage format

Data are stored as double-word 32-bit signed binary in the buffer memory.

- Data range: -999999999 to 999999999 (-999999.999 to 999999.999 kvar)

*Restrictions for measured data including resolution and measuring range, refer to section 4.2.1.

*The sign of the data is as shown in the following figure.

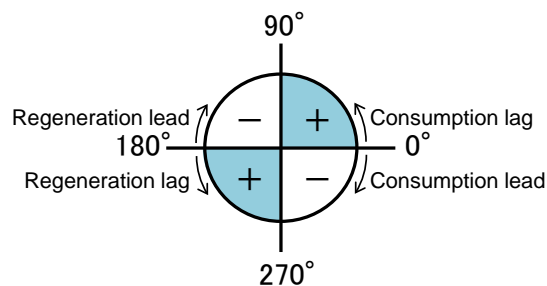

(b) Unit

$\times 10^{-3}$ kvar *Unit is fixed.

(c) Update timing

It will be updated every measuring cycle (250 ms).

6.3.24 Total apparent power(Un\G502, 503)

Stores the total apparent power.

(1) Details of stored data

(a) Storage format

Data are stored as double-word 32-bit signed binary in the buffer memory.

- Data range: 0 to 999999999 (0.000 to 999999.999 kVA)

*Restrictions for measured data including resolution and measuring range, refer to section 4.2.1.

(b) Unit

$\times 10^{-3}$ kVA *Unit is fixed.

(c) Update timing

It will be updated every measuring cycle (250 ms).

6.3.25 Multiplier of power factor (Un\G700)

The multiplier of the power factor is stored.

(1) Details of stored data

(a) Storage format

Data are stored as 16-bit signed binary in the buffer memory.

- Data range: -3 (fixed)

(b) Update timing

Because it is fixed at -3, there is no update.

6.3.26 Power factor (Un\G702, 703)

Stores the power factor.

(1) Details of stored data

(a) Storage format

Data are stored as double-word 32-bit signed binary in the buffer memory.

- Data range: -99900 to 100000 (-99.900 to 100.000%)

*Restrictions for measured data including resolution and measuring range, refer to section 4.2.1.

*The sign of the data is as shown in the following figure.

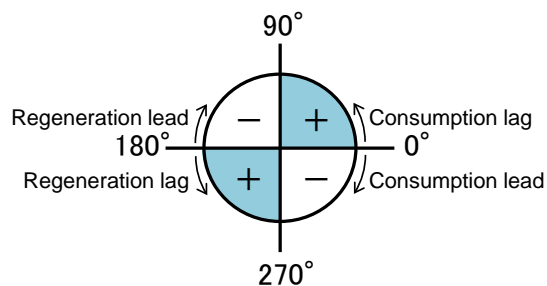

(b) Unit

$\times 10^{-3}\%$ *Unit is fixed.

(c) Update timing

It will be updated every measuring cycle (250 ms).

6.3.27 maximum power factor (Un\G720, 721), minimum power factor (Un\G726, 727)

The max./min. power factors are stored.

(1) Details of stored data

(a) Storage format

Data are stored as double-word 32-bit signed binary in the buffer memory.

- Data range: -100000 to 100000 (-100.000 to 100.000%)

*For the resolution, refer to Section 4.2.1.

(b) Unit

$\times 10^{-3}\%$ *Unit is fixed.

(c) Update timing

It will be updated every measuring cycle (500 ms).

- 6.3.28 Year of time of the max. power factor (Un\G722),
- month and day of time of the max. power factor (Un\G723),
- hour and minute of time of the max. power factor (Un\G724),
- second and day of the week of time of the max. power factor (Un\G725),
- year of time of the min. power factor (Un\G728),
- month and day of time of the min. power factor (Un\G729),
- hour and minute of time of the min. power factor (Un\G730),
- second and day of the week of time of the min. power factor (Un\G731)

Stores year, month, day, hour, minute, and the day of the week of time of maximum power factor (Un\G720, 721) and minimum power factor (Un\G726, 727) were updated.

(1) Details of stored data

(a) Storage format

As indicated below, data are stored as BCD code in the buffer memory.

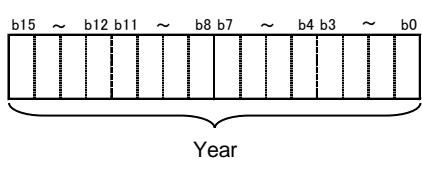
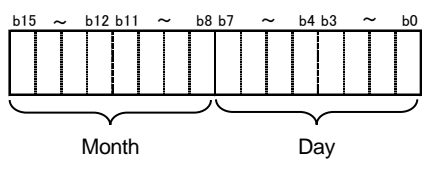
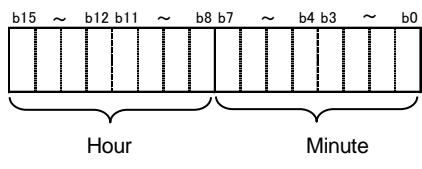
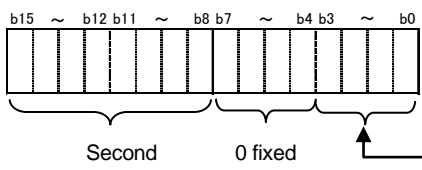
Buffer memory address	Storage format																
Un\G722 /Un\G728																	
Un\G723 /Un\G729																	
Un\G724 /Un\G730																	
Un\G725 /Un\G731	 <table border="1" data-bbox="1149 1590 1372 1780"> <thead> <tr> <th colspan="2">Day of the week</th> </tr> </thead> <tbody> <tr> <td>0</td> <td>Sunday</td> </tr> <tr> <td>1</td> <td>Monday</td> </tr> <tr> <td>2</td> <td>Tuesday</td> </tr> <tr> <td>3</td> <td>Wednesday</td> </tr> <tr> <td>4</td> <td>Thursday</td> </tr> <tr> <td>5</td> <td>Friday</td> </tr> <tr> <td>6</td> <td>Saturday</td> </tr> </tbody> </table>	Day of the week		0	Sunday	1	Monday	2	Tuesday	3	Wednesday	4	Thursday	5	Friday	6	Saturday
Day of the week																	
0	Sunday																
1	Monday																
2	Tuesday																
3	Wednesday																
4	Thursday																
5	Friday																
6	Saturday																

(b) Update timing

It will be updated every measuring cycle (250 ms) if it exceeds the current max. value or goes under the current min. value.

6.3.29 Multiplier of the frequency (Un\G800)

The multiplier of the frequency is stored.

(1) Details of stored data

(a) Storage format

Data are stored as 16-bit signed binary in the buffer memory.

- Data range: -3 (fixed)

(b) Update timing

Because it is fixed at -3, there is no update.

6.3.30 Frequency (Un\G802, 803)

Stores the frequency.

(1) Details of stored data

(a) Storage format

Data are stored as double-word 32-bit signed binary in the buffer memory.

- Data range: 0 to 999900 (-0 to 999.900 Hz)

*Restrictions for measured data including resolution and measuring range, refer to section 4.2.1.

(b) Unit

$\times 10^{-3}\%$ *Unit is fixed.

(c) Update timing

It will be updated every measuring cycle (250 ms).

6.4 Common sections (Un\G3000 to Un\G4999)

6.4.1 Latest error code (Un\G3000)

The latest error code that is detected with this module will be stored.
 *For the list of error codes, refer to section 9.1.

(1) Details of stored data

(a) Storage format

Data are stored as 16-bit signed binary in the buffer memory.
 - Data range: 0000h (normal), 0001h to FFFFh (error code)

(b) Update timing

It will be updated at the time of error occurrence and error recovery.

6.4.2 Year of time of the error (Un\G3001), month and day of time of the error (Un\G3002), hour and minute the error (Un\G3003), second and day of the week of time of the error (Un\G3004)

The year, month, day, hour, minute, and day of the week of time of the error will be stored.

(1) Details of stored data

(a) Storage format

As indicated below, data are stored as BCD code in the buffer memory.

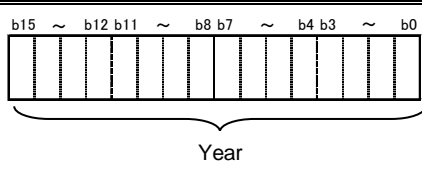
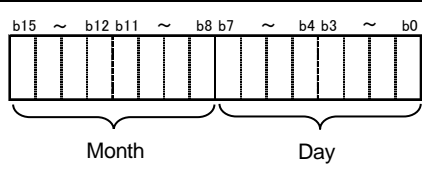
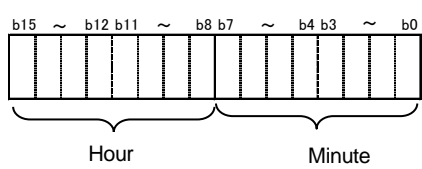
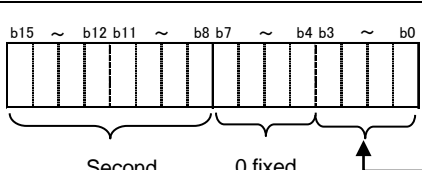
Buffer memory address	Storage format																
Un\G3001	 <p>e.g.) Year 2010 2010h</p>																
Un\G3002	 <p>e.g.) July 30 0730h</p>																
Un\G3003	 <p>e.g.) 10:35 1035h</p>																
Un\G3004	 <p>e.g.) 48sec Friday 4805h</p> <table border="1" data-bbox="1157 1803 1380 1982"> <thead> <tr> <th colspan="2">Day of the week</th> </tr> </thead> <tbody> <tr><td>0</td><td>Sunday</td></tr> <tr><td>1</td><td>Monday</td></tr> <tr><td>2</td><td>Tuesday</td></tr> <tr><td>3</td><td>Wednesday</td></tr> <tr><td>4</td><td>Thursday</td></tr> <tr><td>5</td><td>Friday</td></tr> <tr><td>6</td><td>Saturday</td></tr> </tbody> </table>	Day of the week		0	Sunday	1	Monday	2	Tuesday	3	Wednesday	4	Thursday	5	Friday	6	Saturday
Day of the week																	
0	Sunday																
1	Monday																
2	Tuesday																
3	Wednesday																
4	Thursday																
5	Friday																
6	Saturday																

(b) Update timing

It will be updated at the time of error occurrence and error recovery.

Chapter 7: Setting and procedure for operation

7.1 Precautions for handling

- (1) Do not drop or apply strong shock to the module case.
- (2) Do not remove the printed-circuit board of the module from the case.
Doing so may cause failure.
- (3) Prevent foreign matter such as dust or wire chips from entering the module.
Such foreign matter can cause a fire, failure, or malfunction.
- (4) A protective film is attached to the top of the module to prevent foreign matter, such as wire chips, from entering the module during wiring.
Do not remove the film during wiring.
Remove it for heat dissipation before system operation.
- (5) Module fixing screws must be tightened within the specified range as described below.
Loose screws may cause short-circuit, failure, or malfunction.
*1 The module can be fixed easily to the base unit, using the hook on top of the module. However, if it is used under a vibrating environment, we strongly recommend that the module be fixed with screws.

Table 7.1 Tightening torque

Locations of screws	Torque range
Module-fixing screws (M3 screw) *1	0.36 - 0.48 N•m

- (6) To attach the module to the base unit, firmly insert the protruding portions for fixing the module into the holes on the base unit, and make sure the module is securely attached to the module holes as fulcrum points.
Insecure attachment of the module may cause malfunction, failure, and a falling.
- (7) Before touching the module, make sure that you need to discharge static electricity on your body by touching a metal that is grounded.
Otherwise, it may cause failure or malfunction to the module.

7.2 Procedure for operation

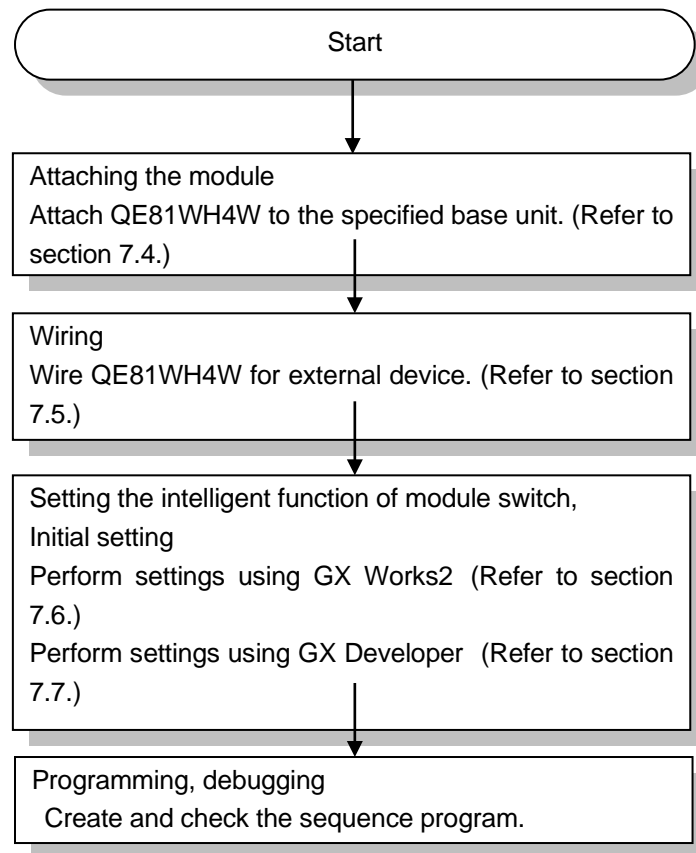

Figure 7.1 Procedure for operation

7.3 Name and function of each part

Names and functions of parts of QE81WH4W are provided below.

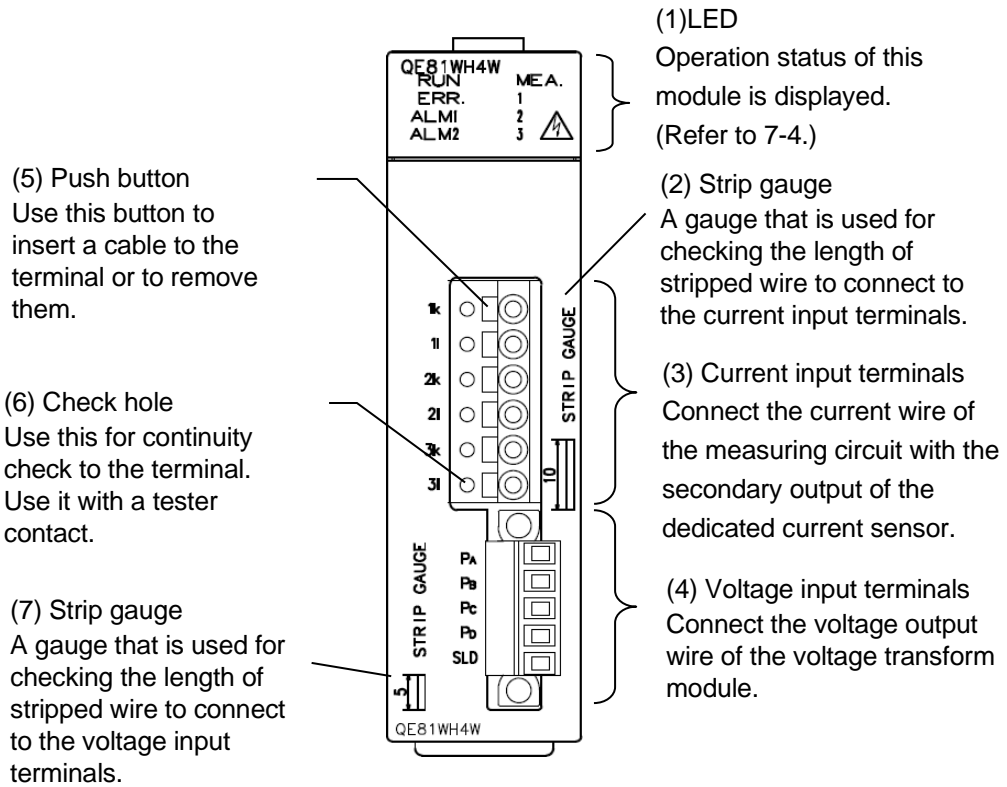

Figure 7.2 Appearance of the module

(1) Names and functions of LEDs

The following describes names and functions of LEDs.

Table 7.2 Names and functions of LEDs

Name	Color	Role	ON/OFF condition
RUN LED	Green	Displays the operation status of this module.	ON: Normal operation OFF: 5V power discontinuity, watch dog timer error
ERR. LED	Red	Displays errors and conditions of this module.	ON: Error occurring (except out-of-range error) *1 Flashing: Out-of-range error *1 OFF: Normal operation
ALM1 LED	Red	Displays alarm 1 occurrence status.	Flashing: Alarm 1 occurring ON: Alarm 1 occurring → Not occurring (In the case of alarm 1 reset method = self-retention) OFF: Alarm 1 not occurring
ALM2 LED	Red	Displays alarm 2 occurrence status.	Flashing: Alarm 2 occurring ON: Alarm 2 occurring → Not occurring (In the case of alarm 2 reset method = self-retention) OFF: Alarm 2 not occurring
MEA. LED	Green	Displays the status of measurement of this module.	ON: Measuring electric energy (consumption) Flashing: Measuring electric energy (regeneration) OFF: Other than the above
1 LED	Green	Displays the status of measurement (regeneration) at side 1 of this module.	ON: Measuring 1-phase electric energy (regeneration) OFF: Other than the above
2 LED	Green	Displays the status of measurement (regeneration) at side 2 of this module.	ON: Measuring 2-phase electric energy (regeneration) OFF: Other than the above
3 LED	Green	Displays the status of measurement (regeneration) at side 3 of this module.	ON: Measuring 3-phase electric energy (regeneration) OFF: Other than the above

*1 For details, check with the list of error codes. (Refer to section 9.1)

(2) Names of signals of terminal block

The following describes names of signals of terminal block.

Table 7.3 Names of signals of terminal block

Terminal symbol	Name of terminal
1k	1-phase current input terminal (power source side)
1l	1-phase current input terminal (load side)
2k	2-phase current input terminal (power source side)
2l	2-phase current input terminal (load side)
3k	3-phase current input terminal (power source side)
3l	3-phase current input terminal (load side)
PA PB PC PD	Voltage input terminals (Connect the output wire of the voltage transform module)
SLD	Shield terminals

7.4 Attaching and removing the module

7.4.1 How to attach to the base unit (Q6□WRB)

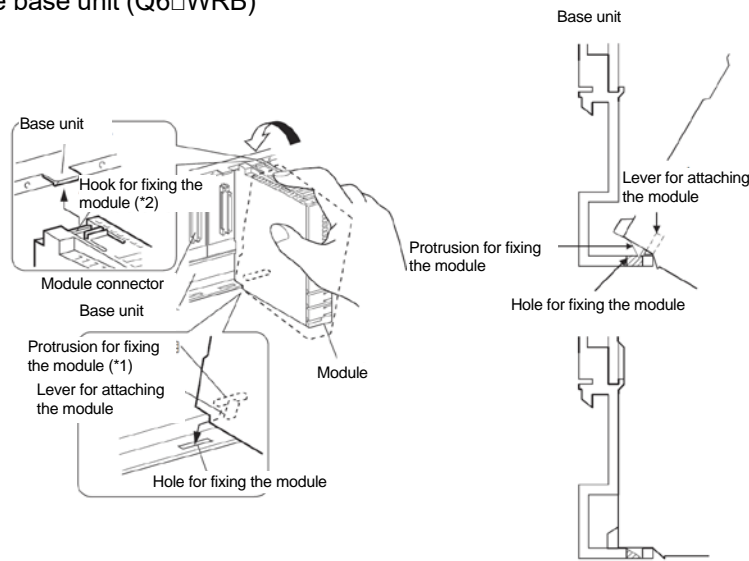
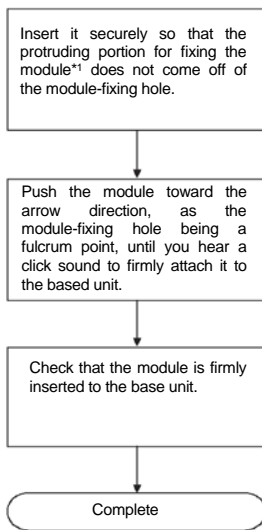

- Attach to the base of MELSEC-Q series.
- When attaching the module, make sure to insert the protruding portions for fixing the module into the holes on the base unit. In doing so, insert it securely so that the protruding portion of the module does not come off of the holes. Do not force to attach the module; otherwise the module may break.
- When installing the module at a vibrating area with strong impact, tighten the module to the base unit using screws. Module-fixing screws: M3 x 12mm (Prepare them yourself.)
- Attaching and detaching the module and the base unit should be performed 50 times or less (to conform to JIS B3502). If the count exceeds 50 times, it may cause a malfunction.

7.4.2 How to detach it from the base unit (Q6□WRB)

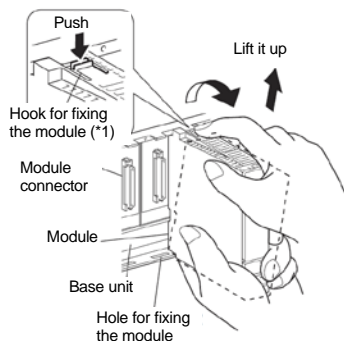
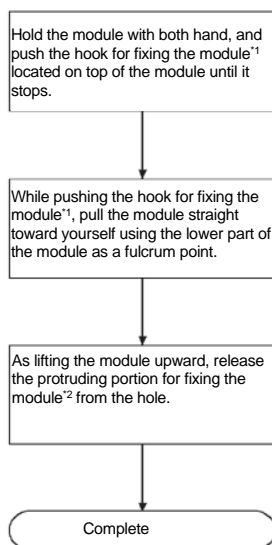

- When module-fixing screws are used, make sure to remove the screws for detaching the module first, and then remove the protruding portion for fixing the module from the holes. Do no force to remove the module; it may break the protruding portions for fixing the module.

7.5 Wiring

7.5.1 Precautions for wiring

- (1) The voltage transform module is required for voltage input. (Refer to section 7.5.3)
- (2) For the current circuit input, Mitsubishi's current sensor is required. (Refer to section 7.5.3)
- (3) Connect cables. For connecting voltage transformer, voltage transform module and current transformer, refer to the corresponding wiring diagram.
- (4) Do not install the input signal wire together with the main circuit lines or power cables. Keep a distance as below. (Except for the terminal input part) Failure to do so may result in malfunction due to noise.

Conditions	Distance
Power line of 600V or less and 600A or less	300mm or more
Other power line	600mm or more

- (5) For input wiring of the measurement circuit, use separate cables from other external signals in order to prevent from AC surge and induction.
- (6) Keep any object off the cables.
- (7) Protect cable coating from scratch.
- (8) Cable length should be routed in length with a margin, please take care to avoid causing stress to pull the terminal block. (Tensile load: less than 22N)
- (9) Please do not connect two or more cables to one terminal hole of the current input terminal block. And, please do not connect three or more cables to one terminal hole of the voltage input terminal block. The engagement of the terminal becomes weak, and cable may fall out.
- (10) In actual use, please connect the SLD terminal to a shield

7.5.2 How to connect wires

(1) Follow the wiring diagram for external connection to QE81WH4W.

(2) Use appropriate electric wires as described below.

<Voltage input terminals>

(a) Stripping length of the used wire in use has to be 5 to 6mm. Check the stripping length please use the strip gauge at the bottom of QE81WH4W main body.

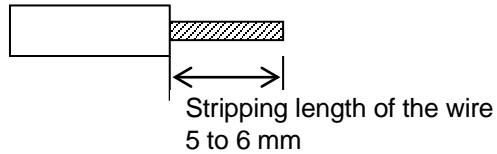

(b) When use stranded wire, twist the tip.

<Current input terminals>

(a) Stripping length of the wire in use has to be 10 to 11mm. Check the stripping length please use the strip gauge at the center of QE81WH4W main body.

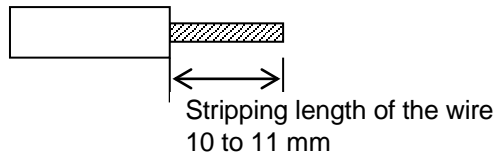

(b) At the connection between the secondary terminal of current sensor (EMU-CT***, EMU-CT***-A) and current input terminals, use twisted pair cable.

Applicable wire (Usable electric wire)	Single wire: AWG24 – AWG18 (φ0.5 - 1.0mm) Stranded wire: AWG22 – AWG18 (0.3 - 0.8 mm ²)
---	--

(c) When stranded wire is used, a bar terminal must be used.

Recommended bar terminal	TGV TC-1.25-11T (Made by Nichifu) or equivalent
--------------------------	---

(d) When attaching and detaching cables to/from the terminal, use the push button. Check that the wire is securely inserted.

(e) Insert a wire to the terminal all the way until it touches the end.

7.5.3 How to wire

Follow the wiring diagram (Figure 7.5.3(1)-(a) ~ 7.5.3(2)-(b)) for external connection of QE81WH4W.

(1) In the case using 5A current sensor.

(a) Case of using EMU2-CT5

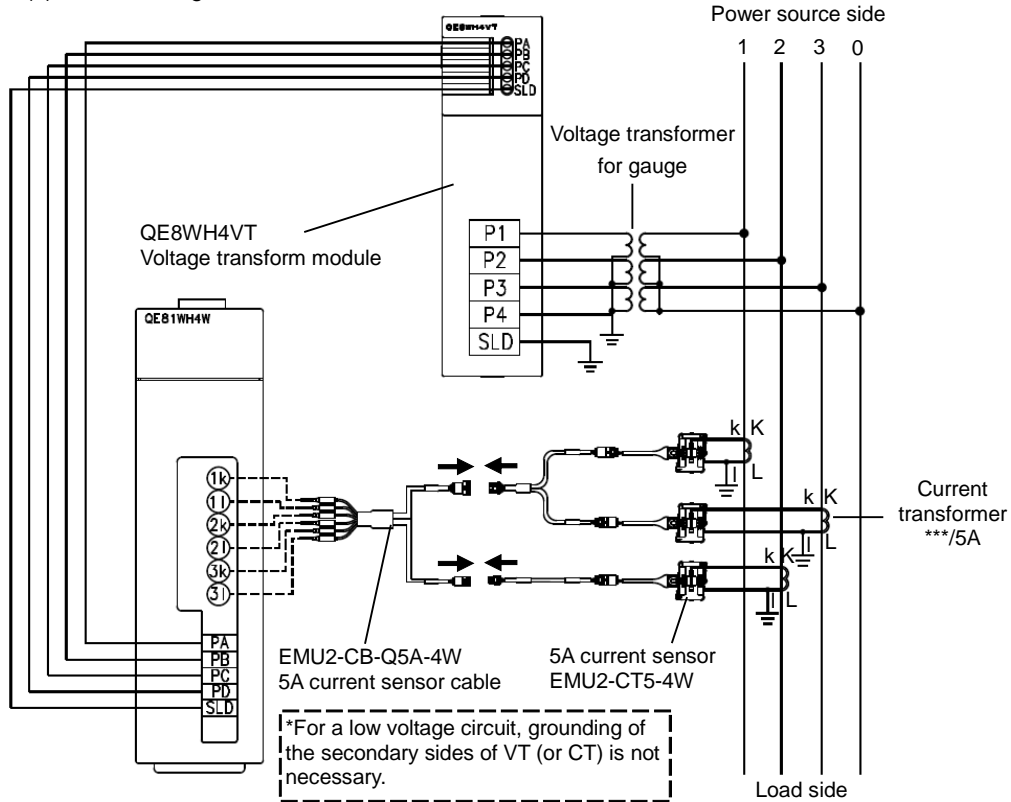

Figure 7.5.3(1)-(a) Wiring diagram (with the Voltage transform module / voltage transformer for gauge / current transformer)

(b) Case of using EMU-CT5-A

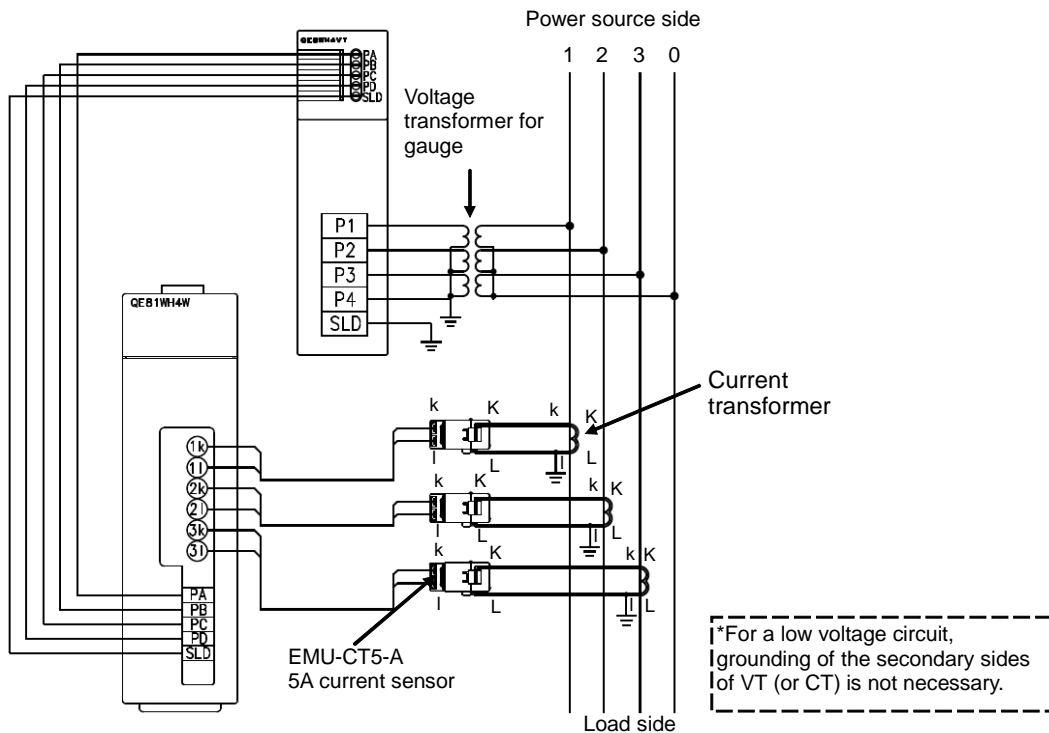

Figure 7.5.3(1)-(b) Wiring diagram (with the voltage transformer for gauge / current transformer)

- (2) In the case using split-type current sensor.
- (a) Case of one QE81Wh4W

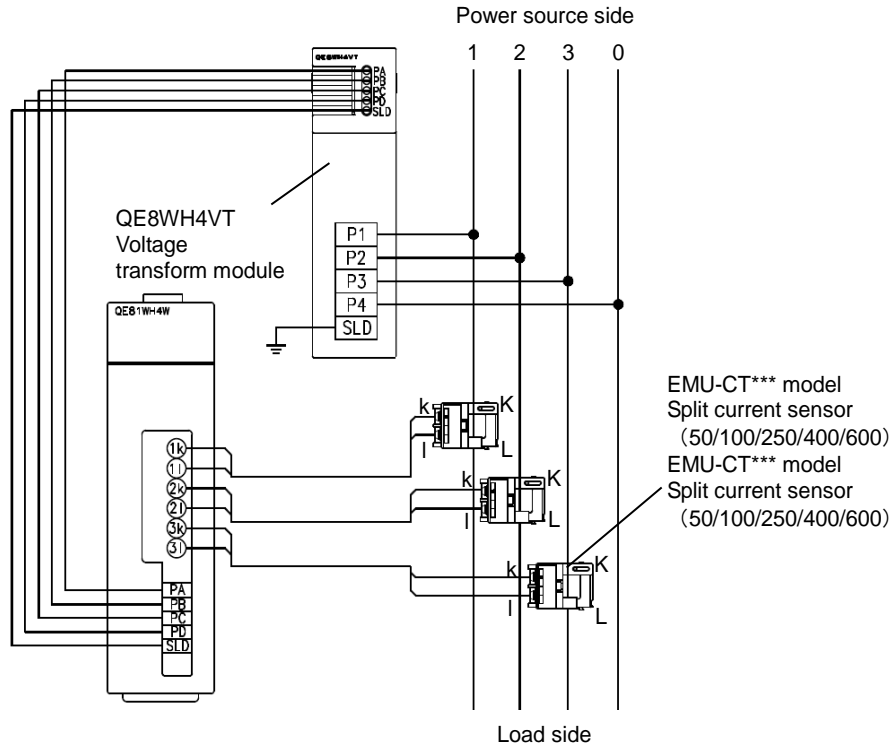

Figure 7.5.3(2)-(a) Wiring diagram

- (b) Case of two or more QE81WH4W

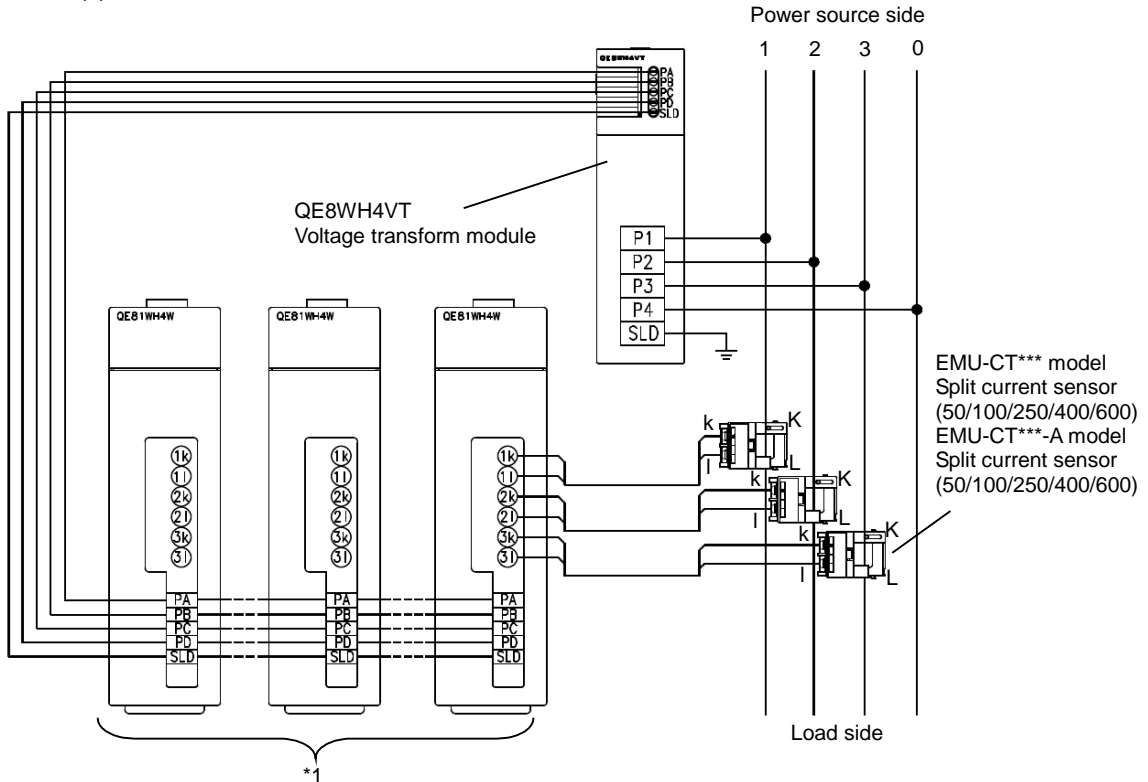

Figure 7.5.3(2)-(b) Wiring diagram

(When connecting several module (QE81WH4W) to Voltage transform module (QE8WH4VT))

*1 Measurement module can be connected to a voltage transform module is up to five.

As shown above, possible to transition wiring for the voltage terminal block of the energy measuring module, because up to two wires can be connected to the voltage terminal block of the energy measuring module.

7.5.3.1 Current circuit connection

A dedicated current sensor (EMU-CT ***, EMU-CT ***-A, EMU2-CT5-4W) is required to connect the current circuit.

■ How to attach EMU-CT5/CT50/CT100/CT250-A

- 1) Press the locking claw of the moving core, please open the moving core by removing the engagement (Figure 1). Before inserting the cable, check the symbols K and L to fit the current sensor in the correct direction. (The direction from the power supply side to the load side is indicated with →.) (Figure 3)
- 2) After checking that the core parting faces are free from dirt, close the moving core. Push down the moving core until the stoppers are securely locked. (Locking claw of the moving core is applied to the stopper, you hear click.) (Figure 2)
- 3) Pass the tying bands into the current sensor locking holes to secure the sensor with the cable. (Figure 3)

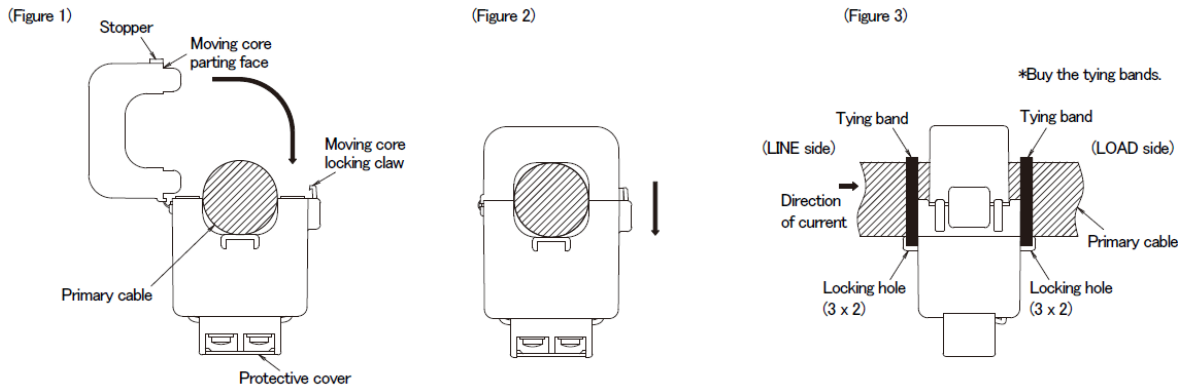

✓ **Supplementary**

- Make sure that before connecting the cable, the orientation of the current sensor is correct for attachment. K to L is the correct direction. K: power source side, L: load side.
- Do not bend the moving core in a direction other than the operation direction (shown in Fig. 1). The current sensor may be damaged.
- Refer to the table below for appropriate size of electric wires.

		EMU-CT5-A	EMU-CT50-A	EMU-CT100-A	EMU-CT250-A
Usable wires size (reference)	IV cable	38 mm ² or less	38 mm ² or less	60 mm ² or less	200 mm ² or less
	CV cable	22 mm ² or less	22 mm ² or less	60 mm ² or less	150 mm ² or less

Size of electric wires conforms to what is described in the catalog of general PVC insulated wires. Thickness of external PVC insulation is different for different wire. Check with the external dimension diagram of this product and make sure the wire can go through the given space.

■ How to attach EMU-CT400/CT600-A

- 1) Press the locking claw of the moving core, please open the moving core by removing the engagement (Figure 1). At this time, the hinge cover opens automatically. Before inserting the cable, check the symbols K and L to fit the current sensor in the correct direction. (The direction from the power supply side to the load side is indicated with →.) (Figure 3)
- 2) After checking that the core parting faces are free from dirt, close the moving core. Push down the moving core until the stoppers are securely locked. (Locking claw of the moving core is applied to the stopper, you hear click.) After the stopper is securely locked, close the hinge cover. (Figure 2)
- 3) Pass the tying bands into the current sensor locking holes to secure the sensor with the cable. (Figure 3)

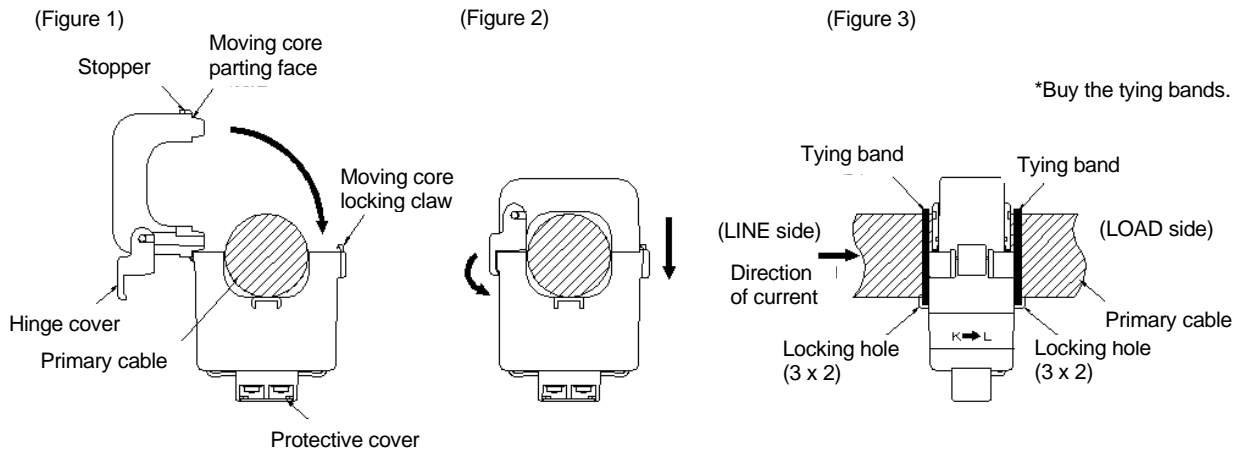

✓ **Supplementary**

- Make sure that before connecting the cable, the orientation of the current sensor is correct for attachment. K to L is the correct direction. K: power source side, L: load side.
- Do not bend the moving core in a direction other than the operation direction (shown in Fig. 1). The current sensor may be damaged.
- Refer to the table below for appropriate size of electric wires.

		EMU-CT400-A	EMU-CT600-A
Usable wires size (reference)	IV cable	500 mm ² or less	500 mm ² or less
	CV cable	400 mm ² or less	400 mm ² or less

Size of electric wires conforms to what is described in the catalog of general PVC insulated wires. Thickness of external PVC insulation is different for different wire. Check with the external dimension diagram of this product and make sure the wire can go through the given space.

■ How to attach EMU-CT50/CT100/CT250

Follow the procedure below to attach to the cable of the target circuit.

- 1) Open the movable core, as shown in the figure on the right.
Lift slowly the hooks located on both sides of the movable core, and detach them from the stopper. **Do not force to open it. You may break the hook.**
- 2) Do not let the cable touch on the core-split surface. Thus, carefully pass the cable from underneath. Before passing the cable, check the direction symbols of K and L, in order to attach the sensor in the correct orientation. (Direction from power source side (K) to load side (L) is indicated with the arrow.)
- 3) Make sure no dust or foreign object is attached on the split-core surface, and after that, close the movable core. Lift the movable core until the stoppers are firmly locked. (When the hooks on both side of movable core are locked to the stoppers, you will hear click sound twice.)
- 4) Put a binding cable through a hole for fixing the current sensor, and then tie it with the cable. Do not tie it too tightly. (Holes for fixing the current sensor are located on both side of the current sensor.)
- 5) Cut off the extra portion of binding cable, using a nipper, etc, to avoid interference of the cable.
- 6) Lift a protective cover of the secondary terminal, by holding the center portion of the protective cover, and remove it. And then, connect the given sensor cable. **Check the terminal symbols printed on the secondary terminal surface, so that connection is performed correctly.**

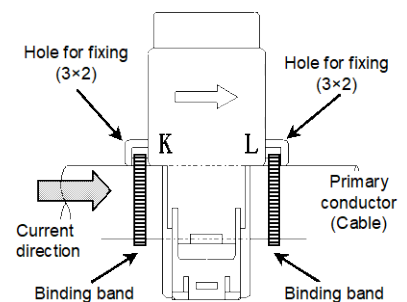
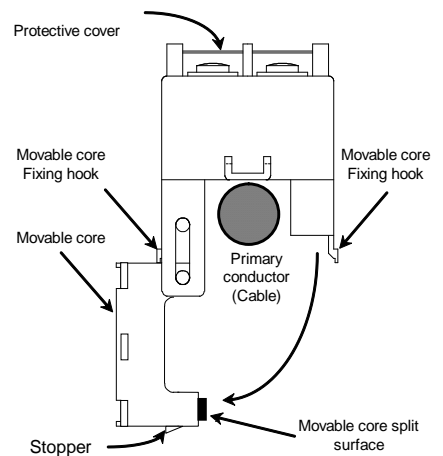
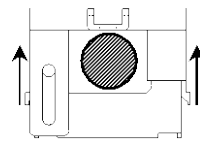

✓ **Supplementary**

- When opening the movable core on current sensor, **do not widen the hook for fixing the movable core too widely.** It may break the hook.
- Refer to the table below for appropriate size of electric wires.

		EMU-CT50	EMU-CT100	EMU-CT250
Usable wires size (reference)	IV cable	60 mm ² or less	60 mm ² or less	150 mm ² or less
	CV cable	38 mm ² or less	38 mm ² or less	150 mm ² or less

Size of electric wires conforms to what is described in the catalog of general PVC insulated wires. Thickness of external PVC insulation is different for different wire. Check with the external dimension diagram of this product and make sure the wire can go through the given space.

■ How to attach EMU-CT400/CT600

Follow the procedure below to attach the cable to the target circuit.

- 1) Release the band 1) to the arrow direction (top), and detach the core cover.
- 2) Remove the terminal cover, and shift the secondary short switch into "short".
- 3) Loosen the screw 2), and open the core band to remove the core. Make sure that no dust, etc attaches on the core.
- 4) Loosen the screw 3). Put this module onto the cable, and fix the module by tightening the screw 3) using the metal bracket that is directly attached to the cable. Tighten the screw as tightly as the metal bracket will not bend.
- 5) Align the symbol of "K" on the removed core and the "K" on the module to return the core as in the original location. And then, tighten the core band using the screw 2).
- 6) Attach the core cover and fix it with the band 1).
- 7) Connect the secondary terminal with multiple-circuit power measuring module, turn the secondary short switch into "open", and then attach the terminal cover.

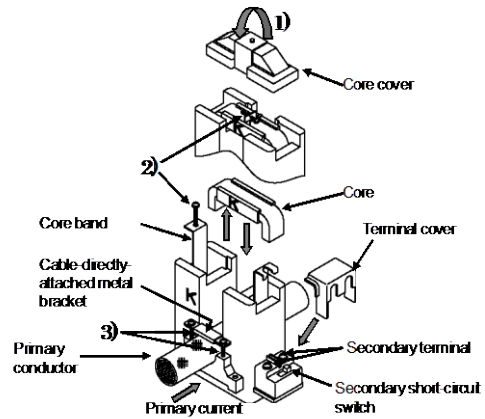

✓ **Supplementary**

- Refer to the table below for appropriate size of electric wires.

		EMU-CT400		EMU-CT600	
		1 wire	2 wire	1 wire	2 wire
Usable wires size (reference)	IV cable	500mm ²	325mm ²	500mm ²	325mm ²
	CV cable				

Size of electric wires conforms to what is described in the catalog of general PVC insulated wires. Thickness of external PVC insulation is different for different wire. Check with the external dimension diagram of this product and make sure the wire can go through the given space.

■ How to attach EMU2-CT5-4W

- Transfix EMU2-CT5-4W current sensor to the secondary-side wire of current transformer (5A rated). Make sure to use it in a correct combination with 5 A current sensor conversion cable: EMU2-CB-Q5A-4W
- EMU2-CT5-4W has polarities. Make sure to connect to the right symbol on the terminal. Power source side: (k side), load side: (l side).

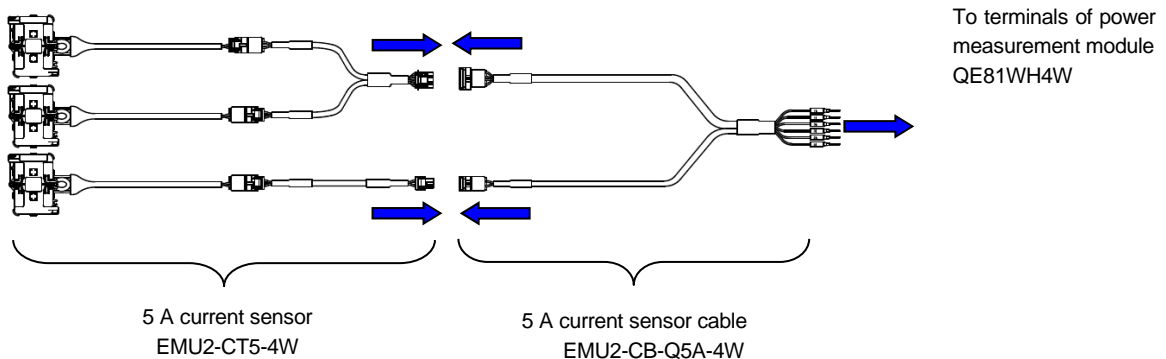

Follow the procedure below to attach the cable to the target circuit.

- 1) Slide the lock pin to the arrow direction.
- 2) Put the electric wire through the clamp, and close the clamp again.
- 3) Use your finger to hold the clamp in the full close position, and push the lock pin until it locks.

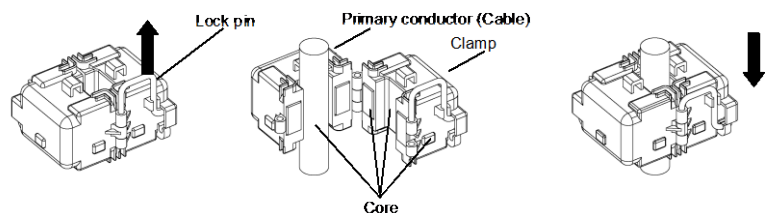

Caution

- The lock pin is made of metal. If you let it touch electrically charged portions, it may cause electric shock or device failure or fire. Be careful handling the lock pin.
- Physical impact to the core may cause breakage. It may directly influence the performance. Be careful handling the core.
- The mating surface on the core is very sensitive. Even a small foreign object on the surface may affect the measurement performance.
- Excessive force to the core during open clamp may cause breakage. Incorrect direction may cause inaccurate measurement.
- For both the transfixing wire and the binding band for fixing the sensor, use the size of $W=2.6$ mm or less. To fix them together Put a binding band through a hole for fixing the current sensor, and tie it with the cable. Do not tie it too tightly. (Total four holes for fixing the current sensor exist on both sides of the current sensor).

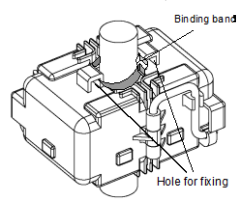

■ Extending the cable of 5 A current sensor

If the cable from current sensor is too short, you can extend it by using an extension cable as shown below.

Extension cable (standard)

Model name	EMU2-CB-T1M	EMU2-CB-T5M	EMU2-CB-T10M
Cable length	1 m	5 m	10 m

Extension cable (separate)

Model name	EMU2-CB-T1MS	EMU2-CB-T5MS	EMU2-CB-T10MS
Cable length	1 m	5 m	10 m

Connecting 5 A current sensor and the cable

◆ Connecting 5 A current sensor and extension cable (standard)

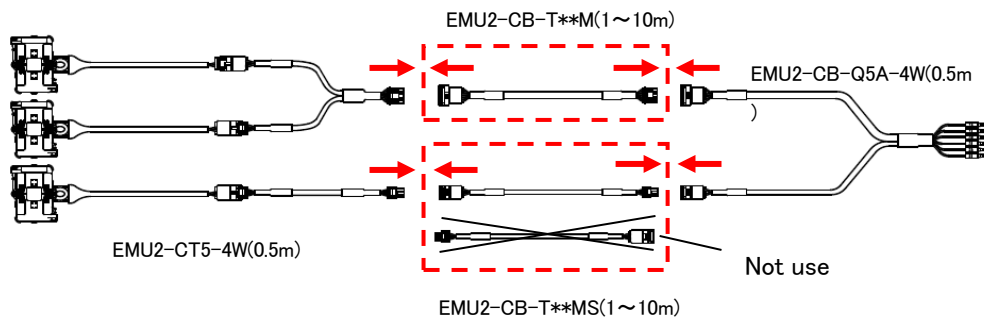

◆ Connecting 5 A current sensor and extension cable (separate)

1)

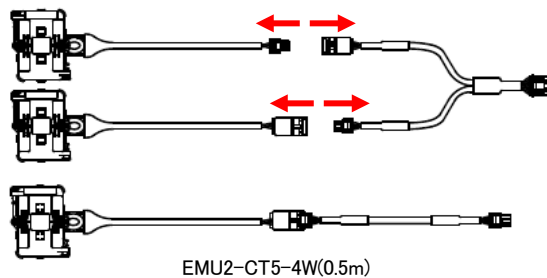

2)

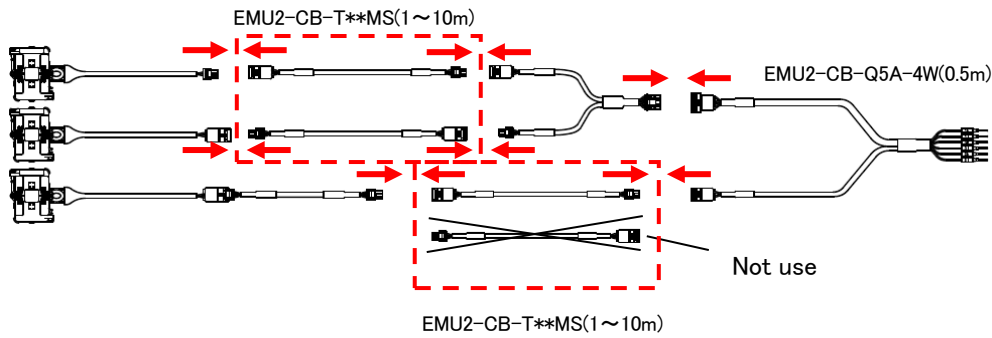

✓ **Supplementary** -----

- Cable extension for EMU2-CT5-4W is 10 m max. (Total cable length is 11m max.)
- Use extension cable (separate) when 1-phase, 2-phase and 3-phase are set apart.

7.5.3.2 Voltage circuit connection

For the voltage circuit connection, there are two ways as follows:

- 1) Connect the voltage transform module direct to the circuit.
- 2) Connect the voltage transform module to voltage transformer secondary side.

- In any case, circuit voltage can't directly connect to voltage input terminal of QE81WH4W. Please connect to voltage output terminal of voltage transform module (QE8WH4VT).
- If used at a circuit higher than 277/480V AC, make sure use a voltage transformer.
- The maximum value of the transformer primary voltage is 6,600V. Please connect the transformer secondary voltage to P1, P2, P3, and P0 terminals of QE8WH4VT. Make sure that terminal symbols are correct.
- In order to perform maintenance work such as changing the wire layout and replacing equipment, we recommend that you connect protective device (breaker) for the voltage input circuit of the voltage transform module (P1, P2, P3, and P0 terminals).

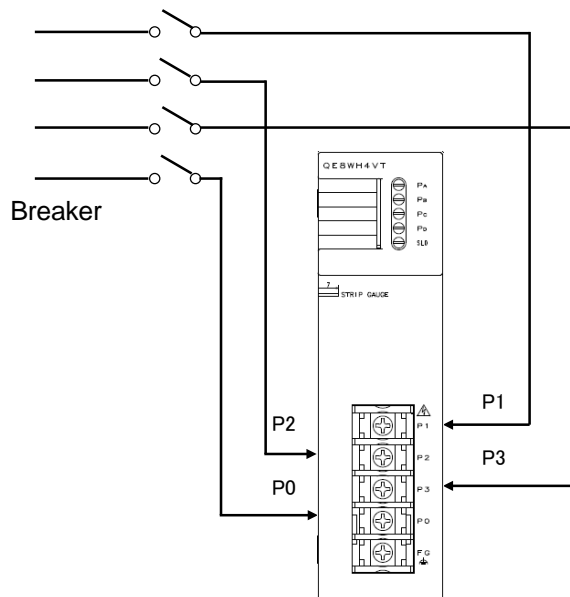

Voltage transform module (QE8WH4VT)

7.6 Setting from GX Works2

This section explains setting from GX Works2 necessary to use QE81WH4W. Before performing this setting, install GX Works2 and connect the Management CPU with the PC using a USB cable. For details, refer to the manual of CPU module.

Point	To addition the unit, enable the switch setting, parameter setting and auto refresh, write the settings to the CPU module, and reset the CPU module or power on the programmable controller again.
--------------	--

7.6.1 Addition the unit

Add the model name of the energy measuring module to use the project.

(1) Addition procedure

Open the “New Module” window.

Project window→[intelligent Function Module]→Right-click→[New Module...]

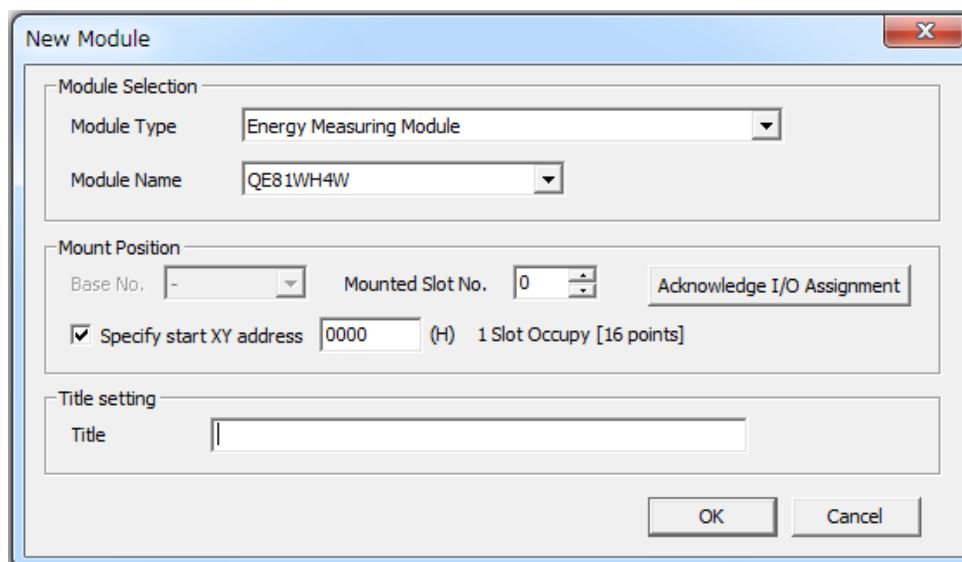

Figure 7.6.1-1 Dialog box of “I/O assignment”

Table 7.6.1-1 Setting items on the “I/O assignment” tab

Item		Description
Module Selection	Module Type	Set [Energy Measuring module].
	Module Name	Set the name of the module to mount.
Mount Position	Base No.	Set the base No. where the module is mounted.
	Mounted Slot No.	Set the slot No. where the module is mounted.
	Specify start XY address	The start I/O number (hexadecimal) of the target module is set, according to the mounted slot No. Any start I/O number can be set.
Title Setting	Title	Set any title.

7.6.2 Setting the intelligent function of the module switch

Set the operation mode.

(1) Setting procedure

Open the "Switch Setting" window.

Project window → [intelligent Function Module] → Module name → [Switch Setting]

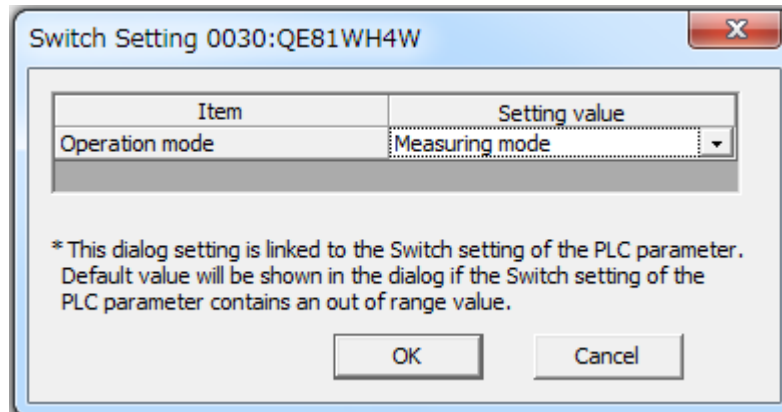

Figure 7.6.2-1 Dialog box to set the intelligent function of the module switch

Table 7.6.2-1 Setting the intelligent function of the module switch

Item	Description	Setting value
Operation mode	Measurement Mode and test mode are changed.	Measuring mode (default) Test mode

7.6.3 Parameter Setting

Set the parameters.

Setting parameters on the screen omits the parameter setting in a program.

(1) Setting procedure

Open the "Parameter" window.

Project window → [intelligent Function Module] → Module name → [Parameter]

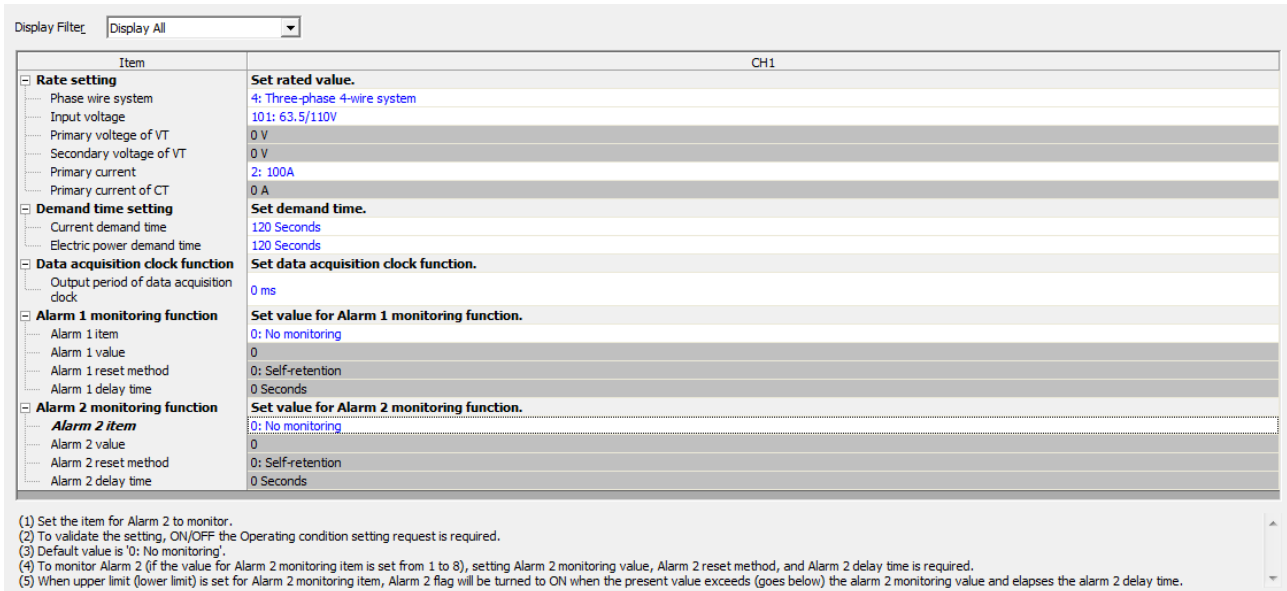

Figure 7.6.3-1 Dialog box to monitor all buffer memories (a case where the module is attached to the slot 0)

(2) Double-click the item to change the setting, and input the setting value.

- Items to input from the pull-down list
Double-click the item to set to display the pull-down list. Select the item.
- Items to input from the text box
Double-click the item to set, and input the setting value.

(3) Setup of CH2 to CH4 is performed by operation of Procedure (2).

Item	Setting value		Reference
Rate setting	Phase wire system	4:three-phase 4-wire system	Section 6.2.1
	Input voltage	0:Any setting 101:63.5/110V 102:100/173V 103:105/182V 104:110/190V 105:115/199V 106:120/208V 107:127/220V 108:200/346V 109:220/380V 110:230/400V 111:240/415V 112:242/420V 113:250/430V 114:254/440V 115:265/460V 116:277/480V	Section 6.2.2
	Primary voltage of VT	0 - 6600V	Section 6.2.2
	Secondary voltage of VT	0 - 220V	Section 6.2.2
	Primary current	0:Any setting 1:50A 2:100A 3:250A 4:400A 5:600A 501:5/5A 502:6/5A 503:7.5/5A 504:8/5A 505:10/5A 506:12/5A 507:15/5A 508:20/5A 509:25/5A 510:30/5A 511:40/5A 512:50/5A 513:60/5A 514:75/5A 515:80/5A 516:100/5A 517:120/5A 518:150/5A 519:200/5A 520:250/5A 521:300/5A 522:400/5A 523:500/5A 524:600/5A 525:750/5A 526:800/5A 527:1000/5A 528:1200/5A 529:1500/5A 530:1600/5A 531:2000/5A 532:2500/5A 533:3000/5A 534:4000/5A 535:5000/5A 536:6000/5A	Section 6.2.3
	Primary current of CT	0~ 6000A	Section 6.2.3
Demand time setting	Current demand time	0~ 1800seconds	Section 6.2.4
	Electric power demand time	0~ 1800seconds	Section 6.2.5
Data acquisition clock function	Output period of data acquisition clock	flag non-use:0 flag use:1~ 8640000ms	Section 6.2.11
Alarm 1 monitoring function	Alarm 1 item	0:No monitoring 1:Current demand upper limit 2:Current demand lower limit 3:Voltage (L-L) upper limit 4:Voltage (L-L) lower limit 5:Electric power demand upper limit 6:Electric power demand lower limit 7:Power factor upper limit 8:Power factor lower limit 9:Voltage (L-N) upper limit 10:Voltage (L-N) lower limit	Section 6.2.6
	Alarm 1 value	-2147483648 to 2147483647	Section 6.2.7
	Alarm 1 reset method	0:Self-retention 1:Auto reset	Section 6.2.8
	Alarm 1 delay time	0 to 300 seconds	Section 6.2.9
Alarm 2 monitoring function	Alarm 2 item	0:No monitoring 1:Current demand upper limit 2:Current demand lower limit 3:Voltage (L-L) upper limit 4:Voltage (L-L) lower limit 5:Electric power demand upper limit 6:Electric power demand lower limit 7:Power factor upper limit 8:Power factor lower limit 9:Voltage (L-N) upper limit 10:Voltage (L-N) lower limit	Section 6.2.6
	Alarm 2 value	-2147483648 to 2147483647	Section 6.2.7
	Alarm 2 reset method	0:Self-retention 1:Auto reset	Section 6.2.8
	Alarm 2 delay time	0 to 300 seconds	Section 6.2.9

7.6.4 Auto Refresh

This function transfers data in the buffer memory to specified devices.
Programming of reading/writing data is unnecessary.

(1) Setting procedure

1) Start "Auto Refresh".

Project window → [Intelligent Function Module] → Module name → [Auto Refresh]

2) Start "Auto Refresh".

Click the item to set, and input the destination device for auto refresh.

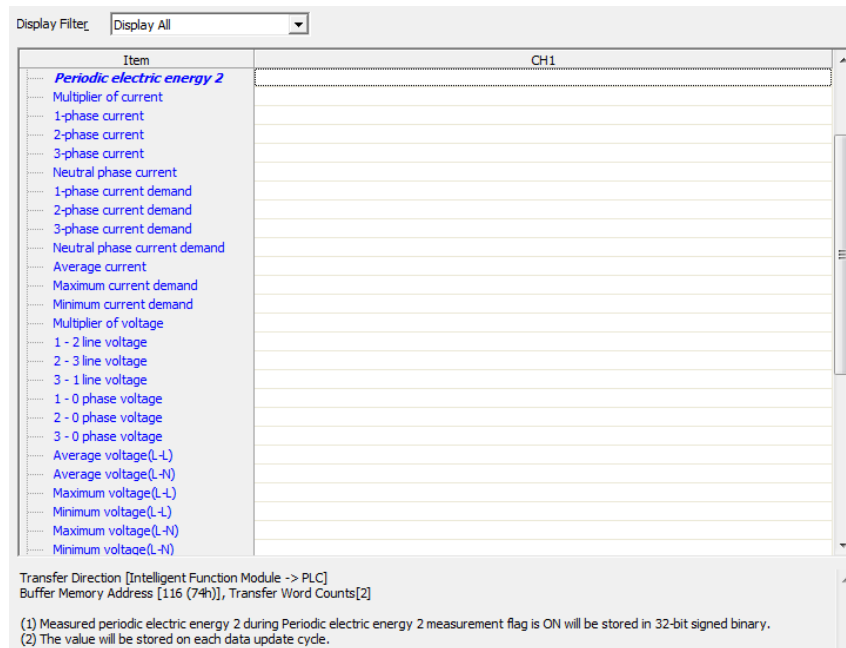

Point

Available devices are X, Y, M, L, B, T, C, ST, D, W, R, and ZR.

When a bit device X, Y, M, L, or B is used, set a number that is divisible by 16 points (example: X10, Y120, M16).

Data in the buffer memory are stored in 16 points of devices starting from the set device No. (Example: When X10 is set, the data are stored in X10 to X1F).

7.6.5 Setting function for integrated value

This function is to set integrated value (electric energy (consumption, regeneration) and reactive energy (consumption lag)) to any value. If you want to clear integrated value, set it to 0.

(1) Setting procedure

- 1) Start "Intelligent unit monitor"
Project window → [Intelligent Function Module] → Module name → Right-Click → [Intelligent monitor]
- 2) Set the integrated value setting target (Un#G51) and integrated value setting value (Un#G52,3)
- 3) Turn integrated value setting request (Yn3) from OFF to ON to enable the setting. (Refer to 5.2.2).

Item	Current Value	Device	Data Type
I/O Signal Monitor			
Input Signal (X)			
Module READY	---	X30	Bit
Periodic electric energy 1 data completion flag	---	X31	Bit
Periodic electric energy 2 data completion flag	---	X32	Bit
Periodic electric energy 1 reset completion flag	---	X33	Bit
Periodic electric energy 2 reset completion flag	---	X34	Bit
Data acquisition clock	---	X38	Bit
Operating condition setting completion flag	---	X39	Bit
Alarm 1 flag	---	X3A	Bit
Alarm 2 flag	---	X3B	Bit
Integrated values set completion flag	---	X3C	Bit
Max./min. value clear completion flag	---	X3D	Bit
Error flag	---	X3F	Bit
Output Signal (Y)			
Periodic electric energy 1 measurement flag	---	Y31	Bit
Periodic electric energy 2 measurement flag	---	Y32	Bit
Periodic electric energy 1 reset request	---	Y33	Bit
Periodic electric energy 2 reset request	---	Y34	Bit
Operating condition setting request	---	Y39	Bit
Alarm 1 reset request	---	Y3A	Bit
Alarm 2 reset request	---	Y3B	Bit
Integrated values clear request	---	Y3C	Bit
Max./min. value clear request	---	Y3D	Bit
Error clear request	---	Y3F	Bit
Buffer Memory Monitor			
Integrated value setting target	---	U3#G51	Word[Unsigned]
Integrated value setting value	---	U3#G52	Double Word[Signed]
Latest error code...	---	U3#G3000	Error Code
Error detection time (Year/Month/Day/Hour/Minute/S...)	---	U3#G3001	Time
OH1			
Multiplier of electric energy, reactive energy	---	U3#G1 00	Word[Signed]
Electric energy (consumption)	---	U3#G1 02	Double Word[Signed]
Electric energy (regeneration)	---	U3#G1 04	Double Word[Signed]
Reactive energy (consumption lag)	---	U3#G1 06	Double Word[Signed]
Periodic electric energy 1	---	U3#G1 14	Double Word[Signed]

- 4) After checking that the Integrated value setting completion flag (Xn3) is in the ON status, turn off the integrated value setting request (Yn3).
After detecting Integrated value setting request (Yn3) is in the OFF status, Integrated value setting completion flag (Xn3) turns to OFF.

(2) Default value

- Integrated value setting target (Un#G51) is set to 0 (No set).
Integrated value setting value (Un#G52,3) is set to 0.

7.6.6 Debugging program

QE81WH4W provides a test function so that you can debug a program with no input of voltage or current. Pseudo-value can be stored into the buffer memory. For detailed explanation for the test function, refer to 4.2.5.

**Caution**

Test function stores pseudo-values for setting value and error information as well as measured value. If you use these data to control the sequence program that controls external devices, there is a chance that erroneous control may occur. For safety of external devices, use this function after disconnecting the device.

- (1) Setting intelligent function of the module switch
 - 1) Configure the operation mode in switch setting as shown below. (Refer to 7.6.2)
Test mode transition : Test mode
 - 2) From the "Online" menu, select "Write to PLC" to display the dialog box of Write to PLC, and then execute the writing to PLC parameter. After resetting the CPU module, the value will become effective.

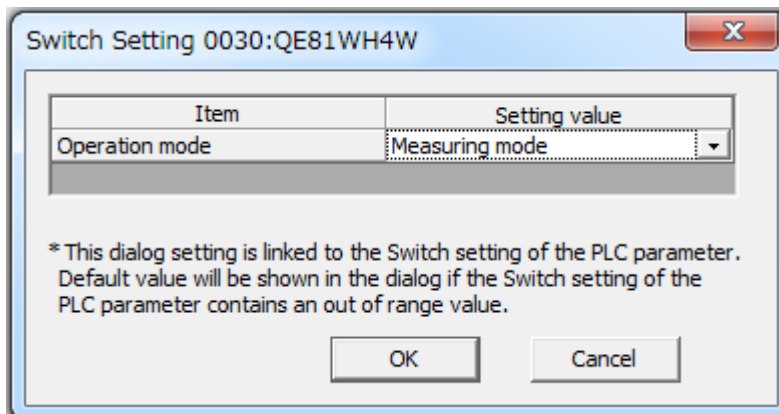

- (2) Starting the test function
 - 1) Reset the CPU module.
 - 2) QE81WH4W starts in the test function mode. All LEDs are turned on. Pseudo-values are stored in the buffer memory.
- (3) Finishing the test function (Move back to the measuring mode)
 - 1) Following 1) in step (1), Configure the operation mode in switch setting as shown below.
Test mode transition : Test mode
 - 2) Following 2) in step (1), write the data into PLC.
 - 3) Reset the CPU module, then the operation goes back to the measuring mode.

7.7 Setting from GX Developer

This section explains setting from GX Developer necessary to use QE81WH4W. Before performing this setting, install GX Developer and connect the Management CPU with the PC using a USB cable. For details, refer to the manual of CPU module.

7.7.1 I/O assignment setting

- (1) Double-click the dialog box of "PLC Parameter" in the GX Developer Project.
- (2) Click "I/O assignment".
- (3) Set the following item to the slot*1 to which QE81WH4W has been attached.

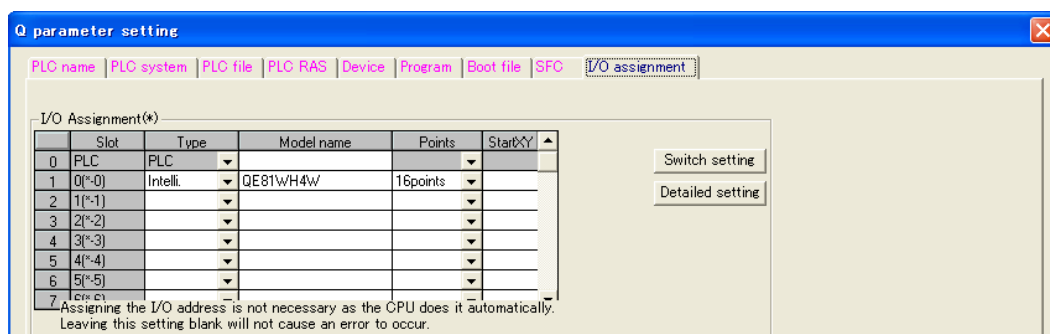

Figure 7.7.1-1 Dialog box of "I/O assignment"

Table 7.7.1-1 Setting items on the "I/O assignment" tab

Item	Descriptions
Type	Select "Intelli."
Model name	Enter the model name of the module.
Points	Select 16 points.
Start XY	Enter the initial I/O number of QE81WH4W.

*1 is a case where QE81WH4W is attached to the slot 0.

7.7.2 Setting the intelligent function of the module switch

- (1) In the “I/O assignment” of 7.7.1, click the **Switch setting** button to display the dialog box of “I/O module, intelligent function module switch setting”.
- (2) The intelligent function module switch setting displays switches 1 to 5; however, only the switch 5 is used for this purpose. Switch setting is configured using 16-bit data. Settings are as shown in Table 7.7.2-1.

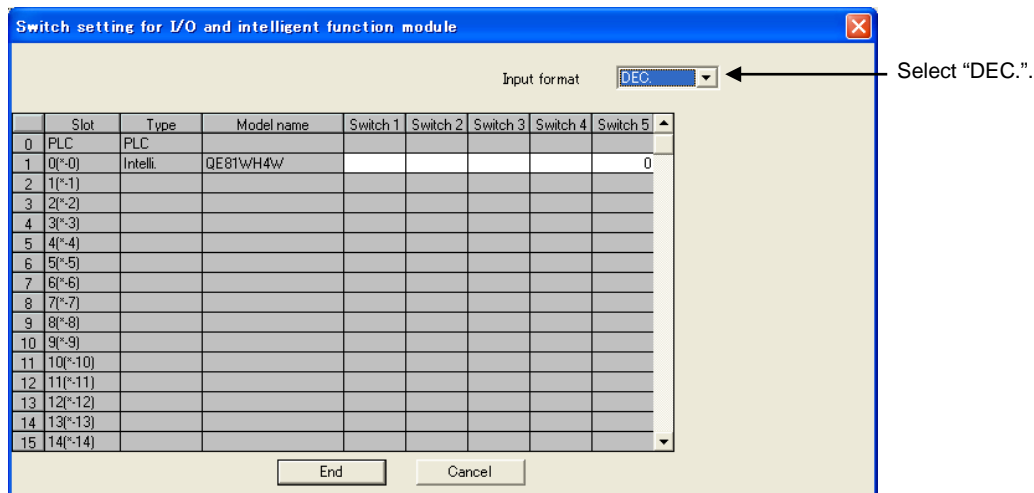

Figure 7.7.2-1 Dialog box to set the intelligent function of the module switch

Table 7.7.2-1 Setting the intelligent function of the module switch

Switch No.	Switch name	Description
1	Not used	-
2	Not used	-
3	Not used	-
4	Not used	-
5	Test mode transition	0: Normal operation (Even if it is not set, normal operation is performed) 1: Test mode * For details of test mode, refer to 4.2.5.

- (3) When the setting is completed, click the Complete setting button.
- (4) From the “Online” menu, select “Write to PLC” to display the dialog box of Write to PLC, and then execute the writing to PLC parameter. After resetting the CPU module, the value will become effective.

7.7.3 Initial setting

This section explains the setting of the operating condition for input voltage, primary current, current demand time, voltage demand time and primary voltage of VT that are required for measurement. Once each value is set, these values will be stored in the nonvolatile memory of the module, so that reconfiguration is not needed. You can also perform the setting using sequence program. In this case, you need to create a program, as referring to Chapter 8.

Follow the procedure below for each setting.

- (1) Check the current setting
- (2) Set the Buffer memory

- (1) Check the current setting

- 1) From the “Online” menu, select “Monitor” – “Buffer memory batch ...”. The dialog box to monitor all buffer memories. After setting the address as shown below, click the **Start monitoring** button to check the current buffer memory status.

Module initial address: Set the initial address of this module.

Buffer memory address: 0

(Display: 16-bit integer, numerical value: check the number in decimal)

- 2) Check each item. The following shows items for operating condition settings. For specific setting value, see the provided references.

Table 7.7.3-1 List of setting items

Buffer memory address	Item	Reference
Un\G0	Phase wire system	Section 6.2.1
Un\G1	Input voltage	Section 6.2.2
Un\G2	Primary current	Section 6.2.3
Un\G3	Current demand time	Section 6.2.4
Un\G4	Electric power demand time	Section 6.2.5
Un\G5	Primary voltage of VT	Section 6.2.6

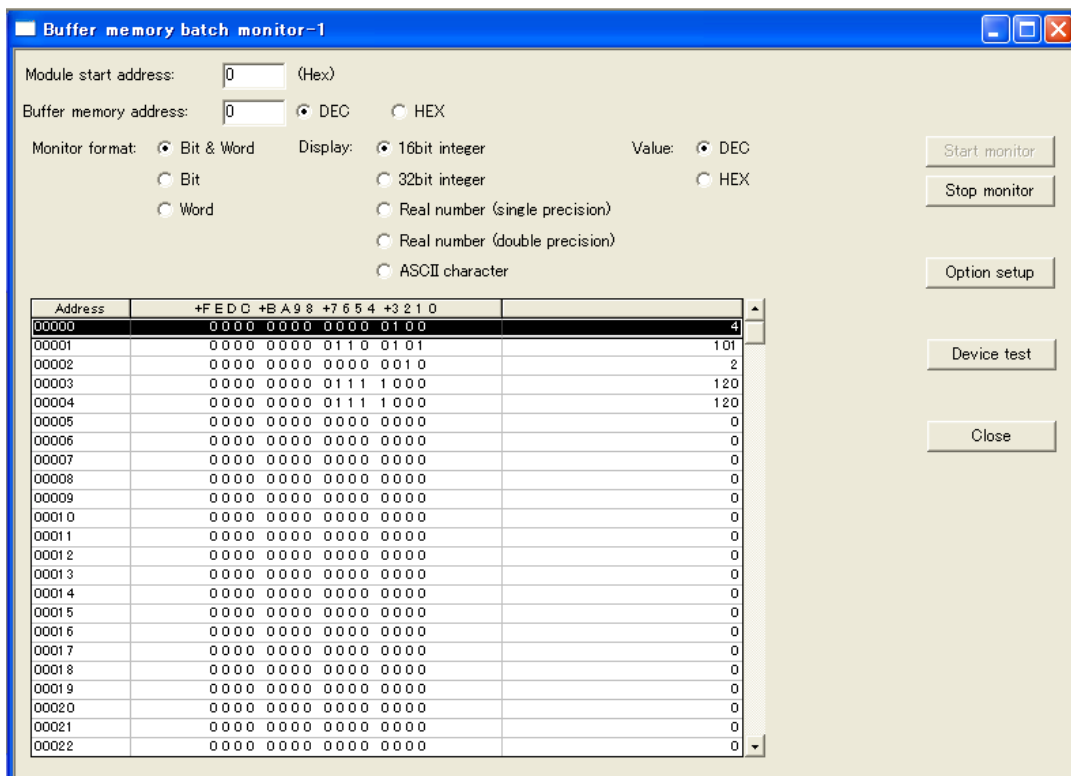

Figure 7.7.3-1 Dialog box to monitor all buffer memories (a case where the module is attached to the slot 0)

- (2) Set the Buffer memory
 - 1) In the dialog box to monitor all buffer memories, click the **Device test** button to display the Device test dialog box.
 - 2) In the Word device / buffer memory, specify the module initial address and buffer address, and click the **Set** button to apply the setting.

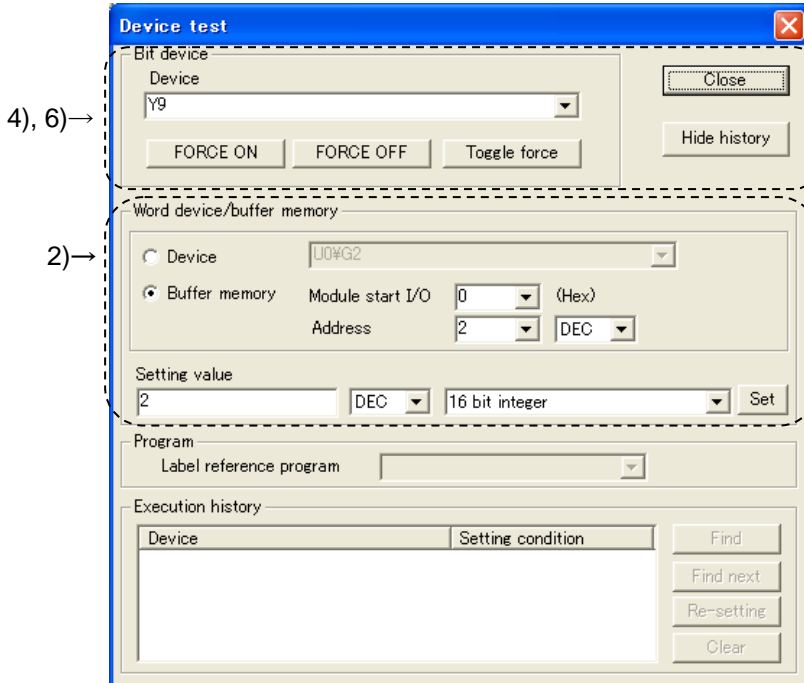

Figure 7.7.3-2 Device test dialog box (a case where this module is attached to the slot 0)

- 3) Change the setting in 2).
- 4) In the section of bit device setting in the device test dialog box, select “Y9”* and click the **FORCE ON** button.
- 5) When the setting is completed without any problem, the Device “X9”* changes to ON. Check this using the procedure as follows:
 - (a) From the “Online” menu, select “Monitor” – “Device batch ...”. The dialog box to monitor all devices is displayed.
 - (b) Set “X0”* to the device, and click “Start monitor”
 - (c) Check that Device “X9”* is in the ON status.

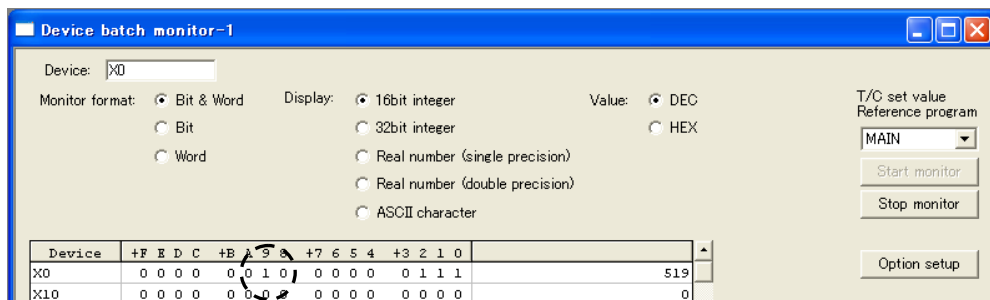

Figure 7.7.3-3 Checking the device “X9”* in the dialog box to monitor all devices

- 6) After checking that the device “X9”* is in the ON status, select “Device: “Y9”*” in the dialog box of device test, and then click the **FORCE OFF** button. Setting is completes.
 - 7) If the Device “X9”* is not in the ON status, this means an error because the set value is out of range (ERR.LED is flashing). Modify the setting, and change the device “Y9” to the OFF status, then change it back to the ON status.
- * Indicates a number in the case where the initial I/O number (initial XY) is set to 0.

7.7.4 Integrated value setting

This function is to set integrated value (electric energy (consumption, regeneration) and reactive energy (consumption lag)) to any value. If you want to clear integrated value, set it to 0.

(1) Check the current setting

- 1) From the "Online" menu, select "Monitor" – "Entry data monitor". After registering the address as shown below, click the Start monitoring button to check the current buffer memory status.

Table 7.7.4-1 List of setting items

Items	Buffer memory	Display
Integrated value setting target	Un¥G51	16bit
Integrated value setting value	Un¥G52	32bit
Electric energy(consumption)	Un¥G102	16bit
Integrated value set request	YC	16bit
Integrated value set completion flag	XC	16bit

2) Check item.

- (a) Set integrated value setting target (Un¥G51) in the buffer memory. Setting range is as follows:

Table 7.7.4-2 List of setting value

Setting value	Description
0	No set
1	Electric energy (consumption)
2	Electric energy (regeneration)
3	Reactive energy (consumption lag)

- (b) Set integrated value setting value (Un¥G52, 53) in the buffer memory.

- Configurable range: 0 to 999999999

- The unit used for the setting value is the same as that used for the electric energy and reactive energy that are output to the buffer memory.

For details, refer to section 6.3.1.

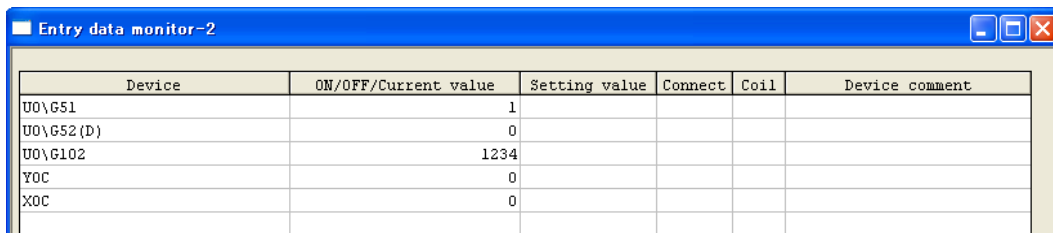

Figure 7.7.4-1 Dialog box to monitor all buffer memories (a case where the module is attached to the slot 0)

(2) Setting function for integrated value

This function is to set integrated value (electric energy (consumption, regeneration) and reactive energy (consumption lag)) to any value. If you want to clear integrated value, set it to 0.

- 1) In the dialog box to monitor all buffer memories, click the **Device test** button to display the Device test dialog box.
- 2) In the Word device / buffer memory, specify the module initial address and buffer address, and click the **Set** button to apply the setting.

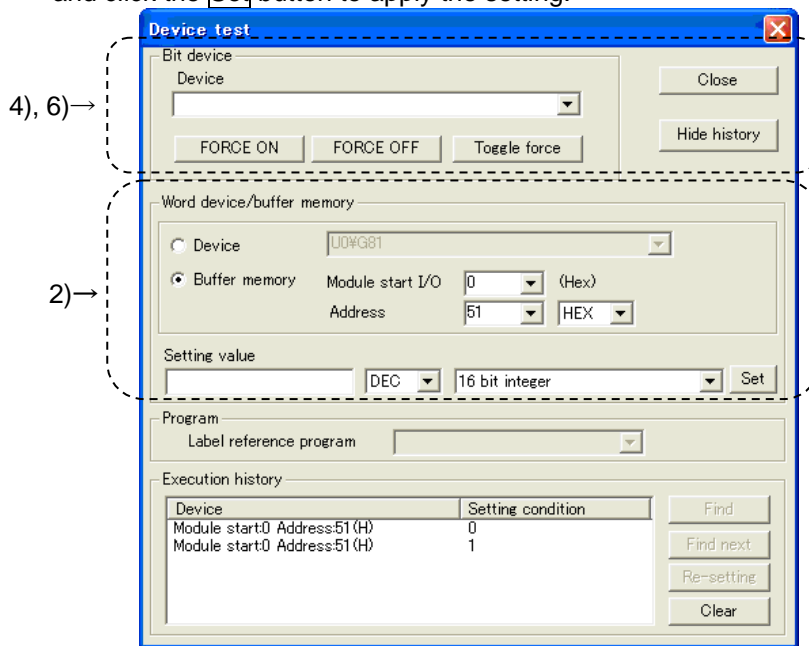

Figure 7.7.4-2 Device test dialog box (a case where this module is attached to the slot 0)

- 3) Change the setting in 2).
- 4) In the section of bit device setting in the device test dialog box, select “YC”^{*} and click the **FORCE ON** button.
- 5) When the setting is completed without any problem, the Device “XC”^{*} changes to ON.

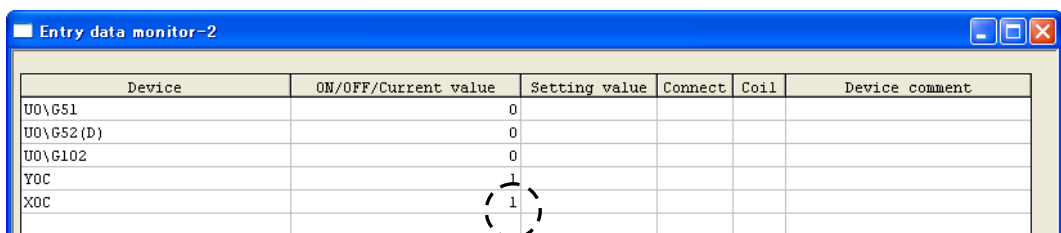

Figure 7.7.4-3 Checking the device “XC”^{*} in the dialog box to monitor all devices

- 6) After checking that the device “XC”^{*} is in the ON status, select “Device: “YC”^{*} in the dialog box of device test, and then click the **FORCE OFF** button. Setting is completes.
- 7) If the Device “XC”^{*} is not in the ON status, this means an error because the set value is out of range (ERR.LED is flashing). Modify the setting, and change the device “YC” to the OFF status, then change it back to the ON status.

* Indicates a number in the case where the initial I/O number (initial XY) is set to 0.

7.7.5 Debugging program

QE81WH4W provides a test function so that you can debug a program with no input of voltage or current. Pseudo-value can be stored into the buffer memory. For detailed explanation for the test function, refer to 4.2.5.

**Caution**

Test function stores pseudo-values for setting value and error information as well as measured value. If you use these data to control the sequence program that controls external devices, there is a chance that erroneous control may occur. For safety of external devices, use this function after disconnecting the device.

- (1) Setting intelligent function of the module switch
 - 1) In the "I/O assignment setting" of 7.7.1, click the **Switch setting** button to display the dialog box of "I/O module, intelligent function module switch setting".
 - 2) The intelligent function module switch setting displays switches 1 to 5; however, only the switch 5 is used for this purpose. Switch setting is configured using 16-bit data.
Setting is as follows:
Switch 5: "1"
 - 3) When the setting is completed, click the **End** button.
 - 4) From the "Online" menu, select "Write to PLC" to display the dialog box of Write to PLC, and then execute the writing to PLC parameter. After resetting the CPU module, the value will become effective.
- (2) Starting the test function
 - 1) Reset the CPU module.
 - 2) QE81WH4W starts in the test function mode. All LEDs are turned on. Pseudo-values are set effective in the buffer memory.
- (3) Finishing the test function (Move back to the normal operation)
 - 1) Following 1) and 2) in step (1), configure the intelligent function switch setting as shown below.
Switch 5: "0"
 - 2) Following 3) and 4) in step (1), complete the setting and write the data into PLC.
 - 3) Reset the CPU module, then the operation goes back to the normal operation.

Chapter 8: Programming

This chapter explains about programming for QE81WH4W.

When you apply sample programs introduced in this chapter into the actual system, make sure to verify in advance that there is no problem with the target system control.

Follow the procedure in Figure 8.1 to create a sample program using QE81WH4W.

The default setting allows you to use either GX Works2 (refer to 7.6), GX Developer (refer to 7.7) or the sequence program to make setting; however, if the setting is made for the first time by using GX Works2 or GX Developer, the program for initial setting can be eliminate, which will reduce time for scanning.

8.1 Programming procedure

Follow the procedure in Figure 8.1 to create a program for acquiring the measured data, alarm monitoring, calculating periodical electricity amount using QE81WH4W.

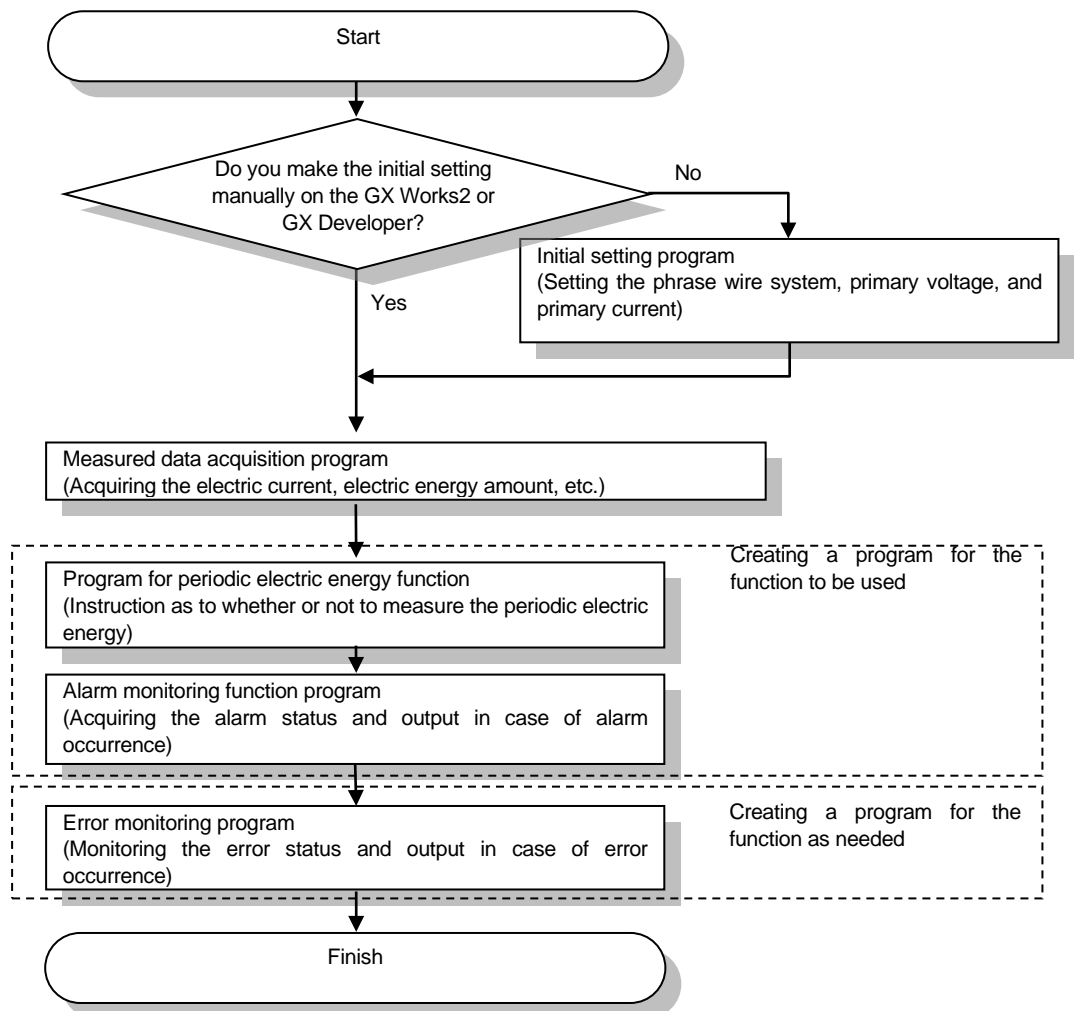

8.2 System configuration and usage conditions for sample program

A sample program under the following system and the usage condition is shown below.

(1) System configuration

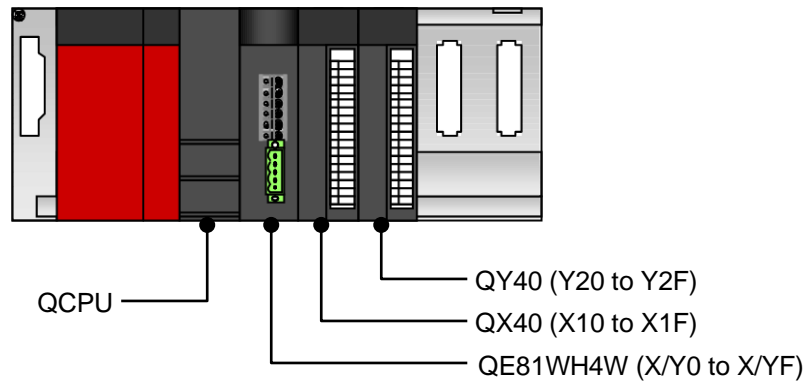

Figure 8.2 Sample system configuration using a sample program

(2) Setting conditions for the intelligent function of the module switch

Setting is as follows:

Table 8.1 Setting the intelligent function of the module switch

Switch No.	Switch name	Description
1	Not used	-
2	Not used	-
3	Not used	-
4	Not used	-
5	Test mode transition	0 (Normal operation)

(3) Programming conditions

(a) Setting the operating conditions

- Phase wire : Three-phase 4-wire
- Input voltage : 220 / 380 V
- Primary current : 250 A
- Current demand time : 30 sec
- Electric power demand time : 30 sec
- Primary voltage of VT : 0 (Without VT)

(b) Alarm monitoring setting

- Alarm 1 item : Current demand upper limit
- Alarm 1 value : 100000 (100 A)
- Alarm 1 reset method : Auto reset
- Alarm 1 delay time : 5 sec
- Alarm 2 item : Current demand upper limit
- Alarm 2 value : 120000 (120 A)
- Alarm 2 reset method : Self-retention
- Alarm 2 delay time : 5 sec

(c) Data acquisition clock setting

- Output period of data acquisition clock : 1000 (1sec)

(4) Before creating a program

Before creating a program, attach QE81WH4W to the base unit, and connect it to external devices.

Current sensor: EMU-CT250

Voltage transform module: QE8WH4VT

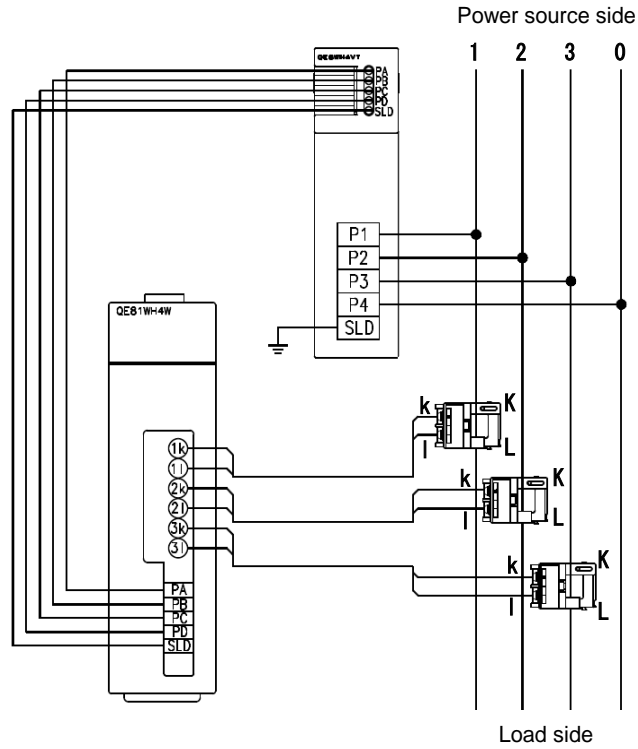

Figure 8.3 Example of wiring using a sample program

8.3 Sample programming

8.3.1 Sample program when make the initial setting using GX Works2 or GX Developer.

(1) List of devices

Table 8.3.1-1 List of devices

Device	Function	
D20	Device that stores latest error code	
X0	Module ready	QE81WH (X/Y0~X/YF)
XA	Alarm 1 flag	
XB	Alarm 2 flag	
XF	Error flag	
Y1	Periodic electric energy 1 measurement flag	
Y2	Periodic electric energy 2 measurement flag	
X10	Device that the user will turn ON in order to support measurement of periodic electric energy	QX40 (X10~X1F)
Y20	Device that turns ON to send an output to the external device when the alarm 1 occurs	QY40 (Y20~Y2F)
Y21	Device that turns ON to send an output to the external device when the alarm 2 occurs	
Y22	Device that turns ON to send an output to the external device in the case of an error	

(2) List of buffer memories to be used

Table 8.3.1-2 List of buffer memories to be used

Device	Description	Setting value	Remarks
U0\G3000	Latest error code	-	Stores latest error code

(3) Sample program

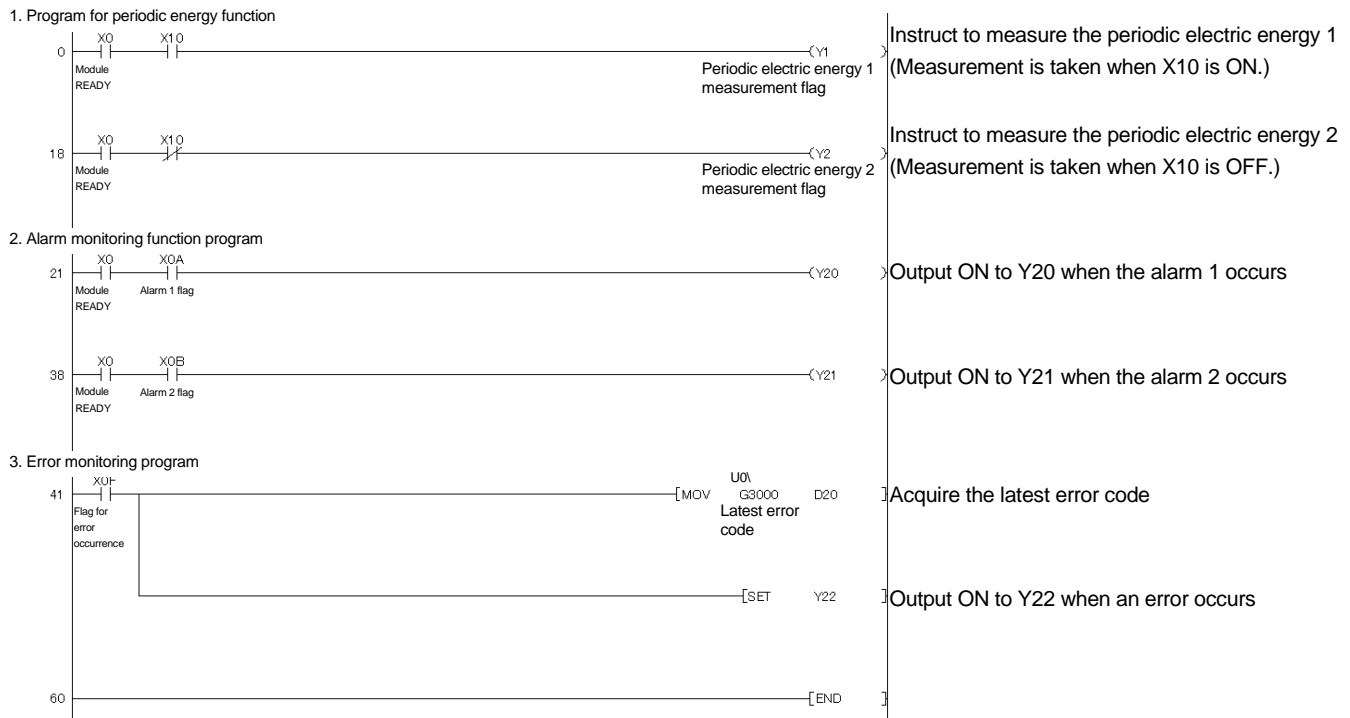

Figure 8.3.1-1 Example of a sample program

8.3.2 Sample program when make the initial setting using sequence program.

(1) List of devices

Table 8.3.2-1 List of devices

Device	Function	
D0, D1	Device that stores Multiplier of electric energy	
D2, D3	Device that stores electric energy (consumption)	
D4, D5	Device that stores Average current	
D6, D7	Device that stores Average value voltage (L-L)	
D8, D9	Device that stores Average value voltage (L-N)	
D10, D11	Device that stores electric energy	
D12, D13	Device that stores reactive energy	
D14, D15	Device that stores apparent power	
D20	Device that stores latest error code	
X0	Module ready	QE81WH (X/Y0~X/YF)
X8	Output period of data acquisition clock	
X9	Operating condition setting completion flag	
XA	Alarm 1 flag	
XB	Alarm 2 flag	
XF	Error flag	
Y1	Periodic electric energy 1 measurement flag	
Y2	Periodic electric energy 2 measurement flag	
Y9	Operating condition setting request	
X10	Device that the user will turn ON in order to support measurement of periodic electric energy	
Y20	Device that turns ON to send an output to the external device when the alarm 1 occurs	QY40 (Y20~Y2F)
Y21	Device that turns ON to send an output to the external device when the alarm 2 occurs	
Y22	Device that turns ON to send an output to the external device in the case of an error	

(2) List of buffer memories to be used

Table 8.3.2-2 List of buffer memories to be used

Device	Description	Setting value	Remarks
U0\G1	Primary voltage	2	220 V
U0\G2	Primary current	3	250 A
U0\G3	Current demand time	30	30 sec
U0\G4	Electric power demand time	30	30 sec
U0\G5	Primary voltage of VT	0	When Primary voltage(U0\G1) is except 0
U0\G6	Secondary voltage of VT	0	When Primary voltage(U0\G1) is except 0
U0\G7	Primary current of CT	0	When Primary current (U0\G2) is except 0
U0\G11	Alarm 1 item	1	Current demand upper limit
U0\G12, 13	Alarm 1 value	100000	100 A
U0\G14	Alarm 1 reset method	1	Auto reset
U0\G15	Alarm 1 delay time	5	5 sec
U0\G21	Alarm 2 item	1	Current demand upper limit
U0\G22, 23	Alarm 2 value	120000	120 A
U0\G24	Alarm 2 reset method	0	Self-retention
U0\G25	Alarm 2 delay time	5	5 sec
U0\G60,61	Output period of data acquisition clock	1000	1 sec
U0\G100	Multiplier of electric energy	-	Stores multiplier of electric energy
U0\G102, 103	Electric energy (consumption)	-	Stores electric energy
U0\G218, 219	Average current	-	Stores Average current
U0\G314, 315	Average voltage	-	Stores Average voltage
U0\G316, 317	Average value voltage (L-N)	-	Stores average value voltage (L-N)
U0\G402, 403	Active energy	-	Stores active energy
U0\G502, 503	Reactive energy	-	Stores reactive energy
U0\G602, 603	Apparent power	-	Stores apparent power
U0\G702, 703	Power factor	-	Stores power factor
U0\G802, 803	Frequency	-	Stores frequency
U0\G3000	Latest error code	-	Stores latest error code

(3) Example of sample program

1. Initial setting program for QE81WH

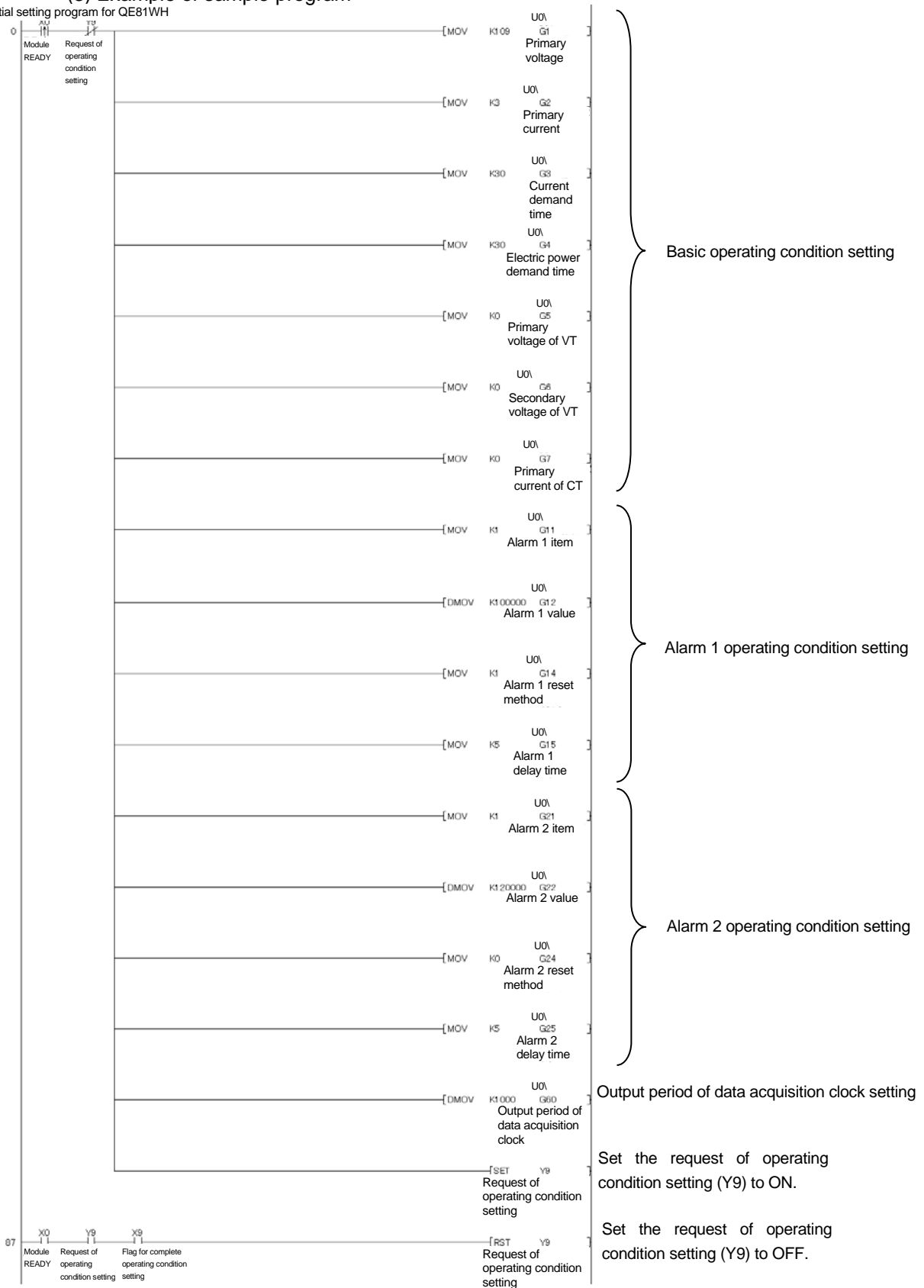

2. Measured data acquisition program

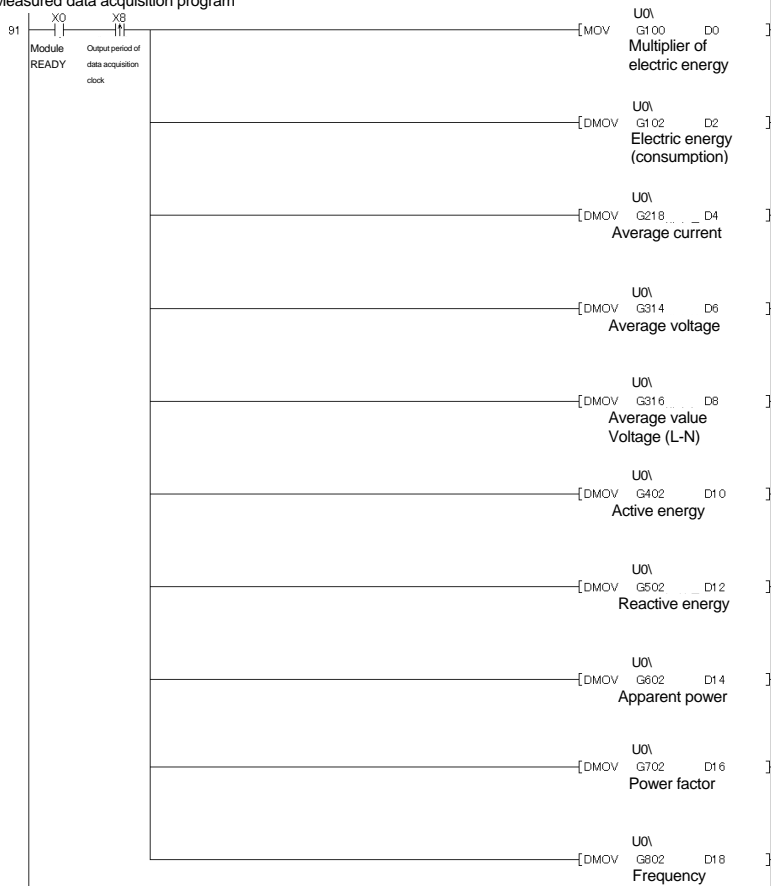

Acquire each type of the measured values

3. Program for periodic energy function

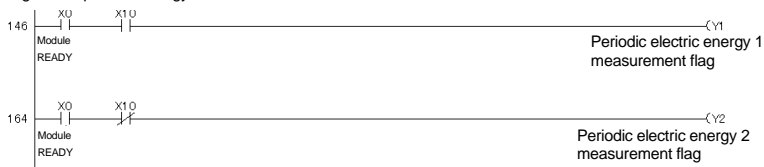

Instruct to measure the periodic electric energy 1 (Measurement is taken when X10 is ON.)

Instruct to measure the periodic electric energy 2 (Measurement is taken when X10 is OFF.)

4. Alarm monitoring function program

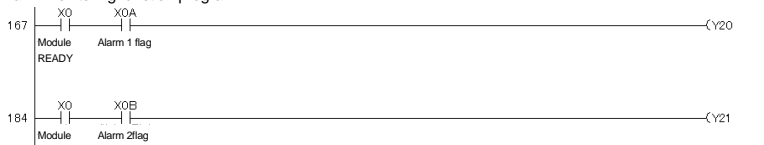

Output ON to Y20 when the alarm 1 occurs

Output ON to Y21 when the alarm 2 occurs

5. エラー監視プログラム (Error monitoring program)

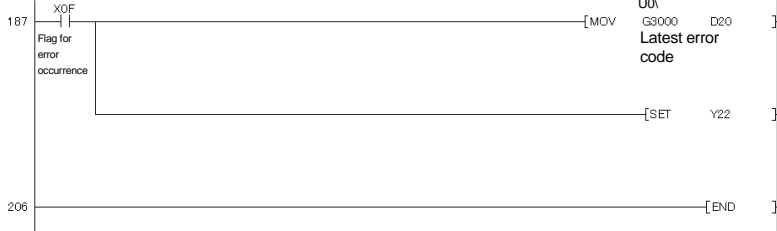

Acquire the latest error code

Output ON to Y22 when an error occurs

Figure 8.4 Example of a sample program (continued)

Chapter 9: Troubleshooting

9.1 List of error codes

When the data are written to the CPU module from this module or when a reading error occurs, error codes will be stored into the following buffer memory.

Table 9.1 Latest error code, storage destination upon error occurrence

Latest error code	Time of error occurrence
Un\G3000	Un\G3001 to Un\G3004

Table below shows error codes.

Table 9.2 List of error codes

Error code (HEX)	Error level	Descriptions	Action	Reference
0001h 0002h 0003h	Mid	Hardware error with the module.	Turn the power OFF/ON. If the error recurs, the module may have a failure. Consult with a nearest sales agent or our company branch for the symptom of the failure.	-
1001h	Low	Phase wire system (Un\G0) is set out of range.	Check phase wire system, and set it within 1-3.	Section 6.2.1
1002h	Low	Input voltage (Un\G1) is set out of range.	Set it within 1 to 9 according to the input voltage.	Section 6.2.2
1003h	Low	Primary current (Un\G2) is set out of range.	Set it within the range* of 1 to 5, 501 to 536 according to the primary current.	Section 6.2.3
1004h	Low	Current demand time (Un\G3) is set out of range.	Set current demand time within the range* of 0 to 1800 (seconds).	Section 6.2.4
1005h	Low	Electric power demand time (Un\G4) is set out of range.	Set electric power demand time within the range* of 0 to 1800 (seconds).	Section 6.2.5
1006h	Low	Alarm 1 item (Un\G11) is set out of range.	Set alarm 1 item within 1 to 8.	Section 6.2.7
1007h	Low	Alarm 2 item (Un\G21) is set out of range.	Set alarm 2 item within 1 to 8.	Section 6.2.7
1008h	Low	Alarm 1 reset method (Un\G14) is set out of range.	Set alarm 1 reset method within 0 to 1.	Section 6.2.9
1009h	Low	Alarm 2 reset method (Un\G24) is set out of range.	Set alarm 2 reset method within 0 to 1.	Section 6.2.9
100Ah	Low	Alarm 1 delay time (Un\G15) is set out of range.	Set alarm 1 delay time within the range* of 0 to 300 (seconds).	Section 6.2.10
100Bh	Low	Alarm 2 delay time (Un\G25) is set out of range.	Set alarm 2 delay time within the range* of 0 to 300 (seconds).	Section 6.2.10
100Ch	Low	Electric energy preset value (Un\G52, 53) is set out of range.	Set electric energy preset value within the range* of 0 to 999999999 in the double word format (32-bit integer).	Section 6.2.11
100Dh	Low	Primary voltage of VT value (Un\G5) is set out of range.	Set primary voltage of VT value within the range* of 0 to 6600 (V).	Section 6.2.6
1041h	Low	Output period of data acquisition clock (Un\G60, 61) is set out of range.	Output period of data acquisition clock within the range* of 0 to 86400000 (ms).	Section 6.2.12
0000h	-	Normal	-	-

* Also check that it is set in decimal.

9.2 Troubleshooting

9.2.1 When "RUN" LED is turned off

Table 9.3 When "RUN" LED is turned off

Check item	Action	Reference
Is power source is supplied?	Check that supply voltage of the power source is within the rating.	Section 3.1
Is capacity of the power source module sufficient?	Calculate the consumption current of CPU module, I/O module, and intelligent function module attached to the base unit, and check that the power capacity is sufficient.	-
Is the watchdog time an error?	Reset CPU module, and check whether it is turned on. If RUN LED is not turned on even after doing the above, the module may have a failure. Consult with a nearest sales agent or our company branch for the symptom of the failure.	-
Is the module properly attached to the base unit?	Check the module attachment status.	-
Is the slot type set to "empty" in the I/O assignment setting of the PC parameter at GX Developer?	Set the slot type to "Intelligent".	Section 7.5.1

9.2.2 When "ERR." LED is turned on or flashing

(1) If it is ON

Table 9.4 When "ERR." LED is turned on

Check item	Action	Reference
Did any error occur?	Check latest error code (Un\G3000), and take a corrective action as described in section 9.1. After that, reset CPU module, and check whether it is turned on. If "ERR." LED is turned on even after doing the above, the module may have a failure. Consult with a nearest sales agent or our company branch for the symptom of the failure.	Section 9.1

(2) If it is flashing

Table 9.5 When "ERR." LED is flashing

Check item	Action	Reference
Did any error occur?	The set value may be out of range. Check that the operating condition settings and the integrated value are correct. Correct configuration or changing the request for error clear (YF*) to ON will recover the error. When the error is cleared using the error clear request (YF*), the operation continues with the previous setting. * In the case where the initial I/O number of this module is 0	Section 7.5.3 Section 6 Section 5.2.2

9.2.3 If the electric energy can't be measured correctly.

Table 9.6 If the electric energy can't be measured correctly.

Check item		Action	Reference
"MEA." LED	"1" "2" "3" LED		
OFF	All "1", "2" and "3" LED are OFF.	The type of current sensor may be incorrect. In addition, if the rating of the used sensor is different from the primary current, measurement cannot be taken correctly.	Section 7.5
		Wiring is not done or wrong. Refer to 7.4 to check the wiring.	
		Current sensor on side 1 may be installed in the reverse order or current sensors on side 1, side 2, and side 3 may be swapped. Check the connection.	
Flashing	All "1", "2" and "3" LED are OFF.	Current sensor on side 1 or 2 or 3 may be installed in the reverse order. Check the connection.	
		Connection of voltage line may be incorrect.	
ON Or Flashing	Only "1" is ON.	Connection between P1 and P2 or P1 and P3 or P1 and P0 may be reserved. Check the connection.	
		Current sensor on side 2 may be installed in the reverse order or current sensors on side 1, side 2, and side 3 may be swapped. Check the connection.	
	Only "2" is ON.	Connection between P1 and P2 or P2 and P3 or P2 and P0 may be reserved. Check the connection.	
		Current sensor on side 3 may be installed in the reverse order or current sensors on side 1 and side 3 may be swapped. Check the connection.	
	Only "3" is ON.	Connection between P2 and P3 or P1 and P3 or P3 and P0 may be reserved. Check the connection.	
		Measurement is taken normally. Check for the correct buffer memory address and data format (double word: 32-bit integer).	
ON	All "1", "2" and "3" LED are OFF.	Measurement is taken correctly in regenerated side.	Chapter 6

9.2.4 If the electric current and voltage that are measured using this module do not match with the ones measured with other gauge

Table 9.7 If current and voltage that are measured using this module do not match with the ones measured with other gauge

Check item	Action	Reference
Are primary current, and input voltage correct?	Check the value in the buffer memory for checking input current and primary voltage. When the value in the buffer memory is changed, you need to turn the request for operating condition setting into ON. Otherwise, it will not be applied to the measurement.	Section 7.5.3
Does the compared gauge measure the effective value correctly?	This module stores the effective value into the buffer memory. If the compared device uses the average value instead of the effective value, the resulted value may largely differ when there is current distortion in the measurement circuit.	-
Is the secondary of CT short-circuited?	Make sure that the secondary of CT is not short-circuited. If it is connected to Mitsubishi's current transformer CW-5S(L), check that the secondary switch is not short-circuited.	-
Are you using other current sensor than recommended ones?	Only the dedicated current sensors can be connected to this module. Check that other company's sensor is not being used.	-
Are you using the voltage transform module?	Circuit voltage cannot be entered directly into this module. Enter the output voltage of the voltage transform module (QE8WH4VT).	-
Do you connect the voltage transform module has been done correctly?	Please check whether wiring of the is voltage transform module performed correctly.	-

9.3 Q&A

9.3.1 General

Q	To what degree is the module durable against overvoltage and overcurrent? Is external protective circuit required?
A	<p>Momentary* : Up to 2 times as high as rated voltage and 20 times as high as rated current. Continuous : Up to 1.1 times as high as rated voltage and rated current.</p> <p>* Momentary means: Energizing 9 times for 0.5 seconds at 1-minute intervals, and then 1 time for 5 seconds.</p> <p>External protective circuit is not required.</p>
Q	Can the module be used as an electric energy meter?
A	<p>This module can be used to measure the electric energy and to manage the use of electric energy.</p> <p>However, it cannot be used for deal and proof of electric energy measurement stipulated in the measurement law.</p>
Q	Are errors in wiring verifiable easily?
A	<p>They are verifiable by the illuminating condition of "MEA.," "1," "2," and "3" LEDs on the front of the module.</p> <p>Refer to Section 9.2.3 for details.</p>
Q	Is it OK to open the secondary terminals of the current sensor?
A	<p>The secondary side of the models EMU2-CT5-4W, EMU-CT50, EMU-CT100, EMU-CT250, EMU-CT5-A, EMU-CT50-A, EMU-CT100-A, EMU-CT250-A, EMU-CT400-A, and EMU-CT600-A is equipped with the protective circuit against opening of secondary terminals. Opening them during the wiring work causes no problems. However, for safety, please do not continuously energize the module with the terminals open.</p> <p>The secondary side of the models EMU-CT400 and EMU-CT600 is equipped with the protective circuit against opening of secondary terminals. However, during the wiring work, be sure to turn the secondary side short-circuit switch to short. After completion of work, be sure to turn the secondary short-circuit switch to open. Note that failing to turn the switch open results in an inaccurate measurement.</p>
Q	Is measurement of inverter circuit possible?
A	<p>Measuring the secondary side of the inverter is impossible due to the large fluctuation of frequency.</p> <p>Make measurement on the primary side of the inverter. However, since a current waveform on the primary side of the inverter has a distortion containing the harmonic components, a slight error occurs.</p>

Q	If a load such as welding equipment exists, a current flows only for a short period (e.g. 2-cycle waveform of commercial frequency (50 Hz: 40 ms, 60 Hz: 33 ms)). Is accurate measurement possible?
A	<p>This module makes measurement with a sampling period of 4340 Hz (for both 50 Hz and 60 Hz). However, measuring part of buffer memory data (Un¥G100 to Un¥G2999) is updated every 250 ms. The electrical amount such as current, voltage, electric power, power factor, and frequency is measured in a cycle of 250 ms period.</p> <p>It is impossible to measure the instantaneous short-term amount of electricity. The amount of electricity and reactive power amount are measured separately from the momentary data described above, using a sampling period of 4340 Hz continuously without intermittence. Therefore, measuring the load for a short period is possible.</p>

Q	Obtained values may be different from other measuring instruments. Why is it so?
A	<p>There are various possible causes. Check the following first, please:</p> <p>[1] Check for wiring errors (polarity of current sensors, connections of current circuits, and connections of voltage circuits, in particular).</p> <p>[2] On the split-type current sensor, check for the poor engagement or separation of fitting surfaces.</p> <p>[3] On the split-type current sensor, check for pinching of foreign object between fitting surfaces.</p> <p>[4] Check that the measuring instrument used for comparison indicates a correct RMS value.</p> <p>[5] If the measuring instrument used for comparison measures an average value instead of rms value, distortion in the current of the circuit to be measured causes a significant difference of values. This module measures an rms value.</p> <p>[6] Check for the short-circuit on the secondary side of the current transformer (CT).</p> <p>[7] Current sensor connectable to the module is the dedicated current sensor only. Check that the proper current sensor is connected or not.</p>

9.3.2 Q&A about Specifications

Q	What accuracy does “measuring accuracy” mean?
A	<p>In terms of the amount of electricity, it means a range of tolerances in reading values. For example, when the reading value is “10 kWh,” a tolerance is ± 0.2 kWh.</p> <p>In terms of measuring elements other than the amount of electricity, it means tolerance for the rated input. For a current, when a rated current is set to 250 A, $\pm 1\%$ of 250 A is a tolerance.</p>

Q	Is accuracy of a current sensor and the voltage transform module included?
A	<p>Accuracy of a current sensor and the voltage transform module are not included in accuracy of the module.</p> <p>A maximum value of tolerance is obtained by summing tolerance of the module and that of a current sensor and the voltage transform module.</p>

Q	To what degree an area of microcurrent is measured?
A	<p>A current value is measured from the area exceeding 0.4% of the rated current. In an area below 0.4%, measurement result is indicated as “0” (zero).</p> <p>However, in that case, still, the amount of electricity is being measured. Even if the indicated value is “0,” measurement value will increase in continuing measurement for a long time. The amount of electricity is measured with a load that is about 0.4% or more of all load power.</p>

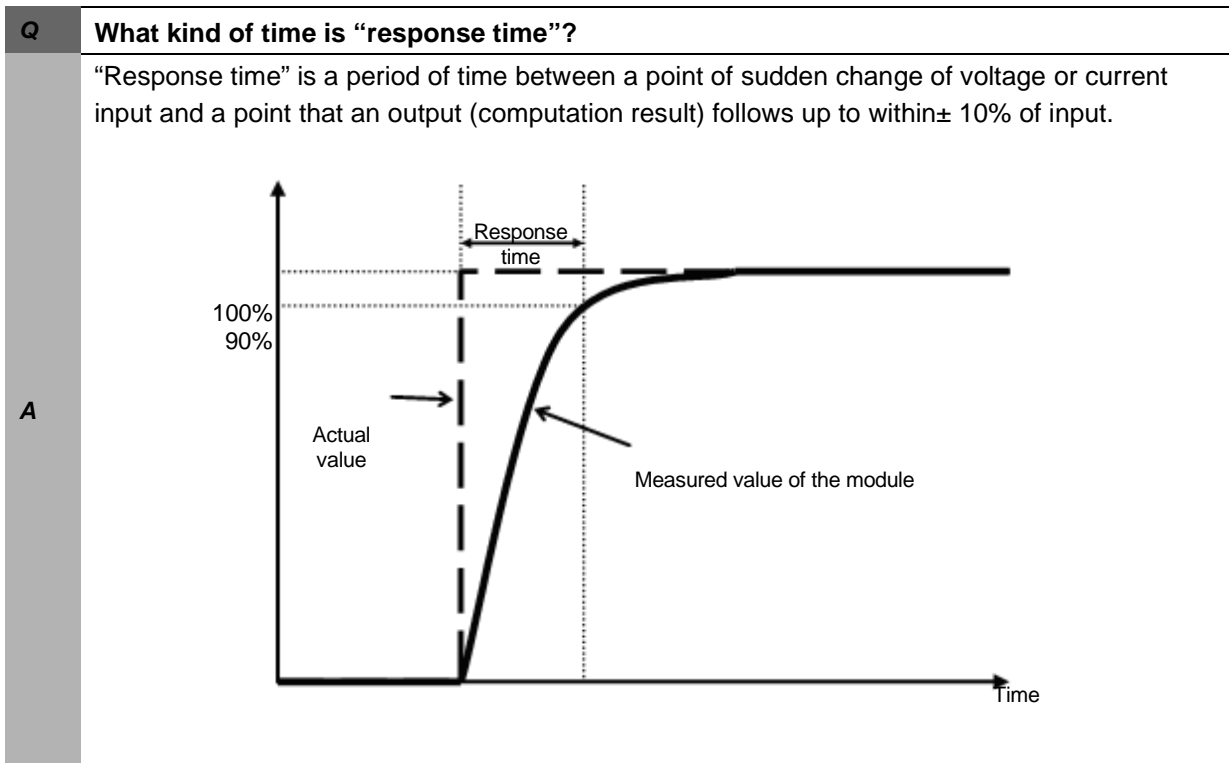

9.3.3 Q&A about Installing

Q	What is wire diameter that allows installing a current sensor?
A	<p>The nominal cross-sectional areas of the conductor of 600-V vinyl coated wires that can penetrate (values for reference), refer to 7.5.3.1.</p> <p>The above shows the standard nominal cross-sectional areas. Due to the outer difference of finished vinyl insulation and deformation (bending) depending on manufacturers, a wire may not penetrate.</p> <p>Make verification on site.</p>
Q	What are the points when installing a current sensor?
A	<p>Models EMU2-CT5-4W, EMU-CT*** and EMU-CT***-A are split-type. If split surfaces are not engaged sufficiently or a foreign object exists between the split surfaces, adequate performances are not obtained. Pay attention in installation.</p>

9.3.4 Q&A about Connection

Q	Does polarity exist in connection between a current sensor and the module?
A	Yes, it does. Make connections so that secondary terminals of current sensor (k, l) and terminal symbols of module agree with each other. If polarity is incorrect, the current value is measurable, but the electric power and the electrical energy cannot be measured correctly.
Q	Does polarity exist in connection between a voltage transform module and the module?
A	Yes, it does. Make connections so that output terminals of voltage transform module (PA, PB, PC, PD) and terminal symbols of module agree with each other. If polarity is incorrect, the voltage value, the electric power and the electrical energy cannot be measured correctly.
Q	Are there any key points in avoiding errors in wiring?
A	Check polarity of current sensor on the primary current side. Power supply side of the circuit is indicated as "K," and the load is indicated as "L." An arrow indicates the direction from K to L. Check the current sensor and the module are connected correctly for the 1-side circuit, 2-side circuit, and 3-side circuit. Besides, check that voltage inputs for voltage transform module are connected correctly among P1, P2, P3, and P0.
Q	How do wires extend between a current sensor and the module?
A	Model EMU-CT***, EMU-CT***-A are extendable up to 50 m. Model EMU2-CT5-4W is extendable up to 11 m, using together with extension cable. To extend the wire further, use the current transformer CW-5S(L) for split-type instrument in combination, extending the secondary wiring on CW-5S(L) side.

9.3.5 Q&A about Setting

Q	Is the setting required?
A	At least, settings of, primary current and input voltage are required. Specify settings in accordance with a circuit to be connected.
Q	If a primary current setting value is different from that of rated current on a connected current sensor, does it cause a breakdown?
A	It does not cause breakdown or burning. However, measurement values will be totally incorrect.

Appendix

Appendix 1: External dimensions

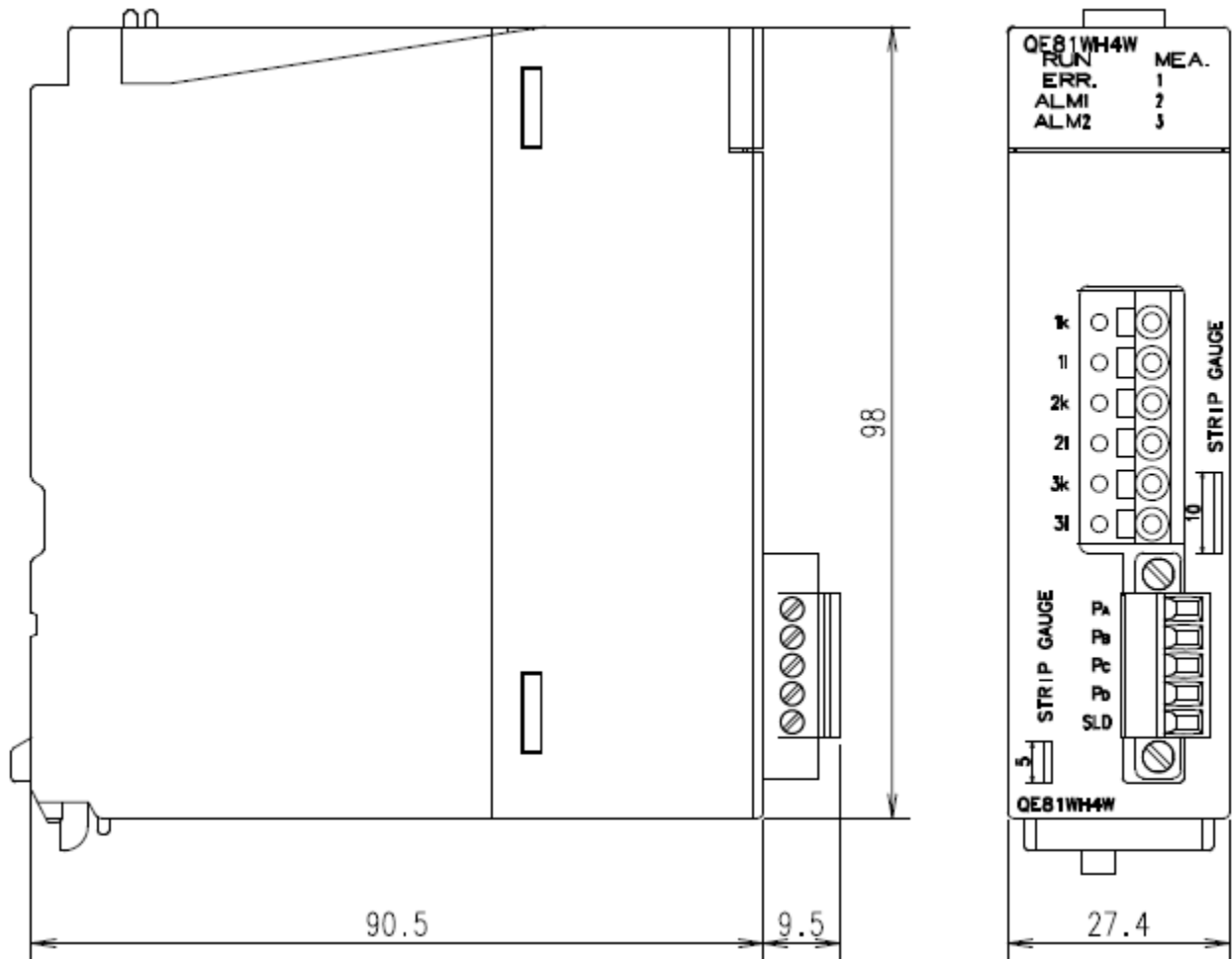

Unit [mm]

Appendix 2: Optional devices

■ Split type current sensor

Item	Specifications				
Model	EMU-CT50	EMU-CT100	EMU-CT250	EMU-CT400	EMU-CT600
Rated primary current	50A AC	100A AC	250A AC	400A AC	600A AC
Rated secondary current	16.66mA	33.33mA	66.66mA	66.66mA	66.66mA
Rated burden	0.1VA				
Maximum voltage (voltage to ground/line voltage)	460V AC				
Ratio error	±1% (5% to 100% of rating, $RL \leq 10\Omega$)				
Phase displacement	±0.9 c rad (5% to 100% of rating, $RL \leq 10\Omega$)				
Measurement(installation)category	III				
Pollution degree	2				
Working temperature range	-5°C to +55°C (daily mean temperature: 35°C or less)				
Working humidity range	5% to 95%RH (no condensation)				
CE marking conformity standard	EN61010-2-32				
CE marking conformity standard Maximum voltage (voltage to ground/line voltage)	460V AC				
Weight (per one)	0.1kg			0.7kg	

*Use an electric wire of the size of penetrating this current sensor for a primary side cable, do not use a non-insulation electric wire or a metal for a primary cable.

*EMU-CT400 and EMU-CT600 are stopped.

Item	Specifications				
Model	EMU-CT50-A	EMU-CT100-A	EMU-CT250-A	EMU-CT400-A	EMU-CT600-A
Rated primary current	50A AC	100A AC	250A AC	400A AC	600A AC
Rated secondary current	16.66mA	33.33mA	66.66mA	66.66mA	66.66mA
Rated burden	0.1VA				
Maximum voltage (voltage to ground/line voltage)	460V AC				
Ratio error	±1% (5% to 100% of rating, $RL \leq 10\Omega$)				
Phase displacement	±1.3 c rad (10% to 100% of rating, $RL=10\Omega$) ±1.8 c rad (5% of rating, $RL=10\Omega$)		±1.2 c rad (5% to 100% of rating, $RL=10\Omega$)	±1.2 c rad (5% to 100% of rating, $RL \leq 10\Omega$)	
Measurement(installation)category	-			III	
Pollution degree	-			2	
Working temperature range	-5°C to +55°C (daily mean temperature: 35°C or less)				
Working humidity range	30% to 85%RH (no condensation)				
CE marking conformity standard	-			EN61010-2-32	
CE marking conformity standard Maximum voltage (voltage to ground/line voltage)	-			460V AC	
Weight (per one)	0.05kg	0.1kg	0.2kg	0.3kg	0.4kg

*Use an electric wire of the size of penetrating this current sensor for a primary side cable, do not use a non-insulation electric wire or a metal for a primary cable.

■ 5A current sensor

Item	Specifications	
	EMU2-CT5-4W	EMU-CT5-A
Model	EMU2-CT5-4W	EMU-CT5-A
Rated primary current	5A AC	
Rated secondary current	1.66mA	
Rated burden	0.1VA	
Maximum voltage (voltage to ground/line voltage)	260V AC	460V AC
Ratio error	±1% (5% to 100% of rating, $R_L \leq 10\Omega$)	±1% (5% to 100% of rating, $R_L \leq 10\Omega$)
Phase displacement	±0.9 c rad (5% to 100% of rating, $R_L \leq 10\Omega$)	±1.3 c rad (10% to 100% of rating, $R_L = 10\Omega$) ±1.8 c rad (5% of rating, $R_L = 10\Omega$)
Measurement(installation)category	III	-
Pollution degree	II	-
Working temperature range	-5°C to +55°C (daily mean temperature: 35°C or less)	-5°C to +55°C (daily mean temperature: 35°C or less)
Working humidity range	5% to 95%RH (no condensation)	30% to 85%RH (no condensation)
CE marking conformity standard	EN61010-2-32	-
CE marking conformity standard Maximum voltage	260V AC	-
Weight (per one)	0.1kg	0.05kg

*Use an electric wire of the size of penetrating this current sensor for a primary side cable, do not use a non-insulation electric wire or a metal for a primary cable.

■ Voltage transform module

Item		Specification
Model		QE8WH4VT
Phase wire system		Three-phase 4-wire
Input voltage range		63.5/110 to 277/480 V AC (The product does not operate on the voltage below 55/95 V AC.)
Frequency		50 Hz/60 Hz
Voltage output tolerance		±1.0% (against the rated primary voltage)
Measurement category		III
Pollution degree		II
Maximum number of connections		5 modules
Operating condition	Operating temperature	0°C to +55°C (Average daily temperature 35°C or below)
	Operating humidity	5% to 95% RH (without condensation)
	Storage temperature	-25°C to +75°C
	Altitude	2000 m or lower
Commercial frequency withstand voltage		Between voltage input terminals (P1, P2, P3, P0) and FG terminal: 2210 V AC 5 sec Between voltage input terminals (P1, P2, P3, P0) and secondary output terminals (PA, PB, PC, PD) (except for SLD terminal) 2210 V AC 5 sec
Insulation resistance		10 MΩ or more (500 V DC) at the same locations as above
Consumption VA		P1-P0: 2 VA, P2-P0: 0.3 VA, P3-P0: 0.3 VA (when inputting 277/480 V AC)
Installation location		Inside the control panel
Secondary wire length		5 m or less
Installation method		Installation on IEC rails, installation with screws
Weight		0.3kg
Product life expectancy		10 years (used under the operating conditions above.)
CE marking compliance		EN 61131-2, EN 61010-1, EN 61326-1
Combined device for CE marking compliance		Compliant with CE when combined with the energy measuring module of Mitsubishi general-purpose sequencer MELSEC-Q series.
Combined device for UL/c-UL compliance		Compliant with UL/c-UL when combined with the energy measuring module of Mitsubishi general-purpose sequencer MELSEC-Q series.

■ Current sensor

◆ EMU-CT50, EMU-CT100, EMU-CT250

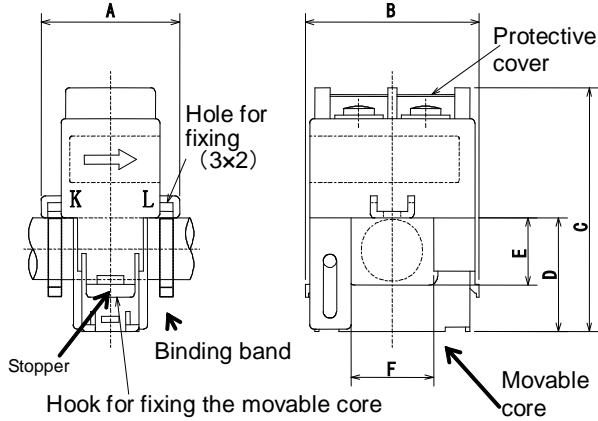

Model	A	B	C	D	E	F
EMU-CT50/CT100	31.5	39.6	55.2	25.7	15.2	18.8
EMU-CT250	36.5	44.8	66	32.5	22	24

◆ EMU-CT400, EMU-CT600

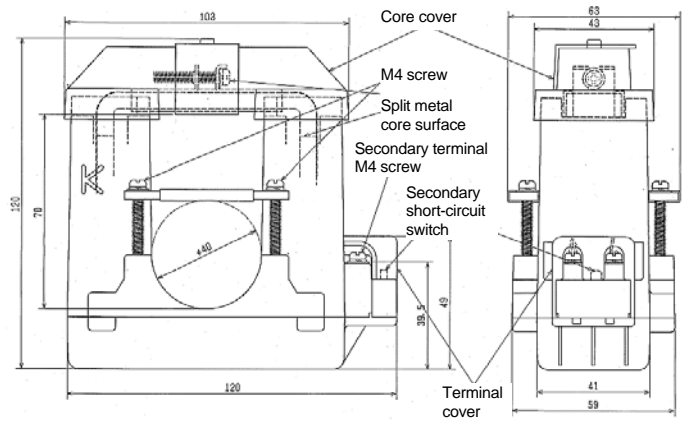

Unit [mm]

◆ EMU-CT5-A, EMU-CT50-A, EMU-CT100-A

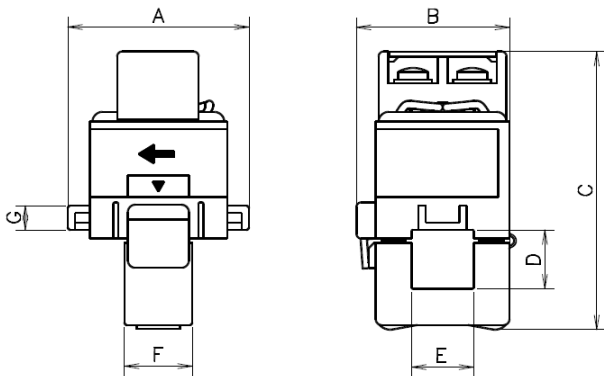

Model	A	B	C	D	E	F	G
EMU-CT5-A	37.4	31.6	57.5	12.2	12.8	14	5
EMU-CT50-A	43.6	33.6	65	16.2	16.2	19	5

Unit [mm]

◆ EMU-CT250-A, EMU-CT400-A, EMU-CT600-A

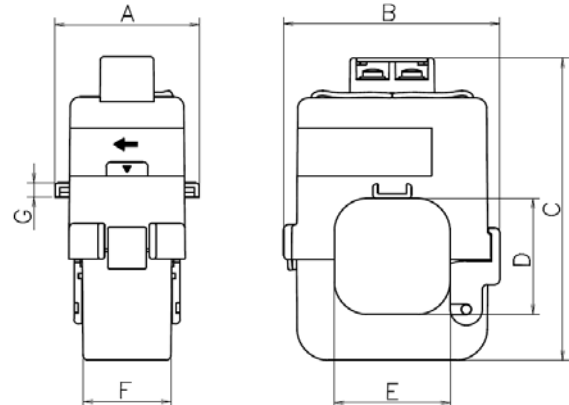

Model	A	B	C	D	E	F	G
EMU-CT250-A	42.6	49.4	74.5	24	24	25.2	4.5
EMU-CT400-A	44.9	67.2	94	36	36	27	4.5

Unit [mm]

◆ EMU2-CT5-4W

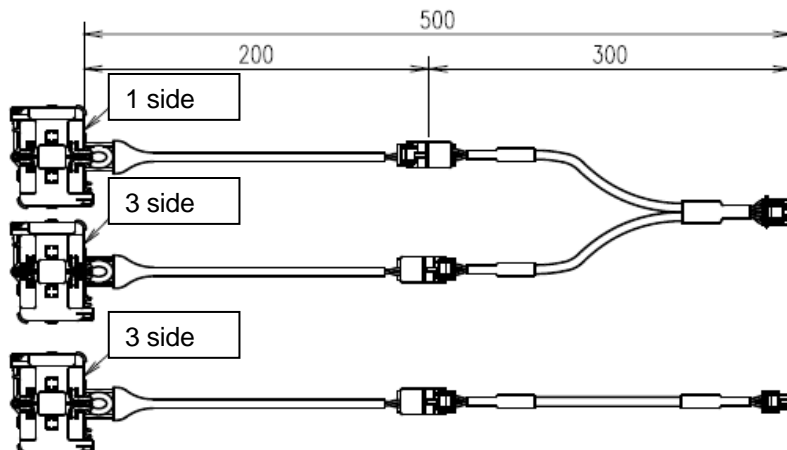

Unit [mm]

Sensor in detail

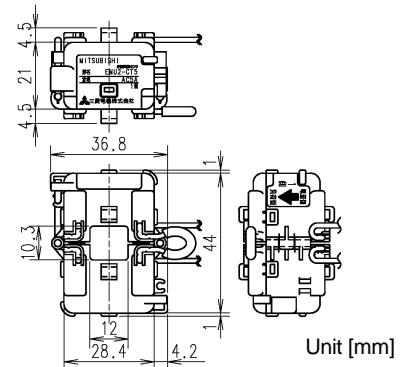

Unit [mm]

■ Dedicated cable

◆ 5A current sensor cable EMU2-CB-Q5A-4W

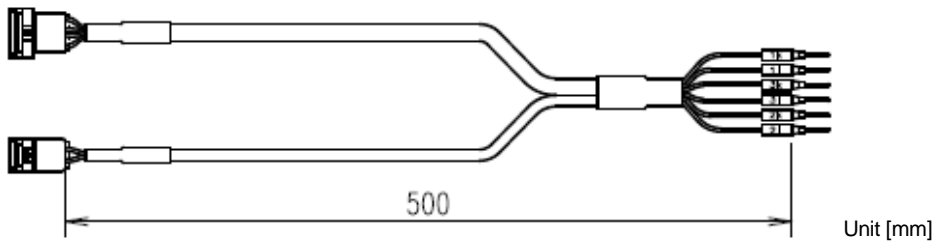

◆ Extension cable(standard) EMU2-CB-T**M

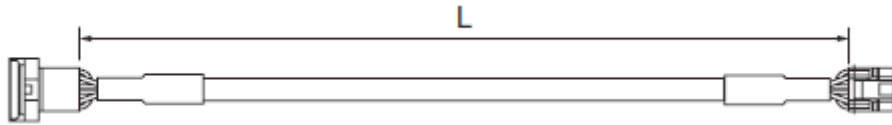

Model	EMU2-CB-T1M	EMU2-CB-T5M	EMU2-CB-T10M
Length	1000mm	5000mm	10000mm

◆ Extension cable(separate) EMU2-CB-T**MS

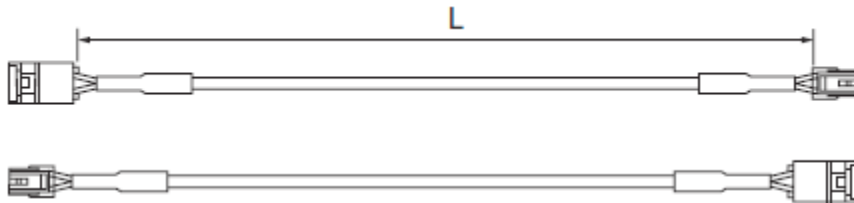

Model	EMU2-CB-T1MS	EMU2-CB-T5MS	EMU2-CB-T10MS
Length	1000mm	5000mm	10000mm

- Dedicated voltage transform module
- ◆ QE8WH4VT

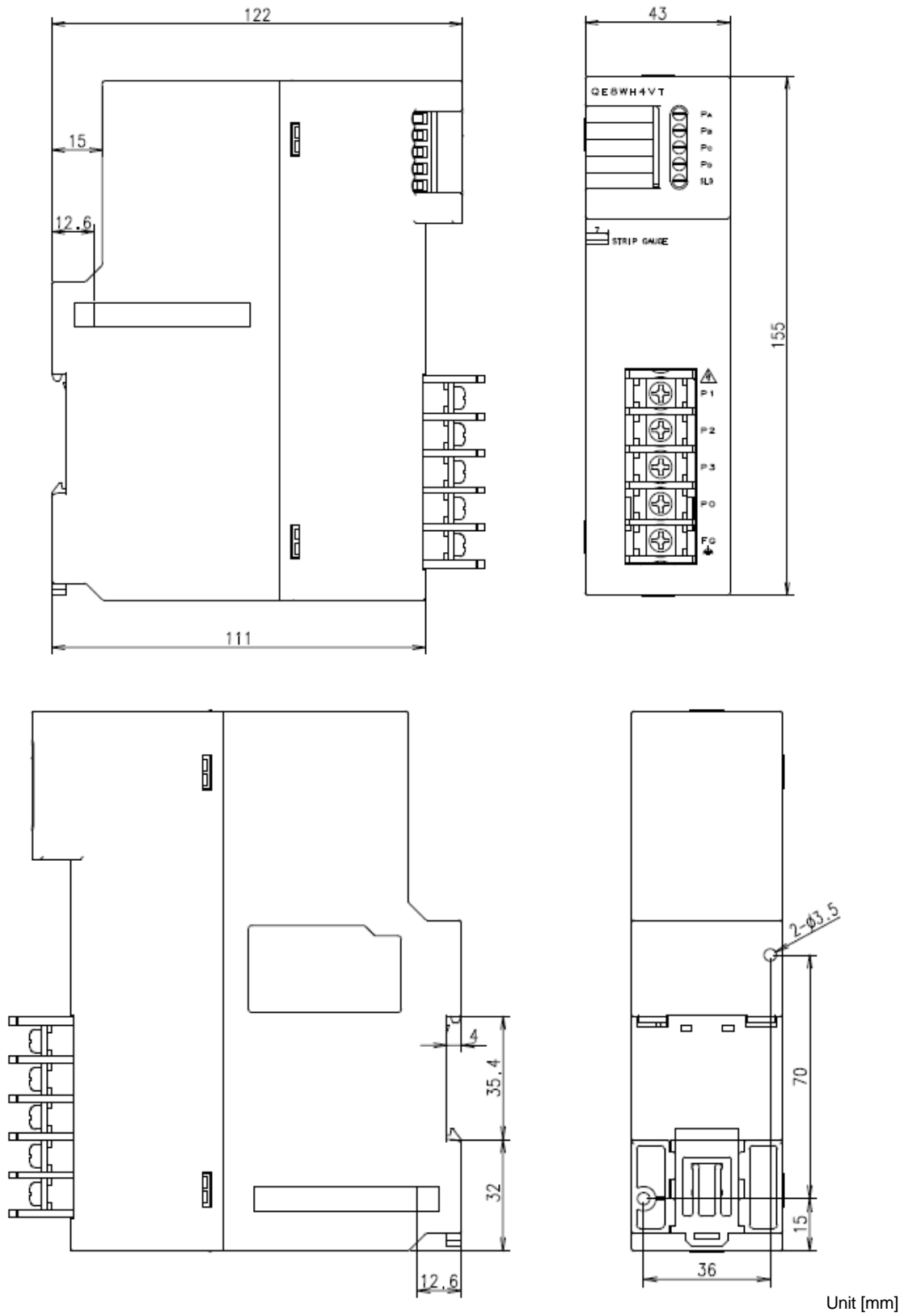

Appendix 3: Addition or change of functions

The following table lists functions added or changed to the QE81WH4W and GX Works2, serial number of compatible QE81WH4W, and software version of compatible GX Works2.

Added or changed contents	serial number with the QE81WH4W *1	Software version with the GX Works2
Support with GX Works2	Upper 6 digits is 120911 or later	1.90U or later

*1: Shown on the front (at the bottom) of the module. When a serial number is not displayed on the front of module, the module does not support added or changed contents.

Index

【5】

5A current sensor cable 7-14

【A】

Alarm delay time 4-11

Alarm flag (XnA, XnB) 4-14, 5-3

Alarm item 4-11

Alarm reset method..... 4-11

Alarm reset request (YnA, YnB)..... 5-6

Applicable wire..... 7-7

Average current 4-3

Average voltage 4-3

【B】

Bar terminal..... 7-7

【C】

Current demand time 4-14, 6-9

【E】

Electric energy (consumption, regeneration)
..... 4-1, 4-3

Electric power demand 4-3

Electric power demand time..... 4-14, 6-9

EMU2-CT5..... 7-13, Appendix-3

EMU-CT50/100/250/400/600 .. 7-12, Appendix-2

EMU-CT5/50/100/250/400/600-A
..... 7-10, Appendix-2

Error clear request (YnF)..... 5-6

Error flag (XnF) 5-4

External dimensions..... Appendix-1

【F】

Full load power 4-5

【G】

GX Developer 7-23

GX Works2 7-16

【I】

Integrated value set completion flag (XnC)..... 5-4

Integrated value set function 4-16

Integrated value set request (YnC) 5-6

【L】

List of functions 4-1

List of I/O signals..... 5-1

【M】

Max./min. value hold function..... 4-10

Max./min. values clear completion flag (XnD)
..... 4-10, 5-4

Max./min. values clear request (YnD) .. 4-10, 5-6

Measured items 4-2

Module ready (Xn0) 5-2

【N】

Name of each part 7-3

【O】

Operating condition setting completion
flag (Xn9) 5-3

Operating condition setting request (Yn9) 5-5

【P】

Periodic electric energy..... 4-3, 4-9

Periodic electric energy data completion
flag (Xn1, Xn2) 4-8, 5-2

Periodic electric energy measurement flag
(Yn1, Yn2)..... 4-8, 5-5

Periodic electric energy reset completion flag
(Xn3, Xn4)..... 4-8, 5-2

Periodic electric energy reset request
(Yn3, Yn4)..... 4-8, 5-5

Phase wire system..... 3-1, 6-6

Programming..... 8-1

【R】

Rated primary current setting 4-4

Rated primary voltage setting..... 4-4

【S】

Split-type current sensor 7-10, Appendix-2

【T】

Test function..... 4-1, 4-15

Troubleshooting 9-1

【U】

Upper/lower limit alarm monitoring 4-1, 4-11

【W】

Wiring 7-6

Warranty

For using this product, please thoroughly read the following product warranty descriptions.

1. Gratis Warranty Period and Gratis Warranty Coverage

If any failure or defect (hereinafter collectively called "failures") for which our company is held responsible occurs on the product during the gratis warranty period, our company shall replace the product for free through the distributor at which you purchased the product or our service company.

However, if an international travel is required for replacement, or a travel to an isolated island or remote location equivalent is required for replacement, the actual cost incurred to send an engineer(s) shall be charged.

[Gratis Warranty Period]

The gratis warranty term of the product shall be for one year after the date of purchase or delivery to a designated place.

Note that after manufacture and shipment from Mitsubishi, the maximum distribution period shall be six (6) months, and the longest gratis warranty term after manufacturing shall be eighteen (18) months. The gratis warranty term of repair parts shall not exceed the gratis warranty term before repairs.

[Gratis Warranty Coverage]

- (1) The gratis warranty shall apply only if the product is being used properly in the conditions, with the methods and under the environments in accordance with the terms and precautions described in the instruction manual, user's manual, caution label on the product, etc.
- (2) Replacement shall be charged for the following cases even during the gratis warranty period.
 - 1) Failures occurring due to your improper storage or handling, carelessness or fault, and failures arising from the design contents of hardware or software you use.
 - 2) Failures arising from modification you performed on the product without prior consent of our company.
 - 3) Failures occurring in the event that the product is assembled into the device you use and that are acknowledged as avoidable if the device is equipped with a safety mechanism that comply with the legal regulations applicable to the device or with functions/architecture which are considered as necessary to be equipped under conventions of the industry.
 - 4) Failures due to accidental force such as a fire, abnormal voltage, etc. and force majeure such as an earthquake, thunderstorm, wind, flood, etc.
 - 5) Failures due to matters unpredictable based on the level of science technology at the time of product
 - 6) Other failures which are beyond responsibility of our company or which you admit that our company is not held responsible for.

2. Fare-Paying Repair Period after Production Discontinued

- (1) The period our company may accept product replacement with charge shall be seven (7) years after production of the product is discontinued.

Production stoppage shall be announced in the technical news, etc. of our company.
- (2) The product (including spare) cannot be supplied after production is discontinued.

3. Exemption of Compensation Liability for Opportunity Loss, Secondary Loss, etc.

Our company shall not be liable to compensate for any loss arising from events not attributable to our company, opportunity loss and lost earning of the customer due to failure of the product, and loss, secondary loss, accident compensation, damage to other products besides our products and other operations caused by a special reason regardless of our company's predictability in both within and beyond the gratis warranty period.

4. Change of Product Specifications

Please be advised in advance that the specifications described in catalogs, manuals or technical materials are subject to change without notice.

5. Application of Products

- (1) For use of our general-purpose sequencer MELSEC-Q series and Energy Measuring Module QE81WH4W, they shall be used for a purpose which shall not lead to a material accident even when a failure or malfunction of the sequencer occurs, and a backup or fail-safe function shall be implemented systematically at external of the device in the event of a failure or malfunction.
- (2) Our general-purpose sequencers are designed and manufactured as general-purpose products which are targeted for general industry applications. Therefore, use of the sequencer for purposes in nuclear power plants and other power plants of each electric power company which greatly affect public, or for purposes in each JR company and the Defense Agency requiring a special quality assurance system shall be excluded from its applications.

However, the sequencer may be used for such purposes if the customer acknowledges that it should be used for limited purpose only and agrees not to require special quality.

Also, if you are considering to use this device for purposes that are expected to greatly affect human life or property and require high reliability especially in safety or control system such as aviation, medical care, railroad, combustion/fuel device, manned carrier device, entertainment machine, safety equipment, please consult with our service representative to exchange necessary specifications.

Energy Measuring Module

Service Network

Country/Region	Corporation Name	Address	Telephone
Australia	Mitsubishi Electric Australia Pty. Ltd.	348 Victoria Road, Rydalmere, N.S.W. 2116, Australia	+61-2-9684-7777
Algeria	Mec Casa	Rue i N 125 Hay-Es-Salem, 02000, W-Chlef, Algeria	+213-27798069
Bangladesh	PROGRESSIVE TRADING CORPORATION	HAQUE TOWER,2ND FLOOR,610/11,JUBILEE ROAD, CHITTAGONG, BANGLADESH	+880-31-624307
	ELECTRO MECH AUTOMATION& ENGINEERING LTD.	SHATABDI CENTER, 12TH FLOOR, SUITES-12-B, 292, INNER CIRCULAR ROAD, FAKIRA POOL, MOTIJHEEL, DHAKA-1000, BANGLADESH	+88-02-7192826
Belarus	Tehnikon	Oktyabrskaya 19, Off. 705, BY-220030 Minsk, Belarus	+375 (0)17 / 210 46 26
Belgium	Koning & Hartman B.V.	Woluwealaan 31, BE-1800 Vilvoorde, Belgium	+32 (0)2 / 2570240
Brazil	Mitsubishi Electric do Brasil Comércio e Serviços Ltda.	Avenida Adelino Cardana, 293 – 21º Andar, Bethaville, Barueri, SP, Brasil, CEP 06401-147	+55-11-4689-3000
Cambodia	DHINIMEX CO.,LTD	#245, St. Tep Phan, Phnom Penh, Cambodia	+855-23-997-725
Central America	Automation International LLC	7050 W. Palmetto Park Road Suite #15 PMB #555, Boca Raton, FL 33433	+1-561-237-5228
Chile	Rhona S.A. (Main office)	Vte. Agua Santa 4211 Casilla 30-D (P.O. Box) Vina del Mar, Chile	+56-32-2-320-600
China	Mitsubishi Electric Automation (China) Ltd.	Mitsubishi Electric Automation Building, No.1386 Hongqiao Road, Shanghai, China 200336	+86-21-2322-3030
	Mitsubishi Electric Automation (China) Ltd. Beijing	5/F, ONE INDIGO,20 Jiuxianqiao Road Chaoyang District, Beijing, China 100016	+86-10-6518-8830
	Mitsubishi Electric Automation (China) Ltd. ShenZhen	Level 8, Galaxy World Tower B, 1 Yabao Road, Longgang District, Shenzhen, China 518129	+86-755-2399-8272
	Mitsubishi Electric Automation (China) Ltd. GuangZhou	Rm.1006, A1 Times E-Park, No.276-282, Hanxi Road East, Zhongcun Street, Panyu Distric, Guangzhou, China 510030	+86-20-8923-6730
	Mitsubishi Electric Automation (China) Ltd. ChengDu	1501-1503,15F, Guang-hua Centre Building-C, No.98 North Guang Hua 3th Rd Chengdu, China 610000	+86-28-8446-8030
	Mitsubishi Electric Automation (Hong Kong) Ltd.	20/F., Cityplaza One, 1111 king's Road, Taikoo shing, Hong Kong	+852-2510-0555
Colombia	Proelectrico Representaciones S.A.	Carrera 42 N° 75 – 367 Bodega 109, Itagüí, Medellín, Antioquia, Colombia	+57-4-4441284
Czech Republic	AUTOCONT CONTROL SYSTEMS S.R.O	Technologická 374/6, CZ-708 00 Ostrava - Pustkovec	+420 595 691 150
Denmark	BEIJER ELECTRONICS A/S	LYKKEGARDSVEJ 17, DK-4000 ROSKILDE, Denmark	+45 (0)46/ 75 76 66
Egypt	Cairo Electrical Group	9, Rostoum St. Garden City P.O. Box 165-11516 Maglis El-Shaab,Cairo - Egypt	+20-2-27961337
France	Mitsubishi Electric Europe B.V. French Branch	FR-92741 Nanterre Cedex	+33 (0)1 55 68 57 01
Germany	Mitsubishi Electric Europe B.V.	Mitsubishi-Electric-Platz 1, 40882 Ratingen, Germany	+49 (0) 2102 4860
Greece	KALAMARAKIS - SAPOUNAS S.A.	IONIAS & NEROMILOU STR., CHAMOIMOS ACHARNES, ATHENS, 13678 Greece	+30-2102 406000
	UTECO	5, MAVROGENOUS STR., 18542 PIRAEUS, Greece	+30-211-1206-900
Hungary	Meltrade Ltd.	Fertő utca 14. HU-1107 Budapest, Hungary	+36 (0)1-431-9726
India	Mitsubishi Electric India Private Limited	2nd Floor, Tower A&B, Cyber Greens, DLF Cyber City, DLF Phase-III, Gurgaon - 122 022 Haryana, India	+91-124-4630300
	Mitsubishi Electric India Private Limited Pune Sales Office	ICC-Devi Gaurav Technology Park, Unit no. 402, Fourth Floor, Survey no. 191-192 (P), Opp. Vallabh Nagar Bus Depot, Pune – 411018, Maharashtra, India	+91-20-68192100
	Mitsubishi Electric India Private Limited FA Center	204-209, 2nd Floor, 31FIVE, Corporate Road, Prahladnagar, Ahmedabad 380015,Gujarat, India	+91-79677-77888
Indonesia	PT.Mitsubishi Electric Indonesia	Gedung Jaya 8th floor, J.L. MH. Thamrin No.12 Jakarta Pusat 10340, Indonesia	+62-21-3192-6461
	P.T. Sahabat Indonesia	P.O.Box 5045 Kawasan Industri Perumahan, Jakarta, Indonesia	+62-(0)21-6610651-9
Ireland	Mitsubishi Electric Europe B.V.	Westgate Business Park, Ballymount, IRL-Dublin 24, Ireland	+353 (0)1-4198800
Israel	Gino Industries Ltd.	26, Ophir Street IL-32235 Haifa, Israel	+972 (0)4-867-0656
Italy	Mitsubishi Electric Europe B.V.	Viale Colleoni 7, I-20041 Agrate Brianza (MI), Italy	+39 039-60531
Kazakhstan	Kazpromavtomatika	Ul. Zhambyla 28, KAZ - 100017 Karaganda	+7-7212-501000
Korea	Mitsubishi Electric Automation Korea Co., Ltd	9F Gangseo Hangang xi-tower A, 401 Yangcheon-ro, Gangseo-gu, Seoul 07528 Korea	+82-2-3660-9573
Laos	AROUNKIT CORPORATION IMPORT-EXPORT SOLE CO.,LTD	SAPHANMO VILLAGE. SAYSETHA DISTRICT, VIENTIANE CAPITAL, LAOS	+856-20-415899
Lebanon	Comptoir d'Electricite Generale-Liban	Cebaco Center - Block A Autostrade Dora, P.O. Box 11-2597 Beirut - Lebanon	+961-1-240445
Lithuania	Rifas UAB	Tinklu 29A, LT-5300 Panevezys, Lithuania	+370 (0)45-582-728
Malaysia	Mitric Sdn Bhd	No. 5 Jalan Pemberita U1/49, Temasya Industrial Park, Glenmarie 40150 Shah Alam,Selangor, Malaysia	+603-5669-3748
	Flexible Automation System Sdn Bhd	60, Jalan USJ 10/1B,UEP Subang Jaya,47620 Selangor Darul Ehsan,Malaysia	+603-5633-1280
Malta	ALFATRADE LTD	99 PAOLA HILL, PAOLA PLA 1702, Malta	+356 (0)21-697-816
Marocco	SCHIELE MAROC	KM 7.2 NOUVELLE ROUTE DE RABAT AIN SEBAA, 20600 Casablanca, Marocco	+212 661 45 15 96
Myanmar	Peace Myanmar Electric Co.,Ltd.	NO137/139 Botahtaung Pagoda Road, Botahtaung Town Ship 11161,Yangon,Myanmar	+95-(0)1-202589
Nepal	Watt&Volt House	KHA 2-65, Volt House Dillibazar Post Box:2108,Kathmandu,Nepal	+977-1-4411330
Netherlands	Imtech Marine & Offshore B.V.	Sluisjesdijk 155, NL-3087 AG Rotterdam, Netherlands	+31 (0)10-487-19 11
North America	Mitsubishi Electric Automation, Inc.	500 Corporate Woods Parkway, Vernon Hills, IL 60061 USA	+847-478-2100
Norway	Scanelec AS	Leirvikasen 43B, NO-5179 Godvik, Norway	+47 (0)55-506000
Mexico	Mitsubishi Electric Automation, Inc. Mexico Branch	Bldv. Miguel de Cervantes Saavedra 301, Torre Norte Piso 5, Col. Ampliación Granada, Miguel Hidalgo, Ciudad de México, CP 11520, México	+52-55-3067-7511
Middle East Arab Countries & Cyprus	Comptoir d'Electricite Generale-International-S.A.L.	Cebaco Center - Block A Autostrade Dora P.O. Box 11-1314 Beirut - Lebanon	+961-1-240430
Pakistan	Prince Electric Co.	2-P GULBERG II, LAHORE, 54600, PAKISTAN	+92-42-575232, 5753373
Peru	Rhona S.A. (Branch office)	Avenida Argentina 2201, Cercado de Lima	+51-1-464-4459
Philippines	MELCO Factory Automation Philippines Inc.	128 Lopez Rizal St., Brgy. Highway Hills, Mandaluyong City, Metro Manila, Philippines	+63-(0)2-256-8042
	Edison Electric Integrated, Inc.	24th Fl. Galleria Corporate Center, Edsa Cr. Ortigas Ave., Quezon City Metro Manila, Philippines	+63-(0)2-634-8691
Poland	Mitsubishi Electric Europe B.V. Polish Branch	Krakowska 48, 32-083 Balice, Poland	+48 12 347 65 00
Republic of Moldova	Intehsis SRL	bld. Traian 23/1, MD-2060 Kishinev, Moldova	+373 (0)22-66-4242
Romania	Sirius Trading & Services SRL	RO-060841 Bucuresti, Sector 6 Aleea Lacul Morii Nr. 3	+40-(0)21-430-40-06
Russia	Mitsubishi Electric (Russia) LLC	2 bld.1, Letnikovskaya street, Moscow, 115114, Russia	+7 495 721-2070
Saudi Arabia	Center of Electrical Goods	Al-Shuwayer St. Side way of Salahuddin Al-Ayoubi St. P.O. Box 15955 Riyadh 11454 - Saudi Arabia	+966-1-4770149
Singapore	Mitsubishi Electric Asia Pte. Ltd.	307 Alexandra Road, Mitsubishi Electric Building, Singapore 159943	+65-6473-2308
Slovakia	PROCONT, Presov	Kupelna 1/, SK - 08001 Presov, Slovakia	+421 (0)51 - 7580 611
	SIMAP	Jana Derku 1671, SK - 91101 Trenčín, Slovakia	+421 (0)32 743 04 72
Slovenia	Inea RBT d.o.o.	Stegne 11, SI-1000 Ljubljana, Slovenia	+386 (0)1-513-8116
South Africa	CBI-electric: low voltage	Private Bag 2016, ZA-1600 Isando Gauteng, South Africa	+27-(0)11-9282000
Spain	Mitsubishi Electric Europe B.V. Spanish Branch	Carretera de Rubí 76-80, E-08190 Sant Cugat del Vallés (Barcelona), Spain	+34 (0)93-565-3131
Sweden	Mitsubishi Electric Europe B.V. (Scandinavia)	Hedvig Möllers gata 6, 223 55 Lund, Sweden	+46 (0)8-625-10-00
	Euro Energy Components AB	Järnvägsgatan 36, S-434 24 Kungälv, Sweden	+46 (0)300-690040
Switzerland	TriElec AG	Muehentalstrasse 136, CH-8201 Schaffhausen, Switzerland	+41-(0)52-6258425
Taiwan	Setsuyo Enterprise Co., Ltd	5th Fl., No.105, Wu Kung 3rd, Wu-Ku Hsiang, Taipei, Taiwan, R.O.C.	+886-(0)2-2298-8889
	United Trading & Import Co., Ltd.	77/12 Bamrungmuang Road,Klong Mahanak Pomprab Bangkok Thailand	+66-223-4220-3
Thailand	MITSUBISHI ELECTRIC FACTORY AUTOMATION (THAILAND) CO.,LTD	101, True Digital Park Office, 5th Floor, Sukhumvit Road, Bangchak, Phara Khanong, Bangkok, 10260 Thailand	+662-092-8600
Tunisia	MOTRA Electric	3, Résidence Imen, Avenue des Martyrs Mourouj III, 2074 - El Mourouj III Ben Arous, Tunisia	+216-71 474 599
Turkey	Mitsubishi Electric Turkey A.Ş	Şerifali Mahallesi Kale Sokak No: 41, 34775 Ümraniye, Istanbul, Turkey	+90-216-969-2666
United Kingdom	Mitsubishi Electric Europe B.V.	Travellers Lane, UK-Hatfield, Herts. AL10 8XB, United Kingdom	+44 (0)1707-276100
Uruguay	Fierro Vignoli S.A.	Avda. Uruguay 1274 Montevideo Uruguay	+598-2-902-0808
Vietnam	Mitsubishi Electric Vietnam Co.,Ltd. Head Office	11th & 12th Floor, Viettel Tower B, 285 Cach Mang Thang 8 Street, Ward 12, District 10, Ho Chi Minh City, Vietnam	+84-28-3910-5945
	Mitsubishi Electric Vietnam Co.,Ltd. Hanoi Branch	24th Floor, Handico Tower, Pham Hung Road, khu do thi moi Me Tri Ha, Nam Tu Liem District, Hanoi City, Vietnam	+84-24-3937-8075

MITSUBISHI ELECTRIC CORPORATION
HEAD OFFICE: TOKYO BUILDING, 2-7-3, MARUNOUCHI, CHIYODA-KU, TOKYO 100-8310, JAPAN