

Mitsubishi Programmable Controller

MELSEC **Q** series

Channel Isolated Thermocouple Input Module User's Manual

-Q68TD-G-H01
-Q68TD-G-H02
-GX Configurator-TI (SW1D5C-QTIU-E)

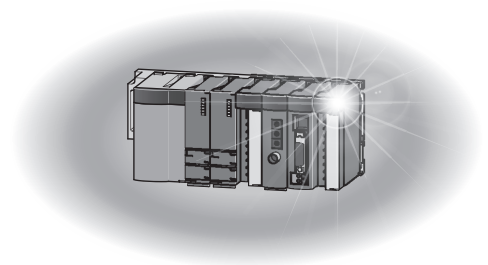

● SAFETY PRECAUTIONS ●

(Read these precautions before using this product.)

Before using this product, please read this manual and the relevant manuals carefully and pay full attention to safety to handle the product correctly.

In this manual, the safety precautions are classified into two levels: "⚠ WARNING" and "⚠ CAUTION".



Indicates that incorrect handling may cause hazardous conditions, resulting in death or severe injury.



Indicates that incorrect handling may cause hazardous conditions, resulting in minor or moderate injury or property damage.

Under some circumstances, failure to observe the precautions given under "⚠ CAUTION" may lead to serious consequences.

Observe the precautions of both levels because they are important for personal and system safety.

Make sure that the end users read this manual and then keep the manual in a safe place for future reference.

[Design Precautions]

⚠ WARNING

- Do not write any data to the "system area" of the buffer memory in the intelligent function module. Also, do not use any "use prohibited" signals as an output signal from the programmable controller CPU to the intelligent function module. Doing so may cause malfunction of the programmable controller system.

⚠ CAUTION

- Do not install the control lines or communication cables together with the main circuit lines or power cables. Keep a distance of 100mm or more between them. Failure to do so may result in malfunction due to noise.

[Installation Precautions]

CAUTION

- Use the programmable controller in an environment that meets the general specifications in the user's manual for the CPU module used.
Failure to do so may result in electric shock, fire, malfunction, or damage to or deterioration of the product.
- To mount the module, while pressing the module mounting lever located in the lower part of the module, fully insert the module fixing projection(s) into the hole(s) in the base unit and press the module until it snaps into place.
Incorrect mounting may cause malfunction, failure or drop of the module.
Fix the module to the base unit with a fixing bracket. (Q68TD-G-H02 only)
When using the programmable controller in an environment of frequent vibrations, fix the module with a module fixing screw. (Q68TD-G-H01 only)
- Tighten the screw within the specified torque range.
Undertightening can cause drop of the screw, short circuit or malfunction.
Overtightening can damage the screw and/or module, resulting in drop, short circuit, or malfunction.
- Shut off the external power supply (all phases) used in the system before mounting or removing the module.
Failure to do so may result in damage to the product.
A module can be replaced online (while power is on) on any MELSECNET/H remote I/O station or in the system where a CPU module supporting the online module change function is used.
Note that there are restrictions on the modules that can be replaced online, and each module has its predetermined replacement procedure.
For details, refer to the relevant chapter in this manual.
- Do not directly touch any conductive parts and electronic components of the module.
Doing so can cause malfunction or failure of the module.

[Wiring Precautions]

CAUTION

- Individually ground the shielded cables of the programmable controller with a ground resistance of 100Ω or less. Failure to do so may result in electric shock or malfunction.
- Connectors for external devices must be crimped or pressed with the tool specified by the manufacturer, or must be correctly soldered.
Incomplete connections may cause short circuit, fire, or malfunction.
- Prevent foreign matter such as dust or wire chips from entering the module.
Such foreign matter can cause a fire, failure, or malfunction.

[Wiring Precautions]

CAUTION

- A protective film is attached to the top of the module to prevent foreign matter, such as wire chips, from entering the module during wiring.
Do not remove the film during wiring.
Remove it for heat dissipation before system operation.
- Place the cables in a duct or clamp them.
If not, dangling cable may swing or inadvertently be pulled, resulting in damage to the module or cables or malfunction due to poor contact.
- When disconnecting the cable from the module, do not pull the cable by the cable part.
For the cable with connector, hold the connector part of the cable.
Pulling the cable connected to the module may result in malfunction or damage to the module or cable.
- Keep a distance of 100mm or more between a thermocouple and the main circuit line or AC control lines.
Also, keep the thermocouple away from a circuit that includes harmonics, such as a high-voltage circuit and a load circuit of an inverter.
- Do not place the module near a device that generates magnetic noise.

[Startup and Maintenance Precautions]

WARNING

- Do not touch any terminal while power is on.
Doing so will cause electric shock or malfunction.
- Shut off the external power supply (all phases) used in the system before cleaning the module or retightening the terminal screws, connector screws, or module fixing screws.
Failure to do so may result in electric shock or cause the module to fail or malfunction.
Undertightening can cause drop of the screw, short circuit or malfunction.
Overtightening can damage the screw and/or module, resulting in drop, short circuit, or malfunction.

CAUTION

- Do not disassemble or modify the modules.
Doing so may cause failure, malfunction, injury, or a fire.
- Shut off the external power supply (all phases) used in the system before mounting or removing the module.
Failure to do so may cause the module to fail or malfunction.
A module can be replaced online (while power is on) on any MELSECNET/H remote I/O station or in the system where a CPU module supporting the online module change function is used.
Note that there are restrictions on the modules that can be replaced online, and each module has its predetermined replacement procedure.
For details, refer to the relevant chapter in this manual.
- After the first use of the product, do not mount/remove the module to/from the base unit more than 50 times (IEC 61131-2 compliant).
Exceeding the limit of 50 times may cause malfunction.
- Before handling the module, touch a grounded metal object to discharge the static electricity from the human body.
Failure to do so may cause the module to fail or malfunction.

[Disposal Precautions]

CAUTION

- When disposing of this product, treat it as industrial waste.

● CONDITIONS OF USE FOR THE PRODUCT ●

- (1) Mitsubishi programmable controller ("the PRODUCT") shall be used in conditions;
 - i) where any problem, fault or failure occurring in the PRODUCT, if any, shall not lead to any major or serious accident; and
 - ii) where the backup and fail-safe function are systematically or automatically provided outside of the PRODUCT for the case of any problem, fault or failure occurring in the PRODUCT.

- (2) The PRODUCT has been designed and manufactured for the purpose of being used in general industries.

MITSUBISHI SHALL HAVE NO RESPONSIBILITY OR LIABILITY (INCLUDING, BUT NOT LIMITED TO ANY AND ALL RESPONSIBILITY OR LIABILITY BASED ON CONTRACT, WARRANTY, TORT, PRODUCT LIABILITY) FOR ANY INJURY OR DEATH TO PERSONS OR LOSS OR DAMAGE TO PROPERTY CAUSED BY the PRODUCT THAT ARE OPERATED OR USED IN APPLICATION NOT INTENDED OR EXCLUDED BY INSTRUCTIONS, PRECAUTIONS, OR WARNING CONTAINED IN MITSUBISHI'S USER, INSTRUCTION AND/OR SAFETY MANUALS, TECHNICAL BULLETINS AND GUIDELINES FOR the PRODUCT.

("Prohibited Application")

Prohibited Applications include, but not limited to, the use of the PRODUCT in;

- Nuclear Power Plants and any other power plants operated by Power companies, and/or any other cases in which the public could be affected if any problem or fault occurs in the PRODUCT.
- Railway companies or Public service purposes, and/or any other cases in which establishment of a special quality assurance system is required by the Purchaser or End User.
- Aircraft or Aerospace, Medical applications, Train equipment, transport equipment such as Elevator and Escalator, Incineration and Fuel devices, Vehicles, Manned transportation, Equipment for Recreation and Amusement, and Safety devices, handling of Nuclear or Hazardous Materials or Chemicals, Mining and Drilling, and/or other applications where there is a significant risk of injury to the public or property.

Notwithstanding the above, restrictions Mitsubishi may in its sole discretion, authorize use of the PRODUCT in one or more of the Prohibited Applications, provided that the usage of the PRODUCT is limited only for the specific applications agreed to by Mitsubishi and provided further that no special quality assurance or fail-safe, redundant or other safety features which exceed the general specifications of the PRODUCTS are required. For details, please contact the Mitsubishi representative in your region.

REVISIONS

* The manual number is given on the bottom left of the back cover.

Print Date	*Manual Number	Revision
Nov., 2008	SH(NA)-080795ENG-A	First printing
Sep., 2011	SH(NA)-080795ENG-B	<p>Correction</p> <p>SAFETY PRECAUTIONS, COMPLIANCE WITH EMC AND LOW VOLTAGE DIRECTIVES, Section 6.2.3, WARRANTY</p> <p>Addition</p> <p>CONDITIONS OF USE FOR THE PRODUCT</p>
Feb., 2012	SH(NA)-080795ENG-C	<p>Correction</p> <p>SAFETY PRECAUTIONS, GENERIC TERMS, ABBREVIATIONS, AND TERMS, Chapter 1, Section 1.1, 2.1 to 2.3, 3.1, 3.2, 3.2.1, 3.2.4, 3.3.1, 3.3.2, 3.4.1, 3.4.4, 3.4.5, 3.4.10, 3.4.11, 4.1, 4.3, 4.4.1, 4.4.2, 4.5 to 4.7, 5.2.1, 5.2.2, 5.3.1, 5.4, 5.5, 5.6.1, 5.6.2, 6.2.1, 6.2.2, 6.3.2, 7.1, 7.2, 7.3.1 to 7.3.6, 7.4.1, 7.4.2, 7.5, 8.1, 8.2.9, Appendix 2.2 to 2.4, Appendix 3</p>
Jun., 2016	SH(NA)-080795ENG-D	<p>Correction</p> <p>COMPLIANCE WITH EMC AND LOW VOLTAGE DIRECTIVES, GENERIC TERMS, ABBREVIATIONS, AND TERMS, Section 2.1, 2.2, 2.3, 3.1, 3.2.1, 4.4.2, 5.2.2, 6.2, 6.2.2, 6.2.3, 6.3, 6.3.2, 6.3.3, 8.1, 8.2.1, 8.2.9</p>

Japanese Manual Version SH-080794-F

This manual confers no industrial property rights or any rights of any other kind, nor does it confer any patent licenses. Mitsubishi Electric Corporation cannot be held responsible for any problems involving industrial property rights which may occur as a result of using the contents noted in this manual.

© 2008 MITSUBISHI ELECTRIC CORPORATION

INTRODUCTION

Thank you for purchasing the MELSEC-Q series Programmable Controller.

Before using the equipment, please read this manual carefully to develop full familiarity with the functions and performance of the Q series Programmable Controller you have purchased, so as to ensure correct use.

Please forward a copy of this manual to the end user.

CONTENTS

SAFETY PRECAUTIONS	A - 1
CONDITIONS OF USE FOR THE PRODUCT.....	A - 5
REVISIONS.....	A - 6
INTRODUCTION.....	A - 7
CONTENTS	A - 7
COMPLIANCE WITH EMC AND LOW VOLTAGE DIRECTIVES.....	A - 11
GENERIC TERMS, ABBREVIATIONS, AND TERMS.....	A - 12
PACKING LIST	A - 14

CHAPTER 1 OVERVIEW **1 - 1 to 1 - 3**

1.1 Features.....	1 - 2
-------------------	-------

CHAPTER 2 SYSTEM CONFIGURATION **2 - 1 to 2 - 7**

2.1 Applicable Systems	2 - 1
2.2 When Using the Q68TD-G-H02 (H01) in the Redundant System	2 - 4
2.3 How to Check the Function Version, Serial No., and Software Version	2 - 5

CHAPTER 3 SPECIFICATIONS **3 - 1 to 3 - 62**

3.1 Performance Specifications	3 - 1
3.2 Function List	3 - 5
3.2.1 Temperature conversion system	3 - 7
3.2.2 Conversion setting for disconnection detection function (Q68TD-G-H02 only).....	3 - 12
3.2.3 Disconnection state conversion setting function (Q68TD-G-H01 only)	3 - 14
3.2.4 Warning output function.....	3 - 16
3.2.5 Cold junction temperature compensation resistor disconnection detection function	3 - 21
3.3 I/O Signals Transferred to/from Programmable Controller CPU.....	3 - 22
3.3.1 I/O signal list	3 - 22
3.3.2 I/O signal details	3 - 23
3.4 Buffer Memory	3 - 30
3.4.1 Buffer memory assignment.....	3 - 30
3.4.2 Conversion enable/disable setting (Un\G0).....	3 - 38
3.4.3 CH[] Time/Count/Moving average/Time constant setting (Un\G1 to Un\G8).....	3 - 39
3.4.4 Conversion completion flag (Un\G10)	3 - 40
3.4.5 CH[] Measured temperature value (Un\G11 to Un\G18)	3 - 41

3.4.6	Error code (Un\G19)	3 - 42
3.4.7	Setting range 1, 2 (Thermocouple type) (Un\G20,Un\G21)	3 - 42
3.4.8	Setting range 3 (Offset/gain setting) (Un\G22)	3 - 42
3.4.9	Averaging processing selection (Un\G24,Un\G25).....	3 - 43
3.4.10	Offset/gain setting mode (Un\G26,Un\G27).....	3 - 44
3.4.11	CH[] Offset/gain temperature setting values (Un\G28 to Un\G43).....	3 - 45
3.4.12	Cold junction compensation setting status (Un\G45) (Q68TD-G-H02 only)	3 - 45
3.4.13	Warning output enable/disable setting (Un\G46).....	3 - 46
3.4.14	Warning output flag (Process alarm/Rate alarm) (Un\G47,Un\G48)	3 - 47
3.4.15	Disconnection detection flag (Un\G49) (Q68TD-G-H02 only).....	3 - 48
3.4.16	Disconnection state monitor flag (Un\G49) (Q68TD-G-H01only)	3 - 50
3.4.17	CH[] Scaling value (Un\G50 to Un\G57)	3 - 52
3.4.18	Scaling valid/invalid setting (Un\G58).....	3 - 53
3.4.19	CH[] Scaling range upper/lower limit values (Un\G62 to Un\G77).....	3 - 54
3.4.20	CH[] Scaling width upper/lower limit values (Un\G78 to Un\G93).....	3 - 55
3.4.21	CH[] Process alarm upper/lower limit values (Un\G94 to Un\G125).....	3 - 56
3.4.22	CH[] Rate alarm warning detection period (Un\G126 to Un\G133).....	3 - 57
3.4.23	CH[] Rate alarm upper/lower limit values (Un\G134 to Un\G149)	3 - 57
3.4.24	Mode switching setting (Un\G158, Un\G159)	3 - 58
3.4.25	Conversion setting for disconnection detection (Un\G164, Un\G165) (Q68TD-G-H02 only)..	3 - 59
3.4.26	Disconnection state conversion setting (Un\G164, Un\G165) (Q68TD-G-H01only).....	3 - 60
3.4.27	CH[] Conversion setting value for disconnection detection (Un\G166 to Un\G173) (Q68TD-G-H02 only)	3 - 61
3.4.28	CH[] Conversion setting value for disconnection state (Un\G166 to Un\G173) (Q68TD-G-H01only)	3 - 61
3.4.29	Factory default offset/gain values, User range settings offset/gain values (Un\G190 to Un\G253).....	3 - 62

CHAPTER 4 SETUP AND PROCEDURES BEFORE OPERATION	4 - 1 to 4 - 20
--	------------------------

4.1	Handling Precautions.....	4 - 1
4.1.1	Fixing module with module fixing bracket (Q68TD-G-H02 only).....	4 - 2
4.2	Setup and Procedures before Operation	4 - 3
4.3	Part Names	4 - 4
4.4	Wiring.....	4 - 7
4.4.1	Wiring precautions	4 - 7
4.4.2	External wiring	4 - 8
4.5	Switch Setting for Intelligent Function Module.....	4 - 11
4.6	Offset/Gain Setting	4 - 13
4.7	Cold Junction Temperature Compensation with/without Setting	4 - 19

CHAPTER 5 UTILITY PACKAGE (GX Configurator-TI)	5 - 1 to 5 - 23
---	------------------------

5.1	Utility Package Functions	5 - 1
5.2	Installing and Uninstalling the Utility Package	5 - 3
5.2.1	Handling precautions	5 - 3
5.2.2	Operating environment	5 - 5
5.3	Utility Package Operation	5 - 7
5.3.1	Common utility package operations.....	5 - 7

5.3.2	Operation overview.....	5 - 9
5.3.3	Starting the Intelligent function module utility	5 - 11
5.4	Initial Setting	5 - 13
5.5	Auto Refresh Settings.....	5 - 15
5.6	Monitoring/Test.....	5 - 17
5.6.1	Monitor/test screen	5 - 17
5.6.2	Offset/gain setting operation.....	5 - 20
5.6.3	OMC (Online Module Change) refresh data.....	5 - 23

CHAPTER 6 PROGRAMMING

6 - 1 to 6 - 30

6.1	Programming Procedure.....	6 - 2
6.2	Using Programs in Normal System Configuration	6 - 4
6.2.1	Before creating a program.....	6 - 6
6.2.2	Program example when Configurator-TI	6 - 8
6.2.3	Program example when GX Configurator-TI is not used.....	6 - 13
6.3	Using Programs on Remote I/O Network	6 - 17
6.3.1	Before creating a program.....	6 - 19
6.3.2	Program example when GX Configurator-TI is used.....	6 - 20
6.3.3	Program example when GX Configurator-TI is not used.....	6 - 24

CHAPTER 7 ONLINE MODULE CHANGE

7 - 1 to 7 - 37

7.1	Online Module Change Conditions	7 - 2
7.2	Online Module Change Operations	7 - 3
7.3	Online Module Change Procedure	7 - 4
7.3.1	When factory default is used and initial setting was made with GX Configurator-TI	7 - 4
7.3.2	When factory default is used and initial setting was made with sequence program.....	7 - 9
7.3.3	When user range setting is used and initial setting was made with GX Configurator-TI (other system is available).....	7 - 13
7.3.4	When user range setting is used and initial setting was made with GX Configurator-TI (other system is unavailable).....	7 - 18
7.3.5	When user range setting is used and initial setting was made with sequence program (other system is available).....	7 - 23
7.3.6	When user range setting is used and initial setting was made with sequence program (other system is unavailable).....	7 - 28
7.4	Range Reference Table.....	7 - 33
7.4.1	Range reference table (Q68TD-G-H02)	7 - 33
7.4.2	Range reference table (Q68TD-G-H01)	7 - 35
7.5	Precautions for Online Module Change.....	7 - 37

CHAPTER 8 TROUBLESHOOTING

8 - 1 to 8 - 8

8.1	Error Code List.....	8 - 1
8.2	Troubleshooting	8 - 4
8.2.1	"RUN" LED is extinguished	8 - 4
8.2.2	"RUN" LED flickers	8 - 4
8.2.3	"ERR" LED flickers	8 - 4

8.2.4	"ERR" LED is lit	8 - 4
8.2.5	"ALM" LED flickers.....	8 - 5
8.2.6	"ALM" LED is lit.....	8 - 5
8.2.7	When Disconnection detection signal (XC) (Q68TD-G-H02 only) or Disconnection state monitor signal (XC) (Q68TD-G-H01 only) turns on.....	8 - 5
8.2.8	Measured temperature value cannot be read.....	8 - 5
8.2.9	Measured temperature value is abnormal	8 - 6
8.2.10	Checking the Q68TD-G-H02(H01) status using GX Developer system monitor	8 - 7

APPENDICES

APPX - 1 to APPX - 14

Appendix 1	Differences of Q68TD-G-H02, Q68TD-G-H01, Q64TD, Q64TDV-GH	APPX - 1
Appendix 2	Dedicated Instruction.....	APPX - 2
Appendix 2.1	Dedicated Instruction List and Available Device	APPX - 2
Appendix 2.2	G(P).OFFGAN	APPX - 3
Appendix 2.3	G(P).OGLOAD	APPX - 5
Appendix 2.4	G(P).OGSTOR	APPX - 9
Appendix 3	External Dimension Diagram.....	APPX - 14

INDEX

INDEX - 1 to INDEX - 2

COMPLIANCE WITH EMC AND LOW VOLTAGE DIRECTIVES

(1) Method of ensuring compliance

To ensure that Mitsubishi programmable controllers maintain EMC and Low Voltage Directives when incorporated into other machinery or equipment, certain measures may be necessary. Please refer to one of the following manuals.

- QCPU User's Manual (Hardware Design, Maintenance and Inspection)
- Safety Guidelines

(This manual is included with the CPU module or base unit.)

The CE mark on the side of the programmable controller indicates compliance with EMC and Low Voltage Directives.

(2) Additional measures

To ensure that this product maintains EMC and Low Voltage Directives, please refer to Section 4.4.1.

GENERIC TERMS, ABBREVIATIONS, AND TERMS

Unless otherwise specified, this manual uses the following general terms, abbreviations, and terms.

Generic term/ Abbreviation/Term	Description
Q68TD-G-H02	The abbreviation for the Q68TD-G-H02 channel isolated thermocouple input module
Q68TD-G-H01	The abbreviation for the Q68TD-G-H01 channel isolated thermocouple input module
Q68TD-G-H02(H01)	The abbreviation for the Q68TD-G-H02 or Q68TD-G-H01 channel isolated thermocouple input module
Up scale	The maximum value in measured temperature range plus 5% value of measured temperature range
Down scale	The minimum value in measured temperature range minus 5% value of measured temperature range
GX Developer GX Works2	The product name of the software package for the MELSEC programmable controllers
GX Configurator-TI	The abbreviation for the thermocouple input module setting and monitor tool GX Configurator-TI (SW1D5C-QTIU-E)
QCPU (Q mode)	A generic term for the Q00JCPU, Q00UJCPU, Q00CPU, Q00UCPU, Q01CPU, Q01UCPU, Q02CPU, Q02HCPU, Q02PHCPU, Q02UCPU, Q03UDCPU, Q03UDVCPU, Q03UDECPU, Q04UDHCPU, Q04UDVCPU, Q04UDEHCPU, Q06HCPU, Q06PHCPU, Q06UDHCPU, Q06UDVCPU, Q06UDEHCPU, Q10UDHCPU, Q10UDEHCPU, Q12HCPU, Q12PHCPU, Q12PRHCPU, Q13UDHCPU, Q13UDVCPU, Q13UDEHCPU, Q20UDHCPU, Q20UDEHCPU, Q25HCPU, Q25PHCPU, Q25PRHCPU, Q26UDHCPU, Q26UDVCPU, Q26UDEHCPU, Q50UDEHCPU, and Q100UDEHCPU
Redundant CPU	A generic term for the Q12PRHCPU and Q25PRHCPU
Process CPU	A generic term for the Q02PHCPU, Q06PHCPU, Q12PHCPU, and Q25PHCPU
Cold junction temperature compensation resistor	A generic term for resistance temperature detectors (RTD) used for cold junction temperature compensation. Pt100 is used.
Personal computer	An IBM PC/AT [®] or compatible computer with DOS/V
Windows Vista [®]	A generic term for the following: Microsoft [®] Windows Vista [®] Home Basic Operating System, Microsoft [®] Windows Vista [®] Home Premium Operating System, Microsoft [®] Windows Vista [®] Business Operating System, Microsoft [®] Windows Vista [®] Ultimate Operating System, Microsoft [®] Windows Vista [®] Enterprise Operating System
Windows [®] XP	A generic term for the following: Microsoft [®] Windows [®] XP Professional Operating System, Microsoft [®] Windows [®] XP Home Edition Operating System

Generic term/ Abbreviation/Term	Description
Windows® 7	<p>A generic term for the following:</p> <p>Microsoft® Windows® 7 Starter Operating System, Microsoft® Windows® 7 Home Premium Operating System, Microsoft® Windows® 7 Professional Operating System, Microsoft® Windows® 7 Ultimate Operating System, Microsoft® Windows® 7 Enterprise Operating System</p> <p>Note that the 32-bit version is designated as "32-bit Windows® 7", and the 64-bit version is designated as "64-bit Windows® 7".</p>

PACKING LIST

The product package contains the following.

(1) Q68TD-G-H02

Model	Product	Quantity
Q68TD-G-H02	Q68TD-G-H02 channel isolated thermocouple input module	1
	Cold junction temperature compensation resistor (RTD)	1
SW1D5C-QTIU-E	GX Configurator-TI Version 1 (Single license product) (CD-ROM)	1
SW1D5C-QTIU-EA	GX Configurator-TI Version 1 (Volume license product) (CD-ROM)	1

(2) Q68TD-G-H01

Model	Product	Quantity
Q68TD-G-H01	Q68TD-G-H01 channel isolated thermocouple input module	1
	Cold junction temperature compensation resistor (RTD)	1
SW1D5C-QTIU-E	GX Configurator-TI Version 1 (Single license product) (CD-ROM)	1
SW1D5C-QTIU-EA	GX Configurator-TI Version 1 (Volume license product) (CD-ROM)	1

CHAPTER 1 OVERVIEW

This user's manual provides the specifications, handling instructions, programming procedures and other information of the Q68TD-G-H02 or Q68TD-G-H01 channel isolated thermocouple input module (hereafter abbreviated as Q68TD-G-H02 (H01)), which is designed to use with the MELSEC-Q series CPU module (referred to as the programmable controller CPU).

The Q68TD-G-H02(H01) is a module designed to convert thermocouple input values from outside the programmable controller into 16-bit signed binary measured temperature values and 16-bit signed binary scaling values (ratios).

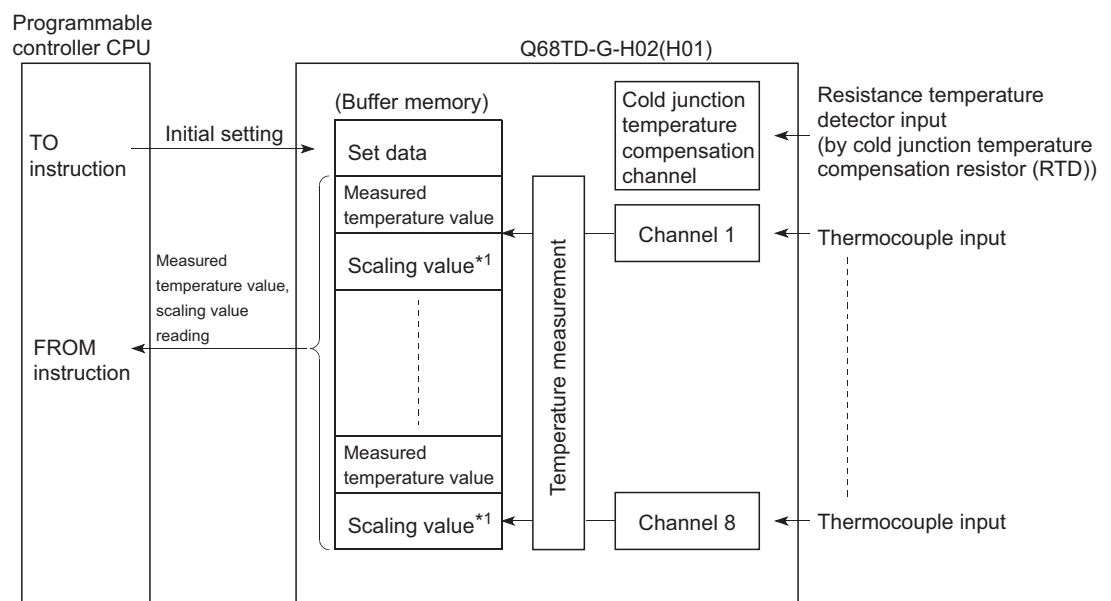

Figure 1.1 Overview of Q68TD-G-H02(H01)

* 1 Refer to Section 3.4.17 for details of the scaling values.

1.1 Features

- (1) Channels isolated
Q68TD-G-H02(H01) is channel isolated modules.
- (2) 8 channels of temperatures measured by one module
One Q68TD-G-H02(H01) module can measure temperatures of 8 channels.
It can also convert the detected temperature values into scaling values (ratios (%)).
- (3) Setting of conversion enable/disable
Conversion enable/disable setting for each channel is possible. Disabling conversion for unused channels prevents unnecessary disconnection detection or monitor of disconnection state on unused channels.
- (4) Use of thermocouples conforming to JIS or IEC standards
Eight types of thermocouple (K, E, J, T, B, R, S, N) conforming to JIS or IEC standards can be used.
A thermocouple type can be selected for each channel.
- (5) Disconnection detection function (Q68TD-G-H02 only)
Disconnection status of thermocouple or compensating lead wire can be detected for each channel by Disconnection detection flag.
Disconnection status can also be detected from the measured temperature value by setting "Up scale", "Down scale" or "Given value" for the Conversion setting for disconnection detection.
- (6) Disconnection monitor function (Q68TD-G-H01 only)
Disconnection status of thermocouple or compensating lead wire can be checked on each channel by Disconnection state monitor flag.
Disconnection status can also be checked from the measured temperature value by setting "Up scale", "Down scale" or "Given value" for the Conversion setting for disconnection detection.
- (7) Selection of sampling processing, time average processing, count average processing, moving average processing, and primary delay filter
As a conversion processing method, sampling processing, time average processing, count average processing, moving average or primary delay filter can be selected for each channel.
- (8) Cold junction temperature compensation by cold junction temperature compensation resistor (RTD)
Cold junction temperature compensation is possible by connecting the supplied cold junction temperature compensation resistor (RTD) and enabling the cold junction temperature compensation.
Resistance temperature detector Pt100 is used for cold junction temperature compensation resistor (RTD).

(9) Error compensation by offset/gain value setting

Error compensation can be made by setting offset and gain values on each channel. As the offset and gain values, you can make selection from user range setting and factory default setting.

(10) Warning output function

(a) Process alarm warning output

A warning can be output when the input range set by the user is exceeded. Upper limit value and lower limit value can be set for each channel, and a setting to have a difference (hysteresis) between warning output and warning clear is also possible.

(b) Rate alarm warning output

By setting a changing rate, a warning can be output when the changing rate is exceeded.

(11) Online module change

The module can be changed without stopping the system.

Furthermore, the following operations can be processed by using sequence programs.

- Transferring the offset/gain set values to the replacement Q68TD-G-H02 (H01)
- Transferring the offset/and gain set values to another Q68TD-G-H02 (H01) mounted on the other slot

(12) Easy settings using GX Configurator-TI

Using GX Configurator-TI which is sold separately, sequence programs can be reduced since settings of the Q68TD-G-H02 (H01) can be made on the screen. Also, the set status or operating status of the module can be checked easily.

CHAPTER 2 SYSTEM CONFIGURATION

This chapter explains the system configuration of the Q68TD-G-H02 (H01).

2.1 Applicable Systems

This section describes applicable systems.

(1) Applicable modules and base units, and number of modules

(a) When mounted with a CPU module

For the CPU modules, the number of modules, and base units applicable to the Q68TD-G-H02 (H01), refer to the user's manual for the CPU module used.

Note the following when the Q68TD-G-H02 (H01) is mounted with a CPU module.

- Depending on the combination with other modules or the number of mounted modules, power supply capacity may be insufficient. Pay attention to the power supply capacity before mounting modules, and if the power supply capacity is insufficient, change the combination of the modules.
- Mount a module within the number of I/O points for the CPU module. If the number of slots is within the available range, the module can be mounted on any slot.

Remark

To use the Q68TD-G-H02 (H01) with a C Controller module, refer to the user's manual for the C Controller module.

.....

(b) When the module is used in a MELSECNET/H remote I/O station

For the MELSECNET/H remote I/O station, the number of modules, and base units applicable to the Q68TD-G-H02 (H01), refer to the Q Corresponding MELSECNET/H Network System Reference Manual (Remote I/O network).

(2) Restrictions on mountable slot position

(a) Restrictions in using both the Q68TD-G-H02 and Q68TD-G-H01

When mounting the Q68TD-G-H02 and Q68TD-G-H01 on the same base unit, provide one or more than one slot of space between the Q68TD-G-H02 and Q68TD-G-H01.

(b) Restriction on mountable slot position of the Q68TD-G-H01

The Q68TD-G-H01 has restrictions on mountable slot position.

The following describes the restrictions of the slot position when mounting the Q68TD-G-H01 with a combination of the power supply module and the base unit. For the slot that the Q68TD-G-H01 cannot be mounted, leave the slot open or mount a module other than the Q68TD-G-H01.

The combination use of modules other than the following power supply modules and the base units does not have restrictions.

When using the Q68TD-G-H01 on the remote I/O station, the restriction is the same as for the main base unit.

When failing to comply with the following restrictions, the accuracy might not be in the specification range.

Table 2.1 Restriction on mountable slot position

Power supply module	Restrictions	
	Main base unit	Extension base unit
Q63P	No restrictions	Mount the module to I/O slot No.1 or later. 2)
Q63RP		
Q64P	Mount the module to I/O slot No.1 or later. 1)	Mount the module to I/O slot No.2 or later. 3)
Q64RP		

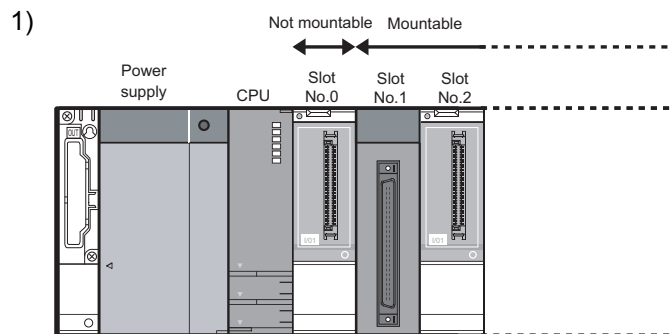

Figure 2.1 Mountable slot position of Q68TD-G-H01

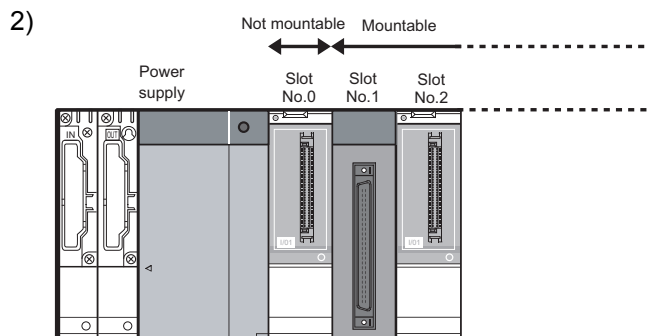

Figure 2.2 Mountable slot position of Q68TD-G-H01

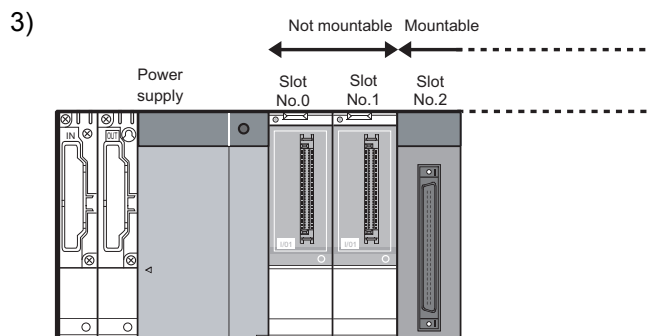

Figure 2.3 Mountable slot position of Q68TD-G-H01

(3) Support of the multiple CPU system

When using the Q68TD-G-H02 (H01) in a multiple CPU system, refer to the following manual first.

- QCPU User's Manual (Multiple CPU System).

(4) Compatibility with online module change

The Q68TD-G-H02 (H01) is compatible with online module change from the initial product with function version C.

Refer to CHAPTER 7.

(5) Supported software packages

Relation between the system containing the Q68TD-G-H02 (H01) and software package is shown in the following table.

GX Developer or GX Works2 is required to use the Q68TD-G-H02 (H01).

Table 2.2 System and compatible software package

System		Software version		
		GX Developer	GX Configurator-TI	GX Works2
Q00J/Q00/Q01CPU	Single CPU system	Version 7 or later	Version 1.28AE or later (Q68TD-G-H02) Version 1.24AA or later (Q68TD-G-H01)	Refer to the GX Works2 Version 1 Operating Manual (Common).
	Multiple CPU system	Version 8 or later		
Q02/Q02H/Q06H/Q12H/Q25HCPU	Single CPU system	Version 4 or later		
	Multiple CPU system	Version 6 or later		
Q02PH/Q06PHCPU	Single CPU system	Version 8.68W or later		
	Multiple CPU system			
Q12PH/Q25PHCPU	Single CPU system	Version 7.10L or later		
	Multiple CPU system			
Q12PRH/Q25PRHCPU	Redundant system	Version 8.45X or later		
Q00UJ/Q00U/Q01UCPU	Single CPU system	Version 8.76E or later		
	Multiple CPU system			
Q02U/Q03UD/Q04UDH/Q06UDHCPU	Single CPU system	Version 8.48A or later		
	Multiple CPU system			
Q10UDH/Q20UDHCPU	Single CPU system	Version 8.76E or later		
	Multiple CPU system			
Q13UDH/Q26UDHCPU	Single CPU system	Version 8.62Q or later		
	Multiple CPU system			
Q03UDE/Q04UDEH/Q06UDEH/Q13UDEH/Q26UDEHCPU	Single CPU system	Version 8.68W or later		
	Multiple CPU system			
Q10UDEH/Q20UDEHCPU	Single CPU system	Version 8.76E or later		
	Multiple CPU system			
CPU modules other than the above	Single CPU system	Cannot be used	Cannot be used	
	Multiple CPU system			
If installed in a MELSECNET/H remote I/O station		Version 6 or later	Version 1.28AE or later (Q68TD-G-H02) Version 1.24AA or later (Q68TD-G-H01)	

POINT

When using GX Works2, refer to the following:

- GX Works2 Version 1 Operating Manual (Common)
- GX Works2 Version 1 Operating Manual (Intelligent Function Module)

2.2 When Using the Q68TD-G-H02 (H01) in the Redundant System

This section describes the use of the Q68TD-G-H02 (H01) in the redundant system.

(1) Dedicated instruction

The dedicated instruction cannot be used.

(2) GX Configurator-TI

Configurator-TI cannot be used when accessing Redundant CPU via an intelligent function module on an extension base unit from GX Developer. Connect a personal computer with a communication path indicated below.

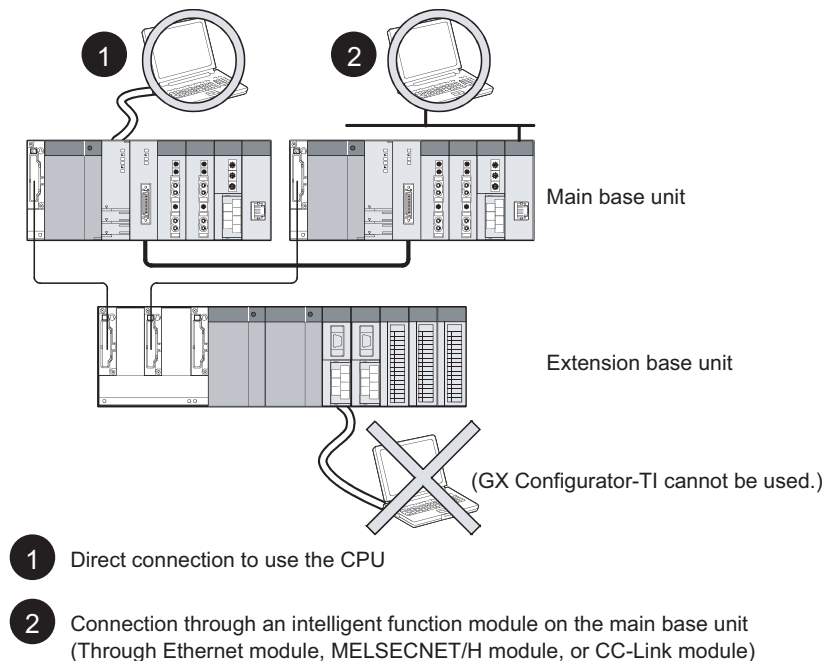

Figure 2.4 Communication path available for GX Configurator-TI

2.3 How to Check the Function Version, Serial No., and Software Version

(1) Checking the function version and serial No.

(a) On the rating plate

The rating plate is put on the side of the Q68TD-G-H02 (H01).

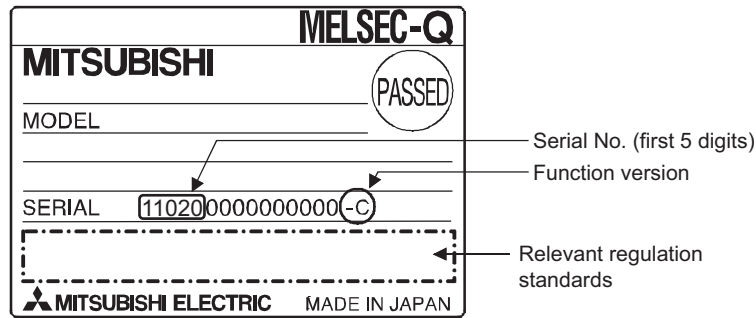
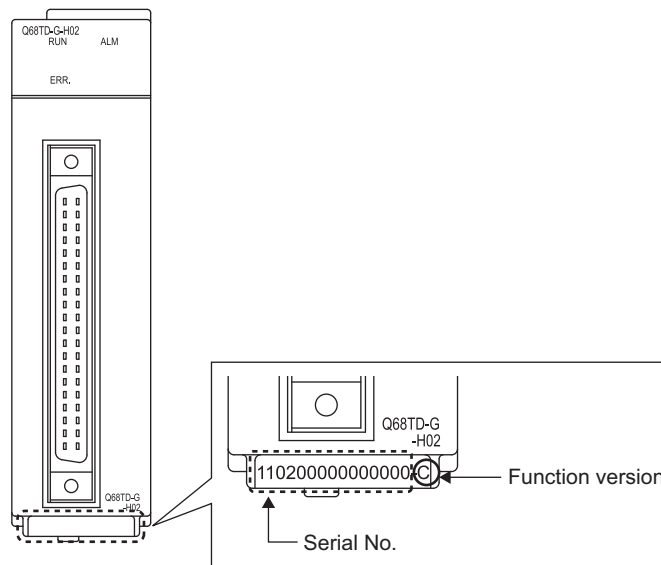

Figure 2.5 Rating plate

(b) On the front of the module

The function version and serial No. on the rating plate is also indicated on the front of the module (lower part).



- (c) On the system monitor (product information list)
 To display the system monitor, select [Diagnostics]→[System monitor]→**Product Inf. List** of GX Developer.

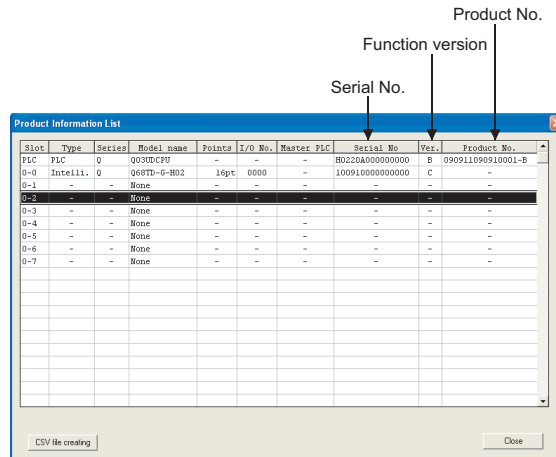

Figure 2.6 "Product Information List" screen

- 1) Production number
 Production number indication is not available for the Q68TD-G-H02 (H01); "-" is shown.

POINT

The serial No. on the rating plate and the front of the module may be different from the serial No. displayed on the product information list in GX Developer.

- The serial No. on the rating plate and the front of the module indicates the management information of the product.
- The serial No. displayed on the product information list in GX Developer indicates the function information of the product. The function information of the product is updated when a new function is added.

(2) Checking the software version of GX Configurator- TI

The software version of GX Configurator-TI can be checked on GX Developer by clicking [Help] →[Product information].

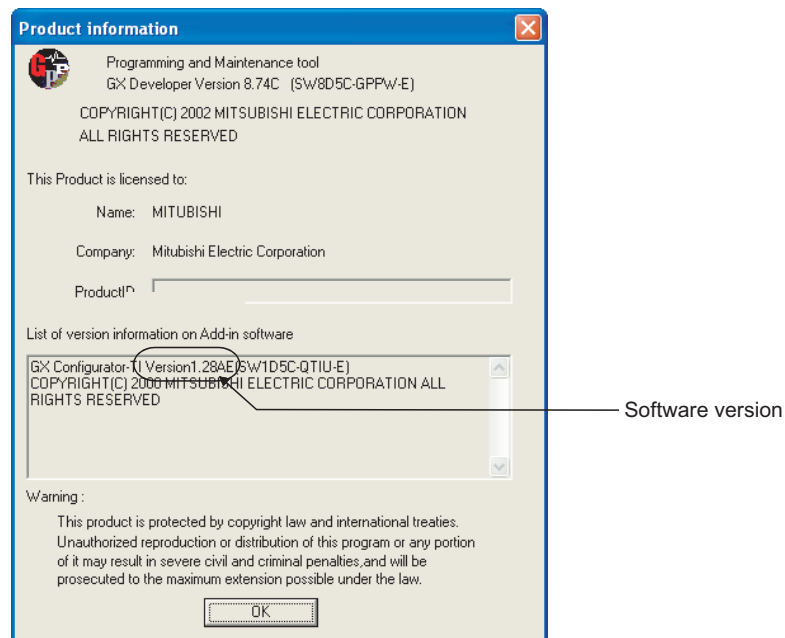

("Product information" screen of GX Developer Version 8)

Figure 2.7 How to check the software version of GX Configurator- TI

CHAPTER 3 SPECIFICATIONS

3.1 Performance Specifications

The following are the performance specifications of the Q68TD-G-H02 (H01).

(1) List of performance specifications

Table 3.1 List of performance specifications

Item	Specifications																	
	Q68TD-G-H02	Q68TD-G-H01																
Number of channels	8 channels																	
Output	Measured temperature value	16-bit signed binary (-2700 to 18200)																
	Scaling value	16-bit signed binary																
Thermocouple compliance standards	JIS C1602-1995, IEC 60584-1(1995), IEC60584-2(1982)																	
Applicable thermocouples, conversion accuracy *1, and effect from wiring resistance of 1Ω	Refer to (2) in this section																	
Cold junction compensation accuracy *1	± 1.0°C																	
Accuracy *1	Calculated with formula *2																	
Resolution	B,R,S,N: 0.3°C K,E,J,T: 0.1°C																	
Conversion speed *3	640ms/8 channels	320ms/8 channels																
Sampling period *4	320ms/8 channels																	
Number of analog input channels	8 channels + cold junction compensation channels/ 1 module																	
Isolation specifications	<table border="1"> <thead> <tr> <th>Specific isolated area</th> <th>Isolation method</th> <th>Dielectric withstand voltage</th> <th>Isolation resistance</th> </tr> </thead> <tbody> <tr> <td>Between thermocouple input channel and programmable controller power supply</td> <td>Transfer isolation</td> <td>500VACrms for 1min</td> <td rowspan="2">500VDC 10MΩ or more</td> </tr> <tr> <td>Between thermocouple input channels</td> <td>Transfer isolation</td> <td>1000VACrms for 1min</td> </tr> <tr> <td>Between cold junction compensation channel and programmable controller power supply</td> <td>No isolation</td> <td>-</td> <td>-</td> </tr> </tbody> </table>	Specific isolated area	Isolation method	Dielectric withstand voltage	Isolation resistance	Between thermocouple input channel and programmable controller power supply	Transfer isolation	500VACrms for 1min	500VDC 10MΩ or more	Between thermocouple input channels	Transfer isolation	1000VACrms for 1min	Between cold junction compensation channel and programmable controller power supply	No isolation	-	-		
	Specific isolated area	Isolation method	Dielectric withstand voltage	Isolation resistance														
	Between thermocouple input channel and programmable controller power supply	Transfer isolation	500VACrms for 1min	500VDC 10MΩ or more														
Between thermocouple input channels	Transfer isolation	1000VACrms for 1min																
Between cold junction compensation channel and programmable controller power supply	No isolation	-	-															
Disconnection detection	Available (each channel respectively) *5	Not available *6																
Maximum number of writes to flash memory	50,000																	
Number of I/O points occupied	16 points (I/O assignment: Intelligent 16 points)																	
External interface	40-pin connector																	
Applicable wire size	0.3mm ² (AWG22) or less (for A6CON1, A6CON4), 0.24mm ² (AWG24) (for A6CON2)																	
External device connector (sold separately)	A6CON1, A6CON2, A6CON4																	
Internal current consumption (5VDC)	0.65A	0.49A																
Weight	0.22kg	0.18kg																
External dimensions	102(H)×27.4(W)×130(D)mm	98(H)×27.4(W)×90(D)mm																

- * 1 To satisfy with the accuracy, a warm-up (power distribution) period of 30 minutes is required.
- * 2 Calculate the accuracy in the following method.
(Accuracy) = (conversion accuracy) + (temperature characteristic) × (operating ambient temperature variation) + (cold junction temperature compensation accuracy)
An operating ambient temperature variation indicates a deviation of the operating ambient temperature from the $25 \pm 5^{\circ}\text{C}$ range.
Example: When using the thermocouple B (refer to Section 3.1 (2)) with the operating ambient temperature of 35°C and the measured temperature of 1000°C , the accuracy is as follows.
 $(\pm 2.5^{\circ}\text{C}) + (\pm 0.4^{\circ}\text{C}) \times (35^{\circ}\text{C} - 30^{\circ}\text{C}) + (\pm 1^{\circ}\text{C}) = \pm 5.5^{\circ}\text{C}$
- * 3 The conversion speed indicates the maximum time from when the input temperature changes till when the measured temperature value of buffer memory is batch-updated.
- * 4 The sampling period indicates the period batch-updating the measured temperature value in one channel.
- * 5 When disconnection state is detected, output values are selected from "Up scale", "Down scale" or "Given scale". (Refer to Section 3.2.2)
- * 6 The Q68TD-G-H01 does not have the disconnection detection function. However, the disconnection monitor function is available to select a measured temperature value on a disconnection occurrence from either "Up scale", "Down scale", or "Given value". (Refer to Section 3.2.3)
It takes up to 11s to check a disconnection state.

3 SPECIFICATIONS

(2) Applicable thermocouples, conversion accuracy, and effect from wiring resistance of 1Ω

The following table lists applicable thermocouples, conversion accuracy, and the effect from wiring resistance of 1Ω.

Table 3.2 Applicable thermocouples, conversion accuracy, and the effect from wiring resistance of 1Ω

Usable Thermocouple Type	Measured Temperature Range ^{*1}	Conversion Accuracy (At operating ambient temperature 25±5°C)	Temperature Characteristic (Per operating ambient temperature variation of 1°C)	Max. Temperature Error at Ambient Temperature 55°C	Effect from wiring resistance of 1Ω ^{*4} (upper: Q68TD-G-H02 lower: Q68TD-G-H01)
B	0 to 600°C	----- ^{*3}	----- ^{*3}	----- ^{*3}	----- ^{*3}
	600 to 800°C ^{*2}	±3.0°C	±0.4°C	±13.0°C	-0.169°C/Ω
	800 to 1700°C ^{*2}	±2.5°C		±12.5°C	-0.042°C/Ω
	1700 to 1820°C	----- ^{*3}	----- ^{*3}	----- ^{*3}	-0.143°C/Ω
R	-50 to 0°C	----- ^{*3}	----- ^{*3}	----- ^{*3}	-0.036°C/Ω
R	0 to 300°C ^{*2}	±2.5°C	±0.4°C	±12.5°C	-0.200°C/Ω
	300 to 1600°C ^{*2}	±2.0°C	±0.3°C	±9.5°C	-0.050°C/Ω
	1600 to 1760°C	----- ^{*3}	----- ^{*3}	----- ^{*3}	-0.112°C/Ω
	S	-50 to 0°C	----- ^{*3}	----- ^{*3}	----- ^{*3}
S	0 to 300°C ^{*2}	±2.5°C	±0.4°C	±12.5°C	-0.200°C/Ω
	300 to 1600°C ^{*2}	±2.0°C	±0.3°C	±9.5°C	-0.050°C/Ω
	1600 to 1760°C	----- ^{*3}	----- ^{*3}	----- ^{*3}	-0.112°C/Ω
	K	-270 to -200°C	----- ^{*3}	----- ^{*3}	----- ^{*3}
K	-200 to 0°C ^{*2}	Larger value of ±0.5°C and ±0.5% of measured temperature	Larger value of ±0.06°C and ±0.2% of measured temperature	±11.0°C	-0.034°C/Ω
	0 to 1200°C ^{*2}	Larger value of ±0.25°C and ±0.5% of measured temperature	Larger value of ±0.06°C and ±0.02% of measured temperature	±9.0°C	-0.009°C/Ω
	1200 to 1370°C	----- ^{*3}	----- ^{*3}	----- ^{*3}	-0.026°C/Ω
	E	-270 to -200°C	----- ^{*3}	----- ^{*3}	----- ^{*3}
E	-200 to 0°C ^{*2}	Larger value of ±0.5°C and ±0.5% of measured temperature	Larger value of ±0.06°C and ±0.15% of measured temperature	±8.5°C	-0.023°C/Ω
	0 to 900°C ^{*2}	Larger value of ±0.5°C and ±0.25% of measured temperature	Larger value of ±0.06°C and ±0.02% of measured temperature	±6.75°C	-0.006°C/Ω
	900 to 1000°C	----- ^{*3}	----- ^{*3}	----- ^{*3}	-0.018°C/Ω
	J	-210 to -40°C	----- ^{*3}	----- ^{*3}	----- ^{*3}
J	-40 to 750°C ^{*2}	Larger value of ±0.5°C and ±0.25% of measured temperature	Larger value of ±0.06°C and ±0.02% of measured temperature	±5.625°C	-0.022°C/Ω
	750 to 1200°C	----- ^{*3}	----- ^{*3}	----- ^{*3}	-0.006°C/Ω
		----- ^{*3}	----- ^{*3}	----- ^{*3}	----- ^{*3}

3 SPECIFICATIONS

Table 3.2 Applicable thermocouples, conversion accuracy, and the effect from wiring resistance of 1Ω

	-270 to -200°C	-----*3	-----*3	-----*3	-----*3
T	-200 to 0°C *2	Larger value of ±0.5°C and ±0.5% of measured temperature	Larger value of ±0.06°C and ±0.1% of measured temperature	±6.0°C	-0.036°C/Ω -0.009°C/Ω
	0 to 350°C *2	Larger value of ±0.5°C and ±0.25% of measured temperature	Larger value of ±0.06°C and ±0.02% of measured temperature	±2.625°C	-0.026°C/Ω -0.007°C/Ω
	350 to 400°C	-----*3	-----*3	-----*3	-----*3
		-----*3	-----*3	-----*3	-----*3
N	-270 to -200°C	-----*3	-----*3	-----*3	-----*3
	-200 to 0°C *2	Larger value of ±0.5°C and ±0.5% of measured temperature	Larger value of ±0.06°C and ±0.2% of measured temperature	±11.0°C	-0.048°C/Ω -0.012°C/Ω
	0 to 1250°C *2	Larger value of ±0.5°C and ±0.25% of measured temperature	Larger value of ±0.06°C and ±0.02% of measured temperature	±9.375°C	-0.039°C/Ω -0.010°C/Ω
	1250 to 1300°C	-----*3	-----*3	-----*3	-----*3

* 1 If a value entered from the thermocouple is outside the measured temperature range given in the table, it is handled as the maximum/minimum value of the measured temperature range.

* 2 The accuracies only in the temperature ranges of Class 1 to 3 (shaded areas) in JIS C1602-1995 apply.

Also, a warm-up (power distribution) period of 30 minutes is required to satisfy with the accuracy.

* 3 Temperature measurement can be executed, but accuracy is not guaranteed.

* 4 This is the temperature error per 1Ω wiring resistance of the thermocouple. Check the wiring resistance value and calculate the temperature error in the system. If the error exceeds the allowable range of the system, correct the measured temperature value by the offset/gain setting. (Refer to Section 4.6.)

3.2 Function List

The following table lists the Q68TD-G-H02 (H01) functions.

Table 3.3 Function list

Item	Description	Refer To
Temperature conversion function	This function allows temperature data to be imported by connecting a thermocouple. Temperature data are 16-bit signed binary (-2700 to 18200) and stored into buffer memory.	Section 3.4.5
Temperature conversion system	<p>(1) Sampling processing A temperature input value is converted one by one on each channel and a measured temperature value is output after every conversion. Then the value is stored into buffer memory.</p> <p>(2) Averaging processing This processing averages a measured temperature value for each channel and the averaged value is stored into buffer memory. Averaging processing contains three methods as described below.</p> <p>(a) Time average (b) Count average (c) Moving average</p> <p>(3) Primary delay filter Measured temperature values are smoothed by a preset time constant.</p>	Section 3.2.1
Conversion enable/disable function	This function specifies whether temperature conversion is enabled or disabled on each channel.	Section 3.4.2
Thermocouple type selection function	This function sets the type of thermocouple on each channel.	Section 4.5
Disconnection detection function (Q68TD-G-H02 only)	This function checks the disconnection of the connected thermocouple on each conversion-enabled channel.	Section 3.4.15
Conversion setting for disconnection detection function (Q68TD-G-H02 only)	This function is to select a value to be stored in the CH□ Measured temperature value (Un\G11 to Un\G18) from "Up scale", "Down scale" or "Given scale" when disconnection is detected.	Section 3.2.2
Disconnection monitor function (Q68TD-G-H01 only)	This function checks the disconnection of the connected thermocouple on each conversion-enabled channel.	Section 3.4.16
Disconnection state conversion setting function (Q68TD-G-H01 only)	This function is to select a value to be stored in the CH□ Measured temperature value (Un\G11 to Un\G18) from "Up scale", "Down scale" or "Given scale" when disconnection is detected.	Section 3.2.3
Cold junction temperature compensation with/without setting function	This function determines whether to use cold junction temperature compensation. Use this function to measure temperature in higher accuracy than the cold junction temperature compensation accuracy ($\pm 1^{\circ}\text{C}$) by the cold junction temperature compensation resistor (RTD) that is included with the Q68TD-G-H02 (H01). The cold junction temperature compensation accuracy can be improved by disabling the cold junction temperature compensation and providing a precision ice bath externally.	Section 4.7
Cold junction temperature compensation resistor disconnection detection function	This function detects a disconnection of connected cold junction temperature compensation resistor (RTD).	Section 3.2.5
Warning output function	<p>(1) Process alarm A warning is output when the measured temperature value is equal to or more than the process alarm upper upper limit value, or equal to or less than the process alarm lower lower limit value.</p> <p>(2) Rate alarm A warning is output when the measured temperature value changes in a rate by which the measured temperature value reaches the rate alarm upper limit value or more, or the rate alarm lower limit value or less.</p>	Section 3.2.4

Table 3.3 Function list

Item	Description	Refer To
Scaling function	This function can convert a measured temperature value into a preset range ratio (%) and import it into buffer memory.	Section 3.4.17 to Section 3.4.20
Offset/gain setting function	This function compensates an error of measured temperature value.	Section 3.4.11 Section 4.6
Online module change	A module change is made without the system being stopped.	CHAPTER 7

3.2.1 Temperature conversion system

(1) Temperature conversion of Q68TD-G-H02(H01)

(a) Sampling period

The Q68TD-G-H02(H01) measures the temperature from CH1 to CH8 every 40ms per channel.

The sampling period indicates the period (320ms) batch-updating the measured temperature value in one channel in the case of that the sampling processing is specified with the Averaging processing selection (Un\G24 and Un\G25).

Regardless of the number of conversion-enabled channels, the measured temperature values are stored in the buffer memory every 320ms.

(b) Conversion speed

The conversion speed indicates the maximum time required before the measured temperature values are stored into the buffer memory.

The following figure shows the timing of storing the measured temperature values of Q68TD-G-H02 and Q68TD-G-H01 respectively.

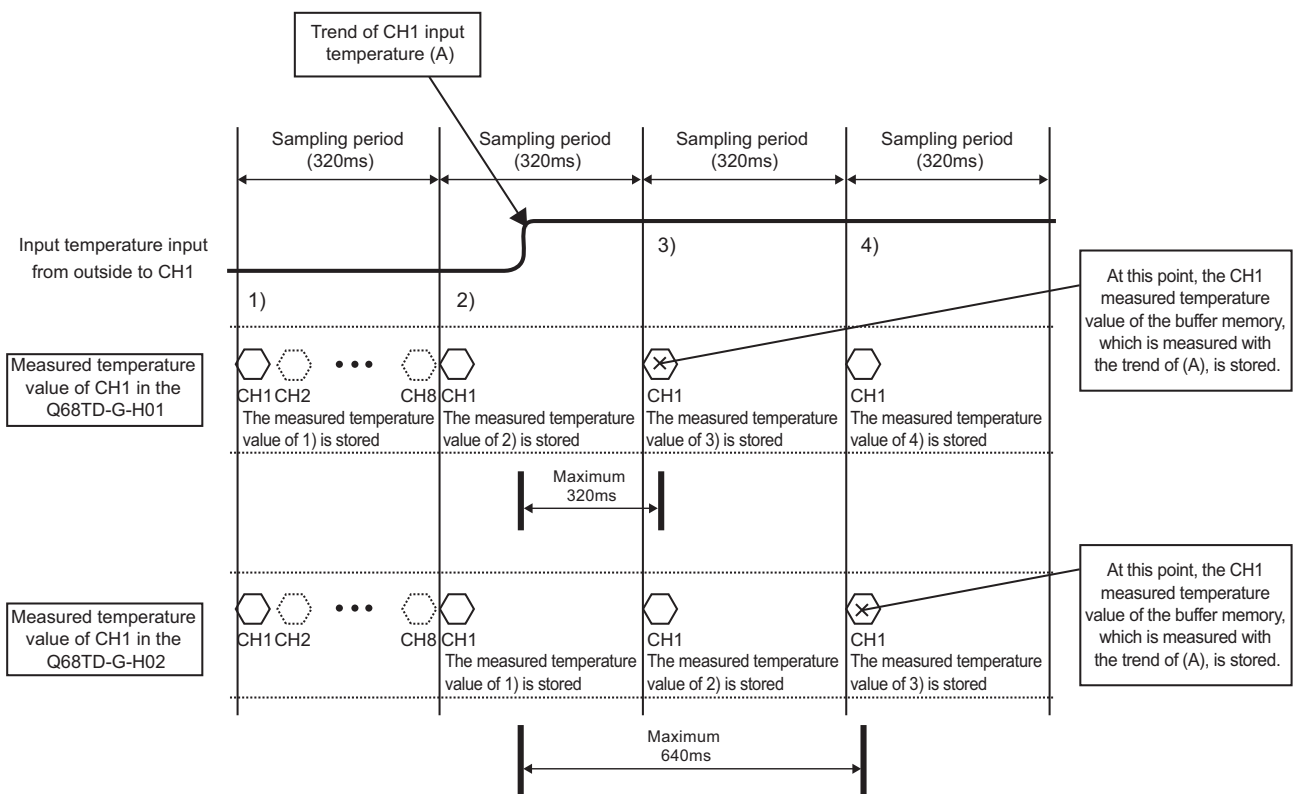

Figure 3.1 Q68TD-G-H01 and Q68TD-G-H02 conversion speed overview

(2) Sampling processing

Measured temperature value that is measured at every 320ms of sampling period is stored in the buffer memory.

(3) Averaging processing

After the first averaging processing is completed, the corresponding bit for a channel where processing has been completed of the Conversion completion flag (Un\G10) turns ON (changes to "1").

(a) Time average

Conversion is executed for a period of set time, and the total value, which excludes the maximum and the minimum values, is averaged and stored in the buffer memory.

The number of processing times within the set time is below.

Number of processing times (times) = set time \div sampling period (320ms)

Setting range of time average is 1280 to 5000ms.

If a value outside the setting range is set, an error (error code: 20□) occurs.

[Example]

When six channels, channels 1, 2, 3, 4, 5, 6, are enabled for conversion and the set time is 2000ms, measurement is executed for six times and the average value is output.

$2000 \div 320 = 6.25$ (times)..... Drop the fractional part

(b) Count average

Conversion is executed for a preset number of times, and the total value excluding the maximum and the minimum values is averaged and stored in the buffer memory.

The processing time is below.

Processing time = set count \times 320(ms)

Setting range of count average is 4 to 500 times.

If a value outside the setting range is set, an error (error code: 30□) occurs.

[Example]

When six channels, channels 1, 2, 3, 4, 5, 6, are enabled for conversion and the count averaging is set to 5 times, the average value is output for every 1600(ms).

$5 \times 320 = 1600$ (ms)

(c) Moving average

Measured temperature values, which are taken at every sampling period for the specified number of times, are averaged and stored in the buffer memory. The latest measured temperature value can be obtained because the averaging processing is executed moving for each sampling period.

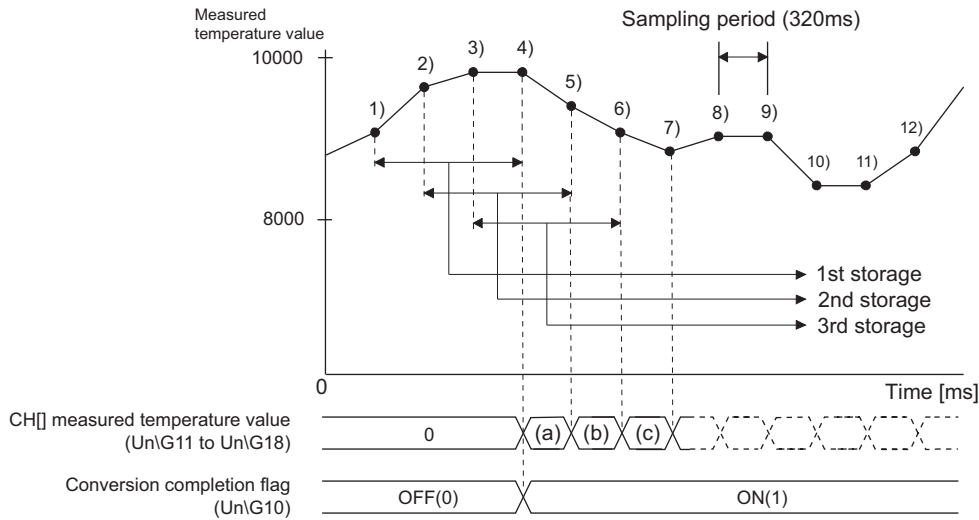

Figure 3.2 Moving average processing for four times settings

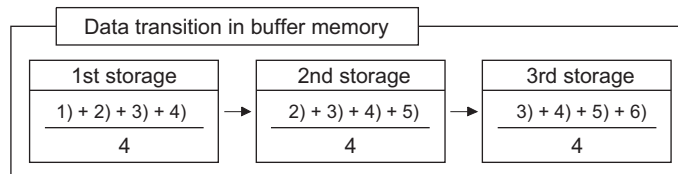

Figure 3.3 Buffer memory data change in average processing

(4) Primary delay filter

By a preset time constant, measured temperature value of which transient noise is smoothed is output.

Depending on the time constant, the degree of smoothness changes.

Time constant is the time until the measured temperature value reaches to 63.2% of the steady-state value.

The relational expression between the time constant and measured temperature value is shown below.

[When $n=1$ *1]

$$Y_n = 0$$

[When $n=2$]

$$Y_n = y_{n-1} + \frac{\Delta t}{\Delta t + TA} (y_n - y_{n-1})$$

[When $n \geq 3$]

$$Y_n = Y_{n-1} + \frac{\Delta t}{\Delta t + TA} (y_n - Y_{n-1})$$

Y_n : Current measured temperature

y_n : Measured temperature value before smoothing

Y_{n-1} : Preceding measured temperature value

y_{n-1} : Preceding measured temperature value before smoothing

n : Number of sampling times

Δt : Conversion time (320ms)

TA : Time constant (320 to 5000ms)

*1: Conversion completion flag turns ON(1) when $n \geq 2$.

Setting range of time constant is 320 to 5000ms.

Set the time constant value which is twice as much as the sampling period (320ms).

If the time constant value is not twice as much as the sampling period (320ms), the value in which the remainder is rounded down is set.

If a value outside the setting range is set, an error (error code: 32□) occurs.

[Example 1: Measured temperature value when the temperature input value is changed from 250.0°C to 260.0°C]

When the time constant setting is 3200ms (3.2s), the measured temperature value changes as indicated below.

At 3200ms (3.2s) after the temperature input value is changed to 260.0°C, the measured temperature value reaches 63.2% (256.3°C) of the value when sampling processing is selected.

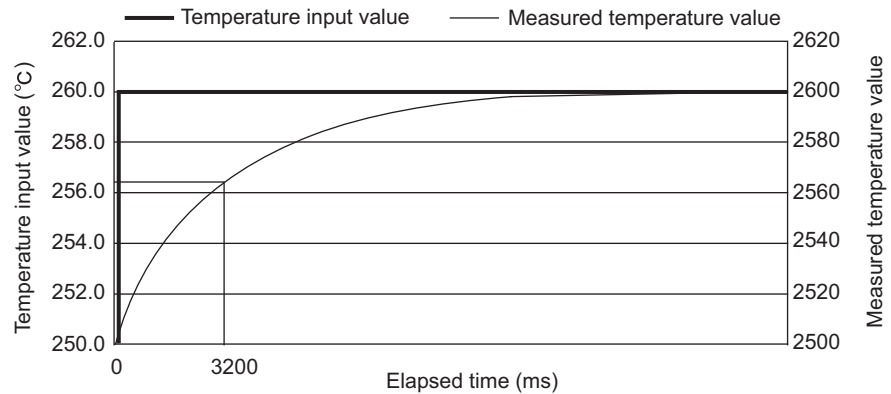

Figure 3.4 Measured temperature value when the temperature input value is changed from 250.0°C to 260.0°C

[Example2: Measured temperature value when the change of temperature input value is a waveform with ringing]

The changes of measured temperature values when the time constant setting is 1280ms(1.28s), 640ms(0.64s) or the moving average processing is 4 times are shown below.

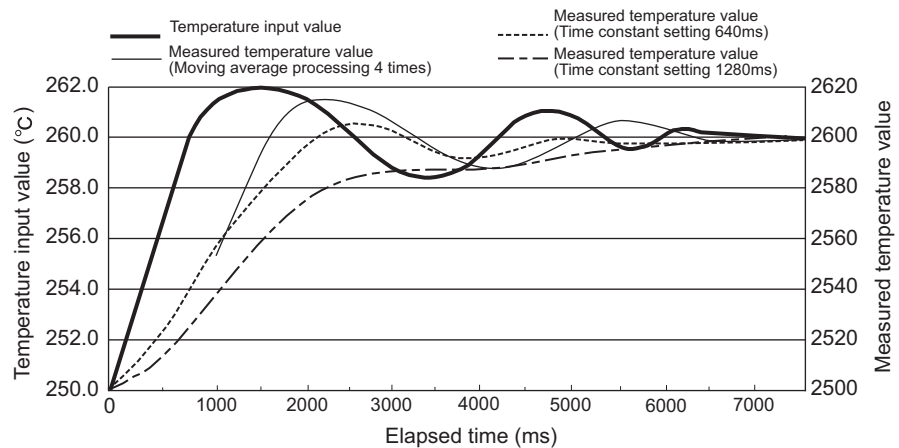

Figure 3.5 Measured temperature value when the change of temperature input value is a waveform with ringing

3.2.2 Conversion setting for disconnection detection function (Q68TD-G-H02 only)

The conversion setting for disconnection detection function stores specific values into measured temperature values when disconnection is detected.

This function can identify the disconnection detection from measured temperature values. This function is only available for channels enable temperature conversion.

(1) Overview of disconnection detection

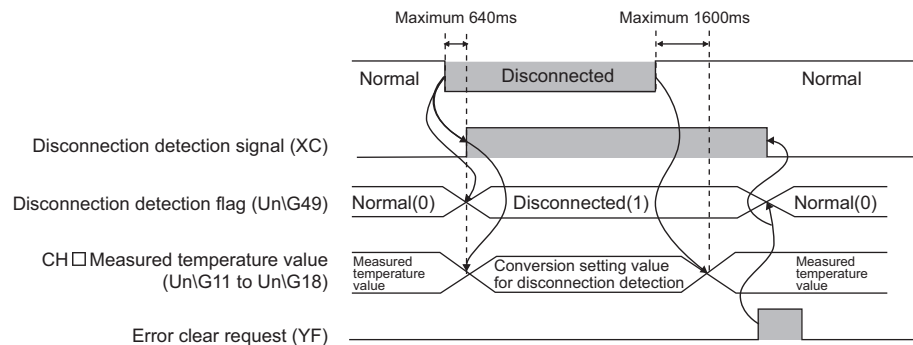

Figure 3.6 Overview of disconnection detection

- (a) It takes up to 640ms till when disconnection is detected.
When disconnection is detected, Disconnection detection flag (UnG49) and Disconnection detection signal (XC) turn on. Consequently, “ALM” LED blinks.
- (b) When disconnection is detected, the value selected from “Up scale”, “Down scale” or “Given value” in Conversion setting for disconnection detection (UnG164, UnG165) is stored into CH Measured temperature value (UnG11 to UnG18).
The values specified in Conversion setting for disconnection detection (UnG164, UnG165) remains from when disconnection state is restored till when normal measured temperature value is stored.
- (c) After disconnection state is restored, the batch-update of measured temperature value restarts automatically.
It takes up to 1600ms from when disconnection state is restored till when measured temperature value is stored into CH Measured temperature value (UnG11 to UnG18).
- (d) The state of Disconnection detection flag (UnG49), Disconnection detection signal (XC), and “ALM” LED, which means the state of disconnection detection, remain even when disconnection state is restored. Turn on Error clear request (YF).
- (e) For operating the warning output function in disconnection and restoration, refer to Section 3.2.4.

(2) Setting methods

When “Up scale”, “Down scale” or “Given value” is selected in Conversion setting for disconnection detection (Un\G164, Un\G165), the value to be stored into CH□ Measured temperature value (Un\G11 to Un\G18) in disconnection detection can be specified.

(a) Up scale and down scale

When “Up scale” (0H) or “Down scale” (1H) is selected, an up scale value or down scale value of thermocouple-type to be used is stored into the CH□ Measured temperature value (Un\G11 to Un\G18).

Table 3.4 Upscale and down scale list

Thermocouple type	Setting value	Measurement range	Measured temperature value when disconnection is detected.	
			Up scale	Down scale
Thermocouple K	0	-270 to 1370°C	1452.0°C	-352.0°C
Thermocouple E	1	-270 to 1000°C	1063.5°C	-333.5°C
Thermocouple J	2	-210 to 1200°C	1270.5°C	-280.5°C
Thermocouple T	3	-270 to 400°C	433.5°C	-303.5°C
Thermocouple B	4	0 to 1820°C	1911.0°C	-91.0°C
Thermocouple R	5	-50 to 1760°C	1850.5°C	-140.5°C
Thermocouple S	6	-50 to 1760°C	1850.5°C	-140.5°C
Thermocouple N	7	-270 to 1300°C	1378.5°C	-348.5°C

(b) Given value

When “Given value” (2H) is selected, set a value in the CH□ Conversion setting value for disconnection detection (Un\G166 to Un\G173) in units of 0.1°C. The value set in the buffer memory above is stored into the CH□ Measured temperature value (Un\G11 to Un\G18) when disconnection is detected.

3.2.3 Disconnection state conversion setting function (Q68TD-G-H01 only)

This disconnection state conversion setting function stores specific values into measured temperature values when disconnection is checked.

This function can identify the disconnection detection from measured temperature values. This function is only available for channels enable temperature conversion.

(1) Overview of disconnection monitor

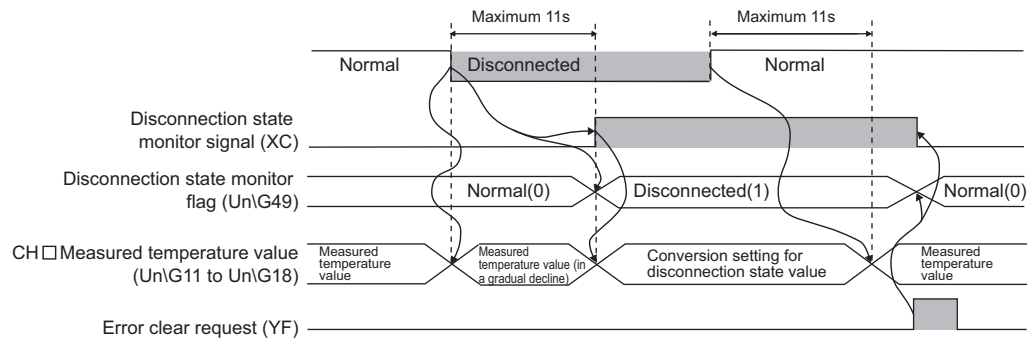

Figure 3.7 Overview of disconnection monitor

- (a) It takes up to 11s from when line is disconnected till when disconnection is monitored.
The measured temperature value decreases till when disconnection state is checked.
When disconnection is checked, Disconnection state monitor flag (UnG49) and Disconnection state monitor signal (XC) turn on. Consequently, “ALM” LED blinks.
- (b) When disconnection is checked, the value selected from “Up scale”, “Down scale” or “Given value” in Disconnection state conversion setting (UnG164, UnG165) is stored into the CH Measured temperature value (UnG11 to UnG18).
The values specified in Disconnection state conversion setting (UnG164, UnG165) remains from when disconnection state is restored till when normal measured temperature value is stored.
- (c) After disconnection state is restored, the batch-update of measured temperature value restarts automatically.
It takes up to 11s from when disconnection state is restored till when measured temperature value is stored into CH Measured temperature value (UnG11 to UnG18).
- (d) The state of Disconnection state monitor flag (UnG49), Disconnection state signal (XC), and “ALM” LED remains, which means the state of disconnection detection, remains even when disconnection state is restored. Turn on Error clear request (YF).
- (e) For operating the warning output function in disconnection and restoration, refer to Section 3.2.4.

(2) Setting methods

When “Up scale”, “Down scale” or “Given value” is selected in Disconnection state conversion setting (Un\G164,Un\G165), the value to be stored into the CH□ Measured temperature value (Un\G11 to Un\G18) in disconnection check can be specified.

(a) Up-scale and down-scale

When “Up scale” (0H) or “Down scale” (1H) is selected, an up-scale value or down-scale value of thermocouple-type to be used is stored into the CH□ Measured temperature value (Un\G11 to Un\G18).

Table 3.5 Up-scale and down-scale list

Thermocouple type	Setting value	Measurement range	Measured temperature value when disconnection is detected	
			Up scale	Down scale
Thermocouple K	0	-270 to 1370°C	1452.0°C	-352.0°C
Thermocouple E	1	-270 to 1000°C	1063.5°C	-333.5°C
Thermocouple J	2	-210 to 1200°C	1270.5°C	-280.5°C
Thermocouple T	3	-270 to 400°C	433.5°C	-303.5°C
Thermocouple B	4	0 to 1820°C	1911.0°C	-91.0°C
Thermocouple R	5	-50 to 1760°C	1850.5°C	-140.5°C
Thermocouple S	6	-50 to 1760°C	1850.5°C	-140.5°C
Thermocouple N	7	-270 to 1300°C	1378.5°C	-348.5°C

(b) Given value

When “Given value” (2H) is selected, set a value in the CH□ CH1 Conversion setting value for disconnection state (Un\G166 to Un\G173) in units of 0.1°C . The value set in the buffer memory above is stored in the CH□ Measured temperature value (Un\G11 to Un\G18) during disconnection state.

3.2.4 Warning output function

(1) Process alarm

(a) Warning occurrence

When the detected measured temperature value is higher than or equal to the process alarm upper upper limit value or lower than or equal to the process alarm lower lower limit value and falls in the warning output range, a warning occurs. When a warning occurs, it is notified by storing "1" in the bit position corresponding to the channel of the warning output flag (process alarm)(Un\G47), and turning ON the warning output signal (XD) and the [ALM] LED.

(b) Warning clearance

After a warning occurrence, when the temperature value falls lower than the process alarm upper lower limit value or rises higher than the process alarm lower upper limit value and returns to within the setting range, the warning is cleared. When the warning is cleared, "0" is stored in the bit position corresponding to the channel of the warning output flag (process alarm)(Un\G47). The warning output signal (XD) turns OFF and the "ALM" LED turns off only when the process alarm and rate alarm warnings for all channels do not occur or are in clearance state.

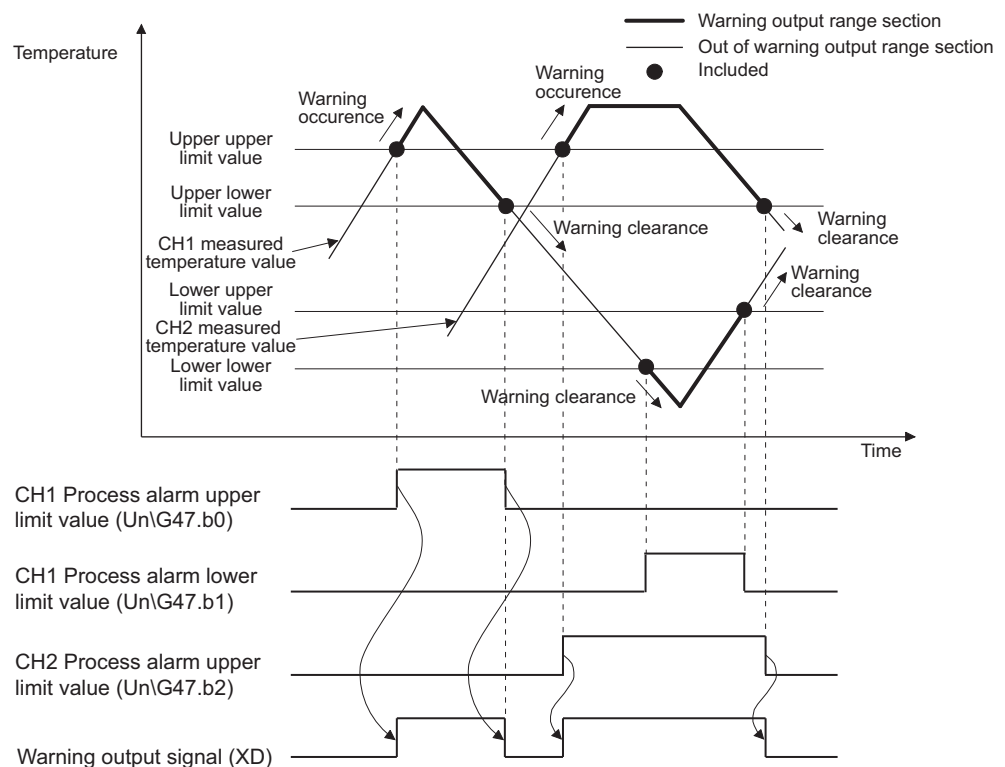

Figure 3.8 Warning output occurrence and clearance (Process alarm)

- (c) Settable range and default value differ according to the thermocouple type.
Set it in unit of 0.1°C.

Table 3.6 Settable range and default value of process alarm

Thermocouple type	Default value				Settable temperature range (Accuracy guarantee range)
	Process alarm lower upper limit value	Process alarm lower limit value	Process alarm upper limit value	Process alarm upper limit value	
Thermocouple K	-2000		12000		-2700 to 13700 (-2000 to 12000)
Thermocouple E	-2000		9000		-2700 to 10000 (-2000 to 9000)
Thermocouple J	-400		7500		-2100 to 12000 (-400 to 7500)
Thermocouple T	-2000		3500		-2700 to 4000 (-2000 to 3500)
Thermocouple B	6000		17000		0 to 18200 (6000 to 17000)
Thermocouple R	0		16000		-500 to 17600 (0 to 16000)
Thermocouple S	0		16000		-500 to 17600 (0 to 16000)
Thermocouple N	-2000		12500		-2700 to 13000 (-2000 to 12500)

- (d) When time average or count average is specified, process-alarm processing is executed for each preset time or count.
When other temperature conversion system (sampling processing, moving average, or primary delay filter) is specified, process-alarm processing is executed at every sampling time.
- (e) When the value of the Conversion setting for disconnection detection (Un\G164,Un\G165) or Disconnection state conversion setting (Un\G164,Un\G165) is set for disconnection detection or disconnection check as follows, a warning occur.
- The lower or equal value to the value set in the process alarm lower lower limit is set.
 - The higher or equal value to the value set in the process alarm upper upper limit is set.

(2) Rate alarm

(a) Warning occurrence

When the measured temperature value is monitored at every rate alarm warning detection period and the changed portion from the preceding value is larger than or equal to the rate alarm upper limit value or smaller than or equal to the rate alarm lower limit value, a warning occurs.

When a warning occurs, it is notified by storing "1" in the bit position corresponding to the channel of the warning output flag (rate alarm)(Un\G48), and turning ON the warning output signal (XD) and the [ALM] LED.

(b) Warning clearance

After a warning occurrence, when the changed portion of the measured temperature value falls lower than the rate alarm upper limit value or rises higher than the rate alarm lower limit value, and returns to within the setting range, the warning is cleared.

When the warning is cleared, "0" is stored in the bit position corresponding to the channel of the warning output flag (rate alarm)(Un\G48).

The warning output signal (XD) turns OFF and the "ALM" LED turns off only when the process alarm and rate alarm warnings for all channels do not occur or are in clearance state.

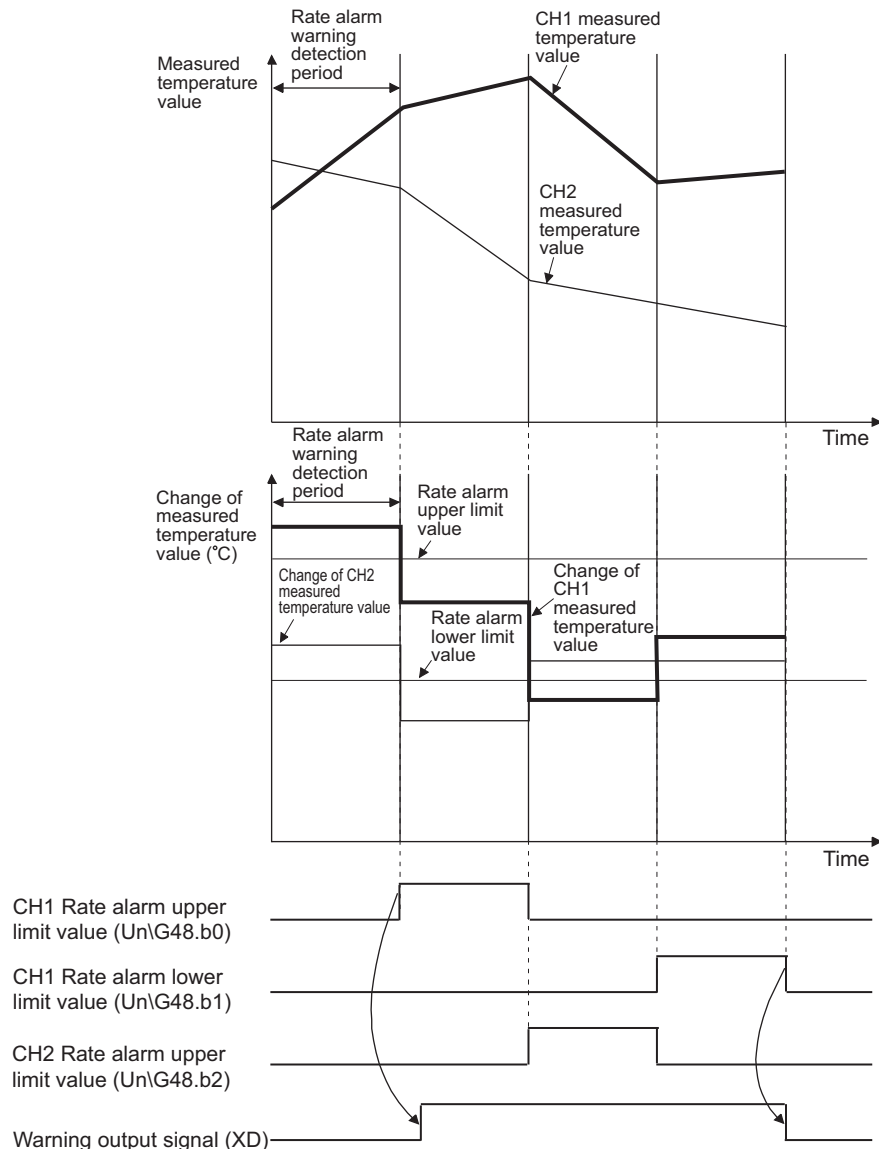

Figure 3.9 Warning output occurrence and clearance (Rate alarm)

(c) Set the rate alarm upper limit/lower limit values in units of 0.1°C for the measured temperature range.

Setting range is -32768 to 32767 (-3276.8°C to 3276.7°C).

Initial value is set to "0".

- (d) The rate alarm warning detection period is set based on the period batch-updating measured temperature values and the number of the periods.

Setting range is 1 to 6000 (times).

Calculation method of the rate alarm warning detection period is below.

$$\begin{aligned} \text{(Rate alarm warning detection period)} = \\ \text{(Setting value of the rate alarm warning detection period)} \\ \times \text{(Temperature measurement value update period)} \end{aligned}$$

[Example 1: When setting the rate alarm warning detection period to 150 times with sampling processing]

$$\text{Rate alarm warning detection period} = 150 \text{ times} \times 320\text{ms} = 48000\text{ms} = 48\text{s}$$

[Example 2: When setting the rate alarm warning detection period to 150 times with 2000ms of time average for the averaging processing]

$$2000 \div 320 = 6.25 \text{ (times)} \cdot \cdot \cdot \text{ Drop the fractional part}$$

The batch-updated period of 2000ms of time average is same as the period of 1920ms (320ms × 6 times)

$$\text{Rate alarm warning detection period} = 150 \text{ times} \times 1920\text{ms} = 288000\text{ms} = 288\text{s}$$

[Example 3: When setting the rate alarm warning detection period to 150 times with 10 times of count average for the averaging processing]

$$\text{Rate alarm warning detection period} = 150 \text{ times} \times 10 \text{ times} \times 320\text{ms} = 480000\text{ms} = 480\text{s}$$

[Example 4: When setting the rate alarm warning detection period to 150 times with 4 times of moving average for the averaging processing]

$$\text{Rate alarm warning detection period} = 150 \text{ times} \times 320\text{ms} = 48000\text{ms} = 48\text{s}$$

- (e) Rate alarm is effective to monitor a change of measured temperature values within a limited range.

- 1) Setting example of the rate alarm upper limit/lower limit values for monitoring that a measured temperature value rises within the specified range

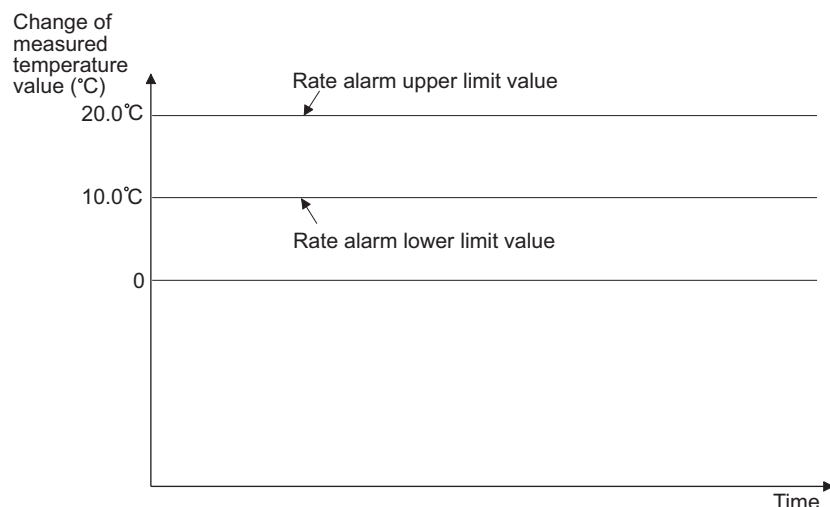

Figure 3.10 Setting example of rate alarm upper limit or lower limit

- 2) Setting example of rate alarm upper limit/lower limit values for monitoring that a measured temperature value drops within the specified range

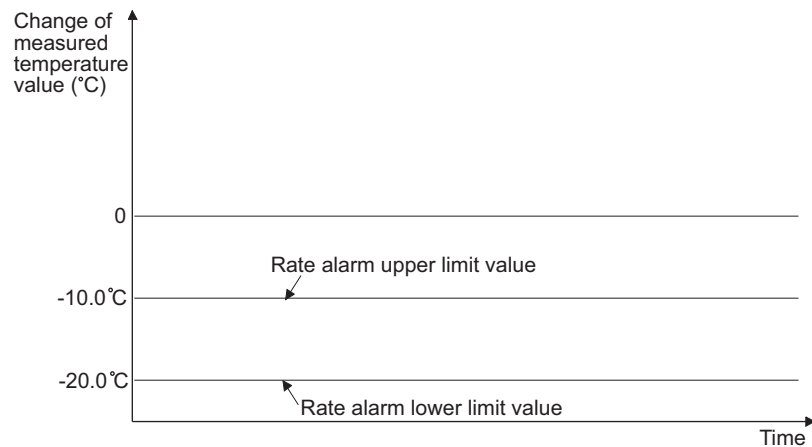

Figure 3.11 Setting example of rate alarm upper limit or lower limit

- 3) Setting example of rate alarm upper limit/lower limit values for monitoring that a measured temperature value changes within the specified range

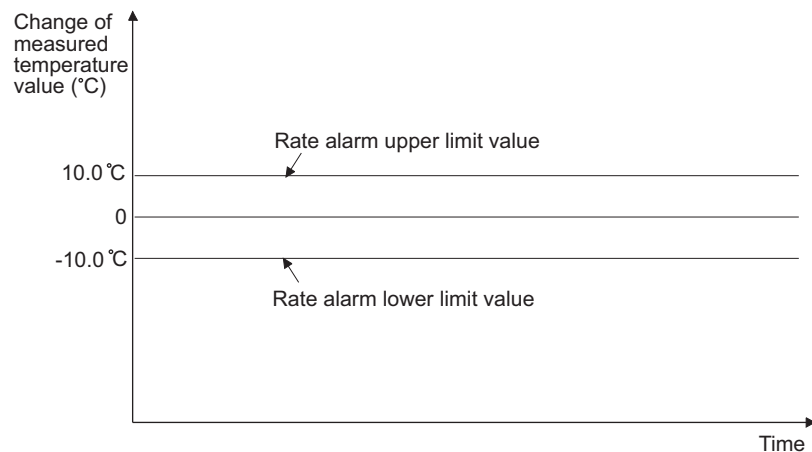

Figure 3.12 Setting example of rate alarm upper limit or lower limit

- (f) When the value of the Conversion setting for disconnection detection (Un\G164,Un\G165) or Disconnection state conversion setting (Un\G164,Un\G165) is set for disconnection detection or disconnection check as follows, a warning occur.
- The changed portion from the preceding value is smaller than or equal to the rate alarm lower limit value.
 - The changed portion from the preceding value is larger than or equal to the rate alarm upper limit value.
- (g) After connection is restored, preceding values required for rate alarm occurrence are cleared.

Therefore, a warning does not occur even though the changed portion of measured temperature values before and after temperature conversion exceeds the setting range when temperature conversion is restarted.

3.2.5 Cold junction temperature compensation resistor disconnection detection function

This function detects disconnection of cold junction compensation resistor (RTD). When a cold junction compensation resistor (RTD) connected with a relay terminal block is disconnected, an error (error code 800) occurs. Consequently, the Error flag (XF) turns on and the “ERR” LED blinks to notify the error.

(1) Condition for detecting disconnection of cold junction compensation resistor (RTD)

Disconnection of the cold junction temperature compensation can be detected only when the switch setting 4 of the intelligent function modules is set to “with cold junction compensation”.

The following shows the conditions in which the disconnection of the cold junction temperature compensation resistor (RTD) can be detected.

Table 3.7 Disconnection detection of cold junction temperature compensation resistor

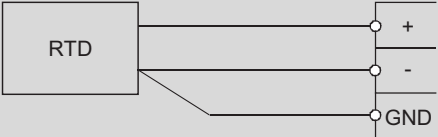
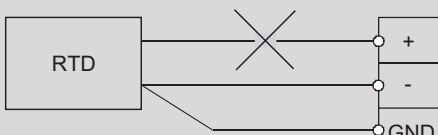
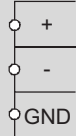
Connection state	Cold junction temperature with/without setting	Error flag
 Without disconnection	with	OFF
	without	
 With disconnection	with	ON
	without	OFF
 Without connection	with	ON
	without	OFF

(2) Operation for detecting disconnection of cold junction compensation resistor (RTD)

When disconnection of cold junction temperature compensation resistor (RTD) is detected, conversion for every conversion-enabled channel stops.

The measured temperature value for cold junction temperature compensation resistor (RTD) disconnection remains the same as the measured value prior to the disconnection detection.

(3) Operation and processing for restoring disconnection of cold junction compensation resistor (RTD)

Conversion processing does not restart even after the disconnection of the cold junction temperature compensation resistor (RTD) is restored.

To restart the conversion processing, turn off the Error clear request (YF).

3.3 I/O Signals Transferred to/from Programmable Controller CPU

This section describes the I/O signal assignment and signal functions.

3.3.1 I/O signal list

The following are the I/O signals of the Q68TD-G-H02 (H01).
The I/O numbers (X/Y) given in this chapter and later assume that the first I/O number of the Q68TD-G-H02 (H01) is set to 0.

Table 3.8 I/O signal list

Input signal (Signal direction: Programmable controller CPU ← Q68TD-G-H02 (H01))		Output signal (Signal direction: Programmable controller CPU → Q68TD-G-H02 (H01))	
Device No.	Signal name	Device No.	Signal name
X0	Module ready	Y0	Reserved *1
X1	Reserved *1	Y1	
X2		Y2	
X3		Y3	
X4		Y4	
X5		Y5	
X6		Y6	
X7		Y7	
X8		Y8	
X9		Operating condition setting completion flag	Y9
XA	Offset/gain setting mode status flag	YA	User range write request
XB	Channel change completion flag	YB	Channel change request
XC	Disconnection detection signal (Q68TD-G-H02 only)	YC	Reserved *1
	Disconnection state monitor signal (Q68TD-G-H01 only)		
XD	Warning output signal	YD	
XE	Conversion completion flag	YE	
XF	Error flag	YF	Error clear request

POINT

The reserved signals marked *1 are used by the system and are unavailable for the user. Should they be turned on/off in a sequence program, we cannot guarantee the functions of the Q68TD-G-H02 (H01).

3.3.2 I/O signal details

The following are details of the Q68TD-G-H02 (H01) I/O signals.

(1) Module ready (X0)

- (a) If the module is in the normal mode at power-on or resetting of the programmable controller CPU, this signal turns on to start conversion processing as soon as it gets ready for conversion.
- (b) When this signal (X0) is off in the normal mode, conversion processing is not performed. In the offset/gain setting mode, conversion processing is performed if this signal (X0) is off.

(c) This signal (X0) turns off when:

- The module is in the offset/gain setting mode
- The Q68TD-G-H02 (H01) is in a watchdog timer error *1

* 1 Occurs if program operation is not completed within the intended time due to errors such as a hardware fault of the Q68TD-G-H02 (H01). The RUN LED of the Q68TD-G-H02 (H01) goes off when a watchdog timer error occurs.

(2) Operation condition setting completion flag (X9)

- (a) When the following settings are changed, this signal is used as an interlock condition to turn ON/OFF the operation condition setting request (Y9).
 - Conversion enable/disable setting (Un\G0)
 - CH□ Time/Count/Moving average/Time constant setting (Un\G1 to Un\G8)
 - Averaging processing selection (Un\G24,Un\G25)
 - Warning output enable/disable setting (Un\G46)
 - Scaling valid/invalid setting (Un\G58)
 - CH□ Scaling range upper/lower limit value (Un\G62 to Un\G77)
 - CH□ Scaling width upper/lower limit value (Un\G78 to Un\G93)
 - CH□ Process alarm upper/lower limit value (Un\G94 to Un\G125)
 - CH□ Rate alarm warning detection period (Un\126 to Un\G133)
 - CH□ Rate alarm upper/lower limit value (Un\G134 to Un\G149)
 - Conversion setting for disconnection detection (Un\G164,Un\G165) (Q68TD-G-H02 only)
 - Disconnection state conversion setting (Un\G164,Un\G165) (Q68TD-G-H01 only)
 - CH□ Conversion setting value for disconnection detection (Un\G166 to Un\G173) (Q68TD-G-H02 only)
 - CH□ Conversion setting value for disconnection state (Un\G166 to Un\G173) (Q68TD-G-H01 only)

When Operation condition setting completion flag (X9) is OFF, conversion processing is not carried out.

- (b) Operating condition setting completion flag (X9) turns OFF in the following status.
- When Operating condition setting request (Y9) is ON.

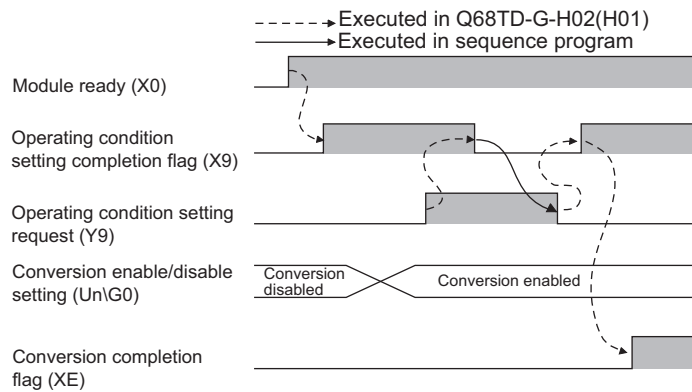

Figure 3.13 When Operating condition setting request (Y9) is ON

(3) Offset/gain setting mode status flag (XA)

(a) In offset/gain setting mode

- 1) This signal is used as an interlock condition to turn ON/OFF the user range write request (YA) when the value at completion of offset/gain setting adjustment is registered.
- 2) See Section 4.6 regarding the offset/gain settings.

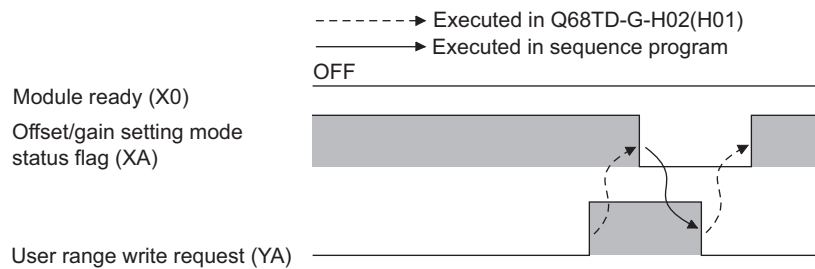

Figure 3.14 Offset/gain setting mode status flag (XA) during offset/gain setting mode

(b) In normal mode

- 1) This signal is used as an interlock condition to turn ON/OFF the user range write request (YA) when the user range is restored.
- 2) Refer to CHAPTER 7 for the user range restoration.

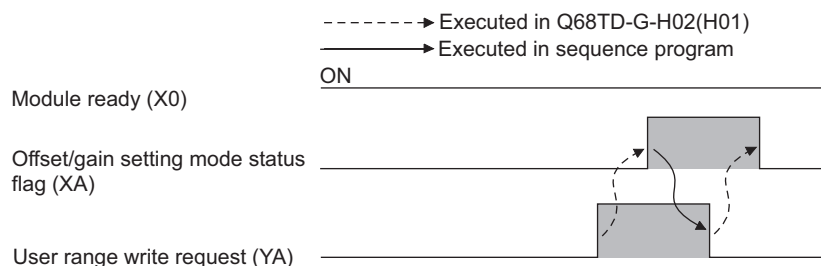

Figure 3.15 Offset/gain setting mode status flag (XA) during normal mode

(4) Channel change completion flag (XB)

- (a) This signal is used as an interlock condition to turn ON/OFF the channel change request (YB) when changing the channel for the offset/gain setting.
- (b) For offset/gain setting, refer to Section 4.6.

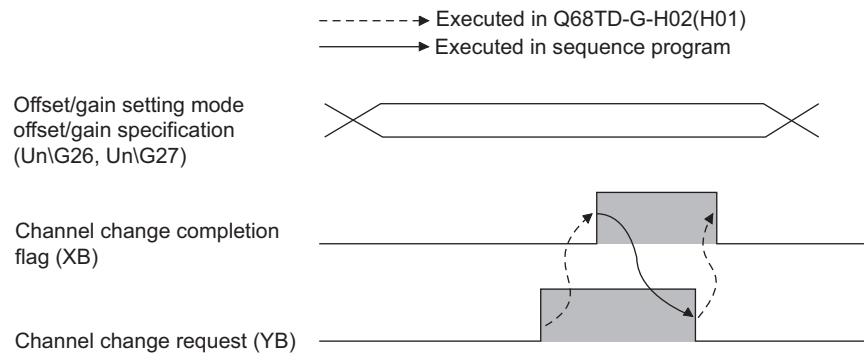

Figure 3.16 Channel change completion flag (XB)

(5) Disconnection detection signal (XC) (Q68TD-G-H02 only)

- (a) This signal turns on when any input signal line including a thermocouple in the input circuit of the conversion-enabled channel is disconnected. To identify the disconnected channel, check Disconnection detection flag (Un\G49). When this signal turns on, conversion update for the conversion-enabled channels stops.
- (b) Measured temperature value when this signal turns on can be selected from "Up scale", "Down scale", or "Given scale". (Refer to Section 3.2.2)
- (c) This signal turns off after eliminating the cause of disconnection and turning on Error clear request (YF).
- (d) When connection is restored, the measured temperature value update is restarted regardless of the reset of this signal.

(6) Disconnection state monitor signal (XC) (Q68TD-G-H01 only)

- (a) The thermocouple input circuit of the conversion-enabled channel turns ON the disconnection state monitor signal (XC) when any input signal line including the thermocouple is disconnected. To identify the disconnected channel, check with the disconnection state monitor flag (Un\G49). In addition, conversion update for the conversion-enabled channels stops.
- (b) For measured temperature values to be stored when the disconnection state monitor signal (XC) turns ON, any of "Up scale", "Down scale", or "Given value" can be selected (refer to Section 3.2.3).
- (c) Removing the cause of disconnection and turning ON the error clear request (YF) turns OFF the disconnection state monitor signal (XC).
- (d) When the line connection is recovered, the temperature conversion value update is restarted regardless of the disconnection state monitor signal (XC) reset.

(7) Warning output signal (XD)

(a) The warning output signal (XD) turns ON when a process alarm or rate alarm is detected.

1) Process alarm

- This signal turns ON when the process alarm is enabled and a measured temperature value exceeds the preset range of the process alarm upper/lower limit value (Un\G94 to Un\G125) in a conversion-enabled channel.
- For every conversion-enabled channel, the signal automatically turns OFF when the measured temperature value returns to within the setting range, and the "ALM" LED also turns off.

2) Rate alarm

- This signal turns ON when the rate alarm is enabled and the change of measured temperature value exceeds the preset range of the rate alarm upper/lower limit value (Un\G134 to Un\G149) in a conversion-enabled channel.
- For every conversion-enabled channel, the signal automatically turns OFF when the change of measured temperature values return to within the setting range, and the "ALM" LED also turns off.

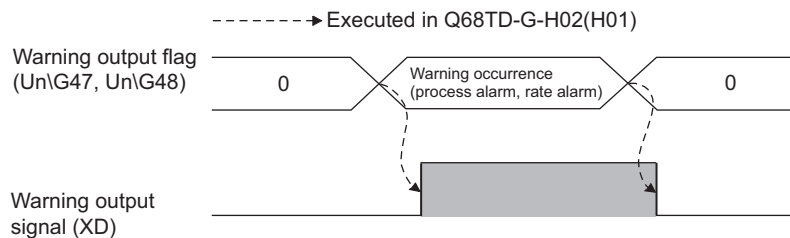

Figure 3.17 On or off for warning output signal (XD)

(8) Conversion completion flag (XE)

- (a) Conversion completion flag (XE) turns ON when the measured temperature values of all conversion-enabled channels are stored into buffer memory after power-on or hardware reset.
- (b) When averaging processing is performed, this signal also turns ON when the converted measured temperature value is stored into buffer memory after completion of averaging processing.
- (c) When Operating condition setting completion flag (X9) turns on (stop → conversion)
 - 1) After the measured temperature value is stored into buffer memory, the bit of corresponding channel in Conversion completion flag (Un\G10) turns on (changes to "1").
 - 2) After the measured temperature values of all conversion-enabled channels are stored into buffer memory, this flag turns on.
- (d) When Operating condition setting completion flag (X9) turns off (conversion → stop)
 - 1) The bits of all channels in Conversion completion flag (Un\G10) are turned off (changes to "0").
 - 2) This flag (XE) turns off.

Note that even though conversion has been stopped, the data immediately before the stop are held in the Measured temperature values stored in the buffer memory.
- (e) Use this signal or Conversion completion flag (Un\G10) as an interlock to read out the measured temperature value.
- (f) This flag (XE) does not turn on when all channels are set to conversion-disabled.

(9) Error Flag (XF)

- (a) Error flag (XF) turns ON when a writing error occurs.
- (b) To clear the error code, turn ON Error clear request (YF).

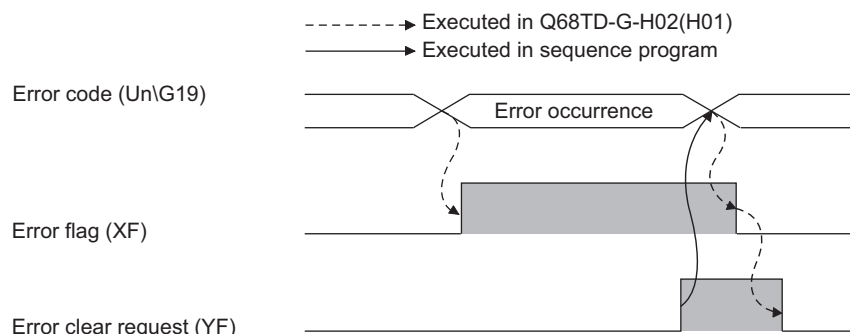

Figure 3.18 On or off for Error flag (XF)

(10) Operating condition setting request (Y9)

- (a) This signal is turned ON when enabling the following setting contents.
- Conversion enable/disable setting (Un\G0)
 - CH□ Time/Count/Moving average/Time constant setting (Un\G1 to Un\G8)
 - Averaging processing selection (Un\G24, Un\G25)
 - Warning output enable/disable setting (Un\G46)
 - Scaling valid/invalid setting (Un\G58)
 - CH□ Scaling range upper/lower limit value (Un\G62 to Un\G77)
 - CH□ Scaling width upper/lower limit value (Un\G78 to Un\G93)
 - CH□ Process alarm upper/lower limit value (Un\G94 to Un\G125)
 - CH□ Rate alarm warning detection period (Un\G126 to Un\G133)
 - CH□ Rate alarm upper/lower limit value (Un\G134 to Un\G149)
 - Conversion setting for disconnection detection (Un\G164, Un\G165) (Q68TD-G-H02 only)
 - Disconnection state conversion setting (Un\G164, Un\G165) (Q68TD-G-H01 only)
 - CH□ Conversion setting value for disconnection detection (Un\G166 to Un\G173) (Q68TD-G-H02 only)
 - CH□ Conversion setting value for disconnection state (Un\G166 to Un\G173) (Q68TD-G-H01 only)
- (b) When this signal is turned on, Disconnection detection signal (XC) and Warning output signal (XD) turn off.
- (c) For the ON/OFF timing, refer to the field of the operating condition setting completion flag (X9).

(11) User range write request (YA)

- (a) In offset/gain setting mode
- 1) This signal turns ON when registering the adjusted value of offset/gain setting to the flash memory.
 - 2) For the ON/OFF timing, refer to the field of the offset/gain setting mode status flag (XA).
For offset/gain settings, refer to Section 4.6.
- (b) In normal mode
- 1) This signal turns ON when the user range is restored.
 - 2) For the ON/OFF timing, refer to the field of the offset/gain setting mode status flag (XA).
For user range restoration, refer to CHAPTER 7.

(12) Channel change request (YB)

- (a) This signal turns ON when changing the channel for executing the offset/gain setting.
- (b) For the ON/OFF timing, refer to the field of the channel change completion flag (XB).
For the offset/gain setting, refer to Section 4.6.

(13) Error clear request (YF)

- (a) This signal turns ON when clearing Error flag (XF) and Disconnection state monitor signal (XC).
However, the setting value error of the intelligent function module switch setting cannot be cleared.
Correct the setting value.
- (b) For the ON/OFF timing, refer to the field of Disconnection state monitor signal (XC) and Error flag (XF)

3.4 Buffer Memory

3.4.1 Buffer memory assignment

This section describes the assignment of the Q68TD-G-H02 (H01) buffer memory.

POINT

Do not write data from system area or sequence program to the buffer memory area where writing is disabled.

Doing so may cause malfunction.

Table 3.9 Buffer memory assignment

Addresses		Description	Default value	Read/Write ^{*1}	Reference section
Hex.	Dec.				
00H	0	Conversion enable/disable setting	00FFH	R/W ^{*2}	Section 3.4.2
01H	1	CH1 Time/Count/Moving average/Time constant setting	0	R/W ^{*2}	Section 3.4.3
02H	2	CH2 Time/Count/Moving average/Time constant setting	0	R/W ^{*2}	
03H	3	CH3 Time/Count/Moving average/Time constant setting	0	R/W ^{*2}	
04H	4	CH4 Time/Count/Moving average/Time constant setting	0	R/W ^{*2}	
05H	5	CH5 Time/Count/Moving average/Time constant setting	0	R/W ^{*2}	
06H	6	CH6 Time/Count/Moving average/Time constant setting	0	R/W ^{*2}	
07H	7	CH7 Time/Count/Moving average/Time constant setting	0	R/W ^{*2}	
08H	8	CH8 Time/Count/Moving average/Time constant setting	0	R/W ^{*2}	
09H	9	System area	-	-	-
0AH	10	Conversion completion flag	0	R	Section 3.4.4
0BH	11	CH1 Measured temperature value	0	R	Section 3.4.5
0CH	12	CH2 Measured temperature value	0	R	
0DH	13	CH3 Measured temperature value	0	R	
0EH	14	CH4 Measured temperature value	0	R	
0FH	15	CH5 Measured temperature value	0	R	
10H	16	CH6 Measured temperature value	0	R	
11H	17	CH7 Measured temperature value	0	R	
12H	18	CH8 Measured temperature value	0	R	
13H	19	Error code	0	R	Section 3.4.6
14H	20	Setting range 1(Thermocouple type CH1-CH4)	0	R	Section 3.4.7
15H	21	Setting range 2(Thermocouple type CH5-CH8)	0	R	Section 3.4.8
16H	22	Setting range 3(Offset/gain setting CH1-CH8)	0	R	Section 3.4.8
17H	23	System area	-	-	-
18H	24	Averaging processing selection (CH1-CH4)	0	R/W ^{*2}	Section 3.4.9
19H	25	Averaging processing selection (CH5-CH8)	0	R/W ^{*2}	
1AH	26	Offset/gain setting mode(Offset specification)	0	R/W ^{*2}	Section 3.4.10
1BH	27	Offset/gain setting mode(Gain specification)	0	R/W ^{*2}	

Table 3.9 Buffer memory assignment

Addresses		Description	Default value	Read/Write*1	Reference section
Hex.	Dec.				
1CH	28	CH1 Offset temperature setting value	0	RW*2	Section 3.4.11
1DH	29	CH1 Gain temperature setting value	0	RW*2	
1EH	30	CH2 Offset temperature setting value	0	RW*2	
1FH	31	CH2 Gain temperature setting value	0	RW*2	
20H	32	CH3 Offset temperature setting value	0	RW*2	
21H	33	CH3 Gain temperature setting value	0	RW*2	
22H	34	CH4 Offset temperature setting value	0	RW*2	
23H	35	CH4 Gain temperature setting value	0	RW*2	
24H	36	CH5 Offset temperature setting value	0	RW*2	
25H	37	CH5 Gain temperature setting value	0	RW*2	
26H	38	CH6 Offset temperature setting value	0	RW*2	
27H	39	CH6 Gain temperature setting value	0	RW*2	
28H	40	CH7 Offset temperature setting value	0	RW*2	
29H	41	CH7 Gain temperature setting value	0	RW*2	
2AH	42	CH8 Offset temperature setting value	0	RW*2	
2BH	43	CH8 Gain temperature setting value	0	RW*2	
2CH	44	System area	-	-	-
2DH	45	Cold junction compensation setting state (Q68TD-G-H02 only)	0	R	Section 3.4.12
		System area (Q68TD-G-H01 only)	-	-	-
2EH	46	Warning output enable/disable setting	FFFFH	RW*2	Section 3.4.13
2FH	47	Warning output flag(Process alarm)	0	R	Section 3.4.14
30H	48	Warning output flag(Rate alarm)	0	R	
31H	49	Disconnection detection flag (Q68TD-G-H02 only)	0	R	Section 3.4.15
		Disconnection state monitor flag (Q68TD-G-H01 only)			Section 3.4.16
32H	50	CH1 Scaling value	0	R	Section 3.4.17
33H	51	CH2 Scaling value	0	R	
34H	52	CH3 Scaling value	0	R	
35H	53	CH4 Scaling value	0	R	
36H	54	CH5 Scaling value	0	R	
37H	55	CH6 Scaling value	0	R	
38H	56	CH7 Scaling value	0	R	
39H	57	CH8 Scaling value	0	R	
3AH	58	Scaling valid/invalid setting	00FFH	RW*2	Section 3.4.18
3BH	59	System area	-	-	-
to	to				
3DH	61				

Table 3.9 Buffer memory assignment

Addresses		Description	Default value	Read/Write *1	Reference section
Hex.	Dec.				
3EH	62	CH1 Scaling range lower limit value	0	R/W*2	Section 3.4.19
3FH	63	CH1 Scaling range upper limit value	0	R/W*2	
40H	64	CH2 Scaling range lower limit value	0	R/W*2	
41H	65	CH2 Scaling range upper limit value	0	R/W*2	
42H	66	CH3 Scaling range lower limit value	0	R/W*2	
43H	67	CH3 Scaling range upper limit value	0	R/W*2	
44H	68	CH4 Scaling range lower limit value	0	R/W*2	
45H	69	CH4 Scaling range upper limit value	0	R/W*2	
46H	70	CH5 Scaling range lower limit value	0	R/W*2	
47H	71	CH5 Scaling range upper limit value	0	R/W*2	
48H	72	CH6 Scaling range lower limit value	0	R/W*2	
49H	73	CH6 Scaling range upper limit value	0	R/W*2	
4AH	74	CH7 Scaling range lower limit value	0	R/W*2	
4BH	75	CH7 Scaling range upper limit value	0	R/W*2	
4CH	76	CH8 Scaling range lower limit value	0	R/W*2	
4DH	77	CH8 Scaling range upper limit value	0	R/W*2	
4EH	78	CH1 Scaling width lower limit value	0	R/W*2	Section 3.4.20
4FH	79	CH1 Scaling width upper limit value	0	R/W*2	
50H	80	CH2 Scaling width lower limit value	0	R/W*2	
51H	81	CH2 Scaling width upper limit value	0	R/W*2	
52H	82	CH3 Scaling width lower limit value	0	R/W*2	
53H	83	CH3 Scaling width upper limit value	0	R/W*2	
54H	84	CH4 Scaling width lower limit value	0	R/W*2	
55H	85	CH4 Scaling width upper limit value	0	R/W*2	
56H	86	CH5 Scaling width lower limit value	0	R/W*2	
57H	87	CH5 Scaling width upper limit value	0	R/W*2	
58H	88	CH6 Scaling width lower limit value	0	R/W*2	
59H	89	CH6 Scaling width upper limit value	0	R/W*2	
5AH	90	CH7 Scaling width lower limit value	0	R/W*2	
5BH	91	CH7 Scaling width upper limit value	0	R/W*2	
5CH	92	CH8 Scaling width lower limit value	0	R/W*2	
5DH	93	CH8 Scaling width upper limit value	0	R/W*2	

Table 3.9 Buffer memory assignment

Addresses		Description	Default value	Read/Write*1	Reference section
Hex.	Dec.				
5EH	94	CH1 Process alarm lower lower limit value	-2000	RW*2	Section 3.4.21
5FH	95	CH1 Process alarm lower upper limit value	-2000	RW*2	
60H	96	CH1 Process alarm upper lower limit value	12000	RW*2	
61H	97	CH1 Process alarm upper upper limit value	12000	RW*2	
62H	98	CH2 Process alarm lower lower limit value	-2000	RW*2	
63H	99	CH2 Process alarm lower upper limit value	-2000	RW*2	
64H	100	CH2 Process alarm upper lower limit value	12000	RW*2	
65H	101	CH2 Process alarm upper upper limit value	12000	RW*2	
66H	102	CH3 Process alarm lower lower limit value	-2000	RW*2	
67H	103	CH3 Process alarm lower upper limit value	-2000	RW*2	
68H	104	CH3 Process alarm upper lower limit value	12000	RW*2	
69H	105	CH3 Process alarm upper upper limit value	12000	RW*2	
6AH	106	CH4 Process alarm lower lower limit value	-2000	RW*2	
6BH	107	CH4 Process alarm lower upper limit value	-2000	RW*2	
6CH	108	CH4 Process alarm upper lower limit value	12000	RW*2	
6DH	109	CH4 Process alarm upper upper limit value	12000	RW*2	
6EH	110	CH5 Process alarm lower lower limit value	-2000	RW*2	
6FH	111	CH5 Process alarm lower upper limit value	-2000	RW*2	
70H	112	CH5 Process alarm upper lower limit value	12000	RW*2	
71H	113	CH5 Process alarm upper upper limit value	12000	RW*2	
72H	114	CH6 Process alarm lower lower limit value	-2000	RW*2	
73H	115	CH6 Process alarm lower upper limit value	-2000	RW*2	
74H	116	CH6 Process alarm upper lower limit value	12000	RW*2	
75H	117	CH6 Process alarm upper upper limit value	12000	RW*2	
76H	118	CH7 Process alarm lower lower limit value	-2000	RW*2	
77H	119	CH7 Process alarm lower upper limit value	-2000	RW*2	
78H	120	CH7 Process alarm upper lower limit value	12000	RW*2	
79H	121	CH7 Process alarm upper upper limit value	12000	RW*2	
7AH	122	CH8 Process alarm lower lower limit value	-2000	RW*2	
7BH	123	CH8 Process alarm lower upper limit value	-2000	RW*2	
7CH	124	CH8 Process alarm upper lower limit value	12000	RW*2	
7DH	125	CH8 Process alarm upper upper limit value	12000	RW*2	
7EH	126	CH1 Rate alarm warning detection period	0	RW*2	Section 3.4.22
7FH	127	CH2 Rate alarm warning detection period	0	RW*2	
80H	128	CH3 Rate alarm warning detection period	0	RW*2	
81H	129	CH4 Rate alarm warning detection period	0	RW*2	
82H	130	CH5 Rate alarm warning detection period	0	RW*2	
83H	131	CH6 Rate alarm warning detection period	0	RW*2	
84H	132	CH7 Rate alarm warning detection period	0	RW*2	
85H	133	CH8 Rate alarm warning detection period	0	RW*2	

Table 3.9 Buffer memory assignment

Addresses		Description	Default value	Read/Write *1	Reference section
Hex.	Dec.				
86H	134	CH1 Rate alarm upper limit value	0	R/W*2	Section 3.4.23
87H	135	CH1 Rate alarm lower limit value	0	R/W*2	
88H	136	CH2 Rate alarm upper limit value	0	R/W*2	
89H	137	CH2 Rate alarm lower limit value	0	R/W*2	
8AH	138	CH3 Rate alarm upper limit value	0	R/W*2	
8BH	139	CH3 Rate alarm lower limit value	0	R/W*2	
8CH	140	CH4 Rate alarm upper limit value	0	R/W*2	
8DH	141	CH4 Rate alarm lower limit value	0	R/W*2	
8EH	142	CH5 Rate alarm upper limit value	0	R/W*2	
8FH	143	CH5 Rate alarm lower limit value	0	R/W*2	
90H	144	CH6 Rate alarm upper limit value	0	R/W*2	
91H	145	CH6 Rate alarm lower limit value	0	R/W*2	
92H	146	CH7 Rate alarm upper limit value	0	R/W*2	
93H	147	CH7 Rate alarm lower limit value	0	R/W*2	
94H	148	CH8 Rate alarm upper limit value	0	R/W*2	
95H	149	CH8 Rate alarm lower limit value	0	R/W*2	
96H	150	System area	-	-	-
to	to				
9DH	157				
9EH	158	Mode switching setting	0	R/W*2	Section 3.4.24
9FH	159				
A0H	160	System area	-	-	-
to	to				
A3H	163				
A4H	164	Conversion setting for disconnection detection (CH1-CH4)(Q68TD-G-H02 only)	1111H	R/W*2	Section 3.4.25 or Section 3.4.26
		Disconnection state conversion setting (CH1-CH4)(Q68TD-G-H01 only)			
A5H	165	Conversion setting for disconnection detection (CH5-CH8)(Q68TD-G-H02 only)	1111H	R/W*2	
		Disconnection state conversion setting (CH5-CH8)(Q68TD-G-H01 only)			

Table 3.9 Buffer memory assignment

Addresses		Description	Default value	Read/Write *1	Reference section
Hex.	Dec.				
A6H	166	CH1 Conversion setting value for disconnection detection (Q68TD-G-H02 only)	0	RW*2	Section 3.4.27 or Section 3.4.28
		CH1 Conversion setting value for disconnection state (Q68TD-G-H01 only)			
A7H	167	CH2 Conversion setting value for disconnection detection (Q68TD-G-H02 only)	0	RW*2	
		CH2 Conversion setting value for disconnection state (Q68TD-G-H01 only)			
A8H	168	CH3 Conversion setting value for disconnection detection (Q68TD-G-H02 only)	0	RW*2	
		CH3 Conversion setting value for disconnection state (Q68TD-G-H01 only)			
A9H	169	CH4 Conversion setting value for disconnection detection (Q68TD-G-H02 only)	0	RW*2	
		CH4 Conversion setting value for disconnection state (Q68TD-G-H01 only)			
AAH	170	CH5 Conversion setting value for disconnection detection (Q68TD-G-H02 only)	0	RW*2	
		CH5 Conversion setting value for disconnection state (Q68TD-G-H01 only)			
ABH	171	CH6 Conversion setting value for disconnection detection (Q68TD-G-H02 only)	0	RW*2	
		CH6 Conversion setting value for disconnection state (Q68TD-G-H01 only)			
ACH	172	CH7 Conversion setting value for disconnection detection (Q68TD-G-H02 only)	0	RW*2	
		CH7 Conversion setting value for disconnection state (Q68TD-G-H01 only)			
ADH	173	CH8 Conversion setting value for disconnection detection (Q68TD-G-H02 only)	0	RW*2	
		CH8 Conversion setting value for disconnection state (Q68TD-G-H01 only)			
AEH	174	System area	-	-	
to	to				
BDH	189				

1	OVERVIEW
2	SYSTEM CONFIGURATION
3	SPECIFICATIONS
4	SETUP AND PROCEDURES BEFORE OPERATION
5	UTILITY PACKAGE (GX CONFIGURATOR-T)
6	PROGRAMMING
7	ONLINE MODULE CHANGE
8	TROUBLESHOOTING

Table 3.9 Buffer memory assignment

Addresses		Description	Default value	Read/Write*1	Reference section
Hex.	Dec.				
BE _H	190	CH1 Factory default offset value*3	0	R/W*2	Section 3.4.29
BF _H	191	CH1 Factory default gain value*3	0	R/W*2	
C0 _H	192	CH1 User range settings offset value*3	0	R/W*2	
C1 _H	193	CH1 User range settings gain value*3	0	R/W*2	
C2 _H	194	CH1 User range settings thermal EMF offset value(L)*3	0	R/W*2	
C3 _H	195	CH1 User range settings thermal EMF offset value(H)*3			
C4 _H	196	CH1 User range settings thermal EMF gain value(L)*3	0	R/W*2	
C5 _H	197	CH1 User range settings thermal EMF gain value(H)*3			
C6 _H	198	CH2 Factory default offset value*3	0	R/W*2	
C7 _H	199	CH2 Factory default gain value*3	0	R/W*2	
C8 _H	200	CH2 User range settings offset value*3	0	R/W*2	
C9 _H	201	CH2 User range settings gain value*3	0	R/W*2	
CA _H	202	CH2 User range settings thermal EMF offset value(L)*3	0	R/W*2	
CB _H	203	CH2 User range settings thermal EMF offset value(H)*3			
CC _H	204	CH2 User range settings thermal EMF gain value(L)*3	0	R/W*2	
CD _H	205	CH2 User range settings thermal EMF gain value(H)*3			
CE _H	206	CH3 Factory default offset value*3	0	R/W*2	
CF _H	207	CH3 Factory default gain value*3	0	R/W*2	
D0 _H	208	CH3 User range settings offset value*3	0	R/W*2	
D1 _H	209	CH3 User range settings gain value*3	0	R/W*2	
D2 _H	210	CH3 User range settings thermal EMF offset value(L)*3	0	R/W*2	
D3 _H	211	CH3 User range settings thermal EMF offset value(H)*3			
D4 _H	212	CH3 User range settings thermal EMF gain value(L)*3	0	R/W*2	
D5 _H	213	CH3 User range settings thermal EMF gain value(H)*3			
D6 _H	214	CH4 Factory default offset value*3	0	R/W*2	
D7 _H	215	CH4 Factory default gain value*3	0	R/W*2	
D8 _H	216	CH4 User range settings offset value*3	0	R/W*2	
D9 _H	217	CH4 User range settings gain value*3	0	R/W*2	
DA _H	218	CH4 User range settings thermal EMF offset value(L)*3	0	R/W*2	
DB _H	219	CH4 User range settings thermal EMF offset value(H)*3			
DC _H	220	CH4 User range settings thermal EMF gain value(L)*3	0	R/W*2	
DD _H	221	CH4 User range settings thermal EMF gain value(H)*3			
DE _H	222	CH5 Factory default offset value*3	0	R/W*2	
DF _H	223	CH5 Factory default gain value*3	0	R/W*2	
E0 _H	224	CH5 User range settings offset value*3	0	R/W*2	
E1 _H	225	CH5 User range settings gain value*3	0	R/W*2	
E2 _H	226	CH5 User range settings thermal EMF offset value(L)*3	0	R/W*2	
E3 _H	227	CH5 User range settings thermal EMF offset value(H)*3			
E4 _H	228	CH5 User range settings thermal EMF gain value(L)*3	0	R/W*2	
E5 _H	229	CH5 User range settings thermal EMF gain value(H)*3			
E6 _H	230	CH6 Factory default offset value*3	0	R/W*2	
E7 _H	231	CH6 Factory default gain value*3	0	R/W*2	
E8 _H	232	CH6 User range settings offset value*3	0	R/W*2	
E9 _H	233	CH6 User range settings gain value*3	0	R/W*2	
EA _H	234	CH6 User range settings thermal EMF offset value(L)*3	0	R/W*2	
EB _H	235	CH6 User range settings thermal EMF offset value(H)*3			
EC _H	236	CH6 User range settings thermal EMF gain value(L)*3	0	R/W*2	

Table 3.9 Buffer memory assignment

Addresses		Description	Default value	Read/Write ^{*1}	Reference section
Hex.	Dec.				
ED _H	237	CH6 User range settings thermal EMF gain value(H) ^{*3}	0	R/W ^{*2}	Section 3.4.29
EE _H	238	CH7 Factory default offset value ^{*3}	0	R/W ^{*2}	
EF _H	239	CH7 Factory default gain value ^{*3}	0	R/W ^{*2}	
F0 _H	240	CH7 User range settings offset value ^{*3}	0	R/W ^{*2}	
F1 _H	241	CH7 User range settings gain value ^{*3}	0	R/W ^{*2}	
F2 _H	242	CH7 User range settings thermal EMF offset value(L) ^{*3}	0	R/W ^{*2}	
F3 _H	243	CH7 User range settings thermal EMF offset value(H) ^{*3}			
F4 _H	244	CH7 User range settings thermal EMF gain value(L) ^{*3}	0	R/W ^{*2}	
F5 _H	245	CH7 User range settings thermal EMF gain value(H) ^{*3}			
F6 _H	246	CH8 Factory default offset value ^{*3}	0	R/W ^{*2}	
F7 _H	247	CH8 Factory default gain value ^{*3}	0	R/W ^{*2}	
F8 _H	248	CH8 User range settings offset value ^{*3}	0	R/W ^{*2}	
F9 _H	249	CH8 User range settings gain value ^{*3}	0	R/W ^{*2}	
FA _H	250	CH8 User range settings thermal EMF offset value(L) ^{*3}	0	R/W ^{*2}	
FB _H	251	CH8 User range settings thermal EMF offset value(H) ^{*3}			
FC _H	252	CH8 User range settings thermal EMF gain value(L) ^{*3}	0	R/W ^{*2}	
FD _H	253	CH8 User range settings thermal EMF gain value(H) ^{*3}			

* 1 Indicates whether reading from and writing to a sequence program are enabled.

R : Read enabled W : Write enabled

* 2 Data must be written to buffer memory under the interlock conditions (buffer memory write conditions) of the following I/O signals.

- Operating condition setting

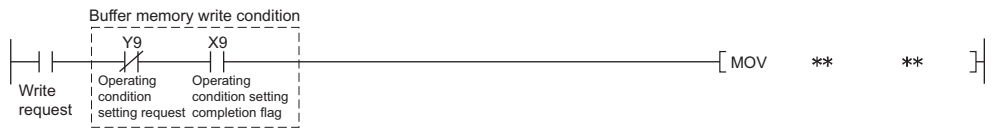

Figure 3.19 Setting of interlock conditions

* 3 This area is related with the user range save/restore function and allows users to re-set the offset/gain values easily in the case of online module change.

3.4.2 Conversion enable/disable setting (Un\G0)

Temperature conversion enable/disable status is set for each channel.

(1) Setting methods

(a) Set enable/disable status for each channel in buffer memory.

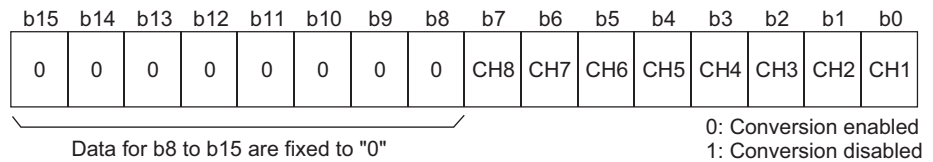

Figure 3.20 Setting of enable/disable status (Un\G0)

[Setting example] Setting enable status for channel 1 and 2

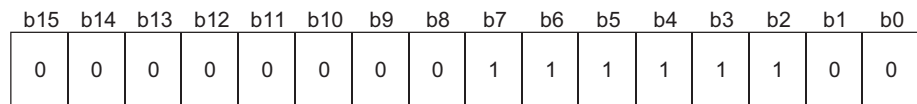

Figure 3.21 Setting example of enable/disable status (Un\G0)

(b) Turn on Operating condition setting request (Y9) to activate the setting.

(2) Default value

The default value is set to "Disable" (00FFH) for all channels.

POINT

Setting "Disable" (1) for unused channels can prevent unnecessary disconnection detection or monitoring disconnection state.

3.4.3 CH[] Time/Count/Moving average/Time constant setting (Un\G1 to Un\G8)

When the averaging processing (1H to 4H) is specified with Averaging processing selection (Un\G24, Un\G25), time average, count average, moving average or time constant for primary delay filter is set. (Refer to Section 3.2.1)

(1) Setting methods

- (a) Set the following setting range in buffer memory.

Table 3.10 Settable range

Processing method	Setting value
Time average	1280 to 5000(ms) ^{*1}
Count average	4 to 500(times)
Moving average	2 to 60(times)
Primary delay filter	320 to 5000(ms) ^{*1}

* 1 Set the values in units of 320ms.

For the details of the setting values, refer to Section 3.2.1 (3) Averaging processing or Section 3.2.1 (4) Primary delay filter.

- (b) Turn on Operating condition setting request (Y9) to activate the setting. (Refer to Section 3.3.2)

(2) Default value

All channels are set to "0".

☒ POINT

- (1) When a value out of the setting range in Table 3.10 is written, an error occurs and the following also occurs.
 - The error codes (20□, 30□, 31□, 32□) are stored to the error code (Un\G19). (Refer to Section 8.1)
 - Error flag (XF) turns on.
 - Conversion processing is performed with the setting before the error occurrence.
- (2) When a value is set on the channels set sampling processing (0H) to Averaging processing selection (Un\G24, Un\G25), the setting value of CH□ Time/Count/Moving average/Time constant setting (Un\G1 to Un\G8) is ignored.

3.4.4 Conversion completion flag (Un\G10)

Conversion state can be checked for each channel.

(1) Data storage

- (a) The bit of the corresponding channel in Conversion completion flag turns on (changes to "1") when conversion of conversion-enabled channels is completed.

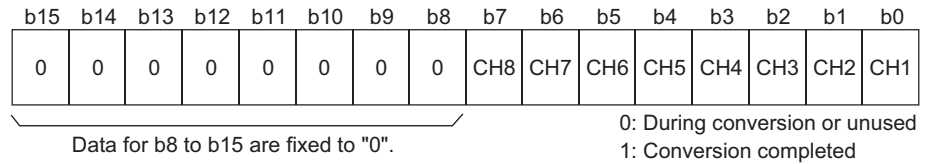

Figure 3.22 Storage of Conversion completion flag (Un\G10)

- (b) Conversion completion flag (XE) turns on when conversion of all conversion-enabled channels is completed.

(2) How to clear stored data

When Operating condition setting request (Y) is turned on, the bit of all channels in the Conversion completion flag returns to default value ("0").

☒ POINT

Use this area or Conversion completion flag (XE) as an interlock to read out the measured temperature value.

3.4.5 CH[] Measured temperature value (Un\G11 to Un\G18)

“Thermal electromotive force values” input from thermocouples are converted into “temperature values” to check values of detected temperature.

(1) Data storage

The measured temperature value rounded off to one decimal place is multiplied by 10 and the result is stored into buffer memory in 16-bit signed binary. (Drop the second decimal place and later.)

[Setting example 1]

When the measured temperature value is 123.025°C 1230 is stored.

b15	b14	b13	b12	b11	b10	b9	b8	b7	b6	b5	b4	b3	b2	b1	b0
0	0	0	0	0	1	0	0	1	1	0	0	1	1	1	0

Figure 3.23 Storage example 1 of CH[] Measured temperature value (Un\G11 to Un\G18)

When the measured temperature value is -123.0°C -1230 is stored.

b15	b14	b13	b12	b11	b10	b9	b8	b7	b6	b5	b4	b3	b2	b1	b0
1	1	1	1	1	0	1	1	0	0	1	1	0	0	1	0

Figure 3.24 Storage example 2 of CH[] Measured temperature value (Un\G11 to Un\G18)

POINT

- (1) When disconnection is detected or checked with a monitor, the values set in Conversion setting for disconnection detection (Un\G164, Un\G165) or Disconnection state conversion setting (Un\G164, Un\G165) are stored into the CH[] Measured temperature value (Un\G11 to Un\G18). (Refer to Section 3.4.25, Section 3.4.26)
- (2) After the disconnection recovery, normal measured temperature value is automatically stored.
- (3) Use Conversion completion flag (XE) or Conversion completion flag (Un\G10) as an interlock to read out the measured temperature value.

3.4.6 Error code (Un\G19)

Error codes that are detected by the Q68TD-G-H02(H01) are stored. (Refer to Section 8.1)

3.4.7 Setting range 1, 2 (Thermocouple type) (Un\G20,Un\G21)

This area is for checking thermocouple type of the Q68TD-G-H02(H01). which is set with Switch 1 and 2 in the intelligent function module switch setting. (Refer to Section 4.5)

(1) Data storage

(a) The setting value of thermocouple type is stored into the position shown in the following figure for each channel.

	b15	to	b12	b11	to	b8	b7	to	b4	b3	to	b0
Un\G20 (Setting range CH1 to CH4)	CH4			CH3			CH2			CH1		
Un\G21 (Setting range CH5 to CH8)	CH8			CH7			CH6			CH5		

Figure 3.25 Storage of setting range 1,2 (thermocouple type) (Un\G20,Un\G21)

(b) The following table shows the setting value for each thermocouple type.

Table 3.11 Thermocouple and setting value

Thermocouple type	Setting value
Thermocouple K	0H
Thermocouple E	1H
Thermocouple J	2H
Thermocouple T	3H
Thermocouple B	4H
Thermocouple R	5H
Thermocouple S	6H
Thermocouple N	7H

3.4.8 Setting range 3 (Offset/gain setting) (Un\G22)

This area is for checking offset/gain setting of the Q68TD-G-H02(H01). which is set with Switch 3 in the intelligent function module switch setting. (Refer to Section 4.5)

(1) Data storage

The setting value of offset/gain setting is stored into the position corresponding to the channels shown in the following figure.

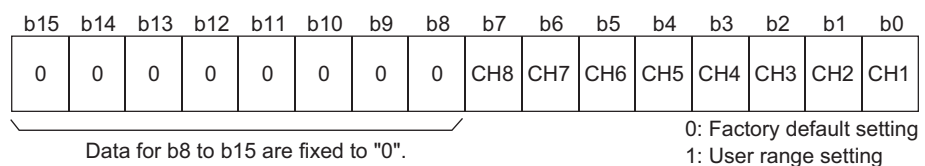

Figure 3.26 Storage of setting range 3 (Offset/gain setting) (Un\G22)

3.4.9 Averaging processing selection (Un\G24,Un\G25)

Averaging processing is selected for each channel.

(1) Setting methods

(a) The Averaging processing selection is set in the position corresponding to each channel of buffer memory shown in the following figure.

	b15	to	b12	b11	to	b8	b7	to	b4	b3	to	b0
Un\G24 (Averaging processing selection CH1 to CH4)	CH4			CH3			CH2			CH1		
Un\G25 (Averaging processing selection CH5 to CH8)	CH8			CH7			CH6			CH5		

Figure 3.27 Setting of Averaging processing selection (Un\G24,Un\G25)

(b) The following table shows the setting value.

Table 3.12 Processing method and setting value

Processing method	Setting value
Sampling processing	0H
Time average	1H
Count average	2H
Moving average	3H
Primary delay filter	4H

(c) Turn on Operating condition setting request (Y9) to activate the setting.

(2) Default value

All channels are set to sampling processing (0000H).

[Setting example]

- CH1 . . . Count average (2H)
- CH2 . . . Time average (1H)
- CH3 . . . Primary delay filter (4H)
- CH4 . . . Sampling processing (0H)

Set "0412H" for Un\G24 as shown in the following figure in the case of the above setting.

	b15	b14	b13	b12	b11	b10	b9	b8	b7	b6	b5	b4	b3	b2	b1	b0
Un\G24 (Averaging processing selection CH1 to CH4)	0	0	0	0	0	1	0	0	0	0	0	1	0	0	1	0

Figure 3.28 Setting example of Averaging processing selection (Un\G24,Un\G25)

POINT

If a value out of the setting range is set, sampling processing is performed.

3.4.10 Offset/gain setting mode (Un\G26,Un\G27)

A channel targeted for adjusting offset/gain setting values in the offset/gain setting mode is specified. (Refer to Section 4.6)

(1) Setting methods

Set a channel targeted for adjusting offset setting in Un\G26, and a channel for gain setting in Un\G27.

	b15	b14	b13	b12	b11	b10	b9	b8	b7	b6	b5	b4	b3	b2	b1	b0
Un\G26 (Offset specification)	0	0	0	0	0	0	0	0	CH8	CH7	CH6	CH5	CH4	CH3	CH2	CH1
Un\G27 (Gain specification)	0	0	0	0	0	0	0	0	CH8	CH7	CH6	CH5	CH4	CH3	CH2	CH1

Data for b8 to b15 are fixed to "0".

1: Setting channel
0: disable

Figure 3.29 Setting of Averaging processing selection (Un\G24,Un\G25)

(2) Default value

All channels are set to "Disable" (0000H).

POINT

Setting multiple channels at the same time is possible, however, set offset and gain values separately (set "0" in either Un\G26 or Un\G27).
If both are set to the same channel, an error (error code500) occurs.

3.4.11 CH[] Offset/gain temperature setting values (Un\G28 to Un\G43)

Measured temperature values equivalent to the input from the sensor are set during the offset/gain setting mode.

(1) Setting methods

- (a) Input a value used as an offset value or gain value in 16-bit signed binary (units of 0.1°C) to the channel set in the Offset/gain setting mode (Un\G26,Un\G27).
- (b) When Channel change request (YB) is turned on, measured temperature value is compensated for the value written in this area.

(2) Default value

All channels are set to "0".

POINT

- (1) High accuracy is ensured for Offset/gain temperature setting values when the minimum or maximum temperature of the operating range is used to compensate errors.
- (2) Set Offset/gain temperature setting values while reading measured temperature values.
- (3) Satisfy the following conditions when setting the Offset/gain temperature setting values. If the conditions are not satisfied, an error (error code: 41□) occurs.
 - Condition 1: Within the input enabled range
 - Condition 2: (Gain temperature setting value) - (Offset temperature setting value) > 0.1[°C]
- (4) Offset/gain temperature setting values are stored into the flash memory of the Q68TD-G-H02(H01) turning on User range write request (YA), and the values are not erased at power-off.

3.4.12 Cold junction compensation setting status (Un\G45) (Q68TD-G-H02 only)

The Cold junction compensation setting status of the Q68TD-G-H02, set with Switch 4 in the intelligent function module, can be checked.

(1) Data storage

Table 3.13 Cold junction compensation setting state (Un\G45)

Storage value	Cold junction compensation setting state
0000H	Available
0001H	Not available

3.4.13 Warning output enable/disable setting (Un\G46)

Enable/disable state of warning output for process alarm or rate alarm is set for each channel.

(1) Setting methods

- (a) Warning output enable/disable setting is set for the corresponding channels in the following figure.

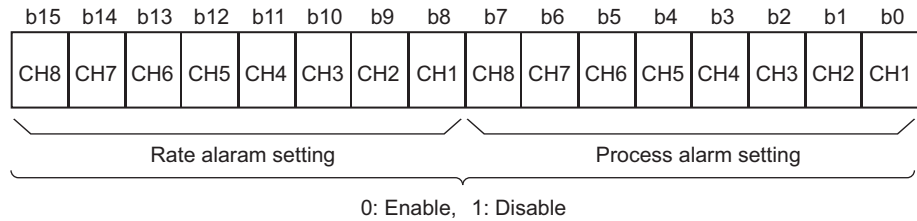

Figure 3.30 Setting of Warning output enable/disable setting (Un\G46)

- (b) Turn on Operating condition setting request (Y9) to activate the setting.

(2) Default value

Both process alarm and rate alarm are set to “Disable” for all channels (FFFFH).

3.4.14 Warning output flag (Process alarm/Rate alarm) (Un\G47,Un\G48)

For both process alarm and rate alarm, whether the warning is for the upper limit value or lower limit value can be checked for each channel.

(1) Data storage

- (a) When a measured temperature value is out of the setting range of the CH□ Process alarm upper/lower limit values (Un\G94 to Un\G125) or CH□ Rate alarm upper/lower limit values (Un\G134 to Un\G149), the bit of the corresponding channels turns on (changes to “1”).

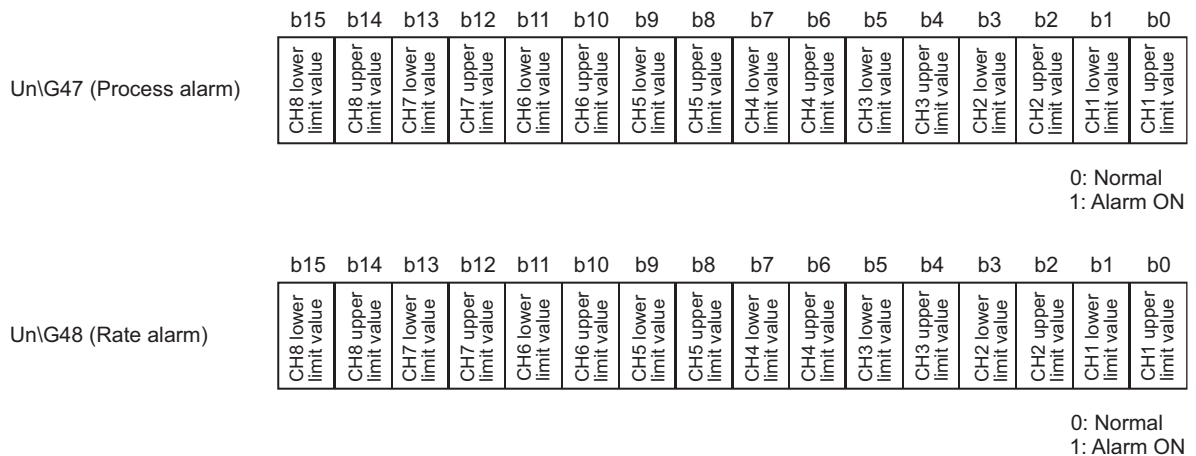

Figure 3.31 Storage of Warning output flag (Process alarm/Rate alarm) (Un\G47,Un\G48)

- (b) When the measured temperature value or the change of measured temperature values returns to within the setting range, this flag will be automatically reset.
- (c) When Operating condition setting request (Y9) is turned on, this flag will be cleared.
- (d) If a warning is detected on any of channels for the conditions described below, Warning output signal (XD) also turns on.
- 1) Conversion enable (“0”) is set in Conversion enable/disable setting (Un\G0).
 - 2) Process alarm setting or rate alarm setting are set to “Enable”(“0”) in the Warning output enable/disable (Un\G46).

3.4.15 Disconnection detection flag (Un\G49) (Q68TD-G-H02 only)

Disconnection state is detectable for each channel.

(1) Data storage

- (a) The bit of the corresponding channel turns on (changes to “1”) when the disconnection state of a thermocouple or compensating lead wire is detected.

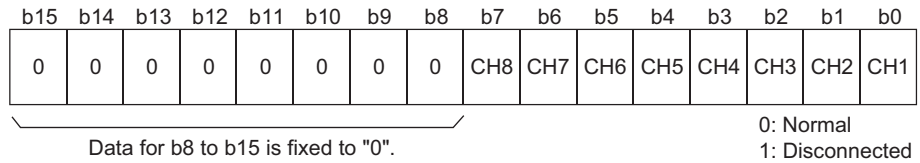

Figure 3.32 Storage of Disconnection detection flag (Un\G49)

- (b) Conversion for the channels not disconnected is continued.

(2) How to clear flag

- (a) Check the sensor connection state of disconnection detection channels.
- (b) When Operating condition setting request (Y9) or Error clear request (YF) is turned on, this flag will be cleared.
 When the signal turns on in disconnection state, the bit of the corresponding channel turns on (changes to “1”) again.

(3) Relationship between the Disconnection detection flag and conversion enable/disable setting.

The following table shows the relationship between the Disconnection detection flag and conversion enable/disable setting.

Table 3.14 Relationship between conversion enable/disable setting and Disconnection detection flag

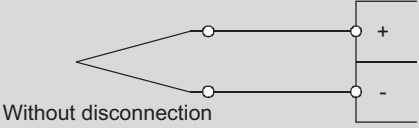
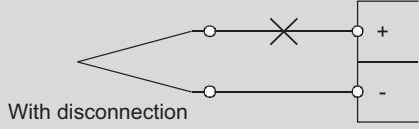
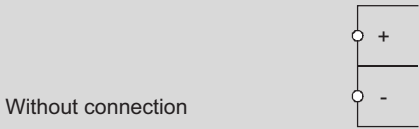
Connection state	Conversion enable/disable setting	Disconnection detection flag
 <p>Without disconnection</p>	Enable	OFF
	Disable	
 <p>With disconnection</p>	Enable	ON
	Disable	OFF
 <p>Without connection</p>	Enable	ON
	Disable	OFF

POINT

- (1) Always set “Disable” for any channel where no thermocouple or compensating lead wire is connected.
If “Enable” is set, the bit of the corresponding channel in the Disconnection detection flag (Un\G49) turns on (changes to “1”).
- (2) For wiring of a thermocouple or compensating lead wire, refer to Section 4.4.
- (3) For troubleshooting of disconnection detection, refer to Section 8.2.7.

3.4.16 Disconnection state monitor flag (Un\G49) (Q68TD-G-H01only)

Disconnection state is detectable for each channel.

(1) Data storage

- (a) The bit of the corresponding channel turns on (changes to "1") when the disconnection state of a thermocouple or compensating lead wire is checked.

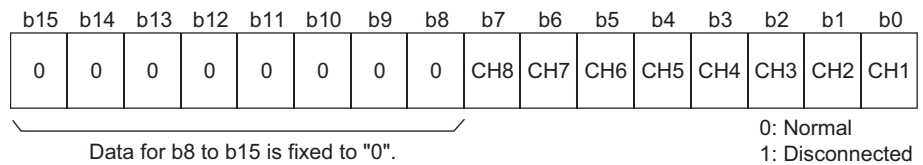

Figure 3.33 Storage of Disconnection state monitor flag (Un\G49)

- (b) Conversion for the channels not disconnected is continued.

(2) How to clear flag

- (a) Check the sensor connection state of disconnection detection channels.
- (b) When Operating condition setting request (Y9) or Error clear request (YF) is turned on, this flag will be cleared.
When the signal turns on in disconnection state, the bit of the corresponding channel turns on (changes to "1") again.

- (3) Relationship between the Disconnection state monitor flag and conversion enable/disable setting.

The following table shows the relationship between the Disconnection state monitor flag and conversion enable/disable setting.

Table 3.15 Relationship between conversion enable/disable setting and Disconnection detection flag

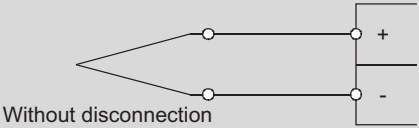
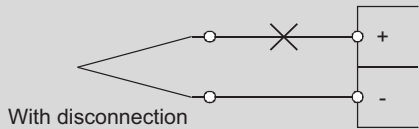
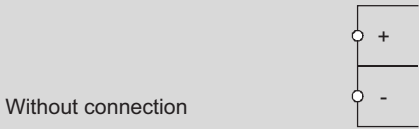
Connection state	Conversion enable/disable setting	Disconnection state monitor flag
 <p>Without disconnection</p>	Enable	OFF
	Disable	
 <p>With disconnection</p>	Enable	ON
	Disable	OFF
 <p>Without connection</p>	Enable	ON
	Disable	OFF

POINT

- (1) Always set “Disable” for any channel where no thermocouple or compensating lead wire is connected.
If “Enable” is set, the bit of the corresponding channel in Disconnection detection flag (Un\G49) turns on (changes to “1”).
- (2) For wiring of a thermocouple or compensating lead wire, refer to Section 4.4.
- (3) For troubleshooting of disconnection state check, refer to Section 8.2.7.

3.4.17 CH[] Scaling value (Un\G50 to Un\G57)

The result of scaling measured temperature values is stored.

(1) Data storage

Measured temperature values within the scaling range set in CH□ Scaling range upper/lower limit values (Un\G62 to Un\G77) are scaled to the scaling width set in CH□ Scaling width upper/lower limit values (Un\G78 to Un\G93), and then the result is stored.

(2) How to calculate the scaling value.

The following is how to calculate the scaling value.

$$\text{Scaling value} = \frac{\text{measured temperature value} - \text{scaling range lower limit value}}{\text{scaling range upper limit value} - \text{scaling range lower limit value}} \times (\text{scaling width upper limit value} - \text{scaling width lower limit value}) + \text{scaling width lower limit value}$$

Figure 3.34 How to calculate the scaling value

[Setting example] To scale a temperature to percent (for the use of thermocouple K)

(a) Setting value

- Scaling range: -100 to 500°C (lower limit value = -1000, upper limit value = 5000)
- Scaling width: 0 to 100% (lower limit value = 0, upper limit value = 100)

(b) Input value

CH1 measured temperature value: 360°C (Measured temperature value = 3600)

$$\text{Scaling value} = (100 - 0) \times \frac{3600 - (-1000)}{5000 - (-1000)} + 0 = 76.666666 \dots$$

Fractional portion is rounded off.

$$= 77[\%]$$

Stores into buffer memory address 50.

Figure 3.35 Setting example of scaling value

POINT

- (1) If the upper limit value is less than the lower limit value in the settings of CH□ Scaling range upper/lower limit values (Un\G62 to Un\G77) or CH□ Scaling width upper/lower limit values (Un\G78 to Un\G93), it will not result in an error and the scaling value calculated with the expression above will be output.
- (2) When the measured temperature is out of the range set in Scaling range upper/lower limit values, the value set in Scaling width upper limit value or lower limit value is stored into this buffer memory.

3.4.18 Scaling valid/invalid setting (Un\G58)

This area is for checking the scaling function valid/invalid status for each channel.

(1) Setting methods

(a) Scaling valid/invalid setting is set for each channel.

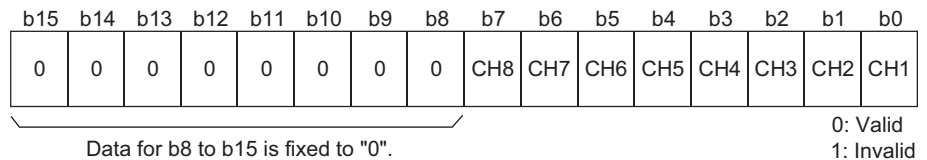

Figure 3.36 Setting of Scaling valid/invalid setting (Un\G58)

(b) Turn on Operating condition setting request (Y9) to activate the setting.

(2) Default value

All channels are set to "Invalid" (00FFH).

[Program example]

Program example with a condition of the following is below.

- Scaling range: -100 to 500°C (lower limit value = -1000, upper limit value = 5000)
- Scaling width: 0 to 100.0% (lower limit value = 0, upper limit value = 100)

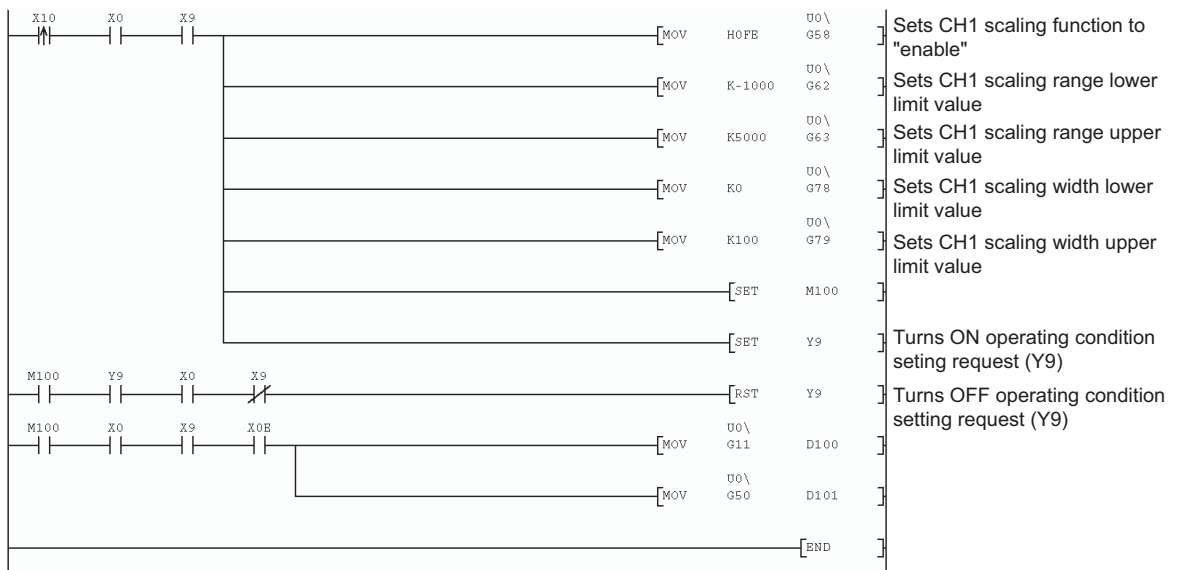

Figure 3.37 Program example of scaling function

3.4.19 CH[] Scaling range upper/lower limit values (Un\G62 to Un\G77)

A scaling range of measured temperature values is set for each channel in units of 0.1°C.

(1) Setting methods

- (a) For use of the scaling function, change the setting value.
- (b) Set the scaling range value in buffer memory.
 - Settable scaling range: -32768 to 32767
- (c) Turn on Operating condition setting request (Y9) to activate the setting.

(2) Default value

All channels are set to "0".

☒ POINT

- (1) When the measured temperature is out of the range set in Scaling range upper/lower limit values, the value set in Scaling width upper limit value or lower limit value is stored into CH□ Scaling value (Un\G50 to Un\G57).
 - (2) Set "Valid" ("1") in Scaling valid/invalid setting (Un\G58). When "Invalid" ("0") is set in the setting of the Scaling valid/invalid setting (Un\G58), CH□ Scaling range upper/lower limit values (Un\G62 to Un\G77) is ignored.
 - (3) If the same value is set for the upper limit and the lower limit, an error (error code: 91□) occurs on the corresponding channel. Then, the following occurs.
 - Error code (91□) is stored into Error code (Un\G19). (Refer to Section 8.1).
 - Error flag (XF) turns on.
 - The module operates with setting before the error occurrence.
-

3.4.20 CH[] Scaling width upper/lower limit values (Un\G78 to Un\G93)

A width for scaling conversion is set.

(1) Setting methods

- (a) For use of the scaling function, change the setting value.
- (b) Set the scaling range value in buffer memory.
 - Settable scaling range: -32768 to 32767
- (c) Turn on Operating condition setting request (Y9) to activate the setting.

(2) Default value

All channels are set to "0".

☒ POINT

- (1) When "Invalid" ("0") is set in Scaling valid/invalid setting (Un\G58), the setting of CH[] Scaling width upper/lower limit values (Un\G78 to Un\G93) is ignored.
- (2) If the same value is set for the upper limit and the lower limit, an error (error code: 91□) occurs on the corresponding channel. Then, the following occurs.
 - Error code (91□) is stored into Error code (Un\G19). (Refer to Section 8.1).
 - Error flag (XF) turns on.
 - The module operates with setting before the error occurrence.

3.4.21 CH[] Process alarm upper/lower limit values (Un\G94 to Un\G125)

Process alarm upper upper limit value, upper lower limit value, lower upper limit value, and lower lower limit value can be set. (Refer to Section 3.2.4)

(1) Setting methods

(a) A scaling range of measured temperature values is set for each channel in units of 0.1°C.

Settable range and default value differ according to the thermocouple type.

The following table shows settable range and default value for each thermocouple type.

Table 3.16 Process alarm settable range and default value

Thermocouple type	Default value				Settable temperature range (Accuracy guarantee range)
	Process alarm lower lower limit value	Process alarm lower upper limit value	Process alarm upper lower limit value	Process alarm upper upper limit value	
Thermocouple K	-2000		12000		-2700 to 13700 (-2000 to 12000)
Thermocouple E	-2000		9000		-2700 to 10000 (-2000 to 9000)
Thermocouple J	-400		7500		-2100 to 12000 (-400 to 7500)
Thermocouple T	-2000		3500		-2700 to 4000 (-2000 to 3500)
Thermocouple B	6000		17000		0 to 18200 (6000 to 17000)
Thermocouple R	0		16000		-500 to 17600 (0 to 16000)
Thermocouple S	0		16000		-500 to 17600 (0 to 16000)
Thermocouple N	-2000		12500		-2700 to 13000 (-2000 to 12500)

(b) Turn on Operating condition setting request (Y9) to activate the setting.

POINT

(1) If any of the following values are set, an error (error code: 6△□) occurs. Then, Error flag (XF) turns on.

- A value out of the above settable range:
- A value that does not satisfy the following condition:

Process alarm lower lower limit value ≤ lower upper limit value ≤ upper lower limit value ≤ upper upper limit value

(2) When "Disable" ("0") is set in the Warning output enable/disable setting (Un\G46), the setting of CH□ Process alarm upper/lower limit values (Un\G94 to Un\G125) is ignored.

3.4.22 CH[] Rate alarm warning detection period (Un\G126 to Un\G133)

The number of conversion periods to check a change in measured temperature values is set for each channel. (Refer to Section 3.2.4)

(1) Setting methods

- (a) For use of the rate alarm, change the setting value.
- (b) Set the number of conversion periods in buffer memory.
 - Settable range: 1 to 6000(times)
- (c) Turn on Operating condition setting request (Y9) to activate the setting.

(2) Default value

All channels are set to "0".

POINT

- (1) When a value out of the above setting range is set, an error (error code: 70□) occurs on the corresponding channel. Then, the following occurs.
 - Error code (71□) is stored into the Error code (Un\G19). (Refer to Section 8.1).
 - Error flag (XF) turns on.
 - The module operates with setting before the error occurrence.
- (2) Set "Enable" in Warning output enable/disable (Un\G46). When "Disable" is set, the settings of CH□ Rate alarm warning detection period (Un\G126 to Un\G133) is ignored.

3.4.23 CH[] Rate alarm upper/lower limit values (Un\G134 to Un\G149)

A scaling range of measured temperature values is set for each channel in units of 0.1°C.(Refer to Section 3.2.4)

(1) Setting methods

- (a) For use of the rate alarm, change the setting value.
- (b) Set the range in buffer memory.
 - Settable range:-32768 to 32767
- (c) Turn on Operating condition setting request (Y9) to activate the setting.

(2) Default value

All channels are set to "0".

3.4.24 Mode switching setting (Un\G158, Un\G159)

This area is used to switch the mode between normal mode and offset/gain setting mode. This mode can be switched without resetting the programmable controller CPU.

Setting methods

- (a) Set the setting value of the switching target mode.

Table 3.17 Switching target mode and setting value

Switching target mode	Setting value	
	Un\G158	Un\G159
Normal mode	0964H	4144H
Offset/gain setting value mode	4144H	0964H

- (b) To switch the mode, turning on Operating condition setting request (Y9) after setting the value is required.
- (c) When the mode is switched completely, this area for Un\G158 and Un\G159 is cleared to "0".

☒ POINT

If a value other than the setting values in Table 3.17 is written, mode switching is not performed.

3.4.25 Conversion setting for disconnection detection (Un\G164, Un\G165) (Q68TD-G-H02 only)

When disconnection is detected, a value stored into CH□ Measured temperature value (Un\G11toUn\G18) is set. (Refer to Section 3.2.2)
The value to be stored is selected from “Up scale”, “Down scale” or “Given value”.

(1) Setting methods

(a) Set the value to be stored into buffer memory.

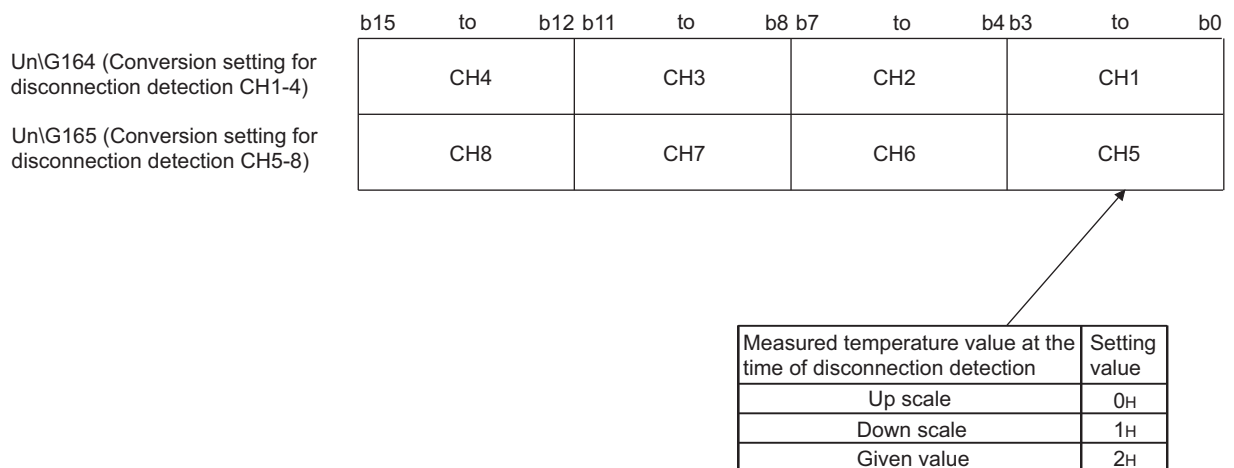

Figure 3.38 Setting of Conversion setting for disconnection detection (Un\G164, Un\G165)

The value to be stored into CH□ Measured temperature value (Un\G11toUn\G18) changes as follows, depending on the setting value.

- 1) Up scale (0H)
Up-scale of the range currently set is stored.
- 2) Down scale (1H)
Down-scale of the range currently set is stored.
- 3) Given value (2H)
The value set in CH□ Conversion setting value for disconnection detection (Un\G166toUn\G173) is stored.

(b) Turn on Operating condition setting request (Y9) to activate the setting.

(2) Default value

All channels are set to “Down scale” (1111H).

☒ POINT

If a value out of the setting range is set, the module operates with the default setting, “Down scale”(1H).

3.4.26 Disconnection state conversion setting (Un\G164, Un\G165) (Q68TD-G-H01only)

When disconnection state is checked, a value stored into CH□ Measured temperature value (Un\G11toUn\G18) is set. (Refer to Section 3.2.3)
The value to be stored is selected from “Up scale”, “Down scale” or “Given value”.

(1) Setting methods

(a) Set the value to be stored in buffer memory.

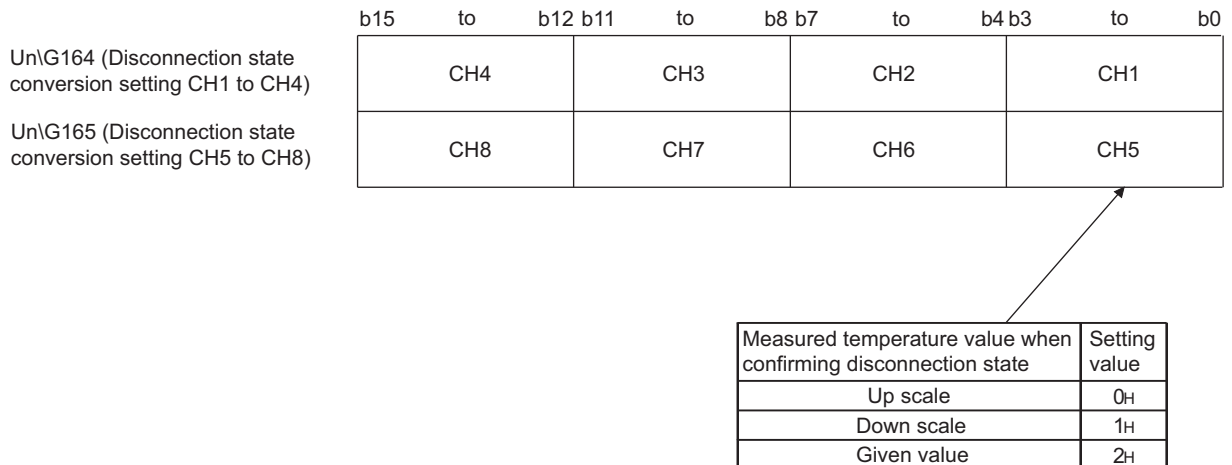

Figure 3.39 Setting of Disconnection state conversion setting (Un\G164, Un\G165)

The value to be stored into CH□ Measured temperature value (Un\G11toUn\G18) in the disconnection state check changes as follows, depending on the setting value.

- 1) Up scale (0H)
Up-scale of the range currently set is stored.
- 2) Down scale (1H)
Down-scale of the range currently set is stored.
- 3) Given value (2H)
The value set in CH□ Conversion setting for disconnection state value (Un\G166toUn\G173) is stored.

(b) Turn on Operating condition setting request (Y9) to activate the setting.

(2) Default value

All channels are set to “Down scale” (1111H).

POINT

If a value out of the setting range is set, the module operates with the default setting, “Down scale”(1H).

3.4.27 CH[] Conversion setting value for disconnection detection (Un\G166 to Un\G173) (Q68TD-G-H02 only)

When “Give value” (2H) is set in Conversion setting for disconnection detection (Un\G164,Un\G165), the value to be stored into CH□ Measured temperature value (Un\G11toUn\G18) can be set by user. (Refer to Section 3.2.2)

(1) Setting methods

- (a) Set the value to be stored in buffer memory in units of 0.1°C.
 - Settable range:-32768 to 32767
- (b) Turn on Operating condition setting request (Y9) to activate the setting.

(2) Default value

All channels are set to “0”.

[Setting example] When the value of 800°C is stored into CH1 Measured temperature value for disconnection detection.

- 1) Set the following in buffer memory.
 - Conversion setting for disconnection detection (Un\G164):2H
 - CH1 Conversion setting value for disconnection detection(Un\G166):8000
- 2) Turn on Operating condition setting request (Y9).

3.4.28 CH[] Conversion setting value for disconnection state (Un\G166 to Un\G173) (Q68TD-G-H01 only)

When “Give value” (2H) is set in the Disconnection state conversion setting (Un\G164,Un\G165), the value to be stored into CH□ Measured temperature value (Un\G11toUn\G18) can be set by user in the disconnection state check. (Refer to Section 3.2.3)

(1) Setting methods

- (a) Set the value to be stored in buffer memory in units of 0.1°C.
 - Settable range:-32768 to 32767
- (b) Turn on Operating condition setting request (Y9) to activate the setting.

(2) Default value

All channels are set to “0”.

[Setting example] When the value of 800°C is stored into CH1 Measured temperature value for the check of disconnection state

- 1) Set the following in buffer memory.
 - Disconnection state conversion setting (Un\G164):2H
 - CH1 Conversion setting value for disconnection state (Un\G166):8000
- 2) Turn on Operating condition setting request (Y9) to activate the setting.

3.4.29 Factory default offset/gain values, User range settings offset/gain values (Un\G190 to Un\G253)

This area is used to reset the offset/gain easily at online module change. (Refer to CHAPTER 7)

(1) Purpose of this buffer memory

- (a) When the offset/gain setting values of the user range setting are restored, the data to be used are stored.

The data are stored (saved) in the following cases.

- When writing default setting by the utility
- When setting the operating condition (Y9 turns from off to on^{*1})
- When writing the offset/gain values in the offset/gain setting mode (YA turns from off to on)

* 1 The data are not saved when a setting value has been written in the Mode switching setting (Un\G158,Un\G159).

- (b) To restore the offset/gain values of the user range setting, set the data saved in this area to the corresponding area of the restoring target module.

(2) How to save data during online module change

Save buffer memory data during online module change in the following procedure.

- 1) Turn on Operating condition setting request (Y9).
- 2) Compare the values of the Factory default offset/gain values, the User range settings offset/gain values, and the User range settings resistance offset/gain values (Un\G190 to Un\G253) to the values in the range reference table. (Refer to Section 7.4)
- 3) When the values are appropriate, take down the buffer memory data compared.

POINT

This area is not used for offset/gain setting.
For offset/gain setting, refer to Section 4.6.

CHAPTER 4 SETUP AND PROCEDURES BEFORE OPERATION

4.1 Handling Precautions

- (1) Do not drop or give a strong impact to the case.
- (2) Do not remove the printed-circuit board of the module from the case. Doing so may cause a failure.
- (3) Be careful to prevent foreign matters such as cutting chips or wire chips from entering the module. Such foreign matter can cause a fire, failure, or malfunction.
- (4) A protective film is attached to the module top to prevent foreign matter such as wire chips from entering the module during wiring. Do not remove the film during wiring. Be sure to remove it for heat dissipation before system operation.
- (5) Tighten the screws such as module fixing screws within the following ranges. Undertightening can cause drop of the screw, short circuit or malfunction.

Table 4.1 Tightening torque

Screw location	Tightening torque range
Module fixing screw (M3 screw) ^{*1}	0.36 to 0.48N•m
Connector screw (M2.6 screw)	0.20 to 0.29N•m

* 1 The module can be easily fixed onto the base unit using the hook at the top of the module. When using the Q68TD-G-H02(H01) in an environment of frequent vibrations, fix the module with a module fixing screw.

- (6) To mount the module, while pressing the module mounting lever located in the lower part of the module, fully insert the module fixing projection into the hole in the base unit and press the module until it snaps into place. Incorrect module mounting may cause a malfunction, failure, or drop of the module. After mounting the module to the base unit, fix the module with a module fixing bracket. (Q68TD-G-H02 only) (Refer to Section 4.1.1) When using the Q68TD-G-H01 in an environment of frequent vibrations, fix the module with a module fixing screw. (Q68TD-G-H01 only)
- (7) Always make sure to touch the grounded metal to discharge the electricity charged in the body, etc., before touching the module. Failure to do so may cause a failure or malfunctions of the module.

4.1.1 Fixing module with module fixing bracket (Q68TD-G-H02 only)

After mounting the Q68TD-G-H02 to the base unit, fix the Q68TD-G-H02 module with a module fixing bracket.

POINT

Make sure that the module fixing bracket is hooked on the third slit viewed from the front of the Q68TD-G-H02. Then, tighten the module fixing screw within the specified torque range.

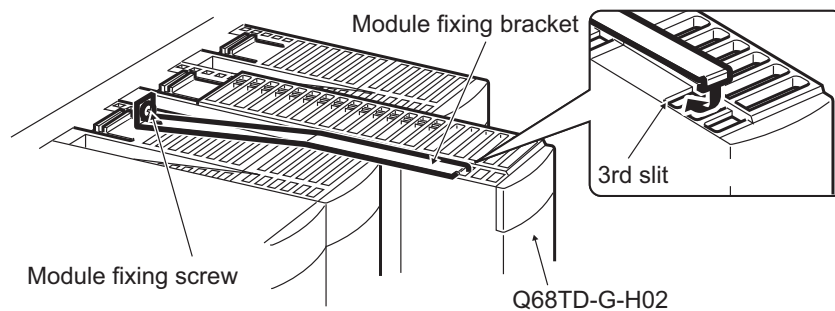

Figure 4.1 Fixing module with module fixing bracket

4.2 Setup and Procedures before Operation

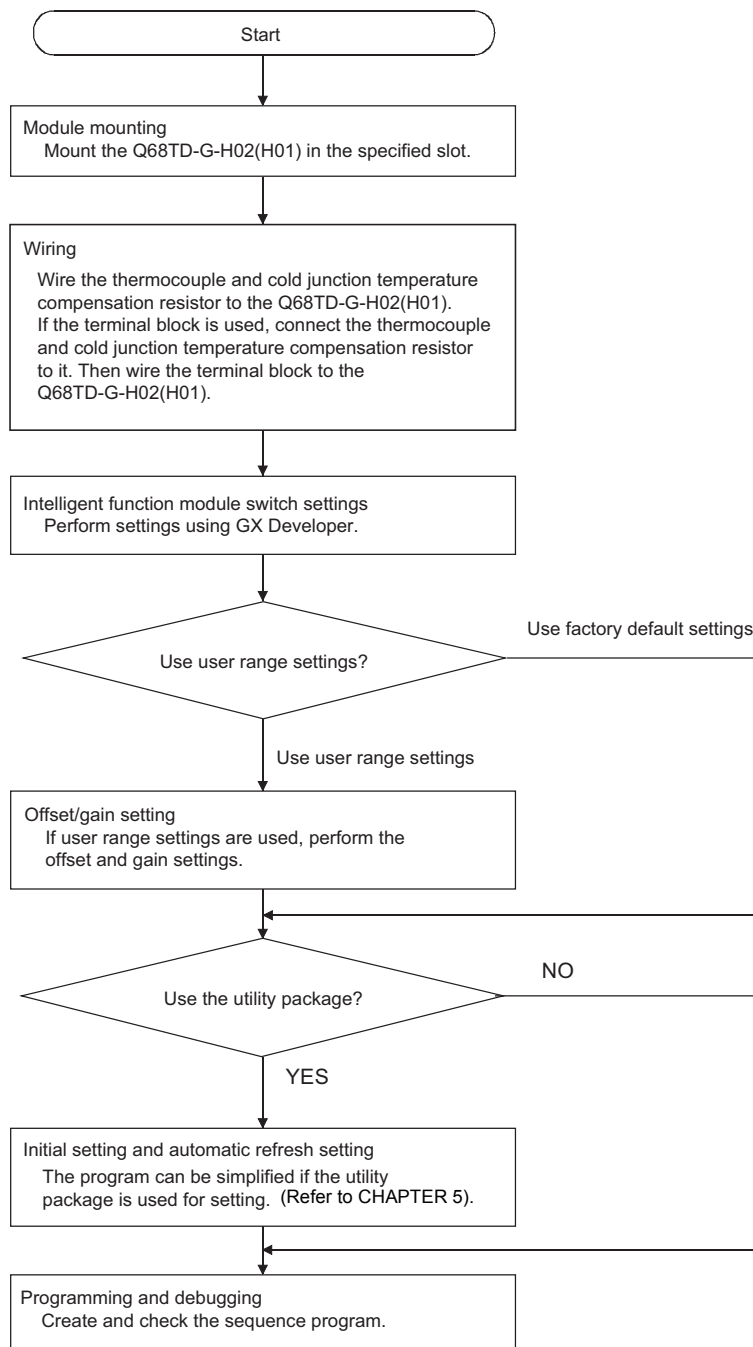

Figure 4.2 Procedures and setting before system operation

4.3 Part Names

The following explains the part names of the Q68TD-G-H02(H01).

The part names and signal names of the Q68TD-G-H02 and Q68TD-G-H01 are same.

(1) Q68TD-G-H02

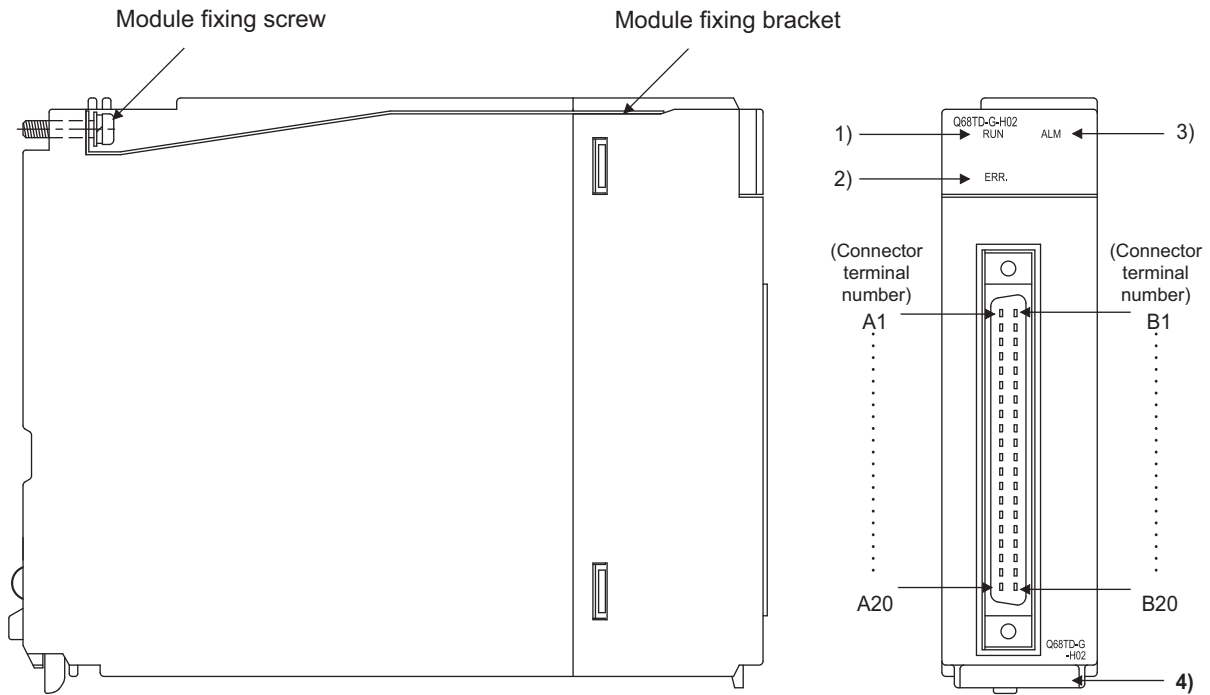

(2) Q68TD-G-H01

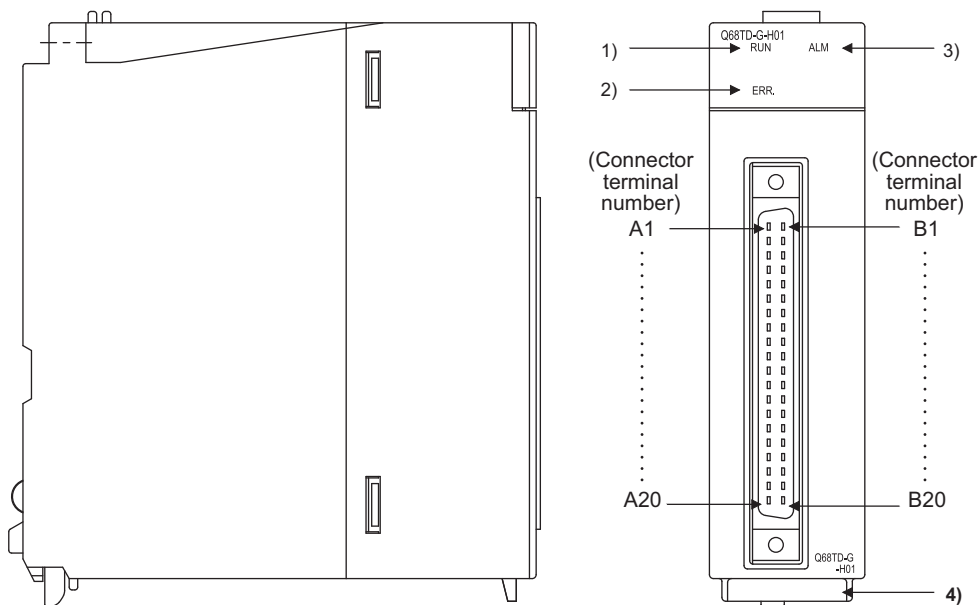

Table 4.2 Part names

Number	Name	Description
1)	RUN LED	Displays the operating status of the Q68TD-G-H02(H01). On : Normal operation Flashing : During offset/gain setting mode Off : 5V power supply interrupted, watchdog timer error occurred, or online module change enabled.
2)	ERR. LED	Displays the error status of the Q68TD-G-H02(H01). On : Error Flashing : Error in switch settings Switch No. 5 of the intelligent function module has been set to a value other than zero. Off : Normal operation
3)	ALM LED	Displays the warning status of the Q68TD-G-H02(H01). On : Warning (process alarm, rate alarm) occurring (Refer to Section 3.4.13) Flashing : Disconnection detected (Q68TD-G-H02) Off : Checking a disconnection status (Q68TD-G-H01) Off : Normal operation
4)	Serial No. display	Displays the serial No. of the Q68TD-G-H02 (H01).

* 1 When the module is mounted on a MELSECNET/H remote I/O station, the RUN LED stays off until a data link starts normally, even after the power is turned on. The RUN LED turns on once a data link starts.

Table 4.3 Signal name

Terminal number	Signal name	Terminal number	Signal name
A1	CH1+	B1	CH1-
A2	---	B2	---
A3	CH2+	B3	CH2-
A4	---	B4	---
A5	CH3+	B5	CH3-
A6	---	B6	---
A7	CH4+	B7	CH4-
A8	---	B8	---
A9	CH5+	B9	CH5-
A10	---	B10	---
A11	CH6+	B11	CH6-
A12	---	B12	---
A13	CH7+	B13	CH7-
A14	---	B14	---
A15	CH8+	B15	CH8-
A16	---	B16	---
A17	---	B17	---
A18	---	B18	---
A19	---	B19	RTD+
A20	RTDG	B20	RTD-

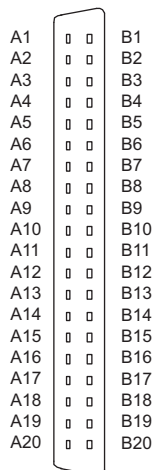

Seen from the front of the module

Figure 4.3 Terminal number

* 1 For actual wiring, refer to Section 4.4.2 External Wiring.

(3) Connector for external wiring

The connectors for use with the Q68TD-G-H02 (H01) should be purchased separately by the user.

The following tables show the connector types and the crimp-contact tool.

(a) Connector types^{*1}

Type	Model name	Applicable wire size
Soldering type (straight out)	A6CON1	0.3mm ² (AWG22) (stranded)
Crimp-contact type (straight out)	A6CON2	0.088mm ² to 0.24mm ² (AWG28 to 24) (stranded)
Soldering type (straight out/diagonal out)	A6CON4	0.3mm ² (AWG22) (stranded)

* 1 The A6CON3 (pressure-displacement type, straight out) connector cannot be used for the Q68TD-G-H02 (H01).

(b) Crimp-contact tool

Type	Model name	Applicable wire size	Contact
Crimp-contact tool	FCN-363T-T005/H	0.088mm ² to 0.24mm ² (AWG28 to 24)	FUJITSU COMPONENT LIMITED www.fcl.fujitsu.com/en

4.4 Wiring

The following explains the wiring precautions and module connection example.

4.4.1 Wiring precautions

External wiring that is less susceptible to noise is required as a condition of enabling a highly reliable system and making full use of the capabilities of the Q68TD-G-H02(H01).

- (1) Use separate cables for the AC control circuit and the external input signals of the Q68TD-G-H02(H01) to avoid the influence of the AC side surges and inductions.
- (2) Always place the thermocouple at least 100mm away from the main circuit cables and AC control circuit lines. Fully keep it away from high-voltage cables and circuits, which include high frequency waves, such as an inverter's load circuit. Not doing so will cause the module more susceptible to noises, surges and inductions.
- (3) The following wiring is required for the product to comply with the EMC and Low Voltage Directives.

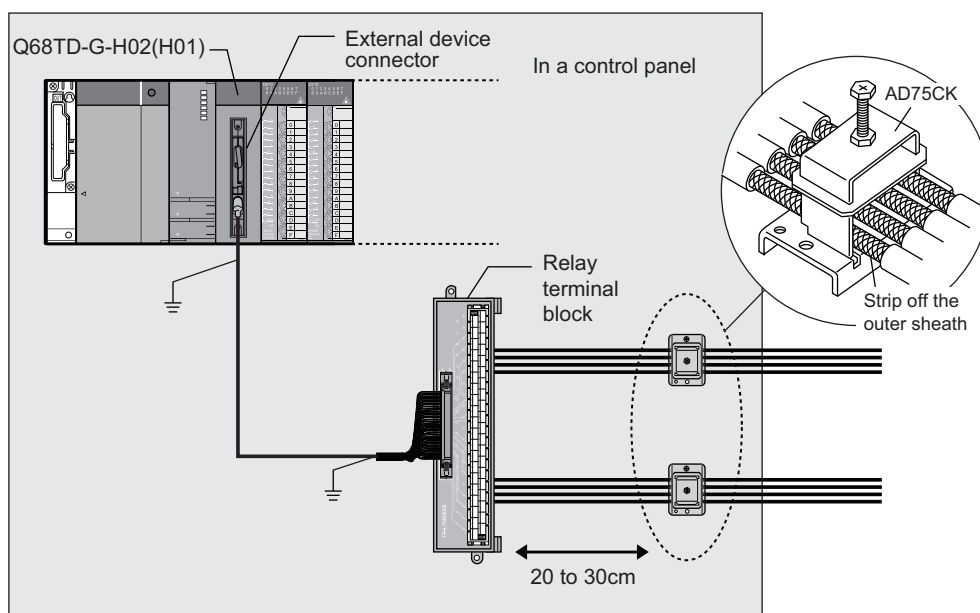

Figure 4.4 Wiring complying with EMC and LOW Voltage Directives

- (a) Use shielded cables for every external wiring and use the AD75CK cable clamp to ground to the panel. AD75CK can ground four cables together when using cables with outer diameter of about $\phi 7\text{mm}$.
- (b) Use shielded cabled between the external device connector and the relay terminal block, and ground it to the control panel. The cable must be 3m or shorter.
- (c) Before touching the relay terminal block, always touch the grounded metal to discharge the electricity charged in the body.

4.4.2 External wiring

(1) Wiring procedure

- 1) Install a relay terminal block for wiring.
- 2) Connect the thermocouple and the compensation conductors to the relay terminal block.
- 3) When setting the Q68TD-G-H02(H01) to "With cold junction temperature compensation", connect the cold junction temperature compensation resistor (RTD), which is supplied with Q68TD-G-H02(H01), to the relay terminal block.
- 4) Wire Q68TD-G-H02 (H01) to the relay terminal block using an external device connector.

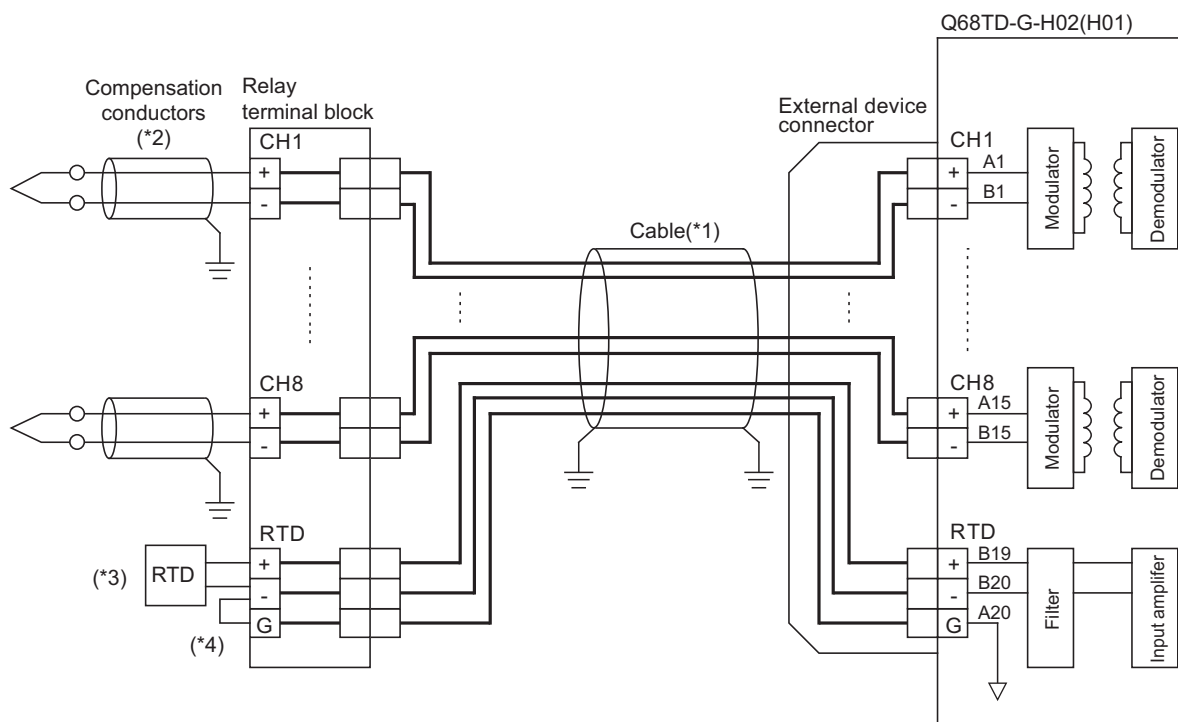

*1 Use shielded cables, and ground the shields.
Do not use compensation conductors.

*2 Use shielded compensation conductors, and ground the shields.
Do not use cables.

*3 When setting the Q68TD-G-H02(H01) to "With cold junction temperature compensation",
always connect the cold junction temperature compensation resistor (RTD).

*4 When connecting the RTD, always connect the terminals between RTD- and RTD G.

POINT

In the following cases (1) and (2), the cold junction temperature compensation resistor (RTD) and the end part of a thermocouple (or the end part of a compensating lead wire) are not connected to the same part, the relay terminal block. In such cases, the measured temperature value may be abnormal due to ambient temperature difference.

- (1) As the following figure, when the end part of the thermocouple and relay terminal block are connected by a cable, the measured temperature may be abnormal due to ambient temperature difference between A and B.

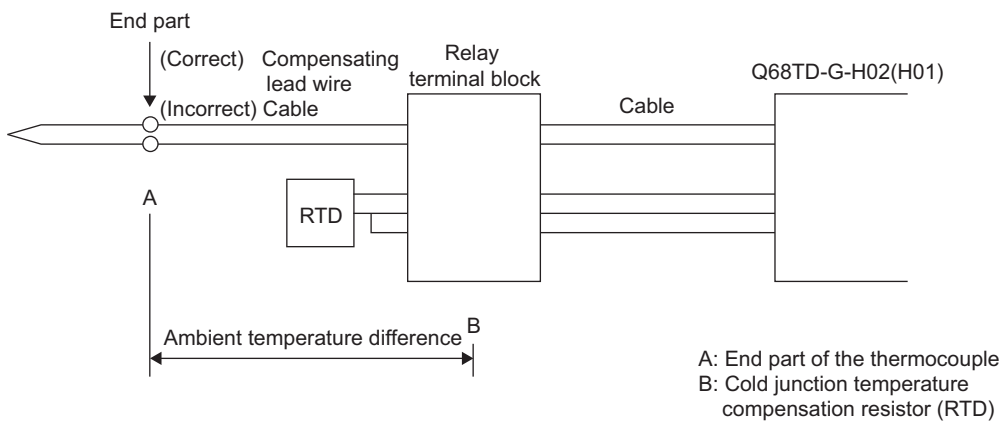

Figure 4.5 When the end part of the thermocouple and relay terminal block are connected by a cable

- (2) As the following figure, when the relay terminal block and the Q68TD-G-H02 (H01) are connected by a compensating lead wire, the measured temperature may be abnormal due to ambient temperature difference between B and C.

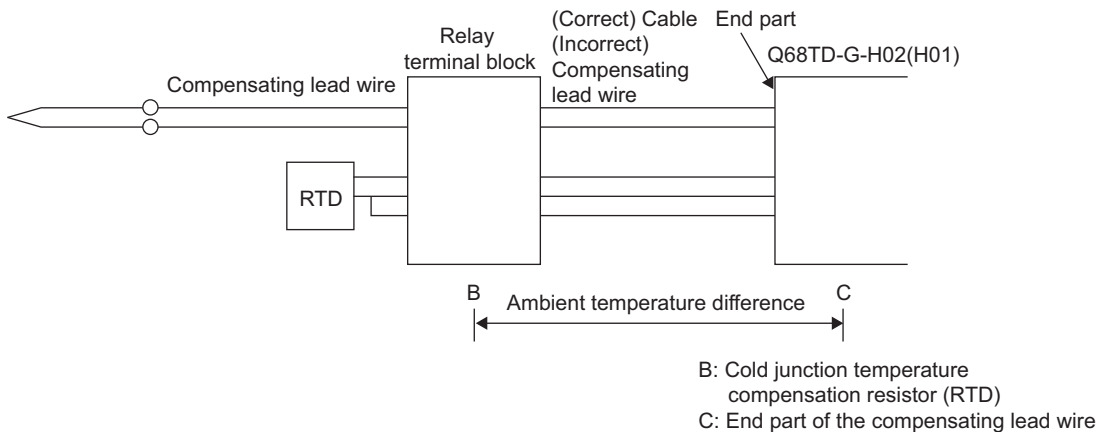

Figure 4.6 When the relay terminal block and the Q68TD-G-H02 (H01) are connected by a compensating lead wire

(2) When a connector/terminal block converter module is used

A connector/terminal block converter module for the Q68TD-G-H02 (H01) and dedicated cables are available.

To use the connector/terminal block converter module, wire modules as shown below.

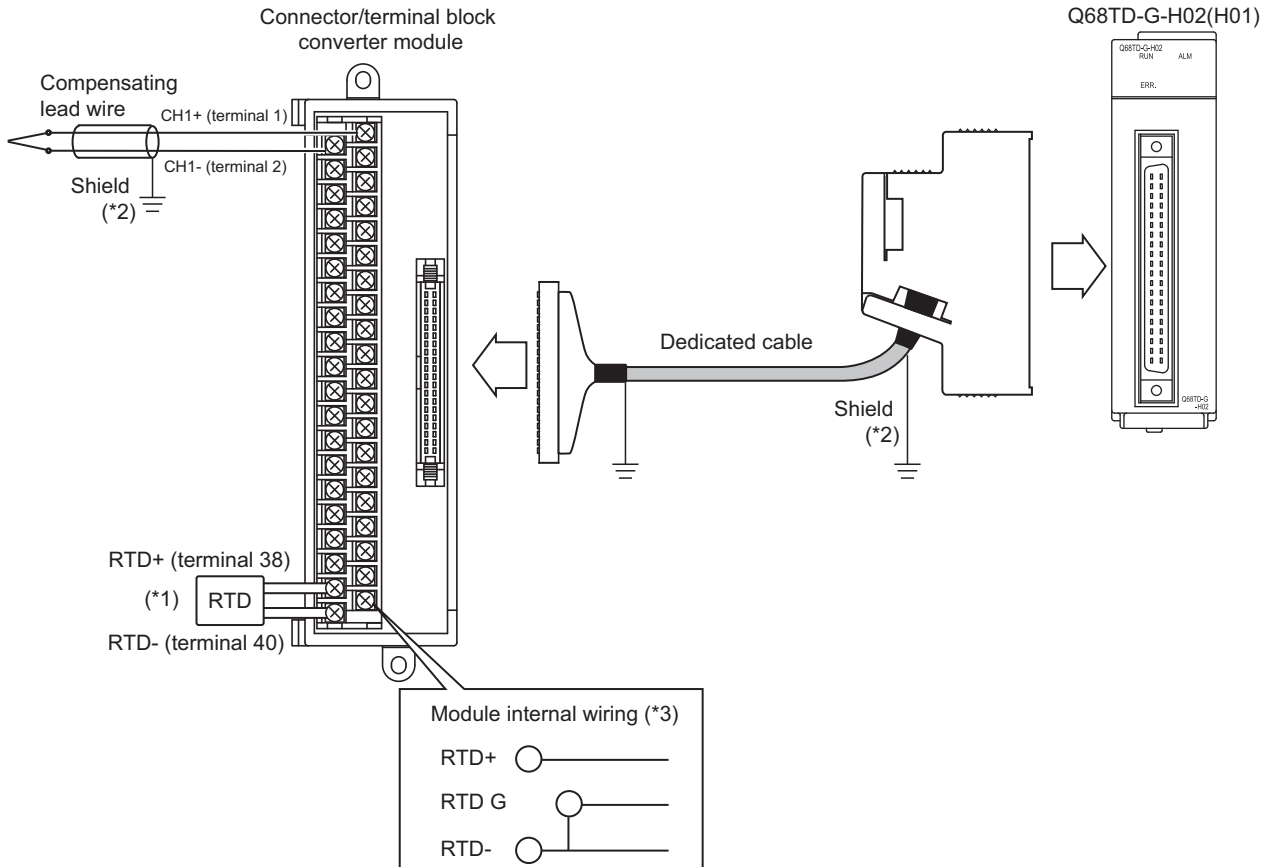

Figure 4.7 Example of the wiring using a connector/terminal block converter module

- * 1 When setting the Q68TD-G-H02 (H01) to "With cold junction temperature compensation", always connect the cold junction temperature compensation resistor (RTD).
- * 2 Always ground the shields.
- * 3 Since RTD- and RTD G are internally connected in the connector/terminal block converter module, connection of RTD- and RTD G at the terminal block is not required.

Table 4.4 List of the model names

Product name	Model name	Remarks	Manufacturer
Connector/terminal block converter module	FA-LTB40TDG	-	Mitsubishi Electric Engineering Co., Ltd.
Dedicated cable	FA-CBL05Q68TDG	Cable length: 0.5m	
	FA-CBL10Q68TDG	Cable length: 1.0m	
	FA-CBL20Q68TDG	Cable length: 2.0m	
	FA-CBL30Q68TDG	Cable length: 3.0m	

For inquiries related to the products or your order, please consult your local Mitsubishi Electric sales office or representative.

4.5 Switch Setting for Intelligent Function Module

The settings for the intelligent function module are performed using the I/O assignment settings for GX Developer.

(1) Setting item

Intelligent function module switch has switches 1 to 5. The setting is executed with 16-bit data.

When not setting the intelligent function module switch, the default of switches 1 to 5 is 0.

Table 4.5 Intelligent Function Module Switch Settings

Setting Item	
Switch 1	<p>Thermocouple type settings (CH1 to CH4)</p> <p><input type="checkbox"/> <input type="checkbox"/> <input type="checkbox"/> <input type="checkbox"/> H CH4 CH3 CH2 CH1</p>
Switch 2	<p>Thermocouple type settings (CH5 to CH8)</p> <p><input type="checkbox"/> <input type="checkbox"/> <input type="checkbox"/> <input type="checkbox"/> H CH8 CH7 CH6 CH5</p>
Switch 3	<p>Offset/gain setting mode</p> <p><input type="checkbox"/> <input type="checkbox"/> <input type="checkbox"/> <input type="checkbox"/> H Fixed to 0H</p> <p>b7 b6 b5 b4 b3 b2 b1 b0 CH8 CH7 CH6 CH5 CH4 CH3 CH2 CH1</p> <p>0: Factory default setting 1: User range setting</p>
Switch 4	<p>Mode setting, Cold junction compensation setting</p> <p><input type="checkbox"/> <input type="checkbox"/> <input type="checkbox"/> <input type="checkbox"/> H Fixed to 0H</p> <p>0H : With cold junction temperature compensation 1H to FH*1 : Without cold junction temperature compensation</p> <p>0H : Normal mode 1H to FH*1 : offset/gain setting mode</p>
Switch 5	0H : Fixed *2

* 1 Setting any value within the setting range will provide the same operation.

When the setting range is 1H to FH, set 1H for example.

* 2 Setting a value other than "0H" results in an error.

(2) Operating procedure

Start the settings with GX Developer assignment setting screen.

(a) I/O assignment setting screen

Set the following for the slot in which the Q68TD-G-H02(H01) is mounted.

The type setting is required; set other items as needed.

Type : Select "intelli."

Model name : Enter the module model name.

Points : Select 16 points.

Start XY : Enter the start I/O number for the Q68TD-G-H02(H01).

Detail setting: Specify the control PLC for the Q68TD-G-H02(H01).

It is unnecessary to set the "Error time output mode" or "H/W error time PLC operation mode" since these settings are invalid for the Q68TD-G-H02(H01).

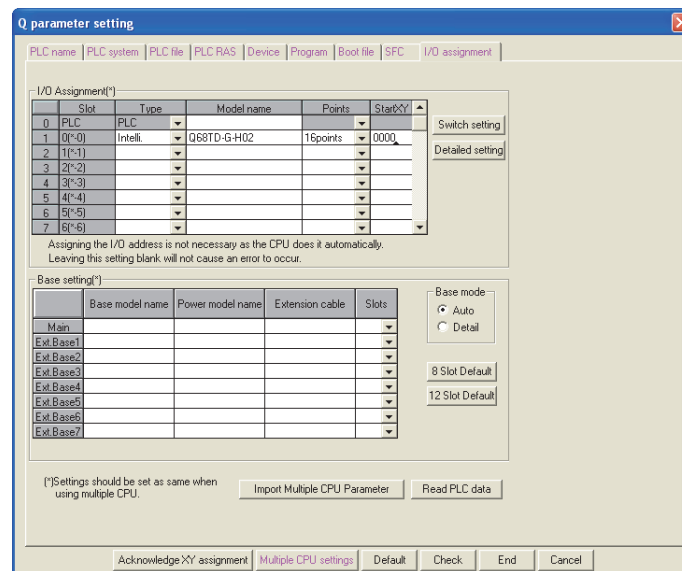

Figure 4.8 I/O assignment tab

(b) Switch setting for intelligent function module screen

Click on [Switch setting] on the I/O assignment setting screen to display the screen shown at left, then set switches 1 to 5.

The switches can easily be set if values are entered in hexadecimal. Change the entry format to hexadecimal and then enter the values.

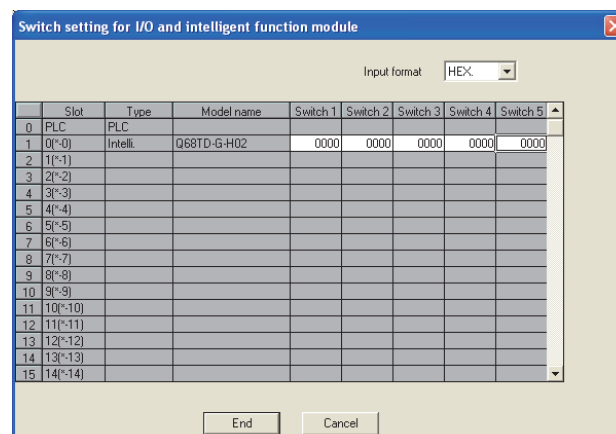

Figure 4.9 Switch setting for intelligent function module screen

4.6 Offset/Gain Setting

Execute offset/gain settings in the following procedure.

When the factory shipped setting is used, offset/gain setting is not necessary.

If the utility package is installed, execute the offset/gain setting according to the procedure in Section 5.6.2.

(1) Setting procedure

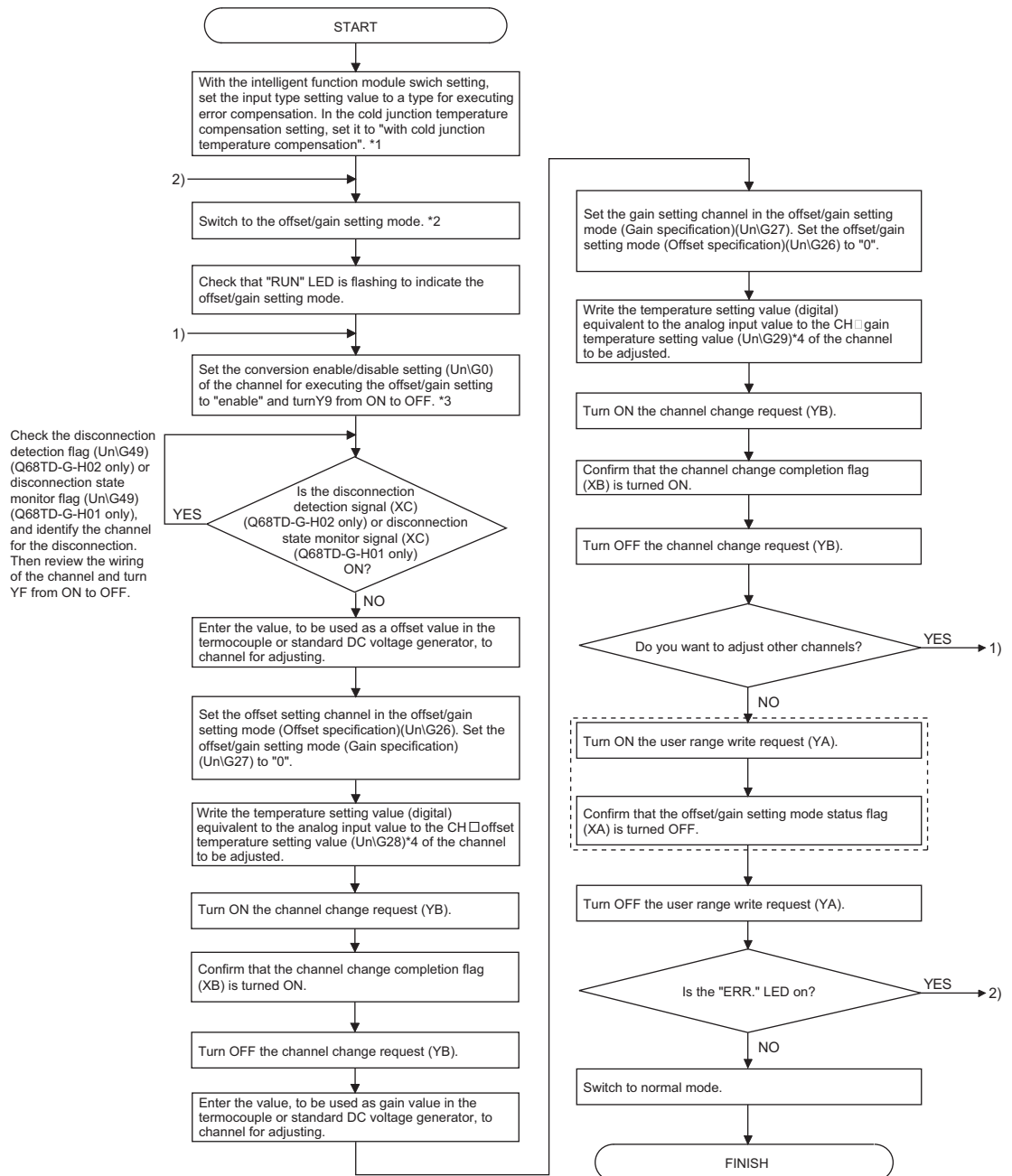

Figure 4.10 Setting procedure for offset/gain setting

- * 1 When inputting a value using such as a standard DC voltage generator, or using without cold junction temperature compensation on actual use, set it to "without cold junction compensation".
- * 2 The mode switching (normal mode to offset/gain setting mode to normal mode) method is indicated below.

Table 4.6 Mode switching method

Mode switching method	Refer to
Dedicated instruction (G(P).OFFGAN)	(2)(a) in this section
Setting the mode switching setting (Un\G158, Un\G159) and turning from OFF to ON the operating condition setting request (Y9).	(2)(b) in this section
Intelligent function module switch setting (After setting the intelligent function module switch, reset or turn from OFF to ON the programmable controller CPU.)	Section 4.5, (2)(c) in this section

- * 3 For the conversion enable/disable setting of unused channels or channels not executing the offset/gain setting, always set it to "disable".
If all channels are set to "Enable", Disconnection detection flag (Disconnection state monitor flag) (Un\G49) of channels that are not connecting a thermocouple turns on (changes to "1")
- * 4 Buffer memory address of channel 1 only is indicated in the chart. For buffer memory address of other channels, refer to Section 3.4.1 Buffer memory assignment.
- * 5 Do not perform the operations below during the steps indicated with *5. If they are performed, the data inside a flash memory will have a problem, and the Q68TD-G-H02 (H01) may not operate normally.
 - Powering off the programmable controller CPU
 - Resetting the programmable controller CPU

POINT

- (1) Execute the offset/gain settings in the actual operating status.
- (2) Offset value and gain value are stored in the Flash memory of the Q68TD-G-H02(H01) by turning ON the user range write request (YA), and the values are not erased at power-off. To prevent unnecessary write to Flash memory, an error (error code 162) occurs if writing is performed 26 times continuously.
- (3) Execute the offset/gain setting within the measured temperature guarantee range (refer to shaded area of Section 3.1 (2) Table 3.2).
If the setting exceeds the measured temperature guarantee range, resolution and accuracy may not be within the ranges of the performance specifications.
- (4) Set the offset and gain values within the ranges where the following conditions are satisfied.
(Gain value) - (offset value) > 0.1[°C]
Set the offset temperature setting value and gain temperature setting value within the range where the following conditions are satisfied.
(Gain temperature setting value) - (offset temperature setting value) > 0.1[°C]
- (5) When the user range write request (YA) is turned ON, consistency check for offset value and gain value, and offset temperature setting value and gain temperature setting value is executed.
If an error occurs on any channel, offset/gain values are not written to the module. Check the value of error code (Un\G19) and take an appropriate measure. Then, execute offset/gain setting again.
- (6) Offset/gain setting can be executed on multiple channels at the same time; however, set the offset and gain separately.
Setting the offset and gain for channels at the same time results in an error, and the [ERR.] LED turns on.
- (7) It takes approximately seven seconds from when Channel change request (YB) turns on till when Channel change completion flag (XB) turns on. During this period, input to channels targeted for offset/gain setting must be constant. In addition, if disconnection is detected or checked during this period, Channel change completion flag (XB) turns on earlier and an error (error code: 51□) occurs simultaneously. If this occurs, perform offset/gain setting again after connection is restored.
- (8) If an error (error code: 51□) described at (7) occurs while performing offset/gain setting simultaneously on multiple channels, values are not set only for the channel of which disconnection is detected or checked but also normally-connected channels. Therefore, perform offset/gain setting again for all adjusting target channels after connection is restored.
- (9) The Module ready (X0) turns from OFF to ON when the offset/gain setting mode is switched to the normal mode by the setting of the dedicated instruction (G(P).OFFGAN) or mode switch settings (Un\G158, Un\G159).
Note that initial setting processing will be executed if there is a sequence program that will execute initial setting when the Module ready (X0) turns ON.
- (10) Warm-up (power distribution) period of 30 minutes is required to satisfy with accuracy before the offset/gain setting is performed.

(2) Program examples

(a) The program in dotted area of (a) is common to (a),(b) and (c).

In this example, the I/O numbers for the Q68TD-G-H02(H01) are X/Y0 to X/YF.

Table 4.7 List of devices

Device	Function
M0	Mode switching
M1	Channel selection
M2	Channel conversion enabling
M3	Offset setting
M4	Gain setting
M5	Channel change instruction
M6	Offset/gain setting value write command to module
M50	Switching to the offset/gain setting mode
M51	Switching to the normal mode
D0	Dedicated instruction (G(P).OFFGAN) setting value storage device
D1	Channel specification storage device
D2	
D3	Offset temperature setting value storage device
D4	Gain temperature setting value storage device

4 SETUP AND PROCEDURES BEFORE OPERATION

- (a) When switching the mode using dedicated instruction (G(P).OFFGAN)
 The following program example is for switching to the offset/gain setting mode with the dedicated instruction (G(P).OFFGAN) and changing the channel for the offset/gain setting, then writing the offset/gain values to the Q68TD-G-H02(H01) and then switching to the normal mode.

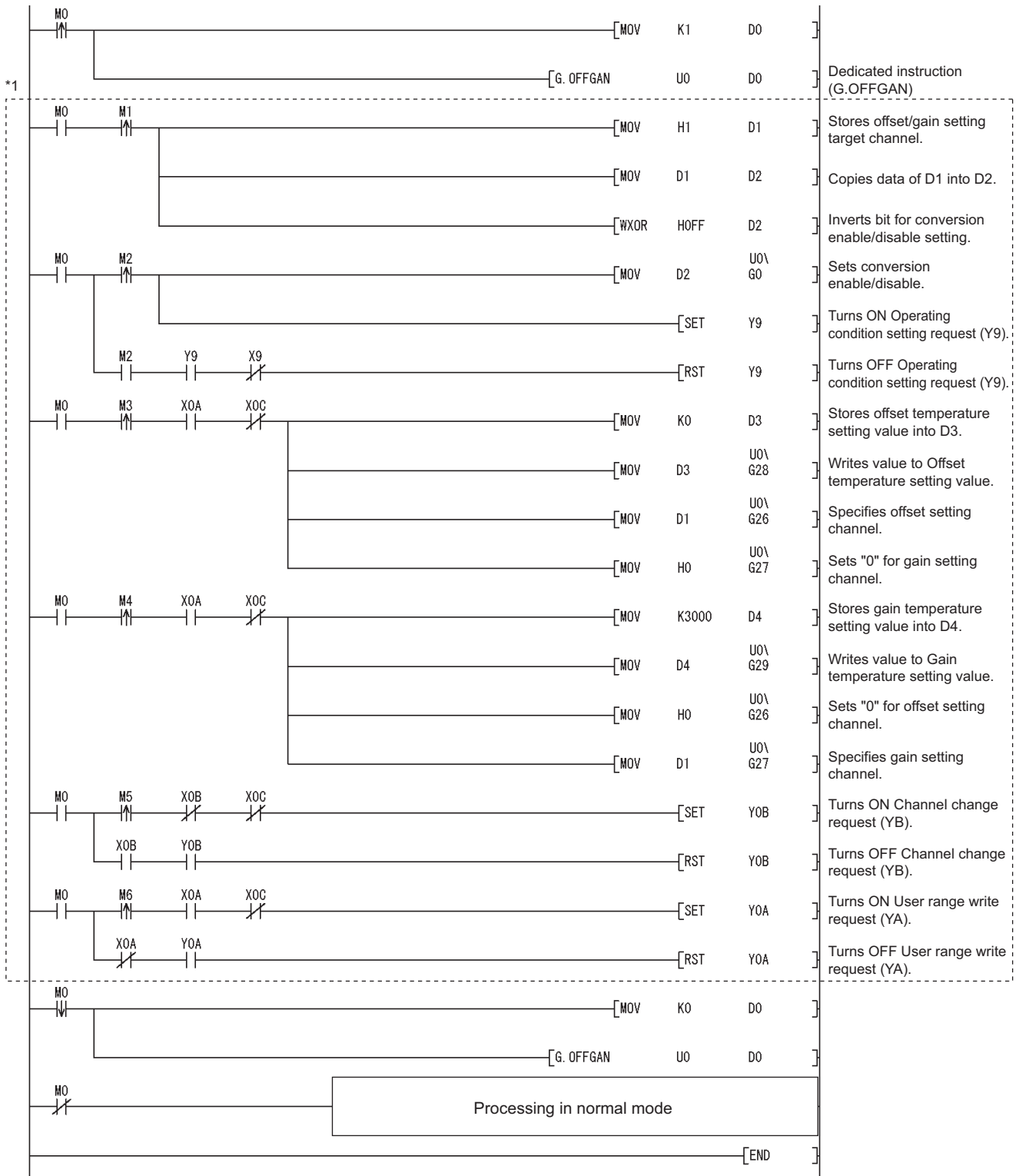

Figure 4.11 When switching the mode using dedicated instruction (G(P).OFFGAN)

* 1 The program in the dotted area is a common program.

(b) When switching the mode using the the mode switching setting (Un\G158, Un\G159) and the operating condition setting request (Y9)

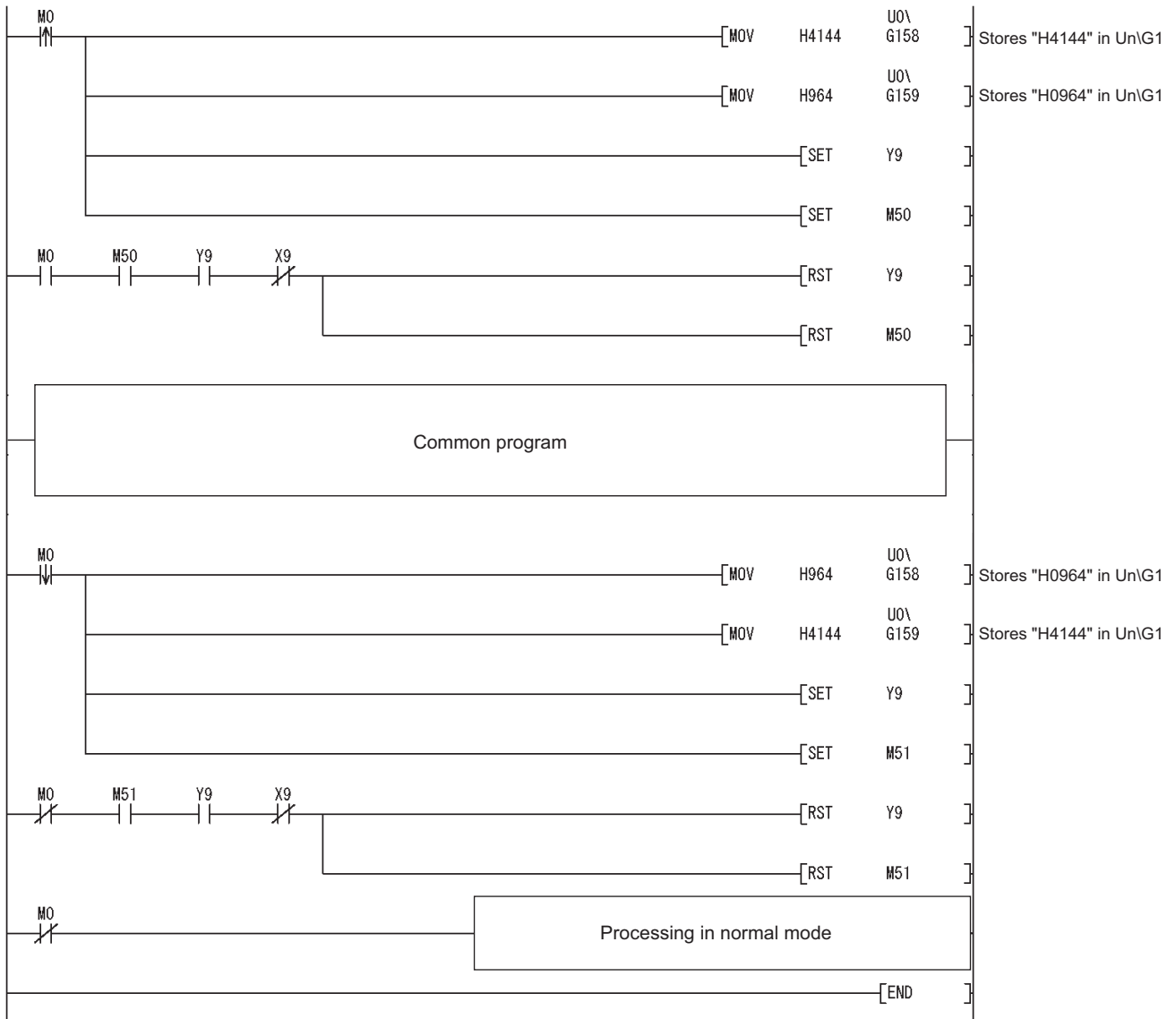

Figure 4.12 When switching the mode using the setting in the Mode switching setting (Un\G158,Un\G159) and Operating condition setting request (Y9)

(c) When switching the mode by making intelligent function module switch setting
Only the common program is necessary.

4.7 Cold Junction Temperature Compensation with/without Setting

The Q68TD-G-H02(H01) can execute the following two different cold junction temperature compensations by setting the intelligent function module switch setting (switch 4) to whether to carry out the cold junction temperature compensation using the cold junction temperature compensation resistor (RTD) or not.

- (1) Executing cold junction temperature compensation with the cold junction temperature compensation resistor (RTD) (set to "with cold junction temperature compensation")

Cold junction temperature compensation is possible by connecting the supplied cold junction temperature compensation resistor (RTD) and setting it to "with cold junction temperature compensation".

Always connect the supplied cold junction temperature compensation resistor (RTD) to the terminal block. (For connection, refer to Section 4.4.2.)

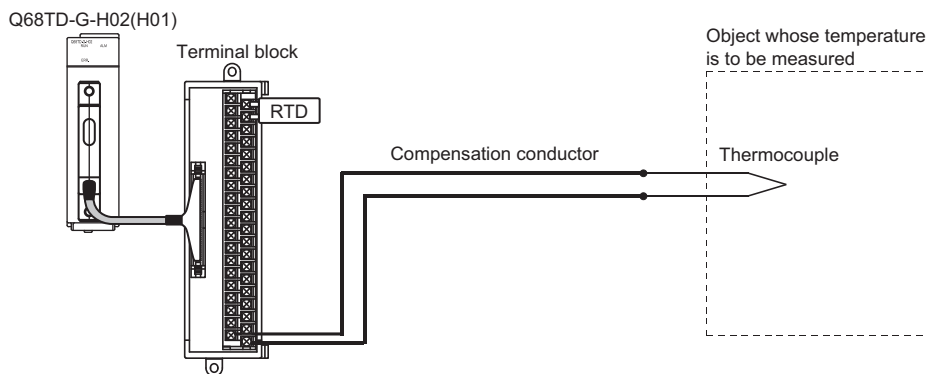

Figure 4.13 Connection between a cold junction compensation resistor (RTD) and a relay terminal block

- (2) Executing cold junction temperature compensation externally (set to "without cold junction temperature compensation")

Use this function to measure temperature in higher accuracy than the cold junction temperature compensation accuracy ($\pm 1^{\circ}\text{C}$) by the cold junction temperature compensation resistor (RTD) that is included with the Q68TD-G-H02 (H01).

Connecting a cold junction temperature compensation resistor (RTD) to the terminal block is unnecessary.

By providing a precision ice bath externally, the thermoelectromotive force generated at the tip of the thermocouple can be led to this module without any change, improving the cold junction temperature compensation accuracy.

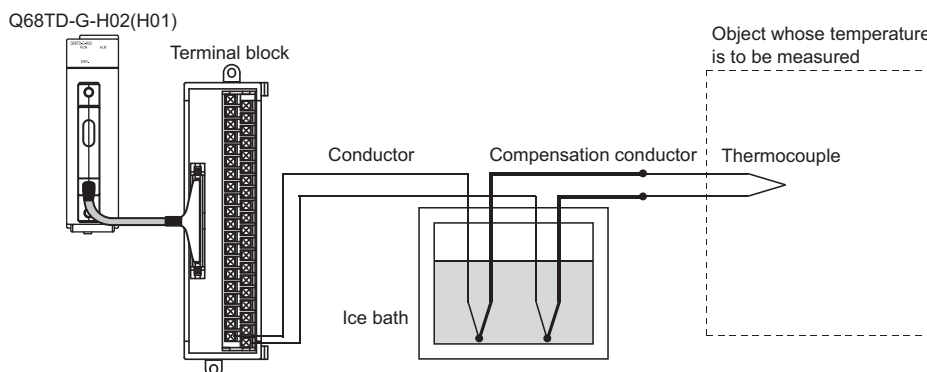

Figure 4.14 Connection between an ice bath and a relay terminal block

☒ POINT

The ice bath is designed to connect the thermocouple/compensation conductor and conductor in the pot whose internal temperature is controlled to be 0°C. Hence, the thermoelectromotive force at the contact portion of the thermocouple/compensation conductor and conductor will be 0mV, preventing the generation of extra thermoelectromotive force which can cause errors.

CHAPTER 5 UTILITY PACKAGE (GX Configurator-TI)

5.1 Utility Package Functions

Table 5.1 shows a list of the utility package functions.

Table 5.1 Utility Package (GX Configurator-TI) Function List

Function	Description	Reference section
Initial setting	(1) Make initial setting for operating the Q68TD-G-H02(H01) channel-by-channel. Set the values of the items which require initial setting. <ul style="list-style-type: none"> •Conversion enable/disable setting •Averaging processing selection •Time/count/moving average/time constant setting •Warning output enable/disable setting (Process alarm) •Thermocouple type •Process alarm lower lower limit value •Process alarm lower upper limit value •Process alarm upper lower limit value •Process alarm upper upper limit value •Warning output enable/disable setting (Rate alarm) •Rate alarm warning detection period •Rate alarm upper limit value 	Section 5.4
	(2) The data for which initial setting has been completed is registered in the parameters for the programmable controller CPU, and automatically written to the Q68TD-G-H02(H01) when the programmable controller CPU changes to the RUN status.	
Automatic refresh setting	(1) Set the automatically refreshed Q68TD-G-H02(H01) buffer memory channel-by-channel. <ul style="list-style-type: none"> •Conversion completion flag •CH\square Measured temperature value •Error code •Setting range 	Section 5.5
	(2) The values stored in the Q68TD-G-H02(H01) buffer memory where automatic refresh setting was made are automatically read or written when the END instruction of the programmable controller CPU is executed.	

Table 5.1 Utility Package (GX Configurator-TI) Function List

Function	Description	Reference section
Monitor/ test	Monitors and tests the buffer memory and I/O signals for the Q68TD-G-H02(H01). <ul style="list-style-type: none"> •Module ready •Operating condition setting completion flag •Operating condition setting request •Offset/gain setting mode status flag •User range write request •Channel change completion flag •Channel change request 	Section 5.6
	(1) CH□ Monitor/test <ul style="list-style-type: none"> •Conversion enable/disable setting •Averaging processing selection •Time/count/moving average/time constant setting •Conversion completion flag •Measured temperature value •Error code •Thermocouple type •Warning output enable/disable setting (Process alarm) •Warning output flag (Process alarm) lower limit value •Warning output flag (Process alarm) upper limit value •Process alarm lower lower limit value •Process alarm lower upper limit value •Process alarm upper lower limit value •Process alarm upper upper limit value •Warning output enable/disable setting (Rate alarm) •Rate alarm warning detection period •Warning output flag (Rate alarm) lower limit value 	
	(2) Offset/Gain Setting <ul style="list-style-type: none"> •Mode switching setting •Mode switching setting status •Conversion enable/disable setting •Operating condition setting request •CH□ Thermocouple type •CH□ Offset setting channel setting 	
	(3) X/Y Monitor/Test <ul style="list-style-type: none"> •Xn0: Module ready •Xn9: Operating condition setting completion flag •XnA: Offset/gain setting mode status flag •XnB: Channel change completion flag •XnC: Disconnection detection signal (Disconnection state monitor signal)^{*1} •XnD: Warning output signal •XnE: Conversion completion flag •XnF: Error flag 	
(4) OMC refresh <ul style="list-style-type: none"> •CH□ Factory default offset/gain value •CH□ User range settings thermal EMF offset/gain value •OMC Refresh data write request 	<ul style="list-style-type: none"> •Disconnection detection signal (Disconnection state monitor signal)^{*1} •Warning output signal •Conversion completion flag •Error flag •Error clear request •Cold junction compensation setting state^{*2} •Warning output flag (Rate alarm) upper limit value •Rate alarm upper limit value •Rate alarm lower limit value •Disconnection detection flag (Disconnection state monitor flag)^{*1} •Scaling value •Scaling valid/invalid setting •Scaling range lower limit value •Scaling range upper limit value •Scaling width lower limit value •Scaling width upper limit value •Scaling value •Conversion setting for disconnection detection (Disconnection state conversion setting)^{*1} •Conversion setting value for disconnection detection (Conversion setting value for disconnection state)^{*1} •CH□ Offset setting value •CH□ Gain setting channel setting •CH□ Gain setting value •CH□ Channel change request •CH□ Offset temperature setting value •Yn9: Operating condition setting request •YnA: User range write request •YnB: Channel change request •YnF: Error clear request •CH□ User range settings offset/gain value •OMC Refresh data read request 	

* 1 The parenthesis name is for the Q68TD-G-H01 and the other is for the Q68TD-G-H02.

* 2 The cold junction compensation setting state is only for the Q68TD-G-H02.

5.2 Installing and Uninstalling the Utility Package

For how to install or uninstall the utility package, refer to "Method of installing the MELSOFT Series" included in the utility package.

5.2.1 Handling precautions

The following explains the precautions on using the GX Configurator-TI.

- (1) For safety
Since GX Configurator-TI is add-in software for GX Developer, read "Safety Precautions" and the basic operating procedures in the GX Developer Operating Manual.
- (2) About installation
The GX Configurator-TI is add-in software for GX Developer Version 4 or later. Therefore, GX Configurator-TI must be installed on the personal computer that has already GX Developer Version 4 or later installed.
- (3) Screen error of Intelligent function module utility
Insufficient system resource may cause the screen to be displayed inappropriately while using the Intelligent function module utility.
If this occurs, close the Intelligent function module utility, GX Developer (program, comments, etc.) and other applications, and then start GX Developer and Intelligent function module utility again.
- (4) To start the Intelligent function module utility
 - (a) In GX Developer, select "QCPU (Q mode)" for PLC series and specify a project. If any PLC series other than "QCPU (Q mode)" is selected, or if no project is specified, the Intelligent function module utility will not start.
 - (b) Multiple Intelligent function module utilities can be started. However, [Open parameters] and [Save parameters] operations under [Intelligent function module parameter] are allowed for one Intelligent function module utility only. Only the [Monitor/test] operation is allowed for the other utilities.

(5) Switching between two or more Intelligent function module utilities

When two or more Intelligent function module utility screens cannot be displayed side by side, select a screen to be displayed on the top of others using the task bar.



Figure 5.1 Display example of task bar

(6) Number of parameters that can be set in GX Configurator-TI

When multiple intelligent function modules are mounted, the number of parameter settings must not exceed the following limit.

Table 5.2 Maximum number of parameters that can be set in GX Configurator

When intelligent function modules are installed to:	Maximum number of parameter settings	
	Initial setting	Auto refresh setting
Q00J/Q00/Q01CPU	512	256
Q02/Q02H/Q06H/Q12H/Q25HCPU	512	256
Q02PH/Q06PH/Q12PH/Q25PHCPU	512	256
Q12PRH/Q25PRHCPU	512	256
Q00UJ/Q00U/Q01UCPU	512	256
Q02UCPU	2048	1024
Q03UD/Q04UDH/Q06UDH/ Q10UDH/Q13UDH/Q20UDH/ Q26UDH/Q03UDE/Q04UDEH/ Q06UDEH/Q10UDEH/Q13UDEH/ Q20UDEH/Q26UDEHCPU	4096	2048
CPU modules other than the above	Not available	Not available
MELSECNET/H remote I/O station	512	256

For example, if multiple intelligent function modules are installed to the MELSECNET/H remote I/O station, configure the settings in GX Configurator-TI so that the number of parameter settings for all the intelligent function modules does not exceed the limit of the MELSECNET/H remote I/O station. Calculate the total number of parameter settings separately for the initial setting and for the auto refresh setting.

The number of parameters that can be set for one module in GX Configurator-TI is as shown below.

Table 5.3 Number of parameter settings that can be set for one module

Target module	Initial setting	Auto refresh setting
Q68TD-G-H02(H01)	6 (Fixed)	24 (Max.)

Example) Counting the number of parameter settings in Auto refresh setting

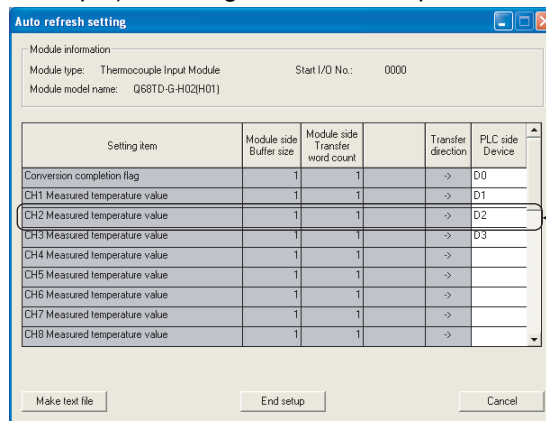

This one row is counted as one setting. Blank rows are not counted. Count up all the setting items on this screen, and add the total to the number of settings for other intelligent function modules to get a grand total.

Figure 5.2 Parameter setting screen for Auto refresh setting

5.2.2 Operating environment

This section explains the operating environment of the personal computer that runs GX Configurator-TI.

Table 5.4 Operating environment of personal computer

Item	Description
Installation (Add-in) target* ¹	Add-in to GX Developer Version 4 (English version) or later * ² * ⁴
Computer	A personal computer with any of the operating systems below
CPU	Refer to the next page "Operating system and performance required for personal computer".
Required memory	
Hard disk space	For installation
	For operation
Display	800 × 600 dots or more resolution* ³
Operating system	Microsoft® Windows® 95 Operating System (English version) Microsoft® Windows® 98 Operating System (English version) Microsoft® Windows® Millennium Edition Operating System (English version) Microsoft® Windows NT® Workstation Operating System Version 4.0 (English version) Microsoft® Windows® 2000 Professional Operating System (English version) Microsoft® Windows® XP Professional Operating System (English version) Microsoft® Windows® XP Home Edition Operating System (English version) Microsoft® Windows Vista® Home Basic Operating System (English version) Microsoft® Windows Vista® Home Premium Operating System (English version) Microsoft® Windows Vista® Business Operating System (English version) Microsoft® Windows Vista® Ultimate Operating System (English version) Microsoft® Windows Vista® Enterprise Operating System (English version) Microsoft® Windows® 7 Starter Operating System (English version)* ⁴ Microsoft® Windows® 7 Home Premium Operating System (English version)* ⁴ Microsoft® Windows® 7 Professional Operating System (English version)* ⁴ Microsoft® Windows® 7 Ultimate Operating System (English version)* ⁴ Microsoft® Windows® 7 Enterprise Operating System (English version)* ⁴

- * 1: Install GX Configurator-TI in GX Developer Version 4 or higher in the same language. GX Developer (English version) and GX Configurator-TI (Japanese version) cannot be used in combination, and GX Developer (Japanese version) and GX Configurator-TI (English version) cannot be used in combination.
- * 2: GX Configurator-TI is not applicable to GX Developer Version 3 or earlier.
- * 3: When Windows Vista® or Windows®7 is used, resolution of 1024 × 768 dots or more is recommended.
- * 4: When 32-bit Windows®7 is used, add GX Configurator-TI Version 1.28AE or later in GX Developer Version 8.91V or later.
When 64-bit Windows®7 is used, add GX Configurator-TI Version 1.28AE or later in GX Developer Version 8.98C or later.

Table 5.5 Operating system and performance required for personal computer

Operating system	Performance required for personal computer	
	CPU	Memory
Windows® 95	Pentium® 133MHz or more	32MB or more
Windows® 98	Pentium® 133MHz or more	32MB or more
Windows® Me	Pentium® 150MHz or more	32MB or more
Windows NT® Workstation 4.0	Pentium® 133MHz or more	32MB or more
Windows® 2000 Professional	Pentium® 133MHz or more	64MB or more
Windows® XP	Pentium® 300MHz or more	128MB or more
Windows Vista®	Pentium® 1GHz or more	1GB or more
Windows® 7	Pentium® 1GHz or more	1GB or more (32-bit) 2GB or more (64-bit)

POINT

(1) The functions shown below are not available for Windows® XP, Windows Vista®, and Windows® 7. If any of the following functions is attempted, this product may not operate normally.

- Start of application in Windows® compatible mode
- Fast user switching
- Remote desktop
- Large fonts (Details setting of Display Properties)
- DPI setting other than 100%
- 64-bit version*1
- Windows XP Mode
- Windows Touch

* 1 It is available for Windows® 7.

(2) A user with USER authority or higher can access GX Configurator-TI for Windows Vista®.

5.3 Utility Package Operation

5.3.1 Common utility package operations

(1) Control keys

Special keys that can be used for operation of the utility package and their applications are shown in the table below.

Table 5.6 Available control keys

Key	Application
Esc	Cancels the current entry in a cell. Closes the window.
Tab	Moves between controls in the window.
Ctrl	Used in combination with the mouse operation to select multiple cells for test execution.
Delete	Deletes the character where the cursor is positioned. When a cell is selected, clears all of the setting contents in the cell.
Back Space	Deletes the character where the cursor is positioned.
↑ ↓ ← →	Moves the cursor.
Page Up	Moves the cursor one page up.
Page Down	Moves the cursor one page down.
Enter	Completes the entry in the cell.

(2) Data created with the utility package

The following data or files that are created with the utility package can be also handled in GX Developer. Figure 5.4 shows respective data or files are handled in which operation.

(a) Intelligent function module parameter

This represents the data created in Auto refresh setting, and they are stored in an intelligent function module parameter file in a project created by GX Developer.

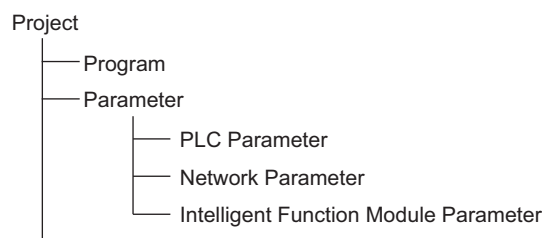

(b) Text files

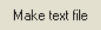
A text file can be created by clicking the  button on the initial setting, Auto refresh setting, or Monitor/Test screen. The text files can be utilized to create user documents.

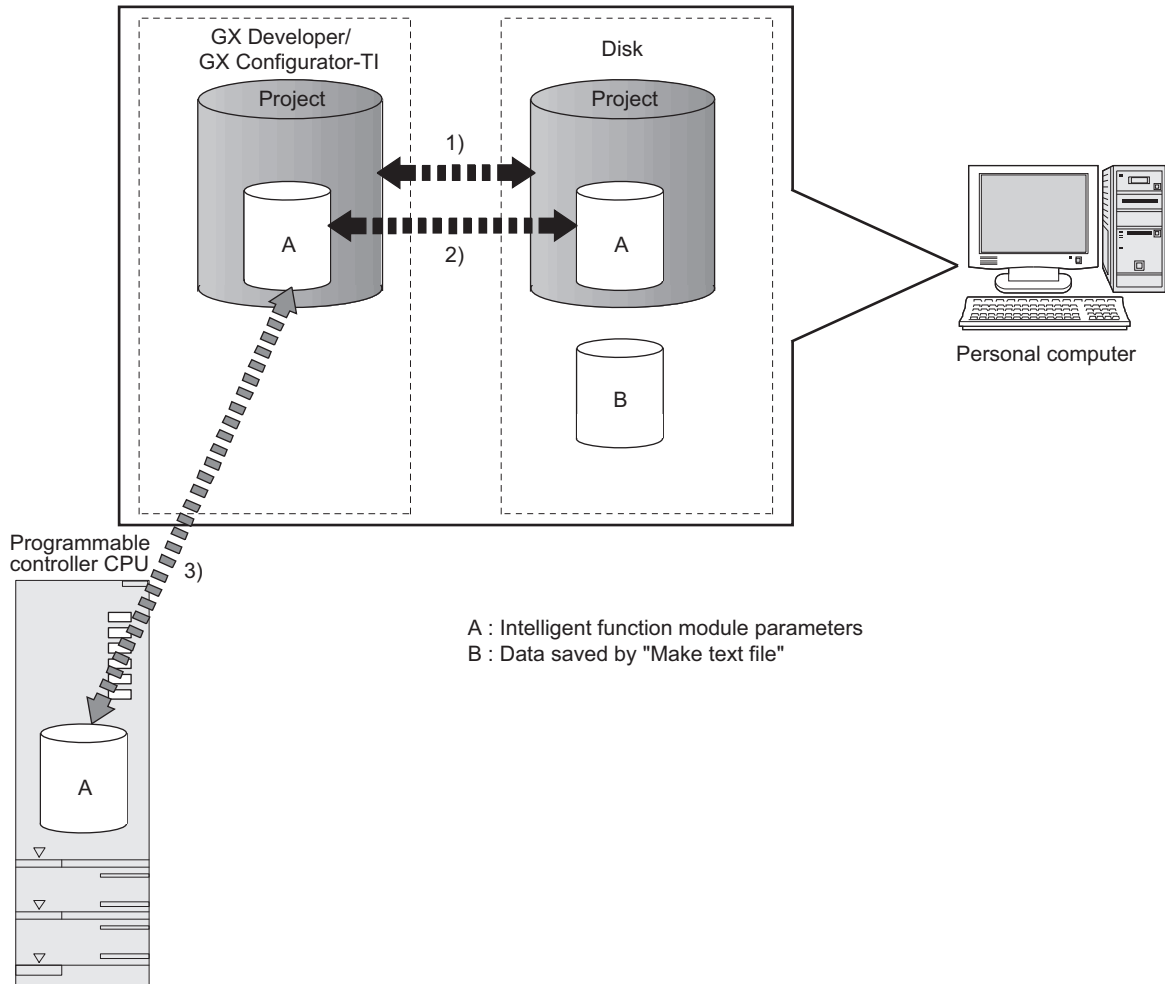
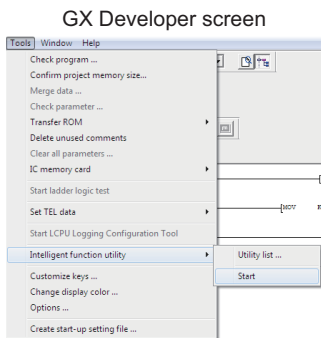

Figure 5.3 Correlation chart for data created with the utility package

Steps 1) to 3) shown in Figure 5.4 are performed as follows:

- 1) From GX Developer, select:
[Project] → [Open project] / [Save] / [Save as]
- 2) On the intelligent function module selection screen of the utility, select:
[Intelligent function module parameter] → [Open parameters] / [Save parameters]
- 3) From GX Developer, select:
[Online] → [Read from PLC] / [Write to PLC] → "Intelligent function module parameters"
Alternatively, from the intelligent function module selection screen of the utility, select:
[Online] → [Read from PLC] / [Write to PLC]

5.3.2 Operation overview



↓ [Tools] - [Intelligent function utility] - [Start]

Screen for selecting a target intelligent function module

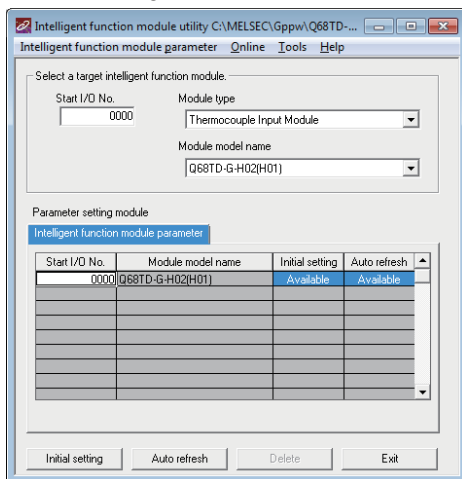

Enter "Start I/O No.", and select "Module type" and "Module model name".

Initial setting

Auto refresh

Initial setting screen

Auto refresh setting screen

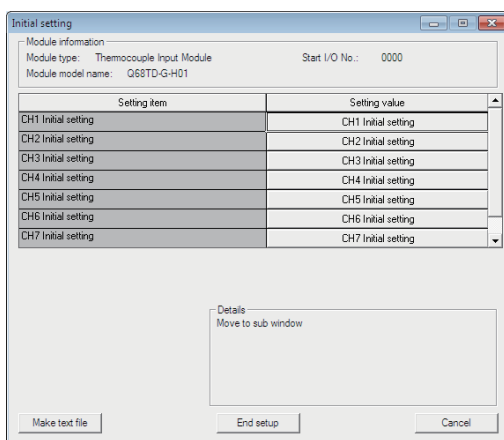

Refer to Section 5.4.

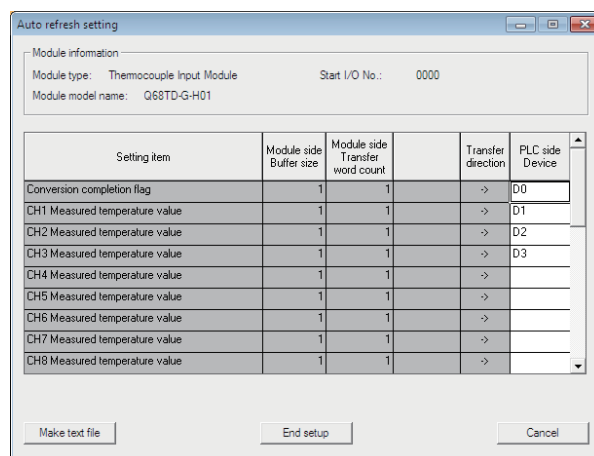

Refer to Section 5.5.

Figure 5.4 Operation overview

1) [Online] - [Monitor/Test]

Select monitor/test module screen

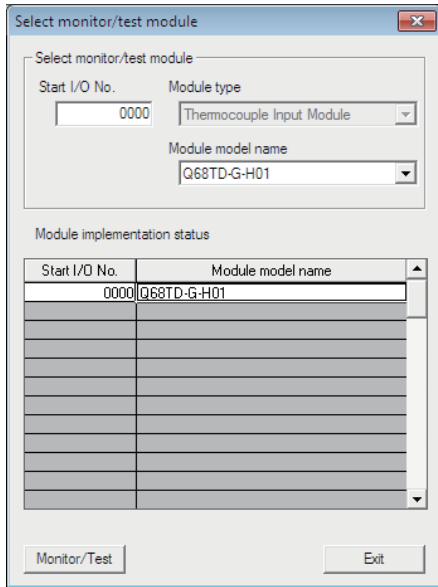

Select a module to be monitored/tested.

Monitor/Test screen

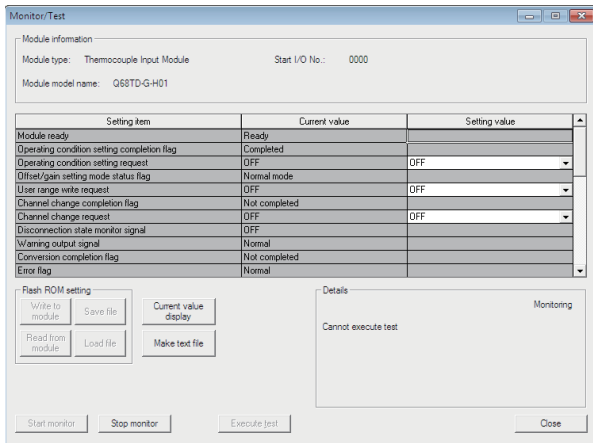

Refer to Section 5.6.

Figure 5.5 Operation overview (continued)

5.3.3 Starting the Intelligent function module utility

[Operating procedure]

Intelligent function module utility is started from GX Developer.

[Tools] → [Intelligent function utility] → [Start]

[Setting screen]

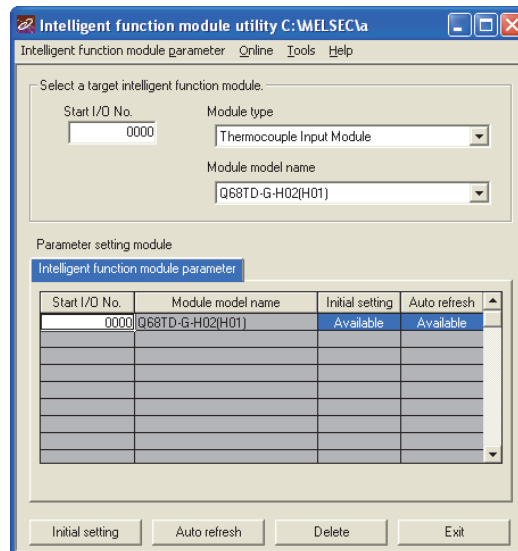

Figure 5.6 Intelligent function module utility setting screen

[Explanation of items]

(1) Activation of other screens

Following screens can be displayed from the intelligent function module utility screen.

(a) Initial setting screen

"Start I/O No.*1" → "Module type" → "Module model name" →

(b) Auto refresh setting screen

"Start I/O No.*1" → "Module type" → "Module model name" →

(c) Select monitor/test module screen

[Online] → [Monitor/test]

* 1 Enter the start I/O No. in hexadecimal.

(2) Command buttons

- Deletes the initial setting and auto refresh setting of the selected module.
- Closes this screen.

(3) Menu bar

(a) File menu

Intelligent function module parameters of the project opened by GX Developer are handled.

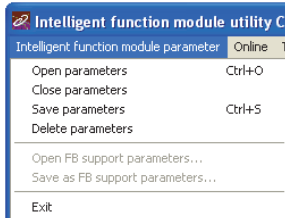

Figure 5.7 File menu

[Open parameters] : Reads a parameter file.

[Close parameters] : Closes the parameter file. If any data are modified, a dialog asking for file saving will appear.

[Save parameters] : Saves the parameter file.

[Delete parameters] : Deletes the parameter file.

[Exit] : Closes this screen.

(b) Online menu

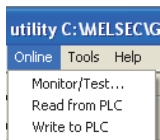

Figure 5.8 Online menu

[Monitor/Test] : Activates the Select monitor/test module screen.

[Read from PLC] : Reads the intelligent function module parameters from the CPU module.

[Write to PLC] : Writes the intelligent function module parameters to the CPU module.

POINT

(1) Saving intelligent function module parameters in a file

Since intelligent function module parameters cannot be saved in a file by the project saving operation of GX Developer, save them on the shown module selection screen for intelligent function module parameter setting.

(2) Reading/writing intelligent function module parameters from/to a programmable controller using GX Developer

- Intelligent function module parameters can be read from and written into a programmable controller after having been saved in a file.
- Set a target programmable controller CPU in GX Developer: [Online] → [Transfer setup].
- When the Q68TD-G-H02(H01) is installed to the remote I/O station, use "Read from PLC" and "Write to PLC".

(3) Checking the required utility

While the start I/O is displayed on the Intelligent function module utility setting screen, "*" may be displayed for the model name.

This means that the required utility has not been installed or the utility cannot be started from GX Developer.

Check the required utility, selecting [Tools] - [Intelligent function unit utility] - [Utility list...] in GX Developer.

5.4 Initial Setting

[Purpose]

Make initial setting for operating the Q68TD-G-H02(H01) on each channel.
 Refer to Section 5.1 for the initial setting parameter types.
 Setting parameters in the Initial setting screen can omit parameter settings in sequence programs.

[Operating procedure]

"Start I/O No.*1" → "Module type" → "Module model name" →

* 1 Enter the start I/O No. in hexadecimal.

[Setting screen]

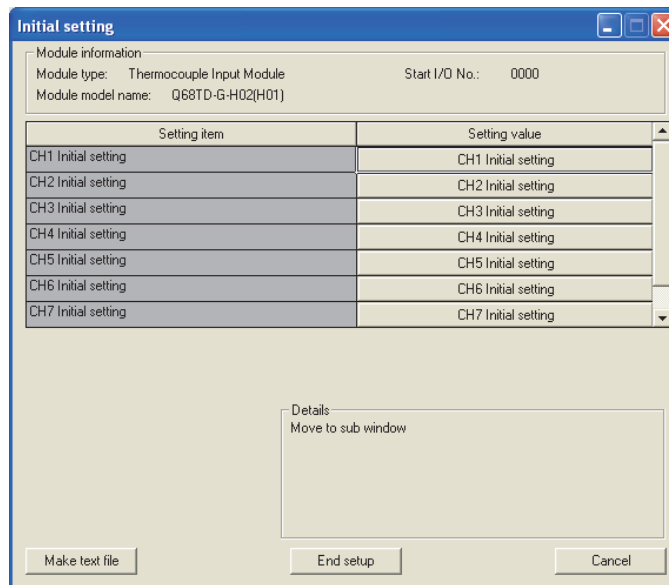

Figure 5.9 Initial setting

[Explanation of items]

(1) Setting contents

Set whether temperature conversion is enabled or disabled and the temperature conversion method for each channel.

(2) Command buttons

- Creates a file containing the screen data in text file format.
- Saves the set data and ends the operation.
- Cancels the setting and ends the operation.

POINT

Initial setting data are stored in intelligent function module parameters. After being written to the CPU module, the initial setting data are made effective by operating either (1) or (2).

(1) Change the RUN/STOP switch of the CPU module: STOP → RUN → STOP → RUN.

(2) After setting the RUN/STOP switch to RUN, power the programmable controller OFF → ON or reset the CPU module.

When using a sequence program to write initial setting data, the data will be written when the CPU module is switched from STOP to RUN. Create a program so that initial setting is re-executed in the sequence program.

5.5 Auto Refresh Settings

[Purpose]

Configure the Q68TD-G-H02(H01)'s buffer memory for automatic refresh.

[Operating procedure]

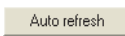
"Start I/O No.*1" → "Module type" → "Module model name" → 

* 1 Enter the start I/O No. in hexadecimal.

[Setting screen]

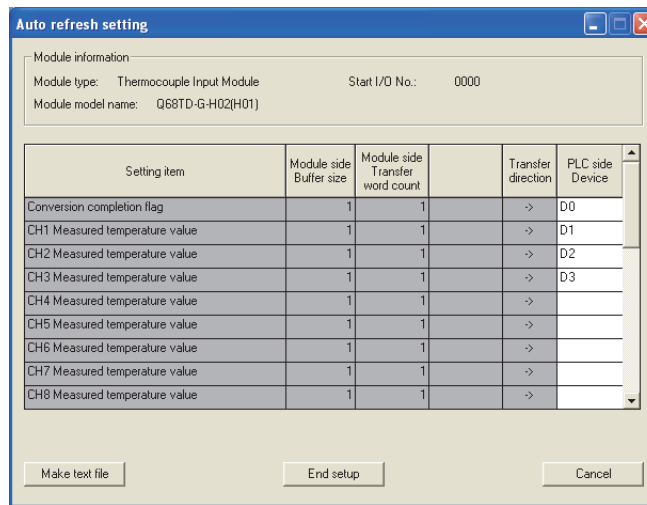

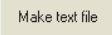

Figure 5.10 Auto refresh settings screen

[Explanation of items]

(1) Items

- Model side Buffer size : Displays the buffer memory size of the setting item that can be transferred (fixed at one word).
- Model side Transfer word count : Displays the number of words to transfer the CPU device from the head device (fixed at one word).
- Transfer direction : "←" indicates that data are written from the device to the buffer memory.
"→" indicates that data are loaded from the buffer memory to the device.
- PLC side Device : Enter a CPU module side device that is to be automatically refreshed.
Applicable devices are X, Y, M, L, B, T, C, ST, D, W, R, and ZR.
When using bit devices X, Y, M, L or B, set a number that can be divided by 16 points (examples: X10, Y120, M16, etc.)
Also, buffer memory data are stored in a 16-point area, starting from the specified device number. For example, if X10 is entered, data are stored in X10 to X1F.

(2) Command buttons

	Creates a file containing the screen data in text file format.
	Saves the set data and ends the operation.
	Cancels the setting and ends the operation.

 POINT

Auto refresh setting data are stored in intelligent function module parameters. After being written to the CPU module, the auto refresh setting data are made effective by operating either (1) or (2).

(1) Change the RUN/STOP switch of the CPU module: STOP → RUN → STOP → RUN.

(2) After setting the RUN/STOP switch to RUN, power the programmable controller OFF → ON or reset the CPU module.

The auto refresh settings cannot be changed from sequence programs. However, processing equivalent to auto refresh can be added using the FROM/TO instruction in the sequence program.

5.6 Monitoring/Test

5.6.1 Monitor/test screen

[Purpose]

Start buffer memory monitoring/testing, I/O signal monitoring/testing, offset/gain settings (refer to Section 5.6.2) and pass data (refer to Section 5.6.3) from this screen.

[Operating procedure]

Monitor/test module selection screen "Start I/O No.*1" → "Module type" → "Module model name" → **Monitor/Test**

* 1 Enter the start I/O numbers in hexadecimal.

The screen can also be started from System monitor of GX Developer Version 6 or later.

Refer to the GX Developer Operating Manual for details.

[Setting screen]

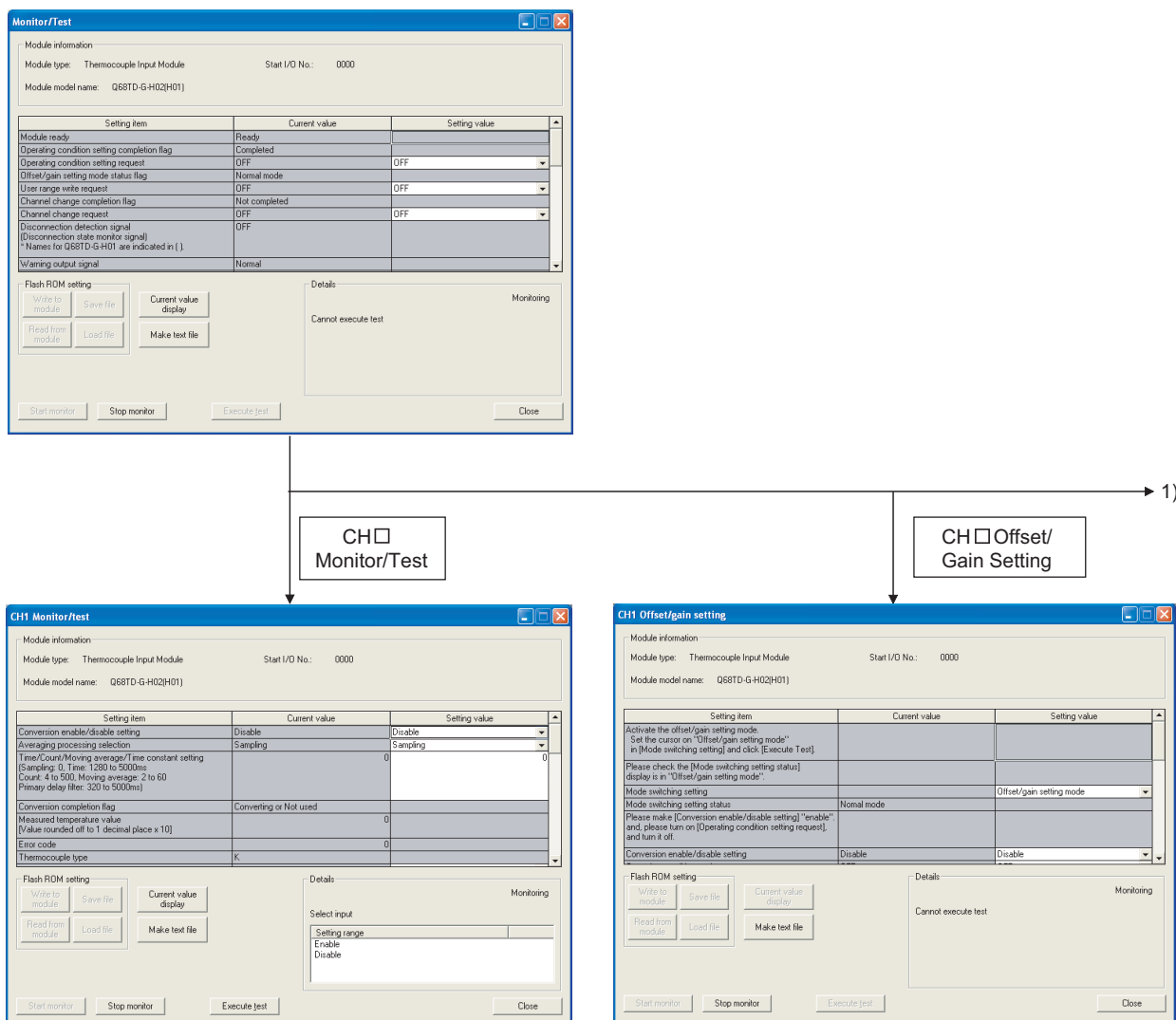

Figure 5.11 Monitor/test screen

1)

X/Y Monitor/Test

OMC (Online Module Change) refresh data

The screenshot shows the 'X/Y Monitor/Test' window. It displays module information for a Thermocouple Input Module (Q68TD-G-H02(H01)) with Start I/O No. 0000. A table lists various status items and their current values.

Setting item	Current value	Setting value
X00 Module ready	Ready	
X08 Operating condition setting completion flag	Completed	
X0A Offset/gain setting mode status flag	Normal mode	
X0B Channel change completion flag	Not completed	
X0C Disconnection detection signal (Disconnection state monitor signal) (*Names for Q68TD-G-H01 are indicated in [].)	OFF	
X0D Warning output signal	Normal	
X0E Conversion completion flag	Not completed	
X0F Error flag	Normal	
Y08 Operating condition setting request	OFF	OFF

Flash ROM settings include 'write to module', 'save file', 'read from module', and 'load file'. The 'Details' section shows 'Cannot execute test' and 'Monitoring'.

The screenshot shows the 'OMC (Online Module Change) refresh data' window. It displays module information for a Thermocouple Input Module (Q68TD-G-H02(H01)) with Start I/O No. 0000. A table lists various gain and offset values.

Setting item	Current value	Setting value
CH1 Factory default offset value	0000	0000
CH1 Factory default gain value	0000	0000
CH1 User range settings offset value	0000	0000
CH1 User range settings gain value	0000	0000
CH1 User range settings thermal EMF offset value	00000000	00000000
CH1 User range settings thermal EMF gain value	00000000	00000000
CH2 Factory default offset value	0000	0000
CH2 Factory default gain value	0000	0000
CH2 User range settings offset value	0000	0000
CH2 User range settings gain value	0000	0000
CH2 User range settings thermal EMF offset value	0000	0000
CH2 User range settings thermal EMF gain value	00000000	00000000

Flash ROM settings include 'write to module', 'save file', 'read from module', and 'load file'. The 'Details' section shows 'Hexadecimal input' with a 'Setting range' of '0000 - FFFF' and 'Monitoring'.

[Explanation of items]

(1) Items

Setting item :Displays I/O signals and buffer memory names.

Current value :Monitors the I/O signal states and present buffer memory values.

Setting value :Enter or select the data to be written into the buffer memory for test operation.

(2) Command buttons

Current value display

Displays the current value of the item selected. (This is used to check the text that cannot be displayed in the current value field. However, in this utility package, all items can be displayed in the display fields).

Make text file

Creates a file containing the screen data in text file format.

Start monitor / Stop monitor

Selects whether or not to monitor current values.

Execute test

Performs a test on the selected items. To select more than one item, select them while holding down the **Ctrl** key.

Close

Closes the currently open screen and returns to the previous screen.

(3) Example of using "Execute test"







The following is an example to change sampling processing of CH1 to count averaging processing in 10 times.

- (a) Click the "CH1 Monitor/test" button in the Monitor/Test screen.
- (b) Select "Count" for "Averaging processing selection".
- (c) Click the setting area for "Time/Count/Moving average/Time constant setting".
- (d) Input "10" as the number of averaging, then click the **Enter** key.
At this point, this setting is not written to the Q68TD-G-H02 (01).
- (e) Select the setting areas (b) to (d), holding the **Ctrl** key.
Multiple items can be selected by dragging the mouse over them also.
- (f) Click **Execute test** to write the data.
After the writing is completed, the written values are displayed in the "Current value" field.
At this point, the module is operating in the setting before the change made in (b) to (d).
- (g) Set "Operating condition setting request" to "Request".
- (h) Activate the set data by clicking **Execute test**, while the setting area for "Operating condition setting request" is selected.

5.6.2 Offset/gain setting operation

Perform the offset/gain setting operation in the following sequence.

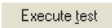
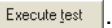
- (1) Display the "CH□ Offset/gain setting" screen
Display the "CH□ Offset/gain setting" screen of the channel where offset/gain setting will be made using the operation described in Section 5.6.1.
- (2) Switch to the offset/gain setting mode
Note) Do not perform this operation when the setting has been changed to the offset/gain setting mode.
Set "Offset/gain setting mode" in the Setting value field for "Mode Switching Setting" and click the button. The indication in the Current value field of "Mode Switching Setting Status" changes to "Offset/gain setting mode".
- (3) Enable the Conversion enable/disable setting
 - (a) Set "Enable" in the Setting value field for "Conversion enable/disable setting" and click the button.
 - (b) Set "Request" in the Setting value field for "Operating condition setting request" setting and click the button. The indication in the Current value field changes from "OFF" to "Request".
 - (c) Set "OFF" in the Setting value field for "Operating condition setting request" setting and click the button. The indication in the Current value field changes from "Request" to "OFF".
- (4) Adjustment of the offset and gain values
 - (a) Adjust the offset setting value
 - 1) Select the offset setting
Select "Offset setting" in the Setting value field for "CH□ Offset setting channel setting" and click the button.
 - 2) Set the offset value
Enter the desired value into the Setting value field for "CH□ Offset temperature setting value", and click the button.
 - 3) Determine the offset value
Select "Request" in the Setting value field for "CH□ Channel change request" setting and click the button.
Confirm that "CH□ Channel change completion flag" has changed to "Completed", and then select "OFF" in the Setting value field of "CH□ Channel change request" and click the button.
Select "Invalid" in the Setting value field for "CH□ Offset setting channel setting" and click the button.

- (b) Adjust the gain setting value
 - 1) Select the gain setting
Set "Gain setting" in the Setting value field for "CH□ Gain setting channel setting" and click the  button.
 - 2) Set the gain value
Enter the desired value into the Setting value field for "CH□ Gain setting value", and click the  button.
 - 3) Determine the gain value
Select "Request" in the Setting value field for "CH□ Channel change request" setting and click the  button.
Confirm that "CH□ Channel change completion flag" has changed to "Completed", and then select "OFF" in the Setting value field of "CH□ Channel change request" and click the  button.
Select "Invalid" in the Setting value field for "CH□ Gain setting channel setting" and click the  button.
- (c) To set offset/gain values for more than one channel, repeat steps (a) 1) to 3) and (b) 1) to 3).
- (5) Returning to the "Monitor/test" screen
Returning to the operation described in Section 5.6.1, close the "CH□ Offset/gain setting" screen and return to the "Monitor/test" screen.
- (6) Write the offset/gain setting values to the module
Write the offset/gain settings to the module after completing the settings for all channels using the user range setting. Note that if settings are written while offset/gain settings are incomplete, the status at that point will be written to the module.
 - (a) How to write the values
 - 1) Write to the Q68TD-G-H02 (H01)
Select "Request" for "User range write request", and click .
 - 2) Confirm the executing of writing
Confirm that the Current value field of "Offset/gain setting mode status flag" shifts from "Offset/gain setting mode" to "Normal mode".
 - 3) Finish writing
Select "OFF" for "User range write request", and click .

☒ POINT

While the set data of the steps (a)1) to (a)2) above are written to the module, do not perform the operations below. If they are performed, the data inside a flash memory will have a problem, and the Q68TD-G-H02 (H01) may not operate normally.

- Powering off the programmable controller CPU
- Resetting the programmable controller CPU

(b) Error handling

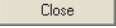
Confirm that the ERR. LED for the Q68TD-G-H02(H01) is off. If the ERR. LED is lit, click on , check the error code on the monitor screen, and then perform the offset/gain settings again.

(7) Switch to the normal mode

Set "Normal mode" in the Setting value field of Mode Switching Setting and click the  button to perform write.

On completion of write, the indication in the Current value field of Mode Switching Setting Status changes to "Normal mode".

5.6.3 OMC (Online Module Change) refresh data

Perform operation in the following sequence to save/restore the user range.

(1) Switch to the OMC refresh data screen

Perform the operation in Section 5.6.1 to display the OMC refresh data screen.

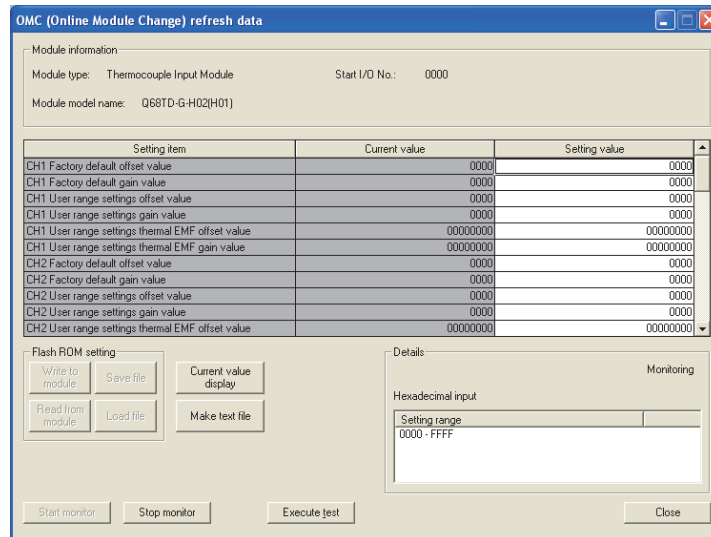

Figure 5.12 OMC data

(2) User range saving

(a) Change the Setting value field of Online Module Change read request to

"Request", and click the **Execute test** button.

When read is completed, the values are displayed in the Current value fields of CH□ Factory default offset/gain value/User range settings offset/gain value/User range settings offset/gain thermal EMF value.

(b) Compare the values with those in the range reference table, and take a note of the values if they are correct.

Refer to Section 7.4 for the range reference table.

(3) User range restoration

(a) Set the noted values into the Setting value fields of CH□ Factory default offset/gain value/User range settings offset/gain value/User range settings thermal EMF offset/gain value.

(b) Select all the Setting value fields of CH□ Factory default offset/gain input value/User range settings offset/gain value/User range settings thermal EMF offset/gain value, and click the **Execute test** button.

When write is completed, the set values are displayed in the Current value fields of them.

(c) Change the Setting value field of online module change write request to

"Request", and click the **Execute test** button.

Make sure that the indication in the Current value field of online module change write request changes from "Request" to "OFF" on completion of write.

CHAPTER 6 PROGRAMMING

This chapter describes programs of the Q68TD-G-H02(H01).

When applying any of the program examples introduced in this chapter to the actual system, make sure to examine the applicability and confirm that no problems will occur in the system control.

6.1 Programming Procedure

Create a program that executes temperature input of the Q68TD-G-H02(H01) in the following procedure.

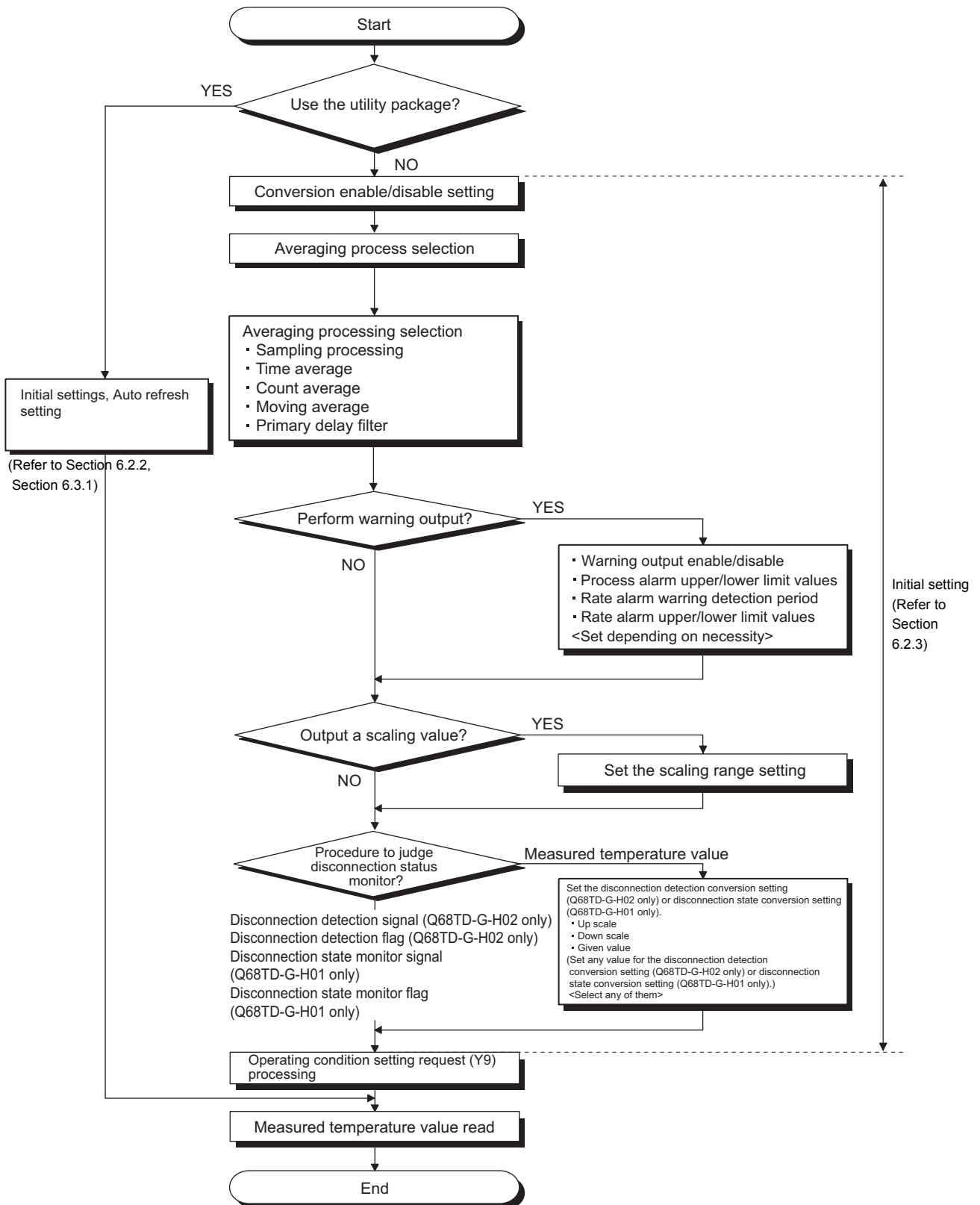

Figure 6.1 Programming chart

(1) Programming example outline

The Q68TD-G-H02 is used in the program example, however, the Q68TD-G-H01 can be used with the program example.

Program examples include following processing.

- (a) Initial setting program of the Q68TD-G-H02
- (b) Measured temperature value read
- (c) Processing at CH1 disconnection detection
- (d) Processing when CH2 process alarm is used
- (e) Processing when CH3 rate alarm is used
- (f) Error code output to an output module in BCD

6.2 Using Programs in Normal System Configuration

This section describes program examples based on the following system configuration and conditions.

(1) System configuration

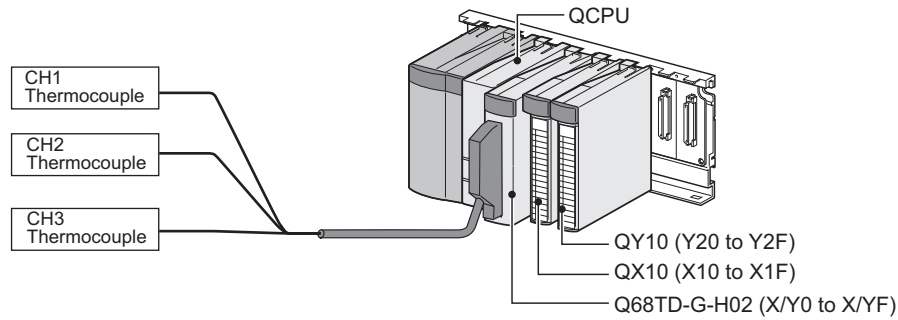

Figure 6.2 Example of system configuration

(2) Setting conditions for the intelligent function module switch setting

Table 6.1 Setting conditions for the intelligent function module switch setting

Channel	Thermocouple type (Measurement range)	Offset/gain setting	Cold junction compensation
CH1	Thermocouple K	Factory default setting	Available
CH2			
CH3			
CH4 to CH8	Not used	-	-

(3) Programming conditions

- (a) Use the following temperature conversion system for each channel.
 - CH1: Sampling processing
 - CH2: Count average (5 times)
 - CH3: Primary delay filter (Time constant 960ms)
- (b) Use the following function at each channel.
 - CH2: Warning output function
 - Process alarm lower lower limit value: 2000 (200 °C)
 - Process alarm lower upper limit value: 2050 (205 °C)
 - Process alarm upper lower limit value: 2950 (295 °C)
 - Process alarm upper upper limit value: 3000 (300 °C)
 - CH3: Warning output function
 - Rate alarm warning detection period: 3 times (960ms)
 - Rate alarm lower limit value: -50 (-5.0 °C)
 - Rate alarm upper limit value: 50 (+5.0 °C)
- (c) Use the following setting for the Conversion setting for disconnection detection of CH1 to CH3.
 - CH1 to CH3: Down scale (-352.0 °C) [Default setting]
- (d) When a write error occurs, the corresponding error code is output to an output module in BCD value.
- (e) Perform the disconnection detection reset operation after the connection is re-established.

6.2.1 Before creating a program

This section describes the steps to be taken before creating a program.

(1) Wiring of external devices

Mount the Q68TD-G-H02 onto the base unit and connect a thermocouple K type to CH1 to CH3.

For details, refer to Section 4.4.2.

[Wiring diagram]

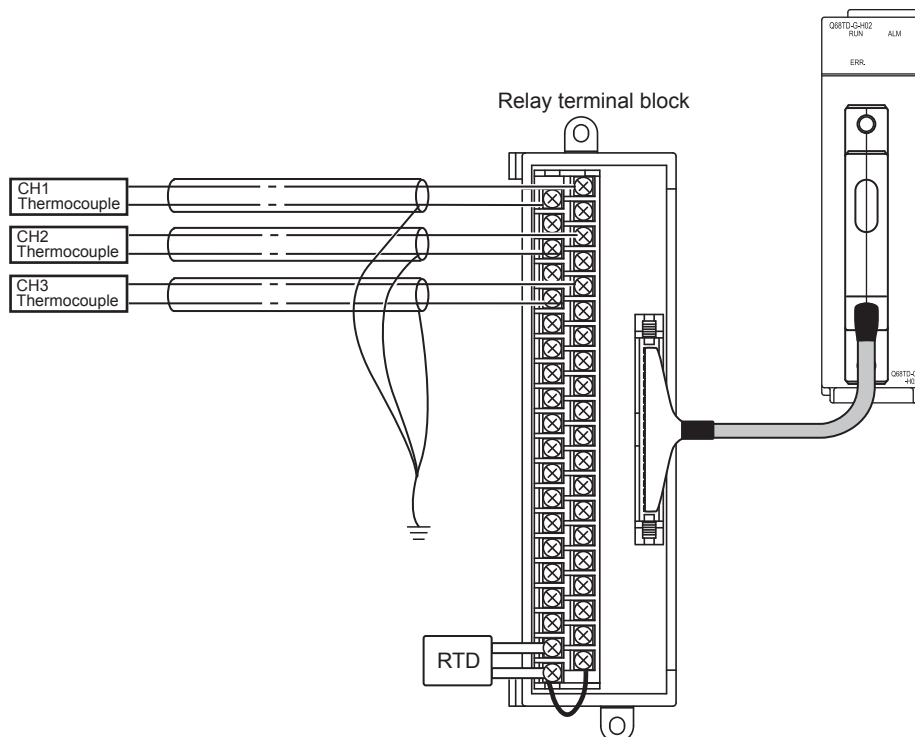

Figure 6.3 Wiring diagram using a relay terminal block

(2) Intelligent function module switch setting

Based on the setting conditions given in Section 6.2 (2), make the intelligent function module switch setting.

(a) Setting details of each switch

1) Switch 1, Switch2: Thermocouple type setting

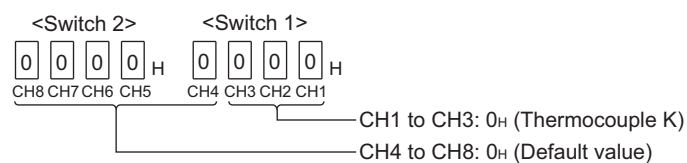

Figure 6.4 Intelligent function module switch setting: Thermocouple type setting

2) Switch 3: Offset/gain setting

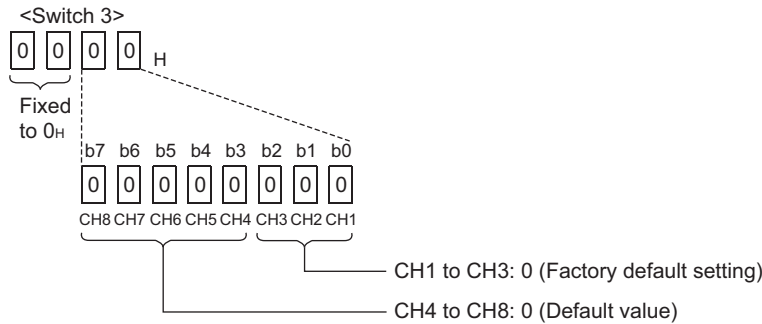

Figure 6.5 Intelligent function module switch setting: Offset/gain setting

3) Switch 4: Cold junction temperature compensation Yes/No setting, Mode setting

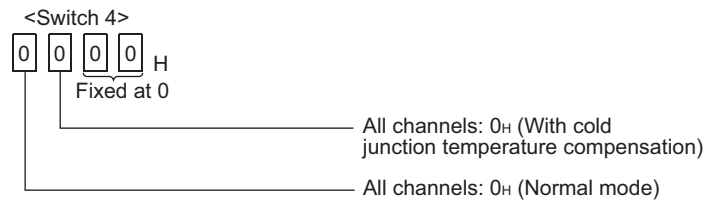

Figure 6.6 Intelligent function module switch setting: Cold junction temperature compensation Yes/No setting, Mode setting

4) Switch 5: Use prohibited (Fixed to 0H^{*1})

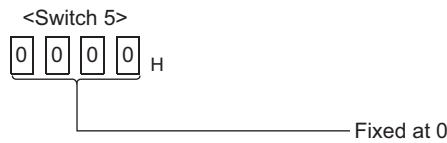

Figure 6.7 Intelligent function module switch setting: Use prohibited

* 1 If any value other than 0H is set, an error occurs.

(b) Intelligent function module switch setting

Click the switch setting button on the "I/O assignment" tab of PLC parameter in GX Developer to display the following screen, and make settings for switch 1 to 5.

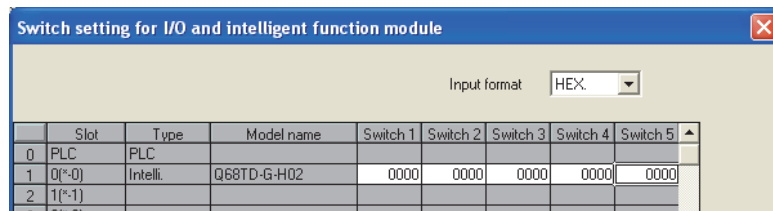

Figure 6.8 Intelligent function module switch setting in GX Developer

6.2.2 Program example when Configurator-TI

(1) List of devices

Table 6.2 List of devices

Device	Function	
D0	Device that Conversion completion flag is written by auto refresh	
D1	Device that CH1 Measured temperature value is written by auto refresh	
D2	Device that CH2 Measured temperature value is written by auto refresh	
D3	Device that CH3 Measured temperature value is written by auto refresh	
D4	Device that Error code is written by auto refresh	
D5	Device that Warning output flag (Process alarm) is written by auto refresh	
D6	Device that Warning output flag (Rate alarm) is written by auto refresh	
D7	Device that Disconnection detection flag is written by auto refresh	
D11	CH1 Measured temperature value	
D12	CH2 Measured temperature value	
D13	CH3 Measured temperature value	
X0	Module ready	Q68TD-G-H02(X/Y0 to X/YF)
XC	Disconnection detection signal	
XF	Error flag	
YF	Error clear request	
X10	Device that user turns on to start reading measured temperature values	QX10(X10 to X1F)
X11	Device that user turns on to rest a disconnection detection state	
X12	Device that user turns on to reset an error	
Y20 to Y2B	Error code display (BCD 3 digits)	QY10(Y20 to Y2F)

(2) GX Configurator-TI operation

(a) Initial setting (Refer to Section 5.4)

Set the items shaded in the table below to CH1 to CH3.

Setting for the items with "-" is not required when "Disable", "Invalid" or "Down scale" has been selected.

(Default value, which will be displayed in the Setting value field, does not need to be changed.)

Table 6.3 list of initial setting items

Setting item	Default	CH1	CH2	CH3
Conversion enable/disable setting	Disable	Enable	Enable	Enable
Averaging processing selection	Sampling	Sampling	Count	Primary delay filter
Time/Count/Moving average/ Time constant setting	0	0	5	960
Process alarm warning output enable/disable setting	Disable	Disable	Enable	Disable
Thermocouple type	K	-	K ^{*1}	-
Process alarm lower lower limit value	-2000		2000	
Process alarm lower upper limit value	-2000		2050	
Process alarm upper lower limit value	12000		2950	
Process alarm upper upper limit value	12000		3000	
Rate alarm warning output enable/disable setting	Disable	Disable	Disable	Enable
Process alarm warning detection period	1	-	-	3
Process alarm upper limit value	0	-	-	50
Process alarm lower limit value	0	-	-	-50
Scaling valid/invalid setting	Invalid	Invalid	Invalid	Invalid
Scaling range lower limit value	0	-	-	-
Scaling range upper limit value	0	-	-	-
Scaling width lower limit value	0	-	-	-
Scaling width upper limit value	0	-	-	-
Conversion setting for disconnection detection (Disconnection state conversion setting) ^{*2}	Down scale	Down scale	Down scale	Down scale
Conversion setting value for disconnection detection (Conversion setting value for disconnection state) ^{*2}	0	-	-	-

* 1 The setting is used to switch the process alarm setting value input range. Use the same range set for the thermocouple type setting at the intelligent function module switch 1 and 2. (In this program example, "New JIS (-200 to 850°C)" is set.)

* 2 The parenthetic name is for the Q68TD-G-H01 and the other is for the Q68TD-G-H02.

- 1) Click the Initial setting button of the setting target channel.
In this program example, CH1 to CH3 are the setting target.
Since CH4 to CH8 are not used, setting is not required.

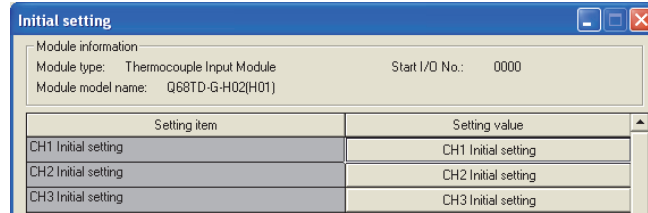

Figure 6.9 Initial setting screen

- 2) The following screen is displayed by clicking the Initial setting button of each channel. (The following is the example of CH1.)
Set the initial setting items listed in Table 6.3.

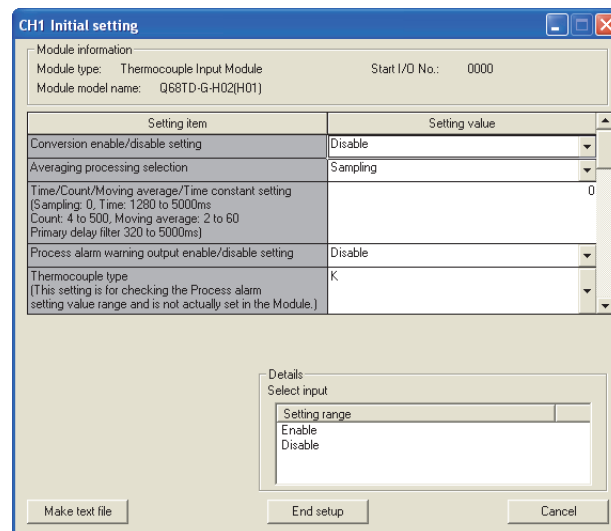

Figure 6.10 CH1 Initial setting screen

(b) Auto refresh setting (Refer to Section 5.5)

Set devices in which the measured temperature values, warning output flags, disconnection detection flags, and error codes of CH1 to CH3 are to be stored. For the devices in the PLC side Device field, refer to "List of devices" at (1) in this section.

Setting item	Module side Buffer size	Module side Transfer word count	Transfer direction	PLC side Device
Conversion completion flag	1	1	->	D0
CH1 Measured temperature value	1	1	->	D1
CH2 Measured temperature value	1	1	->	D2
CH3 Measured temperature value	1	1	->	D3
CH4 Measured temperature value	1	1	->	
CH8 Measured temperature value	1	1	->	
Error code	1	1	->	D4
Setting range(Input type CH1-4)	1	1	->	
Setting range(Input type CH5-8)	1	1	->	
Setting range(Offset/gain setting CH1-8)	1	1	->	
Warning output flag(Process alarm)	1	1	->	D5
Warning output flag(Rate alarm)	1	1	->	D6
Disconnection detection flag (Disconnection state monitor flag)	1	1	->	D7

* Names for Q68TD-G-H01 are indicated in ().

Figure 6.11 Auto refresh setting

(c) Writing intelligent function module parameters (Refer to Section 5.3.3)

Write the intelligent function module parameters to the CPU module. Perform this operation on the screen for selecting a target intelligent function module.

(3) Program example

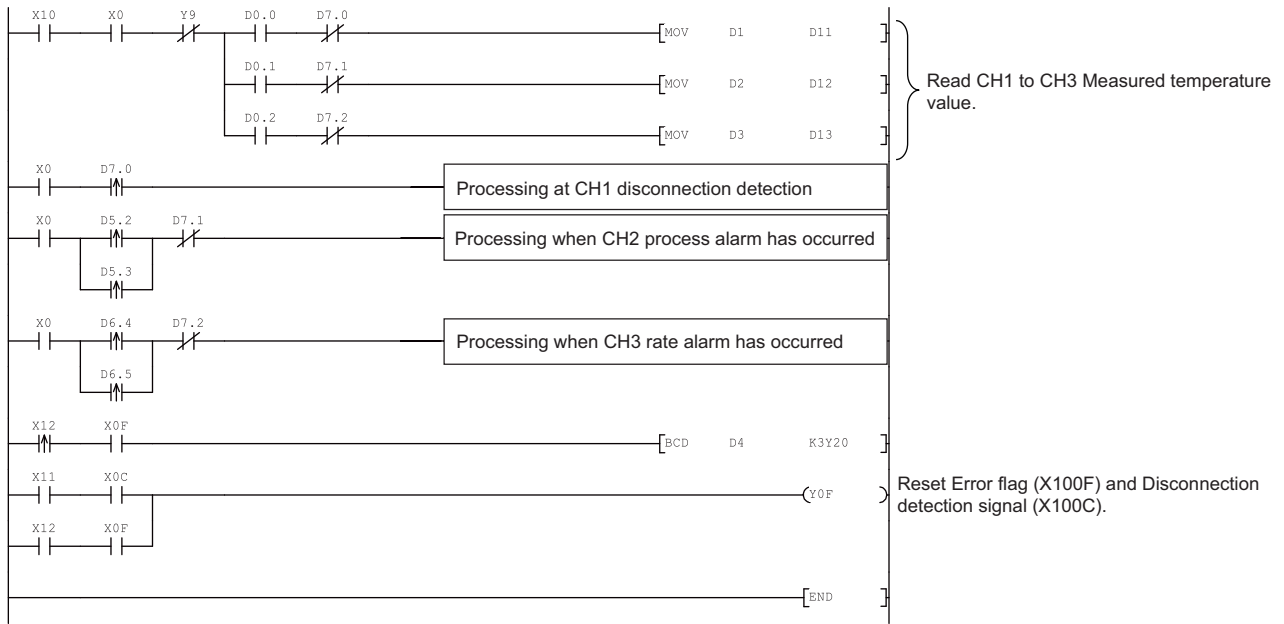

Figure 6.12 Program example for the use of GX Configurator-TI

6.2.3 Program example when GX Configurator-TI is not used

(1) List of devices

Table 6.4 List of devices

Device	Function	
D11	CH1 Measured temperature value	
D12	CH2 Measured temperature value	
D13	CH3 Measured temperature value	
M0	Module ready check flag	
X0	Module ready	Q68TD-G-H02(X/Y0 to X/YF)
X9	Operating condition setting completion flag	
XC	Disconnection detection signal	
XF	Error flag	
Y9	Operating condition setting request	
YF	Error clear request	
X10	Device that user turns on to start reading measured temperature values	QX10(X10 to X1F)
X11	Device that user turns on to reset a disconnection detection state	
X12	Device that user turns on to reset an error	
Y20 to Y2B	Error code display (BCD 3 digits)	QY10(Y20 to Y2F)

(2) List of buffer memory addresses to be used

Table 6.5 List of buffer memory addresses to be used

Address	Description	Setting value	Remarks
UnVG0 ^{*1}	Conversion enable/disable setting	00F8H	"Enable" is set to CH1 to CH3.
UnVG2	CH2 Time/Count/Moving average/Time constant setting	5	Count (times) is set when Count average is set.
UnVG3	CH3 Time/Count/Moving average/Time constant setting	960	Time constant (ms) is set Primary delay filter is set.
UnVG10	Conversion completion flag	-	Conversion state of a channel is stored.
UnVG11	CH1 Measured temperature value		Measured temperature value is stored.
UnVG12	CH2 Measured temperature value		
UnVG13	CH3 Measured temperature value		
UnVG19	Error code		Corresponding error code is stored.
UnVG24 ^{*2}	Averaging processing selection (CH1 to CH4)	0420H	The following conversion system is set. CH1: Sampling processing CH2: Count average CH3: Primary delay filter
UnVG46 ^{*3}	Warning output enable/disable setting	FBFDH	"Enable" is set for the following warning output. CH2: Process alarm CH3: Rate alarm
UnVG47	Warning output flag (Process alarm)	-	Warning output state is stored.
UnVG48	Warning output flag (Rate alarm)		
UnVG49	Disconnection detection flag		

Table 6.5 List of buffer memory addresses to be used

Address	Description	Setting value	Remarks
Un\G98	CH2 Process alarm lower lower limit value	2000	Values required to use CH2 Process alarm are set.
Un\G99	CH2 Process alarm lower upper limit value	2050	
Un\G100	CH2 Process alarm upper lower limit value	2950	
Un\G101	CH2 Process alarm upper upper limit value	3000	
Un\G128	CH3 Rate alarm warning detection period	3	Values required to use CH3 Process alarm are set.
Un\G138	CH3 Rate alarm upper limit value	50	
Un\G139	CH3 Rate alarm lower limit value	-50	

* 1 Un\G0: Conversion enable/disable setting (Refer to Section 3.4.2)

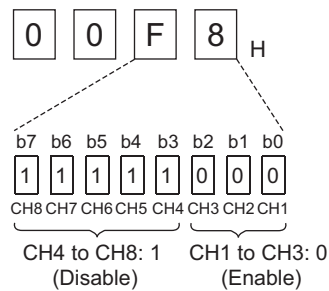

Figure 6.13 Conversion enable/disable setting

* 2 Un\G24: Averaging processing selection (CH1 to CH4) (Refer to Section 3.4.9)

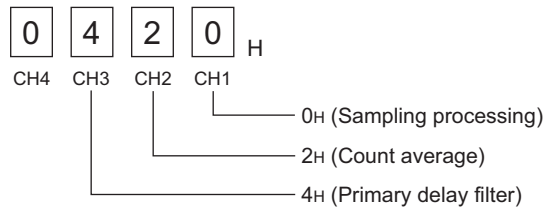

Figure 6.14 Averaging processing selection (CH1 to CH4)

* 3 Un\G46: Warning output enable/disable setting (Refer to Section 3.4.13)

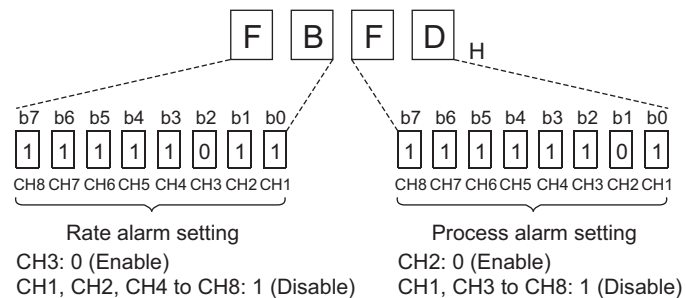

Figure 6.15 Warning output enable/disable setting

(3) Program example

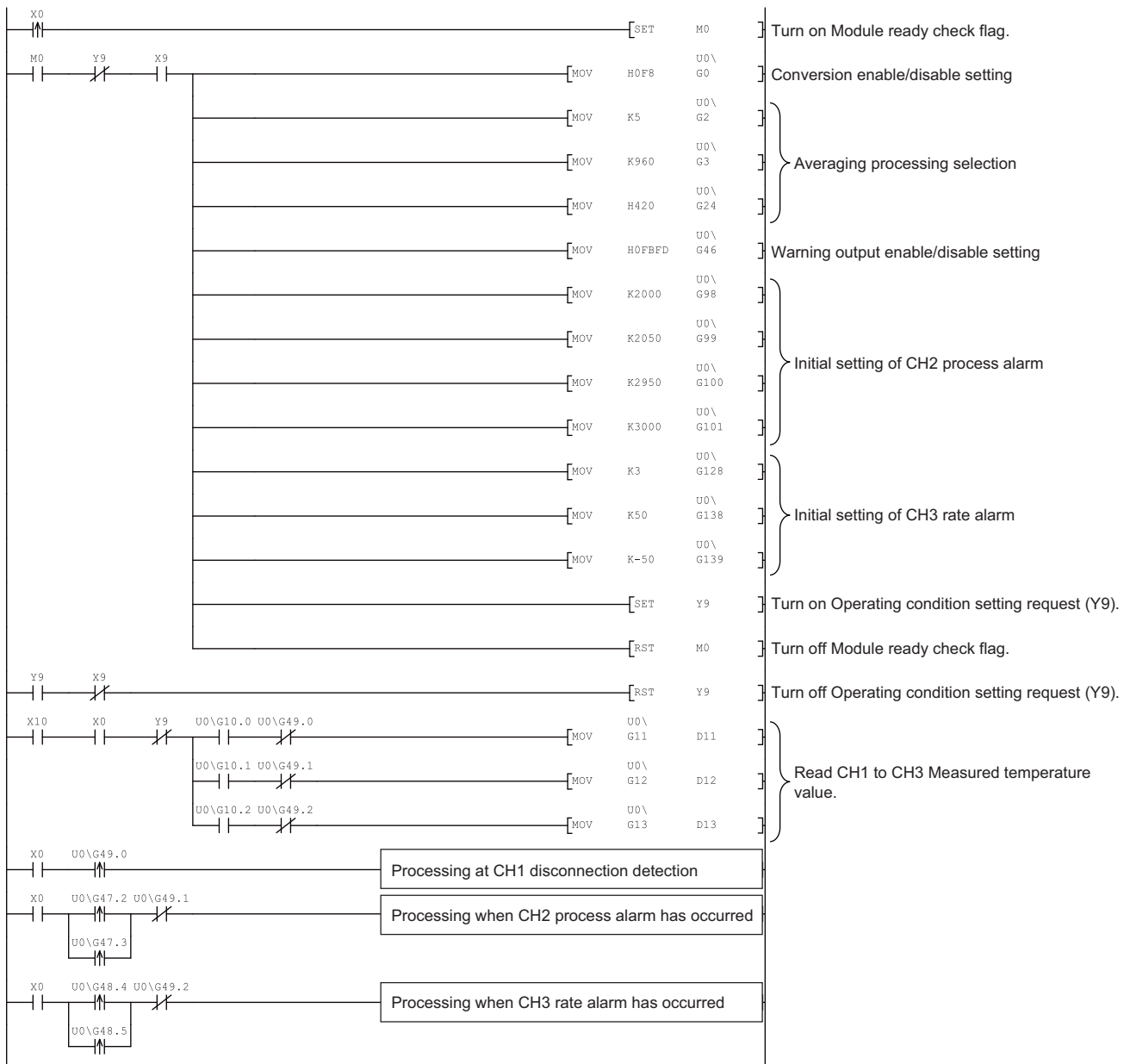

Figure 6.16 Program example for GX Configurator-TI is not used

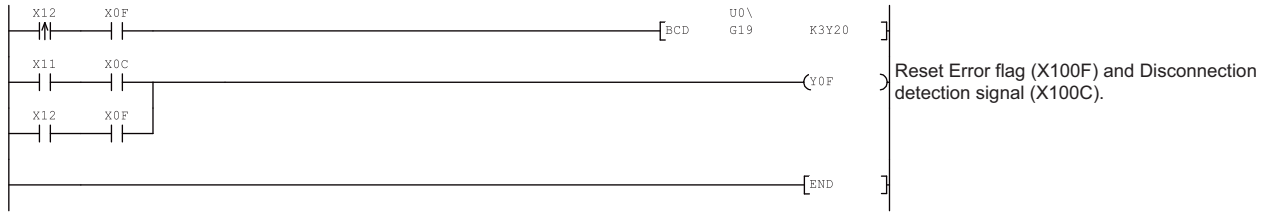

Figure 6.17 Program example for GX Configurator-TI is not used (Continued)

1

OVERVIEW

2

SYSTEM CONFIGURATION

3

SPECIFICATIONS

4

SETUP AND PROCEDURES BEFORE OPERATION

5

UTILITY PACKAGE (GX CONFIGURATOR-TI)

6

PROGRAMMING

7

ONLINE MODULE CHANGE

8

TROUBLESHOOTING

6.3 Using Programs on Remote I/O Network

This section describes programs examples based on the following system configuration and conditions.

(1) System configuraton

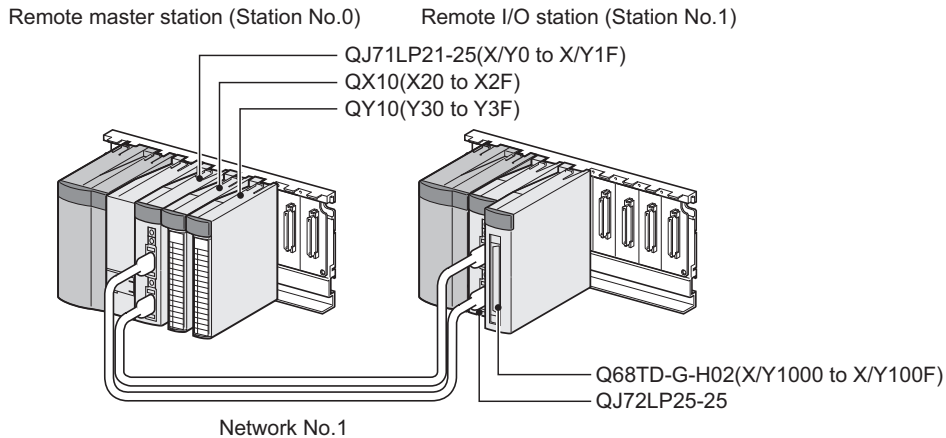

Figure 6.18 System configuratiion using remote I/O network

(2) Setting conditions for the intelligent function module switch setting

Table 6.6 Setting conditions for the intelligent function module switch setting

	Thermocouple type	Offset/gain setting	Cold junction compensation
CH1	Thermocouple type K	Factory default setting	Available
CH2			
CH3			
CH4 to CH8	Not used	-	-

Based on the above conditions, perform the intelligent function module switch setting. Click the switch setting button on the "I/O assignment" tab of PLC parameter in GX Developer to display the following screen, and make settings of values described in the following table.

Table 6.7 Description of Intelligent function module switch setting

Switch number	Setting value	
Switch 1	0000 _H	(CH1 to CH3: Thermocouple K)
Switch 2	0000 _H	(CH4 to CH8: Default)
Switch 3	0000 _H (CH1 to CH3: Factory default setting, CH4 to CH8: Default)	
Switch 4	0000 _H (Cold junction compensation YES, Normal mode)	
Switch 5	0000 _H (0: Fixed)	

(3) Programming conditions

(a) Use the following temperature conversion system for each channel

- CH1: Sampling processing
- CH2: Count average (5 times)
- CH3: Primary delay filter (Time constant 960ms)

(b) Use the following function at each channel.

- CH2: Warning output function

Process alarm lower lower limit value: 2000 (200 °C)

Process alarm lower upper limit value: 2050 (205 °C)

Process alarm upper lower limit value: 2950 (295 °C)

Process alarm upper upper limit value: 3000 (300 °C)

- CH3: Warning output function

Rate alarm warning detection period: 3 times (960ms),

Rate alarm upper limit value: 50 (+ 5.0 °C)

Rate alarm lower limit value: - 50 (- 5.0 °C)

(c) Use the following setting for Conversion setting for disconnection detection of CH1 to CH3.

- CH1 to CH3: Down scale (-352.0 °C) [Default setting]

(d) When a write error occurs, the corresponding error code is output to an output module in BCD value.

(e) Perform the disconnection detection reset operation after the connection is re-established.

6.3.1 Before creating a program

(1) Wiring of external devices

Mount the Q68TD-G-H02 onto the base unit and connect a thermocouple K type to CH1 to CH3.

For details, refer to Section 6.2.1.

(2) Intelligent function module switch setting

Based on the setting conditions given in Section 6.3 (2), make the intelligent function module switch setting.

For setting details of each switch, refer to Section 6.2.1 (2).

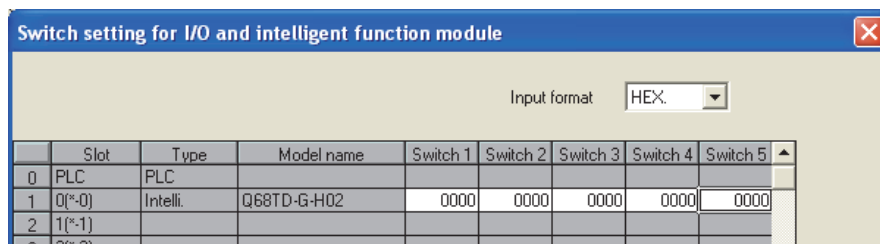

Figure 6.19 Intelligent function module switch setting for the use of remote I/O network

Write the intelligent function module parameters to the remote I/O station.

POINT

For details on the MELSECNET/H remote I/O network, refer to the Q Corresponding MELSECNET/H Network System Reference Manual (Remote I/O Network).

6.3.2 Program example when GX Configurator-TI is used

(1) List of devices

Table 6.8 List of devices

Device	Function	
W0	Device that Conversion completion flag is written by auto refresh	
W1	Device that CH1 Measured temperature value is written by auto refresh	
W2	Device that CH2 Measured temperature value is written by auto refresh	
W3	Device that CH3 Measured temperature value is written by auto refresh	
W4	Device that Error code is written by auto refresh	
W5	Device that Warning output flag (Process alarm) is written by auto refresh	
W6	Device that Warning output flag (Rate alarm) is written by auto refresh	
W7	Device that Disconnection detection flag is written by auto refresh	
D11	CH1 Measured temperature value	
D12	CH2 Measured temperature value	
D13	CH3 Measured temperature value	
X20	Device that user turns on to start reading measured temperature values	QX10(X20 to X2F)
X21	Device that user turns on to reset a disconnection detection state	
X22	Device that user turns on to reset an error	
Y30 to Y3B	Error code display (BCD 3 digits)	QY10(Y30 to Y3F)
X1000	Module ready	Q68TD-G-H02(X/Y1000 to X/Y100F)
X100C	Disconnection detection signal	
X100F	Error flag	
Y100F	Error clear request	

(2) GX Developer operation

(a) CPU parameter setting

- Network type : MNET/H (Remote master)
- Starting I/O No. : 0000H
- Network No. : 1
- Total stations : 1
- Mode : Online
- Network range assignment:

StationNo.	M station -> R station						M station <- R station					
	Y			Y			X			X		
	Points	Start	End	Points	Start	End	Points	Start	End	Points	Start	End
1	256	1000	10FF	256	0000	00FF	256	1000	10FF	256	0000	00FF

StationNo.	M station -> R station			M station <- R station			M station -> R station			M station <- R station		
	B			B			W			W		
	Points	Start	End	Points	Start	End	Points	Start	End	Points	Start	End
1							160	1000	109F	160	0000	009F

Figure 6.20 Network range assignment setting screen

- Refresh parameters:

Assignment method
 Points/Start
 Start/End

Transient transmission error history status
 Overwrite Hold

	Link side				↔	PLC side			
	Dev. name	Points	Start	End		Dev. name	Points	Start	End
Transfer SB	SB	512	0000	01FF	↔	SB	512	0000	01FF
Transfer SW	SW	512	0000	01FF	↔	SW	512	0000	01FF
Random cyclic	LB				↔				
Random cyclic	LW				↔				
Transfer1	LB	8192	0000	1FFF	↔	B	8192	0000	1FFF
Transfer2	LW	8192	0000	1FFF	↔	W	8192	0000	1FFF
Transfer3	LX	256	1000	10FF	↔	X	256	1000	10FF
Transfer4	LY	256	1000	10FF	↔	Y	256	1000	10FF
Transfer5					↔				
Transfer6					↔				

Figure 6.21 Refresh parameters setting screen

(3) GX Configurator-TI operation

Operation is performed on the remote I/O station side.

(a) Initial setting (Refer to Section 5.4)

Set the initial settings of CH1 to CH3.

For setting details, refer to Section 6.2.2 (2).

(b) Auto refresh setting (Refer to Section 5.5.)

Set devices in which the measured temperature values, warning output flags, disconnection detection flags, and error codes of CH1 to CH3 are stored.

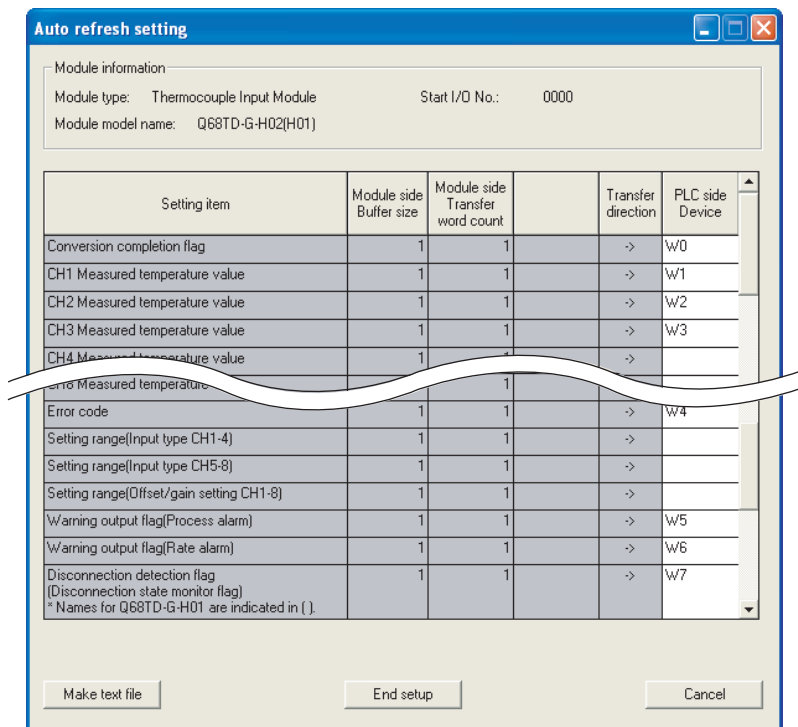

Figure 6.22 Setting with GX Configurator-TI

(c) Writing intelligent function module parameters (Refer to Section 5.3.3.)

Write the intelligent function module parameters to the remote I/O station. Perform this operation on the screen for selecting a target intelligent function module.

POINT

To write the intelligent function module parameters, set a target remote I/O station on the screen displayed by selecting [Online] - [Transfer setup] in GX Developer. The intelligent function module parameters can be written by:

- Directly connecting GX Developer to the remote I/O station.
- Routing the network to the remote I/O station by connecting GX Developer to another device, such as a CPU module.

(4) Program example

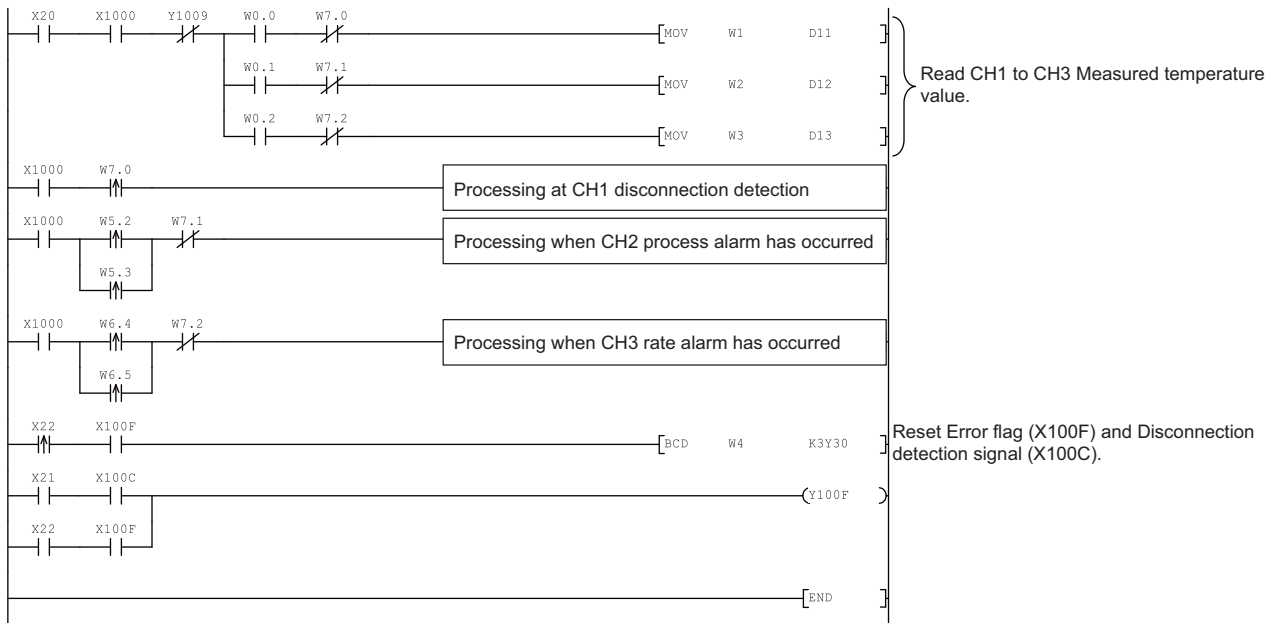

Figure 6.23 Program example when GX Developer-TI is used in remote I/O network use

6.3.3 Program example when GX Configurator-TI is not used

(1) List of devices

Table 6.9 List of devices

Device	Function
D11	CH1 Measured temperature value
D12	CH2 Measured temperature value
D13	CH3 Measured temperature value
X20	Device that user turns on to start reading measured temperature values
X21	Device that user turns on to reset a disconnection detection state
X22	Device that user turns on to reset an error
Y30 to Y3B	Error code display (BCD 3 digits)
X1000	Module ready
X1009	Operating condition setting completion flag
X100C	Disconnection detection signal
X100F	Error flag
Y1009	Operating condition setting request
Y100F	Error clear request
M100	Master module status check device (for the MC and MCR instructions)
M101	Initial setting auxiliary device
M102	
M103	
M104	
M200 to M202	Z(P).REMTO instruction completion device
M210 to M212	
M220 to M222	
M230 to M232	
M240 to M242	
M300 to M302	Z(P).REMFR instruction completion device
M310 to M312	
D1000 to D1003	Write data storage device for REMTO instruction (for initial setting)
D1024	
D1046	
D1098 to D1101	
D1128 to D1139	
D2010 to D2050	Read data storage device for REMFR instruction (for Conversion completion flag, Measured temperature value, Error code)
SB20	Network module status
SB47	Baton pass status of own station
SB49	Data link status of own station
SW70	Baton pass status of each station
SW74	Cyclic transmission status of each station
SW78	Parameter communication status of each station
T100 to T104	Interlock for own station and other stations

(2) List of buffer memory addresses to be used

The Z(P).REMFR/Z(P).REMTO instruction is used to access to the buffer memory of the Q68TD-G-H02.

Check the access device in the "Address (Device)" column in Table 6.10.

Table 6.10 List of buffer memory addresses to be used

Address (device)	Description	Setting value	Remarks
Un\G0(D1000)* ¹	Conversion enable/disable setting	00F8H	"Enable" is set to CH1 to CH3.
Un\G2(D1002)	CH2 Time/Count/Moving average/Time constant setting	5	Count (times) is set when Count average is set.
Un\G3(D1003)	CH3 Time/Count/Moving average/Time constant setting	960	Time constant (ms) is set Primary delay filter is set.
Un\G10(D2010)	Conversion completion flag	-	Conversion state of a channel is stored.
Un\G11(D2011)	CH1 Measured temperature value		Measured temperature value is stored.
Un\G12(D2012)	CH2 Measured temperature value		
Un\G13(D2013)	CH3 Measured temperature value		
Un\G19(D2050)	Error code		Corresponding error code is stored.
Un\G24 (D1024, D2024)* ² * ⁴	Averaging processing selection (CH1 to CH4)	0420H	The following conversion system is set. CH1: Sampling processing CH2: Count average CH3: Primary delay filter
Un\G46 (D1046, D2046)* ³ * ⁴	Warning output enable/disable setting	FBFDH	"Enable" is set for the following warning output. CH2: Process alarm CH3: Rate alarm
Un\G47(D2047)	Warning output flag (Process alarm)	-	Warning output state is stored.
Un\G48(D2048)	Warning output flag (Rate alarm)		
Un\G49(D2049)	Disconnection detection flag		Disconnection state of a channel is stored.
Un\G98(D1098)	CH2 Process alarm lower lower limit value	2000	Values required to use CH2 Process alarm are set.
Un\G99(D1099)	CH2 Process alarm lower upper limit value	2050	
Un\G100(D1100)	CH2 Process alarm upper lower limit value	2950	
Un\G101(D1101)	CH2 Process alarm upper upper limit value	3000	
Un\G128(D1128)	CH3 Rate alarm warning detection period	3	Values required to use CH3 Rate alarm are set.
Un\G138(D1138)	CH3 Rate alarm upper limit value	50	
Un\G139(D1139)	CH3 Rate alarm lower limit value	-50	

* 1 Un\G0: Conversion enable/disable setting (Refer to Section 3.4.2)

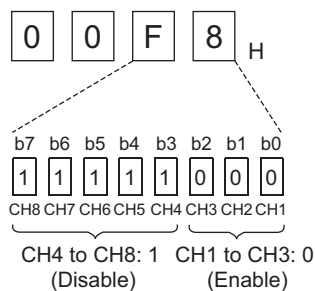

Figure 6.24 Conversion enable/disable setting

* 2 Un\G24: Averaging processing selection (CH1 to CH4) (Refer to Section 3.4.9)

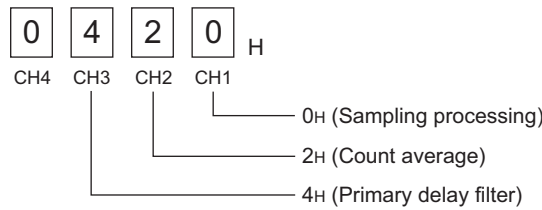

Figure 6.25 Averaging processing selection (CH1 to CH4)

* 3 Un\G46: Warning output enable/disable setting (Refer to Section 3.4.13)

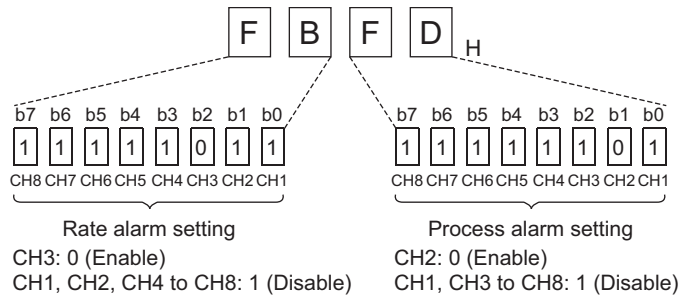

Figure 6.26 Warning output enable/disable setting

* 4 D1024 and D1046 are used for writing the initial setting data. (D2024 and D2046 are used for reading the initial setting data.)

(3) GX Developer operation (Network parameter setting)

- Network type : MNET/H (Remote master)
- Starting I/O No. : 0000H
- Network No. : 1
- Total stations : 1
- Mode : Online
- Network range assignment :

StationNo.	M station → R station						M station ← R station					
	Y		Y		X		X		Y		Y	
	Points	Start	End	Points	Start	End	Points	Start	End	Points	Start	End
1	256	1000	10FF	256	0000	00FF	256	1000	10FF	256	0000	00FF

StationNo.	M station → R station			M station ← R station			M station → R station			M station ← R station		
	B			B			W			W		
	Points	Start	End	Points	Start	End	Points	Start	End	Points	Start	End
1							160	1000	109F	160	0000	009F

Figure 6.27 Network range assignment setting screen

- Refresh parameters:

	Link side				PLC side			
	Dev. name	Points	Start	End	Dev. name	Points	Start	End
Transfer SB	SB	512	0000	01FF	SB	512	0000	01FF
Transfer S/W	S/W	512	0000	01FF	S/W	512	0000	01FF
Random cyclic	LB							
Random cyclic	LW							
Transfer1	LB	8192	0000	1FFF	B	8192	0000	1FFF
Transfer2	LW	8192	0000	1FFF	w	8192	0000	1FFF
Transfer3	LX	256	1000	10FF	X	256	1000	10FF
Transfer4	LY	256	1000	10FF	Y	256	1000	10FF
Transfer5								
Transfer6								

Figure 6.28 Refresh parameters setting screen

(4) Program example

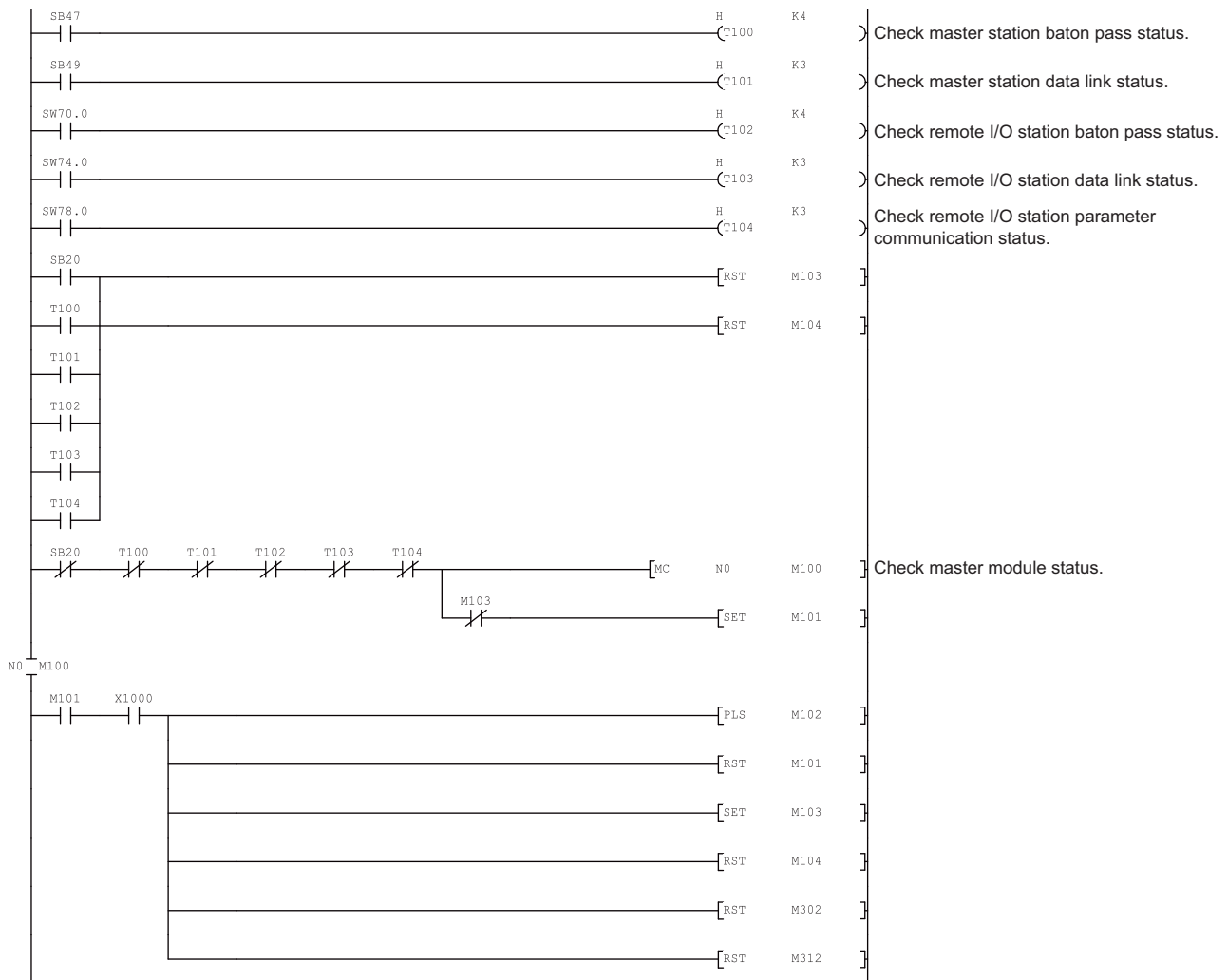

Figure 6.29 Program example when GX Developer-TI is not used in remote I/O network use

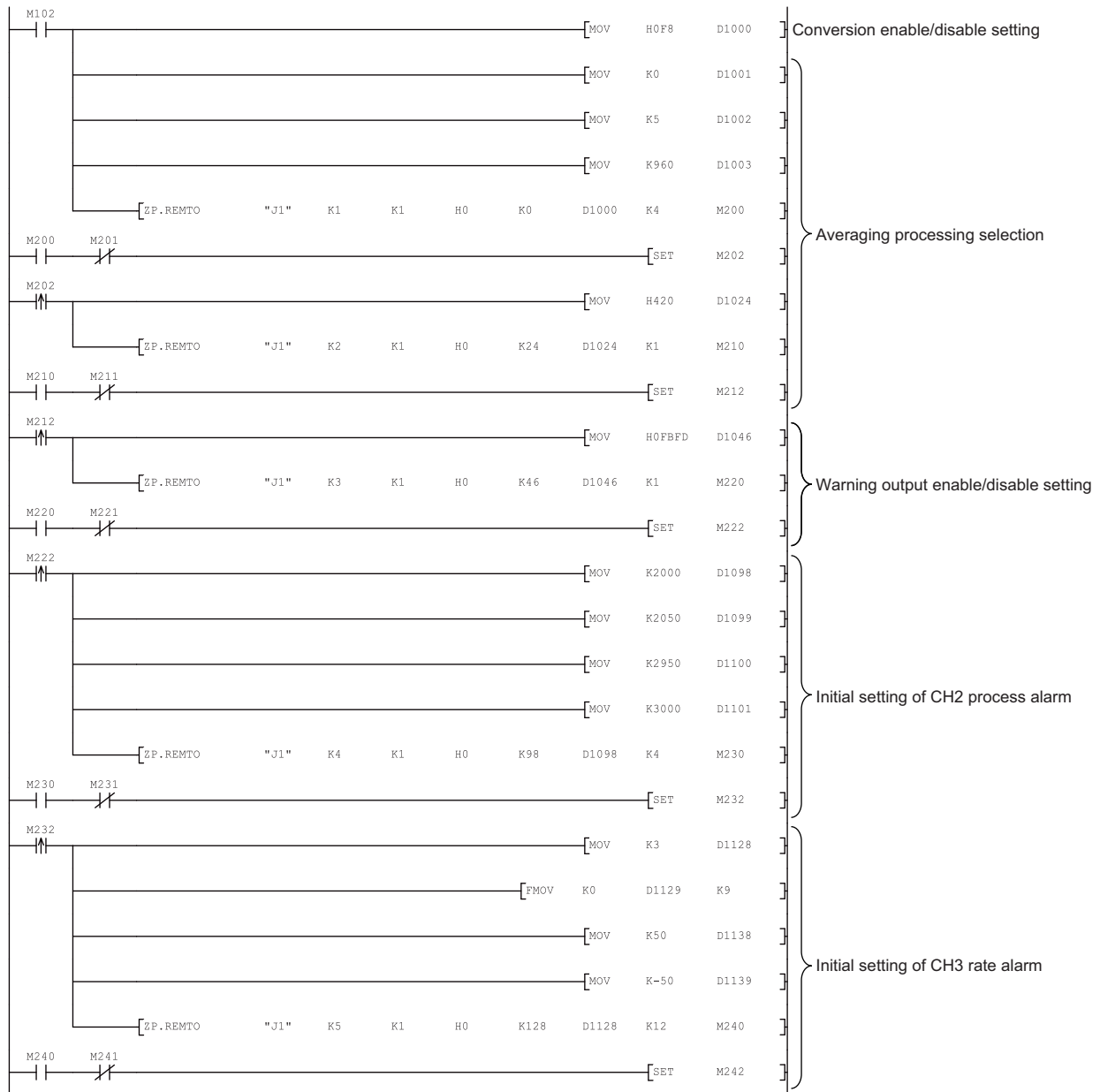

Figure 6.29 Program example when GX Developer-TI is not used in remote I/O network use (Continued)

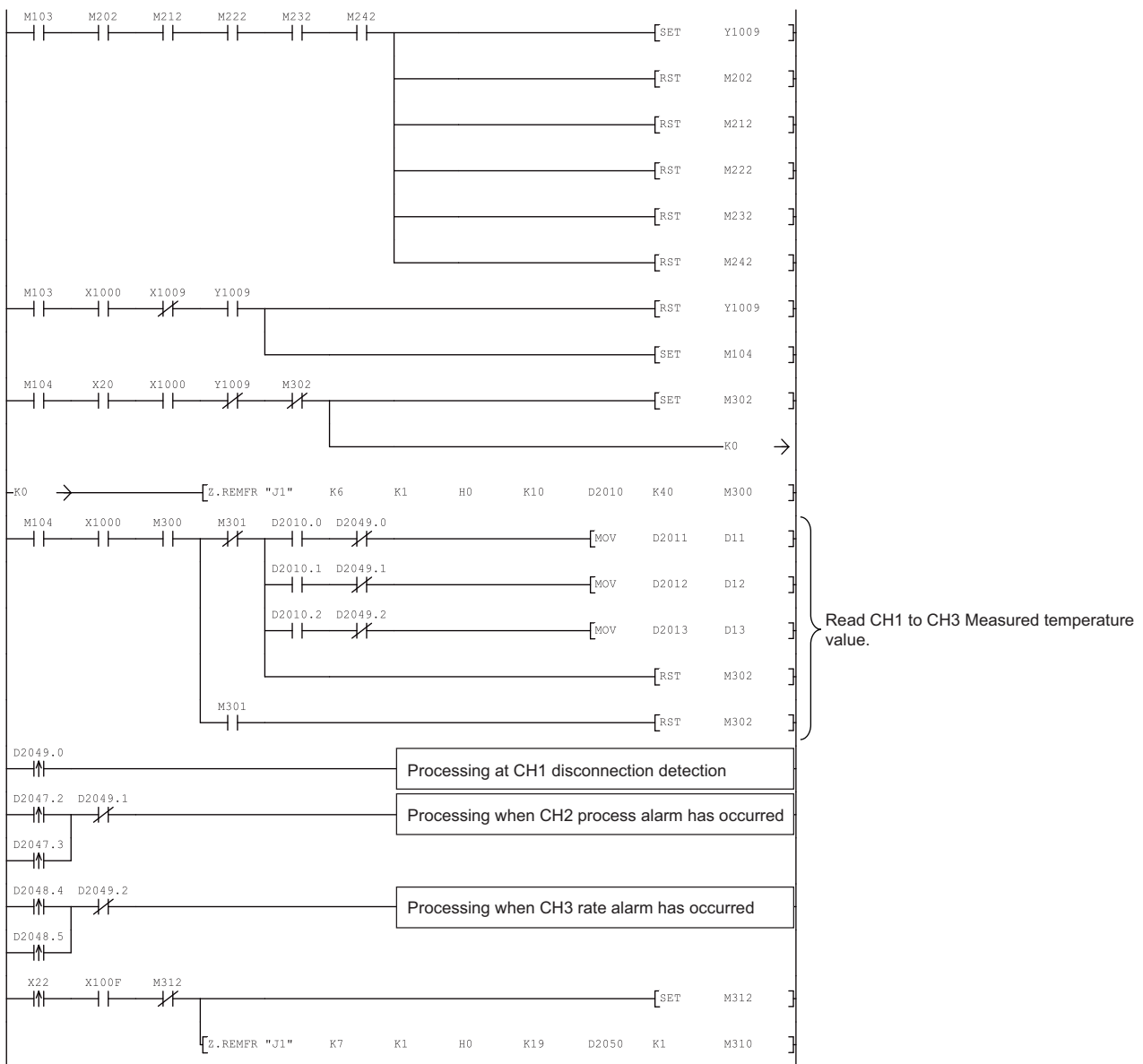

Figure 6.29 Program example when GX Developer-TI is not used in remote I/O network use (Continued)

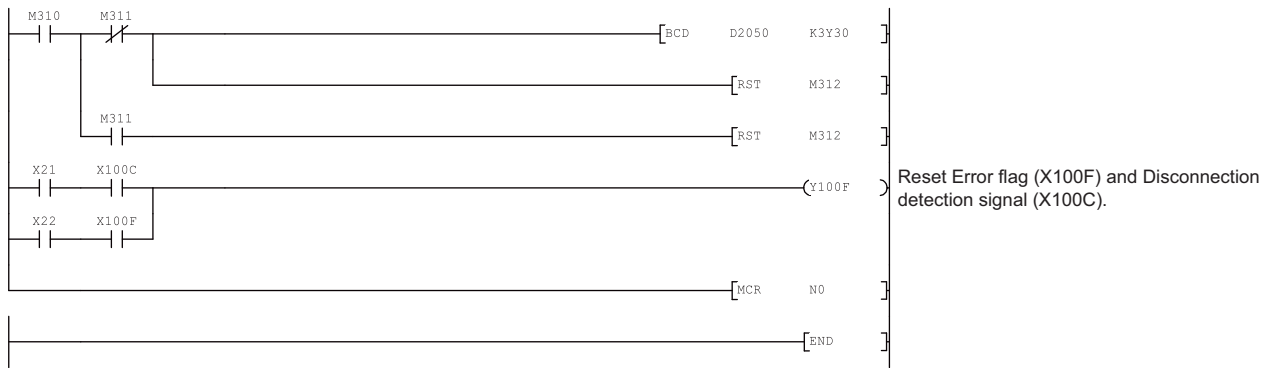

Figure 6.29 Program example when GX Configurator-TI is not used in remote I/O network use (Continued)

CHAPTER 7 ONLINE MODULE CHANGE

When changing a module online, carefully read the QCPU User's Manual (Hardware Design, Maintenance and Inspection), "Online module change".

This chapter describes the specifications of an online module change.

- (1) Perform an online module change by operating GX Developer.
- (2) To ensure ease of offset/gain re-setting, there is a user range save/restoration function that is performed by executing the dedicated instruction or read/write from/to buffer memory.

POINT

- (1) Perform an online module change after making sure that the system outside the programmable controller will not malfunction.
- (2) To prevent an electric shock and malfunction of operating modules, provide means such as switches for powering off each of the external power supply and external devices connected to the module to be replaced online.
- (3) After the module has failed, data may not be saved properly. Referring to Section 3.4.23, therefore, prerecord the data to be saved (Factory default offset/gain value/User range settings offset/gain value/User range settings thermal EMF offset/gain value (Un\G190 to Un\G253)).
- (4) It is recommended to perform an online module change in the actual system in advance to ensure that it would not affect the other modules by checking the following:
 - Means of cutting off the connection to external devices and its configuration are correct.
 - Switching ON/OFF does not bring any undesirable effect.
- (5) Do not install/remove the module to/from the base unit more than 50 times after the first use of the product. (IEC 61131-2 compliant)
Failure to do so may cause malfunction.
- (6) To satisfy with the accuracy, a warm-up (power distribution) period of 30 minutes is required after the online module change.

(Note)

The dedicated instruction cannot be executed during an online module change. When using the dedicated instruction to execute save/restoration, therefore, execute save/restoration in the other system*.

If the other system is unavailable, execute restoration by performing write to the buffer memory.

- * : If the module is mounted on the remote I/O station, execute save/restoration in the other system mounted on the main base unit. (Save/restoration cannot be executed in the other system mounted on the remote I/O station.)

7.1 Online Module Change Conditions

The CPU, MELSECNET/H remote I/O module, Q68TD-G-H02(H01), GX Developer and base unit given below are needed to perform an online module change.

(1) CPU

The Process CPU or Redundant CPU are required.

For precautions on multiple CPU system configuration, refer to the QCPU User's Manual (Multiple CPU System).

For precautions on redundant system configuration, refer to the QnPRHCPU User's Manual (Redundant System).

(2) MELSECNET/H remote I/O module

The module of function version D or later is necessary.

(3) GX Developer

GX Developer of Version 7.10L or later is necessary.

GX Developer of Version 8.18U or later is required to perform an online module change on the remote I/O station.

(4) Base unit

(a) When the slim type main base unit (Q3□SB) is used, an online module change cannot be performed.

(b) When the power supply module unnecessary type extension base unit (Q5□B) is used, online module change cannot be performed for the modules on all the base units connected.

Remark

The function version of the Q68TD-G-H02(H01) has been "C" from the first release, supporting an online module change.

7.2 Online Module Change Operations

The following gives the operations performed for an online module change.

Table 7.1 Online module change operations

CPU operation ○ : Executed × : Not executed						(User operation)	(Intelligent function module operation)
X/Y refresh	FROM/TO instruction *1	Dedicated instruction	Device test	GX Configurator			
				Initial setting parameter	Monitor/test		
○	○	○	○	×	○	(1) Disabling conversion Turn OFF all Y signals that have been turned ON by a sequence program.	Module operates normally.
×	×	×	×	×	×	(2) Removing a module Start an online module change operation using GX Developer. Click the [Execution] button on the screen to enable a module change. Remove the target module.	Module stops operation. "RUN" LED is off. Conversion is disabled.
○	×	×	×	○	×	(3) Mounting a new module Mount a new module. After mounting the module, click the [Execution] button on the screen of GX Developer.	X/Y refresh resumes and module starts operation. "RUN" LED is on. Module operates with default settings. (X0 remains OFF.) If initial setting parameters have been set, module operates according to them at this point.
○	×	×	○	×	○	(4) Checking operation Click the [Cancel] button to leave the online module change mode. Conduct an operation test on the new module using "Device test" of GX Developer or "Monitor/Test" of GX Configurator. Perform user range restoration processing by writing data to buffer memory at this point.	Module operates according to test operation. *2
○	○	○	○	×	○	(5) Restarting control Resume the online module change mode using GX Developer and click the [Execution] button to restart control.	Module ready (X0) turns ON. Module operates according to sequence program which performs initial setting on the rising edge of X0. *2

* 1 Access to the intelligent function module device (U□IG□) is included.

* 2 In the absence of the operation marked *2, the operation of the intelligent function module is the operation performed prior to that.

7.3 Online Module Change Procedure

(1) Procedures of online module change

There are the following online module change procedures depending on whether the user range setting has been made or not, whether the initial setting of GX Configurator-TI has been made or not, and whether the other system exists or not.

Table 7.2 Online module change procedures

Range setting	Initial setting	Other system	Reference section
Factory setting	GX Configurator-TI	-	Section 7.3.1
Factory setting	Sequence program	-	Section 7.3.2
User range setting	GX Configurator-TI	Present	Section 7.3.3
User range setting	GX Configurator-TI	Absent	Section 7.3.4
User range setting	Sequence program	Present	Section 7.3.5
User range setting	Sequence program	Absent	Section 7.3.6

7.3.1 When factory default is used and initial setting was made with GX Configurator-TI

(1) Conversion disable

- (a) Set conversion enable/disable setting (Un\G0) for all channel conversion disable and turn Operating Condition Setting Request (Y9) from OFF to ON to stop conversion.

After confirming that conversion has stopped with the Conversion Completion Flag (Un\G10), turn off Operating Condition Setting Request (Y9).

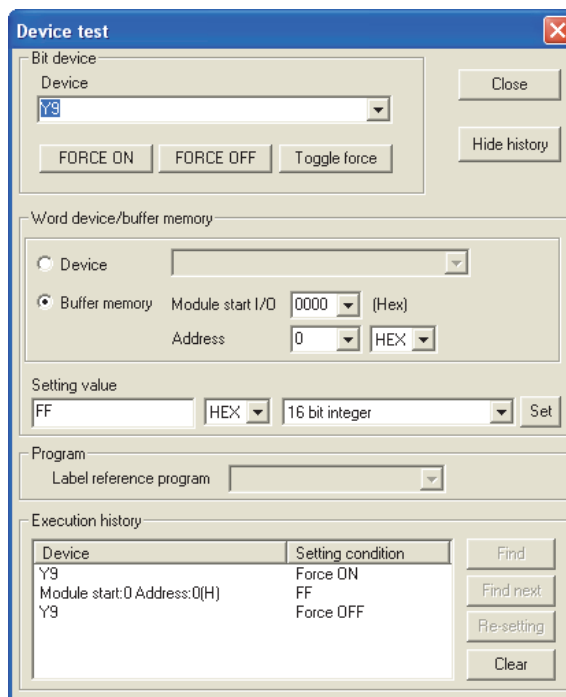

Figure 7.1 Device test screen

(2) Dismounting of module

- (a) After choosing [Diagnosis] - [Online module change] on GX Developer to enter the "Online module change" mode, double-click the module to be changed online to display the "Online module change" screen.

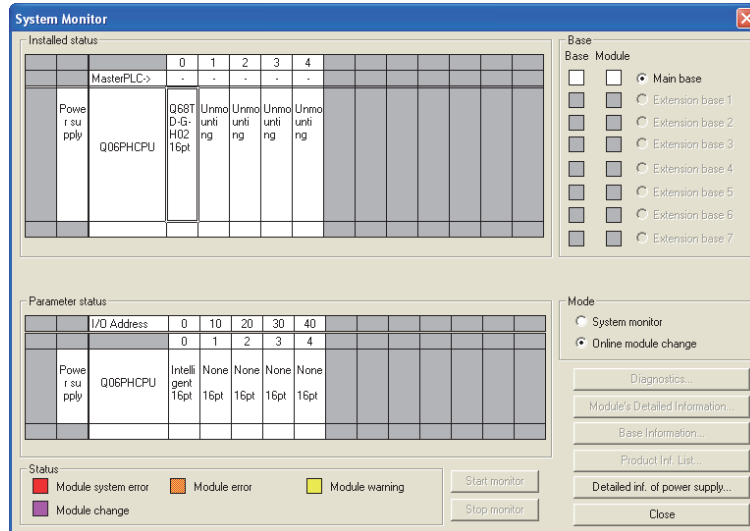

Figure 7.2 System monitor screen

- (b) Click the **Execution** button to enable a module change.

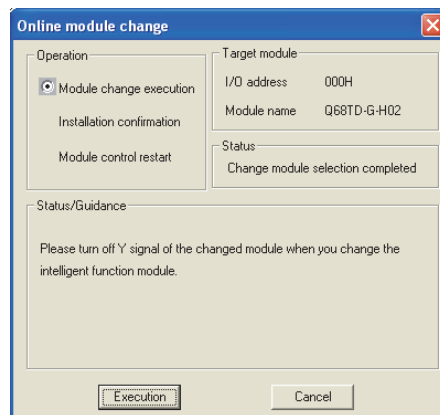

Figure 7.3 "Online module change" screen

If the following error screen appears, click the **OK** button, dismount the module, and mount a new module.

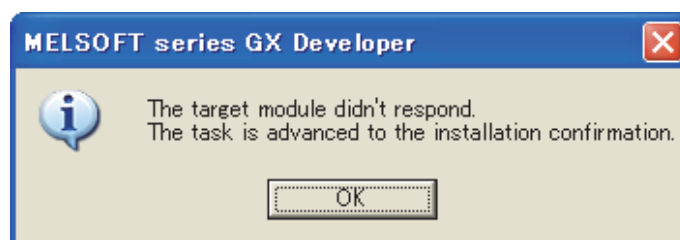

Figure 7.4 Error screen

- (c) After confirming that the "RUN" LED of the module has turned off, remove the external wiring and dismount the module.

POINT

Always dismount the module. If you execute mounting confirmation without dismounting the module, the module will not start properly and the "RUN" LED will not be lit.

(3) Mounting of new module

- (a) Mount a new module to the same slot and install the external wiring.
- (b) After mounting the module, click the **Execution** button and make sure that the "RUN" LED is lit. Module ready (X0) remains OFF.

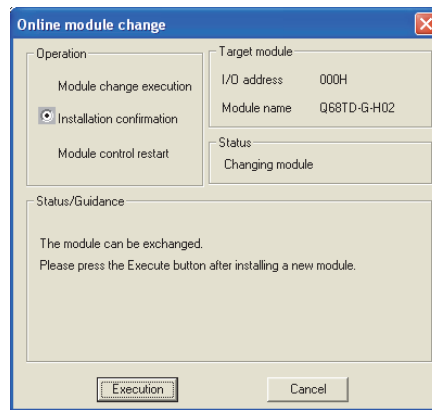

Figure 7.5 "Online module change" screen

(4) Operation check

- (a) To make an operation check, click the **Cancel** button to cancel control resumption.

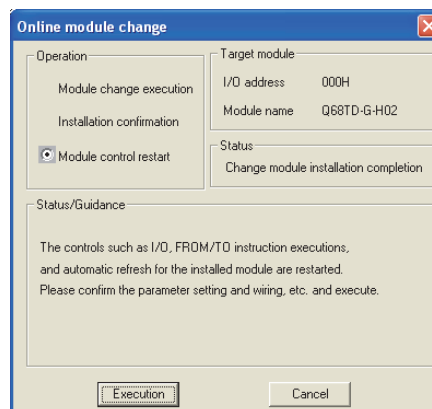



Figure 7.6 Cancel of control resumption

- (b) Click the  button to leave the "Online module change" mode.

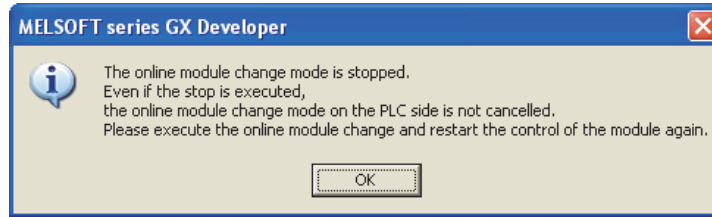



Figure 7.7 "Online module change" mode stop

- (c) Click the  button to close the System monitor screen.

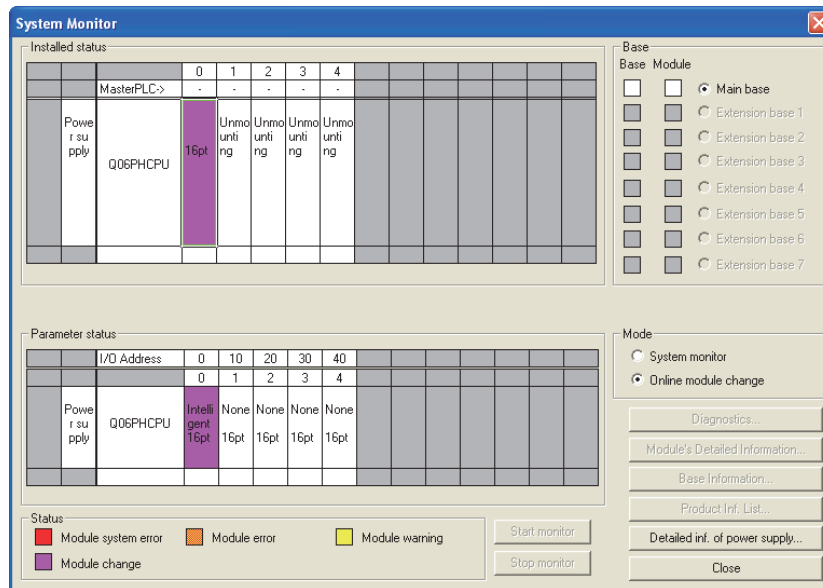

Figure 7.8 "System Monitor" screen

- (d) Monitor the CH□ Measured temperature value (Un\G11 to Un\G18) to check that proper conversion has been made.

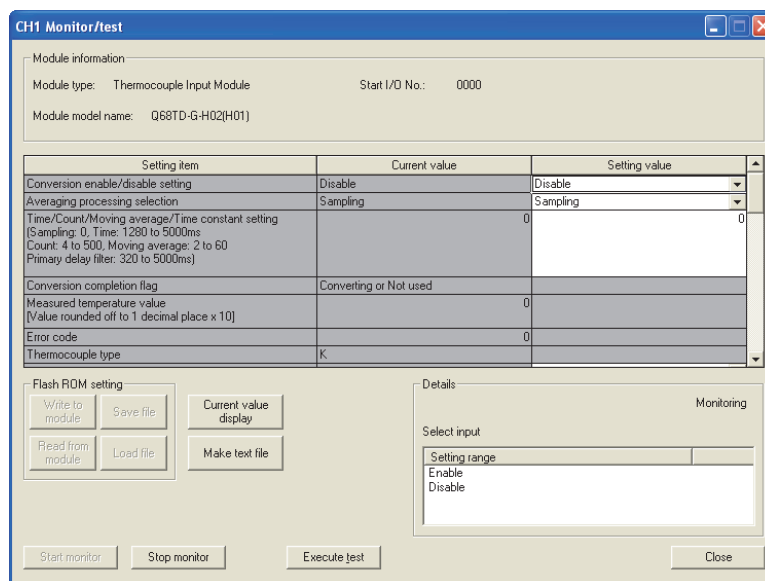

Figure 7.9 "CH□ Monitor/test" screen

(5) Resumption of control

- (a) After choosing [Diagnosis] - [Online module change] on GX Developer to redisplay the "Online module change" screen, click the **Execution** button to resume control. Module ready (X0) turns on.

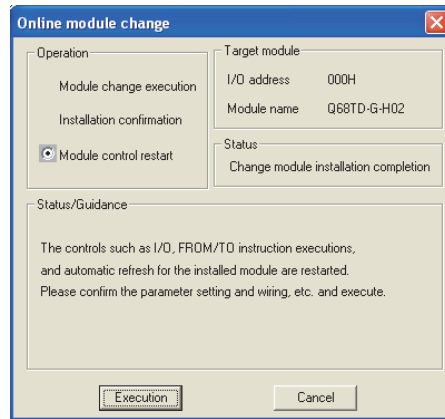

Figure 7.10 "Online module change" screen

- (b) The "Online module change completed" screen appears.



Figure 7.11 "Online module change completed" screen

7.3.2 When factory default is used and initial setting was made with sequence program

(1) Conversion disable

- (a) Set conversion enable/disable setting (Un\G0) for all channel conversion disable and turn Operating Condition Setting Request (Y9) from OFF to ON to stop conversion.

After confirming that conversion has stopped with the Conversion Completion Flag (Un\G10), turn off Operating Condition Setting Request (Y9).

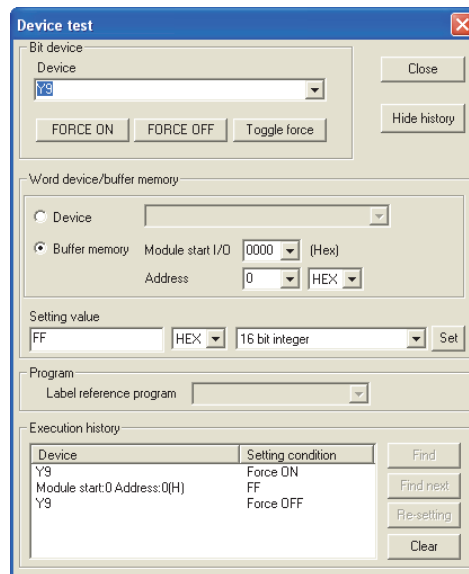

Figure 7.12 "Device test" screen

(2) Dismounting of module

- (a) After choosing [Diagnosis] - [Online module change] on GX Developer to enter the "Online module change" mode, double-click the module to be changed online to display the "Online module change" screen.

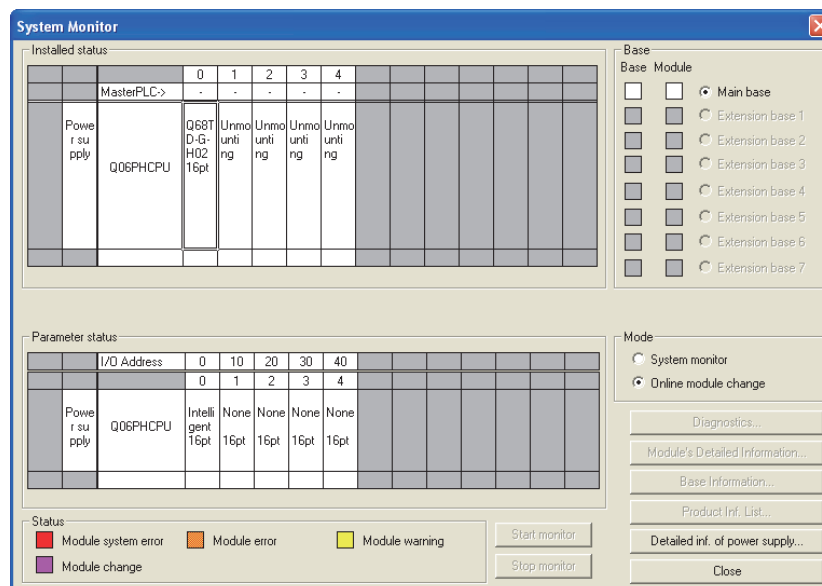

Figure 7.13 "System Monitor" screen

- (b) Click the **Execution** button to enable a module change.

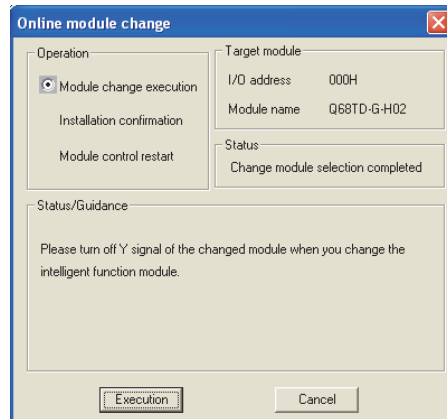

Figure 7.14 "Online module change" screen

If the following error screen appears, click the **OK** button, dismount the module, and mount a new module.

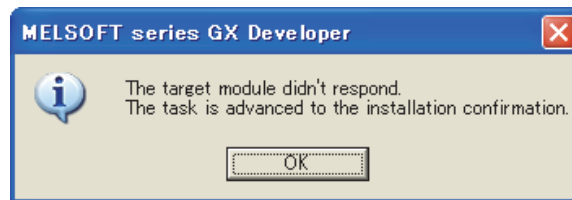

Figure 7.15 Error screen

- (c) After confirming that the "RUN" LED of the module has turned off, remove the connector and dismount the module.

POINT

Always dismount the module. If you execute mounting confirmation without dismounting the module, the module will not start properly and the "RUN" LED will not be lit.

(3) Mounting of new module

- (a) Mount a new module to the same slot and install the external wiring.
- (b) After mounting the module, click the **Execution** button and make sure that the "RUN" LED is lit. Module ready (X0) remains OFF.

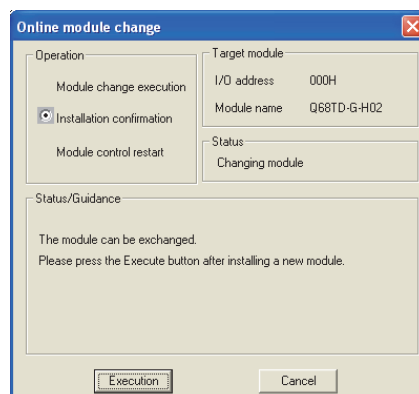



Figure 7.16 "Online module change" screen

(4) Operation check

- (a) To make an operation check, click the  button to cancel control resumption.

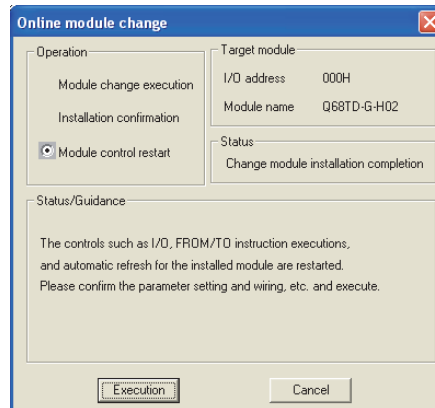

Figure 7.17 Cancel of control resumption

- (b) Click the  button to leave the "Online module change" mode.

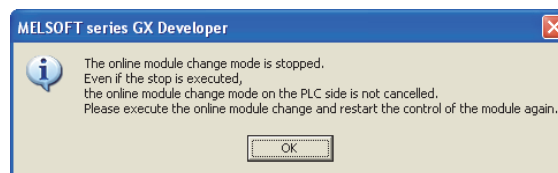
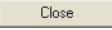

Figure 7.18 "Online module change" mode stop

- (c) Click the  button to close the System monitor screen.

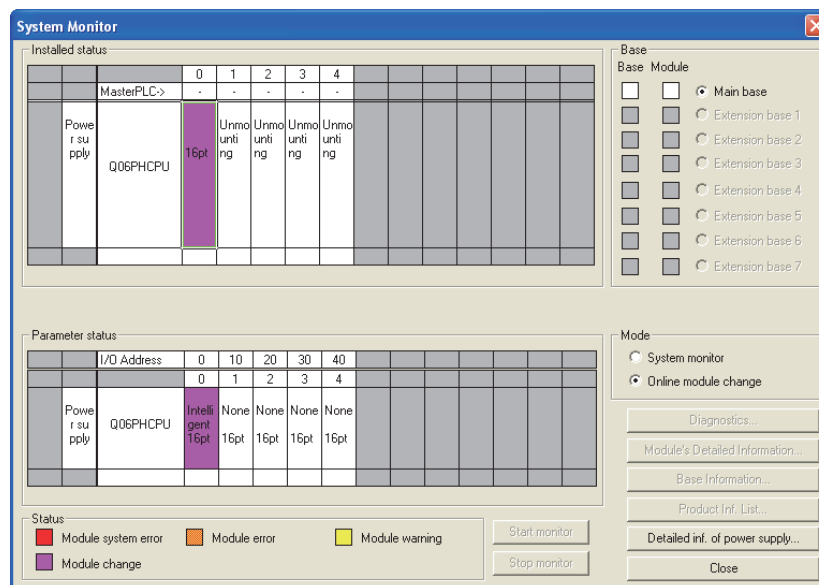

Figure 7.19 "System Monitor" screen

- (d) Enable the conversion of the channel to be used in Conversion enable/disable setting (Un\G0), and turn Operating condition setting request (Y9) from OFF to ON.

- (e) Monitor CH□ Measured temperature value (Un\G11 to Un\G18) to check if the conversion is processed normally.
 - (f) Since the new module is in a default status, it must be initialized by a sequence program after control resumption.
Before performing initialization, check whether the contents of the initialization program are correct or not.
 - 1) Normal system configuration
The sequence program should perform initialization on the leading edge of Module ready (X0) of the Q68TD-G-H02(H01).
When control resumption is executed, Module ready (X0) turns ON and initialization is performed. (If the sequence program performs initialization only one scan after RUN, initialization is not performed.)
 - 2) When used on remote I/O network
Insert a user device that will execute initialization at any timing (initialization request signal) into the sequence program. After control resumption, turn ON the initialization request signal to perform initialization. (If the sequence program performs initialization only one scan after a data link start of the remote I/O network, initialization is not performed.)
- (5) Resumption of control
- (a) After choosing [Diagnosis] - [Online module change] on GX Developer to redisplay the "Online module change" screen, click the **Execution** button to resume control. Module ready (X0) turns on.

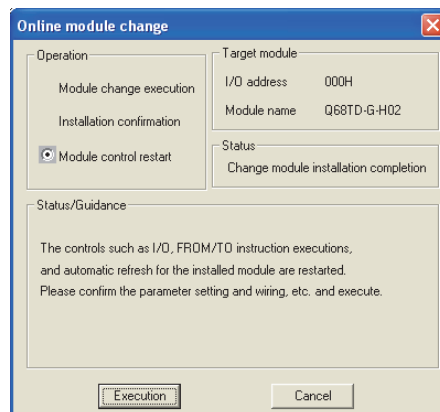

Figure 7.20 Resumption of control

- (b) The "Online module change completed" screen appears.



Figure 7.21 "Online module change completed" screen

7.3.3 When user range setting is used and initial setting was made with GX Configurator-TI (other system is available)

(1) Conversion disable

- (a) Set conversion enable/disable setting (Un\G0) for all channel conversion disable and turn Operating Condition Setting Request (Y9) from OFF to ON to stop conversion.

After confirming that conversion has stopped with the Conversion Completion Flag (Un\G10), turn off Operating Condition Setting Request (Y9).

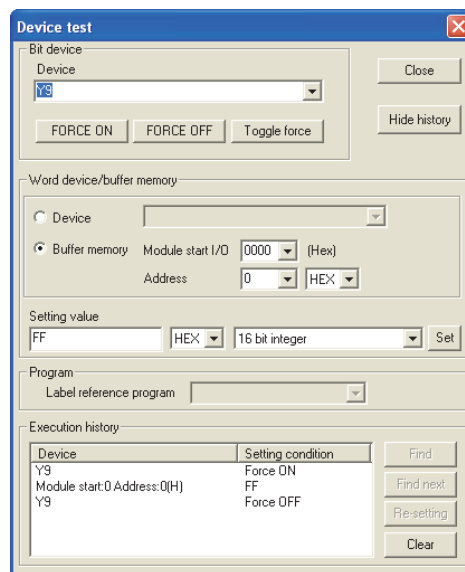

Figure 7.22 "Device test" screen

(2) Dismounting of module

- (a) After choosing [Diagnosis] - [Online module change] on GX Developer to enter the "Online module change" mode, double-click the module to be changed online to display the "Online module change" screen.

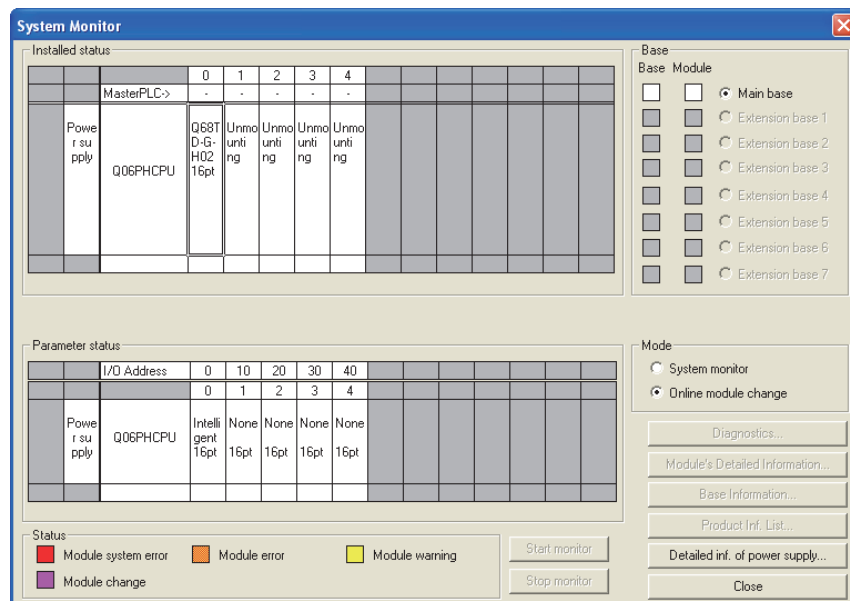

Figure 7.23 "System Monitor" screen

- (b) Click the **Execution** button to enable a module change.

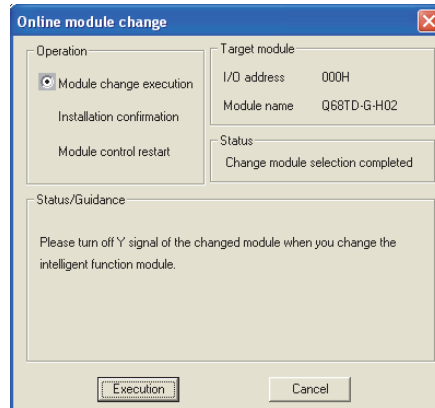

Figure 7.24 "Online module change" screen

If the following error screen appears, the user range cannot be saved.

Click the **OK** button, and perform the operation in Section 7.3.4 (2)(c) and later.

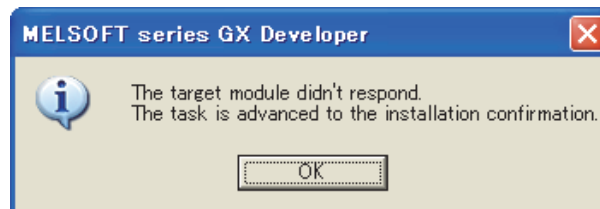

Figure 7.25 Error screen

- (c) After confirming that the "RUN" LED of the module has turned off, remove the connector and dismount the module.

POINT

Always dismount the module. If you execute mounting confirmation without dismounting the module, the module will not start properly and the "RUN" LED will not be lit.

(3) Mounting of new module

- (a) Mount the dismantled module and new module to the other system.
- (b) Using the G(P).OGLOAD instruction, save the user range setting values to the CPU device. Refer to Appendix 2.3 for the G(P).OGLOAD instruction.
- (c) Using the G(P).OGSTOR instruction, restore the user range setting values to the module. Refer to Appendix 2.4 for the G(P).OGSTOR instruction.
- (d) Dismount a new module from the other system, mount it to the slot from where the old module was dismantled in the original system, and install the connector.

- (e) After mounting the module, click the **Execution** button and make sure that the "RUN" LED is lit. Module ready (X0) remains OFF.

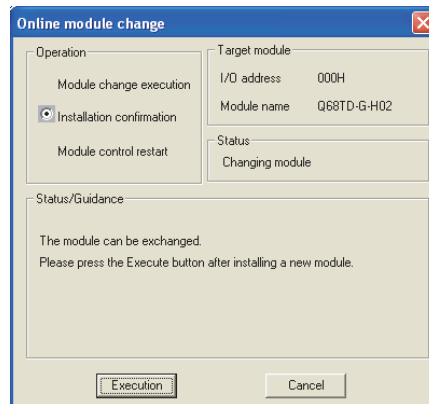

Figure 7.26 "Online module change" screen

(4) Operation check

- (a) To make an operation check, click the **Cancel** button to cancel control resumption.

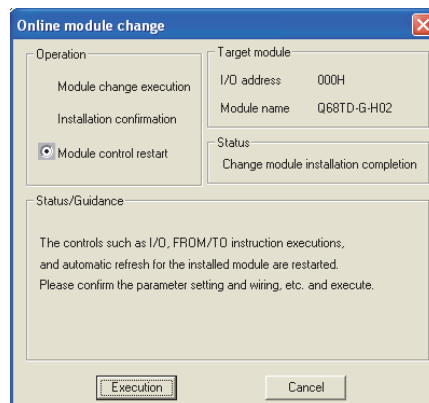

Figure 7.27 Cancel of control resumption

- (b) Click the **OK** button to leave the "Online module change" mode.

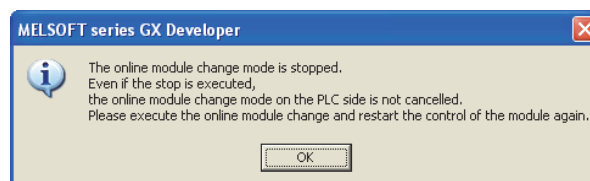



Figure 7.28 "Online module change" mode stop

(c) Click the  button to close the System monitor screen.

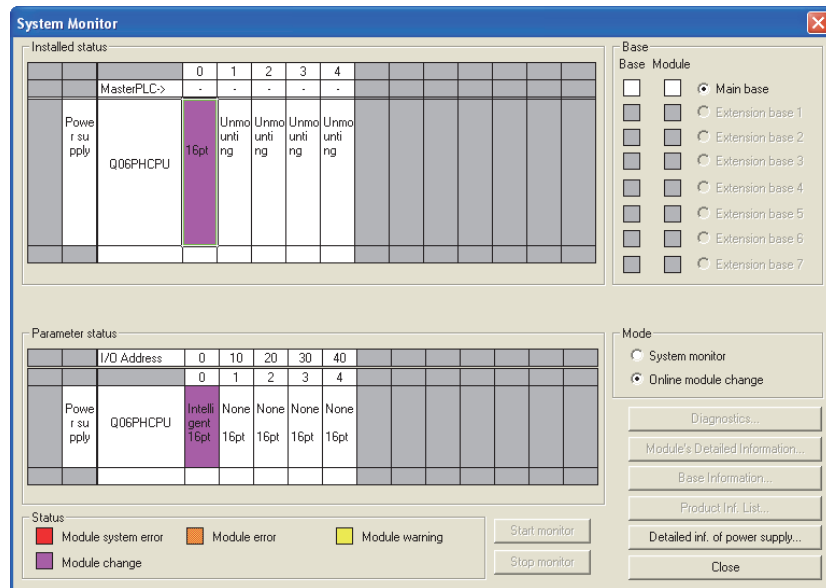

Figure 7.29 "System Monitor" screen

(d) Monitor the CH□ Measured temperature value (Un\G11 to Un\G18) to check that proper conversion has been made.

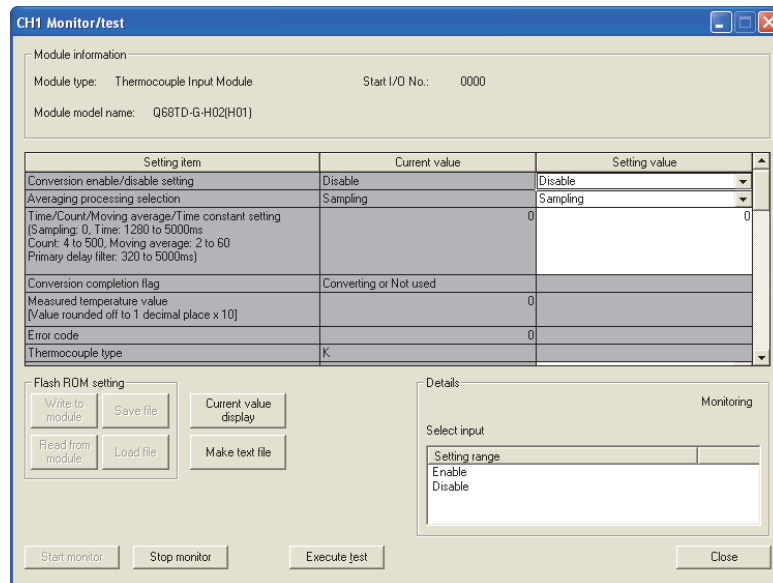

Figure 7.30 "CH□ Monitor/test" screen

(5) Resumption of control

- (a) After choosing [Diagnosis] - [Online module change] on GX Developer to redisplay the "Online module change" screen, click the **Execution** button to resume control. Module ready (X0) turns on.

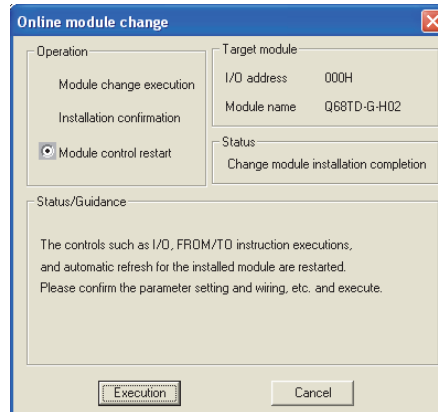

Figure 7.31 Resumption of control

- (b) The "Online module change completed" screen appears.



Figure 7.32 "Online module change completed" screen

7.3.4 When user range setting is used and initial setting was made with GX Configurator-TI (other system is unavailable)

(1) Conversion disable

- (a) Set "Disable" in the Setting value field of Conversion Enable/Disable Setting on the CH Monitor/Test screen of GX Configurator-TI, and click the **Execute test** button.

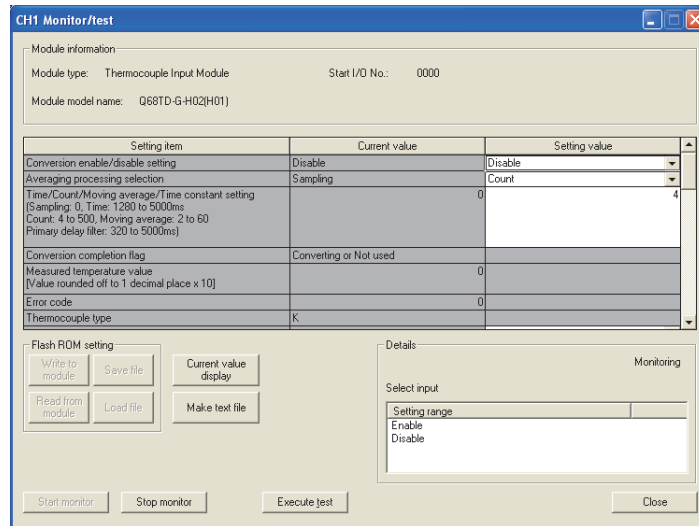

Figure 7.33 "CH Monitor/test" screen

- (b) After making sure that "Disable" is displayed in the Current value field of Conversion Enable/Disable Setting, set "Request" in the Setting value field of Operation Condition Setting Request on the Monitor screen, and click the **Execute test** button to stop conversion.

Monitor the Conversion Completion Flag (Un\G10) and confirm that conversion has stopped.

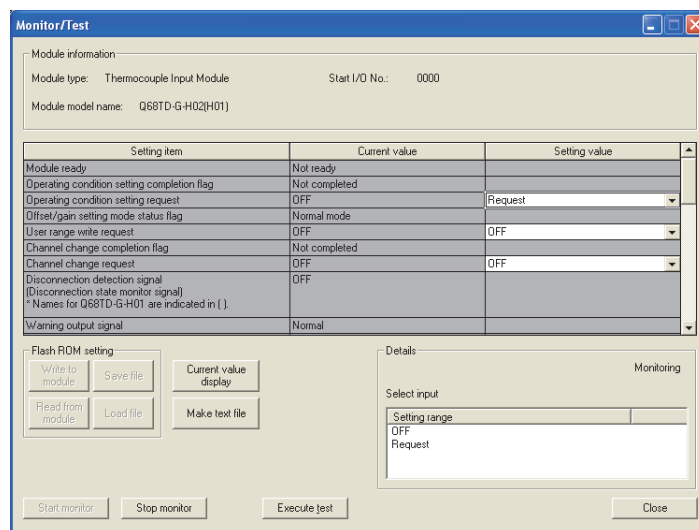

Figure 7.34 Conversion Completion Flag check

(c) If the saved buffer memory contents are not yet prerecorded, record them in the following procedure.

- 1) Display the OMC refresh data screen of GX Configurator-TI.
- 2) Make a OMC refresh data read request. (Refer to Section 5.6.3)
- 3) Compare the current values of the following OMC refresh data with those of the range reference table, make sure those are proper values.

Refer to Section 7.4 for the range reference table.

- CH□ Factory default offset value
- CH□ Factory default gain value
- CH□ User range settings offset value
- CH□ User range settings gain value
- CH□ User range settings thermal EMF offset value
- CH□ User range settings thermal EMF gain value

- 4) Record the current values of OMC refresh data.

POINT

If the buffer memory values compared with the reference table are not proper, save and restoration of the user range cannot be executed.

Before executing module control resumption, make offset/gain setting in the GX Configurator-TI. (Refer to Section 5.6.2.)

Note that if module control is resumed without offset/gain setting being made, operation will be performed with the default values.

(2) Dismounting of module

- (a) After choosing [Diagnosis] - [Online module change] on GX Developer to enter the "Online module change" mode, double-click the module to be changed online to display the "Online module change" screen.

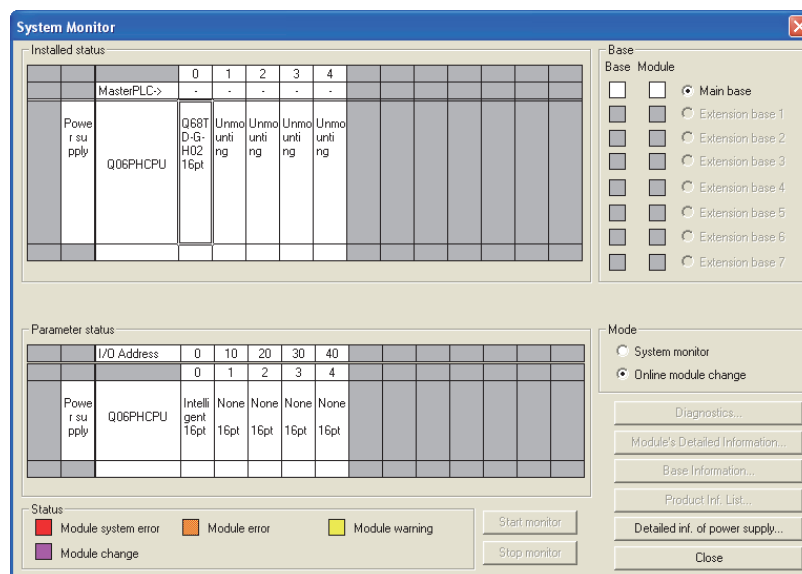

Figure 7.35 "System monitor" screen

- (b) Click the **Execution** button to enable a module change.

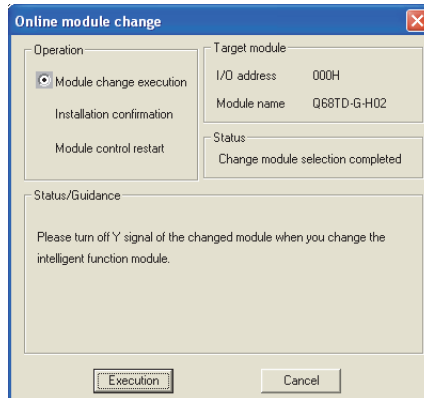

Figure 7.36 "Online module change" screen

If the following error appears, the user range cannot be saved. Click the **OK** button, and perform the operation in Section 7.3.4 (2)(c) and later.

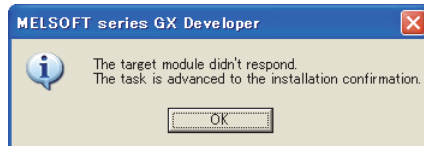

Figure 7.37 Error screen

- (c) After confirming that the "RUN" LED of the module has turned off, remove the connector and dismount the module.

POINT

Always dismount the module. If you execute mounting confirmation without dismounting the module, the module will not start properly and the "RUN" LED will not be lit.

(3) Mounting of new module

- (a) Mount a new module to the same slot, and install the connector.
- (b) After mounting the module, click the **Execution** button and make sure that the "RUN" LED is lit. Module ready (X0) remains OFF.

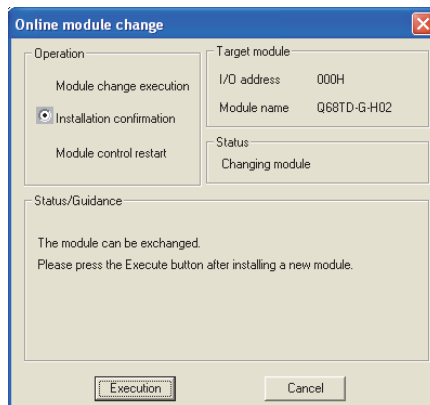



Figure 7.38 "Online module change" screen

(4) Operation check

- (a) To make an operation check, click the  button to cancel control resumption.

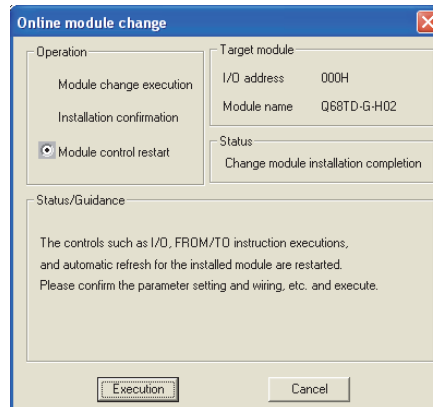

Figure 7.39 Cancel of control resumption

- (b) Click the  button to leave the "Online module change" mode.

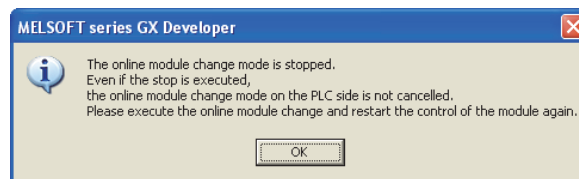



Figure 7.40 "Online module change" mode stop

- (c) Click the  button to close the System monitor screen.

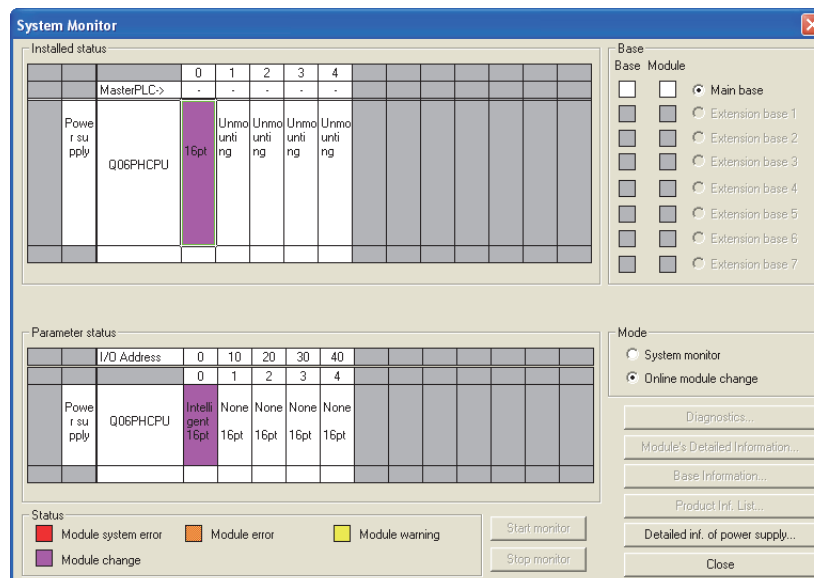

Figure 7.41 "System Monitor" screen

- (d) On the OMC refresh data screen of GX Configurator-TI, set the prerecorded values and make a OMC refresh data write request. (Refer to Section 5.6.3.)

- (e) Monitor the CH□ Measured temperature value (Un\G11 to Un\18) to check that proper conversion has been made.

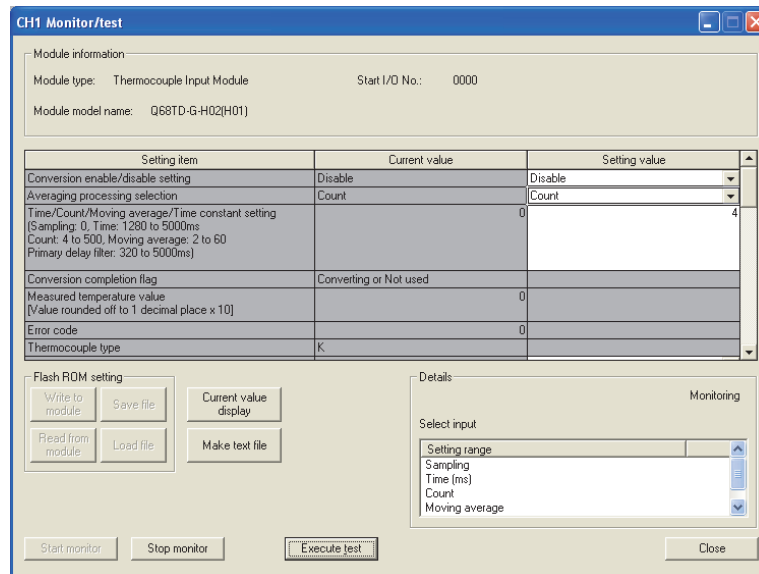

Figure 7.42 "CH□ Monitor/test" screen

(5) Resumption of control

- (a) After choosing [Diagnosis] - [Online module change] on GX Developer to redisplay the "Online module change" screen, click the **Execution** button to resume control. Module ready (X0) turns on.

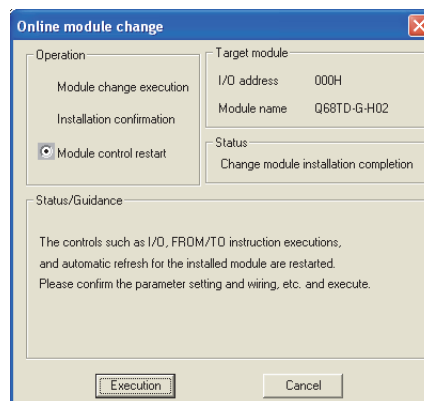

Figure 7.43 Resumption of control

- (b) The "Online module change completed" screen appears.



Figure 7.44 "Online module change completion" screen

7.3.5 When user range setting is used and initial setting was made with sequence program (other system is available)

(1) Conversion disable

- (a) Set conversion enable/disable setting (Un\G0) for all channel conversion disable and turn Operating Condition Setting Request (Y9) from OFF to ON to stop conversion.

After confirming that conversion has stopped with the Conversion Completion Flag (Un\G10), turn off Operating Condition Setting Request (Y9).

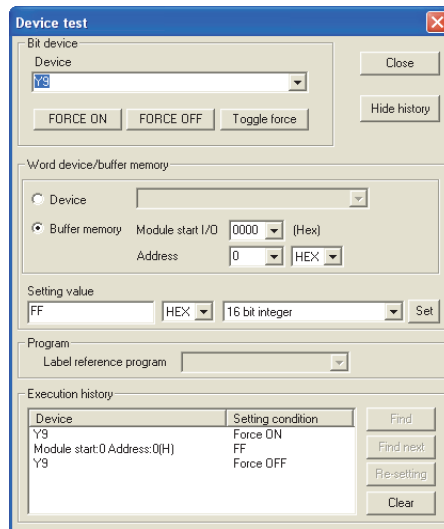

Figure 7.45 "Device test" screen

(2) Dismounting of module

- (a) After choosing [Diagnosis] - [Online module change] on GX Developer to enter the "Online module change" mode, double-click the module to be changed online to display the "Online module change" screen.

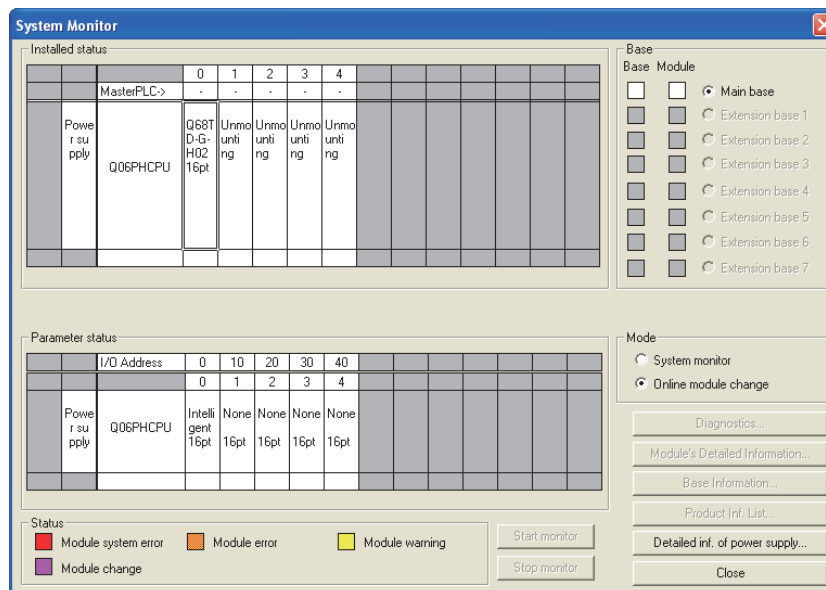

Figure 7.46 "System Monitor" screen

(b) Click the **Execution** button to enable a module change.

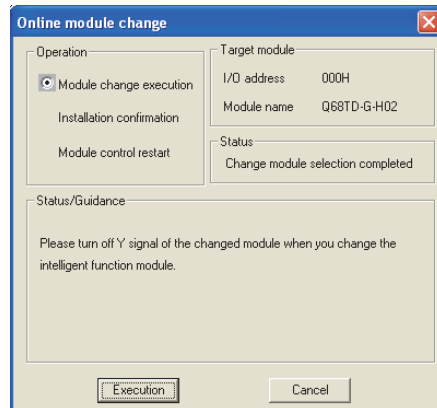

Figure 7.47 "Online module change" screen

If the following error screen appears, the user range cannot be saved.

Click the **OK** button, and perform the operation in Section 7.3.6 (2)(c) and later.

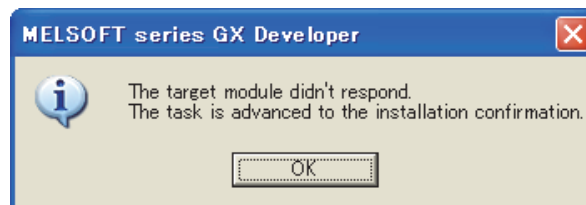

Figure 7.48 Error screen

(c) After confirming that the "RUN" LED of the module has turned off, remove the connector and dismount the module.

POINT

Always dismount the module. If you execute mounting confirmation without dismounting the module, the module will not start properly and the "RUN" LED will not be lit.

(3) Mounting of new module

- (a) Mount the dismantled module and new module to the other system.
- (b) Using the G(P).OGLOAD instruction, save the user range setting values to the CPU device. Refer to Appendix 2.3 for the G(P).OGLOAD instruction.
- (c) Using the G(P).OGSTOR instruction, restore the user range setting set values to the module. Refer to Appendix 2.4 for the G(P).OGSTOR instruction.
- (d) Dismount a new module from the other system, mount it to the slot from where the old module was dismantled in the original system, and install the connector.
- (e) After mounting the module, click the **Execution** button and make sure that the "RUN" LED is lit. Module ready (X0) remains OFF.

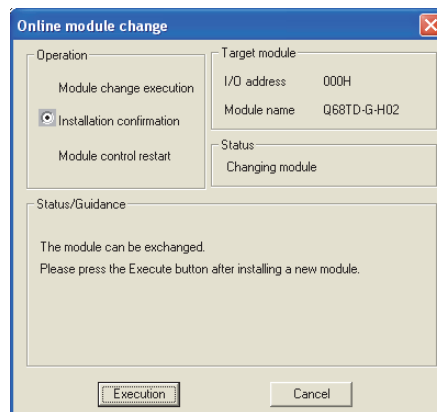

Figure 7.49 "Online module change" screen

(4) Operation check

- (a) To make an operation check, click the **Cancel** button to cancel control resumption.

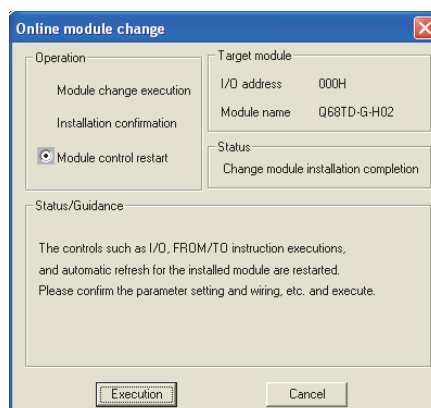

Figure 7.50 Cancel of control resumption

- (b) Click the  button to leave the "Online module change" mode.

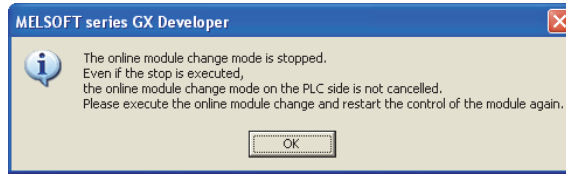



Figure 7.51 "Online module change" mode stop

- (c) Click the  button to close the System monitor screen.

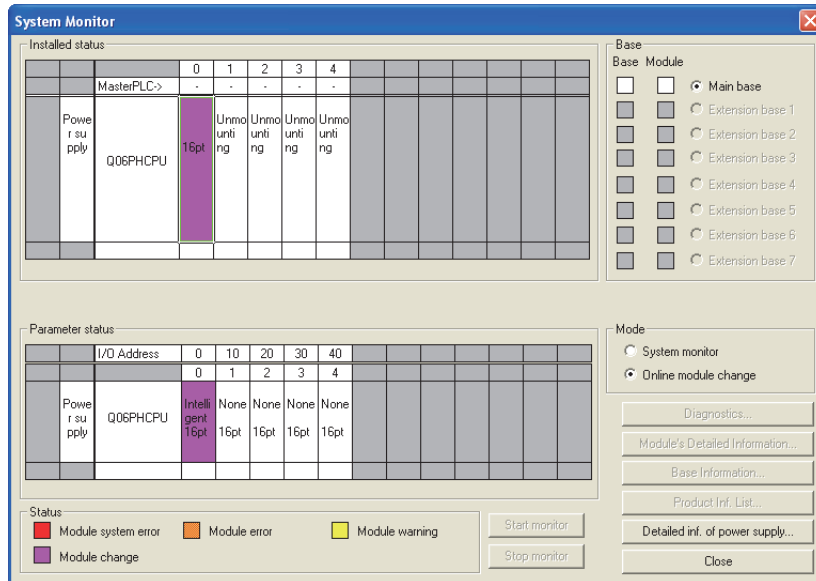

Figure 7.52 "System Monitor" screen

- (d) Enable the conversion of the channel to be used in Conversion enable/disable setting (Un\G0), and turn Operating condition setting request (Y9) from OFF to ON.
- (e) Monitor CH□ Measured temperature value (Un\G11 to Un\G18) to check if the conversion is processed normally.
- (f) Since the new module is in a default status, it must be initialized by a sequence program after control resumption. Before performing initialization, check whether the contents of the initialization program are correct or not.
- 1) Normal system configuration

The sequence program should perform initialization on the leading edge of Module ready (X0) of the Q68TD-G-H02(H01).
When control resumption is executed, Module ready (X0) turns ON and initialization is performed. (If the sequence program performs initialization only one scan after RUN, initialization is not performed.)
 - 2) When used on remote I/O network

Insert a user device that will execute initialization at any timing (initialization request signal) into the sequence program. After control resumption, turn ON the initialization request signal to perform initialization. (If the sequence program performs initialization only one scan after a data link start of the remote I/O network, initialization is not performed.)

(5) Resumption of control

- (a) After choosing [Diagnosis] - [Online module change] on GX Developer to redisplay the "Online module change" screen, click the **Execution** button to resume control. Module ready (X0) turns on.

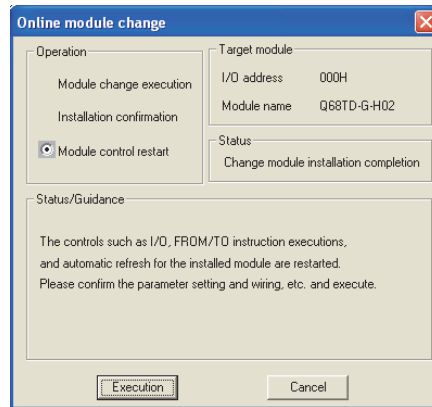

Figure 7.53 Resumption of control

- (b) The "Online module change completed" screen appears.



Figure 7.54 "Online module change completed" screen

7.3.6 When user range setting is used and initial setting was made with sequence program (other system is unavailable)

(1) Conversion disable

- (a) Set "Disable" in the conversion enable/disable setting (Un\G0) for all channels and turn Operating Condition Setting Request (Y9) from OFF to ON to stop conversion.

After confirming that conversion has stopped with the Conversion Completion Flag (Un\G10), turn off Operating Condition Setting Request (Y9).

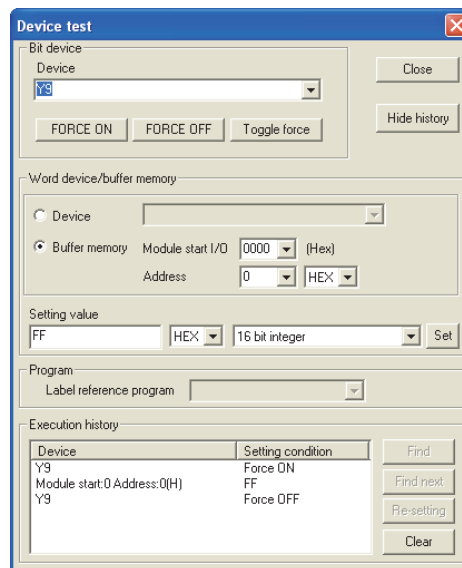

Figure 7.55 "Device test" screen

- (b) If the saved buffer memory contents are not yet prerecorded, record them in the following procedure.

- 1) Turn Operating Condition Setting Request (Y9) from OFF to ON.
- 2) Compare the current values of the following buffer memory with those of the range reference table, make sure those are proper values. Refer to Section 7.4 for the range reference table.
 - CH□ Factory default offset value (Un\G190^{*1})
 - CH□ Factory default gain value (Un\G191^{*1})
 - CH□ User range settings offset value (Un\G192^{*1})
 - CH□ User range settings gain value (Un\G193^{*1})
 - CH□ User range settings thermal EMF offset value (Un\G194,Un\G195^{*1})
 - CH□ User range settings thermal EMF gain value (Un\G196,Un\G197^{*1})

* 1: Only the buffer memory address of channel 1 is given on the above.

Refer to the Section 3.4.1 Buffer memory assignment for the buffer memory address of other channels

- 3) Record the buffer memory values.

POINT

If the buffer memory values compared with the reference table are not proper, save and restoration of the user range cannot be executed.

Before executing module control resumption, follow the flowchart in Section 4.6 and make offset/gain setting in the device test of GX Developer.

Perform mode switching by making the setting of the mode switching setting (Un\G158, Un\G159) and turning Operating Condition Setting Request (Y9) from OFF to ON.

Note that if module control is resumed without offset/gain setting being made, operation will be performed with the default values.

(2) Dismounting of module

- (a) After choosing [Diagnosis] - [Online module change] on GX Developer to enter the "Online module change" mode, double-click the module to be changed online to display the "Online module change" screen.

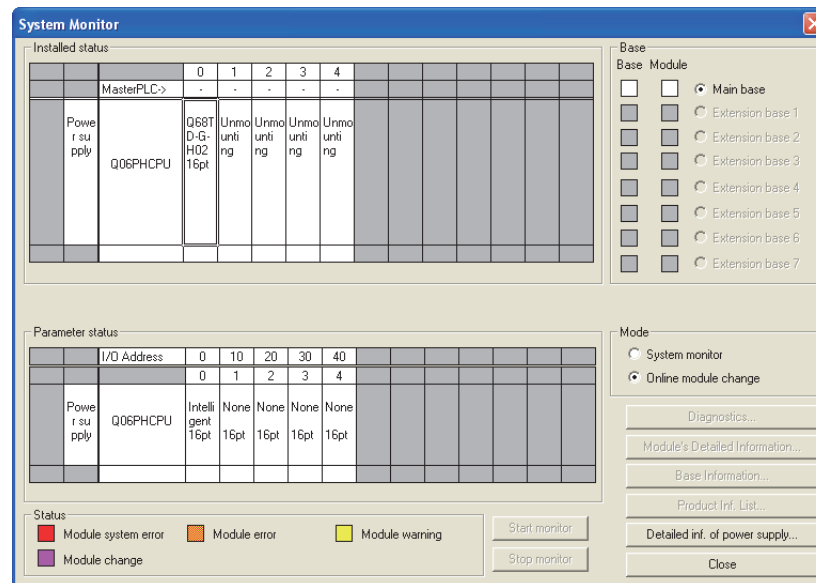

Figure 7.56 "System Monitor" screen

- (b) Click the **Execution** button to enable a module change.

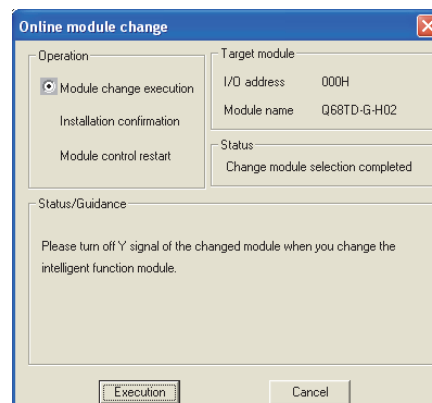



Figure 7.57 "Online module change" screen

If the following error screen appears, the user range cannot be saved. Click the  button, and perform the operation in Section 7.3.6 (2)(c) and later.

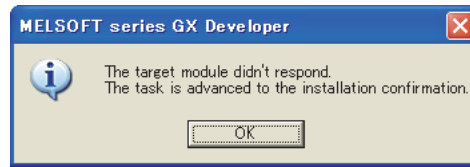



Figure 7.58 Error screen

- (c) After confirming that the "RUN" LED of the module has turned off, remove the connector and dismount the module.

POINT

Always dismount the module. If you execute mounting confirmation without dismounting the module, the module will not start properly and the "RUN" LED will not be lit.

(3) Mounting of new module

- (a) Mount a new module to the same slot, and install the connector.
- (b) After mounting the module, click the  button and make sure that the "RUN" LED is lit. Module ready (X0) remains OFF.

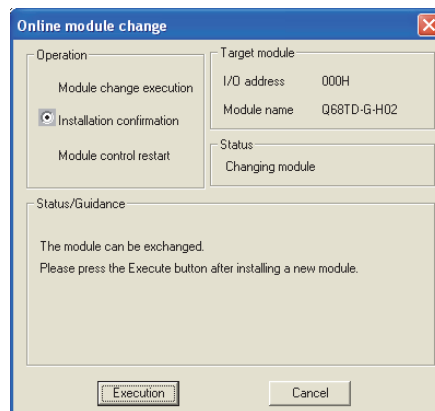



Figure 7.59 "Online module change" screen

(4) Operation check

- (a) To make an operation check, click the  button to cancel control resumption.

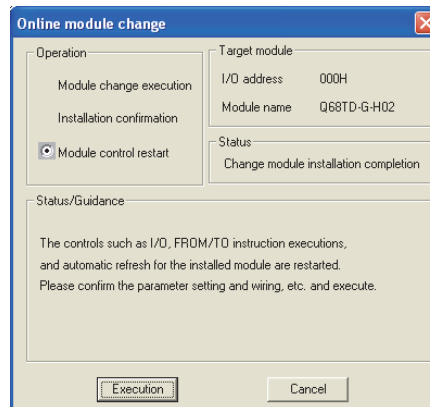

Figure 7.60 Cancel of control resumption

- (b) Click the  button to leave the "Online module change" mode.

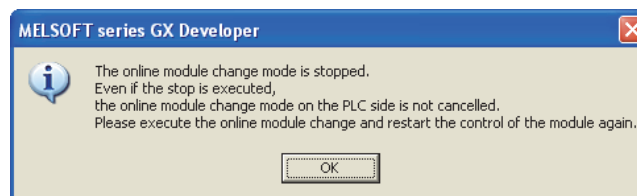
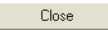

Figure 7.61 "Online module change" mode stop

- (c) Click the  button to close the System monitor screen.

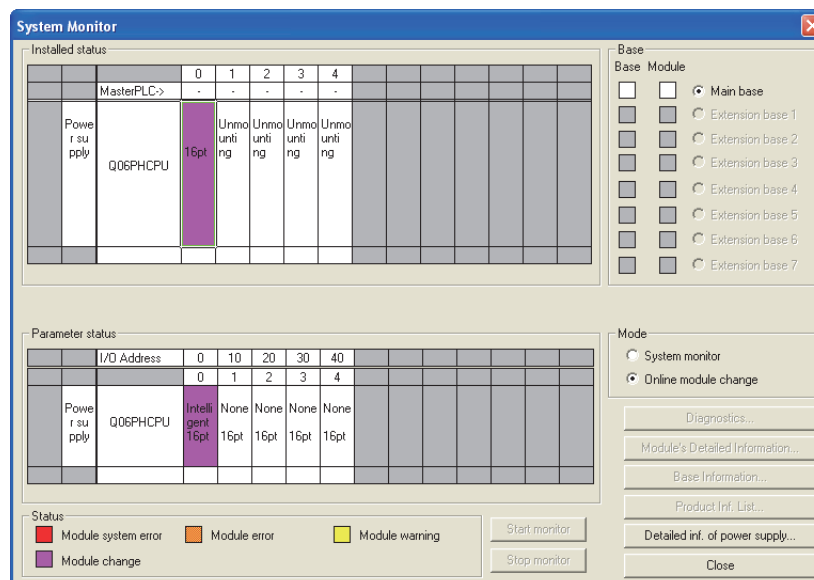

Figure 7.62 "System Monitor" screen

- (d) Choose [Online] - [Debug] - [Device test] on GX Developer and set the values prerecorded in Section 7.3.6 (2) to the buffer memory.
- (e) Turn the user range write request (YA) from OFF to ON to restore the user set values to the module.
After confirming that the offset/gain setting mode status flag (XA) is ON, turn OFF the user range write request (YA).

- (f) Enable the conversion of the channel to be used in Conversion enable/disable setting (Un\G0), and turn Operating condition setting request (Y9) from OFF to ON.
 - (g) Monitor CH□ Measured temperature value (Un\G11 to Un\G18) to check if the conversion is processed normally.
 - (h) Since the new module is in a default status, it must be initialized by a sequence program after control resumption.
Before performing initialization, check whether the contents of the initialization program are correct or not.
 - 1) Normal system configuration
The sequence program should perform initialization on the leading edge of Module ready (X0) of the Q68TD-G-H02(H01).
When control resumption is executed, Module ready (X0) turns ON and initialization is performed. (If the sequence program performs initialization only one scan after RUN, initialization is not performed.)
 - 2) When used on remote I/O network
Insert a user device that will execute initialization at any timing (initialization request signal) into the sequence program. After control resumption, turn ON the initialization request signal to perform initialization. (If the sequence program performs initialization only one scan after a data link start of the remote I/O network, initialization is not performed.)
- (5) Resumption of control
- (a) After choosing [Diagnosis] - [Online module change] on GX Developer to redisplay the "Online module change" screen, click the **Execution** button to resume control. Module ready (X0) turns on.

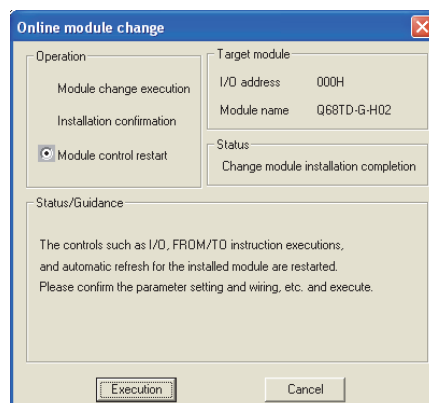

Figure 7.63 Resumption of control

- (b) The "Online module change completed" screen appears.



Figure 7.64 "Online module change completed" screen

7.4 Range Reference Table

The range reference tables are given below.

7.4.1 Range reference table (Q68TD-G-H02)

Address (Decimal)								Description	Reference value
CH1	CH2	CH3	CH4	CH5	CH6	CH7	CH8		
190	198	206	214	222	230	238	246	Factory default offset value	Digital value for offset value set prior to shipment (Reference value F868H)
191	199	207	215	223	231	239	247	Factory default gain value	Digital value for gain value set prior to shipment (Reference value 3640H)
192	200	208	216	224	232	240	248	User range settings offset value	Digital value for user-set offset value (Refer to (3))
193	201	209	217	225	233	241	249	User range settings gain value	Digital value for user-set gain value (Refer to (4))
194	202	210	218	226	234	242	250	User range settings thermal EMF offset value (L)	Thermal EMF for user-set offset set temperature (μV unit) (Refer to (5))
195	203	211	219	227	235	243	251	User range settings thermal EMF offset value (H)	
196	204	212	220	228	236	244	252	User range settings thermal EMF gain value (L)	Thermal EMF for user-set gain set temperature (μV unit) (Refer to (6))
197	205	213	221	229	237	245	253	User range settings thermal EMF gain value (H)	

- (1) Compare the factory default offset value with the reference value F868H.
- (2) Compare the factory default gain value with the reference value 3640H.
- (3) Compare the user range settings offset value with the value obtained from the following expression.

$$(\text{Digital value}) = \left[\begin{array}{l} \text{User range settings thermal} \\ \text{EMF offset value } (\mu V) \end{array} \right] \div 15832 \div 45000 - 185$$

- (4) Compare the user range settings gain value with the value obtained from the following expression.

$$(\text{Digital value}) = \left[\begin{array}{l} \text{User range settings thermal} \\ \text{EMF gain value } (\mu V) \end{array} \right] \div 15832 \div 45000 - 185$$

- (5) Obtain a value that corresponds to the offset setting temperature set by the user from the chart of standard thermal electromotive force that is compliant with JIS C 1602-1995, IEC584-1, and IEC584-2. Compare the value with the user range settings offset thermal electromotive force value.
- (6) Obtain a value that corresponds to the gain setting temperature set by the user from the chart of standard thermal electromotive force that is compliant with JIS C 1602-1995, IEC584-1, and IEC584-2. Compare the value with the user range settings gain thermal electromotive force value.

POINT

The chart of standard thermal electromotive force compliant with JIS C 1602-1995 and IEC584-1, or IEC584-2 needs to be arranged by the user.

7 ONLINE MODULE CHANGE

(Example)

When offset/gain setting is made at the offset set temperature of -200.0°C and the gain set temperature of 900.0°C with an E type thermocouple connected

Value type	Set temperature	Reference value of user range settings thermal EMF offset/gain value	Reference value of user range settings offset/gain value
Offset value	- 200.0 °C	- 8825(μV)	- 8825 ÷ 15832 × 45000-185 =F326H
Gain value	900.0 °C	68787(μV)	68787 ÷ 15832 × 45000-185 = 5DD0H

1

OVERVIEW

2

SYSTEM CONFIGURATION

3

SPECIFICATIONS

4

SETUP AND PROCEDURES BEFORE OPERATION

5

UTILITY PACKAGE (GX CONFIGURATOR-TI)

6

PROGRAMMING

7

ONLINE MODULE CHANGE

8

TROUBLESHOOTING

7.4.2 Range reference table (Q68TD-G-H01)

Address (Decimal)								Description	Reference value
CH1	CH2	CH3	CH4	CH5	CH6	CH7	CH8		
190	198	206	214	222	230	238	246	Factory default offset value	Digital value for offset value set prior to shipment (Reference value F89BH)
191	199	207	215	223	231	239	247	Factory default gain value	Digital value for gain value set prior to shipment (Reference value 3B22H)
192	200	208	216	224	232	240	248	User range settings offset value	Digital value for user-set offset value (Refer to (3))
193	201	209	217	225	233	241	249	User range settings gain value	Digital value for user-set gain value (Refer to (4))
194	202	210	218	226	234	242	250	User range settings thermal EMF offset value (L)	Thermal EMF for user-set offset set temperature (μV unit) (Refer to (5))
195	203	211	219	227	235	243	251	User range settings thermal EMF offset value (H)	
196	204	212	220	228	236	244	252	User range settings thermal EMF gain value (L)	Thermal EMF for user-set gain set temperature (μV unit) (Refer to (6))
197	205	213	221	229	237	245	253	User range settings thermal EMF gain value (H)	

- (1) Compare the factory default offset value with the reference value F89BH.
- (2) Compare the factory default gain value with the reference value 3B22H.
- (3) Compare the user range settings offset value with the value obtained from the following expression.

$$(\text{Digital value}) = \left[\begin{array}{l} \text{User range settings thermal} \\ \text{EMF offset value } (\mu\text{V}) \end{array} \right] \div 90909 \times 32767$$

- (4) Compare the user range settings gain value with the value obtained from the following expression.

$$(\text{Digital value}) = \left[\begin{array}{l} \text{User range settings thermal} \\ \text{EMF gain value } (\mu\text{V}) \end{array} \right] \div 90909 \times 32767$$

- (5) Obtain the chart of standard thermal electromotive force, complying with JIS C 1602-1995 and IEC584-1, or IEC584-2, for the user range settings offset thermal electromotive force value. Then, compare the value with the offset setting temperature set by the user.
- (6) Obtain the chart of standard thermal electromotive force, complying with JIS C 1602-1995 and IEC584-1, or IEC584-2, for the user range settings gain thermal electromotive force value. Then, compare the value with the gain setting temperature set by the user.

POINT

The chart of standard thermal electromotive force compliant with JIS C 1602-1995 and IEC584-1, or IEC584-2 needs to be arranged by the user.

7 ONLINE MODULE CHANGE

(Example)

When offset/gain setting is made at the offset set temperature of -200.0°C and the gain set temperature of 900.0°C with an E type thermocouple connected

Value type	Set temperature	Reference value of user range settings thermal EMF offset/gain value	Reference value of user range settings offset/gain value
Offset value	- 200.0°C	- 8825(μ V)	$- 8825 \div 90909 \times 32767 = -3180$
Gain value	900.0°C	68787(μ V)	$68787 \div 90909 \times 32767 = 24793$

1

OVERVIEW

2

SYSTEM CONFIGURATION

3

SPECIFICATIONS

4

SETUP AND PROCEDURES BEFORE OPERATION

5

UTILITY PACKAGE (GX CONFIGURATOR-TI)

6

PROGRAMMING

7

ONLINE MODULE CHANGE

8

TROUBLESHOOTING

7.5 Precautions for Online Module Change

The following are the precautions for online module change.

- (1) Always perform an online module change in the correct procedure. A failure to do so can cause a malfunction or failure.
- (2) If an online module change is made with the user range setting, the accuracy after that will fall to about less than 1/3 of the accuracy before that.
Re-set the offset/gain values as necessary.
- (3) During an online module change, do not perform the operations below. If they are performed, the Q68TD-G-H02 (H01) may not operate normally.
 - (a) Powering off the programmable controller CPU
 - (b) Resetting the programmable controller CPU

CHAPTER 8 TROUBLESHOOTING

This chapter explains the natures of errors which may occur during use of the Q68TD-G-H02(H01) and troubleshooting.

8.1 Error Code List

If an error occurs during write or read of data to or from the Programmable controller CPU, the Q68TD-G-H02(H01) writes the corresponding error code to the address (Un\G19). The error level has a middle level (Module error) and light level (Module warning). When a middle level error occurs, conversion processing is not performed. When a light level error occurs, conversion processing is performed by the settings that were operated normally last time.

Table 8.1 Error code list (1/2)

Error Code (Decimal)	Error level	Description	Remedy
10□	Middle	The thermocouple type is set with a value other than 0 to 7 in the intelligent function module switch setting. □ indicates the channel number set incorrectly.	Set a correct parameter value in the parameter setting of GX Developer. (Refer to Section 4.5.)
111	Middle	A hardware error of the module	Switch power off, then on again. If the error recurs, the module may have failed. Please consult your local Mitsubishi representative.
112	Middle	The setting of the intelligent function module switch 5 is other than 0.	Set 0 for the intelligent function module switch 5 in the parameter setting of GX Developer. (Refer to Section 4.5.)
120* ¹	Middle	An invalid value is set in the offset/gain setting. The number of the error channel can not be identified.	Perform the offset/gain setting again for all of the channels that use the user range settings. If the error occurs again, the module may be malfunctioning. Please consult your local Mitsubishi representative.
12□* ¹	Middle	An invalid value is set in the offset/gain setting. □ indicates the channel number where an error occurred.	Perform the offset/gain setting again for all of the channels that the error occurred. If the error occurs again, the module may be malfunctioning. Please consult your local Mitsubishi representative.
161* ²	Light	The G(P).OGSTOR instruction was executed in the offset/gain setting mode.	Do not execute the G(P).OGSTOR instruction in the offset/gain setting mode.
162* ¹	Light	•The G(P).OGSTOR instruction was executed consecutively. •At the time of offset/gain setting, a set value was written to the flash memory 26 or more times.	•Execute the G(P).OGSTOR instruction only once for one module. •At the time of offset/gain setting, write a set value only once at one time.
163* ¹	Light	•The G(P).OGSTOR instruction was executed for the model that differs from the model for which the G(P).OGLOAD instruction had been executed. •The G(P).OGSTOR instruction had been executed before the G(P).OGLOAD instruction was executed.	•Execute the G(P).OGLOAD and G(P).OGSTOR instructions for the same model. •Execute the G(P).OGLOAD instruction first, then G(P).OGSTOR instruction.
20□* ¹	Light	The average time setting value set in Un\G1 to Un\G8 is outside the range of 1280 to 5000ms. □ indicates the channel number set incorrectly.	Reset the average time setting value to within 1280 to 5000ms.

Table 8.1 Error code list (2/2)

Error Code (Decimal)	Error level	Description	Remedy
30□ ^{*1}	Light	The averaging count setting value set in Un\G1 to Un\G8 is outside the range of 4 to 500 times. □ indicates the channel number set incorrectly.	Reset the average count setting value to within 4 to 500 times.
31□ ^{*1}	Light	The moving average count setting value set in Un\G1 to Un\G8 is outside the range of 2 to 60 times. □ indicates the channel number set incorrectly.	Reset the moving average count setting value to within 2 to 60 times.
32□ ^{*1}	Light	The time constant setting value for the primary delay filter set in Un\G1 to Un\G8 is outside the range of 320 to 5000ms. □ indicates the channel number set incorrectly.	Reset the time constant setting value to within 320 to 5000ms.
40□ ^{*1}	Light	(Gain value) - (Offset value) ≤ 0.1 [°C] □ indicates the channel number where an error occurred.	Check the voltage at the thermocouple input terminal.
41□ ^{*1}	Light	(Gain temperature setting value) - (Offset temperature setting value) ≤ 0.1 [°C] □ indicates the channel number where an error occurred.	Reset the offset/gain temperature setting value (Un\G28 to Un\G43) of the channel number where an error occurred.
500 ^{*1}	Light	The same channel or 0 is set to both the offset/gain setting (Offset specification) (Un\G26) and offset/gain setting (Gain specification) (Un\G27).	Reset the data of the offset/gain setting (Offset specification) (Un\G26) and offset/gain setting (Gain specification) (Un\G27).
51□ ^{*1}	Light	When the channel change request (YB) is turned ON, the setting status is in the following either status. •The offset temperature setting value or gain temperature setting value of the specified channel is set outside the measured range. •The disconnected channel or the channel for conversion disable is specified. □ indicates the channel number set incorrectly.	<ul style="list-style-type: none"> •Check the measurement range and reset the offset/gain temperature setting value (Un\G28 to Un\G43) within the range. •Check wire disconnection or specify the channel for conversion enable.
6△□ ^{*1}	Light	The process alarm upper/lower limit value (Un\G94 to Un\G125) is set contradictorily. □ indicates the channel number set incorrectly. △ indicates the following status. 0: The lower lower limit value is lower than the measurement range. 1: The upper upper limit value is higher than the measurement range. 2: (Lower lower limit value) > (Lower upper limit value) 3: (Lower upper limit value) > (Upper lower limit value) 4: (Upper lower limit value) > (Upper upper limit value)	Reset the process alarm upper/lower limit value (Un\G94 to Un\G125).
70□ ^{*1}	Light	The rate alarm warning detection period (Un\G126 to Un\G133) is outside the range of 1 to 6000 times □ indicates the channel number set incorrectly.	Reset the rate alarm warning detection period (Un\G126 to Un\G133) to within 1 to 6000 times.
800 ^{*1}	Middle	Wire disconnection of the cold junction temperature compensation resistor (RTD) is detected.	Check wiring status of the cold junction temperature compensation resistor (RTD).
91□ ^{*1}	Light	The setting value in the scaling range upper/lower limit value (Un\G62 to Un\G77) or scaling width upper/lower limit value (Un\G78 to Un\G93) indicates that (Lower limit) = (Upper limit). □ indicates the channel number set incorrectly.	Reset the scaling range upper/lower limit value (Un\G62 to Un\G77) or scaling width upper/lower limit value (Un\G78 to Un\G93).

☒ POINT

- (1) The code of the first error found by the Q68TD-G-H02(H01) is stored when two or more errors occur.
- (2) The error codes marked with *1 can be cleared by turning ON the error clear request (YF).
- (3) The error code 161 marked by *2 can not stored in the error code (Un\G19). It is stored in the completion status area (S)+1 of the G(P).OGSTOR instruction.

8.2 Troubleshooting

8.2.1 "RUN" LED is extinguished

Table 8.2 "RUN" LED is extinguished

Check Item	Remedy
Check that power is supplied.	Confirm that the supply voltage of the power supply module is within the rated range.
Check that the capacity of the power supply module is sufficient.	Calculate the current consumption of the CPU, I/O, intelligent function and other modules loaded on the base unit, and make sure that the power supply capacity is enough.
Check for a watchdog timer error.	Reset the programmable controller CPU and verify that it is lit. If the "RUN" LED does not light even after doing this, the module may be malfunctioning. Please consult your local Mitsubishi representative.
Check whether the modules are loaded normally on the base unit.	Check the module loading status.
Is a module change enabled during an online module change?	Refer to CHAPTER 7 and take corrective action.

8.2.2 "RUN" LED flickers

Table 8.3 "RUN" LED flickers

Check Item	Remedy
Check whether the module is in the offset/gain setting mode or not.	Reset the switch 4 in the intelligent function module switch setting of GX Developer to set to the normal mode. (Refer to Section 4.5)

8.2.3 "ERR" LED flickers

Table 8.4 "ERR" LED flickers

Check Item	Remedy
Check whether the switch 5 of the intelligent function module switches is "other than 0".	Set 0 for the switch 5 of the intelligent function module switch setting of GX Developer. (Refer to Section 4.5)

8.2.4 "ERR" LED is lit

Table 8.5 "ERR" LED is lit

Check Item	Remedy
Check for an error.	Check the error code and take the action given in Section 8.1.

8.2.5 "ALM" LED flickers

Table 8.6 "ALM" LED flickers

Check Item	Remedy
Check for wire disconnection.	Check Disconnection detection signal (XC) (Q68TD-G-H02 only) and Disconnection state monitor signal (XC) (Q68TD-G-H01 only) and take the action given in Section 8.2.7.

8.2.6 "ALM" LED is lit

Table 8.7 "ALM" LED is lit

Check Item	Remedy
Check for a warning output.	Check the warning output flag (Un/G47, Un/G48)

8.2.7 When Disconnection detection signal (XC) (Q68TD-G-H02 only) or Disconnection state monitor signal (XC) (Q68TD-G-H01 only) turns on

Table 8.8 When Disconnection detection signal (Disconnection state monitor signal) turns on

Check Item	Remedy
Check whether the thermocouple or compensation conductor is connected incompletely or not.	Connect the thermocouple and compensation conductor correctly.
Check the connected thermocouple, compensation conductor or cable for wire disconnection.	Make continuity check on the thermocouple, compensation conductor or cable and change the thermocouple, compensation conductor or cable if its wire is disconnected.
Check whether the channel where no thermocouple is connected is set to conversion enable.	Check the channels which are set to conversion enable and the channels where thermocouples are connected, and set to conversion enable correctly.

8.2.8 Measured temperature value cannot be read

Table 8.9 Measured temperature value cannot be read

Check Item	Remedy
Check whether the conversion enable/disable setting (Un/G0) of the used channel has been set for conversion disable.	Set it for conversion enable in sequence program or GX Configurator-TI.
Check whether the programmable controller CPU is set for STOP.	Set the programmable controller CPU for RUN.

8.2.9 Measured temperature value is abnormal

Table 8.10 Measured temperature value is abnormal

Check Item	Remedy
Check whether the connected thermocouple or compensation conductor differs from the setting.	Set the thermocouple type connected to the switch 1 or 2 in the intelligent function module switch setting of GX Developer.
Check whether the connected thermocouple or compensation conductor is connected reversely.	Connect the thermocouple or compensation conductor correctly.
Check the wiring.	Refer to Section 4.4.2 (1) Wiring procedure, and wire cables and compensating lead wires correctly.
Check for noise in the thermocouple input.	Check influence from the ground and adjacent devices, and take action to prevent noise.
Check the cold junction temperature compensation resistor (RTD) for making cold junction temperature compensation for wire disconnection or disconnection from the relay terminal block.	Check that the cold junction temperature compensation resistor (RTD) is connected to the relay terminal block and there is continuity, and if not, connect or change the cold junction temperature compensation resistor (RTD).
Check whether the cold junction temperature compensation yes/no setting is correct.	Set the switch 4 to the correct position in the intelligent function module switch setting of GX Developer. (Refer to Section 4.5.)
Check whether conversion is made with the other thermocouple set after setting of the offset/gain value	Make offset/gain setting again after changing the thermocouple.
Check whether wiring between the module and terminal block is correct.	Check that wiring between the module and terminal block is performed correctly.
The Q68TD-G-H01 module was mounted in the limited position in the system using the power supply module of the Q63P, Q63RP, Q64P or Q64RP.	Refer to Section 2.1 (2) Restrictions on mountable slot position in which the module can be installed.
Check whether the effect of temperature error due to wiring resistance of a thermocouple is large.	Check the wiring resistance value of the thermocouple and calculate the temperature error in the system. (Refer to Section 3.1(2)) If the error is large, it may cause a change of the measured temperature value. Correct the measured temperature value by the offset/gain setting. (Refer to Section 4.6.)

POINT

The module may be faulty if the measured temperature values cannot be read after proper corrective actions have been taken according to the above check items. Please consult your local Mitsubishi representative.

8.2.10 Checking the Q68TD-G-H02(H01) status using GX Developer system monitor

When the Q68TD-G-H02(H01) detail information is selected in GX Developer system monitor, error code can be checked.

(1) Operating GX Developer

[Diagnostics] → [System monitor] → Select "Q68TD-G-H01" or "Q68TD-G-H02" →

Module's Detailed Information...

(2) Module Detail Information

(a) Checking the function version and product information

The function version and product information of the Q68TD-G-H02(H01) is displayed in the product information field.

(b) Checking the error code

The error code stored in the error code (Un\G19) of the Q68TD-G-H02(H01) is displayed in the Present Error field.

(When the **Error History** button is pressed, the contents displayed in the Present Error field are displayed in the No. 1 field.)

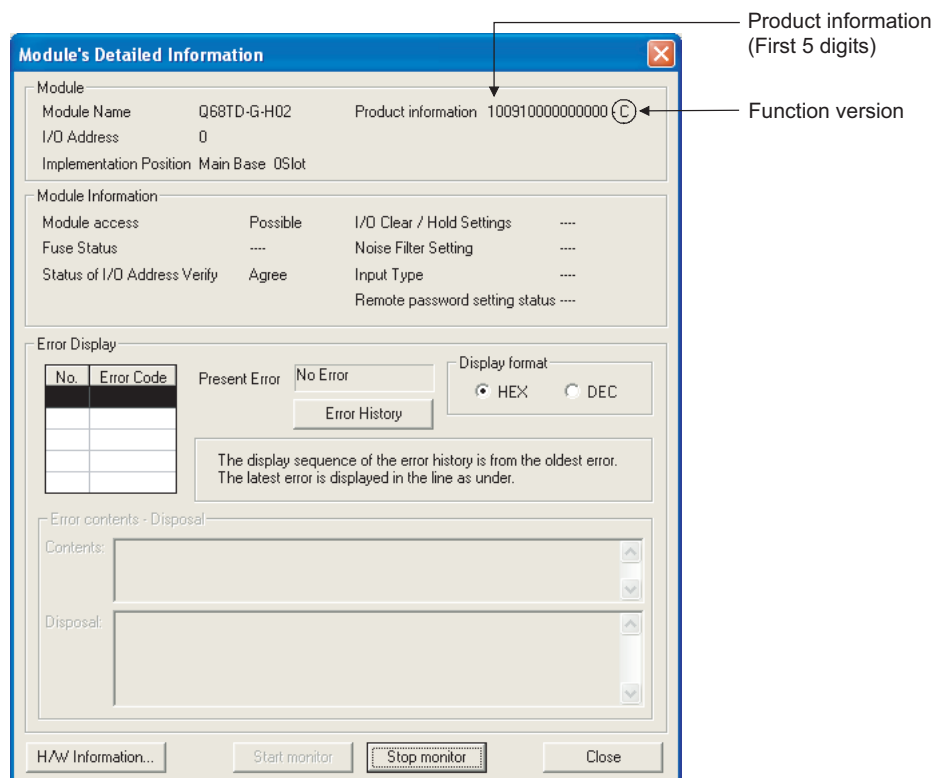

Figure 8.1 Module detail information screen (Q68TD-G-H02 only)

(3) H/W information

(a) H/W LED information

The LED ON status is displayed.

Table 8.11 LED ON status

No.	LED name	Status
1	RUN LED	0000 _H : Indicates that LED is unlit.
2	ERR. LED	0001 _H : Indicates that LED is lit
3	ALM LED	Alternate indication between 0000 _H and 0001 _H : Indicates that LED flickers

(b) H/W SW information

The status of the intelligent function module switch setting is displayed.

Table 8.12 Switch setting status for intelligent function module

No.	Switch setting for intelligent function module
RANGE1	Switch 1
RANGE2	Switch 2
RANGE3	Switch 3
MODE	Switch 4
-	Switch 5

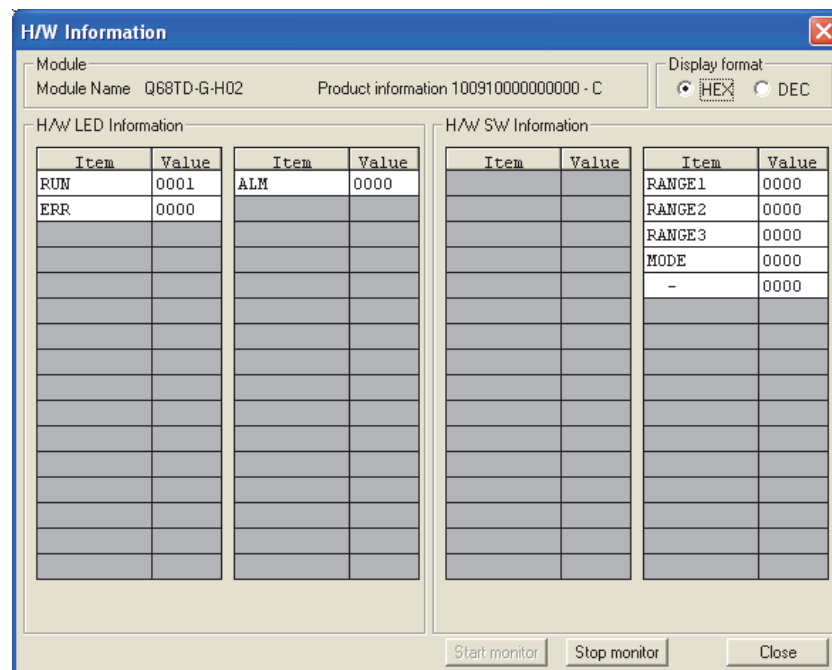

Figure 8.2 H/W information screen

APPENDICES

Appendix 1 Differences of Q68TD-G-H02, Q68TD-G-H01, Q64TD, Q64TDV-GH

(1) Differences

Table APPX.1 Differences of Q68TD-G-H02, Q68TD-G-H01, Q64TD, Q64TDV-GH

Item	Q68TD-G-H02	Q68TD-G-H01	Q64TD	Q64TDV-GH
Number of channels	8 channels	8 channels	4 channels	4 channels
Conversion speed	640ms/8 channels	320ms/8channels	40ms/channel	(20ms/channel) × 3
Disconnection detection function.	Available	Not available (Disconnection monitor function is available.)	Available	Available
Disconnection detection time	Within 640ms	-	40ms × Number of conversion-enabled channels	20ms × Number of conversion-enabled channels) × 3
Time until Disconnection state monitor signal turns on	-	Within 11s	-	-
Cold junction compensation resistor disconnection detection function	Available	Available	Not available	Not available
Micro voltage input	Not available	Not available	Not available	Available
Restriction	-	Restriction of applicable slot position is available × Refer to Section 2.1 (2))	-	-
Internal current consumption (5VDC)	0.65A	0.49A	0.50A	0.50A
External dimensions	102(H) × 27.4(W) × 130(D)mm	98(H) × 27.4(W) × 90(D)mm	98(H) × 27.4(W) × 112(D)mm	98(H) × 27.4(W) × 112(D)mm

(2) Application

Table APPX.2 Differences of module types

Q68TD-G-H02/Q68TD-G-H01	Q64TD/Q64TDV-GH
<ul style="list-style-type: none"> •Used to connect many thermocouples. •For monitoring application such as monitoring a temperature. 	<ul style="list-style-type: none"> •Used to measure a temperature in a relatively fast speed with the less number of channels. •Control applications for temperature. Available for monitoring a temperature or monitoring application.

Appendix 2 Dedicated Instruction

Appendix 2.1 Dedicated Instruction List and Available Device

(1) Dedicated instruction list

The following table lists the dedicated instructions that can be used with the Q68TD-G-H02(H01) converter modules.

Table APPX.3 Dedicated instruction list

Instruction	Description	Reference section
G(P).OFFGAN	Switches to the offset/gain setting mode. Switches to the normal mode.	Appendix 2.2
G(P).OGLOAD	Reads the offset/gain values of the user range setting to the CPU.	Appendix 2.3
G(P).OGSTOR	Restores the offset/gain values of the user range setting stored in the CPU to the Q68TD-G-H02(H01) converter module.	Appendix 2.4

POINT

When the module is mounted to a MELSECNET/H remote station, the dedicated instructions cannot be used.

(2) Available devices

The following devices are available for the dedicated instructions:

Table APPX.4 Available devices

Internal devices		File register	Constant
Bit*1	Word		
X, Y, M, L, F, V, B	T, ST, C, D, W	R, ZR	-

* 1 Word device bit designation can be used as bit data.

Word device bit designation is done by designating , .
(Designation of bit numbers is done in hexadecimal.)

For example, bit 10 of D0 is designated as .

However, there can be no bit designation for timers (T), retentive timers (ST) and counters (C).

Appendix 2.2 G(P).OFFGAN

Switches the mode of the Q68TD-G-H02(H01) converter module. (Normal mode to offset/gain setting mode, offset/gain setting mode to normal mode)

Table APPX.5 Available device list

Set data	Usable devices									
	Internal device (System, user)		File register	Link direct device J□\□		Intelligent function module U□\G□	Index register Z□	Constant		Other
	Bit	Word		Bit	Word			K, H	\$	
(S)	-	○					-	-	-	



Figure APPX.1 How to write a program

Table APPX.6 Set data list

Set data	Description	Setting range	Data type
Un	Start I/O number of the module	0 to FEH	Binary 16 bits
(S)	Mode switching 0: Switching to normal mode 1: Switching to offset/gain setting mode The setting of any other value results in "switching to offset/gain setting mode".	0, 1	Binary 16 bits

(1) Function

Switches the mode of the Q68TD-G-H02(H01) converter module

- Normal mode to offset/gain setting mode (the offset/gain setting mode status flag (XA) turns ON)
- Offset/gain setting mode to normal mode (the offset/gain setting mode status flag (XA) turns OFF)

POINT

- (1) When the offset/gain setting mode is switched to the normal mode, Module ready (X0) turns from OFF to ON.
Note that initial setting processing will be executed if there is a sequence program that makes initial setting when Module ready (X0) turns ON.
- (2) When the normal mode is switched to the offset/gain setting mode, all channels set to temperature conversion disable.
Set the channels where offset/gain setting will be made for conversion enable and turn ON the operating condition setting request (Y9).
- (3) When the offset/gain setting mode is switched to the normal mode, restore the normal mode status prior to switching to the offset/gain setting mode and start temperature conversion.

(2) Operation error

No errors.

(3) Program example

The following program is designed to switch the Q68TD-G-H02(H01) converter module mounted in the position of I/O number X/Y0 to X/YF to the offset/gain setting mode when M10 is turned ON, and to return it to the normal mode when M10 is turned OFF.

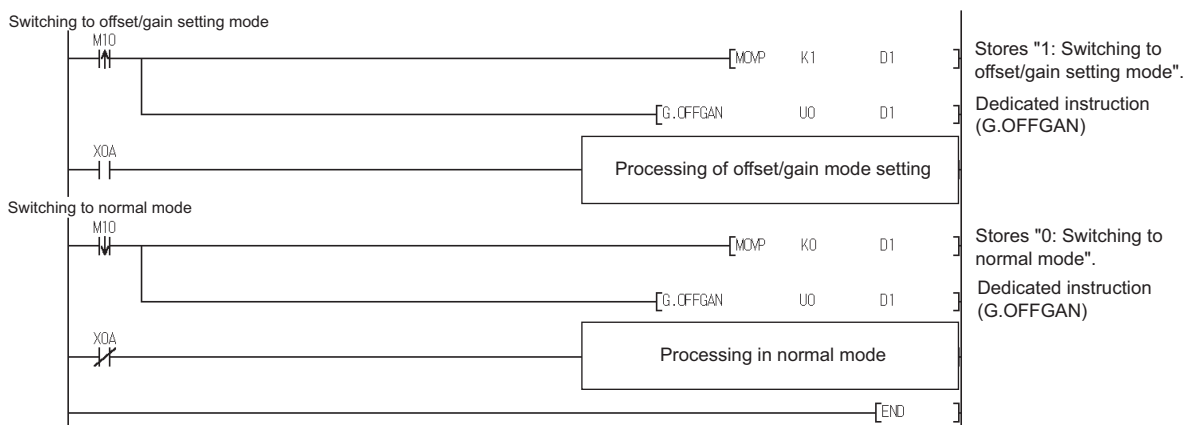

Figure APPX.2 Program example

Appendix 2.3 G(P).OGLOAD

Reads the offset/gain values of the user range setting of the Q68TD-G-H02(H01) converter module to the CPU.

Table APPX.7 Available device List

Set data	Usable devices									
	Internal device (System, user)		File register	Link direct device J□\□		Intelligent function module U□\G□	Index register Z□	Constant		Other
	Bit	Word		Bit	Word			K, H	\$	
(S)	-	○						-	-	-
(D)		○						-	-	-

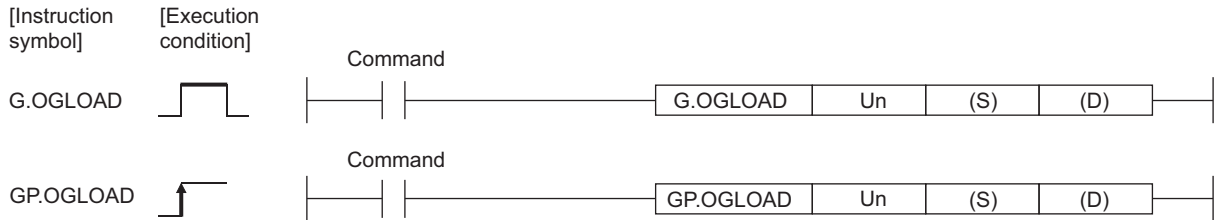

Figure APPX.3 How to write a program

Table APPX.8 Set data list

Set data	Description	Setting range	Data type
Un	Start I/O number of the module	0 to FEH	Binary 16 bits
(S)	Start number of the device in which control data is stored.	Within the range of the specified device	Device name
(D)	Device that is turned ON 1 scan on completion of dedicated instruction processing. (D) + 1 also turns ON at an abnormal completion.	Within the range of the specified device	Bit

Table APPX.9 Control data (1/2)*1

Device	Item	Set data	Setting range	Set by
(S)	System area	-	-	-
(S) + 1	Completion status	Stores the status when the instruction is complete. 0 : Normal completion Other than 0: Abnormal completion	-	System
(S) + 2	System area	-	-	-
(S) + 3				
(S) + 4	CH1 Factory default offset value	-	-	System
(S) + 5	CH1 Factory default gain value	-	-	System
(S) + 6	CH1 User range settings offset value	-	-	System
(S) + 7	CH1 User range settings gain value	-	-	System
(S) + 8	CH1 User range settings thermal EMF offset value (L)	-	-	System
(S) + 9	CH1 User range settings thermal EMF offset value (H)	-	-	System
(S) + 10	CH1 User range settings thermal EMF gain value (L)	-	-	System
(S) + 11	CH1 User range settings thermal EMF gain value (H)	-	-	System
(S) + 12	CH2 Factory default offset value	-	-	System
(S) + 13	CH2 Factory default gain value	-	-	System
(S) + 14	CH2 User range settings offset value	-	-	System
(S) + 15	CH2 User range settings gain value	-	-	System
(S) + 16	CH2 User range settings thermal EMF offset value (L)	-	-	System
(S) + 17	CH2 User range settings thermal EMF offset value (H)	-	-	System
(S) + 18	CH2 User range settings thermal EMF gain value (L)	-	-	System
(S) + 19	CH2 User range settings thermal EMF gain value (H)	-	-	System
(S) + 20	CH3 Factory default offset value	-	-	System
(S) + 21	CH3 Factory default gain value	-	-	System
(S) + 22	CH3 User range settings offset value	-	-	System
(S) + 23	CH3 User range settings gain value	-	-	System
(S) + 24	CH3 User range settings thermal EMF offset value (L)	-	-	System
(S) + 25	CH3 User range settings thermal EMF offset value (H)	-	-	System
(S) + 26	CH3 User range settings thermal EMF gain value (L)	-	-	System
(S) + 27	CH3 User range settings thermal EMF gain value (H)	-	-	System
(S) + 28	CH4 Factory default offset value	-	-	System
(S) + 29	CH4 Factory default gain value	-	-	System
(S) + 30	CH4 User range settings offset value	-	-	System
(S) + 31	CH4 User range settings gain value	-	-	System
(S) + 32	CH4 User range settings thermal EMF offset value (L)	-	-	System
(S) + 33	CH4 User range settings thermal EMF offset value (H)	-	-	System
(S) + 34	CH4 User range settings thermal EMF gain value (L)	-	-	System
(S) + 35	CH4 User range settings thermal EMF gain value (H)	-	-	System

* 1 Setting is not necessary. If setting is made, the offset/gain values will not be read properly.

Table APPX.9 Control data (2/2)*1

Device	Item	Set data	Setting range	Set by
(S) + 36	CH5 Factory default offset value	-	-	System
(S) + 37	CH5 Factory default gain value	-	-	System
(S) + 38	CH5 User range settings offset value	-	-	System
(S) + 39	CH5 User range settings gain value	-	-	System
(S) + 40	CH5 User range settings thermal EMF offset value (L)	-	-	System
(S) + 41	CH5 User range settings thermal EMF offset value (H)	-	-	System
(S) + 42	CH5 User range settings thermal EMF gain value (L)	-	-	System
(S) + 43	CH5 User range settings thermal EMF gain value (H)	-	-	System
(S) + 44	CH6 Factory default offset value	-	-	System
(S) + 45	CH6 Factory default gain value	-	-	System
(S) + 46	CH6 User range settings offset value	-	-	System
(S) + 47	CH6 User range settings gain value	-	-	System
(S) + 48	CH6 User range settings thermal EMF offset value (L)	-	-	System
(S) + 49	CH6 User range settings thermal EMF offset value (H)	-	-	System
(S) + 50	CH6 User range settings thermal EMF gain value (L)	-	-	System
(S) + 51	CH6 User range settings thermal EMF gain value (H)	-	-	System
(S) + 52	CH7 Factory default offset value	-	-	System
(S) + 53	CH7 Factory default gain value	-	-	System
(S) + 54	CH7 User range settings offset value	-	-	System
(S) + 55	CH7 User range settings gain value	-	-	System
(S) + 56	CH7 User range settings thermal EMF offset value (L)	-	-	System
(S) + 57	CH7 User range settings thermal EMF offset value (H)	-	-	System
(S) + 58	CH7 User range settings thermal EMF gain value (L)	-	-	System
(S) + 59	CH7 User range settings thermal EMF gain value (H)	-	-	System
(S) + 60	CH8 Factory default offset value	-	-	System
(S) + 61	CH8 Factory default gain value	-	-	System
(S) + 62	CH8 User range settings offset value	-	-	System
(S) + 63	CH8 User range settings gain value	-	-	System
(S) + 64	CH8 User range settings thermal EMF offset value (L)	-	-	System
(S) + 65	CH8 User range settings thermal EMF offset value (H)	-	-	System
(S) + 66	CH8 User range settings thermal EMF gain value (L)	-	-	System
(S) + 67	CH8 User range settings thermal EMF gain value (H)	-	-	System

* 1 Setting is not necessary. If setting is made, the offset/gain values will not be read properly.

(1) Functions

(a) Reads the offset/gain values of the user range setting of the Q68TD-G-H02(H01) converter module to the CPU.

(b) There are two types of interlock signals for the G(P).OGLOAD instruction: the completion device (D) and the status display device at completion (D) + 1.

1) Completion device

Turns ON in the END processing of the scan where the G(P).OGLOAD instruction is completed, and turns OFF in the next END processing.

2) Status display device at completion

Turns ON and OFF depending on the completion status of the G(P).OGLOAD instruction.

Normal completion : Stays OFF and does not change.

Abnormal completion: Turns ON in the END processing of the scan where the G(P).OGLOAD instruction is completed, and turns OFF in the next END processing.

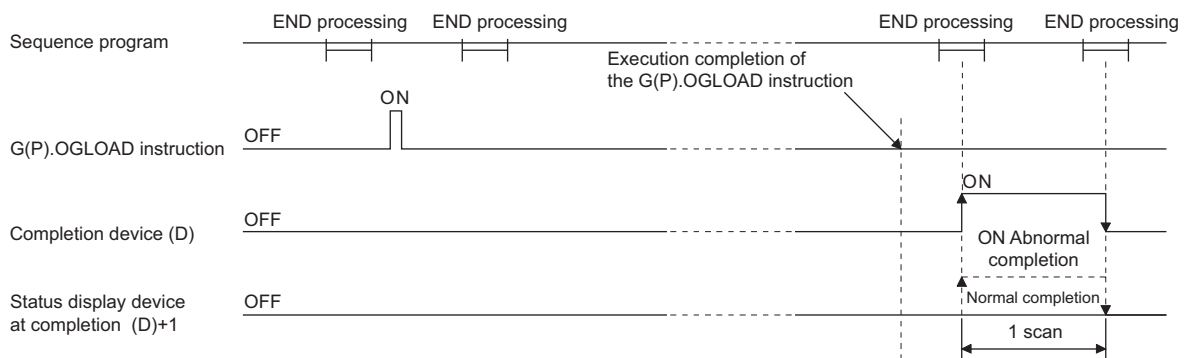

Figure APPX.4 Timing diagram

(2) Operation error

No errors.

(3) Program example

The following program is designed to read the offset/gain values of the Q68TD-G-H02(H01) converter module mounted in the position of I/O number X/Y0 to X/YF when M11 is turned ON.

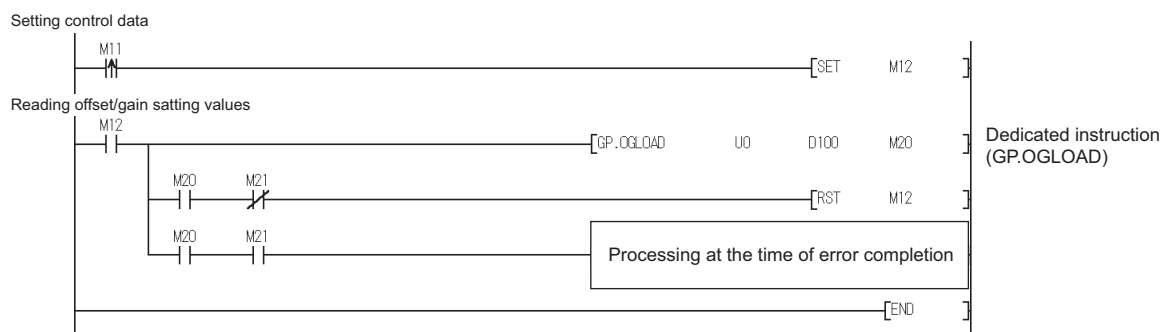

Figure APPX.5 Program example

Appendix 2.4 G(P).OGSTOR

Restores the offset/gain values of the user range setting stored in the CPU to the Q68TD-G-H02(H01) converter module.

Table APPX.10 Available device List

Set data	Usable devices									
	Internal device (System, user)		File register	Link direct device J□\□		Intelligent function module U□\G□	Index register Z□	Constant		Other
	Bit	Word		Bit	Word			K, H	\$	
(S)	-	○						-	-	-
(D)		○						-	-	-

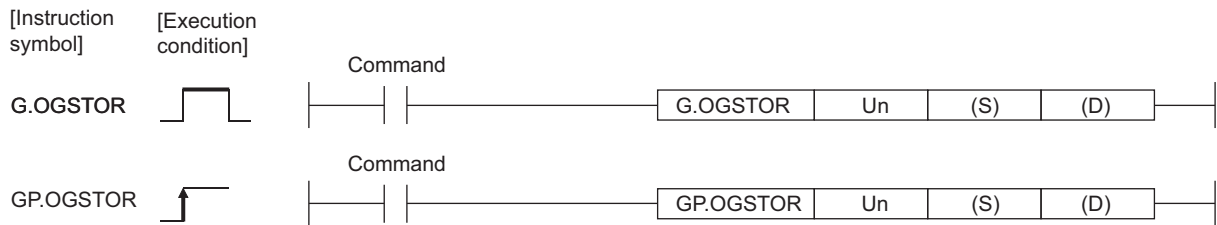

Figure APPX.6 How to write a program

Table APPX.11 Set data list

Set data	Description	Setting range	Data type
Un	Start I/O number of the module	0 to FEH	Binary 16 bits
(S) ^{*1}	Start number of the device in which control data is stored.	Within the range of the specified device	Device name
(D)	Device that is turned ON 1 scan on completion of dedicated instruction processing. (D) + 1 also turns ON at an abnormal completion.	Within the range of the specified device	Bit

* 1 When executing the G.OGLOAD instruction, specify the device designated in (S). Do not change the data read with the G.OGLOAD instruction. If it is changed, normal operation cannot be guaranteed.

Table APPX.12 Control data (1/2)

Device	Item	Set data	Setting range	Set by
(S)	System area	-	-	-
(S) + 1	Completion status	Stores the status when the instruction is complete. 0 : Normal completion Other than 0: Abnormal completion	-	System
(S) + 2	System area	-	-	-
(S) + 3				
(S) + 4	CH1 Factory default offset value	-	-	System
(S) + 5	CH1 Factory default gain value	-	-	System
(S) + 6	CH1 User range settings offset value	-	-	System
(S) + 7	CH1 User range settings gain value	-	-	System
(S) + 8	CH1 User range settings thermal EMF offset value (L)	-	-	System
(S) + 9	CH1 User range settings thermal EMF offset value (H)	-	-	System
(S) + 10	CH1 User range settings thermal EMF gain value (L)	-	-	System
(S) + 11	CH1 User range settings thermal EMF gain value (H)	-	-	System
(S) + 12	CH2 Factory default offset value	-	-	System
(S) + 13	CH2 Factory default gain value	-	-	System
(S) + 14	CH2 User range settings offset value	-	-	System
(S) + 15	CH2 User range settings gain value	-	-	System
(S) + 16	CH2 User range settings thermal EMF offset value (L)	-	-	System
(S) + 17	CH2 User range settings thermal EMF offset value (H)	-	-	System
(S) + 18	CH2 User range settings thermal EMF gain value (L)	-	-	System
(S) + 19	CH2 User range settings thermal EMF gain value (H)	-	-	System
(S) + 20	CH3 Factory default offset value	-	-	System
(S) + 21	CH3 Factory default gain value	-	-	System
(S) + 22	CH3 User range settings offset value	-	-	System
(S) + 23	CH3 User range settings gain value	-	-	System
(S) + 24	CH3 User range settings thermal EMF offset value (L)	-	-	System
(S) + 25	CH3 User range settings thermal EMF offset value (H)	-	-	System
(S) + 26	CH3 User range settings thermal EMF gain value (L)	-	-	System
(S) + 27	CH3 User range settings thermal EMF gain value (H)	-	-	System
(S) + 28	CH4 Factory default offset value	-	-	System
(S) + 29	CH4 Factory default gain value	-	-	System
(S) + 30	CH4 User range settings offset value	-	-	System
(S) + 31	CH4 User range settings gain value	-	-	System
(S) + 32	CH4 User range settings thermal EMF offset value (L)	-	-	System
(S) + 33	CH4 User range settings thermal EMF offset value (H)	-	-	System
(S) + 34	CH4 User range settings thermal EMF gain value (L)	-	-	System
(S) + 35	CH4 User range settings thermal EMF gain value (H)	-	-	System

Table APPX.12 Control data (2/2)

Device	Item	Set data	Setting range	Set by
(S) + 36	CH5 Factory default offset value	-	-	System
(S) + 37	CH5 Factory default gain value	-	-	System
(S) + 38	CH5 User range settings offset value	-	-	System
(S) + 39	CH5 User range settings gain value	-	-	System
(S) + 40	CH5 User range settings thermal EMF offset value (L)	-	-	System
(S) + 41	CH5 User range settings thermal EMF offset value (H)	-	-	System
(S) + 42	CH5 User range settings thermal EMF gain value (L)	-	-	System
(S) + 43	CH5 User range settings thermal EMF gain value (H)	-	-	System
(S) + 44	CH6 Factory default offset value	-	-	System
(S) + 45	CH6 Factory default gain value	-	-	System
(S) + 46	CH6 User range settings offset value	-	-	System
(S) + 47	CH6 User range settings gain value	-	-	System
(S) + 48	CH6 User range settings thermal EMF offset value (L)	-	-	System
(S) + 49	CH6 User range settings thermal EMF offset value (H)	-	-	System
(S) + 50	CH6 User range settings thermal EMF gain value (L)	-	-	System
(S) + 51	CH6 User range settings thermal EMF gain value (H)	-	-	System
(S) + 52	CH7 Factory default offset value	-	-	System
(S) + 53	CH7 Factory default gain value	-	-	System
(S) + 54	CH7 User range settings offset value	-	-	System
(S) + 55	CH7 User range settings gain value	-	-	System
(S) + 56	CH7 User range settings thermal EMF offset value (L)	-	-	System
(S) + 57	CH7 User range settings thermal EMF offset value (H)	-	-	System
(S) + 58	CH7 User range settings thermal EMF gain value (L)	-	-	System
(S) + 59	CH7 User range settings thermal EMF gain value (H)	-	-	System
(S) + 60	CH8 Factory default offset value	-	-	System
(S) + 61	CH8 Factory default gain value	-	-	System
(S) + 62	CH8 User range settings offset value	-	-	System
(S) + 63	CH8 User range settings gain value	-	-	System
(S) + 64	CH8 User range settings thermal EMF offset value (L)	-	-	System
(S) + 65	CH8 User range settings thermal EMF offset value (H)	-	-	System
(S) + 66	CH8 User range settings thermal EMF gain value (L)	-	-	System
(S) + 67	CH8 User range settings thermal EMF gain value (H)	-	-	System

(1) Functions

(a) Restores the offset/gain values of the user range setting stored in the CPU to the Q68TD-G-H02(H01) converter module.

(b) There are two types of interlock signals for the G(P).OGSTOR instruction: the completion device (D) and the status display device at completion (D) + 1.

1) Completion device

Turns ON in the END processing of the scan where the G(P).OGSTOR instruction is completed, and turns OFF in the next END processing.

2) Status display device at completion

Turns ON and OFF depending on the completion status of the G(P).OGSTOR instruction.

Normal completion : Stays OFF and does not change.

Abnormal completion : Turns ON in the END processing of the scan where the G(P).OGLOAD instruction is completed, and turns OFF in the next END processing.

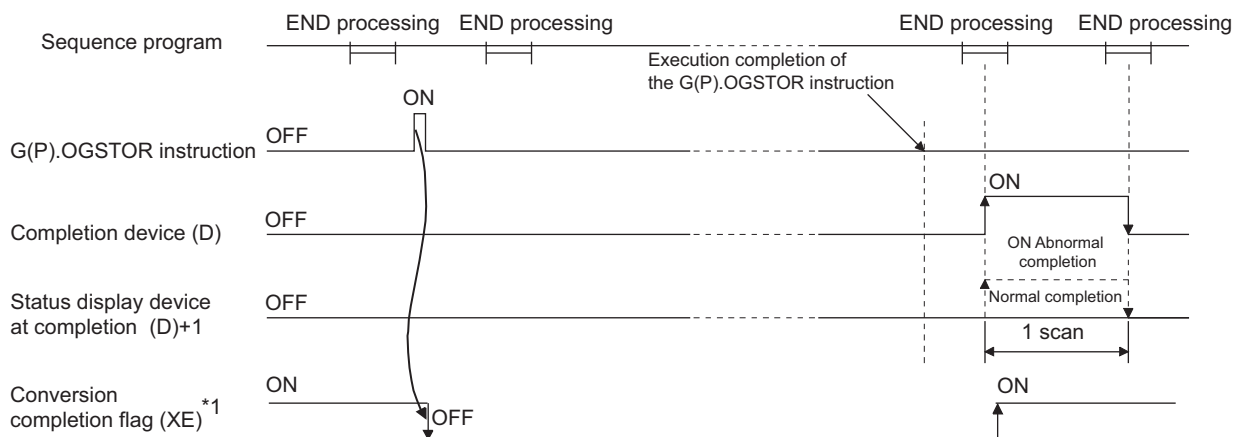

Figure APPX.7 Timing diagram

* 1 When the G(P).OGSTOR instruction is executed, conversion is not performed. After the completion device (D) turns ON, conversion starts, the conversion value is stored into the buffer memory, and the conversion completion flag (XE) turns ON.

(c) When the offset/gain values are restored, the reference accuracy falls to about less than 1/3 times of the previous accuracy.

(2) Operation error

In any of the following cases, an error occurs and the corresponding error code is stored into the completion status area (S)+1.

Table APPX.13 Dedicated instruction error list

Error code	Case resulting in operation error
161	The G(P).OGSTOR instruction was executed in the offset/gain setting mode.
162	The G(P).OGSTOR instruction was executed consecutively.
163	The G(P).OGSTOR instruction was executed for the model that differs from the model for which the G(P).OGLOAD instruction had been executed.

(3) Program example

The following program is designed to read the offset/gain values of the Q68TD-G-H02(H01) converter module mounted in the position of I/O number X/Y0 to X/YF when M11 is turned ON.

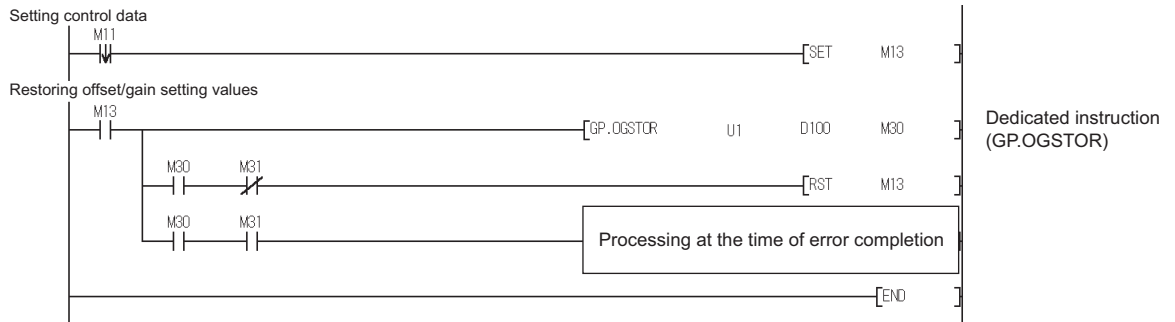
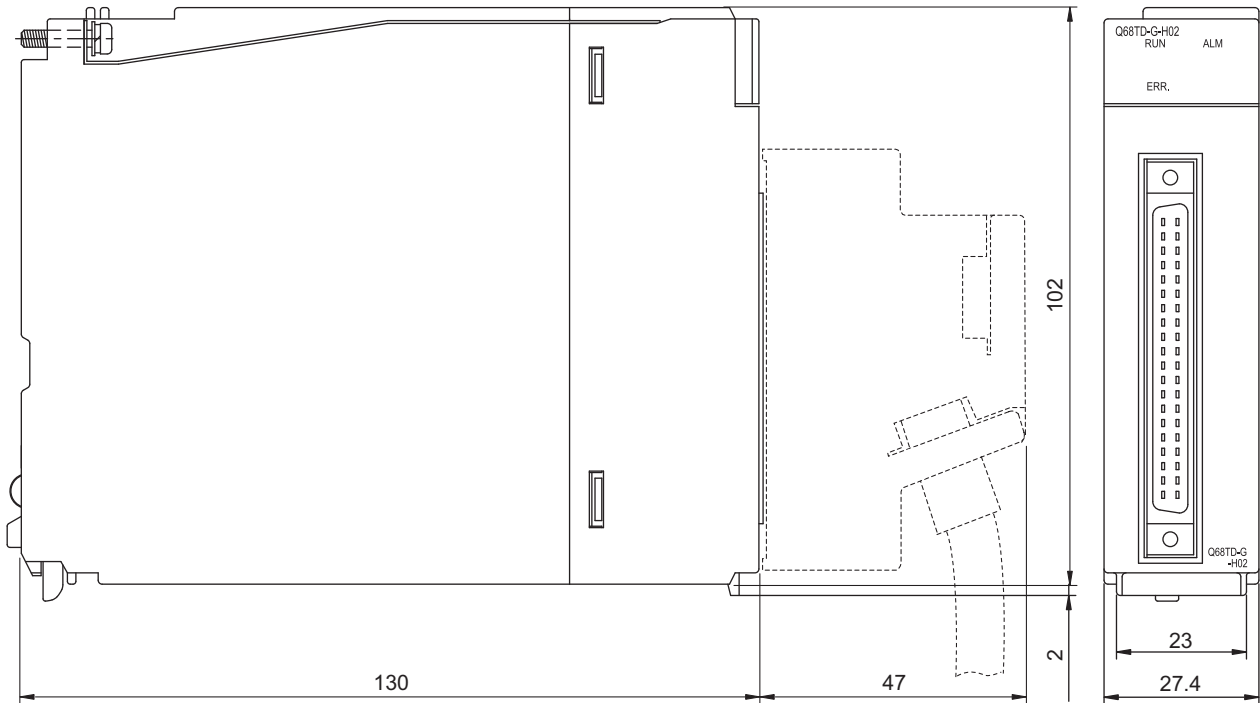

Figure APPX.8 Program example

Appendix 3 External Dimension Diagram

(1) Q68TD-G-H02



unit: mm

(2) Q68TD-G-H01

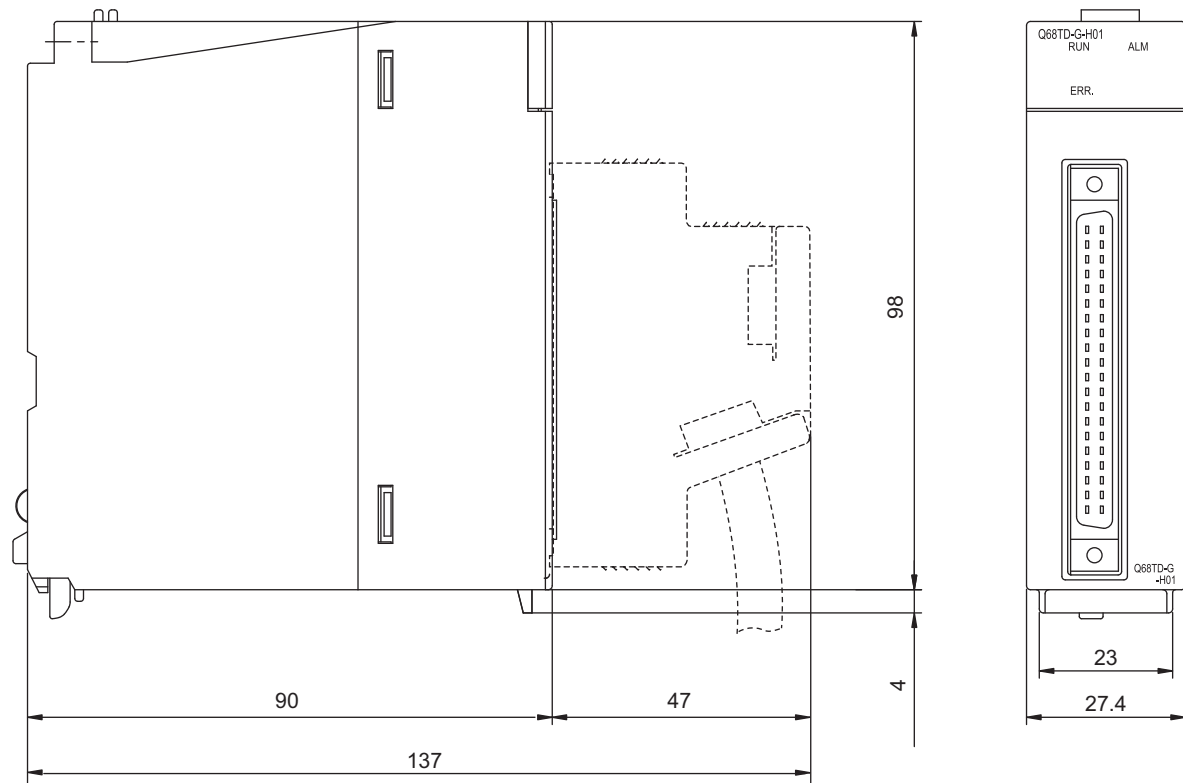

unit: mm

INDEX

[A]

- About use of the Q68TD-G-H02 (H01) with the Q12PRH/Q25PRHCPU 2-4
- Accuracy 3-1
- Applicable systems 2-1
- Auto refresh settings 5-15
- Averaging processing 3-8
- Averaging processing selection 3-43

[B]

- Buffer memory 3-30
- Buffer memory assignment 3-30

[C]

- Channel change completion flag 3-25
- Channel change request 3-29
- Checking the Q68TD-G-H02(H01) status using GX Developer system monitor 8-7
- Cold junction compensation setting status 3-45
- Cold junction temperature compensation resistor disconnection detection function 3-21
- Cold junction temperature compensation with/without setting 4-19
- Common utility package operations 5-7
- Compatibility with online module change 2-3
- Conversion completion flag 3-27,3-40
- Conversion enable/disable setting 3-38
- Conversion setting for disconnection detection ... 3-59
- Conversion setting for disconnection detection function (Q68TD-G-H02 only) 3-12
- Conversion setting value for disconnection detection 3-61
- Conversion setting value for disconnection state 3-61
- Conversion speed 3-1,3-7

[D]

- Dedicated instruction APPX-2
- Dedicated instruction list and available device APPX-2
- Differences of Q68TD-G-H02, Q68TD-G-H01, Q64TD, Q64TDV-GH APPX-1
- Disconnection detection flag 3-48
- Disconnection detection signal 3-25
- Disconnection state conversion setting 3-60
- Disconnection state conversion setting function (Q68TD-G-H01 only) 3-14
- Disconnection state monitor flag 3-50
- Disconnection state monitor signal 3-25
- Down scale A-12

[E]

- EMC A-11
- Error clear request 3-29

- Error code 3-42
- Error code list 8-1
- Error Flag 3-27
- External dimension diagram APPX-14
- External wiring 4-8

[F]

- Factory default offset/gain values, user range settings offset/gain values 3-62
- Features 1-2
- Fixing module with module fixing bracket 4-2
- Function list 3-5

[G]

- GX Configurator-TI 2-3
- GX Developer 2-3
- G(P).OFFGAN APPX-3
- G(P).OGLOAD APPX-5
- G(P).OGSTOR APPX-9

[H]

- Handling precautions 4-1,5-3
- How to check the function version, product information and software version 2-5

[I]

- Initial setting 5-13
- Installing and uninstalling the utility package 5-3
- Isolation specifications 3-1
- I/O signal details 3-23
- I/O signal list 3-22

[L]

- Low voltage directives A-11

[M]

- Measured temperature value 3-41
- Measured temperature value cannot be read 8-5
- Measured temperature value is abnormal 8-6
- Mode switching setting 3-58
- Module ready 3-23
- Monitoring/test 5-17
- Monitor/test screen 5-17
- Moving average 3-9

[N]

- Number of analog input points 3-1
- Number of channels 3-1
- Number of I/O points occupied 3-1

[O]

- Offset/gain setting 4-13
- Offset/gain setting mode 3-44

Offset/gain setting mode status flag	3-24
Offset/gain setting operation	5-20
Offset/gain temperature setting values	3-45
OMC (online module change) refresh data	5-23
Online module change	7-1
Online module change conditions	7-2
Online module change operations	7-3
Online module change procedure	7-4
Operating condition setting request	3-28
Operating environment	5-5
Operation condition setting completion flag	3-23
Operation overview	5-9
Overview	1-1

[P]

Part names	4-4
Performance specifications	3-1
Precautions for online module change	7-37
Primary delay filter	3-10
Process alarm	3-16
Process alarm upper/lower limit values	3-56
Product lineup	A-14
Program example when Configurator-TI	6-8
Program example when GX Configurator-TI is not used	6-13,6-24
Program example when GX Configurator-TI is used	6-20
Programming	6-1
Programming procedure	6-2

[Q]

Q68TD-G-H01	A-12
Q68TD-G-H02	A-12
Q68TD-G-H02(H01)	A-12

[R]

Range reference table (Q68TD-G-H01)	7-35
Range reference table (Q68TD-G-H02)	7-33
Rate alarm	3-17
Rate alarm upper/lower limit values	3-57
Rate alarm warning detection period	3-57
Restrictions on mountable slot position	2-1

[S]

Sampling period	3-1,3-7
Sampling processing	3-7
Scaling range upper/lower limit values	3-54
Scaling valid/invalid setting	3-53
Scaling value	3-52
Scaling width upper/lower limit values	3-55
Setting range 1, 2	3-42
Setting range 3	3-42
Setup and procedures before operation	4-1,4-3
Starting the intelligent function module utility	5-11
Support of the multiple CPU system	2-3
Supported software packages	2-3
Switch setting for intelligent function module	4-11
System configuration	2-1

[T]

Temperature conversion system	3-7
Thermocouple compliance standards	3-1
Time/count/moving average/time constant setting	3-39
Troubleshooting	8-1,8-4

[U]

Up scale	A-12
User range write request	3-28
Using programs in normal system configuration	6-4
Using programs on remote I/O network	6-17
Utility package (GX Configurator-TI)	5-1
Utility package functions	5-1
Utility package operation	5-7

[W]

Warning output enable/disable setting	3-46
Warning output flag	3-47
Warning output function	3-16
Warning output signal	3-26
When factory default is used and initial setting was made with GX Configurator-TI	7-4
When factory default is used and initial setting was made with sequence program	7-9
When user range setting is used and initial setting was made with GX Configurator-TI (other system is available)	7-13
When user range setting is used and initial setting was made with GX Configurator-TI (other system is unavailable)	7-18
When user range setting is used and initial setting was made with sequence program (other system is available)	7-23
When user range setting is used and initial setting was made with sequence program (other system is unavailable)	7-28
Wiring	4-7
Wiring precautions	4-7

Symbols

"ALM" LED flickers	8-5
"ALM" LED is lit	8-5
"ERR" LED flickers	8-4
"ERR" LED is lit	8-4
"RUN" LED flickers	8-4
"RUN" LED is extinguished	8-4

WARRANTY

Please confirm the following product warranty details before using this product.

1. Gratis Warranty Term and Gratis Warranty Range

If any faults or defects (hereinafter "Failure") found to be the responsibility of Mitsubishi occurs during use of the product within the gratis warranty term, the product shall be repaired at no cost via the sales representative or Mitsubishi Service Company.

However, if repairs are required onsite at domestic or overseas location, expenses to send an engineer will be solely at the customer's discretion. Mitsubishi shall not be held responsible for any re-commissioning, maintenance, or testing on-site that involves replacement of the failed module.

[Gratis Warranty Term]

The gratis warranty term of the product shall be for one year after the date of purchase or delivery to a designated place. Note that after manufacture and shipment from Mitsubishi, the maximum distribution period shall be six (6) months, and the longest gratis warranty term after manufacturing shall be eighteen (18) months. The gratis warranty term of repair parts shall not exceed the gratis warranty term before repairs.

[Gratis Warranty Range]

- (1) The range shall be limited to normal use within the usage state, usage methods and usage environment, etc., which follow the conditions and precautions, etc., given in the instruction manual, user's manual and caution labels on the product.
- (2) Even within the gratis warranty term, repairs shall be charged for in the following cases.
 1. Failure occurring from inappropriate storage or handling, carelessness or negligence by the user. Failure caused by the user's hardware or software design.
 2. Failure caused by unapproved modifications, etc., to the product by the user.
 3. When the Mitsubishi product is assembled into a user's device, Failure that could have been avoided if functions or structures, judged as necessary in the legal safety measures the user's device is subject to or as necessary by industry standards, had been provided.
 4. Failure that could have been avoided if consumable parts (battery, backlight, fuse, etc.) designated in the instruction manual had been correctly serviced or replaced.
 5. Failure caused by external irresistible forces such as fires or abnormal voltages, and Failure caused by force majeure such as earthquakes, lightning, wind and water damage.
 6. Failure caused by reasons unpredictable by scientific technology standards at time of shipment from Mitsubishi.
 7. Any other failure found not to be the responsibility of Mitsubishi or that admitted not to be so by the user.

2. Onerous repair term after discontinuation of production

- (1) Mitsubishi shall accept onerous product repairs for seven (7) years after production of the product is discontinued. Discontinuation of production shall be notified with Mitsubishi Technical Bulletins, etc.
- (2) Product supply (including repair parts) is not available after production is discontinued.

3. Overseas service

Overseas, repairs shall be accepted by Mitsubishi's local overseas FA Center. Note that the repair conditions at each FA Center may differ.

4. Exclusion of loss in opportunity and secondary loss from warranty liability

Regardless of the gratis warranty term, Mitsubishi shall not be liable for compensation to:

- (1) Damages caused by any cause found not to be the responsibility of Mitsubishi.
- (2) Loss in opportunity, lost profits incurred to the user by Failures of Mitsubishi products.
- (3) Special damages and secondary damages whether foreseeable or not, compensation for accidents, and compensation for damages to products other than Mitsubishi products.
- (4) Replacement by the user, maintenance of on-site equipment, start-up test run and other tasks.

5. Changes in product specifications

The specifications given in the catalogs, manuals or technical documents are subject to change without prior notice.

Microsoft, Windows, Windows Vista, Windows NT, Windows XP, Windows Server, Visio, Excel, PowerPoint, Visual Basic, Visual C++, and Access are either registered trademarks or trademarks of Microsoft Corporation in the United States, Japan, and other countries.

Intel, Pentium, and Celeron are either registered trademarks or trademarks of Intel Corporation in the United States and other countries.

Ethernet is a trademark of Xerox Corp.

All other company names and product names used in this manual are either trademarks or registered trademarks of their respective companies.

SPREAD

Copyright(C) 1996 FarPoint Technologies, Inc.

SH-080795ENG-D(1606)MEE

MODEL: Q68TD-G-H02-U-SY-E

MODEL CODE: 13JZ26

MITSUBISHI ELECTRIC CORPORATION

HEAD OFFICE : TOKYO BUILDING, 2-7-3 MARUNOUCHI, CHIYODA-KU, TOKYO 100-8310, JAPAN
NAGOYA WORKS : 1-14, YADA-MINAMI 5-CHOME, HIGASHI-KU, NAGOYA, JAPAN

When exported from Japan, this manual does not require application to the
Ministry of Economy, Trade and Industry for service transaction permission.

Specifications subject to change without notice.