

Mitsubishi Programmable Controller

MELSEC **Q** series

Channel Isolated High Resolution Analog-Digital Converter Module / Channel Isolated High Resolution Analog-Digital Converter Module (With Signal Conditioning Function) User's Manual

-Q64AD-GH
-Q62AD-DGH
-GX Configurator-AD (SW2D5C-QADU-E)

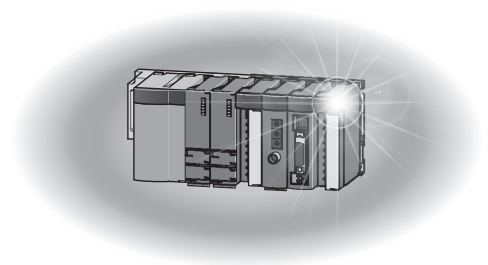

• SAFETY PRECAUTIONS •

(Always read these instructions before using this equipment.)

Before using this product, please read this manual and the relevant manuals introduced in this manual carefully and pay full attention to safety to handle the product correctly.

The instructions given in this manual are concerned with this product. For the safety instructions of the programmable controller system, please read the user's manual for the CPU module to use.

In this manual, the safety instructions are ranked as "⚠️ WARNING" and "⚠️ CAUTION".

 **WARNING**

Indicates that incorrect handling may cause hazardous conditions, resulting in death or severe injury.

 **CAUTION**

Indicates that incorrect handling may cause hazardous conditions, resulting in minor or moderate injury or property damage.

Note that the ⚠️ CAUTION level may lead to a serious consequence according to the circumstances. Always follow the instructions of both levels because they are important to personal safety.

Please store this manual in a safe place and make it accessible when required. Always forward it to the end user.

[DESIGN PRECAUTION]

WARNING

- Do not write data into the "system area" of the buffer memory of intelligent function modules. Also, do not use any "prohibited to use" signals as an output signal to an intelligent function module from the programmable controller CPU. Writing data into the "system area" or outputting a signal for "prohibited to use" may cause a programmable controller system malfunction.

CAUTION

- Do not bunch the control wires or communication cables with the main circuit or power wires, or install them close to each other. They should be installed 100mm(3.9inch) or more from each other. Not doing so could result in noise that may cause malfunction.

[INSTALLATION PRECAUTIONS]

CAUTION

- Use the programmable controller in an environment that meets the general specifications contained in the user's manual of the CPU module to use.
Using this programmable controller in an environment outside the range of the general specifications may cause electric shock, fire, malfunction, and damage to or deterioration of the product.
- While pressing the installation lever located at the bottom of module, insert the module fixing tab into the fixing hole in the base unit until it stops. Then, securely mount the module with the fixing hole as a supporting point.
Improper installation may result in malfunction, breakdown or the module coming loose and dropping.
Securely fix the module with screws if it is subject to vibration during use.
Tighten the screws within the range of specified torque.
If the screws are loose, it may cause the module to fallout, short circuits, or malfunction.
If the screws are tightened too much, it may cause damage to the screw and/or the module, resulting in fallout, short circuits or malfunction.
- Be sure to shut off all phases of the external power supply used by the system before mounting or removing the module.
Not doing so may cause damage to the module.
In the system where a CPU module supporting the online module change is used and on the MELSECNET/H remote I/O stations, modules can be replaced online (during energizing). However, there are some restrictions on replaceable modules and the replacement procedures are predetermined for each module.
For details, refer to the chapter of the online module change in this manual.
- Do not directly touch the conductive area or electronic components of the module.
Doing so may cause malfunction or failure in the module.

[WIRING PRECAUTIONS]

WARNING

- After installation and wiring, attach the included terminal cover to the module before turning it on for operation.
Failure to do so may result in electric shock.

[WIRING PRECAUTIONS]

CAUTION

- Always ground the FG terminal of the Q62AD-DGH.
Not doing so can cause an electric shock or malfunction.
- When turning on the power and operating the module after wiring is completed, always attach the terminal cover that comes with the product.
There is a risk of electric shock if the terminal cover is not attached.
- Use applicable solderless terminals and tighten them with the specified torque. If any solderless spade terminal is used, it may be disconnected when the terminal screw comes loose, resulting in failure.
- Tighten the terminal screws within the range of specified torque.
Undertightening can cause short circuit, fire, or malfunction.
Overtightening can damage the screw and/or module, resulting in drop, short circuit, or malfunction.
- Be careful not to let foreign matter such as sawdust or wire chips get inside the module.
They may cause fires, failure or malfunction.
- The top surface of the module is covered with protective film to prevent foreign objects such as cable offcuts from entering the module when wiring.
Do not remove this film until the wiring is complete.
Before operating the system, be sure to remove the film to provide adequate ventilation.

[STARTING AND MAINTENANCE PRECAUTIONS]

WARNING

- Do not touch the connector while the power is on.
Doing so may cause electric shock or malfunction.
- Be sure to switch off all phases of the externally supplied power used in the system before cleaning the module or retightening the terminal screws, connector mounting screws, and module fixing screws.
Not doing so may cause electric shock, or failure and malfunction of the module.
If the screws are loose, it may cause the module to fallout, short circuits, or malfunction.
If the screws are tightened too much, it may cause damages to the screws and/or the module, resulting in the module falling out, short circuits or malfunction.

[STARTING AND MAINTENANCE PRECAUTIONS]

CAUTION

- Do not disassemble or modify the modules.
Doing so could cause failure, malfunction injury or fire.
- Be sure to shut off all phases of the external power supply used by the system before mounting or removing the module.
Not doing so may cause failure or malfunction of the module.
In the system where a CPU module supporting the online module change is used and on the MELSECNET/H remote I/O stations, modules can be replaced online (during energizing).
However, there are some restrictions on replaceable modules and the replacement procedures are predetermined for each module.
For details, refer to the chapter of the online module change in this manual.
- Do not install/remove the module to/from the base unit, or the terminal block to/from the module more than 50 times after the first use of the product. (IEC 61131-2 compliant)
Failure to do so may cause malfunction.
- Always make sure to touch the grounded metal to discharge the electricity charged in the body, etc., before touching the module.
Failure to do so may cause a failure or malfunctions of the module.

[DISPOSAL PRECAUTIONS]

CAUTION

- When disposing of this product, treat it as industrial waste.

• CONDITIONS OF USE FOR THE PRODUCT •

- (1) Mitsubishi programmable controller ("the PRODUCT") shall be used in conditions;
- i) where any problem, fault or failure occurring in the PRODUCT, if any, shall not lead to any major or serious accident; and
 - ii) where the backup and fail-safe function are systematically or automatically provided outside of the PRODUCT for the case of any problem, fault or failure occurring in the PRODUCT.

- (2) The PRODUCT has been designed and manufactured for the purpose of being used in general industries.

MITSUBISHI SHALL HAVE NO RESPONSIBILITY OR LIABILITY (INCLUDING, BUT NOT LIMITED TO ANY AND ALL RESPONSIBILITY OR LIABILITY BASED ON CONTRACT, WARRANTY, TORT, PRODUCT LIABILITY) FOR ANY INJURY OR DEATH TO PERSONS OR LOSS OR DAMAGE TO PROPERTY CAUSED BY the PRODUCT THAT ARE OPERATED OR USED IN APPLICATION NOT INTENDED OR EXCLUDED BY INSTRUCTIONS, PRECAUTIONS, OR WARNING CONTAINED IN MITSUBISHI'S USER, INSTRUCTION AND/OR SAFETY MANUALS, TECHNICAL BULLETINS AND GUIDELINES FOR the PRODUCT.

("Prohibited Application")

Prohibited Applications include, but not limited to, the use of the PRODUCT in;

- Nuclear Power Plants and any other power plants operated by Power companies, and/or any other cases in which the public could be affected if any problem or fault occurs in the PRODUCT.
- Railway companies or Public service purposes, and/or any other cases in which establishment of a special quality assurance system is required by the Purchaser or End User.
- Aircraft or Aerospace, Medical applications, Train equipment, transport equipment such as Elevator and Escalator, Incineration and Fuel devices, Vehicles, Manned transportation, Equipment for Recreation and Amusement, and Safety devices, handling of Nuclear or Hazardous Materials or Chemicals, Mining and Drilling, and/or other applications where there is a significant risk of injury to the public or property.

Notwithstanding the above, restrictions Mitsubishi may in its sole discretion, authorize use of the PRODUCT in one or more of the Prohibited Applications, provided that the usage of the PRODUCT is limited only for the specific applications agreed to by Mitsubishi and provided further that no special quality assurance or fail-safe, redundant or other safety features which exceed the general specifications of the PRODUCTS are required. For details, please contact the Mitsubishi representative in your region.

REVISIONS

* The manual number is given on the bottom left of the back cover.

Print Date	* Manual Number	Revision
May, 2002	SH (NA)-080277-A	First edition
Feb., 2003	SH (NA)-080277-B	<div style="border: 1px solid black; padding: 2px; display: inline-block;">Correction</div> SAFETY PRECAUTIONS, Section 2.1, 3.4.1, 3.4.23, 4.4.2, 5.1, 5.5.2, 5.6.1, 5.6.3, 6.3.2, 6.5.2, 7.3.4, 7.3.6, 7.4, Appendix 1.2, Appendix 1.3
May, 2003	SH (NA)-080277-C	<div style="border: 1px solid black; padding: 2px; display: inline-block;">Addition</div> Section 2.3 <div style="border: 1px solid black; padding: 2px; display: inline-block;">Correction</div> Section 2.2, 3.4.1, 3.4.22, 3.4.23, 4.5, 4.6, 4.6.1, 4.6.2, 5.3.1
May, 2004	SH (NA)-080277-D	<div style="border: 1px solid black; padding: 2px; display: inline-block;">Correction</div> Section 2.2, 2.3, 3.1.1, 3.1.3, 3.2.1, 7.1, 7.3.1 to 7.3.6, 8.2.6
Aug., 2004	SH (NA)-080277-E	<div style="border: 1px solid black; padding: 2px; display: inline-block;">Addition</div> Section 5.6.3, 5.7, 5.8 <div style="border: 1px solid black; padding: 2px; display: inline-block;">Correction</div> Section 1.1, 5.1, 5.2.1, 5.2.2, 5.3.1, 5.3.2, 5.3.3, 5.6.1, 5.6.2, Appendix 1.3
Oct., 2004	SH (NA)-080277-F	<div style="border: 1px solid black; padding: 2px; display: inline-block;">Correction</div> SAFETY PRECAUTIONS, Section 2.1, 3.1.1, 4.1, 6.3, 6.5.1
Sep., 2005	SH (NA)-080277-G	<div style="border: 1px solid black; padding: 2px; display: inline-block;">Correction</div> SAFETY PRECAUTIONS, Section 2.1, 3.1.1, 5.2.2, 6.3.2
Feb., 2006	SH (NA)-080277-H	<div style="border: 1px solid black; padding: 2px; display: inline-block;">Correction</div> Section 2.2, 6.2.1, 6.2.2, 6.3.1, 6.3.2, 6.4.1, 6.4.2, 6.5.1, 6.5.2, Appendix 1
Jan., 2007	SH (NA)-080277-I	<div style="border: 1px solid black; padding: 2px; display: inline-block;">Correction</div> SAFETY PRECAUTIONS, Section 3.3.2, 4.4.2, 4.6.2, 6.3.1, 6.3.2, 6.5.1, 6.5.2, Chapter 7
Jun., 2007	SH (NA)-080277-J	<div style="border: 1px solid black; padding: 2px; display: inline-block;">Correction</div> Section 4.3, Appendix 3
Jan., 2008	SH (NA)-080277-K	<div style="border: 1px solid black; padding: 2px; display: inline-block;">Addition</div> Section 2.2 <div style="border: 1px solid black; padding: 2px; display: inline-block;">Correction</div> SAFETY PRECAUTIONS, About the Generic Terms and Abbreviations, Section 1.1, Section 2.1, Section 2.3, Section 4.1, Section 4.6.1, Section 4.6.2, Section 5.2.1, Section 5.2.2, Section 5.3.2, Section 5.3.3, Section 5.4, Section 5.6.1, Section 5.6.4, Section 5.6.5, Section 6.2.1, Section 6.3.1, Section 6.4.1, Section 6.5.1, Section 7.3.1, Section 7.3.3, Section 7.3.4, Section 7.3.5, Section 8.1, Appendix 1.1, Appendix 1.2, Appendix 1.3

Print Date	* Manual Number	Revision
May, 2008	SH (NA)-080277-L	<p>Correction</p> <p>SAFETY PRECAUTIONS, Compliance with the EMC and Low Voltage Directives, About the Generic Terms and Abbreviations, Section 2.1, 2.3, Section 3.1.1, 3.2.4, Section 4.1, Section 5.2.1, 5.2.2, 5.3.1 to 5.3.3, Chapter 7, Section 7.1, 7.4</p>
Oct., 2008	SH (NA)-080277-M	<p>Addition</p> <p>Appendix 3</p> <p>Correction</p> <p>Section 2.1, Section 3.1.1, 3.2.2, 3.2.3, 3.3.2, 3.4.1, 3.4.2, 3.4.5, 3.4.6, 3.4.7, 3.4.9, 3.4.11, 3.4.12, 3.4.14, 3.4.17, 3.4.20, Section 4.4.2, 4.5, Section 5.1, 5.4, Section 8.1, 8.2.4, Appendix 1.1, 1.2, 1.3, 2, 4</p>
Sep., 2015	SH (NA)-080277-N	<p>Addition</p> <p>CONDITIONS OF USE FOR THE PRODUCT</p> <p>Correction</p> <p>SAFETY PRECAUTIONS, COMPLIANCE WITH EMC AND LOW VOLTAGE DIRECTIVES, TERMS, Section 1.1, 2.1, 2.2, 2.3, 2.4, 3.1.1, 3.1.2, 3.2, 3.2.1, 3.2.3, 3.2.4, 3.3.1, 3.3.2, 3.4.1, 3.4.6, 3.4.7, 3.4.9, 3.4.11, 3.4.15, 3.4.16, 3.4.17, 3.4.19, 3.4.20, 3.4.23, 4.1, 4.3, 4.4.2, 4.5, 4.6.1, 4.6.2, 5.2.1, 5.2.2, 5.3.1, 5.3.3, 5.4, 5.5, 5.6.1, 5.6.2, 5.7, 6.2.1, 6.2.2, 6.3, 6.3.1, 6.3.2, 6.4.1, 6.4.2, 6.5, 6.5.1, 6.5.2, Chapter 7, Section 7.1, 7.2, 7.3.1, 7.3.2, 7.3.3, 7.3.4, 7.3.5, 7.3.6, 7.4, 7.5, 8.1, 8.2.3, 8.2.4, 8.2.5, 8.2.6, Appendix 1, 1.2, 2, 3, 4</p>

Japanese Manual Version SH-080262-S

This manual confers no industrial property rights or any rights of any other kind, nor does it confer any patent licenses. Mitsubishi Electric Corporation cannot be held responsible for any problems involving industrial property rights which may occur as a result of using the contents noted in this manual.

© 2002 MITSUBISHI ELECTRIC CORPORATION

INTRODUCTION

Thank you for purchasing the MELSEC-Q series programmable controller.
Before using this product, please read this manual carefully to develop familiarity with the functions and performance of the Q series programmable controller to handle the product correctly.

CONTENTS

SAFETY PRECAUTIONS.....	A- 1
CONDITIONS OF USE FOR THE PRODUCT	A- 5
REVISIONS	A- 6
INTRODUCTION.....	A- 8
CONTENTS.....	A- 8
ABOUT MANUALS	A-12
COMPLIANCE WITH EMC AND LOW VOLTAGE DIRECTIVES	A-12
TERMS	A-13
PRODUCT STRUCTURE.....	A-14
1 OVERVIEW	1- 1 to 1- 3
1.1 Features	1- 1
2 SYSTEM CONFIGURATION	2- 1 to 2- 9
2.1 Applicable Systems.....	2- 1
2.2 Precautions on System Configuration.....	2- 5
2.3 How to Check the Function Version, Serial Number, and Software Version.....	2- 6
2.4 Cautions for Power Supply from Q61P-A1/A2 to Q64AD-GH.....	2- 9
3 SPECIFICATIONS	3- 1 to 3-68
3.1 Performance Specifications	3- 1
3.1.1 Performance specifications list	3- 1
3.1.2 I/O conversion characteristic.....	3- 4
3.1.3 Accuracy	3-10
3.2 Function List.....	3-11
3.2.1 A/D conversion methods.....	3-13
3.2.2 Maximum and minimum values hold function	3-16
3.2.3 Input signal error detection function	3-16
3.2.4 Warning output function	3-23
3.2.5 A/D conversion starting time setting function (Q62AD-DGH only).....	3-27
3.3 I/O Signals for the Programmable Controller CPU	3-28
3.3.1 List of I/O signals	3-28
3.3.2 Details of I/O signals	3-30
3.4 Buffer Memory.....	3-37
3.4.1 Buffer memory assignment.....	3-37
3.4.2 A/D conversion enable/disable setting (buffer memory address 0: Un\G0).....	3-51
3.4.3 CH□ average time/average number of times/move average/time constant settings (buffer memory addresses 1 to 4: Un\G1 to Un\G4).....	3-52

3.4.4	CH□ A/D conversion starting time setting (buffer memory addresses 5, 6: Un\G5, Un\G6) (Q62AD-DGH only)	3-52
3.4.5	Averaging process specification (buffer memory address 9: Un\G9).....	3-54
3.4.6	A/D conversion completed flag (buffer memory address 10: Un\G10)	3-55
3.4.7	CH□ digital output value (16bit) (buffer memory addresses 11 to 14: Un\G11 to Un\G14).....	3-56
3.4.8	Write data error codes (buffer memory address 19: Un\G19).....	3-56
3.4.9	Setting range (buffer memory address 20: Un\G20).....	3-57
3.4.10	Offset/gain setting mode (buffer memory addresses 22, 23: Un\G22, Un\G23)	3-58
3.4.11	CH□ maximum value/minimum value storage area (16bit) (buffer memory addresses 30 to 37: Un\G30 to Un\G37)	3-58
3.4.12	Input signal error detection extended/input signal error detection/warning output settings (buffer memory address 47: Un\G47)	3-59
3.4.13	Warning output flag (buffer memory address 48 :Un\G48)	3-60
3.4.14	Input signal error detection flag (buffer memory address 49: Un\G49).....	3-61
3.4.15	CH□ digital output value (32bit) (buffer memory addresses 54 to 61: Un\G54 to Un\G61).....	3-61
3.4.16	CH□ maximum value/minimum value storage area (32bit) (buffer memory addresses 62 to 77: Un\G62 to Un\G77)	3-62
3.4.17	CH□ process alarm upper/lower limit value (buffer memory addresses 86 to 117: Un\G86 to Un\G117)	3-62
3.4.18	CH□ rate alarm warning detection period (buffer memory addresses 118 to 121: Un\G118 to Un\G121)	3-63
3.4.19	CH□ rate alarm upper/lower limit value (buffer memory addresses 122 to 137: Un\G122 to Un\G137)	3-64
3.4.20	CH□ input signal error detection setting value/CH□ input signal error detection lower limit setting value (buffer memory addresses 138 to 141: Un\G138 to Un\G141) CH□ input signal error detection setting upper value (buffer memory addresses 142 to 145: Un\G142 to Un\G145)	3-65
3.4.21	Mode switching setting (buffer memory addresses 158, 159: Un\G158, Un\G159).....	3-67
3.4.22	Pass data classification setting (buffer memory addresses 200: Un\G200) (Q64AD-GH only)..	3-67
3.4.23	Industrial shipment settings and user range settings offset/gain value (buffer memory addresses 202 to 233: Un\G202 to Un\G233)	3-68

4 SETUP AND PROCEDURES BEFORE OPERATION	4- 1 to 4-21
--	---------------------

4.1	Handling Precautions	4- 1
4.2	Setup and Procedures before Operation	4- 2
4.3	Part Identification Nomenclature	4- 3
4.4	Wiring.....	4- 5
4.4.1	Wiring precautions.....	4- 5
4.4.2	External wiring	4- 6
4.5	Switch Setting for Intelligent Function Module	4- 9
4.6	Offset/Gain Settings	4-11
4.6.1	Offset/gain settings (Q64AD-GH)	4-11
4.6.2	Offset/gain settings (Q62AD-DGH)	4-16
4.6.3	A/D conversion value storage during offset/gain setting	4-21

5 UTILITY PACKAGE (GX Configurator-AD)	5- 1 to 5-32
---	---------------------

5.1	Utility Package Functions.....	5- 1
-----	--------------------------------	------

5.2	Installing and Uninstalling the Utility Package	5- 2
5.2.1	Handling precautions	5- 2
5.2.2	Operating environment	5- 4
5.3	Utility Package Operation	5- 6
5.3.1	Common utility package operations	5- 6
5.3.2	Operation overview	5- 9
5.3.3	Starting the intelligent function module utility	5-11
5.4	Initial Setting	5-14
5.5	Auto Refresh Settings	5-16
5.6	Monitoring /Test.....	5-18
5.6.1	Monitor/test screen.....	5-18
5.6.2	Offset/gain setting operation	5-21
5.6.3	Confirmation of conversion characteristic	5-23
5.6.4	Pass data (Q64AD-GH)	5-25
5.6.5	Pass data (Q62AD-DGH)	5-27
5.7	FB Conversion of Initial Setting/Auto Refresh Setting	5-28
5.8	Usage of FB	5-29
5.8.1	Outline	5-29
5.8.2	Paste an FB to a sequence program.....	5-31
5.8.3	Convert (compile) a sequence program.....	5-32

6 PROGRAMMING

6- 1 to 6-27

6.1	Programming Procedure.....	6- 1
6.2	For Use in Normal System Configuration (Q64AD-GH)	6- 2
6.2.1	Programming example using the utility package	6- 3
6.2.2	Programming example without using the utility package.....	6- 5
6.3	For Use in Remote I/O Network (Q64AD-GH).....	6- 7
6.3.1	Programming example using the utility package	6- 9
6.3.2	Programming example without using the utility package.....	6-12
6.4	For Use in Normal System Configuration (Q62AD-DGH)	6-16
6.4.1	Programming example using the utility package	6-17
6.4.2	Programming example without using the utility package.....	6-19
6.5	For Use in Remote I/O Network (Q62AD-DGH)	6-20
6.5.1	Programming example using the utility package	6-21
6.5.2	Programming example without using the utility package.....	6-24

7 ONLINE MODULE CHANGE

7- 1 to 7-36

7.1	Online Module Change Conditions.....	7- 2
7.2	Online Module Change Operations	7- 3
7.3	Online Module Change Procedure	7- 4
7.3.1	When industrial shipment setting is used and initial setting was made with GX Configurator-AD	7- 4
7.3.2	When industrial shipment setting is used and initial setting was made with sequence program..	7- 9
7.3.3	When user range setting is used and initial setting was made with GX Configurator-AD (other system is available)	7-14
7.3.4	When user range setting is used and initial setting was made with GX Configurator-AD (other system is unavailable).....	7-19

7.3.5 When user range setting is used and initial setting was made with sequence program (other system is available)	7-25
7.3.6 When user range setting is used and initial setting was made with sequence program (other system is unavailable)	7-30
7.4 Range Reference Table	7-35
7.5 Precautions for Online Module Change	7-36

8 TROUBLESHOOTING	8- 1 to 8- 7
--------------------------	---------------------

8.1 Error Code List	8- 1
8.2 Troubleshooting	8- 4
8.2.1 When the "RUN" LED is flashing or turned off	8- 4
8.2.2 When the "ERR." LED is on or flashing	8- 4
8.2.3 When the "ALM" LED is on or flashing	8- 4
8.2.4 When the digital output values cannot be read	8- 5
8.2.5 When A/D conversion completed flag does not turn ON during use in normal mode	8- 6
8.2.6 Checking the A/D converter module status using GX Developer system monitor	8- 6

APPENDIX	App.- 1 to App.-17
-----------------	---------------------------

Appendix 1 Dedicated Instruction List and Available Devices	App.- 1
Appendix 1.1 G(P).OFFGAN	App.- 2
Appendix 1.2 G(P).OGLOAD	App.- 4
Appendix 1.3 G(P).OGSTOR	App.- 8
Appendix 2 Performance Comparison between Q64AD-GH and Q64AD	App.-13
Appendix 3 Functions Added or Changed Due to Version Upgrade	App.-15
Appendix 4 External Dimensions	App.-17

INDEX	Index- 1 to Index- 3
--------------	-----------------------------

ABOUT MANUALS

The following manuals are also related to this product.

If necessary, order them by quoting the details in the tables below.

Related Manuals

Manual Name	Manual Number (Model Code)
GX Developer Version 8 Operating Manual Describes the methods of using GX Developer to create a program and print out, monitor, and debug the program. (Sold separately)	SH-080373E (13JU41)
GX Developer Version 8 Operating Manual (Function Block) Describes the methods of using GX Developer to create a function block and print out the function block. (Sold separately)	SH-080376E (13JU44)
GX Works2 Version 1 Operating Manual (Common) Describes the system configuration, parameter settings, and online operations (common to Simple project and Structured project) of GX Works2. (Sold separately)	SH-080779E (13JU63)

REMARK

If you would like to obtain a manual individually, printed matters are available separately. Order the manual by quoting the manual number on the table above (model code).

COMPLIANCE WITH EMC AND LOW VOLTAGE DIRECTIVES

(1) Method of ensuring compliance

To ensure that Mitsubishi programmable controllers maintain EMC and Low Voltage Directives when incorporated into other machinery or equipment, certain measures may be necessary. Please refer to one of the following manuals.

- QCPU User's Manual (Hardware Design, Maintenance and Inspection)
- Safety Guidelines

(This manual is included with the CPU module or base unit.)

The CE mark on the side of the programmable controller indicates compliance with EMC and Low Voltage Directives.

(2) Additional measures

No additional measures are necessary for the compliance of this product with the EMC and Low Voltage Directives.

TERMS

Unless otherwise specified, this manual uses the following general terms and abbreviations.

Abbreviation/general terms	Description of the abbreviation/general terms
A/D converter module	Generic term for Q64AD-GH and Q62AD-DGH
DOS/V personal computer	IBM PC/AT [®] or compatible computer with DOS/V.
GX Developer	Product name of the software package for the MELSEC programmable controllers.
GX Works2	
GX Configurator-AD	Generic term for analog-digital converter module setting and monitor tool GX Configurator-AD (SW2D5C-QADU-E)
QCPU (Q mode)	Generic term for Basic model QCPU, High performance model QCPU, Process CPU, Redundant CPU, and Universal model QCPU
Basic module QCPU	Generic term for Q00JCPU, Q00CPU, and Q01CPU
High performance model QCPU	Generic term for Q02CPU, Q02HCPU, Q06HCPU, Q12HCPU, and Q25HCPU
Process CPU	Generic term for Q02PHCPU, Q06PHCPU, Q12PHCPU and Q25PHCPU.
Redundant CPU	Generic term for Q12PRHCPU and Q25PRHCPU
Universal model QCPU	Generic term for Q00UJCPU, Q00UCPU, Q01UCPU, Q02UCPU, Q03UDCPU, Q03UDVCPU, Q03UDECPU, Q04UDHCPU, Q04UDVCPU, Q04UDEHCPU, Q06UDHCPU, Q06UDVCPU, Q06UDEHCPU, Q10UDHCPU, Q10UDEHCPU, Q13UDHCPU, Q13UDVCPU, Q13UDEHCPU, Q20UDHCPU, Q20UDEHCPU, Q26UDHCPU, Q26UDVCPU, Q26UDEHCPU, Q50UDEHCPU, and Q100UDEHCPU
Personal computer	Generic term for DOS/V personal computer
Industrial shipment setting	Generic term for analog input ranges 0 to 10V, 0 to 5V, 1 to 5V, -10 to 10V, 0 to 20mA and 4 to 20mA
FB	Abbreviation of function block.
Windows Vista [®]	Generic term for the following: Microsoft [®] Windows Vista [®] Home Basic Operating System, Microsoft [®] Windows Vista [®] Home Premium Operating System, Microsoft [®] Windows Vista [®] Business Operating System, Microsoft [®] Windows Vista [®] Ultimate Operating System, Microsoft [®] Windows Vista [®] Enterprise Operating System
Windows [®] XP	Generic term for the following: Microsoft [®] Windows [®] XP Professional Operating System, Microsoft [®] Windows [®] XP Home Edition Operating System
Windows [®] 7	Generic term for the following: Microsoft [®] Windows [®] 7 Starter Operating System, Microsoft [®] Windows [®] 7 Home Premium Operating System, Microsoft [®] Windows [®] 7 Professional Operating System, Microsoft [®] Windows [®] 7 Ultimate Operating System, Microsoft [®] Windows [®] 7 Enterprise Operating System, Note that the description "Windows [®] 7 (32-bit version)" indicates the 32-bit version, and "Windows [®] 7 (64-bit version)" indicates the 64-bit version.

PRODUCT STRUCTURE

The product structure of this product is given in the table below.

Model code	Product name	Quantity
Q64AD-GH	Type Q64AD-GH Channel Isolated High Resolution Analog-Digital Converter Module	1
Q62AD-DGH	Type Q62AD-DGH Channel Isolated High Resolution Analog-Digital Converter Module (with Signal Conditioning Function)	1
SW2D5C-QADU-E	GX Configurator-AD Version 2 (1-license product) (CD-ROM)	1
SW2D5C-QADU-EA	GX Configurator-AD Version 2 (Multiple-license product) (CD-ROM)	1

MEMO

1 OVERVIEW

1

This User's Manual describes the specifications, handling and programming methods for the type Q64AD-GH channel isolated high resolution analog-digital converter module (hereinafter referred to as the Q64AD-GH) and type Q62AD-DGH channel isolated high resolution analog-digital converter module (with signal conditioning function) (hereinafter referred to as the Q62AD-DGH), which are used with the MELSEC-Q series CPU modules.

The Q62AD-DGH is exclusively used for current input.

In this manual, the Q64AD-GH and Q62AD-DGH are collectively referred to as the A/D converter modules.

1.1 Features

(1) Channel isolated

The channels are isolated.

The Q62AD-DGH is also isolated between the external supply power and channels.

(2) High resolution

The resolution is as high as 32-bit signed binary (data part is 16 bits long). (When the range -10 to 10V is selected)

(3) Power supply to 2-wire transmitter (Q62AD-DGH only)

Supplying power to the 2-wire transmitter, the Q62AD-DGH does not require the power supply for the 2-wire transmitter.

Supply power can be switched ON/OFF channel-by-channel by the A/D conversion enable/disable setting.

(4) Module protection provided by short-circuit protection circuit (Q62AD-DGH only)

If an excessive current flows into the module due to a short circuit of the wiring, the short-circuit protection circuit limits the current to within 25 to 35mA, protecting the module.

(5) Analog input check by check terminals (Q62AD-DGH only)

Measurement of a voltage at the check terminals allows the mA of the 2-wire transmitter output to be checked without the wiring being disconnected.

(6) High accuracy

The reference accuracy ^{*1} is as high as $\pm 0.05\%$ and the temperature coefficient ^{*2} is as high as $\pm 71.4\text{ppm}/^\circ\text{C}$.

^{*1} Accuracy of offset/gain setting at ambient temperature

^{*2} Accuracy per temperature change of 1°C

Example) Accuracy when the temperature varies from 25°C to 30°C

0.05% (reference accuracy) + $0.00714\%/^\circ\text{C}$ (temperature

coefficient) $\times 5^\circ\text{C}$ (temperature variation difference) = 0.0857%

(7) Changing the input range

The input range *¹ can easily be set from the GX Developer.

*1: Input range refers to the type of offset/gain settings. The most frequently used range is set as the default but the user can also set the offset/gain.

(8) A/D conversion system

There are the following five A/D conversion systems.

(a) Sampling processing

Analog input values are converted into digital values one by one on a channel basis and the digital output value is output at every conversion.

(b) Averaging processing

1) Time averaging

A/D conversion is averaged in terms of time on a channel basis and a digital average value is output.

2) Count averaging

A/D conversion is averaged in terms of count on a channel basis and a digital average value is output.

3) Move averaging

The specified number of digital output values measured per sampling time are averaged.

(c) Primary delay filter

A digital output value is smoothed according to the preset time constant.

(9) Input signal error detection function

The voltage/current outside the setting range is detected.

(10) Warning output

There are the following two warning outputs.

(a) Process alarm

A warning is output if a digital output value falls outside the setting range.

(b) Rate alarm

A warning is output if the varying rate of a digital output value falls outside the preset varying rate range.

(11) Online module change

The module can be replaced without stopping the system.

Using a sequence program further enables the following (limited to same model pairs, though).

- Inheritance of offset/gain values to the A/D converter module after online module change.
- Transfer of offset/gain values to a different A/D converter module mounted on another slot.

(12) Offset/gain setting

GX Configurator-AD, dedicated instruction (G(P). OFFGAN) or mode switching setting allows a shift to the offset/gain setting mode easily.

(13) Easy configuration with GX Configurator-AD

GX Configurator-AD, which is sold separately, allows the configuration of an A/D converter module on its screen, thus resulting in a reduction of sequence programs.

The setting status and operating status of the modules can be checked easily.

FB *¹ can be generated automatically from the intelligent function module parameters that have been set up, and is available in a sequence program.

*1: FB is the function for making a circuit block used in a sequence program repeatedly a part (FB) to use it in the sequence program.

This function can improve the efficiency of program development and minimize program bugs to improve program qualities.

For the details of FB, refer to "GX Developer Version 8 Operating Manual (Function Block)."

2 SYSTEM CONFIGURATION

This chapter explains the system configuration of the A/D converter module.

2.1 Applicable Systems

This section describes the applicable systems.

2

(1) Applicable modules and base units, and No. of modules

(a) When mounted with a CPU module

For the applicable modules, the number of modules, and base units applicable to the A/D converter module, refer to the user's manual for the CPU module used.

Note the following when the A/D converter module is mounted with a CPU module.

- Depending on the combination with other modules or the number of mounted modules, power supply capacity may be insufficient. Pay attention to the power supply capacity before mounting modules, and if the power supply capacity is insufficient, change the combination of modules.
- Mount a module within the number of I/O points for the CPU module. If the number of slots is within the available range, the module can be mounted on any slot.

REMARK

When the module is used with a C Controller module, refer to the user's manual for the C Controller module.

(b) Mounting to a MELSECNET/H remote I/O station

For the MELSECNET/H remote I/O station, the number of modules, and base units applicable to the A/D converter module, refer to the Q Corresponding MELSECNET/H Network System Reference Manual (Remote I/O network).

(2) Support of the multiple CPU system

When using the A/D converter module in a multiple CPU system, refer to the following manual first.

- QCPU User's Manual (Multiple CPU System)

(3) Compatibility with online module change

The A/D conversion module is configured for function version C by default, and supports online module change.

For the procedure of online module change, refer to Chapter 7.

(4) Q64AD-GH compatible software packages

Relation between the system containing the Q64AD-GH and software package is shown in the following table.

GX Developer or GX Works2 is necessary when using the Q64AD-GH.

		Software Version			
		GX Developer	GX Configurator-AD * 1	GX Works2	
Q00J/Q00/Q01CPU	Single CPU system	Version 7 or later	Version 1.14Q or later	Refer to GX Works2 Operating Manual (Common).	
	Multiple CPU system	Version 8 or later			
Q02/Q02H/Q06H/ Q12H/Q25HCPU	Single CPU system	Version 4 or later			
	Multiple CPU system	Version 6 or later			
Q02PH/Q06PHCPU	Single CPU system	Version 8.68W or later			
	Multiple CPU system				
Q12PH/Q25PHCPU	Single CPU system	Version 7.10L or later			
	Multiple CPU system				
Q12PRH/ Q25PRHCPU	Redundant CPU system	Version 8.45X or later			Version 1.15R or later
Q00UJ/Q00U/Q01U CPU	Single CPU system	Version 8.76E or later			Version 2.09K or later
	Multiple CPU system				
Q02U/Q03UD/ Q04UDH/ Q06UDHCPU	Single CPU system	Version 8.48A or later			
	Multiple CPU system				
Q10UDH/Q20UDHC PU	Single CPU system	Version 8.76E or later			
	Multiple CPU system				
Q13UDH/Q26UDH CPU	Single CPU system	Version 8.62Q or later			
	Multiple CPU system				
Q03UDE/Q04UDEH/ Q06UDEH/ Q13UDEH/ Q26UDEHCPU	Single CPU system	Version 8.68W or later			
	Multiple CPU system				
Q10UDEH/Q20UDE HCPU	Single CPU system	Version 8.76E or later			
	Multiple CPU system				
CPU modules other than the above	Single CPU system	Not supported	Not supported		
	Multiple CPU system				
If installed in a MELSECNET/H remote I/O station		Version 6 or later	Version 1.14Q or later		

* 1: When using the pass data, use the product of Version 1.16S or later.

(5) Q62AD-DGH compatible software packages

Relation between the system containing the Q62AD-DGH and software package is shown in the following table.

GX Developer or GX Works2 is necessary when using the Q62AD-DGH.

		Software Version			
		GX Developer	GX Configurator-AD	GX Works2	
Q00J/Q00/Q01CPU	Single CPU system	Version 7 or later	Version 1.14Q or later		
	Multiple CPU system	Version 8 or later			
Q02/Q02H/Q06H/ Q12H/Q25HCPU	Single CPU system	Version 4 or later			
	Multiple CPU system	Version 6 or later			
Q02PH/Q06PHCPU	Single CPU system	Version 8.68W or later			
	Multiple CPU system				
Q12PH/Q25PHCPU	Single CPU system	Version 7.10L or later			
	Multiple CPU system				
Q12PRH/ Q25PRHCPU	Redundant CPU system	Version 8.45X or later			Version 1.15R or later
Q00UJ/Q00U/Q01U CPU	Single CPU system	Version 8.76E or later			Version 2.09K or later
	Multiple CPU system				
Q02U/Q03UD/ Q04UDH/ Q06UDHCPU	Single CPU system	Version 8.48A or later			
	Multiple CPU system				
Q10UDH/Q20UDHC PU	Single CPU system	Version 8.76E or later			
	Multiple CPU system				
Q13UDH/Q26UDH CPU	Single CPU system	Version 8.62Q or later			
	Multiple CPU system				
Q03UDE/Q04UDEH/ Q06UDEH/ Q13UDEH/ Q26UDEHCPU	Single CPU system	Version 8.68W or later			
	Multiple CPU system				
Q10UDEH/Q20UDE HCPU	Single CPU system	Version 8.76E or later			
	Multiple CPU system				
CPU modules other than the above	Single CPU system	Not supported	Not supported		
	Multiple CPU system				
If installed in a MELSECNET/H remote I/O station		Version 6 or later	Version 1.14Q or later		

POINT
<p>(1) The A/D converter module does not have the products of function versions A and B. The products of function version C include the functions of the products of function versions A and B.</p> <p>(2) Depending on the version of GX Configurator-AD, applicable system, CPU module and functions of A/D converter module. Refer to Appendix 3 for details.</p> <p>(3) When using GX Works2, refer to the following.</p> <ul style="list-style-type: none">• GX Works2 Version1 Operating Manual (Common)• GX Works2 Version1 Operating Manual (Intelligent Function Module)

2.2 Precautions on System Configuration

(1) For use with the Redundant CPU

(a) Dedicated instruction

The dedicated instruction cannot be used.

(b) GX Configurator-AD connection

GX Configurator-AD cannot be used when accessing the Redundant CPU via an intelligent function module on an extension base unit from GX Developer.

Make a connection to the Redundant CPU by way of the communication paths indicated below.

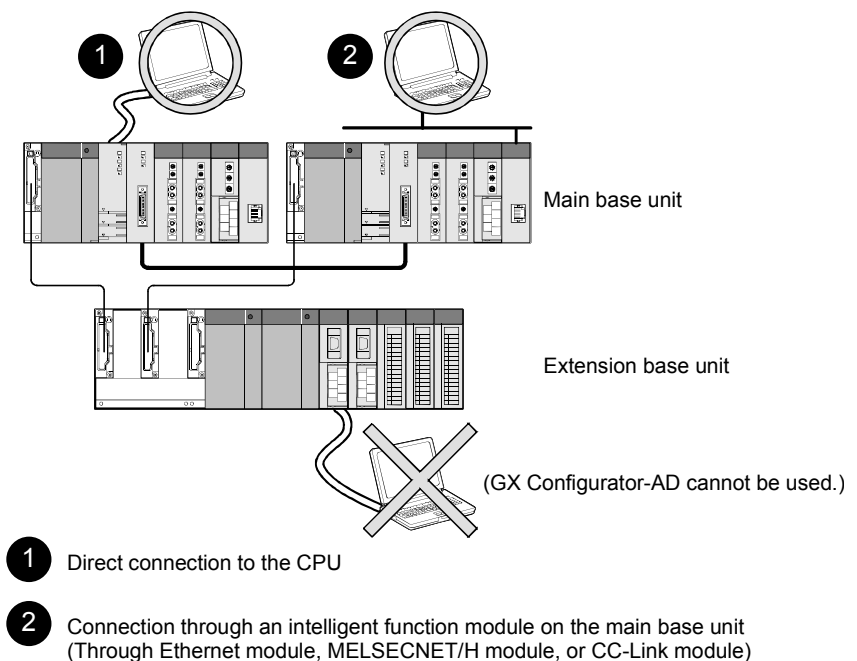

- (c) Check on the system monitor (Production information list)
 To view the system monitor, on GX Developer, go to [Diagnostics] and select [System monitor], then click the **Product Information List** button.

Function version

Serial No. Product No.

Slot	Type	Series	Model name	Points	I/O No.	Master PLC	Serial No.	Ver.	Product No.
PLC	PLC	Q	Q06UDHCPU	-	-	-	110130000000000	B	091013092955015-B
0-0	Intelli. Q	Q	Q64AD-GH	16pt	0000	-	100620000000000	C	-
0-1	-	-	None	-	-	-	-	-	-
0-2	-	-	None	-	-	-	-	-	-
0-3	-	-	None	-	-	-	-	-	-
0-4	-	-	None	-	-	-	-	-	-

1) Indication of the production number

The A/D converter module does not support the production number display; "-" is displayed.

POINT

The serial No. on the rating plate and on the front of the module may be different from the serial No. displayed on the product information screen of GX Developer.

- The serial No. on the rating plate and on the front of the module indicates the management information of the product.
- The serial No. displayed on the product information screen of GX Developer indicates the function information of the product.

The function information of the product is updated when a new function is added.

(2) Checking the software version of GX Configurator-AD

To check the software version of GX Configurator-AD, follow these steps on GX Developer: [Help] → [Product information].

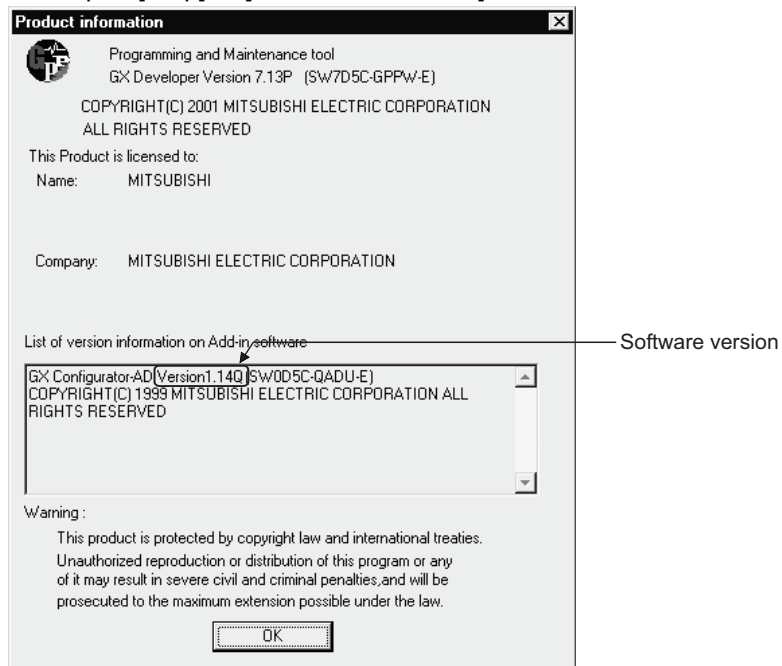

(In the case of GX Developer Version 7)

REMARK

The version indication for the GX Configurator-AD has been changed as shown below from the SW0D5C-QADU-E 50F upgrade product.

Previous product		Upgrade and subsequent versions
SW0D5C-QADU-E 50F	→	GX Configurator-AD Version 1.10L

2.4 Cautions for Power Supply from Q61P-A1/A2 to Q64AD-GH

When using the Q61P-A1/A2 and Q64AD-GH in combination, it is required to use them within the range in Table 2.1.

This requirement applies to the case where the Q64AD-GH satisfies any of the following conditions.

- The first six digits of serial number are "050914" or earlier.
- The first five digits of "Product information" number are "05081" or earlier.

If it satisfies the above conditions but does not meet the ones outlined in Table 2.1, carry out the following:

- Replace the power supply module with the Q64P.
- Mount the Q64AD-GH to another base unit.

Table 2.1 Conditions for Use of Q61P-A1/A2 and Q64AD-GH in Combination

No. of Q64AD-GH modules	Conditions	Available power supply	
		Q61P-A1/A2	Q64P
3 or less	Total current consumption of all modules on the same base is 5.0A or less.	○	○
	Total current consumption of all modules on the same base exceeds 5.0A.	×	○
4	Module other than the Q64AD-GH is not mounted on the same base.	○	○
	Module other than the Q64AD-GH is mounted on the same base.	×	○
5 or more	—	×	○

*1: If the modules are used outside the condition range given in Table 2.1, the "POWER" LED of the power supply module may flash*1 and the programmable controller CPU system may not start up.

REMARK

When the Q64AD-GH satisfies any of the following conditions, the above precaution does not apply.

- The first six digits of serial number are "051217" or later.
- The first five digits of "Product information" number are "05082" or later.

3 SPECIFICATIONS

The description of this chapter and later is based on the Q64AD-GH.

3.1 Performance Specifications

3.1.1 Performance specifications list

Table 3.1 shows the performance specifications of the A/D converter modules.

Table 3.1 Performance Specifications of Q64AD-GH

Model name		Q64AD-GH					
Item		Q64AD-GH					
Number of analog input channels		4 channels					
Analog input	Voltage	-10 to 10VDC (Input resistance 1 MΩ)					
	Current	0 to 20mADC (Input resistance 250 Ω)					
Digital output		16-bit signed binary (-32768 to 32767) 32-bit signed binary (-65536 to 65535)					
I/O characteristics, resolution ⁵	Input	Analog input range	Resolution		Digital output value (32-bit)	Digital output value (16-bit)	
			32-bit	16-bit			
	Voltage	0 to 10V		156.3μV	312.6μV	0 to 64000	0 to 32000
		0 to 5V		78.2μV	156.4μV		
		1 to 5V		62.5μV	125.0μV		
		1 to 5V (Extended mode)		62.5μV	-	-16000 to 72000	-
		Users input range (Uni-polar)		47.4μV ⁶	94.8μV ⁶	0 to 64000	0 to 32000
		-10 to 10V		156.3μV	312.6μV	-64000 to 64000	-32000 to 32000
	Users input range (Bi-polar)		47.4μV ⁶	94.8μV ⁶			
	Current	0 to 20mA		312.5nA	625.0nA	0 to 64000	0 to 32000
		4 to 20mA		250.0nA	500.0nA		
		4 to 20mA (Extended mode)		250.0nA	-	-16000 to 72000	-
		Users input range (Uni-polar)		151.6nA ⁶	303.2nA ⁶	0 to 64000	0 to 32000
	Accuracy (Accuracy relative to digital output value)	Reference accuracy * 1	±0.05% Digital output value (32-bit) : ±32digit * 2 Digital output value (16-bit) : ±16digit * 2				
Temperature coefficient * 3			±71.4ppm/°C (0.00714%/°C)				
	Common mode characteristic		Common mode voltage Input-Common ground (input voltage 0V): 1780VAC Common mode voltage rejection ratio (VCM < 1780V): 60Hz 105dB, 50Hz 107dB				
Conversion speed		10ms/4 channels					
Absolute maximum input		Voltage: ± 15V Current: ± 30mA * 4					
Isolation specifications		Specific isolated area	Isolation method	Dielectric withstand voltage		Insulation resistance	
		Between I/O terminal and programmable controller power supply	Photocoupler isolation	1780VAC rms/3 cycles (elevation 2000m)		500VDC 10MΩ or more	
		Between analog input channels	Transformer isolation				
Maximum number of writes for E ² PROM		100,000					
I/O occupied points		16 points (I/O assignment: Intelligent 16 points)					
External interface		18 points terminal block					
Applicable wire size		0.3 to 0.75mm ²					
Applicable solderless terminals		R1.25-3 (Solderless terminals with sleeves are not applicable)					
Internal current consumption (5VDC)		0.89A					
Weight		0.20kg					

- *1: Accuracy of offset/gain setting at ambient temperature
- *2: "digit" indicates a digital value.
- *3: Accuracy per temperature change of 1°C
 Example) Accuracy when temperature changes from 25 to 30°C
 $0.05\% \text{ (reference accuracy)} + 0.00714\% / ^\circ\text{C} \text{ (temperature coefficient)} \times 5^\circ\text{C} \text{ (temperature change difference)} = 0.0857\%$
- *4: Current value indicates value of instant input current that does not break module inner electrical resistance.
- *5: For details on the I/O conversion characteristics, refer to Section 3.1.2 (1).
- *6: Maximum resolution in the user range setting.

Table 3.2 Performance Specifications of Q62AD-DGH (1/2)

Model name		Q62AD-DGH																									
Item		Q62AD-DGH																									
Number of analog input channels (number of the connected two-wire transmitters)		2 channels																									
Input specifications	With two-wire transmitters connected	4 to 20mADC *4(Input resistance 250Ω)																									
	For analog input without two-wire transmitters	4 to 20mADC *4(Input resistance 250Ω)																									
Power supply part for two-wire transmitters	Supply voltage	26±2VDC																									
	Maximum supply current	24mADC																									
	Short-circuit protection	Available Limit current: 25 to 35mA																									
	Check terminals	Available																									
Digital output		16-bit signed binary (-768 to 32767) 32-bit signed binary (-1536 to 65535)																									
I/O characteristics, resolution *5		<table border="1"> <thead> <tr> <th rowspan="2">Analog input range</th> <th colspan="2">Resolution</th> <th rowspan="2">Digital output value (32-bit)</th> <th rowspan="2">Digital output value (16-bit)</th> </tr> <tr> <th>32-bit</th> <th>16-bit</th> </tr> </thead> <tbody> <tr> <td>4 to 20mA</td> <td>250.0nA</td> <td>500.0nA</td> <td>0 to 64000</td> <td>0 to 32000</td> </tr> <tr> <td>4 to 20mA (Extended mode)</td> <td>250.0nA</td> <td>-</td> <td>-16000 to 72000</td> <td>-</td> </tr> <tr> <td>Users range setting</td> <td>151.6nA *6</td> <td>303.2nA *6</td> <td>0 to 64000</td> <td>0 to 32000</td> </tr> </tbody> </table>				Analog input range	Resolution		Digital output value (32-bit)	Digital output value (16-bit)	32-bit	16-bit	4 to 20mA	250.0nA	500.0nA	0 to 64000	0 to 32000	4 to 20mA (Extended mode)	250.0nA	-	-16000 to 72000	-	Users range setting	151.6nA *6	303.2nA *6	0 to 64000	0 to 32000
Analog input range	Resolution		Digital output value (32-bit)	Digital output value (16-bit)																							
	32-bit	16-bit																									
4 to 20mA	250.0nA	500.0nA	0 to 64000	0 to 32000																							
4 to 20mA (Extended mode)	250.0nA	-	-16000 to 72000	-																							
Users range setting	151.6nA *6	303.2nA *6	0 to 64000	0 to 32000																							
Accuracy (Accuracy relative to digital output value)	Reference accuracy *1	±0.05% Digital output value (32-bit): ±32digit *2 Digital output value (16-bit): ±16digit *2																									
	Temperature coefficient *3	±71.4ppm/°C (0.00714 %/°C)																									
Conversion speed		10ms/2 channels																									
Isolation specifications		<table border="1"> <thead> <tr> <th>Specific isolated area</th> <th>Isolation method</th> <th>Dielectric withstand voltage</th> <th>Insulation resistance</th> </tr> </thead> <tbody> <tr> <td>Between I/O terminal and programmable controller power supply</td> <td>Photocoupler isolation</td> <td rowspan="3">1780VAC rms/3 cycles (elevation 2000m)</td> <td rowspan="3">500VDC 10MΩ or more</td> </tr> <tr> <td>Between analog input channels</td> <td>Transformer isolation</td> </tr> <tr> <td>Between external supply power and analog input</td> <td>Transformer isolation</td> </tr> </tbody> </table>				Specific isolated area	Isolation method	Dielectric withstand voltage	Insulation resistance	Between I/O terminal and programmable controller power supply	Photocoupler isolation	1780VAC rms/3 cycles (elevation 2000m)	500VDC 10MΩ or more	Between analog input channels	Transformer isolation	Between external supply power and analog input	Transformer isolation										
Specific isolated area	Isolation method	Dielectric withstand voltage	Insulation resistance																								
Between I/O terminal and programmable controller power supply	Photocoupler isolation	1780VAC rms/3 cycles (elevation 2000m)	500VDC 10MΩ or more																								
Between analog input channels	Transformer isolation																										
Between external supply power and analog input	Transformer isolation																										

3

Table 3.2 Performance Specifications of Q62AD-DGH (2/2)

Item	Model name	Q62AD-DGH
Maximum number of writes for E ² PROM		100,000
Number of I/O occupied points		16 points
External interface		18 points terminal block
Applicable wire size		0.3 to 0.75mm ²
Applicable solderless terminals		R1.25-3 (Solderless terminals with sleeves are not applicable)
External supply power		24VDC +20%, -15%
		Ripple, spike within 500mV _{P-P}
		Inrush current : 5.5A, within 200μs
Internal current consumption (5VDC)		0.19A
Weight		0.33A
		0.19kg

- *1: Accuracy of offset/gain setting at ambient temperature
Q62AD-DGH needs to be powered on 30 minutes prior to operation for compliance to the specification (accuracy).
- *2: "digit" indicates a digital output value.
- *3: Accuracy per temperature change of 1°C
Example) Accuracy when temperature changes from 25 to 30°C
 $0.05\% \text{ (reference accuracy)} + 0.00714\% / ^\circ\text{C} \text{ (temperature coefficient)} \times 5^\circ\text{C} \text{ (temperature change difference)} = 0.0857\%$
- *4: User range setting is 2 to 24mA.
- *5: For details on the I/O conversion characteristics, refer to Section 3.1.2 (2).
- *6: Maximum resolution in the user range setting.

REMARK

For the general specifications of the A/D converter module, refer to the user's manual for the CPU module used.

3.1.2 I/O conversion characteristic

The I/O conversion characteristic represents the angle formed by a straight line connecting the "offset value" and "gain value" when the analog signals (voltage or current input) from outside the programmable controller are converted to digital values.

Offset value

The offset value denotes the analog input value (voltage or current) that makes the digital output value 0.

Gain value

The gain value denotes the analog input value (voltage or current) that makes the digital output value:

32000 (16 bits)

64000 (32 bits)

(1) Input characteristics of Q64AD-GH

(a) Voltage input characteristic

Fig. 3.1 shows a graph of the voltage input characteristic.

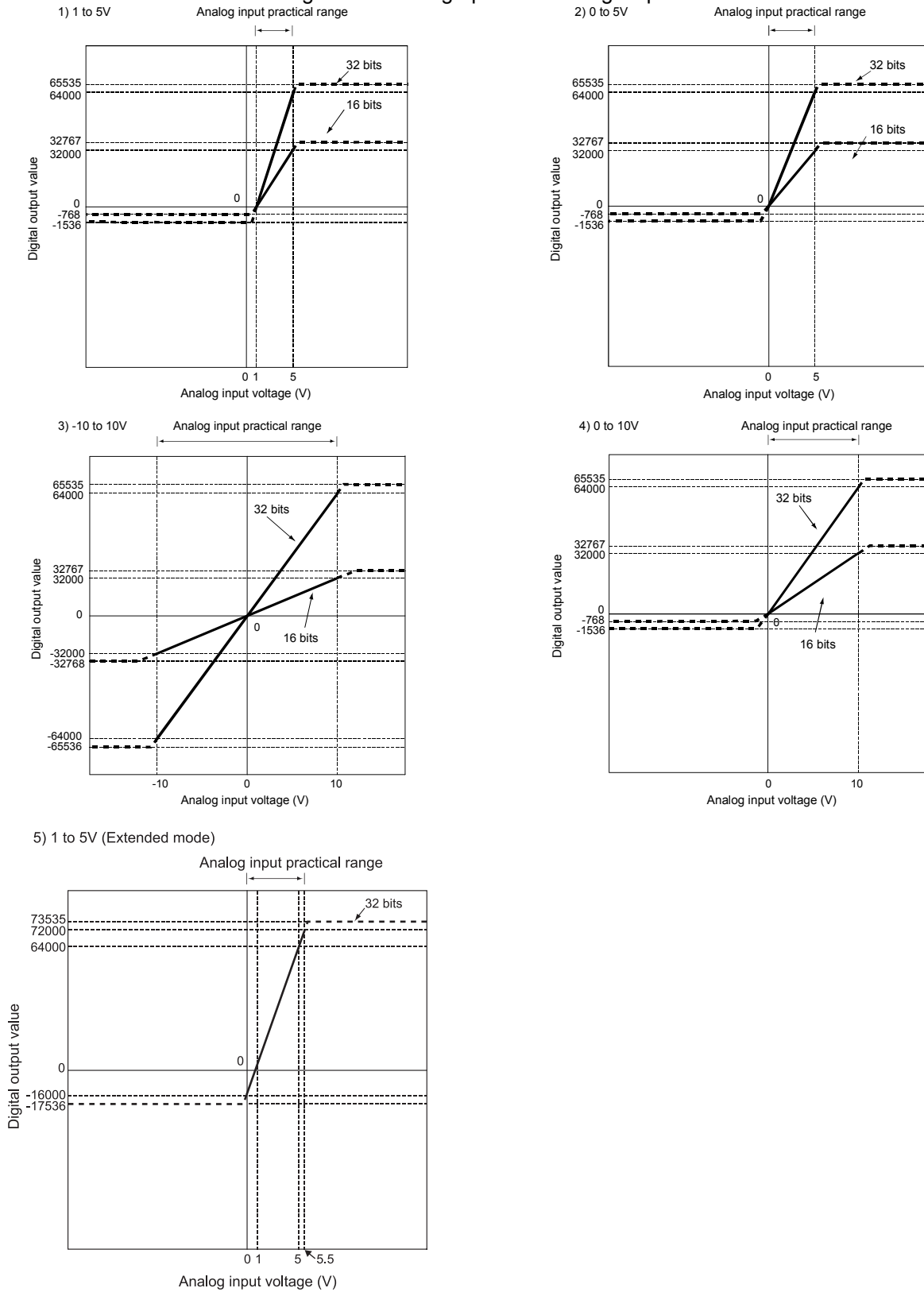

Fig. 3.1 Voltage input characteristic of Q64AD-GH

POINT				
<p>(1) Set within the analog input range and digital output range for each input range. If these ranges are exceeded, the resolution and accuracy may not fall within the performance specifications. (Avoid the use of dotted areas of Fig. 3.1.)</p>				
<p>(2) Do not input an analog input voltage of -15V or less, or +15V or more. Doing so can cause the breakdown of the elements.</p>				
<p>(3) Set the offset/gain values for the user setting range within a range in which the following conditions are satisfied.</p> <p>(a) Offset value, gain value setting range: -10 to 10V</p> <p>(b) { (gain value) - (offset value) } > 3.030V</p>				
<p>(4) When an analog value that exceeds the range for the digital output value is entered, the digital output value will be fixed at the maximum or minimum value.</p>				
Analog input range setting	Digital output value (32 bits)		Digital output value (16 bits)	
	Minimum	Maximum	Minimum	Maximum
1 to 5V	-1536	65535	-768	32767
0 to 5V			-32768	
-10 to 10V			-768	
0 to 10V	-1536			
1 to 5V (Extended mode)	-17536	73535	-	-
User range setting (Uni-polar)	-1536	65535	-768	32767
User range setting (Bi-polar)	-65536		-32768	

(b) Current input characteristic

Fig. 3.2 shows a graph of the current input characteristic.

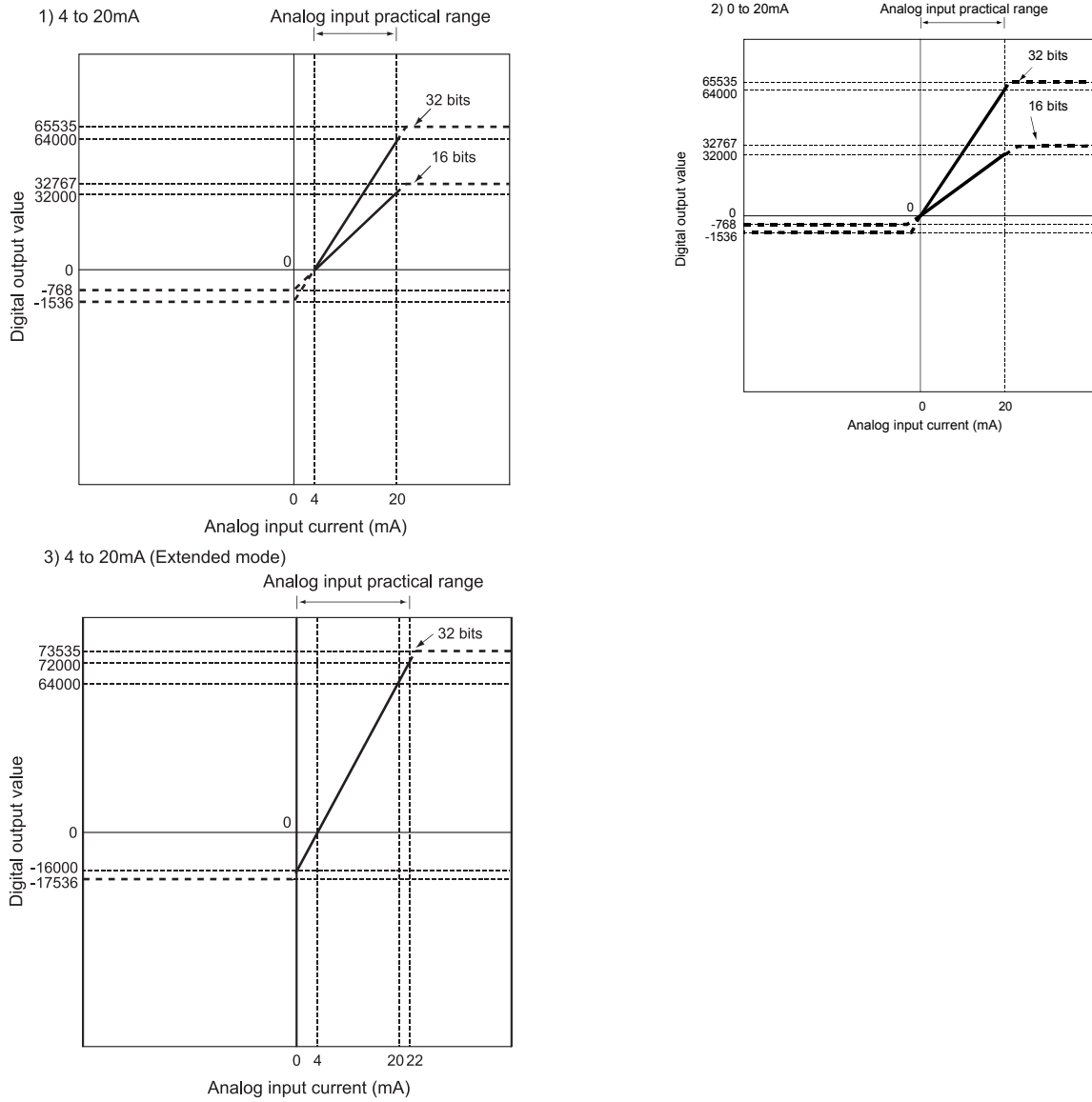

Fig. 3.2 Current input characteristic of Q64AD-GH

POINT				
(1) Set within the analog input range and digital output range for each input range. If these ranges are exceeded, the resolution and accuracy may not fall within the performance specifications. (Avoid the use of dotted areas of Fig. 3.2.)				
(2) Do not input an analog input current of -30mA or less, or +30mA or more. Doing so can cause the breakdown of the elements.				
(3) Set the offset/gain values for the user setting range within a range in which the following conditions are satisfied.				
(a) Gain value \leq 20mA, offset value \geq 0mA				
(b) { (gain value) - (offset value) } > 9.70mA				
(4) When an analog value that exceeds the range of the digital output value is entered, the digital output value will be fixed at the maximum or minimum value.				
Analog input range setting	Digital output value (32 bits)		Digital output value (16 bits)	
	Minimum	Maximum	Minimum	Maximum
4 to 20mA	-1536	65535	-768	32767
0 to 20mA				
4 to 20mA (Extended mode)	-17536	73535	-	-
User range setting (Uni-polar)	-1536	65535	-768	32767

(2) Input characteristic of Q62AD-DGH

Fig. 3.3 shows a graph of the Q62AD-DGH input characteristic.

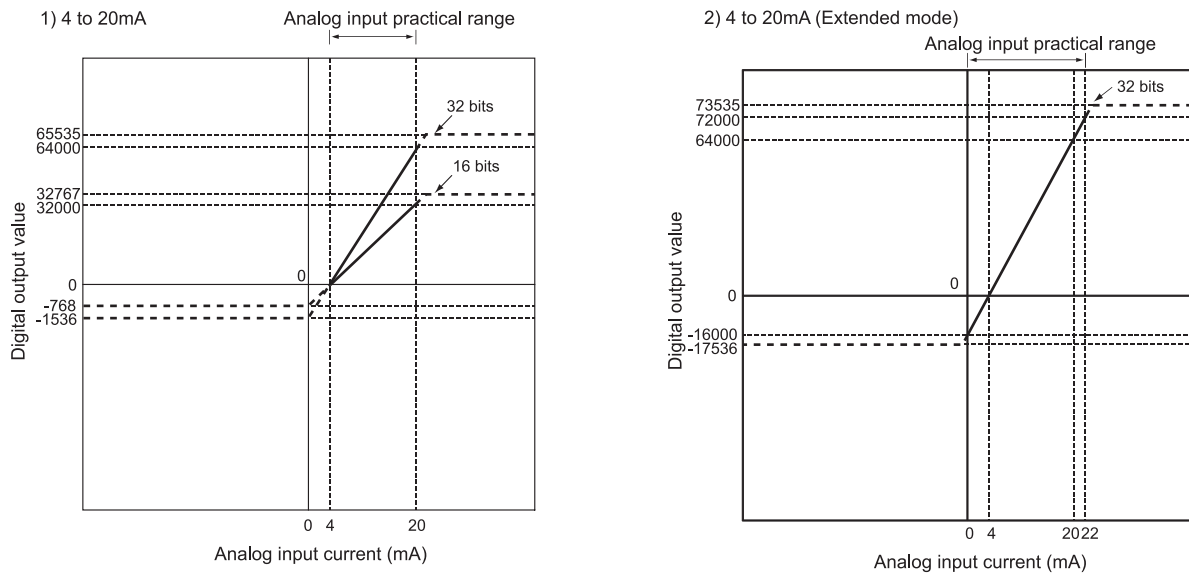

Fig. 3.3 Input characteristic of Q62AD-DGH

POINT					
(1)	Set within the analog input range and digital output range for each input range. If these ranges are exceeded, the resolution and accuracy may not fall within the performance specifications. (Avoid the use of dotted areas of Fig. 3.3.)				
(2)	Do not input an analog input current of 0mA or less, or 30mA or more. Doing so can cause the breakdown of the elements.				
(3)	Set the offset/gain values for the user setting range within a range satisfying the following conditions.				
	(a) Gain value $\leq 24\text{mA}$, offset value $\geq 2\text{mA}$				
	(b) $\{(\text{gain value}) - (\text{offset value})\} > 9.70\text{mA}$				
(4)	When an analog value that exceeds the range of the digital output value is entered, the digital output value will be fixed at the maximum or minimum value.				
	Analog input range setting	Digital output value (32 bits)		Digital output value (16 bits)	
		Minimum	Maximum	Minimum	Maximum
	4 to 20mA	-1536	65535	-768	32767
	4 to 20mA (Extended mode)	-17536	73535	-	-
	User range setting	-1536	65535	-768	32767

3.1.3 Accuracy

The reference accuracy is the accuracy at the ambient temperature for offset/gain setting.

The temperature coefficient is the accuracy per temperature variation of 1°C.

The reference accuracy is the accuracy relative to the maximum value of the digital output value.

If you change the offset/gain setting or input range to change the input characteristic, the reference accuracy and temperature coefficient do not vary and kept within the ranges given in the performance specifications.

Example) Accuracy when the temperature varies from 25°C to 30°C

$$0.05\% \text{ (reference accuracy)} + 0.00714\%/^{\circ}\text{C} \text{ (temperature coefficient)} \times 5^{\circ}\text{C} \text{ (temperature variation difference)} = 0.0857\%$$

3.2 Function List

Table 3.3 lists the functions of the A/D converter modules.

Table 3.3 Function list

Item	Function	Reference section
A/D conversion enable/disable setting	(1) Specifies whether to enable or disable the A/D conversion for each channel. (2) The conversion speed is 10ms regardless of the number of conversion enabled channels.	Section 3.4.2
A/D conversion method	(1) Sampling processing The A/D conversion for analog input values is performed successively for each channel, and the digital output value is output upon each conversion. (2) Averaging processing (a) Time averaging A/D conversion is averaged in terms of time on a channel basis and a digital average value is output. (b) Count averaging A/D conversion is averaged in terms of count on a channel basis and a digital average value is output. (c) Move averaging The specified number of digital output values measured per sampling time are averaged. (3) Primary delay filter A digital output value is smoothed according to the preset time constant.	Section 3.2.1
Maximum and minimum values hold function	(1) The maximum and minimum values of the digital output values are retained in the module.	Section 3.2.2
Input signal error detection function	(1) Voltage/current input that exceeds the input signal error detection upper limit value or falls below the input signal error detection lower limit value is detected.	Section 3.2.3
Warning output function	(1) Process alarm A warning is output if a digital output value exceeds the process alarm upper upper limit value or falls below the process alarm lower lower limit value. (2) Rate alarm A warning is output if the variation rate of a digital output value is so high that the rate alarm upper limit value is exceeded, or is so low that the rate alarm lower limit value is exceeded.	Section 3.2.4
A/D conversion starting time setting function (Q62AD-DGH only)	(1) Setting the A/D conversion starting time allows A/D conversion to be started at the point when the output of the 2-wire transmitter stabilizes.	Section 3.2.5
Supply power ON/OFF function (Q62AD-DGH only)	(1) The power supply to the 2-wire transmitter can be switched ON/OFF channel by channel. (2) Power is supplied to the channel set for "Conversion enable" in the A/D conversion enable/disable setting (buffer memory address 0: Un\G0).	Section 3.4.2
Online module change	(1) The module can be changed without the system being stopped.*1	Chapter 7

*1: When the input range is set as shown below, online module change with a module that does not support the analog input range extended mode causes an intelligent function module switch error.

For the Q64AD-GH: 4 to 20mA (Extended mode): A_H

1 to 5V (Extended mode): B_H

For the Q62AD-DGH: 4 to 20mA (Extended mode): A_H

3.2.1 A/D conversion methods

(1) Sampling processing

A/D conversion is performed successively for the analog input value, and the converted digital output values are stored in the buffer memory. The conversion speed is 10ms regardless of the number of conversion enabled channels.

(2) Averaging processing

(a) Time averaging

A/D conversion is made for the preset period of time, the sum of values other than the maximum and minimum values is averaged, and the result is stored into the buffer memory. The processing count within the set time is uniform independently of the number of used channels (number of channels set for A/D conversion enable).

$$\text{Processing count} = \text{set time}/10 \text{ (times)}$$

[Example] When the averaging processing time is set to 42ms
 $42/10 = 4.2 \text{ (times)}$... Fractional portion is dropped.

(b) Count averaging

A/D conversion is made the preset number of times, the sum of values other than the maximum and minimum values is averaged, and the result is stored into the buffer memory.

The time when the count-based average value is stored into the buffer memory is uniform independently of the number of used channels (number of channels set for A/D conversion enable).

$$\text{Processing time} = \text{set count} \times 10 \text{ (ms)}$$

[Example] When the averaging processing count is set to 5 times
 $5 \times 10 = 50 \text{ (ms)}$

(c) Move averaging

The specified count of digital output values imported per sampling time are averaged to find a value, which is then stored into the buffer memory. Since average processing is performed with data shifted per sampling, the most recent digital output value is available.

Move averaging processing at the preset count of 4 times

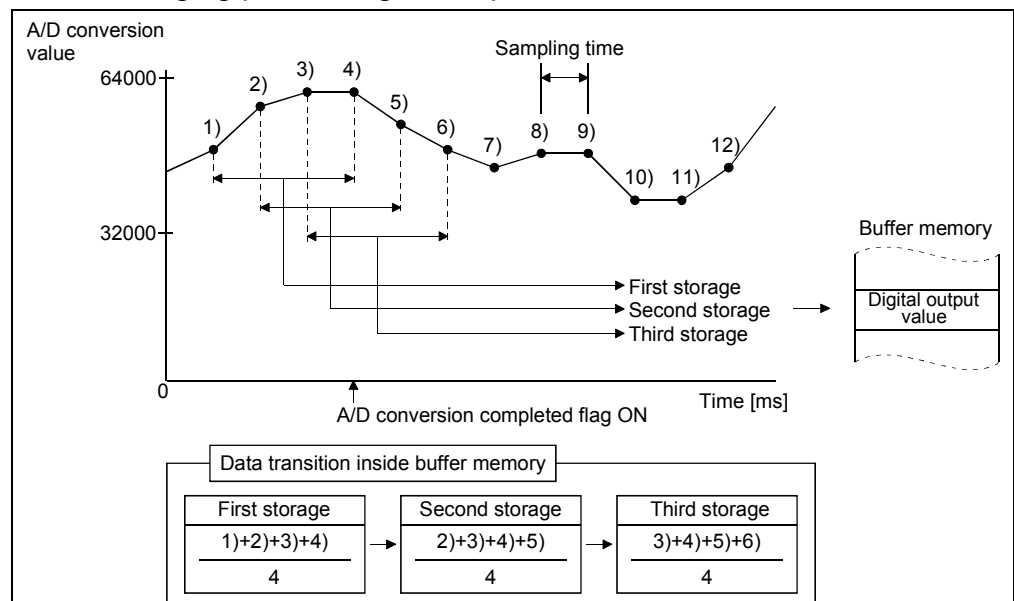

(3) Primary delay filter

A digital value whose transient noise has been smoothed is output according to the preset time constant.

The degree of smoothing varies with the time constant setting.

The relational expression of the time constant and digital output value is indicated below.

[If $n = 1^{*1}$]

$$Y_n = 0$$

[If $n = 2$]

$$Y_n = y_{n-1} + \frac{\Delta t}{\Delta t + TA} (y_n - y_{n-1})$$

[If $n \geq 3$]

$$Y_n = Y_{n-1} + \frac{\Delta t}{\Delta t + TA} (y_n - Y_{n-1})$$

Y_n : Current digital output value

Y_{n-1} : Immediately preceding digital output value

n : Sampling count

TA : Time constant (s)

y_n : Pre-smoothing digital output value

y_{n-1} : Immediately preceding pre-smoothing digital output value

Δt : A/D conversion time (0.01s)

*1: The A/D conversion completed flag turns ON when $n \geq 2$.

[Example 1] Digital output value when the analog input value varied from 0 to 1V
Under the condition that the Q64AD-GH is used with an input range of 0 to 10V, the digital output value with a time constant setting of 1000ms (1s) changes as shown in the figure below.

When the analog input value comes to 1V, and then 1000ms (1s) has elapsed, the digital output value reaches 63.2% of the value attained when the sampling processing is selected.

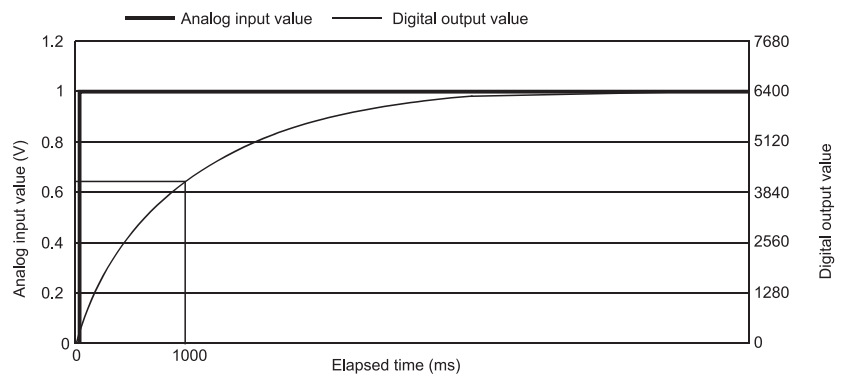

[Example 2] Digital output value when the variation of the analog input value has a ringing waveform
 Under the condition that the Q64AD-GH is used with an input range of 0 to 10V, the digital output value with a time constant setting of 2000ms (2s), with a time constant setting of 1000ms (1s), or with the move averaging processing of 16 times changes as shown in the figure below, respectively.

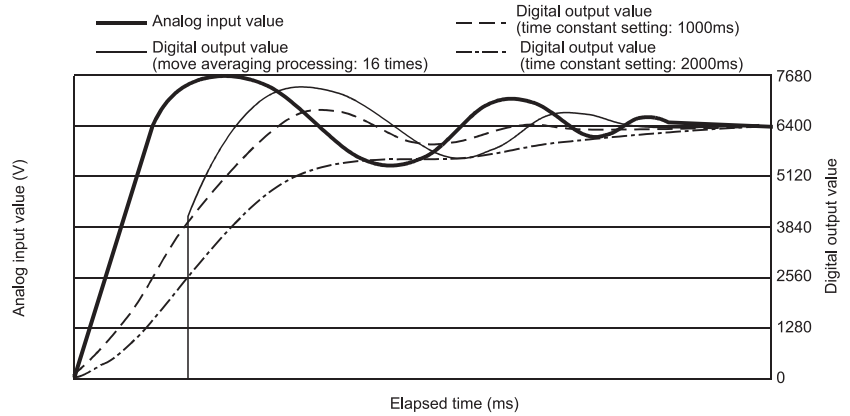

3.2.2 Maximum and minimum values hold function

- (1) The maximum and minimum values are held in the buffer memory channel by channel.
- (2) The maximum and minimum values are cleared to 0 when the maximum value/minimum value reset request (YD) or operating condition setting request (Y9) is turned ON, and new maximum and minimum values are stored when conversion is started.
- (3) Since the area for storing the maximum and minimum values can be rewritten with the sequence program, the maximum and minimum values within a specific period of time can be checked.

3.2.3 Input signal error detection function

- (1) If the input voltage/current rose to or above the input signal error detection upper limit value or fell to or below the lower limit value, the input signal error detection flag (buffer memory address 49: Un\G49) and input signal error detection signal (XC) turn ON and the ALM LED flickers to indicate the error.
- (2) The digital output value of the channel where the input signal error detection flag (buffer memory address 49: Un\G49) turned ON is held as immediately before detection of the error, and the A/D conversion completed flag (buffer memory address 10: Un\G10) of the corresponding channel turns OFF.
- (3) By bringing the analog input value within the setting range and then turning ON the error clear request (YF), the input signal error detection flag (buffer memory address 49: Un\G49) and input signal error detection signal (XC) turn OFF.
- (4) When the analog input value returns to within the setting range, A/D conversion is resumed independently of whether the input signal error detection flag (buffer memory address 49: Un\G49) and input signal error detection signal (XC) are reset or not, the A/D conversion completed flag (buffer memory address 10: Un\G10) of the corresponding channel turns ON again after the first updating. (The ERR. LED remains flickering.)

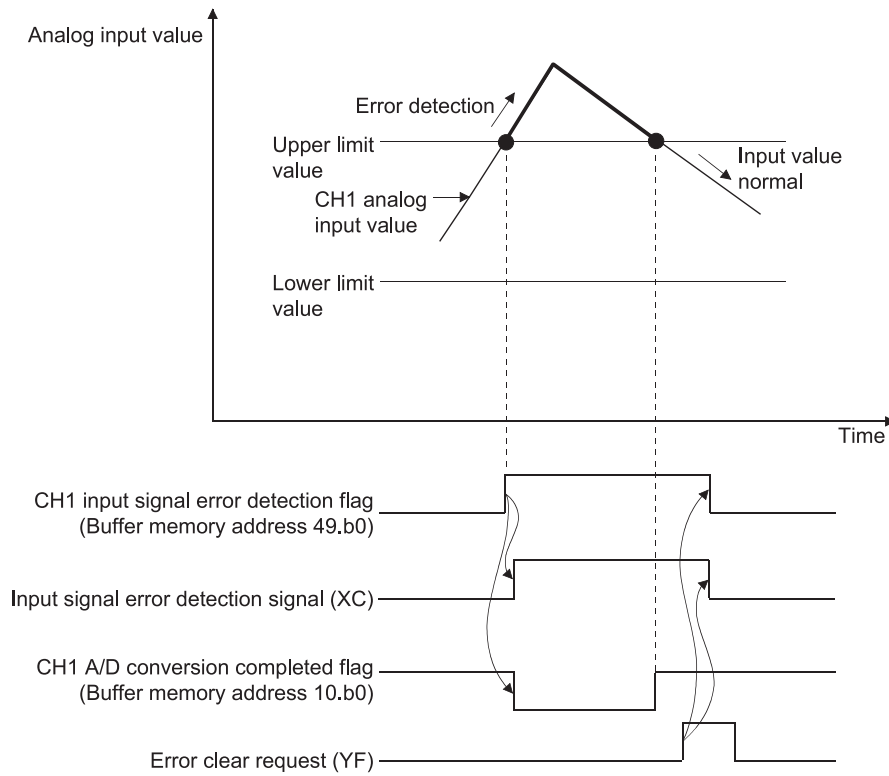

- (5) This function is executed at every sampling processing.
- (6) Perform the following procedure to use this function.
- 1) Set the input signal error detection setting value for the corresponding channel.
 - 2) Enable the A/D conversion of the corresponding channel.
 - 3) Enable the input signal error detection of the corresponding channel.
 - 4) Turn ON the operating condition setting request (Y9).
- (7) How to set the input signal error detection upper limit value and the input signal error detection lower limit value.

The input signal error detection upper value and the input signal error detection lower limit value is determined on the basis of the input signal error detection setting value (set in increments of 1 (0.1%)).

By default, the input signal error detection setting value is reflected in both the input signal error detection upper limit value and the input signal error detection lower limit value.

To set up input signal error detection with customized values for the upper limit value only, lower limit value only, or upper and lower limit values, refer to the section (9).

(a) Input signal error detection upper limit value

This value is determined by adding "the value obtained by multiplying the width of the input range (gain value – offset value) by the input signal error detection setting value (input signal error detection upper limit setting value)" to a gain value.

This setting is limited to a value greater than the gain value.

The setting value (%) is given by the following equation:

$$\frac{\text{Input signal error detection setting value}}{\text{(Input signal error detection upper limit setting value)}} = \frac{\text{Input signal error detection upper limit value} - \text{Gain value of each range}}{\text{Gain value of each range} - \text{Offset value of each range}} \times 1000$$

(b) Input signal error detection lower limit value

This value is determined by subtracting "the value obtained by multiplying the width of the input range (gain value – offset value) by the input signal error detection setting value (input signal error detection lower limit setting value)" from the lower limit value in the input range.

This setting is limited to a value less than the lower limit value in the input range.

The setting value (%) is given by the following equation:

$$\frac{\text{Input signal error detection setting value}}{\text{(Input signal error detection lower limit setting value)}} = \frac{\text{Lower limit value of each range} - \text{Input signal error detection lower limit value}}{\text{Gain value of each range} - \text{Offset value of each range}} \times 1000$$

REMARK

The following table shows the lower limit value, offset value, and gain value for each range.

Table 3.4 Lower limit value, offset value, and gain value for input range (Q64AD-GH)

Input	Analog input range	Lower limit value	Offset value	Gain value
Voltage	0 to 10V	0V		10V
	0 to 5V	0V		5V
	1 to 5V	1V		5V
	1 to 5V (Extended mode)	1V		5V
	-10 to 10V	-10V	0V	10V
	User range setting (Uni-polar)	Analog value set as the offset value by the user		Analog value set as the gain value by the user
Current	User range setting (Bi-polar)	Analog value corresponding to a digital value of -64000	Analog value set as the offset value by the user	Analog value set as the gain value by the user
	0 to 20mA	0mA		20mA
	4 to 20mA	4mA		20mA
	4 to 20mA (Extended mode)	4mA		20mA
User range setting (Uni-polar)	Analog value set as the offset value by the user		Analog value set as the gain value by the user	

Table 3.5 Lower limit value, offset value, and gain value for input range (Q62AD-DGH)

Analog input range	Lower limit value	Offset value	Gain value
4 to 20mA	4mA		20mA
4 to 20mA (Extended mode)	4mA		20mA
User range setting	Analog value set as the offset value by the user		Analog value set as the gain value by the user

(8) Example of setting the input signal error detection

Ex.) To detect an input signal error if the analog input value falls below 2.4mA on the channel with an input range of 4 to 20mA (Extended mode)

Suppose that the following values are substituted into the equation for the input signal error detection lower limit value:

- Input signal error detection lower limit value: 2.4mA
- Lower limit value in the input range (offset value): 4.0mA
- Gain value: 20.0mA

$$\begin{aligned} \text{Input signal error detection setting value} &= \frac{4.0 - 2.4}{20.0 - 4.0} \times 1000 \\ &= 100(10.0\%) \end{aligned}$$

Accordingly, set the input signal error detection setting value to "100 (10.0%)".
 With this setting, the input signal error detection setting value works as show below. (The setting "100 (10.0%)" allows an error to be detected at a level of 21.6mA as well as 2.4mA.)

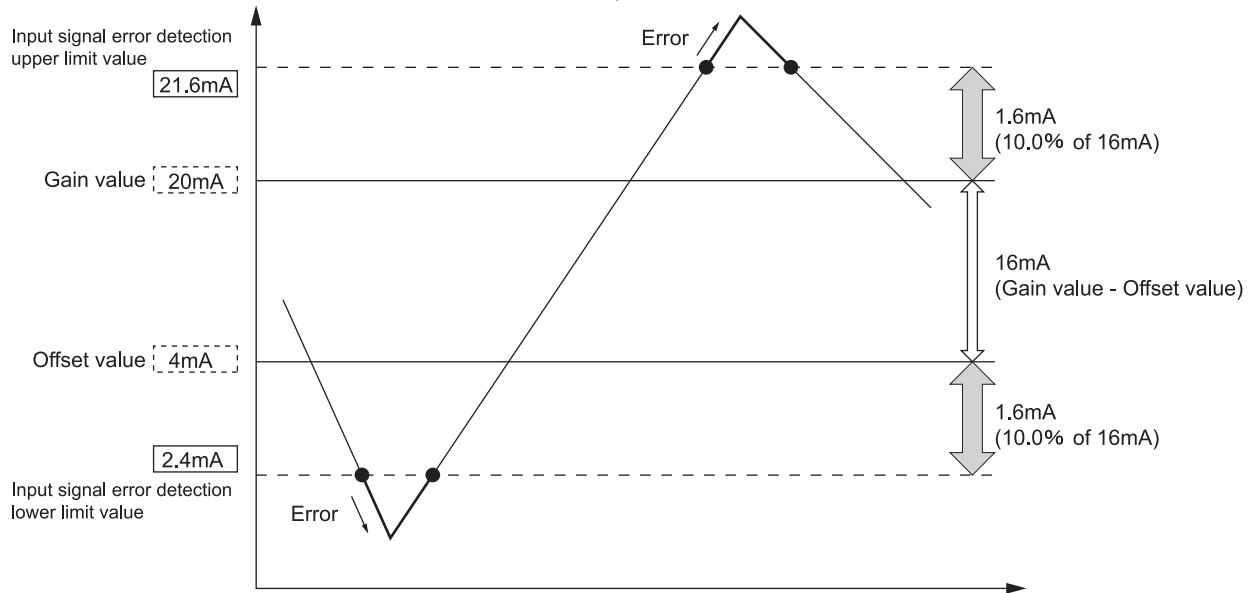

(9) Setting up input signal error detection with customized values for the upper limit value only, lower limit value only, or upper and lower limit values

The following settings allows input signal error detection with customized values for the upper limit value only, lower limit value only, or upper and lower limit values.

- Input signal error detection extended/input signal error detection/warning output settings (buffer memory address 47: Un\G47)
- CH□ input signal error detection setting value/CH□ input signal error detection lower limit setting value (buffer memory addresses 138 to 141: Un\G138 to Un\G141)
- CH□ input signal error detection upper limit setting value (buffer memory addresses 142 to 145: Un\G142 to Un\G145)

The following is an example of how to make the settings.

Ex.) To detect an input signal error if the analog input value falls below 2.4mA on the channel with an input range of 4 to 20mA (Extended mode)

- 1) For input signal error detection at a level of the lower limit value only
 - Input signal error detection extended setting: 1 (Different upper limit value and lower limit value)
 - Input signal error detection upper limit setting value: 251 (Input signal error detection invalid)
 - Input signal error detection lower limit setting value: 100 (10.0%)

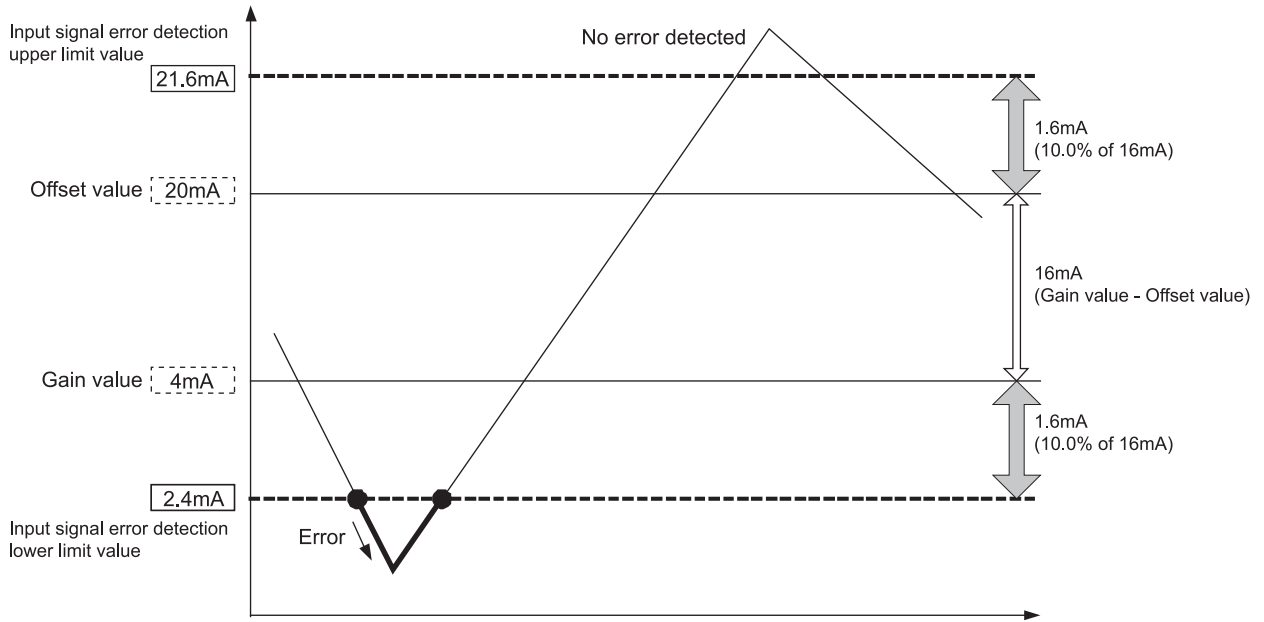

- 2) For input signal error detection at a level of the upper limit value only
 - Input signal error detection extended setting: 1 (Different upper limit value and lower limit value)
 - Input signal error detection upper limit setting value: 100 (10.0%)
 - Input signal error detection lower limit setting value: 251 (Input signal error detection invalid)

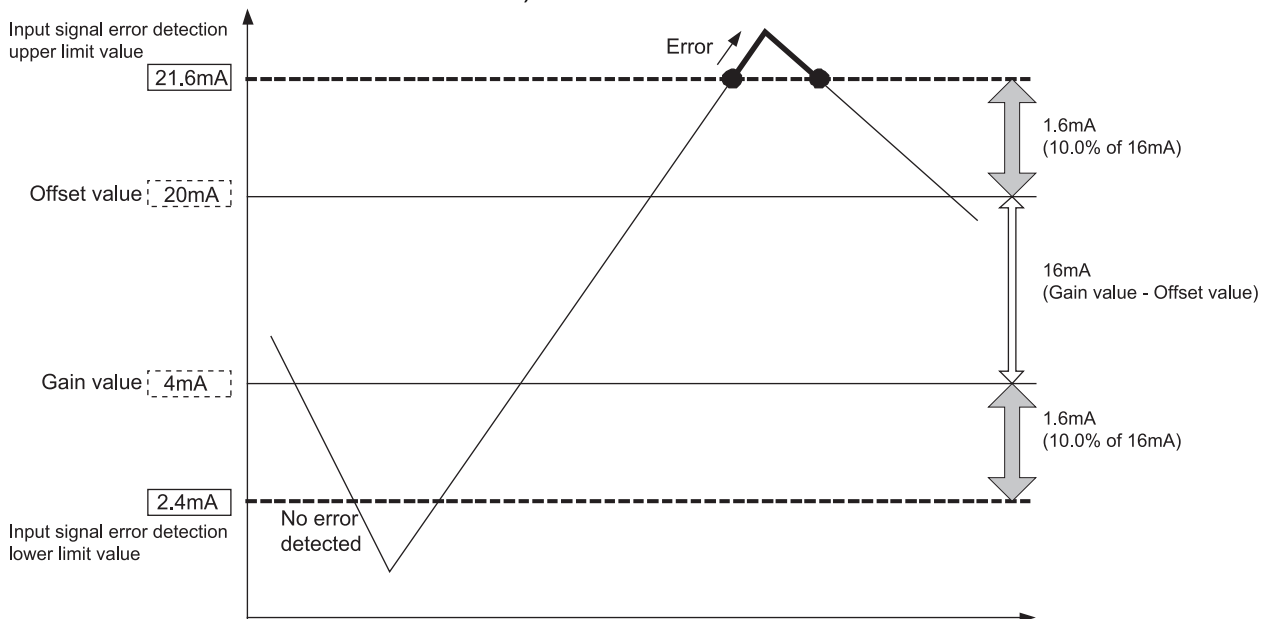

3) For input signal error detection at a level of customized upper and lower limit values

- Input signal error detection extended setting: 1 (Different upper limit value and lower limit value)
- Input signal error detection upper limit value: 50 (5.0%)
- Input signal error detection lower limit value: 120 (12.0%)

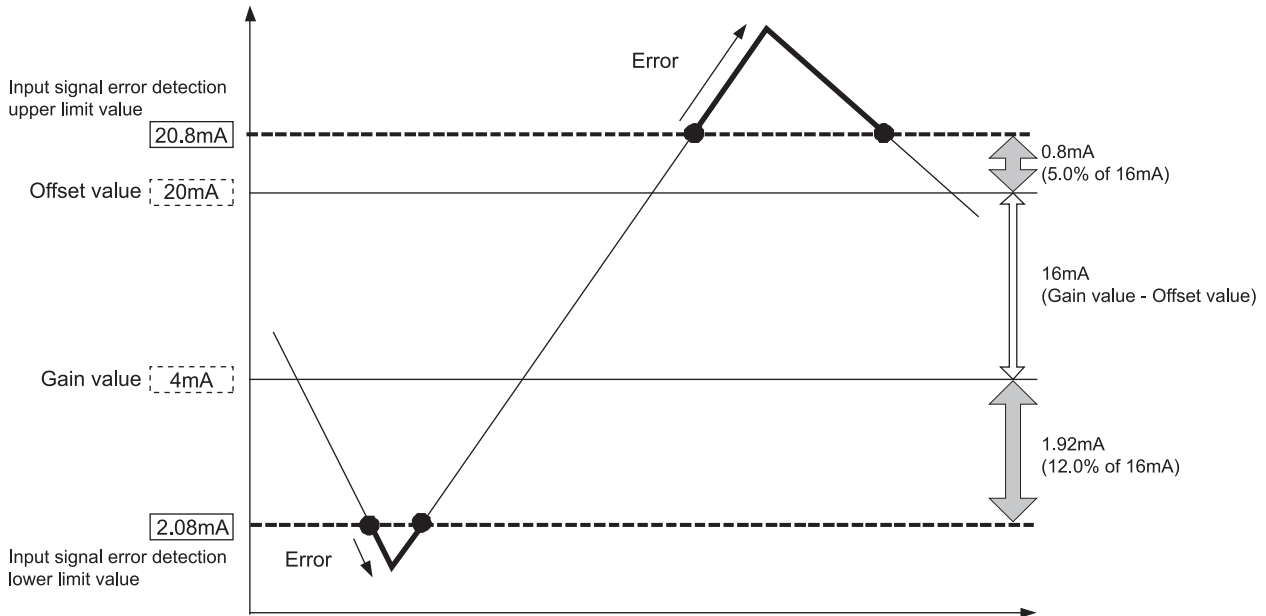

3.2.4 Warning output function

(1) Process alarm

- (a) If the detected digital output value rose to or above the process alarm upper upper limit value or fell to or below the process alarm lower lower limit value and entered the warning output range, the warning output flag (buffer memory address 48: Un\G48) and warning output signal (X8) turn ON and the ALM LED is lit to indicate the warning.
- (b) If, after the output of the warning, the detected digital output value fell below the process alarm upper lower limit value or rose above the process alarm lower upper limit value and returned to within the setting range, "0" is stored into the bit position corresponding to the channel number of the warning output flag (buffer memory address 48: Un\G48). The warning output signal (X8) turns OFF only when all channels return to within the setting range.

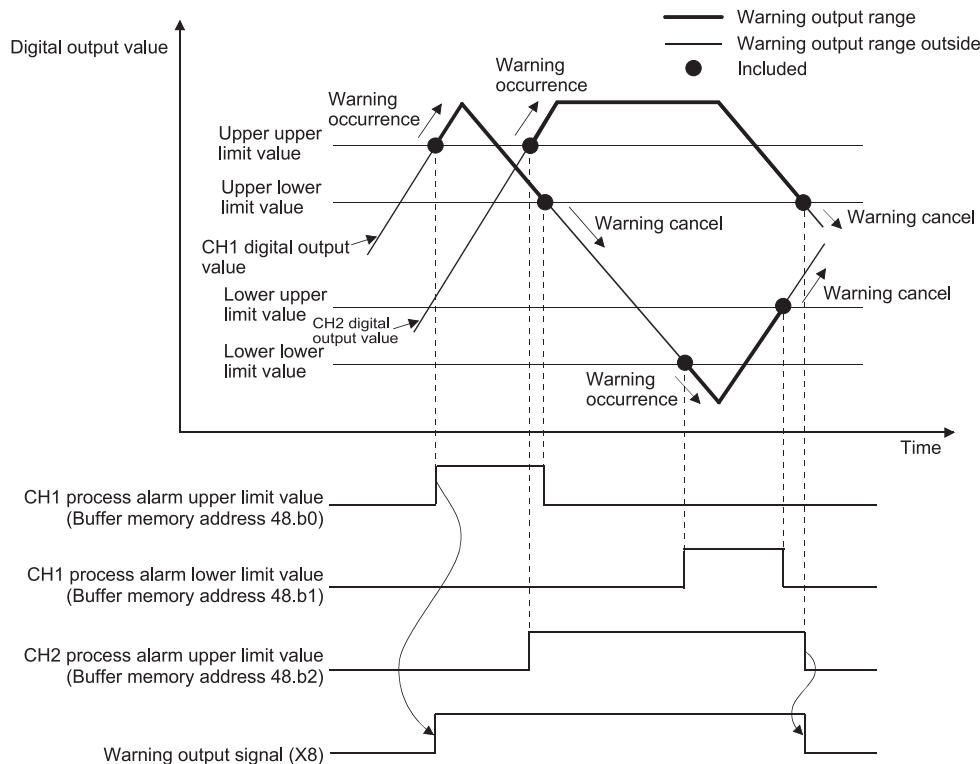

- (c) When time or count averaging is specified, this function is executed at intervals of the preset averaging time or averaging count. When any other A/D conversion system (sampling processing, move averaging, primary delay filter) is specified, this function is executed at intervals of the sampling time.

(2) Rate alarm

- (a) If the digital output value sampled at intervals of the rate alarm warning detection period indicated a varying rate equal to or greater than the rate alarm upper limit value or a varying rate equal to or less than the rate alarm lower limit value, the warning output flag (buffer memory address 48: Un\G48) and warning output signal (X8) turn ON and the ALM LED is lit to indicate the warning of the rate alarm.
- (b) If, after the output of the warning, the varying rate fell below the rate alarm upper limit value or rose above the rate alarm lower limit value and returned to within the setting range, "0" is stored into the bit position corresponding to the channel number of the warning output flag (buffer memory address 48: Un\G48).
The warning output signal (X8) turns OFF only when all channels return to within the setting range.

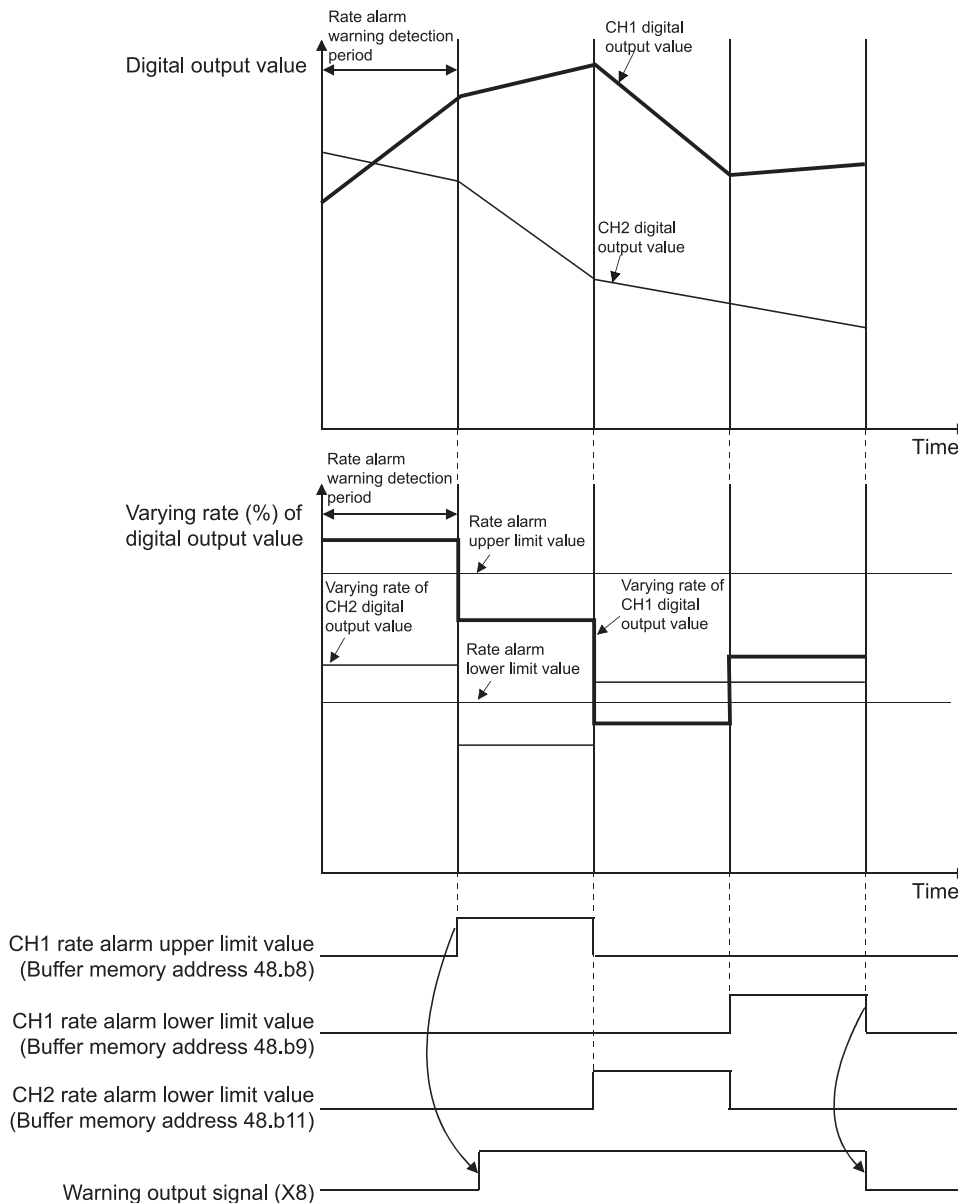

- (c) Set the rate alarm upper limit value/lower limit value in 0.1%/s increments relative to the maximum value (64000) of the digital output value. The setting range is -65536 to 65535 (-6553.6% to 6553.5%).
- (d) The setting range of the rate alarm warning detection period is 10 to 5000ms. When the period is set to 5000ms, the digital values are compared at intervals of 5 seconds to detect the varying rate.
- (e) The rate alarm is judged by converting the rate alarm upper/lower limit value into the digit value per rate alarm warning detection period. The conversion expression of the value used to make judgment per rate alarm warning detection period is as follows.

Value used to make judgment per rate alarm warning detection period [digit]
 =rate alarm upper limit value or lower limit value × 0.001 × 64000 × rate alarm warning detection period ÷ 1000

Example

When the varying rate upper limit value of channel 1 is set to 30%/s (300 is stored into the buffer memory) and the rate alarm warning detection period of channel 1 is 10ms, the current and previous values are compared at intervals of 10ms and whether or not the value has varied 0.3% (192 digits) or more in 10ms is judged.

$$300 \times 0.001 \times 64000 \times 10 \div 1000 = 192(\text{digit})$$

- (f) The rate alarm is useful to watch the varying rate of the digital output value in the limited range.
 - 1) Example of setting the rate alarm upper limit value/lower limit value when it is desired to watch that the digital output value is at the rise rate within the specified range

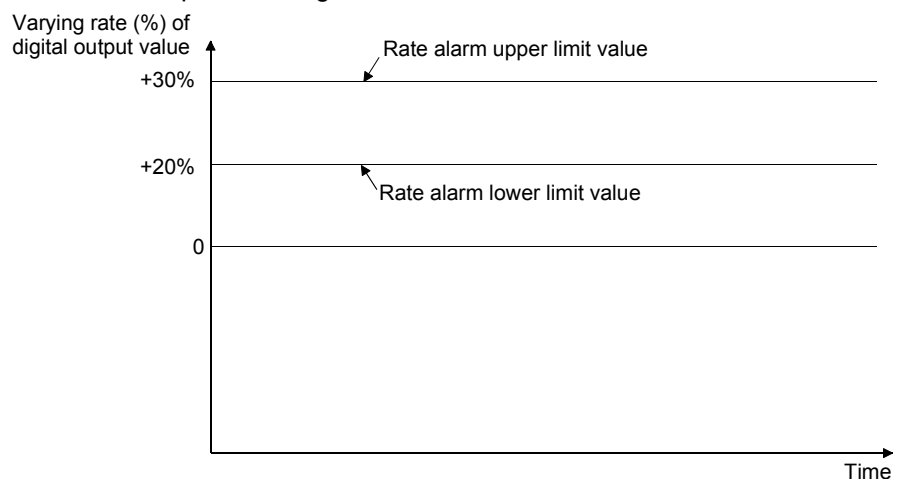

- 2) Example of setting the rate alarm upper limit value/lower limit value when it is desired to watch that the digital output value is at the fall rate within the specified range

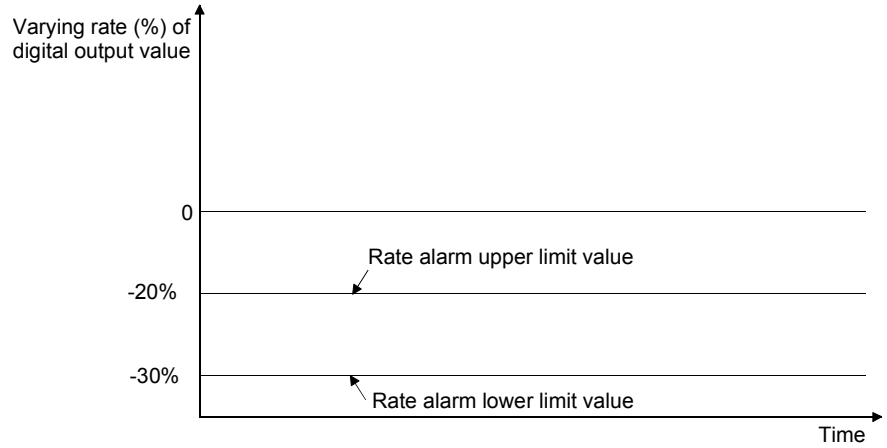

- 3) Example of setting the rate alarm upper limit value/lower limit value when it is desired to watch that the digital output value is at the varying rate within the specified range

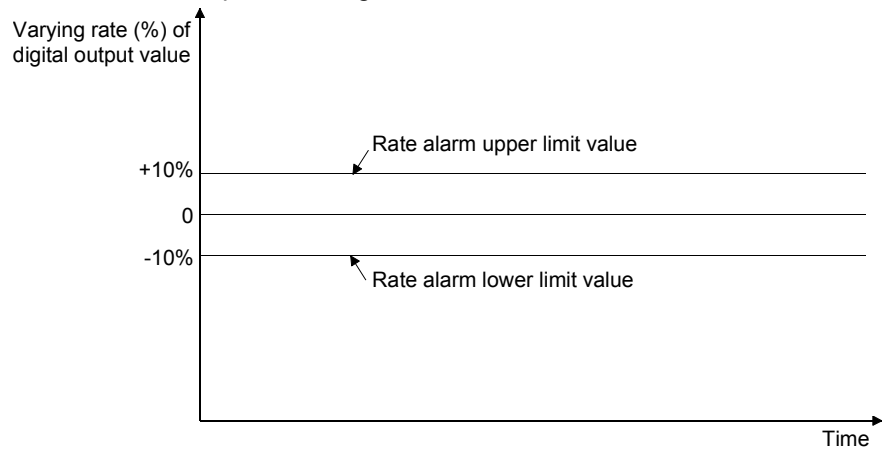

3.2.5 A/D conversion starting time setting function (Q62AD-DGH only)

- (1) As the A/D conversion starting time, set the "time necessary from when the used 2-wire transmitter powers on until its output stabilizes".
This setting allows A/D conversion processing to be started as soon as the output of the 2-wire transmitter stabilizes.
- (2) Set the time to the CH□ A/D conversion starting time setting (buffer memory addresses 5, 6: Un\G5, Un\G6).
- (3) The following indicates the time until the A/D conversion completed flag (buffer memory addresses 10: Un\G10) turns ON when the A/D conversion starting time has been set.

(A/D conversion starting time) + (A/D conversion pre-processing: Approx. 150 to 165ms) + (A/D conversion processing: 10ms)

POINT
Set the A/D conversion starting time in consideration of the time necessary from when the 2-wire transmitter powers on until its output stabilizes and the warm-up time of the 2-wire transmitter.

[Example] When the time necessary from when the 2-wire transmitter powers on until its output stabilizes is 500ms

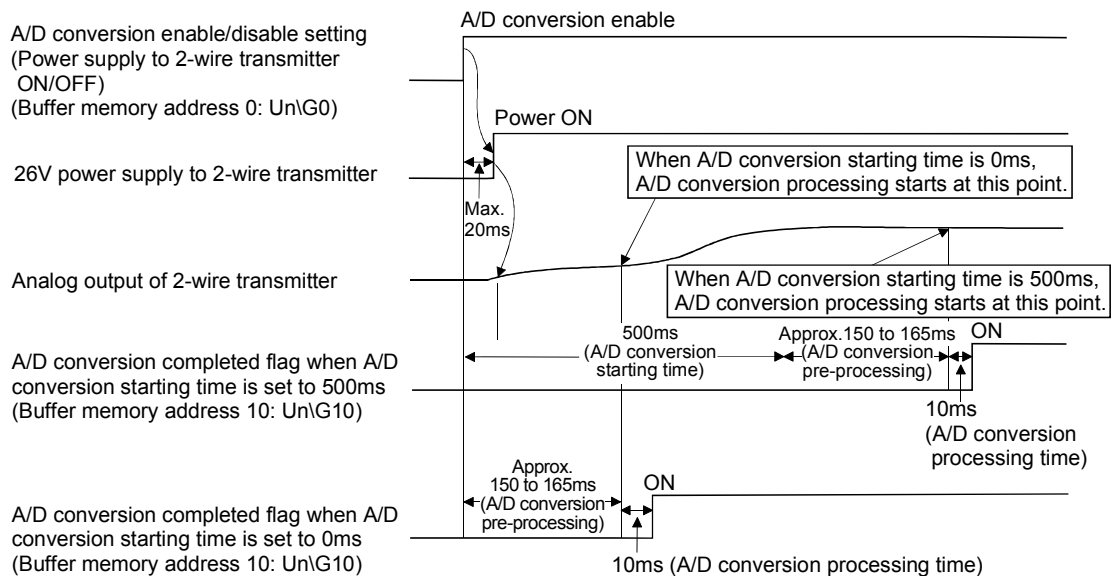

3.3 I/O Signals for the Programmable Controller CPU

3.3.1 List of I/O signals

Table 3.6 lists the I/O signals of the Q64AD-GH.

Table 3.7 lists the I/O signals of the Q62AD-DGH.

Note that I/O numbers (X/Y) shown in this chapter and thereafter are the values when the start I/O number for the A/D converter module is set to 0.

Table 3.6 List of I/O signal (Q64AD-GH)

Signal direction CPU Module ← Q64AD-GH		Signal direction CPU Module → Q64AD-GH	
Device No. (Input)	Signal name	Device No. (Output)	Signal name
X0	Module ready	Y0	Use prohibited * 1
X1	Use prohibited * 1	Y1	
X2		Y2	
X3		Y3	
X4		Y4	
X5		Y5	
X6		Y6	
X7		Y7	
X8	Warning output signal	Y8	
X9	Operating condition setting completed flag	Y9	Operating condition setting request
XA	Offset/gain setting mode flag	YA	User range writing request
XB	Channel change completed flag	YB	Channel change request
XC	Input signal error detection signal	YC	Use prohibited * 1
XD	Maximum value/minimum value reset completed flag	YD	Maximum value/minimum value reset request
XE	A/D conversion completed flag	YE	Use prohibited * 1
XF	Error flag	YF	Error clear request

POINT

*1 These signals cannot be used by the user since they are for system use only. If these are turned ON/OFF by the sequence program, the functioning of the A/D converter module cannot be guaranteed.

Table 3.7 List of I/O signal (Q62AD-DGH)

Signal direction CPU Module ← Q62AD-DGH		Signal direction CPU Module → Q62AD-DGH	
Device No. (Input)	Signal name	Device No. (Output)	Signal name
X0	Module ready	Y0	Use prohibited *1
X1	Use prohibited *1	Y1	
X2		Y2	
X3		Y3	
X4		Y4	
X5		Y5	
X6		Y6	
X7		Y7	
X8	Warning output signal	Y8	
X9	Operating condition setting completed flag	Y9	Operating condition setting request
XA	Offset/gain setting mode flag	YA	User range writing request
XB	Channel change completed flag	YB	Channel change request
XC	Input signal error detection signal	YC	Offset/gain change request
	Offset/gain change completed flag		
XD	Maximum value/minimum value reset completed flag	YD	Maximum value/minimum value reset request
XE	A/D conversion completed flag	YE	Use prohibited *1
XF	Error flag	YF	Error clear request

POINT

*1 These signals cannot be used by the user since they are for system use only. If these are turned ON/OFF by the sequence program, the functioning of the A/D converter module cannot be guaranteed.

3.3.2 Details of I/O signals

I/O signals for the A/D converter modules are explained in detail below.

(1) Input signals

Device No.	Signal Name	Description
X0	Module ready	<p>(1) When the programmable controller CPU is powered on or reset, this signal turns on once the preparation for A/D conversion has been completed, and A/D conversion processing is then performed.</p> <p>(2) In either of the following states, the Module ready (X0) turns OFF.</p> <ul style="list-style-type: none"> • During offset/gain setting mode (A/D conversion processing is performed.) • When the A/D converter module has a watchdog timer error ^{*1} (A/D conversion processing is not performed.)
X8	Warning output signal	<p>(1) The Warning output signal (X8) turns ON at detection of a process alarm or rate alarm.</p> <p>(a) Process alarm</p> <ol style="list-style-type: none"> 1) This signal turns ON when the digital output value falls outside the setting range set to the process alarm upper/lower limit values (buffer memory addresses 86 to 117: Un\G86 to Un\G117) on any of the channels enabled for A/D conversion after the process alarm function has been made valid. 2) As soon as the digital output values return to within the setting ranges on all channels enabled for A/D conversion, this signal turns OFF automatically and the ALM LED is also extinguished. <p>(b) Rate alarm</p> <ol style="list-style-type: none"> 1) This signal turns ON when the varying rate of the digital output value falls outside the varying rate range set to the rate alarm upper/lower limit values (buffer memory addresses 122 to 137: Un\G122 to Un\G137) on any of the channels enabled for A/D conversion after the rate alarm function has been made valid. 2) As soon as the varying rates of the digital output values return to within the preset varying ranges on all channels enabled for A/D conversion, this signal turns OFF automatically and the ALM LED is also extinguished. <p>-----> Performed by the A/D converter module —————> Performed by the sequence program</p> <p>Warning output flag (Buffer memory address 48: Un\G48)</p> <p>Warning output signal (X8)</p>

*1 A watchdog timer error occurs when the program calculations are not completed within the scheduled time due to malfunctions of A/D converter module hardware.
 When a watchdog timer error occurs, the RUN LED for the A/D converter module turns off.

Device No.	Signal Name	Description
X9	Operating condition setting completed flag	<p>(1) This signal is used as an interlock condition to turn ON/OFF the Operating condition setting request (Y9) when any of the following settings has been changed.</p> <ul style="list-style-type: none"> • A/D conversion enable/disable setting (buffer memory address 0: Un\G0) • CH□ Average time/Average number of times/Move average/Time constant settings (buffer memory addresses 1 to 4: Un\G1 to Un\G4) • CH□ A/D conversion starting time setting (buffer memory addresses 5, 6: Un\G5, Un\G6) • Averaging process specification (buffer memory address 9: Un\G9) • Input signal error detection extended/input signal error detection/warning output settings (buffer memory address 47: Un\G47) • CH□ process alarm upper/lower limit value (buffer memory addresses 86 to 117: Un\G86 to Un\G117) • CH□ rate alarm warning detection period (buffer memory addresses 118 to 121: Un\G118 to Un\G121) • CH□ rate alarm upper/lower limit value (buffer memory addresses 122 to 137: Un\G122 to Un\G137) • CH□ input signal error detection setting value/CH□ input signal error detection lower limit setting value (buffer memory addresses 138 to 141: Un\G138 to Un\G141) • CH□ input signal error detection upper limit setting value (buffer memory addresses 142 to 145: Un\G142 to Un\G145) <p>(2) When the operating condition setting completed flag (X9) is OFF, A/D conversion processing is not performed. Under the following conditions, the operating condition setting completed flag (X9) turns OFF.</p> <ul style="list-style-type: none"> • When operating condition setting request (Y9) is ON <div style="text-align: center;"> <p>-----> Performed by the A/D converter module —————> Performed by the sequence program</p> <p>The timing diagram shows four signals over time. Module ready (X0) is a high-level signal. Operating condition setting request (Y9) is a pulse. A/D conversion completed flag (XE) is a pulse that occurs after Y9. Operating condition setting completed flag (X9) is a signal that is high when Y9 is high and XE is high, and low otherwise. Dashed arrows indicate that the rising and falling edges of X9 are performed by the A/D converter module, while the high-level period is performed by the sequence program.</p> </div> <p>(3) Digital outputs are cleared immediately after Operating condition setting request (Y9) turns ON. Therefore, turn ON the A/D conversion completed flag before reading digital outputs.</p>

Device No.	Signal Name	Description
XA	Offset/gain setting mode flag	<p>[In offset/gain setting mode]</p> <p>(1) This signal is used as an interlock condition to turn ON/OFF the User range writing request (YA) when the value at completion of offset/gain setting adjustment is registered.</p> <p>(2) See Section 4.6 regarding the offset/gain settings.</p> <p>-----> Performed by the A/D converter module —————> Performed by the sequence program</p> <p>Module ready (X0) OFF</p> <p>Offset/gain setting mode flag (XA)</p> <p>User range writing request (YA)</p>
		<p>[In normal mode]</p> <p>(1) This signal is used as an interlock condition to turn ON/OFF the User range writing request (YA) when the user range is restored.</p> <p>(2) Refer to Chapter 7 for the user range restoration.</p> <p>-----> Performed by the A/D converter module —————> Performed by the sequence program</p> <p>Module ready (X0) ON</p> <p>Offset/gain setting mode flag (XA)</p> <p>User range writing request (YA)</p>

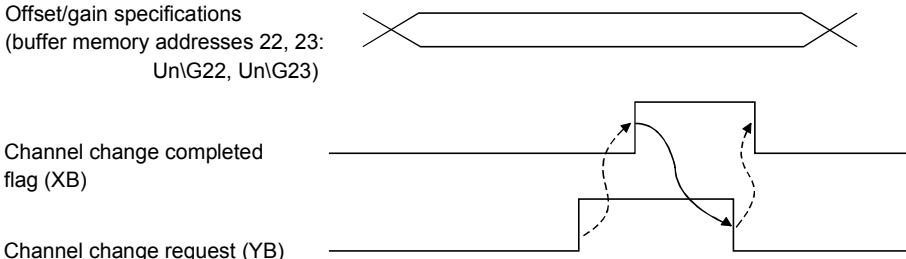
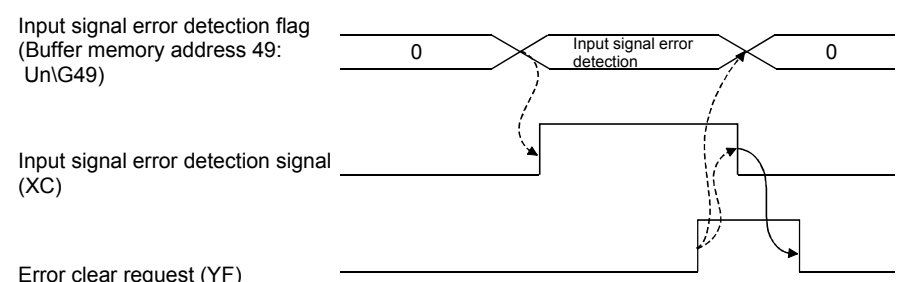
Device No.	Signal Name	Description
XB	Channel change completed flag	<p>(1) This is used as an interlock condition for setting the channel change request (YB) to ON/OFF when changing the channel for which the offset/gain settings are to be performed.</p> <p>(2) See Section 4.6 regarding the offset/gain settings.</p> <p style="text-align: right;"> -----> Performed by the A/D converter module —————> Performed by the sequence program </p> <p>Offset/gain setting mode Offset/gain specifications (buffer memory addresses 22, 23: Un\G22, Un\G23)</p>  <p>Channel change completed flag (XB)</p> <p>Channel change request (YB)</p>
XC	Input signal error detection signal	<p>(1) This signal turns ON when the analog input value falls outside the setting range set to the Input signal error detection setting value/input signal error detection lower limit setting value (buffer memory addresses 138 to 141: Un\G138 to Un\G141), Input signal error detection upper limit setting value (buffer memory addresses 142 to 145: Un\G142 to Un\G145) on any of the channels enabled for A/D conversion after the Input signal error detection is made valid.</p> <p>(2) When the Input signal error detection signal (XC) turns ON</p> <ol style="list-style-type: none"> 1) The A/D conversion completed flag (buffer memory address 10: Un\G10) of the corresponding channel turns OFF. 2) The digital output value is held as at the time of error detection. 3) The ALM LED flickers. <p>(3) By bringing the analog input value within the setting range and then turning ON the Error clear request (YF), the Input signal error detection signal (XC) turns OFF and the ALM LED is extinguished.</p> <p>(4) When the analog input value returns to within the setting range, A/D conversion is resumed independently of whether the Input signal error detection signal (XC) is reset or not, and after the first updating, the A/D conversion completed flag (buffer memory address 10: Un\G10) of the corresponding channel turns ON again. The processing, such as averaging processing or primary delay filter, starts from the first time after resumption of A/D conversion.</p> <p style="text-align: right;"> -----> Performed by the A/D converter module —————> Performed by the sequence program </p> <p>Input signal error detection flag (Buffer memory address 49: Un\G49)</p>  <p>Input signal error detection signal (XC)</p> <p>Error clear request (YF)</p>

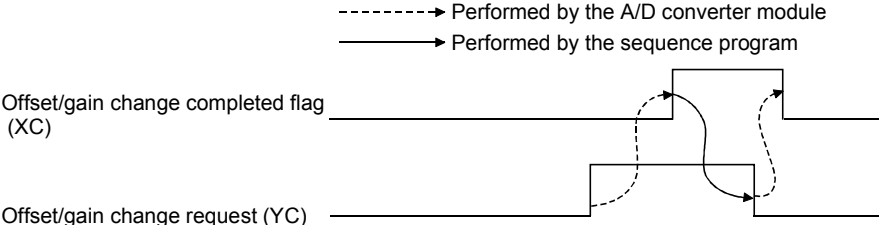
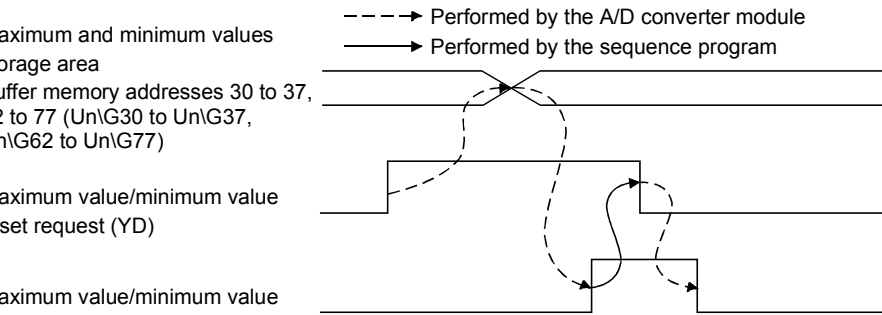
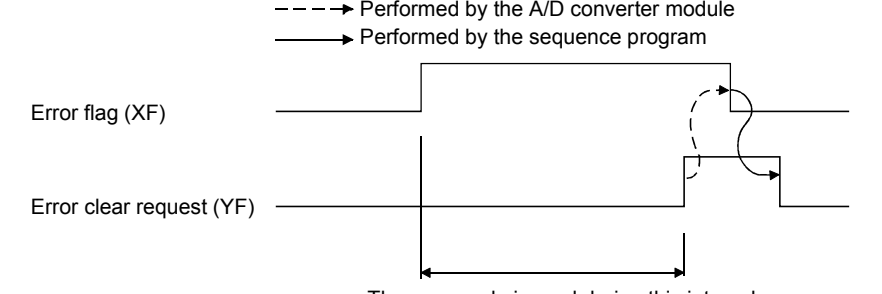
Device No.	Signal Name	Description
XC	Offset/gain change completed flag * 1	<p>(1) This signal is used as an interlock condition to turn ON/OFF the offset/gain change request (YC) when the offset/gain value is changed.</p> <p>(2) Refer to Section 4.6 for the offset/gain setting.</p> <p>-----> Performed by the A/D converter module —————> Performed by the sequence program</p> 
XD	Maximum value/minimum value reset completed flag	<p>(1) This signal turns ON when the maximum value/minimum value stored at any of the buffer memory addresses 30 to 37, 62 to 77 (Un\G30 to Un\G37, Un\G62 to Un\G77) is reset when the Maximum value/minimum value reset request (YD) turns ON.</p> <p>Maximum and minimum values storage area Buffer memory addresses 30 to 37, 62 to 77 (Un\G30 to Un\G37, Un\G62 to Un\G77)</p> <p>-----> Performed by the A/D converter module —————> Performed by the sequence program</p> 
XE	A/D conversion completed flag	<p>(1) This turns ON when conversion for all of the channels that are conversion enabled has been completed.</p> <p>(2) For the read-out of digital output values, configure this signal or A/D conversion completed flag (buffer memory address 10: Un\G10) to act as an interlock.</p> <p>(3) *1 When the external supply power to the Q62AD-DGH switches OFF, the A/D conversion completed flag turns OFF, the digital output values are held as previously, and A/D conversions stop.</p> <p>When the external supply power switches ON, A/D conversions resume, and as soon as all conversion-enabled channels have completed conversions, the A/D conversion completed flag turns ON.</p> <p>The processing, such as averaging processing or primary delay filter, starts from the first time after resumption of A/D conversion.</p>
XF	Error flag	<p>(1) Error flag (XF) turns ON when a write error occurs.</p> <p>(2) To clear the error code, set the error clear request (YF) to ON.</p> <p>-----> Performed by the A/D converter module —————> Performed by the sequence program</p>  <p>The error code is read during this interval.</p>

*1: Q62AD-DGH only

(2) Output signals

Device No.	Signal Name	Description
Y9	Operating condition setting request	<p>(1) Turn this signal ON when making any of the following settings valid.</p> <ul style="list-style-type: none"> • A/D conversion enable/disable setting (buffer memory address 0: Un\G0) • CH□ Average time/Average number of times/Move average/Time constant settings (buffer memory addresses 1 to 4: Un\G1 to Un\G4) • CH□ A/D conversion starting time setting (buffer memory addresses 5, 6: Un\G5, Un\G6) • Averaging process specification (buffer memory address 9: Un\G9) • Input signal error detection extended/input signal error detection/warning output settings (buffer memory address 47: Un\G47) • CH□ process alarm upper/lower limit value (buffer memory addresses 86 to 117: Un\G86 to Un\G117) • CH□ rate alarm warning detection period (buffer memory addresses 118 to 121: Un\G118 to Un\G121) • CH□ rate alarm upper/lower limit value (buffer memory addresses 122 to 137: Un\G122 to Un\G137) • CH□ input signal error detection setting value/CH□ input signal error detection lower limit setting value (buffer memory addresses 138 to 141: Un\G138 to Un\G141) • CH□ input signal error detection upper limit setting value (buffer memory addresses 142 to 145: Un\G142 to Un\G145) <p>(2) See the X9 column for ON/OFF timing.</p>
YA	User range writing request	<p>[In offset/gain setting mode]</p> <p>(1) This turns ON when the value for the adjusted offset/gain settings are registered in the A/D converter module.</p> <p>(2) See the XA column for ON/OFF timing. See Section 4.6 for offset/gain settings.</p> <p>[In normal mode]</p> <p>(1) This signal turns ON when the user range is restored.</p> <p>(2) Refer to the field of XA for the ON/OFF timing. Refer to Chapter 7 for user range restoration.</p>
YB	Channel change request	<p>(1) This turns ON when changing the channel for which offset/gain settings are to be performed.</p> <p>(2) See the XB column for ON/OFF timing. See Section 4.6 for offset/gain settings.</p>
YC	Offset/gain change request * 1	<p>(1) Turn this signal ON when changing the offset/gain value.</p> <p>(2) Refer to the field of XC for the ON/OFF timing. Refer to Section 4.6 for the offset/gain setting.</p>
YD	Maximum value/minimum value reset request	<p>(1) Turning ON the Maximum value/minimum value reset request (YD) clears the maximum value/minimum value stored at any of the buffer memory addresses 30 to 37, 62 to 77 (Un\G30 to Un\G37, Un\G62 to Un\G77).</p> <p>(2) See the XD column for ON/OFF timing.</p>
YF	Error clear request	<p>(1) Turn this signal ON when clearing a write error or input signal error.</p> <p>(2) Refer to the field of XF or XC for the ON/OFF timing.</p>

*1: Q62AD-DGH only

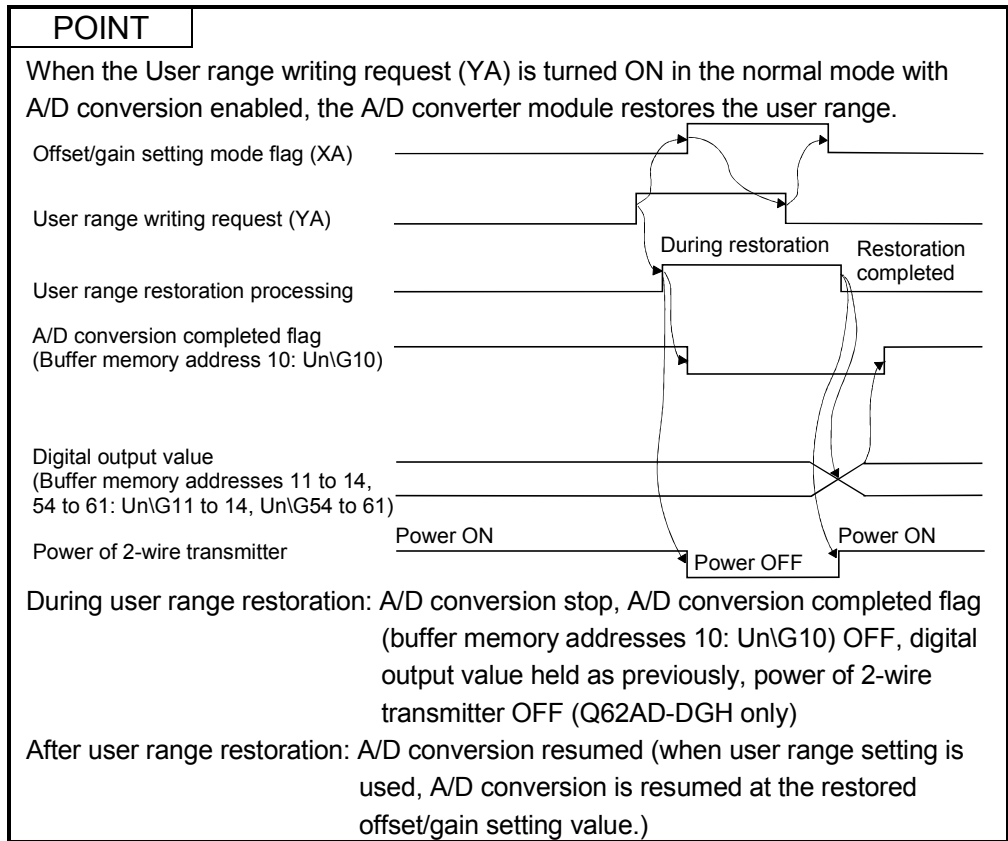

3.4 Buffer Memory

3.4.1 Buffer memory assignment

This section describes the buffer memory assignments of the A/D converter modules.

(1) Buffer memory assignment of Q64AD-GH

POINT
Do not write data from system area or sequence program to the buffer memory area where writing is disabled. Doing so may cause malfunction.

Table 3.8 Buffer memory assignment of Q64AD-GH (1/5)

Address		Description	Default value	Read/Write * 1	Reference
Hexadecimal	Decimal				
0 _H	0	A/D conversion enable/disable setting	0000 _H	R/W * 2	Section 3.4.2
1 _H	1	CH1 Average time/Average number of times/Move average/Time constant settings	0	R/W * 2	Section 3.4.3
2 _H	2	CH2 Average time/Average number of times/Move average/Time constant settings	0	R/W * 2	
3 _H	3	CH3 Average time/Average number of times/Move average/Time constant settings	0	R/W * 2	
4 _H	4	CH4 Average time/Average number of times/Move average/Time constant settings	0	R/W * 2	
5 _H	5	System area	—	—	—
to	to				
8 _H	8				
9 _H	9	Averaging process specification	0	R/W * 2	Section 3.4.5
A _H	10	A/D conversion completed flag	0	R	Section 3.4.6
B _H	11	CH1 Digital output value(16Bit)	0	R	Section 3.4.7
C _H	12	CH2 Digital output value(16Bit)	0	R	
D _H	13	CH3 Digital output value(16Bit)	0	R	
E _H	14	CH4 Digital output value(16Bit)	0	R	
F _H	15	System area	—	—	—
to	to				
12 _H	18				
13 _H	19	Error code	0	R	Section 3.4.8
14 _H	20	Setting range	0	R	Section 3.4.9
15 _H	21	System area	—	—	—
16 _H	22	Offset/gain setting mode offset specification	0	R/W	Section 3.4.10
17 _H	23	Offset/gain setting mode gain specification	0	R/W	
18 _H	24	System area	—	—	—
to	to				
1D _H	29				

*1 Indicates whether reading from and writing to a sequence program are enabled.

R : Read enabled

W : Write enabled

*2 When writing data to the buffer memory, always perform write under the interlock conditions (buffer memory write conditions) of the following I/O signals.

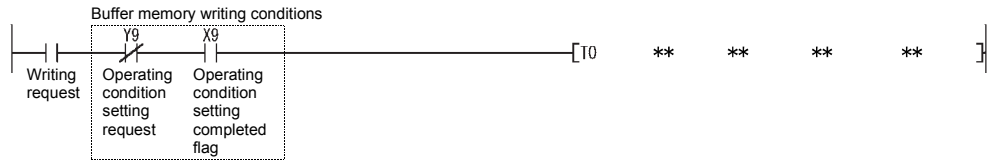

Table 3.8 Buffer memory assignment of Q64AD-GH (2/5)

Address		Description	Default value	Read/Write * 1	Reference
Hexadecimal	Decimal				
1E _H	30	CH1 Maximum value(16Bit)	0	R/W * 2	Section 3.4.11
1F _H	31	CH1 Minimum value(16Bit)	0	R/W * 2	
20 _H	32	CH2 Maximum value(16Bit)	0	R/W * 2	
21 _H	33	CH2 Minimum value(16Bit)	0	R/W * 2	
22 _H	34	CH3 Maximum value(16Bit)	0	R/W * 2	
23 _H	35	CH3 Minimum value(16Bit)	0	R/W * 2	
24 _H	36	CH4 Maximum value(16Bit)	0	R/W * 2	
25 _H	37	CH4 Minimum value(16Bit)	0	R/W * 2	
26 _H	38	System area	—	—	
to	to				
2E _H	46				
2F _H	47	Input signal error detection extended/input signal error detection/warning output settings	0FF _H	R/W * 2	Section 3.4.12
30 _H	48	Warning output flag	0	R	Section 3.4.13
31 _H	49	Input signal error detection flag	0	R	Section 3.4.14
32 _H	50	System area	—	—	—
to	to				
35 _H	53				
36 _H	54	CH1 Digital output value(32Bit) (L)	0	R	Section 3.4.15
37 _H	55	(H)			
38 _H	56	CH2 Digital output value(32Bit) (L)	0	R	
39 _H	57	(H)			
3A _H	58	CH3 Digital output value(32Bit) (L)	0	R	
3B _H	59	(H)			
3C _H	60	CH4 Digital output value(32Bit) (L)	0	R	
3D _H	61	(H)			
3E _H	62	CH1 Maximum value(32Bit) (L)	0	R/W * 2	
3F _H	63	(H)			
40 _H	64	CH1 Minimum value(32Bit) (L)	0	R/W * 2	
41 _H	65	(H)			
42 _H	66	CH2 Maximum value(32Bit) (L)	0	R/W * 2	
43 _H	67	(H)			
44 _H	68	CH2 Minimum value(32Bit) (L)	0	R/W * 2	
45 _H	69	(H)			
46 _H	70	CH3 Maximum value(32Bit) (L)	0	R/W * 2	
47 _H	71	(H)			
48 _H	72	CH3 Minimum value(32Bit) (L)	0	R/W * 2	
49 _H	73	(H)			
4A _H	74	CH4 Maximum value(32Bit) (L)	0	R/W * 2	
4B _H	75	(H)			
4C _H	76	CH4 Minimum value(32Bit) (L)	0	R/W * 2	
4D _H	77	(H)			

*1 Indicates whether reading from and writing to a sequence program are enabled.

R : Read enabled

W : Write enabled

*2 When writing data to the buffer memory, always perform write under the interlock conditions (buffer memory write conditions) of the following I/O signals.

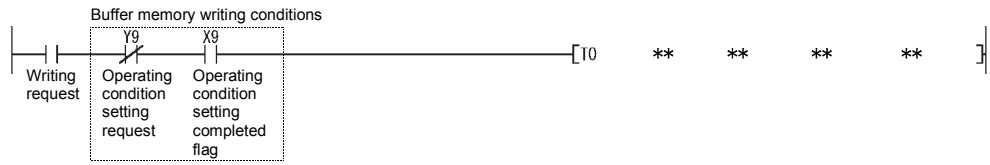

Table 3.8 Buffer memory assignment of Q64AD-GH (3/5)

Address		Description	Default value	Read/Write * 1	Reference
Hexadecimal	Decimal				
4E _H	78	System area	—	—	—
to	to				
55 _H	85				
56 _H	86	CH1 Process alarm lower lower limit value (L)	0	R/W * 2	Section 3.4.17
57 _H	87	(H)			
58 _H	88	CH1 Process alarm lower upper limit value (L)	0	R/W * 2	
59 _H	89	(H)			
5A _H	90	CH1 Process alarm upper lower limit value (L)	0	R/W * 2	
5B _H	91	(H)			
5C _H	92	CH1 Process alarm upper upper limit value (L)	0	R/W * 2	
5D _H	93	(H)			
5E _H	94	CH2 Process alarm lower lower limit value (L)	0	R/W * 2	
5F _H	95	(H)			
60 _H	96	CH2 Process alarm lower upper limit value (L)	0	R/W * 2	
61 _H	97	(H)			
62 _H	98	CH2 Process alarm upper lower limit value (L)	0	R/W * 2	
63 _H	99	(H)			
64 _H	100	CH2 Process alarm upper upper limit value (L)	0	R/W * 2	
65 _H	101	(H)			
66 _H	102	CH3 Process alarm lower lower limit value (L)	0	R/W * 2	
67 _H	103	(H)			
68 _H	104	CH3 Process alarm lower upper limit value (L)	0	R/W * 2	
69 _H	105	(H)			
6A _H	106	CH3 Process alarm upper lower limit value (L)	0	R/W * 2	
6B _H	107	(H)			
6C _H	108	CH3 Process alarm upper upper limit value (L)	0	R/W * 2	
6D _H	109	(H)			
6E _H	110	CH4 Process alarm lower lower limit value (L)	0	R/W * 2	
6F _H	111	(H)			
70 _H	112	CH4 Process alarm lower upper limit value (L)	0	R/W * 2	
71 _H	113	(H)			
72 _H	114	CH4 Process alarm upper lower limit value (L)	0	R/W * 2	
73 _H	115	(H)			
74 _H	116	CH4 Process alarm upper upper limit value (L)	0	R/W * 2	
75 _H	117	(H)			
76 _H	118	CH1 Rate alarm warning detection period	0	R/W * 2	Section 3.4.18
77 _H	119	CH2 Rate alarm warning detection period	0	R/W * 2	
78 _H	120	CH3 Rate alarm warning detection period	0	R/W * 2	
79 _H	121	CH4 Rate alarm warning detection period	0	R/W * 2	
7A _H	122	CH1 Rate alarm upper limit value (L)	0	R/W * 2	Section 3.4.19
7B _H	123	(H)			
7C _H	124	CH1 Rate alarm lower limit value (L)	0	R/W * 2	
7D _H	125	(H)			

*1 Indicates whether reading from and writing to a sequence program are enabled.

R : Read enabled

W : Write enabled

*2 When writing data to the buffer memory, always perform write under the interlock conditions (buffer memory write conditions) of the following I/O signals.

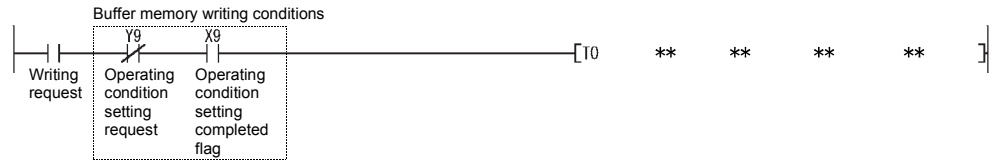

Table 3.8 Buffer memory assignment of Q64AD-GH (4/5)

Address		Description	Default value	Read/Write * 1	Reference
Hexadecimal	Decimal				
7E _H	126	CH2 Rate alarm upper limit value (L) (H)	0	R/W * 2	Section 3.4.19
7F _H	127				
80 _H	128	CH2 Rate alarm lower limit value (L) (H)	0	R/W * 2	
81 _H	129				
82 _H	130	CH3 Rate alarm upper limit value (L) (H)	0	R/W * 2	
83 _H	131				
84 _H	132	CH3 Rate alarm lower limit value (L) (H)	0	R/W * 2	
85 _H	133				
86 _H	134	CH4 Rate alarm upper limit value (L) (H)	0	R/W * 2	
87 _H	135				
88 _H	136	CH4 Rate alarm lower limit value (L) (H)	0	R/W * 2	
89 _H	137				
8A _H	138	CH1 Input signal error detection setting value/CH1 Input signal error detection lower limit setting value	50	R/W * 2	Section 3.4.20
8B _H	139				
8C _H	140	CH3 Input signal error detection setting value/CH3 Input signal error detection lower limit setting value	50	R/W * 2	
8D _H	141				
8E _H	142	CH1 Input signal error detection upper limit setting value	50	R/W * 2	
8F _H	143	CH2 Input signal error detection upper limit setting value	50	R/W * 2	
90 _H	144	CH3 Input signal error detection upper limit setting value	50	R/W * 2	
91 _H	145	CH4 Input signal error detection upper limit setting value	50	R/W * 2	
92 _H	146	System area	—	—	
to	to				
9D _H	157				
9E _H	158	Mode switching setting	0	R/W * 2	Section 3.4.21
9F _H	159				
A0 _H	160	System area	—	—	
to	to				
C7 _H	199				
C8 _H	200	Pass data classification setting * 3	0	R/W * 2	Section 3.4.22
C9 _H	201	System area	—	—	—

* 1 Indicates whether reading from and writing to a sequence program are enabled.

R : Read enabled

W : Write enabled

* 2 When writing data to the buffer memory, always perform write under the interlock conditions (buffer memory write conditions) of the following I/O signals.

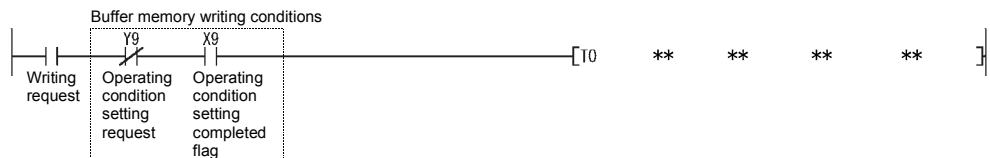

* 3 Areas used to restore the user range settings offset/gain values when online module change is made. Refer to chapter 7 for details of online module change.

Table 3.8 Buffer memory assignment of Q64AD-GH (5/5)

Address		Description	Default value	Read/Write * 1	Reference
Hexadecimal	Decimal				
CA _H	202	CH1 Industrial shipment settings offset value * 3 (L) (H)	0	R/W * 2	Section 3.4.23
CB _H	203				
CC _H	204	CH1 Industrial shipment settings gain value * 3 (L) (H)	0	R/W * 2	
CD _H	205				
CE _H	206	CH2 Industrial shipment settings offset value * 3 (L) (H)	0	R/W * 2	
CF _H	207				
D0 _H	208	CH2 Industrial shipment settings gain value * 3 (L) (H)	0	R/W * 2	
D1 _H	209				
D2 _H	210	CH3 Industrial shipment settings offset value * 3 (L) (H)	0	R/W * 2	
D3 _H	211				
D4 _H	212	CH3 Industrial shipment settings gain value * 3 (L) (H)	0	R/W * 2	
D5 _H	213				
D6 _H	214	CH4 Industrial shipment settings offset value * 3 (L) (H)	0	R/W * 2	
D7 _H	215				
D8 _H	216	CH4 Industrial shipment settings gain value * 3 (L) (H)	0	R/W * 2	
D9 _H	217				
DA _H	218	CH1 User range settings offset value * 3 (L) (H)	0	R/W * 2	
DB _H	219				
DC _H	220	CH1 User range settings gain value * 3 (L) (H)	0	R/W * 2	
DD _H	221				
DE _H	222	CH2 User range settings offset value * 3 (L) (H)	0	R/W * 2	
DF _H	223				
E0 _H	224	CH2 User range settings gain value * 3 (L) (H)	0	R/W * 2	
E1 _H	225				
E2 _H	226	CH3 User range settings offset value * 3 (L) (H)	0	R/W * 2	
E3 _H	227				
E4 _H	228	CH3 User range settings gain value * 3 (L) (H)	0	R/W * 2	
E5 _H	229				
E6 _H	230	CH4 User range settings offset value * 3 (L) (H)	0	R/W * 2	
E7 _H	231				
E8 _H	232	CH4 User range settings gain value * 3 (L) (H)	0	R/W * 2	
E9 _H	233				

* 1 Indicates whether reading from and writing to a sequence program are enabled.

R : Read enabled

W : Write enabled

* 2 When writing data to the buffer memory, always perform write under the interlock conditions (buffer memory write conditions) of the following I/O signals.

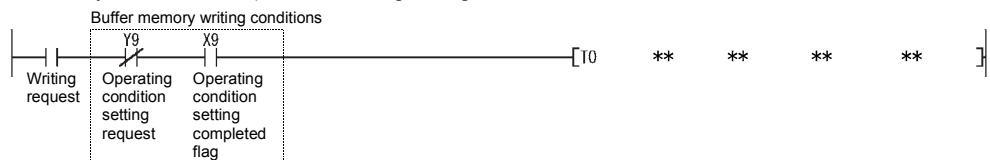

* 3 Areas used to restore the user range settings offset/gain values when online module change is made. Refer to chapter 7 for details of online module change.

(2) Buffer memory assignment of Q62AD-DGH

POINT

Do not write data from system area or sequence program to the buffer memory area where writing is disabled. Doing so may cause malfunction.

Table 3.9 Buffer memory assignment of Q62AD-DGH (1/4)

Address		Description	Default value	Read/Write * 1	Reference
Hexadecimal	Decimal				
0H	0	A/D conversion enable/disable setting	0003H	R/W * 2	Section 3.4.2
1H	1	CH1 Average time/Average number of times/Move average/Time constant settings	0	R/W * 2	Section 3.4.3
2H	2	CH2 Average time/Average number of times/Move average/Time constant settings	0	R/W * 2	
3H	3	System area	—	—	—
4H	4				
5H	5	CH1 A/D conversion starting time setting	30	R/W * 2	Section 3.4.4
6H	6	CH2 A/D conversion starting time setting	30	R/W * 2	
7H	7	System area	—	—	—
8H	8				
9H	9	Averaging process specification	0	R/W * 2	Section 3.4.5
AH	10	A/D conversion completed flag	0	R	Section 3.4.6
BH	11	CH1 Digital output value(16Bit)	0	R	Section 3.4.7
CH	12	CH2 Digital output value(16Bit)	0	R	
DH	13	System area	—	—	—
to	to				
12H	18				
13H	19				
14H	20	Setting range	0	R	Section 3.4.9
15H	21	System area	—	—	—
16H	22	Offset/gain setting mode offset specification	0	R/W	Section 3.4.10
17H	23	Offset/gain setting mode gain specification	0	R/W	
18H	24	System area	—	—	—
to	to				
1DH	29				
1EH	30	CH1 Maximum value(16Bit)	0	R/W * 2	Section 3.4.11
1FH	31	CH1 Minimum value(16Bit)	0	R/W * 2	
20H	32	CH2 Maximum value(16Bit)	0	R/W * 2	
21H	33	CH2 Minimum value(16Bit)	0	R/W * 2	
22H	34	System area	—	—	—
to	to				
2EH	46				
2FH	47	Input signal error detection extended/input signal error detection/warning output settings	0333H	R/W * 2	Section 3.4.12
30H	48	Warning output flag	0	R	Section 3.4.13
31H	49	Input signal error detection flag	0	R	Section 3.4.14

- *1 Indicates whether reading from and writing to a sequence program are enabled.
 R : Read enabled
 W : Write enabled
- *2 When writing data to the buffer memory, always perform write under the interlock conditions (buffer memory write conditions) of the following I/O signals.

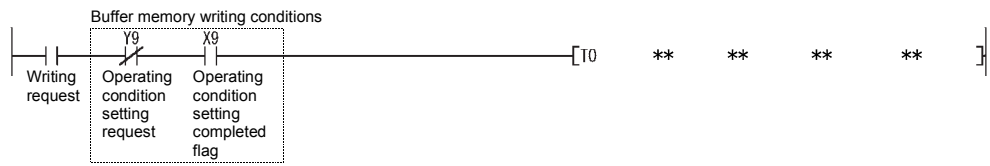

Table 3.9 Buffer memory assignment of Q62AD-DGH (2/4)

Address		Description	Default value	Read/Write * 1	Reference
Hexadecimal	Decimal				
32 _H	50	System area	—	—	—
to	to				
35 _H	53				
36 _H	54	CH1 Digital output value(32Bit) (L)	0	R	Section 3.4.15
37 _H	55	(H)			
38 _H	56	CH2 Digital output value(32Bit) (L)	0	R	
39 _H	57	(H)			
3A _H	58	System area	—	—	—
to	to				
3D _H	61				
3E _H	62	CH1 Maximum value(32Bit) (L)	0	R/W * 2	Section 3.4.16
3F _H	63	(H)			
40 _H	64	CH1 Minimum value(32Bit) (L)	0	R/W * 2	
41 _H	65	(H)			
42 _H	66	CH2 Maximum value(32Bit) (L)	0	R/W * 2	
43 _H	67	(H)			
44 _H	68	CH2 Minimum value(32Bit) (L)	0	R/W * 2	
45 _H	69	(H)			
46 _H	70	System area	—	—	—
to	to				
55 _H	85				
56 _H	86	CH1 Process alarm lower lower limit value (L)	0	R/W * 2	Section 3.4.17
57 _H	87	(H)			
58 _H	88	CH1 Process alarm lower upper limit value (L)	0	R/W * 2	
59 _H	89	(H)			
5A _H	90	CH1 Process alarm upper lower limit value (L)	0	R/W * 2	
5B _H	91	(H)			
5C _H	92	CH1 Process alarm upper upper limit value (L)	0	R/W * 2	
5D _H	93	(H)			
5E _H	94	CH2 Process alarm lower lower limit value (L)	0	R/W * 2	
5F _H	95	(H)			
60 _H	96	CH2 Process alarm lower upper limit value (L)	0	R/W * 2	
61 _H	97	(H)			
62 _H	98	CH2 Process alarm upper lower limit value (L)	0	R/W * 2	
63 _H	99	(H)			
64 _H	100	CH2 Process alarm upper upper limit value (L)	0	R/W * 2	
65 _H	101	(H)			
66 _H	102	System area	—	—	—
to	to				
75 _H	117				
76 _H	118	CH1 Rate alarm warning detection period	0	R/W * 2	Section 3.4.18
77 _H	119	CH2 Rate alarm warning detection period	0	R/W * 2	
78 _H	120	System area	—	—	—

*1 Indicates whether reading from and writing to a sequence program are enabled.

R : Read enabled

W : Write enabled

*2 When writing data to the buffer memory, always perform write under the interlock conditions (buffer memory write conditions) of the following I/O signals.

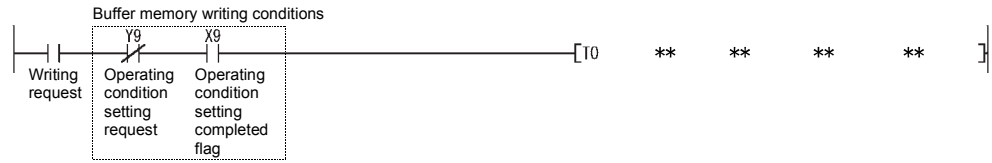

Table 3.9 Buffer memory assignment of Q62AD-DGH (3/4)

Address		Description	Default value	Read/Write * 1	Reference
Hexadecimal	Decimal				
79H	121	System area	—	—	—
7AH	122	CH1 Rate alarm upper limit value (L) (H)	0	R/W * 2	Section 3.4.19
7BH	123				
7CH	124	CH1 Rate alarm lower limit value (L) (H)	0	R/W * 2	
7DH	125				
7EH	126	CH2 Rate alarm upper limit value (L) (H)	0	R/W * 2	
7FH	127				
80H	128	CH2 Rate alarm lower limit value (L) (H)	0	R/W * 2	
81H	129				
82H	130	System area	—	—	
to	to				
89H	137				
8AH	138	CH1 Input signal error detection setting value/CH1 Input signal error detection lower limit setting value	50	R/W * 2	Section 3.4.20
8BH	139	CH2 Input signal error detection setting value/CH2 Input signal error detection lower limit setting value	50	R/W * 2	
8CH	140	System area	—	—	—
8DH	141				
8EH	142	CH1 Input signal error detection upper limit setting value	50	R/W * 2	Section 3.4.20
8FH	143	CH2 Input signal error detection upper limit setting value	50	R/W * 2	
90H	144	System area	—	—	—
to	to				
9DH	157				
9EH	158	Mode switching setting	0	R/W * 2	Section 3.4.21
9FH	159				
A0H	160	System area	—	—	—
to	to				
C9H	201				
CAH	202	CH1 Industrial shipment settings offset value * 3 (L) (H)	0	R/W * 2	Section 3.4.23
CBH	203				
CAH	204	CH1 Industrial shipment settings gain value * 3 (L) (H)	0	R/W * 2	
CDH	205				
CEH	206	CH2 Industrial shipment settings offset value * 3 (L) (H)	0	R/W * 2	
CFH	207				
D0H	208	CH2 Industrial shipment settings gain value * 3 (L) (H)	0	R/W * 2	
D1H	209				
D2H	210	System area	—	—	—
to	to				
D9H	217				

* 1 Indicates whether reading from and writing to a sequence program are enabled.

R : Read enabled

W : Write enabled

* 2 When writing data to the buffer memory, always perform write under the interlock conditions (buffer memory write conditions) of the following I/O signals.

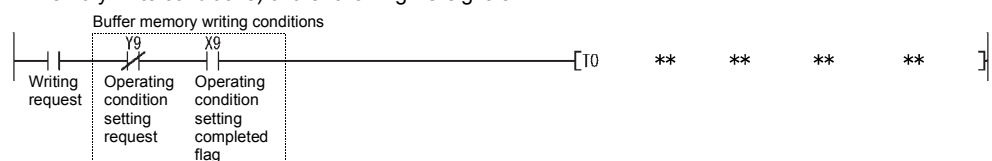

* 3 Areas used to restore the user range settings offset/gain values when online module change is made. Refer to chapter 7 for details of online module change.

Table 3.9 Buffer memory assignment of Q62AD-DGH (4/4)

Address		Description	Default value	Read/Write * 1	Reference
Hexadecimal	Decimal				
DA _H	218	CH1 User range settings offset value * 3 (L) (H)	0	R/W * 2	Section 3.4.23
DB _H	219				
DC _H	220	CH1 User range settings gain value * 3 (L) (H)	0	R/W * 2	
DD _H	221				
DE _H	222	CH2 User range settings offset value * 3 (L) (H)	0	R/W * 2	
DF _H	223				
E0 _H	224	CH2 User range settings gain value * 3 (L) (H)	0	R/W * 2	
E1 _H	225				

* 1 Indicates whether reading from and writing to a sequence program are enabled.

R : Read enabled

W : Write enabled

* 2 When writing data to the buffer memory, always perform write under the interlock conditions (buffer memory write conditions) of the following I/O signals.

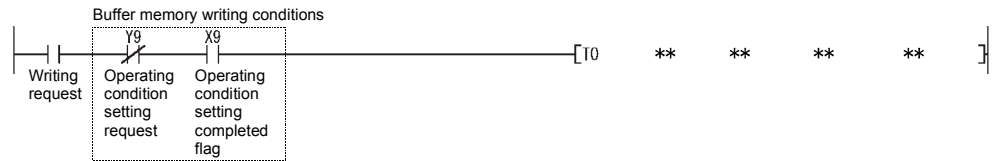

* 3 Areas used to restore the user range settings offset/gain values when online module change is made. Refer to chapter 7 for details of online module change.

3.4.2 A/D conversion enable/disable setting (buffer memory address 0: Un\G0)

- (1) Sets whether the output of an A/D conversion value is enabled or disabled for each channel.
For the Q62AD-DGH, the A/D conversion enable/disable setting also acts as the ON/OFF setting of the power supply to the 2-wire transmitter.
- (2) It is necessary to set the operating condition setting request (Y9) to ON/OFF in order to enable the A/D conversion enable/disable setting. (See Section 3.3.2.)
- (3) The Q64AD-GH defaults to A/D conversion enable on all channels.
- (4) The Q62AD-DGH defaults to A/D conversion disable on all channels.

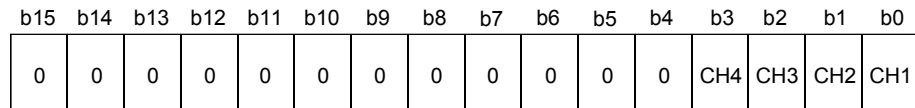

For Q64AD-GH, information of b4 to b15 is fixed at 0.
 For Q62AD-DGH, information of b2 to b15 is fixed at 0.

Q64AD-GH { 0: A/D conversion enable
 1: A/D conversion disable
 Q62AD-DGH { 0: A/D conversion enable, power supply ON
 1: A/D conversion disable, power supply OFF

[Setting example of Q64AD-GH]

When the channels using A/D conversion are 1 and 3, 000AH (10) is stored into the buffer memory address 0 (Un\G0).

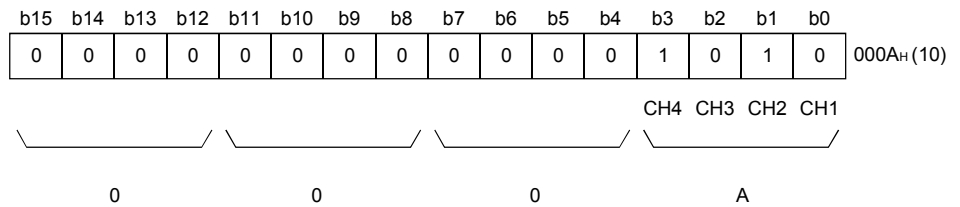

[Setting example of Q62AD-DGH]

When the channels using A/D conversion are 1 and 2, 0000H (0) is stored into the buffer memory address 0 (Un\G0).

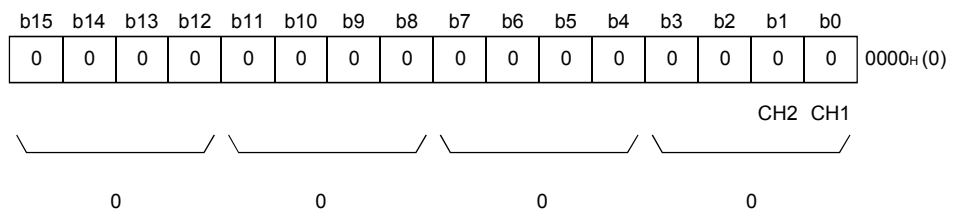

3.4.3 CH□ average time/average number of times/move average/time constant settings (buffer memory addresses 1 to 4: Un\G1 to Un\G4)

- (1) Set the average time, average count, move average count or primary delay filter time constant for each channel specified for averaging processing.
- (2) To make the setting valid, the operating condition setting request (Y9) must be turned ON/OFF. (Refer to Section 3.3.2.)
- (3) 0 is set as the default.
- (4) The setting ranges are as follows.

Processing method	Setting value
Time averaging	40 to 5000 (ms) * ¹
Count averaging	4 to 500 (times)
Move averaging	2 to 60 (times)
Primary delay filter	10 to 5000 (ms) * ¹

*1 The value can be set in 1ms increments, but the first digit is discarded and the value is processed in 10ms increments.

POINT
(1) The channel where the value outside the above setting range has been written results in an error, the error code is stored into the Error code (buffer memory address 19: Un\G19), the error flag (XF) turns ON, and the A/D conversion processing is performed at the pre-error setting.
(2) Since the default setting is 0, change it according to the processing method.
(3) The value, which has been set to the channel specified for sampling processing, is ignored.

3.4.4 CH□ A/D conversion starting time setting (buffer memory addresses 5, 6: Un\G5, Un\G6) (Q62AD-DGH only)

- (1) This area is used to set the "time necessary from when the used 2-wire transmitter powers on until its output stabilizes" on a channel basis.
- (2) To make the setting valid, the operating condition setting request (Y9) must be turned ON/OFF. (Refer to Section 3.3.2.)
- (3) The setting range is 0 to 3276.7 seconds (0 to 54 minutes and 36.7 seconds)[0 to 32767].
Set the time in 100ms increments.
Example) When setting the A/D conversion starting time to 5 seconds, store 50 into the buffer memory.
- (4) The default is set to 3 seconds [30].
- (5) Refer to Section 3.2.5 for details of the A/D conversion starting time setting function.

POINT

The channel where the value outside the above setting range has been written results in an error, the error code is stored into the Error code (buffer memory address 19: Un\G19), the error flag (XF) turns ON, and operation is performed at the pre-error setting.

3.4.5 Averaging process specification (buffer memory address 9: Un\G9)

- (1) When selecting sampling processing or averaging processing, write the setting to buffer memory address 9 (Un\G9).
- (2) When you selected averaging processing, select the average time, average count, move average or primary delay filter.
- (3) To make the setting valid, the operating condition setting request (Y9) must be turned ON/OFF. (Refer to Section 3.3.2.)
- (4) By default, sampling processing is set for all channels.

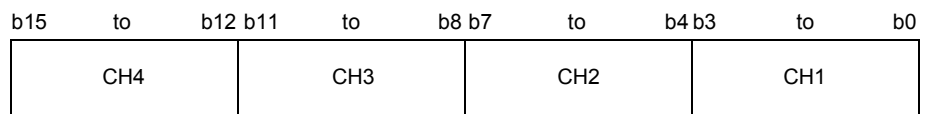

For Q62AD-DGH, information of b8 to b15 is fixed at 0.

Processing method	Setting value
Sampling processing	0H
Time averaging	1H
Count averaging	2H
Move averaging	3H
Primary delay filter	4H

[Setting example of Q64AD-GH]

When setting channel 1 for count averaging, channel 2 for time averaging, channel 3 for primary delay filter, and channel 4 for sampling processing, store 0412H (1042) into the buffer memory address 9 (Un\G9).

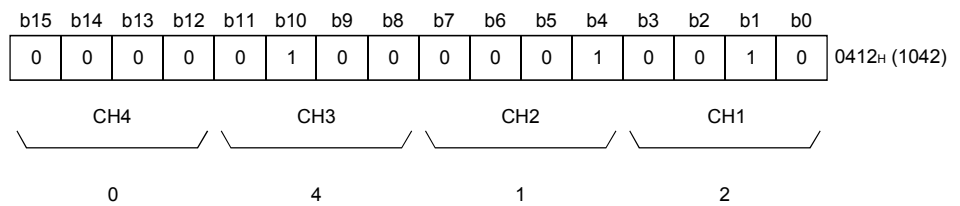

[Setting example of Q62AD-DGH]

When setting channel 1 for time averaging, channel 2 for count averaging, store 0021H (33) into the buffer memory address 9 (Un\G9).

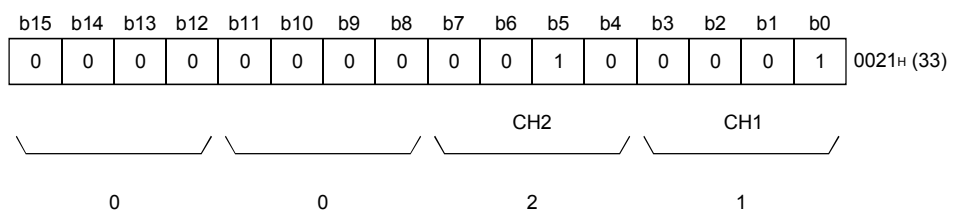

POINT
For the channel where the value outside the above setting range has been written, operation is performed by sampling processing.

3.4.6 A/D conversion completed flag (buffer memory address 10: Un\G10)

- (1) When A/D conversion for the channels enabled for conversion is complete, the A/D conversion completed flag is set to 1.
The A/D conversion completed flag (XE) is set to ON when the conversion for all A/D conversion enabled channels is complete.
- (2) When the operating condition setting request (Y9) is set to ON, the flag returns to the default setting of 0 and changes to 1 when A/D conversion is complete.

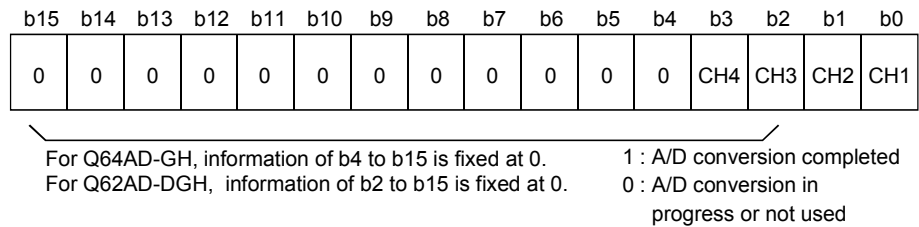

[Setting example of Q64AD-GH]

When all conversions of channels 1 and 2 enabled for A/D conversion are completed, 0003H (3) is stored into the buffer memory address 10 (Un\G10).

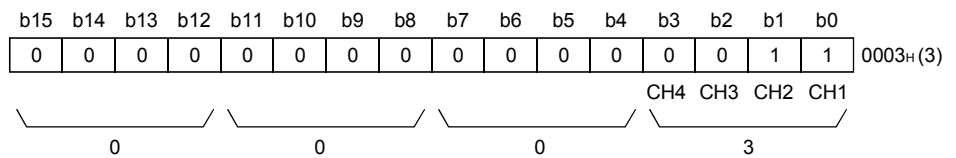

[Setting example of Q62AD-DGH]

When conversion of channel 2 enabled for A/D conversion is completed, 0002H (2) is stored into the buffer memory address 10 (Un\G10).

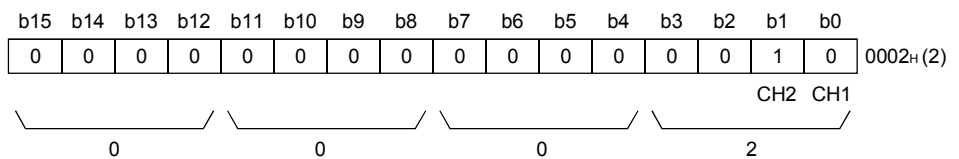

- (3) While Operating condition setting request (Y9) is ON, 0 is stored into A/D conversion completed flag on all the channels.
- (4) For the read-out of digital output values, configure this area or A/D conversion completed flag to act as an interlock.

3.4.7 CH□ digital output value (16bit) (buffer memory addresses 11 to 14: Un\G11 to Un\G14)

- (1) The value in the digital output value (32bit) (buffer memory addresses 54 to 61: Un\G54 to Un\G61) is converted and the result of conversion is stored in 16-bit signed binary.
- (2) When setting the analog input range from 1 to 5V (Extended mode) or 4 to 20 mA (Extended mode), select the digital output value (32bit) (buffer memory addresses 54 to 61: Un\G54 to Un\G61).

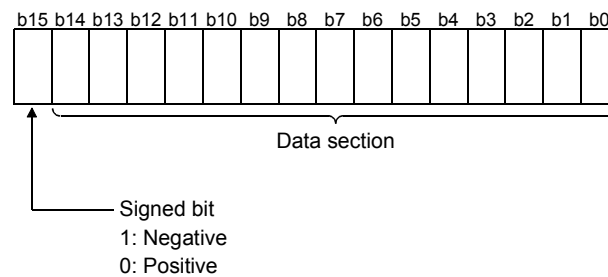

- (3) While Operating condition setting request (Y9) is ON, 0 is stored into this area.
- (4) For the read-out of digital output values, configure A/D conversion completed flag (XE) or A/D conversion completed flag (buffer memory address 10: Un\G10) to act as an interlock.

3.4.8 Write data error codes (buffer memory address 19: Un\G19)

- (1) The error codes generated by the A/D converter modules are stored here.
- (2) See Section 8.1 for the details of the error codes.

3.4.9 Setting range (buffer memory address 20: Un\G20)

- (1) These areas are used to confirm the setting ranges of the A/D converter module.
- (2) The setting value is stored into the buffer memory address 20 (Un\G20).

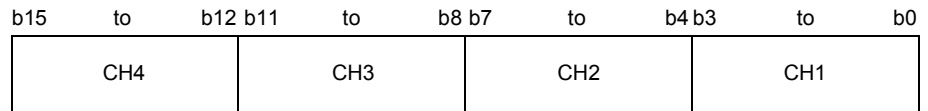

For Q62AD-DGH, information of b8 to b15 is fixed at 0.

Setting ranges of Q64AD-GH

Input range	Setting value
4 to 20mA	0H
0 to 20mA	1H
1 to 5V	2H
0 to 5V	3H
-10 to 10V	4H
0 to 10V	5H
4 to 20mA (Extended mode)	AH
1 to 5V (Extended mode)	BH
User range setting (Uni-polar)	EH
User range setting (Bi-polar)	FH

Setting ranges of Q62AD-DGH

Input range	Setting value
4 to 20mA	0H
4 to 20mA (Extended mode)	AH
User range setting	FH

POINT	<p>The input range cannot be changed in Setting range (buffer memory address 20: Un\G20). Configure the intelligent function module switch setting to change the input range. (Refer to Section 4.5.)</p>
--------------	---

3.4.10 Offset/gain setting mode (buffer memory addresses 22, 23: Un\G22, Un\G23)

- (1) Specifies the channel to be adjusted for the offset/gain settings.
- (2) The channel for which the offset is to be adjusted is specified in buffer memory address 22 (Un\G22) and the channel for which the gain is to be adjusted is specified in buffer memory address 23 (Un\G23).
- (3) Although it is possible to set multiple channels at the same time, set the offset and gain separately (buffer memory addresses 22, 23: Set either Un\G22 or Un\G23 to 0). If both are set at the same time, an offset/gain setting mode error (error code 500) occurs.
- (4) See Section 4.6 for the details of the offset/gain settings.

	b15	b14	b13	b12	b11	b10	b9	b8	b7	b6	b5	b4	b3	b2	b1	b0
Un\G22 (Offset specification)	0	0	0	0	0	0	0	0	0	0	0	0	CH4	CH3	CH2	CH1
Un\G23 (Gain specification)	0	0	0	0	0	0	0	0	0	0	0	0	CH4	CH3	CH2	CH1

For Q64AD-GH, information of b4 to b15 is fixed at 0. 1 : Channel to be set
 For Q62AD-DGH, information of b2 to b15 is fixed at 0. 0 : Invalid

3.4.11 CH□ maximum value/minimum value storage area (16bit) (buffer memory addresses 30 to 37: Un\G30 to Un\G37)

- (1) The value in the maximum value/minimum value storage area (32bit) (buffer memory addresses 62 to 77: Un\G62 to Un\G77) is converted and the result of conversion is stored in 16-bit signed binary at each sampling processing.
- (2) When setting the analog input range from 1 to 5V (Extended mode) or 4 to 20 mA (Extended mode), select the CH□ maximum value/minimum value storage area (32bit) (buffer memory addresses 62 to 77: Un\G62 to Un\G77).
- (3) The stored values for all channels will be cleared to 0 when the operating condition setting request (Y9) is set to ON and the setting is changed or when the maximum value/minimum value reset request (YD) is set to ON.
- (4) The maximum and minimum values of digital values converted by sampling processing are stored even on a channel where averaging processing is specified.

3.4.12 Input signal error detection extended/input signal error detection/warning output settings (buffer memory address 47: Un\G47)

- (1) This area is used to set whether the input signal error detection, process alarm, or rate alarm will be enabled or disabled for each channel.
If the warning of input signal error detection is enabled, the input signal error detection can be performed by setting the same value of upper and lower limit or different value of upper and lower limit.
- (2) To make the input signal error detection extended/input signal error detection/warning output settings valid, the operating condition setting request (Y9) must be turned ON/OFF. (Refer to Section 3.3.2.)
- (3) All channels for the input signal error detection and alarm settings set to disable, and all channels for the input signal error detection extended setting are set to Same upper limit value/lower limit value.

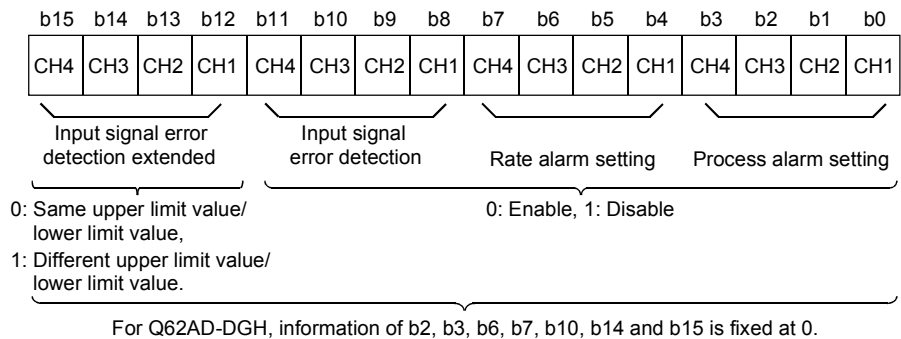

[Setting example of Q64AD-GH]

When performing the following settings, store 49FEH(18942) to the buffer memory address 47 (Un\G47).

- The channel 1 specified for the process alarm setting is set to 0 (enabled).
- The channel 2 and 3 specified for input signal error detection are set to 0 (enabled).
- The channel 3 specified for input signal error detection extended setting is set to 1 (different value of lower and upper limit).

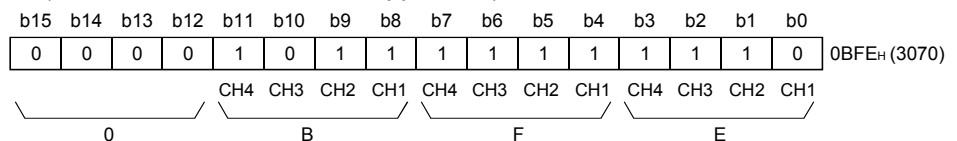

[Setting example of Q62AD-DGH]

When performing the following settings, store 2332H(9010) to the buffer memory address 47 (Un\G47).

- The channel 1 specified for the process alarm setting is set to 0 (enabled).
- The channel 1 and 2 specified for input signal error detection are set to 0 (enabled).
- The channel 2 specified for input signal error detection extended setting is set to 1 (different value of lower and upper limit).

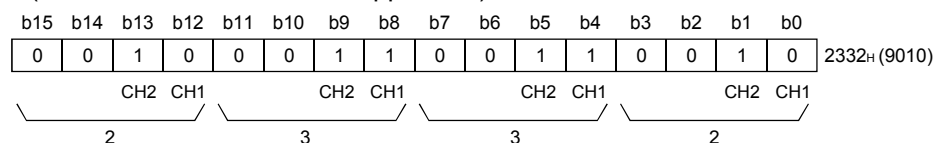

3.4.13 Warning output flag (buffer memory address 48 :Un\G48)

- (1) If the digital output value or its varying rate falls outside the setting range set to the CH□ process alarm upper/lower limit value (buffer memory addresses 86 to 117: Un\G86 to Un\G117) or CH□ rate alarm upper/lower limit value (buffer memory addresses 122 to 137: Un\G122 to Un\G137), the warning output flag for the corresponding channel turns to 1.
- (2) For both the process alarm and rate alarm, whether the warning is for the upper or lower limit value can be checked on a channel basis.
- (3) When the digital output value or its varying rate returns to within the setting range, the warning output flag is automatically reset.
- (4) If the warning is detected on any one of the channels enabled for A/D conversion and enabled for process alarm or rate alarm warning output, the Warning output signal (X8) also turns ON.
- (5) When the operating condition setting request (Y9) is turned ON, the warning output flag is cleared.

b15	b14	b13	b12	b11	b10	b9	b8	b7	b6	b5	b4	b3	b2	b1	b0
CH4	CH4	CH3	CH3	CH2	CH2	CH1	CH1	CH4	CH4	CH3	CH3	CH2	CH2	CH1	CH1
Lower limit value	Upper limit value	Lower limit value	Upper limit value	Lower limit value	Upper limit value	Lower limit value	Upper limit value	Lower limit value	Upper limit value	Lower limit value	Upper limit value	Lower limit value	Upper limit value	Lower limit value	Upper limit value

Rate alarm

Process alarm

0: Normal, 1: Alarm ON

For Q62AD-DGH, information of b4 to b7 and b12 to b15 is fixed at 0.

3.4.14 Input signal error detection flag (buffer memory address 49: Un\G49)

- (1) If the analog input value detected falls outside the setting range sets to the CH□ input signal error detection setting value/CH□ input signal error detection lower limit setting value (buffer memory addresses 138 to 141: Un\G138 to Un\G141), or CH□ input signal error detection upper limit setting value (buffer memory addresses 142 to 145: Un\G142 to Un\G145), the Input signal error detection flag for the corresponding channel turns to 1.
- (2) By bringing the analog input value within the setting range and then turning ON the Error clear request (YF), the Input signal error detection flag turns OFF.
- (3) If the warning is detected on any one of the channels enabled for input signal error detection and enabled for A/D conversion, the Input signal error detection signal (XC) also turns ON.
- (4) When the operating condition setting request (Y9) is turned ON, the Input signal error detection flag is cleared.

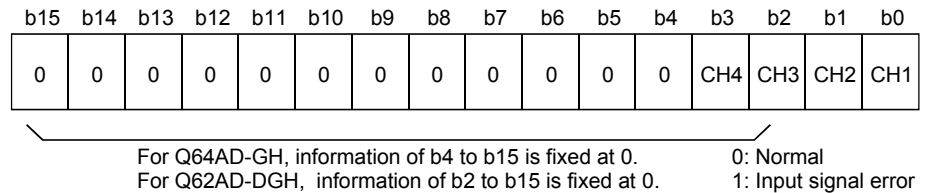

3.4.15 CH□ digital output value (32bit) (buffer memory addresses 54 to 61: Un\G54 to Un\G61)

- (1) The digital output values converted from analog to digital are stored into the buffer memory addresses 54 to 61 (Un\G54 to Un\G61) channel by channel.
- (2) The digital output value is represented in 32-bit signed binary. (The data part is 16 bits long.)

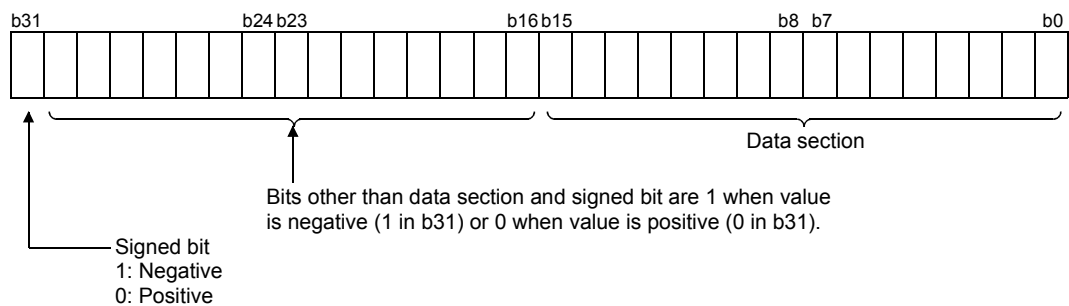

- (3) While Operating condition setting request is ON, 0 is stored in this area.
- (4) For the read-out of digital output values, configure A/D conversion completed flag (XE) or A/D conversion completed flag (buffer memory address 10: Un\G10) to act as an interlock.

3.4.16 CH□ maximum value/minimum value storage area (32bit) (buffer memory addresses 62 to 77: Un\G62 to Un\G77)

- (1) The maximum and minimum values of digital values converted on a channel basis are stored in 32-bit signed binary at each sampling time. (The data part is 16 bits long.)
- (2) The stored values for all channels will be cleared to 0 when the operating condition setting request (Y9) is set to ON and the setting is changed or when the maximum value/minimum value reset request (YD) is set to ON.
- (3) The maximum and minimum values of digital values converted by sampling processing are stored even on a channel where averaging processing is specified.

3.4.17 CH□ process alarm upper/lower limit value (buffer memory addresses 86 to 117: Un\G86 to Un\G117)

- (1) Set the range of the digital output value for each channel.
- (2) To make the setting valid, the operating condition setting request (Y9) must be turned ON/OFF. (Refer to Section 3.3.2.)
- (3) The setting range is -65536 to 65535. (When extended mode is used, the setting range is from -65536 to 73535.)
Make settings in four stages: process alarm upper upper limit value, upper lower limit value, lower upper limit value and lower lower limit value.
- (4) The channel, where the value outside the above setting range has been set or the value that does not satisfy the condition of lower lower limit value \leq lower upper limit value \leq upper lower limit value \leq upper upper limit value has been set, results in an error, the error code is stored into the error code (buffer memory address 19: Un\G19), the error flag (XF) turns ON, and operation is performed at the pre-error setting.
- (5) Refer to Section 3.2.4 for details of the process alarm.

3.4.18 CH□ rate alarm warning detection period (buffer memory addresses 118 to 121: Un\G118 to Un\G121)

- (1) Set the period, at which the varying rate of the digital output value will be checked, on a channel basis.
- (2) To make the setting valid, the operating condition setting request (Y9) must be turned ON/OFF. (Refer to Section 3.3.2.)
- (3) The setting range is 10 to 5000ms.
The value can be set in 1ms increments, but the first digit is discarded and the value is processed in 10ms increments.
- (4) When time averaging or count averaging has been specified for averaging process specification, set the rate alarm warning detection period as a multiple of the time averaging or count averaging conversion period.
Example) When the count setting of count averaging is 20 times, the conversion period is 200ms. Therefore, set a multiple of 200, e.g. 400 or 600.
 $20 \text{ (times)} \times 10 \text{ (ms)} = 200 \text{ (ms)}$
- (5) The default setting is 0ms.
- (6) Refer to Section 3.2.4 for details of the rate alarm.

POINT
<p>(1) The channel where the value outside the above setting range has been written results in an error, the error code is stored into the Error code (buffer memory address 19: Un\G19), the error flag (XF) turns ON, and the time averaging or count averaging processing and rate alarm are executed at the pre-error setting.</p> <p>(2) Since the default setting is 0, change the setting.</p> <p>(3) If the upper limit value and lower limit value settings of the rate alarm are small, the warning output may turn ON due to overreaction to disturbance or like. In this case, overreaction to disturbance or like can be avoided by increasing the setting of the rate alarm warning detection period.</p>

3.4.19 CH□ rate alarm upper/lower limit value (buffer memory addresses 122 to 137: Un\G122 to Un\G137)

- (1) Set the varying rate range of the digital output value for each channel.
- (2) To make the setting valid, the operating condition setting request (Y9) must be turned ON/OFF. (Refer to Section 3.3.2.)
- (3) The setting range is -65536 to 65535 (-6553.6 to 6553.5%). Set the value in 0.1%/s increments.
Example) When setting the rate alarm upper limit value to 30%/s, store 300 into the buffer memory.
- (4) Refer to Section 3.2.4 for details of the rate alarm.

POINT
The channel where the value outside the above setting range has been written results in an error, the error code is stored into the Error code (buffer memory address 19: Un\G19), the error flag (XF) turns ON, and the rate alarm is executed at the pre-error setting.

3.4.20 CH□ input signal error detection setting value/CH□ input signal error detection lower limit setting value (buffer memory addresses 138 to 141: Un\G138 to Un\G141)
CH□ input signal error detection upper limit setting value (buffer memory addresses 142 to 145: Un\G142 to Un\G145)

- (1) Set the value (upper limit setting value and lower limit setting value), at which the error of the entered analog value will be detected, on a channel basis.
The setting value (upper limit value and lower limit value) depends on the input signal error detection extended setting.
 - (a) When Same upper limit value/lower limit value is selected,
 - Set the value of the input signal error detection setting for CH□ Input signal error detection extended setting (buffer memory addresses 138 to 141: Un\G138 to Un\G141).
 - (b) When Different upper limit value/lower limit value is selected,
 - Set the value of the input signal error detection lower limit for CH□ Input signal error detection lower limit setting value (buffer memory addresses 138 to 141: Un\G138 to Un\G141)
 - Set the value of the input signal error detection upper limit for CH□ Input signal error detection upper limit setting value (buffer memory addresses 142 to 145: Un\G142 to Un\G145).
- (2) To make the setting valid, the Operating condition setting request (Y9) must be turned ON/OFF. (Refer to Section 3.3.2.)
- (3) The setting range is 0 to 250 (0 to 25.0%). Set the value in 0.1% increments.
Example) When setting the input signal error detection setting value to 15%, store 150 into the buffer memory.

If 251 is entered in the Input signal error detection upper limit setting value and Input signal error detection lower limit setting value boxes after different upper limit value/lower limit value is selected for the input signal error detection extended setting, the detection function for the upper and lower limits can be disabled.

- (4) Based on the input signal error detection setting values (input signal error detection upper limit setting value and input signal error detection lower limit setting value), the input signal error detection upper limit value and the input signal error detection lower limit value are calculated as shown below.
The calculation results of the input signal error detection upper limit value and the input signal error detection lower limit value depend on the used input range.^{*1}

Input signal error detection upper limit value

$$= \text{gain value of corresponding range} + (\text{gain value of corresponding range} - \text{offset value of corresponding range}) \times \{\text{setting value (upper limit setting value)/1000}\}$$

Input signal error detection lower limit value

$$= \text{lower limit value of corresponding range} + (\text{gain value of corresponding range} - \text{offset value of corresponding range}) \times \{\text{setting value (lower limit setting value)/1000}\}$$

*1: For the lower limit value, offset value, and gain value that correspond to each range, refer to Point (3) in this section.

- (5) Refer to Section 3.2.3 for details of the input signal error detection function.

POINT						
(1)	Set the input signal error detection upper limit value to less than 25mA. If the setting is 25mA or more, the error may not be detected.					
(2)	For the Q62AD-DGH, set the input signal error detection lower limit value to 0mA or more. If it has been set to less than 0mA, the error may not be detected.					
(3)	The following table shows the lower limit value, offset value, and gain value for each range.					
Table 3.10 Lower limit value, offset value, and gain value for input range (Q64AD-GH)						
	Input	Analog input range	Lower limit value	Offset value	Gain value	
Voltage		0 to 10V	0V		10V	
		0 to 5V	0V		5V	
		1 to 5V	1V		5V	
		1 to 5V (Extended mode)	1V		5V	
		-10 to 10V	-10V	0V	10V	
		User range setting (Uni-polar)	Analog value set as the offset value by the user			Analog value set as the gain value by the user
		User range setting (Bi-polar)	Analog value corresponding to a digital value of -64000	Analog value set as the offset value by the user		Analog value set as the gain value by the user
Current		0 to 20mA	0mA		20mA	
		4 to 20mA	4mA		20mA	
		4 to 20mA (Extended mode)	4mA		20mA	
		User range setting (Uni-polar)	Analog value set as the offset value by the user			Analog value set as the offset value by the user.
Table 3.11 Lower limit value, offset value, and gain value for input range (Q62AD-DGH)						
	Analog input range	Lower limit value	Offset value	Gain value		
	4 to 20mA	4mA		20mA		
	4 to 20mA (Extended mode)	4mA		20mA		
	User range setting	Analog value set as the offset value by the user			Analog value set as the gain value by the user	

3.4.21 Mode switching setting (buffer memory addresses 158, 159: Un\G158, Un\G159)

- (1) Set the values of the mode desired to be switched to.
- (2) After setting the values, turning the operating condition setting request (Y9) from OFF to ON switches to that mode.
- (3) When mode switching is performed, this area is cleared to zero and the operating condition setting completed flag (X9) turns OFF.
After confirming that the operating condition setting completed flag (X9) has turned OFF, turn OFF the operating condition setting request (Y9).

Mode to be switched to	Set values	
	Buffer memory address 158	Buffer memory address 159
Normal mode	0964H	4144H
Offset/gain setting mode	4144H	0964H

POINT
If the values written are other than the above, mode switching is not performed and only the operating condition is changed.

3.4.22 Pass data classification setting (buffer memory addresses 200: Un\G200)
(Q64AD-GH only)

- (1) Areas used to restore the user range settings offset/gain values when online module change is made.
Refer to chapter 7 for details of online module change.
- (2) Specify whether the offset/gain values to be saved/restored are voltages or currents when saving/restoring the offset/gain values of the user range setting.

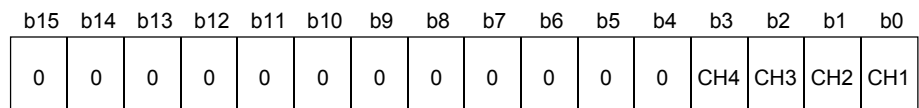

Information of b4 to b15 is fixed to 0.

1: Current specified
0: Voltage specified

POINT
Refer to Section 4.6 for the offset/gain value setting method.

3.4.23 Industrial shipment settings and user range settings offset/gain value (buffer memory addresses 202 to 233: Un\G202 to Un\G233)

- (1) Areas used to restore the user range settings offset/gain values when online module change is made.
Refer to chapter 7 for details of online module change.
- (2) When the offset/gain values of the user range setting are restored, the used data are stored.
The data are stored (saved) when:
 - Initial setting write is performed by the utility;
 - The operating condition is set (Y9 turns from OFF to ON * 1); or
 - The offset/gain values are written in the offset/gain setting mode (YA turns from OFF to ON).
 * 1: The data are not saved when values have been written to the mode switching setting area (buffer memory addresses 158, 159: Un\G158, Un\G159).
- (3) When restoring the offset/gain values of the user range setting, set the data saved here similarly into the corresponding area of the module where the data will be restored.
- (4) Buffer memory saving recording procedure for online module change
 - 1) Set the pass data classification setting * 1 (buffer memory addresses 200: Un\G200).
 - 2) Turn the operating condition setting request (Y9) from OFF to ON.
 - 3) Compare the offset/gain values of the industrial shipment settings and user range settings (buffer memory addresses 202 to 233: Un\G202 to Un\G233) with the range reference values. Refer to Section 7.4 for the range reference values.
 - 4) If the values are proper, record the values of the pass data classification setting * 1, industrial shipment settings and user range settings offset/gain value.
 * 1: The Q62AD-DGH does not require the setting and recording of the pass data classification setting.

POINT	Refer to Section 4.6 for the offset/gain value setting method.
--------------	--

4 SETUP AND PROCEDURES BEFORE OPERATION

4.1 Handling Precautions

- (1) Do not drop the module or subject it to heavy impact.
- (2) Do not remove the PCB of the module from its case.
Doing so may cause the module to fail.
- (3) Be careful not to let foreign particles such as swarf or wire chips enter the module.
They may cause a fire, mechanical failure or malfunction.
- (4) The top surface of the module is covered with a protective film to prevent foreign objects such as wire burrs from entering the module during wiring.
Do not remove this film until the wiring is complete.
Before operating the system, be sure to remove the film to provide adequate ventilation.
- (5) Tighten the screws such as module fixing screws within the following ranges.
Loose screws may cause short circuits, failures, or malfunctions.

Screw location	Tightening torque range
Module fixing screw (M3 screw) ^{*1}	0.36 to 0.48 N·m
Terminal block screw (M3 screw)	0.42 to 0.58 N·m
Terminal block mounting screw (M3.5 screw)	0.66 to 0.89 N·m

*1: The module can be easily fixed onto the base unit using the hook at the top of the module.

However, it is recommended to secure the module with the module fixing screw if the module is subject to significant vibration.

- (6) With the module mounting lever of the lower part of the module pressed down, fully insert the module fixing latch into the fixing hole in the base unit, and mount the module with the hole as a supporting point.
Improper installation may result in a module malfunction, or may cause the module to fall off.

4.2 Setup and Procedures before Operation

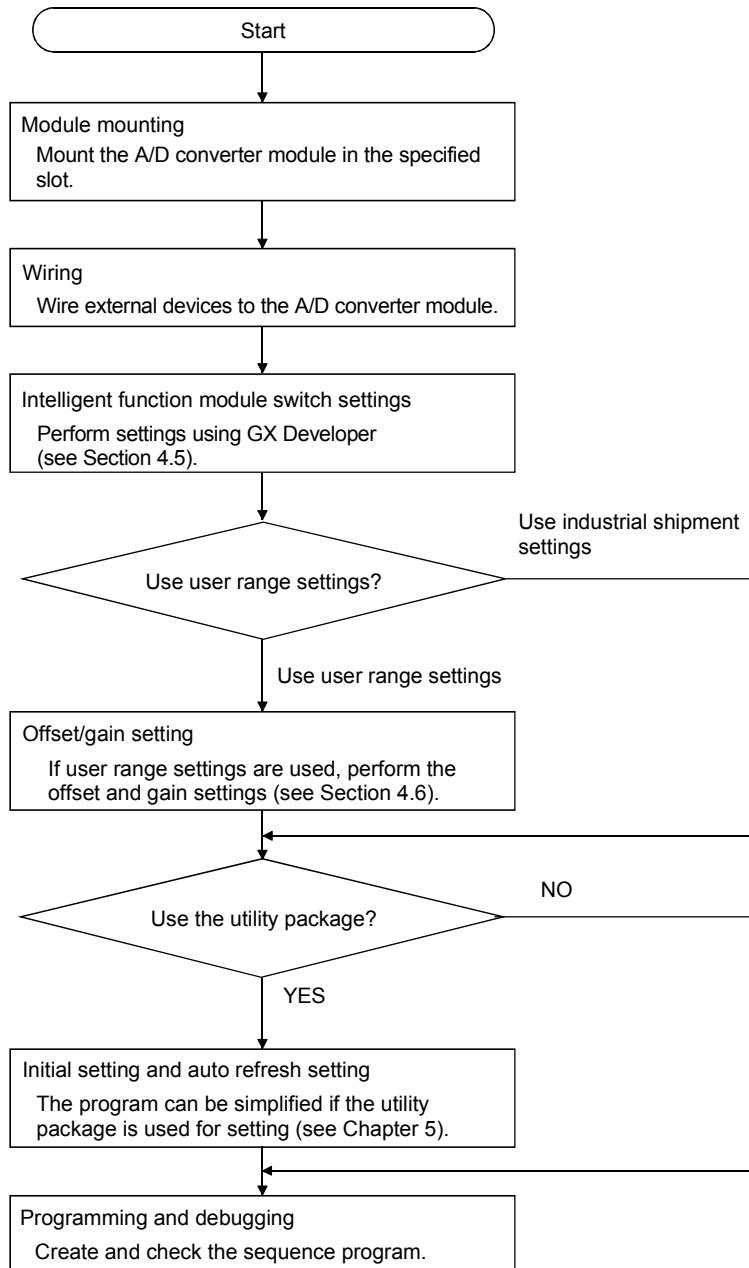

4

4.3 Part Identification Nomenclature

The name of each part of the A/D converter module is listed below.

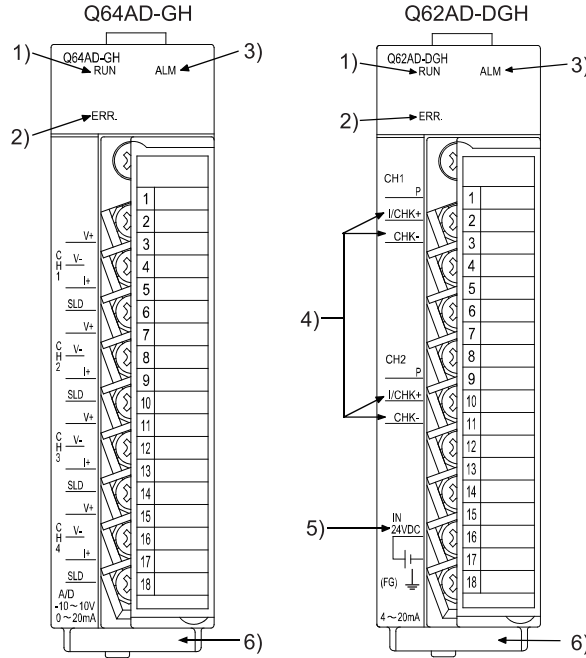

Number	Name and appearance	Description
1)	RUN LED	Displays the operating status of the A/D converter module. On : Normal operation Flickering : During offset/gain setting mode Off : 5V power supply interrupted, watch dog timer error or module exchangeable status during online module change bled
2)	ERR. LED	Displays the error status of the A/D converter module. On : Error *1 (A/D conversion continues.) Flickering : Error *1 (A/D conversion stops.) Off : Normal operation
3)	ALM LED	Displays the warning status of the A/D converter module. On : An alarm (process alarm, rate alarm) is being generated. Flickering : An input signal error is being generated. Off : Normal operation
4)	Check terminals (Q62AD-DGH only)	Terminal used to check the analog input current value. (See Section 4.4.2)
5)	External supply power terminal (Q62AD-DGH only)	Terminal to connect 24VDC external supply power.
6)	Serial No. plate	Displays the serial number of the A/D converter module.

*1: Check the error code for details.

POINT

When two or more errors have occurred, the latest error found by the A/D converter module is displayed on the LED.

Terminal number	Signal name		
	Q64AD-GH		Q62AD-DGH* ¹
1	Empty		CH1
2	Empty		
3	CH1	V +	
4		V -	I/CHK +
5		I +	CHK -
6		SLD	Empty
7	CH2	V +	Empty
8		V -	Empty
9		I +	CH2
10		SLD	
11	CH3	V +	P
12		V -	I/CHK +
13		I +	CHK -
14		SLD	Empty
15	CH4	V +	Empty
16		V -	24V
17		I +	24G
18		SLD	FG

*1: P : Power supply for 2-wire transmitter

I/CHK + : 2-wire transmitter current input/check (+) terminal

CHK - : Check (-) terminal

4.4 Wiring

The wiring precautions and examples of module connection are provided below.

4.4.1 Wiring precautions

In order to optimize the functions of the A/D converter module and ensure system reliability, external wiring that is protected from noise is required.

Please observe the following precautions for external wiring:

- (1) Use separate cables for the AC control circuit and the external input signals of the Q64AD-GH to avoid the influence of the AC side surges and inductions.
- (2) Use separate cables for the AC control circuit and the external input signals and external supply power of the Q62AD-DGH to avoid the influence of the AC side surges and inductions.
- (3) Do not mount the cables close to or bundle them with the main circuit line, a high-voltage cable or a load cable from other than the programmable controller. This may increase the effects of noise, surges and induction.
- (4) Perform an one-point grounding for shielded lines and the shields of sealed cables.
- (5) A solderless terminal with insulating sleeve cannot be used for the terminal block. Covering the cable-connection portion of the solderless terminal with a marked tube or an insulation tube is recommended.

4.4.2 External wiring

(1) Q64AD-GH

(a) For voltage input
Signal source 0 to ±10V

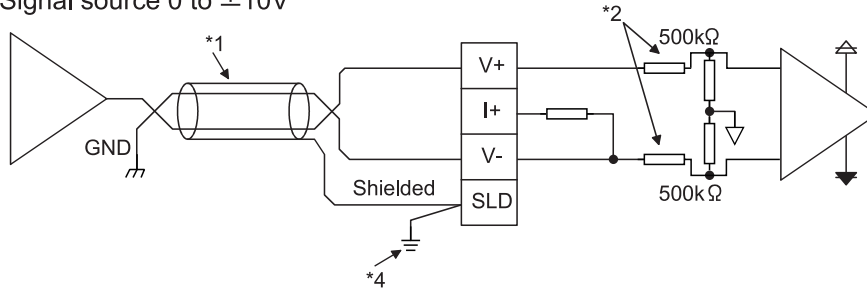

(b) For current input
Signal source 0 to 20mA

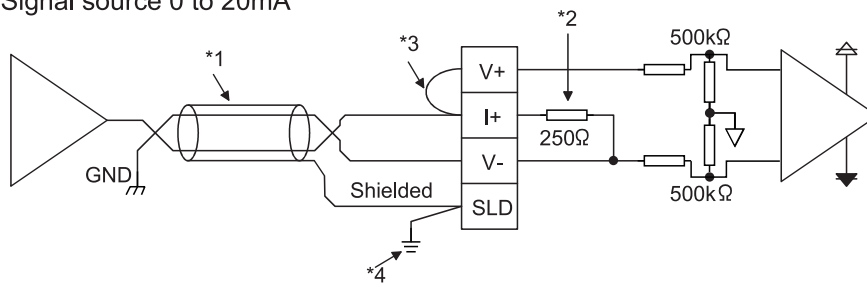

*1: Use a 2-core twisted shielded wire for the power wire.

*2: Shows input resistance.

*3: For current input, be sure to connect to (V+) and (I+) terminals.

*4: Be sure to ground the shield wire of each channel.

The SLD terminal can be used when grounding, however it has not been wired inside the board.

Ground it as shown in the diagram shown above or below.

In addition, ground the FG of the power supply module.

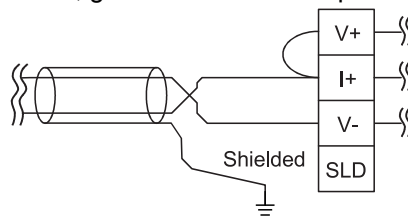

(2) Q62AD-DGH

(a) For 2-wire transmitter input

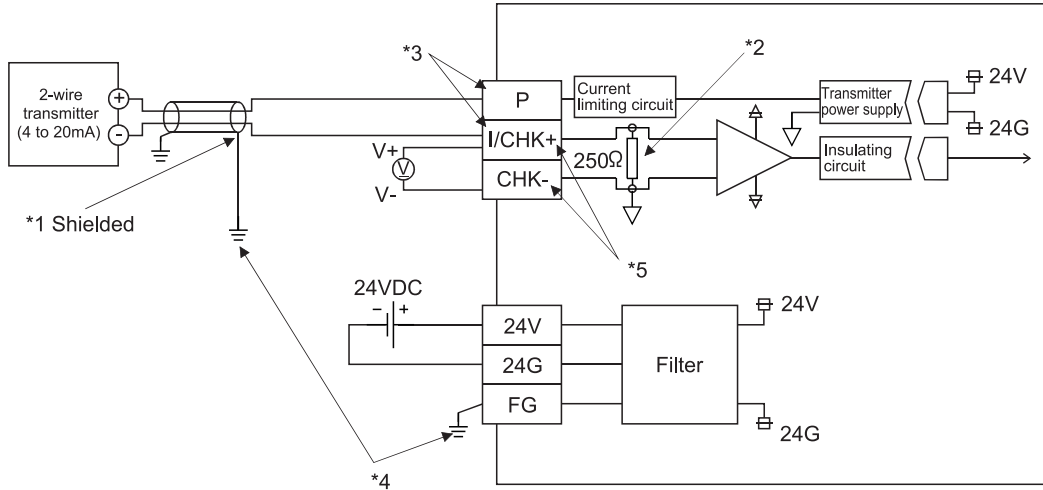

(b) For current input

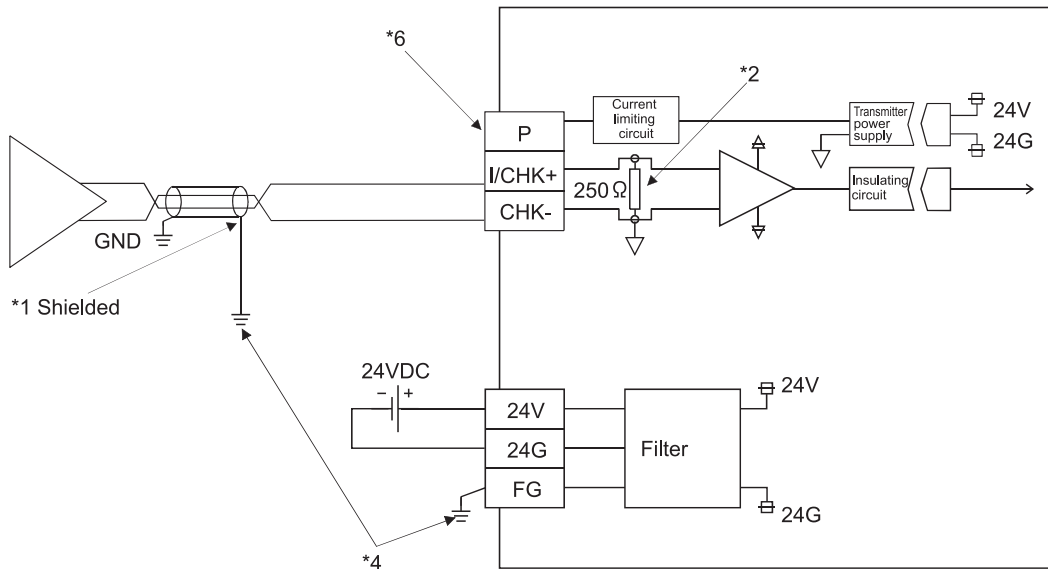

- *1: Use a 2-core twisted shielded wire for the power wire.
- *2: Shows input resistance.
- *3: To connect with the 2-wire transmitter, be sure to connect to P and I/CHK+.
- *4: Always use a ground. In addition, ground the FG of the power supply module.
- *5: The check terminals (I/CHK+, CHK-) are used to check the amount of input in mA in relation to the 2-wire transmitter output. This can be checked since analog inputs of 4 to 20mA are converted to analog outputs of 1 to 5V. The relationship of this conversion can be expressed by the following formula:

$$\text{Analog output (V)} = \frac{\text{Analog input (mA)}}{1000} \times 250\Omega$$
- *6: Open the relay terminal surely because, the power supply for 2-wire transmitter is always on.

IMPORTANT

Q62AD-DGH needs to be powered on 30 minutes prior to operation for compliance to the specification (accuracy).

Therefore, power on 30 minutes prior to offset/gain setting or after online module change.

4.5 Switch Setting for Intelligent Function Module

The settings for the intelligent function module are performed using the I/O assignment settings for GX Developer.

(1) Setting item

The intelligent function module switches consist of switches 1 to 5 and are set using 16 bit data. When the intelligent function module switches are not set, the default value for switches 1 to 5 is 0.

Table 4.1 Switch setting item

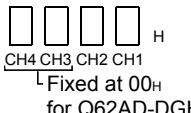
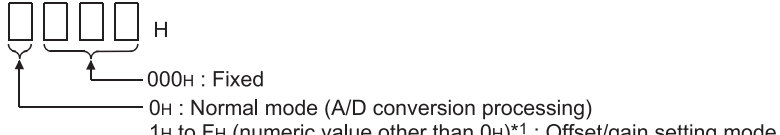
		Setting item																								
Switch 1	Input range setting 	<table border="1"> <thead> <tr> <th colspan="2">Q64AD-GH</th> </tr> <tr> <th>Analog input range</th> <th>Input range setting value</th> </tr> </thead> <tbody> <tr> <td>4 to 20 mA</td> <td>0H</td> </tr> <tr> <td>0 to 20 mA</td> <td>1H</td> </tr> <tr> <td>1 to 5 V</td> <td>2H</td> </tr> <tr> <td>0 to 5 V</td> <td>3H</td> </tr> <tr> <td>- 10 to 10 V</td> <td>4H</td> </tr> <tr> <td>0 to 10 V</td> <td>5H</td> </tr> <tr> <td>4 to 20mA (Extended mode)</td> <td>AH</td> </tr> <tr> <td>1 to 5V (Extended mode)</td> <td>BH</td> </tr> <tr> <td>User range setting (Uni-polar)</td> <td>EH</td> </tr> <tr> <td>User range setting (Bi-polar)</td> <td>FH</td> </tr> </tbody> </table>	Q64AD-GH		Analog input range	Input range setting value	4 to 20 mA	0H	0 to 20 mA	1H	1 to 5 V	2H	0 to 5 V	3H	- 10 to 10 V	4H	0 to 10 V	5H	4 to 20mA (Extended mode)	AH	1 to 5V (Extended mode)	BH	User range setting (Uni-polar)	EH	User range setting (Bi-polar)	FH
		Q64AD-GH																								
		Analog input range	Input range setting value																							
		4 to 20 mA	0H																							
		0 to 20 mA	1H																							
		1 to 5 V	2H																							
		0 to 5 V	3H																							
		- 10 to 10 V	4H																							
		0 to 10 V	5H																							
		4 to 20mA (Extended mode)	AH																							
		1 to 5V (Extended mode)	BH																							
		User range setting (Uni-polar)	EH																							
User range setting (Bi-polar)	FH																									
<table border="1"> <thead> <tr> <th colspan="2">Q62AD-DGH</th> </tr> <tr> <th>Analog input range</th> <th>Input range setting value</th> </tr> </thead> <tbody> <tr> <td>4 to 20 mA</td> <td>0H</td> </tr> <tr> <td>4 to 20mA (Extended mode)</td> <td>AH</td> </tr> <tr> <td>User range setting</td> <td>FH</td> </tr> </tbody> </table>		Q62AD-DGH		Analog input range	Input range setting value	4 to 20 mA	0H	4 to 20mA (Extended mode)	AH	User range setting	FH															
Q62AD-DGH																										
Analog input range	Input range setting value																									
4 to 20 mA	0H																									
4 to 20mA (Extended mode)	AH																									
User range setting	FH																									
Switch 2	Empty																									
Switch 3	Empty																									
Switch 4																										
Switch 5	0H : Fixed																									

*1: Setting any value within the setting range will provide the same operation.
When the setting range is 1H to FH, set 1H for example.

(2) Operating procedure

Start the settings with GX Developer I/O assignment setting screen.

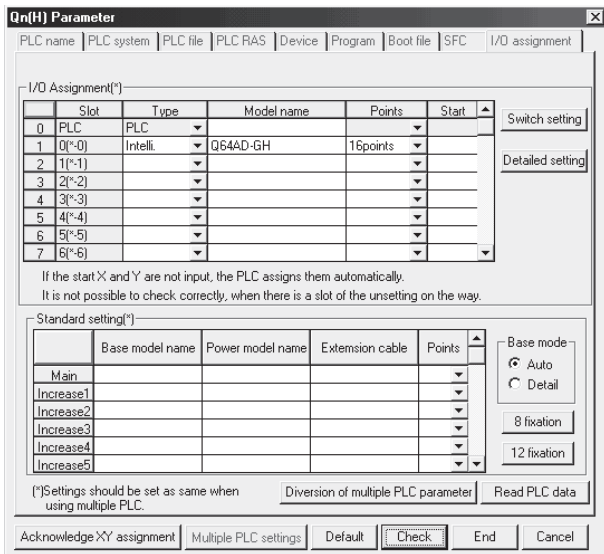

- (a) I/O assignment setting screen
 Set the following for the slot in which the A/D converter module is mounted.
 The type setting is required; set other items as needed.
- Type : Select "intelli."
 - Model name : Enter the module model name.
 - Points : Select 16 points.
 - Start : Enter the start I/O number for the A/D converter module.
- Detailed setting: Specify the control CPU for the A/D converter module.
 It is unnecessary to set the "Error time output mode" or "H/W error time PLC operation mode" since these settings are invalid for the A/D converter module.

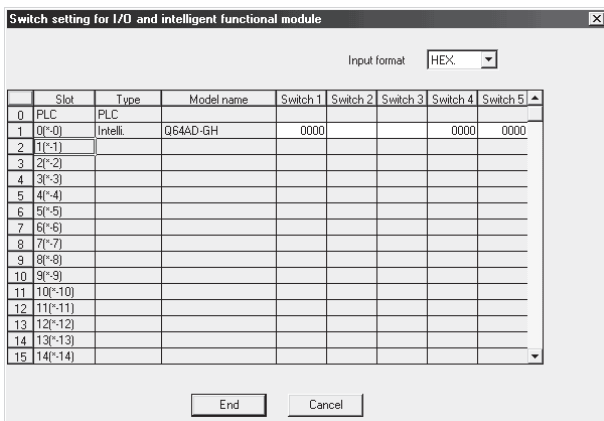

- (b) Switch setting for intelligent function module screen
 Click on [Switch setting] on the I/O assignment setting screen to display the screen shown at left, then set switches 1 to 5.
 The switches can easily be set if values are entered in hexadecimal. Change the entry format to hexadecimal and then enter the values.

4.6 Offset/Gain Settings

When using the user range setting, make the offset/gain setting according to the operation indicated in Section 4.6.1 or Section 4.6.2.
 When the industrial shipment setting is used, offset/gain setting is not necessary.
 If the utility package is installed, perform the offset/gain settings according to the procedure described in Section 5.6.2.

4.6.1 Offset/gain settings (Q64AD-GH)

(1) Offset/gain setting procedure

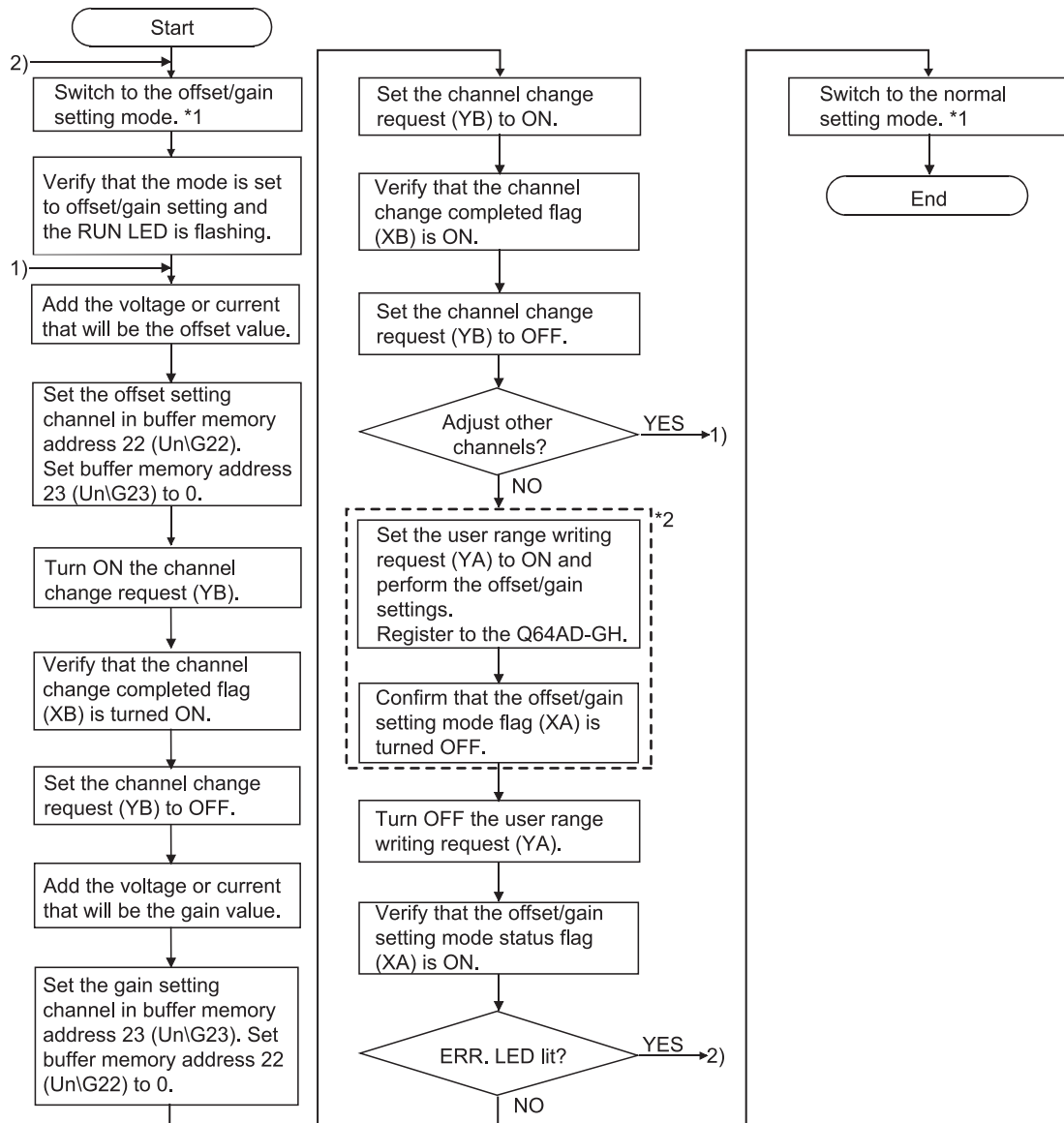

- *1 The mode switching (normal mode to offset/gain setting mode to normal mode) method is given below.
 - Dedicated instruction (G(P).OFFGAN) Refer to Section 4.6.1 (2), (a)
 - Setting made to mode switching setting (buffer memory addresses 158, 159: Un\G158, Un\G159) and turning the operation condition setting request (Y9) from OFF to ONRefer to Section 4.6.1 (2), (b)
 - Intelligent function module switch setting ..Refer to Section 4.5, Section 4.6.1 (2), (c) (After intelligent function module switch setting, reset the programmable controller CPU or switch power OFF, then ON.)
- *2 Avoid the following operations during the steps indicated with *2. Doing so may cause an error in the data inside the E²PROM, resulting in the Q64AD-GH failing to operate normally.
 - Powering Off the programmable controller CPU
 - Resetting the programmable controller CPU

POINT
(1) Perform the offset/gain settings in the range that satisfies the conditions specified in POINT of Section 3.1.2 (1). When the setting exceeds this range, the resolution or accuracy may not be within the range indicated in the performance specification.
(2) Though the offset/gain settings can be performed on multiple channels at the same time, set the offset and gain separately (0 at either of the buffer memory addresses 22, 23). If channels are set at the buffer memory addresses 22 (Un\G22) and 23 (Un\G23) at the same time, an error will occur and the ERR. LED will be lit.
(3) After the offset/gain settings are completed, verify that the offset and gain values have been set correctly under actual usage conditions.
(4) The offset and gain values are stored into the E ² PROM and are not erased at power-off.
(5) In configuring the offset/gain setting, turning ON the user range write request (YA) enables the data to be written to the E ² PROM. Data can be written to the E ² PROM up to 100 thousand times. Writing data 26 times in a row causes an error (error code: 162), which is intended to protect the E ² PROM from inadvertent write.
(6) If an error (error code: 40 □ ^{*1}) occurs during offset/gain setting, re-set the correct offset/gain value. The offset/gain value of the channel where the error has occurred is not written to the module. (*1: □ indicates the corresponding channel number.)
(7) Module ready (X0) turns from OFF to ON when the offset/gain setting mode switches to the normal mode by the dedicated instruction (G(P).OFFGAN) or the setting of the mode switching setting (buffer memory addresses 158, 159: Un\G158, Un\G159). Note that initial setting processing will be executed if there is a sequence program that makes initial setting when module ready (X0) turns ON.
(8) Buffer memory addresses 200 (Un\G200), 202 to 233 (Un\G202 to Un\G233) are the areas used to restore the user range settings offset/gain values when online module change is made. Refer to chapter 7 for details of online module change.

(2) Program examples

The program in the dotted area of (a) is common to (a), (b) and (c).

In this example, the I/O signals for the Q64AD-GH are X/Y0 to X/YF

- Channel selection M0
- Offset setting M1
- Gain setting M2
- Channel change command M3
- Offset/gain setting value write command to the module M4
- Mode switching M5
- Channel designation storage device D0
- Dedicated instruction (G(P).OFFGAN) setting storage device D1

(a) When switching the mode using the dedicated instruction (G(P).OFFGAN)
 The following program switches to the offset/gain setting mode with the dedicated instruction (G(P).OFFGAN), changes the channel where offset/gain setting will be made, writes the offset/gain values to the Q64AD-GH, and then switches to the normal mode.

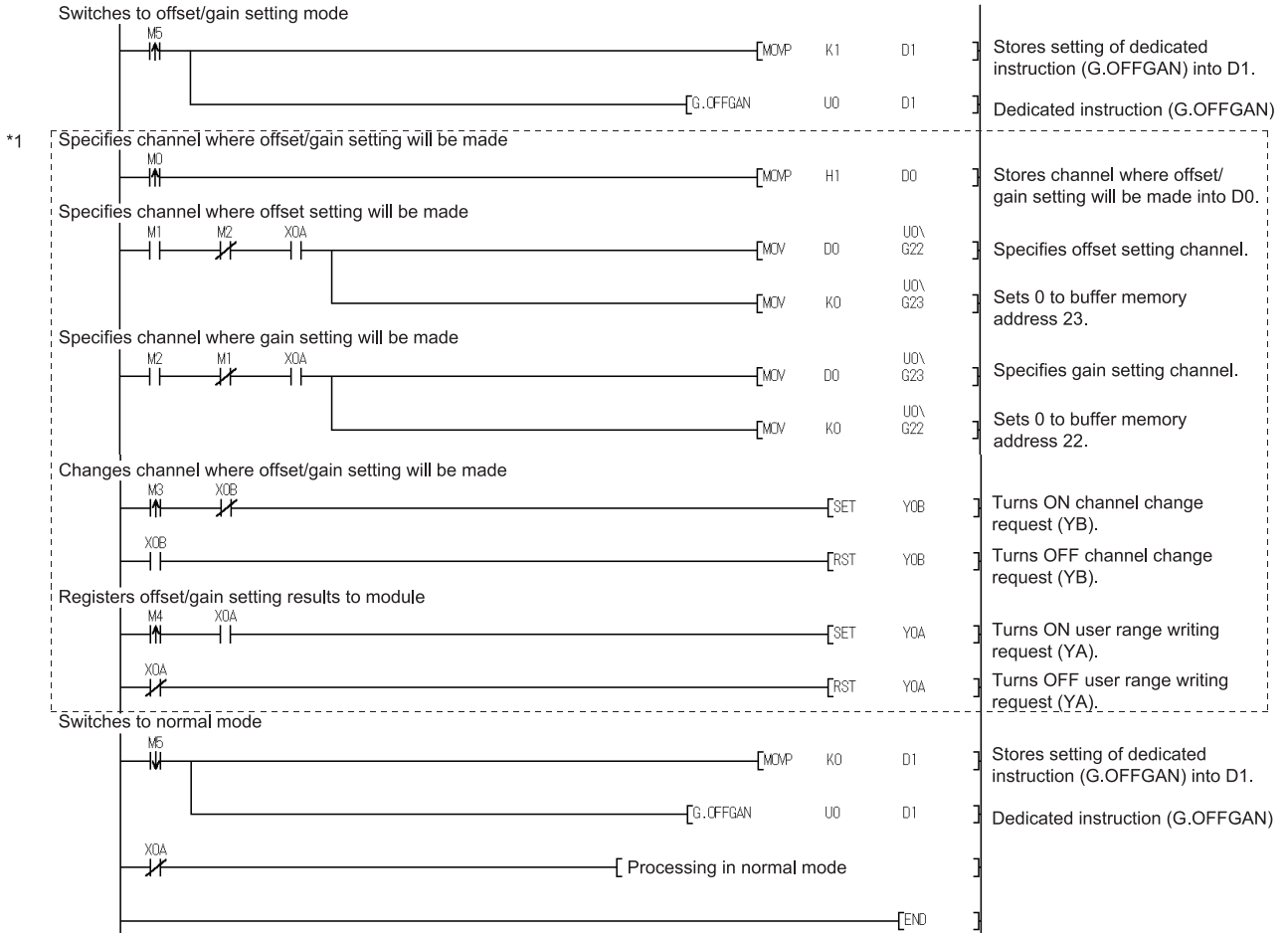

*1: The program in the dotted area is a common program.

- (b) When switching the mode using the setting of the mode switching setting (buffer memory addresses 158, 159: Un\G158, Un\G159) and operation condition setting request (Y9)

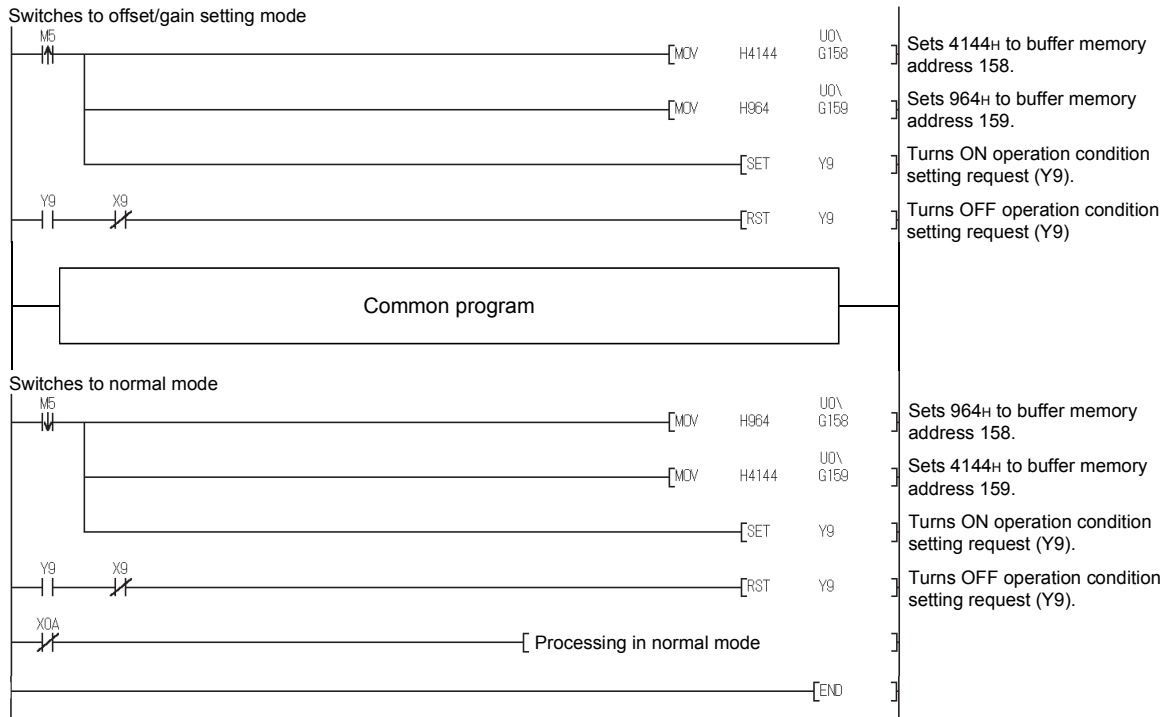

- (c) When switching the mode by making intelligent function module switch setting
Only the common program is necessary.

4.6.2 Offset/gain settings (Q62AD-DGH)

(1) Offset/gain setting procedure

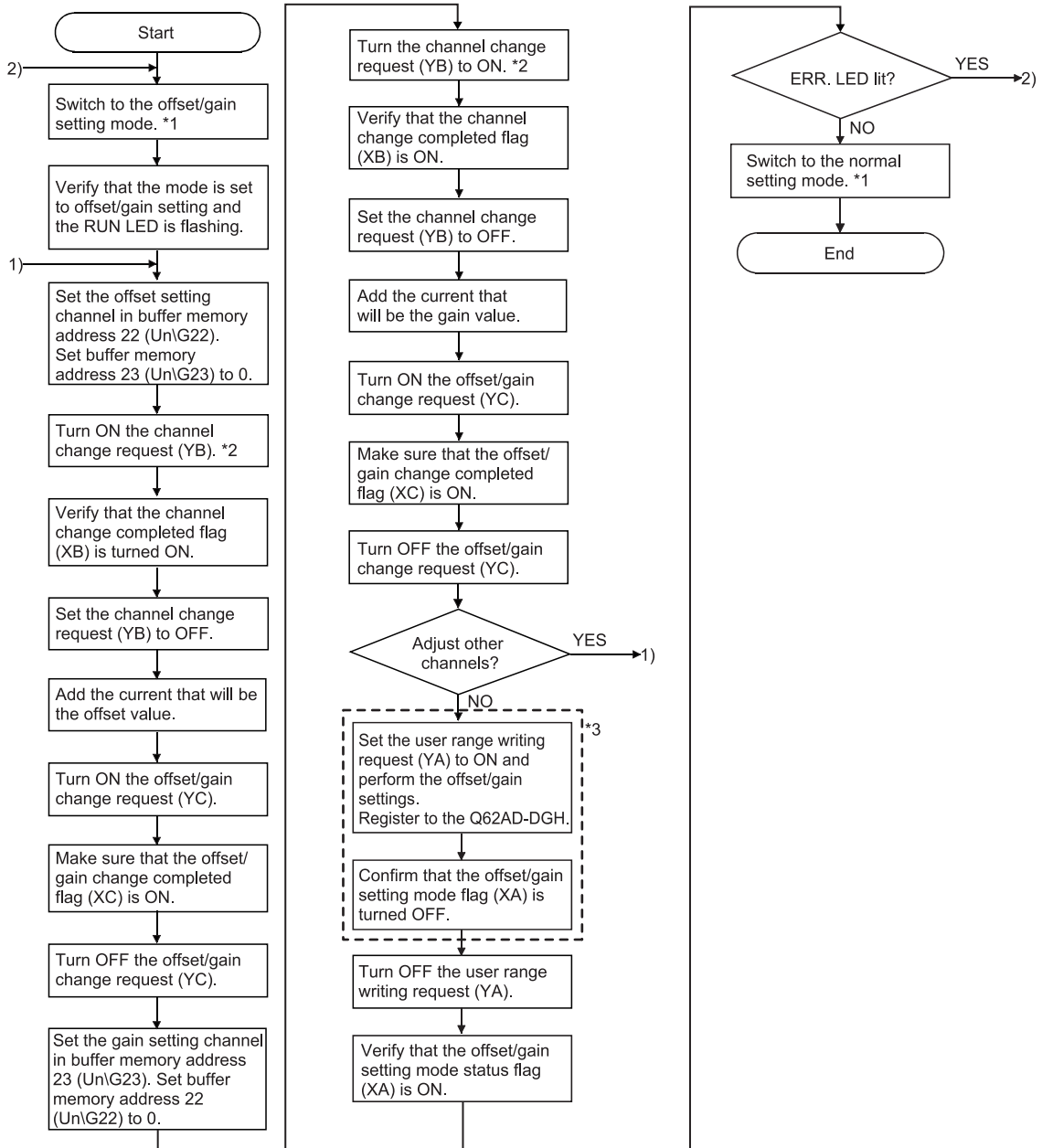

- *1 The mode switching (normal mode to offset/gain setting mode to normal mode) method is given below.
 - Dedicated instruction (G(P).OFFGAN) Refer to Section 4.6.2 (2) (a)
 - Setting made to mode switching setting (buffer memory addresses 158, 159: Un\G158, Un\G159) and turning the operation condition setting request (Y9) from OFF to ONRefer to Section 4.6.2 (2) (b)
 - Intelligent function module switch setting ...Refer to Section 4.5, Section 4.6.2 (2) (c) (After intelligent function module switch setting, reset the programmable controller CPU or switch power OFF, then ON.)
- *2 Turning ON the channel change request (YB) starts power supply from the corresponding channel to the 2-wire transmitter. After fully checking the wiring, settings, etc., turn ON the channel change request (YB).
- *3 Avoid the following operations during the steps indicated with *3. Doing so may cause an error in the data inside the E²PROM, resulting in the Q62AD-DGH failing to operate normally.
 - Powering OFF the programmable controller CPU
 - Resetting the programmable controller CPU

POINT	
(1)	Perform the offset/gain settings in the range that satisfies the conditions specified in POINT of Section 3.1.2 (2).
	If the setting exceeds the range, the resolution or accuracy may not fall within the range indicated in the performance specification.
(2)	Though the offset/gain settings can be performed on multiple channels at the same time, set the offset and gain separately (0 at either of the buffer memory addresses 22, 23).
	If channels are set at the buffer memory addresses 22 (Un\G22) and 23 (Un\G23) at the same time, an error will occur and the ERR. LED will be lit.
(3)	After the offset/gain settings are completed, verify that the offset and gain values have been set correctly under actual usage conditions.
(4)	The offset and gain values are stored into the E ² PROM and are not erased at power-off.
(5)	In configuring the offset/gain setting, turning ON the user range write request (YA) enables the data to be written in the E ² PROM.
	Data can be written to the E ² PROM up to 100 thousand times.
	Writing data 26 times in a row causes an error (error code: 162), which is intended to protect the E ² PROM from inadvertent write.
(6)	If an error (error code: 40 <input type="checkbox"/> *1) occurs during offset/gain setting, re-set the correct offset/gain value.
	The offset/gain value of the channel where the error has occurred is not written to the A/D converter module. (*1: <input type="checkbox"/> indicates the corresponding channel number.)
(7)	When the offset/gain setting mode is switched to the normal mode, the module ready (X0) turns from OFF to ON.
	Note that the initial setting processing will be executed at this time if there is a sequence program that performs initial settings when the module ready (X0) turns ON.
(8)	When one mode is switched to the other (the normal mode is switched to the offset/gain setting mode or the offset/gain setting mode is switched to the normal mode), A/D conversion is suspended and power supply to the 2-wire transmitter is turned OFF.
	To resume A/D conversion and power supply to the 2-wire transmitter, turn ON the operating condition setting request (Y9) after the mode is switched to the normal mode.
(9)	Buffer memory addresses 202 to 225 (Un\G202 to Un\G225) are the areas used to restore the user range settings offset/gain values when online module change is made.
	Refer to chapter 7 for details of online module change.

(2) Program examples

The program in the dotted area of (a) is common to (a), (b) and (c).
 In this example, the I/O signals for the Q62AD-DGH are X/Y0 to X/YF.

- Channel selectionM0
- Offset settingM1
- Gain settingM2
- Channel change commandM3
- Offset/gain setting value write command to the moduleM4
- Mode switchingM5
- Offset/gain change commandM6
- Normal mode checking signalM50
- Channel designation storage deviceD0
- Dedicated instruction (G(P).OFFGAN) setting storage deviceD1

(a) When switching the mode using the dedicated instruction (G(P).OFFGAN)

The following program switches to the offset/gain setting mode with the dedicated instruction (G(P).OFFGAN), changes the channel where offset/gain setting will be made, writes the offset/gain values to the Q62AD-DGH, and then switches to the normal mode.

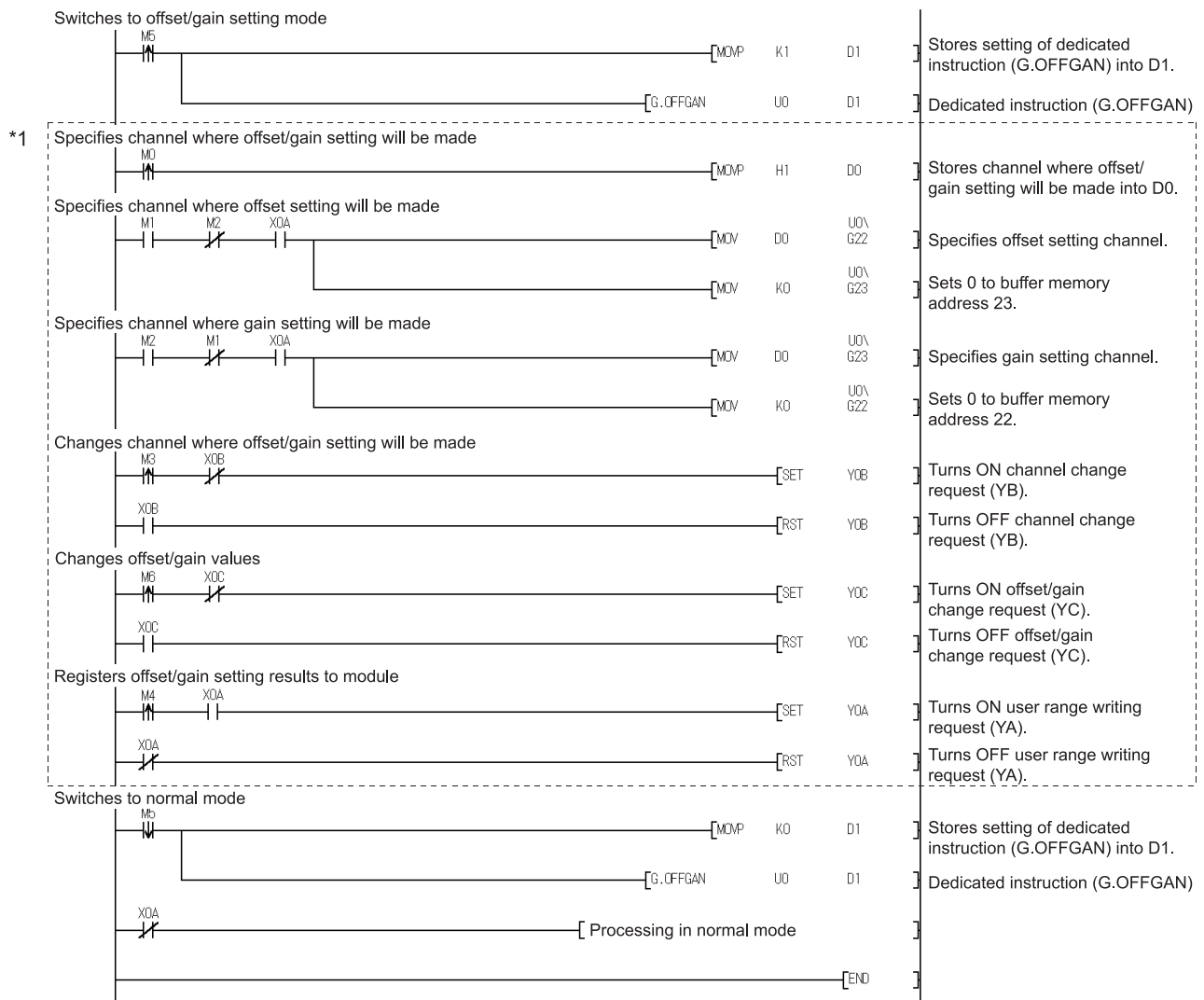

*1: The program in the dotted area is a common program.

(b) When switching the mode using the setting of the mode switching setting (buffer memory addresses 158, 159: Un\G158, Un\G159) and operation condition setting request (Y9)

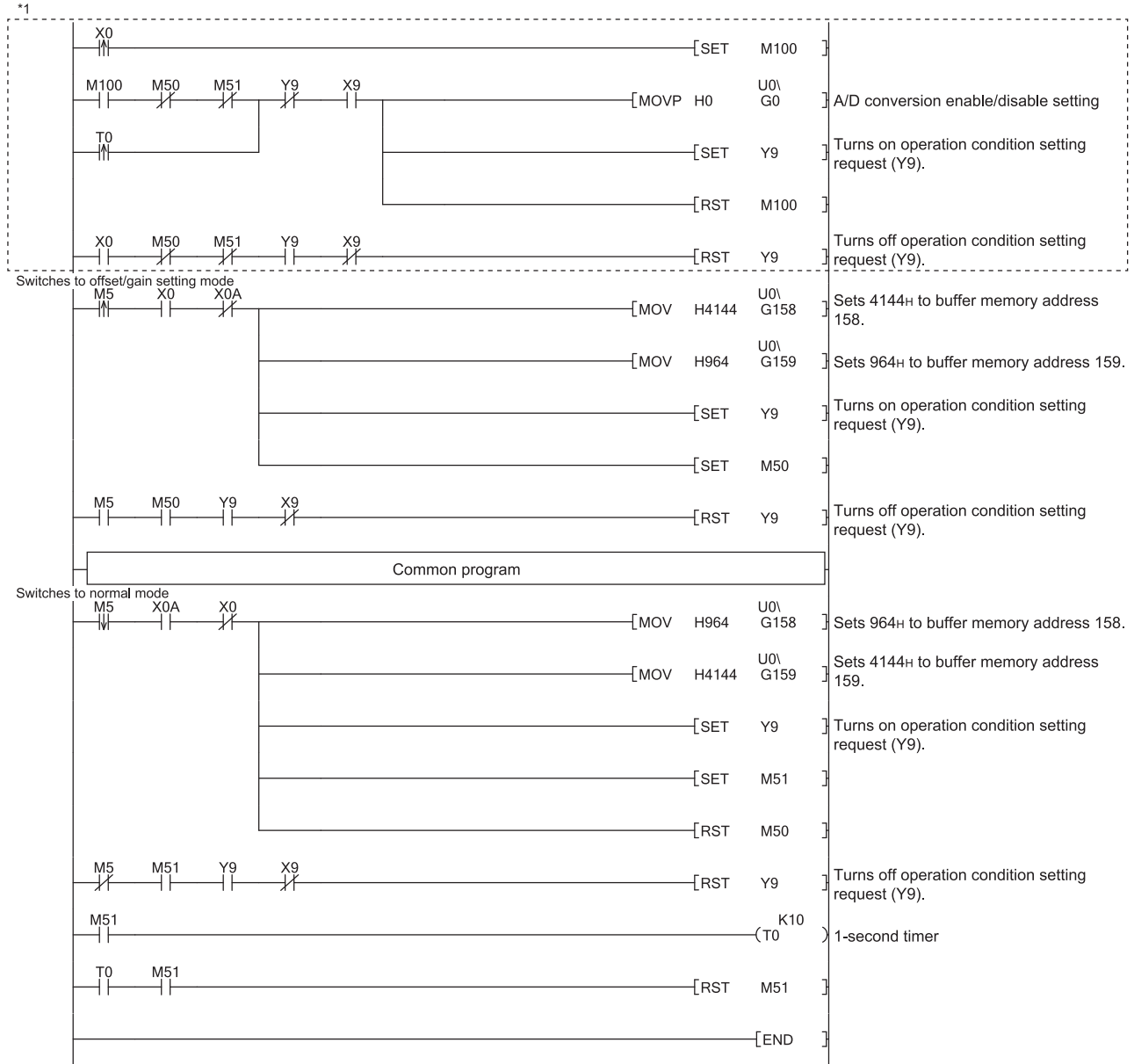

POINT

When running this program together with the normal-mode A/D conversion program (shown in Section 6.4.2), use *1 of this program as the initial setting program. Before using this program, check the device numbers.

Note) When adding this program to the normal-mode A/D conversion program (shown in Section 6.4.2), replace the existing initial setting program with the program marked with *1. Before using this program, check the device numbers.

(c) When switching the mode by making intelligent function module switch setting
Only the common program is necessary.

4.6.3 A/D conversion value storage during offset/gain setting

If during the offset/gain setting, the A/D conversion values are stored into the buffer memory addresses 11 to 14, 54 to 61 (Un\G11 to Un\G14, Un\G54 to Un\G61) as in the normal mode.

(1) Q64AD-GH

The A/D conversion values of all channels are stored into the buffer memory.

(2) Q62AD-DGH

The A/D conversion values of the channels specified in the offset/gain setting mode (buffer memory addresses 22, 23: Un\G22, Un\G23) are stored into the buffer memory.

5 UTILITY PACKAGE (GX Configurator-AD)

5.1 Utility Package Functions

Table 5.1 shows an overview of the utility package functions.

Table 5.1 Utility package (GX Configurator-AD) function list

Item	Description	Reference section
Initial setting * 1	<p>(1) Sets the following items that require initial setting.</p> <ul style="list-style-type: none"> • A/D conversion enable/disable setting • Averaging process specification • Average time/Average number of times/Move average/Time constant settings • A/D conversion starting time setting (Q62AD-DGH) • Warning output settings (Process alarm setting) • Process alarm upper upper limit value/upper lower limit value/lower upper limit value/lower lower limit value • Warning output settings (Rate alarm setting) • Rate alarm upper limit value/lower limit value • Rate alarm warning detection period • Input signal error detection extended/input signal error detection setting • Input signal error detection setting value/input signal error detection lower limit setting value • Input signal error detection upper limit setting value <p>(2) The data for which initial setting has been completed is registered in the parameters for the programmable controller CPU, and automatically written to the A/D converter module when the programmable controller CPU changes to the RUN status.</p>	Section 5.4
Auto refresh setting * 1	<p>(1) Sets auto refresh for the A/D converter module buffer memory.</p> <p>(2) The buffer memory that was set for auto refresh is automatically read and written to the specified device when the END command for the programmable controller CPU is executed.</p>	Section 5.5
Monitor/Test	<p>(1) Monitor/Test The buffer memory and I/O signals for the A/D converter modules are monitored and tested.</p> <p>(2) Operating condition setting Changes the initial setting during operation.</p> <p>(3) Offset/gain setting When setting the offset/gain to a value selected by the user (when the analog output range setting is user range setting), the offset and gain can be easily set while viewing the screen.</p> <p>(4) Pass data The pass data (industrial shipment settings offset/gain values, user range settings offset/gain values) can be monitored and set.</p>	Section 5.6
FB conversion	Generates FB automatically from the intelligent function module parameter (initial setting/auto refresh setting).	Section 5.7

POINT

*1 If initial setting and automatic refresh setting are performed, the intelligent function module parameters require a maximum of 76 bytes per module.

5.2 Installing and Uninstalling the Utility Package

For how to install or uninstall the utility package, refer to "Method of installing the MELSOFT Series" included in the utility package.

5.2.1 Handling precautions

The following explains the precautions on using the GX Configurator-AD.

(1) For safety

Since GX Configurator-AD is add-in software for GX Developer, read "Safety Precautions" and the basic operating procedures in the GX Developer Operating Manual.

(2) About installation

GX Configurator-AD is add-in software for GX Developer Version 4 or later. Therefore, GX Configurator-AD must be installed on the personal computer that has already GX Developer Version 4 or later installed.

(3) Screen error of Intelligent function module utility

Insufficient system resource may cause the screen to be displayed inappropriately while using the Intelligent function module utility. If this occurs, close the Intelligent function module utility, GX Developer (program, comments, etc.), and other applications, and then start GX Developer and Intelligent function module utility again.

(4) To start the Intelligent function module utility

(a) In GX Developer, select "QCPU (Q mode)" for PLC series and specify a project.

If any PLC series other than "QCPU (Q mode)" is selected, or if no project is specified, the Intelligent function module utility will not start.

(b) Multiple Intelligent function module utilities can be started.

However, [Open parameters] and [Save parameters] operations under [Intelligent function module parameter] are allowed for one Intelligent function module utility only. Only the [Monitor/test] operation is allowed for the other utilities.

(5) Switching between two or more Intelligent function module utilities

When two or more Intelligent function module utility screens cannot be displayed side by side, select a screen to be displayed on the top of others using the task bar.



(6) Number of parameters that can be set in GX Configurator-AD

When multiple intelligent function modules are mounted, the number of parameter settings must not exceed the following limit.

When intelligent function modules are installed to:	Maximum number of parameter settings	
	Initial setting	Auto refresh setting
Q00J/Q00/Q01CPU	512	256
Q02/Q02H/Q06H/Q12H/Q25HCPU	512	256
Q02PH/Q06PH/Q12PH/Q25PHCPU	512	256
Q12PRH/Q25PRHCPU	512	256
Q00UJ/Q00U/Q01UCPU	512	256
Q02UCPU	2048	1024
Q03UD/Q04UDH/Q06UDH/Q10UDH/Q13UDH/ Q20UDH/Q26UDH/Q03UDE/Q04UDEH/ Q06UDEH/Q10UDEH/Q13UDEH/Q20UDEH/ Q26UDEHCPU	4096	2048
CPU modules other than the above	Not available	Not available
MELSECNET/H remote I/O station	512	256

For example, if multiple intelligent function modules are installed to the MELSECNET/H remote I/O station, configure the settings in GX Configurator-AD so that the number of parameter settings for all the intelligent function modules does not exceed the limit of the MELSECNET/H remote I/O station. Calculate the total number of parameter settings separately for the initial setting and for the auto refresh setting.

The number of parameters that can be set for one module in GX Configurator-AD is as shown below.

Target module	Initial setting	Auto refresh setting
Q64AD-GH	4 (Fixed)	27 (Max.)
Q62AD-DGH	8 (Fixed)	15 (Max.)

Example) Counting the number of parameter settings in Auto refresh setting

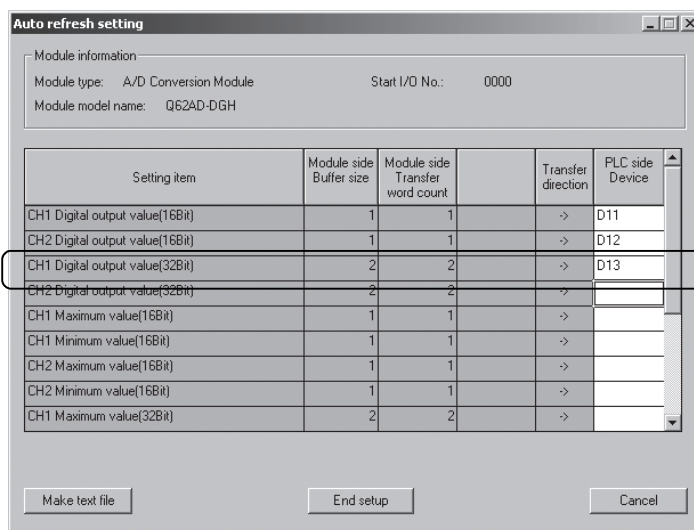

This one row is counted as one setting. Blank rows are not counted. Count up all the setting items on this screen, and add the total to the number of settings for other intelligent function modules to get a grand total.

5.2.2 Operating environment

This section explains the operating environment of the personal computer that runs GX Configurator-AD.

Item	Description
Installation (Add-in) target * 1	Add-in to GX Developer Version 4 (English version) or later * 2
Computer	Personal computer capable of running the operating systems listed below
CPU	Refer to the following table "Operating system and performance required for personal computer".
Required memory	
Hard disk	For installation
space	For operation
Display	800 × 600 dots or more resolution * 3
Operating system	Microsoft® Windows® 95 Operating System (English version) Microsoft® Windows® 98 Operating System (English version) Microsoft® Windows® Millennium Edition Operating System (English version) Microsoft® Windows NT® Workstation Operating System Version 4.0 (English version) Microsoft® Windows® 2000 Professional Operating System (English version) Microsoft® Windows® XP Professional Operating System (English version) SP1 or later Microsoft® Windows® XP Home Edition Operating System (English version) SP1 or later Microsoft® Windows Vista® Home Basic Operating System (English version) Microsoft® Windows Vista® Home Premium Operating System (English version) Microsoft® Windows Vista® Business Operating System (English version) Microsoft® Windows Vista® Ultimate Operating System (English version) Microsoft® Windows Vista® Enterprise Operating System (English version) Microsoft® Windows® 7 Starter Operating System (English version) * 4 Microsoft® Windows® 7 Home Premium Operating System (English version) * 4 Microsoft® Windows® 7 Professional Operating System (English version) * 4 Microsoft® Windows® 7 Ultimate Operating System (English version) * 4 Microsoft® Windows® 7 Enterprise Operating System (English version) * 4

*1: Install the GX Configurator-AD in GX Developer Version 4 or higher in the same language.

GX Developer (English version) and GX Configurator-AD (Japanese version) cannot be used in combination, and GX Developer (Japanese version) and GX Configurator-AD (English version) cannot be used in combination.

*2: GX Configurator-AD cannot be used as an add-in with GX Developer Version 3 or earlier versions.

In addition, GX Developer Version 8 or later is necessary to use the FB conversion function.

*3: For Windows Vista® and Windows® 7, a resolution of 1024 × 768 pixels or more is recommended.

*4: For Windows® 7 (32-bit version), install GX Configurator-AD Version 2.11M or later as an add-in into GX Developer Version 8.91V or later.

For Windows® 7 (64-bit version), install GX Configurator-AD Version 2.12N or later as an add-in into GX Developer Version 8.98C or later.

Operating system and performance required for personal computer

Operating system	Performance required for personal computer	
	CPU	Memory
Windows® 95	Pentium® 133MHz or more	32MB or more
Windows® 98	Pentium® 133MHz or more	32MB or more
Windows® Me	Pentium® 150MHz or more	32MB or more
Windows NT® Workstation 4.0	Pentium® 133MHz or more	32MB or more
Windows® 2000 Professional	Pentium® 133MHz or more	64MB or more
Windows® XP	Pentium® 300MHz or more	128MB or more
Windows Vista®	Pentium® 1GHz or more	1GB or more
Windows® 7	Pentium® 1GHz or more	1GB or more (for 32-bit version) 2GB or more (for 64-bit version)

POINT

- The following functions are not available on Windows® XP, Windows Vista®, and Windows® 7.
An attempt to use the functions may result in this product failing to operate normally.
 - Launching an application in Windows® compatible mode
 - Fast user switching
 - Remote desktop
 - Large fonts (Details setting of Display Properties)
 - DPI setting other than 100%
 - Note that these are not supported by Windows® XP (64-bit version) and Windows Vista® (64-bit version).
- For use on Windows Vista® and Windows® 7, assign User authority or higher to the user.
- Windows® 7 does not support the following functions:
 - Windows XP Mode
 - Windows Touch

5.3 Utility Package Operation

5.3.1 Common utility package operations

(1) Control keys

Special keys that can be used for operation of the utility package and their applications are shown in the table below.

Key	Application
Esc	Cancels the current entry in a cell. Closes the window.
Tab	Moves between controls in the window.
Ctrl	Used in combination with the mouse operation to select multiple cells for test execution.
Delete	Deletes the character where the cursor is positioned. When a cell is selected, clears all of the setting contents in the cell.
Back Space	Deletes the character where the cursor is positioned.
↑ ↓ ← →	Moves the cursor.
Page Up	Moves the cursor one page up.
Page Down	Moves the cursor one page down.
Enter	Completes the entry in the cell.

(2) Data created with the utility package

The following data or files that are created with the utility package can be also handled in GX Developer. Figure 5.1 shows respective data or files are handled in which operation.

(a) Intelligent function module parameter

This represents the data created in Auto refresh setting, and they are stored in an intelligent function module parameter file in a project created by GX Developer.

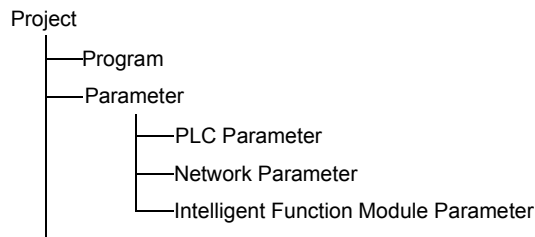

(b) Text files

A text file can be created by clicking the **Make text file** button on the initial setting, Auto refresh setting, or Monitor/Test screen. The text files can be utilized to create user documents.

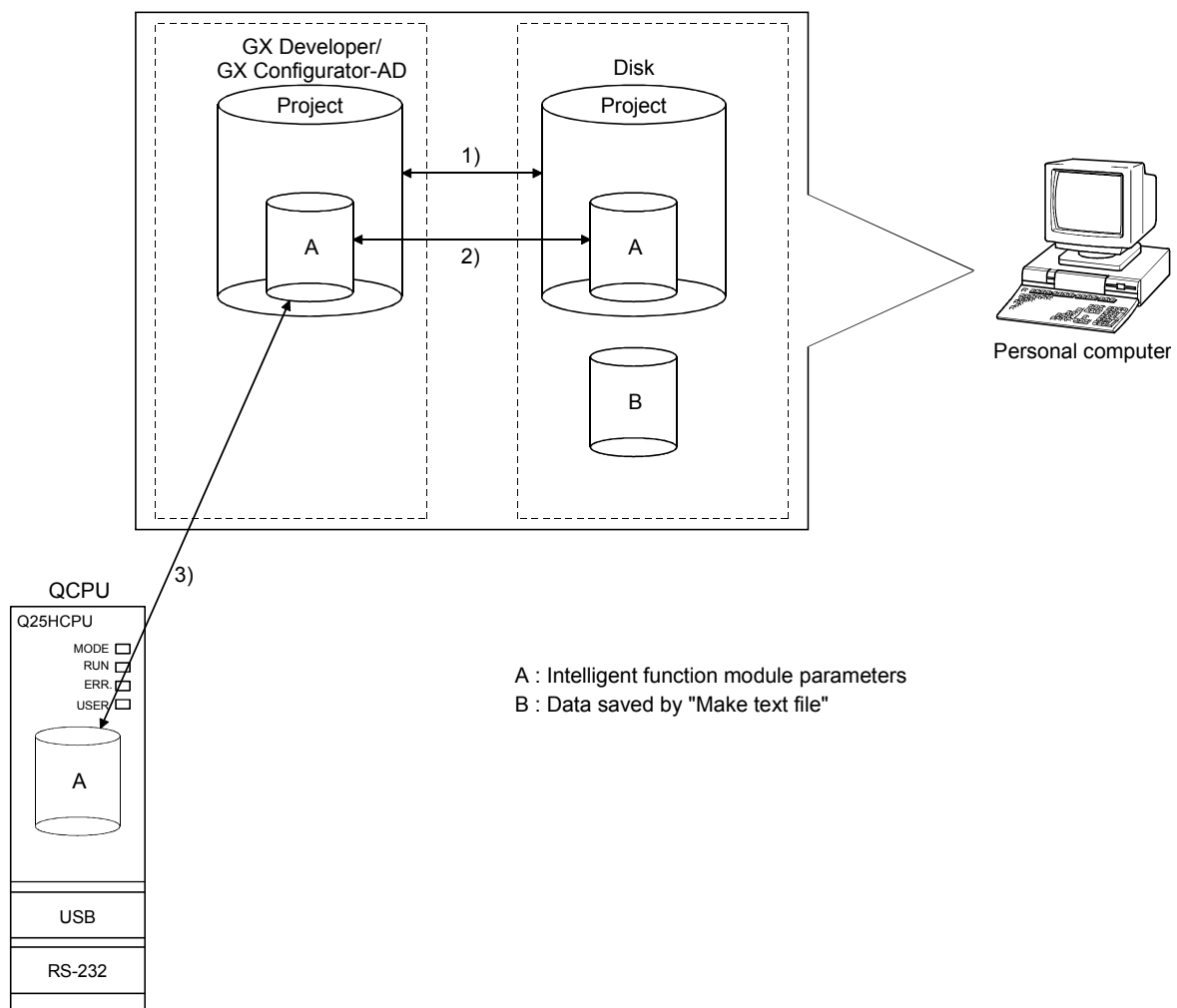

Figure 5.1 Correlation chart for data created with the utility package

Steps 1) to 3) shown in Figure 5.1 are performed as follows:

- 1) From GX Developer, select:
[Project] → [Open project] / [Save] / [Save as]
- 2) On the intelligent function module selection screen of the utility, select:
[Intelligent function module parameter] → [Open parameters] / [Save parameters]
- 3) From GX Developer, select:
[Online] → [Read from PLC] / [Write to PLC] → "Intelligent function module parameters"
Alternatively, from the intelligent function module selection screen of the utility, select:
[Online] → [Read from PLC] / [Write to PLC]

5.3.2 Operation overview

GX Developer screen

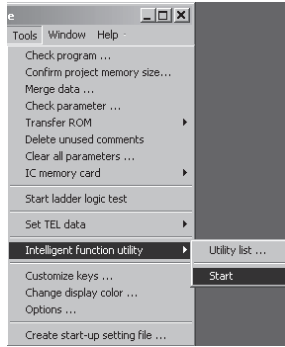

[Tools] – [Intelligent function utility]– [Start]

Screen for selecting a target intelligent function module

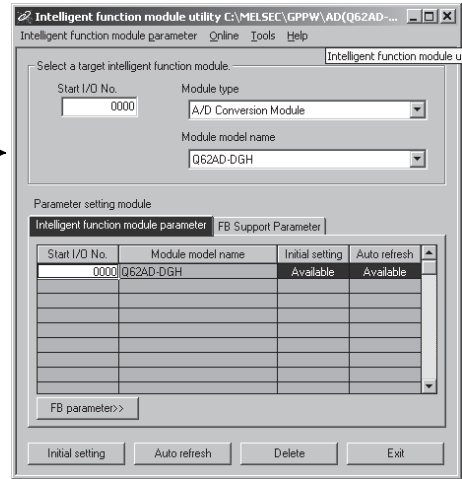

Refer to Section 5.3.3.

Initial setting

Auto refresh

Initial setting screen

Auto refresh setting screen

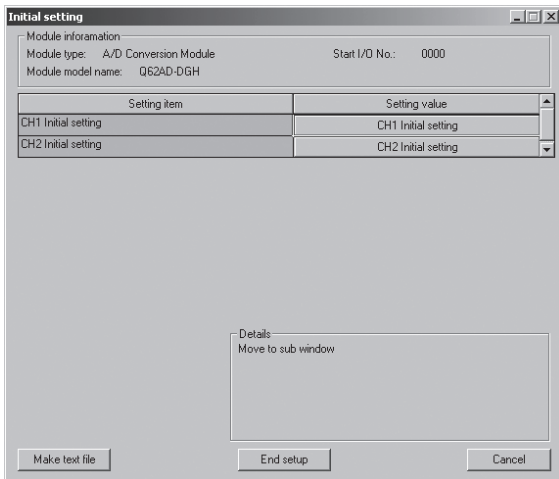

Refer to Section 5.4.

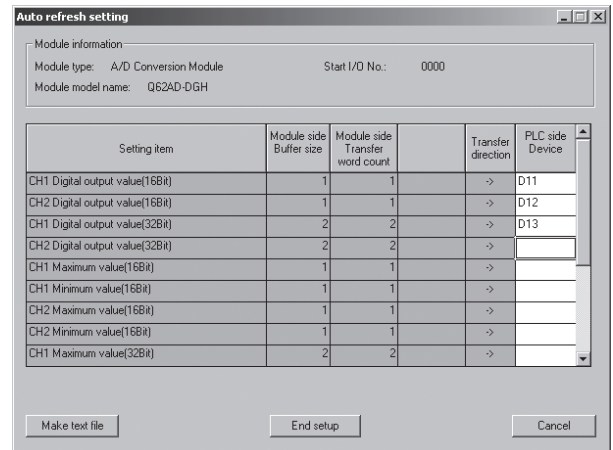

Refer to Section 5.5.

CH1 Initial setting

CH1 Initial setting screen

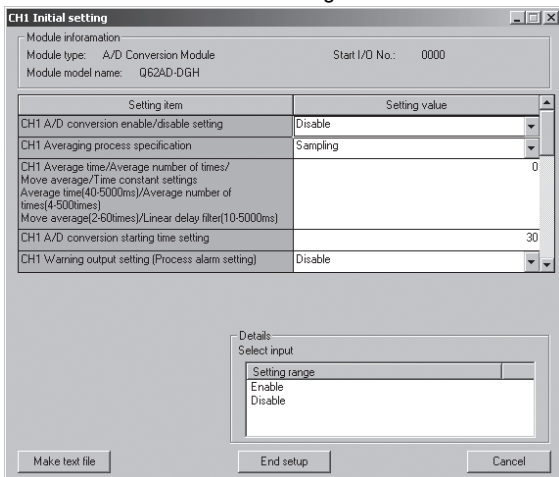

1) [Online] – [Monitor/Test] <<FB support parameter>> tab – **FB conversion**

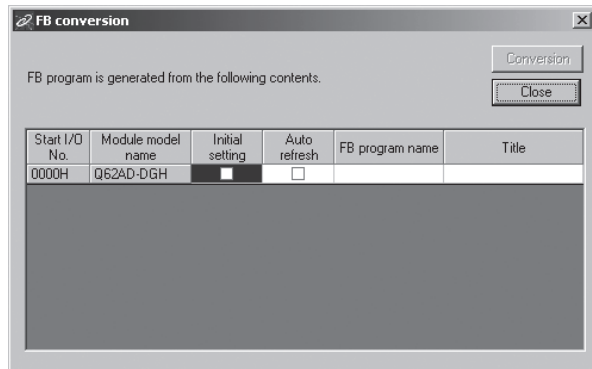
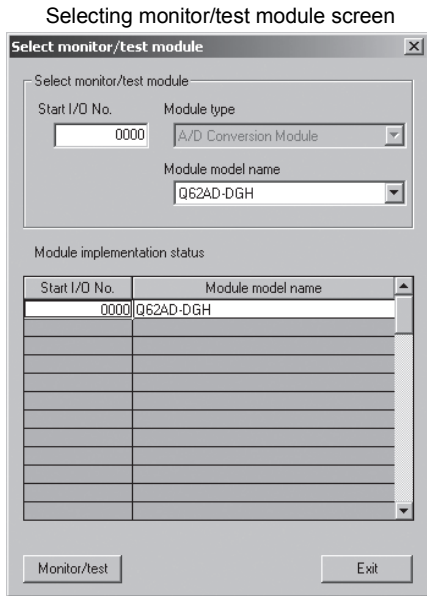

Refer to Section 5.7.

Select a module to be monitored/tested.

Monitor/Test screen

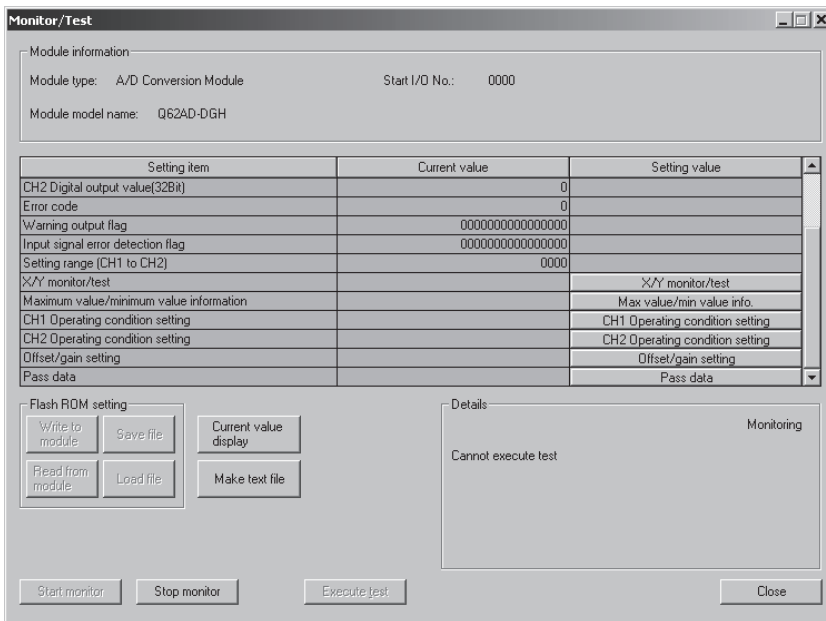

Refer to Section 5.6.

5.3.3 Starting the intelligent function module utility

[Operating procedure]

Intelligent function module utility is started from GX Developer.

[Tools] → [Intelligent function utility] → [Start]

[Setting screen]

Display when the <<FB support parameter>> tab is selected

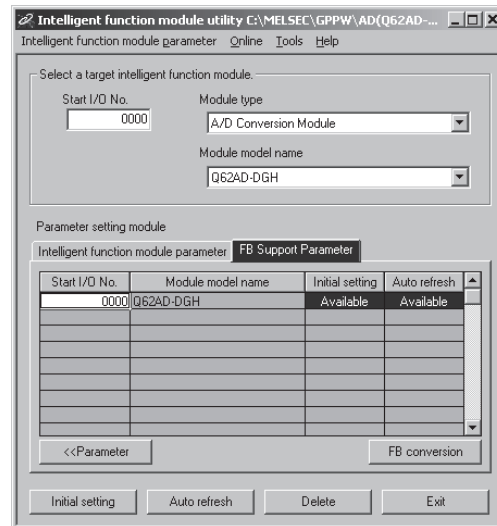

[Explanation of items]

(1) Activation of other screens

Following screens can be displayed from the intelligent function module utility screen.

Common operations to the <<Intelligent function module parameter>> tab and <<FB support parameter>> tab

(a) Initial setting screen

"Start I/O No. *1" → "Module type" → "Module model name" →

Initial setting

(b) Auto refresh setting screen

"Start I/O No. *1 " → "Module type" → "Module model name" →

Auto refresh

(c) Select monitor/test module screen

[Online] → [Monitor/Test]

*1 Enter the start I/O No. in hexadecimal.

On the <<FB support parameter>> tab

(a) Start-up of the FB conversion screen

<<FB support parameter>> tab → **FB conversion**

For details, refer to section 5.7.

POINT

The <<FB support parameter>> tab is displayed when the project which is being edited is a label project.

(2) Command buttons

Common operations to the <<Intelligent function module parameter>> tab and <<FB support parameter>> tab

- Delete** Deletes the initial setting and auto refresh setting of the selected module.
However, if initial setting and auto refresh setting have been prepared and the cell of "Initial setting" or "Auto refresh setting" is selected and executed, only the setting of the selected cell is deleted.
- Exit** Closes this screen.

When the <<FB support parameter>> tab is selected

- <<Parameter** Moves the setting of the selected line to the <<Intelligent function module parameter>> tab.

When the <<Intelligent Function Module Parameter>> tab is selected

- FB parameter>>** Moves the setting of the selected line to the <<FB support parameter>> tab.

(3) Menu bar

(a) File menu

Intelligent function module parameters of the project opened by GX Developer are handled.

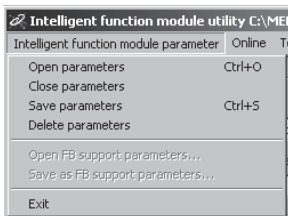

- [Open parameters]:** Reads a parameter file.
- [Close parameters]:** Closes the parameter file. If any data are modified, a dialog asking for file saving will appear.
- [Save parameters]:** Saves the parameter file.
- [Delete parameters]:** Deletes the parameter file.
- [Open FB support parameters]:** Opens the FB support parameter file.
- [Save as FB support parameters]:** Saves the FB support parameter file.
- [Exit]:** Closes this screen.

(b) Online menu

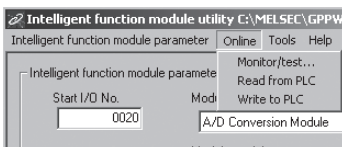

- [Monitor/Test]:** Activates the Select monitor/test module screen.
- [Read from PLC]:** Reads intelligent function module parameters from the CPU module.
- [Write to PLC]:** Writes intelligent function module parameters to the CPU module.

POINT
(1) Saving intelligent function module parameters in a file Since intelligent function module parameters cannot be saved in a file by the project saving operation of GX Developer, save them on the shown module selection screen.
(2) Reading/writing intelligent function module parameters from/to a programmable controller CPU using GX Developer (a) Intelligent function module parameters can be read from and written into a programmable controller after having been saved in a file. (b) Set a target programmable controller CPU in GX Developer: [Online] → [Transfer setup]. (c) When the A/D converter module is installed to the remote I/O station, use "Read from PLC" and "Write to PLC".
(3) Checking the required utility While the start I/O is displayed on the Intelligent function module utility setting screen, "*" may be displayed for the model name. This means that the required utility has not been installed or the utility cannot be started from GX Developer. Check the required utility, selecting [Tools] - [Intelligent function utility] - [Utility list...] in GX Developer.

5.4 Initial Setting

[Purpose]

The following A/D initial setting parameters are set:

- A/D conversion enable/disable setting
- Averaging process specification
- Average time/Average number of times/Move average/Time constant settings
- A/D conversion starting time setting (Q62AD-DGH)
- Warning output settings (Process alarm setting)
- Process alarm upper upper limit value/upper lower limit value/lower upper limit value/lower lower limit value
- Warning output settings (Rate alarm setting)
- Rate alarm upper limit value/lower limit value
- Rate alarm warning detection period
- Input signal error detection extended/input signal error detection setting
- Input signal error detection setting value/input signal error detection lower limit setting value
- Input signal error detection upper limit setting value

Configuring the parameters on the initial setting window eliminates the need for parameter settings using a sequence program.

[Operating procedure]

"Start I/O No.*¹" → "Module type" → "Module model name" → **Initial setting** →

CH□ Initial setting

*1: Enter the start I/O No. in hexadecimal.

[Setting screen]

Setting item	Setting value
CH1 A/D conversion enable/disable setting	Disable
CH1 Averaging process specification	Sampling
CH1 Average time/Average number of times/ Move average/Time constant settings Average time(40-5000ms)/Average number of times(4-500times) Move average(2-60times)/Linear delay filter(10-5000ms)	0
CH1 A/D conversion starting time setting	30
CH1 Warning output setting (Process alarm setting)	Disable

Details
Select input
Setting range
Enable
Disable

Make text file End setup Cancel

[Explanation of items]**(1) Setting contents**

Set A/D conversion enable/disable, averaging process specification and others for each channel.

(2) Command buttons

- | | |
|---|--|
| <input type="button" value="Make text file"/> | Creates a file containing the screen data in text file format. |
| <input type="button" value="End setup"/> | Saves the set data and ends the operation. |
| <input type="button" value="Cancel"/> | Cancel the setting and ends the operation. |

POINT

Initial settings are stored in the intelligent function module parameters. After being written to the CPU module, the initial setting is made effective by either (1) or (2).

(1) Cycle the RUN/STOP switch of the CPU module: STOP → RUN → STOP → RUN.

(2) With the RUN/STOP switch set to RUN, turn off and then on the power or reset the CPU module.

When using a sequencer program to write the initial settings, when the CPU is switched from STOP to RUN the initial settings will be written, So ensures that programming is carried out to re-execute the initial settings.

5.5 Auto Refresh Settings

[Purpose]

Configure the A/D converter module's buffer memory for auto refresh.

[Operating procedure]

"Start I/O No.*¹" → "Module type" → "Module model name" → Auto refresh

*1: Enter the start I/O No. in hexadecimal.

[Setting screen]

Setting item	Module side Buffer size	Module side Transfer word count	Transfer direction	PLC side Device
CH1 Digital output value(16Bit)	1	1	->	D11
CH2 Digital output value(16Bit)	1	1	->	D12
CH1 Digital output value(32Bit)	2	2	->	D13
CH2 Digital output value(32Bit)	2	2	->	
CH1 Maximum value(16Bit)	1	1	->	
CH1 Minimum value(16Bit)	1	1	->	
CH2 Maximum value(16Bit)	1	1	->	
CH2 Minimum value(16Bit)	1	1	->	
CH1 Maximum value(32Bit)	2	2	->	

[Explanation of items]

(1) Items

- Module side Buffer size** : Displays the size of the buffer memory for the setting item that can be transferred (fixed at one word).
- Module side Transfer word count** : Displays the number of words to transfer the CPU device from the head device (fixed at one word).
- Transfer direction** : "←" indicates that data is written from the device to the buffer memory.
"→" indicates that data is read from the buffer memory to the device.
- PLC side Device** : Enter a CPU module side device that is to be automatically refreshed.
Applicable devices are X, Y, M, L, B, T, C, ST, D, W, R, and ZR.
When using bit devices X, Y, M, L or B, set a number that can be divided by 16 points (examples: X10, Y120, M16, etc.)
Also, buffer memory data are stored in a 16-point area, starting from the specified device number. For example, if X10 is entered, data are stored in X10 to X1F.

(2) Command buttons

- | | |
|---|--|
| <input type="button" value="Make text file"/> | Creates a file containing the screen data in text file format. |
| <input type="button" value="End setup"/> | Saves the set data and ends the operation. |
| <input type="button" value="Cancel"/> | Cancels the setting and ends the operation. |

POINT

The auto refresh settings are stored in an intelligent function module parameter file. To enable the auto refresh settings after they are written to the CPU module, perform the operation (1) or (2).

(1) Operate the RUN/STOP switch of the CPU module as follows: STOP → RUN → STOP → RUN.

(2) Set the RUN/STOP switch to RUN, and then turn off and on the power supply or perform reset of the CPU module.

The auto refresh settings cannot be changed from sequence programs. However, processing equivalent to auto refresh can be added using the FROM/TO instruction in the sequence program.

5.6 Monitoring/Test

5.6.1 Monitor/test screen

[Purpose]

Buffer memory monitoring/testing, I/O signals monitoring/testing, operating condition setting, offset/gain settings (see Section 5.6.2) and pass data (see Section 5.6.3, 5.6.4) are started from this screen.

[Operating procedure]

"Select monitor/test module" screen → "Start I/O No.*¹" → "Module type" → "Module model name" → **Monitor/test**

*1: Enter the start I/O No. in hexadecimal.

The screen can also be started from System monitor of GX Developer Version 6 or later.

Refer to the GX Developer Operating Manual for details.

[Setting screen]

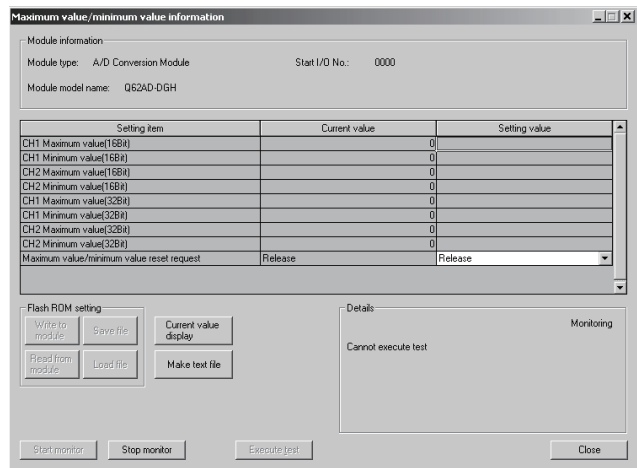
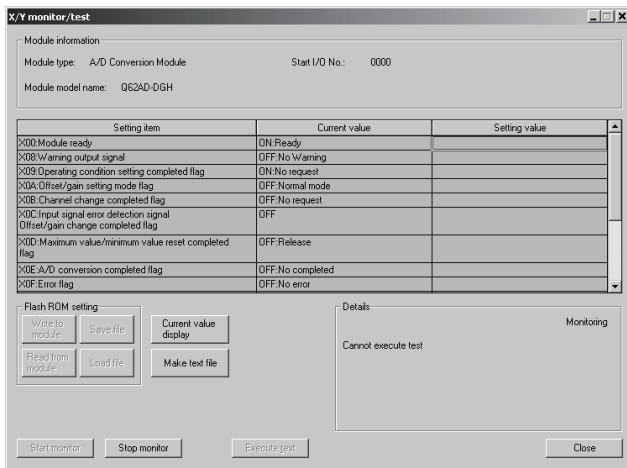
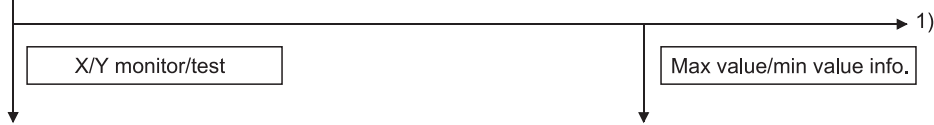
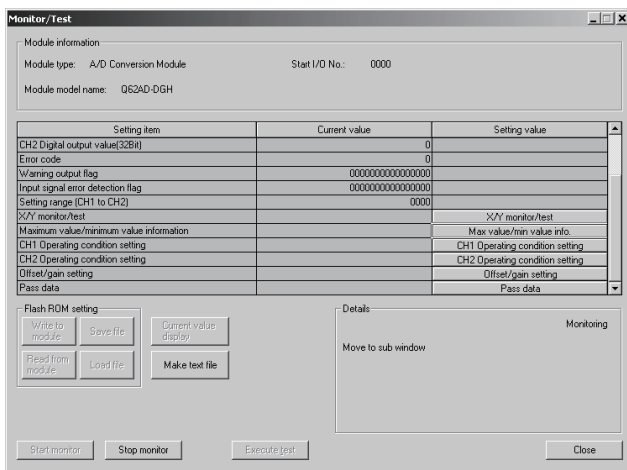

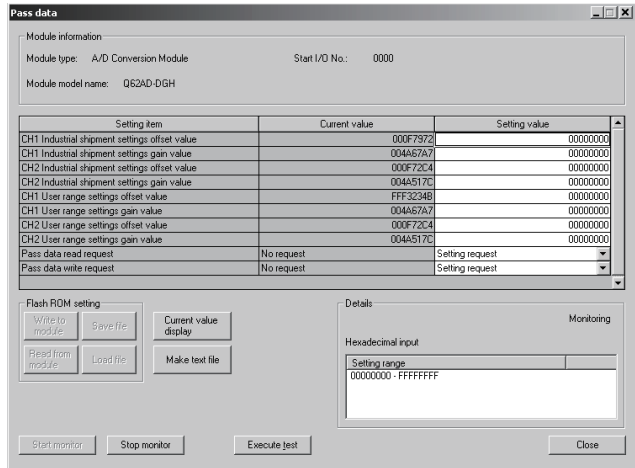

Pass data

Offset/
gain setting

1)

CH \square Operating
condition setting

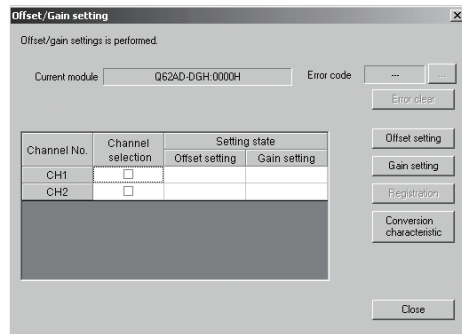
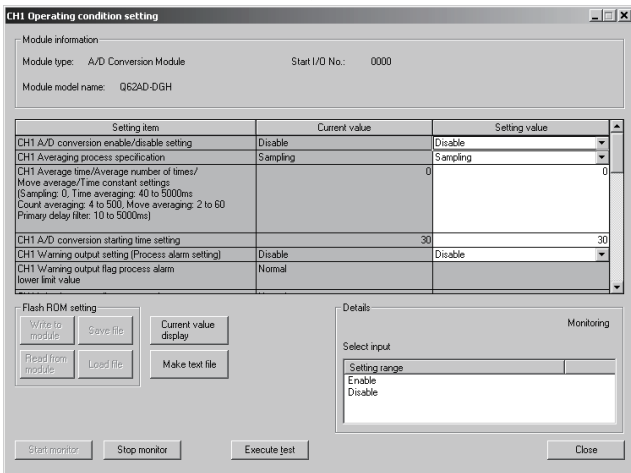

Conversion
characteristic

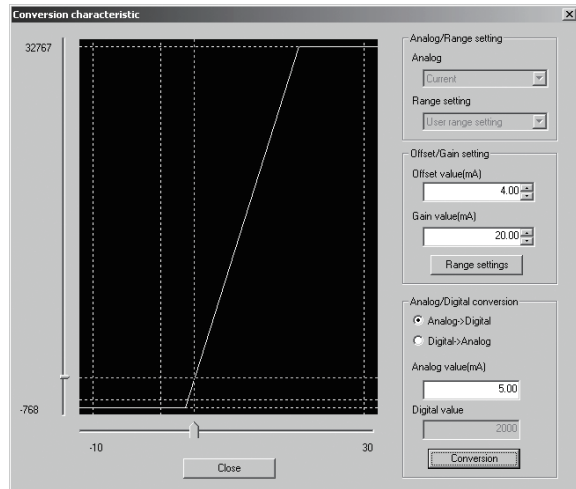

[Explanation of items]

(1) Items

- Setting item : Displays I/O signals and buffer memory names.
 Current value : Monitors the I/O signal states and present buffer memory values.
 Setting value : Select or enter the data to be written during test operation.

(2) Command buttons

Current value display	Displays the current value of the item selected. (This is used to check the text that cannot be displayed in the current value field. However, in this utility package, all items can be displayed in the display fields).
Make text file	Creates a file containing the screen data in text file format.
Start monitor /	Selects whether or not to monitor current values.
Stop monitor	
Execute test	Performs a test on the selected items. To select more than one item, select them while holding down the Ctrl key.
Close	Closes the screen that is currently open and returns to the previous screen.

(3) Example of the operation of selection test

The following is an example of the operation of selection test where sampling processing of CH1 is changed to a 10 times averaging processing.

- (a) On the monitor/test window, click the CH1 Operating condition setting request button.
- (b) Change the Setting value field of CH□ Averaging process specification to "Average number of times".
- (c) Click and select the Setting value field of CH□ Average time/Average number of times/Move average/Time constant settings.
- (d) After entering the average number of times, press the Enter key.
At this point, the value is not yet written to the A/D converter module.
- (e) Hold down the Ctrl key and select the Setting value field where the value has been entered by the operation performed in (b) to (d). Multiple items can also be selected by performing mouse drag operation.
- (f) Click the Execute test button to execute write operation for the set data.
Once writing has been completed, the value that was written will be displayed in the current value field.

5.6.2 Offset/gain setting operation

Perform the offset/gain setting operation in the following sequence.

(1) Switch to the offset/gain setting screen

Perform the operation in Section 5.6.1 to display the offset/gain setting screen. At this point, a dialog box to confirm the transition of module's operation mode (normal mode -> offset/gain setting mode) is displayed. Click the **Yes** button to transit to the offset/gain setting mode.

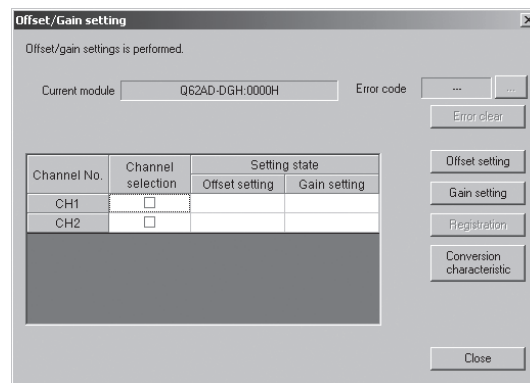

(2) Specify channels

Place check marks in "Channel selection" column to specify the channels for each of which the offset or gain setting is to be made.

(3) Apply current/voltage

Apply current or voltage to the module. Note that "Current" only is allowed for the Q62AD-DGH.

(4) Execute offset/gain setting

For each of the channels specified in (2), click the **Offset setting** or **Gain setting** button to execute respective setting.

(5) Write settings into module

Write the content set up by operations (2) to (4) into module by clicking the **Registration** button.

(a) Precautions

Avoid the following operations while the contents specified in the operations (2) to (4) is written to the module.

Doing so may cause an error in the data inside the E²PROM, resulting in the A/D converter module failing to operate normally.

- 1) Powering OFF the programmable controller CPU
- 2) Resetting the programmable controller CPU

(6) Switch to the normal mode

When the offset/gain setting screen is closed by clicking the button after the setting operation has finished, module's operation mode transits to the normal mode.

POINT

If an error code is displayed while performing the setting operation, the details and measure of the error can be confirmed by clicking the button to the right of the error code display area. In addition, the error code can be cleared by clicking the button.

5.6.3 Confirmation of conversion characteristic

[Purpose]

The converted value of digital-analog conversion can be confirmed according to the tilt of the graph, based on the offset/gain setting.

[Operating procedure]

Monitor/test screen → Offset/gain setting → Conversion characteristic

[Setting screen]

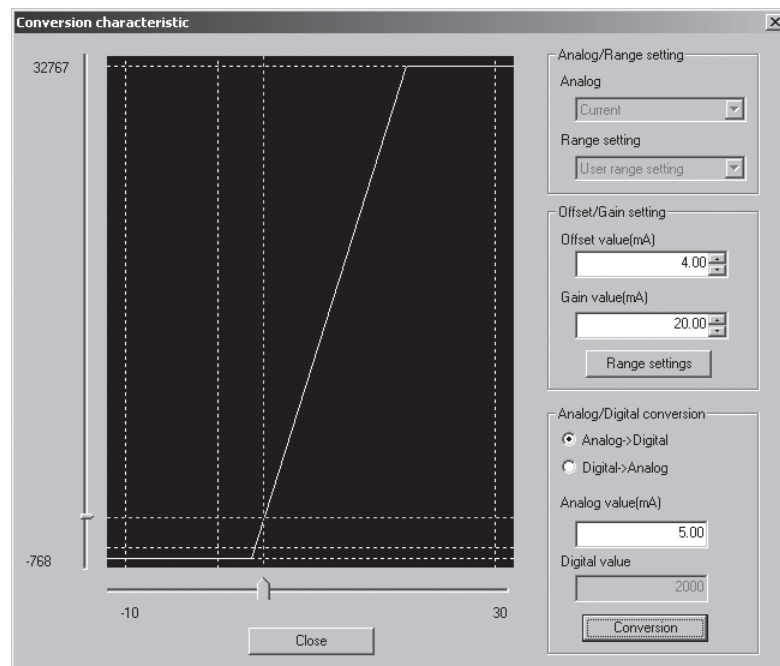

[Explanation of items]

(1) Items displayed on the screen

I/O characteristic diagram: Displays the I/O conversion characteristic to the prepared offset/gain setting.

(2) Setting details

Analog/Range setting

Analog: Select the type of the analog signal input (voltage or current).
When the target module is the Q62AD-DGH, "Current" only can be selected.

Range setting: For the Q64AD-GH, select "Unipolar" or "Bipolar". Note that, when "Current" is selected in "Analog", "Unipolar" only is allowed.
For the Q62AD-DGH, "User range setting" only is selectable.

Offset/Gain setting

Offset value: Enter an offset value to display the I/O characteristic diagram.

Gain value: Enter a gain value to display the I/O characteristic diagram.

Analog/Digital conversion: Select a conversion type shown below for confirming the correspondence between an analog value and a digital value caused by the conversion characteristic.

- Digital → Analog
- Analog → Digital

Analog value: <When converted to a digital value>

Enter an analog value to be converted to a digital value

<When converted to an analog value>

The analog value converted from a digital value is displayed.

Digital value: <When converted to a digital value>

The digital value corresponding to an entered analog value is displayed.

<When converted to an analog value>

Enter a digital value to be converted to an analog value.

POINT

- The offset value is an analog input value (voltage or current) that will produce a digital output value of 0.
- The gain value is the analog value (voltage or current) output when the digital input value set from the programmable controller CPU is as follows:
32000 (When Unipolar/Bipolar are selected)

(3) Explanation of screen command buttons

Range setting

The entered offset/gain value is determined, and the I/O characteristic diagram is updated.

Conversion

Conversion for the entered value is performed.

5.6.4 Pass data (Q64AD-GH)

Perform operation in the following sequence to save/restore the user range.

(1) Switch to the pass data screen

Perform the operation in Section 5.6.1 to display the Pass data screen.

Setting item	Current value	Setting value
CH1 Pass data classification setting	Voltage specified	Voltage specified
CH2 Pass data classification setting	Voltage specified	Voltage specified
CH3 Pass data classification setting	Voltage specified	Voltage specified
CH4 Pass data classification setting	Voltage specified	Voltage specified
CH1 Industrial shipment settings offset value	FFFFFFD42	00000000
CH1 Industrial shipment settings gain value	0033CACF	00000000
CH2 Industrial shipment settings offset value	FFFFFFD5E	00000000
CH2 Industrial shipment settings gain value	0033DD9E	00000000
CH3 Industrial shipment settings offset value	FFFFFFD33	00000000
CH3 Industrial shipment settings gain value	0033E227	00000000
CH4 Industrial shipment settings offset value	FFFFFFD64	00000000

(2) User range saving

- (a) Set "Voltage specified" or "Current specified" in the Setting value field of Pass data classification setting, and click the **Execute test** button.

When the setting is completed, the set data is displayed in the Current value field of CH□ Pass data classification setting.

- (b) Change the Setting value field of Pass data read request to "Request", and click the **Execute test** button.

When read is completed, the values are displayed in the Current value fields of CH□ Industrial shipment settings offset/gain values/CH□ User range settings offset/gain values.

- (c) Compare the values with those in the range reference table, and record them if they are correct.

Refer to Section 7.4 for the range reference table.

(3) User range restoration

- (a) Set "Voltage specified" or "Current specified" in the Setting value field of Pass data classification setting, and click the button.

When the setting is completed, the set data is displayed in the Current value field of CH□ Pass data classification setting.

- (b) Set the recorded values in the Setting value fields of CH□ Industrial shipment settings offset/gain values/user range settings offset/gain values.

- (c) Select all the Setting value fields of CH□ Industrial shipment settings offset/gain values/user range settings offset/gain values, and click the button.

When write is completed, the set values are displayed in the Current value fields of CH□ Industrial shipment settings offset/gain values/CH□ User range settings offset/gain values.

- (d) Change the Setting value field of Pass data write request to "Request", and click the button.

Make sure that the indication in the Current value field of Pass data write request changes from "Request" to "OFF" on completion of write.

5.6.5 Pass data (Q62AD-DGH)

Perform operation in the following sequence to save/restore the user range.

(1) Switch to the Pass data screen

Perform the operation in Section 5.6.1 to display the pass data screen.

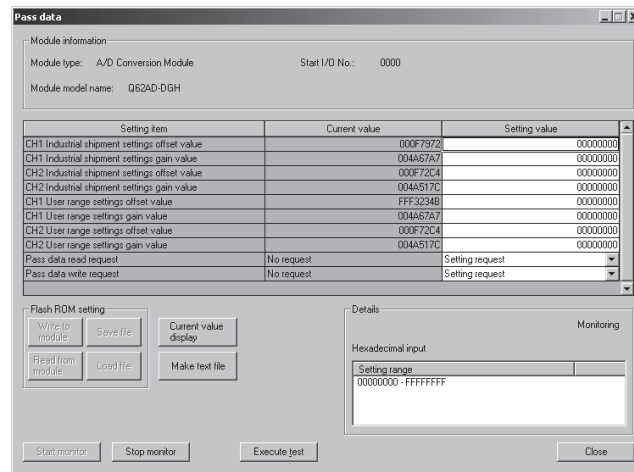

(2) User range saving

- (a) Change the Setting value field of pass data read request to "Request", and click the **Execute test** button.

When read is completed, the values are displayed in the Current value fields of CH□ industrial shipment settings offset/gain values/CH□ user range settings offset/gain values.

- (b) Compare the values with those in the range reference table, and record them if they are correct.
Refer to Section 7.4 for the range reference table.

(3) User range restoration

- (a) Set the recorded values in the Setting value fields of CH□ industrial shipment settings offset/gain values/user range settings offset/gain values.
(b) Select all the Setting value fields of CH□ industrial shipment settings offset/gain values/user range settings offset/gain values, and click the **Execute test** button.

When write is completed, the set values are displayed in the Current value fields of CH□ industrial shipment settings offset/gain values/ CH□ user range settings offset/gain values.

- (c) Change the Setting value field of pass data write request to "Request", and click the **Execute test** button.

Make sure that the indication in the Current value field of pass data write request changes from "Request" to "OFF" on completion of write.

5.7 FB Conversion of Initial Setting/Auto Refresh Setting

[Purpose]

FB is generated automatically from the intelligent function module parameter (initial setting/auto refresh setting).

[Operating procedure]

Intelligent Function Module Parameter Setting Module Selection Screen →
<<FB Support Parameter>> tab → **FB conversion**

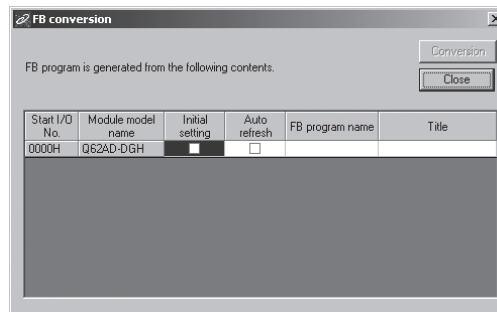
[Setting screen]**[Explanation of items]****(1) Items displayed on the screen**

Start I/O No.:

The start I/O No. of the information which is set up on the currently open intelligent function module parameter is displayed.

Module model name:

The module model name of the information which is set up on the currently open intelligent function module parameter is displayed.

Initial setting:

Set up whether to apply FB conversion to the parameter or not.

Check if you apply FB conversion to the parameter.

Auto refresh:

Set up whether to apply FB conversion to the parameter or not.

Check if you apply FB conversion to the parameter.

FB program name:

Set up the name of the converted FB program.

Up to six single-byte characters can be set up as an FB program name. However, the characters and terms shown below cannot be set up as FB program name.

Character: \, /, :, ;, *, ?, , <, >, |, ", ,, , ,

Term: COM1 to COM9, LPT1 to LPT9, AUX, PRN, CON, NUL, CLOCK\$

In addition, I- is added for initial setting and A- is added for auto refresh setting respectively to the top of the FB name setting to be registered in GX Developer after FB conversion is performed.

Ex.: If the FB program name is "ABCDE, " the initial setting is "I-ABCDE" and the auto refresh setting is "A-ABCDE. "

Title: Set up a title on a converted FB program. Up to 32 single-byte characters can be set up as a title.

(2) Explanation of screen command buttons

Conversion

FB conversion is performed for the checked columns of initial setting and auto refresh setting.

5.8 Usage of FB

This section describes the procedure for using FB with GX Developer.
 For details, refer to "GX Developer Version 8 Operating Manual (Function Block)."

5.8.1 Outline

The procedure for creating FB is shown below.

- (1) Set up the intelligent function module parameter (initial setting/auto refresh setting).
- (2) Convert the intelligent function module parameter into FB.
- (3) Paste the FB to a sequence program.
- (4) Convert (compile) the sequence program.

Next, a flowchart of procedures (1) to (4) is shown below.

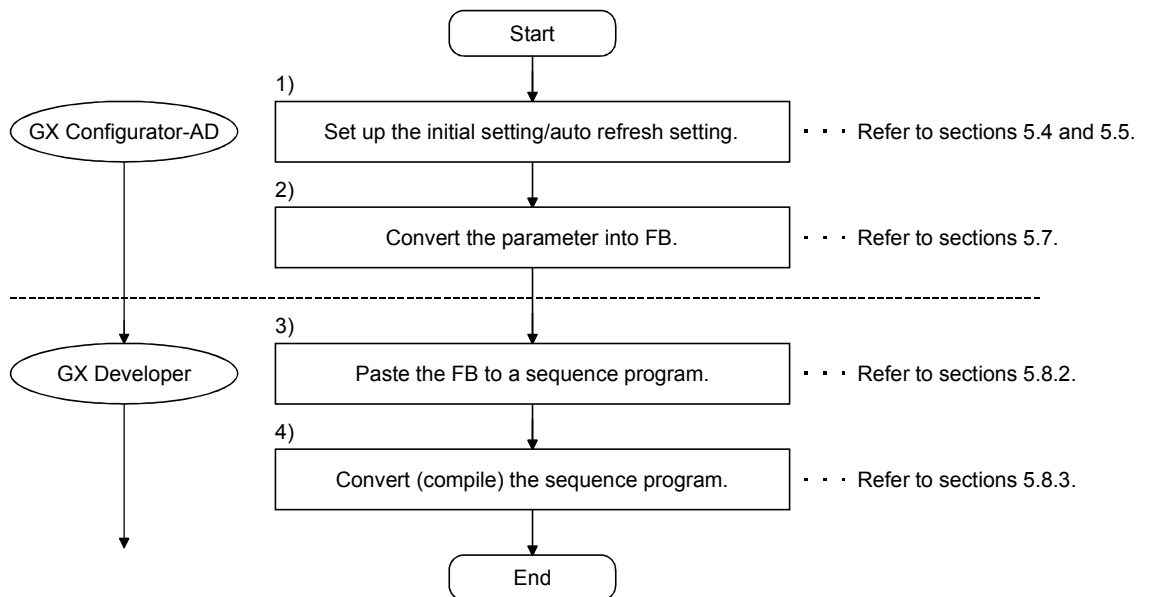

POINT

The initial setting/auto refresh setting of the intelligent function module can be performed by each of the following methods.

- (1) Set intelligent function parameters (Initial setting/Auto refresh setting) and write them to the programmable controller CPU.
- (2) Create an FB of the intelligent function module parameter (initial setting/auto refresh setting) and paste it to the sequence program.

In accordance with the specification of the system, perform the initial setting/auto refresh setting of the intelligent function module by one of the methods above. *¹

*1: The following explains the case in which both of (1) and (2) are performed.

(a) Initial setting

FB setting given in (2) is valid.

(b) Auto refresh setting

- Both (1) and (2) are valid.
- At the time of FB execution and in the END processing of the sequence program, auto refresh is performed.

5.8.2 Paste an FB to a sequence program

[Purpose of operation]

Paste an FB in order to use it with a sequence program.

[Operation procedure]

Switch the <<Project>> tab into the <<FB>> tab on GX Developer, and drag & drop the FB to be used onto the sequence program.

Before pasting

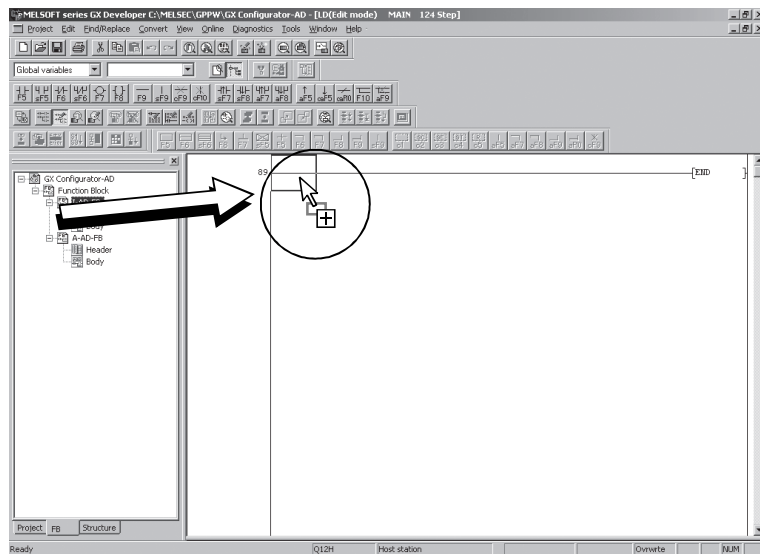

After pasting

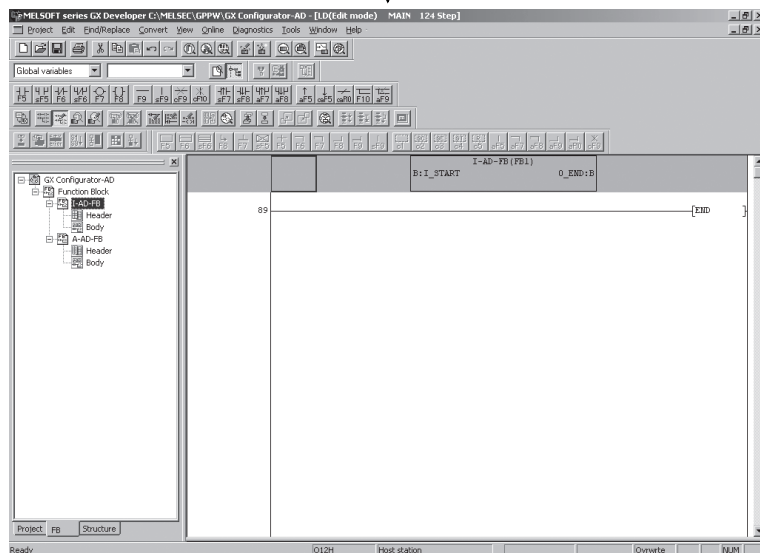

5.8.3 Convert (compile) a sequence program

[Purpose of operation]

Convert (compile) the sequence program to which an FB was pasted so that it can be executed.

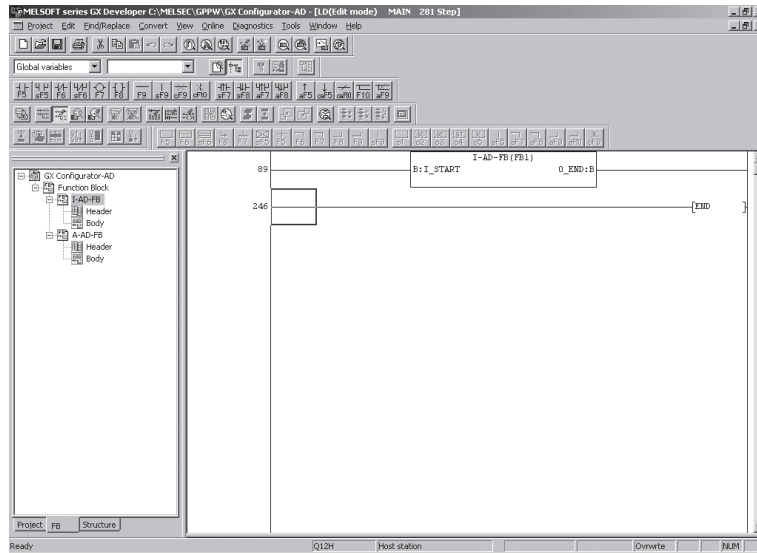

[Operation procedure]

Click the [Convert] menu → [Convert/Compile] menu of GX Developer.

6 PROGRAMMING

This chapter describes the programs of the A/D converter modules. When applying any of the program examples introduced in this chapter to the actual system, verify the applicability and confirm that no problems will occur in the system control.

6.1 Programming Procedure

In the following procedure, create a program that will execute the analog/digital conversion of the A/D converter module.

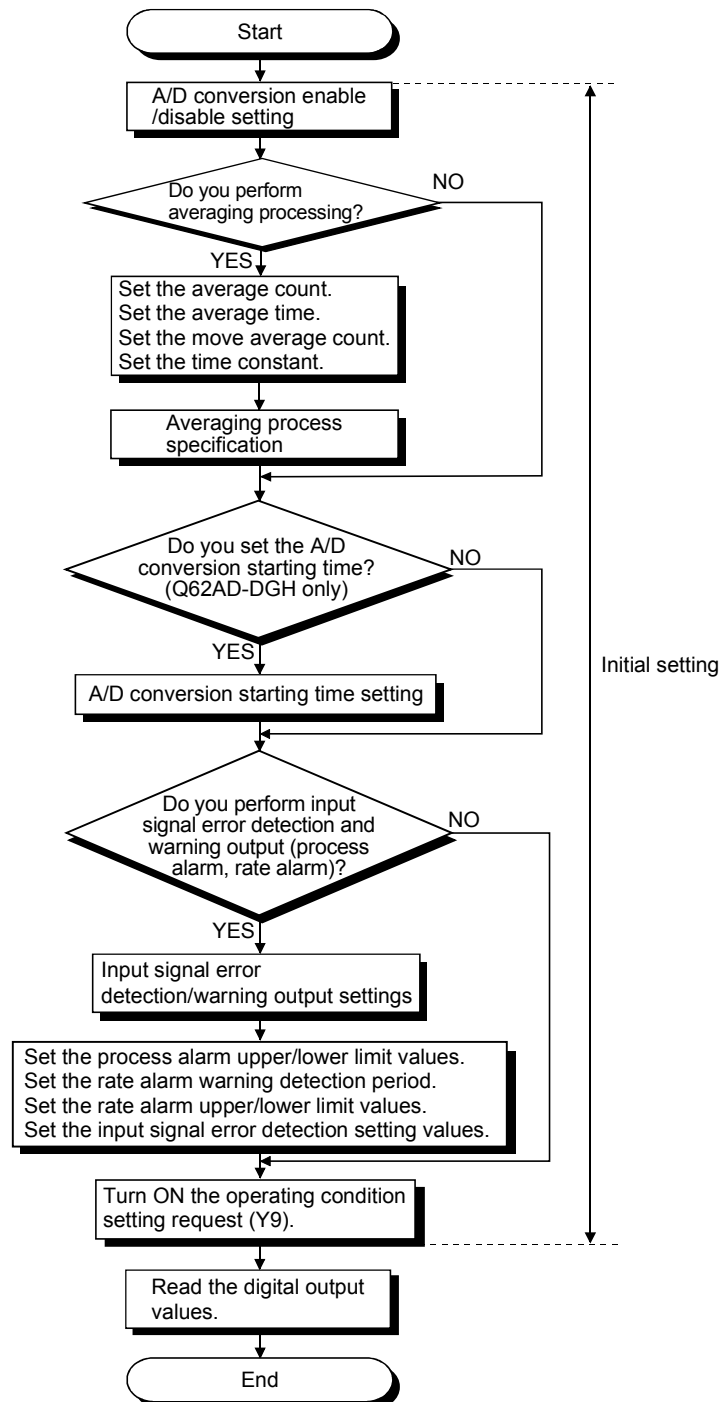

6.2 For Use in Normal System Configuration (Q64AD-GH)

System configuration used in the program explanation

(1) System configuration

Power supply module	Q n C P U	Q 6 4 A D , G H	Q X 1 0	Q Y 1 0		
		X/Y0 to X/YF	X10 to X1F	Y20 to Y2F		

(2) Program conditions

This program reads the digital output values that have been A/D converted using CH1 to CH3 of the Q64AD-GH. CH1 performs sampling processing, CH2 performs averaging processing every 50 times, and CH3 performs primary delay filtering at intervals of 100ms time constant. An error code appears in BCD if a write error occurs.

(a) Initial settings

- A/D conversion enable channel.....CH1 to CH3
- Count-based averaging processing channelAverage count setting of CH2 : 50 times
- Primary delay filter-based averaging processing channelTime constant setting of CH3 : 100ms
- Process alarm channelLower lower limit value setting of CH2: 1000
Lower upper limit value setting : 1500
Upper lower limit value setting : 6000
Upper upper limit value setting : 7000
- Rate alarm channel.....Period setting of CH3: 50ms
Upper limit value setting: 0.3%
Lower limit value setting: 0.1%
- Input signal error detection channelSetting of CH1: 10%

(b) Devices used by the user

- Digital output value read command input signalX10
- Input signal error detection reset signalX11
- Error reset signalX12
- Error code display (BCD 3 digits)Y20 to Y2B
- A/D conversion completed flagM0 to M2
- CH1 digital output value (32bit)D1, D2
- CH2 digital output value (32bit)D3, D4
- CH3 digital output value (32bit)D5, D6
- Warning output flagD7
- Process alarm.....M12, M13
- Rate alarmM22, M23
- Input signal error detection flagD8, M30
- Error code.....D9

6.2.1 Programming example using the utility package

(1) Operating the utility package

(a) Initial setting (see Section 5.4)

Set the initial settings of CH1 to CH3.

Refer to Section 6.2 for the settings.

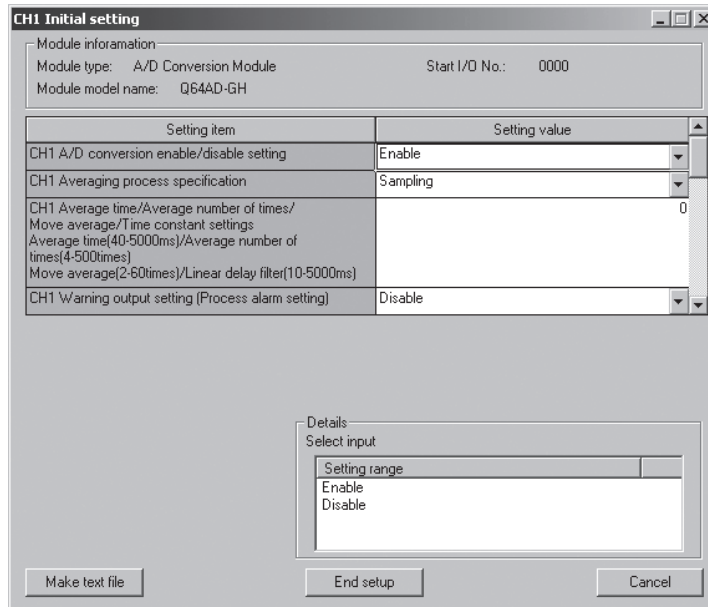

(b) Auto refresh setting (see Section 5.5)

Set the devices for storing digital output values, warning output flags, input signal error detection flags, and error codes of CH1 to CH3.

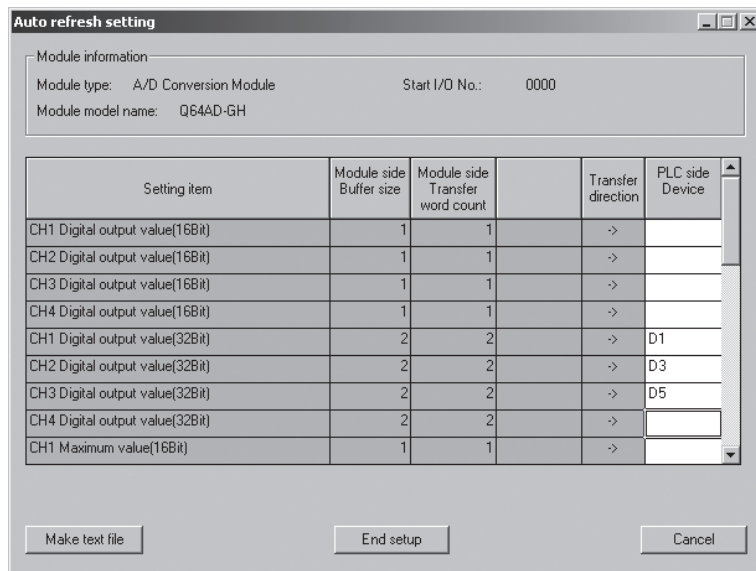

(c) Writing the intelligent function module parameters (see Section 5.3.3)

Write the intelligent function module parameters to the CPU module.

This operation is performed using the parameter setting module selection screen.

(2) Programming example

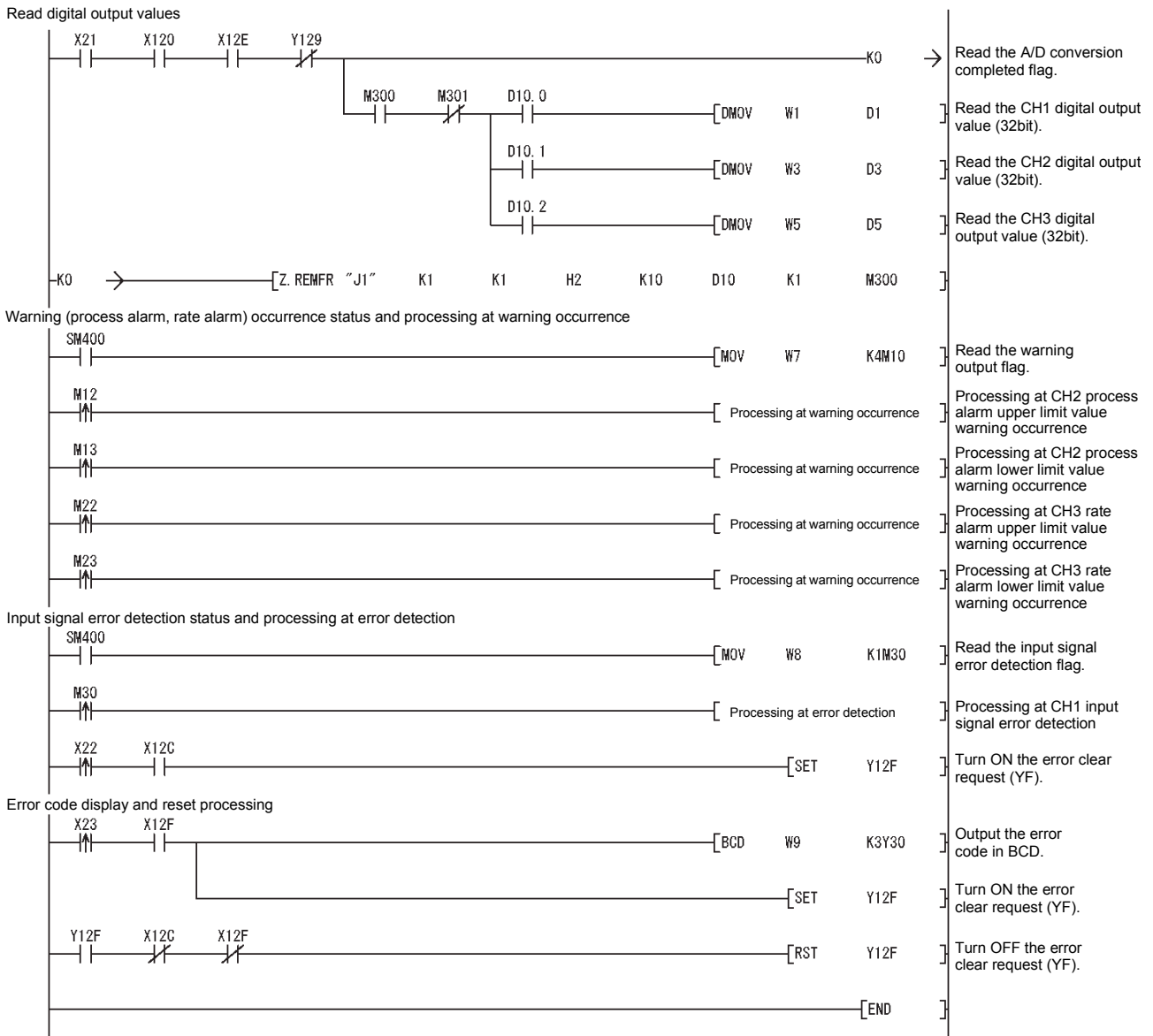

6.2.2 Programming example without using the utility package

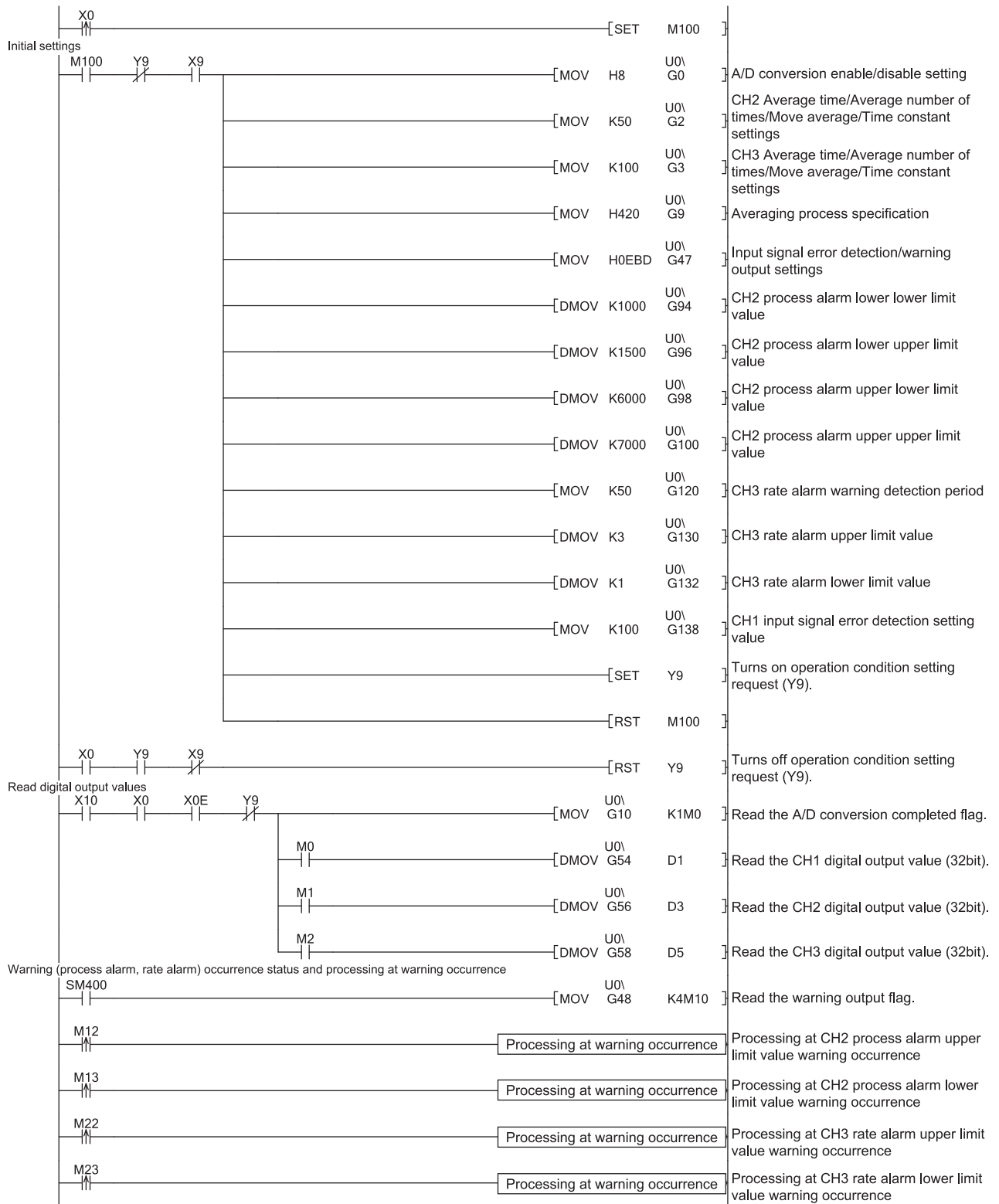

Input signal error detection status and processing at error detection

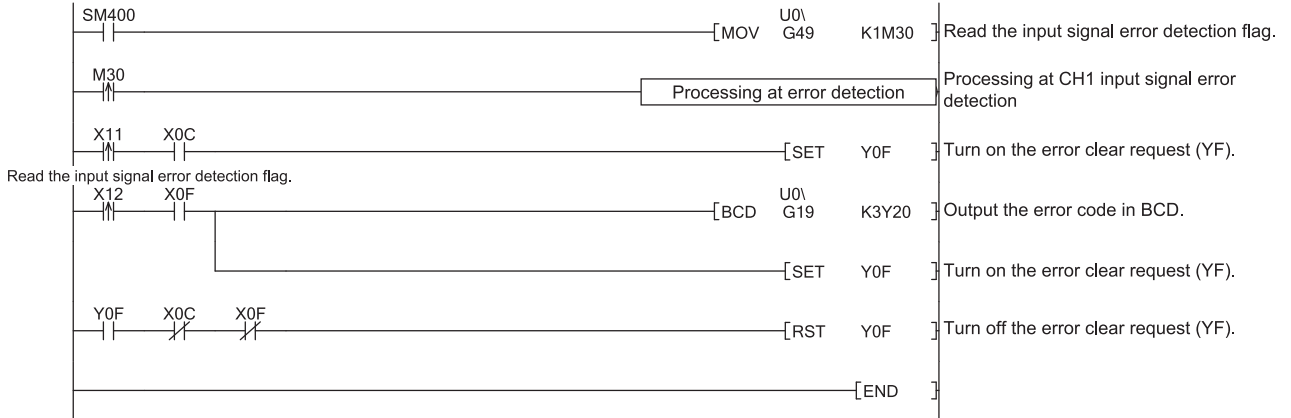

6.3 For Use in Remote I/O Network (Q64AD-GH)

System configuration used in the program explanation

(1) System configuration

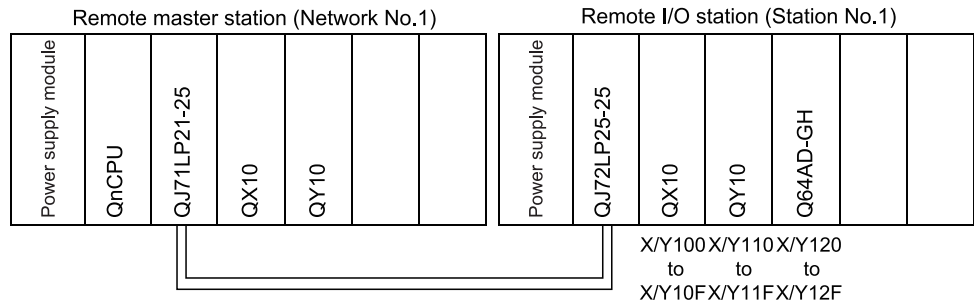

(2) Program conditions

In this program, the digital output values that have been A/D converted using CH1 to CH3 of the Q64AD-GH are read by the CPU of the remote master station. CH1 performs sampling processing, CH2 performs averaging processing every 50 times, and CH3 performs primary delay filtering at intervals of 100ms time constant. An error code appears in BCD if a write error occurs.

(a) Initial settings

- A/D conversion enable channel.....CH1 to CH3
- Count-based averaging processing channelAverage count setting of CH2 : 50 times
- Primary delay filter-based averaging processing channelTime constant setting of CH3 : 100ms
- Process alarm channelLower lower limit value setting of CH2: 1000
Lower upper limit value setting : 1500
Upper lower limit value setting : 6000
Upper upper limit value setting : 7000
- Rate alarm channel.....Period setting of CH3: 50ms
Upper limit value setting: 0.3%
Lower limit value setting: 0.1%
- Input signal error detection channelSetting of CH1: 10%

- (b) Devices used by the user
 - Initial setting request signalX20
 - Digital output value read command input signalX21
 - Input signal error detection reset signalX22
 - Error reset signalX23
 - Error code display (BCD 3 digits)Y30 to Y3B
 - A/D conversion completed flagD10
 - CH1 digital output valueD1, D2 (W1, W2)
 - CH2 digital output valueD3, D4 (W3, W4)
 - CH3 digital output valueD5, D6 (W5, W6)
 - Warning output flagD7 (W7)
 - Process alarmb2, b3 of D7
(M12, M13)
 - Rate alarmb12, b13 of D7
(M22, M23)
 - Input signal error detection flagD8, M30
(W8, M30)
 - Error codeD9 (W9)

POINT	For details on the MELSECNET/H remote I/O network, refer to the Q Corresponding MELSECNET/H Network System Reference Manual (Remote I/O Network).
--------------	---

6.3.1 Programming example using the utility package

(1) Operating GX Developer

(a) CPU parameter setting

- Network type : MNET/H (Remote master)
- Starting I/O No. : 0000H
- Network No. : 1
- Total stations : 1
- Mode : Online
- Network range assignment :

StationNo.	M station -> R station						M station <- R station					
	Y			Y			X			X		
	Points	Start	End	Points	Start	End	Points	Start	End	Points	Start	End
1	256	0100	01FF	256	0000	00FF	256	0100	01FF	256	0000	00FF

StationNo.	M station -> R station			M station <- R station			M station -> R station			M station <- R station		
	B			B			W			W		
	Points	Start	End	Points	Start	End	Points	Start	End	Points	Start	End
1							160	0100	019F	160	0000	009F

- Refresh parameters :

Assignment method

Points/Start

Start/End

Transient transmission error history status

Overwrite Hold

	Link side					PLC side			
	Dev. name	Points	Start	End		Dev. name	Points	Start	End
Transfer SB	SB	512	0000	01FF	↔	SB	512	0000	01FF
Transfer SW	SW	512	0000	01FF	↔	SW	512	0000	01FF
Random cyclic	LB				↔				
Random cyclic	LW				↔				
Transfer1	LB	8192	0000	1FFF	↔	B	8192	0000	1FFF
Transfer2	LW	8192	0000	1FFF	↔	W	8192	0000	1FFF
Transfer3	LX	512	0000	01FF	↔	X	512	0000	01FF
Transfer4	LY	512	0000	01FF	↔	Y	512	0000	01FF
Transfer5					↔				
Transfer6					↔				

(2) Operating the utility package

Operate the utility package on the remote I/O station side.

Set the following in the Intelligent function module parameter setting module select area.

- Start I/O No. : 20
- Module type : A/D Conversion Module
- Module model name : Q64AD-GH

(a) Initial setting (see Section 5.4)

Set the initial settings of CH1 to CH3.

Refer to Section 6.3 for the settings.

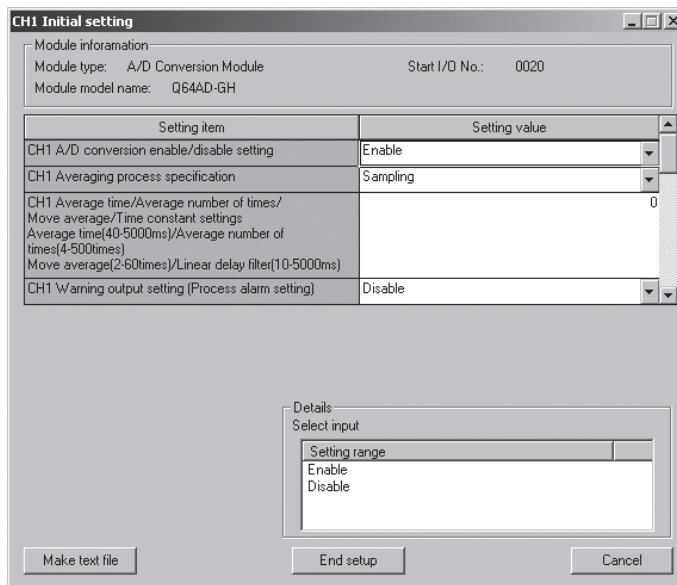

(b) Auto refresh setting (see Section 5.5)

Set the devices for storing digital output values, warning output flags, input signal error detection flags, and error codes of CH1 to CH3.

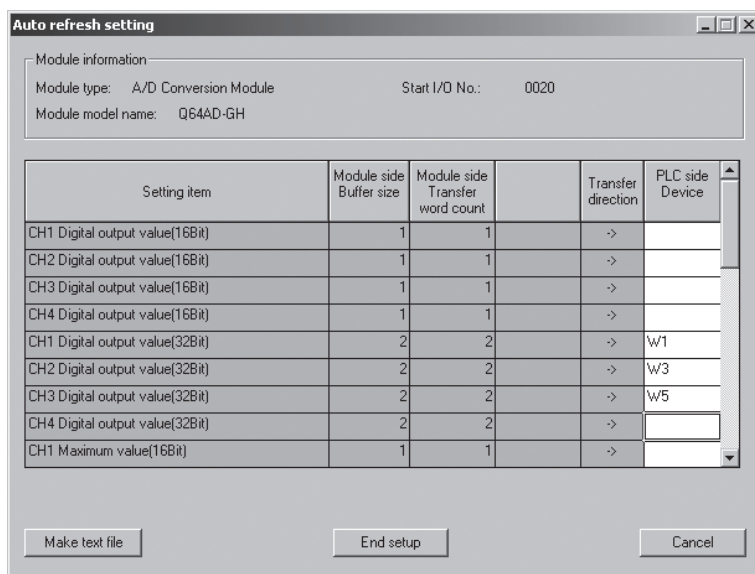

- (c) Writing the intelligent function module parameters (see Section 5.3.3)
 The intelligent function module parameters are written to the remote I/O station.
 This operation is performed using the intelligent function module parameter setting module selection screen.

(3) Programming example

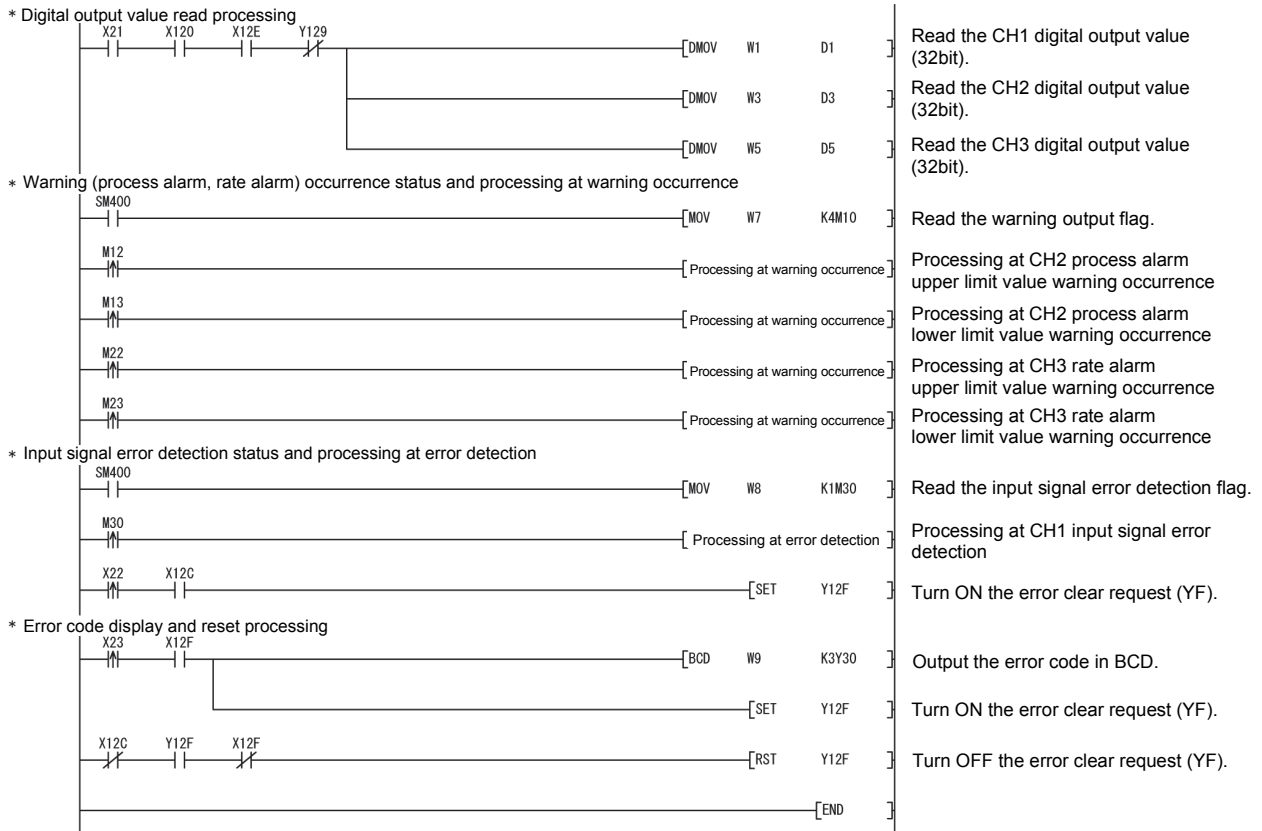

POINT

To write the intelligent function module parameters, set the target remote I/O station from [Online] - [Transfer setup] on GX Developer.
 They can be written by:

- Directly connecting GX Developer to the remote I/O station.
- Connecting GX Developer to another device such as a CPU module and passing through the network.

6.3.2 Programming example without using the utility package

POINT

The dedicated instructions used for reading/writing the buffer memory of the intelligent function module on a remote I/O station (REMTO and REMFR) are the execution type for which several scans are needed. Therefore, transmissions of the execution results are not synchronized with the I/O signal operations. When reading a digital output value on an A/D converter module after changing the operating condition during operation, be sure to read the A/D conversion completed flag (buffer memory address 10) at the same time.

Also, for the case of changing the operating condition, insert an interlock to prevent the execution of the REMFR instruction.

(1) Operating GX Developer (CPU parameter setting)

- Network type : MNET/H (Remote master)
- Starting I/O No. : 0000H
- Network No. : 1
- Total stations : 1
- Mode : Online
- Network range assignment :

StationNo.	M station -> R station						M station <- R station					
	Y			Y			X			X		
	Points	Start	End	Points	Start	End	Points	Start	End	Points	Start	End
1	256	0100	01FF	256	0000	00FF	256	0100	01FF	256	0000	00FF

StationNo.	M station -> R station			M station <- R station			M station -> R station			M station <- R station		
	B			B			W			W		
	Points	Start	End	Points	Start	End	Points	Start	End	Points	Start	End
1							160	0100	019F	160	0000	009F

- Refresh parameters :

Assignment method
 Points/Start
 Start/End

Transient transmission error history status
 Overwrite Hold

	Link side					PLC side			
	Dev. name	Points	Start	End		Dev. name	Points	Start	End
Transfer SB	SB	512	0000	01FF	↔	SB	512	0000	01FF
Transfer SW	SW	512	0000	01FF	↔	SW	512	0000	01FF
Random cyclic	LB				↔				
Random cyclic	LW				↔				
Transfer1	LB	8192	0000	1FFF	↔	B	8192	0000	1FFF
Transfer2	LW	8192	0000	1FFF	↔	W	8192	0000	1FFF
Transfer3	LX	512	0000	01FF	↔	X	512	0000	01FF
Transfer4	LY	512	0000	01FF	↔	Y	512	0000	01FF
Transfer5					↔				
Transfer6					↔				

(2) Programming example

Remote I/O station operating status checking

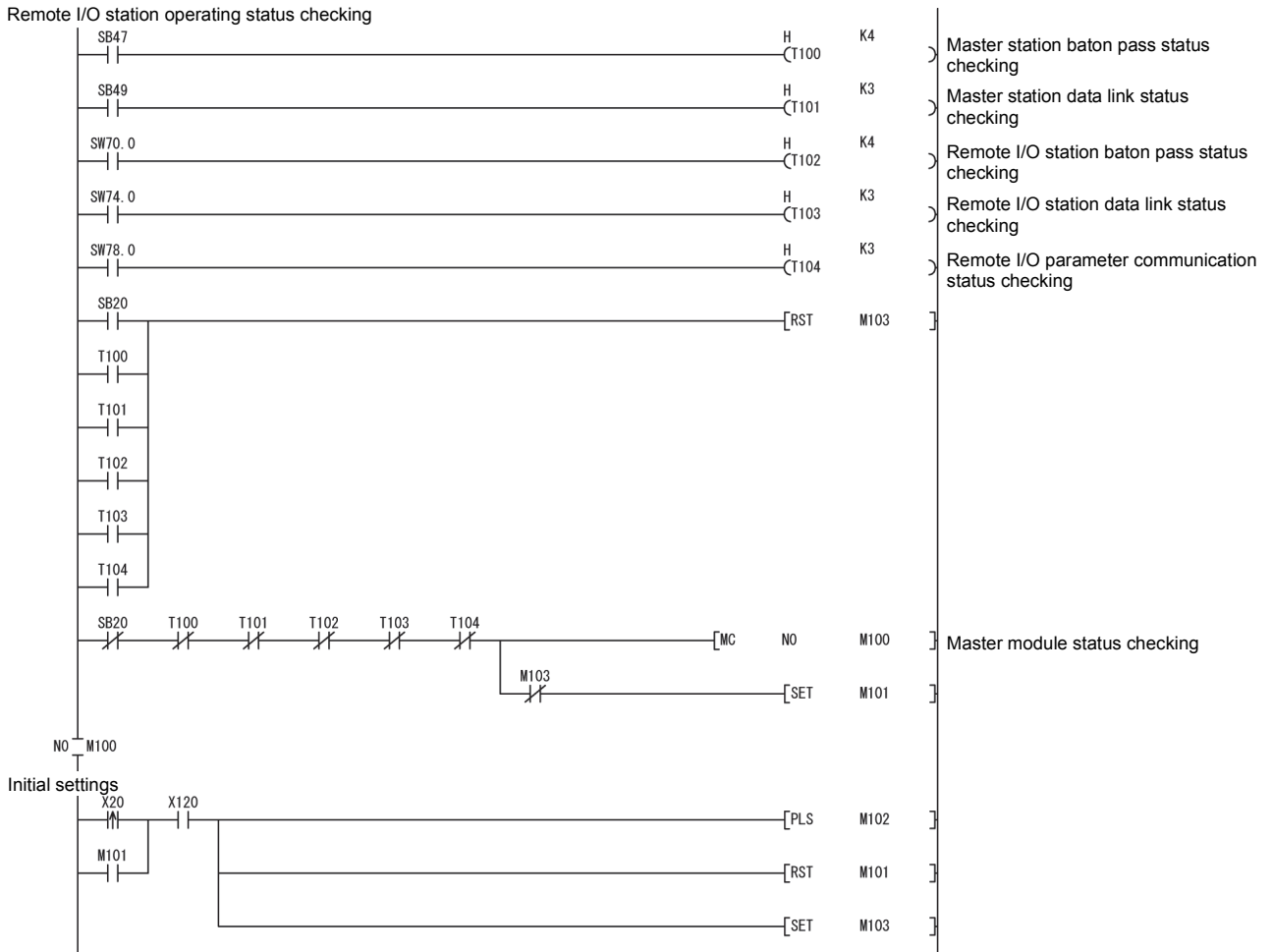

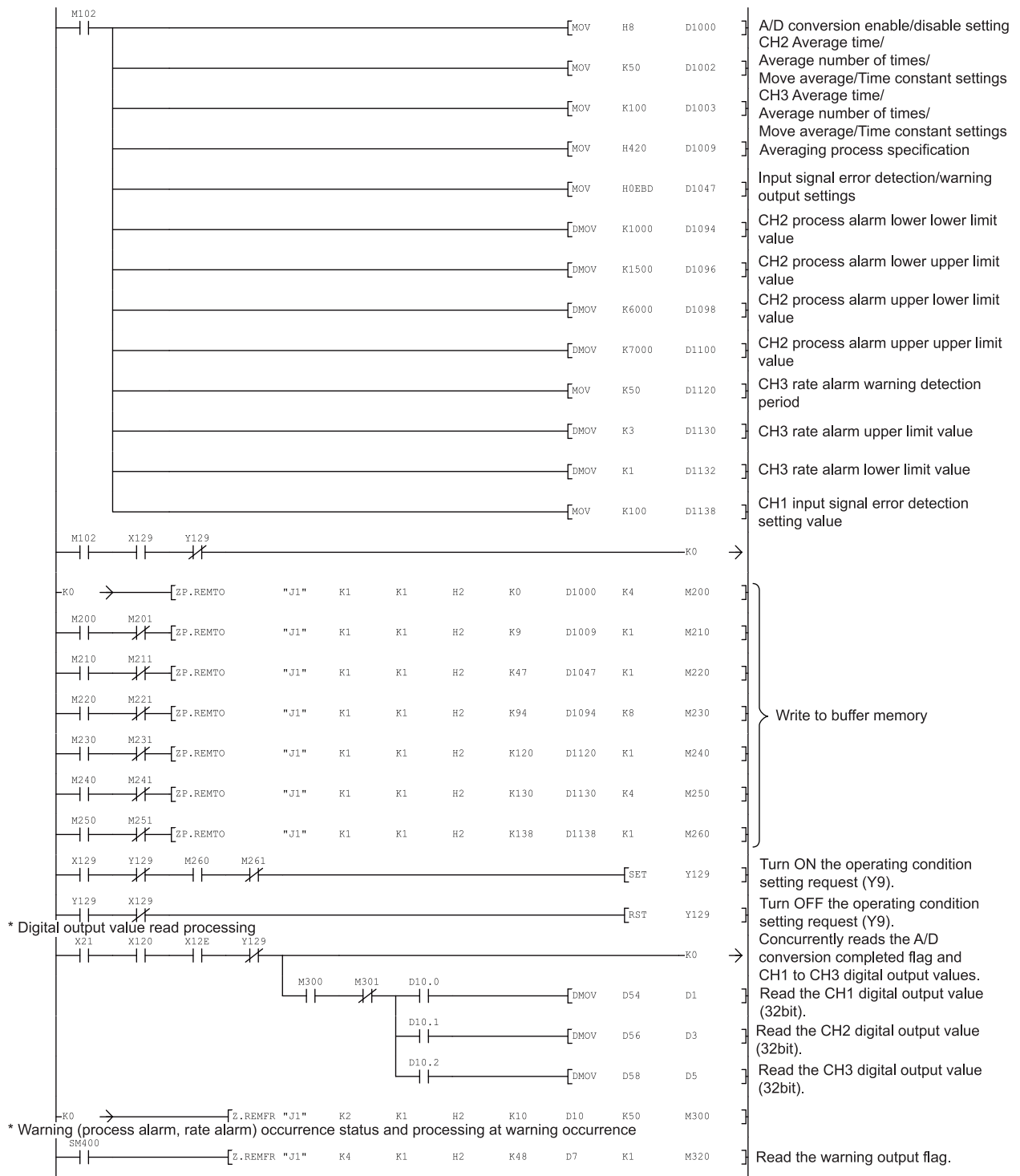

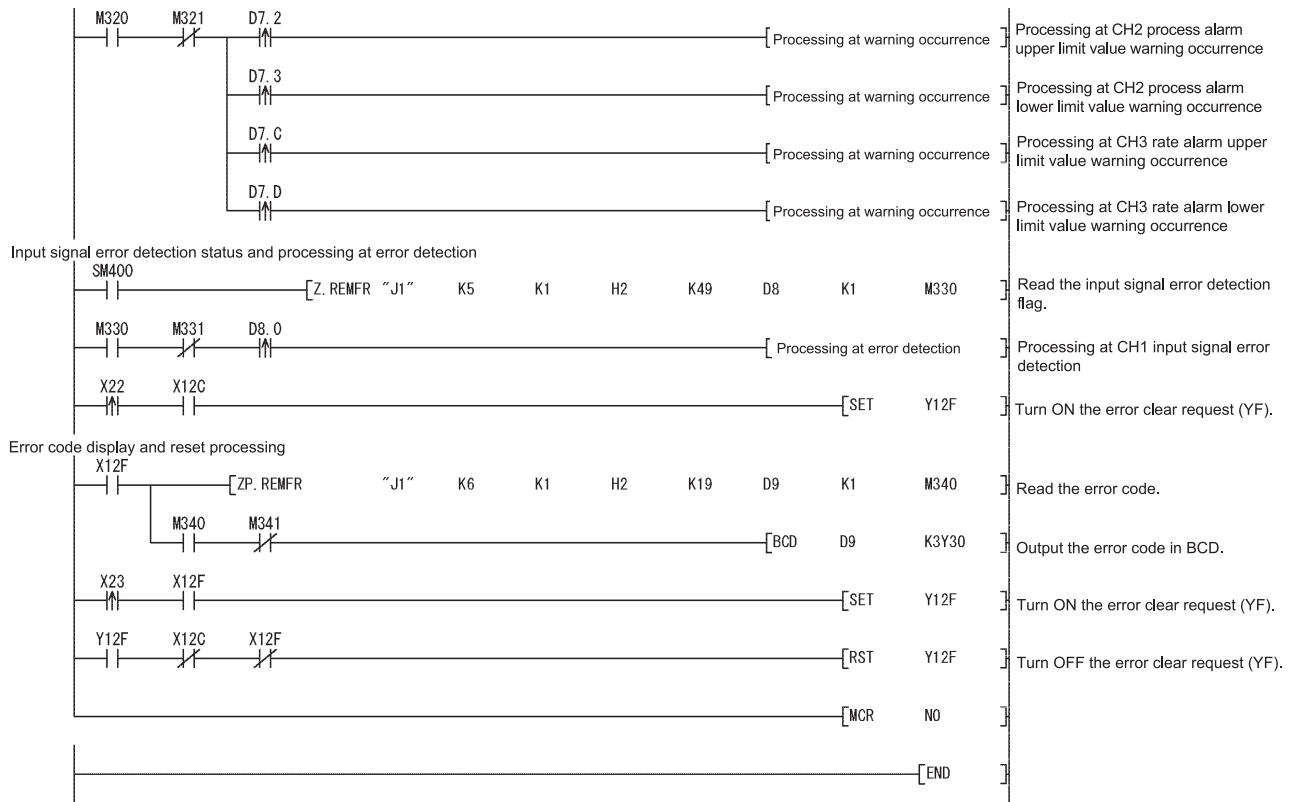

6.4 For Use in Normal System Configuration (Q62AD-DGH)

System configuration used in the program explanation

(1) System configuration

Power supply module	Q n C P U	Q 6 2 A D D G H	Q X 1 0	Q Y 1 0		
		X/Y0 to X/YF	X10 to X1F	Y20 to Y2F		

(2) Program conditions

This program reads the digital output values that have been A/D converted using CH1 and CH2 of the Q62AD-DGH. CH1 performs sampling processing, and CH2 performs averaging processing every 50 times. An error code appears in BCD if a write error occurs.

(a) Initial settings

- A/D conversion enable channel.....CH1, CH2
- Count-based averaging processing channelAverage count setting of CH2 : 50 times
- Process alarm channelLower lower limit value setting of CH2: 1000
Lower upper limit value setting : 1500
Upper lower limit value setting : 6000
Upper upper limit value setting : 7000
- Input signal error detection channelSetting of CH1: 10%

(b) Devices used by the user

- Digital output value read command input signalX10
- Input signal error detection reset signalX11
- Error reset signalX12
- Error code display (BCD 3 digits)Y20 to Y2B
- A/D conversion completed flagM0, M1
- CH1 digital output value (32bit)D1, D2
- CH2 digital output value (32bit)D3, D4
- Warning output flagD5
- Process alarm.....M12, M13
- Input signal error detection flagD6, M30
- Error code.....D7

6.4.1 Programming example using the utility package

(1) Operating the utility package

(a) Initial setting (see Section 5.4)

Set the initial settings of CH1 and CH2.

Refer to Section 6.4 for the settings.

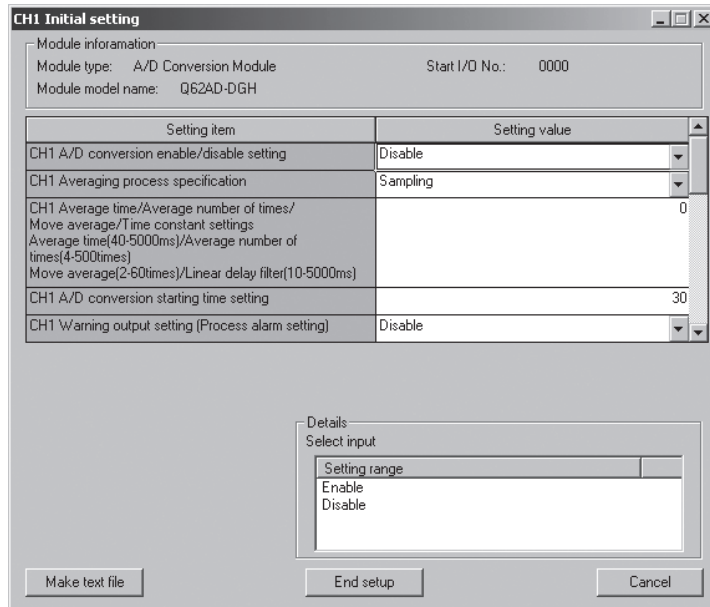

(b) Auto refresh setting (see Section 5.5)

Set the devices for storing digital output values, warning output flags, input signal error detection flags, and error codes of CH1 and CH2.

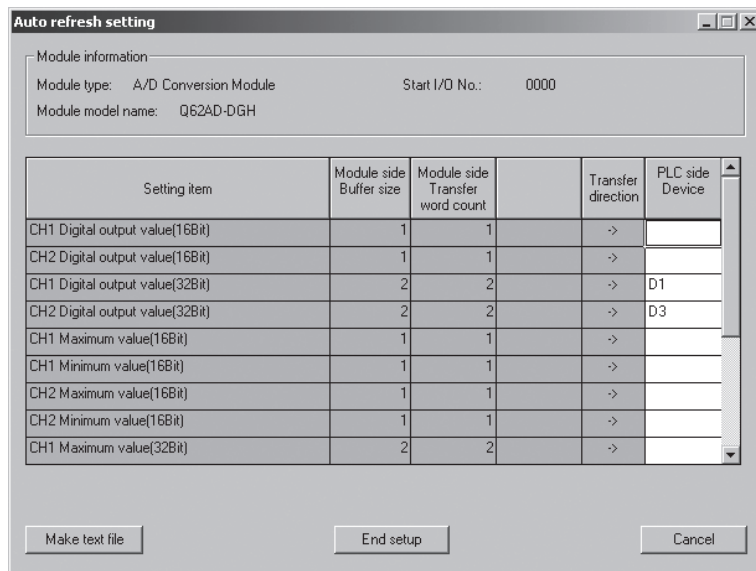

(c) Writing the intelligent function module parameters (see Section 5.3.3)

Write the intelligent function module parameters to the CPU module.

This operation is performed using the parameter setting module selection screen.

(2) Programming example

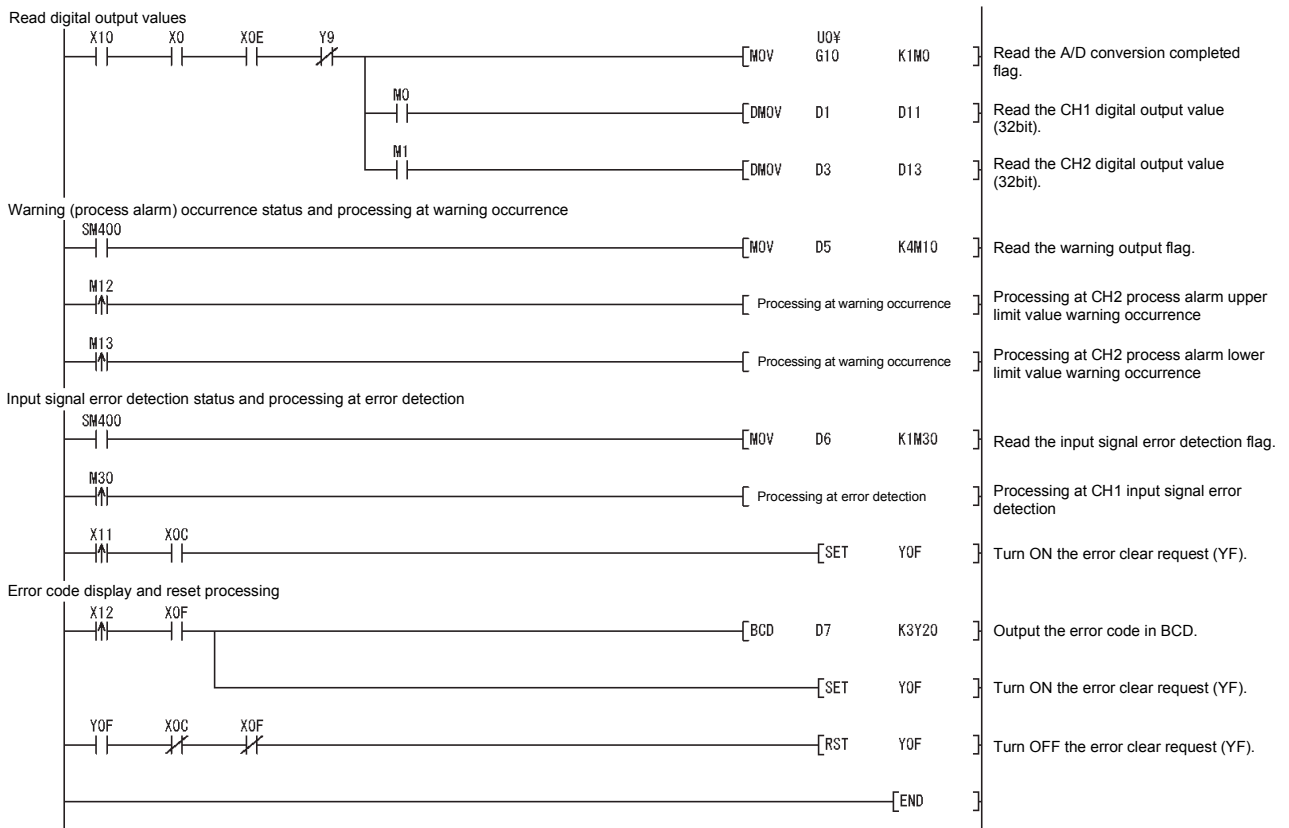

6.4.2 Programming example without using the utility package

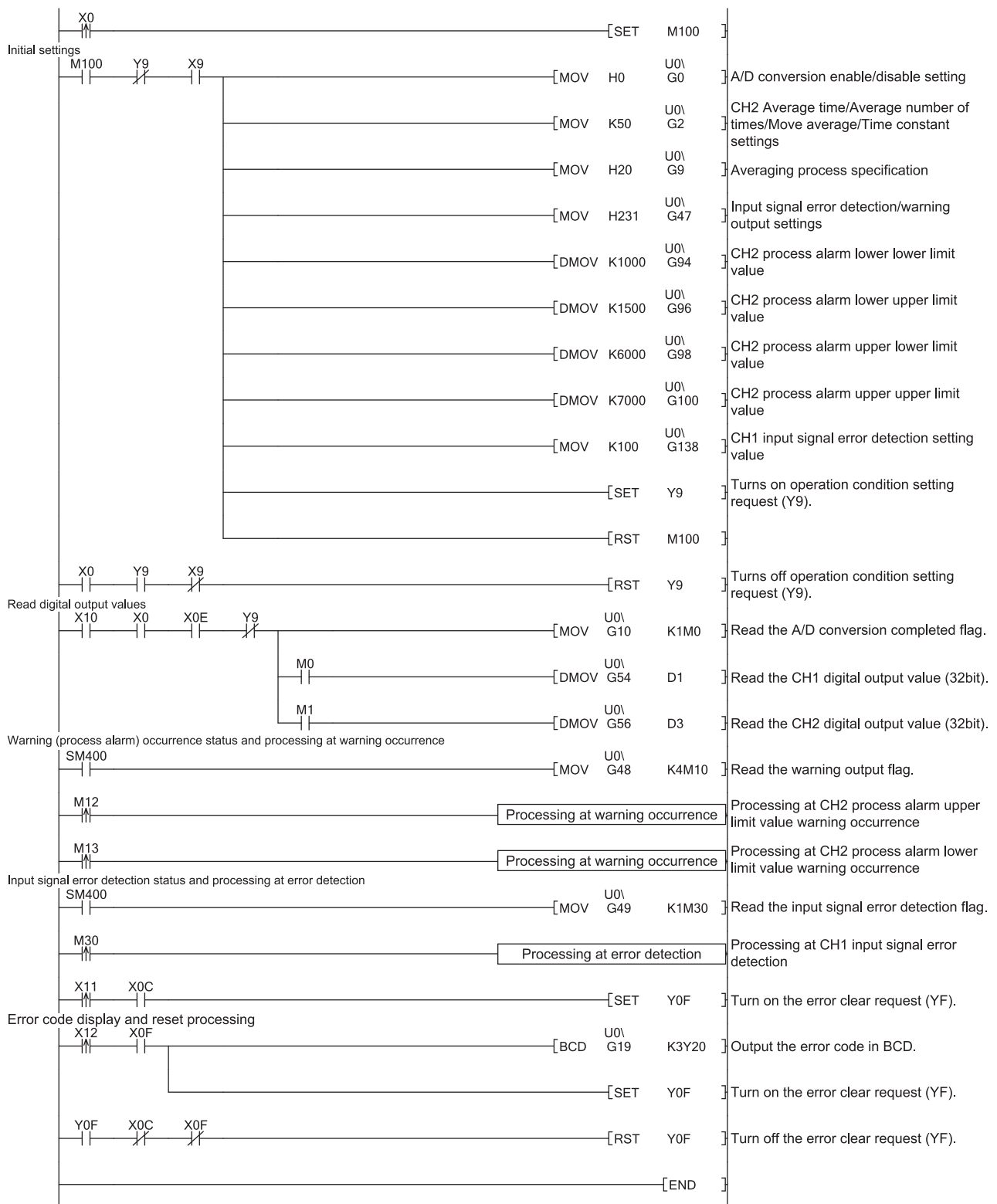

6.5 For Use in Remote I/O Network (Q62AD-DGH)

System configuration used in the program explanation

(1) System configuration

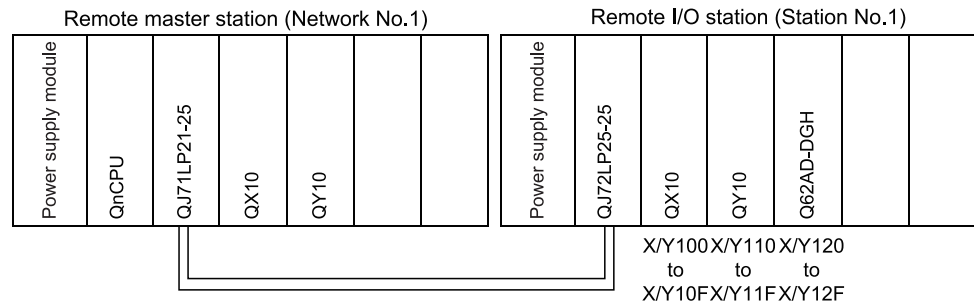

(2) Program conditions

In this program, the digital output values that have been A/D converted using CH1 and CH2 of the Q62AD-DGH are read by the CPU of the remote master station.

CH1 performs sampling processing, and CH2 performs averaging processing every 50 times. An error code appears in BCD if a write error occurs.

(a) Initial settings

- A/D conversion enable channel.....CH1, CH2
- Count-based
averaging processing channelAverage count setting of
CH2: 50 times
- Process alarm channelLower lower limit value setting of
CH2: 1000
Lower upper limit value setting
: 1500
Upper lower limit value setting
: 6000
Upper upper limit value setting
: 7000
- Input signal error detection channelSetting of CH1: 10%

(b) Devices used by the user

- Initial setting request signalX20
- Digital output value read command input signalX21
- Input signal error detection reset signalX22
- Error reset signal.....X23
- Error code display (BCD 3 digits)Y30 to Y3B
- A/D conversion completed flag.....D10
- CH1 digital output value.....D1, D2 (W1, W2)
- CH2 digital output value.....D3, D4 (W3, W4)
- Warning output flag.....D5 (W5)
Process alarm.....b2, b3 of D5 (M12, M13)
- Input signal error detection flagD6, M30 (W6, M30)
- Error code.....D7 (W7)

6.5.1 Programming example using the utility package

(1) Operating GX Developer

(a) CPU parameter setting

- Network type : MNET/H (Remote master)
- Starting I/O No. : 0000H
- Network No. : 1
- Total stations : 1
- Mode : Online
- Network range assignment :

StationNo.	M station -> R station						M station <- R station					
	Y			Y			X			X		
	Points	Start	End	Points	Start	End	Points	Start	End	Points	Start	End
1	256	0100	01FF	256	0000	00FF	256	0100	01FF	256	0000	00FF

StationNo.	M station -> R station			M station <- R station			M station -> R station			M station <- R station		
	B			B			W			W		
	Points	Start	End	Points	Start	End	Points	Start	End	Points	Start	End
1							160	0100	019F	160	0000	009F

- Refresh parameters :

Assignment method

Points/Start

Start/End

Transient transmission error history status

Overwrite Hold

	Link side					PLC side			
	Dev. name	Points	Start	End		Dev. name	Points	Start	End
Transfer SB	SB	512	0000	01FF	↔	SB	512	0000	01FF
Transfer SW	SW	512	0000	01FF	↔	SW	512	0000	01FF
Random cyclic	LB				↔				
Random cyclic	LW				↔				
Transfer1	LB	8192	0000	1FFF	↔	B	8192	0000	1FFF
Transfer2	LW	8192	0000	1FFF	↔	W	8192	0000	1FFF
Transfer3	LX	512	0000	01FF	↔	X	512	0000	01FF
Transfer4	LY	512	0000	01FF	↔	Y	512	0000	01FF
Transfer5					↔				
Transfer6					↔				

(2) Operating the utility package

Operate the utility package on the remote I/O station side.

Set the following in the Intelligent function module parameter setting module select area.

- Start I/O No. : 20
- Module type : A/D Conversion Module
- Module model name : Q62AD-DGH

(a) Initial setting (see Section 5.4)

Set the initial settings of CH1 and CH2.

Refer to Section 6.5 for the settings.

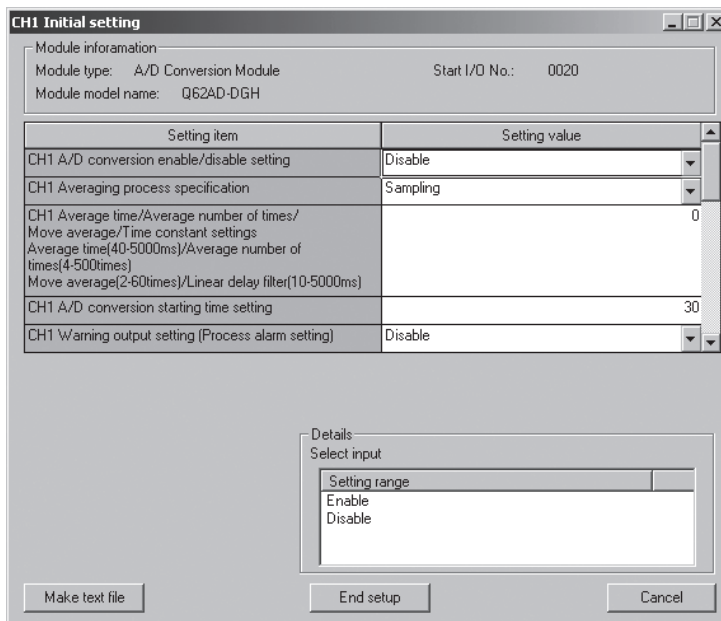

(b) Auto refresh setting (see Section 5.5)

Set the devices for storing the digital output values, warning output flags, input signal error detection flags, and error codes of CH1 and CH2.

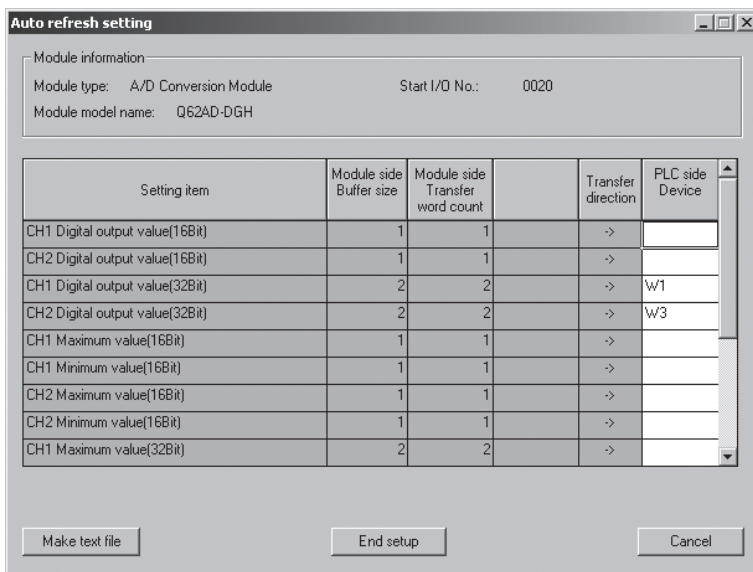

- (c) Writing the intelligent function module parameters (see Section 5.3.3)
 The intelligent function module parameters are written to the remote I/O station.
 This operation is performed using the intelligent function module parameter setting module select screen.

(3) Programming example

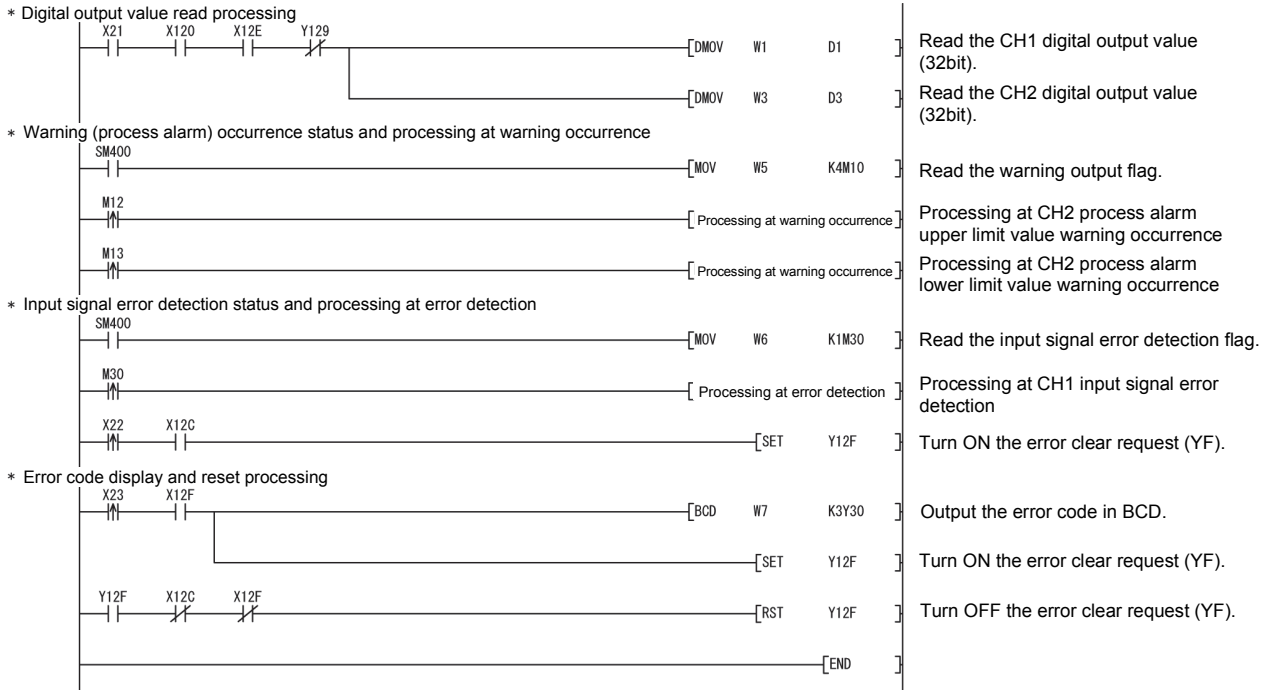

POINT

To write the intelligent function module parameters, set the target remote I/O station from [Online] - [Transfer setup] on GX Developer.
 They can be written by:

- Directly connecting GX Developer to the remote I/O station.
- Connecting GX Developer to another device such as a CPU module and passing through the network.

6.5.2 Programming example without using the utility package

POINT
<p>The dedicated instructions used for reading/writing the buffer memory of the intelligent function module on a remote I/O station (REMTO and REMFR) are the execution type for which several scans are needed. Therefore, transmissions of the execution results are not synchronized with the I/O signal operations. When reading a digital output value on an A/D converter module after changing the operating condition during operation, be sure to read the A/D conversion completed flag (buffer memory address 10) at the same time.</p> <p>Also, for the case of changing the operating condition, insert an interlock to prevent the execution of the REMFR instruction.</p>

(1) Operating GX Developer (CPU parameter setting)

- Network type : MNET/H (Remote master)
- Starting I/O No. : 0000H
- Network No. : 1
- Total stations : 1
- Mode : Online
- Network range assignment :

StationNo.	M station -> R station						M station <- R station					
	Y			Y			X			X		
	Points	Start	End	Points	Start	End	Points	Start	End	Points	Start	End
1	256	0100	01FF	256	0000	00FF	256	0100	01FF	256	0000	00FF

StationNo.	M station -> R station			M station <- R station			M station -> R station			M station <- R station		
	B			B			W			W		
	Points	Start	End	Points	Start	End	Points	Start	End	Points	Start	End
1							160	0100	019F	160	0000	009F

- Refresh parameters :

Assignment method		Transient transmission error history status	
<input type="radio"/> Points/Start	<input checked="" type="radio"/> Overwrite		<input type="radio"/> Hold
<input checked="" type="radio"/> Start/End			

	Link side					PLC side			
	Dev. name	Points	Start	End		Dev. name	Points	Start	End
Transfer SB	SB	512	0000	01FF	↔	SB	512	0000	01FF
Transfer SW	SW	512	0000	01FF	↔	SW	512	0000	01FF
Random cyclic	LB				↔				
Random cyclic	LW				↔				
Transfer1	LB	8192	0000	1FFF	↔	B	8192	0000	1FFF
Transfer2	LW	8192	0000	1FFF	↔	W	8192	0000	1FFF
Transfer3	LX	512	0000	01FF	↔	X	512	0000	01FF
Transfer4	LY	512	0000	01FF	↔	Y	512	0000	01FF
Transfer5					↔				
Transfer6					↔				

(2) Programming example

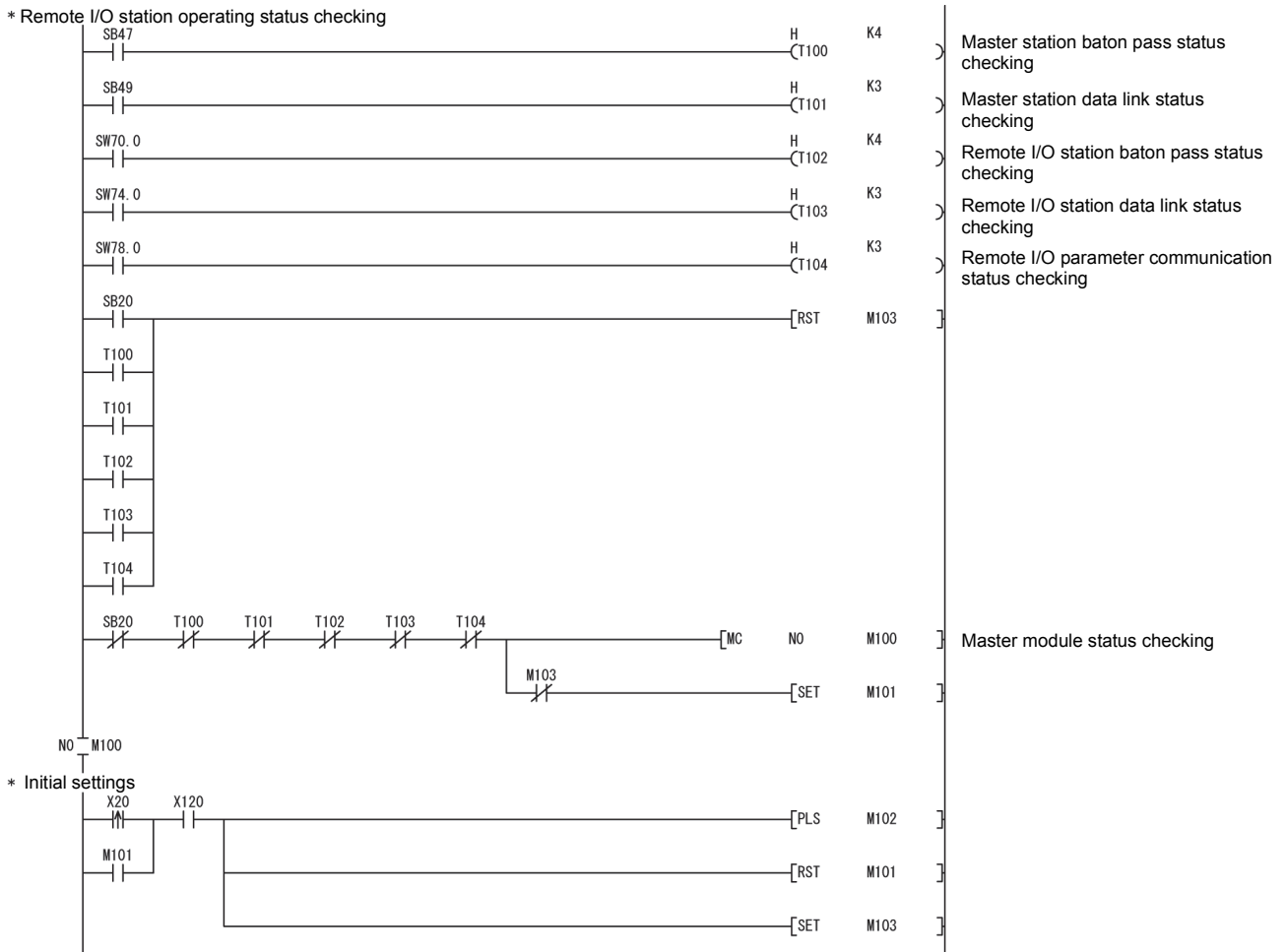

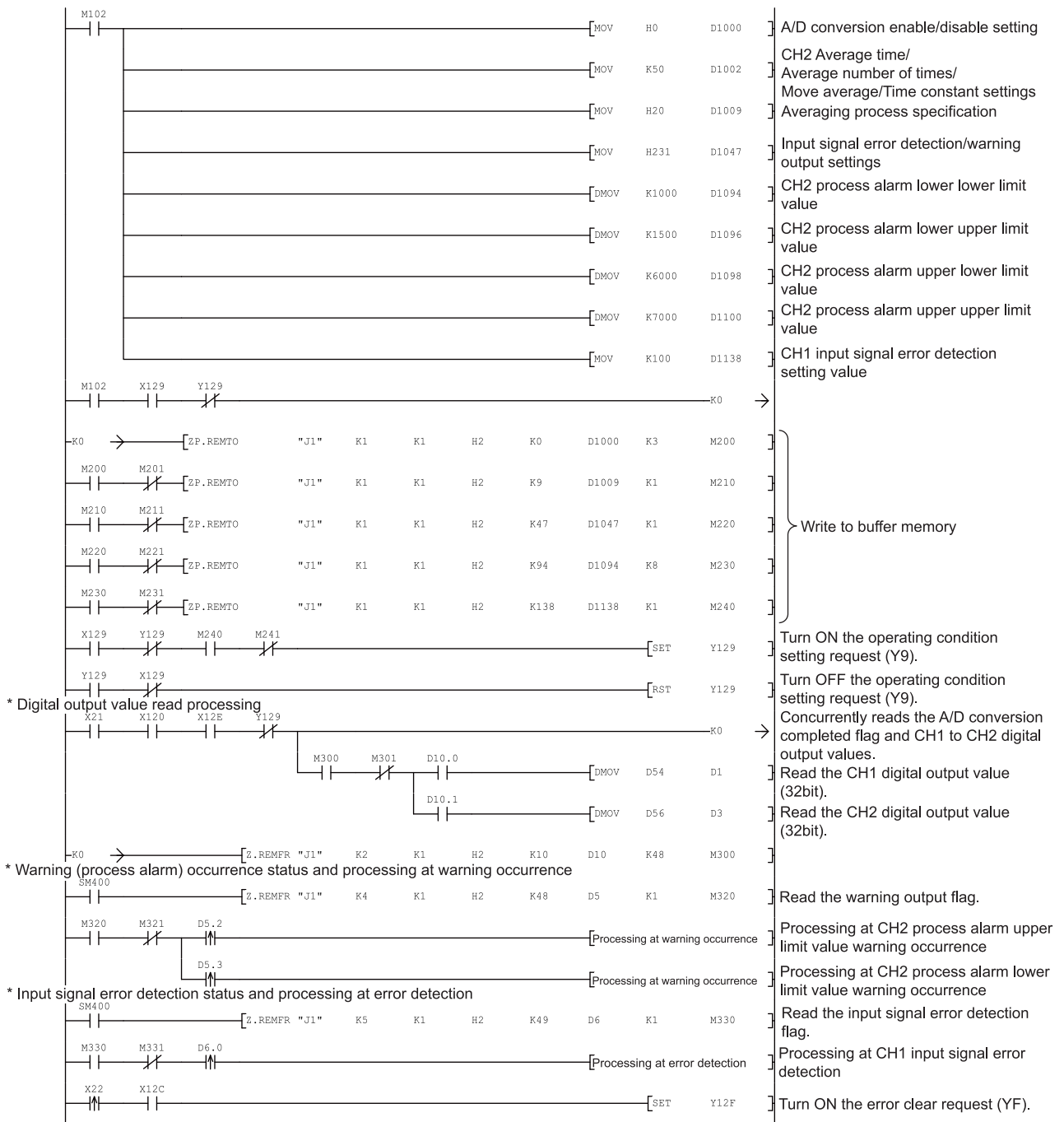

Error code display and reset processing

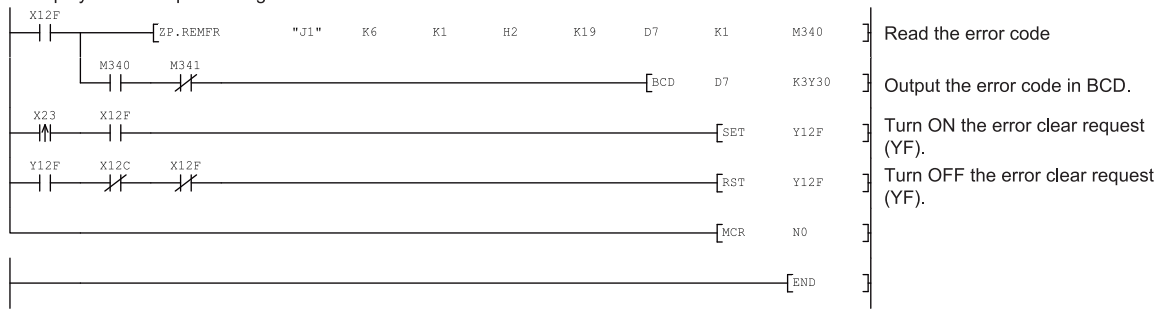

7 ONLINE MODULE CHANGE

When changing a module online, carefully read the following manual.

- QCPU User's Manual (Hardware Design, Maintenance and Inspection)

This chapter describes the specifications of an online module change.

- (1) Perform an online module change by operating GX Developer.
- (2) To ensure ease of offset/gain re-setting, there is a user range save/restoration function that is performed by executing the dedicated instruction or read/write from/to buffer memory.

POINT
(1) Perform an online module change after making sure that the system outside the programmable controller will not malfunction.
(2) To prevent an electric shock and malfunction of operating modules, provide means such as switches for powering off each of the external power supply and external devices connected to the module to be replaced online.
(3) After the module has failed, data may not be saved properly. Referring to Section 3.4.23, therefore, prerecord the data to be saved (offset/gain values of the industrial shipment settings and user range settings in the buffer memory).
(4) It is recommended to perform an online module change in the actual system in advance to ensure that it would not affect the other modules by checking the following: <ul style="list-style-type: none"> • Means of cutting off the connection to external devices and its configuration are correct. • Switching ON/OFF does not bring any undesirable effect.
(5) Do not install/remove the module to/from the base unit, or the terminal block to/from the module more than 50 times after the first use of the product. (IEC 61131-2 compliant) Failure to do so may cause malfunction.

(Note)

The dedicated instruction cannot be executed during an online module change. When using the dedicated instruction to execute save/restoration, therefore, execute save/restoration in the other system^{*1}.

If the other system is unavailable, execute restoration by performing write to the buffer memory.

*1 : If the module is mounted on the remote I/O station, execute save/restoration in the other system mounted on the main base unit. (Save/restoration cannot be executed in the other system mounted on the remote I/O station.)

7.1 Online Module Change Conditions

The CPU, MELSECNET/H remote I/O module, A/D converter module, GX Developer and base unit given below are needed to perform an online module change.

(1) CPU

The Process CPU or Redundant CPU is required.

For the precautions for multiple CPU system configuration, refer to the QCPU User's Manual (Multiple CPU System).

For the precautions for redundant system configuration, refer to the QnPRHCPU User's Manual (Redundant System).

(2) MELSECNET/H remote I/O module

The module of function version D or later is necessary.

(3) A/D converter module

The module of function version C or later is necessary.

(4) GX Developer

GX Developer of Version 7.10L or later is necessary.

GX Developer of Version 8.18U or later is required to perform an online module change on the remote I/O station.

(5) Base unit

1) When the slim type main base unit (Q3□SB) is used, an online module change cannot be performed.

2) When the power supply module unnecessary type extension base unit (Q5□B) is used, online module change cannot be performed for the modules on all the base units connected.

7.2 Online Module Change Operations

The following gives the operations performed for an online module change.

CPU operation ○: Executed ×: Not executed						(User operation)	(Intelligent function module operation)
X/Y refresh	FROM/TO instruction * 1	Dedicated instruction	Device test	GX Configurator			
				Initial setting parameter	Monitor/test		
○	○	○	○	×	○	<p>(1) Conversion disable</p> <p>Turn OFF all Y signals that were turned ON by a sequence program.</p> <p>(2) Dismounting of module</p> <p>Operate GX Developer to start an online module change.</p> <p>Click the [Execution] button of GX Developer to make the module dismountable.</p> <p>Dismount the corresponding module.</p> <p>(3) Mounting of new module</p> <p>Mount a new module. *3</p> <p>After mounting the module, click the [Execution] button of GX Developer.</p> <p>Operation check before control start</p> <p>(4) Operation check</p> <p>Click the [Cancel] button of GX Developer to leave the online mode.</p> <p>Conduct an operation test on the new module using "Device test" of GX Developer or "Monitor/test" of GX Configurator.</p> <p>Perform user range restoration processing by write to buffer memory at this point.</p> <p>Operation check completed</p> <p>(5) Resumption of control</p> <p>Operate GX Developer to resume the online module change mode, and click the [Execution] button to resume control.</p>	<p>Module is operating as usual.</p> <p>Module stops operating.</p> <ul style="list-style-type: none"> • RUN LED turns off. • Conversion disabled. <p>X/Y refresh resumes and the module starts.</p> <ul style="list-style-type: none"> • RUN LED turns on. • Default operation (X0 remains OFF) <p>(When there are initial setting parameters, operation is performed according to the initial setting parameters at this point.)</p> <p>Module operates according to test operation *2</p> <p>X0 (Module ready) turns ON.</p> <p>Start is made when X0 turns from OFF to ON.</p> <p>Operation is performed according to the initial setting sequence. *2</p>
×	×	×	×	×	×		
○	×	×	×	○	×		
○	×	×	○	×	○		
○	○	○	○	×	○		

* 1: Access to the intelligent function module device (U□G□) is included.

* 2: In the absence of the operation marked * 2, the operation of the intelligent function module is the operation performed prior to that.

* 3: With the input range set as shown below, online module change with a module that does not support the analog input range extended mode causes an intelligent function module switch error.

For the Q64AD-GH: 4 to 20mA (Extended mode): A_H
 1 to 5V (Extended mode): B_H

For the Q62AD-DGH: 4 to 20mA (Extended mode): A_H

7.3 Online Module Change Procedure

There are the following online module change procedures depending on whether the user range setting has been made or not, whether the initial setting of GX Configurator-AD has been made or not, and whether the other system exists or not.

Range setting	Initial setting	Other system	Reference section
Industrial shipment setting	GX Configurator-AD	—	Section 7.3.1
Industrial shipment setting	Sequence program	—	Section 7.3.2
User range setting	GX Configurator-AD	Present	Section 7.3.3
User range setting	GX Configurator-AD	Absent	Section 7.3.4
User range setting	Sequence program	Present	Section 7.3.5
User range setting	Sequence program	Absent	Section 7.3.6

7.3.1 When industrial shipment setting is used and initial setting was made with GX Configurator-AD

(1) Conversion disable

(a) Disable the conversion by the following procedures.

- 1) Set the A/D conversion enable/disable setting (buffer memory address 0: Un\G0) for all channel conversion disable (F_H).
- 2) Turn on Operating condition setting request (Y9) to stop the conversion.
- 3) Operating condition setting completed flag (X9) is turned off.
- 4) Check that the conversion stops with the actual analog output value.
- 5) Turn off Operating condition setting request (Y9).

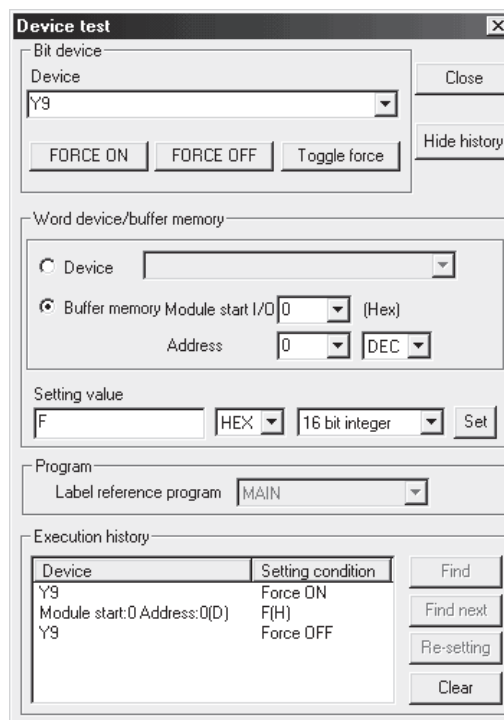

(The screen shows the setting example of the Q64AD-GH.)

(2) Dismounting of module

- (a) After choosing [Diagnosis] - [Online module change] on GX Developer to enter the "Online module change" mode, double-click the module to be changed online to display the "Online module change" screen.

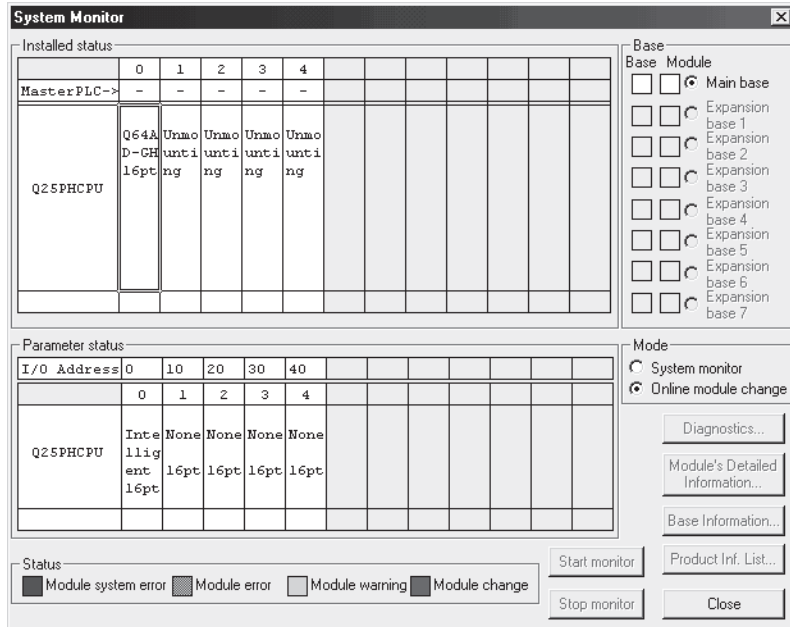

- (b) Click the "Execution" button to enable a module change.

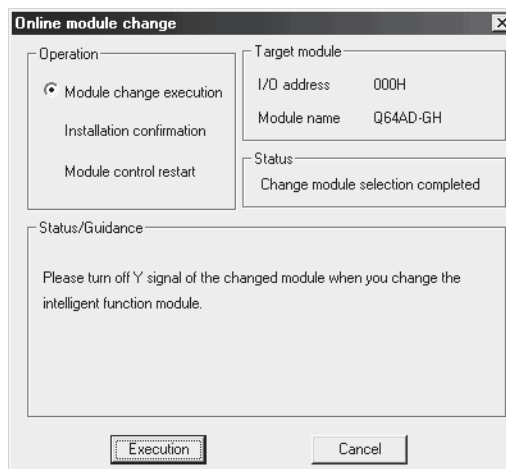

If the following error screen appears, click the [OK] button, dismount the module as-is, and mount a new module.



- (c) After confirming that the "RUN" LED of the module has turned off, remove the terminal block and dismount the module.

POINT
Always dismount the module. If mounting confirmation is made without the module being dismounted, the module will not start properly and the "RUN" LED will not be lit.

(3) Mounting of new module

- (a) Mount a new module to the same slot and install the terminal block.
- (b) After mounting the module, click the [Execution] button and make sure that the "RUN" LED is lit. Module ready (X0) remains OFF.

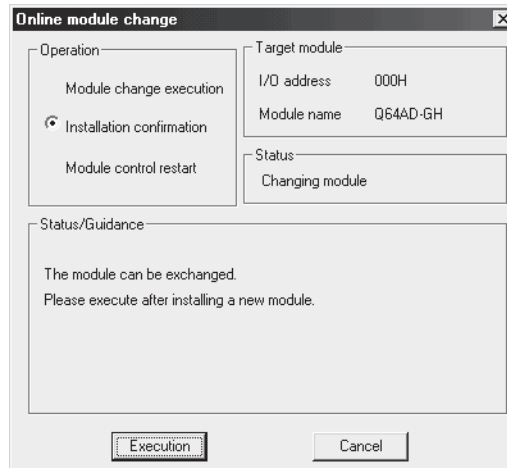

(4) Operation check

- (a) To make an operation check, click the [Cancel] button to cancel control resumption.

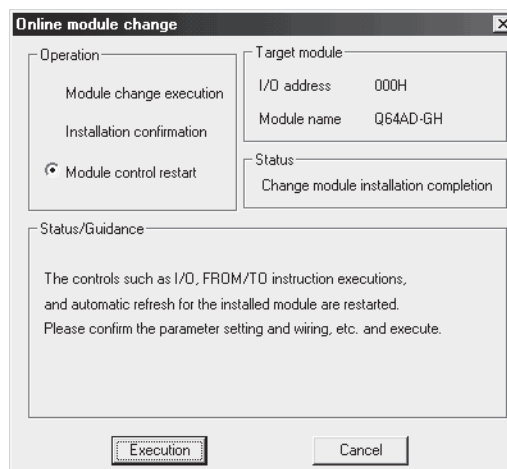

- (b) Click the [OK] button to leave the "Online module change" mode.



(c) Click the [Close] button to close the System monitor screen.

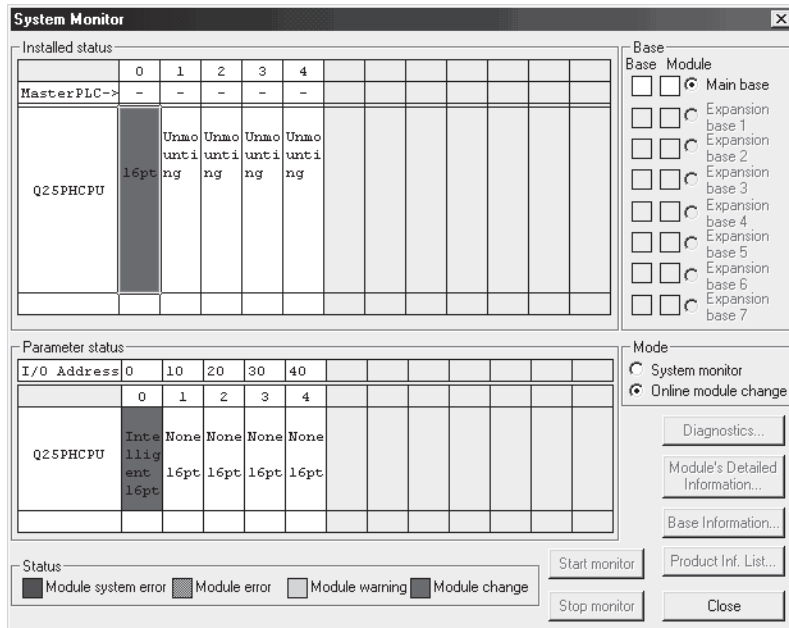

(d) Monitor the digital output values (buffer memory addresses 11 to 14, 54 to 62, Un\G11 to Un\G14, Un\G54 to Un\G62) to check whether proper conversion has been made or not.

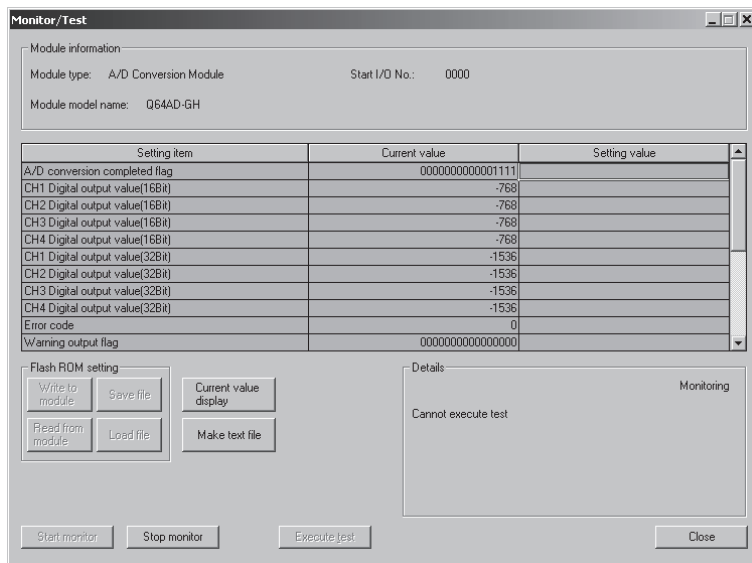

(5) Resumption of control

- (a) After choosing [Diagnosis] - [Online module change] on GX Developer to redisplay the "Online module change" screen, click the [Execution] button to resume control. Module READY (X0) turns on.

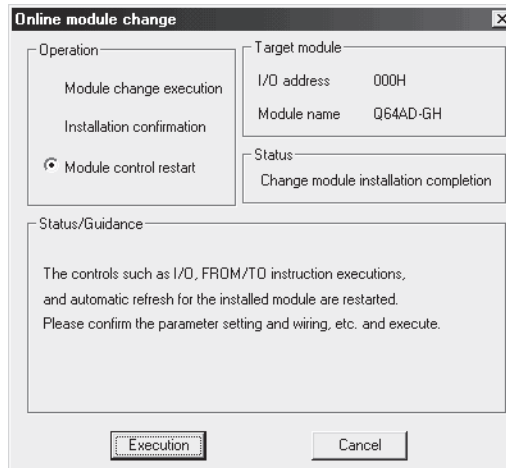

- (b) The "Online module change completed" screen appears.



7.3.2 When industrial shipment setting is used and initial setting was made with sequence program

(1) Conversion disable

(a) Disable the conversion by the following procedures.

- 1) Set the A/D conversion enable/disable setting (buffer memory address 0: Un\G0) for all channel conversion disable (F_H).
- 2) Turn on Operating condition setting request (Y9) to stop the conversion.
- 3) Operating condition setting completed flag (X9) is turned off.
- 4) Check that the conversion stops with the actual analog output value.
- 5) Turn off Operating condition setting request (Y9).

The screenshot shows the 'Device test' window with the following settings:

- Bit device:** Device: Y9. Buttons: FORCE ON, FORCE OFF, Toggle force. Close, Hide history.
- Word device/buffer memory:**
 - Device: (empty)
 - Buffer memory Module start I/O: 0 (Hex)
 - Address: 0 (DEC)
 - Setting value: F (HEX), 16 bit integer. Set.
- Program:** Label reference program: MAIN.
- Execution history:**

Device	Setting condition
Y9	Force ON
Module start:0 Address:0(D)	F(H)
Y9	Force OFF

 Find, Find next, Re-setting, Clear.

(The screen shows the setting example of the Q64AD-GH.)

(2) Dismounting of module

- (a) After choosing [Diagnosis] - [Online module change] on GX Developer to enter the "Online module change" mode, double-click the module to be changed online to display the "Online module change" screen.

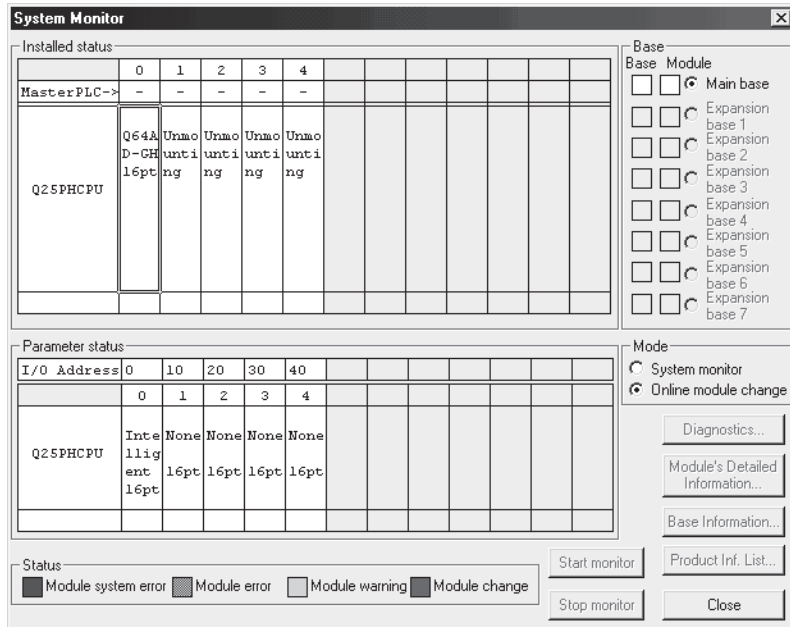

- (b) Click the "Execution" button to enable a module change.

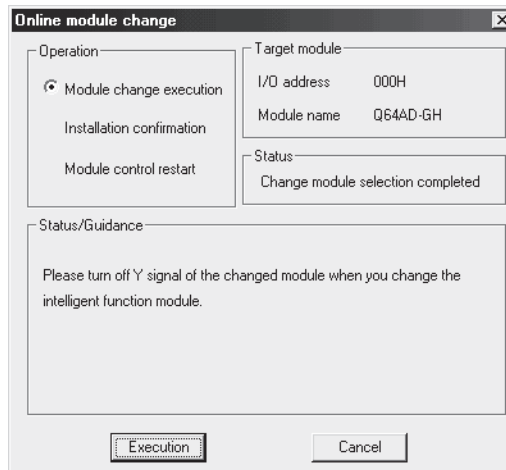

If the following error screen appears, click the [OK] button, dismount the module as-is, and mount a new module.



- (c) After confirming that the "RUN" LED of the module has turned off, remove the terminal block and dismount the module.

POINT	Always dismount the module. If mounting confirmation is made without the module being dismounted, the module will not start properly and the "RUN" LED will not be lit.
--------------	---

(3) Mounting of new module

- (a) Mount a new module to the same slot and install the terminal block.
- (b) After mounting the module, click the [Execution] button and make sure that the "RUN" LED is lit. Module ready (X0) remains OFF.

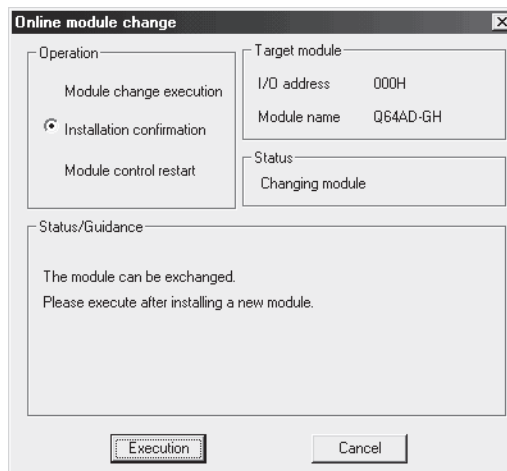

(4) Operation check

- (a) To make an operation check, click the [Cancel] button to cancel control resumption.

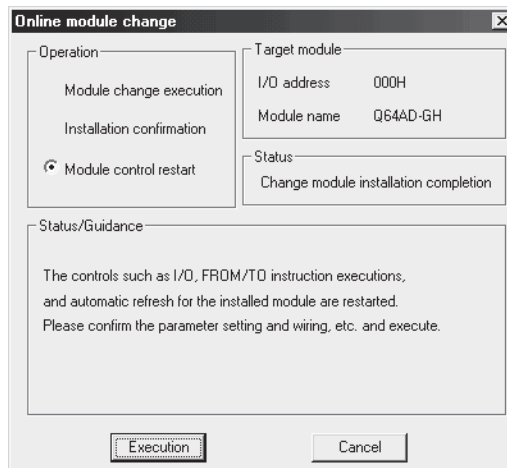

- (b) Click the [OK] button to leave the "Online module change" mode.

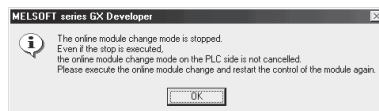

- (c) Click the [Close] button to close the System monitor screen.

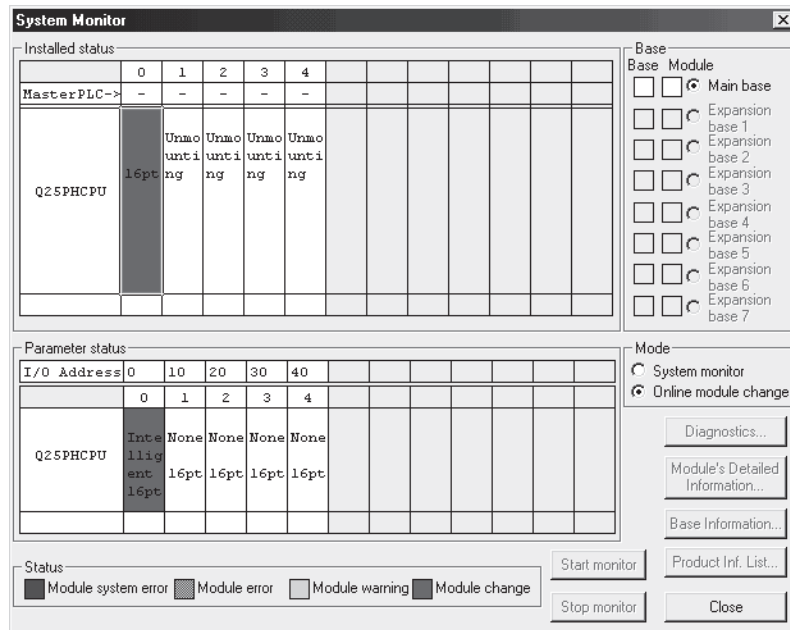

- (d) Set the channel for use to conversion enable in A/D conversion enable/disable setting (buffer memory address 0: Un\G0), and then turn on and off Operating condition setting request (Y9). Monitor the digital output values (buffer memory addresses 11 to 14, 54 to 62: Un\G11 to Un\G14, Un\G54 to Un\G62) to check whether proper conversion has been made or not.
- (e) Since the new module is in a default status, it must be initialized by a sequence program after control resumption.
Before performing initialization, check whether the contents of the initialization program are correct or not.
- 1) Normal system configuration
The sequence program should perform initialization on the leading edge of Module READY (X9) of the A/D converter module.
When control resumption is executed, Module READY (X0) turns ON and initialization is performed. (If the sequence program performs initialization only one scan after RUN, initialization is not performed.)
 - 2) When used on remote I/O network
Insert a user device that will execute initialization at any timing (initialization request signal) into the sequence program. After control resumption, turn ON the initialization request signal to perform initialization. (If the sequence program performs initialization only one scan after a data link start of the remote I/O network, initialization is not performed.)

(5) Resumption of control

- (a) After choosing [Diagnosis] - [Online module change] on GX Developer to redisplay the "Online module change" screen, click the [Execution] button to resume control. Module READY (X0) turns on.

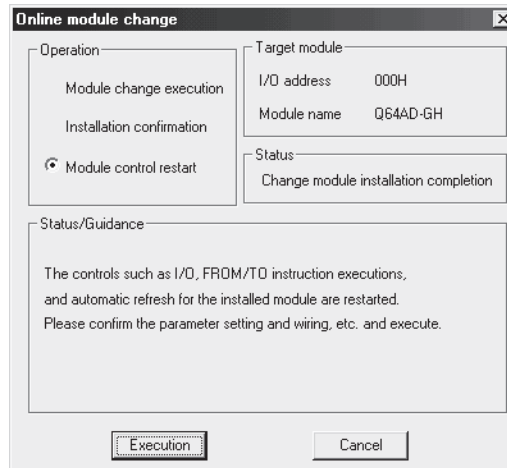

- (b) The "Online module change completed" screen appears.



7.3.3 When user range setting is used and initial setting was made with GX Configurator-AD (other system is available)

(1) Conversion disable

(a) Disable the conversion by the following procedures.

- 1) Set the A/D conversion enable/disable setting (buffer memory address 0: Un\G0) for all channel conversion disable (F_H).
- 2) Turn on Operating condition setting request (Y9) to stop the conversion.
- 3) Operating condition setting completed flag (X9) is turned off.
- 4) Check that the conversion stops with the actual analog output value.
- 5) Turn off Operating condition setting request (Y9).

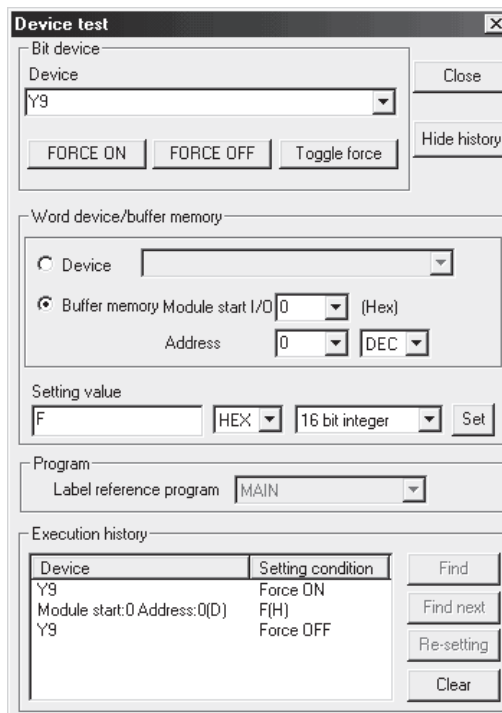

(The screen shows the setting example of the Q64AD-GH.)

(2) Dismounting of module

- (a) After choosing [Diagnosis] - [Online module change] on GX Developer to enter the "Online module change" mode, double-click the module to be changed online to display the "Online module change" screen.

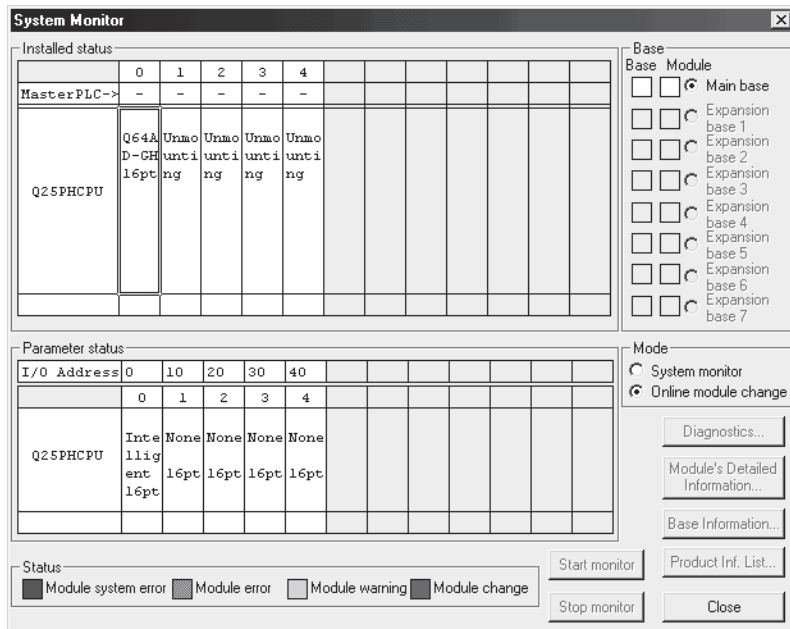

- (b) Click the "Execution" button to enable a module change.

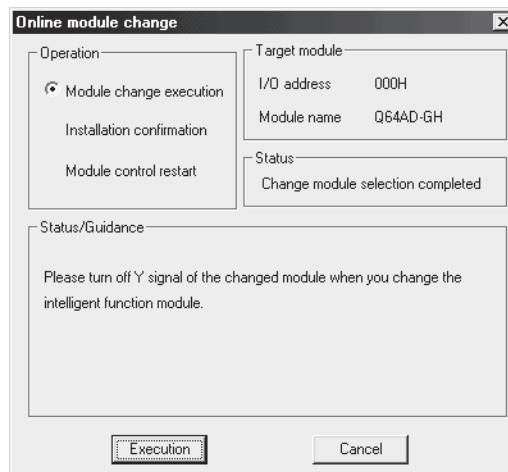

If the following error screen appears, the user range cannot be saved. Click the [OK] button, dismount the module as-is, and perform the operation in Section 7.3.4 (2) (c) and later.



- (c) After confirming that the "RUN" LED of the module has turned off, remove the terminal block and dismount the module.

POINT

Always dismount the module. If mounting confirmation is made without the module being dismounted, the module will not start properly and the "RUN" LED will not be lit.

(3) Mounting of new module

- (a) Mount the dismounted module and new module to the other system.
- (b) Using the G(P).OGLOAD instruction, save the user set values to the CPU device. Refer to Appendix 1.2 for the G(P).OGLOAD instruction.
- (c) Using the G(P).OGSTOR instruction, restore the user set values to the module. Refer to Appendix 1.3 for the G(P).OGSTOR instruction.
- (d) Dismount the new module from the other system, mount it to the slot from where the old module was dismounted in the original system, and install the terminal block.
- (e) After mounting the module, click the [Execution] button and make sure that the "RUN" LED is lit. Module ready (X0) remains OFF.

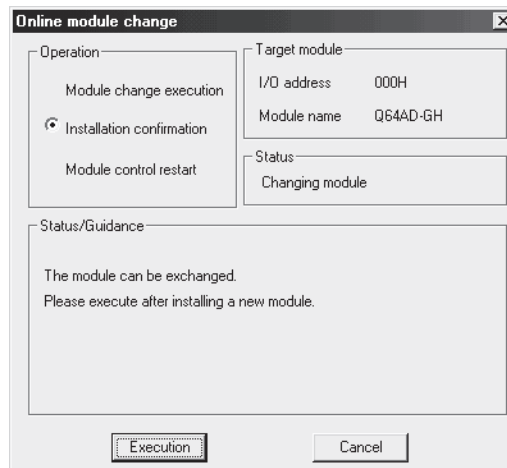

(4) Operation check

- (a) To make an operation check, click the [Cancel] button to cancel control resumption.

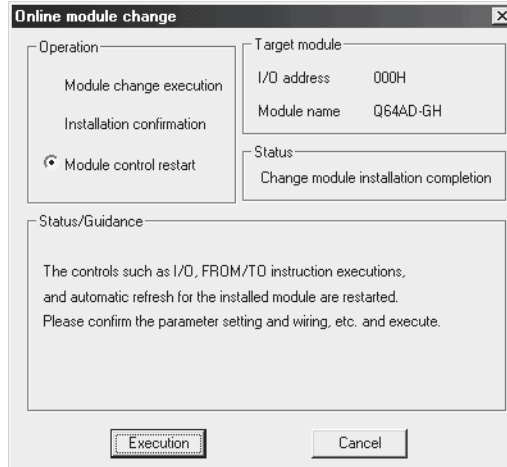

- (b) Click the [OK] button to leave the "Online module change" mode.

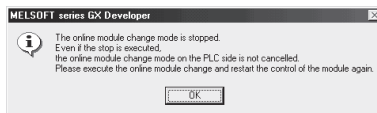

- (c) Click the [Close] button to close the System monitor screen.

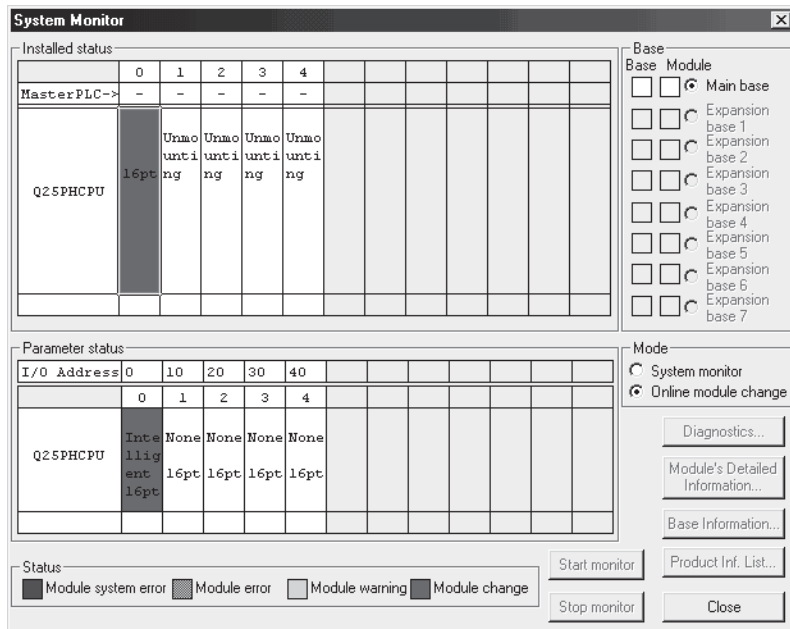

- (d) Monitor the digital output values (buffer memory addresses 11 to 14, 54 to 62, Un\G11 to Un\G14, Un\G54 to Un\G62) to check whether proper conversion has been made or not.

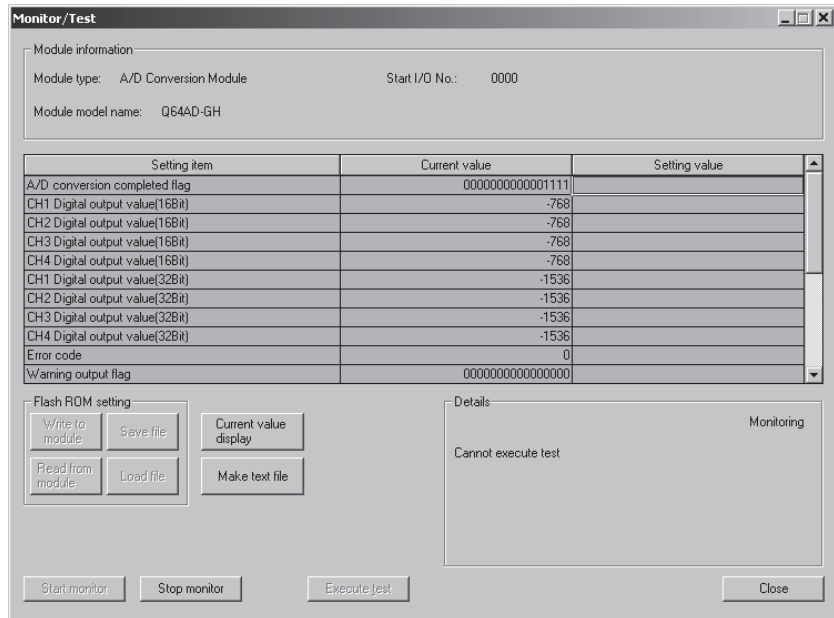

(5) Resumption of control

- (a) After choosing [Diagnosis] - [Online module change] on GX Developer to redisplay the "Online module change" screen, click the [Execution] button to resume control. Module READY (X0) turns on.

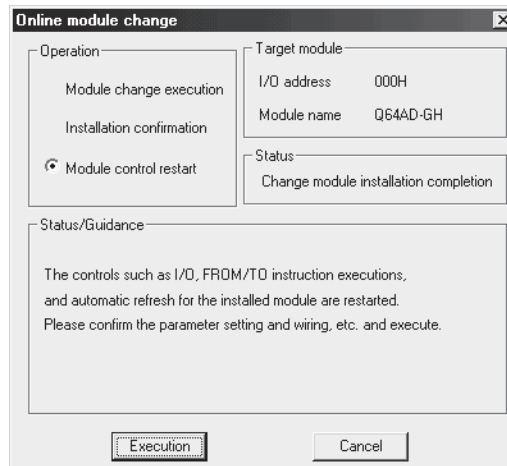

- (b) The "Online module change completed" screen appears.



7.3.4 When user range setting is used and initial setting was made with GX Configurator-AD (other system is unavailable)

(1) Conversion disable

- (a) On the Operating condition setting screen of GX Configurator-AD, set "Disable" in the Setting value field of CH□ A/D conversion enable/disable setting, and click the [Execute test] button.

Setting item	Current value	Setting value
CH1 A/D conversion enable/disable setting	Enable	Disable
CH1 Averaging process specification	Sampling	Sampling
CH1 Average time/Average number of times/ Move average/Time constant settings (Sampling: 0, Time averaging: 40 to 5000ms Count averaging: 4 to 500, Move averaging: 2 to 60 Primary delay filter: 10 to 5000ms)	0	0
CH1 Warning output setting (Process alarm setting)	Disable	Disable
CH1 Warning output flag process alarm lower limit value	Normal	
CH1 Warning output flag process alarm	Normal	

- (b) After making sure that the indication in the Current value field of CH□ A/D conversion enable/disable setting is "Disable", change the Setting value field of Operating condition setting request to "Setting request", and click the [Execute test] button to stop conversion. Monitor the A/D conversion completion flag (buffer memory address 10: Un\G10) and confirm that conversion has stopped.

Setting item	Current value	Setting value
CH1 Process alarm upper upper limit value	0	0
CH1 Warning output setting (Rate alarm setting)	Disable	Disable
CH1 Warning output flag rate alarm lower limit value	Normal	
CH1 Warning output flag rate alarm upper limit value	Normal	
CH1 Rate alarm lower limit value	0	0
CH1 Rate alarm upper limit value	0	0
CH1 Rate alarm warning detection period	10	10
CH1 Input signal error detection flag	Normal	
CH1 Input signal error detection setting	Disable	Disable
CH1 Input signal error detection setting value	50	50
Operating condition setting request	No request	No request

- (c) If the saved buffer memory contents are not yet prerecorded, record them in the following procedure.
- 1) Display the pass data screen of GX Configurator-AD.
 - 2) Set the pass data classification setting*¹ and make a pass data read request. (Refer to Section 5.6.3, 5.6.4)
 - 3) Compare the current values of the industrial shipment settings and user range settings offset/gain values with those of the range reference table. Refer to Section 7.4 for the range reference table.
 - 4) If the values are proper, record the offset/gain values of the pass data classification setting, industrial shipment settings and user range settings.

* 1: The Q62AD-DGH does not require the setting and recording of the pass data classification setting.

POINT
If the buffer memory values compared with the reference table are not proper, save and restoration of the user range cannot be executed. Before executing module control resumption, make offset/gain setting in the GX Configurator-AD. (Refer to Section 5.6.2.) Note that if module control is resumed without offset/gain setting being made, operation will be performed with the default values.

(2) Dismounting of module

- (a) After choosing [Diagnosis] - [Online module change] on GX Developer to enter the "Online module change" mode, double-click the module to be changed online to display the "Online module change" screen.

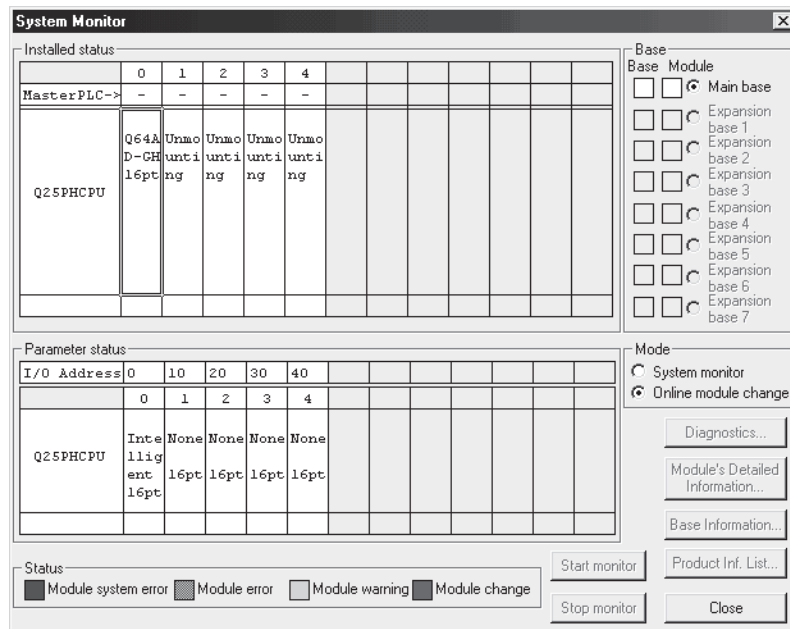

- (b) Click the "Execution" button to enable a module change.

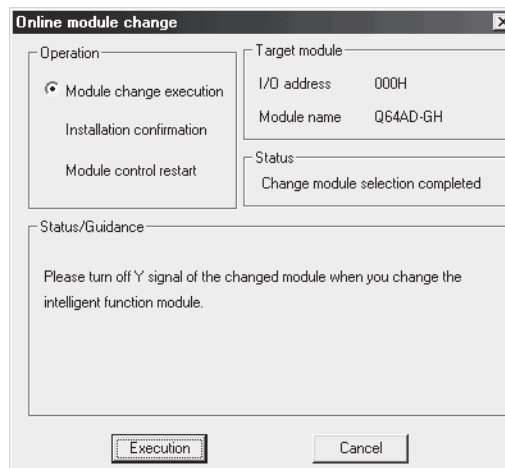

If the following error screen appears, the user range cannot be saved. Click the [OK] button, dismount the module as-is, and perform the operation in Section (2) (c) and later.

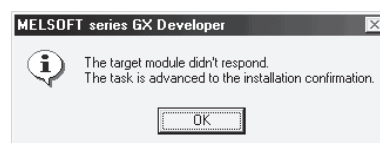

- (c) After confirming that the "RUN" LED of the module has turned off, remove the terminal block and dismount the module.

POINT

<p>Always dismount the module. If mounting confirmation is made without the module being dismounted, the module will not start properly and the "RUN" LED will not be lit.</p>
--

(3) Mounting of new module

- (a) Mount a new module to the same slot and install the terminal block.
- (b) After mounting the module, click the [Execution] button and make sure that the "RUN" LED is lit. Module ready (X0) remains OFF.

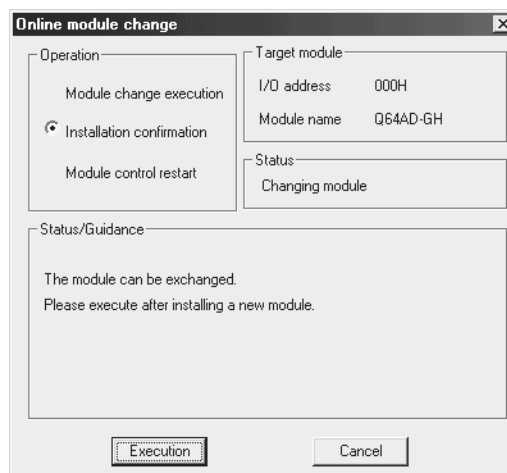

(4) Operation check

- (a) To make an operation check, click the [Cancel] button to cancel control resumption.

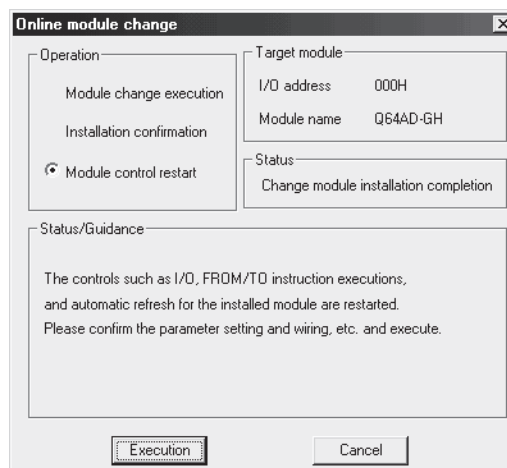

- (b) Click the [OK] button to leave the "Online module change" mode.

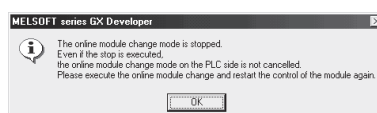

- (c) Click the [Close] button to close the System monitor screen.

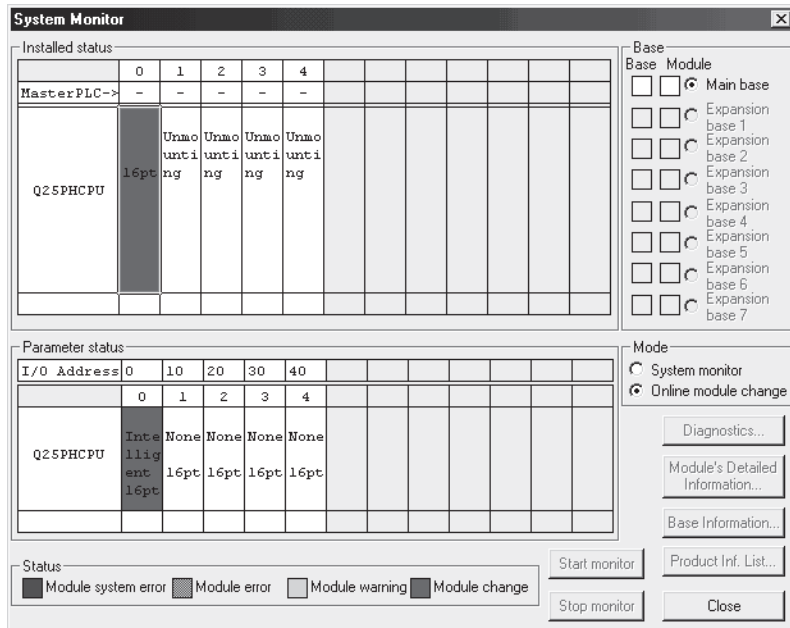

- (d) On the pass data screen of GX Configurator-AD, set the prerecorded values and make a pass data write request. (Refer to Section 5.6.3, 5.6.4.)
- (e) Monitor the digital output values (buffer memory addresses 11 to 14, 54 to 62, Un\G11 to Un\G14, Un\G54 to Un\G62) to check whether proper conversion has been made or not.

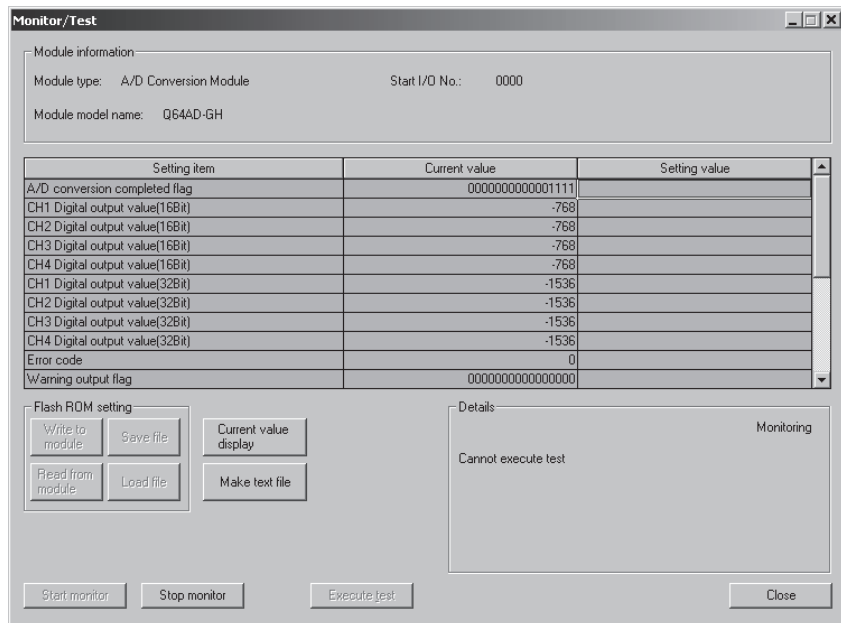

(5) Resumption of control

- (a) After choosing [Diagnosis] - [Online module change] on GX Developer to redisplay the "Online module change" screen, click the [Execution] button to resume control. Module READY (X0) turns on.

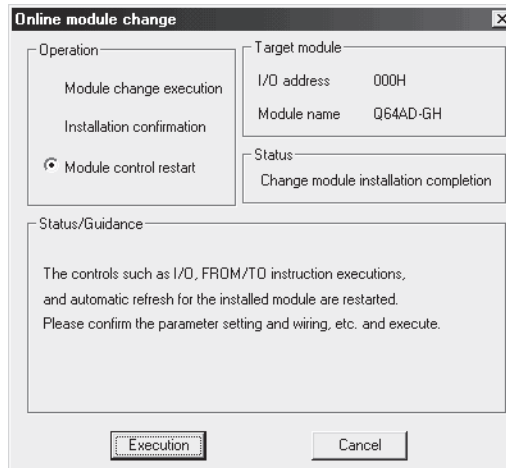

- (b) The "Online module change completed" screen appears.



7.3.5 When user range setting is used and initial setting was made with sequence program (other system is available)

(1) Conversion disable

(a) Disable the conversion by the following procedures.

- 1) Set the A/D conversion enable/disable setting (buffer memory address 0: Un\G0) for all channel conversion disable (F_H).
- 2) Turn on Operating condition setting request (Y9) to stop the conversion.
- 3) Operating condition setting completed flag (X9) is turned off.
- 4) Check that the conversion stops with the actual analog output value.
- 5) Turn off Operating condition setting request (Y9).

The screenshot shows the 'Device test' window with the following configuration:

- Bit device:** Device: Y9. Buttons: FORCE ON, FORCE OFF, Toggle force.
- Word device/buffer memory:**
 - Device: (empty)
 - Buffer memory Module start I/O: 0 (Hex)
 - Address: 0 (DEC)
 - Setting value: F (HEX), 16 bit integer.
- Program:** Label reference program: MAIN
- Execution history:**

Device	Setting condition
Y9	Force ON
Module start:0 Address:0(D)	F(H)
Y9	Force OFF

(The screen shows the setting example of the Q64AD-GH.)

(2) Dismounting of module

- (a) After choosing [Diagnosis] - [Online module change] on GX Developer to enter the "Online module change" mode, double-click the module to be changed online to display the "Online module change" screen.

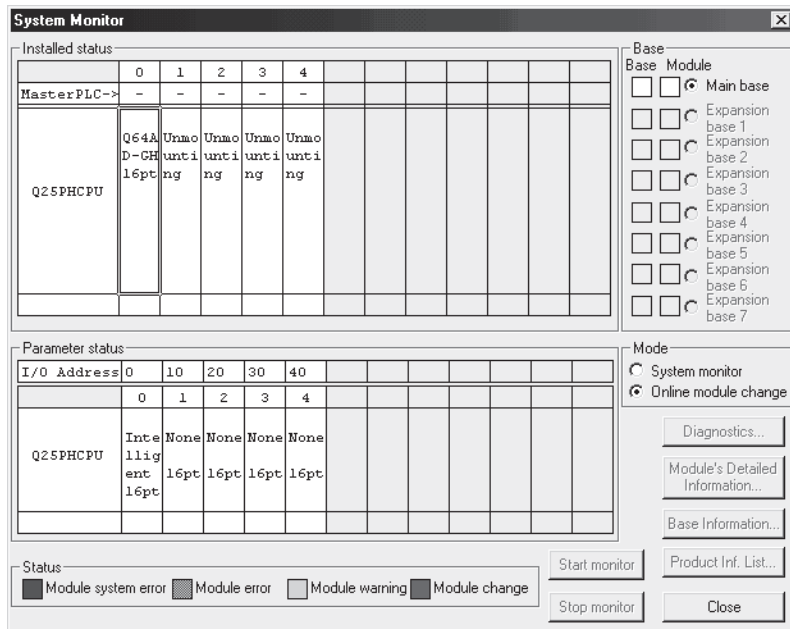

- (b) Click the "Execution" button to enable a module change.

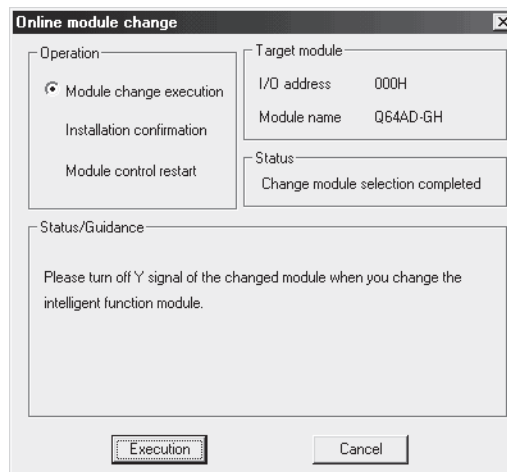

If the following error screen appears, the user range cannot be saved. Click the [OK] button, dismount the module as-is, and perform the operation in Section 7.3.6 (2) (c) and later.

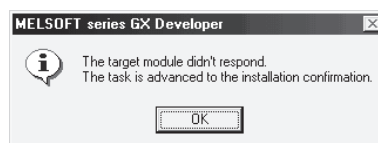

- (c) After confirming that the "RUN" LED of the module has turned off, remove the terminal block and dismount the module.

POINT

Always dismount the module. If mounting confirmation is made without the module being dismounted, the module will not start properly and the "RUN" LED will not be lit.

(3) Mounting of new module

- (a) Mount the dismounted module and new module to the other system.
- (b) Using the G(P).OGLOAD instruction, save the user set values to the CPU device. Refer to Appendix 1.2 for the G(P).OGLOAD instruction.
- (c) Using the G(P).OGSTOR instruction, restore the user set values to the module. Refer to Appendix 1.3 for the G(P).OGSTOR instruction.
- (d) Dismount the new module from the other system, mount it to the slot from where the old module was dismounted in the original system, and install the terminal block.
- (e) After mounting the module, click the [Execution] button and make sure that the "RUN" LED is lit. Module ready (X0) remains OFF.

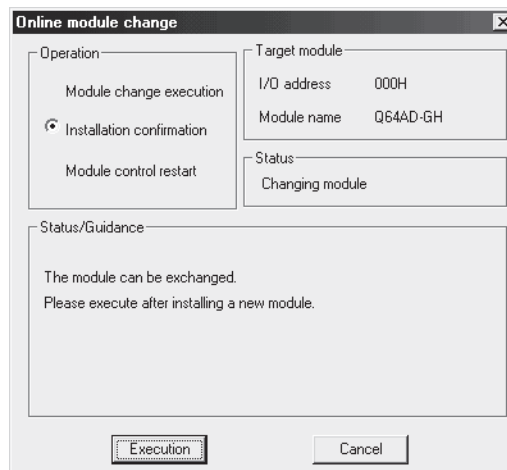

(4) Operation check

- (a) To make an operation check, click the [Cancel] button to cancel control resumption.

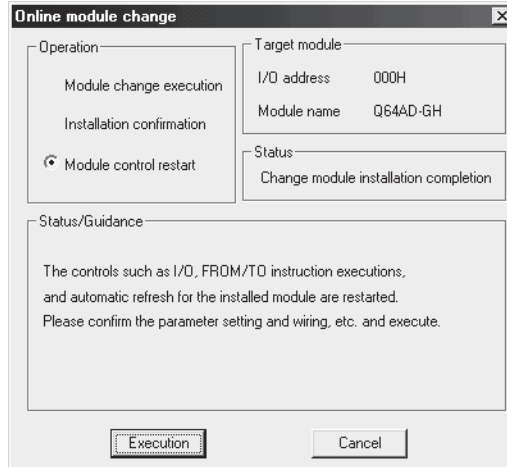

- (b) Click the [OK] button to leave the "Online module change" mode.

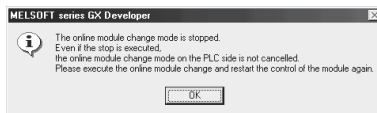

- (c) Click the [Close] button to close the System monitor screen.

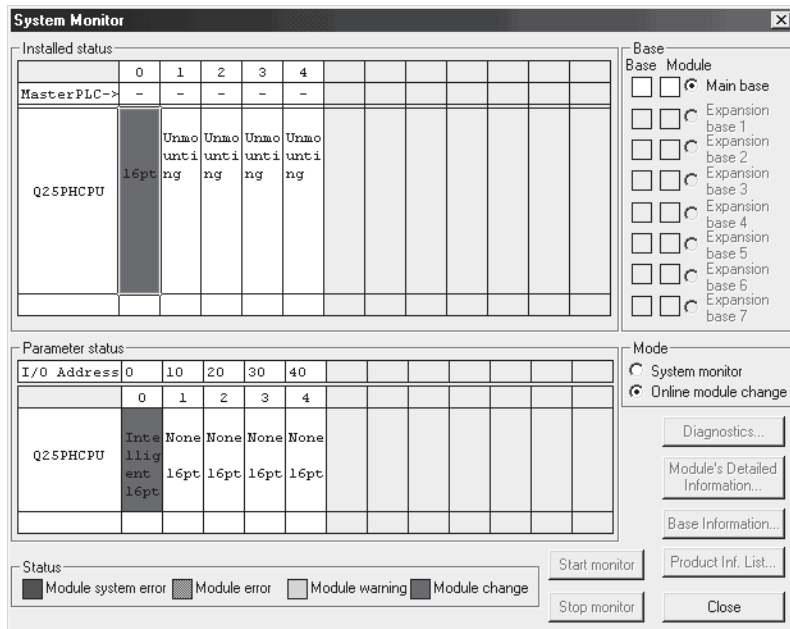

- (d) Set the channel for use to conversion enable in A/D conversion enable/disable setting (buffer memory address 0: Un\G0), and then turn on and off Operating condition setting request (Y9). Monitor the digital output values (buffer memory addresses 11 to 14, 54 to 62, Un\G11 to Un\G14, Un\G54 to Un\G62) to check whether proper conversion has been made or not.

- (e) Since the new module is in a default status, it must be initialized by a sequence program after control resumption.

Before performing initialization, check whether the contents of the initialization program are correct or not.

- 1) Normal system configuration

The sequence program should perform initialization on the leading edge of Module READY (X9) of the A/D converter module.

When control resumption is executed, Module READY (X0) turns ON and initialization is performed. (If the sequence program performs initialization only one scan after RUN, initialization is not performed.)

- 2) When used on remote I/O network

Insert a user device that will execute initialization at any timing (initialization request signal) into the sequence program. After control resumption, turn ON the initialization request signal to perform initialization. (If the sequence program performs initialization only one scan after a data link start of the remote I/O network, initialization is not performed.)

(5) Resumption of control

- (a) After choosing [Diagnosis] - [Online module change] on GX Developer to redisplay the "Online module change" screen, click the [Execution] button to resume control. Module READY (X0) turns on.

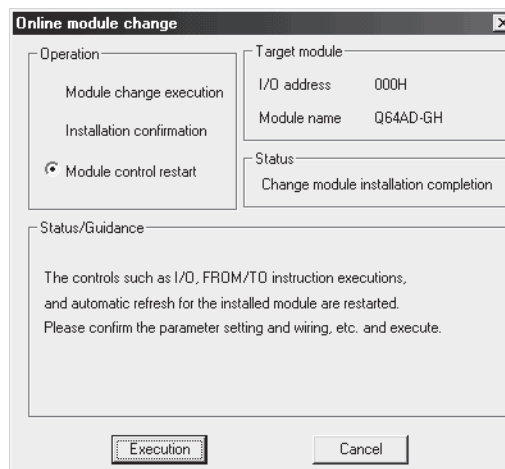

- (b) The "Online module change completed" screen appears.



7.3.6 When user range setting is used and initial setting was made with sequence program (other system is unavailable)

(1) Conversion disable

(a) Disable the conversion by the following procedures.

- 1) Set the A/D conversion enable/disable setting (buffer memory address 0: Un\G0) for all channel conversion disable (F_H).
- 2) Turn on Operating condition setting request (Y9) to stop the conversion.
- 3) Operating condition setting completed flag (X9) is turned off.
- 4) Check that the conversion stops with the actual analog output value.
- 5) Turn off Operating condition setting request (Y9).

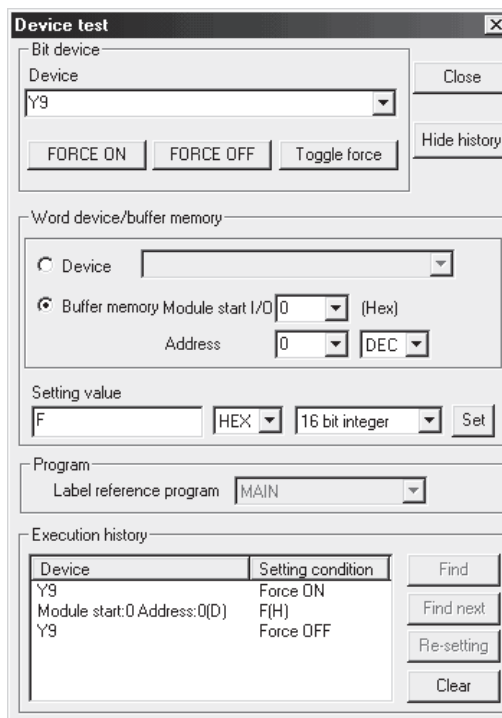

(The screen shows the setting example of the Q64AD-GH.)

- (b) If the saved buffer memory contents are not yet prerecorded, record them in the following procedure.
 - 1) Make the pass data classification setting *1 (buffer memory address 200: Un\G200).
 - 2) Turn operating condition setting request (Y9) from OFF to ON.
 - 3) Compare the offset/gain values of the industrial shipment settings and user range settings (buffer memory addresses 202 to 233: Un\G202 to Un\G233) with the range reference table. Refer to Section 7.4 for the range reference table.
 - 4) If the values are proper, record the offset/gain values of the pass data classification setting *1, industrial shipment settings and user range settings.

*1: The Q62AD-DGH does not require the setting and recording of the pass data classification setting.

POINT

If the buffer memory values compared with the reference table are not proper, save and restoration of the user range cannot be executed. Before resuming module control, follow the flowchart in Section 4.6.1 for the Q64AD-GH, or follow the flowchart in Section 4.6.2 for the Q62AD-DGH, and make offset/gain setting in the device test of GX Developer.

Perform mode switching by making the setting of the mode switching setting (buffer memory addresses 158, 159: Un\G158, Un\G159) and turning operating condition setting request (Y9) from OFF to ON.

Note that if module control is resumed without offset/gain setting being made, operation will be performed with the default values.

(2) Dismounting of module

- (a) After choosing [Diagnosis] - [Online module change] on GX Developer to enter the "Online module change" mode, double-click the module to be changed online to display the "Online module change" screen.

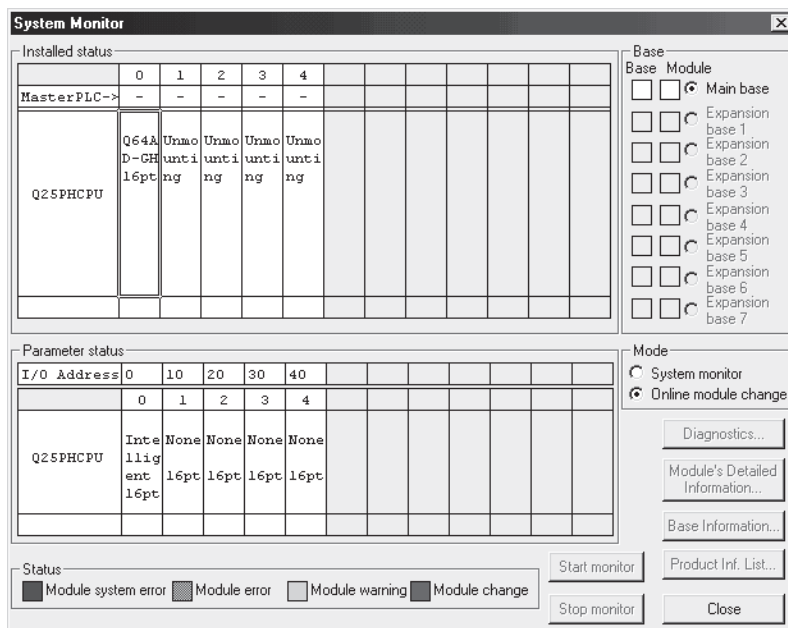

- (b) Click the "Execution" button to enable a module change.

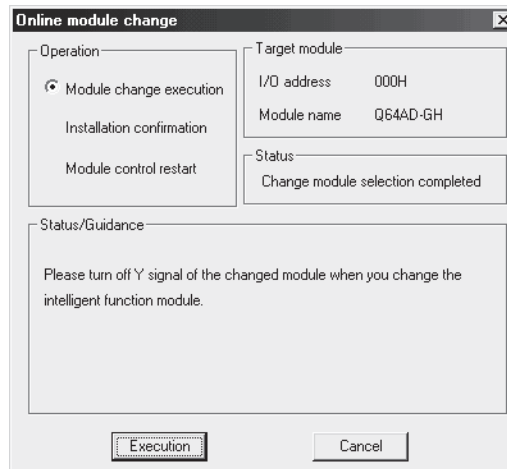

If the following error screen appears, the user range cannot be saved. Click the [OK] button, dismount the module as-is, and perform the operation in Section (2) (c) and later.



- (c) After confirming that the "RUN" LED of the module has turned off, remove the terminal block and dismount the module.

POINT

Always dismount the module. If mounting confirmation is made without the module being dismounted, the module will not start properly and the "RUN" LED will not be lit.

(3) Mounting of new module

- (a) Mount a new module to the same slot and install the terminal block.
- (b) After mounting the module, click the [Execution] button and make sure that the "RUN" LED is lit. Module ready (X0) remains OFF.

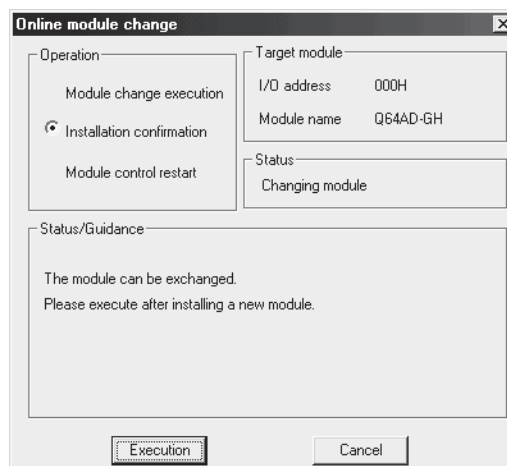

(4) Operation check

- (a) To make an operation check, click the [Cancel] button to cancel control resumption.

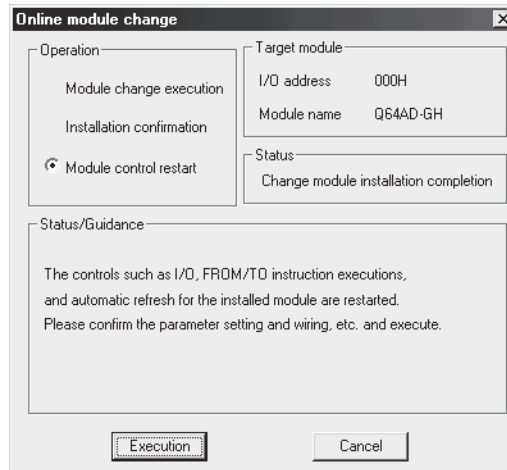

- (b) Click the [OK] button to leave the "Online module change" mode.

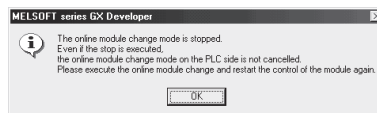

- (c) Click the [Close] button to close the System monitor screen.

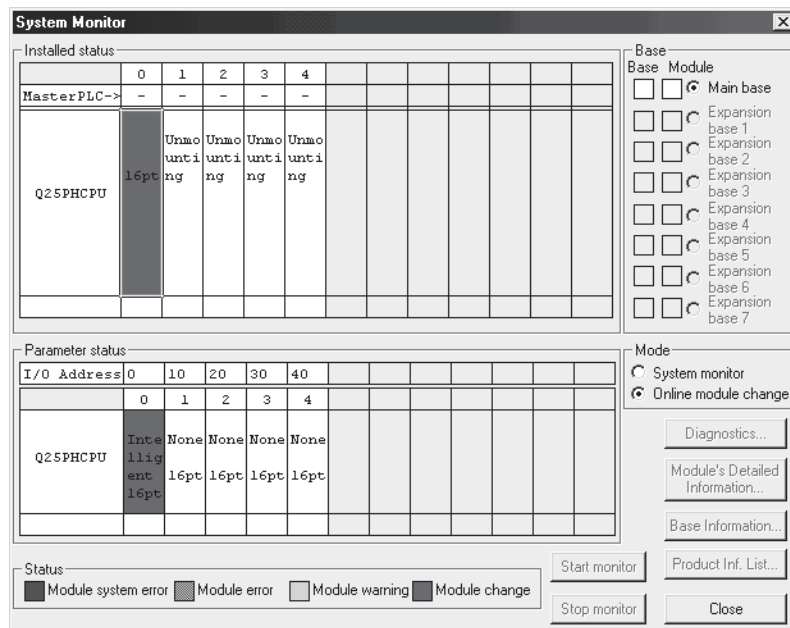

- (d) Choose [Online] - [Debug] - [Device test] on GX Developer and set the prerecorded values to the buffer memory.
- (e) Turn the user range writing request (YA) from OFF to ON to restore the user set values to the module. After confirming that the offset/gain setting mode status flag (XA) is ON, turn OFF the user range write request (YA).

- (f) Set the channel for use to conversion enable in A/D conversion enable/disable setting (buffer memory address 0: Un\G0), and then turn on and off Operating condition setting request (Y9). Monitor the digital output values (buffer memory addresses 11 to 14, 54 to 62, Un\G11 to Un\G14, Un\G54 to Un\G62) to check whether proper conversion has been made or not.
- (g) Since the new module is in a default status, it must be initialized by a sequence program after control resumption.
Before performing initialization, check whether the contents of the initialization program are correct or not.
- 1) Normal system configuration
The sequence program should perform initialization on the leading edge of Module READY (X9) of the A/D converter module.
When control resumption is executed, Module READY (X0) turns ON and initialization is performed. (If the sequence program performs initialization only one scan after RUN, initialization is not performed.)
 - 2) When used on remote I/O network
Insert a user device that will execute initialization at any timing (initialization request signal) into the sequence program. After control resumption, turn ON the initialization request signal to perform initialization. (If the sequence program performs initialization only one scan after a data link start of the remote I/O network, initialization is not performed.)
- (5) Resumption of control
- (a) After choosing [Diagnosis] - [Online module change] on GX Developer to redisplay the "Online module change" screen, click the [Execution] button to resume control. Module READY (X0) turns on.

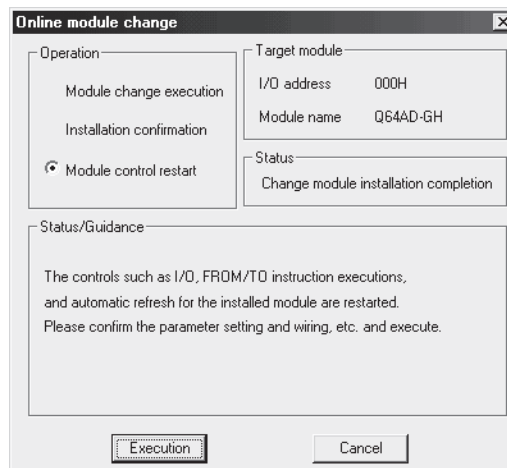

- (b) The "Online module change completed" screen appears.



7.4 Range Reference Table

The range reference tables are given below.

- (1) Reference table for offset/gain values of industrial shipment settings (buffer memory addresses 202 to 217: Un\G202 to Un\G217)

- (a) For Q64AD-GH

The reference values change depending on the setting of the pass data classification setting (buffer memory address 200: Un\G200).

Address (Decimal)				Description	Pass data classification setting	Reference value (Hexadecimal)
CH1	CH2	CH3	CH4			
202	206	210	214	Industrial shipment settings offset value (L) (H)	Voltage specified	Approx. 0H
203	207	211	215		Current specified	Approx. 0H
204	208	212	216	Industrial shipment settings gain value (L) (H)	Voltage specified	Approx. 33E140H
205	209	213	217		Current specified	Approx. 19F0A0H

- (b) For Q62AD-DGH

Address (Decimal)		Description	Reference value (Hexadecimal)
CH1	CH2		
202	206	Industrial shipment settings offset value (L) (H)	Approx. FA000H
203	207		
204	208	Industrial shipment settings gain value (L) (H)	Approx. 4E2000H
205	209		

- (2) Reference table for user range settings offset/gain values (buffer memory addresses 218 to 233: Un\G218 to Un\G233)

Example) When the offset value of the Q64AD-GH channel 1 is 1V and its gain value is 5V, the reference value of the CH1 user range settings offset value (buffer memory addresses 218, 219: Un\G218, Un\G219) is approximately 53020_H, and the reference value of the CH1 user range settings gain value (buffer memory addresses 220, 221: Un\G220, Un\G221) is approximately 19F0A0_H.

- (a) For Q64AD-GH

Offset/gain value		Reference value (Hexadecimal)
Voltage	0V	Approx. 0H
	1V	Approx. 53020H
	5V	Approx. 19F0A0H
	10V	Approx. 33E140H
Current	0mA	Approx. 0H
	4mA	Approx. 53020H
	20mA	Approx. 19F0A0H

- (b) For Q62AD-DGH

Offset/gain value		Reference value (Hexadecimal)
0mA		Approx. 0H
4mA		Approx. FA000H
20mA		Approx. 4E2000H

7.5 Precautions for Online Module Change

The following are the precautions for online module change.

- (1) Always perform an online module change in the correct procedure. A failure to do so can cause a malfunction or failure.
- (2) If an online module change is made with the user range setting, the accuracy after that will fall to about less than three times of the accuracy before that.
Re-set the offset/gain values as necessary.
- (3) Avoid the following operations during online module change. Doing so may cause the A/D conversion module to fail to operate normally.
 - (a) Powering OFF the programmable controller CPU
 - (b) Resetting the programmable controller CPU

8 TROUBLESHOOTING

The following section explains the types of errors that may occur when the A/D converter module is used, and how to troubleshoot such errors.

8.1 Error Code List

If an error occurs in the A/D converter module while writing to or reading data from the programmable controller CPU, the applicable error code is written to buffer memory address 19 (Un\G19).

Table 8.1 Error code list (1/3)

Error code (decimal)	Error description	Processing
10□	The input range is set an illegal value using the intelligent function module switch in GX Developer. □ indicates the channel number set incorrectly.	Set the correct parameter value in the parameter setting of GX Developer. (See Section 4.5.)
111	Module error at startup.	Turn the power OFF and ON again. If the error occurs again, the module may be malfunctioning. Contact the nearest distributor or branch office with the description of the problem.
112	The setting of the intelligent function module switch 5 is other than 0.	Set the correct parameter value in the parameter setting of GX Developer. (See Section 4.5.)
161* ¹	The G(P).OGSTOR instruction was executed in the offset/gain setting mode.	Do not execute the G(P).OGSTOR instruction in the offset/gain setting mode.
162* ²	<ul style="list-style-type: none"> The G(P).OGSTOR instruction was executed consecutively. At the time of offset/gain setting, a set value was written to the E²PROM 26 or more times. 	<ul style="list-style-type: none"> Execute the G(P).OGSTOR instruction only once for one module. At the time of offset/gain setting, write a set value only once at one time.
163* ²	The G(P).OGSTOR instruction was executed for the model that differs from the model for which the G(P).OGLOAD instruction had been executed.	Execute the G(P).OGLOAD and G(P).OGSTOR instructions for the same model.
20□* ³	The average time setting at any of the buffer memory addresses 1 to 4 (Un\G1 to Un\G4) is outside the 40 to 5000ms range. □ indicates the channel number set incorrectly.	Reset the average time setting to within 40 to 5000ms.
30□* ³	The average count setting at any of the buffer memory addresses 1 to 4 (Un\G1 to Un\G4) is outside the 4 to 500 times range. □ indicates the channel number set incorrectly.	Reset the average count setting to within 4 to 500 times.
31□* ³	The move average count setting at any of the buffer memory addresses 1 to 4 (Un\G1 to Un\G4) is outside the 2 to 60 times range. □ indicates the channel number set incorrectly.	Reset the move average count setting to within 2 to 60 times.
32□* ³	The time constant setting of the primary delay filter at any of the buffer memory addresses 1 to 4 (Un\G1 to Un\G4) is outside the 10 to 5000 range. □ indicates the channel number set incorrectly.	Reset the time constant setting to within 10 to 5000.

Table 8.1 Error code list (2/3)

Error code (decimal)	Error description	Processing
33□* ³	The process alarm upper/lower limit value at any of the buffer memory addresses 86 to 117 (Un\G86 to Un\G117) is outside the -65536 to 65535 range. (When the extended mode is used, the process alarm upper or lower value at any of the buffer memory addresses 86 to 117 (Un\G86 to Un\G117) is outside the -65536 to 73535.) □ indicates the channel number set incorrectly.	Reset the process alarm upper/lower limit value to within -65536 to 65535. (When the extended mode is used, reset the process alarm upper or lower value within -65536 to 73535.)
34□* ³	The rate alarm upper/lower limit value at any of the buffer memory addresses 122 to 137 (Un\G122 to Un\G137) is outside the -65536 to 65535 range. □ indicates the channel number set incorrectly.	Reset the rate alarm upper/lower limit value to within -65536 to 65535.
35□* ³ (Q62AD-DGH only)	The A/D conversion starting time setting at any of the buffer memory addresses 5, 6 (Un\G5, Un\G6) is outside the 0 to 32767 range. □ indicates the channel number set incorrectly.	Reset the A/D conversion starting time setting to within 0 to 32767.
40□* ²	The offset value is equal to or greater than the gain value at the time of user range setting or user range restoration. □ indicates the error causing channel number.	Reset so that the offset value becomes smaller than the gain value.
500* ²	The offset/gain channels were set at the same time during offset and gain value settings, or both were set to 0.	Reset the contents of buffer memory addresses 22 and 23 (Un\G22 and Un\G23).
6△□* ³	The process alarm upper/lower limit values at the buffer memory addresses 86 to 117 (Un\G86 to Un\G117) are set contradictorily. □ indicates the channel number set incorrectly. △ indicates the following state. 2: Lower lower limit value > lower upper limit value 3: Lower upper limit value > upper lower limit value 4: Upper lower limit value > upper upper limit value	Reset the contents of the buffer memory addresses 86 to 117 (Un\G86 to Un\G117).
70□* ³	The rate alarm warning detection period at any of the buffer memory addresses 118 to 121 (Un\G118 to Un\G121) is outside the 10 to 5000ms range. □ indicates the channel number set incorrectly.	Reset the rate alarm warning detection period to within 10 to 5000ms.
71□* ³	After the rate alarm warning detection period at any of the buffer memory addresses 118 to 121 (Un\G118 to Un\G121) has been changed, the new rate alarm warning detection period is not a multiple of the corresponding time or count averaging conversion period. □ indicates the channel number set incorrectly.	Reset the rate alarm warning detection period so that it is a multiple of the time or count averaging conversion period.
72□* ³	After the time or count averaging setting at any of the buffer memory addresses 1 to 4 (Un\G1 to Un\G4) has been changed, the rate alarm warning detection period is not a multiple of the corresponding new time or count averaging conversion period. □ indicates the channel number set incorrectly.	Reset the time averaging or count averaging setting so that the corresponding rate alarm warning detection period is a multiple of the time or count averaging conversion period.

Table 8.1 Error code list (3/3)

Error code (decimal)	Error description	Processing
80□* ³	<p>When the "Same upper limit value/lower limit value" is selected for the input signal error detection extended setting,</p> <ul style="list-style-type: none"> The input signal error detection setting value at the buffer memory addresses 138 to 141 (Un\G138 to Un\G141) is outside the 0 to 250 range. <p>□ indicates the channel number set incorrectly.</p>	Reset the input signal error detection setting value to within 0 to 250.
	<p>When the "Different upper limit value/lower limit value" is selected for the input signal error detection extended setting,</p> <ul style="list-style-type: none"> The input signal error detection upper limit setting value at the buffer memory addresses 138 to 141 (Un\G138 to Un\G141) is outside the 0 to 251 range. The input signal error detection upper limit setting value at the buffer memory addresses 138 to 141 (Un\G142 to Un\G145) is outside the 0 to 251 range. <p>□ indicates the channel number set incorrectly.</p>	Reset the input signal error detection lower limit value and input signal error detection upper limit value within 0 to 251.

POINT

- (1) When two or more errors have occurred, the latest error found by the A/D converter module is stored.
- (2) The error codes indicated with *¹ are not written to Buffer memory address 19 (Un\G19). They are written to completion status area (S)+1 of the G(P).OGSTOR instruction.
- (3) The error codes indicated with *² can be cleared by turning on Error clear request (YF).
- (4) The error codes indicated with *³ can be cleared by performing one of the following two operations:
 - Turning on Error clear request (YF)
 - Turning on Operating condition setting request (Y9) after modifying the set value to be within the range.

8.2 Troubleshooting

8.2.1 When the "RUN" LED is flashing or turned off

(1) When flashing

Check item	Corrective action
Is the mode set to the offset/gain setting mode?	Reset switch 4 of the intelligent function module setting for GX Developer to the normal mode (see Section 4.5).

(2) When off

Check item	Corrective action
Is the power being supplied?	Confirm that the supply voltage for the power supply module is within the rated range.
Is the capacity of the power supply module adequate?	Calculate the current consumption of the CPU module, I/O module and intelligent function module mounted on the base unit to see if the power supply capacity is adequate.
Has a watchdog timer error occurred?	Reset the programmable controller CPU and verify that it is lit. If the RUN LED does not light even after doing this, the module may be malfunctioning. Contact the nearest distributor or branch office with a description of the problem.
Is the module correctly mounted on the base unit?	Check the mounting condition of the module.
Is a module change enabled during an online module change?	Refer to Chapter 7 and take corrective action.

8.2.2 When the "ERR." LED is on or flashing

Check item	Corrective action
Is an error being generated?	Confirm the error code and take corrective action described in Section 8.1.

8.2.3 When the "ALM" LED is on or flashing

(1) When on

Check item	Corrective action
Is a warning output being generated?	Check the warning output flag (buffer memory address 48: Un\G48).

(2) When flashing

Check item	Corrective action
Is an input signal error being generated?	Check the input signal error detection flag (buffer memory address 49: Un\G49).

8.2.4 When the digital output values cannot be read

Check item	Corrective action
Is 24VDC external supply power being supplied? (Q62AD-DGH only)	Check that the external supply power terminals (terminal Nos. 16, 17) are supplied with a 24VDC voltage.
Is there any fault with the analog signal lines such as disconnection (for the Q62AD-DGH, disconnection of the signal line with the 2-wire transmitter) or wire break?	Check for faulty condition of the lines visually and perform a continuity check of the signal lines.
Is the CPU module in the STOP status?	Set the CPU module to the RUN status.
Are the offset/gain settings correct?	Verify that the offset/gain settings are correct (see Sections 4.6 and 5.6.2). If the user range is being used, switch to a different default input range and check if A/D conversion is correctly performed. If it is correctly performed, redo the offset/gain settings.
Is the input range setting correct?	Check the buffer memory address 20 (Un\G20) in the monitor of GX Developer. If the input range setting is incorrect, redo the GX Developer intelligent function module switch setting (see Section 4.5).
Is the A/D conversion enable/disable setting for the channel to be used set to A/D conversion disabled?	Check the ON/OFF status with buffer memory 0 (Un\G0) in GX Developer system monitor and review the initial setting of the sequence program or utility package (see Section 3.4).
Is a large value set as the A/D conversion starting time setting? (Q62AD-DGH only)	Check the buffer memory addresses 5, 6 (Un\G5, Un\G6) in the monitor of GX Developer.
Has the operating condition setting request (Y9) been executed?	From GX Developer, turn the operating condition setting request (Y9) from ON to OFF to check that the digital output values are stored into the buffer memory addresses 11 to 14 (Un\G11 to Un\G14), 54 to 61 (Un\G54 to Un\G61). If so, review the initial setting of the Sequence program or utility package (see Section 3.3).
Are the (V+) and (I+) terminals connected in the case of current input? (Q64AD-GH only)	For current input, connect the (V+) and (I+) terminals, referring Section 4.4.2.

POINT

The module may be faulty if the digital output values cannot be read after proper corrective actions have been taken according to the above check items. Consult the nearest representative or branch.

8.2.5 When A/D conversion completed flag does not turn ON during use in normal mode

Check item	Corrective action
Is 24VDC external supply power being supplied? (Q62AD-DGH only)	Check that the external supply power terminals (terminal Nos. 16, 17) are supplied with a 24VDC voltage.
Is an input signal error being generated?	Check the input signal error detection flag (buffer memory address 49: Un\G49).

8.2.6 Checking the A/D converter module status using GX Developer system monitor

When the A/D converter module detail information is selected in GX Developer system monitor, error code, LED ON status and status of the intelligent function module switch setting can be checked.

(1) Operating GX Developer

[Diagnostics] → [System monitor] → Select the A/D conversion module checking the status. → Module Detailed Information

(2) Module Detail Information

(a) Checking the function version and product information

The function version and product information of the A/D converter module are displayed in the product information field.

(b) Checking the error code

The error code stored in buffer memory address 19 (Un\G19) of the A/D converter module is displayed in the Present Error field.

(When the Error History button is pressed, the contents displayed in the Present Error field are displayed in the No. 1 field.)

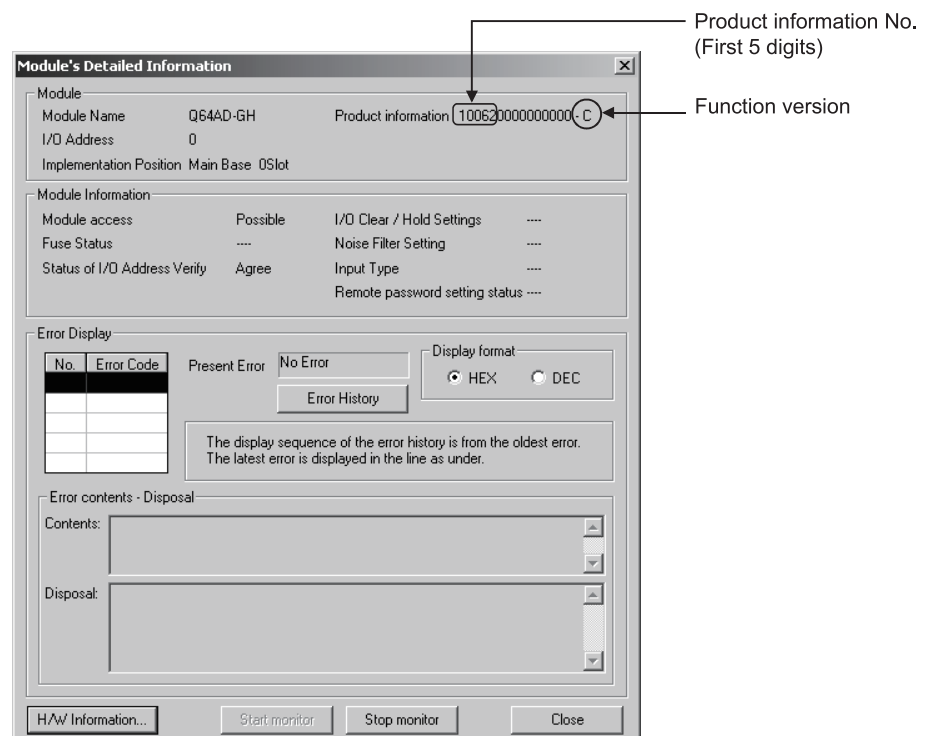

(3) H/W information

(a) H/W LED information

The LED ON status is displayed.

No.	LED name	Status
1)	RUN LED	0000H : Indicates that LED is unlit.
2)	ERR. LED	0001H : Indicates that LED is lit.
3)	ALM LED	Alternate display of 0000H and 0001H: Indicates that LED is flashing.

(b) H/W SW information

The status of the intelligent function module switch setting is displayed.

Item	Switch setting for intelligent function module
RANGE	Switch 1
-	Switch 2
-	Switch 3
MODE	Switch 4
-	Switch 5

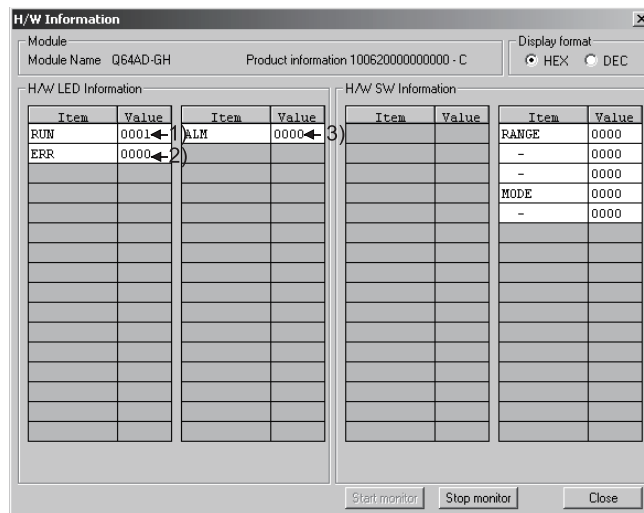

For GX Developer Version 8.90U

APPENDIX

Appendix 1 Dedicated Instruction List and Available Devices

(1) Dedicated instruction list

The following table lists the dedicated instructions that can be used with the A/D converter modules.

Instruction	Description	Reference section
G(P).OFFGAN	Switches to the offset/gain setting mode. Switches to the normal mode.	Appendix 1.1
G(P).OGLOAD	Reads the offset/gain values of the user range setting to the CPU.	Appendix 1.2
G(P).OGSTOR	Restores the offset/gain values of the user range setting stored in the CPU to the A/D converter module.	Appendix 1.3

POINT

When the module is mounted to a MELSECNET/H remote station, the dedicated instructions cannot be used.

(2) Available devices

The following devices are available for the dedicated instructions:

Internal devices		File register	Constant
Bit ^{*1}	Word		
X, Y, M, L, F, V, B	T, ST, C, D, W	R, ZR	-

*1: Word device bit designation can be used as bit data.

Word device bit designation is done by designating Word device . Bit No. .

(Designation of bit numbers is done in hexadecimal.)

For example, bit 10 of D0 is designated as D0.A .

However, there can be no bit designation for timers (T), retentive timers (ST) and counters (C).

Appendix 1.1 G(P).OFFGAN

Switches the mode of the A/D converter module. (Normal mode to offset/gain setting mode, offset/gain setting mode to normal mode)

Set data	Usable devices									
	Internal device (System, user)		File register	Link direct device J□\□		Intelligent function module U□\G□	Index register Z□	Constant		Other
	Bit	Word		Bit	Word			K, H	\$	
(S)	—	○						—	—	—

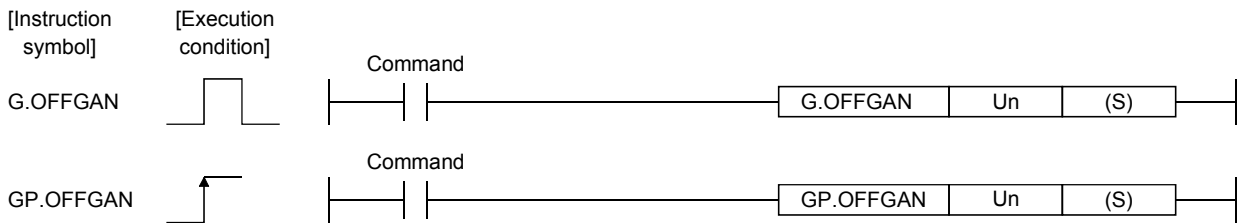

Set data

Set data	Description	Setting range	Data type
Un	Start I/O number of the module	0 to FEH	Binary 16 bits
(S)	Mode switching 0: Switching to normal mode 1: Switching to offset/gain setting mode The setting of any other value results in "switching to offset/gain setting mode".	0, 1	Binary 16 bits

(1) Function

Switches the mode of the A/D converter module.

- Normal mode to offset/gain setting mode (the offset/gain setting mode flag (XA) turns ON)
- Offset/gain setting mode to normal mode (the offset/gain setting mode flag (XA) turns OFF)

POINT

- (1) When the offset/gain setting mode is switched to the normal mode, Module ready (X0) turns from OFF to ON.
Note that initial setting processing will be executed if there is a sequence program that makes initial setting when Module ready (X0) turns ON.
- (2) When the offset/gain setting mode is switched to the normal mode, the Q64AD-GH holds the previous operation condition and resumes operation automatically under the previous operation condition.
- (3) When one mode is switched to the other (the normal mode is switched to the offset/gain setting mode or the offset/gain setting mode is switched to the normal mode), the Q62AD-DGH suspends A/D conversion and switches OFF the power supply to the 2-wire transmitter.
To resume A/D conversion and power supply to the 2-wire transmitter, turn ON the operating condition setting request (Y9) after the mode is switched to the normal mode.

(2) Operation error

No errors.

(3) Program example

The following program is designed to switch the A/D converter module mounted in the position of I/O number X/Y0 to X/YF to the offset/gain setting mode when M10 is turned ON, and to return it to the normal mode when M10 is turned OFF.

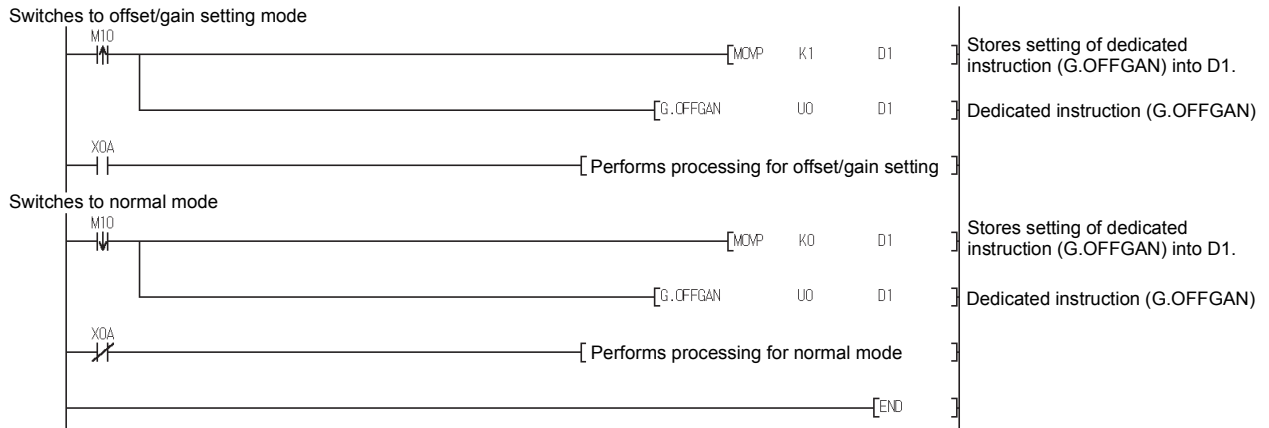

Appendix 1.2 G(P).OGLOAD

Reads the offset/gain values of the user range setting of the A/D converter module to the CPU.

Set data	Usable devices									
	Internal device (System, user)		File register	Link direct device J□\□		Intelligent function module U□\G□	Index register Z□	Constant		Other
	Bit	Word		Bit	Word			K, H	\$	
(S)	—	○			—			—	—	—
(D)		○			—			—	—	—

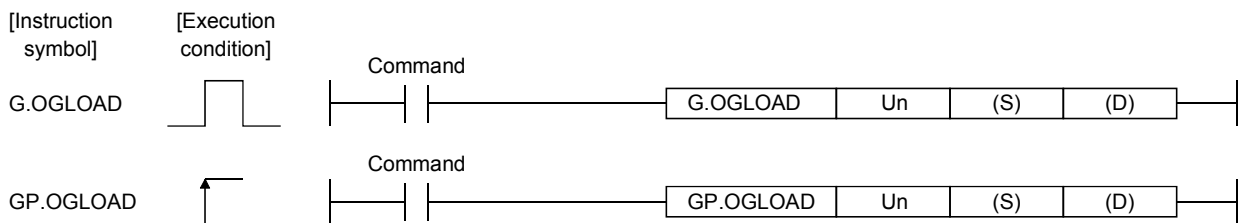

Set data

Set data	Description	Setting range	Data type
Un	Start I/O number of the module	0 to FEH	Binary 16 bits
(S)	Start number of the device in which control data is stored.	Within the range of the specified device	Device name
(D)	Device that is turned ON 1 scan on completion of dedicated instruction processing. (D) + 1 also turns ON at an abnormal completion.	Within the range of the specified device	Bit

Control data *1 of Q64AD-GH (1/2)

Device	Item	Set data	Setting range	Set by													
(S)	System area	—	—	—													
(S) + 1	Completion status	Stores the status when the instruction is complete. 0 : Normal completion Other than 0: Abnormal completion	—	System													
(S) + 2	Pass data classification setting	Specify the voltage/current of the offset/gain values to be read. 0: Voltage specified 1: Current specified <table border="1" style="margin-left: auto; margin-right: auto;"> <tr> <td>b15</td> <td>b4</td> <td>b3</td> <td>b2</td> <td>b1</td> <td>b0</td> </tr> <tr> <td>0</td> <td>to</td> <td>0</td> <td>CH4</td> <td>CH3</td> <td>CH2</td> <td>CH1</td> </tr> </table>	b15	b4	b3	b2	b1	b0	0	to	0	CH4	CH3	CH2	CH1	0000H to 000FH	User
b15	b4	b3	b2	b1	b0												
0	to	0	CH4	CH3	CH2	CH1											
(S) + 3	System area	—	—	—													
(S) + 4	CH1 Industrial shipment settings offset value (L)	—	—	System													
(S) + 5	(H)	—	—	System													
(S) + 6	CH1 Industrial shipment settings gain value (L)	—	—	System													
(S) + 7	(H)	—	—	System													
(S) + 8	CH2 Industrial shipment settings offset value (L)	—	—	System													
(S) + 9	(H)	—	—	System													
(S) + 10	CH2 Industrial shipment settings gain value (L)	—	—	System													
(S) + 11	(H)	—	—	System													

*1 Set only the pass data classification setting (S)+2. If data is written to the area set by the system, the offset/gain values will not be read properly.

Control data*¹ of Q64AD-GH (2/2)

Device	Item	Set data	Setting range	Set by
(S) + 12	CH3 Industrial shipment settings offset value (L)	—	—	System
(S) + 13	(H)			
(S) + 14	CH3 Industrial shipment settings gain value (L)	—	—	System
(S) + 15	(H)			
(S) + 16	CH4 Industrial shipment settings offset value (L)	—	—	System
(S) + 17	(H)			
(S) + 18	CH4 Industrial shipment settings gain value (L)	—	—	System
(S) + 19	(H)			
(S) + 20	CH1 user range settings offset value (L)	—	—	System
(S) + 21	(H)			
(S) + 22	CH1 user range settings gain value (L)	—	—	System
(S) + 23	(H)			
(S) + 24	CH2 user range settings offset value (L)	—	—	System
(S) + 25	(H)			
(S) + 26	CH2 user range settings gain value (L)	—	—	System
(S) + 27	(H)			
(S) + 28	CH3 user range settings offset value (L)	—	—	System
(S) + 29	(H)			
(S) + 30	CH3 user range settings gain value (L)	—	—	System
(S) + 31	(H)			
(S) + 32	CH4 user range settings offset value (L)	—	—	System
(S) + 33	(H)			
(S) + 34	CH4 user range settings gain value (L)	—	—	System
(S) + 35	(H)			

*1 Set only the pass data classification setting (S)+2. If data is written to the area set by the system, the offset/gain values will not be read properly.

Control data*² of Q62AD-DGH (1/2)

Device	Item	Set data	Setting range	Set by
(S)	System area	—	—	—
(S) + 1	Completion status	Stores the status when the instruction is complete. 0 : Normal completion Other than 0: Abnormal completion	—	System
(S) + 2	System area	—	—	—
(S) + 3				
(S) + 4	CH1 Industrial shipment settings offset value (L)	—	—	System
(S) + 5	(H)			
(S) + 6	CH1 Industrial shipment settings gain value (L)	—	—	System
(S) + 7	(H)			
(S) + 8	CH2 Industrial shipment settings offset value (L)	—	—	System
(S) + 9	(H)			
(S) + 10	CH2 Industrial shipment settings gain value (L)	—	—	System
(S) + 11	(H)			
(S) + 12				
to	System area	—	—	—
(S) + 19				

*2 Setting is not necessary. If setting is made, the offset/gain values will not be read properly.

Control data^{*2} of Q62AD-DGH (2/2)

Device	Item	Set data	Setting range	Set by
(S) + 20	CH1 user range settings offset value (L)	—	—	System
(S) + 21	(H)			
(S) + 22	CH1 user range settings gain value (L)	—	—	System
(S) + 23	(H)			
(S) + 24	CH2 user range settings offset value (L)	—	—	System
(S) + 25	(H)			
(S) + 26	CH2 user range settings gain value (L)	—	—	System
(S) + 27	(H)			
(S) + 28 to (S) + 35	System area	—	—	—

*2 Setting is not necessary. If setting is made, the offset/gain values will not be read properly.

(1) Functions

- (a) Reads the offset/gain values of the user range setting of the A/D converter module to the CPU.
- (b) There are two types of interlock signals for the G(P).OGLOAD instruction: the completion device (D) and the status display device at completion (D) + 1.
 - 1) Completion device
Turns ON in the END processing of the scan where the G(P).OGLOAD instruction is completed, and turns OFF in the next END processing.
 - 2) Status display device at completion
Turns ON and OFF depending on the completion status of the G(P).OGLOAD instruction.
Normal completion : Stays OFF and does not change.
Abnormal completion: Turns ON in the END processing of the scan where the G(P).OGLOAD instruction is completed, and turns OFF in the next END processing.

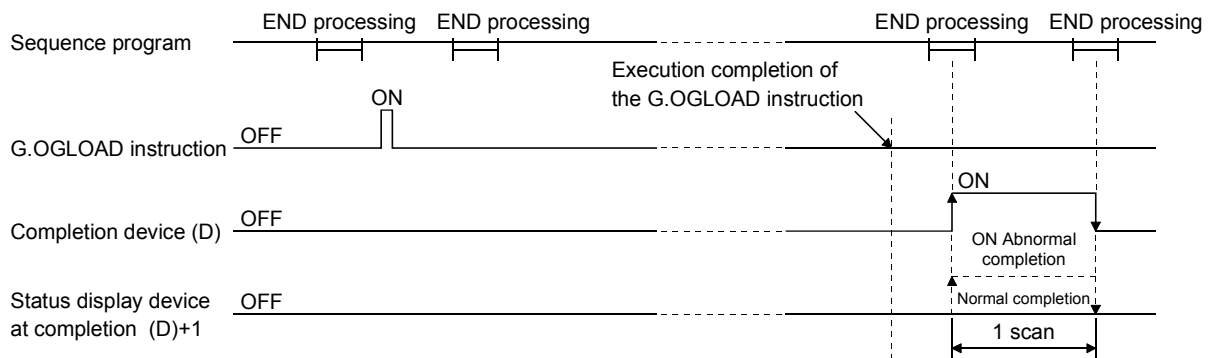

(2) Operation error

No errors.

(3) Program example

The following program is designed to read the offset/gain values of the A/D converter module mounted in the position of I/O number X/Y0 to X/YF when M11 is turned ON.

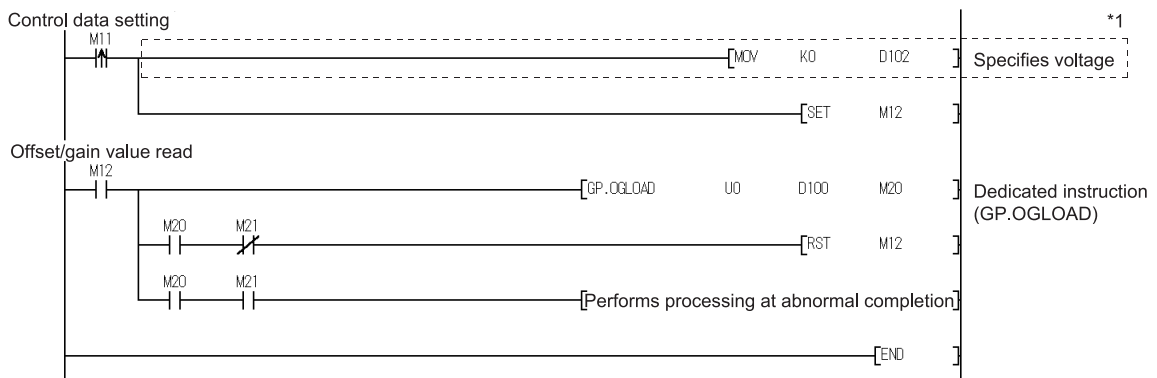

*1: For the Q62AD-DGH, the program in the dotted area is not necessary.

Appendix 1.3 G(P).OGSTOR

Restores the offset/gain values of the user range setting stored in the CPU to the A/D converter module.

Set data	Usable devices									
	Internal device (System, user)		File register	Link direct device J□\□		Intelligent function module U□\G□	Index register Z□	Constant		Other
	Bit	Word		Bit	Word			K, H	\$	
(S)	—	○			—			—	—	—
(D)		○			—			—	—	—

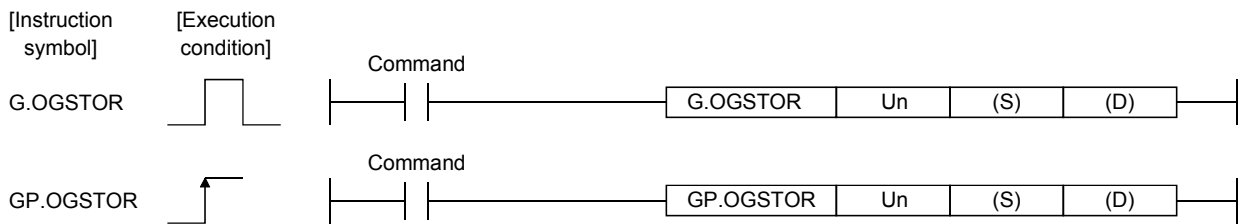

Set data

Set data	Description	Setting range	Data type
Un	Start I/O number of the module	0 to FE _H	Binary 16 bits
(S)* ¹	Start number of the device in which control data is stored.	Within the range of the specified device	Device name
(D)	Device that is turned ON 1 scan on completion of dedicated instruction processing. (D) + 1 also turns ON at an abnormal completion.	Within the range of the specified device	Bit

*1 When executing the G(P).OGLOAD instruction, specify the device designated in (S).
Do not change the data read with the G(P).OGLOAD instruction.
If it is changed, normal operation cannot be guaranteed.

Control data of Q64AD-GH (1/2)

Device	Item	Set data	Setting range	Set by													
(S)	System area	—	—	—													
(S) + 1	Completion status	Stores the status when the instruction is complete. 0 : Normal completion Other than 0: Abnormal completion	—	System													
(S) + 2	Pass data classification setting	The value set to Pass data classification setting (S)+2 using the G(P).OGLOAD instruction is stored. 0: Voltage specified 1: Current specified <table border="1" style="margin-left: auto; margin-right: auto;"> <tr> <td>b15</td> <td>b4</td> <td>b3</td> <td>b2</td> <td>b1</td> <td>b0</td> </tr> <tr> <td>0</td> <td>to</td> <td>0</td> <td>CH4</td> <td>CH3</td> <td>CH2</td> <td>CH1</td> </tr> </table>	b15	b4	b3	b2	b1	b0	0	to	0	CH4	CH3	CH2	CH1	0000 _H to 000F _H	System
b15	b4	b3	b2	b1	b0												
0	to	0	CH4	CH3	CH2	CH1											
(S) + 3	System area	—	—	—													
(S) + 4	CH1 Industrial shipment settings offset value (L)	—	—	System													
(S) + 5	(H)	—	—														
(S) + 6	CH1 Industrial shipment settings gain value (L)	—	—	System													
(S) + 7	(H)	—	—														
(S) + 8	CH2 Industrial shipment settings offset value (L)	—	—	System													
(S) + 9	(H)	—	—														
(S) + 10	CH2 Industrial shipment settings gain value (L)	—	—	System													
(S) + 11	(H)	—	—														

Control data of Q64AD-GH (2/2)

Device	Item	Set data	Setting range	Set by
(S) + 12	CH3 Industrial shipment settings offset value (L)	—	—	System
(S) + 13				
(S) + 14	CH3 Industrial shipment settings gain value (L)	—	—	System
(S) + 15				
(S) + 16	CH4 Industrial shipment settings offset value (L)	—	—	System
(S) + 17				
(S) + 18	CH4 Industrial shipment settings gain value (L)	—	—	System
(S) + 19				
(S) + 20	CH1 user range settings offset value (L)	—	—	System
(S) + 21				
(S) + 22	CH1 user range settings gain value (L)	—	—	System
(S) + 23				
(S) + 24	CH2 user range settings offset value (L)	—	—	System
(S) + 25				
(S) + 26	CH2 user range settings gain value (L)	—	—	System
(S) + 27				
(S) + 28	CH3 user range settings offset value (L)	—	—	System
(S) + 29				
(S) + 30	CH3 user range settings gain value (L)	—	—	System
(S) + 31				
(S) + 32	CH4 user range settings offset value (L)	—	—	System
(S) + 33				
(S) + 34	CH4 user range settings gain value (L)	—	—	System
(S) + 35				

Control data of Q62AD-DGH (1/2)

Device	Item	Set data	Setting range	Set by
(S)	System area	—	—	—
(S) + 1	Completion status	Stores the status when the instruction is complete. 0 : Normal completion Other than 0: Abnormal completion	—	System
(S) + 2	System area	—	—	—
(S) + 3				
(S) + 4	CH1 Industrial shipment settings offset value (L)	—	—	System
(S) + 5				
(S) + 6	CH1 Industrial shipment settings gain value (L)	—	—	System
(S) + 7				
(S) + 8	CH2 Industrial shipment settings offset value (L)	—	—	System
(S) + 9				
(S) + 10	CH2 Industrial shipment settings gain value (L)	—	—	System
(S) + 11				
(S) + 12	System area	—	—	—
to				
(S) + 19				

Control data of Q62AD-DGH (2/2)

Device	Item	Set data	Setting range	Set by
(S) + 20	CH1 user range settings offset value (L)	—	—	System
(S) + 21	(H)			
(S) + 22	CH1 user range settings gain value (L)	—	—	System
(S) + 23	(H)			
(S) + 24	CH2 user range settings offset value (L)	—	—	System
(S) + 25	(H)			
(S) + 26	CH2 user range settings gain value (L)	—	—	System
(S) + 27	(H)			
(S) + 28 to (S) + 35	System area	—	—	—

(1) Functions

(a) Restores the offset/gain values of the user range setting stored in the CPU to the A/D converter module.

(b) There are two types of interlock signals for the G(P).OGSTOR instruction: the completion device (D) and the status display device at completion (D) + 1.

1) Completion device

Turns ON in the END processing of the scan where the G(P).OGSTOR instruction is completed, and turns OFF in the next END processing.

2) Status display device at completion

Turns ON and OFF depending on the completion status of the G(P).OGSTOR instruction.

Normal completion : Stays OFF and does not change.

Abnormal completion: Turns ON in the END processing of the scan where the G(P).OGSTOR instruction is completed, and turns OFF in the next END processing.

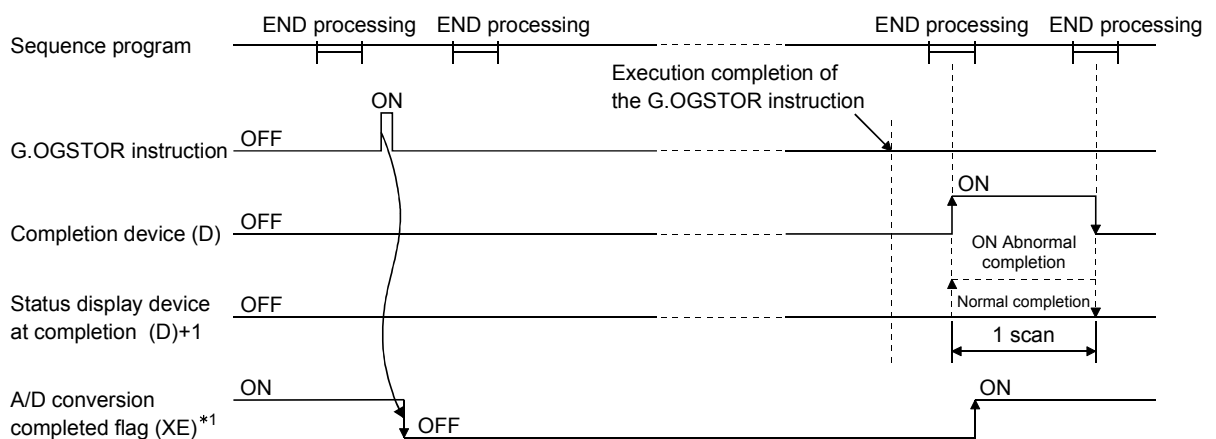

*1 When the G(P).OGSTOR instruction is executed, A/D conversion is not performed. After the completion device (D) turns ON, A/D conversion starts, the A/D conversion value is stored into the buffer memory, and the A/D conversion completed flag (XE) then turns ON.

(c) When the offset/gain values are restored, the reference accuracy falls to about less than three times of the accuracy before that.

(2) Operation error

In any of the following cases, an error occurs and the corresponding error code is stored into the completion status area (S)+1.

Error code	Case resulting in operation error
161	The G(P).OGSTOR instruction was executed in the offset/gain setting mode.
162	The G(P).OGSTOR instruction was executed consecutively.
163	The G(P).OGSTOR instruction was executed for the model that differs from the model for which the G(P).OGLOAD instruction had been executed.

(3) Program example

Program that restores the offset/gain setting to the A/D converter module mounted in the position of I/O No. X/Y10 to X/Y1F when M11 is turned OFF.

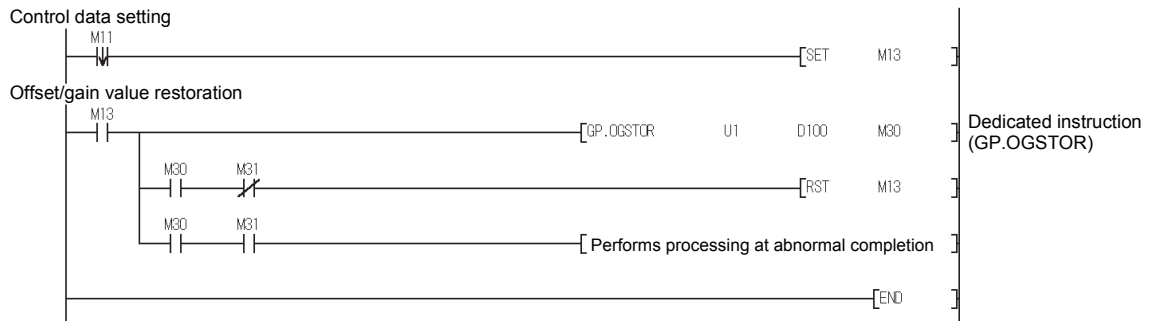

Appendix 2 Performance Comparison between Q64AD-GH and Q64AD

The following table indicates the performance comparison between the Q64AD-GH and Q64AD.

Table Appendix 1 Performance Comparison Table

Item	Model name	Q64AD-GH	Q64AD																																																																		
Number of analog input channels		4 channels																																																																			
Analog input	Voltage	-10 to 10VDC (Input resistance 1 MΩ)																																																																			
	Current	0 to 20mADC (Input resistance 250Ω)																																																																			
Digital output		32-bit signed binary (16-bit: -32768 to 32767, 32-bit: -65536 to 65535)	16-bit signed binary (normal resolution mode: -4096 to 4095, high resolution mode: -12288 to 12287, -16384 to 16383)																																																																		
I/O characteristics, resolution	<table border="1"> <thead> <tr> <th colspan="2">Analog input range</th> <th>Digital output value * 1</th> <th>Resolution * 1</th> </tr> </thead> <tbody> <tr> <td rowspan="7">Voltage</td> <td>0 to 10V</td> <td rowspan="3">0 to 64000 (0 to 32000)</td> <td>156.3μV (312.6μV)</td> </tr> <tr> <td>0 to 5V</td> <td>78.2μV (156.4μV)</td> </tr> <tr> <td>1 to 5V</td> <td>62.5μV (125.0μV)</td> </tr> <tr> <td>1 to 5V (Extended mode)</td> <td>-16000 to 72000</td> <td>62.5μV</td> </tr> <tr> <td>-10 to 10V</td> <td>-64000 to 64000 (-32000 to 32000)</td> <td>156.3μV (312.6μV) * 3</td> </tr> <tr> <td>Users range setting (Uni-polar)</td> <td>0 to 64000 (0 to 32000)</td> <td>47.4μV</td> </tr> <tr> <td>Users range setting (Bi-polar)</td> <td>-64000 to 64000 (-32000 to 32000)</td> <td>(94.8μV) * 3</td> </tr> <tr> <td rowspan="4">Current</td> <td>0 to 20mA</td> <td rowspan="2">0 to 64000 (0 to 32000)</td> <td>312.5nA (625.0nA)</td> </tr> <tr> <td>4 to 20mA</td> <td>250.0nA (500.0nA)</td> </tr> <tr> <td>4 to 20mA (Extended mode)</td> <td>-16000 to 72000</td> <td>250.0nA</td> </tr> <tr> <td>Users range setting (Uni-polar)</td> <td>0 to 64000 (0 to 32000)</td> <td>151.6nA (303.2nA) * 3</td> </tr> </tbody> </table>		Analog input range		Digital output value * 1	Resolution * 1	Voltage	0 to 10V	0 to 64000 (0 to 32000)	156.3μV (312.6μV)	0 to 5V	78.2μV (156.4μV)	1 to 5V	62.5μV (125.0μV)	1 to 5V (Extended mode)	-16000 to 72000	62.5μV	-10 to 10V	-64000 to 64000 (-32000 to 32000)	156.3μV (312.6μV) * 3	Users range setting (Uni-polar)	0 to 64000 (0 to 32000)	47.4μV	Users range setting (Bi-polar)	-64000 to 64000 (-32000 to 32000)	(94.8μV) * 3	Current	0 to 20mA	0 to 64000 (0 to 32000)	312.5nA (625.0nA)	4 to 20mA	250.0nA (500.0nA)	4 to 20mA (Extended mode)	-16000 to 72000	250.0nA	Users range setting (Uni-polar)	0 to 64000 (0 to 32000)	151.6nA (303.2nA) * 3	<table border="1"> <thead> <tr> <th colspan="2">Analog input range</th> <th>Digital output value * 2</th> <th>Resolution * 2</th> </tr> </thead> <tbody> <tr> <td rowspan="5">Voltage</td> <td>0 to 10V</td> <td>0 to 4000 (0 to 16000)</td> <td>2.5mV (0.625mV)</td> </tr> <tr> <td>0 to 5V</td> <td>0 to 4000 (0 to 12000)</td> <td>1.25mV (0.416 mV)</td> </tr> <tr> <td>1 to 5V</td> <td>0 to 4000 (0 to 12000)</td> <td>1.0mV (0.333mV) * 3</td> </tr> <tr> <td>-10 to 10V</td> <td>-4000 to 4000 (-16000 to 16000)</td> <td>2.5mV (0.625mV)</td> </tr> <tr> <td>Users range setting</td> <td>-4000 to 4000 (-12000 to 12000)</td> <td>0.375mV (0.333mV) * 3</td> </tr> <tr> <td rowspan="3">Current</td> <td>0 to 20mA</td> <td rowspan="2">0 to 4000 (0 to 12000)</td> <td>5μA (1.66μA)</td> </tr> <tr> <td>4 to 20mA</td> <td>4μA (1.33μA)</td> </tr> <tr> <td>Users range setting</td> <td>-4000 to 4000 (-12000 to 12000)</td> <td>1.37μA (1.33μA) * 3</td> </tr> </tbody> </table>		Analog input range		Digital output value * 2	Resolution * 2	Voltage	0 to 10V	0 to 4000 (0 to 16000)	2.5mV (0.625mV)	0 to 5V	0 to 4000 (0 to 12000)	1.25mV (0.416 mV)	1 to 5V	0 to 4000 (0 to 12000)	1.0mV (0.333mV) * 3	-10 to 10V	-4000 to 4000 (-16000 to 16000)	2.5mV (0.625mV)	Users range setting	-4000 to 4000 (-12000 to 12000)	0.375mV (0.333mV) * 3	Current	0 to 20mA	0 to 4000 (0 to 12000)	5μA (1.66μA)	4 to 20mA	4μA (1.33μA)	Users range setting	-4000 to 4000 (-12000 to 12000)	1.37μA (1.33μA) * 3
	Analog input range		Digital output value * 1	Resolution * 1																																																																	
Voltage	0 to 10V	0 to 64000 (0 to 32000)	156.3μV (312.6μV)																																																																		
	0 to 5V		78.2μV (156.4μV)																																																																		
	1 to 5V		62.5μV (125.0μV)																																																																		
	1 to 5V (Extended mode)	-16000 to 72000	62.5μV																																																																		
	-10 to 10V	-64000 to 64000 (-32000 to 32000)	156.3μV (312.6μV) * 3																																																																		
	Users range setting (Uni-polar)	0 to 64000 (0 to 32000)	47.4μV																																																																		
	Users range setting (Bi-polar)	-64000 to 64000 (-32000 to 32000)	(94.8μV) * 3																																																																		
Current	0 to 20mA	0 to 64000 (0 to 32000)	312.5nA (625.0nA)																																																																		
	4 to 20mA		250.0nA (500.0nA)																																																																		
	4 to 20mA (Extended mode)	-16000 to 72000	250.0nA																																																																		
	Users range setting (Uni-polar)	0 to 64000 (0 to 32000)	151.6nA (303.2nA) * 3																																																																		
Analog input range		Digital output value * 2	Resolution * 2																																																																		
Voltage	0 to 10V	0 to 4000 (0 to 16000)	2.5mV (0.625mV)																																																																		
	0 to 5V	0 to 4000 (0 to 12000)	1.25mV (0.416 mV)																																																																		
	1 to 5V	0 to 4000 (0 to 12000)	1.0mV (0.333mV) * 3																																																																		
	-10 to 10V	-4000 to 4000 (-16000 to 16000)	2.5mV (0.625mV)																																																																		
	Users range setting	-4000 to 4000 (-12000 to 12000)	0.375mV (0.333mV) * 3																																																																		
Current	0 to 20mA	0 to 4000 (0 to 12000)	5μA (1.66μA)																																																																		
	4 to 20mA		4μA (1.33μA)																																																																		
	Users range setting	-4000 to 4000 (-12000 to 12000)	1.37μA (1.33μA) * 3																																																																		
Accuracy	Accuracy (Accuracy in respect to maximum digital output value): ±0.05% Temperature coefficient: ±71.4ppm/°C		Accuracy (Accuracy in respect to maximum digital output value) Ambient temperature 25 ± 5 °C: ± 0.1 % Ambient temperature 0 to 55 °C with temperature drift correction: ± 0.3 % Ambient temperature 0 to 55 °C without temperature drift correction: ± 0.4 %																																																																		
Common mode characteristic	Common mode voltage Input-Common ground (input voltage 0V): 1780VAC Common mode voltage rejection ratio (VCM < 1780V): 60Hz 105dB, 50Hz 107dB		—																																																																		
Conversion speed	10ms/4 channels		80μs/channel (When there is temperature drift, the time calculated by adding 160μs will be used regardless of the number of channels used)																																																																		
Absolute maximum input	Voltage: ± 15V Current: ± 30mA																																																																				
Isolation specifications	Specific isolated area	Isolation method	Dielectric withstand voltage	Insulation resistance	Specific isolated area	Isolation method	Dielectric withstand voltage	Insulation resistance																																																													
	Between I/O terminal and programmable controller power supply	Photocoupler isolation	1780VAC rms/3 cycles (elevation 2000m)	500VDC 10MΩ or more	Between I/O terminal and programmable controller power supply	Photocoupler isolation	500VAC for 1 minute	500VDC 20MΩ or more																																																													
	Between analog input channels	Transformer isolation	—	—	Between analog input channels	Non-isolated	—	—																																																													
Maximum number of writes for E ² PROM	100,000																																																																				
Number of I/O occupied points	16 points																																																																				
External interface	18 points terminal block																																																																				
Applicable wire size	0.3 to 0.75mm ²																																																																				
Applicable solderless terminals	R1.25-3 (Solderless terminals with sleeves are not applicable)																																																																				
Internal current consumption (5VDC)	0.89A		0.63 A																																																																		
Weight	0.20kg		0.18 kg																																																																		

- * 1 The values in parentheses are the digital output values (16 bits).
- * 2 The values in parentheses are those in the high resolution mode.
- * 3 Maximum resolution in the user range setting.

Appendix 3 Functions Added or Changed Due to Version Upgrade

The A/D converter has been upgraded with new functions and specifications.

The functions available for use of the A/D converter module vary with the first five digits of product number.

Also, use the GX Configurator-AD whose version number is compatible one or later.

(1) Q64AD-GH

Table Appendix 2 Q64AD-GH

Added or changed function	Description	Applicable version		Reference section
		First 5 digits of product number	GX Configurator-AD	
Analog input range extended mode	<p>When the following input ranges are selected in the intelligent function module switch setting, the analog input ranges can be extended.</p> <ul style="list-style-type: none"> • 4 to 20mA (Extended mode) • 1 to 5V (Extended mode) <p>The input ranges supported by the analog input range extended mode cannot be used for products of incompatible version.</p>	10062 or later	2.09K or later	Section 3.1.1 Section 4.5
Input signal error detection extended setting	<p>When the warning of input signal error detection is enabled, the input signal error detection can be performed by setting the same value of upper and lower limit or different value of upper and lower limit.</p> <p>The input signal error detection cannot be performed by setting the different value of upper and lower limit, but can be performed by setting the same value of upper and lower limit.</p> <p>Set the buffer memories as follows.</p> <p>Buffer memory address 47: Un\G47.b15 to b12</p> <p>••• Fixed at 0</p> <p>Buffer memory addresses 142 to 145: Un\G142 to Un\G145 ••• Reserved (system area)</p>	10062 or later	2.09K or later	Section 3.2.3 Section 3.4.12 Section 3.4.20

(2) Q62AD-DGH

Table Appendix 3 Q62AD-DGH

Added or changed function	Description	Applicable version		Reference section
		First 5 digits of product number	GX Configurator-AD	
Analog input range extended mode	<p>When the following input ranges are selected in the intelligent function module switch setting, the analog input ranges can be extended.</p> <ul style="list-style-type: none"> • 4 to 20mA (Extended mode) <p>The input ranges supported by the analog input range extended mode cannot be used for products of incompatible version.</p>	10102 or later	2.09K or later	Section 3.1.1 Section 4.5
Input signal error detection extended setting	<p>When the warning of input signal error detection is enabled, the input signal error detection can be performed by setting the same value of upper and lower limit or different value of upper and lower limit.</p> <p>The input signal error detection cannot be performed by setting the different value of upper and lower limit, but can be performed by setting the same value of upper and lower limit.</p> <p>Set the buffer memories as follows.</p> <p>Buffer memory address 47: Un\G47.b15 to b10 ••• Fixed at 0</p> <p>Buffer memory addresses 142, 143: Un\G142, Un\G143 ••• Reserved (system area)</p>	10102 or later	2.09K or later	Section 3.2.3 Section 3.4.12 Section 3.4.20

Appendix 4 External Dimensions

(1) Q64AD-GH

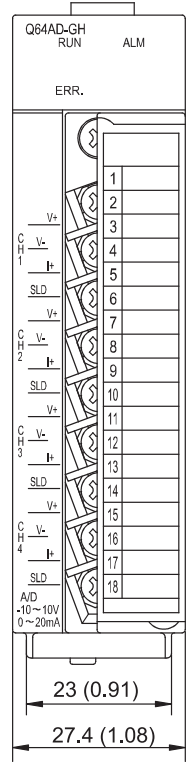
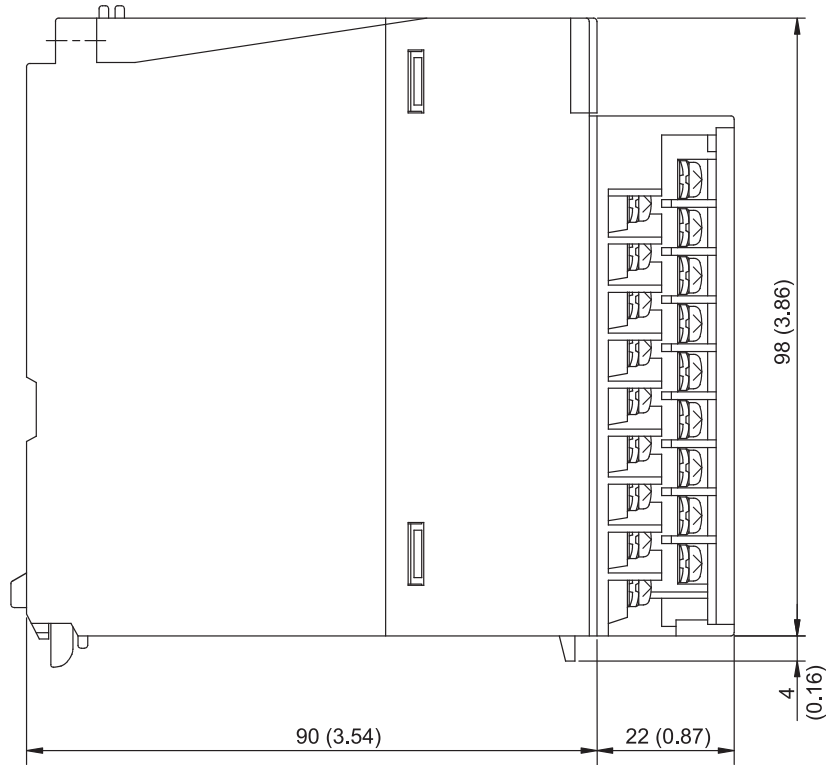

Unit: mm (inch)

(2) Q62AD-DGH

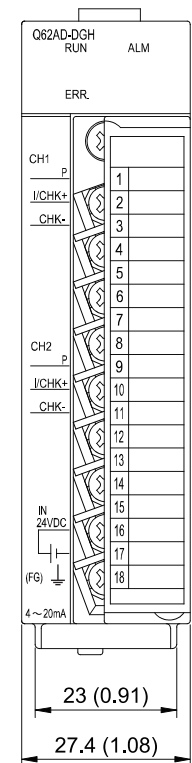
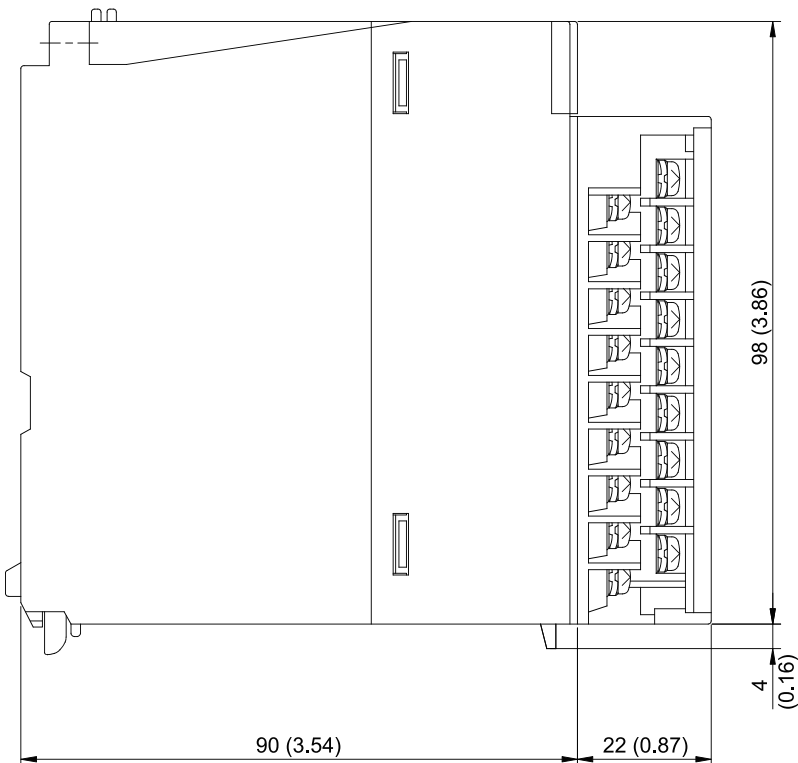

Unit: mm (inch)

INDEX

[Number]

2-wire transmitter..... 1-1

[A]

A/D conversion completed flag..... 3-34, 3-55
 A/D conversion enable/disable setting
 3-11, 3-51
 A/D conversion methods..... 3-13
 A/D conversion starting time setting 3-52
 A/D conversion starting time setting function
 3-27
 A/D conversion value storage during offset/gain
 setting 4-21
 A/D converter module A-13
 Absolute maximum input..... 3-1
 Accuracy..... 3-1, 3-2, 3-10
 ALM LED 4-3
 Analog input..... 3-1, 3-2
 Applicable modules 2-1
 Applicable solderless terminal 3-1, 3-3
 Applicable wire size..... 3-1, 3-3
 Auto refresh setting 5-16
 Average time/Average number of times/Move
 average/Time constant settings..... 3-52
 Averaging processing..... 3-13
 Averaging process specification 3-54

[B]

Buffer memory..... 3-37, 3-45

[C]

Channel change completed flag 3-33
 Channel change request..... 3-35
 Check terminals..... 3-2, 4-3, 4-7
 Close parameters 5-12
 Common mode characteristic 3-1
 Confirmation of conversion characteristic 5-23
 Conversion speed 3-1, 3-2
 Count averaging 3-13
 Current input characteristic 3-7, 3-9

[D]

Dedicated instruction list App.-1
 Delete parameters..... 5-12
 Dielectric withstand voltage 3-1, 3-2

Digital output 3-1, 3-2

Digital output value (16 bits)..... 3-56

Digital output value (32 bits)..... 3-61

[E]

EMC Directive A-12
 ERR. LED..... 4-3
 Error clear request 3-35
 Error code list..... 8-1
 Error flag..... 3-34
 External dimensions App.-17
 External interface 3-1, 3-2
 External supply power 3-2
 External supply power terminal 4-3
 External wiring..... 4-6, 4-7

[F]

FB conversion 5-28
 Function version..... 2-6

[G]

G(P).OFFGAN App.-2
 G(P).OGLOAD App.-4
 G(P).OGSTOR..... App.-8
 Gain value 3-4
 GX Configurator-AD..... 2-2, 2-3, 5-1
 GX Configurator-AD software version..... 2-2, 2-3
 GX Developer A-13, 2-2

[H]

H/W information 8-7
 Handling precautions 4-1

[I]

I/O assignment setting 4-10
 I/O characteristics 3-1, 3-2
 Industrial shipment setting..... A-13
 Industrial shipment settings and user range
 settings offset/gain value 3-68
 Initial setting 5-14
 Input range 3-57, 4-9
 Input signal error detection flag 3-61
 Input signal error detection function 3-16
 Input signal error detection setting value 3-65
 Input signal error detection signal 3-33

Input signal error detection setting 3-59

Input signal error detection extended setting
..... 3-59

Inrush current 3-2

Installing..... 5-2

Insulation resistance 3-1, 3-2

Intelligent function module parameter 5-7

Internal current consumption 3-1, 3-3

Isolation method 3-1, 3-2

[L]

List of I/O signals..... 3-28, 3-29

Low Voltage Directive A-12

[M]

Maximum and minimum values hold function
..... 3-16

Maximum and minimum values storage area
(16bit)..... 3-58

Maximum and minimum values storage area
(32bit)..... 3-62

Maximum number of writes for E²PROM
..... 3-1, 3-3

Maximum supply current..... 3-2

Maximum value/minimum value reset completed
flag 3-34

Maximum value/minimum value reset request
..... 3-35

MELSECNET/H..... 2-1

Mode switching setting..... 3-67

Module ready..... 3-30

Monitoring/test..... 5-18

Move averaging..... 3-13

Multiple CPU system..... 2-1

[N]

Number of analog input channels..... 3-1, 3-2

Number of I/O occupied points 3-1, 3-3

Number of modules..... 2-1

[O]

Offset value 3-4

Offset/gain setting 4-11, 4-16, 5-19, 5-21

Offset/gain setting change completed flag... 3-34

Offset/gain setting change request..... 3-35

Offset/gain setting mode 3-58

Offset/gain setting mode flag 3-32

Online module change 2-2, 7-1

Open parameters5-12

Operating condition setting.....5-19

Operating condition setting completed flag...3-31

Operating condition setting request3-35

Operating environment 5-4

[P]

Part identification nomenclature4-3

Pass data 5-25, 5-27

Pass data classification setting3-67

Performance comparison App.-13

Performance specifications 3-1, 3-2

Primary delay filter3-14

Process alarm3-23

Process alarm upper/lower limit value3-62

Programming procedure.....6-1

[Q]

Q62AD-DGH 1-1

Q64AD-GH..... 1-1

QCPU (Q mode) A-13

[R]

Rate alarm.....3-24

Rate alarm upper/lower limit value3-64

Rate alarm warning detection period3-63

Read from PLC5-12

Reference accuracy..... 3-1, 3-2, 3-10

Remote I/O network..... 6-7, 6-20

Resolution 3-1, 3-2

RUN LED4-3

[S]

Sampling processing3-11

Save parameters.....5-12

Screen for selecting a target intelligent function
module.....5-9

Setting range.....3-57

Setup and procedures before operation4-2

Short circuit protection 1-1, 3-2

Software package2-2

Supply power ON/OFF function3-11

Supply voltage 3-2

Switch setting for intelligent function module
.....4-10

System monitor8-6

[T]

Temperature coefficient..... 3-1, 3-2, 3-10

Text files	5-7
Time averaging.....	3-13
Time constant.....	3-14
Transfer setup	5-13
Troubleshooting.....	8-4
[U]	
Uninstalling	5-2
User range writing request.....	3-35
Utility package	5-1
[M]	
Voltage input characteristic.....	3-5
[W]	
Warning output setting	3-59
Warning output flag	3-60
Warning output function	3-23
Warning output signal	3-30
Weight.....	3-1, 3-3
Write data error code	3-56
Write to PLC	5-12
[X]	
X/Y monitor/test.....	5-18

WARRANTY

Please confirm the following product warranty details before using this product.

1. Gratis Warranty Term and Gratis Warranty Range

If any faults or defects (hereinafter "Failure") found to be the responsibility of Mitsubishi occurs during use of the product within the gratis warranty term, the product shall be repaired at no cost via the sales representative or Mitsubishi Service Company.

However, if repairs are required onsite at domestic or overseas location, expenses to send an engineer will be solely at the customer's discretion. Mitsubishi shall not be held responsible for any re-commissioning, maintenance, or testing on-site that involves replacement of the failed module.

[Gratis Warranty Term]

The gratis warranty term of the product shall be for one year after the date of purchase or delivery to a designated place. Note that after manufacture and shipment from Mitsubishi, the maximum distribution period shall be six (6) months, and the longest gratis warranty term after manufacturing shall be eighteen (18) months. The gratis warranty term of repair parts shall not exceed the gratis warranty term before repairs.

[Gratis Warranty Range]

- (1) The range shall be limited to normal use within the usage state, usage methods and usage environment, etc., which follow the conditions and precautions, etc., given in the instruction manual, user's manual and caution labels on the product.
- (2) Even within the gratis warranty term, repairs shall be charged for in the following cases.
 1. Failure occurring from inappropriate storage or handling, carelessness or negligence by the user. Failure caused by the user's hardware or software design.
 2. Failure caused by unapproved modifications, etc., to the product by the user.
 3. When the Mitsubishi product is assembled into a user's device, Failure that could have been avoided if functions or structures, judged as necessary in the legal safety measures the user's device is subject to or as necessary by industry standards, had been provided.
 4. Failure that could have been avoided if consumable parts (battery, backlight, fuse, etc.) designated in the instruction manual had been correctly serviced or replaced.
 5. Failure caused by external irresistible forces such as fires or abnormal voltages, and Failure caused by force majeure such as earthquakes, lightning, wind and water damage.
 6. Failure caused by reasons unpredictable by scientific technology standards at time of shipment from Mitsubishi.
 7. Any other failure found not to be the responsibility of Mitsubishi or that admitted not to be so by the user.

2. Onerous repair term after discontinuation of production

- (1) Mitsubishi shall accept onerous product repairs for seven (7) years after production of the product is discontinued. Discontinuation of production shall be notified with Mitsubishi Technical Bulletins, etc.
- (2) Product supply (including repair parts) is not available after production is discontinued.

3. Overseas service

Overseas, repairs shall be accepted by Mitsubishi's local overseas FA Center. Note that the repair conditions at each FA Center may differ.

4. Exclusion of loss in opportunity and secondary loss from warranty liability

Regardless of the gratis warranty term, Mitsubishi shall not be liable for compensation of damages caused by any cause found not to be the responsibility of Mitsubishi, loss in opportunity, lost profits incurred to the user by Failures of Mitsubishi products, special damages and secondary damages whether foreseeable or not, compensation for accidents, and compensation for damages to products other than Mitsubishi products, replacement by the user, maintenance of on-site equipment, start-up test run and other tasks.

5. Changes in product specifications

The specifications given in the catalogs, manuals or technical documents are subject to change without prior notice.

Microsoft, Windows, Windows Vista, Windows NT, Windows XP, Windows Server, Visio, Excel, PowerPoint, Visual Basic, Visual C++, and Access are either registered trademarks or trademarks of Microsoft Corporation in the United States, Japan, and other countries.

Intel, Pentium, and Celeron are either registered trademarks or trademarks of Intel Corporation in the United States and other countries.

Ethernet is a trademark of Xerox Corp.

All other company names and product names used in this manual are either trademarks or registered trademarks of their respective companies.

SPREAD

Copyright (C) 1996 Farpoin Technologies, Inc.

SH(NA)-080277-N(1509)MEE

MODEL: Q-A/D-(D)GH-U-SY-E

MODEL CODE: 13JR51

MITSUBISHI ELECTRIC CORPORATION

HEAD OFFICE : TOKYO BUILDING, 2-7-3 MARUNOUCHI, CHIYODA-KU, TOKYO 100-8310, JAPAN
NAGOYA WORKS : 1-14, YADA-MINAMI 5-CHOME, HIGASHI-KU, NAGOYA, JAPAN

When exported from Japan, this manual does not require application to the
Ministry of Economy, Trade and Industry for service transaction permission.

Specifications subject to change without notice.