



Motion Controller

MELSEC **Q** series

Q173DSCPU/Q172DSCPU
Motion Controller (SV22)
Programming Manual
(Advanced Synchronous Control)

-Q172DSCPU
-Q173DSCPU

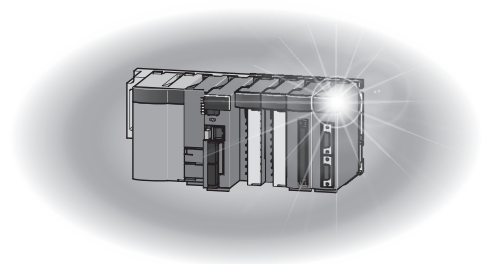

● SAFETY PRECAUTIONS ●

(Please read these instructions before using this equipment.)

Before using this product, please read this manual and the relevant manuals introduced in this manual carefully and pay full attention to safety to handle the product correctly.

These precautions apply only to this product. Refer to the Q173D(S)CPU/Q172D(S)CPU Users manual for a description of the Motion controller safety precautions.

In this manual, the safety instructions are ranked as "DANGER" and "CAUTION".

 **DANGER**

Indicates that incorrect handling may cause hazardous conditions, resulting in death or severe injury.

 **CAUTION**

Indicates that incorrect handling may cause hazardous conditions, resulting in medium or slight personal injury or physical damage.

Depending on circumstances, procedures indicated by  CAUTION may also be linked to serious results.

In any case, it is important to follow the directions for usage.

Please save this manual to make it accessible when required and always forward it to the end user.

For Safe Operations

1. Prevention of electric shocks

DANGER

- Never open the front case or terminal covers while the power is ON or the unit is running, as this may lead to electric shocks.
- Never run the unit with the front case or terminal cover removed. The high voltage terminal and charged sections will be exposed and may lead to electric shocks.
- Never open the front case or terminal cover at times other than wiring work or periodic inspections even if the power is OFF. The insides of the Motion controller and servo amplifier are charged and may lead to electric shocks.
- Completely turn off the externally supplied power used in the system before mounting or removing the module, performing wiring work, or inspections. Failing to do so may lead to electric shocks.
- When performing wiring work or inspections, turn the power OFF, wait at least ten minutes, and then check the voltage with a tester, etc. Failing to do so may lead to electric shocks.
- Be sure to ground the Motion controller, servo amplifier and servo motor. (Ground resistance : 100 Ω or less) Do not ground commonly with other devices.
- The wiring work and inspections must be done by a qualified technician.
- Wire the units after installing the Motion controller, servo amplifier and servo motor. Failing to do so may lead to electric shocks or damage.
- Never operate the switches with wet hands, as this may lead to electric shocks.
- Do not damage, apply excessive stress, place heavy things on or sandwich the cables, as this may lead to electric shocks.
- Do not touch the Motion controller, servo amplifier or servo motor terminal blocks while the power is ON, as this may lead to electric shocks.
- Do not touch the built-in power supply, built-in grounding or signal wires of the Motion controller and servo amplifier, as this may lead to electric shocks.

2. For fire prevention

CAUTION

- Install the Motion controller, servo amplifier, servo motor and regenerative resistor on incombustible. Installing them directly or close to combustibles will lead to fire.
- If a fault occurs in the Motion controller or servo amplifier, shut the power OFF at the servo amplifier's power source. If a large current continues to flow, fire may occur.
- When using a regenerative resistor, shut the power OFF with an error signal. The regenerative resistor may abnormally overheat due to a fault in the regenerative transistor, etc., and may lead to fire.
- Always take heat measures such as flame proofing for the inside of the control panel where the servo amplifier or regenerative resistor is installed and for the wires used. Failing to do so may lead to fire.
- Do not damage, apply excessive stress, place heavy things on or sandwich the cables, as this may lead to fire.

3. For injury prevention

CAUTION

- Do not apply a voltage other than that specified in the instruction manual on any terminal. Doing so may lead to destruction or damage.
- Do not mistake the terminal connections, as this may lead to destruction or damage.
- Do not mistake the polarity (+ / -), as this may lead to destruction or damage.
- Do not touch the heat radiating fins of controller or servo amplifier, regenerative resistor and servo motor, etc., while the power is ON and for a short time after the power is turned OFF. In this timing, these parts become very hot and may lead to burns.
- Always turn the power OFF before touching the servo motor shaft or coupled machines, as these parts may lead to injuries.
- Do not go near the machine during test operations or during operations such as teaching. Doing so may lead to injuries.

4. Various precautions

Strictly observe the following precautions.

Mistaken handling of the unit may lead to faults, injuries or electric shocks.

(1) System structure

CAUTION

- Always install a leakage breaker on the Motion controller and servo amplifier power source.
- If installation of an electromagnetic contactor for power shut off during an error, etc., is specified in the instruction manual for the servo amplifier, etc., always install the electromagnetic contactor.
- Install the emergency stop circuit externally so that the operation can be stopped immediately and the power shut off.
- Use the Motion controller, servo amplifier, servo motor and regenerative resistor with the correct combinations listed in the instruction manual. Other combinations may lead to fire or faults.
- Use the Motion controller, base unit and motion module with the correct combinations listed in the instruction manual. Other combinations may lead to faults.
- If safety standards (ex., robot safety rules, etc.,) apply to the system using the Motion controller, servo amplifier and servo motor, make sure that the safety standards are satisfied.
- Construct a safety circuit externally of the Motion controller or servo amplifier if the abnormal operation of the Motion controller or servo amplifier differ from the safety directive operation in the system.
- In systems where coasting of the servo motor will be a problem during the forced stop, emergency stop, servo OFF or power supply OFF, use dynamic brakes.
- Make sure that the system considers the coasting amount even when using dynamic brakes.
- In systems where perpendicular shaft dropping may be a problem during the forced stop, emergency stop, servo OFF or power supply OFF, use both dynamic brakes and electromagnetic brakes.

CAUTION

- The dynamic brakes must be used only on errors that cause the forced stop, emergency stop, or servo OFF. These brakes must not be used for normal braking.
- The brakes (electromagnetic brakes) assembled into the servo motor are for holding applications, and must not be used for normal braking.
- The system must have a mechanical allowance so that the machine itself can stop even if the stroke limits switch is passed through at the max. speed.
- Use wires and cables that have a wire diameter, heat resistance and bending resistance compatible with the system.
- Use wires and cables within the length of the range described in the instruction manual.
- The ratings and characteristics of the parts (other than Motion controller, servo amplifier and servo motor) used in a system must be compatible with the Motion controller, servo amplifier and servo motor.
- Install a cover on the shaft so that the rotary parts of the servo motor are not touched during operation.
- There may be some cases where holding by the electromagnetic brakes is not possible due to the life or mechanical structure (when the ball screw and servo motor are connected with a timing belt, etc.). Install a stopping device to ensure safety on the machine side.

(2) Security

CAUTION

- To maintain the security (confidentiality, integrity, and availability) of the programmable controller and the system against unauthorized access, denial-of-service (DoS) attacks, computer viruses, and other cyberattacks from external devices via the network, take appropriate measures such as firewalls, virtual private networks (VPNs), and antivirus solutions.

(3) Parameter settings and programming

CAUTION

- Set the parameter values to those that are compatible with the Motion controller, servo amplifier, servo motor and regenerative resistor model and the system application. The protective functions may not function if the settings are incorrect.
- The regenerative resistor model and capacity parameters must be set to values that conform to the operation mode, servo amplifier and servo power supply module. The protective functions may not function if the settings are incorrect.
- Set the mechanical brake output and dynamic brake output validity parameters to values that are compatible with the system application. The protective functions may not function if the settings are incorrect.
- Set the stroke limit input validity parameter to a value that is compatible with the system application. The protective functions may not function if the setting is incorrect.

CAUTION

- Set the servo motor encoder type (increment, absolute position type, etc.) parameter to a value that is compatible with the system application. The protective functions may not function if the setting is incorrect.
- Set the servo motor capacity and type (standard, low-inertia, flat, etc.) parameter to values that are compatible with the system application. The protective functions may not function if the settings are incorrect.
- Set the servo amplifier capacity and type parameters to values that are compatible with the system application. The protective functions may not function if the settings are incorrect.
- Use the program commands for the program with the conditions specified in the instruction manual.
- Set the sequence function program capacity setting, device capacity, latch validity range, I/O assignment setting, and validity of continuous operation during error detection to values that are compatible with the system application. The protective functions may not function if the settings are incorrect.
- Some devices used in the program have fixed applications, so use these with the conditions specified in the instruction manual.
- The input devices and data registers assigned to the link will hold the data previous to when communication is terminated by an error, etc. Thus, an error correspondence interlock program specified in the instruction manual must be used.
- Use the interlock program specified in the intelligent function module's instruction manual for the program corresponding to the intelligent function module.

(4) Transportation and installation

CAUTION

- Transport the product with the correct method according to the mass.
- Use the servo motor suspension bolts only for the transportation of the servo motor. Do not transport the servo motor with machine installed on it.
- Do not stack products past the limit.
- When transporting the Motion controller or servo amplifier, never hold the connected wires or cables.
- When transporting the servo motor, never hold the cables, shaft or detector.
- When transporting the Motion controller or servo amplifier, never hold the front case as it may fall off.
- When transporting, installing or removing the Motion controller or servo amplifier, never hold the edges.
- Install the unit according to the instruction manual in a place where the mass can be withstood.
- Do not get on or place heavy objects on the product.
- Always observe the installation direction.
- Keep the designated clearance between the Motion controller or servo amplifier and control panel inner surface or the Motion controller and servo amplifier, Motion controller or servo amplifier and other devices.

⚠ CAUTION

- Do not install or operate Motion controller, servo amplifiers or servo motors that are damaged or that have missing parts.
- Do not block the intake/outtake ports of the Motion controller, servo amplifier and servo motor with cooling fan.
- Do not allow conductive matter such as screw or cutting chips or combustible matter such as oil enter the Motion controller, servo amplifier or servo motor.
- The Motion controller, servo amplifier and servo motor are precision machines, so do not drop or apply strong impacts on them.
- Securely fix the Motion controller, servo amplifier and servo motor to the machine according to the instruction manual. If the fixing is insufficient, these may come off during operation.
- Always install the servo motor with reduction gears in the designated direction. Failing to do so may lead to oil leaks.
- Store and use the unit in the following environmental conditions.

Environment	Conditions	
	Motion controller/Servo amplifier	Servo motor
Ambient temperature	According to each instruction manual.	0°C to +40°C (With no freezing) (32°F to +104°F)
Ambient humidity	According to each instruction manual.	80% RH or less (With no dew condensation)
Storage temperature	According to each instruction manual.	-20°C to +65°C (-4°F to +149°F)
Atmosphere	Indoors (where not subject to direct sunlight). No corrosive gases, flammable gases, oil mist or dust must exist	
Altitude	According to each instruction manual	
Vibration	According to each instruction manual	

- When coupling with the synchronous encoder or servo motor shaft end, do not apply impact such as by hitting with a hammer. Doing so may lead to detector damage.
- Do not apply a load larger than the tolerable load onto the synchronous encoder and servo motor shaft. Doing so may lead to shaft breakage.
- When not using the module for a long time, disconnect the power line from the Motion controller or servo amplifier.
- Place the Motion controller and servo amplifier in static electricity preventing vinyl bags and store.
- When storing for a long time, please contact with our sales representative.
Also, execute a trial operation.
- When fumigants that contain halogen materials such as fluorine, chlorine, bromine, and iodine are used for disinfecting and protecting wooden packaging from insects, they cause malfunction when entering our products.
Please take necessary precautions to ensure that remaining materials from fumigant do not enter our products, or treat packaging with methods other than fumigation (heat method).
Additionally, disinfect and protect wood from insects before packing products.

(5) Wiring

⚠ CAUTION

- Correctly and securely wire the wires. Reconfirm the connections for mistakes and the terminal screws for tightness after wiring. Failing to do so may lead to run away of the servo motor.
- After wiring, install the protective covers such as the terminal covers to the original positions.
- Do not install a phase advancing capacitor, surge absorber or radio noise filter (option FR-BIF) on the output side of the servo amplifier.
- Correctly connect the output side (terminal U, V, W) and ground. Incorrect connections will lead the servo motor to operate abnormally.
- Do not connect a commercial power supply to the servo motor, as this may lead to trouble.
- Do not mistake the direction of the surge absorbing diode installed on the DC relay for the control signal output of brake signals, etc. Incorrect installation may lead to signals not being output when trouble occurs or the protective functions not functioning.

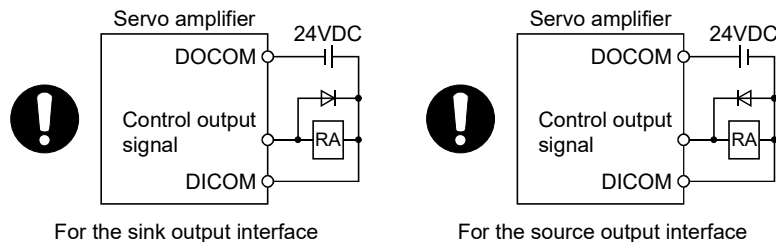

- Do not connect or disconnect the connection cables between each unit, the encoder cable or PLC expansion cable while the power is ON.
- Securely tighten the cable connector fixing screws and fixing mechanisms. Insufficient fixing may lead to the cables coming off during operation.
- Do not bundle the power line or cables.

(6) Trial operation and adjustment

⚠ CAUTION

- Confirm and adjust the program and each parameter before operation. Unpredictable movements may occur depending on the machine.
- Extreme adjustments and changes may lead to unstable operation, so never make them.
- When using the absolute position system function, on starting up, and when the Motion controller or absolute position motor has been replaced, always perform a home position return.
- Before starting test operation, set the parameter speed limit value to the slowest value, and make sure that operation can be stopped immediately by the forced stop, etc. if a hazardous state occurs.

(7) Usage methods

⚠ CAUTION

- Immediately turn OFF the power if smoke, abnormal sounds or odors are emitted from the Motion controller, servo amplifier or servo motor.
- Always execute a test operation before starting actual operations after the program or parameters have been changed or after maintenance and inspection.
- Do not attempt to disassemble and repair the units excluding a qualified technician whom our company recognized.
- Do not make any modifications to the unit.
- Keep the effect or electromagnetic obstacles to a minimum by installing a noise filter or by using wire shields, etc. Electromagnetic obstacles may affect the electronic devices used near the Motion controller or servo amplifier.
- When using the CE Mark-compliant equipment, refer to the User's manual for the Motion controllers and refer to the corresponding EMC guideline information for the servo amplifiers, inverters and other equipment.
- Use the units with the following conditions.

Item	Conditions
Input power	According to each instruction manual.
Input frequency	According to each instruction manual.
Tolerable momentary power failure	According to each instruction manual.

(8) Corrective actions for errors

⚠ CAUTION

- If an error occurs in the self diagnosis of the Motion controller or servo amplifier, confirm the check details according to the instruction manual, and restore the operation.
- If a dangerous state is predicted in case of a power failure or product failure, use a servo motor with electromagnetic brakes or install a brake mechanism externally.
- Use a double circuit construction so that the electromagnetic brake operation circuit can be operated by emergency stop signals set externally.

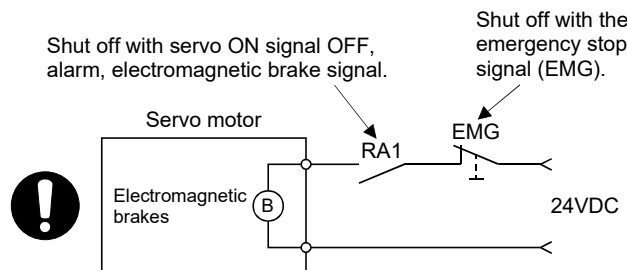

- If an error occurs, remove the cause, secure the safety and then resume operation after alarm release.
- The unit may suddenly resume operation after a power failure is restored, so do not go near the machine. (Design the machine so that personal safety can be ensured even if the machine restarts suddenly.)

(9) Maintenance, inspection and part replacement

CAUTION

- Perform the daily and periodic inspections according to the instruction manual.
- Perform maintenance and inspection after backing up the program and parameters for the Motion controller and servo amplifier.
- Do not place fingers or hands in the clearance when opening or closing any opening.
- Periodically replace consumable parts such as batteries according to the instruction manual.
- Do not touch the lead sections such as ICs or the connector contacts.
- Before touching the module, always touch grounded metal, etc. to discharge static electricity from human body. Failure to do so may cause the module to fail or malfunction.
- Do not directly touch the module's conductive parts and electronic components. Touching them could cause an operation failure or give damage to the module.
- Do not place the Motion controller or servo amplifier on metal that may cause a power leakage or wood, plastic or vinyl that may cause static electricity buildup.
- Do not perform a megger test (insulation resistance measurement) during inspection.
- When replacing the Motion controller or servo amplifier, always set the new module settings correctly.
- When the Motion controller or absolute value motor has been replaced, carry out a home position return operation using one of the following methods, otherwise position displacement could occur.
 - 1) After writing the servo data to the Motion controller using programming software, switch on the power again, then perform a home position return operation.
 - 2) Using the backup function of the programming software, load the data backed up before replacement.
- After maintenance and inspections are completed, confirm that the position detection of the absolute position detector function is correct.
- Do not drop or impact the battery installed to the module. Doing so may damage the battery, causing battery liquid to leak in the battery. Do not use the dropped or impacted battery, but dispose of it.
- Do not short circuit, charge, overheat, incinerate or disassemble the batteries.
- The electrolytic capacitor will generate gas during a fault, so do not place your face near the Motion controller or servo amplifier.
- The electrolytic capacitor and fan will deteriorate. Periodically replace these to prevent secondary damage from faults. Replacements can be made by our sales representative.
- Lock the control panel and prevent access to those who are not certified to handle or install electric equipment.
- Do not burn or break a module and servo amplifier. Doing so may cause a toxic gas.

(10) About processing of waste

When you discard Motion controller, servo amplifier, a battery (primary battery) and other option articles, please follow the law of each country (area).

CAUTION

- This product is not designed or manufactured to be used in equipment or systems in situations that can affect or endanger human life.
- When considering this product for operation in special applications such as machinery or systems used in passenger transportation, medical, aerospace, atomic power, electric power, or submarine repeating applications, please contact your nearest Mitsubishi Electric sales representative.
- Although this product was manufactured under conditions of strict quality control, you are strongly advised to install safety devices to forestall serious accidents when it is used in facilities where a breakdown in the product is likely to cause a serious accident.

(11) General cautions

- All drawings provided in the instruction manual show the state with the covers and safety partitions removed to explain detailed sections. When operating the product, always return the covers and partitions to the designated positions, and operate according to the instruction manual.

REVISIONS

* The manual number is given on the bottom left of the back cover.

Print Date	* Manual Number	Revision
Sep., 2012	IB(NA)-0300198-A	First edition
Apr., 2013	IB(NA)-0300198-B	[Additional function] Multiple CPU synchronous control [Additional correction/partial correction] About Manuals, Restrictions by the software's version, [Rq.324] Connection command of synchronous encoder via device/master CPU (M11602+4n), [Md.412] Execute cam axis length per cycle (D13622+30n, D13623+30n), [Pr.422] Cam axis length per cycle change setting (D15059+150n), Command generation axis parameter, Synchronous encoder axis parameter, Differences with virtual mode switching method, Error code list
Nov., 2013	IB(NA)-0300198-C	[Additional function] Synchronous encoder via servo amplifier [Additional correction/partial correction] Safety precautions, Restrictions by the software's version, Synchronous encoder axis parameter, Error code list, Differences with virtual mode switching method
Dec., 2015	IB(NA)-0300198-D	[Additional correction/partial correction] Restrictions by the software's version, Servo status7 (#8018+20n), Type of cam data, Error codes stored using Motion CPU, Warranty
Mar., 2017	IB(NA)-0300198-E	[Additional correction/partial correction] Safety precautions, Restrictions by the software's version, Cam axis restoration method examples, Error code list, Warranty
Dec., 2019	IB(NA)-0300198-F	[Additional correction/partial correction] Overview of cam operation, Change in structure of Chapter 8 to 9
Apr., 2022	IB(NA)-0300198-G	[Additional model] MR-J5-□B, MR-J5W-□B [Additional correction/partial correction] Safety precautions, About Manuals, Restrictions by the software's version, Gain changing 2 command (M3206+20n), Servo status5 (#8014+20n), Synchronous encoder via servo amplifier, Differences with virtual mode switching method, Warranty

Japanese Manual Number IB(NA)-0300193

This manual confers no industrial property rights or any rights of any other kind, nor does it confer any patent licenses. Mitsubishi Electric Corporation cannot be held responsible for any problems involving industrial property rights which may occur as a result of using the contents noted in this manual.

INTRODUCTION

Thank you for choosing the Mitsubishi Electric Motion controller Q173DSCPU/Q172DSCPU.
Before using the equipment, please read this manual carefully to develop full familiarity with the functions and performance of the Motion controller you have purchased, so as to ensure correct use.

CONTENTS

Safety Precautions	A- 1
Revisions	A-11
Contents	A-12
About Manuals	A-15
1. OVERVIEW	1- 1 to 1-10
1.1 Overview	1- 1
1.2 Overview of Synchronous Control	1- 4
1.3 Performance Specifications	1- 5
1.4 Restrictions by the Software's Version	1- 9
1.5 Programming Software Version	1-10
2. STARTING UP THE SYSTEM	2- 1 to 2- 6
2.1 Starting Up the Advanced Control System	2- 1
2.2 Starting/Ending for Synchronous Control	2- 2
2.3 Stop Operation of Output Axis	2- 5
3. SYNCHRONOUS CONTROL MODULE	3- 1 to 3- 4
3.1 List of Synchronous Control Module	3- 1
4. POSITIONING DEDICATED SIGNALS	4- 1 to 4-40
4.1 Internal Relays	4- 3
4.2 Data Registers	4-20
4.3 Motion Registers (#)	4-37
4.4 Special Relays (SM)	4-39
4.5 Special Registers (SD)	4-40
5. INPUT AXIS MODULE	5- 1 to 5-62
5.1 Servo Input Axis	5- 1
5.1.1 Overview of servo input axis	5- 1
5.1.2 Servo input axis parameters	5- 4
5.1.3 Servo input axis monitor data	5- 8
5.2 Command Generation Axis	5-10
5.2.1 Overview of command generation axis	5-10
5.2.2 Command generation axis parameters	5-15
5.2.3 Command generation axis control data	5-20
5.2.4 Command generation monitor data	5-23

5.3 Synchronous Encoder Axis.....	5-29
5.3.1 Overview of synchronous encoder axis.....	5-29
5.3.2 Setting method for synchronous encoder	5-32
5.3.3 Synchronous encoder axis parameters.....	5-43
5.3.4 Synchronous encoder axis control data	5-52
5.3.5 Synchronous encoder axis monitor data.....	5-57

6. CAM FUNCTION	6- 1 to 6-12
------------------------	---------------------

6.1 Control Details for Cam Function	6- 1
6.1.1 Type of cam data.....	6- 2
6.1.2 Overview of cam operation	6- 5
6.2 Create Cam Data	6- 8
6.2.1 Memory configuration of cam data	6- 8
6.2.2 Cam data operation by Motion SFC program	6-11

7. SYNCHRONOUS CONTROL	7- 1 to 7-60
-------------------------------	---------------------

7.1 Main Shaft Module	7- 1
7.1.1 Overview of main shaft module	7- 1
7.1.2 Main shaft parameters	7- 2
7.1.3 Main shaft clutch parameters.....	7- 5
7.1.4 Main shaft clutch control data	7-13
7.2 Auxiliary Shaft Module	7-14
7.2.1 Overview of auxiliary shaft module.....	7-14
7.2.2 Auxiliary shaft parameters	7-15
7.2.3 Auxiliary shaft clutch parameters.....	7-18
7.2.4 Auxiliary shaft clutch control data	7-26
7.3 Clutch.....	7-27
7.3.1 Overview of clutch.....	7-27
7.3.2 Control method for clutch.....	7-27
7.3.3 Smoothing method for clutch	7-34
7.3.4 Use example of clutch.....	7-38
7.4 Speed Change Gear Module.....	7-39
7.4.1 Overview of speed change gear module.....	7-39
7.4.2 Speed change gear parameters	7-40
7.5 Output Axis Module.....	7-42
7.5.1 Overview of output axis module.....	7-42
7.5.2 Output axis parameters.....	7-44
7.6 Synchronous Control Change Function	7-50
7.6.1 Overview of synchronous control change function	7-50
7.6.2 Synchronous control change control data.....	7-50
7.7 Synchronous Control Monitor Data	7-55

8. SYNCHRONOUS CONTROL INITIAL POSITION	8- 1 to 8-26
------------------------------------------------	---------------------

8.1 Synchronous Control Initial Position.....	8- 1
8.2 Synchronous Control Initial Position Parameters	8- 7
8.3 Cam Axis Position Restoration Method.....	8-11

8.3.1 Cam axis current value per cycle restoration	8-11
8.3.2 Cam reference position restoration	8-17
8.3.3 Cam axis current feed value restoration.....	8-19
8.4 Synchronous Control Analysis Mode	8-22
8.5 Cam Position Calculation Function	8-24
8.6 Method to Restart Synchronous Control.....	8-25

9. AUXILIARY AND APPLIED FUNCTIONS	9- 1 to 9-36
-------------------------------------------	---------------------

9.1 Phase Compensation Function	9- 1
9.2 Relationship between the Output Axis and Each Function	9- 3
9.3 Speed-Torque Control	9- 4
9.4 Multiple CPU Synchronous Control.....	9-11
9.4.1 Overview.....	9-11
9.4.2 Setting for Multiple CPU synchronous control.....	9-15
9.4.3 Multiple CPU synchronous control area.....	9-26
9.4.4 Selection of slave CPU input axis type.....	9-28
9.4.5 Multiple CPU synchronous control monitor device	9-33
9.4.6 Example programs	9-34

APPENDICES	APP- 1 to APP-82
-------------------	-------------------------

APPENDIX 1 Error Codes Stored Using the Motion CPU.....	APP- 1
APPENDIX 1.1 Servo program setting errors (Stored in SD517)	APP- 4
APPENDIX 1.2 Minor errors	APP- 9
APPENDIX 1.3 Major errors	APP-26
APPENDIX 1.4 Servo errors.....	APP-39
APPENDIX 2 Setting Range for Indirect Setting Devices.....	APP-40
APPENDIX 3 Processing Times of the Motion CPU	APP-42
APPENDIX 4 Sample Program of Synchronous Control.....	APP-43
APPENDIX 5 Differences.....	APP-46
APPENDIX 5.1 Differences with virtual mode switching method	APP-46
APPENDIX 6 Device List	APP-49

About Manuals

The following manuals are also related to this product.

When necessary, order them by quoting the details in the tables below.

Related Manuals

(1) Motion controller

Manual Name	Manual Number (Model Code)
Q173D(S)CPU/Q172D(S)CPU Motion controller User's Manual This manual explains specifications of the Motion CPU modules, Q172DLX Servo external signal interface module, Q172DEX Synchronous encoder interface module, Q173DPX Manual pulse generator interface module, Power supply modules, Servo amplifiers, SSCNETⅢ cables and Synchronous encoder, and the maintenance/inspection for the system, trouble shooting and others.	IB-0300133 (1XB927)
Q173D(S)CPU/Q172D(S)CPU Motion controller Programming Manual (COMMON) This manual explains the Multiple CPU system configuration, performance specifications, common parameters, auxiliary/applied functions, error lists and others.	IB-0300134 (1XB928)
Q173D(S)CPU/Q172D(S)CPU Motion controller (SV13/SV22) Programming Manual (Motion SFC) This manual explains the functions, programming, debugging, error lists for Motion SFC and others.	IB-0300135 (1XB929)
Q173D(S)CPU/Q172D(S)CPU Motion controller (SV13/SV22) Programming Manual (REAL MODE) This manual explains the servo parameters, positioning instructions, device lists, error lists and others.	IB-0300136 (1XB930)
Q173D(S)CPU/Q172D(S)CPU Motion controller (SV22) Programming Manual (VIRTUAL MODE) This manual explains the dedicated instructions to use the synchronous control by virtual main shaft, mechanical system program create mechanical module, servo parameters, positioning instructions, device lists, error lists and others.	IB-0300137 (1XB931)
Q173DSCPU/Q172DSCPU Motion controller (SV22) Programming Manual (Advanced Synchronous Control) This manual explains the dedicated instructions to use the synchronous control by synchronous control parameters, device lists, error lists and others.	IB-0300198 (1XB953)
Q173D(S)CPU/Q172D(S)CPU Motion controller Programming Manual (Safety Observation) This manual explains the details, safety parameters, safety sequence program instructions, device lists and error lists and others for safety observation function by Motion controller.	IB-0300183 (1XB945)
Motion controller Setup Guidance (MT Developer2 Version1) This manual explains the items related to the setup of the Motion controller programming software MT Developer2.	IB-0300142 (—)

(2) PLC

Manual Name	Manual Number (Model Code)
<p>QCPU User's Manual (Hardware Design, Maintenance and Inspection)</p> <p>This manual explains the specifications of the QCPU modules, power supply modules, base units, extension cables, memory card battery, and the maintenance/inspection for the system, trouble shooting, error codes and others.</p>	SH-080483ENG (13JR73)
<p>QnUCPU User's Manual (Function Explanation, Program Fundamentals)</p> <p>This manual explains the functions, programming methods and devices and others to create programs with the QCPU.</p>	SH-080807ENG (13JZ27)
<p>QCPU User's Manual (Multiple CPU System)</p> <p>This manual explains the Multiple CPU system overview, system configuration, I/O modules, communication between CPU modules and communication with the I/O modules or intelligent function modules.</p>	SH-080485ENG (13JR75)
<p>QnUCPU User's Manual (Communication via Built-in Ethernet Port)</p> <p>This manual explains functions for the communication via built-in Ethernet port of the CPU module.</p>	SH-080811ENG (13JZ29)
<p>MELSEC-Q/L Programming Manual (Common Instruction)</p> <p>This manual explains how to use the sequence instructions, basic instructions, application instructions and micro computer program.</p>	SH-080809ENG (13JW10)
<p>MELSEC-Q/L/QnA Programming Manual (PID Control Instructions)</p> <p>This manual explains the dedicated instructions used to exercise PID control.</p>	SH-080040 (13JF59)
<p>MELSEC-Q/L/QnA Programming Manual (SFC)</p> <p>This manual explains the system configuration, performance specifications, functions, programming, debugging, error codes and others of MELSAP3.</p>	SH-080041 (13JF60)
<p>I/O Module Type Building Block User's Manual</p> <p>This manual explains the specifications of the I/O modules, connector, connector/terminal block conversion modules and others.</p>	SH-080042 (13JL99)
<p>MELSEC-L SSCNETⅢ/H Head Module User's Manual</p> <p>This manual explains specifications of the head module, procedures before operation, system configuration, installation, wiring, settings, and troubleshooting.</p>	SH-081152ENG (13JZ78)

(3) Servo amplifier

Manual Name	Manual Number (Model Code)
MR-J5-B/MR-J5W-B User's Manual (Introduction) This manual explains the specifications, functions, start-up procedure and others for AC Servo MR-J5-B/MR-J5W-B Servo amplifier.	IB-0300578ENG (—)
MR-J5 User's Manual (Hardware) This manual explains the installation, wiring, use option and others for AC Servo MR-J5-B/MR-J5W-B Servo amplifier.	SH-030298ENG (—)
MR-J5 User's Manual (Function) This manual explains how to use each function required to operate the AC Servo MR-J5-B/MR-J5W-B Servo amplifier.	SH-030300ENG (—)
MR-J5 User's Manual (Adjustment) This manual explains the operation status adjustment procedure, adjustment method and others for AC Servo MR-J5-B/MR-J5W-B Servo amplifier.	SH-030306ENG (—)
MR-J5 User's Manual (Troubleshooting) This manual explains the causes of alarms, and warnings, etc. for AC Servo MR-J5-B/MR-J5W-B Servo amplifier.	SH-030312ENG (—)
MR-J5-B/MR-J5W-B User's Manual (Parameters) This manual explains the parameters for AC Servo MR-J5-B/MR-J5W-B Servo amplifier.	IB-0300581ENG (—)
SSCNETⅢ/H Interface AC Servo MR-J4-_B_(-RJ) Servo amplifier Instruction Manual This manual explains the I/O signals, parts names, parameters, start-up procedure and others for AC Servo MR-J4-_B_(-RJ) Servo amplifier.	SH-030106 (1CW805)
SSCNETⅢ/H Interface Multi-axis AC Servo MR-J4W2-_B_/MR-J4W3-_B_/MR-J4W2-0303B6 Servo amplifier Instruction Manual This manual explains the I/O signals, parts names, parameters, start-up procedure and others for Multi-axis AC Servo MR-J4W2-_B_/MR-J4W3-_B_/MR-J4W2-0303B6 Servo amplifier.	SH-030105 (1CW806)
SSCNETⅢ interface MR-J3-□B Servo amplifier Instruction Manual This manual explains the I/O signals, parts names, parameters, start-up procedure and others for MR-J3-□B Servo amplifier.	SH-030051 (1CW202)
SSCNETⅢ interface 2-axis AC Servo Amplifier MR-J3W-0303BN6/MR-J3W-□B Servo amplifier Instruction Manual This manual explains the I/O signals, parts names, parameters, start-up procedure and others for 2-axis AC Servo Amplifier MR-J3W-0303BN6/MR-J3W-□B Servo amplifier.	SH-030073 (1CW604)
SSCNETⅢ Compatible Linear Servo MR-J3-□B-RJ004U□ Instruction Manual This manual explains the I/O signals, parts names, parameters, start-up procedure and others for Linear Servo MR-J3-□B-RJ004U□ Servo amplifier.	SH-030054 (1CW943)
SSCNETⅢ Compatible Fully Closed Loop Control MR-J3-□B-RJ006 Servo amplifier Instruction Manual This manual explains the I/O signals, parts names, parameters, start-up procedure and others for Fully Closed Loop Control MR-J3-□B-RJ006 Servo amplifier.	SH-030056 (1CW304)
SSCNETⅢ Interface Direct Drive Servo MR-J3-□B-RJ080W Instruction Manual This manual explains the I/O signals, parts names, parameters, start-up procedure and others for Direct Drive Servo MR-J3-□B-RJ080W Servo amplifier.	SH-030079 (1CW601)

Manual Name	Manual Number (Model Code)
<p>SSCNETⅢ interface Drive Safety integrated MR-J3-□B Safety Servo amplifier Instruction Manual</p> <p>This manual explains the I/O signals, parts names, parameters, start-up procedure and others for safety integrated MR-J3-□B Safety Servo amplifier.</p>	<p>SH-030084 (1CW205)</p>

1. OVERVIEW

1.1 Overview

This programming manual describes synchronous control parameters and positioning dedicated devices required to execute the synchronous control in the Motion controller (SV22 advanced synchronous control).

The following positioning control is possible in the Motion controller (SV22 advanced synchronous control).

Applicable CPU	Number of positioning control axes
Q173DSCPU	Up to 32 axes
Q172DSCPU	Up to 16 axes

In this manual, the following abbreviations are used.

Generic term/Abbreviation	Description
Q173D(S)CPU/Q172D(S)CPU or Motion CPU (module)	Q173DSCPU/Q172DSCPU/Q173DCPU/Q172DCPU/Q173DCPU-S1/Q172DCPU-S1 Motion CPU module
Q172DLX/Q172DEX/Q173DPX/Q173DSXY or Motion module	Q172DLX Servo external signals interface module/ Q172DEX Synchronous encoder interface module ^(Note-1) / Q173DPX Manual pulse generator interface module/ Q173DSXY Safety signal module
MR-J5(W)-□B	Servo amplifier model MR-J5-□B/MR-J5W-□B
MR-J4(W)-□B	Servo amplifier model MR-J4-□B/MR-J4W-□B
MR-J3(W)-□B	Servo amplifier model MR-J3-□B/MR-J3W-□B
AMP or Servo amplifier	General name for "Servo amplifier model MR-J5-□B/MR-J5W-□B/MR-J4-□B/MR-J4W-□B/MR-J3-□B/MR-J3W-□B"
QCPU, PLC CPU or PLC CPU module	QnUD(E)(H)CPU/QnUDVCPU
Multiple CPU system or Motion system	Abbreviation for "Multiple PLC system of the Q series"
CPUn	Abbreviation for "CPU No.n (n= 1 to 4) of the CPU module for the Multiple CPU system"
Operating system software	General name for "SW7DNC-SV□□□/SW8DNC-SV□□□"
SV13	Operating system software for conveyor assembly use (Motion SFC) : SW8DNC-SV13Q□
SV22	Operating system software for automatic machinery use (Motion SFC) : SW8DNC-SV22Q□
Programming software package	General name for MT Developer2/GX Works2/GX Developer/MR Configurator□
MELSOFT MT Works2	Abbreviation for "Motion controller engineering environment MELSOFT MT Works2"
MT Developer2 ^(Note-2)	Abbreviation for "Motion controller programming software MT Developer2 (Version 1.00A or later)"
GX Works2	Abbreviation for "Programmable controller engineering software MELSOFT GX Works2 (Version 1.15R or later)"
GX Developer	Abbreviation for "MELSEC PLC programming software package GX Developer (Version 8.48A or later)"
MR Configurator□ ^(Note-2)	General name for "MR Configurator/MR Configurator2"
MR Configurator	Abbreviation for "Servo setup software package MR Configurator (Version C0 or later)"

1 OVERVIEW

Generic term/Abbreviation	Description
MR Configurator2	Abbreviation for "Servo setup software package MR Configurator2 (Version 1.01B or later)"
Manual pulse generator or MR-HDP01	Abbreviation for "Manual pulse generator (MR-HDP01)"
Serial absolute synchronous encoder or Q171ENC-W8/Q170ENC	Abbreviation for "Serial absolute synchronous encoder (Q171ENC-W8/Q170ENC)"
SSCNET III/H ^(Note-3)	High speed synchronous network between Motion controller and servo amplifier
SSCNET III ^(Note-3)	
SSCNET III(H) ^(Note-3)	General name for SSCNET III/H, SSCNET III
Absolute position system	General name for "system using the servo motor and servo amplifier for absolute position"
Battery holder unit	Battery holder unit (Q170DBATC)
Intelligent function module	General name for module that has a function other than input or output, such as A/D converter module and D/A converter module.
SSCNET III/H head module	Abbreviation for "MELSEC-L series SSCNET III/H head module (LJ72MS15)"
Optical hub unit or MR-MV200	Abbreviation for "SSCNET III/H compatible optical hub unit (MR-MV200)"

(Note-1): Q172DEX can be used in SV22.

(Note-2): This software is included in Motion controller engineering environment "MELSOFT MT Works2".

(Note-3): SSCNET: Servo System Controller NETwork

REMARK

For information about each module, design method for program and parameter, refer to the following manuals relevant to each module.

Item	Reference Manual	
Motion CPU module/Motion unit	Q173D(S)CPU/Q172D(S)CPU Motion controller User's Manual	
PLC CPU, peripheral devices for sequence program design, I/O modules and intelligent function module	Manual relevant to each module	
Operation method for MT Developer2	Help of each software	
SV13/SV22	<ul style="list-style-type: none"> Multiple CPU system configuration Performance specification Design method for common parameter Auxiliary and applied functions (common) 	Q173D(S)CPU/Q172D(S)CPU Motion controller Programming Manual (COMMON)
	<ul style="list-style-type: none"> Design method for Motion SFC program Design method for Motion SFC parameter Motion dedicated PLC instruction 	Q173D(S)CPU/Q172D(S)CPU Motion controller (SV13/SV22) Programming Manual (Motion SFC)
	<ul style="list-style-type: none"> Design method for positioning control program in the real mode Design method for positioning control parameter 	Q173D(S)CPU/Q172D(S)CPU Motion controller (SV13/SV22) Programming Manual (REAL MODE)
	<ul style="list-style-type: none"> Design method for safety observation parameter Design method for user made safety sequence program 	Q173D(S)CPU/Q172D(S)CPU Motion controller Programming Manual (Safety Observation)
SV22 (Virtual mode)	<ul style="list-style-type: none"> Design method for mechanical system program 	Q173D(S)CPU/Q172D(S)CPU Motion controller (SV22) Programming Manual (VIRTUAL MODE)

CAUTION

- When designing the system, provide external protective and safety circuits to ensure safety in the event of trouble with the Motion controller.
- There are electronic components which are susceptible to the effects of static electricity mounted on the printed circuit board. When handling printed circuit boards with bare hands you must ground your body or the work bench.
Do not touch current-carrying or electric parts of the equipment with bare hands.
- Make parameter settings within the ranges stated in this manual.
- Use the program instructions that are used in programs in accordance with the conditions stipulated in this manual.
- Some devices for use in programs have fixed applications: they must be used in accordance with the conditions stipulated in this manual.

1 OVERVIEW

1.2 Overview of Synchronous Control

"Synchronous control" can be achieved using software instead of controlling mechanically with gear, shaft, speed change gear or cam etc.

"Synchronous control" synchronizes movement with the input axis (servo input axis, command generation axis, synchronous encoder axis), by setting "the parameters for synchronous control" and starting synchronous control on each output axis.

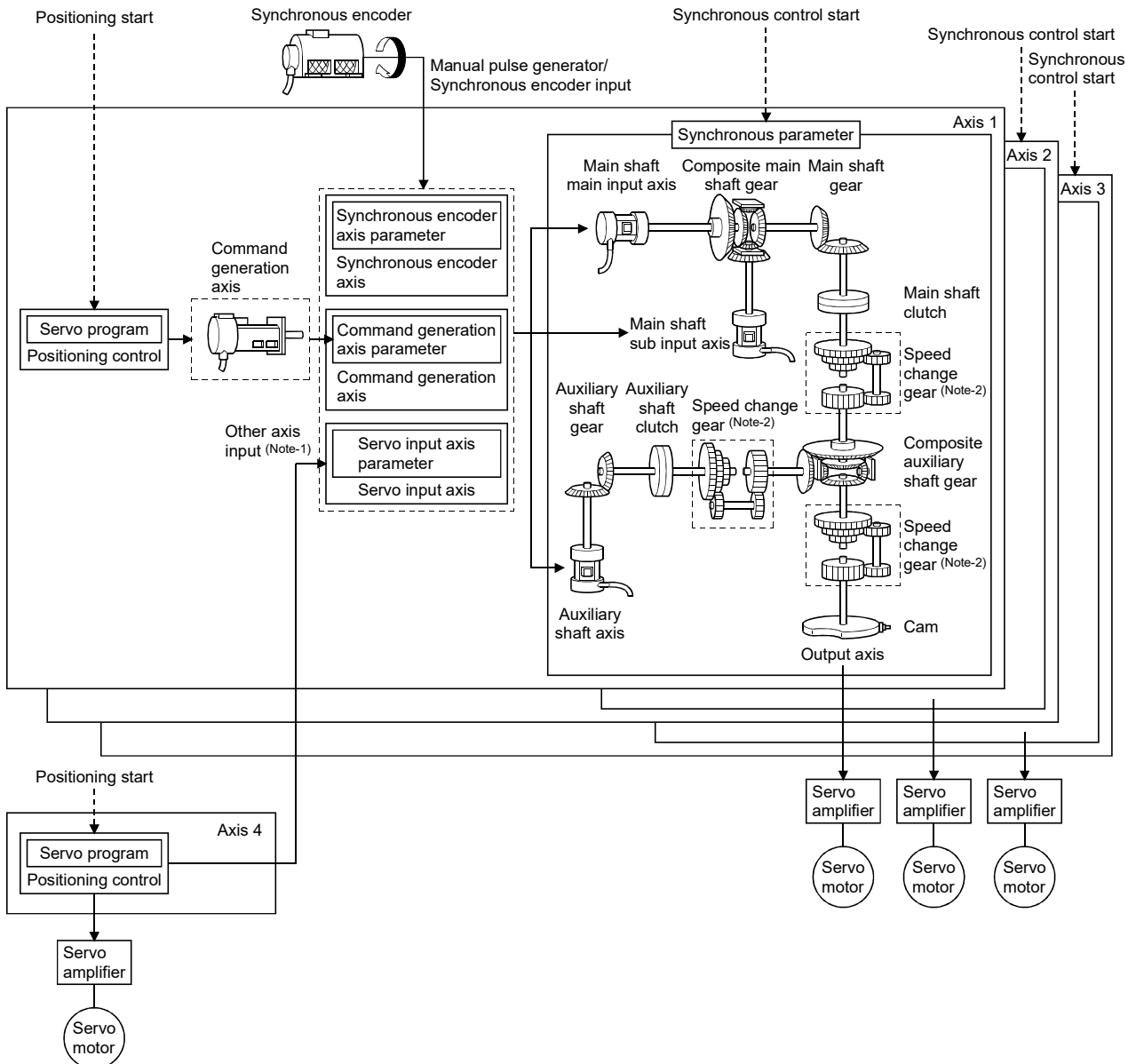

(Note-1): It is possible to drive the servo input axis except the positioning control (home position return, manual control, speed-torque control, synchronous control).

Refer to the "Q173D(S)CPU/Q172D(S)CPU Motion controller (SV13/SV22) Programming Manual (REAL MODE)" for details on the positioning control, home position return, the manual control and the speed-torque control.

(Note-2): Speed change gear can be arranged on two of "Main shaft side", "Auxiliary shaft side" or "After composite auxiliary shaft gear".

1 OVERVIEW

1.3 Performance Specifications

(1) Motion control specifications

Item		Q173DSCPU	Q172DSCPU
Number of control axes		Up to 32 axes	Up to 16 axes
Operation cycle (default)	SV22	0.44ms/ 1 to 6 axes	0.44ms/ 1 to 6 axes
		0.88ms/ 7 to 16 axes	0.88ms/ 7 to 16 axes
		1.77ms/17 to 32 axes	
Interpolation functions		Linear interpolation (Up to 4 axes), Circular interpolation (2 axes), Helical interpolation (3 axes)	
Control modes		PTP(Point to Point) control, Speed control, Speed-position switching control, Fixed-pitch feed, Constant speed control, Position follow-up control, Speed control with fixed position stop, Speed switching control, High-speed oscillation control, Speed-torque control, Synchronous control (SV22 advanced synchronous control method)	
Acceleration/deceleration control		Trapezoidal acceleration/deceleration, S-curve acceleration/deceleration, Advanced S-curve acceleration/deceleration	
Compensation		Backlash compensation, Electronic gear, Phase compensation (SV22)	
Programming language		Motion SFC, Dedicated instruction	
Servo program capacity		16k steps	
Number of positioning points		3200 points (Positioning data can be designated indirectly)	
Peripheral I/F		USB/RS-232/Ethernet (Via PLC CPU) PERIPHERAL I/F (Motion CPU)	
Home position return function		Proximity dog method (2 types), Count method (3 types), Data set method (2 types), Dog cradle method, Stopper method (2 types), Limit switch combined method, Scale home position signal detection method, Dogless home position signal reference method, Driver home position return method ----- Home position return re-try function provided, home position shift function provided	
JOG operation function		Provided	
Manual pulse generator operation function		Possible to connect 3 modules (Q173DPX use) Possible to connect 1 module (Built-in interface in Motion CPU use) (Note-1)	
Synchronous encoder operation function (Note-2)		Possible to connect 12 modules (SV22 use) (Q172DEX + Q173DPX + Built-in interface in Motion CPU + Via device + Via servo amplifier (Note-3) + Multiple CPU synchronous control)	
M-code function		M-code output function provided, M-code completion wait function provided	
Limit switch output function		Number of output points 64 points × 2 settings Output timing compensation Watch data: Motion control data/Word device	
ROM operation function		Provided	
Multiple CPU synchronous control		Provided	
External input signal		Q172DLX, External input signals (FLS/RLS/DOG) of servo amplifier, Built-in interface in Motion CPU (DI), Bit device	
High-speed reading function		None (It can be substituted by the mark detection function.)	
Forced stop		Motion controller forced stop (EMI connector, System setting), Forced stop terminal of servo amplifier	
Number of I/O points		Total 256 points (Built-in interface in Motion CPU (Input 4 points) + I/O module + Intelligent function module)	
Mark detection function	Mark detection mode setting	Continuous detection mode, Specified number of detection mode, Ring buffer mode	
	Mark detection signal	Built-in interface in Motion CPU (4 points), Bit device, DOG/CHANGE signal of Q172DLX	
	Mark detection setting	32 settings	
Clock function		Provided	
Security function		Provided (Protection by software security key or password)	

1 OVERVIEW

Motion control specifications (continued)

Item		Q173DSCPU	Q172DSCPU
All clear function		Provided	
Remote operation		Remote RUN/STOP, Remote latch clear	
Optional data monitor function	SSCNETⅢ/H	Up to 6 data/axis (Communication data: Up to 6 points/axis)	
	SSCNETⅢ	Up to 3 data/axis (Communication data: Up to 3 points/axis)	
Digital oscilloscope function		Motion buffering method (Real-time waveform can be displayed) Sampling data: Word 16CH, Bit 16CH	
Absolute position system		Made compatible by setting battery to servo amplifier. (No battery required when a servo motor with a batteryless absolute position encoder is used) (Possible to select the absolute data method or incremental method for each axis)	
SSCNET communication (Note-4)	Communication type	SSCNETⅢ/H, SSCNETⅢ	
	Number of lines	2 lines (Note-5)	1 line (Note-5)
Driver communication function (Note-6)		Provided	
Number of Motion related modules	Q172DLX	4 modules usable	2 modules usable
	Q172DEX	6 modules usable	
	Q173DPX	4 modules usable (Note-7)	
Number of SSCNETⅢ/H head module connection stations		Up to 8 stations usable (Up to 4 stations/line)	Up to 4 stations usable
Number of optical hub unit connections		Up to 32 units usable (Up to 16 units/line)	Up to 16 units usable

(Note-1): When the manual pulse generator is used via the built-in interface in Motion CPU, the Q173DPX cannot be used.

(Note-2): Any incremental synchronous encoder connected to the built-in interface in Motion CPU will automatically be assigned an Axis No. one integer greater than the number of encoders connected to any Q172DEX modules and Q173DPX modules.

(Note-3): Servo amplifier (MR-J5(W)-□B/MR-J4(W)-□B) only.

Refer to Section 5.3.1 for details on devices that can be used as a synchronous encoder axis.

(Note-4): The servo amplifiers for SSCNET cannot be used.

(Note-5): SSCNETⅢ and SSCNETⅢ/H cannot be combined in the same line.
For Q173DSCPU, SSCNETⅢ or SSCNETⅢ/H can be set every line.

(Note-6): Servo amplifier (MR-J5-□B/MR-J4-□B/MR-J3-□B) only.

(Note-7): When using the incremental synchronous encoder (SV22 use), you can use above number of modules.
When connecting the manual pulse generator, you can use only 1 module.

(2) Synchronous control specifications

Item		Number of settable axes	
		Q173DSCPU	Q172DSCPU
Input axis	Servo input axis	32 axes/module	16 axes/module
	Command generation axis	32 axes/module	16 axes/module
	Synchronous encoder axis	12 axes/module	
Composite main shaft gear		1/output axis	
Main shaft main input axis		1 axis/output axis	
Main shaft sub input axis		1 axis/output axis	
Main shaft gear		1/output axis	
Main shaft clutch		1/output axis	
Auxiliary shaft		1 axis/output axis	
Auxiliary shaft gear		1/output axis	
Auxiliary shaft clutch		1/output axis	
Composite auxiliary shaft gear		1/output axis	
Speed change gear		2/output axis	
Output axis (Cam axis)		32 axes/module	16 axes/module

(3) Cam specifications

Item		Specification	
Memory capacity	Cam storage area	262144 bytes	
	Cam open area	1048576 bytes	
Number of cam registration ^(Note-1)		Up to 256 (Dependent on memory capacity, cam resolution and coordinate number)	
Comment		Up to 32 characters per cam data	
Cam data	Stroke ratio data format	Cam resolution	256/512/1024/2048/4096/8192/16384/32768
		Stroke ratio	-214.7483648 to 214.7483647[%]
	Coordinate data format	Coordinate number	2 to 16384
		Coordinate data	Input value: 0 to 2147483647 Output value: -2147483648 to 2147483647

(Note-1): The maximum number of cam registration by the cam resolution is shown below (In case it created by the same cam resolution).

(a) Stroke ratio data format

Cam resolution	Maximum number of cam registration	
	Cam storage area	Cam open area
256	256	256
512	128	256
1024	64	256
2048	32	128
4096	16	64
8192	8	32
16384	4	16
32768	2	8

(b) Coordinate data format

Coordinate number	Maximum number of cam registration	
	Cam storage area	Cam open area
128	256	256
256	128	256
512	64	256
1024	32	128
2048	16	64
4096	8	32
8192	4	16
16384	2	8

(4) Cam operation specifications

Item	Specification
Operation method of cam data	(a) MT Developer2 Write/read/verify to cam storage area (b) Motion SFC program (Synchronous control instruction) Write/read to cam storage area and cam open area
Cam auto-generation function	Automatically generate the cam for rotary cutter and easy stroke riation cam.
Cam position calculation function	Calculate the cam position by the Motion SFC program. Used to calculate the cam axis feed current value after calculating the cam axis current value per cycle for the synchronous control initial position before starting synchronous control.

(5) Synchronous encoder axis specifications

Item	Specification
Number of control axes	12
Synchronous encoder axis type	Synchronous encoder Pn/Via device/ Synchronous encoder via servo amplifier/ Multiple CPU synchronous control
Control unit	mm, inch, degree, pulse (Possible to select the decimal places of position unit and speed unit)
Unit conversion	Numerator -2147483648 to 2147483647 [Synchronous encoder axis position unit]
	Denominator 1 to 2147483647 [pulse]
Length per cycle setting range	1 to 2147483647 [Synchronous encoder axis position unit]
Current value range	Current value -2147483648 to 2147483647 [Synchronous encoder axis position unit]
	Current value per cycle 0 to (Length per cycle - 1) [Synchronous encoder axis position unit]
Control method	Control instruction Current value change, Counter disable, Counter enable
	Current value setting address Address setting range: -2147483648 to 2147483647 [Synchronous encoder axis position unit]

1 OVERVIEW

1.4 Restrictions by the Software's Version

There are restrictions in the function that can be used by the version of the operating system software and programming software.

The combination of each version and a function is shown in Table 1.1.

Table 1.1 Restrictions by the Software's Version

Function	Operating system software version (Note-1), (Note-2)		Programming software version		Section of reference
	Q173DSCPU/ Q172DSCPU	MELSOFT MT Works2 (MT Developer2)	MR Configurator2		
		Q173DSCPU/Q172DSCPU			
Feed current value update command (M3212+20n) valid in speed control (I)	00B	—	—	(Note-3)	
External forced stop input ON latch (SM506)	00B	—	—	(Note-4)	
Operation method (SD560)	00B	—	—	(Note-4)	
Advanced synchronous control	00B	1.47Z	—	This manual	
Limit switch output function expansion	00B	1.47Z	—	(Note-4)	
Driver communication function (SSCNETⅢ)	00C	—	—	(Note-4)	
Intelligent function module support	00C	1.56J	—	(Note-4)	
SSCNETⅢ/H head module connection	00C	1.56J	—	(Note-4)	
Cam auto-generation (CAMMK) easy stroke ratio cam	00C	1.56J	—	(Note-5)	
Acceleration/deceleration time change function	00C	1.56J	—	(Note-3)	
Home position return of dogless home position signal reference method	00C	1.56J	—	(Note-3)	
Setting range expansion of backlash compensation amount	00C	1.56J	—	(Note-3)	
Multiple CPU synchronous control	00C	1.56J	—	Section 9.4	
Cam axis length per cycle change during synchronous control	00C	1.56J	—	Section 7.5.2 Section 7.7	
Servo driver VCⅡ series manufactured by CKD Nikki Denso Co., Ltd.	SSCNETⅢ	—	1.34L	(Note-3)	
	SSCNETⅢ/H	00D	1.56J	(Note-3)	
Inverter FR-A700 series	—	1.34L	—	(Note-3)	
Synchronous encoder via servo amplifier	00D	1.68W	1.23Z	Section 5.3.2	
Driver communication function (SSCNETⅢ/H)	00D	1.68W	1.23Z	(Note-4)	
Optical hub unit connection	00F	—	—	(Note-3)	
Home position return of driver home position return method	00H	1.118Y	—	(Note-3)	
Stepping motor module AlphaStep/5-phase manufactured by ORIENTAL MOTOR Co., Ltd.	00H	1.118Y	—	(Note-3)	
Servo driver VPH series manufactured by CKD Nikki Denso Co., Ltd.	00H	1.118Y	—	(Note-3)	
IAI electric actuator controller manufactured by IAI Corporation	00H	1.118Y	—	(Note-3)	

—: There is no restriction by the version.

(Note-1): SV13/SV22 is the completely same version.

(Note-2): The operating system software version can be confirmed in the operating system software (CD-ROM), MT Developer2 or GX Works2/GX Developer. (Refer to "Q173D(S)CPU/Q172D(S)CPU Motion controller Programming Manual (COMMON) Section 1.3, 1.4".)

(Note-3): Q173D(S)CPU/Q172D(S)CPU Motion controller (SV13/SV22) Programming Manual (REAL MODE)

(Note-4): Q173D(S)CPU/Q172D(S)CPU Motion controller Programming Manual (COMMON)

(Note-5): Q173D(S)CPU/Q172D(S)CPU Motion controller (SV13/SV22) Programming Manual (Motion SFC)

1 OVERVIEW

Table 1.1 Restrictions by the Software's Version (continued)

Function	Operating system software version (Note-1), (Note-2)	Programming software version		Section of reference
	Q173DSCPU/ Q172DSCPU	MELSOFT MT Works2 (MT Developer2)	MR Configurator2	
		Q173DSCPU/Q172DSCPU		
Inverter FR-A800 series	00J	1.120A	—	(Note-3)
Improvement of absolute positioning operation for servo driver VCI/VPH series manufactured by CKD Nikki Denso Co., Ltd., and stepping motor module AlphaStep/5-phase manufactured by ORIENTAL MOTOR Co., Ltd.	00L	—	—	(Note-3)
Servo amplifier MR-J5(W)-□B support	00Y	1.170C	1.130L	
DOG/CHANGE signal input method support	00Y	1.170C	—	(Note-4)

—: There is no restriction by the version.

(Note-1): SV13/SV22 is the completely same version.

(Note-2): The operating system software version can be confirmed in the operating system software (CD-ROM), MT Developer2 or GX Works2/GX Developer. (Refer to "Q173D(S)CPU/Q172D(S)CPU Motion controller Programming Manual (COMMON) Section 1.3, 1.4".)

(Note-3): Q173D(S)CPU/Q172D(S)CPU Motion controller (SV13/SV22) Programming Manual (REAL MODE)

(Note-4): Q173D(S)CPU/Q172D(S)CPU Motion controller Programming Manual (COMMON)

(Note-5): Q173D(S)CPU/Q172D(S)CPU Motion controller (SV13/SV22) Programming Manual (Motion SFC)

1.5 Programming Software Version

The programming software versions that support Motion CPU are shown below.

Motion CPU	MELSOFT MT Works2 (MT Developer2)		MR Configurator2	MR Configurator
	SV13/SV22	SV43		
Q173DSCPU	1.39R (Note-1)		1.10L	Not support
Q172DSCPU	1.39R (Note-1)		1.10L	Not support

(Note-1): Use version 1.47Z or later to use advanced synchronous control method.

2. STARTING UP THE SYSTEM

The procedure for synchronous control positioning control is shown below.

2.1 Starting Up the Advanced Control System

The procedure to start up for synchronous control system is shown below.

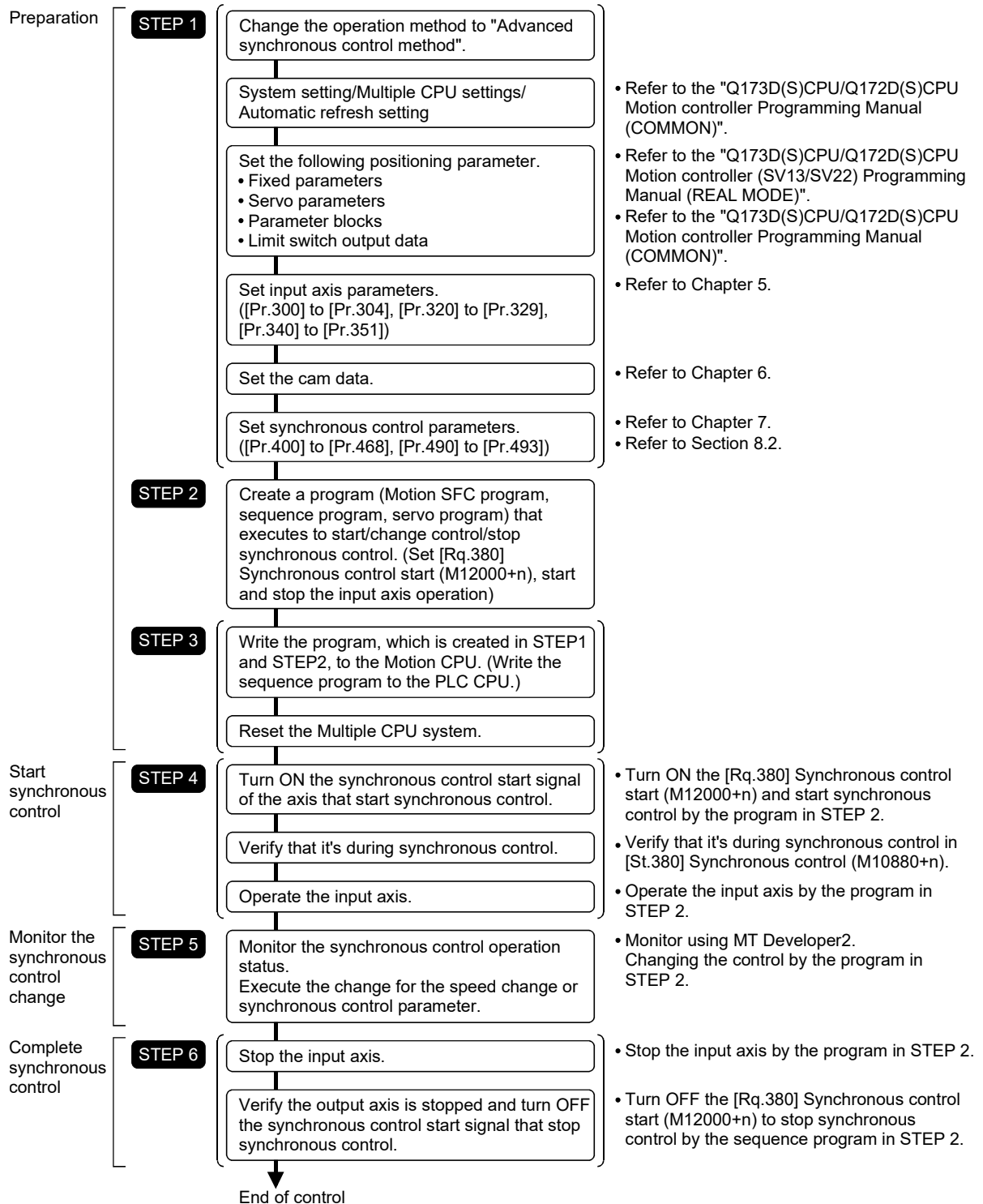

2 STARTING UP THE SYSTEM

2.2 Starting/Ending for Synchronous Control

Set the parameters for synchronous control for each output axis to start synchronous control.

The status changes to synchronous control after the parameters are analyzed at the start of synchronous control, and the output axes synchronize with input axis operations.

The advanced synchronous control is started/ended by the operation of [Rq.380] Synchronous control start (M12000+n) ON/OFF.

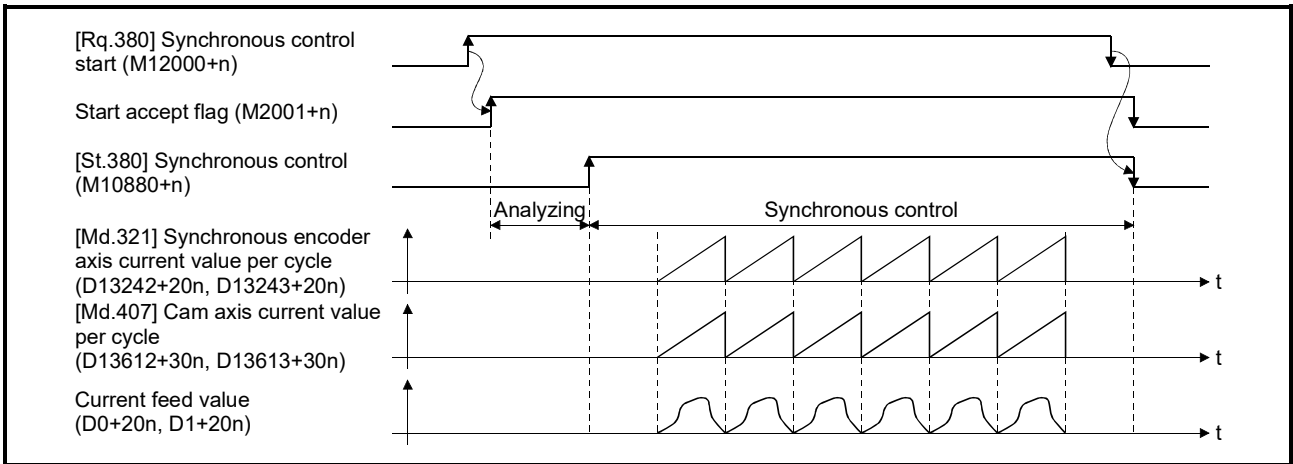

(1) Synchronous control system control data

Symbol	Setting item	Setting details	Setting value	Refresh cycle	Fetch cycle	Default value	Device No.
Rq.380	Synchronous control start	<ul style="list-style-type: none"> Synchronous control begins if the target axis bit device is turned ON. Synchronous control ends if the bit device is turned OFF during synchronous control. 	OFF : Synchronous control end ON : Synchronous control start	/	Operation cycle	OFF	M12000+n
Rq.381	Synchronous analysis request	If the target axis bit device is turned ON and synchronous control is started, the analysis is only executed and the control does not start.	OFF : Synchronous analysis not requested ON : Synchronous analysis requested		At start of the synchronous control	OFF	M12032+n

n: Axis No.-1

(2) Synchronous control system monitor data

Symbol	Setting item	Setting details	Setting value	Refresh cycle	Fetch cycle	Default value	Device No.
St.380	Synchronous control	The bit device turns ON during synchronous control.	OFF : Normal operation ON : Synchronous control	/	/	—	M10880+n
St.381	Synchronous analysis complete	<ul style="list-style-type: none"> The bit device turns ON when the synchronous control analysis is completed. The bit device turns OFF when [Rq.380] Synchronous control start (M12000+n) turns OFF to ON. 	OFF : Synchronous control analysis not completed ON : Synchronous control analysis completed			Operation cycle	—

n: Axis No.-1

2 STARTING UP THE SYSTEM

(3) Starting method for synchronous control

Synchronous control can be started by turning [Rq.380] Synchronous control start (M12000+n) from OFF to ON after setting the parameters for synchronous control.

Start accept flag (M2001+n) turns ON at the synchronous control start, and the parameters for synchronous control are analyzed. [St.380] Synchronous control (M10880+n) turns ON after completion of analysis, and the synchronous control starts.

Start the input axis operation after confirming that [St.380] Synchronous control (M10880+n) of the output axis turns ON.

POINT
When [St.381] Synchronous analysis complete (M10912+n) is ON at the synchronous control start, [St.381] Synchronous analysis complete (M10912+n) turns OFF by turning [Rq.380] Synchronous control start (M12000+n) OFF to ON. However, [St.381] Synchronous analysis complete (M10912+n) does not turn ON by the analysis completion at the synchronous control start. ([St.381] Synchronous analysis complete (M10912+n) turns ON by the analysis completion at the synchronous control analysis mode start.)

(4) Ending method for synchronous control

Synchronous control can be ended by turning [Rq.380] Synchronous control start (M12000+n) from ON to OFF after the input axis operation is stopped.

[St.380] Synchronous control (M10880+n) turns OFF at the synchronous control end, and the start accept flag (M2001+n) turns OFF at the output axis stop.

Synchronous control can also be ended by turning [Rq.380] Synchronous control start (M12000+n) from ON to OFF during the input axis operation. However, it is recommended to end the synchronous control after stopping the input axis operation since the output axis stops immediately.

Refer to "Section 2.3" for the stop operation of output axis at the synchronous control end.

(5) Execute program No. storage device (D12+20n)

This register stores the starting program No. at the servo program starting.

"FFEF" is stored in the execute program No. storage device (D12+20n) when starting advanced synchronous control.

(6) Status when starting synchronous control

The following signals are turned OFF when starting synchronous control.

- Automatic decelerating flag (M2128+n)
- Positioning start complete (M2400+20n)
- Positioning complete (M2401+20n)
- Command in-position (M2403+20n)
- Speed controlling (M2404+20n)
- Speed/position switching latch (M2405+20n)
- Home position return complete (M2410+20n)

(7) Restrictions

- (a) If [Rq.380]Synchronous control start (M12000+n) is turned ON simultaneously in multiple axes, control is not started simultaneously since the analysis is processed for each axis in numerical order. When the multiple axes must be started simultaneously, start the input axis operation after confirming that all axes are configured for the synchronous control.
- (b) If the input axis operates during the analysis at the synchronous control start, the travel value of the input axis is reflected immediately after the synchronous control start. The output axis might suddenly accelerate depending on the travel value of the input axis. Start the input axis operation after confirming that are configured for synchronous control.
- (c) The analysis process for synchronous control start might take time depending on the parameter setting for synchronous control. (Up to 23 ms: In case of searching the cam (cam resolution: 32768) with the setting "0: Cam axis current value per cycle restoration" in [Pr.462] Cam axis position restoration object (D15102+150n).) Set "1: Cam reference position restoration" or "2: Cam axis current feed value restoration" in [Pr.462] Cam axis position restoration object (D15102+150n) to start synchronous control at high speed.
- (d) When the synchronous control parameter is set to the value outside the setting range, the synchronous control does not start, and the error code corresponding to each data of error axis is stored in the data register.

2 STARTING UP THE SYSTEM

2.3 Stop Operation of Output Axis

If the following causes occur in stopping the output axis during synchronous control, [St.380] Synchronous control (M10880+n) turns OFF, and stops processing for the output axis is completed. After that, the start accept flag (M2001+n) turns OFF, and the synchronous control is completed.

Synchronous alignment must be executed for the output axis to restart the synchronous control. (Refer to Section 8.1.)

Stop cause	Stop process
[Rq.380] Synchronous control start (M12000+n) is turned from ON to OFF.	Immediate stop
Main shaft gear/auxiliary shaft gear/speed change gear 1/speed change gear 2 operation overflow error occurrence	
Forced stop (Motion controller forced stop (EMI connector, System setting))	
Forced stop (Forced input terminal of servo amplifier)	
Servo error occurrence	
Servo amplifier power supply is turned from ON to OFF.	
Software stroke limit error occurrence	Deceleration stop
External input signal (STOP/FLS/RLS) input (Deceleration processing on STOP input: Deceleration stop)	
The Motion CPU is turned from RUN to STOP	
The PLC ready flag (M2000) is turned from ON to OFF.	
Stop command input	Rapid stop
External input signal (STOP/FLS/RLS) input (Deceleration processing on STOP input: Rapid stop)	
Rapid stop command input	

(1) Immediate stop

The operation stops without decelerate. The Motion CPU immediately stops the command, but the operation will coast for the droop pulses accumulated in the deviation counter of the servo amplifier.

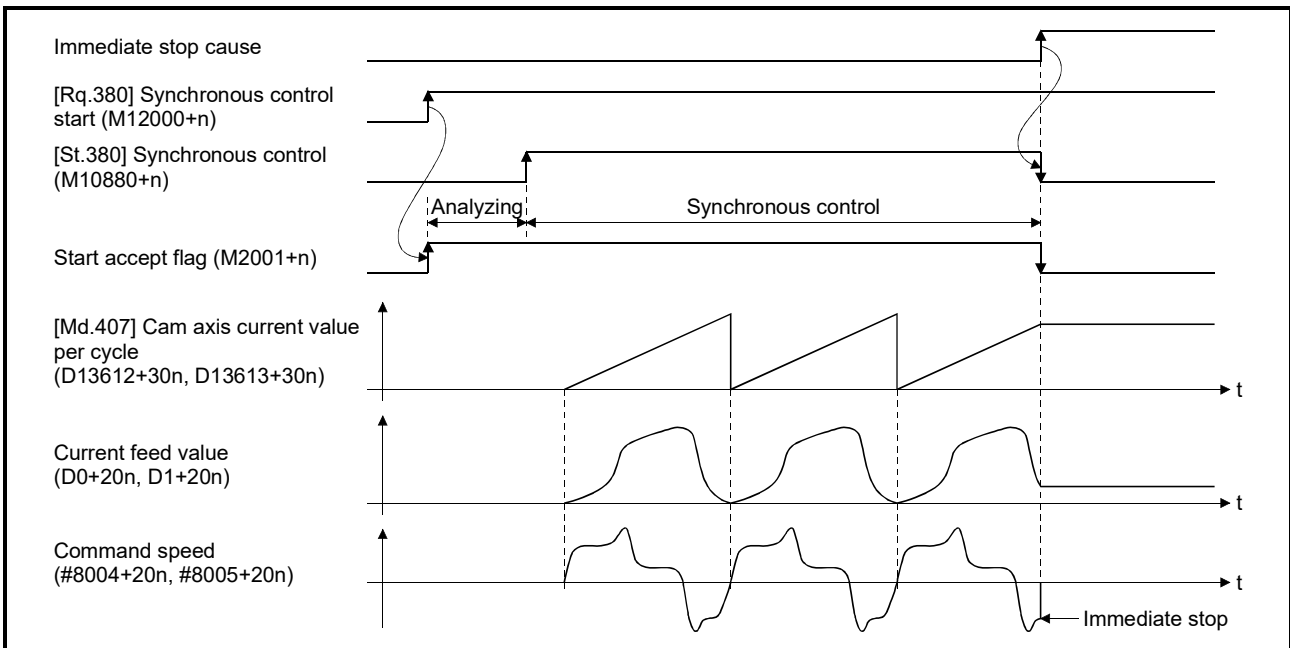

2 STARTING UP THE SYSTEM

(2) Deceleration stop/rapid stop

The output axis stops with deceleration according to the stop and rapid stop conditions.

The deceleration time and deceleration time for rapid stop are according to the parameter block conditions specified by [Pr.448] Synchronous control deceleration time parameter block No. (D15069+150n).

When the synchronous control ends as the deceleration stop begins, the output axis monitor device is not updated, and only the monitor device for each axis is updated.

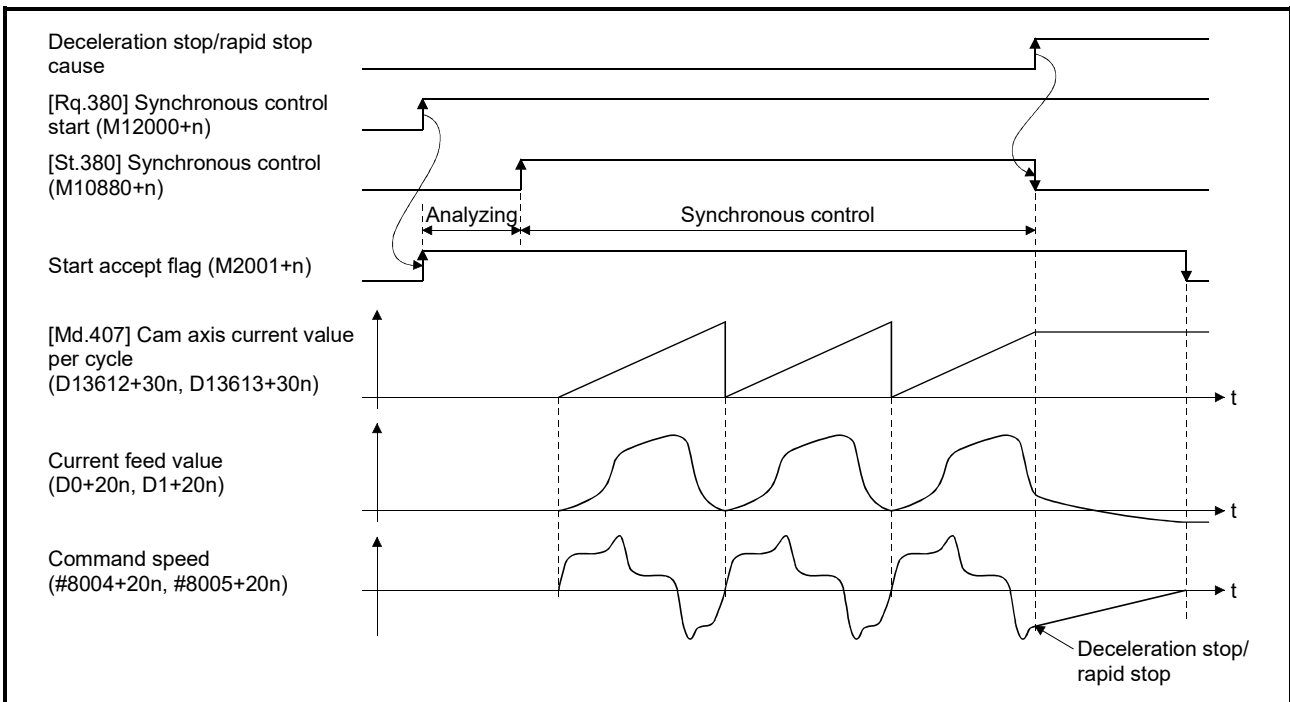

POINT

- (1) Since the synchronous control ends by the output axis stop, the current feed value during deceleration stop draws the path regardless of the cam operation. Therefore, the input axis must be stopped when the output axis is in deceleration stop/rapid stop synchronizing with the input axis.
- (2) Since the synchronous control ends by the output axis stop, [Rq.380] Synchronous control start (M12000+n) ON to OFF during output axis deceleration is invalid.
During output axis stop, use the rapid stop command and forced stop.

3. SYNCHRONOUS CONTROL MODULE

3.1 List of Synchronous Control Module

The module is used in synchronous control as follows.

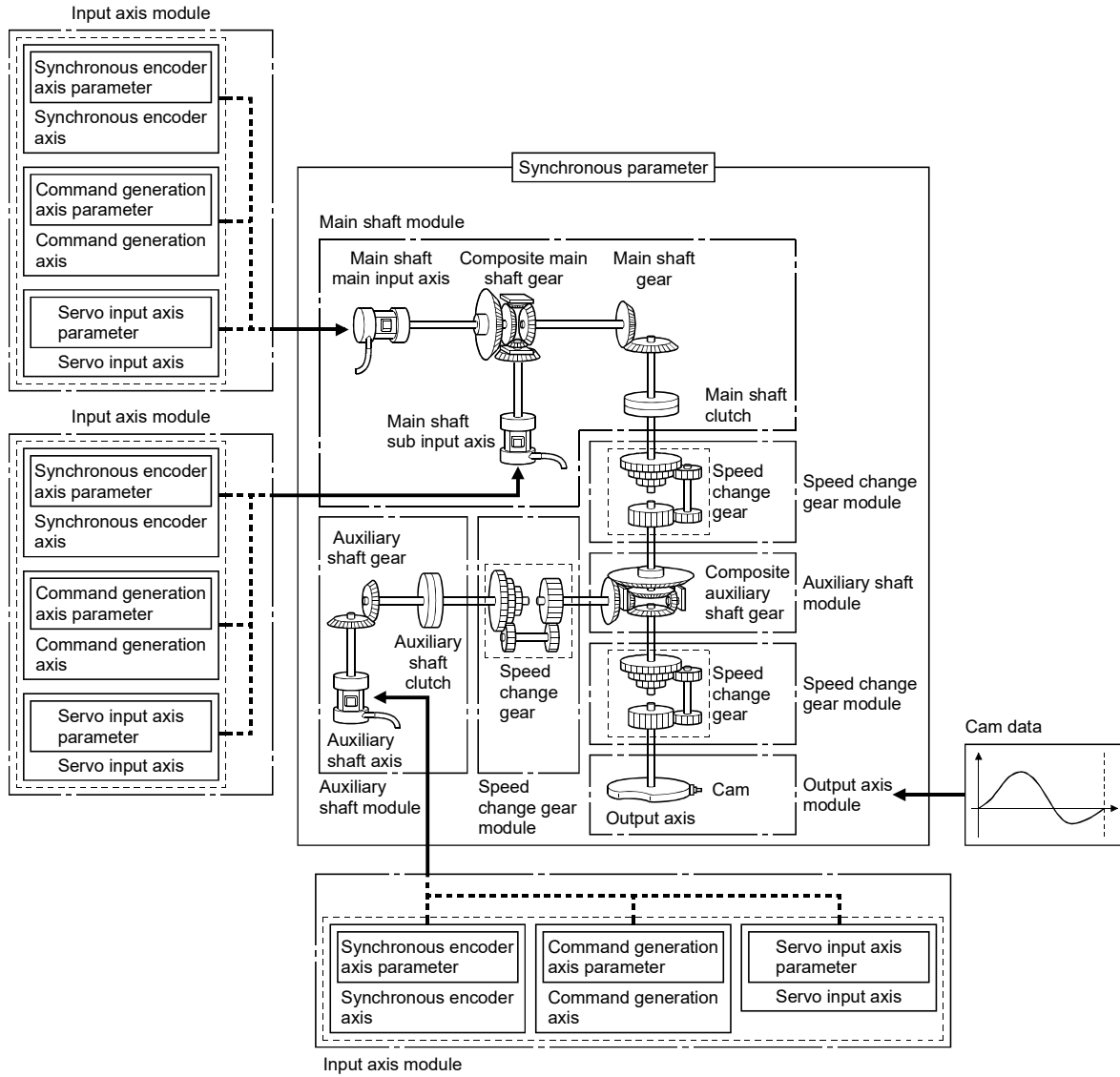

3 SYNCHRONOUS CONTROL MODULE







POINT
(1) Input axis module can be set to one of servo input axis, command generation axis or synchronous encoder axis.
(2) Speed change gear can be arranged on two of main shaft side, auxiliary shaft side or after composite auxiliary shaft gear.
(3) Set the travel value of input axis module so large as possible to prevent the speed fluctuation of output axis module in the synchronous control. If the travel value of input axis module is small, the speed fluctuation of output axis module may occur depending on the setting for synchronous parameter.
(4) All synchronous control monitor data, and the rotation direction of the main shaft main input axis, main shaft sub input axis, auxiliary shaft, output axis (cam axis feed current value) can be monitored in the MT Developer2 synchronous control image screen.

(1) Input axis

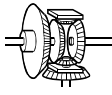
Classification	Name	Parts	Function description	Maximum number of usable			Reference
				Number per module		Number per axis	
				Q173DSCPU	Q172DSCPU		
Input axis module	Servo input axis	—	• Used to drive the input axis with the position of the servo motor controlled by the Q173DSCPU/ Q172DSCPU.	32	16	—	Section 5.1
	Command generation axis	—	• Used to drive the input axis with the only position command generated in the servo program.	32	16	—	Section 5.2
	Synchronous encoder axis	—	• Used to drive the input axis with input pulse from the synchronous encoder.	12		—	Section 5.3

3 SYNCHRONOUS CONTROL MODULE

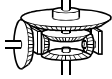
(2) Output axis

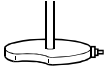
Classification	Name	Parts	Function description	Maximum number of usable			Reference
				Number per module		Number per axis	
				Q173DSCPU	Q172DSCPU		
Main shaft module	Main shaft main input axis		<ul style="list-style-type: none"> The input axis on the main side of the main shaft module. The reference position on the main shaft. 	32	16	1	Section 7.1
	Main shaft sub input axis		<ul style="list-style-type: none"> The input axis on the sub side of the main shaft module. It is used to compensate for the position of the main shaft main input axis. 	32	16	1	Section 7.1
	Composite main shaft gear		<ul style="list-style-type: none"> The composite travel value of the main shaft main input axis and the main shaft sub input axis are transmitted to the main shaft gear. 	32	16	1	Section 7.1
	Main shaft gear		<ul style="list-style-type: none"> The converting travel value after composite main shaft gear is transmitted by the setting gear ratio. 	32	16	1	Section 7.1
	Main shaft clutch		<ul style="list-style-type: none"> The main shaft travel value is transmitted by the clutch ON/OFF. 	32	16	1	Section 7.1 Section 7.3
Auxiliary shaft module	Auxiliary shaft axis		<ul style="list-style-type: none"> The input axis of the auxiliary shaft module. 	32	16	1	Section 7.2
	Auxiliary shaft gear		<ul style="list-style-type: none"> The converting auxiliary shaft travel value is transmitted by the setting gear ratio. 	32	16	1	Section 7.2
	Auxiliary shaft clutch		<ul style="list-style-type: none"> The auxiliary shaft travel value is transmitted by the clutch ON/OFF. 	32	16	1	Section 7.2 Section 7.3
	Composite auxiliary shaft gear		<ul style="list-style-type: none"> The composite travel value of the main shaft and the auxiliary shaft are transmitted. 	32	16	1	Section 7.2
Speed change gear module	Speed change gear		<ul style="list-style-type: none"> It is used to change the speed by setting speed change ratio during the operation. 	64	32	2	Section 7.4
Output axis module	Output axis		<ul style="list-style-type: none"> The cam conversion is processed based on the input travel value and the setting cam data. The current feed value is output as the command to the servo amplifier. 	32	16	1	Section 7.5

(3) Cam data

Classification	Name	Function description	Maximum number of usable		Reference
			Number per module		
Cam data	Cam data	<ul style="list-style-type: none"> It controls the operation pattern of the output axis (two-way operation and feed operation), which is corresponding to the input travel value of the output axis module. 	Up to 256		Chapter 6

4. POSITIONING DEDICATED SIGNALS

The internal signals of the Motion CPU and the external signals to the Motion CPU are used as positioning signals.

(1) Internal signals

The following five devices of the Motion CPU are used as the internal signals of the Motion CPU.

- Internal relay (M) M2000 to M3839 (1840 points)
M8192 to M12287 (4096 points)
- Special relay (SM) SM0 to SM2255 (2256 points)
- Data register (D) D0 to D799 (800 points)
D10240 to D19823 (9584 points)
- Motion register (#) #8000 to #8751 (752 points)
- Special register (SD) SD0 to SD2255 (2256 points)

(2) External signals

The external input signals to the Motion CPU are shown below.

- Upper/lower limit switch input The upper/lower limit of the positioning range is controlled.
- Stop signal This signal makes the starting axis stop.
- Proximity dog signal ON/OFF signal from the proximity dog.
- Speed/position switching signal Signal for switching from speed to position.
- Manual pulse generator input Signal from the manual pulse generator.

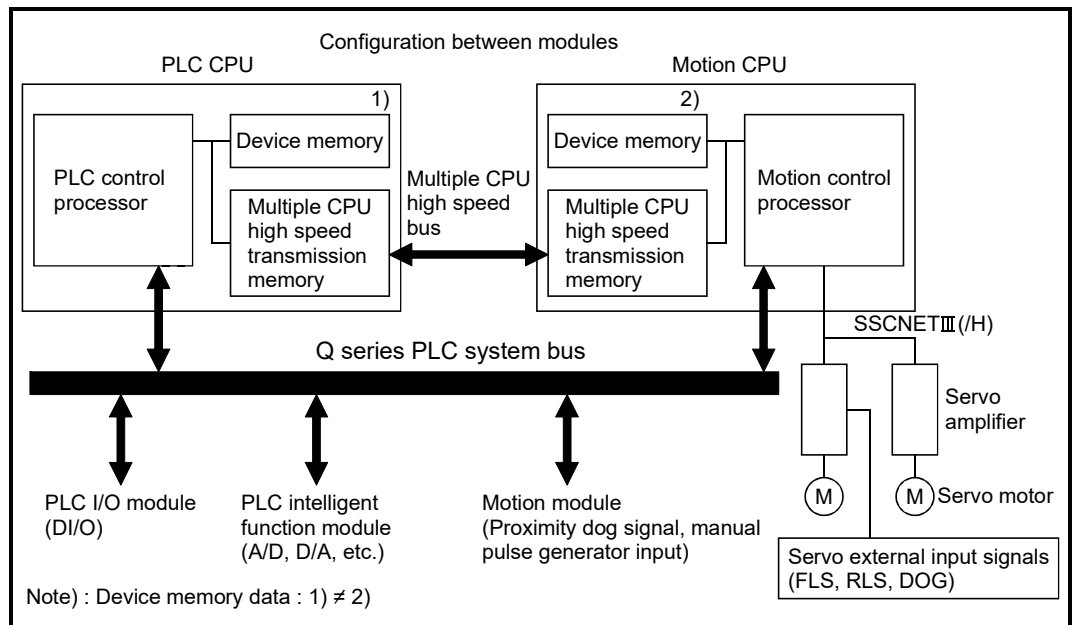

Fig.4.1 Flow of the internal signals/external signals

4 POSITIONING DEDICATED SIGNALS

The positioning dedicated devices are shown below.

It indicates the device refresh cycle of the Motion CPU for status signal with the positioning control, and the device fetch cycle of the Motion CPU for command signal with the positioning control.

The operation cycle and main cycle of the Motion CPU are shown below.

(a) Operation cycle

Item		Q173DSCPU	Q172DSCPU
Number of control axes		Up to 32 axes	Up to 16 axes
Operation cycle (Default)	SV22	0.44ms/ 1 to 6 axes	0.44ms/ 1 to 6 axes
		0.88ms/ 7 to 16 axes	0.88ms/ 7 to 16 axes
		1.77ms/ 17 to 32 axes	

(b) Main cycle is not fixed-cycle as operation cycle. The cycle is dozens[ms] to hundreds[ms].

REMARK

(1) In the positioning dedicated signals, "n" in "M3200+20n", etc. indicates a value corresponding to axis No. such as the following tables.

Axis No.	n	Axis No.	n	Axis No.	n	Axis No.	n
1	0	9	8	17	16	25	24
2	1	10	9	18	17	26	25
3	2	11	10	19	18	27	26
4	3	12	11	20	19	28	27
5	4	13	12	21	20	29	28
6	5	14	13	22	21	30	29
7	6	15	14	23	22	31	30
8	7	16	15	24	23	32	31

• Calculate as follows for the device No. corresponding to each axis.

(Example) For axis 32 $M3200+20n$ (Stop command)= $M3200+20 \times 31=M3820$

$M3215+20n$ (Servo OFF command)= $M3215+20 \times 31=M3835$

• The range of axis No.1 to 16 is valid in the Q172DSCPU.

(2) In the positioning dedicated signals, "n" in "M10440+10n", etc. of the "Synchronous encoder axis status", "Synchronous encoder axis command signal", "Synchronous encoder axis monitor device" and "Synchronous encoder axis control device" indicates a value corresponding to synchronous encoder No. such as the following tables.

Synchronous encoder No.	n	Synchronous encoder No.	n	Synchronous encoder No.	n
P1	0	P5	4	P9	8
P2	1	P6	5	P10	9
P3	2	P7	6	P11	10
P4	3	P8	7	P12	11

• Calculate as follows for the device No. corresponding to each synchronous encoder.

(Example) For synchronous encoder No.12

$M10440+10n$ ([St.320] Synchronous encoder axis setting valid flag)

= $M10440+10 \times 11=M10550$

$D13240+20n$ ([Md.320] Synchronous encoder axis current value)

= $D13240+20 \times 11= D13460$

4 POSITIONING DEDICATED SIGNALS

4.1 Internal Relays

(1) Internal relay list

SV22	
Device No.	Application
M0 to	User device (2000 points)
M2000 to	Common device (320 points)
M2320 to	Unusable (80 points)
M2400 to	Axis status (20 points × 32 axes)
M3040 to	Unusable (32 points)
M3072 to	Common device (Command signal) (64 points)
M3136 to	Unusable (64 points)
M3200 to	Axis command signal (20 points × 32 axes)
M3840 to	User device (4352 points)
M8192 (Note-1) to	System area (1608 points)
M9800 (Note-1) to	Command generation axis status (20 points × 32 axes)
M10440 (Note-1) to	Synchronous encoder axis status (10 points × 12 axes)
M10560 (Note-1) to	Output axis status (10 points × 32 axes)
M10880 (Note-1) to	Synchronous control signal [St.380] (32 points)
M10912 (Note-1) to	Synchronous analysis complete signal [St.381] (32 points)
M10944 (Note-1) to	Unusable (16 points)
M10960 (Note-1) to M11599 (Note-1)	Command generation axis command signal (20 points × 32 axes)

4 POSITIONING DEDICATED SIGNALS

Internal relay list (Continued)

SV22	
Device No.	Application
M11600 (Note-1) to	Synchronous encoder axis command signal (4 points × 12 axes)
M11648 (Note-1) to	Unusable (32 points)
M11680 (Note-1) to	Output axis command signal (10 points × 32 axes)
M12000 (Note-1) to	Synchronous control start [Rq.380] (32 points)
M12032 (Note-1) to	Synchronous analysis request signal [Rq.381] (32 points)
M12064 (Note-1) to	Unusable (224 points)
M12287 (Note-1)	

It can be used as a user device.

POINT

(1) Total number of user device points

(2) (Note-1) : Do not set M8192 to M12287 as the latch range in advanced synchronous control method.

(3) This manual describes only details for internal relays used in the synchronous control. If it is required, refer to the "Q173D(S)CPU/Q172D(S)CPU Motion controller (SV13/SV22) Programming Manual (REAL MODE)".

4 POSITIONING DEDICATED SIGNALS

(2) Axis status list

Axis No.	Device No.	Signal name			
1	M2400 to M2419				
2	M2420 to M2439				
3	M2440 to M2459				
4	M2460 to M2479				
5	M2480 to M2499				
6	M2500 to M2519				
7	M2520 to M2539				
8	M2540 to M2559				
9	M2560 to M2579				
10	M2580 to M2599				
11	M2600 to M2619				
12	M2620 to M2639				
13	M2640 to M2659				
14	M2660 to M2679				
15	M2680 to M2699				
16	M2700 to M2719				
17	M2720 to M2739				
18	M2740 to M2759				
19	M2760 to M2779				
20	M2780 to M2799				
21	M2800 to M2819				
22	M2820 to M2839				
23	M2840 to M2859				
24	M2860 to M2879				
25	M2880 to M2899				
26	M2900 to M2919				
27	M2920 to M2939				
28	M2940 to M2959				
29	M2960 to M2979				
30	M2980 to M2999				
31	M3000 to M3019				
32	M3020 to M3039				



	Signal name	Refresh cycle	Fetch cycle	Signal direction
0	Positioning start complete	Operation cycle		Status signal
1	Positioning complete			
2	In-position			
3	Command in-position			
4	Speed controlling			
5	Speed / position switching latch			
6	Zero pass			
7	Error detection	Immediate		
8	Servo error detection	Operation cycle		
9	Home position return request	Main cycle		
10	Home position return complete	Operation cycle		
11		Main cycle		
12	External signals			
13				
14				
15	Servo ready	Operation cycle		
16	Torque limiting			
17	Unusable	—	—	—
18				
19	M-code outputting	Operation cycle		Status signal

POINT

- (1) The range of axis No.1 to 16 is valid in the Q172DSCPU.
- (2) The device area more than 17 axes in the Q172DSCPU can be used as a user device.
However, when the project of Q172DSCPU is replaced with Q173DSCPU, this area cannot be used as a user device.
- (3) Refer to the "Q173D(S)CPU/Q172D(S)CPU Motion controller (SV13/SV22) Programming Manual (REAL MODE)" for details of axis status.

4 POSITIONING DEDICATED SIGNALS

(3) Axis command signal list

Axis No.	Device No.	Signal name																																																																																																																																										
1	M3200 to M3219	<table border="1"> <thead> <tr> <th></th> <th>Signal name</th> <th>Refresh cycle</th> <th>Fetch cycle</th> <th>Signal direction</th> </tr> </thead> <tbody> <tr> <td>0</td> <td>Stop command</td> <td rowspan="10">/</td> <td rowspan="2">Operation cycle</td> <td rowspan="10">Command signal</td> </tr> <tr> <td>1</td> <td>Rapid stop command</td> </tr> <tr> <td>2</td> <td>Forward rotation JOG start command</td> <td rowspan="2">Main cycle</td> </tr> <tr> <td>3</td> <td>Reverse rotation JOG start command</td> </tr> <tr> <td>4</td> <td>Complete signal OFF command</td> <td rowspan="2">Operation cycle</td> </tr> <tr> <td>5</td> <td>Speed/position switching enable command</td> </tr> <tr> <td>6</td> <td>Gain changing 2 command (Note-1) </td> <td>Operation cycle (Note-2)</td> </tr> <tr> <td>7</td> <td>Error reset command</td> <td rowspan="2">Main cycle</td> </tr> <tr> <td>8</td> <td>Servo error reset command</td> </tr> <tr> <td>9</td> <td>External stop input disable at start command</td> <td>At start</td> </tr> <tr> <td>10</td> <td>Unusable</td> <td>—</td> <td>—</td> <td>—</td> </tr> <tr> <td>11</td> <td>Unusable</td> <td>—</td> <td>—</td> <td>—</td> </tr> <tr> <td>12</td> <td>Feed current value update command</td> <td rowspan="2">/</td> <td rowspan="2">At start</td> <td rowspan="2">Command signal</td> </tr> <tr> <td>13</td> <td>Unusable</td> <td>—</td> <td>—</td> <td>—</td> </tr> <tr> <td>14</td> <td>Unusable</td> <td>—</td> <td>—</td> <td>—</td> </tr> <tr> <td>15</td> <td>Servo OFF command</td> <td rowspan="5">/</td> <td rowspan="2">Operation cycle</td> <td rowspan="5">Command signal</td> </tr> <tr> <td>16</td> <td>Gain changing command</td> </tr> <tr> <td>17</td> <td>PI-PID switching command</td> <td>Operation cycle (Note-2)</td> </tr> <tr> <td>18</td> <td>Control loop changing command</td> <td rowspan="2">Operation cycle</td> </tr> <tr> <td>19</td> <td>FIN signal</td> </tr> <tr> <td>20</td> <td>Unusable</td> <td>—</td> <td>—</td> <td>—</td> </tr> <tr> <td>21</td> <td>Unusable</td> <td>—</td> <td>—</td> <td>—</td> </tr> <tr> <td>22</td> <td>Unusable</td> <td>—</td> <td>—</td> <td>—</td> </tr> <tr> <td>23</td> <td>Unusable</td> <td>—</td> <td>—</td> <td>—</td> </tr> <tr> <td>24</td> <td>Unusable</td> <td>—</td> <td>—</td> <td>—</td> </tr> <tr> <td>25</td> <td>Unusable</td> <td>—</td> <td>—</td> <td>—</td> </tr> <tr> <td>26</td> <td>Unusable</td> <td>—</td> <td>—</td> <td>—</td> </tr> <tr> <td>27</td> <td>Unusable</td> <td>—</td> <td>—</td> <td>—</td> </tr> <tr> <td>28</td> <td>Unusable</td> <td>—</td> <td>—</td> <td>—</td> </tr> <tr> <td>29</td> <td>Unusable</td> <td>—</td> <td>—</td> <td>—</td> </tr> <tr> <td>30</td> <td>Unusable</td> <td>—</td> <td>—</td> <td>—</td> </tr> <tr> <td>31</td> <td>Unusable</td> <td>—</td> <td>—</td> <td>—</td> </tr> <tr> <td>32</td> <td>Unusable</td> <td>—</td> <td>—</td> <td>—</td> </tr> </tbody> </table>		Signal name	Refresh cycle	Fetch cycle	Signal direction	0	Stop command	/	Operation cycle	Command signal	1	Rapid stop command	2	Forward rotation JOG start command	Main cycle	3	Reverse rotation JOG start command	4	Complete signal OFF command	Operation cycle	5	Speed/position switching enable command	6	Gain changing 2 command (Note-1) 	Operation cycle (Note-2)	7	Error reset command	Main cycle	8	Servo error reset command	9	External stop input disable at start command	At start	10	Unusable	—	—	—	11	Unusable	—	—	—	12	Feed current value update command	/	At start	Command signal	13	Unusable	—	—	—	14	Unusable	—	—	—	15	Servo OFF command	/	Operation cycle	Command signal	16	Gain changing command	17	PI-PID switching command	Operation cycle (Note-2)	18	Control loop changing command	Operation cycle	19	FIN signal	20	Unusable	—	—	—	21	Unusable	—	—	—	22	Unusable	—	—	—	23	Unusable	—	—	—	24	Unusable	—	—	—	25	Unusable	—	—	—	26	Unusable	—	—	—	27	Unusable	—	—	—	28	Unusable	—	—	—	29	Unusable	—	—	—	30	Unusable	—	—	—	31	Unusable	—	—	—	32	Unusable	—	—	—
	Signal name		Refresh cycle	Fetch cycle	Signal direction																																																																																																																																							
0	Stop command		/	Operation cycle	Command signal																																																																																																																																							
1	Rapid stop command																																																																																																																																											
2	Forward rotation JOG start command			Main cycle																																																																																																																																								
3	Reverse rotation JOG start command																																																																																																																																											
4	Complete signal OFF command			Operation cycle																																																																																																																																								
5	Speed/position switching enable command																																																																																																																																											
6	Gain changing 2 command (Note-1) 			Operation cycle (Note-2)																																																																																																																																								
7	Error reset command			Main cycle																																																																																																																																								
8	Servo error reset command																																																																																																																																											
9	External stop input disable at start command			At start																																																																																																																																								
10	Unusable		—	—	—																																																																																																																																							
11	Unusable		—	—	—																																																																																																																																							
12	Feed current value update command		/	At start	Command signal																																																																																																																																							
13	Unusable					—	—	—																																																																																																																																				
14	Unusable		—	—	—																																																																																																																																							
15	Servo OFF command		/	Operation cycle	Command signal																																																																																																																																							
16	Gain changing command																																																																																																																																											
17	PI-PID switching command	Operation cycle (Note-2)																																																																																																																																										
18	Control loop changing command	Operation cycle																																																																																																																																										
19	FIN signal																																																																																																																																											
20	Unusable	—	—	—																																																																																																																																								
21	Unusable	—	—	—																																																																																																																																								
22	Unusable	—	—	—																																																																																																																																								
23	Unusable	—	—	—																																																																																																																																								
24	Unusable	—	—	—																																																																																																																																								
25	Unusable	—	—	—																																																																																																																																								
26	Unusable	—	—	—																																																																																																																																								
27	Unusable	—	—	—																																																																																																																																								
28	Unusable	—	—	—																																																																																																																																								
29	Unusable	—	—	—																																																																																																																																								
30	Unusable	—	—	—																																																																																																																																								
31	Unusable	—	—	—																																																																																																																																								
32	Unusable	—	—	—																																																																																																																																								

(Note-1): Servo amplifier (MR-J5(W)-□B) only.

(Note-2): Operation cycle 7.1[ms] or more: Every 3.5[ms]

POINT

- (1) The range of axis No.1 to 16 is valid in the Q172DSCPU.
- (2) The device area more than 17 axes in the Q172DSCPU can be used as a user device.
However, when the project of Q172DSCPU is replaced with Q173DSCPU, this area cannot be used as a user device.
- (3) Refer to the "Q173D(S)CPU/Q172D(S)CPU Motion controller (SV13/SV22) Programming Manual (REAL MODE)" for details of axis command signal.

: Refer to Section 1.4 for the software version that supports this function.

4 POSITIONING DEDICATED SIGNALS

(5) Command generation axis command signal list

Axis No.	Device No.	Signal name			
1	M10960 to M10979				
2	M10980 to M10999				
3	M11000 to M11019				
4	M11020 to M11039				
5	M11040 to M11059				
6	M11060 to M11079				
7	M11080 to M11099				
8	M11100 to M11119				
9	M11120 to M11139				
10	M11140 to M11159				
11	M11160 to M11179				
12	M11180 to M11199				
13	M11200 to M11219				
14	M11220 to M11239				
15	M11240 to M11259				
16	M11260 to M11279				
17	M11280 to M11299				
18	M11300 to M11319				
19	M11320 to M11339				
20	M11340 to M11359				
21	M11360 to M11379				
22	M11380 to M11399				
23	M11400 to M11419				
24	M11420 to M11439				
25	M11440 to M11459				
26	M11460 to M11479				
27	M11480 to M11499				
28	M11500 to M11519				
29	M11520 to M11539				
30	M11540 to M11559				
31	M11560 to M11579				
32	M11580 to M11599				

Symbol	Signal name	Refresh cycle	Fetch cycle	Signal direction
0 Rq.341	Command generation axis stop command	/	Operation cycle	Command signal
1 Rq.342	Command generation axis rapid stop command			
2 Rq.343	Command generation axis forward rotation JOG start command		Main cycle	
3 Rq.344	Command generation axis reverse rotation JOG start command			
4 Rq.345	Command generation axis complete signal OFF command			
5 —	Unusable	—	—	—
6 —	Unusable	—	—	—
7 Rq.346	Command generation axis error reset command	/	Main cycle	Command signal
8 —	Unusable	/	—	—
9 —				
10 —				
11 —				
12 Rq.347	Feed current value update request command	/	At start	Command signal
13 —	Unusable	/	—	—
14 —				
15 —				
16 —				
17 —				
18 —				
19 Rq.348	Command generation axis FIN signal	/	Operation cycle	Command signal

POINT

- (1) The range of axis No.1 to 16 is valid in the Q172DSCPU.
- (2) The device area more than 17 axes in the Q172DSCPU can be used as a user device.
However, when the project of Q172DSCPU is replaced with Q173DSCPU, this area cannot be used as a user device.
- (3) Refer to Section 5.2.3 for details of command generation axis command signal.

4 POSITIONING DEDICATED SIGNALS

(6) Synchronous encoder axis status list

Axis No.	Device No.	Signal name																																											
1	M10440 to M10449	<table border="1"> <thead> <tr> <th>Symbol</th> <th>Signal name</th> <th>Refresh cycle</th> <th>Fetch cycle</th> <th>Signal direction</th> </tr> </thead> <tbody> <tr> <td>0 St.320</td> <td>Synchronous encoder axis setting valid flag</td> <td>At power on</td> <td rowspan="4">/</td> <td rowspan="4">Status signal</td> </tr> <tr> <td>1 St.321</td> <td>Synchronous encoder axis connecting valid flag</td> <td rowspan="3">Operation cycle</td> </tr> <tr> <td>2 St.322</td> <td>Synchronous encoder axis counter enable flag</td> </tr> <tr> <td>3 St.323</td> <td>Synchronous encoder axis current value setting request flag</td> </tr> <tr> <td>4 St.324</td> <td>Synchronous encoder axis error detection flag</td> <td>Immediate</td> <td></td> <td></td> </tr> <tr> <td>5</td> <td>—</td> <td>Unusable</td> <td>—</td> <td>—</td> <td>—</td> </tr> <tr> <td>6 St.325</td> <td>Synchronous encoder axis control complete flag</td> <td>Immediate</td> <td>/</td> <td>Status signal</td> </tr> <tr> <td>7</td> <td>—</td> <td rowspan="3">Unusable</td> <td>—</td> <td>—</td> <td>—</td> </tr> <tr> <td>8</td> <td>—</td> </tr> <tr> <td>9</td> <td>—</td> </tr> </tbody> </table>	Symbol	Signal name	Refresh cycle	Fetch cycle	Signal direction	0 St.320	Synchronous encoder axis setting valid flag	At power on	/	Status signal	1 St.321	Synchronous encoder axis connecting valid flag	Operation cycle	2 St.322	Synchronous encoder axis counter enable flag	3 St.323	Synchronous encoder axis current value setting request flag	4 St.324	Synchronous encoder axis error detection flag	Immediate			5	—	Unusable	—	—	—	6 St.325	Synchronous encoder axis control complete flag	Immediate	/	Status signal	7	—	Unusable	—	—	—	8	—	9	—
Symbol	Signal name		Refresh cycle	Fetch cycle	Signal direction																																								
0 St.320	Synchronous encoder axis setting valid flag		At power on	/	Status signal																																								
1 St.321	Synchronous encoder axis connecting valid flag		Operation cycle																																										
2 St.322	Synchronous encoder axis counter enable flag																																												
3 St.323	Synchronous encoder axis current value setting request flag																																												
4 St.324	Synchronous encoder axis error detection flag		Immediate																																										
5	—		Unusable	—	—	—																																							
6 St.325	Synchronous encoder axis control complete flag		Immediate	/	Status signal																																								
7	—		Unusable	—	—	—																																							
8	—																																												
9	—																																												
2	M10450 to M10459																																												
3	M10460 to M10469																																												
4	M10470 to M10479																																												
5	M10480 to M10489																																												
6	M10490 to M10499																																												
7	M10500 to M10509																																												
8	M10510 to M10519																																												
9	M10520 to M10529																																												
10	M10530 to M10539																																												
11	M10540 to M10549																																												
12	M10550 to M10559																																												

POINT

Refer to Section 5.3.5 for details of synchronous encoder axis status.

(7) Synchronous encoder axis command signal list

Axis No.	Device No.	Signal name																						
1	M11600 to M11603	<table border="1"> <thead> <tr> <th>Symbol</th> <th>Signal name</th> <th>Refresh cycle</th> <th>Fetch cycle</th> <th>Signal direction</th> </tr> </thead> <tbody> <tr> <td>0 Rq.323</td> <td>Synchronous encoder axis error reset</td> <td rowspan="3">/</td> <td>Main cycle</td> <td rowspan="3">Command signal</td> </tr> <tr> <td>1 Rq.320</td> <td>Synchronous encoder axis control request</td> <td>Operation cycle</td> </tr> <tr> <td>2 Rq.324</td> <td>Connection command of synchronous encoder via device/ master CPU</td> <td>Main cycle</td> </tr> <tr> <td>3</td> <td>—</td> <td>Unusable</td> <td>—</td> <td>—</td> <td>—</td> </tr> </tbody> </table>	Symbol	Signal name	Refresh cycle	Fetch cycle	Signal direction	0 Rq.323	Synchronous encoder axis error reset	/	Main cycle	Command signal	1 Rq.320	Synchronous encoder axis control request	Operation cycle	2 Rq.324	Connection command of synchronous encoder via device/ master CPU	Main cycle	3	—	Unusable	—	—	—
Symbol	Signal name		Refresh cycle	Fetch cycle	Signal direction																			
0 Rq.323	Synchronous encoder axis error reset		/	Main cycle	Command signal																			
1 Rq.320	Synchronous encoder axis control request			Operation cycle																				
2 Rq.324	Connection command of synchronous encoder via device/ master CPU			Main cycle																				
3	—		Unusable	—	—	—																		
2	M11604 to M11607																							
3	M11608 to M11611																							
4	M11612 to M11615																							
5	M11616 to M11619																							
6	M11620 to M11623																							
7	M11624 to M11627																							
8	M11628 to M11631																							
9	M11632 to M11635																							
10	M11636 to M11639																							
11	M11640 to M11643																							
12	M11644 to M11647																							

POINT

Refer to Section 5.3.4 for details of synchronous encoder axis command signal.

4 POSITIONING DEDICATED SIGNALS

(8) Output axis status list

Axis No.	Device No.	Signal name			
1	M10560 to M10569				
2	M10570 to M10579				
3	M10580 to M10589				
4	M10590 to M10599				
5	M10600 to M10609				
6	M10610 to M10619				
7	M10620 to M10629				
8	M10630 to M10639				
9	M10640 to M10649				
10	M10650 to M10659	4	—	Unusable	—
11	M10660 to M10669	5	—	Unusable	—
12	M10670 to M10679				
13	M10680 to M10689	6	St.426	Control change complete	Operation cycle
14	M10690 to M10699	7	—	Unusable	—
15	M10700 to M10709	8	—	Unusable	—
16	M10710 to M10719	9	—	Unusable	—
17	M10720 to M10729				
18	M10730 to M10739				
19	M10740 to M10749				
20	M10750 to M10759				
21	M10760 to M10769				
22	M10770 to M10779				
23	M10780 to M10789				
24	M10790 to M10799				
25	M10800 to M10809				
26	M10810 to M10819				
27	M10820 to M10829				
28	M10830 to M10839				
29	M10840 to M10849				
30	M10850 to M10859				
31	M10860 to M10869				
32	M10870 to M10879				

POINT

- (1) The range of axis No.1 to 16 is valid in the Q172DSCPU.
- (2) The device area more than 17 axes in the Q172DSCPU can be used as a user device.
However, when the project of Q172DSCPU is replaced with Q173DSCPU, this area cannot be used as a user device.
- (3) Refer to Section 7.6.2 and Section 7.7 for details of output axis status.

4 POSITIONING DEDICATED SIGNALS

(9) Output axis command signal list

Axis No.	Device No.	Signal name			
1	M11680 to M11689				
2	M11690 to M11699				
3	M11700 to M11709				
4	M11710 to M11719				
5	M11720 to M11729				
6	M11730 to M11739				
7	M11740 to M11749				
8	M11750 to M11759				
9	M11760 to M11769				
10	M11770 to M11779				
11	M11780 to M11789				
12	M11790 to M11799				
13	M11800 to M11809				
14	M11810 to M11819				
15	M11820 to M11829				
16	M11830 to M11839				
17	M11840 to M11849				
18	M11850 to M11859				
19	M11860 to M11869				
20	M11870 to M11879				
21	M11880 to M11889				
22	M11890 to M11899				
23	M11900 to M11909				
24	M11910 to M11919				
25	M11920 to M11929				
26	M11930 to M11939				
27	M11940 to M11949				
28	M11950 to M11959				
29	M11960 to M11969				
30	M11970 to M11979				
31	M11980 to M11989				
32	M11990 to M11999				

	Symbol	Signal name	Refresh cycle	Fetch cycle	Signal direction
0	Rq.400	Main shaft clutch command	/	Operation cycle	Command signal
1	Rq.401	Main shaft clutch control invalid command			
2	Rq.402	Main shaft clutch forced OFF command			
3	—	Unusable	—	—	—
4	Rq.403	Auxiliary shaft clutch command	/	Operation cycle	Command signal
5	Rq.404	Auxiliary shaft clutch control invalid command			
6	Rq.405	Auxiliary shaft clutch forced OFF command			
7	—	Unusable	—	—	—
8	Rq.406	Control change request command	/	Operation cycle	Command signal
9	—	Unusable			

POINT

- (1) The range of axis No.1 to 16 is valid in the Q172DSCPU.
- (2) The device area more than 17 axes in the Q172DSCPU can be used as a user device.
However, when the project of Q172DSCPU is replaced with Q173DSCPU, this area cannot be used as a user device.
- (3) Refer to Section 7.1.4, Section 7.2.4 and Section 7.6.2 for details of output axis command signal.

4 POSITIONING DEDICATED SIGNALS

(10) Synchronous control signal list

Axis No.	Device No.	Symbol	Signal name	Refresh cycle	Fetch cycle	Signal direction
1	M10880	St.380	Synchronous control	Operation cycle		Status signal
2	M10881					
3	M10882					
4	M10883					
5	M10884					
6	M10885					
7	M10886					
8	M10887					
9	M10888					
10	M10889					
11	M10890					
12	M10891					
13	M10892					
14	M10893					
15	M10894					
16	M10895					
17	M10896					
18	M10897					
19	M10898					
20	M10899					
21	M10900					
22	M10901					
23	M10902					
24	M10903					
25	M10904					
26	M10905					
27	M10906					
28	M10907					
29	M10908					
30	M10909					
31	M10910					
32	M10911					

POINT

- (1) The range of axis No.1 to 16 is valid in the Q172DSCPU.
- (2) The device area more than 17 axes in the Q172DSCPU can be used as a user device.
However, when the project of Q172DSCPU is replaced with Q173DSCPU, this area cannot be used as a user device.
- (3) Refer to Section 2.2 for details of synchronous control signal.

4 POSITIONING DEDICATED SIGNALS

(11) Synchronous analysis complete signal list

Axis No.	Device No.	Symbol	Signal name	Refresh cycle	Fetch cycle	Signal direction
1	M10912	St.381	Synchronous analysis complete	Operation cycle		Status signal
2	M10913					
3	M10914					
4	M10915					
5	M10916					
6	M10917					
7	M10918					
8	M10919					
9	M10920					
10	M10921					
11	M10922					
12	M10923					
13	M10924					
14	M10925					
15	M10926					
16	M10927					
17	M10928					
18	M10929					
19	M10930					
20	M10931					
21	M10932					
22	M10933					
23	M10934					
24	M10935					
25	M10936					
26	M10937					
27	M10938					
28	M10939					
29	M10940					
30	M10941					
31	M10942					
32	M10943					

POINT

- (1) The range of axis No.1 to 16 is valid in the Q172DSCPU.
- (2) The device area more than 17 axes in the Q172DSCPU can be used as a user device.
However, when the project of Q172DSCPU is replaced with Q173DSCPU, this area cannot be used as a user device.
- (3) Refer to Section 2.2 for details of synchronous analysis complete signal.

4 POSITIONING DEDICATED SIGNALS

(12) Synchronous control start signal list

Axis No.	Device No.	Symbol	Signal name	Refresh cycle	Fetch cycle	Signal direction
1	M12000	Rq.380	Synchronous control start		Operation cycle	Command signal
2	M12001					
3	M12002					
4	M12003					
5	M12004					
6	M12005					
7	M12006					
8	M12007					
9	M12008					
10	M12009					
11	M12010					
12	M12011					
13	M12012					
14	M12013					
15	M12014					
16	M12015					
17	M12016					
18	M12017					
19	M12018					
20	M12019					
21	M12020					
22	M12021					
23	M12022					
24	M12023					
25	M12024					
26	M12025					
27	M12026					
28	M12027					
29	M12028					
30	M12029					
31	M12030					
32	M12031					

POINT

- (1) The range of axis No.1 to 16 is valid in the Q172DSCPU.
- (2) The device area more than 17 axes in the Q172DSCPU can be used as a user device.
However, when the project of Q172DSCPU is replaced with Q173DSCPU, this area cannot be used as a user device.
- (3) Refer to Section 2.2 for details of synchronous control start signal.

4 POSITIONING DEDICATED SIGNALS

(13) Synchronous analysis request signal list

Axis No.	Device No.	Symbol	Signal name	Refresh cycle	Fetch cycle	Signal direction
1	M12032	Rq.381	Synchronous analysis request		At start of synchronous control	Command signal
2	M12033					
3	M12034					
4	M12035					
5	M12036					
6	M12037					
7	M12038					
8	M12039					
9	M12040					
10	M12041					
11	M12042					
12	M12043					
13	M12044					
14	M12045					
15	M12046					
16	M12047					
17	M12048					
18	M12049					
19	M12050					
20	M12051					
21	M12052					
22	M12053					
23	M12054					
24	M12055					
25	M12056					
26	M12057					
27	M12058					
28	M12059					
29	M12060					
30	M12061					
31	M12062					
32	M12063					

POINT

- (1) The range of axis No.1 to 16 is valid in the Q172DSCPU.
- (2) The device area more than 17 axes in the Q172DSCPU can be used as a user device.
However, when the project of Q172DSCPU is replaced with Q173DSCPU, this area cannot be used as a user device.
- (3) Refer to Section 2.2 for details of synchronous analysis request signal.

4 POSITIONING DEDICATED SIGNALS

(14) Common device list

Device No.	Signal name	Refresh cycle	Fetch cycle	Signal direction	Remark (Note-3)	Device No.	Signal name	Refresh cycle	Fetch cycle	Signal direction	Remark (Note-3)
M2000	PLC ready flag		Main cycle	Command signal	M3072	M2061	Axis 1	Speed change accepting flag	Operation cycle	Status signal (Note-1), (Note-2)	
M2001	Axis 1	Start accept flag	Operation cycle	Status signal (Note-1), (Note-2)		M2062	Axis 2				
M2002	Axis 2				M2063	Axis 3					
M2003	Axis 3				M2064	Axis 4					
M2004	Axis 4				M2065	Axis 5					
M2005	Axis 5				M2066	Axis 6					
M2006	Axis 6				M2067	Axis 7					
M2007	Axis 7				M2068	Axis 8					
M2008	Axis 8				M2069	Axis 9					
M2009	Axis 9				M2070	Axis 10					
M2010	Axis 10				M2071	Axis 11					
M2011	Axis 11				M2072	Axis 12					
M2012	Axis 12				M2073	Axis 13					
M2013	Axis 13				M2074	Axis 14					
M2014	Axis 14				M2075	Axis 15					
M2015	Axis 15				M2076	Axis 16					
M2016	Axis 16				M2077	Axis 17					
M2017	Axis 17				M2078	Axis 18					
M2018	Axis 18				M2079	Axis 19					
M2019	Axis 19				M2080	Axis 20					
M2020	Axis 20				M2081	Axis 21					
M2021	Axis 21				M2082	Axis 22					
M2022	Axis 22				M2083	Axis 23					
M2023	Axis 23				M2084	Axis 24					
M2024	Axis 24				M2085	Axis 25					
M2025	Axis 25				M2086	Axis 26					
M2026	Axis 26				M2087	Axis 27					
M2027	Axis 27				M2088	Axis 28					
M2028	Axis 28				M2089	Axis 29					
M2029	Axis 29				M2090	Axis 30					
M2030	Axis 30				M2091	Axis 31					
M2031	Axis 31				M2092	Axis 32					
M2032	Axis 32								M2093		
M2033	Unusable (2 points)	—	—	—	—	M2094	Unusable (29 points)	—	—	—	—
M2034	Motion error history clear request flag		Main cycle	Command signal	M3080	M2095					
M2035	Unusable (2 points)	—	—	—	—	M2096					
M2036	Unusable (2 points)	—	—	—	—	M2097					
M2037	Motion SFC debugging flag	At debugging mode transition		Status signal		M2098					
M2038	Motion error detection flag	Immediate		Status signal		M2099					
M2039	Speed switching point specified flag		At start	Command signal	M3073	M2100					
M2040	System setting error flag	Operation cycle		Status signal		M2101					
M2041	All axes servo ON command		Operation cycle	Command signal	M3074	M2102					
M2042	Unusable (4 points)	—	—	—	—	M2103					
M2043	Motion slot fault detection flag	Operation cycle		Status signal		M2104					
M2044	JOG operation simultaneous start command		Main cycle	Command signal	M3076	M2105					
M2045	All axes servo ON accept flag	Operation cycle		Status signal		M2106					
M2046	Unusable	—	—	—	—	M2107					
M2047	Manual pulse generator 1 enable flag		Main cycle	Command signal	M3077	M2108					
M2048	Manual pulse generator 2 enable flag					M2109					
M2049	Manual pulse generator 3 enable flag					M2110					
M2050	Operation cycle over flag	Operation cycle		Status signal		M2111					
M2051	Unusable (6 points)	—	—	—	—	M2112					
M2052	Unusable (6 points)	—	—	—	—	M2113					
M2053	Unusable (6 points)	—	—	—	—	M2114					
M2054	Unusable (6 points)	—	—	—	—	M2115					
M2055	Unusable (6 points)	—	—	—	—	M2116					
M2056	Unusable (6 points)	—	—	—	—	M2117					
M2057	Unusable (6 points)	—	—	—	—	M2118					
M2058	Unusable (6 points)	—	—	—	—	M2119					
M2059	Unusable (6 points)	—	—	—	—	M2120					
M2060	Unusable (6 points)	—	—	—	—	M2121					

4 POSITIONING DEDICATED SIGNALS

Common device list (Continued)

Device No.	Signal name	Refresh cycle	Fetch cycle	Signal direction	Remark (Note-3)	Device No.	Signal name	Refresh cycle	Fetch cycle	Signal direction	Remark (Note-3)				
M2122	Unusable (6 points)	-	-	-	-	M2194	Unusable (46 points)	-	-	-	-				
M2123															
M2124															
M2125															
M2126															
M2127															
M2128	Axis 1	Operation cycle	-	-	-	M2200									
M2129	Axis 2														
M2130	Axis 3														
M2131	Axis 4														
M2132	Axis 5														
M2133	Axis 6														
M2134	Axis 7														
M2135	Axis 8														
M2136	Axis 9														
M2137	Axis 10														
M2138	Axis 11														
M2139	Axis 12														
M2140	Axis 13														
M2141	Axis 14														
M2142	Axis 15														
M2143	Axis 16					Automatic decelerating flag						-	-	-	M2215
M2144	Axis 17														
M2145	Axis 18														
M2146	Axis 19														
M2147	Axis 20														
M2148	Axis 21														
M2149	Axis 22														
M2150	Axis 23														
M2151	Axis 24														
M2152	Axis 25														
M2153	Axis 26														
M2154	Axis 27														
M2155	Axis 28														
M2156	Axis 29														
M2157	Axis 30														
M2158	Axis 31														
M2159	Axis 32														
M2160	Unusable (34 points)	-	-	-	-	M2216									
M2161															
M2162															
M2163															
M2164															
M2165															
M2166															
M2167															
M2168															
M2169															
M2170															
M2171															
M2172															
M2173															
M2174															
M2175															
M2176															
M2177															
M2178															
M2179															
M2180															
M2181															
M2182															
M2183															
M2184															
M2185															
M2186															
M2187															
M2188															
M2189															
M2190															
M2191															
M2192															
M2193															
M2201	Speed change "0" accepting flag	Operation cycle	-	-	-	M2202									
M2202															
M2203															
M2204															
M2205															
M2206															
M2207															
M2208															
M2209															
M2210															
M2211															
M2212															
M2213															
M2214															
M2215															
M2216															
M2217															
M2218															
M2219															
M2220															
M2221															
M2222															
M2223															
M2224															
M2225															
M2226															
M2227															
M2228															
M2229															
M2230															
M2231															
M2232															
M2233															
M2234															
M2235															
M2236															
M2237															
M2238															
M2239															
M2240	Axis 1	-	-	-	-	M2240									
M2241	Axis 2														
M2242	Axis 3														
M2243	Axis 4														
M2244	Axis 5														
M2245	Axis 6														
M2246	Axis 7														
M2247	Axis 8														
M2248	Axis 9														
M2249	Axis 10														
M2250	Axis 11														
M2251	Axis 12														
M2252	Axis 13														
M2253	Axis 14														
M2254	Axis 15														
M2255	Axis 16														
M2256	Axis 17														
M2257	Axis 18														
M2258	Axis 19														
M2259	Axis 20														
M2260	Axis 21														
M2261	Axis 22														
M2262	Axis 23														
M2263	Axis 24														
M2264	Axis 25														
M2265	Axis 26														

4 POSITIONING DEDICATED SIGNALS

Common device list (Continued)

Device No.	Signal name	Refresh cycle	Fetch cycle	Signal direction	Remark (Note-3)	Device No.	Signal name	Refresh cycle	Fetch cycle	Signal direction	Remark (Note-3)	
M2266	Axis 27	Operation cycle	/	Status signal (Note-1), (Note-2)		M2293	Axis 22	Operation cycle	/	Status signal (Note-1), (Note-2)		
M2267	Axis 28					M2294	Axis 23					
M2268	Axis 29					Speed change "0" accepting flag	M2295					Axis 24
M2269	Axis 30						M2296					Axis 25
M2270	Axis 31					Control loop monitor status	M2297					Axis 26
M2271	Axis 32						M2298					Axis 27
M2272	Axis 1						M2299					Axis 28
M2273	Axis 2						M2300					Axis 29
M2274	Axis 3						M2301					Axis 30
M2275	Axis 4						M2302					Axis 31
M2276	Axis 5	M2303	Axis 32									
M2277	Axis 6	Unusable (16 points)	M2304									
M2278	Axis 7		M2305									
M2279	Axis 8		M2306									
M2280	Axis 9		M2307									
M2281	Axis 10		M2308									
M2282	Axis 11		M2309									
M2283	Axis 12		M2310									
M2284	Axis 13		M2311									
M2285	Axis 14		M2312									
M2286	Axis 15		M2313									
M2287	Axis 16	M2314										
M2288	Axis 17	M2315										
M2289	Axis 18	M2316										
M2290	Axis 19	M2317										
M2291	Axis 20	M2318										
M2292	Axis 21	M2319										

(Note-1): The range of axis No.1 to 16 is valid in the Q172DSCPU.

(Note-2): Device area of 17 axes or more is unusable in the Q172DSCPU.

(Note-3): It can also be ordered the device of a remark column.

POINT

Refer to the "Q173D(S)CPU/Q172D(S)CPU Motion controller (SV13/SV22) Programming Manual (REAL MODE)" for details of common device.

4 POSITIONING DEDICATED SIGNALS

(15) Common device list (Command signal)

Device No.	Signal name	Refresh cycle	Fetch cycle	Signal direction	Remark (Note-1), (Note-2)
M3072	PLC ready flag	/	Main cycle	Command signal	M2000
M3073	Speed switching point specified flag		At start		M2040
M3074	All axes servo ON command		Operation cycle		M2042
M3075	Unusable	—	—	—	—
M3076	JOG operation simultaneous start command	/	Main cycle	Command signal	M2048
M3077	Manual pulse generator 1 enable flag				M2051
M3078	Manual pulse generator 2 enable flag				M2052
M3079	Manual pulse generator 3 enable flag				M2053
M3080	Motion error history clear request flag				M2035
M3081 to M3135	Unusable (Note-3) (55 points)	—	—	—	—

(Note-1): The state of a device is not in agreement when the device of a remark column is turned ON/OFF directly. In addition, when the request from a data register and the request from the above device are performed simultaneously, the request from the above device becomes effective.

(Note-2): It can also be ordered the device of a remark column.

(Note-3): Do not use it as a user device. It can be used as a device that performs automatic refresh because of area for the reserve of command signal.

POINT

The device of a remark column turns ON by OFF to ON of the above device, and turns OFF by ON to OFF of the above device.
 The command signal cannot be turned ON/OFF by the PLC CPU in the automatic refresh because the statuses and commands are mixed together in M2000 to M2053. Use the above devices in the case.
 And, it can also be turned ON/OFF by the data register.
 (Refer to the "Q173D(S)CPU/Q172D(S)CPU Motion controller (SV13/SV22) Programming Manual (REAL MODE)".)

4 POSITIONING DEDICATED SIGNALS

4.2 Data Registers

(1) Data register list

SV22	
Device No.	Application
D0 to	Axis monitor device (20 points × 32 axes)
D640 to	Control change register (2 points × 32 axes)
D704 to	Common device (Command signal) (54 points)
D758 to	Unusable (42 points)
D800 to	User device (7392 points)
D8192 (Note-1) to	User device (2048 points)
D10240 (Note-1) to	System area (2040 points)
D12280 (Note-1) to	Servo input axis monitor device (10 points × 32 axes)
D12600 (Note-1) to	Command generation axis monitor device (20 points × 32 axes)
D13240 (Note-1) to	Synchronous encoder axis monitor device (20 points × 12 axes)
D13480 (Note-1) to	Unusable (120 points)
D13600 (Note-1) to	Output axis monitor device (30 points × 32 axes)
D14560 (Note-1) to	Unusable (40 points)
D14600 (Note-1) to	Servo input axis control device (2 points × 32 axes)
D14664 (Note-1) to	Unusable (16 points)
D14680 (Note-1) to	Command generation axis control device (4 points × 32 axes)
D14808 (Note-1) to	Unusable (12 points)
D14819 (Note-1)	

4 POSITIONING DEDICATED SIGNALS

Data register list (Continued)

SV22	
Device No.	Application
D14820 (Note-1) to	Synchronous encoder axis control device (10 points × 12 axes)
D14940 (Note-1) to	Unusable (60 points)
D15000 (Note-1) to	Output axis control device (150 points × 32 axes)
D19800 (Note-1) to D19823 (Note-1)	Unusable (24 points)

It can be used as a user device.

POINT

- (1) Total number of points for the user devices
 9440 points
- (2) (Note-1): Do not set D8192 to D19823 as the latch range in advanced synchronous control method.
- (3) This manual describes only details for data registers used in the synchronous control. If it is required, refer to the "Q173D(S)CPU/Q172D(S)CPU Motion controller (SV13/SV22) Programming Manual (REAL MODE)".

4 POSITIONING DEDICATED SIGNALS

(2) Axis monitor device list

Axis No.	Device No.	Signal name			
1	D0 to D19				
2	D20 to D39				
3	D40 to D59				
4	D60 to D79				
5	D80 to D99				
6	D100 to D119				
7	D120 to D139				
8	D140 to D159				
9	D160 to D179				
10	D180 to D199				
11	D200 to D219				
12	D220 to D239				
13	D240 to D259				
14	D260 to D279				
15	D280 to D299				
16	D300 to D319				
17	D320 to D339				
18	D340 to D359				
19	D360 to D379				
20	D380 to D399				
21	D400 to D419				
22	D420 to D439				
23	D440 to D459				
24	D460 to D479				
25	D480 to D499				
26	D500 to D519				
27	D520 to D539				
28	D540 to D559				
29	D560 to D579				
30	D580 to D599				
31	D600 to D619				
32	D620 to D639				

	Signal name	Refresh cycle	Fetch cycle	Signal direction
0	Feed current value	Operation cycle	—	Monitor device
1				
2	Real current value			
3				
4				
5	Deviation counter value			
6	Minor error code	Immediate		
7	Major error code			
8	Servo error code	Main cycle		
9	Home position return re-travel value	Operation cycle		
10	Travel value after proximity dog ON			
11				
12	Execute program No.	At start		
13	M-code	Operation cycle		
14	Torque limit value			
15	Data set pointer for constant-speed control	At start/ during start		
16	Unusable (Note-1)	—	—	—
17				
18	Real current value at stop input	Operation cycle	—	Monitor device
19				

(Note-1): It can be used as the travel value change register. The travel value change register can be set to the device optionally in the servo program.

Refer to the "Q173D(S)CPU/Q172D(S)CPU Motion controller (SV13/SV22) Programming Manual (REAL MODE)" for details.

POINT
(1) The range of axis No.1 to 16 is valid in the Q172DSCPU.
(2) The device area more than 17 axes in the Q172DSCPU can be used as a user device. However, when the project of Q172DSCPU is replaced with Q173DSCPU, this area cannot be used as a user device.
(3) Refer to the "Q173D(S)CPU/Q172D(S)CPU Motion controller (SV13/SV22) Programming Manual (REAL MODE)" for details of axis monitor device.

4 POSITIONING DEDICATED SIGNALS

(3) Control change register list

Axis No.	Device No.	Signal name														
1	D640, D641	<table border="1"> <thead> <tr> <th></th> <th>Signal name</th> <th>Refresh cycle</th> <th>Fetch cycle</th> <th>Signal direction</th> </tr> </thead> <tbody> <tr> <td>0</td> <td rowspan="2">JOG speed setting</td> <td rowspan="2" style="text-align: center;">/</td> <td rowspan="2">At start</td> <td rowspan="2">Command device</td> </tr> <tr> <td>1</td> </tr> </tbody> </table>					Signal name	Refresh cycle	Fetch cycle	Signal direction	0	JOG speed setting	/	At start	Command device	1
	Signal name					Refresh cycle	Fetch cycle	Signal direction								
0	JOG speed setting					/	At start	Command device								
1																
2	D642, D643															
3	D644, D645															
4	D646, D647															
5	D648, D649															
6	D650, D651															
7	D652, D653															
8	D654, D655															
9	D656, D657															
10	D658, D659															
11	D660, D661															
12	D662, D663															
13	D664, D665															
14	D666, D667															
15	D668, D669															
16	D670, D671															
17	D672, D673															
18	D674, D675															
19	D676, D677															
20	D678, D679															
21	D680, D681															
22	D682, D683															
23	D684, D685															
24	D686, D687															
25	D688, D689															
26	D690, D691															
27	D692, D693															
28	D694, D695															
29	D696, D697															
30	D698, D699															
31	D700, D701															
32	D702, D703															

POINT

- (1) The range of axis No.1 to 16 is valid in the Q172DSCPU.
- (2) The device area more than 17 axes in the Q172DSCPU can be used as a user device.
However, when the project of Q172DSCPU is replaced with Q173DSCPU, this area cannot be used as a user device.
- (3) Refer to the "Q173D(S)CPU/Q172D(S)CPU Motion controller (SV13/SV22) Programming Manual (REAL MODE)" for details of control change register.

4 POSITIONING DEDICATED SIGNALS

(4) Servo input axis monitor device list

Axis No.	Device No.	Signal name			
1	D12280 to D12289				
2	D12290 to D12299				
3	D12300 to D12309				
4	D12310 to D12319				
5	D12320 to D12329				
6	D12330 to D12339				
7	D12340 to D12349				
8	D12350 to D12359				
9	D12360 to D12369				
10	D12370 to D12379				
11	D12380 to D12389				
12	D12390 to D12399				
13	D12400 to D12409				
14	D12410 to D12419				
15	D12420 to D12429				
16	D12430 to D12439				
17	D12440 to D12449				
18	D12450 to D12459				
19	D12460 to D12469				
20	D12470 to D12479				
21	D12480 to D12489				
22	D12490 to D12499				
23	D12500 to D12509				
24	D12510 to D12519				
25	D12520 to D12529				
26	D12530 to D12539				
27	D12540 to D12549				
28	D12550 to D12559				
29	D12560 to D12569				
30	D12570 to D12579				
31	D12580 to D12589				
32	D12590 to D12599				

	Symbol	Signal name	Refresh cycle	Fetch cycle	Signal direction
0	Md.300	Servo input axis current value	Operation cycle	/	Monitor device
1		Servo input axis speed			
2	Md.301	Servo input axis phase compensation amount			
3		Servo input axis rotation direction restriction amount			
4		Servo input axis phase compensation amount			
5	Md.302	Servo input axis phase compensation amount			
6		Servo input axis rotation direction restriction amount			
7	Md.303	Servo input axis rotation direction restriction amount			
8	—	Unusable	—	—	—
9	—	Unusable	—	—	—

POINT

- (1) The range of axis No.1 to 16 is valid in the Q172DSCPU.
- (2) The device area more than 17 axes in the Q172DSCPU can be used as a user device.
However, when the project of Q172DSCPU is replaced with Q173DSCPU, this area cannot be used as a user device.
- (3) Refer to Section 5.1.3 for details of servo input axis monitor device.

4 POSITIONING DEDICATED SIGNALS

(5) Servo input axis control device list

Axis No.	Device No.	Signal name			
1	D14600, D14601				
2	D14602, D14603				
3	D14604, D14605				
4	D14606, D14607				
5	D14608, D14609				
6	D14610, D14611				
7	D14612, D14613				
8	D14614, D14615				
9	D14616, D14617				
10	D14618, D14619				
11	D14620, D14621				
12	D14622, D14623				
13	D14624, D14625				
14	D14626, D14627				
15	D14628, D14629				
16	D14630, D14631				
17	D14632, D14633				
18	D14634, D14635				
19	D14636, D14637				
20	D14638, D14639				
21	D14640, D14641				
22	D14642, D14643				
23	D14644, D14645				
24	D14646, D14647				
25	D14648, D14649				
26	D14650, D14651				
27	D14652, D14653				
28	D14654, D14655				
29	D14656, D14657				
30	D14658, D14659				
31	D14660, D14661				
32	D14662, D14663				

	Symbol	Signal name	Refresh cycle	Fetch cycle	Signal direction
0	Pr.302	Servo input axis phase		Operation cycle	Command device
1		compensation advance time			

POINT

- (1) The range of axis No.1 to 16 is valid in the Q172DSCPU.
- (2) The device area more than 17 axes in the Q172DSCPU can be used as a user device.
However, when the project of Q172DSCPU is replaced with Q173DSCPU, this area cannot be used as a user device.
- (3) Refer to Section 5.1.2 for details of servo input axis control device.

4 POSITIONING DEDICATED SIGNALS

(6) Command generation axis monitor device list

Axis No.	Device No.	Signal name			
1	D12600 to D12619				
2	D12620 to D12639				
3	D12640 to D12659				
4	D12660 to D12679				
5	D12680 to D12699				
6	D12700 to D12719				
7	D12720 to D12739				
8	D12740 to D12759				
9	D12760 to D12779				
10	D12780 to D12799				
11	D12800 to D12819				
12	D12820 to D12839				
13	D12840 to D12859				
14	D12860 to D12879				
15	D12880 to D12899				
16	D12900 to D12919				
17	D12920 to D12939				
18	D12940 to D12959				
19	D12960 to D12979				
20	D12980 to D12999				
21	D13000 to D13019				
22	D13020 to D13039				
23	D13040 to D13059				
24	D13060 to D13079				
25	D13080 to D13099				
26	D13100 to D13119				
27	D13120 to D13139				
28	D13140 to D13159				
29	D13160 to D13179				
30	D13180 to D13199				
31	D13200 to D13219				
32	D13220 to D13239				

Symbol	Signal name	Refresh cycle	Fetch cycle	Signal direction	
0	Md.340 Command generation axis feed current value	Operation cycle	/	Monitor device	
1		Immediate			
2	Md.341 Command generation axis minor error code				
3					Md.342 Command generation axis major error code
4	Md.343 Command generation axis execute program No.	At start			
5		Md.344 Command generation axis M-code			Operation cycle
6					
7	Md.345 Command generation axis accumulative current value				
8		—			—
9	Md.346 Command generation axis data set pointer for constant-speed control	At start/ during start			/
10		Md.347 Command generation axis current value per cycle			
11	Md.348 Command generation axis command speed		Operation cycle		
12					
13	—	Unusable	—	—	
14					
15					
16					
17					
18					
19					

POINT

- (1) The range of axis No.1 to 16 is valid in the Q172DSCPU.
- (2) The device area more than 17 axes in the Q172DSCPU can be used as a user device.
However, when the project of Q172DSCPU is replaced with Q173DSCPU, this area cannot be used as a user device.
- (3) Refer to Section 5.2.4 for details of command generation axis monitor device.

4 POSITIONING DEDICATED SIGNALS

(7) Command generation axis control device list

Axis No.	Device No.	Signal name			
1	D14680 to D14683				
2	D14684 to D14687				
3	D14688 to D14691				
4	D14692 to D14695				
5	D14696 to D14699				
6	D14700 to D14703				
7	D14704 to D14707				
8	D14708 to D14711				
9	D14712 to D14715				
10	D14716 to D14719				
11	D14720 to D14723				
12	D14724 to D14727				
13	D14728 to D14731				
14	D14732 to D14735				
15	D14736 to D14739				
16	D14740 to D14743				
17	D14744 to D14747				
18	D14748 to D14751				
19	D14752 to D14755				
20	D14756 to D14759				
21	D14760 to D14763				
22	D14764 to D14767				
23	D14768 to D14771				
24	D14772 to D14775				
25	D14776 to D14779				
26	D14780 to D14783				
27	D14784 to D14787				
28	D14788 to D14791				
29	D14792 to D14795				
30	D14796 to D14799				
31	D14800 to D14803				
32	D14804 to D14807				

	Symbol	Signal name	Refresh cycle	Fetch cycle	Signal direction
0	Cd.340	Command generation axis		At start of	Command
1		JOG speed setting			
2	Pr.348	Command generation axis JOG operation parameter block setting		JOG operation	device
3	—	Unusable	—	—	—

POINT

- (1) The range of axis No.1 to 16 is valid in the Q172DSCPU.
- (2) The device area more than 17 axes in the Q172DSCPU can be used as a user device.
However, when the project of Q172DSCPU is replaced with Q173DSCPU, this area cannot be used as a user device.
- (3) Refer to Section 5.2.2 and Section 5.2.3 for details of command generation axis control device.

4 POSITIONING DEDICATED SIGNALS

(8) Synchronous encoder axis monitor device list

Axis No.	Device No.	Signal name				
1	D13240 to D13259					
2	D13260 to D13279					
3	D13280 to D13299					
4	D13300 to D13319					
5	D13320 to D13339					
6	D13340 to D13359					
7	D13360 to D13379					
8	D13380 to D13399					
9	D13400 to D13419					
10	D13420 to D13439					
11	D13440 to D13459					
12	D13460 to D13479					
		Symbol	Signal name	Refresh cycle	Fetch cycle	Signal direction
		0	Md.320	Synchronous encoder axis current value	Operation cycle	Monitor device
		1	Md.320	Synchronous encoder axis current value per cycle		
		2	Md.321	Synchronous encoder axis speed		
		3	Md.321	Synchronous encoder axis phase compensation amount		
		4	Md.322	Synchronous encoder axis rotation direction restriction amount		
		5	Md.322	Synchronous encoder axis minor error code		
		6	Md.323	Synchronous encoder axis major error code	Immediate	
		7	Md.323	Synchronous encoder axis rotation direction restriction amount		
		8	Md.324	Synchronous encoder axis minor error code	Immediate	
		9	Md.324	Synchronous encoder axis major error code		
		10	Md.327	Synchronous encoder axis minor error code	Immediate	
		11	Md.326	Synchronous encoder axis major error code		
		12	—	Unusable	—	—
		13	—	Unusable	—	—
		14	—	Unusable	—	—
		15	—	Unusable	—	—
		16	—	Unusable	—	—
		17	—	Unusable	—	—
		18	—	Unusable	—	—
		19	—	Unusable	—	—

POINT

Refer to Section 5.3.5 for details of synchronous encoder axis monitor device.

4 POSITIONING DEDICATED SIGNALS

(9) Synchronous encoder axis control device list

Axis No.	Device No.	Signal name																																																					
1	D14820 to D14829	<table border="1"> <thead> <tr> <th></th> <th>Symbol</th> <th>Signal name</th> <th>Refresh cycle</th> <th>Fetch cycle</th> <th>Signal direction</th> </tr> </thead> <tbody> <tr> <td>0</td> <td rowspan="2">Pr.326</td> <td>Synchronous encoder axis phase compensation advance time</td> <td rowspan="12" style="text-align: center;">/</td> <td>Operation cycle</td> <td rowspan="6">Command device</td> </tr> <tr> <td>1</td> <td>Synchronous encoder axis control start condition</td> <td rowspan="6">At synchronous encoder axis control start</td> </tr> <tr> <td>2</td> <td>Cd.320</td> <td>Synchronous encoder axis control method</td> </tr> <tr> <td>3</td> <td>Cd.321</td> <td>Synchronous encoder axis current value setting address</td> </tr> <tr> <td>4</td> <td rowspan="2">Cd.322</td> <td>Input value for synchronous encoder via device</td> </tr> <tr> <td>5</td> <td>—</td> </tr> <tr> <td>6</td> <td>Cd.325</td> <td>Unusable</td> <td>—</td> <td>—</td> <td>—</td> </tr> <tr> <td>7</td> <td>—</td> <td>—</td> <td>—</td> <td>—</td> <td>—</td> </tr> <tr> <td>8</td> <td>—</td> <td>—</td> <td>—</td> <td>—</td> <td>—</td> </tr> <tr> <td>9</td> <td>—</td> <td>—</td> <td>—</td> <td>—</td> <td>—</td> </tr> </tbody> </table>		Symbol	Signal name	Refresh cycle	Fetch cycle	Signal direction	0	Pr.326	Synchronous encoder axis phase compensation advance time	/	Operation cycle	Command device	1	Synchronous encoder axis control start condition	At synchronous encoder axis control start	2	Cd.320	Synchronous encoder axis control method	3	Cd.321	Synchronous encoder axis current value setting address	4	Cd.322	Input value for synchronous encoder via device	5	—	6	Cd.325	Unusable	—	—	—	7	—	—	—	—	—	8	—	—	—	—	—	9	—	—	—	—	—			
	Symbol		Signal name	Refresh cycle	Fetch cycle	Signal direction																																																	
0	Pr.326		Synchronous encoder axis phase compensation advance time	/	Operation cycle	Command device																																																	
1			Synchronous encoder axis control start condition		At synchronous encoder axis control start																																																		
2	Cd.320		Synchronous encoder axis control method																																																				
3	Cd.321		Synchronous encoder axis current value setting address																																																				
4	Cd.322		Input value for synchronous encoder via device																																																				
5			—																																																				
6	Cd.325		Unusable			—	—	—																																															
7	—		—		—	—	—																																																
8	—		—		—	—	—																																																
9	—		—		—	—	—																																																
2	D14830 to D14839																																																						
3	D14840 to D14849																																																						
4	D14850 to D14859																																																						
5	D14860 to D14869																																																						
6	D14870 to D14879																																																						
7	D14880 to D14889																																																						
8	D14890 to D14899																																																						
9	D14900 to D14909																																																						
10	D14910 to D14919																																																						
11	D14920 to D14929																																																						
12	D14930 to D14939																																																						

POINT

Refer to Section 5.3.3 and Section 5.3.4 for details of synchronous encoder axis control device.

4 POSITIONING DEDICATED SIGNALS

(11) Output axis control device list

Axis No.	Device No.	Signal name																																																																																																																																									
1	D15000 to D15149	<table border="1"> <thead> <tr> <th></th> <th>Symbol</th> <th>Signal name</th> <th>Refresh cycle</th> <th>Fetch cycle</th> <th>Signal direction</th> </tr> </thead> <tbody> <tr> <td>0</td> <td>Pr.400</td> <td>Main input axis No.</td> <td rowspan="3">/</td> <td>At start of synchronous control</td> <td rowspan="3">Command device</td> </tr> <tr> <td>1</td> <td>Pr.401</td> <td>Sub input axis No.</td> <td>Operation cycle</td> </tr> <tr> <td>2</td> <td>Pr.402</td> <td>Composite main shaft gear</td> <td>—</td> </tr> <tr> <td>3</td> <td>—</td> <td>Unusable</td> <td>—</td> <td>—</td> <td>—</td> </tr> <tr> <td>4</td> <td rowspan="2">Pr.403</td> <td rowspan="2">Main shaft gear: Numerator</td> <td rowspan="39">/</td> <td rowspan="2">At start of synchronous control</td> <td rowspan="39">Command device</td> </tr> <tr> <td>5</td> </tr> <tr> <td>6</td> <td rowspan="2">Pr.404</td> <td rowspan="2">Main shaft gear: Denominator</td> <td>Operation cycle</td> </tr> <tr> <td>7</td> </tr> <tr> <td>8</td> <td>Pr.405</td> <td>Main shaft clutch control setting</td> <td>At start of synchronous control</td> </tr> <tr> <td>9</td> <td rowspan="2">Pr.406</td> <td rowspan="2">Main shaft clutch reference address setting</td> <td>Operation cycle</td> </tr> <tr> <td>10</td> </tr> <tr> <td>11</td> <td rowspan="2">Pr.407</td> <td rowspan="2">Main shaft clutch ON address</td> <td>At completing clutch ON condition</td> </tr> <tr> <td>12</td> </tr> <tr> <td>13</td> <td rowspan="2">Pr.408</td> <td rowspan="2">Travel value before main shaft clutch ON</td> <td>Operation cycle</td> </tr> <tr> <td>14</td> </tr> <tr> <td>15</td> <td rowspan="2">Pr.409</td> <td rowspan="2">Main shaft clutch OFF address</td> <td>At completing clutch OFF condition</td> </tr> <tr> <td>16</td> </tr> <tr> <td>17</td> <td rowspan="2">Pr.410</td> <td rowspan="2">Travel value before main shaft clutch OFF</td> <td>At start of synchronous control</td> </tr> <tr> <td>18</td> </tr> <tr> <td>19</td> <td rowspan="2">Pr.411</td> <td rowspan="2">Main shaft clutch smoothing method</td> <td>At turning clutch ON</td> </tr> <tr> <td>20</td> </tr> <tr> <td>21</td> <td rowspan="2">Pr.412</td> <td rowspan="2">Main shaft clutch smoothing time constant</td> <td>At turning clutch OFF</td> </tr> <tr> <td>22</td> </tr> <tr> <td>23</td> <td rowspan="2">Pr.413</td> <td rowspan="2">Slippage amount at main shaft clutch ON</td> <td>At start of synchronous control</td> </tr> <tr> <td>24</td> </tr> <tr> <td>25</td> <td rowspan="2">Pr.414</td> <td rowspan="2">Slippage amount at main shaft clutch OFF</td> <td>Operation cycle</td> </tr> <tr> <td>26</td> </tr> <tr> <td>27</td> <td rowspan="2">Pr.418</td> <td rowspan="2">Auxiliary shaft axis No.</td> <td>At start of synchronous control</td> </tr> <tr> <td>28</td> </tr> <tr> <td>29</td> <td rowspan="2">Pr.419</td> <td rowspan="2">Composite auxiliary shaft gear</td> <td>Operation cycle</td> </tr> <tr> <td>30</td> </tr> <tr> <td>31</td> <td rowspan="2">Pr.420</td> <td rowspan="2">Auxiliary shaft gear: Numerator</td> <td>At start of synchronous control</td> </tr> <tr> <td>32</td> </tr> <tr> <td>33</td> <td rowspan="2">Pr.421</td> <td rowspan="2">Auxiliary shaft gear: Denominator</td> <td>Operation cycle</td> </tr> <tr> <td>34</td> </tr> <tr> <td>35</td> <td rowspan="2">Pr.422</td> <td rowspan="2">Auxiliary shaft clutch control setting</td> <td>At start of synchronous control</td> </tr> <tr> <td>36</td> </tr> <tr> <td>37</td> <td rowspan="2">Pr.423</td> <td rowspan="2">Auxiliary shaft clutch reference address setting</td> <td>Operation cycle</td> </tr> <tr> <td>38</td> </tr> <tr> <td>39</td> <td rowspan="2">Pr.424</td> <td rowspan="2">Auxiliary shaft clutch ON address</td> <td>At completing clutch ON condition</td> </tr> <tr> <td>40</td> </tr> <tr> <td>41</td> <td rowspan="2">Pr.425</td> <td rowspan="2">Travel value before auxiliary shaft clutch ON</td> <td>Operation cycle</td> </tr> <tr> <td>42</td> </tr> <tr> <td>43</td> <td rowspan="2">Pr.426</td> <td rowspan="2">Auxiliary shaft clutch OFF address</td> <td>At completing clutch OFF condition</td> </tr> <tr> <td>44</td> </tr> <tr> <td>45</td> <td rowspan="2">Pr.427</td> <td rowspan="2">Travel value before auxiliary shaft clutch OFF</td> <td>Operation cycle</td> </tr> <tr> <td>46</td> </tr> </tbody> </table>		Symbol	Signal name	Refresh cycle	Fetch cycle	Signal direction	0	Pr.400	Main input axis No.	/	At start of synchronous control	Command device	1	Pr.401	Sub input axis No.	Operation cycle	2	Pr.402	Composite main shaft gear	—	3	—	Unusable	—	—	—	4	Pr.403	Main shaft gear: Numerator	/	At start of synchronous control	Command device	5	6	Pr.404	Main shaft gear: Denominator	Operation cycle	7	8	Pr.405	Main shaft clutch control setting	At start of synchronous control	9	Pr.406	Main shaft clutch reference address setting	Operation cycle	10	11	Pr.407	Main shaft clutch ON address	At completing clutch ON condition	12	13	Pr.408	Travel value before main shaft clutch ON	Operation cycle	14	15	Pr.409	Main shaft clutch OFF address	At completing clutch OFF condition	16	17	Pr.410	Travel value before main shaft clutch OFF	At start of synchronous control	18	19	Pr.411	Main shaft clutch smoothing method	At turning clutch ON	20	21	Pr.412	Main shaft clutch smoothing time constant	At turning clutch OFF	22	23	Pr.413	Slippage amount at main shaft clutch ON	At start of synchronous control	24	25	Pr.414	Slippage amount at main shaft clutch OFF	Operation cycle	26	27	Pr.418	Auxiliary shaft axis No.	At start of synchronous control	28	29	Pr.419	Composite auxiliary shaft gear	Operation cycle	30	31	Pr.420	Auxiliary shaft gear: Numerator	At start of synchronous control	32	33	Pr.421	Auxiliary shaft gear: Denominator	Operation cycle	34	35	Pr.422	Auxiliary shaft clutch control setting	At start of synchronous control	36	37	Pr.423	Auxiliary shaft clutch reference address setting	Operation cycle	38	39	Pr.424	Auxiliary shaft clutch ON address	At completing clutch ON condition	40	41	Pr.425	Travel value before auxiliary shaft clutch ON	Operation cycle	42	43	Pr.426	Auxiliary shaft clutch OFF address	At completing clutch OFF condition	44	45	Pr.427	Travel value before auxiliary shaft clutch OFF	Operation cycle	46
	Symbol		Signal name	Refresh cycle	Fetch cycle	Signal direction																																																																																																																																					
0	Pr.400		Main input axis No.	/	At start of synchronous control	Command device																																																																																																																																					
1	Pr.401		Sub input axis No.		Operation cycle																																																																																																																																						
2	Pr.402		Composite main shaft gear		—																																																																																																																																						
3	—		Unusable	—	—	—																																																																																																																																					
4	Pr.403		Main shaft gear: Numerator	/	At start of synchronous control	Command device																																																																																																																																					
5																																																																																																																																											
6	Pr.404		Main shaft gear: Denominator		Operation cycle																																																																																																																																						
7																																																																																																																																											
8	Pr.405		Main shaft clutch control setting		At start of synchronous control																																																																																																																																						
9	Pr.406		Main shaft clutch reference address setting		Operation cycle																																																																																																																																						
10																																																																																																																																											
11	Pr.407		Main shaft clutch ON address		At completing clutch ON condition																																																																																																																																						
12																																																																																																																																											
13	Pr.408		Travel value before main shaft clutch ON		Operation cycle																																																																																																																																						
14																																																																																																																																											
15	Pr.409		Main shaft clutch OFF address		At completing clutch OFF condition																																																																																																																																						
16																																																																																																																																											
17	Pr.410		Travel value before main shaft clutch OFF		At start of synchronous control																																																																																																																																						
18																																																																																																																																											
19	Pr.411		Main shaft clutch smoothing method		At turning clutch ON																																																																																																																																						
20																																																																																																																																											
21	Pr.412		Main shaft clutch smoothing time constant		At turning clutch OFF																																																																																																																																						
22																																																																																																																																											
23	Pr.413		Slippage amount at main shaft clutch ON		At start of synchronous control																																																																																																																																						
24																																																																																																																																											
25	Pr.414		Slippage amount at main shaft clutch OFF		Operation cycle																																																																																																																																						
26																																																																																																																																											
27	Pr.418		Auxiliary shaft axis No.		At start of synchronous control																																																																																																																																						
28																																																																																																																																											
29	Pr.419		Composite auxiliary shaft gear		Operation cycle																																																																																																																																						
30																																																																																																																																											
31	Pr.420		Auxiliary shaft gear: Numerator		At start of synchronous control																																																																																																																																						
32																																																																																																																																											
33	Pr.421		Auxiliary shaft gear: Denominator		Operation cycle																																																																																																																																						
34																																																																																																																																											
35	Pr.422		Auxiliary shaft clutch control setting		At start of synchronous control																																																																																																																																						
36																																																																																																																																											
37	Pr.423	Auxiliary shaft clutch reference address setting	Operation cycle																																																																																																																																								
38																																																																																																																																											
39	Pr.424	Auxiliary shaft clutch ON address	At completing clutch ON condition																																																																																																																																								
40																																																																																																																																											
41	Pr.425	Travel value before auxiliary shaft clutch ON	Operation cycle																																																																																																																																								
42																																																																																																																																											
43	Pr.426	Auxiliary shaft clutch OFF address	At completing clutch OFF condition																																																																																																																																								
44																																																																																																																																											
45	Pr.427	Travel value before auxiliary shaft clutch OFF	Operation cycle																																																																																																																																								
46																																																																																																																																											
2	D15150 to D15299																																																																																																																																										
3	D15300 to D15449																																																																																																																																										
4	D15450 to D15599																																																																																																																																										
5	D15600 to D15749																																																																																																																																										
6	D15750 to D15899																																																																																																																																										
7	D15900 to D16049																																																																																																																																										
8	D16050 to D16199																																																																																																																																										
9	D16200 to D16349																																																																																																																																										
10	D16350 to D16499																																																																																																																																										
11	D16500 to D16649																																																																																																																																										
12	D16650 to D16799																																																																																																																																										
13	D16800 to D16949																																																																																																																																										
14	D16950 to D17099																																																																																																																																										
15	D17100 to D17249																																																																																																																																										
16	D17250 to D17399																																																																																																																																										
17	D17400 to D17549																																																																																																																																										
18	D17550 to D17699																																																																																																																																										
19	D17700 to D17849																																																																																																																																										
20	D17850 to D17999																																																																																																																																										
21	D18000 to D18149																																																																																																																																										
22	D18150 to D18299																																																																																																																																										
23	D18300 to D18449																																																																																																																																										
24	D18450 to D18599																																																																																																																																										
25	D18600 to D18749																																																																																																																																										
26	D18750 to D18899																																																																																																																																										
27	D18900 to D19049																																																																																																																																										
28	D19050 to D19199																																																																																																																																										
29	D19200 to D19349																																																																																																																																										
30	D19350 to D19499																																																																																																																																										
31	D19500 to D19649																																																																																																																																										
32	D19650 to D19799																																																																																																																																										

4 POSITIONING DEDICATED SIGNALS

Output axis control device list (Continued)

Axis No.	Device No.	Signal name					
1	D15000 to D15149						
2	D15150 to D15299						
3	D15300 to D15449						
4	D15450 to D15599						
5	D15600 to D15749						
6	D15750 to D15899						
7	D15900 to D16049						
8	D16050 to D16199						
9	D16200 to D16349						
10	D16350 to D16499						
11	D16500 to D16649						
12	D16650 to D16799						
13	D16800 to D16949						
14	D16950 to D17099						
15	D17100 to D17249						
16	D17250 to D17399						
17	D17400 to D17549						
18	D17550 to D17699						
19	D17700 to D17849						
20	D17850 to D17999						
21	D18000 to D18149						
22	D18150 to D18299						
23	D18300 to D18449						
24	D18450 to D18599						
25	D18600 to D18749						
26	D18750 to D18899						
27	D18900 to D19049						
28	D19050 to D19199						
29	D19200 to D19349						
30	D19350 to D19499						
31	D19500 to D19649						
32	D19650 to D19799						
		Symbol	Signal name	Refresh cycle	Fetch cycle	Signal direction	
		40	Pr.428	Auxiliary shaft clutch smoothing method		At start of synchronous control	Command device
		41	Pr.429	Auxiliary shaft clutch smoothing time constant		At turning clutch ON	
		42	Pr.430	Slippage amount at auxiliary shaft clutch ON		At turning clutch OFF	
		43		Slippage amount at auxiliary shaft clutch OFF			
		44	Pr.431	Speed change gear 1		At start of synchronous control	
		45		Speed change gear 1 smoothing time constant			
		46	Pr.435	Speed change ratio 1: Numerator		Operation cycle	
		47		Speed change ratio 1: Denominator			
		48	Pr.436	Speed change gear 2		At start of synchronous control	
		49		Speed change gear 2 smoothing time constant			
		50	Pr.437	Speed change ratio 2: Numerator		Operation cycle	
		51		Speed change ratio 2: Denominator			
52	Pr.438	Cam axis cycle unit setting	At start of synchronous control				
53		Cam axis length per cycle change setting <small>Ver.!</small>					
54	Pr.439	Cam axis length per cycle	At start of synchronous control, At passing through the 0th point of cam data				
55		Cam No.					
56	—	Unusable	—	—			
57	Pr.441	Cam stroke amount	At start of synchronous control, At passing through the 0th point of cam data	Command device			
58					Cam axis phase compensation advance time		
59	Pr.444	Cam axis phase compensation advance time	Operation cycle				

Ver.!: Refer to Section 1.4 for the software version that supports this function.

4 POSITIONING DEDICATED SIGNALS

Output axis control device list (Continued)

Axis No.	Device No.	Signal name				
1	D15000 to D15149					
2	D15150 to D15299					
3	D15300 to D15449					
4	D15450 to D15599					
5	D15600 to D15749	68	Pr.445	Cam axis phase compensation time constant	At start of synchronous control	Command device
6	D15750 to D15899	69	Pr.448	Synchronous control parameter block No.		
7	D15900 to D16049	70	Pr.447	Output axis smoothing time constant		
8	D16050 to D16199	71		Unusable		
9	D16200 to D16349	72				
10	D16350 to D16499	73				
11	D16500 to D16649	74				
12	D16650 to D16799	75				
13	D16800 to D16949	76				
14	D16950 to D17099	77				
15	D17100 to D17249	78				
16	D17250 to D17399	79				
17	D17400 to D17549	80				
18	D17550 to D17699	81				
19	D17700 to D17849	82				
20	D17850 to D17999	83				
21	D18000 to D18149	84				
22	D18150 to D18299	85	—			
23	D18300 to D18449	86				
24	D18450 to D18599	87				
25	D18600 to D18749	88				
26	D18750 to D18899	89				
27	D18900 to D19049	90				
28	D19050 to D19199	91				
29	D19200 to D19349	92				
30	D19350 to D19499	93				
31	D19500 to D19649	94				
32	D19650 to D19799	95				
		96				
		97				
		98				
		99				
		100	Pr.460	Setting method of current value per cycle after main shaft gear	At start of synchronous control	Command device
		101	Pr.461	Setting method of current value per cycle after auxiliary shaft gear		
		102	Pr.462	Cam axis position restoration object		
		103	Pr.463	Setting method of cam reference position		
		104	Pr.464	Setting method of cam axis current value per cycle		
		105	—	Unusable		

4 POSITIONING DEDICATED SIGNALS

Output axis control device list (Continued)

Axis No.	Device No.	Signal name																																																																																																																											
1	D15000 to D15149	<table border="1"> <thead> <tr> <th></th> <th>Symbol</th> <th>Signal name</th> <th>Refresh cycle</th> <th>Fetch cycle</th> <th>Signal direction</th> </tr> </thead> <tbody> <tr> <td>106</td> <td rowspan="2">Pr.465</td> <td>Current value per cycle after main shaft gear (Initial setting)</td> <td rowspan="14">/</td> <td rowspan="14">At start of synchronous control</td> <td rowspan="14">Command device</td> </tr> <tr> <td>107</td> <td></td> </tr> <tr> <td>108</td> <td rowspan="2">Pr.466</td> <td>Current value per cycle after auxiliary shaft gear (Initial setting)</td> </tr> <tr> <td>109</td> <td></td> </tr> <tr> <td>110</td> <td rowspan="2">Pr.467</td> <td>Cam reference position (Initial setting)</td> </tr> <tr> <td>111</td> <td></td> </tr> <tr> <td>112</td> <td rowspan="2">Pr.468</td> <td>Cam axis current value per cycle (Initial setting)</td> </tr> <tr> <td>113</td> <td></td> </tr> <tr> <td>114</td> <td rowspan="12">Unusable</td> <td></td> <td></td> <td></td> </tr> <tr> <td>115</td> <td></td> </tr> <tr> <td>116</td> <td></td> </tr> <tr> <td>117</td> <td></td> </tr> <tr> <td>118</td> <td></td> </tr> <tr> <td>119</td> <td></td> </tr> <tr> <td>120</td> <td></td> </tr> <tr> <td>121</td> <td></td> </tr> <tr> <td>122</td> <td>—</td> <td>Unusable</td> <td>—</td> <td>—</td> </tr> <tr> <td>123</td> <td></td> </tr> <tr> <td>124</td> <td></td> </tr> <tr> <td>125</td> <td></td> </tr> <tr> <td>126</td> <td></td> </tr> <tr> <td>127</td> <td></td> </tr> <tr> <td>128</td> <td></td> </tr> <tr> <td>129</td> <td></td> </tr> <tr> <td>130</td> <td>D19050 to D19199</td> <td rowspan="4">Cd.407</td> <td>Synchronous control change command</td> <td rowspan="4">/</td> <td rowspan="4">At requesting synchronous control change</td> <td rowspan="4">Command device</td> </tr> <tr> <td>131</td> <td>D19200 to D19349</td> <td>Cd.409</td> <td>Synchronous control reflection time</td> </tr> <tr> <td>132</td> <td>D19350 to D19499</td> <td rowspan="2">Cd.408</td> <td rowspan="2">Synchronous control change value</td> </tr> <tr> <td>133</td> <td>D19500 to D19649</td> </tr> <tr> <td>134</td> <td>D19650 to D19799</td> <td rowspan="16">Unusable</td> <td></td> <td></td> <td></td> </tr> <tr> <td>135</td> <td></td> </tr> <tr> <td>136</td> <td></td> </tr> <tr> <td>137</td> <td></td> </tr> <tr> <td>138</td> <td></td> </tr> <tr> <td>139</td> <td></td> </tr> <tr> <td>140</td> <td></td> </tr> <tr> <td>141</td> <td>—</td> <td>Unusable</td> <td>—</td> <td>—</td> </tr> <tr> <td>142</td> <td></td> </tr> <tr> <td>143</td> <td></td> </tr> <tr> <td>144</td> <td></td> </tr> <tr> <td>145</td> <td></td> </tr> <tr> <td>146</td> <td></td> </tr> <tr> <td>147</td> <td></td> </tr> <tr> <td>148</td> <td></td> </tr> <tr> <td>149</td> <td></td> </tr> </tbody> </table>		Symbol	Signal name	Refresh cycle	Fetch cycle	Signal direction	106	Pr.465	Current value per cycle after main shaft gear (Initial setting)	/	At start of synchronous control	Command device	107		108	Pr.466	Current value per cycle after auxiliary shaft gear (Initial setting)	109		110	Pr.467	Cam reference position (Initial setting)	111		112	Pr.468	Cam axis current value per cycle (Initial setting)	113		114	Unusable				115		116		117		118		119		120		121		122	—	Unusable	—	—	123		124		125		126		127		128		129		130	D19050 to D19199	Cd.407	Synchronous control change command	/	At requesting synchronous control change	Command device	131	D19200 to D19349	Cd.409	Synchronous control reflection time	132	D19350 to D19499	Cd.408	Synchronous control change value	133	D19500 to D19649	134	D19650 to D19799	Unusable				135		136		137		138		139		140		141	—	Unusable	—	—	142		143		144		145		146		147		148		149	
	Symbol		Signal name	Refresh cycle	Fetch cycle	Signal direction																																																																																																																							
106	Pr.465		Current value per cycle after main shaft gear (Initial setting)	/	At start of synchronous control	Command device																																																																																																																							
107																																																																																																																													
108	Pr.466		Current value per cycle after auxiliary shaft gear (Initial setting)																																																																																																																										
109																																																																																																																													
110	Pr.467		Cam reference position (Initial setting)																																																																																																																										
111																																																																																																																													
112	Pr.468		Cam axis current value per cycle (Initial setting)																																																																																																																										
113																																																																																																																													
114	Unusable																																																																																																																												
115																																																																																																																													
116																																																																																																																													
117																																																																																																																													
118																																																																																																																													
119																																																																																																																													
120																																																																																																																													
121																																																																																																																													
122		—	Unusable	—	—																																																																																																																								
123																																																																																																																													
124																																																																																																																													
125																																																																																																																													
126																																																																																																																													
127																																																																																																																													
128																																																																																																																													
129																																																																																																																													
130	D19050 to D19199	Cd.407	Synchronous control change command	/	At requesting synchronous control change	Command device																																																																																																																							
131	D19200 to D19349		Cd.409				Synchronous control reflection time																																																																																																																						
132	D19350 to D19499		Cd.408				Synchronous control change value																																																																																																																						
133	D19500 to D19649																																																																																																																												
134	D19650 to D19799	Unusable																																																																																																																											
135																																																																																																																													
136																																																																																																																													
137																																																																																																																													
138																																																																																																																													
139																																																																																																																													
140																																																																																																																													
141	—		Unusable	—	—																																																																																																																								
142																																																																																																																													
143																																																																																																																													
144																																																																																																																													
145																																																																																																																													
146																																																																																																																													
147																																																																																																																													
148																																																																																																																													
149																																																																																																																													

4 POSITIONING DEDICATED SIGNALS

POINT

- | |
|-----------------------------------------------------------------------------------------------------------------------------------------------------------------------------------------------------------------------------------------------------------------------------------------------------------------------------------------|
| <p>(1) The range of axis No.1 to 16 is valid in the Q172DSCPU.</p> <p>(2) The device area more than 17 axes in the Q172DSCPU can be used as a user device.</p> <p>(3) Refer to Section 7.1.2, Section 7.1.3, Section 7.2.3, Section 7.4.2, Section 7.5.2, Section 7.6.2, and Section 8.2 for details of output axis control device.</p> |
|-----------------------------------------------------------------------------------------------------------------------------------------------------------------------------------------------------------------------------------------------------------------------------------------------------------------------------------------|

4 POSITIONING DEDICATED SIGNALS

(12) Common device list

Device No.	Signal name	Refresh cycle	Fetch cycle	Signal direction	Device No.	Signal name	Refresh cycle	Fetch cycle	Signal direction
D704	PLC ready flag request	/	Main cycle	Command device	D752	Manual pulse generator 1 smoothing magnification setting register	/	At the manual pulse generator enable flag	Command device
D705	Speed switching point specified flag request				D753	Manual pulse generator 2 smoothing magnification setting register			
D706	All axes servo ON command request				D754	Manual pulse generator 3 smoothing magnification setting register			
D707	Unusable	—	—	—	D755	Manual pulse generator 1 enable flag request	/	Main cycle	Command device
D708	JOG operation simultaneous start command request	/	Main cycle	Command device	D756	Manual pulse generator 2 enable flag request			
D709	Unusable	—	—	—	D757	Manual pulse generator 3 enable flag request			
D710	JOG operation simultaneous start axis setting register	/	At start	Command device	D758	Unusable (42 points)	—	—	—
D711					D759				
D712					D760				
D713					D761				
D714	Manual pulse generator axis 1	/	At the manual pulse generator enable flag	Command device	D762				
D715	No. setting register				D763				
D716	Manual pulse generator axis 2				D764				
D717	No. setting register				D765				
D718	Manual pulse generator axis 3				D766				
D719	No. setting register				D767				
D720	Axis 1				D768				
D721	Axis 2				D769				
D722	Axis 3				D770				
D723	Axis 4				D771				
D724	Axis 5				D772				
D725	Axis 6				D773				
D726	Axis 7				D774				
D727	Axis 8				D775				
D728	Axis 9				D776				
D729	Axis 10				D777				
D730	Axis 11				D778				
D731	Axis 12				D779				
D732	Axis 13				D780				
D733	Axis 14				D781				
D734	Axis 15				D782				
D735	Axis 16				D783				
D736	Axis 17				D784				
D737	Axis 18				D785				
D738	Axis 19				D786				
D739	Axis 20				D787				
D740	Axis 21				D788				
D741	Axis 22				D789				
D742	Axis 23				D790				
D743	Axis 24				D791				
D744	Axis 25				D792				
D745	Axis 26				D793				
D746	Axis 27				D794				
D747	Axis 28				D795				
D748	Axis 29				D796				
D749	Axis 30				D797				
D750	Axis 31				D798				
D751	Axis 32				D799				

(Note-1): The range of axis No.1 to 16 is valid in the Q172DSCPU.

(Note-2): Device area 17 axes of more is unusable in the Q172DSCPU.

POINT

Refer to the "Q173D(S)CPU/Q172D(S)CPU Motion controller (SV13/SV22) Programming Manual (REAL MODE)" for details of common device.

4 POSITIONING DEDICATED SIGNALS



4.3 Motion Registers (#)

There are motion registers (#0 to #12287) in the Motion CPU. #8000 to #8639 are used as the monitor device, #8640 to #8735 are used as the Motion error history device and #8736 to #8751 are used as the product information list device. Refer to the "Q173D(S)CPU/Q172D(S)CPU Motion controller (SV13/SV22) Programming Manual (Motion SFC)" for details of the motion registers and Motion error history device.

(1) Monitor devices (#8000 to #8639)

Information for each axis is stored in the monitor devices.

The details of the storage data are shown below.

Axis No.	Device No.	Signal name		
1	#8000 to #8019			
2	#8020 to #8039			
3	#8040 to #8059			
4	#8060 to #8079	0	Servo amplifier type	When the servo amplifier power-on
5	#8080 to #8099	1	Motor current value	Operation cycle 1.7[ms] or less : Operation cycle Operation cycle 3.5[ms] or more : 3.5[ms]
6	#8100 to #8119	2	Motor speed	
7	#8120 to #8139	3		
8	#8140 to #8159	4	Command speed	Operation cycle
9	#8160 to #8179	5		
10	#8180 to #8199	6	Home position return re-travel value	At home position return re-travel
11	#8200 to #8219	7		Main cycle
12	#8220 to #8239	8	Servo amplifier display servo error code	
13	#8240 to #8259	9	Parameter error No.	
14	#8260 to #8279	10	Servo status1	Operation cycle 1.7[ms] or less : Operation cycle Operation cycle 3.5[ms] or more : 3.5[ms]
15	#8280 to #8299	11	Servo status2	
16	#8300 to #8319	12	Servo status3	
17	#8320 to #8339	13	Unusable	—
18	#8340 to #8359	14	Servo status5 	Operation cycle 1.7[ms] or less : Operation cycle Operation cycle 3.5[ms] or more : 3.5[ms]
19	#8360 to #8379	15	Unusable	—
20	#8380 to #8399	16		
21	#8400 to #8419	17		
22	#8420 to #8439	18	Servo status7 	Operation cycle 1.7[ms] or less : Operation cycle Operation cycle 3.5[ms] or more : 3.5[ms]
23	#8440 to #8459	19	Unusable	—
24	#8460 to #8479			
25	#8480 to #8499			
26	#8500 to #8519			
27	#8520 to #8539			
28	#8540 to #8559			
29	#8560 to #8579			
30	#8580 to #8599			
31	#8600 to #8619			
32	#8620 to #8639			

 : Refer to Section 1.4 for the software version that supports this function.

4 POSITIONING DEDICATED SIGNALS

POINT	Refer to the "Q173D(S)CPU/Q172D(S)CPU Motion controller (SV13/SV22) Programming Manual (REAL MODE)" for details of monitor device.
--------------	------------------------------------------------------------------------------------------------------------------------------------

(2) Product information list devices (#8736 to #8751)

The operating system software version and serial number of Motion CPU is stored in ASCII code.

The product information list devices are shown below.

Device No.	Signal name	Refresh cycle	Fetch cycle	Signal direction
#8736 to #8743	Operating system software version	At power on	/	Monitor device
#8744 to #8751	Motion CPU module serial number			

POINT	Refer to the "Q173D(S)CPU/Q172D(S)CPU Motion controller (SV13/SV22) Programming Manual (REAL MODE)" for details of product information list device.
--------------	-----------------------------------------------------------------------------------------------------------------------------------------------------

4 POSITIONING DEDICATED SIGNALS

4.4 Special Relays (SM)

There are 2256 special relay points of SM0 to SM2255 in the Motion CPU. Of these, devices in Table 4.1 are used for the positioning control. The special relay list used for the positioning control is shown below. (Refer to "Q173D(S)CPU/Q172D(S)CPU Motion controller (SV13/SV22) Programming Manual (REAL MODE)" or "Q173D(S)CPU/Q172D(S)CPU Motion controller Programming Manual (COMMON)" for details of special relays.)

Table 4.1 Special relay list

Device No.	Signal name	Refresh cycle	Fetch cycle	Signal type
SM500	PCPU READY complete flag	Main cycle	/	Status signal
SM501	TEST mode ON flag			
SM502	External forced stop input flag	Operation cycle		
SM503	Digital oscilloscope executing flag	Main cycle		
SM506	External forced stop input ON latch flag 	Operation cycle		
SM508	Amplifier-less operation status flag	Main cycle		
SM510	TEST mode request error flag			
SM512	Motion CPU WDT error flag			
SM513	Manual pulse generator axis setting error flag			
SM516	Servo program setting error flag			

: Refer to Section 1.4 for the software version that supports this function.

4 POSITIONING DEDICATED SIGNALS

4.5 Special Registers (SD)

There are 2256 special register points of SD0 to SD2255 in the Motion CPU. Of these, devices in Table 4.2 are used for the positioning control. The special register list used for the positioning control is shown below. (Refer to the "Q173D(S)CPU/Q172D(S)CPU Motion controller (SV13/SV22) Programming Manual (REAL MODE)" or "Q173D(S)CPU/Q172D(S)CPU Motion controller Programming Manual (COMMON)" for details of special registers.)

Table 4.2 Special register list

Device No.	Signal name	Refresh cycle	Fetch cycle	Signal direction		
SD200	State of switch	Main cycle	Main cycle	Monitor device		
SD502	Servo amplifier loading information	At power supply on/ operation cycle				
SD503						
SD508	SSCNET control (status)	Main cycle				
SD510	Test mode request error information	At test mode request				
SD511						
SD512	Motion CPU WDT error cause	At Motion CPU WDT error occurrence				
SD513	Manual pulse generator axis setting error information	At the manual pulse generator enable flag OFF to ON				
SD514						
SD515						
SD516	Error program No.	At start				
SD517	Error item information					
SD522	Motion operation cycle	Operation cycle				
SD523	Operation cycle of the Motion CPU setting	At power supply on				
SD524	Maximum Motion operation cycle	Operation cycle				
SD550	System setting error information	At System setting error occurrence				
SD551						
SD560	Operation method Ver.!	At power supply on				
SD803	SSCNET control (command)				Main cycle	Command device

Ver.!: Refer to Section 1.4 for the software version that supports this function.

5. INPUT AXIS MODULE

5.1 Servo Input Axis

5.1.1 Overview of servo input axis

The servo input axis is used to drive the input axis based on the position of the servo motor that is being controlled by the Motion CPU.

The status of a servo input axis can be monitored even before the synchronous control start since the setting of a servo input axis is valid after Multiple CPU system's power supply ON.

The following shows the relationship between the position of the servo motor and the servo input axis.

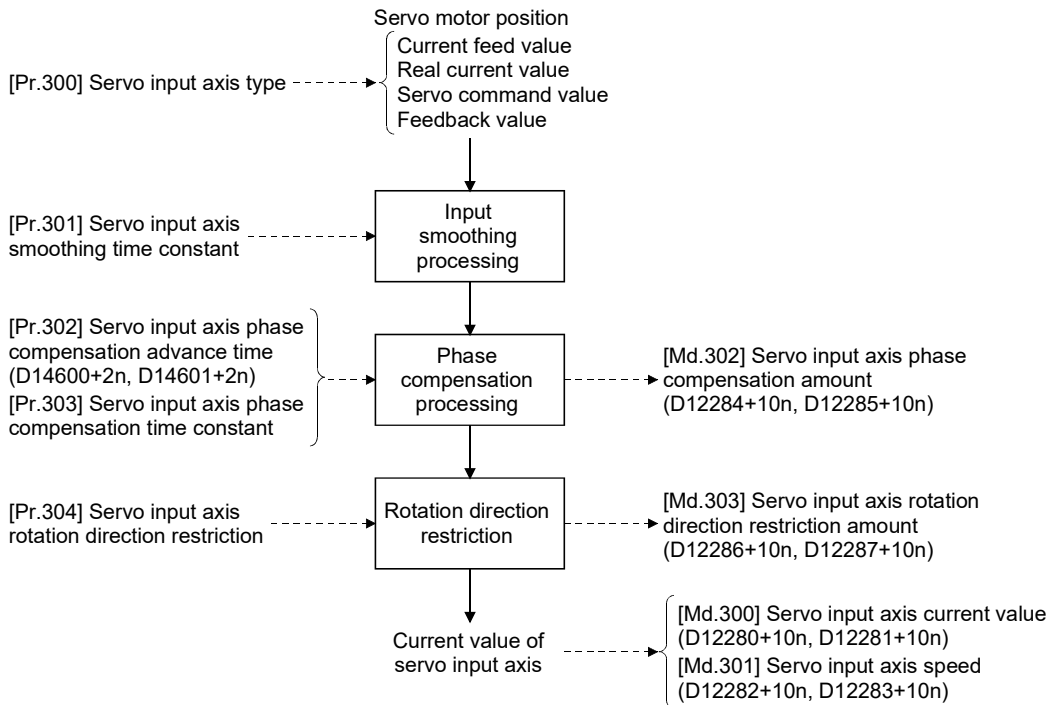

(1) Control method for servo input axis

All controls (including synchronous control) can be executed for a servo input axis.

Refer to the "Q173D(S)CPU/Q172D(S)CPU Motion controller (SV13/SV22) Programming Manual (REAL MODE)" for the controls other than synchronous control.

POINT

When the axis during speed control, torque control, or continuous operation to torque control or the synchronous control output axis is set to the servo input axis, the input axis is driven based on the position of an operation cycle before.

(2) Restrictions

- (a) If "1: Current feed value" or "2: Real current value" is set in [Pr.300] Servo input axis type, turn ON the feed current value update command (M3212+20n) to start the speed-position switching control. If the feed current value update command (M3212+20n) turns OFF, major error (error code: 1809) will occur and the control will not start.
- (b) If [Pr.300] Servo input axis type is set to other than "0: Invalid", when the speed control (II) is started, the major error (error code: 1830) will occur and the control will not start.

(3) Units for the servo input axis

The position units and speed units for the servo input axis are shown below for the setting [Pr.300] Servo input axis type and "Unit setting" of fixed parameter.

Table 5.1 Servo input axis position units

Setting value of [Pr.300] Servo input axis type	Setting value of unit setting	Servo input axis position unit	Range
1: Current feed value 2: Real current value	0: mm	$\times 10^{-4}$ mm (10^{-1} μm)	-214748.3648 to 214748.3647 [mm] (-214748364.8 to 214748364.7 [μm])
	1: inch	$\times 10^{-5}$ inch	-21474.83648 to 21474.83647 [inch]
	2: degree	$\times 10^{-5}$ degree	-21474.83648 to 21474.83647 [degree]
	3: pulse	pulse	-2147483648 to 2147483647 [pulse]
3: Servo command value 4: Feedback value	—	pulse	-2147483648 to 2147483647 [pulse]

Table 5.2 Servo input axis speed units

Setting value of [Pr.300] Servo input axis type	Setting value of unit setting	Servo input axis speed unit	Range
1: Current feed value 2: Real current value	0: mm	$\times 10^{-2}$ mm/min	-21474836.48 to 21474836.47 [mm/min]
	1: inch	$\times 10^{-3}$ inch/min	-2147483.648 to 2147483.647 [inch/min]
	2: degree	$\times 10^{-3}$ degree/min (Note-1)	-2147483.648 to 2147483.647 [degree/min] (Note-1)
	3: pulse	pulse/s	-2147483648 to 2147483647 [pulse/s]
3: Servo command value 4: Feedback value	—	pulse/s	-2147483648 to 2147483647 [pulse/s]

(Note-1): When Speed control 10 x multiplier setting for degree axis" is valid, this will be the speed unit " $\times 10^{-2}$ degree/min" (Range: -21474836.48 to 21474836.47 [degree/min]).

POINT

- | |
|--------------------------------------------------------------------------------------------------------------------------------------------------------------------------------------------------------------------------------------------------------------------------------------------------------------------------------------------------------------------------------------------------------------------------------------------------------------------------------------------------------------------------------------------------------------------------------------------------------------------------------------------------------------------------------------------------------------------------------------------------------------------------------------------------------------------------------------------------------------------------|
| <p>(1) When "1: Current feed value" or "3: Servo command value" is set in [Pr.300] Servo input axis type, and the servo input axis becomes servo OFF by the servo error or forced stop, the amount of value change may be large. This can be prevented by setting "2: Real current value" or "4: Feedback value" in [Pr.300] Servo input axis type.</p> <p>(2) When a home position return for the axis where "1: Current feed value" or "2: Real current value" is set in [Pr.300] Servo input axis type is performed, if the servo input axis operation during home position return is used as the input value, the input is stopped in the midway of home position return.
When the servo input axis operation during home position return is used as the input value, set "3: Servo command value" or "4: Feedback value" in [Pr.300] Servo input axis type.</p> |
|--------------------------------------------------------------------------------------------------------------------------------------------------------------------------------------------------------------------------------------------------------------------------------------------------------------------------------------------------------------------------------------------------------------------------------------------------------------------------------------------------------------------------------------------------------------------------------------------------------------------------------------------------------------------------------------------------------------------------------------------------------------------------------------------------------------------------------------------------------------------------|

5 INPUT AXIS MODULE

5.1.2 Servo input axis parameters

Symbol	Setting item	Setting details	Setting value	Fetch cycle	Default value	Device No.
Pr.300	Servo input axis type	Set the current value type to be generated of the input value for the servo input axis.	0: Invalid 1: Current feed value 2: Real current value 3: Servo command value 4: Feedback value	At power supply ON	0	—
Pr.301	Servo input axis smoothing time constant	Set to smooth the input value.	0 to 5000 [ms]		0 [ms]	—
Pr.302	Servo input axis phase compensation advance time	Set the time to advance or delay the phase.	-2147483648 to 2147483647 [μ s]	Operation cycle	0 [μ s]	D14600+2n D14601+2n
Pr.303	Servo input axis phase compensation time constant	Set the time constant to affect the phase compensation.	0 to 65535 [ms] (Note-1)	At power supply ON	10 [ms]	—
Pr.304	Servo input axis rotation direction restriction	Set this parameter to restrict the input travel value to one direction.	0: Without rotation direction restriction 1: Enable only for current value increase direction 2: Enable only for current value decrease direction		0	—

(1) [Pr.300] Servo input axis type

Set the current value type to be generated of the input value for the servo input axis.

- 0: Invalid Servo input axis is invalid.
- 1: Current feed value Generate the input value based on Current feed value (D0+20n, D1+20n).
- 2: Real current value Generate the input value based on the real current value, which is converted units of the encoder feedback pulses from the servo amplifier.
- 3: Servo command value ... Generate the input value based on the command pulse (encoder pulse units) to the servo amplifier.
- 4: Feedback value Generate the input value based on the encoder feedback pulse from the servo amplifier.

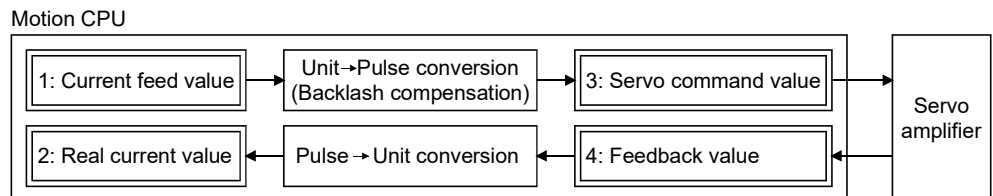

(2) [Pr.301] Servo input axis smoothing time constant

Set the averaging time to execute a smoothing process for the input travel value from the servo input axis.

The smoothing process can moderate speed fluctuation, when the "Real current value" or "Feedback value" is used as input values.

The input response is delayed depending on the time corresponding to the setting by smoothing process setting.

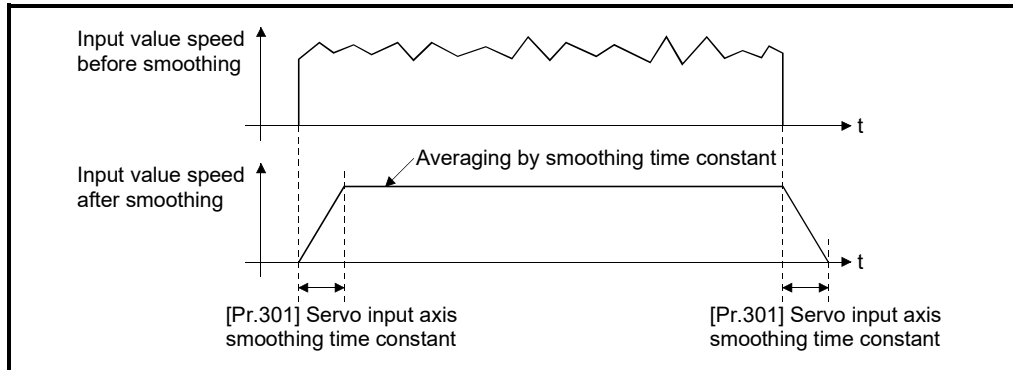

(3) [Pr.302] Servo input axis phase compensation advance time (D14600+2n, D14601+2n)

Set the time to advance or delay the phase (input response) of the servo input axis.

Refer to Section 9.1 for the peculiar time delay of the system using the servo input axis.

- 1 to 2147483647 [μ s].....Advance the phase (input response) according to the setting time.
- 0 [μ s]Do not execute phase compensation.
- -2147483648 to -1 [μ s]Delay the phase (input response) according to the setting time.

If the setting time is too long, the system experiences overshoot or undershoot at acceleration/deceleration of the input speed. In this case, set longer time to affect the phase compensation amount in [Pr.303] Servo input axis phase compensation time constant.

- (4) [Pr.303] Servo input axis phase compensation time constant
 Set the time constant to affect the phase compensation amount for the first order delay. 63 [%] of the phase compensation amount are reflected in the time constant setting.

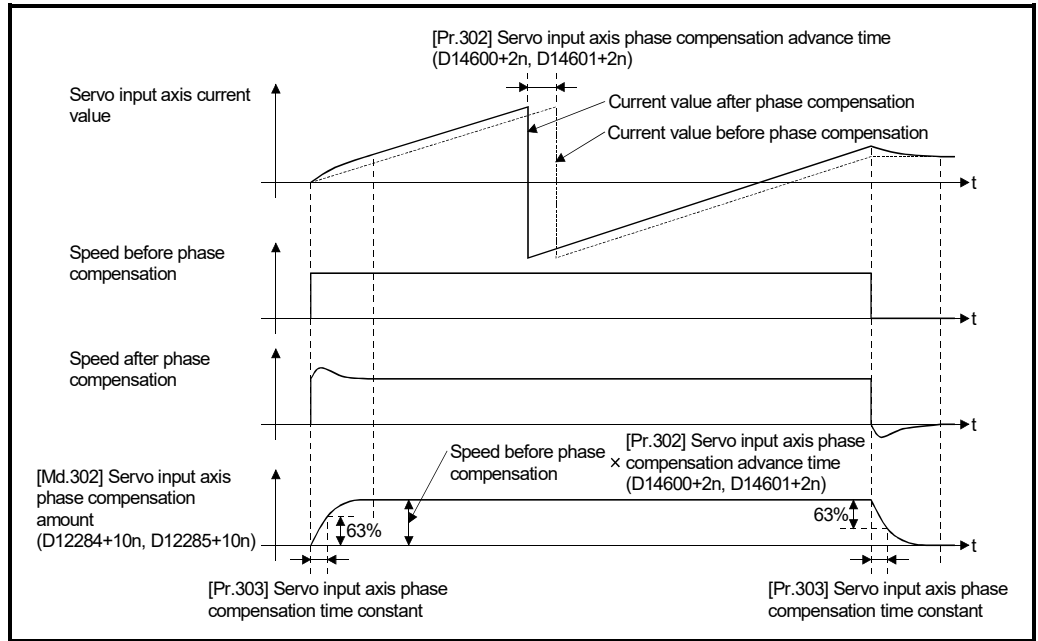

(5) [Pr.304] Servo input axis rotation direction restriction

Set this parameter to restrict the input travel value for the servo input axis to one direction.

This helps to avoid reverse operation caused by machine vibration, etc. when "Real current value" or "Feedback value" is used as input values.

- 0: Without rotation direction restriction.....Rotation direction restriction is not executed.
- 1: Enable only for current value increase directionEnable only the input travel value in the increasing direction of the servo input axis current value.
- 2: Enable only for current value decrease direction ...Enable only the input travel value in the decreasing direction of the servo input axis current value.

The input travel value in the opposite direction of the enable direction accumulates as a rotation direction restricted amount, and will be reflected when the input travel value moves in the enabled direction again. Therefore, the current value of servo input does not deviate when the reverse operation is repeated.

The rotation direction restricted amount is set to 0 at the following timing.

- 1) At home position return complete
- 2) At current value change complete
- 3) At speed control (I) complete (Note-1)
- 4) At fixed-pitch feed control start
- 5) At servo amplifier connection/disconnection
- 6) At speed-position switching control start (Note-1)

(Note-1): When the control is started by turning OFF the feed current value update command (M3212+20n)

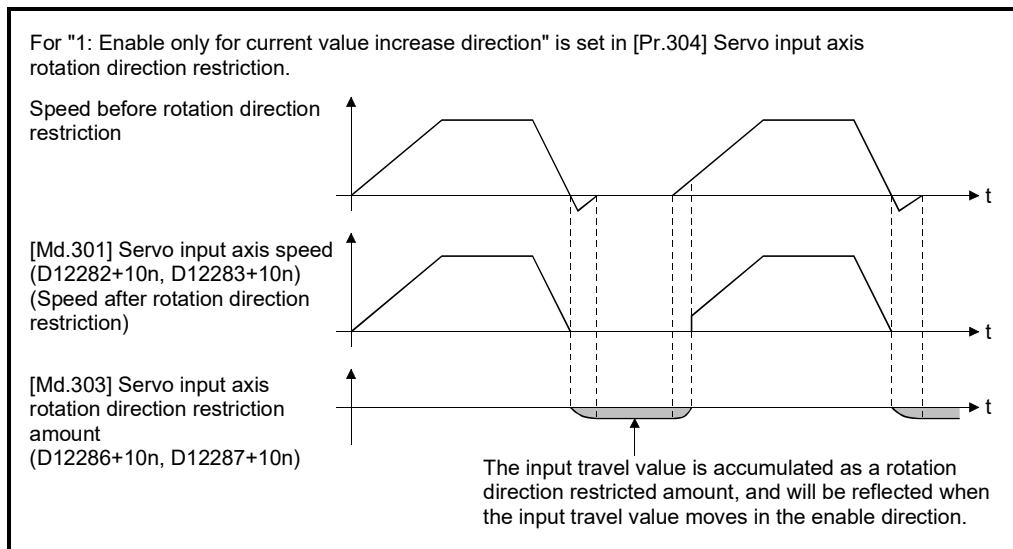

5 INPUT AXIS MODULE

5.1.3 Servo input axis monitor data

Symbol	Monitor item	Storage details	Monitor value	Refresh cycle	Device No.
Md.300	Servo input axis current value	The current value for the servo input axis is stored.	-2147483648 to 2147483647 [Servo input axis position units] (Note-1)	Operation cycle	D12280+10n D12281+10n
Md.301	Servo input axis speed	The speed for the servo input axis is stored.	-2147483648 to 2147483647 [Servo input axis speed units] (Note-2)		D12282+10n D12283+10n
Md.302	Servo input axis phase compensation amount	The current phase compensation amount is stored.	-2147483648 to 2147483647 [Servo input axis position units] (Note-1)		D12284+10n D12285+10n
Md.303	Servo input axis rotation direction restriction amount	While the rotation direction is restricted, the accumulation for the input travel value in the opposite direction of the enable direction is stored.	-2147483648 to 2147483647 [Servo input axis position units] (Note-1)		D12286+10n D12287+10n

(Note-1): Servo input axis position units (Refer to Section 5.1.1)

(Note-2): Servo input axis speed units (Refer to Section 5.1.1)

(1) [Md.300] Servo input axis current value (D12280+10n, D12281+10n)

The current value for the servo input axis is stored in servo input axis position units (Refer to Section 5.1.1) as follows.

The current value for the servo input axis is the value after processing the smoothing, the phase compensation and the rotation direction restriction.

Setting value of [Pr.300] Servo input axis type	Storage details
1: Current feed value 2: Real current value	<ul style="list-style-type: none"> The accumulative current value started with Current feed value/Real current value for the connection to the servo amplifier is stored. It is also stored in the range from -21474.83648 to 21474.83647 [degree] for degree units. When the Current feed value/Real current value is changed by a home position return or a current value change, the value is changed to the new current value.
3: Servo command value 4: Feedback value	<ul style="list-style-type: none"> When of the absolute position detection system setting is invalid, the accumulative current value that starts from 0 for the connected servo amplifier is stored. When of the absolute position detection system setting is valid, the accumulative current value that starts from the absolute position command/encoder feedback pulse for the connected servo amplifier is stored. The servo input axis current value will not change, even if a home position return or the current value is changed.

(2) [Md.301] Servo input axis speed (D12282+10n, D12283+10n)

The speed for the servo input axis is stored in servo input axis speed units (Refer to Section 5.1.1).

The speed for the servo input axis is the value after processing smoothing, phase compensation, and rotation direction restriction.

(3) [Md.302] Servo input axis phase compensation amount
(D12284+10n, D12285+10n)

The phase compensation amount for a servo input axis is stored in servo input axis position units (Refer to Section 5.1.1).

The phase compensation amount for a servo input axis is the value after processing smoothing and phase compensation.

(4) [Md.303] Servo input axis rotation direction restriction amount
(D12286+10n, D12287+10n)

While the rotation direction is restricted for a servo input axis, the accumulation for input travel value in the opposite direction of the enabled direction is stored in servo input axis position units (Refer to Section 5.1.1) as follows.

Setting value of [Pr.304] Servo input axis rotation direction restriction	Storage details
1: Enable only for current value increase direction	A negative accumulation is stored during rotation direction restriction. 0 is stored if there is no restriction.
2: Enable only for current value decrease direction	A positive accumulation is stored during rotation direction restriction. 0 is stored if there is no restriction.

Rotation direction restriction is processed after phase compensation processing. Therefore, if undershoot occurs from phase compensation during deceleration stop, the rotation direction restriction amount might remain.

5.2 Command Generation Axis

5.2.1 Overview of command generation axis

Command generation axis is the axis that performs only the command generation. It can be controlled independently with the axis to which the servo amplifier is connected. It is used to drive the input axis by the servo program or JOG operation. The command generation axis can be controlled or the state of command generation axis can be monitored after Multiple CPU system's power ON.

(1) Control method for command generation axis

The command generation axis uses the servo program within the range assigned to the command generation axis program with the command generation axis program allocation setting of MT Developer2. JOG operation can be executed with Forward rotation JOG command/Reverse rotation JOG command of command generation axis.

The controls that can be used with command generation axis are shown below.

Control mode	Servo instruction	Usable/unusable
Linear control	ABS-1 ABS-2 ABS-3 ABS-4	○
	INC-1 ABS-2 INC-3 INC-4	
Circular interpolation control	ABS circular INC circular	○
Helical interpolation control	ABS helical INC helical	○
Fixed-pitch feed	FEED-1 FEED-2 FEED-3	○
Constant-speed control	CPSTART1 CPSTART2	○
	CPSTART3 CPSTART4	
Speed control (I)	VF VR	○
Speed control (II)	VVF VVR	×
Speed-position switching control	VPF VPR VPSTART	×
Position follow-up control	PFSTART	○
Speed control with fixed position stop	PVF PVR	○
Speed switching control	VSTART	×
Simultaneous start	START	○
JOG operation	Individual start	○
	Simultaneous start	×
Manual pulse generator operation		×
High-speed oscillation	OSC	×
Home position return	ZERO	×
Speed-torque control		×

○: Usable, ×: Unusable

For the servo instruction data item of command generation axis, "torque limit value" and "deceleration processing on STOP input" cannot be set. The items other than that can be set.

Refer to the "Q173D(S)CPU/Q172D(S)CPU Motion controller (SV13/SV22) Programming Manual (REAL MODE)" for details of servo instruction.

5 INPUT AXIS MODULE

- (a) Servo program start request D(P).SVST instruction of command generation axis
 When executing D(P).SVST instruction (Servo program start request) for the command generation axis, specify the axis No. with "Jn". The No. of servo program to be executed must be assigned to the range used by the command generation axis with the command generation axis program allocation setting.
- (b) Command generation axis start accept flag (System area)
 When the servo program start is executed by specifying "Jn" as axis No., the complete status of start accept flag is stored in the address of the start accept flag in the CPU shared memory for target CPU.

CPU shared memory address () is decimal address	Description																					
20EH(526) 20FH(527)	<p>The command generation axis start accept flag for 32 axes are stored corresponding to each bit.</p> <p>Bits are actually set as the following:</p> <ul style="list-style-type: none"> • Q173DSCPU : J1 to J32 • Q172DSCPU : J1 to J16 <p>OFF : Start accept enable ON : Start accept disable</p> <table style="margin-left: auto; margin-right: auto;"> <tr> <td></td> <td style="text-align: center;">b15</td> <td style="text-align: center;">b14</td> <td></td> <td style="text-align: center;">b2</td> <td style="text-align: center;">b1</td> <td style="text-align: center;">b0</td> </tr> <tr> <td style="text-align: right;">20EH(526) address</td> <td style="border: 1px solid black;">J16</td> <td style="border: 1px solid black;">••••••••</td> <td style="border: 1px solid black;"></td> <td style="border: 1px solid black;">J2</td> <td style="border: 1px solid black;">J1</td> <td style="border: 1px solid black;"></td> </tr> <tr> <td style="text-align: right;">20FH(527) address</td> <td style="border: 1px solid black;">J32</td> <td style="border: 1px solid black;">••••••••</td> <td style="border: 1px solid black;"></td> <td style="border: 1px solid black;">J18</td> <td style="border: 1px solid black;">J17</td> <td style="border: 1px solid black;"></td> </tr> </table>		b15	b14		b2	b1	b0	20EH(526) address	J16	••••••••		J2	J1		20FH(527) address	J32	••••••••		J18	J17	
	b15	b14		b2	b1	b0																
20EH(526) address	J16	••••••••		J2	J1																	
20FH(527) address	J32	••••••••		J18	J17																	

The following control change can be performed for the command generation axis.

- 1) Current value change
- a) When CHGA instruction of servo program (Kn) is used
 CHGA instruction of servo program assigned to the range used by the command generation axis with the command generation axis program allocation setting is used.
- b) When the current value changed is executed by Motion dedicated PLC instruction
 D(P).CHGAS instruction is used.
 (Example) The current value is changed to 1000 for the command generation axis 3 of CPU No.2.



- 2) Speed change
- a) When the speed changed is executed by Motion SFC program
 CHGVS instruction is used.
 (Example) The speed is changed to 100000 for the command generation axis 4.

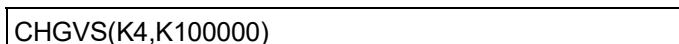

b) When the speed changed is executed by Motion dedicated PLC instruction

D(P).CHGVS instruction is used.

(Example) The speed is changed to 300000 for the command generation axis 5 of CPU No.2.



(c) Simultaneous start instruction of command generation axis program
 In simultaneous start instruction (START), the simultaneous start is not possible with real mode axis program and command generation axis program mixed. If the mixed programs are started with the programs mixed, the servo program setting error (error code: 19) will occur.

(2) Units for the command generation axis

The position units and speed units for the command generation axis are shown below for the setting [Pr.341] Command generation axis type.

Table 5.3 Command generation axis position units

Setting value of [Pr.341] Command generation axis type	Command generation axis position unit	Range
0: mm	$10^{-1}\mu\text{m}$	-214748364.8 to 214748364.7 [μm]
1: inch	$\times 10^{-5}\text{inch}$	-21474.83648 to 21474.83647 [inch]
2: degree	$\times 10^{-5}\text{degree}$	-21474.83648 to 21474.83647 [degree]
3: pulse	pulse	-2147483648 to 2147483647 [pulse]

Table 5.4 Command generation axis speed units

Setting value of [Pr.341] Command generation axis type	Command generation axis position unit	Range
0: mm	$\times 10^{-2}\text{mm/min}$	-21474836.48 to 21474836.47 [mm/min]
1: inch	$\times 10^{-3}\text{inch/min}$	-2147483.648 to 2147483.647 [inch/min]
2: degree	$\times 10^{-3}\text{degree/min}$ (Note-1)	-2147483.648 to 2147483.647 [degree/min] (Note-1)
3: pulse	pulse/s	-2147483648 to 2147483647 [pulse/s]

(Note-1): When [Pr.345] Command generation axis speed control $10\times$ multiplier setting for degree axis is valid, this will be the speed unit " $\times 10^{-2}\text{degree/min}$ " (Range: -21474836.48 to 21474836.47 [degree/min]).

(3) Speed control with fixed position stop for command generation axis
Speed control with fixed position stop can be performed for the command generation axis.

Speed control with fixed position stop is started using the PVF (forward rotation) or PVR (reverse rotation) of servo program instruction.

[Control details]

- (a) After starting of command generation axis, control at the specified speed is executed until the fixed position stop command turns on.
 - PVF Forward rotation direction (Address increase direction) start
 - PVR Reverse rotation direction (Address decrease direction) start
- (b) When the fixed position stop command turns on, a positioning control to the position of the address specified by [Md.347] Command generation axis current value per cycle (D12610+20n, D12611+20n) is executed.
- (c) Speed control with fixed position stop can be executed in the command generation axis with all the control units where [Pr.346] Command generation axis length per cycle is set to 1 to 2147483647. When [Pr.346] Command generation axis length per cycle is "0", the minor error (error code: 130) will occur, and the control will not start.
- (d) Address setting range is "0 to ([Pr.346] Command generation axis length per cycle-1)" in the indirect setting of positioning address. If it is set outside the setting range, a servo program setting error [n03] occurs and it does not start. Positioning address is input at the program start.
- (e) It is controlled in the fixed position stop acceleration/deceleration time set in the servo program at positioning start, speed change request (CHGVS) and fixed position stop command ON. The fixed acceleration/deceleration time method is used as an acceleration/deceleration processing in this case.
- (f) The setting range of fixed position stop acceleration/deceleration time is 1 to 65535[ms].
- (g) In the case of indirect setting, the fixed position stop acceleration/deceleration time is input in the following timing.
 - Positioning start
 - Speed change request (CHGVS)
 - Fixed position stop command ON
- (h) When the positioning to specified address completes, the [St.341] Command generation axis positioning complete signal (M9801+20n) turns ON. It does not turn on at the time of stop by the [Rq.341] Command generation axis stop command (M10960+20n)/[Rq.342] Command generation axis rapid stop command (M10961+20n). The [St.341] Command generation axis positioning complete signal (M9801+20n) turns off at leading edge of [Rq.345] Command generation axis complete signal OFF command (M10964+20n) or positioning start.
- (i) Speed change can be executed any number of times by the speed change request (CHGVS) instruction during operation.

- (j) Deceleration speed by the [Rq.341] Command generation axis stop command (M10960+20n)/[Rq.342] Command generation axis rapid stop command (M10961+20n) is controlled with fixed inclination (deceleration speed). Deceleration processing is executed using the speed limit value or deceleration/rapid stop deceleration time set in the parameter block.
- (k) When the fixed position stop command turns on, the command in-position check starts. When the absolute value of difference between the setting address and feed current value below the [Pr.344] Command generation axis command in-position range set in the command generation axis parameter, the [St.342] Command generation axis command in-position (M9803+20n) turns on. The [St.342] Command generation axis command in-position (M9803+20n) turns on by a positioning start.
- (l) A positioning control is executed the speed specified with the speed limit value when the fixed position stop command turns on with speed "0" (before PVF instruction execution/at speed change to speed "0" during PVF instruction execution).

5 INPUT AXIS MODULE

5.2.2 Command generation axis parameters

Symbol	Setting item	Setting details	Setting value	Fetch cycle	Default value	Device No.
Pr.340	Command generation axis valid setting	Set the invalid/valid of command generation to be used.	0: Invalid 1: Valid	At power supply ON	0	—
Pr.341	Command generation axis unit setting	Set the unit of command generation axis.	0: mm 1: inch 2: degree 3: pulse		3	—
Pr.342	Command generation axis upper stroke limit	Set the upper stroke limit of command generation axis.	-2147483648 to 2147483647 (degree: 0 to 35999999) [Command generation axis position units] (Note-1)		0	—
Pr.343	Command generation axis lower stroke limit	Set the lower stroke limit of command generation axis.	-2147483648 to 2147483647 (degree: 0 to 35999999) [Command generation axis position units] (Note-1)		0	—
Pr.344	Command generation axis command in-position range	Set the in-position range of command generation axis.	1 to 2147483647 [Command generation axis position units] (Note-1)		100	—
Pr.345	Command generation axis speed control 10×multiplier setting for degree axis	Set whether the positioning control is executed with a value 10×multiplier the speed of a command speed setting, when a control unit is degree axis.	0: Invalid 1: Valid		0	—
Pr.346	Command generation axis length per cycle	Set the length per cycle of command generation axis.	0: Invalid 1 to 2147483647 [Command generation axis position units] (Note-1)		0	—
Pr.347	Command generation axis JOG speed limit value	Set the speed limit value at the JOG operation of command generation axis.	1 to 2147483647 [Command generation axis speed units] (Note-2)		20000	—
Pr.348	Command generation axis JOG operation parameter block setting	Set the parameter block No. to be used at the JOG operation of command generation axis.	1 to 64	At JOG operation start	1	D14682+4n
Pr.349	Command generation axis acceleration /deceleration time change enable device (Note-3) 	Set the bit device to enable the change of acceleration/ deceleration time at a speed change request.	Bit device (X, Y, M, B, F, U□VG)	At power supply ON	—	Optional device

: Refer to Section 1.4 for the software version that supports this function.

5 INPUT AXIS MODULE

Symbol	Setting item	Setting details	Setting value	Fetch cycle	Default value	Device No.
Pr.350	Command generation axis new acceleration time value device (Note-3) Ver.	Set the word device to set the change value of acceleration time.	Word device (D, W, #, U□\G)	At power supply ON	—	Optional device
Pr.351	Command generation axis new deceleration time value device (Note-3) Ver.	Set the word device to set the change value of deceleration time.	Word device (D, W, #, U□\G)		—	Optional device

(Note-1): Command generation axis position units (Refer to Section 5.2.1)

(Note-2): Command generation axis speed units (Refer to Section 5.2.1)

(Note-3): This setting can be omitted.

- (1) [Pr.340] Command generation axis valid setting
Set the invalid/valid of command generation axis.
 - 0: Invalid.....Command generation axis is invalid.
 - 1: ValidCommand generation axis is valid.
- (2) [Pr.341] Command generation axis unit setting
Set the unit of command generation axis.
Refer to "Section 5.2.1" for details.
- (3) [Pr.342] Command generation axis upper stroke limit
Set the upper limit for the command generation axis travel range.
To invalidate the software stroke limit, set the setting value to "upper limit value = lower limit value".
- (4) [Pr.343] Command generation axis lower stroke limit
Set the lower limit for the command generation axis travel range.
To invalidate the software stroke limit, set the setting value to "upper limit value = lower limit value".
- (5) [Pr.344] Command generation axis command in-position range
Set the output range for the in-position signal of command generation axis.
- (6) [Pr.345] Command generation axis speed control 10×multiplier setting for degree axis
Set whether the positioning control is executed with a value 10×multiplier the speed of a command speed setting, when a unit setting of control generation axis is degree.

Setting value of [Pr.345] Command generation axis speed control 10×multiplier setting for degree axis	Command generation axis speed unit	Range
0: Invalid	×10 ⁻³ degree/min	-2147483.648 to 2147483.647 [degree/min]
1: Valid	×10 ⁻² degree/min	-21474836.48 to 21474836.47 [degree/min]

Ver.!: Refer to Section 1.4 for the software version that supports this function.

- (7) [Pr.346] Command generation axis length per cycle
 Set the length per cycle for the command generation axis current value per cycle. The current value of command generation axis is stored in [Md.347] Command generation axis current value per cycle (D12610+20n, D12611+20n) at ring counter based on the setting value.
 The unit settings are in command generation axis position units (Refer to Section 5.2.1).
 Set within the range from "1 to 2147483647".
 When "0" is set, [Md.347] Command generation axis current value per cycle (D12610+20n, D12611+20n) is not updated.
- (8) [Pr.347] Command generation axis JOG speed limit value
 Set the maximum speed the JOG operation of command generation axis.
- (9) [Pr.348] Command generation axis JOG operation parameter block setting
 Set the parameter block No. to be used at the JOG operation of command generation axis.
- (10) [Pr.349] Command generation axis acceleration/deceleration time change enable device 
 Set the device to enable the change of acceleration/deceleration time at a command generation axis speed change request (CHGVS, D(P).CHGVS). This setting can be omitted.
 The following describes the operation for ON and OFF of the acceleration/deceleration time change enable device.
- ON..... Speed change is executed at a speed change request by changing the acceleration/deceleration time values of [Pr.350] Command generation axis new acceleration time value device and [Pr.351] Command generation axis new deceleration time value device.
 - OFF..... Does not change acceleration/deceleration time at a speed change request.

The usable setting range of bit devices is shown below.

Bit device	Setting range
X	0000 to 1FFF (Note-1)
Y	0000 to 1FFF
M	0 to 8191
B	0000 to 1FFF
F	0 to 2047
U□IG	10000.0 to (10000+p-1).F (Note-2)

(Note-1): The range of "PXn+4 to PXn+F" cannot be used (fixed at 0) for the input device (PXn+0 to PXn+F) allocated to the built-in interface in Motion CPU (DI). (n: First input No.)

(Note-2): "p" indicates the user setting area points of the Multiple CPU high speed transmission area for each CPU.

: Refer to Section 1.4 for the software version that supports this function.

(11) [Pr.350] Command generation axis new acceleration time value device **Ver.!**

Set the device to set the change value when changing the acceleration time at a speed change request.

This setting can be omitted.

The following change values are set in the new acceleration time value device.

- 0 Acceleration time change is disabled, and speed change is maintained at the current acceleration time.
- 1 to 65535[ms]..... If a speed change request is executed when the [Pr.349] Command generation axis acceleration/deceleration time change enable device is ON, speed change is executed by changing the acceleration time to the set value.

The usable setting range of word devices is shown below.

Word device	Setting range
D	0 to 19823
W	0 to 1FFF
#	0 to 7999
U□AG	10000 to (10000+p-1) (Note-1)

(Note-1): "p" indicates the user setting area points of the Multiple CPU high speed transmission area for each CPU.

(12) [Pr.351] Command generation axis new deceleration time value device **Ver.!**

Set the device to set the change value when changing the deceleration time at a speed change request.

This setting can be omitted.

The following change values are set in the new deceleration time value device.

- 0 Deceleration time change is disabled, and speed change is maintained at the current deceleration time.
- 1 to 65535[ms]..... If a speed change request is executed when the [Pr.349] Command generation axis acceleration/deceleration time change enable device is ON, speed change is executed by changing the deceleration time to the set value.

The usable setting range of word devices is shown below.

Word device	Setting range
D	0 to 19823
W	0 to 1FFF
#	0 to 7999
U□AG	10000 to (10000+p-1) (Note-1)

(Note-1): "p" indicates the user setting area points of the Multiple CPU high speed transmission area for each CPU.

Ver.! : Refer to Section 1.4 for the software version that supports this function.

POINT

- | |
|---------------------------------------------------------------------------------------------------------------------------------------------------------------------------------------------------------------------------------------------------------------------------------------------------------------------------------------------------------------------------------------------------------------------------------------------------------------------------------------------------------------------------------------------------------------------------------|
| <p>(1) When the setting of [Pr.349] Command generation axis acceleration/deceleration time change enable device is omitted, change of acceleration/deceleration time at a speed change request is not executed. When changing acceleration/deceleration time at a speed change, set this parameter.</p> <p>(2) When the setting of [Pr.350] Command generation axis new acceleration time value device and [Pr.351] Command generation axis new deceleration time value device is omitted, change of acceleration/deceleration time of the omitted devices is not executed.</p> |
|---------------------------------------------------------------------------------------------------------------------------------------------------------------------------------------------------------------------------------------------------------------------------------------------------------------------------------------------------------------------------------------------------------------------------------------------------------------------------------------------------------------------------------------------------------------------------------|

5 INPUT AXIS MODULE

5.2.3 Command generation axis control data

[Word device]

Symbol	Setting item	Setting details	Setting value	Fetch cycle	Default value	Device No.
Cd.340	Command generation axis JOG speed setting	Set the JOG speed of command generation axis.	1 to 2147483647 [Command generation axis speed units] (Note-1)	At JOG operation start	0	D14680+4n D14681+4n

(Note-1): Command generation axis speed units (Refer to Section 5.2.1)

(1) [Cd.340] Command generation axis JOG speed setting (D14680+4n, D14681+4n)

Set the JOG speed of command generation axis.

[Bit device]

Symbol	Setting item	Setting details	Setting value	Fetch cycle	Default value	Device No.
Rq.341	Command generation axis stop command	Set the stop command of command generation axis.	ON : Stop requested OFF : Stop not requested	Operation cycle	OFF	M10960+20n
Rq.342	Command generation axis rapid stop command	Set the rapid stop command of command generation axis.	ON : Rapid stop requested OFF : Rapid stop not requested		OFF	M10961+20n
Rq.343	Command generation axis forward rotation JOG start command	Set the forward rotation JOG start command of command generation axis.	ON : Forward rotation started OFF : Forward rotation not started	Main cycle	OFF	M10962+20n
Rq.344	Command generation axis reverse rotation JOG start command	Set the reverse rotation JOG start command of command generation axis.	ON : Reverse rotation started OFF : Reverse rotation not started		OFF	M10963+20n
Rq.345	Command generation axis complete signal OFF command	Set the complete signal OFF command of command generation axis.	ON : Complete signal is turned OFF.		OFF	M10964+20n
Rq.346	Command generation axis error reset command	Set the error reset command of command generation axis.	ON : Error is reset.		OFF	M10967+20n
Rq.347	Feed current value update request command	Set whether update the feed current value in speed control of command generation axis or not.	ON : Feed current value is updated. OFF : Feed current value is 0 cleared and not updated at start	At start	OFF	M10972+20n
Rq.348	Command generation axis FIN signal	Set the FIN signal of command generation axis.	OFF to ON: M code outputting signal is turned OFF. ON to OFF: Transition to the positioning of next block.	Operation cycle	OFF	M10979+20n

- (1) [Rq.341] Command generation axis stop command (M10960+20n)
This command is a signal which stop a starting command generation axis from an external source and becomes effective at leading edge of signal.(A command generation axis for which the stop command is turning on cannot be started.)
The operation at stop command input is the same as the stop command (M3200+20n) of each axis.
Refer to the "Q173D(S)CPU/Q172D(S)CPU Motion controller (SV13/SV22) Programming Manual (REAL MODE)" for details of stop command (M3200+20n).
- (2) [Rq.342] Command generation axis rapid stop command (M10961+20n)
This command stops a starting command generation axis rapidly from an external source and becomes effective at leading edge of signal. (A command generation axis for which the rapid stop command is turning on cannot be started.)
The operation at rapid stop command input is the same as the rapid stop command (M3201+20n) of each axis.
Refer to the "Q173D(S)CPU/Q172D(S)CPU Motion controller (SV13/SV22) Programming Manual (REAL MODE)" for details of rapid stop command (M3201+20n).
- (3) [Rq.343] Command generation axis forward rotation JOG start command (M10962+20n)
JOG operation to the address increase direction is executed while [Rq.343] Command generation axis forward rotation JOG start command (M10962+20n) is turning on.
When [Rq.343] Command generation axis forward rotation JOG start command (M10962+20n) is turned off, a deceleration stop is executed in the deceleration time set in the parameter block.
The operation at forward rotation JOG start command input is the same as the forward rotation JOG start command (M3202+20n) of each axis.
Refer to the "Q173D(S)CPU/Q172D(S)CPU Motion controller (SV13/SV22) Programming Manual (REAL MODE)" for details of forward rotation JOG start command (M3202+20n).
- (4) [Rq.344] Command generation axis reverse rotation JOG start command (M10963+20n)
JOG operation to the address decrease direction is executed while [Rq.344] Command generation axis reverse rotation JOG start command (M10963+20n) is turning on.
When [Rq.344] Command generation axis reverse rotation JOG start command (M10963+20n) is turned off, a deceleration stop is executed in the deceleration time set in the parameter block.
The operation at reverse rotation JOG start command input is the same as the reverse rotation JOG start command (M3203+20n) of each axis.
Refer to the "Q173D(S)CPU/Q172D(S)CPU Motion controller (SV13/SV22) Programming Manual (REAL MODE)" for details of reverse rotation JOG start command (M3203+20n).

(5) [Rq.345] Command generation axis complete signal OFF command (M10964+20n)

This command is used to turn off the [St.340] Command generation axis positioning start complete (M9800+20n) and [St.341] Command generation axis positioning complete (M9801+20n).

The operation at complete signal OFF command input is the same as the complete signal OFF command (M3204+20n) of each axis.

Refer to the "Q173D(S)CPU/Q172D(S)CPU Motion controller (SV13/SV22) Programming Manual (REAL MODE)" for details of complete signal OFF command (M3204+20n).

(6) [Rq.346] Command generation axis error reset command (M10967+20n)

This command is used to clear the [Md.341] Command generation axis minor error code (D12602+20n) and [Md.342] Command generation axis major error code (D12603+20n) storage register of a command generation axis for which the error detection signal has turn on ([St.344] Command generation axis error detection signal (M9807+20n): ON), and reset the [St.344] Command generation axis error detection signal (M9807+20n).

(7) [Rq.347] Feed current value update request command (M10972+20n)

This signal is used to set whether the feed current value will be updated or not at the speed control of command generation axis.

ON/OFF state is loaded at speed control start.

- ON The feed current value is updated.
- OFF The feed current value is cleared at start and is not updated.

(8) [Rq.348] Command generation axis FIN signal (M10979+20n)

When a M-code is set in a servo program, transit to the next block does not execute until the FIN signal changes as follows: OFF ON OFF. Positioning to the next block begins after the FIN signal changes as above.

It is valid, only when the FIN acceleration/deceleration is set and FIN signal wait function is selected.

The operation at FIN signal input is the same as the FIN signal (M3219+20n) of each axis.

Refer to the "Q173D(S)CPU/Q172D(S)CPU Motion controller (SV13/SV22) Programming Manual (REAL MODE)" for details of FIN signal (M3219+20n).

5 INPUT AXIS MODULE

5.2.4 Command generation monitor data

[Word device]

Symbol	Monitor item	Storage details	Monitor value	Refresh cycle	Device No.
Md.340	Command generation axis feed current value	The feed current value for the command generation axis is stored.	-2147483648 to 2147483647 [Command generation axis position units] (Note-1)	Operation cycle	D12600+20n D12601+20n
Md.341	Command generation axis minor error code	The minor error code for the command generation axis is stored.	Refer to APPENDIX 1.2 for details of minor error code.	Immediate	D12602+20n
Md.342	Command generation axis major error code	The major error code for the command generation axis is stored.	Refer to APPENDIX 1.3 for details of major error code.		D12603+20n
Md.343	Command generation axis execute program No.	The execute program No. for the command generation axis is stored.	0 to 4095 : Servo program No. -1(HFFFF) : JOG operation -256(HFF00): Power supply ON -32(HFFE0) : Current value change execution by the Motion dedicated instruction	At start	D12604+20n
Md.344	Command generation axis M-code	The M-code for the command generation axis is stored.	0 to 32767	Operation cycle	D12605+20n
Md.345	Command generation axis accumulative current value	The accumulative current value for the command generation axis is stored.	-2147483648 to 2147483647 [Command generation axis position units] (Note-1)		D12606+20n D12607+20n
Md.346	Command generation axis data set pointer for constant-speed control	The data set pointer for constant-speed control for the command generation axis is stored.	0 to 32767	At start/ during start	D12609+20n
Md.347	Command generation axis current value per cycle	The current value per cycle for the command generation axis is stored.	0 to (Command generation axis length per cycle -1) [Command generation axis position units] (Note-1)	Operation cycle	D12610+20n D12611+20n
Md.348	Command generation axis command speed	The command speed for the command generation axis is stored.	-2147483648 to 2147483647 [Command generation axis speed units] (Note-2)		D12612+20n D12613+20n

(Note-1): Command generation axis position units (Refer to Section 5.2.1)

(Note-2): Command generation axis speed units (Refer to Section 5.2.1)

(1) [Md.340] Command generation axis feed current value (D12600+20n, D12601+20n)

The feed current value for the command generation axis is stored in command generation axis position units (Refer to Section 5.2.1).

- (2) [Md.341] Command generation axis minor error code (D12602+20n)
- (a) This register stores the corresponding error code (Refer to APPENDIX 1.2.) at the minor error occurrence of command generation axis. If another minor error occurs after error code storing, the previous error code is overwritten by the new error code.
 - (b) Minor error codes can be cleared by a [Rq.346] Command generation axis error reset command (M10967+20n).
- (3) [Md.342] Command generation axis major error code (D12603+20n)
- (a) This register stores the corresponding error code (Refer to APPENDIX 1.3.) at the major error occurrence of command generation axis. If another major error occurs after error code storing, the previous error code is overwritten by the new error code.
 - (b) Major error codes can be cleared by a [Rq.346] Command generation axis error reset command (M10967+20n).
- (4) [Md.343] Command generation axis execute program No. (D12604+20n)
- This register stores the starting program No. of command generation axis at the servo program starting.
- (5) [Md.344] Command generation axis M-code (D12605+20n)
- This register stores the M-code set to the executed servo program of command generation axis at the positioning start.
- If M-code is not set in the servo program, the value "0" is stored.
- (6) [Md.345] Command generation axis accumulative current value (D12606+20n, D12607+20n)
- The accumulative current value of a command generation axis is stored in command generation axis position units (Refer to Section 5.2.1).
- For the axis where the unit setting is other than "degree", this will be "feed current value = accumulative current value".
- (7) [Md.346] Command generation axis data set pointer for constant-speed control (D12609+20n)
- This pointer is used in the constant-speed control of command generation axis when specifying positioning data indirectly and substituting positioning data during operation.
- The details operation is the same as the data set pointer for constant-speed control (D15+20n) of each axis.
- Refer to the "Q173D(S)CPU/Q172D(S)CPU Motion controller (SV13/SV22) Programming Manual (REAL MODE)" for details of data set pointer for constant-speed control (D15+20n).

- (8) [Md.347] Command generation axis current value per cycle
(D12610+20n, D12611+20n)
The current value per cycle for a command generation axis is stored in the range from "0 to ([Pr.346] Command generation axis length per cycle-1)".
The unit is command generation axis position units (Refer to Section 5.2.1).
- (9) [Md.348] Command generation axis command speed
(D12612+20n, D12613+20n)
The command speed for a command generation axis is stored in command generation axis speed units (Refer to Section 5.2.1).

5 INPUT AXIS MODULE

[Bit device]

Symbol	Monitor item	Storage details	Monitor value	Refresh cycle	Device No.
St.340	Command generation axis positioning start complete	The positioning start complete signal for the command generation axis is stored.	ON : Positioning start complete OFF : Positioning start incomplete	Operation cycle	M9800+20n
St.341	Command generation axis positioning complete	The positioning complete signal for the command generation axis is stored.	ON : Positioning complete OFF : Positioning incomplete		M9801+20n
St.342	Command generation axis command in-position	The command in-position signal for the command generation axis is stored.	ON : Less than the command in-position range OFF : Outside the command in-position range		M9803+20n
St.343	Command generation axis speed controlling	The speed controlling signal for the command generation axis is stored.	ON : Speed control OFF : Control other than speed control		M9804+20n
St.344	Command generation axis error detection	The error detection signal for the command generation axis is stored.	ON : Error occurred OFF : No error	Immediate	M9807+20n
St.345	Command generation axis start accept flag	The start accept flag for the command generation axis is stored.	ON : Starting OFF : Not started	Operation cycle	M9810+20n
St.346	Command generation axis speed change accepting flag	The speed change accepting flag for the command generation axis is stored.	ON : Speed change accepting OFF : Speed change not accepting		M9811+20n
St.347	Command generation axis speed change "0" accepting flag	The speed change "0" accepting flag for the command generation axis is stored.	ON : Speed change "0" accepting OFF : Speed change "0" not accepting		M9812+20n
St.348	Command generation axis automatic decelerating flag	The automatic decelerating flag for the command generation axis is stored.	ON : Automatic deceleration OFF : No automatic deceleration		M9813+20n
St.349	Command generation axis M-code outputting	The M-code outputting flag for the command generation axis is stored.	ON : M code outputting OFF : M code not outputting		M9819+20n

(1) [St.340] Command generation axis positioning start complete (M9800+20n)

This signal turns on with the start completion for the positioning control of the command generation axis specified with the servo program.

It does not turn on at the starting using JOG operation or speed control.

It can be used to read a M-code at the positioning start.

The details operation is the same as positioning start complete (M2400+20n) of each axis.

Refer to the "Q173D(S)CPU/Q172D(S)CPU Motion controller (SV13/SV22) Programming Manual (REAL MODE)" for details of positioning start complete (M2400+20n).

(2) [St.341] Command generation axis positioning complete (M9801+20n)

This signal turns on with the completion of the positioning control for the command generation axis specified with the servo program.

It does not turn on at the start or stop on the way using JOG operation or speed control.

It does not turn on at the stop on the way during positioning.

It can be used to read a M-code at the positioning completion.

The details operation is the same as positioning complete (M2401+20n) of each axis.

Refer to the "Q173D(S)CPU/Q172D(S)CPU Motion controller (SV13/SV22) Programming Manual (REAL MODE)" for details of positioning complete (M2401+20n).

(3) [St.342] Command generation axis command in-position (M9803+20n)

This signal turns on when the absolute value of difference between the command position and feed current value becomes below the [Pr.344] Command generation axis command in-position range.

This signal turns off in the following cases.

- Positioning control start
- Speed control
- JOG operation

(4) [St.343] Command generation axis speed controlling (M9804+20n)

(a) This signal turns on during speed control of command generation axis, and used to judge if command generation axis is in speed control or position control.

(b) This signal turns off at the power supply on and during position control.

(5) [St.344] Command generation axis error detection (M9807+20n)

(a) This signal turns on with detection of a minor error or major error of command generation axis, and can be used to judge if there is an error or not.

The applicable error code ^(Note-1) is stored in the [Md.341] Command generation axis minor error code (D12602+20n) with detection of a minor error.

The applicable error code ^(Note-1) is stored in the [Md.342] Command generation axis major error code (D12603+20n) with detection of a major error.

(b) This signal turns off when the [Rq.346] Command generation axis error reset command (M10967+20n) turns on.

REMARK

(Note-1): Refer to APPENDIX 1 for the error codes with detection of major/minor errors.

- (6) [St.345] Command generation axis start accept flag (M9810+20n)
This flag turns on when the servo program of command generation axis is started.
The start accept flag corresponding to an axis specified with the servo program turns on.
The details operation is the same as the data set pointer for start accept flag (M2001+n) of each axis.
Refer to the "Q173D(S)CPU/Q172D(S)CPU Motion controller (SV13/SV22) Programming Manual (REAL MODE)" for details of start accept flag (M2001+n).
- (7) [St.346] Command generation axis speed change accepting flag (M9811+20n)
This flag turns on at the start of speed change of command generation axis by the control change (CHGVS) instruction of the Motion SFC program or Motion dedicated PLC instruction (D(P).CHGVS).
- (8) [St.347] Command generation axis speed change "0" accepting flag (M9812+20n)
This flag turns on while the command generation axis is accepting a speed change request to speed "0" or negative speed change request.
The details operation is the same as the data set pointer for speed change "0" accepting flag (M2240+n) of each axis.
Refer to the "Q173D(S)CPU/Q172D(S)CPU Motion controller (SV13/SV22) Programming Manual (REAL MODE)" for details of speed change "0" accepting flag (M2240+n).
- (9) [St.348] Command generation axis automatic decelerating flag (M9813+20n)
This signal turns on while automatic deceleration processing is performed during the positioning control or position follow-up control of command generation axis.
The details operation is the same as the data set pointer for automatic decelerating flag (M2128+n) of each axis.
Refer to the "Q173D(S)CPU/Q172D(S)CPU Motion controller (SV13/SV22) Programming Manual (REAL MODE)" for details of automatic decelerating flag (M2128+n).
- (10) [St.349] Command generation axis M-code outputting (M9819+20n)
(a) This signal turns on during M-code output of command generation axis.
(b) This signal turns off when the stop command, cancel signal, skip signal or FIN signal are inputted.

5.3 Synchronous Encoder Axis

5.3.1 Overview of synchronous encoder axis

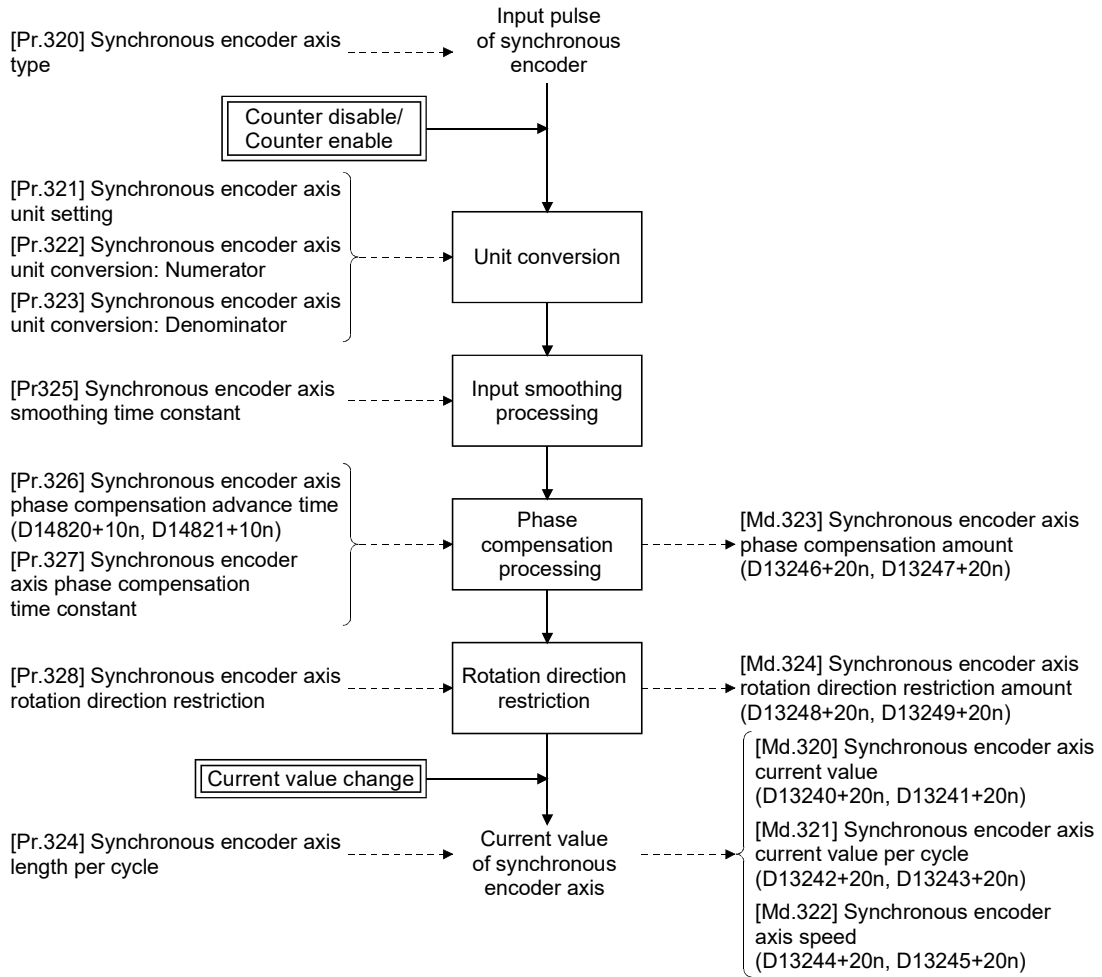

The synchronous encoder is used to drive the input axis based on input pulse from a synchronous encoder that is connected externally.
 The status of a synchronous encoder axis can also be monitored after the Multiple CPU system power supply turns ON.



(1) Synchronous encoder axis type

The following 5 types of synchronous encoders can be used for the synchronous encoder axis.

Refer to Section 5.3.2 for the setting method for each synchronous encoder axis.

Synchronous encoder axis type		Details
Synchronous encoder Pn		The synchronous encoder (P1 to 12) controlled by Motion CPU is used as the synchronous encoder axis.
Synchronous encoder via servo amplifier 		<p>The following devices connected to the servo amplifier can be used as a synchronous encoder axis.</p> <ul style="list-style-type: none"> Rotary servo motor (HK-KT) connected to a servo amplifier (MR-J5(W)-□B) Absolute/incremental scale connected to a servo amplifier (MR-J5(W)-□B/MR-J4(W)-□B) Serial absolute synchronous encoder (Q171ENC-W8) connected to CN2L connector of a servo amplifier (MR-J4-□B-RJ) ^(Note-1) (axis 1 to 32) Rotary servo motor (HG-KR, HG-MR) connected to a servo amplifier (MR-J4(W)-□B) (axis 1 to 32)
Via device		<p>The encoder value is loaded via Motion CPU device.</p> <p>Used to operate a gray code encoder that is connected to the input module as the synchronous encoder axis.</p>
Multiple CPU synchronous control ^(Note-2) 	Master CPU servo input axis	The master CPU servo input axis (axis 1 to 32) is used as the synchronous encoder axis.
	Master CPU command generation axis	The master CPU command generation axis (axis 1 to 32) is used as the synchronous encoder axis.
	Master CPU synchronous encoder axis	The master CPU synchronous encoder axis (axis 1 to 12) is used as the synchronous encoder axis.

(Note-1): Use software version B0 or later for the servo amplifier (MR-J4-□B-RJ) which connects the synchronous encoder.

(Note-2): Can also be set to operate as a slave CPU in the multiple CPU synchronous control system. (Refer to Section 9.4.)

(2) Control method for synchronous encoder axis

The following controls can be executed for the synchronous encoder axis by using [Rq.320] Synchronous encoder axis control request (M11601+4n) and [Cd.321] Synchronous encoder axis control method (D14823+10n).

Setting value of [Cd.321] Synchronous encoder axis control method (D14823+10n)	Control details
0: Current value change	[Md.320] Synchronous encoder axis current value (D13240+20n, D13241+20n) and [Md.321] Synchronous encoder axis current value per cycle (D13242+20n, D13243+20n) are changed based on the setting of [Cd.322] Synchronous encoder axis current value setting address (D14824+10n, D14825+10n).
1: Counter disable	Input from the synchronous encoder is disabled.
2: Counter enable	Input from the synchronous encoder is enabled.

: Refer to Section 1.4 for the software version that supports this function.

(3) Units for the synchronous encoder axis

The position units and speed units for the synchronous encoder axis are shown below for the setting of [Pr.321] Synchronous encoder axis unit setting.

Table 5.5 Synchronous encoder axis position units

Setting value of [Pr.321] Synchronous encoder axis unit setting		Synchronous encoder axis position unit	Range
Control unit	Number of decimal places for position		
0: mm	0	mm	-2147483648 to 2147483647 [mm]
	⋮	⋮	⋮
	9	$\times 10^{-9}$ mm	-2.147483648 to 2.147483647 [mm]
1: inch	0	inch	-2147483648 to 2147483647 [inch]
	⋮	⋮	⋮
	9	$\times 10^{-9}$ inch	-2.147483648 to 2.147483647 [inch]
2: degree	0	degree	-2147483648 to 2147483647 [degree]
	⋮	⋮	⋮
	9	$\times 10^{-9}$ degree	-2.147483648 to 2.147483647 [degree]
3: pulse	0	pulse	-2147483648 to 2147483647 [pulse]
	⋮	⋮	⋮
	9	$\times 10^{-9}$ pulse	-2.147483648 to 2.147483647 [pulse]

Table 5.6 Synchronous encoder axis speed units

Setting value of [Pr.321] Synchronous encoder axis unit setting			Synchronous encoder axis speed unit	Range
Control unit	Speed time unit	Number of decimal places for speed		
0: mm	0: s	0	mm/s	-2147483648 to 2147483647 [mm/s]
		⋮	⋮	⋮
		9	$\times 10^{-9}$ mm/s	-2.147483648 to 2.147483647 [mm/s]
	1: min	0	mm/min	-2147483648 to 2147483647 [mm/min]
		⋮	⋮	⋮
		9	$\times 10^{-9}$ mm/min	-2.147483648 to 2.147483647 [mm/min]
1: inch	0: s	0	inch/s	-2147483648 to 2147483647 [inch/s]
		⋮	⋮	⋮
		9	$\times 10^{-9}$ inch/s	-2.147483648 to 2.147483647 [inch/s]
	1: min	0	inch/min	-2147483648 to 2147483647 [inch/min]
		⋮	⋮	⋮
		9	$\times 10^{-9}$ inch/min	-2.147483648 to 2.147483647 [inch/min]
2: degree	0: s	0	degree/s	-2147483648 to 2147483647 [degree/s]
		⋮	⋮	⋮
		9	$\times 10^{-9}$ degree/s	-2.147483648 to 2.147483647 [degree/s]
	1: min	0	degree/min	-2147483648 to 2147483647 [degree/min]
		⋮	⋮	⋮
		9	$\times 10^{-9}$ degree/min	-2.147483648 to 2.147483647 [degree/min]
3: pulse	0: s	0	pulse/s	-2147483648 to 2147483647 [pulse/s]
		⋮	⋮	⋮
		9	$\times 10^{-9}$ pulse/s	-2.147483648 to 2.147483647 [pulse/s]
	1: min	0	pulse/min	-2147483648 to 2147483647 [pulse/min]
		⋮	⋮	⋮
		9	$\times 10^{-9}$ pulse/min	-2.147483648 to 2.147483647 [pulse/min]

5.3.2 Setting method for synchronous encoder

(1) Incremental synchronous encoder Pn

(a) Setting method

Connect the synchronous encoder to the synchronous encoder No.(Pn) assigned to built-in interface in Motion CPU, Q172DEX and Q173DPX set by the system setting.

When the synchronous encoder axis connection is valid after Multiple CPU system's power supply ON to synchronous encoder type, "Synchronous encoder axis current value", "Synchronous encoder axis current value per cycle" and "Counter enabling status" will be as follows.

Connection method	[Md.320] Synchronous encoder axis current value (D13240+20n, D13241+20n)	[Md.321] Synchronous encoder axis current value per cycle (D13242+20n, D13243+20n)	Counter enable/ Counter disable
Built-in interface in Motion CPU	0	0	Counter enable
Q172DEX	The current value is restored based on the synchronous encoder current value at the last synchronous encoder disconnection. (Note-1)	The current value is restored based on the synchronous encoder current value per cycle at the last synchronous encoder disconnection. (Note-1)	
Q173DPX	0	0	

(Note-1): When [St.323] Synchronous encoder axis current value setting request flag (M10443+10n) is ON at the last synchronous encoder disconnection, the value is 0.

(b) Setting example

The following shows an example for setting an incremental synchronous encoder No.P3 connected to Q173DPX as synchronous encoder axis 2.

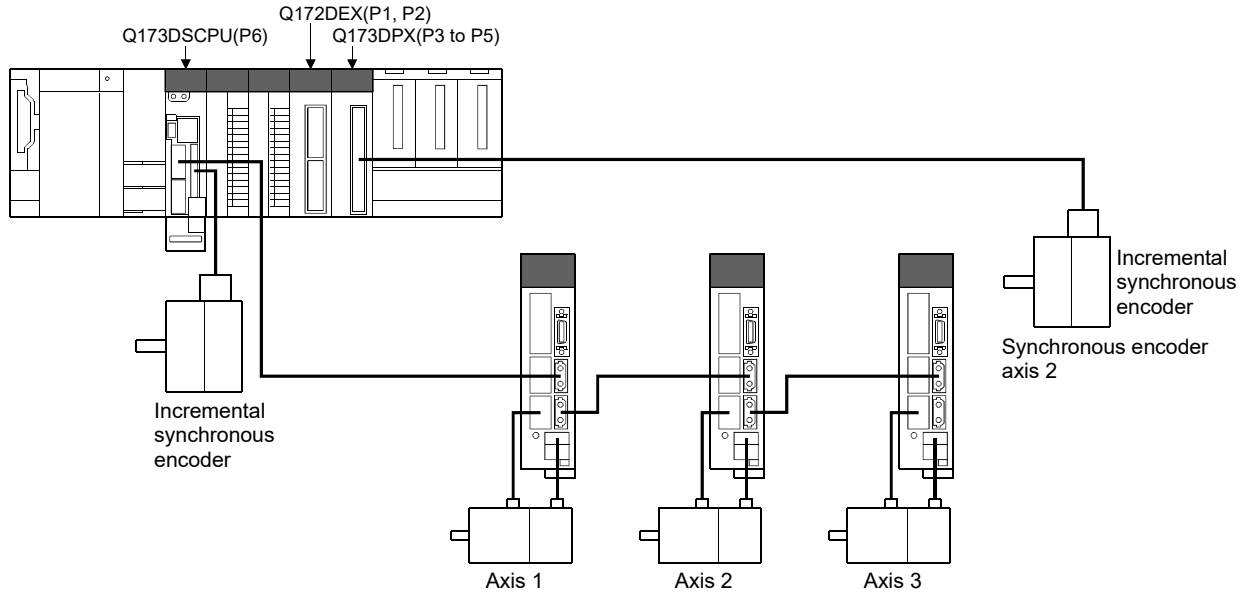

Set the following in [Pr.320] Synchronous encoder axis type for the synchronous encoder axis 2 on the synchronous encoder axis parameter screen of MT Developer2.

- Type "1: Synchronous encoder Pn"
- Synchronous encoder No. (Pn) "3"

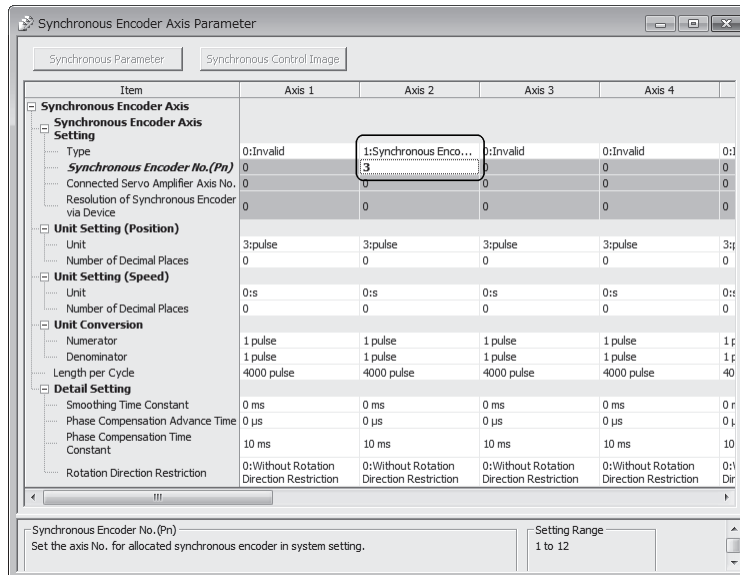

POINT
<p>(1) The counter value, etc. cannot be monitored for the synchronous encoder No.(Pn) that is not assigned to [Pr.320] Synchronous encoder axis type. However, when the manual pulse generator is connected to Q173DPX (first installed to the lowest slot number of the main base, the manual pulse generator operation is possible for the synchronous encoder No.(Pn) that is not assigned to the synchronous encoder axis.</p> <p>(2) When the synchronous encoder No.(Pn) that is not assigned to the system setting is set to [Pr.320] Synchronous encoder axis type, an error does not occur, but [St.320] Synchronous encoder axis setting valid flag (M10440+10n) turns OFF.</p> <p>(3) When a communication error occurs because Q172DEX and the encoder are not connected at Multiple CPU system power's ON in the serial absolute synchronous encoder connected to Q172DEX, the major error (error code: 1820) will occur, and [St.321] Synchronous encoder axis connecting valid flag (M10441+10n) does not turn ON. Remove the error factor, and turn the Multiple CPU system's power again. (Be sure to connect the encoder at Multiple CPU system's power on.)</p> <p>(4) When the major error (error code: 1810) occurs by the communication error in the serial absolute synchronous encoder connected to Q172DEX, [St.321] Synchronous encoder axis connecting valid flag (M10441+10n) turns OFF. When the error factor is removed, and [Rq.323] Synchronous encoder axis error reset (M11600+4n) is turned ON, [St.321] Synchronous encoder axis connecting valid flag (M10441+10n) turns ON.</p>

(2) Synchronous encoder via servo amplifier **Ver.!**

(a) Setting method

The device connected to the servo amplifier is used as the synchronous encoder axis.

The following shows a list of devices that can be connected as a synchronous encoder axis depending on the type of servo amplifier used.

Servo amplifier type	Devices
MR-J5-□B	<ul style="list-style-type: none"> • Rotary servo motor (HK-KT) • Absolute/incremental scale
MR-J5W-□B	
MR-J5-□B-RJ	
MR-J4-□B	<ul style="list-style-type: none"> • Rotary servo motor (HG-KR, HG-MR) • Absolute/incremental scale
MR-J4W-□B	
MR-J4-□B-RJ	<ul style="list-style-type: none"> • Serial absolute synchronous encoder (Q171ENC-W8) connected to CN2L • Rotary servo motor (HG-KR, HG-MR) • Absolute/incremental scale

Setting "101: Synchronous encoder via servo amplifier" in [Pr.320]

Synchronous encoder axis type and "ABS" or "INC" in the "External synchronous encoder input" of amplifier setting enables the serial absolute synchronous encoder connected to the specified servo amplifier axis to be used.

When a servo amplifier axis with a serial absolute synchronous encoder or ABS scale installed is connected, the synchronous encoder axis connection becomes valid. The synchronous encoder axis current value and the synchronous encoder axis current value per cycle are restored, and the synchronous encoder axis connection is on the counter enabling status.

When a servo amplifier axis with an incremental scale installed is connected, the synchronous encoder axis connection becomes valid. 0 is set to the initial value of the synchronous encoder axis current value and the synchronous encoder axis current value per cycle, and the synchronous encoder axis connection is on the counter enabling status.

When the applicable servo amplifier axis is not connected, the synchronous encoder axis connection is invalid.

Ver.! : Refer to Section 1.4 for the software version that supports this function.

For servo amplifiers performing "Synchronous encoder via servo amplifier", use the software version that supports each encoder connected. The software version that supports each encoder is shown in the table below.

Servo amplifier type	Software version
MR-J5-□B	—
MR-J5-□B-RJ	
MR-J5W-□B	
MR-J4-□B	B0 or later
MR-J4-□B-RJ	
MR-J4W-□B	

— : There is no restriction by the version.

POINT
<p>(1) Servo amplifiers with "ABS" or "INC" set to "External synchronous encoder input" of amplifier setting, have servo parameter "Scale measurement function selection (Note-1)" set.</p> <p>(Note): When servo parameter "Scale measurement function selection (Note-1)" has been changed, after transmitting parameter to the servo amplifier, the power supply of the servo amplifier must be turned OFF once, and turned ON again.</p> <p>(2) When a servo amplifier with servo parameter "Scale measurement function selection (Note-1)" set does not support "Scale measurement mode", AL.37 (parameter error) occurs in the servo amplifier.</p> <p>(3) When the battery of the servo amplifier is disconnected, the serial absolute synchronous encoder (Q171ENC-W8) can be used as an incremental system (INC) by setting "External synchronous encoder input" of amplifier setting to "INC".</p> <p>(4) When using the scale measurement function with MR-J5(W)-□B, the Motion CPU internal processing converts the synchronous encoder travel distance so that an encoder resolution of 67108864[pulse/rev] becomes a resolution of 4194304[pulse/rev]. Therefore, [Pr.322] Synchronous encoder axis unit conversion: Numerator and [Pr.323] Synchronous encoder axis unit conversion: Denominator should be set assuming the encoder resolution is 4194304[pulse/rev].</p> <p>(5) (Note-1): The "Scale measurement function selection" servo parameter in the following servo parameters depending on the servo amplifier used.</p> <ul style="list-style-type: none"> • MR-J5(W)-□B: Servo parameter (PA22.3) • MR-J4(W)-□B: Servo parameter (PA22) <p>Refer to the "Servo amplifier Instruction Manual" for more details on servo parameters.</p>

(b) Setting example

The following shows an example for setting a serial absolute synchronous encoder (Q171ENC-W8) via servo amplifier (MR-J4-□B-RJ, axis 3) as synchronous encoder axis 1.

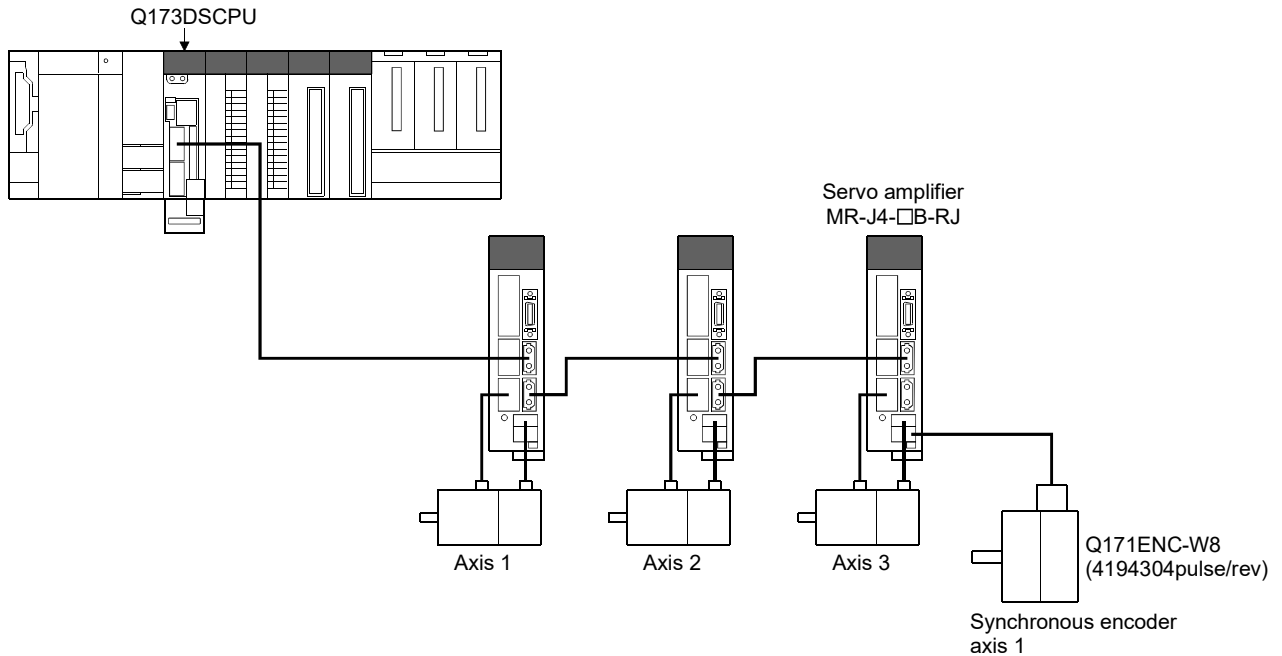

1) Set the following to servo amplifier in amplifier setting of system setting in MT Developer2.

- Amplifier model....."MR-J4(W)-B(-RJ)"
- Amplifier operation mode."Standard"
- External synchronous encoder input."ABS"

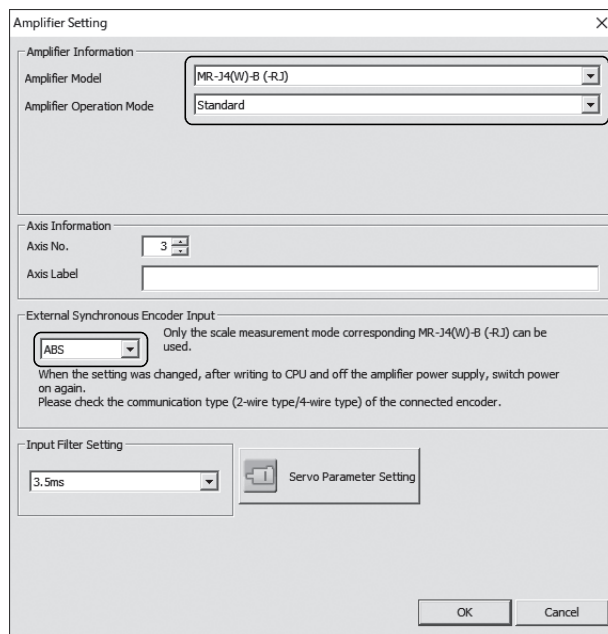

2) Set the following in Synchronous encoder axis setting for the synchronous encoder axis 1 on the synchronous encoder axis parameter screen of MT Developer2.

- Type "101: Synchronous encoder via servo amplifier"
- Connected Servo Amplifier Axis No. "3"

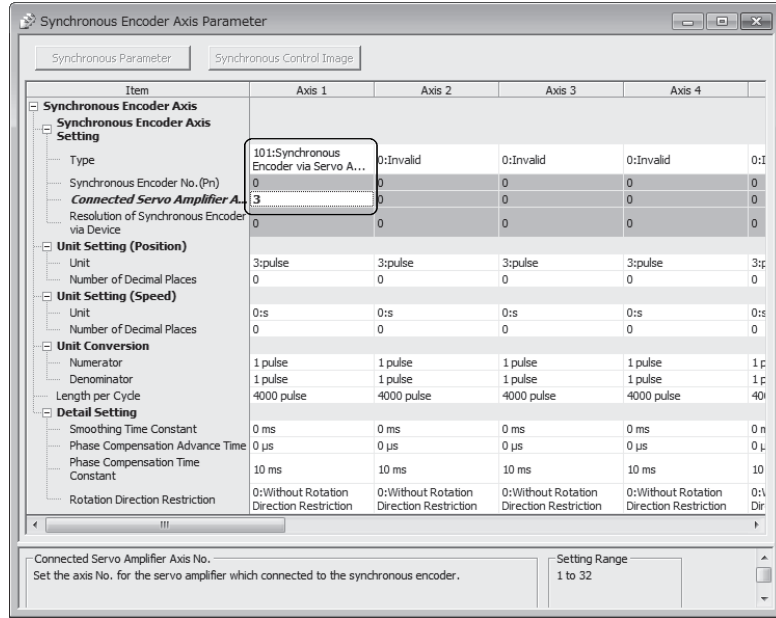

3) Set servo parameter "Function selection C-8 (PC26) (Load-side encoder communication method)" of servo amplifier 3 to "1: Four-wire type".

POINT
<ol style="list-style-type: none"> (1) Set the axis No. (1 to 32) set in the amplifier setting for connected servo amplifier axis No. (2) Turn ON the Multiple CPU system's and servo amplifier's power supply again to validate the set parameter settings in the servo amplifier. (3) Refer to the "Servo amplifier Instruction Manual" when connecting an encoder other than a serial absolute synchronous encoder (Q171ENC-W8).

(c) Restrictions

- 1) When optional data monitor is set to a servo amplifier axis selected as "101: Synchronous encoder via servo amplifier" by [Pr.320] Synchronous encoder axis type, set the number of communication data points so that the total comes to 2 points or less per axis.
- 2) When servo error (error code: 2025, 2070, 2071, 2072) occurs in a servo amplifier axis selected as "101: Synchronous encoder via servo amplifier" by [Pr.320] Synchronous encoder axis type, the servo amplifier axis is in a servo OFF state.
- 3) The following cases are major errors (error code: 1812)
 - When the servo amplifier axis selected as "101: Synchronous encoder via servo amplifier" by [Pr.320] Synchronous encoder axis type does not support synchronous encoder via servo amplifier.
 - When a servo amplifier axis which has not been set by amplifier setting of system setting is set as the connected servo amplifier axis No. for the synchronous encoder via servo amplifier.
 - When a servo amplifier axis which has "External synchronous encoder input" set to "Invalid" in the amplifier setting of system setting is set as the connected servo amplifier axis No. for the synchronous encoder via servo amplifier.
- 4) When an incremental scale is connected to a servo amplifier which has "External synchronous encoder input" set to "ABS", a servo error (error code: 2037) occurs, and the connected scale cannot be used as a synchronous encoder.
- 5) When "Amplifier operation mode" is set to "Fully closed" for a servo amplifier axis that has "External synchronous encoder input" set to "ABS", or "INC", the following servo errors occur.
 - For MR-J5(W)-□B: Servo error (error code: 2000 (AL.37))
 - For MR-J4(W)-□B: Servo error (error code: 2037)

(3) Via device (Synchronous encoder value input of via device)

(a) Setting method

Used to operate a gray code encoder that is connected to the input module of the Motion CPU control as a synchronous encoder axis.

By setting "201: Via device" in [Pr.320] Synchronous encoder axis type, the synchronous encoder is controlled by the encoder value which is the input value of [Cd.325] Input value for synchronous encoder via device (D14826+10n, D14827+10n).

The encoder value can be used as a cycle counter within the range from 0 to (Resolution of synchronous encoder via device - 1).

Connection is invalid just after the system's power supply is ON. When the [Rq.324] Connection command of synchronous encoder via device/master CPU (M11602+4n) turns ON, the synchronous encoder axis current value and the synchronous encoder axis current value per cycle are restored based on [Cd.325] Input value for synchronous encoder via device (D14826+10n, D14827+10n). Therefore, connection becomes valid, and will be on the counter enabling status.

The synchronous encoder axis is controlled based on the amount of change of [Cd.325] Input value for synchronous encoder via device (D14826+10n, D14827+10n) while it is connecting.

(b) Setting example

The following shows an example for setting a synchronous encoder via device as synchronous encoder axis 4.

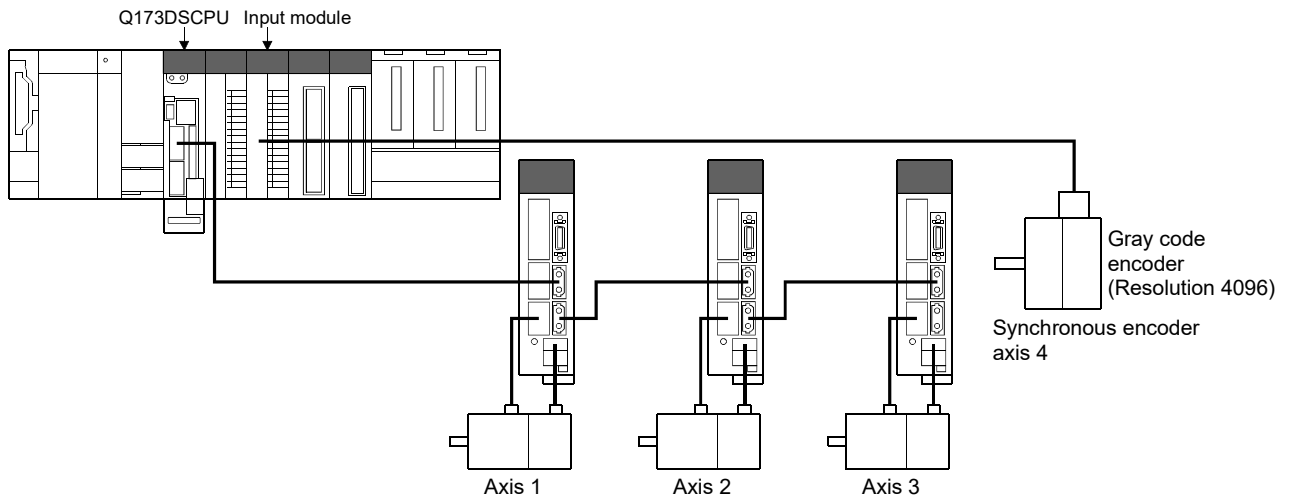

Set the following in Synchronous encoder axis setting of synchronous encoder axis 4 on the synchronous encoder axis parameter screen of MT Developer2.

- Type "201: Via device"
- Resolution of synchronous encoder via device. "4096"

Read the encoder value of the gray code encoder with a sequence program, and update [Cd.325] Input value for synchronous encoder via device (D14826+10n, D14827+10n) of the synchronous encoder axis 4 at every time.

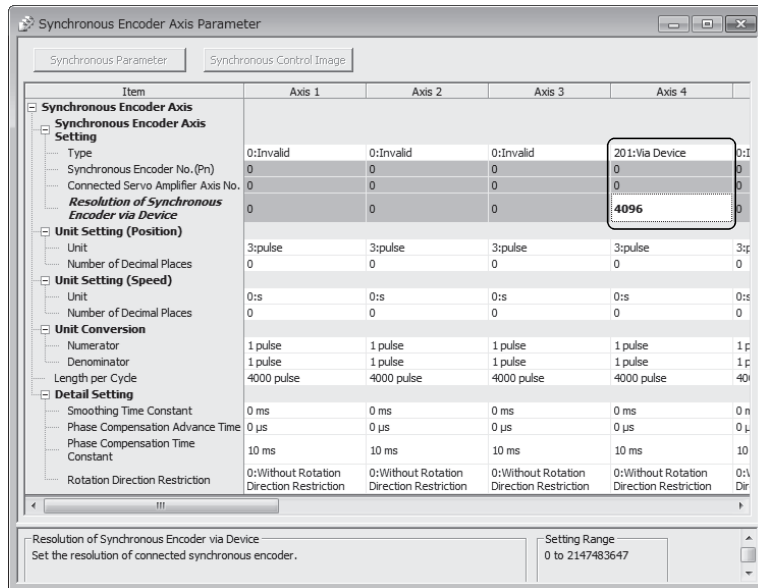

(c) Restrictions

The synchronous encoder current value that is restored for the synchronous encoder connection gets restored into a converted value from the following range based on the synchronous encoder travel value on disconnection.

Setting value of [Pr.329] Resolution of synchronous encoder via device	Range of restored synchronous encoder current value
1 or more	$-(\text{Resolution of synchronous encoder via device} \div 2)$ to $+(\text{Resolution of synchronous encoder via device} \div 2 - 1)$ [pulse] (Note): If the resolution of a synchronous encoder via device is an odd number, round down a negative value after the decimal point, round up a positive value after decimal point.
0	-2147483648 to 2147483647 [pulse]

(4) Multiple CPU synchronous control **Ver.!**

Used when controlling the servo input axis, command generation axis, and synchronous encoder axis of the master CPU as the synchronous encoder axis. In the slave CPU side, by setting the following master CPU input axis type in [Pr.320] Synchronous encoder axis type, the slave CPU controls as a synchronous encoder axis that uses the change amount from the master CPU as input value.

Refer to Section 9.4.4 for details of setting method.

- Master CPU servo input axis..... "301: Master CPU servo input axis"
- Master CPU command generation axis..... "401: Master CPU command generation axis"
- Master CPU synchronous encoder axis "501: Master CPU synchronous encoder axis"

Ver.!: Refer to Section 1.4 for the software version that supports this function.

5 INPUT AXIS MODULE

5.3.3 Synchronous encoder axis parameters

Symbol	Setting item	Setting details	Setting value	Fetch cycle	Default value	Device No.
Pr.320	Synchronous encoder axis type	<ul style="list-style-type: none"> Set the synchronous encoder axis type to be used. If using as the slave CPU in the multiple CPU synchronous control system, set the input axis of the master CPU. 	0 : Invalid 1 : Synchronous encoder Pn (Synchronous encoder axis No.: 1 to 12) 101 : Synchronous encoder via servo amplifier (Connected servo amplifier axis No.: 1 to 32) Ver.! 201 : Via device 301 : Master CPU servo input axis (axis No.: 1 to 32) Ver.! 401 : Master CPU command generation axis (axis No.: 1 to 32) Ver.! 501 : Master CPU synchronous encoder axis (axis No.: 1 to 12) Ver.!	At power supply ON	0	—
Pr.321	Synchronous encoder axis unit setting	<ul style="list-style-type: none"> Set the unit of the synchronous encoder axis. Set the position unit within the range from $\times 1$ to 10^{-9} [control unit]. Set the speed unit within the range from $\times 1$ to 10^{-9} [control unit/s or control unit/min]. 	Control unit 0: mm 1: inch 2: degree 3: pulse		3	—
			Number of decimal places 0 to 9		0	
			Speed time unit 0: s 1: min		0	
Pr.322	Synchronous encoder axis unit conversion: Numerator	Set the numerator to convert the unit from the encoder pulse of the synchronous encoder axis into the synchronous encoder axis unit.	-2147483648 to 2147483647 [Synchronous encoder axis position units] (Note-1)	1	—	
				Pr.323	Synchronous encoder axis unit conversion: Denominator	Set the denominator to convert the unit from the encoder pulse of the synchronous encoder axis into the synchronous encoder axis unit.

Ver.! : Refer to Section 1.4 for the software version that supports this function.

5 INPUT AXIS MODULE

Symbol	Setting item	Setting details	Setting value	Fetch cycle	Default value	Device No.
Pr.324	Synchronous encoder axis length per cycle	Set the length per cycle of the synchronous encoder axis.	1 to 2147483647 [Synchronous encoder axis position units] (Note-1)	At power supply ON	4000	—
Pr.325	Synchronous encoder axis smoothing time constant	Set the time to smooth for the input value.	0 to 5000 [ms]		0 [ms]	—
Pr.326	Synchronous encoder axis phase compensation advance time	Set the time to advance or delay the phase.	-2147483648 to 2147483647 [μs]	Operation cycle	0 [μs]	D14820+10n D14821+10n
Pr.327	Synchronous encoder axis phase compensation time constant	Set the time constant to affect the phase compensation.	0 to 65535 [ms]	At power supply ON	10 [ms]	—
Pr.328	Synchronous encoder axis rotation direction restriction	Set this parameter to restrict the input travel value to one direction.	0: Without rotation direction restriction 1: Enable only for current value increase direction 2: Enable only for current value decrease direction		0	—
Pr.329	Resolution of synchronous encoder via device	<ul style="list-style-type: none"> Set the resolution of the synchronous encoder when the synchronous encoder axis type is set to synchronous encoder via device. If 0 is set, the input value of synchronous encoder via device is processed as 32-bit counter. 	0 to 2147483647 [pulse]		0 [pulse]	—

(Note-1): Synchronous encoder axis position units (Refer to Section 5.3.1)

(1) [Pr.320] Synchronous encoder axis type

Set the type of synchronous encoder that will be the source for generating the input value for the synchronous encoder axis.

If operating as the slave CPU in the multiple CPU synchronous control system, set the input axis of the master CPU.

- 0: Invalid.....Synchronous encoder axis is invalid.
- 1: Synchronous encoder Pn.....Generate the input value based on the synchronous encoder input of P1 to P12 assigned with the system setting.
- 101: Synchronous encoder via servo amplifier **Ver.!**Generate the input value based on the synchronous encoder via servo amplifier input connected to the specified servo amplifier (axis 1 to 32).
- 201: Via deviceGenerate the input value with the value set in the [Cd.325] Input value for synchronous encoder via device (D14826+10n, D14827+10n) as the encoder value.
- 301: Master CPU servo input axis (Note-1) **Ver.!**Generate the input value based on the change amount of the master CPU servo input axis (axis 1 to 32).
- 401: Master CPU command generation axis (Note-1) **Ver.!**Generate the input value based on the change amount of the master CPU command generation axis (axis 1 to 32).
- 501: Master CPU synchronous encoder axis (Note-1) **Ver.!**Generate the input value based on the change amount of the master CPU synchronous encoder axis (axis 1 to 12).

(Note-1): Can set when selecting "Slave CPU" in the multiple CPU synchronous control setting of system setting.

(2) [Pr.321] Synchronous encoder axis unit setting

Set the position and speed unit of the synchronous encoder axis. Refer to Section 5.3.1 for details.

Ver.! : Refer to Section 1.4 for the software version that supports this function.

- (3) [Pr.322] Synchronous encoder axis unit conversion: Numerator, [Pr.323] Synchronous encoder axis unit conversion: Denominator
 The input travel value of synchronous encoder is configured in encoder pulse units. The units can be arbitrarily converted through unit conversation with setting [Pr.322] Synchronous encoder axis unit conversion: Numerator and [Pr.323] Synchronous encoder axis unit conversion: Denominator.
 Set [Pr.322] Synchronous encoder axis unit conversion: Numerator and [Pr.323] Synchronous encoder axis unit conversion: Denominator according to the controlled machine.

$$\begin{array}{l} \text{Synchronous encoder axis} \\ \text{travel value (Travel value} \\ \text{after unit conversion)} \end{array} = \begin{array}{l} \text{Synchronous encoder} \\ \text{input travel value} \\ \text{(Encoder pulse units)} \end{array} \times \frac{\begin{array}{l} \text{[Pr.322] Synchronous encoder axis unit} \\ \text{conversion: Numerator} \end{array}}{\begin{array}{l} \text{[Pr.323] Synchronous encoder axis unit} \\ \text{conversion: Denominator} \end{array}}$$

The travel value in pulses set in [Pr.323] Synchronous encoder axis unit conversion: Denominator is set in [Pr.322] Synchronous encoder axis unit conversion: Numerator in synchronous encoder axis position units (Refer to Section 5.3.1).

The input travel value can be reversed by the setting negative values.
 Set [Pr.323] Synchronous encoder axis unit conversion: Denominator" based on encoder pulse units from the synchronous encoder.
 Set a value within the range from 1 to 2147483647.

(4) [Pr.324] Synchronous encoder axis length per cycle

Set the length per cycle for the synchronous encoder axis current value per cycle.

The current value of synchronous encoder axis is stored in [Md.321]

Synchronous encoder axis current value per cycle (D13242+20n, D13243+20n) at ring counter based on the setting value.

The unit settings are in synchronous encoder axis position units (Refer to Section 5.3.1).

Set a value within the range from 1 to 2147483647.

(Example) Setting example of the unit conversion and the length per cycle.

The following shows an example a rotary encoder is connected which resolution is 4000[pulse/rev] to the motor axis side on the rotation table that drives by 1/5 pulley system, and the control unit is degree.

- Position unit : 0.1 [degree]
- Speed unit : 0.001 [degree/min]
- Length per cycle : 360.0 [degree] (1 cycle of the rotation table)

Setting item		Setting details	Setting value
[Pr.321] Synchronous encoder axis unit setting	Control unit	2: degree	3112h
	Number of decimal places for position	1	
	Speed time unit	1: min	
	Number of decimal places for speed	3	
[Pr.322] Synchronous encoder axis unit conversion: Numerator		360.0 [degree] × 1	3600 [×0.1degree]
[Pr.323] Synchronous encoder axis unit conversion: Denominator		4000 [pulse] × 5	20000 [pulse]
[Pr.324] Synchronous encoder axis length per cycle		360.0 [degree]	3600 [×0.1degree]

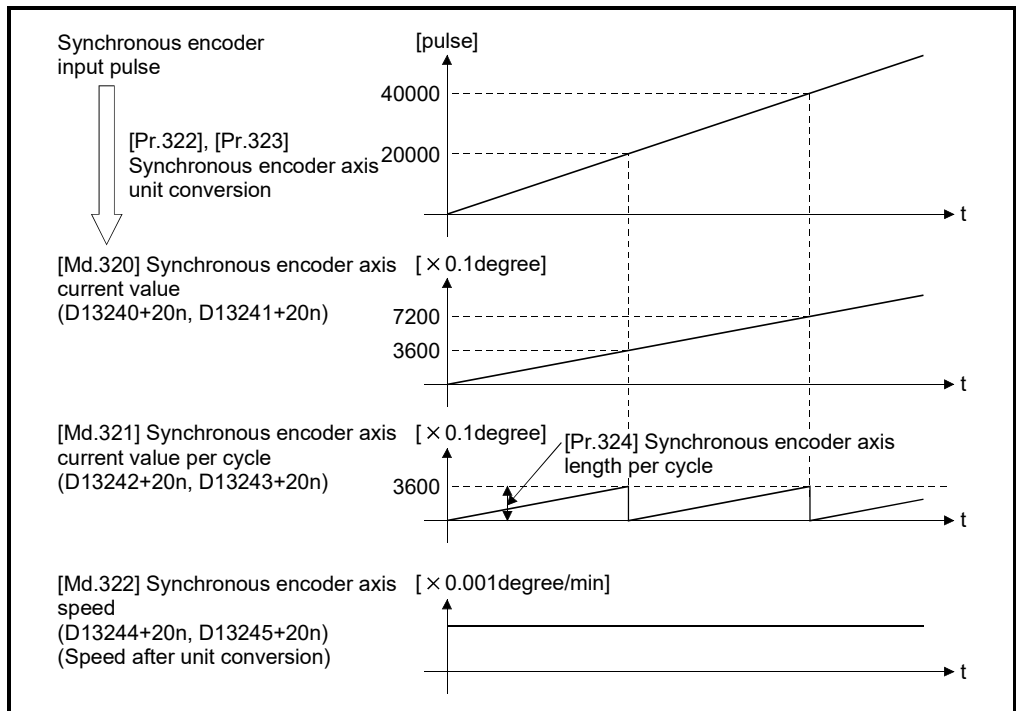

(5) [Pr.325] Synchronous encoder axis smoothing time constant

Set the averaging time to execute a smoothing process for the input travel value from synchronous encoder.

The smoothing process can moderate speed fluctuation of the synchronous encoder input.

The input response is delayed depending on the time corresponding to the setting by smoothing process setting.

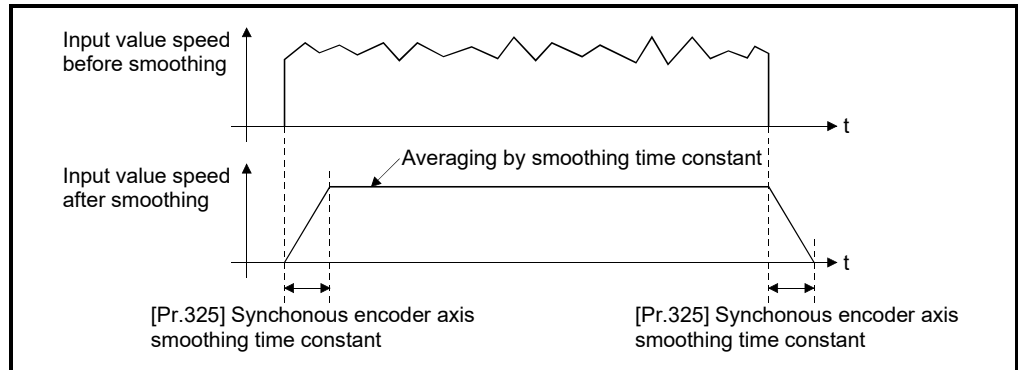

(6) [Pr.326] Synchronous encoder axis phase compensation advance time (D14820+10n, D14821+10n)

Set the time to advance or delay the phase (input response) of the synchronous encoder axis.

Refer to Section 9.1 "Phase compensation function" for the peculiar time delay of the system using the synchronous encoder axis.

- 1 to 2147483647 [μ s].....Advance the phase (input response) according to the setting time.
- 0 [μ s]Do not execute phase compensation.
- -2147483648 to -1 [μ s]Delay the phase (input response) according to the setting time.

If the setting time is too long, the system experiences overshoot or undershoot at acceleration/deceleration of the input speed. In this case, set a longer time to affect the phase compensation amount in [Pr.327] Synchronous encoder axis phase compensation time constant.

(7) [Pr.327] Synchronous encoder axis phase compensation time constant

Set the time constant to affect the phase compensation amount for the first order delay.

63 [%] of the phase compensation amount are reflected in the time constant setting.

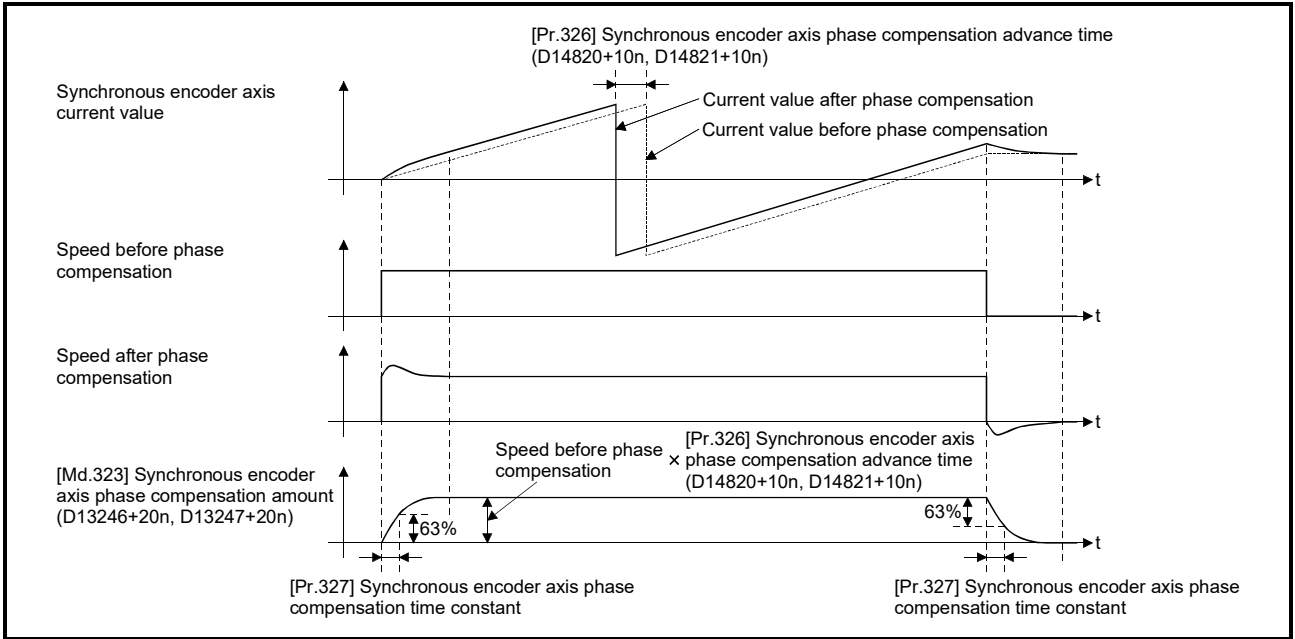

(8) [Pr.328] Synchronous encoder axis rotation direction restriction

Set this parameter to restrict the input travel value for the synchronous encoder axis to one direction.

This helps to avoid reverse operation caused by machine vibration, etc. when "Real current value" or "Feed back value" is used as input values.

- 0: Without rotation direction restriction.....Rotation direction restriction is not executed.
- 1: Enable only for current value increase direction ...Enable only the input travel value in the increasing direction of the synchronous encoder axis current value.
- 2: Enable only for current value decrease direction ...Enable only the input travel value in the decreasing direction of the synchronous encoder axis current value.

The input travel value in the opposite direction of the enable direction accumulates as a rotation direction restricted amount, and it will be reflected when the input travel value moves in the enabled direction again. Therefore, the current value of synchronous encoder axis does not deviate when the reverse operation is repeated.

The rotation direction restricted amount is set to 0 at the synchronous encoder axis connection and current value change.

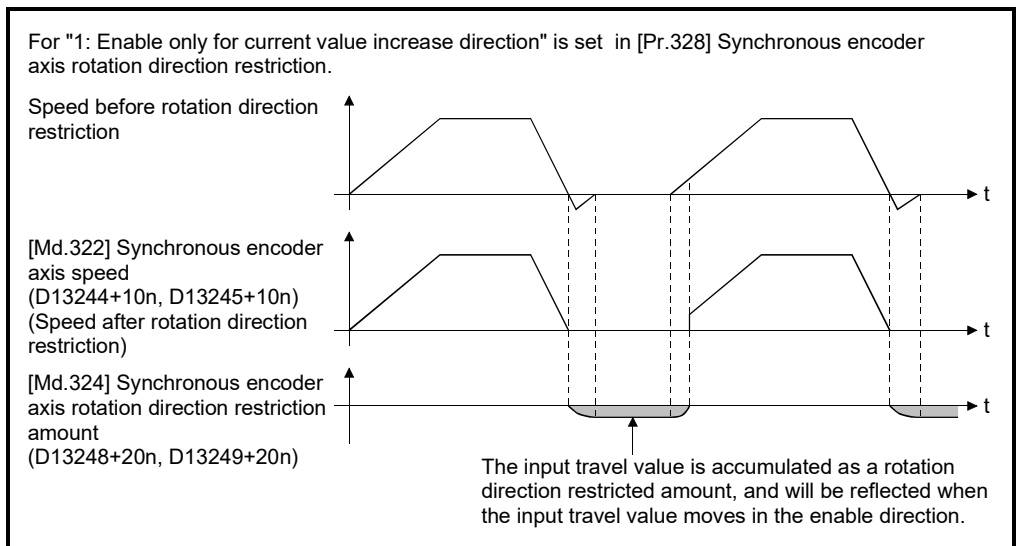

(9) [Pr.329] Resolution of synchronous encoder via device

Set the resolution of connected synchronous encoder when "201: Via device" is set in [Pr.320] Synchronous encoder axis type.

If 1 or more is set, [Cd.325] Input value for synchronous encoder via device (D14826+10n, D14827+10n) is processed as the cycle counter within the range from 0 to (resolution of synchronous encoder via device - 1).

If 0 is set, [Cd.325] Input value for synchronous encoder via device (D14826+10n, D14827+10n) is processed as 32 bit counter within the range from -2147483648 to 2147483647.

POINT

When 1 or more is set to [Pr.329] Resolution of synchronous encoder via device, set the cycle counter within the range from "0 to (resolution of synchronous encoder via device-1)" to [Cd.325] Input value for synchronous encoder via device (D14826+10n, D14827+10n) as the input value.

5 INPUT AXIS MODULE

5.3.4 Synchronous encoder axis control data

[Word device]

Symbol	Setting item	Setting details	Setting value	Fetch cycle	Default value	Device No.
Cd.320	Synchronous encoder axis control start condition	<ul style="list-style-type: none"> If set to "101 to 132", the synchronous encoder axis control starts based on the high-speed input request signal at synchronous encoder axis control request ON. In the case of other than the above, the control starts without any condition at synchronous encoder axis control request OFF to ON. 	Other than below: Start without any condition 101 to 132: High-speed input request signal start (Signal 1 to 32)	At synchronous encoder axis control start	0	D14822+10n
Cd.321	Synchronous encoder axis control method	Set the control method for the synchronous encoder axis.	0: Current value change 1: Counter disable 2: Counter enable		0	D14823+10n
Cd.322	Synchronous encoder axis current value setting address	Set a new current value for changing the current value.	-2147483648 to 2147483647 [Synchronous encoder axis position units] (Note-1)		0	D14824+10n D14825+10n
Cd.325	Input value for synchronous encoder via device	Set a value to be used every time as the input value for the synchronous encoder for the synchronous encoder via device.	-2147483648 to 2147483647 [pulse]		Operation cycle	0 [pulse]

(Note-1): Synchronous encoder axis position units (Refer to Section 5.3.1)

(1) [Cd.320] Synchronous encoder axis control start condition (D14822+10n)

When [Rq.320] Synchronous encoder axis control request (M11601+4n) is turned ON, if set to other than "101 to 132", the synchronous encoder axis control starts without any condition.

If set to "101 to 132", the synchronous encoder axis control starts based on the specified high-speed input request signal.

(2) [Cd.321] Synchronous encoder axis control method (D14823+10n)

Set the control method for the synchronous encoder axis.

- 0: Current value change The synchronous encoder axis current value and the synchronous encoder axis current value per cycle are changed as follows. Set the new current value in [Cd.322] Synchronous encoder axis current value setting address (D14824+10n, D14825+10n).

Item	Change value
[Md.320] Synchronous encoder axis current value	[cd.322] Synchronous encoder axis current value setting address (D14824+10n, D14825+10n)
[Md.321] Synchronous encoder axis current value per cycle	A value that is converted [Cd.322] Synchronous encoder axis current value setting address (D14824+10n, D14825+10n) into the range from "0 to ([Pr.324] Synchronous encoder axis length per cycle-1)".

- 1: Counter disable Input from the synchronous encoder is invalid. Smoothing processing, phase compensation processing and rotation direction restriction processing are continued. While these processes are valid, the input axis speed may not stop immediately when the counter disable is selected.
- 2: Counter enable Input from the synchronous encoder is valid.

(3) [Cd.322] Synchronous encoder axis current value setting address (D14824+20n, D14825+20n)

Set a new current value in synchronous encoder axis position units to apply to the current value change for the synchronous encoder axis (Refer to section 5.3.1).

(4) [Cd.325] Input value for synchronous encoder via device (D14826+10n, D14827+10n)

Use this data when "201: Via device" is set in [Pr.320] Synchronous encoder axis type.

Set a value to be used every time as the input value for the synchronous encoder in encoder pulse units.

If 1 or more is set in [Pr.329] Resolution of synchronous encoder via device, it is processed as a cycle counter within the range from 0 to (resolution of synchronous encoder via device - 1).

5 INPUT AXIS MODULE

[Bit device]

Symbol	Setting item	Setting details	Setting value	Fetch cycle	Default value	Device No.
Rq.323	Synchronous encoder axis error reset	If turns ON for resetting minor error and major error for the synchronous encoder axis, the minor error code and major error code are cleared, and the error detection and warning detection bits status are turned OFF.	ON: Error reset request	Main cycle (Note-1)	OFF	M11600+4n
Rq.320	Synchronous encoder axis control request	If turns ON, the synchronous encoder axis control is started.	ON : Control request ON OFF : Control request OFF	Operation cycle	OFF	M11601+4n
Rq.324	Connection command of synchronous encoder via device/master CPU	<ul style="list-style-type: none"> • If turns ON, the synchronous encoder via device/master CPU is connected. • If turns OFF, the synchronous encoder via device/master CPU is disconnected. 	ON : Connect synchronous encoder via device/master CPU OFF : Disconnect synchronous encoder via device/master CPU	Main cycle (Note-1)	OFF	M11602+4n

(Note-1): With the exception of positioning control, main cycle processing is executed during the next available time.

(1) [Rq.323] Synchronous encoder axis error reset (M11600+4n)

This command is used to clear the [Md.327] Synchronous encoder axis minor error code (D13250+20n) and [Md.326] Synchronous encoder axis major error code (D13251+20n) of an axis for which the error detection signal has turn on ([St.324] Synchronous encoder axis error detection signal (M10444+10n): ON), and reset the [St.324] Synchronous encoder axis error detection signal (M10444+10n).

- (2) [Rq.320] Synchronous encoder axis control request (M11601+4n)
 When this signal is ON, if a value other than "101 to 132" is set to [Cd.320] Synchronous encoder axis control start condition (D14822+10n), the synchronous encoder axis control starts without any condition.

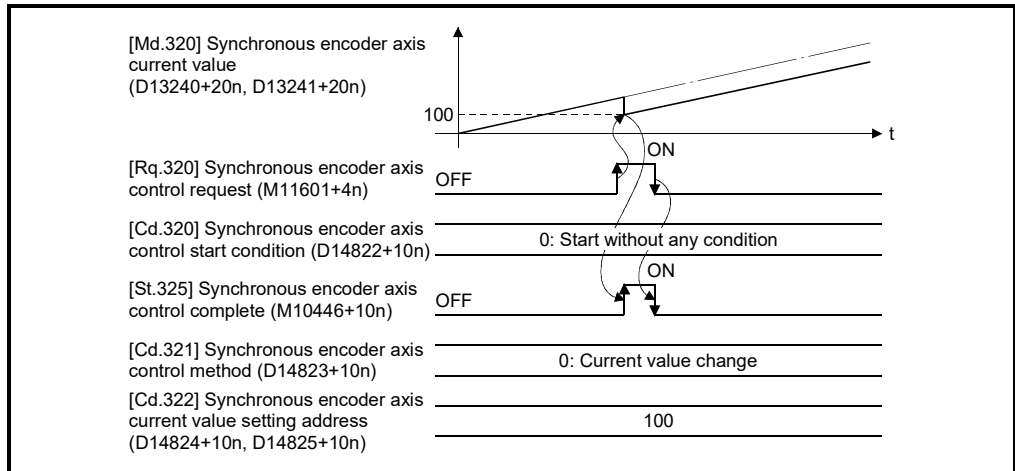

When this signal is ON, if "101 to 132" is set to [Cd.320] Synchronous encoder axis control start condition (D14822+10n), the synchronous encoder axis control starts based on the corresponding high-speed input request signal.

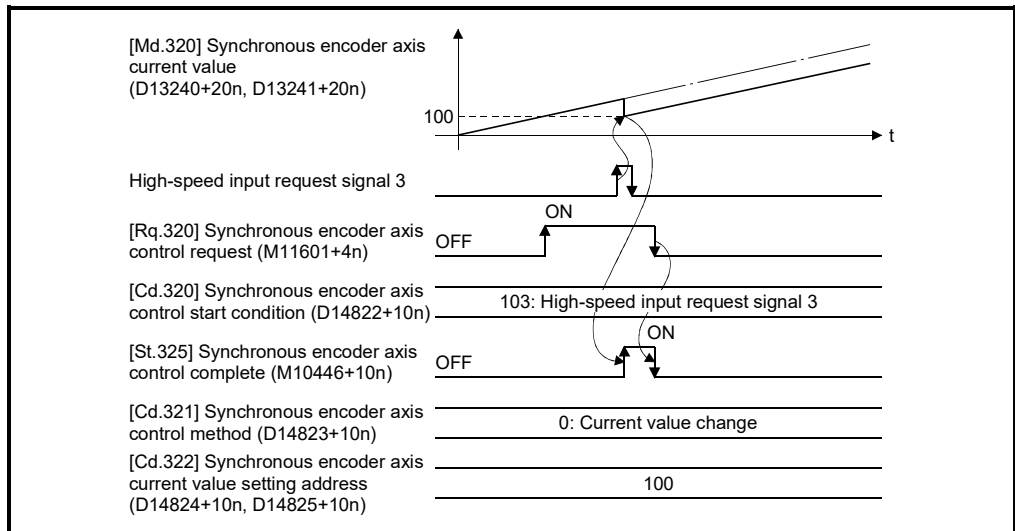

Set the control method for the synchronous encoder axis in [Cd.321] Synchronous encoder axis control method.
 The [St.325] Synchronous encoder axis control complete flag (M10446+10n) turns ON at the after completion of the synchronous encoder axis control.
 When [Rq.320] Synchronous encoder axis control request (M11601+4n) is turned ON to OFF during waiting for the corresponding high-peed input signal accept, the synchronous encoder axis control is cancelled.

(3) [Rq.324] Connection command of synchronous encoder via device/
master CPU (M11602+4n)

Use this data when "201: Via device", "301: Master CPU servo input axis", "401: Master CPU command generation axis", or "501: Master CPU synchronous encoder axis" is set in [Pr.320] Synchronous encoder axis type.

(a) 201: Via device

If device turns ON, the synchronous encoder axis is connected. Once connected, the synchronous encoder current value is restored based on the [Cd.325] Input value for synchronous encoder via device (D14826+10n, D14827+10n).

If device turns OFF, the synchronous encoder axis is disconnected.

(b) 301: Master CPU servo input axis, 401: Master CPU command generation axis, 501: Master CPU synchronous encoder axis

If device turns ON, the synchronous encoder axis is connected, and is counter enable control method.

If device turns OFF, synchronous encoder axis is disconnected.

5 INPUT AXIS MODULE

5.3.5 Synchronous encoder axis monitor data

[Word device]

Symbol	Monitor item	Storage details	Monitor value	Refresh cycle	Device No.
Md.320	Synchronous encoder axis current value	The current value for the synchronous encoder axis is stored.	-2147483648 to 2147483647 [Synchronous encoder axis position units] (Note-1)	Operation cycle	D13240+20n D13241+20n
Md.321	Synchronous encoder axis current value per cycle	The current value per cycle for a synchronous encoder axis is stored.	0 to (Synchronous encoder axis length per cycle-1) [Synchronous encoder axis position units] (Note-1)		D13242+20n D13243+20n
Md.322	Synchronous encoder axis speed	The speed for a synchronous encoder axis is stored.	-2147483648 to 2147483647 [Synchronous encoder axis speed units] (Note-2)		D13244+20n D13245+20n
Md.323	Synchronous encoder axis phase compensation amount	The phase compensation amount is stored.	-2147483648 to 2147483647 [Synchronous encoder axis position units] (Note-1)		D13246+20n D13247+20n
Md.324	Synchronous encoder axis rotation direction restriction amount	While the rotation direction is restricted, the accumulation for the input travel value in the opposite direction of the enable direction is stored.	-2147483648 to 2147483647 [Synchronous encoder axis position units] (Note-1)		D13248+20n D13249+20n
Md.327	Synchronous encoder axis minor error code	The minor error code for the synchronous encoder axis is stored.	Refer to APPENDIX 1.2 for details of minor error code.	Immediate	D13250+20n
Md.326	Synchronous encoder axis major error code	The major error code for the synchronous encoder axis is stored.	Refer to APPENDIX 1.3 for details of major error code.		D13251+20n

(Note-1): Synchronous encoder axis position units (Refer to Section 5.3.1)

(Note-2): Synchronous encoder axis speed units (Refer to Section 5.3.1)

(1) **[Md.320] Synchronous encoder axis current value (D13240+20n, D13241+20n)**

The current value for the synchronous encoder axis is stored in synchronous encoder axis position units (Refer to Section 5.3.1).

The synchronous encoder position for an incremental synchronous encoder is "0" immediately after the Multiple CPU system power supply ON.

(2) **[Md.321] Synchronous encoder axis current value per cycle (D13242+20n, D13243+20n)**

The current value per cycle for a synchronous encoder axis is stored in the range from "0 to ([Pr.324] Synchronous encoder axis length per cycle-1)".

The unit is synchronous encoder axis position units (Refer to Section 5.3.1).

(3) [Md.322] Synchronous encoder axis speed (D13244+20n, D13245+20n)

The speed for a synchronous encoder axis is stored in synchronous encoder axis speed units (Refer to Section 5.3.1).

If the speed for a synchronous encoder axis exceeds the monitor range (Refer to Section 5.3.1), minor error (error code: 882) will occur. In this case, use a smaller number of decimal places for the speed in [Pr.321] Synchronous encoder axis unit setting or set the speed time units to "s".

POINT
Even if an unintended input pulse is input from the synchronous encoder, an error does not occur and the input axis is driven by the input pulse from the synchronous encoder. In this case, check the input pulse from the synchronous encoder with [Md.322] Synchronous encoder axis speed (D13244+20n, D13245+20n).

(4) [Md.323] Synchronous encoder axis phase compensation amount (D13246+20n, D13247+20n)

The phase compensation amount for a synchronous encoder axis is stored in the synchronous encoder axis position units (Refer to Section 5.3.1).

The phase compensation amount for a synchronous encoder axis is the value after smoothing processing and phase compensation processing.

(5) [Md.324] Synchronous encoder axis rotation direction restriction amount (D13248+20n, D13249+20n)

While the rotation direction is restricted for a synchronous encoder axis, the accumulation for input travel in the opposite direction of the enabled direction is stored in synchronous encoder axis position units (Refer to Section 5.3.1) as follows.

Setting value of "[Pr.328] Synchronous encoder axis rotation direction restriction"	Storage details
1: Enable only for current value increase direction	A negative accumulation is stored during rotation direction restriction. 0 is stored if there is no restriction.
2: Enable only for current value decrease direction	A positive accumulation is stored during rotation direction restriction. 0 is stored if there is no restriction.

Rotation direction restriction is processed after phase compensation processing. Therefore, if undershoot occurs from phase compensation during deceleration stop, the rotation direction restriction amount might remain.

- (6) [Md.327] Synchronous encoder axis minor error code (D13250+20n)
- (a) This register stores the corresponding error code (Refer to APPENDIX 1.2.) at the minor error occurrence of synchronous encoder axis. If another minor error occurs after error code storing, the previous error code is overwritten by the new error code.
 - (b) Minor error codes can be cleared by an [Rq.323] Synchronous encoder axis error reset (M11600+4n).
- (7) [Md.326] Synchronous encoder axis major error code (D13251+20n)
- (a) This register stores the corresponding error code (Refer to APPENDIX 1.3.) at the major error occurrence of synchronous encoder axis. If another major error occurs after error code storing, the previous error code is overwritten by the new error code.
 - (b) Major error codes can be cleared by an [Rq.323] Synchronous encoder axis error reset (M11600+4n).

5 INPUT AXIS MODULE

[Bit device]

Symbol	Monitor item	Storage details	Monitor value	Refresh cycle	Device No.
St.320	Synchronous encoder axis setting valid flag	This flag turns ON when the setting of the synchronous encoder axis is valid.	ON : Setting valid OFF : Setting invalid	At power ON	M10440+10n
St.321	Synchronous encoder axis connecting valid flag	This flag turns ON when the synchronous encoder axis connection is valid.	ON : Connection valid OFF : Connection invalid	Operation cycle	M10441+10n
St.322	Synchronous encoder axis counter enable flag	This flag turns ON when input from the synchronous encoder is enabled.	ON : Counter enable OFF : Counter disable		M10442+10n
St.323	Synchronous encoder axis current value setting request flag	This flag turns ON when the current value of synchronous encoder axis is not set.	ON : Current value setting request OFF : Current value setting not requested		M10443+10n
St.324	Synchronous encoder axis error detection flag	This flag turns ON when an error occurs for the synchronous encoder axis.	ON : Error occurred OFF : No error	Immediate	M10444+10n
St.325	Synchronous encoder axis control complete flag	This flag turns ON at the completion of synchronous encoder axis control.	ON : Control completed OFF : Control not completed		M10446+10n

- (1) [St.320] Synchronous encoder axis setting valid flag (M10440+10n)
At Multiple CPU system power supply ON, this flag turns ON when the setting of the synchronous encoder axis is valid.
It is turned OFF when the setting is invalid.
- (2) [St.321] Synchronous encoder axis connecting valid flag (M10441+10n)
At Multiple CPU system's power supply ON, this flag turns ON when the synchronous encoder connection is valid. This flag turns OFF when the connection is invalid.
When setting an incremental synchronous encoder, this flag turns ON simultaneously the Multiple CPU system power supply turns ON regardless of the actual encoder connection.
- (3) [St.322] Synchronous encoder axis counter enable flag (M10442+10n)
This flag turns ON when input from the synchronous encoder is enabled.
If the counter disable control is executed, it is turned OFF, and input from the synchronous encoder becomes invalid.
If the counter enable control is executed, it is turned ON, and input from the synchronous encoder becomes valid.
Just after the synchronous encoder is valid to connect, the status is ON (enable).

(4) [St.323] Synchronous encoder axis current value setting request flag (M10443+10n)

This flag turns ON, when a synchronous encoder axis current value change is never executed or when the synchronous encoder current value is lost by the battery error, etc. in the serial absolute synchronous encoder.

If the current value setting request flag is ON for the synchronous encoder connection, the synchronous encoder axis current value starts counting with 0. This flag turns OFF when a synchronous encoder axis current value change is executed.

POINT

For a system that needs alignment of synchronous encoder, confirm that [St.323] Synchronous encoder axis current value setting request flag (M10443+10n) is OFF.

(5) [St.324] Synchronous encoder axis error detection flag (M10444+10n)

(a) This signal turns ON with detection of a minor error or major error of synchronous encoder axis, and can be used to judge if there is an error or not.

The applicable error code ^(Note-1) is stored in the [Md.327] Synchronous encoder axis minor error code (M13250+20n) with detection of a minor error. The applicable error code ^(Note-1) is stored in the [Md.326] Synchronous encoder axis major error code (M13251+20n) with detection of a major error.

(b) This signal turns off when the [Rq.323] Synchronous encoder axis error reset (M11600+4n) turns on.

REMARK

(Note-1): Refer to APPENDIX 1 for the error codes with detection of major/minor errors.

(6) [St.325] Synchronous encoder axis control complete flag (M10446+10n)

This flag turns ON at the completion of synchronous encoder axis control.

This flag turns OFF when [Rq.320] Synchronous encoder axis control request (M11601+4n) is turned ON to OFF.

6. CAM FUNCTION

6.1 Control Details for Cam Function

The output axis for synchronous control is operated with a cam.

The following operations can be performed with cam functions.

- Two-way operation : Reciprocating operation with a constant cam strokes range.
- Feed operation : Cam reference position is updated every cycle.
- Linear operation : Linear operation (cam No.0) in the cycle as the stroke ratio is 100%.

The output axis is controlled by a value (current feed value), which is converted from the input value (cam axis current value per cycle) by cam data.

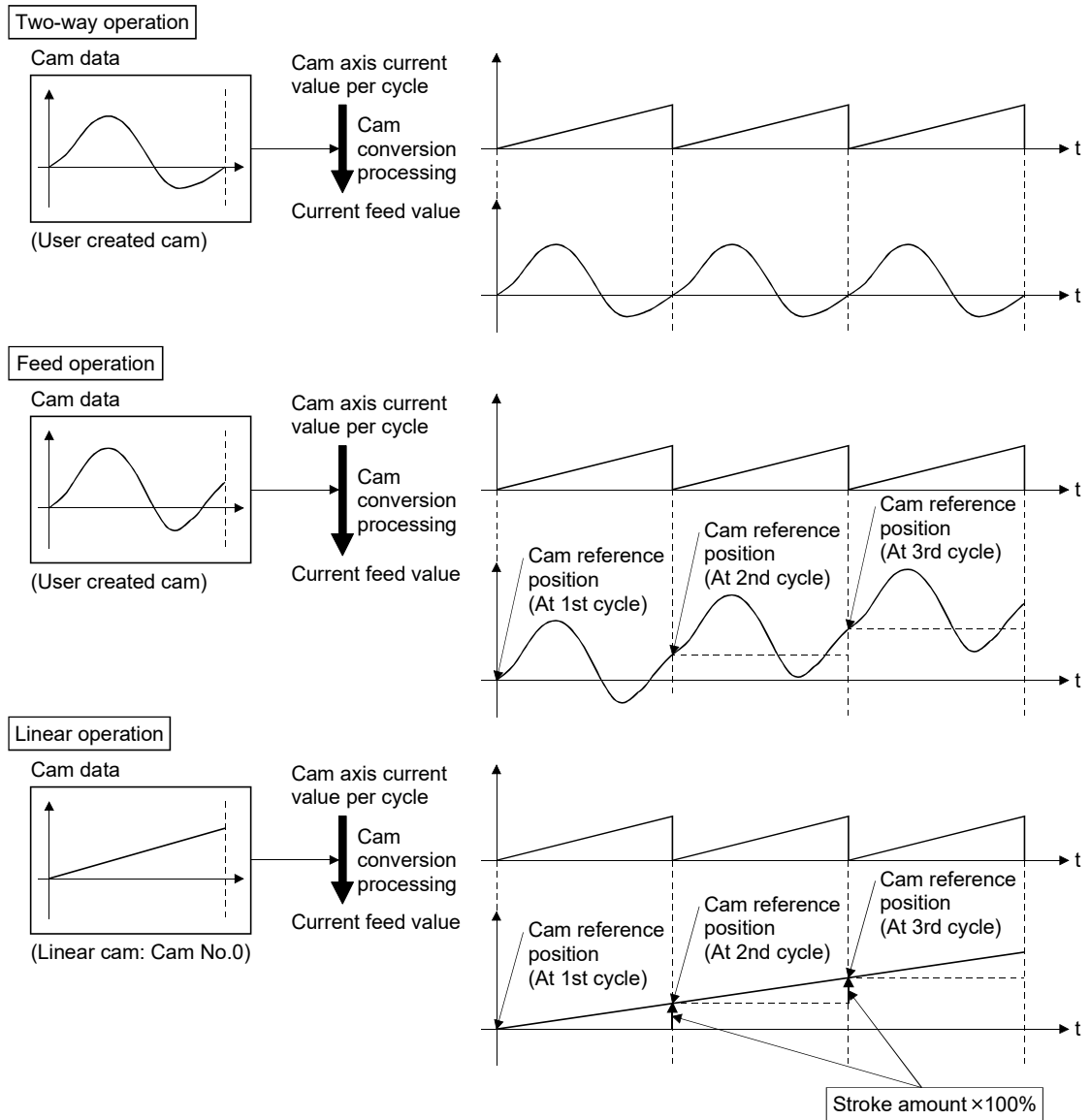

6 CAM FUNCTION

6.1.1 Type of cam data

The cam data methods used in the cam function are linear cam, stroke ratio data format, coordinate data format, and auto-generation data format. Cam data is arranged in the "Cam storage area" and "Cam open area".

Refer to Section 6.2.1 for details of each area.

The following describes each type of cam data.

(1) Linear cam control

When "0" is set for [Pr.440] Cam No. (D15062+150n), the cam data operates as a straight line with a 100% stroke ratio at the last point.

Linear cam data does not consume the cam open area.

Also, linear cam data cannot be read/written as storage data.

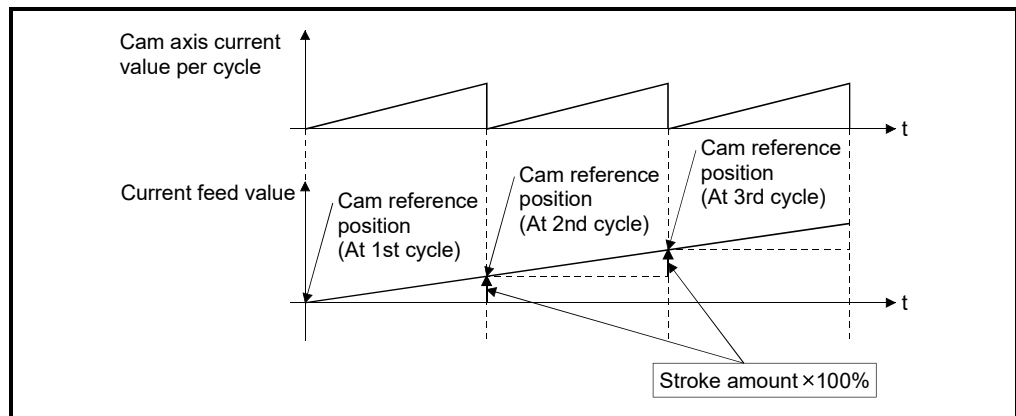

(2) Stroke ratio data format

The stroke ratio data format is defined in equal divisions for one cam cycle based on the cam resolution, and configured with stroke ratio data from points within the cam resolution.

Refer to Section 6.2 for setting methods for cam data.

Setting item	Setting details	Setting range	Default value (MT Developer2)
Cam No.	Set the cam No.	1 to 256: User created cam	1
Cam resolution	Set the number of divisions for one cam cycle.	256/512/1024/2048/4096/8192/ 16384/32768	256
Cam data starting point	Set the cam data point corresponding to "Cam axis current value per cycle = 0".	0 to (Cam resolution - 1)	0
Stroke ratio data	Set the stroke ratio from the 1st to the last point. (The 0th point setting is not required. It is always 0%.)	-2147483648 to 2147483647 [$\times 10^{-7}\%$] (Note-1) (-214.7483648 to 214.7483647%)	0

(Note-1): For setting the stroke ratio out of range $\pm 100\%$ with MT Developer2, check the "Display Advanced Cam Graph Stroke" by selecting the [Cam Data] on the options screen displayed by the menu bar [Tools] - [Options].

Example) Cam resolution: 512

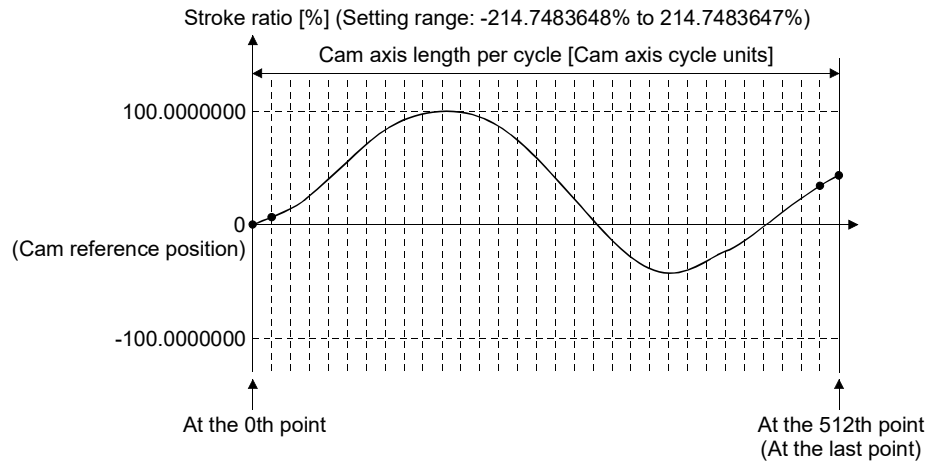

(3) Coordinate data format

The coordinate data format is defined in coordinates of more than 2 points for one cam cycle. The coordinate data is represented as Input value and output value.

- Input value : Cam axis current value per cycle.
- Output value : Stroke position from cam reference position.

With this format, [Pr.441] Cam stroke amount (D15064+150n, D15065+150n) of output axis parameter is ignored and output value of the coordinate data becomes cam stroke position.

Refer to Section 6.2 for setting methods of cam data.

Setting item	Setting details	Setting range	Default value (MT Developer2)
Cam No.	Set the cam No.	1 to 256: User created cam	1
Coordinate number	Set the number of coordinate points in one cam cycle. The coordinates are included at the 0th point.	2 to 16384	2
Cam data starting point	Setting is not required with coordinate data format.	—	—
Coordinate data	Set all coordinate data (input value: X_n , output value: Y_n). Required to set the coordinate data (X_0, Y_0) from the 0th point. The input value should be larger than the previous coordinate data ($X_n < X_{n+1}$).	Input value: 0 to 2147483647 [Cam axis cycle units] Output value: -2147483648 to 2147483647 [Output axis position units]	0

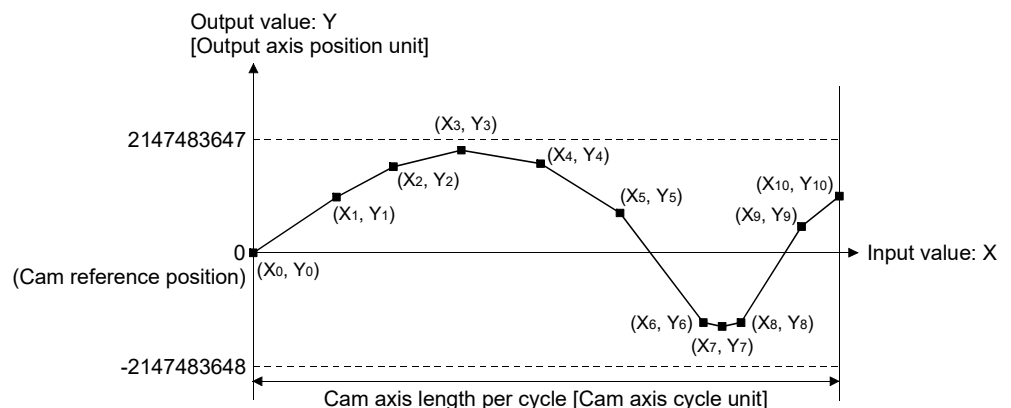

When the coordinate data corresponding to an input value that is 0 or when the cam axis length per cycle setting does not exist, the coordinate is calculated from the line segment between the nearest two coordinates.

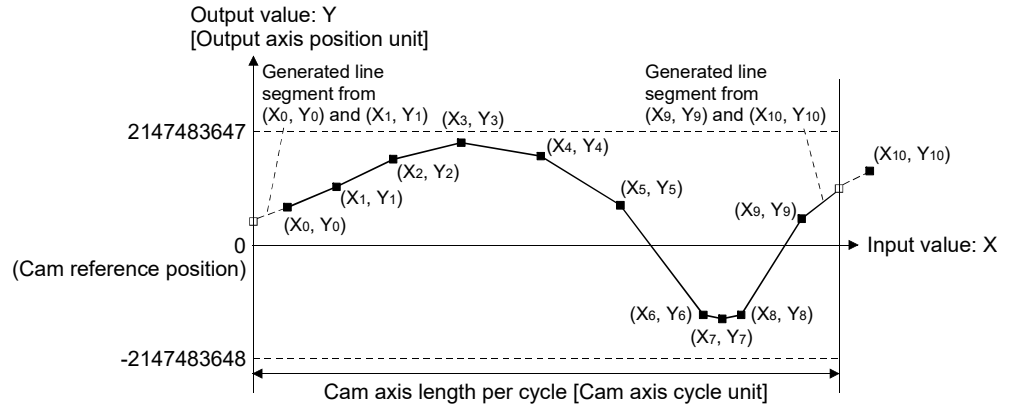

(4) Auto-generation data format

A cam pattern is created using the CAMMK instruction of Motion SFC program based on the specified parameter (data for auto-generation). Control cam data is created in the stroke ratio data format in the cam open area. Therefore, the operation during the control conforms to the cam operation in the stroke ratio data format.

The types of cam patterns for auto-generation data format are as follows.

Auto-generation type	Details
Cam for rotary cutter	Set the auto-generation data, including the sheet length and the synchronization width of the cam data for rotary cutter.
Easy stroke ratio cam	Without using the MT Developer2 cam data, automatically generate cam data by setting the sections and the stroke amounts. Setting of the detailed coefficients of the cam curve is omitted. A cam pattern is created using a limited number of curves and sections.

⚠ CAUTION

- If the cam data is set incorrectly, such as simply setting a target value and command speed similar to positioning control, the position and speed command to the servo amplifier increases, and may cause machine interface and servo errors such as "Overspeed" (error code: 2031) or "Command frequency error" (error code: 2035). When creating and changing cam data, execute a trial operation and provide the appropriate adjustments. Refer to "Safety precautions" for precautions on trial operations and adjustments.

6.1.2 Overview of cam operation

(1) Current feed value of cam axis

The current feed value is calculated as shown below.

(a) Stroke ratio data format

$$\text{Current feed value} = \text{Cam reference position} + \left(\text{Cam stroke amount} \times \text{Stroke ratio corresponding to cam axis current value per cycle} \right)$$

(b) Coordinate data format

$$\text{Current feed value} = \text{Cam reference position} + \text{Output value corresponding to cam axis current value per cycle}$$

When the cam axis current value per cycle is within the defined cam data (Stroke ratio data/Coordinate data), the value is calculated from the nearest cam data.

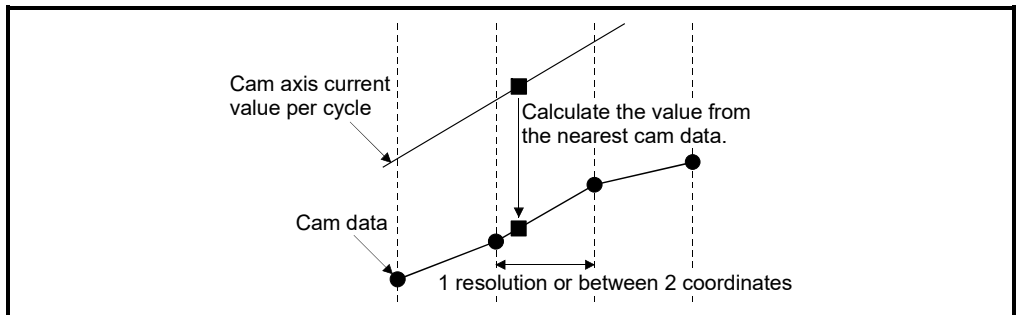

(2) Cam reference position

The cam reference position is calculated as shown below.

(a) Stroke ratio data format

$$\text{Cam reference position} = \text{The preceding cam reference position} + \left(\text{Cam stroke amount} \times \text{Stroke ratio at the last point} \right)$$

(b) Coordinate data format

$$\text{Cam reference position} = \text{The preceding cam reference position} + \left(\begin{array}{l} \text{Output value} \\ \text{corresponding to "Input} \\ \text{value = Cam axis} \\ \text{length per cycle"} \end{array} \right) - \left(\begin{array}{l} \text{Output value} \\ \text{corresponding to} \\ \text{"Input value = 0"} \end{array} \right)$$

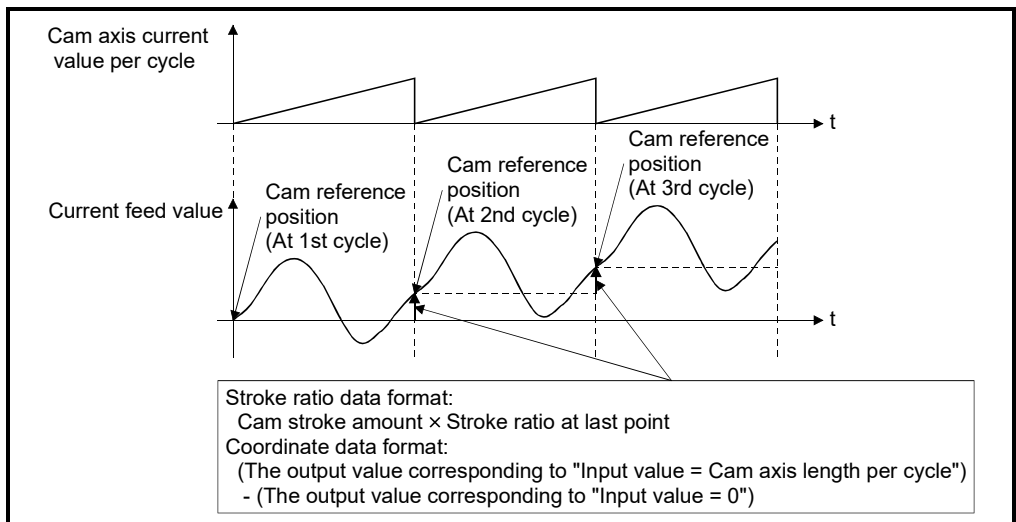

Create cam data for two-way cam operation as shown below.

(a) Stroke ratio data format

Create cam data so that the stroke ratio is 0% at the last point.

(b) Coordinate data format

Create cam data with the same output value for the point where the input value is 0 and the input value is equal to the cam axis length per cycle.

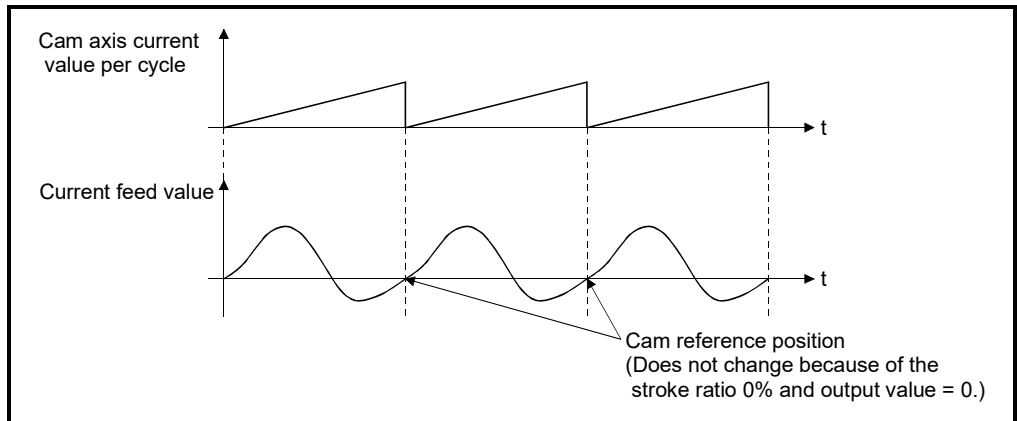

(3) Cam data starting point

This setting is only valid for cam data using the stroke ratio data format.

The cam data point corresponding to "Cam axis current value per cycle = 0" can be set as the cam data starting point.

The default value of the cam data starting point is 0. (The cam axis is controlled with cam data starting from the 0th point (stroke ratio 0%).)

When a value other than 0 is set for the cam data starting point, cam control is started from the point where the stroke ratio is not 0%.

The cam data starting point is set for each cam data. The setting range is from 0 to (cam resolution - 1).

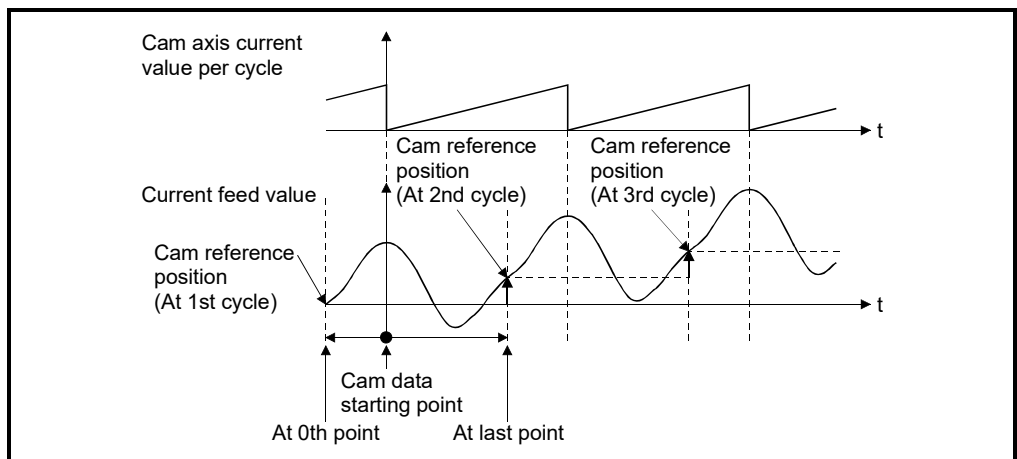

(4) Timing of applying cam control data

(a) Stroke ratio data format

If any one of [Pr.439] Cam axis length per cycle (D15060+150n, D15061+150n), [Pr.440] Cam No. (D15062+150n), or [Pr.441] Cam stroke amount (D15064+150n, D15065+150n) is changed during synchronous control, the new value is accepted and applied when the cam axis current value per cycle passes through the 0th point of cam data, or is on the 0th point.

The cam reference position is updated when the cam axis current value per cycle passes through the 0th point of cam data.

(b) Coordinate data format

If [Pr.439] Cam axis length per cycle (D15060+150n, D15061+150n) or [Pr.440] Cam No. (D15062+150n) is changed during synchronous control, the new value is accepted and applied when the cam axis current value per cycle passes through 0, or is on 0.

The cam reference position is updated when the cam axis current value per cycle passes through 0.

6 CAM FUNCTION

6.2 Create Cam Data

6.2.1 Memory configuration of cam data

Cam data is arranged in the following 2 areas.

Memory configuration	Storage item	Details	Remark
Cam storage area	Cam data	Data is written by the following operations. <ul style="list-style-type: none"> • Write with MT Developer2 • When executing cam data write (CAMWR instruction) of Motion SFC program. 	<ul style="list-style-type: none"> • Data is preserved even when turning the Multiple CPU system power supply OFF.
	Cam auto-generation data	Data is written when the cam auto-generation function (CAMMK instruction) of Motion SFC program is executed.	
Cam open area	Cam data	<ul style="list-style-type: none"> • Cam data is transmitted from the cam storage area, when turning the Multiple CPU system power supply ON, writing to the cam storage area, or turning the PLC ready flag (M2000) OFF to ON. • Writing to the cam open area is possible through the cam data operation function (CAMWR instruction). • Cam data that is generated by the cam auto-generation function (CAMMK instruction) is stored. 	<ul style="list-style-type: none"> • Data is lost when turning the Multiple CPU system power supply OFF. • The cam data that is used in cam control is stored.

Previously written cam data can be used after turning the Multiple CPU system power supply OFF by writing data in the cam storage area. Cam data should be written in the cam storage area for normal use.

It is possible to write the cam data to the cam open area via the device specified by Motion SFC program when registering cam data that exceeds the memory capacity in the cam storage area, etc.

Writing must be executed to the cam open area due to transmitting from the cam storage area when turning the Multiple CPU system power supply ON again, updating the cam storage area, or turning the PLC ready flag (M2000) OFF to ON.

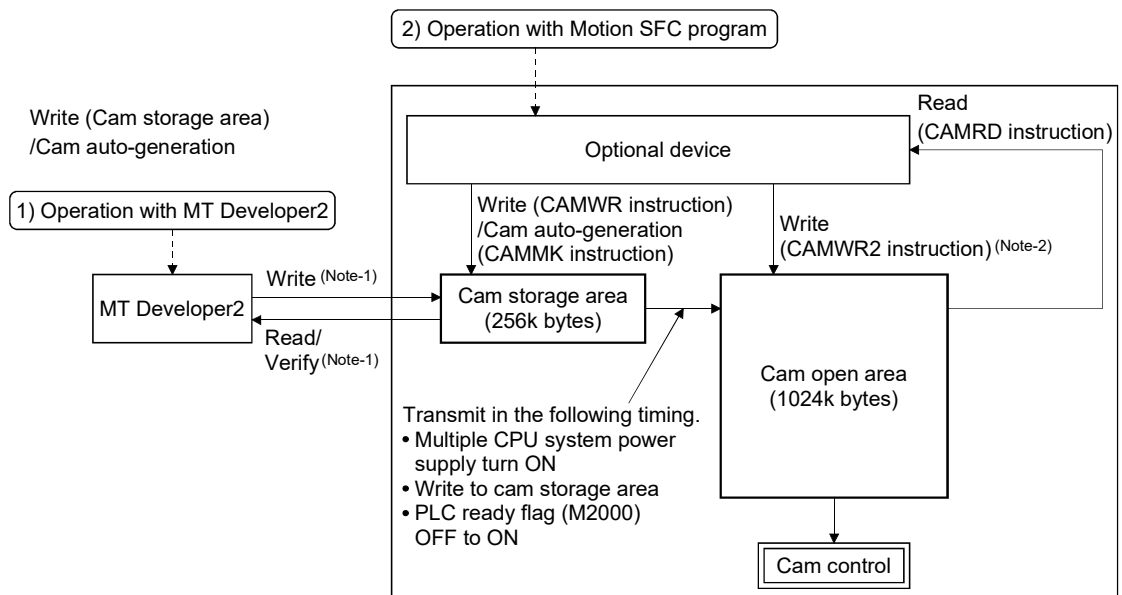

(Note-1): Write/read/verify from MT Developer2 is executed toward cam storage area.

(Note-2): The directly writing in cam open area is not transmitted to cam storage area. The data in cam open area will be returned as cam storage area such as the Multiple CPU system power supply ON again.

(1) Cam data operation with MT Developer2

Cam data can be modified while viewing the waveform with MT Developer2.

The cam data is written/read/verified to the cam storage area with

MT Developer2, however it cannot be executed to the cam open area.

The waveform generated by the cam auto-generation function can be confirmed on the "Cam graph" of the "Cam data window" through reading with MT Developer2.

(2) Cam data operation with Motion SFC program

Cam data read/write operation, cam auto-generation and cam position calculation can be executed with the Motion SFC program. (Refer to Section 6.2.2)

(3) Cam data capacity

The size of the created cam data is shown below for the cam storage area/cam open area.

Operation method	Data method/ Auto-generation type	Cam storage area (262144 bytes)	Cam open area (1048576 bytes)
Create with MT Developer2	Stroke ratio data format	Cam resolution × 4 bytes	Cam resolution × 4 bytes
	Coordinate data format	Coordinate number × 8 bytes	Coordinate number × 8 bytes
Create in cam storage area with Motion SFC program (CAMWR instruction)	Stroke ratio data format	Cam resolution × 4 bytes	Cam resolution × 4 bytes
	Coordinate data format	Coordinate number × 8 bytes	Coordinate number × 8 bytes
Create in cam open area with Motion SFC program (CAMWR2 instruction)	Stroke ratio data format	0 byte	Cam resolution × 4 bytes
	Coordinate data format		Coordinate number × 8 bytes
Create with cam auto- generation in Motion SFC program (CAMMK instruction)	For a rotary cutter	36 bytes	Cam resolution × 4 bytes
	Easy stroke ratio cam 	Number of sections × 12 + 20 bytes (Up to 404 bytes)	

When writing with the Motion SFC program or when the cam auto-generation function is executed, the writing area free capacity size may decrease since the size changes depending on the cam resolution change, etc. In this case, write the cam data with MT Developer2 or delete them once.

(4) Delete method of cam data

Write the empty data in the cam storage area with MT Developer2 to delete only cam data.

: Refer to Section 1.4 for the software version that supports this function.

(5) Password protection for cam data

The cam data can be protected as shown below by password setting.

Registration condition	Cam data operation with MT Developer2	Cam data operation with Motion SFC program
Write protection	Cam data cannot be written without unlocking the password.	Writing cam data and cam data auto- generation is not operated.
Read/write protection	Cam data cannot be read/written without unlocking the password.	Reading/writing cam data and generating cam data auto-generation is not operated.

Refer to the "Q173D(S)CPU/Q172D(S)CPU Motion controller Programming Manual (COMMON)" for details of the password protection.

6 CAM FUNCTION

6.2.2 Cam data operation by Motion SFC program

Cam data read/write operation and cam auto-generation can be executed with the synchronous control dedicated function of Motion SFC program.

Refer to the "Q173D(S)CPU/Q172D(S)CPU Motion controller (SV13/SV22) Programming Manual (Motion SFC)" for details.

Classification	Symbol	Instruction	Description
Synchronous control dedicated function	CAMRD	Cam data read	This is used to read cam data. The upper amount of data for each operation is 4096 points (2 words are used per point.) with the stroke ratio data format, and 2048 points (4 words are used per point.) with the coordinate data format. If the read is not completed in one time, the operation should be separated in multiple times.
	CAMWR	Cam data write	This is used to write cam data. The upper amount of data for each operation is 4096 points (2 words are used per point.) with the stroke ratio data format, and 2048 points (4 words are used per point.) with the coordinate data format. If the write is not completed in one time, the operation should be separated in multiple times.
	CAMWR2	Cam data write (Cam open area)	This is used to write cam data to cam open area. The upper amount of data for each operation is 4096 points (2 words are used per point.) with the stroke ratio data format, and 2048 points (4 words are used per point.) with the coordinate data format. If the write is not completed in one time, the operation should be separated in multiple times.
	CAMMK	Cam auto-generation function	This function is used to automatically generate cam data for specific purposes by setting data for auto-generation. Data for auto-generation is stored in the cam storage area, and the cam data generated by the cam auto-generation function is generated in the cam open area. It is possible to generate up to 1Mbyte including the regular cam data. (Example): 256 cam data (with the stroke ratio format, resolution is 1024) can be automatically generated.

7. SYNCHRONOUS CONTROL

7.1 Main Shaft Module

7.1.1 Overview of main shaft module

For the main shaft module, the input value is generated as a composite value from two input axes (the main and sub input axis) through the composite main shaft gear. The composite input value can be converted by the main shaft gear that provides the deceleration ratio and the rotation direction for the machine system, etc.

Refer to Section 7.1.2 and Section 7.1.3 for details on setting for the main shaft module.

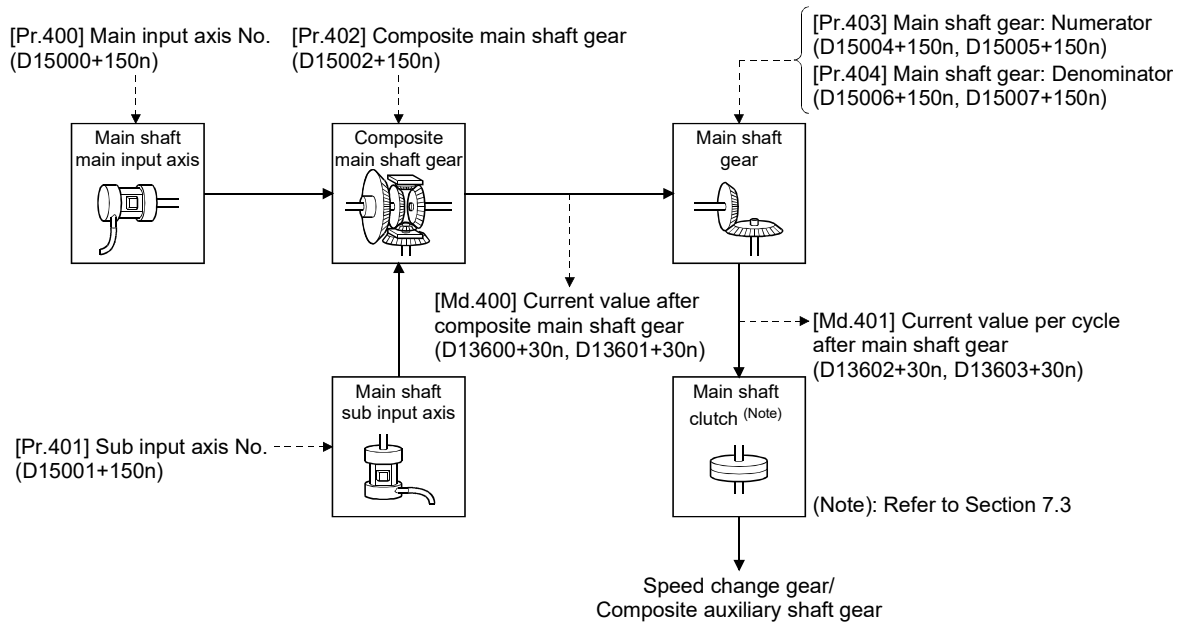

7 SYNCHRONOUS CONTROL

7.1.2 Main shaft parameters

Symbol	Setting item	Setting details	Setting value	Fetch cycle	Default value	Device No.
Pr.400	Main input axis No.	Set the input axis No. on the main input side for the main shaft.	0 : Invalid 1 to 32 : Servo input axis (Note-1) 201 to 232 : Command generation axis (Note-2) 801 to 812 : Synchronous encoder axis	At start of synchronous control	0	D15000+150n
Pr.401	Sub input axis No.	Set the input axis No. on the sub input side for the main shaft.	0 : Invalid 1 to 32 : Servo input axis (Note-1) 201 to 232 : Command generation axis (Note-2) 801 to 812 : Synchronous encoder axis			
Pr.402	Composite main shaft gear	Select the composite method for input values from the main input axis and sub input axis.	<ul style="list-style-type: none"> • Set in hexadecimal. H□□□□ <li style="margin-left: 20px;">└─ Main input method <li style="margin-left: 40px;">0: No input <li style="margin-left: 40px;">1: Input + <li style="margin-left: 40px;">2: Input - <li style="margin-left: 20px;">└─ Sub input method <li style="margin-left: 40px;">0: No input <li style="margin-left: 40px;">1: Input + <li style="margin-left: 40px;">2: Input - 	Operation cycle	0001h	D15002+150n
Pr.403	Main shaft gear: Numerator	Set the numerator for the main shaft gear.	-2147483648 to 2147483647	At start of synchronous control	1	D15004+150n D15005+150n
Pr.404	Main shaft gear: Denominator	Set the denominator for the main shaft gear.	1 to 2147483647		1	D15006+150n D15007+150n

(Note-1): The range from 1 to 16 is valid in the Q172DSCPU.

(Note-2): The range from 201 to 216 is valid in the Q172DSCPU.

(1) [Pr.400] Main input axis No. (D15000+150n), [Pr.401] Sub input axis No. (D15001+150n)

Set the main input axis No. and the sub input axis No. for the main shaft.

- 0 : InvalidThe input value is always 0.
- 1 to 32 : Servo input axis.....Set the servo input axis (axis 1 to 32). When the servo input axis is not set in the system setting, the input value is always 0.
If the number is set to the same value as the output axis, the major error (error code: 1700, 1701) occurs and synchronous control cannot be started.
(Note): The range from 1 to 16 is valid in the Q172DSCPU.
- 201 to 232 : Command generation axis.....Set the command generation axis (axis 1 to 32). When the command generation axis is invalid in the command generation axis parameter setting, the input value is always 0.
As the command generation axis is used only for command generation, it is possible to set the same number as the output axis.
(Note): The range from 201 to 216 is valid in the Q172DSCPU.
- 801 to 812 : Synchronous encoder axisSet the synchronous encoder axis (axis 1 to 12). When synchronous encoder axis is invalid, the input value is always 0.

(2) [Pr.402] Composite main shaft gear (D15002+150n)

Set the composite method for input values from the main and sub input axes.

The setting values for each axis are shown as follows.

- 0: No input..... The input value from the input axis is calculated as 0.
- 1: Input+ The input value from the input axis is calculated as it is.
- 2: Input- The input value from the input axis is calculated with its opposite sign.

Operation assumes "0: No input" if the value is set out of the range from 0 to 2.

POINT	
The composite method for the composite main shaft gear can be changed during synchronous control. It is used as a clutch to switch input values between the main and the sub input axes.	

- (3) [Pr.403] Main shaft gear: Numerator (D15004+150n, D15005+150n), [Pr.404] Main shaft gear: Denominator (D15006+150n, D15007+150n)

Set the numerator and the denominator for the main shaft gear to convert the input value. The input value is converted as follows.

$$\text{Input value after conversion} = \text{Input value before conversion} \times \frac{\text{Main shaft gear: Numerator}}{\text{Main shaft gear: Denominator}}$$

The input value direction can be reversed by setting a negative value in the numerator of the main shaft gear.

Set the denominator of the main shaft gear to a value within the range from 1 to 2147483647.

Example) Convert the cam axis per cycle to be controlled in intervals of 0.1[mm] (0.00394[inch]).

The cam axis synchronizes with a conveyer that moves 100[mm] (3.937[inch]) for every (360.00000[degree]) of the main shaft.

Main shaft gear: Numerator : 1000[× 0.1mm]

Main shaft gear: Denominator: 36000000[× 10⁻⁵degree]

7 SYNCHRONOUS CONTROL

7.1.3 Main shaft clutch parameters

Symbol	Setting item	Setting details	Setting value	Fetch cycle	Default value	Device No.
Pr.405	Main shaft clutch control setting	Set the control method for the clutch.	<p>• Set in hexadecimal. H□□□□</p> <ul style="list-style-type: none"> → ON control mode <ul style="list-style-type: none"> 0: No clutch 1: Clutch command ON/OFF 2: Clutch command leading edge 3: Clutch command trailing edge 4: Address mode 5: High speed input request → OFF control mode <ul style="list-style-type: none"> 0: OFF control invalid 1: One-shot OFF 2: Clutch command leading edge 3: Clutch command trailing edge 4: Address mode 5: High speed input request → High speed input request signal <ul style="list-style-type: none"> 00 to 1F: High speed input request signal from signal 1 to 32 	Operation cycle	0000h	D15008+150n
Pr.406	Main shaft clutch reference address setting	Set the reference address for the clutch.	<ul style="list-style-type: none"> 0: Current value after composite main shaft gear 1: Current value per cycle after main shaft gear 	At start of synchronous control	0	D15009+150n
Pr.407	Main shaft clutch ON address	<ul style="list-style-type: none"> • Set the clutch ON address for address mode. (This setting is invalid except during address mode.) • If the address is out of the range from 0 to (Cam axis length per cycle - 1), the address is converted to a value within range. 	-2147483648 to 2147483647 [Main input axis position units ^(Note-1) , or cam axis cycle units ^(Note-2)]	Operation cycle	0	D15010+150n D15011+150n
Pr.408	Travel value before main shaft clutch ON	<ul style="list-style-type: none"> • Set the travel value for the distance between the clutch ON condition completing and the clutch closing. • Set a positive value when the reference address is increasing, and a negative value when it is decreasing. 	-2147483648 to 2147483647 [Main input axis position units ^(Note-1) , or cam axis cycle units ^(Note-2)]	At completing clutch ON condition	0	D15012+150n D15013+150n

(Note-1): Main input axis position units (Refer to Chapter 5)

(Note-2): Cam axis cycle units (Refer to Section 7.5.1)

7 SYNCHRONOUS CONTROL

Symbol	Setting item	Setting details	Setting value	Fetch cycle	Default value	Device No.
Pr.409	Main shaft clutch OFF address	<ul style="list-style-type: none"> Set the clutch OFF address for the address mode. (This setting is invalid except during address mode.) If the address is out of the range from 0 to (Cam axis length per cycle - 1), the setting address is converted to a value within range. 	-2147483648 to 2147483647 [Main input axis position units ^(Note-1) , or cam axis cycle units ^(Note-2)]	Operation cycle	0	D15014+150n D15015+150n
Pr.410	Travel value before main shaft clutch OFF	<ul style="list-style-type: none"> Set the travel value for the distance between the clutch OFF condition completing and the clutch opening. Set a positive value when the reference address is increasing, and a negative value when it is decreasing. 	-2147483648 to 2147483647 [Main input axis position units ^(Note-1) , or cam axis cycle units ^(Note-2)]	At completing clutch OFF condition	0	D15016+150n D15017+150n
Pr.411	Main shaft clutch smoothing method	Set the clutch smoothing method.	0: Direct 1: Time constant method (Exponent) 2: Time constant method (Linear) 3: Slippage method (Exponent) 4: Slippage method (Linear)	At start of synchronous control	0	D15018+150n
Pr.412	Main shaft clutch smoothing time constant	For smoothing with a time constant method, set the smoothing time constant.	0 to 5000 [ms]		0 [ms]	D15019+150n
Pr.413	Slippage amount at main shaft clutch ON	For smoothing with a slippage method, set the slippage amount at clutch ON.	0 to 2147483647 [Main input axis position units ^(Note-1) , or cam axis cycle units ^(Note-2)]	At turning clutch ON	0	D15020+150n D15021+150n
Pr.414	Slippage amount at main shaft clutch OFF	For smoothing with a slippage method, set the slippage amount at clutch OFF.	0 to 2147483647 [Main input axis position units ^(Note-1) , or cam axis cycle units ^(Note-2)]	At turning clutch OFF	0	D15022+150n D15023+150n

(Note-1): Main input axis position units (Refer to Chapter 5)

(Note-2): Cam axis cycle units (Refer to Section 7.5.1)

(1) [Pr.405] Main shaft clutch control setting (D15008+150n)

Set the ON and OFF control methods separately for the main shaft clutch.

The clutch control setting can be changed during synchronous control, however, the setting "No clutch" (Direct coupled operation) cannot be selected during synchronous control after already selecting another setting.

Refer to Section 7.3.2 for details on the clutch control.

(a) ON control mode

- 0: No clutch Execute direct coupled operation (Direct coupled operation) without clutch control.
- 1: Clutch command ON/OFF The clutch is turned ON/OFF by the operation of [Rq.400] Main shaft clutch command (M11680+10n) ON/OFF. (Setting in the OFF control mode are not applicable in the clutch command ON/OFF mode.)
- 2: Clutch command leading edge ... The clutch is turned ON when [Rq.400] Main shaft clutch command (M11680+10n) passes the leading edge (from OFF to ON).
- 3: Clutch command trailing edge..... The clutch is turned ON when [Rq.400] Main shaft clutch command (M11680+10n) passes the trailing edge (from ON to OFF).
- 4: Address mode..... The clutch is turned ON when the reference address (the current value after composite main shaft gear or the current value per cycle after main shaft gear) reaches [Pr.407] Main shaft clutch ON address (D15010+150n, D15011+150n).
The travel value after passing through the ON address is calculated as the output travel value of the clutch based on the reference address passing through, thereby controlling the clutch with an accurate travel value.
- 5: High speed input request The clutch is turned ON when the high speed input request (DI/DOG/TREN) turns ON.

POINT
Other clutch parameters are not applicable during direct coupled operation by setting "0: No clutch". [Rq.402] Main shaft clutch forced OFF command (M11682+10n) and the change of the clutch control setting are ignored during direct coupled operation.

- (b) OFF control mode
- 0: OFF control invalid..... Clutch OFF control is not used. This setting is applicable only for execution with clutch ON control.
 - 1: One-shot OFF The clutch is turned OFF after moving the distance [Pr.410] Travel value before main shaft clutch OFF (D15016+150n, D15107+150n) (One-shot operation) after the clutch command turns ON.
If [Pr.410] Travel value before main shaft clutch OFF(D15016+150n, D15107+150n) is 0, [St.420] Main shaft clutch ON/OFF status (M10560+10n) does not turn ON in order to turn back OFF immediately.
 - 2: Clutch command leading edge ... The clutch is turned OFF when [Rq.400] Main shaft clutch command (M11680+10n) passes the leading edge (from OFF to ON).
 - 3: Clutch command trailing edge..... The clutch is turned OFF when [Rq.400] Main shaft clutch command (M11680+10n) passes the trailing edge (from ON to OFF).
 - 4: Address mode..... The clutch is turned OFF when the reference address (the current value after composite main shaft gear or the current value per cycle after main shaft gear) reaches [Pr.409] Main shaft clutch OFF address (D15014+150n, D15015+150n).
The travel value before passing through the OFF address is calculated as the output travel value of the clutch based on the reference address passing through, thereby controlling the clutch with an accurate travel value.
 - 5: High speed input request The clutch is turned OFF when the high speed input request (DI/DOG/TREN) turns ON.

(c) High speed input request signal

Set the high speed input request signal No. for the "(a) ON control mode" and the "(b) OFF control mode" when using the setting "5: High speed input request".

Signal No.	Setting value (Hexadecimal)	Signal No.	Setting value (Hexadecimal)	Signal No.	Setting value (Hexadecimal)	Signal No.	Setting value (Hexadecimal)
1	00	9	08	17	10	25	18
2	01	10	09	18	11	26	19
3	02	11	0A	19	12	27	1A
4	03	12	0B	20	13	28	1B
5	04	13	0C	21	14	29	1C
6	05	14	0D	22	15	30	1D
7	06	15	0E	23	16	31	1E
8	07	16	0F	24	17	32	1F

(2) [Pr.406] Main shaft clutch reference address setting (D15009+150n)

Select the address type to be used as the reference address for clutch control.

- 0: Current value after composite main shaft gear
The clutch is controlled by using the current value after composite main shaft gear.
 Output after the clutch control is a converted travel value through the main shaft gear.
- 1: Current value per cycle after main shaft gear
The clutch is controlled by using the current value per cycle after main shaft gear.
 Output after the clutch control is a travel value without conversion.

The setting units for the following parameters are in units based on the reference address setting.

- [Pr.407] Main shaft clutch ON address (D15010+150n, D15011+150n)
- [Pr.409] Main shaft clutch OFF address (D15014+150n, D15015+150n)
- [Pr.408] Travel value before main shaft clutch ON (D15012+150n, D15013+150n), [Pr.410] Travel value before main shaft clutch OFF (D15016+150n, D15017+150n)
- [Pr.413] Slippage amount at main shaft clutch ON (D15020+150n, D15021+150n), [Pr.414] Slippage amount at main shaft clutch OFF (D15022+150n, D15023+150n)

(3) [Pr.407] Main shaft clutch ON address (D15010+150n, D15011+150n)

Set the clutch ON address when address mode is configured for the ON control mode of the main shaft clutch.

When the reference address is the current value per cycle after main shaft gear, the setting address is converted for control within the range from 0 to (Cam axis length per cycle - 1).

Example) Cam axis length per cycle: 20000[pulse]

The ON address is controlled as 19000[pulse] when the setting value is -1000.

(4) [Pr.408] Travel value before main shaft clutch ON (D15012+150n, D15013+150n)

Set the travel value for the reference address with a signed number for the distance between the clutch ON condition completing and the clutch closing.

- 1 to 2147483647 (Positive value) : Used when the reference address is increasing in direction.
- 0 : No movement (The clutch is immediately turned ON with the clutch ON condition completing.)
- -2147483648 to -1 (Negative value): Used when the reference address is decreasing in direction.

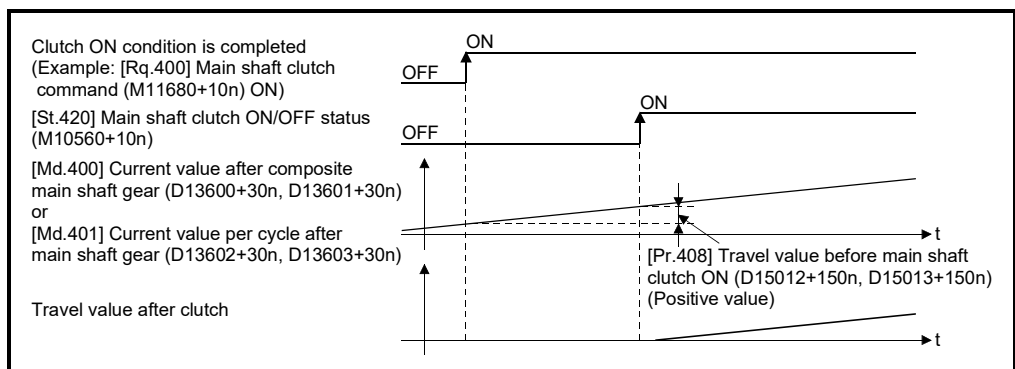

(5) [Pr.409] Main shaft clutch OFF address (D15014+150n, D15015+150n)

Set the clutch OFF address when address mode is configured for the OFF control mode of the main shaft clutch.

When the reference address is the current value per cycle after main shaft gear, the setting address is converted for control within the range from 0 to (Cam axis length per cycle - 1).

Example) Cam axis length per cycle: 20000[pulse]

The OFF address is controlled as 60[pulse] when the setting value is 40060.

(6) [Pr.410] Travel value before main shaft clutch OFF (D15016+150n, D15017+150n)

Set the travel value for the reference address with a signed number for the distance between the clutch OFF condition completing and the clutch opening.

- 1 to 2147483647 (Positive value) : Used when the reference address is increasing in direction.
- 0 : No movement. (The clutch is immediately turned OFF with the clutch OFF condition completing.)
- -2147483648 to -1(Negative value): Used when the reference address is decreasing in direction.

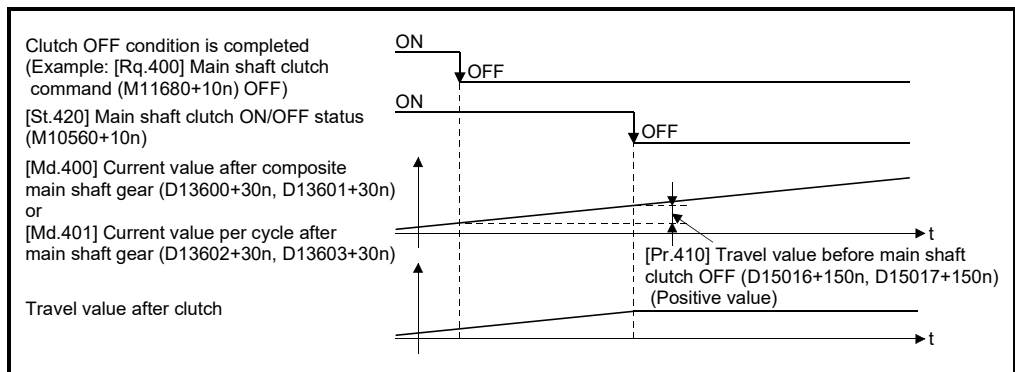

(7) [Pr.411] Main shaft clutch smoothing method (D15018+150n)

Set the smoothing method for clutch ON/OFF.

Refer to Section 7.3.3 for details.

- 0: Direct..... No smoothing
- 1: Time constant method (Exponent).... Smoothing with an exponential curve based on the time constant setting.
- 2: Time constant method (Linear)..... Smoothing with linear acceleration/ deceleration based on the time constant setting.
- 3: Slippage method (Exponent) Smoothing with an exponential curve based on the slippage amount setting.
- 4: Slippage method (Linear)..... Smoothing with linear acceleration/ deceleration based on the slippage amount setting.

(8) [Pr.412] Main shaft clutch smoothing time constant (D15019+150n)

Set a time constant when the time constant method is set in [Pr.411] Main shaft clutch smoothing method (D15018+150n).

The time constant setting applies for both clutch ON/OFF.

(9) [Pr.413] Slippage amount at main shaft clutch ON
(D15020+150n,D15021+150n)

Set the slippage amount at clutch ON when the slippage method is set in [Pr.411] Main shaft clutch smoothing method (D15018+150n).

The slippage amount is set in units based on the current value selected in [Pr.406] Main shaft clutch reference address setting (D15009+150n).

If the set amount is negative, slippage amount at clutch ON is controlled as 0 (direct).

(10) [Pr.414] Slippage amount at main shaft clutch OFF
(D15022+150n,D15023+150n)

Set the slippage amount at clutch OFF when the slippage method is set in [Pr.411] Main shaft clutch smoothing method (D15018+150n).

The slippage amount is set in units based on the current value selected in [Pr.406] Main shaft clutch reference address setting (D15009+150n).

If the set amount is negative, slippage amount at clutch OFF is controlled as 0 (direct).

7 SYNCHRONOUS CONTROL

7.1.4 Main shaft clutch control data

Symbol	Setting item	Setting details	Setting value	Fetch cycle	Default value	Device No.
Rq.400	Main shaft clutch command	Set the clutch command ON/OFF.	OFF : Main shaft clutch command OFF ON : Main shaft clutch command ON	Operation cycle	OFF	M11680+10n
Rq.401	Main shaft clutch control invalid command	Set the command disable the clutch control temporarily.	OFF : Main shaft clutch control valid ON : Main shaft clutch control invalid		OFF	M11681+10n
Rq.402	Main shaft clutch forced OFF command	Set the command to force the clutch OFF.	OFF : Main shaft clutch normal control ON : Main shaft clutch forced OFF		OFF	M11682+10n

(1) [Rq.400] Main shaft clutch command (M11680+10n)

Use ON/OFF for the main shaft clutch command. This command is used with the following settings.

- The clutch ON control mode is "1: Clutch command ON/OFF", "2: Clutch command leading edge" or "3: Clutch command trailing edge".
- The clutch OFF control mode is either "2: Clutch command leading edge" or "3: Clutch command trailing edge".

Status is considered as clutch command OFF just before starting synchronous control. If synchronous control is started while the clutch command is ON, the condition is established just after starting synchronous control, by setting "2: Clutch command leading edge". The condition is not established just after starting, by setting "3: Clutch command trailing edge".

(2) [Rq.401] Main shaft clutch control invalid command (M11681+10n)

The main shaft clutch control is invalid if ON is set. The previous clutch ON/OFF status remains before clutch control becomes invalid.

Clutch control will not become invalid during movement by [Pr.408] and [Pr.410] before clutch ON and clutch OFF. Instead, clutch control will become invalid after movement is completed.

(3) [Rq.402] Main shaft clutch forced OFF command (M11682+10n)

Set ON to force the clutch OFF. The output value from the clutch becomes 0 immediately, even during clutch smoothing. The slippage (accumulative) amount is set to 0 if smoothing with a slippage method.

Reset to OFF to restart the clutch control from the clutch OFF status after using the clutch forced OFF command.

7.2 Auxiliary Shaft Module

7.2.1 Overview of auxiliary shaft module

For the auxiliary shaft module, the input value is generated from the auxiliary shaft. The input value can be converted by the auxiliary shaft gear that provides the deceleration ratio and the rotation direction for the machine system etc. Refer to Section 7.2.2 and Section 7.2.3 for details on setting for the auxiliary shaft module.

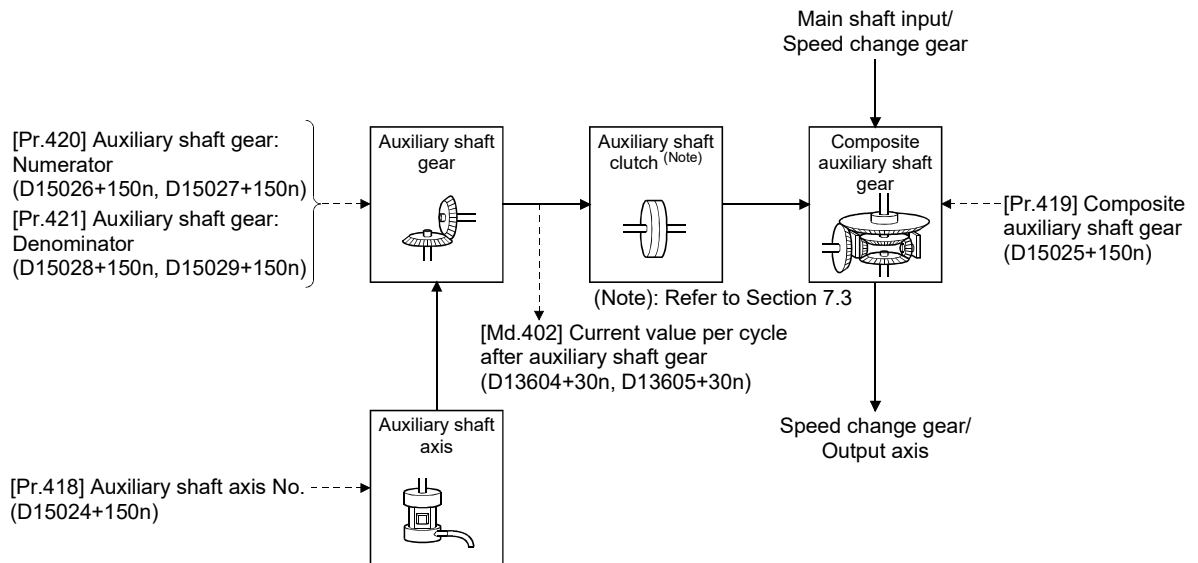

7 SYNCHRONOUS CONTROL

7.2.2 Auxiliary shaft parameters

Symbol	Setting item	Setting details	Setting value	Fetch cycle	Default value	Device No.
Pr.418	Auxiliary shaft axis No.	Set the input axis No. for the auxiliary shaft.	0 : Invalid 1 to 32 : Servo input axis (Note-1) 201 to 232 : Command generation axis (Note-2) 801 to 812 : Synchronous encoder axis	At start of synchronous control	0	D15024+150n
Pr.419	Composite auxiliary shaft gear	Select the composite method for input values from the main shaft and the auxiliary shaft.	<p>• Set in hexadecimal. H□□□□</p> <p>→ Main shaft input method 0: No input 1: Input + 2: Input -</p> <p>→ Auxiliary shaft input method 0: No input 1: Input + 2: Input -</p>	Operation cycle	0001h	D15025+150n
Pr.420	Auxiliary shaft gear: Numerator	Set the numerator for the auxiliary shaft gear.	-2147483648 to 2147483647	At start of synchronous control	1	D15026+150n D15027+150n
Pr.421	Auxiliary shaft gear: Denominator	Set the denominator for the auxiliary shaft gear.	1 to 2147483647		1	D15028+150n D15029+150n

(Note-1): The range from 1 to 16 is valid in the Q172DSCPU.

(Note-2): The range from 201 to 216 is valid in the Q172DSCPU.

(1) [Pr.418] Auxiliary shaft axis No. (D15024+150n)

Set the input axis No. for the auxiliary shaft.

- 0 : Invalid The input value is always 0.
- 1 to 32 : Servo input axis..... Set the servo input axis (axis 1 to 32).
When the servo input axis is not set in the system setting, the input value is always 0.
If the number is set to the same value as the output axis, major error (error code: 1720) occurs and synchronous control cannot be started.
(Note): The range from 1 to 16 is valid in the Q172DSCPU.
- 201 to 232 : Command generation axis.... Set the command generation axis (axis 1 to 32). When the command generation axis is invalid in the command generation axis parameter setting, the input value is always 0. As the command generation axis is used only for command generation, it is possible to set the same number as the output axis.
(Note): The range from 201 to 216 is valid in the Q172DSCPU.
- 801 to 812 : Synchronous encoder axis ... Set the synchronous encoder axis (axis 1 to 12).
When synchronous encoder axis is invalid, the input value is always 0.

(2) [Pr.419] Composite auxiliary shaft gear (D15025+150n)

Set the composite method for input values from the main and auxiliary shafts.

The setting values for each axis are shown as follows.

- 0: No input..... The input value from the input axis is calculated as 0.
- 1: Input+ The input value from the input axis is calculated as it is.
- 2: Input- The input value from the input axis is calculated with its opposite sign.

Operation assumes "0: No input" if the value is set out of the range from 0 to 2.

POINT	The composite method for the composite auxiliary shaft gear can be changed during synchronous control. It is used as a clutch to switch input values between the main and the auxiliary shafts.
--------------	-------------------------------------------------------------------------------------------------------------------------------------------------------------------------------------------------

- (3) [Pr.420] Auxiliary shaft gear: Numerator (D15026+150n, D15027+150n), [Pr.421] Auxiliary shaft gear: Denominator (D15028+150n, D15029+150n)

Set the numerator and the denominator for auxiliary shaft gear to convert the input value. The input value is converted as follows.

$$\text{Input value after conversion} = \text{Input value before conversion} \times \frac{\text{Auxiliary shaft gear: Numerator}}{\text{Auxiliary shaft gear: Denominator}}$$

The input value direction can be reversed by setting a negative value in the numerator of the auxiliary shaft gear.

Set the denominator of the auxiliary shaft gear to a value within the range from 1 to 2147483647.

7 SYNCHRONOUS CONTROL

7.2.3 Auxiliary shaft clutch parameters

Symbol	Setting item	Setting details	Setting value	Fetch cycle	Default value	Device No.
Pr.422	Auxiliary shaft clutch control setting	Set the control method for the clutch.	<p>• Set in hexadecimal. H□□□□</p> <ul style="list-style-type: none"> → ON control mode <ul style="list-style-type: none"> 0: No clutch 1: Clutch command ON/OFF 2: Clutch command leading edge 3: Clutch command trailing edge 4: Address mode 5: High speed input request → OFF control mode <ul style="list-style-type: none"> 0: OFF control invalid 1: One-shot OFF 2: Clutch command leading edge 3: Clutch command trailing edge 4: Address mode 5: High speed input request → High speed input request signal <ul style="list-style-type: none"> 00 to 1F: High speed input request signal from signal 1 to 32 	Operation cycle	0000h	D15030+150n
Pr.423	Auxiliary shaft clutch reference address setting	Set the reference address for the clutch.	<ul style="list-style-type: none"> 0: Current value after composite auxiliary shaft gear 1: Current value per cycle after auxiliary shaft gear 	At start of synchronous control	0	D15031+150n
Pr.424	Auxiliary shaft clutch ON address	<ul style="list-style-type: none"> • Set the clutch ON address for address mode. (This setting is invalid except during address mode.) • If the address is out of the range from 0 to (Cam axis length per cycle - 1), the address is converted to a value within range. 	-2147483648 to 2147483647 [Auxiliary shaft position units ^(Note-1) , or cam axis cycle units ^(Note-2)]	Operation cycle	0	D15032+150n D15033+150n
Pr.425	Travel value before auxiliary shaft clutch ON	<ul style="list-style-type: none"> • Set the travel value for the distance between the clutch ON condition completing and the clutch closing. • Set a positive value when the reference address is increasing, and a negative value when it is decreasing. 	-2147483648 to 2147483647 [Auxiliary shaft position units ^(Note-1) , or cam axis cycle units ^(Note-2)]	At completing clutch ON condition	0	D15034+150n D15035+150n

(Note-1): Auxiliary shaft position units (Refer to Chapter 5)

(Note-2): Cam axis cycle units (Refer to Section 7.5.1)

7 SYNCHRONOUS CONTROL

Symbol	Setting item	Setting details	Setting value	Fetch cycle	Default value	Device No.
Pr.426	Auxiliary shaft clutch OFF address	<ul style="list-style-type: none"> Set the clutch OFF address for the address mode. (This setting is invalid except during address mode.) If the address is out of the range from 0 to (Cam axis length per cycle - 1), the setting address is converted to a value within range. 	-2147483648 to 2147483647 [Auxiliary shaft position units ^(Note-1) , or cam axis cycle units ^(Note-2)]	Operation cycle	0	D15036+150n D15037+150n
Pr.427	Travel value before auxiliary shaft clutch OFF	<ul style="list-style-type: none"> Set the travel value for the distance between the clutch OFF condition completing and the clutch opening. Set a positive value when the reference address is increasing, and a negative value when it is decreasing. 	-2147483648 to 2147483647 [Auxiliary shaft position units ^(Note-1) , or cam axis cycle units ^(Note-2)]	At completing clutch OFF condition	0	D15038+150n D15039+150n
Pr.428	Auxiliary shaft clutch smoothing method	Set the clutch smoothing method.	0: Direct 1: Time constant method (Exponent) 2: Time constant method (Linear) 3: Slippage method (Exponent) 4: Slippage method (Linear)	At start of synchronous control	0	D15040+150n
Pr.429	Auxiliary shaft clutch smoothing time constant	For smoothing with a time constant method, set the smoothing time constant.	0 to 5000 [ms]		0[ms]	D15041+150n
Pr.430	Slippage amount at auxiliary shaft clutch ON	For smoothing with a slippage method, set the slippage amount at clutch ON.	0 to 2147483647 [Auxiliary shaft position units ^(Note-1) , or cam axis cycle units ^(Note-2)]	At turning clutch ON	0	D15042+150n D15043+150n
Pr.431	Slippage amount at auxiliary shaft clutch OFF	For smoothing with a slippage method, set the slippage amount at clutch OFF.	0 to 2147483647 [Auxiliary shaft position units ^(Note-1) , or cam axis cycle units ^(Note-2)]	At turning clutch OFF	0	D15044+150n D15045+150n

(Note-1): Auxiliary shaft position units (Refer to Chapter 5)

(Note-2): Cam axis cycle units (Refer to Section 7.5.1)

(1) [Pr.422] Auxiliary shaft clutch control setting (D15030+150n)

Set the ON and OFF control methods separately for the auxiliary shaft.

The clutch control setting can be changed during synchronous control, however the setting to "No clutch" (Direct coupled operation) cannot be selected during synchronous control after already selecting another setting.

Refer to Section 7.3.2 for details on the clutch control.

(a) ON control mode

- 0: No clutch Execute direct coupled operation (Direct coupled operation) without clutch control.
- 1: Clutch command ON/OFF The clutch is turned ON/OFF by the operation of [Rq.403] Auxiliary shaft clutch command (M11684+10n) ON/OFF. (Setting in the OFF control mode are not applicable in the clutch command ON/OFF mode.)
- 2: Clutch command leading edge ... The clutch is turned ON when [Rq.403] Auxiliary shaft clutch command (M11684+10n) passes the leading edge (from OFF to ON).
- 3: Clutch command trailing edge..... The clutch is turned ON when [Rq.403] Auxiliary shaft clutch command (M11684+10n) passes the trailing edge (from ON to OFF).
- 4: Address mode..... The clutch is turned ON when the reference address (the auxiliary shaft current value or the current value per cycle after auxiliary shaft gear) reaches [Pr.424] Auxiliary shaft clutch ON address (D15032+150n, D15033+150n).
The travel value after passing through the ON address is calculated as the output travel value of the clutch based on the reference address passing through, thereby controlling the clutch with an accurate travel value.
- 5: High speed input request The clutch is turned ON when the high speed input request (DI/DOG/TREN) turns ON.

POINT
Other clutch parameters are not applicable during direct coupled operation by setting "0: No clutch". [Rq.405] Auxiliary shaft clutch forced OFF command (M11686+10n) and the change of the clutch control setting are ignored during direct coupled operation.

(b) OFF control mode

- 0: OFF control invalid..... Clutch OFF control is not used. This setting is applicable only for execution with clutch ON control.
- 1: One-shot OFF The clutch is turned OFF after moving the distance [Pr.427] Travel value before auxiliary shaft clutch OFF (D15038+150n, D15039+150n) (One-shot operation) after the clutch command turns ON.
If [Pr.427] Travel value before auxiliary shaft clutch OFF (D15038+150n, D15039+150n) is 0, [St.423] Auxiliary shaft clutch ON/OFF status (M10562+10n) does not turn ON in order to turn back OFF immediately.
- 2: Clutch command leading edge The clutch is turned OFF when [Rq.403] Auxiliary shaft clutch command (M11684+10n) passes the leading edge (from OFF to ON).
- 3: Clutch command trailing edge The clutch is turned OFF when [Rq.403] Auxiliary shaft clutch command (M11684+10n) passes the trailing edge (from ON to OFF).
- 4: Address mode The clutch is turned OFF when the reference address (the auxiliary shaft current value or the current value per cycle after auxiliary shaft gear) reaches [Pr.426] Auxiliary shaft clutch OFF address (D15036+150n, D15037+150n).
The travel value before passing through the OFF address is calculated as the output travel value of the clutch based on the reference address passing through, thereby controlling the clutch with an accurate travel value.
- 5: High speed input request The clutch is turned OFF when the high speed input request (DI/DOG/TREN) turns ON.

(c) High speed input request signal

Set the high speed input request signal No. for the "(a) ON control mode" and the "(b) OFF control mode" when using the setting "5: High speed input request".

Signal No.	Setting value (Hexadecimal)	Signal No.	Setting value (Hexadecimal)	Signal No.	Setting value (Hexadecimal)	Signal No.	Setting value (Hexadecimal)
1	00	9	08	17	10	25	18
2	01	10	09	18	11	26	19
3	02	11	0A	19	12	27	1A
4	03	12	0B	20	13	28	1B
5	04	13	0C	21	14	29	1C
6	05	14	0D	22	15	30	1D
7	06	15	0E	23	16	31	1E
8	07	16	0F	24	17	32	1F

(2) [Pr.423] Auxiliary shaft clutch reference address setting (D15031+150n)

Select the address type to be used as the reference address for clutch control.

- 0: Auxiliary shaft current valueThe clutch is controlled by using the current value for the servo input axis/command generation axis/synchronous encoder axis that is set for the auxiliary shaft.
Output after the clutch control is a converted travel value through the auxiliary shaft gear.
- 1: Current value per cycle after auxiliary shaft gear
.....The clutch is controlled by using the current value per cycle after auxiliary shaft gear.
Output after the clutch control is a travel value without conversion.

The setting units for the following parameters are in units based on the reference address setting.

- [Pr.424] Auxiliary shaft clutch ON address (D15032+150n, D15033+150n)
- [Pr.426] Auxiliary shaft clutch OFF address (D15036+150n, D15037+150n)
- [Pr.425] Travel value before auxiliary shaft clutch ON (D15034+150n, D15035+150n), [Pr.427] Travel value before auxiliary shaft clutch OFF (D15038+150n, D15039+150n)
- [Pr.430] Slippage amount at auxiliary shaft clutch ON (D15042+150n, D15043+150n), [Pr.431] Slippage amount at auxiliary shaft clutch OFF (D15044+150n, D15045+150n)

(3) [Pr.424] Auxiliary shaft clutch ON address (D15032+150n, D15033+150n)

Set the clutch ON address when address mode is configured for the ON control mode of the auxiliary shaft clutch.

When the reference address is the current value per cycle after auxiliary shaft gear, the setting address is converted for control within the range from 0 to (Cam axis length per cycle - 1).

Example) Cam axis length per cycle: 20000[pulse]

The ON address is controlled as 19000[pulse] when the setting value is -1000.

(4) [Pr.425] Travel value before auxiliary shaft clutch ON (D15034+150n, D15035+150n)

Set the travel value for the reference address with a signed numbers for the distance between the clutch ON condition completing and the clutch closing.

- 1 to 2147483647 (Positive value) : Used when the reference address is increasing in direction.
- 0 : No movement (The clutch is immediately turned ON with the clutch ON condition completing.)
- -2147483648 to -1(Negative value): Used when the reference address is decreasing in direction.

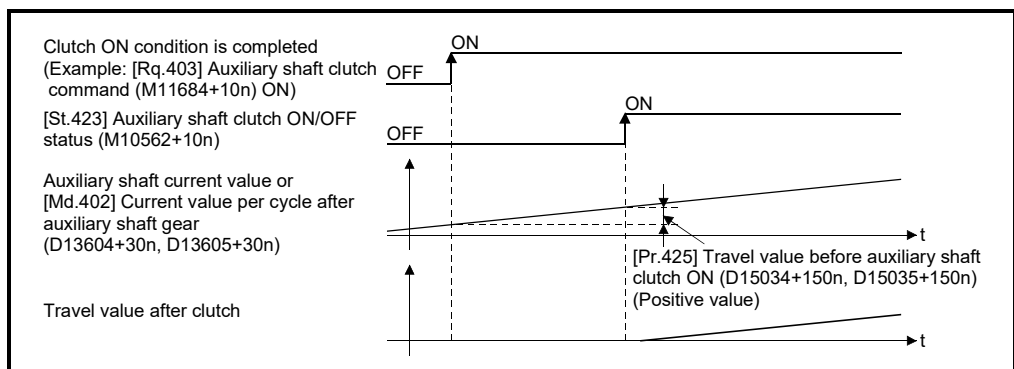

(5) [Pr.426] Auxiliary shaft clutch OFF address (D15036+150n, D15037+150n)

Set the clutch OFF address when address mode is configured for the OFF control mode of the auxiliary shaft clutch.

When the reference address is the current value per cycle after auxiliary shaft gear, the setting address is converted for control within the range from 0 to (Cam axis length per cycle - 1).

Example) Cam axis length per cycle: 20000[pulse]

The OFF address is controlled as 60[pulse] when the setting value is 40060.

(6) [Pr.427] Travel value before auxiliary shaft clutch OFF (D15038+150n, D15039+150n)

Set the travel value for the reference address with a signed numbers for the distance between the clutch OFF condition completing and the clutch opening.

- 1 to 2147483647 (Positive value) : Used when the reference address is increasing in direction.
- 0 : No movement. (The clutch is immediately turned OFF with the clutch OFF condition completing.)
- -2147483648 to -1(Negative value): Used when the reference address is decreasing in direction.

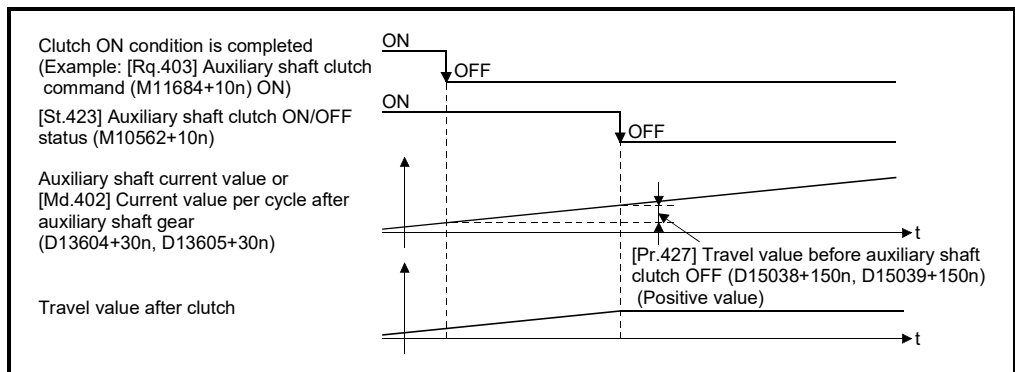

(7) [Pr.428] Auxiliary shaft clutch smoothing method (D15040+150n)

Set the smoothing method for clutch ON/OFF.
Refer to Section 7.3.3 for details.

- 0: Direct..... No smoothing.
- 1: Time constant method (Exponent).... Smoothing with an exponential curve based on the time constant setting.
- 2: Time constant method (Linear)..... Smoothing with linear acceleration/deceleration based on the time constant setting.
- 3: Slippage method (Exponent) Smoothing with an exponential curve based on the slippage amount setting.
- 4: Slippage method (Linear)..... Smoothing with linear acceleration/deceleration based on the slippage amount setting.

(8) [Pr.429] Auxiliary shaft clutch smoothing time constant (D15041+150n)

Set a time constant when the time constant method is set in [Pr.428] Auxiliary shaft clutch smoothing method (D15040+150n).
The time constant setting applies for both clutch ON/OFF.

- (9) [Pr.430] Slippage amount at auxiliary shaft clutch ON
(D15042+150n, D15043+150n)
Set the slippage amount at clutch ON when the slippage method is set in [Pr.428] Auxiliary shaft clutch smoothing method (D15040+150n).
The slippage amount is set in units based on the current value selected in [Pr.423] Auxiliary shaft clutch reference address setting (D15031+150n).
If the set amount is negative, the slippage amount at clutch ON is controlled as 0 (direct).
- (10) [Pr.431] Slippage amount at auxiliary shaft clutch OFF
(D15044+150n, D15045+150n)
Set the slippage amount at clutch OFF when the slippage method is set in [Pr.428] Auxiliary shaft clutch smoothing method (D15040+150n).
The slippage amount is set in units based on the current value selected in [Pr.423] Auxiliary shaft clutch reference address setting (D15031+150n).
If the set amount is negative, the slippage amount at clutch OFF is controlled as 0 (direct).

7 SYNCHRONOUS CONTROL

7.2.4 Auxiliary shaft clutch control data

Symbol	Setting item	Setting details	Setting value	Fetch cycle	Default value	Device No.
Rq.403	Auxiliary shaft clutch command	Set the clutch command ON/OFF.	OFF : Auxiliary shaft clutch command OFF ON : Auxiliary shaft clutch command ON	Operation cycle	OFF	M11684+10n
Rq.404	Auxiliary shaft clutch control invalid command	Set the command to disable the clutch control temporarily.	OFF : Auxiliary shaft clutch control valid ON : Auxiliary shaft clutch control invalid		OFF	M11685+10n
Rq.405	Auxiliary shaft clutch forced OFF command	Set the command to force the clutch OFF.	OFF : Auxiliary shaft clutch normal control ON : Auxiliary shaft clutch forced OFF		OFF	M11686+10n

(1) [Rq.403] Auxiliary shaft clutch command (M11684+10n)

Use ON/OFF for the auxiliary shaft clutch command. This command is used with the following settings.

- The clutch ON control mode is "1: Clutch command ON/OFF", "2: Clutch command leading edge" or "3: Clutch command trailing edge".
- The clutch OFF control mode is either "2: Clutch command leading edge" or "3: Clutch command trailing edge".

Status is considered as clutch command OFF just before starting synchronous control. If synchronous control is started while the clutch command is ON, the condition is established just after starting synchronous control, by setting "2: Clutch command leading edge". The condition is not established just after starting, by setting "3: Clutch command trailing edge".

(2) [Rq.404] Auxiliary shaft clutch control invalid command (M11685+10n)

The auxiliary shaft clutch control is invalid if ON is set. The previous clutch ON/OFF status remains before clutch control becomes invalid.

Clutch control will not become invalid during movement by [Pr.425] Travel value before auxiliary shaft clutch ON (D15034+150n, D15035+150n) and [Pr.427] Travel value before auxiliary shaft clutch OFF (D15038+150n, D15039+150n) before clutch ON and clutch OFF. Instead, clutch control will become invalid after movement is completed.

(3) [Rq.405] Auxiliary shaft clutch forced OFF command (M11686+10n)

Set ON to force the clutch OFF. The output value from the clutch becomes 0 immediately, even during clutch smoothing. The slippage (accumulative) amount is set to 0 if smoothing with a slippage method.

Reset to OFF to restart the clutch control from the clutch OFF status after using the clutch forced OFF command.

7 SYNCHRONOUS CONTROL

7.3 Clutch

7.3.1 Overview of clutch

The clutch is used to transmit/disengage command pulses from the main/auxiliary shaft input side to the output module side through turning the clutch ON/OFF, which controls the operation/stop of the servo motor.

A clutch can be configured for the main and auxiliary shafts.

7.3.2 Control method for clutch

Set the ON and OFF control methods separately in [Pr.405] Main shaft clutch control setting (D15008+150n) and [Pr.422] Auxiliary shaft clutch control setting (D15030+150n).

Although the clutch control setting can be changed during synchronous control, however, the setting "No clutch" (Direct coupled operation) cannot be selected during synchronous control after already selecting another setting.

Item	Setting item		Setting details	Setting value
	Main shaft clutch	Auxiliary shaft clutch		
Clutch control setting	[Pr.405] Main shaft clutch control setting (D15008+150n)	[Pr.422] Auxiliary shaft clutch control setting (D15030+150n)	Set the clutch control method.	<ul style="list-style-type: none"> • Set in hexadecimal. H□□□□ → ON control mode <ul style="list-style-type: none"> 0: No clutch 1: Clutch command ON/OFF 2: Clutch command leading edge 3: Clutch command trailing edge 4: Address mode 5: High speed input request → OFF control mode <ul style="list-style-type: none"> 0: OFF control invalid 1: One-shot OFF 2: Clutch command leading edge 3: Clutch command trailing edge 4: Address mode 5: High speed input request → High speed input request signal 00 to 1F: High speed input request signal from signal 1 to 32

When the clutch ON condition and the clutch OFF condition are completed simultaneously within one operation cycle, both clutch ON and OFF processing are executed within one operation cycle. Therefore, the clutch is from OFF to ON and again to OFF at the clutch OFF status, and it is from ON to OFF and again to ON at the clutch ON status.

The ON and OFF control mode setting for clutch ON/OFF are shown on the next page.

7 SYNCHRONOUS CONTROL

(1) ON control mode

(a) No clutch (Direct coupled operation)

Execute direct coupled operation without clutch control.

POINT

Other clutch parameters are not applicable during direct coupled operation by setting "0: No clutch". "Clutch forced OFF command" and the change of the clutch control setting are ignored during direct coupled operation.

(b) Clutch command ON/OFF

The clutch is turned ON/OFF by the operation of clutch command ON/OFF.

(Setting in the OFF control mode are not applicable in the clutch command ON/OFF mode.)

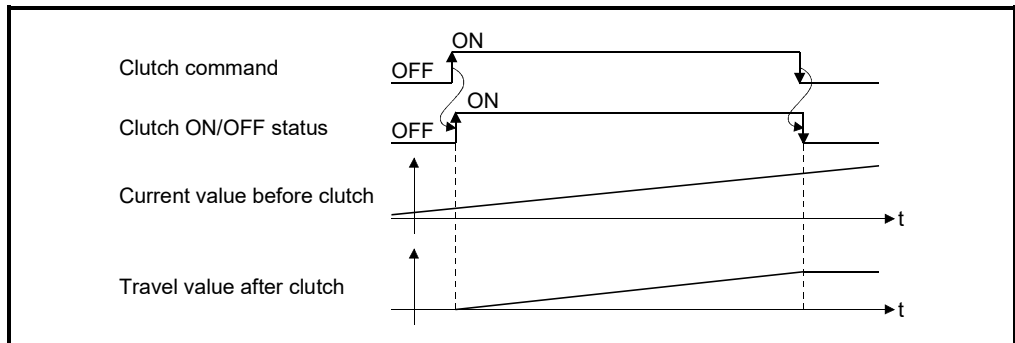

Item	Main shaft clutch	Auxiliary shaft clutch
Clutch command	[Rq.400] Main shaft clutch command (M11680+10n)	[Rq.403] Auxiliary shaft clutch command (M11684+10n)
Clutch ON/OFF status	[St.420] Main shaft clutch ON/OFF status (M10560+10n)	[St.423] Auxiliary shaft clutch ON/OFF status (M10562+10n)

(c) Clutch command leading edge

The clutch is turned ON when the clutch command passes the leading edge (from OFF to ON).

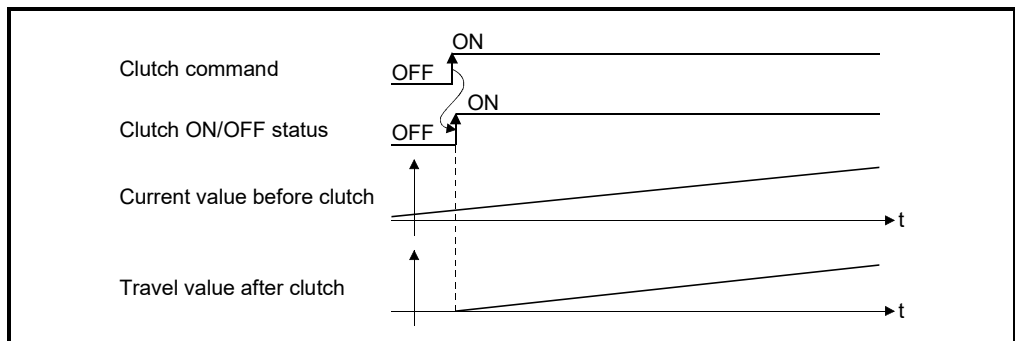

7 SYNCHRONOUS CONTROL

(d) Clutch command trailing edge

The clutch is turned ON when the clutch command passes the trailing edge (from ON to OFF).

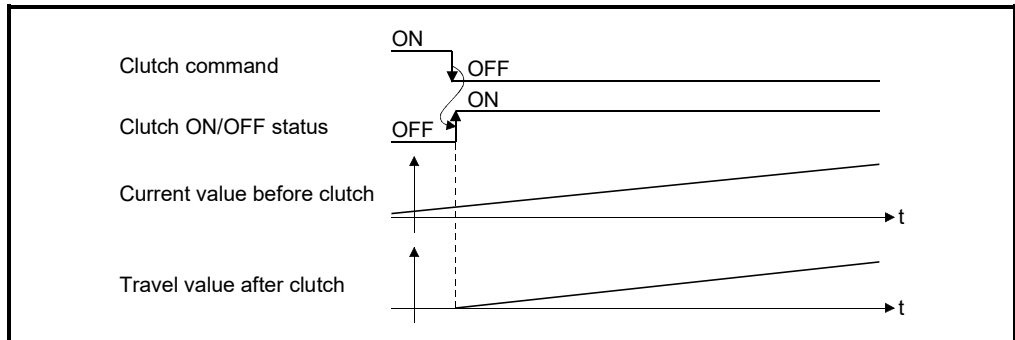

(e) Address mode

The clutch is turned ON when the reference address reaches "Clutch ON address".

The travel value after passing through the ON address is calculated as the output travel value of the clutch based on the reference address passing through, thereby controlling the clutch with an accurate travel value.

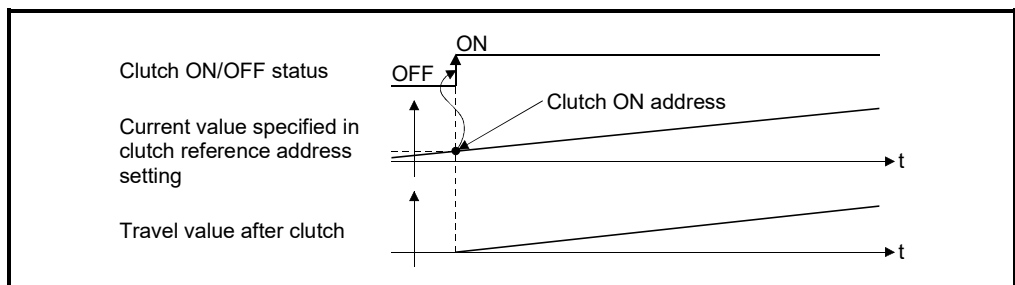

Item	Main shaft clutch	Auxiliary shaft clutch
Reference address	The current value specified in [Pr.406] Main shaft clutch reference address setting (D15009+150n) ([Md.400] Current value after composite main shaft gear (D13600+30n, D13601+30n) or [Md.401] Current value per cycle after main shaft gear (D13602+30n, D13603+30n))	The current value specified in [Pr.423] Auxiliary shaft clutch reference address setting (M15031+150n) (Auxiliary shaft current value (servo input axis current value/synchronous encoder axis current value) or [Md.402] Current value per cycle after auxiliary shaft gear (D13604+30n, D13605+30n))
Clutch ON address	[Pr.407] Main shaft clutch ON address (D15010+150n, D15011+150n)	[Pr.424] Auxiliary shaft clutch ON address (D15032+150n, D15033+150n)
Clutch ON/OFF status	[St.420] Main shaft clutch ON/OFF status (M10560+10n)	[St.423] Auxiliary shaft clutch ON/OFF status (M10562+10n)

7 SYNCHRONOUS CONTROL

(f) High speed input request

The clutch is turned ON when the high speed input request (DI/DOG/TREN) turns ON.

The following actions are required when using the high speed input request.

- Set the signal No. for the "High speed input request signal" clutch control setting.
- Set the input signal to be used by high speed input request of system setting.

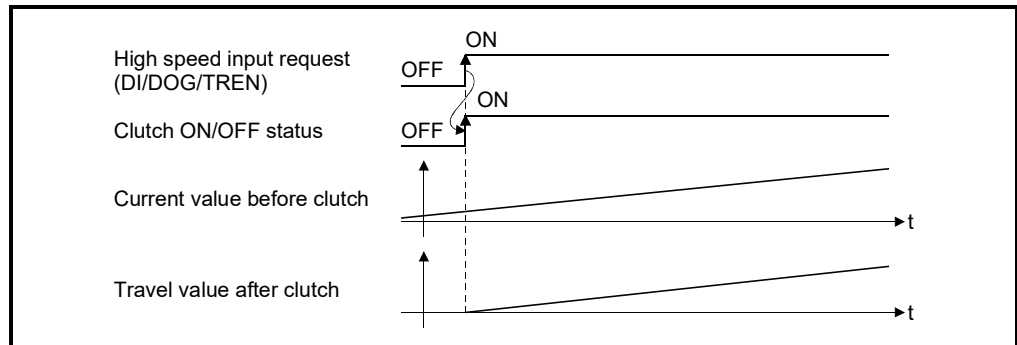

(2) OFF control mode

(a) OFF control invalid

Clutch OFF control is not used. This setting is applicable only for execution with clutch ON control.

(b) One-shot OFF

The clutch is turned OFF after moving the distance "Travel value before clutch OFF" (One-shot operation) after the clutch command turn ON.

If "Travel value before clutch OFF" is 0, "Clutch ON/OFF status" does not turn ON in order to turn back OFF immediately.

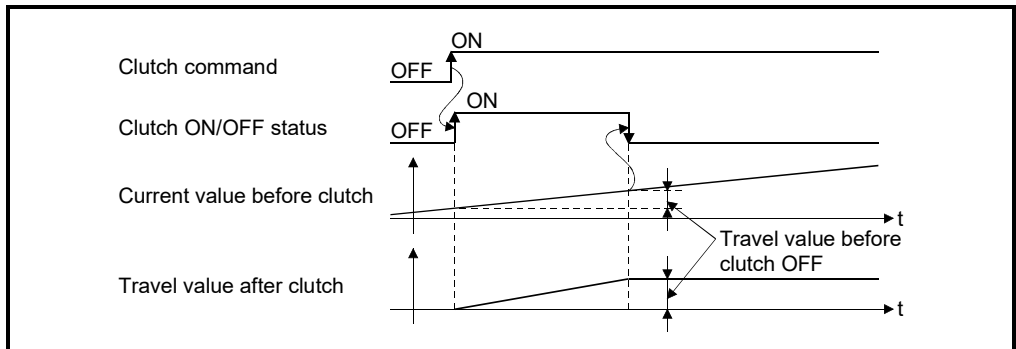

Item	Main shaft clutch	Auxiliary shaft clutch
Clutch command	[Rq.400] Main shaft clutch command (M11680+10n)	[Rq.403] Auxiliary shaft clutch command (M11684+10n)
Clutch ON/OFF status	[St.420] Main shaft clutch ON/OFF status (M10560+10n)	[St.423] Auxiliary shaft clutch ON/OFF status (M10562+10n)
Travel value before clutch OFF	[Pr.410] Travel value before main shaft clutch OFF (D15016+150n, D15017+150n)	[Pr.427] Travel value before auxiliary shaft clutch OFF (D15038+150n, D15039+150n)

(c) Clutch command leading edge

The clutch is turned OFF when the clutch command passes the leading edge (from OFF to ON).

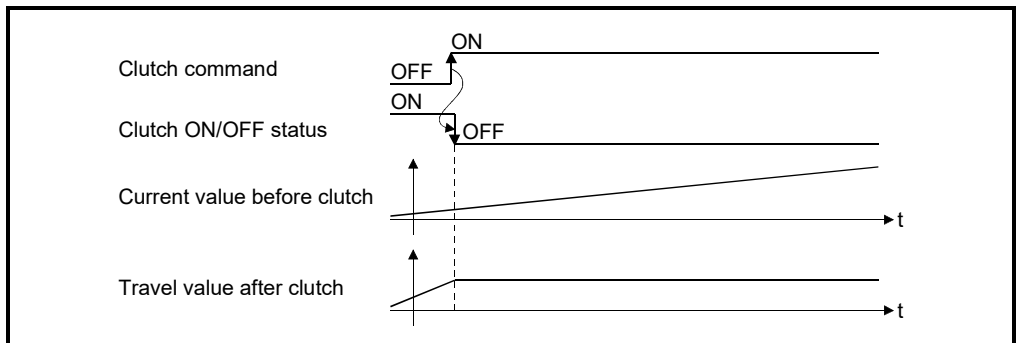

7 SYNCHRONOUS CONTROL

(d) Clutch command trailing edge

The clutch is turned OFF when the clutch command passes the trailing edge (from ON to OFF).

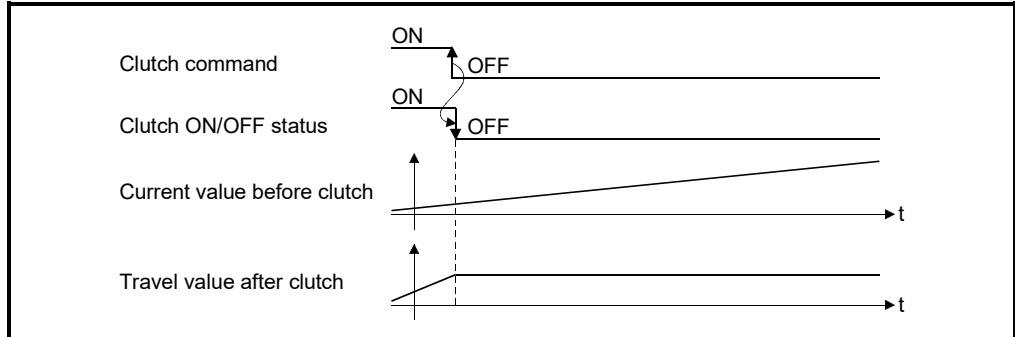

(e) Address mode

The clutch is turned OFF when the reference address reaches "Clutch OFF address".

The travel value before passing through the OFF address is calculated as the output travel value of the clutch based on the reference address passing through, thereby controlling the clutch with an accurate travel value.

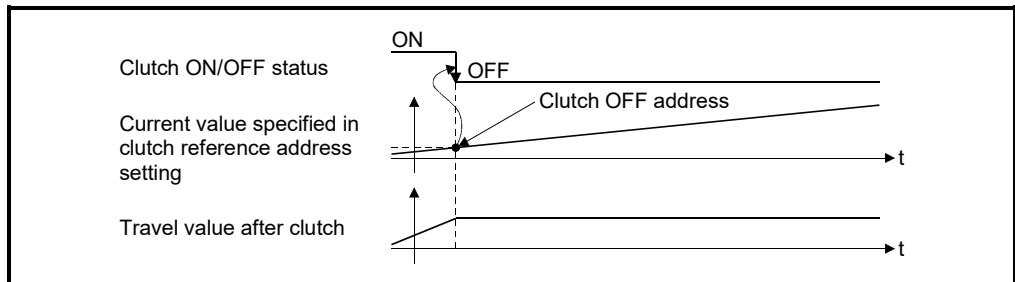

Item	Main shaft clutch	Auxiliary shaft clutch
Reference address	The current value specified in [Pr.406] Main shaft clutch reference address setting (D15009+150n) ([Md.400] Current value after composite main shaft gear (D13600+30n, D13601+30n) or [Md.401] Current value per cycle after main shaft gear (D13602+30n, D13603+30n))	The current value specified in [Pr.423] Auxiliary shaft clutch reference address setting (D15031+150n) (Auxiliary shaft current value (servo input axis current value/synchronous encoder axis current value) or [Md.402] Current value per cycle after auxiliary shaft gear (D13604+30n, D13605+30n))
Clutch OFF address	[Pr.409] Main shaft clutch OFF address (D15014+150n, D15015+150n)	[Pr.426] Auxiliary shaft clutch OFF address (D15036+150n, D15037+150n)
Clutch ON/OFF status	[St.420] Main shaft clutch ON/OFF status (M10560+10n)	[St.423] Auxiliary shaft clutch ON/OFF status (M10562+10n)

7 SYNCHRONOUS CONTROL

(f) High speed input request

The clutch is turned OFF when the high speed input request (DI/DOG/TREN) turns ON.

The following actions are required when using the high speed input request.

- Set the signal No. for the "High speed input request signal" clutch control setting.
- Set the input signal to be used by high speed input request of system setting

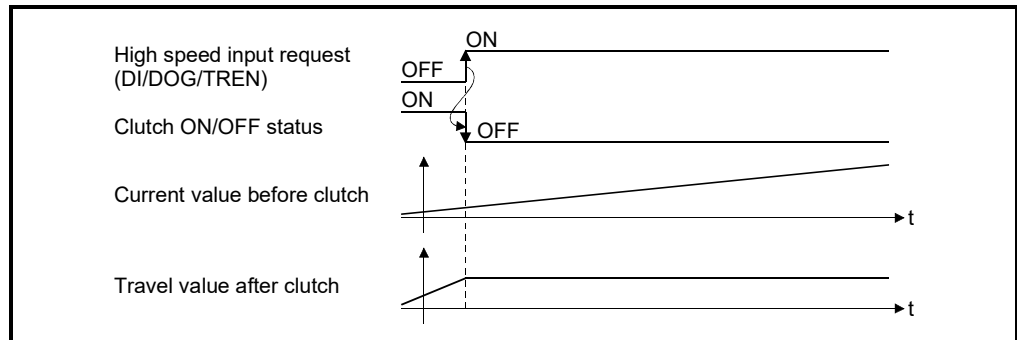

7 SYNCHRONOUS CONTROL

7.3.3 Smoothing method for clutch

Set the clutch smoothing method in [Pr.411] Main shaft clutch smoothing method (D15018+150n) and [Pr.428] Auxiliary shaft clutch smoothing method (D15040+150n). The 2 types of clutch smoothing include the following.

- Time constant method smoothing
- Slippage method smoothing

When not using clutch smoothing, set "0: Direct" in the clutch smoothing method.

Item	Setting item		Setting details	Setting value
	Main shaft clutch	Auxiliary shaft clutch		
Clutch smoothing method	[Pr.411] Main shaft clutch smoothing method (D15018+150n)	[Pr.428] Auxiliary shaft clutch smoothing method (D15040+150n)	Set the clutch smoothing method.	0: Direct 1: Time constant method (Exponent) 2: Time constant method (Linear) 3: Slippage method (Exponent) 4: Slippage method (Linear)

The operation of each smoothing method is shown below.

(1) Time constant method smoothing

Smoothing is processed with the time constant setting value in the smoothing time constant at clutch ON/OFF. After clutch ON smoothing is complete, smoothing is processed with the time constant setting value when the speed of the input values changes.

The travel value between the clutch turning ON and OFF is not changed with smoothing.

Travel value after clutch smoothing = Travel value before clutch smoothing

Item	Setting item		Setting details	Setting value
	Main shaft clutch	Auxiliary shaft clutch		
Clutch smoothing time constant	[Pr.412] Main shaft clutch smoothing time constant (D15019+150n)	[Pr.429] Auxiliary shaft clutch smoothing time constant (D15041+150n)	For smoothing with a time constant method, set the smoothing time constant.	0 to 5000 [ms]

7 SYNCHRONOUS CONTROL

(a) Time constant method exponential curve smoothing

Set "1: Time constant method (Exponential)" in the clutch smoothing method.

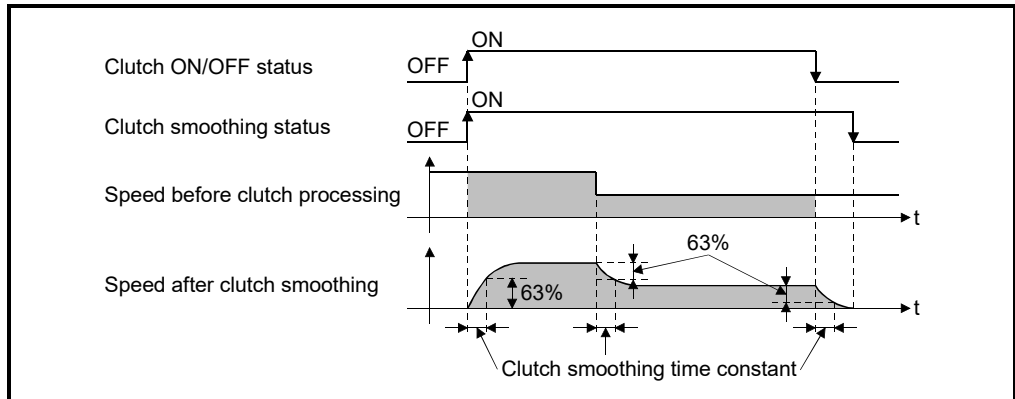

Item	Main shaft clutch	Auxiliary shaft clutch
Clutch ON/OFF status	[St.420] Main shaft clutch ON/OFF status (M10560+10n)	[St.423] Auxiliary shaft clutch ON/OFF status (M10562+10n)
Clutch smoothing status	[St.421] Main shaft clutch smoothing status (M10561+10n)	[St.424] Auxiliary shaft clutch smoothing status (M10563+10n)

(b) Time constant method linear acceleration/deceleration smoothing

Set "2: Time constant method (Linear)" in the clutch smoothing method.

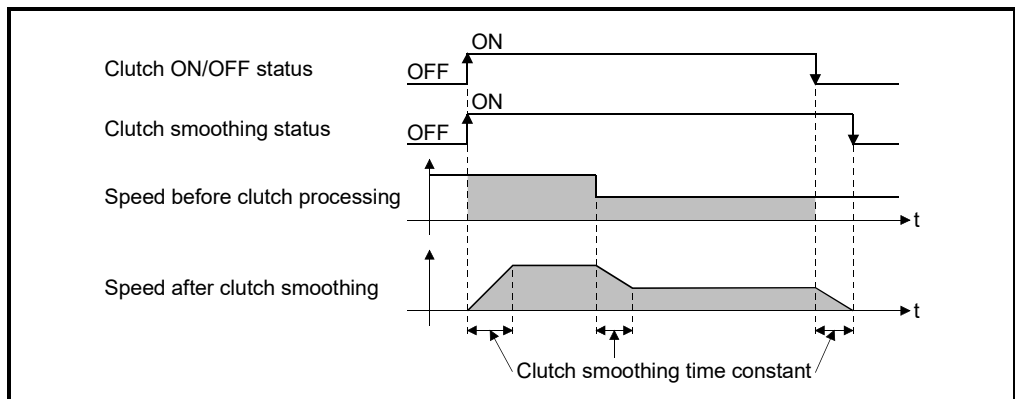

(2) Slippage method smoothing

Smoothing is processed with the value in slippage at clutch ON when the clutch turns ON, and with slippage at clutch OFF when the clutch turns OFF.

Smoothing is also processed with the slippage amount setting when the input speed to the clutch changes, therefore, positioning control at clutch ON/OFF is not affected by speed changes.

Processing proceeds with direct operation after completing clutch ON smoothing. The travel value between the clutch turning ON and OFF is as follows after clutch smoothing.

$$\text{Travel value after clutch smoothing} = \text{Travel value before clutch smoothing} + (\text{Slippage amount at OFF} - \text{Slippage amount at ON})$$

Item	Setting item		Setting details	Setting value
	Main shaft clutch	Auxiliary shaft clutch		
Slippage amount at clutch ON	[Pr.413] Slippage amount at main shaft clutch ON (D15020+150n, D15021+150n)	[Pr.430] Slippage amount at auxiliary shaft clutch ON (D15042+150n, D15043+150n)	For smoothing with a slippage method, set the slippage amount at clutch ON.	0 to 2147483647 [Main input axis position units ^(Note-1) /auxiliary shaft position units ^(Note-2) or cam axis cycle units ^(Note-3)]
Slippage amount at clutch OFF	[Pr.414] Slippage amount at main shaft clutch OFF (D15022+150n, D15023+150n)	[Pr.431] Slippage amount at auxiliary shaft clutch OFF (D15044+150n, D15045+150n)	For smoothing with a slippage method, set the slippage amount at clutch OFF.	

(Note-1): Main input axis position units (Refer to Chapter 5)

(Note-2): Auxiliary shaft position units (Refer to Chapter 5)

(Note-3): Cam axis cycle units (Refer to Section 7.5.1)

(a) Slippage method exponential curve smoothing

Set "3: Slippage (Exponential)" in the clutch smoothing method.

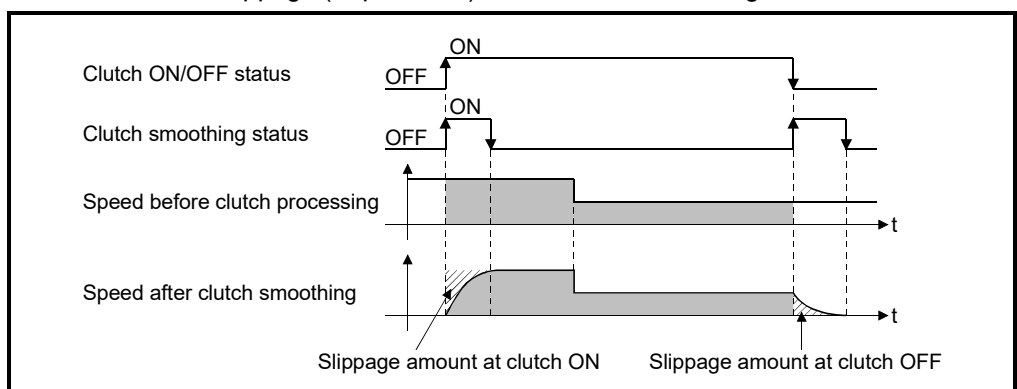

Item	Main shaft clutch	Auxiliary shaft clutch
Clutch ON/OFF status	[St.420] Main shaft clutch ON/OFF status (M10560+10n)	[St.423] Auxiliary shaft clutch ON/OFF status (M10562+10n)
Clutch smoothing status	[St.421] Main shaft clutch smoothing status (M10561+10n)	[St.424] Auxiliary shaft clutch smoothing status (M10563+10n)

(b) Slippage method linear acceleration/deceleration smoothing
 Set "4: Slippage method (Linear)" in the clutch smoothing method.

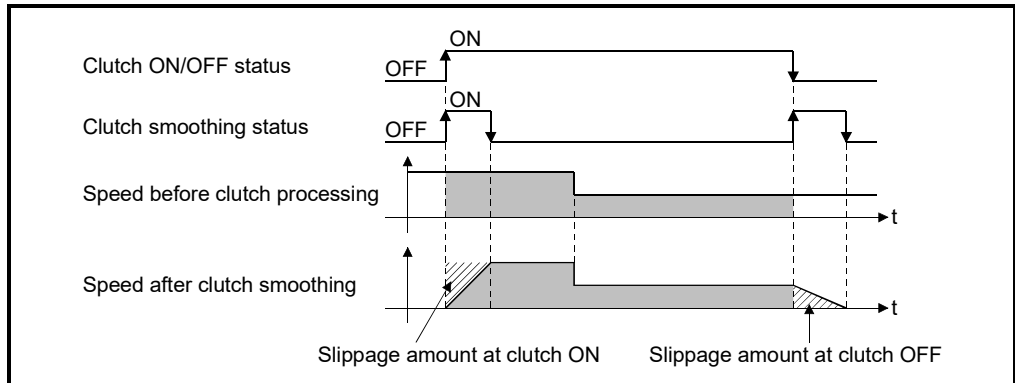

(c) Operation at input speed deceleration during slippage method smoothing
 When the speed before clutch processing decreases, the speed after clutch smoothing is controlled without exceeding the speed before clutch processing.
 If slippage amount remains when the speed before clutch processing becomes 0, the smoothing process will be continued. And when the speed before clutch processing gets faster than the speed after clutch smoothing, clutch smoothing takes place for the remainder slippage amount.

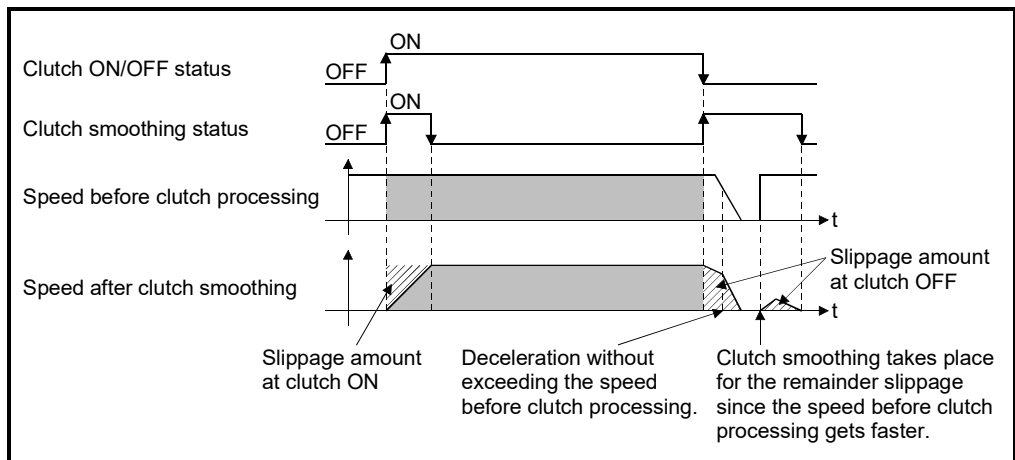

7 SYNCHRONOUS CONTROL

7.3.4 Use example of clutch

The following machine shows an example using clutch control for a flying shear cutting system that synchronizes off a start signal from a sensor input.

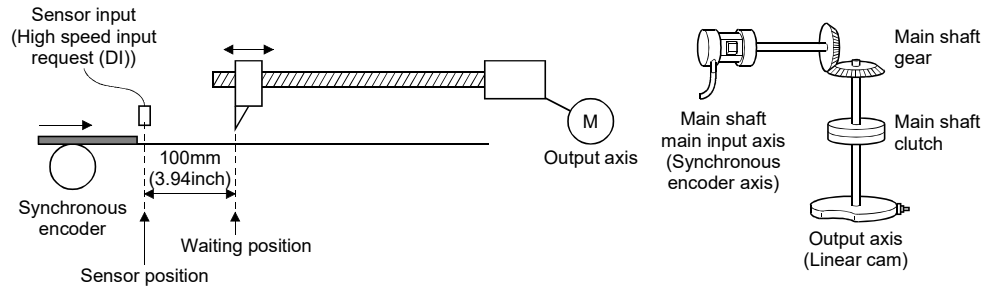

Main shaft clutch setting item		Setting value
[Pr.405] Main shaft clutch control setting (D15008+150n)	ON control mode	5: High speed input request
	OFF control mode	1: One-shot OFF
	High speed input request signal	(Specify the high speed input request signal No., used for sensor input.)
[Pr.406] Main shaft clutch reference address setting (D15009+150n)		0: Current value after composite main shaft gear
[Pr.408] Travel value before main shaft clutch ON (D15012+150n, D15013+150n)		0[mm] (0[inch])
[Pr.410] Travel value before main shaft clutch OFF (D15016+150n, D15017+150n)		380[mm] (14.96[inch])
[Pr.411] Main shaft clutch smoothing method (D15018+150n)		4: Slippage method (Linear)
[Pr.413] Slippage amount at main shaft clutch ON (D15020+150n, D15021+150n)		100[mm] (3.94[inch]) (Distance between the sensor and the waiting position)
[Pr.414] Slippage amount at main shaft clutch OFF (D15022+150n, D15023+150n)		20[mm] (0.79[inch])

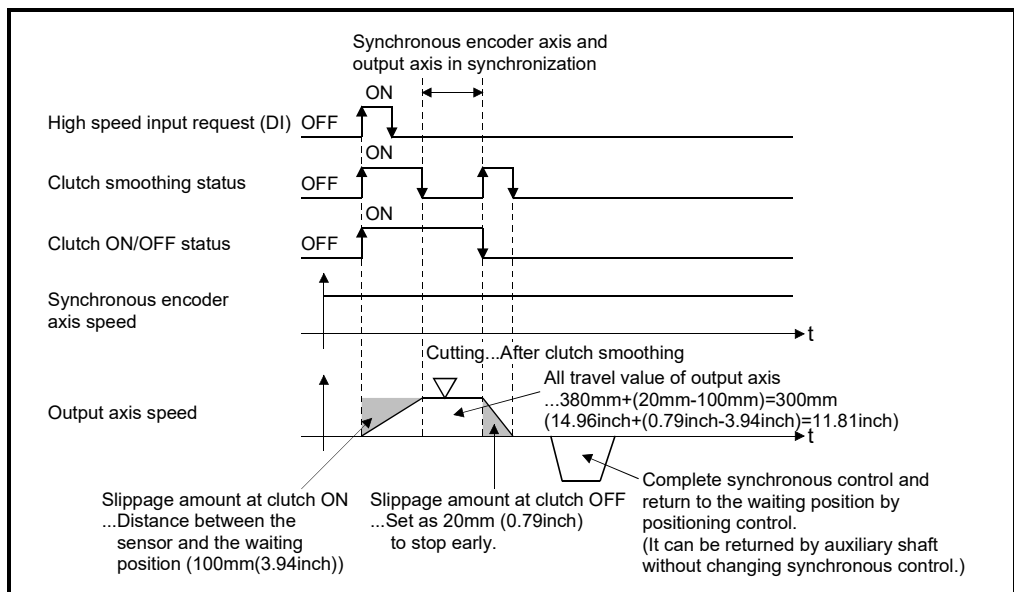

7.4 Speed Change Gear Module

7.4.1 Overview of speed change gear module

A speed change gear module is used to change the input speed from the main shaft/auxiliary shaft/composite auxiliary shaft gear during operation. When not using a speed change gear module, set "0: No speed change gear" in [Pr.434] Speed change gear1 (D15046+150n) and [Pr.490] Speed change gear2 (D15052+150n). With speed change from a speed change gear module, operation is executed with linear acceleration/deceleration based on the setting for the speed change gear smoothing time constant.

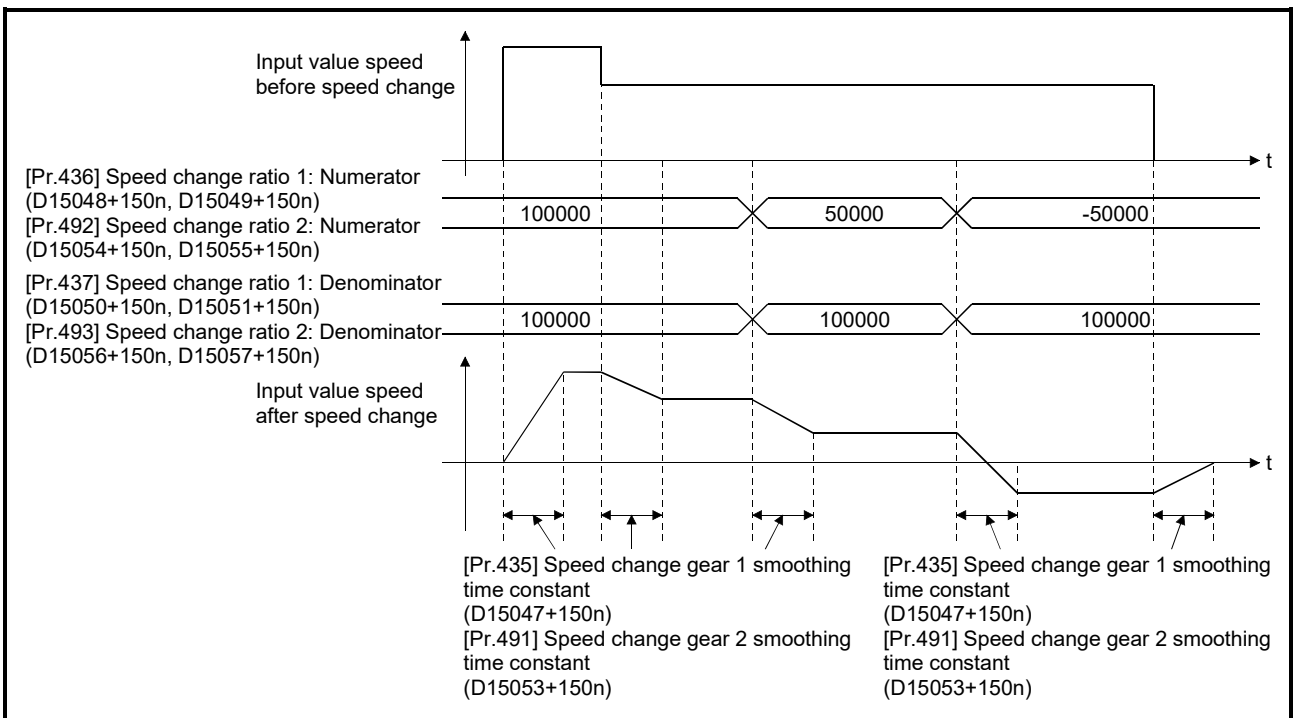
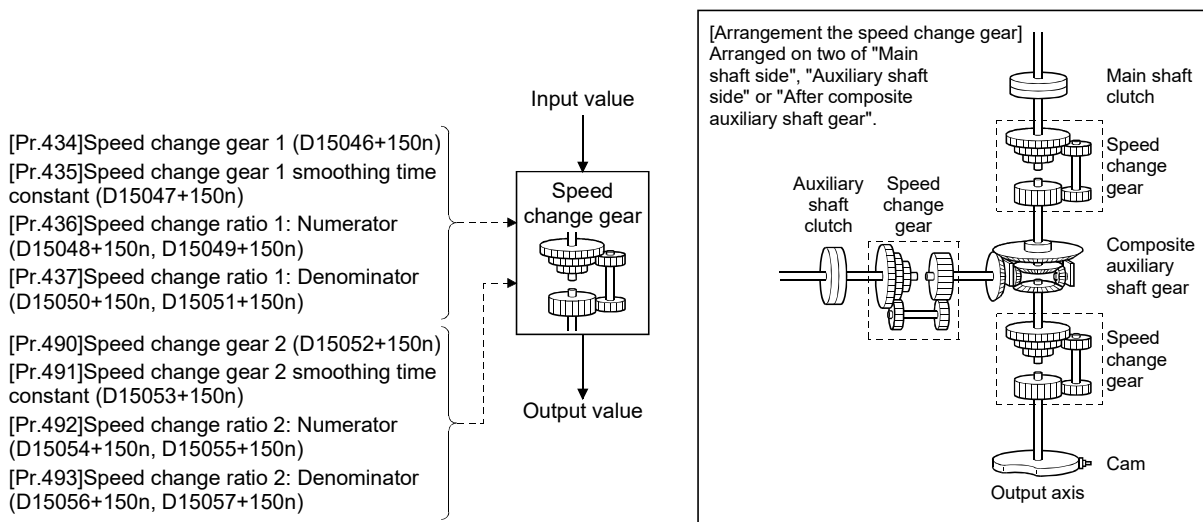

7 SYNCHRONOUS CONTROL

7.4.2 Speed change gear parameters

Symbol	Setting item	Setting details	Setting value	Fetch cycle	Default value	Device No.
Pr.434	Speed change gear 1	Set the arrangement for the speed change gear 1.	0: No speed change gear 1: Main shaft side 2: Auxiliary shaft side 3: After composite auxiliary shaft gear	At start of synchronous control	0	D15046+150n
Pr.435	Speed change gear 1 smoothing time constant	Set the smoothing time constant for the speed change gear 1.	0 to 5000 [ms]		0[ms]	D15047+150n
Pr.436	Speed change ratio 1: Numerator	Set the numerator for the speed change ratio 1.	-2147483648 to 2147483647	Operation cycle	1	D15048+150n D15049+150n
Pr.437	Speed change ratio 1: Denominator	Set the denominator for the speed change ratio 1.	1 to 2147483647		1	D15050+150n D15051+150n
Pr.490	Speed change gear 2	Set the arrangement for the speed change gear 2.	0: No speed change gear 1: Main shaft side 2: Auxiliary shaft side 3: After composite auxiliary shaft gear	At start of synchronous control	0	D15052+150n
Pr.491	Speed change gear 2 smoothing time constant	Set the smoothing time constant for the speed change gear 2.	0 to 5000 [ms]		0[ms]	D15053+150n
Pr.492	Speed change ratio 2: Numerator	Set the numerator for the speed change ratio 2.	-2147483648 to 2147483647	Operation cycle	1	D15054+150n D15055+150n
Pr.493	Speed change ratio 2: Denominator	Set the denominator for the speed change ratio 2.	1 to 2147483647		1	D15056+150n D15057+150n

(1) [Pr.434] Speed change gear 1 (D15046+150n),
[Pr.490] Speed change gear 2 (D15052+150n)

Set the arrangement for the speed change gear 1 or speed change gear 2.

The speed change gear 1 and speed change gear 2 cannot be set in the same arrangement.

If they are set in the same arrangement, the major error (error code: 1748) occurs and the synchronous control cannot be started.

- 0: No speed change gear..... Speed change is not processed, and the input value is transmitted as is.
- 1: Main shaft side..... Speed change is processed for input value after main shaft clutch based on the speed change ratio settings.
- 2: Auxiliary shaft side..... Speed change is processed for input value after auxiliary shaft clutch based on the speed change ratio settings.
- 3: After composite auxiliary shaft gear.... Speed change is processed for input value after composite auxiliary shaft gear based on the speed change ratio settings.

- (2) [Pr.435] Speed change gear 1 smoothing time constant (D15047+150n), [Pr.491] Speed change gear 2 smoothing time constant (D15053+150n)

Set the averaging time to execute a smoothing process for the speed change for the speed change gear.

The input response is delayed depending on the time corresponding the speed change gear smoothing time constant.

Speed is changed directly when "0" is set.

- (3) [Pr.436] Speed change ratio 1: Numerator (D15048+150n, D15049+150n), [Pr.437] Speed change ratio 1: Denominator (D15050+150n, D15051+150n), [Pr.492] Speed change ratio 2: Numerator (D15054+150n, D15055+150n), [Pr.493] Speed change ratio 2: Denominator (D15056+150n, D15057+150n)

Set the numerator and the denominator for the speed change ratio.

Speed change ratio: Numerator and Speed change ratio: Denominator can be changed during synchronous control.

Input values for speed change are processed as follows.

$$\text{Input value after change} = \text{Input value before change} \times \frac{\text{Speed change ratio: Numerator}}{\text{Speed change ratio: Denominator}}$$

The input speed can be reversed by setting a negative value in Speed change ratio: Numerator.

Speed change ratio: Denominator is set within the range from 1 to 2147483647.

7 SYNCHRONOUS CONTROL

7.5 Output Axis Module

7.5.1 Overview of output axis module

For the output axis module, the cam axis current value per cycle is calculated based on the input value (the output value from a speed change gear), and is converted based on the cam data settings as output commands to the servo amplifier.

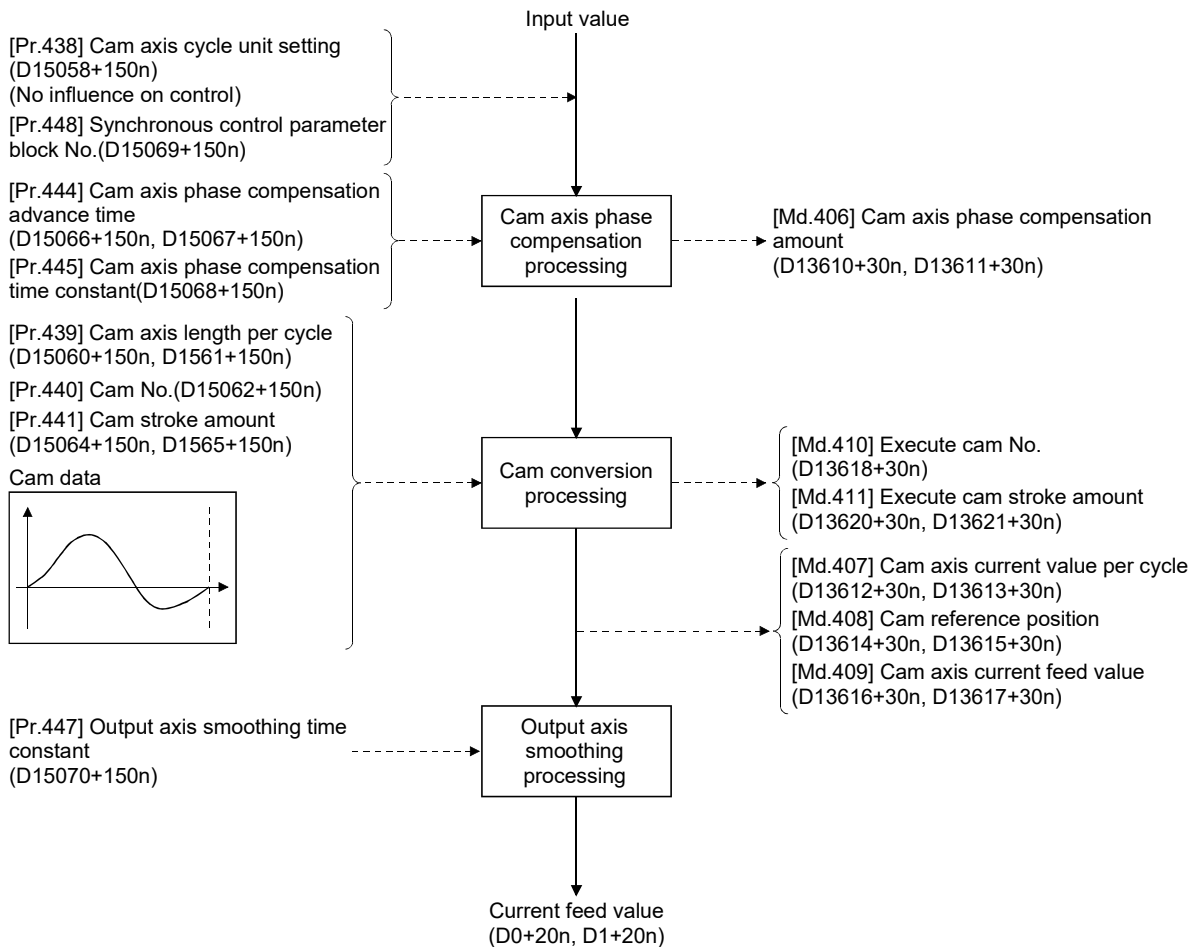

(1) Units for the output axis

The position units for the output axis are shown below based on the setting "Unit setting" of fixed parameter.

Table 7.1 Output axis position units

Setting value of Unit setting	Output axis position unit	Range
0: mm	$\times 10^{-1}\mu\text{m}$	-214748364.8 to 214748364.7 [μm]
1: inch	$\times 10^{-5}\text{inch}$	-21474.83648 to 21474.83647 [inch]
2: degree	$\times 10^{-5}\text{degree}$	-21474.83648 to 21474.83647 [degree]
3: pulse	pulse	-2147483648 to 2147483647 [pulse]

Cam axis cycle units are shown below based on the setting [Pr.438] Cam axis cycle unit setting (D15058+150n).

Table 7.2 Cam axis cycle units

Setting value of [Pr.438] Cam axis cycle unit setting (D15058+150n)			Cam axis cycle unit	Range
Unit setting selection	Control unit	Number of decimal places		
0: Use units of main input axis	—	—	Servo input axis position unit (Refer to Section 5.1.1) Command generation axis position unit (Refer to Section 5.2.1) Synchronous encoder axis position unit (Refer to Section 5.3.1)	
1: Use units of this setting	0: mm	0	mm	-2147483648 to 2147483647 [mm]
		∴	∴	∴
		9	$\times 10^{-9}\text{mm}$	-2.147483648 to 2.147483647 [mm]
	1: inch	0	inch	-2147483648 to 2147483647 [inch]
		∴	∴	∴
		9	$\times 10^{-9}\text{inch}$	-2.147483648 to 2.147483647 [inch]
	2: degree	0	degree	-2147483648 to 2147483647 [degree]
		∴	∴	∴
		9	$\times 10^{-9}\text{degree}$	-2.147483648 to 2.147483647 [degree]
	3: pulse	0	pulse	-2147483648 to 2147483647 [pulse]
		∴	∴	∴
		9	$\times 10^{-9}\text{pulse}$	-2.147483648 to 2.147483647 [pulse]

7 SYNCHRONOUS CONTROL

7.5.2 Output axis parameters

Symbol	Setting item	Setting details	Setting value	Fetch cycle	Default value	Device No.
Pr.438	Cam axis cycle unit setting	<ul style="list-style-type: none"> Set the units for the cam axis length per cycle. There is no influence on the control for the parameter for monitor display. 	• Set in hexadecimal. H□□□□ ↳ Control unit 0: mm 1: inch 2: degree 3: pulse ↳ Number of decimal places 0 to 9 ↳ b0: Unit setting selection 0: Use units of main input axis 1: Use units of this setting	At start of synchronous control	0000h	D15058+150n
Pr.439	Cam axis length per cycle	Set the required input amount with the cam per cycle.	1 to 2147483647 [Cam axis cycle units] (Note-1)	At start of synchronous control,	4194304	D15060+150n D15061+150n
Pr.440	Cam No.	Set the cam No.	0 : Linear cam (Preset) 1 to 256 : User created cam		0	D15062+150n
Pr.441	Cam stroke amount	<ul style="list-style-type: none"> Set the cam stroke amount corresponding to the stroke ratio 100% for cam with stroke ratio data format. This is ignored for cams using the coordinate data format. 	-2147483648 to 2147483647 [Output axis position units] (Note-2)	At passing through the 0th point of cam data	4194304	D15064+150n D15065+150n
Pr.442	Cam axis length per cycle change setting Ver.!	Set when changing [Pr. 439] Cam axis length per cycle (D15060+150n, D15061+150n) during synchronous control.	0: Invalid 1: Valid	At start of synchronous control	0	D15059+150n
Pr.444	Cam axis phase compensation advance time	Set the time to advance or delay the phase of the cam axis.	-2147483648 to 2147483647 [μs]	Operation cycle	0 [μs]	D15066+150n D15067+150n
Pr.445	Cam axis phase compensation time constant	Set the time constant to affect the phase compensation of the cam axis.	0 to 65535 [ms]	At start of synchronous control	10 [ms]	D15068+150n
Pr.448	Synchronous control parameter block No.	Set the parameter block No. for the synchronous control.	1 to 64		1	D15069+150n
Pr.447	Output axis smoothing time constant	Set to smooth the output axis.	0 to 5000 [ms]		0 [ms]	D15070+150n

(Note-1): Cam axis cycle units (Refer to Section 7.5.1)

(Note-2): Output axis position units (Refer to Section 7.5.1)

Ver.!: Refer to Section 1.4 for the software version that supports this function.

7 SYNCHRONOUS CONTROL

(1) [Pr.438] Cam axis cycle unit setting (D15058+150n)

Set the command units for the cam axis input per cycle to be used for cam control.

These units are used for setting the cam axis length per cycle and the cam axis current value per cycle.

There is no influence on the control for the parameter for monitor display.

Refer to Section 7.5.1 for details.

(2) [Pr.439] Cam axis length per cycle (D15060+150n, D15061+150n)

Set the length per cycle of the cam axis to generate the cam axis current value per cycle.

The unit settings are in the cam axis cycle units (Refer to Section 7.5.1).

Set a value within the range from 1 to 2147483647.

The cam axis length per cycle can be changed during synchronous control by setting "1: Valid" in [Pr. 442] Cam axis length per cycle change setting (D15059+150n). When the cam axis current value per cycle passes through the 0th point of cam data, or is at the 0th point of cam data, the value of [Pr.439] Cam axis length per cycle (D15060+150n, D15061+150n) is loaded.

For a cam using the coordinate data format, if the input value of the final coordinate is less than [Pr.439] Cam axis length per cycle (D15060+150n, D15061+150n), it is controlled using a line segment calculated from the nearest two coordinates.

An example of a cam using coordinate data format, and changing [Pr.439] Cam axis length per cycle (D15060+150n, D15061+150n) to a value that exceeds the input value of cam data final coordinate during synchronous control is shown below.

[Coordinate data format]

- Cam axis length per cycle : 4194304[pulse]
- Cam stroke amount : ± 4194304 [pulse]
- Coordinate data

Point	Input value	Output value
1	0	0
2	2097152	4194304
3	4194304	0

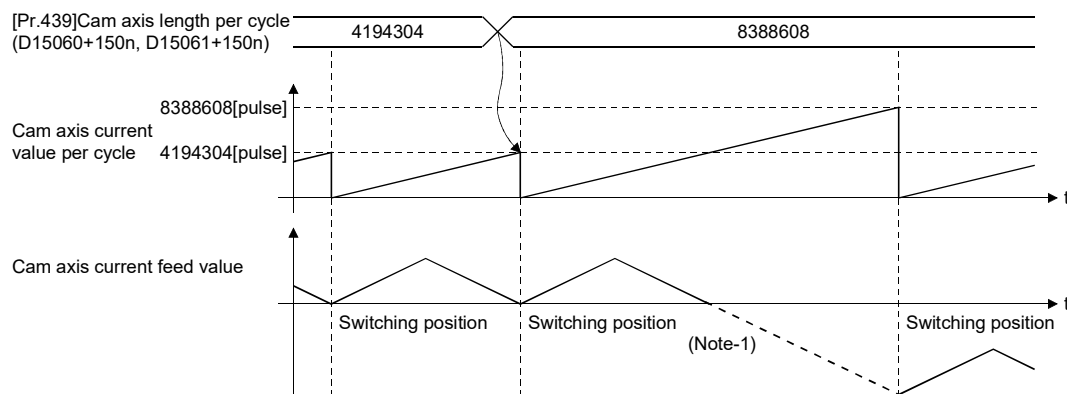

(Note-1): Because the coordinate where "input value = cam axis length per cycle" does not exist, the final coordinate is calculated from the line segment between the nearest two coordinates.

(3) [Pr.440] Cam No. (D15062+150n)

Set the cam No. for cam control.

Cam No.0 is preset in the Motion CPU, and it operates as a linear cam for 100% of its stroke ratio along the cam axis length per cycle.

The cam No. can be changed during synchronous control.

The value set in [Pr.440] Cam No. (D15062+150n) is valid when the cam axis current value per cycle passes through the 0th point of cam data, or is on the 0th point.

(4) [Pr.441] Cam stroke amount (D15064+150n, D15065+150n)

Set the cam stroke amount corresponding to a 100% stroke ratio in output axis position units (Refer to Section 7.5.1) for cam control using the stroke ratio data format.

The cam stroke amount can be changed during synchronous control.

The value set in [Pr.441] Cam stroke amount (D15064+150n, D15065+150n) is valid when the cam axis current value per cycle passes through the 0th point of cam data, or is on the 0th point.

The setting value is ignored for a cam using the coordinate data format.

(5) [Pr.442] Cam axis length per cycle change setting (D15059+150n)

Ver.!

Set when changing [Pr.439] Cam axis length per cycle (D15060+150n, D15061+150n) during synchronous control.

Can change in cam No.0 (linear cam), stroke ratio data format, or coordinate data format. However, this cannot change [Pr.439] Cam axis length per cycle (D15060+150n, D15061+150n) in stroke ratio data format, when using cam data with starting point other than 0.

- 0: Invalid..... Cannot change cam axis length per cycle during synchronous control.
- 1: Valid Loads the value of [Pr.439] Cam axis length per cycle (D15060+150n, D15061+150n) when the cam axis current value per cycle passes through the 0th point of cam data, or is at the 0th point of cam data.

Ver.! : Refer to Section 1.4 for the software version that supports this function.

(6) [Pr.444] Cam axis phase compensation advance time (D15066+150n, D15067+150n)

Set the time to advance or delay the phase of the cam axis current value per cycle in the cam control.

- 1 to 2147483647 [μ s] : Advance the phase according to the setting time.
- 0 [μ s] : Do not execute phase compensation.
- -2147483648 to -1 [μ s]: Delay the phase according to the setting time.

If the setting time is too long, the system experiences overshoot or undershoot at acceleration/deceleration of the input speed. In this case, set a longer time to affect the phase compensation amount in [Pr.445] Cam axis phase compensation time constant (D15068+150n).

(7) [Pr.445] Cam axis phase compensation time constant (D15068+150n)

Set the time constant to affect the phase compensation amount for the first order delay.

63 [%] of the phase compensation amount is reflected in the time constant setting.

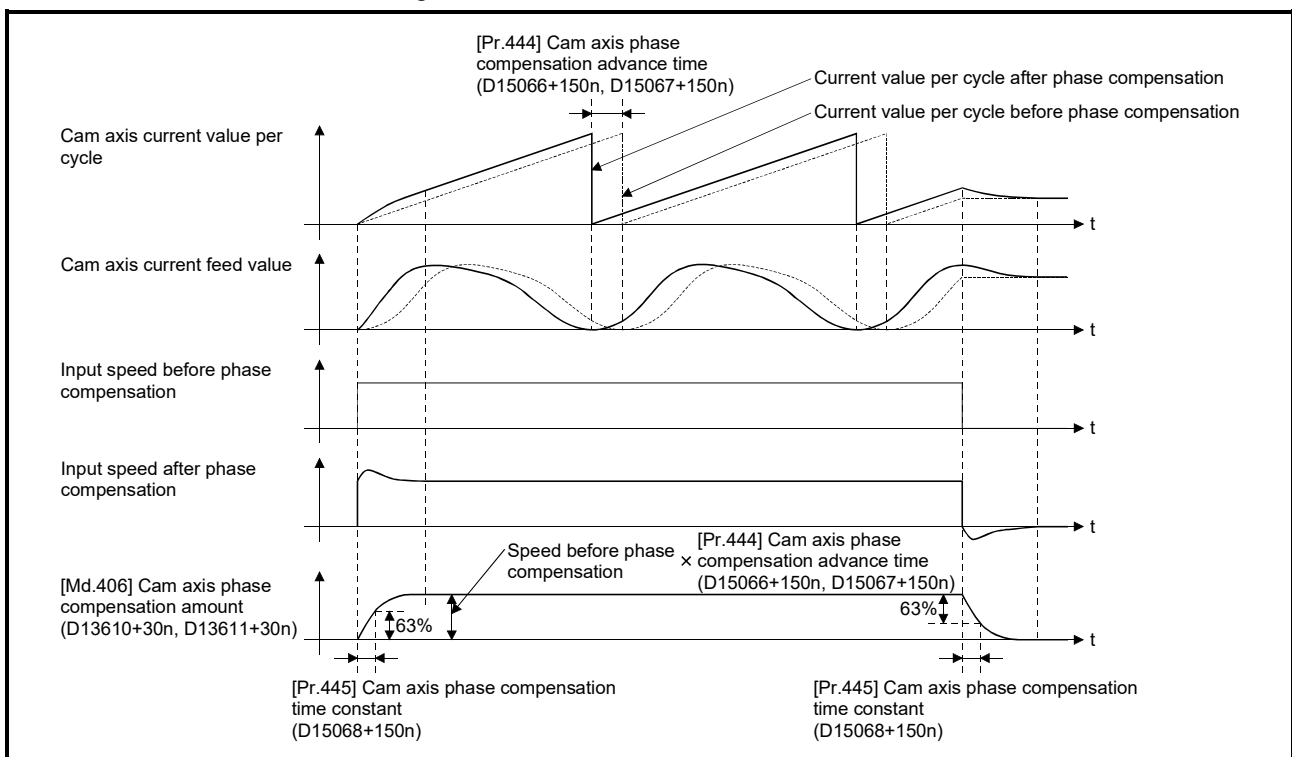

7 SYNCHRONOUS CONTROL

- (8) [Pr.448] Synchronous control parameter block No. (D15069+150n)
Set the parameter block number to be used by output axis of during synchronous control.

Used item for the parameter block is shown below.

Item		Valid/invalid of setting value	Remarks
Interpolation control unit		×	
Speed limit value (Note-1)		○	The setting value is valid only at the synchronous control stop.
Acceleration time		×	
Deceleration time (Note-1)		○	The setting value is valid only at the synchronous control stop.
Rapid stop deceleration time (Note-1)		○	
S-curve ratio (Note-2)		×	
Torque limit value		○	The setting value is changed to the torque limit value of output axis at the synchronous control start.
Deceleration processing on STOP input (Note-1)		○	The setting value is valid only at the synchronous control stop.
Allowable error range for circular interpolation		×	
Acceleration/deceleration system (Note-1), (Note-3)		○	Only "0: Trapezoid/S-curve" is valid.
Advanced S-curve acceleration/ deceleration	Acceleration section 1 ratio	×	
	Acceleration section 2 ratio	×	
	Deceleration section 1 ratio	×	
	Deceleration section 2 ratio	×	

○: Valid, ×: Invalid

(Note-1): The output axis during synchronous control synchronizes with the input axis. Therefore, the output axis depends on the input axis operation and synchronous control parameter, and the setting value is invalid during the synchronous control.

However, at synchronous control stop during output axis operation, the setting value is valid since the stop is processed after the synchronous control completion, and the output axis decelerates to stop with the following slope of deceleration.

$$\text{Slope of deceleration} = \text{Speed limit value} \div \text{Rapid stop deceleration time}$$

(Note-2): The setting of S-curve ratio is invalid.

If a value other than 0% is set to the S-curve ratio, the stop processing is performed with trapezoidal acceleration/deceleration (S-curve ratio = 0[%]).

(Note-3): When "1: Adv. S-curve" is selected, the setting is invalid, and the stop processing is performed with trapezoidal acceleration/deceleration (S-curve ratio = 0[%]).

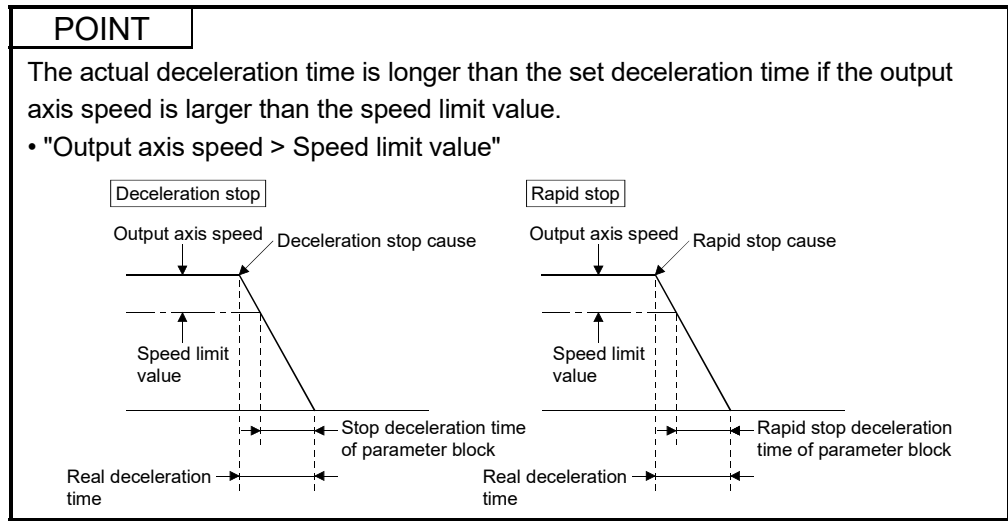

(9) [Pr.447] Output axis smoothing time constant (D15070+150n)

Set the averaging time to execute a smoothing process for the travel value of the output axis after cam data conversion.

The smoothing process can moderate sudden speed fluctuation for cams using the coordinate data format, etc.

The input response is delayed depending on the time corresponding to the setting by smoothing process setting.

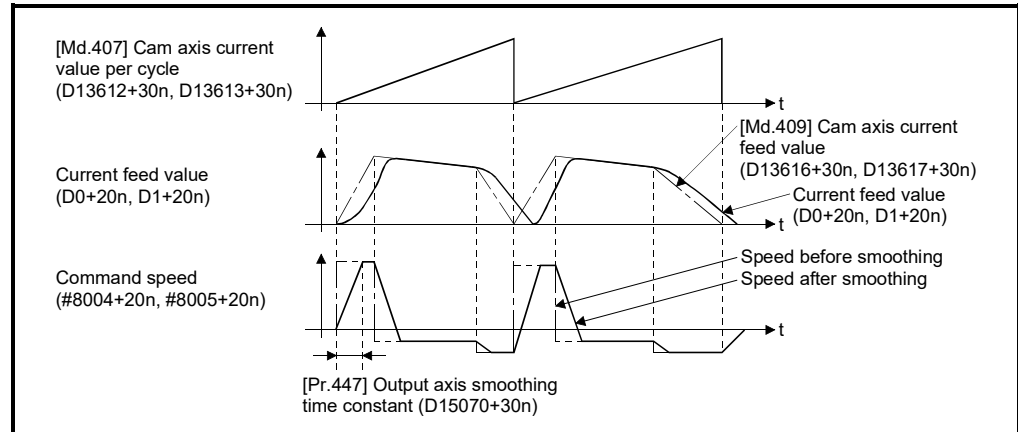

7 SYNCHRONOUS CONTROL

7.6 Synchronous Control Change Function

7.6.1 Overview of synchronous control change function

This function can be used to change the cam reference position, the cam axis current value per cycle and the current value per cycle after the main/auxiliary shaft gear during the synchronous control.

The following 5 methods exist for the synchronous control change function.

Refer to Section 7.6.2 for details on each change command.

Synchronous control change command	Application	Output axis operation
Cam reference position movement	Adjust the cam reference position by travel value.	Operated
Change cam axis current value per cycle	Change the cam axis current value per cycle.	None
Change current value per cycle after main shaft gear	Change the current value per cycle after main shaft gear.	None
Change current value per cycle after auxiliary shaft gear	Change the current value per cycle after auxiliary shaft gear.	None
Cam axis current value per cycle movement	Adjust the phase of the cam axis by travel value.	Operated

7.6.2 Synchronous control change control data

[Bit device]

(1) Control data

Symbol	Setting item	Setting details	Setting value	Refresh cycle	Fetch cycle	Default value	Device No.
Rq.406	Control change request command	Set the control change command request command.	OFF : Control change not requested ON : Control change requested	/	Operation cycle	OFF	M11688+10n

- (a) [Rq.406] Control change request command (M11688+10n)
Set ON to initiate [Cd.407] Synchronous control change command (D15130+150n). The [St.426] Control change complete (M10566+10n) turns ON at the after completion of the synchronous control change.
[Rq.406] Control change request command (M11688+10n) turns OFF at the synchronous control start.

(2) Monitor data

Symbol	Setting item	Setting details	Setting value	Refresh cycle	Fetch cycle	Default value	Device No.
St.426	Control change complete	The complete signal of control change request command processing is stored	OFF: Control change incomplete ON : Control change complete	Operation cycle	/	—	M10566+10n

- (a) [St.426] Control change complete (M10566+10n)
This signal turns ON with the completion of control change.
If the control change processing is stopped midway, the signal remains OFF.

7 SYNCHRONOUS CONTROL

[Word device]

Symbol	Setting item	Setting details	Setting value	Fetch cycle	Default value	Device No.
Cd.407	Synchronous control change command	Set the synchronous control change command.	0: Cam reference position movement 1: Change cam axis current value per cycle 2: Change current value per cycle after main shaft gear 3: Change current value per cycle after auxiliary shaft gear 4: Cam axis current value per cycle movement	At requesting synchronous control change	0	D15130+150n
Cd.408	Synchronous control change value	Set the change value for synchronous control change processing.	-2147483648 to 2147483647 (Refer to the detailed explanation on the next page for units.)		0	D15132+150n D15133+150n
Cd.409	Synchronous control reflection time	Set the reflection time for synchronous control change processing.	0 to 65535 [ms]		0 [ms]	D15131+150n

(1) [Cd.407] Synchronous control change command (D15130+150n)

Set the synchronous control change command.

- 0: Cam reference position movement.....(a)
- 1: Change cam axis current value per cycle.....(b)
- 2: Change current value per cycle after main shaft gear(c)
- 3: Change current value per cycle after auxiliary shaft gear.....(d)
- 4: Cam axis current value per cycle movement(e)

(a) Cam reference position movement

This command is executed to move the cam reference position through adding the setting travel value of [Cd.408] Synchronous control change value (D15132+150n, D15133+150n). The travel value to be added is averaged in [Cd.409] Synchronous control reflection time (D15131+150n) for its output.

Set a long reflection time when a large travel value is used since the cam axis current feed value moves with the travel value.

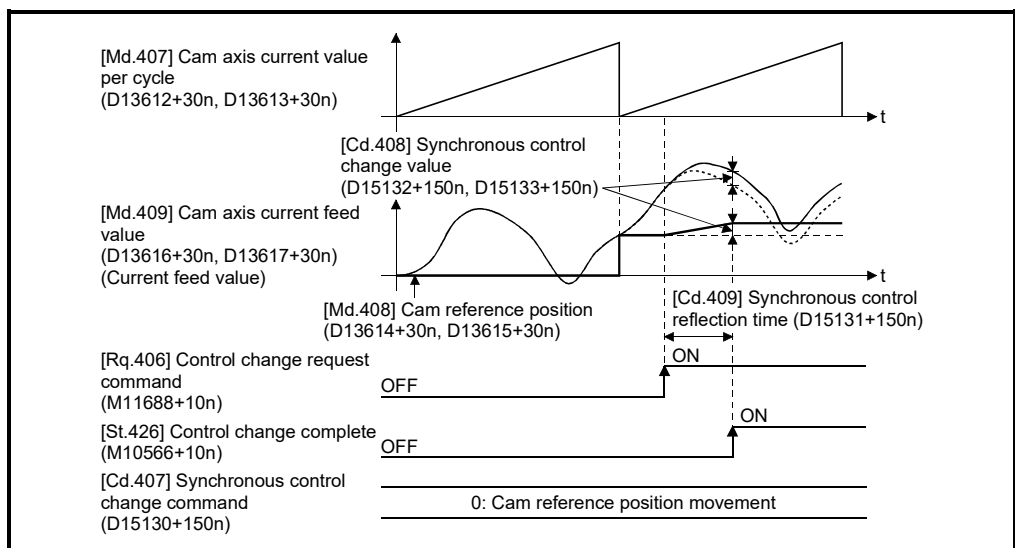

7 SYNCHRONOUS CONTROL

When [Rq.406] Control change request command (M11688+10n) is reset to OFF while executing the cam reference position movement command, operation is stopped midway. If the cam reference position movement command is executed again, the remainder travel value is not reflected, and the operation starts with [Cd.408] Synchronous control change value (D15132+150n, D15133+150n) to be used again.

If synchronous control is stopped while the cam reference position movement command is being executed, operation also stops midway. If synchronous control is restarted, the remainder travel value is not reflected.

(b) Change cam axis current value per cycle

The cam axis current value per cycle is changed to [Cd.408] Synchronous control change value (D15132+20n, D15133+150n). The cam reference position will be also changed to correspond to the changed cam axis current value per cycle.

This operation is completed within one operation cycle.

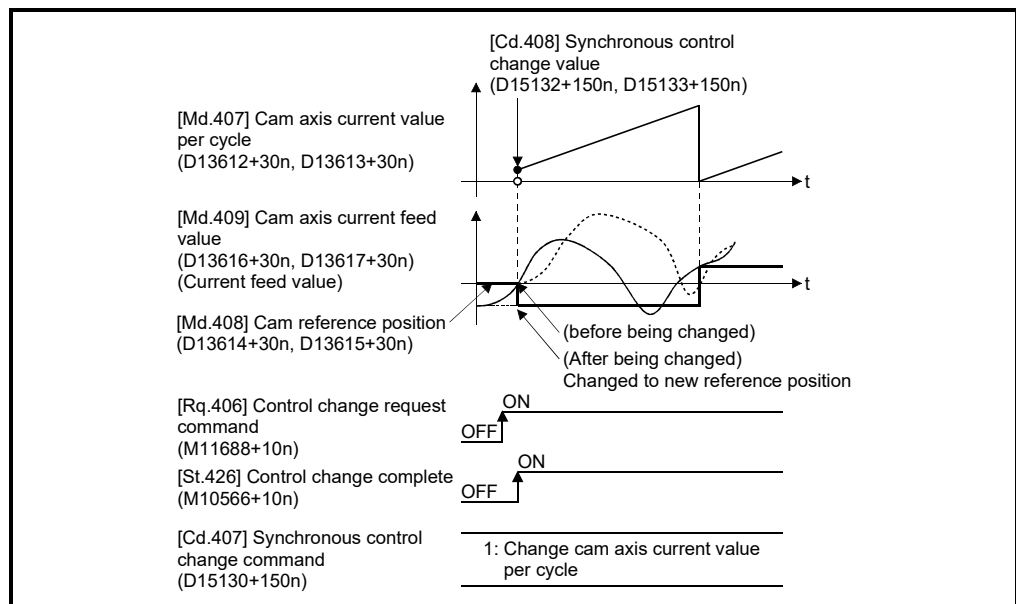

(c) Change current value per cycle after main shaft gear

The current value per cycle after main shaft gear is changed to the value set in [Cd.408] Synchronous control change value (D15132+150n, D15133+150n).

This operation is completed within one operation cycle.

Clutch control is not executed if the current value per cycle after main shaft gear (the value before being changed and after being changed) has already passed through the ON/OFF address in address mode.

(d) Change current value per cycle after auxiliary shaft gear
 The current value per cycle after auxiliary shaft gear is changed to the value set in [Cd.408] Synchronous control change value (D15132+10n, D15133+150n).
 This operation is completed within one operation cycle.
 Clutch control is not executed if the current value per cycle after the auxiliary shaft gear (the value before being changed and after being changed) has already passed through the ON/OFF address in address mode.

(e) Cam axis current value per cycle movement
 This command is executed to move the cam axis current value per cycle through adding the setting travel value of [Cd.408] Synchronous control change value (D15132+20n, D1533+150n). The travel value to be added is averaged in [Cd.409] Synchronous control reflection time (D15131+150n) for its output.
 Set a long reflection time when a large travel value is used since the cam axis current feed value moves with the travel value.

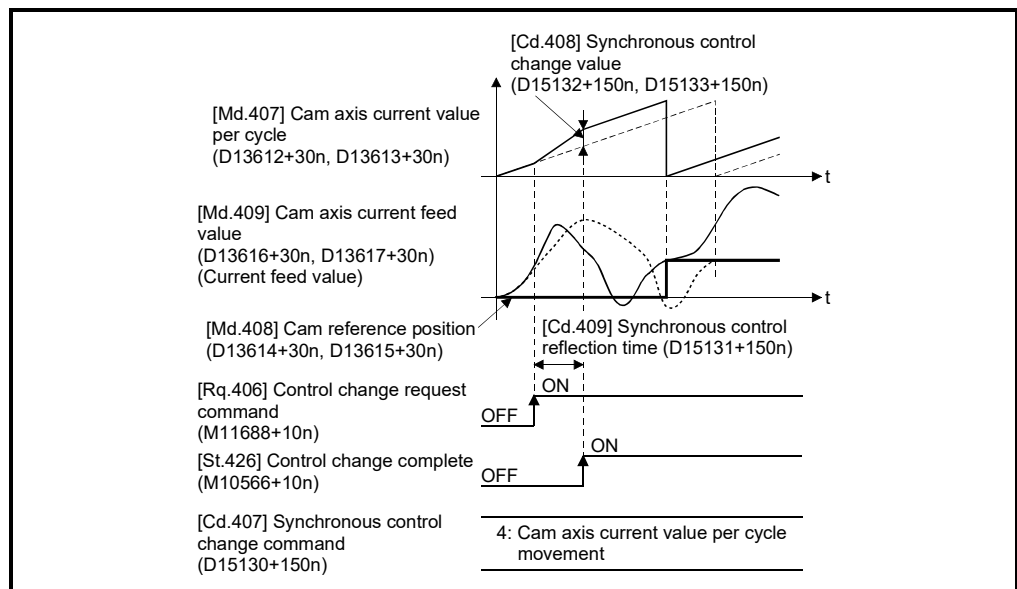

When [Rq.406] Control change request command (M11688+10n) is reset to OFF while executing the cam axis current value per cycle movement, operation is stopped midway. If the cam axis current value per cycle movement is executed again, the remainder travel value is not reflected, and the operation starts with [Cd.408] Synchronous control change value (D15132+150n, D15133+150n) to be used again.
 If synchronous control is stopped while the cam axis current value per cycle movement is being executed, operation also stops midway. If synchronous control is restarted, the remainder travel value is not reflected.

7 SYNCHRONOUS CONTROL

(2) [Cd.408] Synchronous control change value (D15132+150n, D15133+150n)

Set the change value for synchronous control change processing as follows.

[Cd.407] Synchronous control change command (D15130+150n)	[Cd.408] Synchronous control change value (D15132+150n, D15133+150n)		
	Setting range	Unit	Setting details
0: Cam reference position movement	-2147483648 to 2147483647	Output axis position unit	<ul style="list-style-type: none"> Set the travel value of the cam reference position. It moves within the range from -2147483648 to 2147483647.
1: Change cam axis current value per cycle		Cam axis cycle unit	<ul style="list-style-type: none"> Set the change current value per cycle. The setting value is converted within the range from "0 to (Cam axis length per cycle-1)".
2: Change current value per cycle after main shaft gear			<ul style="list-style-type: none"> Set the travel value of the cam axis current value per cycle. It moves within the range from -2147483648 to 2147483647.
3: Change current value per cycle after auxiliary shaft gear			
4: Cam axis current value per cycle movement			

(3) [Cd.409] Synchronous control reflection time (D15131+150n)

Set the reflection time for synchronous control change processing as follows.

[Cd.407] Synchronous control change command (D15130+150n)	Setting details for [Cd.409] Synchronous control reflection time (D15131+150n)
0: Cam reference position movement	The time to reflect the travel value to the cam reference position.
1: Change cam axis current value per cycle	Setting not required.
2: Change current value per cycle after main shaft gear	
3: Change current value per cycle after auxiliary shaft gear	
4: Cam axis current value per cycle movement	The time to reflect the travel value to the cam axis current value per cycle.

7 SYNCHRONOUS CONTROL

7.7 Synchronous Control Monitor Data

Synchronous control monitor data is updated only during synchronous control. The monitor values ([Md.400] Current value after composite main shaft gear (D13600+30n, D13601+30n), [Md.401] Current value per cycle after main shaft gear (D13602+30n, D13603+30n), [Md.402] Current value per cycle after auxiliary shaft gear (D13604+30n, D13605+30n), [Md.407] Cam axis current value per cycle (D13612+30n, D13613+30n), [Md.408] Cam reference position (D13614+30n, D13615+30n), and [Md.409] Cam axis current feed value (D13616+30n, D13617+30n)) from the last synchronous control session are restored the next time the Multiple CPU system power supply turns ON. Restarting operation status from the last synchronous control session is possible through returning to the last position via positioning control. (Refer to Section 8.1).

"The last synchronous control session" indicates status just before the last synchronous control session was stopped as follows. These are listed with the last synchronization status.

- Just before [Rq.380] Synchronous control start (M12000+n) turns from ON to OFF.
- Just before deceleration stop by a stop command or an error, etc.
- Just before the Multiple CPU system power supply turned OFF.

[Word device]

Symbol	Monitor item	Storage details	Monitor value	Refresh cycle	Device No.
Md.400	Current value after composite main shaft gear	<ul style="list-style-type: none"> • The current value after combining the main input and sub input values from the main shaft is stored. • Value is stored even after Multiple CPU system power supply OFF. 	-2147483648 to 2147483647 [Main input axis position units] (Note-1)	Operation cycle (During synchronous control only)	D13600+30n D13601+30n
Md.401	Current value per cycle after main shaft gear	<ul style="list-style-type: none"> • The current value per cycle after the main shaft gear is stored. • One cycle is considered the cam axis length per cycle. • Value is stored even after Multiple CPU system power supply OFF. 	0 to (Cam axis length per cycle-1) [Cam axis cycle units] (Note-2)		D13602+30n D13603+30n
Md.402	Current value per cycle after auxiliary shaft gear	<ul style="list-style-type: none"> • The current value per cycle after the auxiliary shaft gear is stored. • One cycle is considered the cam axis length per cycle. • Value is stored even after Multiple CPU system power supply OFF. 	0 to (Cam axis length per cycle-1) [Cam axis cycle units] (Note-2)		D13604+30n D13605+30n
Md.406	Cam axis phase compensation amount	<ul style="list-style-type: none"> • The current phase compensation amount is stored. 	-2147483648 to 2147483647 [Cam axis cycle units] (Note-2)		D13610+30n D13611+30n
Md.407	Cam axis current value per cycle	<ul style="list-style-type: none"> • The current value per cycle is stored, which is calculated from the input travel value to the cam axis. (The value after phase compensation) • Value is stored even after Multiple CPU system power supply OFF. 	0 to (Cam axis length per cycle-1) [Cam axis cycle units] (Note-2)		D13612+30n D13613+30n

(Note-1): Main input axis position units (Refer to Chapter 5)

(Note-2): Cam axis cycle units (Refer to Section 7.5.1)

7 SYNCHRONOUS CONTROL

Symbol	Monitor item	Storage details	Monitor value	Refresh cycle	Device No.
Md.408	Cam reference position	<ul style="list-style-type: none"> The current feed value as the cam reference position is stored. Value is stored even after system's power supply OFF. 	-2147483648 to 2147483647 [Output axis position units] (Note-3)	Operation cycle (During synchronous control only)	D13614+30n D13615+30n
Md.409	Cam axis current feed value	<ul style="list-style-type: none"> The current feed value while controlling the cam axis is stored. Value is stored even after system's power supply OFF. 	-2147483648 to 2147483647 [Output axis position units] (Note-3)		D13616+30n D13617+30n
Md.410	Execute cam No.	The executing cam No. is stored.	0 to 256		D13618+30n
Md.411	Execute cam stroke amount	The executing cam stroke amount is stored.	-2147483648 to 2147483647 [Output axis position units] (Note-3)		D13620+30n D13621+30n
Md.412	Execute cam axis length per cycle 	The executing cam axis length per cycle is stored.	1 to 2147483647 [Cam axis cycle units] (Note-2)		D13622+30n D13623+30n
Md.422	Main shaft clutch slippage (accumulative)	The accumulative slippage of the main shaft clutch smoothing with slippage method is stored as a signed value.	-2147483648 to 2147483647 [Main input axis position units] (Note-1), or [Cam axis cycle units] (Note-2)		D13606+30n D13607+30n
Md.425	Auxiliary shaft clutch slippage (accumulative)	The accumulative slippage on the auxiliary shaft clutch smoothing with slippage method is stored as a signed value.	-2147483648 to 2147483647 [Main input axis position units] (Note-4), or [Cam axis cycle units] (Note-2)	D13608+30n D13609+30n	

(Note-1): Main input axis position units (Refer to Chapter 5)

(Note-2): Cam axis cycle units (Refer to Section 7.5.1)

(Note-3): Output axis position units (Refer to Section 7.5.1)

(Note-4): Auxiliary shaft position units (Refer to Chapter 5)

: Refer to Section 1.4 for the software version that supports this function.

7 SYNCHRONOUS CONTROL

(1) [Md.400] Current value after composite main shaft gear (D13600+30n, D13601+30n)

The current value after combining the main input and the sub input values going into the composite main shaft gear is stored as an accumulative value. Units are in position units of the main input axis (Refer to Chapter 5). The unit is pulse if the main input axis is invalid.

The current value after composite main shaft gear will be changed when the following operations are executed in the main input axis during synchronous control.

Operation of main input axis (During synchronous control start)	Servo input axis		Command generation axis	Synchronous encoder axis			
	Absolute position detection system valid	Absolute position detection system invalid		Incremental synchronous encoder	Absolute synchronous encoder	Synchronous encoder via device	Multiple CPU synchronous control (Note-3) 
Home position return	Change method 1)		—	—			
Current value change	Change method 1)		Change method 1)	Change method 1)			
Speed control (I) (Note-1)	Change method 1)		Change method 1)	—			
Fixed-pitch feed control	Change method 1)		Change method 1)	—			
Speed-position switching control (Note-2)	Change method 1)		—	—			
Connection to servo amplifier	Change method 2)	Change method 1)	—	—			
Connection to synchronous encoder	—		—	Change method 1)	Change method 2)	Change method 1)	

(Note-1): When it starts by turning OFF the feed current value update command (M3212+20n) or [Rq.347] Feed current value update request command (M10972+20n).

(Note-2): When it starts by turning OFF the feed current value update command (M3212+20n).

(Note-3): If the synchronous encoder axis type (master CPU servo input axis, master CPU command generation axis, master CPU synchronous encoder axis) of the slave CPU in the Multiple CPU synchronous control system is set.

(a) Change method 1)

The new current value after composite main shaft gear is calculated based on the current value of the main input axis.

$$\begin{array}{l} \text{Current value after} \\ \text{composite main} \\ \text{shaft gear} \end{array} = \begin{array}{l} \text{Main input direction of} \\ \text{composite main shaft gear} \\ \text{(Input +/Input -/No input (0))} \end{array} \times \begin{array}{l} \text{Main input axis current} \\ \text{value} \end{array}$$

: Refer to Section 1.4 for the software version that supports this function.

(b) Change method 2)

The travel value of the main input axis from the last synchronous control session is reflected to the current value after composite main shaft gear.

$$\begin{matrix} \text{Current value after} \\ \text{composite main} \\ \text{shaft gear} \end{matrix} = \begin{matrix} \text{Current value after} \\ \text{composite main shaft gear} \\ \text{at the last synchronous} \\ \text{control session} \end{matrix} + \begin{matrix} \text{Main input direction of} \\ \text{composite main shaft gear} \\ \text{(Input +/Input -/No input (0))} \end{matrix} \times \begin{matrix} \text{Amount of change of travel} \\ \text{value of main input axis} \\ \text{from the last synchronous} \\ \text{control session} \end{matrix}$$

(2) [Md.401] Current value per cycle after main shaft gear (D13602+30n, D13603+30n)

The input travel value after the main shaft gear is stored within the range from 0 to (Cam axis length per cycle - 1). The unit is in cam axis cycle units (Refer to Section 7.5.1).

The value is restored according to [Pr.460] Setting method of current value per cycle after main shaft gear (D15100+150n) when starting synchronous control. (Refer to Section 8.1)

(3) [Md.402] Current value per cycle after auxiliary shaft gear (D13604+30n, D13605+30n)

The input travel value after the auxiliary shaft gear is stored within the range from 0 to (Cam axis length per cycle - 1). The unit is in cam axis cycle units (Refer to Section 7.5.1).

The value is restored according to [Pr.461] Setting method of current value per cycle after auxiliary shaft gear (D15101+150n) when starting synchronous control. (Refer to Section 8.1)

(4) [Md.406] Cam axis phase compensation amount (D13610+30n, D13611+30n)

The phase compensation amount for the cam axis is stored with cam axis cycle units (Refer to Section 7.5.1).

The phase compensation amount after smoothing processing with [Pr.445] Cam axis phase compensation time constant (D15068+150n) is stored.

(5) [Md.407] Cam axis current value per cycle (D13612+30n, D13613+30n)

The cam axis current value per cycle is stored within the range from 0 to (Cam axis length per cycle - 1).

The current value after cam axis phase compensation processing can be monitored. The unit is in cam axis cycle units (Refer to Section 7.5.1).

The value is restored according to [Pr.462] Cam axis position restoration object (D15102+150n) when starting synchronous control. (Refer to Section 8.1)

- (6) [Md.408] Cam reference position (D13614+30n, D13615+30n)
The current feed value is stored as the cam reference position. The unit is in output axis position units (Refer to Section 7.5.1). When the unit is in [degree], a range from "0 to 35999999" is used.
The value is restored according to [Pr.462] Cam axis position restoration object (D15102+150n) when starting synchronous control. (Refer to Section 8.1)
- (7) [Md.409] Cam axis current feed value (D13616+30n, D13617+30n)
The current feed value of the cam axis is stored. The value is the same as Current feed value (D0+20n, D1+20n) during synchronous control.
- (8) [Md.410] Execute cam No. (D13618+30n)
The executing cam No. is stored.
When [Pr.440] Cam No. (D15062+150n) is changed during synchronous control, this is updated when the controlling cam No. switches.
- (9) [Md.411] Execute cam stroke amount (D13620+30n, D13621+30n)
The executing cam stroke amount is stored.
When [Pr.441] Cam stroke amount (D15064+150n, D15065+150n) is changed during synchronous control, this is updated when the controlling cam stroke amount switches.
- (10) [Md.412] Execute cam axis length per cycle (D13622+30n, D13623+30n) 
The executing cam axis length per cycle is stored.
When [Pr.439] Cam axis length per cycle (D15060+150n, D15061+150n) is changed during synchronous control, this is updated when the controlling cam axis length per cycle switches.
- (11) [Md.422] Main shaft clutch slippage (accumulative) (D13606+30n, D13607+30n), [Md.425] Auxiliary shaft clutch slippage (accumulative) (D13608+30n, D13609+30n)
The accumulative slippage amount with the slippage method is stored as a signed value.
The absolute value of the accumulative slippage increases to reach the slippage at clutch ON during clutch ON.
The absolute value of the accumulative slippage decreases to reach 0 during clutch OFF.
Monitoring of the accumulative slippage is used to check the smoothing progress with the slippage method.

: Refer to Section 1.4 for the software version that supports this function.

7 SYNCHRONOUS CONTROL

[Bit device]

Symbol	Monitor item	Storage details	Monitor value	Refresh cycle	Device No.
St.420	Main shaft clutch ON/OFF status	The ON/OFF status of main shaft clutch is stored.	OFF : Clutch OFF status ON : Clutch ON status	Operation cycle (During synchronous control only)	M10560+10n
St.421	Main shaft clutch smoothing status	The smoothing status of main shaft clutch is stored.	OFF : Not on clutch smoothing ON : On clutch smoothing		M10561+10n
St.423	Auxiliary shaft clutch ON/OFF status	The ON/OFF status of the auxiliary shaft clutch is stored.	OFF : Clutch OFF status ON : Clutch ON status		M10562+10n
St.424	Auxiliary shaft clutch smoothing status	The smoothing status of the auxiliary shaft clutch is stored.	OFF : Not on clutch smoothing ON : On clutch smoothing		M10563+10n

- (1) [St.420] Main shaft clutch ON/OFF status (M10560+10n),
[St.423] Auxiliary shaft clutch ON/OFF status (M10562+10n)
The clutch ON/OFF status is stored.

- (2) [St.421] Main shaft clutch smoothing status (M10561+10n),
[St.424] Auxiliary shaft clutch smoothing status (M10563+10n)
The smoothing status of the clutch is stored. The status is updated by the clutch smoothing method as follows.
 - Time constant method : The status is always "1:On clutch smoothing" during the clutch ON status.
The status will be "0: Not on clutch smoothing" when the clutch is turned OFF and smoothing is completed.
 - Slippage method : The status is "1:On clutch smoothing " till the clutch accumulative slippage amount reaches the slippage at clutch ON when the clutch is turned ON. The status will change to "0: Not on clutch smoothing " when the clutch accumulative slippage amount reaches the slippage at clutch ON.
The status is "1:On clutch smoothing " till the clutch accumulative slippage amount reaches 0 when the clutch is turned OFF. The status will change to "0: Not on clutch smoothing " when the clutch accumulative slippage amount reaches 0.

8. SYNCHRONOUS CONTROL INITIAL POSITION

8.1 Synchronous Control Initial Position

The following synchronous control monitor data can be aligned to a set position when starting synchronous control, as the initial position for synchronous control. The alignment to a synchronous control initial position is useful for restoring a system based on the last control status along with restarting synchronous control after cancelling midway.

Synchronous control monitor data	The position when starting synchronous control
[Md.400] Current value after composite main shaft gear (D13600+30n, D13601+30n)	Restored to a position based on the main input axis of the main shaft.
[Md.401] Current value per cycle after main shaft gear (D13602+30n, D13603+30n)	Restored according to [Pr.460] Setting method of current value per cycle after main shaft gear (D15100+150n).
[Md.402] Current value per cycle after auxiliary shaft gear (D13604+30n, D13605+30n)	Restored according to [Pr.461] Setting method of current value per cycle after auxiliary shaft gear (D15101+150n).
[Md.407] Cam axis current value per cycle (D13612+30n, D13613+30n)	Restored according to [Pr.462] Cam axis position restoration object (D15102+150n).
[Md.408] Cam reference position (D13614+30n, D13615+30n)	
[Md.409] Cam axis current feed value (D13616+30n, D13617+30n)	

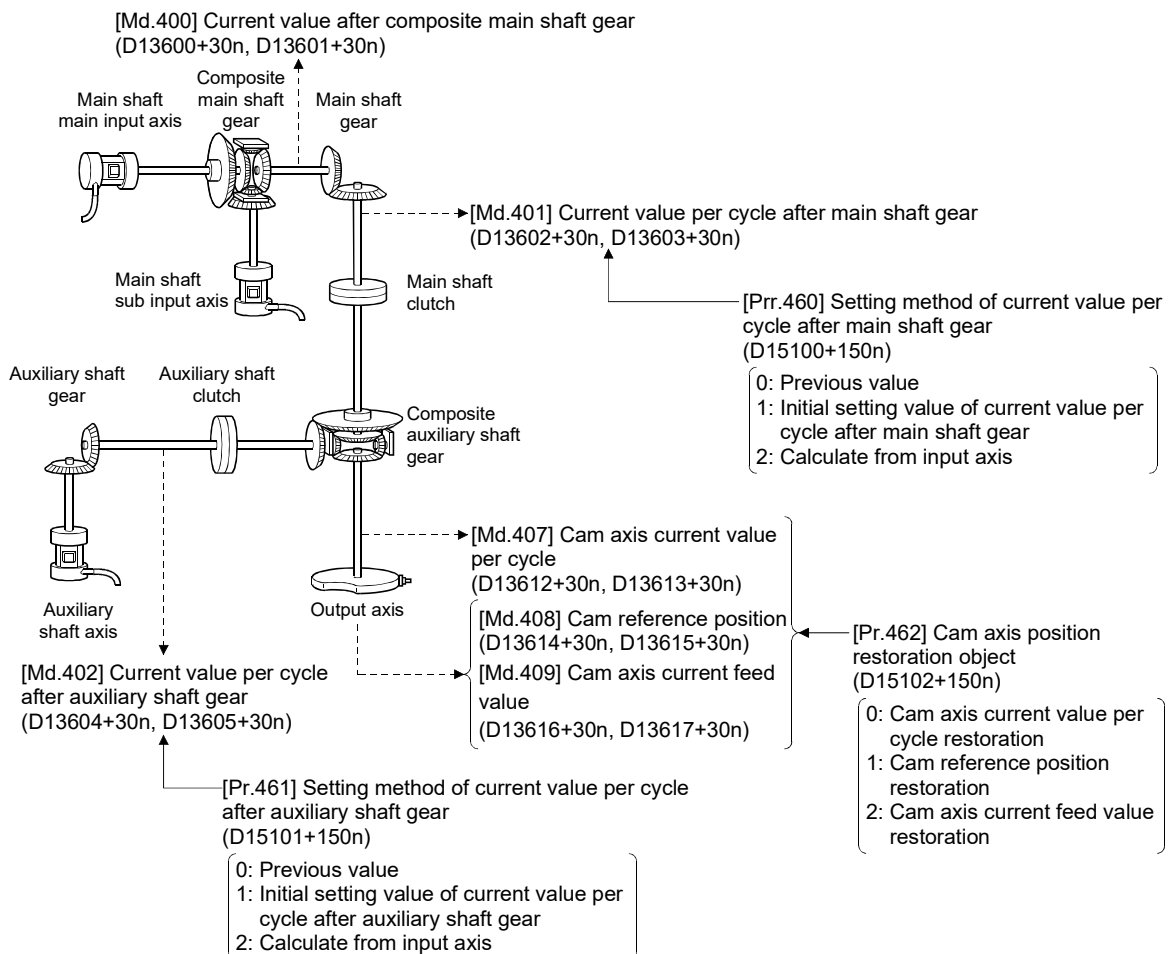

8 SYNCHRONOUS CONTROL INITIAL POSITION

(1) Current value after composite main shaft gear when starting synchronous control

The current value after composite main shaft gear is restored as follows according to the main input axis operation executed before starting synchronous control.

Operation of main input axis (Before synchronous control start)	Servo input axis		Command generation axis	Synchronous encoder axis			
	Absolute position detection system valid	Absolute position detection system invalid		Incremental synchronous encoder	Absolute synchronous encoder	Synchronous encoder via device	Multiple CPU synchronous control (Note-3) 
Home position return	Restoration method 1)		—	—			
Current value change	Restoration method 1)		Restoration method 1)	Restoration method 1)			
Speed control (I) (Note-1)	Restoration method 1)		Restoration method 1)	—			
Fixed-pitch feed control	Restoration method 1)		Restoration method 1)	—			
Speed-position switching control (Note-2)	Restoration method 1)		—	—			
Connection to servo amplifier	Restoration method 2) (Note-4), (Note-5)	—	—	—			
Connection to synchronous encoder	—		—	Restoration method 1)	Restoration method 2)	Restoration method 1)	
Others	Restoration method 2)		Restoration method 2)	Restoration method 2)			

(Note-1): When it starts by turning OFF the feed current value update command (M3212+20n) or [Rq.347] Feed current value update request command (M10972+20n).

(Note-2): When it starts by turning OFF the feed current value update command (M3212+20n).

(Note-3): If the synchronous encoder axis type (master CPU servo input axis, master CPU command generation axis, master CPU synchronous encoder axis) of the slave CPU in the Multiple CPU synchronous control system is set.

(Note-4): When the unit setting of the servo input axis is set to [degree], the servo input axis value is rounded to a value within the range of "0 to 359.99999°", and the difference between this value and the current value of the servo input axis when synchronous control was last conducted is used as the change amount in "(b) Restoration method 2)" below.

(Note-5): When the servo input axis movement since synchronous control was last conducted exceeds "±214783647 (input axis unit)" before synchronous control starts, the change amount cannot be calculated correctly.

(a) Restoration method 1)

The new current value after composite main shaft gear is calculated based on the current value of the main input axis.

$$\begin{array}{l} \text{Current value after} \\ \text{composite main} \\ \text{shaft gear} \end{array} = \begin{array}{l} \text{Main input direction of} \\ \text{composite main shaft gear} \\ \text{(Input +/Input -/No input (0))} \end{array} \times \begin{array}{l} \text{Main input axis current} \\ \text{value} \end{array}$$

: Refer to Section 1.4 for the software version that supports this function.

8 SYNCHRONOUS CONTROL INITIAL POSITION

(b) Restoration method 2)

The travel value of the main input axis from the last synchronous control session is reflected to the current value after composite main shaft gear.

$$\begin{array}{l} \text{Current value after} \\ \text{composite main} \\ \text{shaft gear} \end{array} = \begin{array}{l} \text{Current value after} \\ \text{composite main shaft gear} \\ \text{at the last synchronous} \\ \text{control session} \end{array} + \begin{array}{l} \text{Main input direction of} \\ \text{composite main shaft gear} \\ \text{(Input +/Input -/No input (0))} \end{array} \times \begin{array}{l} \text{Amount of change of main} \\ \text{input axis current value} \\ \text{from the last synchronous} \\ \text{control session} \end{array}$$

The current value after composite main shaft gear at the last synchronous control session is restored when "0: Invalid" is set in [Pr.400] Main input axis No. (D15000+150n), or when a servo input axis or a synchronous encoder axis as the main input axis is not connected.

REMARK

"The last synchronous control session" indicates status just before the last synchronous control session was stopped as follows. These are listed with the last synchronization status.

- Just before [Rq.380] Synchronous control start (M12000+n) turns from ON to OFF.
- Just before deceleration stop by a stop command or an error, etc.
- Just before the Multiple CPU system power supply turned OFF.

8 SYNCHRONOUS CONTROL INITIAL POSITION

- (2) Current value per cycle after main shaft gear, current value per cycle after auxiliary shaft gear when starting synchronous control
 The current value per cycle after main shaft gear/current value per cycle after auxiliary shaft gear is restored as follows according to the main input axis/auxiliary shaft operation executed before starting synchronous control.

Operation of main input axis/auxiliary shaft (Before synchronous control start)	Servo input axis		Command generation axis	Synchronous encoder axis			
	Absolute position detection system valid	Absolute position detection system invalid		Incremental synchronous encoder	Absolute synchronous encoder	Synchronous encoder via device	Multiple CPU synchronous control (Note-3) <small>Ver.!</small>
Home position return	Restoration method 1)		—	—			
Current value change	Restoration method 1)		Restoration method 1)	Restoration method 1)			
Speed control (I) (Note-1)	Restoration method 1)		Restoration method 1)	—			
Fixed-pitch feed control	Restoration method 1)		Restoration method 1)	—			
Speed-position switching control (Note-2)	Restoration method 1)		—	—			
Connection to servo amplifier	Restoration method 2) (Note-4), (Note-5)	—	—	—			
Connection to synchronous encoder	—		—	Restoration method 1)	Restoration method 2)	Restoration method 1)	
Others	Restoration method 2)		Restoration method 2)	Restoration method 2)			

(Note-1): When it starts by turning OFF the feed current value update command (M3212+20n) or [Rq.347] Feed current value update request command (M10972+20n).

(Note-2): When it starts by turning OFF the feed current value update command (M3212+20n).

(Note-3): If the synchronous encoder axis type (master CPU servo input axis, master CPU command generation axis, master CPU synchronous encoder axis) of the slave CPU in the Multiple CPU synchronous control system is set.

(Note-4): When the unit setting of the servo input axis is set to [degree], the servo input axis value is rounded to a value within the range of "0 to 359.99999°", and the difference between this value and the current value of the servo input axis when synchronous control was last conducted is used as the change amount in "(b) Restoration method 2)" below. For that reason, if positioning exceeds "360[degree]", the current value per cycle after main shaft gear and the current value per cycle after auxiliary shaft gear may not be restored correctly. In that case, set [Pr.460] Setting method of current value per cycle after main shaft gear (D15100+150n) and [Pr.461] Setting method of current value per cycle after auxiliary shaft gear (D15101+150n) to the following settings.

Synchronous control initial position parameter	Setting value
[Pr.460] Setting method of current value per cycle after main shaft gear (D15100+150n)	0: Previous value, or 1: Current value per cycle after main shaft gear
[Pr.461] Setting method of current value per cycle after auxiliary shaft gear (D15101+150n)	0: Previous value, or 1: Current value per cycle after auxiliary shaft gear

(Note-5): When the servo input axis movement since synchronous control was last conducted exceeds "±2147483647 (input axis unit)" before synchronous control starts, the change amount cannot be calculated correctly. In that case, set [Pr.460] Setting method of current value per cycle after main shaft gear (D15100+150n) and [Pr.461] Setting method of current value per cycle after auxiliary shaft gear (D15101+150n) to the following settings.

Synchronous control initial position parameter	Setting value
[Pr.460] Setting method of current value per cycle after main shaft gear (D15100+150n)	0: Previous value, or 1: Current value per cycle after main shaft gear
[Pr.461] Setting method of current value per cycle after auxiliary shaft gear (D15101+150n)	0: Previous value, or 1: Current value per cycle after auxiliary shaft gear

Ver.! : Refer to Section 1.4 for the software version that supports this function.

8 SYNCHRONOUS CONTROL INITIAL POSITION

(a) Restoration method 1)

The new value of the current value per cycle after main shaft gear/current value per cycle after auxiliary shaft gear is calculated based on the current value after composite main shaft gear/auxiliary shaft current value.

[Main shaft]

$$\text{Current value per cycle after main shaft gear} = \text{Main shaft gear ratio} \times \text{Current value after composite main shaft gear}$$

[Auxiliary shaft]

$$\text{Current value per cycle after auxiliary shaft gear} = \frac{\text{Auxiliary shaft gear}}{\text{ratio}} \times \text{Auxiliary shaft current value}$$

(b) Restoration method 2)

The travel value from the last synchronous control session is reflected to the current value per cycle after main shaft gear/current value per cycle after auxiliary shaft gear.

[Main shaft]

$$\text{Current value per cycle after main shaft gear} = \text{Current value per cycle after main shaft gear at the last synchronous control session} + \text{Main shaft gear ratio} \times \text{Amount of change of current value after composite main shaft gear from the last synchronous control session}$$

[Auxiliary shaft]

$$\text{Current value per cycle after auxiliary shaft gear} = \text{Current value per cycle after auxiliary shaft gear at the last synchronous control session} + \frac{\text{Auxiliary shaft gear}}{\text{ratio}} \times \text{Amount of change of auxiliary shaft current value from the last synchronous control session}$$

The current value per cycle after main shaft gear/current value per cycle after auxiliary shaft gear at the last synchronous control session is restored when "0: Invalid" is set in [Pr.400] Main input axis No. (D15000+150n) / [Pr.418] Auxiliary shaft axis No. (D15024+150n), or when a servo input axis or a synchronous encoder axis as the main input axis/auxiliary shaft is not connected.

(3) Cam axis position at synchronous control start

The cam axis position is composed of the relationship of 3 positions "Cam axis current value per cycle", "Cam reference position" and "Cam axis current feed value". One of positions can be restored by defining 2 positions when starting synchronous control.

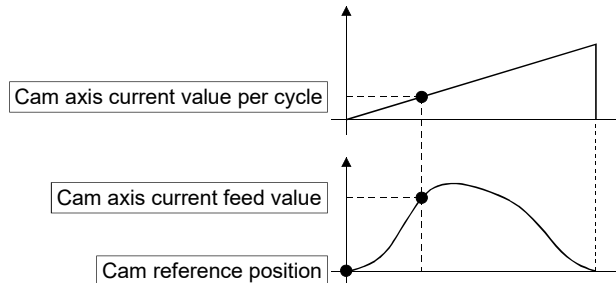

Select from 3 objects as follows in [Pr.462] Cam axis position restoration object (D15102+150n) which position is to be restored.

(Refer to Section 8.3 for details on the restoration method.)

- 1) Cam axis current value per cycle restoration
- 2) Cam reference position restoration
- 3) Cam axis current feed value restoration

Various parameters need to be set for the cam axis position restoration as shown in Table 8.1. (Refer to Section 8.2 for the setting details.)

Table 8.1 Setting list for cam axis position restoration parameters

[Pr.462] Cam axis position restoration object (D15102+150n)	[Pr.463] Setting method of cam reference position (D15103+150n)	[Pr.467] Cam reference position (Initial setting) (D15110+150n, D15111+150n)	[Pr.464] Setting method of cam axis current value per cycle (D15104+150n)	[Pr.468] Cam axis current value per cycle (Initial setting) (D15112+150n, D15113+150n)	Restoration processing details
0: Cam axis current value per cycle restoration	○	△	—	○ (Used as search starting point)	Restore "Cam axis current value per cycle" based on "Cam reference position" and "Cam axis current feed value".
1: Cam reference position restoration	—	—	○	△	Restore "Cam reference position" based on "Cam axis current value per cycle" and "Cam axis current feed value".
2: Cam axis current feed value restoration	○	△	○	△	Restore "Cam axis current feed value" based on "Cam axis current value per cycle" and "Cam reference position".

○: Required, △:Required for initial setting value , —: Not required

8 SYNCHRONOUS CONTROL INITIAL POSITION

8.2 Synchronous Control Initial Position Parameters

Symbol	Setting item	Setting details	Setting value	Fetch cycle	Default value	Device No.
Pr.460	Setting method of current value per cycle after main shaft gear	Select the setting method for the current value per cycle after main shaft gear.	0: Previous value 1: Initial setting value of current value per cycle after main shaft gear ([Pr.465]) 2: Calculate from input axis	At start of synchronous control	0	D15100+150n
Pr.461	Setting method of current value per cycle after auxiliary shaft gear	Select the setting method for the current value per cycle after auxiliary shaft gear.	0: Previous value 1: Initial setting value of current value per cycle after auxiliary shaft gear ([Pr.466]) 2: Calculate from input axis		0	D15101+150n
Pr.462	Cam axis position restoration object	Select the object to restore the cam axis position.	0: Cam axis current value per cycle restoration 1: Cam reference position restoration 2: Cam axis current feed value restoration		0	D15102+150n
Pr.463	Setting method of cam reference position	<ul style="list-style-type: none"> Select the setting method for the cam reference position. Set for the cam axis current value per cycle restoration or the cam axis current feed value restoration. 	0: Previous value 1: Initial setting value of cam reference position 2: Current feed value		2	D15103+150n
Pr.464	Setting method of cam axis current value per cycle	<ul style="list-style-type: none"> Select the setting method for the cam axis current value per cycle. Set for the cam reference position restoration or the cam axis current feed value restoration. 	0: Previous value 1: Initial setting value of cam axis current value per cycle 2: Current value per cycle after main shaft gear 3: Current value per cycle after auxiliary shaft gear		0	D15104+150n
Pr.465	Current value per cycle after main shaft gear (Initial setting)	Set the initial value of the current value per cycle after main shaft gear.	0 to (Cam axis length per cycle - 1) [Cam axis cycle units] (Note-1)		0	D15106+150n D15107+150n
Pr.466	Current value per cycle after auxiliary shaft gear (Initial setting)	Set the initial value of the current value per cycle after auxiliary shaft gear.	0 to (Cam axis length per cycle - 1) [Cam axis cycle units] (Note-1)		0	D15108+150n D15109+150n
Pr.467	Cam reference position (Initial setting)	Set the initial value of the cam reference position.	-2147483648 to 2147483647 [Output axis position units] (Note-2)		0	D15110+150n D15111+150n
Pr.468	Cam axis current value per cycle (Initial setting)	<ul style="list-style-type: none"> Set the initial value for the cam axis current value per cycle. The restoration value for the cam axis current value per cycle is searched from the setting value with the cam axis current value per cycle restoration. 	0 to (Cam axis length per cycle - 1) [Cam axis cycle units] (Note-1)		0	D15112+150n D15113+150n

(Note-1): Cam axis cycle units (Refer to Section 7.5.1)

(Note-2): Output axis position units (Refer to Section 7.5.1)

- (1) [Pr.460] Setting method of current value per cycle after main shaft gear (D15100+150n)
 Select the setting method of [Md.401] Current value per cycle after main shaft gear (D13602+30n, D13603+30n) when starting synchronous control.
- 0: Previous value The current value per cycle after main shaft gear from the last synchronous control session is stored.
 - 1: Initial setting value of current value per cycle after main shaft gear The value set in [Pr.465] Current value per cycle after main shaft gear (Initial setting) (D15106+150n, D15107+150n) is stored.
 - 2: Calculate from input axis The value calculated based on the current value after composite main shaft gear is stored.
- (2) [Pr.461] Setting method of current value per cycle after auxiliary shaft gear (D15101+150n)
 Select the setting method of [Md.402] Current value per cycle after auxiliary shaft gear (D13604+30n, D13605+30n) when starting synchronous control.
- 0: Previous value The current value per cycle after auxiliary shaft gear from the last synchronous control session is stored.
 - 1: Initial setting value of current value per cycle after auxiliary shaft gear The value set in [Pr.466] Current value per cycle after auxiliary shaft gear (Initial setting) (D15108+150n, D15109+150n) is stored.
 - 2: Calculate from input axis The value calculated based on the auxiliary shaft current value is stored.
- (3) [Pr.462] Cam axis position restoration object (D15102+150n)
 Select the object to be restored from "Cam axis current value per cycle", "Cam reference position" or "Cam axis current feed value" when starting synchronous control.
- 0: Cam axis current value per cycle restoration Restore the cam axis current value per cycle from "Cam reference position" and "Cam axis current feed value".
 - 1: Cam reference position restoration Restore the cam reference position from "Cam axis current value per cycle" and "Cam axis current feed value".
 - 2: Cam axis current feed value restoration Restore the cam axis current feed value from "Cam axis current value per cycle" and "Cam reference position".

(4) [Pr.463] Setting method of cam reference position (D15103+150n)

Select the method for the cam reference position to be restored when [Pr.462] Cam axis position restoration object (D15102+150n) is set to "0: Cam axis current value per cycle restoration" or "2: Cam axis current feed value restoration".

- 0: Previous value The cam reference position from the last synchronous control session is stored.
The current feed value is stored when the cam reference position from the last synchronous control session is not saved.
- 1: Initial setting value of cam reference position
..... The value set in [Pr.467] Cam reference position (Initial setting) (D15110+150n, D15111+150n) is stored.
- 2: Current feed value The value set in current feed value (D0+20n, D1+20n) is stored.

(5) [Pr.464] Setting method of cam axis current value per cycle (D15104+150n)

Select the method for the cam axis current value per cycle to be restored when [Pr.462] Cam axis position restoration object (D15102+150n) is set to "1: Cam reference position restoration" or "2: Cam axis current feed value restoration".

- 0: Previous value The cam axis current value per cycle from the last synchronous control session is stored as is.
- 1: Initial setting value of cam axis current value per cycle
..... The value set in [Pr.468] Cam axis current value per cycle (Initial setting) (D15112+150n, D15113+150n) is stored.
- 2: Current value per cycle after main shaft gear
..... The current value per cycle after main shaft gear is stored.
- 3: Current value per cycle after auxiliary shaft gear
..... The current value per cycle after auxiliary shaft gear is stored.

(6) [Pr.465] Current value per cycle after main shaft gear (Initial setting) (D15106+150n, D15107+150n)

Set the initial setting value of the current value per cycle after main shaft gear when [Pr.460] Setting method of current value per cycle after main shaft gear (D15100+150n) is set to "1: Current value per cycle after main shaft gear (Initial setting)".

The unit settings are in cam axis cycle units (Refer to Section 7.5.1). Set within the range from 0 to (Cam axis length per cycle - 1).

(7) [Pr.466] Current value per cycle after auxiliary shaft gear (Initial setting) (D15108+150n, D15109+150n)

Set the initial setting value of the current value per cycle after auxiliary shaft gear when [Pr.461] Setting method of current value per cycle after auxiliary shaft gear (D15101+150n) is set to "1: Current value per cycle after auxiliary shaft gear (Initial setting)".

The unit settings are in cam axis cycle units (Refer to Section 7.5.1). Set within the range from 0 to (Cam axis length per cycle - 1).

(8) [Pr.467] Cam reference position (Initial setting) (D15110+150n, D15111+150n)

Set the initial setting value of the cam reference position in output axis position units (Refer to Section 7.5.1) when [Pr.463] Setting method of cam reference position (D15103+150n) is set to "1: Cam reference position (Initial setting)".

(9) [Pr.468] Cam axis current value per cycle (Initial setting) (D15112+150n, D15113+150n)

Set a value according to the setting for [Pr.462] Cam axis position restoration object (D15102+150n).

The unit settings are in cam axis cycle units (Refer to Section 7.5.1). Set within the range from 0 to (Cam axis length per cycle - 1).

[Pr.462] Cam axis position restoration object (D15102+150n)	Setting value
0: Cam axis current value per cycle restoration	Set the starting point for search processing to restore the cam axis current value per cycle. Set to restore the position on the return path in two-way cam pattern operation. Refer to Section 8.3.1 for details on search processing.
1: Cam reference position restoration	Set the initial setting value for the cam axis current value per cycle when [Pr.464] Setting method of cam axis current value per cycle (D15104+150n) is set to "1: Cam axis current value per cycle (Initial setting)".
2: Cam axis current feed value restoration	

8.3 Cam Axis Position Restoration Method

8.3.1 Cam axis current value per cycle restoration

If [Pr.462] Cam axis position restoration object (D15102+150n) is set to "0: Cam axis current value per cycle restoration" when starting synchronous control, the cam axis current value per cycle is restored based on the cam reference position and the cam axis current feed value.

Select the method for the cam reference position to be restored. The current feed value when starting synchronous control is used as the cam axis current feed value. The cam axis current value per cycle is restored by searching for the corresponding value from the beginning to the end of the cam pattern. Set the starting point from where to search the cam pattern in [Pr.468] Cam axis current value per cycle (Initial setting) (D15112+150n, D15113+150n). (It is also possible to search the return path in a two-way cam pattern operation.)

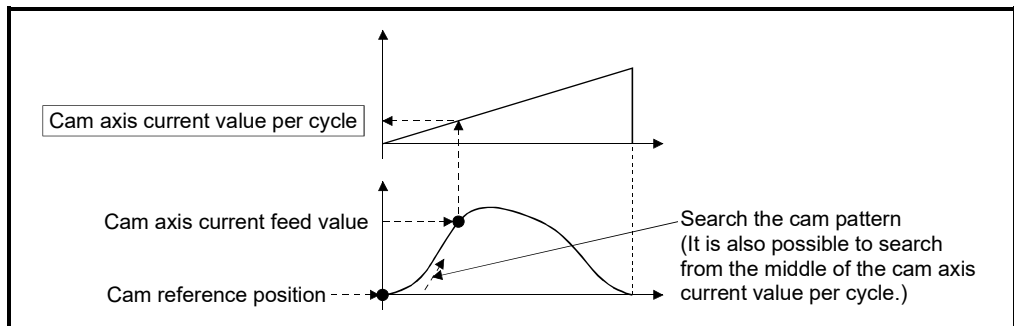
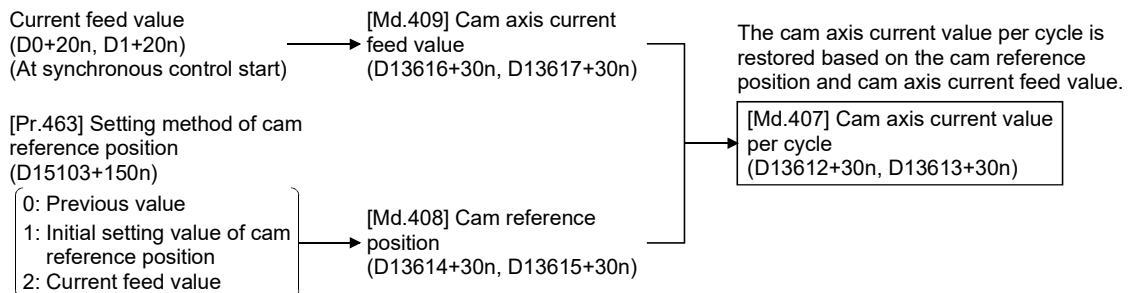

(1) Restrictions

- With two-way cam pattern operation, if the corresponding cam axis current value per cycle is not found, "Major error (error code: 1768)" will occur and synchronous control will not be started.
- When starting synchronous control, the current feed value may change slightly from its original position at starting synchronous control. This is due to the readjustment of the position based on the restored cam axis current value per cycle. This does not result in position displacement.
- With a feed operation cam pattern, if the corresponding cam axis current value per cycle is not found on the first cycle, the cam reference position is changed automatically and the pattern is searched again.
- If the cam resolution is large, search processing may take a long time when starting synchronous control. (Cam resolution 32768: up to about 23ms)

(2) Cam axis current value per cycle restoration operation

(a) With a two-way cam pattern operation

- 1) Search from "Cam axis current value per cycle = 0".
(Cam data starting point = 0)

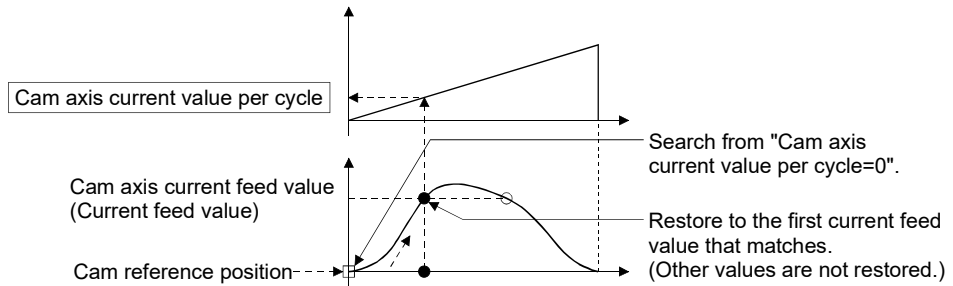

- 2) Search from a value in the middle of the cam axis current value per cycle. (Cam data starting point = 0)

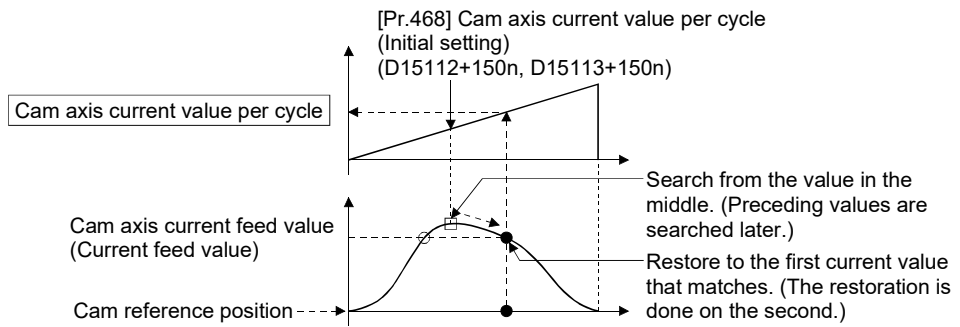

- 3) Search from a value in the middle of the cam axis current value per cycle. (Cam data starting point ≠ 0)

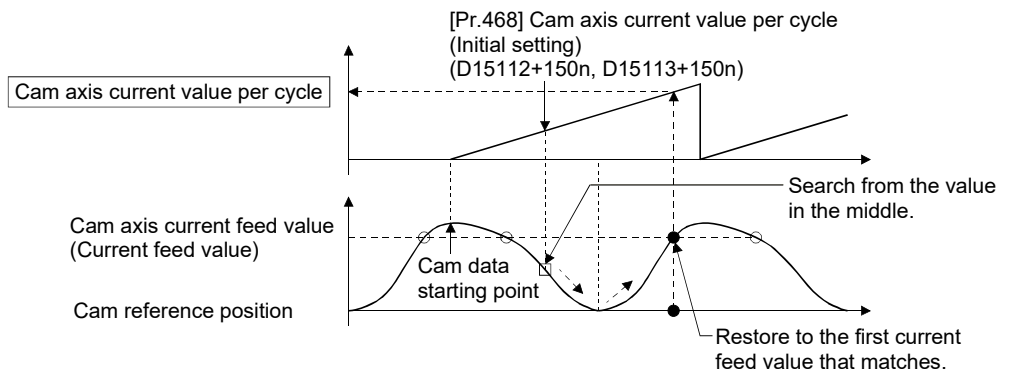

- 4) The search fails.

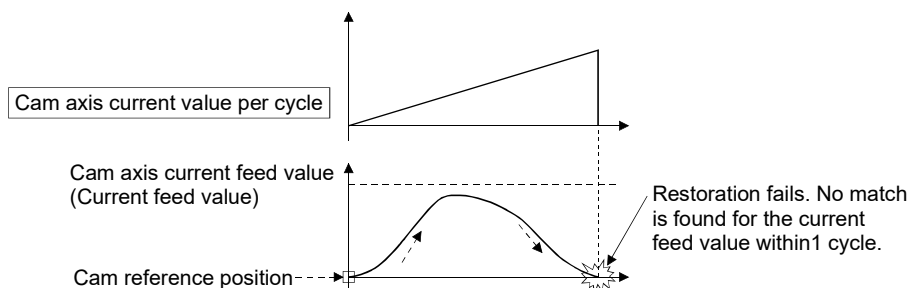

8 SYNCHRONOUS CONTROL INITIAL POSITION

(b) With a feed operation cam pattern

1) Search from "Cam axis current value per cycle = 0".

(Cam data starting point = 0)

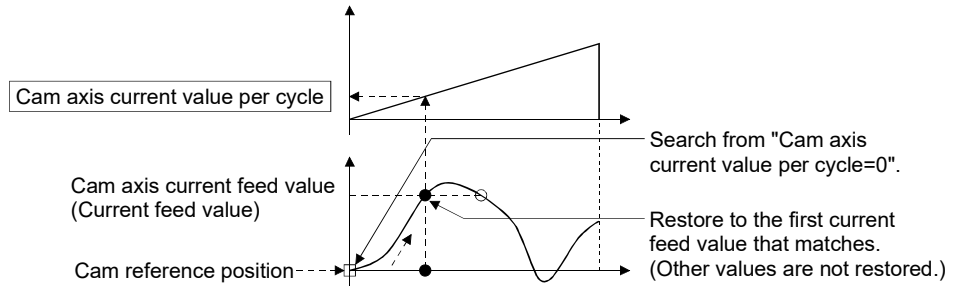

2) Search from a value in the middle of the cam axis current value per cycle. (Cam data starting point = 0)

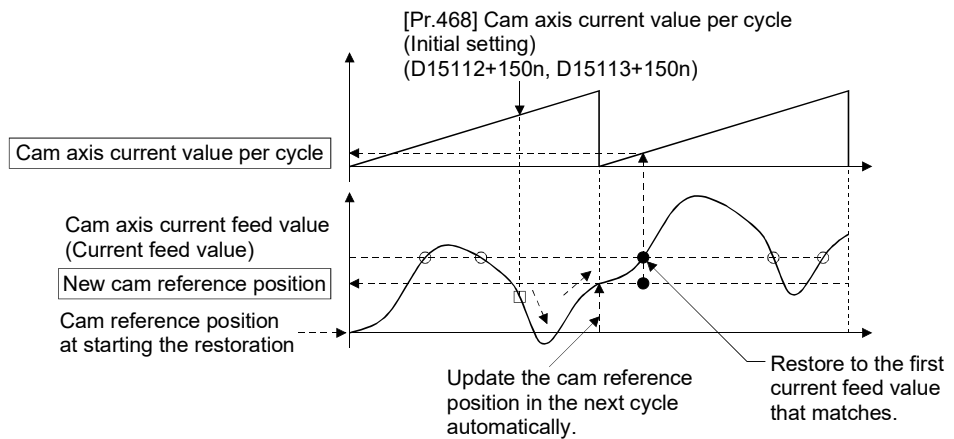

3) Search from a value in the middle of the cam axis current value per cycle. (Cam data starting point ≠ 0)

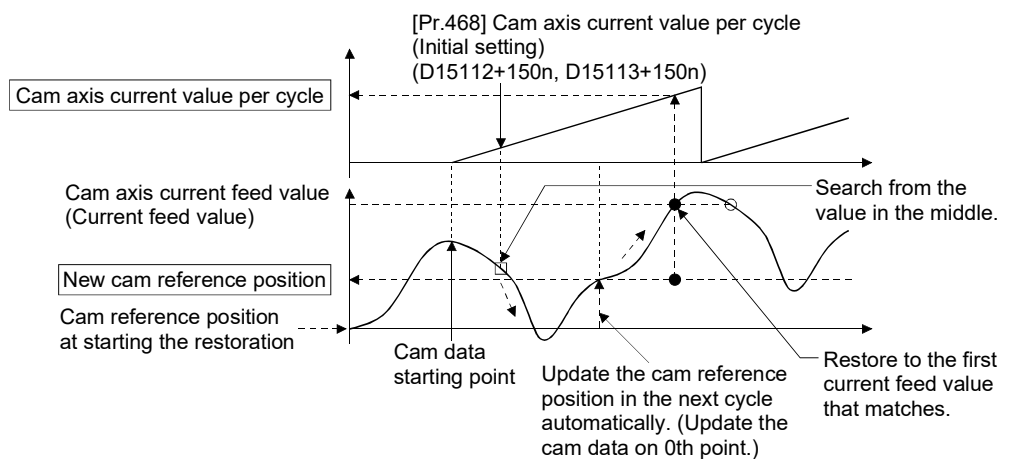

4) The first search is fails and a search begins for the second time.

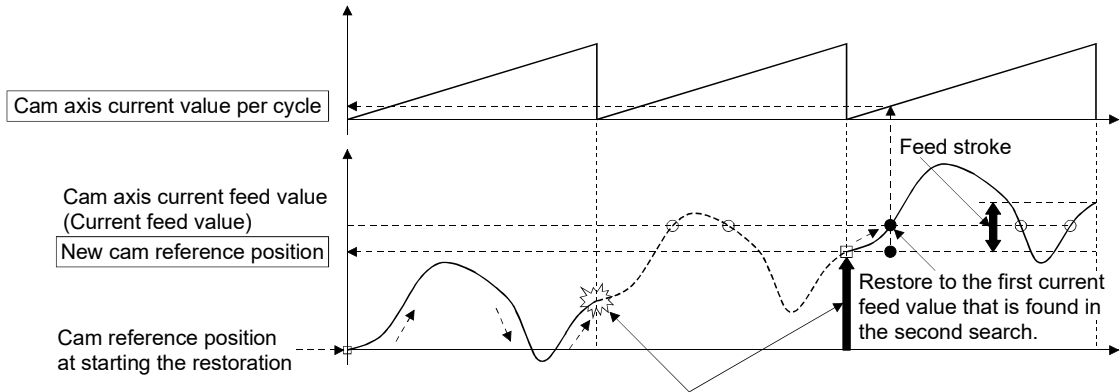

Once the restoration fails in the first search, the new cam reference position is automatically updated to the one within the feed stroke amount, which is equal to "Current feed value - New cam reference position", and the search process starts again.

POINT

If the first search fails, a second search may not be processed on the next cycle for a cam pattern with a feed stroke that is smaller than 100% of the stroke as above. The intended cam axis current value per cycle can be found in the first search, by setting or positioning the cam reference position in advance.

(3) Example

The following shows an example of restarting the cam (a cam similar to a cam with a linear feed where two identical positioning points do not exist on the cam) from the feed current value after a forced stop, when the forced stop has stopped operation.

If the following settings are used in a two-way cam or a cam where identical positioning points exist on the same cam, similar to the cam axis current value per cycle restoration operation (Refer to this section (2)), the first matching feed current value (outward route) is restored, therefore restoration may start from an unintended cam pattern position. To avoid restoring the first matching feed current value, use cam axis current feed value restoration (Refer to Section 8.3.3).

Setting item	Setting value
[Pr.439] Cam axis length per cycle (D15060+150n, D15061+150n)	1000[pulse]
[Pr.441] Cam stroke amount (D15064+150n, D15065+150n)	200[pulse]
[Pr.462] Cam axis restoration object (D15102+150n)	0: Cam axis current value per cycle restoration
[Pr.463] Setting method of cam reference position (D15103+150n)	1: Initial setting value of cam reference position
[Pr.464] Setting method of cam axis current value per cycle (D15104+150n)	0: Previous value
[Pr.467] Cam reference position (Initial setting) (D15110+150n, D15111+150n)	0[pulse]
[Pr.468] Cam axis current value per cycle (Initial setting) (D15112+150n, D15113+150n)	0[pulse]

(a) Advanced synchronous control operation

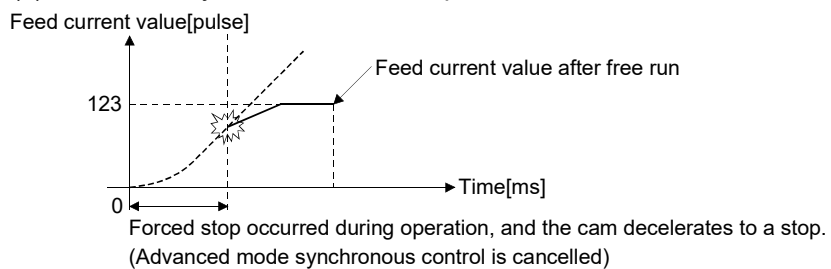

(b) Restore operation at restart of advanced synchronous control

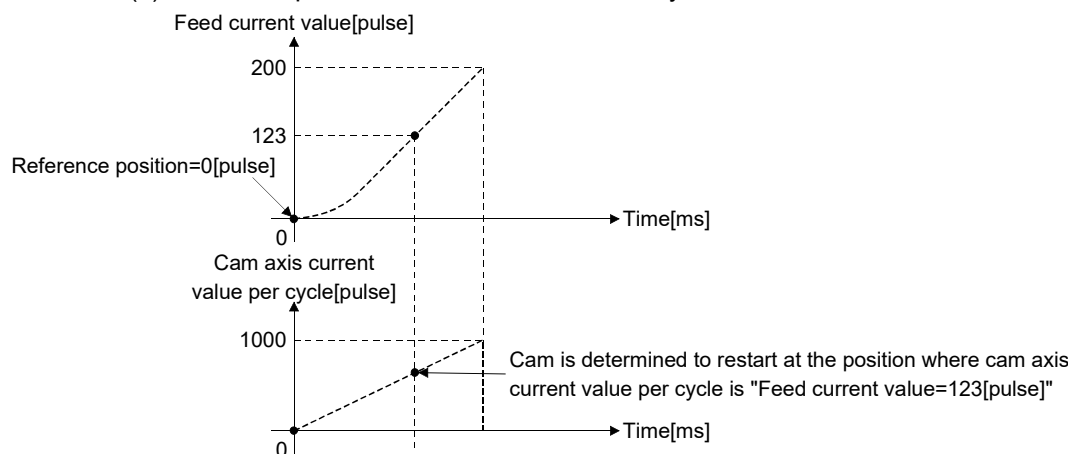

8 SYNCHRONOUS CONTROL INITIAL POSITION

(c) Cam operation

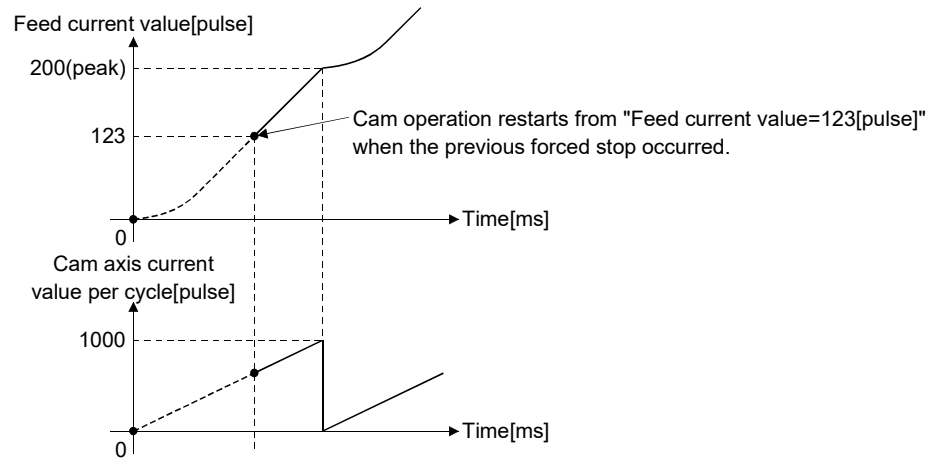

8 SYNCHRONOUS CONTROL INITIAL POSITION

8.3.2 Cam reference position restoration

If [Pr.462] Cam axis position restoration object (D15102+150n) is set to "1: cam reference position restoration" when starting synchronous control, the cam reference position is restored based on the cam axis current value per cycle and the cam axis current feed value.

Select the method for the cam axis current value per cycle to be restored. The current feed value when starting synchronous control is used as the cam axis current feed value.

[Pr.464] Setting method of cam axis current value per cycle (D15104+150n)

- 0: Previous value
- 1: Initial setting value of cam axis current value per cycle
- 2: Current value per cycle after main shaft gear
- 3: Current value per cycle after auxiliary shaft gear

Current feed value (D0+20n, D1+20n)
(At synchronous control start)

[Md.407] Cam axis current value per cycle (D13612+30n, D13613+30n)

[Md.409] Cam axis current feed value (D13616+30n, D13617+30n)

The cam reference position is restored based on the cam axis current value per cycle and the cam axis current feed value.

[Md.408] Cam reference position (D13614+30n, D13615+30n)

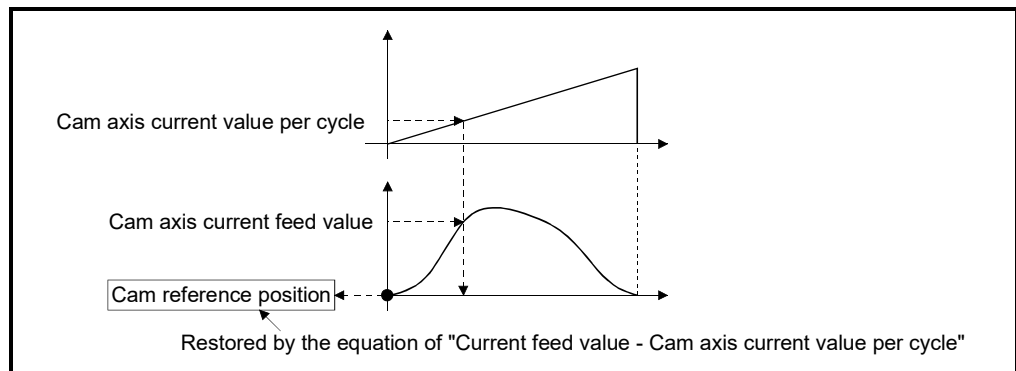

(1) Example

The following shows an example of starting operation from a position of "cam axis current value per cycle=0" by restoring the cam reference position when starting from "feed current value=0[pulse]", in the cam when the cam data starting point is not 0.

Setting item	Setting value
[Pr.439] Cam axis length per cycle (D15060+150n, D15061+150n)	1000[pulse]
[Pr.441] Cam stroke amount (D15064+150n, D15065+150n)	200[pulse]
[Pr.462] Cam axis restoration object (D15102+150n)	1: Cam reference position restoration
[Pr.463] Setting method of cam reference position (D15103+150n)	None
[Pr.464] Setting method of cam axis current value per cycle (D15104+150n)	1: Initial setting value of cam axis current value per cycle
[Pr.467] Cam reference position (Initial setting) (D15110+150n, D15111+150n)	None
[Pr.468] Cam axis current value per cycle (Initial setting) (D15112+150n, D15113+150n)	0[pulse]

8 SYNCHRONOUS CONTROL INITIAL POSITION

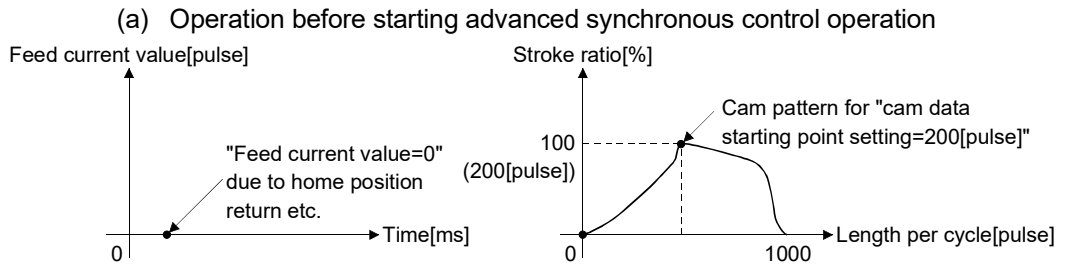

(b) Restore operation at start of advanced synchronous control

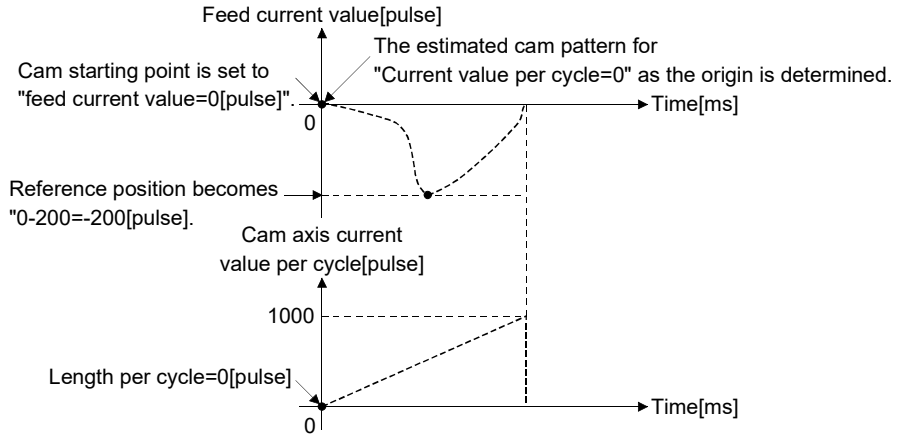

(c) Cam operation

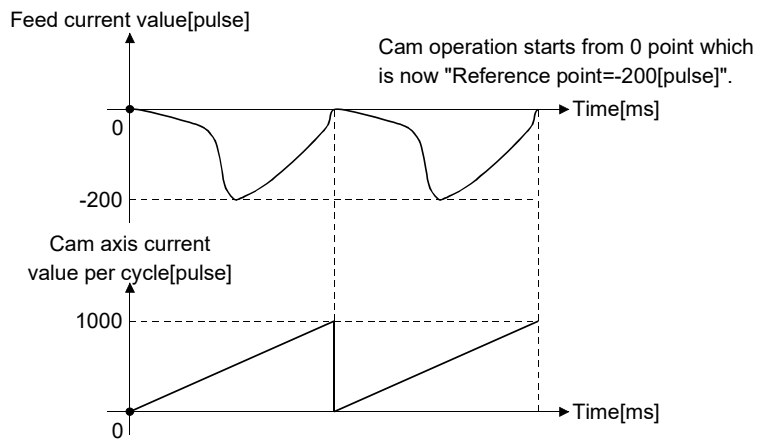

8 SYNCHRONOUS CONTROL INITIAL POSITION

8.3.3 Cam axis current feed value restoration

If [Pr.462] Cam axis position restoration object (D15102+150n) is set to "2: cam current feed value restoration" when starting synchronous control, the cam axis current feed value is restored based on the cam axis current value per cycle and the cam reference position.

Select the method for the cam axis current value per cycle and the method for the cam reference position to be restored.

[Pr.464] Setting method of cam axis current value per cycle (D15104+150n)

- 0: Previous value
- 1: Initial setting value of cam axis current value per cycle
- 2: Current value per cycle after main shaft gear
- 3: Current value per cycle after auxiliary shaft gear

[Md.407] Cam axis current value per cycle (D13612+30n, D13613+30n)

The cam axis current feed value is restored based on the cam axis current value per cycle and the cam reference position.

[Pr.463] Setting method of cam reference position (D15103+150n)

- 0: Previous value
- 1: Initial setting value of cam reference position
- 2: Current feed value

[Md.409] Cam reference position (D13614+30n, D13615+30n)

[Md.409] Cam axis current feed value (D13616+30n, D13617+30n)

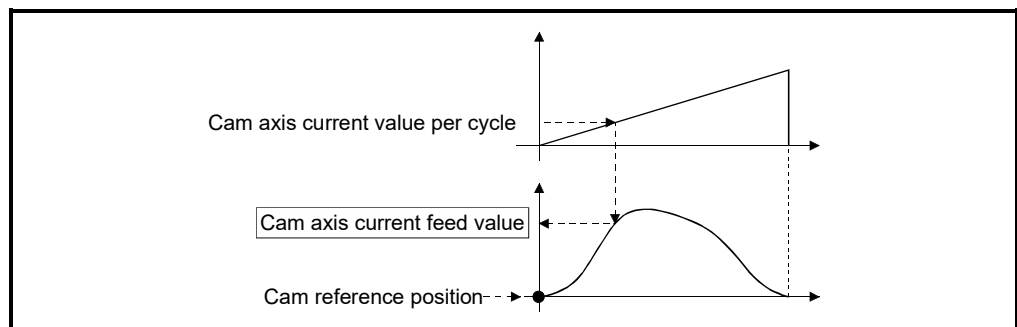

(1) Restrictions

The cam axis current feed value moves to its restored value just after starting synchronous control when the cam axis current feed value to be restored is different from the current feed value at synchronous control start.

If the difference is larger than "In-position width (PA10)" of servo parameter in pulse command units, "Major error (error code: 1769)" will occur and synchronous control cannot be started.

Note that, if the setting value of "In-position width" is large, a rapid operation may occur.

POINT

With cam axis current feed value restoration, calculate the cam axis current feed value with the cam position calculation function (Refer to Section 8.5) or with synchronous control analysis mode (Refer to Section 8.4) before starting synchronous control. Then start synchronous control after positioning to the correct cam axis current feed value.

8 SYNCHRONOUS CONTROL INITIAL POSITION

(2) Example

The following shows an example of starting a cam pattern from the zero point of the cam axis current value per cycle with the current feed current value position as the origin when returning to a specified point, or home position return is completed after a forced stop.

Setting item	Setting value
[Pr.439] Cam axis length per cycle (D15060+150n, D15061+150n)	1000[pulse]
[Pr.441] Cam stroke amount (D15064+150n, D15065+150n)	200[pulse]
[Pr.462] Cam axis restoration object (D15102+150n)	2: Cam reference position restoration
[Pr.463] Setting method of cam reference position (D15103+150n)	2: Current feed value
[Pr.464] Setting method of cam axis current value per cycle (D15104+150n)	1: Initial setting value of cam axis current value per cycle
[Pr.467] Cam reference position (Initial setting) (D15110+150n, D15111+150n)	None
[Pr.468] Cam axis current value per cycle (Initial setting) (D15112+150n, D15113+150n)	0[pulse]

(a) Move to advanced synchronous control starting point

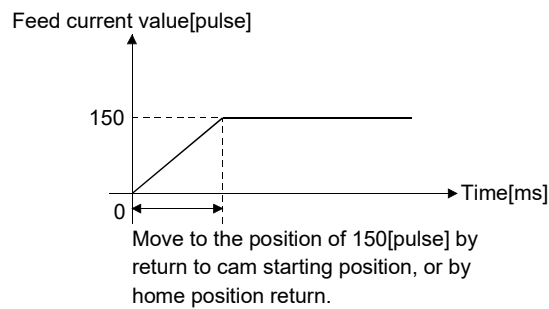

(b) Restore operation

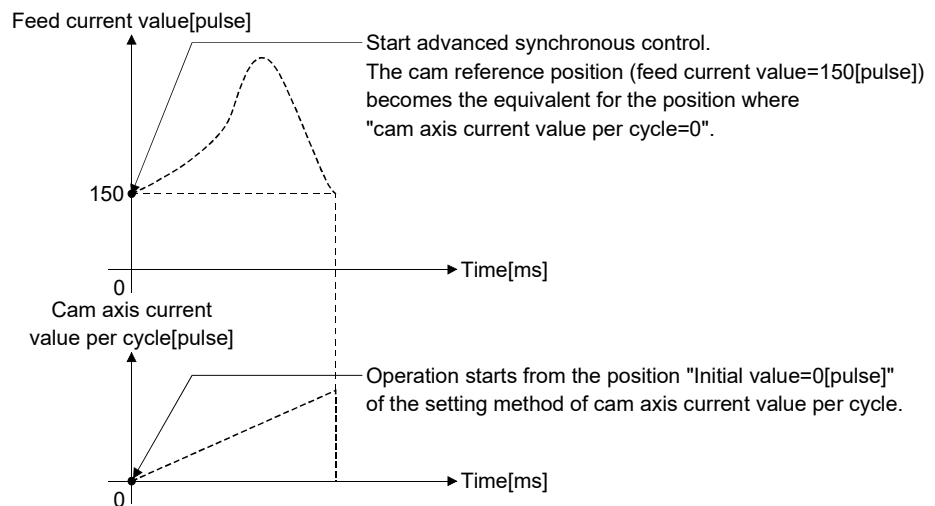

8 SYNCHRONOUS CONTROL INITIAL POSITION

(c) Cam operation

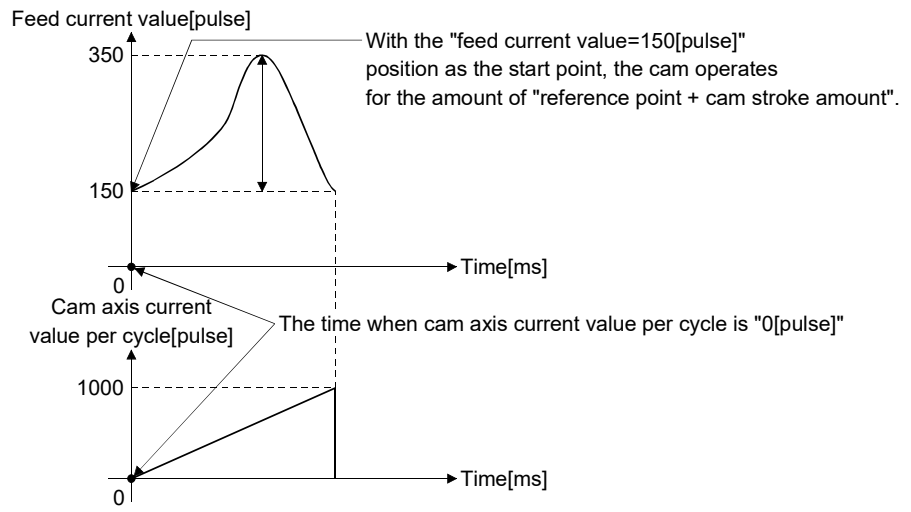

8.4 Synchronous Control Analysis Mode

With synchronous control analysis mode, parameters are only analyzed for synchronous control when there is a command to start synchronous control. This mode is used to confirm the synchronous positions of the output axes in order to align axes with position control before starting synchronous control.

If the target axis bit is ON in [Rq.381] Synchronous analysis request (M12032+n) when starting synchronous control (turning from OFF to ON for [Rq.380] Synchronous control start (M12000+n)), operation enters synchronous control analysis mode.

When the synchronization position analysis is completed, the synchronous control monitor data ([Md.400] to [Md.402], [Md.406] to [Md.411], [Md.422], [Md.425], [St.420], [St.421], [St.423], [St.424] (Refer to Section 7.7)) is updated, and the target axis bit in [St.381] Synchronous analysis complete (M10912+n) turns OFF to ON.

The [St.380] Synchronous control (M10880+n) and start accept flag (M2001+n) is not turned ON during synchronous control analysis mode.

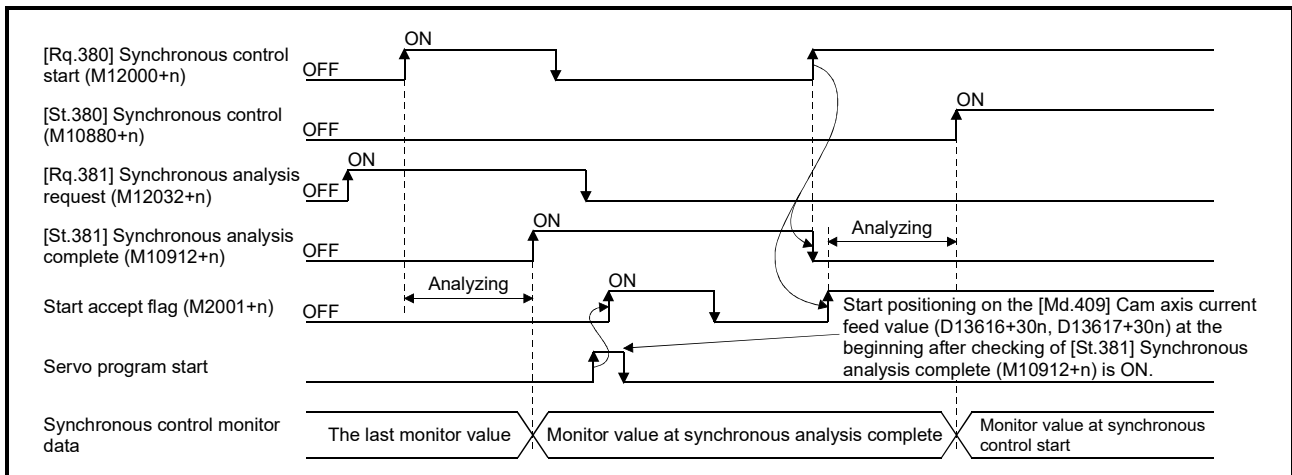

POINT

- (1) Since the synchronous control analysis mode is used for the synchronous control initial position, a major error (error code: 1769) is not detected. Therefore, refer to [Md.409] Cam axis current feed value (D13616+30n, D13617+30n) that is updated by [St.381] Synchronous analysis complete (M10912+n) OFF to ON, and perform the synchronous alignment.
- (2) When [St.381] Synchronous analysis complete (M10912+n) is ON at the synchronous control analysis mode start, [Rq.381] Synchronous control analysis mode request (M10912+n) is turned OFF by turning [Rq.380] Synchronous control start (M12000+n) OFF to ON.

(1) Example

The following shows an example of aligning the synchronous position of an output axis that references the input axis.

- 1) Set the following values in the synchronous control initial position parameters.

Setting item	Setting value
[Pr.460] Setting method of current value per cycle after main shaft gear (D15100+150n)	2: Calculate from input axis
[Pr.462] Cam axis position restoration object (D15102+150n)	2: Cam axis current feed value restoration
[Pr.463] Setting method of cam reference position (D15103+150n)	0: Previous value
[Pr.464] Setting method of cam axis current value per cycle (D15104+150n)	2: Current value per cycle after main shaft gear

- 2) Turn ON the target axis bit of [Rq.381] Synchronous analysis request (M12032+n), and then turn from OFF to ON in [Rq.380] Synchronous control start (M12000+n) to start the synchronous control analysis mode.
- 3) Verify that [St.381] Synchronous analysis complete (M10912+n) is ON, and execute positioning for the output axis to be updated to [Md.409] Cam axis current feed value (D13616+30n, D13617+30n).
- 4) Turn OFF [Rq.381] Synchronous analysis request (M12032+n), and then turn from OFF to ON [Rq.380] Synchronous control start (M12000+n) to start synchronous control.

8.5 Cam Position Calculation Function

The cam position is calculated by the CAMPSCL instruction (Cam position calculation) of Motion SFC program with this function. This function can be used to calculate the cam position for the synchronous control initial position before starting synchronous control.

Refer to the "Q173D(S)CPU/Q172D(S)CPU Motion controller (SV13/SV22) Programming Manual (Motion SFC)" for details of CAMPSCL instruction.

(1) Example

The following shows the procedure for synchronous position alignment, in a synchronous system where cam axes 2 and 3 are synchronized with the cam axis current value per cycle of axis 1.

- 1) Calculate the cam axis current value per cycle using this function based on the current feed value and the cam reference position of axis 1.
- 2) Calculate the cam axis current feed value of axis 2 with this function based on the cam axis current value per cycle that was calculated in 1).
- 3) Calculate the cam axis current feed value of axis 3 with this function based on the cam axis current value per cycle that was calculated in 1).
- 4) Execute positioning on axis 2 to bring the cam to the cam axis current feed value which was calculated in 2), and also on axis 3 to the cam axis current feed value which was calculated in 3).
- 5) Start synchronous control on axis 1, 2 and 3 with the current feed value restoration mode. Use the cam axis current value per cycle that was calculated in 1) for the cam axis current value per cycle (Initial setting).

8.6 Method to Restart Synchronous Control

The relationship of the synchronous position for synchronous control is always saved in the Motion CPU module. Synchronous control can be restarted without returning all axes to their starting points by restoring the synchronized relationship through the synchronous control initial position parameters (Refer to Section 8.2).

The reference axis used to restart synchronous control is different for each system. The following procedure shows an example of how to restore synchronized values based on the servo input axis as reference position.

(1) Example

Restoring 2 output axes (axis 2, axis 3) based on the servo input axis (axis 1) as the reference position.

(Press conveyance device)

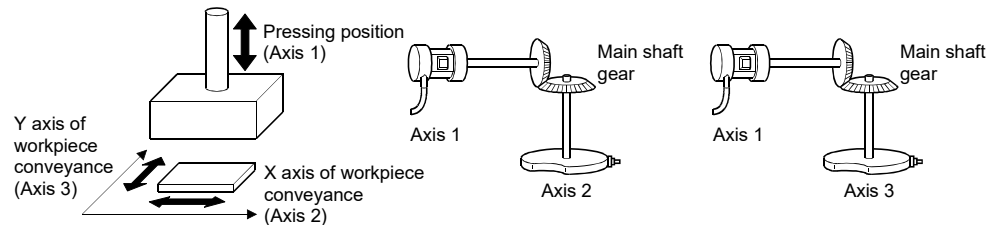

(a) Procedure for synchronous control (first time)

- 1) Execute home position return for axis 1, 2 and 3, and position to the synchronization starting point.
- 2) Set the synchronous control initial position parameters for axis 2 and 3 as follows.

Setting item	Setting value
[Pr.460] Setting method of current value per cycle after main shaft gear (D15100+150n)	2: Calculate from input axis
[Pr.462] Cam axis position restoration object (D15102+150n)	0: Cam axis current value per cycle restoration
[Pr.463] Setting method of cam reference position (D15103+150n)	2: Current feed value
[Pr.468] Cam axis current value per cycle (Initial setting) (D15112+150n, D15113+150n)	0

- 3) Turn ON the bit device for axis 2 and 3 in [Rq.380] Synchronous control start (M12000+n) to start synchronous control.

8 SYNCHRONOUS CONTROL INITIAL POSITION

(b) Procedure for restarting synchronous control

- 1) Set the synchronous control initial position parameters for axis 2 and 3 as follows.

Setting item	Setting value
[Pr.460] Setting method of current value per cycle after main shaft gear (D15100+150n)	2: Calculate from input axis
[Pr.462] Cam axis position restoration object (D15102+150n)	2: Cam axis current feed value restoration
[Pr.463] Setting method of cam reference position (D15103+150n)	0: Previous value
[Pr.464] Setting method of cam axis current value per cycle (D15104+150n)	2: Current value per cycle after main shaft gear

- 2) Turn ON the bit device for axes 2 and 3 in [Rq.381] Synchronous analysis request (M12032+n), and then turn ON the bit device for axes 2 and 3 in [Rq.380] Synchronous control start (M12000+n) to execute the synchronous control analysis. The analyzed result is updated in Synchronous control monitor data ([Md.400] to [Md.402], [Md.406] to [Md.411], [Md.422], [Md.425], [St.420], [St.421], [St.423], [St.424] (Refer to Section 7.7)).
- 3) Position axes 2 and 3 to [Md.409] Cam axis current feed value (D13616+30n, D13617+30n) which has been updated in 2).
- 4) Turn OFF the bit device for axes 2 and 3 in [Rq.381] Synchronous analysis request (M12032+n), and then turn ON the bit device for axes 2 and 3 in [Rq.380] Synchronous control start (M12000+n) to start synchronous control.

9. AUXILIARY AND APPLIED FUNCTIONS

9.1 Phase Compensation Function

In synchronous control, delays in progresses, etc. cause the phase to deviate at the output axis motor shaft end with respect to the input axis (servo input axis or synchronous encoder axis). The phase compensation function compensates in this case so that the phase does not deviate.

Phase compensation can be set for the input and the output axis. It is possible to compensate using the delay time peculiar to the system based on the servo input axis or the synchronous encoder axis on the input axis side. It is also possible to use a compensation delay time equivalent to the position deviation for each servo amplifier on the output axis side.

(1) Phase compensation on delay time of the input axis

Set delay time peculiar to the system in the phase compensation advance time of the input axis ([Pr.302] Servo input axis phase compensation advance time (D14600+2n, D14601+2n), [Pr.326] Synchronous encoder axis phase compensation advance time (D14820+10n, D14821+10n)).

The command generation axis does not have the phase compensation function since the delay time specific to the system is 0.

The delay time peculiar to the system is shown below.

(a) Delay time peculiar to the system for a servo input axis

Operation cycle [ms]	[Pr.300] Servo input axis type			
	Current feed value	Real current value	Command to servo amplifier	Feed back value
0.22	0 [μs]	945 [μs]	0 [μs]	945 [μs]
0.44	0 [μs]	1834 [μs]	0 [μs]	1834 [μs]
0.88	0 [μs]	3612 [μs]	0 [μs]	3612 [μs]
1.77	0 [μs]	3589 [μs]	0 [μs]	3589 [μs]
3.55	0 [μs]	8945 [μs]	0 [μs]	8945 [μs]
7.11	0 [μs]	19612 [μs]	0 [μs]	19612 [μs]

(b) Delay time peculiar to the system for a synchronous encoder axis

Operation cycle [ms]	[Pr.320] Synchronous encoder axis type				
	Incremental synchronous encoder	Absolute synchronous encoder	Synchronous encoder via device	Synchronous encoder via servo amplifier	
				MR-J5(W)-□B	MR-J4(W)-□B
0.22	695 [μs]	603 [μs]	695 + Input value refresh timing [μs]	1972 [μs]	1038 [μs]
0.44	1255 [μs]	1400 [μs]	1255 + Input value refresh timing [μs]	2792 [μs]	1940 [μs]
0.88	2578 [μs]	2717 [μs]	2578 + Input value refresh timing [μs]	4481 [μs]	3763 [μs]
1.77	4395 [μs]	4505 [μs]	4395 + Input value refresh timing [μs]	6356 [μs]	5456 [μs]
3.55	7947 [μs]	8061 [μs]	7947 + Input value refresh timing [μs]	9958 [μs]	9041 [μs]
7.11	18604 [μs]	18728 [μs]	18604 + Input value refresh timing [μs]	20500 [μs]	19608 [μs]

(2) Phase compensation of delay time of the output axis

Set delay time equivalent to the position deviation on the servo amplifier in [Pr.444] Cam axis phase compensation advance time (D15066+150n, D15067+150n) for the output axis. The delay time equivalent to position deviation of the servo amplifier is calculated using the following formula.

$$\text{Delay time } [\mu\text{s}] = \frac{1000000}{\text{Servo parameter "Model loop gain (PB07)"}}$$

(Note): When the feed forward gain is set, the delay time is set to a smaller value than the value listed above.

The model loop gain will change when the gain adjustment method is auto tuning mode 1 or 2. The model loop gain must not be changed on the axis executing phase compensation through preventing change with the manual mode or interpolation mode setting.

(3) Setting example

When axis 1 is synchronized with an incremental synchronous encoder axis, the phase compensation advance time is set as follows.

(If the operation cycle is as 1.77 [ms] and model loop gain of axis 1 is as 80.)

Setting item	Setting value
[Pr.326] Synchronous encoder axis phase compensation advance time (D14820+10n, D14821+10n)	4396 [μs] (Reference: Delay time peculiar to system for a synchronous encoder axis)
[Pr.444] Cam axis phase compensation advance time (D15066+150n, D15067+150n)	$\frac{1000000}{80} = 12500$ [μs]

When overshoot or undershoot occurs during acceleration/deceleration, set a longer time for the phase compensation time constant.

9 AUXILIARY AND APPLIED FUNCTIONS

9.2 Relationship between the Output Axis and Each Function

The relationship between the output axis of synchronous control and each function is shown below.

Function		Output axis	Details
Fixed parameter	Unit setting	○	The same control as other methods.
	Number of pulses per rotation (AP)	○	
	Travel value per rotation (AL)	○	
	Backlash compensation amount	○	
	Upper stroke limit	○	The axis stops immediately when exceeding the software stroke limit range.
	Lower stroke limit	○	To disable the software stroke limit, set the setting value so that "Upper limit value = Lower limit value".
	Command in-position range	—	Setting is ignored.
	Speed control 10 × multiplier setting for degree axis	○	Reflected on monitor data.
Torque limit function		○	The torque limit value can be changed by torque limit value change request instruction (D(P).CHGT, CHGT) and torque limit value individual change request instruction (D(P).CHGT2, CHGT2).
Hardware stroke limit		○	Controlled the same as positioning control.
Forced stop		○	The same control as other methods.
Control change	Current value change	—	Ignored.
	Speed change	—	
	Target position change	—	
Absolute position system		○	The same control as other methods.
M-code output function		—	M code is not able to output.
Operation setting for incompleteness of home position return		○	Controlled the same as positioning control. For a system that needs alignment, start synchronous control after establishing a home position.
Servo ON/OFF request		—	Servo OFF request is ignored during synchronous control similar to positioning control.

○: Valid, —: Invalid

POINT

Functions for an input axis in synchronous control conform to the specification of each control (Home position return control, Positioning control, Manual control, Speed-torque control).

9 AUXILIARY AND APPLIED FUNCTIONS

9.3 Speed-Torque Control

Control mode can be switched for output axis during synchronous control.

The control is performed with "speed-torque control data".

Data that is needed to be set with speed-torque control during synchronous control is shown in Table 9.1.

Table 9.1 Speed-torque control data

No.	Setting item	Setting necessity					
		During control other than synchronous control			During synchronous control		
		Speed control	Torque control	Continuous operation to torque control	Speed control	Torque control	Continuous operation to torque control
1	Control mode switching request device	○	○	○	○	○	○
2	Control mode setting device	○	○	○	○	○	○
3	Speed limit value at speed-torque control	○	○	○	—	—	—
4	Torque limit value at speed-torque control	○	○	○	○	○	○
5	Speed command device	○	○	○	—	—	—
6	Command speed acceleration time	○	—	○	—	—	—
7	Command speed deceleration time	○	—	○	—	—	—
8	Torque command device	—	○	○	—	○	○
9	Command torque time constant (positive direction)	—	○	○	—	○	○
10	Command torque time constant (negative direction)	—	○	○	—	○	○
11	Speed initial value selection at control mode switching	○	—	○	—	—	—
12	Torque initial value selection at control mode switching	—	○	○	—	○	○
13	Invalid selection during zero speed at control mode switching	○	○	○	○	○	○

(Note): Refer to the "Q173D(S)CPU/Q172D(S)CPU Motion controller (SV13/SV22) Programming Manual (REAL MODE)" for details of speed-torque control data.

(1) Speed-torque control in output axis

(a) The speed-torque control can be executed for the output axis of the cam No.0 (linear cam) during synchronous control.

When the control mode switching is executed for the output axis of cam other than cam No.0 or the output axis where synchronous control change function is being performed, the minor error (error code: 756) will occur, and the control mode is not switched.

When the output axis where the speed-torque control is performed is set to other than cam No.0, the minor error (error code: 757) will occur, and it is not switched to the set cam No. When the mode is switched to position control, it is switched to the cam No. set at passing through the 0th point of cam data. When the motor is operating at control mode switching request, a minor error (error code: 156) will occur, and the control mode is not switched. The mode can be switched to continuous operation to torque control mode even when the motor is operating.

(b) Turn OFF to ON the control mode switching request device after setting the control mode (10: Speed control mode, 20: Torque control mode, 30: Continuous operation to torque control mode) in the control mode setting device to switch the control mode.

The following shows the switching condition of each control mode.

- Speed control/Torque control

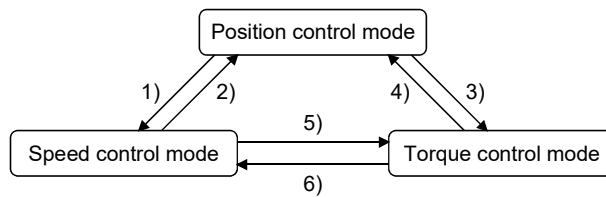

Switching operation		Switching condition
1)	Position control mode → Speed control mode	During synchronous control (Note-1) and during motor stop (Note-2)
2)	Speed control mode → Position control mode	
3)	Position control mode → Torque control mode	
4)	Torque control mode → Position control mode	
5)	Speed control mode → Torque control mode	During synchronous control (Note-1)
6)	Torque control mode → Speed control mode	

(Note-1): The [St.380] Synchronous control (M10880+n) is ON.

During the synchronous control mode switching analysis or during the synchronous control stop due to [Rq.380] Synchronous control start (M12000+n) ON to OFF or stop factor occurrence, the control mode switching request is ignored.

(Note-2): ZERO speed (b3) of Servo status2 (#8011+20n) is ON.

The control mode can be changed without checking the switching condition of "during motor stop" in Motion CPU by setting "1: Condition during zero speed at control mode switching: invalid" in "Invalid selection during zero speed at control mode switching".

Set "1: Condition during zero speed at control mode switching: invalid" to switch the control mode without waiting for stop of servo motor.

• Continuous operation to torque control

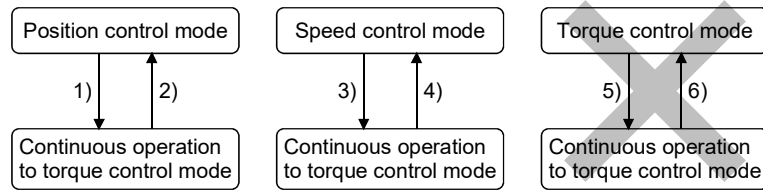

Switching operation		Switching condition
1)	Position control mode → Continuous operation to torque control mode	During synchronous control (Note-1)
2)	Continuous operation to torque control mode → Position control mode	During synchronous control (Note-1) and during motor stop (Note-2)
3)	Speed control mode → Continuous operation to torque control mode	During synchronous control (Note-1)
4)	Continuous operation to torque control mode → Speed control mode	
5)	Torque control mode → Continuous operation to torque control mode	Switching not possible
6)	Continuous operation to torque control mode → Torque control mode	

(Note-1): The [St.380] Synchronous control (M10880+n) is ON.

During the synchronous control mode switching analysis or during the synchronous control stop due to [Rq.380] Synchronous control start (M12000+n) ON to OFF or stop factor occurrence, the control mode switching request is ignored.

(Note-2): ZERO speed (b3) of Servo status2 (#8011+20n) is ON.

The control mode can be changed without checking the switching condition of "during motor stop" in Motion CPU by setting "1: Condition during zero speed at control mode switching: invalid" in "Invalid selection during zero speed at control mode switching". Set "1: Condition during zero speed at control mode switching: invalid" to switch the control mode without waiting for stop of servo motor.

- (c) The command speed at speed control is the speed command to the output axis. The command speed at torque/continuous operation to torque control is the speed limit value.
- (d) Command torque at torque control and continuous operation to torque control are set in the "torque command device" of "speed-torque control data". The command torque is limited with "Torque limit value at speed-torque control". If the torque exceeds torque limit value is set, a minor error (error code: 316) will occur, the operation is controlled with torque limit value at speed-torque control.
Torque limit value to servo amplifier can be changed within the range of "Torque limit value at speed-torque control" by torque limit value change request (CHGT, D(P).CHGT) or torque limit value individual change request (CHGT2, D(P).CHGT2). If the change outside the range of "Torque limit value at speed-torque control" is requested by torque limit value change request torque limit value individual change request, a minor error (error code: 319) will occur, and the torque limit value is not changed.

- (e) Values of [Md.407] Cam axis current value per cycle (D13612+30n, D13613+30n), [Md.408] Cam reference position (D13614+30n, D13615+30n), and [Md.409] Cam axis current feed value (D13616+30n, D13617+30n) during speed-torque control are based on the command from the input axis. It is not based on the actual output axis position. [Md.407] Cam axis current value per cycle (D13612+30n, D13613+30n), [Md.408] Cam reference position (D13614+30n, D13615+30n), and [Md.409] Cam axis current feed value (D13616+30n, D13617+30n) are restored based on the actual output axis position at the position control mode switching.
 - (f) Phase compensation is valid during speed-torque control.
 - (g) Switching to speed control mode, torque control mode, or continuous operation to torque control mode during synchronous control is not reflected on the scroll monitor.
 - (h) During synchronous control start analysis or during the synchronous control stop due to [Rq.380] Synchronous control start (M12000+n) ON to OFF or stop factor occurrence, the control mode switching request is ignored. Take [Rq.380] Synchronous control start (M12000+n) in an interlock.
 - (i) The synchronous control change function cannot be used during speed-torque control.
- (2) Precautions at control mode switching
- (a) When using continuous operation to torque control mode, use the servo amplifiers that are compatible with continuous operation to torque control. If servo amplifiers that are not compatible with continuous operation to torque control are used, a minor error (error code: 318) will occur at request of switching to continuous operation to torque control mode.

(3) Stop cause

(a) Stop cause during speed control mode

The operation for stop cause during speed control mode is shown below.

The synchronous control ends by the stop cause occurrence.

Item	Operation during speed control mode
The [Rq.380] Synchronous control start (M12000+n) turned OFF. (Note-1)	The motor decelerates to speed "0" by setting value of parameter block set in [Pr.448] Synchronous control parameter block No. (D15069+150n) (Note-4). The mode is switched to position control mode when "Zero speed (b3)" of servo status2 (#8011+20n) turns ON, and the operation stops.
The stop command (M3200+20n) turned ON. (Note-1)	
The rapid stop command (M3201+20n) turned ON. (Note-2)	
The external stop input turned ON. (Note-3)	
The all axes servo ON command (M2042) turned OFF.	The servo OFF is not executed during synchronous control. (The synchronous control does not end.) When the synchronous control is ended and the mode is switched to position control mode, the command status at the time becomes valid.
The servo OFF command (M3215+20n) turned ON.	
The current value reached to software stroke limit.	A minor error (error code: 200, 207) and major error (error code: 1101, 1102) will occur, and the motor decelerates to speed "0" by setting value of parameter block set in [Pr.448] Synchronous control parameter block No. (D15069+150n) (Note-4). The mode is switched to position control when "Zero speed (b3)" of servo status2 (#8011+20n) turns ON, and the operation stops.
The position of motor reached to hardware stroke limit. (Note-3)	
The PLC ready flag (M2000) turned OFF.	
The main shaft gear/auxiliary shaft gear/speed change gear 1/speed change gear 2 operation overflow error occurred. (Note-3)	The motor decelerates to speed "0" by setting value of parameter block set in [Pr.448] Synchronous control parameter block No. (D15069+150n) (Note-4). The mode is switched to position control when "Zero speed (b3)" of servo status2 (#8011+20n) turns ON, and the operation stops.
The forced stop input to Motion CPU.	The mode is switched to position control mode when the servo OFF (The servo ready signal (M2415+20n) turns OFF) is executed. (While the servo amplifier is servo OFF, even if the mode is switched to position control mode, the servo motor occurs to the free run. (The operation stops with dynamic brake.))
The forced stop input to servo amplifier.	
The servo error occurred.	
The servo amplifier's power supply turned OFF.	The motor occurs to the free run. (The operation stops with dynamic brake.) (The mode is to position control mode at the servo amplifier's power supply ON again.)

(Note-1): The motor stops based on the deceleration time.

(Note-2): The motor stops based on the rapid stop deceleration time.

(Note-3): The motor stops based on the setting of "Deceleration processing on stop input" of parameter block.

(Note-4): The setting of "S-curve ratio".

9 AUXILIARY AND APPLIED FUNCTIONS

(b) Stop cause during speed control mode

The operation for stop cause during torque control mode is shown below.

The synchronous control ends by the stop cause occurrence.

Item	Operation during torque control mode
The [Rq.380] Synchronous control start (M12000+n) turned OFF.	The mode is switched to position control mode when the speed limit command value is set to "0" and "Zero speed (b3)" of servo status2 (#8011+20n) turns ON, and the operation stops immediately. (Deceleration processing is not executed.)
The stop command (M3200+20n) turned ON.	
The rapid stop command (M3201+20n) turned ON.	The value of command torque is not changed. It might take time to reach at the speed "0" depending on the current torque command value.
The external stop input turned ON.	The servo OFF is not executed during synchronous control. (The synchronous control does not end.) When the synchronous control is ended valid when and the mode is switched to position control mode, the command status at the time becomes valid.
The all axes servo ON command (M2042) turned OFF.	The minor error (error code: 200, 207) and major error (error code: 1101, 1102) will occur. The mode is switched to position control mode at current position, and the operation immediately stops. (Deceleration processing is not executed.) When the operation immediately stops, the motor will start hunting depending on the motor speed. Therefore, be sure not to reach to limit in high speed or do not turn OFF the PLC READY.
The servo OFF command (M3215+20n) turned ON.	
The current value reached to software stroke limit.	
The position of motor reached to hardware stroke limit.	The mode is switched to position control mode at current position, and the operation immediately stops. (Deceleration processing is not executed.) When the operation immediately stops, the motor will start hunting depending on the motor speed.
The PLC ready flag (M2000) turned OFF.	
The main shaft gear/auxiliary shaft gear/speed change gear 1/speed change gear 2 operation overflow error occurred.	The mode is switched to position control mode when the servo OFF (The servo ready signal (M2415+20n) turns OFF) is executed. (While the servo amplifier is servo OFF, even if the mode is switched to position control mode, the servo motor occurs to the free run. (The operation stops with dynamic brake.))
The forced stop input to Motion CPU.	The motor occurs to the free run. (The operation stops with dynamic brake.) (The mode is to position control mode at the servo amplifier's power supply ON again.)
The forced stop input to servo amplifier.	
The servo error occurred.	
The servo amplifier's power supply turned OFF.	

9 AUXILIARY AND APPLIED FUNCTIONS

(c) Stop cause during continuous operation to torque control mode

The operation for stop cause during continuous operation to torque control mode is shown below.

The synchronous control ends by the stop cause occurrence.

Item	Operation during torque control mode
The [Rq.380] Synchronous control start (M12000+n) turned OFF.	The mode is switched to position control mode when the speed limit command value is set to "0" and "Zero speed (b3)" of servo status2 (#8011+20n) turns ON, and the operation stops immediately. (Deceleration processing is not executed.)
The stop command (M3200+20n) turned ON.	
The rapid stop command (M3201+20n) turned ON.	
The external stop input turned ON.	The value of command torque is not changed. It might take time to reach at the speed "0" depending on the current torque command value.
The all axes servo ON command (M2042) turned OFF.	The servo OFF is not executed during synchronous control. (The synchronous control does not end.) When the synchronous control is ended and the mode is switched to position control mode, the command status at the time becomes valid.
Servo OFF command (M3215+20n) turned ON.	
The current value reached to software stroke limit.	
The position of motor reached to hardware stroke limit.	The minor error (error code: 200, 207) and major error (error code: 1101, 1102) will occur. The mode is switched to position control mode at current position, and the operation immediately stops. (Deceleration processing is not executed.) When the operation immediately stops, the motor will start hunting depending on the motor speed. Therefore, be sure not to reach to limit in high speed or do not turn OFF the PLC READY.
The PLC ready flag (M2000) turned OFF.	
The main shaft gear/auxiliary shaft gear/speed change gear 1/speed change gear 2 operation overflow error occurred.	The mode is switched to position control mode at current position, and the operation immediately stops. (Deceleration processing is not executed.) When the operation immediately stops, the motor will start hunting depending on the motor speed.
The forced stop input to Motion CPU.	The mode is switched to position control mode when the servo OFF (The servo ready signal (M2415+20n) turns OFF) is executed. (While the servo amplifier is servo OFF, even if the mode is switched to position control mode, the servo motor occurs to the free run. (The operation stops with dynamic brake.))
The forced stop input to servo amplifier.	
The servo error occurred.	
The servo amplifier's power supply turned OFF.	The motor occurs to the free run. (The operation stops with dynamic brake.) (The mode is to position control mode at the servo amplifier's power supply ON again.)

9 AUXILIARY AND APPLIED FUNCTIONS

9.4 Multiple CPU Synchronous Control **Ver.!**

9.4.1 Overview

By synchronizing with the input axis of the master CPU and executing synchronous control on the slave CPU, synchronous operation between Multiple CPUs can be executed.

The data necessary for synchronous control between Multiple CPUs is transmitted via the Multiple CPU high speed transmission area.

The settings of the master CPU and slave CPU are set with the Multiple CPU synchronous control parameter. Also, by setting the status device to be used in Multiple CPU synchronous control, you can monitor the status of other CPUs that constitute the Multiple CPU synchronous control.

By setting the input axis type (master CPU servo input axis, master CPU command generation axis, master CPU synchronous encoder axis) of the master CPU that is to be connected as a synchronous encoder on the slave CPU side, it can be synchronized with the input axis of the master CPU by starting synchronous control.

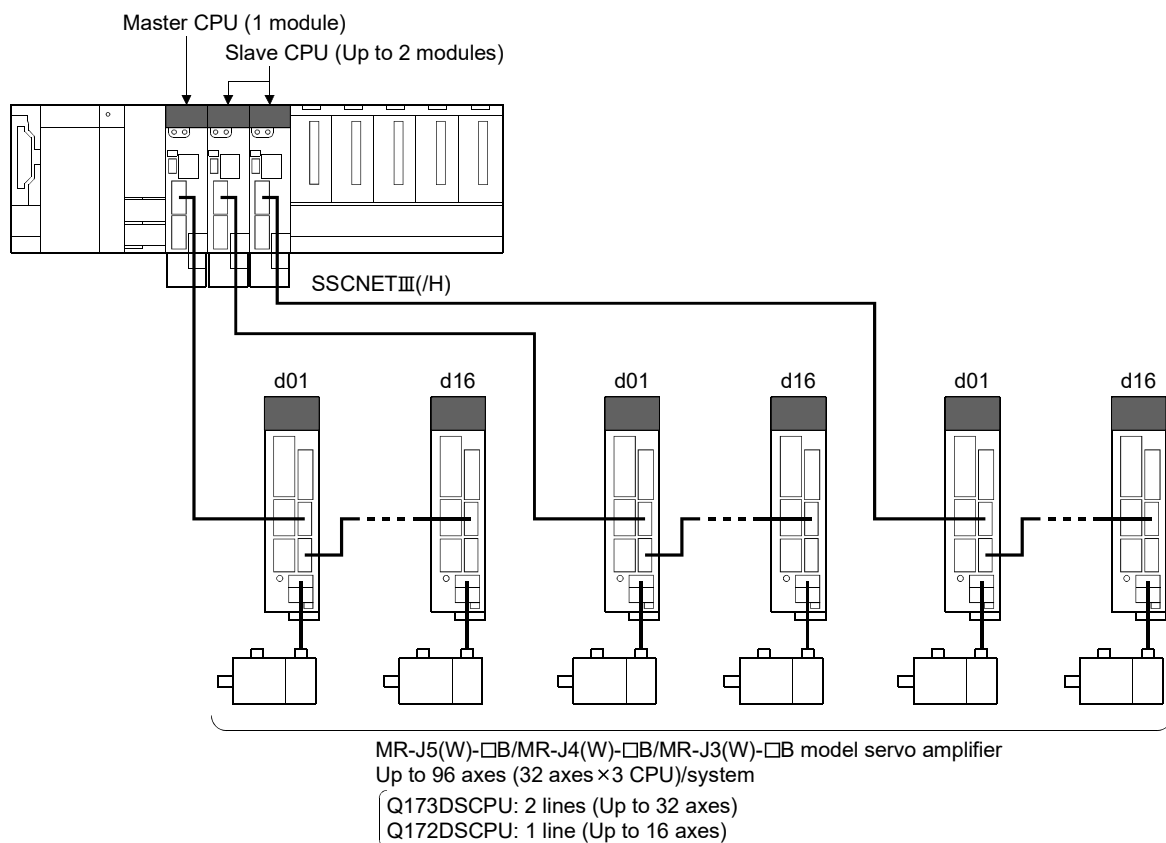

Ver.! : Refer to Section 1.4 for the software version that supports this function.

(1) Features of Multiple CPU synchronous control

The features of Multiple CPU synchronous control are shown below.

(a) Synchronous operation of up to 96 axes

By having up to three Motion CPU modules (One master CPU, up to two slave CPUs) constituting the Multiple CPU system on one base unit, the servo motors of up to 96 axes (32 axes × 3 CPUs) can be synchronized.

(b) Synchronization of the Motion operation of the master CPU and slave CPU

By sending the clock signal (reference for the operation timing of the master CPU) to the slave CPU via the base unit, the Motion operation timing of the master CPU and the slave CPU are synchronized through hardware. The servo motor controlled by the master CPU and the servo motor controlled by the slave CPU can be synchronized with high accuracy.

(c) High speed data exchange via Multiple CPU high speed transmission area

Data exchange between the master CPU and slave CPU is executed via the Multiple CPU high speed transmission area (from U□\G10000) of the CPU shared memory. By accessing directly the Multiple CPU high speed transmission area from the Motion CPU, data exchange between the master CPU and slave CPU is executed at high speed.

(2) Setting example

The following shows an example for synchronizing the output axis of the slave CPU (CPU No.3, CPU No.4) with the command generation axis (Axis 1) of the master CPU (CPU No.2).

Setting item	CPU No.		
	CPU No.2 (Master CPU)	CPU No.3 (Slave CPU)	CPU No.4 (Slave CPU)
Multiple CPU synchronous control setting	Master CPU	Slave CPU	Slave CPU
[Pr.340] Command generation axis valid setting (Axis 1)	1: Valid	—	—
[Pr.320] Synchronous encoder axis type (Axis 1)	—	401: Master CPU command generation axis (Axis 1)	401: Master CPU command generation axis (Axis 1)

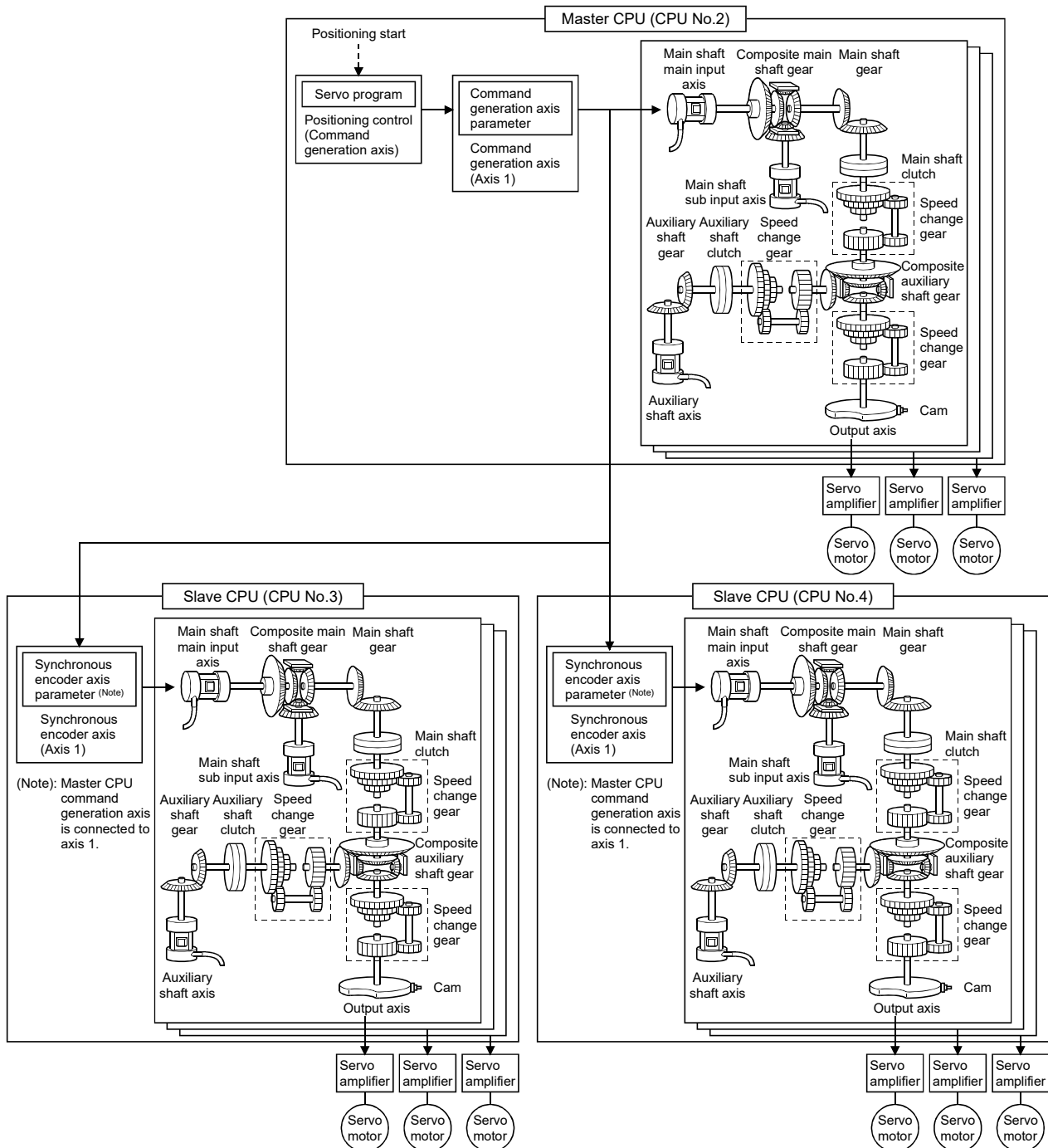

POINT

- (1) By transmitting via the Multiple CPU high speed transmission area, it takes two operation cycles until the slave CPU processes the command value sent from the master CPU. For this reason, the processing software in the Motion CPU, compensates for this by delaying the output axis of the master CPU side by two operation cycles. By doing this, the timing of commands to the output axes of the master CPU and slave CPU do not deviate largely.
- (2) Because of the compensation in (1), the update of the synchronous control monitor data in the output axis for the input axis on the master CPU side, is delayed two operation cycles. Also, when an operation such as a current value change etc. is executed at the main input axis, the timing of the change of [Md.400] Current value after composite main shaft gear (D13600+30n, D13601+30n) is also delayed two operation cycles.
 (Example) For setting the command generation axis in the master CPU

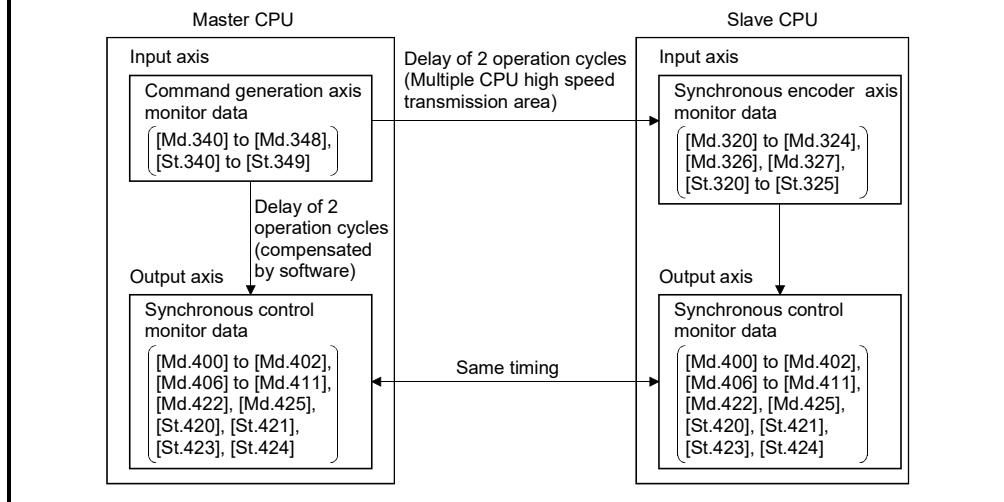

(3) Precautions

(a) Precautions

In the master CPU, when changing [Md.400] Current value after composite main shaft gear (D13600+30n, D13601+30n) continuously, execute after two operation cycles have passed. If executed within two operation cycles, [Md.400] Current value after composite main shaft gear (D13600+30n, D13601+30n) might not be changed.

9 AUXILIARY AND APPLIED FUNCTIONS

9.4.2 Setting for Multiple CPU synchronous control

The setting of the master CPU and slave CPU are necessary for Multiple CPU synchronous control. Also, in order to monitor the information of other CPUs that constitute the Multiple CPU synchronous control, setting of the status device of each CPU is executed.

The settings for Multiple CPU synchronous control are set in the CPU setting of system setting.

No.	Item		Setting range	Default value	Remark	
1	Multiple CPU synchronous control setting		Independent CPU/ Master CPU/Slave CPU	Independent CPU	Multiple CPU setting is possible when the number of CPUs is 3 or 4.	
2	Status device setting (Note-1), (Note-2)	Synchronous controlling	Word device (D, W, #, U□NG)/ Bit device (X, Y, M, B, F)/ — (Note-4)	—		
		Master CPU input axis (Note-3)		Transfer information	—	
				Error information	—	
		Status for each CPU		—		
Error status for each CPU and axis	—					

(Note-1): By setting devices for CPU No.2 to 4, the status of each Motion CPU can be monitored.

(Note-2): If Motion CPU is set to independent operation, nothing will be stored in the device.

(Note-3): Can be set when Multiple CPU synchronous control setting is "Slave CPU".

(Note-4): This setting can be omitted.

POINT

Because the device value assigned to each Motion CPU is transmitted to the Multiple CPU high speed transmission area, a delay of three operation cycles occurs.

(1) Multiple CPU synchronous control setting

Execute the setting of the master CPU and slave CPU that constitute the Multiple CPU synchronous control.

- Independent CPU : Operates as an independent CPU.
(Operation in normal state that does not use Multiple CPU synchronous control.)
- Master CPU : Operates as master CPU.
(Can be set in a Motion CPU other than CPU No.2.)
- Slave CPU : Operates as slave CPU.

In a Multiple CPU system configuration, it is possible to have a mixture of Motion CPU that operate independently (independent CPU), and Motion CPU that operate in Multiple CPU synchronous control (master CPU, slave CPU).

If configuring a Multiple CPU system, it is necessary to have one master CPU, and at least one slave CPU.

POINT
<p>(1) Set the operation cycle setting to 0.8[ms] or more, and set the same operation cycle for all Motion CPU that are executing Multiple CPU synchronous control.</p> <p>(2) For the master CPU and slave CPU, the operation time is approximately an additional 100[μs] more compared to an independent CPU. When an operation cycle over is detected, change the operation cycle to a larger value.</p>

(2) Status device setting

(a) Synchronous controlling (2 words)

Set the start number of the device to monitor the status of CPU No.2 to 4 synchronous control for each Motion CPU.

This setting can be omitted.

1) Word device setting

Word device	Setting range ^(Note-1)
D	0 to 19823
W	0 to 1FFF
#	0 to 7999
U□\G	10000 to (10000+p-1) ^(Note-2)

(Note-1): Set the start device as an even number.

(Note-2): "p" indicates the user setting area points of the Multiple CPU high speed transmission area for each CPU.

The last point 512 of the user setting area is used as a system area and cannot be set as a device.

The status of synchronous control is stored in the set devices as follows.

Offset	Item		
+0	Synchronous control signal		
	Bit	Details	Device
	0	[St.380] Synchronous control Axis 1	M10880
	1	[St.380] Synchronous control Axis 2	M10881
	to	to	to
	15	[St.380] Synchronous control Axis 16	M10895
+1	Synchronous control signal		
	Bit	Details	Device
	0	[St.380] Synchronous control Axis 17	M10896
	1	[St.380] Synchronous control Axis 18	M10897
	to	to	to
	15	[St.380] Synchronous control Axis 32	M10911

2) Bit device setting

Bit device	Setting range ^(Note-1)
X	0000 to 1FFF ^(Note-2)
Y	0000 to 1FFF
M	0 to 8191
B	0000 to 1FFF
F	0 to 2047

(Note-1): Set the start device as a unit of 32 points.

(Note-2): The range of "PXn+4 to PXn+F" cannot be used (fixed at 0) for the input device (PXn+0 to PXn+F) allocated to the built-in interface in Motion CPU (DI). (n: Start input No.)

The status of synchronous control is stored in the set devices as follows.

Offset	Item	Device
+0	[St.380] Synchronous control Axis 1	M10880
+1	[St.380] Synchronous control Axis 2	M10881
to	to	to
+31	[St.380] Synchronous control Axis 32	M10911

(b) Master CPU input axis transfer information (6 words)

Set the start number of the device to monitor the connection status for each input axis type of the master CPU. Only set this when set as "Slave CPU". This setting can be omitted.

- Servo input axis : When the type is set in [Pr. 300] Servo input axis type, and connection to servo amplifier is complete, status turns ON.
- Command generation axis : When the [Pr.340] Command generation axis valid setting is set to "1: Valid", status turns ON.
- Synchronous encoder axis : When the [St.321] Synchronous encoder axis connecting valid flag (M10441+10n) is ON, status turns ON.

1) Word device setting

Word device	Setting range ^(Note-1)
D	0 to 19823
W	0 to 1FFF
#	0 to 7999
U□\G	10000 to (10000+p-1) ^(Note-2)

(Note-1): Set the start device as an even number.

(Note-2): "p" indicates the user setting area points of the Multiple CPU high speed transmission area for each CPU.

The last point 512 of the user setting area is used as a system area and cannot be set as a device.

9 AUXILIARY AND APPLIED FUNCTIONS

The connection status for each input axis type is stored in the set devices as follows.

Offset	Item														
+0	Servo input axis connecting information														
	<table border="1"> <thead> <tr> <th>Bit</th> <th>Details</th> </tr> </thead> <tbody> <tr> <td>0</td> <td>Servo input axis connecting information Axis 1</td> </tr> <tr> <td>1</td> <td>Servo input axis connecting information Axis 2</td> </tr> <tr> <td>to</td> <td>to</td> </tr> <tr> <td>15</td> <td>Servo input axis connecting information Axis 16</td> </tr> </tbody> </table>	Bit	Details	0	Servo input axis connecting information Axis 1	1	Servo input axis connecting information Axis 2	to	to	15	Servo input axis connecting information Axis 16				
	Bit	Details													
	0	Servo input axis connecting information Axis 1													
	1	Servo input axis connecting information Axis 2													
to	to														
15	Servo input axis connecting information Axis 16														
+1	Servo input axis connecting information														
	<table border="1"> <thead> <tr> <th>Bit</th> <th>Details</th> </tr> </thead> <tbody> <tr> <td>0</td> <td>Servo input axis connecting information Axis 17</td> </tr> <tr> <td>1</td> <td>Servo input axis connecting information Axis 18</td> </tr> <tr> <td>to</td> <td>to</td> </tr> <tr> <td>15</td> <td>Servo input axis connecting information Axis 32</td> </tr> </tbody> </table>	Bit	Details	0	Servo input axis connecting information Axis 17	1	Servo input axis connecting information Axis 18	to	to	15	Servo input axis connecting information Axis 32				
	Bit	Details													
	0	Servo input axis connecting information Axis 17													
	1	Servo input axis connecting information Axis 18													
to	to														
15	Servo input axis connecting information Axis 32														
+2	Command generation axis connecting information														
	<table border="1"> <thead> <tr> <th>Bit</th> <th>Details</th> </tr> </thead> <tbody> <tr> <td>0</td> <td>Command generation axis connecting information Axis 1</td> </tr> <tr> <td>1</td> <td>Command generation axis connecting information Axis 2</td> </tr> <tr> <td>to</td> <td>to</td> </tr> <tr> <td>15</td> <td>Command generation axis connecting information Axis 16</td> </tr> </tbody> </table>	Bit	Details	0	Command generation axis connecting information Axis 1	1	Command generation axis connecting information Axis 2	to	to	15	Command generation axis connecting information Axis 16				
	Bit	Details													
	0	Command generation axis connecting information Axis 1													
	1	Command generation axis connecting information Axis 2													
to	to														
15	Command generation axis connecting information Axis 16														
+3	Command generation axis connecting information														
	<table border="1"> <thead> <tr> <th>Bit</th> <th>Details</th> </tr> </thead> <tbody> <tr> <td>0</td> <td>Command generation axis connecting information Axis 17</td> </tr> <tr> <td>1</td> <td>Command generation axis connecting information Axis 18</td> </tr> <tr> <td>to</td> <td>to</td> </tr> <tr> <td>15</td> <td>Command generation axis connecting information Axis 32</td> </tr> </tbody> </table>	Bit	Details	0	Command generation axis connecting information Axis 17	1	Command generation axis connecting information Axis 18	to	to	15	Command generation axis connecting information Axis 32				
	Bit	Details													
	0	Command generation axis connecting information Axis 17													
	1	Command generation axis connecting information Axis 18													
to	to														
15	Command generation axis connecting information Axis 32														
+4	Synchronous encoder axis connecting information														
	<table border="1"> <thead> <tr> <th>Bit</th> <th>Details</th> </tr> </thead> <tbody> <tr> <td>0</td> <td>Synchronous encoder axis connecting information Axis 1</td> </tr> <tr> <td>1</td> <td>Synchronous encoder axis connecting information Axis 2</td> </tr> <tr> <td>to</td> <td>to</td> </tr> <tr> <td>11</td> <td>Synchronous encoder axis connecting information Axis 12</td> </tr> <tr> <td>12</td> <td rowspan="3">Empty</td> </tr> <tr> <td>to</td> </tr> <tr> <td>15</td> </tr> </tbody> </table>	Bit	Details	0	Synchronous encoder axis connecting information Axis 1	1	Synchronous encoder axis connecting information Axis 2	to	to	11	Synchronous encoder axis connecting information Axis 12	12	Empty	to	15
	Bit	Details													
	0	Synchronous encoder axis connecting information Axis 1													
	1	Synchronous encoder axis connecting information Axis 2													
	to	to													
	11	Synchronous encoder axis connecting information Axis 12													
12	Empty														
to															
15															
+5	Empty														

2) Bit device setting

Bit device	Setting range ^(Note-1)
X	0000 to 1FFF ^(Note-2)
Y	0000 to 1FFF
M	0 to 8191
B	0000 to 1FFF
F	0 to 2047

(Note-1): Set the start device as a unit of 32 points.

(Note-2): The range of "PXn+4 to PXn+F" cannot be used (fixed at 0) for the input device (PXn+0 to PXn+F) allocated to the built-in interface in Motion CPU (DI). (n: Start input No.)

The connection status for each input axis type is stored in the set devices as follows.

Offset	Item
+0	Servo input axis connecting information Axis 1
+1	Servo input axis connecting information Axis 2
to	to
+31	Servo input axis connecting information Axis 32
+32	Command generation axis connecting information Axis 1
+33	Command generation axis connecting information Axis 2
to	to
+63	Command generation axis connecting information Axis 32
+64	Synchronous encoder axis connecting information Axis 1
+65	Synchronous encoder axis connecting information Axis 2
to	to
+75	Synchronous encoder axis connecting information Axis 12
+76	Empty
to	
+95	

(c) Master CPU input axis error information (6 words)

Set the start number of the device to monitor the error detection information of each input axis type of the master CPU. Only set this when set as "Slave CPU".

This setting can be omitted.

- Servo input axis error detection : When the master CPU error detection signal (M2407+20n) or servo error detection signal (M2408+20n) is ON, the status is ON.
- Command generation axis error detection : The status of [St.344] Command generation axis error detection (M9807+20n) of the master CPU is stored.
- Synchronous encoder axis error detection : The status of [St.324] Synchronous encoder axis error detection (M10444+20n) of the master CPU is stored.

1) Word device setting

Word device	Setting range ^(Note-1)
D	0 to 19823
W	0 to 1FFF
#	0 to 7999
U□\G	10000 to (10000+p-1) ^(Note-2)

(Note-1): Set the start device as an even number.

(Note-2): "p" indicates the user setting area points of the Multiple CPU high speed transmission area for each CPU. The last point 512 of the user setting area is used as a system area and cannot be set as a device.

9 AUXILIARY AND APPLIED FUNCTIONS

The error detection information for each input axis type is stored in the set devices as follows.

Offset	Item																				
+0	Servo input axis error information																				
	<table border="1"> <thead> <tr> <th>Bit</th> <th>Details</th> <th>Device</th> </tr> </thead> <tbody> <tr> <td>0</td> <td>Servo input axis error detection Axis 1</td> <td>M2407, M2408</td> </tr> <tr> <td>1</td> <td>Servo input axis error detection Axis 2</td> <td>M2427, M2428</td> </tr> <tr> <td>to</td> <td>to</td> <td>to</td> </tr> <tr> <td>15</td> <td>Servo input axis error detection Axis 16</td> <td>M2707, M2708</td> </tr> </tbody> </table>	Bit	Details	Device	0	Servo input axis error detection Axis 1	M2407, M2408	1	Servo input axis error detection Axis 2	M2427, M2428	to	to	to	15	Servo input axis error detection Axis 16	M2707, M2708					
	Bit	Details	Device																		
	0	Servo input axis error detection Axis 1	M2407, M2408																		
	1	Servo input axis error detection Axis 2	M2427, M2428																		
to	to	to																			
15	Servo input axis error detection Axis 16	M2707, M2708																			
+1	Servo input axis error information																				
	<table border="1"> <thead> <tr> <th>Bit</th> <th>Details</th> <th>Device</th> </tr> </thead> <tbody> <tr> <td>0</td> <td>Servo input axis error detection Axis 17</td> <td>M2727, M2728</td> </tr> <tr> <td>1</td> <td>Servo input axis error detection Axis 18</td> <td>M2747, M2748</td> </tr> <tr> <td>to</td> <td>to</td> <td>to</td> </tr> <tr> <td>15</td> <td>Servo input axis error detection Axis 32</td> <td>M3027, M3028</td> </tr> </tbody> </table>	Bit	Details	Device	0	Servo input axis error detection Axis 17	M2727, M2728	1	Servo input axis error detection Axis 18	M2747, M2748	to	to	to	15	Servo input axis error detection Axis 32	M3027, M3028					
	Bit	Details	Device																		
	0	Servo input axis error detection Axis 17	M2727, M2728																		
	1	Servo input axis error detection Axis 18	M2747, M2748																		
to	to	to																			
15	Servo input axis error detection Axis 32	M3027, M3028																			
+2	Command generation axis error information																				
	<table border="1"> <thead> <tr> <th>Bit</th> <th>Details</th> <th>Device</th> </tr> </thead> <tbody> <tr> <td>0</td> <td>Command generation axis error detection Axis 1</td> <td>M9807</td> </tr> <tr> <td>1</td> <td>Command generation axis error detection Axis 2</td> <td>M9827</td> </tr> <tr> <td>to</td> <td>to</td> <td>to</td> </tr> <tr> <td>15</td> <td>Command generation axis error detection Axis 16</td> <td>M10107</td> </tr> </tbody> </table>	Bit	Details	Device	0	Command generation axis error detection Axis 1	M9807	1	Command generation axis error detection Axis 2	M9827	to	to	to	15	Command generation axis error detection Axis 16	M10107					
	Bit	Details	Device																		
	0	Command generation axis error detection Axis 1	M9807																		
	1	Command generation axis error detection Axis 2	M9827																		
to	to	to																			
15	Command generation axis error detection Axis 16	M10107																			
+3	Command generation axis error information																				
	<table border="1"> <thead> <tr> <th>Bit</th> <th>Details</th> <th>Device</th> </tr> </thead> <tbody> <tr> <td>0</td> <td>Command generation axis error detection Axis 17</td> <td>M10127</td> </tr> <tr> <td>1</td> <td>Command generation axis error detection Axis 18</td> <td>M10147</td> </tr> <tr> <td>to</td> <td>to</td> <td>to</td> </tr> <tr> <td>15</td> <td>Command generation axis error detection Axis 32</td> <td>M10427</td> </tr> </tbody> </table>	Bit	Details	Device	0	Command generation axis error detection Axis 17	M10127	1	Command generation axis error detection Axis 18	M10147	to	to	to	15	Command generation axis error detection Axis 32	M10427					
	Bit	Details	Device																		
	0	Command generation axis error detection Axis 17	M10127																		
	1	Command generation axis error detection Axis 18	M10147																		
to	to	to																			
15	Command generation axis error detection Axis 32	M10427																			
+4	Synchronous encoder axis error information																				
	<table border="1"> <thead> <tr> <th>Bit</th> <th>Details</th> <th>Device</th> </tr> </thead> <tbody> <tr> <td>0</td> <td>Synchronous encoder axis error detection Axis 1</td> <td>M10444</td> </tr> <tr> <td>1</td> <td>Synchronous encoder axis error detection Axis 2</td> <td>M10454</td> </tr> <tr> <td>to</td> <td>to</td> <td>to</td> </tr> <tr> <td>11</td> <td>Synchronous encoder axis error detection Axis 12</td> <td>M10554</td> </tr> <tr> <td>12</td> <td rowspan="3">Empty</td> <td rowspan="3">—</td> </tr> <tr> <td>to</td> </tr> <tr> <td>15</td> </tr> </tbody> </table>	Bit	Details	Device	0	Synchronous encoder axis error detection Axis 1	M10444	1	Synchronous encoder axis error detection Axis 2	M10454	to	to	to	11	Synchronous encoder axis error detection Axis 12	M10554	12	Empty	—	to	15
	Bit	Details	Device																		
	0	Synchronous encoder axis error detection Axis 1	M10444																		
	1	Synchronous encoder axis error detection Axis 2	M10454																		
	to	to	to																		
	11	Synchronous encoder axis error detection Axis 12	M10554																		
12	Empty	—																			
to																					
15																					
+5	Empty																				

2) Bit device setting

Bit device	Setting range ^(Note-1)
X	0000 to 1FFF ^(Note-2)
Y	0000 to 1FFF
M	0 to 8191
B	0000 to 1FFF
F	0 to 2047

(Note-1): Set the start device as a unit of 32 points.

(Note-2): The range of "PXn+4 to PXn+F" cannot be used (fixed at 0) for the input device (PXn+0 to PXn+F) allocated to the built-in interface in Motion CPU (DI). (n: Start input No.)

The error detection information for each input axis type is stored in the set devices as follows.

Offset	Item	Device
+0	Servo input axis error detection Axis 1	M2407, M2408
+1	Servo input axis error detection Axis 2	M2427, M2428
to	to	to
+31	Servo input axis error detection Axis 32	M3027, M3028
+32	Command generation axis error detection Axis 1	M9807
+33	Command generation axis error detection Axis 2	M9827
to	to	to
+63	Command generation axis error detection Axis 32	M10427
+64	Synchronous encoder axis error detection Axis 1	M10444
+65	Synchronous encoder axis error detection Axis 2	M10454
to	to	to
+75	Synchronous encoder axis error detection Axis 12	M10554
+76	Empty	—
to		
+95		

(d) Status for each CPU (1 word)

Set the start number of the device to monitor the information of the "PLC ready flag", "PCPU READY complete flag" and other devices in CPU No.2 to 4 below for each Motion CPU.

This setting can be omitted.

1) Word device setting

Word device	Setting range
D	0 to 19823
W	0 to 1FFF
#	0 to 7999
U□\G	10000 to (10000+p-1) ^(Note-1)

(Note-1): "p" indicates the user setting area points of the Multiple CPU high speed transmission area for each CPU.

The last point 512 of the user setting area is used as a system area and cannot be set as a device.

9 AUXILIARY AND APPLIED FUNCTIONS

The device information is stored in the set devices as follows.

Bit	Item	Device
0	PLC ready flag	M2000
1	Unusable	—
2	PCPU READY complete flag	SM500
3	TEST mode ON flag	SM501
4	External forced stop input flag	SM502
5	Unusable	—
6	Operation cycle over flag	M2054
7	Motion error detection flag	M2039
8	Unusable	—
to		
15		

2) Bit device setting

Bit device	Setting range ^(Note-1)
X	0000 to 1FFF ^(Note-2)
Y	0000 to 1FFF
M	0 to 8191
B	0000 to 1FFF
F	0 to 2047

(Note-1): Set the start device as a unit of 16 points.

(Note-2): The range of "PXn+4 to PXn+F" cannot be used (fixed at 0) for the input device (PXn+0 to PXn+F) allocated to the built-in interface in Motion CPU (DI). (n: Start input No.)

The device information is stored in the set devices as follows.

Offset	Item	Device
+0	PLC ready flag	M2000
+1	Unusable	—
+2	PCPU READY complete flag	SM500
+3	TEST mode ON flag	SM501
+4	External forced stop input flag	SM502
+5	Unusable	—
+6	Operation cycle over flag	M2054
+7	Motion error detection flag	M2039
+8	Unusable	—
to		
+1		

9 AUXILIARY AND APPLIED FUNCTIONS

(e) Error status for each CPU and axis (4 words)

Set the start number of the device to monitor the error information of each axis in CPU No. 2 to 4 for each Motion CPU.

This setting can be omitted.

1) Word device setting

Word device	Setting range ^(Note-1)
D	0 to 19823
W	0 to 1FFF
#	0 to 7999
U□\G	10000 to (10000+p-1) ^(Note-2)

(Note-1): Set the start device as an even number.

(Note-2): "p" indicates the user setting area points of the Multiple CPU high speed transmission area for each CPU.

The last point 512 of the user setting area is used as a system area and cannot be set as a device.

The error information of each axis is stored in the set devices as follows.

Offset	Item															
+0	Axis error information															
	<table border="1"> <thead> <tr> <th>Bit</th> <th>Details</th> <th>Device</th> </tr> </thead> <tbody> <tr> <td>0</td> <td>Error detection of axis 1</td> <td>M2407</td> </tr> <tr> <td>1</td> <td>Error detection of axis 2</td> <td>M2427</td> </tr> <tr> <td>to</td> <td>to</td> <td>to</td> </tr> <tr> <td>15</td> <td>Error detection of axis 16</td> <td>M2707</td> </tr> </tbody> </table>	Bit	Details	Device	0	Error detection of axis 1	M2407	1	Error detection of axis 2	M2427	to	to	to	15	Error detection of axis 16	M2707
	Bit	Details	Device													
	0	Error detection of axis 1	M2407													
	1	Error detection of axis 2	M2427													
to	to	to														
15	Error detection of axis 16	M2707														
+1	Axis error information															
	<table border="1"> <thead> <tr> <th>Bit</th> <th>Details</th> <th>Device</th> </tr> </thead> <tbody> <tr> <td>0</td> <td>Error detection of axis 17</td> <td>M2727</td> </tr> <tr> <td>1</td> <td>Error detection of axis 18</td> <td>M2747</td> </tr> <tr> <td>to</td> <td>to</td> <td>to</td> </tr> <tr> <td>15</td> <td>Error detection of axis 32</td> <td>M3027</td> </tr> </tbody> </table>	Bit	Details	Device	0	Error detection of axis 17	M2727	1	Error detection of axis 18	M2747	to	to	to	15	Error detection of axis 32	M3027
	Bit	Details	Device													
	0	Error detection of axis 17	M2727													
	1	Error detection of axis 18	M2747													
to	to	to														
15	Error detection of axis 32	M3027														
+2	Servo error information															
	<table border="1"> <thead> <tr> <th>Bit</th> <th>Details</th> <th>Device</th> </tr> </thead> <tbody> <tr> <td>0</td> <td>Servo error detection of axis 1</td> <td>M2408</td> </tr> <tr> <td>1</td> <td>Servo error detection of axis 2</td> <td>M2428</td> </tr> <tr> <td>to</td> <td>to</td> <td>to</td> </tr> <tr> <td>15</td> <td>Servo error detection of axis 16</td> <td>M2708</td> </tr> </tbody> </table>	Bit	Details	Device	0	Servo error detection of axis 1	M2408	1	Servo error detection of axis 2	M2428	to	to	to	15	Servo error detection of axis 16	M2708
	Bit	Details	Device													
	0	Servo error detection of axis 1	M2408													
	1	Servo error detection of axis 2	M2428													
to	to	to														
15	Servo error detection of axis 16	M2708														
+3	Servo error information															
	<table border="1"> <thead> <tr> <th>Bit</th> <th>Details</th> <th>Device</th> </tr> </thead> <tbody> <tr> <td>0</td> <td>Servo error detection of axis 17</td> <td>M2728</td> </tr> <tr> <td>1</td> <td>Servo error detection of axis 18</td> <td>M2748</td> </tr> <tr> <td>to</td> <td>to</td> <td>to</td> </tr> <tr> <td>15</td> <td>Servo error detection of axis 32</td> <td>M3028</td> </tr> </tbody> </table>	Bit	Details	Device	0	Servo error detection of axis 17	M2728	1	Servo error detection of axis 18	M2748	to	to	to	15	Servo error detection of axis 32	M3028
	Bit	Details	Device													
	0	Servo error detection of axis 17	M2728													
	1	Servo error detection of axis 18	M2748													
to	to	to														
15	Servo error detection of axis 32	M3028														

2) Bit device setting

Bit device	Setting range ^(Note-1)
X	0000 to 1FFF ^(Note-2)
Y	0000 to 1FFF
M	0 to 8191
B	0000 to 1FFF
F	0 to 2047

(Note-1): Set the start device as a unit of 32 points.

(Note-2): The range of "PXn+4 to PXn+F" cannot be used (fixed at 0) for the input device (PXn+0 to PXn+F) allocated to the built-in interface in Motion CPU (DI). (n: Start input No.)

The error information of each axis is stored in the set devices as follows.

Offset	Item	Device
+0	Error detection of axis 1	M2407
+1	Error detection of axis 2	M2427
to	to	to
+31	Error detection of axis 32	M3027
+32	Servo error detection of axis 1	M2408
+33	Servo error detection of axis 2	M2428
to	to	to
+63	Servo error detection of axis 32	M3028

9.4.3 Multiple CPU synchronous control area

In Multiple CPU synchronous control, 512 points (words) from the end device of the user setting area of the Multiple CPU high speed transmission area is used as the Multiple CPU synchronous control area.

Set the Multiple CPU high speed transmission area in the Multiple CPU setting so that 512 points from the end device of the user setting area is ensured for Multiple CPU synchronous control. Do not access the Multiple CPU synchronous control area from user programs.

If the user setting area in the master CPU or slave CPU is less than 512 points, a system setting error occurs at the initial processing completion of Multiple CPU synchronous control after Multiple CPU system's power supply ON.

(Example) Using CPUs No.2 to 4 as CPUs for Multiple CPU synchronous control

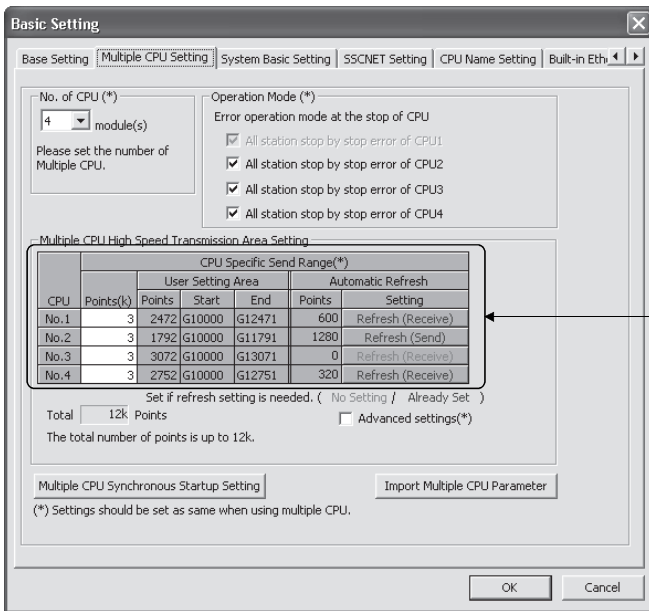

- The following is used as the Multiple CPU synchronous control area .
- CPU No.2: U3E1\G11280 to U3E1\G11791
 - CPU No.3: U3E2\G12560 to U3E2\G13071
 - CPU No.4: U3E3\G12240 to U3E3\G12751

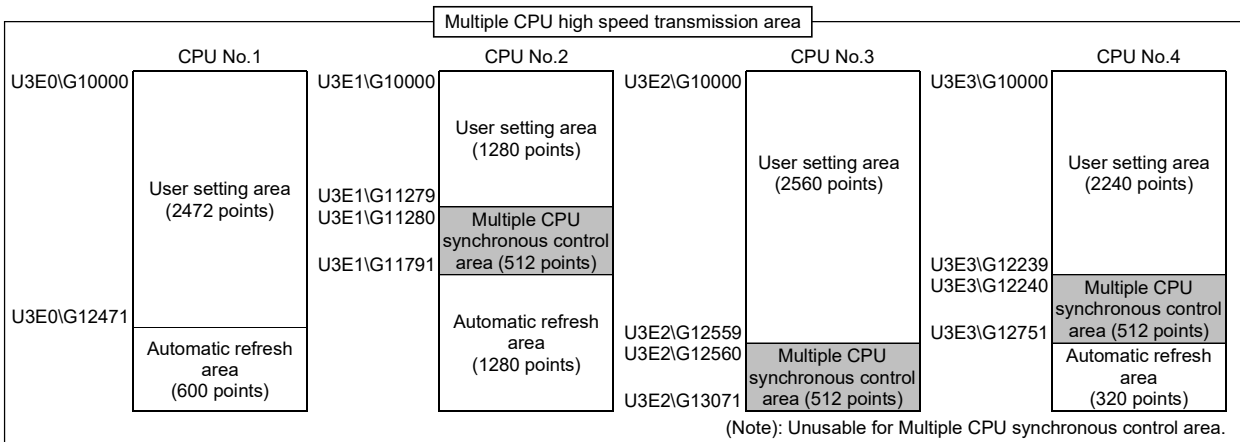

POINT

<p>Be sure to set the Motion CPUs that constitute Multiple CPU synchronous control to "Set Sync. startup setting of CPU□" on the Multiple CPU synchronous startup setting in Multiple CPU setting. If they are not set to "Set Sync. startup setting of CPU□", the startup timing of the Motions CPUs differs, and a system setting error (error code: 32, 33) may occur.</p>

9.4.4 Selection of slave CPU input axis type

In the slave CPU side, by setting the input axis type of the master CPU from the input axis parameter [Pr.320] Synchronous encoder axis type, the change amount from the master CPU becomes the input value, and is controlled as a synchronous encoder axis. When the master CPU input axis type is servo input axis or synchronous encoder axis, the input value transmitted to the slave CPU from the master CPU and the relation with each monitor data of the input axis is shown below. (For the command generation axis, the change amount of the generated command, is transmitted).

- If "301: Master CPU servo input axis" in [Pr.320] Synchronous encoder axis type is selected.

The change amount generated from the current value of the master CPU servo input axis is transmitted to the slave CPU.

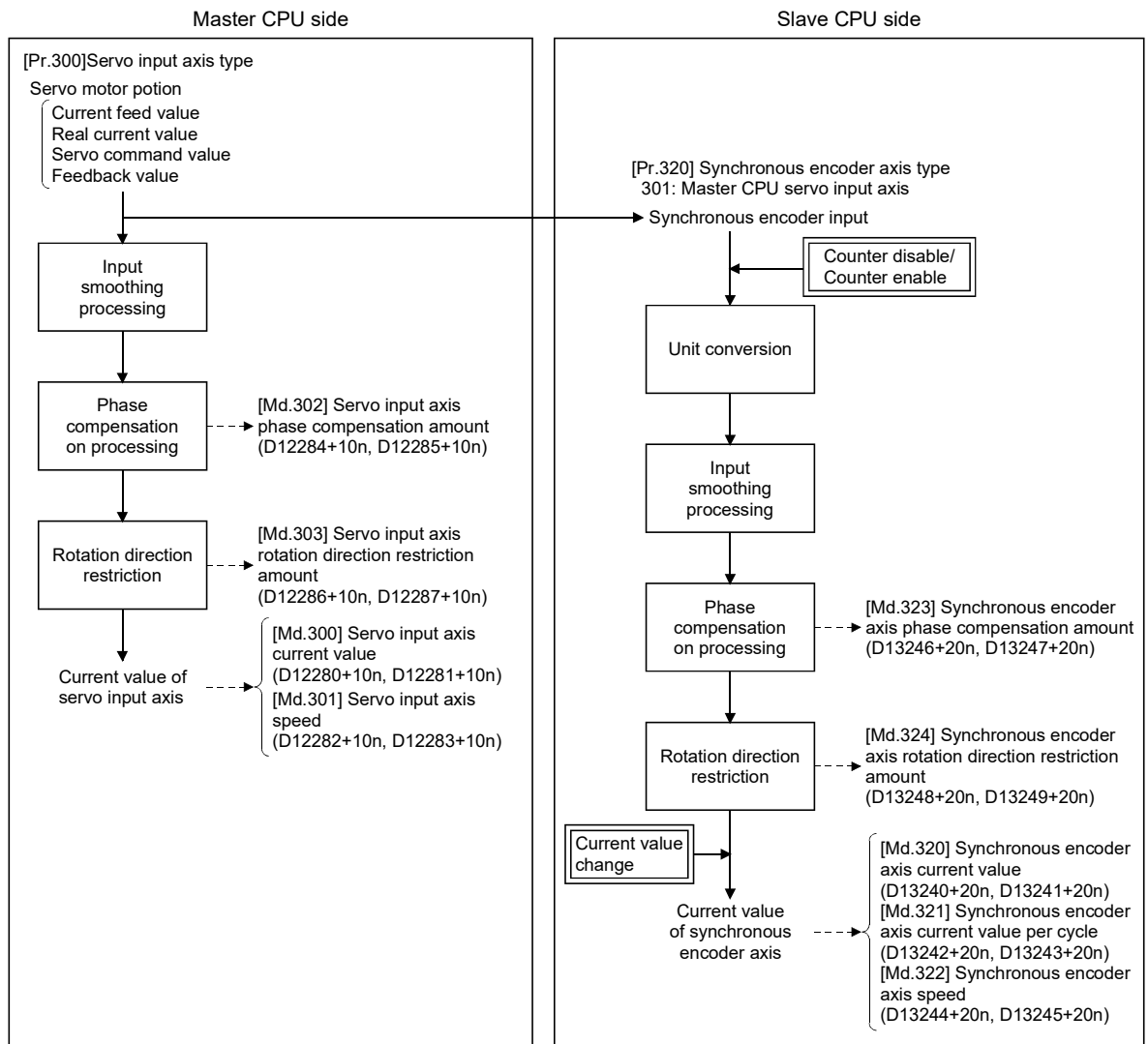

9 AUXILIARY AND APPLIED FUNCTIONS

- If "501: Master CPU synchronous encoder axis" in [Pr.320] Synchronous encoder axis type is selected.

The change amount of the input pulse to the synchronous encoder on the master CPU is transmitted to the slave CPU. Also, control by a current value change by [Rq.320] Synchronous encoder axis control request (D14823+20n), counter enable, and counter disable, are not reflected in the change amount that is transmitted.

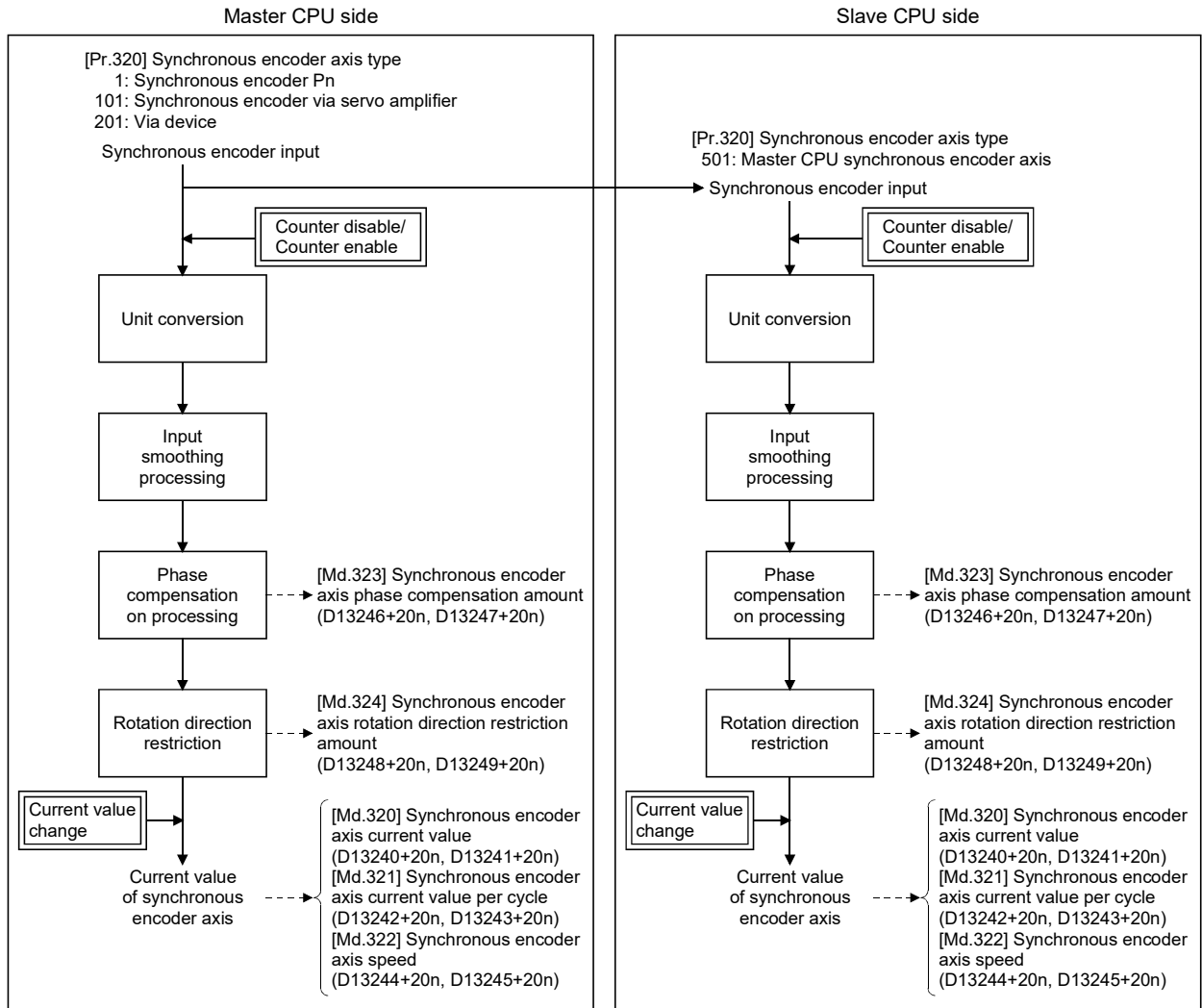

(1) Setting method

Set the input axis of the master CPU in [Pr.320] Synchronous encoder axis type.

Connection is invalid just after the system's power supply is ON. If [Rq.324]

Connection command of synchronous encoder via device/master CPU

(M11602+4n) is turned ON, connection becomes valid, "0" is stored in [Md.320]

Synchronous encoder axis current value (D13240+20n, D13241+20n), [Md.321]

Synchronous encoder axis current value per cycle (D13242+20n, D13243+20n), and will be on the counter enabling status.

At this time, if setting the input axis of the master CPU to current value, execute a current value change.

When the input axis set in [Pr. 320] Synchronous encoder axis type is invalid on the master CPU side, or not connected, a major error (error code: 1825) occurs, and connection becomes invalid.

POINT

Match the control unit of [Pr.321] Synchronous encoder axis unit setting with the unit settings of the input axis of the master CPU.

In the system configuration of Multiple CPU synchronous control, if executing phase compensation for the time delay in the input axis (servo input axis, or synchronous encoder axis) of the master CPU by phase compensation function (refer to Section 9.1), set a value that adds the following "Multiple CPU synchronous control delay time adding value" for the delay time inherent to the system.

Operation cycle[ms]	Multiple CPU synchronous control delay time adding value [μ s]
0.88	1777
1.77	3555
3.55	7111
7.11	14222

(2) Setting example

The following shows an example for setting the input from axis 8 of the master CPU servo input axis to the synchronous encoder axis 2 of the slave CPU.

<Master CPU side>

Set the following in the CPU setting of MT Developer2.

- Multiple CPU synchronous control setting "Master CPU"

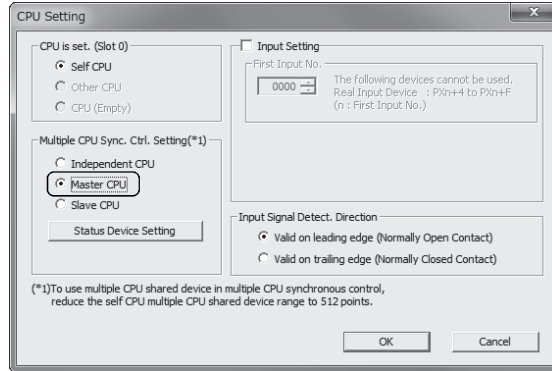

<Slave CPU side>

Set the following in the CPU setting of MT Developer2.

- Multiple CPU synchronous control setting "Slave CPU"

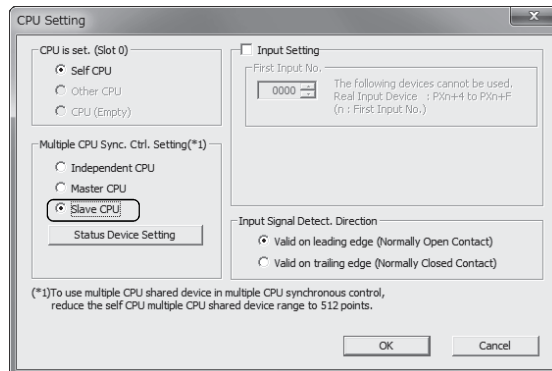

9 AUXILIARY AND APPLIED FUNCTIONS

Set the following in [Pr.320] Synchronous encoder axis type of synchronous encoder axis 2 on the synchronous encoder axis parameter screen of MT Developer2.

- Type "301: Master CPU servo input axis"
- Synchronous encoder No. (Pn)..... "8"

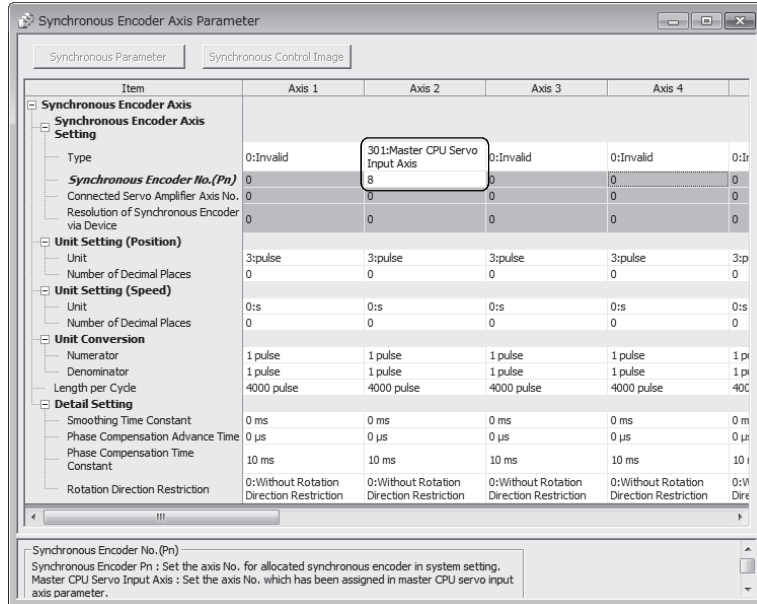

POINT

When confirming the status of other CPUs, in the status device setting, set the device for each item.

9 AUXILIARY AND APPLIED FUNCTIONS

9.4.5 Multiple CPU synchronous control monitor device

The status of initial processing and CPU setting in Multiple CPU synchronous control can be confirmed with the following monitor devices.

Device No.	Monitor item	Storage details	Monitor value	Refresh cycle
SD561	Multiple CPU synchronous control setting status	The CPU setting status of Multiple CPU synchronous control is stored.	0: Independent CPU 1: Master CPU 2: Slave CPU	At power supply ON
SM561	Multiple CPU synchronous control initial complete flag	Turns ON when the initial processing of Multiple CPU synchronous control is completed.	ON : CPU synchronous initial complete OFF: CPU synchronous initial not complete.	

- (1) **Multiple CPU synchronous control setting status (SD561)**
At Multiple CPU system power supply ON, the CPU setting status of Multiple CPU synchronous control is stored.
- (2) **Multiple CPU synchronous control initial complete flag (SM561)**
After Multiple CPU system power supply ON, this flag turns ON when the initial processing of Multiple CPU synchronous control is completed normally.
This flag does not turn ON when a system setting error of Multiple CPU synchronous control occurs or the CPU is operating as an independent CPU.

9.4.6 Example programs

- (1) In order to maintain synchronizing between master CPU and slave CPU, start synchronizing by the following procedure.
 - 1) Match the relationship of the controlling position of the master CPU and slave CPU.
 - 2) Set the [Rq.324] Connection command of synchronous encoder via device/master CPU (M11602+4n) in the slave CPU ON, and confirm the connection is valid in [St.321] Synchronous encoder axis connecting valid flag (M10441+10n).
 - 3) Start synchronous control of the output axis in the slave CPU, and operate the input axis of the master CPU.

If synchronous control in the output axis of the slave CPU is started after operating the input axis of the master CPU first, the synchronous relationship between the master CPU and slave CPU will deviate for the movement up until the synchronous control in the output axis of the slave CPU was started. When ending synchronous control, end synchronous control after stopping operation of the input axis.

(2) Setting of program example

<Master CPU: CPU No.2>

- Input axis : Servo input axis Axis 3
- Output axis : Axis 1
- Multiple CPU synchronous control setting : Master CPU
- Status device setting

Item		CPU No.2	CPU No.3
Status device setting	Synchronous controlling	M128	M160
	Status for each CPU	D1800	D1801
	Error status for each CPU and axis	D2000	D2010

<Slave CPU: CPU No.3>

- Input axis : Synchronous encoder axis Axis 8
(Select master CPU servo input axis Axis 3)
- Output axis : Axis 16
- Multiple CPU synchronous control setting : Slave CPU
- Status device setting

Item		CPU No.2	CPU No.3
Status device setting	Synchronous controlling	M128	M160
	Status for each CPU	D1800	D1801
	Error status for each CPU and axis	D2000	D2010

- Master CPU input axis: Transfer information..... M96
Error information..... D1000

(a) Synchronous control start program

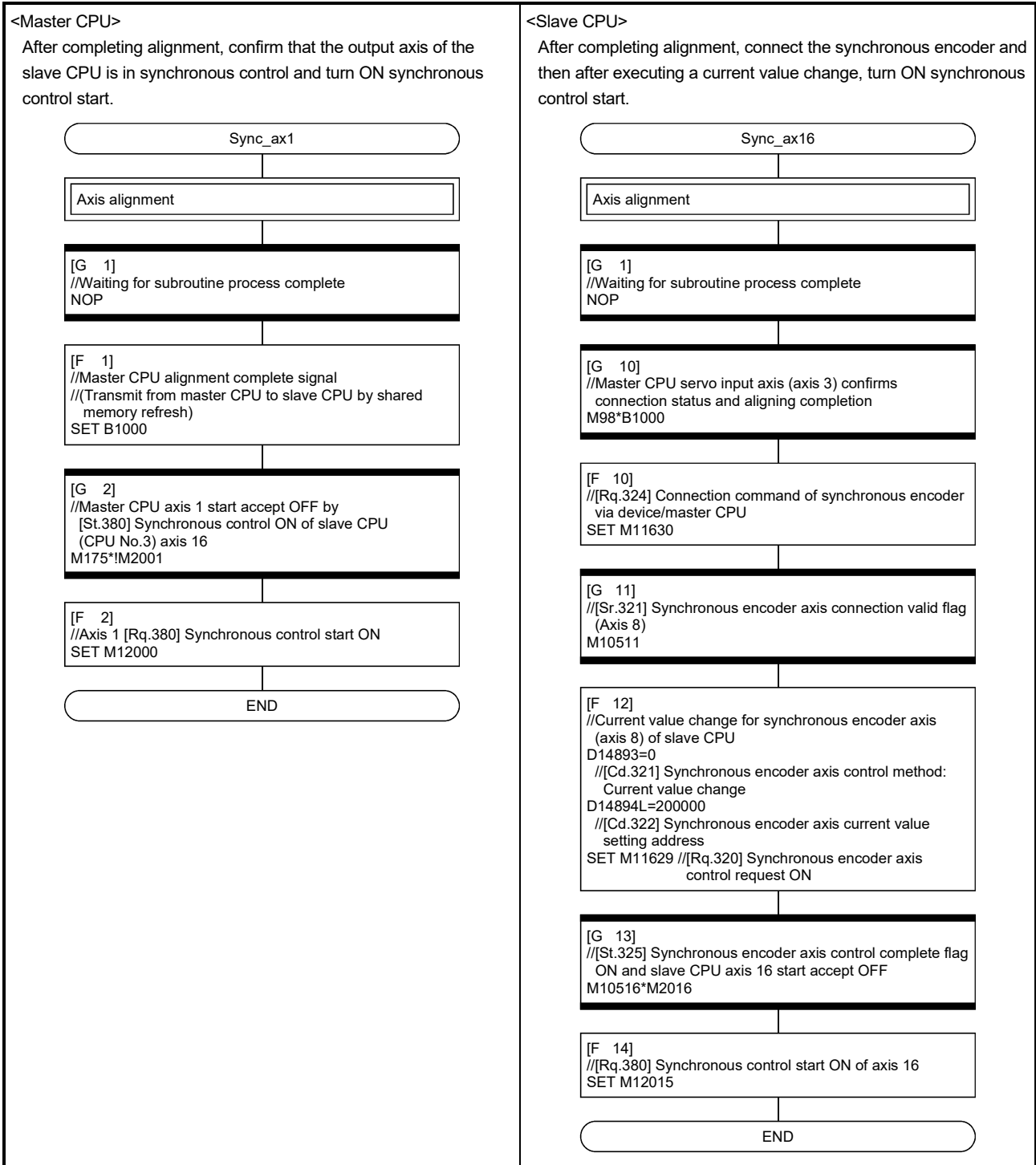

(b) Error detection program

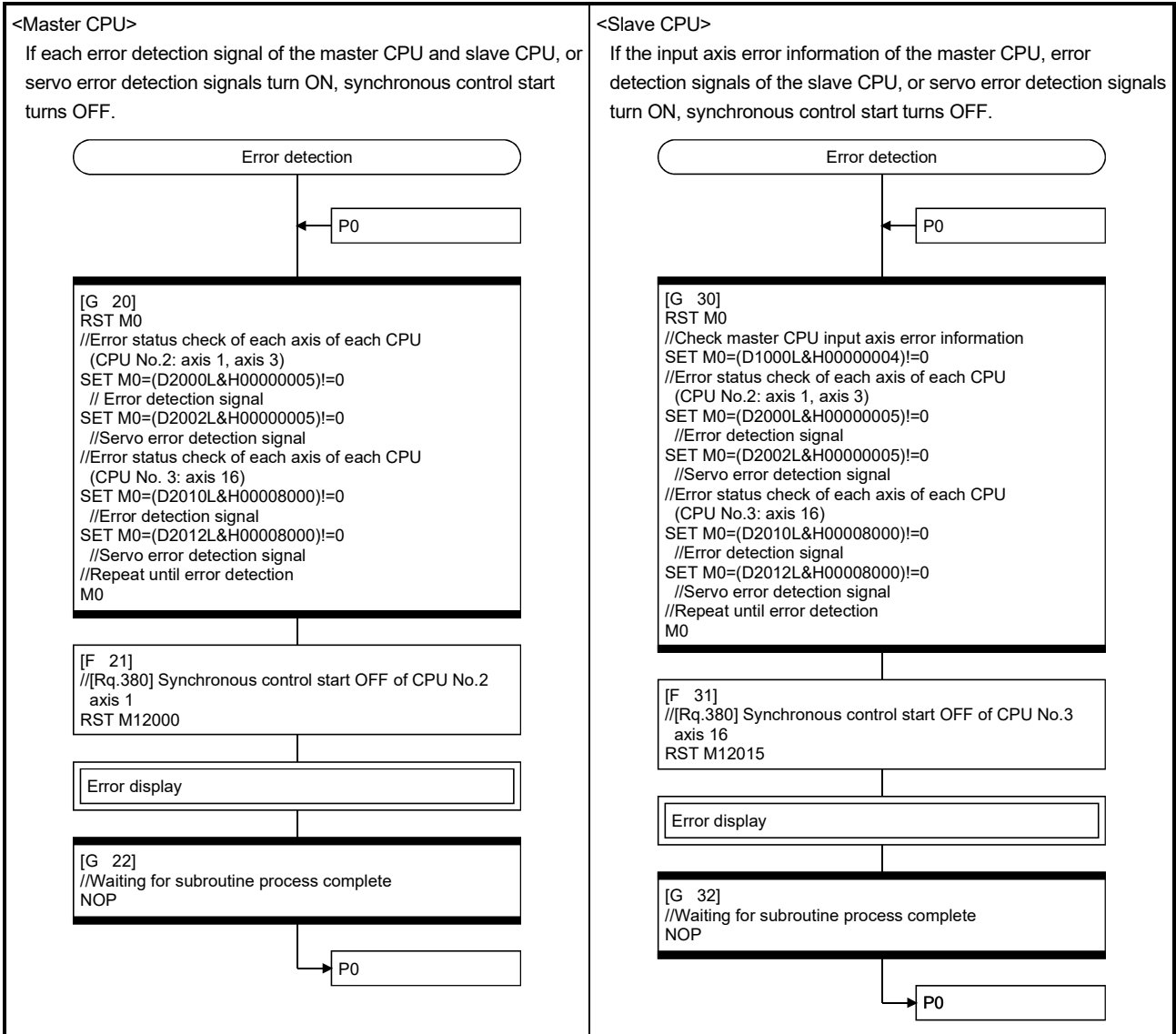

APPENDICES

APPENDIX 1 Error Codes Stored Using the Motion CPU

The following errors are detected in the Motion CPU.

- Servo program setting error
- Positioning error
- Motion SFC error (Note-1)
- Motion SFC parameter error (Note-1)
- Multiple CPU related error (Note-2)

(Note-1): Refer to the "Q173D(S)CPU/Q172D(S)CPU Motion controller (SV13/SV22) Programming Manual (Motion SFC)" for details.

(Note-2): Refer to the "Q173D(S)CPU/Q172D(S)CPU Motion controller Programming Manual (COMMON)" for details.

(1) Servo program setting errors

These are positioning data errors set in the servo program, and it checks at the start of each servo program.

They are errors that occur when the positioning data is specified indirectly.

The operations at the error occurrence are shown below.

- The servo program setting error flag (SM516) turns on.
- The erroneous servo program is stored in the error program No. storage register (SD516).
- The error code is stored in the error item information register (SD517).

(2) Positioning error

(a) Positioning errors occurs at the positioning start or during positioning control. There are minor errors, major errors and servo errors.

- 1) Minor errors..... These errors occur in the Motion SFC program or servo program, and the error codes 1 to 999 are used.
Check the error code, and remove the error cause by correcting the Motion SFC program or servo program.
- 2) Major errors..... These errors occur in the external input signals or control commands from the Motion SFC program, and the error codes 1000 to 1999 are used.
Check the error code, and remove the error cause of the external input signal state or Motion SFC program.
- 3) Servo errors These errors detected in the servo amplifier, and the error codes 2000 to 2999 are used.
Check the error code, and remove the error cause of the servo amplifier side.

APPENDICES

- (b) The error detection signal of the erroneous axis turns on at the error occurrence, and the error codes are stored in the minor error code, major error code or servo error code storage register.

Table 1.1 Error code storage registers, error detection signals, error reset commands

Error class \ Device		Error code storage register								Error detection signal	Error reset command
		Axis 1	Axis 2	Axis 3	Axis 4	Axis 5	Axis 6	Axis 7	Axis 8		
Servo input axis (Note-1)	Minor error	D6	D26	D46	D66	D86	D106	D126	D146	M2407+20n	M3207+20n
	Major error	D7	D27	D47	D67	D87	D107	D127	D147		
	Servo error	D8	D28	D48	D68	D88	D108	D128	D148		
Command generation axis (Note-1)	Minor error	D12602	D12622	D12642	D12662	D12682	D12702	D12722	D12742	M9807+20n	M10967+20n
	Major error	D12603	D12623	D12643	D12663	D12683	D12703	D12723	D12743		
Synchronous encoder axis	Minor error	D13250	D13270	D13290	D13310	D13330	D13350	D13370	D13390	M10444+10n	M11600+4n
	Major error	D13251	D13271	D13291	D13311	D13331	D13351	D13371	D13391		

Error class \ Device		Error code storage register								Error detection signal	Error reset command
		Axis 9	Axis 10	Axis 11	Axis 12	Axis 13	Axis 14	Axis 15	Axis 16		
Servo input axis (Note-1)	Minor error	D166	D186	D206	D226	D246	D266	D286	D306	M2407+20n	M3207+20n
	Major error	D167	D187	D207	D227	D247	D267	D287	D307		
	Servo error	D168	D188	D208	D228	D248	D268	D288	D308		
Command generation axis (Note-1)	Minor error	D12762	D12782	D12802	D12822	D12842	D12862	D12882	D12902	M9807+20n	M10967+20n
	Major error	D12763	D12783	D12803	D12823	D12843	D12863	D12883	D12903		
Synchronous encoder axis	Minor error	D13410	D13430	D13450	D13470					M10444+10n	M11600+4n
	Major error	D13411	D13431	D13451	D13471						

Error class \ Device		Error code storage register								Error detection signal	Error reset command
		Axis 17	Axis 18	Axis 19	Axis 20	Axis 21	Axis 22	Axis 23	Axis 24		
Servo input axis (Note-1)	Minor error	D326	D346	D366	D386	D406	D426	D446	D466	M2407+20n	M3207+20n
	Major error	D327	D347	D367	D387	D407	D427	D447	D467		
	Servo error	D328	D348	D368	D388	D408	D428	D448	D468		
Command generation axis (Note-1)	Minor error	D12922	D12942	D12962	D12982	D13002	D13022	D13042	D13062	M9807+20n	M10967+20n
	Major error	D12923	D12943	D12963	D12983	D13003	D13023	D13043	D13063		
Synchronous encoder axis	Minor error									M10444+10n	M11600+4n
	Major error										

Error class \ Device		Error code storage register								Error detection signal	Error reset command
		Axis 25	Axis 26	Axis 27	Axis 28	Axis 29	Axis 30	Axis 31	Axis 32		
Servo input axis (Note-1)	Minor error	D486	D506	D526	D546	D566	D586	D606	D626	M2407+20n	M3207+20n
	Major error	D487	D507	D527	D547	D567	D587	D607	D627		
	Servo error	D488	D508	D528	D548	D568	D588	D608	D628		
Command generation axis (Note-1)	Minor error	D13082	D13102	D13122	D13142	D13162	D13182	D13202	D13222	M9807+20n	M10967+20n
	Major error	D13083	D13103	D13123	D13143	D13163	D13183	D13203	D13223		
Synchronous encoder axis	Minor error									M10444+10n	M11600+4n
	Major error										

(Note-1): The following range is valid.
 • Q172DSCPU: Axis No.1 to 16

- (c) If another error occurs after an error code has been stored, the existing error code is overwritten, deleting it.
However, the error history can be checked using MT Developer2.
- (d) Error detection signals and error codes are held until the error reset command (M3207+20n), servo error reset command (M3208+20n), [Rq.346] Command generation axis error reset command (M10967+20n) or [Rq.323] Synchronous encoder axis error reset command (M11600+4n) turns on.

POINTS

- | |
|--------------------------------------------------------------------------------------------------------------------------------------------------------------------------------------------------------------------------------------------------------------------------------------------------------------|
| <ul style="list-style-type: none">(1) Even if the servo error reset (M3208+20n) turns on at the servo error occurrence, the same error code might be stored again.(2) Reset the servo error after removing the error cause of the servo amplifier side at the servo error occurrence. |
|--------------------------------------------------------------------------------------------------------------------------------------------------------------------------------------------------------------------------------------------------------------------------------------------------------------|

APPENDIX 1.1 Servo program setting errors (Stored in SD517)

The error codes, error contents and corrective actions for servo program setting errors are shown in Table 1.2.

In the error codes marked with "Note" indicates the axis No. (1 to 32).

Table 1.2 Servo program setting error list

Error code stored in SD517	Error name	Error contents	Error processing	Corrective action															
1	Parameter block No. setting error	The parameter block No. is outside the range of 1 to 64.	Execute the servo program with the default value "1" of parameter block.	Set the parameter block No. within the range of 1 to 64.															
n03 (Note)	Address (travel value) setting error (Except the speed control and speed/position control.) (Setting error for linear axis at the helical-interpolation.)	<p>(1) The address is outside the setting range at the positioning start for absolute data method.</p> <table border="1"> <thead> <tr> <th>Unit</th> <th colspan="2">Address setting range</th> </tr> </thead> <tbody> <tr> <td>degree</td> <td>0 to 35999999</td> <td>$\times 10^{-5}$ [degree]</td> </tr> </tbody> </table> <p>(2) The travel value is set to -2147483648 (H80000000) at the positioning start for incremental data method.</p>	Unit	Address setting range		degree	0 to 35999999	$\times 10^{-5}$ [degree]	<p>(1) Positioning control does not start. (All interpolation control at the interpolation control.)</p> <p>(2) If the error is detected during the speed-switching control or constant-speed control, a deceleration stop is made.</p> <p>(3) If an error occurs in one servo program, all servo programs do not execute during the simultaneous start.</p>	<p>(1) If the control unit is [degree], set the address within the range of 0 to 35999999.</p> <p>(2) Set the travel value within the range of "0 to $\pm (2^{31}-1)$".</p>									
Unit	Address setting range																		
degree	0 to 35999999	$\times 10^{-5}$ [degree]																	
4	Command speed error	<p>(1) The command speed is outside the range of 1 to the speed limit value.</p> <p>(2) The command speed is outside the setting range.</p> <table border="1"> <thead> <tr> <th>Unit</th> <th colspan="2">Speed setting range</th> </tr> </thead> <tbody> <tr> <td>mm</td> <td>1 to 600000000</td> <td>$\times 10^{-2}$ [mm/min]</td> </tr> <tr> <td>inch</td> <td>1 to 600000000</td> <td>$\times 10^{-3}$ [inch/min]</td> </tr> <tr> <td>degree</td> <td>1 to 2147483647</td> <td>$\times 10^{-3}$ [degree /min] (Note-1)</td> </tr> <tr> <td>pulse</td> <td>1 to 2147483647</td> <td>[pulse/s]</td> </tr> </tbody> </table>	Unit	Speed setting range		mm	1 to 600000000	$\times 10^{-2}$ [mm/min]	inch	1 to 600000000	$\times 10^{-3}$ [inch/min]	degree	1 to 2147483647	$\times 10^{-3}$ [degree /min] (Note-1)	pulse	1 to 2147483647	[pulse/s]	<p>(1) Positioning control does not start if the command speed is "0" or less.</p> <p>(2) If the command speed exceeds the speed limit value, control with the speed limit value.</p>	Set the command speed within the range of 1 to the speed limit value.
Unit	Speed setting range																		
mm	1 to 600000000	$\times 10^{-2}$ [mm/min]																	
inch	1 to 600000000	$\times 10^{-3}$ [inch/min]																	
degree	1 to 2147483647	$\times 10^{-3}$ [degree /min] (Note-1)																	
pulse	1 to 2147483647	[pulse/s]																	
5	Dwell time setting error	The dwell time is outside the range of 0 to 5000.	Control with the default value "0".	Set the dwell time within the range of 0 to 5000.															
6	M-code setting error	The M-code is outside the range of 0 to 32767.		Set the M-code within the range of 0 to 32767.															
7	Torque limit value setting error	The torque limit value is outside the range of 1 to 1000.	Control with the torque limit value of the specified parameter block.	Set the torque limit value within the range of 1 to 1000.															

(Note-1): When the "speed control $10 \times$ multiplier setting for degree axis" is set to "valid", the setting range is 0.01 to 21474836.47 [degree/min].

Table 1.2 Servo program setting error list (Continued)

Error code stored in SD517	Error name	Error contents	Error processing	Corrective action						
n08 (Note)	Auxiliary point setting error (At the auxiliary point-specified circular interpolation.) (At the auxiliary point-specified helical interpolation.)	(1) The auxiliary point address is outside the setting range at the positioning start for absolute data method. <table border="1"> <tr> <th>Unit</th> <th colspan="2">Address setting range</th> </tr> <tr> <td>degree</td> <td>0 to 35999999</td> <td>$\times 10^{-5}$ [degree]</td> </tr> </table>	Unit	Address setting range		degree	0 to 35999999	$\times 10^{-5}$ [degree]	Positioning control does not start.	(1) If the control unit is [degree], set the auxiliary point address within the range of 0 to 35999999.
		Unit	Address setting range							
degree	0 to 35999999	$\times 10^{-5}$ [degree]								
(2) The auxiliary point address is set to -2147483648 (H80000000) at the positioning start for incremental data method.	(2) Set the auxiliary point address within the range of 0 to $\pm (2^{31}-1)$.									
n09 (Note)	Radius setting error (At the radius-specified circular interpolation.) (At the radius-specified helical interpolation.)	(1) The radius is outside the setting range at the positioning control for absolute data method. <table border="1"> <tr> <th>Unit</th> <th colspan="2">Address setting range</th> </tr> <tr> <td>degree</td> <td>0 to 35999999</td> <td>$\times 10^{-5}$ [degree]</td> </tr> </table>	Unit	Address setting range		degree	0 to 35999999	$\times 10^{-5}$ [degree]		(1) If the control unit is [degree], set the radius within the range of 0 to 35999999.
		Unit	Address setting range							
degree	0 to 35999999	$\times 10^{-5}$ [degree]								
(2) The radius is set to "0" or negative setting at the positioning start for incremental data method.	(2) Set the radius within the range of 1 to $(2^{31}-1)$.									
n10 (Note)	Central point setting error (At the central point-specified circular interpolation.) (At the central point-specified helical interpolation.)	(1) The central point address is outside the setting range at the positioning start for absolute data method. <table border="1"> <tr> <th>Unit</th> <th colspan="2">Address setting range</th> </tr> <tr> <td>degree</td> <td>0 to 35999999</td> <td>$\times 10^{-5}$ [degree]</td> </tr> </table>	Unit	Address setting range		degree	0 to 35999999	$\times 10^{-5}$ [degree]		(1) If the control unit is [degree], set the central point address within the range of 0 to 35999999.
		Unit	Address setting range							
degree	0 to 35999999	$\times 10^{-5}$ [degree]								
(2) The central point is set to -2147483648 (H80000000) at the positioning start for incremental data method.	(2) Set the central point address within the range of 0 to $\pm (2^{31}-1)$.									
11	Interpolation control unit setting error	The interpolation control unit is set outside the range of 0 to 3.	Control with the default value "3".	Set the interpolation control unit within the range of 0 to 3.						
12	Speed limit value setting error	The speed limit value is set outside the setting range.	Control with the default value 200000[pulse/s].	Set the speed limit value within the setting range. [For pulse] 1 to 2147483647[pulse/s]						
13	Acceleration time setting error	The acceleration time is set to "0".	Control with the default value "1000".	Set the acceleration time within the range of 1 to 65535.						
	FIN acceleration/ deceleration setting error	The FIN acceleration/deceleration time is set except 1 to 5000.		The FIN acceleration/ deceleration time within the range of 1 to 5000.						
	Fixed position stop acceleration/ deceleration time setting error	The fixed position stop acceleration/deceleration time is set to "0".		Set the fixed position stop acceleration/deceleration time within the range of 1 to 65535.						
14	Deceleration time setting error	The deceleration time is set to "0".		Set the deceleration time within the range of 1 to 65535.						

Table 1.2 Servo program setting error list (Continued)

Error code stored in SD517	Error name	Error contents	Error processing	Corrective action										
15	Rapid stop deceleration time setting error	The rapid stop deceleration time is set to "0".	Control with the default value "1000".	Set the rapid stop deceleration time within the range of 1 to 65535.										
16	Torque limit value setting error	The torque limit value is outside the range of 1 to 1000.	Control with the default value "300[%]".	Set the torque limit value within the range of 1 to 1000.										
17	Allowable error range for circular interpolation setting error	The allowable error range for circular interpolation is outside the setting range. <table border="1" style="margin-left: 20px;"> <thead> <tr> <th>Unit</th> <th>Address setting range</th> </tr> </thead> <tbody> <tr> <td>mm</td> <td>0 to 100000 × 10⁻¹ [μm]</td> </tr> <tr> <td>inch</td> <td>× 10⁻⁵ [inch]</td> </tr> <tr> <td>degree</td> <td>× 10⁻⁵ [degree]</td> </tr> <tr> <td>pulse</td> <td>[pulse]</td> </tr> </tbody> </table>	Unit	Address setting range	mm	0 to 100000 × 10 ⁻¹ [μ m]	inch	× 10 ⁻⁵ [inch]	degree	× 10 ⁻⁵ [degree]	pulse	[pulse]	Control with the default value "100[pulse]".	Set the allowable error range for circular interpolation within the setting range.
Unit	Address setting range													
mm	0 to 100000 × 10 ⁻¹ [μ m]													
inch	× 10 ⁻⁵ [inch]													
degree	× 10 ⁻⁵ [degree]													
pulse	[pulse]													
18	Repeat count error	The repeat count is outside the range of 1 to 32767.	Control the repeat count with "1".	Set the repeat count within the range of 1 to 32767.										
19	START instruction setting error	(1) The servo program specified with the START instruction does not exist.	Positioning control does not start.	(1) Create the servo program specified with the START instruction.										
		(2) There is a START instruction in the specified servo program.		(2) Delete the servo program specified with the START instruction.										
		(3) The starting axis of the specified servo program overlap.		(3) Do not overlap the starting axis.										
		(4) The real mode program and virtual mode program are mixed.		(4) Do not allow mixture of the real mode program and virtual mode program.										
		(5) The real axis program and command generation axis program are mixed.		(5) Do not allow mixture of the real axis program and command generation axis program.										
20	Point setting error	Point is not specified in the instruction at the constant-speed control.		Set a point between CPSTART and CPEND.										
21	Reference axis speed setting error	The axis except interpolation axis is set as the reference axis at the linear interpolation of the reference axis speed-specified method.		Set one of the interpolation axes as the reference axis.										
22	S-curve ratio setting error	S-curve ratio is set outside the range of 0 to 100[%] at the S-curve acceleration/deceleration.	Control the S-curve ratio with 0[%] (Trapezoidal acceleration/deceleration).	Set the S-curve ratio within the range of 0 to 100[%].										
23	VSTART setting error	Not even one speed-switching point has been set between a VSTART and VEND instruction, or between FOR and NEXT instruction.	Positioning control does not start.	Set the speed switching point between the VSTART and VEND instructions or the FOR and NEXT instructions.										
24	Cancel function start program No. error	The start program No. for the cancel function is set outside the range 0 to 4095.		Start after set the start program No. within the range of 0 to 4095.										

Table 1.2 Servo program setting error list (Continued)

Error code stored in D517	Error name	Error contents	Error processing	Corrective action
25	High-Speed oscillation command amplitude error	Operation cannot be started because the amplitude specified with the high-speed oscillation function is outside the range 1 to 2147483647.	Positioning control does not start.	Start after set the command amplitude within the range of 1 to 214783647.
26	High-Speed oscillation command starting angle error	Operation cannot be started because the starting angle specified with the high-speed oscillation function is outside the range of 0 to 3599 ($\times 0.1$ [degree]).		Start after set the starting angle within the range of 0 to 3599 ($\times 0.1$ [degree]).
27	High-Speed oscillation command frequency error	Operation cannot be started because the frequency specified with the high-speed oscillation function is outside the range of 1 to 5000[CPM].		Start after set the frequency within the range of 1 to 5000[CPM].
28	Number of helical interpolation pitches error	The specified number of pitches of helical interpolation is outside the range of 0 to 999.		Set the specified number of pitches within the range of 0 to 999.
41	Device error of the home position return data for indirect setting	Any unauthorized devices are set in the home position return data for indirect setting.	Positioning control does not start.	Review the devices of home position return data for indirect setting.
45	Advanced S-curve acceleration/ deceleration setting error	The acceleration section 1 ratio is outside the range of 0.0 to 100.0[%].	Control with acceleration section 1 ratio = 0.0 acceleration section 2 ratio = 0.0 deceleration section 1 ratio = 0.0 deceleration section 2 ratio = 0.0	Set the each ratio within the range of 0.0 to 100.0[%].
46		The acceleration section 2 ratio is outside the range of 0.0 to 100.0[%].		
47		The deceleration section 1 ratio is outside the range of 0.0 to 100.0[%].		
48		The deceleration section 2 ratio is outside the range of 0.0 to 100.0[%].		
49		(Acceleration section 1 + Acceleration section 2) > 100.0[%]		
50		(Deceleration section 1 + Deceleration section 2) > 100.0[%]		
51	Rapid stop deceleration time setting error	The rapid stop deceleration time is bigger than the setting value of deceleration time.	Control the rapid stop deceleration time with the setting value of deceleration time.	Set the rapid stop deceleration time within the range of 1 to deceleration time setting value.
900	START instruction setting error	The servo program specified with the servo program start does not exist.	Positioning control does not start.	Set the correct servo program No.
901	START instruction setting error	The axis No. set in the servo program start is different from the axis No. set in the servo program.		Set the correct axis No.
902	Servo program instruction code error	The instruction code cannot be decoded. (A non-existent instruction code has been specified.)		Set the correct instruction code.

Table 1.2 Servo program setting error list (Continued)

Error code stored in SD517	Error name	Error contents	Error processing	Corrective action
903	Start error	A virtual mode program was started in the real mode.	Positioning control does not start.	Check the program mode allocation.
905	Start error	(1) Operation disable instructions (VPF, VPR, VPSTART, PVF, PVR, ZERO, VVF, VVR, OSC) was started in virtual mode.		Correct the servo program.
		(2) Operation disable instructions (ZERO, OSC, CHGA-C) was started in real mode axis.		
		(3) Operation disable instructions (VPF, VPR, VPSTART, VSTART, ZERO, VVF, VVR, OSC) was started in command generation axis.		
		(4) Operation disable instructions (CHGA-C, CHGA-E) from the D(P).SVST instruction of Motion dedicated instruction was started.		
906	Axis No. setting error	(1) Unused axis of the system setting is set in the servo program start.		Set the axis No. set in the system setting or mechanical system program.
		(2) It was started by setting the real mode axis in the virtual servo program.		
		(3) It was started in the condition that the real mode axis had been mixed with virtual axis in the interpolation axis.		
		(4) It was started by setting the virtual axis in the real mode program in virtual mode.		

APPENDIX 1.2 Minor errors

These errors are detected in the sequence program or servo program, and the error codes of 1 to 999 are used.

Minor errors include the setting data errors, starting errors, positioning control errors and current value/speed/target position change errors, synchronous control output axis errors, synchronous control input axis errors and system errors.

(1) Setting data errors (1 to 99)

These errors occur when the data set in the parameters for positioning control is not correct.

The error codes, causes, processing, and corrective actions are shown in Table 1.3.

Table 1.3 Setting data error (1 to 99) list

Error code	Erroneous data	Check timing	Error cause	Error processing	Corrective action
21	Home position return data	Home position return start of the proximity dog method, count method, data set method, dog cradle method, stopper method, limit switch combined method, scale home position signal detection method, and dogless home position signal reference method	The home position address is outside the range of 0 to 35999999 ($\times 10^{-5}$ [degree]) with degree axis.	Home position return is not started.	Set the home position address within the setting range using MT Developer2.
22		Home position return start of the proximity dog method, count method,	The home position return speed is outside the range of 1 to speed limit value.		Set the home position return speed or less to the speed limit value using MT Developer2.
23		dog cradle method, stopper method, limit switch combined method, scale home position signal detection method, and dogless home position signal reference method	The creep speed is outside the range of 1 to home position return speed.		Set the creep speed below to the home position return speed or less using MT Developer2.
24		Home position return start of the count method	The travel value after the proximity dog ON is outside the range of 0 to $(2^{31}-1)$ (\times unit).		Set the travel value after the proximity dog ON within the setting range using MT Developer2.
25		Home position return start of the count method, proximity dog method, dog cradle method, stopper method, limit switch combined method, scale home position signal detection method, and dogless home position signal reference method	The parameter block No. is outside the range of 1 to 64.		Set the parameter block No. within the setting range using MT Developer2.
26		Home position return start of the stopper method	Torque limit value at the creep speed is outside the range of 1 to 1000[%].		Set the torque limit value at the creep speed within the setting range using MT Developer2.

Table 1.3 Setting data error (1 to 99) list (Continued)

Error code	Erroneous data	Check timing	Error cause	Error processing	Corrective action
27	Home position return data	Home position return start of the usable retry function	Dwell time at the home position return is outside the range of 0 to 5000[ms].	Home position return is not started.	Set the dwell time at the home position return retry within the setting range using MT Developer2.
40	Parameter block	Interpolation control start	The interpolation control unit of the parameter block is different from the control unit of the fixed parameters.	Control with the control unit of the fixed parameters.	Set the same control unit of the fixed parameters and servo parameters.

POINT

When the interpolation control unit of parameter block is different from the control unit of fixed parameters, an error code may not be stored with the combination of units.

Refer to the "Q173D(S)CPU/Q172D(S)CPU Motion controller (SV13/SV22) Programming Manual (REAL MODE)" for details.

(2) Positioning control start errors (100 to 199)

These errors are detected at the positioning control start.

The error codes, causes, processing, and corrective actions are shown in Table 1.4.

Table 1.4 Positioning control start error (100 to 199) list

Error code	Control mode										Error cause	Error processing	Corrective action
	Command generation axis												
	Synchronous control	Positioning	Fixed-pitch feed	Speed	Constant-speed	JOG	Position follow-up control	Speed control with fixed position stop	Synchronous encoder	Servo input axis			
100	<input type="radio"/>	<input type="radio"/>	<input type="radio"/>	<input type="radio"/>	<input type="radio"/>	<input type="radio"/>	<input type="radio"/>	<input type="radio"/>	<input type="radio"/>	<input type="radio"/>	<ul style="list-style-type: none"> The PLC ready flag (M2000) or PCPU READY complete flag (SM500) is OFF. 	Positioning control does not start.	<ul style="list-style-type: none"> Set the Motion CPU to RUN. Turn the PLC ready flag (M2000) on.
101	<input type="radio"/>										<ul style="list-style-type: none"> The start accept flag (M2001 to M2032) for applicable axis is ON. 		<ul style="list-style-type: none"> Take an interlock in the program not to start the starting axis. (Use the start accept flag OFF of the applicable axis as the starting condition).
		<input type="radio"/>	<input type="radio"/>	<input type="radio"/>	<input type="radio"/>	<input type="radio"/>	<input type="radio"/>	<input type="radio"/>	<input type="radio"/>		<ul style="list-style-type: none"> The command generation axis start accept flag (M9810+20n) for applicable axis is ON. 		<ul style="list-style-type: none"> Take an interlock in the program not to start the starting axis. (Use the start accept flag OFF of the applicable axis as the starting condition).
103	<input type="radio"/>										<ul style="list-style-type: none"> The stop command (M3200+20n) for applicable axis is ON. 		<ul style="list-style-type: none"> Turn the stop command (M3200+20n) off and start.
			<input type="radio"/>	<input type="radio"/>	<input type="radio"/>	<input type="radio"/>	<input type="radio"/>	<input type="radio"/>	<input type="radio"/>		<ul style="list-style-type: none"> The command generation axis stop command (M10960+20n) for applicable axis is ON. 		<ul style="list-style-type: none"> Turn the command generation axis stop command (M10960+20n) off and start.
104	<input type="radio"/>										<ul style="list-style-type: none"> The rapid stop command (M3201+20n) for applicable axis is ON. 	<ul style="list-style-type: none"> Turn the rapid stop command (M3201+20n) off and start. 	
			<input type="radio"/>	<input type="radio"/>	<input type="radio"/>	<input type="radio"/>	<input type="radio"/>	<input type="radio"/>	<input type="radio"/>		<ul style="list-style-type: none"> The command generation axis rapid stop command (M10961+20n) for applicable axis is ON. 	<ul style="list-style-type: none"> Turn the command generation axis rapid stop command (M10961+20n) off and start. 	
105 (Note)	<input type="radio"/>	<input type="radio"/>			<input type="radio"/>			<input type="radio"/>			<ul style="list-style-type: none"> The feed current value is outside the range of stroke limit at the start. 	<ul style="list-style-type: none"> Set within the stroke limit range by the JOG operation. Set within the stroke limit range by the home position return or current value change. 	

(Note): These errors are stored the error codes of the all applicable interpolation axes at the interpolation operation.

Table 1.4 Positioning control start error (100 to 199) list (Continued)

Error code	Control mode										Error cause	Error processing	Corrective action
	Command generation axis												
	Synchronous control	Positioning	Fixed-pitch feed	Speed	Constant-speed	JOG	Position follow-up control	Speed control with fixed position stop	Synchronous encoder	Servo input axis			
106 (Note)		○	○		○						<ul style="list-style-type: none"> Positioning is outside the range of stroke limit. When absolute position system is enabled for stepping driver, and software stroke limit is valid with control units as degree, the following instructions were started. <ol style="list-style-type: none"> Absolute system instructions in constant-speed control Position follow-up control Absolute system instructions in speed-switching control 		<ul style="list-style-type: none"> Perform the positioning within the range of stroke limit. When absolute position system is enabled for stepping driver, if software stroke limit is valid and control units are degree, do not use the following instructions. <ol style="list-style-type: none"> Absolute system instructions in constant-speed control Position follow-up control Absolute system instructions in speed-switching control
107 (Note)		○			○						<ul style="list-style-type: none"> The address that does not generate an arc is set at auxiliary point-specified circular interpolation or auxiliary point-specified helical interpolation. <div style="border: 1px solid black; padding: 2px; display: inline-block;">Relationship between the start point, auxiliary point and end point.</div> The auxiliary point-specified circular interpolation or auxiliary point-specified helical interpolation was started in the axis which is "stroke limit invalid". 	Positioning control does not start.	<ul style="list-style-type: none"> Correct the addresses of the servo program. Make the stroke limit valid for the axis starts the auxiliary point-specified circular interpolation or auxiliary point-specified helical interpolation.
108 (Note)		○			○						<ul style="list-style-type: none"> The address that does not generate an arc is set at R (radius) specified circular interpolation or R (radius) specified helical interpolation. <div style="border: 1px solid black; padding: 2px; display: inline-block;">Relationship between the start point, radius and end point.</div> The radius-specified circular interpolation or radius-specified helical interpolation was started in the axis which is "stroke limit invalid". 		<ul style="list-style-type: none"> Correct the addresses of the servo program. Make the stroke limit valid for the axis starts the radius-specified circular interpolation or radius-specified helical interpolation.

(Note): These errors are stored the error codes of the all applicable interpolation axes at the interpolation operation.

Table 1.4 Positioning control start error (100 to 199) list (Continued)

Error code	Control mode										Error cause	Error processing	Corrective action
	Command generation axis												
	Synchronous control	Positioning	Fixed-pitch feed	Speed	Constant-speed	JOG	Position follow-up control	Speed control with fixed position stop	Synchronous encoder	Servo input axis			
109 (Note)		○			○						<ul style="list-style-type: none"> The address that does not generate an arc is set at central point-specified circular interpolation or central point-specified helical interpolation. <div style="border: 1px solid black; padding: 2px; display: inline-block;">Relationship between the start point, central point and end point.</div> The central point-specified circular interpolation or central point-specified helical interpolation was started in the axis which is "stroke limit invalid". 	Positioning control does not start.	<ul style="list-style-type: none"> Correct the addresses of the servo program.
											<ul style="list-style-type: none"> Make the stroke limit valid for the axis starts the central point-specified circular interpolation or central point-specified helical interpolation. 		
110 (Note)		○			○						<ul style="list-style-type: none"> The difference between the end point address and ideal end point is outside the allowable error range for circular interpolation at the circular interpolation. 		<ul style="list-style-type: none"> Correct the addresses of the servo program.
116										○	<ul style="list-style-type: none"> The setting JOG speed is "0". The setting JOG speed exceeded the JOG speed limit value. The setting JOG speed limit value exceeded the setting range. 	Control with the JOG speed limit value.	<ul style="list-style-type: none"> Set the correct speed (within the setting range).
												Control with the maximum setting range of each control unit.	<ul style="list-style-type: none"> Set the correct JOG speed limit value (within the setting range).
121	○										<ul style="list-style-type: none"> When "Not execute servo program" is selected in the operation setting for incompleteness of home position return, the home position return request signal (M2409+20n) turns on. 	Positioning control does not start.	<ul style="list-style-type: none"> Execute servo program after home position return. In the system which enables execution of servo program even if the home position return request signal (M2409+20n) turns on, set "Execute servo program" as "operation setting for incompleteness of home position return".
130										○	<ul style="list-style-type: none"> Speed control with fixed position stop was started in the axis which [Pr.346] Command generation axis length per cycle is "0". 		<ul style="list-style-type: none"> Set the fixed position stop length per cycle in the command generation axis to other than 0.

(Note): These errors are stored the error codes of the all applicable interpolation axes at the interpolation operation.

APPENDICES

Table 1.4 Positioning control start error (100 to 199) list (Continued)

Error code	Control mode										Error cause	Error processing	Corrective action
	Command generation axis												
	Synchronous control	Positioning	Fixed-pitch feed	Speed	Constant-speed	JOG	Position follow-up control	Speed control with fixed position stop	Synchronous encoder	Servo input axis			
140		○									<ul style="list-style-type: none"> The travel value of the reference axis is set at "0" in the linear interpolation for reference axis specification. 	Positioning control does not start.	<ul style="list-style-type: none"> Do not set axis of travel value "0" as the reference axis.
141						○				<ul style="list-style-type: none"> The position command device of position follow-up control is set the odd number. 	<ul style="list-style-type: none"> Set the even number for the position command device of position follow-up control. 		

(3) Positioning control errors (200 to 299)

These are errors detected during the positioning control.

The error codes, causes, processing and corrective actions are shown in Table 1.5.

Table 1.5 Positioning control error (200 to 299) list

Error code	Control mode										Error cause	Error processing	Corrective action
	Command generation axis												
	Synchronous control	Positioning	Fixed-pitch feed	Speed	Constant-speed	JOG	Position follow-up control	Speed control with fixed position stop	Synchronous encoder	Servo input axis			
200	<input type="radio"/>	<input type="radio"/>	<input type="radio"/>	<input type="radio"/>	<input type="radio"/>	<input type="radio"/>	<input type="radio"/>	<input type="radio"/>	<input type="radio"/>		<ul style="list-style-type: none"> The PLC ready flag (M2000) turned off during the control by the servo program. 	Deceleration stop (Immediate stop during torque control and continuous operation to torque control)	<ul style="list-style-type: none"> Turn the PLC ready flag (M2000) on after all axes have stopped.
204	<input type="radio"/>	<input type="radio"/>	<input type="radio"/>	<input type="radio"/>	<input type="radio"/>	<input type="radio"/>	<input type="radio"/>	<input type="radio"/>			<ul style="list-style-type: none"> The PLC ready flag (M2000) turned off to on again during deceleration by turning off the PLC ready flag (M2000). 	No operation	<ul style="list-style-type: none"> Turn the PLC ready flag (M2000) off to on after all axes have stopped. Turn the PLC ready flag (M2000) off to on during deceleration is "no operation"
207	<input type="radio"/>	<input type="radio"/>			<input type="radio"/>	<input type="radio"/>	<input type="radio"/>				<ul style="list-style-type: none"> The feed current value exceeded the stroke limit range during positioning control. Only the axis exceed the stroke limit range is stored at the circular/helical interpolation. All interpolation axes are stored in the linear interpolation. 	Deceleration stop (Immediate stop during torque control and continuous operation to torque control)	<ul style="list-style-type: none"> Correct the stroke limit range or travel value setting so that positioning control is within the range of the stroke limit.
208		<input type="radio"/>			<input type="radio"/>						<ul style="list-style-type: none"> The feed current value of another axis exceeded the stroke limit value during the circular/helical interpolation control or simultaneous manual pulse generator operation. (For detection of other axis errors). 	Deceleration stop	

Table 1.5 Positioning control error (200 to 299) list (Continued)

Error code	Control mode										Error cause	Error processing	Corrective action
	Command generation axis												
	Synchronous control	Positioning	Fixed-pitch feed	Speed	Constant-speed	JOG	Position follow-up control	Speed control with fixed position stop	Synchronous encoder	Servo input axis			
211					○						• During positioning control, an overrun occurred because the deceleration distance for the output speed is not attained at the point where the final positioning address was detected.	Deceleration stop	• Set the speed setting so that overrun does not occur. • Set the travel value so that overrun does not occur.
		○	○		○		○				• During control with acceleration/deceleration time change, an overrun occurred because the deceleration distance to the final positioning address for the output speed was not attained.	Immediate stop after reaching the final positioning address	• Set the speed setting so that overrun does not occur. • Set the travel value so that overrun does not occur. • Change the deceleration time so that overrun does not occur.
220							○				• When the control unit is "degree" during the position follow-up control, the command address exceeded the range of 0 to 35999999.	Deceleration stop	• When the control unit is "degree", set the command address within the range of 0 to 35999999.
											• The command address for the position follow-up control exceeded the stroke limit range.		• Set the address within the stroke limit range.
221							○				• During the speed control with fixed position stop, the setting address exceeded the range of 0 to 35999999 at the fixed position stop command device ON.		• Set the command address within the range of 0 to 35999999.
222							○				• During the speed control with fixed position stop, the fixed position acceleration/ deceleration time is "0" at the fixed position acceleration/ deceleration time input.	Control with the default value "1000".	• Set the acceleration/ deceleration time within the range of 1 to 65535.
225					○						• The speed at the pass point exceeded the speed limit value during constant-speed control.	Control with the speed limit value.	• Set the speed command value within the range of 1 to speed limit value.
											• The speed at the pass point is 0 or less.	Control with the speed of last pass point	

Table 1.5 Positioning control error (200 to 299) list (Continued)

Error code	Control mode										Error cause	Error processing	Corrective action
	Command generation axis												
	Synchronous control	Positioning	Fixed-pitch feed	Speed	Constant-speed	JOG	Position follow-up control	Speed control with fixed position stop	Synchronous encoder	Servo input axis			
230					○						<ul style="list-style-type: none"> When the skip is executed in the constant-speed control, the next interpolation instruction is an absolute circular interpolation or absolute helical interpolation. After the skip is executed in the constant-speed control, an absolute circular interpolation or absolute helical interpolation is executed while passing through only the positioning point for incremental method. 	<p>Immediate stop</p> <hr/> <p>Deceleration stop</p>	<ul style="list-style-type: none"> If ABS arc or ABS helical interpolation is designated at a point after the skip designation point, set an ABS linear interpolation point in the interval.

(4) Current value/speed/target position change errors (300 to 399)

These are errors detected at current value change, speed change or target position change.

The error codes, causes, processing and corrective actions are shown in Table 1.6.

Table 1.6 Current value/speed/target position change error (300 to 399) list

Error code	Control mode										Error cause	Error processing	Corrective action
	Command generation axis												
	Synchronous control	Positioning	Fixed-pitch feed	Speed	Constant-speed	JOG	Position follow-up control	Speed control with fixed position stop	Synchronous encoder	Servo input axis			
300											<ul style="list-style-type: none"> The current value was changed during positioning control of the applicable axis. The current value was changed for the axis that had not been started. The current value was changed for the servo OFF axis. 	Current value is not changed.	<ul style="list-style-type: none"> Use the following devices as interlocks not to change the current value for the applicable axis. <ol style="list-style-type: none"> The start accept flag (M2001 to M2032) OFF for applicable axis. The servo READY signal (M2415+20n) ON.
											<ul style="list-style-type: none"> The current value was changed during positioning control of the applicable command generation axis. 		
305											<ul style="list-style-type: none"> The speed after speed change is set outside the range of 0 to speed limit value. 	Control with the speed limit value.	<ul style="list-style-type: none"> Set the speed after speed change within the range of 0 to speed limit value. Set the absolute value of speed after speed change within the range of 0 to speed limit value.
											<ul style="list-style-type: none"> The absolute value of speed after speed change is set outside the range of 0 to speed limit value. 		
309											<ul style="list-style-type: none"> The current value was changed outside the range of 0 to $35999999 (\times 10^{-5}[\text{degree}])$ for the degree axis. 	Current value is not changed.	<ul style="list-style-type: none"> Set the current value within the range of 0 to $35999999 (\times 10^{-5}[\text{degree}])$.
310											<ul style="list-style-type: none"> Change speed to negative speed in the invalid axis of stroke limit. 	Speed is not changed.	<ul style="list-style-type: none"> Do not change speed to negative speed in the invalid axis of stroke limit.

Table 1.6 Current value/speed/target position change error (300 to 399) list (Continued)

Error code	Control mode										Error cause	Error processing	Corrective action
	Command generation axis												
	Synchronous control	Positioning	Fixed-pitch feed	Speed	Constant-speed	JOG	Position follow-up control	Speed control with fixed position stop	Synchronous encoder	Servo input axis			
311	○										<ul style="list-style-type: none"> The value outside the range of 1 to 1000[%] was set in the torque limit value change request (D(P).CHGT, CHGT). The forward direction torque limit value or the negative direction torque limit value outside the range of 0.1 to 1000.0[%] was set in the torque limit value individual change request (D(P).CHGT2, CHGT2). 	Torque limit value is not changed.	<ul style="list-style-type: none"> Set the change request within the range of 1 to 1000[%] in the torque limit value change request (CHGT). Set the change request within the range of 0.1 to 1000.0[%] for the forward direction torque limit value or the negative direction torque limit value in the torque limit value individual change request (CHGT2).
312											<ul style="list-style-type: none"> The torque limit value change request (D(P).CHGT, CHGT) was made for the axis that had not been started. The torque limit value individual change request (D(P).CHGT2, CHGT2) was made for the axis that had not been started. 		<ul style="list-style-type: none"> Request the change for the starting axis. Request the torque limit change or the torque limit value individual change for the starting axis.
315	○										<ul style="list-style-type: none"> During speed/torque control, the absolute value of the command speed is outside the range of 0 to the speed limit value in speed/torque control. 	Control with the speed limit value at speed-torque control.	<ul style="list-style-type: none"> Set the speed after speed change within the range of 0 to speed limit value in speed/torque control.
316	○										<ul style="list-style-type: none"> During torque control or stopper control, the absolute value of the command torque is outside the range of 0 to the torque limit value in speed/torque control. 	Control with the torque limit value at speed-torque control.	<ul style="list-style-type: none"> Set the torque after torque change within the range of 0 to the torque limit value in speed/torque control.
317	○										<ul style="list-style-type: none"> At the switching request to the stopper control, a control mode which cannot be switched is used. 	The control mode is not switched.	<ul style="list-style-type: none"> Request switching during the control which can be switched to the stopper control.
318	○										<ul style="list-style-type: none"> Switching to the stopper control was requested to the servo amplifier which is not compatible with the stopper control. 	Position control: Deceleration stop Speed control: The mode is switched to position control mode, and the operation stops immediately.	<ul style="list-style-type: none"> Use the servo amplifier where the stopper control is available.

Table 1.6 Current value/speed/target position change error (300 to 399) list (Continued)

Error code	Control mode										Error cause	Error processing	Corrective action
	Command generation axis												
	Synchronous control	Positioning	Fixed-pitch feed	Speed	Constant-speed	JOG	Position follow-up control	Speed control with fixed position stop	Synchronous encoder	Servo input axis			
319	○										<ul style="list-style-type: none"> During the speed/torque control, the change value by the torque limit value change request (D(P).CHGT, CHGT) or torque limit value individual change request (D(P).CHGT2, CHGT2) exceeds the torque limit value in speed/torque control. 	Torque limit value is not changed.	<ul style="list-style-type: none"> Request changing within the range of torque limit value in speed/torque control.
330	○										<ul style="list-style-type: none"> The target position change request (CHGP) was executed for the axis which was executing a servo instruction which was not compatible with target position change. 	Target position is not changed.	<ul style="list-style-type: none"> Change the target position for the axes operated by the following servo instructions. <ol style="list-style-type: none"> Linear interpolation control Fixed-pitch feed operation Constant-speed control

(5) Synchronous control output axis errors (700 to 799)

These are errors detected at the output axis during synchronous control.

The error codes, causes, processing and corrective actions are shown in Table 1.7.

Table 1.7 Synchronous control output axis error (700 to 799) list

Error code	Control mode										Error cause	Error processing	Corrective action
	Command generation axis												
	Synchronous control	Positioning	Fixed-pitch feed	Speed	Constant-speed	JOG	Position follow-up control	Speed control with fixed position stop	Synchronous encoder	Servo input axis			
704	○										<ul style="list-style-type: none"> The synchronous parameter "[Pr.405] Main shaft clutch control setting (D15008+150n)" was set to outside the setting range during the synchronous control. The synchronous parameter "[Pr.405] Main shaft clutch control setting (D15008+150n)" was set from a setting other than "No clutch" to "No clutch" during the synchronous control. 	Synchronous control continues by the previous main shaft clutch control setting.	<ul style="list-style-type: none"> Set a value within the range. Do not change the settings other than "No clutch" to "No clutch".
724	○										<ul style="list-style-type: none"> The synchronous parameter "[Pr.422] Auxiliary shaft clutch control setting (D15030+150n)" was set to outside the setting range during the synchronous control. The synchronous parameter "[Pr.422] Auxiliary shaft clutch control setting (D15030+150n)" was set from a setting other than 'No Clutch' to 'No Clutch' during the synchronous control. 	Synchronous control continues by the previous auxiliary shaft clutch control setting.	
741	○										<ul style="list-style-type: none"> The synchronous parameter "[Pr.437] Speed change ratio 1: Denominator (D15050+150n, D15050+150n)" is set to 0 or lower during synchronous control. 	Synchronous control continues by the previous speed change ratio 1 (Denominator).	<ul style="list-style-type: none"> Set a value within the range of 1 to 2147483647.
745	○										<ul style="list-style-type: none"> The synchronous parameter "[Pr.493] Speed change ratio 2: Denominator (D15056+150n, D15057+150n)" is set to 0 or lower during synchronous control. 	Synchronous control continues by the previous speed change ratio 2 (Denominator).	

Table 1.7 Synchronous control output axis error (700 to 799) list (Continued)

Error code	Control mode										Error cause	Error processing	Corrective action
	Command generation axis												
	Synchronous control	Positioning	Fixed-pitch feed	Speed	Constant-speed	JOG	Position follow-up control	Speed control with fixed position stop	Synchronous encoder	Servo input axis			
750	○										<ul style="list-style-type: none"> The synchronous parameter "[Pr.440] Cam No. (D15062+150n)" is set to other than 0 to 256 during synchronous control. 	Synchronous control	<ul style="list-style-type: none"> Set a value within the range of 0 to 256.
751	○										<ul style="list-style-type: none"> When changing the synchronous parameter "[Pr.440] Cam No. (D15062+150n)", the cam data of the changed cam No. does not exist on the cam open area during synchronous control. 	continues by the previous cam No.	<ul style="list-style-type: none"> Specify the cam No. of an existing cam data.
752	○										<ul style="list-style-type: none"> The synchronous parameter "[Pr.439] Cam axis length per cycle (D15060+150n, D15061+150n)" is set to 0 or lower. 	Synchronous control continues by the previous cam axis length per cycle.	<ul style="list-style-type: none"> Set a value within the range of 1 to 2147483647.
754	○										<ul style="list-style-type: none"> Phase compensation amount of cam axis is equal or lower than the minimum value (-2147483648), or exceeding the maximum value (2147483647). 	The operation is controlled with the minimum or maximum value.	<ul style="list-style-type: none"> Set a smaller cam axis phase compensation advance time. Decrease the cam axis input value speed.
755	○										<ul style="list-style-type: none"> The synchronous parameter "[Pr.439] Cam axis length per cycle (D15060+150n, D15061+150n)" is changed, in synchronous control using the stroke ratio data format cam which cam data starting point is except 0. 	Synchronous control continues by the previous cam axis length per cycle.	<ul style="list-style-type: none"> Use the cam which cam data starting point is 0.
756	○										<ul style="list-style-type: none"> The synchronous parameter "[Pr.440] Cam No. (D15062+150n)" switch the control mode to speed/torque/continuous operation to torque control for the output axis except 0 in synchronous control. Switch the control mode to speed/torque/continuous operation to torque control for the output axis that is executing the synchronous control switching function. 	The control mode is not switched.	<ul style="list-style-type: none"> Set the output axis to linear cam (cam No.0) when executes the speed-torque control during advanced synchronous control. Execute the request switching to the control mode to speed/torque/continuous operation to torque control after executed synchronous control switching function.

Table 1.7 Synchronous control output axis error (700 to 799) list (Continued)

Error code	Control mode										Error cause	Error processing	Corrective action
	Command generation axis												
	Synchronous control	Positioning	Fixed-pitch feed	Speed	Constant-speed	JOG	Position follow-up control	Speed control with fixed position stop	Synchronous encoder	Servo input axis			
757	○										<ul style="list-style-type: none"> The output axis synchronous parameter "[Pr.440] Cam No. (D15062+150n)" is set to other than 0 during speed-torque control. 	Control continues by the linear cam (cam No.0).	<ul style="list-style-type: none"> Set the output axis to linear cam (cam No.0) when executes the speed-torque control during advanced synchronous control.
770	○										<ul style="list-style-type: none"> The "[Cd.407] Synchronous control change command (D15130+150n)" is set to other than 0 to 4 at control change request. 	Control change is not requested.	<ul style="list-style-type: none"> Set a value within the range.

(6) Synchronous control input axis errors (800 to 899)

These are errors detected at the input axis during synchronous control.

The error codes, causes, processing and corrective actions are shown in Table 1.8.

Table 1.8 Synchronous control input axis error (800 to 899) list

Error code	Control mode										Error cause	Error processing	Corrective action	
	Synchronous control	Command generation axis								Synchronous encoder				Servo input axis
		Positioning	Fixed-pitch feed	Speed	Constant-speed	JOG	Position follow-up control	Speed control with fixed position stop						
880	○											<ul style="list-style-type: none"> Phase compensation amount of input axis is equal or lower than the minimum value (-2147483648), or exceeding the maximum value (2147483647). 	The input axis operation continues. It is controlled with the minimum or maximum value.	<ul style="list-style-type: none"> Set a smaller phase compensation advance time. Decrease the input axis speed.
881	○											<ul style="list-style-type: none"> Rotation direction restriction amount of input axis is equal or lower than the minimum value (-2147483648), or exceeding the maximum value (2147483647). 		<ul style="list-style-type: none"> Confirm the enabled direction of the rotation direction restriction setting. (The setting may be reversed.) Check if the input axis moves to the reverse direction of the enabled direction.
882	○											<ul style="list-style-type: none"> Monitor speed display of input axis is equal or lower than the minimum value (-2147483648), or exceeding the maximum value (2147483647). 		<ul style="list-style-type: none"> Set a lower value if the number of decimal places for speed command setting is available in the input axis setting. Switch the units from min to s if the speed command time unit setting is available in the input axis setting. Decrease the input axis speed.
883	○											<ul style="list-style-type: none"> Low voltage at Q172DEX or servo amplifier which connected synchronous encoder. 	Operation is continued.	<ul style="list-style-type: none"> Replace the battery.
884	○											<ul style="list-style-type: none"> The "[Cd.321] Synchronous encoder axis control method (D14823+10n)" is set to other than 0 to 2 at synchronous encoder axis control request. 	Synchronous encoder axis control does not start.	<ul style="list-style-type: none"> Set a value within the range.

(7) System errors (900 to 999)

These are errors detected at the power-on.

The error codes, causes, processing and corrective actions are shown in Table 1.9.

Table 1.9 System error (900 to 999) list

Error code	Control mode										Error cause	Error processing	Corrective action
	Command generation axis												
	Synchronous control	Positioning	Fixed-pitch feed	Speed	Constant-speed	JOG	Position follow-up control	Speed control with fixed position stop	Synchronous encoder	Servo input axis			
901											<ul style="list-style-type: none"> The motor travel value while the power is off exceeded the "System setting mode-allowable travel value during power off" set in the system settings at the turning on of the servo amplifier. 	<p>Further operation is possible.</p>	<ul style="list-style-type: none"> Check the position. Check the battery of servo amplifier.

APPENDIX 1.3 Major errors

These errors occur by control command from the external input signal or Motion SFC program, and the error codes 1000 to 1999 are used.

Major errors include the positioning control start errors, positioning control errors, absolute position system errors, system errors, synchronous control output axis errors and synchronous control input axis errors.

(1) Positioning control start errors (1000 to 1099)

These errors are detected at the positioning control start.

The error codes, causes, processing and corrective actions are shown in Table 1.10.

Table 1.10 Positioning control start error (1000 to 1099) list

Error code	Control mode										Error cause	Error processing	Corrective action	
	Synchronous control	Command generation axis								Synchronous encoder				Servo input axis
		Positioning	Fixed-pitch feed	Speed	Constant-speed	JOG	Position follow-up control	Speed control with fixed position stop						
1000	<input type="radio"/>											• The external STOP signal of the applicable axis turned on.		• Turn the STOP signal off.
1001	<input type="radio"/>											• The external signal FLS (upper limit LS) turned off at the forward direction (address increase direction) start.		• Move in the reverse direction by the JOG operation, etc. and set within the external limit range.
1002	<input type="radio"/>											• The external signal RLS (lower limit LS) turned off at the reverse direction (address decrease direction) start.		• Move in the forward direction by the JOG operation, etc. and set within the external limit range.
1004	<input type="radio"/>											• The applicable axis is not servo READY state. (M2415+20n: OFF). (1) The power supply of the servo amplifier is OFF. (2) During initial processing after turning on the servo amplifier. (3) The servo amplifier is not mounted. (4) A servo error is occurred. (5) Cable fault. (6) Servo OFF command (M3215+20n) is ON.	Positioning control does not start.	• Wait until the servo READY state (M2415+20n: ON).

(2) Positioning control errors (1100 to 1199)

These errors are detected at the positioning control.

The error codes, causes, processing and corrective actions are shown in Table 1.11.

Table 1.11 Positioning control error (1100 to 1199) list

Error code	Control mode										Error cause	Error processing	Corrective action	
	Synchronous control	Command generation axis								Synchronous encoder				Servo input axis
		Positioning	Fixed-pitch feed	Speed	Constant-speed	JOG	Position follow-up control	Speed control with fixed position stop						
1005	○											<ul style="list-style-type: none"> The servo error detection signal of the applicable axis (M2408+20n) turned on. 	Positioning control does not start.	<ul style="list-style-type: none"> Eliminate the servo error, reset the servo error detection signal (M2408+20n) by the servo error reset command (M3208+20n), then start operation.
1101	○											<ul style="list-style-type: none"> The external signal FLS (upper limit LS) turned off during the forward direction (address increase direction). 	Deceleration stop by "Stop processing on STOP input" of	<ul style="list-style-type: none"> Travel in the reverse direction by the JOG operation, etc. and set within the external limit range.
1102	○											<ul style="list-style-type: none"> The external signal RLS (lower limit LS) turned off during the reverse direction (address decrease direction). 	the parameter block. (Deceleration stop during speed control, immediate stop during continuous operation to torque control mode)	<ul style="list-style-type: none"> Travel in the forward direction by the JOG operation, etc. and set within the external limit range.
1104	○											<ul style="list-style-type: none"> The servo error detection signal turned on during positioning control. 	Immediate stop without decelerating.	<ul style="list-style-type: none"> Start after disposal at the servo error.
1105	○											<ul style="list-style-type: none"> The power supply of the servo amplifier turned off during positioning control. (Servo not mounted status detection, cable fault, etc.) Home position return did not complete normally without stop within the in-position range of home position at the home position return. 	Turn the servo READY (M2415+20n) off.	<ul style="list-style-type: none"> Turn on the power supply of the servo amplifier. Check the connecting cable to the servo amplifier. Make the gain adjustment.

Table 1.11 Positioning control error (1100 to 1199) list (Continued)

Error code	Control mode										Error cause	Error processing	Corrective action
	Command generation axis												
	Synchronous control	Positioning	Fixed-pitch feed	Speed	Constant-speed	JOG	Position follow-up control	Speed control with fixed position stop	Synchronous encoder	Servo input axis			
1151											<ul style="list-style-type: none"> • Q172DEX or encoder hardware error. 	Immediate input stop	<ul style="list-style-type: none"> • Check (replace) the Q172DEX or encoder.
											<ul style="list-style-type: none"> • Disconnected encoder cable. 		<ul style="list-style-type: none"> • Check the encoder cable.
										○	<ul style="list-style-type: none"> • A synchronous encoder set in the system setting differs from a synchronous encoder actually connected. 	Input from synchronous encoder does not accept.	<ul style="list-style-type: none"> • Set a synchronous encoder actually connected in the system setting.
												<ul style="list-style-type: none"> • No battery or disconnected battery at Q172DEX. 	Immediate input stop
1152										○	<ul style="list-style-type: none"> • Low voltage at Q172DEX. 	Operation is continued.	<ul style="list-style-type: none"> • Replace the battery.
1153										○	<ul style="list-style-type: none"> • No battery or disconnected battery at Q172DEX 		<ul style="list-style-type: none"> • Replace the battery or check (replace) the Q172DEX.

(3) Absolute position system errors (1200 to 1299)

These errors are detected at the absolute position system.

The error codes, causes, processing and corrective actions are shown in Table 1.12.

Table 1.12 Absolute position system error (1200 to 1299) list

Error code	Control mode										Error cause	Error processing	Corrective action
	Command generation axis								Synchronous encoder	Servo input axis			
	Synchronous control	Positioning	Fixed-pitch feed	Speed	Constant-speed	JOG	Position follow-up control	Speed control with fixed position stop					
1201											<ul style="list-style-type: none"> The error causes why the home position return is required in the absolute position system are as follows: <ol style="list-style-type: none"> The home position return has never been executed after the system start. The home position return is started, but not completed correctly. Absolute data in the Motion CPU is erased due to causes such as a battery error. Servo error [2025], [2143], or [2913] occurred. Major error [1202], [1203] or [1204] occurred. "Rotation direction selection" of the servo parameter is changed. 	Home position return request ON	<ul style="list-style-type: none"> Execute the home position return after checking the batteries of the Motion CPU module and servo amplifier.
1202											<ul style="list-style-type: none"> A communication error between the servo amplifier and encoder occurred at the turning on servo amplifier power supply. 	Depending on the version of operating system software and servo amplifier, home position return request ON, servo error [2016] set. (Fully closed loop control servo amplifier use: Servo error [2070] is set.)	<ul style="list-style-type: none"> Check the motor and encoder cables. If the home position return request signal is turning ON, execute a home position return.

Table 1.12 Absolute position system error (1200 to 1299) list (Continued)

Error code	Control mode										Error cause	Error processing	Corrective action
	Command generation axis												
	Synchronous control	Positioning	Fixed-pitch feed	Speed	Constant-speed	JOG	Position follow-up control	Speed control with fixed position stop	Synchronous encoder	Servo input axis			
1205											<ul style="list-style-type: none"> The following expression holds: "Encoder current value [pulse] ≠ feedback current value [pulse] (encoder effective bit number)" during operation. A continual check is performed (both of servo ON and OFF states) after the servo amplifier power has been turned on. 	Operation continues. (Home position return signal does not turn ON.)	<ul style="list-style-type: none"> Check the motor and encoder cables.

(4) System errors (1300 to 1399)

These errors are detected at the power-on.

The error codes, causes, processing and corrective actions are shown in Table 1.13.

Table 1.13 System error (1300 to 1399) list

Error code	Control mode										Error cause	Error processing	Corrective action
	Command generation axis												
	Synchronous control	Positioning	Fixed-pitch feed	Speed	Constant-speed	JOG	Position follow-up control	Speed control with fixed position stop	Synchronous encoder	Servo input axis			
1310											<ul style="list-style-type: none"> Initial communication with the Multiple CPU system did not complete normally. Motion CPU fault. 	Positioning control does not start.	<ul style="list-style-type: none"> Replace the Motion CPU.
1350											<ul style="list-style-type: none"> An operation cycle that the servo amplifier does not support has been set. 	System setting error	<ul style="list-style-type: none"> Set an operation cycle that is supported.

(5) Synchronous control output axis errors (1700 to 1799)

These are errors detected at the output axis during synchronous control.

The error codes, causes, processing and corrective actions are shown in Table 1.14.

Table 1.14 Synchronous control output axis error (1700 to 1799) list

Error code	Control mode										Error cause	Error processing	Corrective action
	Command generation axis												
	Synchronous control	Positioning	Fixed-pitch feed	Speed	Constant-speed	JOG	Position follow-up control	Speed control with fixed position stop	Synchronous encoder	Servo input axis			
1700	○										<ul style="list-style-type: none"> Setting value of the synchronous parameter "[Pr.400] Main input axis No. (D15000+150n)" is outside the setting range. The same servo input axis No. as the output axis is set in the synchronous parameter "[Pr.400] Main input axis No. (D15000+150n)". 	Synchronous control does not start.	<ul style="list-style-type: none"> Set a value within the range. Do not set up the same servo input axis number as the output axis.
1701	○									<ul style="list-style-type: none"> Setting value of the synchronous parameter "[Pr.401] Sub input axis No. (D15001+150n)" is outside the setting range. The same servo input axis No. as the output axis is set in the synchronous parameter "[Pr.401] Sub input axis No. (D15001+150n)". 			
1702	○									<ul style="list-style-type: none"> The synchronous parameter "[Pr.404] Main shaft gear: Denominator (D15006+150n, D15007+150n)" is set to less than 0 or lower. 	<ul style="list-style-type: none"> Set a value within the range of 1 to 2147483647. 		
1703	○										<ul style="list-style-type: none"> Overflow (sign reversion) occurred in input values, because the main shaft gear ratio is too large. 	Synchronous control is immediately stopped.	<ul style="list-style-type: none"> Set a smaller absolute value for the synchronous parameter "[Pr.403] Main shaft gear: Numerator (D15004+150n, D15005+150n)". Set a larger the synchronous parameter "[Pr.404] Main shaft gear: Denominator (D15006+150n, D15007+150n)". Decrease the input axis speed.
1704	○										<ul style="list-style-type: none"> Setting value of the synchronous parameter "[Pr.405] Main shaft clutch control setting (D15008+150n)" is outside the setting range. 	Synchronous control does not start.	<ul style="list-style-type: none"> Set a value within the range.

Table 1.14 Synchronous control output axis error (1700 to 1799) list (Continued)

Error code	Control mode										Error cause	Error processing	Corrective action									
	Command generation axis																					
	Synchronous control	Positioning	Fixed-pitch feed	Speed	Constant-speed	JOG	Position follow-up control	Speed control with fixed position stop	Synchronous encoder	Servo input axis												
1705	○										<ul style="list-style-type: none"> Setting value of the synchronous parameter "[Pr.406] Main shaft clutch reference address setting (D15009+150n)" is outside the setting range. 	Synchronous control does not start.	<ul style="list-style-type: none"> Set a value within the range. 									
1706	○									<ul style="list-style-type: none"> Setting value of the synchronous parameter "[Pr.411] Main shaft clutch smoothing method (D15018+150n)" is outside the setting range. 	Synchronous control does not start.		<ul style="list-style-type: none"> Set a value within the range. Do not set the same servo input axis number of the output axis. 									
1707	○									<ul style="list-style-type: none"> Setting value of the synchronous parameter "[Pr.412] Main shaft clutch smoothing time constant (D15019+150n)" is outside the setting range. 				Synchronous control does not start.	<ul style="list-style-type: none"> Set a value within the range. Do not set the same servo input axis number of the output axis. 							
1720	○									<ul style="list-style-type: none"> Setting value of the synchronous parameter "[Pr.418] Auxiliary shaft No. (D15024+150n)" is outside the setting range. The same servo input axis No. as the output axis is set in the synchronous parameter "[Pr.418] Auxiliary shaft No. (D15024+150n)". 						Synchronous control does not start.	<ul style="list-style-type: none"> Set a value within the range. Do not set the same servo input axis number of the output axis. 					
1722	○									<ul style="list-style-type: none"> The synchronous parameter "[Pr.421] Auxiliary shaft gear: Denominator (D15028+150n, D15029+150n)" is set to 0 or lower. 								Synchronous control does not start.	<ul style="list-style-type: none"> Set a value within the range of 1 to 2147483647. 			
1723	○									<ul style="list-style-type: none"> Overflow (sign reversion) occurred in input values, because the auxiliary shaft gear ratio is too large. 										Synchronous control is immediately stopped.	<ul style="list-style-type: none"> Set a smaller absolute value for the synchronous parameter "[Pr.420] Auxiliary shaft gear : Numerator (D15026+150n, D15027+150n)". Set a larger synchronous parameter "[Pr.421] Auxiliary shaft gear: Denominator (D15028+150n, D15029+150n)". Decrease the input axis speed. 	
1724	○									<ul style="list-style-type: none"> Setting value of the synchronous parameter "[Pr.422] Auxiliary shaft clutch control setting (D15030+150n)" is outside the setting range. 												Synchronous control does not start.

Table 1.14 Synchronous control output axis error (1700 to 1799) list (Continued)

Error code	Control mode										Error cause	Error processing	Corrective action	
	Command generation axis													
	Synchronous control	Positioning	Fixed-pitch feed	Speed	Constant-speed	JOG	Position follow-up control	Speed control with fixed position stop	Synchronous encoder	Servo input axis				
1725	○										• Setting value of the synchronous parameter "[Pr.423] Auxiliary shaft clutch reference address setting (D15031+150n)" is outside the setting range.	Synchronous control does not start.	• Set a value within the range.	
1726	○										• Setting value of the synchronous parameter "[Pr.428] Auxiliary shaft clutch smoothing method (D15040+150n)" is outside the setting range.			
1727	○										• Setting value of the synchronous parameter "[Pr.429] Auxiliary shaft clutch smoothing time constant (D15041+150n)" is outside the setting range.			
1740	○										• Setting value of the synchronous parameter "[Pr.434] Speed change gear 1 (D15046+150n)" is outside the setting range.			
1741	○										• The synchronous parameter "[Pr.437] Speed change ratio 1: Denominator (D15050+150n, D15051+150n)" is set to 0 or lower.			• Set a value within the range of 1 to 2147483647.
1742	○										• The synchronous parameter "[Pr.435] Speed change gear 1 smoothing time constant (D15047+150n)" is set other than 0 to 5000.			• Set a value within the range of 0 to 5000.
1743	○										• Overflow (sign reversion) occurred in input values, because the speed change ratio of speed change gear 1 is too large.	Synchronous control is immediately stopped.	• Set a smaller absolute value for the synchronous parameter "[Pr.436] Speed change ratio 1: Numerator (D15048+150n, D15049+150n). • Set a larger the synchronous parameter "[Pr.437] Speed change ratio 1: Denominator (D15050+150n, D15051+150n)". • Decrease the input axis speed.	
1744	○										• Setting value of the synchronous parameter "[Pr.490] Speed change gear 2 (D15052+150n)" is outside the setting range.	Synchronous control does not start.	• Set a value within the range.	

Table 1.14 Synchronous control output axis error (1700 to 1799) list (Continued)

Error code	Control mode										Error cause	Error processing	Corrective action
	Command generation axis												
	Synchronous control	Positioning	Fixed-pitch feed	Speed	Constant-speed	JOG	Position follow-up control	Speed control with fixed position stop	Synchronous encoder	Servo input axis			
1745	○										<ul style="list-style-type: none"> The synchronous parameter "[Pr.493] Speed change ratio 2: Denominator (D15056+150n, D15057+150n)" is set to 0 or lower. 	Synchronous control does not start.	<ul style="list-style-type: none"> Set a value within the range of 1 to 2147483647.
1746	○										<ul style="list-style-type: none"> The synchronous parameter "[Pr.491] Speed change gear 2 smoothing time constant (D15053+150n)" is set other than 0 to 5000. 		<ul style="list-style-type: none"> Set a value within the range of 0 to 5000.
1747	○										<ul style="list-style-type: none"> Overflow (sign reversion) occurred in input values, because the speed change ratio of speed change gear 2 is too large. 	Synchronous control is immediately stopped.	<ul style="list-style-type: none"> Set a smaller absolute value for the synchronous parameter "[Pr.492] Speed change ratio 2: Numerator (D15054+150n, D15055+150n). Set a larger the synchronous parameter "[Pr.493] Speed change ratio 2: Denominator (D15056+150n, D15057+150n)". Decrease the input axis speed.
1748	○										<ul style="list-style-type: none"> The setting value of synchronous parameter "[Pr.434] Speed change gear 1 (D15046+150n)" and "[Pr.490] Speed change gear 2 (D15052+150n)" is overlapping. 	Synchronous control does not start.	<ul style="list-style-type: none"> Set the synchronous parameter "[Pr.434] Speed change gear 1 (D15046+150n)" differs from the "[Pr.490] Speed change gear 2 (D15052+150n)".
1750	○										<ul style="list-style-type: none"> The synchronous parameter "[Pr.440] Cam No. (D15062+150n)" is set to other than 0 to 256. 		<ul style="list-style-type: none"> Set a value within the range of 0 to 256.
1751	○										<ul style="list-style-type: none"> Cam data specified in the synchronous parameter "[Pr.440] Cam No. (D15062+150n)" does not exist on the cam open area. 		<ul style="list-style-type: none"> Specify the cam No. of an existing cam data.
1752	○										<ul style="list-style-type: none"> The synchronous parameter "[Pr.439] Cam axis length per cycle (D15060+150n, D15061+150n)" is set to 0 or lower. 		<ul style="list-style-type: none"> Set a value within the range of 1 to 2147483647.
1753	○										<ul style="list-style-type: none"> The synchronous parameter "[Pr.447] Output axis smoothing time constant (D15070+150n)" is set to other than 0 to 5000. 		<ul style="list-style-type: none"> Set a value within the range of 0 to 5000.

Table 1.14 Synchronous control output axis error (1700 to 1799) list (Continued)

Error code	Control mode										Error cause	Error processing	Corrective action
	Command generation axis												
	Synchronous control	Positioning	Fixed-pitch feed	Speed	Constant-speed	JOG	Position follow-up control	Speed control with fixed position stop	Synchronous encoder	Servo input axis			
1759	○										<ul style="list-style-type: none"> The synchronous parameter "[Pr.448] Synchronous control parameter block No. (D15069+150n)" is set to other than 1 to 64. 	Synchronous control does not start.	<ul style="list-style-type: none"> Set a value within the range of 1 to 64.
1760	○									<ul style="list-style-type: none"> The synchronous parameter "[Pr.460] Setting method of current value per cycle after main shaft gear (D15100+150n)" is set to other than 0 to 2. 	<ul style="list-style-type: none"> Set a value within the range of 0 to 2. 		
1761	○									<ul style="list-style-type: none"> The synchronous parameter "[Pr.465] Current value per cycle after main shaft gear (Initial setting) (D15106+150n, D15107+150n)" is other than 0 to (Cam axis length per cycle - 1). 	<ul style="list-style-type: none"> Set within the range of 0 to (Cam axis length per cycle - 1). 		
1762	○									<ul style="list-style-type: none"> The synchronous parameter "[Pr.461] Setting method of current value per cycle after auxiliary shaft gear (D15101+150n)" is set to other than 0 to 2. 	<ul style="list-style-type: none"> Set a value within the range of 0 to 2. 		
1763	○									<ul style="list-style-type: none"> The synchronous parameter "[Pr.466] Current value per cycle after auxiliary shaft gear (Initial setting) (D15108+150n, D15109+150n)" is other than 0 to (Cam axis length per cycle - 1). 	<ul style="list-style-type: none"> Set within the range of 0 to (Cam axis length per cycle - 1). 		
1764	○									<ul style="list-style-type: none"> The synchronous parameter "[Pr.462] Cam axis position restoration object (D15102+150n)" is set to other than 0 to 2. 	<ul style="list-style-type: none"> Set a value within the range of 0 to 2. 		
1765	○									<ul style="list-style-type: none"> The synchronous parameter "[Pr.463] Setting method of cam reference position (D15103+150n)" is set to other than 0 to 2. 			

Table 1.14 Synchronous control output axis error (1700 to 1799) list (Continued)

Error code	Control mode										Error cause	Error processing	Corrective action
	Command generation axis												
	Synchronous control	Positioning	Fixed-pitch feed	Speed	Constant-speed	JOG	Position follow-up control	Speed control with fixed position stop	Synchronous encoder	Servo input axis			
1766	○										<ul style="list-style-type: none"> The synchronous parameter "[Pr.464] Setting method of cam axis current value per cycle (D15104+150n)" is set to other than 0 to 3. "3: Current value per cycle after auxiliary shaft gear" is established when the auxiliary shaft does not exist. 		<ul style="list-style-type: none"> Set a value within the range of 0 to 3. Set other than "3: Current value per cycle after auxiliary shaft gear" when the auxiliary shaft does not exist.
1767	○										<ul style="list-style-type: none"> The synchronous parameter "[Pr.468] Cam axis current value per cycle (Initial setting) (D15112+150n, D15113+150n)" is set to other than 0 to (Cam axis length per cycle - 1). 		<ul style="list-style-type: none"> Set within the range of 0 to (Cam axis length per cycle - 1).
1768	○										<ul style="list-style-type: none"> Cam axis current value per cycle corresponding to the current feed value at synchronous control start could not be restored when the synchronous parameter "[Pr.462] Cam axis position restoration object (D15102+150n)" was "0: Cam axis current value per cycle restoration". (Occurs in reciprocated cam pattern) 	Synchronous control does not start.	<ul style="list-style-type: none"> Start synchronous control after moving the current feed value as to fit within the stroke of two-way operation cam pattern. Set the cam reference position as to fit within the stroke of two-way operation cam pattern.
1769	○										<ul style="list-style-type: none"> Restoration could not be completed when the synchronous parameter "[Pr.462] Cam axis position restoration object (D15102+150n)" was "2: Cam axis current feed value restoration", because the difference between the restored cam axis current feed value and the current feed value at synchronous control start (pulse command unit) was larger than the servo parameter "In-position range". 		<ul style="list-style-type: none"> Start synchronous control after calculating the cam axis current feed value to be restored, using the cam position calculation function, and moving the current feed value. Set a larger setting value for the servo parameter "In-position range", if the current value is too small (such as 0)."

(6) Synchronous control input axis errors (1800 to 1899)

These are errors detected at the input axis during synchronous control.

The error codes, causes, processing and corrective actions are shown in Table 1.15.

Table 1.15 Synchronous control input axis error (1800 to 1899) list

Error code	Control mode									Error cause	Error processing	Corrective action		
	Synchronous control	Command generation axis							Synchronous encoder				Servo input axis	
		Positioning	Fixed-pitch feed	Speed	Constant-speed	JOG	Position follow-up control	Speed control with fixed position stop						
1802										○	<ul style="list-style-type: none"> The input axis parameter "[Pr.323] Synchronous encoder axis unit conversion: Denominator" is set to 0 or lower. 	The setting becomes invalid for input axis.	<ul style="list-style-type: none"> Set the "[Pr.323] Synchronous encoder axis unit conversion: Denominator" within the range of 1 to 2147483647 using (peripheral device). 	
1808											○	<ul style="list-style-type: none"> Internal operation overflow occurred because the unit conversion ratio (unit conversion: Numerator ÷ unit conversion: Denominator) of the input axis is too large. 	The input axis operation is immediately stopped, and a connection becomes invalid.	<ul style="list-style-type: none"> Set a smaller unit conversion ratio (unit conversion: Numerator ÷ unit conversion: Denominator) of the input axis. Decrease the input axis speed.
1809											○	<ul style="list-style-type: none"> When the input axis parameter "[Pr.300] Servo input axis type" is feed current value or real current value, the speed-position switching control is started with the "feed current value update command (M3212+20n)" is OFF. 	The speed-position switching control does not start.	<ul style="list-style-type: none"> Set "[Pr.300] Servo input axis type" to "servo command value" or "feedback value". Start the speed-position switching control after set the "feed current value update command" (M3212+20n) to ON
1810											○	<ul style="list-style-type: none"> A synchronous encoder set in the system setting differs from a synchronous encoder actually connected. 	Input from synchronous encoder does not accept.	<ul style="list-style-type: none"> Set a synchronous encoder actually connected in the system setting.
											○	<ul style="list-style-type: none"> Q172DEX or encoder hardware error. 	Immediate input stop	<ul style="list-style-type: none"> Check (replace) the Q172DEX or encoder.
											○	<ul style="list-style-type: none"> Disconnected encoder cable. No battery or disconnected battery at Q172DEX. 		<ul style="list-style-type: none"> Check the encoder cable. Replace the battery and turn ON the Multiple CPU system power supply a few minutes later.
1811											○	<ul style="list-style-type: none"> No battery or disconnected battery at Q172DEX or servo amplifier which connected synchronous encoder. 	Operation is continued.	<ul style="list-style-type: none"> Replace the battery or check (replace) the Q172DEX or servo amplifier.

Table 1.15 Synchronous control input axis error (1800 to 1899) list (Continued)

Error code	Control mode										Error cause	Error processing	Corrective action
	Command generation axis												
	Synchronous control	Positioning	Fixed-pitch feed	Speed	Constant-speed	JOG	Position follow-up control	Speed control with fixed position stop	Synchronous encoder	Servo input axis			
1812											<ul style="list-style-type: none"> The axis is set as synchronous encoder via servo amplifier is unsupported synchronous encoder via servo amplifier. Unconfigured servo amplifier axis in system setting is setting to synchronous encoder via servo amplifier. 		<ul style="list-style-type: none"> Connect a servo amplifier which is support synchronous encoder via servo amplifier.
											<ul style="list-style-type: none"> Q172DEX or encoder hardware error at the Multiple CPU system's power supply ON. Disconnected encoder cable at the Multiple CPU system's power supply ON. A synchronous encoder set in the system setting differs from a synchronous encoder actually connected at the Multiple CPU system's power supply ON. No battery or disconnected battery in Q172DEX at the Multiple CPU system's power supply ON. 		Input from synchronous encoder does not accept.
1820											<ul style="list-style-type: none"> The axis set by input axis parameter "[Pr.320] Synchronous encoder axis type" became connection invalid in master CPU. 	The synchronous encoder connection becomes invalid.	<ul style="list-style-type: none"> Make the connection of input axis in master CPU.
1825											<ul style="list-style-type: none"> Start speed control (II) when input axis parameter "[Pr.300] Servo input axis type" is valid. 	Speed control (II) does not start.	<ul style="list-style-type: none"> Set the "[Pr.300] Servo input axis type" invalid.(Make use of the speed-torque control function when operates the speed control that does not include the position loop.)
1830													

APPENDIX 1.4 Servo errors

(1) Servo errors (2000 to 2999)

These errors are detected by the servo amplifier, and the error codes are [2000] to [2999].

The servo error detection signal (M2408+20n) turns on at the servo error occurrence. Eliminate the error cause, reset the servo amplifier error by turning on the servo error reset command (M3208+20n) and perform re-start. (The servo error detection signal does not turn on because the codes [2100] to [2599] are for warnings.)

(Note-1): As for the regenerative alarm (error code [2030]) or overload 1 or 2 (error codes [2050], [2051]), the state at the operation is held also for after the protection circuit operation in the servo amplifier. The memory contents are cleared with the external power supply off, but are not cleared by the reset signal.

(Note-2): If resetting by turning off the external power supply is repeated at the occurrence of error code [2030], [2050] or [2051], it may cause devices to be destroyed by overheating. Re-start operation after eliminating the cause of the error certainly.

The hexadecimal display of servo amplifier display servo error code (#8008+20n) is the same as the LED of servo amplifier.

Refer to the "Q173D(S)CPU/Q172D(S)CPU Motion controller (SV13/SV22) Programming Manual (REAL MODE) for details of servo errors.

APPENDIX 2 Setting Range for Indirect Setting Devices

Positioning address, command speed or M-code, etc. (excluding the axis No.) set in the servo program can be set indirectly by the word.

(1) Device range

The number of device words and device range at indirect setting are shown below.

	Item	Number of device words	Device setting range	Remarks														
Common	Parameter block No.	1	<table border="1"> <thead> <tr> <th>Device</th> <th>Range</th> </tr> </thead> <tbody> <tr> <td>D</td> <td>0 to 8191 (Note-1)</td> </tr> <tr> <td>W</td> <td>0000 to 1FFF</td> </tr> <tr> <td>#</td> <td>0 to 7999</td> </tr> <tr> <td>U□\G</td> <td>10000 to (10000+p-1) (Note-2)</td> </tr> </tbody> </table>	Device	Range	D	0 to 8191 (Note-1)	W	0000 to 1FFF	#	0 to 7999	U□\G	10000 to (10000+p-1) (Note-2)					
	Device	Range																
	D	0 to 8191 (Note-1)																
	W	0000 to 1FFF																
	#	0 to 7999																
	U□\G	10000 to (10000+p-1) (Note-2)																
Address (travel value)	2																	
Command speed	2																	
Dwell time	1																	
M-code	1																	
Torque limit value	1																	
Arc	Auxiliary point	2																
	Radius	2																
	Central point	2																
	Pitch	1																
Parameter block	Control unit	1																
	Speed limit value	2																
	Acceleration time	1																
	Deceleration time	1																
	Rapid stop deceleration time	1																
	S-curve ratio	1																
	Advanced S-curve acceleration/ deceleration	Acceleration/deceleration system		1														
		Acceleration section 1 ratio		1														
		Acceleration section 2 ratio		1														
		Deceleration section 1 ratio	1															
		Deceleration section 2 ratio	1															
	Torque limit value	1																
	STOP input deceleration processing	1																
Circular interpolation error allowance range	2																	
Others	Command speed (Constant speed)	2	<table border="1"> <thead> <tr> <th>Device</th> <th>Range</th> </tr> </thead> <tbody> <tr> <td>X</td> <td>0000 to 1FFF (Note-3)</td> </tr> <tr> <td>Y</td> <td>0000 to 1FFF</td> </tr> <tr> <td>M</td> <td>0 to 8191 (Note-1)</td> </tr> <tr> <td>B</td> <td>0000 to 1FFF</td> </tr> <tr> <td>F</td> <td>0 to 2047</td> </tr> <tr> <td>U□\G</td> <td>10000.0 to (10000+p-1).F (Note-2)</td> </tr> </tbody> </table>	Device	Range	X	0000 to 1FFF (Note-3)	Y	0000 to 1FFF	M	0 to 8191 (Note-1)	B	0000 to 1FFF	F	0 to 2047	U□\G	10000.0 to (10000+p-1).F (Note-2)	
	Device	Range																
	X	0000 to 1FFF (Note-3)																
	Y	0000 to 1FFF																
	M	0 to 8191 (Note-1)																
	B	0000 to 1FFF																
	F	0 to 2047																
	U□\G	10000.0 to (10000+p-1).F (Note-2)																
FIN acceleration/deceleration	1																	
Fixed position stop acceleration/deceleration time	1																	
Repetition condition (Number of repetitions)	1																	
Repetition condition (ON/OFF)	Bit																	
Cancel																		
Skip																		
WAIT ON/OFF																		
Fixed position stop																		

(Note-1): Synchronous encoder axis area cannot be set.

(Note-2): "p" indicates the user setting area points of the Multiple CPU high speed transmission area for each CPU.

(Note-3): The range of "PXn+4 to PXn+F" cannot be used (fixed at 0) for the input device (PXn+0 to PXn+F) allocated to the built-in interface in Motion CPU (DI). (n: First input No.)

POINT
<p>(1) Be sure to set even-numbered devices of the items set as 2-word. Be sure to set as 32-bit integer type when the data is set in these devices using the Motion SFC programs. (Example : #0L, D0L)</p> <p>(2) Refer to Chapter 2 of the "Q173D(S)CPU/Q172D(S)CPU Motion controller Programming Manual (COMMON)" for the user setting area points of the Multiple CPU high speed transmission area.</p>

(2) Inputting device data

Indirect setting device data is inputted by the Motion CPU at the servo program start.

Do not change the applicable device before setting to device and start completion.

The procedures by start method for setting data to devices and cautions are shown below.

Start method	Setting method	Notes
Start by the servo program	Set data in indirect setting devices. ↓ Start the servo program.	Do not change the indirect setting device before the "positioning start complete signal" of the starting axis turns on.
Set the loop (FOR - NEXT) point data for CPSTART instruction indirectly	Set initial command data in the indirect setting device. ↓ Start using the servo program (or turn the cancel command device on). ↓ Read the value of "data set pointer for constant-speed control" of the start axis, and update the data input by Motion CPU.	Refer to the positioning signal data register "Monitoring data area" for details.

APPENDIX 3 Processing Times of the Motion CPU

The processing time of each signal and each instruction for positioning control in the Multiple CPU system is shown below.

(1) Motion operation cycle [ms] (Default)

	Q173DSCPU			Q172DSCPU	
	1 to 6	7 to 16	17 to 32	1 to 6	7 to 16
Number of setting axes (SV22)					
Operation cycle [ms]	0.44	0.88	1.77	0.44	0.88

(2) CPU processing time [ms]

The instruction processing time means the time until the content is reflected to servo amplifier side after each instruction is executed.

(Including the transmission time between Motion controller and servo amplifier.)

		Q173DSCPU/Q172DSCPU					
Operation cycle [ms]		0.22	0.44	0.88	1.77	3.55	7.11
Servo program start processing time (Note-1)	"WAIT ON/OFF" + Motion control step	0.44	0.88	1.77	2.66	4.44	7.99
	Only Motion control step	0.6 to 0.9	1.0 to 1.4	1.9 to 2.8	2.8 to 4.6	4.6 to 8.2	8.1 to 15.2
	Dedicated instruction (D(P).SVST) from the PLC CPU	1.4 to 2.3	2.2 to 3.1	3.5 to 4.4	5.3 to 6.2	8.8 to 9.7	16.0 to 16.9
Speed change response time	Instruction (CHGV) from the Motion SFC	0.4 to 0.9	0.8 to 1.3	1.7 to 2.6	2.6 to 4.4	4.4 to 8.0	8.0 to 15.1
	Dedicated instruction (D(P).CHGV) from the PLC CPU	1.4 to 2.3	1.7 to 2.6	2.6 to 3.5	3.5 to 4.4	5.3 to 6.2	8.9 to 9.8
Command generation axis speed change response time	Instruction (CHGVS) from the Motion SFC	0.4 to 0.9	0.8 to 1.3	1.7 to 2.6	2.6 to 4.4	4.4 to 8.0	8.0 to 15.1
	Dedicated instruction (D(P).CHGVS) from the PLC CPU	1.4 to 2.3	1.7 to 2.6	2.6 to 3.5	3.5 to 4.4	5.3 to 6.2	8.9 to 9.8
Torque limit value change response time	Instruction (CHGT) from the Motion SFC	0.4 to 0.9	0.8 to 1.3	1.7 to 2.6	2.6 to 4.4	4.4 to 8.0	4.4 to 11.5
	Dedicated instruction (D(P).CHGT) from the PLC CPU	1.4 to 2.3	1.7 to 2.6	2.6 to 3.5	3.5 to 4.4	5.3 to 6.2	5.3 to 9.7
Torque limit value individual change response time	Instruction (CHGT2) from the Motion SFC	0.4 to 0.9	0.8 to 1.3	1.7 to 2.6	2.6 to 4.4	4.4 to 8.0	4.4 to 11.5
	Dedicated instruction (D(P).CHGT2) from the PLC CPU	1.4 to 2.3	1.7 to 2.6	2.6 to 3.5	3.5 to 4.4	5.3 to 6.2	5.3 to 9.7
Target position change response time	Instruction (CHGP) from the Motion SFC	0.4 to 0.9	0.8 to 1.3	1.7 to 2.6	2.6 to 4.4	4.4 to 8.0	8.0 to 15.1
Time from PLC ready flag (M2000) ON to PCPU READY complete flag (SM500) ON		44 to 60					

(Note-1): FEED instruction varies greatly depending on the condition (whether other axes are operating).

APPENDIX 4 Sample Program of Synchronous Control

The following shows a sample program of executing synchronous control on the axis 1 with the axis 4 as an input axis.

- (1) Set MR-J4(W)-B on the axis 1 in the system setting.

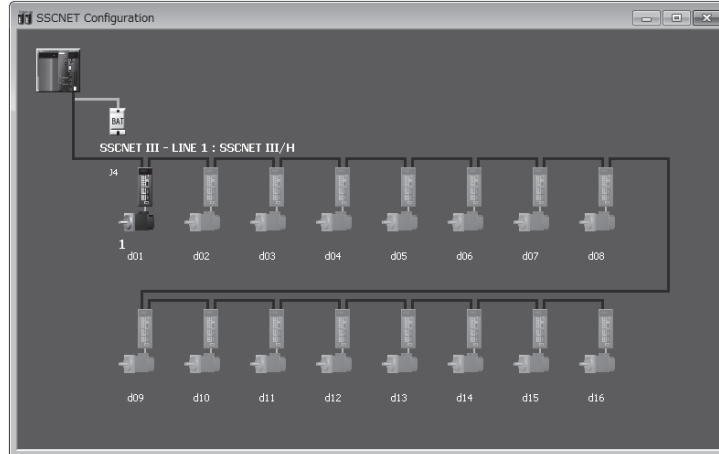

- (2) Set the axis 4 in the command generation axis parameter of synchronous control parameter.

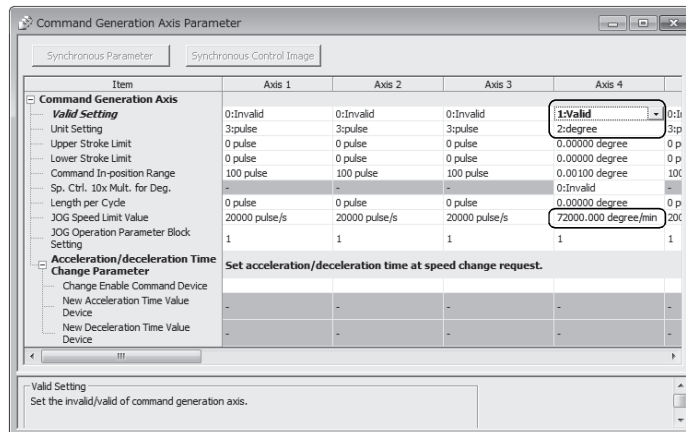

Item	Axis 4
Command generation axis	Valid setting
	Unit setting
	JOG speed limit value

(3) Create the cam data (cam No.1).

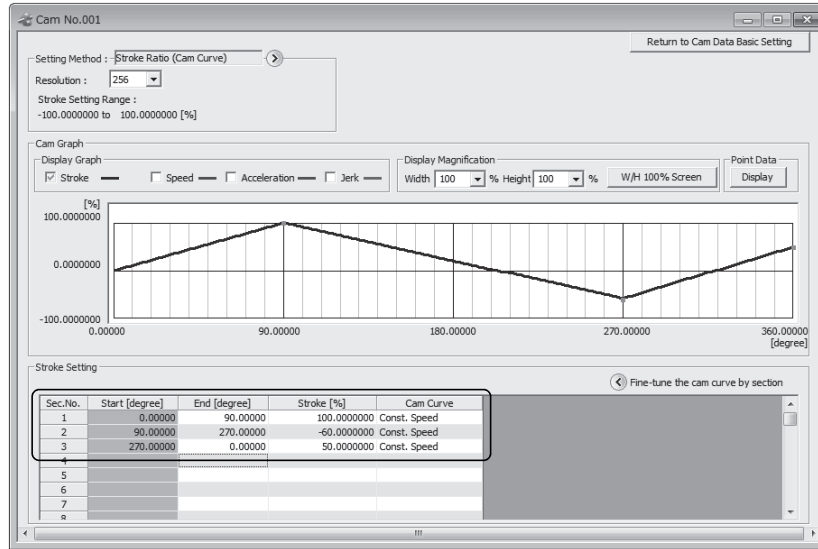

Section No.	Start angle [degree]	End angle [degree]	Stroke [%]	Cam curve
1	0.00000	90.00000	100.0000000	Constant speed
2	90.00000	270.00000	-60.0000000	Constant speed
3	270.00000	0.00000	50.0000000	Constant speed

(4) Set the synchronous parameter of the axis 1.

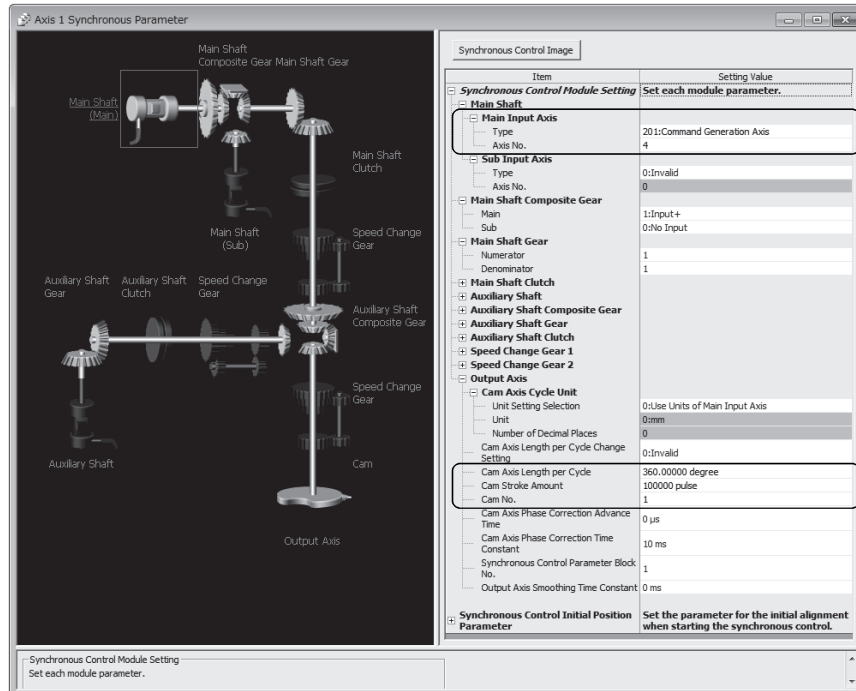

Item			Setting value	
Synchronous control module setting	Main shaft	Main input axis	Type	
		Axis No.	201: Command generation axis	
	Output axis	Cam axis cycle unit	Cam axis length per cycle	4
			Cam stroke amount	360.00000degree
			Cam No.	100000pulse
			1	

- (5) Create the Motion SFC program to start synchronous control.
 (Executed after home position return completion)

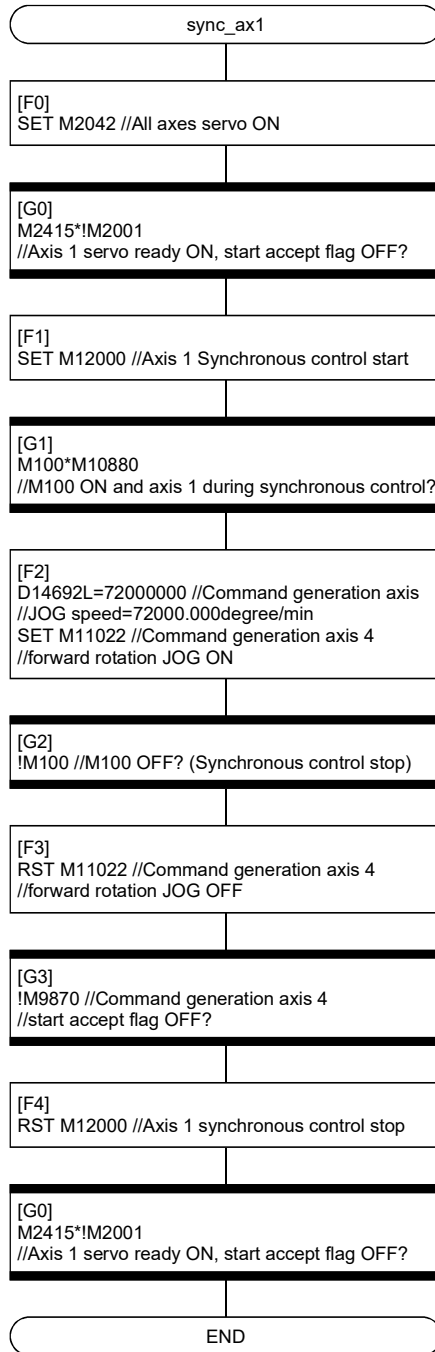

APPENDICES

APPENDIX 5 Differences

APPENDIX 5.1 Differences with virtual mode switching method

Differences between virtual mode switching method and advanced synchronous control method are shown in Table 5.1 below.

Table 5.1 Differences between virtual mode switching method and advanced synchronous control method

Item	Virtual mode switching method	Advanced synchronous control method
General	Starting method	The whole system is switched to the virtual mode by turning ON the real/virtual mode switching request bit.
	Stopping method	The control is started for each axis by turning ON the synchronous control start bit for each axis.
Drive module	Number of settings per output axis	The control is stopped for each axis by turning OFF the synchronous control start bit of each axis.
	Virtual servo motor axis (Command generation axis)	Total 3 axes of main shaft (2 axes) and auxiliary input (1 axis)
	Servo input axis	<ul style="list-style-type: none"> Virtual servo motor axis Q173DSCPU: 32 axes Q172DSCPU: 16 axes Command unit pulse
	Synchronous encoder axis	<ul style="list-style-type: none"> Command generation axis Q173DSCPU: 32 axes Q172DSCPU: 16 axes Command unit mm, inch, degree, pulse
	None	Use the servo amplifier as the drive module (input axis).
	<ul style="list-style-type: none"> Incremental/Absolute synchronous encoder (12 axes) Axis No. The axis 1 to axis 12 corresponds to P1 to P12. 1) Incremental synchronous encoder Built-in interface in Motion CPU :4Mpulse/s Q173DPX :200kpulse/s 2) Absolute synchronous encoder Q172DEX: Connection to Q171ENC-W8 Command unit pulse 	<ul style="list-style-type: none"> Command units mm, inch, degree, pulse The current value per cycle: Provided Smoothing: Provided Phase compensation: Provided Rotation direction restriction: Provided

Table 5.1 Differences between virtual mode switching method and advanced synchronous control method (continued)

Item	Virtual mode switching method	Advanced synchronous control method	
Transmission module	Gear	<ul style="list-style-type: none"> • Number of input side teeth : 1 to 65535 • Number of output side teeth: 1 to 65535 • Rotation direction : Forward/Reverse 	<ul style="list-style-type: none"> • Numerator of gear : -2147483648 to 2147483647 • Denominator of gear: 1 to 2147483647 • Rotation direction : Set by a sign of the numerator of gear
	Clutch (Note-2)	<ul style="list-style-type: none"> • Clutch mode ON/OFF, Address 1, Address 2, One-shot, External input • Smoothing Time constant (Exponential system), Slippage amount (Exponential system/Linear system) 	<ul style="list-style-type: none"> • Clutch mode Clutch command ON/OFF, Clutch command leading edge, Clutch command trailing edge, One-shot OFF, Address mode, High speed input request. (Set mode for ON condition and OFF condition individually.) • Smoothing Time constant (Exponential system/Linear system), Slippage (Exponential system/Linear system)
	Speed change gear	<ul style="list-style-type: none"> • Speed change ratio : 0 to 655.35% • Smoothing : Exponential system 	<ul style="list-style-type: none"> • Numerator of speed change ratio: -2147483648 to 2147483647 • Denominator of speed change ratio: 1 to 2147483647 • Smoothing: Linear system
	Differential gear	Use main shaft and auxiliary input. (Main shaft side: +, Auxiliary shaft side: -)	Use composite main shaft gear and composite auxiliary shaft gear. (Select a composite method for each inputs from "Input+/Input-/No input (0)".)
Output module	Type	Roller shaft, Ball screw shaft, Rotary table shaft, Cam shaft	Cam shaft only. (The linear cam can be controlled as same as the ball screw shaft etc.)
	Phase compensation	<ul style="list-style-type: none"> • Advance time: -2147483648 to 2147483647[μs] • Time constant: 0 to 32767 [Number of operation cycle] 	<ul style="list-style-type: none"> • Advance time: -2147483648 to 2147483647[μs] • Time constant: 0 to 65535 [ms]
	Stroke limit operation	An error is detected by stroke limit. However, the operation is continued.	An error is detected by stroke limit and the operation is stopped.
	Stop command	Invalid	Valid
	Cam/ball screw switching	Provided (Operate the ball screw by inputting the command pulse from the drive axis.)	None (Operate the ball screw by the positioning control after the synchronous control stop of each axis.)
	Cam axis starting point	<ol style="list-style-type: none"> 1) Cam reference position setting ON Start from the point corresponding to "current value within 1 cam shaft revolution is 0". 2) Cam reference position setting OFF Restore the current value within 1 cam shaft revolution based on the current feed value. 	Select the one which is restored, from "cam axis current value per cycle", "cam reference position" or "cam axis current feed value", in the parameter. (The initial setting is same as 1) in Virtual mode switching method.)

Table 5.1 Differences between virtual mode switching method and advanced synchronous control method (continued)

Item	Virtual mode switching method	Advanced synchronous control method	
Cam function	Cam resolution/ Number of coordinate	<ul style="list-style-type: none"> Cam resolution 256, 512, 1024, 2048 (Coordinate data format: None) 	<ul style="list-style-type: none"> Stroke ratio data format 256, 512, 1024, 2048, 4096, 8192, 16384, 32768 Coordinate data format 2 to 16384
	Number of cam	Up to 256	Up to 256
	Cam No.	1 to 64, 101 to 164, 201 to 264, 301 to 364	0 to 256 (0: Linear cam)
	Stroke ratio	0 to 32767 (32767: 100%)	-214.7483648 to 214.7483647%
	Cam mode	<ul style="list-style-type: none"> Two-way cam mode (Endpoint: 0% fixed) Feed cam mode (Endpoint: 100% fixed) 	None (No restrictions by a cam mode due to the possibility of freely setting the endpoint.)
	Motion SFC program for cam data operation	BMOV instruction (New pattern cannot be added.)	CAMWR, CAMWR2, CAMMK instruction (New pattern can be added.) CAMRD instruction, CAMPSCL instruction
	Cam auto- generation	None	Cam pattern for cam auto-generation type can be generated automatically. <ul style="list-style-type: none"> Cam for rotary cutter Easy stroke ratio cam
Cam position calculation	None	Cam axis current feed value and cam axis current value per cycle can be calculated before starting synchronous control.	
Others	Mixed function of virtual mode/real mode	Provided	None (Synchronous control can be started and stopped for each axis.)
	Operation status at servo error occurrence	It is possible to select to continue the virtual mode at a servo error occurrence. (All relevant systems stop even if a continuance is selected.)	No effect on axis operations except the axes that are detecting a servo error. (Use the user program for stopping another axes which are detecting an error.)
	Processing load of synchronous control	Even in the same configuration, the processing load is different for advanced synchronous control method and virtual mode switching method. When changing the operation method, confirm that the operation cycle time over (M2054 ON), etc. does not occur.	
	Multiple CPU synchronous control	None	Provided

(Note-1): Refer to Section 5.3.1 for details on servo motors that can be connected.

(Note-2): Clutch compatibility

The following shows the control methods for the clutch setting in the advanced synchronous control method compared with those in the virtual mode switching method.

Virtual mode switching method	Advanced synchronous control method	
	ON control mode	OFF control mode
Clutch mode		
ON/OFF mode	1: Clutch command ON/OFF	—
Address mode	4: Address mode	4: Address mode
One-shot mode	2: Clutch command leading edge	1: One-shot OFF
External input mode	5: High speed input request	3: Clutch command trailing edge

APPENDIX 6 Device List

(1) Axis status list

Axis No.	Device No.	Signal name																																																											
1	M2400 to M2419	<table border="1"> <thead> <tr> <th>Signal name</th> <th>Refresh cycle</th> <th>Fetch cycle</th> <th>Signal direction</th> </tr> </thead> <tbody> <tr> <td>0</td> <td>Positioning start complete</td> <td rowspan="16">/</td> <td rowspan="16">Status signal</td> </tr> <tr> <td>1</td> <td>Positioning complete</td> </tr> <tr> <td>2</td> <td>In-position</td> </tr> <tr> <td>3</td> <td>Command in-position</td> </tr> <tr> <td>4</td> <td>Speed controlling</td> </tr> <tr> <td>5</td> <td>Speed / position switching latch</td> </tr> <tr> <td>6</td> <td>Zero pass</td> </tr> <tr> <td>7</td> <td>Error detection</td> <td>Immediate</td> </tr> <tr> <td>8</td> <td>Servo error detection</td> <td>Operation cycle</td> </tr> <tr> <td>9</td> <td>Home position return request</td> <td>Main cycle</td> </tr> <tr> <td>10</td> <td>Home position return complete</td> <td>Operation cycle</td> </tr> <tr> <td>11</td> <td rowspan="4">External signals</td> <td>FLS</td> <td rowspan="4">Main cycle</td> </tr> <tr> <td>12</td> <td>RLS</td> </tr> <tr> <td>13</td> <td>STOP</td> </tr> <tr> <td>14</td> <td>DOG/CHANGE</td> </tr> <tr> <td>15</td> <td>Servo ready</td> <td rowspan="2">Operation cycle</td> <td rowspan="2">/</td> </tr> <tr> <td>16</td> <td>Torque limiting</td> </tr> <tr> <td>17</td> <td rowspan="2">Unusable</td> <td>—</td> <td>—</td> </tr> <tr> <td>18</td> <td>—</td> <td>—</td> </tr> <tr> <td>19</td> <td>M-code outputting</td> <td>Operation cycle</td> <td>Status signal</td> </tr> </tbody> </table>	Signal name	Refresh cycle	Fetch cycle	Signal direction	0	Positioning start complete	/	Status signal	1	Positioning complete	2	In-position	3	Command in-position	4	Speed controlling	5	Speed / position switching latch	6	Zero pass	7	Error detection	Immediate	8	Servo error detection	Operation cycle	9	Home position return request	Main cycle	10	Home position return complete	Operation cycle	11	External signals	FLS	Main cycle	12	RLS	13	STOP	14	DOG/CHANGE	15	Servo ready	Operation cycle	/	16	Torque limiting	17	Unusable	—	—	18	—	—	19	M-code outputting	Operation cycle	Status signal
Signal name	Refresh cycle		Fetch cycle	Signal direction																																																									
0	Positioning start complete		/	Status signal																																																									
1	Positioning complete																																																												
2	In-position																																																												
3	Command in-position																																																												
4	Speed controlling																																																												
5	Speed / position switching latch																																																												
6	Zero pass																																																												
7	Error detection				Immediate																																																								
8	Servo error detection				Operation cycle																																																								
9	Home position return request				Main cycle																																																								
10	Home position return complete				Operation cycle																																																								
11	External signals				FLS	Main cycle																																																							
12					RLS																																																								
13					STOP																																																								
14					DOG/CHANGE																																																								
15	Servo ready				Operation cycle	/																																																							
16	Torque limiting																																																												
17	Unusable	—	—																																																										
18		—	—																																																										
19	M-code outputting	Operation cycle	Status signal																																																										
2	M2420 to M2439																																																												
3	M2440 to M2459																																																												
4	M2460 to M2479																																																												
5	M2480 to M2499																																																												
6	M2500 to M2519																																																												
7	M2520 to M2539																																																												
8	M2540 to M2559																																																												
9	M2560 to M2579																																																												
10	M2580 to M2599																																																												
11	M2600 to M2619																																																												
12	M2620 to M2639																																																												
13	M2640 to M2659																																																												
14	M2660 to M2679																																																												
15	M2680 to M2699																																																												
16	M2700 to M2719																																																												
17	M2720 to M2739																																																												
18	M2740 to M2759																																																												
19	M2760 to M2779																																																												
20	M2780 to M2799																																																												
21	M2800 to M2819																																																												
22	M2820 to M2839																																																												
23	M2840 to M2859																																																												
24	M2860 to M2879																																																												
25	M2880 to M2899																																																												
26	M2900 to M2919																																																												
27	M2920 to M2939																																																												
28	M2940 to M2959																																																												
29	M2960 to M2979																																																												
30	M2980 to M2999																																																												
31	M3000 to M3019																																																												
32	M3020 to M3039																																																												

POINT

(1) The range of axis No.1 to 16 is valid in the Q172DSCPU.

(2) The device area more than 17 axes in the Q172DSCPU can be used as a user device.
 However, when the project of Q172DSCPU is replaced with Q173DSCPU, this area cannot be used as a user device.

(3) Refer to the "Q173D(S)CPU/Q172D(S)CPU Motion controller (SV13/SV22) Programming Manual (REAL MODE)" for details of axis status.

(2) Axis command signal list

Axis No.	Device No.	Signal name																																																																																																			
1	M3200 to M3219	<table border="1"> <thead> <tr> <th></th> <th>Signal name</th> <th>Refresh cycle</th> <th>Fetch cycle</th> <th>Signal direction</th> </tr> </thead> <tbody> <tr> <td>0</td> <td>Stop command</td> <td rowspan="10">/</td> <td rowspan="2">Operation cycle</td> <td rowspan="10">Command signal</td> </tr> <tr> <td>1</td> <td>Rapid stop command</td> </tr> <tr> <td>2</td> <td>Forward rotation JOG start command</td> <td rowspan="2">Main cycle</td> </tr> <tr> <td>3</td> <td>Reverse rotation JOG start command</td> </tr> <tr> <td>4</td> <td>Complete signal OFF command</td> <td rowspan="2">Operation cycle</td> </tr> <tr> <td>5</td> <td>Speed/position switching enable command</td> </tr> <tr> <td>6</td> <td>Gain changing 2 command (Note-1) <i>Ver.!</i></td> <td>Operation cycle (Note-2)</td> </tr> <tr> <td>7</td> <td>Error reset command</td> <td rowspan="2">Main cycle</td> </tr> <tr> <td>8</td> <td>Servo error reset command</td> </tr> <tr> <td>9</td> <td>External stop input disable at start command</td> <td>At start</td> </tr> <tr> <td>10</td> <td>Unusable</td> <td>—</td> <td>—</td> <td>—</td> </tr> <tr> <td>11</td> <td>Unusable</td> <td>—</td> <td>—</td> <td>—</td> </tr> <tr> <td>12</td> <td>Feed current value update command</td> <td rowspan="2">/</td> <td>At start</td> <td>Command signal</td> </tr> <tr> <td>13</td> <td>Unusable</td> <td>—</td> <td>—</td> <td>—</td> </tr> <tr> <td>14</td> <td>Unusable</td> <td>—</td> <td>—</td> <td>—</td> </tr> <tr> <td>15</td> <td>Servo OFF command</td> <td rowspan="5">/</td> <td>Operation cycle</td> <td rowspan="5">Command signal</td> </tr> <tr> <td>16</td> <td>Gain changing command</td> <td>Operation cycle (Note-2)</td> </tr> <tr> <td>17</td> <td>PI-PID switching command</td> <td rowspan="2">Operation cycle</td> </tr> <tr> <td>18</td> <td>Control loop changing command</td> </tr> <tr> <td>19</td> <td>FIN signal</td> <td>Operation cycle</td> </tr> <tr> <td>28</td> <td>M3740 to M3759</td> <td></td> <td></td> <td></td> </tr> <tr> <td>29</td> <td>M3760 to M3779</td> <td></td> <td></td> <td></td> </tr> <tr> <td>30</td> <td>M3780 to M3799</td> <td></td> <td></td> <td></td> </tr> <tr> <td>31</td> <td>M3800 to M3819</td> <td></td> <td></td> <td></td> </tr> <tr> <td>32</td> <td>M3820 to M3839</td> <td></td> <td></td> <td></td> </tr> </tbody> </table>		Signal name	Refresh cycle	Fetch cycle	Signal direction	0	Stop command	/	Operation cycle	Command signal	1	Rapid stop command	2	Forward rotation JOG start command	Main cycle	3	Reverse rotation JOG start command	4	Complete signal OFF command	Operation cycle	5	Speed/position switching enable command	6	Gain changing 2 command (Note-1) <i>Ver.!</i>	Operation cycle (Note-2)	7	Error reset command	Main cycle	8	Servo error reset command	9	External stop input disable at start command	At start	10	Unusable	—	—	—	11	Unusable	—	—	—	12	Feed current value update command	/	At start	Command signal	13	Unusable	—	—	—	14	Unusable	—	—	—	15	Servo OFF command	/	Operation cycle	Command signal	16	Gain changing command	Operation cycle (Note-2)	17	PI-PID switching command	Operation cycle	18	Control loop changing command	19	FIN signal	Operation cycle	28	M3740 to M3759				29	M3760 to M3779				30	M3780 to M3799				31	M3800 to M3819				32	M3820 to M3839			
	Signal name		Refresh cycle	Fetch cycle	Signal direction																																																																																																
0	Stop command		/	Operation cycle	Command signal																																																																																																
1	Rapid stop command																																																																																																				
2	Forward rotation JOG start command			Main cycle																																																																																																	
3	Reverse rotation JOG start command																																																																																																				
4	Complete signal OFF command			Operation cycle																																																																																																	
5	Speed/position switching enable command																																																																																																				
6	Gain changing 2 command (Note-1) <i>Ver.!</i>			Operation cycle (Note-2)																																																																																																	
7	Error reset command			Main cycle																																																																																																	
8	Servo error reset command																																																																																																				
9	External stop input disable at start command			At start																																																																																																	
10	Unusable		—	—	—																																																																																																
11	Unusable		—	—	—																																																																																																
12	Feed current value update command		/	At start	Command signal																																																																																																
13	Unusable			—	—	—																																																																																															
14	Unusable		—	—	—																																																																																																
15	Servo OFF command		/	Operation cycle	Command signal																																																																																																
16	Gain changing command			Operation cycle (Note-2)																																																																																																	
17	PI-PID switching command	Operation cycle																																																																																																			
18	Control loop changing command																																																																																																				
19	FIN signal	Operation cycle																																																																																																			
28	M3740 to M3759																																																																																																				
29	M3760 to M3779																																																																																																				
30	M3780 to M3799																																																																																																				
31	M3800 to M3819																																																																																																				
32	M3820 to M3839																																																																																																				

(Note-1): Servo amplifier (MR-J5(W)-□B) only.

(Note-2): Operation cycle 7.1[ms] or more: Every 3.5[ms]

POINT

- (1) The range of axis No.1 to 16 is valid in the Q172DSCPU.
- (2) The device area more than 17 axes in the Q172DSCPU can be used as a user device.
However, when the project of Q172DSCPU is replaced with Q173DSCPU, this area cannot be used as a user device.
- (3) Refer to the "Q173D(S)CPU/Q172D(S)CPU Motion controller (SV13/SV22) Programming Manual (REAL MODE)" for details of axis command signal.

Ver.!: Refer to Section 1.4 for the software version that supports this function.

(3) Command generation axis status list

Axis No.	Device No.	Signal name						
		Symbol	Signal name	Refresh cycle	Fetch cycle	Signal direction		
1	M9800 to M9819							
2	M9820 to M9839							
3	M9840 to M9859							
4	M9860 to M9879							
5	M9880 to M9899	0	St.340	Command generation axis positioning start complete	Operation cycle	/	Status signal	
6	M9900 to M9919	1	St.341					Command generation axis positioning complete
7	M9920 to M9939	2	—	Unusable	—	—	—	
8	M9940 to M9959							
9	M9960 to M9979							
10	M9980 to M9999	3	St.342	Command generation axis command in-position	Operation cycle	/	Status signal	
11	M10000 to M10019	4	St.343					Command generation axis speed controlling
12	M10020 to M10039	5	—	Unusable	—	—	—	
13	M10040 to M10059	6	—	Unusable	—	—	—	
14	M10060 to M10079							
15	M10080 to M10099							
16	M10100 to M10119	7	St.344	Command generation axis error detection	Immediate	/	Status signal	
17	M10120 to M10139	8	—	Unusable	—	—	—	
18	M10140 to M10159	9	—	Unusable	—	—	—	
19	M10160 to M10179	10	St.345	Command generation axis start accept flag	Operation cycle	/	Status signal	
20	M10180 to M10199	11	St.346					Command generation axis speed change accepting flag
21	M10200 to M10219	12	St.347					Command generation axis speed change "0" accepting flag
22	M10220 to M10239	13	St.348					Command generation axis automatic decelerating flag
23	M10240 to M10259	14	—	Unusable	—	—	—	
24	M10260 to M10279	15	—	Unusable	—	—	—	
25	M10280 to M10299	16	—	Unusable	—	—	—	
26	M10300 to M10319	17	—	Unusable	—	—	—	
27	M10320 to M10339	18	—	Unusable	—	—	—	
28	M10340 to M10359							
29	M10360 to M10379							
30	M10380 to M10399							
31	M10400 to M10419							
32	M10420 to M10439	19	St.349	Command generation axis M-code outputting	Operation cycle	/	Status signal	

POINT

- (1) The range of axis No.1 to 16 is valid in the Q172DSCPU.
- (2) The device area more than 17 axes in the Q172DSCPU can be used as a user device.
However, when the project of Q172DSCPU is replaced with Q173DSCPU, this area cannot be used as a user device.
- (3) Refer to Section 5.2.4 for details of command generation axis status.

(4) Command generation axis command signal list

Axis No.	Device No.	Signal name			
1	M10960 to M10979				
2	M10980 to M10999				
3	M11000 to M11019				
4	M11020 to M11039				
5	M11040 to M11059				
6	M11060 to M11079				
7	M11080 to M11099				
8	M11100 to M11119				
9	M11120 to M11139				
10	M11140 to M11159				
11	M11160 to M11179				
12	M11180 to M11199				
13	M11200 to M11219				
14	M11220 to M11239				
15	M11240 to M11259				
16	M11260 to M11279				
17	M11280 to M11299				
18	M11300 to M11319				
19	M11320 to M11339				
20	M11340 to M11359				
21	M11360 to M11379				
22	M11380 to M11399				
23	M11400 to M11419				
24	M11420 to M11439				
25	M11440 to M11459				
26	M11460 to M11479				
27	M11480 to M11499				
28	M11500 to M11519				
29	M11520 to M11539				
30	M11540 to M11559				
31	M11560 to M11579				
32	M11580 to M11599				

Symbol	Signal name	Refresh cycle	Fetch cycle	Signal direction
0 Rq.341	Command generation axis stop command	/	Operation cycle	Command signal
1 Rq.342	Command generation axis rapid stop command			
2 Rq.343	Command generation axis forward rotation JOG start command		Main cycle	
3 Rq.344	Command generation axis reverse rotation JOG start command			
4 Rq.345	Command generation axis complete signal OFF command			
5 —	Unusable	—	—	—
6 —	Unusable	—	—	—
7 Rq.346	Command generation axis error reset command	/	Main cycle	Command signal
8 —	Unusable	/	—	—
9 —				
10 —				
11 —				
12 Rq.347	Feed current value update request command	/	At start	Command signal
13 —	Unusable	/	—	—
14 —				
15 —				
16 —				
17 —				
18 —				
19 Rq.348	Command generation axis FIN signal	/	Operation cycle	Command signal

POINT

(1) The range of axis No.1 to 16 is valid in the Q172DSCPU.
 (2) The device area more than 17 axes in the Q172DSCPU can be used as a user device.
 However, when the project of Q172DSCPU is replaced with Q173DSCPU, this area cannot be used as a user device.
 (3) Refer to Section 5.2.3 for details of command generation axis command signal.

APPENDICES

(5) Synchronous encoder axis status list

Axis No.	Device No.	Signal name																																											
1	M10440 to M10449	<table border="1"> <thead> <tr> <th>Symbol</th> <th>Signal name</th> <th>Refresh cycle</th> <th>Fetch cycle</th> <th>Signal direction</th> </tr> </thead> <tbody> <tr> <td>0 St.320</td> <td>Synchronous encoder axis setting valid flag</td> <td>At power on</td> <td rowspan="4">/</td> <td rowspan="4">Status signal</td> </tr> <tr> <td>1 St.321</td> <td>Synchronous encoder axis connecting valid flag</td> <td rowspan="3">Operation cycle</td> </tr> <tr> <td>2 St.322</td> <td>Synchronous encoder axis counter enable flag</td> </tr> <tr> <td>3 St.323</td> <td>Synchronous encoder axis current value setting request flag</td> </tr> <tr> <td>4 St.324</td> <td>Synchronous encoder axis error detection flag</td> <td>Immediate</td> <td></td> <td></td> </tr> <tr> <td>5</td> <td>—</td> <td>Unusable</td> <td>—</td> <td>—</td> <td>—</td> </tr> <tr> <td>6 St.325</td> <td>Synchronous encoder axis control complete flag</td> <td>Immediate</td> <td>/</td> <td>Status signal</td> </tr> <tr> <td>7</td> <td>—</td> <td rowspan="3">Unusable</td> <td>—</td> <td>—</td> <td>—</td> </tr> <tr> <td>8</td> <td>—</td> </tr> <tr> <td>9</td> <td>—</td> </tr> </tbody> </table>	Symbol	Signal name	Refresh cycle	Fetch cycle	Signal direction	0 St.320	Synchronous encoder axis setting valid flag	At power on	/	Status signal	1 St.321	Synchronous encoder axis connecting valid flag	Operation cycle	2 St.322	Synchronous encoder axis counter enable flag	3 St.323	Synchronous encoder axis current value setting request flag	4 St.324	Synchronous encoder axis error detection flag	Immediate			5	—	Unusable	—	—	—	6 St.325	Synchronous encoder axis control complete flag	Immediate	/	Status signal	7	—	Unusable	—	—	—	8	—	9	—
Symbol	Signal name		Refresh cycle	Fetch cycle	Signal direction																																								
0 St.320	Synchronous encoder axis setting valid flag		At power on	/	Status signal																																								
1 St.321	Synchronous encoder axis connecting valid flag		Operation cycle																																										
2 St.322	Synchronous encoder axis counter enable flag																																												
3 St.323	Synchronous encoder axis current value setting request flag																																												
4 St.324	Synchronous encoder axis error detection flag		Immediate																																										
5	—		Unusable	—	—	—																																							
6 St.325	Synchronous encoder axis control complete flag		Immediate	/	Status signal																																								
7	—		Unusable	—	—	—																																							
8	—																																												
9	—																																												
2	M10450 to M10459																																												
3	M10460 to M10469																																												
4	M10470 to M10479																																												
5	M10480 to M10489																																												
6	M10490 to M10499																																												
7	M10500 to M10509																																												
8	M10510 to M10519																																												
9	M10520 to M10529																																												
10	M10530 to M10539																																												
11	M10540 to M10549																																												
12	M10550 to M10559																																												

POINT
Refer to Section 5.3.5 for details of synchronous encoder axis status.

(6) Synchronous encoder axis command signal list

Axis No.	Device No.	Signal name																						
1	M11600 to M11603	<table border="1"> <thead> <tr> <th>Symbol</th> <th>Signal name</th> <th>Refresh cycle</th> <th>Fetch cycle</th> <th>Signal direction</th> </tr> </thead> <tbody> <tr> <td>0 Rq.323</td> <td>Synchronous encoder axis error reset</td> <td rowspan="3">/</td> <td>Main cycle</td> <td rowspan="3">Command signal</td> </tr> <tr> <td>1 Rq.320</td> <td>Synchronous encoder axis control request</td> <td>Operation cycle</td> </tr> <tr> <td>2 Rq.324</td> <td>Connection command of synchronous encoder via device/ master CPU</td> <td>Main cycle</td> </tr> <tr> <td>3</td> <td>—</td> <td>Unusable</td> <td>—</td> <td>—</td> <td>—</td> </tr> </tbody> </table>	Symbol	Signal name	Refresh cycle	Fetch cycle	Signal direction	0 Rq.323	Synchronous encoder axis error reset	/	Main cycle	Command signal	1 Rq.320	Synchronous encoder axis control request	Operation cycle	2 Rq.324	Connection command of synchronous encoder via device/ master CPU	Main cycle	3	—	Unusable	—	—	—
Symbol	Signal name		Refresh cycle	Fetch cycle	Signal direction																			
0 Rq.323	Synchronous encoder axis error reset		/	Main cycle	Command signal																			
1 Rq.320	Synchronous encoder axis control request			Operation cycle																				
2 Rq.324	Connection command of synchronous encoder via device/ master CPU			Main cycle																				
3	—		Unusable	—	—	—																		
2	M11604 to M11607																							
3	M11608 to M11611																							
4	M11612 to M11615																							
5	M11616 to M11619																							
6	M11620 to M11623																							
7	M11624 to M11627																							
8	M11628 to M11631																							
9	M11632 to M11635																							
10	M11636 to M11639																							
11	M11640 to M11643																							
12	M11644 to M11647																							

POINT
Refer to Section 5.3.4 for details of synchronous encoder axis command signal.

(7) Output axis status list

Axis No.	Device No.	Signal name			
1	M10560 to M10569				
2	M10570 to M10579				
3	M10580 to M10589				
4	M10590 to M10599				
5	M10600 to M10609				
6	M10610 to M10619				
7	M10620 to M10629				
8	M10630 to M10639				
9	M10640 to M10649				
10	M10650 to M10659				
11	M10660 to M10669				
12	M10670 to M10679				
13	M10680 to M10689				
14	M10690 to M10699				
15	M10700 to M10709				
16	M10710 to M10719				
17	M10720 to M10729				
18	M10730 to M10739				
19	M10740 to M10749				
20	M10750 to M10759				
21	M10760 to M10769				
22	M10770 to M10779				
23	M10780 to M10789				
24	M10790 to M10799				
25	M10800 to M10809				
26	M10810 to M10819				
27	M10820 to M10829				
28	M10830 to M10839				
29	M10840 to M10849				
30	M10850 to M10859				
31	M10860 to M10869				
32	M10870 to M10879				

Symbol	Signal name	Refresh cycle	Fetch cycle	Signal direction
0 St.420	Main shaft clutch ON/OFF status	Operation cycle	/	Status signal
1 St.421	Main shaft clutch smoothing status			
2 St.423	Auxiliary shaft clutch ON/OFF status			
3 St.424	Auxiliary shaft clutch smoothing status			
4 —	Unusable	—	—	—
5 —	Unusable	—	—	—
6 St.426	Control change complete	Operation cycle	/	Status signal
7 —	Unusable	—	—	—
8 —				
9 —				

POINT
<p>(1) The range of axis No.1 to 16 is valid in the Q172DSCPU.</p> <p>(2) The device area more than 17 axes in the Q172DSCPU can be used as a user device. However, when the project of Q172DSCPU is replaced with Q173DSCPU, this area cannot be used as a user device.</p> <p>(3) Refer to Section 7.6.2 and Section 7.7 for details of output axis status.</p>

(8) Output axis command signal list

Axis No.	Device No.	Signal name			
1	M11680 to M11689				
2	M11690 to M11699				
3	M11700 to M11709				
4	M11710 to M11719				
5	M11720 to M11729				
6	M11730 to M11739				
7	M11740 to M11749				
8	M11750 to M11759				
9	M11760 to M11769				
10	M11770 to M11779				
11	M11780 to M11789				
12	M11790 to M11799				
13	M11800 to M11809				
14	M11810 to M11819				
15	M11820 to M11829				
16	M11830 to M11839				
17	M11840 to M11849				
18	M11850 to M11859				
19	M11860 to M11869				
20	M11870 to M11879				
21	M11880 to M11889				
22	M11890 to M11899				
23	M11900 to M11909				
24	M11910 to M11919				
25	M11920 to M11929				
26	M11930 to M11939				
27	M11940 to M11949				
28	M11950 to M11959				
29	M11960 to M11969				
30	M11970 to M11979				
31	M11980 to M11989				
32	M11990 to M11999				

	Symbol	Signal name	Refresh cycle	Fetch cycle	Signal direction
0	Rq.400	Main shaft clutch command	/	Operation cycle	Command signal
1	Rq.401	Main shaft clutch control invalid command			
2	Rq.402	Main shaft clutch forced OFF command			
3	—	Unusable	—	—	—
4	Rq.403	Auxiliary shaft clutch command	/	Operation cycle	Command signal
5	Rq.404	Auxiliary shaft clutch control invalid command			
6	Rq.405	Auxiliary shaft clutch forced OFF command			
7	—	Unusable	—	—	—
8	Rq.406	Control change request command	/	Operation cycle	Command signal
9	—	Unusable			

POINT
<p>(1) The range of axis No.1 to 16 is valid in the Q172DSCPU.</p> <p>(2) The device area more than 17 axes in the Q172DSCPU can be used as a user device. However, when the project of Q172DSCPU is replaced with Q173DSCPU, this area cannot be used as a user device.</p> <p>(3) Refer to Section 7.1.4, Section 7.2.4 and Section 7.6.2 for details of output axis command signal.</p>

(9) Synchronous control signal list

Axis No.	Device No.	Symbol	Signal name	Refresh cycle	Fetch cycle	Signal direction
1	M10880	St.380	Synchronous control	Operation cycle		Status signal
2	M10881					
3	M10882					
4	M10883					
5	M10884					
6	M10885					
7	M10886					
8	M10887					
9	M10888					
10	M10889					
11	M10890					
12	M10891					
13	M10892					
14	M10893					
15	M10894					
16	M10895					
17	M10896					
18	M10897					
19	M10898					
20	M10899					
21	M10900					
22	M10901					
23	M10902					
24	M10903					
25	M10904					
26	M10905					
27	M10906					
28	M10907					
29	M10908					
30	M10909					
31	M10910					
32	M10911					

POINT	<p>(1) The range of axis No.1 to 16 is valid in the Q172DSCPU.</p> <p>(2) The device area more than 17 axes in the Q172DSCPU can be used as a user device. However, when the project of Q172DSCPU is replaced with Q173DSCPU, this area cannot be used as a user device.</p> <p>(3) Refer to Section 2.2 for details of synchronous control signal.</p>
--------------	------------------------------------------------------------------------------------------------------------------------------------------------------------------------------------------------------------------------------------------------------------------------------------------------------------------------------------------------------------------------------

(10) Synchronous analysis complete signal list

Axis No.	Device No.	Symbol	Signal name	Refresh cycle	Fetch cycle	Signal direction
1	M10912	St.381	Synchronous analysis complete	Operation cycle		Status signal
2	M10913					
3	M10914					
4	M10915					
5	M10916					
6	M10917					
7	M10918					
8	M10919					
9	M10920					
10	M10921					
11	M10922					
12	M10923					
13	M10924					
14	M10925					
15	M10926					
16	M10927					
17	M10928					
18	M10929					
19	M10930					
20	M10931					
21	M10932					
22	M10933					
23	M10934					
24	M10935					
25	M10936					
26	M10937					
27	M10938					
28	M10939					
29	M10940					
30	M10941					
31	M10942					
32	M10943					

POINT	<p>(1) The range of axis No.1 to 16 is valid in the Q172DSCPU.</p> <p>(2) The device area more than 17 axes in the Q172DSCPU can be used as a user device. However, when the project of Q172DSCPU is replaced with Q173DSCPU, this area cannot be used as a user device.</p> <p>(3) Refer to Section 2.2 for details of synchronous analysis complete signal.</p>
--------------	----------------------------------------------------------------------------------------------------------------------------------------------------------------------------------------------------------------------------------------------------------------------------------------------------------------------------------------------------------------------------------------

(11) Synchronous control start signal list

Axis No.	Device No.	Symbol	Signal name	Refresh cycle	Fetch cycle	Signal direction
1	M12000	Rq.380	Synchronous control start		Operation cycle	Command signal
2	M12001					
3	M12002					
4	M12003					
5	M12004					
6	M12005					
7	M12006					
8	M12007					
9	M12008					
10	M12009					
11	M12010					
12	M12011					
13	M12012					
14	M12013					
15	M12014					
16	M12015					
17	M12016					
18	M12017					
19	M12018					
20	M12019					
21	M12020					
22	M12021					
23	M12022					
24	M12023					
25	M12024					
26	M12025					
27	M12026					
28	M12027					
29	M12028					
30	M12029					
31	M12030					
32	M12031					

POINT	<p>(1) The range of axis No.1 to 16 is valid in the Q172DSCPU.</p> <p>(2) The device area more than 17 axes in the Q172DSCPU can be used as a user device. However, when the project of Q172DSCPU is replaced with Q173DSCPU, this area cannot be used as a user device.</p> <p>(3) Refer to Section 2.2 for details of synchronous control start signal.</p>
--------------	------------------------------------------------------------------------------------------------------------------------------------------------------------------------------------------------------------------------------------------------------------------------------------------------------------------------------------------------------------------------------------

(12) Synchronous analysis request signal list

Axis No.	Device No.	Symbol	Signal name	Refresh cycle	Fetch cycle	Signal direction
1	M12032	Rq.381	Synchronous analysis request		At start of synchronous control	Command signal
2	M12033					
3	M12034					
4	M12035					
5	M12036					
6	M12037					
7	M12038					
8	M12039					
9	M12040					
10	M12041					
11	M12042					
12	M12043					
13	M12044					
14	M12045					
15	M12046					
16	M12047					
17	M12048					
18	M12049					
19	M12050					
20	M12051					
21	M12052					
22	M12053					
23	M12054					
24	M12055					
25	M12056					
26	M12057					
27	M12058					
28	M12059					
29	M12060					
30	M12061					
31	M12062					
32	M12063					

POINT	<p>(1) The range of axis No.1 to 16 is valid in the Q172DSCPU.</p> <p>(2) The device area more than 17 axes in the Q172DSCPU can be used as a user device. However, when the project of Q172DSCPU is replaced with Q173DSCPU, this area cannot be used as a user device.</p> <p>(3) Refer to Section 2.2 for details of synchronous analysis request signal.</p>
--------------	---------------------------------------------------------------------------------------------------------------------------------------------------------------------------------------------------------------------------------------------------------------------------------------------------------------------------------------------------------------------------------------

(13) Common device list

Device No.	Signal name	Refresh cycle	Fetch cycle	Signal direction	Remark (Note-3)	Device No.	Signal name	Refresh cycle	Fetch cycle	Signal direction	Remark (Note-3)
M2000	PLC ready flag	/	Main cycle	Command signal	M3072	M2061	Axis 1	Operation cycle	/	Status signal (Note-1), (Note-2)	
M2001	Axis 1	Start accept flag	/	/		M2062	Axis 2				
M2002	Axis 2					M2063	Axis 3				
M2003	Axis 3					M2064	Axis 4				
M2004	Axis 4					M2065	Axis 5				
M2005	Axis 5					M2066	Axis 6				
M2006	Axis 6					M2067	Axis 7				
M2007	Axis 7					M2068	Axis 8				
M2008	Axis 8					M2069	Axis 9				
M2009	Axis 9					M2070	Axis 10				
M2010	Axis 10					M2071	Axis 11				
M2011	Axis 11					M2072	Axis 12				
M2012	Axis 12					M2073	Axis 13				
M2013	Axis 13					M2074	Axis 14				
M2014	Axis 14					M2075	Axis 15				
M2015	Axis 15					M2076	Axis 16				
M2016	Axis 16					M2077	Axis 17				
M2017	Axis 17					M2078	Axis 18				
M2018	Axis 18					M2079	Axis 19				
M2019	Axis 19					M2080	Axis 20				
M2020	Axis 20					M2081	Axis 21				
M2021	Axis 21					M2082	Axis 22				
M2022	Axis 22					M2083	Axis 23				
M2023	Axis 23					M2084	Axis 24				
M2024	Axis 24					M2085	Axis 25				
M2025	Axis 25					M2086	Axis 26				
M2026	Axis 26					M2087	Axis 27				
M2027	Axis 27					M2088	Axis 28				
M2028	Axis 28					M2089	Axis 29				
M2029	Axis 29					M2090	Axis 30				
M2030	Axis 30					M2091	Axis 31				
M2031	Axis 31					M2092	Axis 32				
M2032	Axis 32									M2093	
M2033	Unusable (2 points)	—	—	—	—	M2094	Unusable (29 points)	—	—	—	—
M2034	Motion error history clear request flag	/	Main cycle	Command signal	M3080	M2095					
M2035	Unusable (2 points)	—	—	—	—	M2096					
M2036	Unusable (2 points)	—	—	—	—	M2097					
M2037	Motion SFC debugging flag	At debugging mode transition	/	Status signal		M2098					
M2038	Motion error detection flag	Immediate	/	Status signal		M2099					
M2039	Speed switching point specified flag	/	At start	Command signal	M3073	M2100					
M2040	System setting error flag	Operation cycle	/	Status signal		M2101					
M2041	All axes servo ON command	/	Operation cycle	Command signal	M3074	M2102					
M2042	Unusable (4 points)	—	—	—	—	M2103					
M2043	Motion slot fault detection flag	Operation cycle	/	Status signal		M2104					
M2044	JOG operation simultaneous start command	/	Main cycle	Command signal	M3076	M2105					
M2045	All axes servo ON accept flag	Operation cycle	/	Status signal		M2106					
M2046	Unusable	—	—	—	—	M2107					
M2047	Manual pulse generator 1 enable flag	/	Main cycle	Command signal	M3077	M2108					
M2048	Manual pulse generator 2 enable flag	/	Main cycle	Command signal	M3078	M2109					
M2049	Manual pulse generator 3 enable flag	/	Main cycle	Command signal	M3079	M2110					
M2050	Operation cycle over flag	Operation cycle	/	Status signal		M2111					
M2051	Unusable (6 points)	—	—	—	—	M2112					
M2052	Unusable (6 points)	—	—	—	—	M2113					
M2053	Unusable (6 points)	—	—	—	—	M2114					
M2054	Unusable (6 points)	—	—	—	—	M2115					
M2055	Unusable (6 points)	—	—	—	—	M2116					
M2056	Unusable (6 points)	—	—	—	—	M2117					
M2057	Unusable (6 points)	—	—	—	—	M2118					
M2058	Unusable (6 points)	—	—	—	—	M2119					
M2059	Unusable (6 points)	—	—	—	—	M2120					
M2060	Unusable (6 points)	—	—	—	—	M2121					

APPENDICES

Common device list (Continued)

Device No.	Signal name	Refresh cycle	Fetch cycle	Signal direction	Remark (Note-3)	Device No.	Signal name	Refresh cycle	Fetch cycle	Signal direction	Remark (Note-3)
M2122	Unusable (6 points)	-	-	-	-	M2194	Unusable (46 points)	-	-	-	-
M2123						M2195					
M2124						M2196					
M2125						M2197					
M2126						M2198					
M2127						M2199					
M2128	Axis 1	Operation cycle	/	Status signal (Note-1), (Note-2)		M2200					
M2129	Axis 2					M2201					
M2130	Axis 3					M2202					
M2131	Axis 4					M2203					
M2132	Axis 5					M2204					
M2133	Axis 6					M2205					
M2134	Axis 7					M2206					
M2135	Axis 8					M2207					
M2136	Axis 9					M2208					
M2137	Axis 10					M2209					
M2138	Axis 11					M2210					
M2139	Axis 12					M2211					
M2140	Axis 13					M2212					
M2141	Axis 14					M2213					
M2142	Axis 15					M2214					
M2143	Axis 16					M2215					
M2144	Axis 17					M2216					
M2145	Axis 18					M2217					
M2146	Axis 19					M2218					
M2147	Axis 20					M2219					
M2148	Axis 21					M2220					
M2149	Axis 22					M2221					
M2150	Axis 23					M2222					
M2151	Axis 24					M2223					
M2152	Axis 25					M2224					
M2153	Axis 26					M2225					
M2154	Axis 27					M2226					
M2155	Axis 28					M2227					
M2156	Axis 29					M2228					
M2157	Axis 30					M2229					
M2158	Axis 31					M2230					
M2159	Axis 32					M2231					
M2160	Unusable (34 points)	-	-	-	-	M2232					
M2161						M2233					
M2162						M2234					
M2163						M2235					
M2164						M2236					
M2165						M2237					
M2166						M2238					
M2167						M2239					
M2168						M2240					
M2169						M2241					
M2170	Axis 2	Speed change "0" accepting flag	Operation cycle	Status signal (Note-1), (Note-2)		M2242					
M2171	Axis 3					M2243					
M2172	Axis 4					M2244					
M2173	Axis 5					M2245					
M2174	Axis 6					M2246					
M2175	Axis 7					M2247					
M2176	Axis 8					M2248					
M2177	Axis 9					M2249					
M2178	Axis 10					M2250					
M2179	Axis 11					M2251					
M2180	Axis 12	M2252									
M2181	Axis 13	M2253									
M2182	Axis 14	M2254									
M2183	Axis 15	M2255									
M2184	Axis 16	M2256									
M2185	Axis 17	M2257									
M2186	Axis 18	M2258									
M2187	Axis 19	M2259									
M2188	Axis 20	M2260									
M2189	Axis 21	M2261									
M2190	Axis 22	M2262									
M2191	Axis 23	M2263									
M2192	Axis 24	M2264									
M2193	Axis 25	M2265									
	Axis 26	M2266									

APPENDICES

Common device list (Continued)

Device No.	Signal name	Refresh cycle	Fetch cycle	Signal direction	Remark (Note-3)	Device No.	Signal name	Refresh cycle	Fetch cycle	Signal direction	Remark (Note-3)		
M2266	Axis 27	Operation cycle	/	Status signal (Note-1), (Note-2)		M2293	Axis 22	Operation cycle	/	Status signal (Note-1), (Note-2)			
M2267	Axis 28					M2294	Axis 23						
M2268	Axis 29					Speed change "0" accepting flag	M2295					Axis 24	
M2269	Axis 30						M2296					Axis 25	
M2270	Axis 31					Control loop monitor status	M2297					Axis 26	
M2271	Axis 32						M2298					Axis 27	
M2272	Axis 1						M2299					Axis 28	
M2273	Axis 2						M2300					Axis 29	
M2274	Axis 3						M2301					Axis 30	
M2275	Axis 4						M2302					Axis 31	
M2276	Axis 5						M2303					Axis 32	
M2277	Axis 6						Unusable (16 points)					M2304	
M2278	Axis 7											M2305	
M2279	Axis 8							M2306					
M2280	Axis 9					M2307							
M2281	Axis 10					M2308							
M2282	Axis 11					M2309							
M2283	Axis 12					M2310							
M2284	Axis 13					M2311							
M2285	Axis 14					M2312							
M2286	Axis 15					M2313							
M2287	Axis 16	M2314											
M2288	Axis 17	M2315											
M2289	Axis 18	M2316											
M2290	Axis 19	M2317											
M2291	Axis 20	M2318											
M2292	Axis 21	M2319											

(Note-1): The range of axis No.1 to 16 is valid in the Q172DSCPU.

(Note-2): Device area of 17 axes or more is unusable in the Q172DSCPU.

(Note-3): It can also be ordered the device of a remark column.

POINT

Refer to the "Q173D(S)CPU/Q172D(S)CPU Motion controller (SV13/SV22) Programming Manual (REAL MODE)" for details of common device.

(14) Common device list (Command signal)

Device No.	Signal name	Refresh cycle	Fetch cycle	Signal direction	Remark (Note-1), (Note-2)
M3072	PLC ready flag	/	Main cycle	Command signal	M2000
M3073	Speed switching point specified flag		At start		M2040
M3074	All axes servo ON command		Operation cycle		M2042
M3075	Unusable	—	—	—	—
M3076	JOG operation simultaneous start command	/	Main cycle	Command signal	M2048
M3077	Manual pulse generator 1 enable flag				M2051
M3078	Manual pulse generator 2 enable flag				M2052
M3079	Manual pulse generator 3 enable flag				M2053
M3080	Motion error history clear request flag				M2035
M3081 to M3135	Unusable (Note-3) (55 points)	—	—	—	—

- (Note-1): The state of a device is not in agreement when the device of a remark column is turned ON/OFF directly. In addition, when the request from a data register and the request from the above device are performed simultaneously, the request from the above device becomes effective.
- (Note-2): It can also be ordered the device of a remark column.
- (Note-3): Do not use it as a user device. It can be used as a device that performs automatic refresh because of area for the reserve of command signal.

POINT
<p>The device of a remark column turns ON by OFF to ON of the above device, and turns OFF by ON to OFF of the above device.</p> <p>The command signal cannot be turned ON/OFF by the PLC CPU in the automatic refresh because the statuses and commands are mixed together in M2000 to M2053. Use the above devices in the case.</p> <p>And, it can also be turned ON/OFF by the data register. (Refer to the "Q173D(S)CPU/Q172D(S)CPU Motion controller (SV13/SV22) Programming Manual (REAL MODE)".)</p>

(15) Axis monitor device list

Axis No.	Device No.	Signal name			
1	D0 to D19				
2	D20 to D39				
3	D40 to D59				
4	D60 to D79				
5	D80 to D99				
6	D100 to D119				
7	D120 to D139				
8	D140 to D159				
9	D160 to D179				
10	D180 to D199				
11	D200 to D219				
12	D220 to D239				
13	D240 to D259				
14	D260 to D279				
15	D280 to D299				
16	D300 to D319				
17	D320 to D339				
18	D340 to D359				
19	D360 to D379				
20	D380 to D399				
21	D400 to D419				
22	D420 to D439				
23	D440 to D459				
24	D460 to D479				
25	D480 to D499				
26	D500 to D519				
27	D520 to D539				
28	D540 to D559				
29	D560 to D579				
30	D580 to D599				
31	D600 to D619				
32	D620 to D639				

	Signal name	Refresh cycle	Fetch cycle	Signal direction
0	Feed current value	Operation cycle	—	Monitor device
1				
2	Real current value			
3				
4				
5	Deviation counter value			
6	Minor error code	Immediate		
7	Major error code			
8	Servo error code	Main cycle		
9	Home position return re-travel value	Operation cycle		
10	Travel value after proximity dog ON			
11				
12	Execute program No.	At start		
13	M-code	Operation cycle		
14	Torque limit value			
15	Data set pointer for constant-speed control	At start/ during start		
16	Unusable (Note-1)	—	—	—
17				
18	Real current value at stop input	Operation cycle	—	Monitor device
19				

(Note-1): It can be used as the travel value change register. The travel value change register can be set to the device optionally in the servo program.

Refer to the "Q173D(S)CPU/Q172D(S)CPU Motion controller (SV13/SV22) Programming Manual (REAL MODE)" for details.

POINT
<p>(1) The range of axis No.1 to 16 is valid in the Q172DSCPU.</p> <p>(2) The device area more than 17 axes in the Q172DSCPU can be used as a user device. However, when the project of Q172DSCPU is replaced with Q173DSCPU, this area cannot be used as a user device.</p> <p>(3) Refer to the "Q173D(S)CPU/Q172D(S)CPU Motion controller (SV13/SV22) Programming Manual (REAL MODE)" for details of axis monitor device.</p>

(16) Control change register list

Axis No.	Device No.	Signal name														
1	D640, D641	<table border="1"> <thead> <tr> <th></th> <th>Signal name</th> <th>Refresh cycle</th> <th>Fetch cycle</th> <th>Signal direction</th> </tr> </thead> <tbody> <tr> <td>0</td> <td rowspan="2">JOG speed setting</td> <td rowspan="2" style="text-align: center;">/</td> <td rowspan="2">At start</td> <td rowspan="2">Command device</td> </tr> <tr> <td>1</td> </tr> </tbody> </table>					Signal name	Refresh cycle	Fetch cycle	Signal direction	0	JOG speed setting	/	At start	Command device	1
	Signal name					Refresh cycle	Fetch cycle	Signal direction								
0	JOG speed setting					/	At start	Command device								
1																
2	D642, D643															
3	D644, D645															
4	D646, D647															
5	D648, D649															
6	D650, D651															
7	D652, D653															
8	D654, D655															
9	D656, D657															
10	D658, D659															
11	D660, D661															
12	D662, D663															
13	D664, D665															
14	D666, D667															
15	D668, D669															
16	D670, D671															
17	D672, D673															
18	D674, D675															
19	D676, D677															
20	D678, D679															
21	D680, D681															
22	D682, D683															
23	D684, D685															
24	D686, D687															
25	D688, D689															
26	D690, D691															
27	D692, D693															
28	D694, D695															
29	D696, D697															
30	D698, D699															
31	D700, D701															
32	D702, D703															

POINT
<p>(1) The range of axis No.1 to 16 is valid in the Q172DSCPU.</p> <p>(2) The device area more than 17 axes in the Q172DSCPU can be used as a user device. However, when the project of Q172DSCPU is replaced with Q173DSCPU, this area cannot be used as a user device.</p> <p>(3) Refer to the "Q173D(S)CPU/Q172D(S)CPU Motion controller (SV13/SV22) Programming Manual (REAL MODE)" for details of control change register.</p>

(17) Servo input axis monitor device list

Axis No.	Device No.	Signal name			
1	D12280 to D12289				
2	D12290 to D12299				
3	D12300 to D12309				
4	D12310 to D12319				
5	D12320 to D12329				
6	D12330 to D12339				
7	D12340 to D12349				
8	D12350 to D12359				
9	D12360 to D12369				
10	D12370 to D12379				
11	D12380 to D12389				
12	D12390 to D12399				
13	D12400 to D12409				
14	D12410 to D12419				
15	D12420 to D12429				
16	D12430 to D12439				
17	D12440 to D12449				
18	D12450 to D12459				
19	D12460 to D12469				
20	D12470 to D12479				
21	D12480 to D12489				
22	D12490 to D12499				
23	D12500 to D12509				
24	D12510 to D12519				
25	D12520 to D12529				
26	D12530 to D12539				
27	D12540 to D12549				
28	D12550 to D12559				
29	D12560 to D12569				
30	D12570 to D12579				
31	D12580 to D12589				
32	D12590 to D12599				

	Symbol	Signal name	Refresh cycle	Fetch cycle	Signal direction
0	Md.300	Servo input axis current value	Operation cycle	/	Monitor device
1		Servo input axis speed			
2	Md.301	Servo input axis phase compensation amount			
3		Servo input axis rotation direction restriction amount			
4		Servo input axis phase compensation amount			
5	Md.302	Servo input axis phase compensation amount			
6		Servo input axis rotation direction restriction amount			
7	Md.303	Servo input axis rotation direction restriction amount			
8	—	Unusable	—	—	—
9	—	Unusable	—	—	—

POINT
<p>(1) The range of axis No.1 to 16 is valid in the Q172DSCPU.</p> <p>(2) The device area more than 17 axes in the Q172DSCPU can be used as a user device. However, when the project of Q172DSCPU is replaced with Q173DSCPU, this area cannot be used as a user device.</p> <p>(3) Refer to Section 5.1.3 for details of servo input axis monitor device.</p>

(18) Servo input axis control device list

Axis No.	Device No.	Signal name			
1	D14600, D14601				
2	D14602, D14603				
3	D14604, D14605				
4	D14606, D14607				
5	D14608, D14609				
6	D14610, D14611				
7	D14612, D14613				
8	D14614, D14615				
9	D14616, D14617				
10	D14618, D14619				
11	D14620, D14621				
12	D14622, D14623				
13	D14624, D14625				
14	D14626, D14627				
15	D14628, D14629				
16	D14630, D14631				
17	D14632, D14633				
18	D14634, D14635				
19	D14636, D14637				
20	D14638, D14639				
21	D14640, D14641				
22	D14642, D14643				
23	D14644, D14645				
24	D14646, D14647				
25	D14648, D14649				
26	D14650, D14651				
27	D14652, D14653				
28	D14654, D14655				
29	D14656, D14657				
30	D14658, D14659				
31	D14660, D14661				
32	D14662, D14663				

	Symbol	Signal name	Refresh cycle	Fetch cycle	Signal direction
0	Pr.302	Servo input axis phase		Operation cycle	Command device
1		compensation advance time			

POINT
<p>(1) The range of axis No.1 to 16 is valid in the Q172DSCPU.</p> <p>(2) The device area more than 17 axes in the Q172DSCPU can be used as a user device. However, when the project of Q172DSCPU is replaced with Q173DSCPU, this area cannot be used as a user device.</p> <p>(3) Refer to Section 5.1.2 for details of servo input axis control device.</p>

(19) Command generation axis monitor device list

Axis No.	Device No.	Signal name																																																																																																										
1	D12600 to D12619	<table border="1"> <thead> <tr> <th></th> <th>Symbol</th> <th>Signal name</th> <th>Refresh cycle</th> <th>Fetch cycle</th> <th>Signal direction</th> </tr> </thead> <tbody> <tr> <td>0</td> <td rowspan="2">Md.340</td> <td>Command generation axis feed current value</td> <td>Operation cycle</td> <td rowspan="10">/</td> <td rowspan="10">Monitor device</td> </tr> <tr> <td>1</td> <td>Command generation axis minor error code</td> <td rowspan="3">Immediate</td> </tr> <tr> <td>2</td> <td>Md.341</td> <td>Command generation axis major error code</td> </tr> <tr> <td>3</td> <td>Md.342</td> <td>Command generation axis execute program No.</td> <td>At start</td> </tr> <tr> <td>4</td> <td>Md.343</td> <td>Command generation axis M-code</td> <td rowspan="3">Operation cycle</td> </tr> <tr> <td>5</td> <td>Md.344</td> <td>Command generation axis accumulative current value</td> </tr> <tr> <td>6</td> <td rowspan="2">Md.345</td> <td>Unusable</td> <td>—</td> <td>—</td> <td>—</td> </tr> <tr> <td>7</td> <td>—</td> <td>—</td> <td>—</td> <td>—</td> </tr> <tr> <td>8</td> <td>—</td> <td>Unusable</td> <td>—</td> <td>—</td> <td>—</td> </tr> <tr> <td>9</td> <td>Md.346</td> <td>Command generation axis data set pointer for constant-speed control</td> <td>At start/ during start</td> <td rowspan="4">/</td> <td rowspan="4">Monitor device</td> </tr> <tr> <td>10</td> <td rowspan="2">Md.347</td> <td>Command generation axis current value per cycle</td> <td rowspan="2">Operation cycle</td> </tr> <tr> <td>11</td> <td>Command generation axis command speed</td> </tr> <tr> <td>12</td> <td>Md.348</td> <td>Unusable</td> <td>—</td> <td>—</td> <td>—</td> </tr> <tr> <td>13</td> <td>—</td> <td>Unusable</td> <td>—</td> <td>—</td> <td>—</td> </tr> <tr> <td>14</td> <td>—</td> <td>Unusable</td> <td>—</td> <td>—</td> <td>—</td> </tr> <tr> <td>15</td> <td>—</td> <td>Unusable</td> <td>—</td> <td>—</td> <td>—</td> </tr> <tr> <td>16</td> <td>—</td> <td>Unusable</td> <td>—</td> <td>—</td> <td>—</td> </tr> <tr> <td>17</td> <td>—</td> <td>Unusable</td> <td>—</td> <td>—</td> <td>—</td> </tr> <tr> <td>18</td> <td>—</td> <td>Unusable</td> <td>—</td> <td>—</td> <td>—</td> </tr> <tr> <td>19</td> <td>—</td> <td>Unusable</td> <td>—</td> <td>—</td> <td>—</td> </tr> </tbody> </table>		Symbol	Signal name	Refresh cycle	Fetch cycle	Signal direction	0	Md.340	Command generation axis feed current value	Operation cycle	/	Monitor device	1	Command generation axis minor error code	Immediate	2	Md.341	Command generation axis major error code	3	Md.342	Command generation axis execute program No.	At start	4	Md.343	Command generation axis M-code	Operation cycle	5	Md.344	Command generation axis accumulative current value	6	Md.345	Unusable	—	—	—	7	—	—	—	—	8	—	Unusable	—	—	—	9	Md.346	Command generation axis data set pointer for constant-speed control	At start/ during start	/	Monitor device	10	Md.347	Command generation axis current value per cycle	Operation cycle	11	Command generation axis command speed	12	Md.348	Unusable	—	—	—	13	—	Unusable	—	—	—	14	—	Unusable	—	—	—	15	—	Unusable	—	—	—	16	—	Unusable	—	—	—	17	—	Unusable	—	—	—	18	—	Unusable	—	—	—	19	—	Unusable	—	—	—
	Symbol		Signal name	Refresh cycle	Fetch cycle	Signal direction																																																																																																						
0	Md.340		Command generation axis feed current value	Operation cycle	/	Monitor device																																																																																																						
1			Command generation axis minor error code	Immediate																																																																																																								
2	Md.341		Command generation axis major error code																																																																																																									
3	Md.342		Command generation axis execute program No.				At start																																																																																																					
4	Md.343		Command generation axis M-code	Operation cycle																																																																																																								
5	Md.344		Command generation axis accumulative current value																																																																																																									
6	Md.345		Unusable				—	—	—																																																																																																			
7			—	—			—	—																																																																																																				
8	—		Unusable	—			—	—																																																																																																				
9	Md.346		Command generation axis data set pointer for constant-speed control	At start/ during start			/	Monitor device																																																																																																				
10	Md.347		Command generation axis current value per cycle	Operation cycle																																																																																																								
11			Command generation axis command speed																																																																																																									
12	Md.348		Unusable	—	—	—																																																																																																						
13	—		Unusable	—	—	—																																																																																																						
14	—		Unusable	—	—	—																																																																																																						
15	—		Unusable	—	—	—																																																																																																						
16	—		Unusable	—	—	—																																																																																																						
17	—		Unusable	—	—	—																																																																																																						
18	—		Unusable	—	—	—																																																																																																						
19	—		Unusable	—	—	—																																																																																																						
2	D12620 to D12639																																																																																																											
3	D12640 to D12659																																																																																																											
4	D12660 to D12679																																																																																																											
5	D12680 to D12699																																																																																																											
6	D12700 to D12719																																																																																																											
7	D12720 to D12739																																																																																																											
8	D12740 to D12759																																																																																																											
9	D12760 to D12779																																																																																																											
10	D12780 to D12799																																																																																																											
11	D12800 to D12819																																																																																																											
12	D12820 to D12839																																																																																																											
13	D12840 to D12859																																																																																																											
14	D12860 to D12879																																																																																																											
15	D12880 to D12899																																																																																																											
16	D12900 to D12919																																																																																																											
17	D12920 to D12939																																																																																																											
18	D12940 to D12959																																																																																																											
19	D12960 to D12979																																																																																																											
20	D12980 to D12999																																																																																																											
21	D13000 to D13019																																																																																																											
22	D13020 to D13039																																																																																																											
23	D13040 to D13059																																																																																																											
24	D13060 to D13079																																																																																																											
25	D13080 to D13099																																																																																																											
26	D13100 to D13119																																																																																																											
27	D13120 to D13139																																																																																																											
28	D13140 to D13159																																																																																																											
29	D13160 to D13179																																																																																																											
30	D13180 to D13199																																																																																																											
31	D13200 to D13219																																																																																																											
32	D13220 to D13239																																																																																																											

POINT
<p>(1) The range of axis No.1 to 16 is valid in the Q172DSCPU.</p> <p>(2) The device area more than 17 axes in the Q172DSCPU can be used as a user device. However, when the project of Q172DSCPU is replaced with Q173DSCPU, this area cannot be used as a user device.</p> <p>(3) Refer to Section 5.2.4 for details of command generation axis monitor device.</p>

(20) Command generation axis control device list

Axis No.	Device No.	Signal name			
1	D14680 to D14683				
2	D14684 to D14687				
3	D14688 to D14691				
4	D14692 to D14695				
5	D14696 to D14699				
6	D14700 to D14703				
7	D14704 to D14707				
8	D14708 to D14711				
9	D14712 to D14715				
10	D14716 to D14719				
11	D14720 to D14723				
12	D14724 to D14727				
13	D14728 to D14731				
14	D14732 to D14735				
15	D14736 to D14739				
16	D14740 to D14743				
17	D14744 to D14747				
18	D14748 to D14751				
19	D14752 to D14755				
20	D14756 to D14759				
21	D14760 to D14763				
22	D14764 to D14767				
23	D14768 to D14771				
24	D14772 to D14775				
25	D14776 to D14779				
26	D14780 to D14783				
27	D14784 to D14787				
28	D14788 to D14791				
29	D14792 to D14795				
30	D14796 to D14799				
31	D14800 to D14803				
32	D14804 to D14807				

	Symbol	Signal name	Refresh cycle	Fetch cycle	Signal direction
0	Cd.340	Command generation axis		At start of	Command
1		JOG speed setting			
2	Pr.348	Command generation axis JOG operation parameter block setting		JOG operation	device
3	—	Unusable	—	—	—

<p>POINT</p> <p>(1) The range of axis No.1 to 16 is valid in the Q172DSCPU.</p> <p>(2) The device area more than 17 axes in the Q172DSCPU can be used as a user device. However, when the project of Q172DSCPU is replaced with Q173DSCPU, this area cannot be used as a user device.</p> <p>(3) Refer to Section 5.2.2 and Section 5.2.3 for details of command generation axis control device.</p>

APPENDICES

(21) Synchronous encoder axis monitor device list

Axis No.	Device No.	Signal name																																																																						
1	D13240 to D13259	<table border="1"> <thead> <tr> <th></th> <th>Symbol</th> <th>Signal name</th> <th>Refresh cycle</th> <th>Fetch cycle</th> <th>Signal direction</th> </tr> </thead> <tbody> <tr> <td>0</td> <td rowspan="2">Md.320</td> <td>Synchronous encoder axis current value</td> <td rowspan="6">Operation cycle</td> <td rowspan="6"></td> <td rowspan="6">Monitor device</td> </tr> <tr> <td>1</td> <td>Synchronous encoder axis current value per cycle</td> </tr> <tr> <td>2</td> <td rowspan="2">Md.321</td> <td>Synchronous encoder axis speed</td> </tr> <tr> <td>3</td> <td>Synchronous encoder axis phase compensation amount</td> </tr> <tr> <td>4</td> <td rowspan="2">Md.322</td> <td>Synchronous encoder axis rotation direction restriction amount</td> </tr> <tr> <td>5</td> <td>Synchronous encoder axis minor error code</td> </tr> <tr> <td>6</td> <td rowspan="2">Md.323</td> <td>Synchronous encoder axis major error code</td> <td rowspan="2">Immediate</td> </tr> <tr> <td>7</td> <td></td> </tr> <tr> <td>8</td> <td rowspan="2">Md.324</td> <td></td> </tr> <tr> <td>9</td> <td></td> </tr> <tr> <td>10</td> <td rowspan="2">Md.327</td> <td></td> </tr> <tr> <td>11</td> <td></td> </tr> <tr> <td>12</td> <td rowspan="8">D13460 to D13479</td> <td></td> <td></td> <td></td> <td></td> </tr> <tr> <td>13</td> <td></td> <td></td> <td></td> <td></td> </tr> <tr> <td>14</td> <td></td> <td></td> <td></td> <td></td> </tr> <tr> <td>15</td> <td rowspan="4">—</td> <td rowspan="4">Unusable</td> <td rowspan="4">—</td> <td rowspan="4">—</td> <td rowspan="4">—</td> </tr> <tr> <td>16</td> </tr> <tr> <td>17</td> </tr> <tr> <td>18</td> </tr> <tr> <td>19</td> <td></td> <td></td> <td></td> <td></td> </tr> </tbody> </table>		Symbol	Signal name	Refresh cycle	Fetch cycle	Signal direction	0	Md.320	Synchronous encoder axis current value	Operation cycle		Monitor device	1	Synchronous encoder axis current value per cycle	2	Md.321	Synchronous encoder axis speed	3	Synchronous encoder axis phase compensation amount	4	Md.322	Synchronous encoder axis rotation direction restriction amount	5	Synchronous encoder axis minor error code	6	Md.323	Synchronous encoder axis major error code	Immediate	7		8	Md.324		9		10	Md.327		11		12	D13460 to D13479					13					14					15	—	Unusable	—	—	—	16	17	18	19				
	Symbol		Signal name	Refresh cycle	Fetch cycle	Signal direction																																																																		
0	Md.320		Synchronous encoder axis current value	Operation cycle		Monitor device																																																																		
1			Synchronous encoder axis current value per cycle																																																																					
2	Md.321		Synchronous encoder axis speed																																																																					
3			Synchronous encoder axis phase compensation amount																																																																					
4	Md.322		Synchronous encoder axis rotation direction restriction amount																																																																					
5			Synchronous encoder axis minor error code																																																																					
6	Md.323		Synchronous encoder axis major error code	Immediate																																																																				
7																																																																								
8	Md.324																																																																							
9																																																																								
10	Md.327																																																																							
11																																																																								
12	D13460 to D13479																																																																							
13																																																																								
14																																																																								
15		—	Unusable	—	—	—																																																																		
16																																																																								
17																																																																								
18																																																																								
19																																																																								
2	D13260 to D13279																																																																							
3	D13280 to D13299																																																																							
4	D13300 to D13319																																																																							
5	D13320 to D13339																																																																							
6	D13340 to D13359																																																																							
7	D13360 to D13379																																																																							
8	D13380 to D13399																																																																							
9	D13400 to D13419																																																																							
10	D13420 to D13439																																																																							
11	D13440 to D13459																																																																							

POINT
Refer to Section 5.3.5 for details of synchronous encoder axis monitor device.

(22) Synchronous encoder axis control device list

Axis No.	Device No.	Signal name																																														
1	D14820 to D14829	<table border="1"> <thead> <tr> <th></th> <th>Symbol</th> <th>Signal name</th> <th>Refresh cycle</th> <th>Fetch cycle</th> <th>Signal direction</th> </tr> </thead> <tbody> <tr> <td>0</td> <td>Pr.326</td> <td>Synchronous encoder axis phase compensation advance time</td> <td rowspan="7" style="text-align: center;">/</td> <td>Operation cycle</td> <td rowspan="7" style="text-align: center;">Command device</td> </tr> <tr> <td>1</td> <td></td> <td>Synchronous encoder axis control start condition</td> </tr> <tr> <td>2</td> <td>Cd.320</td> <td>Synchronous encoder axis control start condition</td> </tr> <tr> <td>3</td> <td>Cd.321</td> <td>Synchronous encoder axis control method</td> </tr> <tr> <td>4</td> <td rowspan="2">Cd.322</td> <td>Synchronous encoder axis current value setting address</td> </tr> <tr> <td>5</td> <td>Synchronous encoder axis current value setting address</td> </tr> <tr> <td>6</td> <td rowspan="2">Cd.325</td> <td>Input value for synchronous encoder via device</td> </tr> <tr> <td>7</td> <td>Input value for synchronous encoder via device</td> </tr> <tr> <td>8</td> <td>—</td> <td>Unusable</td> <td>—</td> <td>—</td> <td>—</td> </tr> <tr> <td>9</td> <td></td> <td></td> <td></td> <td></td> <td></td> </tr> </tbody> </table>		Symbol	Signal name	Refresh cycle	Fetch cycle	Signal direction	0	Pr.326	Synchronous encoder axis phase compensation advance time	/	Operation cycle	Command device	1		Synchronous encoder axis control start condition	2	Cd.320	Synchronous encoder axis control start condition	3	Cd.321	Synchronous encoder axis control method	4	Cd.322	Synchronous encoder axis current value setting address	5	Synchronous encoder axis current value setting address	6	Cd.325	Input value for synchronous encoder via device	7	Input value for synchronous encoder via device	8	—	Unusable	—	—	—	9								
	Symbol		Signal name	Refresh cycle	Fetch cycle	Signal direction																																										
0	Pr.326		Synchronous encoder axis phase compensation advance time	/	Operation cycle	Command device																																										
1			Synchronous encoder axis control start condition																																													
2	Cd.320		Synchronous encoder axis control start condition																																													
3	Cd.321		Synchronous encoder axis control method																																													
4	Cd.322		Synchronous encoder axis current value setting address																																													
5			Synchronous encoder axis current value setting address																																													
6	Cd.325		Input value for synchronous encoder via device																																													
7			Input value for synchronous encoder via device																																													
8	—		Unusable	—	—	—																																										
9																																																
2	D14830 to D14839																																															
3	D14840 to D14849																																															
4	D14850 to D14859																																															
5	D14860 to D14869																																															
6	D14870 to D14879																																															
7	D14880 to D14889																																															
8	D14890 to D14899																																															
9	D14900 to D14909																																															
10	D14910 to D14919																																															
11	D14920 to D14929																																															
12	D14930 to D14939																																															

POINT
Refer to Section 5.3.3 and Section 5.3.4 for details of synchronous encoder axis control device.

(24) Output axis control device list

Axis No.	Device No.	Signal name																																																																																																																																									
1	D15000 to D15149	<table border="1"> <thead> <tr> <th></th> <th>Symbol</th> <th>Signal name</th> <th>Refresh cycle</th> <th>Fetch cycle</th> <th>Signal direction</th> </tr> </thead> <tbody> <tr> <td>0</td> <td>Pr.400</td> <td>Main input axis No.</td> <td rowspan="3">/</td> <td>At start of synchronous control</td> <td rowspan="3">Command device</td> </tr> <tr> <td>1</td> <td>Pr.401</td> <td>Sub input axis No.</td> <td>Operation cycle</td> </tr> <tr> <td>2</td> <td>Pr.402</td> <td>Composite main shaft gear</td> <td>—</td> </tr> <tr> <td>3</td> <td>—</td> <td>Unusable</td> <td>—</td> <td>—</td> <td>—</td> </tr> <tr> <td>4</td> <td rowspan="2">Pr.403</td> <td rowspan="2">Main shaft gear: Numerator</td> <td rowspan="39">/</td> <td rowspan="2">At start of synchronous control</td> <td rowspan="39">Command device</td> </tr> <tr> <td>5</td> </tr> <tr> <td>6</td> <td rowspan="2">Pr.404</td> <td rowspan="2">Main shaft gear: Denominator</td> <td>Operation cycle</td> </tr> <tr> <td>7</td> </tr> <tr> <td>8</td> <td>Pr.405</td> <td>Main shaft clutch control setting</td> <td>At start of synchronous control</td> </tr> <tr> <td>9</td> <td rowspan="2">Pr.406</td> <td rowspan="2">Main shaft clutch reference address setting</td> <td>Operation cycle</td> </tr> <tr> <td>10</td> </tr> <tr> <td>11</td> <td rowspan="2">Pr.407</td> <td rowspan="2">Main shaft clutch ON address</td> <td>At start of synchronous control</td> </tr> <tr> <td>12</td> </tr> <tr> <td>13</td> <td rowspan="2">Pr.408</td> <td rowspan="2">Travel value before main shaft clutch ON</td> <td>Operation cycle</td> </tr> <tr> <td>14</td> </tr> <tr> <td>15</td> <td rowspan="2">Pr.409</td> <td rowspan="2">Main shaft clutch OFF address</td> <td>At start of synchronous control</td> </tr> <tr> <td>16</td> </tr> <tr> <td>17</td> <td rowspan="2">Pr.410</td> <td rowspan="2">Travel value before main shaft clutch OFF</td> <td>Operation cycle</td> </tr> <tr> <td>18</td> </tr> <tr> <td>19</td> <td rowspan="2">Pr.411</td> <td rowspan="2">Main shaft clutch smoothing method</td> <td>At start of synchronous control</td> </tr> <tr> <td>20</td> </tr> <tr> <td>21</td> <td rowspan="2">Pr.412</td> <td rowspan="2">Main shaft clutch smoothing time constant</td> <td>Operation cycle</td> </tr> <tr> <td>22</td> </tr> <tr> <td>23</td> <td rowspan="2">Pr.413</td> <td rowspan="2">Slippage amount at main shaft clutch ON</td> <td>At start of synchronous control</td> </tr> <tr> <td>24</td> </tr> <tr> <td>25</td> <td rowspan="2">Pr.414</td> <td rowspan="2">Slippage amount at main shaft clutch OFF</td> <td>Operation cycle</td> </tr> <tr> <td>26</td> </tr> <tr> <td>27</td> <td rowspan="2">Pr.418</td> <td rowspan="2">Auxiliary shaft axis No.</td> <td>At start of synchronous control</td> </tr> <tr> <td>28</td> </tr> <tr> <td>29</td> <td rowspan="2">Pr.419</td> <td rowspan="2">Composite auxiliary shaft gear</td> <td>Operation cycle</td> </tr> <tr> <td>30</td> </tr> <tr> <td>31</td> <td rowspan="2">Pr.420</td> <td rowspan="2">Auxiliary shaft gear: Numerator</td> <td>At start of synchronous control</td> </tr> <tr> <td>32</td> </tr> <tr> <td>33</td> <td rowspan="2">Pr.421</td> <td rowspan="2">Auxiliary shaft gear: Denominator</td> <td>Operation cycle</td> </tr> <tr> <td>34</td> </tr> <tr> <td>35</td> <td rowspan="2">Pr.422</td> <td rowspan="2">Auxiliary shaft clutch control setting</td> <td>At start of synchronous control</td> </tr> <tr> <td>36</td> </tr> <tr> <td>37</td> <td rowspan="2">Pr.423</td> <td rowspan="2">Auxiliary shaft clutch reference address setting</td> <td>Operation cycle</td> </tr> <tr> <td>38</td> </tr> <tr> <td>39</td> <td rowspan="2">Pr.424</td> <td rowspan="2">Auxiliary shaft clutch ON address</td> <td>At start of synchronous control</td> </tr> <tr> <td>40</td> </tr> <tr> <td>41</td> <td rowspan="2">Pr.425</td> <td rowspan="2">Travel value before auxiliary shaft clutch ON</td> <td>Operation cycle</td> </tr> <tr> <td>42</td> </tr> <tr> <td>43</td> <td rowspan="2">Pr.426</td> <td rowspan="2">Auxiliary shaft clutch OFF address</td> <td>At start of synchronous control</td> </tr> <tr> <td>44</td> </tr> <tr> <td>45</td> <td rowspan="2">Pr.427</td> <td rowspan="2">Travel value before auxiliary shaft clutch OFF</td> <td>Operation cycle</td> </tr> <tr> <td>46</td> </tr> </tbody> </table>		Symbol	Signal name	Refresh cycle	Fetch cycle	Signal direction	0	Pr.400	Main input axis No.	/	At start of synchronous control	Command device	1	Pr.401	Sub input axis No.	Operation cycle	2	Pr.402	Composite main shaft gear	—	3	—	Unusable	—	—	—	4	Pr.403	Main shaft gear: Numerator	/	At start of synchronous control	Command device	5	6	Pr.404	Main shaft gear: Denominator	Operation cycle	7	8	Pr.405	Main shaft clutch control setting	At start of synchronous control	9	Pr.406	Main shaft clutch reference address setting	Operation cycle	10	11	Pr.407	Main shaft clutch ON address	At start of synchronous control	12	13	Pr.408	Travel value before main shaft clutch ON	Operation cycle	14	15	Pr.409	Main shaft clutch OFF address	At start of synchronous control	16	17	Pr.410	Travel value before main shaft clutch OFF	Operation cycle	18	19	Pr.411	Main shaft clutch smoothing method	At start of synchronous control	20	21	Pr.412	Main shaft clutch smoothing time constant	Operation cycle	22	23	Pr.413	Slippage amount at main shaft clutch ON	At start of synchronous control	24	25	Pr.414	Slippage amount at main shaft clutch OFF	Operation cycle	26	27	Pr.418	Auxiliary shaft axis No.	At start of synchronous control	28	29	Pr.419	Composite auxiliary shaft gear	Operation cycle	30	31	Pr.420	Auxiliary shaft gear: Numerator	At start of synchronous control	32	33	Pr.421	Auxiliary shaft gear: Denominator	Operation cycle	34	35	Pr.422	Auxiliary shaft clutch control setting	At start of synchronous control	36	37	Pr.423	Auxiliary shaft clutch reference address setting	Operation cycle	38	39	Pr.424	Auxiliary shaft clutch ON address	At start of synchronous control	40	41	Pr.425	Travel value before auxiliary shaft clutch ON	Operation cycle	42	43	Pr.426	Auxiliary shaft clutch OFF address	At start of synchronous control	44	45	Pr.427	Travel value before auxiliary shaft clutch OFF	Operation cycle	46
	Symbol		Signal name	Refresh cycle	Fetch cycle	Signal direction																																																																																																																																					
0	Pr.400		Main input axis No.	/	At start of synchronous control	Command device																																																																																																																																					
1	Pr.401		Sub input axis No.		Operation cycle																																																																																																																																						
2	Pr.402		Composite main shaft gear		—																																																																																																																																						
3	—		Unusable	—	—	—																																																																																																																																					
4	Pr.403		Main shaft gear: Numerator	/	At start of synchronous control	Command device																																																																																																																																					
5																																																																																																																																											
6	Pr.404		Main shaft gear: Denominator		Operation cycle																																																																																																																																						
7																																																																																																																																											
8	Pr.405		Main shaft clutch control setting		At start of synchronous control																																																																																																																																						
9	Pr.406		Main shaft clutch reference address setting		Operation cycle																																																																																																																																						
10																																																																																																																																											
11	Pr.407		Main shaft clutch ON address		At start of synchronous control																																																																																																																																						
12																																																																																																																																											
13	Pr.408		Travel value before main shaft clutch ON		Operation cycle																																																																																																																																						
14																																																																																																																																											
15	Pr.409		Main shaft clutch OFF address		At start of synchronous control																																																																																																																																						
16																																																																																																																																											
17	Pr.410		Travel value before main shaft clutch OFF		Operation cycle																																																																																																																																						
18																																																																																																																																											
19	Pr.411		Main shaft clutch smoothing method		At start of synchronous control																																																																																																																																						
20																																																																																																																																											
21	Pr.412		Main shaft clutch smoothing time constant		Operation cycle																																																																																																																																						
22																																																																																																																																											
23	Pr.413		Slippage amount at main shaft clutch ON		At start of synchronous control																																																																																																																																						
24																																																																																																																																											
25	Pr.414		Slippage amount at main shaft clutch OFF		Operation cycle																																																																																																																																						
26																																																																																																																																											
27	Pr.418		Auxiliary shaft axis No.		At start of synchronous control																																																																																																																																						
28																																																																																																																																											
29	Pr.419		Composite auxiliary shaft gear		Operation cycle																																																																																																																																						
30																																																																																																																																											
31	Pr.420		Auxiliary shaft gear: Numerator		At start of synchronous control																																																																																																																																						
32																																																																																																																																											
33	Pr.421		Auxiliary shaft gear: Denominator		Operation cycle																																																																																																																																						
34																																																																																																																																											
35	Pr.422		Auxiliary shaft clutch control setting		At start of synchronous control																																																																																																																																						
36																																																																																																																																											
37	Pr.423	Auxiliary shaft clutch reference address setting	Operation cycle																																																																																																																																								
38																																																																																																																																											
39	Pr.424	Auxiliary shaft clutch ON address	At start of synchronous control																																																																																																																																								
40																																																																																																																																											
41	Pr.425	Travel value before auxiliary shaft clutch ON	Operation cycle																																																																																																																																								
42																																																																																																																																											
43	Pr.426	Auxiliary shaft clutch OFF address	At start of synchronous control																																																																																																																																								
44																																																																																																																																											
45	Pr.427	Travel value before auxiliary shaft clutch OFF	Operation cycle																																																																																																																																								
46																																																																																																																																											
2	D15150 to D15299																																																																																																																																										
3	D15300 to D15449																																																																																																																																										
4	D15450 to D15599																																																																																																																																										
5	D15600 to D15749																																																																																																																																										
6	D15750 to D15899																																																																																																																																										
7	D15900 to D16049																																																																																																																																										
8	D16050 to D16199																																																																																																																																										
9	D16200 to D16349																																																																																																																																										
10	D16350 to D16499																																																																																																																																										
11	D16500 to D16649																																																																																																																																										
12	D16650 to D16799																																																																																																																																										
13	D16800 to D16949																																																																																																																																										
14	D16950 to D17099																																																																																																																																										
15	D17100 to D17249																																																																																																																																										
16	D17250 to D17399																																																																																																																																										
17	D17400 to D17549																																																																																																																																										
18	D17550 to D17699																																																																																																																																										
19	D17700 to D17849																																																																																																																																										
20	D17850 to D17999																																																																																																																																										
21	D18000 to D18149																																																																																																																																										
22	D18150 to D18299																																																																																																																																										
23	D18300 to D18449																																																																																																																																										
24	D18450 to D18599																																																																																																																																										
25	D18600 to D18749																																																																																																																																										
26	D18750 to D18899																																																																																																																																										
27	D18900 to D19049																																																																																																																																										
28	D19050 to D19199																																																																																																																																										
29	D19200 to D19349																																																																																																																																										
30	D19350 to D19499																																																																																																																																										
31	D19500 to D19649																																																																																																																																										
32	D19650 to D19799																																																																																																																																										

Output axis control device list (Continued)

Axis No.	Device No.	Signal name					
1	D15000 to D15149						
2	D15150 to D15299						
3	D15300 to D15449						
4	D15450 to D15599						
5	D15600 to D15749						
6	D15750 to D15899						
7	D15900 to D16049						
8	D16050 to D16199						
9	D16200 to D16349						
10	D16350 to D16499						
11	D16500 to D16649						
12	D16650 to D16799						
13	D16800 to D16949						
14	D16950 to D17099						
15	D17100 to D17249						
16	D17250 to D17399						
17	D17400 to D17549						
18	D17550 to D17699						
19	D17700 to D17849						
20	D17850 to D17999						
21	D18000 to D18149						
22	D18150 to D18299						
23	D18300 to D18449						
24	D18450 to D18599						
25	D18600 to D18749						
26	D18750 to D18899						
27	D18900 to D19049						
28	D19050 to D19199						
29	D19200 to D19349						
30	D19350 to D19499						
31	D19500 to D19649						
32	D19650 to D19799						
		40	Pr.428	Auxiliary shaft clutch smoothing method		At start of synchronous control	Command device
		41	Pr.429	Auxiliary shaft clutch smoothing time constant		At turning clutch ON	
		42	Pr.430	Slippage amount at auxiliary shaft clutch ON		At turning clutch OFF	
		43		Slippage amount at auxiliary shaft clutch OFF			
		44	Pr.431	Speed change gear 1		At start of synchronous control	
		45		Speed change gear 1 smoothing time constant			
		46	Pr.436	Speed change ratio 1: Numerator		Operation cycle	
		47		Speed change ratio 1: Denominator			
		48		Speed change gear 2			
		49	Pr.490	Speed change gear 2 smoothing time constant		At start of synchronous control	
		50		Speed change ratio 2: Numerator			
		51	Pr.493	Speed change ratio 2: Denominator		Operation cycle	
		52		Cam axis cycle unit setting			
53	Cam axis length per cycle change setting <small>Ver.!</small>						
54	Pr.439	Cam axis length per cycle	At start of synchronous control, At passing through the 0th point of cam data				
55		Cam No.					
56	—	Unusable	—	—			
57	Pr.441	Cam stroke amount	At start of synchronous control, At passing through the 0th point of cam data	Command device			
58					Cam axis phase compensation advance time		
59	Pr.444	Cam axis phase compensation advance time	Operation cycle				

Ver.! : Refer to Section 1.4 for the software version that supports this function.

APPENDICES

Output axis control device list (Continued)

Axis No.	Device No.	Signal name				
1	D15000 to D15149					
2	D15150 to D15299					
3	D15300 to D15449					
4	D15450 to D15599					
5	D15600 to D15749	68	Pr.445	Cam axis phase compensation time constant	At start of synchronous control	Command device
6	D15750 to D15899	69	Pr.448	Synchronous control parameter block No.		
7	D15900 to D16049	70	Pr.447	Output axis smoothing time constant		
8	D16050 to D16199	71		Unusable		
9	D16200 to D16349	72				
10	D16350 to D16499	73				
11	D16500 to D16649	74				
12	D16650 to D16799	75				
13	D16800 to D16949	76				
14	D16950 to D17099	77				
15	D17100 to D17249	78				
16	D17250 to D17399	79				
17	D17400 to D17549	80				
18	D17550 to D17699	81				
19	D17700 to D17849	82				
20	D17850 to D17999	83				
21	D18000 to D18149	84				
22	D18150 to D18299	85	—			
23	D18300 to D18449	86				
24	D18450 to D18599	87				
25	D18600 to D18749	88				
26	D18750 to D18899	89				
27	D18900 to D19049	90				
28	D19050 to D19199	91				
29	D19200 to D19349	92				
30	D19350 to D19499	93				
31	D19500 to D19649	94				
32	D19650 to D19799	95				
		96				
		97				
		98				
		99				
		100	Pr.460	Setting method of current value per cycle after main shaft gear	At start of synchronous control	Command device
		101	Pr.461	Setting method of current value per cycle after auxiliary shaft gear		
		102	Pr.462	Cam axis position restoration object		
		103	Pr.463	Setting method of cam reference position		
		104	Pr.464	Setting method of cam axis current value per cycle		
		105	—	Unusable		

POINT

- | |
|-----------------------------------------------------------------------------------------------------------------------------------------------------------------------------------------------------------------------------------------------------------------------------------------------------------------------------------|
| <p>(1) The range of axis No.1 to 16 is valid in the Q172DSCPU.</p> <p>(2) The device area more than 17 axes in the Q172DSCPU can be used as a user device.</p> <p>(3) Refer to Section 7.1.2, Section 7.1.3, Section7.2.3, Section7.4.2, Section7.5.2, Section7.6.2 and Section8.5 for details of output axis control device.</p> |
|-----------------------------------------------------------------------------------------------------------------------------------------------------------------------------------------------------------------------------------------------------------------------------------------------------------------------------------|

(25) Common device list

Device No.	Signal name	Refresh cycle	Fetch cycle	Signal direction	Device No.	Signal name	Refresh cycle	Fetch cycle	Signal direction	
D704	PLC ready flag request	/	Main cycle	Command device	D752	Manual pulse generator 1 smoothing magnification setting register	/	At the manual pulse generator enable flag OFF to ON	Command device	
D705	Speed switching point specified flag request				D753	Manual pulse generator 2 smoothing magnification setting register				
D706	All axes servo ON command request				D754	Manual pulse generator 3 smoothing magnification setting register				
D707	Unusable	—	—	—	D755	Manual pulse generator 1 enable flag request	/	Main cycle	Command device	
D708	JOG operation simultaneous start command request	/	Main cycle	Command device	D756	Manual pulse generator 2 enable flag request				
D709	Unusable	—	—	—	D757	Manual pulse generator 3 enable flag request				
D710	JOG operation simultaneous start axis setting register	/	At start	Command device	D758	Unusable (42 points)	—	—	—	
D711			/		At the manual pulse generator enable flag OFF to ON					D759
D712										D760
D713										D761
D714	Manual pulse generator axis 1 No. setting register	/	At the manual pulse generator enable flag OFF to ON	Command device	D762					
D715	Manual pulse generator axis 2 No. setting register				D763					
D716	Manual pulse generator axis 3 No. setting register				D764					
D717	Axis 1				D765					
D718	Axis 2				D766					
D719	Axis 3				D767					
D720	Axis 4				D768					
D721	Axis 5				D769					
D722	Axis 6				D770					
D723	Axis 7				D771					
D724	Axis 8				D772					
D725	Axis 9				D773					
D726	Axis 10				D774					
D727	Axis 11				D775					
D728	Axis 12				D776					
D729	Axis 13				D777					
D730	Axis 14				D778					
D731	Axis 15				D779					
D732	Axis 16				D780					
D733	Axis 17				D781					
D734	Axis 18				D782					
D735	Axis 19				D783					
D736	Axis 20				D784					
D737	Axis 21				D785					
D738	Axis 22				D786					
D739	Axis 23				D787					
D740	Axis 24				D788					
D741	Axis 25				D789					
D742	Axis 26				D790					
D743	Axis 27				D791					
D744	Axis 28				D792					
D745	Axis 29				D793					
D746	Axis 30	D794								
D747	Axis 31	D795								
D748	Axis 32	D796								
D749		D797								
D750		D798								
D751		D799								

(Note-1): The range of axis No.1 to 16 is valid in the Q172DSCPU.
 (Note-2): Device area 17 axes of more is unusable in the Q172DSCPU.

POINT

Refer to the "Q173D(S)CPU/Q172D(S)CPU Motion controller (SV13/SV22) Programming Manual (REAL MODE)" for details of common device.

(26) Motion register list (#)

Axis No.	Device No.	Signal name		
1	#8000 to #8019			
2	#8020 to #8039			
3	#8040 to #8059			
4	#8060 to #8079			
5	#8080 to #8099			
6	#8100 to #8119			
7	#8120 to #8139			
8	#8140 to #8159			
9	#8160 to #8179			
10	#8180 to #8199			
11	#8200 to #8219			
12	#8220 to #8239			
13	#8240 to #8259			
14	#8260 to #8279			
15	#8280 to #8299			
16	#8300 to #8319			
17	#8320 to #8339			
18	#8340 to #8359			
19	#8360 to #8379			
20	#8380 to #8399			
21	#8400 to #8419			
22	#8420 to #8439			
23	#8440 to #8459			
24	#8460 to #8479			
25	#8480 to #8499			
26	#8500 to #8519			
27	#8520 to #8539			
28	#8540 to #8559			
29	#8560 to #8579			
30	#8580 to #8599			
31	#8600 to #8619			
32	#8620 to #8639			

	Signal name	Refresh cycle	Signal direction	
0	Servo amplifier type	When the servo amplifier power-on	Monitor device	
1	Motor current value	Operation cycle 1.7[ms] or less : Operation cycle Operation cycle 3.5[ms] or more : 3.5[ms]		
2	Motor speed			
3				
4	Command speed	Operation cycle		
5				
6	Home position return re-travel value	At home position return re-travel		
7				
8	Servo amplifier display servo error code	Main cycle		
9				Parameter error No.
10				Servo status1
11	Servo status2	Operation cycle 1.7[ms] or less : Operation cycle Operation cycle 3.5[ms] or more : 3.5[ms]		
12	Servo status3			
13	Unusable	—	—	
14	Servo status5 Ver.!	Operation cycle 1.7[ms] or less : Operation cycle Operation cycle 3.5[ms] or more : 3.5[ms]	Monitor device	
15	Unusable	—	—	
16				
17				
18	Servo status7 Ver.!	Operation cycle 1.7[ms] or less : Operation cycle Operation cycle 3.5[ms] or more : 3.5[ms]	Monitor device	
19	Unusable	—	—	

POINT
Refer to the "Q173D(S)CPU/Q172D(S)CPU Motion controller (SV13/SV22) Programming Manual (REAL MODE)" for details of monitor device.

Ver.! : Refer to Section 1.4 for the software version that supports this function.

(27) Product information list devices

Device No.	Signal name	Refresh cycle	Fetch cycle	Signal direction
#8736 to #8743	Operating system software version	At power on	/	Monitor device
#8744 to #8751	Motion CPU module serial number			

POINT
 Refer to the "Q173D(S)CPU/Q172D(S)CPU Motion controller (SV13/SV22) Programming Manual (REAL MODE)" for details of product information list device.

(28) Special relay list

Device No.	Signal name	Refresh cycle	Fetch cycle	Signal type
SM500	PCPU READY complete flag	Main cycle	/	Status signal
SM501	TEST mode ON flag			
SM502	External forced stop input flag	Operation cycle		
SM503	Digital oscilloscope executing flag	Main cycle		
SM506	External forced stop input ON latch flag ^{Ver.!}	Operation cycle		
SM508	Amplifier-less operation status flag	Main cycle		
SM510	TEST mode request error flag			
SM512	Motion CPU WDT error flag			
SM513	Manual pulse generator axis setting error flag			
SM516	Servo program setting error flag			

Ver.! : Refer to Section 1.4 for the software version that supports this function.

(29) Special register list

Device No.	Signal name	Refresh cycle	Fetch cycle	Signal direction		
SD200	State of switch	Main cycle		Monitor device		
SD502	Servo amplifier loading information	At power supply on/ operation cycle				
SD503						
SD508	SSCNET control (status)	Main cycle				
SD510	Test mode request error information	At test mode request				
SD511						
SD512	Motion CPU WDT error cause	At Motion CPU WDT error occurrence				
SD513	Manual pulse generator axis setting error information	At the manual pulse generator enable flag \uparrow				
SD514						
SD515						
SD516	Error program No.	At start				
SD517	Error item information					
SD522	Motion operation cycle	Operation cycle				
SD523	Operation cycle of the Motion CPU setting	At power supply on				
SD524	Maximum Motion operation cycle	Operation cycle				
SD550	System setting error information	At System setting error occurrence				
SD551						
SD560	Operation method Ver.1	At power supply on				
SD803	SSCNET control (command)				Main cycle	Command device

Ver.1: Refer to Section 1.4 for the software version that supports this function.

MEMO

WARRANTY

Please confirm the following product warranty details before using this product.

1. Gratis Warranty Term and Gratis Warranty Range

We will repair any failure or defect hereinafter referred to as "failure" in our FA equipment hereinafter referred to as the "Product" arisen during warranty period at no charge due to causes for which we are responsible through the distributor from which you purchased the Product or our service provider. However, we will charge the actual cost of dispatching our engineer for an on-site repair work on request by customer in Japan or overseas countries. We are not responsible for any on-site readjustment and/or trial run that may be required after a defective unit is repaired or replaced.

[Gratis Warranty Term]

The term of warranty for Product is thirty six (36) months after your purchase or delivery of the Product to a place designated by you or forty two (42) months from the date of manufacture whichever comes first "Warranty Period". Warranty period for repaired Product cannot exceed beyond the original warranty period before any repair work.

[Gratis Warranty Range]

- (1) You are requested to conduct an initial failure diagnosis by yourself, as a general rule.
It can also be carried out by us or our service company upon your request and the actual cost will be charged. However, it will not be charged if we are responsible for the cause of the failure.
- (2) This limited warranty applies only when the condition, method, environment, etc. of use are in compliance with the terms and conditions and instructions that are set forth in the instruction manual and user manual for the Product and the caution label affixed to the Product.
- (3) Even during the term of warranty, the repair cost will be charged on you in the following cases;
 - 1) A failure caused by your improper storing or handling, carelessness or negligence, etc., and a failure caused by your hardware or software problem
 - 2) A failure caused by any alteration, etc. to the Product made on your side without our approval
 - 3) A failure which may be regarded as avoidable, if your equipment in which the Product is incorporated is equipped with a safety device required by applicable laws and has any function or structure considered to be indispensable according to a common sense in the industry
 - 4) A failure which may be regarded as avoidable if consumable parts designated in the instruction manual, etc. are duly maintained and replaced
 - 5) Any replacement of consumable parts (battery, fan, etc.)
 - 6) A failure caused by external factors such as inevitable accidents, including without limitation fire and abnormal fluctuation of voltage, and acts of God, including without limitation earthquake, lightning and natural disasters
 - 7) A failure generated by an unforeseeable cause with a scientific technology that was not available at the time of the shipment of the Product from our company
 - 8) Any other failures which we are not responsible for or which you acknowledge we are not responsible for

2. Onerous Repair Term after Discontinuation of Production

- (1) We may accept the repair at charge for another seven (7) years after the production of the product is discontinued.
The announcement of the stop of production for each model can be seen in our Sales and Service, etc.
- (2) Please note that the Product (including its spare parts) cannot be ordered after its stop of production.

3. Service in overseas countries

Our regional FA Center in overseas countries will accept the repair work of the Product; However, the terms and conditions of the repair work may differ depending on each FA Center. Please ask your local FA center for details.

4. Exclusion of Loss in Opportunity and Secondary Loss from Warranty Liability

Regardless of the gratis warranty term, Mitsubishi shall not be liable for compensation to:

- (1) Damages caused by any cause found not to be the responsibility of Mitsubishi.
- (2) Loss in opportunity, lost profits incurred to the user by Failures of Mitsubishi products.
- (3) Special damages and secondary damages whether foreseeable or not, compensation for accidents, and compensation for damages to products other than Mitsubishi products.
- (4) Replacement by the user, maintenance of on-site equipment, start-up test run and other tasks.

5. Change of Product specifications

Specifications listed in our catalogs, manuals or technical documents may be changed without notice.

6. Precautions for Choosing the Products

- (1) For the use of our Motion controller, its applications should be those that may not result in a serious damage even if any failure or malfunction occurs in Motion controller, and a backup or fail-safe function should operate on an external system to Motion controller when any failure or malfunction occurs.
- (2) Our Motion controller is designed and manufactured as a general purpose product for use at general industries. Therefore, applications substantially influential on the public interest for such as atomic power plants and other power plants of electric power companies, and also which require a special quality assurance system, including applications for railway companies and government or public offices are not recommended, and we assume no responsibility for any failure caused by these applications when used.
In addition, applications which may be substantially influential to human lives or properties for such as airlines, medical treatments, railway service, incineration and fuel systems, man-operated material handling equipment, entertainment machines, safety machines, etc. are not recommended, and we assume no responsibility for any failure caused by these applications when used.
We will review the acceptability of the abovementioned applications, if you agree not to require a specific quality for a specific application. Please contact us for consultation.
- (3) Mitsubishi shall have no responsibility or liability for any problems involving programmable controller trouble and system trouble caused by DoS attacks, unauthorized access, computer viruses, and other cyberattacks.

Microsoft, Windows, Windows NT, Windows Vista, and Windows XP are either registered trademarks or trademarks of Microsoft Corporation in the United States and/or other countries.

The company names, system names and product names mentioned in this manual are either registered trademarks or trademarks of their respective companies.

In some cases, trademark symbols such as '™' or '®' are not specified in this manual.

IB(NA)-0300198-G(2204)MEE

MODEL: Q173D-P-SV22-ADV-E

MODEL CODE: 1XB953

MITSUBISHI ELECTRIC CORPORATION

HEAD OFFICE : TOKYO BUILDING, 2-7-3 MARUNOUCHI, CHIYODA-KU, TOKYO 100-8310, JAPAN
NAGOYA WORKS : 1-14, YADA-MINAMI 5-CHOME, HIGASHI-KU, NAGOYA, JAPAN

When exported from Japan, this manual does not require application to the
Ministry of Economy, Trade and Industry for service transaction permission.

Specifications subject to change without notice.