

Motion Controller

MELSEC **Q** series

Q173D(S)CPU/Q172D(S)CPU
Motion Controller (SV13/SV22)
Programming Manual (REAL MODE)

- Q172DCPU
- Q173DCPU
- Q172DCPU-S1
- Q173DCPU-S1
- Q172DSCPU
- Q173DSCPU

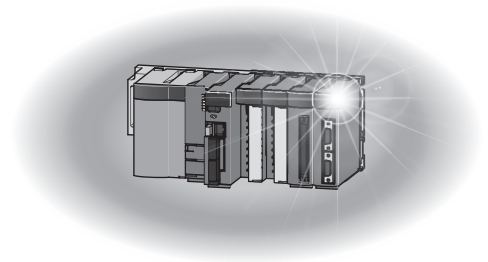

● SAFETY PRECAUTIONS ●

(Please read these instructions before using this equipment.)

Before using this product, please read this manual and the relevant manuals introduced in this manual carefully and pay full attention to safety to handle the product correctly.

These precautions apply only to this product. Refer to the Q173D(S)CPU/Q172D(S)CPU Users manual for a description of the Motion controller safety precautions.

In this manual, the safety instructions are ranked as "DANGER" and "CAUTION".

 **DANGER**

Indicates that incorrect handling may cause hazardous conditions, resulting in death or severe injury.

 **CAUTION**

Indicates that incorrect handling may cause hazardous conditions, resulting in medium or slight personal injury or physical damage.

Depending on circumstances, procedures indicated by  CAUTION may also be linked to serious results.

In any case, it is important to follow the directions for usage.

Please save this manual to make it accessible when required and always forward it to the end user.

For Safe Operations

1. Prevention of electric shocks

DANGER

- Never open the front case or terminal covers while the power is ON or the unit is running, as this may lead to electric shocks.
- Never run the unit with the front case or terminal cover removed. The high voltage terminal and charged sections will be exposed and may lead to electric shocks.
- Never open the front case or terminal cover at times other than wiring work or periodic inspections even if the power is OFF. The insides of the Motion controller and servo amplifier are charged and may lead to electric shocks.
- Completely turn off the externally supplied power used in the system before mounting or removing the module, performing wiring work, or inspections. Failing to do so may lead to electric shocks.
- When performing wiring work or inspections, turn the power OFF, wait at least ten minutes, and then check the voltage with a tester, etc. Failing to do so may lead to electric shocks.
- Be sure to ground the Motion controller, servo amplifier and servo motor. (Ground resistance : 100 Ω or less) Do not ground commonly with other devices.
- The wiring work and inspections must be done by a qualified technician.
- Wire the units after installing the Motion controller, servo amplifier and servo motor. Failing to do so may lead to electric shocks or damage.
- Never operate the switches with wet hands, as this may lead to electric shocks.
- Do not damage, apply excessive stress, place heavy things on or sandwich the cables, as this may lead to electric shocks.
- Do not touch the Motion controller, servo amplifier or servo motor terminal blocks while the power is ON, as this may lead to electric shocks.
- Do not touch the built-in power supply, built-in grounding or signal wires of the Motion controller and servo amplifier, as this may lead to electric shocks.

2. For fire prevention

CAUTION

- Install the Motion controller, servo amplifier, servo motor and regenerative resistor on incombustible. Installing them directly or close to combustibles will lead to fire.
- If a fault occurs in the Motion controller or servo amplifier, shut the power OFF at the servo amplifier's power source. If a large current continues to flow, fire may occur.
- When using a regenerative resistor, shut the power OFF with an error signal. The regenerative resistor may abnormally overheat due to a fault in the regenerative transistor, etc., and may lead to fire.
- Always take heat measures such as flame proofing for the inside of the control panel where the servo amplifier or regenerative resistor is installed and for the wires used. Failing to do so may lead to fire.
- Do not damage, apply excessive stress, place heavy things on or sandwich the cables, as this may lead to fire.

3. For injury prevention

CAUTION

- Do not apply a voltage other than that specified in the instruction manual on any terminal. Doing so may lead to destruction or damage.
- Do not mistake the terminal connections, as this may lead to destruction or damage.
- Do not mistake the polarity (+ / -), as this may lead to destruction or damage.
- Do not touch the heat radiating fins of controller or servo amplifier, regenerative resistor and servo motor, etc., while the power is ON and for a short time after the power is turned OFF. In this timing, these parts become very hot and may lead to burns.
- Always turn the power OFF before touching the servo motor shaft or coupled machines, as these parts may lead to injuries.
- Do not go near the machine during test operations or during operations such as teaching. Doing so may lead to injuries.

4. Various precautions

Strictly observe the following precautions.

Mistaken handling of the unit may lead to faults, injuries or electric shocks.

(1) System structure

CAUTION

- Always install a leakage breaker on the Motion controller and servo amplifier power source.
- If installation of an electromagnetic contactor for power shut off during an error, etc., is specified in the instruction manual for the servo amplifier, etc., always install the electromagnetic contactor.
- Install the emergency stop circuit externally so that the operation can be stopped immediately and the power shut off.
- Use the Motion controller, servo amplifier, servo motor and regenerative resistor with the correct combinations listed in the instruction manual. Other combinations may lead to fire or faults.
- Use the Motion controller, base unit and motion module with the correct combinations listed in the instruction manual. Other combinations may lead to faults.
- If safety standards (ex., robot safety rules, etc.,) apply to the system using the Motion controller, servo amplifier and servo motor, make sure that the safety standards are satisfied.
- Construct a safety circuit externally of the Motion controller or servo amplifier if the abnormal operation of the Motion controller or servo amplifier differ from the safety directive operation in the system.
- In systems where coasting of the servo motor will be a problem during the forced stop, emergency stop, servo OFF or power supply OFF, use dynamic brakes.
- Make sure that the system considers the coasting amount even when using dynamic brakes.
- In systems where perpendicular shaft dropping may be a problem during the forced stop, emergency stop, servo OFF or power supply OFF, use both dynamic brakes and electromagnetic brakes.

CAUTION

- The dynamic brakes must be used only on errors that cause the forced stop, emergency stop, or servo OFF. These brakes must not be used for normal braking.
- The brakes (electromagnetic brakes) assembled into the servo motor are for holding applications, and must not be used for normal braking.
- The system must have a mechanical allowance so that the machine itself can stop even if the stroke limits switch is passed through at the max. speed.
- Use wires and cables that have a wire diameter, heat resistance and bending resistance compatible with the system.
- Use wires and cables within the length of the range described in the instruction manual.
- The ratings and characteristics of the parts (other than Motion controller, servo amplifier and servo motor) used in a system must be compatible with the Motion controller, servo amplifier and servo motor.
- Install a cover on the shaft so that the rotary parts of the servo motor are not touched during operation.
- There may be some cases where holding by the electromagnetic brakes is not possible due to the life or mechanical structure (when the ball screw and servo motor are connected with a timing belt, etc.). Install a stopping device to ensure safety on the machine side.

(2) Security

CAUTION

- To maintain the security (confidentiality, integrity, and availability) of the programmable controller and the system against unauthorized access, denial-of-service (DoS) attacks, computer viruses, and other cyberattacks from external devices via the network, take appropriate measures such as firewalls, virtual private networks (VPNs), and antivirus solutions.

(3) Parameter settings and programming

CAUTION

- Set the parameter values to those that are compatible with the Motion controller, servo amplifier, servo motor and regenerative resistor model and the system application. The protective functions may not function if the settings are incorrect.
- The regenerative resistor model and capacity parameters must be set to values that conform to the operation mode, servo amplifier and servo power supply module. The protective functions may not function if the settings are incorrect.
- Set the mechanical brake output and dynamic brake output validity parameters to values that are compatible with the system application. The protective functions may not function if the settings are incorrect.
- Set the stroke limit input validity parameter to a value that is compatible with the system application. The protective functions may not function if the setting is incorrect.

CAUTION

- Set the servo motor encoder type (increment, absolute position type, etc.) parameter to a value that is compatible with the system application. The protective functions may not function if the setting is incorrect.
- Set the servo motor capacity and type (standard, low-inertia, flat, etc.) parameter to values that are compatible with the system application. The protective functions may not function if the settings are incorrect.
- Set the servo amplifier capacity and type parameters to values that are compatible with the system application. The protective functions may not function if the settings are incorrect.
- Use the program commands for the program with the conditions specified in the instruction manual.
- Set the sequence function program capacity setting, device capacity, latch validity range, I/O assignment setting, and validity of continuous operation during error detection to values that are compatible with the system application. The protective functions may not function if the settings are incorrect.
- Some devices used in the program have fixed applications, so use these with the conditions specified in the instruction manual.
- The input devices and data registers assigned to the link will hold the data previous to when communication is terminated by an error, etc. Thus, an error correspondence interlock program specified in the instruction manual must be used.
- Use the interlock program specified in the intelligent function module's instruction manual for the program corresponding to the intelligent function module.

(4) Transportation and installation

CAUTION

- Transport the product with the correct method according to the mass.
- Use the servo motor suspension bolts only for the transportation of the servo motor. Do not transport the servo motor with machine installed on it.
- Do not stack products past the limit.
- When transporting the Motion controller or servo amplifier, never hold the connected wires or cables.
- When transporting the servo motor, never hold the cables, shaft or detector.
- When transporting the Motion controller or servo amplifier, never hold the front case as it may fall off.
- When transporting, installing or removing the Motion controller or servo amplifier, never hold the edges.
- Install the unit according to the instruction manual in a place where the mass can be withstood.
- Do not get on or place heavy objects on the product.
- Always observe the installation direction.
- Keep the designated clearance between the Motion controller or servo amplifier and control panel inner surface or the Motion controller and servo amplifier, Motion controller or servo amplifier and other devices.

⚠ CAUTION

- Do not install or operate Motion controller, servo amplifiers or servo motors that are damaged or that have missing parts.
- Do not block the intake/outtake ports of the Motion controller, servo amplifier and servo motor with cooling fan.
- Do not allow conductive matter such as screw or cutting chips or combustible matter such as oil enter the Motion controller, servo amplifier or servo motor.
- The Motion controller, servo amplifier and servo motor are precision machines, so do not drop or apply strong impacts on them.
- Securely fix the Motion controller, servo amplifier and servo motor to the machine according to the instruction manual. If the fixing is insufficient, these may come off during operation.
- Always install the servo motor with reduction gears in the designated direction. Failing to do so may lead to oil leaks.
- Store and use the unit in the following environmental conditions.

Environment	Conditions	
	Motion controller/Servo amplifier	Servo motor
Ambient temperature	According to each instruction manual.	0°C to +40°C (With no freezing) (32°F to +104°F)
Ambient humidity	According to each instruction manual.	80% RH or less (With no dew condensation)
Storage temperature	According to each instruction manual.	-20°C to +65°C (-4°F to +149°F)
Atmosphere	Indoors (where not subject to direct sunlight). No corrosive gases, flammable gases, oil mist or dust must exist	
Altitude	According to each instruction manual	
Vibration	According to each instruction manual	

- When coupling with the synchronous encoder or servo motor shaft end, do not apply impact such as by hitting with a hammer. Doing so may lead to detector damage.
- Do not apply a load larger than the tolerable load onto the synchronous encoder and servo motor shaft. Doing so may lead to shaft breakage.
- When not using the module for a long time, disconnect the power line from the Motion controller or servo amplifier.
- Place the Motion controller and servo amplifier in static electricity preventing vinyl bags and store.
- When storing for a long time, please contact with our sales representative.
Also, execute a trial operation.
- When fumigants that contain halogen materials such as fluorine, chlorine, bromine, and iodine are used for disinfecting and protecting wooden packaging from insects, they cause malfunction when entering our products.
Please take necessary precautions to ensure that remaining materials from fumigant do not enter our products, or treat packaging with methods other than fumigation (heat method).
Additionally, disinfect and protect wood from insects before packing products.

(5) Wiring

⚠ CAUTION

- Correctly and securely wire the wires. Reconfirm the connections for mistakes and the terminal screws for tightness after wiring. Failing to do so may lead to run away of the servo motor.
- After wiring, install the protective covers such as the terminal covers to the original positions.
- Do not install a phase advancing capacitor, surge absorber or radio noise filter (option FR-BIF) on the output side of the servo amplifier.
- Correctly connect the output side (terminal U, V, W) and ground. Incorrect connections will lead the servo motor to operate abnormally.
- Do not connect a commercial power supply to the servo motor, as this may lead to trouble.
- Do not mistake the direction of the surge absorbing diode installed on the DC relay for the control signal output of brake signals, etc. Incorrect installation may lead to signals not being output when trouble occurs or the protective functions not functioning.

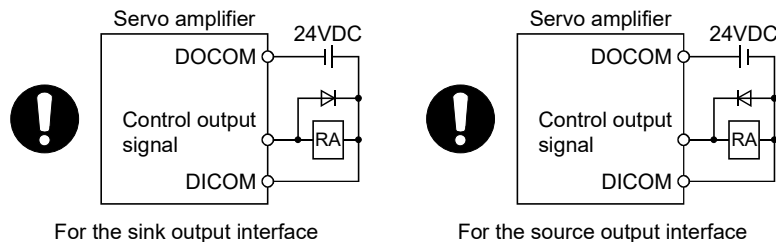

- Do not connect or disconnect the connection cables between each unit, the encoder cable or PLC expansion cable while the power is ON.
- Securely tighten the cable connector fixing screws and fixing mechanisms. Insufficient fixing may lead to the cables coming off during operation.
- Do not bundle the power line or cables.

(6) Trial operation and adjustment

⚠ CAUTION

- Confirm and adjust the program and each parameter before operation. Unpredictable movements may occur depending on the machine.
- Extreme adjustments and changes may lead to unstable operation, so never make them.
- When using the absolute position system function, on starting up, and when the Motion controller or absolute position motor has been replaced, always perform a home position return.
- Before starting test operation, set the parameter speed limit value to the slowest value, and make sure that operation can be stopped immediately by the forced stop, etc. if a hazardous state occurs.

(7) Usage methods

⚠ CAUTION

- Immediately turn OFF the power if smoke, abnormal sounds or odors are emitted from the Motion controller, servo amplifier or servo motor.
- Always execute a test operation before starting actual operations after the program or parameters have been changed or after maintenance and inspection.
- Do not attempt to disassemble and repair the units excluding a qualified technician whom our company recognized.
- Do not make any modifications to the unit.
- Keep the effect or electromagnetic obstacles to a minimum by installing a noise filter or by using wire shields, etc. Electromagnetic obstacles may affect the electronic devices used near the Motion controller or servo amplifier.
- When using the CE Mark-compliant equipment, refer to the User's manual for the Motion controllers and refer to the corresponding EMC guideline information for the servo amplifiers, inverters and other equipment.
- Use the units with the following conditions.

Item	Conditions
Input power	According to each instruction manual.
Input frequency	According to each instruction manual.
Tolerable momentary power failure	According to each instruction manual.

(8) Corrective actions for errors

⚠ CAUTION

- If an error occurs in the self diagnosis of the Motion controller or servo amplifier, confirm the check details according to the instruction manual, and restore the operation.
- If a dangerous state is predicted in case of a power failure or product failure, use a servo motor with electromagnetic brakes or install a brake mechanism externally.
- Use a double circuit construction so that the electromagnetic brake operation circuit can be operated by emergency stop signals set externally.

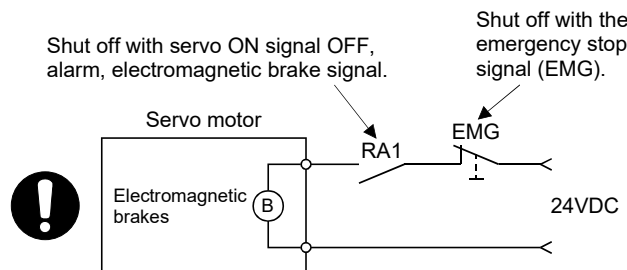

- If an error occurs, remove the cause, secure the safety and then resume operation after alarm release.
- The unit may suddenly resume operation after a power failure is restored, so do not go near the machine. (Design the machine so that personal safety can be ensured even if the machine restarts suddenly.)

(9) Maintenance, inspection and part replacement

CAUTION

- Perform the daily and periodic inspections according to the instruction manual.
- Perform maintenance and inspection after backing up the program and parameters for the Motion controller and servo amplifier.
- Do not place fingers or hands in the clearance when opening or closing any opening.
- Periodically replace consumable parts such as batteries according to the instruction manual.
- Do not touch the lead sections such as ICs or the connector contacts.
- Before touching the module, always touch grounded metal, etc. to discharge static electricity from human body. Failure to do so may cause the module to fail or malfunction.
- Do not directly touch the module's conductive parts and electronic components. Touching them could cause an operation failure or give damage to the module.
- Do not place the Motion controller or servo amplifier on metal that may cause a power leakage or wood, plastic or vinyl that may cause static electricity buildup.
- Do not perform a megger test (insulation resistance measurement) during inspection.
- When replacing the Motion controller or servo amplifier, always set the new module settings correctly.
- When the Motion controller or absolute value motor has been replaced, carry out a home position return operation using one of the following methods, otherwise position displacement could occur.
 - 1) After writing the servo data to the Motion controller using programming software, switch on the power again, then perform a home position return operation.
 - 2) Using the backup function of the programming software, load the data backed up before replacement.
- After maintenance and inspections are completed, confirm that the position detection of the absolute position detector function is correct.
- Do not drop or impact the battery installed to the module. Doing so may damage the battery, causing battery liquid to leak in the battery. Do not use the dropped or impacted battery, but dispose of it.
- Do not short circuit, charge, overheat, incinerate or disassemble the batteries.
- The electrolytic capacitor will generate gas during a fault, so do not place your face near the Motion controller or servo amplifier.
- The electrolytic capacitor and fan will deteriorate. Periodically replace these to prevent secondary damage from faults. Replacements can be made by our sales representative.
- Lock the control panel and prevent access to those who are not certified to handle or install electric equipment.
- Do not burn or break a module and servo amplifier. Doing so may cause a toxic gas.

(10) About processing of waste

When you discard Motion controller, servo amplifier, a battery (primary battery) and other option articles, please follow the law of each country (area).

CAUTION

- This product is not designed or manufactured to be used in equipment or systems in situations that can affect or endanger human life.
- When considering this product for operation in special applications such as machinery or systems used in passenger transportation, medical, aerospace, atomic power, electric power, or submarine repeating applications, please contact your nearest Mitsubishi Electric sales representative.
- Although this product was manufactured under conditions of strict quality control, you are strongly advised to install safety devices to forestall serious accidents when it is used in facilities where a breakdown in the product is likely to cause a serious accident.

(11) General cautions

- All drawings provided in the instruction manual show the state with the covers and safety partitions removed to explain detailed sections. When operating the product, always return the covers and partitions to the designated positions, and operate according to the instruction manual.

REVISIONS

* The manual number is given on the bottom left of the back cover.

Print Date	* Manual Number	Revision
Sep., 2007	IB(NA)-0300136-A	First edition
Nov., 2009	IB(NA)-0300136-B	[Additional model] MR-J3W-□B, MR-J3-□B-RJ080W, MR-J3-□BS [Additional correction/partial correction] Safety precautions, About Manuals, Restrictions by the software's version or serial number, Servo amplifier display servo error code (#8008+20), Amplifier-less operation status flag (SM508), SSCNET control (Status_SD508), SSCNET control (Command_SD803), Advanced S-curve acceleration/deceleration, Error code list, Warranty
Sep., 2011	IB(NA)-0300136-C	[Additional model] Q173DCPU-S1, Q172DCPU-S1, GX Works2, MR Configurator2 [Additional function] External input signal (DOG) of servo amplifier, Home position return of scale home position signal detection method [Additional correction/partial correction] Safety precautions, About Manuals, Restrictions by the software's version, Error code list
Mar., 2012	IB(NA)-0300136-D	[Additional model] Q173DSCPU, Q172DSCPU, MR-J4-□B, MR-J4W-□B [Additional function] Stroke limit invalid setting, Rapid stop deceleration time setting error invalid, Expansion parameters, Speed-torque control [Additional correction/partial correction] About Manuals, Manual Page Organization, Restrictions by the software's version, Programming software version, PI-PID switching command (M3217+20n), Parameter error No. (#8009+20n), Servo status1 (#8010+20n), Servo status2 (#8011+20n), Servo status3 (#8012+20n), Maximum Motion operation cycle (SD524), System setting error information (SD550, SD551), Torque limit function, Error code list, Processing times of the Motion CPU
Sep., 2012	IB(NA)-0300136-E	[Additional function] Advanced synchronous control [Additional correction/partial correction] About Manuals, Restrictions by the software's version, Programming software version, Positioning dedicated devices (Internal relays (M8192 to M12063), Data registers (D8192 to D19823)), External forced stop input ON latch flag (SM506), Operation method (SD560), Error code list, Processing times of the Motion CPU
Apr., 2013	IB(NA)-0300136-F	[Additional function] Acceleration/deceleration time change function, Home position return by the dogless home position signal reference method [Additional correction/partial correction] About Manuals, Restrictions by the software's version, Error code list, Processing times of the Motion CPU
Nov., 2013	IB(NA)-0300136-G	[Additional function] Compatible with servo driver VCII series manufactured by CKD Nikki Denso Co., Ltd., compatible with inverter FR-A700 series [Additional correction/partial correction] Safety precautions, Restrictions by the software's version, Error code list

Print Date	* Manual Number	Revision
Dec., 2015	IB(NA)-0300136-H	[Additional function] Compatible with optical hub unit, Driver home position return method home position return, Compatible with servo driver VPH series manufactured by CKD Nikki Denso Co., Ltd., Compatible with AlphaStep/5-phase stepping motor manufactured by ORIENTAL MOTOR Co., Ltd., Compatible with inverter FR-A800 series [Additional correction/partial correction] Restrictions by the software's version, Servo status7 (#8018+20n), Torque limit function, Error codes stored using the Motion CPU, Servo driver VCII series manufactured by CKD Nikki Denso Co., Ltd., Inverter FR-A700 series, Warranty
Mar., 2017	IB(NA)-0300136-J	[Additional function] Compatible with IAI electric actuator controller manufactured by IAI Corporation [Additional correction/partial correction] Safety precautions, Restrictions by the software's version, Error code list, Servo driver VCII series/VPH series manufactured by CKD Nikki Denso Co., Ltd., AlphaStep/5-phase stepping motor driver manufactured by ORIENTAL MOTOR Co., Ltd., Warranty
Dec., 2019	IB(NA)-0300136-K	[Additional correction/partial correction] Servo status1 (#8010+20n), Backlash compensation amount, Upper/lower stroke limit value, S-curve ratio, Control in the control unit "degree", Speed control with fixed position stop, Precautions for the manual pulse generator
Apr., 2022	IB(NA)-0300136-L	[Additional function] MR-J5-□B, MR-J5W-□B [Additional correction/partial correction] Safety precautions, About Manuals, Restrictions by the software's version, Gain changing 2 command (M3206+20n), Servo status5 (#8014+20n), Number of pulses/travel value per rotation, Position follow-up control, Error code list, Warranty

Japanese Manual Number IB(NA)-0300128

This manual confers no industrial property rights or any rights of any other kind, nor does it confer any patent licenses. Mitsubishi Electric Corporation cannot be held responsible for any problems involving industrial property rights which may occur as a result of using the contents noted in this manual.

INTRODUCTION

Thank you for choosing the Mitsubishi Electric Motion controller Q173D(S)CPU/Q172D(S)CPU.
Before using the equipment, please read this manual carefully to develop full familiarity with the functions and performance of the Motion controller you have purchased, so as to ensure correct use.

CONTENTS

Safety Precautions	A- 1
Revisions	A-11
Contents	A-13
About Manuals	A-17
Manual Page Organization	A-20
1. OVERVIEW	1- 1 to 1-14
1.1 Overview.....	1- 1
1.2 Features	1- 4
1.2.1 Performance Specifications	1- 4
1.3 Restrictions by the Software's Version.....	1- 8
1.4 Programming Software Version.....	1-14
2. POSITIONING CONTROL BY THE MOTION CPU	2- 1 to 2-14
2.1 Positioning Control by the Motion CPU.....	2- 1
3. POSITIONING DEDICATED SIGNALS	3- 1 to 3-74
3.1 Internal Relays	3- 3
3.1.1 Axis statuses	3-11
3.1.2 Axis command signals	3-23
3.1.3 Common devices	3-31
3.2 Data Registers.....	3-44
3.2.1 Axis monitor devices	3-49
3.2.2 Control change registers.....	3-55
3.2.3 Common devices	3-56
3.3 Motion Registers(#)... ..	3-59
3.4 Special Relays (SM)	3-66
3.5 Special Registers (SD).....	3-69
4. PARAMETERS FOR POSITIONING CONTROL	4- 1 to 4-42
4.1 System Settings	4- 1
4.2 Fixed Parameters.....	4- 2
4.2.1 Number of pulses/travel value per rotation.....	4- 3
4.2.2 Backlash compensation amount.....	4- 8
4.2.3 Upper/lower stroke limit value.....	4- 8
4.2.4 Command in-position range.....	4-12
4.2.5 Speed control 10×multiplier setting for degree axis	4-13
4.3 Parameter Block.....	4-16

4.3.1 Relationships between the speed limit value, acceleration time, deceleration time and rapid stop deceleration time.....	4-19
4.3.2 S-curve ratio	4-21
4.3.3 Advanced S-curve acceleration/deceleration.....	4-23
4.3.4 Allowable error range for circular interpolation.....	4-37
4.4 Expansion Parameters.....	4-38
4.4.1 Positive direction torque limit value monitor device/negative direction torque limit value monitor device	4-40
4.4.2 Acceleration/deceleration time change parameter	4-41

5. SERVO PROGRAMS FOR POSITIONING CONTROL	5- 1 to 5-26
--	---------------------

5.1 Servo Program Composition Area.....	5- 1
5.1.1 Servo program composition	5- 1
5.1.2 Servo program area	5- 2
5.2 Servo Instructions	5- 3
5.3 Positioning Data	5-16
5.4 Setting Method for Positioning Data	5-22
5.4.1 Setting method by specifying numerical values	5-22
5.4.2 Indirect setting method by devices	5-23

6. POSITIONING CONTROL	6- 1 to 6-260
-------------------------------	----------------------

6.1 Basics of Positioning Control.....	6- 1
6.1.1 Positioning speed.....	6- 1
6.1.2 Positioning speed at the interpolation control	6- 2
6.1.3 Control units for 1 axis positioning control.....	6- 7
6.1.4 Control units for interpolation control.....	6- 7
6.1.5 Control in the control unit "degree"	6- 9
6.1.6 Stop processing and restarting after stop.....	6-12
6.1.7 Acceleration/deceleration processing.....	6-18
6.2 1 Axis Linear Positioning Control.....	6-22
6.3 2 Axes Linear Interpolation Control	6-25
6.4 3 Axes Linear Interpolation Control	6-30
6.5 4 Axes Linear Interpolation Control	6-36
6.6 Auxiliary Point-Specified Circular Interpolation Control	6-41
6.7 Radius-Specified Circular Interpolation Control	6-46
6.8 Central Point-Specified Circular Interpolation Control	6-52
6.9 Helical Interpolation Control.....	6-58
6.9.1 Circular interpolation specified method by helical interpolation.....	6-59
6.10 1 Axis Fixed-Pitch Feed Control.....	6-79
6.11 Fixed-Pitch Feed Control Using 2 Axes Linear Interpolation	6-83
6.12 Fixed-Pitch Feed Control Using 3 Axes Linear Interpolation	6-87
6.13 Speed Control (I).....	6-91
6.14 Speed Control (II).....	6-96
6.15 Speed-Position Switching Control	6-100
6.15.1 Speed-position switching control start.....	6-100
6.15.2 Re-starting after stop during control	6-108
6.16 Speed-Switching Control	6-113

6.16.1	Speed-switching control start, speed-switching points and end specification	6-113
6.16.2	Specification of speed-switching points using repetition instructions.....	6-119
6.17	Constant-Speed Control	6-125
6.17.1	Specification of pass points by repetition instructions	6-129
6.17.2	Speed-switching by instruction execution	6-134
6.17.3	1 axis constant-speed control	6-139
6.17.4	2 to 4 axes constant-speed control.....	6-143
6.17.5	Constant speed control for helical interpolation	6-150
6.17.6	Pass point skip function	6-155
6.17.7	FIN signal wait function.....	6-157
6.18	Position Follow-Up Control	6-167
6.19	Speed Control with Fixed Position Stop.....	6-175
6.20	Simultaneous Start.....	6-181
6.21	JOG Operation	6-184
6.21.1	JOG operation data.....	6-184
6.21.2	Individual start	6-185
6.21.3	Simultaneous start	6-190
6.22	Manual Pulse Generator Operation	6-193
6.23	Home Position Return.....	6-200
6.23.1	Home position return data.....	6-202
6.23.2	Home position return by the proximity dog method 1	6-211
6.23.3	Home position return by the proximity dog method 2	6-214
6.23.4	Home position return by the count method 1	6-216
6.23.5	Home position return by the count method 2	6-218
6.23.6	Home position return by the count method 3.....	6-220
6.23.7	Home position return by the data set method 1	6-222
6.23.8	Home position return by the data set method 2	6-223
6.23.9	Home position return by the dog cradle method.....	6-224
6.23.10	Home position return by the stopper method 1	6-229
6.23.11	Home position return by the stopper method 2.....	6-231
6.23.12	Home position return by the limit switch combined method	6-232
6.23.13	Home position return by the scale home position signal detection method.....	6-234
6.23.14	Home position return by the dogless home position signal reference method.....	6-237
6.23.15	Home position return by the driver home position return method	6-244
6.23.16	Home position return retry function	6-245
6.23.17	Home position shift function.....	6-249
6.23.18	Home position set condition selection	6-253
6.23.19	Servo program for home position return	6-255
6.24	High-Speed Oscillation	6-258

7. AUXILIARY AND APPLIED FUNCTIONS

7- 1 to 7-48

7.1	M-code Output Function	7- 1
7.2	Backlash Compensation Function.....	7- 4
7.3	Torque Limit Function	7- 6
7.4	Skip Function in which Disregards Stop Command	7- 9
7.5	Cancel of the Servo Program	7-11
7.5.1	Cancel/start	7-12
7.6	Synchronous Encoder.....	7-13

7.7 Speed-Torque Control	7-14
7.7.1 Speed-torque control data	7-16
7.7.2 Operation of speed-torque control.....	7-24
7.8 Acceleration/Deceleration Time Change Function	7-42

APPENDICES

APP- 1 to APP-144

APPENDIX 1 Error Codes Stored Using the Motion CPU	APP- 1
APPENDIX 1.1 Servo program setting errors (Stored in SD517).....	APP- 3
APPENDIX 1.2 Minor errors	APP- 8
APPENDIX 1.3 Major errors	APP-27
APPENDIX 1.4 Servo errors.....	APP-34
APPENDIX 2 Example Programs.....	APP-82
APPENDIX 2.1 Reading M-code.....	APP-82
APPENDIX 2.2 Reading error code.....	APP-83
APPENDIX 3 Setting Range for Indirect Setting Devices.....	APP-84
APPENDIX 4 Processing Times of the Motion CPU	APP-86
APPENDIX 5 Device List	APP-89
APPENDIX 6 Compatible Devices with SSCNET III(/H)	APP-100
APPENDIX 6.1 Servo driver VCII series/VPH series manufactured by CKD Nikki Denso Co., Ltd.....	APP-100
APPENDIX 6.2 Inverter FR-A700 series	APP-110
APPENDIX 6.3 Inverter FR-A800 series	APP-119
APPENDIX 6.4 Optical hub unit.....	APP-126
APPENDIX 6.5 AlphaStep/5-phase stepping motor driver manufactured by ORIENTAL MOTOR Co., Ltd.....	APP-131
APPENDIX 6.6 IAI electric actuator controller manufactured by IAI Corporation	APP-138

About Manuals

The following manuals are also related to this product.

When necessary, order them by quoting the details in the tables below.

Related Manuals

(1) Motion controller

Manual Name	Manual Number (Model Code)
Q173D(S)CPU/Q172D(S)CPU Motion controller User's Manual This manual explains specifications of the Motion CPU modules, Q172DLX Servo external signal interface module, Q172DEX Synchronous encoder interface module, Q173DPX Manual pulse generator interface module, Power supply modules, Servo amplifiers, SSCNETⅢ cables and Synchronous encoder, and the maintenance/inspection for the system, trouble shooting and others.	IB-0300133 (1XB927)
Q173D(S)CPU/Q172D(S)CPU Motion controller Programming Manual (COMMON) This manual explains the Multiple CPU system configuration, performance specifications, common parameters, auxiliary/applied functions, error lists and others.	IB-0300134 (1XB928)
Q173D(S)CPU/Q172D(S)CPU Motion controller (SV13/SV22) Programming Manual (Motion SFC) This manual explains the functions, programming, debugging, error lists for Motion SFC and others.	IB-0300135 (1XB929)
Q173D(S)CPU/Q172D(S)CPU Motion controller (SV13/SV22) Programming Manual (REAL MODE) This manual explains the servo parameters, positioning instructions, device lists, error lists and others.	IB-0300136 (1XB930)
Q173D(S)CPU/Q172D(S)CPU Motion controller (SV22) Programming Manual (VIRTUAL MODE) This manual explains the dedicated instructions to use the synchronous control by virtual main shaft, mechanical system program create mechanical module, servo parameters, positioning instructions, device lists, error lists and others.	IB-0300137 (1XB931)
Q173DSCPU/Q172DSCPU Motion controller (SV22) Programming Manual (Advanced Synchronous Control) This manual explains the dedicated instructions to use the synchronous control by synchronous control parameters, device lists, error lists and others.	IB-0300198 (1XB953)
Q173D(S)CPU/Q172D(S)CPU Motion controller Programming Manual (Safety Observation) This manual explains the details, safety parameters, safety sequence program instructions, device lists and error lists and others for safety observation function by Motion controller.	IB-0300183 (1XB945)
Motion controller Setup Guidance (MT Developer2 Version1) This manual explains the items related to the setup of the Motion controller programming software MT Developer2.	IB-0300142 (—)

(2) PLC

Manual Name	Manual Number (Model Code)
<p>QCPU User's Manual (Hardware Design, Maintenance and Inspection)</p> <p>This manual explains the specifications of the QCPU modules, power supply modules, base units, extension cables, memory card battery, and the maintenance/inspection for the system, trouble shooting, error codes and others.</p>	SH-080483ENG (13JR73)
<p>QnUCPU User's Manual (Function Explanation, Program Fundamentals)</p> <p>This manual explains the functions, programming methods and devices and others to create programs with the QCPU.</p>	SH-080807ENG (13JZ27)
<p>QCPU User's Manual (Multiple CPU System)</p> <p>This manual explains the Multiple CPU system overview, system configuration, I/O modules, communication between CPU modules and communication with the I/O modules or intelligent function modules.</p>	SH-080485ENG (13JR75)
<p>QnUCPU User's Manual (Communication via Built-in Ethernet Port)</p> <p>This manual explains functions for the communication via built-in Ethernet port of the CPU module.</p>	SH-080811ENG (13JZ29)
<p>MELSEC-Q/L Programming Manual (Common Instruction)</p> <p>This manual explains how to use the sequence instructions, basic instructions, application instructions and micro computer program.</p>	SH-080809ENG (13JW10)
<p>MELSEC-Q/L/QnA Programming Manual (PID Control Instructions)</p> <p>This manual explains the dedicated instructions used to exercise PID control.</p>	SH-080040 (13JF59)
<p>MELSEC-Q/L/QnA Programming Manual (SFC)</p> <p>This manual explains the system configuration, performance specifications, functions, programming, debugging, error codes and others of MELSAP3.</p>	SH-080041 (13JF60)
<p>I/O Module Type Building Block User's Manual</p> <p>This manual explains the specifications of the I/O modules, connector, connector/terminal block conversion modules and others.</p>	SH-080042 (13JL99)
<p>MELSEC-L SSCNETⅢ/H Head Module User's Manual</p> <p>This manual explains specifications of the head module, procedures before operation, system configuration, installation, wiring, settings, and troubleshooting.</p>	SH-081152ENG (13JZ78)



(3) Servo amplifier

Manual Name	Manual Number (Model Code)
MR-J5-B/MR-J5W-B User's Manual (Introduction) This manual explains the specifications, functions, start-up procedure and others for AC Servo MR-J5-B/ MR-J5W-B Servo amplifier.	IB-0300578ENG (—)
MR-J5 User's Manual (Hardware) This manual explains the installation, wiring, use option and others for AC Servo MR-J5-B/MR-J5W-B Servo amplifier.	SH-030298ENG (—)
MR-J5 User's Manual (Function) This manual explains how to use each function required to operate the AC Servo MR-J5-B/MR-J5W-B Servo amplifier.	SH-030300ENG (—)
MR-J5 User's Manual (Adjustment) This manual explains the operation status adjustment procedure, adjustment method and others for AC Servo MR-J5-B/MR-J5W-B Servo amplifier.	SH-030306ENG (—)
MR-J5 User's Manual (Troubleshooting) This manual explains the causes of alarms, and warnings, etc. for AC Servo MR-J5-B/MR-J5W-B Servo amplifier.	SH-030312ENG (—)
MR-J5-B/MR-J5W-B User's Manual (Parameters) This manual explains the parameters for AC Servo MR-J5-B/MR-J5W-B Servo amplifier.	IB-0300581ENG (—)
SSCNETⅢ/H Interface AC Servo MR-J4-_B_(-RJ) Servo amplifier Instruction Manual This manual explains the I/O signals, parts names, parameters, start-up procedure and others for AC Servo MR-J4-_B_(-RJ) Servo amplifier.	SH-030106 (1CW805)
SSCNETⅢ/H Interface Multi-axis AC Servo MR-J4W2-_B_/MR-J4W3-_B_/MR-J4W2-0303B6 Servo amplifier Instruction Manual This manual explains the I/O signals, parts names, parameters, start-up procedure and others for Multi- axis AC Servo MR-J4W2-_B_/MR-J4W3-_B_/MR-J4W2-0303B6 Servo amplifier.	SH-030105 (1CW806)
SSCNETⅢ interface MR-J3-□B Servo amplifier Instruction Manual This manual explains the I/O signals, parts names, parameters, start-up procedure and others for MR-J3-□B Servo amplifier.	SH-030051 (1CW202)
SSCNETⅢ interface 2-axis AC Servo Amplifier MR-J3W-0303BN6/MR-J3W-□B Servo amplifier Instruction Manual This manual explains the I/O signals, parts names, parameters, start-up procedure and others for 2-axis AC Servo Amplifier MR-J3W-0303BN6/MR-J3W-□B Servo amplifier.	SH-030073 (1CW604)
SSCNETⅢ Compatible Linear Servo MR-J3-□B-RJ004U□ Instruction Manual This manual explains the I/O signals, parts names, parameters, start-up procedure and others for Linear Servo MR-J3-□B-RJ004U□ Servo amplifier.	SH-030054 (1CW943)
SSCNETⅢ Compatible Fully Closed Loop Control MR-J3-□B-RJ006 Servo amplifier Instruction Manual This manual explains the I/O signals, parts names, parameters, start-up procedure and others for Fully Closed Loop Control MR-J3-□B-RJ006 Servo amplifier.	SH-030056 (1CW304)
SSCNETⅢ Interface Direct Drive Servo MR-J3-□B-RJ080W Instruction Manual This manual explains the I/O signals, parts names, parameters, start-up procedure and others for Direct Drive Servo MR-J3-□B-RJ080W Servo amplifier.	SH-030079 (1CW601)

Manual Name	Manual Number (Model Code)
SSCNETⅢ interface Drive Safety integrated MR-J3-□B Safety Servo amplifier Instruction Manual This manual explains the I/O signals, parts names, parameters, start-up procedure and others for safety integrated MR-J3-□B Safety Servo amplifier.	SH-030084 (1CW205)

Manual Page Organization

The symbols used in this manual are shown below.

Symbol	Description
	Symbol that indicates correspondence to only Q173DSCPU/Q172DSCPU.
	Symbol that indicates correspondence to only Q173DCPU(-S1)/Q172DCPU(-S1).

1. OVERVIEW

1.1 Overview

This programming manual describes the positioning control parameters, positioning dedicated devices and positioning method required to execute positioning control in the Motion controller (SV13/22 real mode).

The following positioning control is possible in the Motion controller (SV13/22 real mode).

Applicable CPU	Number of positioning control axes
Q173DSCPU	Up to 32 axes
Q173DCPU (-S1)	
Q172DSCPU	Up to 16 axes
Q172DCPU (-S1)	Up to 8 axes

In this manual, the following abbreviations are used.

Generic term/Abbreviation	Description
Q173D(S)CPU/Q172D(S)CPU or Motion CPU (module)	Q173DSCPU/Q172DSCPU/Q173DCPU/Q172DCPU/Q173DCPU-S1/Q172DCPU-S1 Motion CPU module
Q172DLX/Q172DEX/Q173DPX/Q173DSXY or Motion module	Q172DLX Servo external signals interface module/ Q172DEX Synchronous encoder interface module ^(Note-1) / Q173DPX Manual pulse generator interface module/ Q173DSXY Safety signal module
MR-J5(W)-□B	Servo amplifier model MR-J5-□B/MR-J5W-□B
MR-J4(W)-□B	Servo amplifier model MR-J4-□B/MR-J4W-□B
MR-J3(W)-□B	Servo amplifier model MR-J3-□B/MR-J3W-□B
AMP or Servo amplifier	General name for "Servo amplifier model MR-J5-□B/MR-J5W-□B/MR-J4-□B/MR-J4W-□B/MR-J3-□B/MR-J3W-□B"
QCPU, PLC CPU or PLC CPU module	QnUD(E)(H)CPU/QnUDVCPU
Multiple CPU system or Motion system	Abbreviation for "Multiple PLC system of the Q series"
CPU _n	Abbreviation for "CPU No.n (n= 1 to 4) of the CPU module for the Multiple CPU system"
Operating system software	General name for "SW7DNC-SV□Q□/SW8DNC-SV□Q□"
SV13	Operating system software for conveyor assembly use (Motion SFC) : SW8DNC-SV13Q□
SV22	Operating system software for automatic machinery use (Motion SFC) : SW8DNC-SV22Q□
Programming software package	General name for MT Developer2/GX Works2/GX Developer/MR Configurator□
MELSOFT MT Works2	Abbreviation for "Motion controller engineering environment MELSOFT MT Works2"
MT Developer2 ^(Note-2)	Abbreviation for "Motion controller programming software MT Developer2 (Version 1.00A or later)"
GX Works2	Abbreviation for "Programmable controller engineering software MELSOFT GX Works2 (Version 1.15R or later)"
GX Developer	Abbreviation for "MELSEC PLC programming software package GX Developer (Version 8.48A or later)"
MR Configurator□	General name for "MR Configurator/MR Configurator2"

1 OVERVIEW

Generic term/Abbreviation	Description
MR Configurator	Abbreviation for "Servo setup software package MR Configurator (Version C0 or later)"
MR Configurator2 ^(Note-2)	Abbreviation for "Servo setup software package MR Configurator2 (Version 1.01B or later)"
Serial absolute synchronous encoder or Q171ENC-W8/Q170ENC	Abbreviation for "Serial absolute synchronous encoder (Q171ENC-W8/Q170ENC)"
SSCNET III/H ^(Note-3)	High speed synchronous network between Motion controller and servo amplifier
SSCNET III ^(Note-3)	
SSCNET III(/H)	General name for SSCNET III/H, SSCNET III
Absolute position system	General name for "system using the servo motor and servo amplifier for absolute position"
Battery holder unit	Battery holder unit (Q170DBATC)
Intelligent function module	General name for module that has a function other than input or output, such as A/D converter module and D/A converter module.
SSCNET III/H head module	Abbreviation for "MELSEC-L series SSCNET III/H head module (LJ72MS15)"
Optical hub unit or MR-MV200	Abbreviation for "SSCNET III/H compatible optical hub unit (MR-MV200)"

(Note-1): Q172DEX can be used in SV22.

(Note-2): This software is included in Motion controller engineering environment "MELSOFT MT Works2".

(Note-3): SSCNET: Servo System Controller NETwork

1 OVERVIEW

REMARK

For information about each module, design method for program and parameter, refer to the following manuals relevant to each module.

Item		Reference Manual
Motion CPU module/Motion unit		Q173D(S)CPU/Q172D(S)CPU Motion controller User's Manual
PLC CPU, peripheral devices for sequence program design, I/O modules and intelligent function module		Manual relevant to each module
Operation method for MT Developer2		Help of each software
SV13/SV22	<ul style="list-style-type: none"> • Multiple CPU system configuration • Performance specification • Design method for common parameter • Auxiliary and applied functions (common) 	Q173D(S)CPU/Q172D(S)CPU Motion controller Programming Manual (COMMON)
	<ul style="list-style-type: none"> • Design method for Motion SFC program • Design method for Motion SFC parameter • Motion dedicated PLC instruction 	Q173D(S)CPU/Q172D(S)CPU Motion controller (SV13/SV22) Programming Manual (Motion SFC)
	<ul style="list-style-type: none"> • Design method for safety observation parameter • Design method for user made safety sequence program 	Q173D(S)CPU/Q172D(S)CPU Motion controller Programming Manual (Safety Observation)
SV22 (Virtual mode)	<ul style="list-style-type: none"> • Design method for mechanical system program 	Q173D(S)CPU/Q172D(S)CPU Motion controller (SV22) Programming Manual (VIRTUAL MODE)
SV22 (Advanced synchronous control)	<ul style="list-style-type: none"> • Design method for synchronous control parameter 	Q173DSCPU/Q172DSCPU Motion controller (SV22) Programming Manual (Advanced Synchronous Control)

CAUTION

- When designing the system, provide external protective and safety circuits to ensure safety in the event of trouble with the Motion controller.
- There are electronic components which are susceptible to the effects of static electricity mounted on the printed circuit board. When handling printed circuit boards with bare hands you must ground your body or the work bench.
Do not touch current-carrying or electric parts of the equipment with bare hands.
- Make parameter settings within the ranges stated in this manual.
- Use the program instructions that are used in programs in accordance with the conditions stipulated in this manual.
- Some devices for use in programs have fixed applications: they must be used in accordance with the conditions stipulated in this manual.

1 OVERVIEW

1.2 Features

1.2.1 Performance Specifications

(1) Motion control specifications

Item	Q173DSCPU	Q172DSCPU	Q173DCPU(-S1)	Q172DCPU(-S1)
Number of control axes	Up to 32 axes	Up to 16 axes	Up to 32 axes	Up to 8 axes
Operation cycle (default)	SV13 0.22ms/ 1 to 4 axes 0.44ms/ 5 to 10 axes 0.88ms/ 11 to 24 axes 1.77ms/25 to 32 axes	0.22ms/ 1 to 4 axes 0.44ms/ 5 to 10 axes 0.88ms/ 11 to 16 axes	0.44ms/ 1 to 6 axes 0.88ms/ 7 to 18 axes 1.77ms/19 to 32 axes	0.44ms/ 1 to 6 axes 0.88ms/ 7 to 8 axes
	SV22 0.44ms/ 1 to 6 axes 0.88ms/ 7 to 16 axes 1.77ms/17 to 32 axes	0.44ms/ 1 to 6 axes 0.88ms/ 7 to 16 axes	0.44ms/ 1 to 4 axes 0.88ms/ 5 to 12 axes 1.77ms/13 to 28 axes 3.55ms/29 to 32 axes	0.44ms/ 1 to 4 axes 0.88ms/ 5 to 8 axes
Interpolation functions	Linear interpolation (Up to 4 axes), Circular interpolation (2 axes), Helical interpolation (3 axes)			
Control modes	PTP(Point to Point) control, Speed control, Speed-position switching control, Fixed-pitch feed, Constant speed control, Position follow-up control, Speed control with fixed position stop, Speed switching control, High-speed oscillation control, Speed-torque control, Synchronous control (SV22 (Virtual mode switching method/Advanced synchronous control method))		PTP(Point to Point) control, Speed control, Speed-position switching control, Fixed-pitch feed, Constant speed control, Position follow-up control, Speed control with fixed position stop, Speed switching control, High-speed oscillation control, Synchronous control (SV22)	
Acceleration/deceleration control	Trapezoidal acceleration/deceleration, S-curve acceleration/deceleration, Advanced S-curve acceleration/deceleration			
Compensation	Backlash compensation, Electronic gear, Phase compensation (SV22)			
Programming language	Motion SFC, Dedicated instruction, Mechanical support language (SV22) ^(Note-1)		Motion SFC, Dedicated instruction, Mechanical support language (SV22)	
Servo program capacity	16k steps			
Number of positioning points	3200 points (Positioning data can be designated indirectly)			
Peripheral I/F	USB/RS-232/Ethernet (Via PLC CPU) PERIPHERAL I/F (Motion CPU)		USB/RS-232/Ethernet (Via PLC CPU) PERIPHERAL I/F (Motion CPU) ^(Note-2)	
Home position return function	Proximity dog method (2 types), Count method (3 types), Data set method (2 types), Dog cradle method, Stopper method (2 types), Limit switch combined method, Scale home position signal detection method, Dogless home position signal reference method, Driver home position return method		Proximity dog method (2 types), Count method (3 types), Data set method (2 types), Dog cradle method, Stopper method (2 types), Limit switch combined method, Scale home position signal detection method	
	----- Home position return re-try function provided, home position shift function provided			
JOG operation function	Provided			
Manual pulse generator operation function	Possible to connect 3 modules (Q173DPX use) Possible to connect 1 module (Built-in interface in Motion CPU use) ^(Note-3)		Possible to connect 3 modules (Q173DPX use)	
Synchronous encoder operation function ^(Note-4)	Possible to connect 12 modules (SV22 use) (Q172DEX + Q173DPX + Built-in interface in Motion CPU + Via device ^(Note-5) + Via servo amplifier ^{(Note-5), (Note-6)} + Multiple CPU synchronous control ^(Note-5)		Possible to connect 12 modules (SV22 use) (Q172DEX + Q173DPX)	Possible to connect 8 modules (SV22 use) (Q172DEX + Q173DPX)

1 OVERVIEW

Motion control specifications (continued)

Item		Q173DSCPU	Q172DSCPU	Q173DCPU(-S1)	Q172DCPU(-S1)
M-code function		M-code output function provided, M-code completion wait function provided			
Limit switch output function	SV13	Number of output points 32 points Watch data: Motion control data/Word device			
	SV22	Virtual mode switching method: Number of output points 32 points Advanced synchronous control method: Number of output points 64 points × 2 settings Output timing compensation Watch data: Motion control data/Word device	Number of output points 32 points Watch data: Motion control data/Word device		
ROM operation function		Provided			
Multiple CPU synchronous control (Note-5)		Provided		None	
External input signal		Q172DLX, External input signals (FLS/RLS/DOG) of servo amplifier, Built-in interface in Motion CPU (DI), Bit device		Q172DLX or External input signals (FLS/RLS/DOG) of servo amplifier	
High-speed reading function (Note-7)		Provided (Via built-in interface in Motion CPU, Via input module, Via tracking of Q172DEX/Q173DPX)		Provided (Via input module, Via tracking of Q172DEX/Q173DPX)	
Forced stop		Motion controller forced stop (EMI connector, System setting), Forced stop terminal of servo amplifier			
Number of I/O points		Total 256 points (Built-in interface in Motion CPU (Input 4 points) + I/O module + Intelligent function module)		Total 256 points (I/O module)	
Mark detection function	Mark detection mode setting	Continuous detection mode, Specified number of detection mode, Ring buffer mode		None	
	Mark detection signal	Built-in interface in Motion CPU (4 points), Bit device, DOG/CHANGE signal of Q172DLX			
	Mark detection setting	32 settings			
Clock function		Provided			
Security function		Provided (Protection by software security key or password)		Provided (Protection by password)	
All clear function		Provided			
Remote operation		Remote RUN/STOP, Remote latch clear			
Optional data monitor function	SSCNETⅢ/H	Up to 6 data/axis (Communication data: Up to 6 points/axis)		None	
	SSCNETⅢ	Up to 3 data/axis (Communication data: Up to 3 points/axis)			
Digital oscilloscope function		Motion buffering method (Real-time waveform can be displayed) Sampling data: Word 16CH, Bit 16CH		Motion buffering method (Real-time waveform can be displayed) Sampling data: Word 4CH, Bit 8CH	
Absolute position system		Made compatible by setting battery to servo amplifier. (No battery required when a servo motor with a batteryless absolute position encoder is used) (Possible to select the absolute data method or incremental method for each axis)			
SSCNET communication (Note-8)	Communication type	SSCNETⅢ/H, SSCNETⅢ		SSCNETⅢ	
	Number of lines	2 lines (Note-9)	1 line (Note-9)	2 lines	1 line

1 OVERVIEW

Motion control specifications (continued)

Item		Q173DSCPU	Q172DSCPU	Q173DCPU(-S1)	Q172DCPU(-S1)
Driver communication function (Note-10)		Provided		None	
Number of Motion related modules	Q172DLX	4 modules usable	2 modules usable	4 modules usable	1 module usable
	Q172DEX	6 modules usable			4 modules usable
	Q173DPX	4 modules usable (Note-11)			3 modules usable (Note-11)
Number of SSCNETⅢ/H head module connection stations		Up to 8 stations usable (Up to 4 stations/line)	Up to 4 stations usable	Unusable	
Number of optical hub unit connections		Up to 32 units usable (Up to 16 units/line)	Up to 16 units usable	Unusable	

(Note-1): SV22 virtual mode only

(Note-2): Q173DCPU-S1/Q172DCPU-S1 only

(Note-3): When the manual pulse generator is used via the built-in interface in Motion CPU, the Q173DPX cannot be used.

(Note-4): Any incremental synchronous encoder connected to the built-in interface in Motion CPU will automatically be assigned an Axis No. one integer greater than the number of encoders connected to any Q172DEX modules and Q173DPX modules.

(Note-5): SV22 advanced synchronous control only

(Note-6): Servo amplifier (MR-J5(W)-□B/MR-J4(W)-□B) only.

Refer to "Q173DSCPU/Q172DSCPU Motion controller Programming Manual (Advanced Synchronous Control)" for details on devices that can be used as a synchronous encoder axis.

(Note-7): This cannot be used in SV22 advanced synchronous control.

(Note-8): The servo amplifiers for SSCNET cannot be used.

(Note-9): SSCNETⅢ and SSCNETⅢ/H cannot be combined in the same line.

For Q173DSCPU, SSCNETⅢ or SSCNETⅢ/H can be set every line.

(Note-10): Servo amplifier (MR-J5-□B/MR-J4-□B/MR-J3-□B) only.

(Note-11): When using the incremental synchronous encoder (SV22 use), you can use above number of modules.

When connecting the manual pulse generator, you can use only 1 module.

1 OVERVIEW

1.3 Restrictions by the Software's Version

There are restrictions in the function that can be used by the version of the operating system software and programming software.

The combination of each version and a function is shown in Table 1.1.

Table 1.1 Restrictions by the Software's Version

Function	Operating system software version ^{(Note-1), (Note-2)}		
	Q173DSCPU/Q172DSCPU	Q173DCPU(-S1)/Q172DCPU(-S1)	
Checking Motion controller's serial number and operating system software version in GX Developer	—	00D	
Advanced S-curve acceleration/deceleration (Except constant-speed control (CPSTART) of servo program.)	—	00H	
Direct drive servo MR-J3-□B-RJ080W	—	00H	
Servo amplifier display servo error code (#8008+20n)	—	00H	
0.44ms fixed-cycle event task	—	00H	
444μs coasting timer (SD720, SD721)	—	00H	
Synchronous encoder current value monitor in real mode	—	00H	
Display of the past ten times history in current value history monitor	—	00H	
Amplifier-less operation	—	00H	
Servo instruction (Home position return (ZERO), high speed oscillation (OSC)) and manual pulse generator operation in mixed function of virtual mode/real mode	—	00H	
Advanced S-curve acceleration/deceleration in constant-speed control (CPSTART) of servo program.	—	00K	
External input signal (DOG) of servo amplifier in home position return of count method and speed-position switching control	—	00G	
Communication via PERIPHERAL I/F	—	00H	
Motion SFC operation control instruction Type conversion (DFLT, SFLT)	—	00L	
Vision system dedicated function (MVOPEN, MVLOAD, MVTRG, MVPST, MVIN, MVFIN, MVCLOSE, MVCOM)	—	00L	
Home position return of scale home position signal detection method	—	00L	
Real time display function in digital oscilloscope function	—	00N	
Rapid stop deceleration time setting error invalid function	—	00S	

1 OVERVIEW

	Programming software version				Section of reference
	MELSOFT MT Works2 (MT Developer2)		MR Configurator2	MR Configurator	
	Q173DSCPU/Q172DSCPU	Q173DCPU(-S1)/Q172DCPU(-S1)			
	—	—	—	—	(Note-2)
	1.39R	1.06G	—	—	Section 4.3.3 Section 6.1.7
	1.39R	1.06G	1.01B	C2	
	—	—	—	—	Section 3.3
	1.39R	1.06G	—	—	(Note-3)
	—	—	—	—	(Note-5)
	—	—	—	—	(Note-4)
	1.39R	1.06G	—	—	(Note-5)
	—	—	—	—	(Note-5)
	1.39R	1.09K	—	—	(Note-4)
	1.39R	1.09K	—	—	Section 6.17.3 Section 6.17.4
	1.39R	1.15R	—	—	
	1.39R	1.15R	—	—	(Note-5)
	1.39R	1.15R	—	—	(Note-3)
	1.39R	1.15R	—	—	(Note-3)
	1.39R	1.15R	—	—	Section 6.23.13
	1.39R	1.17T	—	—	
	—	—	—	—	Section 4.3.1

—: There is no restriction by the version.

(Note-1): SV13/SV22 is the completely same version.

(Note-2): The operating system software version can be confirmed in the operating system software (CD-ROM), MT Developer2 or GX Works2/GX Developer. (Refer to "Q173D(S)CPU/Q172D(S)CPU Motion controller Programming Manual (COMMON) Section 1.3, 1.4".)

(Note-3): Q173D(S)CPU/Q172D(S)CPU Motion controller (SV13/SV22) Programming Manual (Motion SFC)

(Note-4): Q173D(S)CPU/Q172D(S)CPU Motion controller (SV22) Programming Manual (VIRTUAL MODE)

(Note-5): Q173D(S)CPU/Q172D(S)CPU Motion controller Programming Manual (COMMON)

(Note-6): Q173D(S)CPU/Q172D(S)CPU Motion controller Programming Manual (Safety Observation)

(Note-7): Q173DSCPU/Q172DSCPU Motion controller (SV22) Programming Manual (Advanced Synchronous Control)

1 OVERVIEW

Table 1.1 Restrictions by the Software's Version (continued)

Function	Operating system software version ^{(Note-1), (Note-2)}		
	Q173DSCPU/Q172DSCPU	Q173DCPU(-S1)/Q172DCPU(-S1)	
Vision system dedicated function (MVOOUT)	—	00S	
Motion SFC operation control instruction Program control (IF - ELSE - IEND, SELECT -CASE - SEND, FOR -NEXT, BREAK)	—	00R	
Display format depending on the error setting data information of motion error history device (#8640 to #8735)	—	00S	
Product information list device (#8736 to #8751)	—	00S	
Safety observation function	—	00S	
Feed current value update command (M3212+20n) valid in speed control (I)	00B	Not support	
External forced stop input ON latch (SM506)	00B	00S	
Operation method (SD560)	00B	Not support	
Advanced synchronous control	00B	Not support	
Limit switch output function expansion	00B	Not support	
Driver communication function (SSCNETⅢ)	00C	Not support	
Intelligent function module support	00C	Not support	
SSCNETⅢ/H head module connection	00C	Not support	
Cam auto-generation (CAMMK) easy stroke ratio cam	00C	Not support	
Acceleration/deceleration time change function	00C	Not support	
Home position return of dogless home position signal reference method	00C	Not support	
Setting range expansion of backlash compensation amount	00C	Not support	
Multiple CPU synchronous control	00C	Not support	
Cam axis length per cycle change during synchronous control	00C	Not support	
Servo driver VCI series manufactured by CKD Nikki Denso Co., Ltd.	SSCNETⅢ	—	00L
	SSCNETⅢ/H	00D	Not support
Inverter FR-A700 series	—	—	
Synchronous encoder via servo amplifier	00D	Not support	
Driver communication function (SSCNETⅢ/H)	00D	Not support	
Optical hub unit connection	00F	Not support	
Home position return of driver home position return method	00H	Not support	
Stepping motor module AlphaStep/5-phase manufactured by ORIENTAL MOTOR Co., Ltd.	00H	Not support	
Servo driver VPH series manufactured by CKD Nikki Denso Co., Ltd.	00H	Not support	
IAI electric actuator controller manufactured by IAI Corporation	00H	Not support	
Inverter FR-A800 series	00J	Not support	

1 OVERVIEW

	Programming software version				Section of reference
	MELSOFT MT Works2 (MT Developer2)		MR Configurator2	MR Configurator	
	Q173DSCPU/Q172DSCPU	Q173DCPU(-S1)/Q172DCPU(-S1)			
	1.39R	1.39R	—	—	(Note-3)
	1.39R	1.39R	—	—	(Note-3)
	—	—	—	—	(Note-3)
	—	—	—	—	Section 3.3
	1.39R	1.39R	—	—	(Note-6)
	—	Not support	—	—	Section 6.13
	—	—	—	—	(Note-5)
	—	Not support	—	—	(Note-5)
	1.47Z	Not support	—	—	(Note-7)
	1.47Z	Not support	—	—	(Note-5)
	—	Not support	—	—	(Note-5)
	1.56J	Not support	—	—	(Note-5)
	1.56J	Not support	—	—	(Note-5)
	1.56J	Not support	—	—	(Note-3)
	1.56J	Not support	—	—	Section 7.8
	1.56J	Not support	—	—	Section 6.23.14
	1.56J	Not support	—	—	Section 7.2
	1.56J	Not support	—	—	(Note-7)
	1.56J	Not support	—	—	(Note-7)
	1.34L	1.15R	—	—	Appendix 6.1
	1.56J	Not support	—	—	Appendix 6.1
	1.34L	1.15R	—	—	Appendix 6.2
	1.68W	Not support	1.23Z	Not support	(Note-7)
	1.68W	Not support	1.23Z	Not support	(Note-5)
	—	Not support	—	—	Appendix 6.4
	1.118Y	Not support	—	—	Section 6.23.15
	1.118Y	Not support	—	—	Appendix 6.5
	1.118Y	Not support	—	—	Appendix 6.1
	1.118Y	Not support	—	—	Appendix 6.6
	1.120A	Not support	—	—	Appendix 6.3

—: There is no restriction by the version.

(Note-1): SV13/SV22 is the completely same version.

(Note-2): The operating system software version can be confirmed in the operating system software (CD-ROM), MT Developer2 or GX Works2/GX Developer. (Refer to "Q173D(S)CPU/Q172D(S)CPU Motion controller Programming Manual (COMMON) Section 1.3, 1.4".)

(Note-3): Q173D(S)CPU/Q172D(S)CPU Motion controller (SV13/SV22) Programming Manual (Motion SFC)

(Note-4): Q173D(S)CPU/Q172D(S)CPU Motion controller (SV22) Programming Manual (VIRTUAL MODE)

(Note-5): Q173D(S)CPU/Q172D(S)CPU Motion controller Programming Manual (COMMON)

(Note-6): Q173D(S)CPU/Q172D(S)CPU Motion controller Programming Manual (Safety Observation)

(Note-7): Q173DSCPU/Q172DSCPU Motion controller (SV22) Programming Manual (Advanced Synchronous Control)

1 OVERVIEW

Table 1.1 Restrictions by the Software's Version (continued)

Function	Operating system software version ^{(Note-1), (Note-2)}		
	Q173DSCPU/Q172DSCPU	Q173DCPU(-S1)/Q172DCPU(-S1)	
Improvement of absolute positioning operation for servo driver VCI/VPH series manufactured by CKD Nikki Denso Co., Ltd., and stepping motor module AlphaStep/5-phase manufactured by ORIENTAL MOTOR Co., Ltd.	00L	Not support	
Servo amplifier MR-J5(W)-□B support	00Y	Not support	
DOG/CHANGE signal input method support	00Y	Not support	

1 OVERVIEW

	Programming software version				Section of reference
	MELSOFT MT Works2 (MT Developer2)		MR Configurator2	MR Configurator	
	Q173DSCPU/Q172DSCPU	Q173DCPU(-S1)/Q172DCPU(-S1)			
	—	Not support	—	—	Appendix 6.1 Appendix 6.5
	1.170C	Not support	1.130L	Not support	
	1.170C	Not support	—	—	(Note-5)

—: There is no restriction by the version.

(Note-1): SV13/SV22 is the completely same version.

(Note-2): The operating system software version can be confirmed in the operating system software (CD-ROM), MT Developer2 or GX Works2/GX Developer. (Refer to "Q173D(S)CPU/Q172D(S)CPU Motion controller Programming Manual (COMMON) Section 1.3, 1.4".)

(Note-3): Q173D(S)CPU/Q172D(S)CPU Motion controller (SV13/SV22) Programming Manual (Motion SFC)

(Note-4): Q173D(S)CPU/Q172D(S)CPU Motion controller (SV22) Programming Manual (VIRTUAL MODE)

(Note-5): Q173D(S)CPU/Q172D(S)CPU Motion controller Programming Manual (COMMON)

(Note-6): Q173D(S)CPU/Q172D(S)CPU Motion controller Programming Manual (Safety Observation)

(Note-7): Q173DSCPU/Q172DSCPU Motion controller (SV22) Programming Manual (Advanced Synchronous Control)

1 OVERVIEW

1.4 Programming Software Version

The programming software versions that support Motion CPU are shown below.

Motion CPU	MELSOFT MT Works2 (MT Developer2)		MR Configurator2	MR Configurator
	SV13/SV22	SV43		
Q173DSCPU	1.39R (Note-1)		1.10L	Not support
Q172DSCPU	1.39R (Note-1)		1.10L	Not support
Q173DCPU-S1	1.00A (Note-2)	1.03D (Note-3)	1.00A	C0 (Note-4)
Q172DCPU-S1	1.00A (Note-2)	1.03D (Note-3)	1.00A	C0 (Note-4)
Q173DCPU	1.00A	1.03D	1.00A	C0 (Note-4)
Q172DCPU	1.00A	1.03D	1.00A	C0 (Note-4)

(Note-1): Use version 1.47Z or later to use advanced synchronous control method.

(Note-2): Use version 1.12N or later to communicate via PERIPHERAL I/F.

(Note-3): Use version 1.23Z or later to communicate via PERIPHERAL I/F.

(Note-4): Use version C1 or later to use MR Configurator combination with MT Developer2.

2. POSITIONING CONTROL BY THE MOTION CPU

2.1 Positioning Control by the Motion CPU

The following positioning controls are possible in the Motion CPU.

- Q173DSCPU/Q173DCPU(-S1) : Up to 32 axes
- Q172DSCPU : Up to 16 axes
- Q172DCPU(-S1) : Up to 8 axes

There are following five functions as controls toward the servo amplifier/servo motor.

(1) Servo operation by the positioning instructions.

There are following two methods for execution of the positioning instruction.

(a) Programming using the motion control step "K" of Motion SFC.

The starting method of Motion SFC program is shown below.

- 1) Motion SFC start request of PLC CPU
- 2) Automatic start setting of Motion SFC program

(Note): Step "K" of the positioning instruction cannot be programmed to NMI task and event task.

- 3) Start by the Motion SFC program

(b) Execution of servo program by the servo program start request of PLC CPU.

(2) JOG operation by each axis command signal of Motion CPU.

(3) Manual pulse generator operation by the positioning dedicated device of Motion CPU.

(4) Speed change, torque limit value change, torque limit value individual change and target position change during positioning control by the Motion dedicated PLC instruction and Motion dedicated function of operation control step "F".

(Note): Refer to the "Q173D(S)CPU/Q172D(S)CPU Motion controller (SV13/SV22)Programming Manual (Motion SFC)" for the Motion dedicated PLC instruction.

(5) Current value change by the Motion dedicated PLC instruction or servo instructions.

2 POSITIONING CONTROL BY THE MOTION CPU

[Execution of the Motion SFC program start (D(P).SFCS instruction)]

Positioning control is executed by starting the Motion SFC program specified with D(P).SFCS instruction of the PLC CPU in the Motion CPU. (The Motion SFC program can also be started automatically by parameter setting.)

An overview of the starting method using the Motion SFC is shown below.

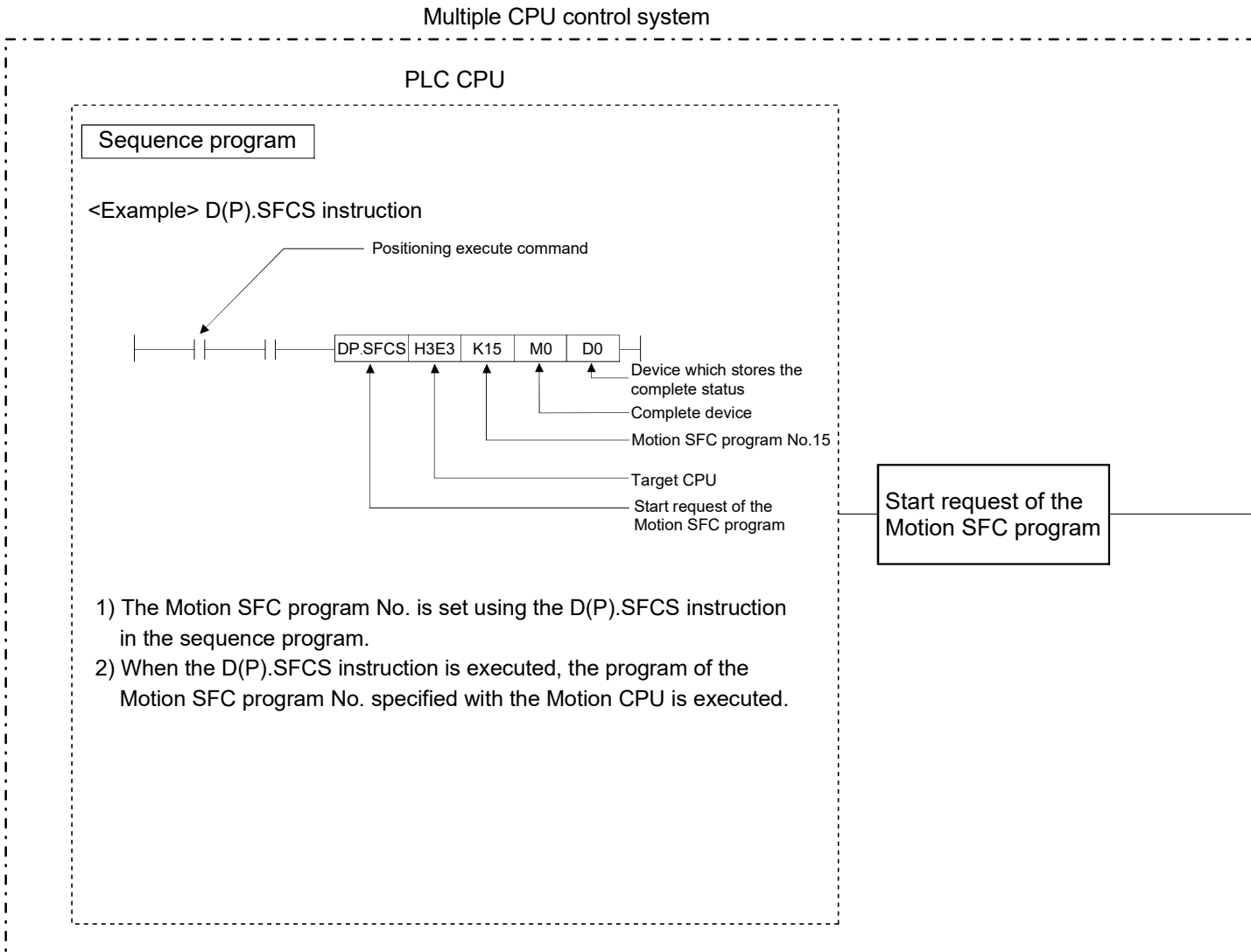

- (1) Create/set the sequence programs, Motion SFC programs and positioning control parameters using a programming software package.
- (2) Perform the positioning start using the sequence program (D(P).SFCS instruction) of PLC CPU.
 - (a) Motion SFC program No. is specified with the D(P).SFCS instruction.
 - 1) Motion SFC program No. can be set either directly or indirectly.
- (3) Perform the specified positioning control using the specified with Motion SFC program.

2 POSITIONING CONTROL BY THE MOTION CPU

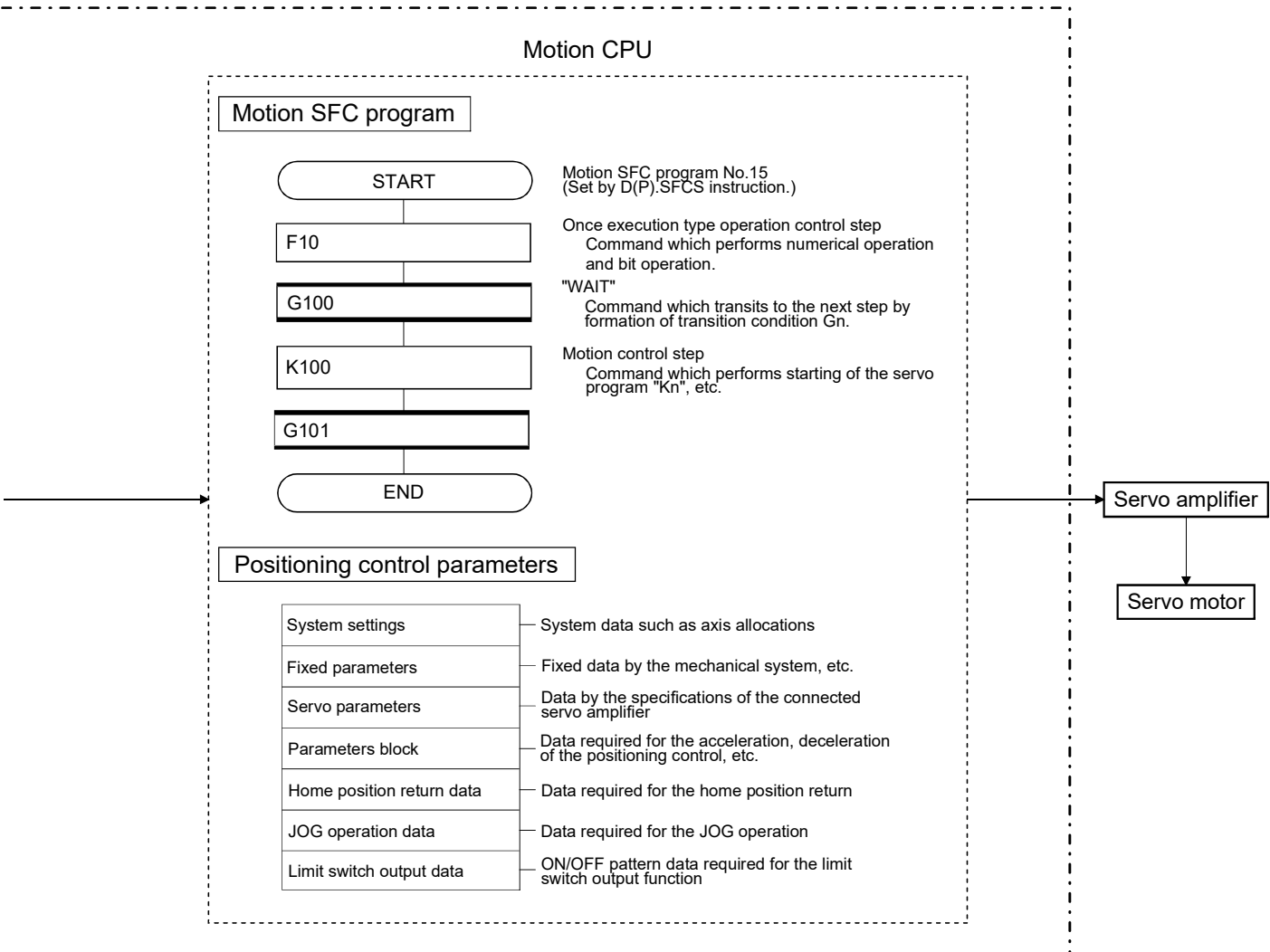

2 POSITIONING CONTROL BY THE MOTION CPU

[Execution of the positioning control (Motion SFC program)]

The positioning control is executed using the servo program specified with the Motion SFC program in the Motion CPU system.

An overview of the positioning control is shown below.

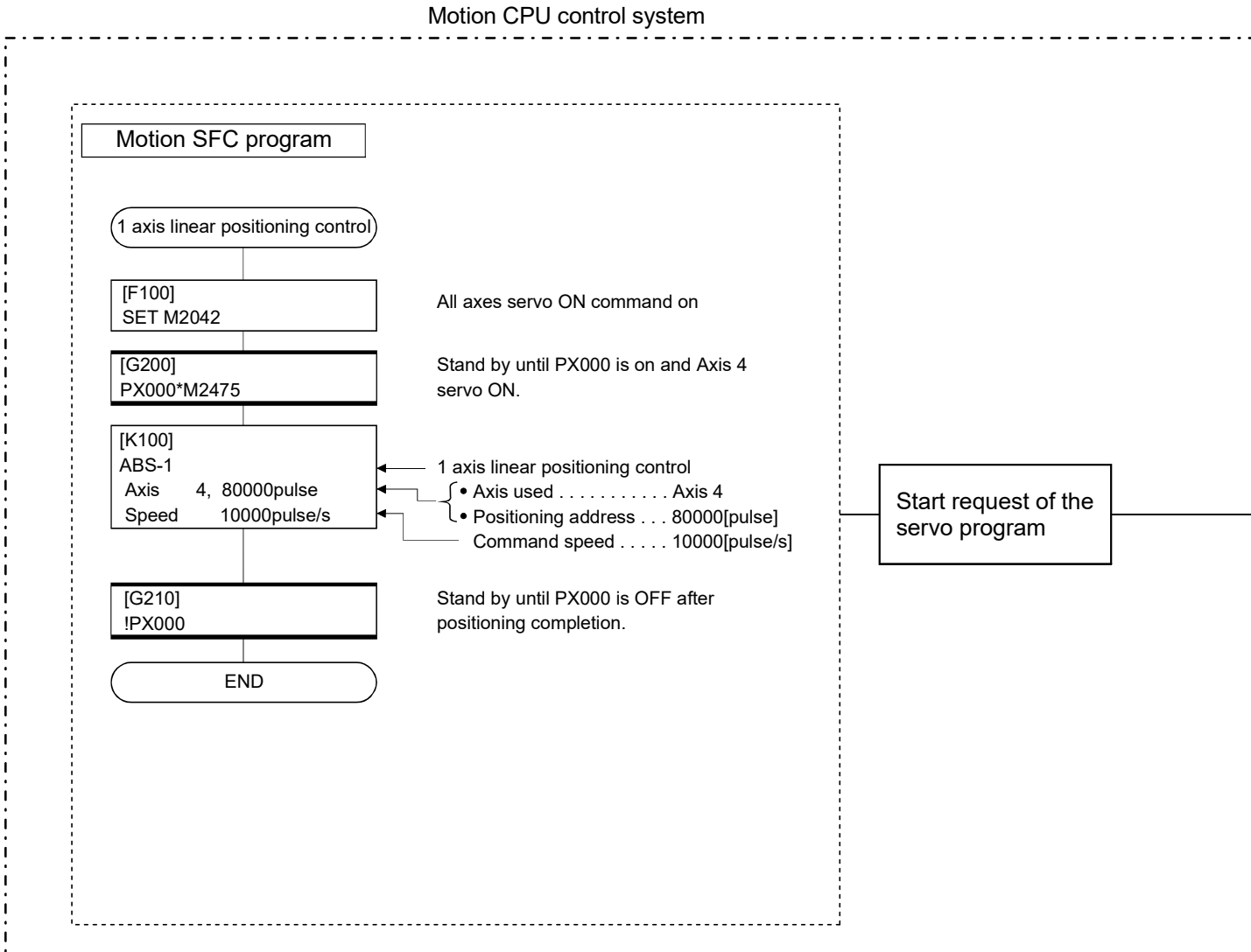

- (1) Create/set the Motion SFC programs, servo programs and positioning control parameters using a programming software package.
- (2) Specify the servo program started by the Motion SFC program.
- (3) Perform the specified positioning control using the specified with servo program.

2 POSITIONING CONTROL BY THE MOTION CPU

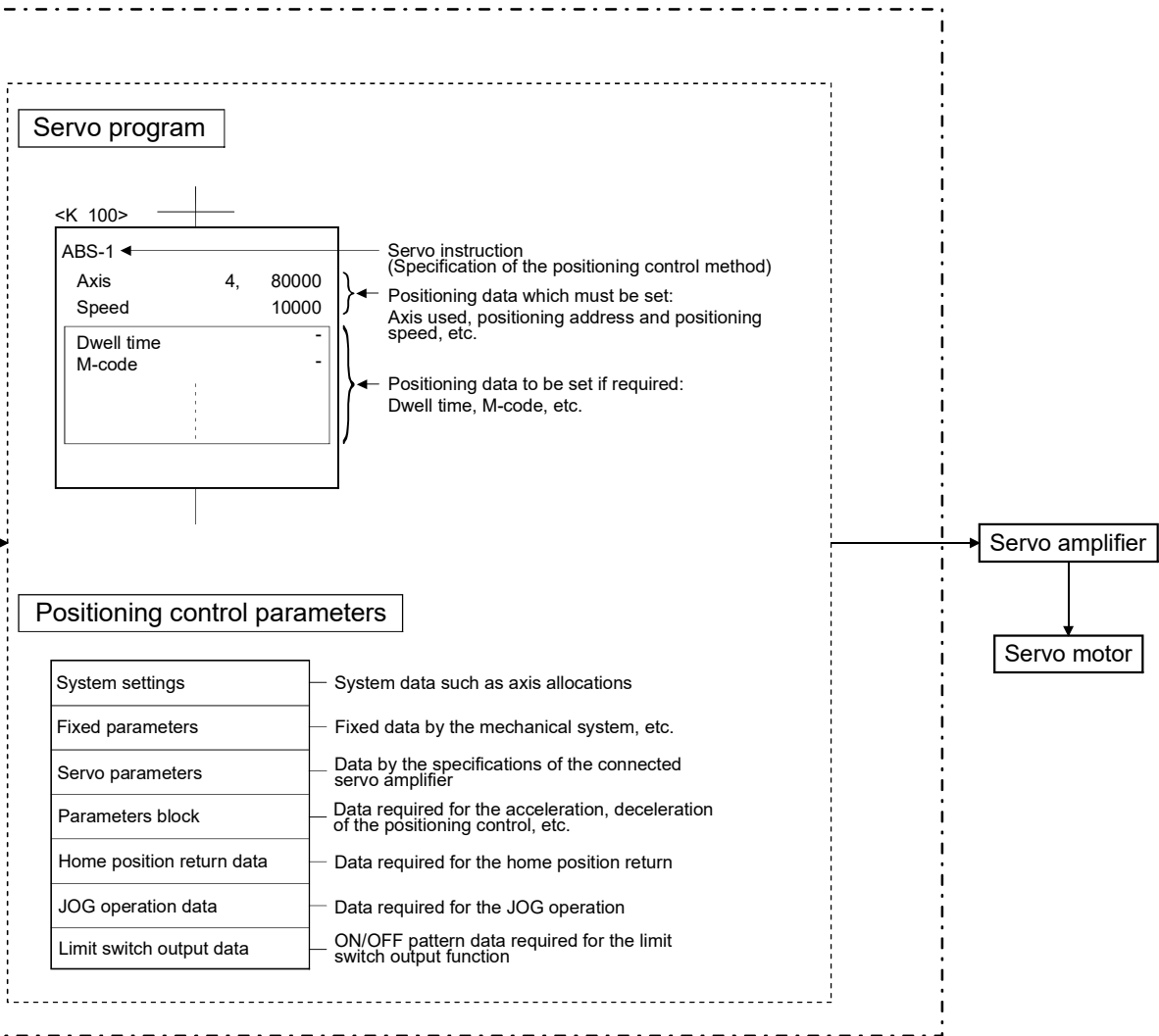

2 POSITIONING CONTROL BY THE MOTION CPU

[Execution of the servo program start (D(P).SVST instruction)]

Positioning control is executed by starting the specified servo program toward the axis specified with D(P).SVST instruction of PLC CPU in the Motion CPU.
An overview of the starting method using the servo program is shown below.

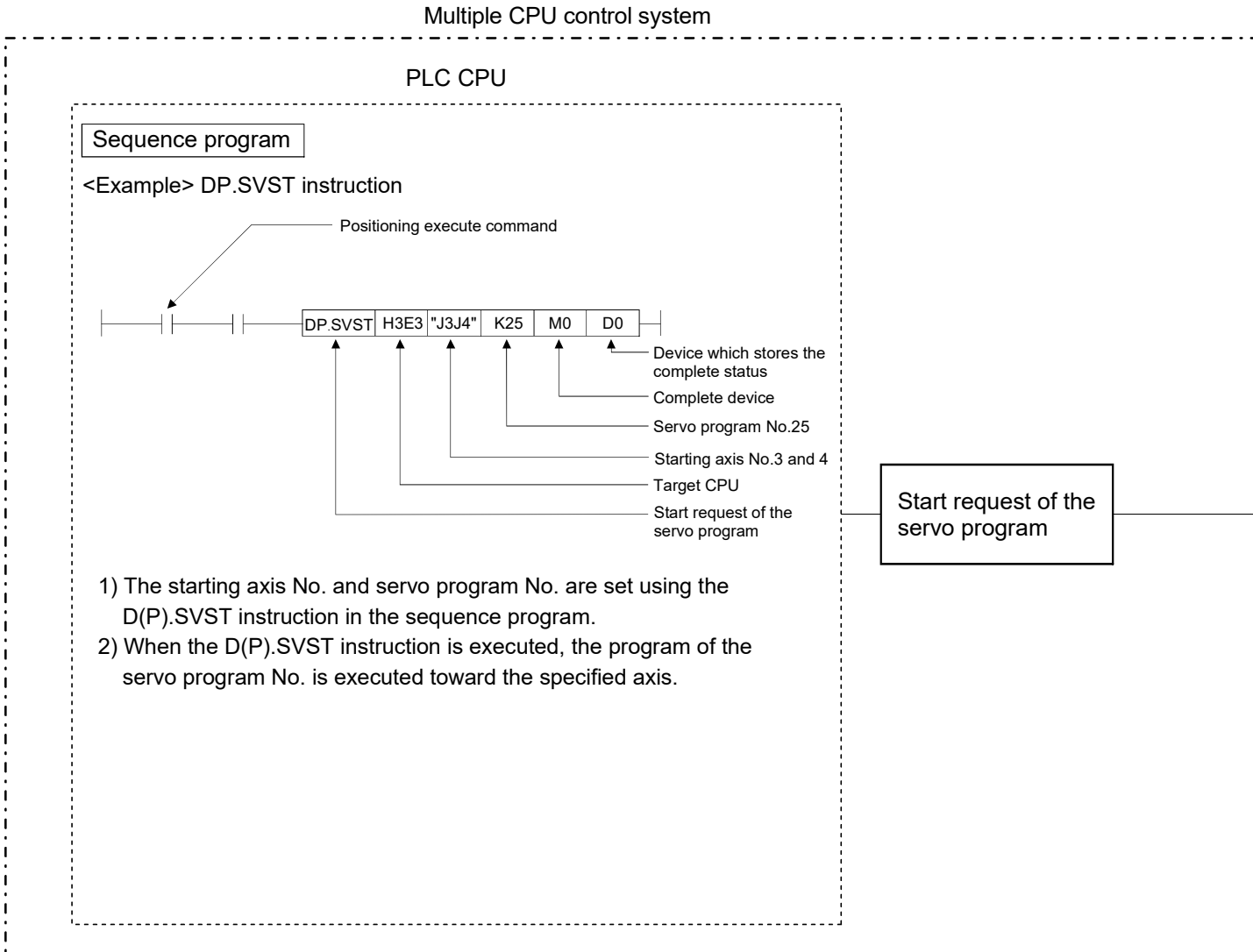

- (1) Create/set the sequence programs, servo programs and positioning control parameters using a programming software package.
- (2) Perform the positioning start using the sequence program (D(P).SVST instruction) of PLC CPU.
 - (a) Starting axis No. and servo program No. are specified with the D(P).SVST instruction.
 - 1) Servo program No. can be set either directly or indirectly.
- (3) Perform the positioning control of specified servo program toward the specified axis.

2 POSITIONING CONTROL BY THE MOTION CPU

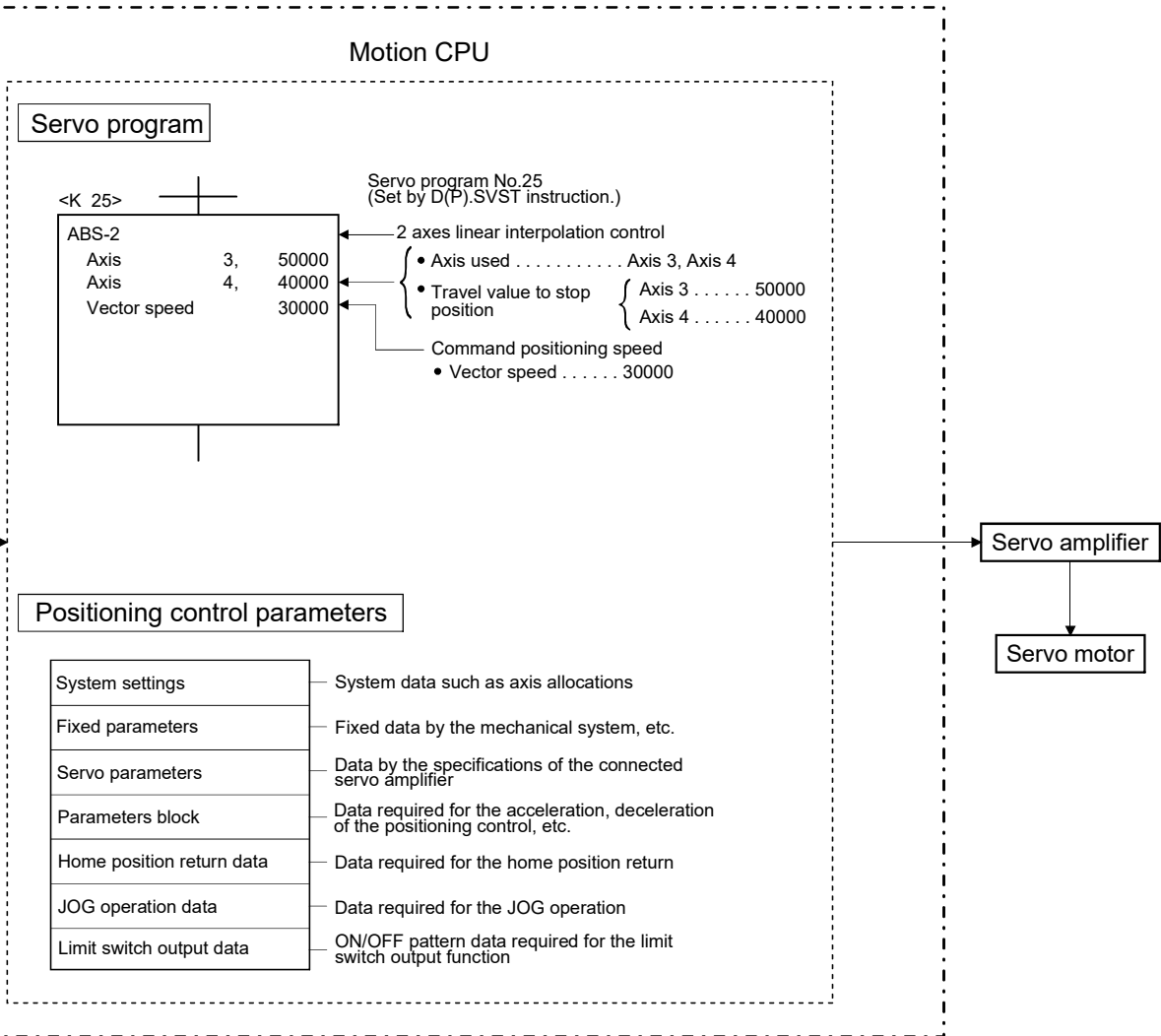

2 POSITIONING CONTROL BY THE MOTION CPU

[Execution of the JOG operation]

JOG operation of specified axis is executed using the Motion SFC program in the Motion CPU. JOG operation can also be executed by controlling the JOG dedicated device of specified axis.

An overview of JOG operation is shown below.

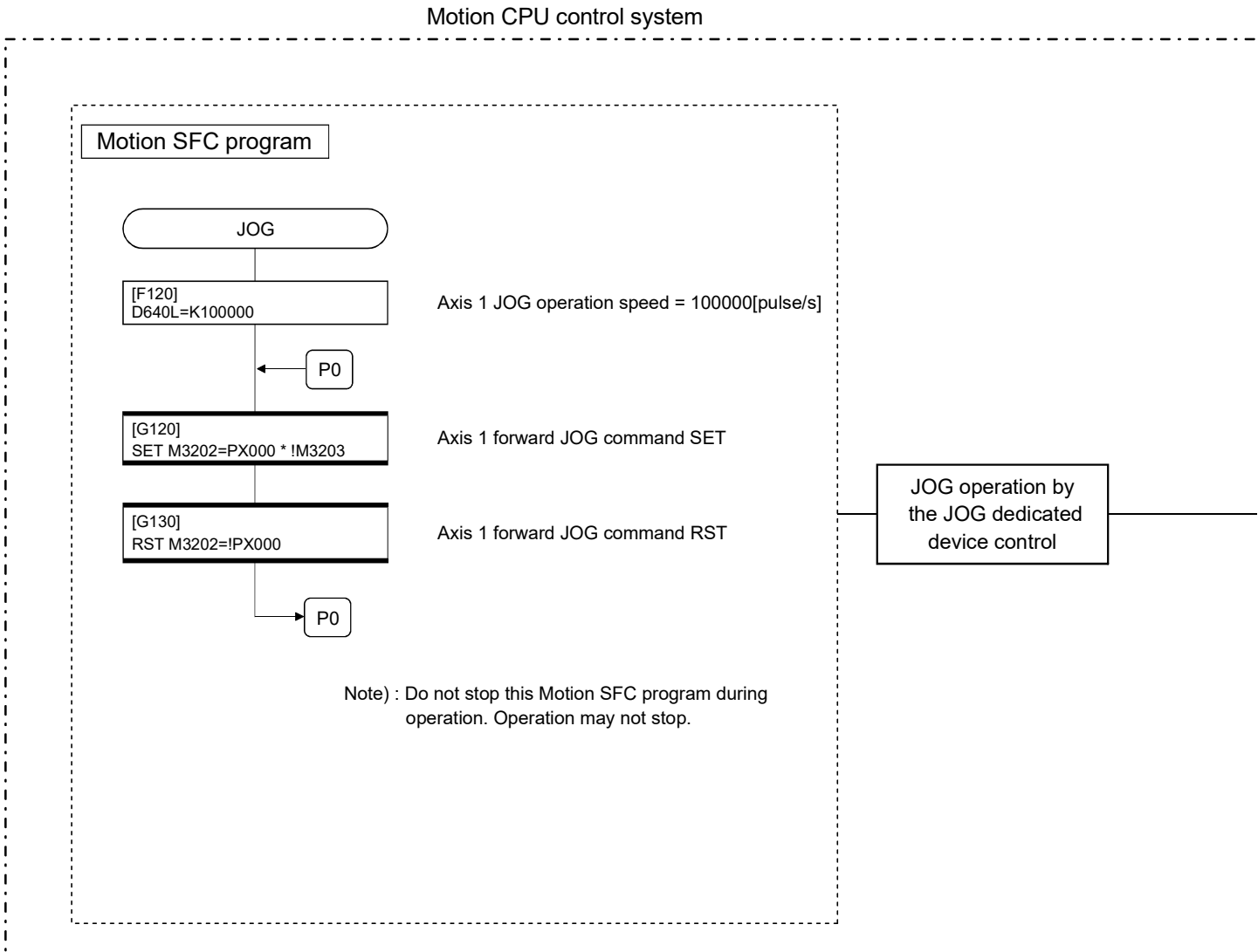

- (1) Create/set the Motion SFC programs, positioning control parameters using a programming software package.
- (2) Set the JOG speed to the JOG speed setting register for each axis using the Motion SFC program.
- (3) Perform the JOG operation while the JOG start command signal is ON in the Motion SFC program.

2 POSITIONING CONTROL BY THE MOTION CPU

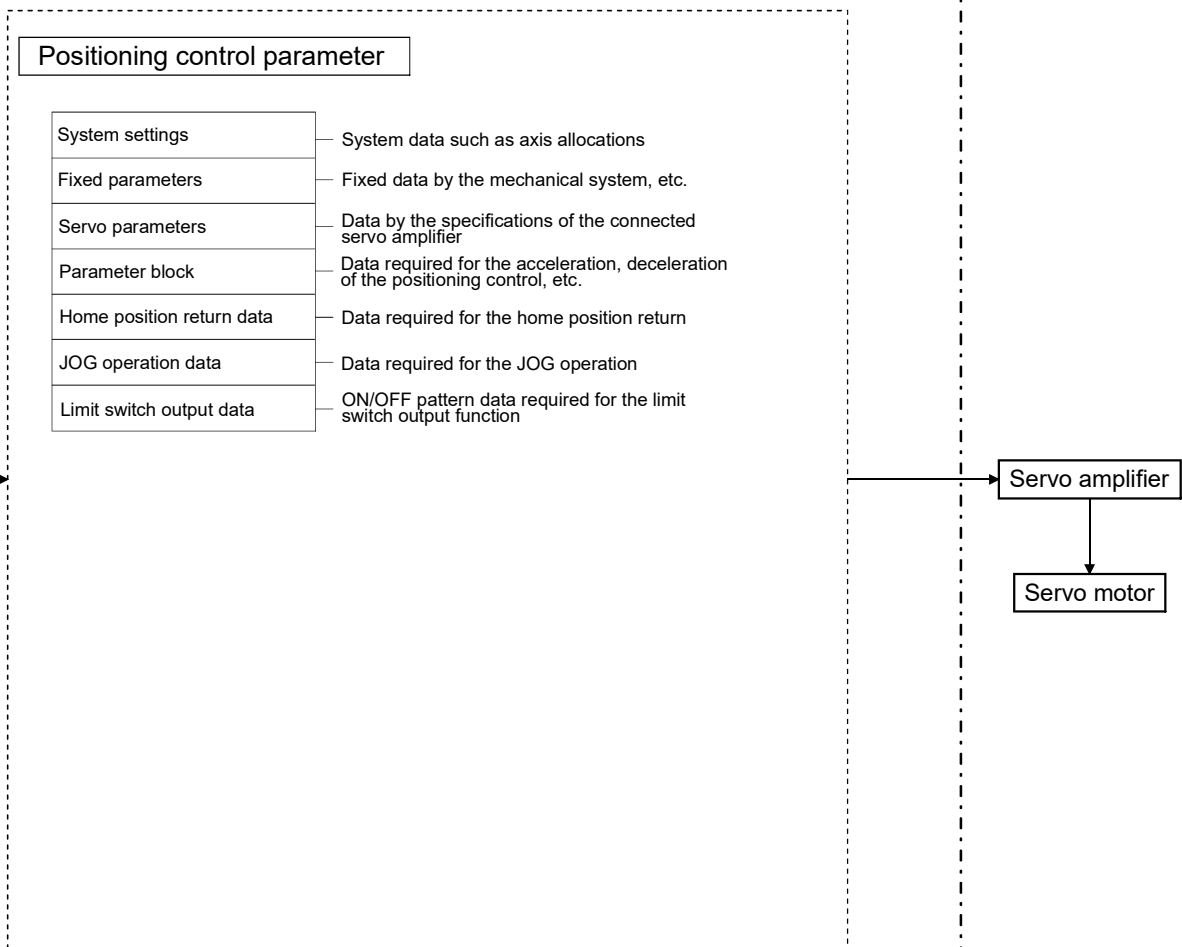

2 POSITIONING CONTROL BY THE MOTION CPU

[Executing Manual Pulse Generator Operation]

When the positioning control is executed by the manual pulse generator connected to the Q173DPX, manual pulse generator operation must be enabled using the Motion SFC program.

An overview of manual pulse generator operation is shown below.

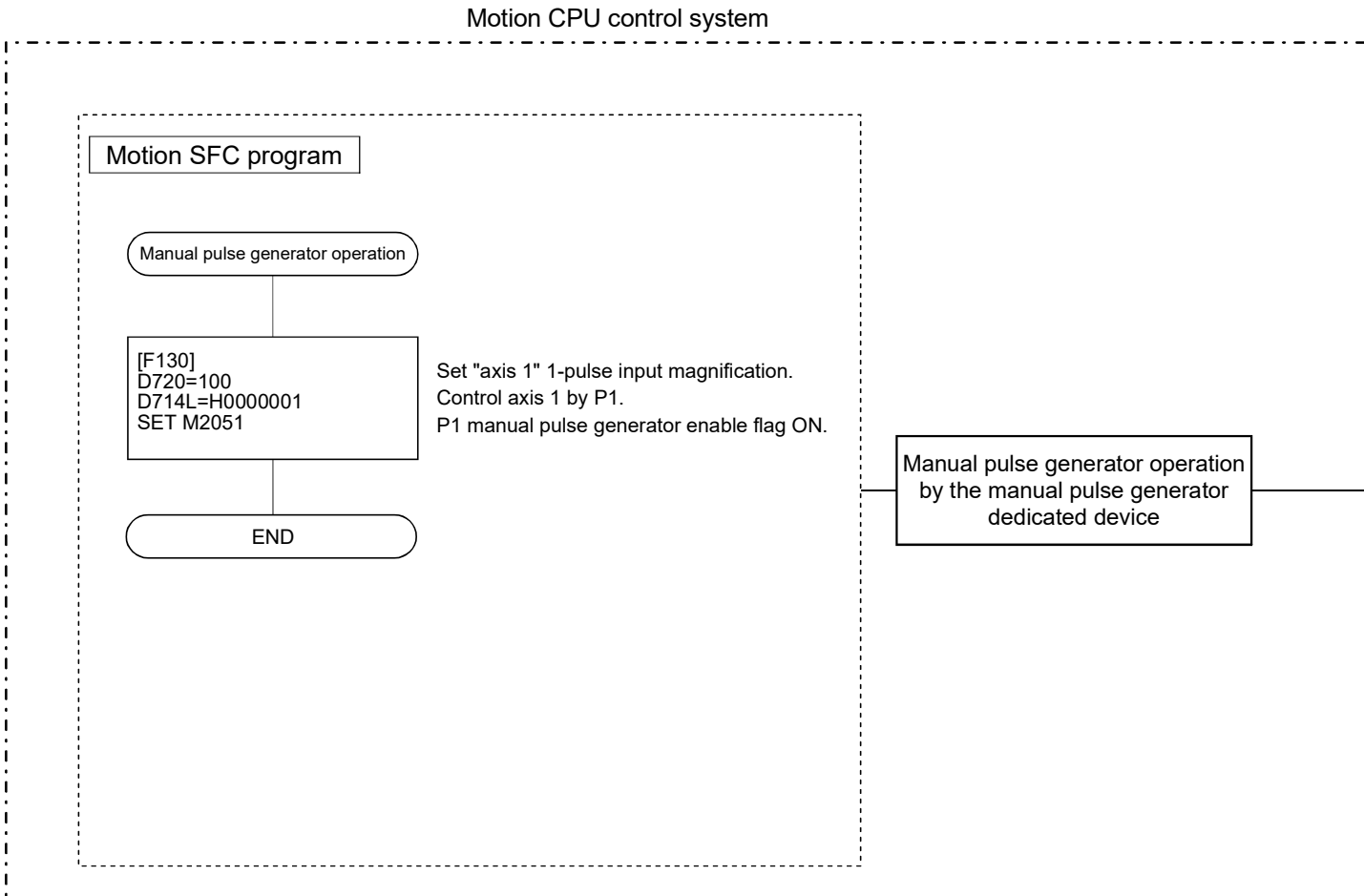

- (1) Create/set the Motion SFC programs, positioning control parameters using a programming software package.
- (2) Set the used manual pulse generator, operated axis No. and magnification for 1 pulse input using the Motion SFC program.
- (3) Turn the manual pulse generator enable flag on using the Motion SFC program
..... Manual pulse generator operation enabled
- (4) Perform the positioning by operating the manual pulse generator.
- (5) Turn the manual pulse generator enable flag OFF using the Motion SFC program
..... Manual pulse generator operation completion

2 POSITIONING CONTROL BY THE MOTION CPU

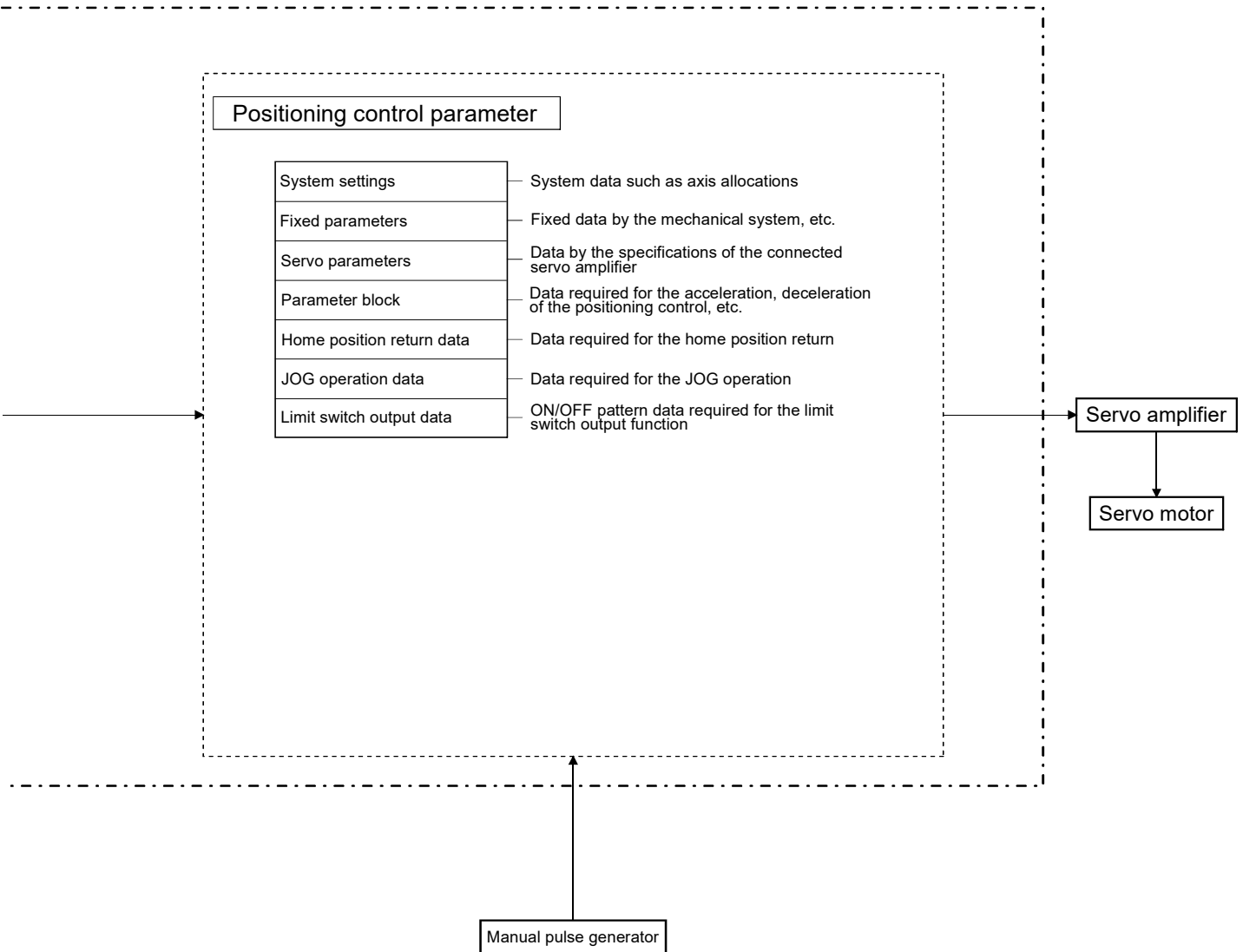

2 POSITIONING CONTROL BY THE MOTION CPU

(1) Positioning control parameters

There are following seven types as positioning control parameters.

Parameter data can be set and corrected using MT Developer2.

	Item	Description	Reference
1	System settings	Multiple system settings, Motion modules and axis No., etc. are set.	Section 4.1
2	Fixed parameters	Data by such as the mechanical system are set for every axis. They are used for calculation of a command position at the positioning control.	Section 4.2
3	Servo parameters	Data by such as the servo amplifier and motor type with connected servo motor are set for every axis. They are set to control the servo motors at the positioning control.	(Note-1)
4	Home position return data	Data such as the direction, method and speed of the home position return used at the positioning control are set for every axis.	Section 6.23.1
5	JOG operation data	Data such as the JOG speed limit value and parameter block No. used at the JOG operation are set for every axis.	Section 6.21.1
6	Parameter block	Data such as the acceleration, deceleration time and speed control value at the positioning control are set up to 64 parameter blocks. They are set with the servo program, JOG operation data and home position return data, and it is used to change easily the acceleration/deceleration processing (acceleration/deceleration time and speed limit value) at the positioning control.	Section 4.3
7	Limit switch output data	Output device, watch data, ON section, output enable/disable bit and forced output bit used for the limit output function for every limit output are set.	(Note-2)

(Note-1): Refer to Section 3.3 of the "Q173D(S)CPU/Q172D(S)CPU Motion controller Programming Manual (COMMON)".

(Note-2): Refer to Section 4.1 of the "Q173D(S)CPU/Q172D(S)CPU Motion controller Programming Manual (COMMON)".

(2) Servo program

The servo program is used for the positioning control in the Motion SFC program.

The positioning control by servo program is executed using the Motion SFC program and Motion dedicated PLC instruction (Servo program start request (D(P).SVST)) .

It comprises a program No., servo instructions and positioning data.

Refer to Chapter 5 for details.

- Program No. It is specified using the Motion SFC program and Motion dedicated PLC instruction.
- Servo instruction It indicates the type of positioning control.
- Positioning data It is required to execute the servo instructions.

The required data is fixed for every servo instruction.

(3) Motion SFC program

Motion SFC program is used to execute the operation sequence or transition control combining "Step", "Transition", or "End" to the servo program.

The positioning control, JOG operation and manual pulse generator operation by the servo program can be executed.

Refer to the "Q173D(S)CPU/Q172D(S)CPU Motion controller (SV13/SV22) Programming Manual (Motion SFC)" for details.

(4) Sequence program

The positioning control by the servo program can be executed using the Motion dedicated PLC instruction of sequence program.

Refer to the "Q173D(S)CPU/Q172D(S)CPU Motion controller (SV13/SV22) Programming Manual (Motion SFC)" for details.

3. POSITIONING DEDICATED SIGNALS

The internal signals of the Motion CPU and the external signals to the Motion CPU are used as positioning signals.

(1) Internal signals

The following five devices of the Motion CPU are used as the internal signals of the Motion CPU.

- Internal relay (M) M2000 to M3839 (1840 points)
- Special relay (SM) SM0 to SM2255 (2256 points)
- Data register (D) D0 to D799 (800 points)
- Motion register (#) #8000 to #8751 (752 points)
- Special register (SD) SD0 to SD2255 (2256 points)

(2) External signals

The external input signals to the Motion CPU are shown below.

- Upper/lower limit switch input The upper/lower limit of the positioning range is controlled.
- Stop signal This signal makes the starting axis stop.
- Proximity dog signal ON/OFF signal from the proximity dog.
- Speed/position switching signal Signal for switching from speed to position.
- Manual pulse generator input Signal from the manual pulse generator.

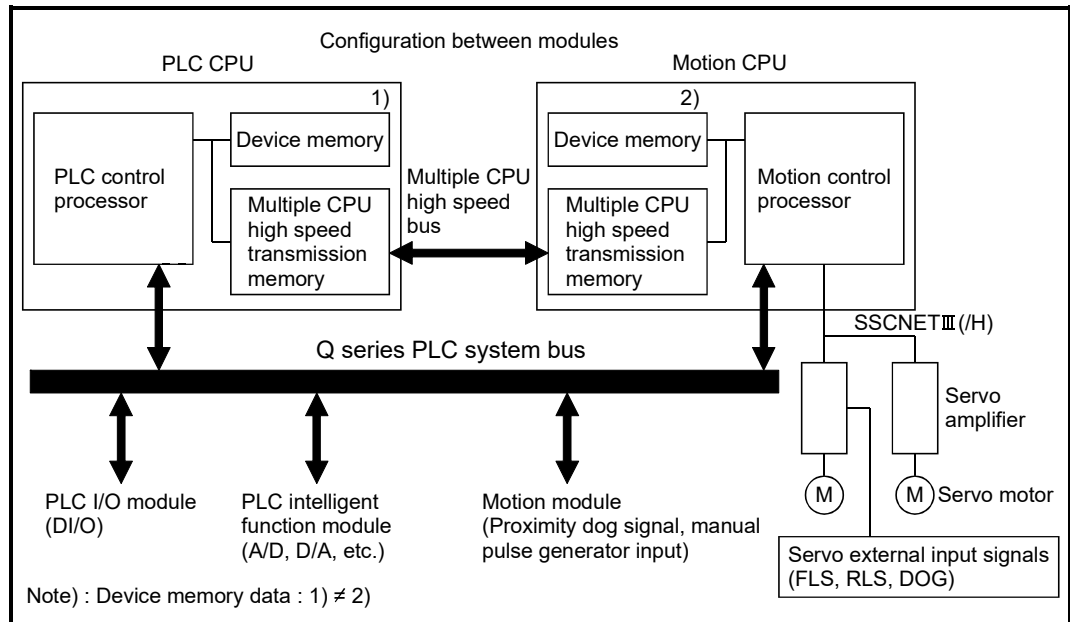

Fig.3.1 Flow of the internal signals/external signals

3 POSITIONING DEDICATED SIGNALS

The positioning dedicated devices are shown below.

It indicates the device refresh cycle of the Motion CPU for status signal with the positioning control, and the device fetch cycle of the Motion CPU for command signal with the positioning control.

The operation cycle of the Motion CPU is shown below.

Item		Q173DSCPU	Q172DSCPU	Q173DCPU(-S1)	Q172DCPU(-S1)
Number of control axes		Up to 32 axes	Up to 16 axes	Up to 32 axes	Up to 8 axes
Operation cycle (Default)	SV13	0.22ms/ 1 to 4 axes 0.44ms/ 5 to 10 axes 0.88ms/ 11 to 24 axes 1.77ms/ 25 to 32 axes	0.22ms/ 1 to 4 axes 0.44ms/ 5 to 10 axes 0.88ms/ 11 to 16 axes	0.44ms/ 1 to 6 axes 0.88ms/ 7 to 18 axes 1.77ms/ 19 to 32 axes	0.44ms/ 1 to 6 axes 0.88ms/ 7 to 8 axes
	SV22	0.44ms/ 1 to 6 axes 0.88ms/ 7 to 16 axes 1.77ms/ 17 to 32 axes	0.44ms/ 1 to 6 axes 0.88ms/ 7 to 16 axes	0.44ms/ 1 to 4 axes 0.88ms/ 5 to 12 axes 1.77ms/ 13 to 28 axes 3.55ms/ 29 to 32 axes	0.44ms/ 1 to 4 axes 0.88ms/ 5 to 8 axes

REMARK

In the positioning dedicated signals, "n" in "M3200+20n", etc. indicates a value corresponding to axis No. such as the following tables.

Axis No.	n	Axis No.	n	Axis No.	n	Axis No.	n
1	0	9	8	17	16	25	24
2	1	10	9	18	17	26	25
3	2	11	10	19	18	27	26
4	3	12	11	20	19	28	27
5	4	13	12	21	20	29	28
6	5	14	13	22	21	30	29
7	6	15	14	23	22	31	30
8	7	16	15	24	23	32	31

- Calculate as follows for the device No. corresponding to each axis.

(Example) For axis 32

$$M3200+20n \text{ (Stop command)}=M3200+20 \times 31=M3820$$

$$M3215+20n \text{ (Servo OFF command)}=M3215+20 \times 31=M3835$$

- The range (n=0 to 15) of axis No.1 to 16 is valid in the Q172DSCPU.
- The range (n=0 to 7) of axis No.1 to 8 is valid in the Q172DCPU(-S1).

3 POSITIONING DEDICATED SIGNALS

3.1 Internal Relays

(1) Internal relay list

SV13		SV22			
Device No.	Purpose	Virtual mode switching method		Advanced synchronous control method	
		Device No.	Purpose	Device No.	Purpose
M0 to	User device (2000 points)	M0 to	User device (2000 points)	M0 to	User device (2000 points)
M2000 to	Common device (320 points)	M2000 to	Common device (320 points)	M2000 to	Common device (320 points)
M2320 to	Unusable (80 points)	M2320 to	Unusable (80 points)	M2320 to	Unusable (80 points)
M2400 to	Axis status (20 points × 32 axes)	M2400 to	Axis status (20 points × 32 axes) Real mode : Each axis Virtual mode : Output module	M2400 to	Axis status (20 points × 32 axes)
M3040 to	Unusable (32 points)	M3040 to	Unusable (32 points)	M3040 to	Unusable (32 points)
M3072 to	Common device (Command signal) (64 points)	M3072 to	Common device (Command signal) (64 points)	M3072 to	Common device (Command signal) (64 points)
M3136 to	Unusable (64 points)	M3136 to	Unusable (64 points)	M3136 to	Unusable (64 points)
M3200 to	Axis command signal (20 points × 32 axes)	M3200 to	Axis command signal (20 points × 32 axes) Real mode : Each axis Virtual mode : Output module	M3200 to	Axis command signal (20 points × 32 axes)
M3840 to	User device (4352 points)	M3840 to	Unusable (160 points)	M3840 to	User device (4352 points)
		M4000 to	Virtual servo motor axis status (Note-1) (20 points × 32 axes)		
		M4640 to	Synchronous encoder axis status (4 points × 12 axes)		
		M4688 to	Unusable (Note-1) (112 points)		
		M4800 to	Virtual servo motor axis command signal (Note-1) (20 points × 32 axes)		
		M5440 to	Synchronous encoder axis command signal (4 points × 12 axes)		
		M5488 to	User device (Note-3) (2704 points)		
M8191		M8191		M8191	

3 POSITIONING DEDICATED SIGNALS

Internal relay list (Continued)

SV13		SV22						
Device No.	Purpose	Virtual mode switching method		Advanced synchronous control method				
		Device No.	Purpose	Device No.	Purpose			
M8192	System area (4096 points)	M8192	System area (4096 points)	M8192 to	System area (1608 points)			
to		M9800 to		Command generation axis status (20 points × 32 axes)				
		M10440 to		Synchronous encoder axis status (10 points × 12 axes)				
		M10560 to		Output axis status (10 points × 32 axes)				
		M10880 to		Synchronous control signal [St.380] (32 points)				
		M10912 to		Synchronous analysis complete signal [St.381] (32 points)				
		M10944 to		Unusable (16 points)				
		M10960 to		Command generation axis command signal (20 points × 32 axes)				
		M11600 to		Synchronous encoder axis command signal (4 points × 12 axes)				
		M11648 to		Unusable (32 points)				
		M11680 to		Output axis command signal (10 points × 32 axes)				
		M12000 to		Synchronous control start signal [Rq.380] (32 points)				
		M12032 to		Synchronous analysis request signal [Rq.381] (32 points)				
		M12064 to		Unusable (224 points)				
		M12287			M12287		M12287	

It can be used as a user device.

(Note-1): It can be used as a user device in the SV22 real mode only.

POINT
• Total number of user device points
• SV13 : 6352 points
• SV22 virtual mode switching method : 4704 points (Note)
• SV22 advanced synchronous control method : 6352 points
(Note): Up to 6096 points can be used when not using it in the virtual mode.

: Refer to Section 1.3 for the software version that supports this function.

3 POSITIONING DEDICATED SIGNALS

(2) Axis status list

Axis No.	Device No.	Signal name		
1	M2400 to M2419			
2	M2420 to M2439			
3	M2440 to M2459			
4	M2460 to M2479			
5	M2480 to M2499			
6	M2500 to M2519			
7	M2520 to M2539			
8	M2540 to M2559			
9	M2560 to M2579			
10	M2580 to M2599			
11	M2600 to M2619			
12	M2620 to M2639			
13	M2640 to M2659			
14	M2660 to M2679			
15	M2680 to M2699			
16	M2700 to M2719			
17	M2720 to M2739			
18	M2740 to M2759			
19	M2760 to M2779			
20	M2780 to M2799			
21	M2800 to M2819			
22	M2820 to M2839			
23	M2840 to M2859			
24	M2860 to M2879			
25	M2880 to M2899			
26	M2900 to M2919			
27	M2920 to M2939			
28	M2940 to M2959			
29	M2960 to M2979			
30	M2980 to M2999			
31	M3000 to M3019			
32	M3020 to M3039			







Signal name	Refresh cycle	Fetch cycle	Signal direction	
0	Positioning start complete	Operation cycle	Status signal	
1	Positioning complete			
2	In-position			
3	Command in-position			
4	Speed controlling			
5	Speed/position switching latch			
6	Zero pass			
7	Error detection			Immediate
8	Servo error detection			Operation cycle
9	Home position return request			Main cycle
10	Home position return complete	Operation cycle		
11	External signals	Main cycle	Status signal	
12				FLS
13				RLS
14				STOP
15	DOG/CHANGE	Operation cycle	Status signal	
15	Servo ready			
16	Torque limiting			
17	Unusable	—	—	
18	Virtual mode continuation operation disable warning (SV22) <small>(Note-1)</small>	At virtual mode transition	Status signal	
19	M-code outputting	Operation cycle		

(Note-1): It is unusable in the SV13/SV22 real mode and SV22 advanced synchronous control.

POINT
<p>(1) The following range is valid.</p> <ul style="list-style-type: none"> • Q172DSCPU : Axis No.1 to 16 • Q172DCPU(-S1): Axis No.1 to 8 <p>(2) The following device area can be used as a user device.</p> <ul style="list-style-type: none"> • Q172DSCPU : 17 axes or more • Q172DCPU(-S1): 9 axes or more <p>However, when the project of Q172DSCPU/Q172DCPU(-S1) is replaced with Q173DSCPU/Q173DCPU(-S1), this area cannot be used as a user device.</p>

3 POSITIONING DEDICATED SIGNALS

(3) Axis command signal list

Axis No.	Device No.	Signal name																																													
1	M3200 to M3219	<table border="1"> <thead> <tr> <th>Signal name</th> <th>Refresh cycle</th> <th>Fetch cycle</th> <th>Signal direction</th> </tr> </thead> <tbody> <tr> <td>0 Stop command</td> <td rowspan="19">/</td> <td rowspan="2">Operation cycle</td> <td rowspan="19">Command signal</td> </tr> <tr> <td>1 Rapid stop command</td> </tr> <tr> <td>2 Forward rotation JOG start command</td> <td rowspan="2">Main cycle</td> </tr> <tr> <td>3 Reverse rotation JOG start command</td> </tr> <tr> <td>4 Complete signal OFF command</td> <td rowspan="2">Operation cycle</td> </tr> <tr> <td>5 Speed/position switching enable command</td> </tr> <tr> <td>6 Gain changing 2 command (Note-1) </td> <td>Operation cycle (Note-2)</td> </tr> <tr> <td>7 Error reset command</td> <td rowspan="2">Main cycle</td> </tr> <tr> <td>8 Servo error reset command</td> </tr> <tr> <td>9 External stop input disable at start command</td> <td>At start</td> </tr> <tr> <td>10 Unusable</td> <td>—</td> <td>—</td> <td>—</td> </tr> <tr> <td>12 Feed current value update command</td> <td rowspan="8">/</td> <td>At start</td> <td rowspan="8">Command signal</td> </tr> <tr> <td>13 Address clutch reference setting command (SV22 only) (Note-3)</td> <td>At virtual mode transition</td> </tr> <tr> <td>14 Cam reference position setting command (SV22 only) (Note-3)</td> <td rowspan="2">Operation cycle</td> </tr> <tr> <td>15 Servo OFF command</td> </tr> <tr> <td>16 Gain changing command</td> <td>Operation cycle (Note-2)</td> </tr> <tr> <td>17 PI-PID switching command </td> <td rowspan="2">Operation cycle</td> </tr> <tr> <td>18 Control loop changing command</td> </tr> <tr> <td>19 FIN signal</td> <td>Operation cycle</td> </tr> </tbody> </table>	Signal name	Refresh cycle	Fetch cycle	Signal direction	0 Stop command	/	Operation cycle	Command signal	1 Rapid stop command	2 Forward rotation JOG start command	Main cycle	3 Reverse rotation JOG start command	4 Complete signal OFF command	Operation cycle	5 Speed/position switching enable command	6 Gain changing 2 command (Note-1) 	Operation cycle (Note-2)	7 Error reset command	Main cycle	8 Servo error reset command	9 External stop input disable at start command	At start	10 Unusable	—	—	—	12 Feed current value update command	/	At start	Command signal	13 Address clutch reference setting command (SV22 only) (Note-3)	At virtual mode transition	14 Cam reference position setting command (SV22 only) (Note-3)	Operation cycle	15 Servo OFF command	16 Gain changing command	Operation cycle (Note-2)	17 PI-PID switching command 	Operation cycle	18 Control loop changing command	19 FIN signal	Operation cycle			
Signal name	Refresh cycle		Fetch cycle	Signal direction																																											
0 Stop command	/		Operation cycle	Command signal																																											
1 Rapid stop command																																															
2 Forward rotation JOG start command			Main cycle																																												
3 Reverse rotation JOG start command																																															
4 Complete signal OFF command			Operation cycle																																												
5 Speed/position switching enable command																																															
6 Gain changing 2 command (Note-1) 			Operation cycle (Note-2)																																												
7 Error reset command			Main cycle																																												
8 Servo error reset command																																															
9 External stop input disable at start command			At start																																												
10 Unusable			—		—	—																																									
12 Feed current value update command			/		At start	Command signal																																									
13 Address clutch reference setting command (SV22 only) (Note-3)					At virtual mode transition																																										
14 Cam reference position setting command (SV22 only) (Note-3)					Operation cycle																																										
15 Servo OFF command																																															
16 Gain changing command					Operation cycle (Note-2)																																										
17 PI-PID switching command 					Operation cycle																																										
18 Control loop changing command																																															
19 FIN signal		Operation cycle																																													
2	M3220 to M3239																																														
3	M3240 to M3259																																														
4	M3260 to M3279																																														
5	M3280 to M3299																																														
6	M3300 to M3319																																														
7	M3320 to M3339																																														
8	M3340 to M3359																																														
9	M3360 to M3379																																														
10	M3380 to M3399																																														
11	M3400 to M3419																																														
12	M3420 to M3439																																														
13	M3440 to M3459																																														
14	M3460 to M3479																																														
15	M3480 to M3499																																														
16	M3500 to M3519																																														
17	M3520 to M3539																																														
18	M3540 to M3559																																														
19	M3560 to M3579																																														
20	M3580 to M3599																																														
21	M3600 to M3619																																														
22	M3620 to M3639																																														
23	M3640 to M3659																																														
24	M3660 to M3679																																														
25	M3680 to M3699																																														
26	M3700 to M3719																																														
27	M3720 to M3739																																														
28	M3740 to M3759																																														
29	M3760 to M3779																																														
30	M3780 to M3799																																														
31	M3800 to M3819																																														
32	M3820 to M3839																																														

(Note-1): Servo amplifier (MR-J5(W)-□B) only.

(Note-2): Operation cycle 7.1[ms] or more: Every 3.5[ms]

(Note-3): It is unusable in the SV13/SV22 real mode and SV22 advanced synchronous control.

POINT

(1) The following range is valid.

- Q172DSCPU : Axis No.1 to 16
- Q172DCPU(-S1): Axis No.1 to 8

(2) The following device area can be used as a user device.

- Q172DSCPU : 17 axes or more
- Q172DCPU(-S1): 9 axes or more

However, when the project of Q172DSCPU/Q172DCPU(-S1) is replaced with Q173DSCPU/Q173DCPU(-S1), this area cannot be used as a user device.

: Refer to Section 1.3 for the software version that supports this function.

3 POSITIONING DEDICATED SIGNALS

(4) Common device list

Device No.	Signal name	Refresh cycle	Fetch cycle	Signal direction	Remark (Note-7)				
M2000	PLC ready flag		Main cycle	Command signal	M3072				
M2001	Axis 1	Start accept flag	Operation cycle	Status signal (Note-1), (Note-2), (Note-3), (Note-4)					
M2002	Axis 2								
M2003	Axis 3								
M2004	Axis 4								
M2005	Axis 5								
M2006	Axis 6								
M2007	Axis 7								
M2008	Axis 8								
M2009	Axis 9								
M2010	Axis 10								
M2011	Axis 11								
M2012	Axis 12								
M2013	Axis 13								
M2014	Axis 14								
M2015	Axis 15								
M2016	Axis 16								
M2017	Axis 17								
M2018	Axis 18								
M2019	Axis 19								
M2020	Axis 20								
M2021	Axis 21								
M2022	Axis 22								
M2023	Axis 23								
M2024	Axis 24								
M2025	Axis 25								
M2026	Axis 26								
M2027	Axis 27								
M2028	Axis 28								
M2029	Axis 29								
M2030	Axis 30								
M2031	Axis 31								
M2032	Axis 32								
M2033	Unusable (2 points)	—	—	—	—				
M2035	Motion error history clear request flag		Main cycle	Command signal	M3080				
M2036	Unusable (2 points)	—	—	—	—				
M2037	Unusable (2 points)	—	—	—	—				
M2038	Motion SFC debugging flag	At debugging mode transition		Status signal					
M2039	Motion error detection flag	Immediate		Status signal					
M2040	Speed switching point specified flag		At start	Command signal	M3073				
M2041	System setting error flag	Operation cycle		Status signal					
M2042	All axes servo ON command		Operation cycle	Command signal	M3074				
M2043	Real mode/virtual mode switching request (SV22) (Note-5)		At virtual mode transition	Command signal	M3075				
M2044	Real mode/virtual mode switching status (SV22) (Note-5)			Status signal					
M2045	Real mode/virtual mode switching error detection signal (SV22) (Note-5)	At virtual mode transition		Status signal					
M2046	Out-of-sync warning (SV22) (Note-5)			Status signal					
M2047	Motion slot fault detection flag	Operation cycle		Status signal					
M2048	JOG operation simultaneous start command		Main cycle	Command signal	M3076				
M2049	All axes servo ON accept flag	Operation cycle		Status signal					
M2050	Unusable	—	—	—	—				
M2051	Manual pulse generator 1 enable flag		Main cycle	Command signal	M3077				
M2052	Manual pulse generator 2 enable flag		Main cycle	Command signal	M3078				
M2053	Manual pulse generator 3 enable flag		Main cycle	Command signal	M3079				
M2054	Operation cycle over flag	Operation cycle		Status signal					
M2055									
M2056	Unusable (6 points)	—	—	—	—				
M2057									
M2058									
M2059									
M2060									
M2061	Axis 1	Speed change accepting flag	Operation cycle	Status signal (Note-1), (Note-2), (Note-3), (Note-4)					
M2062	Axis 2								
M2063	Axis 3								
M2064	Axis 4								
M2065	Axis 5								
M2066	Axis 6								
M2067	Axis 7								
M2068	Axis 8								
M2069	Axis 9								
M2070	Axis 10								
M2071	Axis 11								
M2072	Axis 12								
M2073	Axis 13								
M2074	Axis 14								
M2075	Axis 15								
M2076	Axis 16								
M2077	Axis 17								
M2078	Axis 18								
M2079	Axis 19								
M2080	Axis 20								
M2081	Axis 21								
M2082	Axis 22								
M2083	Axis 23								
M2084	Axis 24								
M2085	Axis 25								
M2086	Axis 26								
M2087	Axis 27								
M2088	Axis 28								
M2089	Axis 29								
M2090	Axis 30								
M2091	Axis 31								
M2092	Axis 32								
M2093									
M2094									
M2095									
M2096									
M2097	Unusable (8 points)	—	—	—	—				
M2098									
M2099									
M2100									
M2101	Axis 1	Synchronous encoder current value changing flag (Note-5), (Note-6)	Operation cycle	Status signal (Note-2), (Note-4)					
M2102	Axis 2								
M2103	Axis 3								
M2104	Axis 4								
M2105	Axis 5								
M2106	Axis 6								
M2107	Axis 7								
M2108	Axis 8								
M2109	Axis 9								

3 POSITIONING DEDICATED SIGNALS

Common device list (Continued)

Device No.	Signal name	Refresh cycle	Fetch cycle	Signal direction	Remark (Note-7)	Device No.	Signal name	Refresh cycle	Fetch cycle	Signal direction	Remark (Note-7)
M2110	Axis 10	Synchronous encoder current value changing flag (Note-5), (Note-6)	Operation cycle	/	Status signal (Note-2), (Note-4)	M2179	Unusable (45 points) (Note-8)	-	-	-	-
M2111	Axis 11										
M2112	Axis 12										
M2113	Unusable (15 points)	-	-	-	-	M2182					
M2114											
M2115											
M2116											
M2117											
M2118											
M2119											
M2120											
M2121											
M2122											
M2123											
M2124											
M2125											
M2126											
M2127											
M2128	Axis 1	Automatic decelerating flag	Operation cycle	/	Status signal (Note-1), (Note-2), (Note-3), (Note-4)	M2197					
M2129	Axis 2										
M2130	Axis 3										
M2131	Axis 4										
M2132	Axis 5										
M2133	Axis 6										
M2134	Axis 7										
M2135	Axis 8										
M2136	Axis 9										
M2137	Axis 10										
M2138	Axis 11										
M2139	Axis 12										
M2140	Axis 13										
M2141	Axis 14										
M2142	Axis 15										
M2143	Axis 16										
M2144	Axis 17										
M2145	Axis 18										
M2146	Axis 19										
M2147	Axis 20										
M2148	Axis 21										
M2149	Axis 22										
M2150	Axis 23										
M2151	Axis 24										
M2152	Axis 25										
M2153	Axis 26										
M2154	Axis 27										
M2155	Axis 28										
M2156	Axis 29										
M2157	Axis 30										
M2158	Axis 31										
M2159	Axis 32										
M2160	Unusable (19 points) (Note-9)	-	-	-	-	M2208					
M2161											
M2162											
M2163											
M2164											
M2165											
M2166											
M2167											
M2168											
M2169											
M2170											
M2171	Speed change "0" accepting flag	Operation cycle	/	Status signal (Note-1), (Note-2), (Note-3), (Note-4)	-	M2209					
M2172											
M2173											
M2174											
M2175											
M2176											
M2177											
M2178											
M2200	Unusable (16 points)	-	-	-	-	M2210					
M2201											
M2202											
M2203											
M2204											
M2205											
M2206											
M2207											
M2208											
M2209											
M2210											
M2211											
M2212											
M2213											
M2214											
M2215											
M2216											
M2217											
M2218											
M2219											
M2220											
M2221											
M2222											
M2223											
M2224											
M2225											
M2226											
M2227											
M2228											
M2229											
M2230											
M2231											
M2232											
M2233											
M2234											
M2235											
M2236											
M2237											
M2238											
M2239											
M2240	Axis 1	Speed change "0" accepting flag	Operation cycle	/	Status signal (Note-1), (Note-2), (Note-3), (Note-4)	M2240					
M2241	Axis 2										
M2242	Axis 3										
M2243	Axis 4										
M2244	Axis 5										
M2245	Axis 6										
M2246	Axis 7										
M2247	Axis 8										

3 POSITIONING DEDICATED SIGNALS

Common device list (Continued)

Device No.	Signal name	Refresh cycle	Fetch cycle	Signal direction	Remark (Note-7)	Device No.	Signal name	Refresh cycle	Fetch cycle	Signal direction	Remark (Note-7)
M2248	Axis 9	Operation cycle			Status signal (Note-1), (Note-2), (Note-3), (Note-4)	M2284	Axis 13	Operation cycle			Status signal (Note-1), (Note-2), (Note-3), (Note-4)
M2249	Axis 10					M2285	Axis 14				
M2250	Axis 11					M2286	Axis 15				
M2251	Axis 12					M2287	Axis 16				
M2252	Axis 13					M2288	Axis 17				
M2253	Axis 14					M2289	Axis 18				
M2254	Axis 15					M2290	Axis 19				
M2255	Axis 16					M2291	Axis 20				
M2256	Axis 17					M2292	Axis 21				
M2257	Axis 18					M2293	Axis 22				
M2258	Axis 19					M2294	Axis 23				
M2259	Axis 20					M2295	Axis 24				
M2260	Axis 21					M2296	Axis 25				
M2261	Axis 22					M2297	Axis 26				
M2262	Axis 23					M2298	Axis 27				
M2263	Axis 24					M2299	Axis 28				
M2264	Axis 25					M2300	Axis 29				
M2265	Axis 26					M2301	Axis 30				
M2266	Axis 27					M2302	Axis 31				
M2267	Axis 28					M2303	Axis 32				
M2268	Axis 29	M2304									
M2269	Axis 30	M2305									
M2270	Axis 31	M2306									
M2271	Axis 32	M2307									
M2272	Axis 1	M2308									
M2273	Axis 2	M2309									
M2274	Axis 3	M2310									
M2275	Axis 4	M2311	Unusable								
M2276	Axis 5	M2312	(16 points)								
M2277	Axis 6	M2313									
M2278	Axis 7	M2314									
M2279	Axis 8	M2315									
M2280	Axis 9	M2316									
M2281	Axis 10	M2317									
M2282	Axis 11	M2318									
M2283	Axis 12	M2319									

(Note-1): The range of axis No.1 to 16 is valid in the Q172DSCPU.

(Note-2): The range of axis No.1 to 8 is valid in the Q172DCPU(-S1).

(Note-3): Device area of 17 axes or more is unusable in the Q172DSCPU.

(Note-4): Device area of 9 axes or more is unusable in the Q172DCPU(-S1).

(Note-5): It is unusable in the SV22 advanced synchronous control.

(Note-6): It is unusable in the real mode.

(It can be used in the real mode for the version (Refer to Section 1.3) that supports "synchronous encoder current value monitor in real mode".)

(Note-7): It can also be ordered the device of a remark column.

(Note-8): These devices can be used as the clutch statuses.

The clutch status can also be set as the optional device at the clutch parameter.

Refer to Chapter 7 of the "Q173D(S)CPU/Q172D(S)CPU Motion controller (SV22) Programming Manual (VIRTUAL MODE)" for details.

3 POSITIONING DEDICATED SIGNALS

(5) Common device list (Command signal)

Device No.	Signal name	Refresh cycle	Fetch cycle	Signal direction	Remark (Note-1), (Note-2)
M3072	PLC ready flag	/	Main cycle	Command signal	M2000
M3073	Speed switching point specified flag		At start		M2040
M3074	All axes servo ON command		Operation cycle		M2042
M3075	Real mode/virtual mode switching request (SV22) (Note-3)		At virtual mode transition		M2043
M3076	JOG operation simultaneous start command		Main cycle		M2048
M3077	Manual pulse generator 1 enable flag				M2051
M3078	Manual pulse generator 2 enable flag				M2052
M3079	Manual pulse generator 3 enable flag				M2053
M3080	Motion error history clear request flag				M2035
M3081 to M3135	Unusable (Note-4) (55 points)		—		—

(Note-1): The state of a device is not in agreement when the device of a remark column is turned ON/OFF directly. In addition, when the request from a data register and the request from the above device are performed simultaneously, the request from the above device becomes effective.

(Note-2): It can also be ordered the device of a remark column.

(Note-3): It is unusable in the SV22 advanced synchronous control.

(Note-4): Do not use it as a user device. It can be used as a device that performs automatic refresh because of area for the reserve of command signal.

POINT
<p>The device of a remark column turns ON by OFF to ON of the above device, and turns OFF by ON to OFF of the above device.</p> <p>The command signal cannot be turned ON/OFF by the PLC CPU in the automatic refresh because the statuses and commands are mixed together in M2000 to M2053. Use the above devices in the case.</p> <p>And, it can also be turned ON/OFF by the data register. (Refer to Section 3.2.3.)</p>

3 POSITIONING DEDICATED SIGNALS

3.1.1 Axis statuses

- (1) Positioning start complete signal (M2400+20n) Status signal
- (a) This signal turns on with the start completion for the positioning control of the axis specified with the servo program. It does not turn on at the starting using JOG operation or manual pulse generator operation. It can be used to read a M-code at the positioning start. (Refer to Section 7.1.)
 - (b) This signal turns off at leading edge of complete signal OFF command (M3204+20n) or positioning completion.

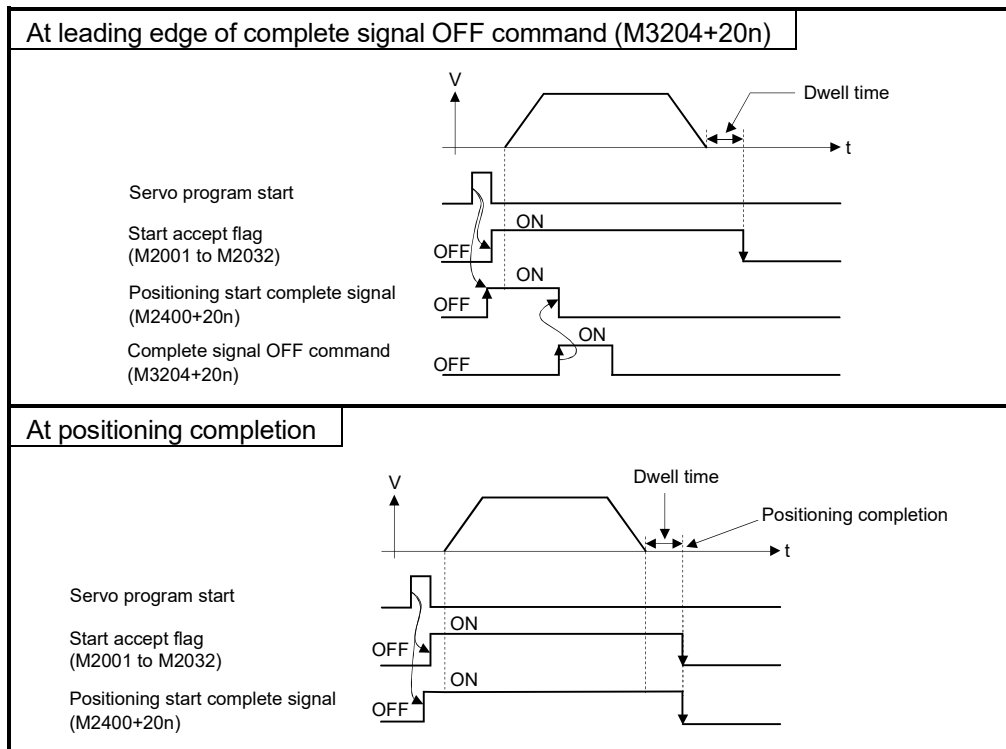

3 POSITIONING DEDICATED SIGNALS

(2) Positioning complete signal (M2401+20n) Status signal

(a) This signal turns on with the completion of the command output to positioning address for the axis specified with the servo program. It does not turn on at the start or stop on the way using home position return, JOG operation, manual pulse generator operation or speed control. It does not turn on at the stop on the way during positioning. It can be used to read a M-code at the positioning completion. (Refer to Section 7.1.)

(b) This signal turns off at leading edge of complete signal OFF command (M3204+20n) or positioning start.

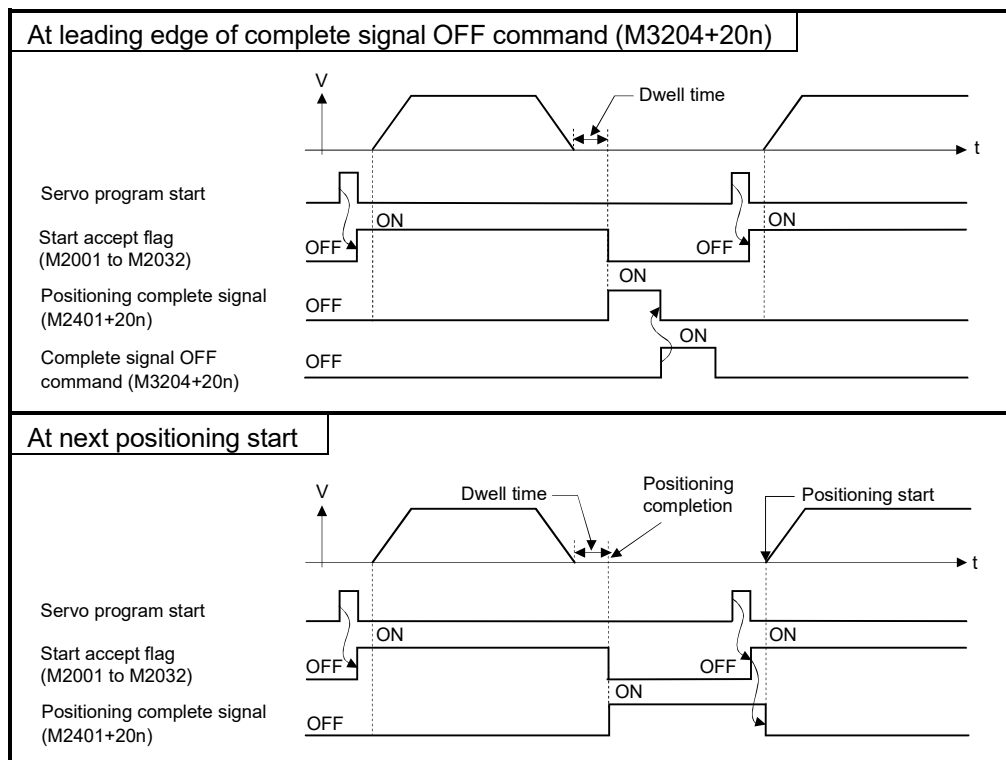

(c) The positioning complete signal turns ON by the execution of servo program even if the travel value of the axis specified with the servo program is set to "0".

⚠ CAUTION

- The deviation counter value is not considered, so that the positioning complete signal (M2401+20n) turns on with the completion of the command output to positioning address. Use the positioning complete signal (M2401+20n) together with the in-position signal (M2402+20n) to confirm the positioning completion of servo axis in the final instruction under program.

3 POSITIONING DEDICATED SIGNALS

(3) In-position signal (M2402+20n) Status signal

- (a) This signal turns on when the number of droop pulses in the deviation counter becomes below the "in-position range" set in the servo parameters. It turns off at positioning start.

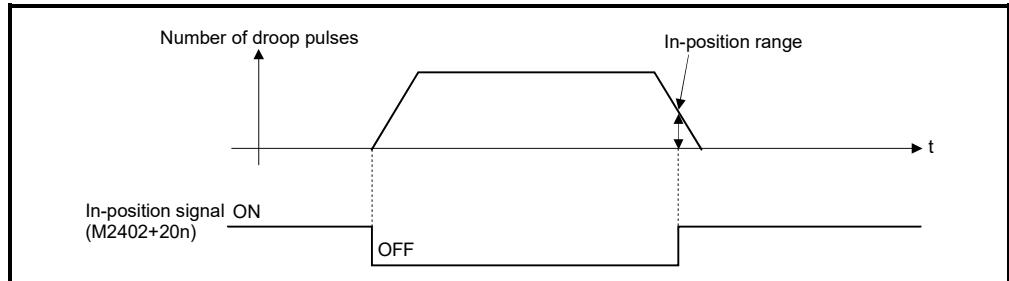

- (b) While the control circuit power supply of the servo amplifier is ON, the status of the in-position signal of the servo amplifier (Servo status1 (#8010+20n): b12 **QDS**) is reflected.

However, the state of the signal is always OFF for the following.

- Servo error
- From positioning start until deceleration start (Note-1)
- Current value change
- Home position return (Note-2)
- Speed-torque control **QDS**

(Note-1): Except during position follow-up control, high-speed oscillation control, manual pulse generator operation, and synchronous control. (The in-position signal is constantly updated during such controls.)

(Note-2): The in-position signal may be updated after a proximity dog is turned ON during home position return.

3 POSITIONING DEDICATED SIGNALS

(4) Command in-position signal (M2403+20n) Status signal

(a) This signal turns on when the absolute value of difference between the command position and feed current value becomes below the "command in-position range" set in the fixed parameters.

This signal turns off in the following cases.

- Positioning control start
- Home position return
- Speed control
- JOG operation
- Manual pulse generator operation
- Speed-torque control **QDS**

(b) Command in-position check is continually executed during position control.

This check is not executed during speed control or speed control in the speed-position switching control.

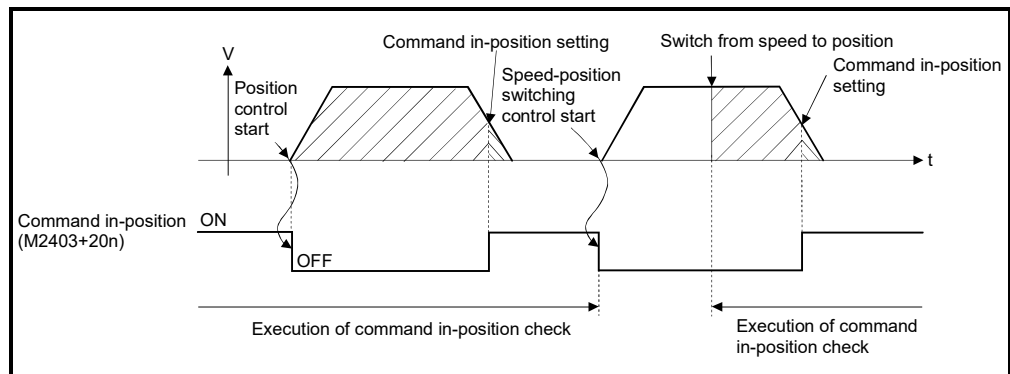

(5) Speed controlling signal (M2404+20n) Status signal

(a) This signal turns on during speed control, and it is used as judgement of during the speed control or position control.

It is turning on while the switching from speed control to position control by the external CHANGE signal at the speed-position switching control.

(b) This signal turns off at the power supply on and during position control.

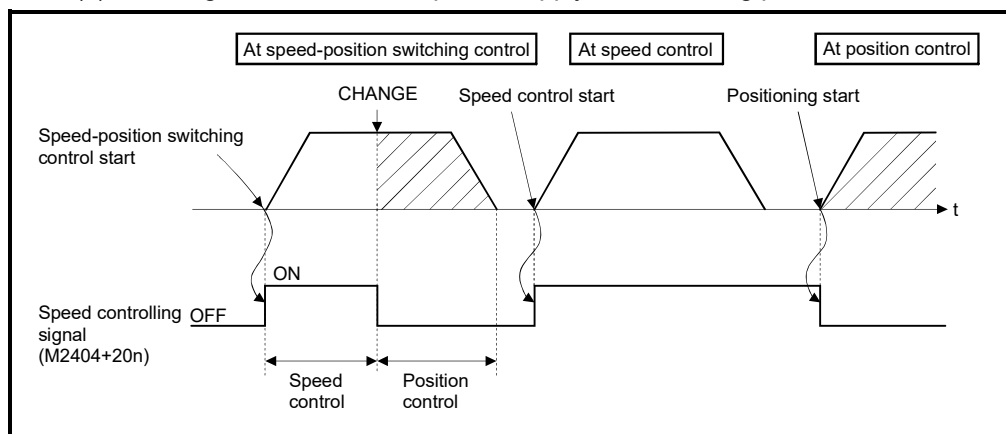

(c) It does not turn on at the speed control mode in speed-torque control. **QDS**

(6) Speed/position switching latch signal (M2405+20n) Status signal

- (a) This signal turns on when the control is switched from speed control to position control.
It can be used as an interlock signal to enable or disable changing of the travel value in position control.
- (b) The signal turns off at the following start.
- Position control
 - Speed-position switching control
 - Speed control
 - JOG operation
 - Manual pulse generator operation
 - Speed-torque control **QDS**

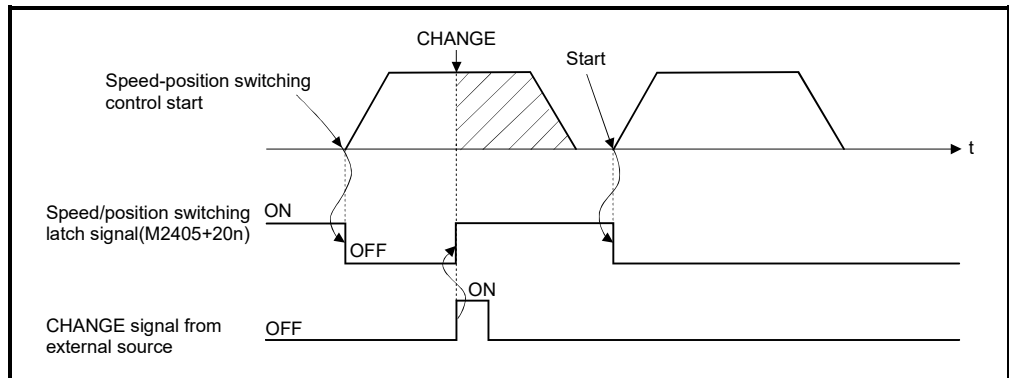

(7) Zero pass signal (M2406+20n) Status signal

This signal turns on when the zero point is passed after the control circuit power supply on of the servo amplifier.
Once the zero point has been passed, it remains on state until the Multiple CPU system has been reset.
However, in the home position return method of proximity dog method, count method, dog cradle method, limit switch combined method, scale home position signal detection method, or dogless home position signal reference method, this signal turns off once at the home position return start and turns on again at the next zero point passage.

3 POSITIONING DEDICATED SIGNALS

(8) Error detection signal (M2407+20n) Status signal

(a) This signal turns on with detection of a minor error or major error, and can be used to judge if there is an error or not.

The applicable error code ^(Note-1) is stored in the minor error code storage register (D6+20n) with detection of a minor error.

The applicable error code ^(Note-1) is stored in the major error code storage register (D7+20n) with detection of a major error.

(b) This signal turns off when the error reset command (M3207+20n) turns on.

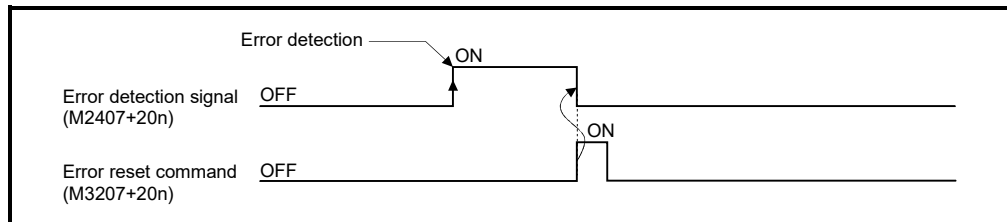

REMARK

(Note-1): Refer to APPENDIX 1 for the error codes with detection of major/minor errors.

(9) Servo error detection signal (M2408+20n) Status signal

(a) This signal turns on when an error occurs at the servo amplifier side (except for errors cause of alarms and emergency stops) ^(Note-1), and can be used to judge is there is a servo error or not.

When an error is detected at the servo amplifier side, the applicable error code ^(Note-1) is stored in the servo error code storage register (D8+20n).

(b) This signal turns off when the servo error reset command (M3208+20n) turns on or the servo power supply turns on again.

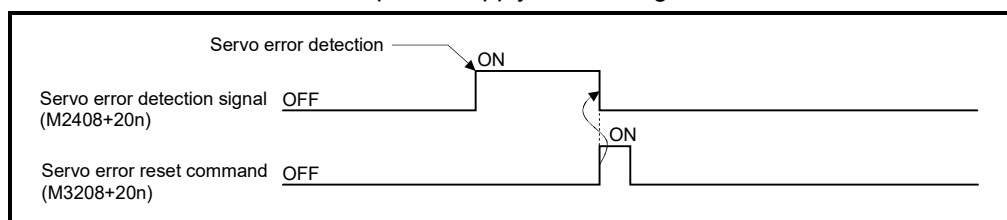

REMARK

(Note-1): Refer to APPENDIX 1.4 for the error codes on errors detected at the servo amplifier side.

(10) Home position return request signal (M2409+20n)
..... Status signal

This signal turns on when it is necessary to confirm the home position address.

- (a) When not using an absolute position system
 - 1) This signal turns on in the following cases:
 - Multiple CPU system power supply on or reset
 - Servo amplifier power supply on
 - Home position return start
(Unless a home position return is completed normally, the home position return request signal does not turn off.)
 - 2) This signal turns off by the completion of home position return.
- (b) When using an absolute position system
 - 1) This signal turns on in the following cases:
 - When not executing a home position return once after system start.
 - Home position return start
(Unless a home position return is completed normally, the home position return request signal does not turn off.)
 - Erase of an absolute data in Motion CPU according to causes, such as battery error
 - Servo error [2025] (absolute position erase) occurrence
 - Servo error [2143] (absolute position counter warning) occurrence
 - Servo error [2913] (encoder counter error) occurrence
 - Major error [1201], [1202], [1203], or [1204] occurrence
 - When the "rotation direction selection" of servo parameter is changed.
 - 2) This signal turns off by the completion of the home position return.

 CAUTION
--

- | |
|--|
| <ul style="list-style-type: none">● When using the absolute position system function, on starting up, and when the Motion controller or absolute value motor has been replaced, always perform a home position return. In the case of the absolute position system, use the sequence program to check the home position return request before performing the positioning control. Failure to observe this could lead to an accident such as a collision. |
|--|

(11) Home position return complete signal (M2410+20n)
..... Status signal

- (a) This signal turns on when the home position return operation using the servo program has been completed normally.
- (b) This signal turns off at the positioning start, JOG operation start and manual pulse generator operation start.
- (c) If the home position return of proximity dog, dog cradle or stopper method using the servo program is executed during this signal on, the a minor error (error code: 115) occurs, and home position return cannot start.

(12) FLS signal (M2411+20n) ^(Note-1) Status signal

(a) This signal is controlled by the ON/OFF state for the upper stroke limit switch input (FLS) of the Q172DLX/servo amplifier and bit device **QDS**.

- Upper stroke limit switch input OFF FLS signal: ON
- Upper stroke limit switch input ON FLS signal: OFF

(b) The state for the upper stroke limit switch input (FLS) when the FLS signal is ON/OFF is shown below.

1) Q172DLX use ^(Note-2)

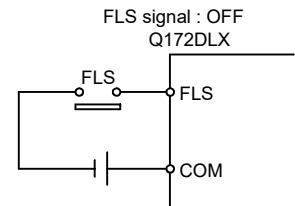
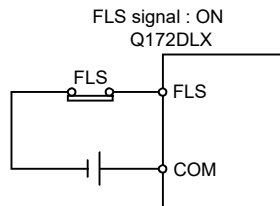

2) Servo amplifier input use ^(Note-3)

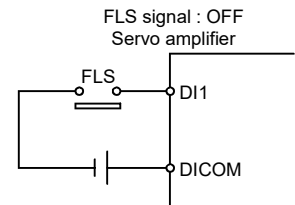
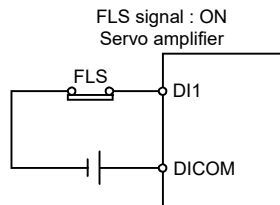

3) Bit device use ^(Note-1) **QDS**

The set bit device is the FLS signal.

(Note-1): Refer to the "Q173D(S)CPU/Q172D(S)CPU Motion controller Programming Manual (COMMON)" for an external signal and bit device.

(Note-2): Refer to the "Q173D(S)CPU/Q172D(S)CPU Motion controller User's Manual" for a pin configuration.

(Note-3): Refer to the "Servo Amplifier Instruction Manual" for a pin configuration.

(c) "Normally open contact input" and "Normally closed contact input" of the servo data setting can be selected. **QDS**

(13) RLS signal (M2412+20n) ^(Note-1) Status signal

(a) This signal is controlled by the ON/OFF state for the lower stroke limit switch input (RLS) of the Q172DLX/servo amplifier and bit device **QDS**.

- Lower stroke limit switch input OFF RLS signal: ON
- Lower stroke limit switch input ON RLS signal: OFF

(b) The state of the lower stroke limit switch input (RLS) when the RLS signal is ON/OFF is shown below.

1) Q172DLX use ^(Note-2)

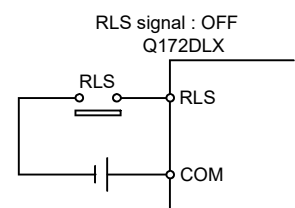
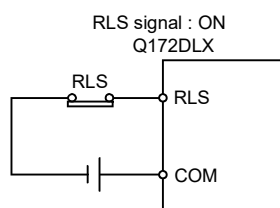

2) Servo amplifier input use (Note-3)

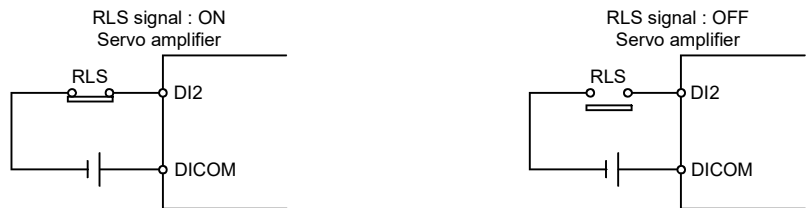

3) Bit device use (Note-1) **QDS**

The set bit device is the RLS signal.

(Note-1): Refer to the "Q173D(S)CPU/Q172D(S)CPU Motion controller Programming Manual (COMMON)" for an external signal and bit device.

(Note-2): Refer to the "Q173D(S)CPU/Q172D(S)CPU Motion controller User's Manual" for a pin configuration.

(Note-3): Refer to the "Servo Amplifier Instruction Manual" for a pin configuration.

(c) "Normally open contact input" and "Normally closed contact input" of the servo data setting can be selected. **QDS**

(14) STOP signal (M2413+20n) (Note-1) Status signal

(a) This signal is controlled by the ON/OFF state for the stop signal input (STOP) of the Q172DLX and bit device **QDS**.

- Stop signal input of the Q172DLX OFF STOP signal: OFF
- Stop signal input of the Q172DLX ON STOP signal: ON

(b) The state of the stop signal input (STOP) when the STOP signal input is ON/OFF is shown below.

1) Q172DLX use (Note-2)



2) Bit device use (Note-1) **QDS**

The set bit device is the STOP signal.

(Note-1): Refer to the "Q173D(S)CPU/Q172D(S)CPU Motion controller Programming Manual (COMMON)" for an external signal and bit device.

(Note-2): Refer to the "Q173D(S)CPU/Q172D(S)CPU Motion controller User's Manual" for a pin configuration.

(c) "Normally open contact input" and "Normally closed contact input" of the servo data setting can be selected. **QDS**

(15) DOG/CHANGE signal (M2414+20n)^(Note-1) Status signal

(a) This signal turns on/off by the proximity dog input (DOG) of the Q172DLX/ servo amplifier/input(DI) of built-in interface in Motion CPU **QDS**/bit device **QDS** at the home position return.

This signal turns on/off by the speed/position switching input (CHANGE) of the Q172DLX/proximity dog input (DOG) of servo amplifier/input (DI) of built-in interface in Motion CPU **QDS**/bit device **QDS** at the speed/position switching control.^(Note-2) (There is no CHANGE signal in the servo amplifier.)

(b) The state of the speed/position switching input (CHANGE) when the CHANGE signal is ON/OFF is shown below.

1) Q172DLX use ^(Note-3)

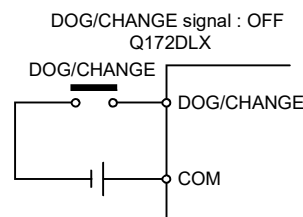
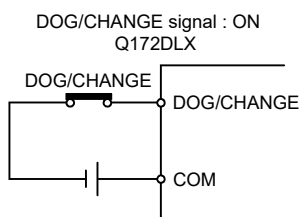

2) Servo amplifier input use ^(Note-4)

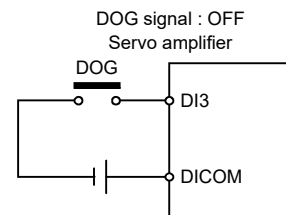
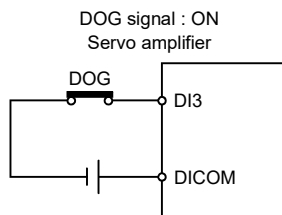

3) Built-in interface in Motion CPU use^(Note-3) **QDS**

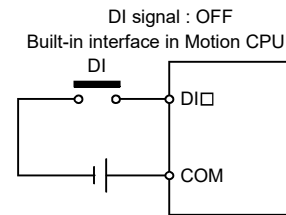
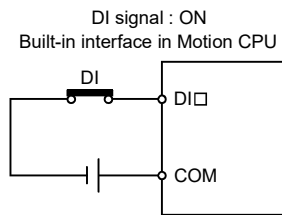

4) Bit device use ^(Note-1) **QDS**

The set bit device is the DOG/CHANGE signal.

(Note-1): Refer to the "Q173D(S)CPU/Q172D(S)CPU Motion controller Programming Manual (COMMON)" for an external signal and bit device.

(Note-2): When using the Q173DCPU(-S1)/Q172DCPU(-S1), the external input signal (DOG) of servo amplifier can also be used in the speed-position switching control. (Refer to Section 1.3 for the software version that supports this function.)

(Note-3): Refer to the "Q173D(S)CPU/Q172D(S)CPU Motion controller User's Manual" for a pin configuration.

(Note-4): Refer to the "Servo Amplifier Instruction Manual" for a pin configuration.

3 POSITIONING DEDICATED SIGNALS

(c) When using the Q172DLX/built-in interface in Motion CPU, "Normally open contact input" and "Normally closed contact input" of the system setting can be selected.

When using the proximity dog input (DOG) of servo amplifier/bit device, "Normally open contact input" and "Normally closed contact input" of the servo data setting can be selected. **QDS**

(16) Servo ready signal (M2415+20n) Status signal

(a) This signal turns on when the servo amplifiers connected to each axis are in the READY state (READY ON and Servo ON).

(b) This signal turns off in the following cases.

- All axes servo ON command (M2042) is off
- Servo amplifier is not mounted
- Servo parameter is not set
- It is received the forced stop input from an external source
- Servo OFF by the servo OFF command (M3215+20n) ON of each axis
- Servo error occurs

Refer to "APPENDIX 1.4 Servo errors" for details.

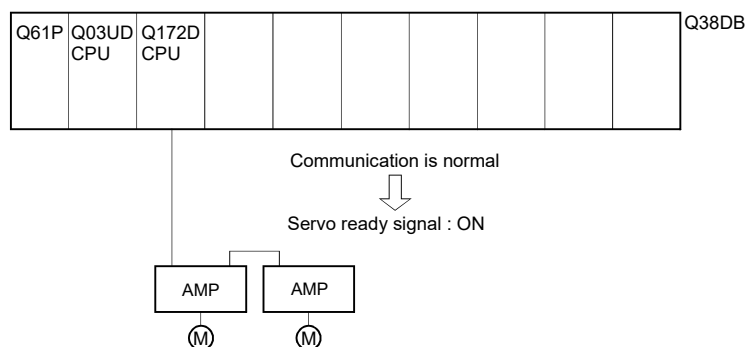

POINT

When the part of multiple servo amplifiers connected to the SSCNET III(/H) becomes a servo error, only an applicable axis becomes the servo OFF state.

(17) Torque limiting signal (M2416+20n) Status signal

This signal turns on while torque limit is executed.

The signal toward the torque limiting axis turns on

3 POSITIONING DEDICATED SIGNALS

(18) M-code outputting signal (M2419+20n) Status signal

(a) This signal turns during M-code is outputting.

(b) This signal turns off when the stop command, cancel signal, skip signal or FIN signal are inputted.

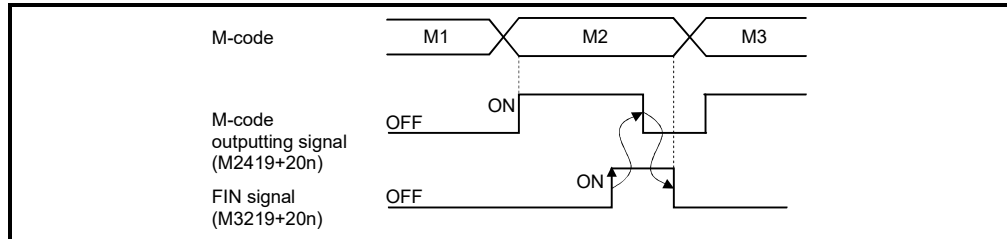

POINTS

(1) The FIN signal (M3219+20n) and M-code outputting signal (M2419+20n) are both for the FIN signal wait function.

(2) The FIN signal (M3219+20n) and M-code outputting signal (M2419+20n) are effective only when FIN acceleration/deceleration is designated in the servo program.

Otherwise, the FIN signal wait function is disabled, and the M-code outputting signal (M2419+20n) does not turn on.

3 POSITIONING DEDICATED SIGNALS

3.1.2 Axis command signals

(1) Stop command (M3200+20n) Command signal

(a) This command is a signal which stop a starting axis from an external source and becomes effective at leading edge of signal. (An axis for which the stop command is turning on cannot be started.)

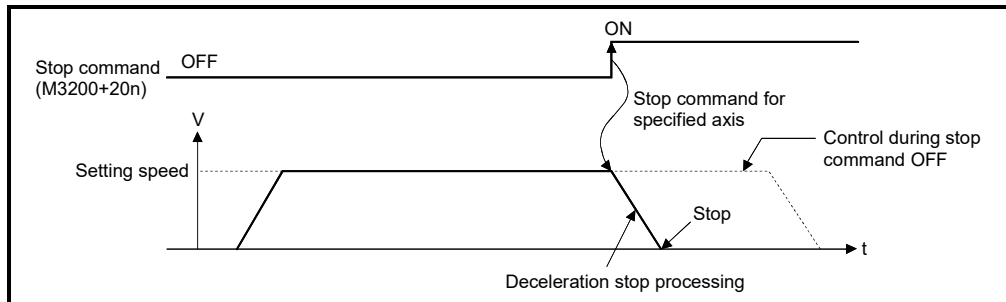

(b) The details of stop processing when the stop command turns on are shown below. (Refer to Section 6.13 or 6.14 for details of the speed control.)

Control details during execution	Processing at the turning stop command on	
	During control	During deceleration stop processing
Positioning control	The axis decelerates to a stop in the deceleration time set in the parameter block or servo program.	The deceleration stop processing is continued.
Speed control (I)		
Speed control (II)		
JOG operation		
Speed control with fixed position stop		
Manual pulse generator operation	An immediate stop is executed without deceleration processing.	—
Home position return	(1) The axis decelerates to a stop in the deceleration time set in the parameter block. (2) A "stop error during home position return" occurs and minor error (error code: 202) is stored in the minor error storage register (D6+20n) for each axis.	
Speed-torque control 	The speed commanded to servo amplifier is "0". The mode is switched to position control mode when "Zero speed" turns ON, and the operation stops.	—

(c) The stop command in a dwell time is invalid. (After a dwell time, the start accept flag (M2001+n) turns OFF, and the positioning complete signal (M2401+20n) turns ON.)

POINT
<p>If it is made to stop by turning on the stop command (M3200+20n) during a home position return, execute the home position return again.</p> <p>If the stop command is turned on after the proximity dog ON in the proximity dog method, execute the home position return after move to before the proximity dog ON by the JOG operation or positioning.</p>

3 POSITIONING DEDICATED SIGNALS

(2) Rapid stop command (M3201+20n) Command signal

- (a) This command stops a starting axis rapidly from an external source and becomes effective at leading edge of signal. (An axis for which the rapid stop command is turning on cannot be started.)

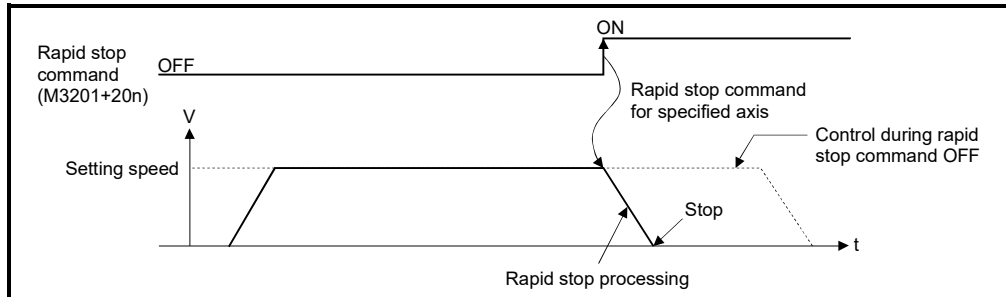

- (b) The details of stop processing when the rapid stop command turns on are shown below.

Control details during execution	Processing at the turning rapid stop command on	
	During control	During deceleration stop processing
Position control	The axis decelerates to a rapid stop deceleration time set in the parameter block or servo program.	Deceleration processing is stopped and rapid stop processing is executed.
Speed control (I)		
Speed control (II)		
JOG operation		
Speed control with fixed position stop		
Manual pulse generator operation	An immediate stop is executed without deceleration processing.	—
Home position return	(1) The axis decelerates to a stop in the rapid stop deceleration time set in the parameter block. (2) A "stop error during home position return" error occurs and minor error (error code: 203) is stored in the minor error storage register (D6+20n) for each axis.	
Speed-torque control QDS	The speed commanded to servo amplifier is "0". The mode is switched to position control mode when "Zero speed" turns ON, and the operation stops.	—

- (c) The rapid stop command in a dwell time is invalid. (After a dwell time, the start accept flag (M2001+n) turns OFF, and the positioning complete signal (M2401+20n) turns ON.)

POINT
<p>If it is made to stop rapidly by turning on the rapid stop command (M3201+20n) during a home position return, execute the home position return again.</p> <p>If the rapid stop command turned on after the proximity dog ON in the proximity dog method, execute the home position return after move to before the proximity dog ON by the JOG operation or positioning.</p>

3 POSITIONING DEDICATED SIGNALS

- (3) Forward rotation JOG start command (M3202+20n)/Reverse rotation JOG start command (M3203+20n) Command signal
- (a) JOG operation to the address increase direction is executed while forward rotation JOG start command (M3202+20n) is turning on.
When M3202+20n is turned off, a deceleration stop is executed in the deceleration time set in the parameter block.
 - (b) JOG operation to the address decrease direction is executed while reverse rotation JOG start command (M3203+20n) is turning on.
When M3203+20n is turned off, a deceleration stop is executed in the deceleration time set in the parameter block.

POINT

Take an interlock so that the forward rotation JOG start command (M3202+20n) and reverse rotation JOG start command (M3203+20n) may not turn on simultaneously.

- (4) Complete signal OFF command (M3204+20n) Command signal
- (a) This command is used to turn off the positioning start complete signal (M2400+20n) and positioning complete signal (M2401+20n).

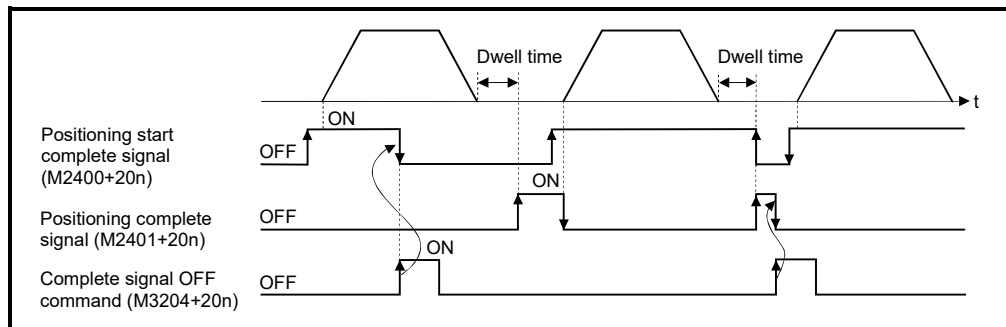

POINT

Do not turn the complete signal OFF command on with a PLS instruction. If it is turned on with a PLS instruction, it cannot be turned off the positioning start complete signal (M2400+20n) and the positioning complete signal (M2401+20n). Be sure to turn OFF the complete signal OFF, command after confirming the positioning start complete signal (M2400+20n) and positioning complete signal (M2401+20n) are OFF.

(5) Speed/position switching enable command (M3205+20n) Command signal

- (a) This command is used to make the CHANGE signal (speed/position switching signal) effective from an external source.
- ON Control switches from speed control to position control when the CHANGE signal turned on.
 - OFF Control does not switch from speed to position control even if the CHANGE signal turns on.

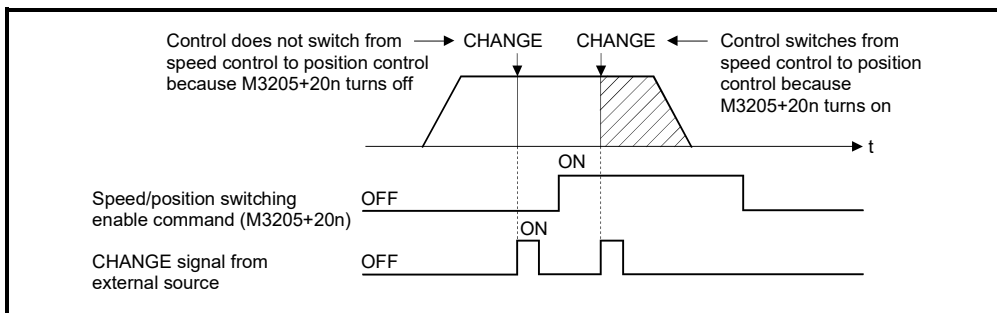

(6) Gain changing 2 command (M3206+20n) **QDS** **Ver.!** Command signal

This signal is used to change the gain of servo amplifier (MR-J5(W)-□B) in the Motion controller by the gain changing 2 command ON/OFF.

- ON Gain changing 2 command ON
- OFF Gain changing 2 command OFF

When gain changing command (M3216+20n) and gain changing 2 command (M3206+20n) are both ON, the setting details of gain changing 2 command (M3206+20n) are prioritized.

Refer to the "Servo amplifier Instruction Manual" for details of gain changing function.

(7) Error reset command (M3207+20n) Command signal

This command is used to clear the minor error code storage register (D6+20n) and major error code storage register (D7+20n) of an axis for which the error detection signal has turn on (M2407+20n: ON), and reset the error detection signal (M2407+20n).

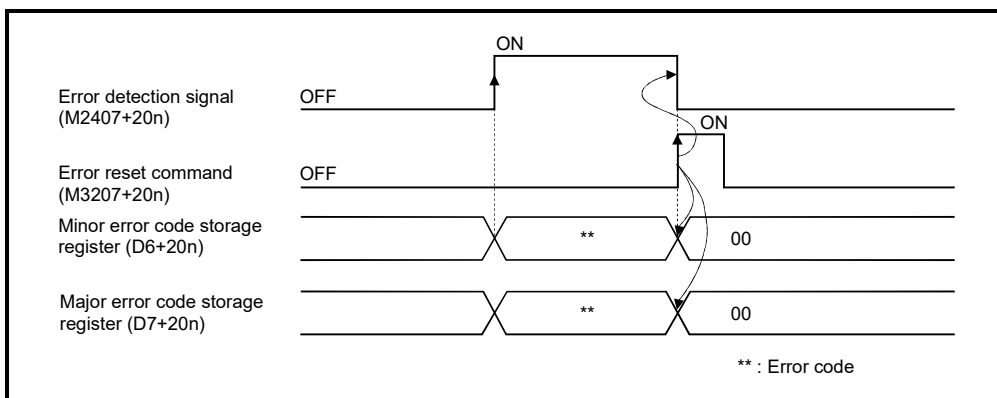

Ver.! : Refer to Section 1.3 for the software version that supports this function.

3 POSITIONING DEDICATED SIGNALS

(8) Servo error reset command (M3208+20n) Command signal

This command is used to clear the servo error code storage register (D8+20n) of an axis for which the servo error detection signal has turn on (M2408+20n: ON), and reset the servo error detection signal (M2408+20n).

Even when the servo warning is detected (Servo error detection (M2408+20n): OFF), servo error code storage register (D8+20n) can be cleared by servo error reset command (M3208+20n).

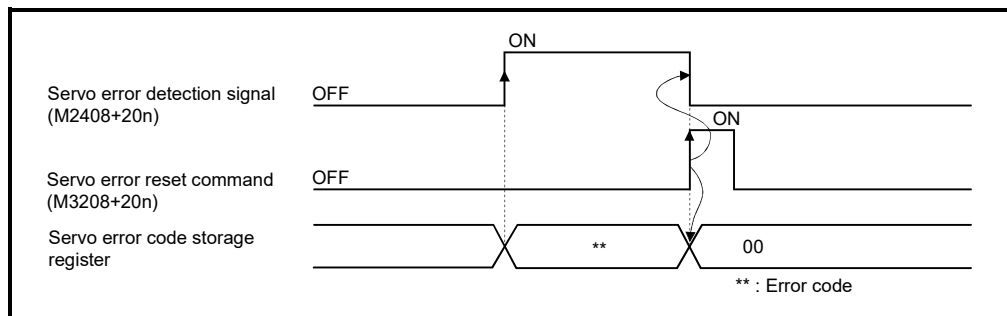

REMARK

Refer to APPENDIX 1 for details on the minor error code, major error code and servo error code storage registers.

(9) External stop input disable at start command (M3209+20n) Command signal

This signal is used to set the external stop signal input valid or invalid.

- ON External stop input is set as invalid, and even axes which stop input is turning on can be started.
- OFF External stop input is set as valid, and axes which stop input is turning on cannot be started.

POINT

When it stops an axis with the external stop input after it starts by turning on the external stop input disable at start command (M3209+20n), switch the external stop input from OFF → ON (if the external stop input is turning on at the starting, switch it from ON → OFF → ON).

(10) Feed current value update request command (M3212+20n) Command signal

This signal is used to set whether the feed current value will be cleared or not at the starting in speed-position switching control or speed control (I).

- ON The feed current value is not cleared at the starting.
The feed current value is updated from the starting.
In speed control (I), the software stroke limit is valid. **QDS** **Ver.!**
- OFF The feed current value is cleared at the starting.
In speed-position switching control, the feed current value is updated from the starting.
In speed control (I), "0" is stored in the feed current value.
QDS **Ver.!**

POINT	When it starts by turning on the feed current value update request command (M3212+20n), keep M3212+20n on until completion of the positioning control. If M3212+20n is turned off on the way, the feed current value may not be reliable.
--------------	---

(11) Servo OFF command (M3215+20n) Command signal

This command is used to execute the servo OFF state (free run state) when all axes servo ON command (M2042) is ON.

- OFF Servo ON
- ON Servo OFF (free run state)

Execute this command after positioning completion because it becomes invalid during positioning.

⚠ CAUTION

- Turn the power supply of the servo amplifier side off before touching a servo motor, such as machine adjustment.

(12) Gain changing command (M3216+20n) Command signal

This signal is used to change the gain of servo amplifier in the Motion controller by the gain changing command ON/OFF.

- ON Gain changing command ON
- OFF Gain changing command OFF

When gain changing command (M3216+20n) and gain changing 2 command (M3206+20n) are both ON, the setting details of gain changing 2 command (M3206+20n) are prioritized. **QDS**

Refer to the "Servo amplifier Instruction Manual" for details of gain changing function.

Ver.!: Refer to Section 1.3 for the software version that supports this function.

(13) PI-PID switching command (M3217+20n) **QDS** Command signal

This signal is used to change the PI-PID switching of servo amplifier in the Motion controller by the PI-PID switching command ON/OFF.

- ON..... PI-PID switching command ON(PID control)
- OFF PI-PID switching command OFF(PI control)

Refer to the "Servo amplifier Instruction Manual" for details of PI-PID switching function.

(14) Control loop changing command (M3218+20n) Command signal

When using the fully closed loop control servo amplifier, this signal is used to change the fully closed loop control/semi closed loop control of servo amplifier in the Motion controller by the control loop changing command ON/OFF.

- ON..... During fully closed loop control
- OFF During semi closed loop control

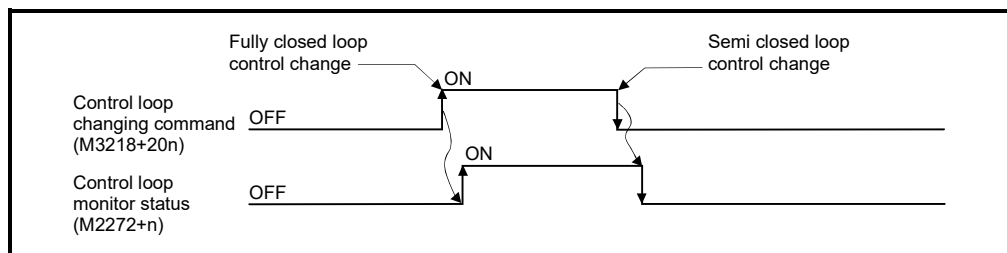

Refer to the "Servo amplifier Instruction Manual" for details of control loop changing function.

POINTS
<p>(1) When the servo amplifier is not started (LED: "AA", "Ab", "AC", "Ad" or "AE"), if the control loop changing command is turned ON/OFF, the command becomes invalid.</p> <p>(2) When the following are operated during the fully closed loop, it returns to the semi closed loop control.</p> <ul style="list-style-type: none"> (a) Power supply OFF or reset of the Multiple CPU system (b) Wire breakage of the SSCNET III cable between the servo amplifier and Motion controller (c) Control circuit power supply OFF of the servo amplifier

3 POSITIONING DEDICATED SIGNALS

- (15) FIN signal (M3219+20n) Command signal
 When a M-code is set in a servo program, transit to the next block does not execute until the FIN signal changes as follows: OFF → ON → OFF. Positioning to the next block begins after the FIN signal changes as above.
 It is valid, only when the FIN acceleration/deceleration is set and FIN signal wait function is selected.

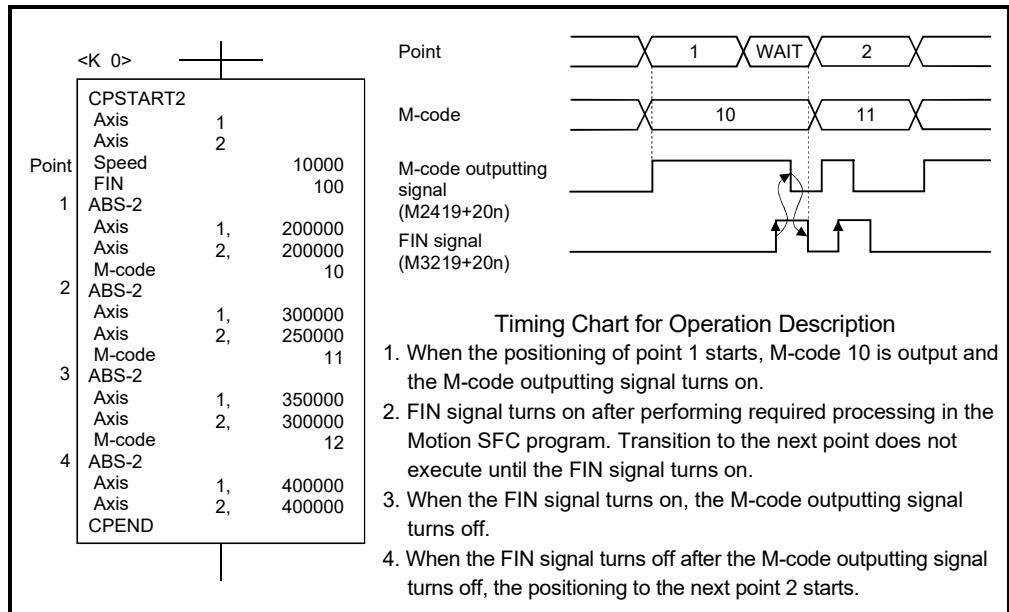

POINTS

- (1) The FIN signal (M3219+20n) and M-code outputting signal (M2419+20n) are both signal for the FIN signal wait function.
- (2) The FIN signal (M3219+20n) and M-code outputting signal (M2419+20n) are valid only when FIN acceleration/deceleration is designated in the servo program.
 Otherwise, the FIN signal wait function is disabled, and the M-code outputting signal (M2419+20n) does not turn on.

3 POSITIONING DEDICATED SIGNALS

3.1.3 Common devices

POINTS
(1) Internal relays for positioning control are not latched even within the latch range.
(2) The range devices allocated as internal relays for positioning control cannot be used by the user even if their applications have not been set.

- (1) PLC ready flag (M2000) Command signal
- (a) This signal informs the Motion CPU that the PLC CPU is normal.
 - 1) The positioning control, home position return, JOG operation or manual pulse generator operation using the servo program which performs the Motion SFC program when the M2000 is ON.
 - 2) The above 1) control is not performed even if the M2000 is turned on during the test mode [TEST mode ON flag (SM501): ON] using MT Developer2.
 - (b) The setting data such as the fixed parameters, servo parameters and limit switch output data can be changed using MT Developer2 when the M2000 is OFF only.
The above data using MT Developer2 cannot be written when the M2000 is ON.
 - (c) The following processing are performed when the M2000 turns OFF to ON.
 - 1) Processing details
 - Clear the M-code storage area of all axes.
 - Turn the PCPU READY complete flag (SM500) on. (Motion SFC program can be executed.)
 - Start to execute the Motion SFC program of the automatic starting from the first.
 - 2) If there is a starting axis, an error occurs, and the processing in above (c) 1) is not executed.
 - 3) The processing in above (c) 1) is not executed during the test mode. It is executed when the test mode is cancelled and M2000 is ON.

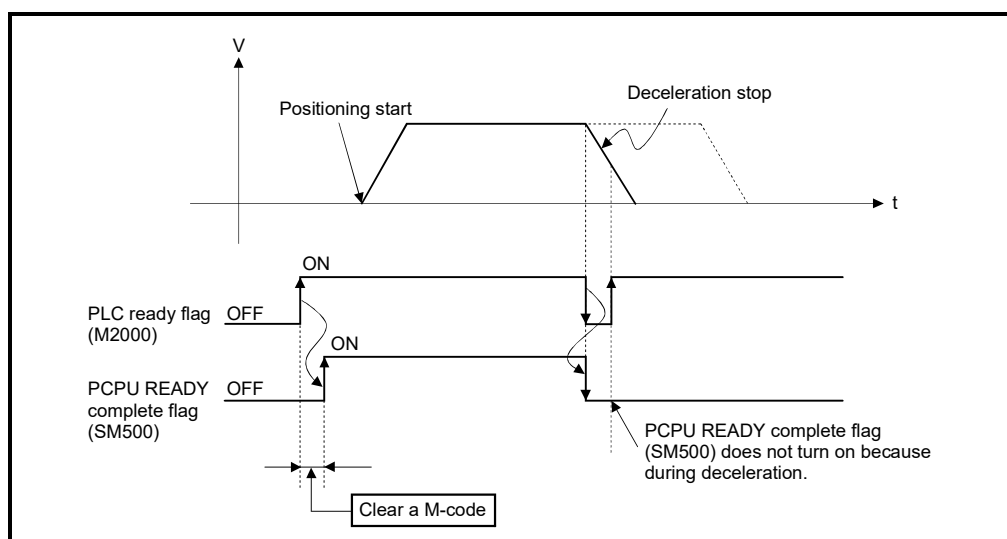

3 POSITIONING DEDICATED SIGNALS

(d) The following processes are performed when the M2000 turns ON to OFF.

1) Processing details

- Turn the PCPU READY complete flag (SM500) off.
- Deceleration stop of the starting axis.
- Stop to execute the Motion SFC program.
- Turn all points of the real output PY off.

(e) Operation at STOP to RUN

Set the condition in which the PLC ready flag (M2000) turns ON. Select the following either.

1) M2000 turns ON by switching from STOP to RUN. (Default)

Condition in which the M2000 turns from OFF to ON.

- Move the RUN/STOP switch from STOP to RUN.
- Turn ON the Multiple CPU system's power supply with the RUN/STOP switch set to RUN.

Condition in which the M2000 turns from ON to OFF

- Move the RUN/STOP switch from RUN to STOP.

2) M2000 turns ON by switching from STOP to RUN and by setting "1" in the setting register.

Condition in which the M2000 turns from OFF to ON

- Set "1" in the setting register (D704) of the PLC ready flag or turn ON the PLC ready flag (M3072) with the RUN/STOP switch set to RUN. (The Motion CPU detects the change from "0" to "1" in the lowest bit of D704.)

Condition in which the M2000 turns from ON to OFF

- Set "0" in the setting register (D704) of the PLC ready flag or turn OFF the PLC ready flag (M3072) with the RUN/STOP switch set to RUN. (The Motion CPU detects the change from "1" to "0" in the lowest bit of D704.)
- Move the RUN/STOP switch from RUN to STOP.

3 POSITIONING DEDICATED SIGNALS

(2) Start accept flag (M2001 to M2032) Status signal

(a) This flag turns on when the servo program is started. The start accept flag corresponding to an axis specified with the servo program turns on.

(b) The ON/OFF processing of the start accept flag is shown below.

1) When the servo program is started using the Motion SFC program or Motion dedicated PLC instruction (D(P).SVST), the start accept flag corresponding to an axis specified with the servo program turns on and it turns off at the positioning completion. This flag also turns off when it is made to stopping on the way.

(When it is made to stop on the way by the speed change to speed "0", this flag remains on.)

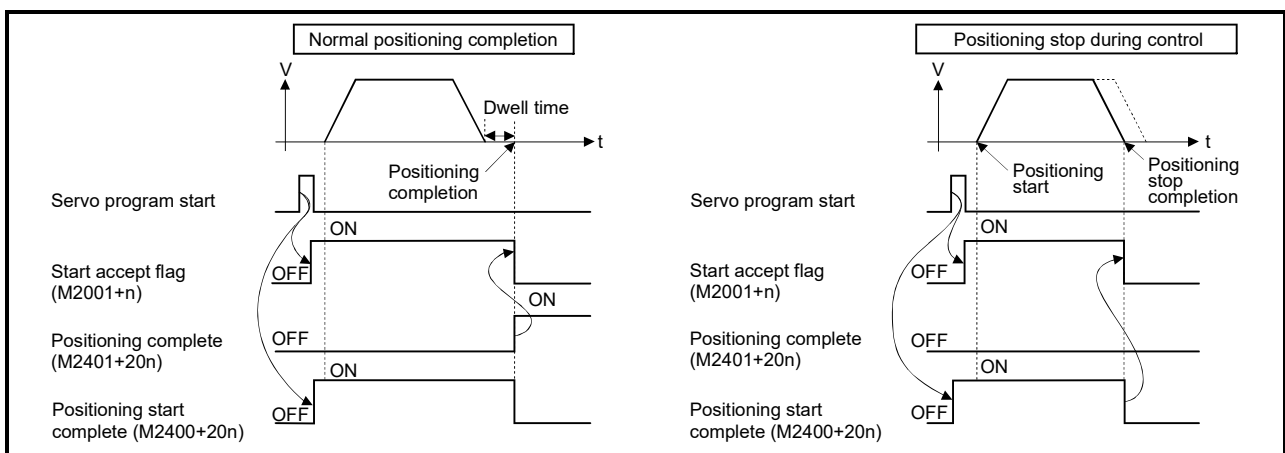

2) This flag turns on at the positioning control by turning on the JOG start command (M3202+20n or M3203+20n), and turns off at the positioning stop by turning off the JOG start command.

3) This flag turns on during the manual pulse generator enable (M2051 to M2053: ON), and turns off at the manual pulse generator disable (M2051 to M2053: OFF).

4) This flag turns on during a current value change by the CHGA instruction of servo program or Motion dedicated PLC instruction (D(P).CHGA), and turns off at the completion of the current value change.

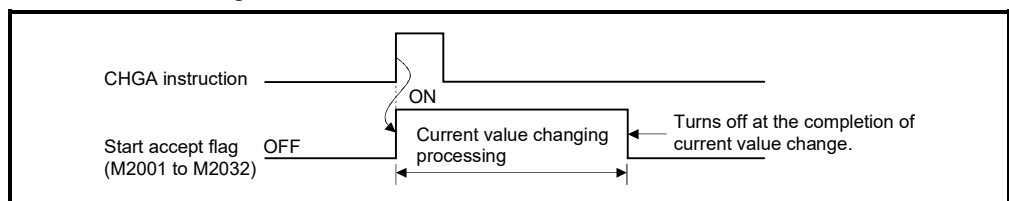

3 POSITIONING DEDICATED SIGNALS

The start accept flag list is shown below.

Axis No.	Device No.	Axis No.	Device No.	Axis No.	Device No.	Axis No.	Device No.
1	M2001	9	M2009	17	M2017	25	M2025
2	M2002	10	M2010	18	M2018	26	M2026
3	M2003	11	M2011	19	M2019	27	M2027
4	M2004	12	M2012	20	M2020	28	M2028
5	M2005	13	M2013	21	M2021	29	M2029
6	M2006	14	M2014	22	M2022	30	M2030
7	M2007	15	M2015	23	M2023	31	M2031
8	M2008	16	M2016	24	M2024	32	M2032

(Note): The following range is valid.

- Q172DSCPU : Axis No.1 to 16
- Q172DCPU(-S1) : Axis No.1 to 8

⚠ CAUTION

- Do not turn the start accept flags ON/OFF in the user side.
 - If the start accept flag is turned off using the Motion SFC program or MT Developer2 while this flag is on, no error will occur but the positioning operation will not be reliable. Depending on the type of machine, it might operate in an unanticipated operation.
 - If the start accept flag is turned on using the Motion SFC program or MT Developer2 while this flag is off, no error will occur but the "start accept on error" will occur at the next starting and cannot be started.

- (3) Motion error history clear request flag (M2035) Command signal
 This flag is used to clear the backed-up Motion error history (#8640 to #8735).
 The Motion error history is cleared at leading edge of M2035.
 After detection of leading edge of M2035, the Motion error history is cleared, and then the M2035 is automatically turned OFF.
- (4) Motion SFC debugging flag (M2038) Status signal
 This flag turns on when it switches to the debug mode of the Motion SFC program using MT Developer2.
 It turns off with release of the debug mode.
- (5) Motion error detection flag (M2039) Status signal
 This flag turns on with error occurrence of the Motion CPU.
 Turn off this flag by the user side, after checking the error contents and removing the error cause.
 The self-diagnosis error information except stop error is cleared at the turning M2039 ON to OFF.

3 POSITIONING DEDICATED SIGNALS

(6) Speed switching point specified flag (M2040) Command signal
 This flag is used when the speed change is specified at the pass point of the constant speed control.

- (a) By turning M2040 on before the starting of the constant speed control (before the servo program is started), control with the change speed can be executed from the first of pass point.
- OFF Speed is changed to the specified speed from the pass point of the constant speed control.
 - ON Speed has been changed to the specified speed at the pass point of the constant speed control.

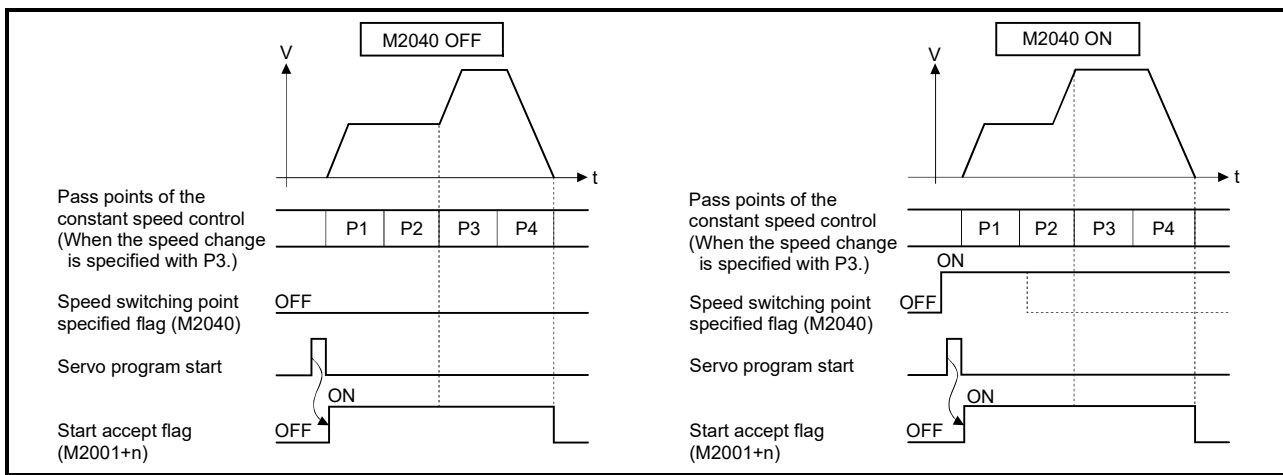

(7) System setting error flag (M2041) Status signal
 This flag inputs the "system setting data" set by MT Developer2 and performs an adjustment check with a real mounting state (main base unit/extension base units) at Multiple CPU system's power supply on or reset.

- ON Error
 - OFF Normal
- (a) When an error occurs, the 7-segment LED at the front side of Motion CPU shows the system setting error.
 The error contents can be confirmed using the monitor of MT Developer2.
- (b) When M2041 is ON, positioning cannot be started. Remove an error factor, and turn the Multiple CPU system's power supply on again or reset.

REMARK

Even if the module which is not set as the system setting of MT Developer2 is installed in the slot, it is not set as the object of an adjustment check. And, the module which is not set as the system setting cannot be used in the Motion CPU.

3 POSITIONING DEDICATED SIGNALS

(8) All axes servo ON command (M2042) Command signal

This command is used to enable servo operation.

(a) Servo operation enabled M2042 turns on while the servo OFF command (M3215+20n) is off and there is no servo error.

(b) Servo operation disable • M2042 is off
 • The servo OFF command (M3215+20n) is on
 • Servo error state
 • Forced stop

Execute this command after positioning completion because it becomes invalid during positioning.

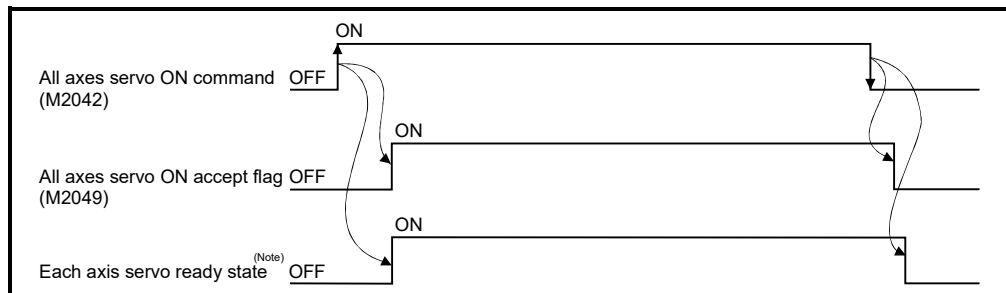

(Note): Refer to servo ready signal (M2415+20n) in Section 3.1.1 for details.

POINT
<p>When M2042 turns ON, it is not turned off even if the Motion CPU is set in the STOP state. M2042 turns OFF by the forced stop of Motion CPU.</p>

(9) Motion slot fault detection flag (M2047) Status signal

This flag is used as judgement of which modules installed in the slot of Motion management are "normal" or "abnormal".

- ON Installed module is abnormal
- OFF Installed module is normal

The module information at the power supply on and after the power supply ON are always checked, and errors are detected.

- (a) When M2047 turns OFF in operation, the operating axis decelerates to a stop.
- (b) When an error occurs, the 7-segment LED at the front side of Motion CPU shows the system setting error.
 The error contents can be confirmed using the monitor of MT Developer2.
- (c) When M2047 is ON, positioning cannot be started. Remove an error factor, and turn the Multiple CPU system's power supply on again or reset.

(10) JOG operation simultaneous start command (M2048) Command signal

(a) When M2048 turns on, JOG operation simultaneous start based on the JOG operation execution axis set in the JOG operation simultaneous start axis setting register (D710 to D713).

(b) When M2048 turns OFF, the operating axis decelerates to a stop.

- (11) All axes servo ON accept flag (M2049) Status signal
 This flag turns on when the Motion CPU accepts the all axes servo ON command (M2042).
 Since the servo ready state of each axis is not checked, confirm it in the servo ready signal (M2415+20n).

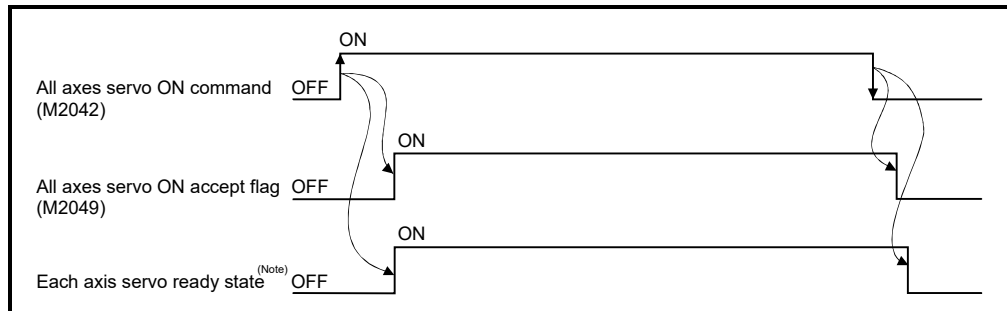

(Note): Refer to servo ready signal (M2415+20n) in Section 3.1.1 for details.

- (12) Manual pulse generator enable flag (M2051 to M2053) Command signal
 This flag set the enabled or disabled state for positioning with the pulse input from the manual pulse generators connected to P1 to P3 (Note) of the Q173DPX.
- ON Positioning control is executed by the input from the manual pulse generators.
 - OFF Positioning control cannot be executed by the manual pulse generators because of the input from the manual pulse generators is ignored.
- Default value is invalid (OFF).

REMARK

(Note): Refer to the "Q173D(S)CPU/Q172D(S)CPU User's Manual" for P1 to P3 connector of the Q173DPX.

- (13) Operation cycle over flag (M2054) Status signal
 This flag turns on when the time concerning motion operation exceeds the operation cycle of the Motion CPU setting (SD523). Perform the following operation, in making it turn off.
- Turn the power supply of the Multiple CPU system on to off
 - Reset the Multiple CPU system
 - Reset using the user program
- [Operation cycle over measures]
- 1) Change the operation cycle into a large value in the system setting.
 - 2) The number of instruction completions of an event task or NMI task in the Motion SFC program.

3 POSITIONING DEDICATED SIGNALS

(14) Speed change accepting flag (M2061 to M2092)

..... Status signal

This flag turns on at start of speed change by the control change (CHGV) instruction (or Motion dedicated PLC instruction (D(P).CHGV)) of the Motion SFC program.

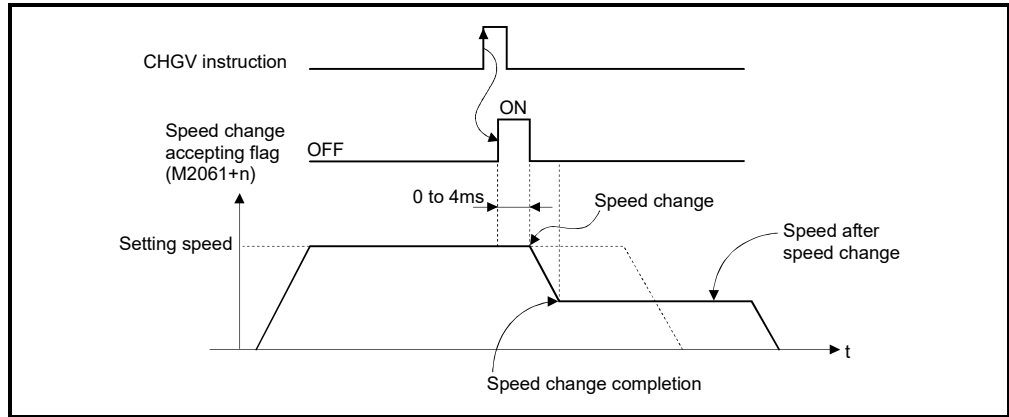

The speed change accepting flag list is shown below.

Axis No.	Device No.	Axis No.	Device No.	Axis No.	Device No.	Axis No.	Device No.
1	M2061	9	M2069	17	M2077	25	M2085
2	M2062	10	M2070	18	M2078	26	M2086
3	M2063	11	M2071	19	M2079	27	M2087
4	M2064	12	M2072	20	M2080	28	M2088
5	M2065	13	M2073	21	M2081	29	M2089
6	M2066	14	M2074	22	M2082	30	M2090
7	M2067	15	M2075	23	M2083	31	M2091
8	M2068	16	M2076	24	M2084	32	M2092

(Note): The following range is valid.

- Q172DSCPU : Axis No.1 to 16
- Q172DCPU(-S1) : Axis No.1 to 8

REMARK

In the SV22 virtual mode, the flag is that of the virtual servo motor axis.

3 POSITIONING DEDICATED SIGNALS

(15) Automatic decelerating flag (M2128 to M2159) Status signal

This signal turns on while automatic deceleration processing is performed during the positioning control or position follow-up control.

- (a) This flag turns on while automatic deceleration to the command address at the position follow-up control, but it turns off if the command address is changed.
- (b) This signal turns on while automatic deceleration processing is performed during execution of positioning to final point while in constant speed control.

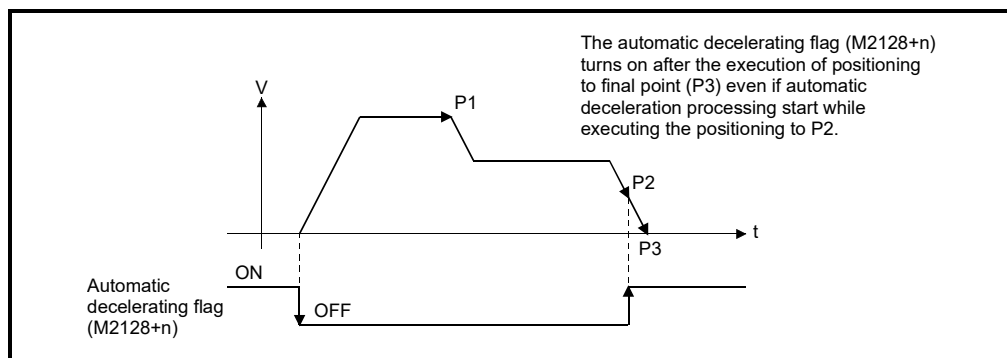
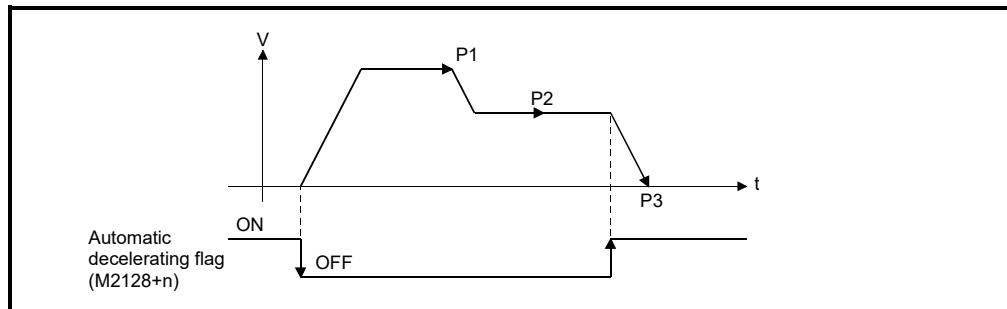

POINT

Set a travel value in which automatic deceleration processing can be started at the final positioning point, therefore the automatic decelerating flag turns on at the start point of automatic deceleration processing after this final point.

- (c) The signal turns off when all normal start complete commands became achieve.
- (d) The automatic decelerating flag (M2128+n) might be turned ON even during acceleration at advanced S-curve acceleration/deceleration.

3 POSITIONING DEDICATED SIGNALS

- (e) In any of the following cases, the automatic decelerating flag (M2128+n) does not turn ON.
- During deceleration due to JOG signal off
 - During manual pulse generator operation
 - During deceleration due to stop command or stop cause occurrence
 - When travel value is 0

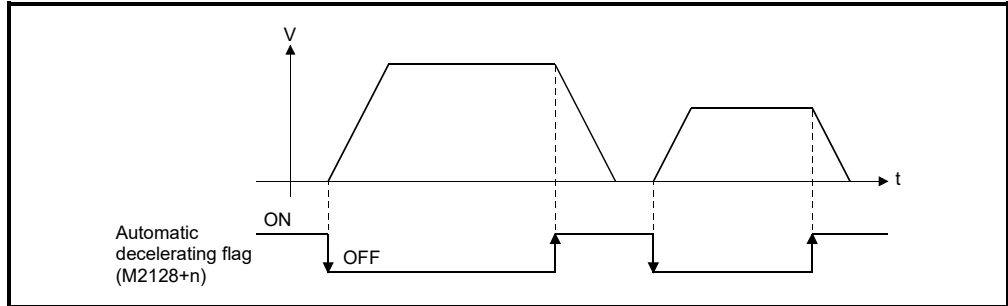

The automatic decelerating flag list is shown below.

Axis No.	Device No.	Axis No.	Device No.	Axis No.	Device No.	Axis No.	Device No.
1	M2128	9	M2136	17	M2144	25	M2152
2	M2129	10	M2137	18	M2145	26	M2153
3	M2130	11	M2138	19	M2146	27	M2154
4	M2131	12	M2139	20	M2147	28	M2155
5	M2132	13	M2140	21	M2148	29	M2156
6	M2133	14	M2141	22	M2149	30	M2157
7	M2134	15	M2142	23	M2150	31	M2158
8	M2135	16	M2143	24	M2151	32	M2159

(Note): The following range is valid.

- Q172DSCPU : Axis No.1 to 16
- Q172DCPU(-S1) : Axis No.1 to 8

REMARK

In the SV22 virtual mode, the flag is that of the virtual servo motor axis.

(16) Speed change "0" accepting flag (M2240 to M2271)

..... Status signal

This flag turns on while a speed change request to speed "0" or negative speed change request is being accepted.

It turns on when the speed change request to speed "0" or negative speed change request is accepted during a start. After that, this signal turns off when a speed change is accepted or on completion of a stop due to a stop cause.

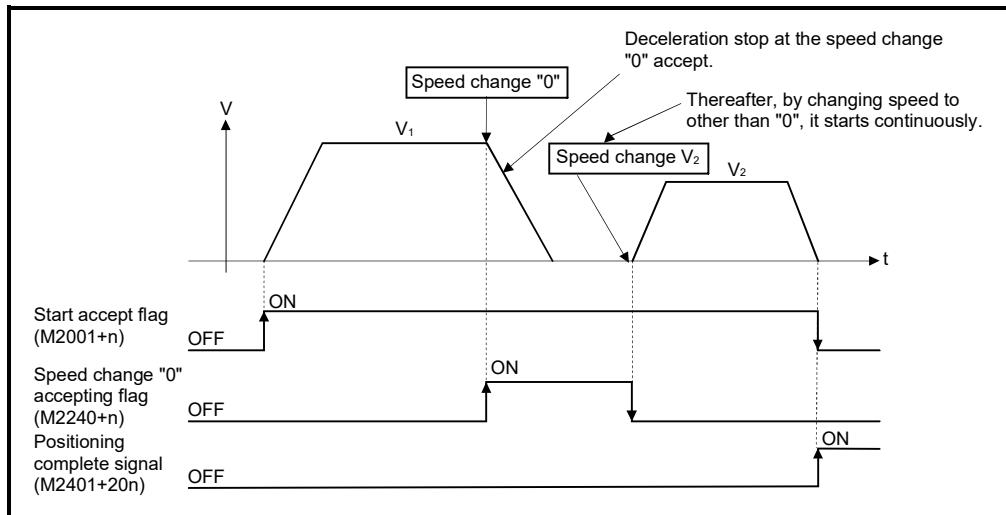

The speed change "0" accepting flag list is shown below.

Axis No.	Device No.	Axis No.	Device No.	Axis No.	Device No.	Axis No.	Device No.
1	M2240	9	M2248	17	M2256	25	M2264
2	M2241	10	M2249	18	M2257	26	M2265
3	M2242	11	M2250	19	M2258	27	M2266
4	M2243	12	M2251	20	M2259	28	M2267
5	M2244	13	M2252	21	M2260	29	M2268
6	M2245	14	M2253	22	M2261	30	M2269
7	M2246	15	M2254	23	M2262	31	M2270
8	M2247	16	M2255	24	M2263	32	M2271

(Note): The following range is valid.

- Q172DSCPU : Axis No.1 to 16
- Q172DCPU(-S1) : Axis No.1 to 8

REMARK

- (1) Even if it has stopped, when the start accept flag (M2001+n) is ON state, the state where the request of speed change "0" is accepted is indicated. Confirm by this speed change "0" accepting flag (M2240+n).
- (2) During interpolation, the flags corresponding to the interpolation axes are set.
- (3) In any of the following cases, the speed change "0" request is invalid.
 - After deceleration by the JOG signal off
 - During manual pulse generator operation
 - After positioning automatic deceleration start
 - After deceleration due to stop cause
- (4) During the SV22 virtual mode, the flag is that of the virtual servo motor axis.

3 POSITIONING DEDICATED SIGNALS

(a) The flag turns off if a speed change request occurs during deceleration to a stop due to speed change "0".

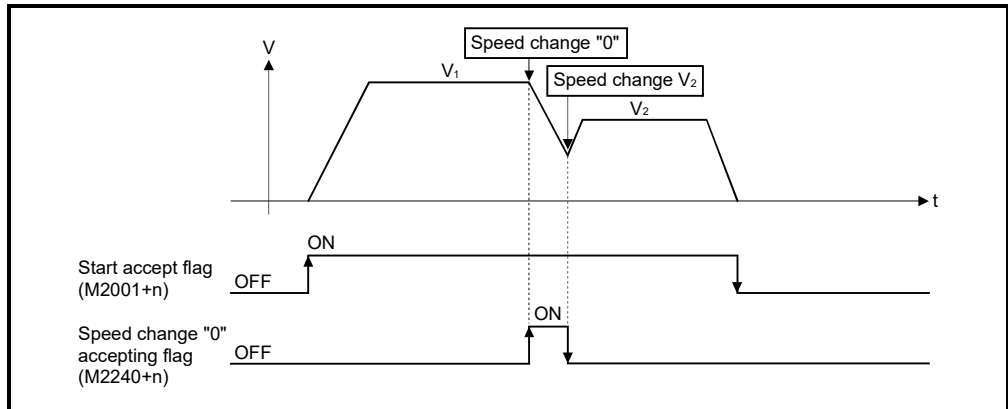

(b) The flag turns off if a stop cause occurs after speed change "0" accept.

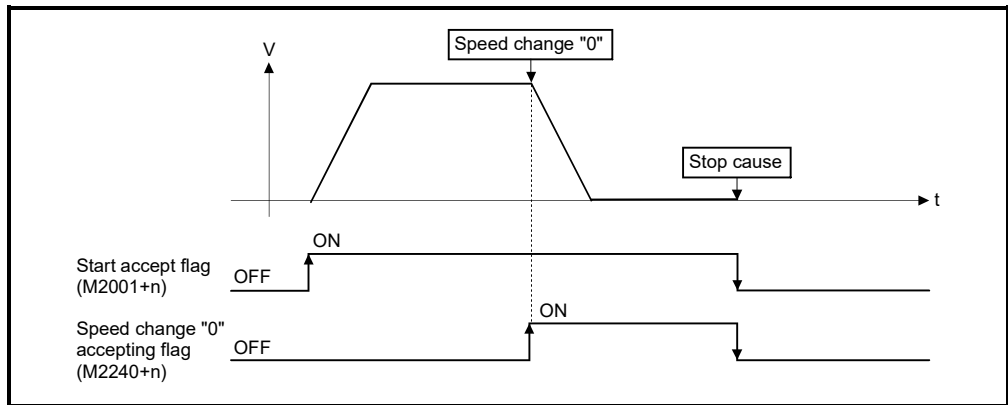

(c) The speed change "0" accepting flag (M2240+n) does not turn on if a speed change "0" occurs after an automatic deceleration start.

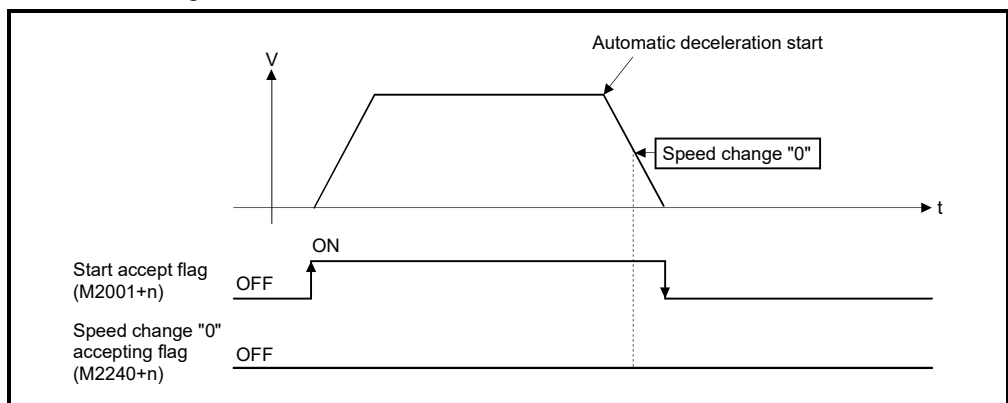

3 POSITIONING DEDICATED SIGNALS

(d) Even if it is speed change "0" after the automatic deceleration start to the "command address", speed change "0" accepting flag (M2240+n) turns on.

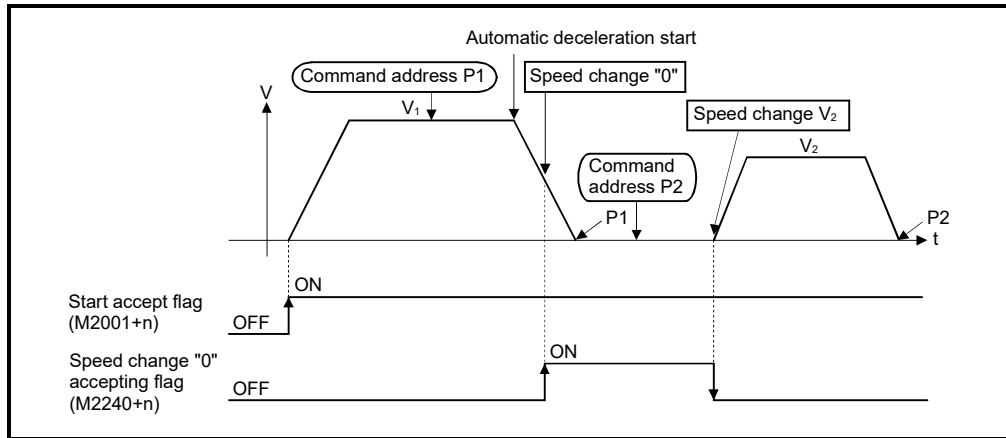

REMARK

It does not start, even if the "command address" is changed during speed change "0" accepting.

(17) Control loop monitor status (M2272 to M2303)

..... Command signal

When using the fully closed loop control servo amplifier, this signal is used to check the fully closed loop control/semi closed loop control of servo amplifier.

- ON During fully closed loop control
- OFF During semi closed loop control

It can be changed the fully closed loop control/semi closed loop control of servo amplifier in the Motion controller by the control loop changing command ON/OFF.

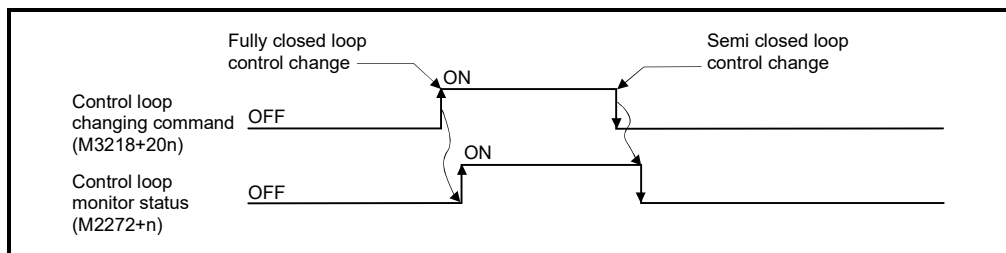

The Control loop monitor status list is shown below.

Axis No.	Device No.	Axis No.	Device No.	Axis No.	Device No.	Axis No.	Device No.
1	M2272	9	M2280	17	M2288	25	M2296
2	M2273	10	M2281	18	M2289	26	M2297
3	M2274	11	M2282	19	M2290	27	M2298
4	M2275	12	M2283	20	M2291	28	M2299
5	M2276	13	M2284	21	M2292	29	M2300
6	M2277	14	M2285	22	M2293	30	M2301
7	M2278	15	M2286	23	M2294	31	M2302
8	M2279	16	M2287	24	M2295	32	M2303

















(Note): The following range is valid.

- Q172DSCPU : Axis No.1 to 16
- Q172DCPU(-S1) : Axis No.1 to 8

3 POSITIONING DEDICATED SIGNALS

3.2 Data Registers

(1) Data register list

SV13		SV22			
Device No.	Purpose	Virtual mode switching method		Advanced synchronous control method	
		Device No.	Purpose	Device No.	Purpose
D0 to	Axis monitor device (20 points × 32 axes)	D0 to	Axis monitor device (20 points × 32 axes) Real mode : Each axis Virtual mode : Output module	D0 to	Axis monitor device (20 points × 32 axes)
D640 to	Control change register (2 points × 32 axes)	D640 to	Control change register (2 points × 32 axes)	D640 to	Control change register (2 points × 32 axes)
D704 to	Common device (Command signal) (54 points)	D704 to	Common device (Command signal) (54 points)	D704 to	Common device (Command signal) (54 points)
D758 to	Unusable (42 points)	D758 to	Unusable (42 points)	D758 to	Unusable (42 points)
D800 to D8191	User device (7392 points)	D800 to D1120 to D1240 to D1560 to D8191	Virtual servo motor axis monitor device (Note-1) (10 points × 32 axes) Synchronous encoder axis monitor device (10 points × 12 axes) Cam axis monitor device (Note-1) (10 points × 32 axes) User device (6632 points)	D800 to D8191	User device (7392 points)
/		/		D8192 to	User device (2048 points)  
				D10240 to	System area (2040 points)  
				D12280 to	Servo input axis monitor device (10 points × 32 axes)  
				D12600 to	Command generation axis monitor device (20 points × 32 axes)  
				D13240 to	Synchronous encoder axis monitor device (20 points × 12 axes)  
				D13480 to	Unusable (120 points)  
				D13600 to	Output axis monitor device (30 points × 32 axes)  
				D14560 to D14599	Unusable (40 points)  

: Refer to Section 1.3 for the software version that supports this function.

3 POSITIONING DEDICATED SIGNALS

Data register list (Continued)

SV13		SV22			
Device No.	Purpose	Virtual mode switching method		Advanced synchronous control method	
		Device No.	Purpose	Device No.	Purpose
/	/	/	/	D14600 to	Servo input axis control device (2 points × 32 axes) QDS Ver.!
				D14664 to	Unusable (16 points) QDS Ver.!
				D14680 to	Command generation axis control device (4 points × 32 axes) QDS Ver.!
				D14808 to	Unusable (12 points) QDS Ver.!
				D14820 to	Synchronous encoder axis control device (10 points × 12 axes) QDS Ver.!
				D14940 to	Unusable (60 points) QDS Ver.!
				D15000 to	Output axis control device (150 points × 32 axes) QDS Ver.!
				D19800 to	Unusable (24 points) QDS Ver.!
				D19823	

It can be used as a user device.

(Note-1): It can be used as a user device in the SV22 real mode only.

POINT
<ul style="list-style-type: none"> • Total number of user device points • SV13 : 7392 points • SV22 virtual mode switching method : 6632 points (Note) • SV22 advanced synchronous control method : 9440 points QDS Ver.! <p>(Note): Up to 7272 points can be used when not using it in the virtual mode.</p>

Ver.! : Refer to Section 1.3 for the software version that supports this function.

3 POSITIONING DEDICATED SIGNALS

(2) Axis monitor device list

Axis No.	Device No.	Signal name			
1	D0 to D19				
2	D20 to D39				
3	D40 to D59				
4	D60 to D79				
5	D80 to D99				
6	D100 to D119				
7	D120 to D139				
8	D140 to D159				
9	D160 to D179				
10	D180 to D199				
11	D200 to D219				
12	D220 to D239				
13	D240 to D259				
14	D260 to D279				
15	D280 to D299				
16	D300 to D319				
17	D320 to D339				
18	D340 to D359				
19	D360 to D379				
20	D380 to D399				
21	D400 to D419				
22	D420 to D439				
23	D440 to D459				
24	D460 to D479				
25	D480 to D499				
26	D500 to D519				
27	D520 to D539				
28	D540 to D559				
29	D560 to D579				
30	D580 to D599				
31	D600 to D619				
32	D620 to D639				

	Signal name	Refresh cycle	Fetch cycle	Unit	Signal direction
0	Feed current value	Operation cycle	/	Command unit	Monitor device
1					
2	Real current value				
3					
4	Deviation counter value			pulse	
5					
6	Minor error code	Immediate		—	
7					
8	Servo error code	Main cycle		pulse	
9	Home position return re-travel value	Operation cycle			
10	Travel value after proximity			Command unit	
11	dog ON				
12	Execute program No.	At start	—		
13	M-code	Operation cycle			
14	Torque limit value		%		
15	Data set pointer for constant-speed control	At start/during start	—		
16	Unusable <small>(Note-1)</small>	—	—	—	
17					
18	Real current value at stop	Operation cycle	/	Command unit	Monitor device
19	input				

(Note-1): It can be used as the travel value change register. The travel value change register can be set to the device optionally in the servo program. Refer to Section 6.15 for details.

POINT

- (1) The following range is valid.
 - Q172DSCPU : Axis No.1 to 16
 - Q172DCPU(-S1): Axis No.1 to 8
- (2) The following device area can be used as a user device.
 - Q172DSCPU : 17 axes or more
 - Q172DCPU(-S1): 9 axes or more

However, when the project of Q172DSCPU/Q172DCPU(-S1) is replaced with Q173DSCPU/Q173DCPU(-S1), this area cannot be used as a user device.

3 POSITIONING DEDICATED SIGNALS

(3) Control change register list

Axis No.	Device No.	Signal name																	
1	D640, D641	<table border="1"> <thead> <tr> <th></th> <th>Signal name</th> <th>Refresh cycle</th> <th>Fetch cycle</th> <th>Unit</th> <th>Signal direction</th> </tr> </thead> <tbody> <tr> <td>0</td> <td rowspan="2">JOG speed setting</td> <td rowspan="2" style="text-align: center;">/</td> <td rowspan="2">At start</td> <td rowspan="2">Command unit</td> <td rowspan="2">Command device</td> </tr> <tr> <td>1</td> </tr> </tbody> </table>						Signal name	Refresh cycle	Fetch cycle	Unit	Signal direction	0	JOG speed setting	/	At start	Command unit	Command device	1
	Signal name						Refresh cycle	Fetch cycle	Unit	Signal direction									
0	JOG speed setting						/	At start	Command unit	Command device									
1																			
2	D642, D643																		
3	D644, D645																		
4	D646, D647																		
5	D648, D649																		
6	D650, D651																		
7	D652, D653																		
8	D654, D655																		
9	D656, D657																		
10	D658, D659																		
11	D660, D661																		
12	D662, D663																		
13	D664, D665																		
14	D666, D667																		
15	D668, D669																		
16	D670, D671																		
17	D672, D673																		
18	D674, D675																		
19	D676, D677																		
20	D678, D679																		
21	D680, D681																		
22	D682, D683																		
23	D684, D685																		
24	D686, D687																		
25	D688, D689																		
26	D690, D691																		
27	D692, D693																		
28	D694, D695																		
29	D696, D697																		
30	D698, D699																		
31	D700, D701																		
32	D702, D703																		

POINT

(1) The following range is valid.

- Q172DSCPU : Axis No.1 to 16
- Q172DCPU(-S1): Axis No.1 to 8

(2) The following device area can be used as a user device.

- Q172DSCPU : 17 axes or more
- Q172DCPU(-S1): 9 axes or more

However, when the project of Q172DSCPU/Q172DCPU(-S1) is replaced with Q173DSCPU/Q173DCPU(-S1), this area cannot be used as a user device.

3 POSITIONING DEDICATED SIGNALS

(4) Common device list

Device No.	Signal name	Refresh cycle	Fetch cycle	Signal direction	Device No.	Signal name	Refresh cycle	Fetch cycle	Signal direction		
D704	PLC ready flag request	/	Main cycle	Command device	D752	Manual pulse generator 1 smoothing magnification setting register	/	At the manual pulse generator enable flag OFF to ON	Command device		
D705	Speed switching point specified flag request				D753	Manual pulse generator 2 smoothing magnification setting register					
D706	All axes servo ON command request				D754	Manual pulse generator 3 smoothing magnification setting register					
D707	Real mode/virtual mode switching request (SV22) (Note-1)				D755	Manual pulse generator 1 enable flag request					
D708	JOG operation simultaneous start command request				D756	Manual pulse generator 2 enable flag request					
D709	Unusable	—	—	—	D757	Manual pulse generator 3 enable flag request	/	Main cycle	Command device		
D710	JOG operation simultaneous start axis setting register	/	At start	Command device	D758		—	—	—		
D711			Manual pulse generator axis 1 No. setting register		At the manual pulse generator enable flag OFF to ON					D759	
D712										Manual pulse generator axis 2 No. setting register	D760
D713											Manual pulse generator axis 3 No. setting register
D714	D762										
D715	D763										
D716	D764										
D717	D765										
D718	D766										
D719	D767										
D720	Axis 1	D768									
D721	Axis 2	D769									
D722	Axis 3	D770									
D723	Axis 4	D771									
D724	Axis 5	D772									
D725	Axis 6	D773									
D726	Axis 7	D774									
D727	Axis 8	D775									
D728	Axis 9	D776									
D729	Axis 10	D777									
D730	Axis 11	D778	Unusable (42 points)	—							
D731	Axis 12	D779	—	—							
D732	Axis 13	D780	—	—							
D733	Axis 14	D781	—	—							
D734	Axis 15	D782	—	—							
D735	Axis 16	D783	—	—							
D736	Axis 17	D784	—	—							
D737	Axis 18	D785	—	—							
D738	Axis 19	D786	—	—							
D739	Axis 20	D787	—	—							
D740	Axis 21	D788	—	—							
D741	Axis 22	D789	—	—							
D742	Axis 23	D790	—	—							
D743	Axis 24	D791	—	—							
D744	Axis 25	D792	—	—							
D745	Axis 26	D793	—	—							
D746	Axis 27	D794	—	—							
D747	Axis 28	D795	—	—							
D748	Axis 29	D796	—	—							
D749	Axis 30	D797	—	—							
D750	Axis 31	D798	—	—							
D751	Axis 32	D799	—	—							

(Note-1): It is unusable in the SV22 advanced synchronous control.

(Note-2): The following range is valid.

- Q172DSCPU : Axis No. 1 to 16
- Q172DCPU(-S1) : Axis No. 1 to 8

(Note-3): The following device area is unusable.

- Q172DSCPU : 17 axes or more
- Q172DCPU(-S1) : 9 axes or more

3.2.1 Axis monitor devices

The monitoring data area is used by the Motion CPU to store data such as the feed current value during positioning control, the real current value and the deviation counter value.

It can be used to check the positioning control state using the Motion SFC program. The user cannot write data to the monitoring data area.

Refer to "APPENDIX 4 Processing Times of the Motion CPU" for the delay time between a positioning device (input, internal relay and special relay) turning on/off and storage of data in the monitor data area.

(1) Feed current value storage register (D0+20n, D1+20n)
..... Monitor device

- (a) This register stores the target address output to the servo amplifier on the basis of the positioning address/travel value specified with the servo program.
 - 1) A part for the amount of the travel value from "0" after starting is stored in the fixed-pitch feed control.
 - 2) The feed current value storage register (D0+20n, D1+20n) during speed-position switching control and speed control is as follows.
 - a) When using Q173DSCPU/Q172DSCPU
 - In the speed-position switching control and speed control (I), the address at the start depends on the state of feed current value update command (M3212+20n) as shown below.
 - M3212+20n: OFF ... Resets the feed current value to "0" at the start.
 - M3212+20n: ON ... Not reset the feed current value at the start.
 - "0" is stored during speed control (II).
 - b) When using Q173DCPU(-S1)/Q172DCPU(-S1)
 - In the speed-position switching control, the address at the start depends on the state of feed current value update command (M3212+20n) as shown below.
 - M3212+20n: OFF ... Resets the feed current value to "0" at the start.
 - M3212+20n: ON ... Not reset the feed current value at the start.
 - "0" is stored during speed control (I) and speed control (II).
- (b) The stroke range check is performed on this feed current value data.

(2) Real current value storage register (D2+20n, D3+20n)
..... Monitor device

- (a) This device stores the converted value (in an axis control unit) of the feedback position of the motor encoder (in pulse unit).
- (b) The "feed current value" is equal to the "real current value" in the stopped state.

(3) Deviation counter value storage register (D4+20n, D5+20n)
..... Monitor device

This register stores the droop pulses read from the servo amplifier.

3 POSITIONING DEDICATED SIGNALS

- (4) Minor error code storage register (D6+20n) Monitor device
 - (a) This register stores the corresponding error code (Refer to APPENDIX 1.2.) at the minor error occurrence. If another minor error occurs after error code storing, the previous error code is overwritten by the new error code.
 - (b) Minor error codes can be cleared by an error reset command (M3207+20n).
- (5) Major error code storage register (D7+20n) Monitor device
 - (a) This register stores the corresponding error code (Refer to APPENDIX 1.3.) at the major error occurrence. If another major error occurs after error code storing, the previous error code is overwritten by the new error code.
 - (b) Major error codes can be cleared by an error reset command (M3207+20n).
- (6) Servo error code storage register (D8+20n) Monitor device
 - (a) This register stores the corresponding error code (Refer to APPENDIX 1.4.) at the servo error occurrence. If another servo error occurs after error code storing, the previous error code is overwritten by the new error code.
 - (b) Servo error codes can be cleared by an error reset command (M3208+20n).
 - (c) For MR-J5(W)-□B, the register stores error codes (2000 or 2100) (Refer to APPENDIX 1.4.) at the servo error occurrence. **QDS**
Error codes read by the servo amplifier are stored in the servo amplifier display servo error code (#8008+20n).

- (7) Home position return re-travel value storage register (D9+20n) Monitor device

If the position specified with travel value after proximity dog ON (Refer to Section 6.23.1) using MT Developer2 is used to stop at a position that is not a zero point, the position is made to travel to a zero point by re-travel in the Motion CPU. In this case, the travel value (signed) of making it travel to a zero point by re-travel is stored. (Data does not change with the last value in the data setting type.) The following value is stored according to the number of feedback pulses of the motor connected.

Number of feedback pulses	Stored data
Less than 131072[pulse]	Home position return re-travel value ([pulse] units)
131072[pulse] or more, 262144[pulse] or less	1/10 of the home position return re-travel value ($\times 10^{-1}$ [pulse] units) ^(Note-1)
More than 262144[pulse]	1/10000 of the home position return re-travel value ($\times 10^{-4}$ [pulse] units) ^(Note-1)

(Note-1): Confirm the actual value in home position return re-travel value (#8006+20n, #8007+20n).

- (8) Travel value after proximity dog ON storage register (D10+20n, D11+20n) Monitor device
 - (a) This register stores the travel value (unsigned) from the proximity dog ON to home position return completion after the home position return start.
 - (b) The travel value (unsigned) of the position control is stored at the time of speed-position switching control.

- (9) Execute program No. storage register (D12+20n) Monitor device
- (a) This register stores the starting program No. at the servo program starting.
- (b) The following value is stored in the JOG operation and manual pulse generator operation.
- | | |
|--|-------|
| 1) JOG operation | FFFFh |
| 2) Manual pulse generator operation | FFFEh |
| 3) Speed control QDS | FFDFh |
| 4) Torque control QDS | FFDEh |
| 5) Continuous operation to torque control QDS | FFDDh |
| 6) Power supply on | FF00h |
| 7) Current value change execution
by the Motion dedicated instruction | FFE0h |
| 8) Advanced synchronous control QDS | FFEFh |
- (c) When the following control is being executed using MT Developer2 in the test mode, FFFDh is stored in this register.
- Home position return
- (10) M-code storage register (D13+20n) Monitor device
- (a) This register stores the M-code ^(Note) set to the executed servo program at the positioning start.
If M-code is not set in the servo program, the value "0" is stored.
- (b) It does not change except positioning start using the servo program.
- (c) The value "0" is stored at leading edge of PLC ready flag (M2000).

REMARK

(Note): Refer to the following sections for M-codes and reading M-codes.

- M-code Section 7.1
- Reading M-code APPENDIX 2.1

- (11) Torque limit value storage register (D14+20n) Monitor device
- (a) This register stores the positive direction torque limit value to command the servo amplifier (unit: [%]).
The default value "300[%]" is stored at the power supply of servo amplifier ON.
- (b) To monitor the positive/negative direction torque limit value, set "positive direction torque limit value monitor device" and "negative direction torque limit value monitor device" with the expansion parameter (Refer to Section 4.4). **QDS**

(12) Data set pointer for constant-speed control (D15+20n) Monitor device

This pointer is used in the constant-speed control when specifying positioning data indirectly and substituting positioning data during operation. It stores a "point" that indicates which of the values stored in indirect devices has been input to the Motion CPU.

Use this pointer to confirm which positioning data is to be updated using the Motion SFC program.

Also, store the positioning data updated last time to the end of a selected device to use as an updated data set pointer for checking the extent to which the positioning data has been updated.

Data set pointer for constant-speed control and updated data set pointer are described here using the example servo program below.

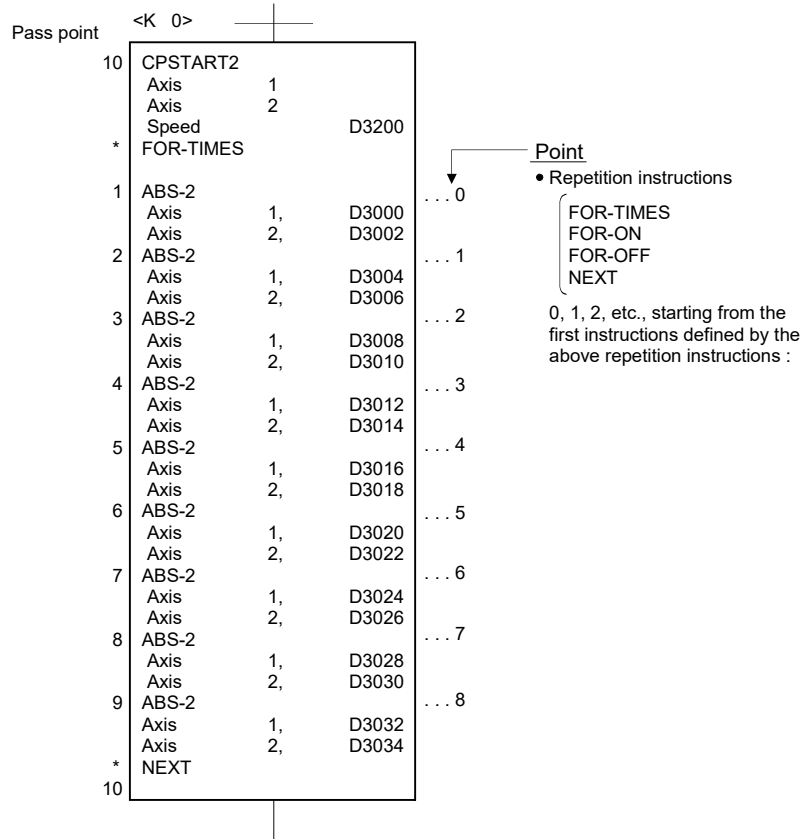

The input situation of positioning data to the Motion CPU is shown the next page by executing the 2-axes constant-speed control using above the servo program and updating the positioning data in indirect devices D3000 to D3006.

3 POSITIONING DEDICATED SIGNALS

[Input situation of positioning data in the Motion CPU]

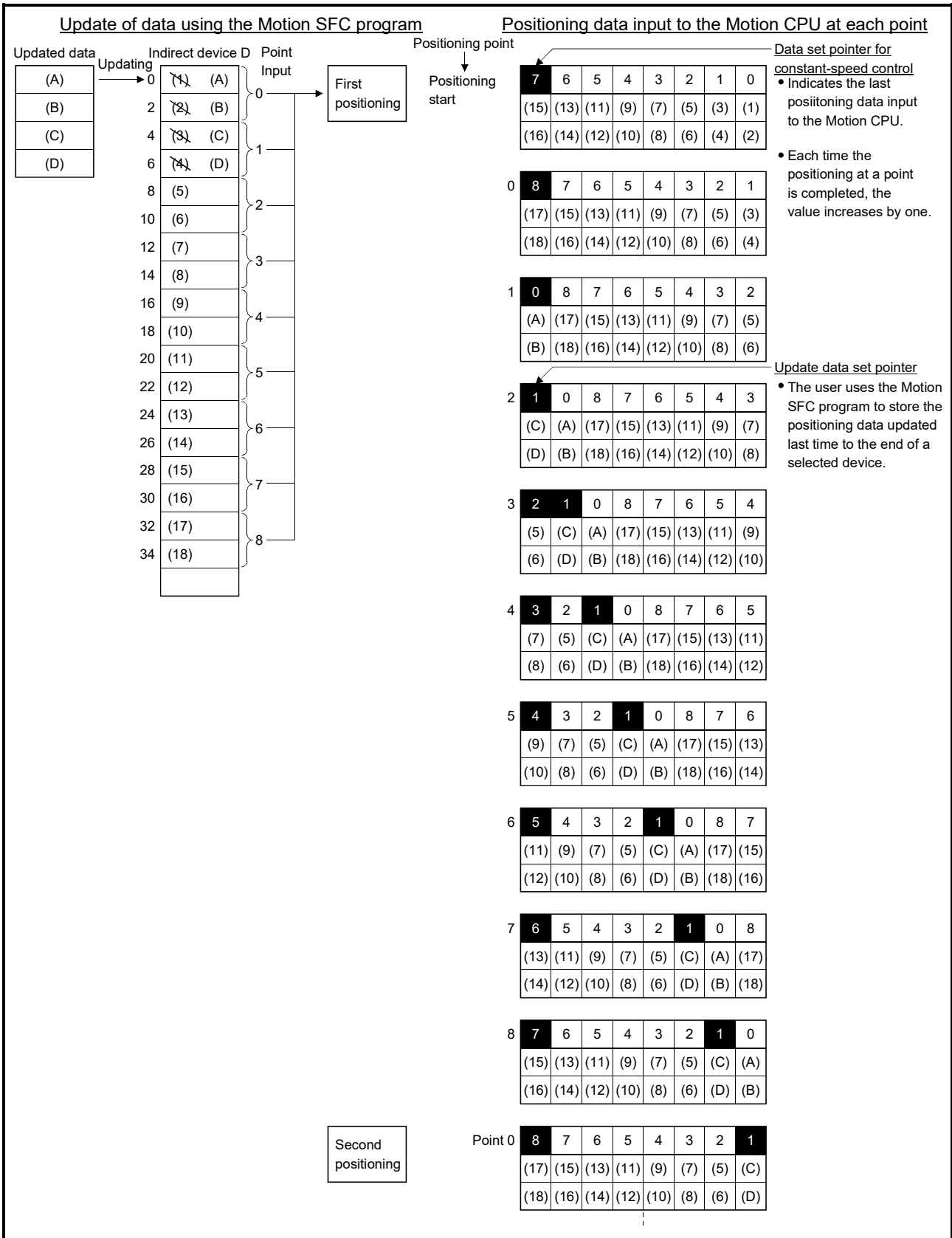

The internal processing shown above is described in the next page.

3 POSITIONING DEDICATED SIGNALS

[Internal processing]

- (a) The positioning data ((1) to (16)) of points 0 to 7 is input to the Motion CPU by the constant-speed control starting process (before positioning start). The last point "7" of the input data to be input is stored in the data set pointer for constant-speed control at this time. Because the positioning for point 0 starts immediately after, space opens in the input area for positioning data and the Motion CPU inputs point 8 ((17) to (18)) positioning data. The last point "8" of the input data is stored in the data set pointer for constant-speed control. The "8" stored in the data set pointer for constant-speed control indicates that the second updating of the positioning data stored in points 0 to 8 is possible.
- (b) The positioning data ((1) to (4)) of points 0 to 1 is updated to positioning data ((A) to (D)) using the Motion SFC program. The last point "1" of the updated positioning data is stored in the updated data set pointer (the user must create a Motion SFC program) at this time. Positioning data of points 2 to 8 (data (5) to (18)) can still be updated. However, the positioning data ((A) to (D)) of the updated points 0 to 1 can also be updated because at this point it has still not been input to the Motion CPU.
- (c) On completion of the positioning for point 0, point 1 positioning starts, the Motion CPU discards the positioning data ((3) to (4)) of point 1, and inputs the positioning data ((A) to (B)) of point 0 (second positioning). At this time, the value of the data set pointer for constant-speed control automatically proceeds and changes to "0".
- (d) Hereafter, whenever positioning of each point is completed, the positioning data shifts one place. The positioning data that can be updated is the data which has not yet been input to the Motion CPU. Even if the values of the indirect devices D3008 and D3010 are updated by the Motion SFC program after the positioning completion of the point 3, the positioning data of point 2 that is input to the Motion CPU will not be updated and the second positioning will be executed using the unupdated data. The data set pointer for constant-speed control has not yet been input to the Motion CPU, and indicates the positioning data which a user can update using the Motion SFC program.

POINT
Number of points that can be defined by a repeat instruction <ul style="list-style-type: none">• The Motion CPU inputs 8 points in advance, so create a servo program of at least 9 points.• Even when there are 9 points or more, if pass points with small travel values are included the positioning at each point may complete, and the data input to the Motion CPU, before the data has been updated using the Motion SFC program.• Create a sufficient number of points to ensure that data will not be input before the Motion CPU has updated the values in the indirect devices.

3 POSITIONING DEDICATED SIGNALS

- (13) Real current value at STOP input storage register
 (D18+20n, D19+20n) Monitor device
 This register stores the real current value at the detection of a stop/rapid stop cause.

3.2.2 Control change registers

This area stores the JOG operation speed data.

Table 3.1 Data storage area for control change list

Name	Axis 1	Axis 2	Axis 3	Axis 4	Axis 5	Axis 6	Axis 7	Axis 8
JOG speed setting register	D641, D640	D643, D642	D645, D644	D647, D646	D649, D648	D651, D650	D653, D652	D655, D654
	Axis 9	Axis 10	Axis 11	Axis 12	Axis 13	Axis 14	Axis 15	Axis 16
	D657, D656	D659, D658	D661, D660	D663, D662	D665, D664	D667, D666	D669, D668	D671, D670
	Axis 17	Axis 18	Axis 19	Axis 20	Axis 21	Axis 22	Axis 23	Axis 24
	D673, D672	D675, D674	D677, D676	D679, D678	D681, D680	D683, D682	D685, D684	D687, D686
	Axis 25	Axis 26	Axis 27	Axis 28	Axis 29	Axis 30	Axis 31	Axis 32
	D689, D688	D691, D690	D693, D692	D695, D694	D697, D696	D699, D698	D701, D700	D703, D702

(Note): The following range is valid.

- Q172DSCPU : Axis No. 1 to 16
- Q172DCPU(-S1) : Axis No. 1 to 8

- (1) JOG speed setting registers (D640+2n, D641+2n)
 Command device

(a) This register stores the JOG speed at the JOG operation.

(b) Setting range of the JOG speed is shown below.

Unit	mm		inch		degree		pulse	
	Setting range	Unit	Setting range	Unit	Setting range	Unit (Note-1)	Setting range	Unit
JOG speed	1 to 600000000	$\times 10^{-2}$ [mm/min]	1 to 600000000	$\times 10^{-3}$ [inch/min]	1 to 2147483647	$\times 10^{-3}$ [degree/min]	1 to 2147483647	[pulse/s]

(Note-1) : When the " speed control $10 \times$ multiplier setting for degree axis" is set to "valid" in the fixed parameter, the unit is " $\times 10^{-2}$ [degree/min]".

(c) The JOG speed is the value stored in the JOG speed setting registers (D640+2n, D641+2n) at leading edge of JOG start signal.

Even if data is changed during JOG operation, JOG speed cannot be changed.

(d) Refer to Section 6.21 for details of JOG operation.

3 POSITIONING DEDICATED SIGNALS

3.2.3 Common devices

- (1) Common bit device SET/RST request register (D704 to D708, D755 to D757) Command device
 Because cannot be turn on/off in every bit from the PLC CPU, the bit device is assigned to data register (D), and each bit device turns on with the lowest rank bit 0 to 1 and each bit device becomes off with 1 to 0.
 The details of request register are shown below.
 (Refer to Section "3.1.3 Common devices" for the bit device M2000 to M2053.)

Details of the request register

No.	Function	Request register	Bit device	Remark (Note-1)
1	PLC ready flag	D704	M2000	M3072
2	Speed switching point specified flag	D705	M2040	M3073
3	All axes servo ON command	D706	M2042	M3074
4	Real mode/virtual mode switching request (SV22) (Note-2)	D707	M2043	M3075
5	JOG operation simultaneous start command	D708	M2048	M3076
6	Manual pulse generator 1 enable flag	D755	M2051	M3077
7	Manual pulse generator 2 enable flag	D756	M2052	M3078
8	Manual pulse generator 3 enable flag	D757	M2053	M3079

(Note-1): It can also be ordered the device of a remark column.

(Note-2): It is unusable in the SV22 advanced synchronous control.

- (2) JOG operation simultaneous start axis setting registers (D710 to D713) Command device
 (a) These registers set the axis No. and direction which start simultaneously the JOG operation.

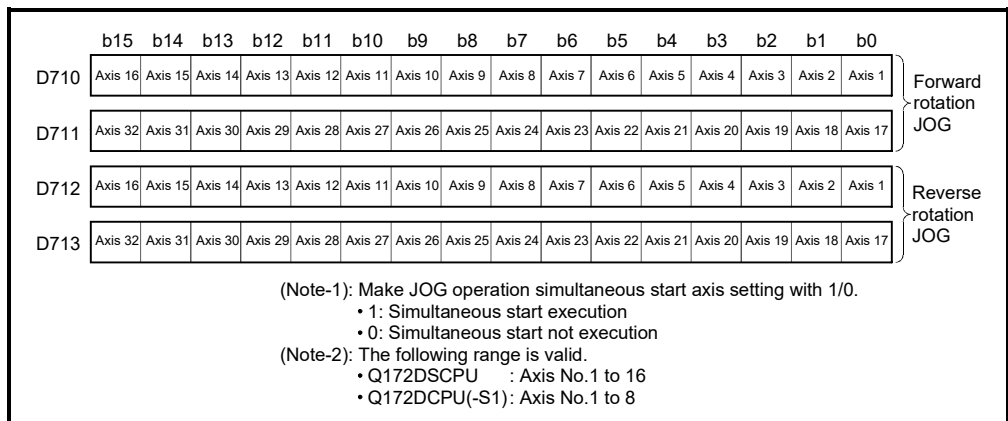

- (b) Refer to Section 6.21.3 for details of the JOG operation simultaneous start.

3 POSITIONING DEDICATED SIGNALS

(3) Manual pulse generator axis No. setting registers (D714 to D719) Command device

(a) These registers stores the axis No. controlled with the manual pulse generator.

	b15	b14	b13	b12	b11	b10	b9	b8	b7	b6	b5	b4	b3	b2	b1	b0	
P1	D714	Axis 16	Axis 15	Axis 14	Axis 13	Axis 12	Axis 11	Axis 10	Axis 9	Axis 8	Axis 7	Axis 6	Axis 5	Axis 4	Axis 3	Axis 2	Axis 1
	D715	Axis 32	Axis 31	Axis 30	Axis 29	Axis 28	Axis 27	Axis 26	Axis 25	Axis 24	Axis 23	Axis 22	Axis 21	Axis 20	Axis 19	Axis 18	Axis 17
P2	D716	Axis 16	Axis 15	Axis 14	Axis 13	Axis 12	Axis 11	Axis 10	Axis 9	Axis 8	Axis 7	Axis 6	Axis 5	Axis 4	Axis 3	Axis 2	Axis 1
	D717	Axis 32	Axis 31	Axis 30	Axis 29	Axis 28	Axis 27	Axis 26	Axis 25	Axis 24	Axis 23	Axis 22	Axis 21	Axis 20	Axis 19	Axis 18	Axis 17
P3	D718	Axis 16	Axis 15	Axis 14	Axis 13	Axis 12	Axis 11	Axis 10	Axis 9	Axis 8	Axis 7	Axis 6	Axis 5	Axis 4	Axis 3	Axis 2	Axis 1
	D719	Axis 32	Axis 31	Axis 30	Axis 29	Axis 28	Axis 27	Axis 26	Axis 25	Axis 24	Axis 23	Axis 22	Axis 21	Axis 20	Axis 19	Axis 18	Axis 17

(Note-1): Make the axis No. controlled with the manual pulse generator setting with 1/0.
 • 1 : Specified axis
 • 0 : Unspecified axis

(Note-2): The following range is valid.
 • Q172DSCPU : Axis No.1 to 16
 • Q172DCPU(-S1): Axis No.1 to 8

(b) Refer to Section 6.22 for details of the manual pulse generator operation.

(4) Manual pulse generator 1-pulse input magnification setting registers (D720 to D751) Command device

(a) These register set the magnification (1 to 10000) per pulse of number of the input pulses from manual pulse generator at the pulse generator operation.

1-pulse input magnification setting register	Axis No.	Setting range	1-pulse input magnification setting register	Axis No.	Setting range
D720	Axis 1	1 to 10000	D736	Axis 17	1 to 10000
D721	Axis 2		D737	Axis 18	
D722	Axis 3		D738	Axis 19	
D723	Axis 4		D739	Axis 20	
D724	Axis 5		D740	Axis 21	
D725	Axis 6		D741	Axis 22	
D726	Axis 7		D742	Axis 23	
D727	Axis 8		D743	Axis 24	
D728	Axis 9		D744	Axis 25	
D729	Axis 10		D745	Axis 26	
D730	Axis 11		D746	Axis 27	
D731	Axis 12		D747	Axis 28	
D732	Axis 13		D748	Axis 29	
D733	Axis 14		D749	Axis 30	
D734	Axis 15		D750	Axis 31	
D735	Axis 16		D751	Axis 32	

(Note): The following range is valid.
 • Q172DSCPU : Axis No. 1 to 16
 • Q172DCPU(-S1): Axis No. 1 to 8

(b) Refer to Section 6.22 for details of the manual pulse generator operation.

3 POSITIONING DEDICATED SIGNALS

(5) Manual pulse generator smoothing magnification setting registers (D752 to D754) Command device

(a) These registers set the smoothing time constants of manual pulse generators.

Manual pulse generator smoothing magnification setting register	Setting range
Manual pulse generator 1 (P1): D752	0 to 59
Manual pulse generator 2 (P1): D753	
Manual pulse generator 3 (P1): D754	

(b) When the smoothing magnification is set, the smoothing time constant is as indicated by the following expression.

$$\text{Smoothing time constant (t)} = (\text{smoothing magnification} + 1) \times 56.8 \text{ [ms]}$$

(c) Operation

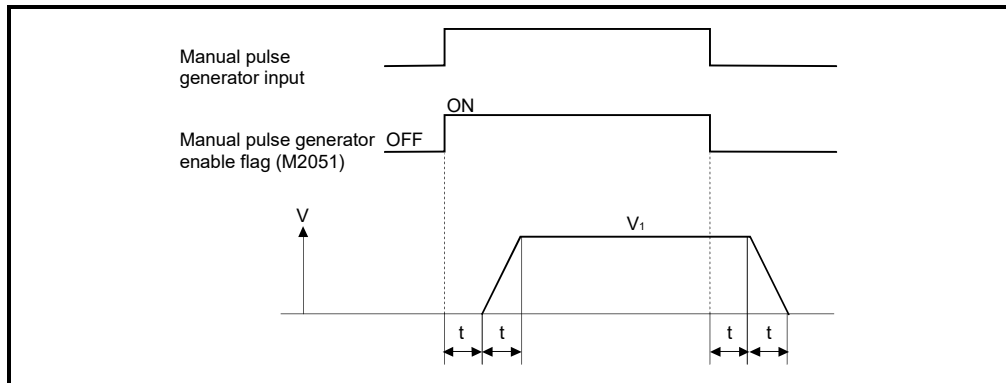

$$\text{Output speed (V}_1\text{) [pulse/s]} = (\text{Number of input pulses/s}) \times (\text{Manual pulse generator 1-pulse input magnification setting})$$

$$\text{Travel value (L)} = \left[\text{Travel value per pulse} \right] \times \left[\text{Number of input pulses} \right] \times \left[\text{Manual pulse generator 1-pulse input magnification setting} \right]$$

REMARK

(1) The travel value per pulse of the manual pulse generator is shown below.

Setting unit	Setting range
mm	0.1[μm]
inch	0.00001[inch]
degree	0.00001[degree]
pulse	1[pulse]

(2) The smoothing time constant is 56.8[ms] to 3408[ms].

3 POSITIONING DEDICATED SIGNALS

3.3 Motion Registers (#)

There are motion registers (#0 to #12287) in the Motion CPU. #8000 to #8639 are used as the monitor device, #8640 to #8735 are used as the Motion error history device and #8736 to #8751 are used as the product information list device. Refer to the "Q173D(S)CPU/Q172D(S)CPU Motion Controller (SV13/SV22) Programming Manual (Motion SFC)" for details of the motion registers and Motion error history device.

(1) Monitor devices (#8000 to #8639)

Information for each axis is stored in the monitor devices.
The details of the storage data are shown below.

Axis No.	Device No.	Signal name		
1	#8000 to #8019			
2	#8020 to #8039			
3	#8040 to #8059			
4	#8060 to #8079			
5	#8080 to #8099			
6	#8100 to #8119			
7	#8120 to #8139			
8	#8140 to #8159			
9	#8160 to #8179			
10	#8180 to #8199			
11	#8200 to #8219			
12	#8220 to #8239			
13	#8240 to #8259			
14	#8260 to #8279			
15	#8280 to #8299			
16	#8300 to #8319			
17	#8320 to #8339			
18	#8340 to #8359			
19	#8360 to #8379			
20	#8380 to #8399			
21	#8400 to #8419			
22	#8420 to #8439			
23	#8440 to #8459			
24	#8460 to #8479			
25	#8480 to #8499			
26	#8500 to #8519			
27	#8520 to #8539			
28	#8540 to #8559			
29	#8560 to #8579			
30	#8580 to #8599			
31	#8600 to #8619			
32	#8620 to #8639			

Axis No.	Device No.	Signal name	Refresh cycle	Signal direction	
0		Servo amplifier type	When the servo amplifier power-on	Monitor device	
1		Motor current value	Operation cycle 1.7[ms] or less : Operation cycle 3.5[ms] or more : 3.5[ms]		
2		Motor speed			
3		Command speed	Operation cycle		
4		Home position return re-travel value	At home position return re-travel		
5		Servo amplifier display servo error code	Main cycle		
6		Parameter error No.			
7		Servo status1	Operation cycle 1.7[ms] or less : Operation cycle 3.5[ms] or more : 3.5[ms]		
8		Servo status2			
9		Servo status3			
10		Unusable	—		—
11		Servo status5	Operation cycle 1.7[ms] or less : Operation cycle 3.5[ms] or more : 3.5[ms]		Monitor device
12		Unusable	—		—
13		Unusable	—	—	
14		Servo status7	Operation cycle 1.7[ms] or less : Operation cycle 3.5[ms] or more : 3.5[ms]	Monitor device	
15		Unusable	—	—	
16		Unusable	—	—	
17		Unusable	—	—	
18		Unusable	—	—	
19		Unusable	—	—	

: Refer to Section 1.3 for the software version that supports this function.

3 POSITIONING DEDICATED SIGNALS

(a) Servo amplifier type (#8000+20n) Monitor device

This register stores the servo amplifier type for each axis at the servo amplifier power supply ON.

- 0 Unused
- 256 MR-J3-□B
MR-J3W-□B (For 2-axis type)
- 257 MR-J3-□B-RJ006 (For fully closed loop control)
MR-J3-□B Safety (For drive safety servo)
- 258 MR-J3-□B-RJ004 (For Linear servo motor)
- 263 MR-J3-□B-RJ080W (For direct drive motor) **Ver.!**
- 4096 MR-J4-□B **QDS**
MR-J4W-□B (For 2-axis type, 3-axis type) **QDS**
- 4352 VCII series ^(Note-1) (CKD Nikki Denso Co., Ltd. make) **QDS**
Ver.!
- 4354 VCII series (For Linear stage) ^(Note-2)
(CKD Nikki Denso Co., Ltd. make) **Ver.!**
- 4359 VCII series (For direct drive motor) ^(Note-2)
(CKD Nikki Denso Co., Ltd. make) **Ver.!**
- 4864 VPH series ^(Note-1) (CKD Nikki Denso Co., Ltd. make) **QDS**
Ver.!
- 4866 VPH series (For Linear stage) ^(Note-2)
(CKD Nikki Denso Co., Ltd. make) **QDS** **Ver.!**
- 4871 VPH series (For direct drive motor) ^(Note-2)
(CKD Nikki Denso Co., Ltd. make) **QDS** **Ver.!**
- 5210 MR-J5-□B **QDS** **Ver.!**
MR-J5W-□B (For 2-axis type, 3-axis type) **QDS** **Ver.!**
- 8192 FR-A800-1 (Inverter) **QDS** **Ver.!**
- 8193 FR-A800-2 (Inverter) **QDS** **Ver.!**
- 8193 IAI electric actuator controller
(IAI Corporation make) **QDS** **Ver.!**
- 8233 5-phase stepping motor driver
(ORIENTAL MOTOR Co., Ltd. make) **QDS** **Ver.!**
- 8234 Stepping motor driver AlphaStep (AZ series)
(ORIENTAL MOTOR Co., Ltd. make) **QDS** **Ver.!**
- 16640 FR-A700 series (Inverter) **Ver.!**
(Note-1): When connecting SSCNETIII/H
(Note-2): When connecting SSCNETIII

It is not cleared even if the servo amplifier power supply turns OFF.

(b) Motor current value (#8001+20n) Monitor device

This register stores the motor current value (×0.1[%]) (signed) read from the servo amplifier.

Ver.!: Refer to Section 1.3 for the software version that supports this function.

3 POSITIONING DEDICATED SIGNALS

- (c) Motor speed (#8002+20n, #8003+20n) Monitor device
 This register stores the motor speed ($\times 0.1$ [r/min]) (signed) read from the servo amplifier.
 The motor speed ($\times 0.1$ [mm/s]) (signed) is stored at linear servo use.
- (d) Command speed (#8004+20n, #8005+20n)..... Monitor device
 This register stores the speed (signed) at which command value to the servo amplifier for every operation cycle is converted into [pulse/s].
- (e) Home positions return re-travel value (#8006+20n, #8007+20n)Monitor device
 If the position stopped in the position specified with the travel value after proximity dog ON using MT Developer2 is not zero point, it made to travel to zero point by re-travel in the Motion CPU. The travel value (signed ([pulse] units)) of making it travel to zero point by re-travel at this time is stored.
 (Data does not change with the last value in the data setting type.)
- (f) Servo amplifier display servo error code (#8008+20n) **Ver.!** Monitor device
 This register stores the servo error code read from the servo amplifier.
 The hexadecimal display is the same as the LED of servo amplifier.
 Refer to the "Servo amplifier Instruction Manual" for details of the servo error codes.

Servo amplifier type	Servo amplifier LED display
MR-J5(W)-□B QDS Ver.!	Displays 4 digits ^(Note-1) on the LED display
MR-J4(W)-□B QDS	Displays 3 digits on the LED display
MR-J3-□B	Displays 2 digits on the LED display
MR-J3W-□B	Displays the first 2 digits on the LED display

(Note-1): Alarm No. (3 digits) + Alarm detail No. (1 digit)

- (g) Parameter error No. (#8009+20n) **QDS** Monitor device
 The parameter number of error servo parameter is stored in hexadecimal at the servo error occurrence.

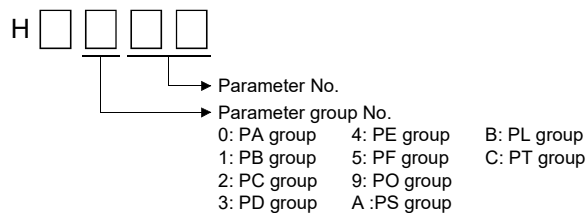

Ver.! : Refer to Section 1.3 for the software version that supports this function.

3 POSITIONING DEDICATED SIGNALS

(h) Servo status1 (#8010+20n) **QDS** Monitor device
 This register stores the servo status read from the servo amplifier.

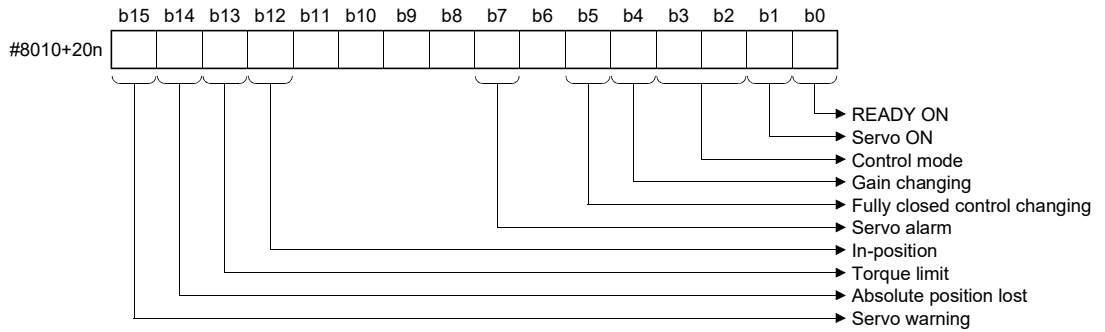

(Note): The 0/1 is stored in the servo status 1.
 • 0: OFF
 • 1: ON

- READY ON (b0)..... Indicates the ready ON/OFF.
- Servo ON (b1)..... Indicates the servo ON/OFF.
- Control mode (b2, b3)..... Indicates the control mode of the servo amplifier.

b3	b2	Control mode
0	0	Position control mode
0	1	Speed control mode
1	0	Torque control mode

- Gain changing (b4) Turns ON when the servo amplifier is gain changing.
- Fully closed control changing (b5) Turns ON when the servo amplifier is using fully closed loop control.
- Servo alarm (b7) Turn ON during the servo alarm.
- In-position (b12) The dwell pulse turns ON within the servo parameter "in-position".
- Torque limit (b13) Turns ON when the servo amplifier is having the torque restricted.
- Absolute position lost (b14) Turns ON when the servo amplifier has lost the absolute position.
- Servo warning (b15) Turn ON during the servo warning.

POINT
Servo warning (b15) turns ON during Motion controller forced stop or servo forced stop.

3 POSITIONING DEDICATED SIGNALS

(i) Servo status2 (#8011+20n) **QDS** Monitor device
 This register stores the servo status read from the servo amplifier.

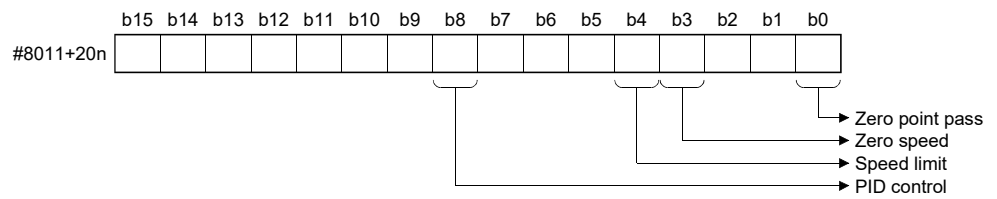

(Note): The 0/1 is stored in the servo status 2.
 • 0: OFF
 • 1: ON

- Zero point pass (b0)..... Turns ON if the zero point of the encoder has been passed even once.
- Zero speed (b3) Turns ON when the motor speed is lower than the servo parameter "zero speed."
- Speed limit (b4)..... Turn ON during the speed limit in torque control mode.
- PID control (b8)..... Turn ON when the servo amplifier is PID control.

(j) Servo status3 (#8012+20n) **QDS** Monitor device
 This register stores the servo status read from the servo amplifier.

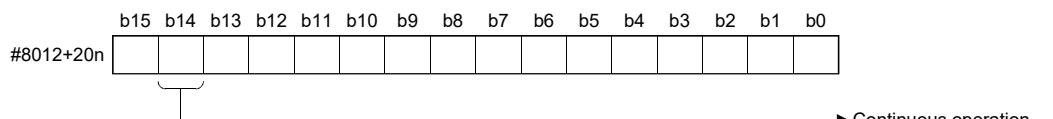

(Note): The 0/1 is stored in the servo status 3.
 • 0: OFF
 • 1: ON

- Continuous operation to torque control mode (b14)
 Turn ON when the continuous operation to torque control mode.

(k) Servo status5 (#8014+20n) **QDS** **Ver.!** Monitor device
 This register stores the servo status read from the servo amplifier (MR-J5(W)-□B).

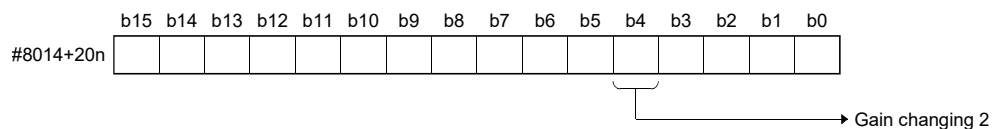



(Note): The 0/1 is stored in the servo status 5.
 • 0: OFF
 • 1: ON

- Gain changing 2 (b4) Turns ON when the servo amplifier (MR-J5(W)-□B) is in gain changing 2.

Ver.! : Refer to Section 1.3 for the software version that supports this function.

3 POSITIONING DEDICATED SIGNALS

(l) Servo status7 (#8018+20n)   Monitor device
This register stores the servo status read from the servo amplifier.

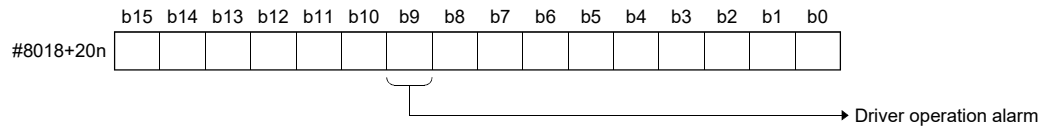

(Note): The 0/1 is stored in the servo status 7.
• 0: OFF
• 1: ON

- Driver operation alarm (b9) Turn ON when the driver operation alarm occurs.

 : Refer to Section 1.3 for the software version that supports this function.

3 POSITIONING DEDICATED SIGNALS

(2) Product information list devices (#8736 to #8751) **Ver.!**

The operating system software version and serial number of Motion CPU is stored in ASCII code.

The product information list devices are shown below.

Device No.	Signal name	Refresh cycle	Fetch cycle	Signal direction
#8736 to #8743	Operating system software version	At power on	/	Monitor device
#8744 to #8751	Motion CPU module serial number			

(a) Operating system software version (#8736 to #8743) Monitor device

The operating system software version of Motion CPU displayed on the system monitor (product information list) of GX Works2/GX Developer is stored in ASCII code.

(Example) Operating system software version: "SV22j VER300A"

	Device No.															
	#8736		#8737		#8738		#8739		#8740		#8741		#8742		#8743	
	Low	High	Low	High	Low	High	Low	High	Low	High	Low	High	Low	High	Low	High
ASCII code	20H	53H	56H	32H	32H	6AH	20H	20H	56H	45H	52H	33H	30H	30H	41H	20H
Character	␣	S	V	2	2	j	␣	␣	V	E	R	3	0	0	A	␣

␣ : Space.

(b) Motion CPU module serial number (#8744 to #8751) Monitor device

The serial number of Motion CPU displayed on the system monitor (product information list) of GX Works2/GX Developer is stored in ASCII code.

(Example) Serial number: "A7Z123015"

	Device No.															
	#8744		#8745		#8746		#8747		#8748		#8749		#8750		#8751	
	Low	High	Low	High	Low	High	Low	High	Low	High	Low	High	Low	High	Low	High
ASCII code	41H	37H	5AH	31H	32H	33H	30H	31H	35H	20H	20H	20H	20H	20H	20H	20H
Character	A	7	Z	1	2	3	0	1	5	␣	␣	␣	␣	␣	␣	␣

␣ : Space.

POINT

Refer to the "Q173D(S)CPU/Q172D(S)CPU Motion Controller User's Manual" or "Q173D(S)CPU/Q172D(S)CPU Motion Controller Programming Manual (COMMON)" for checking of the operating system software version and serial number.

Ver.! : Refer to Section 1.3 for the software version that supports this function.

3 POSITIONING DEDICATED SIGNALS

3.4 Special Relays (SM)

There are 2256 special relay points of SM0 to SM2255 in the Motion CPU. Of these, devices in a Table 3.2 are used for the positioning control. The special relay list used for the positioning control is shown below. (Refer to "Q173D(S)CPU/Q172D(S)CPU Motion controller Programming Manual (COMMON)" for the application of special relays except below.)

Table 3.2 Special relay list

Device No.	Signal name	Refresh cycle	Fetch cycle	Signal type
SM500	PCPU READY complete flag	Main cycle	/	Status signal
SM501	TEST mode ON flag			
SM502	External forced stop input flag	Operation cycle		
SM503	Digital oscilloscope executing flag	Main cycle		
SM506	External forced stop input ON latch flag <small>Ver.1</small>	Operation cycle		
SM508	Amplifier-less operation status flag	Main cycle		
SM510	TEST mode request error flag			
SM512	Motion CPU WDT error flag			
SM513	Manual pulse generator axis setting error flag			
SM516	Servo program setting error flag			

(1) PCPU READY complete flag (SM500) Status signal

This flag is used as judgement of the normal or abnormal in the Motion CPU side using the sequence program.

- (a) The fixed parameters, servo parameters and limit switch output data are checked at leading edge of PLC ready flag (M2000), and if error is not detected, this flag turns on.

The servo parameters are written to the servo amplifiers and the M-codes are cleared.

- (b) This flag turns off when the PLC ready flag (M2000) turns off.

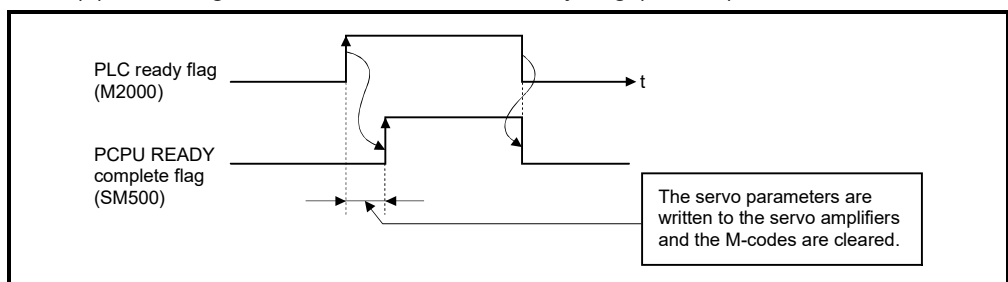

Ver.1: Refer to Section 1.3 for the software version that supports this function.

- (2) TEST mode ON flag (SM501) Status signal
- (a) This flag is used as judgement of during the test mode or not using MT Developer2.
Use it for an interlock, etc. at the starting of the servo program using the Motion SFC program.
- OFFExcept the test mode
 - ON.....During the test mode
- (b) If the test mode is not executed in the test mode request from MT Developer2, the TEST mode request error flag (SM510) turns on.
- (3) External forced stop input flag (SM502) Status signal
- This flag is used to check the external forced stop input signal ON/OFF.
- OFF External forced stop input ON
 - ON External forced stop input OFF

POINTS
<p>(1) If the forced stop signal is input during positioning, the operation is as follows.</p> <ul style="list-style-type: none"> • When using Q173DSCPU/Q172DSCPU The feed current value becomes the same value as the real current value. • When using Q173DCPU(-S1)/Q172DCPU(-S1) The feed current value is advanced within the rapid stop deceleration time set in the parameter block. <p>At the same time, the servo OFF state is established because the all axes servo ON command (M2042) turns off.</p> <p>When the rapid stop deceleration time has elapsed after input of the forced stop signal, the feed current value returns to the value at the point when the emergency stop was initiated.</p> <p>(2) If the forced stop is cancelled while the rapid stop deceleration time isn't progressing, an overspeed error or error excessive error may occur.</p>

- (4) Digital oscilloscope executing flag (SM503) Status signal
- This flag is used to check the state of execution for the digital oscilloscope.
- OFF Digital oscilloscope has stopped.
 - ON Digital oscilloscope is executing.
- (5) External forced stop input ON latch flag (SM506)  Status signal
- This flag turns on when an external forced stop input is detected.
After that, it remains ON even if the external forced stop input is cancelled.
Reset the external forced stop input ON latch flag using the Motion SFC program.
- OFF External forced stop input is not detected.
 - ON External forced stop input is detected.

 : Refer to Section 1.3 for the software version that supports this function.

- (6) Amplifier-less operation status flag (SM508) Status signal
This flag is used to check the state of amplifier-less operation.
- OFF During normal operation
 - ON During amplifier-less operation
- (7) TEST mode request error flag (SM510) Status signal
- (a) This flag turns on when the test mode is not executed in the test mode request using MT Developer2.
- (b) When SM510 turns on, the error contents are stored in the test mode request error information (SD510, SD511).
- (8) Motion CPU WDT error flag (SM512) Status signal
This flag turns on when a WDT error (watchdog timer error) is detected of the Motion CPU self-diagnosis function.
When the Motion CPU detects a WDT error, it executes an immediate stop without deceleration of the operating axes.
If the Motion CPU WDT error flag has turn on, reset the Multiple CPU system.
If SM512 remains on after resetting, there is a fault at the Motion CPU side.
The error cause is stored in the "Motion CPU WDT error cause (SD512)".
(Refer to Section 3.5.)
- (9) Manual pulse generator axis setting error flag (SM513) Status signal
- (a) This flag is use as judgement of normal or abnormal setting of the manual pulse generator axis No. setting registers (D714 to D719).
- OFFD714 to D719 is normal
 - ON.....D714 to D719 is abnormal
- (b) This flag turns ON by turning ON the manual pulse generator enable flag (M2051 to M2053) with the manual pulse generator axis P1 to P3 unused after setting the manual pulse generator interface module (Q173DPX) in the system setting.
- (c) When SM513 turns on, the error contents are stored in the manual pulse generator axis setting error information (SD513 to SD515).
- (10) Servo program setting error flag (SM516) Status signal
This flag is used as judgement of normal or abnormal for the servo program positioning data.
- OFF Normal
 - ON Abnormal

3 POSITIONING DEDICATED SIGNALS

3.5 Special Registers (SD)

There are 2256 special register points of SD0 to SD2255 in the Motion CPU. Of these, devices in a Table 3.3 are used for the positioning control. The special register list used for the positioning control is shown below. (Refer to the "Q173D(S)CPU/Q172D(S)CPU Motion controller Programming Manual (COMMON)" for the applications of special registers except below.)

Table 3.3 Special register list

Device No.	Signal name	Refresh cycle	Fetch cycle	Signal direction		
SD200	State of switch	Main cycle	Main cycle	Monitor device		
SD500	Real mode axis information register (SV22)					
SD501	(Note-1)					
SD502	Servo amplifier loading information	At power supply on/ operation cycle				
SD503						
SD504	Real mode/virtual mode switching error information (SV22) (Note-1)	At virtual mode transition				
SD505						
SD506						
SD508	SSCNET control (status)	Main cycle				
SD510	Test mode request error information	At test mode request				
SD511						
SD512	Motion CPU WDT error cause	At Motion CPU WDT error occurrence				
SD513	Manual pulse generator axis setting error information	At the manual pulse generator enable flag OFF to ON				
SD514						
SD515						
SD516	Error program No.	At start				
SD517	Error item information					
SD522	Motion operation cycle	Operation cycle				
SD523	Operation cycle of the Motion CPU setting	At power supply on				
SD524	Maximum Motion operation cycle	Operation cycle				
SD550	System setting error information	At System setting error occurrence				
SD551						
SD560	Operation method	At power supply on				
SD803	SSCNET control (command)				Main cycle	Command device

(Note-1): It is unusable in the SV22 advanced synchronous control.

(1) State of switch (SD200) Monitor device

The switch state of CPU is stored in the form of the following.

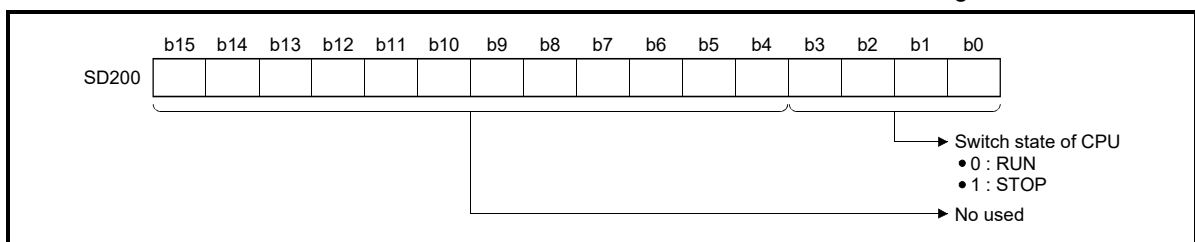

: Refer to Section 1.3 for the software version that supports this function.

3 POSITIONING DEDICATED SIGNALS

(2) Real mode axis information register (SD500, SD501) Monitor device

This signal is used to store the information used as a real mode axis at the time of switching from real mode to virtual mode.

The real mode axis information does not change at the time of switching from virtual mode to real mode.

	b15	b14	b13	b12	b11	b10	b9	b8	b7	b6	b5	b4	b3	b2	b1	b0
SD500	Axis 16	Axis 15	Axis 14	Axis 13	Axis 12	Axis 11	Axis 10	Axis 9	Axis 8	Axis 7	Axis 6	Axis 5	Axis 4	Axis 3	Axis 2	Axis 1
SD501	Axis 32	Axis 31	Axis 30	Axis 29	Axis 28	Axis 27	Axis 26	Axis 25	Axis 24	Axis 23	Axis 22	Axis 21	Axis 20	Axis 19	Axis 18	Axis 17

▶ Real mode axis information
 • 0 : Except real mode axis
 • 1 : Real mode axis

(Note-1): The following range is valid.
 • Q172DSCPU : Axis No.1 to 16
 • Q172DCPU(-S1): Axis No.1 to 8

(Note-2): Refer to APPENDIX of the "Q173D(S)CPU/Q172D(S)CPU Motion controller (SV22) Programming Manual (VIRTUAL MODE)" for the expression method of the axis number corresponding to each bit of word data.

(3) Servo amplifier loading information (SD502, SD503) Monitor device

The mounting status of the servo amplifier is checked at the power supply on or reset of the Multiple CPU system and its results are stored in this device.

If communication with servo amplifier stops, it is reset.

The mounting status of changed axis after the power supply on is stored.

	b15	b14	b13	b12	b11	b10	b9	b8	b7	b6	b5	b4	b3	b2	b1	b0
SD502	Axis 16	Axis 15	Axis 14	Axis 13	Axis 12	Axis 11	Axis 10	Axis 9	Axis 8	Axis 7	Axis 6	Axis 5	Axis 4	Axis 3	Axis 2	Axis 1
SD503	Axis 32	Axis 31	Axis 30	Axis 29	Axis 28	Axis 27	Axis 26	Axis 25	Axis 24	Axis 23	Axis 22	Axis 21	Axis 20	Axis 19	Axis 18	Axis 17

▶ Servo amplifier mounting status
 • 0: Not mounted
 • 1: Mounted

(Note-1): The following range is valid.
 • Q172DSCPU : Axis No.1 to 16
 • Q172DCPU(-S1): Axis No.1 to 8

(a) Servo amplifier mounting status

1) Mounting status

- Mounted The servo amplifier is normal. (Communication with the servo amplifier is normal.)
- Not mounted The servo amplifier is not mounted.
 The servo amplifier control circuit power is off.
 Normal communication with the servo amplifier is not possible due to a connecting cable fault, etc.

2) The system settings and servo amplifier mounting status are shown below.

System Settings	Servo amplifier	
	Mounted	Not mounted
Used (axis No. setting)	1 is stored	0 is stored
Unused	0 is stored	

3 POSITIONING DEDICATED SIGNALS

(4) SSCNET control (status) (SD508) Monitor device
 SSCNET control (status) (SD508) stores the executing state for connect/disconnect of SSCNET communication and start/release of amplifier-less operation.

- 0 Command accept waiting
- -1 Execute waiting
- -2 Executing

Refer to the "Q173D(S)CPU/Q172D(S)CPU Motion controller Programming Manual (COMMON)" for details of the SSCNET control function.

(5) Test mode request error information (SD510, SD511) Monitor device

If there are operating axis at a test mode request using MT Developer2, a test mode request error occurs, the test mode request error flag (SM510) turns on, and the during operation/stop data of each axis are stored.

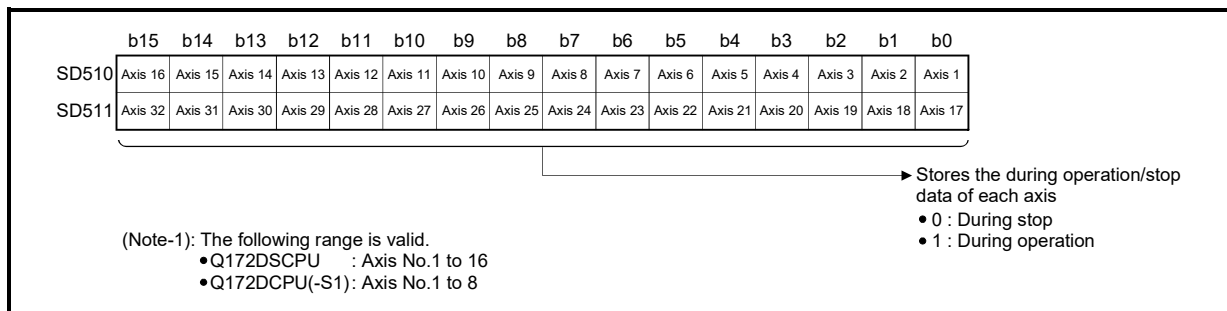

(6) Motion CPU WDT error cause (SD512) Monitor device
 This register is used as judgement of the error contents in the Motion CPU.

Error code	Error cause	Operation when error occurs	Action to take
1	S/W fault 1	All axes stop immediately, after which operation cannot be started.	<ul style="list-style-type: none"> • Reset the Multiple CPU system. • If the an operation cycle time over reoccurs after resetting, or a main cycle is lengthened (more than 1.0[s]), 1) Change the operation cycle into a large value in the system setting. 2) Reduce the number of command execution of the event task or NMI task in the system setting.
2	Operation cycle time over		
4	WDT error		<ul style="list-style-type: none"> • Reset the Multiple CPU system. • If the error reoccurs after resetting, explain the error symptom and get advice from our sales representative.
300	S/W fault 3		
303	S/W fault 4		
304	RIO WDT error		

3 POSITIONING DEDICATED SIGNALS

(7) Manual pulse generator axis setting error information (SD513 to SD515) Monitor device

The setting information is checked at leading edge of manual pulse generator enable signal, if an error is found, the following error information is stored into SD513 to SD515 and the manual pulse generator axis setting error flag (SM513) turns on.

If there is an unused setting error for the manual pulse generator axis, a correspondence bit of SD513 turns ON.

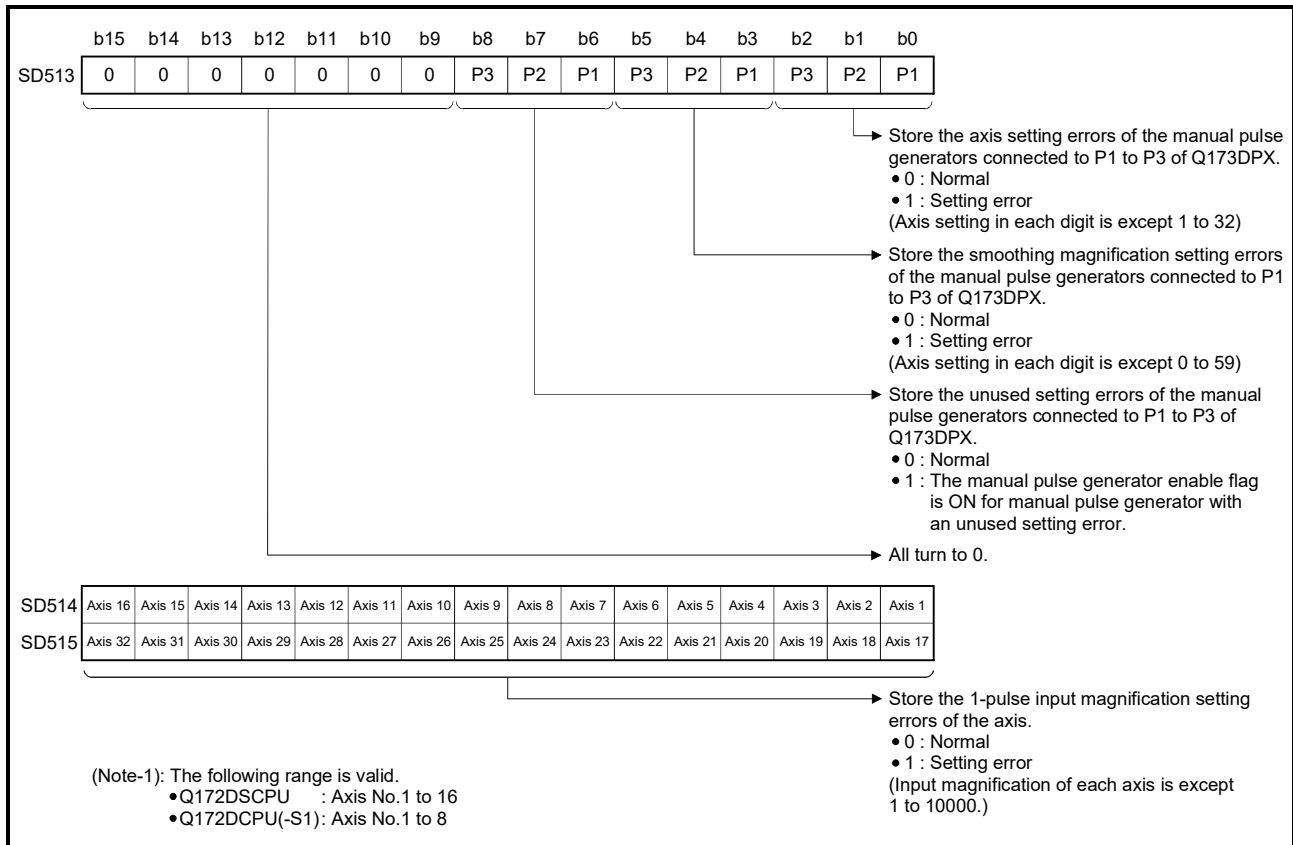

(8) Error program No. (SD516) Monitor device

(a) When the servo program error occurs at the servo program start, the servo program setting error flag (SM516) turns on and the error servo program No. (0 to 4095).

(b) If an error occurs in another servo program when error program No. has been stored, the program No. of the new error is stored.

(9) Error item information (SD517) Monitor device

When the servo program error occurs at the servo program start, the servo program setting error flag (SM516) turns on and the error code corresponds to the error setting item is stored.

Refer to APPENDIX 1.1 for details of servo program setting errors.

(10) Motion operation cycle (SD522) Monitor device

The time which motion operation took for every motion operation cycle is stored in [μ s] unit.

- (11) Operation cycle of the Motion CPU setting (SD523) Monitor device
 The setting operation cycle is stored in [μ s] unit.
 When the "Default Setting" is set in the system setting, the operation cycle corresponding to the number of setting axes. When "0.2[ms]^{QDS}/ 0.4[ms] / 0.8[ms] / 1.7[ms] / 3.5[ms] / 7.1[ms] / 14.2[ms]^{QD}" is set in the system setting, the operation cycle corresponding to each setting.
 (Note): If the servo amplifiers of 9 axes or more are connected to one SSCNETⅢ line, it does not support an operation cycle of 0.4[ms]. 0.8[ms] is used as the real operation cycle, even if 0.4[ms] is set in the system setting.
- (12) Maximum Motion operation cycle (SD524) ^{QDS} Monitor device
 The maximum time for motion operation is stored every motion operation cycle in [μ s] unit.
- (13) System setting error information (SD550,SD551) ^{QDS} Monitor device
 The error code and error individual information are stored at the system setting error occurrence.
 Refer to the "Q173D(S)CPU/Q172D(S)CPU Motion controller Programming Manual (COMMON)" for details of the system setting errors.
- (14) Operation method (SD560) ^{QDS} ^{Ver.!} Monitor device
 When the operating system software is SV22, the operation method information is stored.
- 0 Virtual mode switching method
 - 1 Advanced synchronous control method
- (15) SSCNET control (command) (SD803) Command device
 SSCNET control (command) (SD803) is required for connect/disconnect of SSCNET communication and start/release of amplifier-less operation.
- 0 No command
 - 1 to 32 Disconnect command of SSCNET communication
 - -10 Re-connect command of SSCNET communication
 - -20 Start command 1 of amplifier-less operation (EMI invalid)
 - -21 Start command 2 of amplifier-less operation (EMI valid)
 - -25 Release command of amplifier-less operation
 - -2 Execute command
- Refer to the "Q173D(S)CPU/Q172D(S)CPU Motion controller Programming Manual (COMMON)" for details of the SSCNET control function.



^{Ver.!}: Refer to Section 1.3 for the software version that supports this function.

MEMO

4. PARAMETERS FOR POSITIONING CONTROL

4.1 System Settings

In the Multiple CPU system, the common system parameters and individual parameters are set for each CPU and written to each CPU.

- (1) The base settings, Multiple CPU settings and Motion slot settings are set in the common system parameter setting.
- (2) The following are set in the individual parameter setting.
 - System basic setting
 - SSCNET setting 
 - CPU name setting
 - Built-in Ethernet port setting
 - CPU setting
 - Manual pulse generator/synchronous encoder setting 
 - Servo amplifier setting
 - High-speed read setting
 - Optional data monitor setting
 - Mark detection setting 
- (3) The data setting and correction can be performed in MT Developer2.
(Refer to the "Q173D(S)CPU/Q172D(S)CPU Motion Controller Programming Manual (COMMON)" for details of the setting contents.)

4 PARAMETERS FOR POSITIONING CONTROL

4.2 Fixed Parameters

- (1) The fixed parameters are set for each axis and their data is fixed based on the mechanical system, etc.
- (2) The fixed parameters are set using MT Developer2.
- (3) The fixed parameters to be set are shown in Table 4.1.

Table 4.1 Fixed parameter list

No.	Item	Setting range								Initial value	Units	Remarks	Section	
		mm		inch		degree		pulse						
		Setting range	Units	Setting range	Units	Setting range	Units	Setting range	Units					
1	Unit setting	0	—	1	—	2	—	3	—	3	—	• Set the command unit for each axis at the positioning control.	—	
2	Number of pulses per rotation (AP)	1 to 2147483647[pulse]								20000	pulse	• Set the number of feedback pulses per motor rotation based on the mechanical system.	4.2.1	
3	Travel value per rotation (AL)	0.1 to 214748364.7	μm	0.00001 to 21474.83647	inch	0.00001 to 21474.83647	degree	1 to 2147483647	pulse	20000		• Set the travel value per motor based on the mechanical system.		
4	Backlash compensation amount ^(Note)	0 to 6553.5		0 to 0.65535		0 to 0.65535		0 to 65535		0		• Set the backlash amount of the machine. • Every time of the positioning direction changes at the positioning, compensation by the backlash compensation amount is executed.		7.2
5	Upper stroke limit ^(Note)	-214748364.8 to 214748364.7		-21474.83648 to 21474.83647		0 to 359.99999		-2147483648 to 2147483647		2147483647		• Set the upper limit for the machine travel range.		4.2.3
6	Lower stroke limit ^(Note)	-214748364.8 to 214748364.7		-21474.83648 to 21474.83647		0 to 359.99999		-2147483648 to 2147483647		0		• Set the lower limit for the machine travel range.		
7	Command in-position range ^(Note)	0.1 to 214748364.7		0.00001 to 21474.83647		0.00001 to 359.99999		1 to 2147483647		100	• Set the position at which the command in-position signal (M2403+20n) turns on [(positioning address) - (current value)].	4.2.4		
8	Speed control 10×multiplier setting for degree axis	—	—	—	Invalid/Valid	—	—	—	Invalid	—	• Set whether the positioning control is executed with a value 10×multiplier the speed of a command speed setting, when a control unit is degree axis.	4.2.5		

(Note): The display of the possible setting range changes according to the electronic gear value at Q173DCPU(-S1)/Q172DCPU(-S1).

4 PARAMETERS FOR POSITIONING CONTROL

4.2.1 Number of pulses/travel value per rotation

The "Electronic gear function" adjusts the actual machine movement amount and number of pulse output to servo amplifier according to the parameter set in the Motion CPU.

It is defined by the "Number of pulses per rotation" and "Travel value per revolution".

POINTS
(1) The mechanical system error of the command travel value and real travel value is rectified by adjustment the "electronic gear".
(2) The value of less than 1 pulse that cannot be execute an output when the machine travels is incremented in the Motion CPU, and a total incremented output is performed when the total incremented value becomes more than 1 pulse.
(3) The total incremented value of less than 1 pulse that cannot be execute an output is cleared and it is referred to as "0" at the home position return completion, current value change completion, speed-switching control start (except the feed current value update) and fixed-pitch feed control start. (When the total incremented value is cleared, the error occurs to the feed machine value only a part to have been cleared.)
(4) Set the electronic gear within the following range. $0.001 \leq \frac{\text{Number of pulses per rotation (AP)}}{\text{Travel value per rotation (AL)}} \leq 20000$

4 PARAMETERS FOR POSITIONING CONTROL

(1) Number of pulses/travel value per rotation

Number of pulses (AP)/travel value (AL) per rotation is an item which determines how many rotations (number of pulses per rotation) of the servo motor in order to make it a machine as the travel value ordered by the program.

The position control toward the servo motor is controlled with the number of feedback pulses of the encoder connected to the servo motor in the servo amplifier.

The control content of the Motion CPU is shown below.

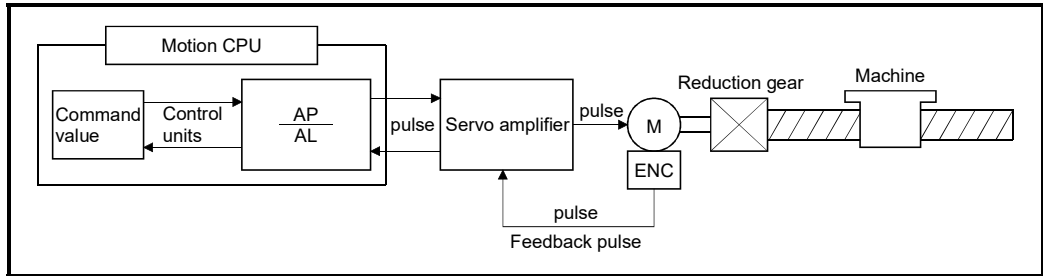

Fig. 4.1 Control content of the Motion CPU

For example, suppose that the servo motor was connected to the ball screw. Because the travel value (ΔS) of machine per motor rotation is [mm] / [inch] unit, the travel value (positioning address) set in the program is commanded in [mm] / [inch] unit. However, the servo motor is positioning controlled by the servo amplifier in pulse unit.

Therefore, AP/AL is set so that the following expression of relations may be materialized in order to convert the travel value of [mm] / [inch] unit set in the program into a pulse.

Number of pulses per motor rotation = AP

Travel value of machine per motor rotation = AL

$$\text{Electronic gear} = \frac{AP}{AL} \dots\dots (1)$$

(There is a range which can be set in the numerical value set as AP/AL, so it is necessary to make the setting range of AP/AL the value calculated from the above expression (reduced) of relations.)

(Note): For MR-J5(W)-□B, the servo amplifier electronic gear is taken into account for the number of pulses per motor rotation (AP).

$$\text{Number of pulses per motor rotation (AP)} = \text{Resolution per servo motor revolution} \times \frac{\text{Electronic gear denominator (PA07)}^{(Note-1)}}{\text{Electronic gear numerator (PA06)}^{(Note-1)}}$$

(Note-1): Servo amplifier servo parameter

4 PARAMETERS FOR POSITIONING CONTROL

POINTS

When using a servo motor (such as HK-KT) that has an encoder resolution of 67108864[pulse/rev], set the MR-J5(W)-□B servo parameters to the values below so that the encoder resolution becomes 4194304[pulse/rev].

If the settings are different, a major error (error code: 1340) occurs.

After changing the parameters, turn OFF the servo amplifier power supply before turning ON the power supply again.

- Electronic gear numerator (PA06) : 16
- Electronic gear denominator (PA07) : 1

The control content of the Motion CPU is shown below.

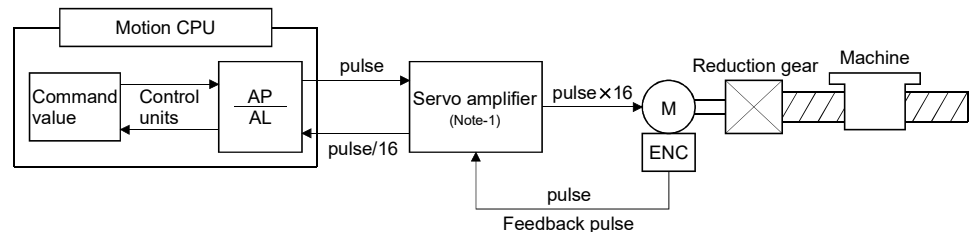

(Note-1): Electronic gear numerator(PA06): 16
Electronic gear denominator(PA07): 1

(Note): When a major error (error code: 1340) occurs, the servo amplifier LED display alternates between "AC" and "Ad" and servo amplifier cannot be connected. Additionally, the servo amplifiers after cannot connect to the last station.

Example of the real setting is shown below.

(Note): Refer to this section (2) for the setting at linear servo.

4 PARAMETERS FOR POSITIONING CONTROL

(a) For ball screw

When the ball screw pitch is 20[mm], the servo motor is HF-KP (262144[pulse/rev]) and direct connection (No reduction gear) is set.

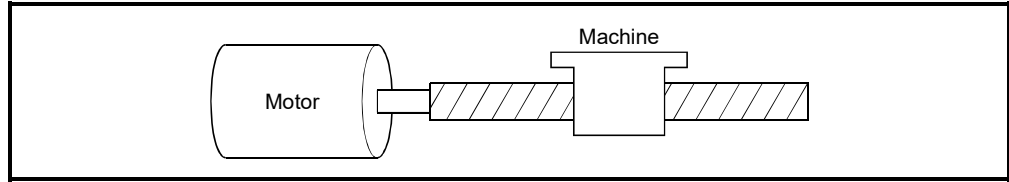

Fig. 4.2 For ball screw

First, find how many millimeters the load (machine) will travel (AL) when the servo motor runs for one rotation (AP).

AP (Number of pulses per motor rotation) = 262144[pulse] (Note-1)

AL (Travel value of machine per rotation)

$$= \text{Ball screw pitch} \times \text{Reduction ratio} \\ = 20[\text{mm}]$$

Substitute this for the above expression (1).

$$\frac{AP}{AL} = \frac{262144[\text{pulse}]}{20[\text{mm}]}$$

Although it becomes above, when a control unit is set to [mm] unit, the minimum unit of the command value in a program is 0.1[μm] and converted from 20[mm] (20.0000[mm]) to 20000.0[μm].

$$\frac{AP}{AL} = \frac{262144[\text{pulse}]}{20000.0[\mu\text{m}]}$$

The travel value per motor rotation in this example is 0.000076[mm].

For example, when ordering the travel value of 19[mm], it becomes 249036.8[pulse] and the fraction of 0.8[pulse]. At this time, the Motion CPU orders the travel value of 249036[pulse] to the servo motor and the fraction is memorized in the Motion CPU.

Positioning is performed by taking into account the travel value with this fraction at the next positioning.

(Note-1): When controlling a servo motor (HK-KT) (67108864[pulse/rev]) using MR-J5(W)-□B, the AP (Number of pulses per motor rotation) is as follows.

$$AP (\text{Number of pulses per motor rotation}) = 67108864[\text{pulse}] \times \frac{1}{16} = 4194304[\text{pulse}]$$

4 PARAMETERS FOR POSITIONING CONTROL

(2) Number of pulses/travel value at linear servo use

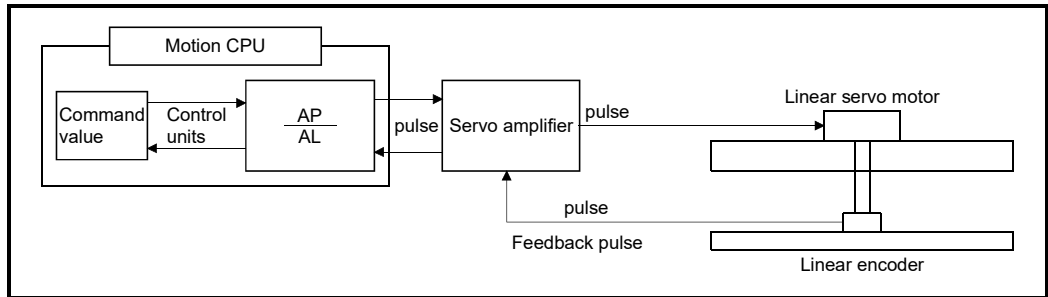

Fig. 4.3 Linear servo use

Calculate the number of pulses (AP) and travel value (AL) for the linear encoder in the following conditions.

$$\text{Linear encoder resolution} = \frac{\text{Number of pulses (AP)}}{\text{Travel value (AL)}}$$

Linear encoder resolution: 0.05[μm]

$$\frac{\text{Number of pulses (AP) [pulse]}}{\text{Travel value (AL) [μm]}} = \frac{1}{0.05} = \frac{20}{1.0}$$

Set the number of pulses in "Number of pulses per rotation", and the movement amount in "Travel value per rotation" in the actual setting.

(Note): Set the same value as the value set in the fixed parameter to the servo parameter "PS02 (Linear encoder resolution setting Numerator)" and "PS03 (Linear encoder resolution setting Denominator)".

For MR-J5(W)-□B, set servo parameters "Electronic gear numerator (PA06)" and "Electronic gear denominator (PA07)" to "1".

Refer to the "Servo amplifier Instruction Manual" for details.

Servo amplifier type	Instruction manual name
MR-J5-□B	MR-J5-B/MR-J5W-B User's Manual (Parameters) (IB-0300581ENG)
MR-J5W-□B	
MR-J4-□B	SSCNETⅢ/H Interface AC Servo MR-J4-_B_(-RJ) Servo amplifier Instruction Manual (SH-030106)
MR-J4W-□B	SSCNETⅢ/H Interface Multi-axis AC Servo MR-J4W2-_B_/MR-J4W3-_B_/MR-J4W2-0303B6 Servo amplifier Instruction Manual (SH-030105)
MR-J3-□B-RJ004	SSCNETⅢ Compatible Linear Servo MR-J3-□B-RJ004U□ Instruction Manual (SH-030054)

4 PARAMETERS FOR POSITIONING CONTROL

4.2.2 Backlash compensation amount

- (1) Backlash compensation amount can be set within the following range.
(Refer to Section "7.2 Backlash Compensation Function" for details.)
(Note): The following restriction does not apply to versions compatible with the setting range expansion of backlash compensation amount. **Ver.!**

$$0 \leq \frac{\text{Backlash compensation amount} \times \text{Number of pulses per rotation (AP)}}{\text{Travel value per rotation (AL)}} (=A) \leq 65535[\text{pulse}]$$

- (2) The servo error may occur depending on the type of the servo amplifier (servo motor) or operation cycle even if the backlash compensation amount which fulfill the above condition.
Set the backlash compensation amount within the following range in order for servo error may not occur.

$$A \leq \frac{\text{Motor instantaneous permissible speed [r/min]} \times \text{Encoder resolution [pulse]} \times \text{Operation cycle [ms]}}{60[\text{s}] \times 1000[\text{ms}]} [\text{pulse}]$$

(Note): The backlash compensation amount is output in one operation cycle.

4.2.3 Upper/lower stroke limit value

The upper/lower limit value for the travel range of mechanical system is set.

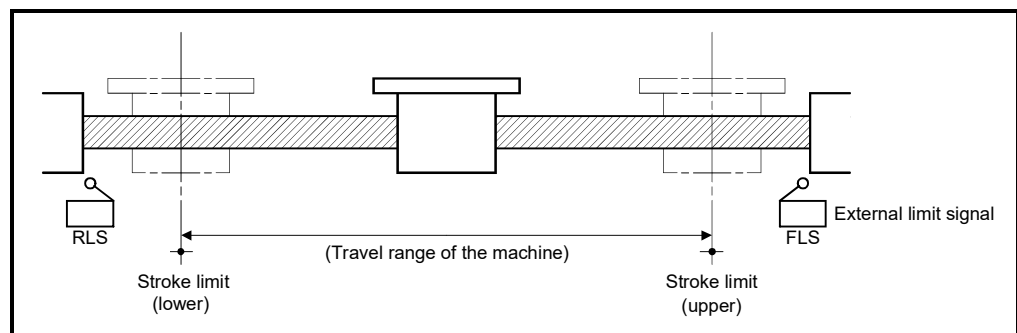

Fig. 4.4 Travel range at the upper/lower stroke limit value setting

Ver.! : Refer to Section 1.3 for the software version that supports this function.

4 PARAMETERS FOR POSITIONING CONTROL

(1) Stroke limit range check

The stroke limit range is checked at the following start or during operation.

Operation start	Check	Remarks
<ul style="list-style-type: none"> • Position follow-up control • Constant-speed control • Speed switching control • Positioning control • Fixed-pitch feed control • Speed control (I) (Note-1) 	Check	<ul style="list-style-type: none"> • Checks whether or not the feed current value is within the stroke limit range at the positioning start. If the value is outside the range, a minor error occurs (error code: 106) and positioning is not executed. • If the interpolation path exceeds the stroke limit range during circular interpolation start, a minor error occurs (error codes: 207, 208) and deceleration stop is executed. • If the current value exceeds the stroke limit range, deceleration stop is executed.
<ul style="list-style-type: none"> • Speed control (I) (Note-2) • Speed control (II) 	Not check	<ul style="list-style-type: none"> • The current value becomes "0", and operation continues until the external limit signal (FLS, RLS, STOP) is received.
<ul style="list-style-type: none"> • Speed-position switching control (including restart) 	Check	<ul style="list-style-type: none"> • Checks the stroke limit range after the switch to position control, but not while executing speed control.
<ul style="list-style-type: none"> • JOG operation 		<ul style="list-style-type: none"> • When the current value executes a deceleration stop from the current command speed, if the current value exceeds the stroke limit range, a minor error occurs (error code: 207), and deceleration stop is made before reaching the stroke limit. Travel from outside the stroke limit range to the direction that returns the axis into the stroke limit range is possible. • For a degree axis, depending on the stroke limit setting, the direction that can return the axis into the stroke limit range is different. <ol style="list-style-type: none"> 1) When upper stroke limit value > lower stroke limit value When "Feed current value > upper stroke limit value", movement in the negative direction is possible. When "Feed current value < lower stroke limit value", movement in the positive direction is possible. 2) When upper stroke limit value < lower stroke limit value Movement in both the positive and negative direction is possible.
<ul style="list-style-type: none"> • Manual pulse generator operation 		<ul style="list-style-type: none"> • If the current value exceeds the stroke limit range, a minor error occurs (error code: 207), and it stops at stroke limit. In this case, a deceleration stop is not made. Travel from outside the stroke limit range to the direction that returns the axis into the stroke range is possible. • For a degree axis, depending on the stroke limit setting, the direction that can return the axis into the stroke limit range is different. <ol style="list-style-type: none"> 1) When upper stroke limit value > lower stroke limit value When "Feed current value > upper stroke limit value", movement in the negative direction is possible. When "Feed current value < lower stroke limit value", movement in the positive direction is possible. 2) When upper stroke limit value < lower stroke limit value Movement in both the positive and negative direction is possible.
<ul style="list-style-type: none"> • Speed-torque control 		<ul style="list-style-type: none"> • If the current feed value exceeds the software stroke limit range, a minor error occurs (error code: 207), and the mode is switched to position control.

(Note-1): When feed current value update command (M3212+20n) is ON.

(Note-2): When feed current value update command (M3212+20n) is OFF.

POINTS

- (1) Besides setting the upper/lower stroke limit value in the fixed parameters, the range of mechanical system can also be controlled by using the external limit signals (FLS, RLS).
- (2) When the external limit signal turns off, a deceleration stop is executed. "Deceleration time" and "Rapid stop deceleration time" can be used in the parameter block for deceleration stop time.

4 PARAMETERS FOR POSITIONING CONTROL

(2) Setting range of upper/lower stroke limit value (SV13 only) **QD**

Upper/lower stroke limit value can be set within the following range.

$$-2147483648 \leq \text{Upper/lower stroke limit value} \times \frac{\text{Number of pulses per rotation (AP)}}{\text{Travel value per rotation (AL)}} \leq 2147483647$$

(3) Stroke limit invalid setting **QDS**

The unlimited length feed is possible by setting the stroke limit to invalid even the control unit is "other than degree axis" (mm, inch, pulse). When "(Upper stroke limit) = (Lower stroke limit)" is set as the upper and lower stroke limit is set in the fixed parameter, the stroke limit becomes invalid and the unlimited length feed is possible.

Refer to Section 6.1.5 for details of degree axis.

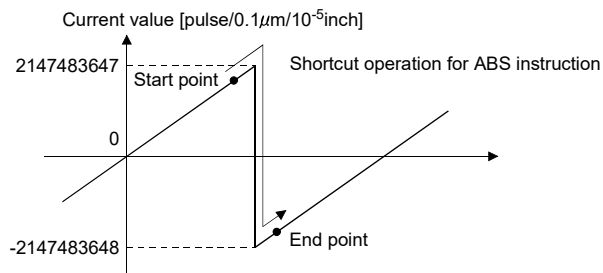

4 PARAMETERS FOR POSITIONING CONTROL

POINTS																				
(1)	If the current feed value and real current value exceeds 2147483647 [pulse/0.1 μ m/10 ⁻⁵ inch], it is controlled with -2147483648[pulse/0.1 μ m/10 ⁻⁵ inch]. If those values are less than -2147483648[pulse/0.1 μ m/10 ⁻⁵ inch], it is controlled with 2147483647[pulse/0.1 μ m/10 ⁻⁵ inch].																			
(2)	If the absolute position command (ABS instruction) is set when the stroke limit is invalid, it is controlled as shortcut operation.																			
(3)	The circular interpolation and helical interpolation (other than linear axis) including axis that the stroke limit is set to invalid cannot be executed. A minor error (error code: 107 to 109) will occur, and operation does not start.																			
(4)	If the stroke limit is set to invalid for axis of unit (pulse, mm, inch) in the real mode or real mode axis, the ABS-□ instruction cannot be executed unit (pulse, mm, inch) when the absolute method is set as end point address in the speed-switching control (VSTART). A minor error (error code: 119) will occur, and operation does not start.																			
(5)	The high-speed oscillation function cannot be used in the axis that set the stroke limit invalid.																			
(6)	When executing a speed change to negative speed for the axis with stroke limit set to invalid, the operations below occur based on the control mode being executed.																			
	<table border="1"> <thead> <tr> <th>Control mode</th> <th>Operation</th> </tr> </thead> <tbody> <tr> <td>Speed control (I)</td> <td rowspan="2">Negative speed-change accept.</td> </tr> <tr> <td>Speed control (II)</td> </tr> <tr> <td>Home position return</td> <td>Minor error (error code: 301) occurs and speed change is ignored.</td> </tr> <tr> <td>Speed-position control</td> <td rowspan="4">Minor error (error code: 305) occurs and speed change is ignored.</td> </tr> <tr> <td>Position follow-up control</td> </tr> <tr> <td>Speed control with fixed position stop</td> </tr> <tr> <td>Speed-position switching control</td> </tr> <tr> <td>JOG operation</td> <td></td> </tr> <tr> <td>Manual pulse generator operation</td> <td rowspan="2">Speed change is ignored.</td> </tr> <tr> <td>Speed-torque control</td> </tr> <tr> <td>Others</td> <td>Minor error (error code: 310) occurs and speed change is ignored.</td> </tr> </tbody> </table>	Control mode	Operation	Speed control (I)	Negative speed-change accept.	Speed control (II)	Home position return	Minor error (error code: 301) occurs and speed change is ignored.	Speed-position control	Minor error (error code: 305) occurs and speed change is ignored.	Position follow-up control	Speed control with fixed position stop	Speed-position switching control	JOG operation		Manual pulse generator operation	Speed change is ignored.	Speed-torque control	Others	Minor error (error code: 310) occurs and speed change is ignored.
Control mode	Operation																			
Speed control (I)	Negative speed-change accept.																			
Speed control (II)																				
Home position return	Minor error (error code: 301) occurs and speed change is ignored.																			
Speed-position control	Minor error (error code: 305) occurs and speed change is ignored.																			
Position follow-up control																				
Speed control with fixed position stop																				
Speed-position switching control																				
JOG operation																				
Manual pulse generator operation	Speed change is ignored.																			
Speed-torque control																				
Others	Minor error (error code: 310) occurs and speed change is ignored.																			

4 PARAMETERS FOR POSITIONING CONTROL

4.2.4 Command in-position range

The command in-position is the difference between the positioning address (command position) and feed current value.

Once the value for the command in-position has been set, the command in-position signal (M2403+20n) turns on when the difference between the command position and the feed current value enters the set range [(command position - feed current value) ≤ (command in-position range)].

The command in-position range check is executed continuously during position control.

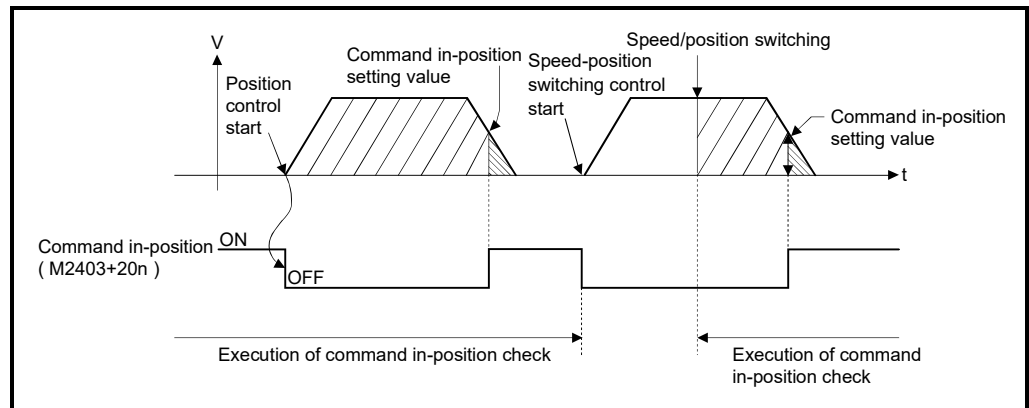

(1) Command in-position can be set within the following range.

(a) Q173DSCPU/Q172DSCPU use

$$1 \leq \text{Command in-position range} \leq 2147483647$$

(b) Q173DCPU(-S1)/Q172DCPU(-S1) use

$$1 \leq \text{Command in-position range} \times \frac{\text{Number of pulses per rotation (AP)}}{\text{Travel value per rotation (AL)}} \leq 32767$$

4 PARAMETERS FOR POSITIONING CONTROL

4.2.5 Speed control 10×multiplier setting for degree axis

The setting range of command speed is 0.001 to 2147483.647[degree/min] normally in the axis of control unit [degree]. However, when the "speed control 10×multiplier setting for degree axis" is set to "valid" in the fixed parameter the speed setting range increases 10×multiplier "0.01 to 21474836.47[degree/min]".

- (1) When the "speed control 10×multiplier setting for degree axis" is set to "valid", the positioning control is executed by the speed increased 10×multiplier command speed set in the servo program or servo parameter, and speed limit value.
- (2) In the interpolation control for the axis of "control unit [degree] and [except degree]", if the interpolation control unit of parameter block is set as [degree]," the positioning control is executed by the speed increased 10×multiplier command speed and speed limit value.
- (3) When the "speed control 10×multiplier setting for degree axis" is set as "valid", 2 figures below the decimal point of ***.** [degree/min] is displayed on the screen of MT Developer2.

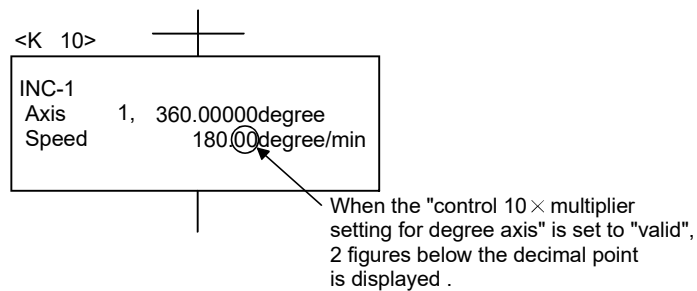

- (4) Speed setting range in the interpolation operation is shown below.
 - (a) Vector speed specification/Long-axis speed specification
If the "speed control 10×multiplier setting for degree axis" is set to "valid" even by one axis among interpolation axes, the speed setting range is "0.01 to 21474836.47[degree/min]".
 - (b) Reference-axis speed specification
If the "speed control 10×multiplier setting for degree axis" is set to "valid" in the specified reference axis, the speed setting range is "0.01 to 21474836.47[degree/min]".

4 PARAMETERS FOR POSITIONING CONTROL

Example

- An example for positioning control is shown below when the "speed control 10× multiplier setting for degree axis" of fixed parameter and "interpolation control unit" of parameter block are set as follows.

- Speed control 10× multiplier setting for degree axis

Axis	Speed control 10× multiplier setting for degree axis
Axis 1	Invalid
Axis 2	Valid

- Interpolation control unit of parameter block

	Block 10
Interpolation control unit	degree

- (1) 1 axis linear positioning control program (Axis 1) (2) 1 axis linear positioning control program (Axis 2)

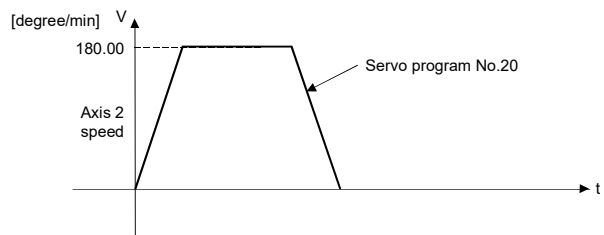
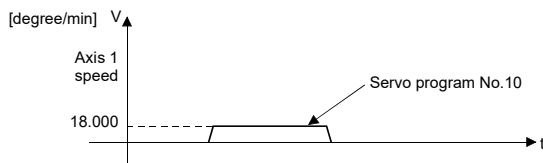
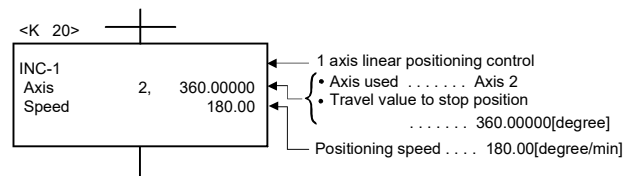
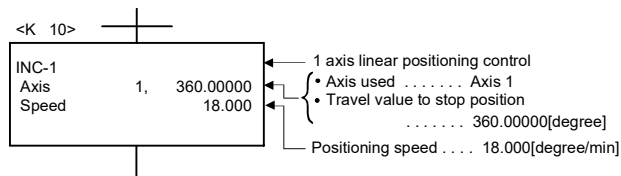

- (3) 2 axes linear interpolation control program (Axis 1, Axis 2)

(a) Vector speed specification

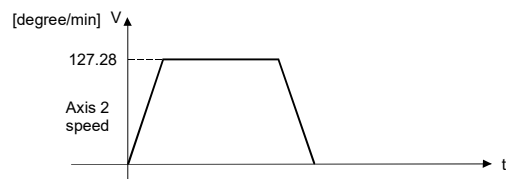
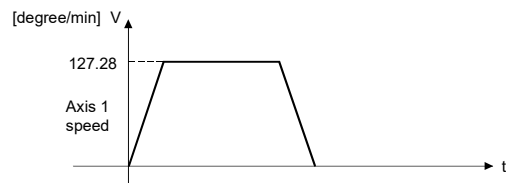
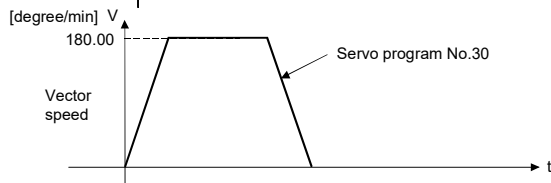
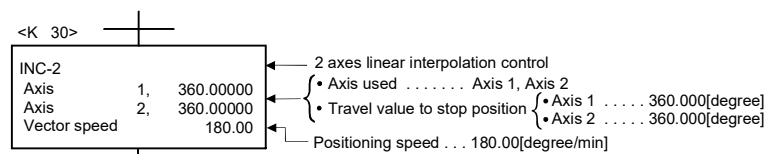

4 PARAMETERS FOR POSITIONING CONTROL

Example

(b) Long-axis reference specification

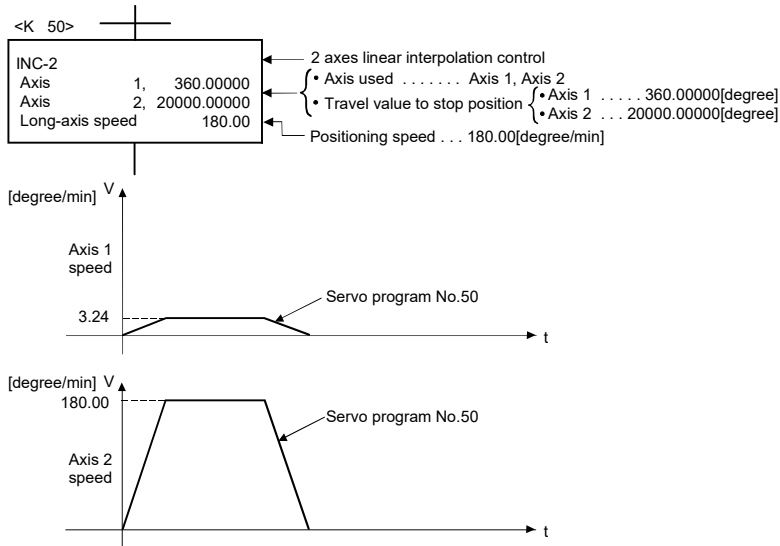

(c) Reference-axis speed setting

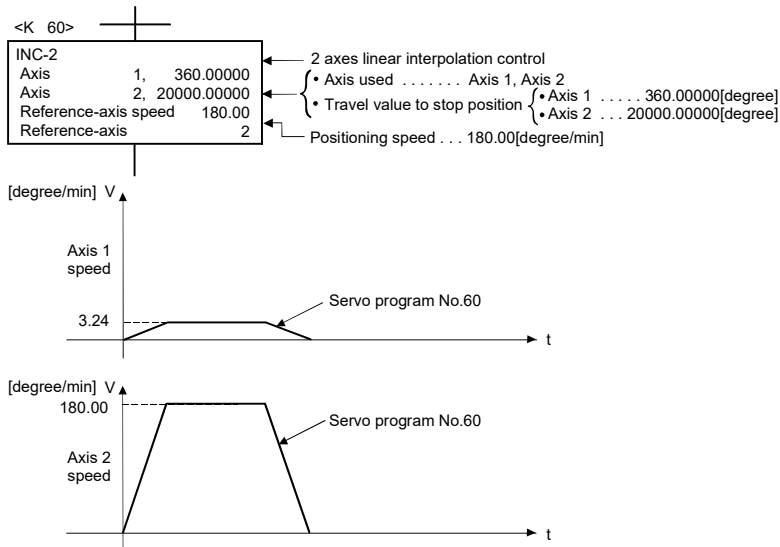

POINTS

When a speed change is executed by the Motion dedicated PLC instruction (D(P).CHGV) or Motion SFC program (CHGV instruction) after setting the "speed control 10×multiplier setting for degree axis is valid", the positioning control is executed by the speed increased 10×multiplier setting value.

4 PARAMETERS FOR POSITIONING CONTROL

4.3 Parameter Block

- (1) The parameter blocks serve to make setting changes easy by allowing data such as the acceleration/deceleration control to be set for each positioning processing.
- (2) A maximum 64 blocks can be set as parameter blocks.
- (3) Parameter blocks can be set using MT Developer2.
- (4) Parameter block to be set are shown in Table 4.2.

Table 4.2 Parameter Block Setting List

No.	Item	Setting range								Initial value	Units	Remarks	Section
		mm		inch		degree		pulse					
		Setting range	Units	Setting range	Units	Setting range	Units	Setting range	Units				
1	Interpolation control unit	0	—	1	—	2	—	3	—	3	—	<ul style="list-style-type: none"> Set the units for compensation control. It can be also used as the units for the command speed and allowable error range for circular interpolation set in the servo program. 	6.1.4
2	Speed limit value	0.01 to 6000000.00	mm/min	0.001 to 600000.000	inch/min	0.001 to 2147483.647 (Note-1)	degree/min	1 to 2147483647	pulse/s	200000	pulse/s	<ul style="list-style-type: none"> Set the maximum speed for positioning/home position return. If the positioning speed or home position return speed setting exceeds the speed limit value, control is executed at the speed limit value. 	4.3.1
3	Acceleration time	1 to 65535[ms]								1000	ms	<ul style="list-style-type: none"> Set the time taken to reach the speed limit value from the positioning start. 	4.3.1
4	Deceleration time	1 to 65535[ms]								1000	ms	<ul style="list-style-type: none"> Set the time taken to stop from the speed limit value. 	
5	Rapid stop deceleration time	1 to 65535[ms]								1000	ms	<ul style="list-style-type: none"> Set the time taken to stop from the speed limit value at rapid stop. 	
6	S-curve ratio	0 to 100[%]								0	%	<ul style="list-style-type: none"> Set the S-curve ratio for S-pattern processing. When the S-curve ratio is 0[%], trapezoidal acceleration/deceleration processing is executed. 	4.3.2
7	Acceleration/deceleration system	Trapezoid/S-curve: Trapezoidal acceleration/deceleration/ S-curve acceleration/deceleration Advanced S-curve: Advanced S-curve acceleration/deceleration								Trapezoid/ S-curve	—	<ul style="list-style-type: none"> Set the control method for acceleration/deceleration. 	4.3.3
	Advanced S-curve acceleration/deceleration	0.0 to 100.0[%]								20.0	%	<ul style="list-style-type: none"> Set the ratio for advanced S-curve acceleration/deceleration processing. 	
	Acceleration section 1 ratio												
	Acceleration section 2 ratio												
	Deceleration section 1 ratio												
Deceleration section 2 ratio													

4 PARAMETERS FOR POSITIONING CONTROL

Table 4.2 Parameter Block Setting List (Continued)

No.	Item	Setting range								Initial value	Units	Remarks	Section
		mm		inch		degree		pulse					
		Setting range	Units	Setting range	Units	Setting range	Units	Setting range	Units				
8	Torque limit value	1 to 1000[%]								300	%	• Set the torque limit value in the servo program.	—
9	Deceleration processing on STOP input	0 : Deceleration stop is executed based on the deceleration time. 1 : Deceleration stop is executed based on the rapid stop deceleration time.								0	—	• Set the deceleration processing when external signals (STOP, FLS, RLS) are input.	—
10	Allowable error range for circular interpolation	0 to 10000.0	μm	0 to 1.00000	inch	0 to 1.00000	degree	0 to 100000	pulse	100	pulse	• Set the permissible range for the locus of the arc and the set end point coordinates.	4.3.4

(Note-1): When the "speed control 10×multiplier setting for degree axis" is set to "valid", the setting range is 0.01 to 21474836.47[degree/min]. However, setting range of 0.001 to 2147483.647[degree/min] is displayed in the parameter block setting screen of MT Developer2.

POINTS

- (1) Parameter blocks are specified in the home position return data, JOG operation data or servo program.
- (2) The various parameter block data can be changed using the servo program. (Refer to Section 5.3.)
- (3) The data set in the parameter block is used in the positioning control, home position return and JOG operation.
 - (a) The parameter block No. used in the positioning control is set using MT Developer2 at the creating of the servo program. If it is not set, control is executed with the contents of parameter block No.1. Also, it is possible to set parameter block data individually in the servo program.

[Servo program editor screen]

- | | | | |
|---------|---|--------------|--|
| Unit | : Interpolation control unit | S.R. | : Speed limit value |
| △ | : Acceleration time | △ | : Deceleration time |
| EL | : Rapid stop deceleration time | P. Torque | : Torque limit value |
| STOP | : Deceleration processing on STOP input | ⊖ | : Allowable error range for circular interpolation |
| S Ratio | : S-curve ratio when S-pattern processing is executed | Adv. S-curve | : Advanced S-curve acceleration/ deceleration |

POINTS

- (b) The parameter block No. used in the home position return or JOG operation is set at the setting of the "home position return data" or "JOG operation data" using MT Developer2. Refer to Section "6.23.1 Home position return data" or "6.21.1 JOG operation data" for details.

[Home position return data setting screen]

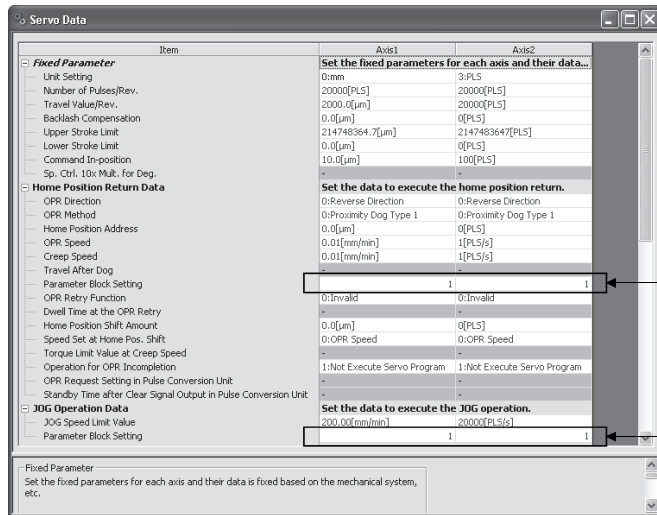

- (4) The processing method of acceleration/deceleration is set by the acceleration/deceleration method and S-curve set in the parameter block.
 - (a) Set "Trapezoid/S-curve" as acceleration/deceleration method to execute the trapezoidal acceleration/deceleration or S-curve acceleration/deceleration. Set 0[%] as S-curve ratio to execute the trapezoidal acceleration/deceleration, and set 1 to 100[%] to execute the S-curve acceleration/deceleration.
 - (b) Set "Advanced S-curve" to execute the Advanced S-curve acceleration/deceleration. At this time, the S-curve ratio is invalid.

	Parameter block	
	Acceleration/deceleration system	S-curve ratio[%]
Trapezoidal acceleration/deceleration	Trapezoid/S-curve	0
S-curve acceleration/deceleration		1 to 100
Advanced S-curve acceleration/deceleration	Advanced S-curve	—

- (c) When the FIN acceleration/deceleration (Fixed acceleration/deceleration time method) is set in the constant speed control, the setting for advanced S-curve acceleration/deceleration is invalid.

4 PARAMETERS FOR POSITIONING CONTROL

4.3.1 Relationships between the speed limit value, acceleration time, deceleration time and rapid stop deceleration time

The speed limit value is the maximum speed at the positioning/home position return.

The acceleration time is the time taken to reach the set speed limit value from the start of positioning.

The deceleration time and rapid stop deceleration time are the time taken to effect a stop from the set speed limit value.

Accordingly, the actual acceleration time, deceleration time, and rapid stop deceleration time are faster, because the positioning speed is faster than the speed limit value.

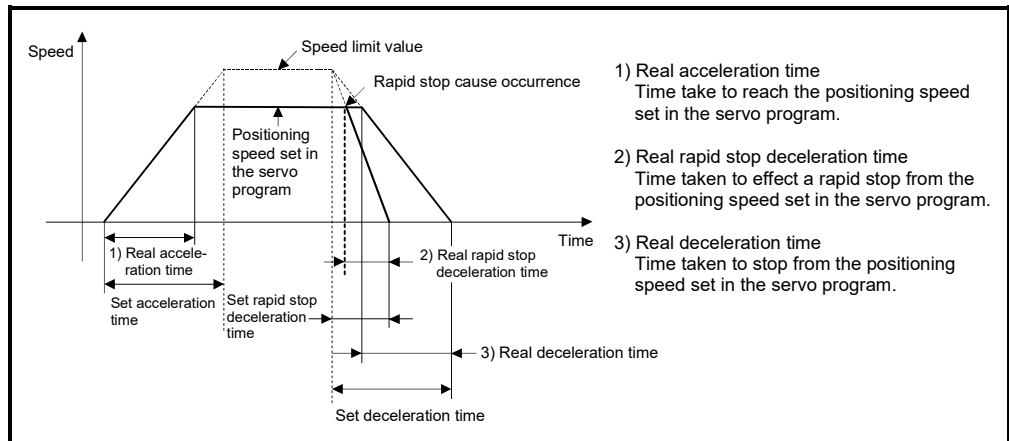

Refer to Section 4.3.3 for acceleration time, deceleration time and rapid stop deceleration time of the advanced S-curve acceleration/deceleration processing.

Set the rapid stop deceleration time to a time shorter than the deceleration time.

(1) Deceleration time < Rapid stop deceleration time

- (a) The servo program setting error (error code: 51) is stored in the error item information (SD517) at start, and the servo program setting error flag (SM516) is turned ON. When the rapid stop cause occurs during deceleration, the axis decelerates to a stop in the deceleration time.

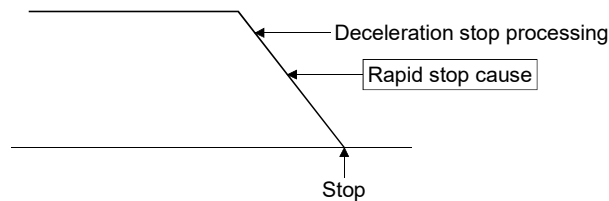

4 PARAMETERS FOR POSITIONING CONTROL

- (b) The rapid stop deceleration time can be set to a value larger than the deceleration time by turning ON the rapid stop deceleration time setting error invalid flag (SM805). **Ver.!**
- 1) Turn ON the rapid stop deceleration time setting error invalid flag (SM805) before operation to use the rapid stop deceleration time setting error invalid.

(The setting value is input at start.)
 - 2) For the advanced S-curve acceleration/deceleration, operation is controlled with either small value of setting value for rapid stop deceleration time and deceleration time even if the rapid stop deceleration time setting error invalid flag (SM805) turns ON.

POINTS

(1) If the rapid stop deceleration time is longer than the deceleration time, an overrun may occur.

The deceleration distance increases by rapid stop command.

Real deceleration time

Rapid stop command OFF (M3201+20n)

ON

(2) If a value larger than the deceleration time is set as the rapid stop deceleration time for the parameter block and positioning data of servo program, a warning will occur. However, writing to the Motion CPU is possible.

(2) Rapid stop deceleration time \leq Deceleration time

When the rapid stop cause occurs during deceleration, the axis decelerates to a stop in the rapid stop time.

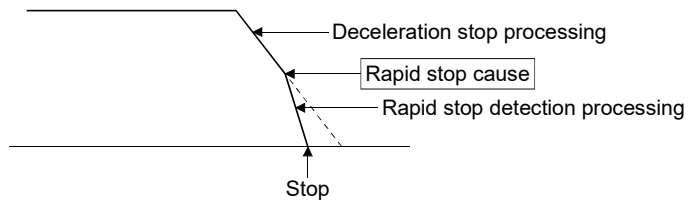

Ver.! Refer to Section 1.3 for the software version that supports this function.

4 PARAMETERS FOR POSITIONING CONTROL

4.3.2 S-curve ratio

S-curve ratio can be set as the acceleration/deceleration processing method for S-curve acceleration/deceleration processing.

(Refer to Section 6.1.7 for details of S-curve acceleration/deceleration processing.)

Setting range of the S-curve ratio is 0 to 100[%].

If it is set outside the range, an error occurs at the start and control is executed with the S-curve ratio set as 0[%] (Trapezoidal acceleration/deceleration).

Errors are set in the error item information (SD517).

Setting of the S-curve ratio enables acceleration/deceleration processing to be executed gently.

The graph for S-curve acceleration/deceleration is a sine curve as shown below.

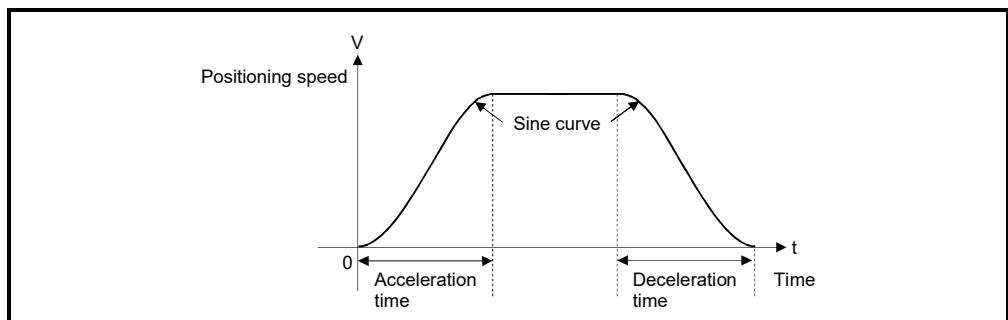

As shown below, the S-curve ratio setting serves to select the part of the sine curve to be used as the acceleration/deceleration curve.

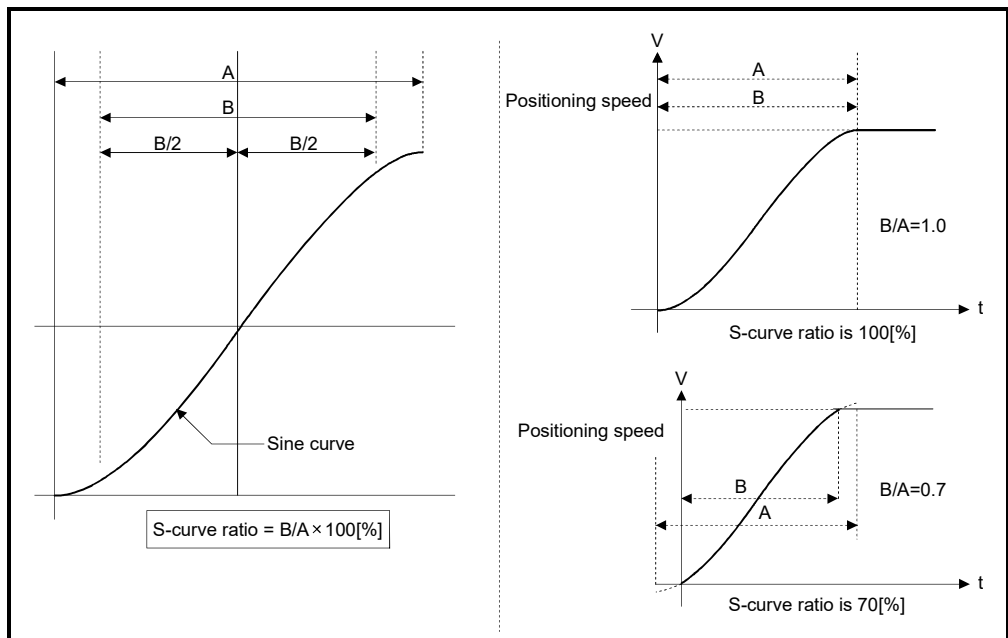

POINTS

The S-curve pattern is recreated in the cases shown below during S-curve deceleration processing for the S-curve ratio.

In these cases the deceleration pattern may not continue or an overrun may occur.

- (1) When the same speed control command turns ON the stop command or the skip signal during S-curve deceleration processing for the end point

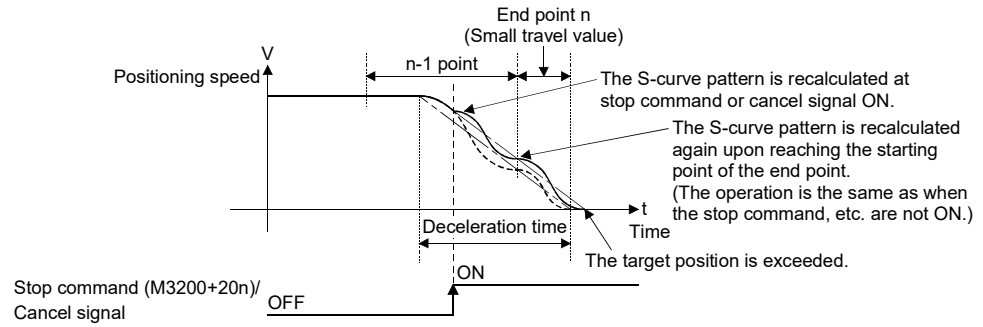

(Note-1): The processing described above is also performed at STOP signal input when "Deceleration stop based on the deceleration time" is set in "Deceleration processing on STOP input" for the parameter block or servo program.

(Note-2): The same processing is also performed when the rapid stop command is set (including when "Deceleration stop based on the rapid stop deceleration time" is set in Deceleration processing on STOP input). However, it is possible to prevent the end point from overrunning by adjusting the setting for the rapid stop deceleration time.

- (2) When the skip signal is turned ON during end point processing for the constant-speed control instruction

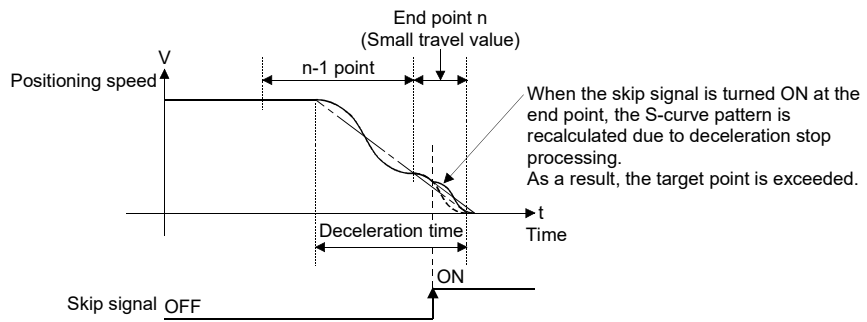

- (3) When the rapid stop command is turned ON during S-curve deceleration processing

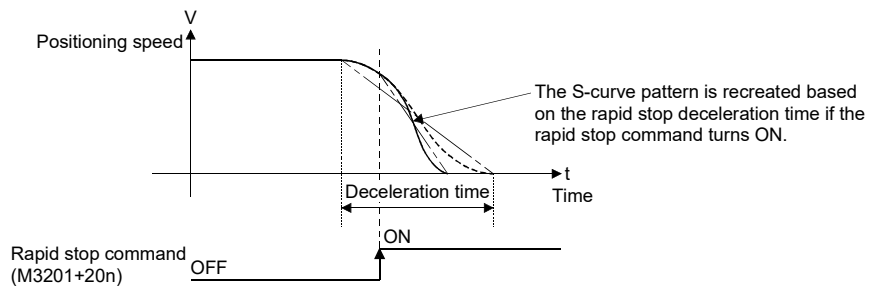

4 PARAMETERS FOR POSITIONING CONTROL

4.3.3 Advanced S-curve acceleration/deceleration Ver.!

Processing for smooth acceleration/deceleration can be executed by using the advanced S-curve acceleration/deceleration function. The acceleration section is set as a sine curve as shown in the diagram below.

Each section of acceleration/deceleration is set as a ration using the advanced S-curve acceleration/deceleration setting.

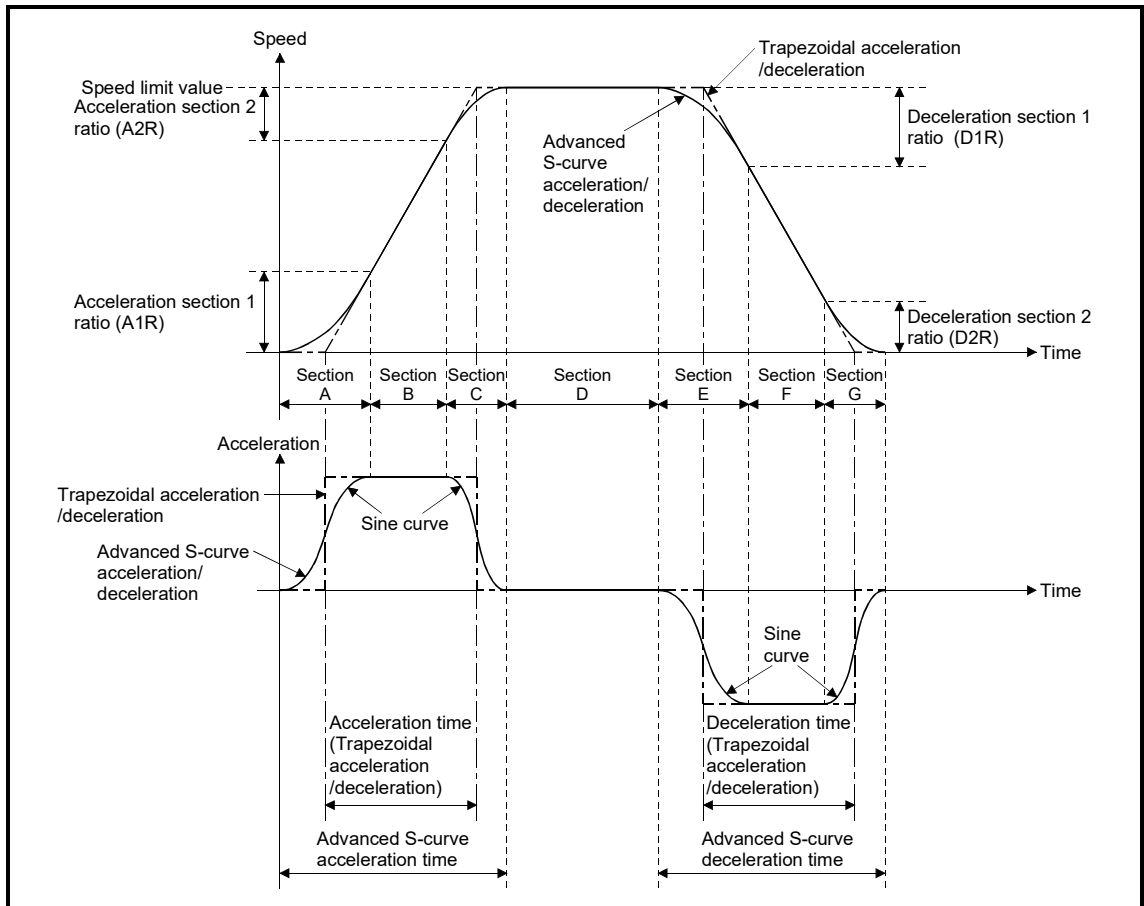

Ver.! : Refer to Section 1.3 for the software version that supports this function.

4 PARAMETERS FOR POSITIONING CONTROL

Processing for advanced S-curve acceleration/deceleration is shown below.

Section	Processing	Operation		
		Acceleration	Deceleration	Rapid stop
A	Acceleration section 1 At the start of acceleration, acceleration continuously changes in a sinusoidal manner until reaching the maximum acceleration for trapezoidal acceleration/deceleration. Set this section in acceleration section 1 ratio (A1R).	○	—	—
B	Maximum acceleration section The maximum acceleration for trapezoidal acceleration/deceleration			
C	Acceleration section 2 At the end of acceleration, acceleration continuously changes in a sinusoidal manner until reaching zero acceleration. Set this section in acceleration section 2 ratio (A2R).			
D	Constant-speed section The specified control positioning speed	—	—	—
E	Deceleration section 1 At the start of deceleration, deceleration continuously changes in a sinusoidal manner until reaching the maximum negative acceleration for trapezoidal acceleration/deceleration. Set this section in deceleration section 1 ratio (D1R).	—	○	○
F	Maximum negative acceleration section The same maximum negative acceleration for trapezoidal acceleration/deceleration			
G	Deceleration section 2 At the end of deceleration, deceleration continuously changes in a sinusoidal manner until reaching zero acceleration. Set this section in deceleration section 2 ratio (D2R).			

Set the following parameters in the parameter block.

Item	Abbreviation	Setting range	Processing	Operation			
				Acceleration	Deceleration	Rapid stop	
Speed limit value	S.R.	mm	0.01 to 6000000.00[mm/min]	• Maximum speed at positioning/home position return	○	○	○
		inch	0.001 to 600000.000[inch/min]				
		degree	0.001 to 2147483.647[degree/min] <small>(Note-1)</small>				
		pulse	1 to 2147483647[pulse/s]				
Acceleration time	AT	1 to 65535[ms]	• Time to reach the speed limit value (S.R.) after positioning start. (During trapezoidal acceleration)	○	—	—	
Deceleration time	DT		• Time to stop from the speed limit value (S.R.). (During trapezoidal deceleration)	—	○	—	
Rapid stop deceleration time	ET		• Time to stop from the speed limit value (S.R.) at rapid stop. (Trapezoidal deceleration)	—	—	○	
Acceleration section 1 ratio	A1R	0.0 to 100.0[%] (A1R + A2R ≤ 100.0[%])	• Ratio of speed limit value (S.R.) to acceleration peak from zero acceleration.	○	—	—	
Acceleration section 2 ratio	A2R		• Ratio of speed limit value (S.R.) to zero acceleration from acceleration peak.	○	—	—	
Deceleration section 1 ratio	D1R	0.0 to 100.0[%] (D1R + D2R ≤ 100.0[%])	• Ratio of speed limit value (S.R.) to negative acceleration peak from zero acceleration.	—	○	○	
Deceleration section 2 ratio	D2R		• Ratio of speed limit value (S.R.) to zero acceleration from negative acceleration peak.	—	○	○	

(Note-1): When the "speed control 10×multiplier setting for degree axis" is set to "valid", the setting range is 0.01 to 21474836.47[degree/min].

POINTS

The acceleration time to reach the command speed and the travel value during acceleration changes by setting the Acceleration section 1 ratio and acceleration section 2 ratio. The deceleration time to stop from the commanded speed and the travel value during deceleration changes by setting the deceleration section 1 ratio and deceleration section 2 ratio.

4 PARAMETERS FOR POSITIONING CONTROL

- (1) There are patterns (below pattern 1 to 4 respectively) that depends on the positioning speed of the acceleration pattern/deceleration pattern of advanced S-curve acceleration/deceleration.

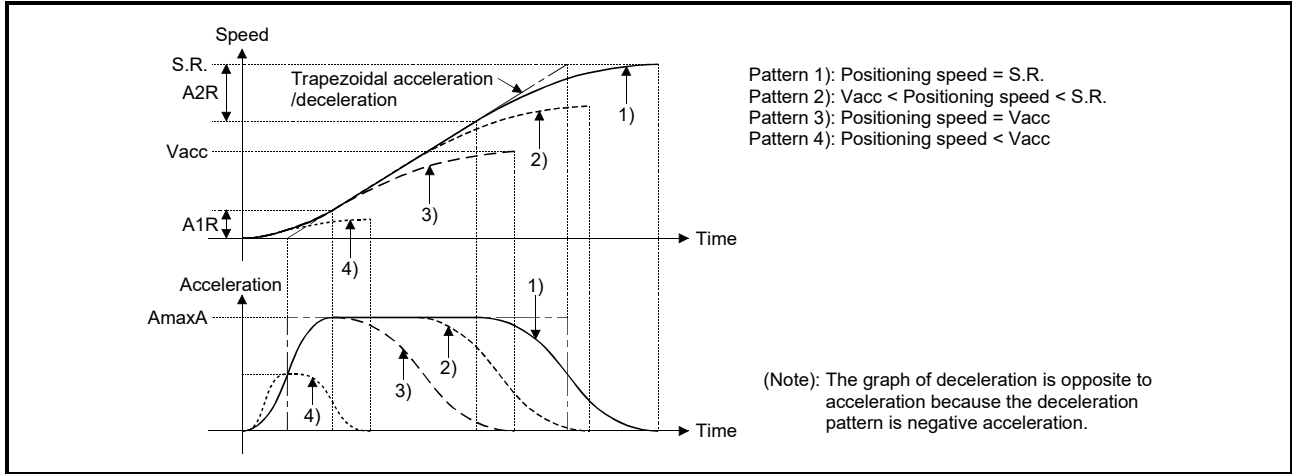

Fig.4.5 Acceleration pattern

4 PARAMETERS FOR POSITIONING CONTROL

The maximum acceleration and advanced S-curve acceleration time/ deceleration time are calculated by parameters.

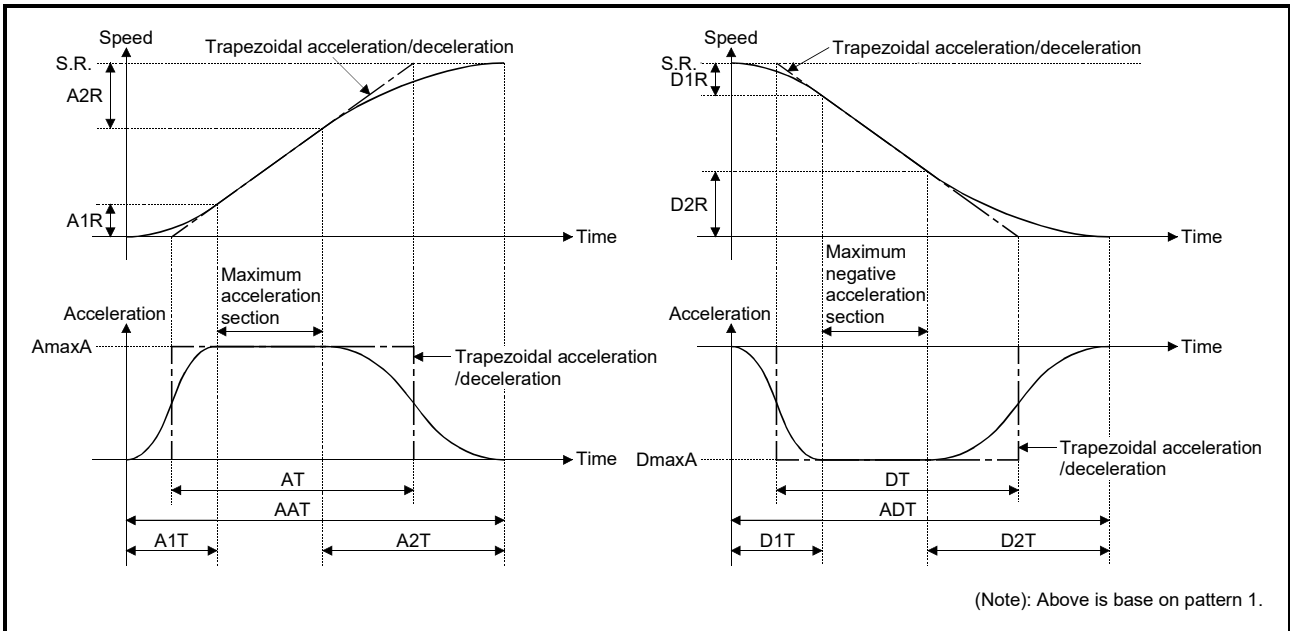

Fig.4.6 Maximum acceleration, advanced S-curve acceleration time/deceleration time

Item	Abbreviation	Description	Calculation expression	Operation		
				Acceleration	Deceleration	Rapid stop
Maximum acceleration	AmaxA	<ul style="list-style-type: none"> Maximum acceleration Same acceleration as trapezoidal acceleration/deceleration 	$S.R. \div AT$	○	—	—
Maximum negative acceleration	DmaxA	<ul style="list-style-type: none"> Maximum negative acceleration at (rapid stop) deceleration Same negative acceleration as trapezoidal acceleration/deceleration 	$S.R. \div DT$	—	○	—
Maximum negative acceleration at rapid stop	EmaxA		$S.R. \div ET$	—	—	○
Advanced S-curve acceleration time (Note-1)	AAT	<ul style="list-style-type: none"> Time to reach the speed limit value (S.R.) after positioning start. (At advanced S-curve acceleration/deceleration) It can be lengthened more than trapezoidal acceleration/deceleration by using A1R or A2R. 	$AT \times (100.0 + A1R + A2R) \div 100.0$	○	—	—
Advanced S-curve deceleration time (Note-1)	ADT	<ul style="list-style-type: none"> Time to stop from the speed limit value (S.R.) at (rapid stop) deceleration. (Advanced S-curve acceleration/deceleration) It can be lengthened more than trapezoidal acceleration/deceleration by using D1R or D2R. 	$DT \times (100.0 + D1R + D2R) \div 100.0$	—	○	—
Advanced S-curve rapid stop deceleration time (Note-1)	AET		$ET \times (100.0 + D1R + D2R) \div 100.0$	—	—	○
Time of acceleration section 1	A1T	Time to reach acceleration peak from zero acceleration.	$AT \times (A1R \div 100.0) \times 2$	○	—	—
Time of acceleration section 2	A2T	Time to reach zero acceleration from acceleration peak.	$AT \times (A2R \div 100.0) \times 2$	○	—	—
Time of deceleration section 1	D1T	Time to reach negative acceleration peak from zero acceleration.	$DT \times (D1R \div 100.0) \times 2$	—	○	—
Time of deceleration section 2	D2T	Time to reach zero acceleration from negative acceleration peak.	$DT \times (D2R \div 100.0) \times 2$	—	○	—
Velocity when "AAT=A1T+A2T"	Vacc	The velocity when total acceleration is only "A1T+A2T". (No maximum acceleration section)	$S.R. \times (A1R + A2R) \div 100.0$	○	—	—
Velocity when "ADT=D1T+D2T"	Vdac	The velocity when total deceleration is only "D1T+D2T". (No maximum deceleration section)	$S.R. \times (D1R + D2R) \div 100.0$	—	○	—

(Note-1): The actual acceleration time, actual deceleration time and actual rapid stop deceleration time are shortened when the positioning speed is less than the speed limit value.

4 PARAMETERS FOR POSITIONING CONTROL

The actual acceleration/deceleration time for each pattern (Fig.4.5 pattern 1 to 4) based on positioning speed is shown below.

[Actual acceleration time]

	Pattern	Positioning speed	Description	Actual acceleration time	Actual maximum acceleration
High ↑	1)	Positioning speed = S.R.	• It accelerates with the acceleration section 1, maximum acceleration section and acceleration section 2.	AAT	AmaxA
	2)	Vacc < Positioning speed < S.R.	• Maximum acceleration section is short than pattern 1.	$AAT - \frac{(S.R. - \text{Positioning speed})}{AmaxA}$	
	3)	Positioning speed = Vacc	• No maximum acceleration section • It accelerates with only acceleration section 1 and acceleration section 2.	A1T + A2T	
Low ↓	4)	Positioning speed < Vacc	• No maximum acceleration section • Maximum acceleration and acceleration increase/decrease time of acceleration section 1 and 2 are shortened.	$(A1T + A2T) \times \frac{1}{\sqrt{(\text{Positioning speed}/Vacc)}}$	$AmaxA \times \frac{1}{\sqrt{(\text{Positioning speed}/Vacc)}}$

[Actual deceleration time]

	Pattern	Positioning speed	Description	Actual Deceleration time	Negative actual maximum acceleration
High ↑	1)	Positioning speed = S.R.	• It accelerates with the deceleration section 1, maximum negative acceleration section and deceleration section 2.	ADT	DmaxA
	2)	Vdac < Positioning speed < S.R.	• Maximum negative acceleration section is shortened than pattern 1.	$ADT - \frac{(S.R. - \text{Positioning speed})}{DmaxA}$	
	3)	Positioning speed = Vdac	• No maximum negative acceleration section. • It decelerates with only deceleration section 1 and deceleration section 2.	D1T + D2T	
Low ↓	4)	Positioning speed < Vdac	• No maximum negative acceleration section. • Maximum acceleration of deceleration section 1 and deceleration section 2, and negative acceleration increase/decrease time are shortened.	$(D1T + D2T) \times \frac{1}{\sqrt{(\text{Positioning speed}/Vdac)}}$	$DmaxA \times \frac{1}{\sqrt{(\text{Positioning speed}/Vdac)}}$

(2) When the positioning speed is slower than the speed limit value, adjust the acceleration in the following procedure.

- (a) Shorten time of maximum acceleration section. (Fig.4.5 Pattern 2, 3)
- (b) Reduce maximum acceleration and acceleration increase/decrease time of acceleration section 1 and 2. (Fig.4.5 Pattern 4)

4 PARAMETERS FOR POSITIONING CONTROL

- (3) Advanced S-curve acceleration/deceleration time is calculated as a function of the acceleration/deceleration time set in the parameter block by using the parameter setting of advanced S-curve acceleration/deceleration as shown below.

• Advanced S-curve acceleration time

Condition	Advanced S-curve acceleration time
Acceleration section 1 ratio (A1R) = Acceleration section 2 ratio (A2R) = 0.0	Same as acceleration time of the parameter block (Trapezoidal acceleration processing)
Acceleration section 1 ratio (A1R) or Acceleration section 2 ratio (A2R) \neq 0.0	Longer acceleration time compared with the parameter block.
Acceleration section 1 ratio (A1R) + Acceleration section 2 ratio (A2R) = 100.0	Double the acceleration time of the parameter block.

• Advanced S-curve deceleration time

Condition	Advanced S-curve deceleration time
Deceleration section 1 ratio (D1R) = Deceleration section 2 ratio (D2R) = 0.0	Same as deceleration time of the parameter block (Trapezoidal acceleration processing)
Deceleration section 1 ratio (D1R) or Deceleration section 2 ratio (D2R) \neq 0.0	Longer deceleration time compared with the parameter block.
Deceleration section 1 ratio (D1R) + Deceleration section 2 ratio (D2R) = 100.0	Double the deceleration time of the parameter block.

- (4) Deceleration processing is executed by using the deceleration section 1 ratio (D1R) and deceleration section 2 ratio (D2R) at rapid stop deceleration.
- (5) When the FIN acceleration/deceleration (Fixed acceleration/deceleration time method) is set in the constant-speed control, the setting for advanced S-curve acceleration/deceleration is invalid. However, advanced S-curve acceleration/deceleration can be used regardless whether the speed switching point specified flag (M2040) is ON or OFF.
- (6) Advanced S-curve acceleration/deceleration control is enabled at home position return operation.
 When executing a home position return using a proximity dog, the movement amount to decelerate to creep speed is different compared to trapezoid acceleration/deceleration and s-curve acceleration/deceleration. This is to ensure smoothness of acceleration/deceleration. For this reason, the stop position (zero point) upon completion of home position return is different to when trapezoid acceleration/deceleration and s-curve acceleration/deceleration is used.

4 PARAMETERS FOR POSITIONING CONTROL

POINTS

Set the advanced S-curve acceleration/deceleration setting using the parameter block on the following screen of MT Developer2. The Advanced S-curve Acceleration time and maximum acceleration are displayed by setting acceleration section 1 ratio, acceleration section 2 ratio and the acceleration time.

The advanced S-curve deceleration time and advanced S-curve rapid stop deceleration time, maximum negative acceleration and maximum negative at rapid stop are displayed by setting deceleration section 1 ratio, deceleration section 2 ratio and deceleration time

[Advanced S-curve acceleration/deceleration setting screen (Acceleration setting)]

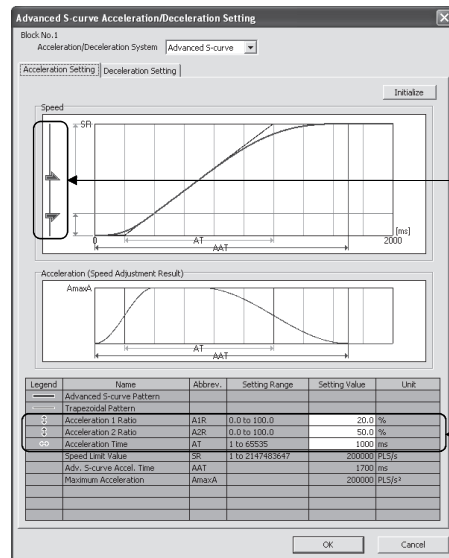

Adjust the acceleration 1 ratio and acceleration 2 ratio by dragging the slider up and down.

Acceleration section 1 ratio
Acceleration section 2 ratio
Acceleration time

4 PARAMETERS FOR POSITIONING CONTROL

[Error]

In the following cases, the servo program setting error (error code: 45 to 50) will occur, and controls will be executed as trapezoidal acceleration/deceleration ($A1R = A2R = D1R = D2R = 0.0$).

- Acceleration section 1 ratio is outside the range of 0.0 to 100.0[%].
- Acceleration section 2 ratio is outside the range of 0.0 to 100.0[%].
- Deceleration section 1 ratio is outside the range of 0.0 to 100.0[%].
- Deceleration section 2 ratio is outside the range of 0.0 to 100.0[%].
- "Acceleration section 1 ratio + Acceleration section 2 ratio" > 100.0[%]
- "Deceleration section 1 ratio + Deceleration section 2 ratio" > 100.0[%]

[Program]

A sample servo program using the advanced S-curve acceleration/deceleration is shown below.

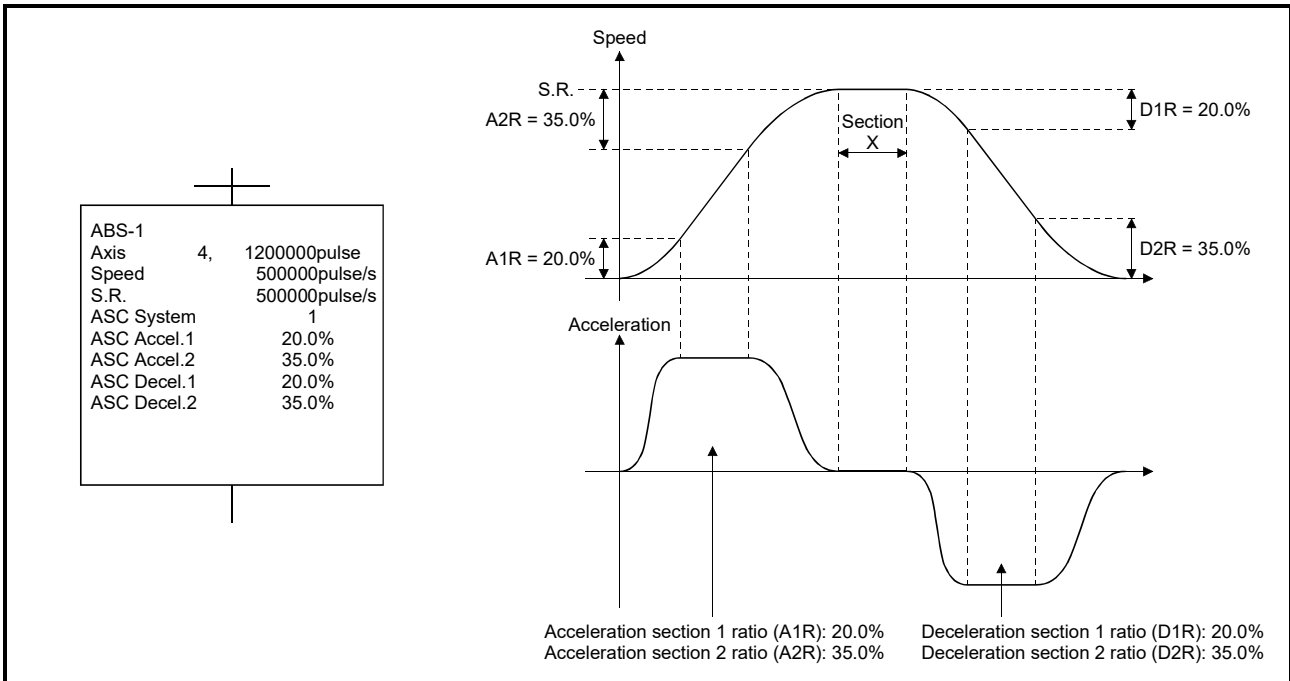

POINTS

When the advanced S-curve acceleration/deceleration is set, the travel value (section X above) at the commanded speed is different than when using trapezoidal acceleration/deceleration ($A1R=A2R=D1R=D2R=0.0$).

4 PARAMETERS FOR POSITIONING CONTROL

[Operation]

(1) Stop processing

When the stop command turns ON during acceleration, the acceleration is decreased until it reaches zero according to acceleration section 2 ratio setting. Therefore, the speed will continue to increase for a while before deceleration stop processing is executed.

(Deceleration is smooth.)

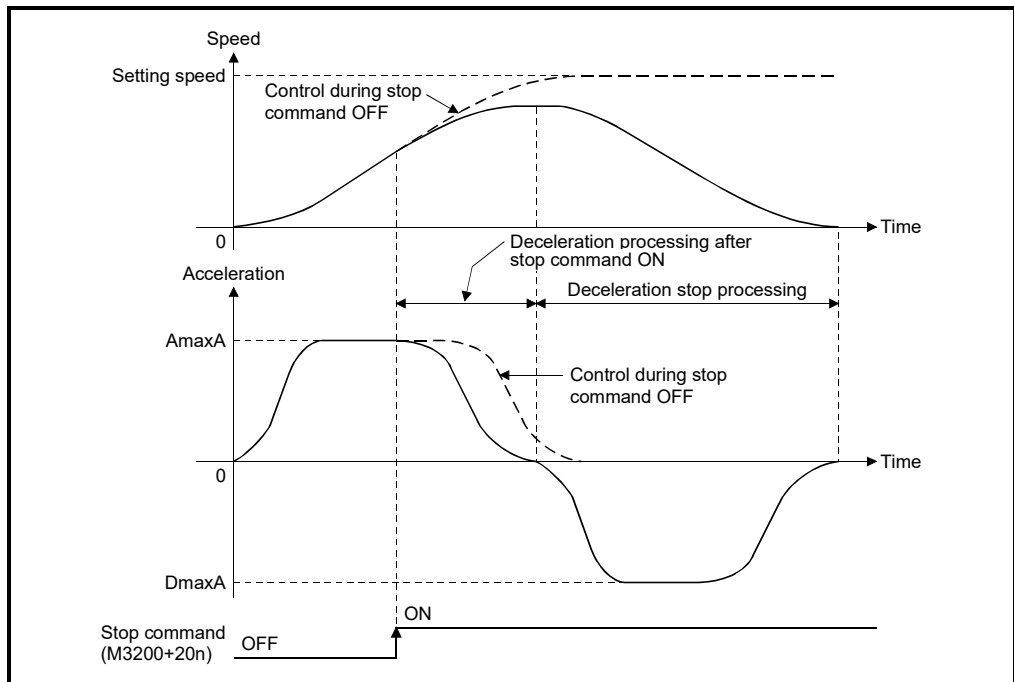

POINTS

When the stop command turns ON during acceleration processing of advanced S-curve acceleration/deceleration, in order to maintain smoothness of acceleration, the speed will continue to increase until acceleration reaches zero.

Use the rapid stop command if an increase in speed is not desired.

4 PARAMETERS FOR POSITIONING CONTROL

(2) Rapid stop processing

(a) Rapid stop during acceleration

When the rapid stop command turns ON during acceleration, acceleration immediately goes to zero, and rapid stop deceleration processing is executed. (Deceleration is abrupt.)

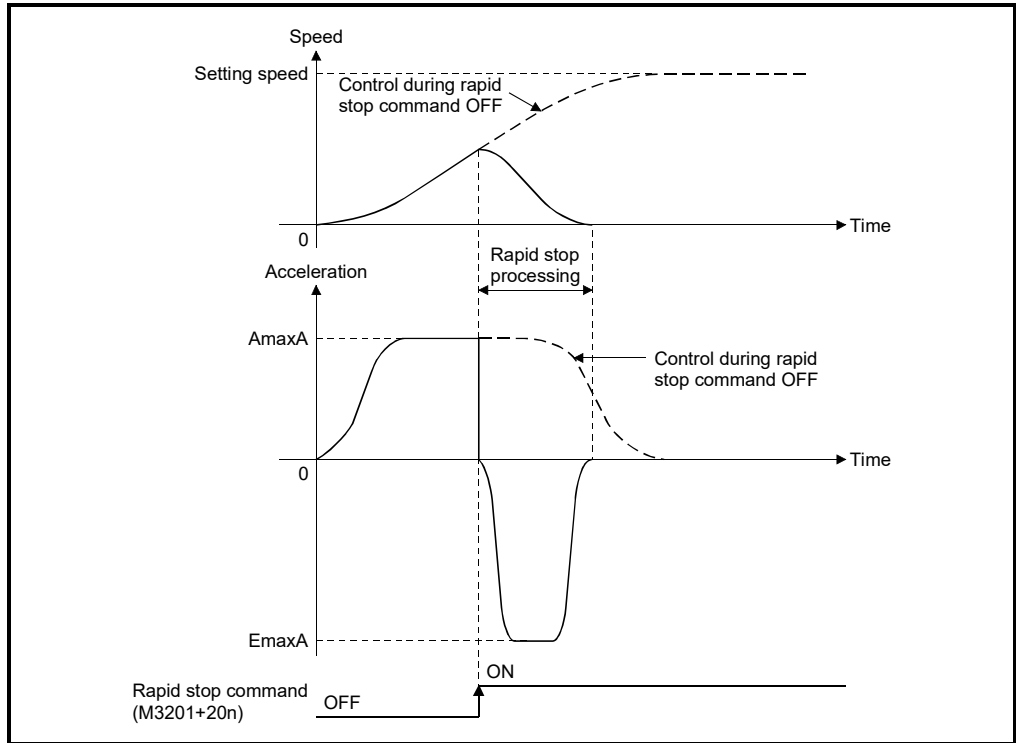

(b) Rapid stop during deceleration

When the rapid stop command turns ON during deceleration, the negative acceleration is decreased, and the rapid stop deceleration processing is executed.

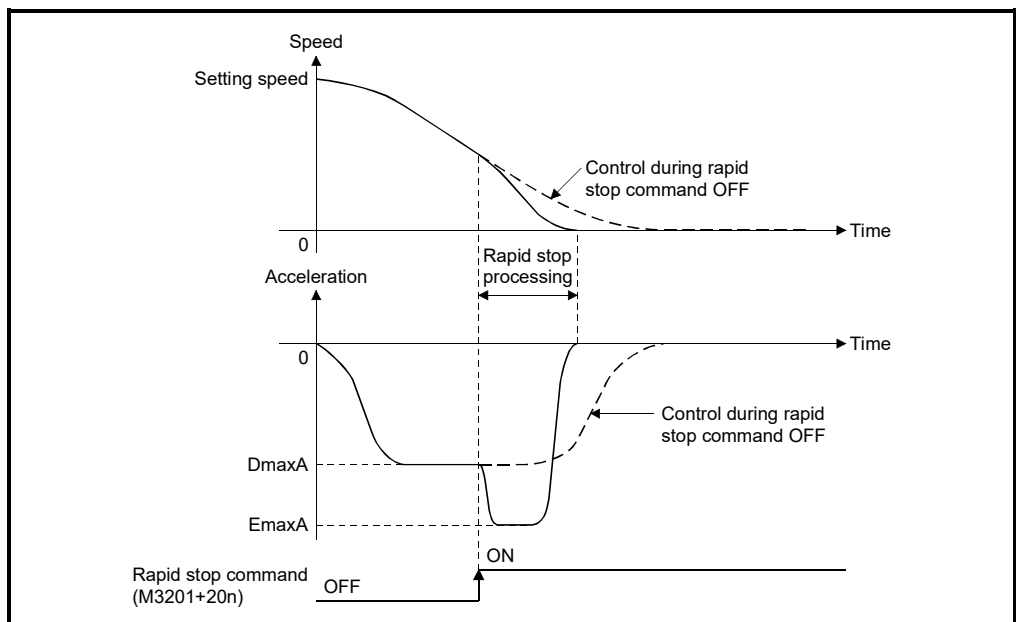

4 PARAMETERS FOR POSITIONING CONTROL

POINTS

When the rapid stop command turns ON during deceleration stop processing of advanced S-curve acceleration/deceleration, timing may be such that a rapid stop will take longer than the advanced S-curve deceleration.

In this case, the advanced S-curve deceleration stop processing will automatically continue instead of using the rapid stop processing.

(3) Speed change processing

Operation in which a speed change is executed during each section of acceleration is shown below.

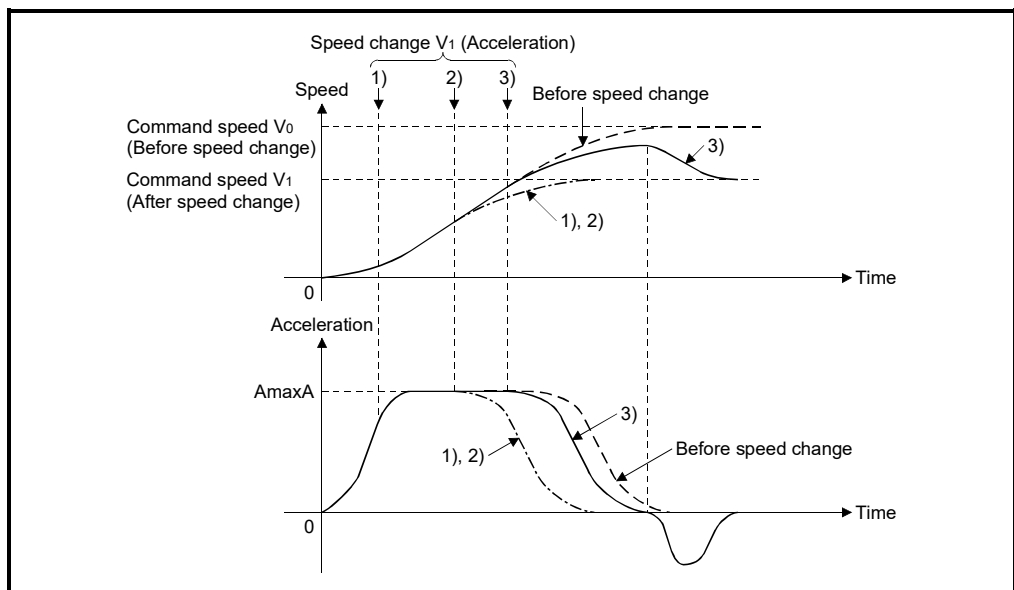

Pattern	Speed change command	Acceleration/deceleration processing at speed change	Operation
1)	Speed change V ₁ (Acceleration)	Acceleration section 1 (Increasing acceleration section)	• Length of maximum acceleration section is adjusted to reach speed V ₁ at acceleration end.
2)		Maximum acceleration section	• The acceleration is decreased until the acceleration reaches zero.
3)		Maximum acceleration section (When the speed change occurs in situations where V ₀ will surpass V ₁ during the decreasing acceleration section.)	• The maximum acceleration section is interrupted, and the acceleration is decreased until the acceleration reaches zero. • The deceleration processing is executed to reach speed V ₁ .

4 PARAMETERS FOR POSITIONING CONTROL

(4) Speed control with fixed position stop processing

The "fixed position stop acceleration/deceleration time" set in the servo program is used during acceleration/deceleration processing when a positioning start, speed change request (CHGV) or fixed position stop command ON occurs. It operates in the fixed acceleration/deceleration time method.

(a) Acceleration/deceleration processing in the fixed acceleration/deceleration time method

Actual acceleration time, deceleration time and maximum acceleration are shown below.

Acceleration time	Specified acceleration time (AT) $\times (100.0 + A1R + A2R) \div 100.0$
Deceleration time	Specified deceleration time (DT) $\times (100.0 + D1R + D2R) \div 100.0$
Maximum acceleration	Speed difference \div Specified acceleration/deceleration time

(b) Acceleration processing from zero speed and deceleration processing to zero speed (fixed time method)

Operation for positioning to fixed position stop command position at servo program start is shown below.

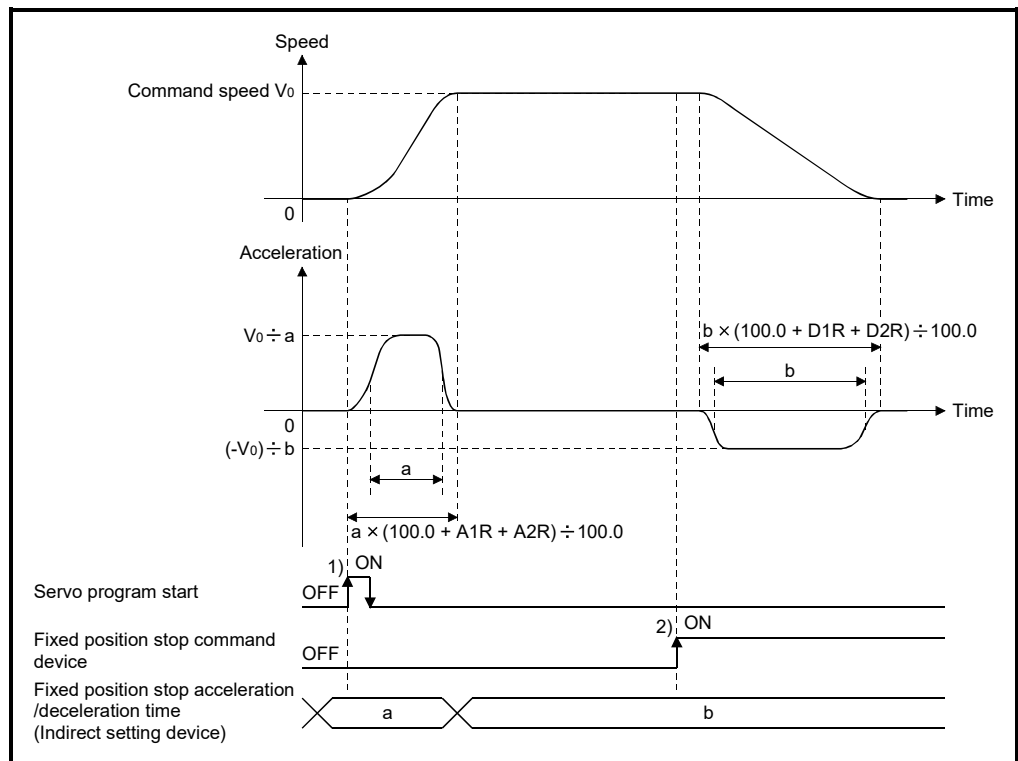

Speed change command	Speed difference	Acceleration/ deceleration time	Maximum acceleration	Operation
1) Servo program start (Acceleration from speed 0 to V_0)	V_0	a	$V_0 \div a$	Actual acceleration time " $a \times (100.0 + A1R + A2R) \div 100.0$ "
2) Positioning to fixed position stop command position (Deceleration from speed V_0 to 0)	$-V_0$	b	$(-V_0) \div b$	Actual deceleration time " $b \times (100.0 + D1R + D2R) \div 100.0$ "

4 PARAMETERS FOR POSITIONING CONTROL

(5) Speed change (fixed time method)

Operation in which a speed change during deceleration is executed is shown below.

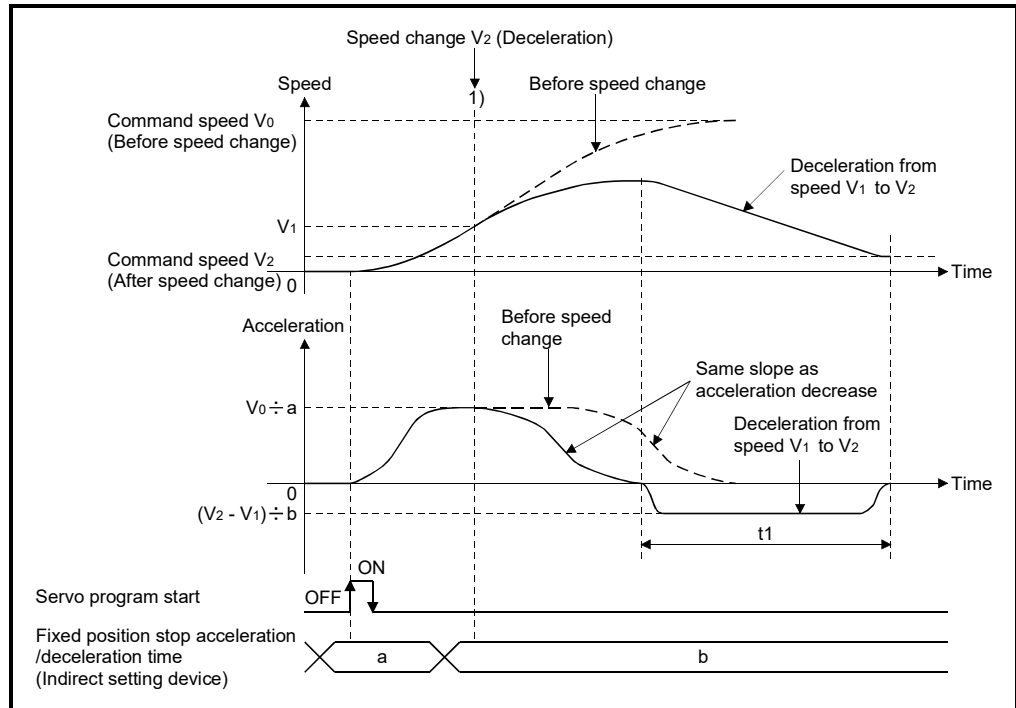

Speed change command	Speed difference	Acceleration/ deceleration time	Maximum acceleration	Operation
1) Deceleration from speed V_0 to 0	$(V_2 - V_1)$	b	$(V_2 - V_1) \div b$	<p>(a) The acceleration is decreased until the acceleration becomes from acceleration to "0" at speed change. This inclination of acceleration section 2 (acceleration decrease section) is calculated based on the acceleration/deceleration time before speed change.</p> <p>(b) Deceleration processing is executed.</p> <p>(Note): The acceleration time "t_1" is lengthened than "$b \times (100.0 + D1R + D2R) \div 100.0$", because the acceleration continues until the acceleration reaches zero after a speed change.</p>

POINTS

When a speed change is executed during decreasing acceleration of advanced S-curve acceleration/deceleration, in order to maintain smoothness of acceleration, the speed will continue to increase until acceleration reaches zero. Therefore, the time for speed change is lengthened.

4 PARAMETERS FOR POSITIONING CONTROL

(6) Automatic decelerating flag (M2128 to M2159)

When the automatic deceleration processing is started during acceleration, the acceleration is decreased according to the acceleration section 2 ratio setting until the acceleration reaches zero. Therefore, the speed increases for a while before deceleration stop processing is executed.

(Deceleration is smooth.)

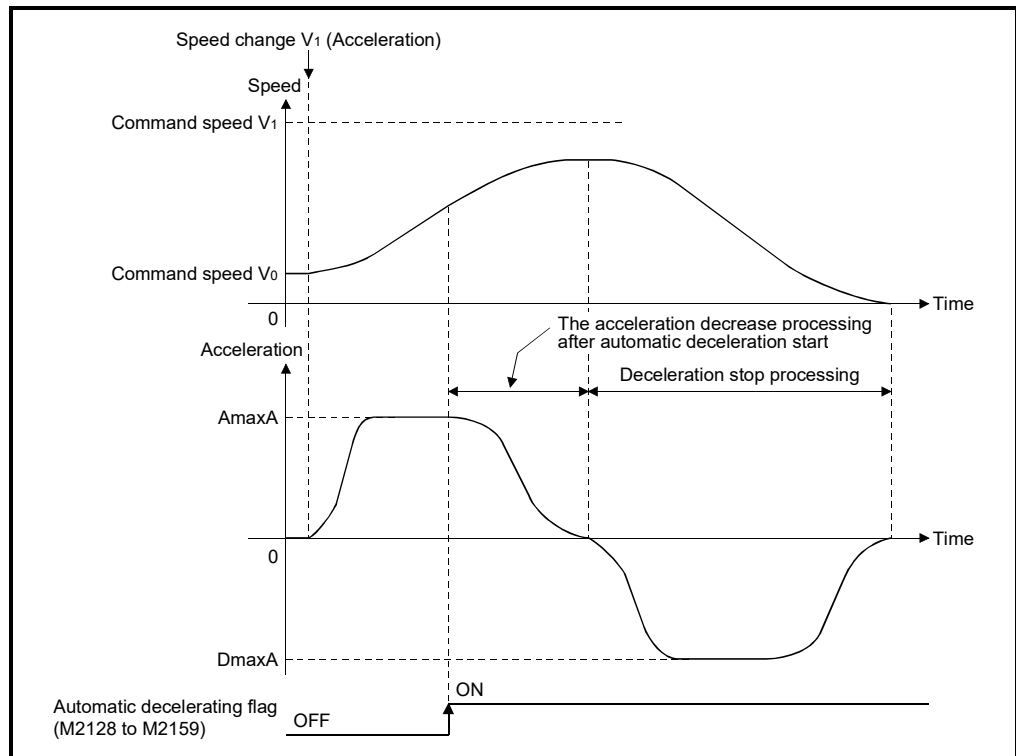

POINTS

When the automatic deceleration processing is started during acceleration processing of advanced S-curve acceleration/deceleration, in order to maintain smoothness of acceleration, the speed will continue to increase until acceleration reaches zero.

4.3.4 Allowable error range for circular interpolation

The locus of the arc calculated from the start point address and central point address may not coincide with the set end point address for the central-specified control. The allowable error range for circular interpolation sets the allowable range for the error between the locus of the arc determined by calculation and the end point address. If the error is within the allowable range, circular interpolation to the set end point address is executed while also executing error compensation by means of spiral interpolation.

If it exceeds the setting range, an error occurs at the start and positioning does not start. Such an error are set the applicable axis or minor error code area.

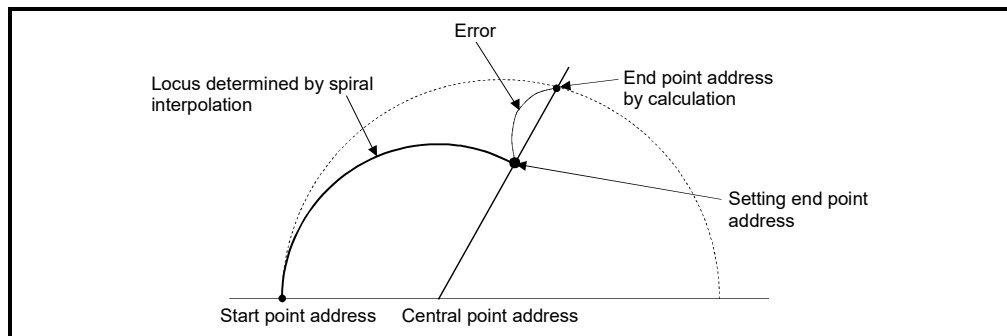



Fig. 4.7 Spiral Interpolation

4 PARAMETERS FOR POSITIONING CONTROL

4.4 Expansion Parameters

- (1) The expansion parameters are data to execute the following operation by the parameters set in each axis.
 - Monitor individually the positive and negative direction torque limit value.
 - Change the acceleration/deceleration time when changing speed.
- (2) The expansion parameters are set using MT Developer2.
- (3) The expansion parameters to be set are shown in Table 4.3.

Table 4.3 Expansion parameter list

No.	Item		Setting range								Initial value	Units	Indirect setting		Remarks	Section
			mm		inch		degree		pulse				Valid/invalid	Number of words		
			Setting range	Units	Setting range	Units	Setting range	Units	Setting range	Units						
1	Positive direction torque limit value monitor device (Note-1)		—								—	—	○	1	• Set the device to monitor the positive torque limit value.	4.4.1
2	Negative direction torque limit value monitor device (Note-1)		—								—	—	○	1	• Set the device to monitor the negative torque limit value.	
3	Acceleration/deceleration time change parameter 	Acceleration/deceleration time change enable device (Note-1)	—								—	—	○	Bit	• Set the device to enable the change of acceleration/deceleration time at a speed change request.	4.2.2
4		New acceleration time value device (Note-1)	—								—	—	○	1	• Set the device to set the change value of acceleration time.	
5		New deceleration time value device (Note-1)	—								—	—	○	1	• Set the device to set the change value of deceleration time.	

(Note-1): This setting can be omitted.

: Refer to Section 1.3 for the software version that supports this function.

4 PARAMETERS FOR POSITIONING CONTROL

(4) Indirect setting of expansion parameter

(a) Word devices for indirect setting

The word devices for indirect setting are the data registers (D), link registers (W), Motion registers (#) and Multiple CPU area device (U□G).

Word devices except the above devices cannot be used.

The usable setting range of word devices are shown below.

Word devices	Setting range
D	0 to 8191
W	0 to 1FFF
#	0 to 9215
U□G	10000 to (10000+p-1) (Note-1) (Note-2)

(Note-1): "p" indicates the user setting area points of the Multiple CPU high speed transmission area for each CPU.

(Note-2): Positive direction torque limit value monitor device and negative direction torque limit value monitor device can use the device of the self CPU only.

(b) Bit devices for indirect setting

The bit devices for indirect setting are the input (X), output (Y), internal relay (M), link relay (B), annunciator (F) and Multiple CPU area device (U□G).

Bit devices except the above devices cannot be used.

The usable setting range of bit devices are shown below.

Bit device	Setting range
X	0000 to 1FFF (Note-1)
Y	0000 to 1FFF
M	0 to 8191
B	0000 to 1FFF
F	0 to 2047
U□G	10000.0 to (10000+p-1).F (Note-2)

(Note-1): The range of "PXn+4 to PXn+F" cannot be used (fixed at 0) for the input device (PXn+0 to PXn+F) allocated to the built-in interface in Motion CPU (DI). (n: First input No.)

(Note-2): "p" indicates the user setting area points of the Multiple CPU high speed transmission area for each CPU.

(c) Input of expansion parameter

- 1) The positive direction torque limit value monitor device and negative direction torque limit value monitor device input the monitor value in the specified word device for every operation cycle.
- 2) The acceleration/deceleration time change parameter inputs the data of the specified device at request of speed change.

POINT

Refer to Chapter 2 of the "Q173D(S)CPU/Q172D(S)CPU Motion controller Programming Manual (COMMON)" for the user setting area points of the Multiple CPU high speed transmission area.

4 PARAMETERS FOR POSITIONING CONTROL

4.4.1 Positive direction torque limit value monitor device/negative direction torque limit value monitor device

The positive direction torque limit value monitor device and negative direction torque limit value monitor device are set for every axis, and the positive and negative direction torque limit value are monitored (0.1 to 1000.0[%]) individually.

(1) Positive direction torque limit value monitor device

Set the device to monitor the positive torque limit value.

The positive torque limit value (forward rotation (CCW) driving, reverse rotation (CW) regenerative torque limit value) to command the servo amplifier is stored.

The default value "300.0[%]" is stored at the power supply of servo amplifier ON.

(2) Negative direction torque limit value monitor device

Set the device to monitor the negative torque limit value.

The negative torque limit value (reverse rotation (CW) driving, forward rotation (CCW) regenerative torque limit value) to command the servo amplifier is stored.

The default value "300.0[%]" is stored at the power supply of servo amplifier ON.

POINT

The positive torque limit value is stored in the torque limit value storage register (D14+20n) in 1[%] unit. (The negative torque limit value is not stored.)

4.4.2 Acceleration/deceleration time change parameter

The acceleration/deceleration time change parameter arbitrarily changes the acceleration/deceleration time at speed change, when changing speed with the Motion dedicated function (CHGV) of Motion SFC program (and also the Motion dedicated PLC instruction (D(P). CHGV)).

(1) Acceleration/deceleration time change enable device

Set the device to enable the change of acceleration/deceleration time at a speed change request.

The following describes the operation for ON and OFF of the acceleration/deceleration time change enable device.

- ON Speed change is executed at a speed change request by changing the acceleration/deceleration time values in the new acceleration time value device and new deceleration time value device.
- OFF Does not change acceleration/deceleration time at a speed change request.

(2) New acceleration time value device

Set the device to set the change value when changing the acceleration time at a speed change request.

The following change values are set in the new acceleration time value device.

- 0..... Acceleration time change is disabled, and speed change is maintained at the current acceleration time.
- 1 to 65535[ms] If a speed change request is executed when the acceleration/deceleration time change enable device is ON, speed change is executed by changing the acceleration time to the set value.

(3) New deceleration time value device

Set the device to set the change value when changing the deceleration time at a speed change request.

The following change values are set in the new deceleration time value device.

- 0..... Deceleration time change is disabled, and speed change is maintained at the current deceleration time.
- 1 to 65535[ms] If a speed change request is executed when the acceleration/deceleration time change enable device is ON, speed change is executed by changing the deceleration time to the set value.

 : Refer to Section 1.3 for the software version that supports this function.

4 PARAMETERS FOR POSITIONING CONTROL

POINTS
(1) When the setting of acceleration/deceleration time change enable device is omitted, change of acceleration/deceleration time at a speed change request is not executed. When changing acceleration/deceleration time at a speed change, set this parameter.
(2) When the setting of new acceleration time value device and new deceleration time value device is omitted, change of acceleration/deceleration time of the omitted devices is not executed.

5. SERVO PROGRAMS FOR POSITIONING CONTROL

Servo programs specify the type of the positioning data required to execute the positioning control in the Multiple CPU system.

This chapter describes the configuration and setting method of the servo programs. Refer to Chapter "6 POSITIONING CONTROL" for details of the servo program.

5.1 Servo Program Composition Area

This section is described the composition of servo programs and the area in which stores the servo program.

5.1.1 Servo program composition

A servo program is composed a program No., servo instructions and positioning data. When a program No. and the required servo instructions are specified using MT Developer2, the positioning data required to execute the specified servo instructions can be set.

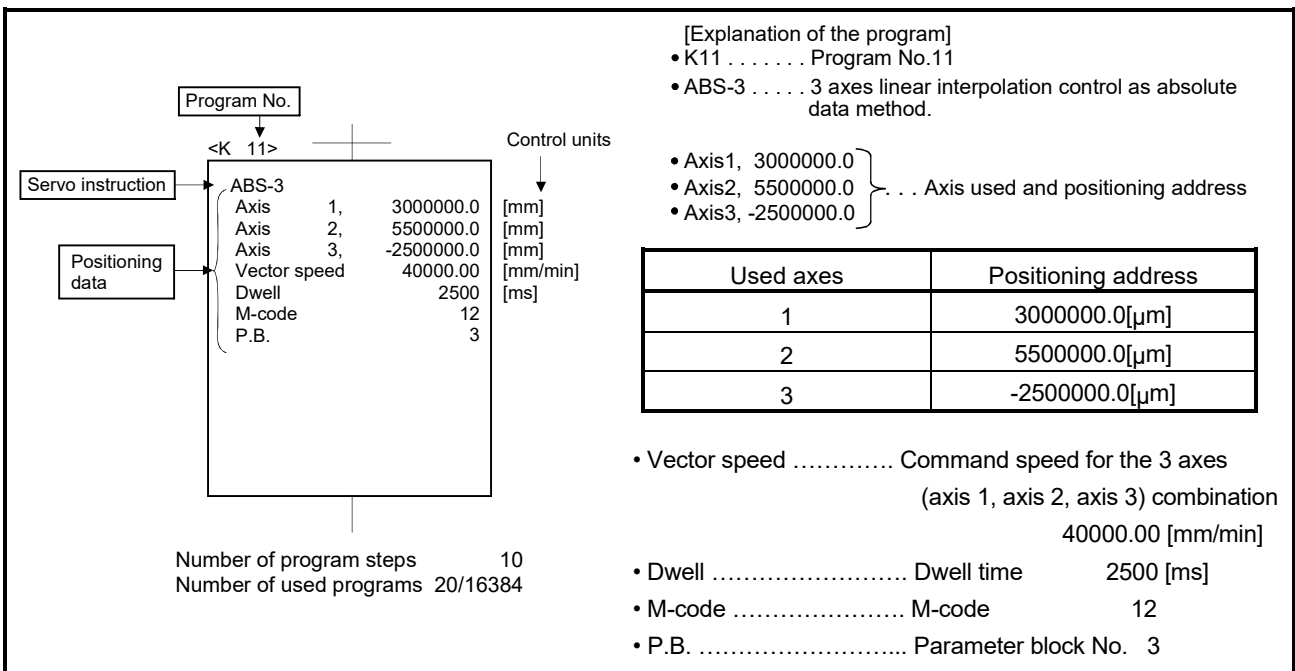

Fig. 5.1 Composition example of servo program

(1) Program No. This No. is specified using the Motion SFC program. Any No. in the range of 0 to 4095 can be set.

(2) Servo instruction Type of positioning control is indicated. Refer to Section 5.2 for details.

5 SERVO PROGRAMS FOR POSITIONING CONTROL

- (3) Positioning data This is the data required to execute servo instructions. The data required to execute is fixed for each servo instruction.

Refer to Section 5.3 for details.

The follows applies for the servo program shown in Figure 5.1:

- Axis used and positioning address
 - Command speed
 - Dwell time
 - M-code
 - P.B. (parameter block)
- } Data which must be set in order to execute the servo instruction.
 } Data which will be set to default values for control if not set.
 } Control is executed using the data of parameter block 3 (P.B.3).

5.1.2 Servo program area

(1) Servo program area

This area is an internal memory of the Multiple CPU system which store the servo program created using MT Developer2.

This area is an internal RAM.

(2) Servo program capacity

The servo program area has a capacity of 16384 steps.

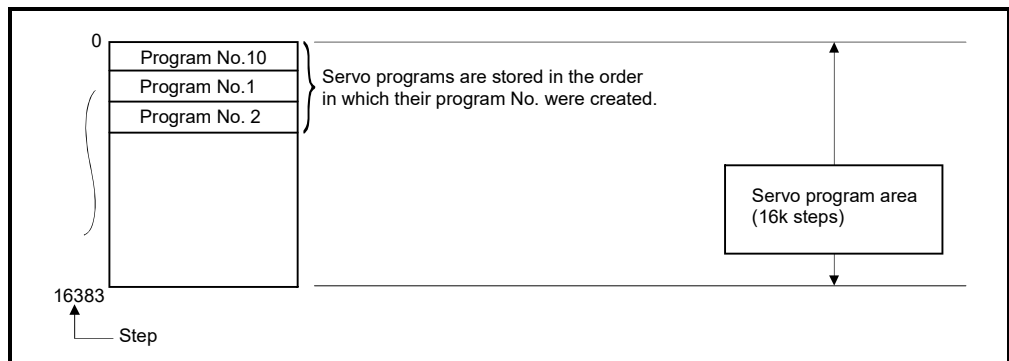

Fig. 5.2 Servo program area

POINT

If the servo program area has insufficient capacity, execute the multiple positioning control operations with one program by indirect setting of the positioning data used in the servo program. (Refer to Section 5.4.2 for details of indirect setting.)

5 SERVO PROGRAMS FOR POSITIONING CONTROL

(2) Servo instruction list

The servo instructions that can be used in servo programs and the positioning data set in the servo instruction are shown in Table 5.2. Refer to Section 5.3 for details of the positioning data set in the servo instructions.

Table 5.2 Servo instruction list

Positioning control	Instruction symbol	Processing	Positioning data														
			Common						Arc/Helical			OSC					
			Parameter block No.	Axis	Address/travel value	Command speed	Dwell time	M-code	Torque limit value	Auxiliary point	Radius	Central point	Pitch	Starting angle	Amplitude	Frequency	
		Virtual enable	○	○	○	○	○	○	—	○	○	○	○	—	—	—	
		Number of steps	1	1	1	1	1	1	1	1	1	1	1	1	1	1	
		Number of indirect words	1	—	2	2	1	1	1	2	2	2	1	2	2	2	
Linear interpolation control	1 axis	ABS-1	Absolute 1-axis positioning	△	○	○	○	△	△								
		INC-1	Incremental 1-axis positioning	△	○	○	○	△	△								
	2 axes	ABS-2	Absolute 2-axes linear interpolation	△	○	○	○	△	△								
		INC-2	Incremental 2-axes linear interpolation	△	○	○	○	△	△								
	3 axes	ABS-3	Absolute 3-axes linear interpolation	△	○	○	○	△	△								
		INC-3	Incremental 3-axes linear interpolation	△	○	○	○	△	△								
	4 axes	ABS-4	Absolute 4-axes linear interpolation	△	○	○	○	△	△								
		INC-4	Incremental 4-axes linear interpolation	△	○	○	○	△	△								
Circular interpolation control	Auxiliary point-specified	ABS ↻	Absolute auxiliary point-specified circular interpolation	△	○	○	○	△	△		○						
		INC ↻	Incremental auxiliary point-specified circular interpolation	△	○	○	○	△	△		○						
	Radius-specified	ABS ↻	Absolute radius-specified circular interpolation less than CW 180°	△	○	○	○	△	△			○					
		ABS ↻	Absolute radius-specified circular interpolation CW 180° or more	△	○	○	○	△	△			○					
		ABS ↻	Absolute radius-specified circular interpolation less than CCW 180°	△	○	○	○	△	△			○					
		ABS ↻	Absolute radius-specified circular interpolation CCW 180° or more	△	○	○	○	△	△			○					
		INC ↻	Incremental radius-specified circular interpolation less than CW 180°	△	○	○	○	△	△			○					
		INC ↻	Incremental radius-specified circular interpolation CW 180° or more	△	○	○	○	△	△			○					
		INC ↻	Incremental radius-specified circular interpolation less than CCW 180°	△	○	○	○	△	△			○					
		INC ↻	Incremental radius-specified circular interpolation CCW 180° or more	△	○	○	○	△	△			○					

5 SERVO PROGRAMS FOR POSITIONING CONTROL

Positioning data																				Number of steps											
Reference axis No.	Parameter block														Others																
	Interpolation control unit	Speed limit value	Acceleration time	Deceleration time	Rapid stop deceleration time	Torque limit value	Deceleration processing at stop input	Allowable error range for circular interpolation	S-curve ratio	Advanced S-curve acceleration/deceleration					Repeat condition	Program No.	Command speed (constant speed)	Cancel	Skip		FIN acceleration/deceleration	WAIT-ON/OFF	Fixed position stop acceleration/deceleration time	Fixed position stop							
										Acceleration/deceleration system	Acceleration section 1 ratio	Acceleration section 2 ratio	Deceleration section 1 ratio	Deceleration section 2 ratio																	
(Note-1)	—	○	○	○	○	—	—	○	○	○	○	○	○	○	○	○	○	○	○	○	○	○	○	○							
1	1	2	1	1	1	1	1	1	1	1	1	1	1	1	1	1	2	2	2	1	2	1	1								
1	1	2	1	1	1	1	1	2	1	1	1	1	1	1	(Note-2) 1/ 1(B)	—	2	(Note-2) 1(B)	(Note-2) 1(B)	1	(Note-2) 1(B)	1	(Note-2) 1(B)								
		△	△	△	△	△	△		△	△	△	△	△	△				△							4 to 17						
		△	△	△	△	△	△		△	△	△	△	△	△				△							4 to 17						
○	△	△	△	△	△	△	△		△	△	△	△	△	△				△							5 to 20						
○	△	△	△	△	△	△	△		△	△	△	△	△	△				△							5 to 20						
○	△	△	△	△	△	△	△		△	△	△	△	△	△				△							7 to 21						
○	△	△	△	△	△	△	△		△	△	△	△	△	△				△							7 to 21						
○	△	△	△	△	△	△	△		△	△	△	△	△	△				△							8 to 22						
○	△	△	△	△	△	△	△		△	△	△	△	△	△				△							8 to 22						
	△	△	△	△	△	△	△	△	△	△	△	△	△	△				△							7 to 22						
	△	△	△	△	△	△	△	△	△	△	△	△	△	△				△							7 to 22						
	△	△	△	△	△	△	△	△	△	△	△	△	△	△				△							6 to 21						
	△	△	△	△	△	△	△	△	△	△	△	△	△	△				△								6 to 21					
	△	△	△	△	△	△	△	△	△	△	△	△	△	△				△									6 to 21				
	△	△	△	△	△	△	△	△	△	△	△	△	△	△				△										6 to 21			
	△	△	△	△	△	△	△	△	△	△	△	△	△	△				△											6 to 21		
	△	△	△	△	△	△	△	△	△	△	△	△	△	△				△												6 to 21	
	△	△	△	△	△	△	△	△	△	△	△	△	△	△				△													6 to 21
	△	△	△	△	△	△	△	△	△	△	△	△	△	△				△													

○ : Must be set. △ : Set if required.
 (Note-1) : Only reference axis speed specification.
 (Note-2) : (B) indicates a bit device.

5 SERVO PROGRAMS FOR POSITIONING CONTROL

Table 5.2 Servo instruction list (continued)

Positioning control	Instruction symbol	Processing	Positioning data														
			Common							Arc/Helical				OSC			
			Parameter block No.	Axis	Address/travel value	Command speed	Dwell time	M-code	Torque limit value	Auxiliary point	Radius	Central point	Pitch	Starting angle	Amplitude	Frequency	
			Virtual enable	Number of steps	Number of indirect words												
			○	○	○	○	○	○	○	—	○	○	○	○	—	—	—
			1	1	1	1	1	1	1	1	1	1	1	1	1	1	
			1	—	2	2	1	1	1	1	2	2	2	1	2	2	2
Circular interpolation control	Central point-specified	ABS ↻	△	○	○	○	△	△				○					
		ABS ↺	△	○	○	○	△	△				○					
		INC ↻	△	○	○	○	△	△				○					
		INC ↺	△	○	○	○	△	△				○					
Helical interpolation control	Auxiliary point-specified	ABH ↻	△	○	○	○	△	△		○			○				
		INH ↻	△	○	○	○	△	△		○			○				
	Radius-specified	ABH ↻	△	○	○	○	△	△			○			○			
		ABH ↻	△	○	○	○	△	△			○			○			
		ABH ↺	△	○	○	○	△	△			○			○			
		ABH ↺	△	○	○	○	△	△			○			○			
		INH ↻	△	○	○	○	△	△			○			○			
		INH ↻	△	○	○	○	△	△			○			○			
		INH ↺	△	○	○	○	△	△			○			○			
		INH ↺	△	○	○	○	△	△			○			○			
	Central point-specified	ABH ↻	△	○	○	○	△	△				○	○				
		ABH ↺	△	○	○	○	△	△				○	○				
INH ↻		△	○	○	○	△	△				○	○					
INH ↺		△	○	○	○	△	△				○	○					

5 SERVO PROGRAMS FOR POSITIONING CONTROL

Positioning data																					Number of steps			
Reference axis No. <small>(Note-1)</small>	Parameter block													Others										
	Interpolation control unit	Speed limit value	Acceleration time	Deceleration time	Rapid stop deceleration time	Torque limit value	Deceleration processing at stop input	Allowable error range for circular interpolation	S-curve ratio	Advanced S-curve acceleration/deceleration					Repeat condition	Program No.	Command speed (constant speed)	Cancel	Skip	FIN acceleration/deceleration		WAIT-ON/OFF	Fixed position stop acceleration/deceleration time	Fixed position stop
										Acceleration/deceleration system	Acceleration section 1 ratio	Acceleration section 2 ratio	Deceleration section 1 ratio	Deceleration section 2 ratio										
○	—	○	○	○	○	—	—	○	○	○	○	○	○	○	○	○	○	○	○	○	○	○	○	
1	1	2	1	1	1	1	1	1	1	1	1	1	1	1	1	2	2	2	2	1	2	1	1	
1	1	2	1	1	1	1	1	2	1	1	1	1	1	1	<small>(Note-2)</small> 1/ 1(B)	—	2	<small>(Note-2)</small> 1(B)	<small>(Note-2)</small> 1(B)	1	<small>(Note-2)</small> 1(B)	1	<small>(Note-2)</small> 1(B)	
	△	△	△	△	△	△	△	△	△	△	△	△	△	△				△						
	△	△	△	△	△	△	△	△	△	△	△	△	△	△				△						
	△	△	△	△	△	△	△	△	△	△	△	△	△	△				△						
	△	△	△	△	△	△	△	△	△	△	△	△	△	△				△						
	△	△	△	△	△	△	△		△	△	△	△	△	△				△						
	△	△	△	△	△	△	△		△	△	△	△	△	△				△						
	△	△	△	△	△	△	△		△	△	△	△	△	△				△						
	△	△	△	△	△	△	△		△	△	△	△	△	△				△						
	△	△	△	△	△	△	△		△	△	△	△	△	△				△						
	△	△	△	△	△	△	△		△	△	△	△	△	△				△						
	△	△	△	△	△	△	△		△	△	△	△	△	△				△						
	△	△	△	△	△	△	△		△	△	△	△	△	△				△						
	△	△	△	△	△	△	△		△	△	△	△	△	△				△						

○ : Must be set. △ : Set if required.
 (Note-1) : Only reference axis speed specification.
 (Note-2) : (B) indicates a bit device.

5 SERVO PROGRAMS FOR POSITIONING CONTROL

Table 5.2 Servo instruction list (continued)

Positioning control	Instruction symbol	Processing	Positioning data													
			Common						Arc/Helical				OSC			
			Parameter block No.	Axis	Address/travel value	Command speed	Dwell time	M-code	Torque limit value	Auxiliary point	Radius	Central point	Pitch	Starting angle	Amplitude	Frequency
		Virtual enable	○	○	○	○	○	○	—	○	○	○	○	—	—	—
		Number of steps	1	1	1	1	1	1	1	1	1	1	1	1	1	1
		Number of indirect words	1	—	2	2	1	1	1	2	2	2	1	2	2	2
Fixed-pitch feed	1 axis	FEED-1	△	○	○	○	△	△								
	2 axes	FEED-2	△	○	○	○	△	△								
	3 axes	FEED-3	△	○	○	○	△	△								
Speed control (I)	Forward rotation	VF	△	○		○		△								
	Reverse rotation	VR	△	○		○		△								
Speed control (II)	Forward rotation	VVF	△	○		○		△	△							
	Reverse rotation	VVR	△	○		○		△	△							
Speed-position switching control	Forward rotation	VPF	△	○	○	○	△	△	△							
	Reverse rotation	VPR	△	○	○	○	△	△	△							
	Restart	VPSTART		○												
Speed-switching control	VSTART	Speed-switching control start	△													
	VEND	Speed-switching control end														
	ABS-1	Speed-switching control end point address		○	○	○	△	△	△							
	ABS-2			○	○	○	△	△	△							
	ABS-3			○	○	○	△	△	△							
	INC-1	Travel value up to speed-switching control end point		○	○	○	△	△	△							
	INC-2			○	○	○	△	△	△							
	INC-3			○	○	○	△	△	△							
	VABS	Speed-switching point absolute specification			○	○		△	△							
	VINC	Speed-switching point incremental specification			○	○		△	△							

5 SERVO PROGRAMS FOR POSITIONING CONTROL

Positioning data																				Number of steps				
Reference axis No. <small>(Note-1)</small>	Parameter block													Others										
	Interpolation control unit	Speed limit value	Acceleration time	Deceleration time	Rapid stop deceleration time	Torque limit value	Deceleration processing at stop input	Allowable error range for circular interpolation	S-curve ratio	Advanced S-curve acceleration/deceleration					Repeat condition	Program No.	Command speed (constant speed)	Cancel	Skip		FIN acceleration/deceleration	WAIT-ON/OFF	Fixed position stop acceleration /deceleration time	Fixed position stop
										Acceleration/deceleration system	Acceleration section 1 ratio	Acceleration section 2 ratio	Deceleration section 1 ratio	Deceleration section 2 ratio										
○	—	○	○	○	○	—	—	○	○	○	○	○	○	○	○	○	○	○	○	○	○	○	○	○
1	1	2	1	1	1	1	1	1	1	1	1	1	1	1	1	1	2	2	2	1	2	1	1	
1	1	2	1	1	1	1	1	2	1	1	1	1	1	1	<small>(Note-2)</small> 1/ 1(B)	—	2	<small>(Note-2)</small> 1(B)	<small>(Note-2)</small> 1(B)	1	<small>(Note-2)</small> 1(B)	1	<small>(Note-2)</small> 1(B)	
		△	△	△	△	△	△		△	△	△	△	△	△				△						4 to 17
	△	△	△	△	△	△	△		△	△	△	△	△	△				△						5 to 19
	△	△	△	△	△	△	△		△	△	△	△	△	△				△						7 to 21
		△	△	△	△	△	△		△	△	△	△	△	△				△						3 to 15
		△	△	△	△	△	△		△	△	△	△	△	△				△						3 to 16
		△	△	△	△	△	△		△	△	△	△	△	△				△						3 to 16
		△	△	△	△	△	△		△	△	△	△	△	△				△						4 to 18
		△	△	△	△	△	△		△	△	△	△	△	△				△						4 to 18
																		△						2 to 4
	△	△	△	△	△	△	△		△	△	△	△	△	△				△						1 to 13
																								1
																		△						4 to 9
																		△						5 to 10
																		△						7 to 12
																		△						4 to 9
																		△						5 to 10
																		△						7 to 12
																								4 to 6

○ : Must be set. △ : Set if required.
 (Note-1) : Only reference axis speed specification.
 (Note-2) : (B) indicates a bit device.

5 SERVO PROGRAMS FOR POSITIONING CONTROL

Table 5.2 Servo instruction list (continued)

Positioning control	Instruction symbol	Processing	Positioning data													
			Common							Arc/Helical			OSC			
			Parameter block No.	Axis	Address/travel value	Command speed	Dwell time	M-code	Torque limit value	Auxiliary point	Radius	Central point	Pitch	Starting angle	Amplitude	Frequency
		Virtual enable	○	○	○	○	○	○	—	○	○	○	○	—	—	—
		Number of steps	1	1	1	1	1	1	1	1	1	1	1	1	1	1
		Number of indirect words	1	—	2	2	1	1	1	2	2	2	1	2	2	2
Speed control with fixed position stop	Forward rotation	PVF	△	○	○	○	△	△								
	Reverse rotation	PVR	△	○	○	○	△	△								
Position follow-up control		PFSTART	△	○	○	○		△								
Constant-speed control		CPSTART1	△	○		○										
		CPSTART2	△	○		○										
		CPSTART3	△	○		○										
		CPSTART4	△	○		○										
		ABS-1		○	○			△	△							
		ABS-2		○	○			△	△							
		ABS-3		○	○			△	△							
		ABS-4		○	○			△	△							
		ABS↗		○	○			△	△	○						
		ABS↖		○	○			△	△		○					
		ABS↘		○	○			△	△		○					
		ABS↙		○	○			△	△		○					
		ABH↗		○	○			△	△	○		○				
		ABH↖		○	○			△	△		○	○				
		ABH↘		○	○			△	△		○	○				
		ABH↙		○	○			△	△		○	○				

5 SERVO PROGRAMS FOR POSITIONING CONTROL

Positioning data																				Number of steps					
Reference axis No. <small>(Note-1)</small>	Parameter block													Others											
	Interpolation control unit	Speed limit value	Acceleration time	Deceleration time	Rapid stop deceleration time	Torque limit value	Deceleration processing at stop input	Allowable error range for circular interpolation	S-curve ratio	Advanced S-curve acceleration/deceleration					Repeat condition	Program No.	Command speed (constant speed)	Cancel	Skip		FIN acceleration/deceleration	WAIT-ON/OFF	Fixed position stop acceleration /deceleration time	Fixed position stop	
										Acceleration/deceleration system	Acceleration section 1 ratio	Acceleration section 2 ratio	Deceleration section 1 ratio	Deceleration section 2 ratio											
○	—	○	○	○	○	—	—	○	○	○	○	○	○	○	○	○	○	○	○	○	○	○	○	○	
1	1	2	1	1	1	1	1	1	1	1	1	1	1	1	1	2	2	2	2	1	2	1	1		
1	1	2	1	1	1	1	1	2	1	1	1	1	1	1	<small>(Note-2)</small> 1/ 1(B)	—	2	<small>(Note-2)</small> 1(B)	<small>(Note-2)</small> 1(B)	1	<small>(Note-2)</small> 1(B)	1	<small>(Note-2)</small> 1(B)		
		△		△	△	△	△		△	△	△	△	△	△				△					○	○	6 to 19
		△		△	△	△	△		△	△	△	△	△	△				△					○	○	6 to 19
		△	△	△	△	△	△		△	△	△	△	△	△				△							4 to 16
		△	△	△	△	△	△		△	△	△	△	△	△				△		△					3 to 15
	△	△	△	△	△	△	△	△	△	△	△	△	△	△				△		△					3 to 17
	△	△	△	△	△	△	△	△	△	△	△	△	△	△				△		△					4 to 17
	△	△	△	△	△	△	△	△	△	△	△	△	△	△				△		△					4 to 17
																		△		△					2 to 10
																		△		△					3 to 11
																		△		△					4 to 12
																		△		△					5 to 13
																		△		△					5 to 14
																		△		△					4 to 13
																		△		△					4 to 13
																		△		△					5 to 14
																		△		△					5 to 14
																		△		△					9 to 14
																		△		△					9 to 14
																		△		△					8 to 13
																		△		△					8 to 13
																		△		△					9 to 14
																		△		△					9 to 14

○ : Must be set. △ : Set if required.
(Note-1) : Only reference axis speed specification.
(Note-2) : (B) indicates a bit device.

5 SERVO PROGRAMS FOR POSITIONING CONTROL

Table 5.2 Servo instruction list (continued)

Positioning control	Instruction symbol	Processing	Positioning data														
			Common							Arc/Helical				OSC			
			Parameter block No.	Axis	Address/travel value	Command speed	Dwell time	M-code	Torque limit value	Auxiliary point	Radius	Central point	Pitch	Starting angle	Amplitude	Frequency	
		Virtual enable	○	○	○	○	○	○	—	○	○	○	○	—	—	—	
		Number of steps	1	1	1	1	1	1	1	1	1	1	1	1	1	1	
		Number of indirect words	1	—	2	2	1	1	1	2	2	2	1	2	2	2	
Constant-speed control	INC-1	Constant-speed control passing point incremental specification		○	○				△	△							
	INC-2			○	○				△	△							
	INC-3			○	○					△	△						
	INC-4			○	○					△	△						
	INC ↗			○	○					△	△	○					
	INC ↖			○	○						△	△		○			
	INC ↘			○	○						△	△			○		
	INC ↙			○	○						△	△				○	
	INC ↗↖			○	○						△	△					○
	INC ↘↙			○	○						△	△					○
	INH ↗		Constant-speed control passing point helical incremental specification		○	○					△	△	○			○	
	INH ↖				○	○						△	△		○		○
	INH ↘			○	○						△	△			○		
	INH ↙			○	○						△	△				○	
	INH ↗↖			○	○						△	△					○
	INH ↘↙			○	○						△	△					○
	CPEND	Constant-speed control end								△							

5 SERVO PROGRAMS FOR POSITIONING CONTROL

Positioning data																					Number of steps			
Reference axis No.	Parameter block												Others											
	Interpolation control unit	Speed limit value	Acceleration time	Deceleration time	Rapid stop deceleration time	Torque limit value	Deceleration processing at stop input	Allowable error range for circular interpolation	S-curve ratio	Advanced S-curve acceleration/deceleration					Repeat condition	Program No.	Command speed (constant speed)	Cancel	Skip	FIN acceleration/deceleration		WAIT-ON/OFF	Fixed position stop acceleration /deceleration time	Fixed position stop
										Acceleration/deceleration system	Acceleration section 1 ratio	Acceleration section 2 ratio	Deceleration section 1 ratio	Deceleration section 2 ratio										
○	—	○	○	○	○	—	—	○	○	○	○	○	○	○	○	○	○	○	○	○	—	—		
1	1	2	1	1	1	1	1	1	1	1	1	1	1	1	1	1	2	2	2	1	2	1	1	
1	1	2	1	1	1	1	1	2	1	1	1	1	1	(Note-2) 1/1(B)	—	2	(Note-2) 1(B)	(Note-2) 1(B)	1	(Note-2) 1(B)	1	(Note-2) 1(B)		
																							2 to 10	
																							3 to 11	
																							4 to 12	
																							5 to 13	
																							5 to 14	
																							4 to 13	
																							5 to 14	
																							9 to 14	
																							8 to 13	
																							9 to 14	
																							1 to 2	

○ : Must be set. △ : Set if required.
 (Note-1) : Only reference axis speed specification.
 (Note-2) : (B) indicates a bit device.

5 SERVO PROGRAMS FOR POSITIONING CONTROL

Table 5.2 Servo instruction list (continued)

Positioning control	Instruction symbol	Processing	Positioning data													
			Common							Arc/Helical			OSC			
			Parameter block No.	Axis	Address/travel value	Command speed	Dwell time	M-code	Torque limit value	Auxiliary point	Radius	Central point	Pitch	Starting angle	Amplitude	Frequency
		Virtual enable	○	○	○	○	○	○	—	○	○	○	○	—	—	—
		Number of steps	1	1	1	1	1	1	1	1	1	1	1	1	1	1
		Number of indirect words	1	—	2	2	1	1	1	2	2	2	1	2	2	2
Repetition of same control (used in speed switching control, constant-speed control)	FOR-TIMES	Repeat range start setting														
	FOR-ON															
	FOR-OFF															
	NEXT	Repeat range end setting														
Simultaneous start	START	Simultaneous start														
Home position return	ZERO	Home position return start		○												
High speed oscillation	OSC	High-speed oscillation	△	○					△					○	○	○
Current value change	CHGA	Servo motor/Virtual Servo motor Shaft Current Value Change		○	○											
	CHGA-E	Encoder current value change		○	○											
	CHGA-C	CAM shaft current value change		○	○											

5 SERVO PROGRAMS FOR POSITIONING CONTROL

Reference axis No.	Positioning data																				Number of steps				
	Parameter block															Others									
	Interpolation control unit	Speed limit value	Acceleration time	Deceleration time	Rapid stop deceleration time	Torque limit value	Deceleration processing at stop input	Allowable error range for circular interpolation	S-curve ratio	Advanced S-curve acceleration/deceleration					Repeat condition	Program No.	Command speed (constant speed)	Cancel	Skip	FIN acceleration/deceleration		WAIT-ON/OFF	Fixed position stop acceleration /deceleration time	Fixed position stop	
										Acceleration/deceleration system	Acceleration section 1 ratio	Acceleration section 2 ratio	Deceleration section 1 ratio	Deceleration section 2 ratio											
										1	1	1	1	1											
1										1	1	1	1												
○	—	○	○	○	—	—	○	○	○	○	○	○	○	○	○	○	○	○	○	○	○	○			
1	1	2	1	1	1	1	1	1	1	1	1	1	1	1	1	2	2	2	1	2	1	1			
1	1	2	1	1	1	1	1	2	1	1	1	1	1	(Note-2) 1/ 1(B)	—	2	(Note-2) 1(B)	(Note-2) 1(B)	1	(Note-2) 1(B)	1	(Note-2) 1(B)			
																								2	
																									3
																	○								2 to 3
																									2
							△													△					5 to 10
																									3

○ : Must be set. △ : Set if required.
 (Note-1) : Only reference axis speed specification.
 (Note-2) : (B) indicates a bit device.

5 SERVO PROGRAMS FOR POSITIONING CONTROL

5.3 Positioning Data

The positioning data set in the servo programs is shown in Table 5.3.

Table 5.3 Positioning data

Name	Explanation	Default value	Setting value using MT Developer2					
			Setting range					
			mm	inch	degree	pulse		
Parameter block No.	<ul style="list-style-type: none"> Set based on which parameter block deceleration processing at the acceleration/ deceleration processing and STOP input. 	1	1 to 64					
Axis	<ul style="list-style-type: none"> Set the starting axis. It becomes the interpolation starting axis No. at the interpolation. 	—	1 to 32					
Common Settings	Absolute data method	Address	Set the positioning address as an absolute method with an absolute address.	—	-214748364.8 to 214748364.7 [μm]	-21474.83648 to 21474.83647	0 to 359.99999	-2147483648 to 2147483647
	Incremental data method	Travel value	Set the positioning address as an incremental data method with a travel value. Travel direction is indicated by the sign. Only positive settings can be made at the speed/position control. Positive : Forward rotation (address increase direction) Negative: Reverse rotation (address decrease direction)	—	Except for speed-position switching control			
					-214748364.7 to 214748364.7 [μm]	-21474.83647 to 21474.83647	-21474.83647 to 21474.83647	-2147483647 to 2147483647
				Speed-position switching control				
				0 to 214748364.7 [μm]	0 to 21474.83647	0 to 21474.83647	0 to 2147483647	
Command speed	<ul style="list-style-type: none"> Sets the positioning speed. Units for speed are the "control units" set in the parameter block. It becomes the vector speed/long-axis reference speed/reference axis speed at the interpolation starting. (PTP control only) 	—	0.01 to 6000000.00 [mm/min]	0.001 to 600000.000 [inch/min]	0.001 to 2147483.647 [degree/min] (Note-5)	1 to 2147483647 [pulse/s]		
Dwell time	<ul style="list-style-type: none"> Set the time until outputs the positioning complete signal (M2401+20n) after positioning to positioning address. 	0[ms]	0 to 5000[ms]					
M-code	<ul style="list-style-type: none"> Set the M-code. Set for each point at the speed-switching control and constant-speed control. Updated it at the start or specified point. 	0	0 to 32767					
Torque limit value	<ul style="list-style-type: none"> Set the torque limit value. The torque limit is performed based on the parameter block data at the start. The speed-switching control can be set for each point and the setting torque limit values can be performed with the specified point. 	Torque limit setting valued [%] in the parameter block	1 to 1000[%]					

5 SERVO PROGRAMS FOR POSITIONING CONTROL

Setting value using the Motion SFC program (Indirect setting)				Indirect setting		Processing at the setting error		
Setting range				Possible/ not possible	Number of used words	Error item information (Stored in SD517) (Note-4)	Control using default value	Not start
mm	inch	degree	pulse					
1 to 64				○	1	1	○	
—				×	—	—		
-2147483648 to 2147483647 ($\times 10^{-1}$ [μm])	-2147483648 to 214748647 ($\times 10^{-5}$ [inch])	0 to 35999999 ($\times 10^{-5}$ [degree])	-2147483648 to 2147483647	○	2	n03 (Note-1)		○
Except for speed-position switching control								
-2147483647 to 2147483647 ($\times 10^{-1}$ [μm])	-2147483647 to 214748647 ($\times 10^{-5}$ [inch])	-2147483647 to 214748647 ($\times 10^{-5}$ [inch])	-2147483647 to 2147483647					
Speed-position switching control						—		
0 to 2147483647 ($\times 10^{-1}$ [μm])	0 to 2147483647 ($\times 10^{-5}$ [inch])	0 to 2147483647 ($\times 10^{-5}$ [degree])	0 to 2147483647					
1 to 600000000 ($\times 10^{-2}$ [mm/min])	1 to 600000000 ($\times 10^{-3}$ [inch/min])	1 to 2147483647 ($\times 10^{-3}$ [degree/min]) (Note-5)	1 to 2147483647 [pulse/s]	○	2	4	○ (Note-2)	○ (Note-3)
0 to 5000[ms]				○	1	5	○	
0 to 32767				○	1	6	○	
1 to 1000[%]				○	1	7	○	

(Note-1): The "n" in n03, n08, n09 and n10, indicates the axis No. (1 to 32).

(Note-2): When an error occurs because the speed limit value is exceeded, it is controlled at the speed limit value.

(Note-3): Applies when the command speed is "0".

(Note-4): If there are multiple errors in the same program, the latest error item information is stored.

(Note-5): When the "speed control $10 \times$ multiplier setting for degree axis" is set to "valid", the setting range is 0.01 to 21474836.47 [degree/min].

5 SERVO PROGRAMS FOR POSITIONING CONTROL

Table 5.3 Positioning data (Continued)

Name		Explanation	Setting value using MT Developer2				
			Default value	Setting range			
				mm	inch	degree	pulse
Circular Interpolation	Auxiliary point	Absolute data method	—	-214748364.8 to 214748364.7 [μm]	-21474.83648 to 21474.83647	0 to 359.99999	-2147483648 to 2147483647
		Incremental data method		-214748364.7 to 214748364.7 [μm]	-21474.83647 to 21474.83647	-21474.83647 to 21474.83647	-2147483647 to 2147483647
	Radius	Absolute data method	—	0.1 to 429496729.5 [μm]	0.00001 to 42949.67295	0 to 359.99999	1 to 4294967295
		Incremental data method		0.1 to 214748364.7 [μm]	0.00001 to 21474.83647	0.00001 to 21474.83647	1 to 2147483647
	Central point	Absolute data method	—	-214748364.8 to 214748364.7 [μm]	-21474.83648 to 21474.83647	0 to 359.99999	-2147483648 to 2147483647
		Incremental data method		-214748364.7 to 214748364.7 [μm]	-21474.83647 to 21474.83647	-21474.83647 to 21474.83647	-2147483647 to 2147483647
Number of pitches		• Set at the helical interpolation.	—	0 to 999			
Parameter block	Interpolation control unit		3	0	1	2	3
	Speed limit value		200000 [pulse/s]	0.01 to 6000000.00 [mm/min]	0.001 to 600000.000 [inch/min]	0.001 to 2147483.647 [degree/min] (Note-5)	1 to 2147483647 [pulse/s]
	Acceleration time		1000[ms]	1 to 65535[ms]			
	Deceleration time		1000[ms]	1 to 65535[ms]			
	Rapid stop deceleration time		1000[ms]	1 to 65535[ms]			
	S-curve ratio		0[%]	0 to 100[%]			
	Acceleration/deceleration system		0	0: Trapezoidal acceleration/deceleration/ S-curve acceleration/deceleration 1: Advanced S-curve acceleration/deceleration			
	Acceleration section 1 ratio		20.0[%]	0.0 to 100.0[%]			
	Acceleration section 2 ratio		20.0[%]	0.0 to 100.0[%]			
	Deceleration section 1 ratio		20.0[%]	0.0 to 100.0[%]			
	Deceleration section 2 ratio		20.0[%]	0.0 to 100.0[%]			
	Torque limit value		300[%]	1 to 1000[%]			
	Deceleration processing on STOP input		0	0: Deceleration stop based on the deceleration time 1: Deceleration stop based on the rapid stop deceleration time			
	Allowable error range for circular interpolation		100[pulse]	0 to 10000.0 [μm]	0 to 1.00000	0 to 1.00000	0 to 100000

5 SERVO PROGRAMS FOR POSITIONING CONTROL

Setting value using the Motion SFC program (Indirect setting)				Indirect setting		Processing at the setting error		
Setting range				Possible/ not possible	Number of used words	Error item information (Stored in SD517) (Note-4)	Control using default value	Not start
mm	inch	degree	pulse					
-2147483648 to 2147483647 ($\times 10^{-1}$ [μm])	-2147483648 to 2147483647 ($\times 10^{-5}$ [inch])	0 to 35999999 ($\times 10^{-5}$ [degree])	-2147483648 to 2147483647	○	2 \times 2	n08 (Note-1)		
-2147483647 to 2147483647 ($\times 10^{-1}$ [μm])	-2147483647 to 214748647 ($\times 10^{-5}$ [inch])	-2147483647 to 214748647 ($\times 10^{-5}$ [inch])	-2147483647 to 2147483647					
1 to 4294967295 ($\times 10^{-1}$ [μm])	1 to 4294967295 ($\times 10^{-5}$ [inch])	0 to 35999999 ($\times 10^{-5}$ [degree])	1 to 4294967295	○	2	n09 (Note-1)		○
1 to 2147483647 ($\times 10^{-1}$ [μm])	1 to 2147483647 ($\times 10^{-5}$ [inch])	1 to 2147483647 ($\times 10^{-5}$ [degree])	1 to 2147483647	○				
-2147483648 to 2147483647 ($\times 10^{-1}$ [μm])	-2147483648 to 2147483647 ($\times 10^{-5}$ [inch])	0 to 35999999 ($\times 10^{-5}$ [degree])	-2147483648 to 2147483647	○	2 \times 2	n10 (Note-1)		
-2147483647 to 2147483647 ($\times 10^{-1}$ [μm])	-2147483647 to 214748647 ($\times 10^{-5}$ [inch])	-2147483647 to 214748647 ($\times 10^{-5}$ [inch])	-2147483647 to 2147483647	○				
0 to 999				○	1	28		
0	1	2	3	○	1	11		
1 to 600000000 ($\times 10^{-2}$ [mm/min])	1 to 600000000 ($\times 10^{-3}$ [inch/min])	1 to 2147483647 ($\times 10^{-3}$ [degree/min]) (Note-5)	1 to 2147483647 [pulse/s]	○	2	12	○	
1 to 65535[ms]				○	1	13		
1 to 65535[ms]				○	1	14		
1 to 65535[ms]				○	1	15		
0 to 100[%]				○	1	21		
0: Trapezoidal acceleration/deceleration/ S-curve acceleration/deceleration 1: Advanced S-curve acceleration/deceleration (Note-6)				○	1	—		
0.0 to 100.0[%]				○	1	45, 49		
0.0 to 100.0[%]				○	1	46, 49		
0.0 to 100.0[%]				○	1	47, 50		
0.0 to 100.0[%]				○	1	48, 50		
1 to 1000[%]				○	1	16		
0: Deceleration to a stop in accordance with the deceleration time 1: Deceleration to a stop in accordance with the rapid stop deceleration time (Note-6)				○	1	—		
1 to 100000 ($\times 10^{-1}$ [μm])	1 to 100000 ($\times 10^{-5}$ [inch])	1 to 100000 ($\times 10^{-5}$ [degree])	1 to 100000 [pulse]	○	2	17		

(Note-1): The "n" in n03, n08, n09 and n10, indicates the axis No. (1 to 32).

(Note-4): If there are multiple errors in the same program, the latest error item information is stored.

(Note-5): When the "speed control $10 \times$ multiplier setting for degree axis" is set to "valid", the setting range is 0.01 to 21474836.47 [degree/min].

(Note-6): Only bit0 is valid. If the value outside the range is set, the state except bit0 is ignored.

5 SERVO PROGRAMS FOR POSITIONING CONTROL

Table 5.3 Positioning data (Continued)

Name	Explanation	Setting value using MT Developer2					
		Default value	Setting range				
			mm	inch	degree	pulse	
Repeat condition (Number of repetitions)	Set the repeat conditions between FOR-TIMES instruction and NEXT instruction.	—	1 to 32767				
Repeat condition (ON/OFF)	Set the repeat conditions between FOR-ON/OFF instruction and NEXT instruction.	—	X, Y, M, B, F, U□G				
Program No.	Set the program No. for simultaneous start.	—	0 to 4095				
Command speed (constant-speed)	Set the speed for points on the way in the servo program.	—	0.01 to 6000000.00 [mm/min]	0.001 to 600000.000 [inch/min]	0.001 to 2147483.647 [degree/min] (Note-5)	1 to 2147483647 [pulse/s]	
Cancel	Set to stop execution of a servo program by deceleration stop by turning on the specified bit device in the servo program.	—	X, Y, M, B, F, U□G				
Others	Skip	Set to cancel positioning to pass point and execute the positioning to the next point by turning on the specified bit device during positioning at each pass point for constant-speed control instruction.	—	X, Y, M, B, F, U□G			
	FIN acceleration/ deceleration	Set to execute positioning to each pass point for constant-speed control instruction by turning on the FIN signal.	—	1 to 5000[ms]			
	WAIT-ON/OFF	Set to make state of the waiting for execution by constant-speed control and execute the positioning immediately by turning on/off the command bit device.	—	X, Y, M, B, F, U□G			
	Fixed position stop acceleration/ deceleration time	Acceleration/deceleration time used in the starting of speed control with fixed position stop, speed change request (CHGV) or fixed position stop command ON.	—	1 to 65535[ms]			
	Fixed position stop	Command bit device of fixed position stop is set.	—	X, Y, M, B, F, U□G			

5 SERVO PROGRAMS FOR POSITIONING CONTROL

Setting value using the Motion SFC program (Indirect setting)				Indirect setting		Processing at the setting error		
Setting range				Possible/ not possible	Number of used words	Error item information (Stored in SD517) (Note-4)	Control using default value	Not start
mm	inch	degree	pulse					
1 to 32767				○	1	18	Control by K1	
—				—	—	—		
0 to 4095				○	1	19		○
1 to 600000000 ($\times 10^{-2}$ [mm/min])	1 to 600000000 ($\times 10^{-3}$ [inch/min])	1 to 2147483647 ($\times 10^{-3}$ [degree/min]) (Note-5)	1 to 2147483647 [pulse/s]	○	2	4	○ (Note-2)	○ (Note-3)
—				—	—	—		
—				—	—	—		
1 to 5000[ms]				○	1	13	Control by 1000[ms]	
—				—	—	—		
1 to 65535[ms]				○	1	13	Control by 1000[ms]	
—				—	—	—		

(Note-2): When an error occurs because the speed limit value is exceeded, it is controlled at the speed limit value.

(Note-3): Applies when the command speed is "0".

(Note-4): If there are multiple errors in the same program, the latest error item information is stored.

(Note-5): When the "speed control $10 \times$ multiplier setting for degree axis is set to "valid", the setting range is 0.01 to 21474836.47 [degree/min].

5.4 Setting Method for Positioning Data

This section describes how to set the positioning data used in the servo program. There are two ways to set positioning data, as follows:

- (1) Setting by specifying numerical values ... Refer to Section 5.4.1
- (2) Indirect setting by devices Refer to Section 5.4.2

"Setting by specifying numerical values" and "indirect setting by word devices" can be used together in one servo program.

5.4.1 Setting method by specifying numerical values

In the setting method by specifying numerical values, each positioning data is set by a numerical value, and it becomes fixed data.

Data can be set and corrected using MT Developer2 only.

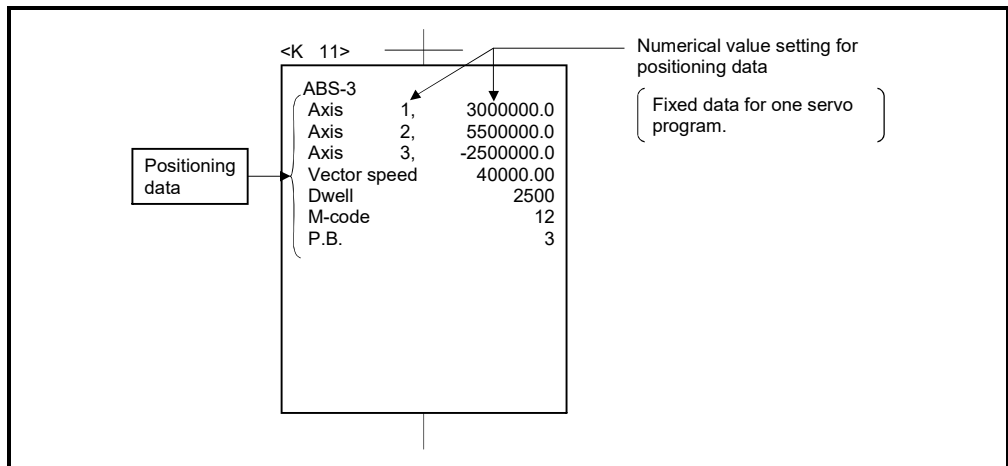

Fig. 5.3 Setting example of positioning data by specifying numerical value

5 SERVO PROGRAMS FOR POSITIONING CONTROL

5.4.2 Indirect setting method by devices

In the indirect setting method ^(Note-1) by devices, the device No. is specified to the positioning data specified with the servo program.

By using the contents (data) of specified device using the Motion SFC program (Automatic refresh, etc.), multiple positioning controls can be executed in one servo program.

The device used in the indirect setting is the device of the Motion CPU but the device of the PLC CPU.

The device memory composition of the Motion CPU and PLC CPU is shown below.

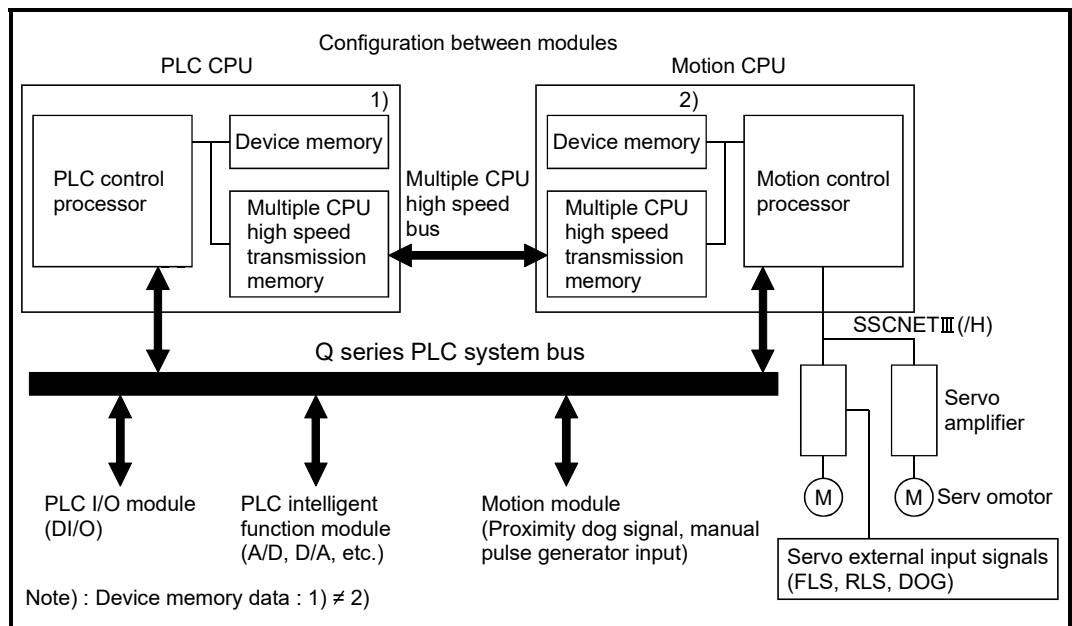

(Note-1): Device memory in the Motion CPU.

5 SERVO PROGRAMS FOR POSITIONING CONTROL

(1) Word devices for indirect setting

The word devices for indirect setting are the data registers (D), link registers (W), motion registers (#) and Multiple CPU area device (U□\G). Word devices except the above devices cannot be used.

The usable setting range of word devices is shown below.

Word device	Setting range
D	0 to 8191
W	0 to 1FFF
#	0 to 7999
U□\G	10000 to (10000+p-1) (Note-1)

(Note-1): "p" indicates the user setting area points of the Multiple CPU high speed transmission area for each CPU.

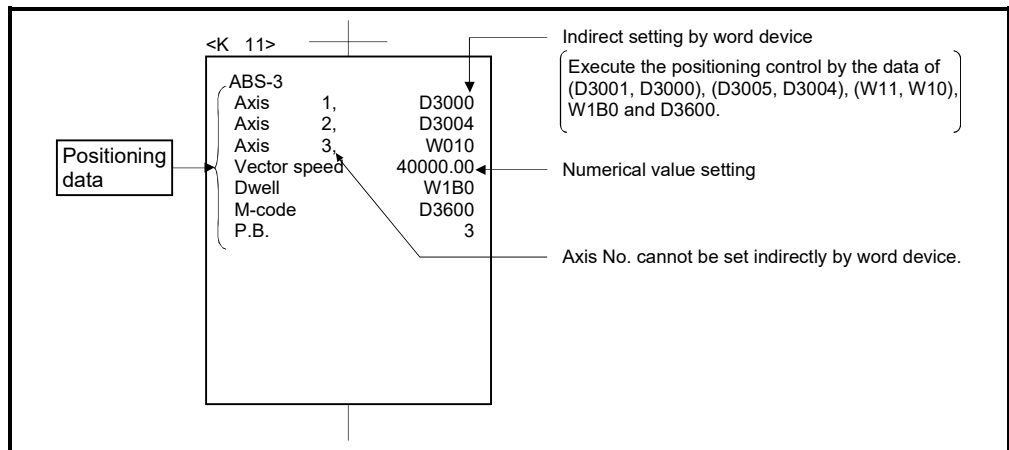



Fig. 5.4 Example of indirect setting by word device for positioning data

(2) Bit devices for indirect setting

The bit devices for indirect setting are the input (X), output (Y), internal relay (M), link relay (B), annunciator (F) and Multiple CPU area device (U□\G). Bit devices except the above devices cannot be used.

The usable setting range of bit devices is shown below.

Bit device	Setting range
X	0000 to 1FFF (Note-1)
Y	0000 to 1FFF
M	0 to 8191
B	0000 to 1FFF
F	0 to 2047
U□\G	10000.0 to (10000+p-1).F (Note-2)

(Note-1): The range of "PXn+4 to PXn+F" cannot be used (fixed at 0) for the input device (PXn+0 to PXn+F) allocated to the built-in interface in Motion CPU (DI). (n: First input No.) 

(Note-2): "p" indicates the user setting area points of the Multiple CPU high speed transmission area for each CPU.

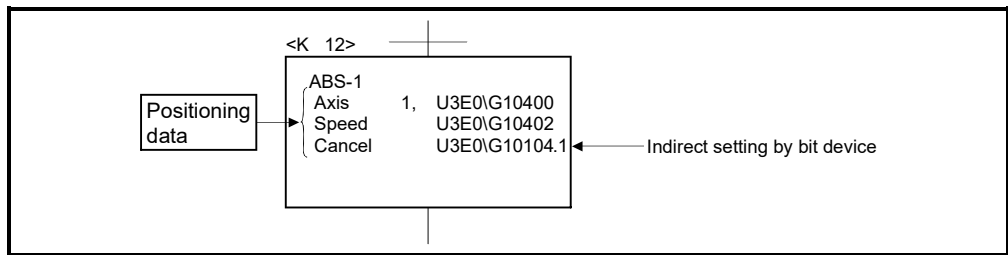

Fig. 5.5 Example of indirect setting by bit device for positioning data

(3) Inputting of positioning data

In indirect setting by word devices, the word device data is inputted when the servo program is executed using the Motion CPU.

It must be executed the start request of the servo program after data is set in the device used for indirect setting at the positioning control.

POINTS

- (1) Indirect setting by word devices of the axis No. cannot be set in the servo program.
- (2) Take an interlock condition by using a start accept flag (M2001 to M2032) not to change the device data for indirect setting until the specified axis has accepted the start command.
If the data is changed before the start command is accepted, positioning may not be controlled in a normal value.
- (3) Refer to Chapter 2 of the "Q173D(S)CPU/Q172D(S)CPU Motion controller Programming Manual (COMMON)" for the user setting area points of the Multiple CPU high speed transmission area.

5 SERVO PROGRAMS FOR POSITIONING CONTROL

(4) Program example that uses the Multiple CPU high speed transmission memory

Program example to control by the data transmitted from the PLC CPU to Motion CPU is shown below.

Program that starts the servo program (positioning) by the DP.SVST instruction after the data is written to the Multiple CPU high speed transmission memory (U3E0\G10000 to U3E0\G10003) from the PLC CPU (CPU No.1).

Sequence program (PLC CPU side)

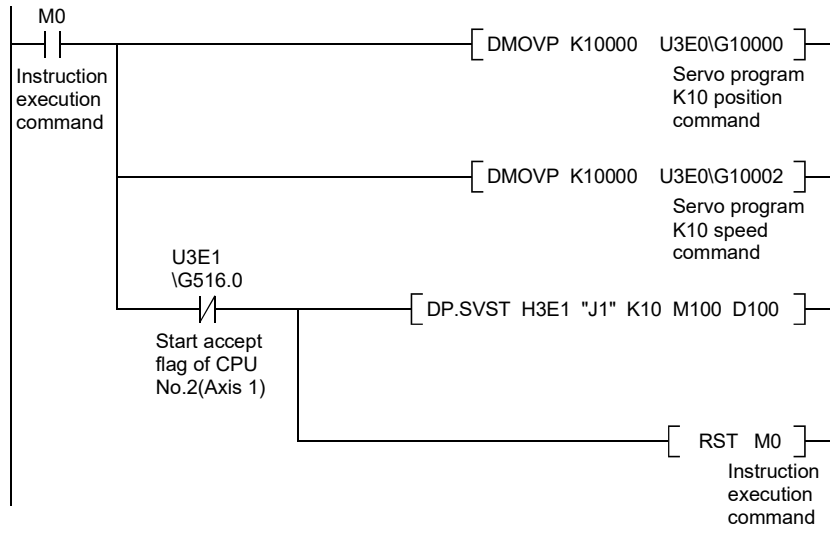

Servo program (Motion CPU side)

[K 10: Real]
1 INC-1
Axis 1, U3E0\G10000 μ m
Speed U3E0\G10002 mm/min

6. POSITIONING CONTROL

This section describes the positioning control methods.

6.1 Basics of Positioning Control

This section describes the common items for positioning control, which is described in detail after Section 6.2.

6.1.1 Positioning speed

The positioning speed is set using the servo program.

Refer to Chapter 5 for details of the servo programs.

The real positioning speed is set in the positioning speed and speed limit value using the servo program is shown below:

- If the positioning speed setting is less than speed limit value, the positioning is executed with the setting positioning speed.
- If the positioning speed setting is less than speed limit value, the positioning is executed with the positioning speed.

Example

- (1) If the speed limit value is 120000[mm/min] and the positioning speed setting is 100000[mm/min], the positioning speed is as follows.

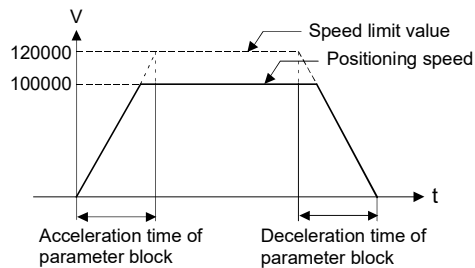

- (2) If the speed limit value is 100000[mm/min] and the positioning speed setting is 120000[mm/min], the positioning speed is as follows.

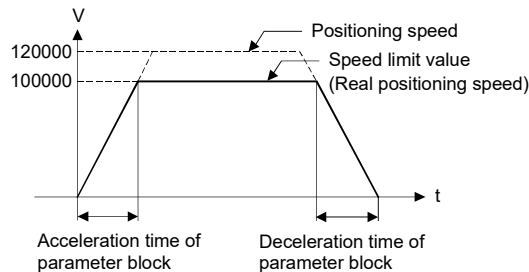

6.1.2 Positioning speed at the interpolation control

The positioning speed of the Motion CPU sets the travel speed of the control system.

(1) 1 axis linear control

Travel speed is the positioning speed of the specified axis at the 1 axis positioning control.

(2) Linear interpolation control

Positioning is controlled with the speed which had the control system specified at the interpolation control.

The positioning speed can be set using one of the following three methods at the 2 to 4 axes linear interpolation control:

- Vector speed specification
- Long-axis speed specification
- Reference-axis speed specification

Control method of the Motion CPU control for every specified method is shown below.

(a) Vector speed specification

The Motion CPU calculates the positioning speed of each axis (V_1 to V_2) using the travel value (D_1 to D_2) of each axis based on the positioning speed (V) of the setting control system.

Positioning speed of the control system is called the vector speed.

Set the vector speed and the travel value of each axis in the servo program.

-----Example-----

2 axes linear interpolation control is shown below.

[Program example]

```

<K 50>
ABS-2
Axis      1,      10000 [pulse]
Axis      2,      15000 [pulse]
Vector speed      7000 [pulse/s]
            
```

Axis 1 travel value : $D_1 = 10000$ [pulse]
 Axis 2 travel value : $D_2 = 15000$ [pulse]
 Vector speed : $V = 7000$ [pulse/s]

The Motion CPU calculates the positioning speed of each axis using the following calculation formulas in the above condition:

Axis 1 positioning speed : $V_1 = V \times D_1 / \sqrt{D_1^2 + D_2^2}$
 Axis 2 positioning speed : $V_2 = V \times D_2 / \sqrt{D_1^2 + D_2^2}$

(b) Long-axis speed specification

It is controlled based on the positioning speed (Long-axis speed: V) of the largest travel value axis among address set as each axis.

The Motion CPU calculates the positioning speed of other axes (V1 to V3) using each axis travel value (D1 to D4).

Set the long-axis speed and the travel value of each axis using the servo program.

----- Example -----

4 axes linear interpolation control is shown below.

Axis 1 travel value : D1 = 10000[pulse]
 Axis 2 travel value : D2 = 15000[pulse]
 Axis 3 travel value : D3 = 5000[pulse]
 Axis 4 travel value : D4 = 20000[pulse]
 Long-axis speed : V = 7000[pulse/s]

[Program example]

ABS-4			
Axis	1,	10000	[pulse]
Axis	2,	15000	[pulse]
Axis	3,	5000	[pulse]
Axis	4,	20000	[pulse]
Long-axis speed		7000	[pulse/s]

In this example, since the reference axis is axis 4 of the largest travel value, it is controlled with the positioning speed specified with axis 4.

The Motion CPU calculates the positioning speed of other axes using the following calculation formulas:

Axis 1 positioning speed : $V_1 = D_1 / D_4 \times V$
 Axis 2 positioning speed : $V_2 = D_2 / D_4 \times V$
 Axis 3 positioning speed : $V_3 = D_3 / D_4 \times V$

The following conversions are performed if the control units of each axis differ.

1) Combination of axes set in [mm] and [inch]

a) If the interpolation control units are [mm]

- Travel value: Convert the travel value of axis set in [inch] into [mm] using the formula: inch setting value \times 25.4.
- Speed : The largest travel value axis is controlled with the long-axis speed and the other axes are controlled with the speed based on the long-axis speed, as the result of conversion.

b) If the interpolation control units are [inch]

- Travel value: Convert the travel value of axis set in [mm] into [inch] using the formula: mm setting value \div 25.4.
- Speed : The largest travel value axis is controlled with the long-axis speed and the other axes are controlled with the speed based on the long-axis speed, as the result of conversion.

2) Discrepancy between interpolation control units and control units

- Travel value: The travel value of each axis is converted into [pulse] unit with the electronic gear of self axis.
- Speed : The largest travel value axis is controlled with the long-axis speed and the other axes are controlled with the speed based on the long-axis speed, as the result of conversion.
The positioning speed is converted into [pulse/s] unit as the long-axis speed with the electronic gear that the interpolation control units correspond to control units.

POINTS

- (1) Speed limit value and positioning speed
- The setting speed limit value applies to the long-axis speed.
 - Be careful that the vector speed may exceed the speed limit value at the long-axis speed specification.

--- Example ---

The following settings at the 2 axes linear interpolation, the vector speed exceeds the speed limit value.

Axis 1 travel value : 100 [pulse]
 Axis 2 travel value : 200 [pulse]
 Long-axis speed : 50 [pulse/s]
 Speed limit value : 55 [pulse/s]

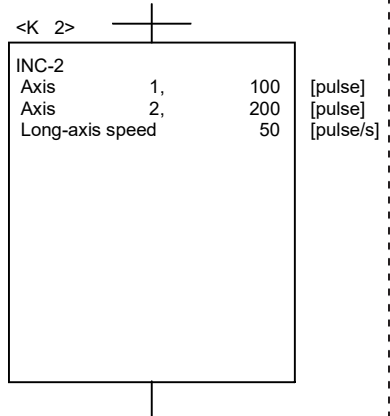

In this example, since the reference-axis is axis 2 of the largest travel value, it is controlled with the speed limit value specified with axis 2.

The positioning speed and vector speed for each axis are as follows:

Axis 1 positioning speed : $100 / 200 \times 50 = 25$ [pulse/s]

Axis 2 positioning speed : 50 [pulse/s]

Vector speed : $\sqrt{25^2 + 50^2} = 55.9$ [pulse/s]

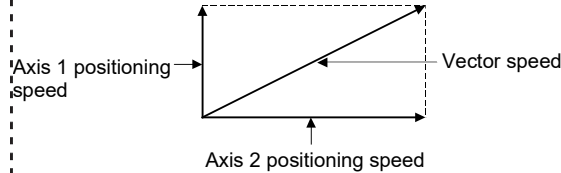

The vector speed exceeds the speed limit value setting of 55.

- (2) Relationship between speed limit value, acceleration time, deceleration time and rapid stop deceleration time.

- The real acceleration time, deceleration time and rapid stop deceleration time are set by the setting long-axis speed.

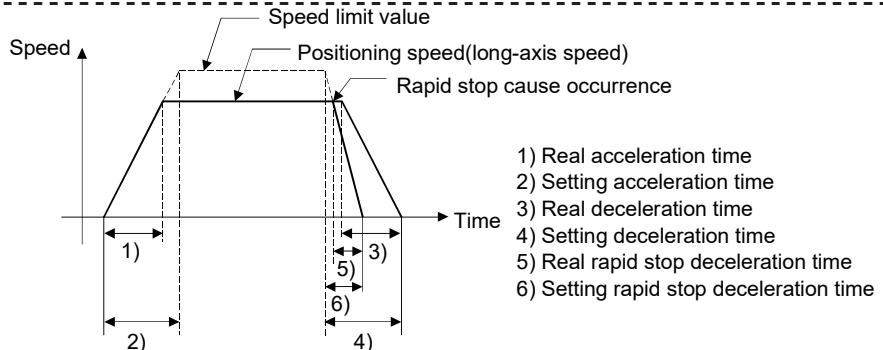

(c) Reference-axis speed specification

The Motion CPU calculates the positioning speed of other axes (V₁ to V₃) based on the positioning speed (reference-axis speed : V) of the setting reference-axis using each axis travel value (D₁ to D₄).

Set the reference-axis No., reference-axis speed and each axis travel value using the servo program.

----- Example -----

4 axes linear interpolation control is shown below.

Axis 1 travel value	: D ₁ = 10000 [pulse]	[Program example]
Axis 2 travel value	: D ₂ = 15000 [pulse]	
Axis 3 travel value	: D ₃ = 5000 [pulse]	
Axis 4 travel value	: D ₄ = 20000 [pulse]	
Reference axis speed	: V = 7000 [pulse/s]	
Reference axis	: Axis 4	

```

<K 52>
ABS-4
Axis 1, 10000 [pulse]
Axis 2, 15000 [pulse]
Axis 3, 5000 [pulse]
Axis 4, 20000 [pulse]
Reference-axis speed 7000 [pulse/s]
Reference-axis 4
    
```

In this example, since the reference-axis is axis 4, it is controlled with the positioning speed specified with axis 4.

The Motion CPU calculates the positioning speed of other axes using the following calculation formulas:

Axis 1 positioning speed	: V ₁ = D ₁ / D ₄ × V
Axis 2 positioning speed	: V ₂ = D ₂ / D ₄ × V
Axis 3 positioning speed	: V ₃ = D ₃ / D ₄ × V

POINTS

- (1) Reference-axis speed and positioning speed of other axes
 - Be careful that the positioning speed of an axis for a larger travel value than the reference-axis may exceed the setting reference-axis speed.
- (2) Indirect specification of the reference-axis
 - The reference-axis can be set indirectly using the word devices.
(Refer to Section 5.4.2.)
- (3) Relationship between speed limit value, acceleration time, deceleration time and rapid stop deceleration time.
 - The real acceleration time, deceleration time and rapid stop deceleration time are set by the reference-axis speed setting.

Speed

Time

Speed limit value

Positioning speed (reference-axis speed)

Rapid stop cause occurrence

- 1) Real acceleration time
- 2) Setting acceleration time
- 3) Real deceleration time
- 4) Setting deceleration time
- 5) Real rapid stop deceleration time
- 6) Setting rapid stop deceleration time

6 POSITIONING CONTROL

(3) Circular interpolation control

The angular speed is controlled with the setting speed at the circular interpolation control.

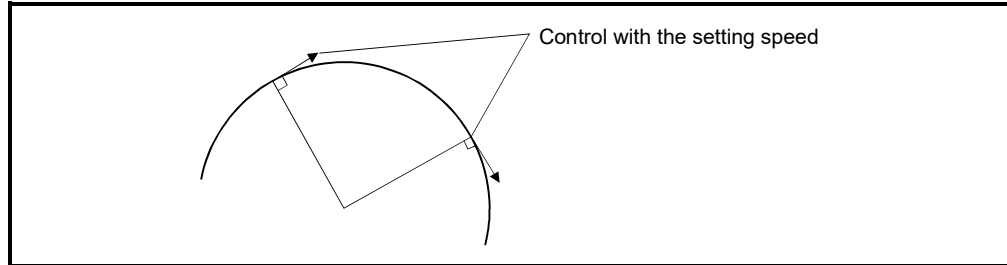

6.1.3 Control units for 1 axis positioning control

It is controlled in the control units specified with the fixed parameters at the 1 axis positioning control.

(The control unit specified with the parameter block is ignored.)

6.1.4 Control units for interpolation control

(1) The interpolation control units specified with the parameter block and the control units of the fixed parameter are checked.

If the interpolation control units specified with the parameter block differ from the control units of each axis fixed parameter for the interpolation control, it shown below.

	Interpolation control units in the parameter block				Starting method
	mm	inch	degree	pulse	
Normal start	There are axes whose control unit set in the fixed parameter is [mm] and [inch].	There are axes whose control unit set in the fixed parameter is [degree].	There are axes whose control unit set in the fixed parameter is [pulse].		Positioning control starts by the interpolation control units of parameter block.
Unit mismatch (Minor error (error code: 40))	Control units of the fixed parameter for all axes differ from the interpolation control units specified with parameter block.				<ul style="list-style-type: none"> • If the control units of axes to be interpolation-controlled are the same, control starts in the preset control unit. • If the control units of axes to be interpolation-controlled are different, control starts in the unit of highest priority as indicated below. <p style="text-align: center;">Priority: pulse > degree > inch > mm</p> <p><Example> If axis is set to 1000[pulse] and 10.000[inch], 10.000[inch] setting is considered to be 10000[pulse].</p>

6 POSITIONING CONTROL

(2) The combinations of each axis control units for interpolation control are shown in the table below.

	mm	inch	degree	pulse
mm	1)	2)	3)	3)
inch	2)	1)	3)	3)
degree	3)	3)	1)	3)
pulse	3)	3)	3)	1)

1): Same units

2): Combination of [mm] and [inch]

3): Unit mismatch

(a) Same units (1)

The position command is calculated with the setting address (travel value), positioning speed or electronic gear, the positioning is executed.

POINT

If control units for one axis are "degree" at the circular interpolation control, use "degree" also for the other axis.

(b) Combination of [mm] and [inch] (2)

- If interpolation control units are [mm], positioning is controlled by calculating position commands from the address, travel value, positioning speed and electronic gear, which have been converted to [mm] using the formula: inch setting value \times 25.4 = mm setting value.
- If interpolation control units are [inch], positioning is controlled by calculating position commands from the address, travel value, positioning speed and electronic gear, which have been converted to [inch] using the formula: mm setting value \div 25.4 = inch setting value.

(c) Discrepancy units (3)

- The travel value and positioning speed are calculated for each axis.
 - a) The electronic gear converts the travel value for the axis to [pulse].
 - b) For axis where the units match, the electronic gear converts the positioning speed to units of [pulse/s].
Positioning is conducted using position commands calculated from travel values converted to [pulse] and speeds and electronic gear converted to [pulse/s].
- If the interpolation control units match for two or more axes at the 3-axes or more linear interpolation, the positioning speed is calculated with the electronic gear for the axis with the lowest No.

6 POSITIONING CONTROL

6.1.5 Control in the control unit "degree"

If the control units are "degree", the following items differ from other control units.

(1) Current value address

The current addresses in the control unit "degree" are ring addresses from 0° to 360° .

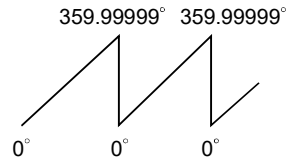

(2) Stroke limit valid/invalid setting

The upper/lower limit value of the stroke limit in the control unit "degree" is within the range of 0° to 359.99999°

(a) Stroke limit is valid

Set the "lower limit value to upper limit value of the stroke limit" in a clockwise direction to validate the stroke limit value.

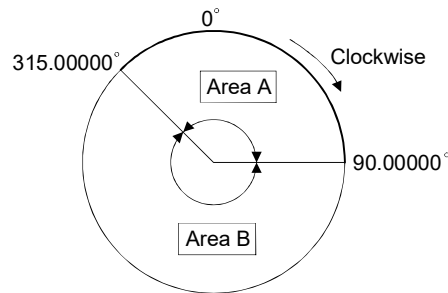

1) If the travel range in area A or area B is set, the limit values are as follows:

Area	Lower stroke limit value	Upper stroke limit value	Remark
Area A	315.00000°	90.00000°	When the feed current value is outside of the stroke limit range, movement in both the positive and negative direction is possible with JOG operation or manual pulse generator operation.
Area B	90.00000°	315.00000°	When the feed current value is outside of the stroke limit range, movement is possible with JOG operation and manual pulse generator operation in the negative direction if "feed current value > upper stroke limit value", or in the positive direction if "feed current value < lower stroke limit value".

(b) Stroke limit is invalid

Set the "upper stroke limit value" equal to "lower stroke limit value" to invalidate the stroke limit value.

It can be controlled regardless the stroke limit settings.

POINTS

- | |
|--|
| <p>(1) Circular interpolation including the axis which set the stroke limit as invalid cannot be executed.</p> <p>(2) When the upper/lower limit value of the axis which set the stroke limit as valid are changed, perform the home position return after that.</p> <p>(3) When the stroke limit is set as valid in the incremental data system, perform the home position return after power supply on.</p> <p>(4) Do not use the high-speed oscillation in the axis that invalidates a stroke limit of control unit "degree".</p> <p>(5) The unlimited length feed is possible by setting the stroke limit to invalid even the control unit is "other than degree axis" (mm, inch, pulse).
(Refer to Section 4.2.3.) QDS</p> |
|--|

(3) Positioning control

Positioning control method in the control unit "degree" is shown below.

(a) Absolute data method (ABS□ instructions)

Positioning in a near direction to the specified address is performed based on the current value.

Example

(1) Positioning is executed in a clockwise direction to travel from the current value of 315.00000° to 0°.

(2) Positioning is executed in a counter clockwise direction to travel from the current value of 0° to 315.00000°.

POINTS

(1) The positioning direction of absolute data method is set a clockwise/counter clockwise direction by the setting method of stroke limit range, positioning in the shortest direction may not be possible.

Example

Travel from the current value 0° to 315.00000° must be clockwise positioning if the lower stroke limit value is set to 0° and the upper limit value is set to 345.00000°.

(2) Set the positioning address within the range of 0° to 360°. Use the incremental data method for positioning of one revolution or more.

(b) Incremental data method (INC□ instructions)

Positioning by the specified travel value to the specified direction.

The travel direction is set by the sign of the travel value, as follows:

- 1) Positive travel valueClockwise rotation
- 2) Negative travel value.....Counter clockwise rotation

POINT

Positioning of 360° or more can be executed in the incremental data method.

6.1.6 Stop processing and restarting after stop

This section describes the stop processing after a stop cause is input during positioning and restarting after stop.

(1) Stop processing

(a) Stop processing methods

Stop processing during positioning by stop cause are as follows.

1) Deceleration stop (Process 1).....Deceleration stop by "stop deceleration time" of parameter block.

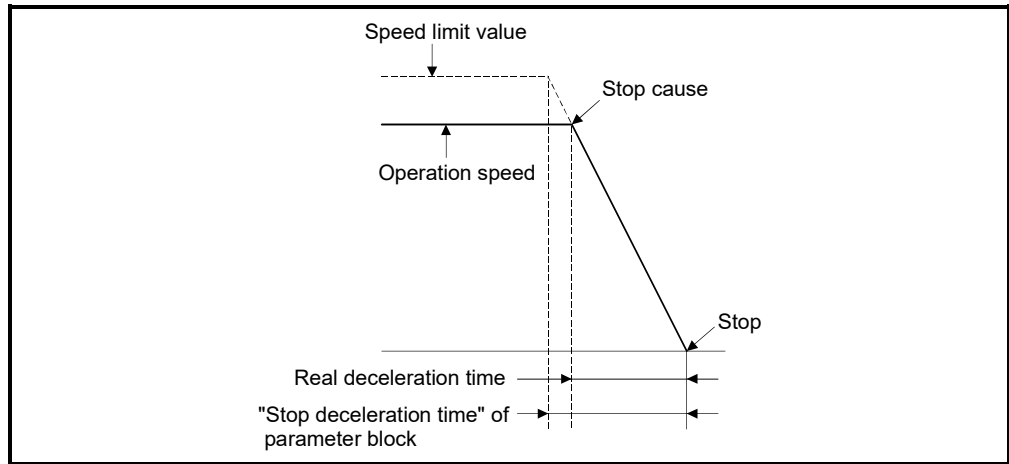

2) Rapid stop (Process 2).....Deceleration stop by "rapid stop deceleration time" of parameter block.

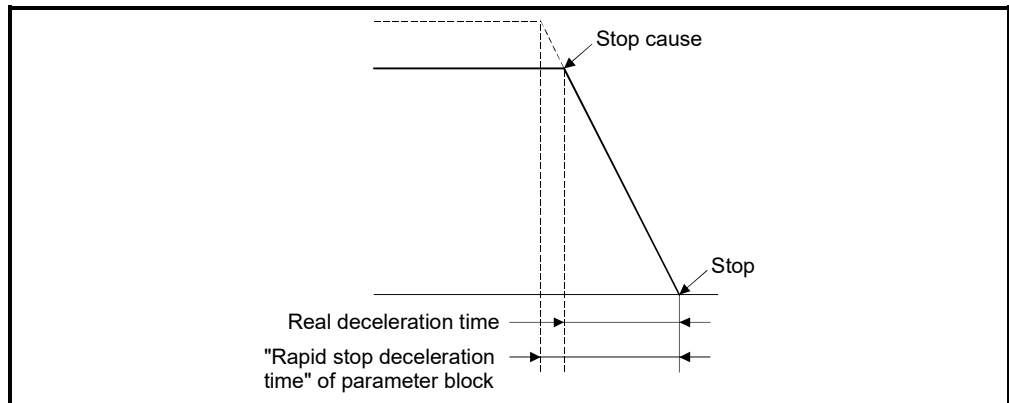

3) Immediate stop (Process 3).....Stop without deceleration processing.

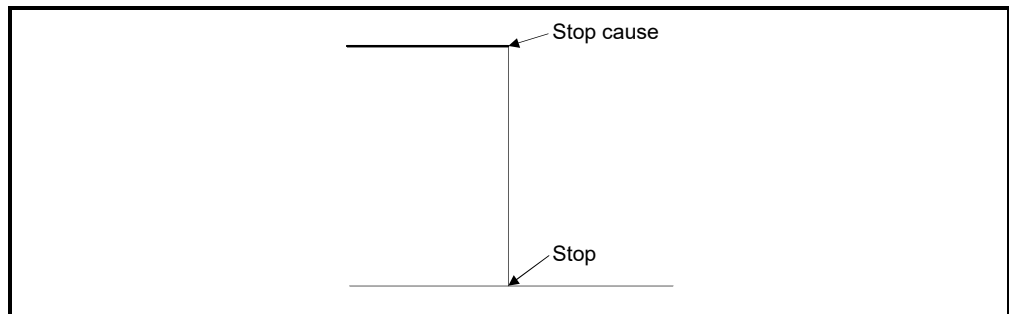

4) Stop using the manual pulse generator (Process 4)
.....Deceleration stop by the "deceleration time" of
(Smoothing magnification + 1) × 56.8[ms].

(b) Priority for stop processing
Priority for stops when a stop cause is input is as follows:

Process 1 < Process 2 < Process 3

Example

A rapid stop is started if a rapid stop cause is input during one of the following types of deceleration stop processing :

- After automatic deceleration start during positioning control;
- During deceleration after JOG start signal turns off;
- During deceleration stop processing by stop cause (Process 1).

The diagram illustrates the transition from a normal deceleration stop to a rapid stop. It shows a velocity profile where the velocity is constant, then decelerates linearly. A 'Rapid stop cause' is input at the end of the normal deceleration phase. This triggers a 'Rapid stop detection processing' phase, which is a steeper deceleration that brings the system to a 'Stop' state more quickly than the original deceleration phase.

6 POSITIONING CONTROL

(c) Stop commands and stop causes

Some stop commands and stop causes affect individual axis and others affect all axes.

However, during interpolation control, stop commands and stop causes which affect individual axis also stop the interpolation axis.

For example, both Axis 1 and Axis 2 stop after input of a stop command (stop cause) during the Axis 1 and Axis 2 interpolation control.

No.	Stop cause	Axis classification	Stop processing					Error processing		
			Positioning control	Speed control	JOG operation	Home position return	Manual pulse generator			
1	STOP signal input (STOP) of the Q172DLX ON	Individual	Process 1 or Process 2 • According to deceleration processing on STOP input parameter of parameter block.				Process 4	Refer to "APPENDIX 1 Error Codes Stored Using The Motion CPU"		
2	Stop command (M3200+20n) ON		Process 1							
3	Rapid stop command (M3201+20n) ON		Process 2							
4	FLS input signal OFF of Q172DLX/servo amplifier		Process 1 or Process2 • According to deceleration processing on STOP input parameter of parameter block.							
5	RLS input signal OFF of Q172DLX/servo amplifier									
6	Servo error detection (M2408+20n) ON		Process 2 (The servo motor stops with dynamic brake.)							
7	PLC ready flag (M2000) OFF	All axes	Process 1			Process 4	—			
8	Deceleration stop using MT Developer2 (Note-1)		Process 1							
9	Rapid stop of the all axes using MT Developer2 (Note-1)		Process 2							
10	Motion CPU stop		Process 1							
11	Multiple CPU system reset		Process 3						—	
12	Motion CPU WDT error		Process 3						SM512 (Motion CPU WDT error flag) ON	
13	Other CPU WDT error	Process 1				—				
14	Multiple CPU system power off	Process 3				—				
15	Forced stop	Process 3				Servo amplifier is stopped at the servo OFF.				
16	Servo amplifier control circuit power off	Individual	Process 3						Major error at the start (no servo)	
17	Speed change to speed "0"	Individual (Note-2)	Process 1			—			—	

(Note-1): Test mode

(Note-2): Applies to all axes used in the servo program set in the speed "0".

(2) Re-starting after stop

(a) If it stopped by the stop command or stop cause (except change speed to speed "0"), re-starting is not possible.

However, if stopped by the STOP input of the Q172DLX ON, the stop command (M3200+20n) ON or the rapid stop command (M3201+20n) ON during speed-position switching control, re-starting is possible using VPSTART instruction.

(b) If it stopped by the speed change to speed "0" using CHGV instruction, re-starting is possible by executing the speed change to speed other than "0".

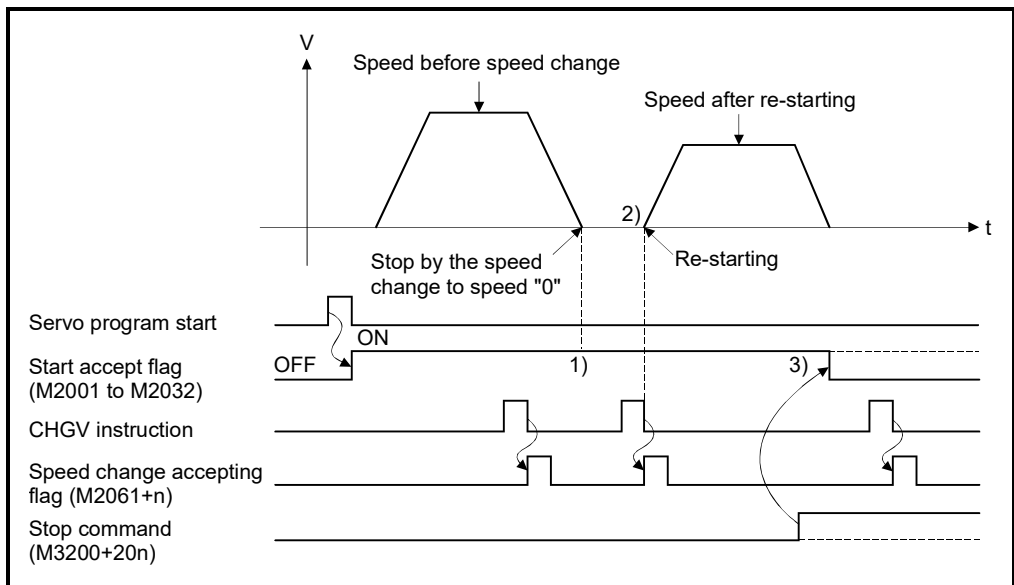

1) The start accept flag (M2001 to M2032) remains on after stop by the speed change to "0".

2) Re-starting by changing the speed again.

3) However, if the start accept flag (M2001 to M2032) turns off by turning on the stop command (M3200+20n), re-starting is not possible even if make a speed change once again.

(3) Continuation of positioning control

This section describes the processing which performed servo program No. which was being performed before the stop, after stop by turning on the STOP input of the Q172DLX ON, the stop command (M3200+20n) ON or the rapid stop command (M3201+20n) ON.

(a) 1 axis linear control/2 or 3 axes linear interpolation control

1) For ABS□ Positioning control from the stop address to target address by the target address specification.

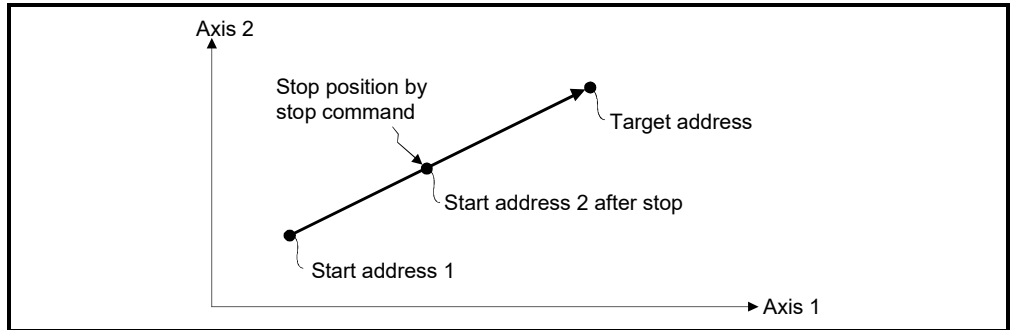

2) For INC□ Positioning control of the travel value from the stop address.

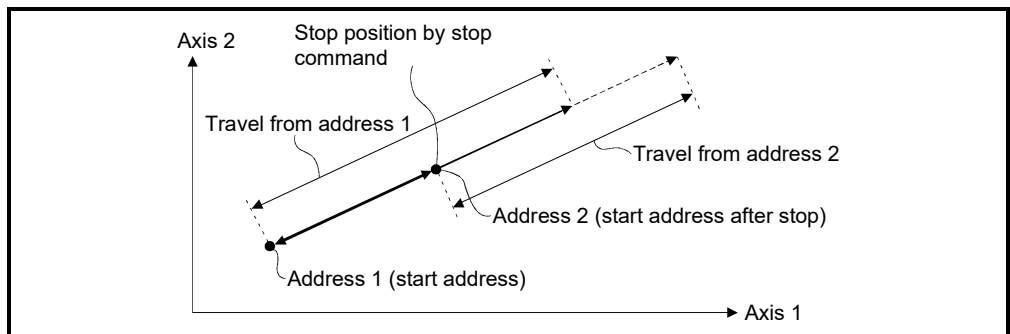

When the address 2 is moved to the same address (address which calculates with start address + specified travel value) using the INC□, the following processing using the servo program and Motion SFC program is required.

[Servo Program]

The travel value of servo program which executes the positioning from address is set indirectly by the word devices, as follows.

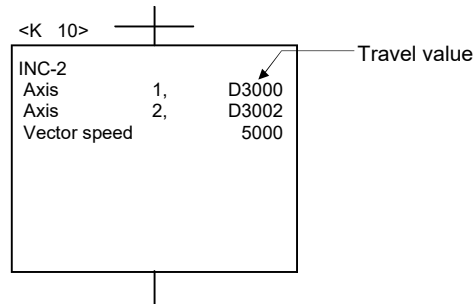

6 POSITIONING CONTROL

[Processing in the Motion SFC Program]

- 1) Transfer the start address to word devices of the Motion CPU before starting.
- 2) Calculate the target address by applying the travel value to the address before starting.
- 3) Calculate the residual travel value by subtracting the stop address from the target address.
- 4) Store the residual travel value in the servo program for travel value register.
- 5) Perform the servo program.

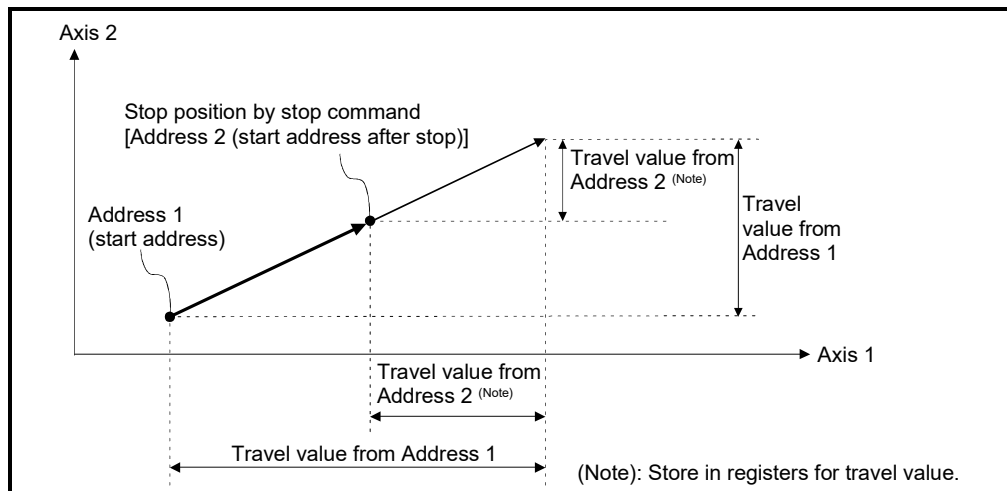

6.1.7 Acceleration/deceleration processing

Acceleration/deceleration are processed by the following three methods.

(1) Trapezoidal acceleration/deceleration processing

This is a conventional linear acceleration/deceleration processing.

The acceleration/deceleration graph resembles a trapezoid, as shown in the diagram below.

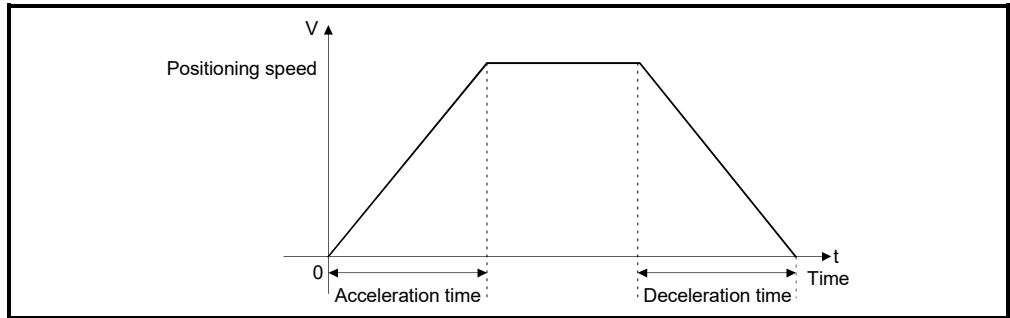

(2) S-curve acceleration/deceleration processing

S-curve ratio is set as a parameter to smoothly provide acceleration/deceleration processing than trapezoidal acceleration/deceleration processing. The acceleration/deceleration graph is a sine curve as shown in the diagram below.

Set the S-curve ratio by the parameter block (Refer to Section 4.3.2) or using the servo program.

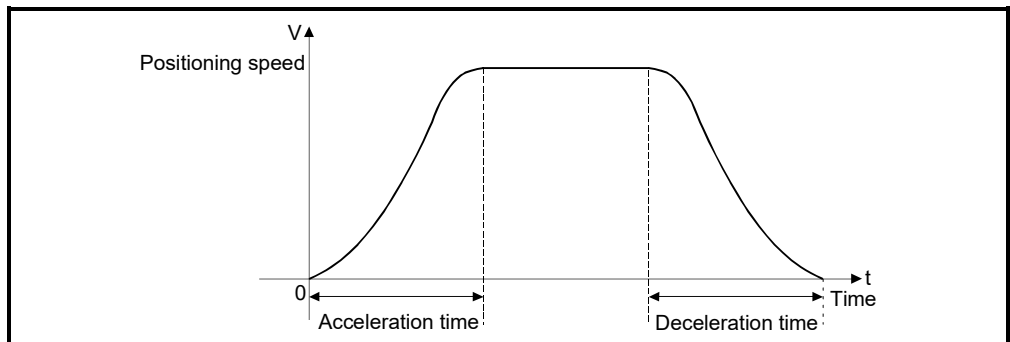

S-curve ratio set the part of the sine curve used to produce the acceleration and deceleration curve as shown in the diagram below.

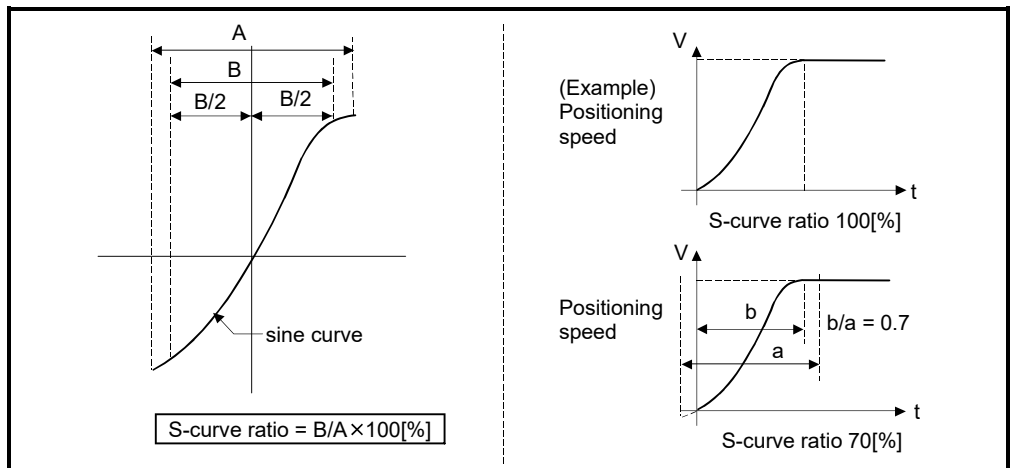

S-curve ratio can be set by the servo program is following two methods.

(a) Direct specification

S-curve ratio is set directly as a numeric value from 0 to 100.

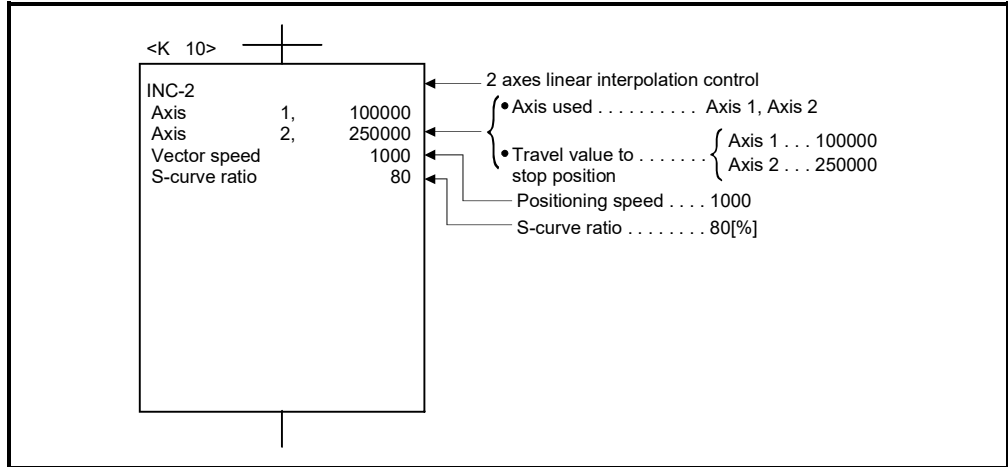

(b) Indirect specification

S-curve ratio is set by the contents of data registers.

The usable data registers are shown below.

Word devices	Usable devices
D	0 to 8191
W	0 to 1FFF
#	0 to 7999
U□G	10000 to (10000+p-1) (Note-1)

(Note-1): "p" indicates the user setting area points of the Multiple CPU high speed transmission area for each CPU.

Refer to Chapter 2 of the "Q173D(S)CPU/Q172D(S)CPU Motion controller Programming Manual (COMMON)" for the user setting area points of the Multiple CPU high speed transmission area.

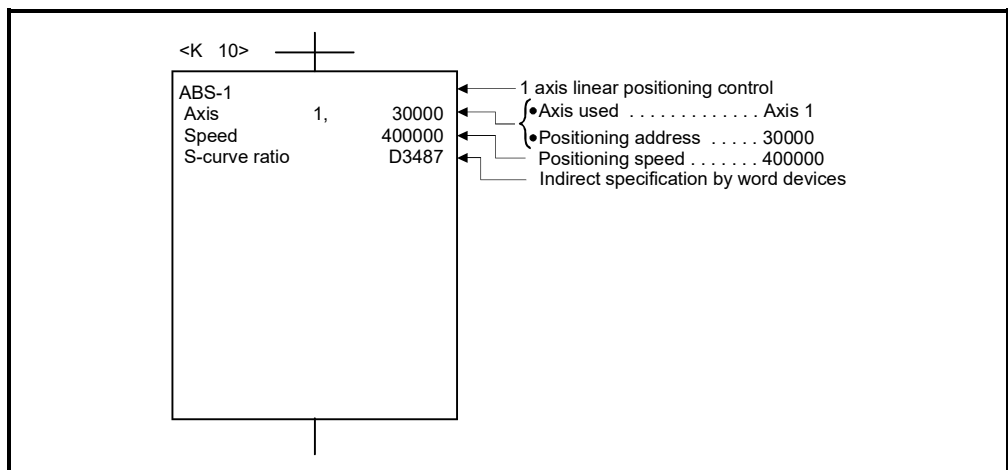

(3) Advanced S-curve acceleration/deceleration processing **Ver.!**

Processing for smooth acceleration/deceleration can be executed by using the Advanced S-curve acceleration/deceleration function. The acceleration section is set as a sine curve as shown in the diagram below.

Set the advanced S-curve acceleration/deceleration by the parameter block (Refer to Section 4.3.3) or servo program.

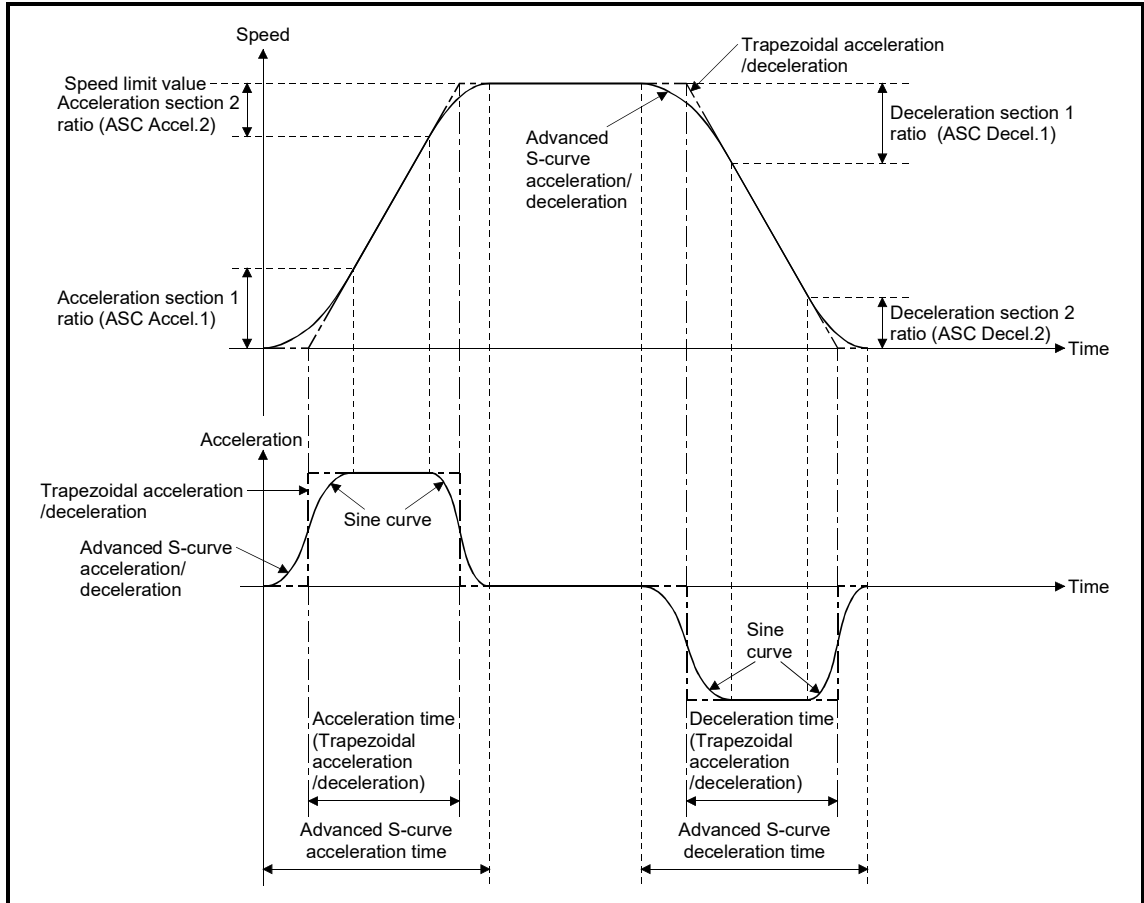

Ver.! : Refer to Section 1.3 for the software version that supports this function.

Advanced S-curve acceleration/deceleration can be set by the servo program is following two methods.

(a) Direct specification

Advanced S-curve acceleration/deceleration system and advanced S-curve acceleration/deceleration ratio are set directly as a numeric value.

Setting items	Setting range
ASC System	0: Trapezoidal/S-curve acceleration/deceleration 1: Advanced S-curve acceleration/deceleration
ASC Accel.1	0.0 to 100.0[%] (Note)
ASC Accel.2	
ASC Decel.1	
ASC Decel.2	

(Note): ASC Accel.1 + ASC Accel.2 ≤ 100.0%, ASC Decel.1 + ASC Decel.2 ≤ 100.0%

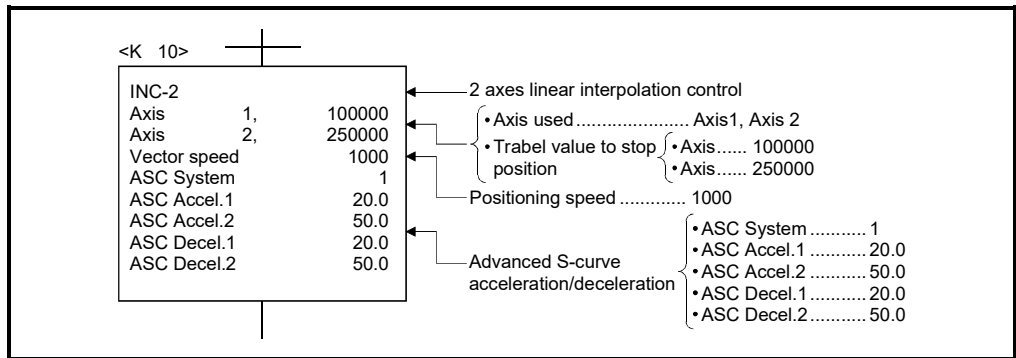

(b) Direct specification

Advanced S-curve acceleration/deceleration system and advanced S-curve acceleration/deceleration ratio is set by the contents of data registers.

Word devices	Usable devices
D	0 to 8191
W	0 to 1FFF
#	0 to 7999
U□VG	10000 to (10000+p-1) (Note-1)

(Note-1): "p" indicates the user setting area points of the Multiple CPU high speed transmission area for the each CPU.

Refer to Chapter 2 of the "Q173D(S)CPU/Q172D(S)CPU Motion controller Programming Manual (COMMON)" for the user setting area points of the Multiple CPU high speed transmission area.

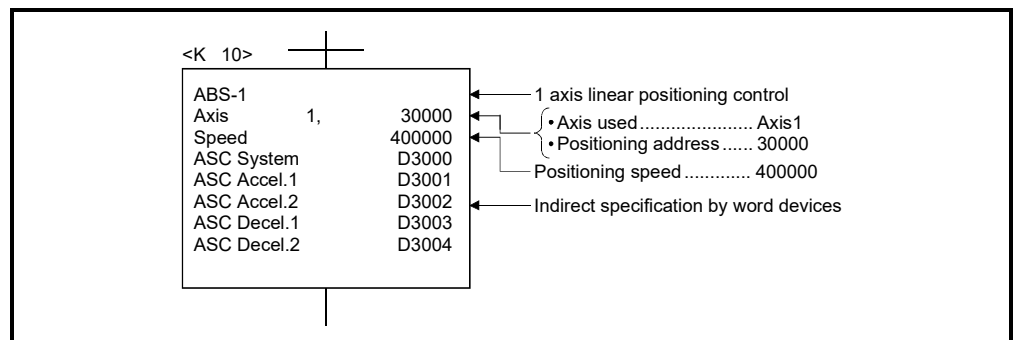

Control using INC-1 (Incremental data method)

- (1) Positioning control of the specified travel value from the current stop position address is executed.
- (2) The travel direction is set by the sign (+/-) of the travel value, as follows:
 - Positive travel valuePositioning control to forward direction (Address Increase direction)
 - Negative travel value.....Positioning control to reverse direction (Address decrease direction)

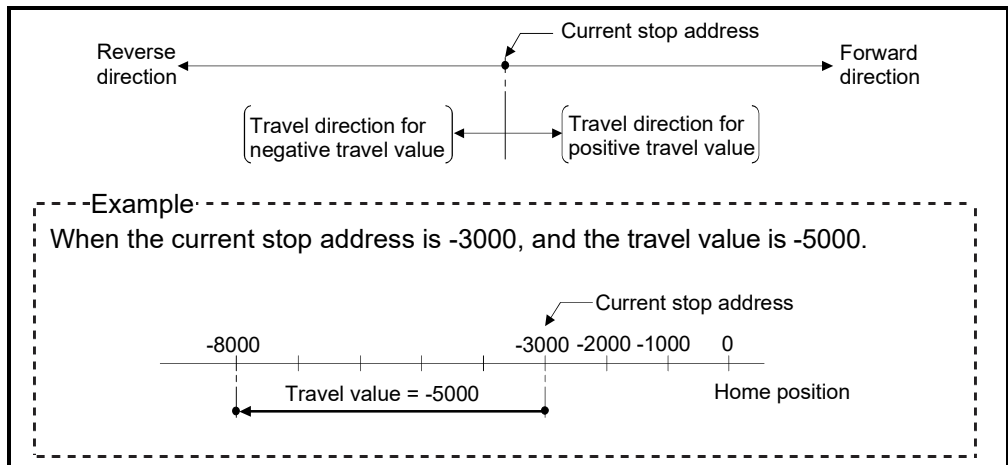

Fig.6.2 Positioning using incremental data method

[Program]

Servo program No. 0 for positioning control is shown as the following conditions.

(1) System configuration

1 axis linear positioning control of Axis 4.

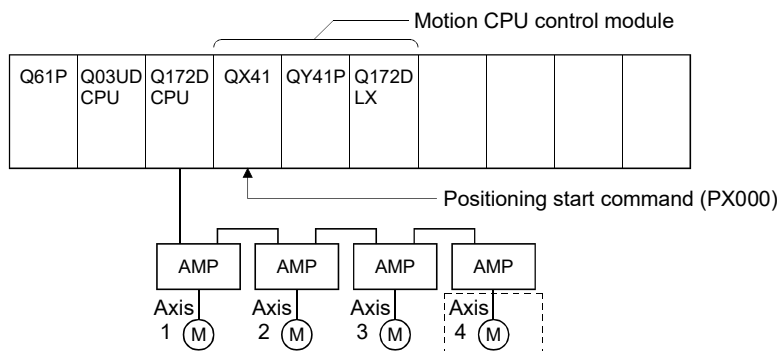

(2) Positioning operation details

Positioning using the servo program No.0 is shown below.

In this example, Axis 4 is used in servo program No.0.

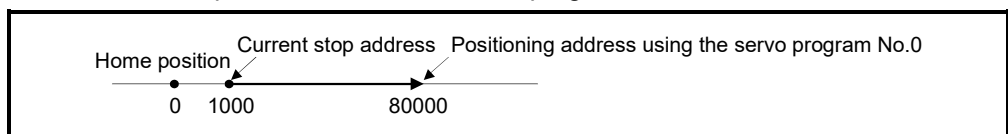

(3) Operation timing

Operation timing for the servo program No.0 is shown below.

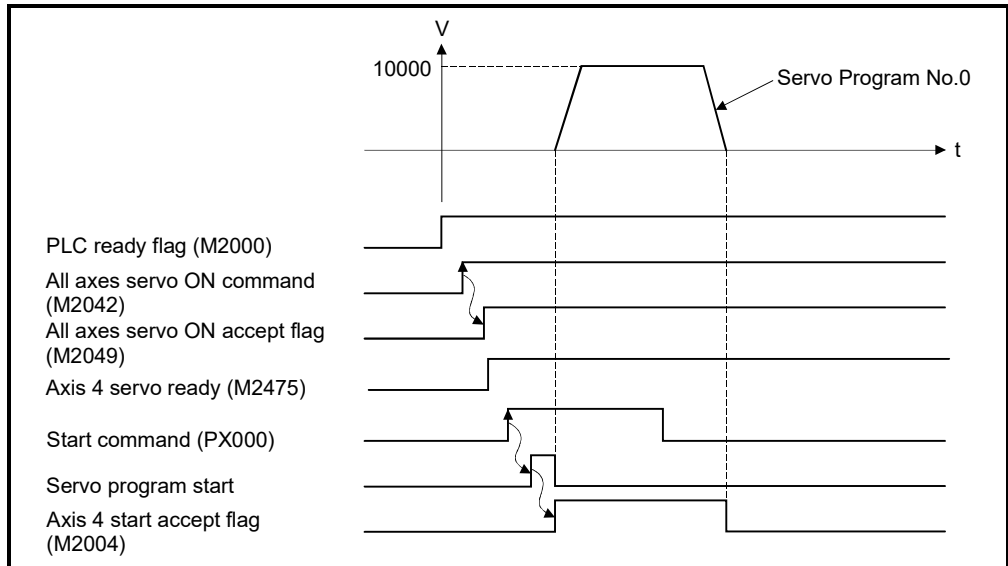

(4) Servo program

Servo program No.0 for positioning control is shown below.

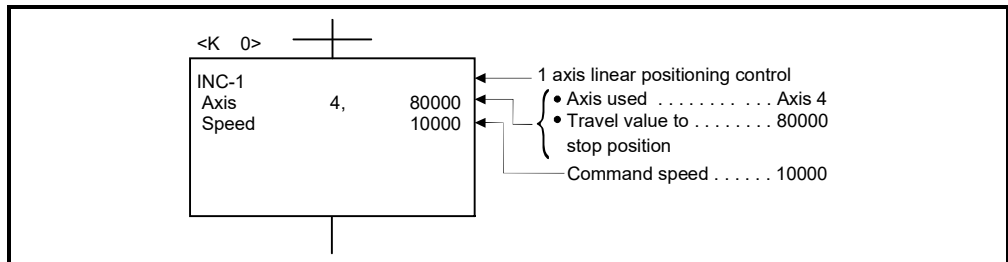

(5) Motion SFC program

Motion SFC program for which executes the servo program is shown below.

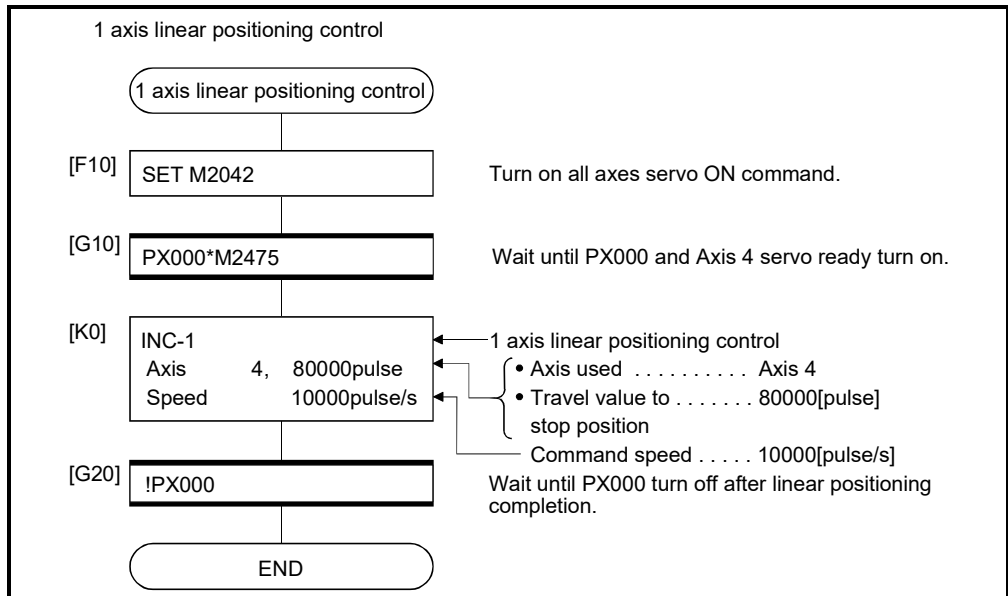

(Note): Example of the above Motion SFC program is started using the automatic start or sequence program.

6 POSITIONING CONTROL

6.3 2 Axes Linear Interpolation Control

Linear interpolation control from the current stop position with the specified 2 axes is executed.

ABS-2 (Absolute data method) and INC-2 (Incremental data method) servo instructions are used in the 2 axes linear interpolation control.

Servo instruction	Positioning method	Number of control axes	Items set using MT Developer2																	Speed change				
			Common							Arc		Parameter block							Others					
			Parameter block No.	Axis	Address/travel value	Command speed	Dwell time	M-code	Torque limit value	Auxiliary point	Radius	Central point	Interpolation control unit	Speed limit value	Acceleration time	Deceleration time	Rapid Stop deceleration time	Torque limit value	Deceleration processing on stop input		Allowable error range for circular interpolation	S-curve ratio	Advanced S-curve acceleration/deceleration	Cancel
ABS-2	Absolute	2	△	○	○	○	△	△					△	△	△	△	△			△	△	△		Valid
INC-2	Incremental																							

○: Must be set
△: Set if required

[Control details]

Control using ABS-2 (Absolute data method)

- (1) 2 axes linear interpolation from the current stop address (X1 or Y1) based on the home position to the specified address (X2 or Y2) is executed.

- (2) The travel direction is set by the stop address (starting address) and positioning address of each axis.

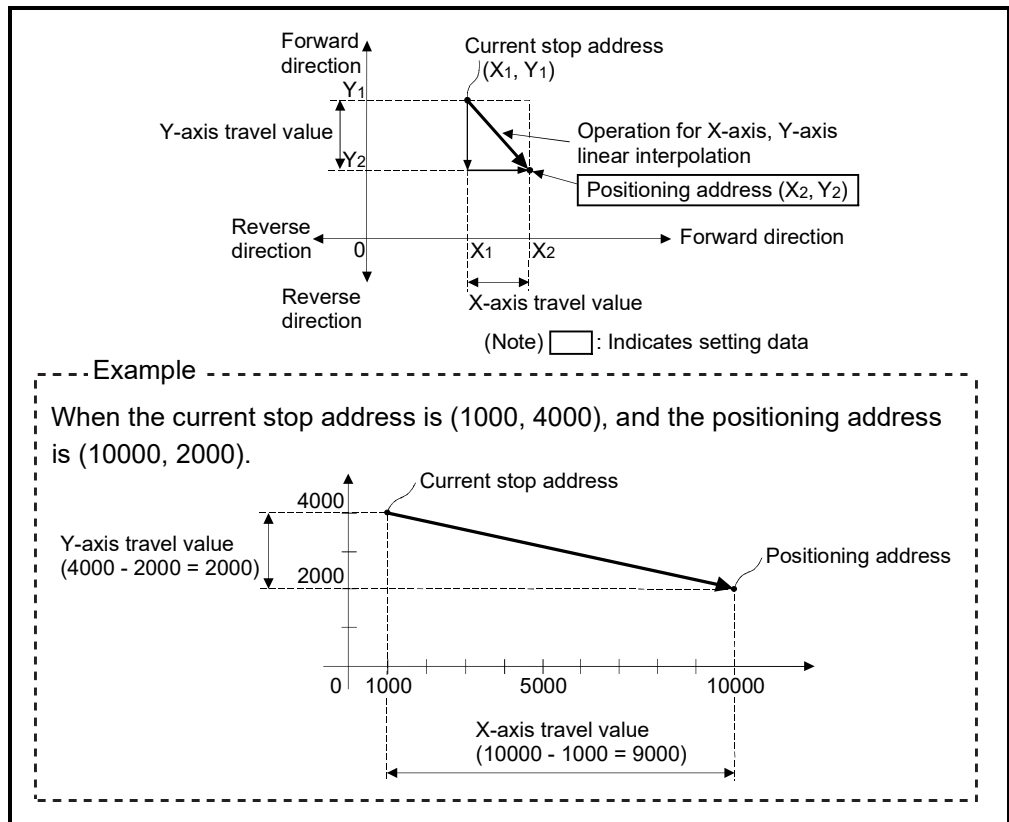

Fig.6.3 Positioning using absolute data method

Control using INC-2 (Incremental data method)

- (1) Positioning control from the current stop address to the position which combined travel direction and travel value specified with each axis is executed.
- (2) The travel direction for each axis is set by the sign (+/-) of the travel value for each axis, as follows:
 - Positive travel valuePositioning control to forward direction (Address increase direction)
 - Negative travel value.....Positioning control to reverse direction (Address decrease direction)

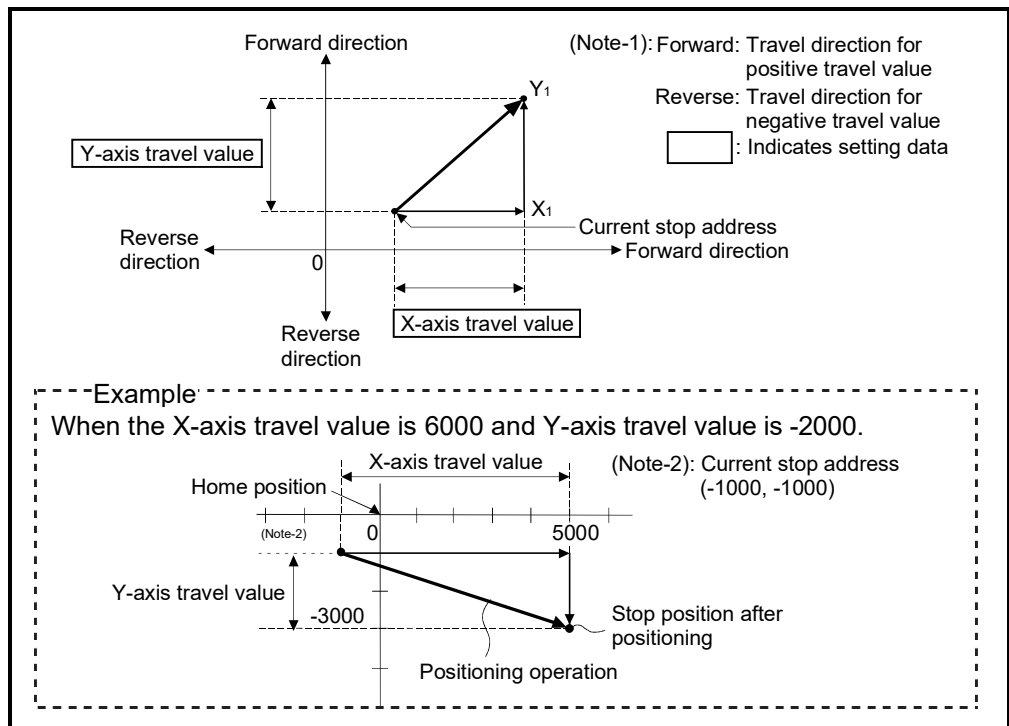

Fig.6.4 Positioning using incremental data method

[Program]

Program for 2 axes linear interpolation control is shown as the following conditions.

(1) System configuration

2 axes linear interpolation control of Axis 3 and Axis 4.

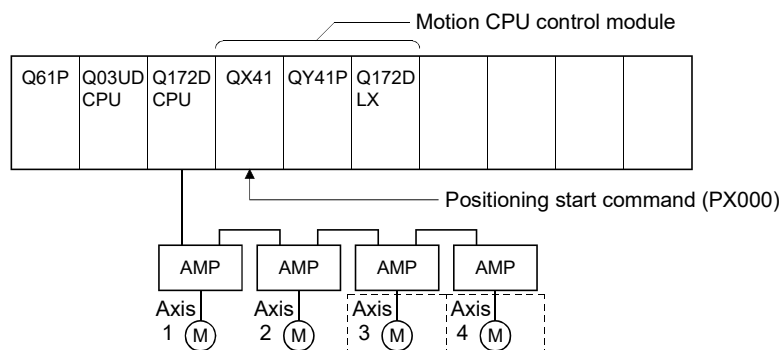

(2) Positioning operation details

The positioning is used the Axis 3 and Axis 4 servo motors.

The positioning operation by the Axis 3 and Axis 4 servo motors is shown in the diagram below.

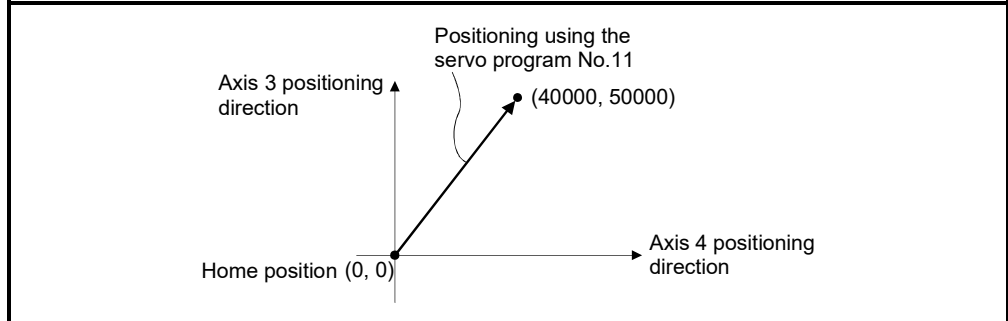

(3) Positioning conditions

(a) Positioning conditions are shown below.

Item	Servo Program No.
	No.11
Positioning speed	30000

(b) Positioning start command PX000 Leading edge (OFF → ON)

(4) Operation timing

Operation timing for 2 axes linear interpolation control is shown below.

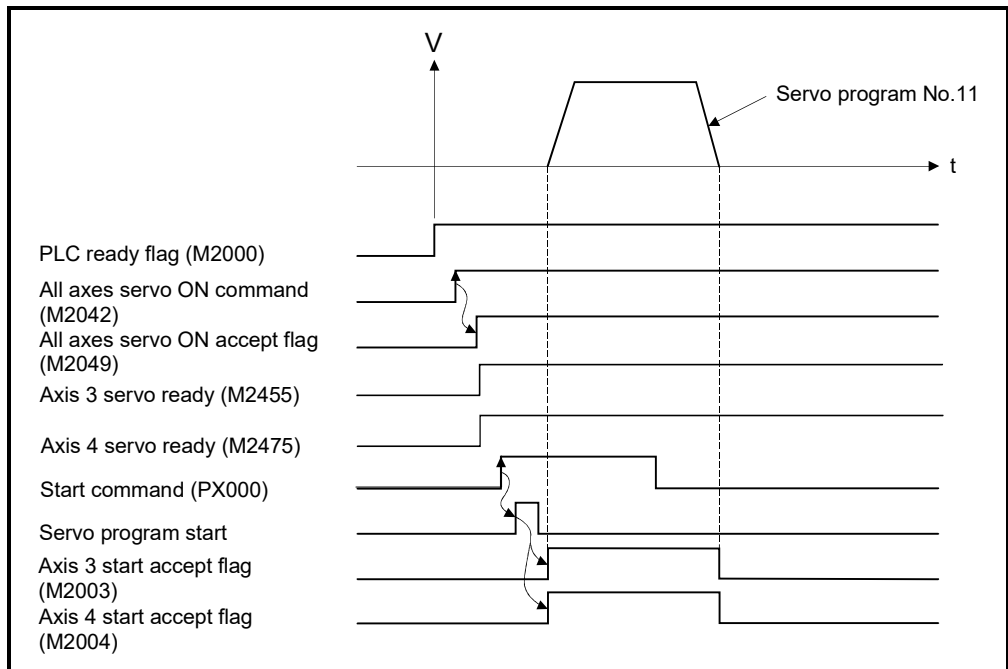

(5) Servo program

Servo program No.11 for 2 axes linear interpolation control is shown below.

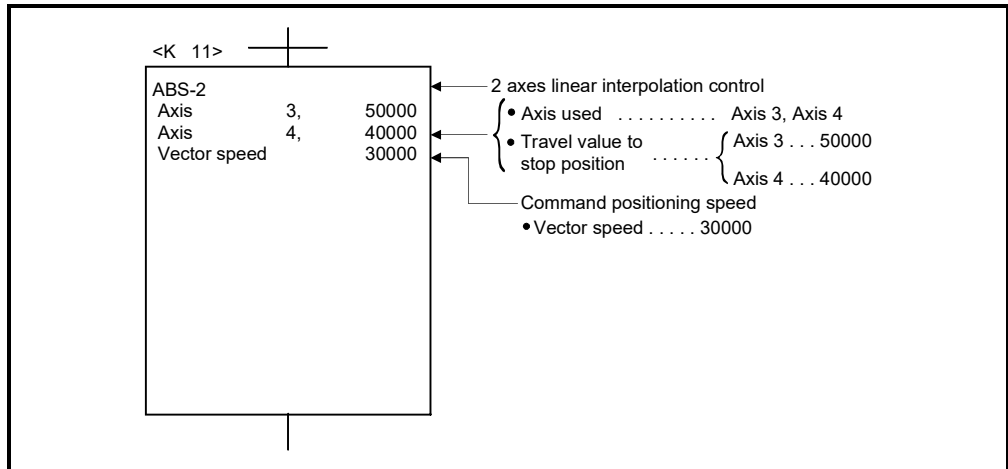

(6) Motion SFC program

Motion SFC program for which executes the servo program is shown below.

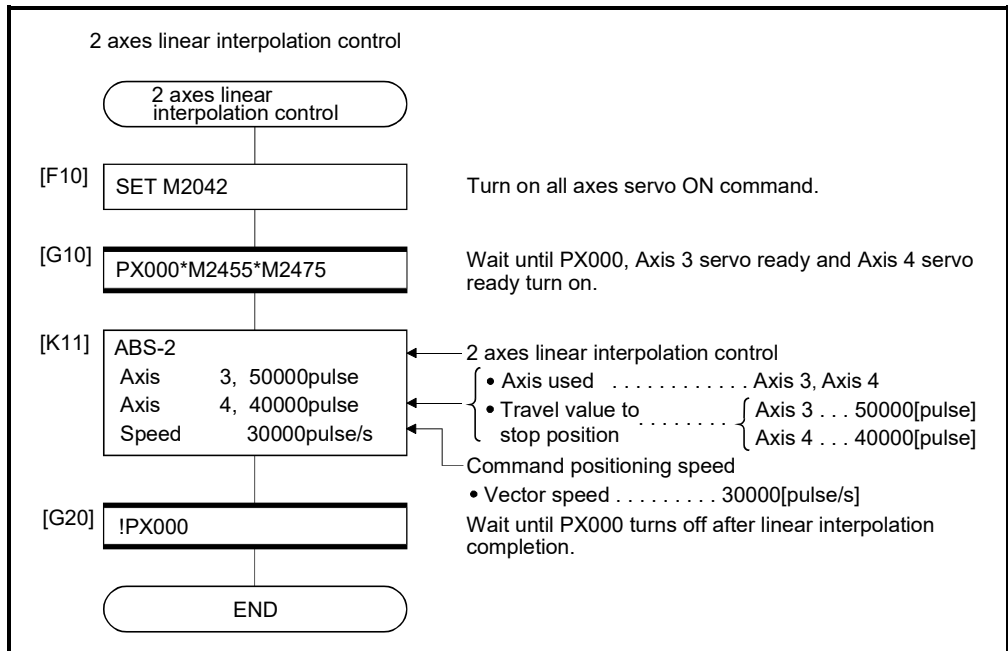

(Note): Example of the above Motion SFC program is started using the automatic start or sequence program.

6 POSITIONING CONTROL

6.4 3 Axes Linear Interpolation Control

Linear interpolation control from the current stop position with the specified 3 axes is executed.

Servo instruction	Positioning method	Number of control axes	Items set using MT Developer2																Speed change					
			Common						Arc			Parameter block						Others						
			Parameter block No.	Axis	Address/travel value	Command speed	Dwell time	M-code	Torque limit value	Auxiliary point	Radius	Central point	Interpolation control unit	Speed limit value	Acceleration time	Deceleration time	Rapid Stop deceleration time	Torque limit value		Deceleration processing on stop input	Allowable error range for circular interpolation	S-curve ratio	Advanced S-curve acceleration/deceleration	Cancel
ABS-3	Absolute	3	△	○	○	○	△	△					△	△	△	△	△			△	△	△		Valid
INC-3	Incremental																							

○: Must be set
△: Set if required

[Control details]

Control using ABS-3 (Absolute data method)

- (1) 3 axes linear interpolation from the current stop address (X_1, Y_1 or Z_1) based on the home position to the specified positioning address (X_2, Y_2, Z_2) is executed.
- (2) The travel direction is set by the stop address and specified address of each axis.

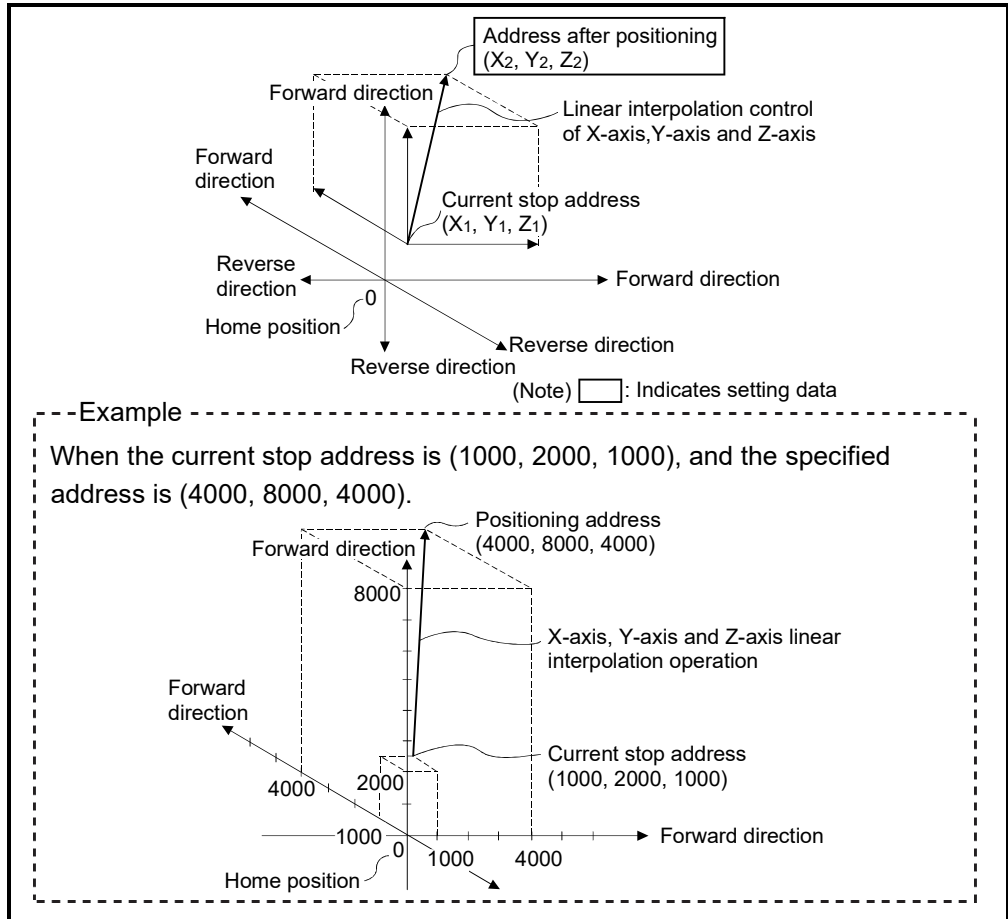

Fig.6.5 Positioning using absolute data method

Control using INC-3 (Incremental data method)

- (1) Positioning control from the current stop address to the position which combined travel direction and travel value specified with each axis is executed.
- (2) The travel direction for each axis is set by the sign (+/-) of the travel value for each axis, as follows:
 - Positive travel valuePositioning control to forward direction (Address increase direction)
 - Negative travel value.....Positioning control to reverse direction (Address decrease direction)

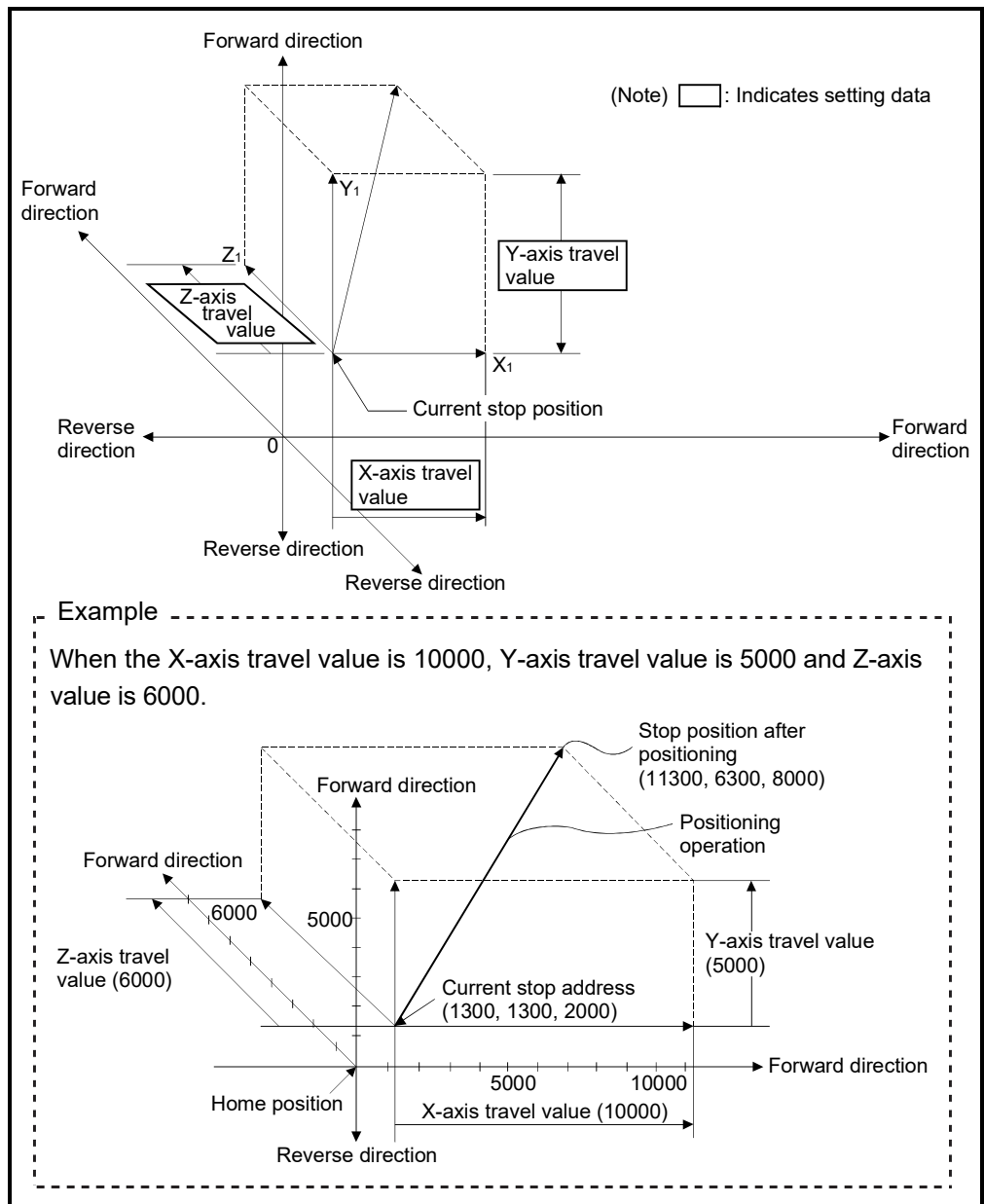

Fig.6.6 Positioning using incremental data method

[Program]

Program for 3 axes linear interpolation control is shown as the following conditions.

(1) System configuration

3 axes linear interpolation control of Axis 1, Axis 2 and Axis 3.

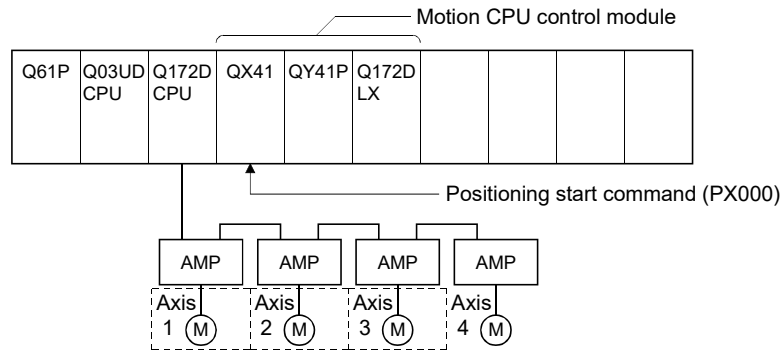

(2) Positioning operation details

The positioning is used the Axis 1, Axis 2 and Axis 3 servo motors.

The positioning operation by the Axis 1, Axis 2 and Axis 3 servo motors is shown in the diagram below.

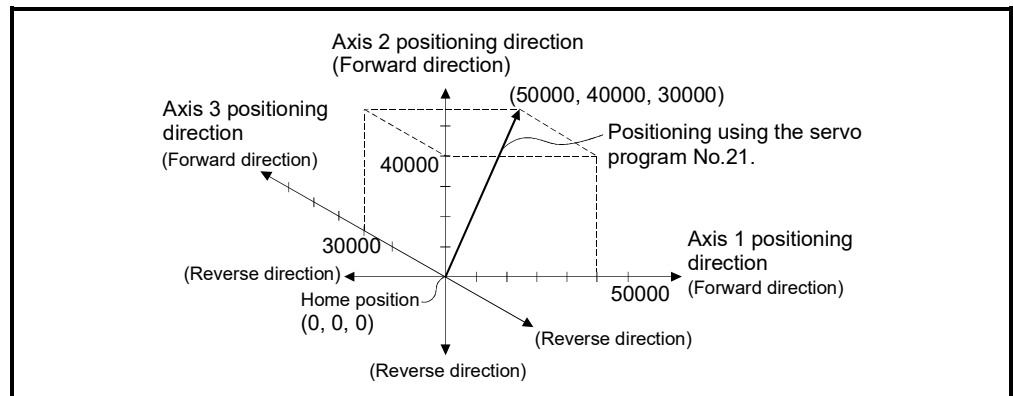

(3) Positioning conditions

(a) Positioning conditions are shown below.

Item	Servo Program No.
Positioning method	Absolute data method
Positioning speed	1000

(b) Positioning start command PX000 Leading edge (OFF → ON)

(4) Operation timing

Operation timing for 3 axes linear interpolation control is shown below.

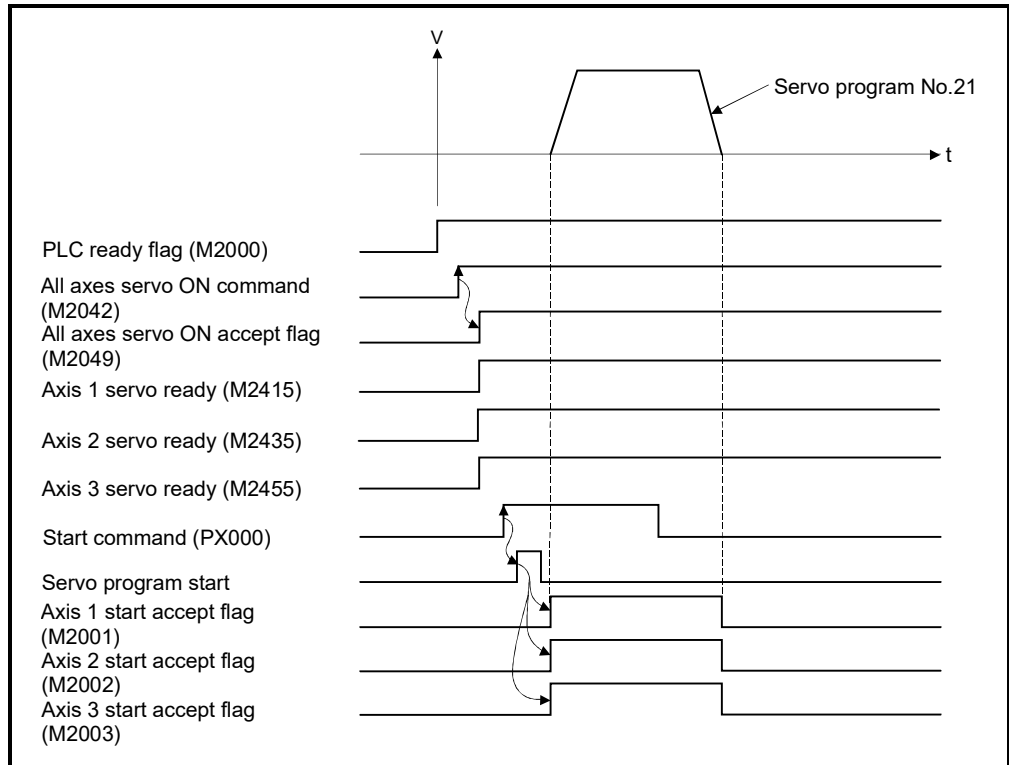

(5) Servo program

Servo program No.21 for 3 axes linear interpolation control is shown below.

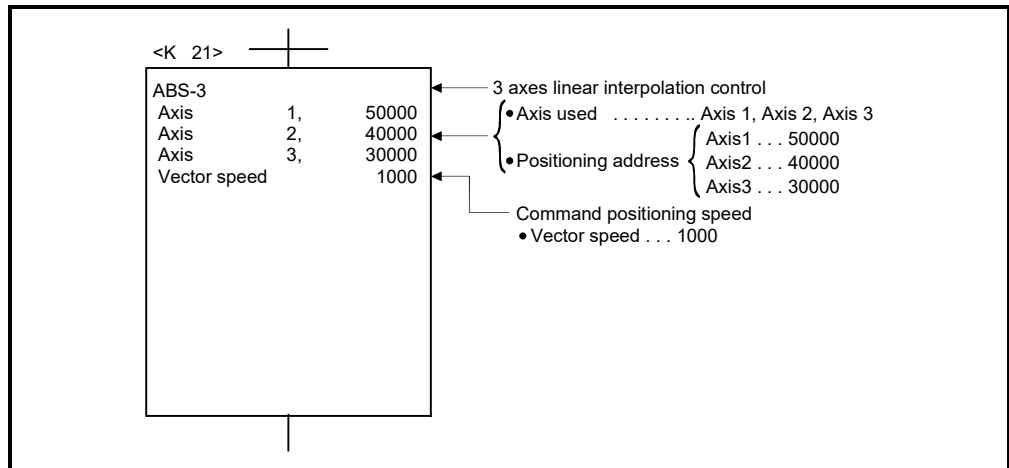

(Note): Example of the Motion SFC program for positioning control is shown next page.

(6) Motion SFC program

Motion SFC program for which executes the servo program is shown below.

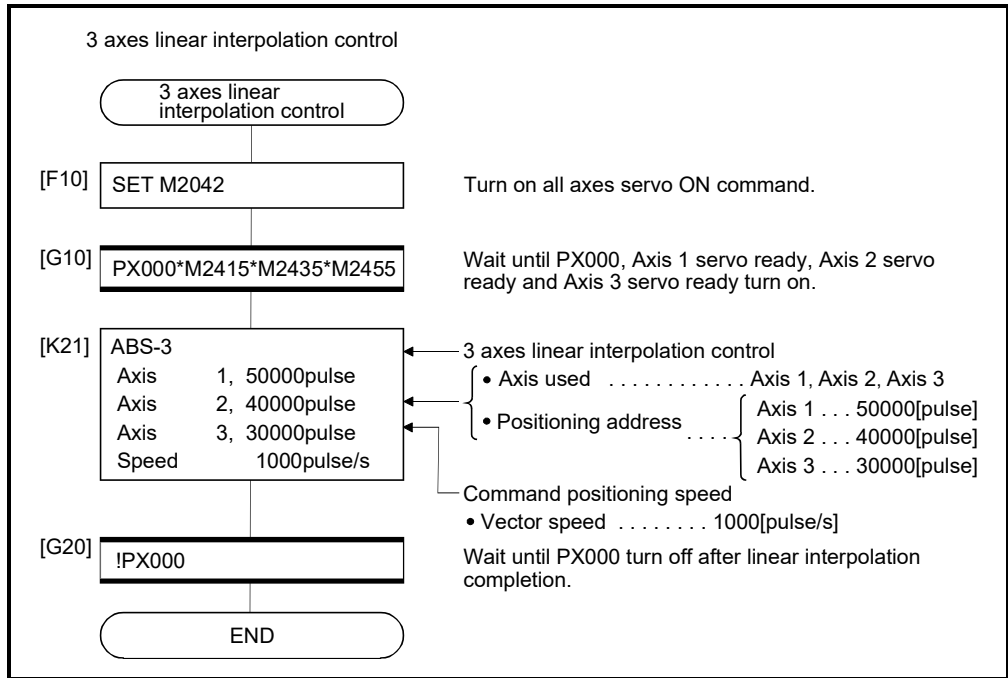

(Note): Example of the above Motion SFC program is started using the automatic start or sequence program.

6 POSITIONING CONTROL

6.5 4 Axes Linear Interpolation Control

Linear interpolation control from the current stop position with 4 axes specified with the positioning command of the sequence program is executed.

Servo instruction	Positioning method	Number of control axes	Items set using MT Developer2																Speed change					
			Common						Arc			Parameter block						Others						
			Parameter block No.	Axis	Address/travel value	Command speed	Dwell time	M-code	Torque limit value	Auxiliary point	Radius	Central point	Interpolation control unit	Speed limit value	Acceleration time	Deceleration time	Rapid Stop deceleration time	Torque limit value		Deceleration processing on stop input	Allowable error range for circular interpolation	S-curve ratio	Advanced S-curve acceleration/deceleration	Cancel
ABS-4	Absolute	4	△	○	○	○	△	△					△	△	△	△	△			△	△	△		Valid
INC-4	Incremental																							

○ : Must be set
△ : Set if required

[Control details]

Positioning control which starts and completes the 4 axes simultaneously is executed.

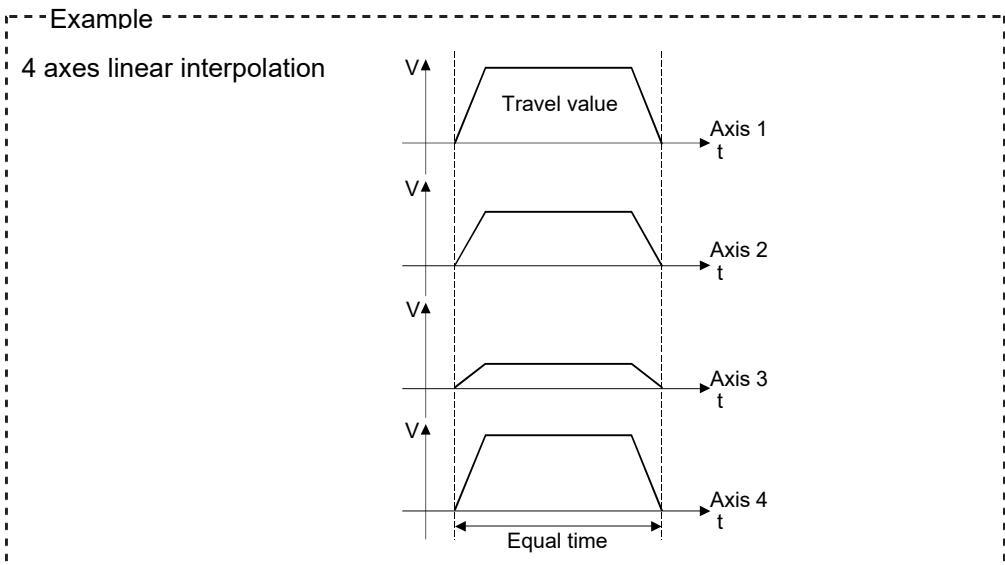

[Program]

Program for 4 axes linear interpolation control is shown as the following conditions.

(1) System configuration

4 axes linear interpolation control of Axis 1, Axis 2, Axis 3 and Axis 4.

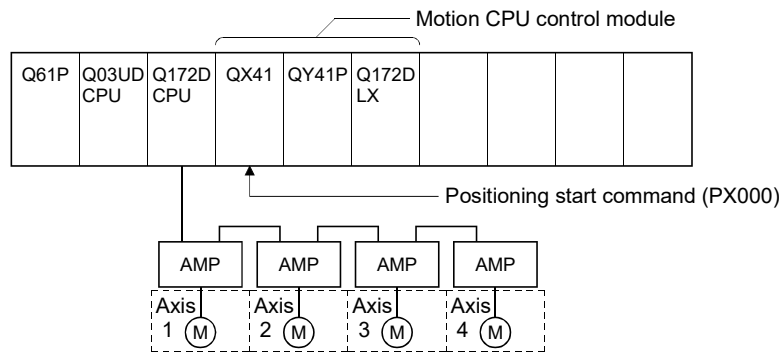

(2) Positioning operation details

The positioning is used the Axis 1, Axis 2, Axis 3 and Axis 4 servo motors.

The positioning by the Axis 1, Axis 2, Axis 3 and Axis 4 servo motors is shown in the diagram below.

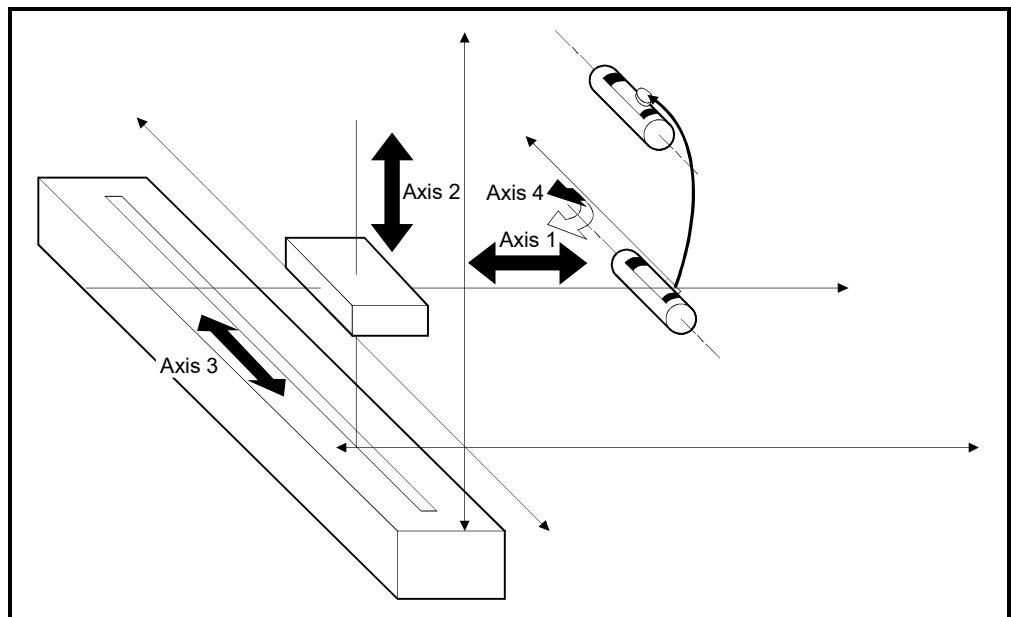

Fig.6.7 Axis configuration

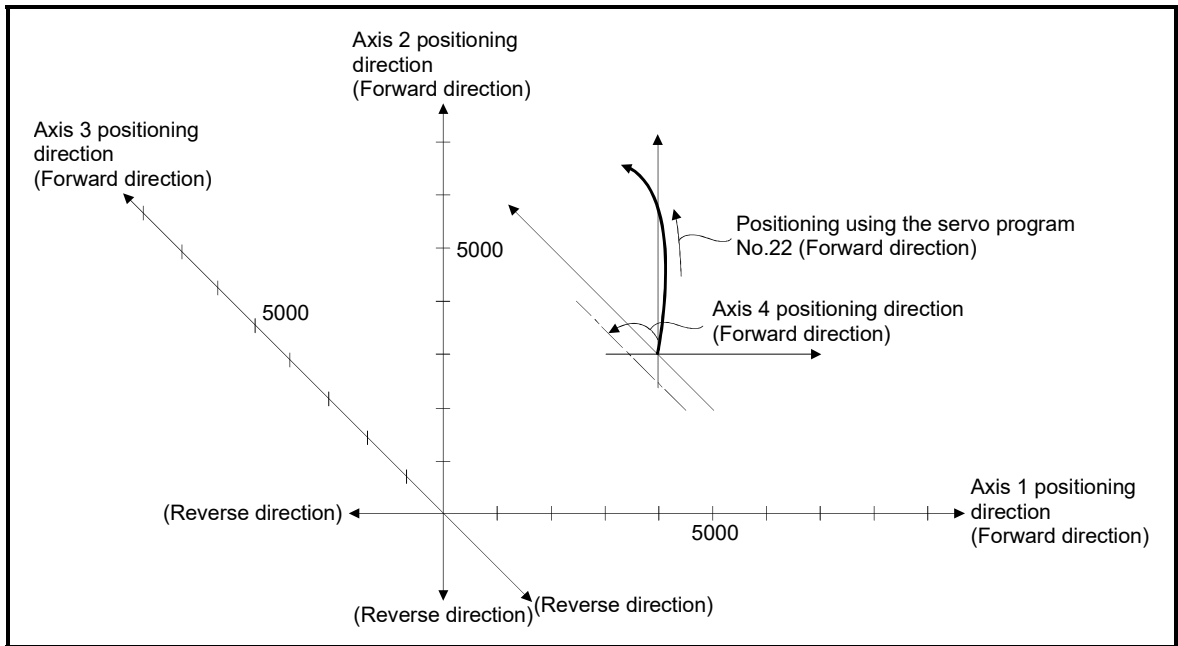

Fig.6.8 Positioning for 4 axes linear interpolation control

(3) Positioning conditions

(a) Positioning conditions are shown below.

Item	Servo Program No.
	No.22
Positioning method	Incremental data method
Positioning speed	10000

(b) Positioning start command PX000 Leading edge (OFF → ON)

(4) Operation timing

Operation timing for 4 axes linear interpolation control is shown below.

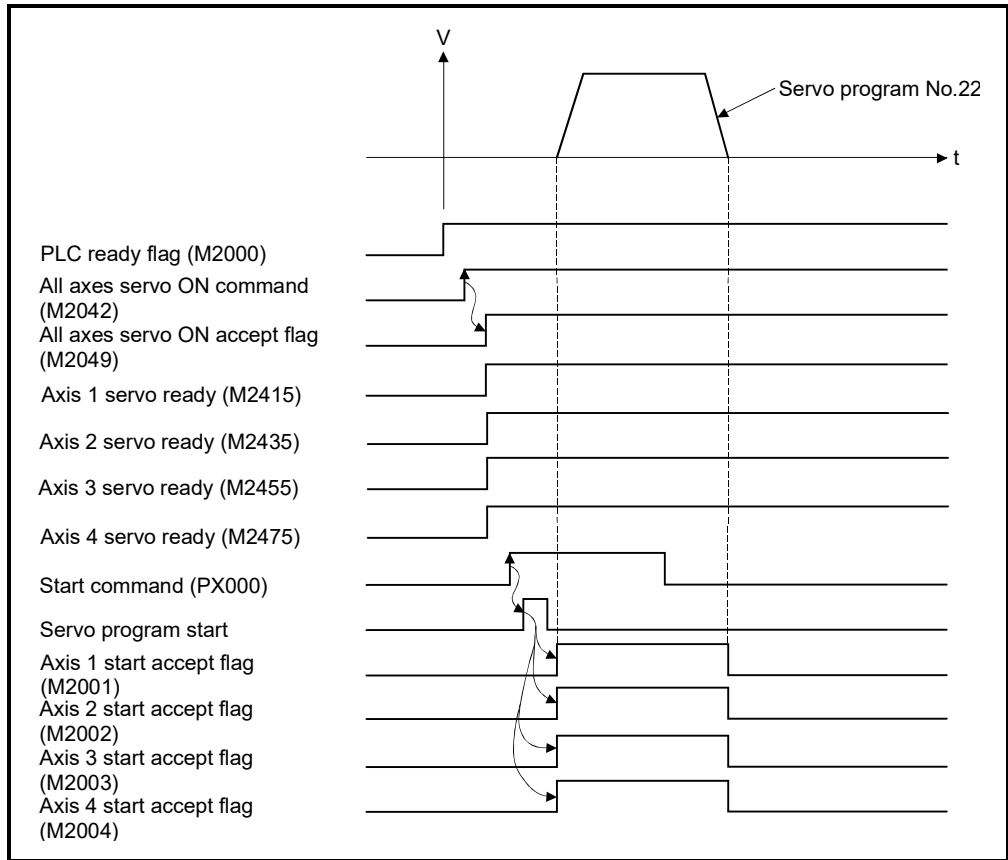

(5) Servo program

Servo program No.22 for 4 axes linear interpolation control is shown below.

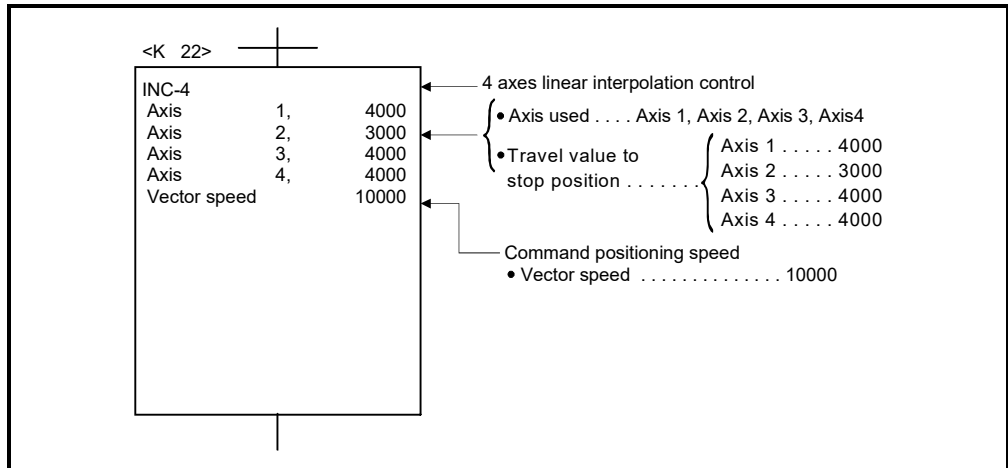

(Note): Example of the Motion SFC program for positioning control is shown next page.

(6) Motion SFC program

Motion SFC program for which executes the servo program is shown below.

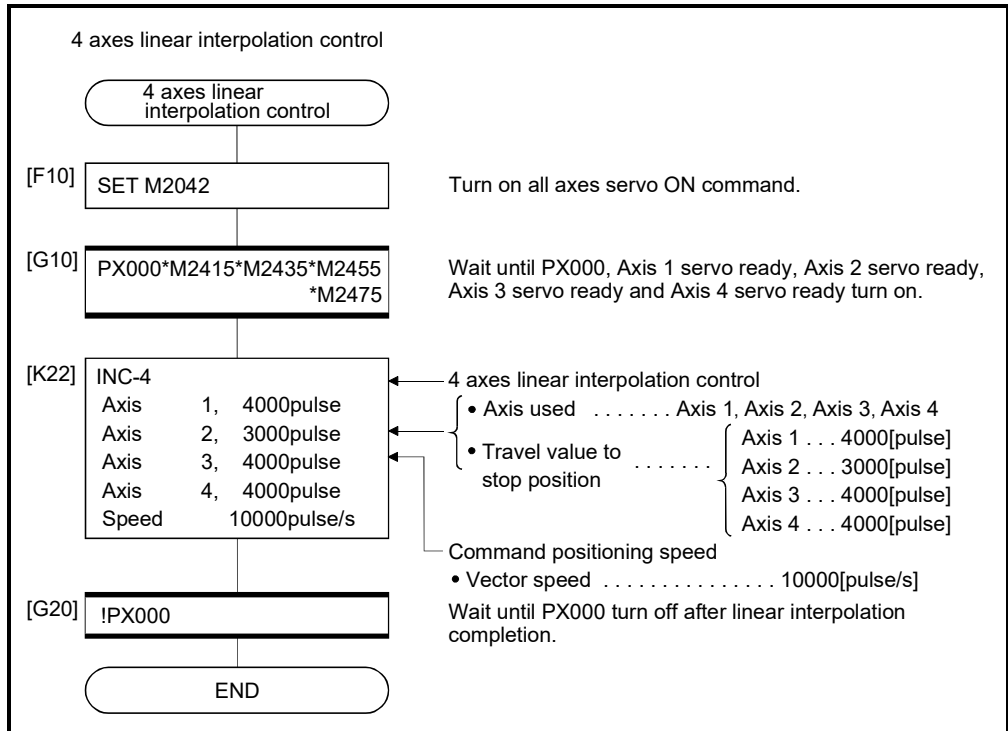

(Note): Example of the above Motion SFC program is started using the automatic start or sequence program.

6.6 Auxiliary Point-Specified Circular Interpolation Control

Circular interpolation control by specification of the end point address and auxiliary point address (a point on the arc) for circular interpolation is executed.

Auxiliary point-specified circular uses ABS_Δ (Absolute data method) and INC_Δ (Incremental data method) servo instructions.

Servo instruction	Positioning method	Number of control axes	Items set using MT Developer2																Speed change						
			Common						Arc			Parameter block						Others							
			Parameter block No.	Axis	Address/travel value	Command speed	Dwell time	M-code	Torque limit value	Auxiliary point	Radius	Central point	Interpolation control unit	Speed limit value	Acceleration time	Deceleration time	Rapid Stop deceleration time	Torque limit value		Deceleration processing on stop input	Allowable error range for circular interpolation	S-curve ratio	Advanced S-curve acceleration/deceleration	Cancel	WAIT-ON/OFF
ABS _Δ	Absolute	2	△	○	○	○	△	△	○				△	△	△	△	△	△	△	△	△	△	△		Valid
INC _Δ	Incremental																								

○ : Must be set
 △ : Set if required

[Control details]

Control using ABS_Δ (Absolute data method)

- (1) Circular interpolation from the current stop address (address before positioning) based on the home position through the specified auxiliary point address to the end point address is executed.
- (2) The center of the arc is the point of intersection of the perpendicular bisectors of the start point address (current stop address) to the auxiliary point address, and the auxiliary point address to the end point address.

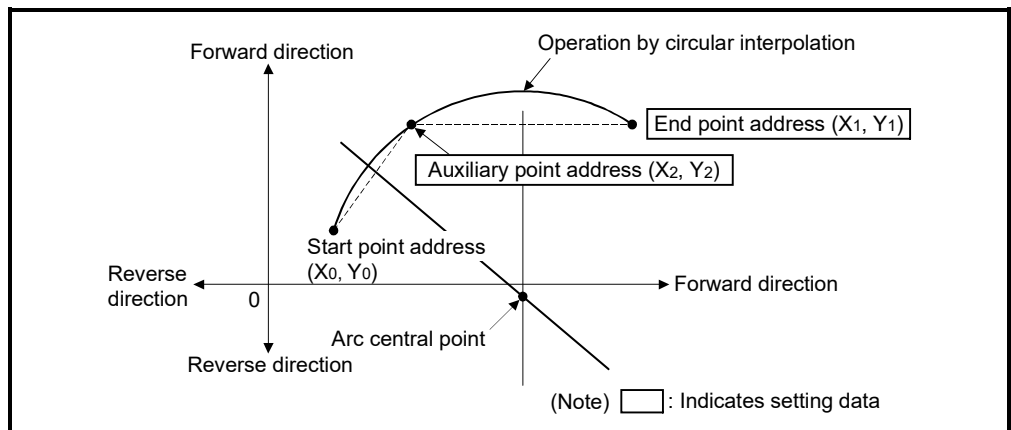

Fig.6.9 Circular interpolation control using absolute data method

- (3) The setting range of the end point address and auxiliary point address is (-2^{31}) to $(2^{31}-1)$.
- (4) The maximum arc radius is $2^{32}-1$.

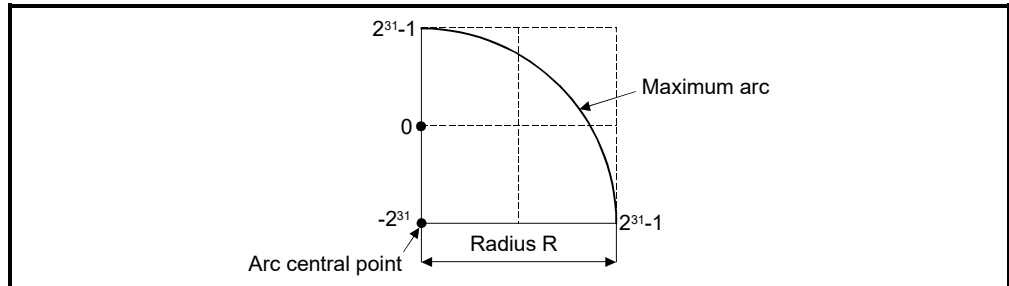

Fig.6.10 Maximum arc

Control using INC. (Incremental data method)

- (1) Circular interpolation from the current stop address through the specified auxiliary point address to the end point address is executed.
- (2) The center of the arc is the point of intersection of the perpendicular bisectors of the start point address (current stop address) to the auxiliary point address, and the auxiliary point address to the end point address.

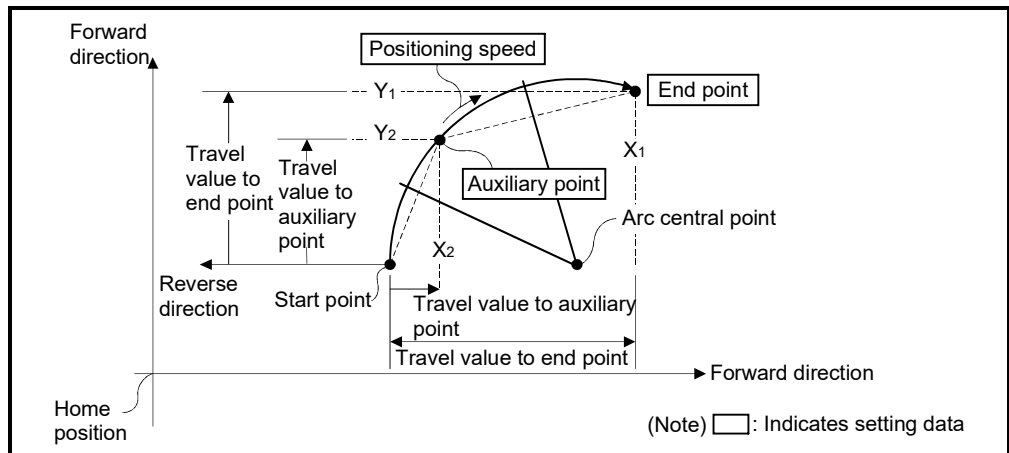

Fig.6.11 Circular interpolation control using incremental data method

- (3) The setting range for the travel value to the end point address and auxiliary point address is 0 to $\pm (2^{31}-1)$.

- (4) The maximum arc radius is $2^{31}-1$.
 If the end point and auxiliary point are set more than a radius of $2^{31}-1$, an error occurs at the start and minor error (error code: 107) is stored in the data register.

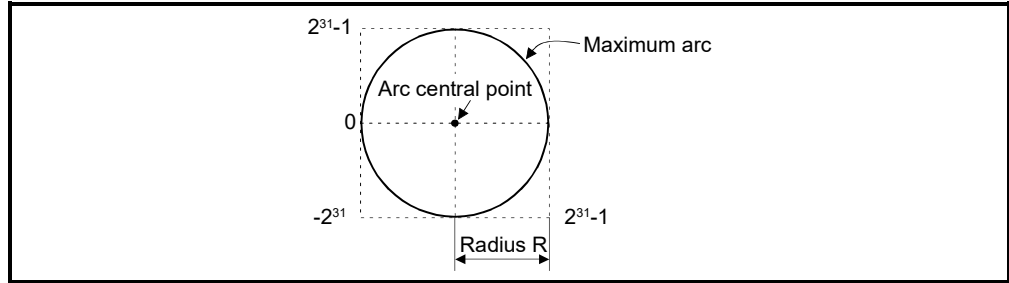

Fig.6.12 Maximum arc

[Program]

Program for auxiliary point-specified circular interpolation control is shown as the following conditions.

(1) System configuration

Auxiliary point-specified circular interpolation control of Axis 1 and Axis 2.

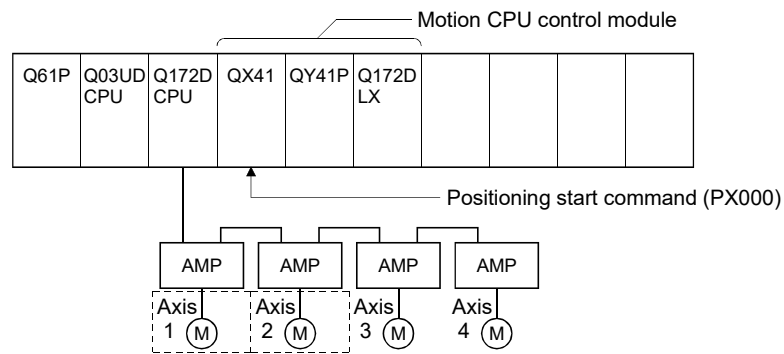

(2) Positioning details

The positioning uses the Axis 1 and Axis 2 servo motors.

The positioning by the Axis 1 and Axis 2 servo motors is shown in the diagram below.

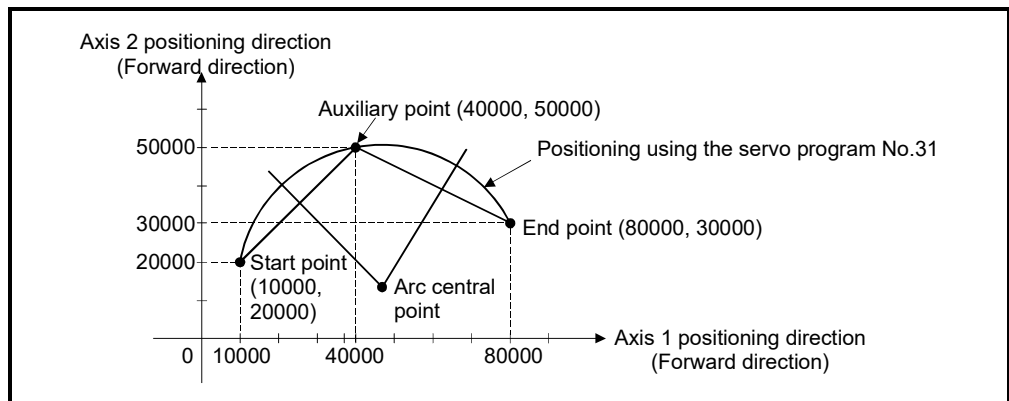

(3) Positioning conditions

(a) Positioning conditions are shown below.

Item	Servo program No.
	No.31
Positioning method	Absolute data method
Positioning speed	1000

(b) Positioning start command PX000 Leading edge (OFF → ON)

(4) Operation timing

Operation timing for auxiliary point-specified circular interpolation control is shown below.

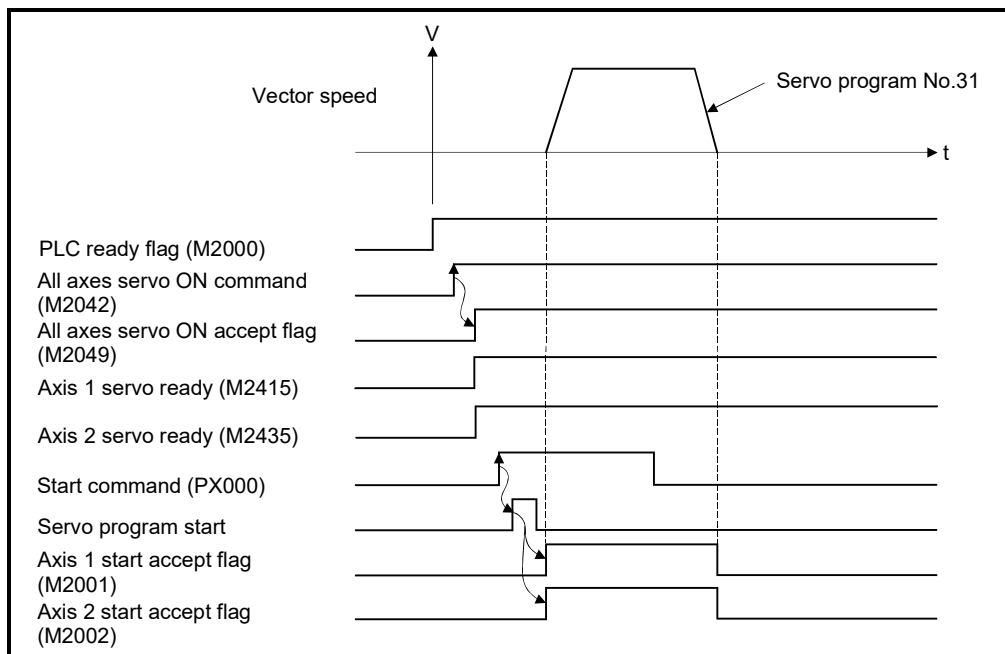

(5) Servo program

Servo program No.31 for auxiliary point-specified circular interpolation control is shown below.

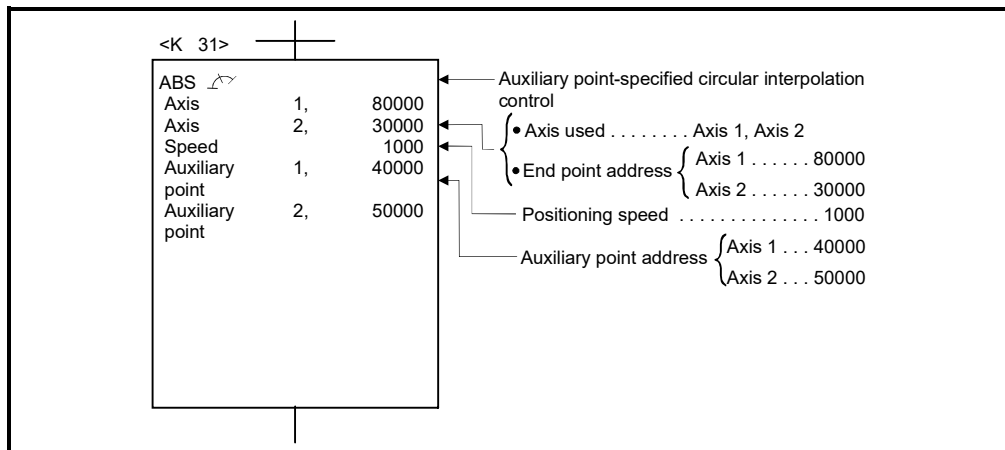

(Note): Example of the Motion SFC program for positioning control is shown next page.

(6) Motion SFC program

Motion SFC program for which executes the servo program is shown below.

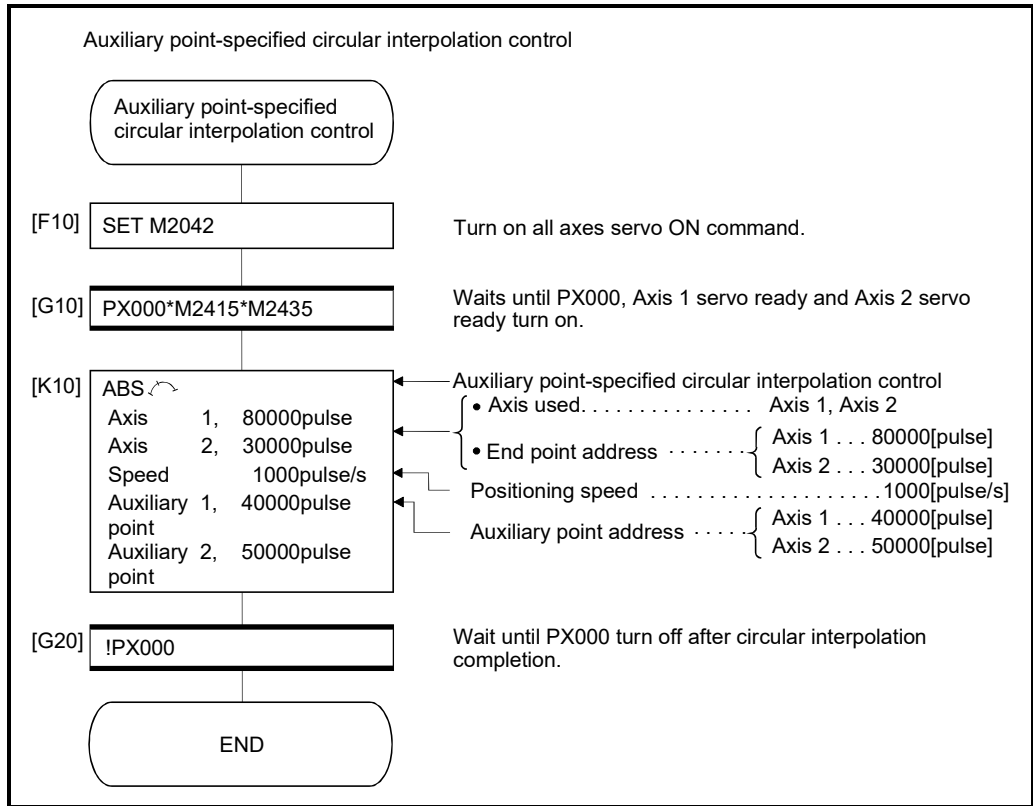

















(Note): Example of the above Motion SFC program is started using the automatic start or sequence program.

6 POSITIONING CONTROL

6.7 Radius-Specified Circular Interpolation Control

Circular interpolation control by specification of the end point address and radius for circular interpolation is executed.

Radius-specified circular interpolation control uses ABS , ABS , ABS  and ABS  (Absolute data method) and INC , INC , INC  and INC  (Incremental data method) servo instructions.

Servo instruction	Positioning method	Number of control axes	Items set using MT Developer2														Speed change												
			Common						Arc		Parameter block							Others											
			Parameter block No.	Axis	Address/travel value	Command speed	Dwell time	M-code	Torque limit value	Auxiliary point	Radius	Central point	Interpolation control unit	Speed limit value	Acceleration time	Deceleration time		Rapid Stop deceleration time	Torque limit value	Deceleration processing on stop input	Allowable error range for circular interpolation	S-curve ratio	Advanced S-curve acceleration/deceleration	Cancel	WAIT-ON/OFF				
ABS 	Absolute	2																								Valid			
ABS 																													
ABS 																													
ABS 																													
INC 	Incremental			△	○	○	○	△	△		○		△	△	△	△	△	△	△	△	△	△	△	△	△				
INC 																													
INC 																													
INC 																													

○: Must be set
△: Set if required

6 POSITIONING CONTROL

[Control details]

Details for the servo instructions are shown in the table below.

Instruction	Rotation direction of the servo motors	Maximum controllable angle of arc	Positioning path
ABS ↻	Clockwise	$0^\circ < \theta < 180^\circ$	
INC ↻			
ABS ↺	Counter clockwise		
INC ↺			
ABS ↻	Clockwise	$180^\circ \leq \theta < 360^\circ$	
INC ↻			
ABS ↺	Counter clockwise		
INC ↺			

Control using ABS ↻, ABS ↺, ABS ↻, ABS ↺ (Absolute data method)

- (1) Circular interpolation from the current stop address (address before positioning) based on the home position to the specified end address with the specified radius is executed.
- (2) The center of the arc is the point of intersection of the perpendicular bisectors of the start point address (current stop address) to the end address.

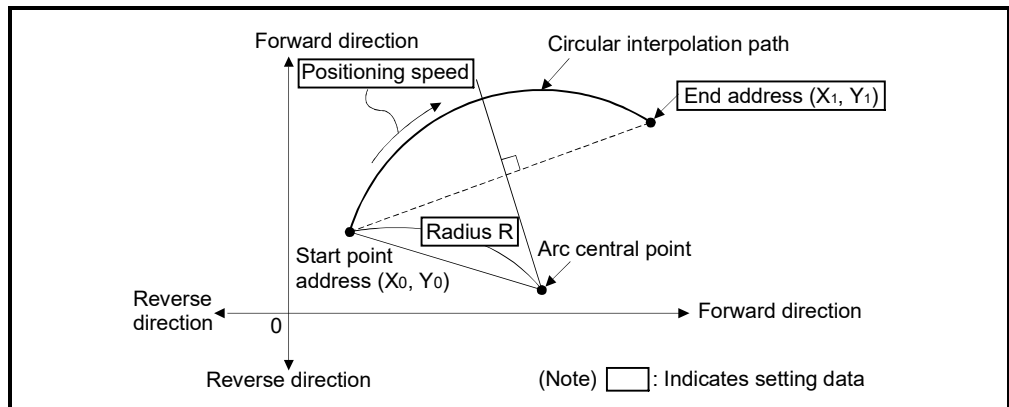

Fig.6.13 Circular interpolation control using absolute data method

- (3) The setting range of end point address is (-2^{31}) to $(2^{31}-1)$.

(4) The setting range for the radius is 1 to $(2^{31}-1)$.

(5) The maximum arc radius is $(2^{32}-1)$.

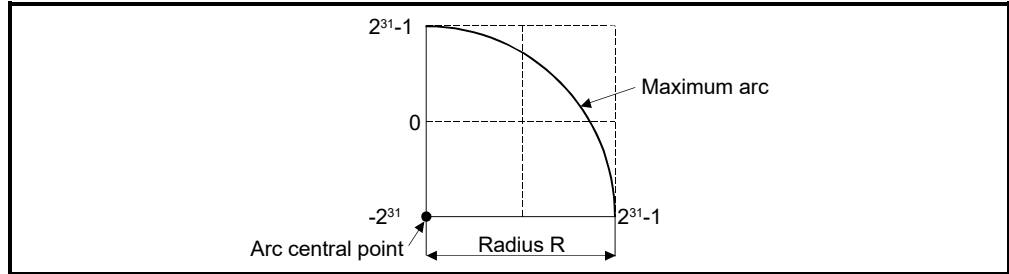

Fig.6.14 Maximum arc

Control using INC ↶, INC ↷, INC ↵, INC ↶ (Incremental data method)

(1) Circular interpolation from the current stop address (0, 0) to the specified end point with specified radius.

(2) The center of the arc is the point of intersection of the perpendicular bisectors of the start point address (current stop address) to the end address.

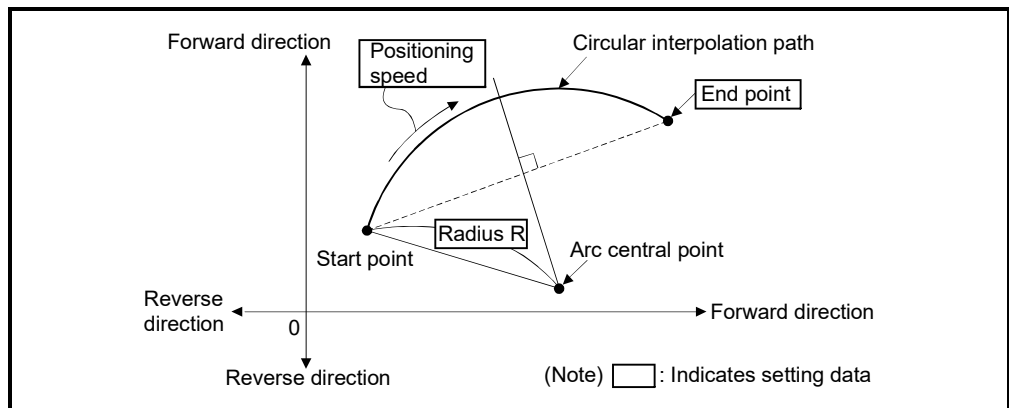

Fig.6.15 Circular interpolation control using incremental data method

(3) Setting range of end point address is (-2^{31}) to $(2^{31}-1)$.

(4) Setting range of radius is 1 to $(2^{31}-1)$.

(5) Maximum arc radius is $(2^{31}-1)$.

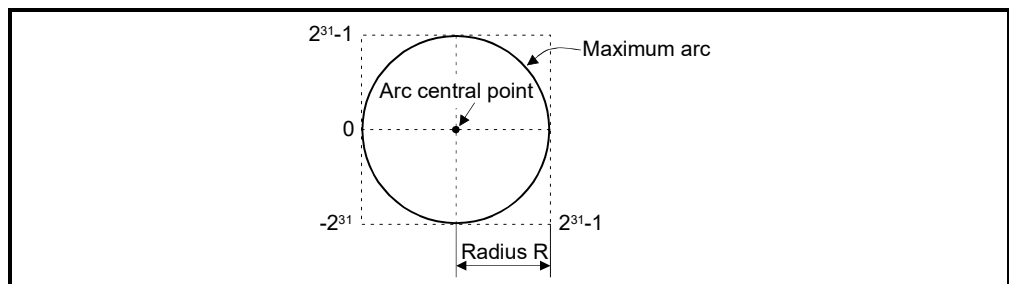

Fig.6.16 Maximum arc

[Program]

Program for radius-specified circular interpolation control is shown as the following conditions.

(1) System configuration

Radius-specified circular interpolation control of Axis 1 and Axis 2.

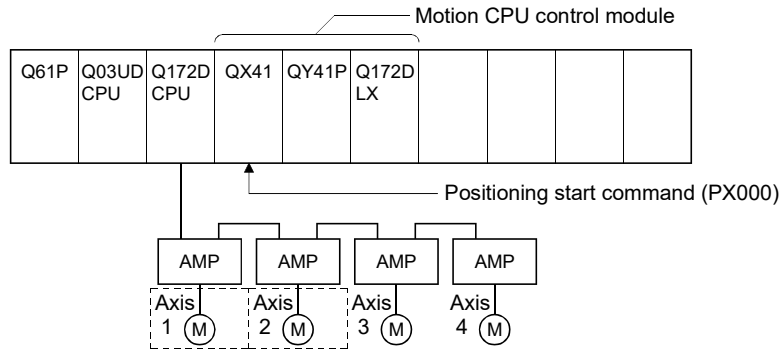

(2) Positioning operation details

The positioning uses the Axis 1 and Axis 2 servo motors.

The positioning by the Axis 1 and Axis 2 servo motors is shown in the diagram below.

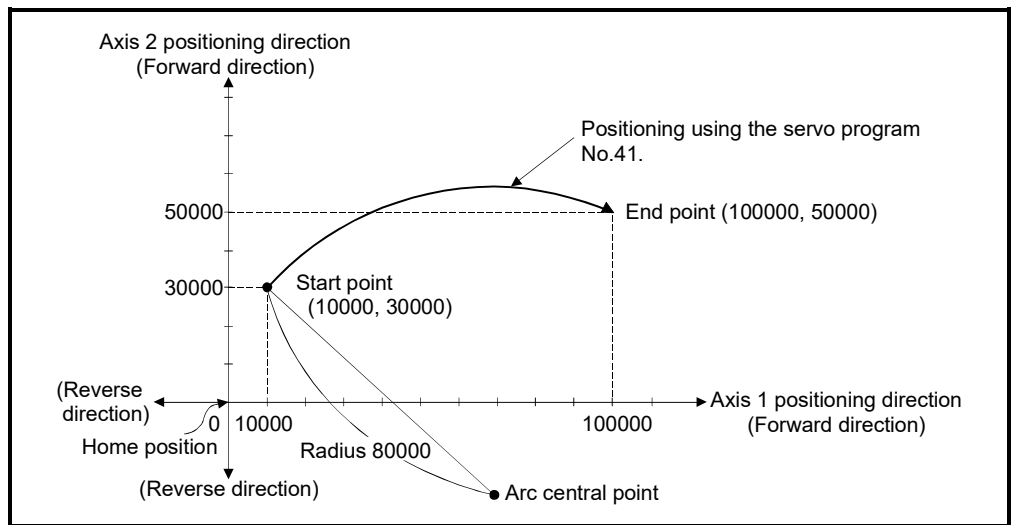

(3) Positioning conditions

(a) Positioning conditions are shown below.

Item	Servo Program No.
	No.41
Positioning method	Absolute data method
Positioning speed	1000

(b) Positioning start command PX000 Leading edge (OFF → ON)

(4) Operation timing

Operation timing for radius-specified circular interpolation control is shown below.

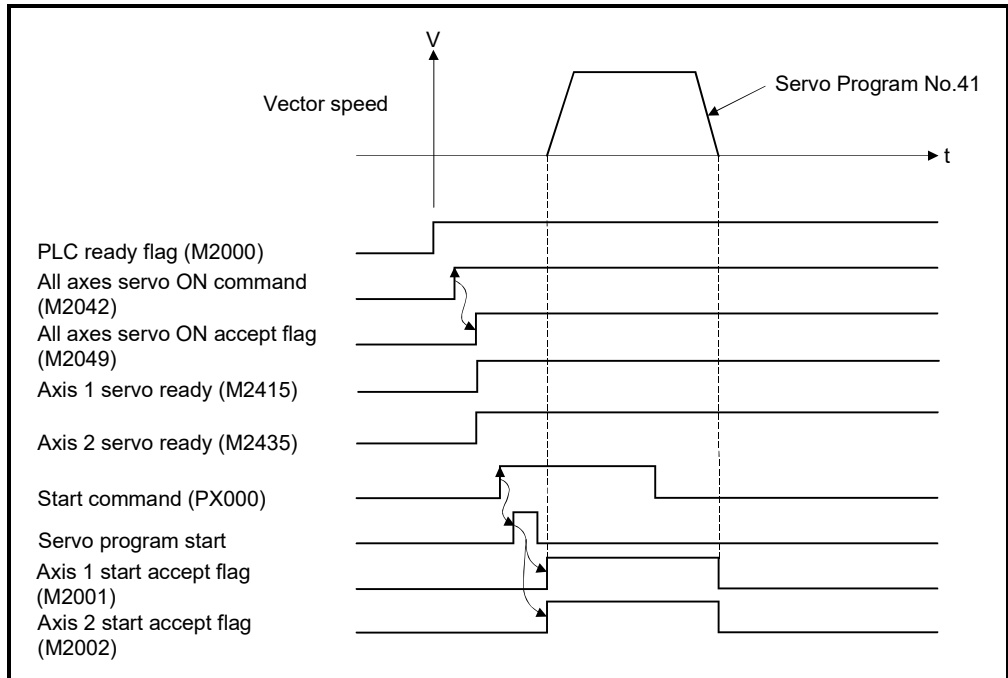

(5) Servo program

Servo program No.41 for radius-specified circular interpolation control is shown below.

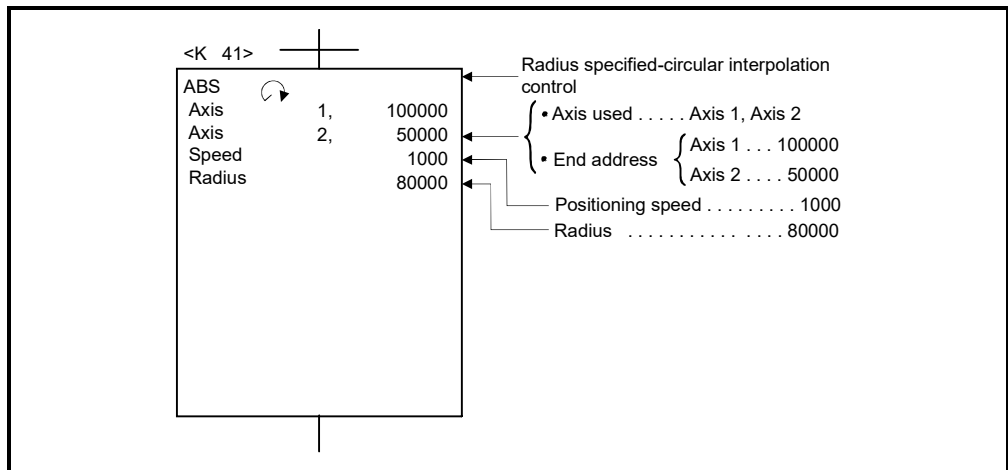

(Note): Example of the Motion SFC program for positioning control is shown next page.

(6) Motion SFC program

Motion SFC program for which executes the servo program is shown below.

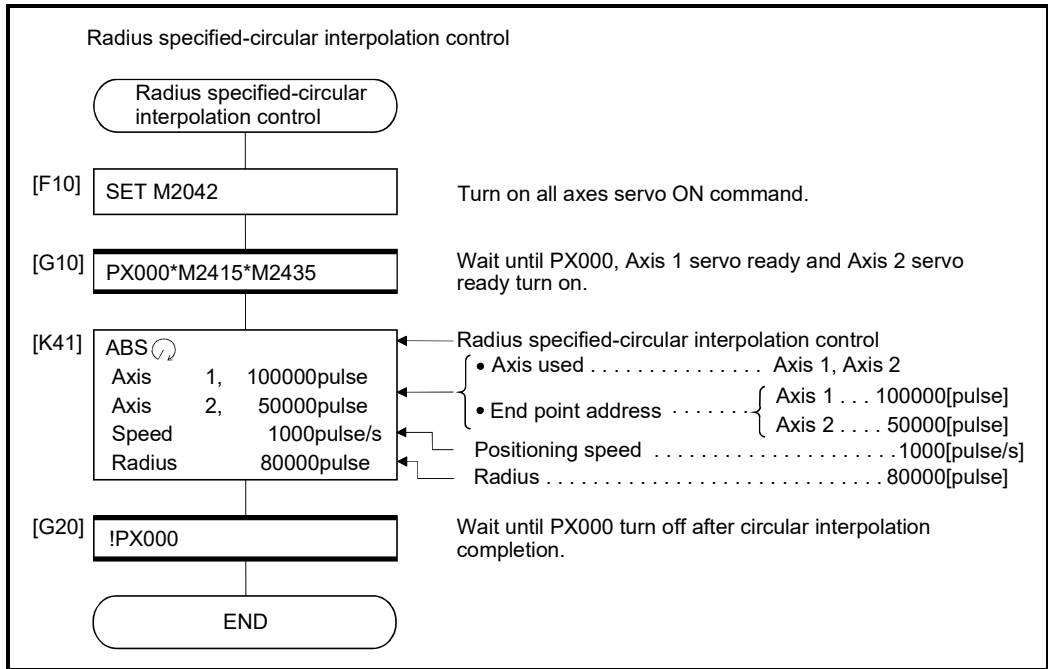

(Note): Example of the above Motion SFC program is started using the automatic start or sequence program.

Control using ABS ↻, ABS ↺ (Absolute data method)

- (1) Circular interpolation of an arc with a radius equivalent to the distance between the start point and central point, between the current stop address (address before positioning) based on the home position and the specified end point address.

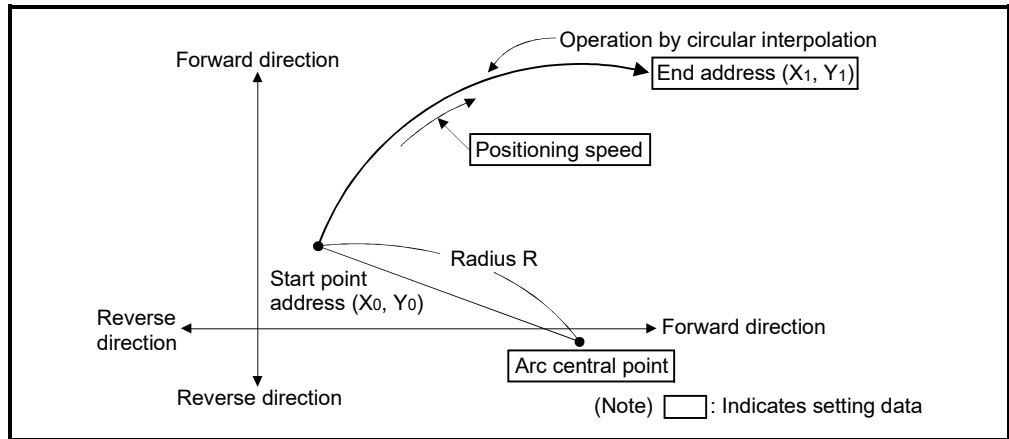

Fig.6.17 Circular interpolation control using absolute date method

- (2) Positioning control of a complete round is possible in the central point-specified circular interpolation control.

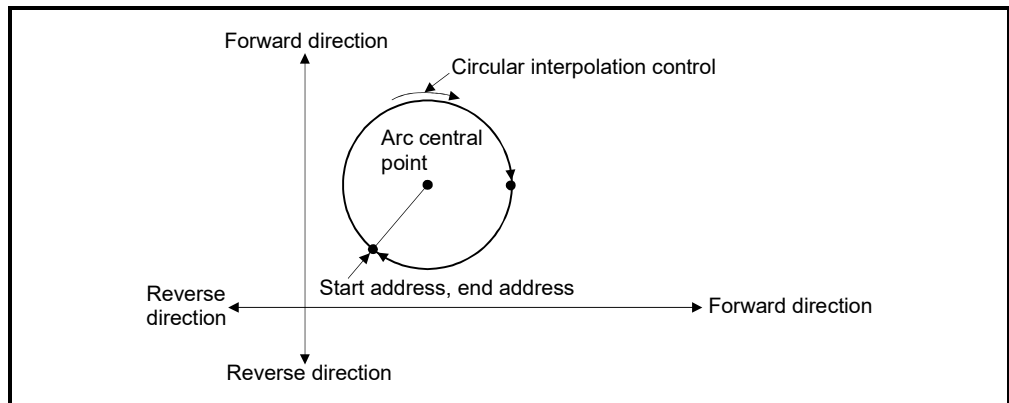

Fig.6.18 Positioning control of a complete round

- (3) Setting range of end point address and arc central point is (-2^{31}) to $(2^{31}-1)$.
- (4) The maximum arc radius is $(2^{32}-1)$.

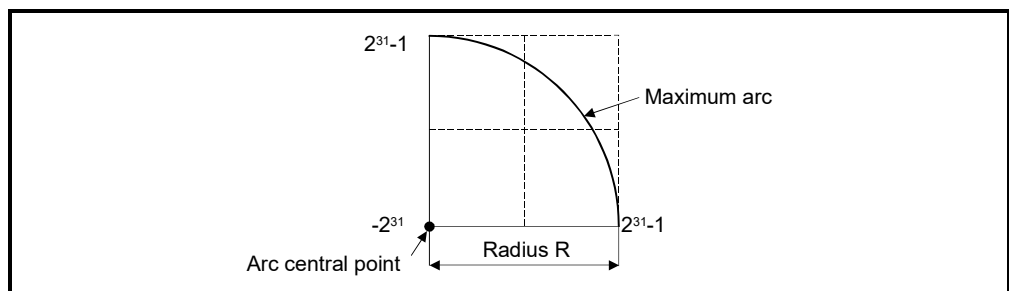

Fig.6.19 Maximum arc

Control using INC ↻, INC ↺ (Incremental method)

- (1) Circular interpolation from the current stop address (0, 0) with a radius equivalent to the distance between the start point (0, 0) and central point.

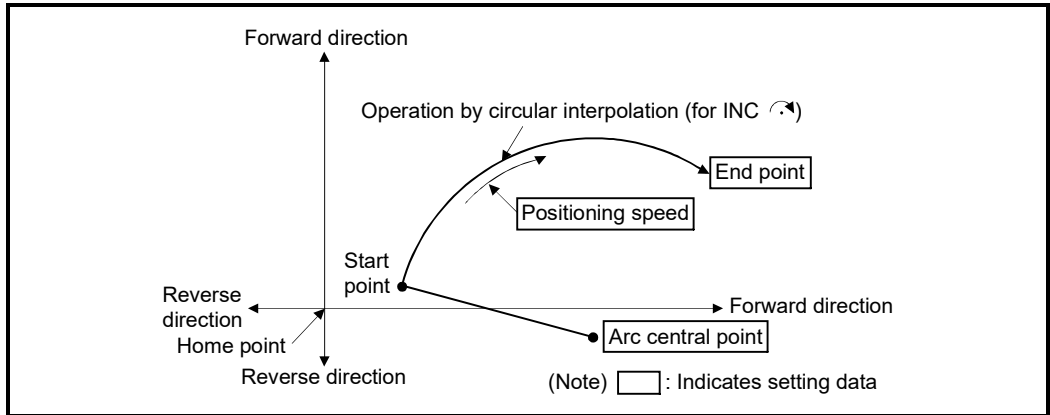

Fig.6.20 Circular interpolation control using incremental data method (INC ↻)

- (2) Positioning control of a complete round is possible in the central point-specified circular interpolation control.

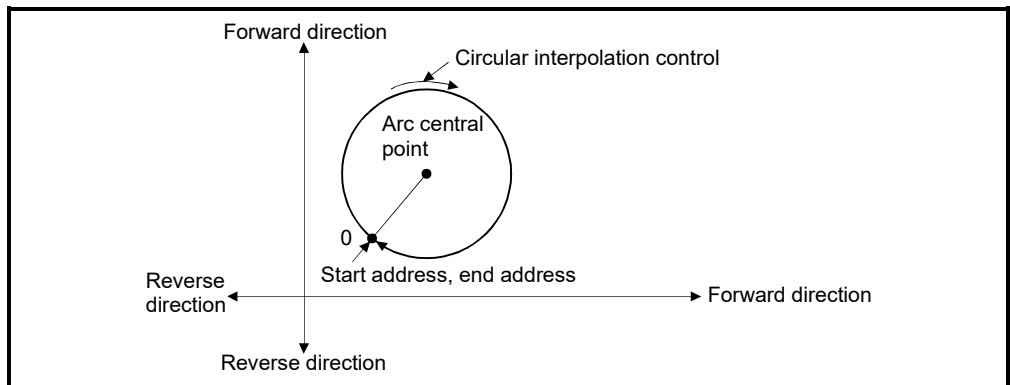

Fig.6.21 Positioning control of a complete round

- (3) Setting range of travel value to end point address and arc central point is 0 to $(2^{31}-1)$.
- (4) The maximum arc radius is $(2^{31}-1)$.
If the end point and central point are set more than a radius of $(2^{31}-1)$, an error occurs at the start and minor error (error code: 109) is stored in the data register.

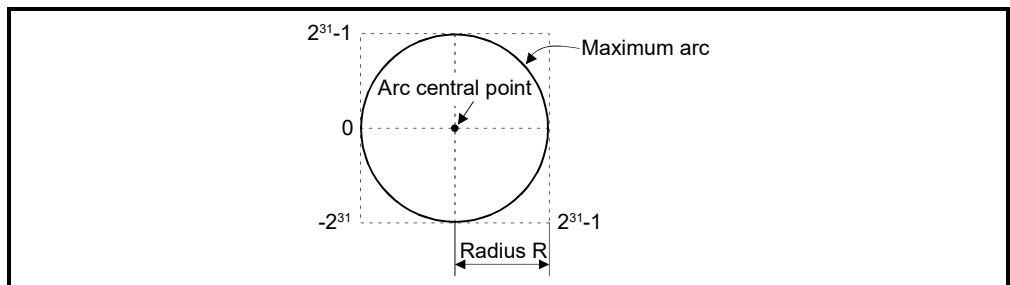

Fig.6.22 Maximum arc radius

[Program]

Program for central point-specified circular interpolation control is shown as the following conditions.

(1) System configuration

Central point-specified circular interpolation control of Axis 1 and Axis 2.

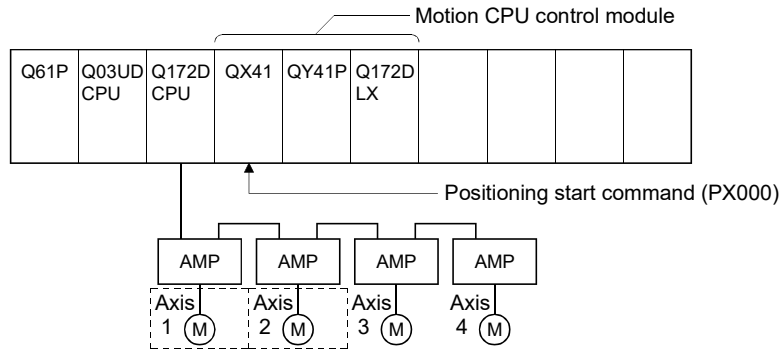

(2) Positioning operation details

The positioning uses the Axis 1 and Axis 2 servo motors.

The positioning by the Axis 1 and Axis 2 servo motors is shown in the diagram below.

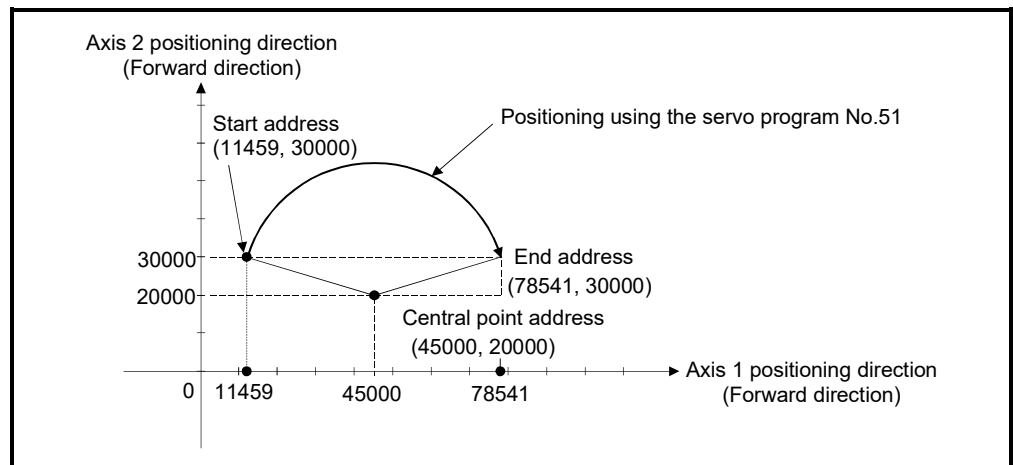

(3) Positioning conditions

(a) Positioning conditions are shown below.

Item	Servo Program No.
	No.51
Positioning method	Absolute data method
Positioning speed	1000

(b) Positioning start command PX000 Leading edge (OFF → ON)

(4) Operation timing

Operation timing for central point-specified circular interpolation is shown below.

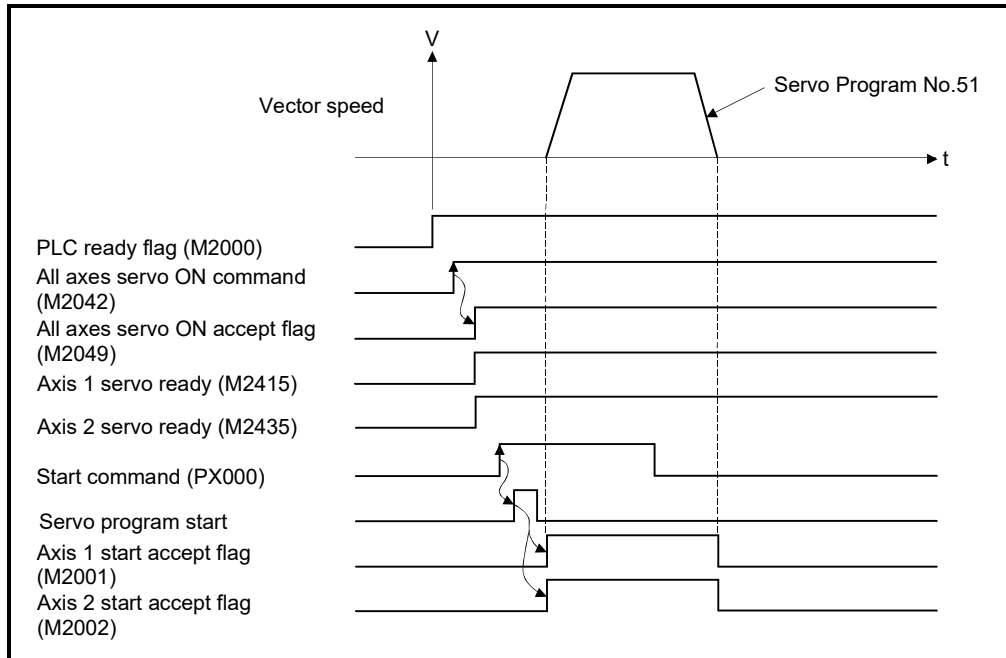

(5) Servo program

Servo program No.51 for central point-specified circular interpolation is shown below.

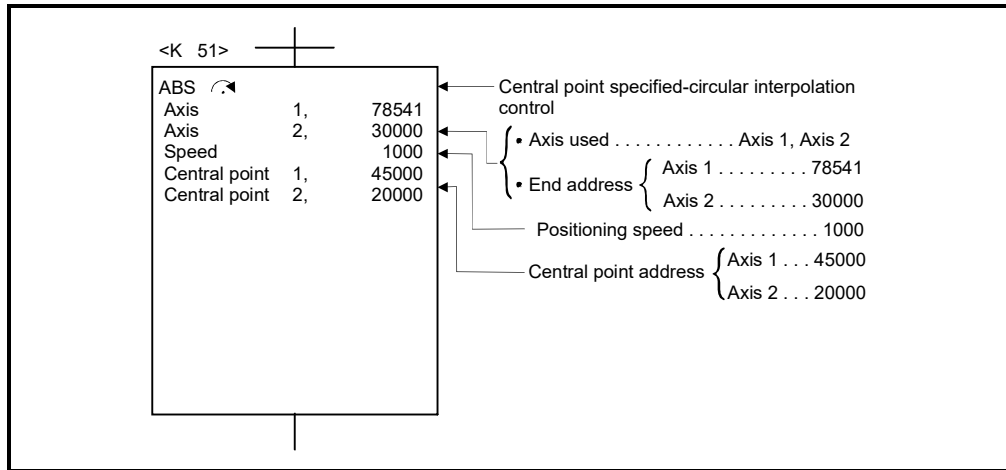

(Note): Example of the Motion SFC program for positioning control is shown next page.

(6) Motion SFC program

Motion SFC program for which executes the servo program is shown below.

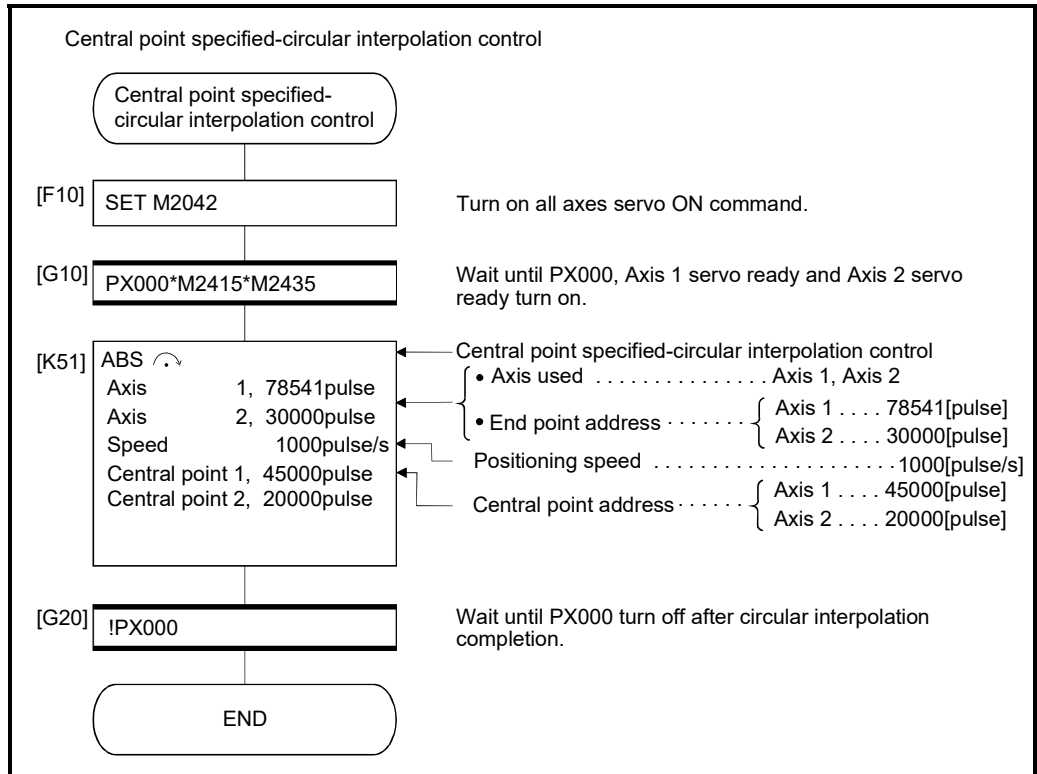

(Note): Example of the above Motion SFC program is started using the automatic start or sequence program.

6 POSITIONING CONTROL

6.9 Helical Interpolation Control

The linear interpolation control with linear axis is executed simultaneously while the circular interpolation specified with any 2 axes is executed, the specified number of pitches rotates spirally and performs the locus control to command position.

Servo instruction	Positioning method	Number of control axes	Items set using MT Developer2																Speed change									
			Common						Arc/Helical			Parameter block						Others										
			Parameter block No.	Axis	Address/travel value	Command speed	Dwell time	M-code	Torque limit value	Auxiliary point	Radius	Central point	Pitch count	Interpolation control unit	Speed limit value	Acceleration time	Deceleration time	Rapid Stop deceleration time		Torque limit value	Deceleration processing on stop input	Allowable error range for circular interpolation	S-curve ratio	Advanced S-curve acceleration/deceleration	Cancel	WAIT-ON/OFF		
 	Absolute	3																						Valid				
			 	Incremental	△	○	○	○	△	△		○	○	△	△	△	△	△	△	△		△	△		△			
					 	Absolute	△	○	○	○	△	△		○	○	△	△	△	△	△	△	△			△	△	△	
							 	Incremental	△	○	○	○	△	△		○	○	△	△	△	△	△	△		△		△	△
 	Absolute				△	○			○	○	△	△		○	○	△	△	△	△	△	△	△			△	△	△	
			 	Incremental	△	○	○	○	△	△		○	○	△	△	△	△	△	△	△		△	△		△			

○ : Must be set
 △ : Set if required

6 POSITIONING CONTROL

6.9.1 Circular interpolation specified method by helical interpolation

The following method of circular interpolation is possible for the helical interpolation. The specified method of circular interpolation connected start point and end point at the seeing on the plane for which performs circular interpolation are as follows.

Servo instruction	Positioning method	Circular interpolation specified method
ABH	Absolute	Radius-specified method less than CW180°
INH	Incremental	
ABH	Absolute	Radius-specified method less than CCW180°
INH	Incremental	
ABH	Absolute	Radius-specified method CW180° or more.
INH	Incremental	
ABH	Absolute	Radius-specified method CCW180° or more.
INH	Incremental	
ABH	Absolute	Central point-specified method CW
INH	Incremental	
ABH	Absolute	Central point- specified method CCW
INH	Incremental	
ABH	Absolute	Auxiliary point-specified method
INH	Incremental	

[Cautions]

- (1) The helical interpolation instruction can be used at the both of real mode/virtual mode.
- (2) When the travel value of linear axis is "0" is set, it can be controlled.

Condition	Operation
Number of pitches is 0	Same control as normal circular interpolation control. (Allowable error range for circular interpolation can be set.)
Number of pitches is not 0	Linear interpolation to linear axis does not executed, circle for the number of pitches is drawn on the circle plane. (Allowable error range for circular interpolation can be set.)

- (3) Units for linear axis have not restrictions.
- (4) Circular interpolation axis has the following restrictions.
 - When the unit of one axis is [degree] axis (with stroke range), set another axis also as [degree] axis (without stroke range).
 - The axis of [degree] unit as without stroke range cannot be set.
 - The axis as without stroke range cannot be set in the virtual mode.

- (5) Specified the speed which executes speed change by CHGV instruction during helical interpolation operation with the vector speed of circular interpolation axis 2. If speed change is requested by specifying negative speed by CHGV instruction during helical interpolation operation, deceleration starts from the time and it is possible to return to reverse direction at the deceleration completion.
- (6) If start point = end point, number of pitches = 1 and travel value of linear axis = 0, at the only central point-specified circular interpolation, full circle can be drawn. When the address of "start point = end point" is set at the radius-specified helical interpolation or auxiliary point-specified helical interpolation, a minor error occurs at the start and cannot be start.
 - At auxiliary point-specified helical interpolation : Minor error (error code: 107)
 - At radius-specified helical interpolation : Minor error (error code: 108)
- (7) When the control unit is [degree] and the stroke limit is invalid, if the helical interpolation control is executed using absolute data method, positioning in near direction to specified address based on the current value.
- (8) Allowable error range for circular interpolation can be set.

ABH ↺, ABH ↻, ABH ↻, ABH ↻ Absolute radius-specified helical interpolation control

[Control details]

The linear interpolation to other linear axis is executed performing 2 axes circular interpolation from current stop position (X0, Y0, Z0) to specified circular end address (X1, Y1) or linear axis end point address (Z1), and the absolute helical interpolation is executed so that it may become a spiral course.

It goes around on the specified circle for the specified number of pitches, the circular interpolation which had remainder specified is executed, and positioning to end address is executed. The radius-specified circle specifies circular interpolation method connected start point and end point at the seeing on the plane for which performs circular interpolation.

Operation details for absolute radius-specified helical interpolation are shown below.

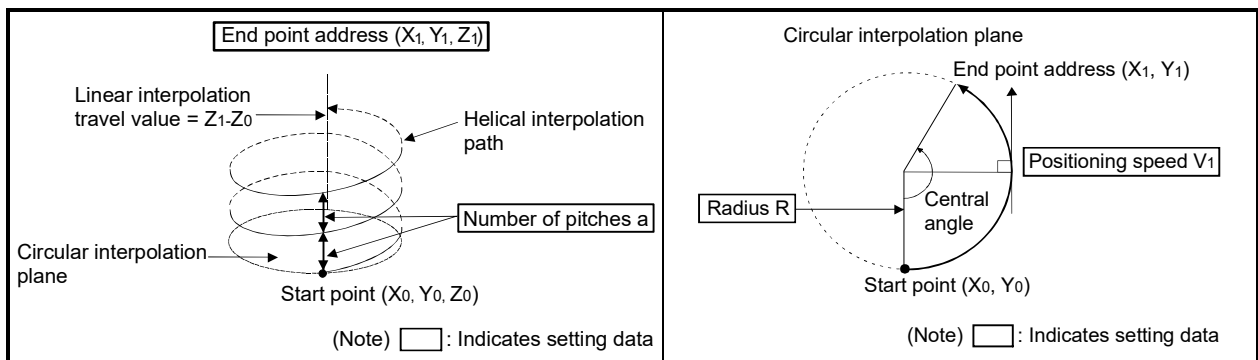

Control details for the servo instructions are shown below.

Instruction	Rotation direction of servo motor	Controllable angle of arc	Positioning pass
ABH ↻ Radius-specified helical interpolation less than CW 180°	Clockwise (CW)	$0^\circ < \theta < 180^\circ$	
ABH ↻ Radius-specified helical interpolation less than CCW 180°	Counter clockwise (CCW)		
ABH ↻ Radius-specified helical interpolation CW 180° or more	Clockwise (CW)	$180^\circ \leq \theta \leq 360^\circ$	
ABH ↻ Radius-specified helical interpolation CCW 180° or more	Counter clockwise (CCW)		

- (1) The setting range of end point address for the both of circular interpolation axis and linear interpolation axis is (-2^{31}) to $(2^{31}-1)$.
- (2) The maximum arc radius on the circular interpolation plane is $(2^{31}-1)$.
For example, the maximum arc radius for electronic gear 1:1 of unit [mm] is 214748364.7[μm].

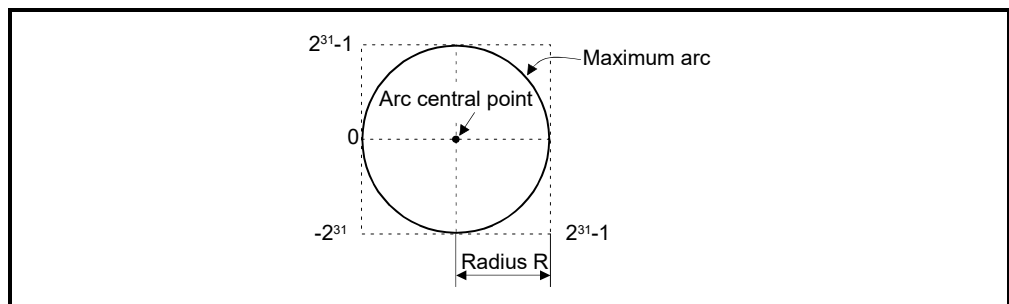

- (3) Set the command speed with the vector speed for 2 axes circular interpolation axis.
- (4) The command speed unit is specified in the parameter block.
- (5) Set the number of pitches within the range of 0 to 999. If it is set outside the setting range, the servo program setting error (error code: 28) occurs, and cannot be started.

6 POSITIONING CONTROL

- (6) All of the circular interpolation axis, linear axis and point address, command speed, radius (2 word data above) and number of pitches (1 word data) are set indirectly by the word devices.

[Program]

(1) Servo program

Servo program No.52 for absolute radius-specified helical interpolation control is shown below.

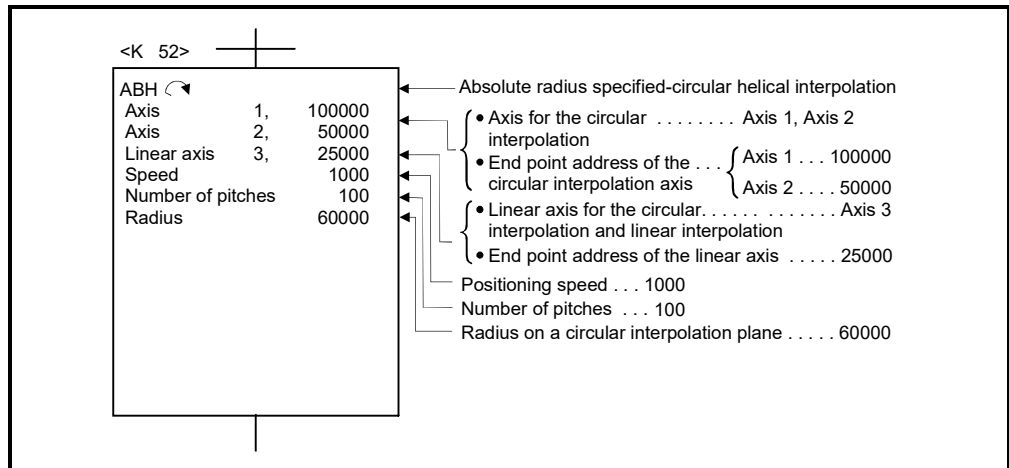

(Note): Example of the Motion SFC program for positioning control is shown next page.

(2) Motion SFC program

Motion SFC program for which executes the servo program is shown below.

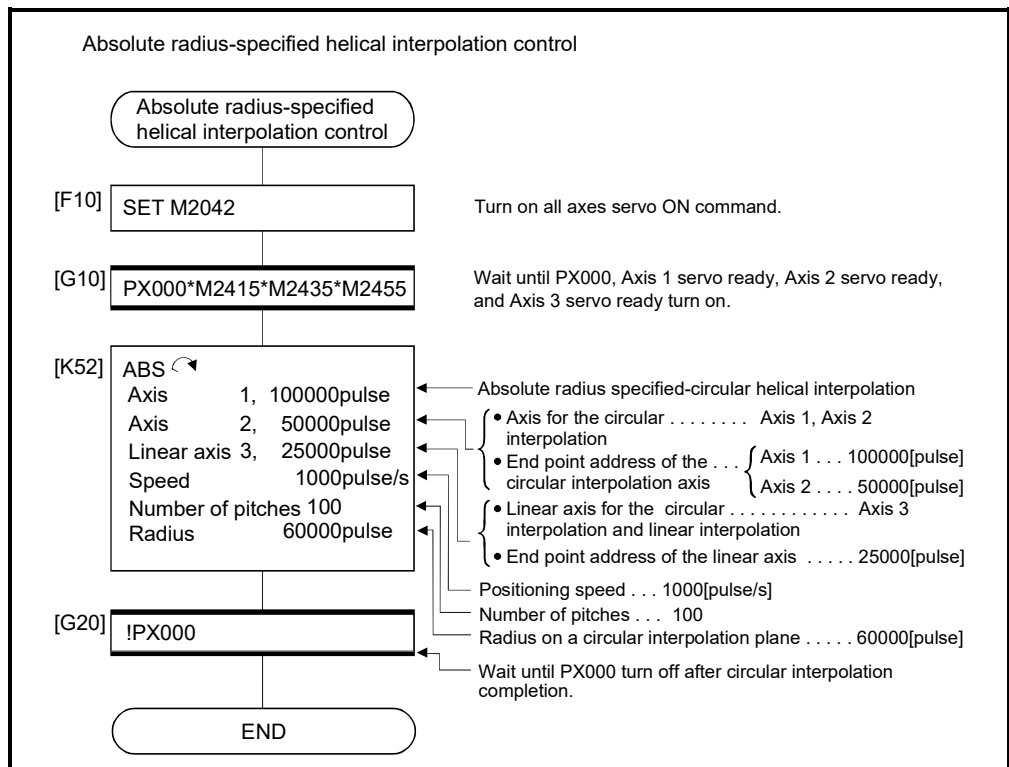

(Note): Example of the above Motion SFC program is started using the automatic start or sequence program.

INH ↺, INH ↻, INH ↻, INH ↺ Incremental radius-specified helical interpolation control

[Control details]

The linear interpolation to other linear axis is executed performing circular interpolation from current stop position (start point) to specified circular relative end address (X1, Y1) or linear axis end point relative address (Z1), and the incremental helical interpolation control is executed so that it may become a spiral course.

It goes around on the specified circle for the specified number of pitches, the circular interpolation which had remainder specified is executed, and positioning to end address is executed. The radius-specified circle specifies circular interpolation method connected start point and end point at the seeing on the plane for which performs circular interpolation.

Operation details for incremental radius-specified helical interpolation are shown below.

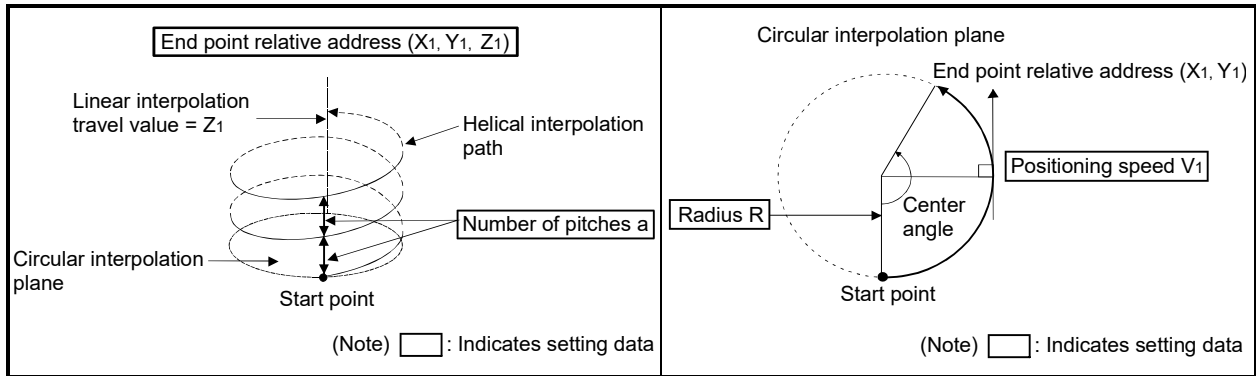

Control details for the servo instructions are shown below.

Instruction	Rotation direction of servo motor	Controllable angle of arc	Positioning pass
INH ↻ Radius-specified helical interpolation less than CW 180°	Clockwise (CW)	$0^\circ < \theta < 180^\circ$	
INH ↻ Radius-specified helical interpolation less than CCW 180°	Counter clockwise (CCW)		
INH ↻ Radius-specified helical interpolation CW 180° or more	Clockwise (CW)	$180^\circ \leq \theta \leq 360^\circ$	
INH ↻ Radius-specified helical interpolation CCW 180° or more	Counter clockwise (CCW)		

(1) The setting range of end point relative address for the both of circular interpolation axis and linear interpolation axis is 0 to $\pm (2^{31}-1)$.

The travel direction is set by the sign (+/-) of the travel value, as follows:

- Positive travel valuePositioning control to forward direction (Address increase direction)
- Negative travel value.....Positioning control to reverse direction (Address decrease direction)

(2) The maximum arc radius on the circular interpolation plane is $2^{31}-1$.

For example, the maximum arc radius for electronic gear 1:1 of unit [mm] is 214748364.7[μm].

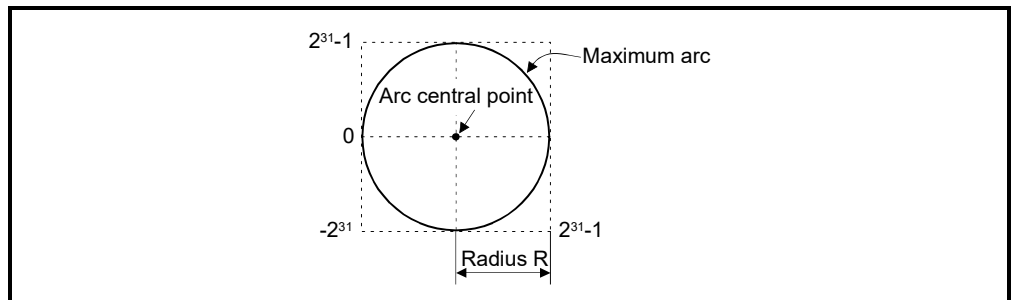

- (3) Set the command speed with the vector speed for 2 axes circular interpolation axis.
- (4) The command speed unit is specified in the parameter block.
- (5) Set the number of pitches within the range of 0 to 999. If it is set outside the setting range, the servo program setting error (error code: 28) occurs and operation does not start.
- (6) All of the circular interpolation axis, linear axis end point relative address, command speed, radius (2 word data above) and number of pitches (1 word data) are set indirectly by the word devices.

[Program]

(1) Servo program

Servo program No.53 for incremental radius-specified helical interpolation control is shown below.

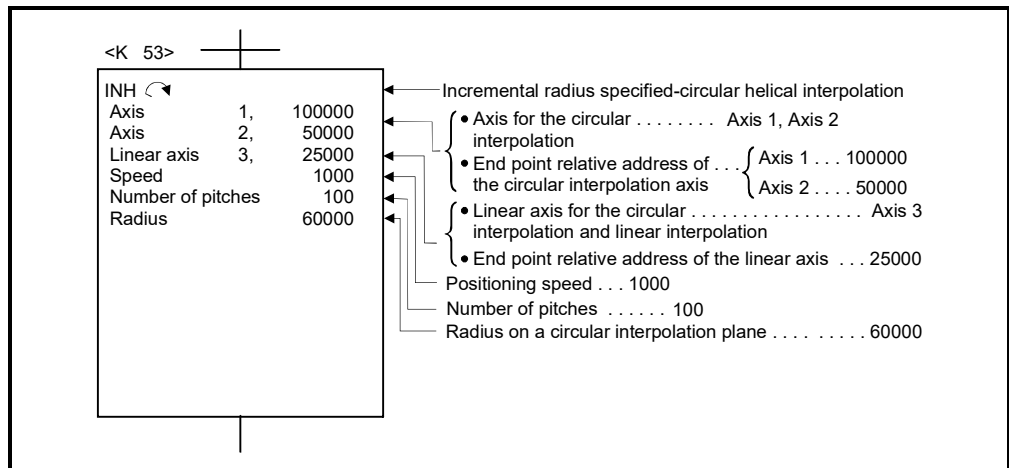

(Note): Example of the Motion SFC program for positioning control is shown next page.

(2) Motion SFC program

Motion SFC program for which executes the servo program is shown below.

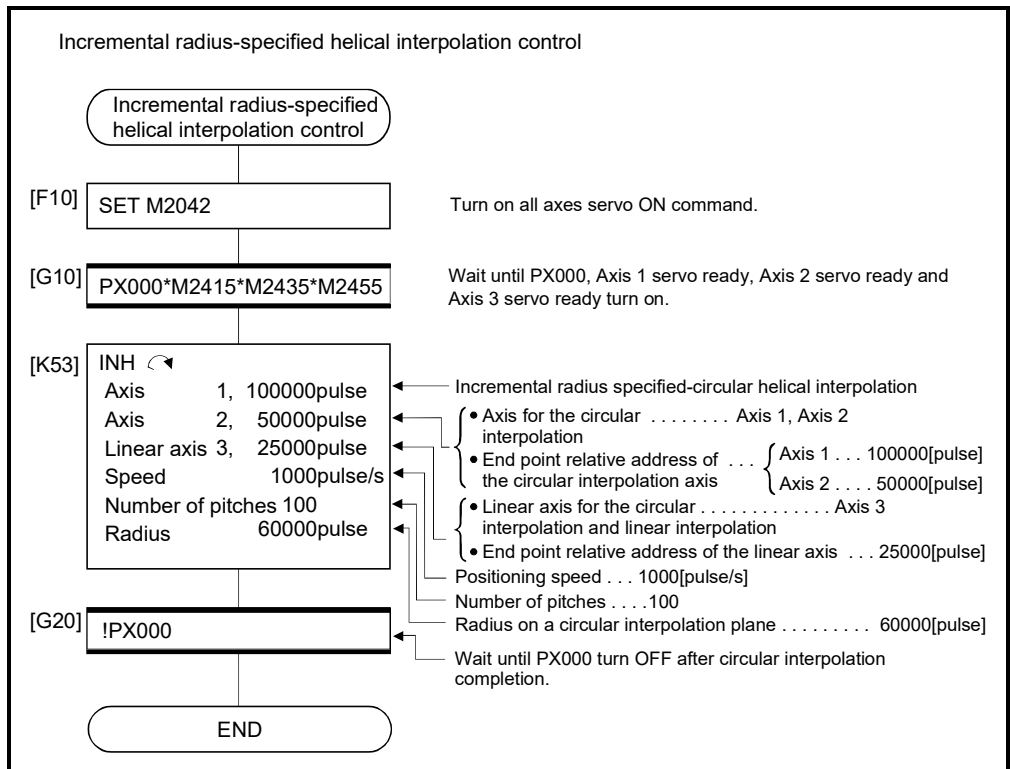

(Note): Example of the above Motion SFC program is started using the automatic start or sequence program.

6 POSITIONING CONTROL

ABH ↻, ABH ↺ Absolute central point-specified helical interpolation control

[Control details]

The linear interpolation to other linear axis is executed performing 2 axes circular interpolation from current stop position (X_0, Y_0, Z_0) to specified circular end address (X_1, Y_1) or linear axis end point address (Z_1), and the absolute helical interpolation is executed so that it may become a spiral course.

It goes around on the specified circle for the specified number of pitches, the circular interpolation which had remainder specified is executed, and positioning to end address is executed. The central point-specified circle specifies circular interpolation method connected start point and end point at the seeing on the plane for which performs circular interpolation.

Operation details for absolute central point-specified helical interpolation are shown below.

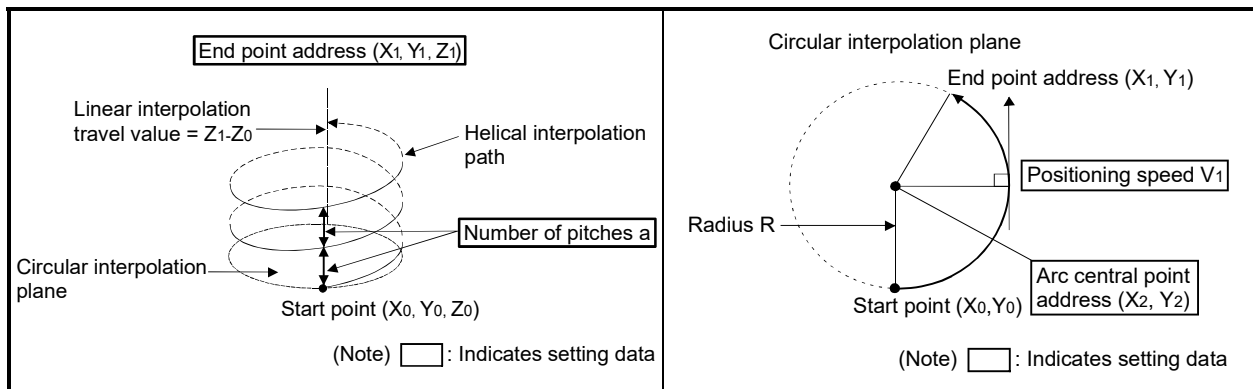

Control details for the servo instructions are shown below.

Instruction	Rotation direction of servo motor	Controllable angle of arc	Positioning pass
ABH ↻ Central point-specified helical interpolation CW	Clockwise (CW)	$0^\circ < \theta \leq 360^\circ$	
ABH ↺ Central point-specified helical interpolation CCW	Counter clockwise (CCW)		

(1) The setting range of end point address for the both of circular interpolation axis and linear interpolation axis is (-2^{31}) to $(2^{31}-1)$.

(2) The setting range of central point address is (-2^{31}) to $(2^{31}-1)$.

- (3) The maximum arc radius on the circular interpolation plane is $2^{31}-1$.
For example, the maximum arc radius for electronic gear 1:1 of unit [mm] is 214748364.7[μm].

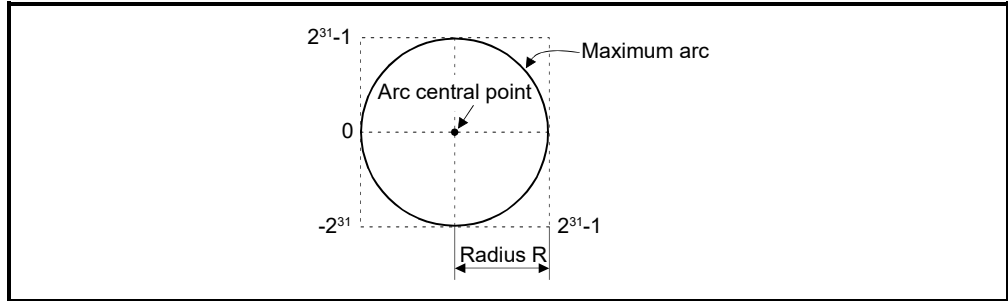

- (4) Set the command speed with the vector speed for 2 axes circular interpolation axis.
- (5) The command speed unit is specified in the parameter block.
- (6) Set the number of pitches within the range of 0 to 999. If it is set outside the setting range, the servo program setting error (error code: 28) occurs and operation does not start.
- (7) All of the circular interpolation axis, linear axis end point address, command speed, radius (2 word data above) and number of pitches (1 word data) are set indirectly by the word devices.
- (8) If start point = end point, number of pitches = 1 and travel value of linear axis = 0, at the only central point-specified circular interpolation, full circle can be drawn.

[Program]

(1) Servo program

Servo program No.55 for absolute central point-specified helical interpolation control is shown below.

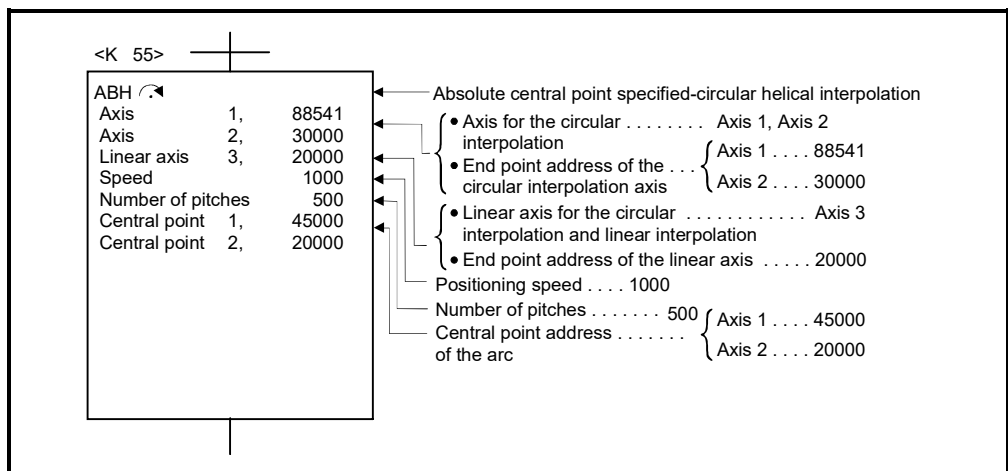

(Note): Example of the Motion SFC program for positioning control is shown next page.

(2) Motion SFC program

Motion SFC program for which executes the servo program is shown below.

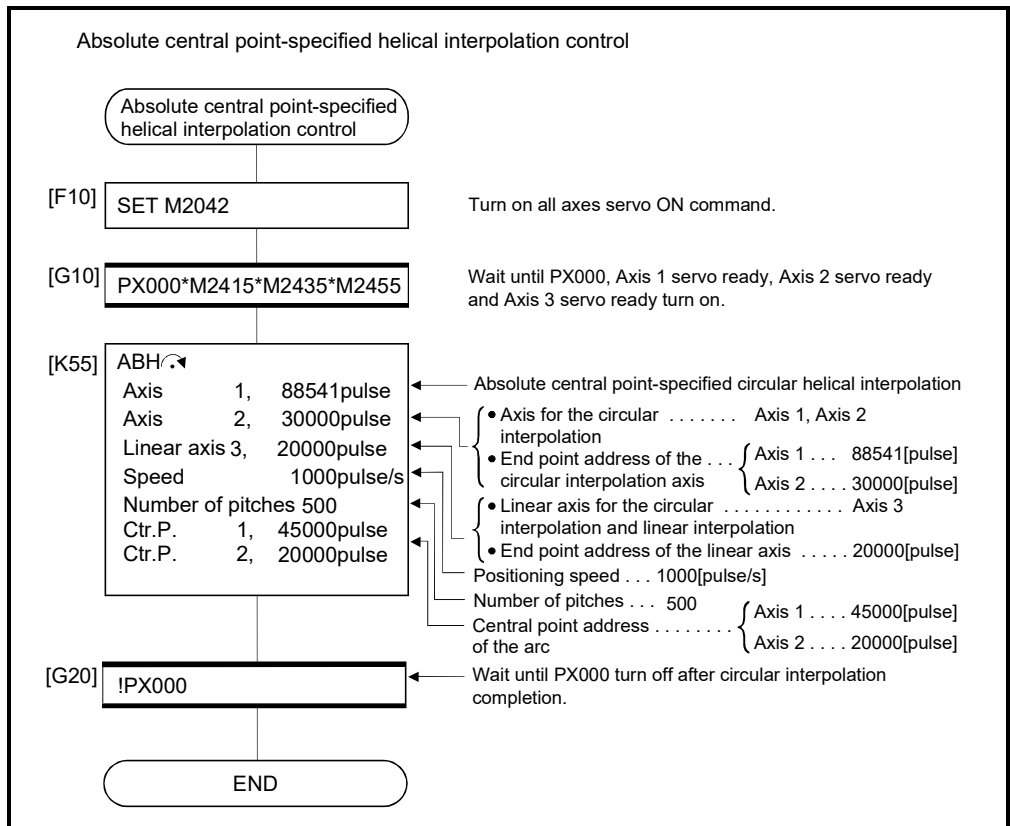

(Note): Example of the above Motion SFC program is started using the automatic start or sequence program.

6 POSITIONING CONTROL

INH , INH  Incremental central point-specified helical interpolation control

[Control details]



The linear interpolation to other linear axis is executed performing circular interpolation from current stop position (start point) to specified circular relative end address (X1, Y1) or linear axis end point relative address (Z1), and the incremental helical interpolation control is executed so that it may become a spiral course.

It goes around on the specified circle for the specified number of pitches, the circular interpolation which had remainder specified is executed, and positioning to end address is executed. The central point-specified circle specifies circular interpolation method connected start point and end point at the seeing on the plane for which performs circular interpolation.

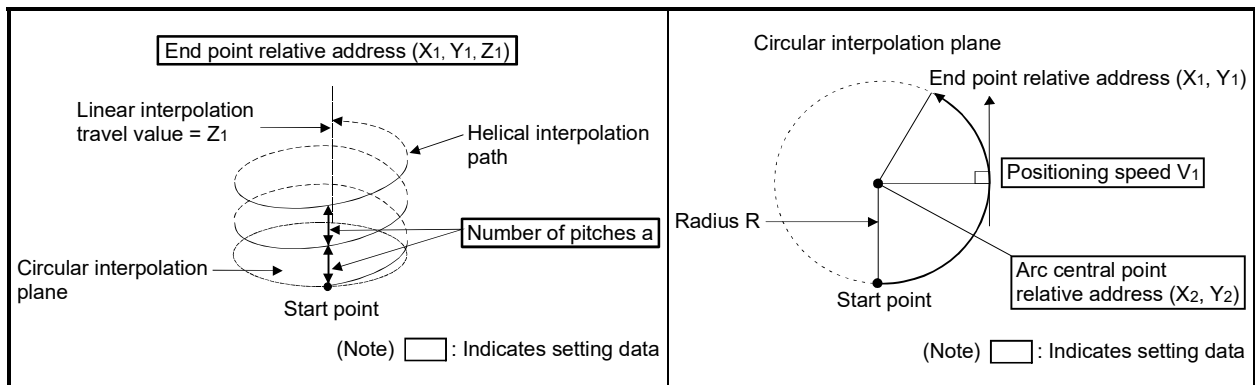
Operation details for incremental central point -specified helical interpolation are shown below.



Control details for the servo instructions are shown below.

Instruction	Rotation direction of servo motor	Controllable angle of arc	Positioning pass
INH  Central point-specified helical interpolation CW	Clockwise (CW)	$0^\circ < \theta \leq 360^\circ$	
INH  Central point-specified helical interpolation CCW	Counter clockwise (CCW)		

- (1) The setting range of end point relative address for the both of circular interpolation axis and linear interpolation axis is 0 to $\pm (2^{31}-1)$.
- (2) The setting range of central point relative is 0 to $\pm (2^{31}-1)$.

- (3) The maximum arc radius on the circular interpolation plane is $(2^{31}-1)$.
 For example, the maximum arc radius for electronic gear 1:1 of unit [mm] is 214748364.7[μm].

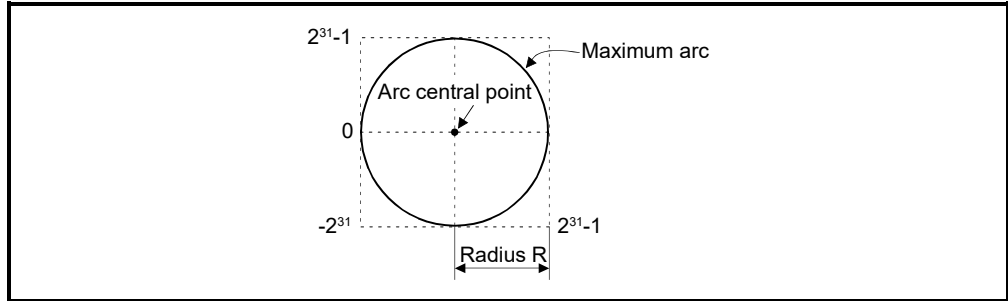

- (4) Set the command speed with the vector speed for 2 axes circular interpolation axis.
- (5) The command speed unit is specified in the parameter block.
- (6) Set the number of pitches within the range of 0 to 999. If it is set outside the setting range, the servo program setting error (error code: 28) occurs and operation does not start.
- (7) All of the circular interpolation axis, linear axis end relative address, command speed, radius (2 word data above) and number of pitches (1 word data) are set indirectly by the word devices.
- (8) If start point = end point, number of pitches = 1 and travel value of linear axis = 0, at the only central point-specified circular interpolation, full circle can be drawn.

[Program]

(1) Servo program

Servo program No.56 for incremental central point-specified helical interpolation control is shown below.

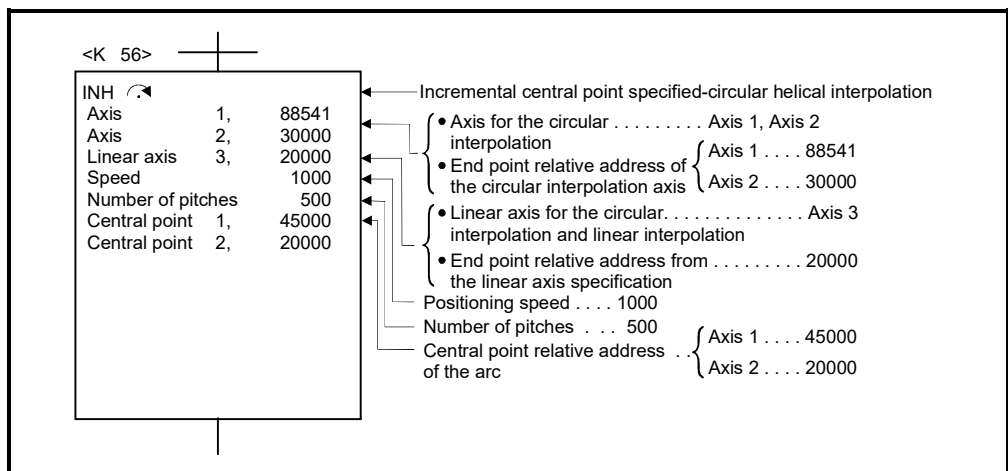

(Note): Example of the Motion SFC program for positioning control is shown next page.

(2) Motion SFC program

Motion SFC program for which executes the servo program is shown below.

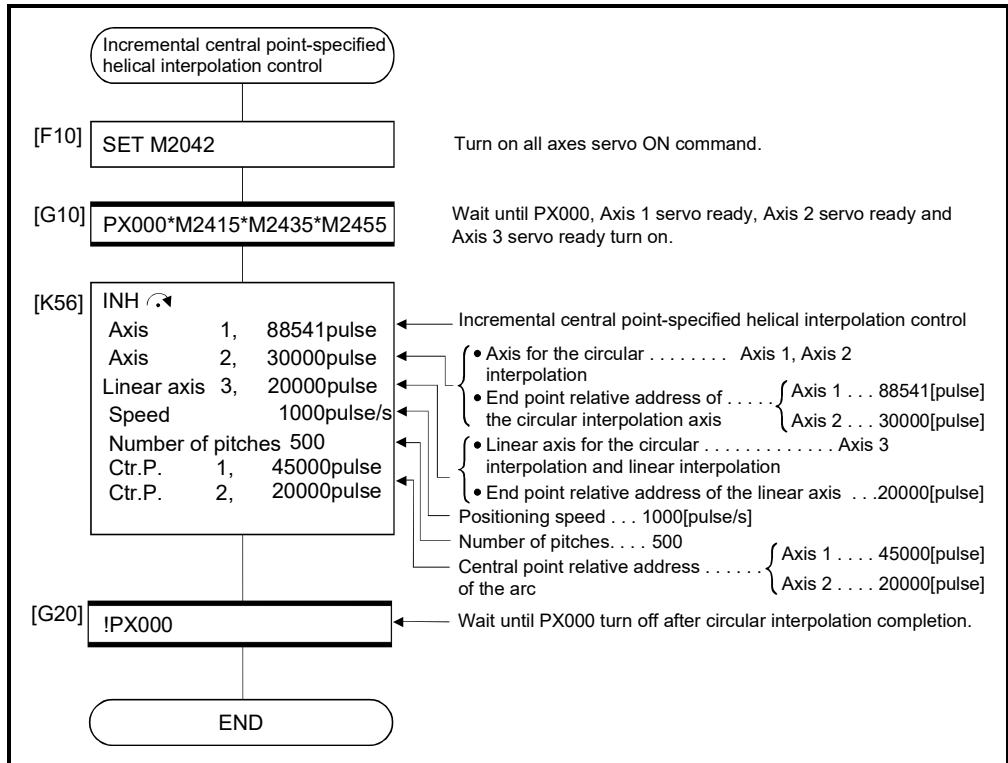

(Note): Example of the above Motion SFC program is started using the automatic start or sequence program.

6 POSITIONING CONTROL

ABH \curvearrowright Absolute auxiliary point-specified helical interpolation control

[Control details]

The linear interpolation to other linear axis is executed performing 2 axes circular interpolation from current stop position (X_0, Y_0, Z_0) to specified circular end address (X_1, Y_1) or linear axis end point address (Z_1), and the absolute helical interpolation is executed so that it may become a spiral course.

It goes around on the specified circle for the specified number of pitches, the circular interpolation which had remainder specified is executed, and positioning to end address is executed. The auxiliary point-specified circle specifies circular interpolation method connected start point and end point at the seeing on the plane for which performs circular interpolation.

Operation details for absolute auxiliary point-specified helical interpolation are shown below.

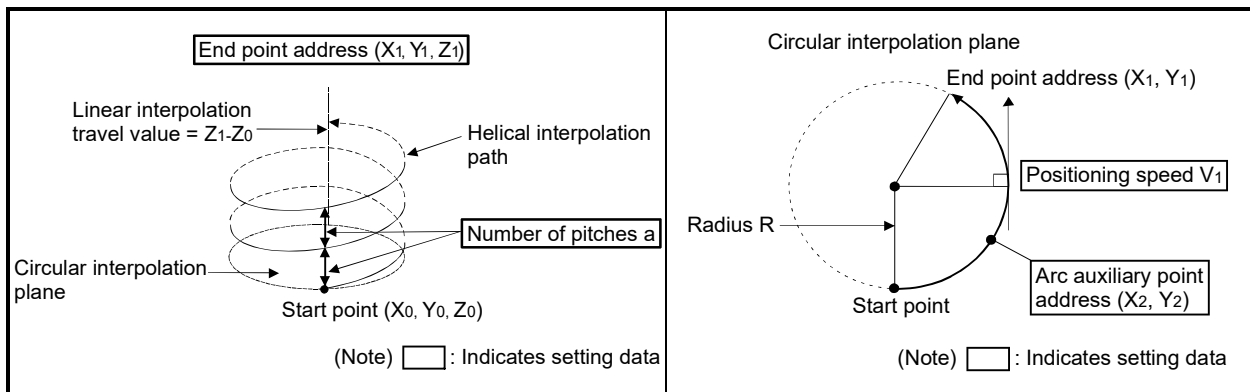

Control details for the servo instructions are shown below.

Instruction	Rotation direction of servo motor	Controllable angle of arc
ABH \curvearrowright Auxiliary point-specified helical interpolation	Clockwise (CW)/ Counter clockwise (CCW)	$0^\circ < \theta \leq 360^\circ$

- (1) The setting range of end point address for the both of circular interpolation axis and linear interpolation axis is (-2^{31}) to $(2^{31}-1)$.
- (2) The setting range of auxiliary point address is (-2^{31}) to $(2^{31}-1)$.

- (3) The maximum arc radius on the circular interpolation plane is $2^{31}-1$.
For example, the maximum arc radius for electronic gear 1:1 of unit [mm] is 214748364.7[μm].

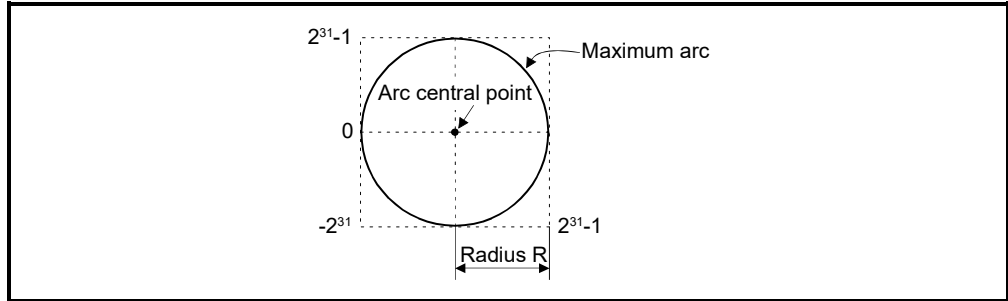

- (4) Set the command speed with the vector speed for 2 axes circular interpolation axis.
- (5) The command speed unit is specified in the parameter block.
- (6) Set the number of pitches within the range of 0 to 999. If it is set outside the setting range, the servo program setting error (error code: 28) occurs and operation does not start.
- (7) All of the circular interpolation axis, linear axis end relative address, command speed, radius (2 word data above) and number of pitches (1 word data) are set indirectly by the word devices.

[Program]

(1) Servo program

Servo program No.60 for absolute auxiliary point-specified helical interpolation control is shown below.

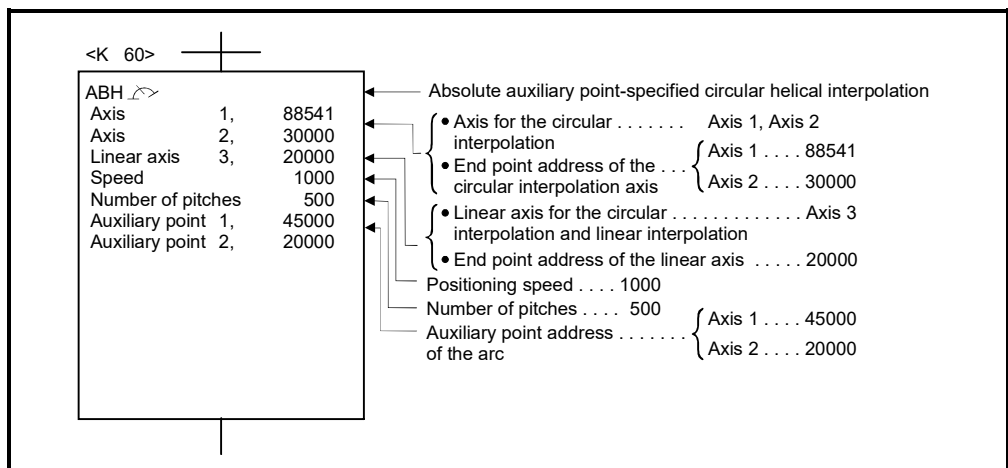

(Note): Example of the Motion SFC program for positioning control is shown next page.

(2) Motion SFC program

Motion SFC program for which executes the servo program is shown below.

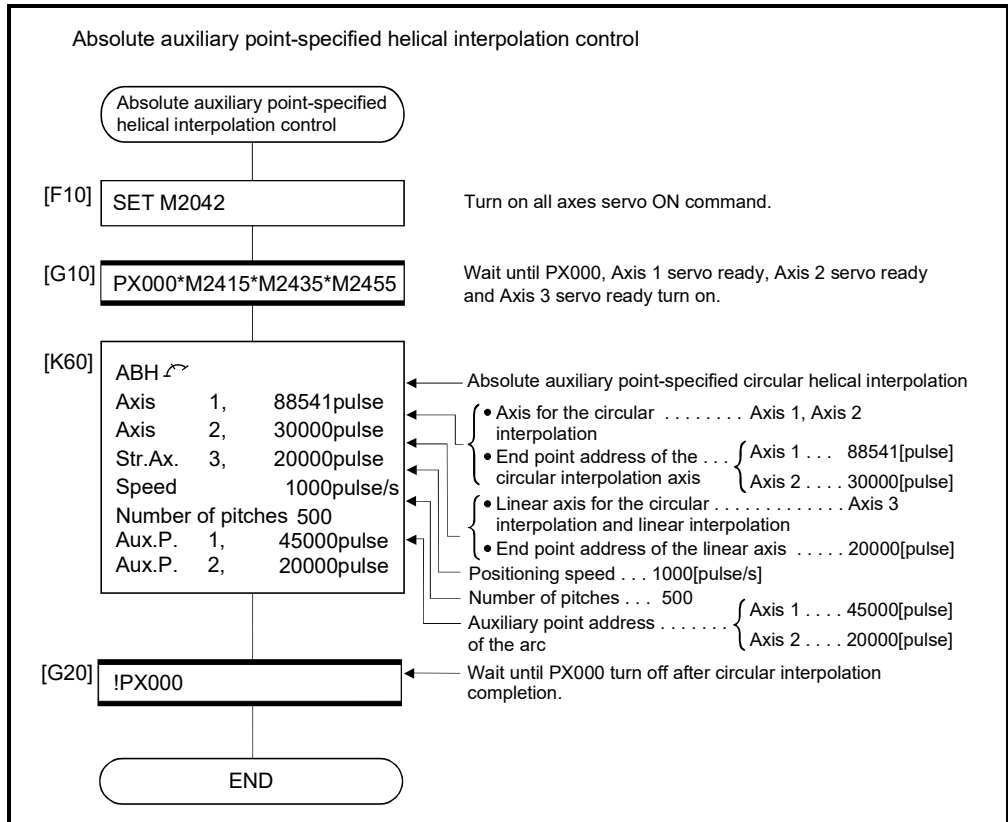

(Note): Example of the above Motion SFC program is started using the automatic start or sequence program.

6 POSITIONING CONTROL

INH \curvearrowright Incremental auxiliary point-specified helical interpolation control

[Control details]

The linear interpolation to other linear axis is executed performing circular interpolation from current stop position (start point) to specified circular relative end address (X1, Y1) or linear axis end point relative address (Z1), and the incremental helical interpolation control is executed so that it may become a spiral course.

It goes around on the specified circle for the specified number of pitches, the circular interpolation which had remainder specified is executed, and positioning to end address is executed. The auxiliary point-specified circle specifies circular interpolation method connected start point and end point at the seeing on the plane for which performs circular interpolation.

Operation details for incremental auxiliary point-specified helical interpolation are shown below.

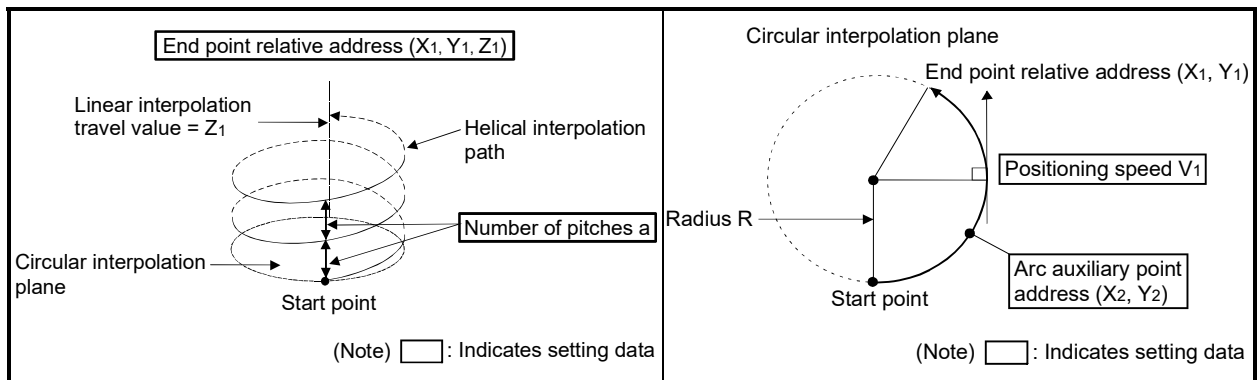

Control details for the servo instructions are shown below.

Instruction	Rotation direction of servo motor	Controllable angle of arc
INH \curvearrowright Auxiliary point-specified helical interpolation	Clockwise (CW)/ Counter clockwise (CCW)	$0^\circ < \theta \leq 360^\circ$

- (1) The setting range of end point relative address for the both of circular interpolation axis and linear interpolation axis is 0 to $\pm (2^{31}-1)$.
- (2) The setting range of auxiliary point relative is 0 to $\pm (2^{31}-1)$.

- (3) The maximum arc radius on the circular interpolation plane is $(2^{31}-1)$.
For example, the maximum arc radius for electronic gear 1:1 of unit [mm] is 214748364.7[μm].

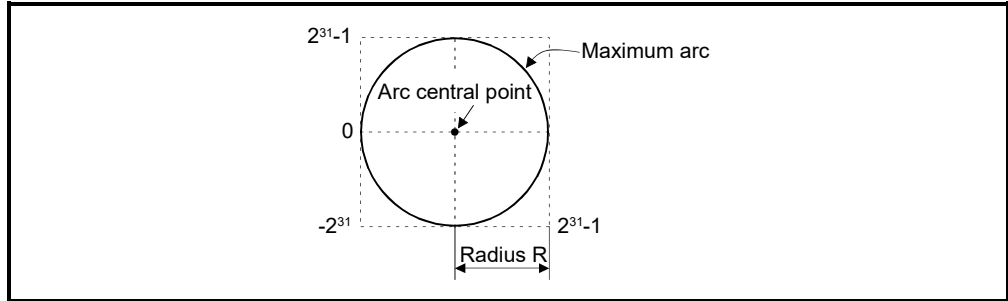

- (4) Set the command speed with the vector speed for 2 axes circular interpolation axis.
- (5) The command speed unit is specified in the parameter block.
- (6) Set the number of pitches within the range of 0 to 999. If it is set outside the setting range, the servo program setting error (error code: 28) occurs and operation does not start.
- (7) All of the circular interpolation axis, linear axis end point address, command speed, radius (2 word data above), and number of pitches (1 word data) are set indirectly by the word devices.

[Program]

(1) Servo program

Servo program No.61 for incremental auxiliary point-specified helical interpolation control is shown below.

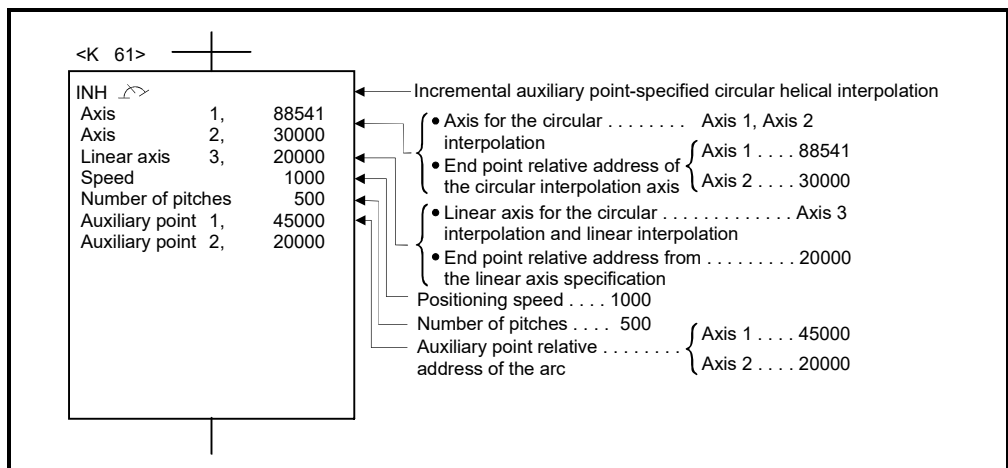

(Note): Example of the Motion SFC program for positioning control is shown next page.

(2) Motion SFC program

Motion SFC program for which executes the servo program is shown below.

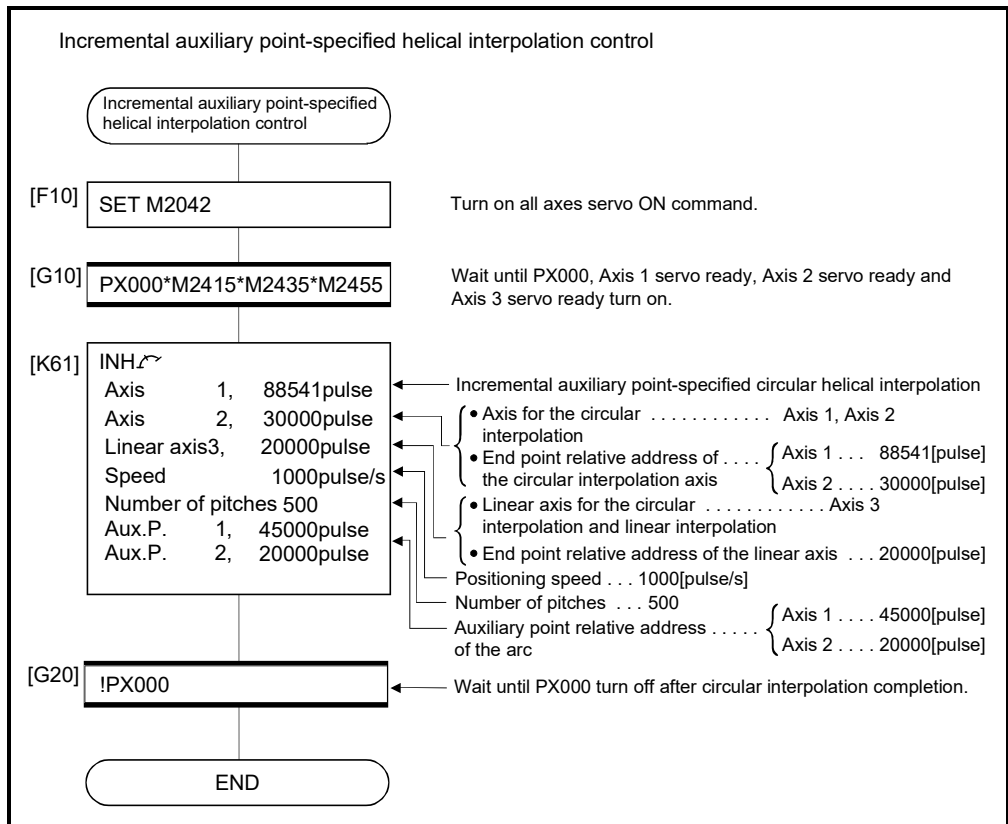

(Note): Example of the above Motion SFC program is started using the automatic start or sequence program.

6 POSITIONING CONTROL

6.10 1 Axis Fixed-Pitch Feed Control

Positioning control for specified axis of specified travel value from the current stop point.

Fixed-pitch feed control uses the FEED-1 servo instruction.

Servo instruction	Positioning method	Number of control axes	Items set using MT Developer2																Speed change					
			Common						Arc		Parameter block						Others							
			Parameter block No.	Axis	Address/travel value	Command speed	Dwell time	M-code	Torque limit value	Auxiliary point	Radius	Central point	Interpolation control unit	Speed limit value	Acceleration time	Deceleration time	Rapid Stop deceleration time	Torque limit value		Deceleration processing on stop input	Allowable error range for circular interpolation	S-curve ratio	Advanced S-curve acceleration/deceleration	Cancel
FEED-1	Incremental	1	△	○	○	○	△	△							△	△	△	△	△	△	△	△	△	Valid

○ : Must be set
△ : Set if required

[Control details]

- (1) Positioning control for the specified travel value from the current stop position "0" is executed.
- (2) The travel direction is set by the sign (+/-) of the travel value, as follows:
 - Positive travel valuePositioning control to forward direction
(Address increase direction)
 - Negative travel value.....Positioning control to reverse direction
(Address decrease direction)

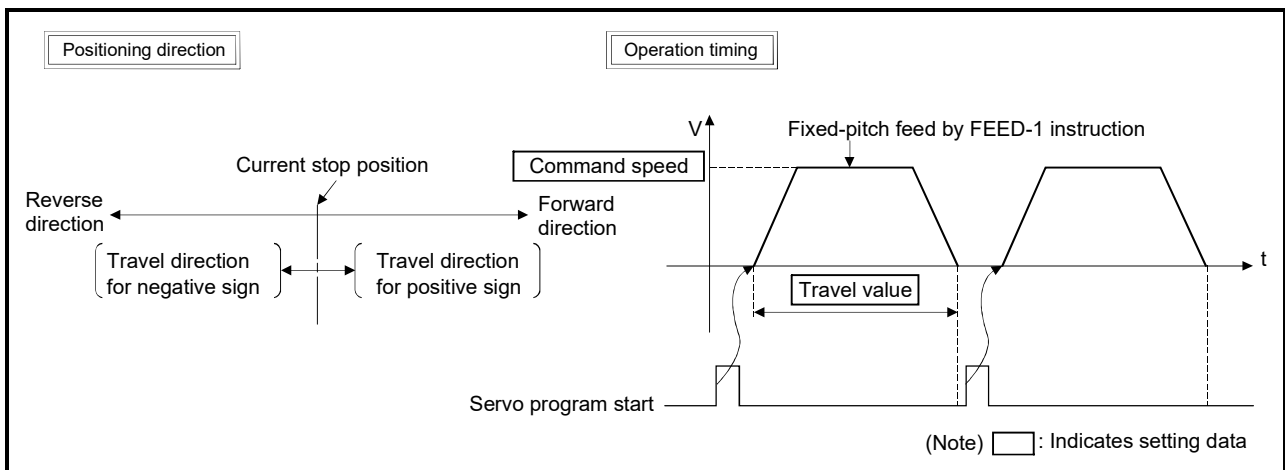

Fig.6.23 1 axis fixed-pitch feed control

POINT

Do not set the travel value to "0" for fixed-pitch feed control.

If the travel value is set to "0", fixed-pitch feed completion without fixed-pitch feed.

[Cautions]

- (1) The feed current value is changed to "0" at the start.
When fixed-pitch feed control is executed in the absolute position system, the feed current value that is restored when the control circuit power supply of the servo amplifier or the Multiple CPU system power supply is turned ON again, may be different from the feed current value before the power supply was turned ON again.

[Program]

Program for repetition 1 axis fixed-pitch feed control is shown as the following conditions.

(1) System configuration

Fixed-pitch feed control of Axis 4.

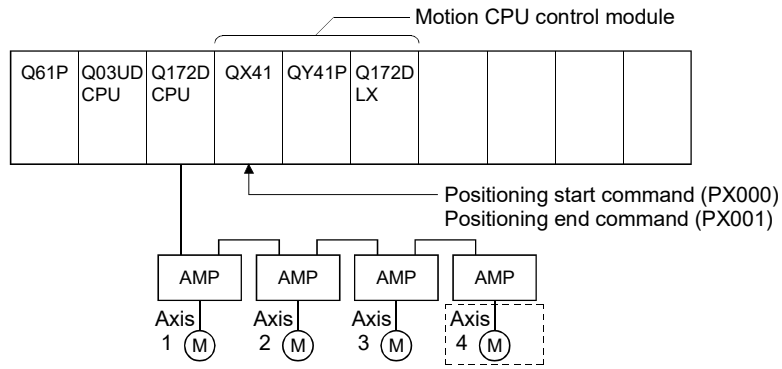

(2) Fixed-pitch feed control conditions

(a) Positioning conditions are shown below.

Item	Setting
Servo program No.	No.300
Control axis	Axis 4
Control speed	10000
Travel value	80000

- (b) Fixed-pitch feed control start command PX000 Leading edge (OFF → ON)
- (c) Fixed-pitch feed control end command PX001 Leading edge (OFF → ON)

(3) Operation timing

Operation timing for fixed-pitch feed control is shown below.

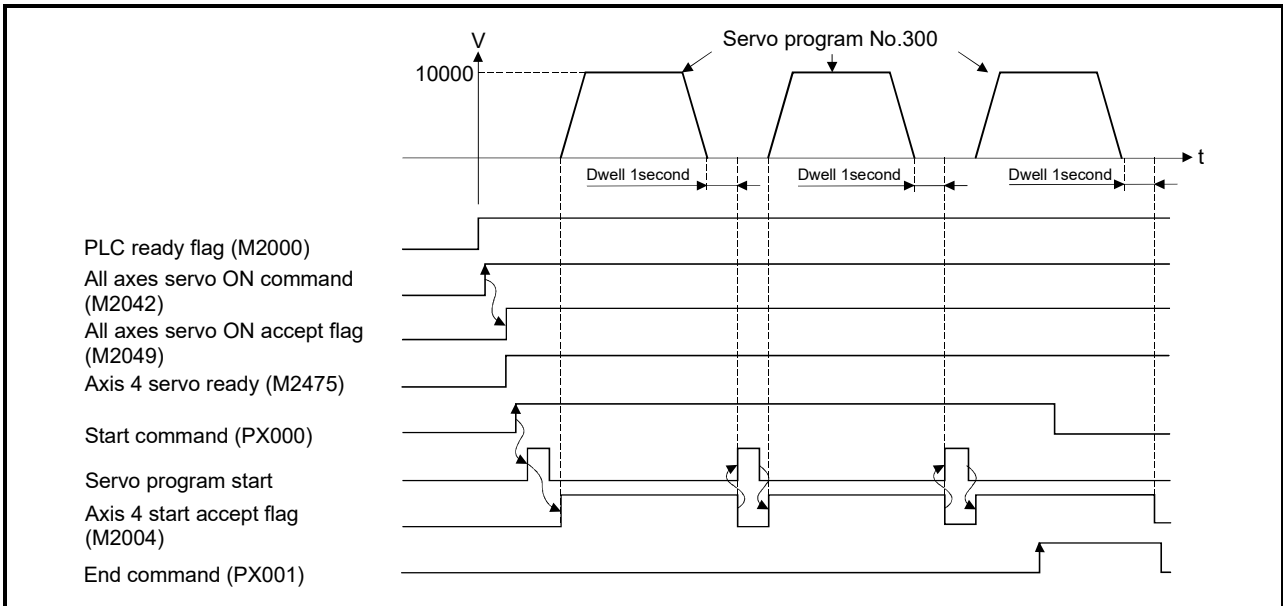

(4) Servo program

Servo program No.300 for fixed-pitch feed control is shown below.

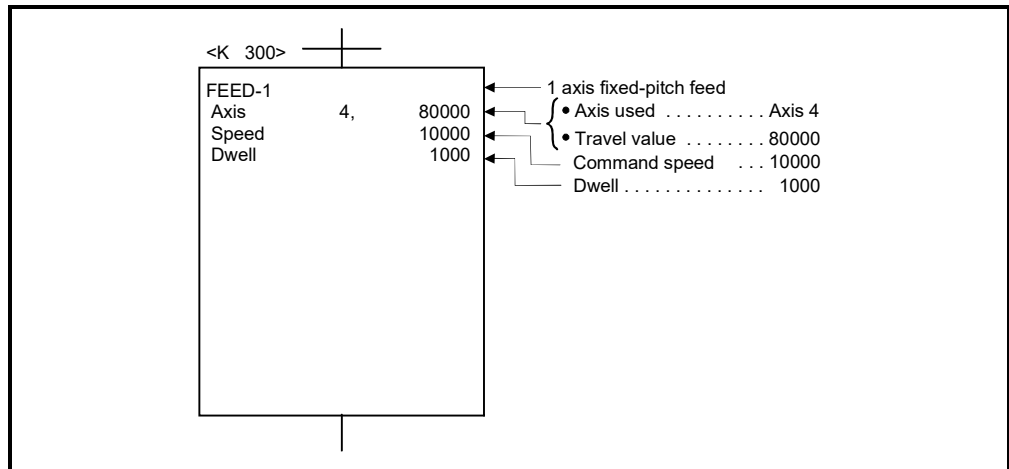

(Note): Example of the Motion SFC program for positioning control is shown next page.

(5) Motion SFC program

Motion SFC program for which executes the servo program is shown below.

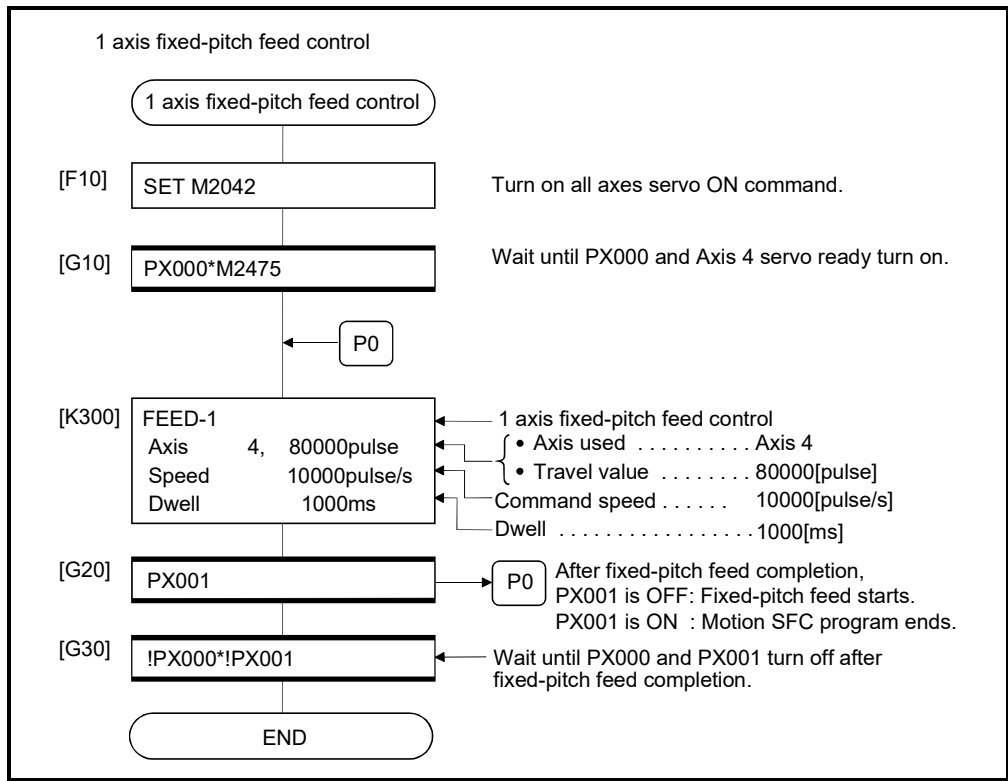

(Note): Example of the above Motion SFC program is started using the automatic start or sequence program.

6 POSITIONING CONTROL

6.11 Fixed-Pitch Feed Control Using 2 Axes Linear Interpolation

Fixed-pitch feed control using 2 axes linear interpolation from the current stop position with the specified 2 axes.

Fixed-pitch feed control using 2 axes linear interpolation uses the FEED-2 servo instruction.

Servo instruction	Positioning method	Number of control axes	Items set using MT Developer2																	Speed change					
			Common							Arc			Parameter block						Others						
			Parameter block No.	Axis	Address/travel value	Command speed	Dwell time	M-code	Torque limit value	Auxiliary point	Radius	Central point	Interpolation control unit	Speed limit value	Acceleration time	Deceleration time	Rapid Stop deceleration time	Torque limit value	Deceleration processing on stop input		Allowable error range for circular interpolation	S-curve ratio	Advanced S-curve acceleration/deceleration	Cancel	WAIT-ON/OFF
FEED-2	Incremental	2	△	○	○	○	△	△					△	△	△	△	△	△	△	△	△	△	△	△	Valid

○ : Must be set
△ : Set if required

[Control details]

- (1) Positioning control from the current stop position "0" to the position which combined travel direction and travel value specified with each axis is executed.
- (2) The travel direction for each axis is set by the sign (+/-) of the travel value for each axis, as follows:
 - Positive travel valuePositioning control to forward direction
(Address increase direction)
 - Negative travel value.....Positioning control to reverse direction
(Address decrease direction)

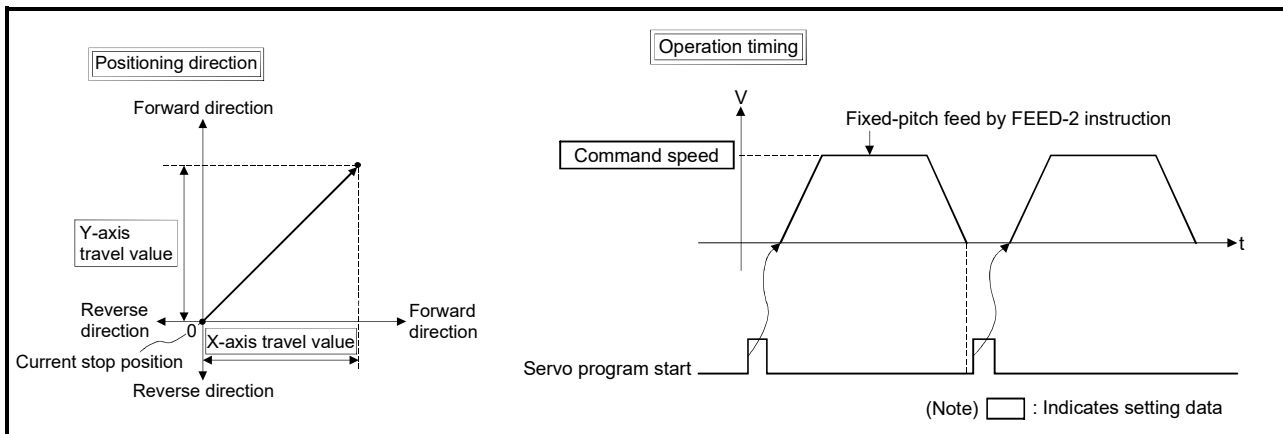

Fig.6.24 Fixed-pitch feed control using 2 axes linear interpolation

6 POSITIONING CONTROL

POINT

Do not set the travel value to "0" for fixed-pitch feed control.

The following results if the travel value is set to "0":

- (1) If the travel value of both is set to "0", fixed-pitch feed completion without fixed-pitch feed.

[Cautions]

- (1) The feed current value is changed to "0" at the start.
When fixed-pitch feed control is executed in the absolute position system, the feed current value that is restored when the control circuit power supply of the servo amplifier or the Multiple CPU system power supply is turned ON again, may be different from the feed current value before the power supply was turned ON again.

[Program]

Program for fixed-pitch feed control using 2 axes linear interpolation is shown as the following conditions.

(1) System configuration

Fixed-pitch feed control using 2 axes linear interpolation of Axis 2 and Axis 3.

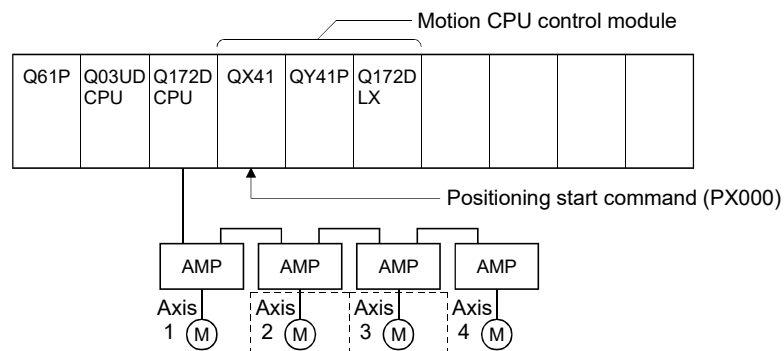

(2) Fixed-pitch feed control

(a) Fixed-pitch feed control conditions are shown below.

Item	Setting	
Servo program No.	No.310	
Positioning speed	10000	
Control axis	Axis 2	Axis 3
Travel value	500000	300000

(b) Fixed-pitch feed control start command PX000 Leading edge
(OFF → ON)

(3) Operation timing

Operation timing for fixed-pitch feed control using 2 axes linear interpolation is shown below.

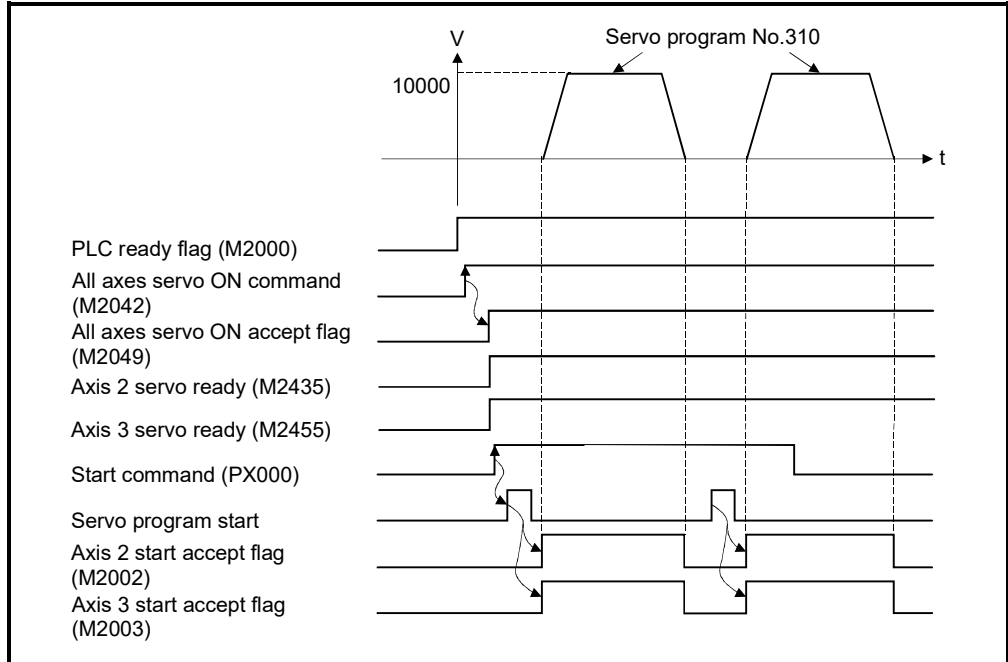

(4) Servo program

Servo program No.310 for fixed-pitch feed control using 2 axes linear interpolation is shown below.

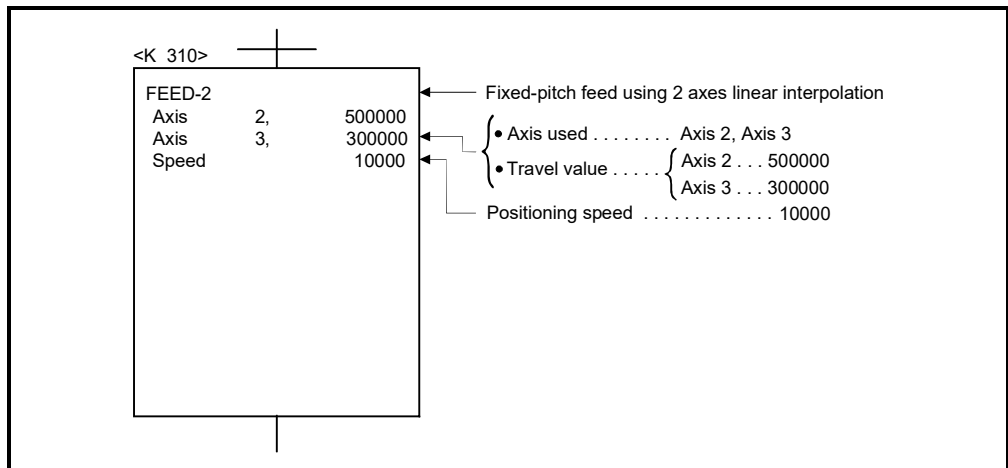

(Note): Example of the Motion SFC program for positioning control is shown next page.

(5) Motion SFC program

Motion SFC program for which executes the speed-switching control is shown below.

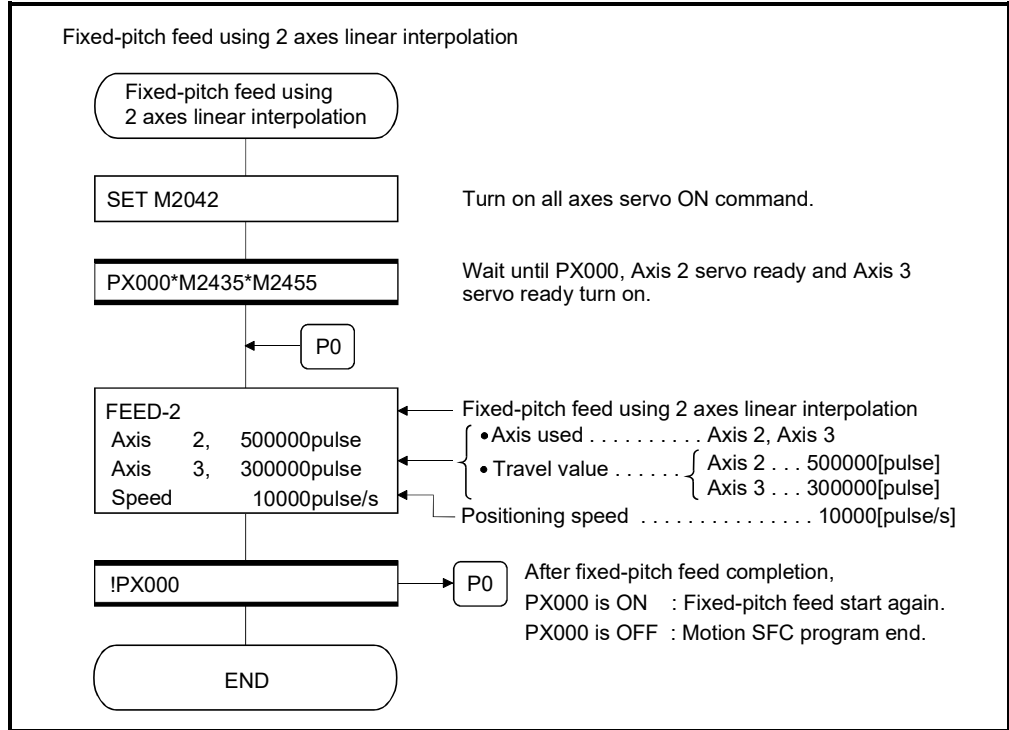

(Note): Example of the above Motion SFC program is started using the automatic start or sequence program.

6 POSITIONING CONTROL

6.12 Fixed-Pitch Feed Control Using 3 Axes Linear Interpolation

Fixed-pitch feed control using 3 axes linear interpolation from the current stop position with the specified 3 axes.

Fixed-pitch feed control using 3 axes linear interpolation uses the FEED-3 servo instruction.

Servo instruction	Positioning method	Number of control axes	Items set using MT Developer2																	Speed change					
			Common							Arc			Parameter block						Others						
			Parameter block No.	Axis	Address/travel value	Command speed	Dwell time	M-code	Torque limit value	Auxiliary point	Radius	Central point	Interpolation control unit	Speed limit value	Acceleration time	Deceleration time	Rapid Stop deceleration time	Torque limit value	Deceleration processing on stop input		Allowable error range for circular interpolation	S-curve ratio	Advanced S-curve acceleration/deceleration	Cancel	WAIT-ON/OFF
FEED-3	Incremental	2	△	○	○	○	△	△					△	△	△	△	△	△	△	△	△	△	△	△	Valid

○ : Must be set
△ : Set if required

[Control details]

- Positioning control from the current stop position "0" to the position which combined travel direction and travel value specified with each axis is executed.
- The travel direction for each axis is set by the sign (+/-) of the travel value for each axis, as follows:
 - Positive travel valuePositioning control to forward direction (Address increase direction)
 - Negative travel value.....Positioning control to reverse direction (Address decrease direction)

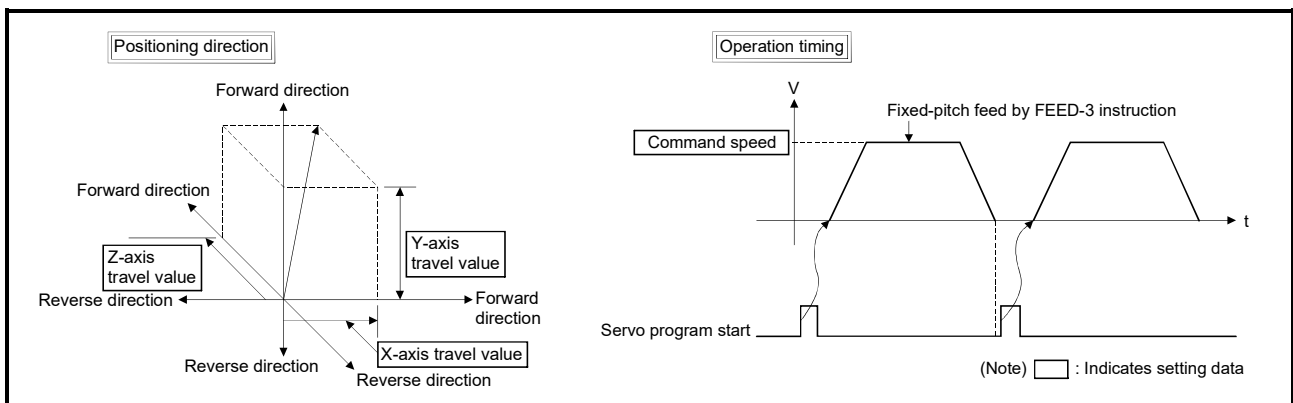

Fig. 6.25 Fixed-pitch feed control using 3 axes linear interpolation

6 POSITIONING CONTROL

POINT

Do not set the travel value to "0" for fixed-pitch feed control.

The following results if the travel value is set to "0":

- (1) If the travel value of all axes are set to "0", fixed-pitch feed completion without fixed-pitch feed.

[Cautions]

- (1) The feed current value is changed to "0" at the start.
When fixed-pitch feed control is executed in the absolute position system, the feed current value that is restored when the control circuit power supply of the servo amplifier or the Multiple CPU system power supply is turned ON again, may be different from the feed current value before the power supply was turned ON again.

[Program]

Program for fixed-pitch feed control using 3 axes linear interpolation is shown as the following conditions.

(1) System configuration

Fixed-pitch feed control using 3 axes linear interpolation of Axis 1, Axis 2 and Axis 3.

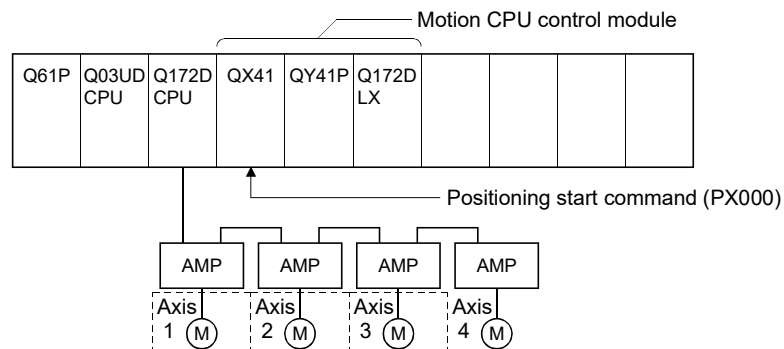

(2) Fixed-pitch feed control

(a) Fixed-pitch feed control conditions are shown below.

Item	Setting		
Servo program No.	No.320		
Positioning speed	1000		
Control axes	Axis 1	Axis 2	Axis 3
Travel value	50000	40000	30000

(b) Fixed-pitch feed control start command PX000 Leading edge
(OFF → ON)

(3) Operation timing

Operation timing for fixed-pitch feed control using 3 axes linear interpolation is shown below.

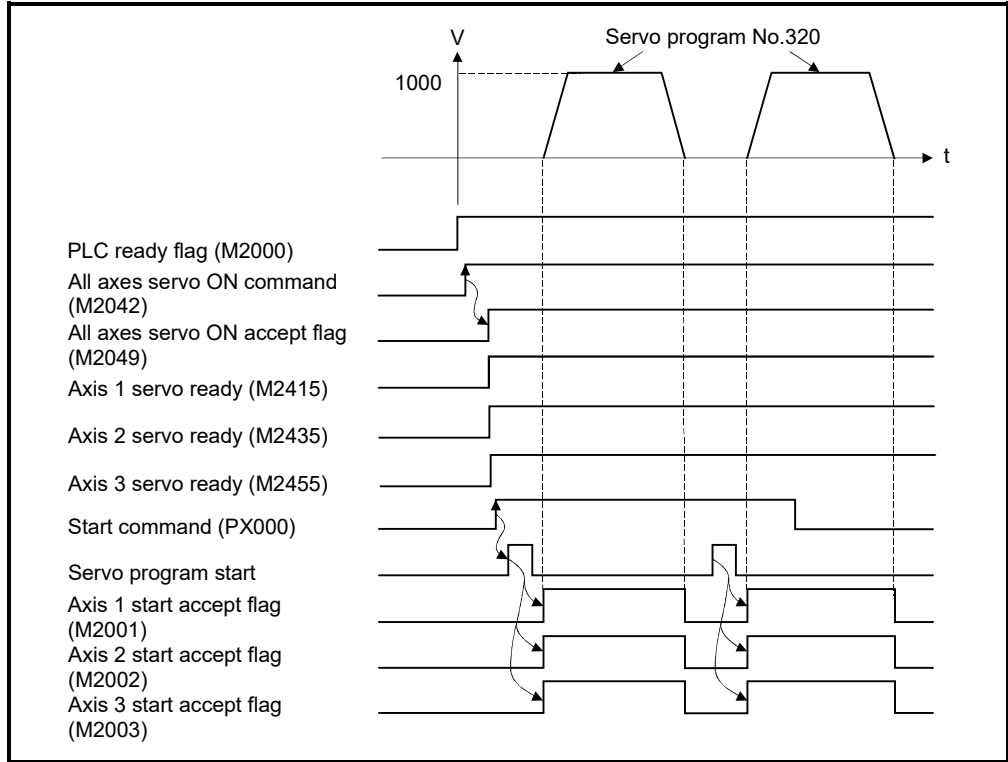

(4) Servo program

Servo program No.320 for fixed-pitch feed control using 3 axes linear interpolation is shown below.

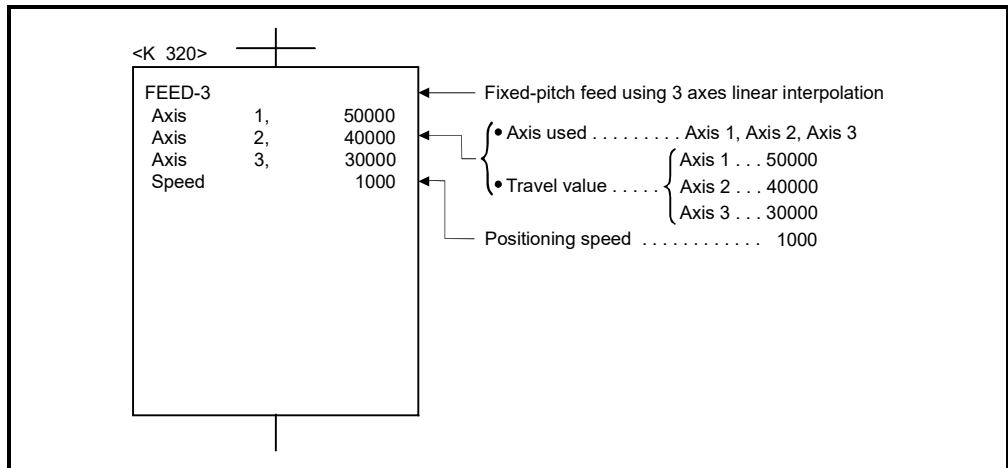

(Note): Example of the Motion SFC program for positioning control is shown next page.

(5) Motion SFC program

Motion SFC program for which executes the servo program is shown below.

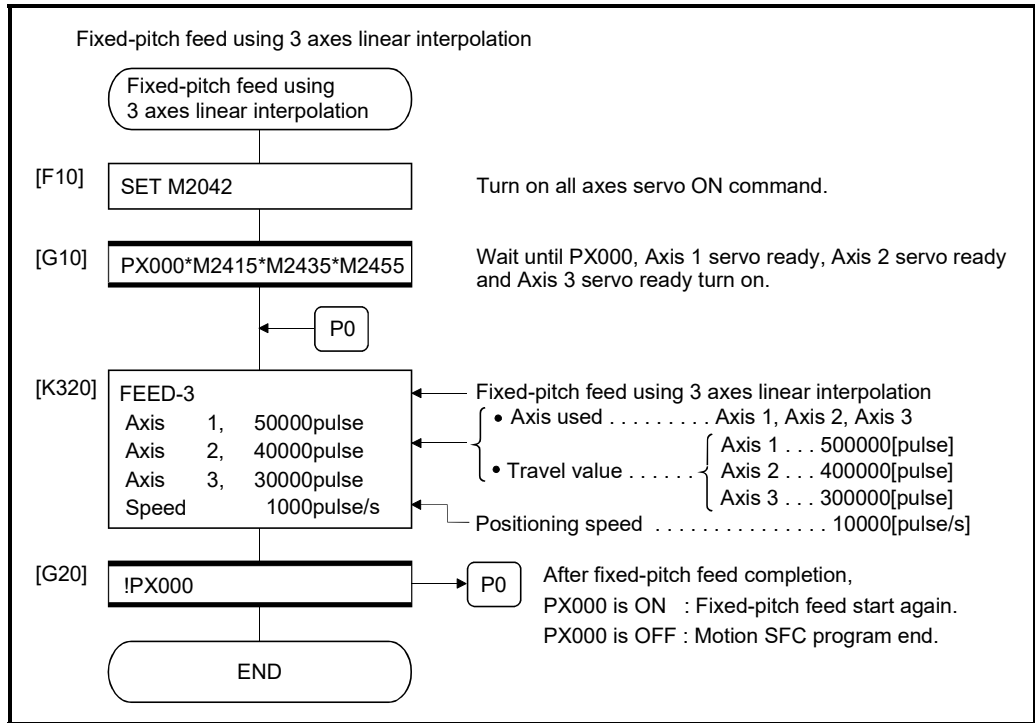

(Note): Example of the above Motion SFC program is started using the automatic start or sequence program.

6 POSITIONING CONTROL

6.13 Speed Control (I)

- (1) Speed control for the specified axis is executed.
- (2) Control includes positioning loops for control of servo amplifiers.

POINT

Refer to Section 7.7 for performing speed control that does not include positioning loops without using the servo program. **QDS**

- (3) Speed control (I) uses the VF (Forward) and VR (Reverse) servo instructions.

Servo instruction	Positioning method	Number of control axes	Items set using MT Developer2																				Speed change			
			Common					Arc			Parameter block										Others					
			Parameter block No.	Axis	Address/travel value	Command speed	Dwell time	M-code	Torque limit value	Auxiliary point	Radius	Central point	Interpolation control unit	Speed limit value	Acceleration time	Deceleration time	Rapid Stop deceleration time	Torque limit value	Deceleration processing on stop input	Allowable error range for circular interpolation	S-curve ratio	Advanced S-curve acceleration/deceleration		Cancel	WAIT-ON/OFF	
VF	—	1	△	○		○		△							△	△	△	△	△	△	△	△	△	△	△	Valid
VR																										

○: Must be set
△: Set if required

[Control details]

- (1) Controls the axis at the specified speed until the input of the stop command after starting of the servo motors.
 - VF Forward direction start
 - VR Reverse direction start
- (2) The operation of the current value is as follows.
 - (a) Q173DSCPU/Q172DSCPU **Ver.!**
 The operation is as follows depending on the status of the feed current value update command (M3212+20n).
 - ON The feed current value is updated. The software stroke limit is valid.
 - OFF "0" is stored in the feed current value.
 (Note): When the operating system software is 00A, the operation is same as (b).

Ver.!: Refer to Section 1.3 for the software version that supports this function.

(b) Q173DCPU(-S1)/Q172DCPU(-S1)
Current value does not change at "0".

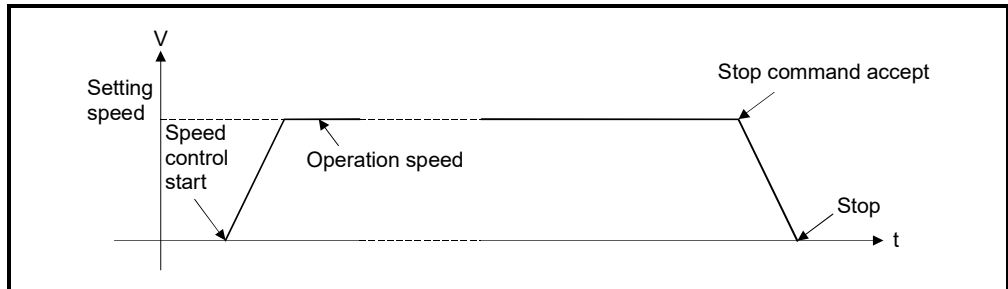

Fig.6.26 Speed control (I)

(3) Stop commands and stop processing

The stop commands and stop processing for speed control are shown in the table.6.1.

Table.6.1 Stop commands and stop processing

Stop command	Stop condition	Stop axis	Stop processing
STOP signal input of the Q172DLX (STOP)	OFF → ON	Specified axis	Deceleration stop based on the parameter block or the "deceleration time on STOP input" specified with the servo instruction.
Stop command (M3200+20n)			Deceleration stop based on the parameter block or the "deceleration time" specified with the servo instruction.
Rapid stop command (Note) (M3201+20n)			Deceleration stop based on the parameter block or the "rapid stop deceleration time" specified with the servo instruction.
Rapid stop of the all axes/ deceleration stop from MT Developer2. (Note) (Test mode)	Click icon	All axes	Deceleration stop based on the parameter block or the "rapid stop deceleration time" specified with the servo instruction.
Speed change to speed "0"	Speed change request	Specified axis	Deceleration stop based on the parameter block or the "deceleration time" specified with the servo instruction.

POINT

(Note): The rapid stop command and the rapid stop of the all axes from MT Developer2 are also valid during deceleration by the "STOP signal input of the Q172DLX" (STOP) or stop command (M3200+20n), and processing based on the "rapid stop deceleration time" parameter starts at the time the stop condition occurs.

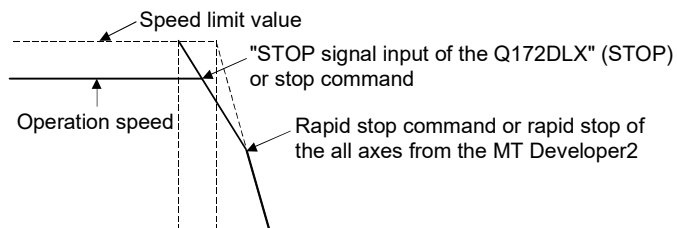

6 POSITIONING CONTROL

[Cautions]

- (1) The operation for feed current value is as follows. When speed control (I) is executed in the absolute position system, the feed current value that is restored when the control circuit power supply of the servo amplifier or the Multiple CPU system power supply is turned ON again, may be different from the feed current value before the power supply was turned ON again.
 - (a) Q173DSCPU/Q172DSCPU
When feed current value update command (M3212+20n) is OFF, the feed current value is changed to "0".
 - (b) Q173DCPU(-S1)/Q172DCPU(-S1)
The feed current value is changed to "0" at the start.
- (2) The dwell time cannot be set.

[Program]

Program for speed control (I) is shown as the following conditions.

(1) System configuration

Speed control (I) of Axis 1.

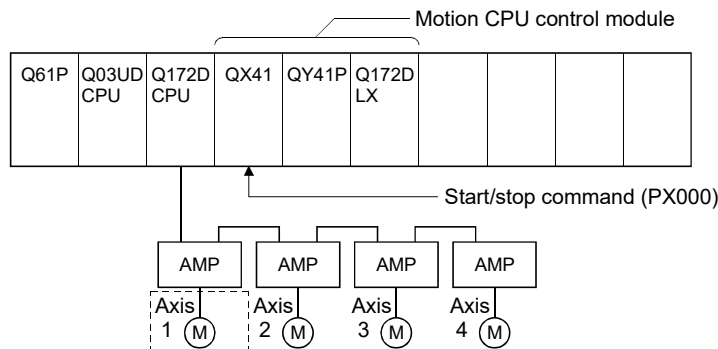

(2) Speed control (I) conditions

(a) Speed control (I) conditions are shown below.

Item	Setting
Servo program No.	No.91
Control axis	Axis 1
Control speed	3000
Rotation direction	Forward

- (b) Speed control (I) start command..... PX000 Leading edge (OFF → ON)
- (c) Stop command..... PX000 Trailing edge (ON → OFF)

(3) Operation timing

Operation timing for speed control (I) is shown below.

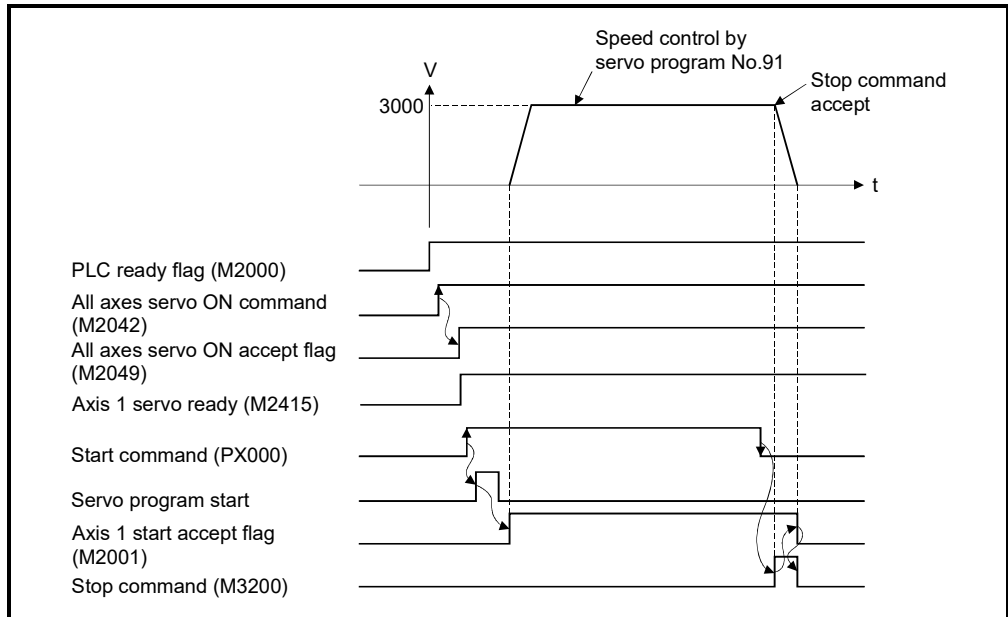

(4) Servo program

Servo program No.91 for speed control (I) is shown below.

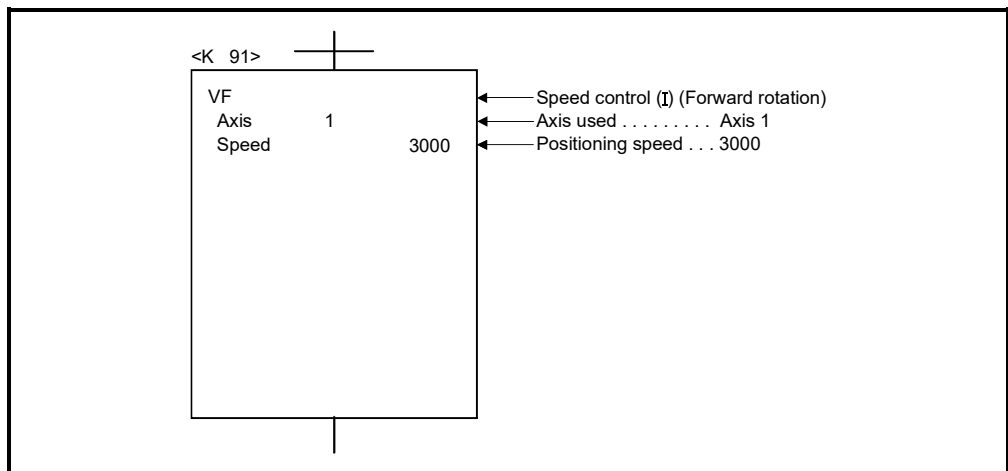

(5) Motion SFC program

Motion SFC program for which executes the servo program is shown below.

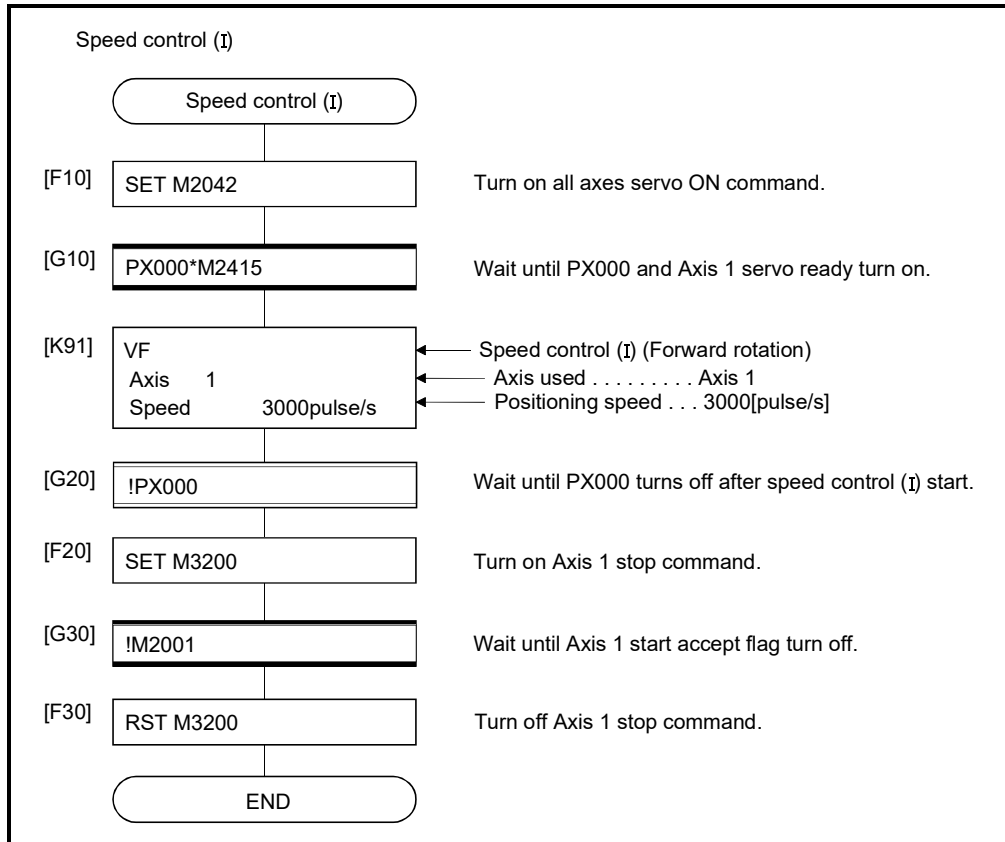

(Note): Example of the above Motion SFC program is started using the automatic start or sequence program.

6 POSITIONING CONTROL

6.14 Speed Control (II)

- (1) Speed control for the specified axis is executed.
- (2) Speed control not includes positioning loops for control of servo amplifiers. It can be used for stopper control, etc. so that it may not become error excessive.

POINT

Refer to Section 7.7 for performing speed control that does not include positioning loops without using the servo program. **QDS**

- (3) Speed control (II) uses the VVF (Forward) and VVR (Reverse) servo instructions.

Servo instruction	Positioning method	Number of control axes	Items set using MT Developer2																Speed change						
			Common						Arc			Parameter block						Others							
			Parameter block No.	Axis	Address/travel value	Command speed	Dwell time	M-code	Torque limit value	Auxiliary point	Radius	Central point	Interpolation control unit	Speed limit value	Acceleration time	Deceleration time	Rapid Stop deceleration time	Torque limit value		Deceleration processing on stop input	Allowable error range for circular interpolation	S-curve ratio	Advanced S-curve acceleration/deceleration	Cancel	WAIT-ON/OFF
VVF	—	1	△	○		○		△	△							△	△	△	△	△	△	△	△		Valid
VVR																									

○ : Must be set
△ : Set if required

[Control details]

- (1) Controls the axis at the specified speed until the input of the stop command after starting of the servo motors.
 - VVF Forward direction start
 - VVR Reverse direction start
- (2) Current value or deviation counter do not change at "0".
- (3) When the setting for "torque" is set in the servo program and an indirect setting made, the torque limit value can be changed during operation by changing the value of the indirect device.
- (4) The stop command and stop processing are the same as for speed control (I).

[Cautions]

- (1) The feed current value is changed to "0" at the start.
When speed control (II) is executed in the absolute position system, the feed current value that is restored when the control circuit power supply of the servo amplifier or the Multiple CPU system power supply is turned ON again, may be different from the feed current value before the power supply was turned ON again.
- (2) The dwell time cannot be set.
- (3) Even if the speed command is set as probe data by the digital oscilloscope function, the value on digital oscilloscope does not change with "0".

[Program]

Program for speed control (II) is shown as the following conditions.

(1) System configuration

Speed control (II) of Axis 3.

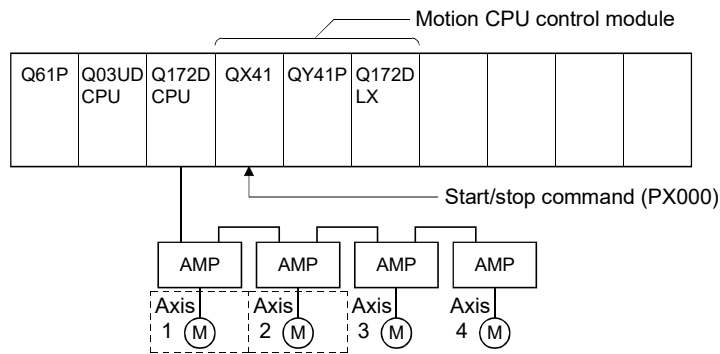

(2) Speed control (II) conditions

(a) Speed control (II) conditions are shown below.

Item	Setting
Servo program No.	No.55
Control axis	Axis 3
Control speed	4000
Rotation direction	Forward

- (b) Speed control (II) start command PX000 Leading edge (OFF → ON)
- (c) Stop command PX000 Trailing edge (ON → OFF)

(3) Operation timing

Operation timing for speed control (II) is shown below.

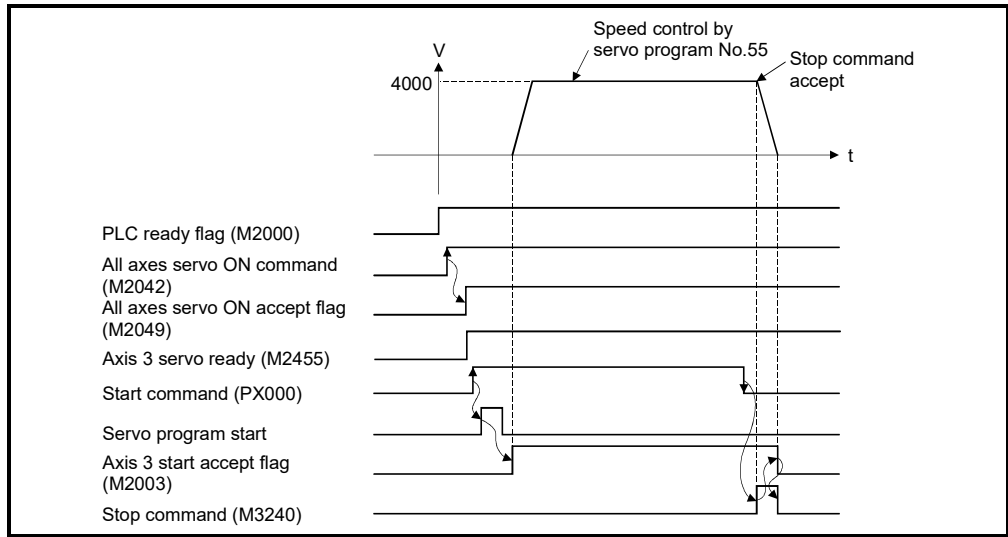

(4) Servo program

Servo program No.55 for speed control (II) is shown below.

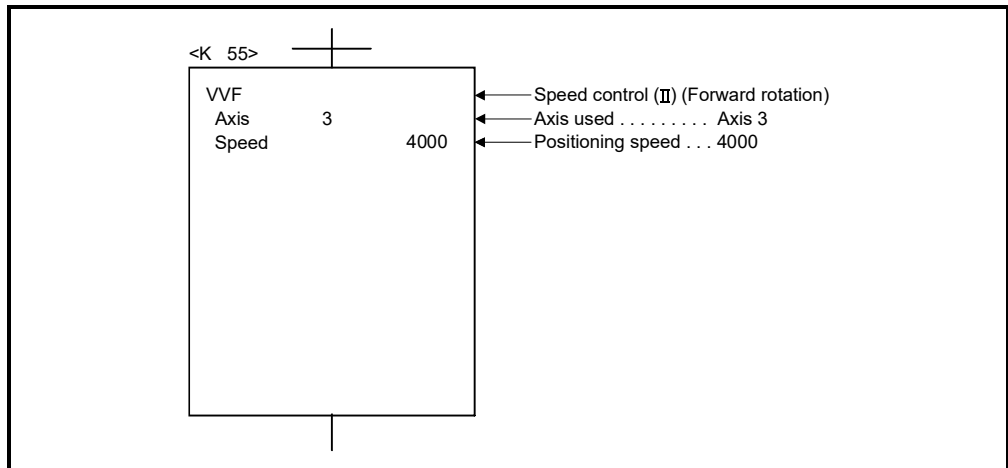

(5) Motion SFC program

Motion SFC program for which executes the servo program is shown below.

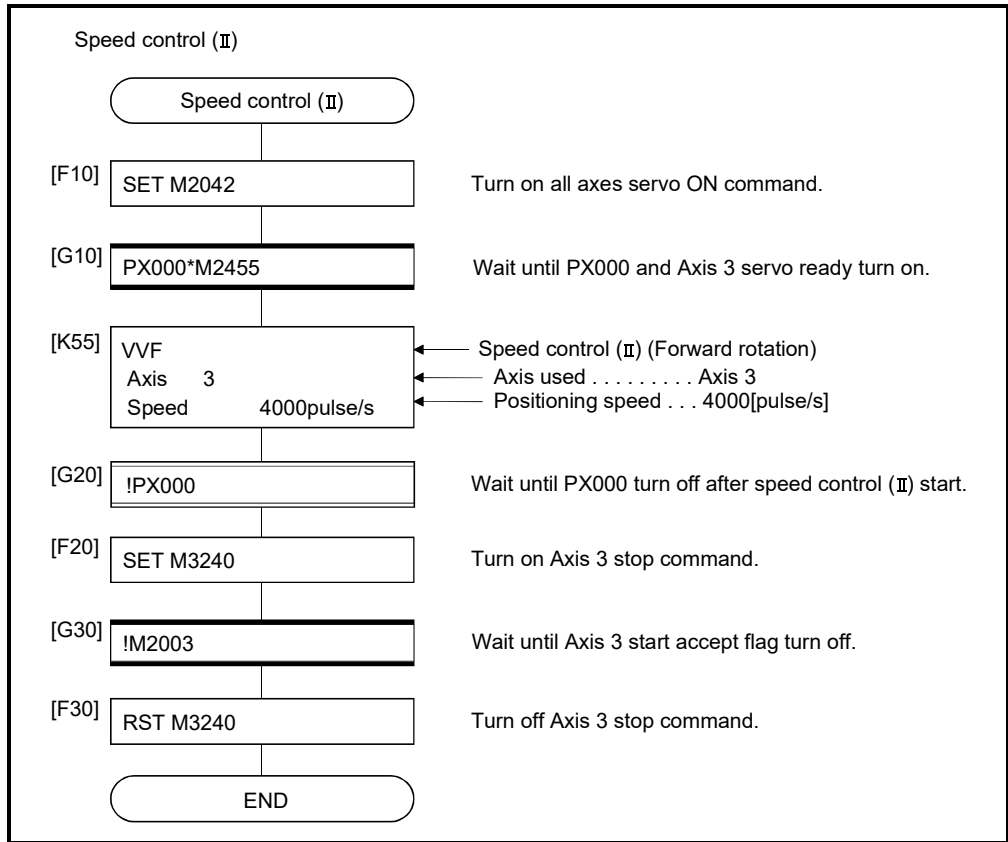

(Note): Example of the above Motion SFC program is started using the automatic start or sequence program.

REMARK

(Note): "The external CHANGE signal input from external source" is inputted to CHANGE of signal type set in speed/position switching signal from external source. When "normally open contact input" is set, CHANGE input occurs at the CHANGE signal on, and when "normally closed contact input" is set, CHANGE input occurs at the CHANGE signal off. (Refer to the "Q173D(S)CPU/Q172D(S)CPU Motion controller User's Manual".)
 The signal types that can be used with speed/position switching signal are shown below.

Signal type	Q173DSCPU/ Q172DSCPU	Q173DCPU(-S1)/ Q172DCPU(-S1)
CHANGE signal of Q172DLX	○	○
External input signal (DOG) of servo amplifier (Note-1)	○	○ 
Built-in interface in Motion CPU (DI)	○	×
Bit device	○	×

○: Usable, ×: Unusable

(Note-1): The variation for ON/OFF timing of the external input signal (DOG) of servo amplifier may occur according to the input filter setting value of external signal input setting. Review the input filter setting value compatible with the applications. Use the Q172DLX or built-in interface in Motion CPU (DI) to execute the high-accuracy control.

: Refer to Section 1.3 for the software version that supports this function.

6 POSITIONING CONTROL

(3) Feed current value processing

The feed current value is as follows by turning feed current value update command (M3212+20n) on/off at the speed-position switching control start.

- (a) M3212+20n OFF.....
- The feed current value is cleared to "0" at the start.
 - The feed current value is updated from the start (speed control).
 - The feed current value after stop is as follows:

$$\boxed{\text{Feed current value after stop}} = \boxed{\text{Travel value during speed control}} + \boxed{\text{Travel value for position control}}$$

- (b) M3212+20n ON.....
- The feed current value is not cleared at the start.
 - The feed current value is updated from the start (speed control).
 - The feed current value after stop is as follows:

$$\boxed{\text{Feed current value after stop}} = \boxed{\text{Address before speed control start}} + \boxed{\text{Travel value during speed control}} + \boxed{\text{Travel value for position control}}$$

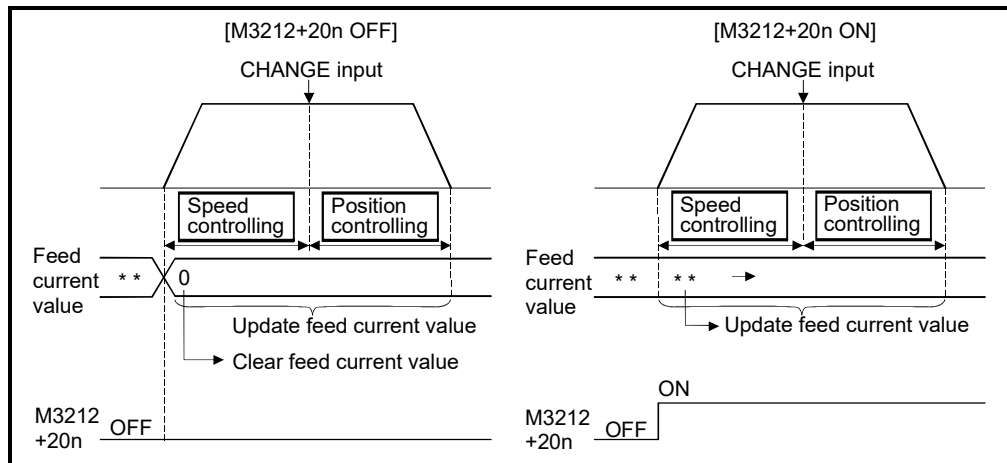

POINT

If it is started with M3212+20n on, leave M3212+20n on until positioning control is completed. If it turns off during control, the feed current value cannot be guaranteed.

(4) Change of the travel value during speed control

The travel value for position control can be changed during speed control after speed-position switching control start.

- (a) The travel value is set in indirect specification by optional device (2-word data) in the servo program. When a negative value is set in the travel value, a deceleration stop is made after switching to the position control.

-Example-

The following servo program which performs the speed control for axis 4 to the forward direction at speed 50000, and the position control of the travel value set in D3000, D3001 after the CHANGE signal from external source turns on.

<pre> <K 11> VPF Axis 4, D3000 Speed 50000 </pre>	<p>← Indicates indirect specification of travel value</p>
---	---

- (b) The travel value is stored in the data register for travel value change during speed control in the Motion SFC program. When the CHANGE signal turns on, the contents of the data register for travel value change are set as the travel value.

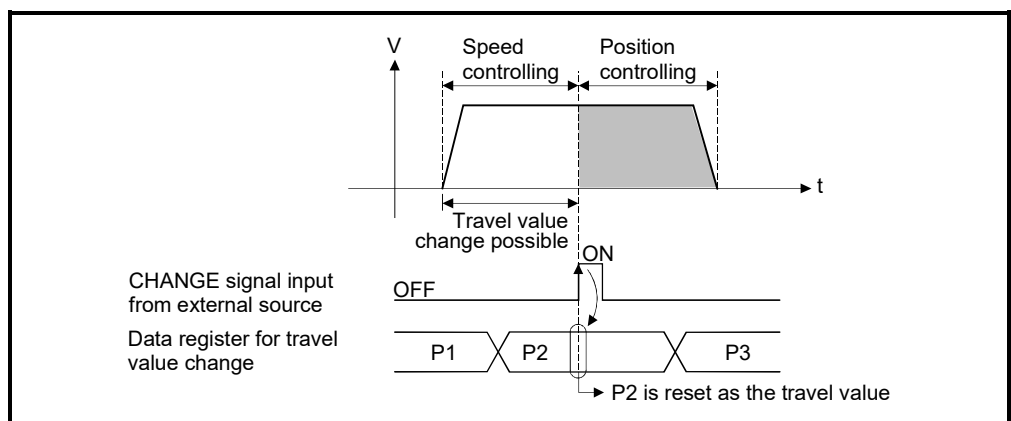

(5) Travel value area after proximity dog ON

The travel value since the position mode was selected by the CHANGE signal input from external source is stored in the travel value after proximity dog ON storage register (D10+20n, D11+20n).

6 POSITIONING CONTROL

[Cautions]

- (1) Item check at the CHANGE signal ON from external source
When the external CHANGE signal turns on, speed control switches to position control if the following conditions are met:
 - Start accept flag (M2001+n) is turning on.
 - Speed control is executing after starting of the speed-position switching control.
 - Speed/position switching enable command (M3205+20n) is turning on.

- (2) No speed control
Position control only is executed if M3205+20n and CHANGE signal are turning on at the start. The speed controlling signal (M2404+20n) does not turn on.

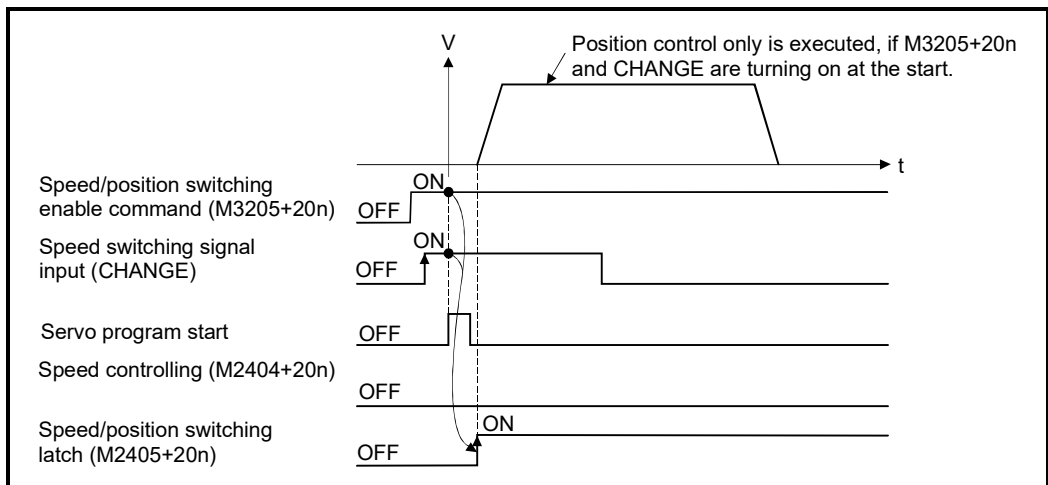

- (3) "Travel value for position control" is less than "deceleration distance"
 - (a) The deceleration distance from the time when CHANGE is input is calculated based on the controlling speed, the real current value, and the deviation counter. When the travel value for position control is less than this deceleration distance, deceleration processing starts immediately when CHANGE is input.
 - (b) The difference between the deceleration distance and the travel value for position control is the overrun. At this time, the error detection signal (M2407+20n) turns on and minor error (error code: 209) is stored in the data register.
 - (c) The positioning complete signal (M2401+20n) does not turn on.

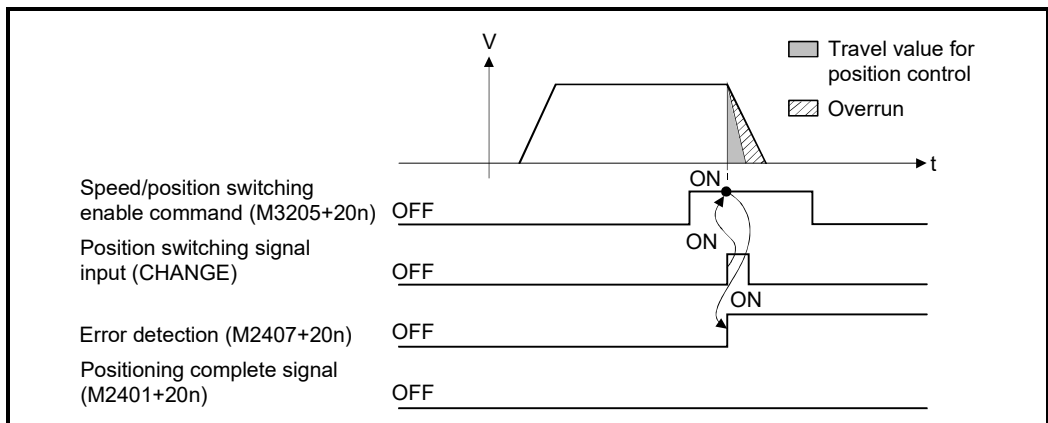

- (4) Stroke limit check
Stroke limit range is not checked during the speed mode. If the travel value exceeds the stroke limit range, a minor error (error code: 210) occurs when position mode is selected, and performs a deceleration stop.
- (5) When feed current value update command (M3212+20n) is OFF, the feed current value is changed to "0" at the start.
When speed-position switching control is executed in the absolute position system, the feed current value that is restored when the control circuit power supply of the servo amplifier or the Multiple CPU system power supply is turned ON again, may be different from the feed current value before the power supply was turned ON again.

[Program]

Program for speed-position switching control is shown as the following conditions.

(1) System configuration

Speed-position switching control of Axis 4.

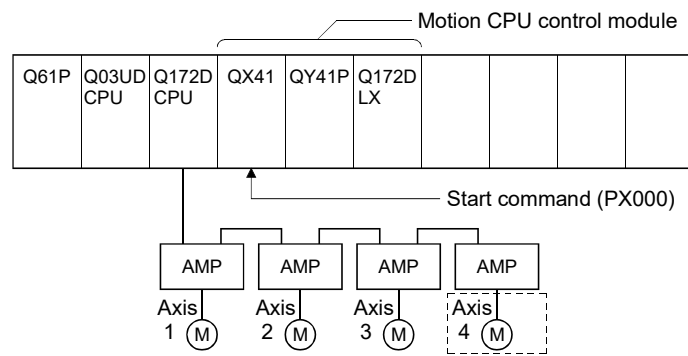

(2) Positioning conditions

(a) Positioning conditions are shown below.

Item	Positioning conditions
Servo program No.	101
Control axis	Axis 4
Travel value for positioning control	40000
Command speed	1000

- (b) Positioning start command PX000 Leading edge
- (c) Speed/position switching enable command M3265

(3) Operation timing

Operation timing for speed-position switching control is shown below.

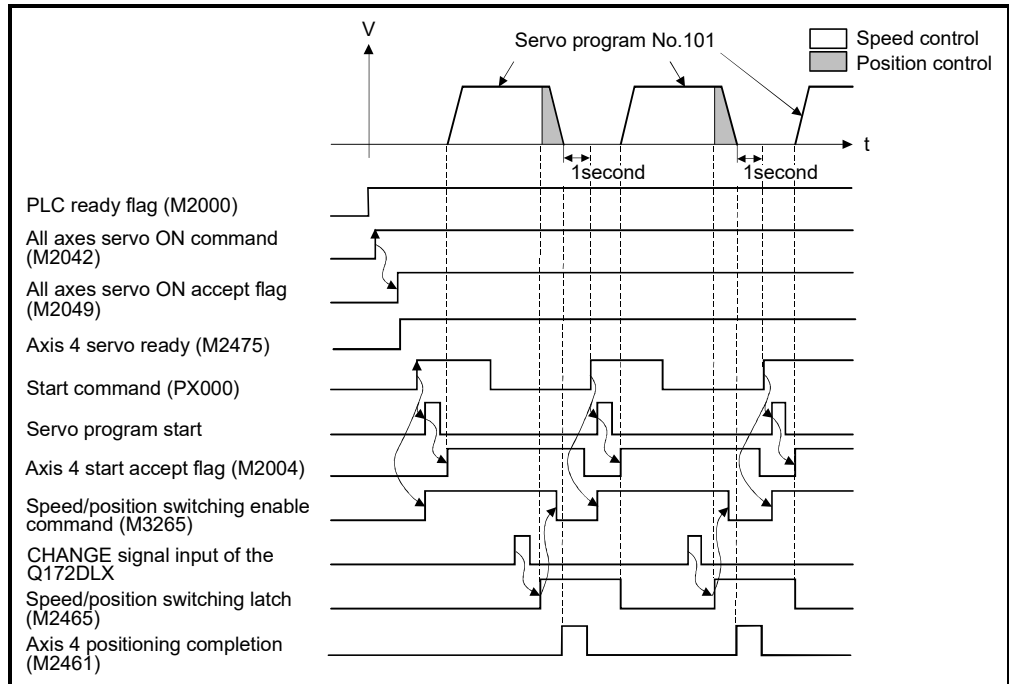

(4) Servo program

Servo program No.101 for speed-position switching control is shown below.

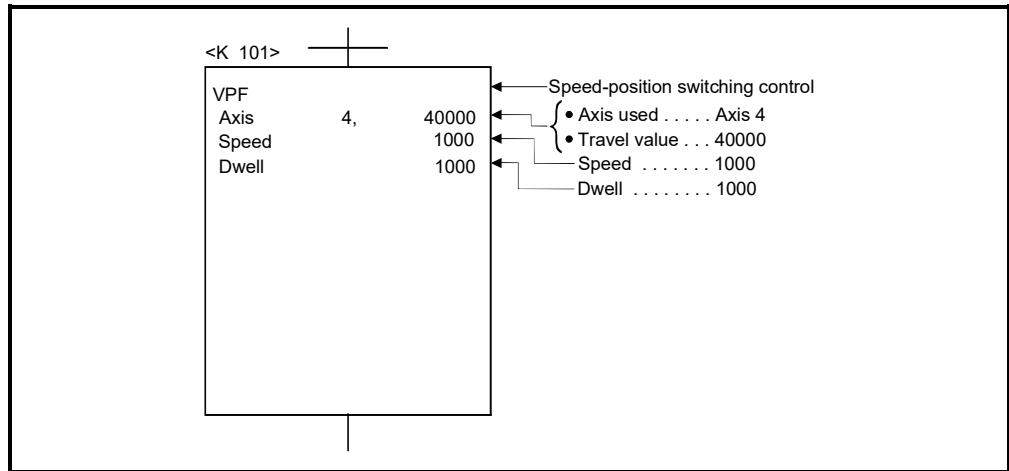

(Note): Example of the Motion SFC program for positioning control is shown next page.

(5) Motion SFC program

Motion SFC program for which executes the servo program is shown below.

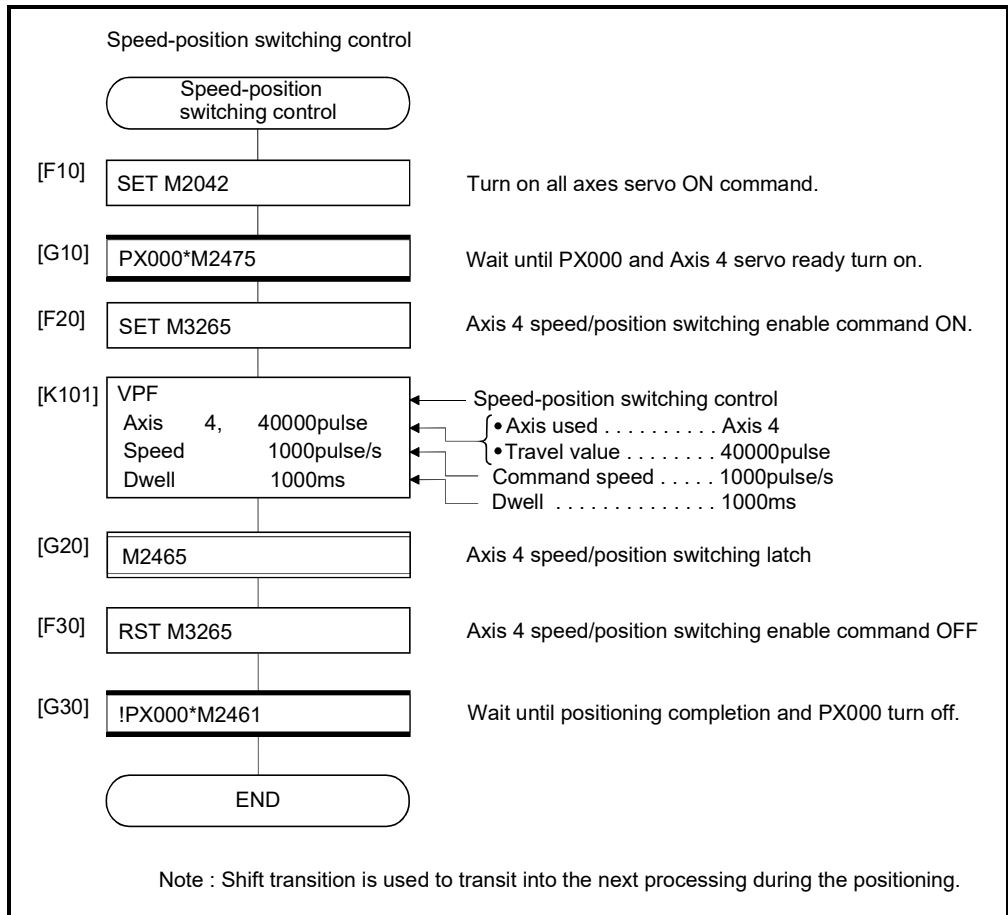

(Note): Example of the above Motion SFC program is started using the automatic start or sequence program.

6 POSITIONING CONTROL

6.15.2 Re-starting after stop during control

Re-starting (continuing) after stop with stop command during speed-position switching control is executed.

Re-starting uses VPSTART servo instruction.

Servo instruction	Positioning method	Number of control axes	Items set using MT Developer2																	Speed change				
			Common					Arc			Parameter block							Others						
			Parameter block No.	Axis	Address/travel value	Command speed	Dwell time	M-code	Torque limit value	Auxiliary point	Radius	Central point	Interpolation control unit	Speed limit value	Acceleration time	Deceleration time	Rapid Stop deceleration time	Torque limit value	Deceleration processing on stop input		Allowable error range for circular interpolation	S-curve ratio	Advanced S-curve acceleration/deceleration	Cancel
VPSTART	Incremental	1		○																			△	Valid

○ : Must be set
△ : Set if required

[Control details]

- (1) The continuous control after stop during speed control is executed, after speed-position switching control start.
- (2) Re-starting using the VPSTART is effective by stop during speed control or position control.
 - (a) Re-starts with the speed control at the stop during speed control, then switches to position control by turning on the CHANGE signal. The control contents after re-starting are same as the speed-position switching control. Refer to Section 6.15.1.

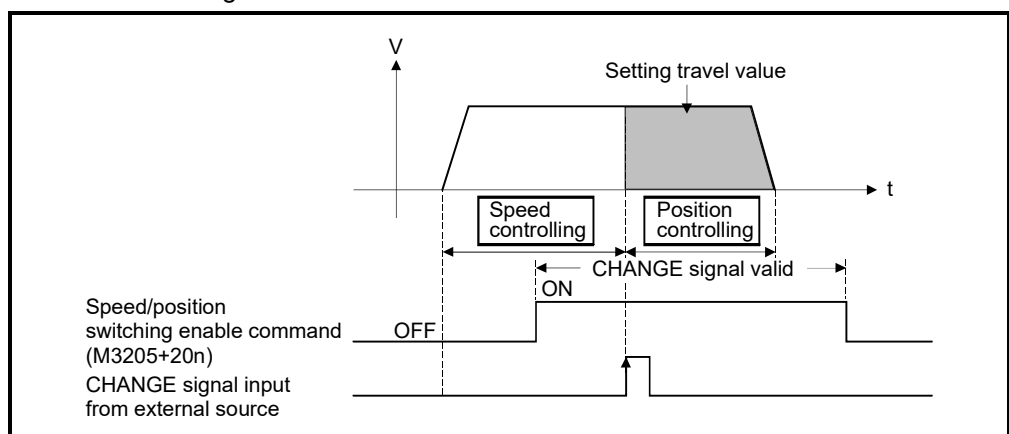

Fig. 6.27 Re-starting during speed control

- (b) If the stop occurred during position control, re-start with position, and the positioning control of setting travel value.

The travel value after the re-start is calculated as follows:

$$\boxed{\text{Travel value after re-start (P2)}} = \boxed{\text{Setting travel value(P)}} - \boxed{\text{Travel value before stop (P1)}}$$

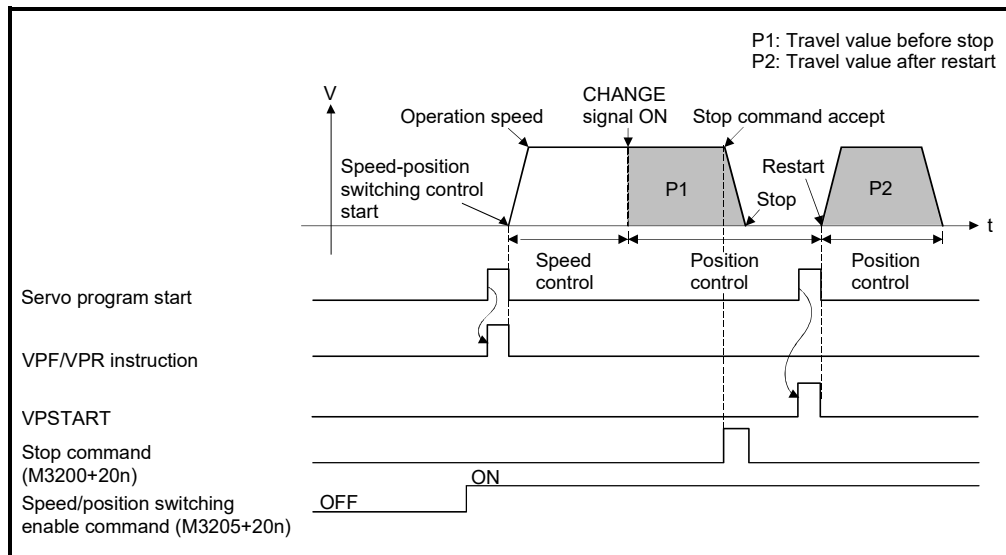

Fig.6.28 Re-starting during speed control

- (3) It controls at the speed stored at the VPF/VPR instruction execution in the re-starting.

Therefore, even if the speed change before stop during control, it becomes the speed at the VPF/VPR instruction execution.

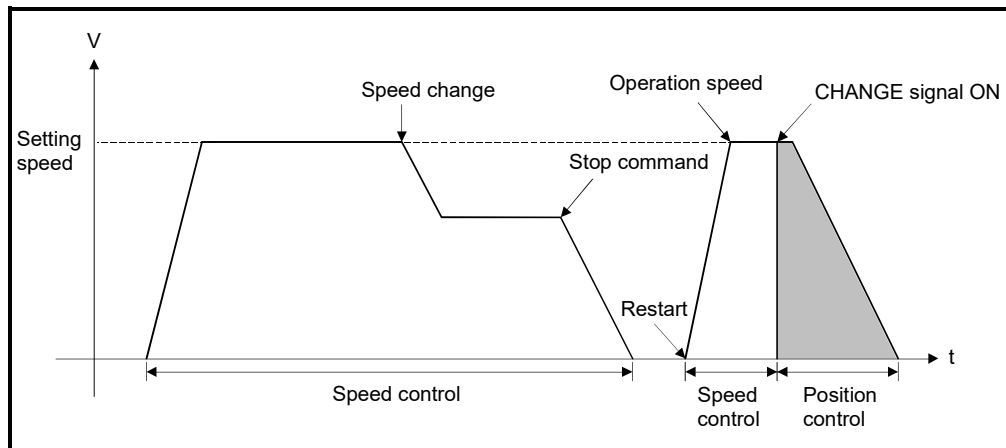

Fig.6.29 Re-starting after speed change

[Program]

Program for restarting after stop during control with the speed-position switching control is shown as the following conditions.

(1) System configuration

Speed-position switching control of Axis 4.

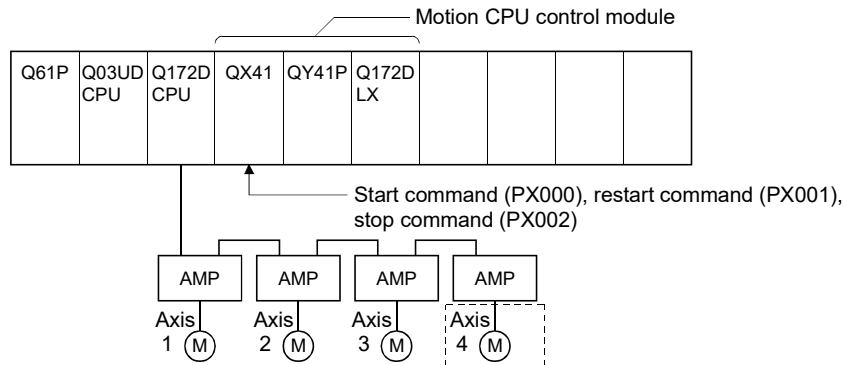

(2) Positioning conditions

(a) Positioning conditions are shown below.

Item	Positioning conditions	
	Speed-position switching control	Restart
Servo program No.	101	102
Control axis	Axis 4	Axis 4
Travel value for positioning control	40000	—
Command speed	1000	—

- (b) Positioning start command PX000 Leading edge (OFF → ON)
- (c) Speed/position switching enable command M3265
- (d) Re-start command PX001 Leading edge (OFF → ON)
- (e) Stop command PX002 Leading edge (OFF → ON)

(3) Operation timing

Operation timing for speed-position switching control and re-starting are shown below.

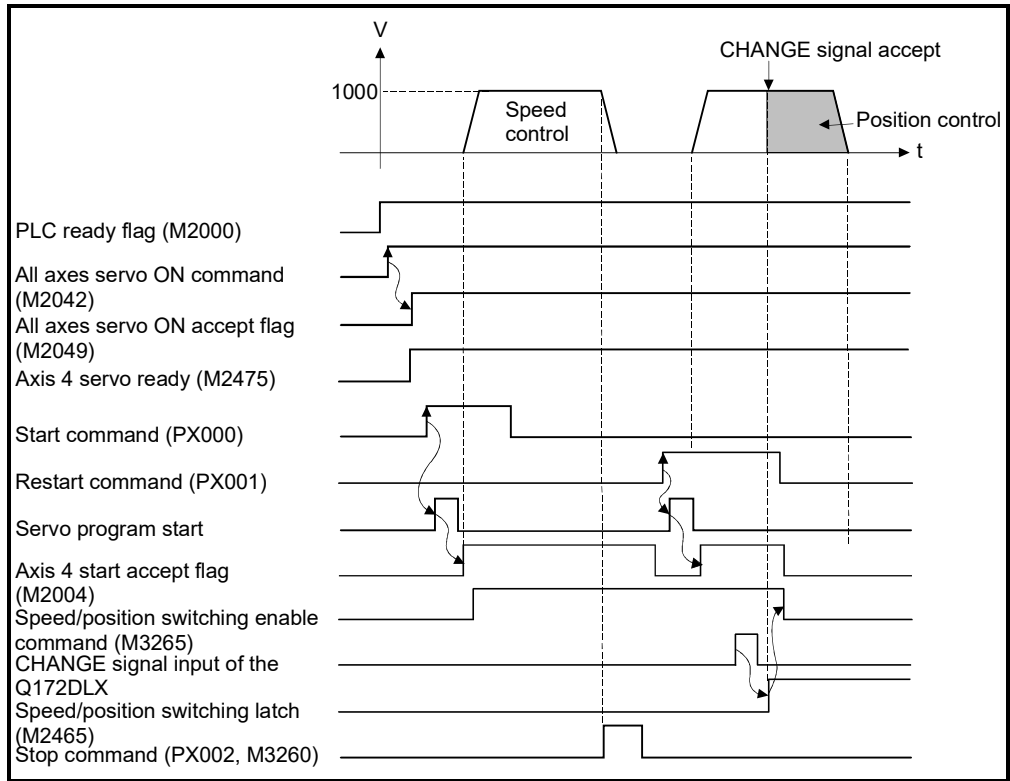

(4) Servo program

Servo program No.101 and No.2 for speed-position switching control and re-starting are shown below.

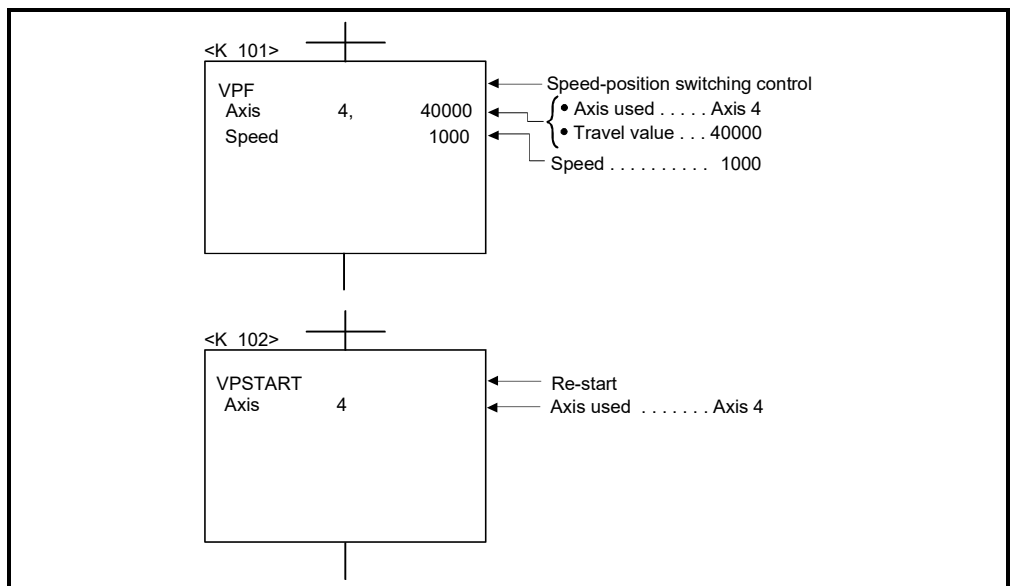

(Note): Example of the Motion SFC program for positioning control is shown next page.

(5) Motion SFC program

Motion SFC program for which executes the servo program is shown below.

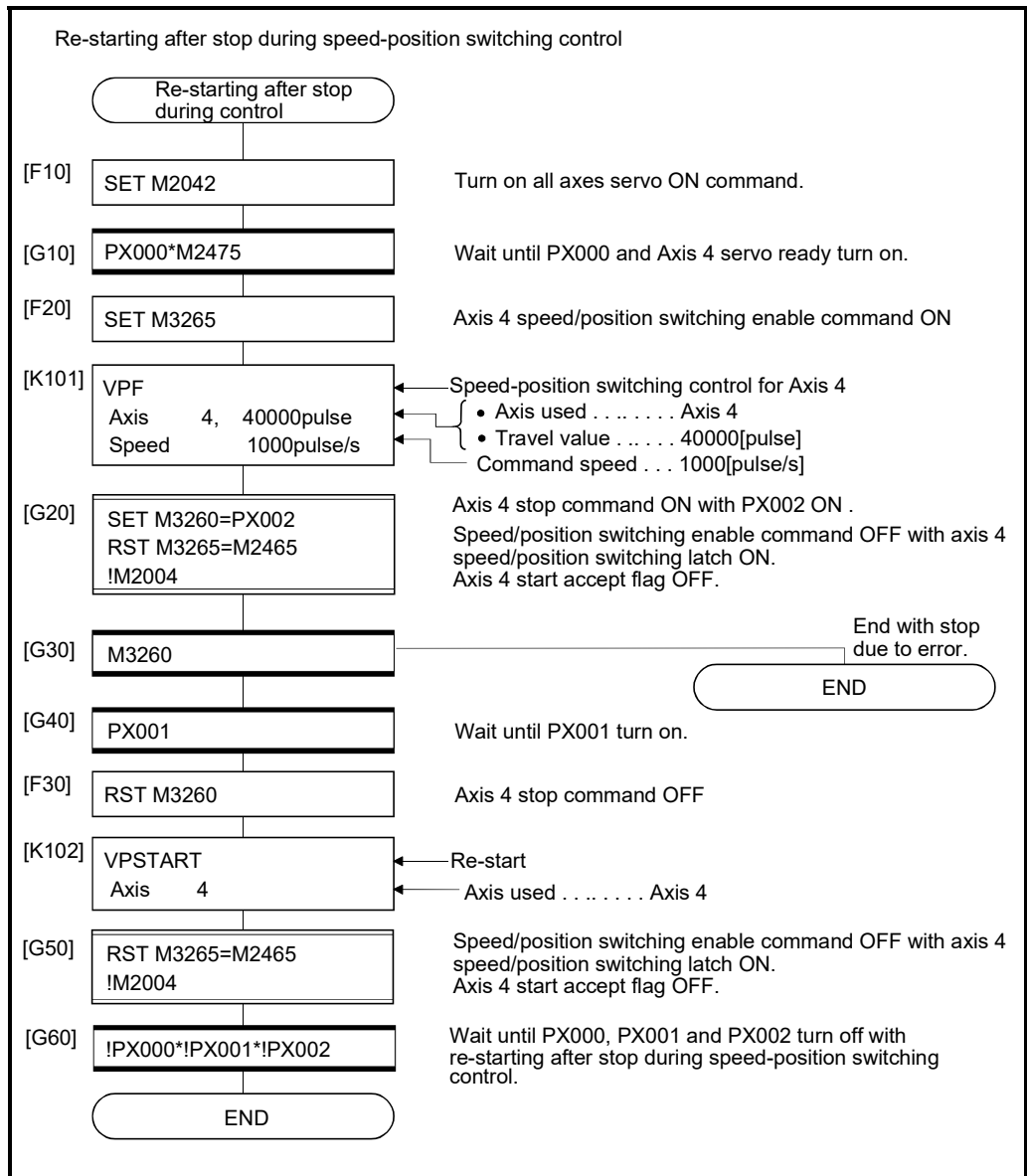

(Note): Example of the above Motion SFC program is started using the automatic start or sequence program.

6 POSITIONING CONTROL

6.16 Speed-Switching Control

- (1) Positioning control performs changing the speed on the point beforehand set by one start.
- (2) The speed-switching points and speed are set using the servo program.
- (3) Repetition control between any speed-switching points can be performed by using repetition instructions.
- (4) M-codes and torque limit values can be changed at each speed-switching point.

6.16.1 Speed-switching control start, speed-switching points and end specification

Servo instruction	Positioning method	Number of control axes	Items set using MT Developer2																		Speed change				
			Common						Arc			Parameter block							Others						
			Parameter block No.	Axis	Address/travel value	Command speed	Dwell time	M-code	Torque limit value	Auxiliary point	Radius	Central point	Interpolation control unit	Speed limit value	Acceleration time	Deceleration time	Rapid Stop deceleration time	Torque limit value	Deceleration processing on stop input	Allowable error range for circular interpolation		S-curve ratio	Advanced S-curve acceleration/deceleration	Cancel	WAIT-ON/OFF
Start	VSTART	—	△								△	△	△	△	△	△			△	△	△			—	
End	VEND	—																							—
End point address	ABS-1	Absolute data	1																					Valid	
	ABS-2		2																						
	ABS-3		3																						
Travel value to end point	INC-1	Incremental	1	○	○	○	△	△	△														△	Valid	
	INC-2		2																						
	INC-3		3																						
Speed-Switching point	VABS	Absolute data	—																					—	
	VINC	Incremental		○	○		△	△																	

○: Must be set
△: Set if required

[Control details]

Start and end of the speed-switching control

Speed-switching control is started and ended using the following instructions:

- (1) **VSTART**
Starts the speed-switching control.
- (2) **VEND**
Ends the speed-switching control.

Travel value setting to end address/end point

The travel value to end address/end point with the speed-switching control, positioning control method and positioning speed to the end point are set using the following instructions:

- (1) **ABS-1/INC-1**
Set 1 axis linear positioning control.
The control contents are same as Section 6.2 "1 Axis Linear Positioning Control".
- (2) **ABS-2/INC-2**
Set 2 axes linear interpolation control.
The control contents are same as Section 6.3 "2 Axes Linear Interpolation Control".
- (3) **ABS-3/INC-3**
Set 3 axes linear interpolation control.
The control contents are same as Section 6.4 "3 Axes Linear Interpolation Control".

Speed-switching point setting

The address (travel value) of the speed-switching point and the positioning speed are set using the following instructions:

- (1) **VABS**
Set the speed-switching point using the absolute data method.
- (2) **VINC**
Set the speed-switching point using the incremental data method.

POINT									
<p>The axis which set the speed-switching point (travel value) and positioning speed by 2 or 3 axes linear interpolation control is first set in the "travel value to end address/end point".</p>									
<div style="display: flex; align-items: center; justify-content: center;"> <div style="border: 1px solid black; padding: 5px; margin-right: 10px;"> <p style="margin: 0;"><K 101></p> <p style="margin: 0;">VSTART</p> <p style="margin: 0;">ABS-2</p> <table style="margin: 0; border-collapse: collapse;"> <tr> <td style="padding: 2px 10px;">Axis</td> <td style="padding: 2px 10px;">2,</td> <td style="padding: 2px 10px;">75000</td> </tr> <tr> <td style="padding: 2px 10px;">Axis</td> <td style="padding: 2px 10px;">3,</td> <td style="padding: 2px 10px;">60000</td> </tr> <tr> <td style="padding: 2px 10px;">Speed</td> <td></td> <td style="padding: 2px 10px;">2000</td> </tr> </table> </div> <div style="font-size: 2em; vertical-align: middle;">←</div> <div style="padding-left: 10px;"> <p style="margin: 0;">Set the speed-switching point (travel value) and positioning speed.</p> </div> </div>	Axis	2,	75000	Axis	3,	60000	Speed		2000
Axis	2,	75000							
Axis	3,	60000							
Speed		2000							

Procedure of the servo program and operation timing

Servo programs for speed-switching control and the operation timing are shown below.

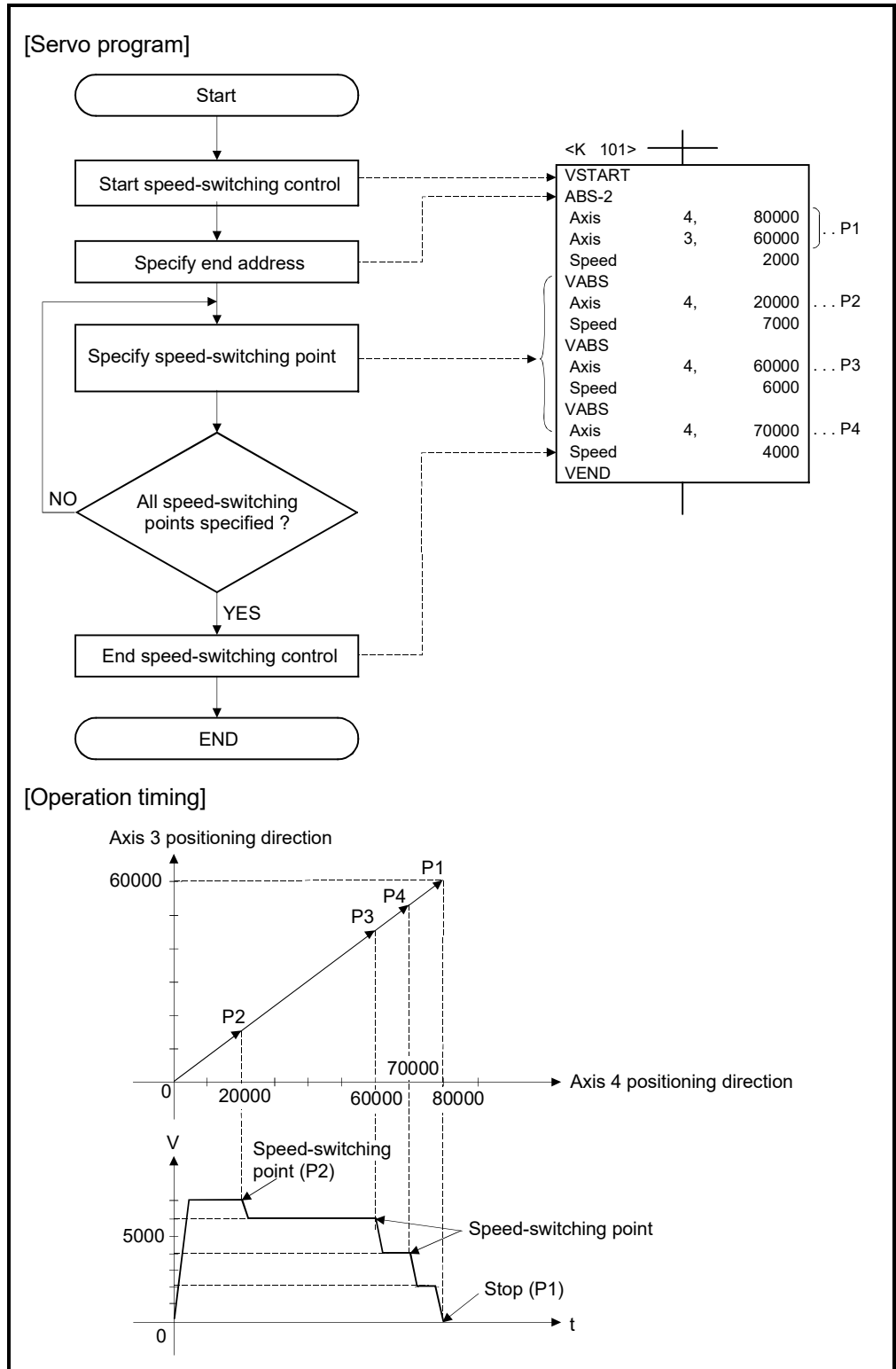

[Cautions]

- (1) The number of control axes cannot be changed during control.
- (2) The speed-switching point can be specified the absolute data method (VABS□) and incremental data method (VINCS□) by mixed use.
- (3) The speed-switching point cannot be specified an address which change in travel direction. If the travel direction change, the minor error (error code: 215) is stored in the minor error storage register (D6+20n) for each axis and the rapid stop is performed.
- (4) It checks whether to be the end address within the stroke limit range at the start. If it is positioning to outside the stroke limit range, the minor error (error code: 106) is stored in the minor error storage register (D6+20n) for each axis and operation does not start.
- (5) If the travel value between speed-switching points is so short and it shifts to the next speed-switching point during speed-switching control, the speed-switching does not perform.
- (6) The M-code from the previous point is retained in the point with which M-code is not specified.
- (7) Be sure to set the travel value between speed-switching points. (The torque limit value is not correctly set by restricting the internal control processing, and the servo errors might occur or a work might fall.)

[Program]

Program for speed-switching is shown as the following conditions.

(1) System configuration

Speed-switching control of Axis 2 and Axis 3.

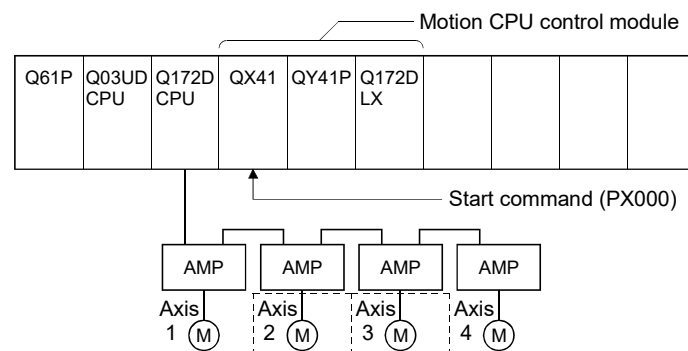

(2) Positioning conditions

(a) Speed-switching control conditions are shown below.

Item	Setting	
Servo program No.	500	
Control axis	Axis 2	Axis 3
End address	100000	50000

(b) Speed-switching control start command PX000 Leading edge (OFF → ON)

(3) Operation timing and speed-switching positions

Operation timing and speed-switching points for speed-switching control are shown below.

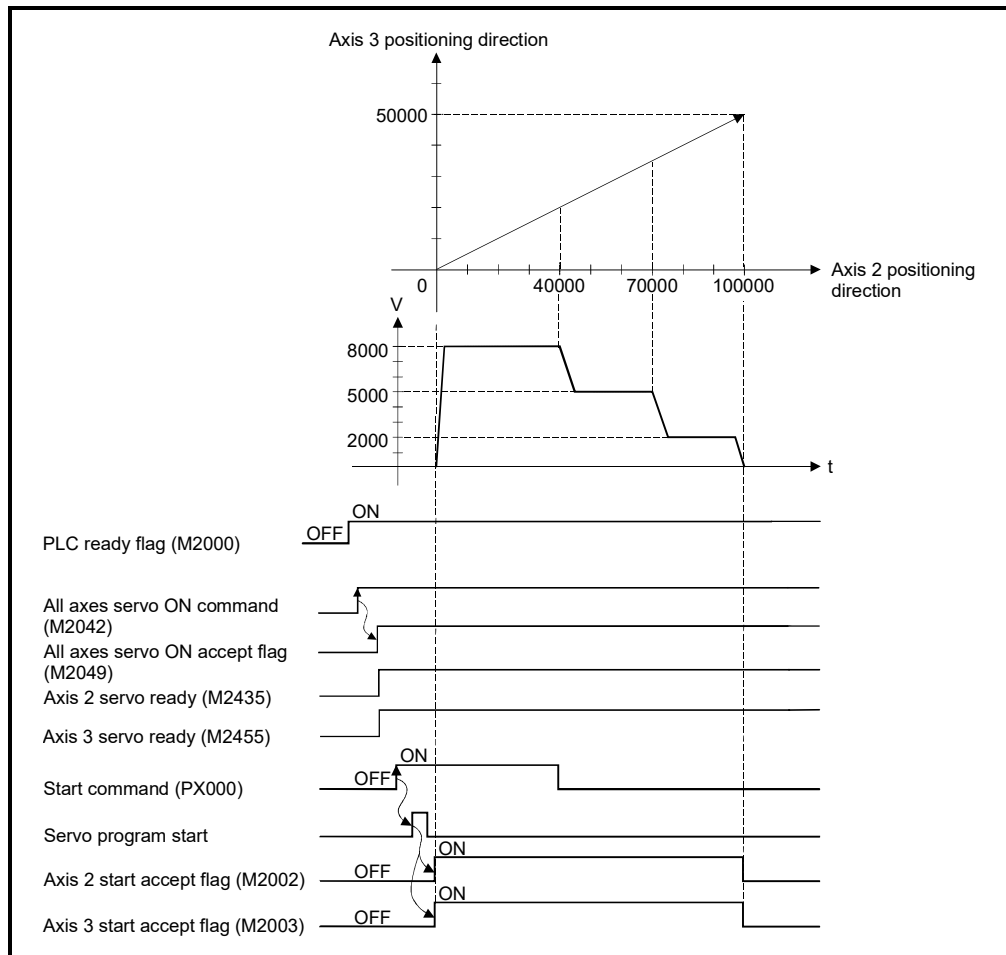

(4) Servo program

Servo program No.500 for speed-switching control is shown below.

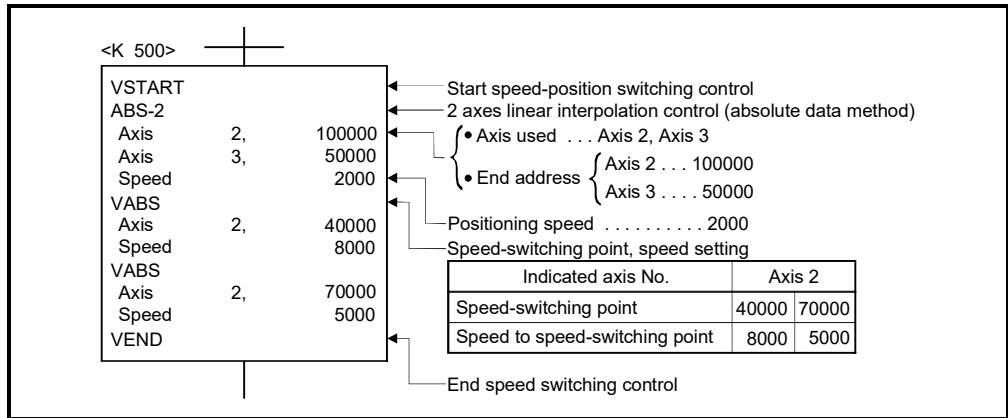

(Note): Example of the Motion SFC program for positioning control is shown next page.

(5) Motion SFC program

Motion SFC program for which executes the speed-switching control is shown below.

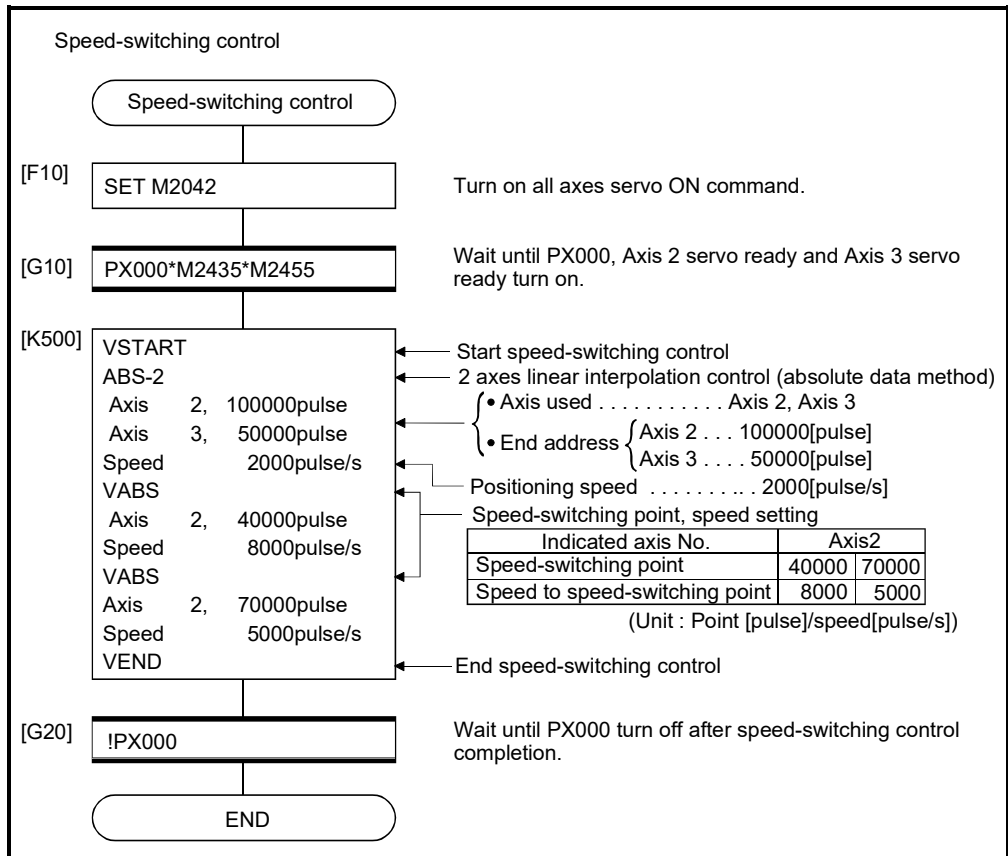

(Note): Example of the above Motion SFC program is started using the automatic start or sequence program.

(3) FOR-OFF (loop-out trigger condition setting)

- (a) The repetition range set until the specified bit device turns off is executed repeatedly.
- (b) The following devices are used as the loop-out trigger condition:
 - 1) Input (X/PX)
 - 2) Output (Y/PY)
 - 3) Internal relay (M)
 - 4) Special relay (SM)
 - 5) Link relay (B)
 - 6) Annunciator (F)

Operation of the repetition control using FOR-TIMES, FOR-ON, and FOR-OFF is shown below.

[Servo program]

<K 701>

```

VSTART
INC-2
Axis 1, 230000
Axis 2, 10000
Speed 2000
VINC
Axis 1, 40000
Speed 2000
1)
VINC
Axis 1, 30000
Speed 500
2)
VINC
Axis 1, 20000
Speed 1000
NEXT
VEND
                    
```

1)	2)		
	Condition 1	Condition 2	Condition 3
FOR-TIMES	K1	K2	K3
FOR-ON	X010 → ON from start	X010 → ON during first execution of 3)	X010 → ON during third execution of 3)
FOR-OFF	X011 → OFF from start	X011 → OFF during first execution of 3)	X011 → OFF during third execution of 3)

(1) Operation in condition 1

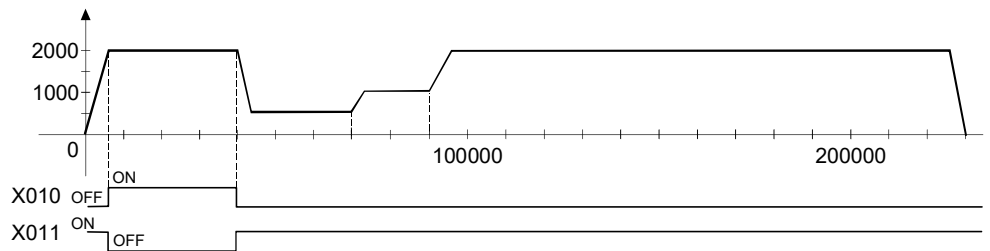

(2) Operation in condition 2

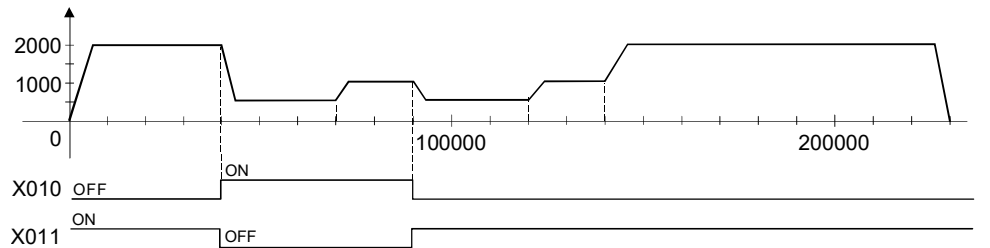

(3) Operation in condition 3

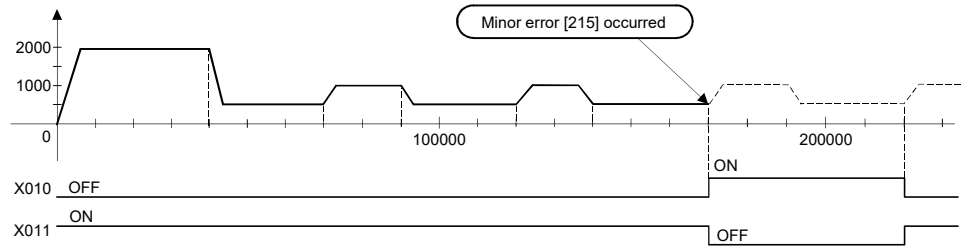

Error occurs because it exceeds the travel value to the stop position.

[Program]

Program for repetition speed-switching control is shown as the following conditions.

(1) System configuration

Speed-switching control of Axis 2 and Axis 3.

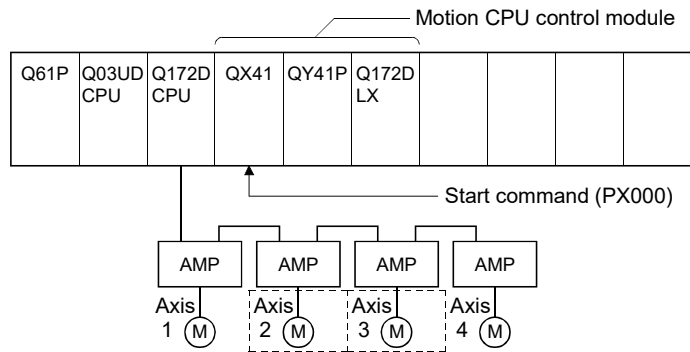

(2) Positioning conditions

(a) Speed-switching control conditions are shown below.

Item	Setting	
Servo program No.	501	
Control axes	Axis 2	Axis 3
End address	230000	100000

(b) Speed-switching control start command PX000 Leading edge (OFF → ON)

6 POSITIONING CONTROL

(3) Operation timing and speed-switching positions

Operation timing and speed-switching points for speed-switching control are shown below.

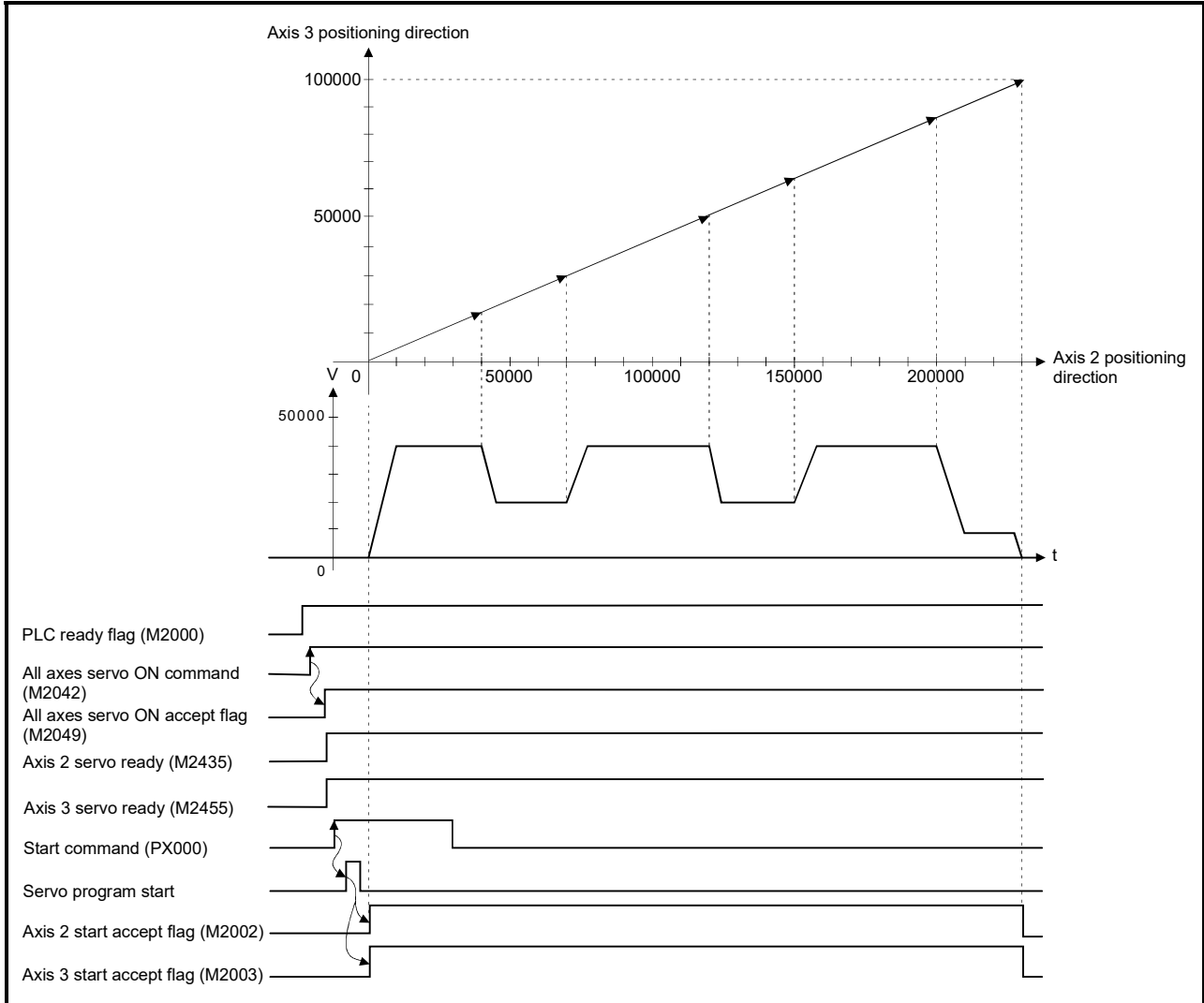

(4) Servo program

Servo program No. 501 for speed-switching control by the repetition instruction is shown below.

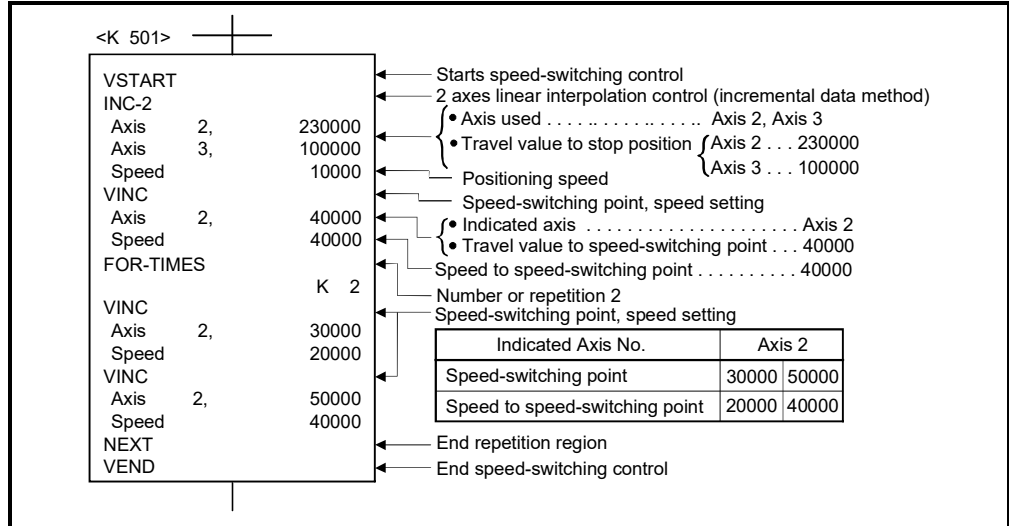

(Note): Example of the Motion SFC program for positioning control is shown next page.

(5) Motion SFC program

Motion SFC program for which executes speed-switching control using repetition instructions is shown below.

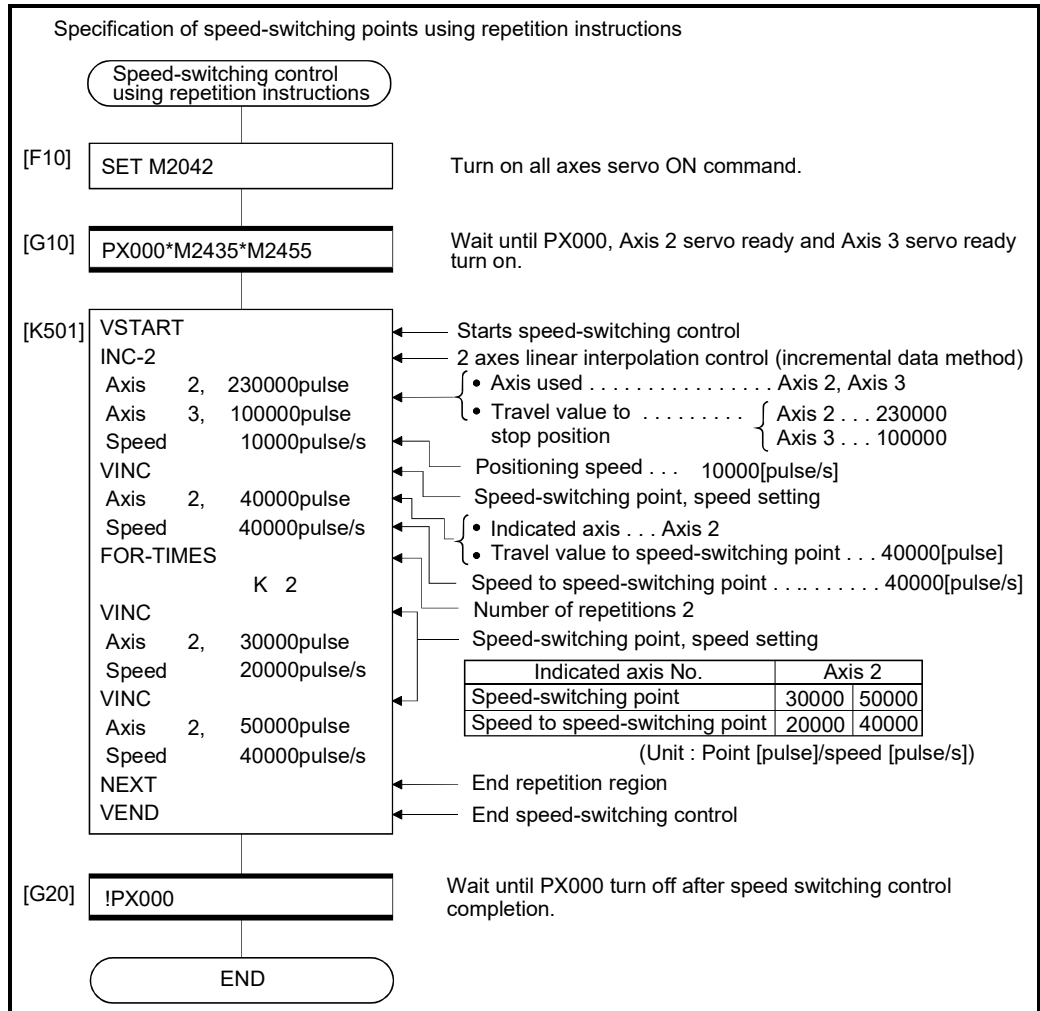

(Note): Example of the above Motion SFC program is started using the automatic start or sequence program.

6 POSITIONING CONTROL

6.17 Constant-Speed Control

- (1) Positioning to the pass point beforehand set by one starting is executed with the specified positioning method and positioning speed.
- (2) The positioning method and positioning speed can be changed for each pass point.
- (3) The following parameters is set in the servo program.
 - Pass point
 - Positioning method from any pass point to the next pass point.
 - Positioning speed from any pass point to the next pass point.
- (4) Repetition control between any pass points can be performed by using repetition instructions.
- (5) M-codes and torque limit values can be changed at each speed-switching point.
- (6) 1 to 4 axes can be controlled.

[Procedure to write servo programs]

The method to write the servo programs for constant-speed control is shown below.

[Procedure]

[Example : Servo program for 2 axes constant-speed control]

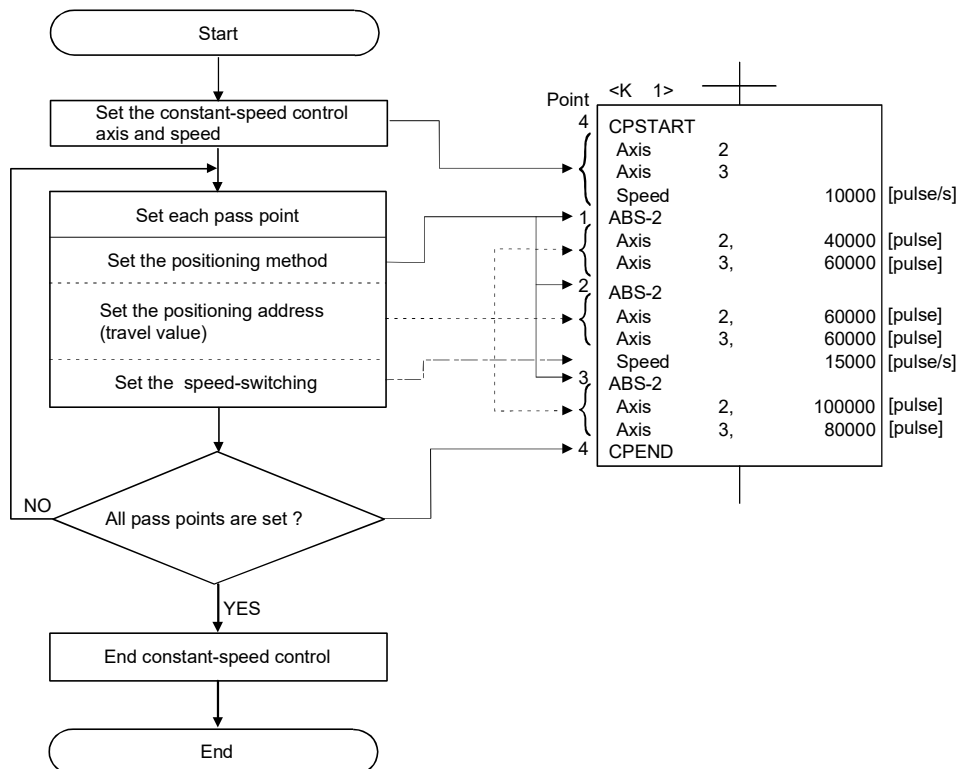

[Operation timing]

Operation timing for constant-speed control is shown below.

[Example : Operation timing for 2 axes constant-speed control]

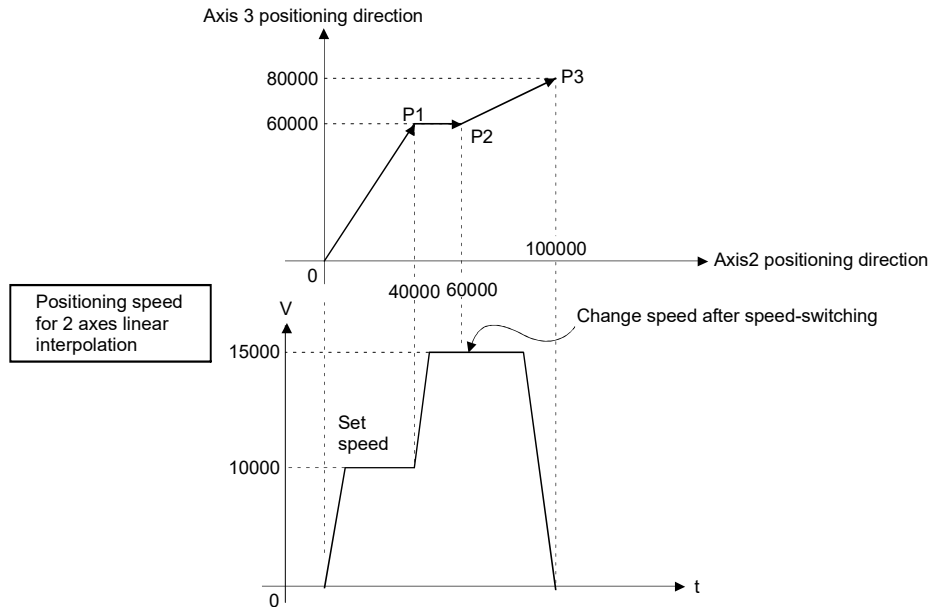

[Caution]

- (1) The number of control axes cannot be changed during control.
- (2) The pass point can be specified the absolute data method (ABS□) and incremental method (INC□) by mixed use.
- (3) The pass point can also be specified an address which change in travel direction. The acceleration processing at a pass point is executed for 1 axis constant-speed. However, the acceleration/deceleration processing at a pass point is not executed for 2 to 4 axes constant-speed, so be careful of the servo error occurrence, etc.
- (4) When the FIN acceleration/deceleration is not set in the program with only one pass point, this operation is the same as PTP control.
- (5) Speed change is possible after the start.

Note the following points at the speed change.

 - (a) The central point-specified circular interpolation is included the constant-speed control.

When the arc path calculated from the start address and central-point address is differ (within the allowable error range for circular interpolation) from the setting end address, if the speed is changed, error compensation (Refer to Section 4.3.4) may not function normally.

When the central point-specified circular interpolation as positioning method is used at the constant-speed control, set the start address, central point address and end address becomes arc correctly.

- (b) The speed switching and change speed by CHGV instruction are executed toward the same program in the servo program.
The lower of the speed change by CHGV instructions and the command speed in the servo program is selected.

The speed change by CHGV instructions are executed if the speed is lower than the speed set in the servo program; otherwise the CHGV instructions are not executed.

- 1) Change speed by CHGV instruction > command speed in the servo program

The command speed in the servo program is selected.

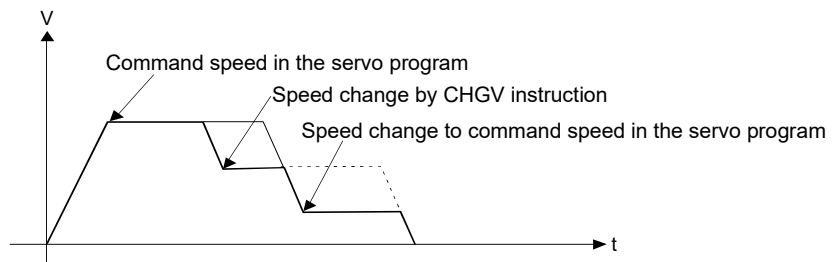

- 2) Change speed by CHGV instruction < command speed in the servo program

The change speed by CHGV instructions is effective.

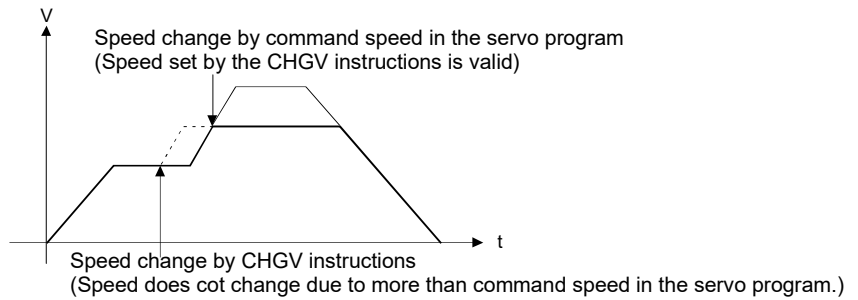

- (6) An overrun occurs if the distance remaining to the final positioning point when the final positioning point is detected is less than the deceleration distance at the positioning speed after the start (command speed).
The minor error (error code: 211) is stored in the minor error storage register (D6+20n) for each axis.
- (7) If positioning to outside the stroke limit range is executed after the start, the minor error (error code: 106) is stored in the minor error storage register (D6+20n) for each axis and a deceleration stop is executed.

- (8) The minimum travel value between constant-speed control pass points is shown below:

$$\text{Command speed per second (control unit/s)} \times \text{Main cycle [s]} < \text{Travel distance [control unit]}$$

Positioning speed drops if the distance between pass points is short the minimum travel value.

Example) Main cycle: 20[ms], Command speed: 600[mm/min]

If the command speed (600[mm/min]) is divided by 60, the command speed per second is 10[mm/s], and the main cycle is 0.02[s].

Therefore, the travel distance is as follow.

$$10[\text{mm/s}] \times 0.02[\text{s}] = 0.2[\text{mm}]$$

Set the travel distance to more than 0.2[mm].

6 POSITIONING CONTROL

6.17.1 Specification of pass points by repetition instructions

This section describes the method of the pass points for which executes between any pass points repeatedly.

Servo instruction	Positioning method	Number of control axes	Items set using MT Developer2														Speed change												
			Common					Arc			Parameter block							Others											
			Parameter block No.	Axis	Address/travel value	Command speed	Dwell time	M-code	Torque limit value	Auxiliary point	Radius	Central point	Interpolation control unit	Speed limit value	Acceleration time	Deceleration time		Rapid Stop deceleration time	Torque limit value	Deceleration processing on stop input	Allowable error range for circular interpolation	S-curve ratio	Advanced S-curve acceleration/deceleration	Repeated condition	Cancel	WAIT-ON/OFF			
FOR-TIMES	—	—																											
FOR-ON																							○						
FOR-OFF																													
NEXT																													

○ : Must be set
△ : Set if required

[Control details]

Setting the first of repetition range

The first of repetition range is set by the following instructions:

(1) FOR-TIMES (number of loops setting)

- (a) The repetition range set specified number of times is executed repeatedly.
- (b) The setting range is 1 to 32767.
Outside the range of -32768 to 0 is controlled as a setting of "1".
- (c) The following devices can be used as the repetition number of times:

<ol style="list-style-type: none"> 1) Data register (D) 2) Link register (W) 3) Motion register (#) 4) Multiple CPU area device (U□G) 5) Decimal constant (K) 6) Hexadecimal constant (H) 	}	For indirect setting
---	---	----------------------

(2) FOR-ON (Loop-out trigger condition setting)

- (a) The repetition range set until the specified bit device turns on is executed repeatedly.
- (b) The following devices are used as the loop-out trigger condition:
 - 1) Input (X/PX)
 - 2) Output (Y/PY)
 - 3) Internal relay (M)
 - 4) Special relay (SM)
 - 5) Link relay (B)
 - 6) Annunciator (F)

(3) FOR-OFF (loop-out trigger condition setting)

- (a) The repetition range set until the specified bit device turns off is executed repeatedly.
- (b) The following devices are used as the loop-out trigger condition:
 - 1) Input (X/PX)
 - 2) Output (Y/PY)
 - 3) Internal relay (M)
 - 4) Special relay (SM)
 - 5) Link relay (B)
 - 6) Annunciator (F)

The repetition control operation using FOR-TIMES, FOR-ON and FOR-OFF is shown below.

[Servo program]

```

<K 701>
CPSTART
Axis 1
Axis 2
Speed 1000
ABS-2
Axis 1, 40000
Axis 2, 20000
1)
2)
INC-2
Axis 1, 30000
Axis 2, 0
3)
INC-2
Axis 1, 20000
Axis 2, 20000
NEXT
CPEND
    
```

1)	2)		
	Condition 1	Condition 2	Condition 3
FOR-TIMES	K1	K2	K3
FOR-ON	X010 → ON during first positioning 3)	X010 → ON during second positioning 3)	X010 → ON during third positioning 3)
FOR-OFF	X011 → OFF during first positioning 3)	X011 → OFF during second positioning 3)	X011 → OFF during third positioning 3)

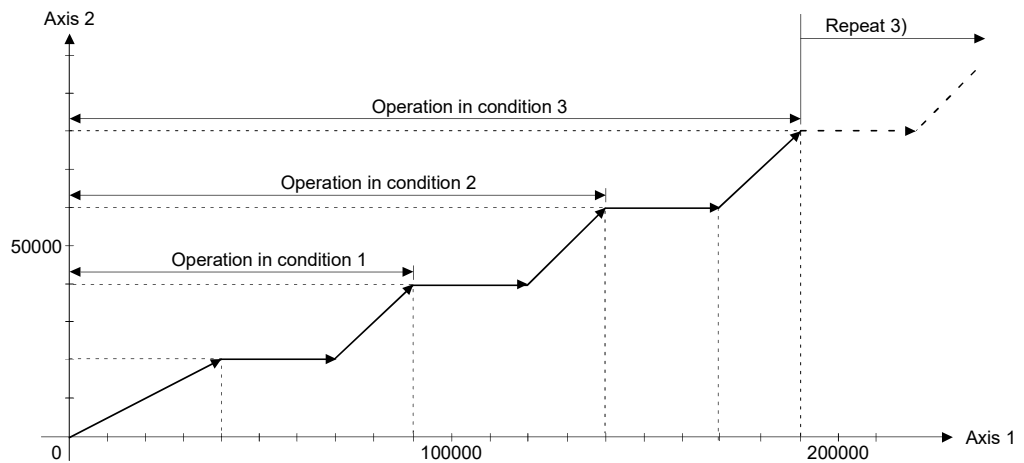

6 POSITIONING CONTROL

[Caution]

- (1) During a FOR-ON loop, or a FOR-OFF loop, if the travel value of the specified pass point is smaller than the travel value of one operation cycle shown below, it will not loop-out even when trigger conditions are satisfied.
 To perform a loop-out, make the travel value of the pass point larger than the travel value of one operation cycle, or set a smaller speed command.
 The travel value for which positioning is completed in one operation cycle is shown below.

$\text{Travel value of one operation cycle [control unit]} = \frac{\text{Command speed per second [control unit/s]} \times \text{Operation cycle [s]}}{6}$
--

<Example> Command speed: 100.00[mm/min], Operation cycle: 0.44[ms]

$$\frac{100}{6} \text{ [mm/s]} \times 0.44 \text{ [ms]} = 0.74 \text{ [\mu m]}$$

If the travel value of the pass point exceeds 0.74[μm], it will loop-out normally.

- (2) During a FOR-ON loop, or a FOR-OFF loop, if the time from satisfaction of trigger conditions until reaching end point of the loop is shorter than the indicated time below, positioning operations are not normal. Set the trigger conditions so that the time from satisfaction of trigger conditions until reaching end point of the loop is longer than the indicated time below.

$\text{Time required from satisfaction of trigger conditions until reaching end point of the loop} = \text{Main cycle} + \text{Time required for deceleration stop}$
--

- (3) When the last positioning address is detected and the deceleration distance is not enough for the output speed, an overrun, and a minor error (error code:211) occur. However, a minor error does not occur if a movement amount of 0 is the last point.

[Program]

Program for repetition constant-speed control is shown as the following conditions.

(1) System configuration

Constant-speed control for Axis 2 and Axis 3.

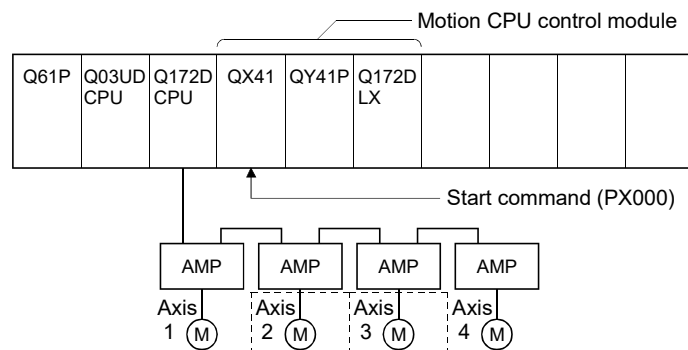

(2) Positioning conditions

(a) Constant-speed control conditions are shown below.

Item	Setting
Servo program No.	510
Control axis	Axis 2, Axis 3
Positioning speed	10000

(b) Constant-speed control start command PX000 Leading edge (OFF → ON)

(3) Operation timing

Operation timing for constant-speed control is shown below.

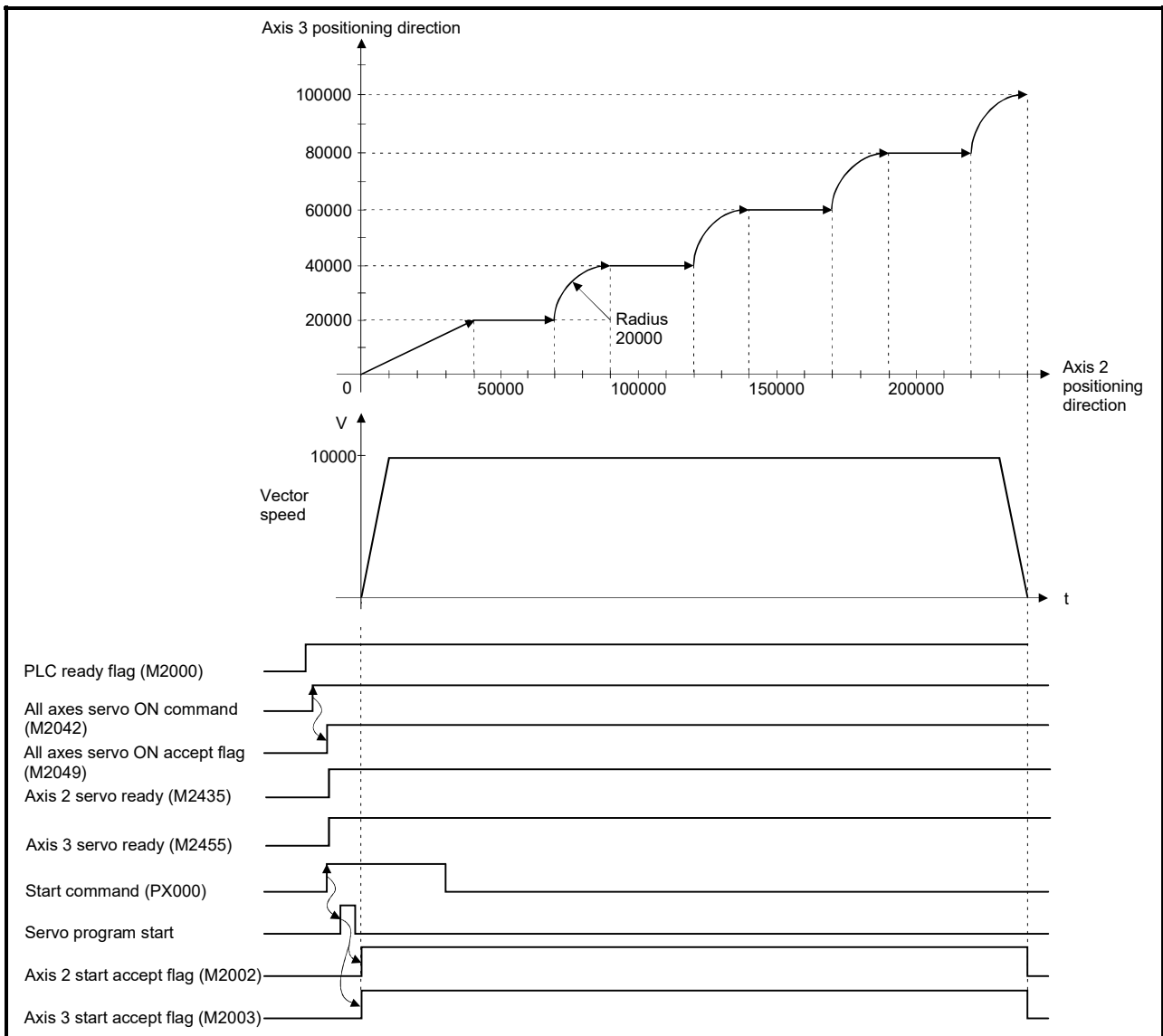

(4) Servo program

Servo program No.510 for constant-speed control is shown below.

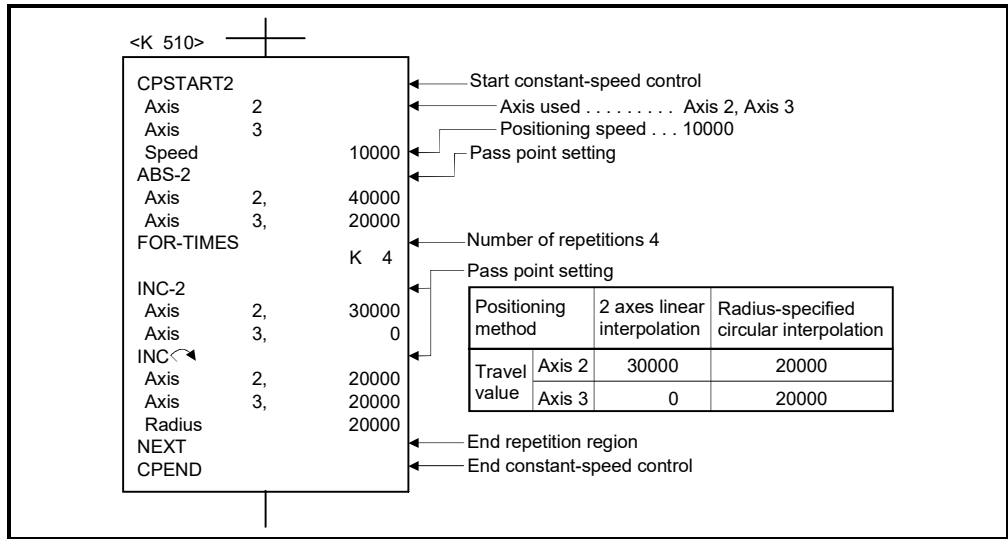

(5) Motion SFC program

Motion SFC program for which executes the servo program is shown below.

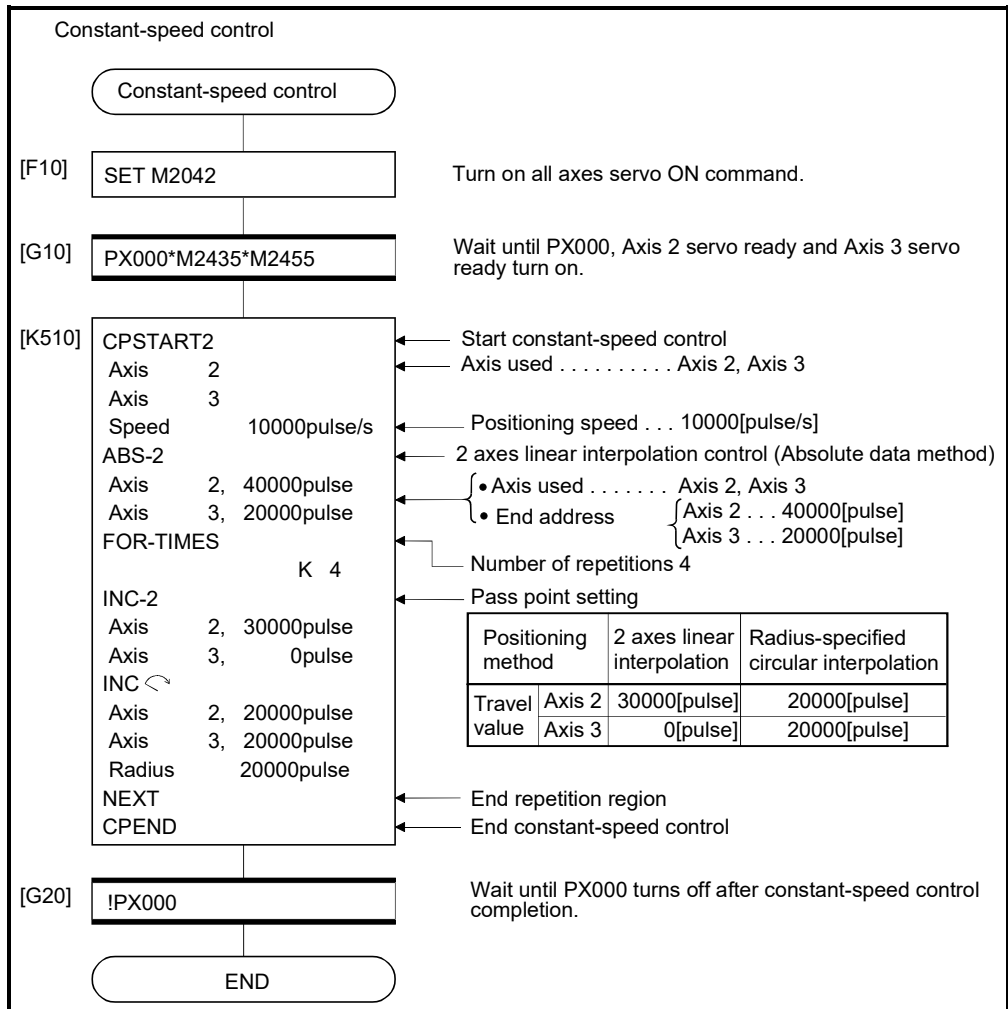

(Note): Example of the above Motion SFC program is started using the automatic start or sequence program.

6.17.2 Speed-switching by instruction execution

The speed can be specified for each pass point during the constant-speed control instruction.

The speed change from a point can be specified directly or indirectly in the servo program.

[Cautions]

- (1) The speed switching during servo instruction is possible at the constant-speed control for 1 to 4 axes.
- (2) The speed command can be set for point.
- (3) By turning on the speed-switching point specified flag (M2040) before the start, the point which completes speed change can be specified.

The speed change timing at the flag ON/OFF.

(a) M2040 is OFF

The speed change starts with the specified speed-switching point.

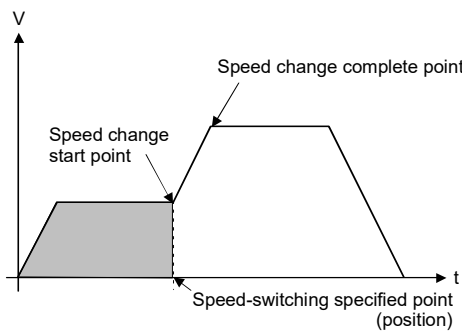

(b) M2040 is ON

The speed change ends with the specified speed-switching point.

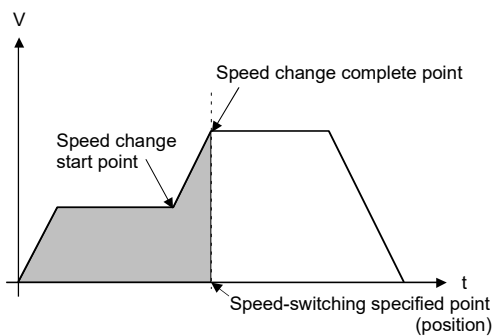

[Program]

Program for which executes the speed-switching control by turning on M2040 during constant-speed instruction is shown as the following conditions.

(1) System configuration

Switches speed for Axis 1 and Axis 2.

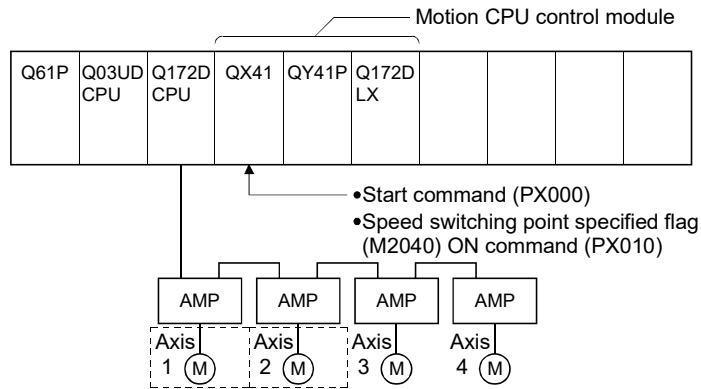

(2) Positioning conditions

(a) Speed switching conditions are shown below.

Item		Setting			
Servo program No.		310			
Positioning speed		10000		15000	
Positioning method		2 axes linear interpolation	Central point-specified circular interpolation	2 axes linear interpolation	2 axes linear interpolation
Pass point	Axis 1	20000	30000	40000	50000
	Axis 2	10000	20000	25000	40000

(b) The constant-speed start command for speed switching

.....PX000 Leading edge (OFF → ON)

(3) Operation timing and speed-switching positions

Operation timing and positions for speed switching are shown below.

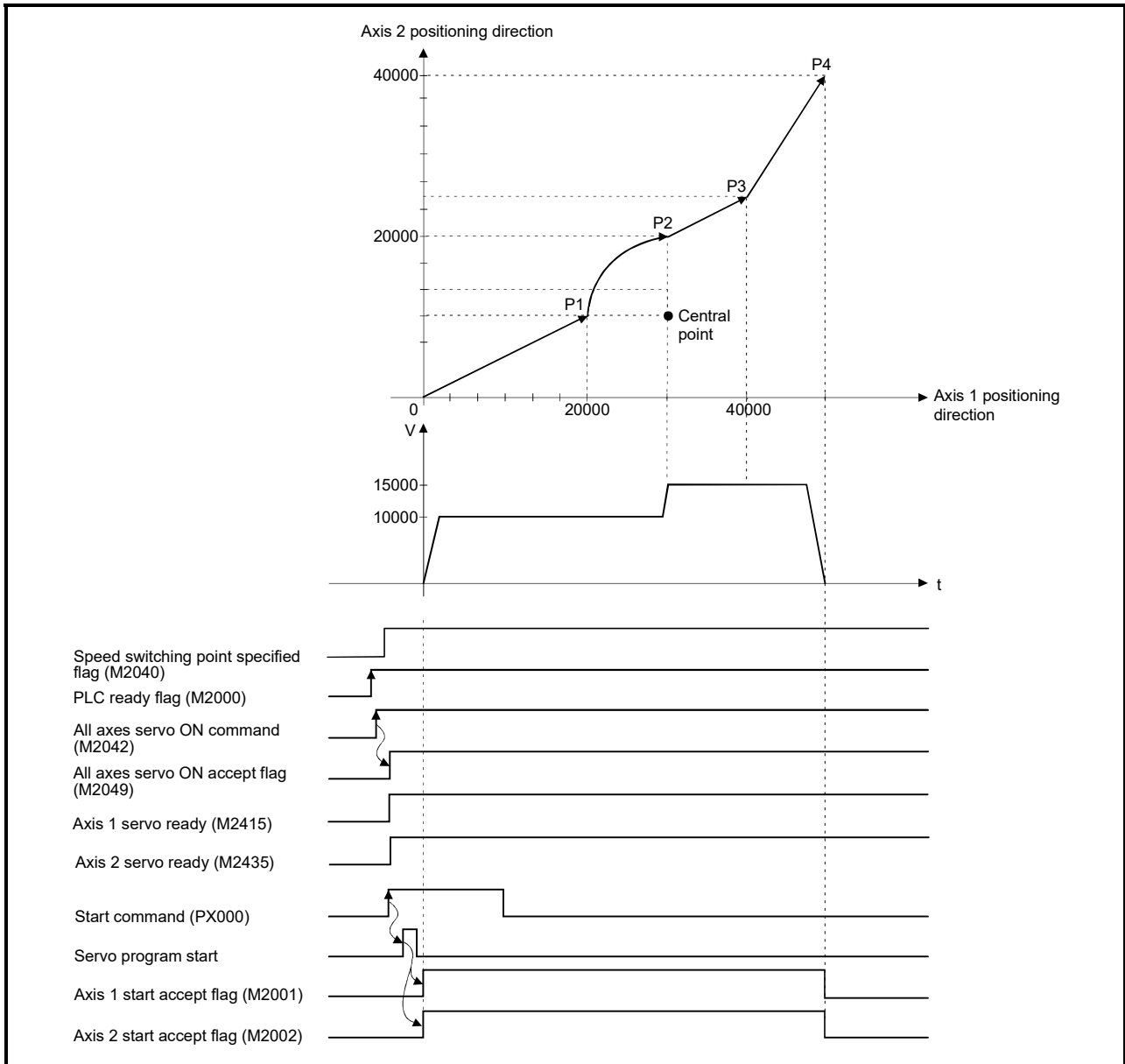

(4) Servo program

Servo program No.310 for speed-switching is shown below.

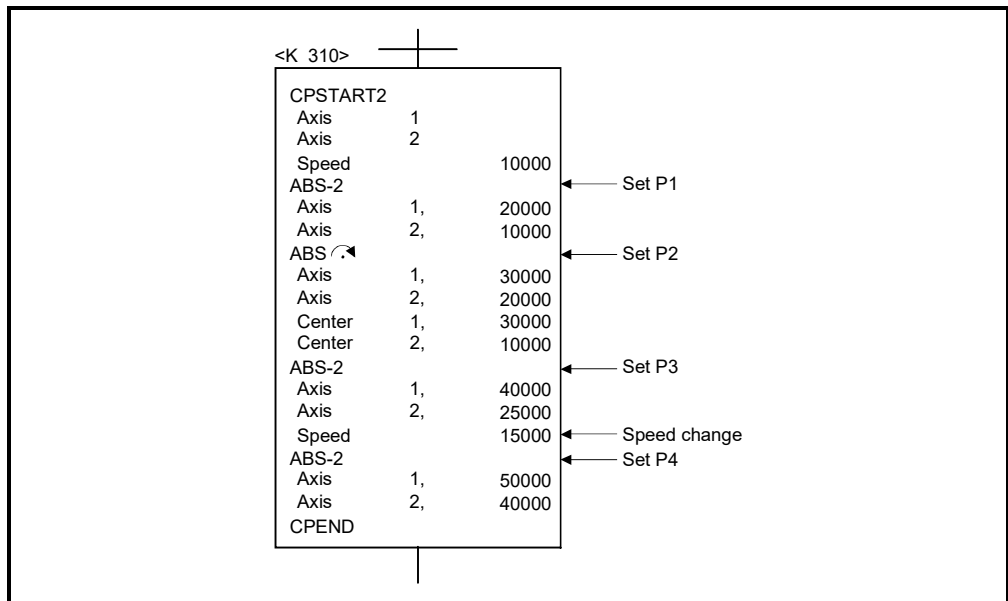

(Note): Example of the Motion SFC program for positioning control is shown next page.

(5) Motion SFC program

Motion SFC program for which executes the servo program is shown below.

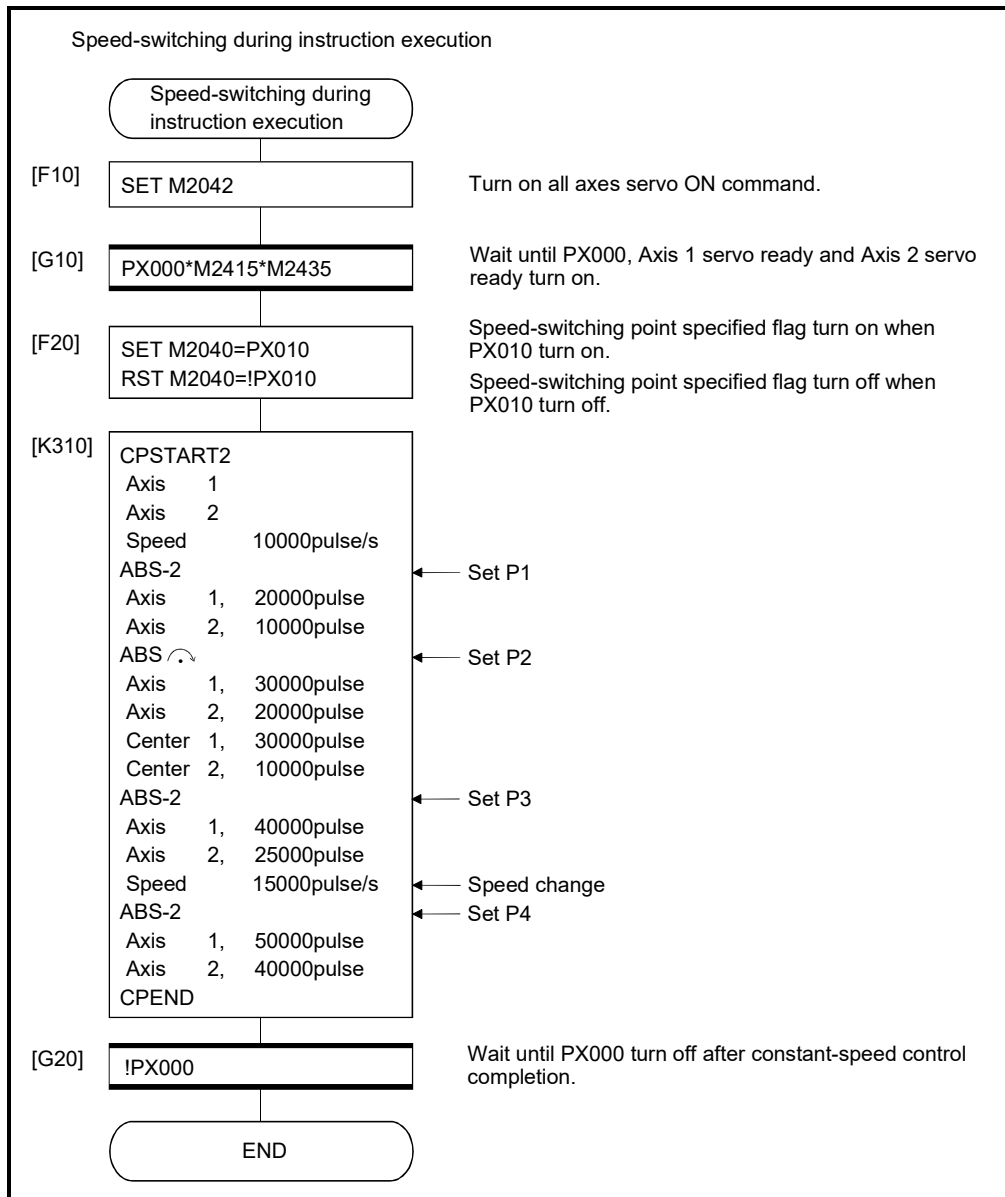

(Note): Example of the above Motion SFC program is started using the automatic start or sequence program.

[Program]

Program for repetition 1 axis constant-speed control is shown as the following conditions.

(1) System configuration

Axis 4 constant-speed control.

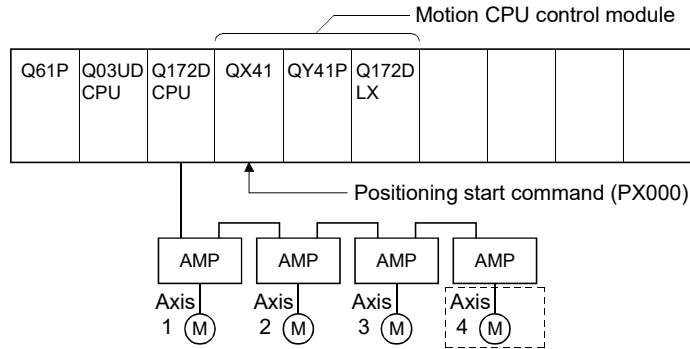

(2) Positioning conditions

(a) Constant-speed control conditions are shown below.

Item	Setting	
Servo program No.	500	
Control axis	Axis 4	
Positioning speed	10000	
Number of repetitions	100	
Pass point travel value	P1	-1000
	P2	2000
	P3	-2000
	P4	1000

(b) Constant-speed control start command PX000 Leading edge (OFF → ON)

(3) Details of positioning operation

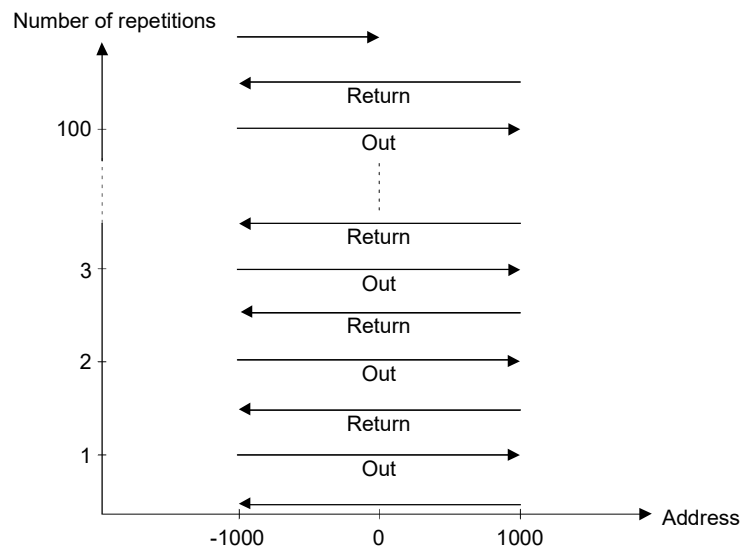

(4) Operation timing

Operation timing for servo program No.500 is shown below.

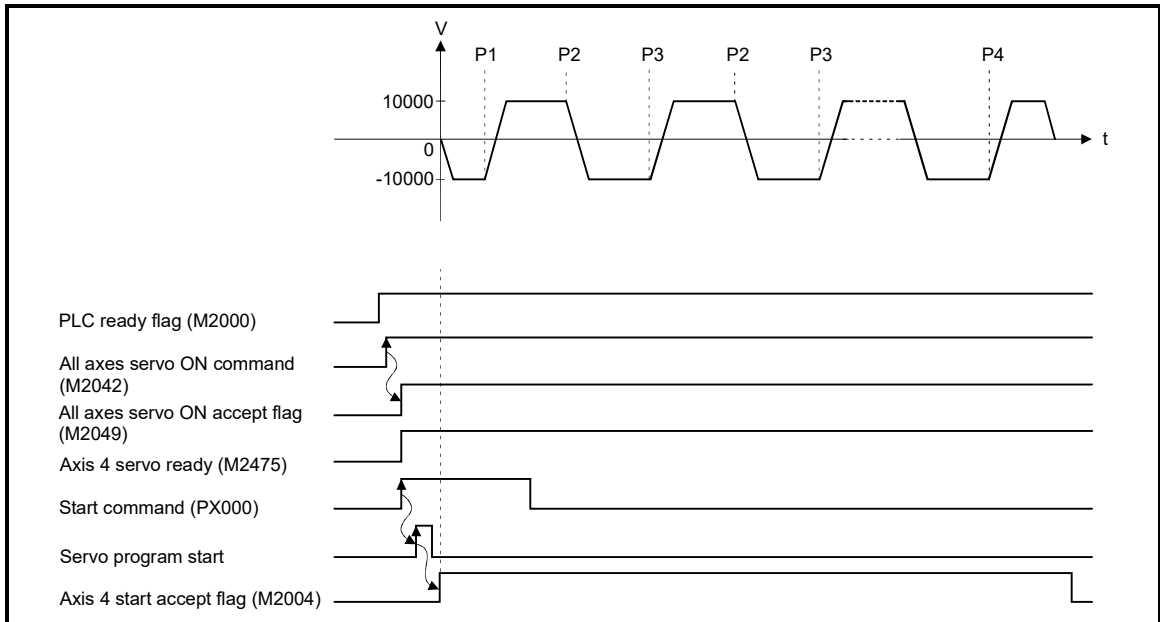

(5) Servo program

Servo program No.500 for constant-speed control is shown below.

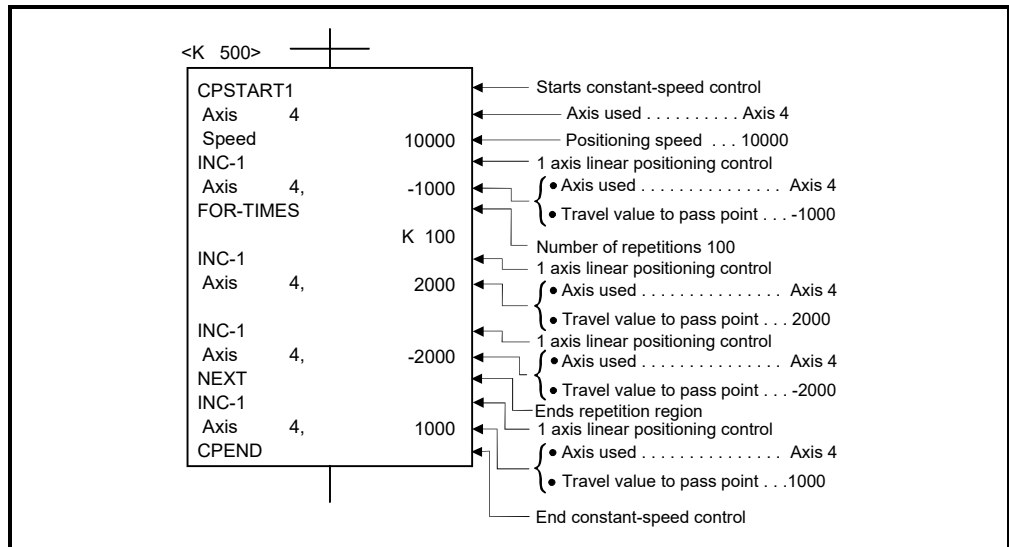

(Note): Example of the Motion SFC program for positioning control is shown next page.

(6) Motion SFC program

Motion SFC program for which executes the servo program is shown below.

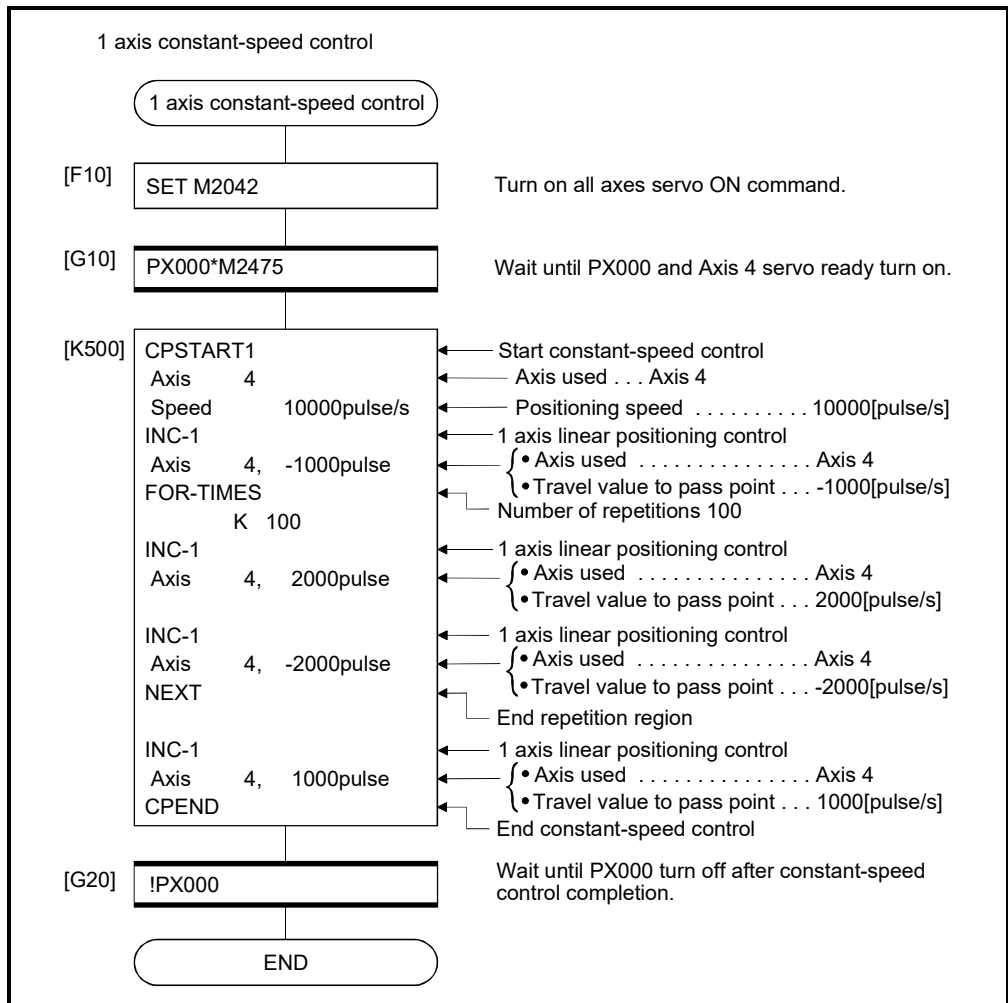

(Note): Example of the above Motion SFC program is started using the automatic start or sequence program.

6 POSITIONING CONTROL

6.17.4 2 to 4 axes constant-speed control

Constant-speed control for 2 to 4 axes.



Servo instruction	Positioning method	Number of control axes	Items set using MT Developer2																				Speed change						
			Common							Arc			Parameter block								Others								
			Parameter block No.	Axis	Address/travel value	Command speed	Dwell time	M-code	Torque limit value	Auxiliary point	Radius	Central point	Interpolation control unit	Speed limit value	Acceleration time	Deceleration time	Rapid Stop deceleration time	Torque limit value	Deceleration processing on stop input	Allowable error range for circular interpolation	S-curve ratio	Advanced S-curve acceleration/deceleration		Commanded speed (Constant)	Cancel	Skip	FIN acceleration/deceleration	WAIT-ON/OFF	
Start	CPSTART2	—	2	△	○	○						△	△	△	△	△	△	△	△	△	△	△	△	△					
	CPSTART3		3	△	○	○							△	△	△	△	△	△	△	△	△	△	△	△	△	△	△		
	CPSTART4		4	△	○	○							△	△	△	△	△	△	△	△	△	△	△	△	△	△	△		
End	CPEND	—				△																							
Pass point	ABS-2	Absolute data	2		○	○		△	△													△	△	△	△				
	ABS-3		3		○	○		△	△														△	△	△	△			
	ABS-4		4		○	○		△	△														△	△	△	△			
	ABS↗		2		○	○		△	△	○													△	△	△	△			
	ABS↖																												
	ABS↘		2		○	○		△	△	○													△	△	△	△			
	ABS↙																												
	ABS↗↘		2		○	○		△	△	○													△	△	△	△			
	ABS↖↙																												
	INC-2		Incremental data	2		○	○		△	△													△	△	△	△			
	INC-3			3		○	○		△	△														△	△	△	△		
	INC-4			4		○	○		△	△														△	△	△	△		
	INC↗			2		○	○		△	△	○													△	△	△	△		
	INC↖																												
INC↘	2			○	○		△	△	○													△	△	△	△				
INC↙																													
INC↗↘	2			○	○		△	△	○													△	△	△	△				
INC↖↙																													

○: Must be set
△: Set if required

[Control details]





Start and end for 2 to 4 axes constant-speed control

2 to 4 axes constant-speed control is started and ended using the following instructions:

- (1) CPSTART2 
Starts the 2 axes constant-speed control. Sets the axis No. and command speed.
- (2) CPSTART3 
Starts the 3 axes constant-speed control. Sets the axis No. and command speed.
- (3) CPSTART4 
Starts the 4 axes constant-speed control. Sets the axis No. and command speed.
- (4) CPEND
Ends the 2, 3, or 4 axes constant-speed control for CPSTART2, CPSTART3, or CPSTART4.

Positioning control method to the pass point

Positioning control to change control is specified using the following instructions:

- (1) ABS-2/INC-2
Sets 2 axes linear interpolation control.
Refer to Section 6.3 "2 Axes Linear Interpolation Control" for details.
- (2) ABS-3/INC-3
Sets 3 axes linear interpolation control.
Refer to Section 6.4 "3 Axes Linear Interpolation Control" for details.
- (3) ABS-4/INC-4
Sets 4 axes linear interpolation control.
Refer to Section 6.5 "4 Axes Linear Interpolation Control" for details.
- (4) ABS/INC 
Sets circular interpolation control using auxiliary point specification.
Refer to Section 6.6 "Auxiliary Point-Specified Circular Interpolation Control" for details.
- (5) ABS/INC , ABS/INC , ABS/INC , ABS/INC 
Sets circular interpolation control using radius specification.
Refer to Section 6.7 "Radius-Specified Circular Interpolation Control" for details.

: Refer to Section 1.3 for the software version that supports the advanced S-curve acceleration/deceleration in constant-speed (CPSTART).

(6) ABS/INC ↻, ABS/INC ↻

Sets circular interpolation control using center point specification.

Refer to Section 6.8 "Central Point-Specified Circular Interpolation Control" for details.

[Cautions]

- (1) For circular interpolation control at the pass points for constant-speed control of 2 to 4 axes, specify any 2 axes among the controlled axes. When axes other than the axes specified for circular interpolation control are detected, an error occurs, resulting in a deceleration stop.

[Program]

- (1) Program for 2 axes constant-speed control is shown as the following conditions.

(a) System configuration

Constant-speed control for Axis 2 and Axis 3.

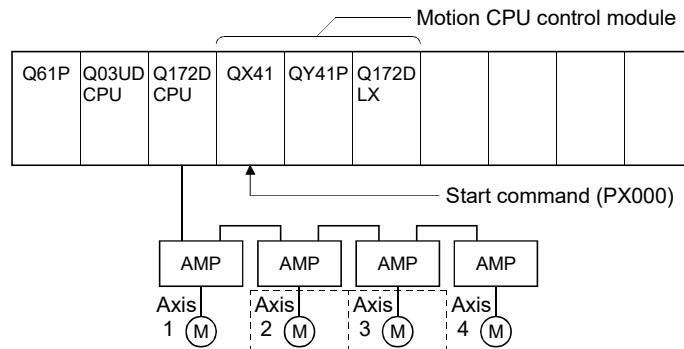

(b) Positioning operation details

Axis 2 and axis 3 servo motors are used for positioning operation.

Positioning details for Axis 2 and Axis 3 servo motors are shown below.

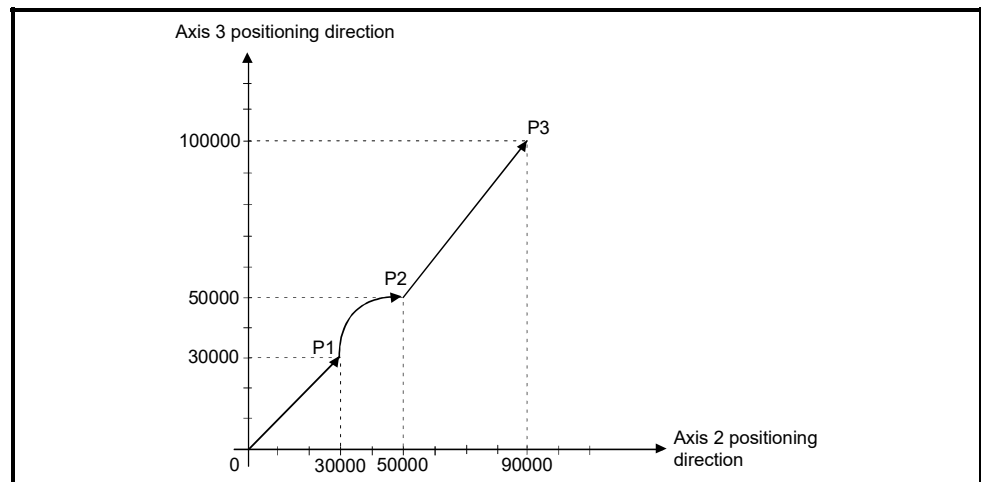

Fig.6.30 Positioning for Axis 2 and Axis 3

6 POSITIONING CONTROL

(c) Positioning conditions

1) Constant-speed control conditions are shown below.

Item		Setting		
Servo program No.		505		
Positioning speed		10000		
Positioning method		2 axes linear interpolation	Radius-specified circular interpolation	2 axes linear interpolation
Pass point	Axis 2	30000	50000	90000
	Axis 3	30000	50000	100000

2) Constant-speed control start command ... PX000 Leading edge (OFF → ON)

(d) Servo program

Servo program No.505 for constant-speed control is shown below.

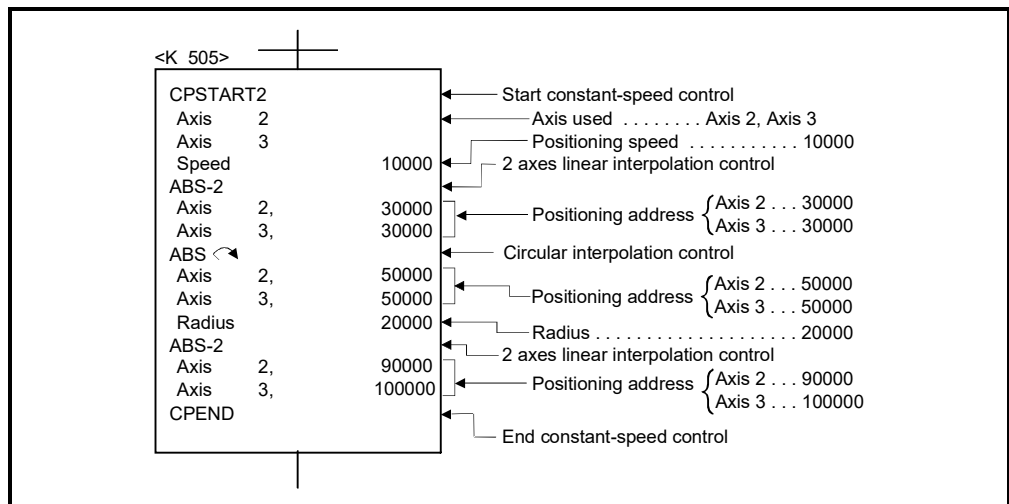

(Note): Example of the Motion SFC program for positioning control is shown next page.

(e) Motion SFC program

Motion SFC program for which executes the servo program is shown below.

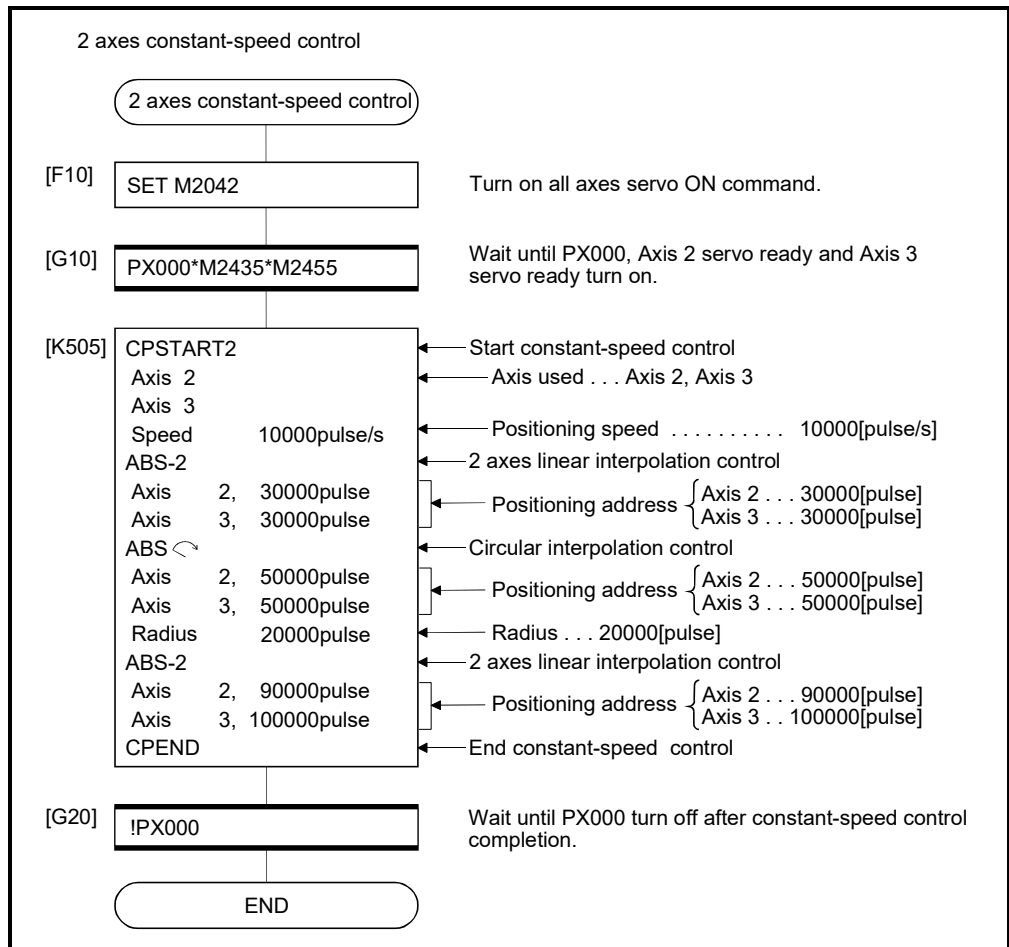

(Note): Example of the above Motion SFC program is started using the automatic start or sequence program.

(2) Program for 4 axes constant-speed control is shown as the following conditions.

(a) System configuration

Constant-speed control for Axis 1, Axis 2, Axis 3, and Axis 4.

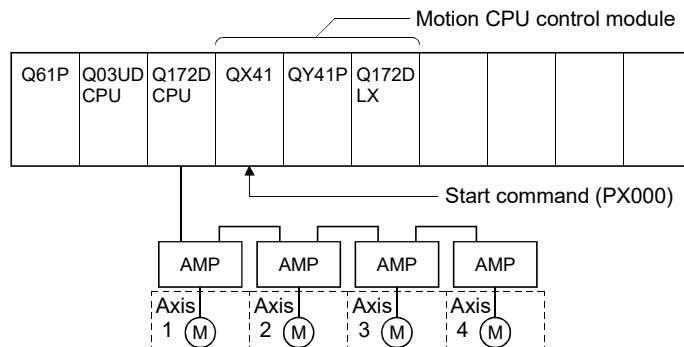

6 POSITIONING CONTROL

(b) Positioning conditions

1) Constant-speed control conditions are shown below.

Item		Setting		
Servo program No.		506		
Positioning speed		10000		
Positioning method		4 axes linear interpolation	4 axes linear interpolation	4 axes linear interpolation
Pass point	Axis 1	3000	5000	5000
	Axis 2	4000	3500	3500
	Axis 3	4000	-4000	3000
	Axis 4	4000	-6000	6000

2) Constant-speed control start command... PX000 Leading edge (OFF → ON)

(c) Servo program

Servo program No.506 for constant-speed control is shown below.

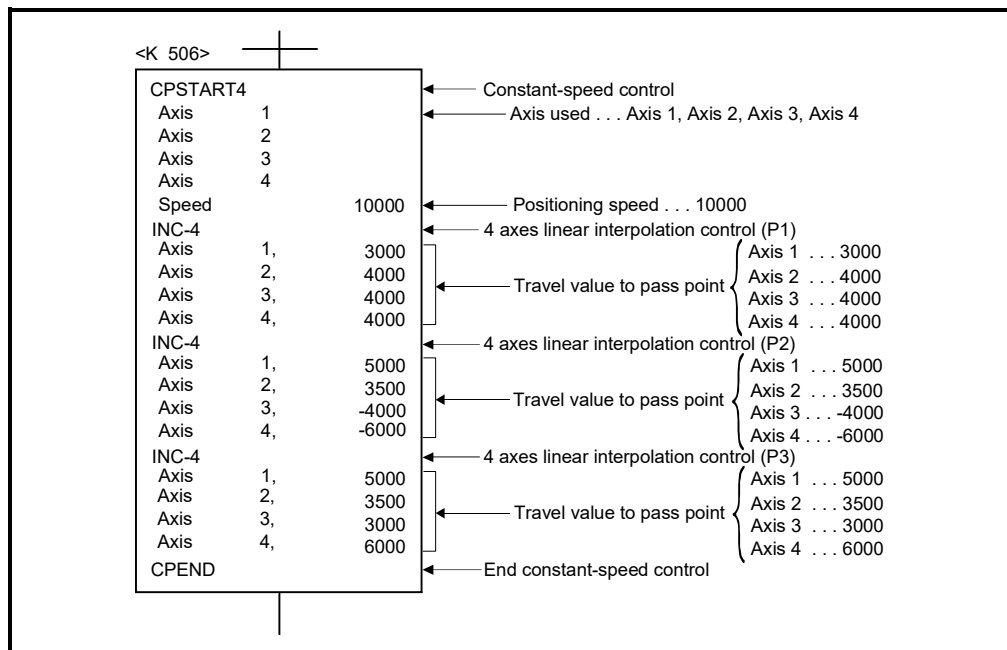

(Note): Example of the Motion SFC program for positioning control is shown next page.

6 POSITIONING CONTROL

(d) Motion SFC program

Motion SFC program for which executes the servo program is shown below.

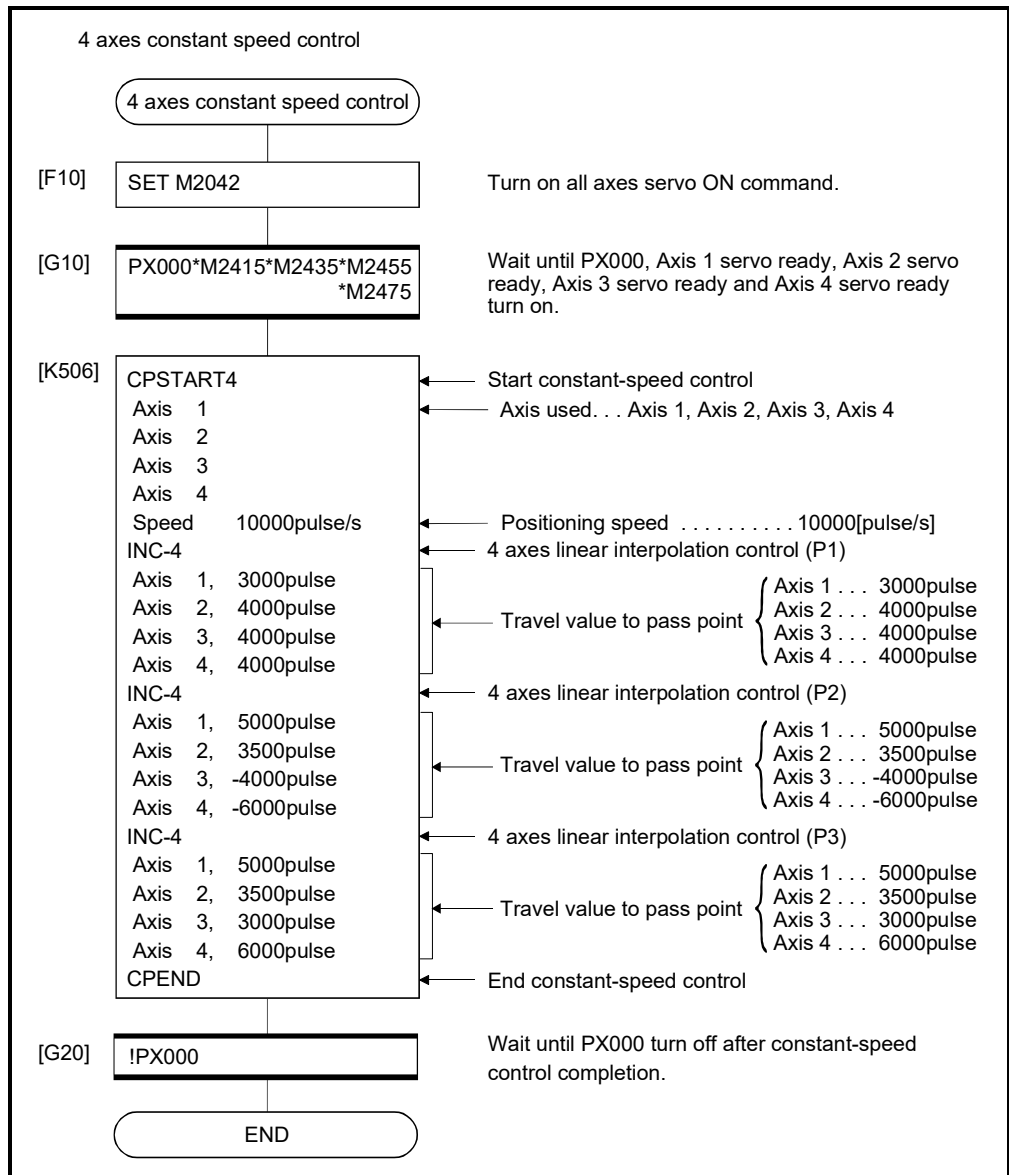

(Note): Example of the above Motion SFC program is started using the automatic start or sequence program.

6 POSITIONING CONTROL

6.17.5 Constant speed control for helical interpolation















The helical interpolation can be specified as the positioning control method to pass point for 3 or 4 axes constant-speed control.

Starting or ending instruction for constant-speed control uses the same CPSTART3, CPSTART4 or CPEND as 3 or 4 axes constant-speed control instruction.

Servo instruction	Positioning method	Number of control axes	Items set using MT Developer2																Speed change										
			Common				Arc/Helical				Parameter block						Others												
			Parameter block No.	Axis	Address/travel value	Command speed	M-code	Torque limit value	Auxiliary point	Radius	Central point	Pitch	Interpolation control unit	Speed limit value	Acceleration time	Deceleration time	Rapid Stop deceleration time	Torque limit value		Deceleration processing on stop input	Allowable error range for circular interpolation	S-curve ratio	Advanced S-curve acceleration/deceleration	Commanded speed (Constant)	Cancel	Skip	FIN acceleration/deceleration	WAIT-ON/OFF	
	Absolute	2	<input type="radio"/>	<input type="radio"/>	<input type="radio"/>	<input type="radio"/>	<input type="radio"/>	<input type="radio"/>	<input type="radio"/>	<input type="radio"/>	<input type="radio"/>	<input type="radio"/>	<input type="radio"/>	<input type="radio"/>	<input type="radio"/>	<input type="radio"/>	<input type="radio"/>	<input type="radio"/>	<input type="radio"/>	<input type="radio"/>	<input type="radio"/>	<input type="radio"/>	<input type="radio"/>	<input type="radio"/>	<input type="radio"/>	<input type="radio"/>	Valid		
			<input type="radio"/>	<input type="radio"/>	<input type="radio"/>	<input type="radio"/>	<input type="radio"/>	<input type="radio"/>	<input type="radio"/>	<input type="radio"/>	<input type="radio"/>	<input type="radio"/>	<input type="radio"/>	<input type="radio"/>	<input type="radio"/>	<input type="radio"/>	<input type="radio"/>	<input type="radio"/>	<input type="radio"/>	<input type="radio"/>	<input type="radio"/>	<input type="radio"/>	<input type="radio"/>	<input type="radio"/>	<input type="radio"/>	<input type="radio"/>		<input type="radio"/>	
			<input type="radio"/>	<input type="radio"/>	<input type="radio"/>	<input type="radio"/>	<input type="radio"/>	<input type="radio"/>	<input type="radio"/>	<input type="radio"/>	<input type="radio"/>	<input type="radio"/>	<input type="radio"/>	<input type="radio"/>	<input type="radio"/>	<input type="radio"/>	<input type="radio"/>	<input type="radio"/>	<input type="radio"/>	<input type="radio"/>	<input type="radio"/>	<input type="radio"/>	<input type="radio"/>	<input type="radio"/>	<input type="radio"/>	<input type="radio"/>		<input type="radio"/>	<input type="radio"/>
			<input type="radio"/>	<input type="radio"/>	<input type="radio"/>	<input type="radio"/>	<input type="radio"/>	<input type="radio"/>	<input type="radio"/>	<input type="radio"/>	<input type="radio"/>	<input type="radio"/>	<input type="radio"/>	<input type="radio"/>	<input type="radio"/>	<input type="radio"/>	<input type="radio"/>	<input type="radio"/>	<input type="radio"/>	<input type="radio"/>	<input type="radio"/>	<input type="radio"/>	<input type="radio"/>	<input type="radio"/>	<input type="radio"/>	<input type="radio"/>		<input type="radio"/>	<input type="radio"/>
			<input type="radio"/>	<input type="radio"/>	<input type="radio"/>	<input type="radio"/>	<input type="radio"/>	<input type="radio"/>	<input type="radio"/>	<input type="radio"/>	<input type="radio"/>	<input type="radio"/>	<input type="radio"/>	<input type="radio"/>	<input type="radio"/>	<input type="radio"/>	<input type="radio"/>	<input type="radio"/>	<input type="radio"/>	<input type="radio"/>	<input type="radio"/>	<input type="radio"/>	<input type="radio"/>	<input type="radio"/>	<input type="radio"/>	<input type="radio"/>		<input type="radio"/>	<input type="radio"/>
			<input type="radio"/>	<input type="radio"/>	<input type="radio"/>	<input type="radio"/>	<input type="radio"/>	<input type="radio"/>	<input type="radio"/>	<input type="radio"/>	<input type="radio"/>	<input type="radio"/>	<input type="radio"/>	<input type="radio"/>	<input type="radio"/>	<input type="radio"/>	<input type="radio"/>	<input type="radio"/>	<input type="radio"/>	<input type="radio"/>	<input type="radio"/>	<input type="radio"/>	<input type="radio"/>	<input type="radio"/>	<input type="radio"/>	<input type="radio"/>		<input type="radio"/>	<input type="radio"/>
	Incremental		<input type="radio"/>	<input type="radio"/>	<input type="radio"/>	<input type="radio"/>	<input type="radio"/>	<input type="radio"/>	<input type="radio"/>	<input type="radio"/>	<input type="radio"/>	<input type="radio"/>	<input type="radio"/>	<input type="radio"/>	<input type="radio"/>	<input type="radio"/>	<input type="radio"/>	<input type="radio"/>	<input type="radio"/>	<input type="radio"/>	<input type="radio"/>	<input type="radio"/>	<input type="radio"/>	<input type="radio"/>	<input type="radio"/>	<input type="radio"/>			
			<input type="radio"/>	<input type="radio"/>	<input type="radio"/>	<input type="radio"/>	<input type="radio"/>	<input type="radio"/>	<input type="radio"/>	<input type="radio"/>	<input type="radio"/>	<input type="radio"/>	<input type="radio"/>	<input type="radio"/>	<input type="radio"/>	<input type="radio"/>	<input type="radio"/>	<input type="radio"/>	<input type="radio"/>	<input type="radio"/>	<input type="radio"/>	<input type="radio"/>	<input type="radio"/>	<input type="radio"/>	<input type="radio"/>	<input type="radio"/>		<input type="radio"/>	
			<input type="radio"/>	<input type="radio"/>	<input type="radio"/>	<input type="radio"/>	<input type="radio"/>	<input type="radio"/>	<input type="radio"/>	<input type="radio"/>	<input type="radio"/>	<input type="radio"/>	<input type="radio"/>	<input type="radio"/>	<input type="radio"/>	<input type="radio"/>	<input type="radio"/>	<input type="radio"/>	<input type="radio"/>	<input type="radio"/>	<input type="radio"/>	<input type="radio"/>	<input type="radio"/>	<input type="radio"/>	<input type="radio"/>	<input type="radio"/>		<input type="radio"/>	<input type="radio"/>
			<input type="radio"/>	<input type="radio"/>	<input type="radio"/>	<input type="radio"/>	<input type="radio"/>	<input type="radio"/>	<input type="radio"/>	<input type="radio"/>	<input type="radio"/>	<input type="radio"/>	<input type="radio"/>	<input type="radio"/>	<input type="radio"/>	<input type="radio"/>	<input type="radio"/>	<input type="radio"/>	<input type="radio"/>	<input type="radio"/>	<input type="radio"/>	<input type="radio"/>	<input type="radio"/>	<input type="radio"/>	<input type="radio"/>	<input type="radio"/>		<input type="radio"/>	<input type="radio"/>
			<input type="radio"/>	<input type="radio"/>	<input type="radio"/>	<input type="radio"/>	<input type="radio"/>	<input type="radio"/>	<input type="radio"/>	<input type="radio"/>	<input type="radio"/>	<input type="radio"/>	<input type="radio"/>	<input type="radio"/>	<input type="radio"/>	<input type="radio"/>	<input type="radio"/>	<input type="radio"/>	<input type="radio"/>	<input type="radio"/>	<input type="radio"/>	<input type="radio"/>	<input type="radio"/>	<input type="radio"/>	<input type="radio"/>	<input type="radio"/>		<input type="radio"/>	<input type="radio"/>
			<input type="radio"/>	<input type="radio"/>	<input type="radio"/>	<input type="radio"/>	<input type="radio"/>	<input type="radio"/>	<input type="radio"/>	<input type="radio"/>	<input type="radio"/>	<input type="radio"/>	<input type="radio"/>	<input type="radio"/>	<input type="radio"/>	<input type="radio"/>	<input type="radio"/>	<input type="radio"/>	<input type="radio"/>	<input type="radio"/>	<input type="radio"/>	<input type="radio"/>	<input type="radio"/>	<input type="radio"/>	<input type="radio"/>	<input type="radio"/>		<input type="radio"/>	<input type="radio"/>

○: Must be set
△: Set if required

Helical interpolation specified methods for constant-speed control are shown below.

Servo instruction	Positioning method	Circular interpolation specified method
ABH 	Absolute	Radius-specified method less than CW180°
INH 	Incremental	
ABH 	Absolute	Radius-specified method less than CCW180°
INH 	Incremental	
ABH 	Absolute	Radius-specified method CW180° or more.
INH 	Incremental	
ABH 	Absolute	Radius-specified method CCW180° or more.
INH 	Incremental	
ABH 	Absolute	Central point-specified method CW
INH 	Incremental	
ABH 	Absolute	Central point-specified method CCW
INH 	Incremental	
ABH 	Absolute	Auxiliary point-specified method
INH 	Incremental	

[Cautions]

- (1) The helical interpolation specification at pass point for constant-speed control can be used in the both of real mode/virtual mode. When axes other than the axes specified for helical interpolation control are detected, an error occurs, resulting in a deceleration stop.
- (2) Specify any 3 axes among 4 controlled axes in the helical interpolation control at the pass point for 4 axes constant-speed control (CPSTART4).
- (3) Command speed at the helical interpolation specified point is controlled with the speed of circumference. Control is the same as before at the point except for the helical interpolation specification. (Both of the linear interpolation-specified point and circular interpolation-specified point are the vector speed for number of interpolation axes.)
- (4) Skip function toward the helical interpolation-specified each point for constant-speed control is possible. If the absolute-specified helical interpolation is specified to point since the skip signal specified point, set the absolute linear interpolation between them. If it does not set, it may occur an error and stop.
- (5) FIN signal wait function toward the helical interpolation specified each pass point for constant-speed control is possible. M-code outputting signal is outputted to all circular interpolation axes and linear axes. Fin signal can be operated with the both of circular interpolation axes and linear axes.
- (6) If negative speed change toward the helical interpolation-specified each pass point for constant-speed control is executed, it can be returned before 1 point during positioning control.

- (7) Speed-switching point-specified flag is effective toward the helical interpolation-specified each pass point for constant-speed control.

[Program1]

(1) Servo program

Servo program for which helical interpolation specified pass point for constant-speed control is shown below.

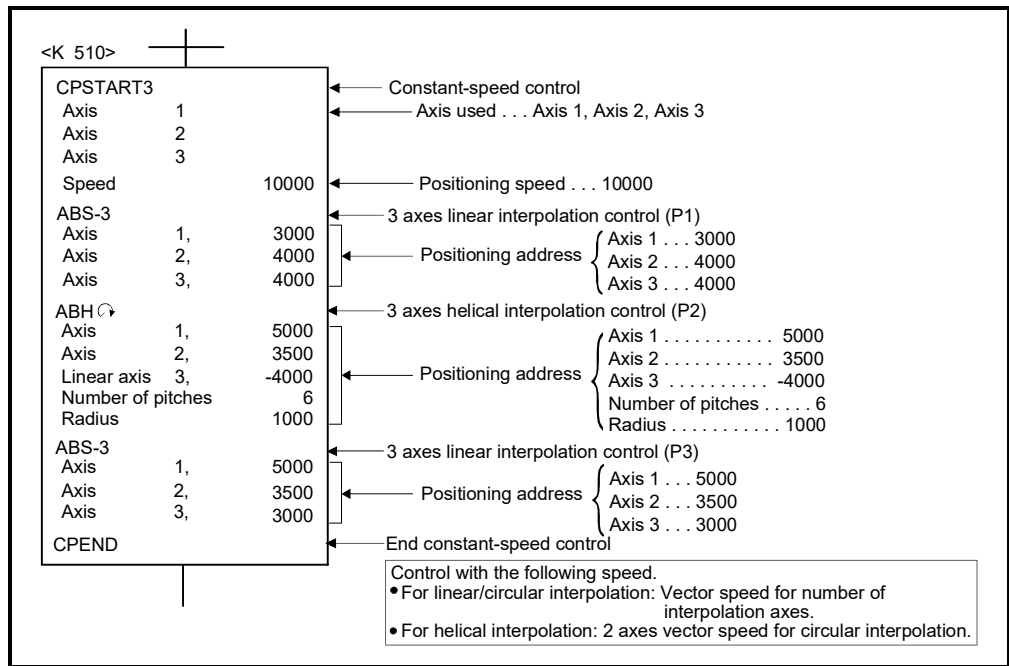

[Program2]

Program for direction of the nozzle of controlling the normal for circular arc curve is shown as the following conditions.

(1) System configuration

Helical interpolation with constant-speed control of Axis 1, Axis 2 and Axis 3

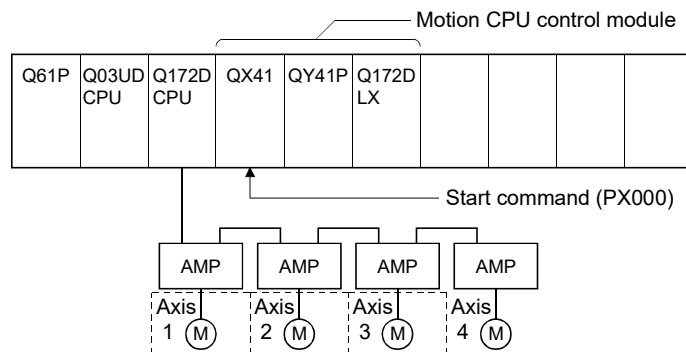

6 POSITIONING CONTROL

(2) Positioning operation details

The operation to start as the following figure from start point and which keeps a nozzle at right angles toward the contour of line and that it goes around the contour and which is returned to start point. It is the following program when a helical interpolation function is used.

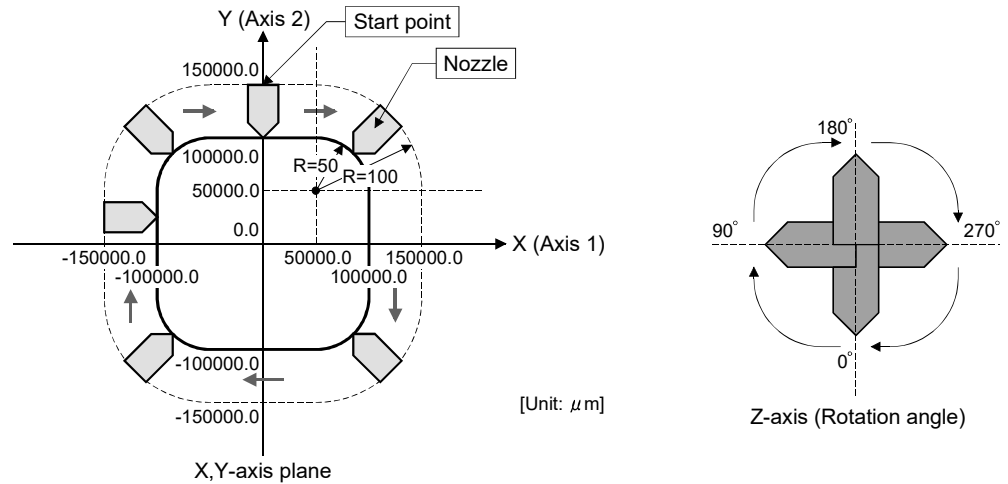

(3) Positioning conditions

(a) Helical interpolation conditions for constant-speed control are shown below.

Item		Setting				
Servo program No.		61, 62				
Positioning speed		1000.00 [mm/min]				
Control axis		Positioning address			Central point	
		Axis 1 [μm]	Axis 2 [μm]	Axis 3 [degree]	Axis 1 [μm]	Axis 2 [μm]
Pass point	Start point	0.0	150000.0	0.00000	—	—
	P1	50000.0	150000.0	0.00000	—	—
	P2	150000.0	50000.0	90.00000	50000.0	50000.0
	P3	150000.0	-50000.0	90.00000	—	—
	P4	50000.0	-150000.0	180.00000	50000.0	-50000.0
	P5	-50000.0	-150000.0	180.00000	—	—
	P6	-150000.0	-50000.0	270.00000	-50000.0	-50000.0
	P7	-150000.0	50000.0	270.00000	—	—
P8	-50000.0	150000.0	0.00000	-50000.0	50000.0	

Vibration may cause the machine at the pass point depend on the speed change. In this case, reduce the speed change (acceleration) in the FIN acceleration/deceleration.

However, a locus will change depend on the setting time of the FIN acceleration/deceleration.

(b) Constant-speed control start command PX000 Leading edge
(OFF \rightarrow ON)

(4) Motion SFC program

Motion SFC program for is shown below.

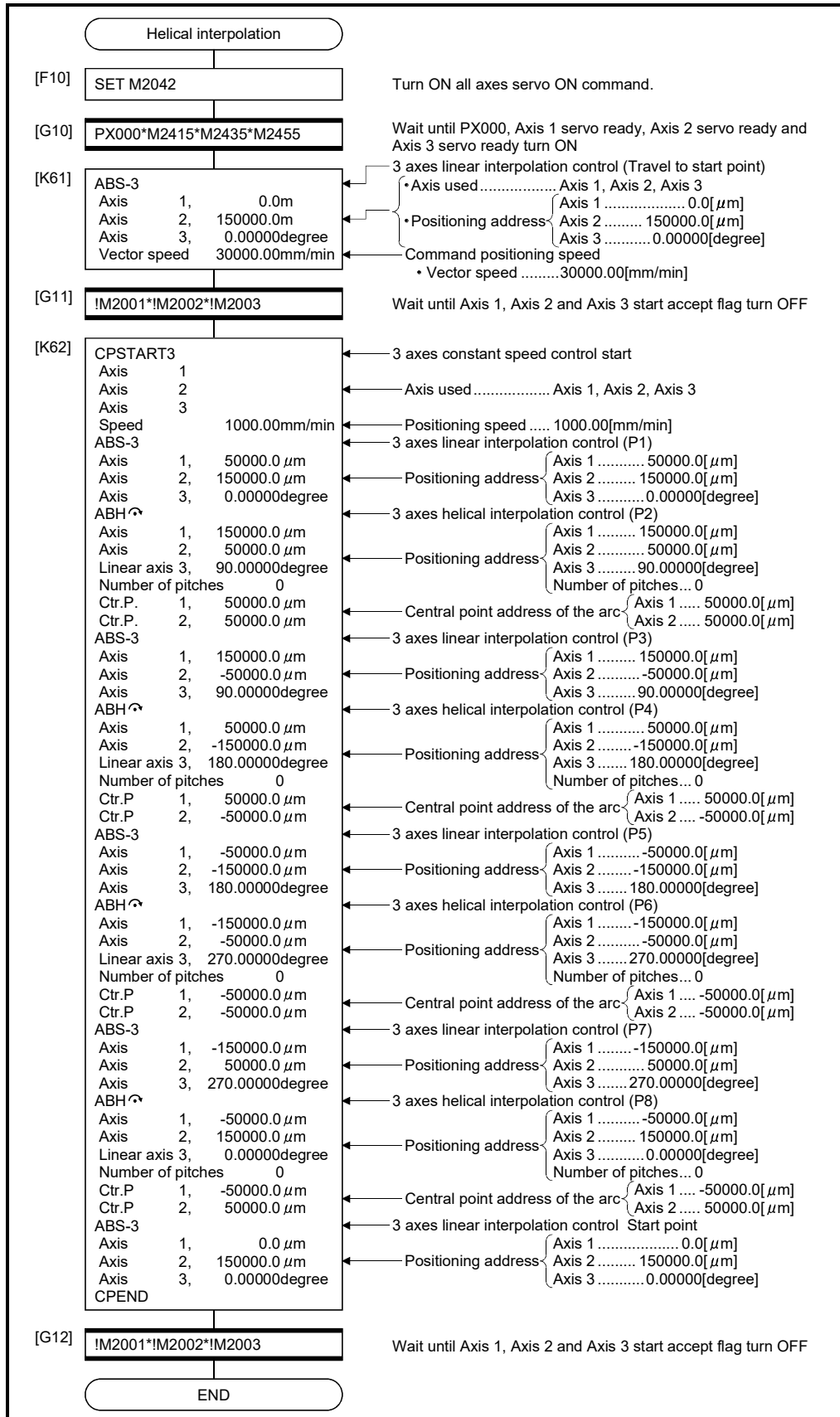

6 POSITIONING CONTROL

6.17.6 Pass point skip function

This function stops positioning to the executing point and executes positioning to the next point by setting a skip signal for each pass point for constant-speed control.

[Data setting]

(1) Skip signal devices

The following devices can be specified as skip signal devices.

X, Y, M, B, F, U□\G

[Cautions]

(1) When absolute circular interpolation or absolute helical interpolation is specified to a point after the skip signal specified point, set the absolute linear interpolation between them.
If not set, an error may occur that causes a stop.

(2) If a skip signal is inputted at the end point, a deceleration stop occurs at that point and the program is ended.

(2) If a skip signal is inputted at the end point, a deceleration stop occurs at that point and the program is ended.

When setting the S-curve ratio, the S-curve pattern is recalculated upon input of the skip signal. Refer to Section 4.3.2 for details of the operation.

[Program]

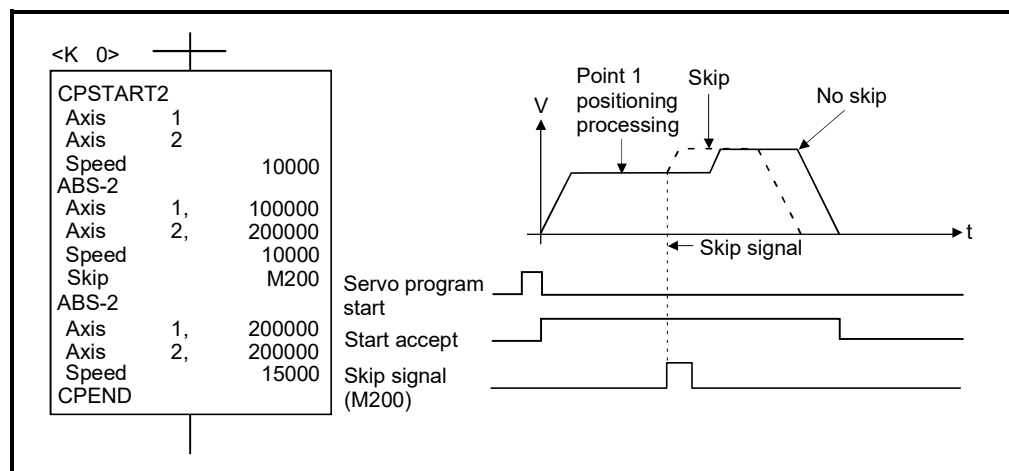

⚠ CAUTION

- When a skip is specified during constant-speed control and the axis which has no stroke range [degree] is included, the operation at the execution of skip is described.

(Note-1): If there is an ABS instruction after the skip in these conditions, the end positioning point and the travel distance in the program as a whole will be the same regardless of whether the skip is executed or not.

(1) All instructions after the skip are INC instructions:

Program example

```

CPSTART1
Axis      1
Speed    10.000
INC-1
Axis      1, 180.00000
Skip      M100
INC-1
Axis      1, 180.00000
INC-1
Axis      1, 270.00000
CPEND
    
```

When skip is not executed

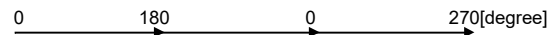

When skip is executed



When the skip occurs at 100 [degree]

(2) Instruction immediately after the skip is ABS instruction:

Program example

```

CPSTART1
Axis      1
Speed    10.000
INC-1
Axis      1, 180.00000
Skip      M100
ABS-1
Axis      1, 350.00000
INC-1
Axis      1, 270.00000
CPEND
    
```

When skip is not executed



When skip is executed

(The end positioning point is same regardless of whether the skip is executed or not.)



When the skip occurs at 100 [degree]

(3) Instruction immediately after the skip is INC instruction and there is ABS instruction after that:

Program example

```

CPSTART1
Axis      1
Speed    10.000
INC-1
Axis      1, 360.00000
Skip      M100
INC-1
Axis      1, 180.00000
INC-1
Axis      1, 180.00000
ABS-1
Axis      1, 90.00000
CPEND
    
```

When skip is not executed



When skip is executed

(The end positioning point is same regardless of whether the skip is executed or not.)

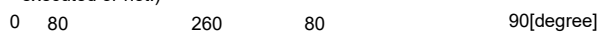

When the skip occurs at 80 [degree]

This point moves at 370 [degree], not 10 [degree].

6 POSITIONING CONTROL

6.17.7 FIN signal wait function

By selecting the FIN signal wait function and setting a M-code at each executing point, a process end of each executing point is synchronized with the FIN signal, the FIN signal turns ON to OFF and then the next positioning is executed.

Turn the FIN signal on/off using the Motion SFC program or sequence program.

[Data setting]

- (1) When the FIN signal wait function is selected, the fixed acceleration/deceleration time method is used. Set the acceleration/deceleration time within the range of 1 to 5000 [ms] by "FIN acceleration/deceleration" (selecting item) in the servo program.

Indirect setting is also possible by the word devices (1 word).

[Cautions]

- (1) If the acceleration/deceleration time is specified outside the setting range, the servo program setting error (error code: 13) will occur at the start and it is controlled with the acceleration/deceleration time of 1000[ms].
- (2) M-code outputting signal is output to all interpolation axes at the interpolation control. In this case, turn on the FIN signal for one of the interpolation axes.
- (3) When M-code is set at the end point, positioning ends after the FIN signal has turn OFF to ON to OFF.
- (4) When the FIN acceleration/deceleration (Fixed acceleration/deceleration time method) is set in the constant speed control, the setting for advanced S-curve acceleration/deceleration is invalid.

[Operation]

Servo program K0 for FIN signal wait function is shown below.

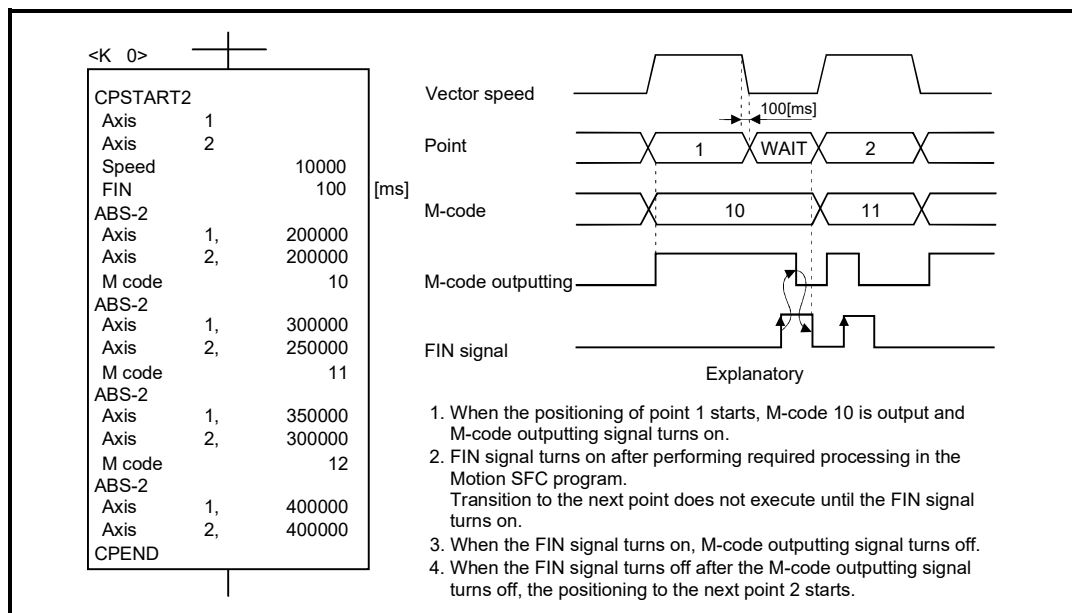

[Program example]

(1) FIN signal wait function by the PLC program

(a) System configuration

FIN signal wait function toward constant-speed control for Axis 1 and Axis 2.

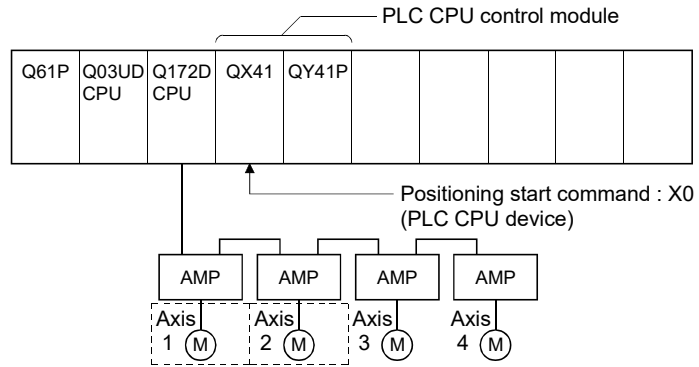

(b) Positioning conditions

1) Constant-speed control conditions are shown below.

Item		Setting			
Servo program No.		0			
Positioning speed		10000			
FIN acceleration/deceleration time		100[ms]			
Positioning method		2 axes linear interpolation control			
Pass point	Axis 1	200000	300000	350000	400000
	Axis 2	200000	250000	300000	400000
M-code		10	11	12	—

2) Constant-speed control start command

.....X0 Leading edge (OFF → ON)
(PLC CPU device)

(c) Servo program

Servo program No.0 for constant-speed control is shown below.

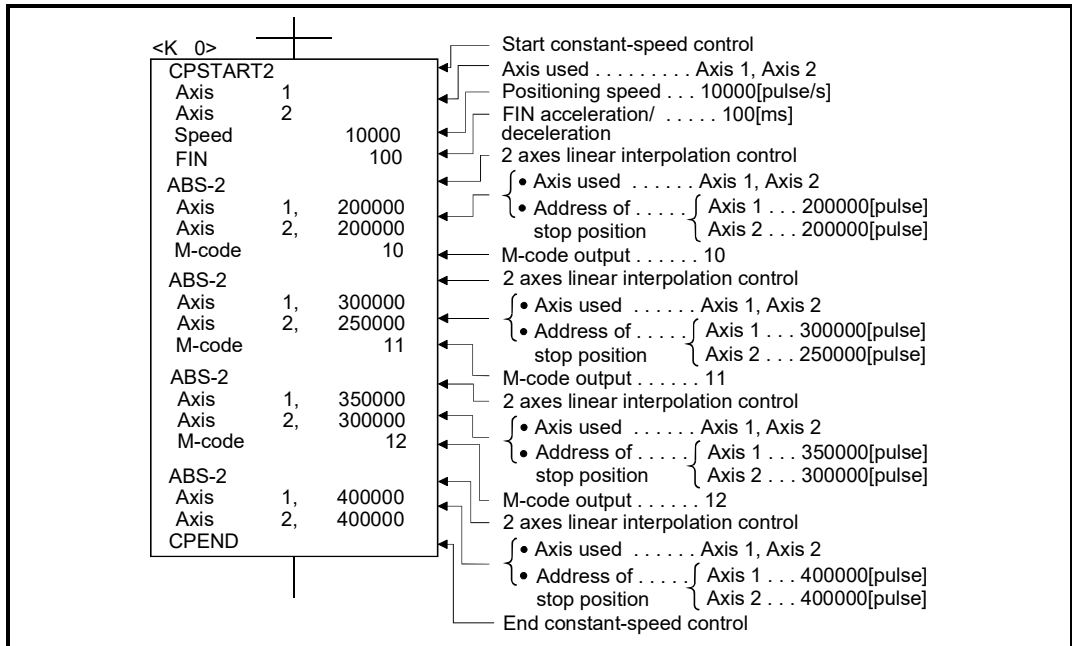

(d) Motion SFC program

Motion SFC program for constant-speed control is shown below.

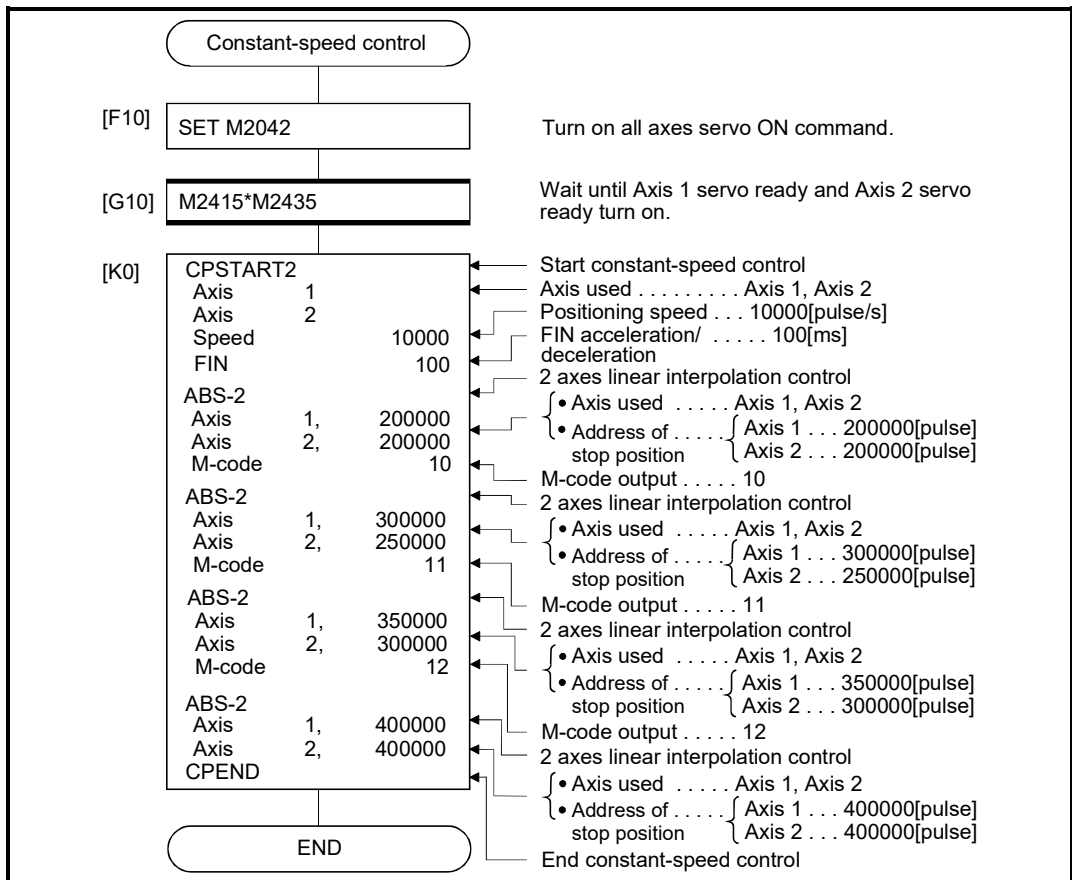

(Note): Example of the above Motion SFC program is started using the automatic start or sequence program.

(e) Sequence program

Sequence program for FIN signal wait function is shown below.

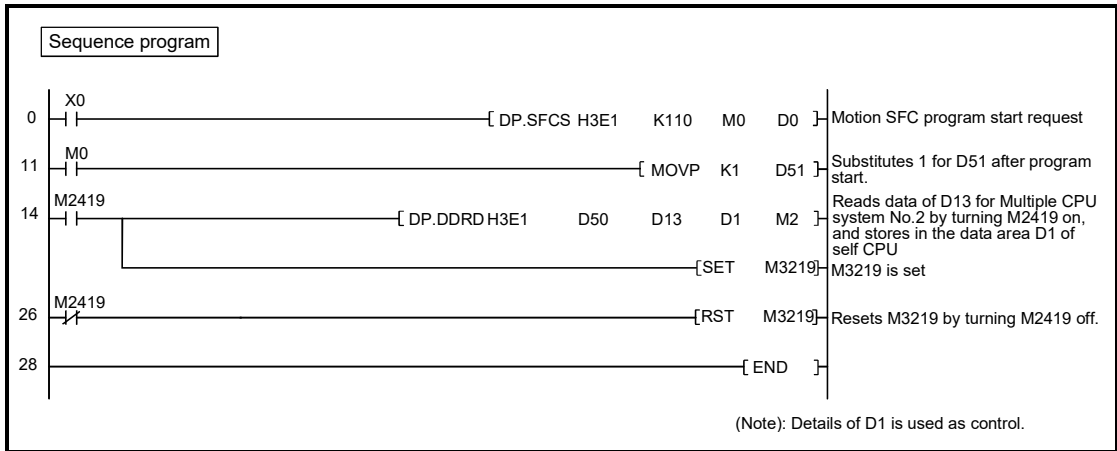

(Note): The automatic refresh setting example for FIN signal wait function is shown next page.

6 POSITIONING CONTROL

(f) Parameter setting

The automatic refresh setting example for FIN signal wait function is shown below.

[Example of allocating the devices allocated as Motion dedicated devices to the PLC CPU]

- CPU No. 1 (PLC CPU) (GX Works2/GX Developer)

<Screen : GX Works2>

Set the device transmitted to CPU No.2 (M3200 to M3295)

No.	Points(*)	Auto Refresh		CPU Specific Send Range (USED)	
		Start	End	Start	End
1	6	M3200	M3295	-->	G17162
2					
3					
4					
5					
6					
7					
8					
9					
10					
11					
12					
13					
14					
15					
16					

Total Points: 6 Settable Points: 7168

Available start devices are X, Y, M, L, B, D, W, R, ZR, SM, SD, SB, SW. Word is used for points. Every 2 points are counted as a set.

(*1) Setting should be set as same when using multiple CPU.

Set the device received from CPU No.2 (M2400 to M2495)

No.	Points(*)	Auto Refresh		CPU Specific Send Range (USED)	
		Start	End	Start	End
1	6	M2400	M2495	<--	G17162
2					
3					
4					
5					
6					
7					
8					
9					
10					
11					
12					
13					
14					
15					
16					

Total Points: 6 Settable Points: 7168

Available start devices are X, Y, M, L, B, D, W, R, ZR, SM, SD, SB, SW. Word is used for points. Every 2 points are counted as a set.

(*1) Setting should be set as same when using multiple CPU.

- CPU No. 2 (Motion CPU) (MT Developer2)

Set the device received from CPU No.1 (M3200 to M3295)

Setting No.	Points (*)	Automatic Refresh		CPU Specific Send Range(USED)	
		Start	End	Start	End
1	6	M3200	M3295	<--	G17162
2					
3					
4					
5					
6					
7					
8					
9					
10					
11					
12					
13					
14					
15					
16					

The total points: 6 Points can be set up: 7168

The applicable device of start device is X,Y,M,B,D,W,#,SM,SD. The unit of points of CPU specific send range is word. Please set the point by 2 points.

Automatic Refresh Setting List Multiple CPU High-speed Refresh Setting

(*1) Settings should be set as same when using multiple CPU.

Set the device transmitted to CPU No.1 (M2400 to M2495)

Setting No.	Points (*)	Automatic Refresh		CPU Specific Send Range(USED)	
		Start	End	Start	End
1	6	M2400	M2495	-->	G17162
2					
3					
4					
5					
6					
7					
8					
9					
10					
11					
12					
13					
14					
15					
16					

The total points: 6 Points can be set up: 7168

The applicable device of start device is X,Y,M,B,D,W,#,SM,SD. The unit of points of CPU specific send range is word. Please set the point by 2 points.

Automatic Refresh Setting List Multiple CPU High-speed Refresh Setting

(*1) Settings should be set as same when using multiple CPU.

Multiple CPU high speed refresh setting (MT Developer2 only)

No.	Points	Device Setting		CPU
		Start	End	
1	2	M2400	M2431	No.2
2	2	M3200	M3231	No.1
3				
4				
5				
6				
7				
8				
9				
10				
11				
12				
13				
14				
15				
16				
17				
18				
19				
20				
Total	4			

The applicable device of start device is X,Y,M,B,D,W,#,SM,SD. The unit of points of CPU specific send range is word. Please set the total number to 256 or less.

POINT

Set the following operation for automatic refresh setting using GX Works2/ GX Developer.

- 1) Select tab "Multiple CPU high speed communication area setting".
- 2) Set "Use multiple CPU high speed communication".

The screenshot shows the 'Q Parameter Setting' dialog box with the 'Multiple CPU Setting' tab selected. The 'Multiple CPU High Speed Transmission Area Setting' sub-tab is active, where the 'Use Multiple CPU High Speed Transmission' checkbox is checked. A table titled 'CPU Specific Send Range (*)' is visible, showing settings for PLC No. 1 to 4. Callout 1 points to the 'Communication Area Setting (Refresh Setting)' section, and callout 2 points to the 'Use Multiple CPU High Speed Transmission' checkbox.

PLC	Points(X)	I/O No.	User Setting Area			Auto Refresh Setting
			Points	Start	End	
PLC No.1	7	USE0	7162	G10000	G17161	6 (Refresh/Send)
PLC No.2	7	USE1	7162	G10000	G17161	6 (Refresh/Recv)
PLC No.3						
PLC No.4						

Total: 14K Points. The total number of points is up to 14K.

<Screen: GX Works2>

(2) FIN signal wait function using the Motion SFC program

(a) System configuration

FIN signal wait function toward constant-speed control for Axis 1 and Axis 2.

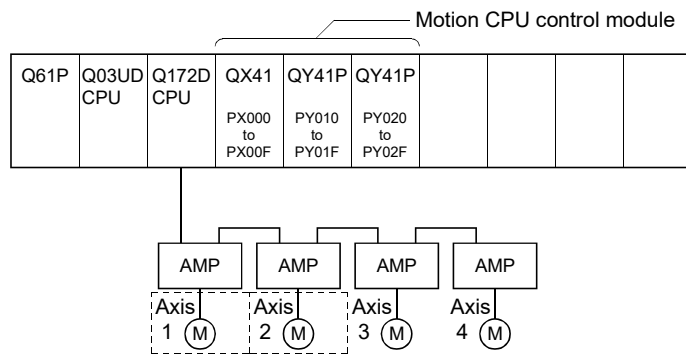

6 POSITIONING CONTROL

(b) Positioning conditions

1) Constant-speed control conditions are shown below.

Item		Setting			
Servo program No.		0			
Positioning speed		10000			
FIN acceleration/deceleration time		100[ms]			
Positioning method		2 axes linear interpolation control			
Pass point	Axis 1	200000	300000	350000	400000
	Axis 2	200000	250000	300000	400000
M-code		10	11	12	—

2) Constant-speed control start command ... PX000 Leading edge
(OFF → ON)

(c) Servo program

Servo program No.0 for constant speed control is shown below.

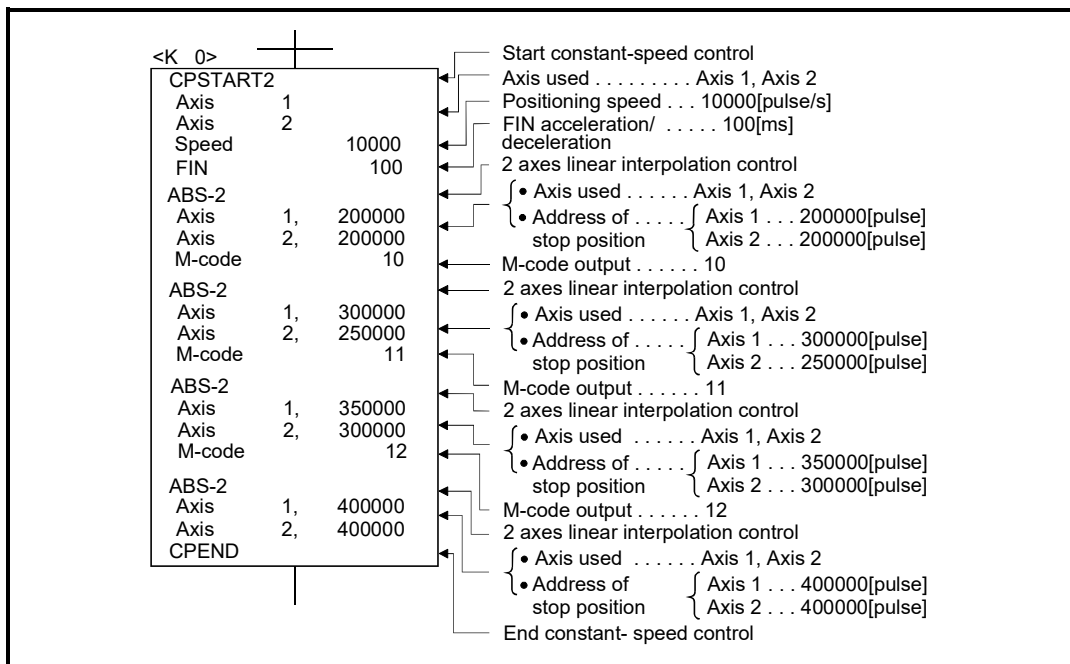

(Note): Example of the Motion SFC program for positioning control is shown next page.

(d) Motion SFC program

1) Motion SFC program for constant-speed control is shown below.

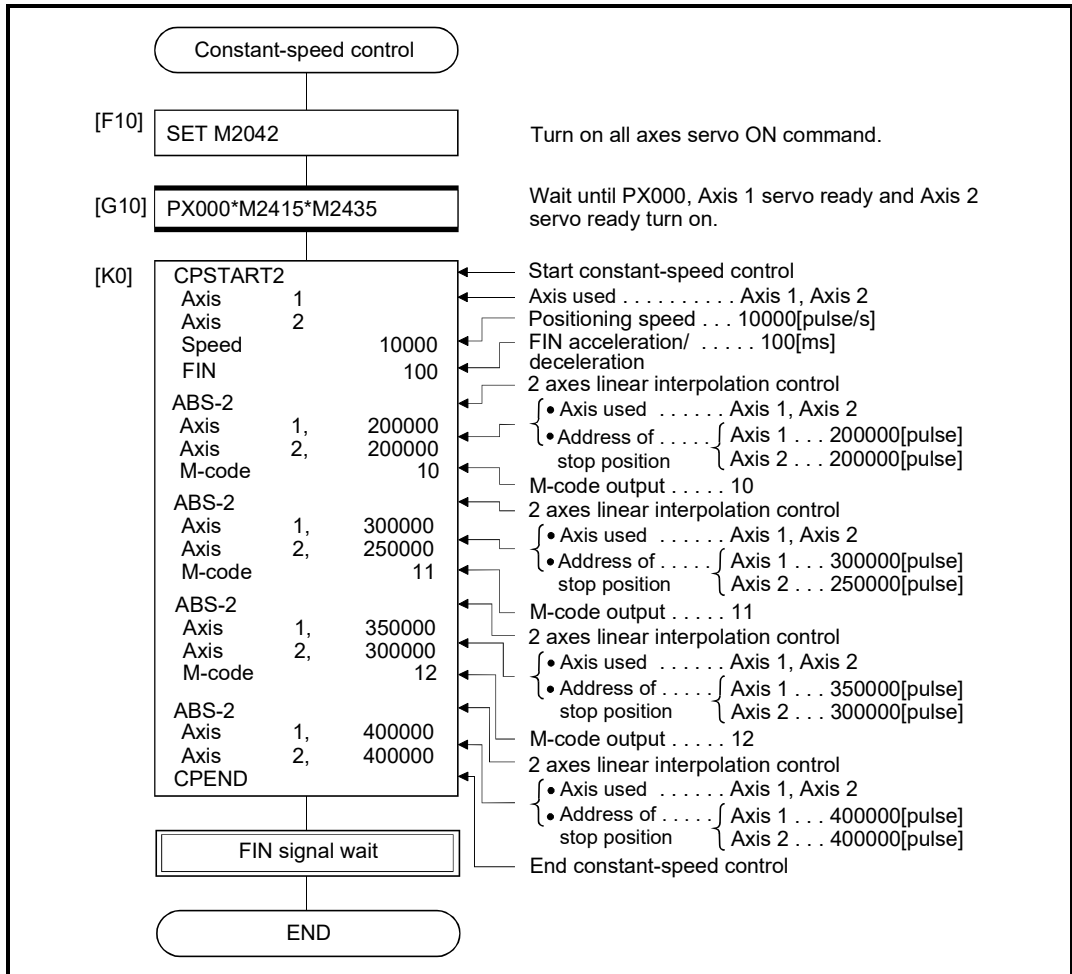

(Note): Example of the above Motion SFC program is started using the automatic start or sequence program.

6 POSITIONING CONTROL

2) Motion SFC program which outputs M-code of each point for constant-speed control to PY20 to PY2F by BCD code is shown below.

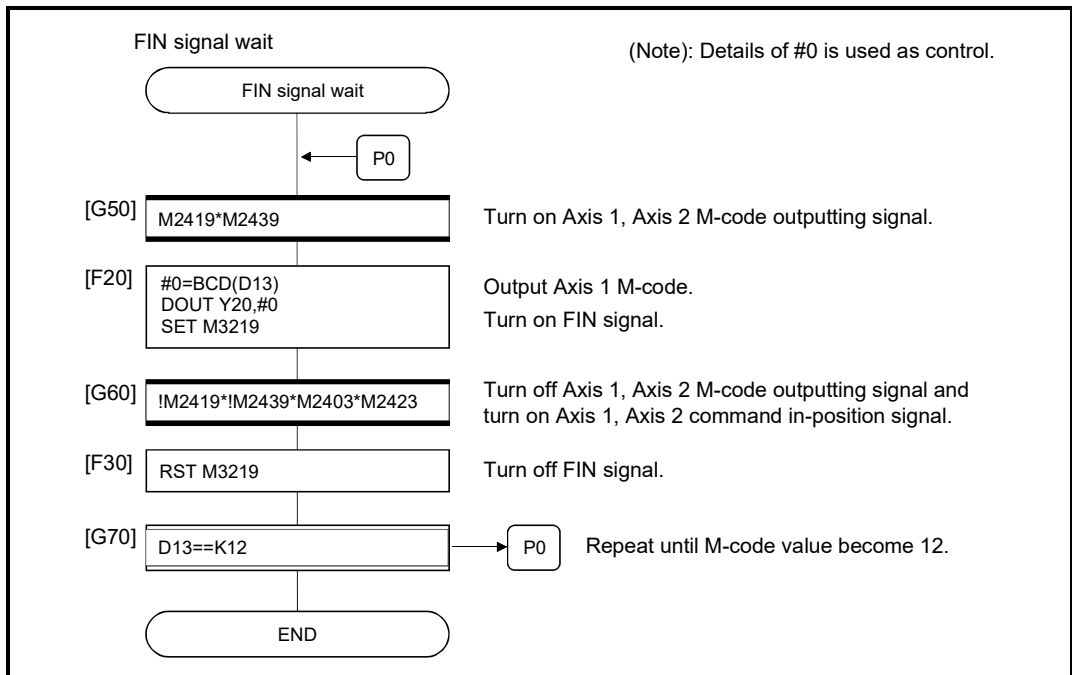

POINTS

- (1) The fixed acceleration/deceleration time method is acceleration/deceleration processing that the time which acceleration/deceleration takes is fixed, even if the command speed differs.

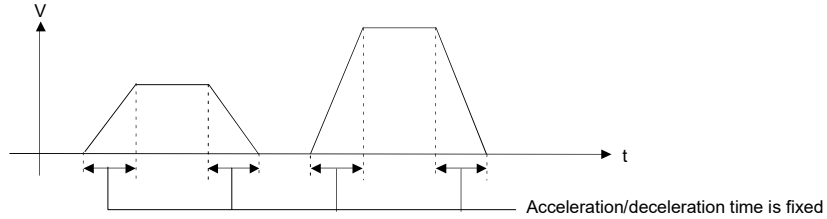

- (a) The following processing and parameters are invalid in the fixed acceleration/deceleration time method.
- Rapid stop deceleration time in parameter block
 - Completion point specification method for speed change point
 - S-curve acceleration/deceleration

- (b) The speed processing for each axis is as shown below in positioning operation (constant-speed) as shown in the following figure.

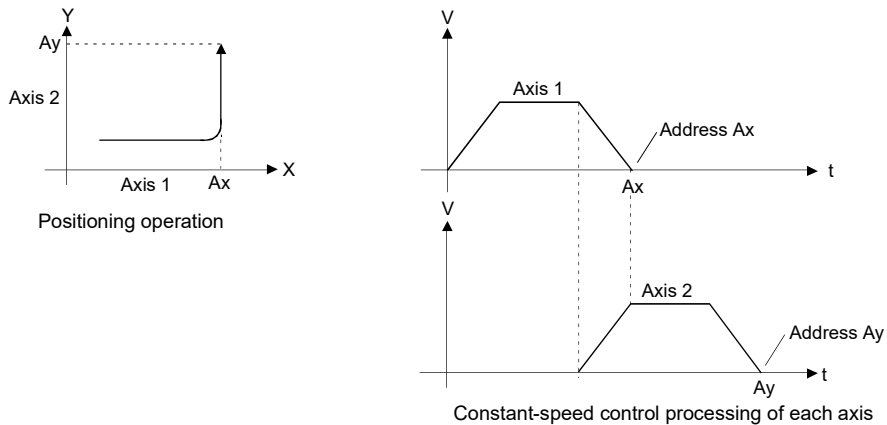

- (2) When the rapid stop command is executed by the setting "deceleration time < rapid stop deceleration time" during constant-speed control, the point data currently executed in the middle of deceleration, and the positioning may be completed suddenly as a speed "0". In the case of, "deceleration time ≥ rapid stop deceleration time", the above operation is not executed. For the following condition, note that the speed may become 0 in the middle of deceleration.

Travel value by the point data currently executed at the rapid stop command
 (Up to 9 points) < speed at rapid stop command input × rapid stop deceleration time/2

[Operation pattern]

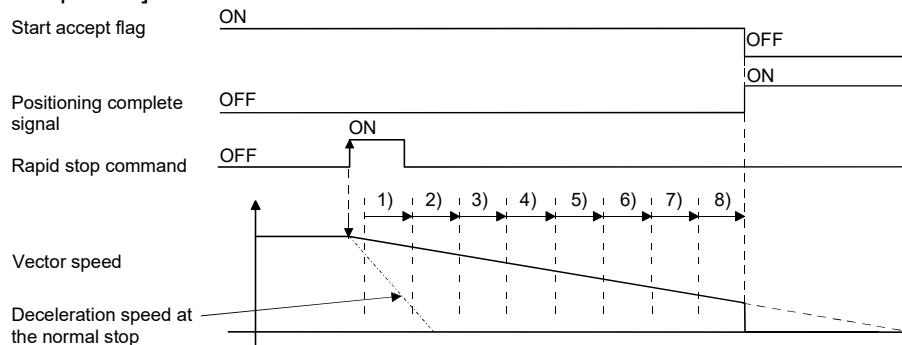

6 POSITIONING CONTROL

6.18 Position Follow-Up Control

Positioning to the address set in the word device of the Motion CPU specified with the servo program at one start is executed.

Position follow-up control is started using the PFSTART servo program instruction.

Servo instruction	Positioning method	Number of control axes	Items set using MT Developer2																	Speed change			
			Common							Arc			Parameter block						Others				
			Parameter block No.	Axis	Address/travel value	Command speed	Dwell time	M-code	Torque limit value	Auxiliary point	Radius	Central point	Interpolation control unit	Speed limit value	Acceleration time	Deceleration time	Rapid Stop deceleration time	Torque limit value	Deceleration processing on stop input		Allowable error range for circular interpolation	S-curve ratio	Advanced S-curve acceleration/deceleration
PFSTART	Absolute	1	△	○	○	○		△					△	△	△	△	△		△	△	△		Valid

○ : Must be set
△ : Set if required

[Control details]

- (1) Positioning to the address set in the word device of the Motion CPU specified with the servo program is executed.
- (2) Position follow-up control is executed until the stop instruction is input. If the word device value changes during operation, positioning is executed to the changed address.

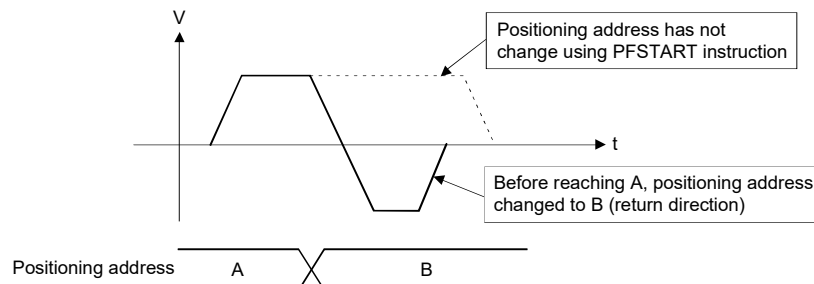

6 POSITIONING CONTROL

[Cautions]

- (1) Number of control axes is 1 axis.
- (2) Only the absolute data method (ABS□) is used for positioning control to the pass points.
- (3) The speed can be changed during the start.
The changed speed is effective until the stop command is input.
- (4) Set the positioning address in the servo program using indirect setting with the word devices.
- (5) Use only even-numbered devices for indirect setting of positioning address in the servo program.
If odd-numbered devices are used, a minor error (error code: 141) occurs at the start and control does not start.
- (6) Positioning speeds can be set in the servo program using indirect setting with the word devices.
However, this data is effective only at the position follow-up control start (servo program start) and the speed does not change if the indirect setting are changed during the start.
- (7) Change the value of the positioning address so that it is within the range below.

$$-2147483648 \leq (\text{Change in positioning address} \div \text{Travel value per rotation} \times \text{Number of pulses per rotation}) \leq 2147483647$$

- (a) The following is an example of a calculation of the positioning address values with the conditions below.

Item	Value
Number of pulses per servo motor revolution	4194304[pulse]
Ball screw pitch	1[mm]
External gear ratio	1/100

When the electronic gear setting is:

- Number of pulses per servo motor revolution : 4194304[pulse]
- Travel distance per servo motor revolution : 100.0[μm]

$$\begin{aligned} \text{Actual change in positioning address}[\mu\text{m}] &= \frac{\text{Maximum value of change in positioning address}[\text{pulse}] \times \text{Travel distance per servo motor revolution}}{\text{Number of pulses per servo motor revolution}} \\ &= \frac{2147483647[\text{pulse}] \times 100}{4194304} \approx 51200.0[\mu\text{m}] \end{aligned}$$

However, the actual change in positioning address needs to be less than "±51200.0[μm]".

[Program]

(1) System configuration

Axis 3 position follow-up control for PLC CPU (CPU No.1) to Motion CPU (CPU No.2).

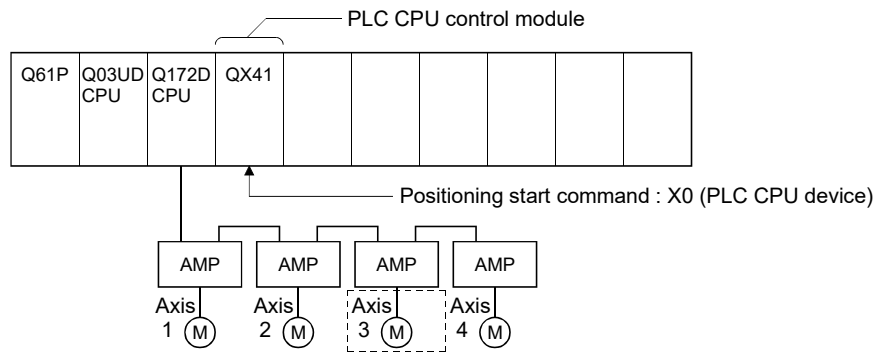

(2) Positioning conditions

(a) Position follow-up conditions are shown below.

Item	Setting
Servo program No.	100
Control axis	Axis 3
Positioning address	D4000
Positioning speed	20000

(b) Position follow-up control start command

..... X0 Leading edge (OFF → ON)
(PLC CPU device)

(3) Operation timing

Operation timing for position follow-up control is shown below.

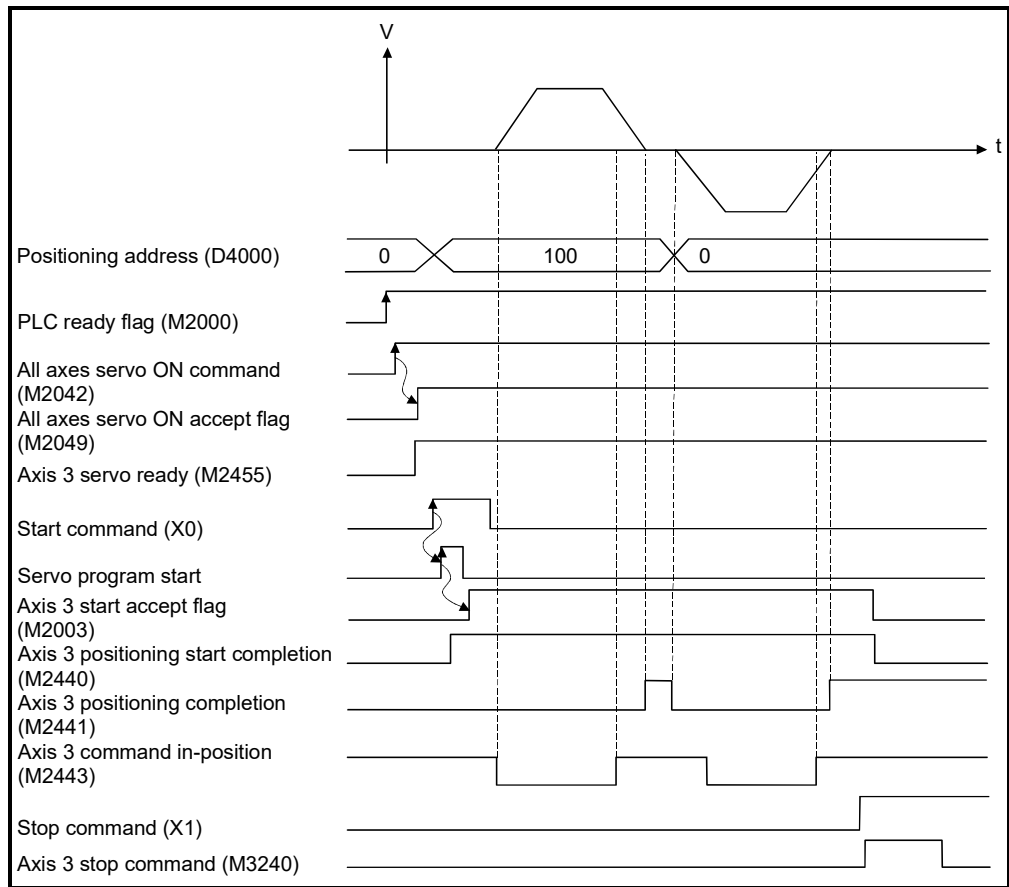

(4) Servo program

Servo program No.100 for position follow-up control is shown below.

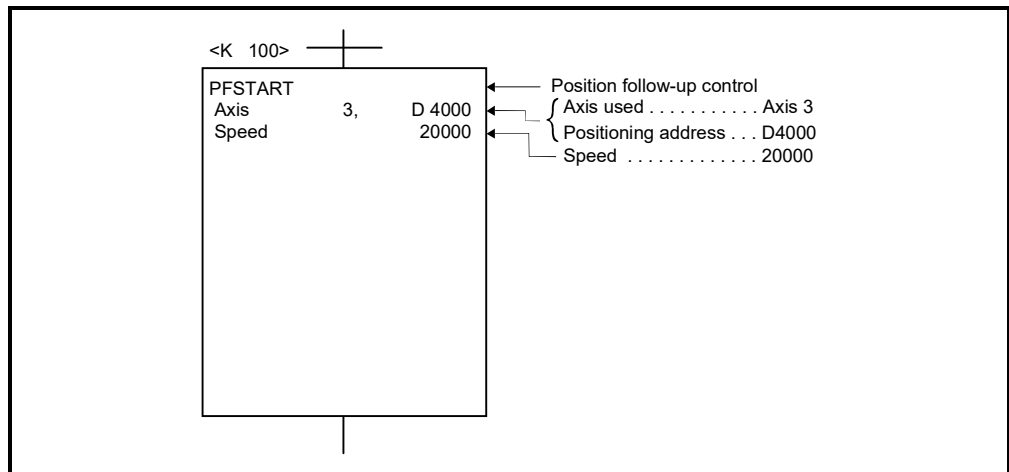

(Note): Example of the Motion SFC program for positioning control is shown next page.

(5) Motion SFC program

Motion SFC program, sequence program and parameter setting for position follow-up control is shown below.

(a) Motion SFC program

Motion SFC program example for position follow-up control is shown below. This program is started using D(P).SFCS instruction from PLC CPU (CPU No.1).

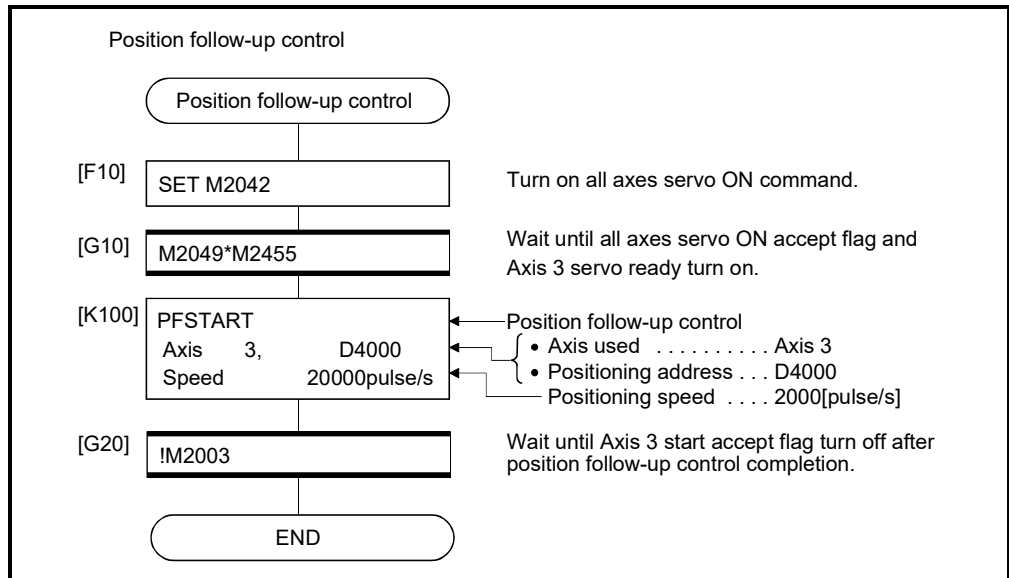

6 POSITIONING CONTROL

(b) Sequence program

Sequence program example for position follow-up control is shown below.

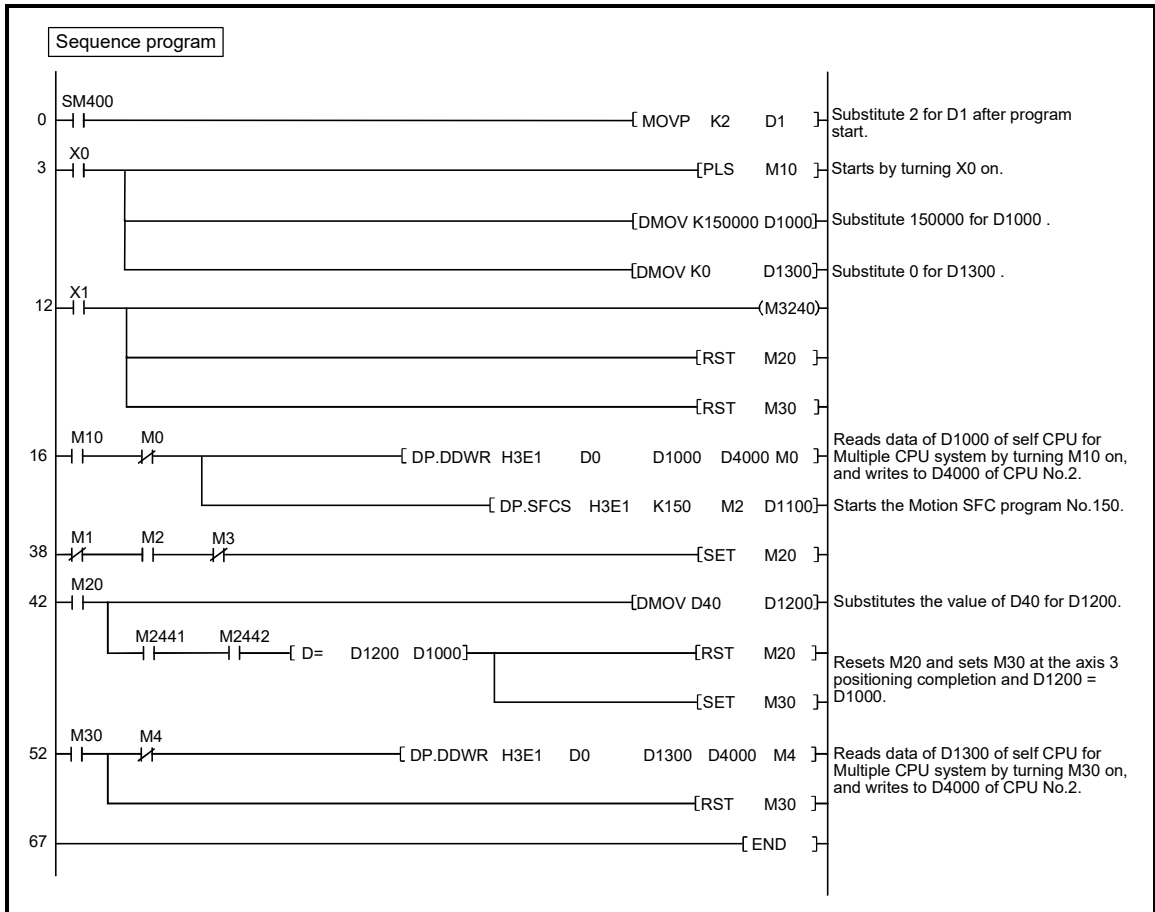

(Note): The automatic refresh setting example for position follow-up control is shown next page.

(c) Parameter setting

The automatic refresh setting example for position follow-up control is shown below.

[Allocation example of devices allocated in the Motion dedicated device to the PLC CPU]

- CPU No. 1 (PLC CPU) (GX Works2/GX Developer)

<Screen: GX Works2>

Set the device transmitted to CPU No.2 (M3200 to M3295)

No.	Points(*)	Auto Refresh		CPU Specific Send Range (USE0)	
		Start	End	Start	End
1	6	M3200	M3295	-->	G17162 G17167
2					
3					
4					
5					
6					
7					
8					
9					
10					
11					
12					
13					
14					
15					
16					

Total Points: 6 Settable Points: 7168

Set the device received from CPU No.2 (M2400 to M2495, D40 to D59)

No.	Points(*)	Auto Refresh		CPU Specific Send Range (USE1)	
		Start	End	Start	End
1	6	M2400	M2495	<--	G17142 G17147
2	20	D40	D59	<--	G17148 G17167
3					
4					
5					
6					
7					
8					
9					
10					
11					
12					
13					
14					
15					
16					

Total Points: 26 Settable Points: 7168

- CPU No. 2 (Motion CPU) (MT Developer2)

Set the device received from CPU No.1 (M3200 to M3295)

Setting No.	Points (*)	Automatic Refresh		CPU Specific Send Range(USE0)	
		Start	End	Start	End
1	6	M3200	M3295	<--	G17162 G17167
2					
3					
4					
5					
6					
7					
8					
9					
10					
11					
12					
13					
14					
15					
16					

The total points: 6 Points can be set up: 7168

Set the device transmitted to CPU No.1 (M2400 to M2495, D40 to D59)

Setting No.	Points (*)	Automatic Refresh		CPU Specific Send Range(USE1)	
		Start	End	Start	End
1	6	M2400	M2495	-->	G17142 G17147
2	20	D40	D59	-->	G17148 G17167
3					
4					
5					
6					
7					
8					
9					
10					
11					
12					
13					
14					
15					
16					

The total points: 26 Points can be set up: 7168

Multiple CPU high speed refresh setting (MT Developer2 only)

No.	Points	Device Setting		CPU
		Start	End	
1	2	M2400	M2431	No.2
2	2	M3200	M3231	No.1
3	2	D40	D41	No.2
4				
5				
6				
7				
8				
9				
10				
11				
12				
13				
14				
15				
16				
17				
18				
19				
20				
Total	6			

The applicable device of start device is X,Y,M,B,D,W,#,SM,SD. The unit of points of CPU specific send range is word. Please set the total number to 256 or less.

POINT

Set the following operation for automatic refresh setting using GX Works2/ GX Developer.

- 1) Select tab "Multiple CPU high speed communication area setting".
- 2) Set "Use multiple CPU high speed communication".

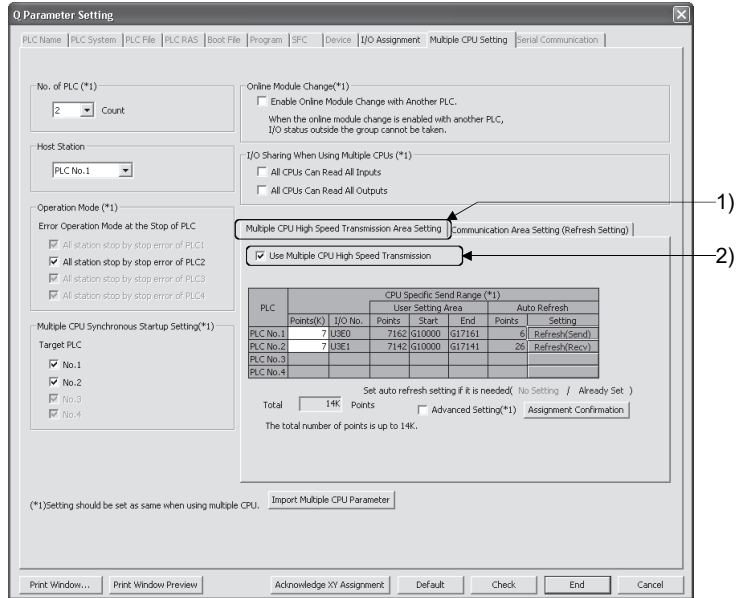

<Screen: GX Works2>

6 POSITIONING CONTROL

6.19 Speed Control with Fixed Position Stop

Speed control with fixed position stop of the specified axis is executed.

Speed control with fixed position stop is started using the PVF (forward rotation) or PVR (reverse rotation) of servo program instruction.

Servo instruction	Positioning method	Number of control axes	Items set using MT Developer2																Speed change								
			Common						Arc/Helical		Parameter block						Others										
			Parameter block No.	Axis	Address/travel value	Command speed	Dwell time	M-code	Torque limit value	Auxiliary point	Radius	Central point	Interpolation control unit	Speed limit value	Acceleration time	Deceleration time	Rapid Stop deceleration time	Torque limit value		Deceleration processing on stop input	Allowable error range for circular interpolation	S-curve ratio	Advanced S-curve acceleration/deceleration	Cancel	WAIT-ON/OFF	Fixed position stop accel./decel.time	Fixed position stop
PVF PVR	Absolute	1	△	○	○	○	△	△																			Valid

○ : Must be set
△ : Set if required

[Control details]

- After starting of servo motor, control at the specified speed is executed until the fixed position stop command turns on.
 - PVF..... Forward rotation direction (Address increase direction) start
 - PVR..... Reverse rotation direction (Address decrease direction) start
- When the fixed position stop command turns on, a positioning control to the specified address is executed.

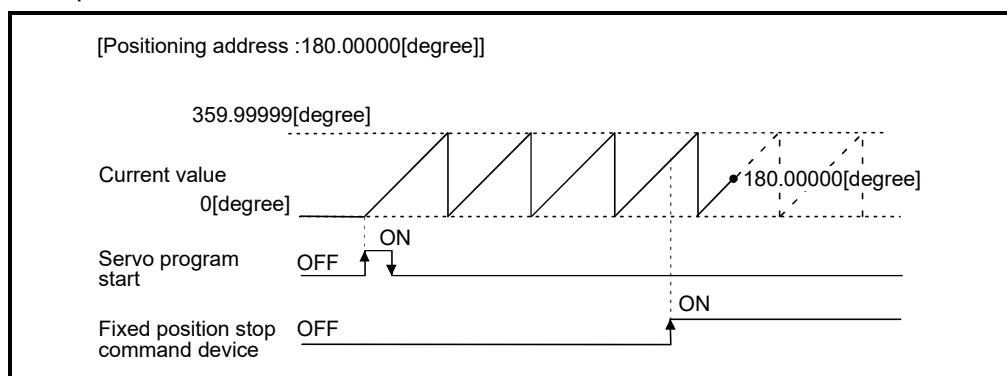

- It can be controlled in the real mode only for axis which "control unit is [degree] and stroke limit is invalid ("upper stroke limit value" equal to "lower stroke limit value")". If it is started for axis which "control unit is except [degree] or stroke limit is not invalid", a minor error (error code: 130) occurs and it does not start. And, if it is started for the virtual servo motor axis in the virtual mode, a servo program setting error (error code: 905) occurs and it does not start. (It can be started for real mode axis.)

6 POSITIONING CONTROL

- (4) Address setting range is 0 to 35999999 (0 to 359.99999[degree]) in the indirect setting of positioning address. If it is set outside the setting range, a servo program setting error (error code: n03) occurs and it does not start. Positioning address is input at the program start.
- (5) It is controlled in the fixed position stop acceleration/deceleration time set in the servo program at positioning start, speed change request (CHGV) and fixed position stop command ON. The fixed acceleration/deceleration time method is used as an acceleration/deceleration processing in this case.
- (6) The setting range of fixed position stop acceleration/deceleration time is 1 to 65535[ms].
- (7) In the case of indirect setting, the fixed position stop acceleration/deceleration time is input in the following timing.
 - Positioning start
 - Speed change request (CHGV)
 - Fixed position stop command ON
- (8) When the positioning to specified address completes, the positioning complete signal (M2401+20n) turns on. It does not turn on at the time of stop by the stop command (M3200+20n)/rapid stop command (M3201+20n). The positioning complete signal (M2401+20n) turns off at leading edge of complete signal OFF command (M3204+20n) or positioning start.
- (9) Prior to turning ON the fixed position stop command device, speed change can be executed any number of times by the speed change request (CHGV) instruction during operation. The speed change request (CHGV) instruction is disabled after the fixed position stop command device turns ON. If the fixed position stop command device turns ON while changing the speed by the speed change request (CHGV) instruction, the acceleration/deceleration is stopped and positioning is performed for the specified address using the speed at that time.

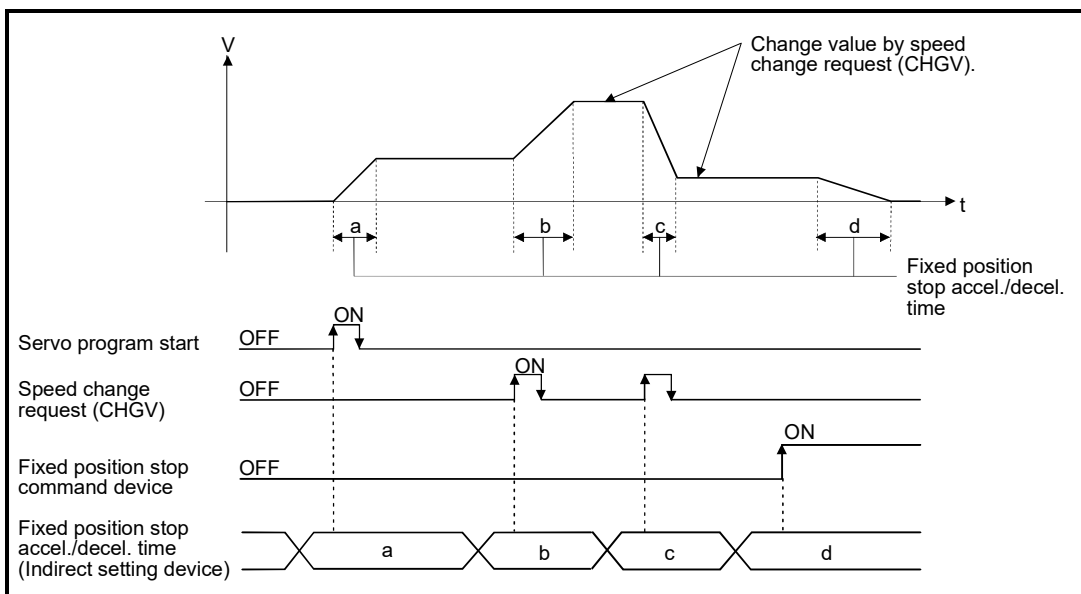

6 POSITIONING CONTROL

- (10) Deceleration speed by the stop command (M3200+20n)/rapid stop command (M3201+20n) is controlled with fixed inclination (deceleration speed). Deceleration processing is executed using the speed limit value or deceleration/rapid stop deceleration time set in the parameter block.

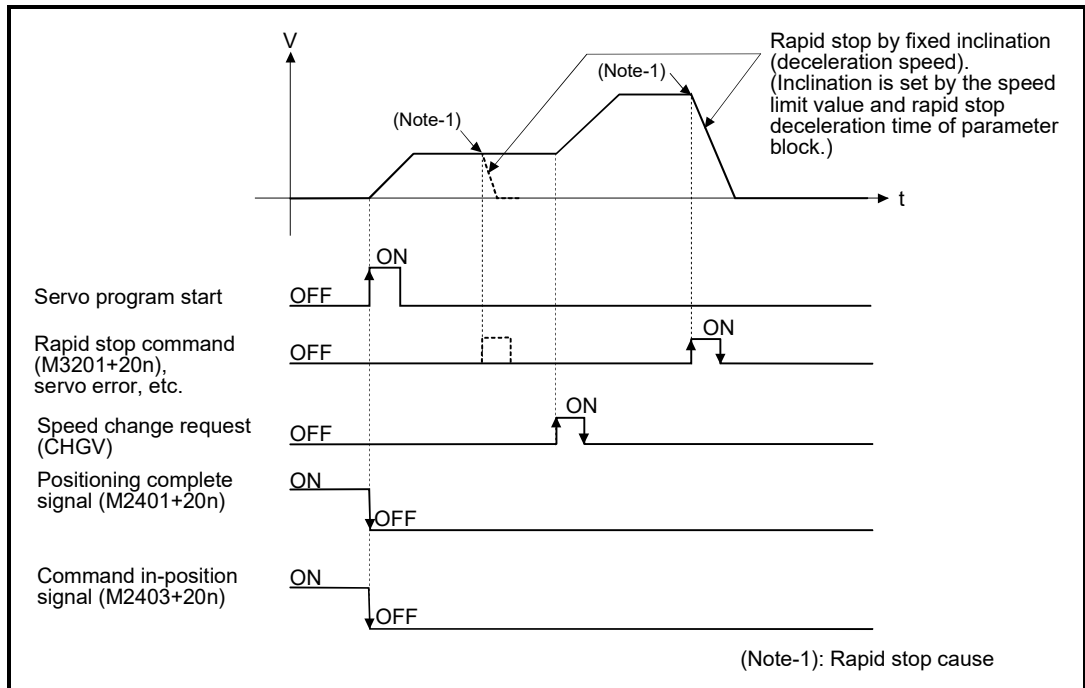

- (11) When the fixed position stop command turns on, the command in-position check starts. When the absolute value of difference between the setting address and feed current value below the "command in-position range" set in the fixed parameter, the command in-position signal (M2403+20n) turns on. The command in-position signal (M2403+20n) turns on by a positioning start.
- (12) In any of the following cases, positioning is executed at the speed that was specified by the speed limit value.
- Speed control with fixed position stop is started with the fixed position stop command turned ON.
 - The fixed position stop command is turned ON after a speed change to "0".

[Program]

Program for speed control with fixed position stop is shown as the following conditions.

(1) System configuration

Speed control with fixed position stop for "Axis 1".

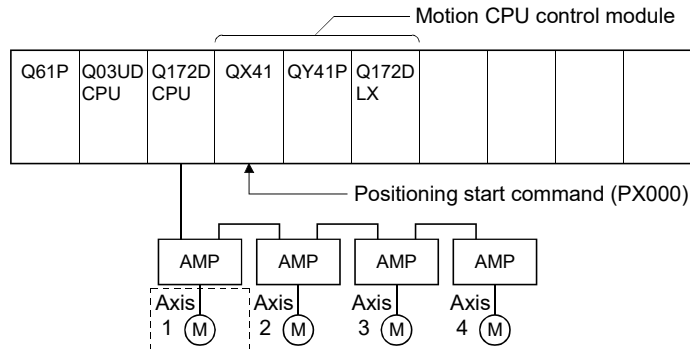

(2) Positioning conditions

(a) Speed control with fixed position stop conditions are shown below.

Item	Setting
Servo program No.	55
Start direction	Forward
Control axis	Axis 1
Positioning address	120.00000[degree]
Control speed	30000[degree/min]
Acceleration/deceleration time	20ms
Fixed position stop command device	M100

(b) Speed control with fixed position stop start command

..... PX000 Leading edge (OFF → ON)

(c) Speed control with fixed position stop command

..... PX000 Trailing edge (ON → OFF)

(3) Operation timing

Operation timing for speed control with fixed position stop is shown below.

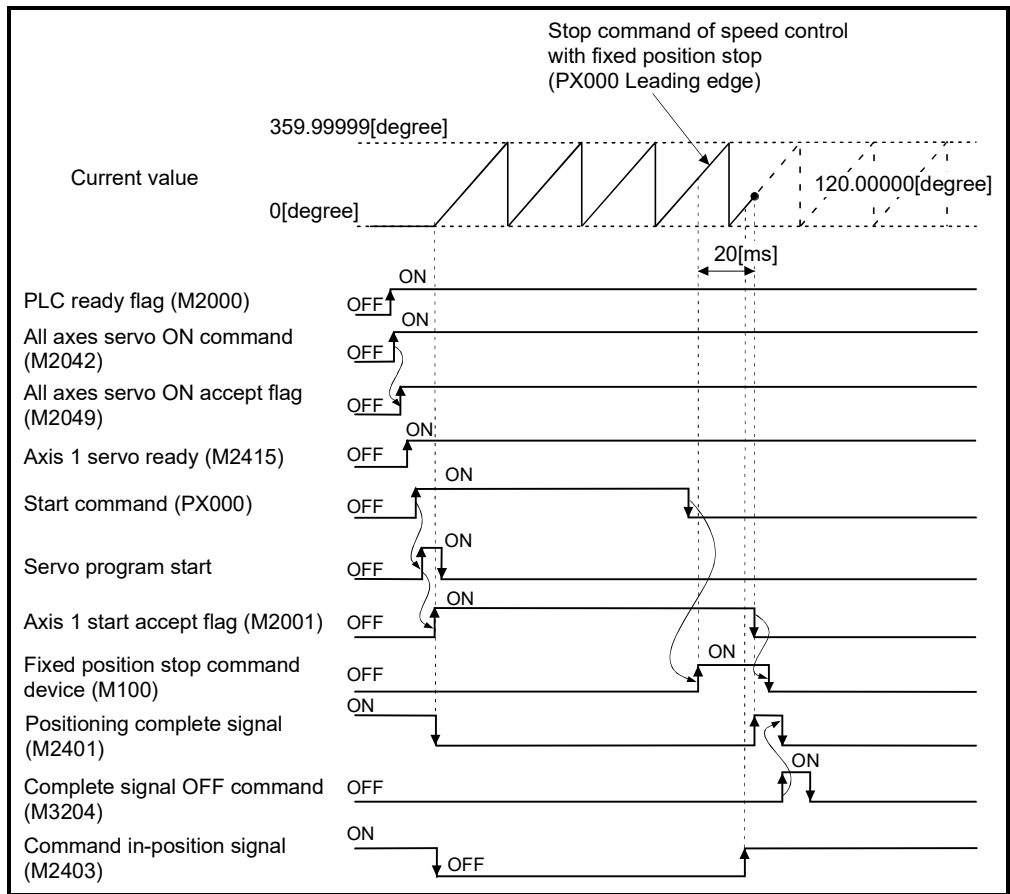

(4) Servo program

Servo program No.55 for speed control with fixed position stop is shown below.

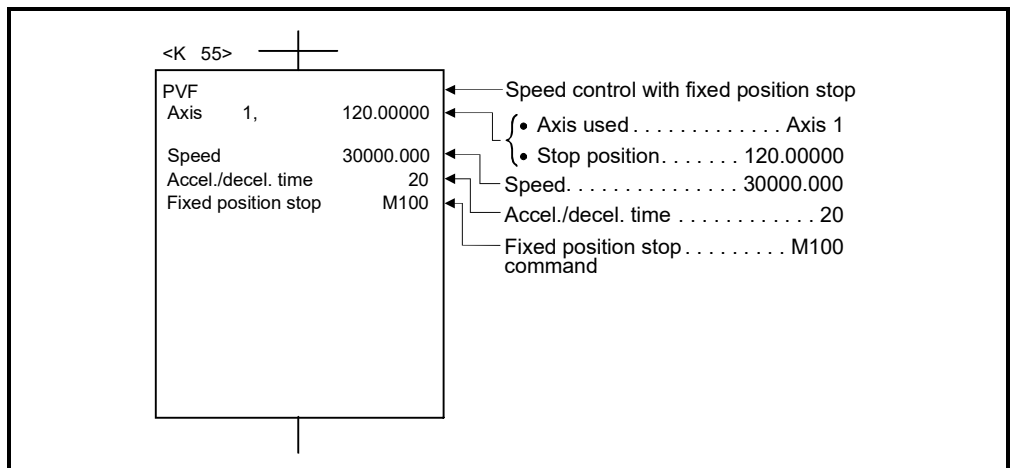

(5) Motion SFC program

Motion SFC program for which executes the servo program is shown below.

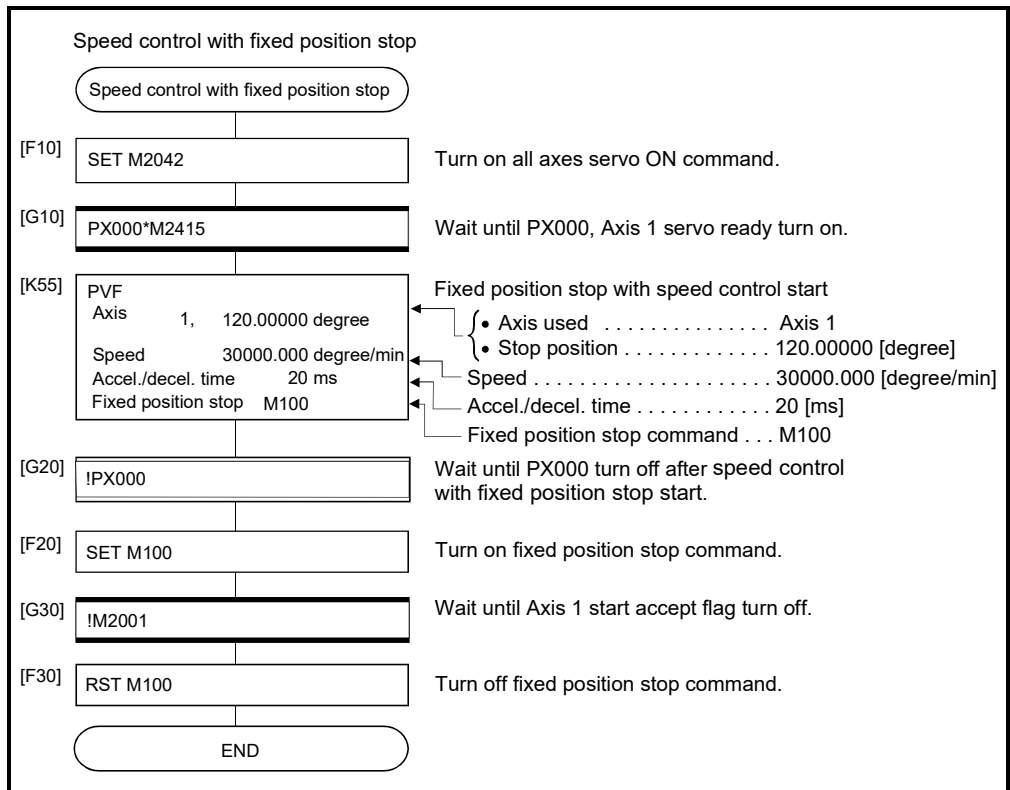

(Note): Example of the above Motion SFC program is started using the automatic start or sequence program.

[Program]

Program for simultaneous start is shown as the following conditions.

(1) System configuration

Simultaneous start for "Axis 1 and Axis 2", Axis 3 and Axis 4.

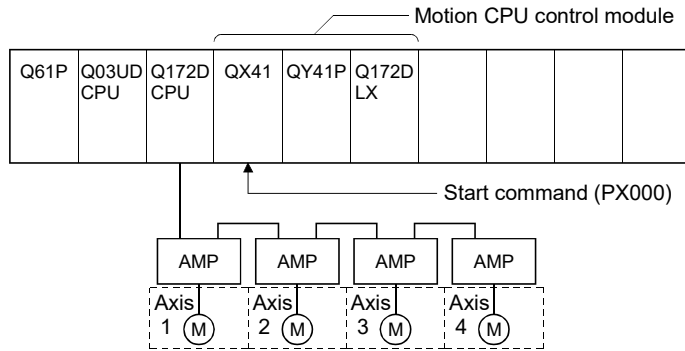

(2) Number of specified servo programs and program No.

- (a) Number of specified servo programs : 3
- (b) Specified servo program No. are shown below.

Servo Program No.	Used axis	Control Details
No.1	Axis 1, Axis 2	Circular interpolation control
No.14	Axis 3	Speed control
No.45	Axis 4	Home position return control

(3) Start conditions

- (a) Simultaneous start servo program No. No.121
- (b) Simultaneous start execute command PX000 Leading edge (OFF → ON)

(4) Servo program

Servo program No.121 for simultaneous start is shown below.

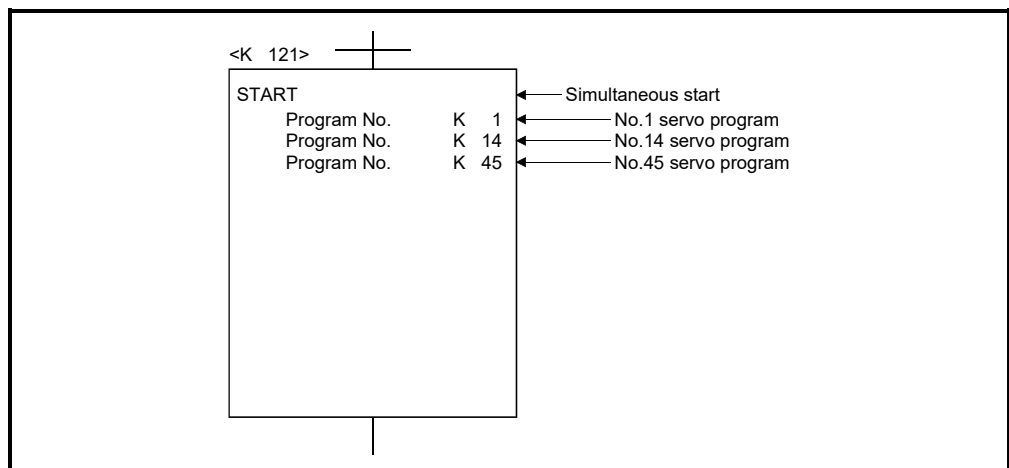

(Note): Example of the Motion SFC program for positioning control is shown next page.

(5) Motion SFC program

Motion SFC program for which executes the servo program is shown below.

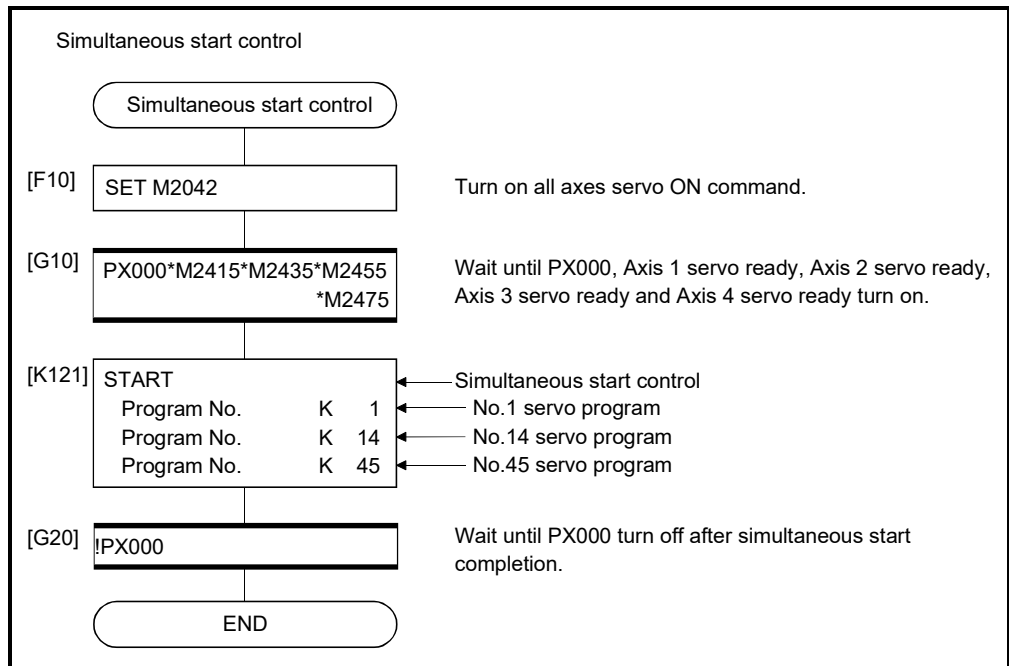

(Note): Example of the above Motion SFC program is started using the automatic start or sequence program.

6 POSITIONING CONTROL

6.21 JOG Operation

The setting JOG operation is executed.

Individual start or simultaneous start can be used in the JOG operation.

JOG operation can be executed using the Motion SFC program or test mode of MT Developer2. (Refer to the help of MT Developer2 for JOG operation method in the test mode of MT Developer2.)

JOG operation data must be set for each axis for JOG operation. (Refer to Section 6.21.1.)

6.21.1 JOG operation data

JOG operation data is the data required to execute JOG operation.

Set the JOG operation data using MT Developer2.

Table 6.2 JOG operation data list

No.	Item	Setting range								Initial value	Units	Remarks	Explanatory section
		mm		inch		degree		pulse					
		Setting range	Units	Setting range	Units	Setting range	Units	Setting range	Units				
1	JOG speed limit value	0.01 to 6000000.00	mm /min	0.001 to 600000.000	inch /min	0.001 to 2147483.647 (Note-1)	degree /min	1 to 2147483647	pulse /s	20000	pulse /s	<ul style="list-style-type: none"> • Sets the maximum speed at the JOG operation. • If JOG speed setting exceeds the JOG speed limit value, it is controlled with JOG speed limit value. 	—
2	Parameter block setting	1 to 64								1	—	<ul style="list-style-type: none"> • Sets the parameter block No. to be used at the JOG operation. 	4.3

(Note-1): When the "speed control 10×multiplier speed setting for degree axis" is set to "valid", the setting range is 0.01 to 21474836.47[degree/min].

(1) JOG operation data check

A relative check of the JOG operation data is executed at the following timing:

- JOG operation Individual start
- JOG operation simultaneous start
- JOG operation request

(2) Data error processing

- Only data for which detected errors is controlled as default value.
- The error code corresponding to each data for erroneous axis is stored in the data register.

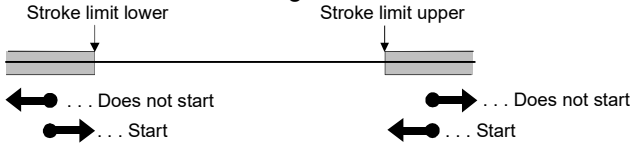
POINT	<p>Start to outside the range of stroke limit of fixed parameter cannot be executed. However, JOG operation is possible in the direction from outside the stroke limit range to back inside the stroke limit range.</p>  <p>For a degree axis, depending on the stroke limit setting, the direction that can return the axis into the stroke limit range is different.</p> <ul style="list-style-type: none"> • When upper stroke limit value > lower stroke limit value When "Feed current value > upper stroke limit value", movement in the negative direction is possible. When "Feed current value < lower stroke limit value", movement in the positive direction is possible. • When upper stroke limit value < lower stroke limit value Movement in both the positive and negative direction is possible.
--------------	---

6.21.2 Individual start

JOG operation for the specified axes is started.

JOG operation is executed by the following JOG start commands:

- Forward JOG start command (M3202+20n)
- Reverse JOG start command (M3203+20n)

[Control details]

- (1) JOG operation continues at the JOG speed setting register (D640+2n, D641+2n) value while the JOG start command turns on, and a deceleration stop is made by the JOG start command OFF.
Control of acceleration/deceleration is based on the data set in JOG operation data.

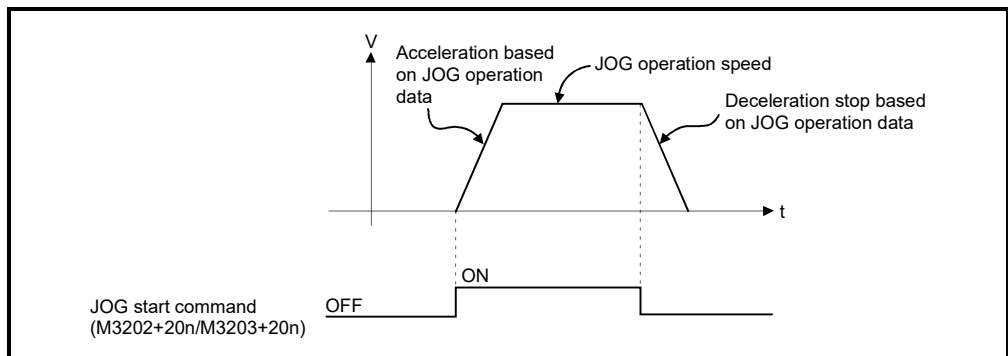

JOG operation for axis for which JOG start command is turning on is executed.

6 POSITIONING CONTROL

(2) The setting range for JOG speed setting registers (D640+2n, D641+2n) are shown below.

Axis No. (Note-2)	JOG operation		JOG speed setting register		Setting range							
					mm		inch		degree		pulse	
	Forward JOG	Reverse JOG	Most significant	Least significant	Setting range	Units	Setting range	Units	Setting range	Units	Setting range	Units
1	M3202	M3203	D641	D640	1 to 600000000	$\times 10^{-2}$ mm /min	1 to 600000000	$\times 10^{-3}$ inch /min	1 to 2147483647	$\times 10^{-3}$ degree /min (Note-1)	1 to 2147483647	pulse/ s
2	M3222	M3223	D643	D642								
3	M3242	M3243	D645	D644								
4	M3262	M3263	D647	D646								
5	M3282	M3283	D649	D648								
6	M3302	M3303	D651	D650								
7	M3322	M3323	D653	D652								
8	M3342	M3343	D655	D654								
9	M3362	M3363	D657	D656								
10	M3382	M3383	D659	D658								
11	M3402	M3403	D661	D660								
12	M3422	M3423	D663	D662								
13	M3442	M3443	D665	D664								
14	M3462	M3463	D667	D666								
15	M3482	M3483	D669	D668								
16	M3502	M3503	D671	D670								
17	M3522	M3523	D673	D672								
18	M3542	M3543	D675	D674								
19	M3562	M3563	D677	D676								
20	M3582	M3583	D679	D678								
21	M3602	M3603	D681	D680								
22	M3622	M3623	D683	D682								
23	M3642	M3643	D685	D684								
24	M3662	M3663	D687	D686								
25	M3682	M3683	D689	D688								
26	M3702	M3703	D691	D690								
27	M3722	M3723	D693	D692								
28	M3742	M3743	D695	D694								
29	M3762	M3763	D697	D696								
30	M3782	M3783	D699	D698								
31	M3802	M3803	D701	D700								
32	M3822	M3823	D703	D702								

(Note-1): When the "speed control $10 \times$ multiplier setting for degree axis" is set to "valid" in the fixed parameter, the unit is " $\times 10^{-2}$ [degree/min]".

(Note-2): The following is valid.

- Q172DSCPU : Axis No. to 16
- Q172DCPU(-S1): Axis No. to 8

POINT

When the JOG operation speed is set in the Motion SFC program, stores a value which is 100 times the real speed in units of [mm] or 1000 times the speed in units of [inch] or [degree] in the JOG speed setting register (D640+2n, D641+2n).

----- Example -----

⋮ If JOG operation speed of 6000.00[mm/min] is set, stores the value "600000" in the JOG speed setting register (D640+2n, D641+2n).

(Note): Store a value which is 100 times the real speed in the JOG speed setting register (D640+2n, D641+2n) for the "degree axis control $10 \times$ multiplier speed setting valid".

6 POSITIONING CONTROL

[Cautions]

- (1) If the forward JOG start command (M3202+20n) and reverse JOG start command (M3203+20n) turn on simultaneously for a single axis, the forward JOG operation is executed.

When a deceleration stop is made by the forward JOG start command (M3202+20n) OFF the reverse JOG operation is not executed even if the reverse JOG start command (M3203+20n) is ON. After that, when the reverse JOG start command (M3203+20n) turns off to on, the reverse JOG operation is executed.

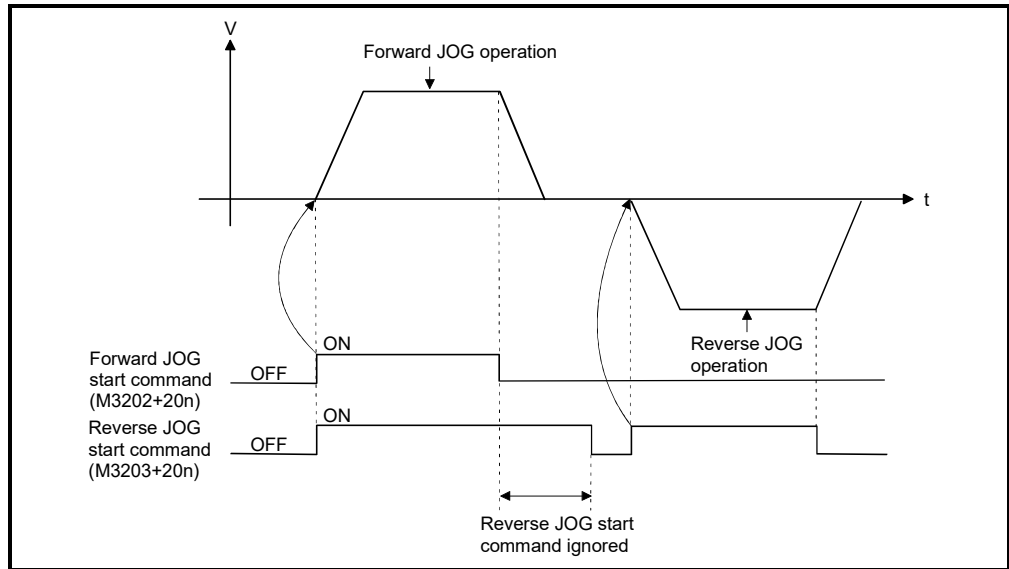

- (2) If the JOG start command (M3202+20n/M3203+20n) turns on during deceleration by the JOG start command OFF, after deceleration stop, JOG operation is not executed.

After that, the JOG operation is executed by the JOG start command OFF to ON.

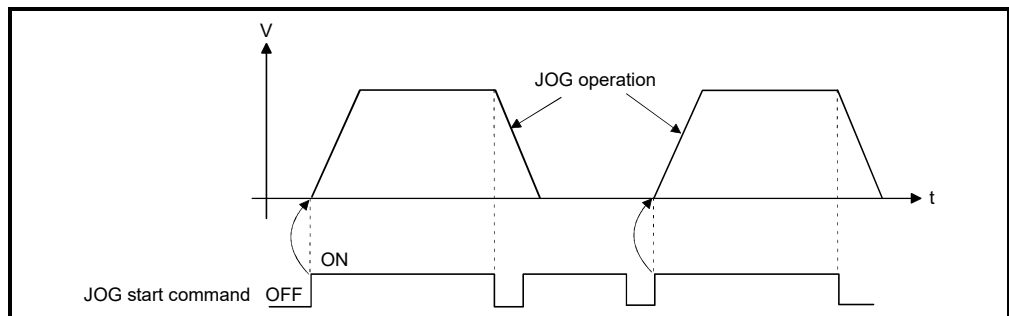

- (3) JOG operation by the JOG start command (M3202+20n/M3203+20n) is not executed during the test mode using MT Developer2.
 After release of test mode, the JOG operation is executed by turning the JOG start command off to on.

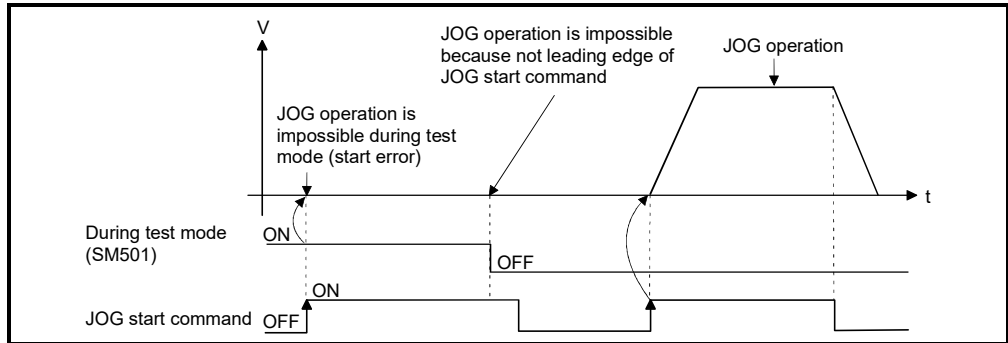

[Program]

Program for JOG operation is shown as the following conditions.

(1) System configuration

JOG operation for Axis 1 and Axis 2.

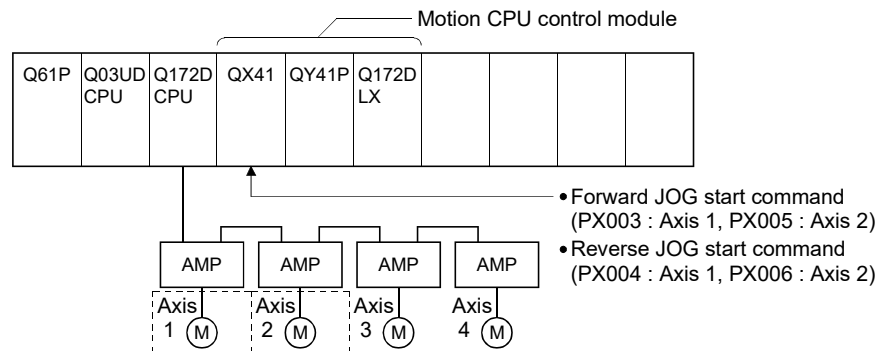

(2) JOG operation conditions

- (a) Axis No. Axis 1, Axis 2
- (b) JOG start speed 100000 (1000.00[mm/min])
- (c) JOG start commands
 - 1) Forward JOG start Axis 1: PX003 ON, Axis 2: PX005 ON
 - 2) Reverse JOG start Axis 1: PX004 ON, Axis 2: PX006 ON

(3) Motion SFC program

Motion SFC program for which executes JOG operation is shown below.

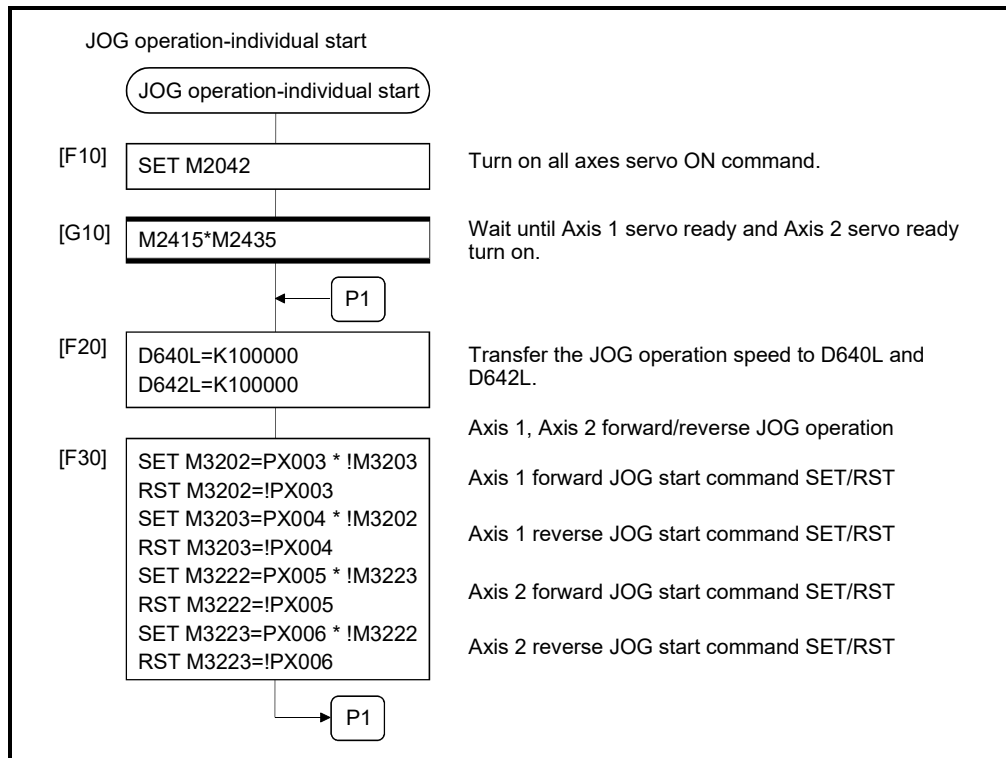

(Note): Example of the above Motion SFC program is started using the automatic start or sequence program.

6 POSITIONING CONTROL

6.21.3 Simultaneous start

[Control details]

Simultaneous start JOG operation for specified multiple axes.

- (1) JOG operation continues at the JOG speed setting register value for each axis while the JOG operation simultaneous start command (M2048) turns on, and a deceleration stop is made by the M2048 OFF.

Control of acceleration/deceleration is based on the data set in the JOG operation data.

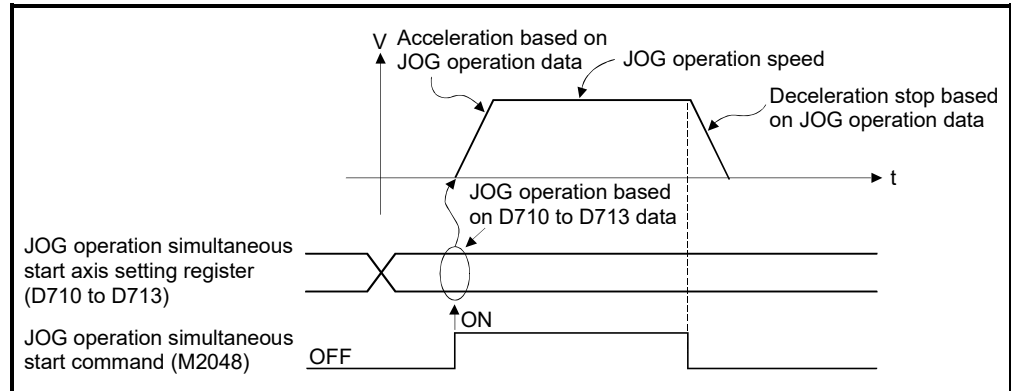

- (2) JOG operation axis is set in the JOG operation simultaneous start axis setting register (D710 to D713).

	b15	b14	b13	b12	b11	b10	b9	b8	b7	b6	b5	b4	b3	b2	b1	b0	
D710	Axis 16	Axis 15	Axis 14	Axis 13	Axis 12	Axis 11	Axis 10	Axis 9	Axis 8	Axis 7	Axis 6	Axis 5	Axis 4	Axis 3	Axis 2	Axis 1	Forward rotation JOG
D711	Axis 32	Axis 31	Axis 30	Axis 29	Axis 28	Axis 27	Axis 26	Axis 25	Axis 24	Axis 23	Axis 22	Axis 21	Axis 20	Axis 19	Axis 18	Axis 17	
D712	Axis 16	Axis 15	Axis 14	Axis 13	Axis 12	Axis 11	Axis 10	Axis 9	Axis 8	Axis 7	Axis 6	Axis 5	Axis 4	Axis 3	Axis 2	Axis 1	Reverse rotation JOG
D713	Axis 32	Axis 31	Axis 30	Axis 29	Axis 28	Axis 27	Axis 26	Axis 25	Axis 24	Axis 23	Axis 22	Axis 21	Axis 20	Axis 19	Axis 18	Axis 17	

(Note-1): Make JOG operation simultaneous start axis setting with 1/0.
 • 1: Simultaneous start execution
 • 0: Simultaneous start not execution

(Note-2): The following range is valid.
 • Q172DSCPU : Axis No.1 to 16
 • Q172DCPU(-S1): Axis No.1 to 8

6 POSITIONING CONTROL

(3) The setting range for JOG speed setting registers (D640+2n, D641+2n) are shown below.

Axis No. (Note-2)	JOG operation		JOG speed setting register		Setting range							
					mm		inch		degree		pulse	
	Forward JOG	Reverse JOG	Most significant	Least significant	Setting range	Units	Setting range	Units	Setting range	Units	Setting range	Units
1	M3202	M3203	D641	D640	1 to 600000000	$\times 10^{-2}$ mm /min	1 to 600000000	$\times 10^{-3}$ inch /min	1 to 2147483647	$\times 10^{-3}$ degree /min (Note-1)	1 to 2147483647	pulse /s
2	M3222	M3223	D643	D642								
3	M3242	M3243	D645	D644								
4	M3262	M3263	D647	D646								
5	M3282	M3283	D649	D648								
6	M3302	M3303	D651	D650								
7	M3322	M3323	D653	D652								
8	M3342	M3343	D655	D654								
9	M3362	M3363	D657	D656								
10	M3382	M3383	D659	D658								
11	M3402	M3403	D661	D660								
12	M3422	M3423	D663	D662								
13	M3442	M3443	D665	D664								
14	M3462	M3463	D667	D666								
15	M3482	M3483	D669	D668								
16	M3502	M3503	D671	D670								
17	M3522	M3523	D673	D672								
18	M3542	M3543	D675	D674								
19	M3562	M3563	D677	D676								
20	M3582	M3583	D679	D678								
21	M3602	M3603	D681	D680								
22	M3622	M3623	D683	D682								
23	M3642	M3643	D685	D684								
24	M3662	M3663	D687	D686								
25	M3682	M3683	D689	D688								
26	M3702	M3703	D691	D690								
27	M3722	M3723	D693	D692								
28	M3742	M3743	D695	D694								
29	M3762	M3763	D697	D696								
30	M3782	M3783	D699	D698								
31	M3802	M3803	D701	D700								
32	M3822	M3823	D703	D702								

(Note-1): When the "speed control $10 \times$ multiplier setting for degree axis" is set to "valid" in the fixed parameter, the unit is " $\times 10^{-2}$ [degree/min]".

(Note-2): The following is valid.

- Q172DSCPU : Axis No.1 to 16
- Q172DCPU(-S1): Axis No.1 to 8

[Program]

Program for simultaneous start of JOG operations are shown as the following conditions.

(1) System configuration

JOG operation for Axis 1 and Axis 2.

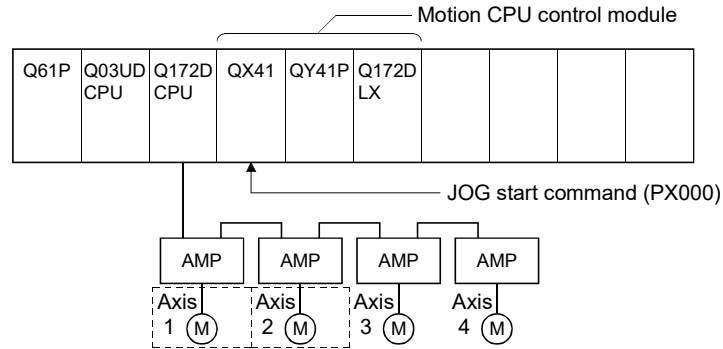

(2) JOG operation conditions

(a) JOG operation conditions are shown below.

Item	JOG operation conditions	
Axis No.	Axis 1	Axis 2
JOG operation speed	150000	150000

(b) JOG start command During PX000 ON

(3) Motion SFC program

Motion SFC program for which executes the simultaneous start of JOG operation is shown below.

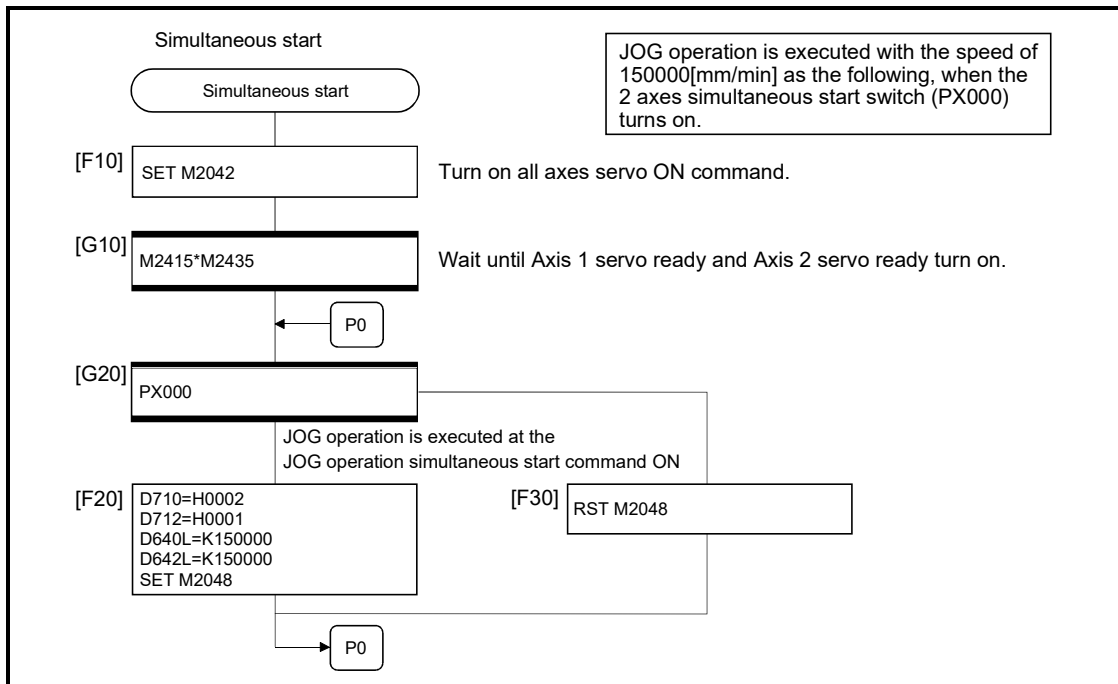

(Note): Example of the above Motion SFC program is started using the automatic start or sequence program.

6 POSITIONING CONTROL

6.22 Manual Pulse Generator Operation

Positioning control based on the number of pulses inputted from the manual pulse generator is executed.

Simultaneous operation for 1 to 3 axes is possible with one manual pulse generator, the number of connectable modules are shown below.

Number of connectable to the manual pulse generator
3

POINT
<ul style="list-style-type: none"> When two or more Q173DPXs are installed, connect the manual pulse generator to first (It counts from 0 slot of the main base) Q173DPX. (When the manual pulse generator is used, only first Q173DPX is valid.)

[Control details]

- (1) Positioning of the axis set in the manual pulse generator axis setting register based on the pulse input from the manual pulse generator.
Manual pulse generator operation is only valid while the manual pulse generator enable flag turn ON.

Manual pulse generator connecting position	Manual pulse generator axis No. setting register	Manual pulse generator enable flag
P1	D714, D715	M2051
P2	D716, D717	M2052
P3	D718, D719	M2053

- (2) The travel value and output speed for positioning control based on the pulse input from manual pulse generator are shown below.
(a) Travel value

The travel value based on the pulse input from a manual pulse generator is calculated using the following formula.

$$[\text{Travel value}] = [\text{Travel value per pulse}] \times [\text{Number of input pulses}] \times [\text{Manual pulse generator 1- pulse input magnification setting}]$$

The travel value per pulse for manual pulse generator operation is shown below.

Unit	Travel value
mm	0.1 [μm]
inch	0.00001 [inch]
degree	0.00001 [degree]
pulse	1 [pulse]

If units is [mm], the command travel value for input of one pulse is:
(0.1[μm]) \times (1[pulse]) \times (Manual pulse generator 1- pulse input magnification setting)

(b) Output speed

The output speed is the positioning speed corresponding to the number of pulses input from a manual pulse generator in unit time.

$$[\text{Output speed}] = [\text{Number of input pulses per 1[ms]}] \times [\text{Manual pulse generator 1- pulse input magnification setting}]$$

(3) Setting of the axis operated by the manual pulse generator

The axis operated by the manual pulse generator is set in the manual pulse generator axis setting register (D714 to D719).

The bit corresponding to the axis controlled (1 to 32) is set.

(4) Manual pulse generator 1- pulse input magnification setting

Make magnification setting for 1- pulse input from the manual pulse generator for each axis.

1- pulse input magnification setting register	Applicable axis No. (Note-1)	Setting range
D720	Axis 1	1 to 10000
D721	Axis 2	
D722	Axis 3	
D723	Axis 4	
D724	Axis 5	
D725	Axis 6	
D726	Axis 7	
D727	Axis 8	
D728	Axis 9	
D729	Axis 10	
D730	Axis 11	
D731	Axis 12	
D732	Axis 13	
D733	Axis 14	
D734	Axis 15	
D735	Axis 16	
D736	Axis 17	
D737	Axis 18	
D738	Axis 19	
D739	Axis 20	
D740	Axis 21	
D741	Axis 22	
D742	Axis 23	
D743	Axis 24	
D744	Axis 25	
D745	Axis 26	
D746	Axis 27	
D747	Axis 28	
D748	Axis 29	
D749	Axis 30	
D750	Axis 31	
D751	Axis 32	

(Note-1): The following range is valid.

- Q172DSCPU : Axis No.1 to 16
- Q172DCPU(-S1) : Axis No.1 to 8

(Note): The manual pulse generator does not have a speed limit value, so set the magnification setting within the rated speed of the servo motor.

- (5) The setting manual pulse generator 1- pulse input magnification checks the "1-pulse input magnification setting registers of the manual pulse generator" of the applicable axis at leading edge of manual pulse generator enable flag. If the value is outside of range, the manual pulse generator axis setting error register (SD513 to SD515) and manual pulse generator axis setting error flag (SM513) are set and a value of "1" is used for the magnification.
- (6) Manual pulse generator smoothing magnification setting
A magnification to smooth leading edge/trailing edge of manual pulse generator operation is set.

Manual pulse generator smoothing magnification setting register	Setting range
Manual pulse generator 1 (P1): D752	0 to 59
Manual pulse generator 2 (P2): D753	
Manual pulse generator 3 (P3): D754	

(a) Operation

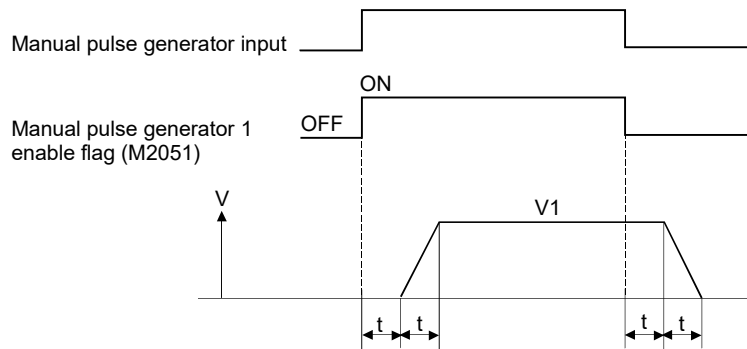

$$\text{Output speed (V1)} = [\text{Number of input pulses/ms}] \times [\text{Manual pulse generator 1- pulse input magnification setting}]$$

$$\text{Travel value (L)} = [\text{Travel value per pulse}] \times [\text{Number of input pulses}] \times [\text{Manual pulse generator 1-pulse input magnification setting}]$$

- (b) When the smoothing magnification is set, the smoothing time constant is as following formula.

$$\text{Smoothing time constant (t)} = (\text{Smoothing magnification} + 1) \times 56.8 \text{ [ms]}$$

REMARK

The smoothing time constant is within the range of 56.8 to 3408 [ms].

- (7) Errors details at the data setting for manual pulse generator operation are shown below.

Error details	Error processing
Axis setting is 4 axes or more	Manual pulse generator operation is executed according to valid for 3 axes from the lowest manual pulse generator axis setting register.
All of bit is "0" for the effective axis No. of manual pulse generator axis No. setting register.	Manual pulse generator operation is not executed.

[Cautions]

- (1) The start accept flag turns on for axis during manual pulse generator operation. Positioning control or home position return cannot be started using the Motion CPU or MT Developer2. Turn off the manual pulse generator enable flag after the manual pulse generator operation end.
- (2) When the torque limit value is not specified with D(P).CHGT (torque limit value change request instruction form the PLC CPU to the Motion CPU), D(P).CHGT2 (torque limit value individual change request instruction form the PLC CPU to the Motion CPU) ~~QDSX~~, CHGT (torque limit value change request) or CHGT2 (torque limit value individual change request) ~~QDSX~~. The torque limit value is fixed at 300[%] during manual pulse generator operation.
- (3) If the manual pulse generator enable flag turns on for the axis for which the start accept flag is ON, a minor error (error code: 214) is set to the applicable axis and manual pulse generator input is not enabled. When enabling the manual pulse generator input, turn the manual pulse generator flag ON again while the start accept flag is OFF.

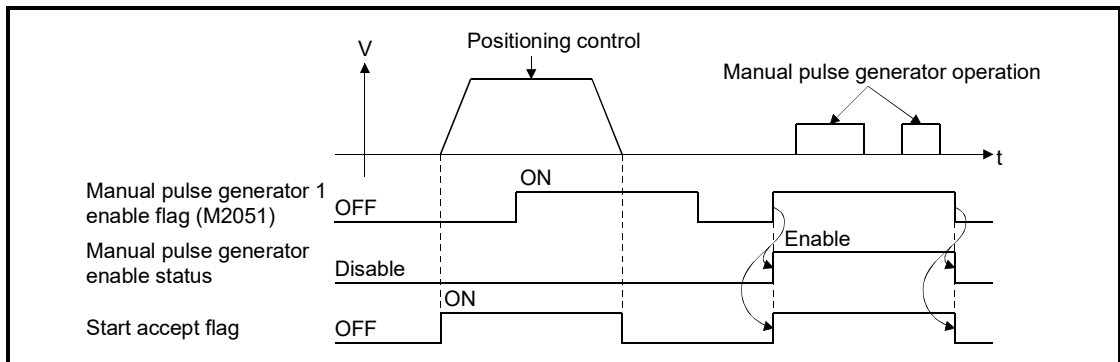

- (4) If another axis is set and the same manual pulse generator enable flag turns on again during smoothing deceleration after manual pulse generator enable flag turns off, the manual pulse generator input is not enabled. At this time, the manual pulse generator axis setting error bit of the manual pulse generator axis setting error storage register (SD513 to SD515) turns on, and the manual pulse generator axis setting error flag (SM513) turns on. Include the start accept flag OFF for specified axis as an interlock condition for turning on the manual pulse generator enable flag.

6 POSITIONING CONTROL

[Procedure for manual pulse generator operation]

Procedure for manual pulse generator operation is shown below.

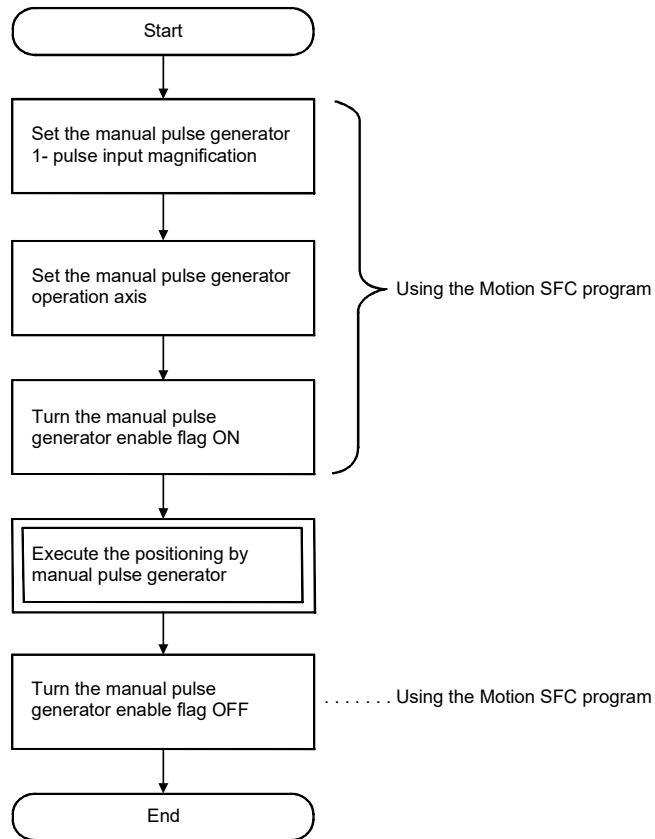

[Program]

Program executes manual pulse generator operation is shown as the following conditions.

(1) System configuration

Manual pulse generator operation of Axis 1 and Axis 2.

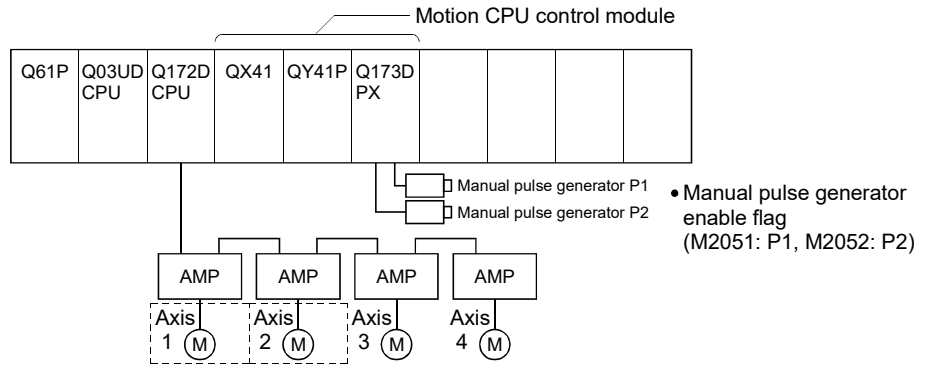

(2) Manual pulse generator operation conditions

- (a) Manual pulse generator operation axis.....Axis 1, Axis 2
- (b) Manual pulse generator 1- pulse input magnification..... 100
- (c) Manual pulse generator operation enableM2051 (Axis 1)/
M2052 (Axis 2) ON
- (d) Manual pulse generator operation endM2051 (Axis 1)/
M2052 (Axis 2) OFF

(3) Motion SFC program

Motion SFC program for manual pulse generator operation is shown below.

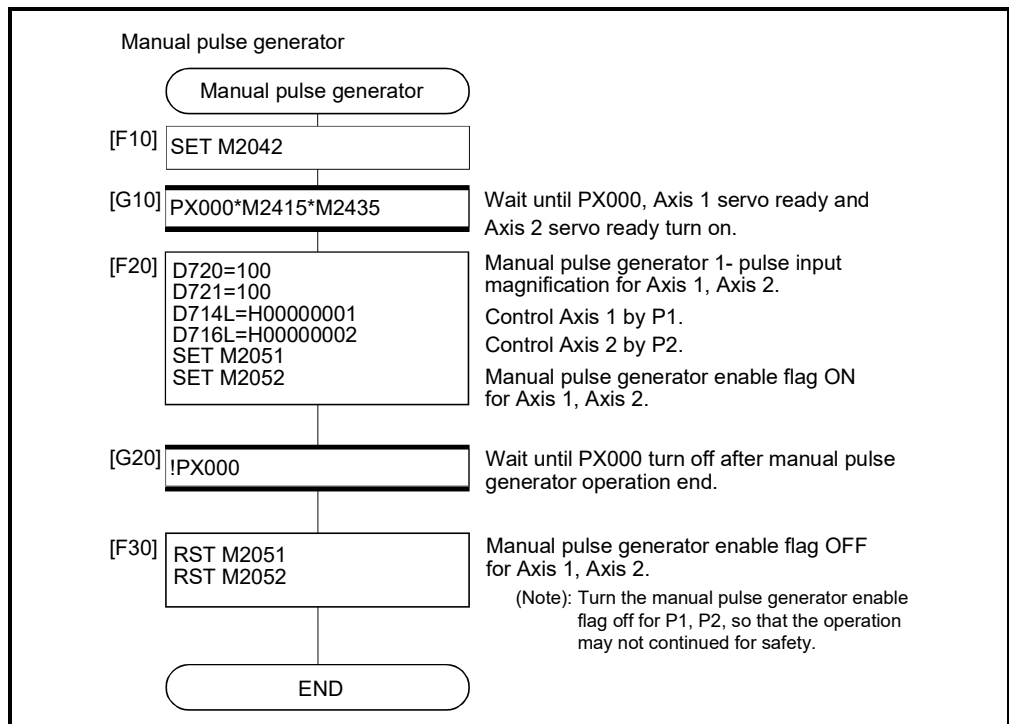

(Note): Example of the above Motion SFC program is started using the automatic start or sequence program.

6 POSITIONING CONTROL

6.23 Home Position Return

- (1) Use the home position return at the power supply ON and other times where decision of axis is at the machine home position is required.
- (2) The home position return data must be set for each axis to execute the home position return.
- (3) The home position return methods that are available are proximity dog method, count method, data set method, dog cradle method, stopper method, limit switch combined method, scale home position signal detection method, dogless home position signal reference method, and driver home position return method. Select the optimal home position return method for the system configuration and applications with reference to the following.

Home position return methods		Reference position	External signal	Applications
Proximity dog method	Proximity dog method 1	Motor zero point	DOG (FLS/RLS)	<ul style="list-style-type: none"> It is used in the system which can surely pass a zero point from the home position return start to proximity dog ON → OFF. When the proximity dog is ON, it cannot be started.
	Proximity dog method 2			<ul style="list-style-type: none"> This method is valid when the stroke range is short and "proximity dog method 1" cannot be used. When the proximity dog is ON, it cannot be started.
Count method	Count method 1	Command position		<ul style="list-style-type: none"> It is used in the system which can surely pass a zero point from the home position return start to point of travel distance set as "travel value after proximity dog ON".
	Count method 2			<ul style="list-style-type: none"> This method is used when the proximity dog is near the stroke end and the stroke range is narrow.
	Count method 3			Motor zero point
Data set method	Data set method 1	Command position		—
	Data set method 2	Motor actual position	—	<ul style="list-style-type: none"> It is used in a system where external input signals such as dog signal are not set in the absolute position system.
Dog cradle method		Motor zero point	DOG (FLS/RLS)	<ul style="list-style-type: none"> Home position is zero point of servo motor immediately after the proximity dog signal ON. It is easy to set the position of proximity dog, because the proximity dog is set near the position made to the home position.
Stopper method	Stopper method 1	Motor actual position	DOG	<ul style="list-style-type: none"> This method is valid to improve home position accuracy in order to make the home position for the position which stopped the machine by the stopper.
	Stopper method 2		—	

6 POSITIONING CONTROL

Home position return methods	Reference position	External signal	Applications
Limit switch combined method	Motor zero point	FLS (for forward home position return direction)/RLS (for reverse home position return direction)	<ul style="list-style-type: none"> It is used in a system where the proximity dog signal cannot be used and only external limit switch can be used.
Scale home position signal detection method Ver.!		DOG	<ul style="list-style-type: none"> The travel direction is reversed at the proximity dog ON, and home position is encoder zero point after reversal. This method is valid to make the home position for the load side at the linear motors or direct drive motors use.
Dogless home position signal reference method Ver.!		(FLS/RLS)	<ul style="list-style-type: none"> It is used in a system where proximity dog signal cannot be used and stops at the zero point of servo motor. Home position return operation differs by servo amplifier.
Driver home position return method Ver.!	Position in driver settings	—	<ul style="list-style-type: none"> The driver performs home position return operation autonomously according to the settings on the driver-side.

Ver.! : Refer to Section 1.3 for the software version that supports this function.

6 POSITIONING CONTROL

6.23.1 Home position return data

This data is used to execute the home position return.
Set this data using MT Developer2.

Table 6.3 Home position return data list

No.	Item	Setting range								Initial value	Units
		mm		inch		degree		pulse			
		Setting range	Units	Setting range	Units	Setting range	Units	Setting range	Units		
1	Home position return direction	0: Reverse direction (Address decrease direction) 1: Forward direction (Address increase direction)								0	—
2	Home position return method	0: Proximity dog method 1 4: Proximity dog method 2 1: Count method 1 5: Count method 2 6: Count method 3 2: Data set method 1 3: Data set method 2 7: Dog cradle method 8: Stopper method 1 9: Stopper method 2 10: Limit switch combined method 11: Scale home position signal detection method 12: Dogless home position signal reference method 13: Driver home position return method								0	—
3	Home position address	-214748364.8 to 214748364.7	μm	-21474.83648 to 21474.83647	inch	0 to 359.99999	degree	-2147483648 to 2147483647	pulse	0	pulse
4	Home position return speed	0.01 to 6000000.00	mm/min	0.001 to 600000.000	inch/min	0.001 to 2147483.647 (Note-1)	degree/min	1 to 2147483647	pulse/s	1	pulse/s
5	Creep speed	0.01 to 6000000.00	mm/min	0.001 to 600000.000	inch/min	0.001 to 2147483.647 (Note-1)	degree/min	1 to 2147483647	pulse/s	1	pulse/s
6	Travel value after proximity dog ON	0.0 to 214748364.7	μm	0.00000 to 21474.83647	inch	0.00000 to 21474.83647	degree	0 to 2147483647	pulse	0	pulse
7	Parameter block setting	1 to 64								1	—
8	Home position return retry function	0: Invalid (Do not execute the home position return retry by limit switch.) 1: Valid (Execute the home position return retry by limit switch.)								0	—
9	Dwell time at the home position return retry	0 to 5000 [ms]								0	ms
10	Home position shift amount	-214748364.8 to 214748364.7	μm	-21474.83648 to 21474.83647	inch	-21474.83648 to 21474.83647	degree	-2147483648 to 2147483647	pulse	0	pulse
11	Speed set at the home position shift	0: Home position return speed 1: Creep speed								0	—
12	Torque limit value at the creep speed	1 to 1000 [%]								300	%
13	Operation setting for incompletion of home position return	0: Execute a servo program 1: Not execute a servo program								1	—

6 POSITIONING CONTROL

	Indirect setting		Remarks	Explanatory section
	Valid/invalid	Number of words		
	—	—	• The home position return direction is set.	—
	—	—	• The home position return method is set. • The proximity dog method or count method are recommended for the servo amplifier which does not support absolute value.	—
	○	2	• The current value of home position after the home position return is set.	—
	○	2	• The home position return speed is set.	—
	○	2	• The creep speed (low speed immediately before stopping after deceleration from home position return speed) after the proximity dog ON is set.	—
	○	2	• The travel value after the proximity dog ON for the count method is set. • More than the deceleration distance at the home position return speed is set.	6.23.1 (1)
	—	—	• The parameter block (Refer to Section 4.3) No. to use for home position return is set.	—
	—	—	• Valid/invalid of home position return retry is set.	6.23.1 (2)
	○	1	• The stop time at the deceleration stop during the home position return retry is set.	
	○	2	• The shift amount at the home position shift is set.	6.23.1 (3)
	—	—	• The operation speed which set the home position shift amount except "0" is set.	
	○	1	• The torque limit value with creep speed at the stopper method home position return is set.	6.23.1 (4)
	—	—	• When the home position return request signal is ON, it set whether a servo program is executed or not.	6.23.1 (5)

(Note-1): When the "speed control 10×multiplier setting for degree axis" is set to "valid" in the fixed parameter, the setting range is "0.01 to 21474836.47[degree/min]".

(1) Travel value after proximity dog ON

- (a) The travel value after proximity dog ON is set to execute the count method home position return.
- (b) After the proximity dog ON, the home position is the first zero-point after travel by the setting travel value.
- (c) Set the travel value after proximity dog ON more than the deceleration distance from the home position return speed.

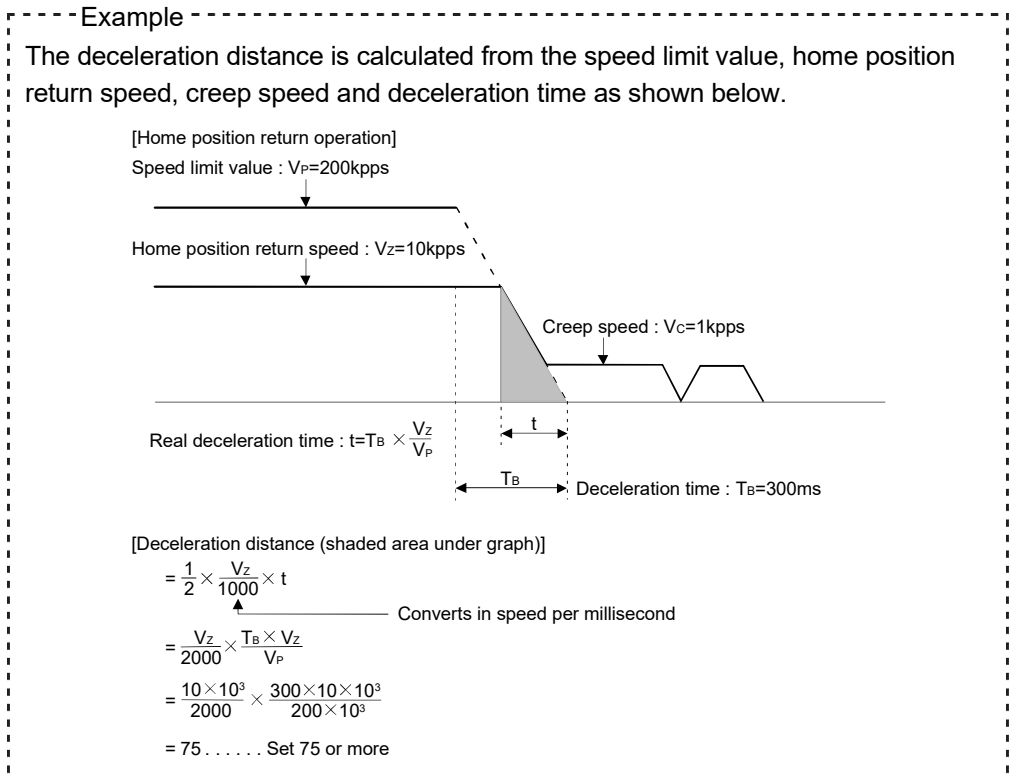

POINT

A home position return must be made after the servo motor has been rotated more than one revolution to pass the axis through the Z-phase (motor reference position signal).

For a proximity dog method or count method home position return, the distance between the point where the home position return program is started and the deceleration stop point before re-travel must be such that the servo motor is rotated more than one revolution to pass the axis through the Z-phase.

When a data set method home position return is made in an ABS (absolute position) system, the servo motor must also have been rotated more than one revolution by JOG operation or the like to pass the axis through the Z-phase.

(Note) : When "1 : No servo motor Z-phase pass after power ON" is selected in the "function selection C-4 (PC17)" of servo parameter (expansion setting parameter), even if it does not pass zero point, the home position return can be executed and restrictions are lost.

- (2) Home position return retry function/dwell time at the home position return retry
 - (a) Valid/invalid of home position return retry is set.
 - (b) When the valid of home position return retry function is set, the time to stop at return of travel direction is set with dwell time at the home position return retry.
 - (c) Operation for the proximity dog method home position return by setting "valid" for home position return retry function is shown below.

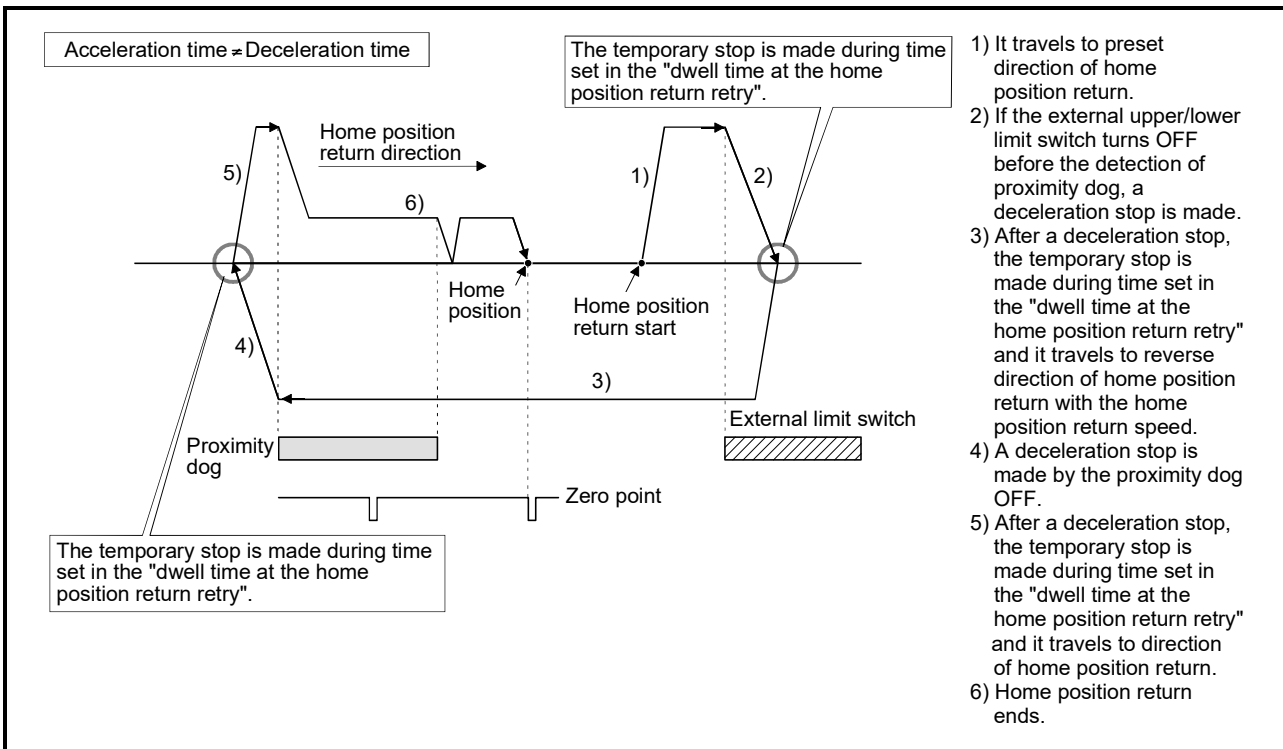

Fig. 6.31 Operation for home position return retry function

- (d) Valid/invalid of home position return retry function by the home position return method is shown below.

Home position return methods	Valid/invalid of home position return retry function
Proximity dog method	○
Count method	○
Data set method	×
Dog cradle method	○
Stopper method	×
Limit switch combined method	×
Scale home position signal detection method	×
Dogless home position signal reference method	Operation A ○ Operation B × Operation C ×
Driver home position return method	×

○: Valid, ×: Invalid

- (3) Home position shift amount/speed set at the home position shift
 - (a) The shift (travel) amount from position stopped by home position return is set.
 - (b) If the home position shift amount is positive value, it shifts from detected zero point signal to address increase direction. If it is negative value, it shifts from detected zero point signal to address decrease direction.
 - (c) Operation speed which set the home position shift amount except "0" is set in the speed set at the home position shift. Select one of the "home position return speed" or "creep speed".

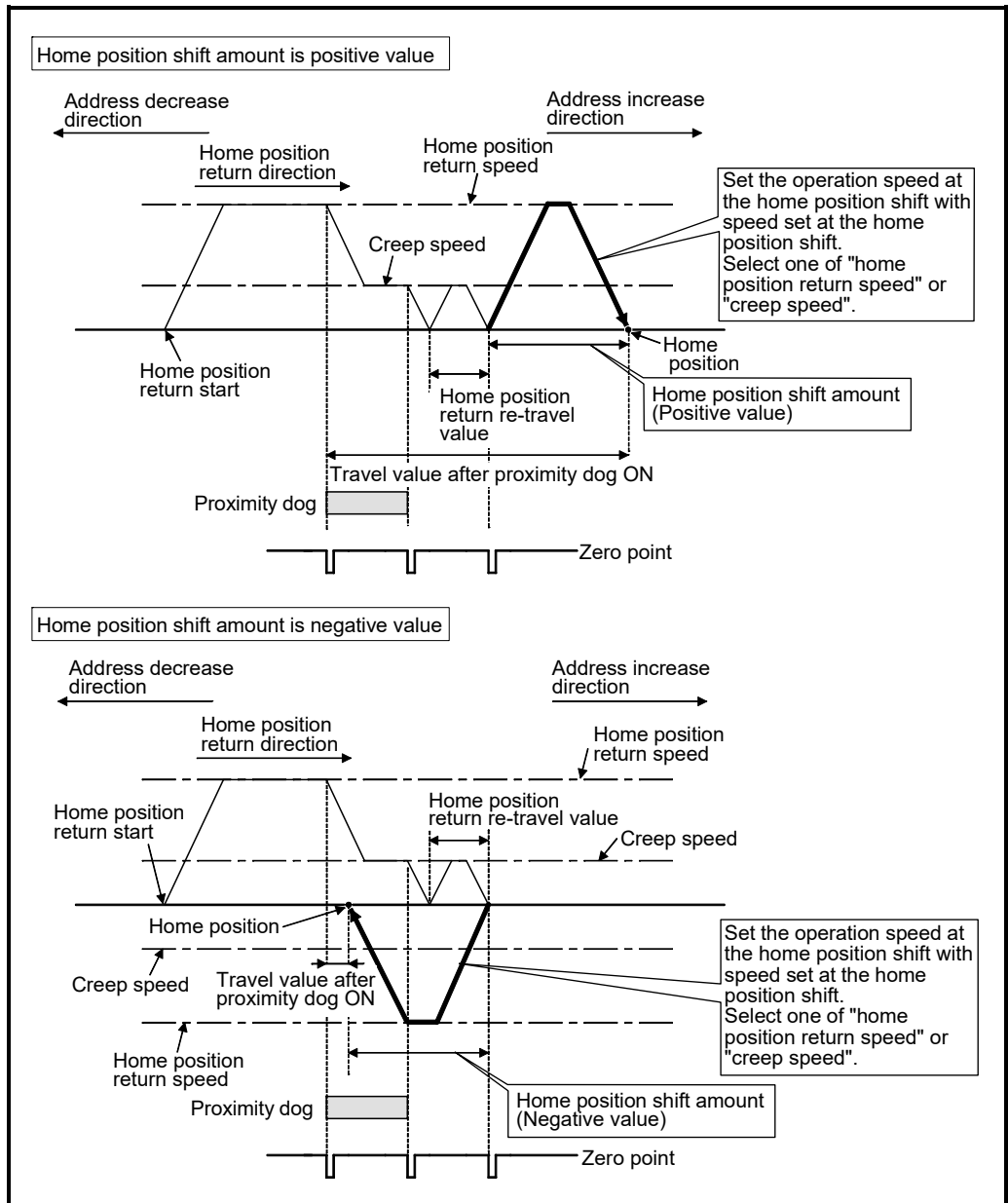

Fig. 6.32 Home position shift amount/speed set at the home position shift

- (d) Valid/invalid of the setting value for home position shift amount by the home position return method is shown below.

Home position return methods	Valid/invalid of home position shift amount
Proximity dog method	○
Count method	○
Data set method	×
Dog cradle method	○
Stopper method	×
Limit switch combined method	○
Scale home position signal detection method	○
Dogless home position signal reference method	○
Driver home position return method	×

○: Valid, ×: Invalid

POINT
<p>(1) Home position shift function is used to rectify a home position stopped by the home position return. When there are physical restrictions in the home position by the relation of a proximity dog setting position, the home position is rectified to the optimal position. In addition, by using the home position shift function it is not necessary to consider the zero point when mounting the servo motor.</p> <p>(2) After proximity dog ON, if the travel value including home position shift amount exceeds the range of "-2147483648 to 2147483647" [$\times 10^{-1}\mu\text{m}$, $\times 10^{-5}\text{inch}$, $\times 10^{-5}\text{degree}$, pulse], "travel value after proximity dog ON" of monitor register is not set correctly.</p>

(4) Torque limit value at the creep speed

- (a) Torque limit value at the creep speed (on press) is set in the case of using the pressed position as the home position by the home position return of stopper method 1, 2.
- (b) Valid/invalid of the torque limit value at the creep speed by the home position return method is shown below.

Home position return methods	Valid/invalid of torque limit value at the creep speed
Proximity dog method	×
Count method	×
Data set method	×
Dog cradle method	×
Stopper method	○
Limit switch combined method	×
Scale home position signal detection method	×
Dogless home position signal reference method	×
Driver home position return method	×

○: Valid, ×: Invalid

- (5) Operation setting for incompleteness of home position return
- (a) Operation in selecting "1: Not execute servo program"
- 1) Servo program cannot be executed if the home position return request signal (M2409+20n) is ON. However, the servo program can be executed even if the home position return request signal (M2409+20n) is ON in the case of only servo program of home position return instruction (ZERO).
 - 2) At the time of servo program start, when "1: Not execute servo program" is selected in the operation setting for incompleteness of home position return and the axis which the home position return request signal (M2409+20n) is ON exists also with one axis, a minor error (error code: 121) occurs and the servo program does not start.
 - 3) JOG operation and manual pulse generator operation can be executed regardless of the home position return request signal (M2409+20n) ON/OFF.
 - 4) Same operation is executed regardless of absolute position system or not. When "1: Not execute servo program" is selected in the case of not absolute position system, the home position return request signal (M2409+20n) turns ON at power supply ON or reset of Multiple CPU system and power supply ON of servo amplifier. Therefore, it must be executed home position return before a servo program start.
 - 5) Same operation is executed in also TEST mode.
 - 6) This setting is valid in the real mode only. Servo program can be executed for a virtual axis connected to the output axis which the home position return request signal (M2409+20n) is ON.
- (b) Operation in selecting "0: Execute servo program"
- 1) Servo program can be executed even if the home position return request signal (M2409+20n) is ON.

CAUTION

- Do not execute the positioning control in home position return request signal (M2409+20n) ON for the axis which uses in the positioning control.
Failure to observe this could lead to an accident such as a collision.

(6) Indirect setting of home position return data

A part of home position return data can be executed the indirect setting by the word devices of Motion CPU.

(a) Word devices for indirect setting

The word devices for indirect setting are the data registers (D), link registers (W), Motion registers (#) and Multiple CPU area device (U□\G).

Word devices except the above devices cannot be used.

The usable setting range of word devices are shown below. (For data that uses 2 words, set as an even number.)

Word devices	Setting range
D	0 to 8191
W	0 to 1FFF
#	0 to 7999
U□\G	10000 to (10000+p-1) (Note-1)

(Note-1): "p" indicates the user setting area points of the Multiple CPU high speed transmission area for each CPU.

(b) Input of home position return

In the indirect setting by the word devices, the specified word device data are read at servo program execution by Motion CPU.

Set data to devices for indirect setting and then execute the start request of servo program at home position return.

POINT
(1) Indirect setting of axis cannot be executed using word devices in the servo program.
(2) Take an interlock with start accept flag (M2001 to M2032) not to change until the device data specified for indirect setting. If the device data is changed before starting accept, it may not execute the home position return at the normal value.
(3) Refer to the Chapter 2 of "Q173D(S)CPU/Q172D(S)CPU Motion controller Programming Manual (COMMON)" for the user setting area points of the Multiple CPU high speed transmission area.

(7) Setting items for home position return data

Items		Home position return methods														
		Proximity dog method 1	Proximity dog method 2	Count method 1	Count method 2	Count method 3	Data set method 1	Data set method 2	Dog cradle method	Stopper method 1	Stopper method 2	Limit switch combined method	Scale home position signal detection method	Dogless home position signal reference method		
													Operation A	Operation B	Operation C	
Home position return data	Home position return direction	○	○	○	○	○	○	○	○	○	○	○	○	○	○	○
	Home position address	⊙	⊙	⊙	⊙	⊙	⊙	⊙	⊙	⊙	⊙	⊙	⊙	⊙	⊙	⊙
	Home position return speed	⊙	⊙	⊙	⊙	⊙	—	—	⊙	⊙	—	⊙	⊙	⊙	⊙	—
	Creep speed	⊙	⊙	⊙	⊙	⊙	—	—	⊙	⊙	⊙	⊙	⊙	⊙	⊙	—
	Travel value after proximity dog ON	—	—	⊙	⊙	⊙	—	—	—	—	—	—	—	—	—	—
	Parameter block setting	○	○	○	○	○	—	—	○	○	○	○	○	○	○	—
	Home position return retry function	○	○	○	○	○	—	—	○	—	—	—	—	○	—	—
	Dwell time at the home position return retry	⊙	⊙	⊙	⊙	⊙	—	—	⊙	—	—	—	—	⊙	—	—
	Home position shift amount	⊙	⊙	⊙	⊙	⊙	—	—	⊙	—	—	⊙	⊙	⊙	⊙	—
	Speed set at the home position shift	○	○	○	○	○	—	—	○	—	—	○	○	○	○	—
	Torque limit value at the creep speed	—	—	—	—	—	—	—	—	⊙	⊙	—	—	—	—	—
	Operation setting for incompleteness of home position return	○	○	○	○	○	○	○	○	○	○	○	○	○	○	○
	Parameter blocks	Interpolation control unit	—	—	—	—	—	—	—	—	—	—	—	—	—	—
Speed limit value		—	—	—	—	—	—	—	—	—	—	—	—	—	—	
Acceleration time		○	○	○	○	○	—	—	○	○	○	○	○	○	○	
Deceleration time		○	○	○	○	○	—	—	○	○	○	○	○	○	○	
Rapid stop deceleration time		○	○	○	○	○	—	—	○	○	○	○	○	○	○	
S-curve ratio		○	○	○	○	○	—	—	○	○	○	○	○	○	○	
Advanced S-curve acceleration/deceleration		Acceleration/deceleration system	○	○	○	○	○	—	—	○	○	○	○	○	○	—
		Acceleration section 1 ratio	○	○	○	○	○	—	—	○	○	○	○	○	○	—
		Acceleration section 2 ratio	○	○	○	○	○	—	—	○	○	○	○	○	○	—
		Deceleration section 1 ratio	○	○	○	○	○	—	—	○	○	○	○	○	○	—
Deceleration section 2 ratio		○	○	○	○	○	—	—	○	○	○	○	○	○	—	
Torque limit value		○	○	○	○	○	—	—	○	○	○	○	○	○	○	
Deceleration processing at the stop time		○	○	○	○	○	—	—	○	○	○	○	○	○	○	
Allowable error range for circular interpolation	—	—	—	—	—	—	—	—	—	—	—	—	—	—		

⊙: Must be set (Indirect setting)
 ○: Must be set
 —: Must be not set

6.23.2 Home position return by the proximity dog method 1

(1) Proximity dog method 1

Zero point position after proximity dog ON to OFF is home position in this method. When it does not pass (zero pass signal: M2406+20n OFF) the zero point from home position return start to deceleration stop by proximity dog ON to OFF, an error will occur and home position return is not executed. However, when "1 : Not need to pass motor Z phase after the power supply is switched on" is selected in the "function selection C-4 (PC17)" of servo parameter (expansion setting parameter), if it does not pass zero point from home position return start to deceleration stop by proximity dog ON to OFF, the home position return can be executed.

(2) Home position return by the proximity dog method 1

Operation of home position return by proximity dog method 1 for passing (zero pass signal: M2406+20n ON) the zero point from home position return start to deceleration stop by proximity dog ON to OFF is shown below.

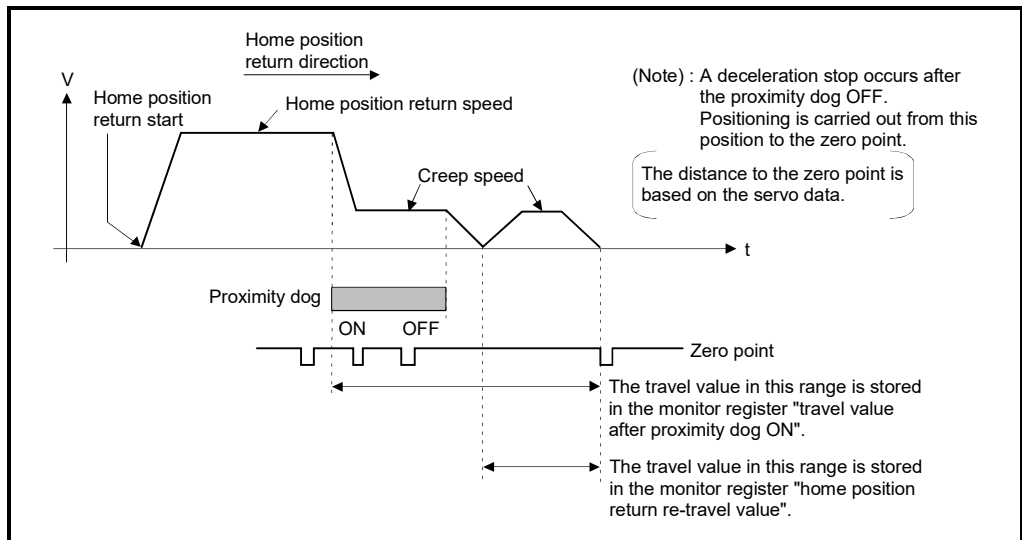

Fig. 6.33 Home position return operation by the proximity dog method 1

(3) Home position return execution

Home position return by the proximity dog method 1 is executed using the servo program in Section 6.23.19.

(4) Cautions

(a) Keep the proximity dog ON during deceleration from the home position return speed to the creep speed.

If the proximity dog turns OFF before deceleration to the creep speed, a deceleration stop is made and the next zero point is set as the home position.

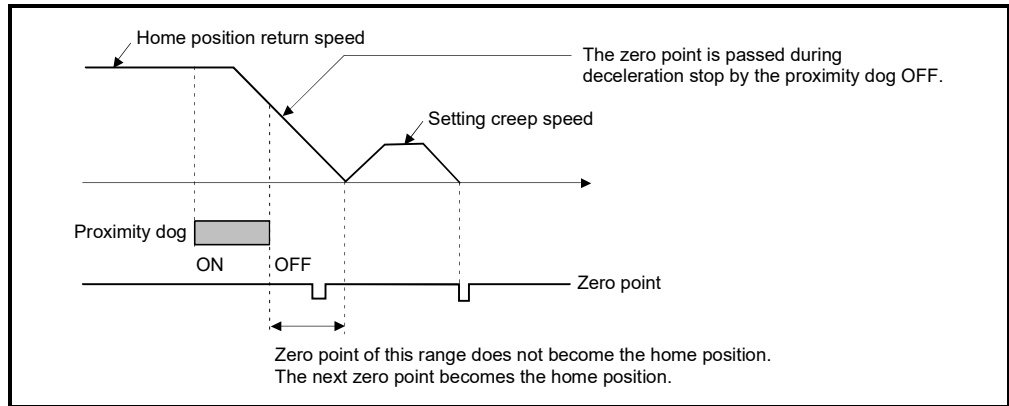

(b) The position executed deceleration stop by the proximity dog OFF is near zero point, a home position discrepancy equivalent to one revolution of the servo motor may occur. Adjust the position of proximity dog OFF, such that the home position return re-travel value becomes half the travel value for one revolution of the servo motor.

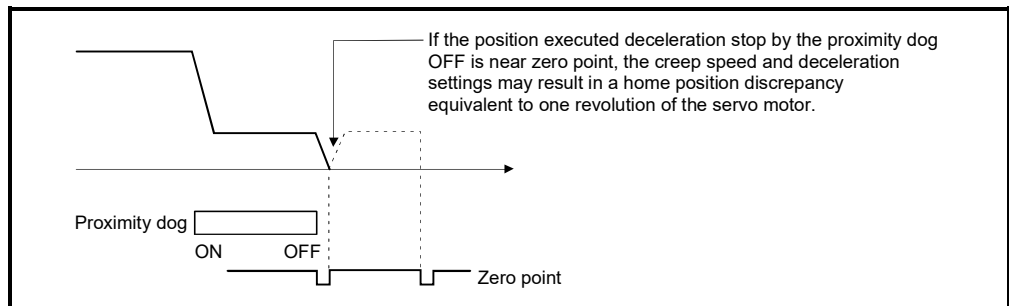

POINT

When the home position return retry function is not set in the following cases, execute the home position return, after return the axis once to position before the proximity dog ON by the JOG operation, etc.

Home position return cannot be executed without returning to position before the proximity dog ON.

- (1) Home position return with a position after the proximity dog ON to OFF.
- (2) When the power supply turned OFF to ON after home position return end.

- (c) When it does not pass (zero pass signal: M2406+20n ON) the zero point from home position return start to deceleration stop by proximity dog ON to OFF, a minor error (error code: 120) will occur, a deceleration stop is made and home position return does not end normally. When a distance between home position return start position and home position is near and a zero point is not passed, select the proximity dog method 2.
- (d) If home position return is executed in the proximity dog ON, a major error (error code: 1003) will occur, the home position return is not executed. Use the proximity dog method 2 in this case.
- (e) When home position return retry function is not set, if home position return is executed again after home position return end, a minor error (error code: 115) will occur, the home position return is not executed.
- (f) If in-position signal (M2402+20n) does not turn ON, home position return is not ended.

6.23.3 Home position return by the proximity dog method 2

(1) Proximity dog method 2

Zero point position after proximity dog ON to OFF is home position in this method. When it passed (zero pass signal: M2406+20n ON) the zero point from home position return start to deceleration stop by proximity dog ON to OFF, operation for "proximity dog method 2" is the same as "proximity dog method 1". (Refer to Section 6.23.2)

When it does not pass (zero pass signal: M2406+20n OFF) the zero point from home position return start to deceleration stop by proximity dog ON to OFF, it moves to home position return direction after the servo motor is rotated one revolution to reverse direction and it passed the zero point, and the first zero point position is set as home position after proximity dog ON to OFF.

(2) Home position return by the proximity dog method 2

Operation of home position return by proximity dog method 2 for not passing the zero point from home position return start to deceleration stop by proximity dog ON to OFF is shown below.

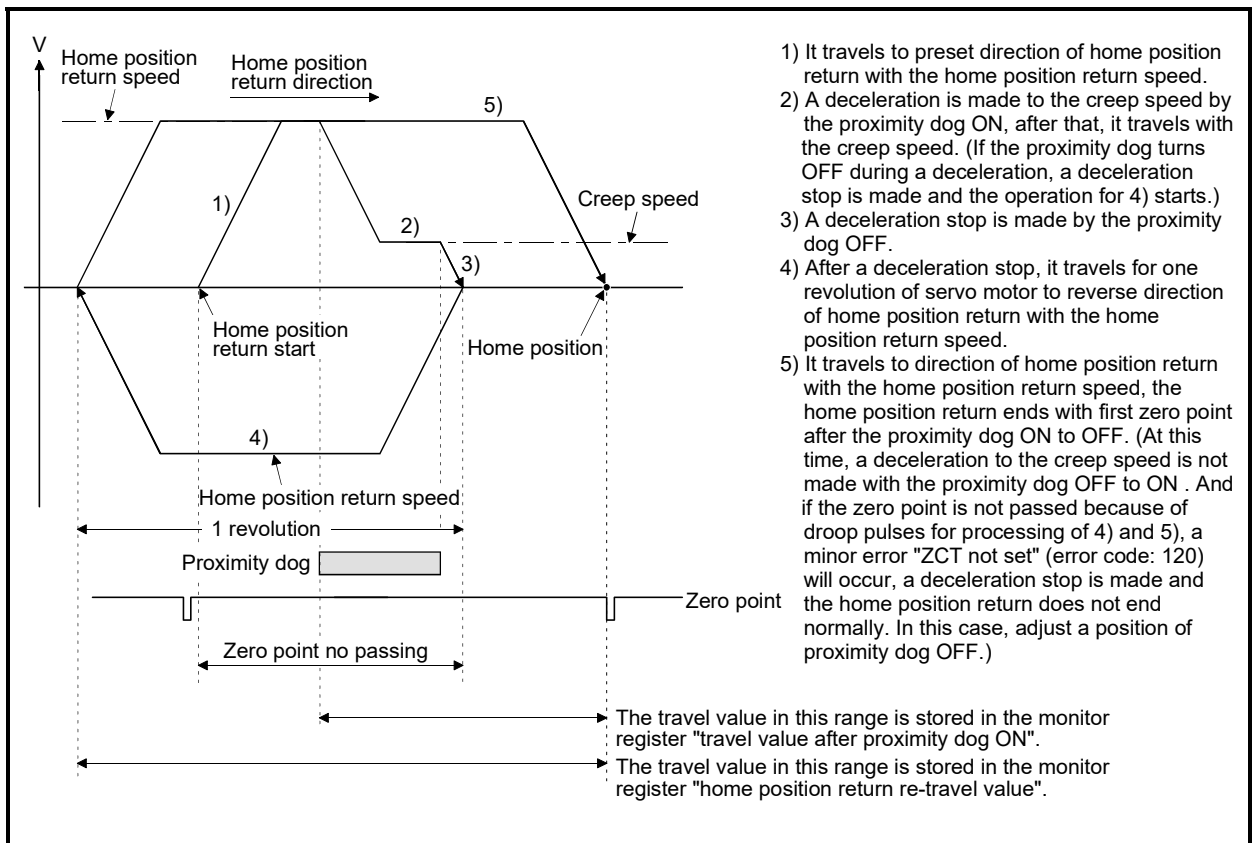

Fig. 6.34 Home position return operation by the proximity dog method 2 (zero point no passing)

(3) Home position return execution

Home position return by the proximity dog method 2 is executed using the servo program in Section 6.23.19.

(4) Cautions

- (a) A system in which the servo motor can rotate one time or more is required.
- (b) When a servo motor stops with the specified condition enabled and rotates to reverse direction one time after proximity dog ON, make a system which does not turn OFF the external upper/lower stroke limit.
- (c) Keep the proximity dog ON during deceleration from the home position return speed to the creep speed.
If the proximity dog turns OFF before deceleration to the creep speed, a deceleration stop is made and the next zero point is set as the home position.
- (d) If home position return is executed in the proximity dog ON, it starts with the creep speed.
- (e) When home position return retry function is not set, if home position return is executed again after home position return completion, a minor error (error code: 115) will occur, the home position return is not executed.
- (f) When "1 : Not need to pass motor Z phase after the power supply is switched on" is selected in the "function selection C-4 (PC17)" of servo parameter (expansion setting parameter), even if it does not pass zero point at the servo amplifier power ON, the zero pass signal (M2406+20n) turns ON. This operation is the same as proximity dog method 1.
- (g) If in-position signal (M2402+20n) does not turn ON, home position return is not ended.

6.23.4 Home position return by the count method 1

(1) Count method 1

After the proximity dog ON, the zero point after the specified distance (travel value after proximity dog ON) is home position in this method. When the zero point is not passed (zero pass signal: M2406+20n OFF) until it travels the distance set in the "travel value after proximity dog ON" from home position return start, an error will occur and home position return is not executed. However, when "1 : Not need to pass motor Z phase after the power supply is switched on" is selected in the "function selection C-4 (PC17)" of servo parameter (expansion setting parameter), if the zero point is not passed until it travels the distance set in the "travel value after proximity dog ON" from home position return start, the home position return can be executed. The travel value after proximity dog ON is set in the home position return data (Refer to Section 6.23.1).

(2) Home position return by the count method 1

Operation of home position return by count method 1 for passing the zero point during travel of specified distance set in the "travel value after proximity dog ON" from the home position return start is shown below.

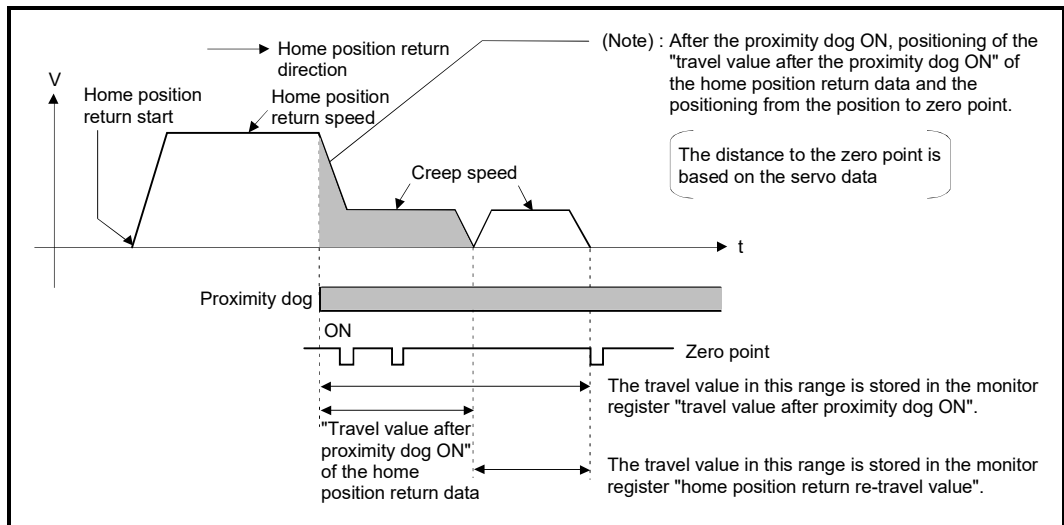

Fig. 6.35 Home position return operation by the count method 1

(3) Home position return execution

Home position return by the count method 1 is executed using the servo program in Section 6.23.19.

(4) Cautions

- (a) Home position return and continuously start of home position return are also possible in the proximity dog ON in the count method 1.
When the home position return or continuously start of home position return are executed in the proximity dog ON, the home position return is executed after return the axis once to position of the proximity dog OFF.
- (b) When the zero point is not passed (zero pass signal: M2406+20n ON) until it travels the distance set in the "travel value after proximity dog ON" from home position return start, a minor error (error code: 120) will occur, a deceleration stop is made and home position return does not end normally. When a distance between home position return start position and home position is near and a zero point is not passed, select the count method 3.
- (c) When the "travel value after proximity dog ON" is less than the deceleration distance from "home position return speed" to "creep speed", a minor error (error code: 209) will occur and deceleration stop is made.
- (d) If in-position signal (M2402+20n) does not turn ON, home position return is not ended.

REMARK

The signal types that can be used with home position return by the count method 1 are shown below.

Signal type	Q173DSCPU/ Q172DSCPU	Q173DCPU(-S1)/ Q172DCPU(-S1)
DOG signal of Q172DLX	○	○
External input signal (DOG) of servo amplifier (DOG)	○	○ Ver.1
Built-in interface in Motion CPU (DI)	○	×
Bit device	○	×

○: Usable, ×: Unusable

Ver.1: Refer to Section 1.3 for the software version that supports this function.

6.23.5 Home position return by the count method 2

(1) Count method 2

After the proximity dog ON, the position which traveled the specified distance (travel value after proximity dog ON) is home position in this method.

It is not related for zero point pass or not pass.

A count method 2 is effective method when a zero point signal cannot be taken. (However, dispersions will occur to the stop position at the home position return compared with the count method 1.)

The travel value after proximity dog ON is set in the home position return data (Refer to Section 6.23.1).

(2) Home position return by the count method 2

Operation of home position return by count method 2 is shown below.

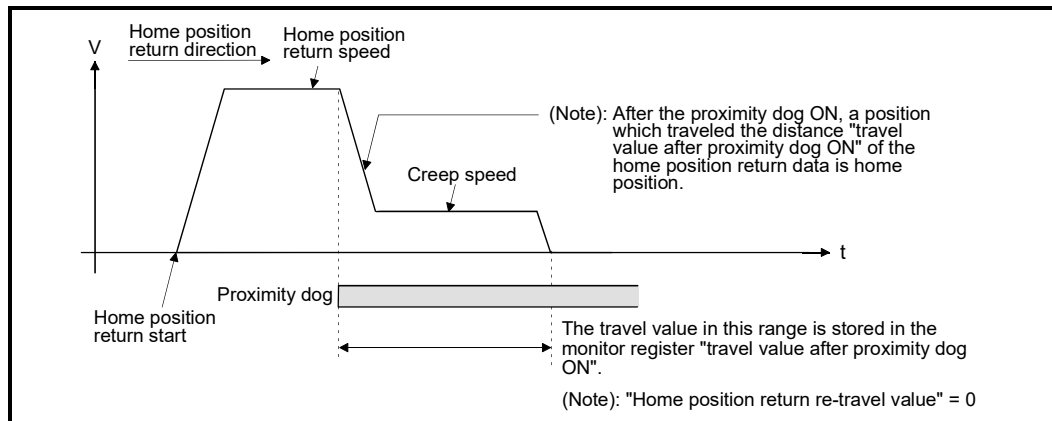

Fig. 6.36 Home position return operation by the count method 2

(3) Home position return execution

Home position return by the count method 2 is executed using the servo program in Section 6.23.19.

(4) Cautions

- (a) Home position return and continuously start of home position return are also possible in the proximity dog ON in the count method 2. When the home position return and continuously start of home position return are executed in the proximity dog ON, the home position return is executed after return the axis once to position of the proximity dog OFF.
- (b) When the "travel value after proximity dog ON" is less than the deceleration distance from "home position return speed" to "creep speed", a minor error (error code: 209) will occur and deceleration stop is made.
- (c) Command position is the home position.
- (d) If in-position signal (M2402+20n) does not turn ON, home position return is not ended.

REMARK

The signal types that can be used with home position return by the count method 2 are shown below.

Signal type	Q173DSCPU/ Q172DSCPU	Q173DCPU(-S1)/ Q172DCPU(-S1)
DOG signal of Q172DLX	○	○
External input signal (DOG) of servo amplifier (DOG) <small>(Note-1)</small>	○	○ Ver.!
Built-in interface in Motion CPU (DI)	○	×
Bit device	○	×

○: Usable, ×: Unusable

(Note-1): The variation for ON/OFF timing of the external input signal (DOG) of servo amplifier may occur according to the input filter setting value of external signal input setting.

Review the input filter setting value compatible with the applications.

Use the Q172DLX or built-in interface in Motion CPU (DI) to execute the high-accuracy control.

Ver.!: Refer to Section 1.3 for the software version that supports this function.

6.23.6 Home position return by the count method 3

(1) Count method 3

After the proximity dog ON, the zero point after the specified distance (travel value after proximity dog ON) is home position in this method.

When the zero point is passed (zero pass signal: M2406+20n ON) during travel of specified distance set in the "travel value after proximity dog ON" from the home position return start, home position return operation is the same as "count method 1". (Refer to Section 6.23.4)

When a zero point is not passed (zero pass signal: M2406+20n OFF) during travel of specified distance set in the "travel value after proximity dog ON" from the home position return start, it rotates one time to reverse direction and passes the zero point, re-travels to home position return direction, and then the first zero point after the specified distance (travel value after proximity dog ON) after proximity dog ON is set as home position.

The travel value after proximity dog ON is set in the home position return data (Refer to Section 6.23.1).

(2) Home position return by the count method 3

Operation of home position return by count method 3 for not passing the zero point during travel of specified distance set in the "travel value after proximity dog ON" from the home position return start is shown below.

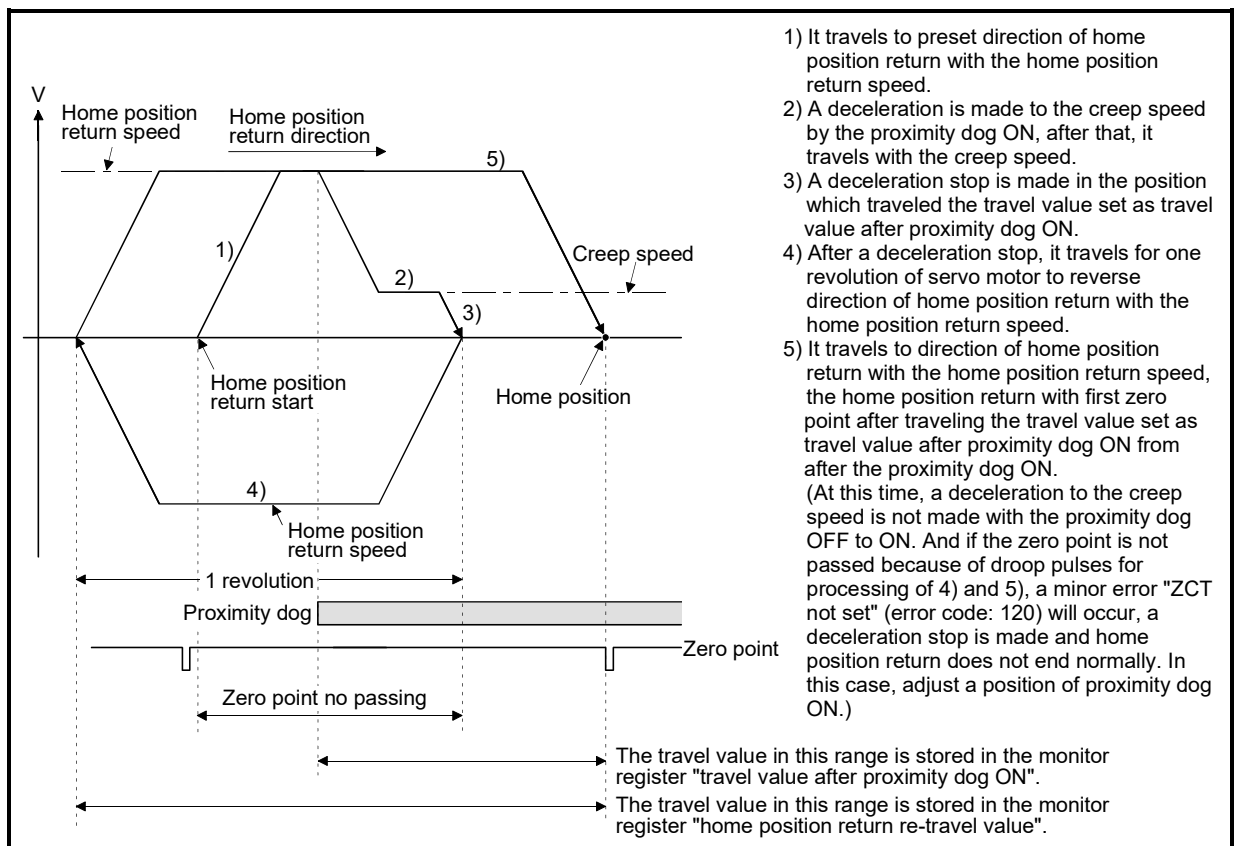

Fig. 6.37 Home position return operation by the count method 3 (zero point no passing)

(3) Home position return execution

Home position return by the count method 3 is executed using the servo program in Section 6.23.19.

(4) Cautions

- (a) A system in which the servo motor can rotate one time or more is required.
- (b) After the proximity dog ON, when a servo motor rotates one time to reverse direction after stop with travel value set in the "travel value after proximity dog ON", make a system which does not turn OFF the external upper/lower stroke limit.
- (c) Home position return and continuously start of home position return are also possible in the proximity dog ON in the count method 3.
When the home position return and continuously start of home position return are executed in the proximity dog ON, the home position return is executed after return the axis once to position of the proximity dog OFF.
- (d) When the "travel value after proximity dog ON" is less than the deceleration distance from "home position return speed" to "creep speed", a minor error (error code: 209) will occur and deceleration stop is made.
- (e) When "1 : Not need to pass motor Z phase after the power supply is switched on" is selected in the "function selection C-4 (PC17)" of servo parameter (expansion setting parameter), even if it does not pass zero point at the servo amplifier power ON, the zero pass signal (M2406+20n) turns ON. This operation is the same as count method 1.
- (f) If in-position signal (M2402+20n) does not turn ON, home position return is not ended.

REMARK

The signal types that can be used with home position return by the count method 3 are shown below.

Signal type	Q173DSCPU/ Q172DSCPU	Q173DCPU(-S1)/ Q172DCPU(-S1)
DOG signal of Q172DLX	○	○
External input signal (DOG) of servo amplifier (DOG)	○	○ Ver.!
Built-in interface in Motion CPU (DI)	○	×
Bit device	○	×

○: Usable, ×: Unusable

Ver.!: Refer to Section 1.3 for the software version that supports this function.

6.23.7 Home position return by the data set method 1

(1) Data set method 1

The proximity dog is not used in this method.

(2) Home position return by the data set method 1

Home position is the command position at the home position return operation.

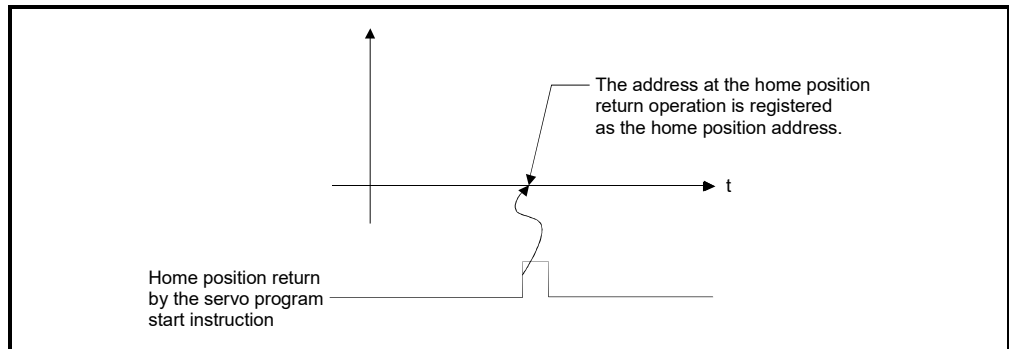

Fig. 6.38 Home position return operation by the data set method 1

(3) Home position return execution

Home position return by the data set method 1 is executed using the servo program in Section 6.23.19.

(4) Cautions

- (a) A zero point must be passed (zero pass signal: M2406+20n ON) between turning ON the power supply and executing home position return. If home position return is executed without passing a zero point once, "no zero point passed error" occurs. If "no zero point passed error" occurred, perform the home position return again after resetting the error and turn the servo motor at least one revolution by the JOG operation. The zero point passing can be confirmed with the zero pass signal (M2406+20n). However, when "1 : Not need to pass motor Z phase after the power supply is switched on" is selected in the "function selection C-4 (PC17)" of servo parameter (expansion setting parameter), even if it does not pass zero point at the servo amplifier power ON, the home position return is possible because the zero pass signal (M2406+20n) turns ON.
- (b) Home position return is started by the data set method 1 when the absolute position system does not support, it becomes same function as the current value change command.
- (c) The home position return data required for the data set method 1 are the home position return direction and home position address.
- (d) If in-position signal (M2402+20n) does not turn ON, home position return is not ended.

6.23.8 Home position return by the data set method 2

(1) Data set method 2

The proximity dog is not used in this method.

(2) Home position return by the data set method 2

Home position is the real position of the servo motor at the home position return operation.

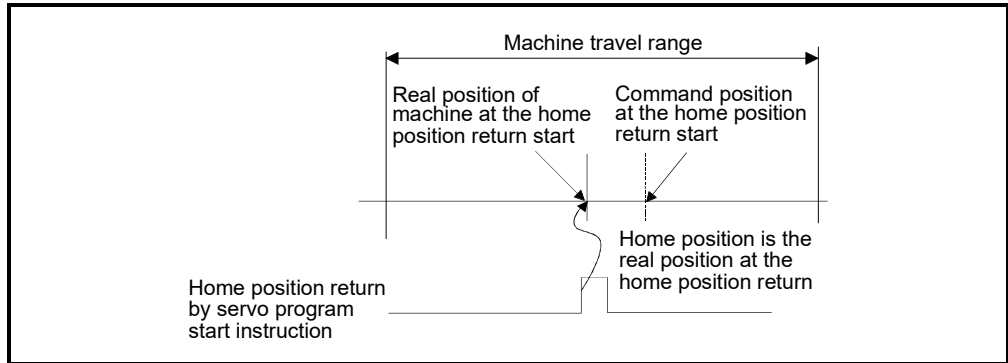

Fig. 6.39 Home position return operation by the data set method 2

(3) Home position return execution

Home position return by the data set method 2 is executed using the servo program in Section 6.23.19.

(4) Cautions

- (a) A zero point must be passed (zero pass signal: M2406+20n ON) between turning on the power supply and executing home position return. If home position return is executed without passing a zero point once, "no zero point passed error" occurs. If "no zero point passed error" occurred, perform the home position return again after resetting the error and turn the servo motor at least one revolution by the JOG operation. The zero point passing can be confirmed with the zero pass signal (M2406+20n). However, when "1 : Not need to pass motor Z phase after the power supply is switched on" is selected in the "function selection C-4 (PC17)" of servo parameter (expansion setting parameter), even if it does not pass zero point at the servo amplifier power ON, the home position return is possible because the zero pass signal (M2406+20n) turns ON.
- (b) The home position return data required for the data set method 2 are the home position return direction and home position address.

6.23.9 Home position return by the dog cradle method

(1) Dog cradle method

After deceleration stop by the proximity dog ON, if the zero point is passed (zero pass signal: M2406+20n ON) after traveling to reverse direction and turning the proximity dog OFF, the deceleration stop is made. And it moves to direction of home position return again with creep speed and the first zero point after proximity dog ON is home position in this method.

(2) Home position return by the dog cradle method

Operation of home position return by the dog cradle method for setting the proximity dog in the home position return direction is shown below.

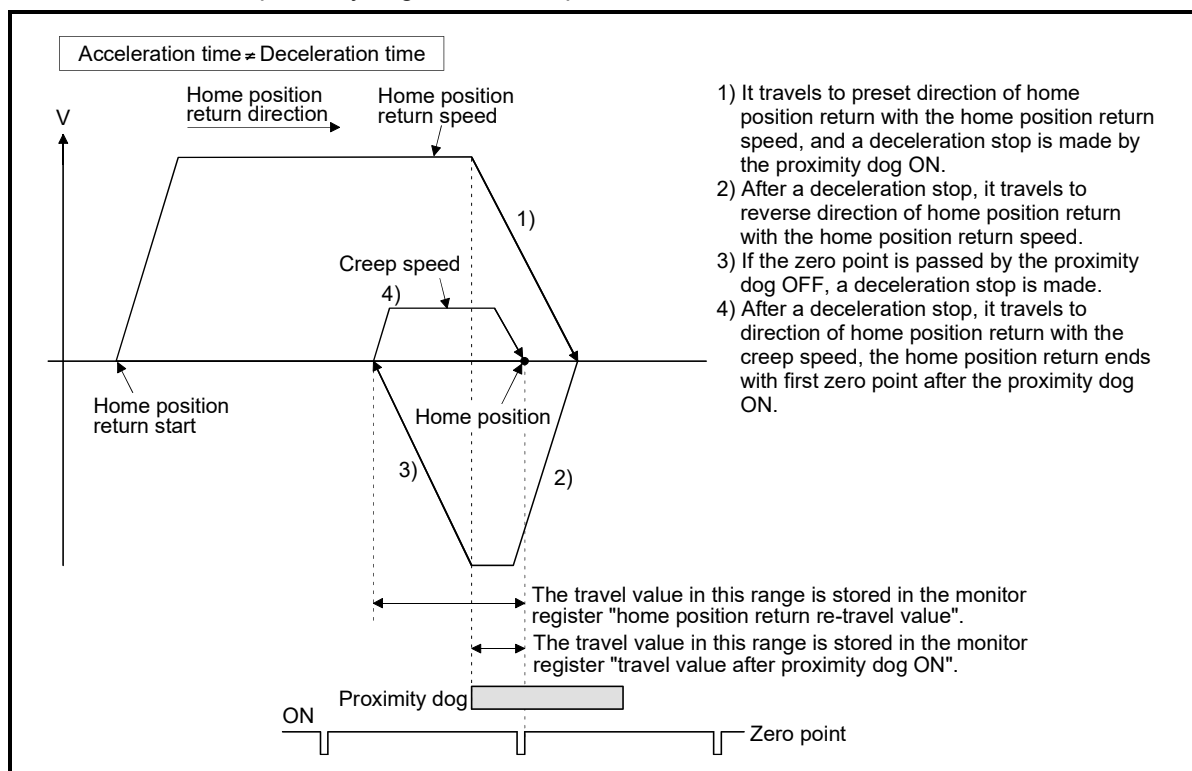

Fig. 6.40 Home position return operation by the dog cradle method

(3) Home position return execution

Home position return by the dog cradle method is executed using the servo program in Section 6.23.19.

(4) Cautions

- (a) When home position return retry function is not set, if home position return is executed again after home position return end, a minor error (error code: 115) will occur, the home position return is not executed.

6 POSITIONING CONTROL

- (b) If the home position return is executed in the proximity dog, it travels to reverse direction of home position return. If proximity dog turns OFF, a deceleration stop is made, it travels to direction of home position return again with the creep speed and the first zero point after proximity dog ON is home position.

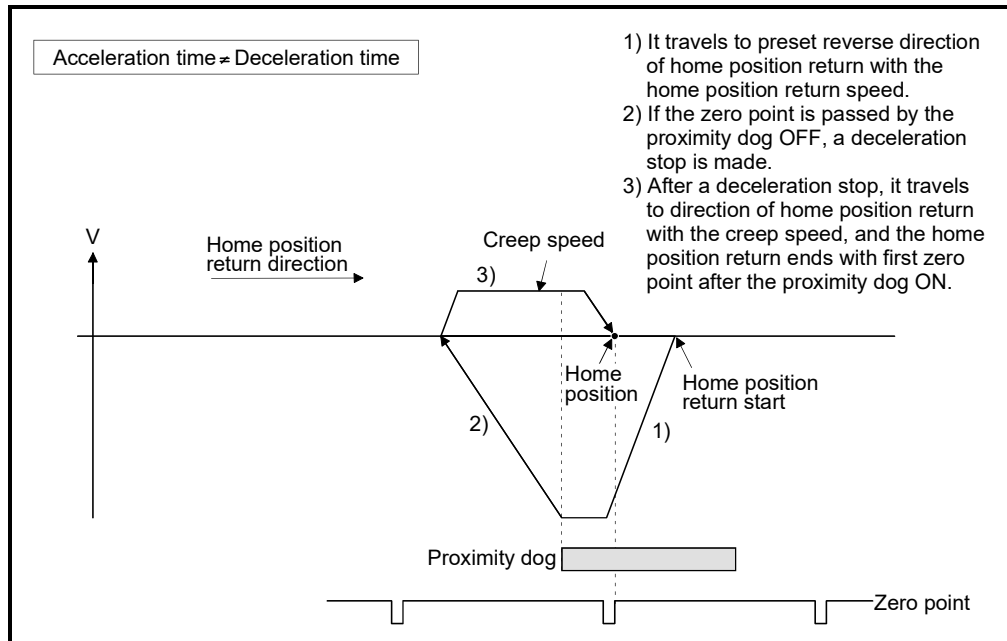

6 POSITIONING CONTROL

- (c) When the proximity dog is set in the home position return direction, the proximity dog is turned OFF during travel to reverse direction of home position return, and the zero point is not passed (zero pass signal: M2406+20n OFF), it continues to travel in the reverse direction of home position return with home position return speed until the zero point is passed. The zero point is passed again during deceleration by zero point pass, the home position becomes this side compared with the case to pass zero point at the time of the proximity dog OFF.

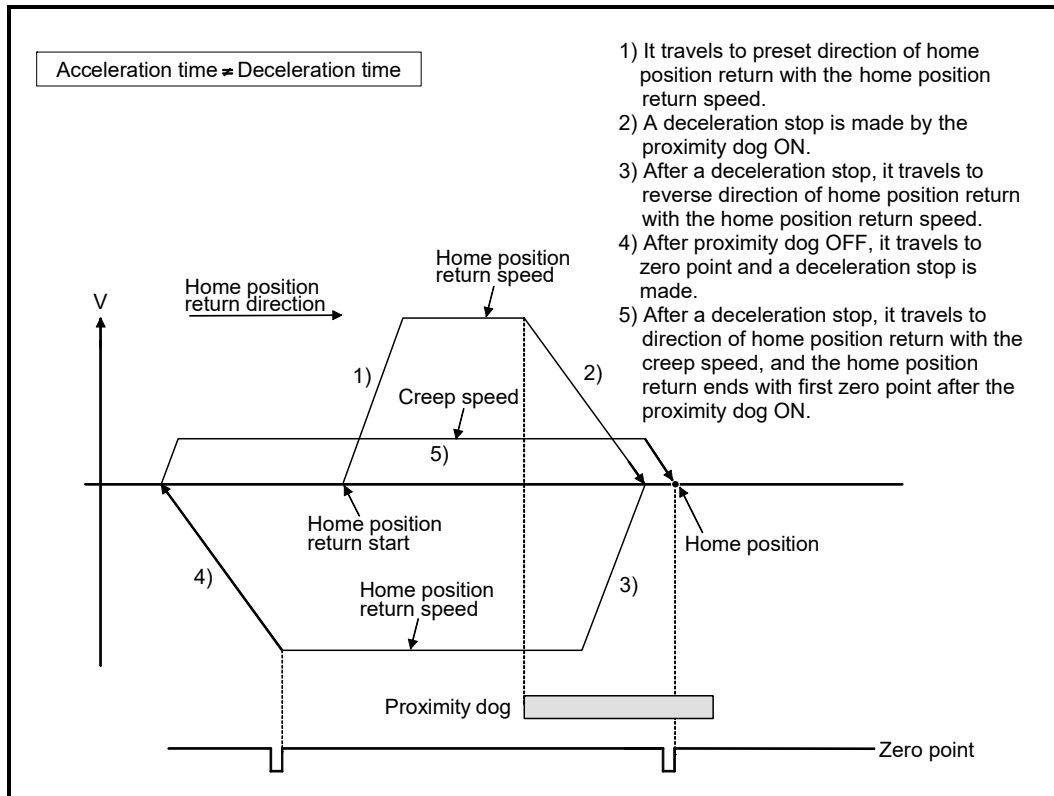

(d) When it starts in the proximity dog, the zero point is not passed (zero pass signal: M2406+20n OFF) at the time of the proximity dog is turned OFF during travel to reverse direction of home position return, it continues to travel with home position return speed until the zero point is passed. The zero point is passed again during deceleration by zero point pass, the home position becomes this side compared with the case to pass zero point at the time of the proximity dog OFF.

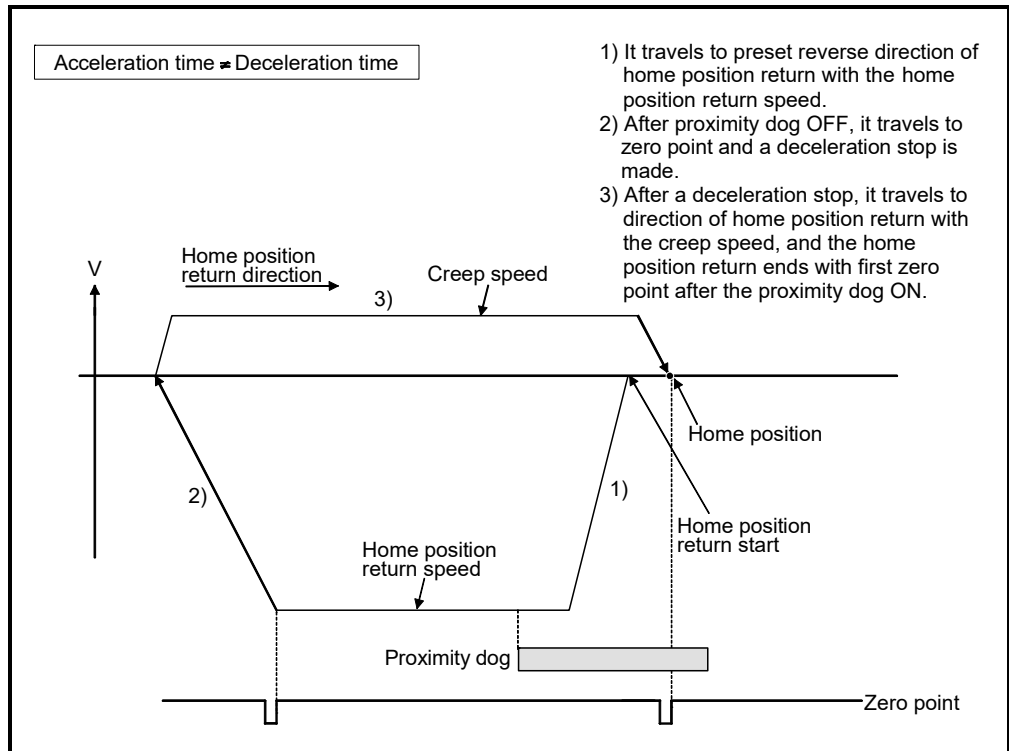

6 POSITIONING CONTROL

- (e) If the zero point is passed during deceleration, the nearest zero point from deceleration stop position to home position return direction is set as the home position.

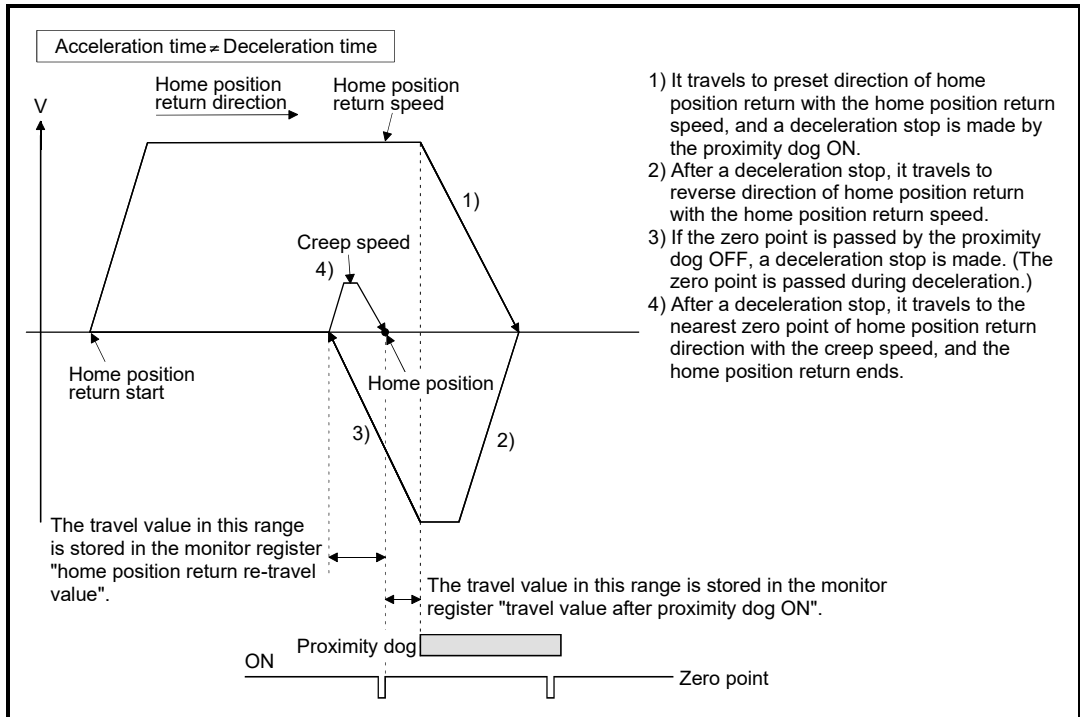

6.23.10 Home position return by the stopper method 1

(1) Stopper method 1

Position of stopper is home position in this method.

It travels to the direction set in the "home position return direction" with the "home position return speed", after a deceleration starts by proximity dog OFF to ON and it presses against the stopper and makes to stop with the torque limit value set in the "torque limit value at the creep speed" and "creep speed" of home position return data. The actual position of the servo motor at the time that the torque limiting signal OFF to ON is detected is the home position.

Torque limit value after reaching creep speed is set in the "torque limit value at the creep speed" of home position return data.

(2) Home position return by the stopper method 1

Operation of home position return by the stopper method 1 is shown below.

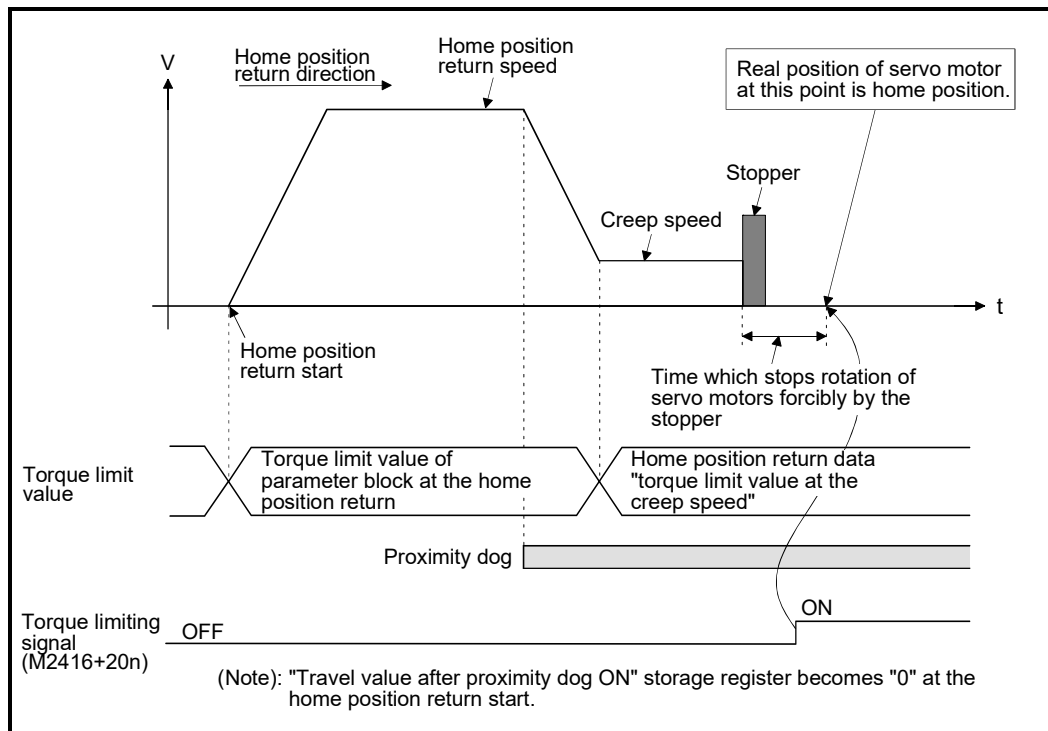

Fig. 6.41 Home position return operation by the stopper method 1

(3) Home position return execution

Home position return by the stopper method 1 is executed using the servo program in Section 6.23.19.

(4) Cautions

- (a) A zero point does not must be passed (zero pass signal: M2406+20n ON) between turning on the power supply and executing home position return.
- (b) Home position return retry function cannot be used in the stopper method 1.
- (c) Set the torque limit value after reaching the creep speed for system.
When the torque limit value is too large, servo motors or machines may be damaged after pressing the stopper. Also, when the torque limit value is too small, it becomes the torque limiting before pressing the stopper and ends the home position return.
- (d) If the home position return is executed again after home position return completion, a minor error (error code: 115) will occur, the home position return is not executed.
- (e) Home position return is started during the proximity dog ON, it is started from the "creep speed".

6.23.11 Home position return by the stopper method 2

(1) Stopper method 2

Position of stopper is home position in this method.

It travels the direction set in the "home position return direction" with the "creep speed", and it presses against the stopper and makes to stop with the "creep speed". (The torque limit value is valid set in the "torque limit value at the creep speed" of the home position return data from the home position return start.)

The actual position of the servo motor at the time that the torque limiting signal OFF to ON is detected is the home position.

Torque limit value after reaching creep speed is set in the "torque limit value at the creep speed" of home position return data.

(2) Home position return by the stopper method 2

Operation of home position return by the stopper method 2 is shown below.

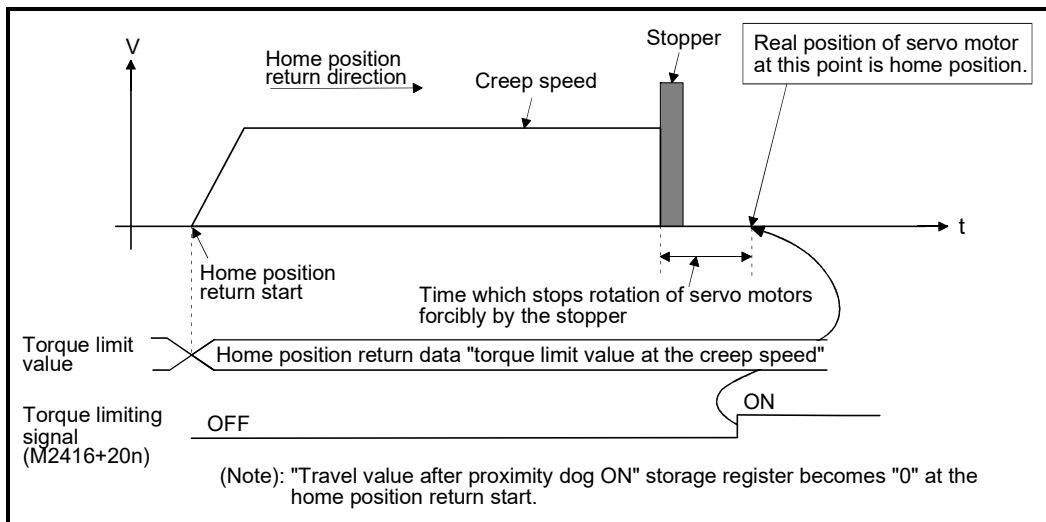

Fig. 6.42 Home position return operation by the stopper method 2

(3) Home position return execution

Home position return by the stopper method 2 is executed using the servo program in Section 6.23.19.

(4) Cautions

- (a) A zero point does not must be passed (zero pass signal: M2406+20n ON) between turning on the power supply and executing home position return.
- (b) Home position return retry function cannot be used in the stopper method 2.
- (c) Set the torque limit value at the reaching creep speed for system.
When the torque limit value is too large, servo motors or machines may be damaged after pressing the stopper. Also, when the torque limit value is too small, it becomes the torque limiting before pressing the stopper and ends the home position return.
- (d) If the home position return is executed again after home position return completion, a minor error (error code: 115) will occur, the home position return is not executed.

6.23.12 Home position return by the limit switch combined method

(1) Limit switch combined method

The proximity dog is not used in this method. Home position return can be executed by using the external upper/lower limit switch.

When the home position return is started, it travels to direction of home position return with "home position return speed". Deceleration is made by turning the limit switch of home position return direction ON to OFF, it travels to reverse direction of home position return with creep speed, and the zero point just before limit switch is home position.

(2) Home position return by the limit switch combined method

Operation of home position return by limit switch combined method for setting the limit switch in the home position return direction is shown below.

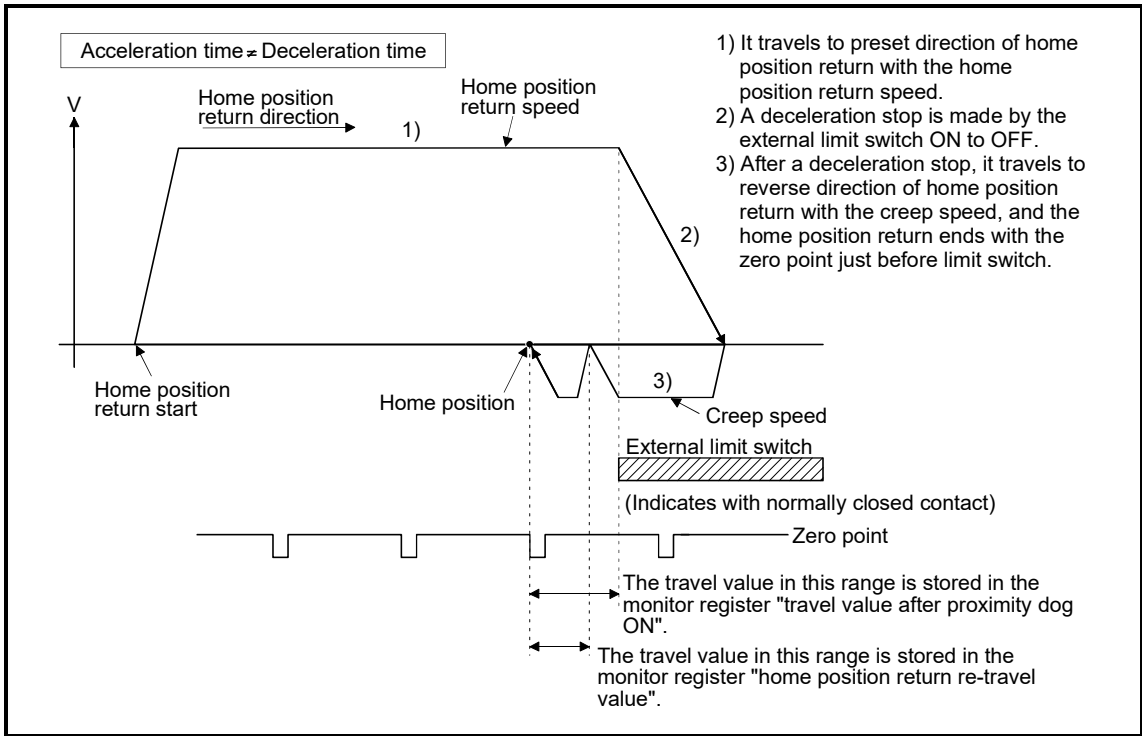

Fig. 6.43 Home position return operation by the limit switch combined method

(3) Home position return execution

Home position return by the limit switch combined method is executed using the servo program in Section 6.23.19.

(4) Cautions

- (a) For the axis which executes the home position return by the limit switch combined method, if the external input signal has not set in the system settings, a minor error (error code: 142) will occur and home position return is not executed.
- (b) When the limit switch reverse to home position return direction is turned ON to OFF, deceleration stop is made, home position return is not completed and a major error (error code : 1101, 1102) will occur.
- (c) Home position return retry function cannot be used in the limit switch combined method.
- (d) If the home position return is executed with the limit switch OFF, it is started to reverse direction of home position return with creep speed.
- (e) When it does not pass (zero pass signal: M2406+20n ON) the zero point from home position return start to deceleration stop by limit switch OFF, a minor error (error code: 120) will occur, a deceleration stop is made and home position return does not end normally. However, when "1 : Not need to pass motor Z phase after the power supply is switched on" is selected in the "function selection C-4 (PC17)" of servo parameter (expansion setting parameter), if the zero point is not passed until from home position return start to deceleration stop by limit switch OFF, the home position return can be executed.
- (f) Deceleration stop is executed after the limit switch OFF. Set the limit switch in expectation of deceleration distance.
- (g) If the in-position signal (M2402+20n) is turned ON, home position return is not ended.
- (h) When the width is in a zero point, the home position differs from the home position return by the proximity dog method 1, proximity dog method 2, count method 1, count method 3, dog cradle method and scale home position signal detection method.

6.23.13 Home position return by the scale home position signal detection method **Ver.!**

(1) Scale home position signal detection method

Home position return is executed using home position signal (zero point). After detecting the proximity dog, it makes to travel to reverse direction of home position return. And the detecting position of home position signal (zero point) is home position in this method.

(2) Home position return by the scale home position signal detection method

Operation of home position return by the scale home position signal detection method for setting the proximity dog in the home position return direction is shown below.

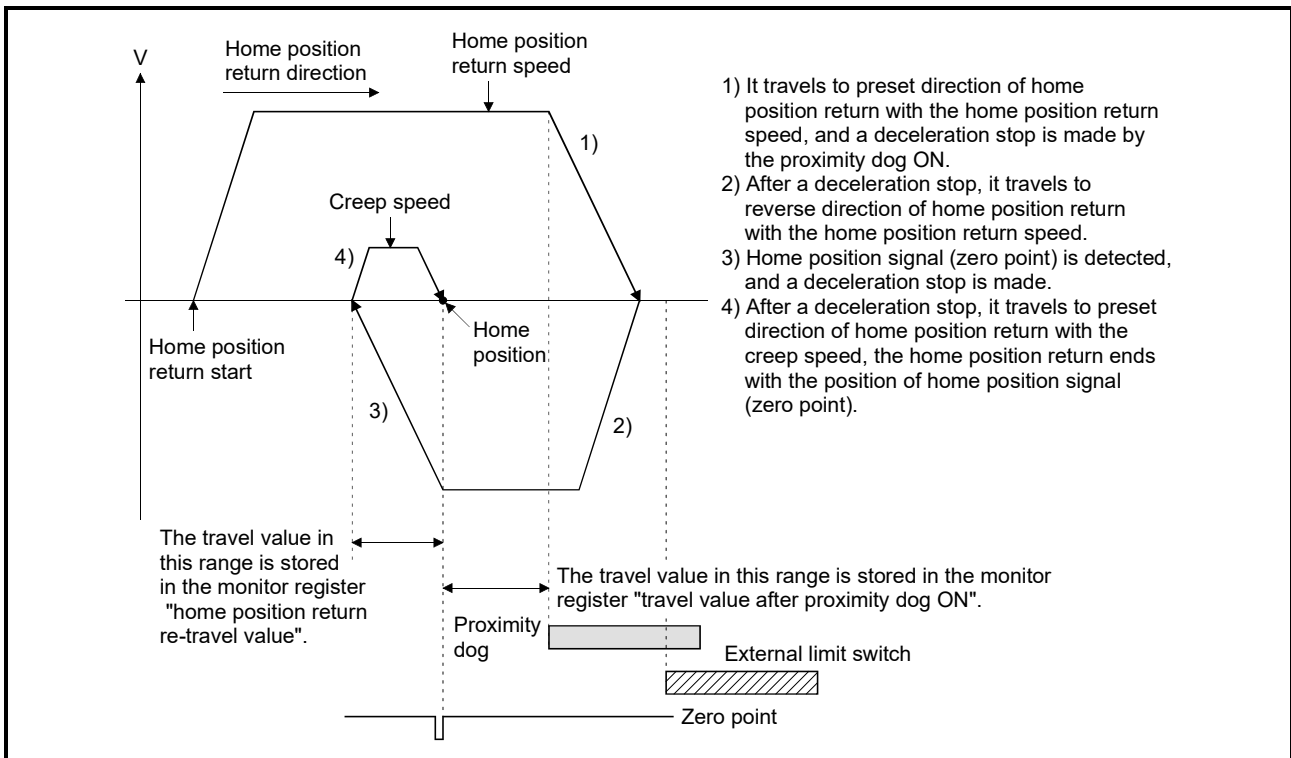

Fig. 6.44 Home position return operation by the scale home position signal detection method

(3) Home position return execution

Home position return by the scale home position signal detection method is executed using the servo program in Section 6.23.19.

Ver.! : Refer to Section 1.3 for the software version that supports this function.

(4) Cautions

- (a) When home position is in the proximity dog, if home position return is executed again after home position return end, a minor error (error code: 123) will occur, the home position return is not executed.
- (b) Set "0: Need to pass motor Z phase after the power supply is switched on" in the "function selection C-4 (PC17)" of servo parameter (expansion setting parameter). When "1: Not need to pass motor Z phase after the power supply is switched on" is set, a minor error (error code: 124) will occur at home position return by the scale home position signal detection method starting, the home position return is not executed.
- (c) When zero pass signal (M2406+20n) turns on by passing zero point at home position return start, this signal turns off once at the reverse direction of home position return start and turns on again at the next zero point passage.
- (d) Home position return is executed in the proximity dog, it travels to reverse direction of home position return. If home position signal (zero point) is detected, a deceleration stop is made, it travels to direction of home position return again with the creep speed and the detecting position of home position signal (zero point) is home position.

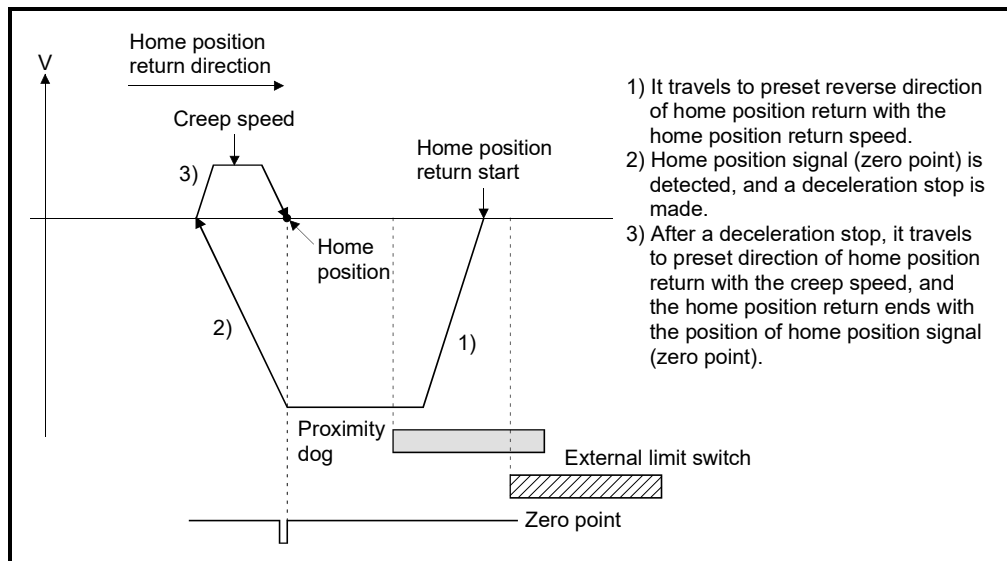

- (e) If the zero point is passed during deceleration, the nearest position of home position signal (zero point) of home position return direction from deceleration stop position is set as the home position.

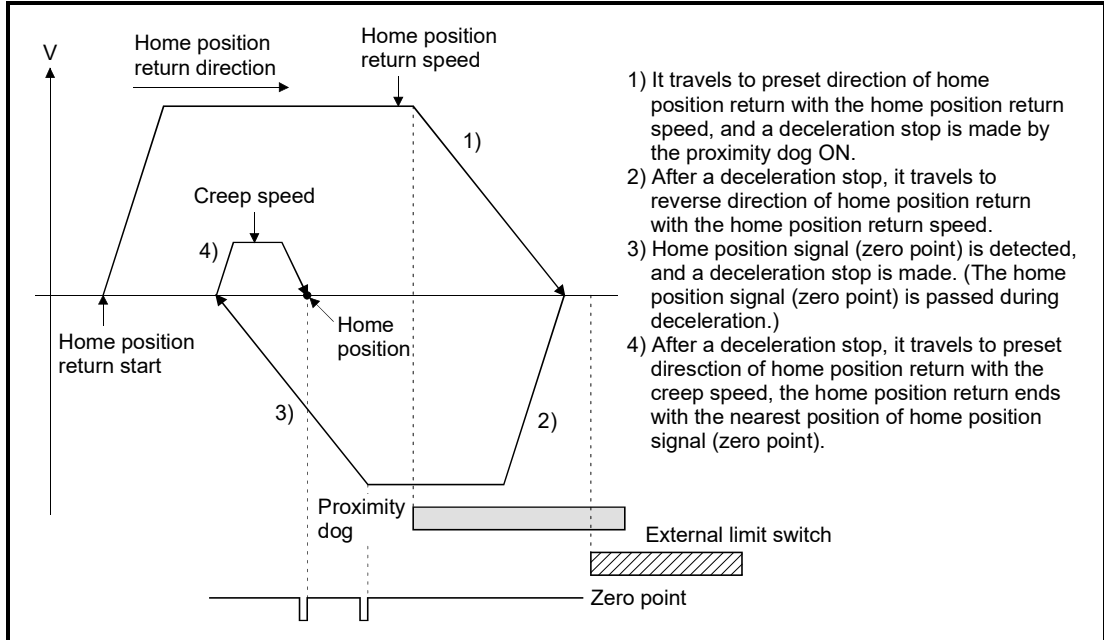

- (f) Home position return retry function cannot be used in the scale home position signal detection method.
- (g) An error always occurs without the proximity dog in home position return direction from home position return starting position, so that the proximity dog is set before limit switch of home position return direction for making the proximity dog overlap in limit switch like Fig. 6.44. And, when home position return is executed in the proximity dog, an error will occur if zero point is not in reverse direction of home position return from home position return starting position.
- (h) When there is only one zero point in the motor like linear motor, home position return may not be ended if zero point is in the proximity dog. Set zero point before the proximity dog.
- (i) If the in-position signal (M2402+20n) is not turned ON, home position return is not ended.

6.23.14 Home position return by the dogless home position signal reference method **Ver.!**

(1) Dogless home position signal reference method

Home position return is executed using home position signal (zero point). This is a home position return method that does not use proximity dogs.

Home position, home position return operation, home position return data (home position return retry function, dwell time at the home position return retry) differ by the servo amplifier connected as shown below.

Also, set the servo parameter "Function selection C-4 (PC17) (Selection of home position setting condition)" as follows.

Servo amplifier model		Linear encoder type	Home position	Home position return operation (Note-1)	Home position return data		servo parameter "Function selection C-4 (PC17) (Selection of home position setting condition)"
					Home position return retry function	Dwell time at the home position return retry	
MR-J5-□B MR-J5W-□B MR-J5-□B-RJ MR-J4-□B MR-J4W-□B MR-J4-□B-RJ	Standard	—	Home position signal (zero point)	Operation B	Invalid	1: Not need to pass motor Z phase after the power supply is switched on.	
	Direct drive motor	—		Operation A			Valid
	Linear servo	Absolute position type	Position where address of absolute linear encoder becomes 0.	Operation C	Invalid	Both	
		Incremental type	Reference mark	Operation A	Valid	0: Need to pass motor Z phase after the power supply is switched on.	
	Fully closed loop control (Note-2)	Absolute position type	Position where address of absolute linear encoder becomes 0.	Operation C	Invalid	Both	
		Incremental type	Reference mark	Operation A	Valid	0: Need to pass motor Z phase after the power supply is switched on.	
MR-J3-□B MR-J3-□B Safety MR-J3W-□B	—	Home position signal (zero point)	Operation B	Invalid	1: Not need to pass motor Z phase after the power supply is switched on.		
MR-J3-□B-RJ004 MR-J3-□B Safety	Absolute position type	Position where address of absolute linear encoder becomes 0.	Operation C		Both		
	Incremental type	Reference mark	Operation A	Valid	0: Need to pass motor Z phase after the power supply is switched on.		
MR-J3-□B-RJ006 (Note-2) MR-J3-□B Safety	Absolute position type	Position where address of absolute linear encoder becomes 0.	Operation C	Invalid	Both		
	Incremental type	Reference mark	Operation A	Valid	0: Need to pass motor Z phase after the power supply is switched on.		
MR-J3-□B-RJ080W	—	Home position signal (zero point)					

(Note-1): Refer to (2) to (4) of this section for home position return operation.

(Note-2): During semi closed loop control is equivalent to MR-J5-□B (standard), MR-J4-□B (standard), and MR-J3-□B.

Ver.! : Refer to Section 1.3 for the software version that supports this function.

(2) Home position return by the dogless home position signal reference method (Operation A)

"Operation A" of a home position return by the dogless home position signal reference type is shown in Fig. 6.45 and Fig. 6.46.

(a) When the zero point is in the home position return direction.

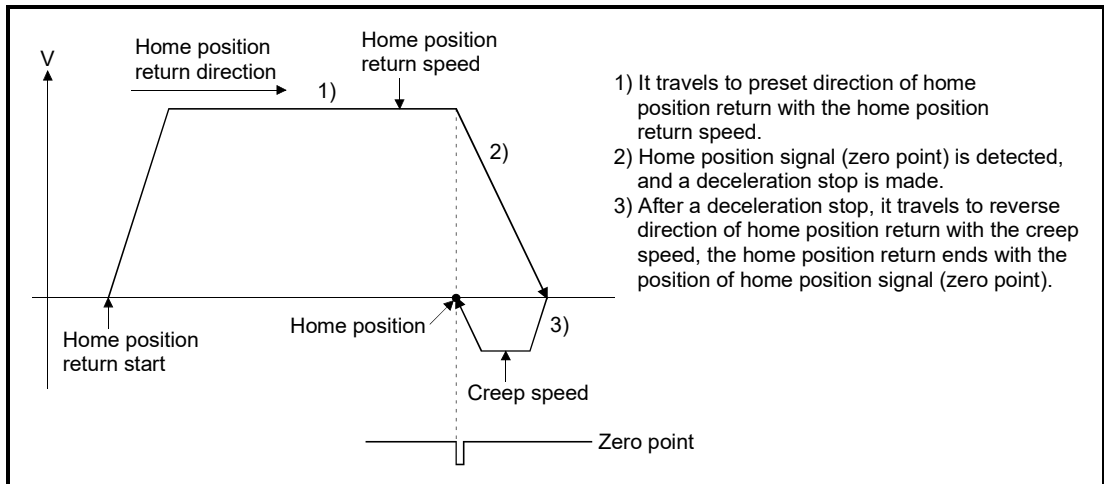

Fig. 6.45 Home position return by the dogless home position signal reference method (Operation A)

POINT

- (1) If an external limit switch is detected during a deceleration stop after zero point detection, an error occurs and stops. Ensure there is enough distance between the zero point signal and external limit switch, or set the deceleration time so the decelerating distance is shortened.
- (2) If multiple home position signals (zero points) are passed during deceleration after zero point detection, by the connected servo amplifier, the following operation occurs.

Servo amplifier model		Operation
MR-J5-□B	Direct drive motor	Home position return ends at the position of the last home position signal (zero point) passed.
MR-J5W-□B		
MR-J5-□B-RJ	Linear servo	Home position return ends at the position of the first home position signal (zero point) passed.
MR-J4-□B		
MR-J4W-□B	Fully closed loop control	
MR-J4-□B-RJ		
MR-J3-□B-RJ004		
MR-J3-□B-RJ006		
MR-J3-□B-RJ080W		Home position return ends at the position of the last home position signal (zero point) passed.

(b) When the zero point is not in the home position return direction.

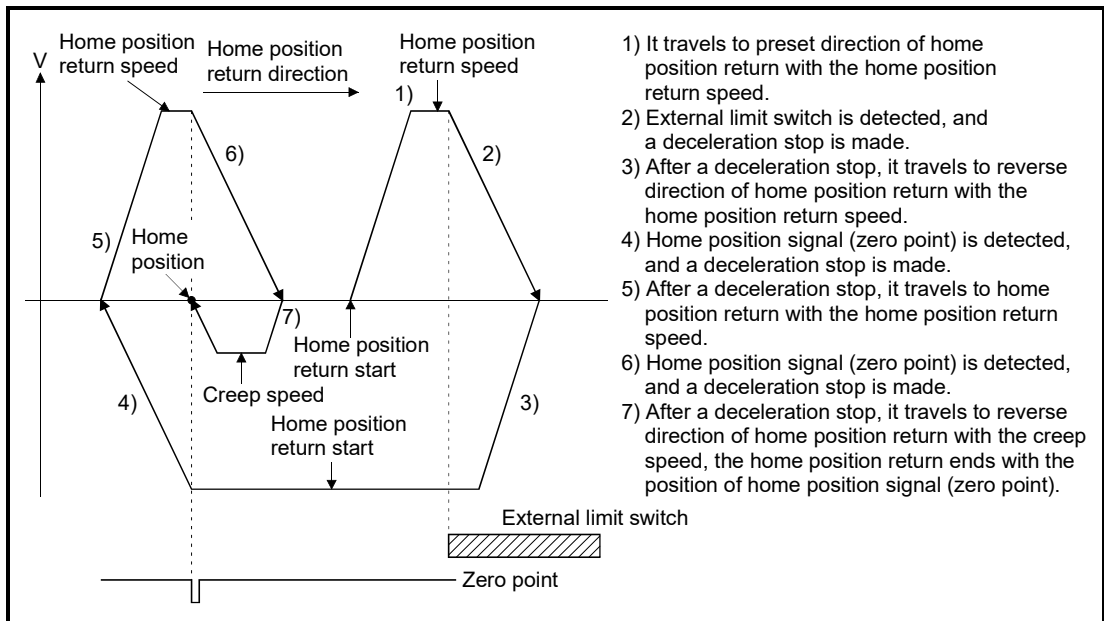

Fig. 6.46 Home position return by the dogless home position signal reference method (Operation A)

POINT
Set home position return retry function to "valid". When set as "invalid" at the detection of the external limit switch, an error occurs and stops.

(3) Home position return by the dogless home position signal reference method (Operation B)

"Operation B" of a home position return by the dogless home position signal reference method is shown below.

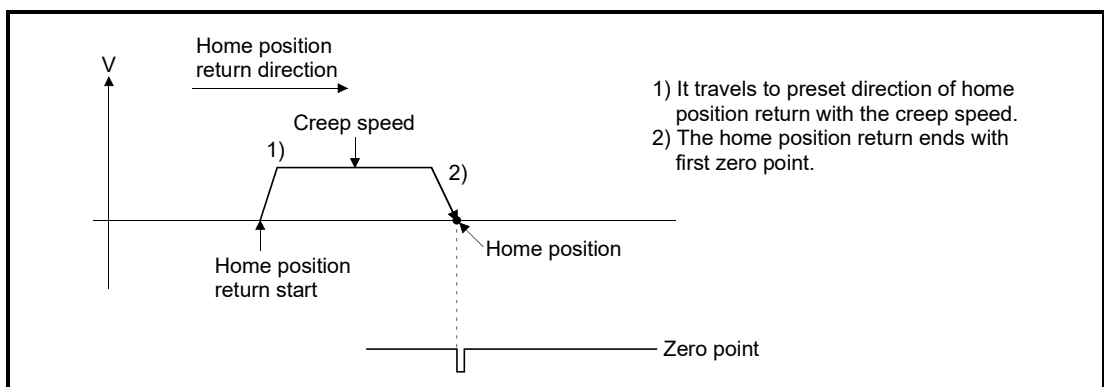

Fig. 6.47 Home position return by the dogless home position signal reference method (Operation B)

POINT
(1) If an external limit switch is detected during home position return operation, an error occurs and stops.
(2) Home position return retry function cannot be used.

(4) Home position return by the dogless home position signal reference method (Operation C)

"Operation C" of a home position return by the dogless home position signal reference method is shown in Fig. 6.48 and Fig. 6.49.

(a) When the position where address of absolute linear encoder becomes 0 is in the home position return direction.

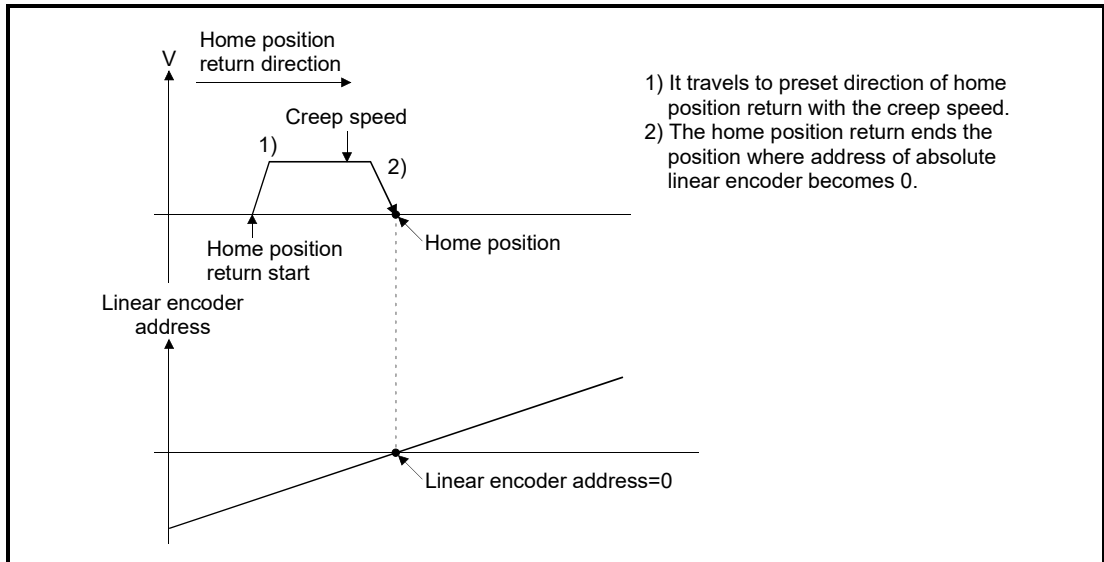

Fig. 6.48 Home position return by the dogless home position signal reference method (Operation C)

POINT
(1) If an external limit switch is detected during home position return operation, an error occurs and stops.
(2) Home position return retry function cannot be used.

(b) When the position where address of absolute linear encoder becomes 0 is not in the home position return direction.

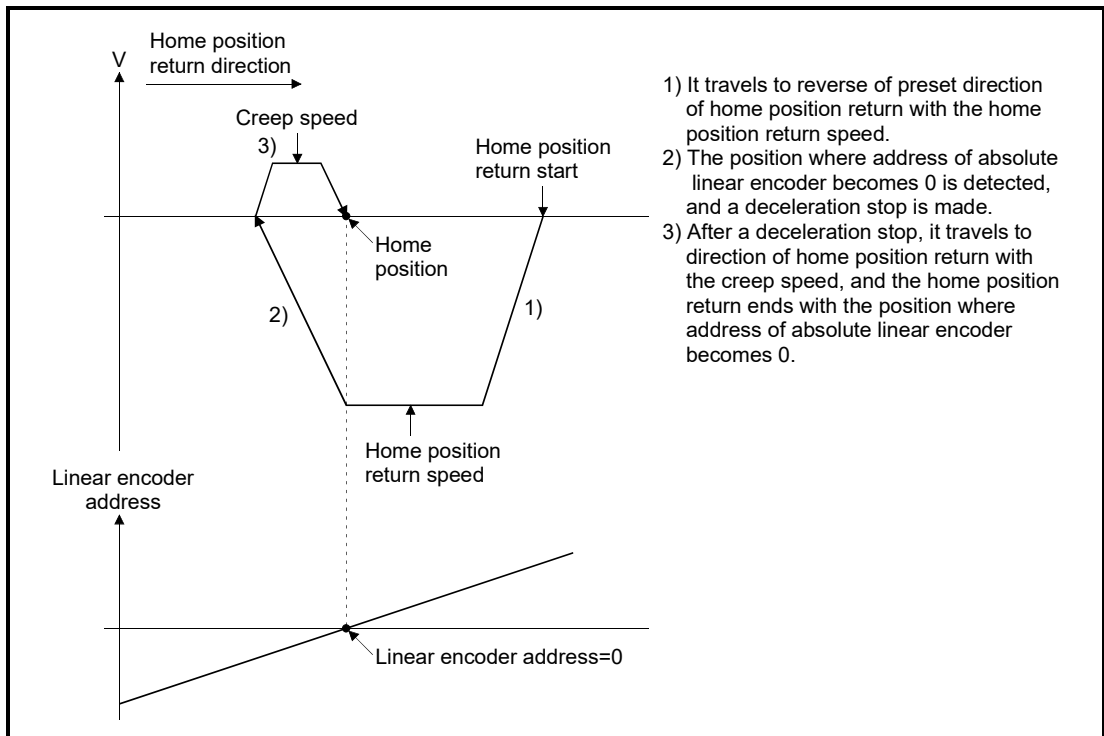

Fig. 6.49 Home position return by the dogless home position signal reference method (Operation C)

POINT
(1) If an external limit switch is detected during home position return operation, an error occurs and stops.
(2) Home position return retry function cannot be used.

(5) Home position return execution

Home position return by dogless home position signal reference method is executed using the servo program in Section 6.23.19.

(6) Cautions

- (a) If a home position return is started for an axis connected with servo amplifiers other than MR-J5(W)-□B, MR-J4(W)-□B, and MR-J3(W)-□B, a minor error (error code: 192) will occur and the home position return is not executed.
- (b) If home position return is executed again after home position return end, a minor error (error code: 115) will occur, the home position return is not executed.
- (c) If connecting a rotational motor on the load side with a fully closed loop control servo amplifier (MR-J5-□B, MR-J4-□B, and MR-J3-□B-RJ006), execute home position return in a semi closed loop control state. (The home position return operation becomes that of "Operation B".)

POINT
<p>If a home position return is performed in a fully closed loop control state, the home position return is at the position of encoder current value of multiple revolution position =0, and single revolution position =0 (The home position return operation becomes that of "Operation C"), and the motor might revolve more than necessary. When connecting a rotational motor on the load side, execute home position return in a semi closed loop control state.</p>

- (d) If executing home position return with a fully closed loop control servo amplifier (MR-J5-□B, MR-J4-□B, and MR-J3-□B-RJ006), do not change fully closed loop control/semi closed loop control during home position return operation. When fully closed loop control/semi closed loop control is changed during home position return operation, the home position return might not be completed normally
- (e) If performing home position return from zero point, depending on the actual motor position at the start, and it's relative position to zero point, the home position return might be completed at the next zero point. It is recommended to move the start of the home position return from the zero point to a position in the in the reverse direction of home position return direction.
- (f) If home position return is executed during operation of amplifier-less operation function:
 - 1) MR-J5(W)-□B/MR-J4(W)-□B
Home position return is executed by the home position return operation stated in amplifier operation mode that is set in amplifier setting of system setting.
 - 2) MR-J3(W)-□B
Regardless of the servo amplifier model, home position return is executed by the home position return operation of "Operation B".

- (g) Home position return by dogless home position signal reference method (Operation A)
 - 1) Set the servo parameter (expansion parameter) "Function selection C-4 (PC17)" to "0: Need to pass motor Z phase after the power supply is switched on". If set to "1: Not need to pass motor Z phase after the power supply is switched on", when home position return by dogless home position signal reference method (operation A) is started, a minor error (error code: 124) will occur and the home position return is not executed.
 - 2) If the zero pass signal (M2046+20n) was on at home position return start, this signal turns off once at the home position return start and turns on again at the next zero point passage.
 - 3) If an external limit switch is detected during a deceleration stop after zero point detection, an error occurs and stops. Ensure there is enough distance between the zero point signal and external limit switch, or set the deceleration time so the decelerating distance is shortened.
 - 4) With home position return retry function valid, if zero point is detected during a deceleration stop after external limit switch is detected, an error occurs and stops.
Set the external limit switch in a position that puts the zero signal inside the external limit switch.
- (h) Home position return by dogless home position signal reference method (Operation B)
 - 1) Set the servo parameter (expansion parameter) "Function selection C-4 (PC17)" to "1: Not need to pass motor Z phase after the power supply is switched on". If set to "0: Need to pass motor Z phase after the power supply is switched on", when home position return by dogless home position signal reference method (operation B) is started, a minor error (error code: 193) will occur and the home position return is not executed.
 - 2) Home position return retry function cannot be used.
- (i) Home position return by dogless home position signal reference method (Operation C)
 - 1) If an external limit switch is detected during home position return operation, an error occurs and stops.
 - 2) Home position return retry function cannot be used.

6.23.15 Home position return by the driver home position return method **Ver.!**

(1) Driver home position return method

The stepping driver performs home position return autonomously based on the positioning patterns set on the stepping driver side. Home position return data is set with the parameters on the stepping driver side.

Driver home position return method cannot be used on anything other than a stepping driver. Refer to the instruction manual of the stepping driver being used for home position return operations and parameters.

(2) Home position return by driver home position return method

The operation for home position return by driver home position return method is shown below.

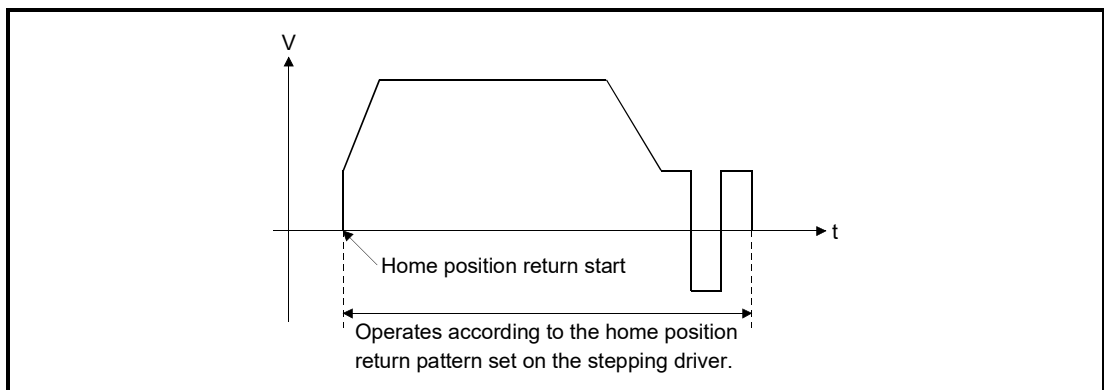

Fig. 6.50 Home position return by driver home position return method

(3) Home position return execution

Home position return by driver home position return method is executed using the servo program in Section 6.23.19.

(4) Cautions

- (a) If a home position return is started for an axis that is not connected to a stepping driver, a minor error (error code: 194) will occur and the home position return is not executed.
- (b) When a stop cause is detected during driver home position return, home position return operation is stopped.
The stopping operation for when a stop cause is detected depends on the stepping driver.
Refer to the instruction manual of the stepping driver being used for details.
- (c) During driver home position return, the home position return is performed based on the home position return direction of the parameters on the stepping driver side. Make sure the home position return direction is the same as home position return direction of the parameters on the stepping driver side.

Ver.! Refer to Section 1.3 for the software version that supports this function.

6.23.16 Home position return retry function

When a current value has been exceeded home position during positioning control, etc., even if it executes the home position return, depending on the position of current value, a current value may not travel to home position direction. In this case, a current value is normally travelled before the proximity dog by the JOG operation, etc, and the home position return is started again. However, by using the home position return retry function, the home position return can be executed regardless of current value position. Refer to Section 6.23.1(7) for home position return method by using the home position return retry function.

[Data Setting]

When the "home position return retry function" is used, set the following "home position return data" using MT Developer2.
 Set the "dwell time at the home position return retry" as required.
 Set the parameters for every axis.

Table 6.4 Home position return data

Items	Setting details	Setting value	Initial value
Home position return retry function	0 : Invalid (Do not execute the home position return retry by limit switch.) 1 : Valid (Execute the home position return retry by limit switch.)	0, 1	0
Dwell time at the home position return retry	The stop time at the deceleration stop during the home position return retry is set.	0 to 5000 [ms]	0

[Control details]

Operation for the home position return retry function is shown below.

- (1) Home position return retry operation setting a current value within the range of external limit switch

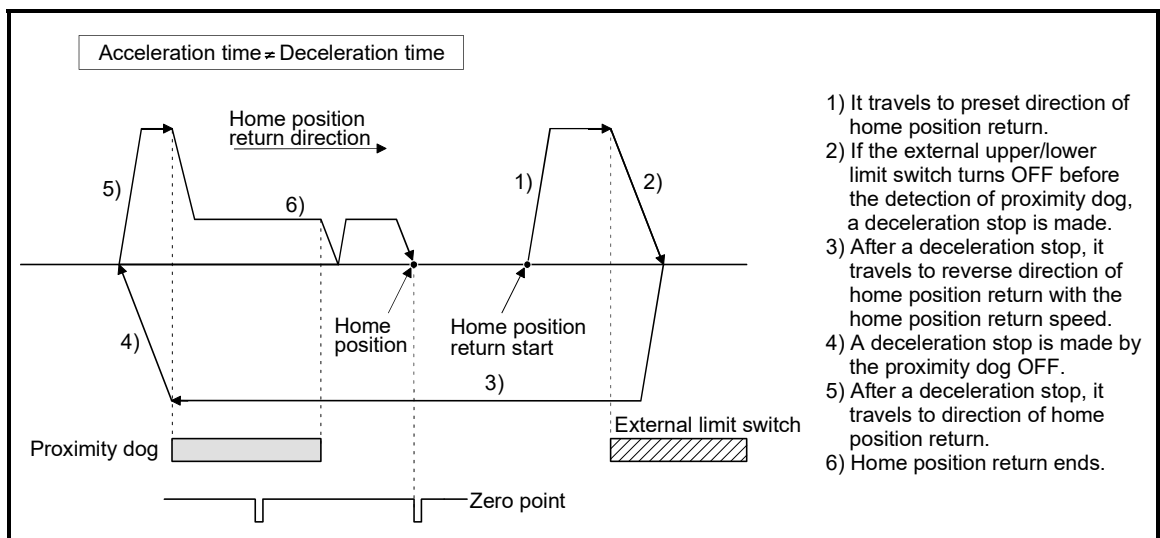
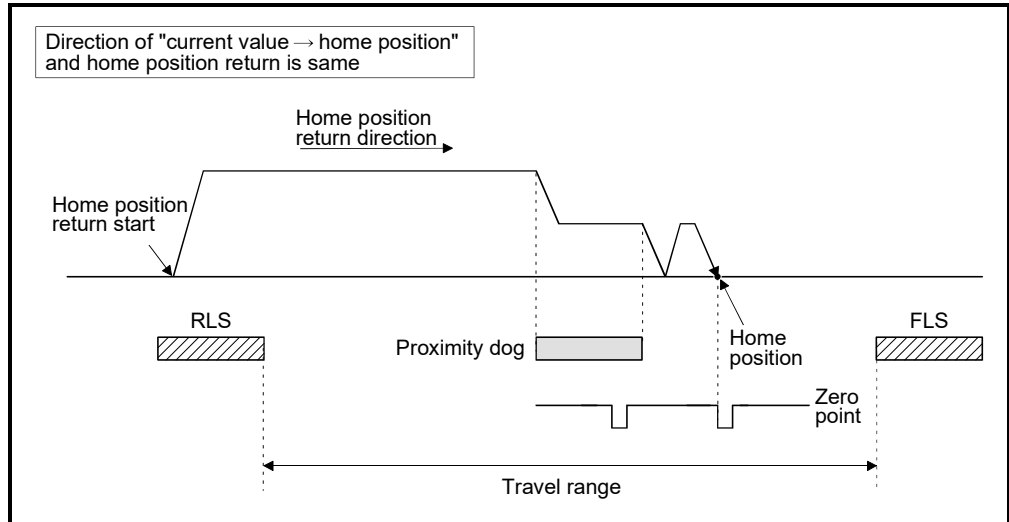

Fig. 6.51 Operation for home position return retry (proximity dog method)

(2) Home position return retry operation setting a current value outside the range of external limit switch

(a) When the direction of "current value → home position" and home position return is same, normal home position return is operated.



(b) When the direction of "current value → home position" and home position return is reverse, deceleration stop is made with the proximity dog OFF and home position return is operated to preset direction of home position return.

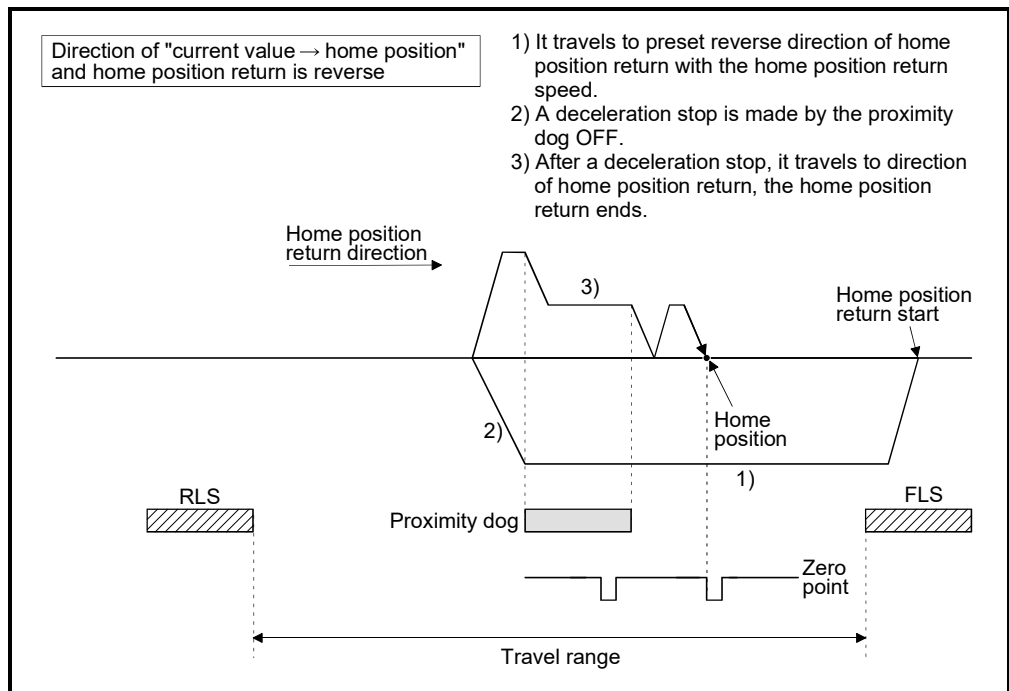

(3) Dwell time setting at the home position return retry

Reverse operation by detection of the external upper/lower limit switch and dwell time function at the home position return start after stop by proximity dog OFF are possible with the dwell time at the home position return retry in the home position return retry function.

Dwell time at the home position return retry becomes valid at the time of deceleration stop of the following 2) and 4). (Dwell time operates with the same value.)

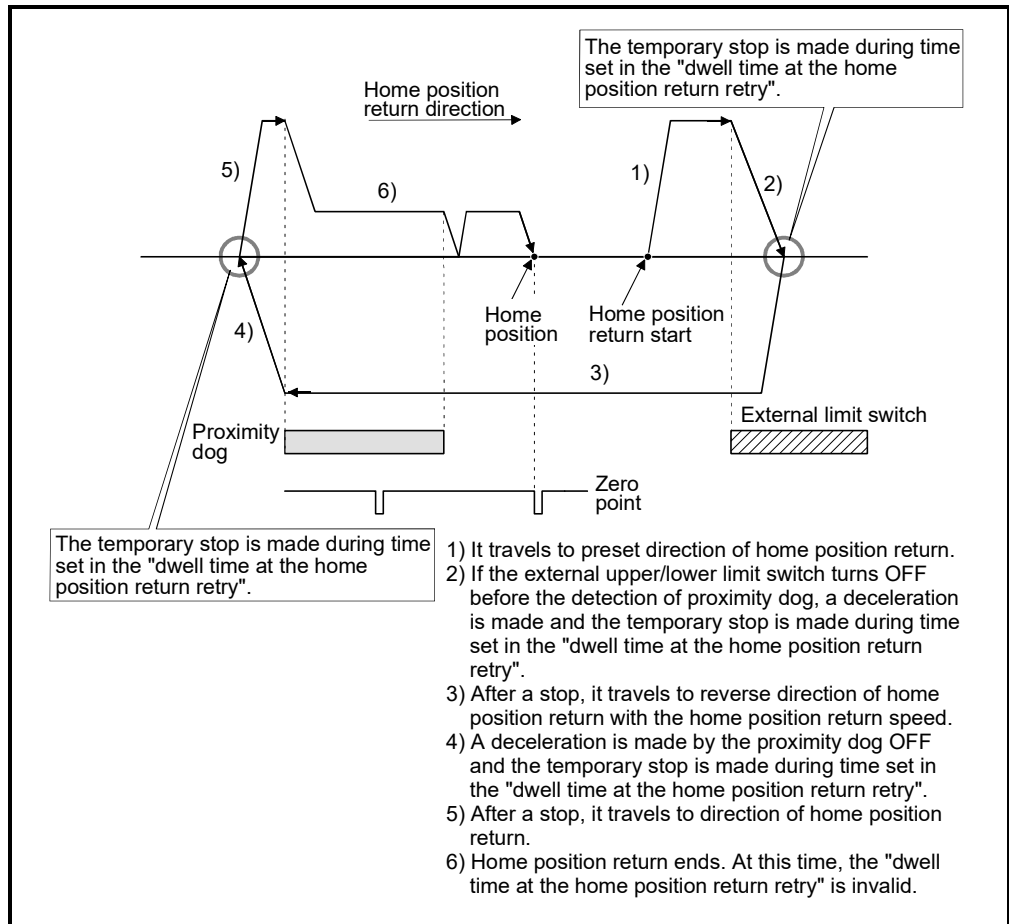

Fig. 6.52 Dwell time setting at the home position return retry

[Cautions]

- (1) Valid/invalid of home position return retry function by the home position return method is shown below.

Home position return methods		Valid/invalid of home position return retry function
Proximity dog method		○
Count method		○
Data set method		×
Dog cradle method		○
Stopper method		×
Limit switch combined method		×
Scale home position signal detection method		×
Dogless home position signal reference method	Operation A	○
	Operation B	×
	Operation C	×
Driver home position return method		×

○: Valid, ×: Invalid

- (2) Make a system for which does not execute the servo amplifier power off or servo OFF by the external upper/lower limit switch. Home position return retry cannot be executed only in the state of servo ON.
- (3) Deceleration is made by detection of the external limit switch and travel to reverse direction of home position return is started. In this case, a major error (error codes: 1001, 1002, 1101, 1102) will not occur.

⚠ CAUTION

- Be sure to set the external limit switch (FLS, RLS) in the upper/lower position of machines. If the home position return retry function is used without external limit switch, servo motors continue rotating.

6.23.17 Home position shift function

Normally, when the machine home position return is executed, a position of home position is set by using the proximity dog or zero point signal. However, by using the home position shift function, the position to which only the specified travel value was travelled from the position which detected the zero point signal can be regarded as home position.

[Data Setting]

Set the following "home position return data" using MT Developer2 to use the home position shift function.

Refer to Section 6.23.1(7) for home position return method by using the home position shift function.

Set the parameters for every axis.

Table 6.5 Home position return data

Items	Setting details	Setting value	Initial value
Home position shift amount	The shift amount at the home position shift is set.	-2147483648 to 2147483647 [$\times 10^{-1}\mu\text{m}$, $\times 10^{-5}\text{inch}$, 10^{-5}degree , pulse]	0
Speed set at the home position shift	The speed at the home position shift is set.	0 : Home position return speed 1: Creep speed	0

[Control details]

(1) Home position shift operation

Operation for the home position shift function is shown below.

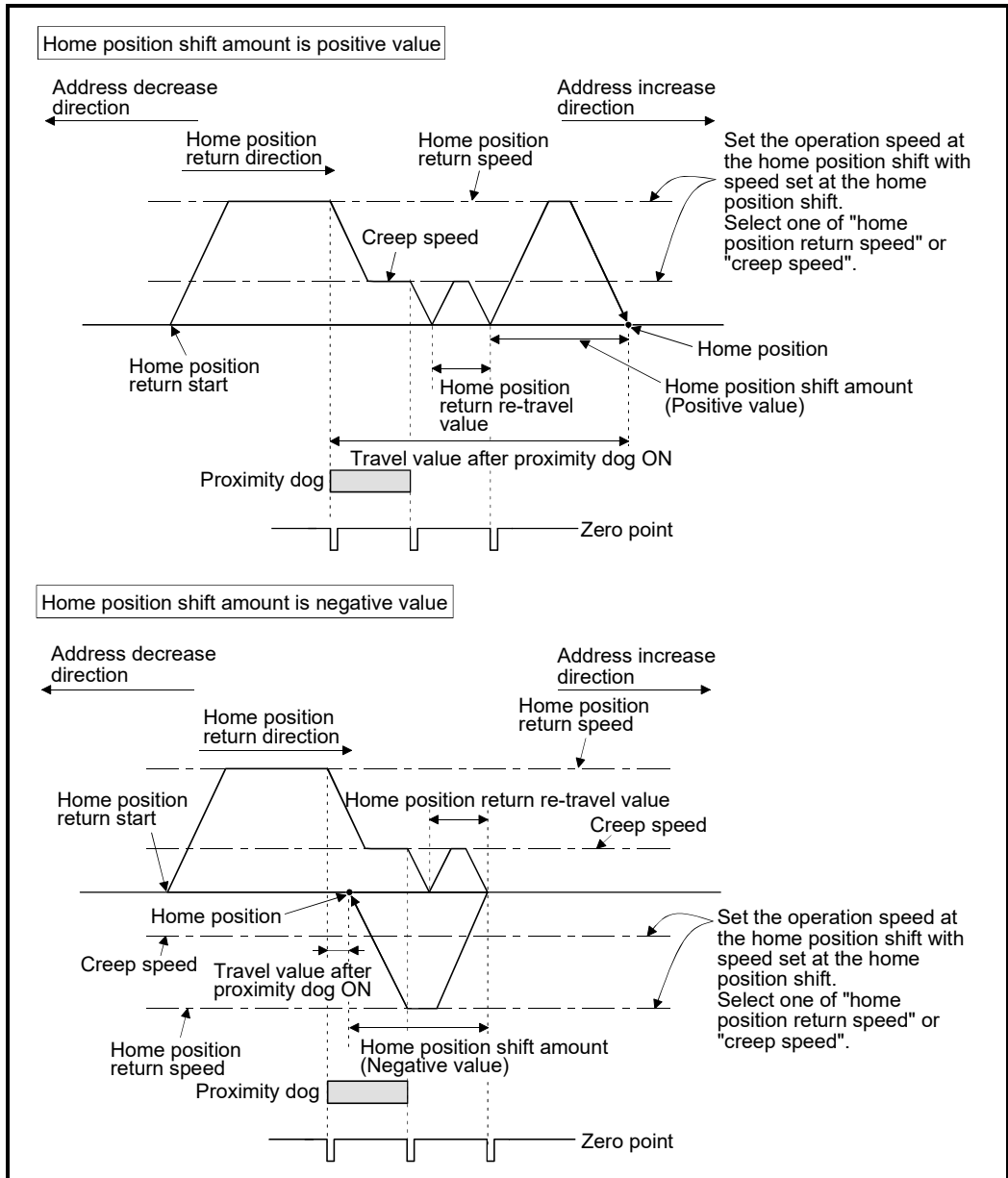

Fig. 6.53 Operation for home position shift

(2) Setting range of home position shift amount

Set the home position shift amount within the range of from the detected zero signal to external upper/lower limit switch (FLS/RLS). If the range of external upper/lower limit switch is exceeded, a major error (error code: 1102, 1103) will occur at that time and the home position return is not ended.

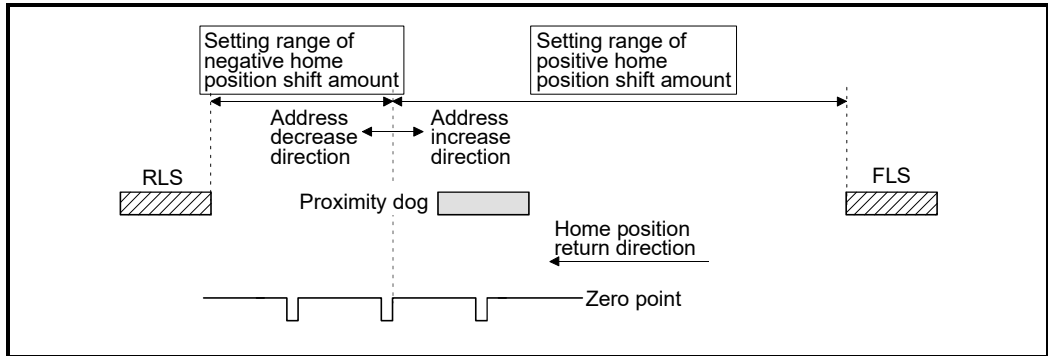

Fig. 6.54 Setting range of home position shift amount

(3) Travel speed at the home position shift

When the home position shift function is used, set the travel speed at the home position shift as the speed set at the home position shift. Either the home position return speed or creep speed is selected as the travel speed at the home position shift.

The travel speed at the home position shift for the home position return by proximity dog method is shown below.

(a) Home position shift operation with the "home position return speed"

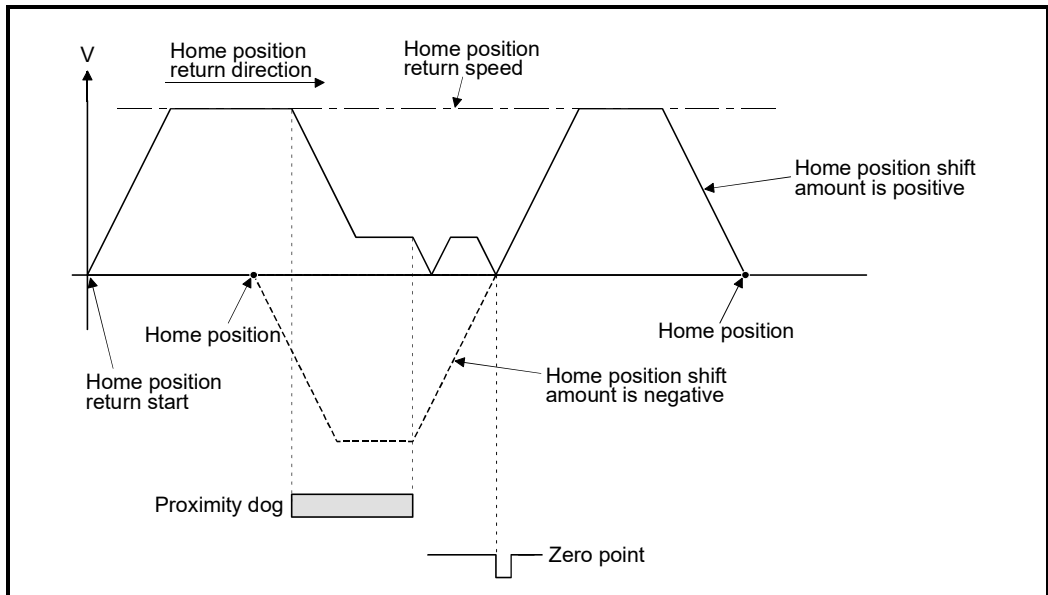

Fig. 6.55 Operation for home position shift with the home position return speed

(b) Home position shift operation with the "creep speed"

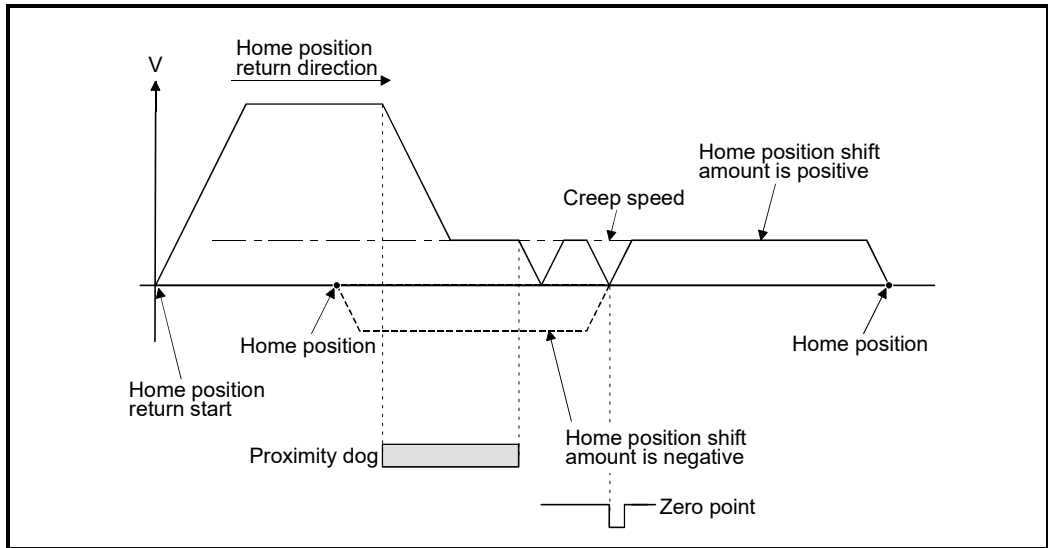

Fig. 6.56 Operation for home position shift with the creep speed

[Cautions]

- (1) Valid/invalid of home position shift amount setting value by the home position return method.

Home position return methods	Valid/invalid of home position return retry function
Proximity dog method	○
Count method	○
Data set method	×
Dog cradle method	○
Stopper method	×
Limit switch combined method	○
Scale home position signal detection method	○
Dogless home position signal reference method	○
Driver home position return method	×

○: Valid, ×: Invalid

- (2) Axis monitor devices and axis statuses are set after completion of home position shift.
- (3) When the home position return by proximity dog method set the travel value after proximity dog ON and home position shift amount within the range of "-2147483648 to 2147483647" [$\times 10^{-1} \mu\text{m}$, $\times 10^{-5}$ inch, 10^{-5} degree, pulse].

6.23.18 Home position set condition selection

A home position return must be made after the servo motor has been rotated more than one revolution to pass the axis through the Z-phase (motor reference position signal) and the zero pass signal (M2406+20n) has been turned ON.

When "1 : Not need to pass motor Z phase after the power supply is switched on" is selected in "Function selection C-4 (PC17), Selection of home position setting condition" in the servo parameter (expansion setting parameter), the zero pass signal (M2406+20n) can be turned ON even if the servo motor does not pass zero point with the motor rotation after turning the servo amplifier power ON.

[Data Setting]

Set the following "Servo parameter" using MT Developer2 to select "Function selection C-4 (PC17)".

Set the servo parameters for every axis.

Table 6.6 Servo parameter (expansion setting parameter)

Items	Setting details	Setting value	Initial value
Function selection C-4 (PC17) (Selection of home position setting condition)	Set the home position set condition for the absolute position system.	0: Need to pass motor Z phase after the power supply is switched on 1: Not need to pass motor Z phase after the power supply is switched on	0

[Cautions]

- (1) When "1 : Not need to pass motor Z phase after the power supply is switched on" is set as the above servo parameter, a restrictions such as "make the home position return after the servo motor is rotated more than one revolution to pass the axis through the Z-phase (motor reference position signal) " is lost.
- (2) When "1 : Not need to pass motor Z phase after the power supply is switched on" is selected in the "function selection C-4 (PC17)" of servo parameter (expansion setting parameter), if it does not pass zero point at the servo amplifier power ON, the zero pass signal (M2406+20n) turns ON.
- (3) When the above parameter is changed, turn the servo amplifier control circuit power OFF to ON after resetting or turning power OFF to ON of Multiple CPU system.

POINT

- | |
|---|
| <p>(1) Set "0: Need to pass motor Z phase after the power supply is switched on" in the "function selection C-4 (PC17)" of servo parameter (expansion setting parameter) for the home position return by the scale home position signal detection method.</p> <p>If "1: Not need to pass motor Z phase after the power supply is switched on" is set, a minor error (error code: 124) will occur at the home position return start and the home position return is not executed.</p> <p>(2) When executing home position return by dogless home position signal reference method, set the servo parameter (expansion parameter) "Function selection C-4 (PC17)" by the servo amplifier connected.</p> <p>(Refer to Section 6.23.14)</p> |
|---|

[Program]

Servo program No. 0 for home position return is shown as the following conditions.

(1) System configuration

Home position return of Axis 4.

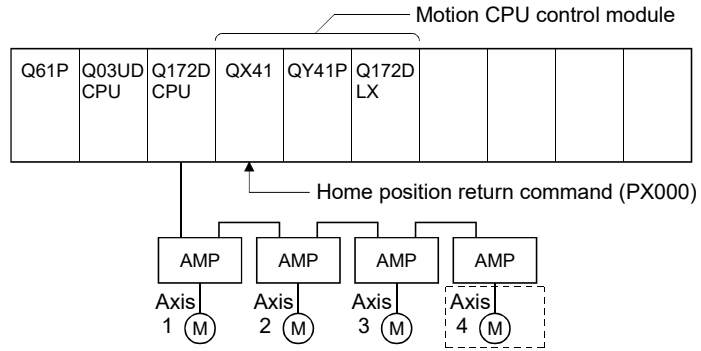

(2) Servo program example

Servo program No. 0 for home position return is shown below.

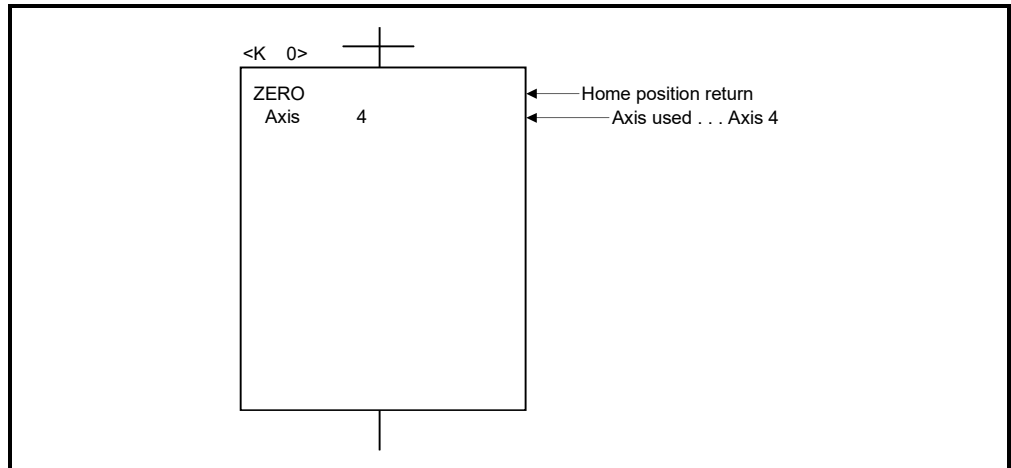

(3) Motion SFC program

Motion SFC program for which executes the servo program is shown below.

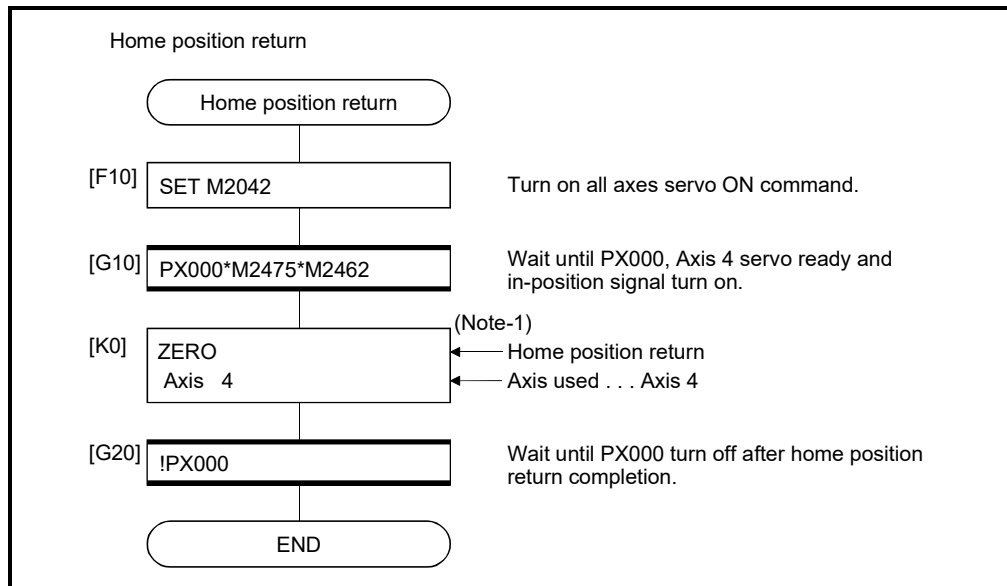

(Note-1): It is necessary to turn on the zero pass signal before execution of the home position return instruction for data set method home position return.

(Note-2): Example of the above Motion SFC program is started using the automatic start or sequence program.

[Cautions]

If the home position is not within the in-position range of servo parameter, it does not mean having reached the home position and the home position return does not end in the proximity dog method, count method, data set method 1, dog cradle method, limit switch combined method, scale home position signal detection method, dogless home position signal reference method, or driver home position return method home position return. In this case, adjusts the in-position range of servo parameter or position control gain.

6 POSITIONING CONTROL

6.24 High-Speed Oscillation

Positioning of a specified axis is caused to oscillate on a sine wave.

Servo instruction	Positioning method	Number of control axes	Items set using MT Developer2																				Speed change				
			Common										OSC			Parameter block						Others					
			Parameter block No.	Axis	Address/travel value	Command speed	Dwell time	M-code	Torque limit value	Starting angle	Amplitude	Frequency	Interpolation control unit	Speed limit value	Acceleration time	Deceleration time	Rapid Stop deceleration time	Torque limit value	Deceleration processing on stop input	Allowable error range for circular interpolation	S-curve ratio	Advanced S-curve acceleration/deceleration		Cancel	WAIT-ON/OFF		
OSC	—	1	△	○					△		○	○	○											△			Invalid

○ : Must be set
△ : Set if required

[Control details]

The designated axis caused to oscillate on a specified sine wave.
Acceleration/deceleration processing is not performed.

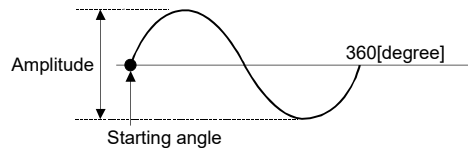

- (1) **Amplitude**
Set the amplitude of the oscillation in the setting units.
The amplitude can be set within the range of 1 to 2147483647.
- (2) **Starting angle**
Set the angle on the sine curve at which oscillation is to start.
The setting range is 0 to 359.9 [degree]
- (3) **Frequency**
Set how many sine curve cycles occur in one minute.
The setting range is 1 to 5000 [CPM].

POINT

Since acceleration/deceleration processing is not performed, you should set the starting angle to 90 or 270 [degree] in order to avoid an abrupt start.

6 POSITIONING CONTROL

[Cautions]

- (1) If the amplitude setting is outside the range, the servo program setting error (error code: 25) occurs and operation does not start.
- (2) If the starting angle setting is outside the range, the servo program setting error (error code: 26) occurs and operation does not start.
- (3) If the frequency setting is outside the range, the servo program setting error (error code:27) occurs and operation does not start.
- (4) Operation is continually repeated until a stop signal is input after the start.
- (5) Speed changes during operation are not possible. Attempted speed changes will cause minor error (error code:310).
- (6) Do not use the high-speed oscillation in the axis that invalidates a stroke limit of control unit "degree".

[Program]

An example of a program for high-speed oscillation is shown below.

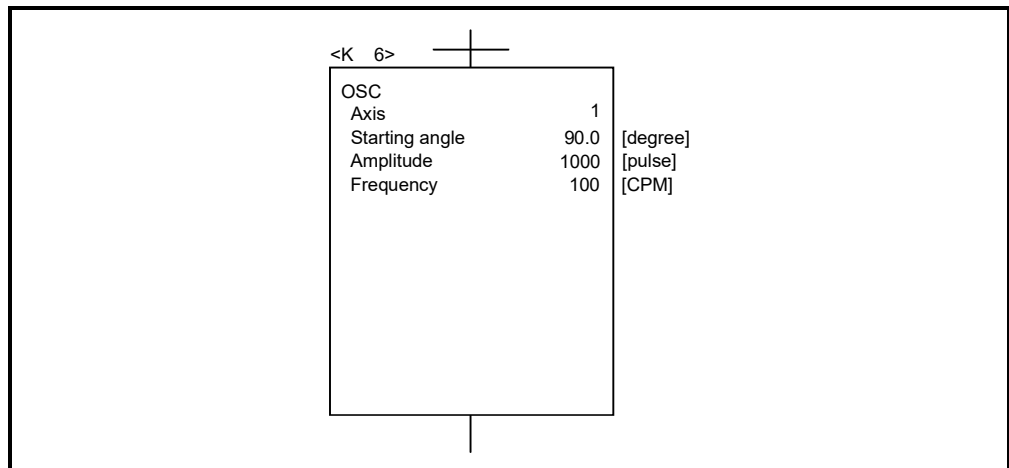

7. AUXILIARY AND APPLIED FUNCTIONS

This section describes the auxiliary and applied functions for positioning control in the Multiple CPU system.

7.1 M-code Output Function

M-code is a code No. between 0 and 32767 which can be set for every positioning control. During positioning control, these M-codes are read using the Motion SFC program to check the servo program during operation and to command auxiliary operations, such as clamping, drill rotation and tool replacement.

(1) Setting of M-codes

M-code can be set using MT Developer2 at the creation and correction of the servo program.

(2) Storage of M-code and read timing

(a) M-codes are stored in the M-code storage register of the axis specified with the positioning start completion and specified points (at the speed switching control or constant-speed control).

During interpolation control, the M-codes are stored in all axes which perform interpolation control.

(b) When the M-code is read at the positioning start completion, use the positioning start complete signal (M2400+20n) as the reading command.

(c) When the M-code is read at positioning completion, use the positioning complete signal (M2401+20n) as the read command.

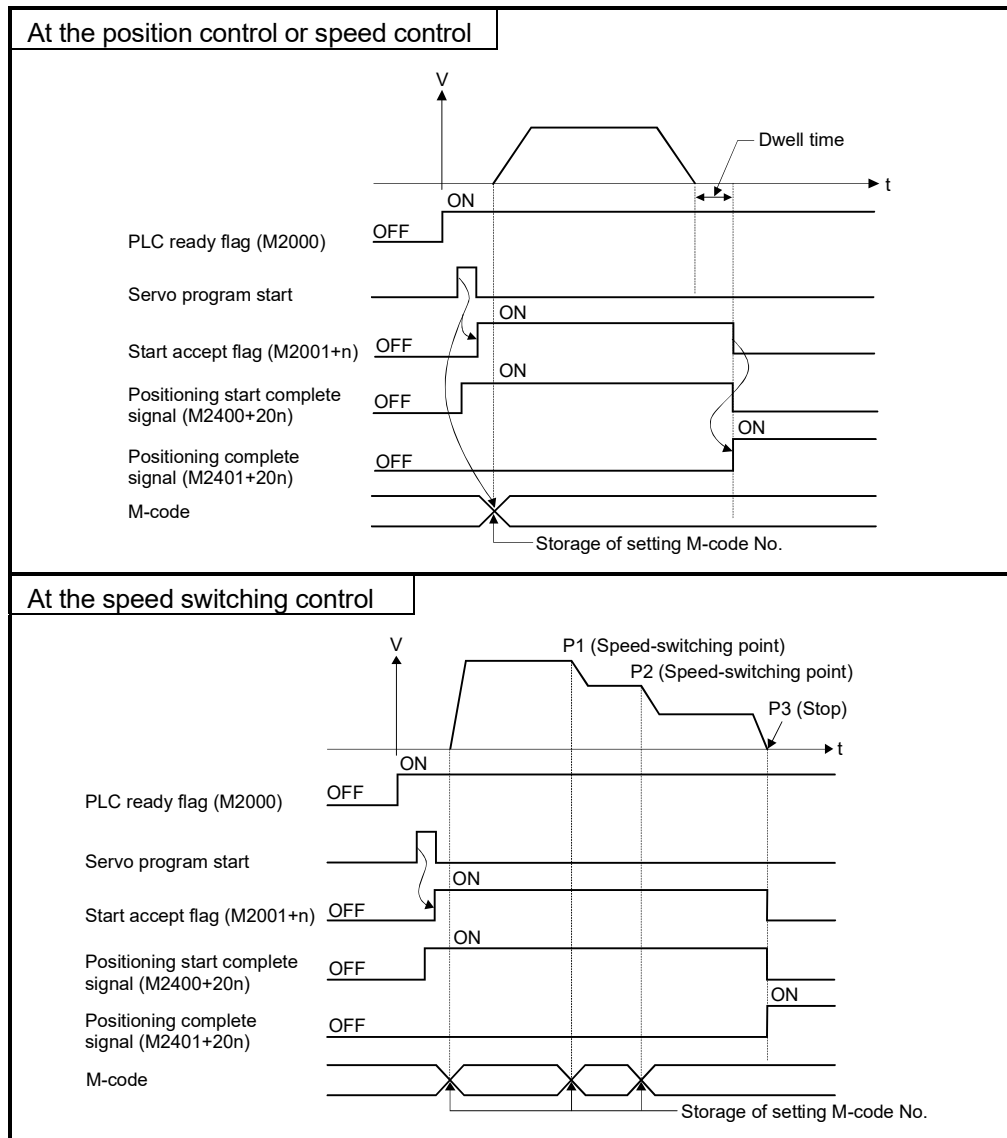

(3) Resetting of M-codes

M-codes can be reset by setting of the M-code output devices to zero.

Use this method during positioning control to perform operations unrelated to the servo program, such as when it has been difficult to output the M-code during the previous positioning control.

However, M-code is set during the speed switching control or constant-speed control, the M-code output of the servo program takes priority.

7 AUXILIARY AND APPLIED FUNCTIONS

(4) Program example

(a) The Motion SFC program to read M-codes is shown as the following conditions.

- 1) Axis used No. Axis 3
- 2) Processing at the positioning start by M-code M-code No. is output as BCD code to Y110 to Y11F
- 3) Processing at the positioning completion by M-code
 - a) M-code = 3 Y120 turns on
 - b) M-code = 5 Y121 turns on
 - c) M-code is except for (3 or 5) Y122 turns on

(b) Motion SFC program with the above conditions are shown below.

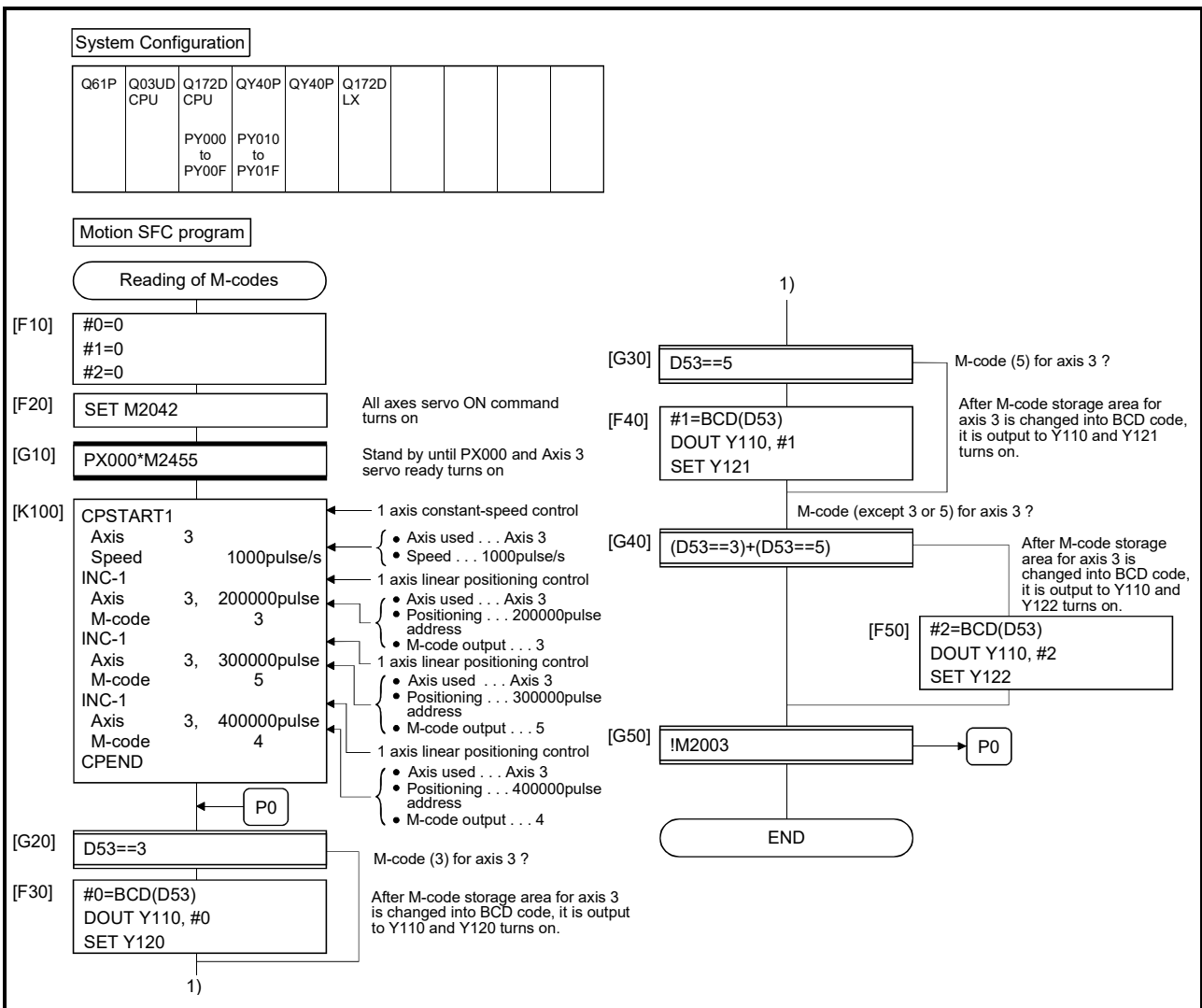

7.2 Backlash Compensation Function

This function compensates for the backlash amount in the machine system. When the backlash compensation amount is set, extra feed pulses equivalent to the backlash compensation amount set up whenever the travel direction is generated at the positioning control, JOG operation or manual pulse generator operation.

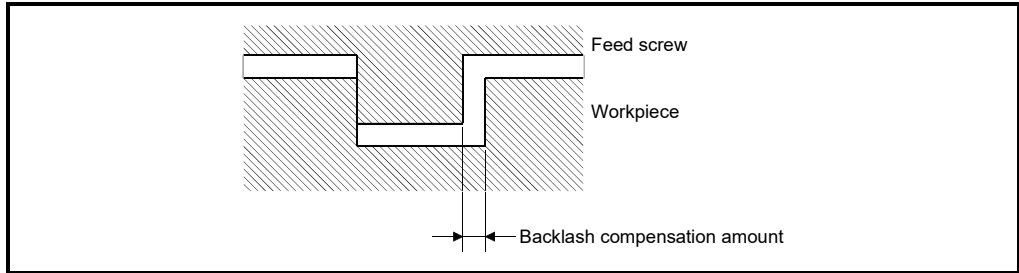

Fig.7.1 Backlash compensation amount

(1) Setting of the backlash compensation amount

The backlash compensation amount is one of the fixed parameters, and is set for each axis using MT Developer2.

The setting range differs according to whether [mm], [inch], [degree] or [pulse] units are used as shown below.

(a) [mm] units

- 0 to 6553.5

$$\bullet 0 \leq \frac{(\text{Backlash compensation amount})}{(\text{Travel value per pulse})} \leq 65535[\text{pulse}] \text{ (Note-1)}$$

(Decimal fraction rounded down)

(b) [inch] or [degree] units

- 0 to 0.65535

$$\bullet 0 \leq \frac{(\text{Backlash compensation amount})}{(\text{Travel value per pulse})} \leq 65535[\text{pulse}] \text{ (Note-1)}$$

(Decimal fraction rounded down)

(c) [pulse] units

- 0 to 65535

$$\bullet 0 \leq \frac{(\text{Backlash compensation amount}) \times (\text{pulse per rotation})}{(\text{Travel value per rotation})}$$

$$\leq 65535[\text{pulse}] \text{ (Note-1)}$$

(Decimal fraction rounded down)

(Note-1): The following restriction does not apply to versions compatible with the setting range expansion of backlash compensation amount. **Ver.!**

Ver.! : Refer to Section 1.3 for the software version that supports this function.

(2) Backlash compensation processing

Details of backlash compensation processing are shown below.

Table 7.1 Details of backlash compensation processing

Condition	Processing
First start after power on	<ul style="list-style-type: none"> • If travel direction is equal to home position return direction, the backlash compensation is not executed. • If travel direction is not equal to home position return direction, the backlash compensation is executed.
JOG operation start	<ul style="list-style-type: none"> • If travel direction is changed at the JOG operation start, the backlash compensation is executed.
Positioning start	<ul style="list-style-type: none"> • If travel direction is changed, the backlash compensation is executed.
Manual pulse generator operation	<ul style="list-style-type: none"> • If travel direction is changed, the backlash compensation is executed.
Home position return completion	<ul style="list-style-type: none"> • The backlash compensation is executed after home position return completion.
Absolute position system	<ul style="list-style-type: none"> • Status stored at power off and applied to absolute position system.

POINTS

- (1) When backlash compensation amount has been set, feed pulses of the backlash compensation amount are added to the position command value but are not added to feed current value.
- (2) When the backlash compensation amount is changed, the home position return is required.
When the home position return is not executed, the original backlash compensation amount is not changed.

7.3 Torque Limit Function

This function restricts the generating torque of the servo motor within the setting range. If the torque required for control exceeds the torque limit value during positioning control, it restricts with the setting torque limit value.

(1) Default of the torque limit value

The default 300[%] is set as torque limit value at the servo amplifier's power supply or Multiple CPU system's power supply ON.

POINTS

Even while the Multiple CPU system power supply is ON, the torque limit value is returned to the default value of 300[%] when the control circuit power supply of the servo amplifier is turned ON again, or when the SSCNET communication is disconnected or connected again. Set the torque control value again as required using the Motion SFC program or the Motion dedicated PLC instruction.

(2) Setting method of torque limit value

Set the torque limit value by the following method.

The positive direction of torque limit value restricts the forward rotation (CCW) driving and reverse rotation (CW) regenerative torque of servo motor, and the negative direction of torque limit value restricts the reverse rotation (CW) driving and forward rotation (CCW) regenerative torque.

Setting method		Setting details	Setting range	Setting units	Reference
Parameter block		Set the torque limit value in the parameter block. By setting the parameter block No. used in the servo program, the torque limit value of specified axis is changed to same value for both of positive direction and negative direction for every positioning control.	1 to 1000	[%]	Section 4.3
		Set the torque limit value in the parameter block. By setting the parameter block in the home position return data and JOG operation data for every axis, the torque limit value at home position return and JOG operation is changed to same value for both of positive direction and negative direction.			
Servo program		By setting the torque limit value in the servo program, the torque limit value of specified axis at servo program execution is changed to same value for both of positive direction and negative direction.			Section 5.3
Motion SFC program	Torque limit value change request (CHGT)	By executing the torque limit value change request (CHGT) in the operating control step of Motion SFC program, the torque limit value of specified axis is changed to same value for both of positive direction and negative direction.	1 to 10000	[0.1%]	(Note-1)
	Torque limit value individual change request (CHGT2) 	By executing the torque limit value individual change request (CHGT2) in the operating control step of Motion SFC program, the torque limit value of specified axis is changed to different value for positive direction and negative direction.			

7 AUXILIARY AND APPLIED FUNCTIONS

Setting method		Setting details	Setting range	Setting units	Reference
Motion dedicated instruction (D(P).CHGT)	Torque limit value change request instruction	By executing the torque limit value change request instruction (D(P).CHGT) in the PLC CPU, the torque limit value of specified axis is changed to same value for both of positive direction and negative direction.	1 to 1000	[%]	(Note-1)
PLC instruction (D(P).CHGT2) 	Torque limit value individual change request instruction	By executing the torque limit value individual change request instruction (D(P).CHGT2) in the PLC CPU, the torque limit value of specified axis is changed to different value for positive direction and negative direction.	1 to 10000	[0.1%]	

(Note-1): Q173D(S)CPU/Q172D(S)CPU Motion controller (SV13/SV22) Programming Manual (Motion SFC)

(3) Priority of torque limit value setting

When the multiple torque limit values are set on the same axis, the latest torque limit value is valid. However, the setting of torque limit value set in the parameter block or servo program is valid only if lower than the torque limit value set in the Motion SFC program, Motion dedicated PLC instruction, and speed-torque control. Also, the setting of torque limit value in speed-torque control is valid only if lower than the current torque limit value.

POINTS

When the torque limit value is set individually for positive direction and negative direction in the Motion SFC program or Motion dedicated PLC instruction, only either one of the positive direction or negative direction may become valid depending on the setting value of servo program. 

(4) Monitoring of torque limit status

(a) When using Q173DSCPU/Q172DSCPU

The torque limit value of each axis can be monitored with torque limit value (D14+20n), and the positive/negative direction torque limit value can be monitored by setting "Positive Direction Torque Limit Value Monitor Device" and "Negative Direction Torque Limit Value Monitor Device" in the expansion parameter.

The torque limit status of each axis can be also monitored with torque limiting (M2416+20n).

(b) When using Q173DCPU(-S1)/Q172DCPU(-S1)

The positive direction torque limit value of each axis can be monitored with the torque limit value (D14+20n).

The torque limit status of each axis can be also monitored with torque limiting (M2416+20n).

(5) Operation description

(a) When using Q173DSCPU/Q172DSCPU

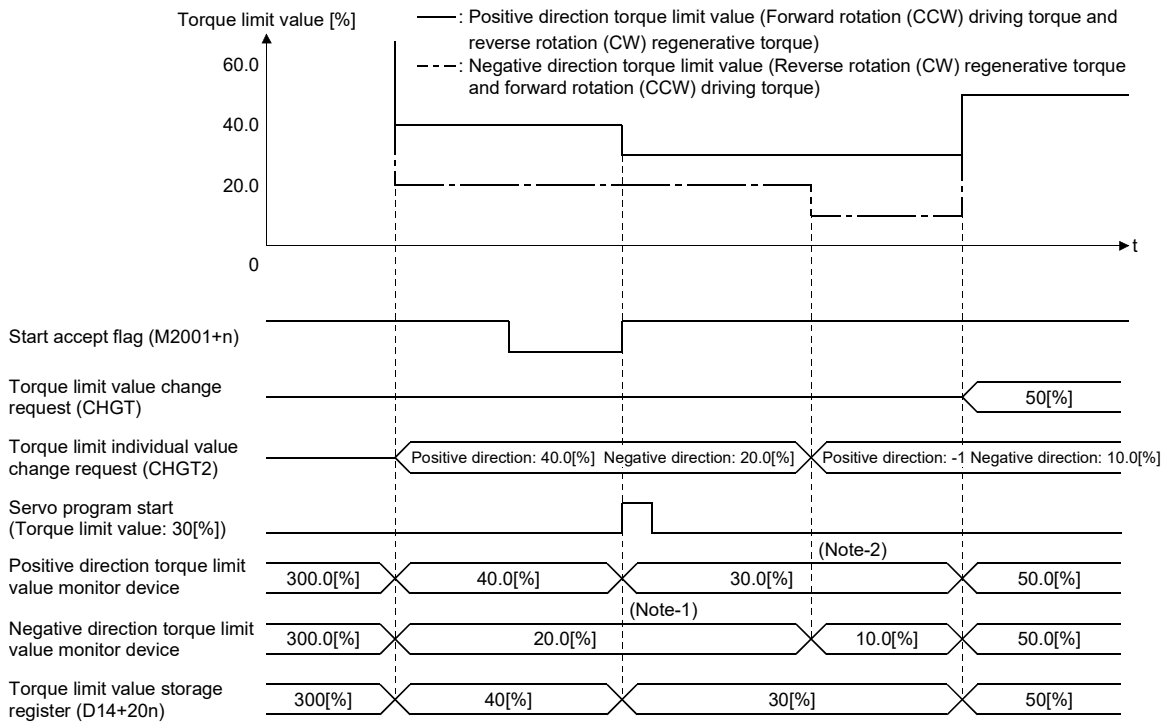

(b) When using Q173DCPU(-S1)/Q172DCPU(-S1)

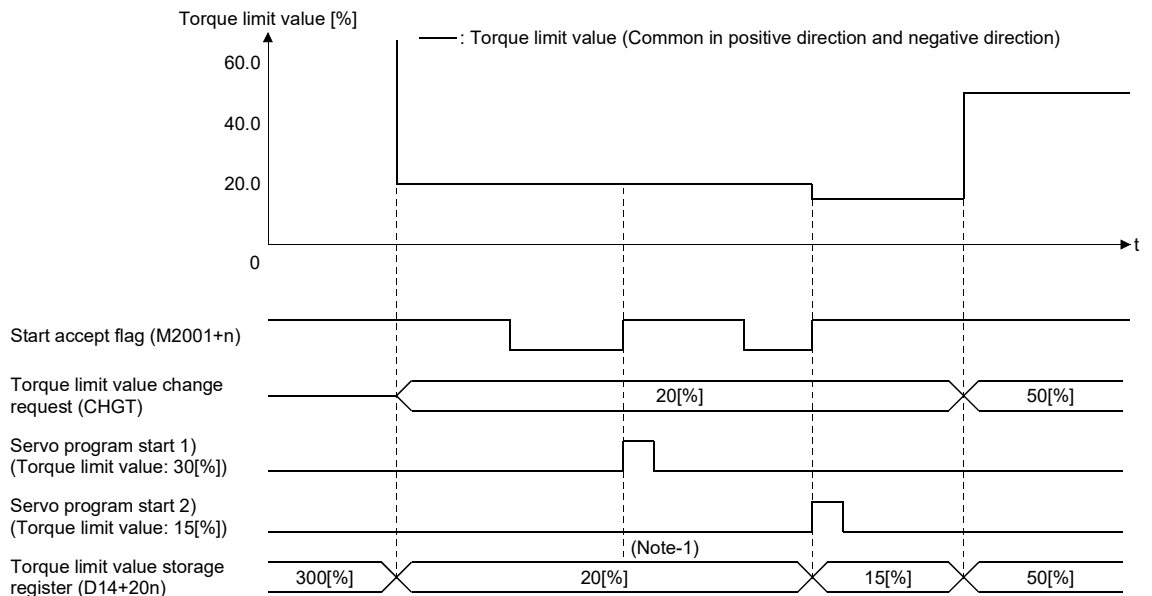

(6) Maintaining of torque limit value

The setting of torque limit value is held during servo amplifier's power supply ON and Multiple CPU system's power supply ON. When the default of torque limit value becomes 300[%] by turning ON again the servo amplifier's power supply or Multiple CPU system's power supply.

7.4 Skip Function in which Disregards Stop Command

When the current positioning is stopped by input from external source and the next positioning control is performed, it enables starting of the next positioning control even if the input from external source is on (continuation).

There are following two functions in the function called "Skip".

- Skip during constant-speed control (CPSTART command) (Refer to Section 6.17.6.)

- Skip in which disregards stop command

Usually, although an error [***] occurs with the servo program start during the STOP signal on, if external stop input disable at start command (M3209+20n) turns on and the servo program starts, the next servo program starts even if during the STOP signal on.

- (1) The procedure for the skip function by the external STOP signal and Motion SFC program is shown below.

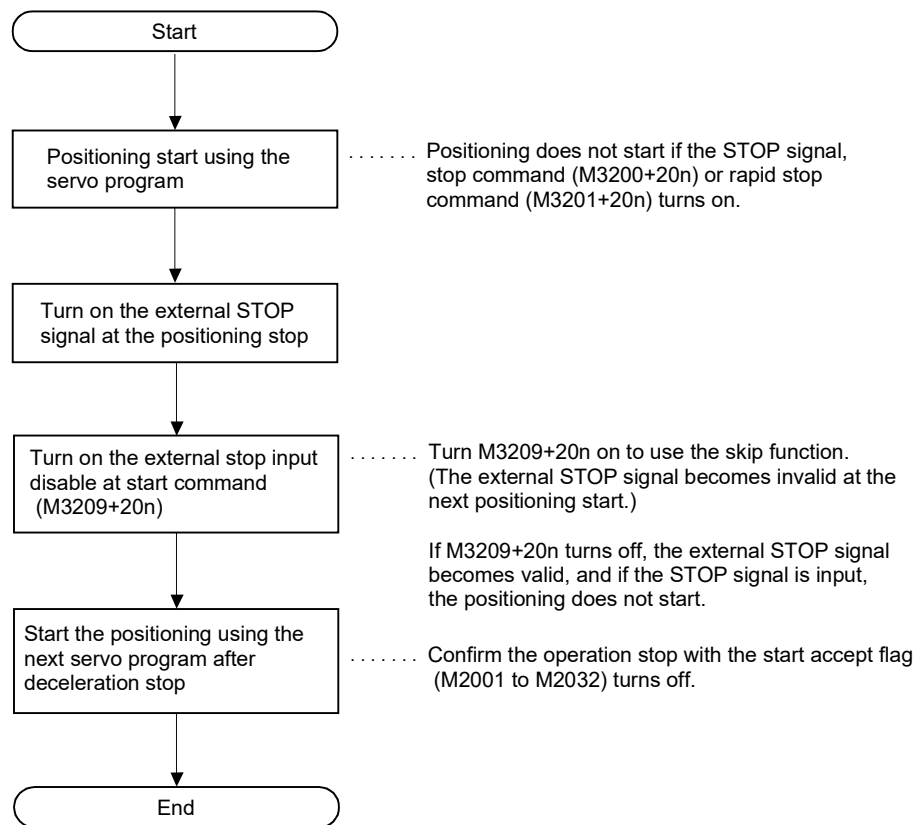

7 AUXILIARY AND APPLIED FUNCTIONS

(2) Operation timing

The operation timing for the skip function is shown below.

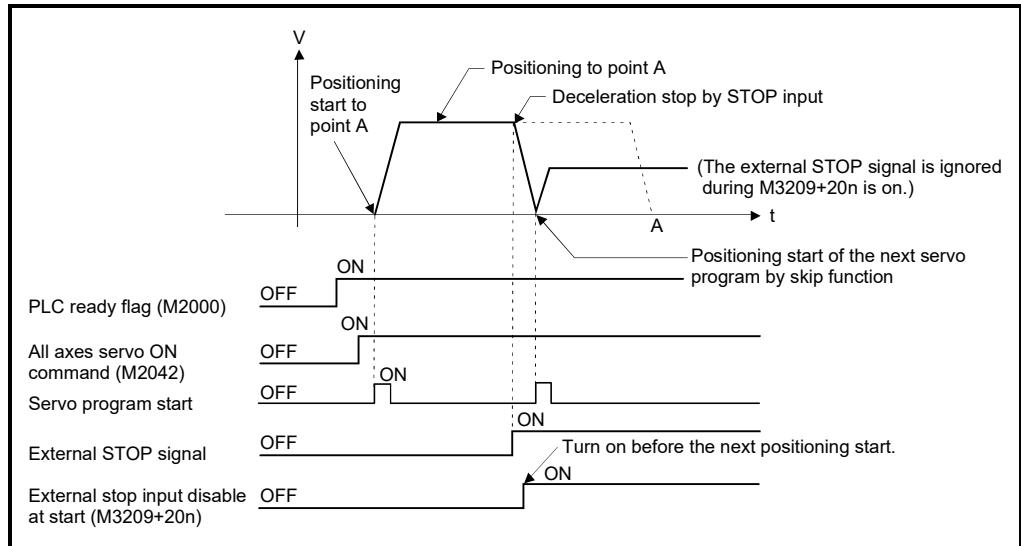

7 AUXILIARY AND APPLIED FUNCTIONS

7.5 Cancel of the Servo Program

This function performs a deceleration stop of executing servo program during execution by turning on the cancel signal.

[Control details]

- (1) When the cancel signal is turned on during execution of a program for which the cancel has been specified, the positioning processing is suspended, and a deceleration stop is executed.

[Data setting]

- (1) Cancel signal device
The usable cancel signal devices are shown below.
X, Y, M, B, F, U□\G

[Note]

- (1) This function cannot be used in the home position return instruction (ZERO) or simultaneous start instruction (START).
Refer to the servo instruction list (5.2(2)) for setting of other instructions.
- (2) Refer to Section 4.3.2 for details of operation when S-curve ratio is set.

[Operation timing]

The operation timing for deceleration stop is shown below.

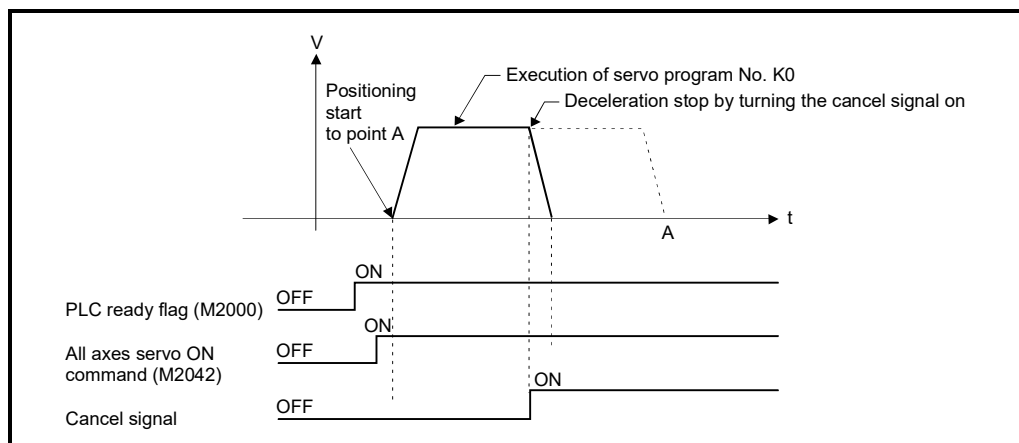

[Program example]

Motion SFC program is shown bellow.

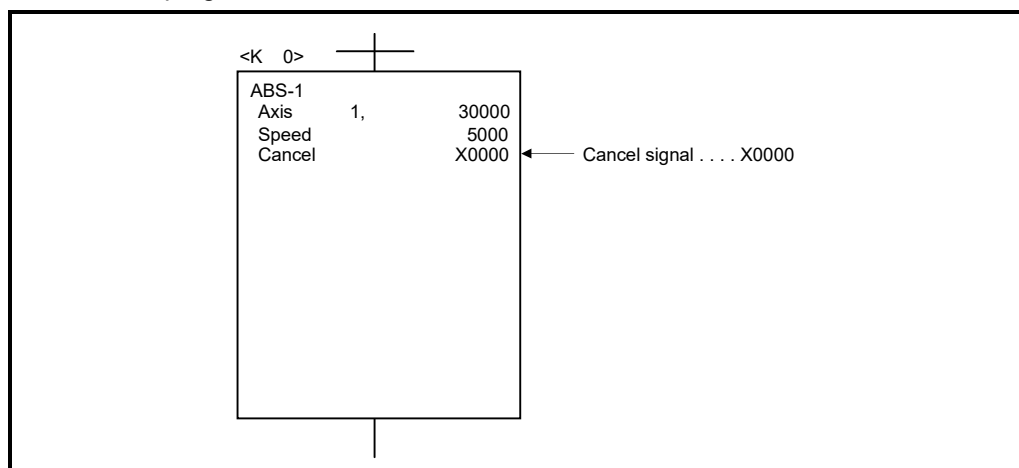

7.5.1 Cancel/start

When a cancel/start has been set in the setting items of the servo program which was started at the motion control step of the Motion SFC program, the cancel of the running servo program is valid but the servo program specified to start after a cancel is ignored, without being started.

Example of the Motion SFC program which executed control equivalent to a cancel start is shown below.

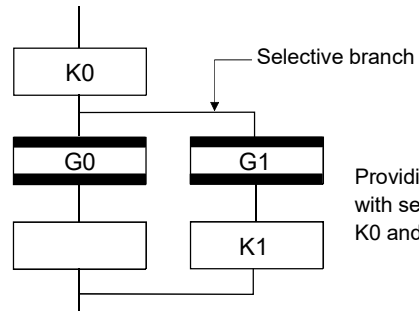

Providing transition G1 with cancel device condition specified with servo program K0 will cancel to execute of servo program K0 and allow servo program K1 to start.

7 AUXILIARY AND APPLIED FUNCTIONS

7.6 Synchronous Encoder

The synchronous encoder can be used in real mode by setting the synchronous encoder used in the system setting.

The synchronous encoder set in the system setting can be used the following functions in both of the real mode and virtual mode regardless of whether or not the synchronous encoder is set in the mechanical program.

Functions	Description
Current value storage register (D1120+10n, D1121+10n)	A current value of synchronous encoder is updated for operation cycle.
Synchronous encoder current value change • Servo instruction of Motion SFC (CHGA-E) • Motion dedicated PLC instruction (D(P).CHGA)	A current value change of synchronous encoder axis is executed.
Error reset command (M5440+4n)	An error reset of synchronous encoder axis is executed.

[Control details]

The input pulse from external synchronous encoder is always input after Multiple CPU system's power ON. The input pulse is always input in real mode regardless of the state for the clutch of mechanical system program or external signal.

Refer to the "Q173D(S)CPU/Q172D(S)CPU Motion controller Programming Manual (VIRTUAL MODE)" for operation in virtual mode.

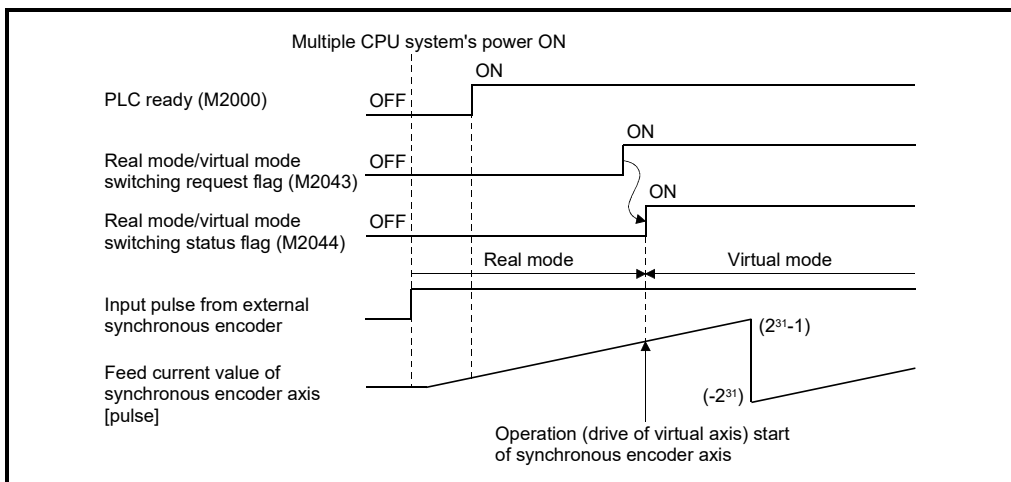

: Refer to Section 1.3 for the software version that supports this function.

7 AUXILIARY AND APPLIED FUNCTIONS

7.7 Speed-Torque Control

This function is used to execute the speed control or torque control that does not include the position loop for the command to servo amplifier.

The "continuous operation to torque control mode" switches the control mode to torque control mode without stopping the servo motor during positioning operation when tightening a bottle cap or a screw.

Switch the control mode from "position control mode" to "speed control mode", "torque control mode" or "continuous operation to torque control mode" to execute the "Speed-torque control".

Control mode	Control	Remark
Position control mode	Positioning control ^(Note-1) , home position return control, JOG operation, and manual pulse generator operation	Control that include the position loop for the command to servo amplifier
Speed control mode	Speed-torque control	Control that does not include the position loop for the command to servo amplifier
Torque control mode		Control that does not include the position loop for the command to servo amplifier
Continuous operation to torque control mode		Control mode can be switched during positioning control or speed control.

(Note-1): Excluding speed control (II).

Use the servo amplifiers whose software versions are compatible with each control mode to execute the "Speed-torque control".

Servo amplifier software versions that are compatible with each control mode are shown below.

Servo amplifier model	Software version		
	Speed control	Torque control ^(Note-1)	Continuous operation to torque control
MR-J5-□B	—	—	—
MR-J5W-□B	—	—	—
MR-J4-□B	—	—	—
MR-J4W-□B	—	—	—
MR-J3-□B	—	B3 or later	C7 or later
MR-J3W-□B	—	—	Not compatible
MR-J3-□B Safety	—	—	C7 or later

—: There is no restriction by the version.

(Note-1): In the servo amplifier that supports continuous operation to torque control, the torque generation direction of servo motor can be switched by setting "Function selection C-B (PC29) (POL reflection selection at torque control)". (Refer to Section 7.7.1 (7).)

In the servo amplifier that does not support continuous operation to torque control, the operation is the same as when "0: Valid" is set in "Function selection C-B (PC29) (POL reflection selection at torque control)".

CAUTION

- If operation that generates torque more than 100% of the rating is performed with an abnormally high frequency in a servo motor stop status (servo lock status) or in a 30r/min or less low-speed operation status, the servo amplifier may malfunction regardless of the electronic thermal relay protection.

7 AUXILIARY AND APPLIED FUNCTIONS

7.7.1 Speed-torque control data

Speed-torque control data are for executing "speed-torque control".
Set the data using servo data setting of MT Developer2.

Table 7.2 Speed-torque control data list

No.	Setting item	Setting necessity			Setting value using MT Developer2					
		Speed control	Torque control	Continuous operation to torque control	Initial value	Units	Setting range			
							mm	inch	degree	pulse
1	Control mode switching request device	<input type="radio"/>	<input type="radio"/>	<input type="radio"/>	—	—	—			
2	Control mode setting device	<input type="radio"/>	<input type="radio"/>	<input type="radio"/>	—	—	—			
3	Speed limit value at speed-torque control	<input type="radio"/>	<input type="radio"/>	<input type="radio"/>	200000	Selected unit	0.01 to 6000000.00 [mm/min]	0.001 to 600000.000 [mm/min]	0.001 to 2147483.647 [degree/min] (Note-1)	1 to 2147483647 [pulse/s]
4	Torque limit value at speed-torque control	<input type="radio"/>	<input type="radio"/>	<input type="radio"/>	300.0	%	0.1 to 1000.0 [%]			
5	Speed command device	<input type="radio"/>	<input type="radio"/>	<input type="radio"/>	—	—	—			
6	Command speed acceleration time	<input type="radio"/>	<input type="radio"/>	<input type="radio"/>	1000	ms	0 to 65535 [ms]			
7	Command speed deceleration time	<input type="radio"/>	<input type="radio"/>	<input type="radio"/>	1000	ms	0 to 65535 [ms]			
8	Torque command device	<input type="radio"/>	<input type="radio"/>	<input type="radio"/>	—	—	—			
9	Command torque time constant (positive direction)	<input type="radio"/>	<input type="radio"/>	<input type="radio"/>	1000	ms	0 to 65535 [ms]			
10	Command torque time constant (negative direction)	<input type="radio"/>	<input type="radio"/>	<input type="radio"/>	1000	ms	0 to 65535 [ms]			
11	Speed initial value selection at control mode switching	<input type="radio"/>	<input type="radio"/>	<input type="radio"/>	0	—	0: Command speed 1: Feedback speed 2: Automatic selection			
12	Torque initial value selection at control mode switching	<input type="radio"/>	<input type="radio"/>	<input type="radio"/>	0	—	0: Command torque 1: Feedback torque			
13	Invalid selection during zero speed at control mode switching	<input type="radio"/>	<input type="radio"/>	<input type="radio"/>	0	—	0: Condition at control mode switching: valid 1: Condition during zero speed at control mode switching: invalid			

7 AUXILIARY AND APPLIED FUNCTIONS

Setting value using the Motion SFC program (Indirect setting)				Indirect setting		Remarks
Setting range				Valid/ invalid	Number of words	
mm	inch	degree	pulse			
—				○	Bit	
0 : Position control mode 10 : Speed control mode 20 : Torque control mode 30 : Continuous operation to torque control mode				○	1	
1 to 600000000 ($\times 10^{-2}$ [mm/min])	1 to 600000000 ($\times 10^{-3}$ [inch/min])	1 to 2147483647 ($\times 10^{-3}$ [degree/min]) (Note-2)	1 to 2147483647 [pulse/s]	○	2	
1 to 10000 ($\times 0.1$ [%])				○	1	
-600000000 to 600000000 ($\times 10^{-2}$ [mm/min])	-600000000 to 600000000 ($\times 10^{-3}$ [inch/min])	-2147483648 to 2147483647 ($\times 10^{-3}$ [degree/min]) (Note-3)	-2147483648 to 2147483647 [pulse/s]	○	2	
0 to 65535 [ms]				○	1	
0 to 65535 [ms]				○	1	
-10000 to 10000 ($\times 0.1$ [%])				○	1	
0 to 65535 [ms]				○	1	
0 to 65535 [ms]				○	1	
—				—	—	
—				—	—	
—				—	—	

(Note-1): When the "speed control 10×multiplier setting for degree axis" is set to "valid", the setting range is 0.01 to 21474836.47[degree/min].

(Note-2): When the "speed control 10×multiplier setting for degree axis" is set to "valid", the setting range is 1 to 2147483647[$\times 10^{-2}$ degree/min].

(Note-3): When the "speed control 10×multiplier setting for degree axis" is set to "valid", the setting range is -2147483648 to 2147483647[$\times 10^{-2}$ degree/min].

7 AUXILIARY AND APPLIED FUNCTIONS

A part of speed-torque control data can be executed the indirect setting by the word devices of Motion CPU

- Word devices for indirect setting

The word devices for indirect setting are the data registers (D), link registers (W), motion registers (#) and Multiple CPU area device (U□\G). Word devices except the above devices cannot be used.

The usable setting range of word devices is shown below.

Word device	Setting range
D	0 to 8191
W	0 to 1FFF
#	0 to 7999
U□\G	10000 to (10000+p-1) (Note-1)

(Note-1): "p" indicates the user setting area points of the Multiple CPU high speed transmission area for each CPU.

(Note-2): Refer to Chapter 2 of the "Q173D(S)CPU/Q172D(S)CPU Motion controller Programming Manual (COMMON)" for the user setting area points of the Multiple CPU high speed transmission area.

- Bit devices for indirect setting

The bit devices for indirect setting are the input (X), output (Y), internal relay (M), link relay (B), annunciator (F) and Multiple CPU area device (U□\G).

Bit devices except the above devices cannot be used.

The usable setting range of bit devices is shown below.

Bit device	Setting range
X	0000 to 1FFF (Note-1)
Y	0000 to 1FFF
M	0 to 8191
B	0000 to 1FFF
F	0 to 2047
U□\G	10000.0 to (10000+p-1).F (Note-2)

(Note-1): The range of "PXn+4 to PXn+F" cannot be used (fixed at 0) for the input device (PXn+0 to PXn+F) allocated to the built-in interface in Motion CPU (DI). (n: First input No.)

(Note-2): "p" indicates the user setting area points of the Multiple CPU high speed transmission area for each CPU.

(Note-3): Refer to Chapter 2 of the "Q173D(S)CPU/Q172D(S)CPU Motion controller Programming Manual (COMMON)" for the user setting area points of the Multiple CPU high speed transmission area.

- Input of speed-torque control data

Input timing of each setting device is shown below.

Setting item	Input timing of device
Control mode switching request device	Operation cycle
Control mode setting device	Control mode switching
Speed limit value at speed-torque control	
Torque limit value at speed-torque control	
Speed command device	Operation cycle
Command speed acceleration time	Control mode switching
Command speed deceleration time	
Torque command device	Operation cycle
Command torque time constant (positive direction)	Control mode switching
Command torque time constant (negative direction)	

7 AUXILIARY AND APPLIED FUNCTIONS

(1) Control mode switching request device

Set the device to request switching of the control mode.

When the control mode switching request device is turned OFF to ON, the mode is switched to the control mode set in the control mode setting device.

(2) Control mode setting device

Set the device to set the control mode after switching.

When the control mode switching request device is turned OFF to ON, the following mode is applied based on the value set in the control mode setting device.

Control mode setting device value	Control mode
0	Position control mode
10	Speed control mode
20	Torque control mode
30	Continuous operation to torque control mode

If the value of control mode setting device is outside the range at control mode switching request, a minor error (error code: 155) will occur, and the control mode is not switched.

(3) Speed limit value at speed-torque control

Set the speed limit value (absolute value) at speed control, torque control or continuous operation to torque control. If the command speed exceeds the speed limit value at speed-torque control, a minor error (error code: 315) will occur, and the control is executed with the speed limit value at speed-torque control.

(4) Torque limit value at speed-torque control

Set the torque limit value (absolute value) in speed control, torque control or continuous operation to torque control. If the command torque exceeds the torque limit value at speed-torque control, a minor error (error code: 316) will occur, and the control is executed with the torque limit value at speed-torque control.

(5) Speed command device

Set the command speed at speed control and the speed limit command value to servo amplifier at torque control or continuous operation to torque control.

The value of speed command device can be changed at any time.

POINTS

The actual motor speed may not reach the speed limit value depending on the machine load situation during torque control or continuous operation to torque control.

(6) Command speed acceleration time, Command speed deceleration time

Set the acceleration time for the speed to increase from "0" to reach the speed limit value at speed-torque control and deceleration time taken to stop from the speed limit value at speed-torque control during speed control or continuous operation to torque control.

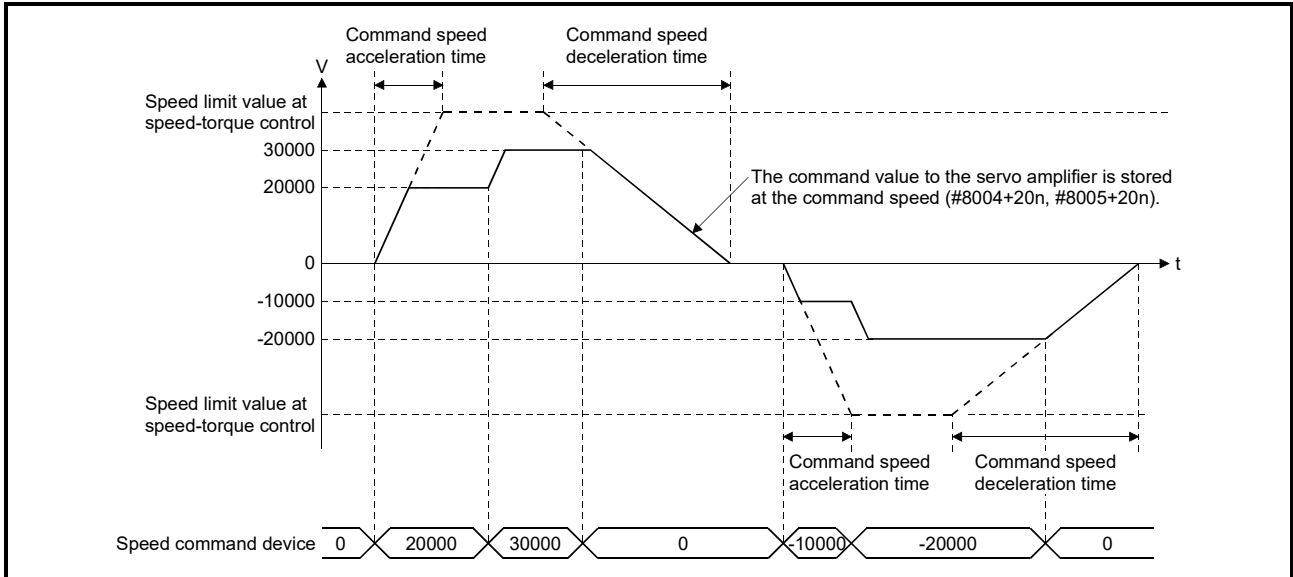

When the rotation direction is changed due to the command speed change during speed control, the operation is as follows.

- A deceleration is made to 0 [r/min] according to the setting value of command speed deceleration time. After that, an acceleration is made to the command speed according to the setting value of command speed acceleration time.

7 AUXILIARY AND APPLIED FUNCTIONS

(7) Torque command device

Set the command torque at torque control and continuous operation to torque control. Command torque can be changed at any time.

(a) Torque control

The relation between setting of command torque and torque generation direction of servo motor differs from the setting of servo parameter "Rotation direction selection (PA14)" and "Function selection C-B (PC29) (POL reflection selection at torque control)".

Table 7.3 Relation between setting of command torque and torque generation direction of servo motor (Torque control)

Function selection C-B (PC29) (POL reflection selection at torque control)"	Rotation direction selection (PA14)	Torque command device	Torque generation direction of servo motor
0: Valid	0: Forward rotation (CCW) with the increase of the positioning address	Positive value (Forward direction)	CCW direction
		Negative value (Reverse direction)	CW direction
	1: Reverse rotation (CW) with the increase of the positioning address	Positive value (Forward direction)	CW direction
		Negative value (Reverse direction)	CCW direction
1: Invalid	0: Forward rotation (CCW) with the increase of the positioning address	Positive value (Forward direction)	CCW direction
		Negative value (Reverse direction)	CW direction
	1: Reverse rotation (CW) with the increase of the positioning address	Positive value (Forward direction)	CCW direction
		Negative value (Reverse direction)	CW direction

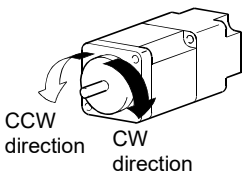

(b) Continuous operation to torque control

The relation between setting of command torque and torque generation direction of servo motor is fixed regardless of the setting of servo parameter "Rotation direction selection (PA14)" and "Function selection C-B (PC29) (POL reflection selection at torque control)".

Table 7.4 Relation between setting of command torque and torque generation direction of servo motor (Continuous operation to torque control)

Function selection C-B (PC29) (POL reflection selection at torque control)"	Rotation direction selection (PA14)	Torque command device	Torque generation direction of servo motor
0: Valid	0: Forward rotation (CCW) with the increase of the positioning address	Positive value (Forward direction)	CCW direction
		Negative value (Reverse direction)	CW direction
	1: Reverse rotation (CW) with the increase of the positioning address	Positive value (Forward direction)	CCW direction
		Negative value (Reverse direction)	CW direction
1: Invalid	0: Forward rotation (CCW) with the increase of the positioning address	Positive value (Forward direction)	CCW direction
		Negative value (Reverse direction)	CW direction
	1: Reverse rotation (CW) with the increase of the positioning address	Positive value (Forward direction)	CCW direction
		Negative value (Reverse direction)	CW direction

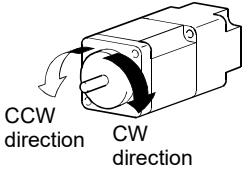

7 AUXILIARY AND APPLIED FUNCTIONS

(8) Command torque time constant (positive direction), Command torque time constant (negative direction)

Set the time (positive direction) for torque to increase from "0" to reach the torque limit value at speed-torque control and the time (negative direction) to decrease to "0" from the torque limit value at speed-torque control during torque control or continuous operation to torque control.

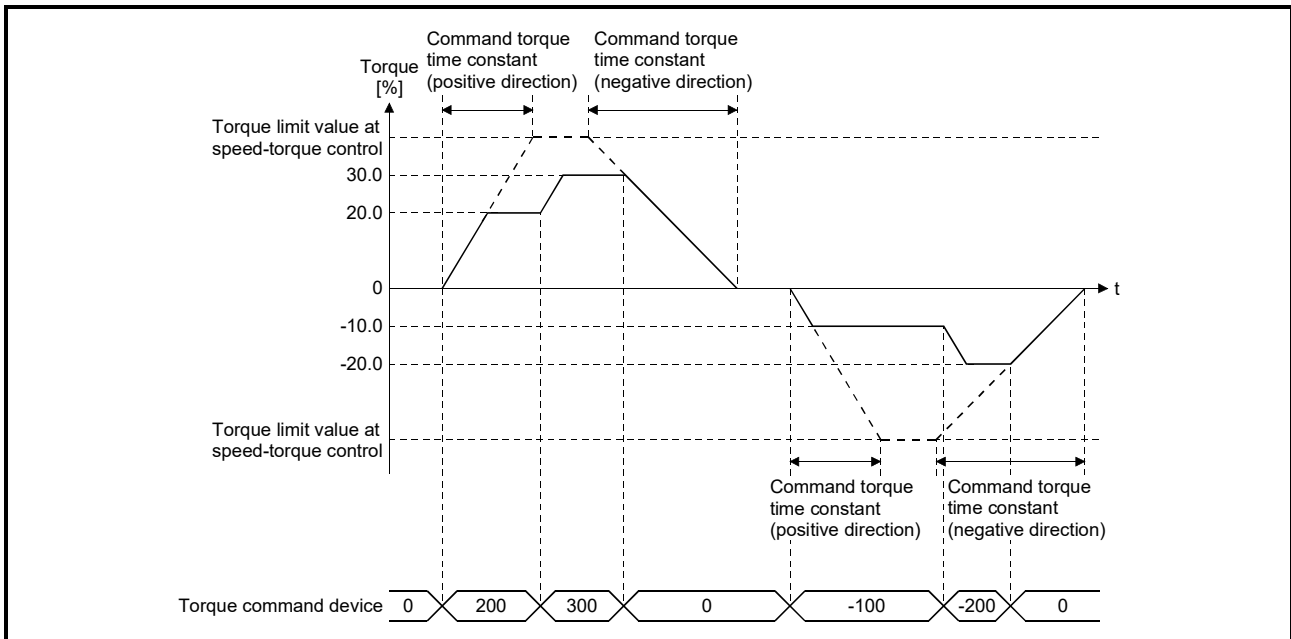

When the torque generation direction of servo motor is changed due to the command torque change during torque control or continuous operation to torque control, the operation is as follows.

- The torque output value is 0 [%] according to the setting value of command torque time constant (negative direction). After that, the value becomes command torque according to the setting value of command torque time constant (positive direction).

7 AUXILIARY AND APPLIED FUNCTIONS

(9) Speed initial value selection at control mode switching

Set the speed initial value at the following control mode switching.

- Position control to speed control
- Position control to continuous operation to torque control
- Speed control to continuous operation to torque control

Speed initial value selection at control mode switching	Command speed to servo amplifier immediately after control mode switching
0: Command speed	The speed to servo amplifier immediately after switching is the speed during command.
1: Feedback speed	Motor speed received from servo amplifier at switching.
2: Automatic selection	The speed to servo amplifier immediately after switching is the lower speed between "0: Command speed" and "1: Feedback speed".

POINT

When the mode is switched to continuous operation to torque control mode in cases where command speed and actual speed are different such as during acceleration/deceleration or when the speed does not reach command speed due to torque limit, set "1: Feedback speed".

(10) Torque initial value selection at control mode switching

Set the torque initial value at switching to torque control mode or continuous operation to torque control mode.

Torque initial value selection at control mode switching	Command torque to servo amplifier immediately after control mode switching
0: Command speed	Immediately after switching the control mode, the value of torque command device is the torque to servo amplifier regardless of the command torque time constant.
1: Feedback speed	Motor current value received from servo amplifier at switching is the command torque to servo amplifier.

(11) Invalid selection during zero speed at control mode switching

Set to switch the control mode without waiting for stop of servo motor.

Invalid selection during zero speed at control mode switching
0: Condition at control mode switching: valid
1: Condition during zero speed at control mode switching: invalid

POINT

Normally, set "0". Set "1" to switch to the control mode without waiting for stop of servo motor immediately after completion of the command to servo motor. At switching to continuous operation to torque control, switching of control mode is possible without stop regardless of the setting value.

7.7.2 Operation of speed-torque control

(1) Switching of control mode (Speed control/Torque control)

(a) Switching method of control mode

Turn OFF to ON the control mode switching request device after setting the control mode (10: Speed control mode, 20: Torque control mode) in the control mode setting device to switch to the speed control or torque control. When the mode is switched to the speed control mode or torque control mode, the control data used in each control mode must be set before turning ON the control mode switching request device.

When the switching condition is satisfied at control mode switching request, the control mode is switched, and the start accept flag (M2001+n) turns ON. A minor error (error code: 101, 156) will occur if the switching condition is not satisfied, and the control mode is not switched.

The following shows the switching condition of each control mode.

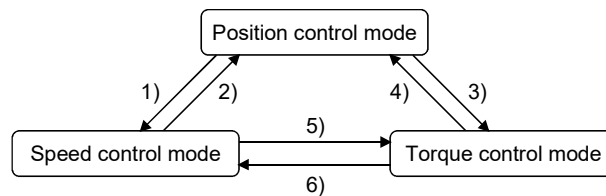

Switching operation		Switching condition
1)	Position control mode → Speed control mode	Not during positioning ^(Note-1) and during motor stop ^(Note-2)
2)	Seed control mode → Position control mode	During motor stop ^(Note-2)
3)	Position control mode → Torque control mode	Not during positioning ^(Note-1) and during motor stop ^(Note-2)
4)	Torque control mode → Position control mode	During motor stop ^(Note-2)
5)	Speed control mode → Torque control mode	None
6)	Torque control mode → Speed control mode	

(Note-1): The start accept flag (M2001+n) is OFF.

(Note-2): ZERO speed (b3) of Servo status2 (#8011+20n) is ON.

The control mode can be changed without checking the switching condition of "during motor stop" in Motion CPU by setting "1: Condition during zero speed at control mode switching: invalid" in "Invalid selection during zero speed at control mode switching". Set "1: Condition during zero speed at control mode switching: invalid" to switch the control mode without waiting for stop of servo motor.

Confirm the control mode with "control mode (b2, b3)" of servo status1 (#8010+20n).

1) Control mode (b2, b3) of servo status1 (#8010+20n)

b3	b2	Control mode
0	0	Position control mode
0	1	Speed control mode
1	0	Torque control mode

7 AUXILIARY AND APPLIED FUNCTIONS

(b) Precautions at control mode switching

- 1) The positioning start complete signal (M2400+20n) and positioning complete signal (M2401+20n) do not turn ON at control mode switching.
- 2) During speed control or torque control, the start accept flag (M2001+n) turns ON.
- 3) The motor speed might change momentarily at switching from the speed control mode to torque control mode. Therefore, it is recommended to switch from the speed control mode to torque control mode after the servo motors are stopped.
- 4) Cannot use press with limited torque during speed control mode.
- 5) In speed controlling signal (M2404+20n) does not turn ON during speed control mode in the speed-torque control.

(c) Operation for "Position control mode ↔ Speed control mode switching"

When the mode is switched from position control mode to speed control mode, the command speed immediately after switching is the speed set in "speed initial value selection at control mode switching".

Speed initial value selection at control mode switching	Command speed to servo amplifier immediately after switching from position control mode to speed control mode
0: Command speed	The speed to servo amplifier immediately after switching is "0".
1: Feedback speed	Motor speed received from servo amplifier at switching.
2: Automatic selection	At control mode switching, operation is the same as "0: Command speed".

When the mode is switched from speed control mode to position control mode, the command position immediately after switching is the current feed value at switching.

The following chart shows the operation timing.

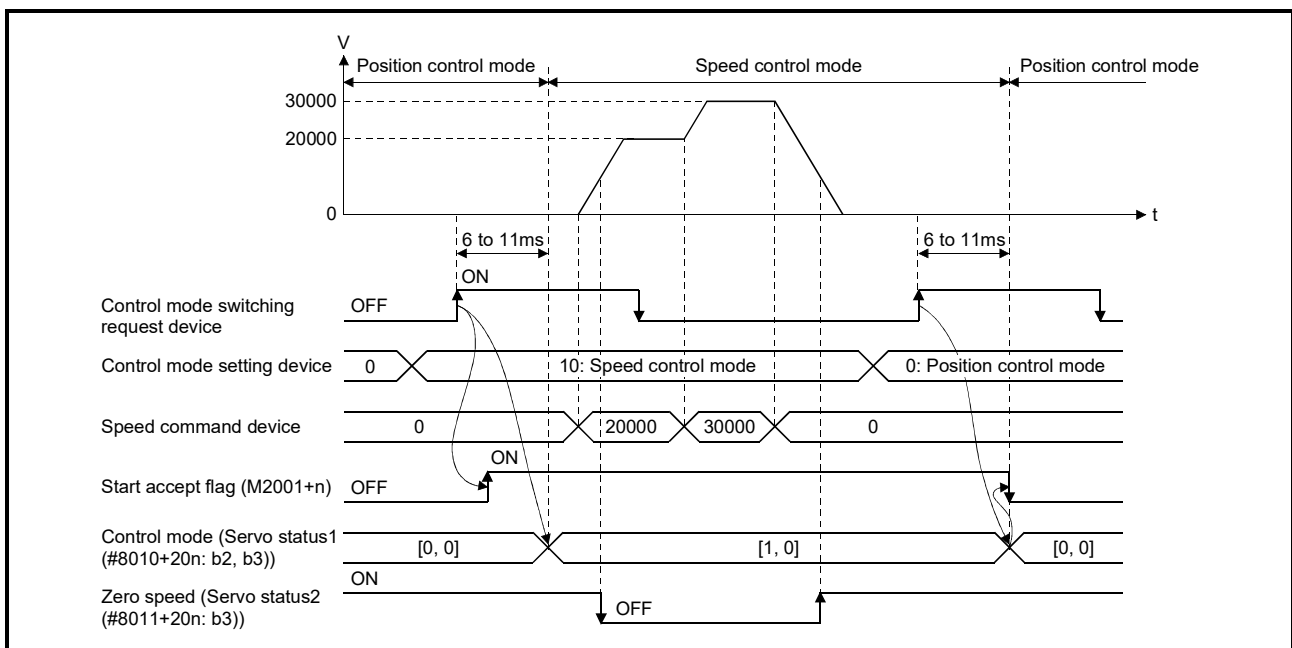

7 AUXILIARY AND APPLIED FUNCTIONS

- (d) Operation for "Position control mode ↔ Speed control mode switching"
 When the mode is switched from position control mode to torque control mode, the command torque immediately after switching is the torque set in "torque initial value selection at control mode switching".

Torque initial value selection at control mode switching	Command torque to servo amplifier immediately after switching from position control mode to torque control mode
0: Command torque	Immediately after switching the control mode, the value of torque command device is the torque to servo amplifier regardless of the command torque time constant.
1: Feedback torque	Motor current value received from servo amplifier at switching is the torque to servo amplifier.

POINT

When the servo parameter "POL reflection selection at torque control (PC29)" is set to "0: Valid" and "Torque initial value selection at control mode switching" is set to "1: Feedback torque", a minor error (error code: 154) will occur at control mode switching, and the command value immediately after switching is the same as the case of selecting "0: Command torque". If the feedback torque is selected, set "1: Invalid" in the servo parameter "POL reflection selection at torque control (PC29)".

When the mode is switched from torque control mode to position control mode, the command position immediately after switching is the current feed value at switching.

The following chart shows the operation timing.

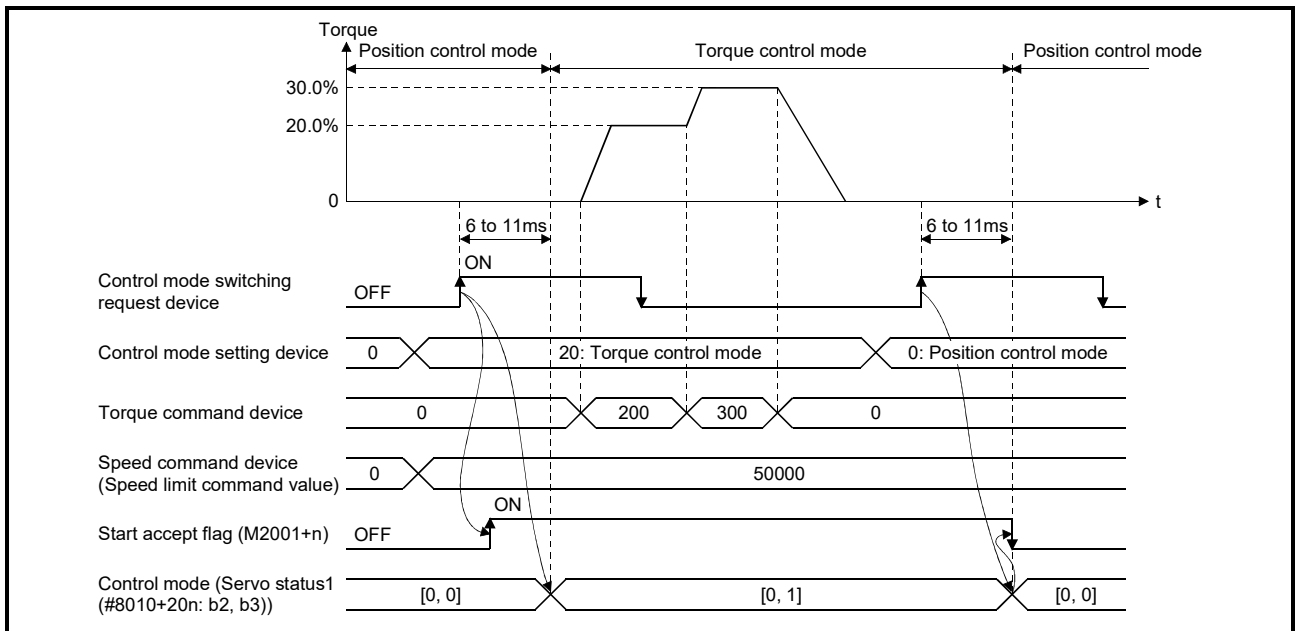

7 AUXILIARY AND APPLIED FUNCTIONS

(e) Operation for "Speed control mode ↔ Torque control mode switching"

When the mode is switched from speed control mode to torque control mode, the command torque immediately after switching is the torque set in "Torque initial value selection at control mode switching".

Torque initial value selection at control mode switching	Command torque to servo amplifier immediately after switching from speed control mode to torque control mode
0: Command torque	Immediately after switching the control mode, the value of torque command device is the torque to servo amplifier regardless of the command torque time constant.
1: Feedback torque	Motor current value received from servo amplifier at switching is the torque to servo amplifier.

POINT

When the servo parameter "POL reflection selection at torque control (PC29)" is set to "0: Valid" and "Torque initial value selection at control mode switching" is set to "1: Feedback torque", a minor error (error code: 154) will occur at control mode switching, and the command value immediately after switching is the same as the case of selecting "0: Command torque". If the feedback torque is selected, set "1: Invalid" in the servo parameter "POL reflection selection at torque control (PC29)".

When the mode is switched from torque control mode to speed control mode, the command speed immediately after switching is the motor speed at switching.

The following chart shows the operation timing.

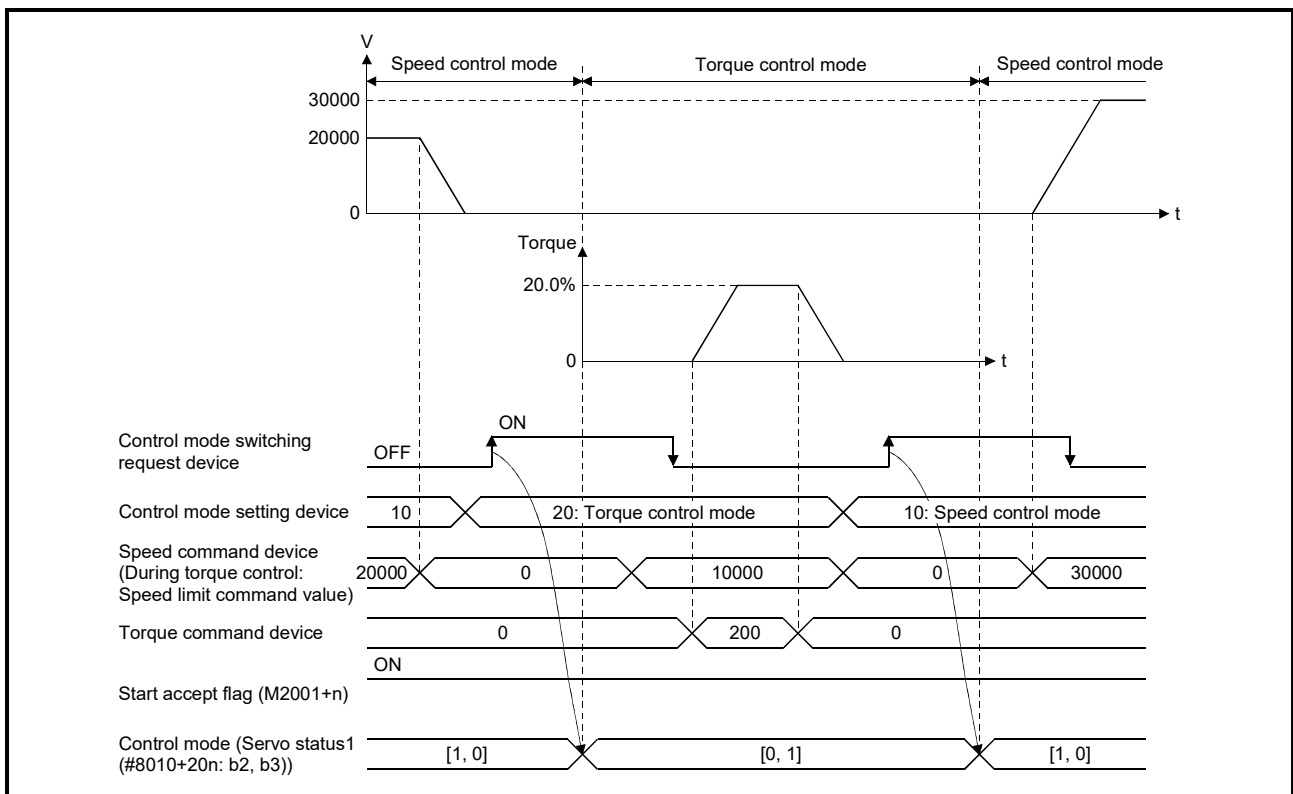

(2) Switching of control mode (Continuous operation to torque control)

(a) Switching method of control mode

Turn OFF to ON the control mode switching request device after setting the control mode in the control mode setting device (30: Continuous operation to torque control mode) to switch from position control mode or speed control mode to continuous operation to torque control.

When the mode is switched to continuous operation to torque control mode, the control data used in continuous operation to torque control mode must be set before turning on the control mode switching request device.

When the switching condition is satisfied at control mode switching request, the control mode is switched, and the start accept flag (M2001+n) turns ON. The following shows the switching condition of continuous operation to torque control mode.

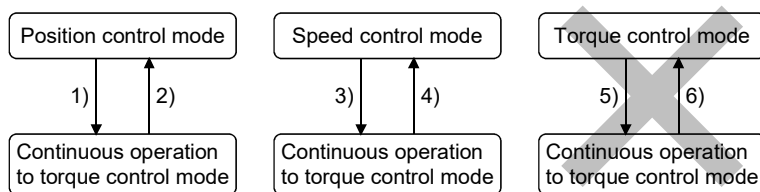

Switching operation		Switching condition
1)	Position control mode → Continuous operation to torque control mode	Not during positioning ^(Note-1) or during following positioning mode • ABS-1 : 1-axis linear control (ABS) • INC-1 : 1-axis linear control (INC) • FEED-1 : 1-axis fixed-feed control • VF : Speed control (I) (Forward) • VR : Speed control (I) (Reverse) • VPF : Speed-position switching control (Forward) • VPR : Speed-position switching control (Reverse) • PFSTART : Position follow-up control • CPSTART : 1-axis constant-speed control • PVF : Speed control with fixed position stop (Forward) • PVR : Speed control with fixed position stop (Reverse) (Note): JOG operation, Speed control (I) (VVF, VVR), Speed switching control (VSTART), High-speed oscillation control (OSC) are not supported.
2)	Continuous operation to torque control mode → Position control mode	During motor stop ^(Note-2)
3)	Speed control mode → Continuous operation to torque control mode	None
4)	Continuous operation to torque control mode → Speed control mode	
5)	Torque control mode → Continuous operation to torque control mode	Switching not possible
6)	Continuous operation to torque control mode → Torque control mode	

(Note-1): The start accept flag (M2001+n) is OFF.

(Note-2): ZERO speed (b3) of Servo status2 (#8011+20n) is ON.

The control mode can be changed without checking the switching condition of "during motor stop" in Motion CPU by setting "1: Condition during zero speed at control mode switching: invalid" in "Invalid selection during zero speed at control mode switching". Set "1: Condition during zero speed at control mode switching: invalid" to switch the control mode without waiting for stop of servo motor.

7 AUXILIARY AND APPLIED FUNCTIONS

Confirm the status of continuous operation to torque control mode with "Continuous operation to torque control (b14)" of servo status3 (#8012+20n). When the mode is switched to continuous operation to torque control mode, the value in "control mode (b2, b3)" of servo status1 (#8010+20n) will stay the same before control mode switching.

- 1) Continuous operation to torque control mode (b14) of servo status3 (#8012+20n)

b14	Continuous operation to torque control mode
0	Not continuous operation to torque control mode
1	Continuous operation to torque control mode

POINTS

- (1) When the mode is switched from position control mode to continuous operation to torque control mode, only the switching from continuous operation to torque control mode to position control mode is possible. If the mode is switched to other control modes, a minor error (error code: 155) will occur, and the control mode is not switched.
- (2) When the mode is switched from speed control mode to continuous operation to torque control mode, only the switching from continuous operation to torque control mode to speed control mode is possible. If the mode is switched to other control modes, a minor error (error code: 155) will occur, and the control mode is not switched.

(b) Precautions at control mode switching

- 1) The positioning start complete signal (M2400+20n) and positioning complete signal (M2401+20n) do not turn ON at control mode switching.
- 2) During continuous operation to torque control, the start accept flag (M2001+n) turns ON.
- 3) When using continuous operation to torque control mode, use the servo amplifiers that are compatible with continuous operation to torque control. If servo amplifiers that are not compatible with continuous operation to torque control are used, a minor error (error code: 318) will occur at request of switching to continuous operation to torque control mode. (A deceleration stop is made during the positioning control. The mode is switched to position control during the speed control, and the operation immediately stops.)

7 AUXILIARY AND APPLIED FUNCTIONS

- (c) Operation for "Position control mode ↔ Continuous operation to torque control mode switching

When the mode is switched from position control mode to continuous operation to torque control mode, the command torque and command speed immediately after switching are the values set in "Torque initial value selection at control mode switching" and "Speed initial value selection at control mode switching".

Torque initial value selection at control mode switching	Command torque to servo amplifier immediately after switching from position control mode to continuous operation to torque control mode
0: Command torque	Immediately after switching the control mode, the value of torque command device is the torque to servo amplifier regardless of the command torque time constant.
1: Feedback torque	Motor current value received from servo amplifier at switching is the torque to servo amplifier.

Speed initial value selection at control mode switching	Command speed to servo amplifier immediately after switching from position control mode to continuous operation to torque control mode
0: Command speed	The speed to servo amplifier immediately after switching is the speed during command.
1: Feedback speed	Motor speed received from servo amplifier at switching.
2: Automatic selection	The speed commanded to servo amplifier immediately after switching is the lower speed between "0: Command speed" and "1: Feedback speed".

POINT
When the mode is switched to continuous operation to torque control mode in cases where command speed and actual speed are different such as during acceleration/deceleration or when the speed does not reach command speed due to torque limit, set "1: Feedback speed" in "Speed initial value selection at control mode switching".

7 AUXILIARY AND APPLIED FUNCTIONS

The following chart shows the operation timing.

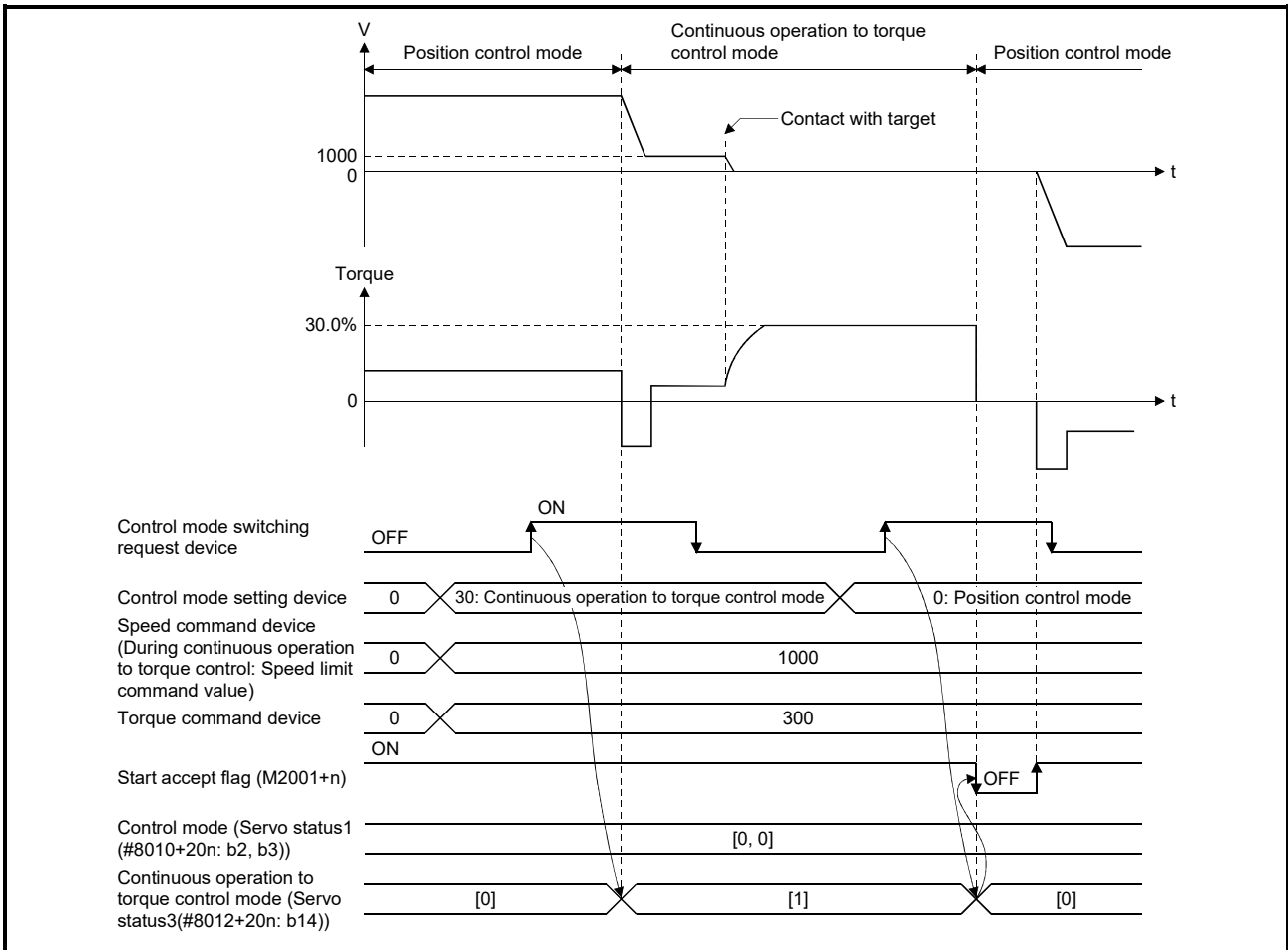

7 AUXILIARY AND APPLIED FUNCTIONS

(d) Operation for "Speed control mode ↔ Continuous operation to torque control mode switching"

When the mode is switched from speed control mode to continuous operation to torque control mode, the command torque and command speed immediately after switching are the values set in "Torque initial value selection at control mode switching" and "Speed initial value selection at control mode switching".

Torque initial value selection at control mode switching	Command torque to servo amplifier immediately after switching from speed control mode to continuous operation to torque control mode
0: Command torque	Immediately after switching the control mode, the value of torque command device is the torque to servo amplifier regardless of the command torque time constant.
1: Feedback torque	Motor current value received from servo amplifier at switching is the torque to servo amplifier.

Speed initial value selection at control mode switching	Command speed to servo amplifier immediately after switching from speed control mode to continuous operation to torque control mode
0: Command speed	The speed to servo amplifier immediately after switching is the speed during command.
1: Feedback speed	Motor speed received from servo amplifier at switching.
2: Automatic selection	The speed to servo amplifier immediately after switching is the lower speed between "0: Command speed" and "1: Feedback speed".

The following chart shows the operation timing.

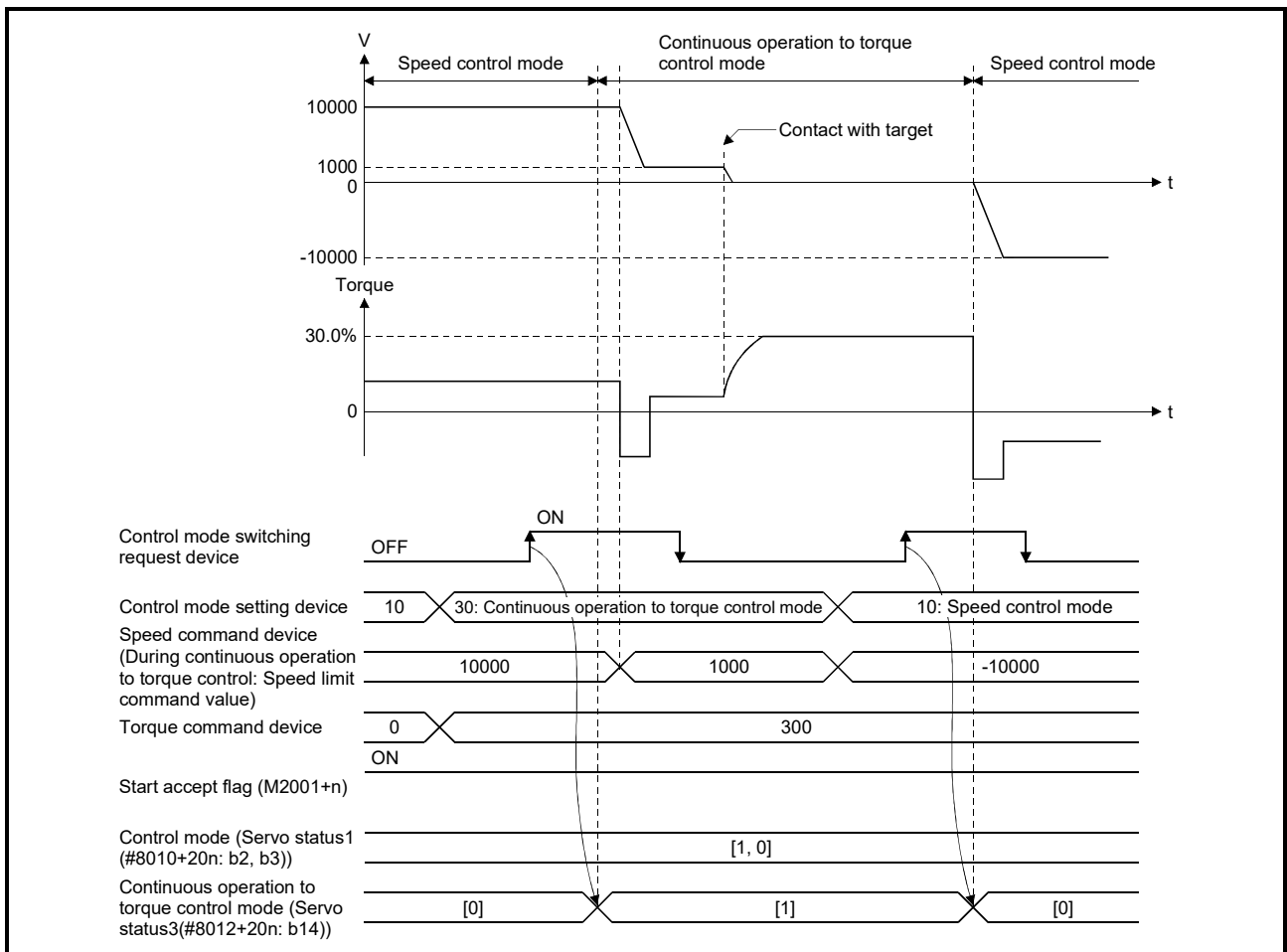

POINT
<p>When the mode is switched from continuous operation to torque control mode to speed control mode, the torque command during continuous operation to torque control is invalid. As shown in the figure above, when the target is pressed in continuous operation to torque control direction, if the mode is switched to speed control, torque is output to the torque limit value.</p> <p>Execute the following either if such operation will be a problem.</p> <ul style="list-style-type: none"> • Set the speed command which is in opposite direction of continuous operation to torque control direction in the speed command device before switching to the speed control mode. • Change the torque limit value to the lower value by torque limit value change request (CHGT) before switching to the speed control mode.

(3) Speed control mode

(a) Operation for speed control mode

The speed control is executed at speed set in "Speed command device" in the speed control mode.

Set a positive value for forward rotation and a negative value for reverse rotation. "Speed command device" can be changed any time during speed control mode.

Acceleration/deceleration is a trapezoidal acceleration/deceleration processing. Set acceleration/deceleration time toward "Speed limit value at speed-torque control" in "Command speed acceleration time" and "Command speed deceleration time". The value when the control mode switching request device turns OFF to ON is valid.

The command speed during speed control mode is limited with "Speed limit value at speed-torque control". If the speed exceeds speed limit value is set, a minor error (error code: 315) will occur, and the operation is controlled with speed limit value.

Confirm the command speed to servo amplifier the command speed (#8004+20n, #8005+20n).

Speed change request (CHGV, D(P).CHGV) is invalid (no operation).

Torque limit value can be changed within the range of "Torque limit value at speed-torque control" by torque limit value change request (CHGT, D(P).CHGT) or torque limit value individual change request (CHGT2, D(P).CHGT2). If the change outside the range of "Torque limit value at speed-torque control" is requested by torque limit value change request or torque limit value individual change request, a minor error (error code: 319) will occur, and the torque limit value is not changed.

(b) Current feed value during speed control mode

Feed current value (D0+20n, D1+20n) and real current value (D2+20n, D3+20n) are updated even during speed control mode.

If the current feed value exceeds the software stroke limit, a minor error (error code: 207) will occur and the operation is switched to position control mode. Invalidate the software stroke limit to execute one-way feed.

7 AUXILIARY AND APPLIED FUNCTIONS

(c) Stop cause during speed control mode

The operation for stop cause during speed control mode is shown below.

Item	Operation during speed control mode
The stop command (M3200+20n) turned ON.	The motor decelerates to speed "0" by setting value of "command speed deceleration time". The mode is switched to position control mode when "Zero speed (b3)" of servo status2 (#8011+20) turns ON, and the operation stops.
The rapid stop command (M3201+20n) turned ON.	
The external stop input turned ON.	
The all axes servo ON (M2042) turned OFF.	The servo OFF is not executed during speed control mode.
The servo OFF command (M3215+20n) turned ON.	The command status at that time becomes valid when the mode is switched to position control mode.
The current value reached to software stroke limit.	A minor error (error code: 200, 207) and major error (error code: 1101, 1102) will occur, and the motor decelerates to speed "0" by setting value of "Command speed deceleration time". The mode is switched to position control when "Zero speed (b3)" of servo status2 (#8011+20n) turns ON, and the operation stops.
The position of motor reached to hardware stroke limit	
The PLC ready flag (M2000) turned OFF.	
The forced stop input to Motion CPU.	The mode is switched to position control mode when the servo OFF (The servo ready signal (M2415+20n) turns OFF) is executed. (While the servo amplifier is servo OFF, even if the mode is switched to position control mode, the servo motor occurs to the free run. (The operation stops with dynamic brake.))
The forced stop input to servo amplifier.	
The servo error occurred.	
The servo amplifier's power supply turned OFF.	The motor occurs to the free run. (The operation stops with dynamic brake.) (The mode is to position control mode at the servo amplifier's power supply ON again.)

(4) Torque control mode

(a) Operation for torque control mode

The torque control is executed at command torque set in "Torque command device" in the torque control mode. Command torque can be changed any time during torque control mode.

Set time that reaches "Torque limit value at speed-torque control" from 0[%] in "Command torque time constant (Positive direction)" and time that decreases 0[%] from "Torque limit value at speed-torque control" in "Command torque time constant (Negative direction)". The value when the control mode switching request turns OFF to ON is valid for command torque time constant (Positive direction) and command torque time constant (Negative direction).

The command torque during torque control mode is limited with "Torque limit value at speed-torque control". If the torque exceeds torque limit value is set, a minor error (error code: 316) will occur, the operation is controlled with torque limit value at speed-torque control.

Speed change request (CHGV, D(P).CHGV) is invalid (no operation).

Torque limit value to servo amplifier can be changed within the range of "Torque limit value at speed-torque control" by torque limit value change request (CHGT, D(P).CHGT) or torque limit value individual change request (CHGT2, D(P).CHGT2), but the value is valid when the mode is switched to position control mode. Command torque time constant is calculated based on the "Torque limit value at speed-torque control" at torque control mode switching after the torque limit value is changed. If the change outside the range of "Torque limit value at speed-torque control" is requested by torque limit value change request torque limit value individual change request, a minor error (error code: 319) will occur, and the torque limit value is not changed.

(b) Speed during torque control mode

The speed during torque control mode is controlled with the absolute value of value set in "Speed command device" as speed limit command value.

When the speed reaches the absolute value of "Speed command device", "Speed limit (b4)" of servo status2 (#8011+20n) turns ON.

And, the value of "Speed command device" (speed limit command value for torque control) is limited with "Speed limit value at speed-torque control". If the speed limit command value exceeds speed limit value at speed-torque control is set, a minor error (error code: 315) will occur, and the operation is controlled with speed limit value at speed-torque control.

The acceleration/deceleration processing is invalid for the value of "Speed command device".

POINTS
The actual motor speed may not reach the speed limit command value depending on the machine load situation during torque control.

7 AUXILIARY AND APPLIED FUNCTIONS

(c) Current feed value during torque control mode

Feed current value (D0+20n, D1+20n) and real current value (D2+20n, D3+20n) are updated even in torque control. If the current feed value exceeds the software stroke limit, a minor error (error code: 207) will occur and the operation is switched to position control mode. Invalidate the software stroke limit to execute one-way feed.

(d) Stop cause during speed control mode

The operation for stop cause during torque control mode is shown below.

Item	Operation during torque control mode
The stop command (M3200+20n) turned ON.	The speed limit command value commanded to servo amplifier is "0" regardless of the setting value of "Speed command device". The mode is switched to position control mode when "Zero speed (b3)" of servo status2 (#8011+20n) turns ON, and the operation stops immediately. (Deceleration processing is not executed.) The value of command torque is not changed. It might take time to reach at the speed "0" depending on the current torque command value.
The rapid stop command (M3201+20n) turned ON.	
The external stop input turned ON.	
The all axes servo ON command (M2042) turned OFF.	The servo OFF is not executed during torque control mode. The command status at that time becomes valid when the mode is switched to position control mode.
The servo OFF command (M3215+20n) turned ON.	
The current value reached to software stroke limit.	The minor error (error code: 200, 207) and major error (error code: 1101, 1102) will occur. The mode is switched to position control mode at current position, and the operation immediately stops. (Deceleration processing is not executed.)
The position of motor reached to hardware stroke limit	
The PLC ready flag (M2000) turned OFF.	
The forced stop input to Motion CPU.	The mode is switched to position control mode when the servo OFF (The servo ready signal (M2415+20n) turns OFF) is executed. (While the servo amplifier is servo OFF, even if the mode is switched to position control mode, the servo motor occurs to the free run. (The operation stops with dynamic brake.))
The forced stop input to servo amplifier.	
The servo error occurred.	
The servo amplifier's power supply turned OFF.	The motor occurs to the free run. (The operation stops with dynamic brake.) (The mode is to position control mode at the servo amplifier's power supply ON again.)

(5) Continuous operation to torque control mode

(a) Operation for continuous operation to torque control mode

In continuous operation to torque control, the torque control can be executed by the speed limit command value after acceleration/deceleration processing without stopping the operation during the positioning in position control mode or speed command in speed control mode.

(Example) When the torque command is changed from 0.0% to 100% with the torque command device.

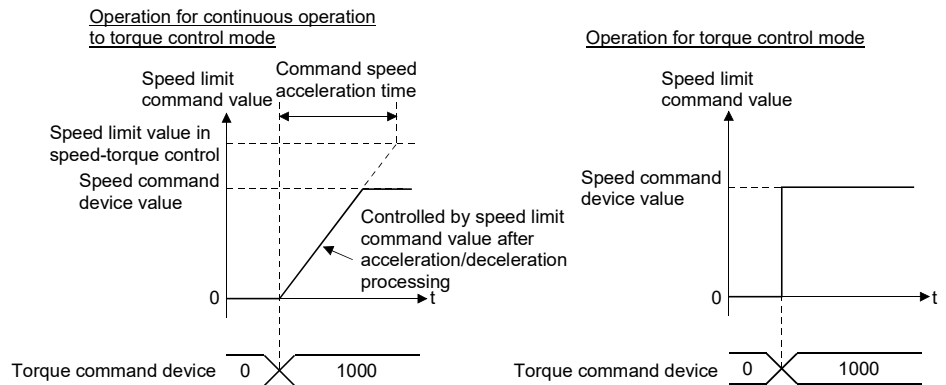

During continuous operation to torque control mode, the torque control is executed at command torque set in "Torque command device".

Command torque can be changed any time during continuous operation to torque control mode.

Speed change request (CHGV, D(P).CHGV) is invalid (no operation).

Torque limit value to servo amplifier can be changed within the range of "Torque limit value at speed-torque control" by torque limit value change request (CHGT, D(P).CHGT) or torque limit value individual change request (CHGT2, D(P).CHGT2), but the value is valid when the mode is switched to position control mode. Command torque time constant is calculated based on the "Torque limit value at speed-torque control" at torque control mode switching after the torque limit value is changed. If the change outside the range of "Torque limit value at speed-torque control" is requested by torque limit value change request or torque limit value individual change request, a minor error (error code: 319) will occur, and the torque limit value is not changed.

POINTS
When oscillations such as vibrations occur during continuous operation to torque control, check if lowering the value of the "Torque feedback loop gain (PB03)" servo parameter reduces the oscillations.

(b) Torque command setting method

During continuous operation to torque control mode, set time for the command torque to increase from 0[%] to torque limit value at speed-torque control" in "Command torque time constant (Positive direction)", and the command torque to decrease from "Torque limit value at speed-torque control" to 0[%] in "Command torque time constant (Negative direction)".

The value when the control mode switching request turns OFF to ON is valid for "Command torque time constant (Positive direction) and command torque time constant (Negative direction). The command torque during continuous operation to torque control mode is limited with "Torque limit value at speed-torque control".

If torque exceeds torque limit value is commanded, a minor error (error code: 316) will occur, and the operation is controlled with torque limit value at speed-torque control.

7 AUXILIARY AND APPLIED FUNCTIONS

(c) Acceleration/deceleration processing at continuous operation to torque control mode

Acceleration/deceleration is a trapezoidal acceleration/deceleration processing. Set acceleration/deceleration time toward "Speed limit value at speed-torque control" in "Command speed acceleration time" and "Command speed deceleration time". The value when the control mode switching request device turns OFF to ON is valid.

Command speed during continuous operation to torque control mode is limited with "Speed limit value at speed-torque control". If the speed exceeds speed limit value is commanded, a minor error (error code: 315) will occur, and the operation is controlled with speed limit value.

Confirm the command speed to servo amplifier with command speed (#8004+20n, #8005+20n).

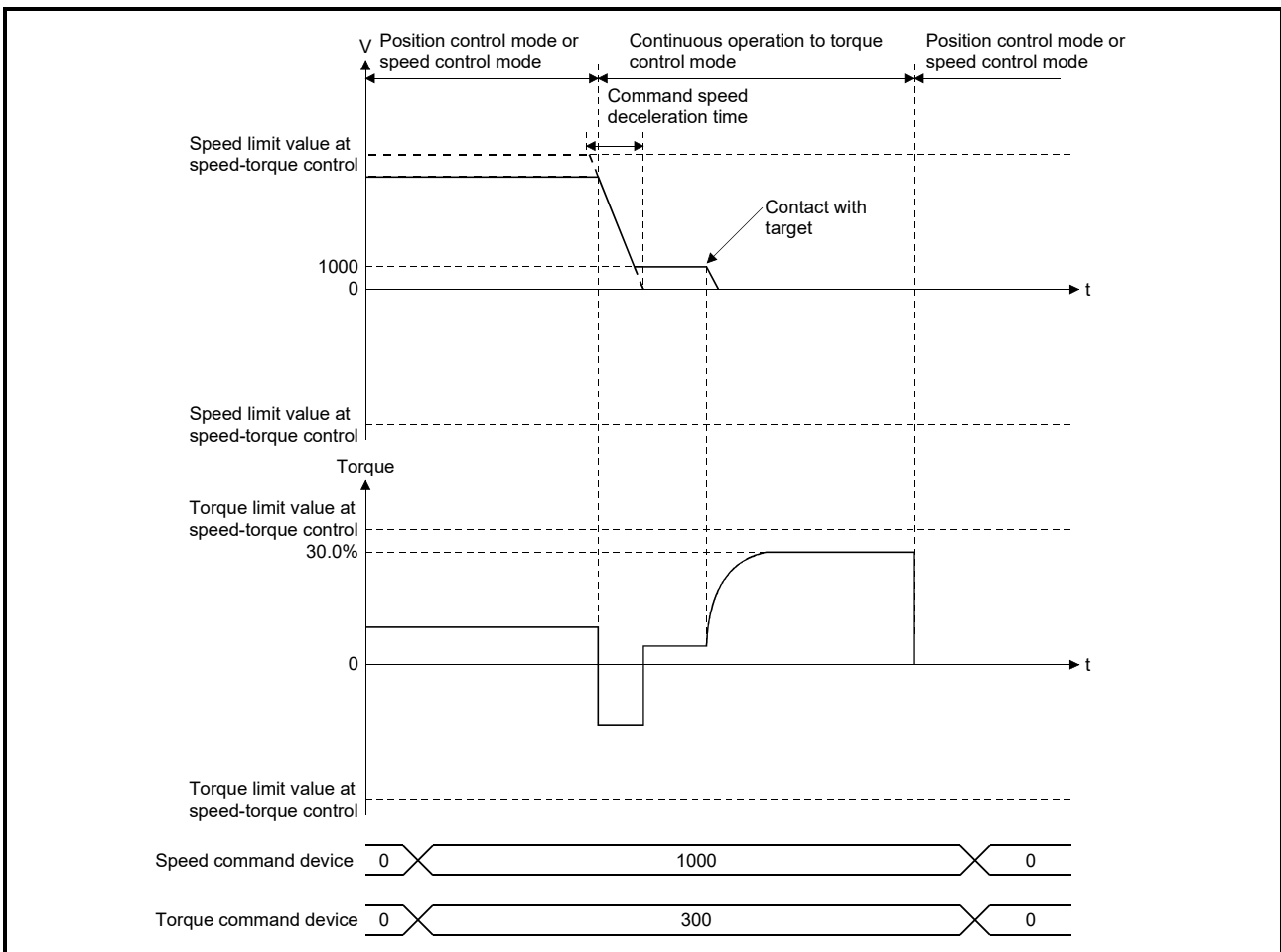

(d) Precautions at continuous operation to torque control mode

The following servo amplifier functions cannot be used during continuous operation to torque mode.

- Base cut delay time function
- Forced stop deceleration function
- Vertical axis freefall prevention function

7 AUXILIARY AND APPLIED FUNCTIONS

(e) Speed during continuous operation to torque control mode

The speed during continuous operation to torque control mode is limited with the absolute value of speed limit command value after acceleration/ deceleration processing with signed value set in "Speed command device". Speed direction depends on the torque command. When the speed reaches the absolute value of speed limit command value, "Speed limit (b4)" of servo status2 (#8011+20n) turns ON".

And, the value of "Speed command device" (speed limit command value for continuous operation to torque control) is limited with "Speed limit value at speed-torque control". If the speed limit command value exceeds speed limit value at speed-torque control is set, a minor error (error code: 315) will occur, and the operation is controlled with speed limit value at speed-torque control.

POINTS
(1) The actual motor speed may not reach the speed limit command value depending on the machine load situation during continuous operation to torque control mode.
(2) It is recommended to match the direction of torque command and speed command. When the direction of torque command and speed command is different, the speed may decelerate to 0.

(f) Current feed value during continuous operation to torque control mode

Feed current value (D0+20n, D1+20n) and real current value (D2+20n, D3+20n) are updated even in continuous operation to torque control mode. If the current feed value exceeds the software stroke limit, a minor error (error code: 207) will occur and the operation is switched to position control mode. Invalidate the software stroke limit to execute one-way feed.

7 AUXILIARY AND APPLIED FUNCTIONS

- (g) Stop cause during continuous operation to torque control mode
 The operation for stop cause during continuous operation to torque control mode is shown below.

Item	Operation during torque control mode
The stop command (M3200+20n) turned ON.	The speed limit command value commanded to servo amplifier is "0" regardless of the setting value of "Speed command device". The mode is switched to position control mode when "Zero speed (b3)" of servo status2 (#8011+20n) turns ON, and the operation stops immediately. (Deceleration processing is not executed.) The value of command torque is not changed. It might take time to reach at the speed "0" depending on the current torque command value.
The rapid stop command (M3201+20n) turned ON.	
The external stop input turned ON.	
The all axes servo ON command (M2042) turned OFF.	The servo OFF is not executed during torque control mode. The command status at that time becomes valid when the mode is switched to position control mode.
Servo OFF command (M3215+20n) turned ON.	
The current value reached to software stroke limit.	The minor error (error code: 200, 207) and major error (error code: 1101, 1102) will occur. The mode is switched to position control mode at current position, and the operation immediately stops. (Deceleration processing is not executed.) When the operation immediately stops, the motor will start hunting depending on the motor speed. Therefore, be sure not to reach to limit in high speed or do not turn OFF the PLC READY.
The position of motor reached to hardware stroke limit	
The PLC ready flag (M2000) turned OFF.	
The forced stop input to Motion CPU.	The mode is switched to position control mode when the servo OFF (The servo ready signal (M2415+20n) turns OFF) is executed. (While the servo amplifier is servo OFF, even if the mode is switched to position control mode, the servo motor occurs to the free run. (The operation stops with dynamic brake.))
The forced stop input to servo amplifier.	
The servo error occurred.	
The servo amplifier's power supply turned OFF.	The motor occurs to the free run. (The operation stops with dynamic brake.) (The mode is to position control mode at the servo amplifier's power supply ON again.)

7.8 Acceleration/Deceleration Time Change Function  

This function arbitrarily changes the acceleration/deceleration time at speed change, when changing speed with Motion dedicated functions (CHGV, CHGVS) of Motion SFC program (and also the Motion dedicated PLC instruction D(P).CHGV, D(P).CHGVS).

Normally (speed change without changing the acceleration/deceleration time), the acceleration/deceleration time is controlled by the positioning data of the servo program or the parameter block at the start. However, if a speed change is executed after setting the acceleration/deceleration time change parameter, speed changes at the set acceleration/deceleration time.

POINTS
"Acceleration/deceleration time after change" is the acceleration/deceleration time of positioning control being executed. "Acceleration/deceleration time after change" is valid until the switching of the next positioning point. (Automatic decelerating processing at positioning completion is also controlled by "Acceleration/deceleration time after change".)

(1) Speed change instructions for acceleration/deceleration time change

Classification	Instruction	Description	Remarks
Motion SFC program (Motion dedicated function)	CHGV	Speed change request	The acceleration/deceleration time change function toward the virtual servo axis is invalid.
	CHGVS	Command generation axis speed change request	
Motion dedicated PLC instruction	D(P).CHGV	Speed change request of the specified axis	The acceleration/deceleration time change function toward the virtual servo axis is invalid.
	D(P).CHGVS	Speed change request of the specified command generation axis	

(2) Control details

After setting the acceleration/deceleration time change parameter, if speed change command is executed, the acceleration/deceleration time changes.

The acceleration/deceleration time change parameter is set for every axis in the servo data settings of MT Developer2.

Refer to Section 4.4 for details of acceleration/deceleration time change parameter.

Refer to the "Q173DSCPU/Q172DSCPU Motion controller (SV22) Programming Manual (Advanced Synchronous Control)" for details of command generation axis parameter.

: Refer to Section 1.3 for the software version that supports this function.

7 AUXILIARY AND APPLIED FUNCTIONS

- (a) Set the change value of acceleration/deceleration time in the device set by acceleration time change value device/deceleration time change value device.

Name	Setting range
New acceleration time value device	0: Time change invalid
New deceleration time value device	1 to 65535[ms]

- (b) Device set by the acceleration/deceleration time change enable device turns ON (valid).

Operation at acceleration/deceleration time change is shown below.

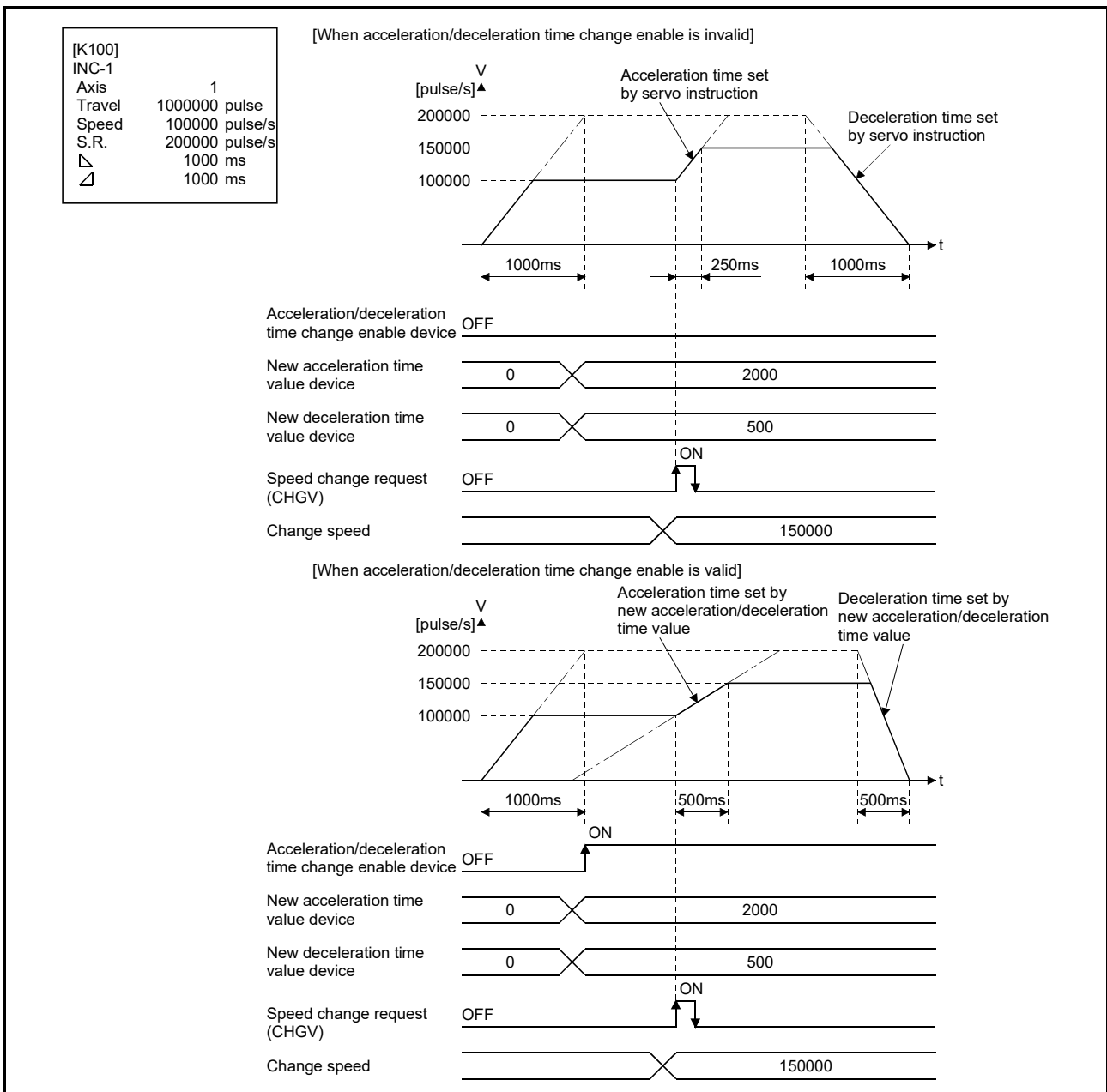

(3) Cautions

- (a) In the following cases acceleration time or deceleration time does not change when a speed change is executed. The acceleration time or deceleration time at the time of speed change accept is maintained.
- When setting of the acceleration/deceleration time change enable device was omitted.
 - When setting of new acceleration time value device or new deceleration time value device was omitted.
 - When the device set by new acceleration time value device or new deceleration time value device is set to "0".

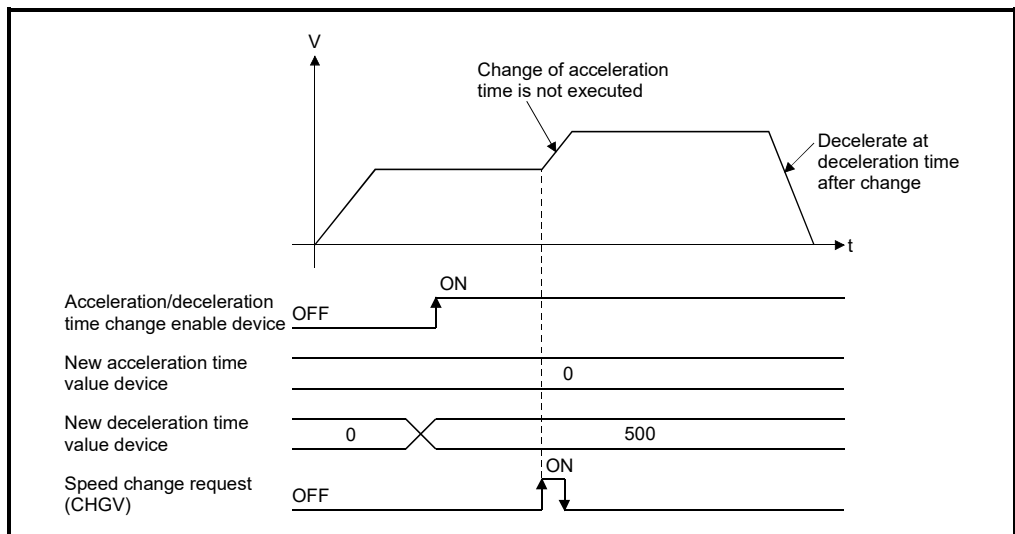

- (b) During interpolation control, change of acceleration/deceleration time is executed by the acceleration/deceleration time change parameter of the axis No. specified with the speed change command.
- (c) Acceleration/deceleration time change function becomes invalid for axes executing the following servo instructions:
- Circular interpolation control (including point during CPSTART)
 - Helical interpolation control (including point during CPSTART)
 - Speed control with fixed position stop
- (d) Acceleration/deceleration time change function becomes invalid for axes executing the following acceleration/deceleration methods:
- FIN acceleration/deceleration
 - Advanced S-curve acceleration/deceleration control

- (e) If a negative speed change request is executed acceleration/deceleration time change function is only valid for axes executing speed control (I), or speed control (II).

If a negative speed change request is executed for axes executing other instructions, acceleration/deceleration time change function becomes invalid. Also, if an acceleration/deceleration time change is performed for axes operating at a negative speed, acceleration/deceleration time change function becomes invalid.

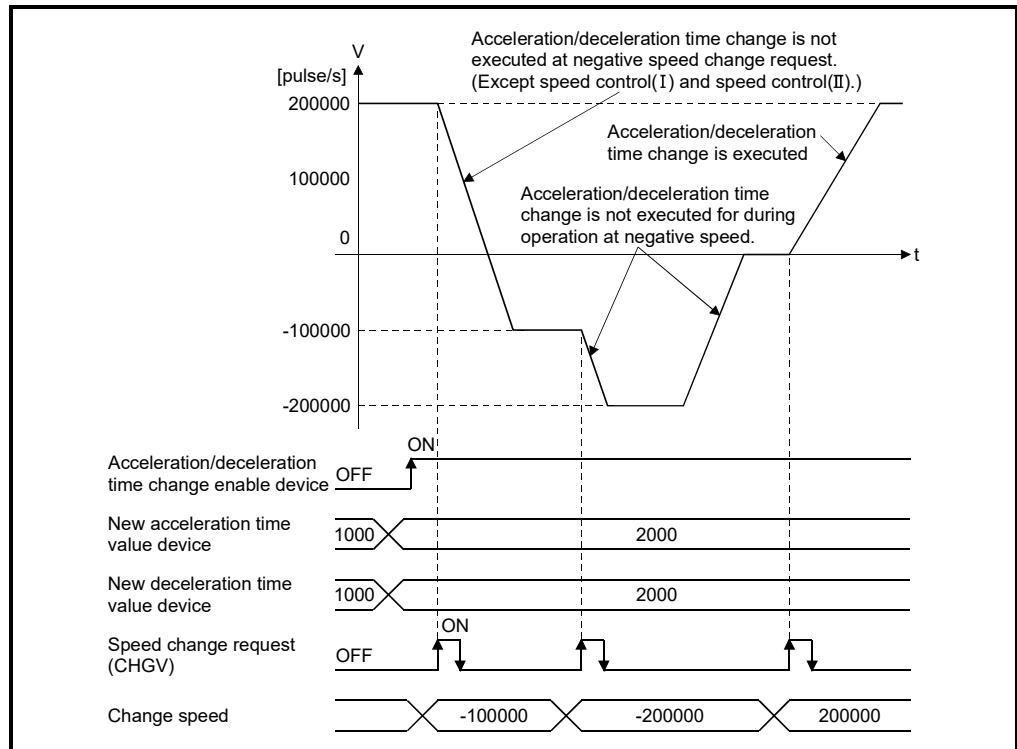

- (f) After changing deceleration time, operations for a stop or rapid stop are shown below:
 - Stop Deceleration stop by the deceleration speed after change.
 - Rapid stop Rapid stop by parameter setting values at start.

If changing deceleration time by the acceleration/deceleration time change function, regardless of whether the rapid stop deceleration time setting error invalid flag (SM805) is ON or OFF, deceleration time can be changed. Therefore, if the setting values of the rapid stop deceleration time are larger than the deceleration time change value after change, an overrun may occur. Refer to Section 4.3.1 for details of operation.

- (g) When the current value is to execute a deceleration stop from current command speed, if the current value exceeds the stroke limit range, a minor error (error code: 207) occurs, and deceleration stop is made before a stroke limit. However, if the deceleration distance after the deceleration time change is longer than the distance until the stroke limit, deceleration stop exceeds the stroke limit. Execute a speed change at a position where enough movement amount until the stroke limit is ensured.

7 AUXILIARY AND APPLIED FUNCTIONS

- (h) During a positioning operation where acceleration/deceleration time is changed, and the deceleration distance to the final positioning address for the output speed is not enough, a minor error (error code: 211) occurs and the operation immediately stops at the final positioning address. Execute a speed change at a position where enough movement amount until the stop position is ensured.
- (i) If acceleration/deceleration time is changed during speed control in speed-position switching (VPF/VPR), control continues at the acceleration/deceleration times changed during speed control even after switching from speed to position control. To control with the acceleration/deceleration time of the start after switching to position control, execute speed change again.
- (j) If acceleration/deceleration time is changed during speed switching control (VSTART), constant-speed control (CPSTART), control at the "acceleration/deceleration time after change" occurs only between the points where change was executed. From the next point onward, control at the "acceleration/deceleration time at start" set beforehand occurs. If the speed switching point specified flag (M2040) is ON in constant-speed control (CPSTART), speed change is executed up to the speed switching point at the "acceleration/deceleration time after change". (If the acceleration/deceleration time is changed to a large value, speed change may not be completed up to the speed switching point).

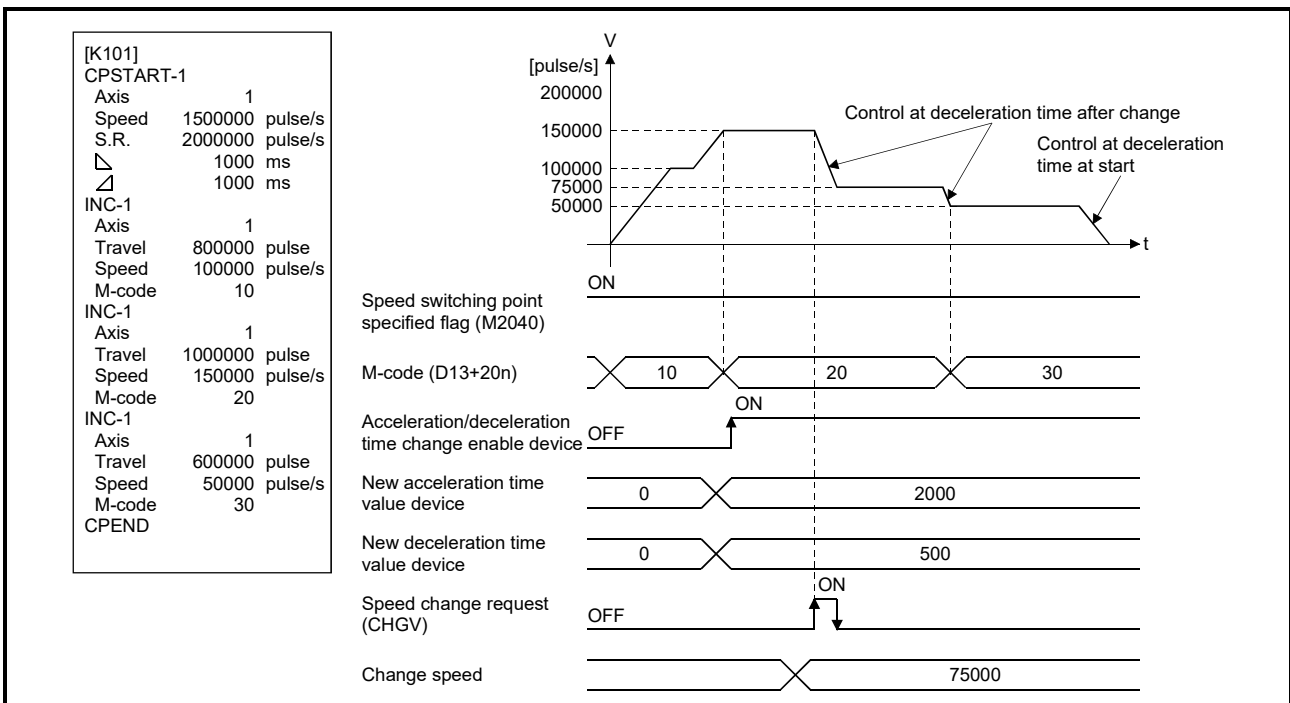

- (k) For control with changed acceleration/deceleration time, even if acceleration/deceleration time change enable device is turned OFF (invalid), control at acceleration/deceleration time after change continues until the operation ends.

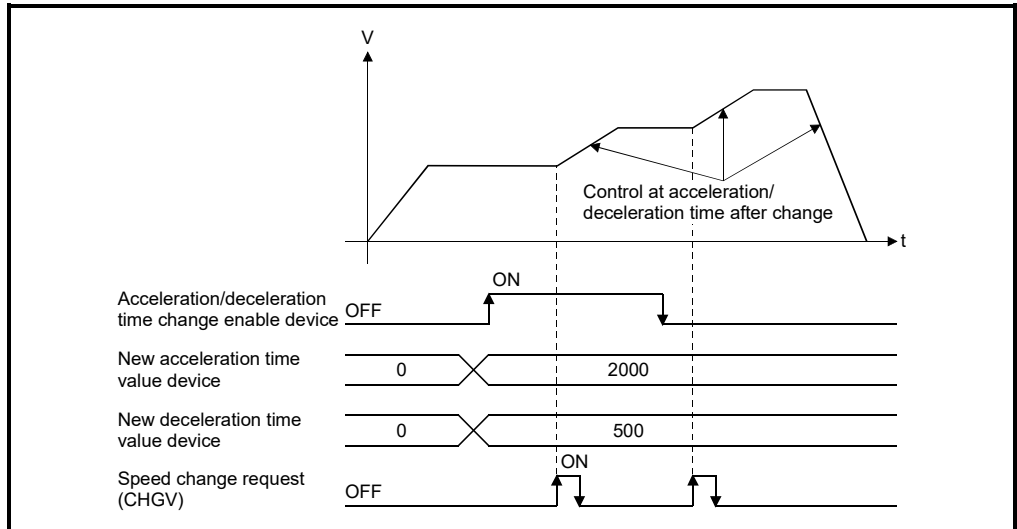

- (l) When position follow-up control (PFSTART) is performed in an axis where trapezoidal acceleration/deceleration is set, and deceleration time is changed to a value smaller than the operation cycle by the acceleration/deceleration time change function during automatic deceleration, positioning to the set address is completed instantly. This can cause vibrations or collisions, and depending on the remaining movement amount, servo errors can occur. Add automatic decelerating flag (M2128+n) to an interlock condition to so that acceleration/deceleration time change is not performed during automatic deceleration, or change the acceleration/deceleration time at a deceleration time where deceleration stop can be performed without fail.

APPENDICES

APPENDIX 1 Error Codes Stored Using the Motion CPU

The servo program setting errors and positioning errors are detected in the Motion CPU side.

(1) Servo program setting errors

These are positioning data errors set in the servo program, and it checks at the start of each servo program.

They are errors that occur when the positioning data is specified indirectly.

The operations at the error occurrence are shown below.

- The servo program setting error flag (SM516) turns on.
- The erroneous servo program is stored in the error program No. storage register (SD516).
- The error code is stored in the error item information register (SD517).

(2) Positioning error

(a) Positioning errors occurs at the positioning start or during positioning control.

There are minor errors, major errors and servo errors.

- 1) Minor errors..... These errors occur in the Motion SFC program or servo program, and the error codes 1 to 999 are used.
Check the error code, and remove the error cause by correcting the Motion SFC program or servo program.
- 2) Major errors..... These errors occur in the external input signals or control commands from the Motion SFC program, and the error codes 1000 to 1999 are used.
Check the error code, and remove the error cause of the external input signal state or Motion SFC program.
- 3) Servo errors These errors detected in the servo amplifier, and the error codes 2000 to 2999 are used.
Check the error code, and remove the error cause of the servo amplifier side.

- (b) The error detection signal of the erroneous axis turns on at the error occurrence, and the error codes are stored in the minor error code, major error code or servo error code storage register.

Table 1.1 Error code storage registers, error detection signals

Device Error class	Error code storage register																Error detection signal
	Axis 1	Axis 2	Axis 3	Axis 4	Axis 5	Axis 6	Axis 7	Axis 8	Axis 9	Axis 10	Axis 11	Axis 12	Axis 13	Axis 14	Axis 15	Axis 16	
Minor error	D6	D26	D46	D66	D86	D106	D126	D146	D166	D186	D206	D226	D246	D266	D286	D306	M2407+20n
Major error	D7	D27	D47	D67	D87	D107	D127	D147	D167	D187	D207	D227	D247	D267	D287	D307	
Servo error	D8	D28	D48	D68	D88	D108	D128	D148	D168	D188	D208	D228	D248	D268	D288	D308	

Device Error class	Error code storage register																Error detection signal
	Axis 17	Axis 18	Axis 19	Axis 20	Axis 21	Axis 22	Axis 23	Axis 24	Axis 25	Axis 26	Axis 27	Axis 28	Axis 29	Axis 30	Axis 31	Axis 32	
Minor error	D326	D346	D366	D386	D406	D426	D446	D466	D486	D506	D526	D546	D566	D586	D606	D626	M2407+20n
Major error	D327	D347	D367	D387	D407	D427	D447	D467	D487	D507	D527	D547	D567	D587	D607	D627	
Servo error	D328	D348	D368	D388	D408	D428	D448	D468	D488	D508	D528	D548	D568	D588	D608	D628	

(Note): The following range is valid.

- Q172DSCPU : Axis No.1 to 16
- Q172DCPU(-S1) : Axis No.1 to 8

- (c) If another error occurs after an error code has been stored, the existing error code is overwritten, deleting it.
However, the error history can be checked using MT Developer2.
- (d) Error detection signals and error codes are held until the error reset command (M3207+20n) or servo error reset command (M3208+20n) turns on.

POINTS
(1) Even if the servo error reset (M3208+20n) turns on at the servo error occurrence, the same error code might be stored again.
(2) Reset the servo error after removing the error cause of the servo amplifier side at the servo error occurrence.

APPENDIX 1.1 Servo program setting errors (Stored in SD517)

The error codes, error contents and corrective actions for servo program setting errors are shown in Table 1.2.

In the error codes marked with "Note" indicates the axis No. (1 to 32).

Table 1.2 Servo program setting error list

Error code stored in SD517	Error name	Error contents	Error processing	Corrective action															
1	Parameter block No. setting error	The parameter block No. is outside the range of 1 to 64.	Execute the servo program with the default value "1" of parameter block.	Set the parameter block No. within the range of 1 to 64.															
n03 (Note)	Address (travel value) setting error (Except the speed control and speed/position control.) (Setting error for linear axis at the helical-interpolation.)	<p>(1) The address is outside the setting range at the positioning start for absolute data method.</p> <table border="1"> <thead> <tr> <th>Unit</th> <th colspan="2">Address setting range</th> </tr> </thead> <tbody> <tr> <td>degree</td> <td>0 to 35999999</td> <td>$\times 10^{-5}$ [degree]</td> </tr> </tbody> </table> <p>(2) The travel value is set to -2147483648 (H80000000) at the positioning start for incremental data method.</p>	Unit	Address setting range		degree	0 to 35999999	$\times 10^{-5}$ [degree]	<p>(1) Positioning control does not start. (All interpolation control at the interpolation control.)</p> <p>(2) If the error is detected during the speed-switching control or constant-speed control, a deceleration stop is made.</p> <p>(3) If an error occurs in one servo program, all servo programs do not execute during the simultaneous start.</p>	<p>(1) If the control unit is [degree], set the address within the range of 0 to 35999999.</p> <p>(2) Set the travel value within the range of "0 to $\pm (2^{31}-1)$".</p>									
Unit	Address setting range																		
degree	0 to 35999999	$\times 10^{-5}$ [degree]																	
4	Command speed error	<p>(1) The command speed is outside the range of 1 to the speed limit value.</p> <p>(2) The command speed is outside the setting range.</p> <table border="1"> <thead> <tr> <th>Unit</th> <th colspan="2">Speed setting range</th> </tr> </thead> <tbody> <tr> <td>mm</td> <td>1 to 600000000</td> <td>$\times 10^{-2}$ [mm/min]</td> </tr> <tr> <td>inch</td> <td>1 to 600000000</td> <td>$\times 10^{-3}$ [inch/min]</td> </tr> <tr> <td>degree</td> <td>1 to 2147483647</td> <td>$\times 10^{-3}$ [degree /min] (Note-1)</td> </tr> <tr> <td>pulse</td> <td>1 to 2147483647</td> <td>[pulse/s]</td> </tr> </tbody> </table>	Unit	Speed setting range		mm	1 to 600000000	$\times 10^{-2}$ [mm/min]	inch	1 to 600000000	$\times 10^{-3}$ [inch/min]	degree	1 to 2147483647	$\times 10^{-3}$ [degree /min] (Note-1)	pulse	1 to 2147483647	[pulse/s]	<p>(1) Positioning control does not start if the command speed is "0" or less.</p> <p>(2) If the command speed exceeds the speed limit value, control with the speed limit value.</p>	Set the command speed within the range of 1 to the speed limit value.
Unit	Speed setting range																		
mm	1 to 600000000	$\times 10^{-2}$ [mm/min]																	
inch	1 to 600000000	$\times 10^{-3}$ [inch/min]																	
degree	1 to 2147483647	$\times 10^{-3}$ [degree /min] (Note-1)																	
pulse	1 to 2147483647	[pulse/s]																	
5	Dwell time setting error	The dwell time is outside the range of 0 to 5000.	Control with the default value "0".	Set the dwell time within the range of 0 to 5000.															
6	M-code setting error	The M-code is outside the range of 0 to 32767.		Set the M-code within the range of 0 to 32767.															
7	Torque limit value setting error	The torque limit value is outside the range of 1 to 1000.	Control with the torque limit value of the specified parameter block.	Set the torque limit value within the range of 1 to 1000.															

(Note-1): When the "speed control $10 \times$ multiplier setting for degree axis" is set to "valid", the setting range is 0.01 to 21474836.47 [degree/min].

Table 1.2 Servo program setting error list (Continued)

Error code stored in SD517	Error name	Error contents	Error processing	Corrective action						
n08 (Note)	Auxiliary point setting error (At the auxiliary point-specified circular interpolation.) (At the auxiliary point-specified helical interpolation.)	(1) The auxiliary point address is outside the setting range at the positioning start for absolute data method. <table border="1" style="margin-left: 20px;"> <tr> <th>Unit</th> <th colspan="2">Address setting range</th> </tr> <tr> <td>degree</td> <td>0 to 35999999</td> <td>$\times 10^{-5}$ [degree]</td> </tr> </table>	Unit	Address setting range		degree	0 to 35999999	$\times 10^{-5}$ [degree]	Positioning control does not start.	(1) If the control unit is [degree], set the auxiliary point address within the range of 0 to 35999999.
		Unit	Address setting range							
degree	0 to 35999999	$\times 10^{-5}$ [degree]								
(2) The auxiliary point address is set to -2147483648 (H80000000) at the positioning start for incremental data method.	(2) Set the auxiliary point address within the range of 0 to $\pm (2^{31}-1)$.									
n09 (Note)	Radius setting error (At the radius-specified circular interpolation.) (At the radius-specified helical interpolation.)	(1) The radius is outside the setting range at the positioning control for absolute data method. <table border="1" style="margin-left: 20px;"> <tr> <th>Unit</th> <th colspan="2">Address setting range</th> </tr> <tr> <td>degree</td> <td>0 to 35999999</td> <td>$\times 10^{-5}$ [degree]</td> </tr> </table>	Unit	Address setting range		degree	0 to 35999999	$\times 10^{-5}$ [degree]		(1) If the control unit is [degree], set the radius within the range of 0 to 35999999.
		Unit	Address setting range							
degree	0 to 35999999	$\times 10^{-5}$ [degree]								
(2) The radius is set to "0" or negative setting at the positioning start for incremental data method.	(2) Set the radius within the range of 1 to $(2^{31}-1)$.									
n10 (Note)	Central point setting error (At the central point-specified circular interpolation.) (At the central point-specified helical interpolation.)	(1) The central point address is outside the setting range at the positioning start for absolute data method. <table border="1" style="margin-left: 20px;"> <tr> <th>Unit</th> <th colspan="2">Address setting range</th> </tr> <tr> <td>degree</td> <td>0 to 35999999</td> <td>$\times 10^{-5}$ [degree]</td> </tr> </table>	Unit	Address setting range		degree	0 to 35999999	$\times 10^{-5}$ [degree]		(1) If the control unit is [degree], set the central point address within the range of 0 to 35999999.
		Unit	Address setting range							
degree	0 to 35999999	$\times 10^{-5}$ [degree]								
(2) The central point is set to -2147483648 (H80000000) at the positioning start for incremental data method.	(2) Set the central point address within the range of 0 to $\pm (2^{31}-1)$.									
11	Interpolation control unit setting error	The interpolation control unit is set outside the range of 0 to 3.	Control with the default value "3".	Set the interpolation control unit within the range of 0 to 3.						
12	Speed limit value setting error	The speed limit value is set outside the setting range.	Control with the default value 200000[pulse/s].	Set the speed limit value within the setting range. [For pulse] 1 to 2147483647[pulse/s]						
13	Acceleration time setting error	The acceleration time is set to "0".	Control with the default value "1000".	Set the acceleration time within the range of 1 to 65535.						
	FIN acceleration/deceleration setting error	The FIN acceleration/deceleration time is set except 1 to 5000.		The FIN acceleration/deceleration time within the range of 1 to 5000.						
	Fixed position stop acceleration/deceleration time setting error	The fixed position stop acceleration/deceleration time is set to "0".		Set the fixed position stop acceleration/deceleration time within the range of 1 to 65535.						
14	Deceleration time setting error	The deceleration time is set to "0".		Set the deceleration time within the range of 1 to 65535.						

Table 1.2 Servo program setting error list (Continued)

Error code stored in SD517	Error name	Error contents	Error processing	Corrective action										
15	Rapid stop deceleration time setting error	The rapid stop deceleration time is set to "0".	Control with the default value "1000".	Set the rapid stop deceleration time within the range of 1 to 65535.										
16	Torque limit value setting error	The torque limit value is outside the range of 1 to 1000.	Control with the default value "300[%]".	Set the torque limit value within the range of 1 to 1000.										
17	Allowable error range for circular interpolation setting error	The allowable error range for circular interpolation is outside the setting range. <table border="1" style="margin-left: 20px;"> <thead> <tr> <th>Unit</th> <th>Address setting range</th> </tr> </thead> <tbody> <tr> <td>mm</td> <td>0 to 100000 $\times 10^{-1}$ [μm]</td> </tr> <tr> <td>inch</td> <td>$\times 10^{-5}$ [inch]</td> </tr> <tr> <td>degree</td> <td>$\times 10^{-5}$ [degree]</td> </tr> <tr> <td>pulse</td> <td>[pulse]</td> </tr> </tbody> </table>	Unit	Address setting range	mm	0 to 100000 $\times 10^{-1}$ [μm]	inch	$\times 10^{-5}$ [inch]	degree	$\times 10^{-5}$ [degree]	pulse	[pulse]	Control with the default value "100[pulse]".	Set the allowable error range for circular interpolation within the setting range.
Unit	Address setting range													
mm	0 to 100000 $\times 10^{-1}$ [μm]													
inch	$\times 10^{-5}$ [inch]													
degree	$\times 10^{-5}$ [degree]													
pulse	[pulse]													
18	Repeat count error	The repeat count is outside the range of 1 to 32767.	Control the repeat count with "1".	Set the repeat count within the range of 1 to 32767.										
19	START instruction setting error	(1) The servo program specified with the START instruction does not exist.	Positioning control does not start.	(1) Create the servo program specified with the START instruction.										
		(2) There is a START instruction in the specified servo program.		(2) Delete the servo program specified with the START instruction.										
		(3) The starting axis of the specified servo program overlap.		(3) Do not overlap the starting axis.										
		(4) The real mode program and virtual mode program are mixed.		(4) Do not allow mixture of the real mode program and virtual mode program.										
		(5) The real axis program and command generation axis program are mixed.		(5) Do not allow mixture of the real axis program and command generation axis program.										
20	Point setting error	Point is not specified in the instruction at the constant-speed control.		Set a point between CPSTART and CPEND.										
21	Reference axis speed setting error	The axis except interpolation axis is set as the reference axis at the linear interpolation of the reference axis speed-specified method.		Set one of the interpolation axes as the reference axis.										
22	S-curve ratio setting error	S-curve ratio is set outside the range of 0 to 100[%] at the S-curve acceleration/deceleration.	Control the S-curve ratio with 0[%] (Trapezoidal acceleration/deceleration).	Set the S-curve ratio within the range of 0 to 100[%].										
23	VSTART setting error	Not even one speed-switching point has been set between a VSTART and VEND instruction, or between FOR and NEXT instruction.	Positioning control does not start.	Set the speed switching point between the VSTART and VEND instructions or the FOR and NEXT instructions.										
24	Cancel function start program No. error	The start program No. for the cancel function is set outside the range 0 to 4095.		Start after set the start program No. within the range of 0 to 4095.										

Table 1.2 Servo program setting error list (Continued)

Error code stored in D517	Error name	Error contents	Error processing	Corrective action
25	High-Speed oscillation command amplitude error	Operation cannot be started because the amplitude specified with the high-speed oscillation function is outside the range 1 to 2147483647.	Positioning control does not start.	Start after set the command amplitude within the range of 1 to 214783647.
26	High-Speed oscillation command starting angle error	Operation cannot be started because the starting angle specified with the high-speed oscillation function is outside the range of 0 to 3599 ($\times 0.1$ [degree]).		Start after set the starting angle within the range of 0 to 3599 ($\times 0.1$ [degree]).
27	High-Speed oscillation command frequency error	Operation cannot be started because the frequency specified with the high-speed oscillation function is outside the range of 1 to 5000[CPM].		Start after set the frequency within the range of 1 to 5000[CPM].
28	Number of helical interpolation pitches error	The specified number of pitches of helical interpolation is outside the range of 0 to 999.		Set the specified number of pitches within the range of 0 to 999.
41	Device error of the home position return data for indirect setting	Any unauthorized devices are set in the home position return data for indirect setting.	Positioning control does not start.	Review the devices of home position return data for indirect setting.
45	Advanced S-curve acceleration/ deceleration setting error	The acceleration section 1 ratio is outside the range of 0.0 to 100.0[%].	Control with acceleration section 1 ratio = 0.0 acceleration section 2 ratio = 0.0 deceleration section 1 ratio = 0.0 deceleration section 2 ratio = 0.0	Set the each ratio within the range of 0.0 to 100.0[%].
46		The acceleration section 2 ratio is outside the range of 0.0 to 100.0[%].		
47		The deceleration section 1 ratio is outside the range of 0.0 to 100.0[%].		
48		The deceleration section 2 ratio is outside the range of 0.0 to 100.0[%].		
49		(Acceleration section 1 + Acceleration section 2) > 100.0[%]		
50		(Deceleration section 1 + Deceleration section 2) > 100.0[%]		
51	Rapid stop deceleration time setting error	The rapid stop deceleration time is bigger than the setting value of deceleration time.	Control the rapid stop deceleration time with the setting value of deceleration time.	Set the rapid stop deceleration time within the range of 1 to deceleration time setting value.
900	START instruction setting error	The servo program specified with the servo program start does not exist.	Positioning control does not start.	Set the correct servo program No.
901	START instruction setting error	The axis No. set in the servo program start is different from the axis No. set in the servo program.		Set the correct axis No.
902	Servo program instruction code error	The instruction code cannot be decoded. (A non-existent instruction code has been specified.)		Set the correct instruction code.

Table 1.2 Servo program setting error list (Continued)

Error code stored in SD517	Error name	Error contents	Error processing	Corrective action
903	Start error	A virtual mode program was started in the real mode.	Positioning control does not start.	Check the program mode allocation.
905	Start error	(1) Operation disable instructions (VPF, VPR, VPSTART, PVF, PVR, ZERO, VVF, VVR, OSC) was started in virtual mode.		Correct the servo program.
		(2) Operation disable instructions (ZERO, OSC, CHGA-C) was started in real mode axis.		
		(3) Operation disable instructions (VPF, VPR, VPSTART, VSTART, ZERO, VVF, VVR, OSC) was started in command generation axis.		
		(4) Operation disable instructions (CHGA-C, CHGA-E) from the D(P).SVST instruction of Motion dedicated instruction was started.		
906	Axis No. setting error	(1) Unused axis of the system setting is set in the servo program start.		Set the axis No. set in the system setting or mechanical system program.
		(2) It was started by setting the real mode axis in the virtual servo program.		
		(3) It was started in the condition that the real mode axis had been mixed with virtual axis in the interpolation axis.		
		(4) It was started by setting the virtual axis in the real mode program in virtual mode.		
907	Start error	It was started during processing for switching from real mode to virtual mode.	Use M2043 (real mode/virtual mode switching request), M2044 (real mode/virtual mode switching status) as interlocks for start.	
908	Start error	It was stated during processing for switching from virtual mode to real mode.		

APPENDIX 1.2 Minor errors

These errors are detected in the sequence program or servo program, and the error codes of 1 to 999 are used.

Minor errors include the setting data errors, starting errors, positioning control errors and current value/speed/target position change errors and system errors.

(1) Setting data errors (1 to 99)

These errors occur when the data set in the parameters for positioning control is not correct.

The error codes, causes, processing, and corrective actions are shown in Table 1.3.

Table 1.3 Setting data error (1 to 99) list

Error code	Erroneous data	Check timing	Error cause	Error processing	Corrective action
21	Home position return data	Home position return start of the proximity dog method, count method, data set method, dog cradle method, stopper method, limit switch combined method, scale home position signal detection method, and dogless home position signal reference method.	The home position address is outside the range of 0 to 35999999 ($\times 10^{-5}$ [degree]) with degree axis.	Home position return is not started.	Set the home position address within the setting range using MT Developer2.
22		Home position return start of the proximity dog method, count method, data set method, dog cradle method, stopper method, limit switch combined method, scale home position signal detection method, and dogless home position signal reference method.	The home position return speed is outside the range of 1 to speed limit value.		Set the home position return speed or less to the speed limit value using MT Developer2.
23		Home position return start of the proximity dog method, count method, data set method, dog cradle method, stopper method, limit switch combined method, scale home position signal detection method, and dogless home position signal reference method.	The creep speed is outside the range of 1 to home position return speed.		Set the creep speed below to the home position return speed or less using MT Developer2.
24		Home position return start of the count method.	The travel value after the proximity dog ON is outside the range of 0 to $(2^{31}-1) (\times \text{unit})$.		Set the travel value after the proximity dog ON within the setting range using MT Developer2.
25		Home position return start of the count method, proximity dog method, dog cradle method, stopper method, limit switch combined method, scale home position signal detection method, and dogless home position signal reference method.	The parameter block No. is outside the range of 1 to 64.		Set the parameter block No. within the setting range using MT Developer2.
26		Home position return start of the stopper method.	Torque limit value at the creep speed is outside the range of 1 to 1000[%].		Set the torque limit value at the creep speed within the setting range using MT Developer2.

Table 1.3 Setting data error (1 to 99) list (Continued)

Error code	Erroneous data	Check timing	Error cause	Error processing	Corrective action
27	Home position return data	Home position return start of the usable retry function.	Dwell time at the home position return is outside the range of 0 to 5000[ms].	Home position return is not started.	Set the dwell time at the home position return retry within the setting range using MT Developer2.
40	Parameter block	Interpolation control start	The interpolation control unit of the parameter block is different from the control unit of the fixed parameters.	Control with the control unit of the fixed parameters.	Set the same control unit of the fixed parameters and servo parameters.

POINT

When the interpolation control unit of parameter block is different from the control unit of fixed parameters, an error code may not be stored with the combination of units.

Refer to Section 6.1.4 for details.

(2) Positioning control start errors (100 to 199)

These errors are detected at the positioning control start.

The error codes, causes, processing, and corrective actions are shown in Table 1.4.

Table 1.4 Positioning control start error (100 to 199) list

Error code	Control mode													Error cause	Error processing	Corrective action
	Positioning	Fixed-pitch feed	Speed	Speed-position switching	Speed switching	Constant-speed	JOG	Manual pulse generator	Home position return	Position follow-up control	OSC	Speed control with fixed position stop	Speed-torque control			
100	<input type="checkbox"/>	<input type="checkbox"/>	<input type="checkbox"/>	<input type="checkbox"/>	<input type="checkbox"/>	<input type="checkbox"/>	<input type="checkbox"/>	<input type="checkbox"/>	<input type="checkbox"/>	<input type="checkbox"/>	<input type="checkbox"/>	<input type="checkbox"/>	<input type="checkbox"/>	• The PLC ready flag (M2000) or PCPU READY complete flag (SM500) is OFF.	Positioning control does not start.	• Set the Motion CPU to RUN. • Turn the PLC ready flag (M2000) on.
101	<input type="checkbox"/>	<input type="checkbox"/>	<input type="checkbox"/>	<input type="checkbox"/>	<input type="checkbox"/>	<input type="checkbox"/>	<input type="checkbox"/>	<input type="checkbox"/>	<input type="checkbox"/>	<input type="checkbox"/>	<input type="checkbox"/>	<input type="checkbox"/>	<input type="checkbox"/>	• The start accept flag (M2001 to M2032) for applicable axis is ON.		• Take an interlock in the program not to start the starting axis. (Use the start accept flag OFF of the applicable axis as the starting condition).
103	<input type="checkbox"/>	<input type="checkbox"/>	<input type="checkbox"/>	<input type="checkbox"/>	<input type="checkbox"/>	<input type="checkbox"/>	<input type="checkbox"/>	<input type="checkbox"/>	<input type="checkbox"/>	<input type="checkbox"/>	<input type="checkbox"/>	<input type="checkbox"/>	<input type="checkbox"/>	• The stop command (M3200+20n) for applicable axis is ON.		• Turn the stop command (M3200+20n) off and start.
104	<input type="checkbox"/>	<input type="checkbox"/>	<input type="checkbox"/>	<input type="checkbox"/>	<input type="checkbox"/>	<input type="checkbox"/>	<input type="checkbox"/>	<input type="checkbox"/>	<input type="checkbox"/>	<input type="checkbox"/>	<input type="checkbox"/>	<input type="checkbox"/>	<input type="checkbox"/>	• The rapid stop command (M3201+20n) for applicable axis is ON.		• Turn the rapid stop command (M3201+20n) off and start.
105 (Note)	<input type="checkbox"/>				<input type="checkbox"/>	<input type="checkbox"/>								• The feed current value is outside the range of stroke limit at the start.		• Set within the stroke limit range by the JOG operation. • Set within the stroke limit range by the home position return or current value change.
106 (Note)	<input type="checkbox"/>	<input type="checkbox"/>			<input type="checkbox"/>	<input type="checkbox"/>					<input type="checkbox"/>	<input type="checkbox"/>		• Positioning is outside the range of stroke limit. • When absolute position system is enabled for stepping driver, and software stroke limit is valid with control units as degree, the following instructions were started. (1) Absolute system instructions in constant-speed control (2) Position follow-up control (3) Absolute system instructions in speed-switching control		• Perform the positioning within the range of stroke limit. • When absolute position system is enabled for stepping driver, if software stroke limit is valid and control units are degree, do not use the following instructions. (1) Absolute system instructions in constant-speed control (2) Position follow-up control (3) Absolute system instructions in speed-switching control

(Note): These errors are stored the error codes of the all applicable interpolation axes at the interpolation operation.

Table 1.4 Positioning control start error (100 to 199) list (Continued)

Error code	Control mode												Error cause	Error processing	Corrective action	
	Positioning	Fixed-pitch feed	Speed	Speed-position switching	Speed switching	Constant-speed	JOG	Manual pulse generator	Home position return	Position follow-up control	OSC	Speed control with fixed position stop				Speed-torque control
107 (Note)	○													<ul style="list-style-type: none"> The address that does not generate an arc is set at auxiliary point-specified circular interpolation or auxiliary point-specified helical interpolation. (Relationship between the start point, auxiliary point and end point.) 	Positioning control does not start.	<ul style="list-style-type: none"> Correct the addresses of the servo program.
		<ul style="list-style-type: none"> The auxiliary point-specified circular interpolation or auxiliary point-specified helical interpolation was started in the control unit degree axis which is "stroke limit invalid". 	<ul style="list-style-type: none"> Make the stroke limit valid for the control unit degree axis starts the auxiliary point-specified circular interpolation or auxiliary point-specified helical interpolation. 													
		<ul style="list-style-type: none"> The auxiliary point-specified circular interpolation or auxiliary point-specified helical interpolation was started in the axis which is "stroke limit invalid". 	<ul style="list-style-type: none"> Make the stroke limit valid for the axis starts the auxiliary point-specified circular interpolation or auxiliary point-specified helical interpolation. 													
108 (Note)	○													<ul style="list-style-type: none"> The address that does not generate an arc is set at R (radius) specified circular interpolation or R (radius) specified helical interpolation. (Relationship between the start point, radius and end point.) 	Positioning control does not start.	<ul style="list-style-type: none"> Correct the addresses of the servo program.
		<ul style="list-style-type: none"> The radius-specified circular interpolation or radius-specified helical interpolation was started in the control unit degree axis which is "stroke limit invalid". 	<ul style="list-style-type: none"> Make the stroke limit valid for the control unit degree axis starts the radius-specified circular interpolation or radius-specified helical interpolation. 													
		<ul style="list-style-type: none"> The radius-specified circular interpolation or radius-specified helical interpolation was started in the axis which is "stroke limit invalid". 	<ul style="list-style-type: none"> Make the stroke limit valid for the axis starts the radius-specified circular interpolation or radius-specified helical interpolation. 													

(Note): These errors are stored the error codes of the all applicable interpolation axes at the interpolation operation.

Table 1.4 Positioning control start error (100 to 199) list (Continued)

Error code	Control mode												Error cause	Error processing	Corrective action	
	Positioning	Fixed-pitch feed	Speed	Speed-position switching	Speed switching	Constant-speed	JOG	Manual pulse generator	Home position return	Position follow-up control	OSC	Speed control with fixed position stop				Speed-torque control
109 (Note)	○					○								<ul style="list-style-type: none"> The address that does not generate an arc is set at central point-specified circular interpolation or central point-specified helical interpolation. (Relationship between the start point, central point and end point.) The central point-specified circular interpolation or central point-specified helical interpolation was started in the control unit degree axis which is "stroke limit invalid". The central point-specified circular interpolation or central point-specified helical interpolation was started in the axis which is "stroke limit invalid". 	Positioning control does not start.	<ul style="list-style-type: none"> Correct the addresses of the servo program.
110 (Note)	○				○								<ul style="list-style-type: none"> The difference between the end point address and ideal end point is outside the allowable error range for circular interpolation at the circular interpolation. 	<ul style="list-style-type: none"> Make the stroke limit valid for the control unit degree axis starts the central point-specified circular interpolation or central point-specified helical interpolation. Make the stroke limit valid for the axis starts the central point-specified circular interpolation or central point-specified helical interpolation. 		
111				○										<ul style="list-style-type: none"> The speed/position control restarting was performed, although it was not after stop during operation of the speed-position switching control. 		<ul style="list-style-type: none"> Correct the addresses of the servo program.
																<ul style="list-style-type: none"> Do not re-start except the stop during speed-position switching control.

(Note): These errors are stored the error codes of the all applicable interpolation axes at the interpolation operation.

Table 1.4 Positioning control start error (100 to 199) list (Continued)

Error code	Control mode												Error cause	Error processing	Corrective action	
	Positioning	Fixed-pitch feed	Speed	Speed-position switching	Speed switching	Constant-speed	JOG	Manual pulse generator	Home position return	Position follow-up control	OSC	Speed control with fixed position stop				Speed-torque control
115									○					<ul style="list-style-type: none"> The home position return complete signal (M2410+20n) turned on at the home position return of proximity dog method, dog cradle method, stopper method, and dogless home position signal reference method. 	Positioning control does not start.	<ul style="list-style-type: none"> Do not start continuously for the home position return. <ol style="list-style-type: none"> At the home position return of proximity dog method, dog cradle method or stopper method: Return to a point before the proximity dog signal ON by JOG operation or positioning operation, etc., and perform the home position return. At the home position return of dogless home position signal reference method: Return to a point before the home position by JOG operation or positioning operation, etc., and perform the home position return.
116														<ul style="list-style-type: none"> The setting JOG speed is "0". 	Control with the JOG speed limit value.	<ul style="list-style-type: none"> Set the correct speed (within the setting range).
	<ul style="list-style-type: none"> The setting JOG speed exceeded the JOG speed limit value. 	<ul style="list-style-type: none"> The setting JOG speed limit value exceeded the setting range. 	Control with the maximum setting range of each control unit.	<ul style="list-style-type: none"> Set the correct JOG speed limit value (within the setting range). 												
117									○					<ul style="list-style-type: none"> Both of forward and reverse rotation were set at the simultaneous start for the JOG operation. 	Only the applicable axis set to the forward direction starts.	<ul style="list-style-type: none"> Set a correct data.
119														<ul style="list-style-type: none"> In the real mode or at the real mode axis, the instruction to specify the end point address by absolute data method in speed switching control was executed for the axis with unit [pulse/mm/inch] where the stroke limit is disabled. 	Positioning control does not start.	<ul style="list-style-type: none"> When specifying the end point address by absolute data method in speed switching control, make the stroke limit valid.

Table 1.4 Positioning control start error (100 to 199) list (Continued)

Error code	Control mode												Error cause	Error processing	Corrective action	
	Positioning	Fixed-pitch feed	Speed	Speed-position switching	Speed switching	Constant-speed	JOG	Manual pulse generator	Home position return	Position follow-up control	OSC	Speed control with fixed position stop				Speed-torque control
120									○					<ul style="list-style-type: none"> • ZCT not set The zero pass signal (M2406+20n) turned off at the re-travel at the home position return for proximity dog, count and limit switch combined method or start in the home position return for data set method. 	Home position return is not completed correctly.	<ul style="list-style-type: none"> • Execute the home position return after the zero point passed.
121	○	○	○	○	○	○				○	○	○	○	<ul style="list-style-type: none"> • When "Not execute servo program" is selected in the operation setting for incompleteness of home position return, the home position return request signal (M2409+20n) turns on. 	Positioning control does not start.	<ul style="list-style-type: none"> • Execute servo program after home position return. • In the system which enables execution of servo program even if the home position return request signal (M2409+20n) turns on, set "Execute servo program" as "operation setting for incompleteness of home position return".
122									○					<ul style="list-style-type: none"> • Home position return is started on the direct drive motor when the absolute position data of the encoder has not been established. 		
123									○					<ul style="list-style-type: none"> • When the home position is on the proximity dog, the scale home position signal detection method home position return was started up again, at the home position return complete signal ON, after completion of the home position return. 	Home position return does not start.	<ul style="list-style-type: none"> • When the home position is on the proximity dog, continuous home position returns of scale home position signal detection method are not supported. • Execute JOG operation or positioning to return before the proximity dog ON, and execute home position return.
124									○					<ul style="list-style-type: none"> • When using the scale home position signal detection method home position return or the dogless home position signal reference method home position return (operation A), the servo parameter PC17 is other than "Need to pass motor Z phase after the power supply is switched on". 		

Table 1.4 Positioning control start error (100 to 199) list (Continued)

Error code	Control mode												Error cause	Error processing	Corrective action		
	Positioning	Fixed-pitch feed	Speed	Speed-position switching	Speed switching	Constant-speed	JOG	Manual pulse generator	Home position return	Position follow-up control	OSC	Speed control with fixed position stop				Speed-torque control	
130														○	<ul style="list-style-type: none"> Speed control with fixed position stop with was started for the axis set in except unit [degree]. Speed control with fixed position stop was started in the axis which is not "stroke limit invalid". 	Positioning control does not start.	<ul style="list-style-type: none"> Set the unit [degree] in the axis which starts speed control with fixed position stop. Set the stroke limit invalid "(Upper stroke limit value) equal to (lower stroke limit value)" in the axis which starts speed control with fixed position stop.
133									○						<ul style="list-style-type: none"> A data set method 2 and stopper method 1/2 home position return were started when using VCI (CKD Nikki Denso) and VPH (CKD Nikki Denso). 	Home position return does not start.	<ul style="list-style-type: none"> VCI (CKD Nikki Denso) and VPH (CKD Nikki Denso) does not support data set method 2 and stopper method 1/2 home position return. Change to the usable home position return system.
136			○												<ul style="list-style-type: none"> An unusable instruction (VVF/VVR) was started in an axis that does not support VVF/VVR instruction. 		<ul style="list-style-type: none"> Cannot start VVF/VVR instruction in an axis that does not support VVF/VVR instruction.
140	○														<ul style="list-style-type: none"> The travel value of the reference axis is set at "0" in the linear interpolation for reference axis specification. 		<ul style="list-style-type: none"> Do not set axis of travel value "0" as the reference axis.
141										○					<ul style="list-style-type: none"> The position command device of position follow-up control is set the odd number. 	Positioning control does not start.	<ul style="list-style-type: none"> Set the even number for the position command device of position follow-up control.
142				○							○				<ul style="list-style-type: none"> The positioning control which use the external input signal was executed for the axis which has not set the external input signal in the system settings. 		<ul style="list-style-type: none"> Set the external input signal in the system setting.
145				○							○				<ul style="list-style-type: none"> Unusable instructions were started in the external input signal setting via servo amplifier. 		<ul style="list-style-type: none"> Do not start the speed-position switching control and count method home position return in the external input signal setting via servo amplifier.
151	○	○	○	○	○	○	○	○		○					<ul style="list-style-type: none"> Not allowed axis started in the virtual mode. (It cannot be started with error at real mode/virtual mode switching.) 	Positioning control does not start.	<ul style="list-style-type: none"> Start in the virtual mode again after correct the error cause in the real mode.
152	○	○	○	○	○	○	○	○		○					<ul style="list-style-type: none"> It started at the virtual mode and during deceleration by all axes servo OFF (M2042 OFF). 		

Table 1.4 Positioning control start error (100 to 199) list (Continued)

Error code	Control mode												Error cause	Error processing	Corrective action	
	Positioning	Fixed-pitch feed	Speed	Speed-position switching	Speed switching	Constant-speed	JOG	Manual pulse generator	Home position return	Position follow-up control	OSC	Speed control with fixed position stop				Speed-torque control
153	<input type="radio"/>	<input type="radio"/>	<input type="radio"/>	<input type="radio"/>	<input type="radio"/>	<input type="radio"/>	<input type="radio"/>	<input type="radio"/>	<input type="radio"/>	<input type="radio"/>	<input type="radio"/>	<input type="radio"/>	<input type="radio"/>	<ul style="list-style-type: none"> It started at the virtual mode and during deceleration by occurrence of the output module servo error. 	Positioning control does not start.	<ul style="list-style-type: none"> Start in the virtual mode again after correct the error cause in the real mode.
154														<ul style="list-style-type: none"> One of the devices set in the speed-torque control operation data is outside the range. 	The control mode is not switched.	<ul style="list-style-type: none"> Correct the speed-torque control operation data device.
														<ul style="list-style-type: none"> The servo parameter "POL reflection selection at torque control (PC29)" is set to "0: Valid" in the axis where the torque initial value selection at control mode switching is set to the feedback torque. 	Control with the initial value selection of torque at control mode switching as command torque.	<ul style="list-style-type: none"> Use the servo amplifier compatible with the reflection selection at torque control and set the POL reflection selection at torque control to "1: Invalid". Set the command torque to the torque initial value selection at control mode switching.
155														<ul style="list-style-type: none"> The control mode switching was executed with an invalid value specified in the control mode setting device. 	The control mode is not switched.	<ul style="list-style-type: none"> Correct the value of the control mode setting device. When switching the mode from the continuous operation to torque control mode to another, return the mode to the previous one.
156														<ul style="list-style-type: none"> The control mode switching request was executed during the zero speed was OFF. 		<ul style="list-style-type: none"> Switch the control mode while the axis is stopped and the zero speed is turned on. Make "Invalid selection during zero speed at control mode switching" valid when not waiting for the stop of the servo motor.
157														<ul style="list-style-type: none"> At the control mode switching, a value set to the speed limit value at speed-torque control is outside the range. 	Control with the maximum setting range of each axis unit.	<ul style="list-style-type: none"> Set the correct speed limit value (within the setting range).
158														<ul style="list-style-type: none"> At the control mode switching, a value set to the torque limit value at speed-torque control is outside the range. 	Control with the default value "300[%]".	<ul style="list-style-type: none"> Set the torque limit value to 0.1[%] to 1000.0[%].
159														<ul style="list-style-type: none"> The control mode switching request of speed/torque control was executed for the axis that connects to the stepping driver which do not support the control mode switching. 	The control mode is not switched.	<ul style="list-style-type: none"> Do not switch the control mode switching request of speed/torque control for the axis that connects to the stepping driver which does not support the control mode switching.

Table 1.4 Positioning control start error (100 to 199) list (Continued)

Error code	Control mode											Error cause	Error processing	Corrective action		
	Positioning	Fixed-pitch feed	Speed	Speed-position switching	Speed switching	Constant-speed	JOG	Manual pulse generator	Home position return	Position follow-up control	OSC				Speed control with fixed position stop	Speed-torque control
192									○					<ul style="list-style-type: none"> The dogless home position signal reference method home position return was started for the axis which is connected with an amplifier other than MR-J3(W)-B series, MR-J4(W)-B series, and MR-J5(W)-B series. 	Home position return does not start.	<ul style="list-style-type: none"> Start the dogless home position signal reference method home position return for the axis which is connected with either of MR-J3(W)-B series, MR-J4(W)-B series or MR-J5(W)-B series.
193								○					<ul style="list-style-type: none"> When using the dogless home position signal reference method home position return (operation B), the servo parameter PC17 is other than "Not need to pass motor Z phase after the power supply is switched on". 	<ul style="list-style-type: none"> Set the servo parameter PC17 to "Not need to pass motor Z phase after the power supply is switched on". When you change the servo parameter PC17, please once turn off the power supply of servo amplifier and turn it on again. 		
194								○					<ul style="list-style-type: none"> A home position return instruction that cannot be executed on stepping driver was executed. The driver home position return method home position return was started for the axis which is not connected with a stepping driver. 	<ul style="list-style-type: none"> Home position return methods other than the following cannot be used for stepping driver. Change to a home position return method that can be used. <ol style="list-style-type: none"> Count method 2 Data set method 1 Driver home position return method Start the driver home position return method home position return for the axis which is connected with a stepping driver. 		

(3) Positioning control errors (200 to 299)

These are errors detected during the positioning control.

The error codes, causes, processing and corrective actions are shown in Table 1.5.

Table 1.5 Positioning control error (200 to 299) list

Error code	Control mode													Error cause	Error processing	Corrective action
	Positioning	Fixed-pitch feed	Speed	Speed-position switching	Speed switching	Constant-speed	JOG	Manual pulse generator	Home position return	Position follow-up control	OSC	Speed control with fixed position stop	Speed-torque control			
200	<input type="radio"/>	<input type="radio"/>	<input type="radio"/>	<input type="radio"/>	<input type="radio"/>	<input type="radio"/>	<input type="radio"/>	<input type="radio"/>	<input type="radio"/>	<input type="radio"/>	<input type="radio"/>	<input type="radio"/>	<input type="radio"/>	<ul style="list-style-type: none"> The PLC ready flag (M2000) turned off during the control by the servo program. 	Deceleration stop (Immediate stop during torque control and continuous operation to torque control)	<ul style="list-style-type: none"> Turn the PLC ready flag (M2000) on after all axes have stopped.
201								<input type="radio"/>						<ul style="list-style-type: none"> The PLC ready flag (M2000) turned off during the home position return. 	Deceleration stop	<ul style="list-style-type: none"> Perform the home position return again after turning the PLC ready flag (M2000) on or turning the stop command (M3200+20n) or rapid stop command (M3201+20n) off.
202								<input type="radio"/>						<ul style="list-style-type: none"> The stop command (M3200+20n) turned on during the home position return. 		
203									<input type="radio"/>					<ul style="list-style-type: none"> The rapid stop command (M3201+20n) turned on during the home position return. 	Rapid stop	<ul style="list-style-type: none"> Return to a point before the proximity dog signal ON using JOG operation or positioning operation, and perform the home position return again in the proximity dog method.
204	<input type="radio"/>	<input type="radio"/>	<input type="radio"/>	<input type="radio"/>	<input type="radio"/>	<input type="radio"/>	<input type="radio"/>	<input type="radio"/>	<input type="radio"/>	<input type="radio"/>	<input type="radio"/>	<input type="radio"/>	<input type="radio"/>	<ul style="list-style-type: none"> The PLC ready flag (M2000) turned off to on again during deceleration by turning off the PLC ready flag (M2000). 	No operation	<ul style="list-style-type: none"> Turn the PLC ready flag (M2000) off to on after all axes have stopped. Turn the PLC ready flag (M2000) off to on during deceleration is "no operation".

Table 1.5 Positioning control error (200 to 299) list (Continued)

Error code	Control mode												Error cause	Error processing	Corrective action	
	Positioning	Fixed-pitch feed	Speed	Speed-position switching	Speed switching	Constant-speed	JOG	Manual pulse generator	Home position return	Position follow-up control	OSC	Speed control with fixed position stop				Speed-torque control
206									○					<ul style="list-style-type: none"> All axes rapid stop is executed using the test mode of MT Developer2 during the home position return. 	Rapid stop	<ul style="list-style-type: none"> Return to a point before the proximity dog signal ON using JOG operation or positioning operation, and perform the home position return again in the proximity dog method. Return to a point before the proximity dog signal ON using JOG operation or positioning operation, and perform the home position return again, when the proximity dog signal turns off in the count method. [Perform the home position return operation again, when the proximity dog signal turns on in the count method.]
207	○				○	○	○			○				<ul style="list-style-type: none"> The feed current value exceeded the stroke limit range during positioning control. Only the axis exceed the stroke limit range is stored at the circular/helical interpolation. All interpolation axes are stored in the linear interpolation. 	Deceleration stop (Immediate stop during torque control and continuous operation to torque control)	<ul style="list-style-type: none"> Correct the stroke limit range or travel value setting so that positioning control is within the range of the stroke limit.
208	○				○	○		○						<ul style="list-style-type: none"> The feed current value of another axis exceeded the stroke limit value during the circular/helical interpolation control or simultaneous manual pulse generator operation. (For detection of other axis errors). 		
209				○					○					<ul style="list-style-type: none"> An overrun occurred because the setting travel value is less than the deceleration distance at the speed/position switching (CHANGE) signal input during speed-position switching control, or at the proximity dog signal input during home position return of count method. 	Deceleration stop	<ul style="list-style-type: none"> Set the speed setting so that overrun does not occur. Set the travel value so that overrun does not occur.

Table 1.5 Positioning control error (200 to 299) list (Continued)

Error code	Control mode												Error cause	Error processing	Corrective action	
	Positioning	Fixed-pitch feed	Speed	Speed-position switching	Speed switching	Constant-speed	JOG	Manual pulse generator	Home position return	Position follow-up control	OSC	Speed control with fixed position stop				Speed-torque control
210				○										<ul style="list-style-type: none"> The setting travel value exceeded the stroke limit range at the speed/position switching (CHANGE) signal input during the speed-position switching control. 		<ul style="list-style-type: none"> Correct the stroke limit range or setting travel value so that positioning control is within the range of stroke limit.
211					○									<ul style="list-style-type: none"> During positioning control, an overrun occurred because the deceleration distance for the output speed is not attained at the point where the final positioning address was detected. 	Deceleration stop	<ul style="list-style-type: none"> Set the speed setting so that overrun does not occur. Set the travel value so that overrun does not occur.
	○	○		○						○				<ul style="list-style-type: none"> During control with acceleration/deceleration time change, an overrun occurred because the deceleration distance to the final positioning address for the output speed was not attained. 	Immediate stop after reaching the final positioning address	<ul style="list-style-type: none"> Set the speed setting so that overrun does not occur. Set the travel value so that overrun does not occur. Change the deceleration time so that overrun does not occur.
214							○							<ul style="list-style-type: none"> The manual pulse generator was enabled during the start of the applicable axis, the manual pulse generator operation was executed. 	Manual pulse generator input is ignored until the axis stops.	<ul style="list-style-type: none"> Execute the manual pulse generator operation after the applicable axis stopped.
215				○										<ul style="list-style-type: none"> The speed switching point address exceed the end point address. 	Rapid stop	<ul style="list-style-type: none"> Set the speed-switching point between the previous speed switching point address and the end point address.
														<ul style="list-style-type: none"> The positioning address in the reverse direction was set during the speed switching control. 		
220										○				<ul style="list-style-type: none"> When the control unit is "degree" during the position follow-up control, the command address exceeded the range of 0 to 35999999. 	Deceleration stop	<ul style="list-style-type: none"> When the control unit is "degree", set the command address within the range of 0 to 35999999.
														<ul style="list-style-type: none"> The command address for the position follow-up control exceeded the stroke limit range. 		<ul style="list-style-type: none"> Set the address within the stroke limit range.

Table 1.5 Positioning control error (200 to 299) list (Continued)

Error code	Control mode												Error cause	Error processing	Corrective action			
	Positioning	Fixed-pitch feed	Speed	Speed-position switching	Speed switching	Constant-speed	JOG	Manual pulse generator	Home position return	Position follow-up control	OSC	Speed control with fixed position stop				Speed-torque control		
221															○	<ul style="list-style-type: none"> During the speed control with fixed position stop, the setting address exceeded the range of 0 to 35999999 at the fixed position stop command device ON. 	Deceleration stop	<ul style="list-style-type: none"> Set the command address within the range of 0 to 35999999.
222															○	<ul style="list-style-type: none"> During the speed control with fixed position stop, the fixed position acceleration/ deceleration time is "0" at the fixed position acceleration/ deceleration time input. 	Control with the default value "1000".	<ul style="list-style-type: none"> Set the acceleration/ deceleration time within the range of 1 to 65535.
225																<ul style="list-style-type: none"> The speed at the pass point exceeded the speed limit value during constant-speed control. 	Control with the speed limit value.	<ul style="list-style-type: none"> Set the speed command value within the range of 1 to speed limit value.
																<ul style="list-style-type: none"> The speed at the pass point is 0 or less. 	Control with the speed of last pass point	
230																<ul style="list-style-type: none"> When the skip is executed in the constant-speed control, the next interpolation instruction is an absolute circular interpolation or absolute helical interpolation. 	Immediate stop	<ul style="list-style-type: none"> If absolute circular interpolation or absolute helical interpolation is designated at a point after the skip designation point, set an absolute linear interpolation in the interval.
																<ul style="list-style-type: none"> After the skip is executed in the constant-speed control, an absolute circular interpolation or absolute helical interpolation is executed while passing through only the positioning point for incremental method. 	Deceleration stop	
260	○	○														<ul style="list-style-type: none"> The target position change request (CHGP) specifying the address where the target position is outside the range of 0 to 35999999 is executed to the axis whose unit is [degree]. 		<ul style="list-style-type: none"> When executing the target position change request specifying the address to the axis whose unit is [degree], set the target position within the range of 0 to 35999999.

Table 1.5 Positioning control error (200 to 299) list (Continued)

Error code	Control mode												Error cause	Error processing	Corrective action		
	Positioning	Fixed-pitch feed	Speed	Speed-position switching	Speed switching	Constant-speed	JOG	Manual pulse generator	Home position return	Position follow-up control	OSC	Speed control with fixed position stop				Speed-torque control	
261	<input type="radio"/>	<input type="radio"/>				<input type="radio"/>									<ul style="list-style-type: none"> At the target position change request (CHGP), since the travel to the target position after the change was shorter than the deceleration distance, an overrun occurred. 	Deceleration stop	<ul style="list-style-type: none"> Set the speed so that an overrun will not occur. Set the target position so that an overrun will not occur.
262	<input type="radio"/>	<input type="radio"/>				<input type="radio"/>									<ul style="list-style-type: none"> At the target position change request (CHGP), the target position after the change exceeds the range of the stroke limit. 		<ul style="list-style-type: none"> Set the stroke limit range or the target position after the change so that the positioning control is performed within the stroke limit range.
263	<input type="radio"/>	<input type="radio"/>				<input type="radio"/>									<ul style="list-style-type: none"> The target position change request (CHGP) is executed to the program where the following acceleration/deceleration system is set. <ol style="list-style-type: none"> FIN acceleration/deceleration Advanced S-curve acceleration/deceleration 		<ul style="list-style-type: none"> Do not execute the target position change to the program where the FIN acceleration/deceleration or the advanced S-curve acceleration/deceleration is set. Set the acceleration/deceleration system of the parameter block or the servo program to the trapezoid/S-curve acceleration/deceleration.
264	<input type="radio"/>														<ul style="list-style-type: none"> In reference axis-specified linear interpolation or the long axis-specified linear interpolation, the travel of the reference axis or the long axis after the target position change request (CHGP) is 0. 		<ul style="list-style-type: none"> Set a target position so that the travel of the reference axis or the long axis after the target position change is not 0.
270								<input type="radio"/>							<ul style="list-style-type: none"> An operation alarm occurred in the stepping driver when a driver home position return method home position return was performed. 	Immediate stop	<ul style="list-style-type: none"> Check the operation alarm details and perform a home position return again.
271								<input type="radio"/>							<ul style="list-style-type: none"> During home position return, data could not be obtained from the stepping driver correctly. 		<ul style="list-style-type: none"> Perform a home position return again. When the same error is displayed, the possible cause is a hardware failure of the Motion CPU or stepping driver. Explain the error symptom and get advice from our sales representative.
272								<input type="radio"/>									
273								<input type="radio"/>									

(4) Current value/speed/target position change errors (300 to 399)

These are errors detected at current value change, speed change or target position change.

The error codes, causes, processing and corrective actions are shown in Table 1.6.

Table 1.6 Current value/speed/target position change error (300 to 399) list

Error code	Control mode												Error cause	Error processing	Corrective action	
	Positioning	Fixed-pitch feed	Speed	Speed-position switching	Speed switching	Constant-speed	JOG	Manual pulse generator	Home position return	Position follow-up control	OSC	Speed control with fixed position stop				Speed-torque control
300	<input type="radio"/>	<input type="radio"/>	<input type="radio"/>	<input type="radio"/>	<input type="radio"/>	<input type="radio"/>	<input type="radio"/>	<input type="radio"/>	<input type="radio"/>	<input type="radio"/>	<input type="radio"/>	<input type="radio"/>	<input type="radio"/>	<ul style="list-style-type: none"> The current value was changed during positioning control of the applicable axis. The current value was changed for the axis that had not been started. The current value was changed for the servo OFF axis. 	Current value is not changed.	<ul style="list-style-type: none"> Use the following devices as interlocks not to change the current value for the applicable axis. <ul style="list-style-type: none"> (1) The start accept flag (M2001 to M2032) OFF for applicable axis. (2) The servo READY signal (M2415+20n) ON.
301									<input type="radio"/>					<ul style="list-style-type: none"> The speed was changed for the axis during home position return. 	Speed is not changed.	<ul style="list-style-type: none"> Do not change speed during home position return.
305				<input type="radio"/>	<input type="radio"/>					<input type="radio"/>				<ul style="list-style-type: none"> The speed after speed change is set outside the range of 0 to speed limit value. 	Control with the speed limit value.	<ul style="list-style-type: none"> Set the speed after speed change within the range of 0 to speed limit value.
	<input type="radio"/>	<input type="radio"/>	<input type="radio"/>		<input type="radio"/>									<ul style="list-style-type: none"> The absolute value of speed after speed change is set outside the range of 0 to speed limit value. 		<ul style="list-style-type: none"> Set the absolute value of speed after speed change within the range of 0 to speed limit value.
309														<ul style="list-style-type: none"> The current value was changed outside the range of 0 to 35999999 ($\times 10^{-5}$ [degree]) for the degree axis. 	Current value is not changed.	<ul style="list-style-type: none"> Set the current value within the range of 0 to 35999999 ($\times 10^{-5}$[degree]).
310													<input type="radio"/>	<ul style="list-style-type: none"> The speed was changed during high-speed oscillation. The speed change to "0" was requested during high-speed oscillation. 	Speed is not changed.	<ul style="list-style-type: none"> Do not change speed during high-speed oscillation.
	<input type="radio"/>	<input type="radio"/>			<input type="radio"/>									<ul style="list-style-type: none"> Change speed to negative speed in the invalid axis of stroke limit. 		<ul style="list-style-type: none"> Do not change speed to negative speed in the invalid axis of stroke limit.

Table 1.6 Current value/speed/target position change error (300 to 399) list(Continued)

Error code	Control mode												Error cause	Error processing	Corrective action	
	Positioning	Fixed-pitch feed	Speed	Speed-position switching	Speed switching	Constant-speed	JOG	Manual pulse generator	Home position return	Position follow-up control	OSC	Speed control with fixed position stop				Speed-torque control
311														<ul style="list-style-type: none"> The value outside the range of 1 to 1000[%] was set in the torque limit value change request (D(P).CHGT, CHGT). The positive direction torque limit value or the negative direction torque limit value outside the range of 0.1 to 1000.0[%] was set in the torque limit value individual change request (D(P).CHGT2, CHGT2). 	Torque limit value is not changed.	<ul style="list-style-type: none"> Set the change request within the range of 1 to 1000[%] in the torque limit value change request (CHGT). Set the change request within the range of 0.1 to 1000.0[%] for the positive direction torque limit value or the negative direction torque limit value in the torque limit value individual change request (CHGT2).
312														<ul style="list-style-type: none"> The torque limit value change request (D(P).CHGT, CHGT) was made for the axis that had not been started. The torque limit value individual change request (D(P).CHGT2, CHGT2) was made for the axis that had not been started. 		<ul style="list-style-type: none"> Request the torque limit change or the torque limit value individual change for the starting axis.
315												○		<ul style="list-style-type: none"> During speed-torque control, the absolute value of the command speed is outside the range of 0 to the speed limit value at speed-torque control. 	Control with the speed limit value at speed-torque control.	<ul style="list-style-type: none"> Set the speed after speed change within the range of 0 to speed limit value at speed-torque control.
316												○		<ul style="list-style-type: none"> During torque control or continuous operation to torque control, the absolute value of the command torque is outside the range of 0 to the torque limit value at speed-torque control. 	Control with the torque limit value at speed-torque control.	<ul style="list-style-type: none"> Set the torque after torque change within the range of 0 to the torque limit value at speed-torque control.
317	○	○	○		○		○	○	○			○		<ul style="list-style-type: none"> At the switching request to the continuous operation to torque control, a control mode which cannot be switched is used. 	The control mode is not switched.	<ul style="list-style-type: none"> Request switching during the control which can be switched to the continuous operation to torque control.

Table 1.6 Current value/speed/target position change error (300 to 399) list(Continued)

Error code	Control mode											Error cause	Error processing	Corrective action		
	Positioning	Fixed-pitch feed	Speed	Speed-position switching	Speed switching	Constant-speed	JOG	Manual pulse generator	Home position return	Position follow-up control	OSC				Speed control with fixed position stop	Speed-torque control
318	<input type="radio"/>	<input type="radio"/>	<input type="radio"/>	<input type="radio"/>	<input type="radio"/>	<input type="radio"/>	<input type="radio"/>	<input type="radio"/>	<input type="radio"/>	<input type="radio"/>	<input type="radio"/>	<input type="radio"/>	<input type="radio"/>	<ul style="list-style-type: none"> Switching to the stopper control was requested to the servo amplifier which is not compatible with the continuous operation to torque control. 	Position control: Deceleration stop Speed control: The mode is switched to position control mode, and the operation stops immediately.	<ul style="list-style-type: none"> Use the servo amplifier where the continuous operation to torque control is available.
319												<input type="radio"/>		<ul style="list-style-type: none"> During the speed-torque control, the change value by the torque limit value change request (D(P).CHGT, CHGT) or torque limit value individual change request (D(P).CHGT2, CHGT2) exceeds the torque limit value at speed-torque control. 	Torque limit value is not changed.	<ul style="list-style-type: none"> Request changing within the range of torque limit value at speed-torque control.
330			<input type="radio"/>	<input type="radio"/>	<input type="radio"/>	<input type="radio"/>	<input type="radio"/>	<input type="radio"/>	<input type="radio"/>	<input type="radio"/>	<input type="radio"/>	<input type="radio"/>	<input type="radio"/>	<ul style="list-style-type: none"> The target position change request (CHGP) was executed for the axis which was executing a servo instruction which was not compatible with target position change. 	Target position is not changed.	<ul style="list-style-type: none"> Change the target position for the axes operated by the following servo instructions. <ol style="list-style-type: none"> Linear interpolation control Fixed-pitch feed operation Constant-speed control

(5) System errors (900 to 999)

These are errors detected at the power-on.

The error codes, causes, processing and corrective actions are shown in Table 1.7.

Table 1.7 System error (900 to 999) list

Error code	Control mode												Error cause	Error processing	Corrective action	
	Positioning	Fixed-pitch feed	Speed	Speed-position switching	Speed switching	Constant-speed	JOG	Manual pulse generator	Home position return	Position follow-up control	OSC	Speed control with fixed position stop				Speed-torque control
901														<ul style="list-style-type: none"> The motor travel value while the power is off exceeded the "System setting mode-allowable travel value during power off" set in the system settings at the turning on of the servo amplifier. 	Further operation is possible.	<ul style="list-style-type: none"> Check the position. Check the battery of encoder.
902														<ul style="list-style-type: none"> At VCI (CKD Nikki Denso) power-on, ABS/INC setting in "System Setting" differs from the installed servo driver setting. (Check when VCI is used only). 	Further operation is possible according to servo driver setting.	<ul style="list-style-type: none"> Correct ABS/INC setting in "System Setting".

APPENDIX 1.3 Major errors

These errors occur by control command from the external input signal or Motion SFC program, and the error codes 1000 to 1999 are used.

Major errors include the positioning control start errors, positioning control errors, absolute position system errors and system errors.

(1) Positioning control start errors (1000 to 1099)

These errors are detected at the positioning control start.

The error codes, causes, processing and corrective actions are shown in Table 1.8.

Table 1.8 Positioning control start error (1000 to 1099) list

Error code	Control mode													Error cause	Error processing	Corrective action
	Positioning	Fixed-pitch feed	Speed	Speed-position switching	Speed switching	Constant-speed	JOG	Manual pulse generator	Home position return	Position follow-up control	OSC	Speed control with fixed position stop	Speed-torque control			
1000	<input type="radio"/>	<input type="radio"/>	<input type="radio"/>	<input type="radio"/>	<input type="radio"/>	<input type="radio"/>	<input type="radio"/>	<input type="radio"/>	<input type="radio"/>	<input type="radio"/>	<input type="radio"/>	<input type="radio"/>	<input type="radio"/>	• The external STOP signal of the applicable axis turned on.	Positioning control does not start.	• Turn the STOP signal off.
1001	<input type="radio"/>	<input type="radio"/>	<input type="radio"/>	<input type="radio"/>	<input type="radio"/>	<input type="radio"/>	<input type="radio"/>	<input type="radio"/>	<input type="radio"/>	<input type="radio"/>	<input type="radio"/>	<input type="radio"/>	<input type="radio"/>	• The external signal FLS (upper limit LS) turned off at the forward direction (address increase direction) start.		• Move in the reverse direction by the JOG operation, etc. and set within the external limit range.
1002	<input type="radio"/>	<input type="radio"/>	<input type="radio"/>	<input type="radio"/>	<input type="radio"/>	<input type="radio"/>	<input type="radio"/>	<input type="radio"/>	<input type="radio"/>	<input type="radio"/>	<input type="radio"/>	<input type="radio"/>	<input type="radio"/>	• The external signal RLS (lower limit LS) turned off at the reverse direction (address decrease direction) start.		• Move in the forward direction by the JOG operation, etc. and set within the external limit range.
1003	<input type="radio"/>	<input type="radio"/>	<input type="radio"/>	<input type="radio"/>	<input type="radio"/>	<input type="radio"/>	<input type="radio"/>	<input type="radio"/>	<input type="radio"/>	<input type="radio"/>	<input type="radio"/>	<input type="radio"/>	<input type="radio"/>	• The external DOG (proximity dog) signal turned on at the home position return start of the proximity dog method.		• Perform the home position return after move to the proximity dog ON by the JOG operation, etc. at the home position return of the proximity dog method.
1004	<input type="radio"/>	<input type="radio"/>	<input type="radio"/>	<input type="radio"/>	<input type="radio"/>	<input type="radio"/>	<input type="radio"/>	<input type="radio"/>	<input type="radio"/>	<input type="radio"/>	<input type="radio"/>	<input type="radio"/>	<input type="radio"/>	• The applicable axis is not servo READY state. (M2415+20n: OFF). (1) The power supply of the servo amplifier is OFF. (2) During initial processing after turning on the servo amplifier. (3) The servo amplifier is not mounted. (4) A servo error is occurred. (5) Cable fault. (6) Servo OFF command (M3215+20n) is ON.		• Wait until the servo READY state (M2415+20n: ON).
1005	<input type="radio"/>	<input type="radio"/>	<input type="radio"/>	<input type="radio"/>	<input type="radio"/>	<input type="radio"/>	<input type="radio"/>	<input type="radio"/>	<input type="radio"/>	<input type="radio"/>	<input type="radio"/>	<input type="radio"/>	<input type="radio"/>	• The servo error detection signal of the applicable axis (M2408+20n) turned on.	• Eliminate the servo error, reset the servo error detection signal (M2408+20n) by the servo error reset command (M3208+20n), then start operation.	

(2) Positioning control errors (1100 to 1199)

These errors are detected at the positioning control.

The error codes, causes, processing and corrective actions are shown in Table 1.9.

Table 1.9 Positioning control error (1100 to 1199) list

Error code	Control mode													Error cause	Error processing	Corrective action
	Positioning	Fixed-pitch feed	Speed	Speed-position switching	Speed switching	Constant-speed	JOG	Manual pulse generator	Home position return	Position follow-up control	OSC	Speed control with fixed position stop	Speed-torque control			
1101	<input type="checkbox"/>	<input type="checkbox"/>	<input type="checkbox"/>	<input type="checkbox"/>	<input type="checkbox"/>	<input type="checkbox"/>	<input type="checkbox"/>	<input type="checkbox"/>	<input type="checkbox"/>	<input type="checkbox"/>	<input type="checkbox"/>	<input type="checkbox"/>	<input type="checkbox"/>	<ul style="list-style-type: none"> The external signal FLS (upper limit LS) turned off during the forward direction (address increase direction). 	Deceleration stop by "Stop processing on STOP input" of the parameter block.	<ul style="list-style-type: none"> Travel in the reverse direction by the JOG operation, etc. and set within the external limit range.
1102	<input type="checkbox"/>	<input type="checkbox"/>	<input type="checkbox"/>	<input type="checkbox"/>	<input type="checkbox"/>	<input type="checkbox"/>	<input type="checkbox"/>	<input type="checkbox"/>	<input type="checkbox"/>	<input type="checkbox"/>	<input type="checkbox"/>	<input type="checkbox"/>	<input type="checkbox"/>	<ul style="list-style-type: none"> The external signal RLS (lower limit LS) turned off during the reverse direction (address decrease direction). 	(Deceleration stop during speed control, immediate stop during continuous operation to torque control mode)	<ul style="list-style-type: none"> Travel in the forward direction by the JOG operation, etc. and set within the external limit range.
1103	<input type="checkbox"/>	<input type="checkbox"/>	<input type="checkbox"/>	<input type="checkbox"/>	<input type="checkbox"/>	<input type="checkbox"/>	<input type="checkbox"/>	<input type="checkbox"/>	<input type="checkbox"/>	<input type="checkbox"/>	<input type="checkbox"/>	<input type="checkbox"/>	<input type="checkbox"/>	<ul style="list-style-type: none"> The external stop signal (stop signal) turned on during home position return. 	Deceleration stop by "Stop processing on STOP input" of the parameter block.	<ul style="list-style-type: none"> Execute the home position return so that the external stop signal (stop signal) may not turn on.
1104	<input type="checkbox"/>	<input type="checkbox"/>	<input type="checkbox"/>	<input type="checkbox"/>	<input type="checkbox"/>	<input type="checkbox"/>	<input type="checkbox"/>	<input type="checkbox"/>	<input type="checkbox"/>	<input type="checkbox"/>	<input type="checkbox"/>	<input type="checkbox"/>	<input type="checkbox"/>	<ul style="list-style-type: none"> The servo error detection signal turned on during positioning control. 	Immediate stop without decelerating.	<ul style="list-style-type: none"> Start after disposal at the servo error.
1105	<input type="checkbox"/>	<input type="checkbox"/>	<input type="checkbox"/>	<input type="checkbox"/>	<input type="checkbox"/>	<input type="checkbox"/>	<input type="checkbox"/>	<input type="checkbox"/>	<input type="checkbox"/>	<input type="checkbox"/>	<input type="checkbox"/>	<input type="checkbox"/>	<input type="checkbox"/>	<ul style="list-style-type: none"> The power supply of the servo amplifier turned off during positioning control. (Servo not mounted status detection, cable fault, etc.) Home position return did not complete normally without stop within the in-position range of home position at the home position return. 	Turn the servo READY (M2415+20n) off.	<ul style="list-style-type: none"> Turn on the power supply of the servo amplifier. Check the connecting cable to the servo amplifier. Make the gain adjustment.

Table 1.9 Positioning control error (1100 to 1199) list (Continued)

Error code	Control mode													Error cause	Error processing	Corrective action
	Positioning	Fixed-pitch feed	Speed	Speed-position switching	Speed switching	Constant-speed	JOG	Manual pulse generator	Home position return	Position follow-up control	OSC	Speed control with fixed position stop	Speed-torque control			
1151														• Q172DEX or encoder hardware error.	Immediate input stop	• Check (replace) the Q172DEX or encoder.
														• Disconnected encoder cable.		• Check the encoder cable.
															• A synchronous encoder set in the system setting differs from a synchronous encoder actually connected.	Input from synchronous encoder does not accept.
														• No battery or disconnected battery at Q172DEX.	Immediate input stop	• Replace the battery and turn ON the Multiple CPU system power supply a few minutes later.
1152														• Low voltage at Q172DEX.	Operation continues.	• Replace the battery.
1153														• No battery or disconnected battery at Q172DEX.		• Replace the battery or check (replace) the Q172DEX.

(3) Absolute position system errors (1200 to 1299)

These errors are detected at the absolute position system.

The error codes, causes, processing and corrective actions are shown in Table 1.10.

Table 1.10 Absolute position system error (1200 to 1299) list

Error code	Control mode											Error cause	Error processing	Corrective action		
	Positioning	Fixed-pitch feed	Speed	Speed-position switching	Speed switching	Constant-speed	JOG	Manual pulse generator	Home position return	Position follow-up control	OSC				Speed control with fixed position stop	Speed-torque control
1201														<ul style="list-style-type: none"> The error causes why the home position return is required in the absolute position system are as follows: <ol style="list-style-type: none"> The home position return has never been executed after the system start. The home position return is started, but not completed correctly. Absolute data in the Motion CPU is erased due to causes such as a battery error. Servo error [2025], [2143], or [2913] occurred. Major error [1202], [1203] or [1204] occurred. "Rotation direction selection" of the servo parameter is changed. 	Home position return request ON	<ul style="list-style-type: none"> Execute the home position return after checking the batteries of the Motion CPU module and servo amplifier.
1202														<ul style="list-style-type: none"> A communication error between the servo amplifier and encoder occurred at the turning on servo amplifier power supply. 	Depending on the version of operating system software and servo amplifier, home position return request ON, servo error [2016] set. (Fully closed loop control servo amplifier use: Servo error [2070] is set.)	<ul style="list-style-type: none"> Check the motor and encoder cables. If the home position return request signal is turning ON, execute a home position return.

Table 1.10 Absolute position system error (1200 to 1299) list (Continued)

Error code	Control mode												Error cause	Error processing	Corrective action	
	Positioning	Fixed-pitch feed	Speed	Speed-position switching	Speed switching	Constant-speed	JOG	Manual pulse generator	Home position return	Position follow-up control	OSC	Speed control with fixed position stop				Speed-torque control
1203														<ul style="list-style-type: none"> The amount of change in encoder current value is excessive during operation. A continual check is performed (both of servo ON and OFF states) after the servo amplifier power has been turned ON. (Q17□DCPU(-S1) use) 		<ul style="list-style-type: none"> Check the motor and encoder cables.
1204														<ul style="list-style-type: none"> The following expression holds: "Encoder current value [pulse] ≠ feedback current value [pulse] (encoder effective bit number)" during operation. A continual check is performed (both of servo ON and OFF states) after the servo amplifier power has been turned on. (Q17□DCPU(-S1) use) 	Home position return request ON	
1205														<ul style="list-style-type: none"> The following expression holds: "Encoder current value [pulse] ≠ feedback current value [pulse] (encoder effective bit number)" during operation. A continual check is performed (both of servo ON and OFF states) after the servo amplifier power has been turned on. 	Operation continues. (Home position return signal does not turn ON.)	

(4) System errors (1300 to 1399)

These errors are detected at the power-on.

The error codes, causes, processing and corrective actions are shown in Table 1.11.

Table 1.11 System error (1300 to 1399) list

Error code	Control mode												Error cause	Error processing	Corrective action	
	Positioning	Fixed-pitch feed	Speed	Speed-position switching	Speed switching	Constant-speed	JOG	Manual pulse generator	Home position return	Position follow-up control	OSC	Speed control with fixed position stop				Speed-torque control
1310														<ul style="list-style-type: none"> Initial communication with the Multiple CPU system did not complete normally. Motion CPU fault. 	Positioning control does not start.	<ul style="list-style-type: none"> Replace the Motion CPU.
1340														<ul style="list-style-type: none"> When using a rotary servo motor with an encoder resolution of 67108864[pulse/rev] with a MR-J5(W)-B series servo amplifier, the values set to "Electronic gear numerator (PA06)" and "Electronic gear denominator (PA07)" servo parameters are not a compatible combination. 		<ul style="list-style-type: none"> Set the values below to the "Electronic gear numerator (PA06)" and the "Electronic gear denominator (PA07)" servo parameters of the corresponding axis. After changing the parameters, turn OFF the servo amplifier power supply before turning ON the power supply again. <ul style="list-style-type: none"> (1) Electronic gear numerator (PA06) : 16 (2) Electronic gear denominator (PA07) : 1
1350														<ul style="list-style-type: none"> An operation cycle that the servo amplifier does not support has been set. 	System setting error	<ul style="list-style-type: none"> Set an operation cycle that is supported.
1360														<ul style="list-style-type: none"> Number of axes set for the master axis in servo parameter "Driver communication setting (PD15)" exceed the setting range. 		<ul style="list-style-type: none"> Set the number of master axis to 4 axes or less for SSCNET III lines, and 8 axes or less for SSCNET III/H lines in servo parameter "PD15".
1361														<ul style="list-style-type: none"> Servo parameters "Driver communication setting Master axis No. selection 1 for slave (PD20)" or "PD21 to PD23" are set the self axis. 		<ul style="list-style-type: none"> Review the servo parameters "PD20" or "PD21 to PD23" of applicable slave axis.
1362														<ul style="list-style-type: none"> There is no master axis setting corresponding to the slave axis. 		
1363														<ul style="list-style-type: none"> Setting the driver communication to servo amplifier which does not support the driver communication. 		<ul style="list-style-type: none"> Confirm the driver communication and the actually connected servo amplifier.

Table 1.11 System error (1300 to 1399) list (Continued)

Error code	Control mode													Error cause	Error processing	Corrective action
	Positioning	Fixed-pitch feed	Speed	Speed-position switching	Speed switching	Constant-speed	JOG	Manual pulse generator	Home position return	Position follow-up control	OSC	Speed control with fixed position stop	Speed-torque control			
1365														<ul style="list-style-type: none"> Setting the driver communication in the operation cycle setting of 0.2ms. 		<ul style="list-style-type: none"> For SSCNETⅢ, set the operation cycle setting to 0.4ms or more.
1366														<ul style="list-style-type: none"> The servo amplifier type of the master axis that corresponds with the slave axis is different. 	System setting error	<ul style="list-style-type: none"> For MR-J4-□B slaves axes, set the master axis to MR-J4-□B. For MR-J5-□B slaves axes, set the master axis to MR-J5-□B.

APPENDIX 1.4 Servo errors

(1) Servo errors (2000 to 2999)

These errors are detected by the servo amplifier, and the error codes are [2000] to [2999].

The servo error detection signal (M2408+20n) turns on at the servo error occurrence. Eliminate the error cause, reset the servo amplifier error by turning on the servo error reset command (M3208+20n) and perform re-start. (The servo error detection signal does not turn on because the codes [2100] to [2599] are for warnings.)

(Note-1): As for the regenerative alarm (error code [2030]) or overload 1 or 2 (error codes [2050], [2051]), the state at the operation is held also for after the protection circuit operation in the servo amplifier. The memory contents are cleared with the external power supply off, but are not cleared by the reset signal.

(Note-2): If resetting by turning off the external power supply is repeated at the occurrence of error code [2030], [2050] or [2051], it may cause devices to be destroyed by overheating. Re-start operation after eliminating the cause of the error certainly.

The hexadecimal display of servo amplifier display servo error code (#8008+20n) is the same as the LED of servo amplifier. **Ver.!**

CAUTION

- If a controller, servo amplifier self-diagnosis error occurs, check the points stated in this manual and clear the error.

List of servo errors are shown in next page or later.
Refer to the "Servo amplifier Instruction Manual" for details.

Servo amplifier type	Instruction manual name
MR-J5-□B	MR-J5 User's Manual (Troubleshooting) (SH-030312ENG)
MR-J5W-□B	
MR-J4-□B	SSCNETⅢ/H Interface AC Servo MR-J4-□B (-RJ) Servo amplifier Instruction Manual (SH-030106)
MR-J4W-□B	SSCNETⅢ/H Interface Multi-axis AC Servo MR-J4W2-□B/MR-J4W3-□B/MR-J4W2-0303B6 Servo amplifier Instruction Manual (SH-030105)
MR-J3-□B	SSCNETⅢ interface MR-J3-□B Servo amplifier Instruction Manual (SH-030051)
MR-J3W-□B	SSCNETⅢ interface 2-axis AC Servo Amplifier MR-J3W-0303BN6/MR-J3W-□B Servo amplifier Instruction Manual (SH-030073)
MR-J3-□B-RJ004	SSCNETⅢ Compatible Linear Servo MR-J3-□B-RJ004U□ Instruction Manual (SH-030054)
MR-J3-□B-RJ006	SSCNETⅢ Compatible Fully Closed Loop Control MR-J3-□B-RJ006 Servo amplifier Instruction Manual (SH-030056)
MR-J3-□B-RJ080	SSCNETⅢ Interface Direct Drive Servo MR-J3-□B-RJ080W Instruction Manual (SH-030079)
MR-J3-□B Safety	SSCNETⅢ interface Drive Safety integrated MR-J3-□B Safety Servo amplifier Instruction Manual (SH-030084)

Ver.! : Refer to Section 1.3 for the software version that supports this function.

(a) MR-J5(W)-□B

The servo errors below are all displayed with the same error codes (2000 or 2100).

Check servo amplifier display servo error code (#8008+20n) for the details of servo errors read by the servo amplifier.

Table 1.12 Servo error (2000 and 2100) list (MR-J5(W)-□B)

Error code	Servo amplifier LED display	Name	Details name	Remarks
2000	010.1	Undervoltage	Voltage drop in the control circuit power	
	010.2		Voltage drop in the main circuit power	
	011.1	Switch setting error	Rotary switch setting error	
	011.2		Disabled axis setting error	
	012.1	Memory error 1 (RAM)	RAM error 1	
	012.2		RAM error 2	
	012.4		RAM error 4	
	012.5		RAM error 5	
	012.6		RAM error 6	
	012.7		RAM error 7	
	012.8		RAM error 8	
	012.9		RAM error 9	
	013.1		CPU error	CPU error 1
	013.2	CPU error 2		
	013.4	CPU error 4		
	013.5	CPU error 5		
	014.1	Control process error	Control process error 1	
	014.2		Control process error 2	
	014.3		Control process error 3	
	014.4		Control process error 4	
	014.5		Control process error 5	
	014.8		Control process error 8	
	014.9		Control process error 9	
	014.C		Control process error 12	
	016.1	Encoder initial communication error 1	Encoder initial communication – Receive data error 1	
	016.2		Encoder initial communication – Receive data error 2	
	016.3		Encoder initial communication – Receive data error 3	
	016.5		Encoder initial communication – Transmission data error 1	
	016.6		Encoder initial communication – Transmission data error 2	
	016.7		Encoder initial communication – Transmission data error 3	
	016.A		Encoder initial communication – Process error 1	
	016.B		Encoder initial communication – Process error 2	
	016.C		Encoder initial communication – Process error 3	
	016.D		Encoder initial communication – Process error 4	
	016.E		Encoder initial communication – Process error 5	
	016.F		Encoder initial communication – Process error 6	

Table 1.12 Servo error (2000 and 2100) list (MR-J5(W)-□B) (Continued)

Error code	Servo amplifier LED display	Name	Details name	Remarks
2000	017.1	Board error	Board error 1	
	017.3		Board error 2	
	017.4		Board error 3	
	017.5		Board error 4	
	017.6		Board error 5	
	017.7		Board error 7	
	017.9		Board error 8	
	019.1		Memory error 3	Flash-ROM error 1
	019.2	Flash-ROM error 2		
	019.3	Flash-ROM error 3		
	019.6	Flash-ROM error 6		
	01A.1	Servo motor combination error	Servo motor combination error 1	
	01A.2		Servo motor control mode combination error	
	01A.3		Control mode/load-side encoder combination error	
	01A.4		Servo motor combination error 2	
	01A.5		Servo motor combination error 3	
	01A.6		Servo motor combination error 4	
	01E.1	Encoder initial	Encoder malfunction	
	01E.2	communication error 2	Load-side encoder malfunction	
	01F.1	Encoder initial	Incompatible encoder	
	01F.2	communication error 3	Incompatible load-side encoder	
	020.1	Encoder normal communication error 1	Encoder normal communication – Receive data error 1	
	020.2		Encoder normal communication – Receive data error 2	
	020.3		Encoder normal communication – Receive data error 3	
	020.5		Encoder normal communication – Transmission data error 1	
	020.6		Encoder normal communication – Transmission data error 2	
	020.7		Encoder normal communication – Transmission data error 3	
	021.1		Encoder normal communication error 2	Encoder data error 1
	021.2	Encoder data update error		
	021.3	Encoder data waveform error		
	021.4	No encoder signal		
	021.5	Encoder hardware error 1		
021.6	Encoder hardware error 2			
024.1	Main circuit error	Ground fault detected via hardware detection circuit		
024.2		Ground fault detected via software detection processing		
025.1	Absolute position erased	Servo motor encoder absolute position erased		
025.2		Scale measurement encoder – Absolute position erased		

Table 1.12 Servo error (2000 and 2100) list (MR-J5(W)-□B) (Continued)

Error code	Servo amplifier LED display	Name	Details name	Remarks
2000	027.1	Initial magnetic pole detection error	Initial magnetic pole detection – Abnormal termination	
	027.2		Initial magnetic pole detection – Time out error	
	027.3		Initial magnetic pole detection – Limit switch error	
	027.4		Initial magnetic pole detection – Estimation error	
	027.5		Initial magnetic pole detection – Speed deviation error	
	027.6		Initial magnetic pole detection – Position deviation error	
	027.7		Initial magnetic pole detection – Current error	
	028.1	Linear encoder error 2	Linear encoder environmental error	
	028.2		Load-side linear encoder environmental error	
	02A.1	Linear encoder error 1	Linear encoder error 1-1	
	02A.2		Linear encoder error 1-2	
	02A.3		Linear encoder error 1-3	
	02A.4		Linear encoder error 1-4	
	02A.5		Linear encoder error 1-5	
	02A.6		Linear encoder error 1-6	
	02A.7		Linear encoder error 1-7	
	02A.8		Linear encoder error 1-8	
	02B.1	Encoder counter error	Encoder counter error 1	
	02B.2		Encoder counter error 2	
	030.1	Regenerative error	Regenerative heat error	
	030.2		Regenerative signal error	
	030.3		Regenerative feedback signal error	
	031.1	Overspeed	Servo motor speed error	
	032.1	Overcurrent	Overcurrent detected via hardware detection circuit (during operation)	
	032.2		Overcurrent detected via software detection processing (during operation)	
	032.3		Overcurrent detected via hardware detection circuit (during a stop)	
	032.4		Overcurrent detected via software detection processing (during a stop)	
	033.1	Overvoltage	Main circuit voltage error	
	034.1	SSCNET receive error 1	SSCNET receive data error	
	034.2		SSCNET connector connection error	
	034.3		SSCNET communication data error	
	034.4		Hardware error signal detection	
	034.7		SSCNET communication data error 2	
	035.1	Command frequency error	Command frequency error	
	036.1	SSCNET receive error 2	Intermittent communication data error	
	037.1	Parameter error (Note-1)	Parameter setting range error	
037.2	Parameter combination error			
037.6	Parameter mismatch error			
03A.1	Inrush current suppression circuit error	Inrush current suppression circuit error		

(Note-1): Refer to the parameter No. stored in parameter error No. (#8009+20n) for details of the parameter for which the error occurred.

Table 1.12 Servo error (2000 and 2100) list (MR-J5(W)-□B) (Continued)

Error code	Servo amplifier LED display	Name	Details name	Remarks
2000	03D.1	Driver communication parameter setting error	Slave-side driver communication parameter combination error	
	03D.2		Master-side driver communication parameter combination error	
	03E.9	Operation mode error	Connection mode error 1	
	042.1	Servo control error	Servo control error based on position deviation	
	042.2		Servo control error based on speed deviation	
	042.3		Servo control error based on torque/thrust deviation	
	042.8		Fully closed loop control error based on position deviation	
	042.9		Fully closed loop control error based on speed deviation	
	042.A	Fully closed loop control error based on position deviation during command stop		
	045.1	Main circuit device overheat	Main circuit device overheat error 1	
	045.2		Main circuit device overheat error 2	
	046.1	Servo motor overheat	Servo motor temperature error 1	
	046.2		Servo motor temperature error 2	
	046.3		Thermistor disconnected error	
	046.4		Thermistor circuit error	
	046.5		Servo motor temperature error 3	
	046.6		Servo motor temperature error 4	
	046.7	Servo motor temperature error 5		
	047.1	Cooling fan error	Cooling fan stop error	
	047.2		Decreased cooling fan speed error	
	050.1	Overload 1	Thermal overload error 1 during operation	
	050.2		Thermal overload error 2 during operation	
	050.3		Thermal overload error 4 during operation	
	050.4		Thermal overload error 1 during a stop	
	050.5		Thermal overload error 2 during a stop	
	050.6		Thermal overload error 4 during a stop	
	051.1	Overload 2	Thermal overload error 3 during operation	
	051.2		Thermal overload error 3 during a stop	
	052.1	Excessive error	Excessive droop pulse 1	
	052.3		Excessive droop pulse 2	
	052.4		Excessive error during 0 torque limit	
	052.5		Excessive droop pulse 3	
	052.6		Excessive droop pulse at servo-off	
	054.1	Oscillation detection	Oscillation detection error	
	056.2	Forced stop error	Speed exceeded during forced stop	
	056.3		Estimated distance exceeded during forced stop	
	056.5		Travel distance exceeded during forced stop 2	
	063.1	STO timing error	STO1 off	
	063.2		STO2 off	
	068.1	STO diagnosis error	STO signal mismatch error	

Table 1.12 Servo error (2000 and 2100) list (MR-J5(W)-□B) (Continued)

Error code	Servo amplifier LED display	Name	Details name	Remarks
2000	070.1	Load-side encoder initial communication error 1	Load-side encoder initial communication – Receive data error 1	
	070.2		Load-side encoder initial communication – Receive data error 2	
	070.3		Load-side encoder initial communication – Receive data error 3	
	070.5		Load-side encoder initial communication – Transmission data error 1	
	070.6		Load-side encoder initial communication – Transmission data error 2	
	070.7		Load-side encoder initial communication – Transmission data error 3	
	070.A		Load-side encoder initial communication – Process error 1	
	070.B		Load-side encoder initial communication – Process error 2	
	070.C		Load-side encoder initial communication – Process error 3	
	070.D		Load-side encoder initial communication – Process error 4	
	070.E		Load-side encoder initial communication – Process error 5	
	070.F		Load-side encoder initial communication – Process error 6	
	071.1	Load-side encoder normal communication error 1	Load-side encoder normal communication – Receive data error 1	
	071.2		Load-side encoder normal communication – Receive data error 2	
	071.3		Load-side encoder normal communication – Receive data error 3	
	071.5		Load-side encoder normal communication – Transmission data error 1	
	071.6		Load-side encoder normal communication – Transmission data error 2	
	071.7		Load-side encoder normal communication – Transmission data error 3	
	072.1	Load-side encoder normal communication error 2	Load-side encoder data error 1	
	072.2		Load-side encoder data update error	
	072.3		Load-side encoder data waveform error	
	072.4		No load-side encoder signal	
	072.5		Load-side encoder hardware error 1	
	072.6		Load-side encoder hardware error 2	
	082.1	Master-slave operation error 1	Master-slave operation error 1	
	088.1	Watchdog	Watchdog 1-1	
	088.2		Watchdog 1-2	
	088.4		Watchdog 1-4	
088.8	Watchdog 1-8			

Table 1.12 Servo error (2000 and 2100) list (MR-J5(W)-□B) (Continued)

Error code	Servo amplifier LED display	Name	Details name	Remarks
2000	08E.1	Serial communication error	Serial communication receive error	
	08E.2		Serial communication checksum error	
	08E.3		Serial communication character error	
	08E.4		Serial communication command error	
	08E.5		Serial communication data number error	
	118.1	Encoder diagnosis	Encoder communication circuit diagnosis in progress	
	119.1	Memory error 4	Memory error 4-1	
	119.2		Memory error 4-2	
	119.3		Memory error 4-3	
	119.4		Memory error 4-4	
	119.5		Memory error 4-5	
	119.6		Memory error 4-6	
	119.7		Memory free space error 4-1	
	119.8		Memory free space error 4-2	
	11A.1	Servo motor constant error	Servo motor constant file error	
	11A.2		Servo motor constant file extension error	
	11A.3		Servo motor constant file amount error	
	130.1	Regenerative error 2	Regenerative heat error	
	139.1	Open-phase error	Input open-phase error	
	139.2		Output open-phase error	
	139.3		Motor wiring error	
	17A.1	Load-side linear encoder error 1	Load-side linear encoder error 1-1	
	17A.2		Load-side linear encoder error 1-2	
	17A.3		Load-side linear encoder error 1-3	
	17A.4		Load-side linear encoder error 1-4	
	17A.5		Load-side linear encoder error 1-5	
	17A.6		Load-side linear encoder error 1-6	
	17A.7		Load-side linear encoder error 1-7	
17A.8	Load-side linear encoder error 1-8			
188.1	Watchdog 2	Watchdog 2-1		
2100	091.1	Servo amplifier overheat warning	Main circuit device overheat warning	
	092.1	Battery cable disconnection warning	Encoder battery cable disconnection warning	
	092.2		Load-side encoder battery cable disconnection warning	
	092.3		Battery degradation	
	095.1	STO warning	STO1 off detection	
	095.2		STO2 off detection	
	096.1	Home position setting warning	In-position warning at homing	
	096.2		Command input warning at homing	
	09B.1	Excessive error warning	Excessive droop pulse 1 warning	
	09B.3		Excessive droop pulse 2 warning	
	09B.4		Excessive error warning during 0 torque limit	
	09F.1	Battery warning	Low battery	
	09F.2		Battery degradation warning	
0E0.1	Excessive regeneration warning	Excessive regeneration warning		

Table 1.12 Servo error (2000 and 2100) list (MR-J5(W)-□B) (Continued)

Error code	Servo amplifier LED display	Name	Details name	Remarks
2100	0E1.1	Overload warning 1	Thermal overload warning 1 during operation	
	0E1.2		Thermal overload warning 2 during operation	
	0E1.3		Thermal overload warning 3 during operation	
	0E1.4		Thermal overload warning 4 during operation	
	0E1.5		Thermal overload warning 1 during a stop	
	0E1.6		Thermal overload warning 2 during a stop	
	0E1.7		Thermal overload warning 3 during a stop	
	0E1.8		Thermal overload warning 4 during a stop	
	0E2.1	Servo motor overheat warning	Servo motor temperature warning	
	0E2.2		Servo motor temperature warning 2	
	0E3.2	Absolute position counter warning	Absolute position counter warning	
	0E3.5		Encoder absolute position counter warning	
	0E3.6		Scale measurement encoder absolute position counter warning	
	0E4.1	Parameter warning (Note-1)	Parameter setting range error warning	
	0E6.1	Servo forced stop warning	Forced stop warning	
	0E7.1	Controller forced stop warning	Controller forced stop input warning	
	0E8.1	Decreased cooling fan speed warning	Decreased cooling fan speed	
	0E8.2		Cooling fan stop	
	0E9.1	Main circuit off warning	Servo-on signal on during main circuit off	
	0E9.2		Bus voltage drop during low speed operation	
	0E9.3		Ready-on signal on during main circuit off	
	0EB.1	The other axis error warning	The other axis error warning	
	0EC.1	Overload warning 2	Overload warning 2	
	0ED.1	Output watt excess warning	Output watt excess warning	
	0F0.1	Tough drive warning	Instantaneous power failure tough drive warning	
	0F0.3		Vibration tough drive warning	
	0F2.1	Drive recorder warning	Drive recorder warning 1	
	0F2.2		Drive recorder warning 2	
	0F2.3		Drive recorder warning 3	
	0F2.4		Drive recorder warning 4	
	0F2.5		Drive recorder warning 5	
	0F2.6		Drive recorder warning 6	
0F3.1	Oscillation detection warning	Oscillation detection warning		
0F7.1	Machine diagnosis warning	Vibration failure prediction warning		
0F7.2		Friction failure prediction warning		
0F7.3		Failure prediction warning based on servo motor total travel distance		
0F7.4		Gear failure prediction warning		
0F7.5		Static friction failure prediction warning		
0F7.6		Belt failure prediction warning		
19E.4		Network warning 2	SSCNET communication error warning	

(Note-1): Refer to the parameter No. stored in parameter error No. (#8009+20n) for details of the parameter for which the error occurred.

APPENDICES

Table 1.12 Servo error (2000 and 2100) list (MR-J5(W)-□B) (Continued)

Error code	Servo amplifier LED display	Name	Details name	Remarks
2100	1E9.1	Open-phase warning	Input open-phase warning	
	1F8.1	Memory warning 1	Memory writing frequency warning	
	1F8.2		Memory free space warning	

(b) MR-J4(W)-□B

Table 1.13 Servo error (2000 to 2999) list (MR-J4(W)-□B)

Error code	Servo amplifier LED display	Name	Details name	Remarks
2010	10.1	Undervoltage	Voltage drop in the control power	
	10.2		Voltage drop in the main circuit power	
2011	11.1	Switch setting error	Axis number setting error/Station number setting error	
	11.2		Disabling control axis setting error	
2012	12.1	Memory error 1 (RAM)	RAM error 1	
	12.2		RAM error 2	
	12.3		RAM error 3	
	12.4		RAM error 4	
	12.5		RAM error 5	
2013	13.1	Clock error	Clock error 1	
	13.2		Clock error 2	
2014	14.1	Control process error	Control process error 1	
	14.2		Control process error 2	
	14.3		Control process error 3	
	14.4		Control process error 4	
	14.5		Control process error 5	
	14.6		Control process error 6	
	14.7		Control process error 7	
	14.8		Control process error 8	
	14.9		Control process error 9	
	14.A		Control process error 10	
2015	15.1	Memory error 2 (EEP-ROM)	EEP-ROM error at power on	
	15.2		EEP-ROM error during operation	
	15.4		Home position information read error	
2016	16.1	Encoder initial communication error 1	Encoder initial communication - Receive data error 1	
	16.2		Encoder initial communication - Receive data error 2	
	16.3		Encoder initial communication - Receive data error 3	
	16.4		Encoder initial communication - Encoder malfunction	
	16.5		Encoder initial communication - Transmission data error 1	
			Encoder initial communication - Transmission data error 2	
	16.6		Encoder initial communication - Transmission data error 3	
	16.7		Encoder initial communication - Incompatible encoder	
	16.8		Encoder initial communication - Process error 1	
	16.A		Encoder initial communication - Process error 2	
	16.B		Encoder initial communication - Process error 3	
	16.C		Encoder initial communication - Process error 4	
	16.D		Encoder initial communication - Process error 5	
16.E	Encoder initial communication - Process error 6			
16.F	Encoder initial communication - Process error 6			

APPENDICES

Table 1.13 Servo error (2000 to 2999) list (MR-J4(W)-□B) (Continued)

Error code	Servo amplifier LED display	Name	Details name	Remarks
2017	17.1	Board error	Board error 1	
	17.3		Board error 2	
	17.4		Board error 3	
	17.5		Board error 4	
	17.6		Board error 5	
	17.7		Board error 7	
	17.8		Board error 6	
	17.9		Board error 8	
2019	19.1	Memory error 3 (Flash-ROM)	Flash-ROM error 1	
	19.2		Flash-ROM error 2	
	19.3		Flash-ROM error 3	
2020	20.1	Encoder normal communication error 1	Encoder normal communication - Receive data error 1	
	20.2		Encoder normal communication - Receive data error 2	
	20.3		Encoder normal communication - Receive data error 3	
	20.5		Encoder normal communication - Transmission data error 1	
	20.6		Encoder normal communication - Transmission data error 2	
	20.7		Encoder normal communication - Transmission data error 3	
	20.9		Encoder normal communication - Receive data error 4	
	20.A		Encoder normal communication - Receive data error 5	
2021	21.1	Encoder normal communication error 2	Encoder error 1	
	21.2		Encoder data update error	
	21.3		Encoder data waveform error	
	21.4		Encoder non-signal error	
	21.5		Encoder hardware error 1	
	21.6		Encoder hardware error 2	
	21.9		Encoder error 2	
2024	24.1	Main circuit error	Ground fault detected at hardware detection circuit	
	24.2		Ground fault detected at software detection function	
2025	25.1	Absolute position erased	Servo motor encoder - Absolute position erased	
	25.2		Scale measurement encoder - Absolute position erased	
2027	27.1	Initial magnetic pole detection error	Initial magnetic pole detection - Abnormal termination	
	27.2		Initial magnetic pole detection - Time out error	
	27.3		Initial magnetic pole detection - Limit switch error	
	27.4		Initial magnetic pole detection - Estimated error	
	27.5		Initial magnetic pole detection - Speed deviation error	
	27.6		Initial magnetic pole detection - Position deviation error	
	27.7		Initial magnetic pole detection - Current error	
2028	28.1	Linear encoder error 2	Linear encoder - Environment error	
2030	30.1	Regenerative error	Regeneration heat error	
	30.2		Regeneration signal error	
	30.3		Regeneration feedback signal error	
2031	31.1	Overspeed	Abnormal motor speed	

APPENDICES

Table 1.13 Servo error (2000 to 2999) list (MR-J4(W)-□B) (Continued)

Error code	Servo amplifier LED display	Name	Details name	Remarks
2032	32.1	Overcurrent	Overcurrent detected at hardware detection circuit (during operation)	
	32.2		Overcurrent detected at software detection function (during operation)	
	32.3		Overcurrent detected at hardware detection circuit (during a stop)	
	32.4		Overcurrent detected at software detection function (during a stop)	
2033	33.1	Overvoltage	Main circuit voltage error	
2034	34.1	SSCNET receive error 1	SSCNET receive data error	
	34.2		SSCNET connector connection error	
	34.3		SSCNET communication data error	
	34.4		Hardware error signal detection	
	34.5		SSCNET receive data error (safety observation function)	
	34.6		SSCNET communication data error (safety observation function)	
2035	35.1	Command frequency error	Command frequency error	
2036	36.1	SSCNET receive error 2	Continuous communication data error	
	36.2		Continuous communication data error (safety observation function)	
2037 (Note-1)	37.1	Parameter error	Parameter setting range error	
	37.2		Parameter combination error	
	37.3		Point table setting error	
2042	42.1	Servo control error	Servo control error by position deviation	
	42.2		Servo control error by speed deviation	
	42.3		Servo control error by torque/thrust deviation	
	42.8	Fully closed loop control error	Fully closed loop control error by position deviation	
	42.9		Fully closed loop control error by speed deviation	
	42.A		Fully closed loop control error by position deviation (during command stop)	
2045	45.1	Main circuit device overheat	Main circuit device overheat error 1	
	45.2		Main circuit device overheat error 2	
2046	46.1	Servo motor overheat	Abnormal temperature of servo motor 1	
	46.2		Abnormal temperature of servo motor 2	
	46.3		Thermistor disconnected error	
	46.4		Thermistor circuit error	
	46.5		Abnormal temperature of servo motor 3	
	46.6		Abnormal temperature of servo motor 4	
2047	47.1	Cooling fan error	Cooling fan stop error	
	47.2		Cooling fan speed reduction error	
2050	50.1	Overload 1	Thermal overload error 1 during operation	
	50.2		Thermal overload error 2 during operation	
	50.3		Thermal overload error 4 during operation	
	50.4		Thermal overload error 1 during a stop	
	50.5		Thermal overload error 2 during a stop	
	50.6		Thermal overload error 4 during a stop	

(Note-1): Refer to the parameter No. stored in parameter error No. (#8009+20n) for details of the parameter for which the error occurred.

APPENDICES

Table 1.13 Servo error (2000 to 2999) list (MR-J4(W)-□B) (Continued)

Error code	Servo amplifier LED display	Name	Details name	Remarks
2051	51.1	Overload 2	Thermal overload error 3 during operation	
	51.2		Thermal overload error 3 during a stop	
2052	52.1	Error excessive	Excess droop pulse 1	
	52.3		Excess droop pulse 2	
	52.4		Error excessive during 0 torque limit	
	52.5		Excess droop pulse 3	
	52.6		Excessive droop pulse at servo-off	
2054	54.1	Oscillation detection	Oscillation detection error	
2056	56.2	Forced stop error	Over speed during forced stop	
	56.3		Estimated distance over during forced stop	
2060	1A.1	Servo motor combination error	Servo motor combination error	
	1A.2		Servo motor control mode combination error	
	1A.4		Servo motor combination error 2	
2061	2A.1	Linear encoder error 1	Linear encoder error 1-1	
	2A.2		Linear encoder error 1-2	
	2A.3		Linear encoder error 1-3	
	2A.4		Linear encoder error 1-4	
	2A.5		Linear encoder error 1-5	
	2A.6		Linear encoder error 1-6	
	2A.7		Linear encoder error 1-7	
	2A.8		Linear encoder error 1-8	
2063	63.1	STO timing error	STO1 off	
	63.2		STO2 off	
	63.5		STO by functional safety unit	
	1E.1	Encoder initial communication error 2	Encoder malfunction	
	1E.2		Load-side encoder malfunction	
2064	64.1	Functional safety unit setting error	STO input error	
	64.2		Compatibility mode setting error	
	64.3		Operation mode setting error	
	1F.1	Encoder initial communication error 3	Incompatible encoder	
	1F.2		Incompatible load-side encoder	
2065	65.1	Functional safety unit connection error	Functional safety unit communication error 1	
	65.2		Functional safety unit communication error 2	
	65.3		Functional safety unit communication error 3	
	65.4		Functional safety unit communication error 4	
	65.5		Functional safety unit communication error 5	
	65.6		Functional safety unit communication error 6	
	65.7		Functional safety unit communication error 7	
	65.8		Functional safety unit shut-off signal error 1	
	65.9		Functional safety unit shut-off signal error 2	
2066	66.1	Encoder initial communication error (safety observation function)	Encoder initial communication - Receive data error 1 (safety observation function)	
	66.2		Encoder initial communication - Receive data error 2 (safety observation function)	
	66.3		Encoder initial communication - Receive data error 3 (safety observation function)	
	66.7		Encoder initial communication - Transmission data error 1 (safety observation function)	
	66.9		Encoder initial communication - Process error 1 (safety observation function)	

APPENDICES

Table 1.13 Servo error (2000 to 2999) list (MR-J4(W)-□B) (Continued)

Error code	Servo amplifier LED display	Name	Details name	Remarks
2067	67.1	Encoder normal communication error 1 (safety observation function)	Encoder normal communication - Receive data error 1 (safety observation function)	
	67.2		Encoder normal communication - Receive data error 2 (safety observation function)	
	67.3		Encoder normal communication - Receive data error 3 (safety observation function)	
	67.4	Encoder normal communication error 1 (safety observation function)	Encoder normal communication - Receive data error 4 (safety observation function)	
	67.7		Encoder normal communication - Transmission data error 1 (safety observation function)	
2068	68.1	STO diagnosis error	Mismatched STO signal error	
2070	70.1	Load-side encoder initial communication error 1	Load-side encoder initial communication - Receive data error 1	
	70.2		Load-side encoder initial communication - Receive data error 2	
	70.3		Load-side encoder initial communication - Receive data error 3	
	70.4		Load-side encoder initial communication - Encoder malfunction	
	70.5		Load-side encoder initial communication - Transmission data error 1	
	70.6		Load-side encoder initial communication - Transmission data error 2	
	70.7		Load-side encoder initial communication - Transmission data error 3	
	70.8		Load-side encoder initial communication - Incompatible encoder	
	70.A		Load-side encoder initial communication - Process error 1	
	70.B		Load-side encoder initial communication - Process error 2	
	70.C		Load-side encoder initial communication - Process error 3	
	70.D		Load-side encoder initial communication - Process error 4	
	70.E		Load-side encoder initial communication - Process error 5	
	70.F		Load-side encoder initial communication - Process error 6	

Table 1.13 Servo error (2000 to 2999) list (MR-J4(W)-□B) (Continued)

Error code	Servo amplifier LED display	Name	Details name	Remarks
2071	71.1	Load-side encoder normal communication error 1	Load-side encoder communication - Receive data error 1	
	71.2		Load-side encoder communication - Receive data error 2	
	71.3		Load-side encoder communication - Receive data error 3	
	71.5		Load-side encoder communication - Transmission data error 1	
	71.6		Load-side encoder communication - Transmission data error 2	
	71.7		Load-side encoder communication - Transmission data error 3	
	71.9		Load-side encoder communication - Transmission data error 4	
	71.A		Load-side encoder communication - Transmission data error 5	
2072	72.1	Load-side encoder normal communication error 2	Load-side encoder data error 1	
	72.2		Load-side encoder data update error	
	72.3		Load-side encoder data waveform error	
	72.4		Load-side encoder non-signal error	
	72.5		Load-side encoder hardware error 1	
	72.6		Load-side encoder hardware error 2	
	72.9		Load-side encoder data error 2	
2079	79.1	Functional safety unit diagnosis error	Functional safety unit power voltage error	
	79.2		Functional safety unit internal error	
	79.3		Abnormal temperature of functional safety unit	
	79.4		Servo amplifier error	
	79.5		Input device error	
	79.6		Output device error	
	79.7		Mismatched input signal error	
	79.8		Position feedback fixing error	
2082	82.1	Master-slave operation error 1	Master-slave operation error 1	
2088	888	Watchdog	Watchdog	
2091	91.1	Servo amplifier overheat warning	Main circuit device overheat warning	
2095	95.1	STO warning	STO1 off detection	
	95.2		STO2 off detection	
	95.3		STO warning 1 (safety observation function)	
	95.4		STO warning 2 (safety observation function)	
	95.5		STO warning 3 (safety observation function)	
2102	92.1	Battery cable disconnection warning	Encoder battery cable disconnection warning	
	92.3		Battery degradation	
2106	96.1	Home position setting warning	In-position warning at home positioning	
	96.2		Command input warning at home positioning	
	96.3		Servo off warning at home positioning	
	96.4		Home positioning warning during magnetic pole detection	
2116	9F.1	Battery warning	Low battery	
	9F.2		Battery degradation warning	

APPENDICES

Table 1.13 Servo error (2000 to 2999) list (MR-J4(W)-□B) (Continued)

Error code	Servo amplifier LED display	Name	Details name	Remarks
2140	E0.1	Excessive regeneration warning	Excessive regeneration warning	
2141	E1.1	Overload warning 1	Thermal overload warning 1 during operation	
	E1.2		Thermal overload warning 2 during operation	
	E1.3		Thermal overload warning 3 during operation	
	E1.4		Thermal overload warning 4 during operation	
	E1.5		Thermal overload error 1 during a stop	
	E1.6		Thermal overload error 2 during a stop	
	E1.7		Thermal overload error 3 during a stop	
	E1.8		Thermal overload error 4 during a stop	
2142	E2.1	Servo motor overheat warning	Servo motor temperature warning	
2143	E3.1	Absolute position counter warning	Multi-revolution counter travel distance excess warning	
	E3.2		Absolute position counter warning	
	E3.4		Absolute positioning counter EEPROM writing frequency warning	
	E3.5		Encoder absolute positioning counter warning	
2144 (Note-1)	E4.1	Parameter warning	Parameter setting range error warning	
2146	E6.1	Servo forced stop warning	Forced stop warning	
	E6.2		SS1 forced stop warning 1 (safety observation function)	
	E6.3		SS1 forced stop warning 2 (safety observation function)	
2147	E7.1	Controller forced stop warning	Controller forced stop warning	
2148	E8.1	Cooling fan speed reduction warning	Decreased cooling fan speed warning	
	E8.2		Cooling fan stop	
2149	E9.1	Main circuit off warning	Servo-on signal on during main circuit off	
	E9.2		Bus voltage drop during low speed operation	
	E9.3		Ready-on signal on during main circuit off	
	E9.4		Converter unit forced stop	
2151	EB.1	The other axis error warning	The other axis error warning	
2152	EC.1	Overload warning 2	Overload warning 2	
2153	ED.1	Output watt excess warning	Output watt excess warning	
2160	F0.1	Tough drive warning	Instantaneous power failure tough drive warning	
	F0.3		Vibration tough drive warning	
2162	F2.1	Drive recorder - Miswriting warning	Drive recorder - Area writing time-out warning	
	F2.2		Drive recorder - Data miswriting warning	
2163	F3.1	Oscillation detection warning	Oscillation detection warning	
2167	F7.1	Machine diagnosis warning	Vibration failure prediction warning	
	F7.2		Friction failure prediction warning	
	F7.3		Total travel distance failure prediction warning	
2907	1B.1	Converter error	Converter unit error	
2913	2B.1	Encoder counter error	Encoder counter error 1	
	2B.2		Encoder counter error 2	

(Note-1): Refer to the parameter No. stored in parameter error No. (#8009+20n) for details of the parameter for which the error occurred.

APPENDICES

Table 1.13 Servo error (2000 to 2999) list (MR-J4(W)-□B) (Continued)

Error code	Servo amplifier LED display	Name	Details name	Remarks
2918	3A.1	Inrush current suppression circuit error	Inrush current suppression circuit error	
2921	3D.1	Parameter setting error for driver communication	Parameter combination error for driver communication on slave	
	3D.2		Parameter combination error for driver communication on master	
2922	3E.1	Operation mode error	Operation mode error	
	3E.6		Operation mode switch error	
2942	7A.1	Parameter setting error (safety observation function)	Parameter verification error (safety observation function)	
	7A.2		Parameter setting range error (safety observation function)	
	7A.3		Parameter combination error (safety observation function)	
	7A.4		Functional safety unit combination error (safety observation function)	
2943	7B.1	Encoder diagnosis error (safety observation function)	Encoder diagnosis error 1 (safety observation function)	
	7B.2		Encoder diagnosis error 2 (safety observation function)	
	7B.3		Encoder diagnosis error 3 (safety observation function)	
	7B.4		Encoder diagnosis error 4 (safety observation function)	
2944	7C.1	Functional safety unit communication diagnosis error (safety observation function)	Functional safety unit communication cycle error (safety observation function)	
	7C.2		Functional safety unit communication data error (safety observation function)	
2945	7D.1	Safety observation error	Stop observation error	
	7D.2		Speed observation error	
2948	8A.1	USB communication time-out error/serial communication time-out error/Modbus-RTU communication time-out error	USB communication time-out error/serial communication time-out error	
	8A.2		Modbus-RTU communication time-out error	
2952	8E.1	USB communication error/serial communication error/Modbus-RTU communication error	USB communication receive error/serial communication receive error	
	8E.2		USB communication checksum error/serial communication checksum error	
	8E.3		USB communication character error/serial communication character error	
	8E.4		USB communication command error/serial communication command error	
	8E.5		USB communication data number error/serial communication data number error	
	8E.6		Modbus-RTU communication receive error	
	8E.7		Modbus-RTU communication message frame error	
	8E.8		Modbus-RTU communication CRC error	

APPENDICES

Table 1.13 Servo error (2000 to 2999) list (MR-J4(W)-□B) (Continued)

Error code	Servo amplifier LED display	Name	Details name	Remarks
2955	9B.1	Error excessive warning	Excess droop pulse 1 warning	
	9B.3		Excess droop pulse 2 warning	
	9B.4		Error excessive warning during 0 torque limit	
2956	9C.1	Converter error	Converter unit error	

(c) MR-J3-□B

Table 1.14 Servo error (2000 to 2999) list (MR-J3-□B)

Error code	Servo amplifier LED display (Note-1)	Name	Remarks
2010	10	Undervoltage	
2012	12	Memory error 1 (RAM)	
2013	13	Clock error	
2015	15	Memory error 2 (EEP-ROM)	
2016	16	Encoder error 1 (At power on)	
2017	17	Board error	
2019	19	Memory error 3 (Flash ROM)	
2020	20	Encoder error 2 (During runtime)	
2021	21	Encoder error 3 (During runtime)	
2024	24	Main circuit error	
2025	25	Absolute position erase	
2030	30	Regenerative error	
2031	31	Overspeed	
2032	32	Overcurrent	
2033	33	Overvoltage	
2034	34	Receive error 1	
2035	35	Command frequency error	
2036	36	Receive error 2	
2045	45	Main circuit device overheat	
2046	46	Servo motor overheat	
2047	47	Cooling fan error	
2050	50	Overload 1	
2051	51	Overload 2	
2052	52	Error excessive	
2060	1A	Motor combination error	
2082	82	Master/slave operation error 1	
2088	888	Watchdog	
2102	92	Battery cable disconnection warning	
2106	96	Home position setting warning	
2116	9F	Battery warning	
2140	E0	Excessive regeneration warning	
2141	E1	Overload warning 1	
2143	E3	Absolute position counter warning	
2146	E6	Servo forced stop warning	
2147	E7	Controller forced stop warning	
2148	E8	Cooling fan speed reduction warning	
2149	E9	Main circuit off warning	
2152	EC	Overload warning 2	
2153	ED	Output watt excess warning	
2301 to 2599	E4	Parameter warning (Refer to the table 1.15)	
2601 to 2899	37	Parameter error (Refer to the table 1.15)	

(Note-1): The LED display is different when using the servo amplifiers with a large capacity. Refer to the "Servo amplifier Instruction Manual" for details.

Table 1.14 Servo error (2000 to 2999) list (MR-J3-□B) (Continued)

Error code	Servo amplifier LED display (Note-1)	Name	Remarks
2907 (Note-2)	1B	Converter alarm	
2921 (Note-2)	3D	Driver communication parameter setting error	
2948 (Note-2)	8A	USB communication time-out error	
2952 (Note-2)	8E	USB communication error	
2956 (Note-2)	9C	Converter warning	

(Note-1): The LED display is different when using the servo amplifiers with a large capacity. Refer to the "Servo amplifier Instruction Manual" for details.

(Note-2): Error codes will differ depending on the operating system software version. **QD**

Error code		Servo amplifier LED display	Name
Operating system software version			
"00F" or earlier	"00G" or later		
2021	2907	1B	Converter alarm
2043	2921	3D	Driver communication parameter setting error
2090	2948	8A	USB communication time-out error
2094	2952	8E	USB communication error
2102	2956	9C	Converter warning

APPENDICES

Table 1.15 Parameter warning (2301 to 2599)/Parameter error (2601 to 2899) error detail

Error code	Parameter No.	Name	Error code	Parameter No.	Name		
2301	2601	PA01	Control mode	2339	2639	PB20	Vibration suppression control resonance frequency setting
2302	2602	PA02	Regenerative option	2340	2640	PB21	For manufacturer setting
2303	2603	PA03	Absolute position detection system	2341	2641	PB22	
2304	2604	PA04	Function selection A-1	2342	2642	PB23	Low-pass filter selection
2305	2605	PA05	For manufacturer setting	2343	2643	PB24	Slight vibration suppression control selection
2306	2606	PA06					
2307	2607	PA07					
2308	2608	PA08	Auto tuning mode	2344	2644	PB25	For manufacturer setting
2309	2609	PA09	Auto tuning response	2345	2645	PB26	Gain changing selection
2310	2610	PA10	In-position range	2346	2646	PB27	Gain changing condition
2311	2611	PA11	For manufacturer setting	2347	2647	PB28	Gain changing time constant
2312	2612	PA12					
2313	2613	PA13					
2314	2614	PA14	Rotation direction selection	2348	2648	PB29	Gain changing ratio of load inertia moment to servo motor inertia moment
2315	2615	PA15	Encoder output pulse	2349	2649	PB30	Gain changing position loop gain
2316	2616	PA16	For manufacturer setting	2350	2650	PB31	Gain changing speed loop gain
2317	2617	PA17					
2318	2618	PA18					
2319	2619	PA19	Parameter write inhibit	2351	2651	PB32	Gain changing speed integral compensation
2320	2620	PB01	Adaptive tuning mode (adaptive filter II)	2352	2652	PB33	Gain changing vibration suppression control vibration frequency setting
2321	2621	PB02	Vibration suppression control tuning mode (advanced vibration suppression control)	2353	2653	PB34	Gain changing vibration suppression control resonance frequency setting
2322	2622	PB03	For manufacturer setting	2354	2654	PB35	For manufacturer setting
2323	2623	PB04	Feed forward gain	2355	2655	PB36	
2324	2624	PB05	For manufacturer setting	2356	2656	PB37	
2325	2625	PB06	Ratio of load inertia moment to servo motor inertia moment	2357	2657	PB38	
2326	2626	PB07	Model loop gain	2358	2658	PB39	
2327	2627	PB08	Position loop gain	2359	2659	PB40	
2328	2628	PB09	Speed loop gain	2360	2660	PB41	
2329	2629	PB10	Speed integral compensation	2361	2661	PB42	
2330	2630	PB11	Speed differential compensation	2362	2662	PB43	
2331	2631	PB12	Overshoot amount compensation	2363	2663	PB44	
2332	2632	PB13	Machine resonance suppression filter 1	2364	2664	PB45	Vibration suppression control filter 2
2333	2633	PB14	Notch shape selection 1	2365	2665	PC01	Error excessive alarm level
2334	2634	PB15	Machine resonance suppression filter 2	2366	2666	PC02	Electromagnetic brake sequence output
2335	2635	PB16	Notch shape selection 2	2367	2667	PC03	Encoder output pulse selection
2336	2636	PB17	Automatic setting parameter	2368	2668	PC04	Function selection C-1
2337	2637	PB18	Low-pass filter setting	2369	2669	PC05	Function selection C-2
2338	2638	PB19	Vibration suppression control vibration frequency setting	2370	2670	PC06	Function selection C-3
				2371	2671	PC07	Zero speed
				2372	2672	PC08	For manufacturer setting
				2373	2673	PC09	Analog monitor 1 output
				2374	2674	PC10	Analog monitor 2 output
				2375	2675	PC11	Analog monitor 1 offset
				2376	2676	PC12	Analog monitor 2 offset

(Note): The details are different when using the servo amplifiers with a large capacity. Refer to the "Servo amplifier Instruction Manual" for details.

APPENDICES

Table 1.15 Parameter warning (2301 to 2599)/Parameter error (2601 to 2899) error detail (Continued)

Error code		Parameter No.	Name	Error code		Parameter No.	Name
2377	2677	PC13	Analog monitor feedback position output standard data Low	2416	2716	PD20	Driver communication setting Master axis No. selection1 for slave
2378	2678	PC14	Analog monitor feedback position output standard data High	2417	2717	PD21	For manufacturer setting
2379	2679	PC15	For manufacturer setting	2418	2718	PD22	
2380	2680	PC16	Function selection C-3A	2419	2719	PD23	
2381	2681	PC17	Function selection C-4	2420	2720	PD24	
2382	2682	PC18	For manufacturer setting	2421	2721	PD25	
2383	2683	PC19		2422	2722	PD26	
2384	2684	PC20	Function selection C-7	2423	2723	PD27	
2385	2685	PC21	Alarm history clear	2424	2724	PD28	
2386	2686	PC22	For manufacturer setting	2425	2725	PD29	
2387	2687	PC23		2426	2726	PD30	
2388	2688	PC24		2427	2727	PD31	Master-slave operation - Speed limit coefficient on slave
2389	2689	PC25		2428	2728	PD32	Master-slave operation - Speed limit adjustment value on slave
2390	2690	PC26		For manufacturer setting	2429	2729	PE01
2391	2691	PC27			2430	2730	PE02
2392	2692	PC28			2431	2731	PE03
2393	2693	PC29			2432	2732	PE04
2394	2694	PC30			2433	2733	PE05
2395	2695	PC31			2434	2734	PE06
2396	2696	PC32	2435		2735	PE07	
2397	2697	PD01	2436		2736	PE08	
2398	2698	PD02	2437		2737	PE09	
2399	2699	PD03	2438		2738	PE10	
2400	2700	PD04	2439	2739	PE11		
2401	2701	PD05	2440	2740	PE12		
2402	2702	PD06	2441	2741	PE13		
2403	2703	PD07	Output signal device selection 1 (CN3-13)	2442	2742	PE14	For manufacturer setting
2404	2704	PD08	Output signal device selection 2 (CN3-9)	2443	2743	PE15	
2405	2705	PD09	Output signal device selection 3 (CN3-15)	2444	2744	PE16	
2406	2706	PD10	For manufacturer setting	2445	2745	PE17	
2407	2707	PD11	Input filter setting	2446	2746	PE18	
2408	2708	PD12	For manufacturer setting	2447	2747	PE19	
2409	2709	PD13		2448	2748	PE20	
2410	2710	PD14	Function selection D-3	2449	2749	PE21	
2411	2711	PD15	Driver communication setting	2450	2750	PE22	
2412	2712	PD16	Driver communication setting Master transmit data selection1	2451	2751	PE23	
2413	2713	PD17	Driver communication setting Master transmit data selection2	2452	2752	PE24	
2414	2714	PD18	For manufacturer setting	2453	2753	PE25	
2415	2715	PD19		2454	2754	PE26	Filter coefficient 2-1

(Note): The details are different when using the servo amplifiers with a large capacity. Refer to the "Servo amplifier Instruction Manual" for details.

APPENDICES

Table 1.15 Parameter warning (2301 to 2599)/Parameter error (2601 to 2899) error detail (Continued)

Error code	Parameter No.	Name	Error code	Parameter No.	Name	
2455	2755	PE27	Filter coefficient 2-2	2462	2762	PE34
2456	2756	PE28	Filter coefficient 2-3	2463	2763	PE35
2457	2757	PE29	Filter coefficient 2-4	2464	2764	PE36
2458	2758	PE30	Filter coefficient 2-5	2465	2765	PE37
2459	2759	PE31	Filter coefficient 2-6	2466	2766	PE38
2460	2760	PE32	Filter coefficient 2-7	2467	2767	PE39
2461	2761	PE33	Filter coefficient 2-8	2468	2768	PE40

(Note): The details are different when using the servo amplifiers with a large capacity. Refer to the "Servo amplifier Instruction Manual" for details.

(d) MR-J3W-□B

Table 1.16 Servo error (2000 to 2999) list (MR-J3W-□B)

Error code	Servo amplifier LED display	Name	Details name	Remarks
2010	10.1	Undervoltage	Voltage drop in the control circuit power supply	
	10.2		Voltage drop in the main circuit power	
2011	11.1	Switch setting error	Rotary switch setting error	
	11.2		DIP switch setting error	
	11.3		Servo motor selection switch setting error	
	11.4		Servo motor selection switch setting error 2	
2012	12.1	Memory error 1 (RAM)	CPU built-in RAM error	
	12.2		CPU data RAM error	
	12.3		Custom IC RAM error	
2013	13.1	Clock error	Clock error	
2015	15.1	Memory error 2 (EEP-ROM)	EEP-ROM error at power on	
	15.2		EEP-ROM error during operation	
2016	16.1	Encoder initial communication error 1	Encoder receive data error 1	
	16.2		Encoder receive data error 2	
	16.3		Encoder receive data error 3	
	16.5		Encoder transmission data error 1	
	16.6		Encoder transmission data error 2	
	16.7		Encoder transmission data error 3	
2017	17.1	Board error	AD converter error	
	17.2		Current feedback data error	
	17.3		Custom IC error	
	17.4		Amplifier detection signal error	
	17.5		Rotary switch error	
	17.6		DIP switch error	
2019	19.1	Memory error 3 (Flash ROM)	Flash-ROM error 1	
	19.2		Flash-ROM error 2	
2020	20.1	Encoder normal communication error 1	Encoder receive data error 1	
	20.2		Encoder receive data error 2	
	20.3		Encoder receive data error 3	
	20.5		Encoder transmission data error 1	
	20.6		Encoder transmission data error 2	
	20.7		Encoder transmission data error 3	
2021	21.1	Encoder normal communication error 2	Encoder data error	
	21.2		Encoder data update error	
	21.3		Encoder waveform error	Direct drive motor use
2024	24.1	Main circuit error	Ground fault detected at hardware detection circuit	
	24.2		Ground fault detected at software detection function	
2025	25.1	Absolute position erase	Absolute position data erase	
2027	27.1	Initial magnetic pole detection error	Magnetic pole detection abnormal termination	Linear servo motor/ direct drive motor use
	27.2		Magnetic pole detection time out error	
	27.3		Magnetic pole detection limit switch error	
	27.4		Magnetic pole detection estimated error	
	27.5		Magnetic pole detection position deviation error	
	27.6		Magnetic pole detection speed deviation error	
	27.7		Magnetic pole detection current error	
2028	28.1	Linear encoder error 2	Linear encoder environment error	Linear servo motor use

APPENDICES

Table 1.16 Servo error (2000 to 2999) list (MR-J3W-□B) (Continued)

Error code	Servo amplifier LED display	Name	Details name	Remarks
2030	30.1	Regenerative error	Regeneration heat error	
	30.2		Regenerative transistor error	
	30.3		Regenerative transistor feedback data error	
2031	31.1	Overspeed	Abnormal motor speed (Note-1), (Note-2)	
2032	32.1	Overcurrent	Overcurrent detected at hardware detection circuit (during operation).	
	32.2		Overcurrent detected at software detection function (during operation).	
	32.3		Overcurrent detected at hardware detection circuit (during a stop).	
	32.4		Overcurrent detected at software detection function (during a stop).	
2033	33.1	Overvoltage	Main circuit voltage error	
2034	34.1	SSCNET receive error 1	SSCNET receive data error	
	34.2		SSCNET communication connector connection error	
	34.3		Communication data error	
	34.4		Hardware error signal detection	
2035	35.1	Command frequency error	Command frequency error	
2036	36.1	SSCNET receive error 2	Continuous communication data error	
2042	42.1	Linear servo control error	Linear servo control error on the positioning detection	Linear servo motor use
		Servo control error	Servo control error due to position deviation	Direct drive motor use
	42.2	Linear servo control error	Linear servo control error on the speed detection	Linear servo motor use
		Servo control error	Servo control error due to speed deviation	Direct drive motor use
	42.3	Linear servo control error	Linear servo control error on the thrust detection	Linear servo motor use
		Servo control error	Servo control error due to torque detection	Direct drive motor use
2045	45.1	Main circuit device overheat	Main circuit abnormal temperature	
	45.2		Board temperature error	
2046	46.1	Servo motor overheat (Note-2)	Abnormal temperature of servo motor	
	46.2		Linear servo motor thermal sensor error	Linear servo motor use
			Direct drive motor thermal sensor error	Direct drive motor use
46.3	Thermistor wires are not connected error	Linear servo motor/direct drive motor use		
2047	47.1	Cooling fan error	Cooling fan stop error	
	47.2		Decreased cooling fan speed error	
2050	50.1	Overload 1	Thermal overload error 1 during operation	
	50.2		Thermal overload error 2 during operation	
	50.3		Thermal overload error 4 during operation	
	50.4		Thermal overload error 1 during a stop	
	50.5		Thermal overload error 2 during a stop	
	50.6		Thermal overload error 4 during a stop	

(Note-1): The name is different when using the linear servo motors. Refer to the "Servo amplifier Instruction Manual" for details.

(Note-2): The name is different when using the direct drive motors. Refer to the "Servo amplifier Instruction Manual" for details.

APPENDICES

Table 1.16 Servo error (2000 to 2999) list (MR-J3W-□B) (Continued)

Error code	Servo amplifier LED display	Name	Details name	Remarks
2051	51.1	Overload 2	Thermal overload error 3 during operation	
	51.2		Thermal overload error 3 during a stop	
2052	52.3	Error excessive	Excess droop pulse (Note-1), (Note-2)	
	52.4		Maximum deviation at 0 torque limit (Note-1), (Note-2)	
2060	1A.1	Motor combination error	Motor combination error	
2061	2A.1	Linear encoder error 1	Linear encoder side error 1	Linear servo motor use
	2A.2		Linear encoder side error 2	
	2A.3		Linear encoder side error 3	
	2A.4		Linear encoder side error 4	
	2A.5		Linear encoder side error 5	
	2A.6		Linear encoder side error 6	
	2A.7		Linear encoder side error 7	
	2A.8		Linear encoder side error 8	
2063 (Note-3)	1E.1	Encoder initial communication error 2	Encoder failure	
2064 (Note-3)	1F.1	Encoder initial communication error 3	Incompatible encoder	
2088	888	Watchdog	—	
2101 (Note-3)	91.1	Main circuit device overheat warning	Main circuit device overheat warning	
	91.2		Board temperature warning	
2102	92.1	Battery cable disconnection warning	Encoder battery disconnection warning signal detection	
2106	96.1	Home position setting warning	In-position error at home positioning	
	96.2		Command input error at home positioning	
2116	9F.1	Battery warning	Low battery	
2140	E0.1	Excessive regeneration warning	Excessive regeneration warning	
2141	E1.1	Overload warning 1	Thermal overload warning 1 during operation	
	E1.2		Thermal overload warning 2 during operation	
	E1.3		Thermal overload warning 3 during operation	
	E1.4		Thermal overload warning 4 during operation	
	E1.5		Thermal overload warning 1 during a stop	
	E1.6		Thermal overload warning 2 during a stop	
	E1.7		Thermal overload warning 3 during a stop	
	E1.8		Thermal overload warning 4 during a stop	
2142	E2.1	Linear servo motor overheat warning	Linear servo motor overheat warning	Linear servo motor use
		Direct drive motor overheat warning	Direct drive motor overheat warning	Direct drive motor use

(Note-1): The name is different when using the linear servo motors. Refer to the "Servo amplifier Instruction Manual" for details.

(Note-2): The name is different when using the direct drive motors. Refer to the "Servo amplifier Instruction Manual" for details.

(Note-3): Error codes will differ depending on the operating system software version. **QD**

Error code		Servo amplifier LED display	Name
Operating system software version			
"00F" or earlier	"00G" or later		
2024	2063	1E	Encoder initial communication error 2
2025	2064	1F	Encoder initial communication error 3
2091	2101	91	Main circuit device overheat warning

APPENDICES

Table 1.16 Servo error (2000 to 2999) list (MR-J3W-□B) (Continued)

Error code	Servo amplifier LED display	Name	Details name	Remarks
2143	E3.1	Absolute position counter warning	The multi-revolution counter travel distance excess warning	
	E3.2		Absolute positioning counter error	
2146	E6.1	Servo forced stop warning	Servo forced stop warning	
2147	E7.1	Controller forced stop warning	Controller forced stop warning	
2148	E8.1	Cooling fan speed reduction warning	Decreased cooling fan speed warning	
2149	E9.1	Main circuit off warning	Ready-on signal on at main circuit off	
	E9.2		Bus voltage drop during low speed operation ^(Note-1)	
	E9.3		Servo-on signal on at main circuit off	
2151	EB.1	The other axis fault warning	The other axis fault warning	
2152	EC.1	Overload warning 2	Overload warning 2	
2153	ED.1	Output watt excess warning	Output watt excess	
2301 to 2599	E4.1	Parameter warning (Refer to the table 1.17)	Parameter setting range error warning	
2601 to 2899	37.1	Parameter error (Refer to the table 1.17)	Parameter setting range error	
	37.2		Parameter combination error	
2913 ^(Note-3)	2B.1	Encoder counter error	Encoder counter error 1	Direct drive motor use
	2B.2		Encoder counter error 2	
2948 ^(Note-3)	8A.1	USB communication time-out error	USB communication time-out error	
2952 ^(Note-3)	8E.1	USB communication error	USB communication receive error	
	8E.2		USB communication checksum error	
	8E.3		USB communication character error	
	8E.4		USB communication command error	
	8E.5		USB communication data No. error	

(Note-1): The name is different when using the linear servo motors. Refer to the "Servo amplifier Instruction Manual" for details.

(Note-2): The name is different when using the direct drive motors. Refer to the "Servo amplifier Instruction Manual" for details.

(Note-3): Error codes will differ depending on the operating system software version. **QD**

Error code		Servo amplifier LED display	Name
Operating system software version			
"00F" or earlier	"00G" or later		
2031	2913	2B	Encoder counter error
2090	2948	8A	USB communication time-out error
2094	2958	8E	USB communication error

APPENDICES

Table 1.17 Parameter warning (2301 to 2599)/Parameter error (2601 to 2899) error detail

Error code	Parameter No.	Name	Error code	Parameter No.	Name		
2301	2601	PA01	Control mode	2340	2640	PB21	For manufacturer setting
2302	2602	PA02	Regenerative option	2341	2641	PB22	
2303	2603	PA03	Absolute position detection system	2342	2642	PB23	Low-pass filter selection
2304	2604	PA04	Function selection A-1	2343	2643	PB24	Slight vibration suppression control selection
2305	2605	PA05	For manufacturer setting	2344	2644	PB25	For manufacturer setting
2306	2606	PA06					
2307	2607	PA07					
2308	2608	PA08	Auto tuning mode	2345	2645	PB26	Gain changing selection
2309	2609	PA09	Auto tuning response	2346	2646	PB27	Gain changing condition
2310	2610	PA10	In-position range	2347	2647	PB28	Gain changing time constant
2311	2611	PA11	For manufacturer setting	2348	2648	PB29	Gain changing ratio of load inertia moment to servo motor inertia moment
2312	2612	PA12					
2313	2613	PA13					
2314	2614	PA14	Rotation direction selection	2349	2649	PB30	Gain changing position loop gain
2315	2615	PA15	Encoder output pulse	2350	2650	PB31	Gain changing speed loop gain
2316	2616	PA16	Encoder output pulse 2	2351	2651	PB32	Gain changing speed integral compensation
2317	2617	PA17	For manufacturer setting	2352	2652	PB33	Gain changing vibration suppression control vibration frequency setting
2318	2618	PA18					
2319	2619	PA19	Parameter write inhibit	2353	2653	PB34	Gain changing vibration suppression control resonance frequency setting
2320	2620	PB01	Adaptive tuning mode (adaptive filter II)	2354	2654	PB35	For manufacturer setting
2321	2621	PB02	Vibration suppression control tuning mode (advanced vibration suppression control)	2355	2655	PB36	
2322	2622	PB03	For manufacturer setting	2356	2656	PB37	
2323	2623	PB04	Feed forward gain	2357	2657	PB38	
2324	2624	PB05	For manufacturer setting	2358	2658	PB39	
2325	2625	PB06	Ratio of load inertia moment to servo motor inertia moment	2359	2659	PB40	
2326	2626	PB07	Model loop gain	2360	2660	PB41	
2327	2627	PB08	Position loop gain	2361	2661	PB42	
2328	2628	PB09	Speed loop gain	2362	2662	PB43	
2329	2629	PB10	Speed integral compensation	2363	2663	PB44	
2330	2630	PB11	Speed differential compensation	2364	2664	PB45	
2331	2631	PB12	For manufacturer setting	2365	2665	PC01	Error excessive alarm level
2332	2632	PB13	Machine resonance suppression filter 1	2366	2666	PC02	Electromagnetic brake sequence output
2333	2633	PB14	Notch shape selection 1	2367	2667	PC03	Encoder output pulse selection
2334	2634	PB15	Machine resonance suppression filter 2	2368	2668	PC04	Function selection C-1
2335	2635	PB16	Notch shape selection 2	2369	2669	PC05	Function selection C-2
2336	2636	PB17	Automatic setting parameter	2370	2670	PC06	Function selection C-3
2337	2637	PB18	Low-pass filter setting	2371	2671	PC07	Zero speed
2338	2638	PB19	Vibration suppression control vibration frequency setting	2372	2672	PC08	For manufacturer setting
2339	2639	PB20	Vibration suppression control resonance frequency setting	2373	2673	PC09	Analog monitor 1 output
				2374	2674	PC10	Analog monitor 2 output
				2375	2675	PC11	Analog monitor 1 offset
				2376	2676	PC12	Analog monitor 2 offset
				2377	2677	PC13	For manufacturer setting
				2378	2678	PC14	

APPENDICES

Table 1.17 Parameter warning (2301 to 2599)/Parameter error (2601 to 2899) error detail (Continued)

Error code	Parameter No.	Name	Error code	Parameter No.	Name		
2379	2679	PC15	Station number selection	2412	2712	PD16	
2380	2680	PC16	For manufacturer setting	2413	2713	PD17	
2381	2681	PC17	Function selection C-4	2414	2714	PD18	
2382	2682	PC18	For manufacturer setting	2415	2715	PD19	
2383	2683	PC19		2416	2716	PD20	
2384	2684	PC20	For manufacturer setting	2417	2717	PD21	
2385	2685	PC21		Alarm history clear	2418	2718	PD22
2386	2686	PC22		2419	2719	PD23	
2387	2687	PC23		2420	2720	PD24	
2388	2688	PC24		2421	2721	PD25	
2389	2689	PC25		2422	2722	PD26	
2390	2690	PC26		2423	2723	PD27	
2391	2691	PC27		2424	2724	PD28	
2392	2692	PC28		2425	2725	PD29	
2393	2693	PC29		2426	2726	PD30	
2394	2694	PC30		2427	2727	PD31	
2395	2695	PC31		2428	2728	PD32	
2396	2696	PC32	2485	2785	Po01	Function selection O-1	
2397	2697	PD01	2486	2786	Po02	Axis selection for graphing analog data (MR Configurator)	
2398	2698	PD02	2487	2787	Po03	Axis selection for graphing digital data (MR Configurator)	
2399	2699	PD03	2488	2788	Po04	Function selection O-2	
2400	2700	PD04	2489	2789	Po05	For manufacturer setting	
2401	2701	PD05	2490	2790	Po06		
2402	2702	PD06	2491	2791	Po07		
2403	2703	PD07	2492	2792	Po08		
2404	2704	PD08	2493	2793	Po09		
2405	2705	PD09	2494	2794	Po10		
2406	2706	PD10	2495	2795	Po11		
2407	2707	PD11	2496	2796	Po12		
2408	2708	PD12	2497	2797	Po13		
2409	2709	PD13	2498	2798	Po14		
2410	2710	PD14	2499	2799	Po15		
2411	2711	PD15	2500	2800	Po16		

(e) MR-J3-□B-RJ004 (For linear servo)

Table 1.18 Servo error (2000 to 2999) list (MR-J3-□B-RJ004)

Error code	Servo amplifier LED display	Name	Remarks
2010	10	Undervoltage	
2012	12	Memory error 1 (RAM)	
2013	13	Clock error	
2015	15	Memory error 2 (EEP-ROM)	
2016	16	Encoder error 1 (At power on)	
2017	17	Board error	
2019	19	Memory error 3 (Flash ROM)	
2020	20	Encoder error 2	
2021	21	Encoder error 3	
2024	24	Main circuit error	
2027	27	Initial magnetic pole detection error	
2028	28	Linear encoder error 2	
2030	30	Regenerative error	
2031	31	Overspeed	
2032	32	Overcurrent	
2033	33	Overvoltage	
2034	34	Receive error 1	
2035	35	Command frequency alarm	
2036	36	Receive error 2	
2042	42	Linear servo control error	
2045	45	Main circuit device overheat	
2046	46	Linear servo motor overheat	
2047	47	Cooling fan alarm	
2050	50	Overload 1	
2051	51	Overload 2	
2052	52	Error excessive	
2061	2A	Linear encoder error 1	
2088	888	Watchdog	
2106	96	Home position setting error	
2140	E0	Excessive regeneration warning	
2141	E1	Overload warning 1	
2142	E2	Linear servo motor overheat warning	
2146	E6	Servo forced stop warning	
2147	E7	Controller emergency stop warning	
2148	E8	Cooling fan speed reduction warning	
2149	E9	Main circuit off warning	
2152	EC	Overload warning 2	
2153	ED	Output watt excess warning	
2301 to 2599	E4	Parameter warning (Refer to the table 1.19)	
2601 to 2899	37	Parameter error (Refer to the table 1.19)	

APPENDICES

Table 1.18 Servo error (2000 to 2999) list (MR-J3-□B-RJ004) (Continued)

Error code	Servo amplifier LED display	Name	Remarks
2948 (Note-1)	8A	USB communication time-out error	
2952 (Note-1)	8E	USB communication error	

(Note-1): Error codes will differ depending on the operating system software version. 

Error code		Servo amplifier LED display	Name
Operating system software version			
"00F" or earlier	"00G" or later		
2090	2948	8A	USB communication time-out error
2094	2952	8E	USB communication error

APPENDICES

Table 1.19 Parameter warning (2301 to 2599)/Parameter error (2601 to 2899) error detail

Error code	Parameter No.	Name	Error code	Parameter No.	Name		
2301	2601	PA01	For manufacturer setting	2341	2641	PB22	For manufacturer setting
2302	2602	PA02	Regenerative option	2342	2642	PB23	Low-pass filter selection
2303	2603	PA03	Absolute position detection system	2343	2643	PB24	Slight vibration suppression control selection
2304	2604	PA04	Function selection A-1	2344	2644	PB25	For manufacturer setting
2305	2605	PA05	For manufacturer setting	2345	2645	PB26	Gain changing selection
2306	2606	PA06		2346	2646	PB27	Gain changing condition
2307	2607	PA07		2347	2647	PB28	Gain changing time constant
2308	2608	PA08	Auto tuning mode	2348	2648	PB29	Gain load mass ratio to the linear servo motor primary side (coil)
2309	2609	PA09	Auto tuning response	2349	2649	PB30	Gain changing position loop gain
2310	2610	PA10	In-position range	2350	2650	PB31	Gain changing speed loop gain
2311	2611	PA11	For manufacturer setting	2351	2651	PB32	Gain changing speed integral compensation
2312	2612	PA12		2352	2652	PB33	Gain changing vibration suppression control vibration frequency setting
2313	2613	PA13		2353	2653	PB34	Gain changing vibration suppression control resonance frequency setting
2314	2614	PA14	Moving direction selection	2354	2654	PB35	For manufacturer setting
2315	2615	PA15	Encoder output pulse	2355	2655	PB36	
2316	2616	PA16	Encoder output pulse 2	2356	2656	PB37	
2317	2617	PA17	For manufacturer setting	2357	2657	PB38	
2318	2618	PA18		2358	2658	PB39	
2319	2619	PA19	Parameter write inhibit	2359	2659	PB40	
2320	2620	PB01	Adaptive tuning mode (adaptive filter II)	2360	2660	PB41	
2321	2621	PB02	Vibration suppression control tuning mode (advanced vibration suppression control)	2361	2661	PB42	
2322	2622	PB03	For manufacturer setting	2362	2662	PB43	
2323	2623	PB04	Feed forward gain	2363	2663	PB44	
2324	2624	PB05	For manufacturer setting	2364	2664	PB45	Vibration suppression control filter 2
2325	2625	PB06	Load mass ratio to the linear servo motor primary side (coil)	2365	2665	PC01	Error excessive alarm level
2326	2626	PB07	Model loop gain	2366	2666	PC02	Electromagnetic brake sequence output
2327	2627	PB08	Position loop gain	2367	2667	PC03	Encoder output pulse selection
2328	2628	PB09	Speed loop gain	2368	2668	PC04	For manufacturer setting
2329	2629	PB10	Speed integral compensation	2369	2669	PC05	
2330	2630	PB11	Speed differential compensation	2370	2670	PC06	
2331	2631	PB12	For manufacturer setting	2371	2671	PC07	Zero speed
2332	2632	PB13	Machine resonance suppression filter 1	2372	2672	PC08	For manufacturer setting
2333	2633	PB14	Notch form selection 1	2373	2673	PC09	Analog monitor 1 output
2334	2634	PB15	Machine resonance suppression filter 2	2374	2674	PC10	Analog monitor 2 output
2335	2635	PB16	Notch form selection 2	2375	2675	PC11	Analog monitor 1 offset
2336	2636	PB17	Automatic setting parameter	2376	2676	PC12	Analog monitor 2 offset
2337	2637	PB18	Low-pass filter setting	2377	2677	PC13	For manufacturer setting
2338	2638	PB19	Vibration suppression control vibration frequency setting	2378	2678	PC14	
2339	2639	PB20	Vibration suppression control resonance frequency setting	2379	2679	PC15	
2340	2640	PB21	For manufacturer setting	2380	2680	PC16	

APPENDICES

Table 1.19 Parameter warning (2301 to 2599)/Parameter error (2601 to 2899) error detail (Continued)

Error code	Parameter No.	Name	Error code	Parameter No.	Name	
2381	2681	PC17	Function selection C-4	2427	2727	PD31
2382	2682	PC18	For manufacturer setting	2428	2728	PD32
2383	2683	PC19		2429	2729	PE01
2384	2684	PC20		2430	2730	PE02
2385	2685	PC21	Alarm history clear	2431	2731	PE03
2386	2686	PC22	For manufacturer setting	2432	2732	PE04
2387	2687	PC23		2433	2733	PE05
2388	2688	PC24		2434	2734	PE06
2389	2689	PC25		2435	2735	PE07
2390	2690	PC26	Function selection C-8	2436	2736	PE08
2391	2691	PC27	Function selection C-9	2437	2737	PE09
2392	2692	PC28	For manufacturer setting	2438	2738	PE10
2393	2693	PC29		2439	2739	PE11
2394	2694	PC30		2440	2740	PE12
2395	2695	PC31		2441	2741	PE13
2396	2696	PC32		2442	2742	PE14
2397	2697	PD01		2443	2743	PE15
2398	2698	PD02		Input signal automatic ON selection	2444	2744
2399	2699	PD03	For manufacturer setting	2445	2745	PE17
2400	2700	PD04		2446	2746	PE18
2401	2701	PD05		2447	2747	PE19
2402	2702	PD06		2448	2748	PE20
2403	2703	PD07	Output signal device selection 1 (CN3-13)	2449	2749	PE21
2404	2704	PD08	Output signal device selection 2 (CN3-9)	2450	2750	PE22
2405	2705	PD09	Output signal device selection 3 (CN3-15)	2451	2751	PE23
2406	2706	PD10	For manufacturer setting	2452	2752	PE24
2407	2707	PD11	Input filter setting	2453	2753	PE25
2408	2708	PD12	For manufacturer setting	2454	2754	PE26
2409	2709	PD13		2455	2755	PE27
2410	2710	PD14	Function selection D-3	2456	2756	PE28
2411	2711	PD15	For manufacturer setting	2457	2757	PE29
2412	2712	PD16		2458	2758	PE30
2413	2713	PD17		2459	2759	PE31
2414	2714	PD18		2460	2760	PE32
2415	2715	PD19		2461	2761	PE33
2416	2716	PD20		2462	2762	PE34
2417	2717	PD21		2463	2763	PE35
2418	2718	PD22		2464	2764	PE36
2419	2719	PD23		2465	2765	PE37
2420	2720	PD24		2466	2766	PE38
2421	2721	PD25		2467	2767	PE39
2422	2722	PD26		2468	2768	PE40
2423	2723	PD27		2501	2801	PS01
2424	2724	PD28	2502	2802	PS02	
2425	2725	PD29	2503	2803	PS03	
2426	2726	PD30	2504	2804	PS04	

APPENDICES

Table 1.19 Parameter warning (2301 to 2599)/Parameter error (2601 to 2899) error detail (Continued)

Error code		Parameter No.	Name	Error code		Parameter No.	Name
2505	2805	PS05	Linear servo motor control position deviation error detection level	2519	2819	PS19	For manufacturer setting
2506	2806	PS06	Linear servo motor control speed deviation error detection level	2520	2820	PS20	
2507	2807	PS07	Linear servo motor control thrust deviation error detection level	2521	2821	PS21	
2508	2808	PS08	Linear function selection 3	2522	2822	PS22	
2509	2809	PS09	Magnetic pole detection voltage level	2523	2823	PS23	
2510	2810	PS10	At magnetic pole detection current detection method Identification signal frequency	2524	2824	PS24	
2511	2811	PS11	At magnetic pole detection current detection method Identification signal amplitude	2525	2825	PS25	
2512	2812	PS12	For manufacturer setting	2526	2826	PS26	
2513	2813	PS13		2527	2827	PS27	
2514	2814	PS14		2528	2828	PS28	
2515	2815	PS15		2529	2829	PS29	
2516	2816	PS16		2530	2830	PS30	
2517	2817	PS17		2531	2831	PS31	
2518	2818	PS18		2532	2832	PS32	

(f) MR-J3-□B-RJ006 (For fully closed control)

Table 1.20 Servo error (2000 to 2999) list (MR-J3-□B-RJ006)

Error code	Servo amplifier LED display	Name	Remarks
2010	10	Undervoltage	
2012	12	Memory error 1 (RAM)	
2013	13	Clock error	
2015	15	Memory error 2 (EEP-ROM)	
2016	16	Encoder error 1 (At power on)	
2017	17	Board error	
2019	19	Memory error 3 (Flash ROM)	
2020	20	Encoder error 2 (During runtime)	
2021	21	Encoder error 3 (During runtime)	
2024	24	Main circuit error	
2028	28	Linear encoder error 2	
2030	30	Regenerative error	
2031	31	Overspeed	
2032	32	Overcurrent	
2033	33	Overvoltage	
2034	34	Receive error 1	
2035	35	Command frequency alarm	
2036	36	Receive error 2	
2042	42	Fully closed control error detection	
2045	45	Main circuit device overheat	
2046	46	Servo motor overheat	
2047	47	Cooling fan alarm	
2050	50	Overload 1	
2051	51	Overload 2	
2052	52	Error excessive	
2060	1A	Motor combination error	
2061	2A	Linear encoder error 1	
2070	70	Load side encoder error 1	
2071	71	Load side encoder error 2	
2088	888	Watchdog	
2106	96	Home position setting error	
2140	E0	Excessive regeneration warning	
2141	E1	Overload warning 1	
2146	E6	Servo forced stop warning	
2147	E7	Controller emergency stop warning	
2148	E8	Cooling fan speed reduction warning	
2149	E9	Main circuit off warning	
2152	EC	Overload warning 2	
2153	ED	Output watt excess warning	
2301 to 2599	E4	Parameter warning (Refer to the table 1.21)	
2601 to 2899	37	Parameter error (Refer to the table 1.21)	

APPENDICES

Table 1.20 Servo error (2000 to 2999) list (MR-J3-□B-RJ006) (Continued)

Error code	Servo amplifier LED display	Name	Remarks
2948 (Note-1)	8A	USB communication time-out error	
2952 (Note-1)	8E	USB communication error	

(Note-1): Error codes will differ depending on the operating system software version. 

Error code		Servo amplifier LED display	Name
Operating system software version			
"00F" or earlier	"00G" or later		
2090	2948	8A	USB communication time-out error
2094	2952	8E	USB communication error

APPENDICES

Table 1.21 Parameter warning (2301 to 2599)/Parameter error (2601 to 2899) error detail

Error code	Parameter No.	Name	Error code	Parameter No.	Name		
2301	2601	PA01	Control mode	2341	2641	PB22	For manufacturer setting
2302	2602	PA02	Regenerative option	2342	2642	PB23	Low-pass filter selection
2303	2603	PA03	Absolute position detection system	2343	2643	PB24	Slight vibration suppression control selection
2304	2604	PA04	Function selection A-1	2344	2644	PB25	For manufacturer setting
2305	2605	PA05	For manufacturer setting	2345	2645	PB26	Gain changing selection
2306	2606	PA06		2346	2646	PB27	Gain changing condition
2307	2607	PA07		2347	2647	PB28	Gain changing time constant
2308	2608	PA08	Auto tuning mode	2348	2648	PB29	Gain changing ratio of load inertia moment to servo motor inertia moment
2309	2609	PA09	Auto tuning response	2349	2649	PB30	Gain changing position loop gain
2310	2610	PA10	In-position range	2350	2650	PB31	Gain changing speed loop gain
2311	2611	PA11	For manufacturer setting	2351	2651	PB32	Gain changing speed integral compensation
2312	2612	PA12		2352	2652	PB33	Gain changing vibration suppression control vibration frequency setting
2313	2613	PA13		2353	2653	PB34	Gain changing vibration suppression control resonance frequency setting
2314	2614	PA14	Rotation direction selection	2354	2654	PB35	For manufacturer setting
2315	2615	PA15	Encoder output pulse	2355	2655	PB36	
2316	2616	PA16	Encoder output pulse 2	2356	2656	PB37	
2317	2617	PA17	For manufacturer setting	2357	2657	PB38	
2318	2618	PA18		2358	2658	PB39	
2319	2619	PA19	Parameter write inhibit	2359	2659	PB40	
2320	2620	PB01	Adaptive tuning mode (adaptive filter II)	2360	2660	PB41	
2321	2621	PB02	Vibration suppression control tuning mode (advanced vibration suppression control)	2361	2661	PB42	
2322	2622	PB03	For manufacturer setting	2362	2662	PB43	
2323	2623	PB04	Feed forward gain	2363	2663	PB44	
2324	2624	PB05	For manufacturer setting	2364	2664	PB45	Vibration suppression control filter 2
2325	2625	PB06	Ratio of load inertia moment to servo motor inertia moment	2365	2665	PC01	Error excessive alarm level
2326	2626	PB07	Model loop gain	2366	2666	PC02	Electromagnetic brake sequence output
2327	2627	PB08	Position loop gain	2367	2667	PC03	Encoder output pulse selection
2328	2628	PB09	Speed loop gain	2368	2668	PC04	Function selection C-1
2329	2629	PB10	Speed integral compensation	2369	2669	PC05	Function selection C-2
2330	2630	PB11	Speed differential compensation	2370	2670	PC06	Function selection C-3
2331	2631	PB12	Overshoot amount compensation	2371	2671	PC07	Zero speed
2332	2632	PB13	Machine resonance suppression filter 1	2372	2672	PC08	For manufacturer setting
2333	2633	PB14	Notch shape selection 1	2373	2673	PC09	Analog monitor 1 output
2334	2634	PB15	Machine resonance suppression filter 2	2374	2674	PC10	Analog monitor 2 output
2335	2635	PB16	Notch shape selection 2	2375	2675	PC11	Analog monitor 1 offset
2336	2636	PB17	Automatic setting parameter	2376	2676	PC12	Analog monitor 2 offset
2337	2637	PB18	Low-pass filter setting	2377	2677	PC13	For manufacturer setting
2338	2638	PB19	Vibration suppression control vibration frequency setting	2378	2678	PC14	
2339	2639	PB20	Vibration suppression control resonance frequency setting	2379	2679	PC15	
2340	2640	PB21	For manufacturer setting	2380	2680	PC16	Function selection C-3A

APPENDICES

Table 1.21 Parameter warning (2301 to 2599)/Parameter error (2601 to 2899) error detail (Continued)

Error code	Parameter No.	Name	Error code	Parameter No.	Name		
2381	2681	PC17	Function selection C-4	2425	2725	PD29	
2382	2682	PC18	For manufacturer setting	2426	2726	PD30	
2383	2683	PC19		2427	2727	PD31	
2384	2684	PC20		2428	2728	PD32	
2385	2685	PC21	Alarm history clear	2429	2729	PE01	Fully closed loop selection 1
2386	2686	PC22	For manufacturer setting	2430	2730	PE02	For manufacturer setting
2387	2687	PC23		2431	2731	PE03	Fully closed loop selection 2
2388	2688	PC24		2432	2732	PE04	Fully closed loop feedback pulse electronic 1 gear numerator
2389	2689	PC25		2433	2733	PE05	Fully closed loop feedback pulse electronic gear 1 denominator
2390	2690	PC26	Function selection C-8	2434	2734	PE06	Fully closed loop control speed deviation error detection level
2391	2691	PC27	Function selection C-9	2435	2735	PE07	Fully closed loop control position deviation error detection level
2392	2692	PC28	For manufacturer setting	2436	2736	PE08	Fully closed loop dual feedback filter
2393	2693	PC29		2437	2737	PE09	For manufacturer setting
2394	2694	PC30		2438	2738	PE10	Fully closed loop selection 3
2395	2695	PC31		2439	2739	PE11	For manufacturer setting
2396	2696	PC32		2440	2740	PE12	
2397	2697	PD01		2441	2741	PE13	
2398	2698	PD02		2442	2742	PE14	
2399	2699	PD03		2443	2743	PE15	
2400	2700	PD04		2444	2744	PE16	
2401	2701	PD05		2445	2745	PE17	
2402	2702	PD06	2446	2746	PE18		
2403	2703	PD07	2447	2747	PE19		
2404	2704	PD08	2448	2748	PE20		
2405	2705	PD09	2449	2749	PE21		
2406	2706	PD10	2450	2750	PE22		
2407	2707	PD11	2451	2751	PE23		
2408	2708	PD12	2452	2752	PE24		
2409	2709	PD13	2453	2753	PE25		
2410	2710	PD14	Function selection D-3	2454	2754	PE26	Filter coefficient 2-1
2411	2711	PD15	For manufacturer setting	2455	2755	PE27	Filter coefficient 2-2
2412	2712	PD16		2456	2756	PE28	Filter coefficient 2-3
2413	2713	PD17		2457	2757	PE29	Filter coefficient 2-4
2414	2714	PD18		2458	2758	PE30	Filter coefficient 2-5
2415	2715	PD19		2459	2759	PE31	Filter coefficient 2-6
2416	2716	PD20		2460	2760	PE32	Filter coefficient 2-7
2417	2717	PD21		2461	2761	PE33	Filter coefficient 2-8
2418	2718	PD22		2462	2762	PE34	Fully closed loop feedback pulse electronic gear 2 numerator
2419	2719	PD23		2463	2763	PE35	Fully closed loop feedback pulse electronic gear 2 denominator
2420	2720	PD24		2464	2764	PE36	For manufacturer setting
2421	2721	PD25	2465	2765	PE37		
2422	2722	PD26	2466	2766	PE38		
2423	2723	PD27	2467	2767	PE39		
2424	2724	PD28		2468	2768	PE40	

(g) MR-J3-□B-RJ080W (For direct drive motor)

Table 1.22 Servo error (2000 to 2999) list (MR-J3-□B-RJ080W)

Error code	Servo amplifier LED display	Name	Remarks
2010	10	Undervoltage	
2012	12	Memory error 1 (RAM)	
2013	13	Clock error	
2015	15	Memory error 2 (EEP-ROM)	
2016	16	Encoder error 1	
2017	17	Board error	
2019	19	Memory error 3 (Flash ROM)	
2020	20	Encoder error 2	
2021	21	Encoder error 3	
2024	24	Main circuit error	
2025	25	Absolute position erase	
2027	27	Initial magnetic pole detection error	
2030	30	Regenerative error	
2031	31	Overspeed	
2032	32	Overcurrent	
2033	33	Overvoltage	
2034	34	Receive error 1	
2035	35	Command frequency alarm	
2036	36	Receive error 2	
2042	42	Servo control error	
2045	45	Main circuit device overheat	
2046	46	Direct drive motor overheat	
2047	47	Cooling fan alarm	
2050	50	Overload 1	
2051	51	Overload 2	
2052	52	Error excessive	
2060	1A	Motor combination error	
2064 (Note-1)	1F	Encoder combination error	
2088	888	Watchdog	
2102	92	Battery cable disconnection warning	
2106	96	Home position setting error	
2116	9F	Battery warning	
2140	E0	Excessive regeneration warning	
2141	E1	Overload warning 1	
2142	E2	Direct drive motor overheat warning	
2143	E3	Absolute position counter warning	
2146	E6	Servo forced stop warning	
2147	E7	Controller emergency stop warning	
2148	E8	Cooling fan speed reduction warning	
2149	E9	Main circuit off warning	
2152	EC	Overload warning 2	
2153	ED	Output watt excess warning	

(Note-1): Error codes will differ depending on the operating system software version. 

Error code		Servo amplifier LED display	Name
Operating system software version			
"00F" or earlier	"00G" or later	1F	Encoder combination error
2025	2064		

APPENDICES

Table 1.22 Servo error (2000 to 2999) list (MR-J3-□B-RJ080W) (Continued)

Error code	Servo amplifier LED display	Name	Remarks
2301 to 2599	E4	Parameter warning (Refer to the table 1.23)	
2601 to 2899	37	Parameter error (Refer to the table 1.23)	
2913 (Note-1)	2B	Encoder counter error	
2948 (Note-1)	8A	USB communication time-out error	
2952 (Note-1)	8E	USB communication error	

(Note-1): Error codes will differ depending on the operating system software version. **QD**

Error code		Servo amplifier LED display	Name
Operating system software version			
"00F" or earlier	"00G" or later		
2031	2913	2B	Encoder counter error
2090	2948	8A	USB communication time-out error
2094	2952	8E	USB communication error

APPENDICES

Table 1.23 Parameter warning (2301 to 2599)/Parameter error (2601 to 2899) error detail

Error code	Parameter No.	Name	Error code	Parameter No.	Name
2301	2601	PA01	2340	2640	PB21
2302	2602	PA02	2341	2641	PB22
2303	2603	PA03	2342	2642	PB23
2304	2604	PA04	2343	2643	PB24
2305	2605	PA05	2344	2644	PB25
2306	2606	PA06	2345	2645	PB26
2307	2607	PA07	2346	2646	PB27
2308	2608	PA08	2347	2647	PB28
2309	2609	PA09	2348	2648	PB29
2310	2610	PA10	2349	2649	PB30
2311	2611	PA11	2350	2650	PB31
2312	2612	PA12	2351	2651	PB32
2313	2613	PA13	2352	2652	PB33
2314	2614	PA14	2353	2653	PB34
2315	2615	PA15	2354	2654	PB35
2316	2616	PA16	2355	2655	PB36
2317	2617	PA17	2356	2656	PB37
2318	2618	PA18	2357	2657	PB38
2319	2619	PA19	2358	2658	PB39
2320	2620	PB01	2359	2659	PB40
2321	2621	PB02	2360	2660	PB41
2322	2622	PB03	2361	2661	PB42
2323	2623	PB04	2362	2662	PB43
2324	2624	PB05	2363	2663	PB44
2325	2625	PB06	2364	2664	PB45
2326	2626	PB07	2365	2665	PC01
2327	2627	PB08	2366	2666	PC02
2328	2628	PB09	2367	2667	PC03
2329	2629	PB10	2368	2668	PC04
2330	2630	PB11	2369	2669	PC05
2331	2631	PB12	2370	2670	PC06
2332	2632	PB13	2371	2671	PC07
2333	2633	PB14	2372	2672	PC08
2334	2634	PB15	2373	2673	PC09
2335	2635	PB16	2374	2674	PC10
2336	2636	PB17	2375	2675	PC11
2337	2637	PB18	2376	2676	PC12
2338	2638	PB19	2377	2677	PC13
2339	2639	PB20	2378	2678	PC14

APPENDICES

Table 1.23 Parameter warning (2301 to 2599)/Parameter error (2601 to 2899) error detail (Continued)

Error code	Parameter No.	Name	Error code	Parameter No.	Name			
2379	2679	PC15	2426	2726	PD30			
2380	2680	PC16						
2381	2681	PC17				2427	2727	PD31
2382	2682	PC18				2428	2728	PD32
2383	2683	PC19				2429	2729	PE01
2384	2684	PC20				2430	2730	PE02
2385	2685	PC21				2431	2731	PE03
2386	2686	PC22				2432	2732	PE04
2387	2687	PC23				2433	2733	PE05
2388	2688	PC24				2434	2734	PE06
2389	2689	PC25				2435	2735	PE07
2390	2690	PC26				2436	2736	PE08
2391	2691	PC27				2437	2737	PE09
2392	2692	PC28				2438	2738	PE10
2393	2693	PC29				2439	2739	PE11
2394	2694	PC30				2440	2740	PE12
2395	2695	PC31				2441	2741	PE13
2396	2696	PC32				2442	2742	PE14
2397	2697	PD01				2443	2743	PE15
2398	2698	PD02				2444	2744	PE16
2399	2699	PD03				2445	2745	PE17
2400	2700	PD04				2446	2746	PE18
2401	2701	PD05				2447	2747	PE19
2402	2702	PD06				2448	2748	PE20
2403	2703	PD07				2449	2749	PE21
2404	2704	PD08				2450	2750	PE22
2405	2705	PD09				2451	2751	PE23
2406	2706	PD10				2452	2752	PE24
2407	2707	PD11				2453	2753	PE25
2408	2708	PD12	2454	2754	PE26			
2409	2709	PD13	2455	2755	PE27			
2410	2710	PD14	2456	2756	PE28			
2411	2711	PD15	2457	2757	PE29			
2412	2712	PD16	2458	2758	PE30			
2413	2713	PD17	2459	2759	PE31			
2414	2714	PD18	2460	2760	PE32			
2415	2715	PD19	2461	2761	PE33			
2416	2716	PD20	2462	2762	PE34			
2417	2717	PD21	2463	2763	PE35			
2418	2718	PD22	2464	2764	PE36			
2419	2719	PD23	2465	2765	PE37			
2420	2720	PD24	2466	2766	PE38			
2421	2721	PD25	2467	2767	PE39			
2422	2722	PD26	2468	2768	PE40			
2423	2723	PD27	2501	2801	PS01			
2424	2724	PD28	2502	2802	PS02			
2425	2725	PD29	2503	2803	PS03			
			2504	2804	PS04			

APPENDICES

Table 1.23 Parameter warning (2301 to 2599)/Parameter error (2601 to 2899) error detail (Continued)

Error code		Parameter No.	Name	Error code		Parameter No.	Name
2505	2805	PS05	Servo control position deviation error detection level	2519	2819	PS19	For manufacturer setting
2506	2806	PS06	Servo control speed deviation error detection level	2520	2820	PS20	
2507	2807	PS07	Servo control torque deviation error detection level	2521	2821	PS21	
2508	2808	PS08	Special function selection 3	2522	2822	PS22	
2509	2809	PS09	Magnetic pole detection voltage level	2523	2823	PS23	
2510	2810	PS10	For manufacturer setting	2524	2824	PS24	
2511	2811	PS11					
2512	2812	PS12					
2513	2813	PS13					
2514	2814	PS14					
2515	2815	PS15					
2516	2816	PS16					
2517	2817	PS17	Minimal position detection method function selection	2525	2825	PS25	
2518	2818	PS18	Minimal position detection method identification signal amplitude	2526	2826	PS26	
				2527	2827	PS27	
				2528	2828	PS28	
				2529	2829	PS29	
				2530	2830	PS30	
				2531	2831	PS31	
				2532	2832	PS32	

(h) MR-J3-□B Safety (For safety servo)

Table 1.24 Servo error (2000 to 2999) list (MR-J3-□B Safety)

Error code	Servo amplifier LED display	Name	Remarks
2010	10	Undervoltage	
2012	12	Memory error 1 (RAM)	
2013	13	Clock error	
2015	15	Memory error 2 (EEP-ROM)	
2016	16	Encoder error 1 (At power on)	
2017	17	Board error	
2019	19	Memory error 3 (Flash ROM)	
2020	20	Encoder error 2 (during runtime)	
2021	21	Encoder error 3 (during runtime)	
2024	24	Main circuit error	
2025	25	Absolute position erase	
2028	28	Linear encoder error 2	
2030	30	Regenerative error	
2031	31	Overspeed	
2032	32	Overcurrent	
2033	33	Overvoltage	
2034	34	Receive error 1	
2035	35	Command frequency error	
2036	36	Receive error 2	
2042	42	Fully closed control error detection	
2045	45	Main circuit device overheat	
2046	46	Servo motor overheat	
2047	47	Cooling fan error	
2050	50	Overload 1	
2051	51	Overload 2	
2052	52	Error excessive	
2056	56	Forced stop error	
2070	70	Load side encoder error 1	
2071	71	Load side encoder error 2	
2060	1A	Motor combination error	
2061	2A	Linear encoder error 1	
2063	63	STO timing error	
2088	888	Watchdog	
2095	95	STO warning	
2102	92	Battery cable disconnection warning	
2106	96	Home position setting warning	
2116	9F	Battery warning	
2140	E0	Excessive regeneration warning	
2141	E1	Overload warning 1	
2143	E3	Absolute position counter warning	
2146	E6	Servo forced stop warning	
2147	E7	Controller forced stop warning	
2148	E8	Cooling fan speed reduction warning	
2149	E9	Main circuit off warning	
2152	EC	Overload warning 2	
2153	ED	Output watt excess warning	

APPENDICES

Table 1.24 Servo error (2000 to 2999) list (MR-J3-□B Safety) (Continued)

Error code	Servo amplifier LED display	Name	Remarks
2301 to 2599	E4	Parameter warning (Refer to the table 1.25)	
2601 to 2899	37	Parameter error (Refer to the table 1.25)	
2948 (Note-1)	8A	USB communication time-out error	
2952 (Note-1)	8E	USB communication error	

(Note-1): Error codes will differ depending on the operating system software version. 

Error code		Servo amplifier LED display	Name
Operating system software version			
"00F" or earlier	"00G" or later		
2090	2948	8A	USB communication time-out error
2094	2952	8E	USB communication error

APPENDICES

Table 1.25 Parameter warning (2301 to 2599)/Parameter error (2601 to 2899) error detail

Error code	Parameter No.	Name	Error code	Parameter No.	Name		
2301	2601	PA01	Control mode	2340	2640	PB21	For manufacturer setting
2302	2602	PA02	Regenerative option	2341	2641	PB22	
2303	2603	PA03	Absolute position detection system	2342	2642	PB23	Low-pass filter selection
2304	2604	PA04	Function selection A-1	2343	2643	PB24	Slight vibration suppression control selection
2305	2605	PA05	For manufacturer setting	2344	2644	PB25	For manufacturer setting
2306	2606	PA06					
2307	2607	PA07					
2308	2608	PA08	Auto tuning mode	2345	2645	PB26	Gain changing selection
2309	2609	PA09	Auto tuning response	2346	2646	PB27	Gain changing condition
2310	2610	PA10	In-position range	2347	2647	PB28	Gain changing time constant
2311	2611	PA11	For manufacturer setting	2348	2648	PB29	Gain changing ratio of load inertia moment to servo motor inertia moment
2312	2612	PA12					
2313	2613	PA13					
2314	2614	PA14	Rotation direction selection	2349	2649	PB30	Gain changing position loop gain
2315	2615	PA15	Encoder output pulse	2350	2650	PB31	Gain changing speed loop gain
2316	2616	PA16	Encoder output pulse 2	2351	2651	PB32	Gain changing speed integral compensation
2317	2617	PA17	For manufacturer setting	2352	2652	PB33	Gain changing vibration suppression control vibration frequency setting
2318	2618	PA18					
2319	2619	PA19	Parameter write inhibit	2353	2653	PB34	Gain changing vibration suppression control resonance frequency setting
2320	2620	PB01	Adaptive tuning mode (adaptive filter II)	2354	2654	PB35	For manufacturer setting
2321	2621	PB02	Vibration suppression control tuning mode (advanced vibration suppression control)	2355	2655	PB36	
2322	2622	PB03	For manufacturer setting	2356	2656	PB37	
2323	2623	PB04	Feed forward gain	2357	2657	PB38	
2324	2624	PB05	For manufacturer setting	2358	2658	PB39	
2325	2625	PB06	Ratio of load inertia moment to servo motor inertia moment	2359	2659	PB40	
2326	2626	PB07	Model loop gain	2360	2660	PB41	
2327	2627	PB08	Position loop gain	2361	2661	PB42	
2328	2628	PB09	Speed loop gain	2362	2662	PB43	
2329	2629	PB10	Speed integral compensation	2363	2663	PB44	
2330	2630	PB11	Speed differential compensation	2364	2664	PB45	Vibration suppression control filter 2
2331	2631	PB12	Overshoot amount compensation	2365	2665	PC01	Error excessive alarm level
2332	2632	PB13	Machine resonance suppression filter 1	2366	2666	PC02	Electromagnetic brake sequence output
2333	2633	PB14	Notch shape selection 1	2367	2667	PC03	Encoder output pulse selection
2334	2634	PB15	Machine resonance suppression filter 2	2368	2668	PC04	Function selection C-1
2335	2635	PB16	Notch shape selection 2	2369	2669	PC05	Function selection C-2
2336	2636	PB17	Automatic setting parameter	2370	2670	PC06	Function selection C-3
2337	2637	PB18	Low-pass filter setting	2371	2671	PC07	Zero speed
2338	2638	PB19	Vibration suppression control vibration frequency setting	2372	2672	PC08	For manufacturer setting
2339	2639	PB20	Vibration suppression control resonance frequency setting	2373	2673	PC09	Analog monitor 1 output
				2374	2674	PC10	Analog monitor 2 output
				2375	2675	PC11	Analog monitor 1 offset
				2376	2676	PC12	Analog monitor 2 offset
				2377	2677	PC13	Analog monitor feedback position output standard data Low
				2378	2678	PC14	Analog monitor feedback position output standard data High

APPENDICES

Table 1.25 Parameter warning (2301 to 2599)/Parameter error (2601 to 2899) error detail (Continued)

Error code	Parameter No.	Name	Error code	Parameter No.	Name	
2379	2679	PC15	For manufacturer setting	2421	2721	PD25
2380	2680	PC16	Function selection C-3A	2422	2722	PD26
2381	2681	PC17	Function selection C-4	2423	2723	PD27
2382	2682	PC18	For manufacturer setting	2424	2724	PD28
2383	2683	PC19		2425	2725	PD29
2384	2684	PC20	Function selection C-7	2426	2726	PD30
2385	2685	PC21	Alarm history clear	2427	2727	PD31
2386	2686	PC22	For manufacturer setting	2428	2728	PD32
2387	2687	PC23		2429	2729	PE01
2388	2688	PC24	Forced stop deceleration time constant	2430	2730	PE02
2389	2689	PC25	For manufacturer setting	2431	2731	PE03
2390	2690	PC26	Function selection C-8	2432	2732	PE04
2391	2691	PC27	Function selection C-9	2433	2733	PE05
2392	2692	PC28	For manufacturer setting	2434	2734	PE06
2393	2693	PC29		2435	2735	PE07
2394	2694	PC30		2436	2736	PE08
2395	2695	PC31	Vertical axis freefall prevention compensation amount	2437	2737	PE09
2396	2696	PC32	For manufacturer setting	2438	2738	PE10
2397	2697	PD01		2439	2739	PE11
2398	2698	PD02		2440	2740	PE12
2399	2699	PD03		2441	2741	PE13
2400	2700	PD04		2442	2742	PE14
2401	2701	PD05		2443	2743	PE15
2402	2702	PD06		2444	2744	PE16
2403	2703	PD07	Output signal device selection 1 (CN3-13)	2445	2745	PE17
2404	2704	PD08	Output signal device selection 2 (CN3-9)	2446	2746	PE18
2405	2705	PD09	Output signal device selection 3 (CN3-15)	2447	2747	PE19
2406	2706	PD10	For manufacturer setting	2448	2748	PE20
2407	2707	PD11	Input filter setting	2449	2749	PE21
2408	2708	PD12	For manufacturer setting	2450	2750	PE22
2409	2709	PD13		2451	2751	PE23
2410	2710	PD14	Function selection D-3	2452	2752	PE24
2411	2711	PD15	For manufacturer setting	2453	2753	PE25
2412	2712	PD16		2454	2754	PE26
2413	2713	PD17		2455	2755	PE27
2414	2714	PD18		2456	2756	PE28
2415	2715	PD19		2457	2757	PE29
2416	2716	PD20		2458	2758	PE30
2417	2717	PD21		2459	2759	PE31
2418	2718	PD22		2460	2760	PE32
2419	2719	PD23		2461	2761	PE33
2420	2720	PD24		2462	2762	PE34
					Fully closed loop feedback pulse electronic gear 2 numerator	
					Fully closed loop selection 1	
					For manufacturer setting	
					Fully closed loop selection 2	
					Fully closed loop feedback pulse electronic gear 1 numerator	
					Fully closed loop feedback pulse electronic gear 1 denominator	
					Fully closed loop speed deviation error detection level	
					Fully closed loop position deviation error detection level	
					Fully closed loop dual feedback filter	
					For manufacturer setting	
					Fully closed loop selection 3	
					For manufacturer setting	
					Filter coefficient 2-1	
					Filter coefficient 2-2	
					Filter coefficient 2-3	
					Filter coefficient 2-4	
					Filter coefficient 2-5	
					Filter coefficient 2-6	
					Filter coefficient 2-7	
					Filter coefficient 2-8	

APPENDICES

Table 1.25 Parameter warning (2301 to 2599)/Parameter error (2601 to 2899) error detail (Continued)

Error code		Parameter No.	Name	Error code		Parameter No.	Name
2463	2763	PE35	Fully closed loop feedback pulse electronic gear 2 denominator	2466	2766	PE38	For manufacturer setting
2464	2764	PE36	For manufacturer setting	2467	2767	PE39	
2465	2765	PE37		2468	2768	PE40	

APPENDIX 2 Example Programs

APPENDIX 2.1 Reading M-code

The program example for reading M-code at the completion of positioning start or positioning is shown below.

The judgement of the positioning start completion and positioning completion is made with the following signals.

- Positioning start completionM2400+20n (positioning start complete signal)
- Positioning completionM2401+20n (positioning complete signal)

[Program Example]

- (1) A program that outputs the M-code from PY000 to PY00F to external destination after conversion into BCD code at the positioning start completion is shown below.

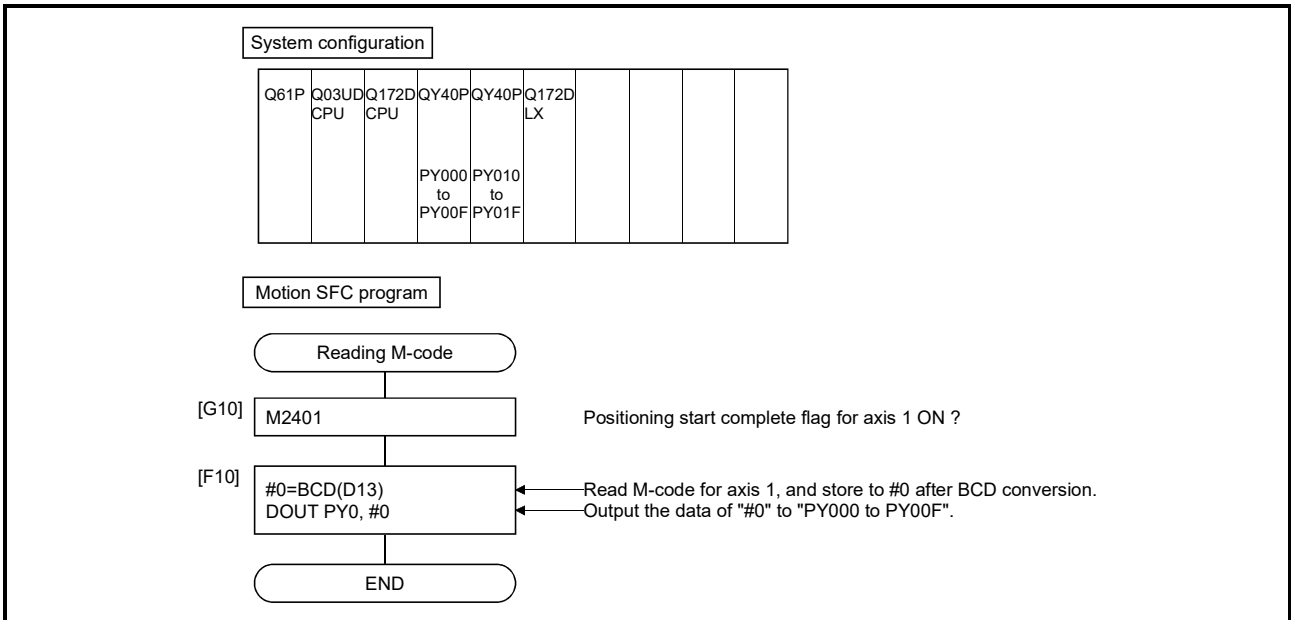

APPENDIX 2.2 Reading error code

The program example for reading error code at the error occurrence is shown below.

The following signals are used to determine whether or not an error has occurred:

- Minor errors, major errors Error detection signal (M2407+20n)
- Servo errors Servo error detection signal (M2408+20n)

POINT
<p>(1) The following delay occurs for leading edge of M2407+20n/M2408+20n and storage of the error code.</p> <p>(a) If the sequence program scan time is 80[ms] or less, there will be a delay of up to 80[ms].</p> <p>(b) If the sequence program scan time is 80[ms] or more, there will be a delay of up to one scan time.</p> <p>The error code is stored to each error code storage area after turning on M2407+20n/M2408+20n, and then read the error code.</p>

[Program Example]

- (1) A program that outputs each error code to PY000 to PY00F (minor error), PY010 to PY01F (major error) and PY020 to PY02F (servo error) after conversion into BCD code at the error occurrence with axis 1 is shown below.

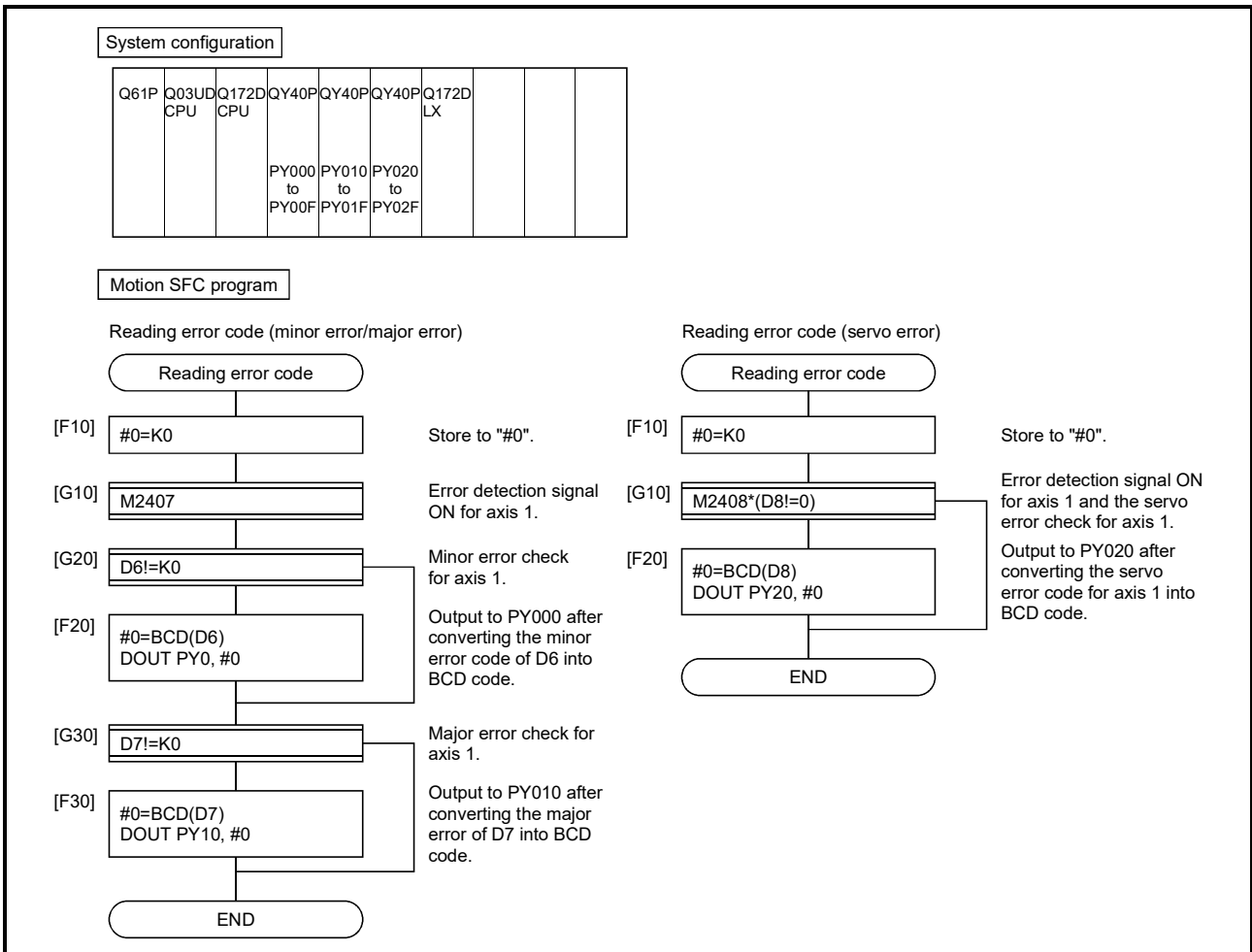

APPENDIX 3 Setting Range for Indirect Setting Devices

Positioning address, command speed or M-code, etc. (excluding the axis No.) set in the servo program can be set indirectly by the word.

(1) Device range

The number of device words and device range at indirect setting are shown below.

	Item	Number of device words	Device setting range	Remarks														
Common	Parameter block No.	1	<table border="1"> <thead> <tr> <th>Device</th> <th>Range</th> </tr> </thead> <tbody> <tr> <td>D</td> <td>0 to 8191 (Note-1)</td> </tr> <tr> <td>W</td> <td>0000 to 1FFF</td> </tr> <tr> <td>#</td> <td>0 to 7999</td> </tr> <tr> <td>U□\G</td> <td>10000 to (10000+p-1) (Note-2)</td> </tr> </tbody> </table>	Device	Range	D	0 to 8191 (Note-1)	W	0000 to 1FFF	#	0 to 7999	U□\G	10000 to (10000+p-1) (Note-2)					
	Device	Range																
	D	0 to 8191 (Note-1)																
	W	0000 to 1FFF																
	#	0 to 7999																
	U□\G	10000 to (10000+p-1) (Note-2)																
Address (travel value)	2																	
Command speed	2																	
Dwell time	1																	
M-code	1																	
Torque limit value	1																	
Arc	Auxiliary point	2																
	Radius	2																
	Central point	2																
	Pitch	1																
Parameter block	Control unit	1																
	Speed limit value	2																
	Acceleration time	1																
	Deceleration time	1																
	Rapid stop deceleration time	1																
	S-curve ratio	1																
	Advanced S-curve acceleration/ deceleration	Acceleration/deceleration system		1														
		Acceleration section 1 ratio		1														
		Acceleration section 2 ratio		1														
		Deceleration section 1 ratio	1															
	Deceleration section 2 ratio	1																
	Torque limit value	1																
	Deceleration processing on STOP input	1																
Allowable error range for circular interpolation	2																	
Others	Command speed (Constant speed)	2	<table border="1"> <thead> <tr> <th>Device</th> <th>Range</th> </tr> </thead> <tbody> <tr> <td>X</td> <td>0000 to 1FFF (Note-3)</td> </tr> <tr> <td>Y</td> <td>0000 to 1FFF</td> </tr> <tr> <td>M</td> <td>0 to 8191 (Note-1)</td> </tr> <tr> <td>B</td> <td>0000 to 1FFF</td> </tr> <tr> <td>F</td> <td>0 to 2047</td> </tr> <tr> <td>U□\G</td> <td>10000.0 to (10000+p-1).F (Note-2)</td> </tr> </tbody> </table>	Device	Range	X	0000 to 1FFF (Note-3)	Y	0000 to 1FFF	M	0 to 8191 (Note-1)	B	0000 to 1FFF	F	0 to 2047	U□\G	10000.0 to (10000+p-1).F (Note-2)	
	Device	Range																
	X	0000 to 1FFF (Note-3)																
	Y	0000 to 1FFF																
	M	0 to 8191 (Note-1)																
	B	0000 to 1FFF																
	F	0 to 2047																
	U□\G	10000.0 to (10000+p-1).F (Note-2)																
	FIN acceleration/deceleration	1																
Fixed position stop acceleration/deceleration time	1																	
Repetition condition (Number of repetitions)	1																	
Repetition condition (ON/OFF)	Bit																	
Cancel																		
Skip																		
WAIT ON/OFF																		
Fixed position stop																		

(Note-1): Synchronous encoder axis area cannot be set.

(Note-2): "p" indicates the user setting area points of the Multiple CPU high speed transmission area for each CPU.

(Note-3): The range of "PXn+4 to PXn+F" cannot be used (fixed at 0) for the input device (PXn+0 to PXn+F) allocated to the built-in interface in Motion CPU (DI). (n: First input No.) 

POINT
<p>(1) Be sure to set even-numbered devices of the items set as 2-word. Be sure to set as 32-bit integer type when the data is set in these devices using the Motion SFC programs. (Example : #0L, D0L)</p> <p>(2) Refer to Chapter 2 of the "Q173D(S)CPU/Q172D(S)CPU Motion controller Programming Manual (COMMON)" for the user setting area points of the Multiple CPU high speed transmission area.</p>

(2) Inputting device data

Indirect setting device data is inputted by the Motion CPU at the servo program start.

Do not change the applicable device before setting to device and start completion.

The procedures by start method for setting data to devices and cautions are shown below.

Start method	Setting method	Notes
Start by the servo program	Set data in indirect setting devices. ↓ Start the servo program.	Do not change the indirect setting device before the "positioning start complete signal" of the starting axis turns on.
Set the loop (FOR - NEXT) point data for CPSTART instruction indirectly	Set initial command data in the indirect setting device. ↓ Start using the servo program (or turn the cancel command device on). ↓ Read the value of "data set pointer for constant-speed control" of the start axis, and update the data input by Motion CPU.	Refer to the positioning signal data register "Monitoring data area" for details.

APPENDIX 4 Processing Times of the Motion CPU

The processing time of each signal and each instruction for positioning control in the Multiple CPU system is shown below.

(1) Motion operation cycle [ms] (Default)

(a) Q173DSCPU/Q172DSCPU

	Q173DSCPU				Q172DSCPU		
Number of setting axes (SV22)	—	1 to 6	7 to 16	17 to 32	—	1 to 6	7 to 16
Number of setting axes (SV13)	1 to 4	5 to 10	11 to 24	25 to 32	1 to 4	5 to 10	11 to 16
Operation cycle [ms]	0.22	0.44	0.88	1.77	0.22	0.44	0.88

(b) Q173DCPU(-S1)/Q172DCPU(-S1)

	Q173DCPU(-S1)				Q172DCPU(-S1)	
Number of setting axes (SV22)	1 to 4	5 to 12	13 to 28	29 to 32	1 to 4	5 to 8
Number of setting axes (SV13)	1 to 6	7 to 18	19 to 32		1 to 6	7 to 8
Operation cycle [ms]	0.44	0.88	1.77	3.55	0.44	0.88

APPENDICES

(2) CPU processing time [ms]

The instruction processing time means the time until the content is reflected to servo amplifier side after each instruction is executed.

(Including the transmission time between Motion controller and servo amplifier.)

(a) Q173DSCPU/Q172DSCPU

		Q173DSCPU/Q172DSCPU					
Operation cycle [ms]		0.22	0.44	0.88	1.77	3.55	7.11
Servo program start processing time (Note-1)	"WAIT ON/OFF" + Motion control step	0.44	0.88	1.77	2.66	4.44	7.99
	Only Motion control step	0.6 to 0.9	1.0 to 1.4	1.9 to 2.8	2.8 to 4.6	4.6 to 8.2	8.1 to 15.2
	Dedicated instruction (D(P).SVST) from the PLC CPU	1.4 to 2.3	2.2 to 3.1	3.5 to 4.4	5.3 to 6.2	8.8 to 9.7	16.0 to 16.9
Speed change response time	Instruction (CHGV) from the Motion SFC	0.4 to 0.9	0.8 to 1.3	1.7 to 2.6	2.6 to 4.4	4.4 to 8.0	8.0 to 15.1
	Dedicated instruction (D(P).CHGV) from the PLC CPU	1.4 to 2.3	1.7 to 2.6	2.6 to 3.5	3.5 to 4.4	5.3 to 6.2	8.9 to 9.8
Command generation axis speed change response time	Instruction (CHGVS) from the Motion SFC	0.4 to 0.9	0.8 to 1.3	1.7 to 2.6	2.6 to 4.4	4.4 to 8.0	8.0 to 15.1
	Dedicated instruction (D(P).CHGVS) from the PLC CPU	1.4 to 2.3	1.7 to 2.6	2.6 to 3.5	3.5 to 4.4	5.3 to 6.2	8.9 to 9.8
Torque limit value change response time	Instruction (CHGT) from the Motion SFC	0.4 to 0.9	0.8 to 1.3	1.7 to 2.6	2.6 to 4.4	4.4 to 8.0	4.4 to 11.5
	Dedicated instruction (D(P).CHGT) from the PLC CPU	1.4 to 2.3	1.7 to 2.6	2.6 to 3.5	3.5 to 4.4	5.3 to 6.2	5.3 to 9.7
Torque limit value individual change response time	Instruction (CHGT2) from the Motion SFC	0.4 to 0.9	0.8 to 1.3	1.7 to 2.6	2.6 to 4.4	4.4 to 8.0	4.4 to 11.5
	Dedicated instruction (D(P).CHGT2) from the PLC CPU	1.4 to 2.3	1.7 to 2.6	2.6 to 3.5	3.5 to 4.4	5.3 to 6.2	5.3 to 9.7
Target position change response time	Instruction (CHGP) from the Motion SFC	0.4 to 0.9	0.8 to 1.3	1.7 to 2.6	2.6 to 4.4	4.4 to 8.0	8.0 to 15.1
Time from PLC ready flag (M2000) ON to PCPU READY complete flag (SM500) ON		44 to 60					

(Note-1): FEED instruction varies greatly depending on the condition (whether other axes are operating).

APPENDICES

(b) Q173DCPU(-S1)/Q172DCPU(-S1)

		Q173DCPU(-S1)/Q172DCPU(-S1)					
Operation cycle [ms]		0.44	0.88	1.77	3.55	7.11	14.2
Servo program start processing time (Note-1)	"WAIT ON/OFF" + Motion control step	0.88	1.77	2.66	4.44	7.99	15.11
	Only Motion control step	1.0 to 1.4	1.9 to 2.8	2.8 to 4.6	4.6 to 8.2	8.1 to 15.2	15.2 to 29.4
	Dedicated instruction (D(P).SVST) from the PLC CPU	2.2 to 3.1	3.5 to 4.4	5.3 to 6.2	8.8 to 9.7	16.0 to 16.9	30.2 to 31.1
Speed change response time	Instruction (CHGV) from the Motion SFC	0.8 to 1.3	1.7 to 2.6	2.6 to 4.4	4.4 to 8.0	8.0 to 15.1	15.1 to 29.3
	Dedicated instruction (D(P).CHGV) from the PLC CPU	1.7 to 2.6	2.6 to 3.5	3.5 to 4.4	5.3 to 6.2	8.9 to 9.8	16.0 to 16.9
Torque limit value change response time	Instruction (CHGT) from the Motion SFC	0.8 to 1.3	1.7 to 2.6	2.6 to 4.4	4.4 to 8.0	4.4 to 11.5	4.4 to 18.6
	Dedicated instruction (D(P).CHGT) from the PLC CPU	1.7 to 2.6	2.6 to 3.5	3.5 to 4.4	5.3 to 6.2	5.3 to 9.7	5.3 to 16.0
Time from PLC ready flag (M2000) ON to PCPU READY complete flag (SM500) ON		22 to 28					

(Note-1): FEED instruction varies greatly depending on the condition (whether other axes are operating).

APPENDICES

APPENDIX 5 Device List

(1) Axis status list

Axis No.	Device No.	Signal name																																																										
1	M2400 to M2419	<table border="1"> <thead> <tr> <th>Signal name</th> <th>Refresh cycle</th> <th>Fetch cycle</th> <th>Signal direction</th> </tr> </thead> <tbody> <tr> <td>0</td> <td>Positioning start complete</td> <td rowspan="10">Operation cycle</td> <td rowspan="19">Status signal</td> </tr> <tr> <td>1</td> <td>Positioning complete</td> </tr> <tr> <td>2</td> <td>In-position</td> </tr> <tr> <td>3</td> <td>Command in-position</td> </tr> <tr> <td>4</td> <td>Speed controlling</td> </tr> <tr> <td>5</td> <td>Speed/position switching latch</td> </tr> <tr> <td>6</td> <td>Zero pass</td> </tr> <tr> <td>7</td> <td>Error detection</td> <td>Immediate</td> </tr> <tr> <td>8</td> <td>Servo error detection</td> <td>Operation cycle</td> </tr> <tr> <td>9</td> <td>Home position return request</td> <td>Main cycle</td> </tr> <tr> <td>10</td> <td>Home position return complete</td> <td>Operation cycle</td> </tr> <tr> <td>11</td> <td rowspan="4">External signals</td> <td>FLS</td> <td rowspan="4">Main cycle</td> </tr> <tr> <td>12</td> <td>RLS</td> </tr> <tr> <td>13</td> <td>STOP</td> </tr> <tr> <td>14</td> <td>DOG/CHANGE</td> </tr> <tr> <td>15</td> <td>Servo ready</td> <td rowspan="2">Operation cycle</td> </tr> <tr> <td>16</td> <td>Torque limiting</td> </tr> <tr> <td>17</td> <td>Unusable</td> <td>—</td> <td>—</td> </tr> <tr> <td>18</td> <td>Virtual mode continuation operation disable warning (SV22) ^(Note-1)</td> <td>At virtual mode transition</td> <td rowspan="2">Status signal</td> </tr> <tr> <td>19</td> <td>M-code outputting</td> <td>Operation cycle</td> </tr> </tbody> </table>	Signal name	Refresh cycle	Fetch cycle	Signal direction	0	Positioning start complete	Operation cycle	Status signal	1	Positioning complete	2	In-position	3	Command in-position	4	Speed controlling	5	Speed/position switching latch	6	Zero pass	7	Error detection	Immediate	8	Servo error detection	Operation cycle	9	Home position return request	Main cycle	10	Home position return complete	Operation cycle	11	External signals	FLS	Main cycle	12	RLS	13	STOP	14	DOG/CHANGE	15	Servo ready	Operation cycle	16	Torque limiting	17	Unusable	—	—	18	Virtual mode continuation operation disable warning (SV22) ^(Note-1)	At virtual mode transition	Status signal	19	M-code outputting	Operation cycle
Signal name	Refresh cycle		Fetch cycle	Signal direction																																																								
0	Positioning start complete		Operation cycle	Status signal																																																								
1	Positioning complete																																																											
2	In-position																																																											
3	Command in-position																																																											
4	Speed controlling																																																											
5	Speed/position switching latch																																																											
6	Zero pass																																																											
7	Error detection				Immediate																																																							
8	Servo error detection				Operation cycle																																																							
9	Home position return request				Main cycle																																																							
10	Home position return complete		Operation cycle																																																									
11	External signals		FLS		Main cycle																																																							
12			RLS																																																									
13			STOP																																																									
14			DOG/CHANGE																																																									
15	Servo ready		Operation cycle																																																									
16	Torque limiting																																																											
17	Unusable	—	—																																																									
18	Virtual mode continuation operation disable warning (SV22) ^(Note-1)	At virtual mode transition	Status signal																																																									
19	M-code outputting	Operation cycle																																																										
2	M2420 to M2439																																																											
3	M2440 to M2459																																																											
4	M2460 to M2479																																																											
5	M2480 to M2499																																																											
6	M2500 to M2519																																																											
7	M2520 to M2539																																																											
8	M2540 to M2559																																																											
9	M2560 to M2579																																																											
10	M2580 to M2599																																																											
11	M2600 to M2619																																																											
12	M2620 to M2639																																																											
13	M2640 to M2659																																																											
14	M2660 to M2679																																																											
15	M2680 to M2699																																																											
16	M2700 to M2719																																																											
17	M2720 to M2739																																																											
18	M2740 to M2759																																																											
19	M2760 to M2779																																																											
20	M2780 to M2799																																																											
21	M2800 to M2819																																																											
22	M2820 to M2839																																																											
23	M2840 to M2859																																																											
24	M2860 to M2879																																																											
25	M2880 to M2899																																																											
26	M2900 to M2919																																																											
27	M2920 to M2939																																																											
28	M2940 to M2959																																																											
29	M2960 to M2979																																																											
30	M2980 to M2999																																																											
31	M3000 to M3019																																																											
32	M3020 to M3039																																																											

(Note-1): It is unusable in the SV13/SV22 real mode and SV22 advanced synchronous control.

POINT

(1) The following range is valid.







- Q172DSCPU : Axis No.1 to 16
- Q172DCPU(-S1): Axis No.1 to 8

(2) The following device area can be used as a user device.

- Q172DSCPU : 17 axes or more
- Q172DCPU(-S1): 9 axes or more

However, when the project of Q172DSCPU/Q172DCPU(-S1) is replaced with Q173DSCPU/Q173DCPU(-S1), this area cannot be used as a user device.

(2) Axis command signal list

Axis No.	Device No.	Signal name																																																													
1	M3200 to M3219	<table border="1"> <thead> <tr> <th>Signal name</th> <th>Refresh cycle</th> <th>Fetch cycle</th> <th>Signal direction</th> </tr> </thead> <tbody> <tr> <td>0 Stop command</td> <td rowspan="19">/</td> <td rowspan="2">Operation cycle</td> <td rowspan="19">Command signal</td> </tr> <tr> <td>1 Rapid stop command</td> </tr> <tr> <td>2 Forward rotation JOG start command</td> <td rowspan="2">Main cycle</td> </tr> <tr> <td>3 Reverse rotation JOG start command</td> </tr> <tr> <td>4 Complete signal OFF command</td> <td rowspan="2">Operation cycle</td> </tr> <tr> <td>5 Speed/position switching enable command</td> </tr> <tr> <td>6 Gain changing 2 command (Note-1) </td> <td>Operation cycle (Note-2)</td> </tr> <tr> <td>7 Error reset command</td> <td rowspan="2">Main cycle</td> </tr> <tr> <td>8 Servo error reset command</td> </tr> <tr> <td>9 External stop input disable at start command</td> <td>At start</td> </tr> <tr> <td>10 Unusable</td> <td>—</td> <td>—</td> <td>—</td> </tr> <tr> <td>11 Unusable</td> <td>—</td> <td>—</td> <td>—</td> </tr> <tr> <td>12 Feed current value update command</td> <td rowspan="9">/</td> <td>At start</td> <td rowspan="9">Command signal</td> </tr> <tr> <td>13 Address clutch reference setting command (SV22 only) (Note-3)</td> <td>At virtual mode transition</td> </tr> <tr> <td>14 Cam reference position setting command (SV22 only) (Note-3)</td> <td rowspan="2">Operation cycle</td> </tr> <tr> <td>15 Servo OFF command</td> </tr> <tr> <td>16 Gain changing command</td> <td rowspan="2">Operation cycle (Note-2)</td> </tr> <tr> <td>17 PI-PID switching command </td> </tr> <tr> <td>18 Control loop changing command</td> <td rowspan="2">Operation cycle</td> </tr> <tr> <td>19 FIN signal</td> </tr> <tr> <td>29 M3760 to M3779</td> <td></td> <td></td> <td></td> </tr> <tr> <td>30 M3780 to M3799</td> <td></td> <td></td> <td></td> </tr> <tr> <td>31 M3800 to M3819</td> <td></td> <td></td> <td></td> </tr> <tr> <td>32 M3820 to M3839</td> <td></td> <td></td> <td></td> </tr> </tbody> </table>	Signal name	Refresh cycle	Fetch cycle	Signal direction	0 Stop command	/	Operation cycle	Command signal	1 Rapid stop command	2 Forward rotation JOG start command	Main cycle	3 Reverse rotation JOG start command	4 Complete signal OFF command	Operation cycle	5 Speed/position switching enable command	6 Gain changing 2 command (Note-1) 	Operation cycle (Note-2)	7 Error reset command	Main cycle	8 Servo error reset command	9 External stop input disable at start command	At start	10 Unusable	—	—	—	11 Unusable	—	—	—	12 Feed current value update command	/	At start	Command signal	13 Address clutch reference setting command (SV22 only) (Note-3)	At virtual mode transition	14 Cam reference position setting command (SV22 only) (Note-3)	Operation cycle	15 Servo OFF command	16 Gain changing command	Operation cycle (Note-2)	17 PI-PID switching command 	18 Control loop changing command	Operation cycle	19 FIN signal	29 M3760 to M3779				30 M3780 to M3799				31 M3800 to M3819				32 M3820 to M3839			
Signal name	Refresh cycle		Fetch cycle	Signal direction																																																											
0 Stop command	/		Operation cycle	Command signal																																																											
1 Rapid stop command																																																															
2 Forward rotation JOG start command			Main cycle																																																												
3 Reverse rotation JOG start command																																																															
4 Complete signal OFF command			Operation cycle																																																												
5 Speed/position switching enable command																																																															
6 Gain changing 2 command (Note-1) 			Operation cycle (Note-2)																																																												
7 Error reset command			Main cycle																																																												
8 Servo error reset command																																																															
9 External stop input disable at start command			At start																																																												
10 Unusable			—		—	—																																																									
11 Unusable			—		—	—																																																									
12 Feed current value update command			/		At start	Command signal																																																									
13 Address clutch reference setting command (SV22 only) (Note-3)					At virtual mode transition																																																										
14 Cam reference position setting command (SV22 only) (Note-3)					Operation cycle																																																										
15 Servo OFF command																																																															
16 Gain changing command					Operation cycle (Note-2)																																																										
17 PI-PID switching command 																																																															
18 Control loop changing command		Operation cycle																																																													
19 FIN signal																																																															
29 M3760 to M3779																																																															
30 M3780 to M3799																																																															
31 M3800 to M3819																																																															
32 M3820 to M3839																																																															

(Note-1): Servo amplifier (MR-J5(W)-□B) only.

(Note-2): Operation cycle 7.1[ms] or more: Every 3.5[ms]

(Note-3): It is unusable in the SV13/SV22 real mode and SV22 advanced synchronous control.

POINT
<p>(1) The following range is valid.</p> <ul style="list-style-type: none"> • Q172DSCPU : Axis No.1 to 16 • Q172DCPU(-S1) : Axis No.1 to 8 <p>(2) The following device area can be used as a user device.</p> <ul style="list-style-type: none"> • Q172DSCPU : 17 axes or more • Q172DCPU(-S1) : 9 axes or more <p>However, when the project of Q172DSCPU/Q172DCPU(-S1) is replaced with Q173DSCPU/Q173DCPU(-S1), this area cannot be used as a user device.</p>

: Refer to Section 1.3 for the software version that supports this function.

(3) Common device list

Device No.	Signal name	Refresh cycle	Fetch cycle	Signal direction	Remark (Note-7)	Device No.	Signal name	Refresh cycle	Fetch cycle	Signal direction	Remark (Note-7)					
M2000	PLC ready flag	/	Main cycle	Command signal	M3072	M2055	Unusable (6 points)	—	—	—	—					
M2001	Axis 1	Start accept flag	Operation cycle	Status signal (Note-1), (Note-2), (Note-3), (Note-4)		M2056		Speed change accepting flag	Operation cycle		Status signal (Note-1), (Note-2), (Note-3), (Note-4)					
M2002	Axis 2					M2061							Axis 1			
M2003	Axis 3					M2062							Axis 2			
M2004	Axis 4					M2063							Axis 3			
M2005	Axis 5					M2064							Axis 4			
M2006	Axis 6					M2065	Axis 5									
M2007	Axis 7					M2066	Axis 6									
M2008	Axis 8					M2067	Axis 7									
M2009	Axis 9					M2068	Axis 8									
M2010	Axis 10					M2069	Axis 9									
M2011	Axis 11					M2070	Axis 10									
M2012	Axis 12					M2071	Axis 11									
M2013	Axis 13					M2072	Axis 12									
M2014	Axis 14					M2073	Axis 13									
M2015	Axis 15					M2074	Axis 14									
M2016	Axis 16					M2075	Axis 15									
M2017	Axis 17					M2076	Axis 16									
M2018	Axis 18					M2077	Axis 17									
M2019	Axis 19					M2078	Axis 18									
M2020	Axis 20					M2079	Axis 19									
M2021	Axis 21					M2080	Axis 20									
M2022	Axis 22					M2081	Axis 21									
M2023	Axis 23					M2082	Axis 22									
M2024	Axis 24					M2083	Axis 23									
M2025	Axis 25					M2084	Axis 24									
M2026	Axis 26					M2085	Axis 25									
M2027	Axis 27					M2086	Axis 26									
M2028	Axis 28					M2087	Axis 27									
M2029	Axis 29					M2088	Axis 28									
M2030	Axis 30					M2089	Axis 29									
M2031	Axis 31					M2090	Axis 30									
M2032	Axis 32					M2091	Axis 31									
M2033	Unusable (2 points)	—	—	—	—	M2092	Axis 32	—	—	—	—					
M2034	Motion error history clear request flag	/	Main cycle	Command signal	M3080	M2093	Unusable (8 points)	—	—	—	—					
M2035	Unusable (2 points)	—	—	—	—	M2094		Synchronous encoder current value changing flag (Note-5), (Note-6)	Operation cycle		Status signal (Note-2), (Note-4)					
M2036	Motion SFC debugging flag	At debugging mode transition	/	Status signal		M2095						Axis 1				
M2037	Motion error detection flag	Immediate	/	Status signal		M2096							Axis 2			
M2038	Speed switching point specified flag	/	At start	Command signal	M3073	M2097								Axis 3		
M2039	System setting error flag	Operation cycle	/	Status signal		M2098									Axis 4	
M2040	All axes servo ON command	/	Operation cycle	Command signal	M3074	M2099										Axis 5
M2041	Real mode/virtual mode switching request (SV22) (Note-5)	/	At virtual mode transition	Command signal	M3075	M2100										
M2042	Real mode/virtual mode switching status (SV22) (Note-5)	At virtual mode transition	/	Status signal		M2101	Axis 7									
M2043	Real mode/virtual mode switching error detection signal (SV22) (Note-5)		At virtual mode transition	/	Status signal			M2102	Axis 8							
M2044	Out-of-sync warning (SV22) (Note-5)			At virtual mode transition	/	Status signal				M2103	Axis 9					
M2045	Motion slot fault detection flag	Operation cycle	/		Status signal			M2104		Axis 10						
M2046	JOG operation simultaneous start command	/	Main cycle	Command signal	M3076	M2105		Axis 11								
M2047	All axes servo ON accept flag	Operation cycle	/	Status signal		M2106						Axis 12				
M2048	Unusable	—	—	—	—	M2107							Axis 13			
M2049	Manual pulse generator 1 enable flag	Manual pulse generator	Main cycle	Command signal	M3077	M2108								Axis 14		
M2050	Manual pulse generator 2 enable flag					M3078	Axis 15									
M2051	Manual pulse generator 3 enable flag								M3079						Axis 16	
M2052	Operation cycle over flag	Operation cycle	/	Status signal		M2109					Axis 17					
M2053	Unusable	—	—	—	—				Axis 18							
M2054	Unusable	—	—	—	—			Axis 19								
M2055	Unusable	—	—	—	—					Axis 20						
M2056	Unusable	—	—	—	—							Axis 21				
M2057	Unusable	—	—	—	—								Axis 22			
M2058	Unusable	—	—	—	—		Axis 23									
M2059	Unusable	—	—	—	—									Axis 24		
M2060	Unusable	—	—	—	—						Axis 25					
M2061	Unusable	—	—	—	—				Axis 26							
M2062	Unusable	—	—	—	—			Axis 27								
M2063	Unusable	—	—	—	—					Axis 28						
M2064	Unusable	—	—	—	—							Axis 29				
M2065	Unusable	—	—	—	—								Axis 30			
M2066	Unusable	—	—	—	—		Axis 31									
M2067	Unusable	—	—	—	—									Axis 32		
M2068	Unusable	—	—	—	—						Axis 33					
M2069	Unusable	—	—	—	—				Axis 34							
M2070	Unusable	—	—	—	—			Axis 35								
M2071	Unusable	—	—	—	—					Axis 36						
M2072	Unusable	—	—	—	—							Axis 37				
M2073	Unusable	—	—	—	—								Axis 38			
M2074	Unusable	—	—	—	—		Axis 39									
M2075	Unusable	—	—	—	—									Axis 40		
M2076	Unusable	—	—	—	—						Axis 41					
M2077	Unusable	—	—	—	—				Axis 42							
M2078	Unusable	—	—	—	—			Axis 43								
M2079	Unusable	—	—	—	—					Axis 44						
M2080	Unusable	—	—	—	—							Axis 45				
M2081	Unusable	—	—	—	—								Axis 46			
M2082	Unusable	—	—	—	—		Axis 47									
M2083	Unusable	—	—	—	—									Axis 48		
M2084	Unusable	—	—	—	—						Axis 49					
M2085	Unusable	—	—	—	—				Axis 50							
M2086	Unusable	—	—	—	—			Axis 51								
M2087	Unusable	—	—	—	—					Axis 52						
M2088	Unusable	—	—	—	—							Axis 53				
M2089	Unusable	—	—	—	—								Axis 54			
M2090	Unusable	—	—	—	—		Axis 55									
M2091	Unusable	—	—	—	—									Axis 56		
M2092	Unusable	—	—	—	—						Axis 57					
M2093	Unusable	—	—	—	—				Axis 58							
M2094	Unusable	—	—	—	—			Axis 59								
M2095	Unusable	—	—	—	—					Axis 60						
M2096	Unusable	—	—	—	—							Axis 61				
M2097	Unusable	—	—	—	—								Axis 62			
M2098	Unusable	—	—	—	—		Axis 63									
M2099	Unusable	—	—	—	—									Axis 64		
M2100	Unusable	—	—	—	—						Axis 65					
M2101	Unusable	—	—	—	—				Axis 66							
M2102	Unusable	—	—	—	—			Axis 67								
M2103	Unusable	—	—	—	—					Axis 68						
M2104	Unusable	—	—	—	—							Axis 69				
M2105	Unusable	—	—	—	—								Axis 70			
M2106	Unusable	—	—	—	—		Axis 71									
M2107	Unusable	—	—	—	—									Axis 72		
M2108	Unusable	—	—	—	—						Axis 73					
M2109	Unusable	—	—	—	—				Axis 74							

APPENDICES

Common device list (Continued)

Device No.	Signal name	Refresh cycle	Fetch cycle	Signal direction	Remark (Note-7)	Device No.	Signal name	Refresh cycle	Fetch cycle	Signal direction	Remark (Note-7)
M2110	Axis 10	Operation cycle		Status signal (Note-2), (Note-4)		M2179					
M2111	Axis 11					Synchronous encoder current value changing flag (Note-5), (Note-6)					
M2112	Axis 12										
M2113	Unusable (15 points)	—	—	—	—	M2180					
M2114											
M2115											
M2116											
M2117											
M2118											
M2119											
M2120											
M2121											
M2122											
M2123											
M2124											
M2125											
M2126											
M2127											
M2128	Axis 1	Operation cycle		Status signal (Note-1), (Note-2), (Note-3), (Note-4)		M2182					
M2129											
M2130											
M2131											
M2132											
M2133											
M2134											
M2135											
M2136											
M2137											
M2138											
M2139											
M2140											
M2141											
M2142											
M2143											
M2144											
M2145											
M2146											
M2147											
M2148											
M2149											
M2150											
M2151											
M2152											
M2153											
M2154											
M2155											
M2156											
M2157											
M2158											
M2159											
M2160	Unusable (19 points) (Note-8)	—	—	—	—	M2181					
M2161											
M2162											
M2163											
M2164											
M2165											
M2166											
M2167											
M2168											
M2169											
M2170											
M2171											
M2172											
M2173											
M2174											
M2175											
M2176											
M2177											
M2178											
M2200	Automatic decelerating flag	Operation cycle		Status signal (Note-1), (Note-2), (Note-3), (Note-4)		M2182					
M2201											
M2202											
M2203											
M2204											
M2205											
M2206											
M2207											
M2208											
M2209											
M2210											
M2211											
M2212											
M2213											
M2214											
M2215											
M2216											
M2217											
M2218											
M2219											
M2220											
M2221											
M2222											
M2223											
M2224	Unusable (16 points)	—	—	—	—	M2182					
M2225											
M2226											
M2227											
M2228											
M2229											
M2230											
M2231											
M2232											
M2233											
M2234											
M2235											
M2236											
M2237											
M2238											
M2239											
M2240	Axis 1	Speed change "0" accepting flag	Operation cycle			M2182					
M2241											
M2242											
M2243											
M2244											
M2245											
M2246											
M2247											

Common device list (Continued)

Device No.	Signal name	Refresh cycle	Fetch cycle	Signal direction	Remark (Note-7)	Device No.	Signal name	Refresh cycle	Fetch cycle	Signal direction	Remark (Note-7)
M2248	Axis 9	Operation cycle		Status signal (Note-1), (Note-2), (Note-3), (Note-4)		M2284	Axis 13	Operation cycle		Status signal (Note-1), (Note-2), (Note-3), (Note-4)	
M2249	Axis 10					M2285	Axis 14				
M2250	Axis 11					M2286	Axis 15				
M2251	Axis 12					M2287	Axis 16				
M2252	Axis 13					M2288	Axis 17				
M2253	Axis 14					M2289	Axis 18				
M2254	Axis 15					M2290	Axis 19				
M2255	Axis 16					M2291	Axis 20				
M2256	Axis 17					M2292	Axis 21				
M2257	Axis 18					M2293	Axis 22				
M2258	Axis 19					M2294	Axis 23				
M2259	Axis 20					M2295	Axis 24				
M2260	Axis 21					M2296	Axis 25				
M2261	Axis 22					M2297	Axis 26				
M2262	Axis 23					M2298	Axis 27				
M2263	Axis 24					M2299	Axis 28				
M2264	Axis 25					M2300	Axis 29				
M2265	Axis 26					M2301	Axis 30				
M2266	Axis 27					M2302	Axis 31				
M2267	Axis 28					M2303	Axis 32				
M2268	Axis 29					M2304					
M2269	Axis 30	M2305									
M2270	Axis 31	M2306									
M2271	Axis 32	M2307									
M2272	Axis 1	M2308									
M2273	Axis 2	M2309									
M2274	Axis 3	M2310									
M2275	Axis 4	M2311	Unusable (16 points)								
M2276	Axis 5	M2312		—							
M2277	Axis 6	M2313		—							
M2278	Axis 7	M2314		—							
M2279	Axis 8	M2315		—							
M2280	Axis 9	M2316		—							
M2281	Axis 10	M2317		—							
M2282	Axis 11	M2318		—							
M2283	Axis 12	M2319		—							

(Note-1): The range of axis No.1 to 16 is valid in the Q172DSCPU.

(Note-2): The range of axis No.1 to 8 is valid in the Q172DCPU(-S1).

(Note-3): Device area of 17 axes or more is unusable in the Q172DSCPU.

(Note-4): Device area of 9 axes or more is unusable in the Q172DCPU(-S1).

(Note-5): It is unusable in the SV22 advanced synchronous control.

(Note-6): It is unusable in the real mode.

(It can be used in the real mode for the version (Refer to Section 1.3) that supports "synchronous encoder current value monitor in real mode".)

(Note-7): It can also be ordered the device of a remark column.

(Note-8): These devices can be used as the clutch statuses.

The clutch status can also be set as the optional device at the clutch parameter.

Refer to Chapter 7 of the "Q173D(S)CPU/Q172D(S)CPU Motion controller (SV22) Programming Manual (VIRTUAL MODE)" for details.

(4) Common device list (Command signal)

Device No.	Signal name	Refresh cycle	Fetch cycle	Signal direction	Remark (Note-1), (Note-2)
M3072	PLC ready flag	/	Main cycle	Command signal	M2000
M3073	Speed switching point specified flag		At start		M2040
M3074	All axes servo ON command		Operation cycle		M2042
M3075	Real mode/virtual mode switching request (SV22) (Note-3)		At virtual mode transition		M2043
M3076	JOG operation simultaneous start command		Main cycle		M2048
M3077	Manual pulse generator 1 enable flag				M2051
M3078	Manual pulse generator 2 enable flag				M2052
M3079	Manual pulse generator 3 enable flag				M2053
M3080	Motion error history clear request flag				M2035
M3081 to M3135	Unusable (Note-4) (55 points)		—		—

(Note-1): The state of a device is not in agreement when the device of a remark column is turned ON/OFF directly. In addition, when the request from a data register and the request from the above device are performed simultaneously, the request from the above device becomes effective.

(Note-2): It can also be ordered the device of a remark column.

(Note-3): It is unusable in the SV22 advanced synchronous control.

(Note-4): Do not use it as a user device. It can be used as a device that performs automatic refresh because of area for the reserve of command signal.

POINT
<p>The device of a remark column turns ON by OFF to ON of the above device, and turns OFF by ON to OFF of the above device.</p> <p>The command signal cannot be turned ON/OFF by the PLC CPU in the automatic refresh because the statuses and commands are mixed together in M2000 to M2053. Use the above devices in the case.</p> <p>And, it can also be turned ON/OFF by the data register. (Refer to Section 3.2.3)</p>

(5) Axis monitor device list

Axis No.	Device No.	Signal name			
1	D0 to D19				
2	D20 to D39				
3	D40 to D59				
4	D60 to D79				
5	D80 to D99				
6	D100 to D119				
7	D120 to D139				
8	D140 to D159				
9	D160 to D179				
10	D180 to D199				
11	D200 to D219				
12	D220 to D239				
13	D240 to D259				
14	D260 to D279				
15	D280 to D299				
16	D300 to D319				
17	D320 to D339				
18	D340 to D359				
19	D360 to D379				
20	D380 to D399				
21	D400 to D419				
22	D420 to D439				
23	D440 to D459				
24	D460 to D479				
25	D480 to D499				
26	D500 to D519				
27	D520 to D539				
28	D540 to D559				
29	D560 to D579				
30	D580 to D599				
31	D600 to D619				
32	D620 to D639				

	Signal name	Refresh cycle	Fetch cycle	Unit	Signal direction
0	Feed current value	Operation cycle	/	Command unit	Monitor device
1					
2	Real current value				
3					
4				Deviation counter value	
5	Minor error code	Immediate		—	
6					
7	Major error code	Main cycle		—	
8	Servo error code				
9	Home position return re-travel value	Operation cycle		/	
10	Travel value after proximity dog ON		Command unit		
11					
12	Execute program No.	At start	/	—	
13	M-code	Operation cycle		%	
14	Torque limit value				
15	Data set pointer for constant-speed control	At start/during start	/	—	
16	Unusable <small>(Note-1)</small>	—		—	
17					
18	Real current value at stop	Operation cycle	/	Command unit	Monitor device
19	input				

(Note-1): It can be used as the travel value change register. The travel value change register can be set to the device optionally in the servo program. Refer to Section 6.15 for details.

POINT
<p>(1) The following range is valid.</p> <ul style="list-style-type: none"> • Q172DSCPU : Axis No.1 to 16 • Q172DCPU(-S1): Axis No.1 to 8 <p>(2) The following device area can be used as a user device.</p> <ul style="list-style-type: none"> • Q172DSCPU : 17 axes or more • Q172DCPU(-S1): 9 axes or more <p>However, when the project of Q172DSCPU/Q172DCPU(-S1) is replaced with Q173DSCPU/Q173DCPU(-S1), this area cannot be used as a user device.</p>

(6) Control change register list

Axis No.	Device No.	Signal name				
1	D640, D641					
2	D642, D643					
3	D644, D645					
4	D646, D647					
5	D648, D649					
6	D650, D651					
7	D652, D653					
8	D654, D655					
9	D656, D657					
10	D658, D659					
11	D660, D661					
12	D662, D663					
13	D664, D665					
14	D666, D667					
15	D668, D669					
16	D670, D671					
17	D672, D673					
18	D674, D675					
19	D676, D677					
20	D678, D679					
21	D680, D681					
22	D682, D683					
23	D684, D685					
24	D686, D687					
25	D688, D689					
26	D690, D691					
27	D692, D693					
28	D694, D695					
29	D696, D697					
30	D698, D699					
31	D700, D701					
32	D702, D703					

	Signal name	Refresh cycle	Fetch cycle	Unit	Signal direction
0	JOG speed setting	/	At start	Command unit	Command device
1					

POINT
<p>(1) The following range is valid.</p> <ul style="list-style-type: none"> • Q172DSCPU : Axis No.1 to 16 • Q172DCPU(-S1): Axis No.1 to 8 <p>(2) The following device area can be used as a user device.</p> <ul style="list-style-type: none"> • Q172DSCPU : 17 axes or more • Q172DCPU(-S1): 9 axes or more <p>However, when the project of Q172DSCPU/Q172DCPU(-S1) is replaced with Q173DSCPU/Q173DCPU(-S1), this area cannot be used as a user device.</p>

(7) Common device list

Device No.	Signal name	Refresh cycle	Fetch cycle	Signal direction	Device No.	Signal name	Refresh cycle	Fetch cycle	Signal direction		
D704	PLC ready flag request	/	Main cycle	Command device	D752	Manual pulse generator 1 smoothing magnification setting register	/	At the manual pulse generator enable flag OFF to ON	Command device		
D705	Speed switching point specified flag request				D753	Manual pulse generator 2 smoothing magnification setting register					
D706	All axes servo ON command request				D754	Manual pulse generator 3 smoothing magnification setting register					
D707	Real mode/virtual mode switching request (SV22) (Note-1)				D755	Manual pulse generator 1 enable flag request					
D708	JOG operation simultaneous start command request				D756	Manual pulse generator 2 enable flag request					
D709	Unusable	—	—	—	D757	Manual pulse generator 3 enable flag request	/	Main cycle	Command device		
D710	JOG operation simultaneous start axis setting register	/	At start	Command device	D758		—	—	—		
D711			Manual pulse generator axis 1 No. setting register		At the manual pulse generator enable flag OFF to ON					D759	
D712										Manual pulse generator axis 2 No. setting register	D760
D713											Manual pulse generator axis 3 No. setting register
D714	D762										
D715	D763										
D716	D764										
D717	D765										
D718	D766										
D719	D767										
D720	Axis 1	D768									
D721	Axis 2	D769									
D722	Axis 3	D770									
D723	Axis 4	D771									
D724	Axis 5	D772									
D725	Axis 6	D773									
D726	Axis 7	D774									
D727	Axis 8	D775									
D728	Axis 9	D776									
D729	Axis 10	D777									
D730	Axis 11	D778	Unusable (42 points)	—							
D731	Axis 12	D779	—	—							
D732	Axis 13	D780	—	—							
D733	Axis 14	D781	—	—							
D734	Axis 15	D782	—	—							
D735	Axis 16	D783	—	—							
D736	Axis 17	D784	—	—							
D737	Axis 18	D785	—	—							
D738	Axis 19	D786	—	—							
D739	Axis 20	D787	—	—							
D740	Axis 21	D788	—	—							
D741	Axis 22	D789	—	—							
D742	Axis 23	D790	—	—							
D743	Axis 24	D791	—	—							
D744	Axis 25	D792	—	—							
D745	Axis 26	D793	—	—							
D746	Axis 27	D794	—	—							
D747	Axis 28	D795	—	—							
D748	Axis 29	D796	—	—							
D749	Axis 30	D797	—	—							
D750	Axis 31	D798	—	—							
D751	Axis 32	D799	—	—							

(Note-1): It is unusable in the SV22 advanced synchronous control.

(Note-2): The following range is valid.

- Q172DSCPU : Axis No. 1 to 16
- Q172DCPU(-S1) : Axis No. 1 to 8

(Note-3): The following device area is unusable.

- Q172DSCPU : 17 axes or more
- Q172DCPU(-S1) : 9 axes or more

(8) Motion register list (#)

Axis No.	Device No.	Signal name		
1	#8000 to #8019			
2	#8020 to #8039			
3	#8040 to #8059			
4	#8060 to #8079			
5	#8080 to #8099			
6	#8100 to #8119			
7	#8120 to #8139			
8	#8140 to #8159			
9	#8160 to #8179			
10	#8180 to #8199			
11	#8200 to #8219			
12	#8220 to #8239			
13	#8240 to #8259			
14	#8260 to #8279			
15	#8280 to #8299			
16	#8300 to #8319			
17	#8320 to #8339			
18	#8340 to #8359			
19	#8360 to #8379			
20	#8380 to #8399			
21	#8400 to #8419			
22	#8420 to #8439			
23	#8440 to #8459			
24	#8460 to #8479			
25	#8480 to #8499			
26	#8500 to #8519			
27	#8520 to #8539			
28	#8540 to #8559			
29	#8560 to #8579			
30	#8580 to #8599			
31	#8600 to #8619			
32	#8620 to #8639			

	Signal name	Refresh cycle	Signal direction	
0	Servo amplifier type	When the servo amplifier power-on	Monitor device	
1	Motor current value	Operation cycle 1.7[ms] or less : Operation cycle Operation cycle 3.5[ms] or more : 3.5[ms]		
2	Motor speed			
3				
4	Command speed	Operation cycle		
5				
6	Home position return re-travel value	At home position return re-travel		
7				
8	Servo amplifier display servo error code	Main cycle		
9				Parameter error No.
10				Servo status1
11	Servo status2	Operation cycle 1.7[ms] or less : Operation cycle Operation cycle 3.5[ms] or more : 3.5[ms]		
12	Servo status3			
13	Unusable	—	—	
14	Servo status5	Operation cycle 1.7[ms] or less : Operation cycle Operation cycle 3.5[ms] or more : 3.5[ms]	Monitor device	
15	Unusable	—	—	
16				
17	Unusable	—	—	
18				
18	Servo status7	Operation cycle 1.7[ms] or less : Operation cycle Operation cycle 3.5[ms] or more : 3.5[ms]	Monitor device	
19	Unusable	—	—	

(9) Product information list devices





Device No.	Signal name	Refresh cycle	Fetch cycle	Signal direction
#8736 to #8743	Operating system software version	At power supply ON		Monitor device
#8744 to #8751	Motion CPU module serial number			

: Refer to Section 1.3 for the software version that supports this function.

(10) Special relay list

Device No.	Signal name	Refresh cycle	Fetch cycle	Signal type
SM500	PCPU READY complete flag	Main cycle	/	Status signal
SM501	TEST mode ON flag			
SM502	External forced stop input flag	Operation cycle		
SM503	Digital oscilloscope executing flag	Main cycle		
SM506	External forced stop input ON latch flag 	Operation cycle		
SM508	Amplifier-less operation status flag	Main cycle		
SM510	TEST mode request error flag			
SM512	Motion CPU WDT error flag			
SM513	Manual pulse generator axis setting error flag			
SM516	Servo program setting error flag			

(11) Special register list

Device No.	Signal name	Refresh cycle	Fetch cycle	Signal direction
SD200	State of switch	Main cycle	/	Monitor device
SD500	Real mode axis information register (SV22)			
SD501	(Note-1)			
SD502	Servo amplifier loading information	At power supply on/ operation cycle		
SD503				
SD504	Real mode/virtual mode switching error information (SV22) (Note-1)	At virtual mode transition		
SD505				
SD506				
SD508	SSCNET control (status)	Main cycle		
SD510	Test mode request error information	At test mode request		
SD511				
SD512	Motion CPU WDT error cause	At Motion CPU WDT error occurrence		
SD513	Manual pulse generator axis setting error information	At the manual pulse generator enable flag 		
SD514				
SD515				
SD516	Error program No.	At start		
SD517	Error item information			
SD522	Motion operation cycle	Operation cycle		
SD523	Operation cycle of the Motion CPU setting	At power supply on		
SD524	Maximum Motion operation cycle 	Operation cycle		
SD550	System setting error information 	At System setting error occurrence		
SD551				
SD560	Operation method  	At power supply on		
SD803	SSCNET control (command)			

(Note-1): It is unusable in the SV22 advanced synchronous control.

: Refer to Section 1.3 for the software version that supports this function.

APPENDIX 6 Compatible Devices with SSCNETIII(/H)

APPENDIX 6.1 Servo driver VCI series/VPH series manufactured by CKD Nikki Denso Co., Ltd. **QDS** **Ver.!**

The direct drive τ DISC/ τ iD roll/ τ Servo compass/ τ Linear stage, etc. manufactured by CKD Nikki Denso Co., Ltd. can be controlled by connecting with the servo driver VCI series/VPH series manufactured by the same company using the Motion CPU and SSCNETIII(/H).

Contact the CKD Nikki Denso overseas sales office for details of VCI series/VPH series.

(1) System configuration

The system configuration using VCI series/VPH series is shown below.

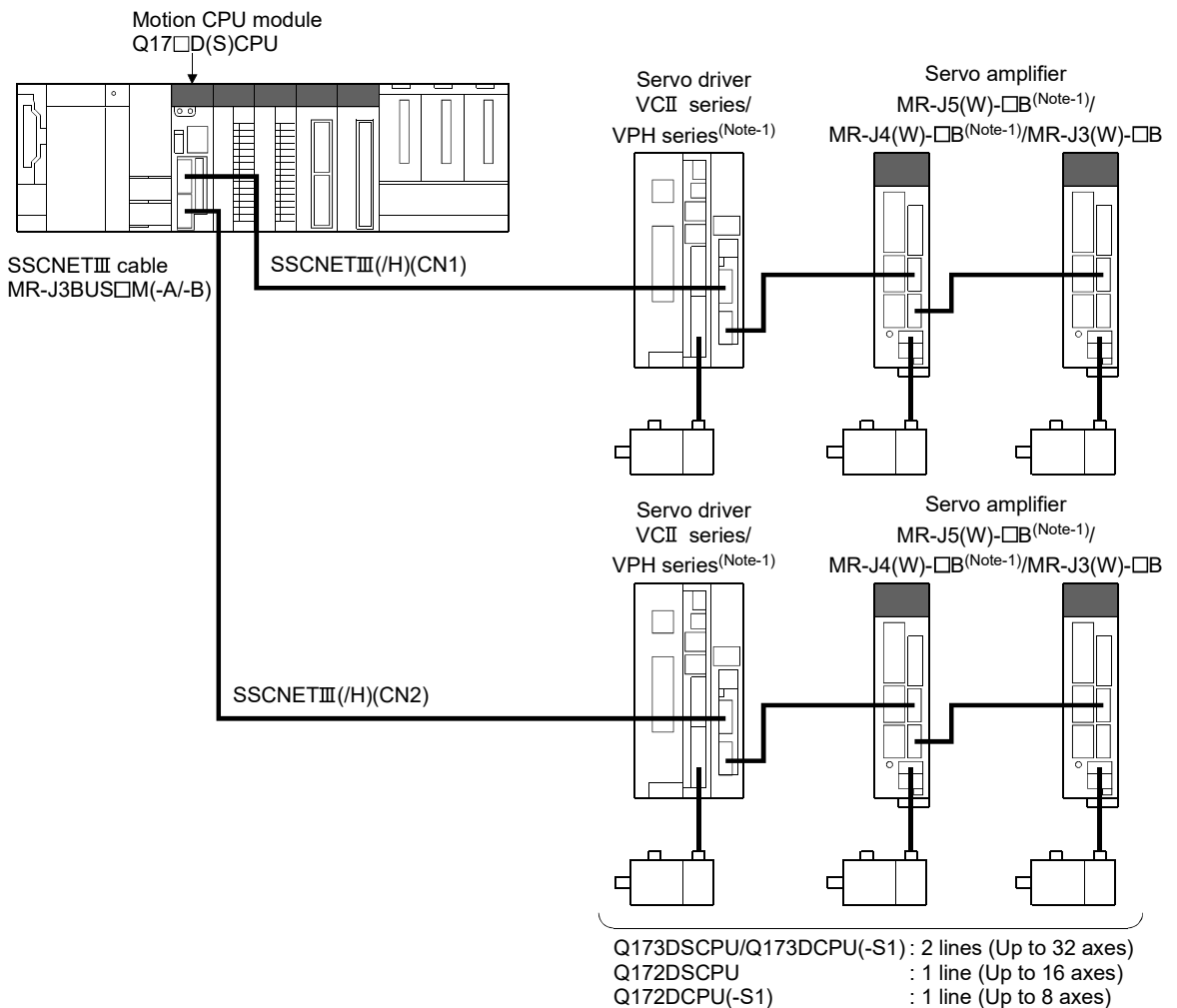

(Note-1): MR-J5(W)-□B, MR-J4(W)-□B, and the VPH series can only be used with Q173DSCPU/Q172DSCPU.

Ver.! : Refer to Section 1.3 for the software version that supports this function.

(2) Parameter setting

(a) To connect VCII series, set the following in the system setting of MT Developer2.

- 1) When using Q173DSCPU/Q172DSCPU
 - Set the following for communication type in SSCNET setting.
 - When connecting SSCNET III/H : "SSCNET III/H"
 - When connecting SSCNET III : "SSCNET III"
 - Set the amplifier model in amplifier setting to "VCII (CKD Nikki Denso)".
 - Set the ABS/INC setting in amplifier setting to "INC", or "ABS".
- 2) When using Q173DCPU(-S1)/ Q172DCPU(-S1)
 - Set the amplifier model in amplifier setting to "VCII (CKD Nikki Denso)".
 - Set the ABS/INC setting in amplifier setting to "INC", or "ABS".

POINT	Match the ABS/INC setting with the setting of VCII series. Otherwise, it does not operate correctly.
--------------	--

(b) To connect VPH series, set the following in the system setting of MT Developer2. 

- Set the following for communication type in SSCNET setting.
 - When connecting SSCNET III/H : "SSCNET III/H"
 - When connecting SSCNET III : "SSCNET III"
- Set the amplifier model in amplifier setting to "VPH (CKD Nikki Denso)".

(3) Control of VCII series/VPH series parameters

Parameters set in VCII series/VPH series are not controlled by the Motion CPU. They are set directly using VCII/VPH data editing software. For details on setting items for VCII series/VPH series, refer to the instruction manual of VCII series/VPH series.

(4) Comparisons of specifications with MR-J5(W)-□B/MR-J4(W)-□B/
MR-J3(W)-□B

Item	VCII series (Note-1)	VPH series (Note-1) QDS	MR-J5(W)-□B QDS	MR-J4(W)-□B QDS	MR-J3(W)-□B
Amplifier type	VCII (CKD Nikki Denso)	VPH (CKD Nikki Denso)	MR-J5(W)-B(-RJ)	MR-J4(W)-B(-RJ)	MR-J3(W)-B, MR-J3-□B(S) (For fully closed loop control), MR-J3(W)-B (Linear servo), MR-J3(W)-B (Direct drive motor)
Control of servo amplifier parameters	Controlled by VCII series (Note-2)	Controlled by VPH series	Controlled by Motion CPU		
External input signal	Bit devices are available		External input signals of servo amplifier, and bit devices are available.		
Optional data monitor (Data type)	<ul style="list-style-type: none"> Effective load ratio Regenerative load ratio Peak load ratio Position F/B Encoder position within 1 revolution Encoder Multi-revolution counter QDS Position loop gain 1 Cumulative current value QDS 	<ul style="list-style-type: none"> Effective load ratio Regenerative load ratio Peak load ratio Position F/B Encoder position within 1 revolution Encoder Multi-revolution counter Position loop gain 1 Bus voltage Cumulative current value 	<ul style="list-style-type: none"> Effective load ratio Regenerative load ratio Peak load ratio Position F/B Encoder position within 1 revolution Encoder Multi-revolution counter Load inertia moment ratio Model loop gain Bus voltage Cumulative current value Servo motor speed Selected droop pulse Unit power consumption Unit total power consumption Instantaneous torque Load side encoder information1 Load side encoder information2 Z-phase counter Servo motor thermistor temperature Torque equivalent to disturbance Overload alarm margin Excessive error alarm margin Settling time Overshoot amount Servo motor/Load side position deviation Servo motor/Load side speed deviation Internal temperature of encoder 	<ul style="list-style-type: none"> Effective load ratio Regenerative load ratio Peak load ratio Position F/B Encoder position within 1 revolution Encoder Multi-revolution counter QDS Load inertia moment ratio Model loop gain 1 Bus voltage Cumulative current value QDS Servo motor speed QDS Selected droop pulse QDS Load side encoder information1 QDS Load side encoder information2 QDS Servo motor thermistor temperature QDS 	
Absolute position detection system	Usable (Note-3)		Usable		
Home position return method	Proximity dog method (1, 2), Count method (1 to 3), Data set method (1), Dog cradle method, Limit switch combined method, Scale home position signal detection method, Dogless home position signal reference method QDS		Proximity dog method (1, 2), Count method (1 to 3), Data set method (1, 2), Dog cradle method, Stopper method (1, 2), Limit switch combined method, Scale home position signal detection method, Dogless home position signal reference method QDS		
Speed-torque control QDS	Position control mode, Speed control mode, Torque control mode		Position control mode, Speed control mode, Torque control mode, Continuous operation to torque control mode		

APPENDICES

Item	VCI series (Note-1)	VPH series (Note-1) QDS	MR-J5(W)-□B QDS	MR-J4(W)-□B QDS	MR-J3(W)-□B
Torque limit value change	Usable (Separate setting: Restrictions (Note-4))		Usable		
Gain changing command	Valid		Valid		
PI-PID switching command	Valid	Invalid	Valid		
Control loop changing command	Invalid	Valid	Valid when using servo amplifier for fully closed loop control (MR-J3-□B-RJ006)		
Amplifier-less operation function (Note-5)	Usable		Usable		
Servo parameter read/change	Usable		Usable		
Driver communication QDS	Unusable		Usable (Note-6)		
Servo error (Motion error history)	Error codes detected by VCI series are stored	Error codes detected by VPH series are stored	Error codes detected by servo amplifier are stored.		
Programming tool	MR Configurator2 is not available. Use VCI data editing software.		MR Configurator2 is available.		

(Note-1): Confirm the specifications of VCI series/VPH series for details.

(Note-2): Match the absolute position detection system setting in each setting of VCI series and Motion CPU.

(Note-3): The direct drive τDISC series manufactured by CKD Nikki Denso Co., Ltd. can restore the absolute position in the range from -2147483648 to 2147483647. Confirm the specifications of VCI series/VPH series for restrictions by the version of VCI series/VPH series.

(Note-4): The specification of torque limit direction differs by the version of VCI series/VPH series. Confirm the specifications of VCI series/VPH series for details.

(Note-5): During amplifier-less operation function, the following are spuriously connected.

	Q173DSCPU/Q172DSCPU				Q173DCPU(-S1)/ Q172DCPU(-S1)
	Communication type				
	SSCNETⅢ/H			SSCNETⅢ	
	VCI / VPH series	MR-J4(W)-□B	MR-J5(W)-□B		
Servo amplifier	MR-J4-10B		MR-J5-10B	MR-J3-10B	MR-J3-10B
Servo motor	HG-KR053		HK-KT053	HF-KP053	HF-KP053

(Note-6): Refer to the "Servo Amplifier Instruction Manual" for the servo amplifiers that can be used.

(5) Precautions during control

(a) Absolute position system (ABS)/Incremental system (INC).

Match the ABS/INC setting in each setting of VCI series and Motion CPU. Otherwise, a minor error (error code: 902) occurs, and it is controlled by the setting of VCI series side.

ABS/INC setting for the VPH series is set on the VPH series side.

1) Absolute position system (ABS)

When control units are degree axis and the stroke limit is valid, operation may not be normal when the following positioning controls are started.

Do not use the following controls.

Operating system software version	Positioning control
"00L" or later	<ul style="list-style-type: none"> Absolute specification instructions in speed-switching control (VSTART instruction)
"00K" or later	<ul style="list-style-type: none"> Instructions for pass point absolute specifications in constant-speed control (CPSTART instruction) (linear interpolation, circular interpolation, helical interpolation) Position follow-up control (PFSTART instruction) Absolute specification instructions in speed-switching control (VSTART instruction)

2) Incremental system (INC)

There are no restrictions.

(b) Home position return

1) Home position return operation types

The home position return methods that can be used in VCI series/VPH series are shown below.

Home position return method		Possible/Not possible
Proximity dog method	Proximity dog method 1	○
	Proximity dog method 2	○
Count method	Count method 1	○
	Count method 2	○
	Count method 3	○
Data set method	Data set method 1	○
	Data set method 2	× (Note-1)
Dog cradle method		○
Stopper method	Stopper method 1	× (Note-1)
	Stopper method 2	× (Note-1)
Limit switch combined method		○
Scale home position signal detection method		○
Dogless home position signal reference method		○
Driver home position return method		× (Note-2)

○: Possible, ×: Not possible

(Note-1): Minor error (error code: 133) occurs, and home position return is not performed.

(Note-2): Minor error (error code: 194) occurs, and home position return is not performed.

2) Dogless home position signal reference method

When performing "dogless home position signal reference method" in VCII series, the home position, home position return operation, and home position return data (home position return retry function, dwell time at the home position return retry) is the following.

Also, set the VCII series parameter "Function select of SSCNET III communication mode (P612) (Condition selection of home position set)" as follows.

Servo amplifier type		Linear encoder type	Home position	Home position return operation (Note-1)	Home position return data		Parameter "Function select of SSCNET III communication mode (P612) (Condition selection of home position set)"
					Home position return retry function	Dwell time at the home position return retry	
VCII series/ VPH series	Linear stage	Absolute position type	Position where address of absolute linear encoder becomes 0	Operation C	Invalid		—
		Incremental type	Reference mark	Operation A	Valid		0
	Direct drive motor	Absolute position type	Home position signal (zero point)	Operation A/ Operation B	Valid/Invalid		0/1
		Incremental type		Operation A	Valid		0

(Note-1): Refer to Section 6.23.14 for home position return operation.

3) Home position return without passing motor Z phase

- When "1" is set in the first digit of the parameter of VCII series "Function select of SSCNET III communication mode (P612)", it is possible to carry out the home position return without passing the zero point. (Return to home position after power is supplied will be executed when passing of motor Z phase is not necessary.) When "0" is set, a minor error (error code: 120) occurs because the home position is executed without passing the motor Z phase (motor reference position signal).
- When the parameter of VPH series "Marker (zero point/Z-phase) transit selection in communication mode (P800)" is set to "Zero return operation allowed", it is possible to carry out the home position return without passing the zero point. (Return to home position after power is supplied will be executed when passing of motor Z phase is not necessary.) When "Zero return operation allowed after the marker is passed" is set, a minor error (error code: 120) occurs because the home position is executed without passing the motor Z phase (motor reference position signal).

(c) Control mode **QDS**

Control modes that can be used are shown below.

- Position control mode (position control, and speed control including position loop)
- Speed control mode (speed control not including position loop)
- Torque control mode (torque control)

However, it is not available to switch to continuous operation to torque control mode of "Speed-torque control". If the mode is switched to continuous operation to torque control mode, a minor error (error code: 318) occurs and the operation stops.

"1: Feedback torque" cannot be set in "Torque initial value selection at control mode switching". If it is set, a minor error (error code: 154) occurs and the command value immediately after switching is the same as the case of selecting "0: Command torque".

(d) Servo parameter

1) Control of servo parameters

Parameters of VCII series/VPH series are not controlled by Motion CPU. Therefore, even though the parameter of VCII series/VPH series is changed during the communication between Motion CPU and VCII series/VPH series, it does not process, and is not reflected to the parameter.

2) Servo parameter change function **QDS**

a) Change function of servo parameter can be executed.

The following is the operation for the servo parameter change function.

	Operation for the servo parameter change function
Servo parameter write request	The servo parameter of VCII series/VPH series is controlled in a unit of 2 words, so that it is necessary to set "3: 2 words write request" in servo parameter write/read request (SD804) for executing the parameter write. If "1: 1 word write request" is executed to VCII series/VPH series, the parameter write fails, and "-1" is stored in servo parameter write/read request (SD804).
Servo parameter read request	The servo parameter of VCII series/VPH series is controlled in a unit of 2 words, so that it is necessary to set "4: 2 words read request" in servo parameter write/read request (SD804) for executing the parameter read. If "2: 1 word read request" is executed to VCII series/VPH series, the parameter read fails, and "-1" is stored in servo parameter write/read request (SD804).

- b) When the servo parameter of VCII series/VPH series is changed by the servo parameter change function, the parameter value after changing the servo parameter cannot be confirmed using VCII/VPH data editing software. When confirming the parameter value, execute the servo parameter read request. Also, when the power of VCII series/VPH series is turned OFF, the parameter changed by the servo parameter change function becomes invalid, and the value written by VCII/VPH data editing software becomes valid.

c) "Servo parameter write/read" device

Store the value in the following special registers to change or display the servo parameter.

No.	Name	Meaning	Details	Set by
SD552	Servo parameter write/read request	Servo parameter read value	• The read value (low 1 word) of servo parameter which executed "4: 2 word read request" in SD804 is stored.	System (At read request)
SD553			• The read value (high 1 word) of servo parameter which executed "4: 2 word read request" in SD804 is stored.	
SD804 (Note-1)		Servo parameter write/read request flag	<ul style="list-style-type: none"> • The "write/read request" is executed after setting of the axis No. and servo parameter No. 3: 2 word write request 4: 2 word read request • "0" is automatically set by Motion CPU after completion of servo parameter write/read request. ("1" is stored by Motion CPU at write/read error.) 	User/ System
SD805		Axis No.	• The axis No. to write/read servo parameter is stored. Q173DSCPU: 1 to 32 Q172DSCPU: 1 to 16	User
SD806		Servo parameter No.	<ul style="list-style-type: none"> • The servo parameter No. to be written/read is stored in hexadecimal. <div style="margin-left: 40px;"> H □ □ □ □ ↳ Parameter No. ↳ Parameter group No. <ul style="list-style-type: none"> • 0: Group 0 • 5: Group 5 • 1: Group 1 • 6: Group 6 • 2: Group 2 • 7: Group 7 • 3: Group 3 • 8: Group 8 • 4: Group 4 • 9: Group 9 </div>	
SD808		Servo parameter setting value	• The setting value of servo parameter to be written is stored when "3: 2 word write request" is set in SD804.	
SD809	(2 word)			

(Note-1): Do not execute the automatic refresh.

(e) Optional data monitor setting

The following table shows data types that can be set.

Set the total number of communication data points per 1 axis so there are no more than 6 points on a SSCNET III/H line, and no more than 3 points on a SSCNET III line.

Data type	Unit	Number of words	Number of communication data points	Data types that can be set		
				VCI series		VPH series 
				Q173DSCPU/ Q172DSCPU	Q173DCPU(-S1)/ Q172DCPU(-S1)	
Effective load ratio	[%]	1	1	○	○	○
Regenerative load ratio	[%]	1	1	○	○	○
Peak load ratio	[%]	1	1	○	○	○
Position F/B	[pulse]	2	0	○	○	○
Encoder position within 1 revolution	[pulse]	2	0	○	○	○
Encoder Multi-revolution counter	[rev]	1	0	○	×	○
Position loop gain 1	[rad/s]	1	1	○	○	○
Bus voltage	[V]	1	1	×	×	○
Cumulative current value	[Position command] (Note-1)	2	0	○	×	○

○: Settable ×: Unsettable

(Note-1): The position command is the command unit set in the fixed parameter.

(f) Gain changing command, PI-PID switching command, control loop changing command.

1) VCI series

Gain changing command and PI-PID switching command are available.
Control loop changing command becomes invalid.

2) VPH series 

Gain changing command is available.
PI-PID switching command and control loop changing command become invalid.

(g) Driver communication 

The driver communication is not supported. If the driver communication is set in a servo parameter, a major error (error code: 1363) will occur when the power of Multiple CPU system is turned ON.

(h) Monitor devices (#8000 to #8639)

1) Servo amplifier type (#8000 + 20n)

This register stores the servo amplifier types below when using VCII series/VPH series.

- 4352 VCII series ^(Note-1) (CKD Nikki Denso Co., Ltd. make)
QDS
- 4354 VCII series (For Linear stage) ^(Note-2)
(CKD Nikki Denso Co., Ltd. make)
- 4359 VCII series (For direct drive motor) ^(Note-2)
(CKD Nikki Denso Co., Ltd. make)
- 4864 VPH series ^(Note-1) (CKD Nikki Denso Co., Ltd. make)
QDS
- 4866 VPH series (For Linear stage) ^(Note-2)
(CKD Nikki Denso Co., Ltd. make) **QDS**
- 4871 VPH series (For direct drive motor) ^(Note-2)
(CKD Nikki Denso Co., Ltd. make) **QDS**
^(Note-1): When connecting SSCNET III/H
^(Note-2): When connecting SSCNET III

(i) Operation cycle **QDS**

If "SSCNET III" is set as the SSCNET settings communication type, the operation cycle of 0.22[ms] cannot be used.

Furthermore, even if the operation cycle is set to 0.22[ms] in the setting for axes 1 to 4 for 1 line, if the servo amplifier is mixed with the VCII series, the servo amplifier operates with an operation cycle of 0.44[ms].

If "SSCNET III/H" is set as the SSCNET settings communication type, there are no restrictions.

(6) VCII series/VPH series detection error

When an error occurs on VCII series/VPH series, the servo error detection signal (M2408 + 20n) turns ON. Eliminate the error cause, reset the servo amplifier error by turning ON servo error reset command (M3208+20n) and perform re-start.

However, "0" is always stored in parameter error No. (#8009+20n).

Refer to the instruction manual of VCII series/VPH series for details of the errors.

APPENDIX 6.2 Inverter FR-A700 series **Ver.!**

FR-A700 series can be connected via SSCNET III by using built-in option FR-A7AP and FR-A7NS.

POINT
 FR-A700 series cannot be used on a line where the communication type in SSCNET setting of MT Developer2 is set to "SSCNET III/H". **QDS**

(1) System configuration

The system configuration using FR-A700 series is shown below.

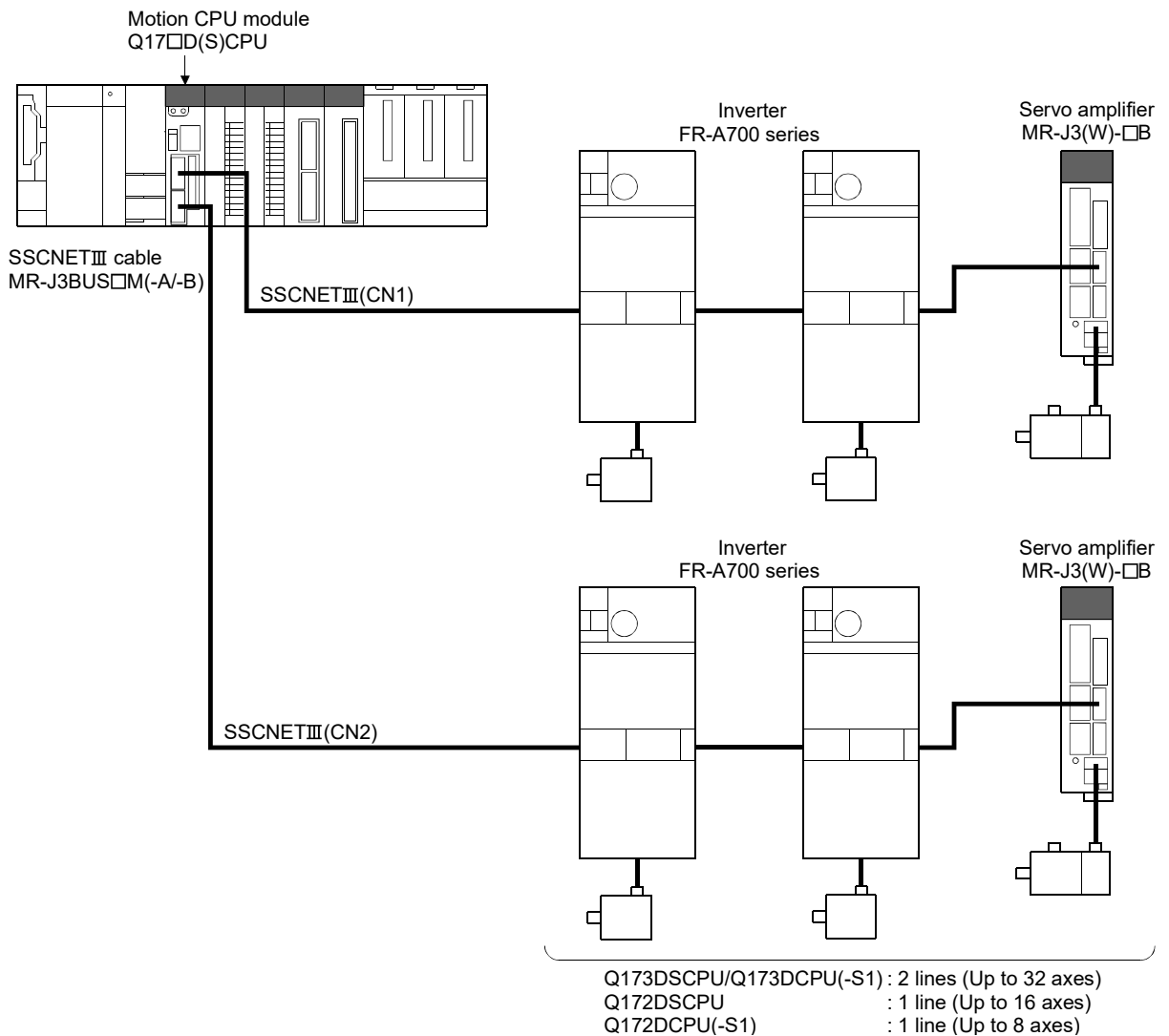

Ver.! : Refer to Section 1.3 for the software version that supports this function.

(2) Parameter setting

To connect FR-A700 series, set the following in the system setting of MT Developer2.

(a) When using Q173DSCPU/Q172DSCPU

- Set "SSCNET III" for communication type in SSCNET setting.
- Set the amplifier model in amplifier setting to "FR-A700".

(b) When using Q173DCPU(-S1)/ Q172DCPU(-S1)

- Set the amplifier model in amplifier setting to "FR-A700".

(3) Control of FR-A700 series parameters

Parameters set in FR-A700 series are not controlled by Motion CPU.

Set the parameters by connecting FR-A700 series directly with the operation panel on the front of inverter (FR-DU07/FR-PU07) or FR Configurator that is inverter setup software. For details on setting items for FR-A700 series, refer to the instruction manual of the FR-A700 series.

POINT

<p>In the state of connecting between FR-A700 series and Motion CPU, only a part of parameters can be set if the parameter of the inverter "Pr.77 Parameter write selection" is in the initial state. Set "2: Write parameters during operation" to rewrite the parameters of FR-A700 series.</p>

(4) Reset selection/disconnected PU detection/PU stop selection

When PU stop is executed in FR-A700 series, position error excessive, etc. occur because a command from Motion CPU does not stop. Set "0 to 3" in the parameter of the inverter " Pr.75 Reset selection/disconnected PU detection/PU stop selection". To stop FR-A700 series, use the stop signal and the forced stop of Motion CPU, or use the output stop (MRS) of FR-A700 series.

Setting item	Default value	Setting value	Details
Reset selection/ disconnected PU detection/ PU stop selection (Pr. 75)	14	0	<ul style="list-style-type: none"> Reset input is always enabled. If the PU is disconnected, operation will be continued. PU stop is disabled at SSCNETⅢ connection.
		1	<ul style="list-style-type: none"> A reset can be input only when the protective function is activated. If the PU is disconnected, operation will be continued. PU stop is disabled at SSCNETⅢ connection.
		2	<ul style="list-style-type: none"> Reset input is always enabled. When the PU is disconnected, the inverter trips. PU stop is disabled at SSCNETⅢ connection.
		3	<ul style="list-style-type: none"> A reset can be input only when the protective function is activated. When the PU is disconnected, the inverter trips. PU stop is disabled at SSCNETⅢ connection.
		14	<ul style="list-style-type: none"> Reset input is always enabled. If the PU is disconnected, operation will be continued. Deceleration stop by PU stop in any operation mode.
		15	<ul style="list-style-type: none"> A reset can be input only when the protective function is activated. If the PU is disconnected, operation will be continued. Deceleration stop by PU stop in any operation mode.
		16	<ul style="list-style-type: none"> Reset input is always enabled. When the PU is disconnected, the inverter trips. Deceleration stop by PU stop in any operation mode.
		17	<ul style="list-style-type: none"> A reset can be input only when the protective function is activated. When the PU is disconnected, the inverter trips. Deceleration stop by PU stop in any operation mode.

(Note): Note that the default value is set to "14". (Change the value to "0 to 3")

(5) In-position range

Set the in-position range in the parameter of the inverter "In-position width (Pr. 426)".

When the position of the cam axis is restored in advanced synchronous control, a check is performed by the servo parameter "In-position range"(PA10). However, because the servo parameter settings are not performed in FR-A700 series, the "In-position range" is checked as 100[pulse] (fixed value).

(6) Optional data monitor setting

The following table shows data types that can be set.

Set the data so that the total number of communication points per axis is no more than 3 points.

Data type	Unit	Number of words	Number of communication data points	Data types that can be set	
				Q173DSCPU/ Q172DSCPU	Q173DCPU(-S1)/ Q172DCPU(-S1)
Motor load ratio	[%]	1	1	○	○
Position F/B	[pulse]	2	0	○	○
Encoder position within 1 revolution	[pulse]	2	0	○	○
Load inertia moment ratio	[× 0.1 times]	1	1	○	○
Position loop gain	[rad/s]	1	1	○	○
Converter output voltage	[V]	1	1	○	○
Cumulative current value	[Position command] (Note-1)	2	0	○	×

○: Settable ×: Unsettable

(Note-1): The position command is the command unit set in the fixed parameter.

POINT														
When FR-A700 series is used, each data is delayed for "update delay time + communication cycle" because of the update cycle of the inverter. The update delay time for each data is shown in the table below.														
<table border="1"> <thead> <tr> <th>Data type</th> <th>Update delay time of FR-A700 series</th> </tr> </thead> <tbody> <tr> <td>Motor load ratio</td> <td>12.5ms</td> </tr> <tr> <td>Position F/B</td> <td>222μs</td> </tr> <tr> <td>Encoder position within 1 revolution</td> <td>222μs</td> </tr> <tr> <td>Load inertia moment ratio</td> <td>56ms or more (up to 2500ms)</td> </tr> <tr> <td>Position loop gain</td> <td>56ms or more (up to 2500ms)</td> </tr> <tr> <td>Converter output voltage</td> <td>9.888ms</td> </tr> </tbody> </table>	Data type	Update delay time of FR-A700 series	Motor load ratio	12.5ms	Position F/B	222μs	Encoder position within 1 revolution	222μs	Load inertia moment ratio	56ms or more (up to 2500ms)	Position loop gain	56ms or more (up to 2500ms)	Converter output voltage	9.888ms
Data type	Update delay time of FR-A700 series													
Motor load ratio	12.5ms													
Position F/B	222μs													
Encoder position within 1 revolution	222μs													
Load inertia moment ratio	56ms or more (up to 2500ms)													
Position loop gain	56ms or more (up to 2500ms)													
Converter output voltage	9.888ms													









(7) External input signal

Set as the following to fetch the external input signal (FLS/RLS/DOG) via FR-A700 series.

- (a) Set the following items with MT Developer2
 - When using Q173DSCPU/Q172DSCPU
Set "Amplifier input" for every axis with signal type in the servo external signal parameter of servo data setting.
 - When using Q173DCPU(-S1)/ Q172DCPU(-S1)
Set "Amplifier input valid" as the external signal input setting in the "Amplifier setting" of system setting.
- (b) Set the parameters of the inverter as below.
(Otherwise, each signal remains OFF.)

Setting item	Default value	Setting value	Details
STF terminal function selection (Pr. 178)	60	60	Use with the default value
STR terminal function selection (Pr. 179)	61	61	
JOG terminal function selection (Pr. 185)	5	76	Set 76 (Proximity dog)
SSCNETIII input filter selection (Pr. 449)	4	0: None 1: 0.88ms 2: 1.77ms 3: 2.66ms 4: 3.55ms	Set the input filter setting value at reading an external signal.

(8) Comparisons of specifications with MR-J3(W)-□B

Item	FR-A700 series (Note-1)	MR-J3(W)-□B
Amplifier type	FR-A700	MR-J3(W)-B, MR-J3-□B(S) (For fully closed loop control), MR-J3(W)-B (Linear servo), MR-J3(W)-B (Direct drive motor)
Control of servo amplifier parameters	Set directly by inverter. (Not controlled by Motion CPU.)	Controlled by Motion CPU.
External input signal	External input signals of FR-A700 series, and bit devices are available.	External input signals of servo amplifier, and bit devices are available.
Optional data monitor (Data type)	<ul style="list-style-type: none"> • Motor load ratio • Position F/B • Encoder position within 1 revolution • Load inertia moment ratio • Position loop gain • Converter output voltage • Cumulative current value  	<ul style="list-style-type: none"> • Effective load ratio • Regenerative load ratio • Peak load ratio • Position F/B • Encoder position within 1 revolution • Encoder multi-revolution counter  • Load inertia moment ratio • Model loop gain • Bus voltage • Cumulative current value  • Servo motor speed  • Selected droop pulse  • Load side encoder information1  • Load side encoder information2  • Servo motor thermistor temperature 

APPENDICES

Item	FR-A700 series ^(Note-1)	MR-J3(W)-□B
Absolute position detection system	Unusable	Usable
Home position return method	Proximity dog method (1, 2), Count method (1 to 3), Data set method (1), Dog cradle method, Limit switch combined method, Scale home position signal detection method	Proximity dog method (1, 2), Count method (1 to 3), Data set method (1, 2), Dog cradle method, Stopper method (1, 2), Limit switch combined method, Scale home position signal detection method, Dogless home position signal reference method QDS
Speed-torque control QDS	Position control mode, Speed control mode, Torque control mode	Position control mode, Speed control mode, Torque control mode, Continuous operation to torque control mode
Gain changing command	Valid	Valid
PI-PID switching command	Valid	Valid
Control loop changing command	Invalid	Valid when using servo amplifier for fully closed loop control (MR-J3-□B-RJ006)
Servo parameter read/write QDS	Unusable	Usable
Amplifier-less operation function ^(Note-2)	Usable ^(Note-3)	Usable
Driver communication QDS	Unusable	Usable ^(Note-4)
Monitoring of servo parameter error No.	Unusable	Usable

(Note-1): For details of FR-A700 series, refer to FR-A700 series instruction manual.

(Note-2): During amplifier-less operation function, the following are spuriously connected.

- Servo amplifier : MR-J3-10B
- Servo motor : HF-KP053

(Note-3): Parameters set in FR-A700 series are not controlled by Motion CPU. Therefore, the operation is the same as when the servo parameter "Rotation direction selection/travel direction selection (PA14)" is set as below during amplifier-less operation mode.

Setting item	Setting value	Details
Rotation direction selection/travel direction selection (PA14)	0	Positioning address increase: CCW or positive direction
		Positioning address decrease: CW or negative direction

(Note-4): Refer to the "Servo Amplifier Instruction Manual" for the servo amplifiers that can be used.

(9) Precautions during control

(a) Absolute position system (ABS)/Incremental system (INC)

When using FR-A700 series, absolute position system (ABS) cannot be used.

(b) Control mode 

Control modes that can be used are shown below.

- Position control mode (position control, and speed control including position loop)
- Speed control mode (speed control not including position loop)
- Torque control mode (torque control)

However, it is not available to switch to continuous operation to torque control mode of "Speed-torque control". If the mode is switched to continuous operation to torque control mode, a minor error (error code: 318) occurs and the operation stops.

"1: Feedback torque" cannot be set in "Torque initial value selection at control mode switching". If it is set, a minor error (error code: 154) occurs and the command value immediately after switching is the same as the case of selecting "0: Command torque".

(c) Control mode switching of speed-torque control 

The axis connected with FR-A700 series takes more time to switch the control mode than the axis connected with the servo amplifier.

Switching operation	Switching time at the servo amplifier use	Switching time at FR-A700 series use
Position control mode → Speed control mode	6 to 11ms	19 to 24ms
Speed control mode → Position control mode		
Position control mode → Torque control mode		
Torque control mode → Position control mode		
Speed control mode → Torque control mode		
Torque control mode → Speed control mode		

(d) Driver communication 

The driver communication is not supported. If the driver communication is set in a servo parameter, a major error (error code: 1363) will occur when the power supply of the Multiple CPU system is turned ON.

(e) Monitor devices (#8000 to #8639)

1) Servo amplifier type (#8000+20n)

This register stores the servo amplifier types below when using FR-A700 series.

- 16640 FR-A700 series (Inverter)

(f) Operation cycle 

The operation cycle of 0.22[ms] cannot be used.

Furthermore, even if the operation cycle is set to 0.22[ms] in the setting for axes 1 to 4 for 1 line, if the servo amplifier is mixed with the FR-A700 series, the servo amplifier operates with an operation cycle of 0.44[ms].

(10) FR-A700 series detection error

When an error occurs on FR-A700 series, the servo error detection signal (M2408+20n) turns ON. Eliminate the error cause, reset the servo amplifier error by turning ON servo error reset command (M3208+20n) and perform re-start.

However, "0" is always stored in parameter error No. (#8009+20n), and "Absolute position lost (b14)" of servo status 1 (#8010+20n).

The errors detected by FR-A700 series are shown in Table 6.2.

Refer to the instruction manual of FR-A700 series for details of the errors.

(a) FR-A700 series

Table 6.2 FR-A700 series error list (2000 to 2199)

Error code	FR-A700 series LED display	Name	Remarks
2010	E.OC1	Overcurrent trip during acceleration	
2011	E.OC2	Overcurrent trip during constant speed	
2012	E.OC3	Overcurrent trip during deceleration or stop	
2015	E.OV3	Regenerative overvoltage trip during deceleration or stop	
2016	E.THM	Motor overload trip (electronic thermal relay function)	
2017	E.THT	Inverter overload trip (electronic thermal relay function)	
2018	E.IPF	Instantaneous power failure	
2019	E.UVT	Undervoltage	
2020	E.BE	Brake transistor alarm detection	
2021	E.GF	Output side earth (ground) fault overcurrent	
2022	E.OHT	External thermal relay operation	
2023	E.OLT	Stall prevention stop	
2024	E.OPT	Option fault	
2027	E.PE	Parameter storage device fault	
2028	E.PUE	PU disconnection	
2030	E.CPU	CPU fault	
2031	E.ILF	Input phase loss	
2032	E.FIN	Heatsink overheat	
2033	E.OS	Overspeed occurrence	
2034	E.OSD	Speed deviation excess detection	
2035	E.ECT	Signal loss detection	
2036	E.OD	Excessive position fault	
2045	E.P24	24VDC power output short circuit	
2046	E.CTE	Operation panel power supply short circuit, RS-485 terminal power supply short circuit	
2047	E.LF	Output phase loss	
2048	E.PTC	PTC thermistor operation	
2049	E.PE2	Parameter storage device fault	
2050	E.CDO	Output current detection value exceeded	
2051	E.IOH	Inrush current limit circuit fault	
2052	E.SER	Communication fault (inverter)	
2053	E.AIE	Analog input fault	
2055	E.USB	USB communication fault	

APPENDICES

Table 6.2 FR-A700 series error list (2000 to 2199)

Error code	FR-A700 series LED display	Name	Remarks
2056	E.1	Option fault	
2057	E.2		
2058	E.3		
2060	E.5	CPU fault	
2061	E.6		
2062	E.7		
2070	E.EP	Encoder phase fault	
2088	—	Watchdog	
2090	E.OP3	Communication option fault	
2091	E.OP3		
2092	E.OP3		
2093	E.OP3		
2099	—	SSCNET receive error	
2100	OL	Stall prevention (overcurrent)	
2101	oL	Stall prevention (overvoltage)	
2102	PS	PU stop	
2103	RB	Regenerative brake pre-alarm	
2104	TH	Electronic thermal relay function pre-alarm	
2105	MT	Maintenance signal output	
2106	CP	Parameter copy	
2107	SL	Speed limit indication (Output during speed limit)	
2108	Fn	Fan alarm	
2146	—	Output stop	
2147	—	Emergency stop	

APPENDIX 6.3 Inverter FR-A800 series **QDS** *Ver.!*

FR-A800 series can be connected via SSCNET III/H by using built-in option FR-A8AP and FR-A8NS.

(1) System configuration

The system configuration using FR-A800 series is shown below.

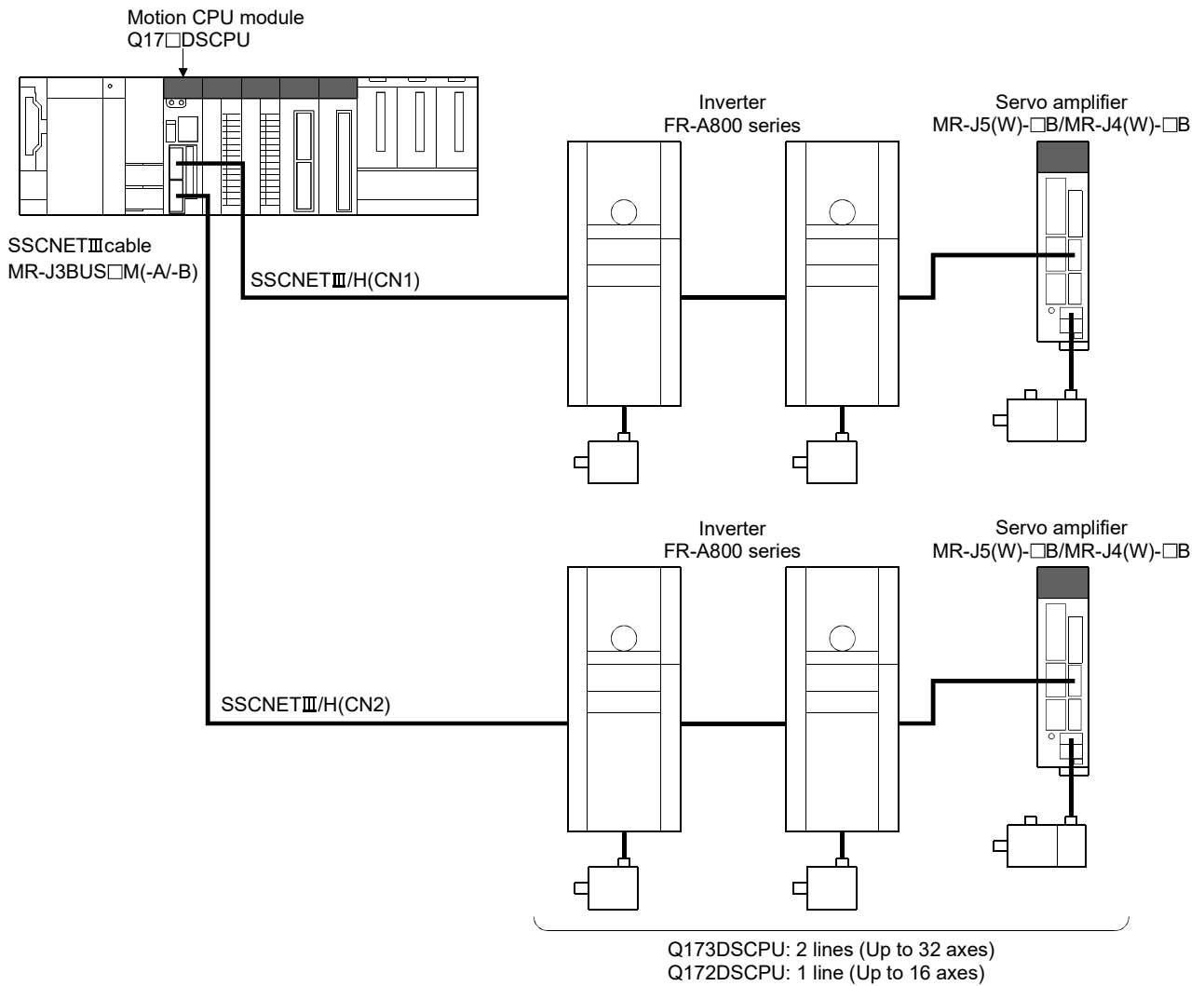

Ver.! : Refer to Section 1.3 for the software version that supports this function.

(2) Parameter setting

To connect FR-A800 series, set the following in the system setting of MT Developer2.

- Set "SSCNETⅢ/H" for communication type in SSCNET setting.
- Set the amplifier model in amplifier setting to "FR-A800-1" or "FR-A800-2".

(3) Control of FR-A800 series parameters

Parameters set in FR-A800 series are not controlled by Motion CPU.

Set the parameters by connecting FR-A800 series directly with the operation panel on the front of inverter (FR-DU08/FR-LU08/FR-PU07) or FR Configurator2 that is inverter setup software. For details on setting items for FR-A800 series, refer to the instruction manual of the FR-A800 series.

POINT

<p>In the state of connecting between FR-A800 series and Motion CPU, only a part of parameters can be set if the parameter of the inverter "Pr.77 Parameter write selection" is in the initial state. Set "2: Write parameters during operation" to rewrite the parameters of FR-A800 series.</p>

(4) In-position range

Set the in-position range in the parameter of the inverter "In-position width (Pr. 426)".

When the position of the cam axis is restored in advanced synchronous control, a check is performed by the servo parameter "In-position range"(PA10). However, because the servo parameter settings are not performed in FR-A800 series, the "In-position range" is checked as 100[pulse] (fixed value).

(5) Optional data monitor setting

The following table shows data types that can be set.

Set the data so that the total number of communication points per axis is no more than 6 points.

Data type	Unit	Number of words	Number of communication data points
Motor load ratio	[%]	1	1
Position F/B	[pulse]	2	0
Encoder position within 1 revolution	[pulse]	2	0
Encoder Multi-revolution counter	[rev]	1	0
Load inertia moment ratio	[× 0.1 times]	1	1
Position loop gain	[rad/s]	1	1
Converter output voltage	[V]	1	1
Cumulative current value	[Position command] (Note-1)	2	0

(Note-1): The position command is the command unit set in the fixed parameter.

POINT																
<p>When FR-A800 series is used, each data is delayed for "update delay time + communication cycle" because of the update cycle of the inverter. The update delay time for each data is shown in the table below.</p> <table border="1"> <thead> <tr> <th>Data type</th> <th>Update delay time of FR-A800 series</th> </tr> </thead> <tbody> <tr> <td>Motor load ratio</td> <td>10ms</td> </tr> <tr> <td>Position F/B</td> <td>222μs</td> </tr> <tr> <td>Encoder position within 1 revolution</td> <td>222μs</td> </tr> <tr> <td>Encoder Multi-revolution counter</td> <td>222μs</td> </tr> <tr> <td>Load inertia moment ratio</td> <td>10ms</td> </tr> <tr> <td>Position loop gain</td> <td>10ms</td> </tr> <tr> <td>Converter output voltage</td> <td>5ms</td> </tr> </tbody> </table>	Data type	Update delay time of FR-A800 series	Motor load ratio	10ms	Position F/B	222μs	Encoder position within 1 revolution	222μs	Encoder Multi-revolution counter	222μs	Load inertia moment ratio	10ms	Position loop gain	10ms	Converter output voltage	5ms
Data type	Update delay time of FR-A800 series															
Motor load ratio	10ms															
Position F/B	222μs															
Encoder position within 1 revolution	222μs															
Encoder Multi-revolution counter	222μs															
Load inertia moment ratio	10ms															
Position loop gain	10ms															
Converter output voltage	5ms															

(6) External input signal

Set as the following to fetch the external input signal (FLS/RLS/DOG) via FR-A800 series.

- (a) Set the following items with MT Developer2.
 - Set "Amplifier input" for every axis with signal type in the servo external signal parameter of servo data setting.
- (b) Refer to the instruction manual of FR-A800 series for parameter settings on the inverter side.

(7) Comparisons of specifications with MR-J5(W)-□B/MR-J4(W)-□B

Item	FR-A800 series ^(Note-1)	MR-J5(W)-□B	MR-J4(W)-□B
Amplifier type	FR-A800-1, FR-A800-2	MR-J5(W)-B(-RJ)	MR-J4(W)-B(-RJ)
Control of servo amplifier parameters	Set directly by inverter. (Not controlled by Motion CPU.)	Controlled by Motion CPU.	
External input signal	External input signals of FR-A800 series, and bit devices are available.	External input signals of servo amplifier, and bit devices are available.	
Optional data monitor (Data type)	<ul style="list-style-type: none"> • Motor load ratio • Position F/B • Encoder position within 1 revolution • Encoder multi-revolution counter • Load inertia moment ratio • Position loop gain • Converter output voltage • Cumulative current value 	<ul style="list-style-type: none"> • Effective load ratio • Regenerative load ratio • Peak load ratio • Position F/B • Encoder position within 1 revolution • Encoder multi-revolution counter • Load inertia moment ratio • Model loop gain • Bus voltage • Cumulative current value • Servo motor speed • Selected droop pulse • Unit power consumption • Unit total power consumption • Instantaneous torque • Load side encoder information1 • Load side encoder information2 • Z-phase counter • Servo motor thermistor temperature • Torque equivalent to disturbance • Overload alarm margin • Excessive error alarm margin • Settling time • Overshoot amount • Servo motor/Load side position deviation • Servo motor/Load side speed deviation • Internal temperature of encoder 	
Absolute position detection system	Unusable	Usable	
Home position return method	Proximity dog method (1, 2), Count method (1 to 3), Data set method (1), Dog cradle method, Limit switch combined method, Scale home position signal detection method	Proximity dog method (1, 2), Count method (1 to 3), Data set method (1, 2), Dog cradle method, Stopper method (1, 2), Limit switch combined method, Scale home position signal detection method, Dogless home position signal reference method	
Speed-torque control	Position control mode, Speed control mode, Torque control mode	Position control mode, Speed control mode, Torque control mode, Continuous operation to torque control mode	
Gain changing command	Valid	Valid	
PI-PID switching command	Valid	Valid	
Control loop changing command	Invalid	Valid	
Servo parameter read/write	Unusable	Usable	

APPENDICES

Item	FR-A800 series ^(Note-1)	MR-J5(W)-□B	MR-J4(W)-□B
Amplifier-less operation function ^(Note-2)	Usable ^(Note-3)	Usable	
Driver communication	Unusable	Usable ^(Note-4)	
Monitoring of servo parameter error No.	Unusable	Usable	
Servo error (Motion error history)	Error codes detected by FR-A800 series are stored.	Error codes detected by servo amplifier are stored.	
Programming tool	MR Configurator2 is not available. Use FR-DU08/FR-LU08/FR-PU07, or FR Configurator2.	MR Configurator2 is available.	

(Note-1): For details of FR-A800 series, refer to FR-A800 series instruction manual.

(Note-2): During amplifier-less operation function, the following are spuriously connected.

	FR-A800 series	MR-J4(W)-□B	MR-J5(W)-□B
Servo amplifier	MR-J4-10B		MR-J5-10B
Servo motor	HG-KR053		HK-KT053

(Note-3): Parameters set in FR-A800 series are not controlled by Motion CPU. Therefore, the operation is the same as when the servo parameter "Rotation direction selection/travel direction selection (PA14)" is set as below during amplifier-less operation mode.

Setting item	Setting value	Details
Rotation direction selection/travel direction selection (PA14)	0	Positioning address increase: CCW or positive direction
		Positioning address decrease: CW of negative direction

(Note-4): Refer to the "Servo Amplifier Instruction Manual" for the servo amplifiers that can be used.

(8) Precautions during control

(a) Absolute position system (ABS)/Incremental system (INC)

When using FR-A800 series, absolute position system (ABS) cannot be used.

(b) Control mode

Control modes that can be used are shown below.

- Position control mode (position control, and speed control including position loop)
- Speed control mode (speed control not including position loop)
- Torque control mode (torque control)

However, it is not available to switch to continuous operation to torque control mode of "Speed-torque control". If the mode is switched to continuous operation to torque control mode, a minor error (error code: 318) occurs and the operation stops.

"1: Feedback torque" cannot be set in "Torque initial value selection at control mode switching". If it is set, a minor error (error code: 154) occurs and the command value immediately after switching is the same as the case of selecting "0: Command torque".

(c) Driver communication

The driver communication is not supported. If the driver communication is set in a servo parameter, a major error (error code: 1363) will occur when the power supply of the Multiple CPU system is turned ON.

(d) Monitor devices (#8000 to #8639)

1) Servo amplifier type (#8000+20n)

This register stores the servo amplifier types below when using FR-A800 series.

- 8192 FR-A800-1 (Inverter)
- 8193 FR-A800-2 (Inverter)

(e) Command speed

If FR-A800 series is operated at a command speed more than the maximum speed, the stop position may be overshoot.

(9) FR-A800 series detection error

When an error occurs on FR-A800 series, the servo error detection signal (M2408 + 20n) turns ON. Eliminate the error cause, reset the servo amplifier error by turning ON servo error reset command (M3208 + 20n) and perform re-start.

However, "0" is always stored in parameter error No. (#8009 + 20n), and "Absolute position lost (b14)" of servo status 1 (#8010 + 20n).

The errors detected by FR-A800 series are shown in Table 6.3.

Refer to the instruction manual of FR-A800 series for details of the errors.

(a) FR-A800 series

Table 6.3 FR-A800 series error list (2000 to 2199)

Error code	FR-A800 series LED display	Name	Remarks
2010	E.OC1	Overcurrent trip during acceleration	
2011	E.OC2	Overcurrent trip during constant speed	
2012	E.OC3	Overcurrent trip during deceleration or stop	
2015	E.OV3	Regenerative overvoltage trip during deceleration or stop	
2016	E.THM	Motor overload trip (electronic thermal relay function)	
2017	E.THT	Inverter overload trip (electronic thermal relay function)	
2018	E.IPF	Instantaneous power failure	
2019	E.UVT	Undervoltage	
2020	E.BE	Brake transistor alarm detection	
2021	E.GF	Output side earth (ground) fault overcurrent	
2022	E.OHT	External thermal relay operation	
2023	E.OLT	Stall prevention stop	
2024	E.OPT	Option fault	
2027	E.PE	Parameter storage device fault	
2028	E.PUE	PU disconnection	
2030	E.CPU	CPU fault	
2031	E.ILF	Input phase loss	
2032	E.FIN	Heatsink overheat	
2033	E.OS	Overspeed occurrence	
2034	E.OSD	Speed deviation excess detection	
2035	E.ECT	Signal loss detection	
2036	E.OD	Excessive position fault	
2045	E.P24	24VDC power fault	
2046	E.CTE	Operation panel power supply short circuit/ RS-485 terminals power supply short circuit	
2047	E.LF	Output phase loss	

APPENDICES

Table 6.3 FR-A800 series error list (2000 to 2199) (continued)

Error code	FR-A800 series LED display	Name	Remarks
2048	E.PTC	PTC thermistor operation	
2049	E.PE2	Parameter storage device fault	
2050	E.CDO	Abnormal output current detection	
2051	E.IOH	Inrush current limit circuit fault	
2052	E.SER	Communication fault (inverter)	
2053	E.AIE	Analog input fault	
2055	E.USB	USB communication fault	
2056	E.1	Option fault	
2057	E.2		
2058	E.3		
2060	E.5	CPU fault	
2061	E.6		
2062	E.7		
2070	E.EP	Encoder phase fault	
2088	—	Watchdog	
2090	E.OP1	Communication option fault	
2091	E.OP1		
2092	E.OP1		
2093	E.OP1		
2099	—	SSCNET receive error	
2100	OL	Stall prevention (overcurrent)	
2101	oL	Stall prevention (overvoltage)	
2102	PS	PU stop	
2103	RB	Regenerative brake pre-alarm	
2104	TH	Electronic thermal relay function pre-alarm	
2105	MT	Maintenance signal output	
2106	CP	Parameter copy	
2107	SL	Speed limit indication	
2108	Fn	Fan alarm	
2130	SA	Safety stop	
2132	FN2	Internal fan alarm	
2133	UF	USB host error	
2134	MT1	Maintenance signal output	
2135	MT2	Maintenance signal output	
2136	MT3	Maintenance signal output	
2146	—	Output stop	
2147	—	Emergency stop	
2200	E.SAF	Safety circuit fault	
2201	E.PBT	Internal circuit fault	
2204	E.IAH	Abnormal internal temperature	

APPENDIX 6.4 Optical hub unit  

The SSCNET III/H Compatible Optical Hub Unit (MR-MV200) is a unit that enables the branching of SSCNET III/H communication on 1 line (3 branches for 1 input). SSCNET III/H communication can be branched by installing an optical hub unit in a SSCNET III/H system. The optical hub unit is compatible with all slave equipment (servo amplifiers etc.) that supports SSCNET III/H communication.

Setting the optical hub unit station settings on Motion CPUs and MT Developer2 is not required.

The power supply of equipment connected to the optical hub unit can be turned OFF/ON (Disconnect/Reconnect) during operation.

(1) Restrictions on SSCNET communication

Set the communication type to "SSCNET III/H" for the SSCNET setting connecting the optical hub unit.

SSCNET III/H communication equipment set in MT Developer2 can be connected.

There are no restrictions on connection order or connection position.

The servo amplifiers and SSCNET III/H compatible equipment that can be used with the optical hub unit are shown below.

SSCNET setting	Servo amplifier			SSCNET III/H compatible equipment
	MR-J5(W)-□B	MR-J4(W)-□B	MR-J3(W)-□B	
SSCNET III/H	○	○	×	○
SSCNET III	×	×	×	×

○: Available ×: Not available

: Refer to Section 1.3 for the software version that supports this function.

(2) System configuration

A connection example using optical hub units is shown below.

The transmission route that passes through the optical hub unit IN connector (CN1A connector for servo amplifier) and OUT1 connector (CN1B connector for servo amplifier) is called the "Main route", and the transmission routes that pass through OUT2 connector and OUT3 connectors are called the "Sub route".

The optical hub unit can only be connected on the main route. Also, the optical hub unit is not included in the number of connected modules on a line.

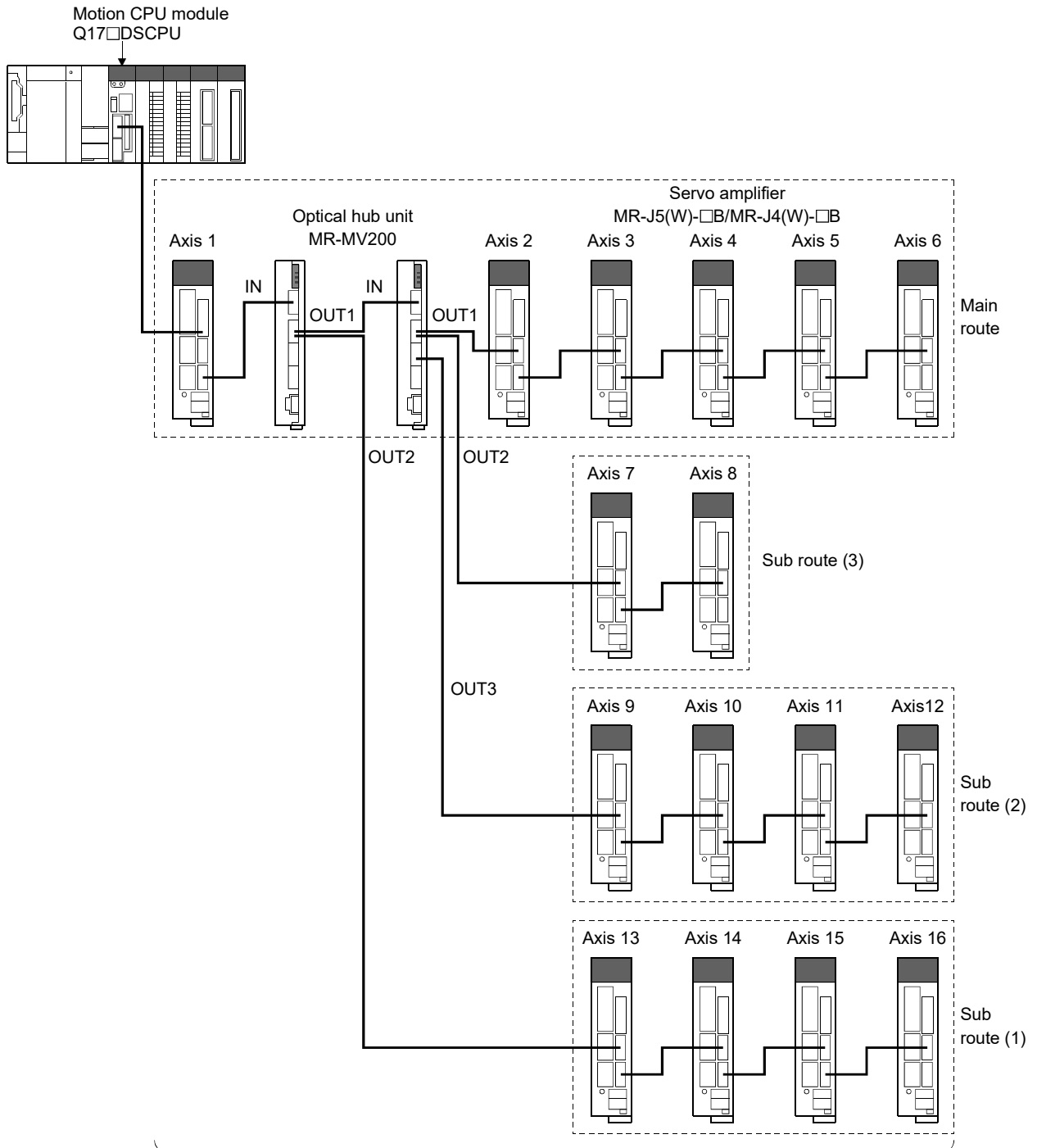

Q173DSCPU: 2 lines (Up to 32 axes (Up to 16 axes per line))

Q172DSCPU: 1 line (Up to 16 axes)

(Note): The optical hub unit is not included in the count

POINTS
<p>(1) If the optical hub unit is connected to a sub route, an error occurs, and the optical hub unit does not communicate with the Motion CPU.</p> <p>(2) A servo amplifier can be connected between two optical hub units, and between a Motion CPU and an optical hub unit.</p> <p>(3) When turning OFF the control circuit power supply of SSCNETⅢ/H compatible equipment connected to an optical hub unit, use the "connect/disconnect function of SSCNET communication". Refer to "Q173D(S)CPU/Q172D(S)CPU Motion controller Programming Manual (COMMON)" for details of "connect/disconnect function of SSCNET communication".</p>

(3) Checking the status of the optical hub unit

The connection status of the optical hub unit can be checked with the special registers below.

Device No.	Name	Meaning	Details	Set by
SD724	SSCNETⅢ/H compatible optical hub unit loading information (Line 1)	SSCNETⅢ/H compatible optical hub unit loading information (Line 1)	<ul style="list-style-type: none"> Checks the connection status (Installed: 1/Not installed: 0) of the optical hub unit and stores as bit data. SD724: b0 to b15 (Optical hub unit No.1 to No.16 on line 1) SD725: b0 to b15 (Optical hub unit No.1 to No.16 on line 2) (Note): No. 1 to No. 16 is the connection order from the Motion CPU 	System (Operation cycle)
SD725	SSCNETⅢ/H compatible optical hub unit loading information (Line 2)	SSCNETⅢ/H compatible optical hub unit loading information (Line 2)	<ul style="list-style-type: none"> "1" is stored to the installation status of an optical hub unit with a servo amplifier connected. "0" is stored to the installation status when an optical hub unit is not connected after an optical hub unit that is not connected to a servo amplifier, or when the optical hub unit connected after an optical hub unit is not connected to a servo amplifier either. For optical hub units connected before an optical hub unit connected to a servo amplifier, "1" is stored to the installation status, regardless of whether there is a servo amplifier connection or not. 	
SD726	SSCNETⅢ/H compatible optical hub unit communication error information (Line 1)	SSCNETⅢ/H compatible optical hub unit communication error information (Line 1)	<ul style="list-style-type: none"> Checks the communication status (Communication error detected: 1/No communication error detected: 0) of the optical hub unit and stores as bit data. SD726: b0 to b15 (Optical hub unit No.1 to No.16 on line 1) SD727: b0 to b15 (Optical hub unit No.1 to No.16 on line 2) (Note): No. 1 to No. 16 is the connection order from the Motion CPU The device contents are not reset by turning power supply of optical hub unit OFF/reset, or by disconnecting/reconnecting communication with the Motion CPU. Reset the device contents manually. 	System (Occur an error)
SD727	SSCNETⅢ/H compatible optical hub unit communication error information (Line 2)	SSCNETⅢ/H compatible optical hub unit communication error information (Line 2)		

(4) Driver communication function

Driver communication function is only supported between servo amplifiers on the same route starting from the Motion CPU until the last module.

Driver communication is not performed between servo amplifiers on different sub routes, or between a servo amplifier connected on the main route after an optical hub unit and a servo amplifier on a sub route connected to an optical hub unit.

When an axis set for driver communication is in a position where driver communication cannot be performed, or when the connection of an axis set for driver communication is not confirmed, all servo amplifiers including those that are on axes not set to driver communication, cannot communicate with the Motion CPU.

Routes where driver communication function is possible are shown below.

Route	Supported
Within the main route	○
Within the same sub route	○
Between different sub routes	×
Between main route and sub route (Between slaves on first optical hub unit (main route) and sub route)	○
Between main route and sub route (Between slaves on later optical hub unit (main route) and sub route)	×

○: Driver communication ×: No driver communication

POINTS	Refer to "Q173D(S)CPU/Q172D(S)CPU Motion controller Programming Manual (COMMON)" for details of "Driver communication function".
---------------	--

(a) Servo amplifier layout for driver communication

A connection example showing where driver communication is possible/not possible is shown below.

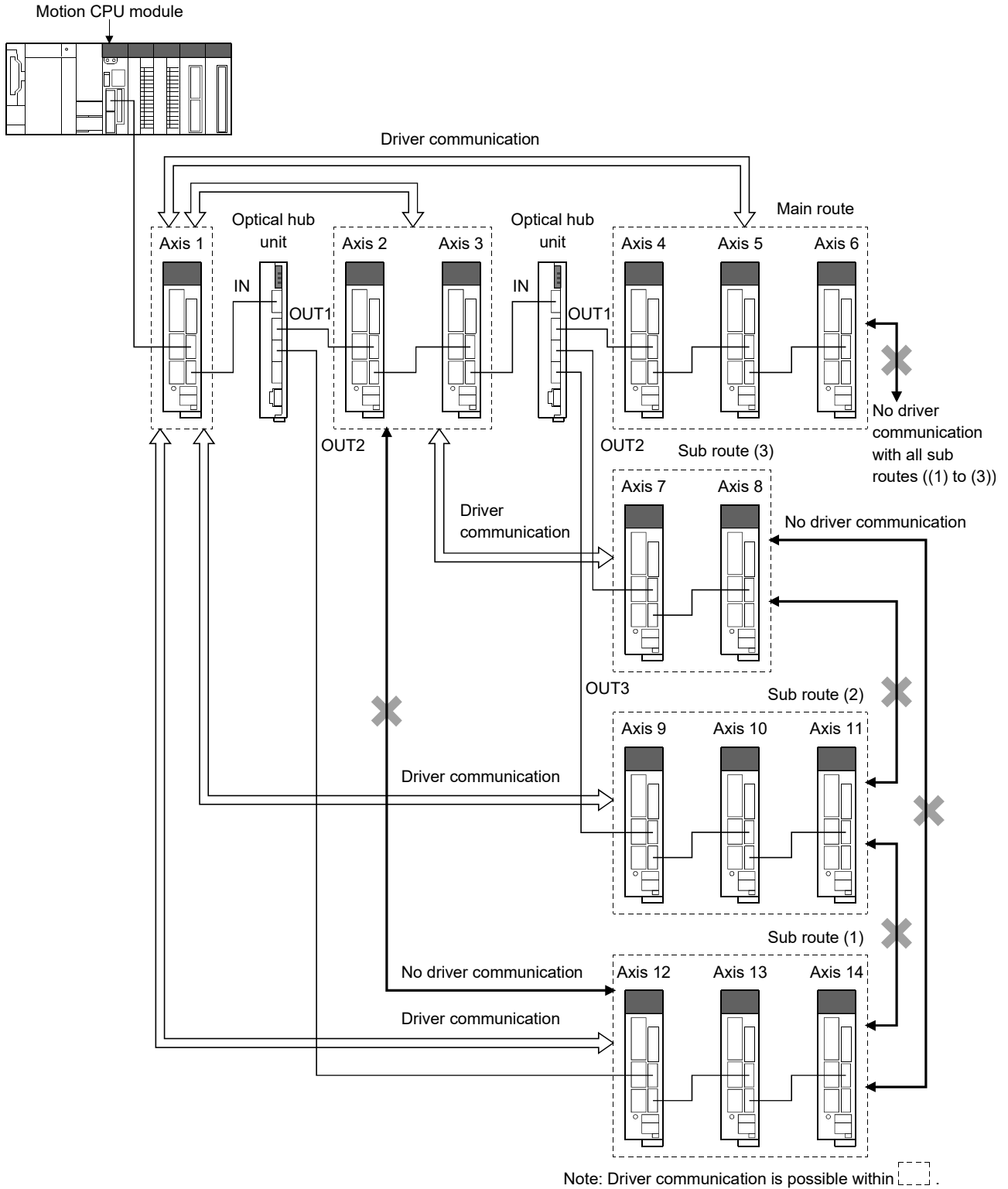

APPENDIX 6.5 AlphaStep/5-phase stepping motor driver manufactured by ORIENTAL MOTOR Co., Ltd. **QDS** *Ver.!*

The ORIENTAL MOTOR Co., Ltd. made stepping motor driver AlphaStep/5-phase can be connected via SSCNET III/H.
 Contact to ORIENTAL MOTOR Co., Ltd. overseas sales office for details of AlphaStep/5-phase.

POINT
 AlphaStep/5-phase cannot be used on a line where the communication type in SSCNET setting of MT Developer2 is set to "SSCNET III".

(1) System configuration

The system configuration using AlphaStep/5-phase is shown below.

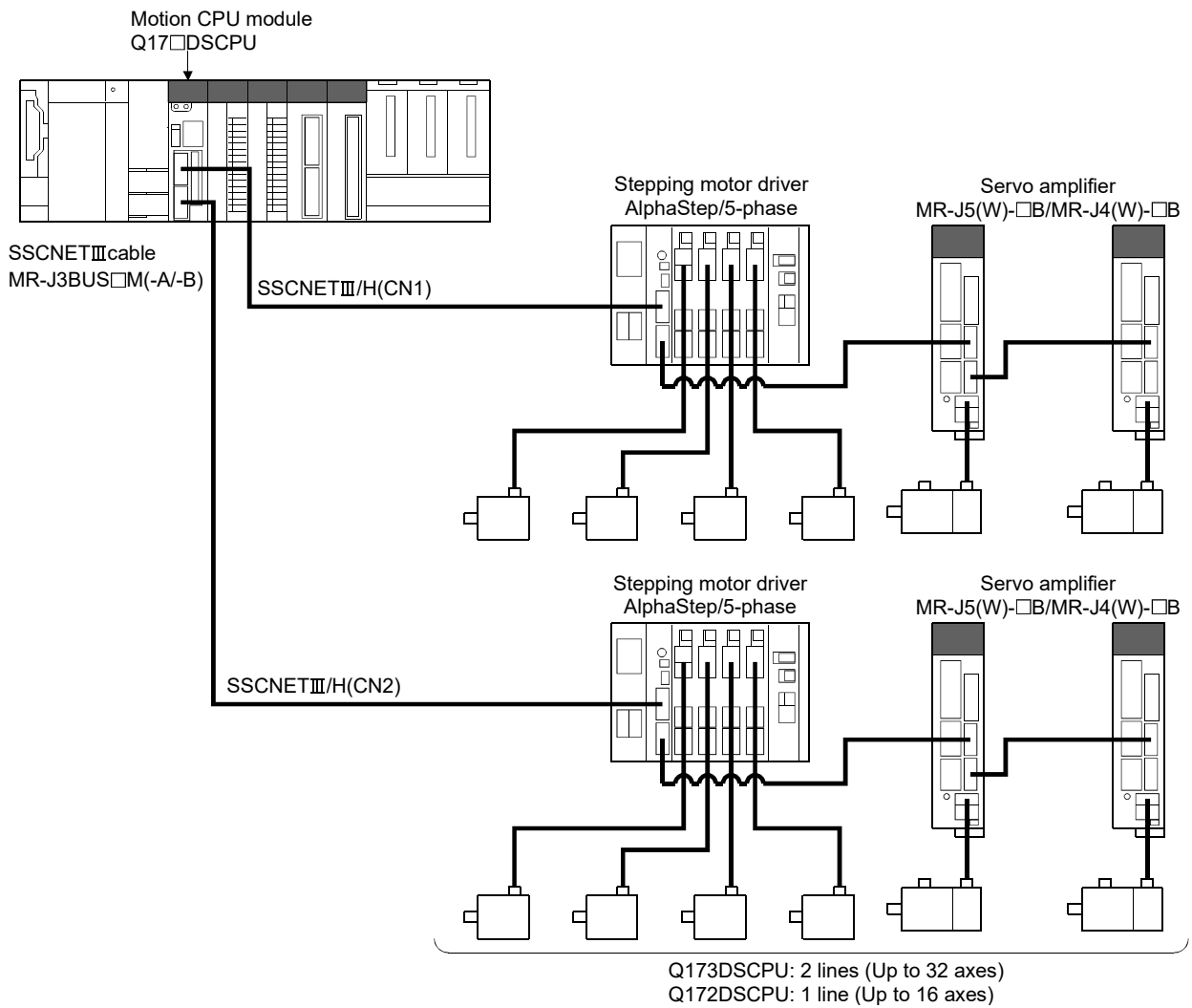

Ver.! : Refer to Section 1.3 for the software version that supports this function.

(2) Parameter setting

To connect AlphaStep/5-phase, set the following in the system setting of MT Developer2.

- Set "SSCNET III/H" for communication type in SSCNET setting.
- Set the amplifier model in amplifier setting to "αSTEP/5-Phase (ORIENTAL MOTOR)".

(3) Control of AlphaStep/5-phase parameters

Parameters set in AlphaStep/5-phase are not controlled by Motion CPU.

They are set directly using AlphaStep/5-phase data editing software. For details on setting items for AlphaStep/5-phase, refer to the instruction manual of the AlphaStep/5-phase.

(4) Comparisons of specifications with MR-J5(W)-□B/MR-J4(W)-□B

Item	AlphaStep/5-phase (Note-1)	MR-J5(W)-□B	MR-J4(W)-□B
Amplifier type	αSTEP/5-Phase (ORIENTAL MOTOR)	MR-J5(W)-B(-RJ)	MR-J4(W)-B(-RJ)
Control of servo amplifier parameters	Controlled by AlphaStep/5-phase	Controlled by Motion CPU	
External input signal	External input signals of AlphaStep/5-phase, and bit devices are available.	External input signals of servo amplifier, and bit devices are available.	
Optional data monitor (Data type)	<ul style="list-style-type: none"> • Position F/B • Encoder position within 1 revolution • Encoder Multi-revolution counter • Cumulative current value • External encoder counter value 	<ul style="list-style-type: none"> • Effective load ratio • Regenerative load ratio • Peak load ratio • Position F/B • Encoder position within 1 revolution • Encoder Multi-revolution counter • Load inertia moment ratio • Model loop gain • Bus voltage • Cumulative current value • Servo motor speed • Selected droop pulse • Unit power consumption • Unit total power consumption • Instantaneous torque • Load side encoder information1 • Load side encoder information2 • Z-phase counter • Servo motor thermistor temperature • Torque equivalent to disturbance • Overload alarm margin • Excessive error alarm margin • Settling time • Overshoot amount • Servo motor/Load side position deviation • Servo motor/Load side speed deviation • Internal temperature of encoder 	
Absolute position detection system	Usable	Usable	
Unlimited length feed	Usable	Usable	

APPENDICES

Item	AlphaStep/5-phase (Note-1)	MR-J5(W)-□B	MR-J4(W)-□B
Home position return method	Count method (2), Data set method (1), Driver home position return method	Proximity dog method (1, 2), Count method (1 to 3), Data set method (1, 2), Dog cradle method, Stopper method (1, 2), Limit switch combined method, Scale home position signal detection method, Dogless home position signal reference method	
Speed-torque control	Position control mode	Position control mode, Speed control mode, Torque control mode, Continuous operation to torque control mode	
Gain changing command	Invalid	Valid	
PI-PID switching command	Invalid	Valid	
Control loop changing command	Invalid	Valid	
Amplifier-less operation function	Unusable	Usable	
Servo parameter read/change	Usable	Usable	
Driver communication	Unusable	Usable (Note-2)	
Servo error (Motion error history)	Error codes detected by AlphaStep/5-phase are stored	Error codes detected by servo amplifier are stored.	
Programming tool	MR Configurator2 is not available. Use AlphaStep/5-phase editing software.	MR Configurator2 is available.	

(Note-1): Confirm the specifications of AlphaStep/5-phase for details.

(Note-2): Refer to the "Servo Amplifier Instruction Manual" for the servo amplifiers that can be used.

(5) Precautions during control

(a) Absolute position system (ABS)/Incremental system (INC).

Set the ABS/INC settings with the AlphaStep/5-phase

1) Incremental system (INC)

When the Multiple CPU system power supply is turned OFF and turned ON again, the home position request turns ON, and the feed current value from the AlphaStep/5-phase is displayed.

2) Absolute position system (ABS)

a) "3: Servo command value" and "4: Feedback value" for [Pr.300]

Servo input axis type cannot be used. If they are used the current value of the servo input axis may not be correctly restored therefore use "1: Feed current value" and "2: Actual current value".

b) When control units are degree axis and the stroke limit is valid, the following positioning controls may not operate correctly when they are started, therefore do not use them.

Operating system software version	Positioning control
"00L" or later	<ul style="list-style-type: none"> Absolute specification instructions in speed-switching control (VSTART instruction)
"00K" or later	<ul style="list-style-type: none"> Instructions for pass point absolute specifications in constant-speed control (CPSTART instruction) (linear interpolation, circular interpolation, helical interpolation) Position follow-up control (PFSTART instruction) Absolute specification instructions in speed-switching control (VSTART instruction)

(b) Home position return

1) Home position return operation types

The home position return methods that can be used in AlphaStep/5-phase are shown below.

Home position return method		Possible/Not possible
Proximity dog method	Proximity dog method 1	× (Note-1)
	Proximity dog method 2	× (Note-1)
Count method	Count method 1	× (Note-1)
	Count method 2	○
	Count method 3	× (Note-1)
Data set method	Data set method 1	○
	Data set method 2	× (Note-1)
Dog cradle method		× (Note-1)
Stopper method	Stopper method 1	× (Note-1)
	Stopper method 2	× (Note-1)
Limit switch combined method		× (Note-1)
Scale home position signal detection method		× (Note-1)
Dogless home position signal reference method		× (Note-1)
Driver home position return method		○

○: Possible, ×: Not possible

(Note-1): Minor error (error code: 194) occurs, and home position return is not performed.

- 2) Servo external signals when using driver home position return method
At driver home position return method home position return, check the status of the servo external signals. Also check that external signals are OFF when external signal parameters are not set. For contacts (normally open contact/normally closed contact), match each setting of the AlphaStep/5-phase with the servo external signal parameters of MT Developer2.
Refer to AlphaStep/5-phase instruction manual for details.
- (c) Control mode
Control modes that can be used are shown below.
 - Position control mode (position control, and speed control including position loop)
However, speed-torque control (speed control not including position loop, torque control, continuous operation to torque control) cannot be used. If a control mode switch is performed, a minor error (error code: 159) occurs.
- (d) Servo OFF
The following occurs for 5-phase (open loop control configuration).
 - 1) When servo OFF occurs, if the motor is moved by an external force it is not possible to detect the position and position information is not updated. Do not rotate the motors during servo OFF. If the motors are rotated a position displacement occurs.
 - 2) In a servo OFF state the home position return request turns ON. After turning servo ON, perform a home position return again.
 - 3) When an encoder is installed, checking position displacement and maladjustments is possible by monitoring "position F/B" and "external encoder counter value" in the optional data monitor. Refer to the instruction manual of AlphaStep/5-phase for the units and increase direction of the encoder count value, and checking methods.
- (e) Servo instructions
Speed control (**II**) (VVF instruction, VVR instruction) cannot be used. If the VVF instruction or VVR instruction are started, a minor error (error code: 136) occurs.
- (f) Servo parameter
 - 1) Control of servo parameters
Parameters of AlphaStep/5-phase are not controlled by Motion CPU. Therefore, even though the parameter of AlphaStep/5-phase is changed during the communication between Motion CPU and AlphaStep/5-phase, it does not process, and is not reflected to the parameter.
 - 2) Servo parameter change function
 - a) Change function of servo parameter can be executed.
 - b) When the power of AlphaStep/5-phase is turned OFF, the parameter changed by the servo parameter change function becomes invalid, and the value written by AlphaStep/5-phase data editing software becomes valid.

c) "Servo parameter write/read" device

Store the value in the following special registers to change or display the servo parameter.

No.	Name	Meaning	Details	Set by
SD552	Servo parameter write/read request	Servo parameter read value	• The read value of servo parameter which executed "2: 1 word read request" in "servo parameter write/read request (SD804)" is stored.	System (At read request)
SD804 (Note-1)		Servo parameter write/read request flag	• The "write/read request" is executed after setting of the axis No. and servo parameter No. 1: 1 word write request 2: 1 word read request • "0" is automatically set by Motion CPU after completion of servo parameter write/read request. ("1" is stored by Motion CPU at write/read error.)	User/ System
SD805		Axis No.	• The axis No. to write/read servo parameter is stored. Q173DSCPU: 1 to 32 Q172DSCPU: 1 to 16	User
SD806		Servo parameter No.	• The servo parameter No. to be written/read is stored in hexadecimal. H <input type="text"/> <input type="text"/> <input type="text"/> <input type="text"/> Parameter ID (Note) (Note): Refer to the AlphaStep/5-phase instruction manual for details.	
SD807		Servo parameter setting value	• The setting value of servo parameter to be written is stored when "1: 1 word write request" is set in "servo parameter write/read request (SD804)".	

(Note-1): Do not execute the automatic refresh.

(g) Optional data monitor setting

The following table shows data types that can be set.

Set the data so that the total number of communication points per axis is no more than 6 points.



Data type	Unit	Number of words	Number of communication data points
Position F/B	[pulse]	2	0
Encoder position within 1 revolution	[pulse]	2	0
Encoder Multi-revolution counter	[rev]	1	0
Cumulative current value	[Position command] (Note-1)	2	0
External encoder counter value	[pulse]	2	2

(Note-1): The position command is the command unit set in the fixed parameter.

(h) Gain changing command, PI-PID switching command, control loop changing command

Gain changing command, PI-PID switching command, and control loop changing command becomes invalid.

- (i) Amplifier-less operation
Amplifier-less operation cannot be used for axes connected to AlphaStep/5-phase. When amplifier-less operation is executed, the axis changes to a disconnected state, and servo ready does not turn ON.
 - (j) Driver communication
The driver communication is not supported. If the driver communication is set in a servo parameter, a major error (error code: 1363) will occur when the power of Multiple CPU system is turned ON.
 - (k) Monitor devices (#8000 to #8639)
 - 1) Servo amplifier type (#8000+20n)
This register stores the servo amplifier types below when using AlphaStep/5-phase.
 - 8233 5-phase stepping motor driver
(ORIENTAL MOTOR Co., Ltd. make)
 - 8234 Stepping motor driver AlphaStep (AZ series)
(ORIENTAL MOTOR Co., Ltd. make)
 - 2) Motor current value (#8001+20n) is always "0".
 - (l) Torque limit
The torque limit value set by the Motion CPU is ignored. Set the torque limit value with the parameter on the AlphaStep/5-phase side.
 - (m) In-position range
When the position of the cam axis is restored during virtual mode switching or in advanced synchronous control, a check is performed by the servo parameter "In-position range (PA10)". However, because the servo parameter settings are not performed in AlphaStep/5-phase, the "In-position range" is checked as 100[pulse].
 - (n) Operation cycle
The operation cycle of 0.22[ms] cannot be used.
Furthermore, even if the operation cycle is set to 0.22[ms] in the setting for axes 1 to 4 for 1 line, if the servo amplifier is mixed with the AlphaStep/5-phase, the servo amplifier operates with an operation cycle of 0.44[ms].
- (6) AlphaStep/5-phase detection error
When an error occurs on AlphaStep/5-phase, the servo error detection signal (M2408+20n) turns ON. Also, when an error occurs during home position return by driver home position return method, "Driver operation alarm (b9)" of servo status7 (#8018+20n) turns ON. Eliminate the error cause, reset the servo amplifier error by turning ON servo error reset command (M3208+20n) and perform re-start.
However, "0" is always stored in parameter error No. (#8009+20n).
Refer to the instruction manual of AlphaStep/5-phase for details of the errors.

APPENDIX 6.6 IAI electric actuator controller manufactured by IAI Corporation  

The IAI Corporation made IAI electric actuator controller can be connected via SSCNET III/H.

Contact your nearest IAI sales office for details of IAI electric actuator controller.

POINT

IAI electric actuator controller cannot be used on a line where the communication type in SSCNET setting of MT Developer2 is set to "SSCNET III".

: Refer to Section 1.3 for the software version that supports this function.

(1) System configuration

The system configuration using IAI electric actuator controller is shown below.

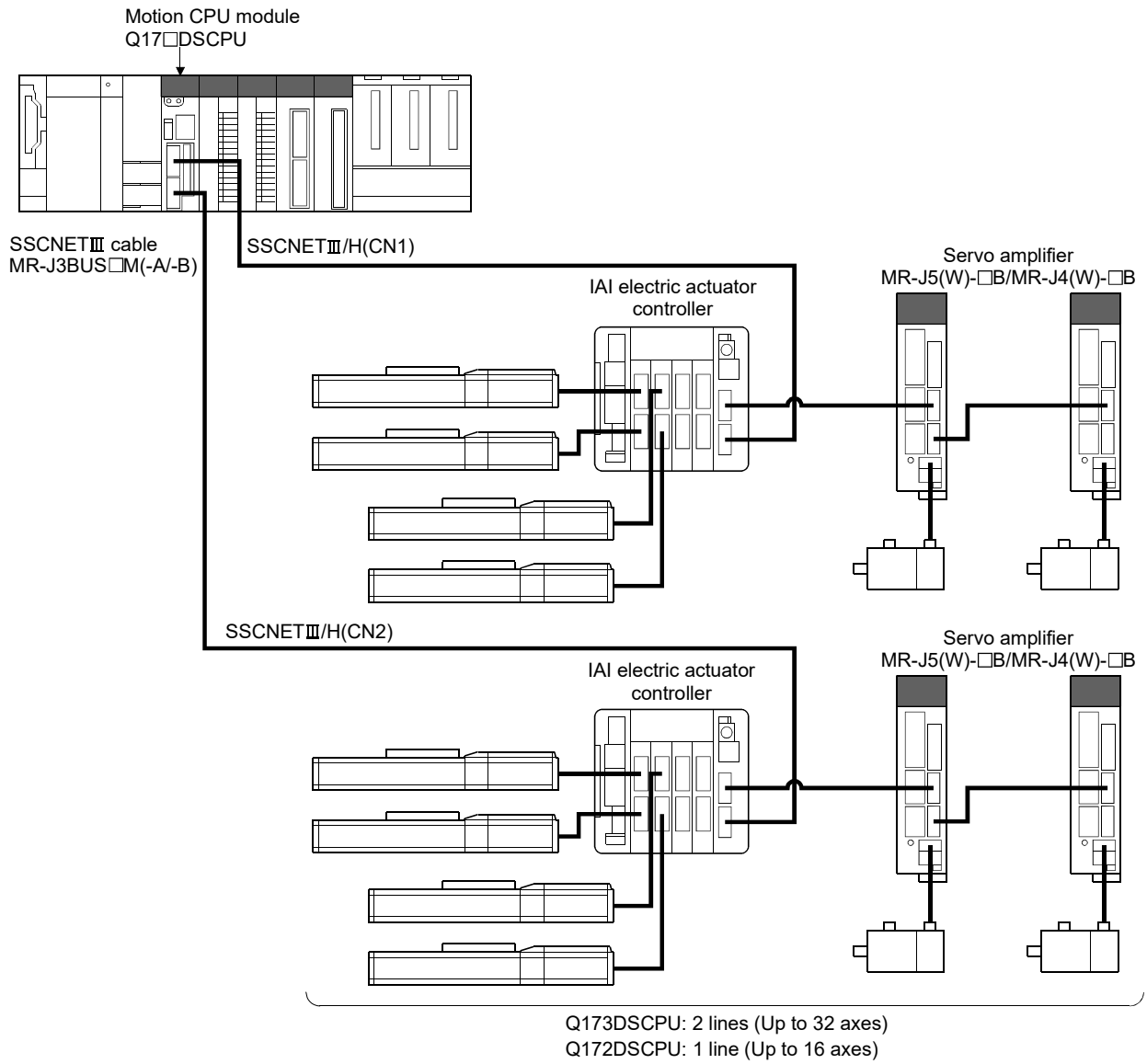

POINT
The IAI electric actuator controller can only be set on even-numbered axes.

(2) Parameter setting

To connect IAI electric actuator controller, set the following in the system setting of MT Developer2.

- Set "SSCNETⅢ/H" for communication type in SSCNET setting.
- Set the amplifier model in amplifier setting to "IAI Driver for Electric Actuator (IAI)".

(3) Control of IAI electric actuator controller parameters

Parameters set in IAI electric actuator controller are not controlled by Motion CPU. They are set directly using IAI electric actuator controller data editing software. For details on setting items for IAI electric actuator controller, refer to the instruction manual of the IAI electric actuator controller.

(4) Comparisons of specifications with MR-J5(W)-□B/MR-J4(W)-□B

Item	IAI electric actuator controller (Note-1)	MR-J5(W)-□B	MR-J4(W)-□B
Amplifier type	IAI Driver for Electric Actuator (IAI)	MR-J5(W)-B(-RJ)	MR-J4(W)-B(-RJ)
Control of servo amplifier parameters	Controlled by IAI electric actuator controller	Controlled by Motion CPU	
External input signal	Bit devices are available.	External input signals of servo amplifier, and bit devices are available.	
Optional data monitor (Data type)	<ul style="list-style-type: none"> • Position F/B • Cumulative current value 	<ul style="list-style-type: none"> • Effective load ratio • Regenerative load ratio • Peak load ratio • Position F/B • Encoder position within 1 revolution • Encoder Multi-revolution counter • Load inertia moment ratio • Model loop gain • Bus voltage • Cumulative current value • Servo motor speed • Selected droop pulse • Unit power consumption • Unit total power consumption • Instantaneous torque • Load side encoder information1 • Load side encoder information2 • Z-phase counter • Servo motor thermistor temperature • Torque equivalent to disturbance • Overload alarm margin • Excessive error alarm margin • Settling time • Overshoot amount • Servo motor/Load side position deviation • Servo motor/Load side speed deviation • Internal temperature of encoder 	
Absolute position detection system	Unusable	Usable	
Unlimited length feed	Unusable	Usable	
Home position return method	Driver home position return method	Proximity dog method (1, 2), Count method (1 to 3), Data set method (1, 2), Dog cradle method, Stopper method (1, 2), Limit switch combined method, Scale home position signal detection method, Dogless home position signal reference method	
Speed-torque control	Position control mode	Position control mode, Speed control mode, Torque control mode, Continuous operation to torque control mode	
Gain changing command	Invalid	Valid	
PI-PID switching command	Invalid	Valid	

APPENDICES

Item	IAI electric actuator controller (Note-1)	MR-J5(W)-□B	MR-J4(W)-□B
Control loop changing command	Invalid	Valid	
Amplifier-less operation function	Unusable	Usable	
Servo parameter read/change	Usable	Usable	
Driver communication	Unusable	Usable (Note-2)	
Servo error (Motion error history)	Error codes detected by IAI electric actuator controller are stored	Error codes detected by servo amplifier are stored.	
Programming tool	MR Configurator2 is not available. Use IAI electric actuator controller editing software.	MR Configurator2 is available.	

(Note-1): Confirm the specifications of IAI electric actuator controller for details.

(Note-2): Refer to the "Servo Amplifier Instruction Manual" for the servo amplifiers that can be used.

(5) Precautions during control

(a) Absolute position system (ABS)/Incremental system (INC).

The IAI electric actuator controller is not compatible with the absolute position system. When the Multiple system power supply is turned OFF and ON again, home position return request turns ON, and the feed current value taken from the IAI electric actuator controller is displayed.

(b) Home position return

1) Home position return operation types

The home position return methods that can be used in IAI electric actuator controller are shown below.

Home position return method		Possible/Not possible
Proximity dog method	Proximity dog method 1	× (Note-1)
	Proximity dog method 2	× (Note-1)
Count method	Count method 1	× (Note-1)
	Count method 2	× (Note-1)
	Count method 3	× (Note-1)
Data set method	Data set method 1	× (Note-1)
	Data set method 2	× (Note-1)
Dog cradle method		× (Note-1)
Stopper method	Stopper method 1	× (Note-1)
	Stopper method 2	× (Note-1)
Limit switch combined method		× (Note-1)
Scale home position signal detection method		× (Note-1)
Dogless home position signal reference method		× (Note-1)
Driver home position return method		○

○: Possible, ×: Not possible

(Note-1): Minor error (error code: 194) occurs, and home position return is not performed.

2) Servo external signals when using driver home position return method
 At driver home position return method home position return, check the status of the servo external signals. Also check that external signals are OFF when external signal parameters are not set. For contacts (normally open contact/normally closed contact), match each setting of the IAI electric actuator controller with the servo external signal parameters of MT Developer2.
 Refer to IAI electric actuator controller instruction manual for details.

(c) Control mode

Control modes that can be used are shown below.

- Position control mode (position control, and speed control including position loop)

However, speed-torque control (speed control not including position loop, torque control, continuous operation to torque control) cannot be used. If a control mode switch is performed, a minor error (error code: 159) occurs.

(d) Servo OFF

When the motor is moved by an external force during servo OFF, position information is updated.

(e) Servo instructions

Speed control (II) (VVF instruction, VVR instruction) cannot be used.

If the VVF instruction or VVR instruction are started, a minor error (error code: 136) occurs.

(f) Servo parameter

1) Control of servo parameters

Parameters of IAI electric actuator controller are not controlled by Motion CPU.

Therefore, even though the parameter of IAI electric actuator controller is changed during the communication between Motion CPU and IAI electric actuator controller, it does not process, and is not reflected to the parameter.

2) Servo parameter change function

a) Change function of servo parameter can be executed.

The operation for the servo parameter change function is shown below.

	Operation for the servo parameter change function
Servo parameter write request	The servo parameter of IAI electric actuator controller is controlled in a unit of 2 words, so that it is necessary to set "3: 2 words write request" in servo parameter write/read request (SD804) for executing the parameter write. If "1: 1 word write request" is executed to IAI electric actuator controller, the parameter write fails, and "-1" is stored in servo parameter write/read request (SD804).
Servo parameter read request	The servo parameter of IAI electric actuator controller is controlled in a unit of 2 words, so that it is necessary to set "4: 2 words read request" in servo parameter write/read request (SD804) for executing the parameter read. If "2: 1 word read request" is executed to IAI electric actuator controller, the parameter read fails, and "-1" is stored in servo parameter write/read request (SD804).

- b) The parameter changed by the servo parameter change function can be saved by writing to the Motion CPU. The changed parameter becomes valid by turning ON the power supply of the IAI electric actuator controller again.
- c) "Servo parameter write/read" device
Store the value in the following special registers to change or display the servo parameter.

No.	Name	Meaning	Details	Set by
SD552	Servo parameter write/read request	Servo parameter read value	• The read value (low 1 word) of servo parameter which executed "4: 2 word read request" in SD804 is stored.	System (At read request)
SD553			• The read value (high 1 word) of servo parameter which executed "4: 2 word read request" in SD804 is stored.	
SD804 (Note-1)		Servo parameter write/read request flag	<ul style="list-style-type: none"> • The "write/read request" is executed after setting of the axis No. and servo parameter No. 3: 2 word write request 4: 2 word read request • "0" is automatically set by Motion CPU after completion of servo parameter write/read request. ("1" is stored by Motion CPU at write/read error.) 	User/ System
SD805		Axis No.	• The axis No. to write/read servo parameter is stored. Q173DSCPU: 1 to 32 Q172DSCPU: 1 to 16	User
SD806		Servo parameter No.	<ul style="list-style-type: none"> • The servo parameter No. to be written/read is stored in hexadecimal. H <input type="checkbox"/> <input type="checkbox"/> <input type="checkbox"/> <input type="checkbox"/> <input type="checkbox"/> └─ Parameter No. ID (Note) (Note): Refer to IAI electric actuator controller instruction manual for details. 	
SD808		Servo parameter setting value	• The setting value of servo parameter to be written is stored when "3: 2 word write request" is set in SD804.	
SD809	(2 word)			

(Note-1): Do not execute the automatic refresh.

(g) Optional data monitor setting

The following table shows data types that can be set.

Set the data so that the total number of communication points per axis is no more than 6 points.

Data type	Unit	Number of words	Number of communication data points
Position F/B	[pulse]	2	0
Cumulative current value	[Position command] (Note-1)	2	0

(Note-1): The position command is the command unit set in the fixed parameter.

(h) Gain changing command, PI-PID switching command, control loop changing command

Gain changing command, PI-PID switching command, and control loop changing command becomes invalid.

(i) Amplifier-less operation

Amplifier-less operation cannot be used for axes connected to IAI electric actuator controller. When amplifier-less operation is executed, the axis changes to a disconnected state, and servo ready does not turn ON.

(j) Driver communication

The driver communication is not supported. If the driver communication is set in a servo parameter, a major error (error code: 1363) will occur when the power of Multiple CPU system is turned ON.

(k) Monitor devices (#8000 to #8639)

1) Servo amplifier type (#8000+20n)

This register stores the servo amplifier types below when using IAI electric actuator controller.

- 8193 IAI electric actuator controller
(IAI Corporation make)

2) Motor current value (#8001+20n) is always "0".

(l) Torque limit

The torque limit value set by the Motion CPU is ignored. Set the torque limit value with the parameter on the IAI electric actuator controller side.

(m) In-position range

When the position of the cam axis is restored during virtual mode switching or in advanced synchronous control, a check is performed by the servo parameter "In-position range (PA10)". However, because the servo parameter settings are not performed in IAI electric actuator controller, the "In-position range" is checked as 100[pulse].

(n) Operation cycle

For each operation cycle, the following number of axes per controller can be set. When the number of axes is more than what can be set, and an operation cycle other than those below is set, a major error (error code: 1350) occurs.

Operation cycle	Number of axes per controller available
0.22ms or longer	1 to 2 axes
0.44ms or longer	3 to 4 axes
0.88ms or longer	5 axes or more

(6) IAI electric actuator controller detection error

When an error occurs on IAI electric actuator controller, the servo error detection signal (M2408+20n) turns ON. Also, when an error occurs during home position return by driver home position return method, "Driver operation alarm (b9)" of servo status7 (#8018+20n) turns ON. Eliminate the error cause, reset the servo amplifier error by turning ON servo error reset command (M3208+20n) and perform re-start.

However, "0" is always stored in parameter error No. (#8009+20n).

Refer to the instruction manual of IAI electric actuator controller for details of the errors.

WARRANTY

Please confirm the following product warranty details before using this product.

1. Gratis Warranty Term and Gratis Warranty Range

We will repair any failure or defect hereinafter referred to as "failure" in our FA equipment hereinafter referred to as the "Product" arisen during warranty period at no charge due to causes for which we are responsible through the distributor from which you purchased the Product or our service provider. However, we will charge the actual cost of dispatching our engineer for an on-site repair work on request by customer in Japan or overseas countries. We are not responsible for any on-site readjustment and/or trial run that may be required after a defective unit is repaired or replaced.

[Gratis Warranty Term]

The term of warranty for Product is thirty six (36) months after your purchase or delivery of the Product to a place designated by you or forty two (42) months from the date of manufacture whichever comes first "Warranty Period". Warranty period for repaired Product cannot exceed beyond the original warranty period before any repair work.

[Gratis Warranty Range]

- (1) You are requested to conduct an initial failure diagnosis by yourself, as a general rule.
It can also be carried out by us or our service company upon your request and the actual cost will be charged. However, it will not be charged if we are responsible for the cause of the failure.
- (2) This limited warranty applies only when the condition, method, environment, etc. of use are in compliance with the terms and conditions and instructions that are set forth in the instruction manual and user manual for the Product and the caution label affixed to the Product.
- (3) Even during the term of warranty, the repair cost will be charged on you in the following cases;
 - 1) A failure caused by your improper storing or handling, carelessness or negligence, etc., and a failure caused by your hardware or software problem
 - 2) A failure caused by any alteration, etc. to the Product made on your side without our approval
 - 3) A failure which may be regarded as avoidable, if your equipment in which the Product is incorporated is equipped with a safety device required by applicable laws and has any function or structure considered to be indispensable according to a common sense in the industry
 - 4) A failure which may be regarded as avoidable if consumable parts designated in the instruction manual, etc. are duly maintained and replaced
 - 5) Any replacement of consumable parts (battery, fan, etc.)
 - 6) A failure caused by external factors such as inevitable accidents, including without limitation fire and abnormal fluctuation of voltage, and acts of God, including without limitation earthquake, lightning and natural disasters
 - 7) A failure generated by an unforeseeable cause with a scientific technology that was not available at the time of the shipment of the Product from our company
 - 8) Any other failures which we are not responsible for or which you acknowledge we are not responsible for

2. Onerous Repair Term after Discontinuation of Production

- (1) We may accept the repair at charge for another seven (7) years after the production of the product is discontinued.
The announcement of the stop of production for each model can be seen in our Sales and Service, etc.
- (2) Please note that the Product (including its spare parts) cannot be ordered after its stop of production.

3. Service in overseas countries

Our regional FA Center in overseas countries will accept the repair work of the Product; However, the terms and conditions of the repair work may differ depending on each FA Center. Please ask your local FA center for details.

4. Exclusion of Loss in Opportunity and Secondary Loss from Warranty Liability

Regardless of the gratis warranty term, Mitsubishi shall not be liable for compensation to:

- (1) Damages caused by any cause found not to be the responsibility of Mitsubishi.
- (2) Loss in opportunity, lost profits incurred to the user by Failures of Mitsubishi products.
- (3) Special damages and secondary damages whether foreseeable or not, compensation for accidents, and compensation for damages to products other than Mitsubishi products.
- (4) Replacement by the user, maintenance of on-site equipment, start-up test run and other tasks.

5. Change of Product specifications

Specifications listed in our catalogs, manuals or technical documents may be changed without notice.

6. Precautions for Choosing the Products

- (1) For the use of our Motion controller, its applications should be those that may not result in a serious damage even if any failure or malfunction occurs in Motion controller, and a backup or fail-safe function should operate on an external system to Motion controller when any failure or malfunction occurs.
- (2) Our Motion controller is designed and manufactured as a general purpose product for use at general industries. Therefore, applications substantially influential on the public interest for such as atomic power plants and other power plants of electric power companies, and also which require a special quality assurance system, including applications for railway companies and government or public offices are not recommended, and we assume no responsibility for any failure caused by these applications when used.
In addition, applications which may be substantially influential to human lives or properties for such as airlines, medical treatments, railway service, incineration and fuel systems, man-operated material handling equipment, entertainment machines, safety machines, etc. are not recommended, and we assume no responsibility for any failure caused by these applications when used.
We will review the acceptability of the abovementioned applications, if you agree not to require a specific quality for a specific application. Please contact us for consultation.
- (3) Mitsubishi shall have no responsibility or liability for any problems involving programmable controller trouble and system trouble caused by DoS attacks, unauthorized access, computer viruses, and other cyberattacks.

Microsoft, Windows, Windows NT, Windows Vista, and Windows XP are either registered trademarks or trademarks of Microsoft Corporation in the United States and/or other countries.

The company names, system names and product names mentioned in this manual are either registered trademarks or trademarks of their respective companies.

In some cases, trademark symbols such as '™' or '®' are not specified in this manual.

IB(NA)-0300136-L(2204)MEE

MODEL: Q173D-P-SV13/22REALE

MODEL CODE: 1XB930

MITSUBISHI ELECTRIC CORPORATION

HEAD OFFICE : TOKYO BUILDING, 2-7-3 MARUNOUCHI, CHIYODA-KU, TOKYO 100-8310, JAPAN
NAGOYA WORKS : 1-14, YADA-MINAMI 5-CHOME, HIGASHI-KU, NAGOYA, JAPAN

When exported from Japan, this manual does not require application to the
Ministry of Economy, Trade and Industry for service transaction permission.

Specifications subject to change without notice.