

MITSUBISHI

Analog Input/Output Module Type A1S66ADA

User's Manual

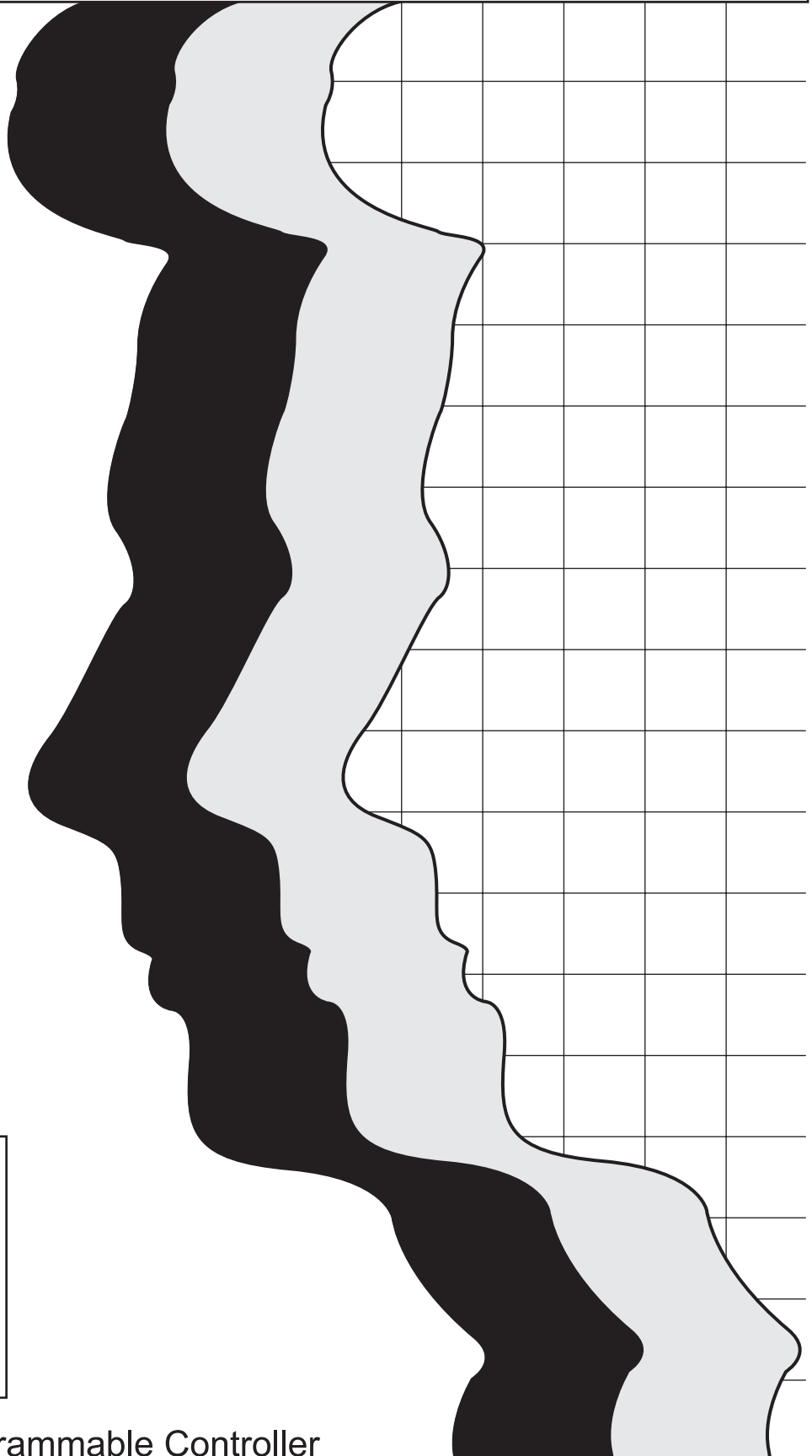

Mitsubishi Programmable Controller

• SAFETY PRECAUTIONS •

(Read these precautions before using this product.)

Before using this product, please read this manual and the relevant manuals carefully and pay full attention to safety to handle the product correctly.

The instructions given in this manual are concerned with this product. For the safety instructions of the programmable controller system, please read the CPU module user's manual.

In this manual, the safety precautions are classified into two levels: "⚠ WARNING" and "⚠ CAUTION".

 **WARNING**

Indicates that incorrect handling may cause hazardous conditions, resulting in death or severe injury.

 **CAUTION**

Indicates that incorrect handling may cause hazardous conditions, resulting in minor or moderate injury or property damage.

Under some circumstances, failure to observe the precautions given under "⚠ CAUTION" may lead to serious consequences.

Observe the precautions of both levels because they are important for personal and system safety.

Make sure that the end users read this manual and then keep the manual in a safe place for future reference.

[DESIGN PRECAUTIONS]

WARNING

- In case of the external power supply failure or the programmable controller failure, set up a safety circuit outside the programmable controller so that the entire system can operate safely. The mis-output and malfunction may cause an accident.

CAUTION

- Use the programmable controller in an environment that meets the general specifications contained in this manual. Using this programmable controller in an environment outside the range of the general specifications could result in electric shock, fires, malfunctions, and damage to or deterioration of the product.
- Do not bunch the control wires with the main circuit or power wires, or install them close to each other. They should be installed 100 mm (3.94 inch) or more from each other. Failure to do so may result in noise that would cause malfunctions.
- At power ON/OFF, voltage or current may instantaneously be output from the output terminal of this module.
In such case, wait until the analog output becomes stable to start controlling the external device.

[INSTALLATION PRECAUTIONS]

CAUTION

- Insert the tabs at the bottom of the module into the mounting holes in the base unit. If the module is not properly installed, it may result in malfunctions, failure, or fallout.
- Do not directly touch the module's conductive parts. Doing so could cause malfunctions or failure in the module.

[WIRING PRECAUTIONS]

CAUTION

- Ground the AG and FG terminals to the protected grounding conductor when there are a lot of noise. Failure to ground these terminals may cause malfunctions.
- When wiring programmable controller, check the rated voltage and terminal layout of the wiring, and make sure the wiring is done correctly. Connecting a power supply that differs from the rated voltage or wiring it incorrectly may cause fires or failure.
- Tighten the terminal screws within the range of specified torque.
If the terminal screws are loose, it may result in short circuits or malfunctions.
Tightening the screws too far may cause damage to the screw, resulting in short circuits, or malfunctions.
- Be sure there are no foreign substances such as sawdust or wiring debris inside the module.
Such debris could cause fires, failure, malfunctions.

[STARTING AND MAINTENANCE PRECAUTIONS]

CAUTION

- Do not touch the connector while the power is on. Doing so could cause malfunctions.
- Be sure to shut off all phases of the external power supply used by the system before cleaning or retightening the terminal screws. If you do not switch off the external power supply, it will cause failure or malfunctions of the module.
- Do not disassemble or modify the modules. Doing so could cause failure, malfunctions, injury, or fires.
- Be sure to shut off all phases of the external power supply used by the system before mounting or dismounting the module. If you do not switch off the external power supply, it will cause failure or malfunctions of the module.
- Do not install/remove the terminal block more than 50 times after the first use of the product. (IEC 61131-2 compliant)
- Before handling the module, always touch grounded metal, etc. to discharge static electricity from the human body.
Failure to do so can cause the module to fail or malfunction.

[OPERATING PRECAUTIONS]

CAUTION

- Do not output (turn ON) the "usage disable" signal as an output signal to special modules from the programmable controller CPU.
Outputting the "usage disable" signal may cause programmable controller system malfunctions.

[DISPOSAL PRECAUTIONS]

CAUTION

- When disposing of this product, treat it as industrial waste.

• CONDITIONS OF USE FOR THE PRODUCT •

- (1) Mitsubishi programmable controller ("the PRODUCT") shall be used in conditions;
- i) where any problem, fault or failure occurring in the PRODUCT, if any, shall not lead to any major or serious accident; and
 - ii) where the backup and fail-safe function are systematically or automatically provided outside of the PRODUCT for the case of any problem, fault or failure occurring in the PRODUCT.

- (2) The PRODUCT has been designed and manufactured for the purpose of being used in general industries.

MITSUBISHI SHALL HAVE NO RESPONSIBILITY OR LIABILITY (INCLUDING, BUT NOT LIMITED TO ANY AND ALL RESPONSIBILITY OR LIABILITY BASED ON CONTRACT, WARRANTY, TORT, PRODUCT LIABILITY) FOR ANY INJURY OR DEATH TO PERSONS OR LOSS OR DAMAGE TO PROPERTY CAUSED BY the PRODUCT THAT ARE OPERATED OR USED IN APPLICATION NOT INTENDED OR EXCLUDED BY INSTRUCTIONS, PRECAUTIONS, OR WARNING CONTAINED IN MITSUBISHI'S USER, INSTRUCTION AND/OR SAFETY MANUALS, TECHNICAL BULLETINS AND GUIDELINES FOR the PRODUCT.

("Prohibited Application")

Prohibited Applications include, but not limited to, the use of the PRODUCT in;

- Nuclear Power Plants and any other power plants operated by Power companies, and/or any other cases in which the public could be affected if any problem or fault occurs in the PRODUCT.
- Railway companies or Public service purposes, and/or any other cases in which establishment of a special quality assurance system is required by the Purchaser or End User.
- Aircraft or Aerospace, Medical applications, Train equipment, transport equipment such as Elevator and Escalator, Incineration and Fuel devices, Vehicles, Manned transportation, Equipment for Recreation and Amusement, and Safety devices, handling of Nuclear or Hazardous Materials or Chemicals, Mining and Drilling, and/or other applications where there is a significant risk of injury to the public or property.

Notwithstanding the above, restrictions Mitsubishi may in its sole discretion, authorize use of the PRODUCT in one or more of the Prohibited Applications, provided that the usage of the PRODUCT is limited only for the specific applications agreed to by Mitsubishi and provided further that no special quality assurance or fail-safe, redundant or other safety features which exceed the general specifications of the PRODUCTS are required. For details, please contact the Mitsubishi representative in your region.

REVISIONS

* The manual number is given on the bottom left of the back cover.

Print Date	* Manual Number	Revision
Jan., 1998	IB(NA)-66819-A	First printing
Feb., 1998	IB(NA)-66819-B	Correction Section 4.4
Apr., 2001	IB(NA)-66819-C	Addition WARRANTY Correction SAFETY PRECAUTIONS, Chapter2, Section3.1, 3.2, 3.3.3, 3.4.3, 4.2, 4.5.2, 5.3
Mar., 2003	IB(NA)-66819-D	Correction SAFETY PRECAUTIONS, Section3.1, 3.2, 5.3, Appendix1
July, 2003	IB(NA)-66819-E	Correction Section5.3 Addition Appendix3
Oct., 2004	IB(NA)-66819-F	Correction SAFETY PRECAUTIONS, Section 4.5.2
June, 2005	IB(NA)-66819-G	Addition Conformation to the EMC Directive and Low Voltage Instruction Correction SAFETY PRECAUTIONS, Chapter 5
Sep., 2006	IB(NA)-66819-H	Correction SAFETY PRECAUTIONS
Jul., 2007	IB(NA)-66819-I	Correction Section4.4, Section4.5.2, Appendix2
Mar., 2010	IB(NA)-66819-J	Addition CONDITIONS OF USE FOR THE PRODUCT Correction SAFETY PRECAUTIONS, Chapter2, Section3.1, 3.2, Warranty, "PLC" was changed to "programmable controller".
Jun., 2012	IB(NA)-66819-K	Correction COMPLIANCE WITH EMC AND LOW VOLTAGE DIRECTIVES

Japanese Manual Version SH-3642-K

This manual confers no industrial property rights or any rights of any other kind, nor does it confer any patent licenses. Mitsubishi Electric Corporation cannot be held responsible for any problems involving industrial property rights which may occur as a result of using the contents noted in this manual.

© 1998 MITSUBISHI ELECTRIC CORPORATION

INTRODUCTION

Thank you for purchasing the Mitsubishi Graphic Operation Terminal.
Before using the equipment, please read this manual carefully to develop full familiarity with the functions and performance of the graphic operation terminal you have purchased, so as to ensure correct use.
Please forward a copy of this manual to the end user.

CONTENTS

SAFETY PRECAUTIONS.....	A - 1
CONDITIONS OF USE FOR THE PRODUCT	A - 4
REVISIONS	A - 5
INTRODUCTION.....	A - 6
COMPLIANCE WITH EMC AND LOW VOLTAGE DIRECTIVES	A - 8
1 OVERVIEW	1 - 1 to 1 - 3
1.1 Features	1 - 2
1.2 Comparison with A1S63ADA.....	1 - 3
2 SYSTEM CONFIGURATION	2 - 1
3 SPECIFICATION	3 - 1 to 3 - 13
3.1 General Specification.....	3 - 1
3.2 Performance Specifications	3 - 2
3.3 D/A Conversion I/O Characteristics.....	3 - 4
3.3.1 Voltage output characteristic.....	3 - 5
3.3.2 Current output characteristic.....	3 - 6
3.3.3 Overall accuracy.....	3 - 7
3.4 A/D Conversion I/O Characteristic	3 - 8
3.4.1 Voltage input characteristic.....	3 - 9
3.4.2 Current input characteristic	3 - 10
3.4.3 Overall accuracy.....	3 - 11
3.5 I/O Signals Against the programmable controller CPU	3 - 12
3.5.1 List of I/O signals	3 - 12
3.5.2 I/O signal functions.....	3 - 13
4 PROCEDURES AND SETTINGS BEFORE OPERATION	4 - 1 to 4 - 12
4.1 Procedures before Operation	4 - 1
4.2 Handling Precautions	4 - 2
4.3 Installation and Removal of the Shield Cover	4 - 3
4.4 Part Identification and Settings	4 - 4
4.5 Wiring.....	4 - 7
4.5.1 Precautions when wiring	4 - 7
4.5.2 Wiring between the A1S66ADA and the external devices	4 - 8

4.6 Fine Adjustment of the Offset /Gain Values.....	4 - 10
4.6.1 Fine adjustment methods of the offset/gain values	4 - 10
4.7 Maintenance and Inspection.....	4 - 12

5 PROGRAMMING	5 - 1 to 5 - 4
----------------------	-----------------------

5.1 Program Creation Procedures.....	5 - 1
5.1.1 Outputting digital values as voltage/current (D/A conversion).....	5 - 1
5.1.2 Receiving voltage/current as digital values (A/D conversion)	5 - 1
5.2 Basic Read and Write Programs	5 - 2
5.3 Program Example	5 - 3

6 TROUBLESHOOTING	6 - 1
--------------------------	--------------

APPENDICES	APPX - 1 to APPX - 5
-------------------	-----------------------------

Appendix 1 Comparison with the Conventional Analog I/O Module (A1S63ADA).....	APPX - 1
Appendix 2 External Dimensions.....	APPX - 3
Appendix 3 Precautions For Reading A Digital Output Value (For Hardware Version "C" or Earlier)	
.....	APPX - 4

COMPLIANCE WITH EMC AND LOW VOLTAGE DIRECTIVES

(1) Method of ensuring compliance

To ensure that Mitsubishi programmable controllers maintain EMC and Low Voltage Directives when incorporated into other machinery or equipment, certain measures may be necessary. Please refer to one of the following manuals.

- User's manual for the CPU module used
- User's manual (hardware) for the CPU module or base unit used

The CE mark on the side of the programmable controller indicates compliance with EMC and Low Voltage Directives.

(2) Additional measures

No additional measures are necessary for the compliance of this product with EMC and Low Voltage Directives.

1 OVERVIEW

This user's manual describes the handling, specifications and programming method of the A1S66ADA type Analog I/O Module (hereafter referred to as A1S66ADA), which is utilized in combination with the MELSEC-A series CPU module (hereafter referred to as programmable controller CPU). The A1S66ADA is a special module with a four-channel analog input and two-channel analog output. (Hereinafter, D/A conversion shall mean digital to analog conversion and A/D conversion shall mean analog to digital conversion.)

(1) D/A conversion

Digital values are converted to analog values such as voltage and current, and output externally.

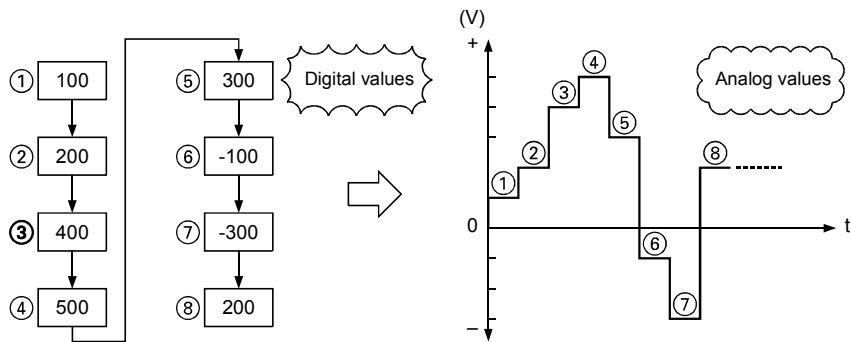

(2) A/D Conversion

Analog values such as voltage and current are converted to digital values so they can be imported into the programmable controller CPU.

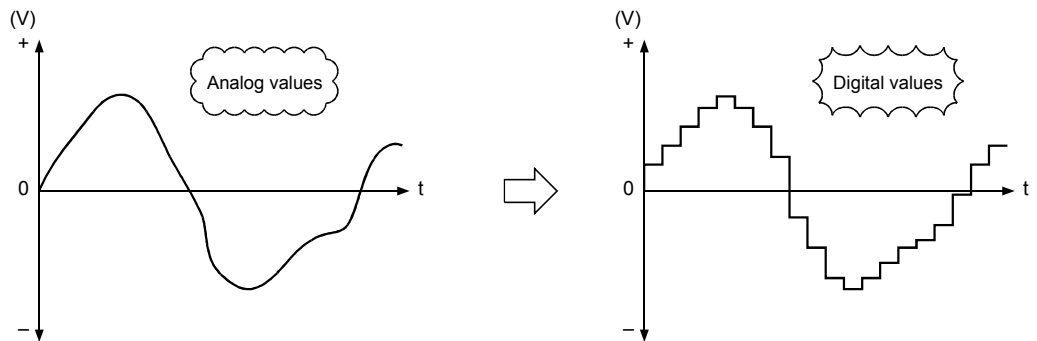

The voltage, current and digital values that the A1S66ADA may input or output are ranged as follows:

Voltage I/O range.....0 to 10 V, 1 to 5 V, -10 to 10 V, 0 to 20 mA (switched by range)

Current I/O range.....0 to 20 mA, 4 to 20 mA (switched by range)

Digital output value.....0 to 4095 (12 bit binary value)

Digital input value.....0 to 4000 (12 bit binary value)

1.1 Features

1

(1) High-speed D/A conversion and A/D conversion are possible.

The A1S66ADA can perform conversion at high speeds, as shown below:

240 μs/2 CH or below (for D/A conversion)

400 μs/4 CH or below (for A/D conversion)

(2) High-speed sequence scan is possible

Because the reading and writing of digital and analog values is performed using I/O signals (X/Y) instead of the buffer memory, which conventionally has been used, the A1S66DA can reduce the sequence scan time.

Buffer memory method

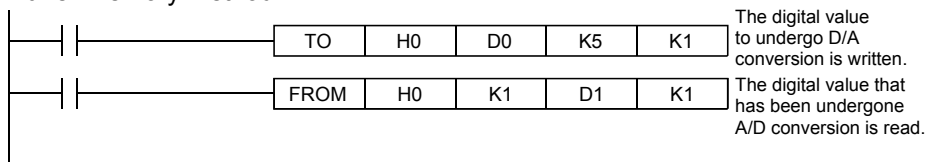

Item		Processing time	
		A2USHCPU	Q2ASHCPU
Command	TO	212.1 μs	162.0 μs
	FROM	183.5 μs	160.0 μs
Total		395.6 μs	322.0 μs

I/O signal (X/Y) format

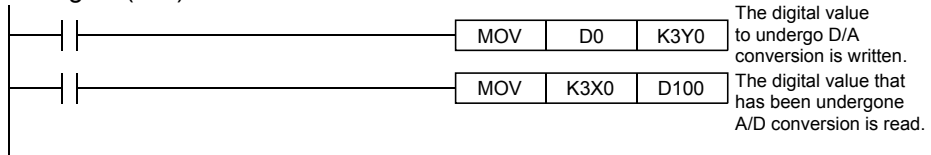

Item		Processing time	
		A2USHCPU	Q2ASHCPU
Command	MOV (D/A conversion)	0.55 μs	0.30 μs
	MOV (A/D conversion)	0.55 μs	0.30 μs
Total		1.10 μs	0.60 μs

(3) D/A conversion and A/D conversion may be performed with one module.

An A1S66ADA module can perform D/A conversion at two channels and A/D conversion at four channels.

1.2 Comparison with A1S63ADA

The following is a comparison with the conventional analog I/O module (A1S63ADA).

1. Number of channels

Type		A1S66ADA	A1S63ADA
Number of channels	Output	2 channels	1 channel
	Input	4 channels	2 channels

2. Maximum conversion speed

Type		A1S66ADA	A1S63ADA
Conversion speed	D/A conversion	240 μ s/2 channels or below (Resolution 1/4000)	1 μ s/CH (Resolution 1/4000) 2 μ s/CH (Resolution 1/8000)
	A/D conversion	400 μ s/4 channels or below (Resolution 1/4000)	3 μ s/CH (Resolution 1/12000)

3. D/A conversion

Type	A1S66ADA		A1S63ADA	
	Voltage output	Current output	Voltage output	Current output
Digital input	0 to 4000 (12 - bit binary value)		-4000 to 4000 (Resolution 1/4000) -8000 to 8000 (Resolution 1/8000) -12000 to 12000 (Resolution 1/12000)	0 to 4000 (Resolution 1/4000) 0 to 8000 (Resolution 1/8000) 0 to 12000 (Resolution 1/12000)
Analog output	Voltage: -10 to 10 V DC (External load resistance 2 k Ω to 1 M Ω) Current: 0 to 20 mA DC (External load resistance 0 Ω to 600 Ω)		Voltage: -10 to 0 to 10 V DC (External load resistance 2 k Ω to 1 M Ω) Current: -20 to 20 mA DC (External load resistance 0 Ω to 600 Ω)	

4. A/D conversion

Type	A1S66ADA	A1S63ADA
Analog input	Voltage: -10 to 0 to 10 V DC (Input resistance 1 M Ω) Current: 0 to 20 mA DC (Input resistance 250 Ω)	Voltage: -10 to 0 to 10 V DC (Input resistance 1 M Ω) Current: -20 to 20 mA DC (Input resistance 250 Ω)
Digital output	0 to 4095 (12 - bit binary value)	-4096 to 4095 (Resolution 1/4000) -8192 to 8191 (Resolution 1/8000) -12288 to 12287 (Resolution 1/12000)

5. Accuracy

Type	A1S66ADA	A1S63ADA
Accuracy	Within ± 1 %	

2 SYSTEM CONFIGURATION

(1) Applicable CPU

· A1SCPU(S1) · A1SJCPU(S3) · A2ASCPU(S1/S30) · A2SCPU(S1) · A52GCPU(T21B)
 · A1SJHCPU(S8) · A1SHCPU · A2SHCPU(S1) · A2USHCPU-S1
 · Q2ASCPU(S1) · Q2ASHCPU(S1) · A1SCPUC24-R2

(2) Number of modules loaded

As long as the number of I/O points for the applicable CPU is not exceeded, there is no limit in the number of modules used.

(3) Slots for loading

The module may be loaded into any of the base module slots, except the following:

If the module is loaded in a slot on an extension base module that is not equipped with a power supply module (A1S52B, A1S55B or A1S58B), the power capacity may be insufficient to cover all the modules.

When loading to an A1S66ADA extension base module without a power supply module, select a proper power supply module, basic base module, extension base module and extension cable by taking the following points into consideration:

- 1) Current capacity of the power supply module on the basic base module
- 2) Voltage drops of the basic base module
- 3) Voltage drops of the extension base module
- 4) Voltage drops in the extension cable

(4) Data link system

In a data link system, the module may be loaded to the master station, local station or remote I/O station. Refer to the MELSECNET or MELSECNET/B Data Link System Reference Manual for program examples for remote I/O stations.

Remark

Refer to the respective manual listed below for calculation methods for the range of I/O points and voltage drops. This shows the system configuration when using the graphics software to create monitor screens.

- A1S/A1SC24-R2/A2SCPU(S1) User's Manual.....IB(NA)-66320
- A2ASCPU(S1/S30) User's Manual.....IB(NA)-66455
- A2USHCPU-S1 User's Manual.....IB(NA)-66789
- A1SJH(S8)/A1SH/A2SHCPU(S1) User's Manual.....IB(NA)-66779
- Q2AS(H)CPU(S1) User's Manual.....SH(NA)-3599

3 SPECIFICATION

This section explains the A1S66ADA the general specifications, performance specifications and I/O signals.

3.1 General Specification

Refer to the user's manual of the programmable controller CPU for the general specifications.

3.2 Performance Specifications

The Table 3.1 describes the performance specifications of the A1S66ADA.

Table 3.1 Performance specification of the A1S66ADA

Item	Performance specifications								
D/A conversion	—	Voltage output				Current output			
	Digital input	0 to 4000 (12-bit binary value)							
	Analog output	-10 to 10 V DC (External load resistance : 2 kΩ to 1 MΩ)				0 to 20 mA DC (External load resistance : 0 Ω to 600 Ω)			
	I/O characteristics * 1	Digital input	Analog output				Digital input	Analog output	
			0 to 10 V range	0 to 5 V range	1 to 5 V range	-10 to 10 V range		0 to 20 mA range	4 to 20 mA range
		0	0 V	0 V	1 V	-10 V	0	0 mA	4 mA
		1000	2.5 V	1.25 V	2 V	-5 V	1000	5 mA	8 mA
		2000	5 V	2.5 V	3 V	0 V	2000	10 mA	12 mA
	3000	7.5 V	3.75 V	4 V	5 V	3000	15 mA	16 mA	
	4000	10 V	5 V	5 V	10 V	4000	20 mA	20 mA	
	Maximum resolution	2.5 mV	1.25 mV	1.0 mV	5.0 mV	5 μA	4 μA		
	Conversion speed * 2	240 μs/2 channels or less (Sampling : 80 μs/1 channel)							
Absolute maximum output	Voltage : ±12 V Current : +28 mA								
Output short protection	Present								
Analog output points	2 channels								
Offset/gain adjustment	Adjust the two channels simultaneously with the control knob on the front side of the module. The adjustment should be done on-line.								
D/A conversion	Analog input	Voltage : -10 to 0 to 10 V DC (Input resistance: 1 MΩ) Current: 0 to 20 mA DC (Input resistance: 250 Ω)							
	Digital output	0 to 4095 (12-bit binary value)							
	I/O characteristics * 3	Analog input (voltage)			Analog input (current)			Digital output	
		0 to 10 V range	0 to 5 V range	1 to 5 V range	-10 to 10 V range	0 to 20 mA range	4 to 20 mA range		
		0 V	0 V	1 V	-10 V	0 mA	4 mA	0	
		2.5 V	1.25 V	2 V	-5 V	5 mA	8 mA	1000	
		5 V	2.5 V	3 V	0 V	10 mA	12 mA	2000	
	7.5 V	3.75 V	4 V	5 V	15 mA	16 mA	3000		
	10 V	5 V	5 V	10 V	20 mA	20 mA	4000		
	Maximum resolution	2.5 mV	1.25 mV	1.0 mV	5.0 mV	5 μA	4 μA		
Conversion speed * 4	400 μs/4 channels or less (Sampling : 80 μs/1 channel)								
Absolute maximum input	Voltage : ±15 V Current : ±30 mA * 5								
Analog input points	4 channels								
Offset/gain adjustment	Adjust the four channels simultaneously with the control knob on the front side of the module. Check the digital output value on-line while making the adjustments.								

3

Table 3.1 Performance specification of the A1S66ADA (continued)

Item		Performance specifications	
Overall accuracy	D/A conversion (accuracy against the maximum value)	Voltage output	current output
		Within ±1% (±100 mV)	Within ±1% (±200 μA)
	A/D conversion (accuracy against the scale)	Within ±1% (±40)	
Insulation method		Between I/O terminals and programmable controller power supply.....Photocoupler isolation	Between each channel.....No isolation
Number of occupying I/O points		64 points (Input 64 points, output 64 points) *6	
Connecting terminal base		20-point terminal base (M3.5 × 7 screws)	
Applicable wire size		0.75 to 1.25 mm ²	
Applicable solderless terminal		R1.25 - 3 1.25 - YS3 2 - 3.5 2 - YS3A V1.25 - M3 V1.25 -YS3A V2 - S3 V2 - YS3A	
5 V DC internal current consumption		0.21 A	
External power supply	Voltage	21.6 to 26.4 V DC	
	Current consumption	0.16 A	
Weight		0.33 kg	

- *1 The analog output range is set commonly for CH1 to CH2.
- *2 The conversion speed refers to the speed between the times when a digital value is written to the A1S66ADA and when an analog output which corresponds to the aforementioned value begins to be outputted.
- *3 The analog input range is set commonly for CH3 to CH6.
- *4 The conversion speed refers to the speed while a change in an analog input is converted to a digital output. (Excluding the sequence scan)
- *5 Current value indicates value of instant input current that does not break module inner electrical resistance.
- *6 Inputs and outputs are assigned to the same number. Therefore, the I/O occupied points are 64.

POINT
When utilizing the peripheral device to assign the I/O numbers, set it as a 64-point output module.

3.3 D/A Conversion I/O Characteristics

The I/O characteristic of D/A conversion will be explained below.

(1) I/O conversion characteristic

The I/O conversion characteristic refers to the angle produced by a straight line connecting the "offset value" and "gain value" created when the digital values set by the programmable controller CPU are converted to analog values (voltage or current).

(2) Offset value and gain value

Offset value and gain value are defined as follows:

- (a) Offset value...The current value or voltage value that is output from the A1S66ADA when the digital value set by the programmable controller CPU is "0."
- (b) Gain value...The current value or voltage value that is output from the A1S66ADA when the digital value set by the programmable controller CPU is "4000."

(3) I/O conversion characteristic

Examples of A1S66ADA's I/O conversion characteristic are shown below.

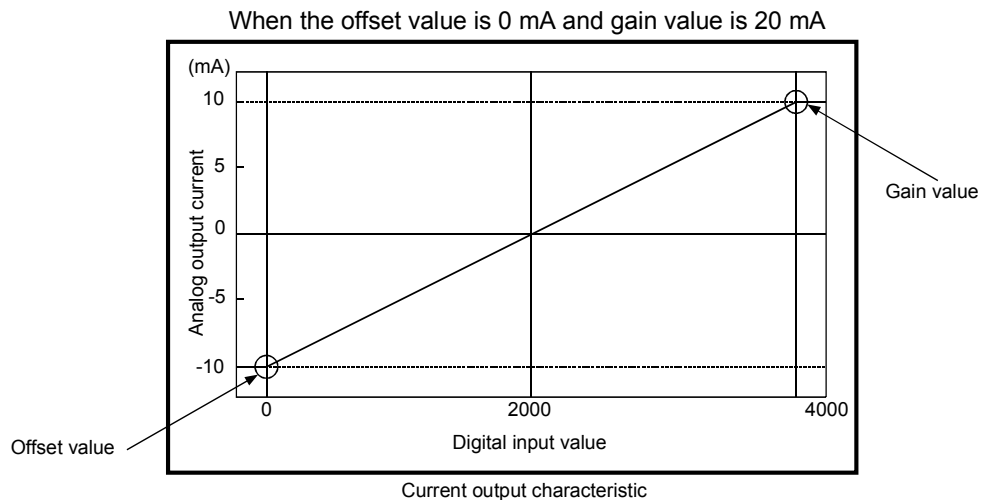
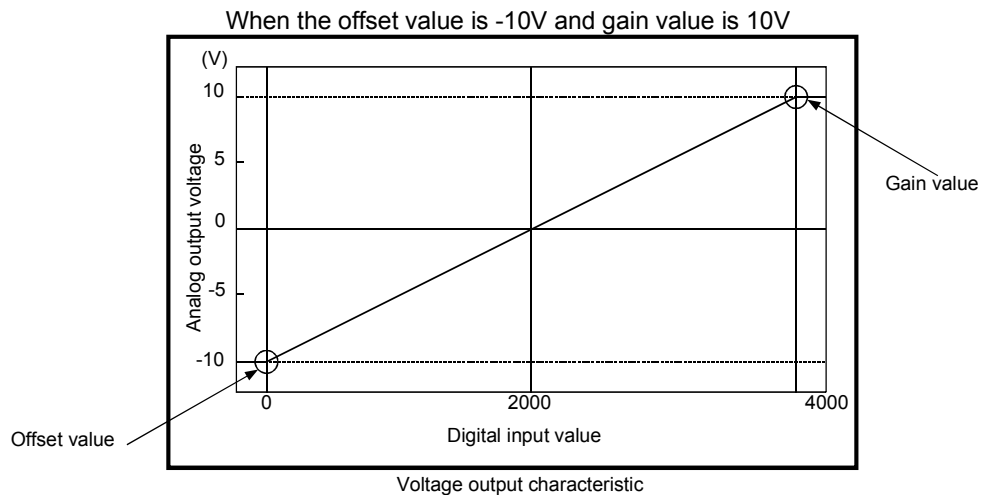

3.3.1 Voltage output characteristic

An example of voltage output characteristic graph when the offset and gain settings are changed is shown in Fig. 3.1.

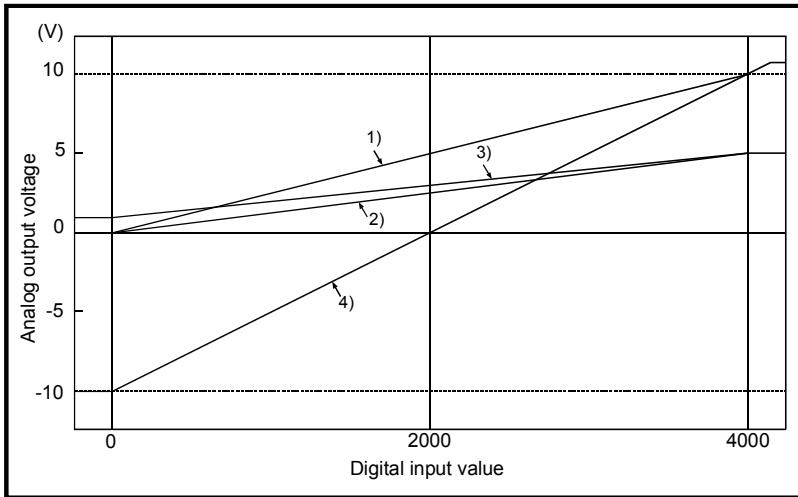

The I/O conversion characteristic when the off set value and gain value are set, as shown in the table below, is shown in the figure at left.

	Offset value	Gain value
1)	0 V	10 V
2)	0 V	5 V
3)	1 V	5 V
4)	-10 V	10 V

Fig. 3.1 Voltage output characteristic graph

[Example]

On the characteristic graphs 1) to 4), the analog output voltage will be as follows when the digital input value is set to 500 and 2000:

No.	Digital input value	Analog output value
1)	500	1.25 V
	2000	5 V
2)	500	0.625 V
	2000	2.5 V
3)	500	1.5 V
	2000	3 V
4)	500	-7.5 V
	2000	0 V

3.3.2 Current output characteristic

An example of current output characteristic graph when the offset and gain settings are changed is shown in Fig. 3.2.

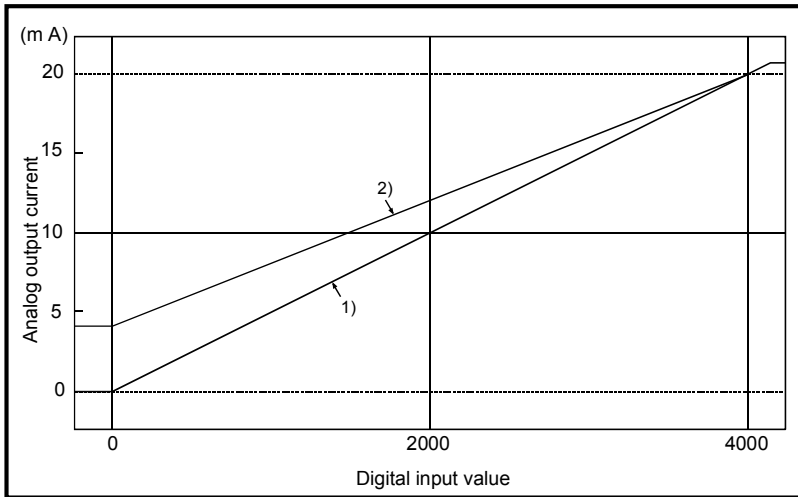

The I/O conversion characteristic when the off set value and gain value are set, as shown in the table below, is shown in the figure at left.

	Offset value	Gain value
1)	0 mA	20 mA
2)	4 mA	20 mA

Fig. 3.2 Current output characteristic graph

[Example]

On the characteristic graphs 1) to 2), the analog output voltage will be as follows when the digital input value is set to 1000 and 2000:

No.	Digital input value	Analog output value
1)	1000	5 mA
	2000	10 mA
2)	1000	8 mA
	2000	12 mA

3.3.3 Overall accuracy

Overall accuracy refers to the accuracy relative to the maximum analog output value. Even if the output characteristic is altered by changing the offset/gain settings, the overall accuracy does not change but is maintained within the performance range as outlined in the specifications.

The overall accuracy of voltage and current output characteristics are shown in Fig. 3.3 and 3.4.

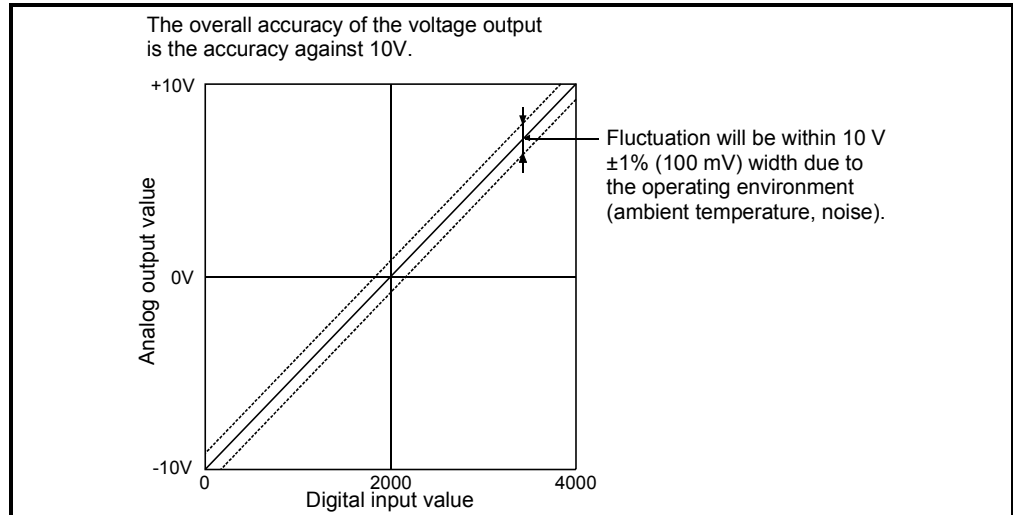

Fig. 3.3 Overall accuracy of voltage output characteristics

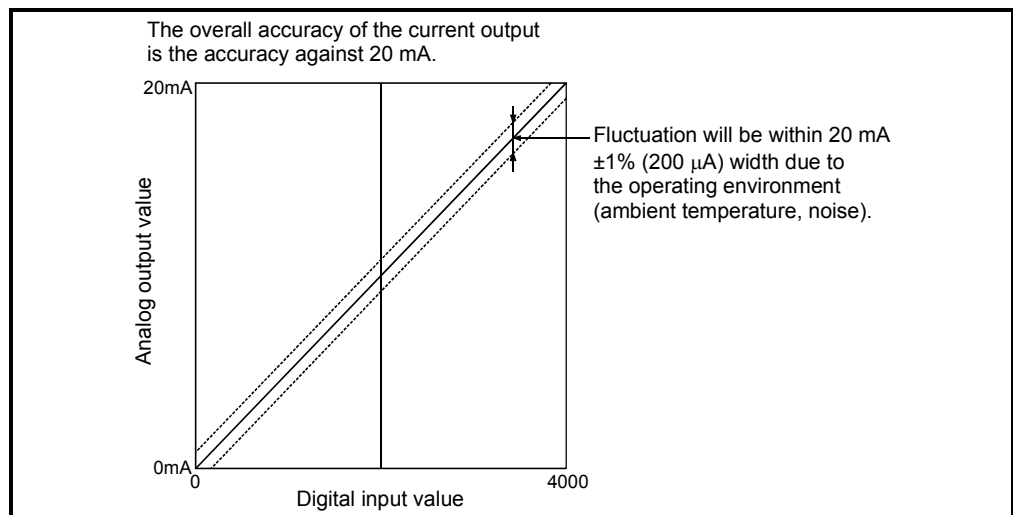

Fig. 3.4 Overall accuracy of current output characteristic

3.4 A/D Conversion I/O Characteristic

The I/O characteristic of A/D conversion will be explained below.

(1) I/O conversion characteristic

The I/O conversion characteristic refers to the angle produced when the "offset value" and "gain value" created when the analog values (voltage or current) from outside the programmable controller are converted to digital values are connected with a straight line.

The I/O conversion characteristic refers to the angle produced by a straight line that connects the "offset value" and "gain value" created when the digital values set by the programmable controller CPU are converted to analog values (voltage or current).

(2) Offset value and gain value

Offset value and gain value are defined as follows:

- (a) Offset value.....The analog value (voltage or current) that makes the digital output value "0."
- (b) Gain value.....The analog value (voltage or current) that makes the digital output value "4000."

(3) I/O conversion characteristic

Examples of A1S66ADA's I/O conversion characteristic are shown below.

When the offset value is -10 V and gain value is 10 V

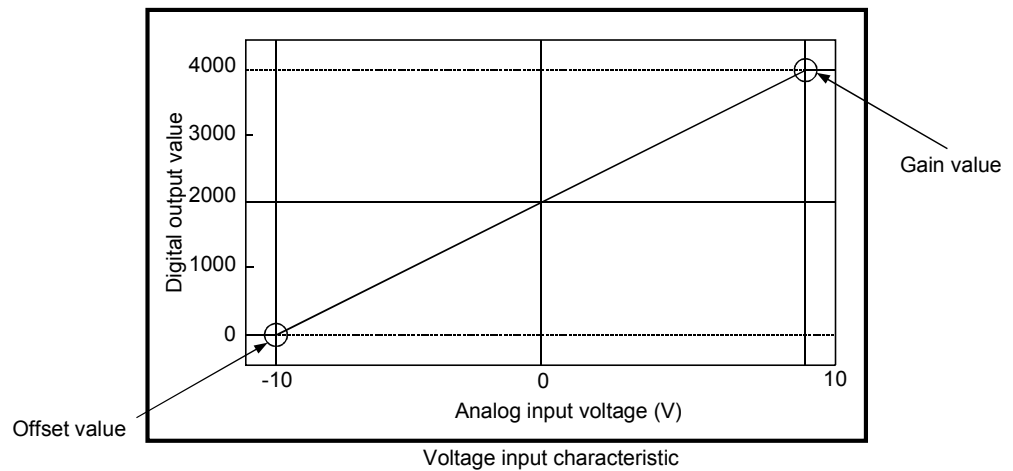

Voltage input characteristic

When the offset value is 0 mA and gain value is 20 mA

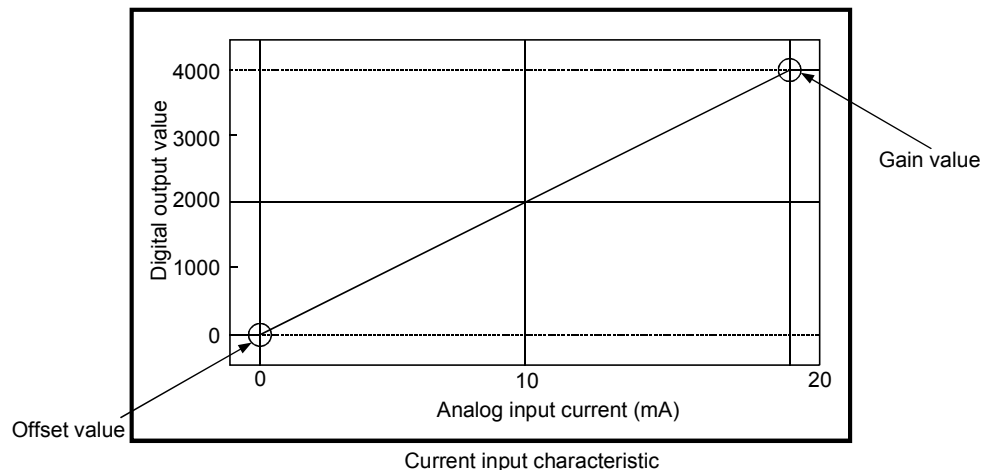

Current input characteristic

3.4.1 Voltage input characteristic

An example of voltage input characteristic graph when the offset/gain settings are changed is shown in Fig. 3.5.

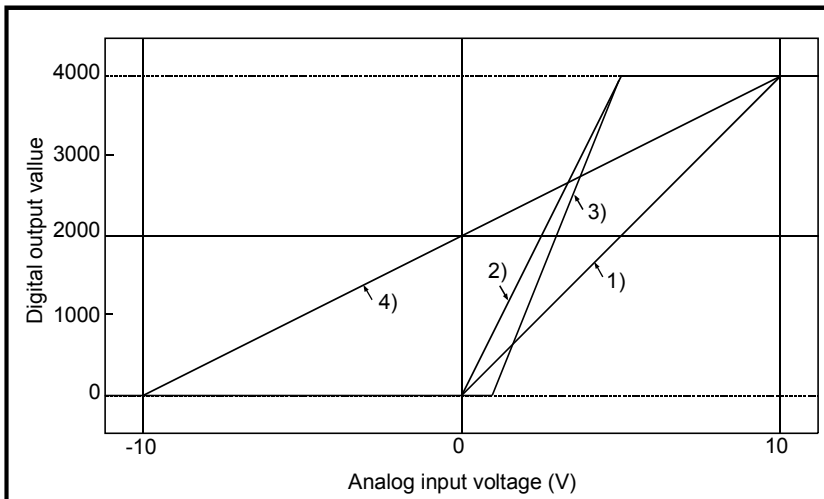

The voltage input characteristic when the offset value and gain value are set as shown in the table below, is shown in the figure.

	Offset value	Gain value
1)	0 V	10 V
2)	0 V	5 V
3)	1 V	5 V
4)	-10 V	10 V

Fig. 3.5 Voltage input characteristic graph

[Example]

On the characteristic graphs 1) to 4), the digital output voltage will be as follows when the analog input value is set to 1 V and 3 V:

No.	Analog input value	Digital output value
1)	1 V	400
	3 V	1200
2)	1 V	800
	3 V	2400
3)	1 V	0
	3 V	2000
4)	1 V	2200
	3 V	2600

POINT

- When a voltage that exceeds the range of -15 V to 15 V is input, the elements may be damaged.
- The overall accuracy is the accuracy outlined in the performance specifications when the input voltage is in the range of -10 to 10 V. If the input voltage is outside the range of -10 to 10 V, the accuracy may not be as indicated in the performance specifications.
- When a value which causes the digital output value to exceed the maximum (4095) or minimum (0) digital value is input, the digital output value will be fixed at the maximum (4095) or minimum (0) digital value.

3.4.2 Current input characteristic

An example of current input characteristic graph when the offset/gain settings are changed is shown in Fig. 3.6.

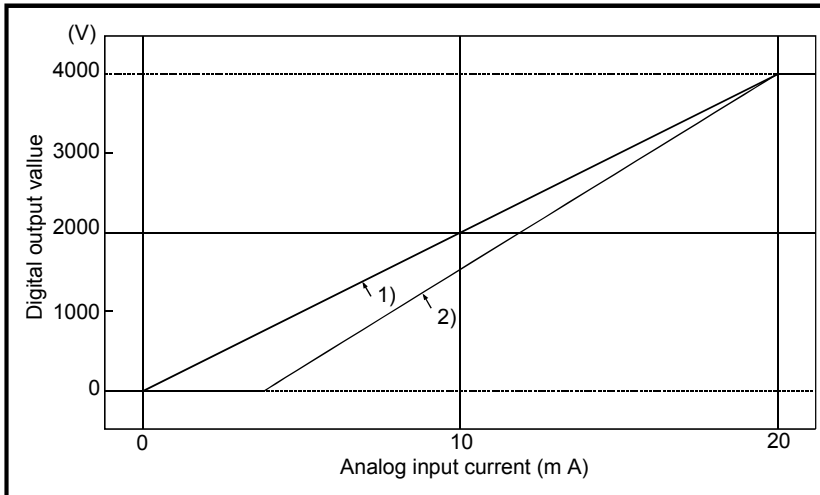

The current input characteristic when the offset value and gain value are set as shown in the table below is shown in the figure at left.

	Offset value	Gain value
1)	0 mA	20 mA
2)	4 mA	20 mA

Fig. 3.6 Current input characteristic graph

[Example]

On the characteristic graphs 1) to 2), the digital output current will be as follows when the analog input value is set to 5 mA and 12 mA:

No.	Analog input value	Digital output value
1)	5 mA	1000
	12 mA	2400
2)	8 mA	250
	12 mA	2000

POINT

- When a current exceeding the range of -30mA to 30mA is input, the elements may be damaged due to heating.
- The overall accuracy is the accuracy outlined in the performance specifications when the input current is in the range of 0 to 20mA. If the input current is outside the range of 0 to 20mA, the accuracy may not be as indicated in the performance specifications.
- When a value which causes the digital output value to exceed the maximum (4000) or minimum (0) digital value is input, the digital output value will be fixed at the maximum (4000) or minimum (0) digital value.

3.4.3 Overall accuracy

The overall accuracy refers to the accuracy relative to the maximum digital output value.

Even if the I/O characteristic is altered by changing the offset/gain settings, the overall accuracy does not change but is maintained within the performance range as outlined in the specification. The overall accuracy of voltage and current input characteristics are shown in Fig. 3.7 and 3.8.

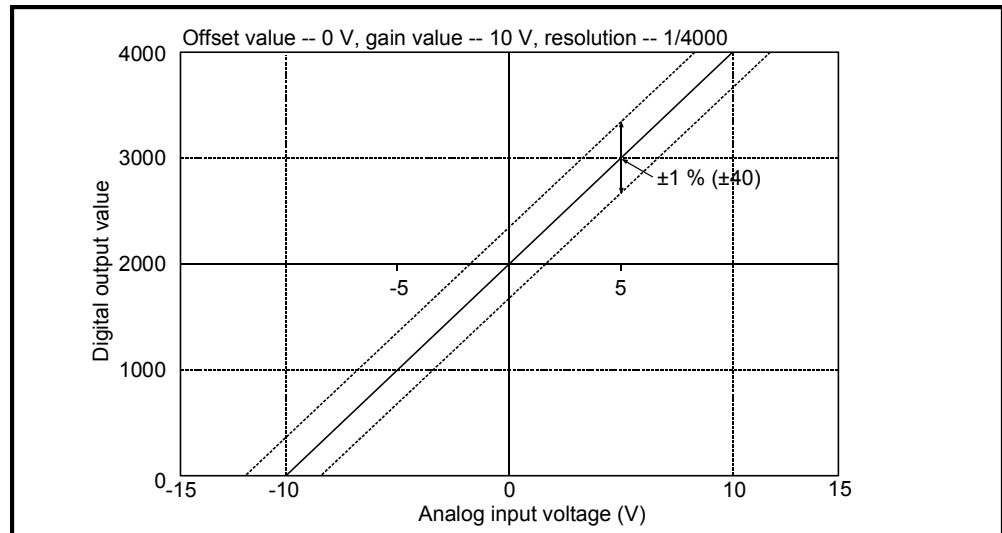

Fig. 3.7 Overall accuracy of voltage input characteristic

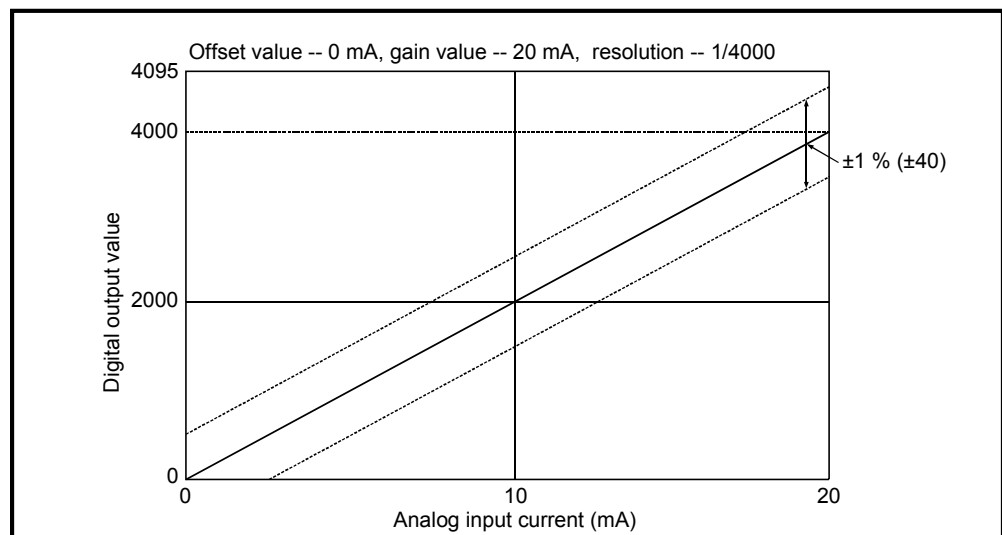

Fig. 3.8 Overall accuracy of current input characteristic

3.5 I/O Signals Against the programmable controller CPU

3.5.1 List of I/O signals

The A1S66ADA utilizes 64 input points and 64 output points for the communication with the programmable controller CPU.

The device numbers of the I/O signals and signal names are shown in Table 3.2. The device X indicates the input signal from the A1S66ADA to the programmable controller CPU, and the device Y the output signal from the programmable controller CPU to the A1S66ADA.

The I/O numbers indicated the occasion when the A1S66ADA is installed in the "slot 0" of the basic base.

Table 3.2 List of the A1S66ADA I/O signals

Signal Direction A1S66ADA → programmable controller CPU		Signal Direction programmable controller CPU → A1S66ADA	
Device No.	Signal Name	Device No.	Signal Name
X00 to X0B	CH3 digital output value	Y00 to Y0B	CH1 digital value setting
X0C to X0F	Usage disable	Y0C to Y0E	Usage disable
		Y0F	CH1 D/A conversion value output enable flag
X10 to X1B	CH4 digital output value	Y10 to Y1B	CH2 digital value setting
X1C to X1F	Usage disable	Y1C to Y1E	Usage disable
		Y1F	CH2 D/A conversion value output enable flag
X20 to X2B	CH5 digital output value	Y20 to Y3F	Usage disable
X2C to X2F	Usage disable		
X30 to X3B	CH6 digital output value		
X3C to X3F	Usage disable		

POINT

- Do not output (turn ON) the "usage disable" signal as an output signal to special modules from the programmable controller CPU. Outputting the "usage disable" signal may cause programmable controller system malfunctions.

3.5.2 I/O signal functions

I/O signal functions of the A1S66ADA are explained below.

(1) X00 to X0B, X10 to X1B, X20 to X2B, X30 to X3B: Digital output value

The A/D converted digital values in CH3 to CH6 are stored in Xn0 to XnB as binary data, as shown below:

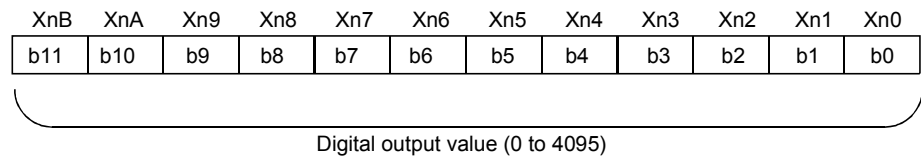

(Example) When the digital output value in CH3 is 2000 (H07D0)



(2) Y00 to Y0B, Y10 Y1B: Digital value setting

The digital values to be D/A converted in CH1 and CH2 are set in Yn0 to YnB as binary data, as shown below:

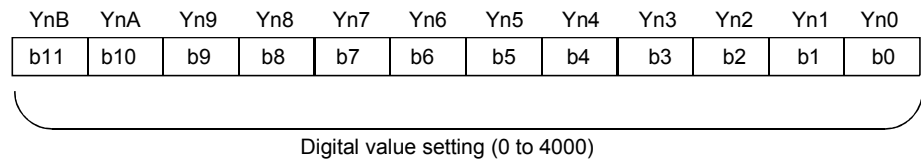

(Example) When the digital value in CH2 is set to 2500 (H09C4)

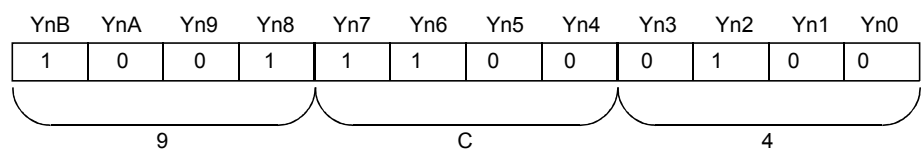

(3) Y0F, Y1F: CH1, CH2 D/A conversion value output enable flag

Outputting the D/A converted analog value to outside the module may be enabled or disabled.

ON.....Output enabled

The D/A converted analog value is output externally.

OFF.....Output disabled

The analog value 0 V/0 mA is output.

4 PROCEDURES AND SETTINGS BEFORE OPERATION

The procedures before operation, handling precautions, name and setting for each area, wiring, etc. will be explained below.

4.1 Procedures before Operation

The procedures before the operation of the module are shown in Fig. 4.1 below.

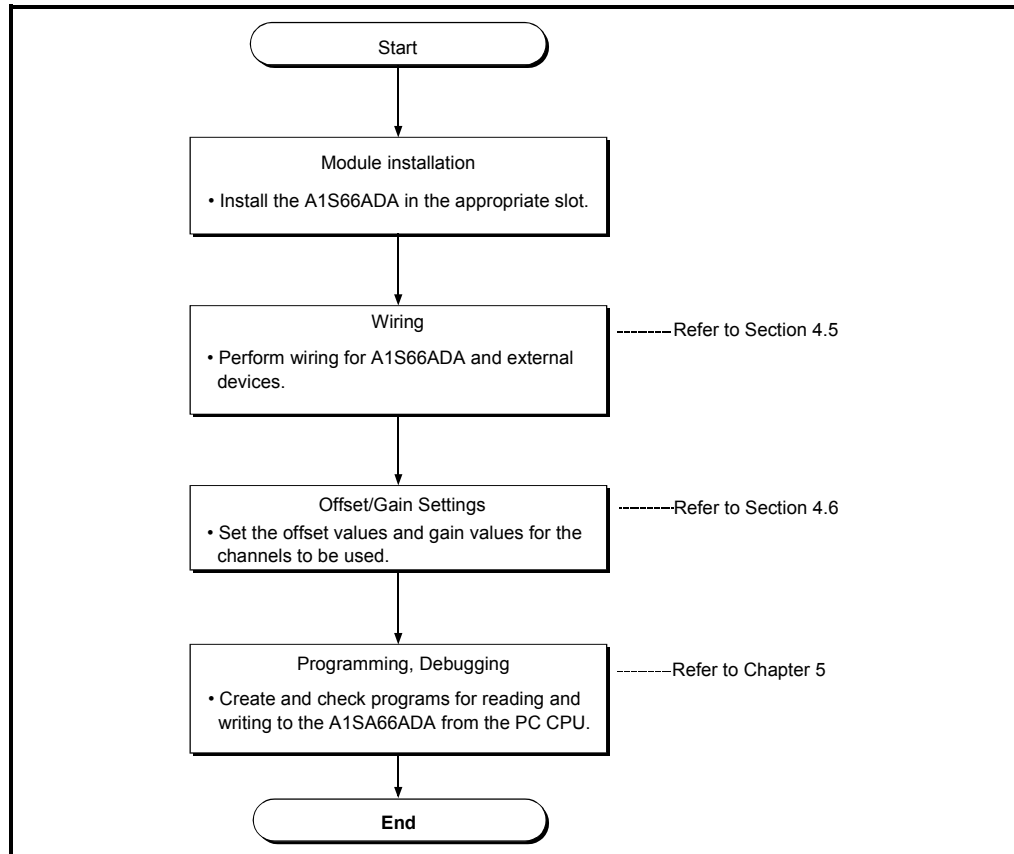

Fig. 4.1 Procedures before operation

4.2 Handling Precautions

- (1) Do not drop or put a great impact on the module case and the terminal block because they are made of resin.
- (2) Do not take the printed circuit board of the module out of the case. It may result in a failure.
- (3) Be careful not to let foreign matter such as filings or wire chips get inside the module while wiring. Remove all foreign matters if any get inside.
- (4) Tighten the module installation screws and terminal screws within the range as follows :

Screw Area	Tightening Torque Range
Module fixing screws (M4 screw)	78 to 118 N·cm
Terminal block terminal screws (M3.5 screw)	59 to 88 N·cm
Terminal block installation screws (M4 screw)	78 to 118 N·cm

- (5) When loading the module to the base unit, be sure to insert the module latch to the fixing hole, and secure the module using module mounting screw. When removing the module, be sure to remove the module mounting screw first, then remove the module latch from the fixing hole.

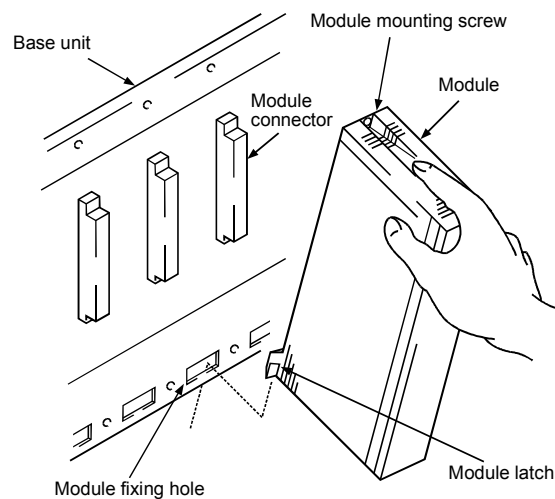

4.3 Installation and Removal of the Shield Cover

It is necessary to install the shield cover when using.
Procedures for installing and removing the shield cover are described below.

(1) Installation

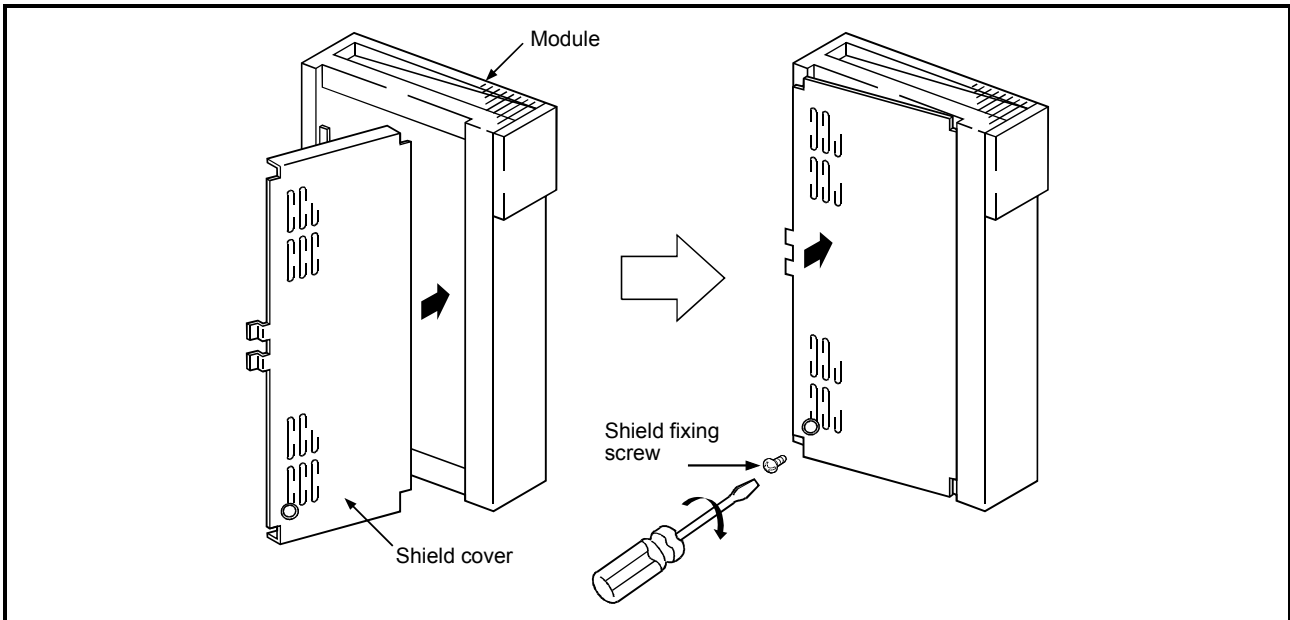

To install the shield cover to the module, install the cover to the terminal side first as shown in the figure, then it will be completed by pushing the cover to the module and tightening the shield fixing screw.

(2) Removal

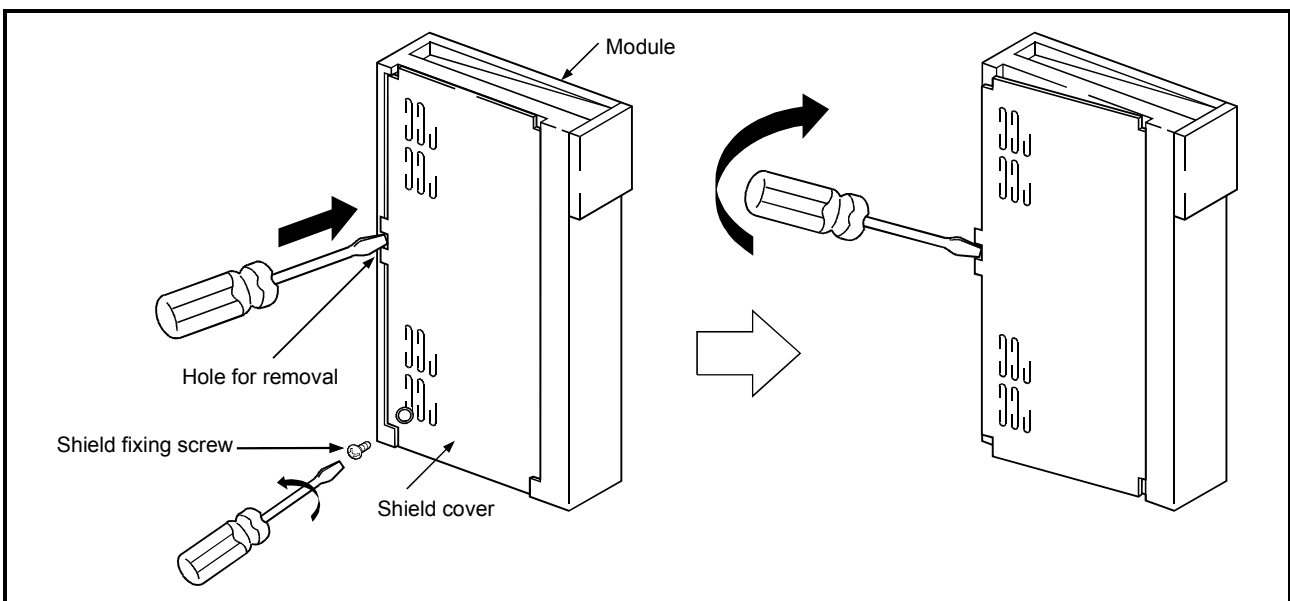



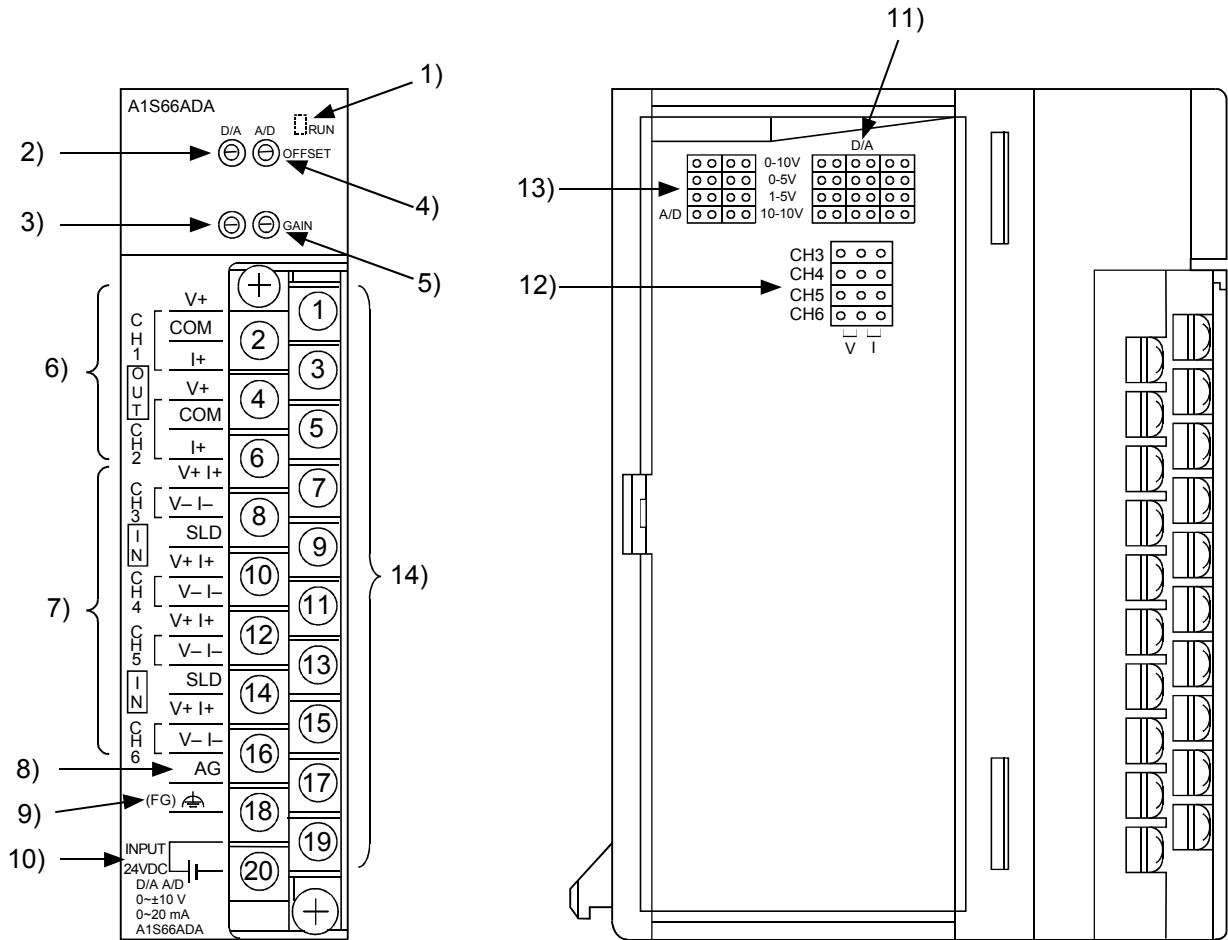

To remove the shield cover from the module, remove the shield fixing screw first and install the tip of a flat-tip screwdriver into the removal hole as shown in the figure, then move the screwdriver towards the rear of the module to separate the clip from the removal hole and remove the cover.

4.4 Part Identification and Settings

The following describes the part names and settings of the A1S66ADA :

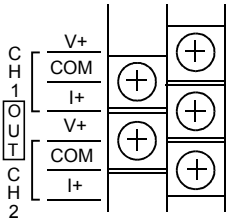
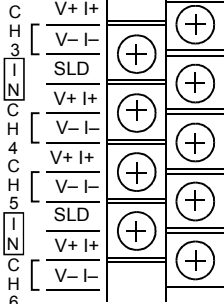

No.	Name	Description
1)	RUN LED 	Indicates the operating conditions of the A1S66ADA On : Power is ON Off : Power is OFF
2)	D/A conversion offset control knob D/A 	Used when making a fine adjustment of the D/A conversion offset. The offset value is increased by turning the control knob to the right. The offset value is decreased by turning the control knob to the left.
3)	D/A conversion gain control knob D/A 	Used when making a fine adjustment of the D/A conversion gain. The gain value is increased by turning the control knob to the right. The gain value is decreased by turning the control knob to the left.
4)	A/D conversion offset control knob A/D 	Used when making a fine adjustment of the A/D conversion offset. The offset value is increased by turning the control knob to the right. The offset value is decreased by turning the control knob to the left.
5)	A/D conversion gain control knob A/D 	Used when making a fine adjustment of the A/D conversion gain. The gain value is increased by turning the control knob to the right. The gain value is decreased by turning the control knob to the left.
6)	Analog output terminal (CH1, CH2) 	Outputs the analog values (voltage/current) of CH1 to CH2. Refer to Section 4.5.2 on the wiring method.
7)	Analog input terminal (CH3 to CH6) 	Inputs the analog values (voltage/current) of CH3 to CH6. Refer to Section 4.5.2 on the wiring method.

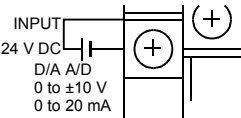
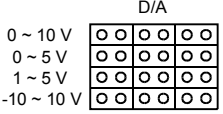
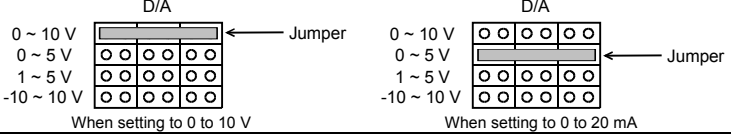
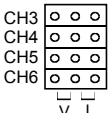
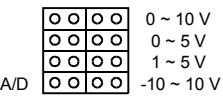
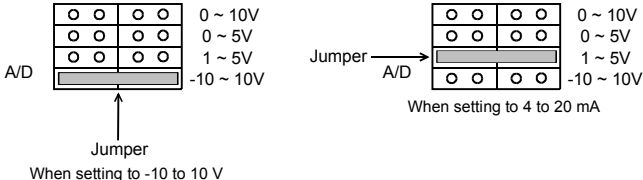
No.	Name	Description
8)	Analog ground terminal	The ground terminal of the analog signal (Refer to Section 4.4 on the wiring method.)
9)	Frame ground terminal	The ground terminal of the shielded cable (Refer to Section 4.4 on the wiring method.)
10)	Power supply input terminal 	Connect 24 V DC at the input terminal of the power supply.
11)	Analog-output range switching setting pin 	Set the analog output range. CH1, CH2 common. When setting the current output range, set as follows: When switching to 0 to 20 mA → Set a jumper at a position between 0 V and 5 V. When switching to 4 to 20 mA → Set a jumper at a position between 1 V and 5 V. Set the jumper as it always makes a line. (Set it with the jumper) (Setting at shipment : 0 to 10 V range) (Example) When the analog output range is set to 0 to 10 V or 0 to 20 mA, the jumper should be set as follows. 
12)	Analog-input voltage/current switching setting pin 	Set the analog input (voltage input or current input) for each channel (CH3 to CH6). (Set it with the jumper) (Setting at shipment : V) For voltage input setting : V For current input setting : I
13)	Analog-input range switching setting pin 	Set the analog input range. CH3 to CH6 common. When setting the current input range, set as follows: When switching to 0 to 20 mA → Set a jumper at a position between 0 V and 5 V. When switching to 4 to 20 mA → Set a jumper at a position between 1 V and 5 V. (Setting at shipment : 0 to 10 V range) (Set it with the jumper) (Example) When the analog input range is set to -10 to 10 V or 4 to 20 mA, the jumper should be set as follows. 
14)	Terminal block	Numbers in a diagram indicates terminal numbers.

IMPORTANT

When inputting or outputting current, do not set a jumper at a position between 0 V and 10V or between -10 V and 10 V of the analog-input and output range switching setting pin. This may cause a module breakdown or malfunction.

4.5 Wiring

The following describes the precautionary items on wiring as well as wiring to the external devices.

4.5.1 Precautions when wiring

To obtain the maximum performance from the functions of A1S66ADA and improve the system reliability, a wiring with the high durability against the noise is required. The external wiring precautions described below make more improvement in the wiring not to be affected by the noise.

- (1) Use separate cables for the AC and the analog input to the A1S66ADA, in order not to be affected by the AC side surge or conductivity.
- (2) Do not bundle or place the cable close to the main circuit line, high voltage line or load carrying wires from other than the programmable controller. It is influenced more easily by the noise, surge, or conductivity.
- (3) Place a one-point grounding on the programmable controller side for the shield line or shield cable. However, depending on the external noise conditions, it may be better to have a grounding externally.

4.5.2 Wiring between the A1S66ADA and the external devices

The following shows the wiring method for the A1S66ADA.

(1) CH1 and CH2

(a) For voltage output

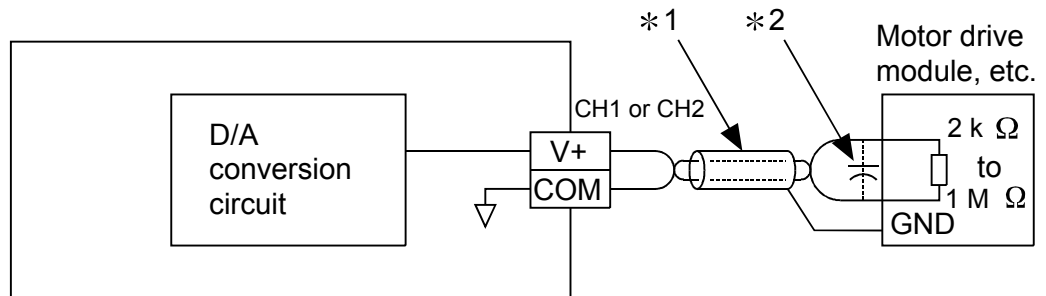

(b) For current output

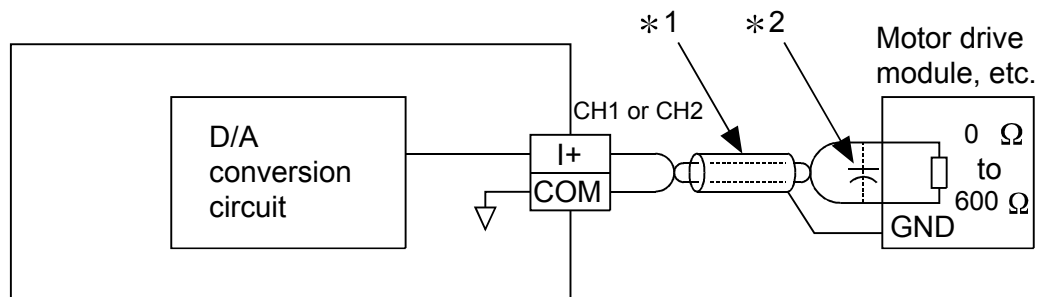

*1 Use a two-core twisted shield line for the power cable.

*2 When noise or ripple occurs with the external cable, connect a condenser with 0.1 to 0.47 μ FWV to the input terminal of the external device.

IMPORTANT

The voltage and current output can not be used simultaneously on the same channel.

In the event it is used, the internal elements are destroyed; therefore always open unused terminals.

(2) CH3 to CH6

(a) For voltage input

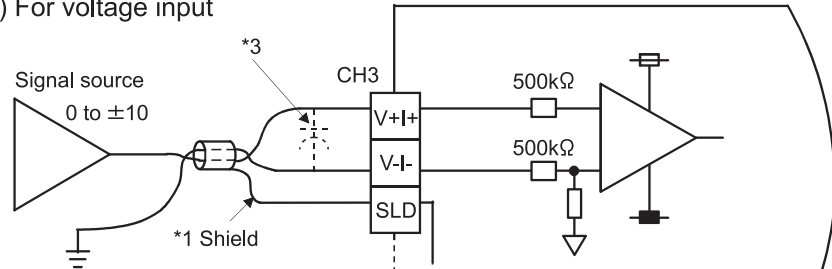

(b) For current input

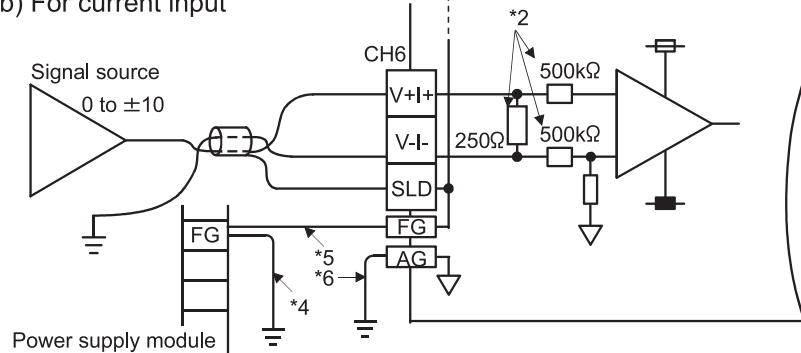

*1 Use a two-core twisted shield line for the power cable.

*2 Indicates the A1S66ADA input resistance.

*3 When noise or ripple occurs with the external cable, connect a condenser with about 0.1 to 0.47 μ F (Part with voltage resistance of 25V or more) between the terminal V+I+ and V-I-.

*4 The FG terminal of the power supply module should always be grounded.

*5 Make sure to connect between the FG of the power supply module and the FG of A1S66ADA.

*6 Due to noise in the environment, AG terminal may attain better accuracy when grounded.

POINT

- The FG terminal of A1S66ADA and the FG terminal of the power supply module are not connected.
- In an unused channel, if terminals remain open, an erratic digital value may be output.
To prevent this, take any of the following measures.
 1. Short-circuit the input terminals (terminal V+I+ and V-I-) of the unused channel.
 2. Connect the AG terminal to the GND terminal of the external device.

4.6 Fine Adjustment of the Offset /Gain Values

Offset/gain values are set by selecting an I/O characteristic, which is preset using the analog input/output range switch setting pins.

Each module will have slight characteristic differences from the I/O characteristic selected by the analog input/output range switch setting pins due to the ambient temperature, characteristic variances of the A/D conversion module, and so on. Offset/gain fine adjustment is performed to correct such slight differences in characteristics.

4.6.1 Fine adjustment methods of the offset/gain values

The following flow chart describes the fine adjustment procedure of the offset/gain value of A1s66ADA. This setting is for when the module is installed in the slot No. 0, the D/A conversion to CH1 and A/D conversion to CH3.

(1) Fine adjustment procedures for the D/A conversion offset/gain values

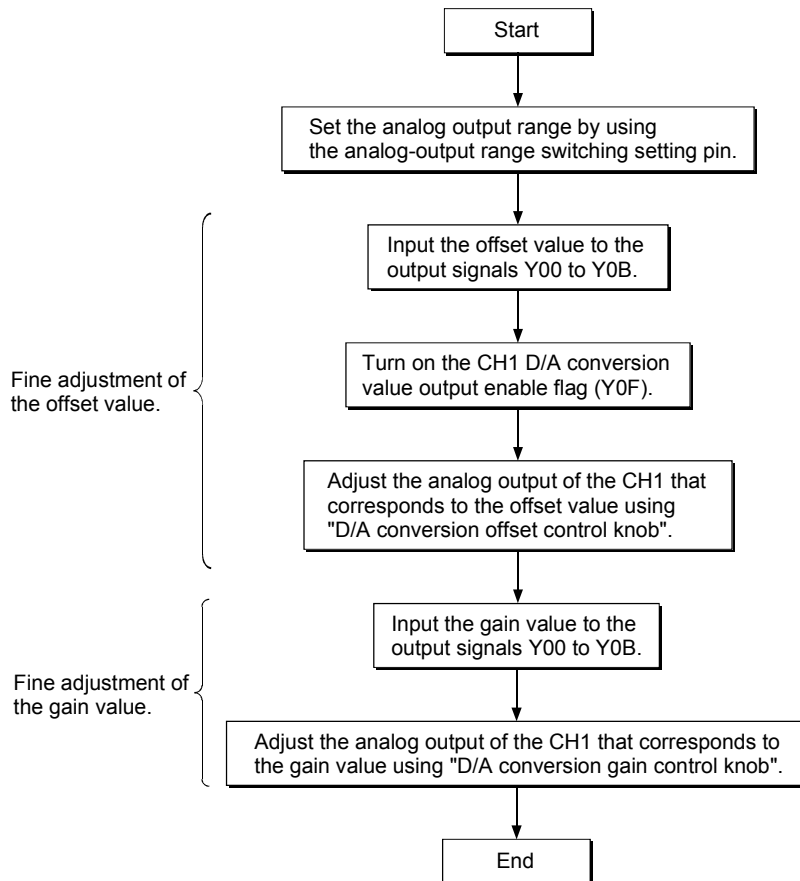

POINT
 If the analog output range is set to -10 V to 10 V, and if a fine adjustment of the offset value is performed by setting the offset value to 0 and the analog output to -10 V, the analog output may shift slightly. In such cases, the offset value can be set correctly in one attempt if fine adjustment of the offset value is performed by setting the offset value to 2000 and the analog output to 0 V.

(2) Fine adjustment procedure for the A/D conversion offset/gain values

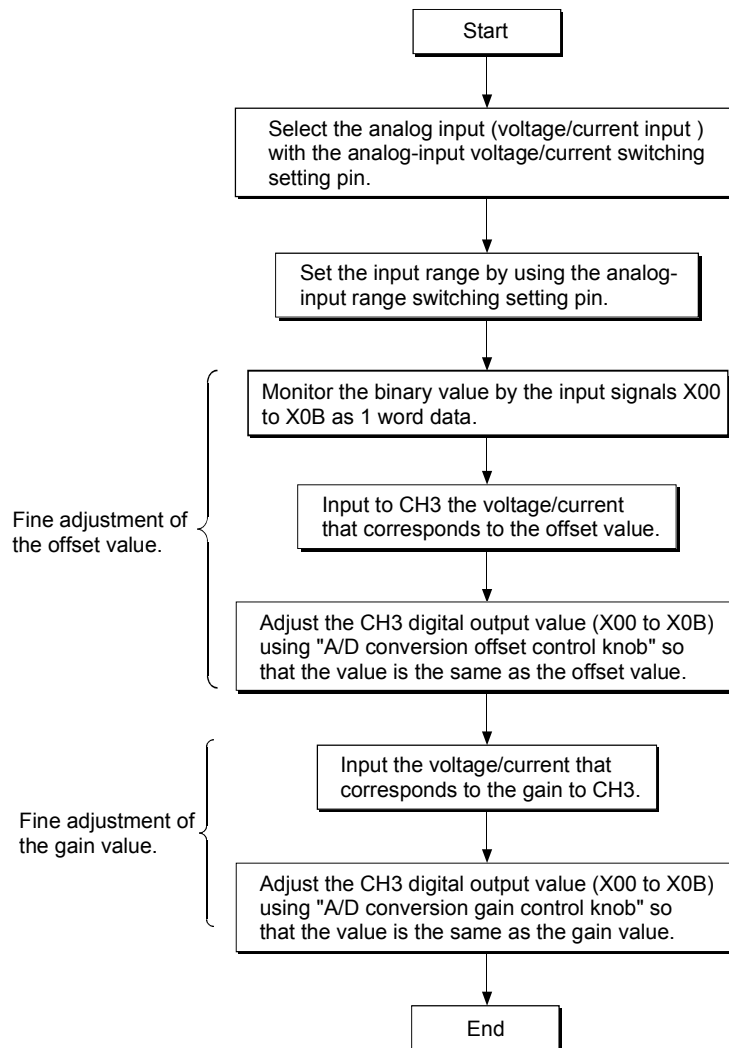

POINT	Disconnect the power supply for the programmable controller CPU or the external power supply for A1S66ADA at all phases when setting the output range and making voltage/current selection.
--------------	---

4.7 Maintenance and Inspection

The A1S66ADA has no particular inspection items, but in order to maintain the system in the best condition, perform inspection according to the categories listed in the programmable controller CPU Users' Manual.

5 PROGRAMMING

The program creation procedures, basic read and write programs, and program examples for A1S66ADA are explained.

When utilizing the program example introduced in this chapter for an actual system, fully verify that there are no problems in controllability in the target system.

For details of instructions, refer to the ACPU Programming Manual.

5.1 Program Creation Procedures

The procedures to create programs are described using flowcharts.

5.1.1 Outputting digital values as voltage/current (D/A conversion)

The following flow shows the procedure to create a program that converts the digital value input to CH1 and CH2 into analog values (voltage/current).

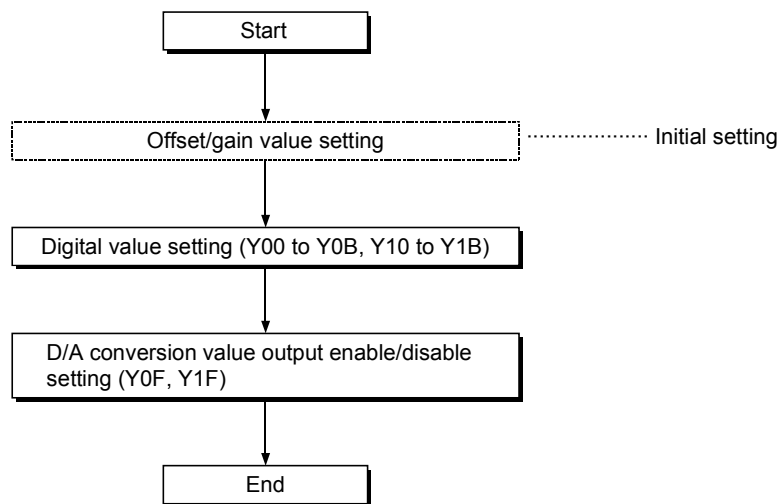

5.1.2 Receiving voltage/current as digital values (A/D conversion)

The following flow shows the procedure to create a program that converts the analog values (voltage/current) input to CH3 to CH6 into digital values.

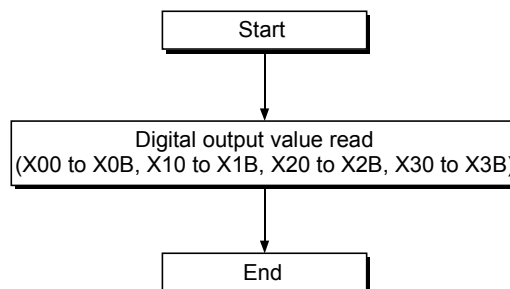

5.2 Basic Read and Write Programs

(1) Write to A1S66ADA.....MOV, MOVP instruction

Form

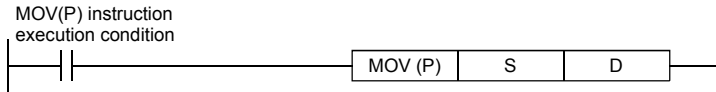

Symbol	Description	Usable device
S	Number of the head device containing write data, or a constant	T, C, D, W, R
D	Head number of the I/O signals where data is to be stored	X, Y

Example

When assigning the A1S66ADA to I/O X40 to X7F and Y40 to Y7F, then writing the binary data stored in D10 to I/O signals Y40 to Y4B



5

(2) Read from A1S66ADA.....MOV, MOVP instruction

Form

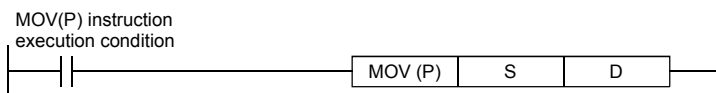

Symbol	Description	Usable device
S	Head number of the I/O signals where data is stored	X, Y
D	Head number of the device where the data read is to be stored	T, C, D, W, R

Example

When assigning the A1S66ADA to I/O X20 to X5F and Y20 to Y5F, then reading the CH 3 digital output value, which is stored in I/O signals X20 to X2B as binary data, to D20



5.3 Program Example

This program example converts the value set by the BCD digital switch into an analog value (voltage/current) and reads the digital values that have undergone A/D conversion at channels 3 through 6.

When applying any of the program examples introduced in this chapter to the actual system, verify the applicability and confirm that no problems will occur in the system control.

Conditions of program example

(1) System configuration

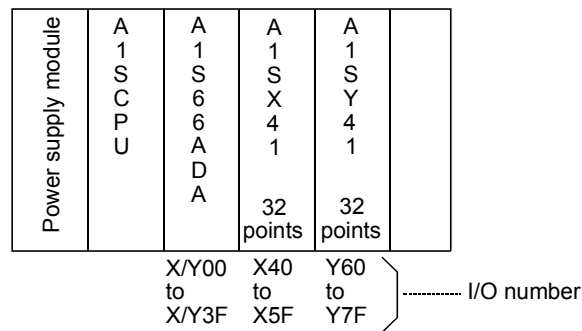

(2) Initial setting description

- 1) D/A conversion value output enable channel.....1 channel

(3) Device to be used by user

- 1) Offset value setting command signal.....X40
- 2) Gain value setting command signal.....X41
- 3) Digital setting value input command signal.....X42
- 4) Digital output value read command signal.....X43
- 5) Digital value setting (BCD 4 digits)X50 to X5F
- 6) D/A conversion offset value storage data register.....D0
- 7) D/A conversion gain value storage data register.....D1
- 8) Digital output value read detection data register.....D10 to D13
- 9) Digital setting value storage data register.....D20

Offset/gain setting

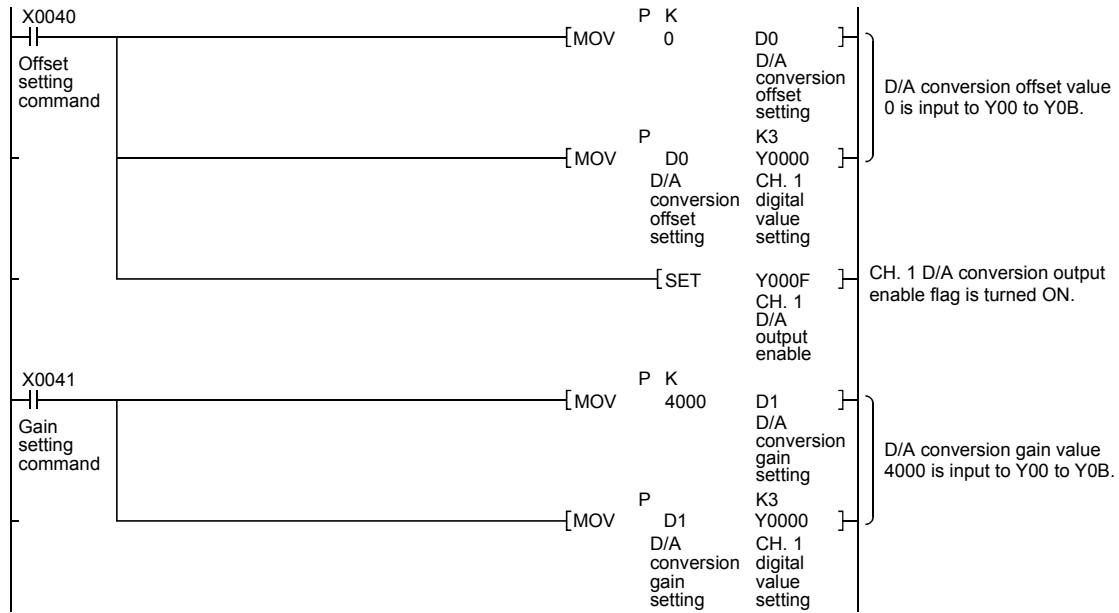

Digital value setting/read

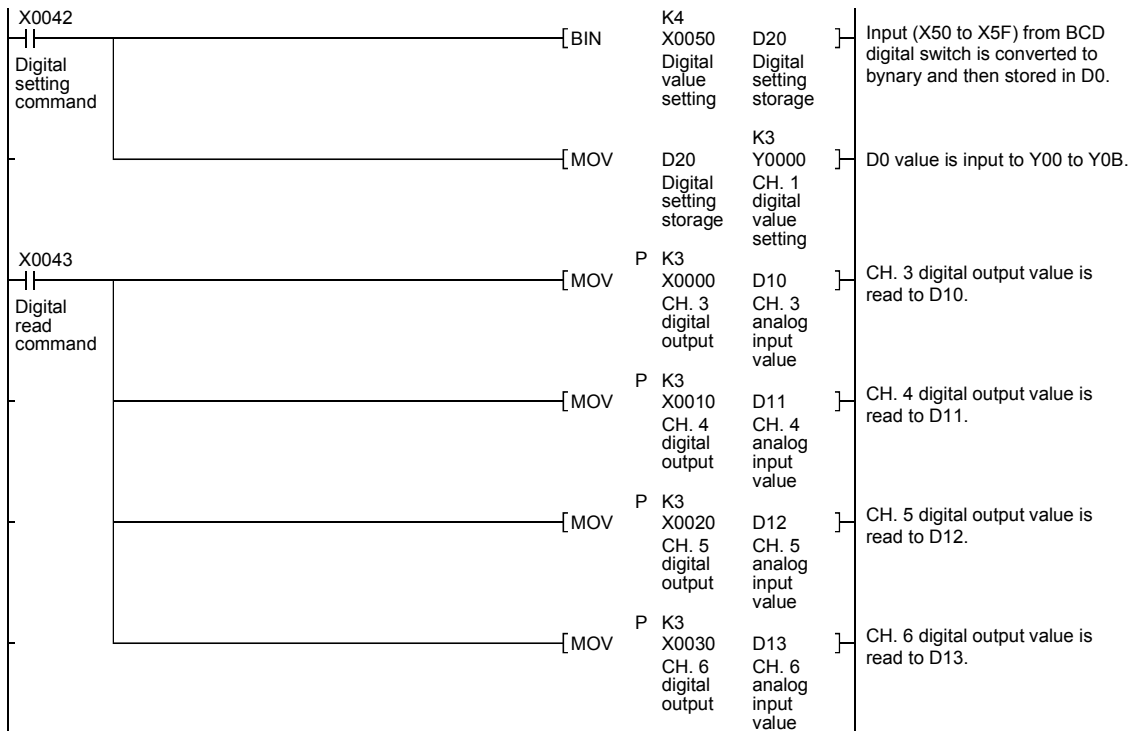

POINT

For modules of hardware version "C" or earlier, excessively large (or small) data may be temporarily read out when a module reads a digital output value from the programmable controller CPU.

To prevent this, refer to Appendix 3 and incorporate a sequence program for ignoring illegal data into the original program.

For modules of hardware version "D" or later, such excessively large (or small) data may not be read out.

6 TROUBLESHOOTING

The following describes the possible causes and the corrective actions for troubles occurred when using the A1S66ADA.

(1) When it does not read digital output values

Check Item	Corrective Action
Is the voltage and current supplied properly?	Measure using a tester to see whether they are being supplied.
Is the conditions for executing the MOV instruction turned on?	Check for the ON/OFF status by monitoring from the peripheral device.
Are the I/O signals correctly specified in the MOV instruction?	Check the sequence program.
Is the programmable controller CPU in the "RUN" state?	Position the RUN key switch of the programmable controller CPU at "RUN".
Is the RUN LED of the programmable controller CPU flashing or turned off?	Check the contents by referring to the User's Manual of the programmable controller CPU.
Is there any faulty connections of the analog input signal wires, such as loose wires or wire breakage?	Check for the faulty areas of the signal wires by visual inspection and continuity checking.
Measure the digital output value by disconnecting the cable for the analog input of the A1S66ADA then applying the test voltage (stabilized power supply or batteries) to the terminal of the main module.	Check the grounding method and wiring, as it may be influenced by the noise from the external wiring, if the digital output values are normal at the individual A1S66ADA station.
Is the 24VDC power supply turned on?	Check the power supply (external power supply).

(2) When it does not output analog values

Check Item	Corrective Action
Are the D/A conversion value output enable flags (YnF, Y(n+1)F) for CH1 and CH2 turned "ON"?	Monitor from the peripheral device to see whether all the conditions to be ON are satisfied.
Are the I/O signals correctly specified in the MOV instruction?	Check the sequence program.
Is the programmable controller CPU in the "RUN" state?	Position the RUN key switch of the programmable controller CPU at "RUN".
Is the RUN LED of the programmable controller CPU flashing or turned off?	Check the contents by referring to the User's Manual of the programmable controller CPU.
Is there any loose wires or wire breakage?	Eliminate the faulty area by visual inspection and continuity checking.
Is the 24VDC power supply turned on?	Check the power supply (external power supply).

APPENDICES

Appendix1 Comparison with the Conventional Analog I/O Module (A1S63ADA)

Comparison of specifications for A1S66ADA with those for the conventional analog I/O module, A1S63ADA, is shown below.

Item		Specification				
		A1S66ADA		A1S63ADA		
D/A conversion	I/O characteristics	Digital input	Analog output	Digital input	Analog output	
		0 to 4000 (12-bit binary)		0 to 10 V	-4000 to 4000	-10 to 10 V
				0 to 5 V	-8000 to 8000	
				1 to 5 V	-12000 to 12000	
				-10 to 10V	0 to 4000	4 to 20 mA
				0 to 20 mA	0 to 8000	
		4 to 20 mA	0 to 12000			
	Maximum resolution	Voltage 1.0 mV (when analog output range is set to 1 V to 5 V) Current 4 μA (when analog output range is set to 4 mA to 20 mA)		Voltage 0.83 mV (when resolution is set to 1/12000) Current 1.7 μA (when resolution is set to 1/12000)		
	Resolution range switching	2 CH in batch		—		
	Conversion speed	240 μs or below/2 CH		1 ms/1 CH (when resolution is set to 1/4000) 2 ms/1 CH (when resolution is set to 1/8000) 3 ms/1 CH (when resolution is set to 1/12000)		
Offset/gain adjustment	Adjust using the front knob Perform on-line adjustment for the 2 CH in batch		Set using the front switch			
No. of channels	2 channels		1 channel			
A/D conversion	I/O characteristics	Analog input	Digital output	Analog input	Digital output	
			0 to 4000 (12-bit binary)	-10 to 10 V	-4000 to 4000	
					-8000 to 8000	
					-12000 to 12000	
				-20 mA to 20 mA	-2000 to 2000	
					-4000 to 4000	
					-6000 to 6000	
	Maximum resolution	Voltage 1.0 mV (when analog input range is set to 1 to 5 V) Current 4 μA (when analog input range is set to 4 to 20 mA)		Voltage 0.83 mV (when resolution is set to 1/12000) Current 3.33 μA (when resolution is set to 1/6000)		
	Resolution range switching	4 CH in batch		3 CH in batch (resolution) Individual channels (current/voltage)		
Conversion speed	400 μs or below/4 CH		1 ms/1 CH (when resolution is set to 1/4000) 2 ms/1 CH (when resolution is set to 1/8000) 3 ms/1 CH (when resolution is set to 1/12000)			
Offset/gain adjustment	Adjust using the front knob of the module Perform on-line adjustment for the 4 CH in batch		Set each channel individually using the module front switch			
No. of channels	4 channels		2 channels			



Item	Specification	
	A1S66ADA	A1S63ADA
Simple loop control	Not available	Available
Analog value read/write method	I/O signal method	Buffer memory method
Overall accuracy	Within ±1 % (accuracy relative to the maximum value)	
Insulation method	Between I/O terminal and programmable controller power supply.....	Photocoupler insulation
	Between channels.....	No insulation
Number of I/O occupied points	64 points	32 points
Connected terminal base	20 points terminal block (M3.5 × 7 screw)	
Applicable wire size	0.75 to 1.25 mm ²	
Applicable solderless terminal	R1.25-3 1.25-YS3 2-3.5 2-YS3A V1.25-M3 V1.25-YS3A V2-S3 V2-YS3A	1.25-3.5 1.25-YS3A 2-3.5 2-YS3A V1.25-M3 V1.25-YS3A V2-S3 V2-YS3A
5 V DC internal current consumption	0.21 A	0.8 A
External power supply	Voltage	21.6 to 26.4 V DC
	Current consumption	0.16 A
Weight	0.33 kg	0.30 kg

Appendix 2 External Dimensions

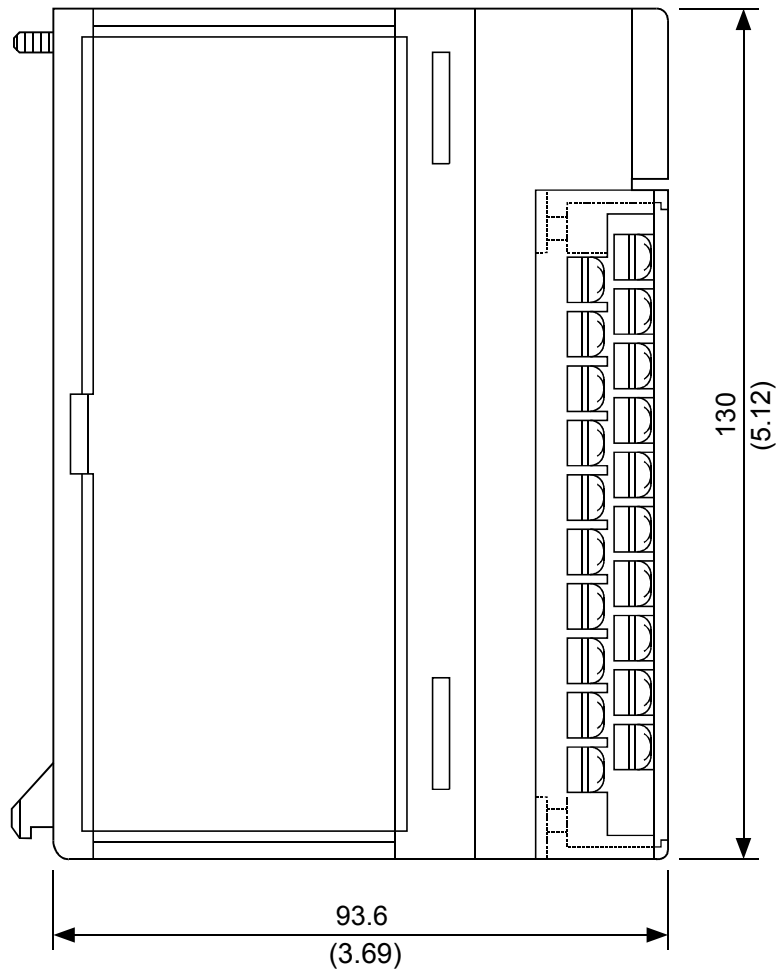
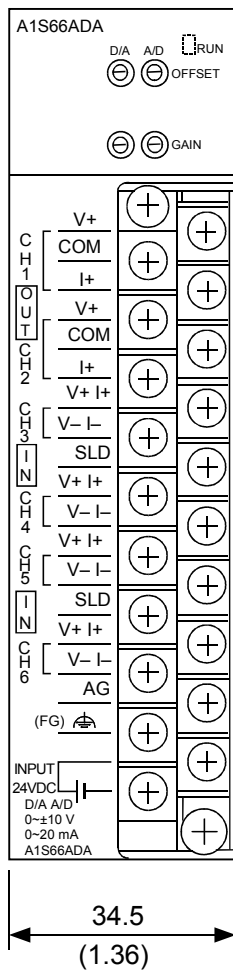

Unit: mm (in.)

Appendix 3 Precautions For Reading A Digital Output Value (For Hardware Version "C" or Earlier)

If a digital output value is read from the programmable controller CPU during A/D conversion processing of the A1S66ADA (For Hardware Version "C" or Earlier), data may be read to the lower order byte (Xn0 to Xn7) and higher order byte (Xn8 to XnB) at different timings.

In this case, old A/D conversion data are stored into the lower order byte, and new A/D conversion data into the higher order byte as the read data from the programmable controller CPU, resulting in data mismatch. (When a carry or borrow occurs, a difference of 256 occurs in the digital output value.)

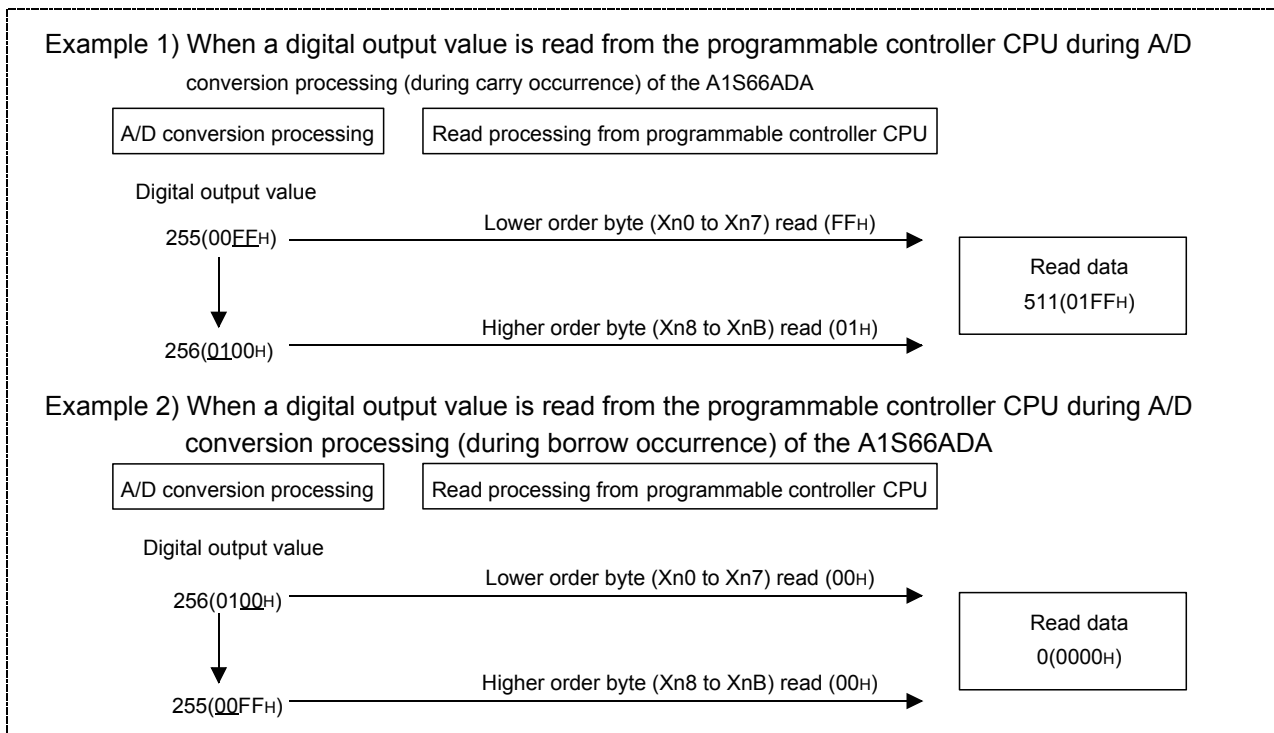

The read digital output value is compared every scan with the digital output value read at the previous scan to update only normal data.

An example of a program to read a digital output value converted from analog on Channel 3 is shown below.

POINT
<p>Since data inconsistency does not occur in modules of hardware version "D" or later, measures for updating only normal data are not needed.</p> <p>For checking the hardware version, refer to the next page.</p>

Program example

In the following program example, an error of 100 or more in digital value is judged as abnormal.

As the value used for judgment, set "(input variation per scan) + (digital value for error 40)" or more.

(1) System configuration

Install the A1S66ADA on "Slot 0" of the main base.

(2) Devices used by the user

- 1) Digital output value read command signal.....M0
- 2) Digital output value read switching signal.....M1
- 3) Digital output value comparison data read interlock signal.....M2
- 4) Digital output value comparison source data storage data register.....D0
- 5) Digital output value comparison data storage data register.....D1
- 6) D0-D1 difference storage data register.....D2
- 7) Normal digital output value storage data register.....D10

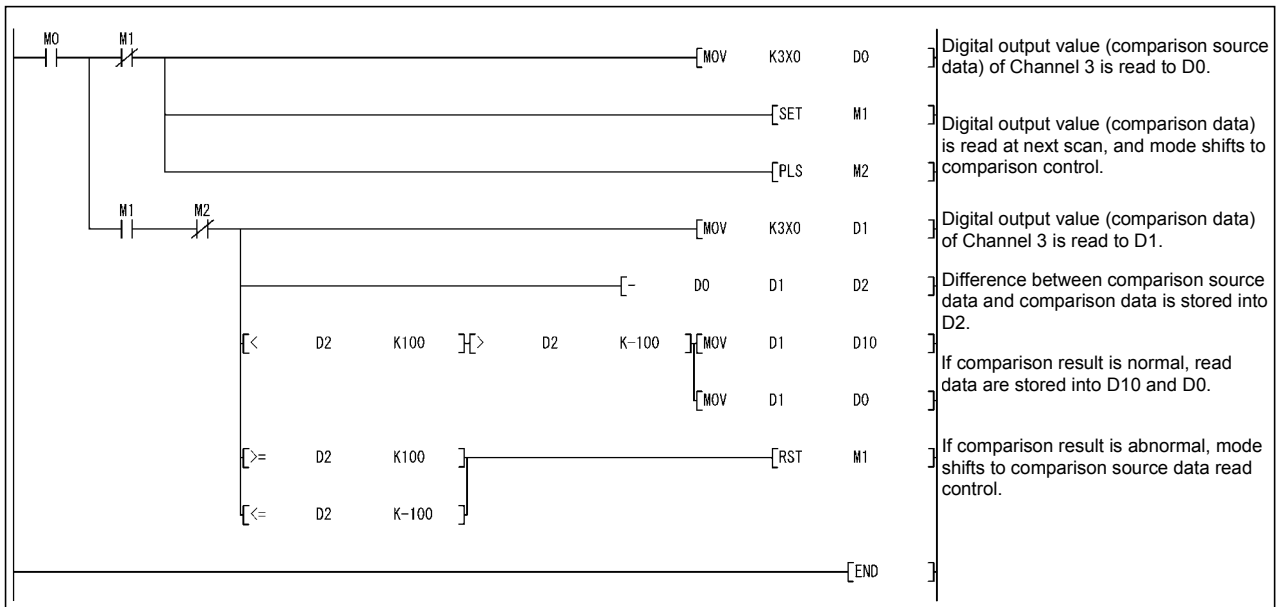

• Checking the hardware version

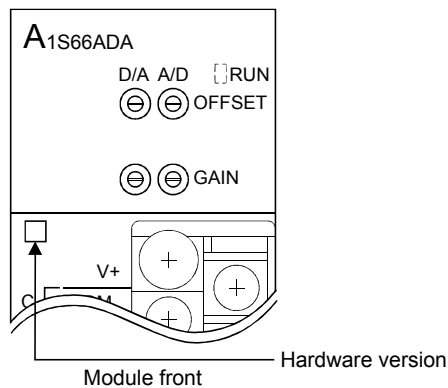

WARRANTY

Please confirm the following product warranty details before using this product.

1. Gratis Warranty Term and Gratis Warranty Range

If any faults or defects (hereinafter "Failure") found to be the responsibility of Mitsubishi occurs during use of the product within the gratis warranty term, the product shall be repaired at no cost via the sales representative or Mitsubishi Service Company.

However, if repairs are required onsite at domestic or overseas location, expenses to send an engineer will be solely at the customer's discretion. Mitsubishi shall not be held responsible for any re-commissioning, maintenance, or testing on-site that involves replacement of the failed module.

[Gratis Warranty Term]

The gratis warranty term of the product shall be for one year after the date of purchase or delivery to a designated place.

Note that after manufacture and shipment from Mitsubishi, the maximum distribution period shall be six (6) months, and the longest gratis warranty term after manufacturing shall be eighteen (18) months. The gratis warranty term of repair parts shall not exceed the gratis warranty term before repairs.

[Gratis Warranty Range]

- (1) The range shall be limited to normal use within the usage state, usage methods and usage environment, etc., which follow the conditions and precautions, etc., given in the instruction manual, user's manual and caution labels on the product.
- (2) Even within the gratis warranty term, repairs shall be charged for in the following cases.
 1. Failure occurring from inappropriate storage or handling, carelessness or negligence by the user. Failure caused by the user's hardware or software design.
 2. Failure caused by unapproved modifications, etc., to the product by the user.
 3. When the Mitsubishi product is assembled into a user's device, Failure that could have been avoided if functions or structures, judged as necessary in the legal safety measures the user's device is subject to or as necessary by industry standards, had been provided.
 4. Failure that could have been avoided if consumable parts (battery, backlight, fuse, etc.) designated in the instruction manual had been correctly serviced or replaced.
 5. Failure caused by external irresistible forces such as fires or abnormal voltages, and Failure caused by force majeure such as earthquakes, lightning, wind and water damage.
 6. Failure caused by reasons unpredictable by scientific technology standards at time of shipment from Mitsubishi.
 7. Any other failure found not to be the responsibility of Mitsubishi or that admitted not to be so by the user.

2. Onerous repair term after discontinuation of production

- (1) Mitsubishi shall accept onerous product repairs for seven (7) years after production of the product is discontinued. Discontinuation of production shall be notified with Mitsubishi Technical Bulletins, etc.
- (2) Product supply (including repair parts) is not available after production is discontinued.

3. Overseas service

Overseas, repairs shall be accepted by Mitsubishi's local overseas FA Center. Note that the repair conditions at each FA Center may differ.

4. Exclusion of loss in opportunity and secondary loss from warranty liability

Regardless of the gratis warranty term, Mitsubishi shall not be liable for compensation of damages caused by any cause found not to be the responsibility of Mitsubishi, loss in opportunity, lost profits incurred to the user by Failures of Mitsubishi products, special damages and secondary damages whether foreseeable or not, compensation for accidents, and compensation for damages to products other than Mitsubishi products, replacement by the user, maintenance of on-site equipment, start-up test run and other tasks.

5. Changes in product specifications

The specifications given in the catalogs, manuals or technical documents are subject to change without prior notice.

Analog Input/Output Module Type A1S66ADA

User's Manual

MODEL	A1S66ADA-U-E
MODEL CODE	13JL41
IB(NA)-66819-K(1206)MEE	

 **MITSUBISHI ELECTRIC CORPORATION**

HEAD OFFICE : TOKYO BUILDING, 2-7-3 MARUNOUCHI, CHIYODA-KU, TOKYO 100-8310, JAPAN
NAGOYA WORKS : 1-14, YADA-MINAMI 5-CHOME, HIGASHI-KU, NAGOYA, JAPAN

When exported from Japan, this manual does not require application to the Ministry of Economy, Trade and Industry for service transaction permission.

Specifications subject to change without notice.