

FACTORY AUTOMATION

**e-Factory**

# Mitsubishi Electric Programmable Controller MELSEC iQ-F Series

## Quick Start Guide CC-Link IE TSN Master/Local Module



**MELSEC iQ-F**  
series



**CC-Link IE TSN**



# INTRODUCTION

---

Thank you for purchasing the Mitsubishi Electric MELSEC iQ-F series programmable controllers.

This manual describes the handling of MELSEC iQ-F series FX5-CCLGN-MS CC-Link IE TSN master/local module.

Before using this product, please read this manual and relevant manuals carefully and develop familiarity with the specifications to handle the product correctly.

## Regarding use of this product

- This product has been manufactured as a general-purpose part for general industries, and has not been designed or manufactured to be incorporated in a device or system used in purposes related to human life.
- Before using the product for special purposes such as nuclear power, electric power, aerospace, medicine or passenger movement vehicles, please contact Mitsubishi Electric sales office.
- This product has been manufactured under strict quality control. However when installing the product where major accidents or losses could occur if the product fails, install appropriate backup or failsafe functions into the system.

## Note

- If in doubt at any stage during the installation of the product, always consult a professional electrical engineer who is qualified and trained to the local and national standards. If in doubt about the operation or use, please contact your local Mitsubishi Electric representative.
- Mitsubishi Electric will not accept responsibility for actual use of the product based on these illustrative examples. Please use it after confirming the function and safety of the equipment and system.
- The content, specification etc. of this manual may be changed, for improvement, without notice.
- The information in this manual has been carefully checked and is believed to be accurate; however, if you notice a doubtful point, an error, etc., please contact your local Mitsubishi Electric representative. When doing so, please provide the manual number given at the end of this manual.

# CONTENTS

INTRODUCTION	1
RELEVANT MANUALS	4
TERMS	5
GENERIC TERMS AND ABBREVIATIONS	5
KEY FEATURES	6
<b>CHAPTER 1 PREPARATION</b>	<b>7</b>
1.1 Applicable Models	7
1.2 Operation Flow Diagram	7
Sample QR code for the code reader	8
1.3 System Configuration	9
1.4 Required Products	11
<b>CHAPTER 2 SETTING PROGRAMMABLE CONTROLLER MASTER STATION</b>	<b>13</b>
2.1 Communication Settings	13
2.2 Network Configuration Settings	13
2.3 Refresh Settings	14
2.4 Setting Parameters	15
2.5 Communication Settings on GX Works3	18
2.6 Writing Programs to the Programmable Controller	20
<b>CHAPTER 3 SETTING PROGRAMMABLE CONTROLLER LOCAL STATION</b>	<b>22</b>
3.1 Communication Settings	22
3.2 Refresh Settings	22
3.3 Setting Parameters	23
3.4 Communication Settings on GX Works3	24
3.5 Writing Programs to the Programmable Controller	24
<b>CHAPTER 4 SETTING REMOTE STATION</b>	<b>25</b>
4.1 Setting the IP Address/Station Number Setting Switches	25
4.2 Setting the Function Setting Switch	26
<b>CHAPTER 5 TCP/IP COMMUNICATION SETTING of CODE READER</b>	<b>27</b>
5.1 Setting an IP Address of the Personal Computer	27
5.2 Setting the Code Reader	27
<b>CHAPTER 6 OPERATION CHECK</b>	<b>29</b>
6.1 Operation Check of the Local Station	29
6.2 Operation Check of the Remote Station	35
6.3 Operation Check of the Code Reader (TCP/IP Communications)	37
<b>CHAPTER 7 TROUBLESHOOTING</b>	<b>39</b>
7.1 Checking Procedure	39
7.2 Checking the LED Status	40
7.3 Checking the Error Details	46

## **APPENDICES**

**49**

**Appendix 1 CC-Link IE TSN/CC-Link IE Field Diagnostics. . . . .49**

**Appendix 2 Setting an IP Address of the Personal Computer. . . . .50**

REVISIONS . . . . .53

WARRANTY . . . . .54

SAFETY PRECAUTIONS . . . . .54

TRADEMARKS . . . . .54

# RELEVANT MANUALS

The following relevant manuals can be downloaded from the Mitsubishi Electric FA site.

[https://www.mitsubishielectric.co.jp/fa/ref/ref.html?kisyu=plcf&manual=download\\_all](https://www.mitsubishielectric.co.jp/fa/ref/ref.html?kisyu=plcf&manual=download_all)

[○: Available, —: Not available]

Manual name <manual number>	Available form	
	e-Manual	PDF
MELSEC iQ-F FX5U User's Manual (Hardware) <JY997D55301>	○	○
MELSEC iQ-F FX5UC User's Manual (Hardware) <JY997D61401>	○	○
MELSEC iQ-F FX5 User's Manual (CC-Link IE TSN) <SH-082215ENG>	○	○
GX Works3 Operating Manual <SH-081215ENG>	○	○
CC-Link IE TSN Remote I/O Module User's Manual (CC-Link IE TSN Communication Mode) <SH-082135ENG>	○	○
Code Reader Connection Guide BCN-P5999-1074	○	○
Code Reader CF26 User's Manual <SH-082092ENG>	○	○
Code Reader Setting Guide <BCN-P5999-1258>	○	○



## Quick and satisfying browsing e-Manual Viewer

e-Manual Viewer allows users to browse optimized FA-related documents such as Mitsubishi Electric FA product manuals. e-Manual Viewer can be downloaded for free from the Mitsubishi Electric FA Website.

### Easy on-demand download of latest documents

All necessary documents can be easily downloaded with one click. The latest documents are available at any time.

### Quick cross document search for necessary information

Refine search and fuzzy search are available for all downloaded documents. Intuitive search using illustrations is available for hardware specifications of the product.

### Copying example programs to an engineering tool

Example programs contained in a document can be directly copied to an engineering tool, eliminating the need of inputting the programs.

### Sharing information among multiple users

The documents can be customized by adding useful information as a note freely. Latest documents and notes can be shared with multiple users using the document sharing function.

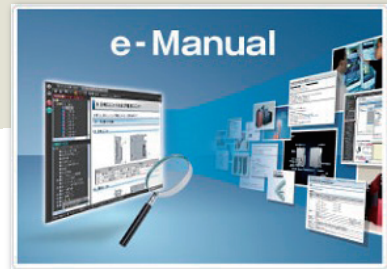

■ Introduction for the concept and features of e-Manual Viewer is available on the following website.

[http://fa-mel.com/fa/ref/ref.html?k=plceng&smerit=emaviewer\\_win](http://fa-mel.com/fa/ref/ref.html?k=plceng&smerit=emaviewer_win)

■ The installation file for Windows® can be downloaded from the following website.

[http://fa-mel.com/fa/ref/ref.html?k=plceng&software=emaviewer\\_en](http://fa-mel.com/fa/ref/ref.html?k=plceng&software=emaviewer_en)

# TERMS

Unless otherwise specified, this manual uses the following terms.

Term	Description
Authentication Class	A group of devices and switching hubs compatible with CC-Link IE TSN, ranked according to the functions and performance by the CC-Link Partner Association ( <a href="http://www.cc-link.org">www.cc-link.org</a> ).
Cyclic transmission	A function by which data is periodically exchanged among stations on the same network using link devices
Data link	Communications performed by cyclic transmission and transient transmission
Disconnection	Processing for stopping the data link when a data link error occurs
Engineering tool	A tool for setting, programming, debugging, and maintenance of programmable controller.
GX Works3	A generic product name for SWnDND-GXW3. ('n' indicates its version.)
Link device	A device in a module on CC-Link IE TSN
Local station	A station that performs cyclic transmission and transient transmission with the master station and other local stations. The station is controlled by programs in the CPU module or other equivalent modules on the station.
Master station	A station that controls the entire network. This station can perform cyclic transmission and transient transmission with all stations. Only one master station can be used in a network.
Remote station	A station that exchanges I/O signals (bit data) and I/O data (word data) with another station by cyclic transmission. This station can perform transient transmission.
Return	Processing for resuming the data link when a faulty station becomes normal
RWr	A remote register of the link device. RWr refers to word data input from a slave station to the master station. (For some areas in a local station, data are input in the opposite direction.)
RWw	A remote register of the link device. RWw refers to word data output from the master station to a slave station. (For some areas in a local station, data are output in the opposite direction.)
RX	A remote input of the link device. Bit data input from a slave station to the master station. (For some areas in a local station, data are input in the opposite direction.)
RY	A remote output of the link device. Bit data output from the master station to a slave station. (For some areas in a local station, data are output in the opposite direction.)
Slave station	A station other than a master station: a local station, a remote station
SLMP	An abbreviation for SeamLess Message Protocol. This protocol is used to access an SLMP-compatible device or a programmable controller connected to an SLMP-compatible device from an external device.
TCP/IP communications	One of the standard network protocols used for internet communications. SLMP (SeamLess Message Protocol) is a communication method that uses TCP/IP.
Transient transmission	A function of communications with other stations, which is used when requested by a dedicated instruction or an engineering tool

## GENERIC TERMS AND ABBREVIATIONS

Unless otherwise specified, this manual uses the following generic terms and abbreviations.

Generic term/abbreviation	Description
CC-Link IE TSN remote module	A generic term for an A/D converter module, a D/A converter module, an I/O module
FX5U CPU module	A generic term for FX5U-32MR/ES, FX5U-32MT/ES, FX5U-32MT/ESS, FX5U-64MR/ES, FX5U-64MT/ES, FX5U-64MT/ESS, FX5U-80MR/ES, FX5U-80MT/ES, FX5U-80MT/ESS, FX5U-32MR/DS, FX5U-32MT/DS, FX5U-32MT/DSS, FX5U-64MR/DS, FX5U-64MT/DS, FX5U-64MT/DSS, FX5U-80MR/DS, FX5U-80MT/DS, and FX5U-80MT/DSS
FX5UC CPU modules	A generic term for FX5UC-32MT/D, FX5UC-32MT/DSS, FX5UC-64MT/D, FX5UC-64MT/DSS, FX5UC-96MT/D, FX5UC-96MT/DSS, FX5UC-32MT/DS-TS, FX5UC-32MT/DSS-TS, and FX5UC-32MR/DS-TS
I/O module	An abbreviation for the CC-Link IE TSN remote I/O module

# KEY FEATURES

## Point1

### Flexible and optimum system construction with standard Ethernet devices

Since the CC-Link IE TSN and the TCP/IP network can coexist, the standard Ethernet devices can be used on the same line. This enables to perform control communications and information communications on the same Ethernet, reducing the design and installation cost for the system construction. Even if various data communications are performed over the network, the system control is not affected and the punctuality of control data can be ensured.

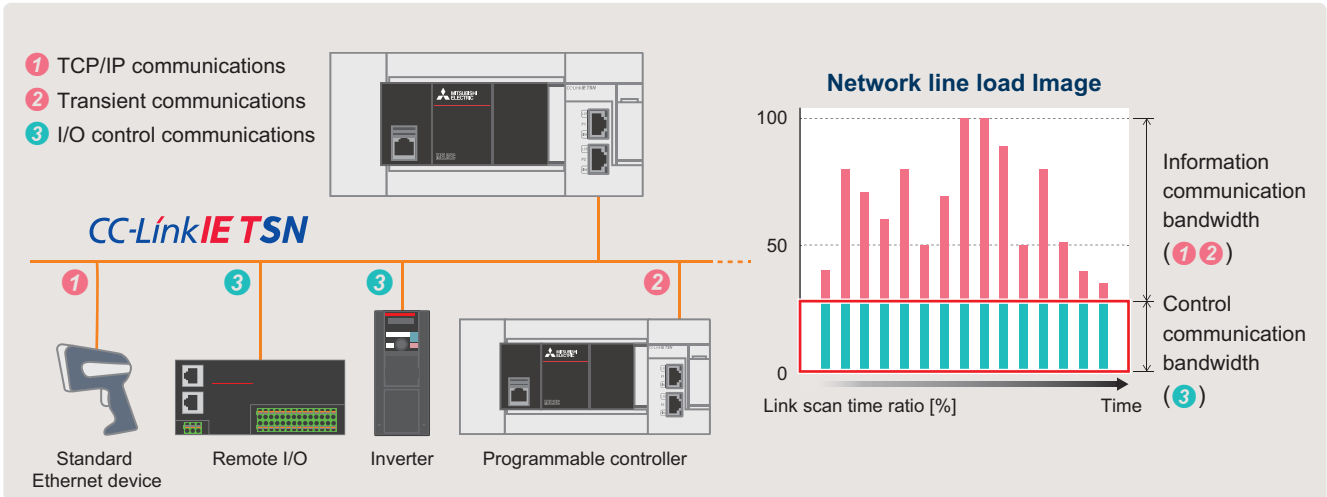

## Point2

### Easy replacement of slave stations using the automatic parameter distribution function

Parameters stored in the CPU module by the master station are automatically distributed to the slave stations when the slave station is powered ON or disconnected stations return to the network. This eliminates the need of writing parameters individually to each slave station even after replacement, facilitating replacement of the slave stations.

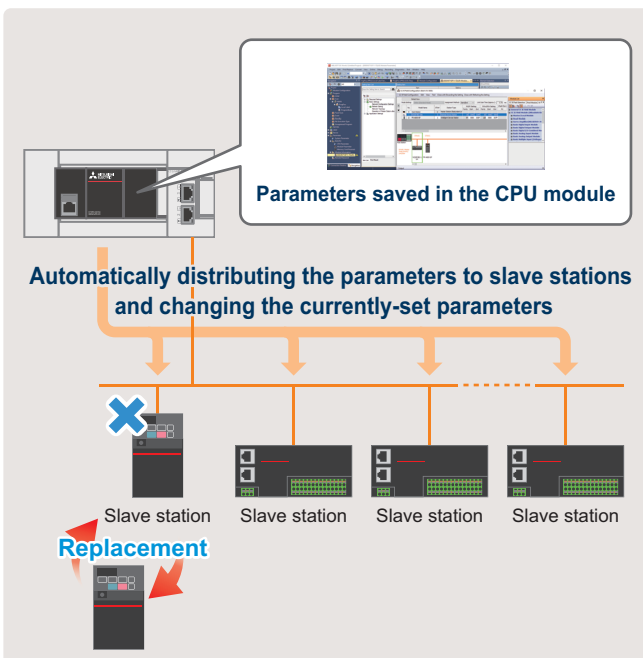

## Point3

### Easy debug of the entire network

Parameters of all stations can be set and monitored by connecting GX Works3 to any one of the ports in the CC-Link IE TSN network. This eliminates the need of rewiring cables, reducing the debug cost.

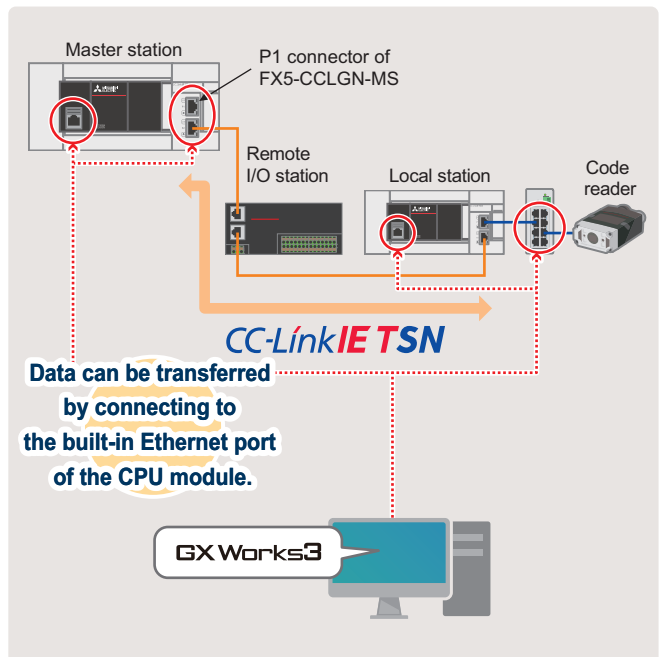

For a setting example when GX Works3 is connected to P1 connector of the FX5-CCLGN-MS, refer to Page 29 Operation Check of the Local Station.



# 1 PREPARATION

This manual describes the settings for cyclic transmission (communicating data periodically among stations on the network using link devices). For other communication functions, refer to the following.

📖 Section 4.1 Function List in the MELSEC iQ-F FX5 User's Manual (CC-Link IE TSN)

## 1.1 Applicable Models

The programmable controllers described in this manual are shown in the following table.

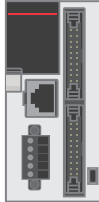
Programmable controller	
	
FX5U CPU module	FX5UC CPU module

## 1.2 Operation Flow Diagram

1. Preparing the required products
2. Setting the programmable controller master station
3. Setting the programmable controller local station

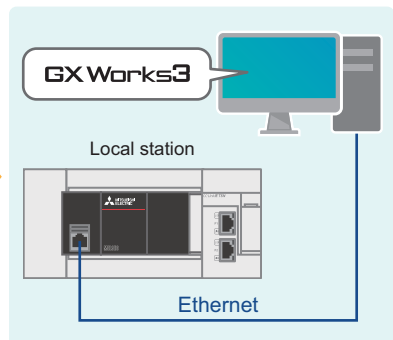
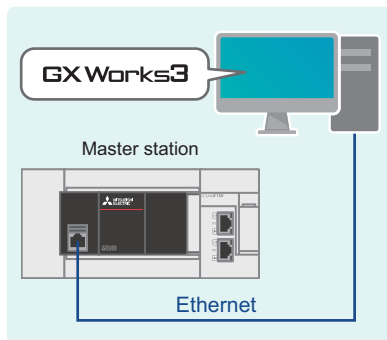
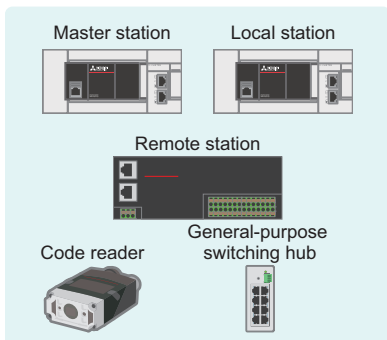

4. Setting the remote station
5. Setting TCP/IP communications of a code reader
6. Checking the operation

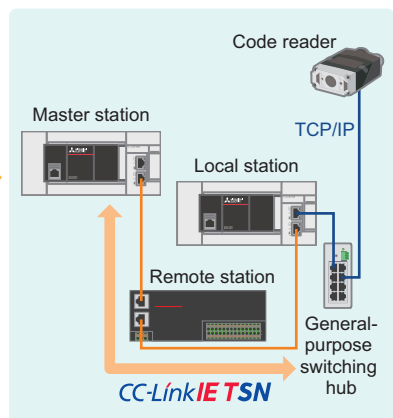
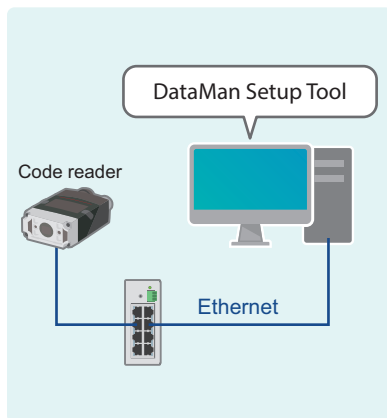
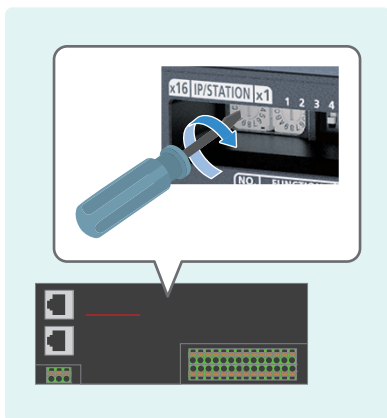

## Sample QR code for the code reader

---

To read the QR code below, refer to the following for the procedure. (☞ Page 37 Operation Check of the Code Reader (TCP/IP Communications))

Ex.

ABCDEFG01234

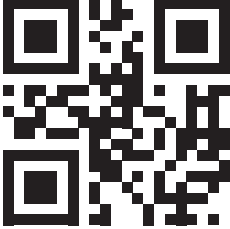

## 1.3 System Configuration

This section describes the system configuration in which two slave stations (a remote station and a local station) are connected to the master station (FX5U CPU module, FX5-CCLGN-MS). They are connected in a line topology. In this system, TCP/IP communications (code reader) are mixed.

IP addresses for the modules and devices used in the system must be set in advance by a user. The same address must be set for all the subnet masks.

In this manual, the IP addresses are set to "192.168.3.□" and the subnet mask is set to "255.255.255.0".

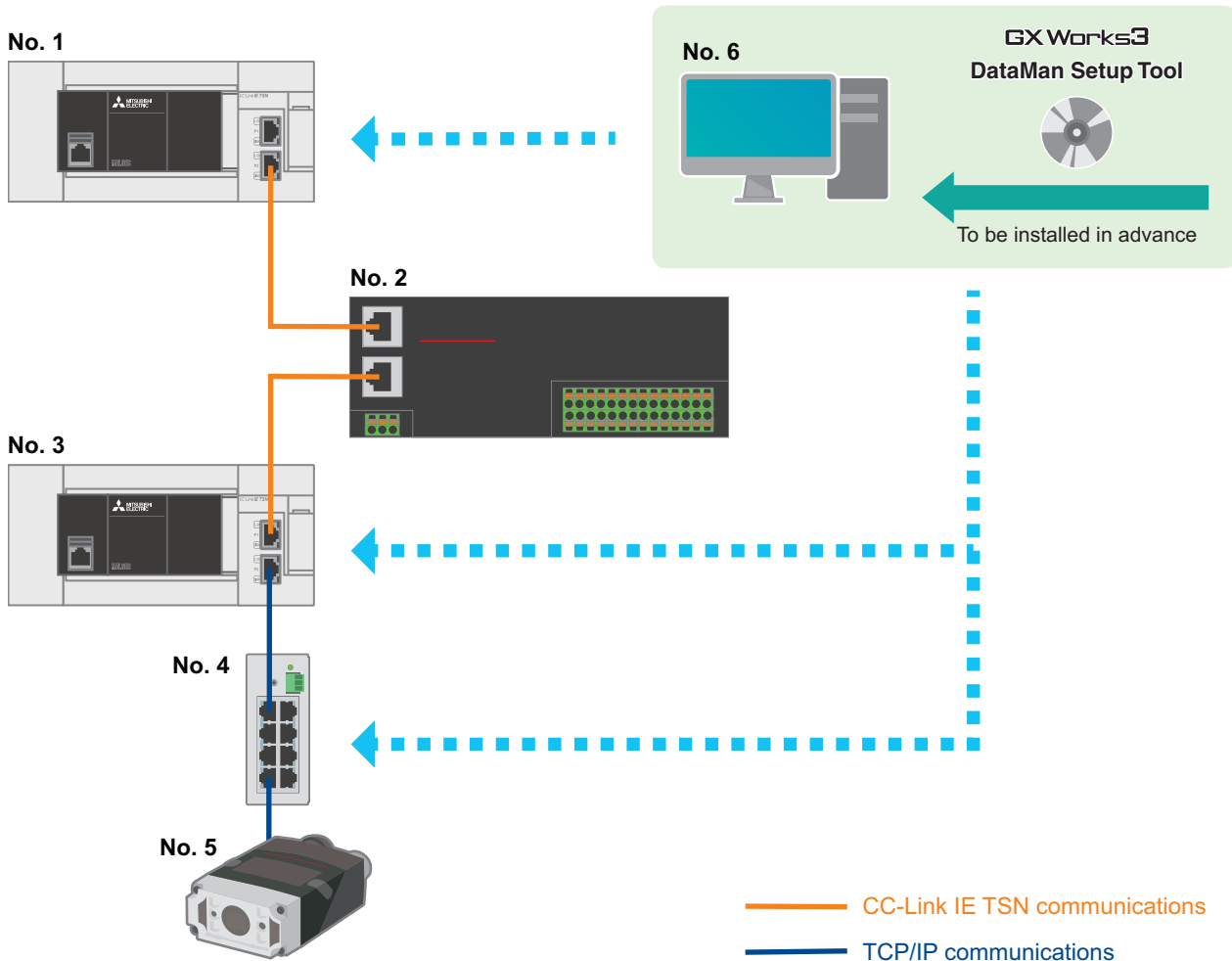

No.	Connected station/device	Product	IP address	Communication speed <sup>*1</sup>
1	Master station (station number 0)	FX5U CPU module, CC-Link IE TSN master/local module (authentication Class B)	192.168.3.249	1Gbps
2	Remote station (station number 1)	CC-Link IE TSN remote module (authentication Class B)	192.168.3.1	1Gbps
3	Local station (station number 2)	FX5U CPU module, CC-Link IE TSN master/local module (authentication Class B)	192.168.3.11	1Gbps
4	General-purpose switching hub	—	—	1 Gbps
5	TCP/IP communication device	Code reader CF26	192.168.3.4	100Mbps
6	Personal computer	—	192.168.3.3	100Mbps

\*1 Connectable products differ depending on the communication mode and communication speed. For details, refer to the following.

📖 When the communication speed for the master station is set to 1Gbps in the MELSEC iQ-F FX5 User's Manual (CC-Link IE TSN)

For the power supply wiring of FX5U/FX5UC CPU modules, refer to the following.

 Section 6.4 Power Supply Wiring in the MELSEC iQ-F FX5U User's Manual (Hardware)

 Section 6.4 Power Supply Wiring in the MELSEC iQ-F FX5UC User's Manual (Hardware)

For the power supply wiring of CC-Link IE TSN remote module, refer to the following.

 Chapter 6 INSTALLATION AND WIRING in the CC-Link IE TSN Remote I/O Module User's Manual (CC-Link IE TSN Communication Mode)



For the power supply wiring of code reader, refer to the following.

 Connecting and wiring a code reader in the Code Reader Connection Guide

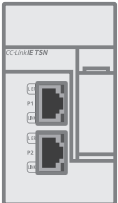

# 1.4 Required Products

In the system configuration (refer to  Page 9 System Configuration) of this manual, the following products are used.

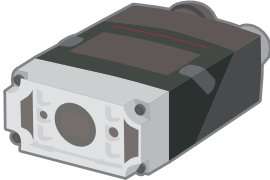

## Modules for CC-Link IE TSN communications

FX5U CPU module × 2	CC-Link IE TSN master/local module FX5-CCLGN-MS × 2	CC-Link IE TSN remote module NZ2GN2S1-32DT × 1
 <p>Use an FX5U CPU module that meets the following conditions.</p> <ul style="list-style-type: none"> <li>• Firmware version 1.210 or later</li> </ul>		 <ul style="list-style-type: none"> <li>• Input 16 points (DC input, positive common)</li> <li>• Output 16 points (transistor output, sink)</li> <li>• RX and RY (32 points each)</li> <li>• RWr and RWw (4 points each)</li> </ul>

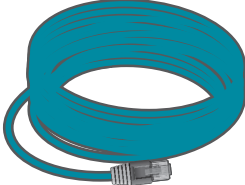
## Device and cables for TCP/IP communications

MELSENSOR code reader CF26 × 1 (manufactured by Mitsubishi Electric)	Breakout cable (manufactured by Cognex Corporation)	Ethernet cable × 1 (manufactured by Cognex Corporation)
		

## General-purpose products

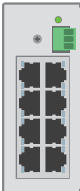
Ethernet cable × 3	Personal computer × 1	General-purpose switching hub × 1 <sup>*2</sup>
 <p>Use Ethernet cables compliant with the following standards.</p> <ul style="list-style-type: none"> <li>• Supporting a communication speed of 1 Gbps</li> <li>• Category 5e or higher straight cable (double shielded / STP)</li> <li>• IEEE 802.3 (1000BASE-T)</li> <li>• ANSI/TIA/EIA-568-B (Category 5e)</li> </ul>	 <ul style="list-style-type: none"> <li>• GX Works3</li> </ul> <p>Supported software version: 1.065T or later</p> <ul style="list-style-type: none"> <li>• DataMan Setup Tool<sup>*1</sup></li> </ul> <p>Supported software version: 6.1.5 or later</p>	 <p>Use a switching hub that meets the following conditions.</p> <ul style="list-style-type: none"> <li>• Supporting a communication speed of 1 Gbps</li> <li>• Compliance with the IEEE 802.3 (1000BASE-T)</li> <li>• Equipped with the auto MDI/MDI-X function</li> <li>• Equipped with the auto-negotiation function</li> <li>• Switching hub (layer 2 switch)<sup>*2</sup></li> </ul>

\*1 For information on how to obtain DataMan Setup Tool (configuration tool for MELSENSOR Code Reader), please contact your local Mitsubishi Electric sales office or representative.

\*2 A repeater hub cannot be used.

**Point** 

---

Wiring of CC-Link IE TSN supports a star topology and a line topology. In the system configuration example of this manual, the master station, the slave stations and other devices are connected in a line topology. To connect them in a star topology, a dedicated TSN switching hub is required.

For details, refer to the following.

 Chapter 5 SYSTEM CONFIGURATION in the MELSEC iQ-F FX5 User's Manual (CC-Link IE TSN)

---

# 2 SETTING PROGRAMMABLE CONTROLLER MASTER STATION

This chapter describes the settings for the programmable controller master station in the system and the setting procedure.

## 2.1 Communication Settings

For the communication setting procedure, refer to  Page 15 Setting Parameters, Step 4.

Setting item	Initial value	Setting range	Setting value
Station Type	Local Station	Master Station, Local Station	Master Station*1
Network No.	1	1 to 239	1
Station No./IP Address Setting	Parameter Editor	Parameter Editor (fixed)	Parameter Editor (fixed)
Station No.	1	Master station: 0 (fixed) Local station: 1 to 120	0 (fixed)
IP Address	Master station: 192.168.3.249 Local station: 192.168.3.11	0.0.0.1 to 223.255.255.254	192.168.3.249*1
Subnet Mask	255.255.255.0	0.0.0.1 to 255.255.255.255	255.255.255.0

\*1 Refer to the system configuration ( Page 9 System Configuration).

## 2.2 Network Configuration Settings

For the network configuration setting procedure, refer to  Page 15 Setting Parameters, Step 6.

Model Name	STA#*1	Station Type*1	RX Setting	RY Setting	RWr Setting	RWw Setting	IP Address*1
			Points	Points	Points	Points	
Host Station	0	Master Station	—	—	—	—	192.168.3.249
NZ2GN2S1-32DT	1	Remote Station	32	32	4	4	192.168.3.1
FX5-CCLGN-MS	2	Local Station	32	32	16	16	192.168.3.11

\*1 Refer to the system configuration ( Page 9 System Configuration).

## 2.3 Refresh Settings

This section describes the refresh settings to perform the following data communications between the master station and the remote/local station using the link devices.

For the refresh setting procedure, refer to  Page 15 Setting Parameters, Step 8.

### Refresh Settings

■ Remote station (station number 1)		
Assignment target device on the programmable controller side	Point	Link device on the remote station side
M2000 to M2031	32	RX0 to RX1F
M3008 to M3039	32	RY0 to RY1F
■ Local station (station number 2)		
Assignment target device on the programmable controller side	Point	Link device on the local station side
M4000 to M4031	32	RX20 to RX3F
M5008 to M5039	32	RY20 to RY3F
D100 to D115	16	RWr4 to RWr13
D200 to D215	16	RWw4 to RWw13

### Data communications with link devices

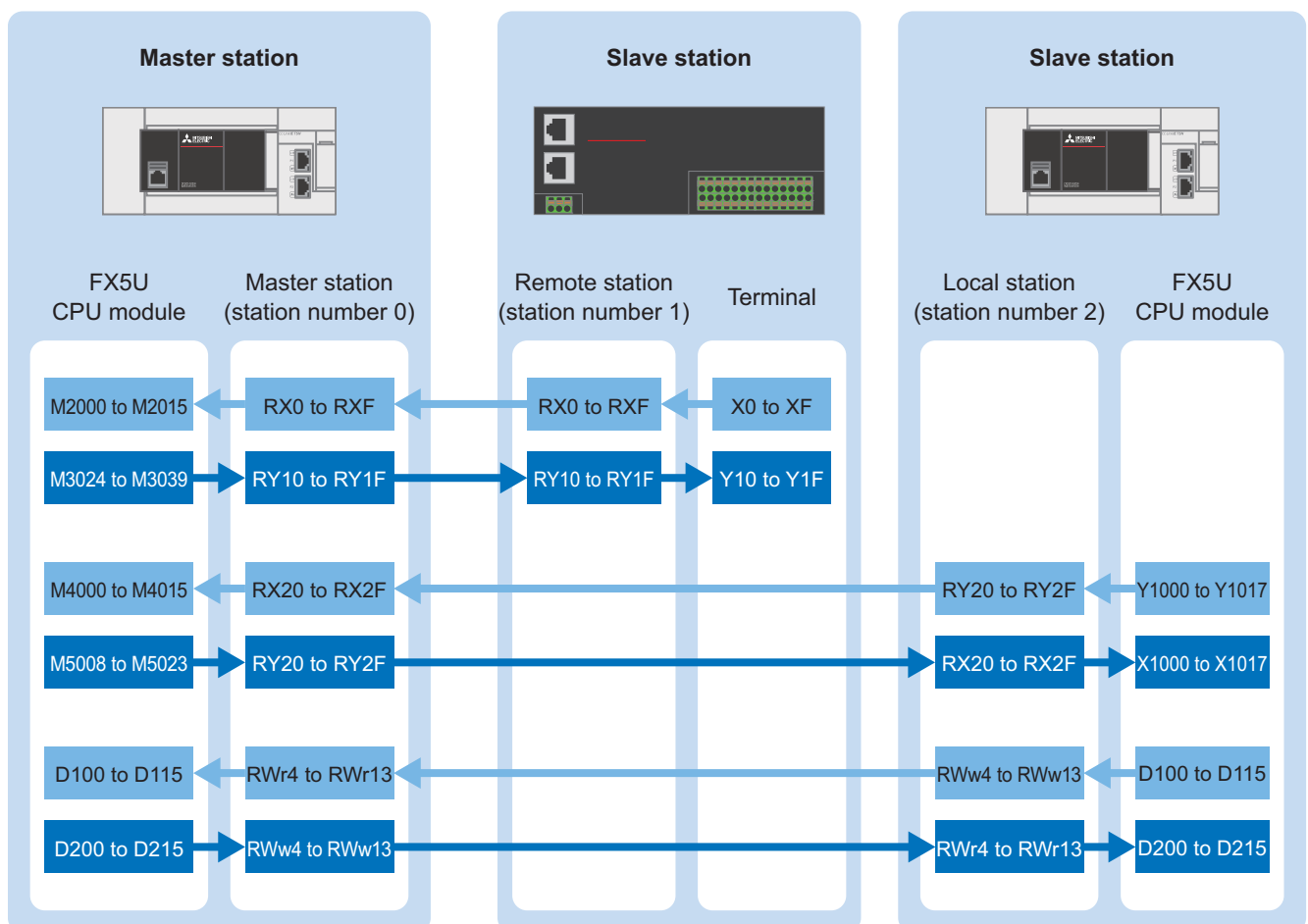

### Precautions

The above areas are used as the link devices for network. Do not use these areas for other purposes.



## 2.4 Setting Parameters

This section describes the communication settings, network configuration settings, and refresh settings on GX Works3.

1. Open the "Module Configuration" window. Select "FX5-CCLGN-MS", and drag and drop it onto the "Module Configuration" window.

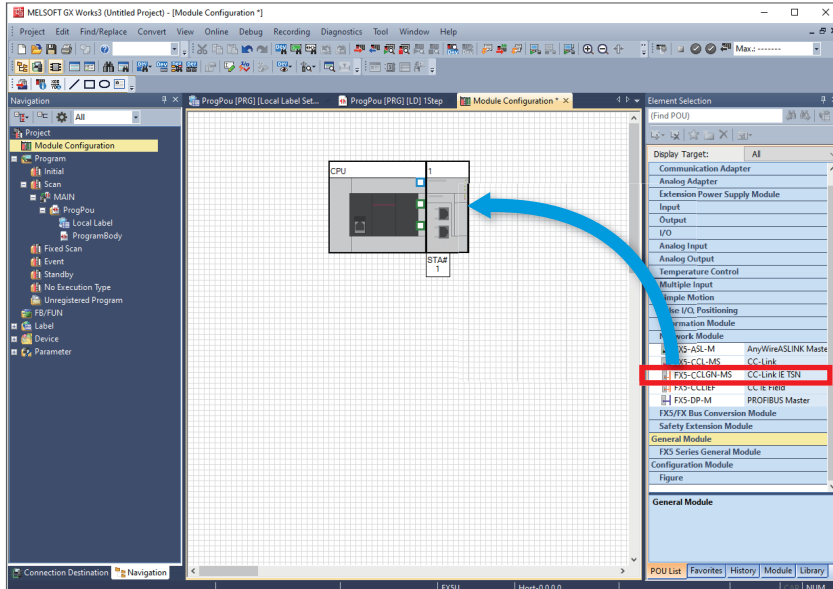

2. Double-click the added "FX5-CCLGN-MS". When the following window appears, click the [Yes] button.

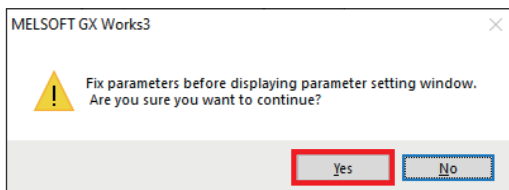

3. When the following window appears, click the [OK] button.

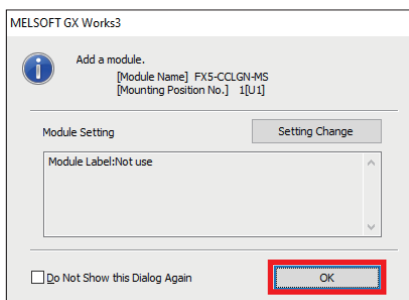

- Set the parameters according to the communication settings (  Page 13 Communication Settings), and click the [Apply] button.

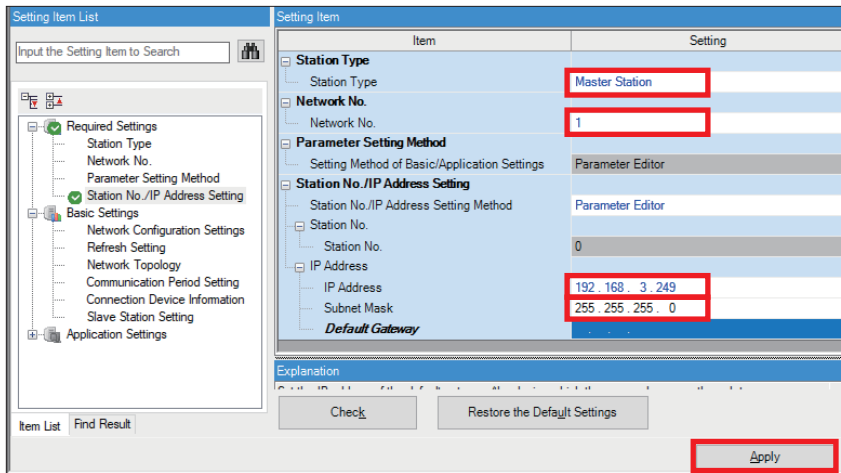

- Click "Basic Settings" ⇒ Double-click <Detailed Setting> of "Network Configuration Settings".

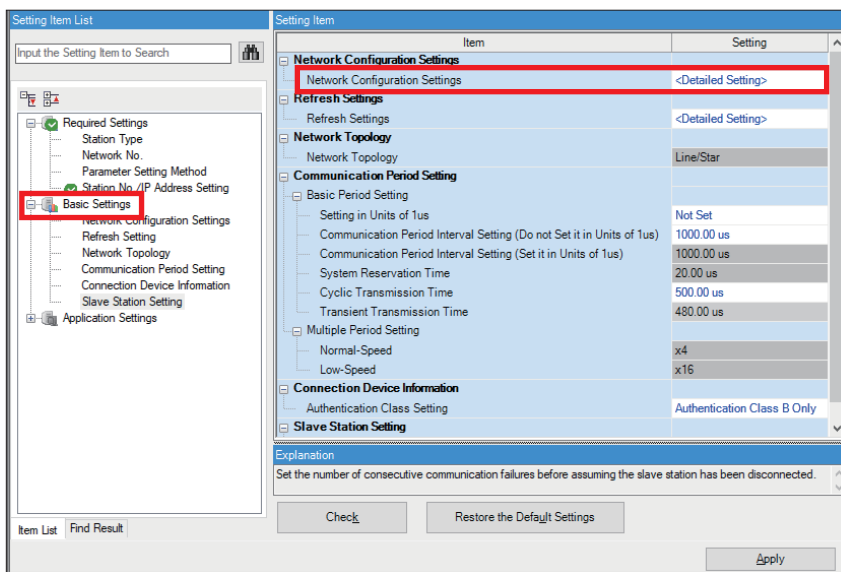

- Select the remote station (N22GN2S1-32DT) and the local station (FX5-CCLGN-MS) from "Module List", and drag and drop them to the network map. Set the parameters according to the network configuration settings (  Page 13 Network Configuration Settings), and click the [Close with Reflecting the Setting] button.

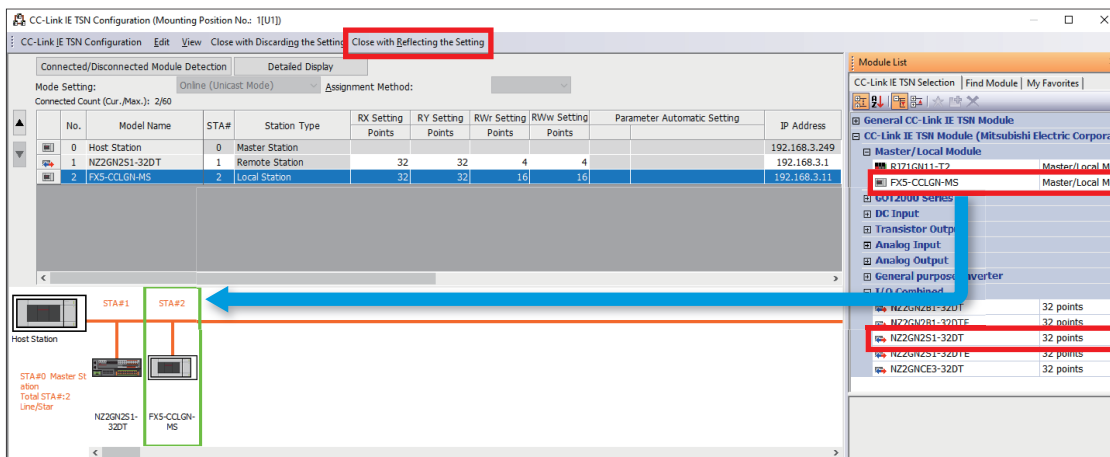

**Point**

The parameters for the TCP/IP communication device is not set at "Network Configuration Settings" on the master station side. Set the parameters on the TCP/IP communication device. For the parameter settings on the TCP/IP communication device in this manual, refer to  Page 27 Setting the Code Reader.

7. Double-click <Detailed Setting> of "Refresh Settings".

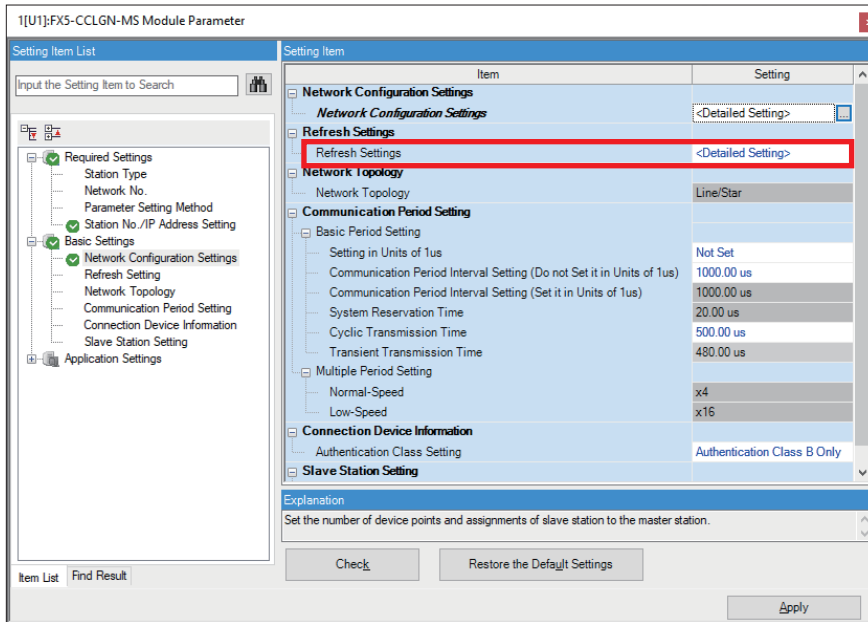

8. Set the parameters according to the refresh settings, and click the [Apply] button. (Page 14 Refresh Settings)

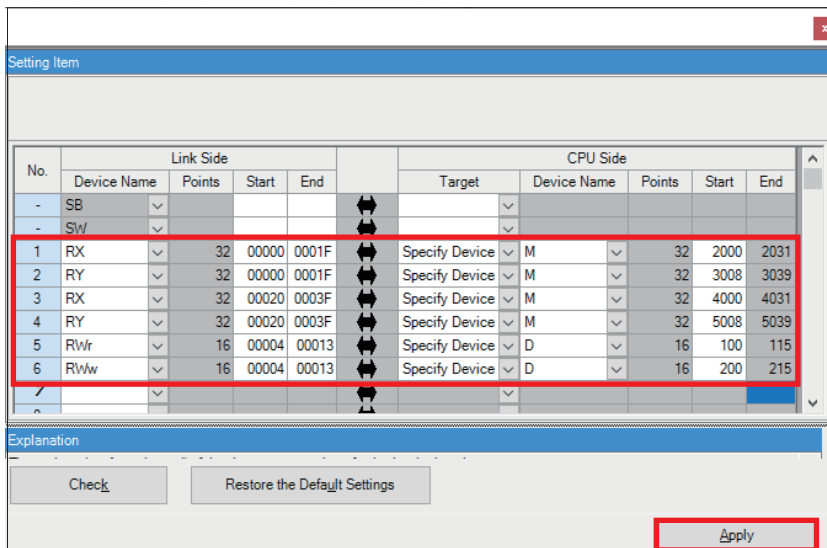

## 2.5 Communication Settings on GX Works3

This section describes how to perform the communication test before writing programs to the programmable controller. Directly connect the Ethernet ports with a cable as shown below.

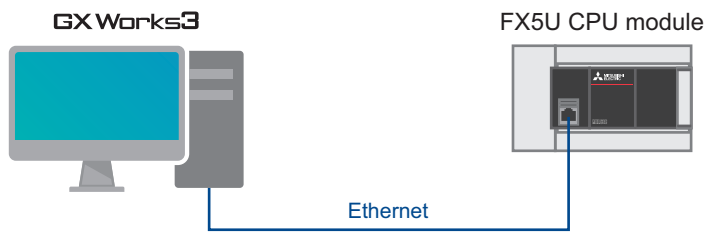

1. Select [Online] ⇒ [Current Connection Destination].

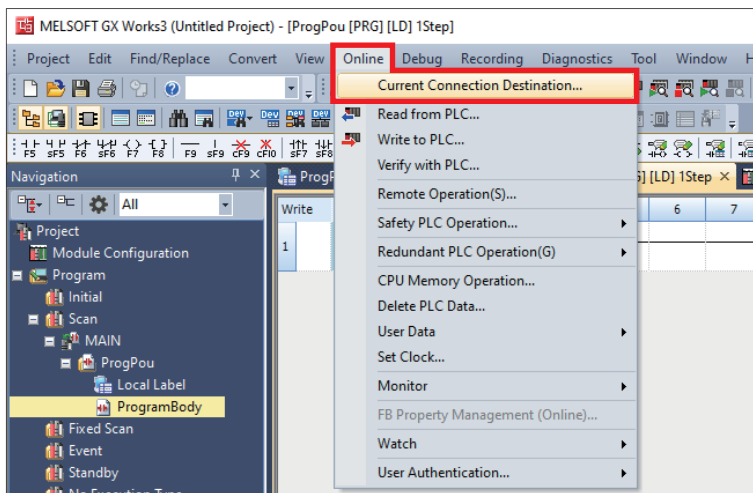

2. Select "Direct Coupled Setting".

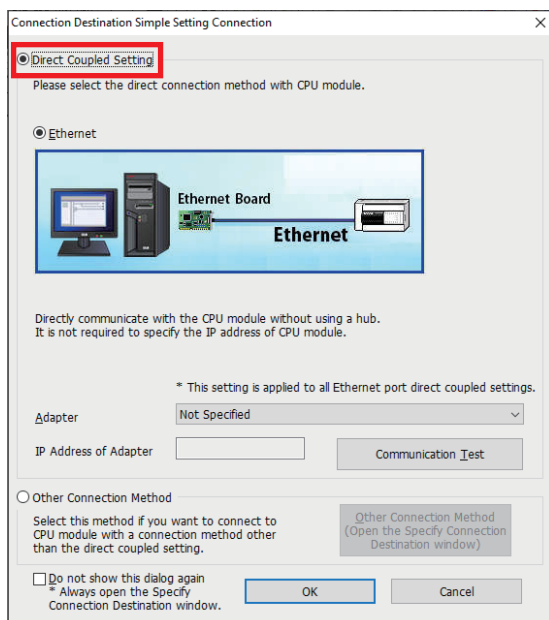

- Specify an Ethernet adapter of the personal computer which is used when the personal computer is directly connected to the CPU module.

When "Not Specified" is set, select an adapter to be used from the drop-down list.

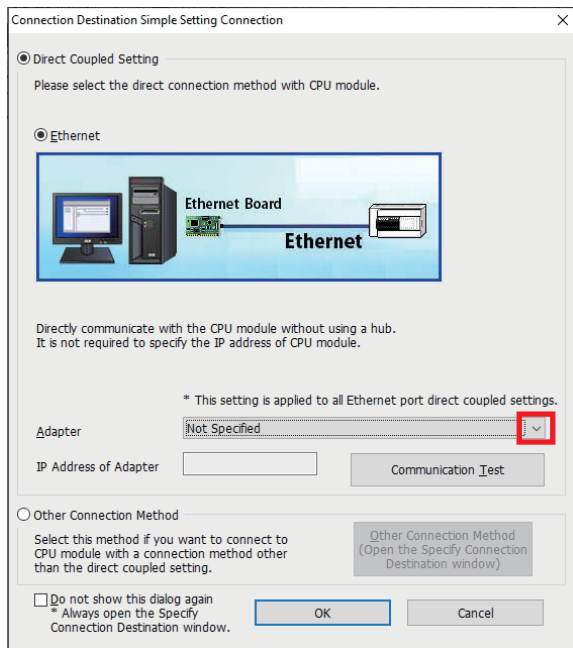

- After the adapter is selected, click the [Communication Test] button.

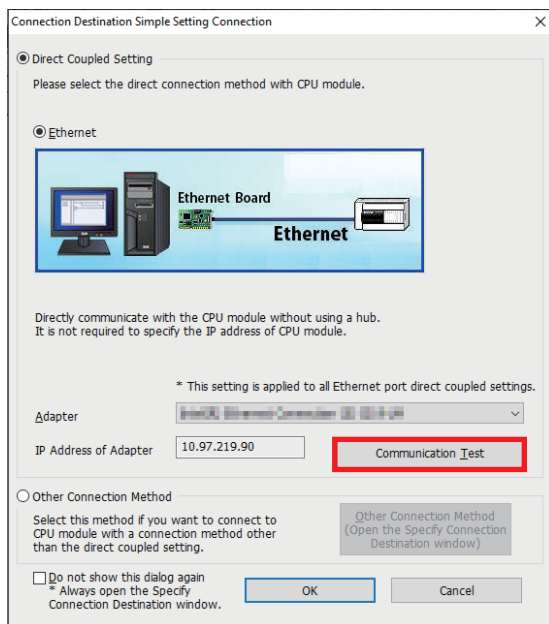

- When the following window appears, click the [OK] button.

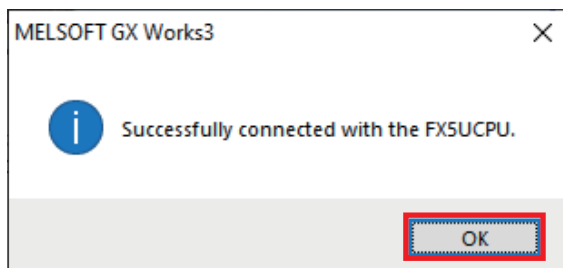

For the connection via a hub, refer to the following.

📖 Section 4.2 Connection Via a Hub in the MELSEC iQ-F FX5 User's Manual (Ethernet Communication)

## 2.6 Writing Programs to the Programmable Controller

This section describes how to write programs to the programmable controller.

Before writing the program to the programmable controller, an operation to finalize the logic and parameters must be performed.

1. Select [Convert] ⇒ [Rebuild All].

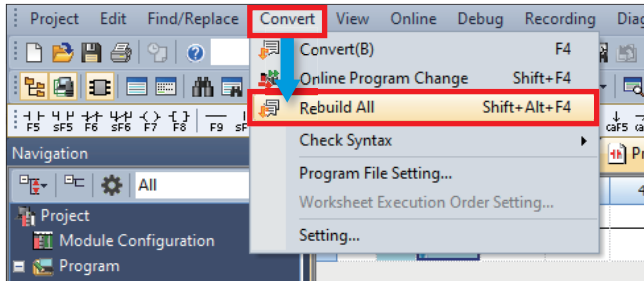

2. Click the [OK] button.

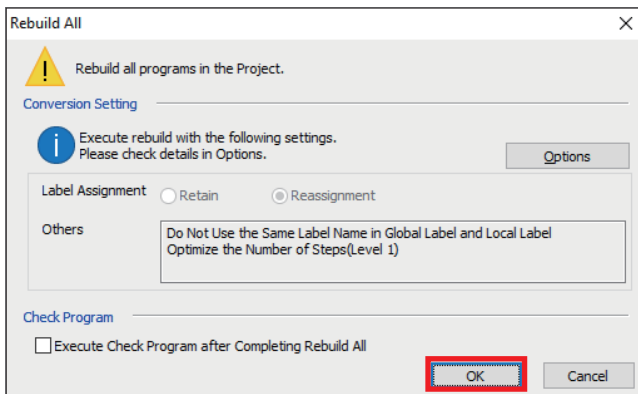

3. Select [Online] ⇒ [Write to PLC].

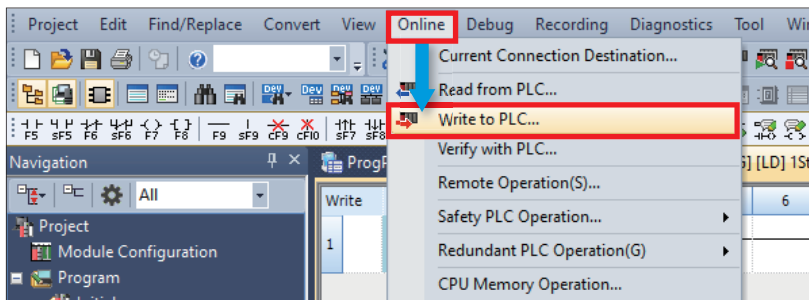

4. Click the [Parameter + Program] button, and click the [Execute] button.

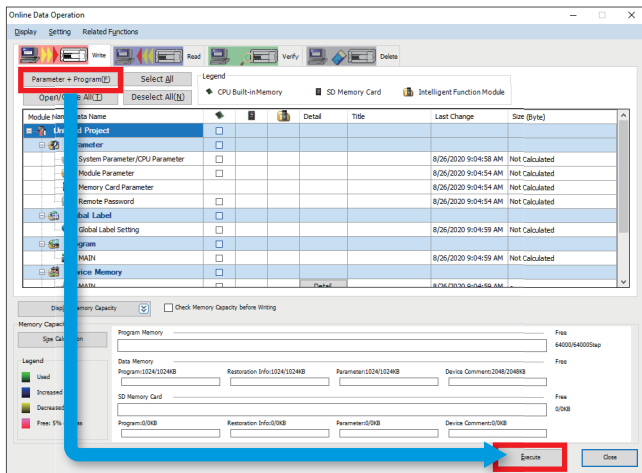

5. When the following window appears, click the [Yes to all] button.

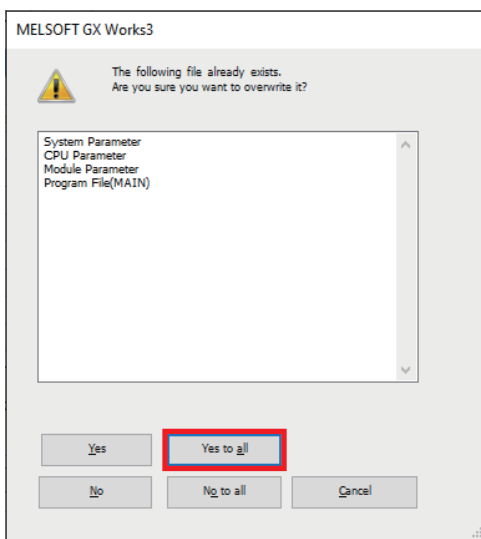

6. After the programs are written to the programmable controller, reset or power OFF and ON the programmable controller.

# 3 SETTING PROGRAMMABLE CONTROLLER LOCAL STATION

This chapter describes the settings for the programmable controller local station in the system.

## 3.1 Communication Settings

For the communication setting procedure, refer to  Page 23 Setting Parameters, Step 4.

Setting item	Initial value	Setting range	Setting value
Station Type	Local Station	Master Station, Local Station	Local Station* <sup>1</sup>
Network No.	1	1 to 239	1
Station No./IP Address Setting Method	Parameter Editor	Parameter Editor (fixed)	Parameter Editor (fixed)
Station No.	1	Master station: 0 (fixed) Local station: 1 to 120	2* <sup>1</sup>
IP Address	Master station: 192.168.3.249 Local station: 192.168.3.11	0.0.0.1 to 223.255.255.254	192.168.3.11* <sup>1</sup>
Subnet Mask	255.255.255.0	0.0.0.1 to 255.255.255.255	255.255.255.0

\*<sup>1</sup> Refer to the system configuration ( Page 9 System Configuration).

## 3.2 Refresh Settings

This section describes the refresh settings for the local station by referring to Section 2.3 Refresh Setting. ( Page 14 Refresh Settings)

For the refresh setting procedure, refer to  Page 23 Setting Parameters, Step 6.

Assignment target device on the programmable controller side	Point	Link device
Y1000 to Y1017	16	RY20 to RY2F
X1000 to X1017	16	RX20 to RX2F
D100 to D115	16	RWw4 to RWw13
D200 to D215	16	RWr4 to RWr13



# 3.3 Setting Parameters

This section describes the communication settings and refresh settings on GX Works3.

1. Open the "Module Configuration" window. Select "FX5-CCLGN-MS", and drag and drop it onto the "Module Configuration" window.

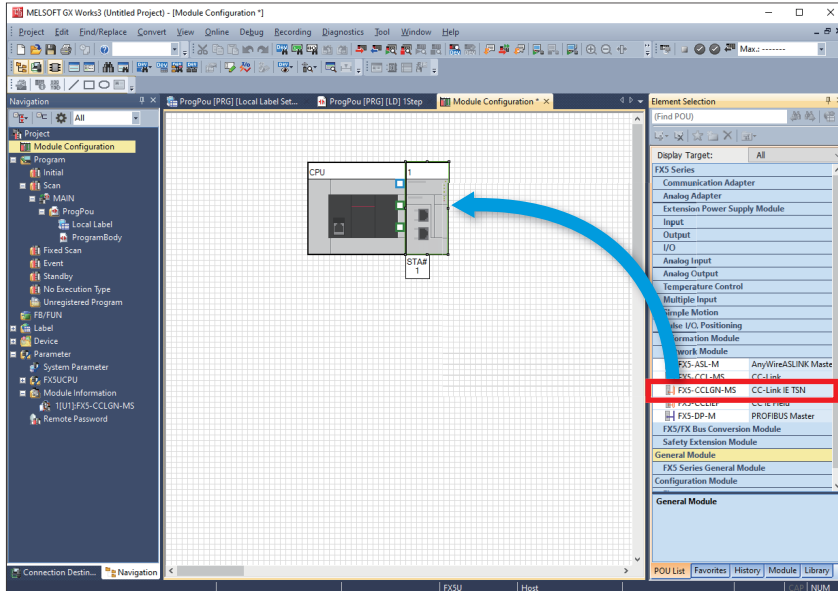

2. Double-click the added "FX5-CCLGN-MS". When the following window appears, click the [Yes] button.

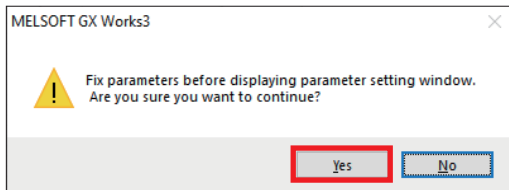

3. When the following window appears, click the [OK] button.

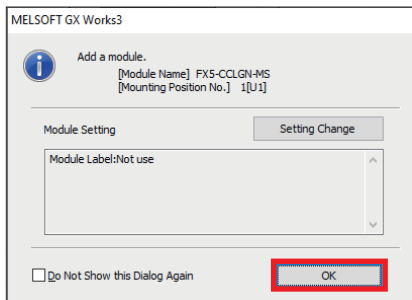

- Set the parameters according to the communication settings (☞ Page 22 Communication Settings), and click the [Apply] button.

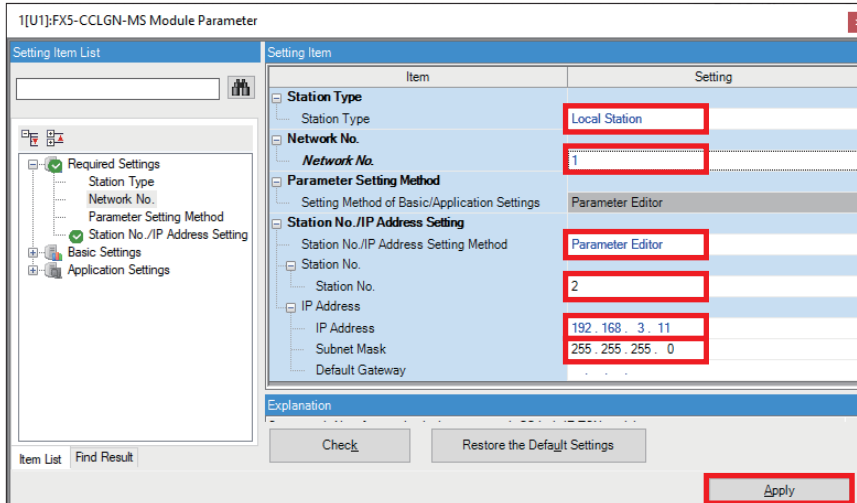

- Double-click <Detailed Setting> of "Refresh Settings".

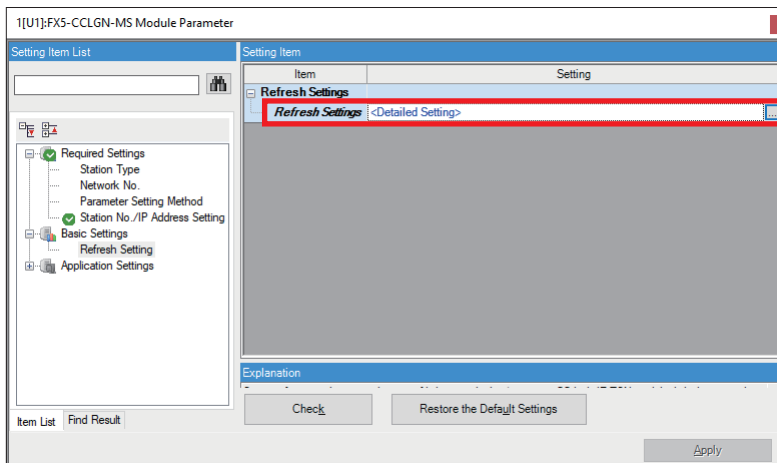

- Set the parameters according to the refresh settings (☞ Page 22 Refresh Settings), and click the [Apply] button.

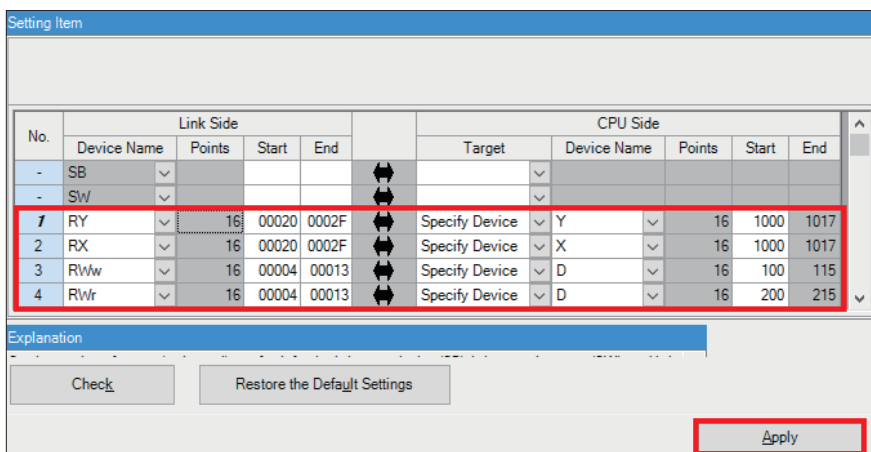

## 3.4 Communication Settings on GX Works3

Directly connect the Ethernet ports with a cable. (☞ Page 18 Communication Settings on GX Works3)

## 3.5 Writing Programs to the Programmable Controller

The programs are transferred to the programmable controller. (☞ Page 20 Writing Programs to the Programmable Controller)

# 4 SETTING REMOTE STATION

The functions of the I/O module can be set using the function setting switch on the CC-Link IE TSN remote I/O module. The setting using the IP address/station number setting switches is enabled when the power of the I/O module is ON. Therefore, use the IP address/station number setting switches when the power of the I/O module is OFF.

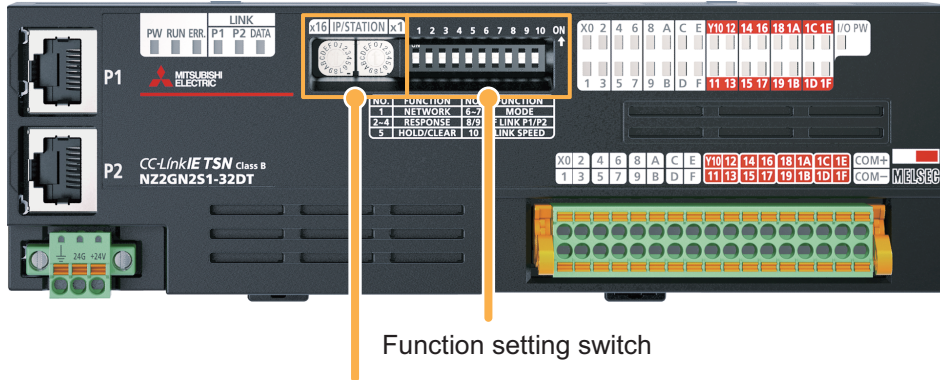

Function setting switch

IP address/station number setting switches

## 4.1 Setting the IP Address/Station Number Setting Switches

The fourth octet of the IP address is set using the IP address/station number setting switches on the front of the I/O module. IP address (192.168.3.1) is set for the CC-Link IE TSN remote I/O module (NZ2GN2S1-32DT) in this manual. (Page 9 System Configuration)

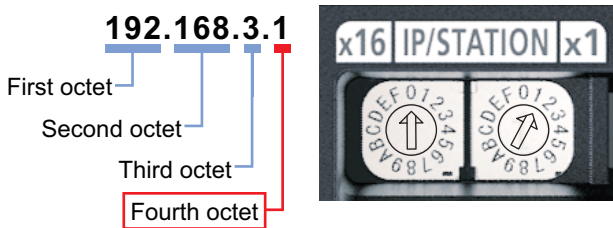

For details, refer to the following.

Section 6.2 Setting Switch in the CC-Link IE TSN Remote I/O Module User's Manual (CC-Link IE TSN Communication Mode)

## 4.2 Setting the Function Setting Switch

The following functions are set using the function setting switch (1 to 10) on the front of the I/O module. The setting using the function setting switch is enabled when the power of the I/O module is ON. Therefore, use the function setting switch when the power of the I/O module is OFF.

The following table lists the functions to be set in this manual.

Switch		Function	Setting	Setting value	Setting value to be set
Function setting switch 1	NETWORK	Network setting function	Set this switch to OFF in normal operation.	OFF	—
Function setting switch 2	RESPONSE	Input response time setting function	Set the input response time.	OFF	1 ms
Function setting switch 3				OFF	
Function setting switch 4				OFF	
Function setting switch 5	HOLD/CLEAR	Output HOLD/CLEAR setting function	Set output HOLD/CLEAR.	OFF	CLEAR
Function setting switch 6, function setting switch 7	MODE	Use prohibited	Fix these switches to OFF.	OFF	—
Function setting switch 8, function setting switch 9	F LINK P1/P2	Use prohibited	Fix these switches to OFF.	OFF	—
Function setting switch 10	LINK SPEED	Communication speed setting function	Set the communication speed.	OFF	1 Gbps



For details on the function setting switch, refer to the following.

📖 Section 6.2 Setting Switch in the CC-Link IE TSN Remote I/O Module User's Manual (CC-Link IE TSN Communication Mode)

# 5 TCP/IP COMMUNICATION SETTING of CODE READER

This chapter describes the settings for communicating with the symbols to be read and the master station by connecting the code reader to the personal computer.

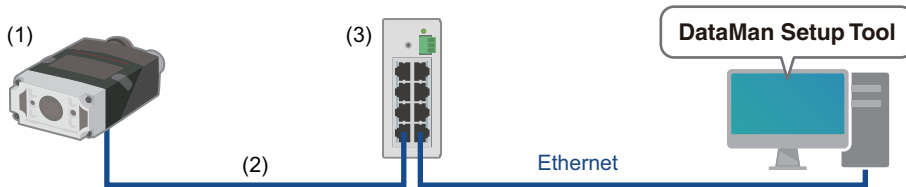

- (1) Code reader
- (2) Ethernet cable (manufactured by Cognex Corporation)
- (3) General-purpose switching hub

## 5.1 Setting an IP Address of the Personal Computer

Set the IP address (192.168.3.3) to the personal computer. (☞ Page 50 Setting an IP Address of the Personal Computer)

## 5.2 Setting the Code Reader

Set the following setting values to the code reader using DataMan Setup Tool. For the setting procedure, refer to the following.   
 ☞ Section 2.3 Setting the Code Reader in the Code Reader Connection Guide

	Setting item	Initial value	Setting value
Repair & Support	Code reader	None	CF26
Network Settings	IP Address	None	192.168.3.4 <sup>*1</sup>
	Subnet Mask	None	255.255.255.0
Application Type		Undefined	Indexed, Stationary
Application Details	Trigger Settings	Single (external)	Single (external)
	Exposure	Manual Exposure	Automatic Exposure
Format Data	Universal	None	Standard
	General	None	Full string
	Terminating Text	None	CR/LF
Communications	Industrial Protocols	None	SLMP
	IP Address	None	192.168.3.249 <sup>*2</sup>
	Host Port	None	1393 <sup>*3</sup>
	Timeout [ms]	0	1000
	Poll Interval [ms]	0	100
	PLC Series	QCPU	iQFCPU
	Network Number	0	0
	PC Number [hex]	1	FF
	Destination Module	0x3FF = Local station	0x3FF = Local station
Device assignment on the PLC side	None	☞ Page 28	

\*1 For the IP address assigned to the code reader, refer to ☞ Page 9 System Configuration.

\*2 For the IP address assigned to the CPU module (master station), refer to ☞ Page 9 System Configuration.

\*3 The port number that corresponds to SLMP (TCP/IP) of the CPU module (master station). The port number is a fixed value depending on its application. For details, refer to the following.

☞ Appendix 7 Port Number in the MELSEC iQ-F FX5 User's Manual (CC-Link IE TSN)

## Device assignment on the PLC side

Name	Selected device	Offset	Number of devices	Description
Control	D-Data Register	1000	2	Vision control block starting address
Status	D-Data Register	1002	2	Vision status block starting address
PLC Input	D-Data Register	1005	5	User data block starting address
PLC Output	D-Data Register	1010	100	Inspection results block starting address
Command	D-Data Register	2000	100	Command string starting address
Command Result	D-Data Register	2100	100	Command result data starting address

## Devices to be used in this manual

Device	Device name	Description
D1000.0	Trigger Enable	Image Capturing Trigger (D1000.1) is enabled while this device is ON.
D1000.1	Trigger	An image is captured when this device is turned ON.
D1002.9	Decode Complete	The state of the device changes from "0" to "1" at the completion of decoding of a code reader.
D1015 to D1020	PLC Output	A QR code (  Page 7 Operation Flow Diagram) read result is stored. Read result: ABCDEFG01234

# 6 OPERATION CHECK

This chapter describes the operation check based on the system configuration (☞ Page 9).

## 6.1 Operation Check of the Local Station

This section checks whether communications are performed between the master station and the local station normally. Configure the system as shown below.

Set the RUN/STOP/RESET switch of the CPU module on the master station to the RUN position.

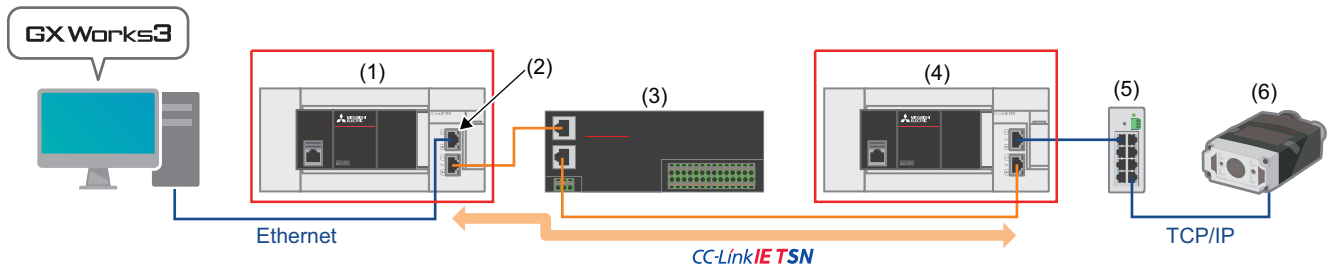

- (1) Master station (station number 0)
- (2) P1 connector
- (3) Remote station (station number 1)
- (4) Local station (station number 2)
- (5) General-purpose switching hub
- (6) Code reader

### Checking communications from the master station to the local station

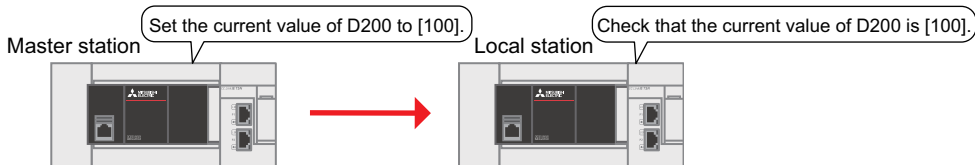

1. Start project data of the master station and the local station on the personal computer.

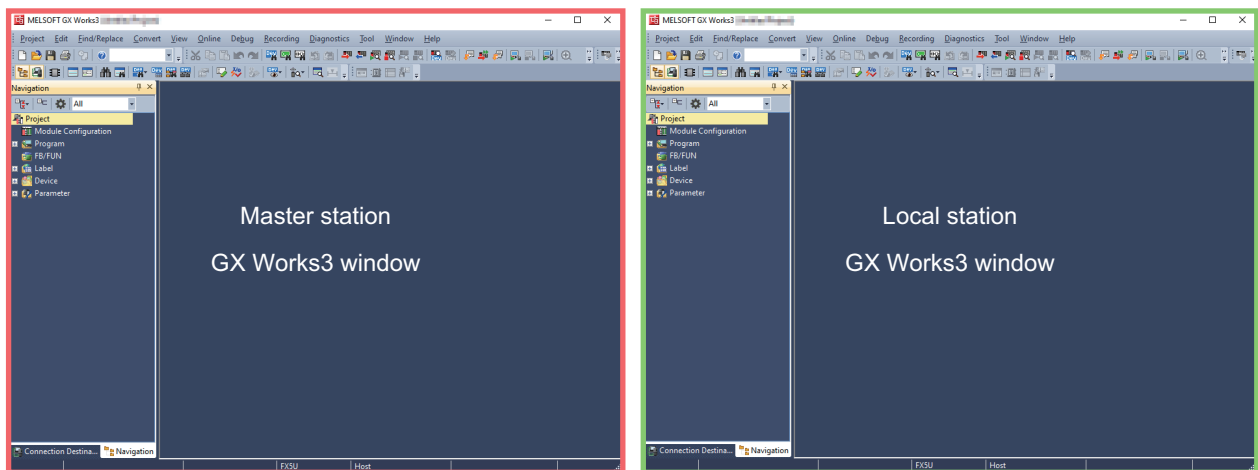

- On GX Works3 window of the master station, select [Online] ⇒ [Current Connection Destination]. The "Connection Destination Simple Setting Connection" window appears. To set the connection other than "Direct Coupled Setting", perform Steps ① and ②.

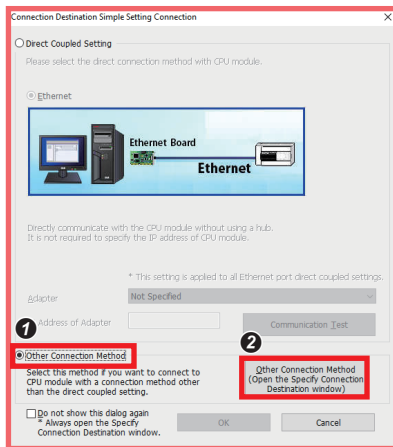

- Select "Other Connection Method".
- Select "Other Connection Method (Open the Specify Connection Destination window)".

- Click "CC IE TSN/Field Module".

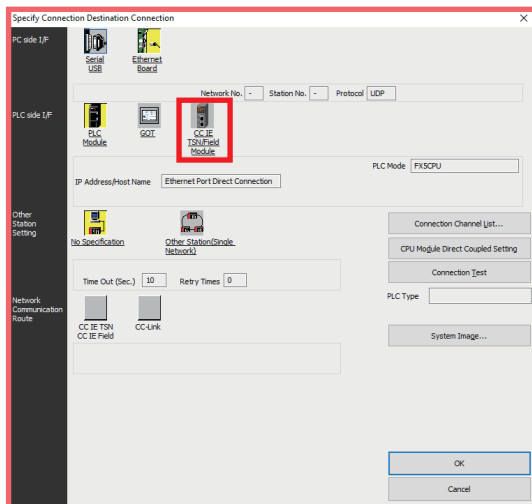

- Click the [Yes] button.

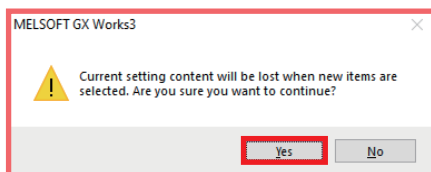

- Double-click "CC IE TSN/Field Module".

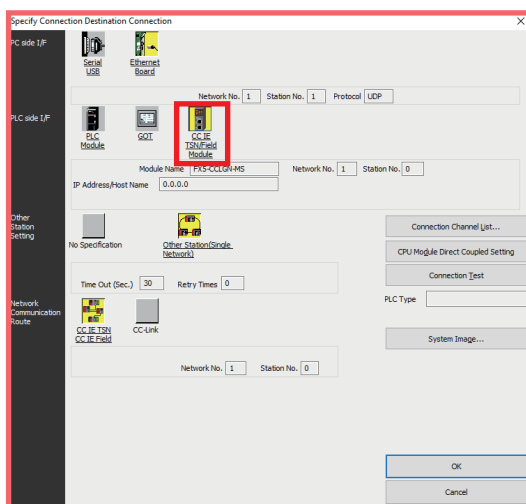



6. Click the [Find] button.

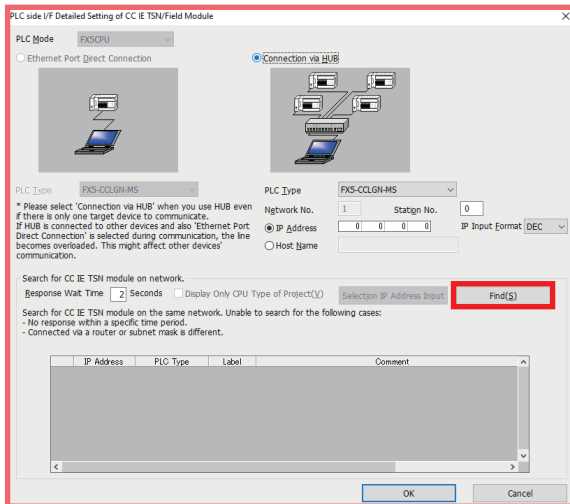

7. Click the [Yes] button.

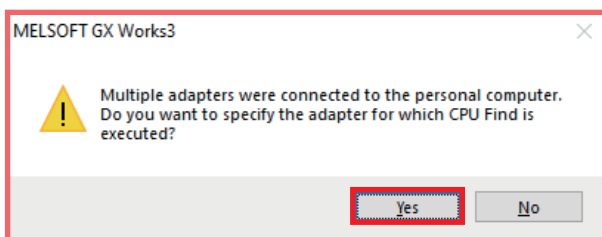

8. Select an Ethernet adapter connected to P1 connector of the personal computer from the drop-down list, and click the [OK] button.

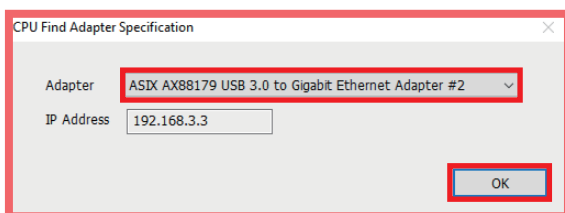

9. To set the connection destination to the IP address of the master station or the local station, perform Steps ❶ to ❺.

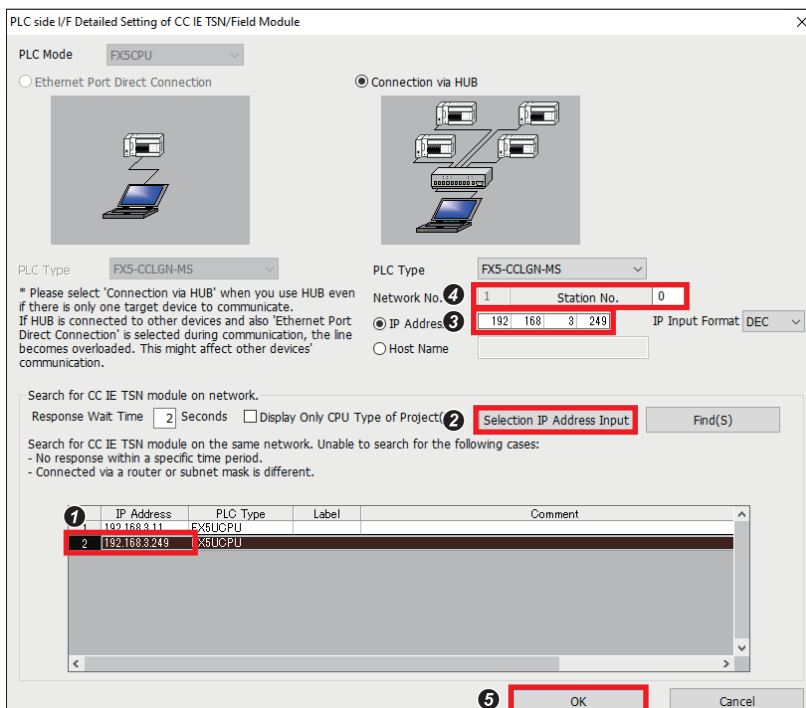

- ❶ Select an IP address.  
Master station: 192.168.3.249  
Local station: 192.168.3.11
- ❷ Click the [Selection IP Address Input] button.
- ❸ Check that the selected IP address is displayed.  
Master station: 192.168.3.249  
Local station: 192.168.3.11
- ❹ Select a station number.  
Master station: 0  
Local station: 2
- ❺ Click the [OK] button.

**10.** Double-click "Ethernet Board".

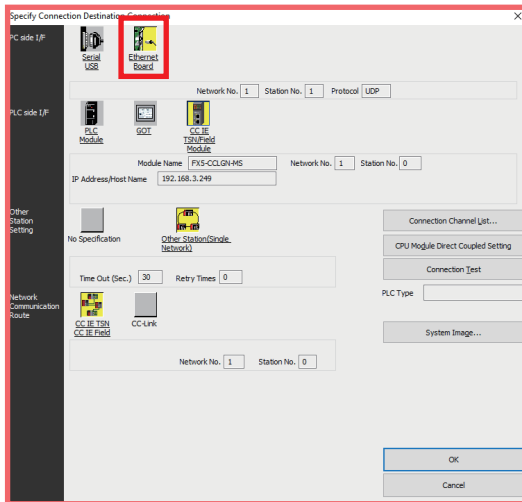

**11.** Set a unique station number in "Station No." on the same loop. Set "3" in this manual. Select "TCP" for "Protocol". Click the [OK] button.

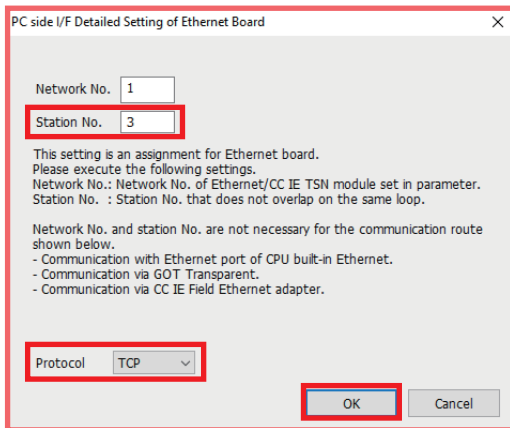

**12.** Click the [Communication Test] button. When the message "Successfully connected with the FX5UCPU" appears, click the [OK] button.

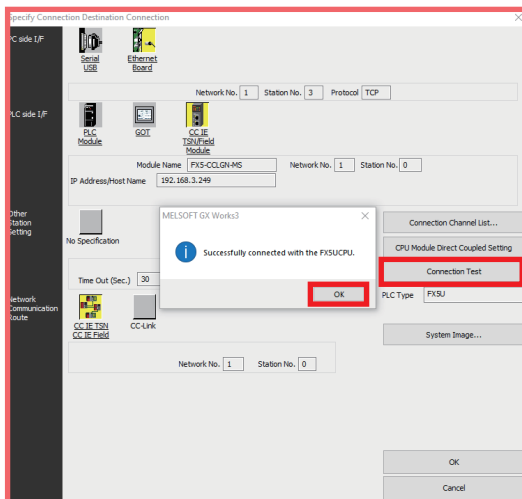

**13.** Repeat Steps 2 to 12 on GX Works3 window of the local station. However, the setting values in Step 9 are as follows.

Setting item	Setting value	Description
IP Address	192.168.3.11	An IP address of the local station
Station No.	2	A station number of the local station

14. On GX Works3 window of the master station, select [Online] on the menu bar ⇒ [Watch] ⇒ [Register to Watch Window] ⇒ [Watch Window 1].

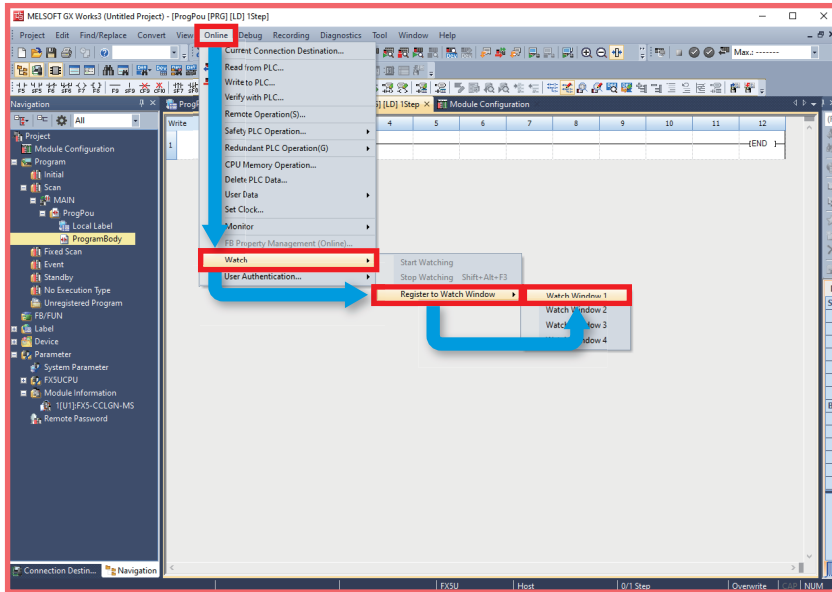

15. Enter "D200" in "Name". Right-click on "D200", and select [Start Watching].

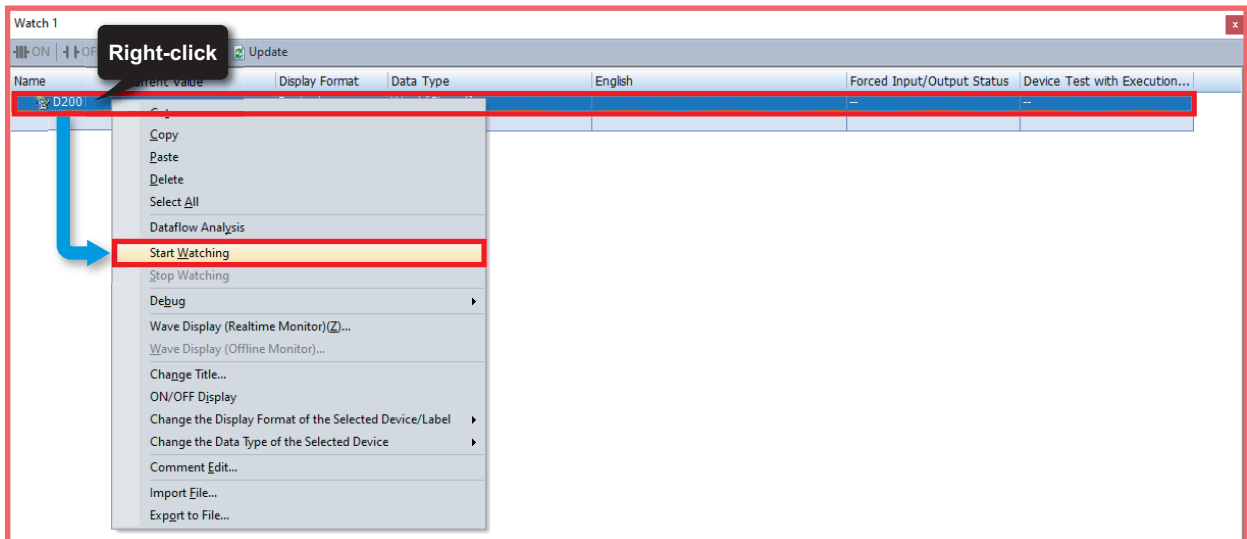

16. Enter "100" in the "Current Value" column.

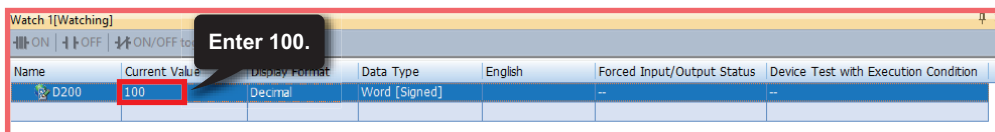

17. On GX Works3 window of the local station, select [Online] on the menu bar ⇒ [Watch] ⇒ [Register to Watch Window] ⇒ [Watch Window 1].

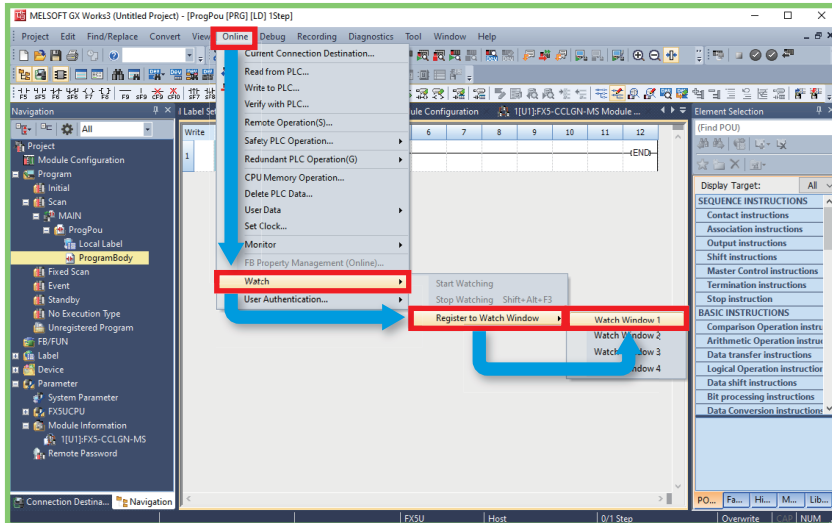

18. Enter "D200" in "Name". Right-click on "D200", and select [Start Watching].

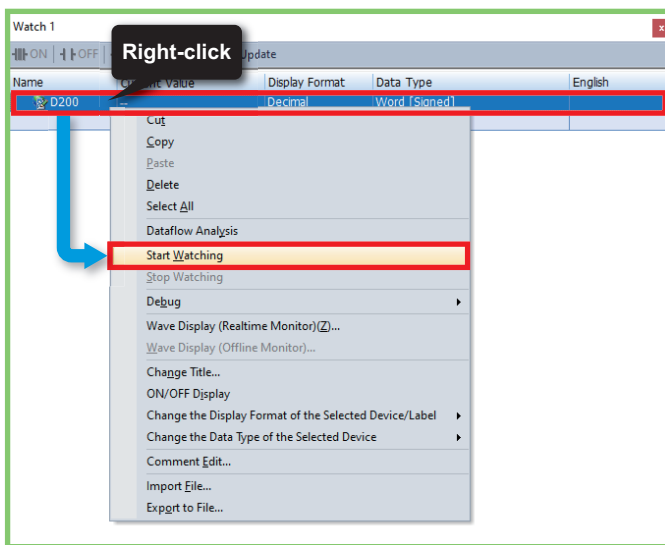

19. Check that "100" is entered in the "Current Value" column.

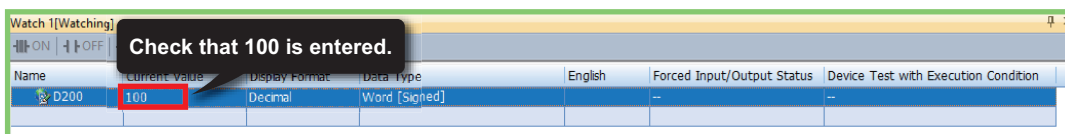

## 6.2 Operation Check of the Remote Station

This section checks whether communications are performed between the master station and the remote station normally. Configure the system as shown below.

Set the RUN/STOP/RESET switch of the CPU module on the master station to the RUN position.

For the communication setting, refer to Page 18 Communication Settings on GX Works3.

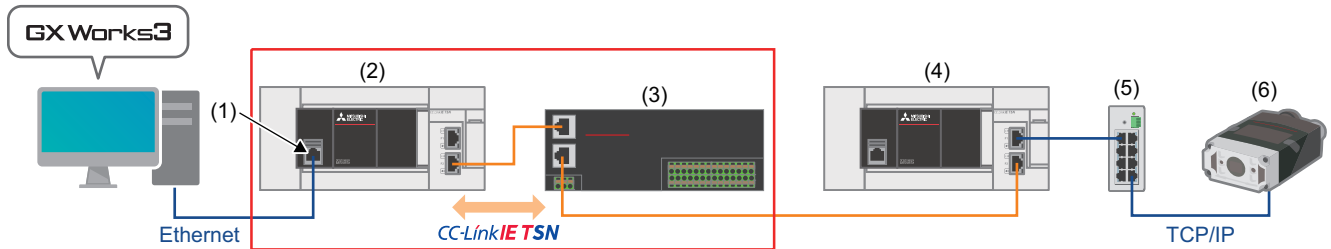

- (1) Built-in Ethernet port
- (2) Master station (station number 0)
- (3) Remote station (station number 1)
- (4) Local station (station number 2)
- (5) General-purpose switching hub
- (6) Code reader

### Checking communications from the master station to the remote station

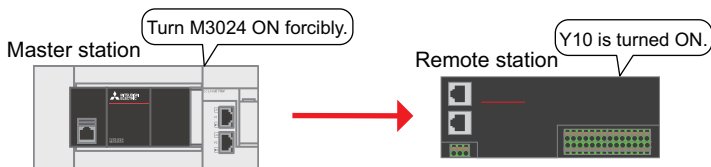

1. On GX Works3, select [Online] on the menu bar ⇒ [Monitor] ⇒ [Device/Buffer Memory Batch Monitor].

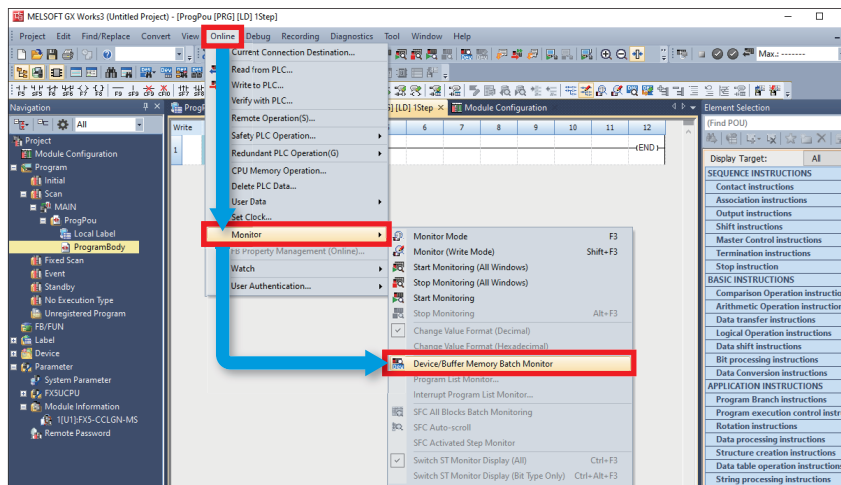

2. Enter "M3024" in "Device Name", and click the value as shown below to turn ON M3024 forcibly.

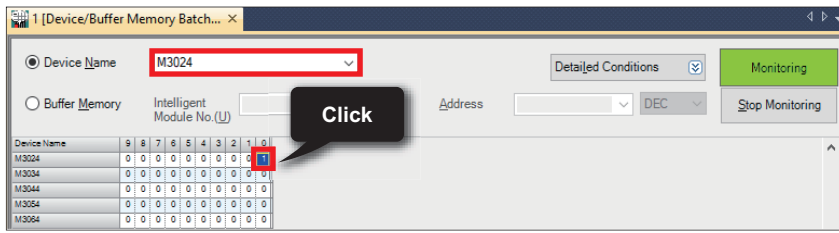

3. Check that Y10 LED at the remote station is ON.

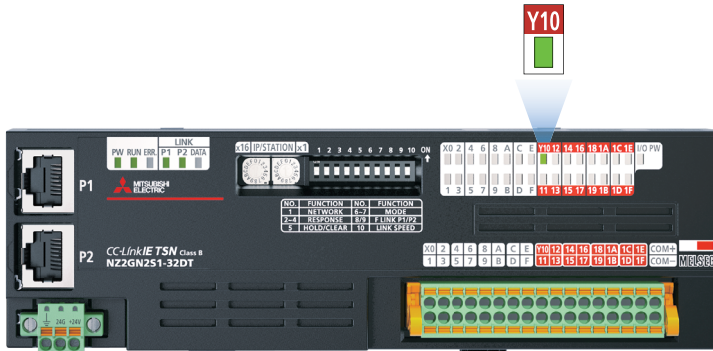

## 6.3 Operation Check of the Code Reader (TCP/IP Communications)

This section checks whether communications are performed between the master station and the code reader normally. Configure the system as shown below.

For the communication setting, refer to Page 18 Communication Settings on GX Works3.

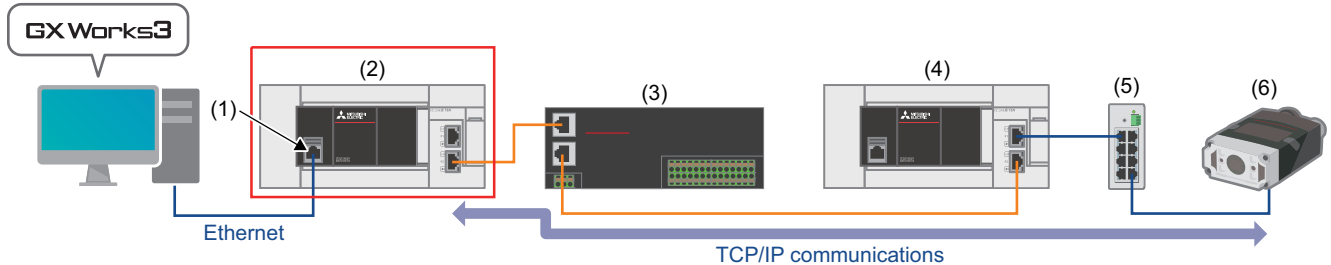

- (1) Built-in Ethernet port
- (2) Master station (station number 0)
- (3) Remote station (station number 1)
- (4) Local station (station number 2)
- (5) General-purpose switching hub
- (6) Code reader

1. Place the QR code ( Page 8 Sample QR code for the code reader) in front of the code reader.

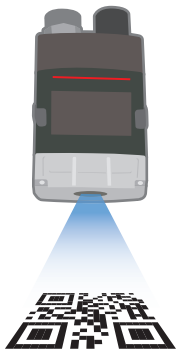

2. On GX Works3, select [Online] on the menu bar ⇒ [Monitor] ⇒ [Device/Buffer Memory Batch Monitor].

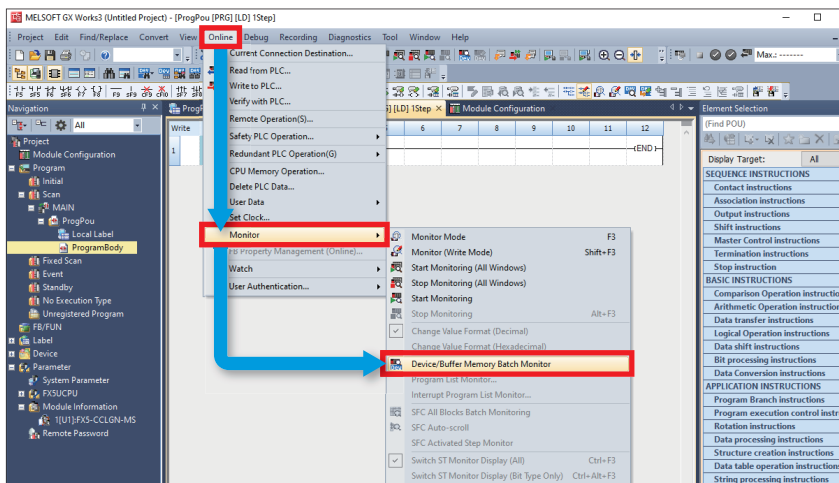

3. To start reading the QR code by the code reader, perform Steps ① to ③.

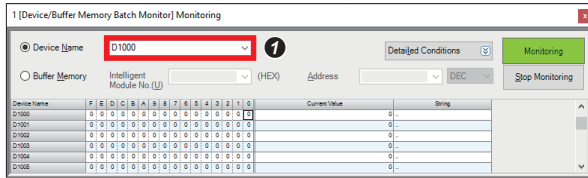

① Enter "D1000" in "Device Name".



② Click Image Capturing Trigger Enable (D1000.0).  
(Change D1000.0 from "0" to "1".)

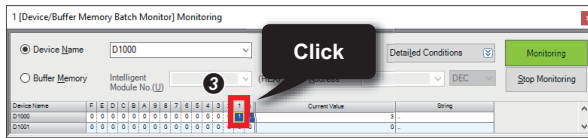

③ Click Image Capturing Trigger (D1000.1).  
(Change D1000.1 from "0" to "1".)

4. Check that Decode Complete (D1002.9) of the code reader has been changed from "0" to "1".

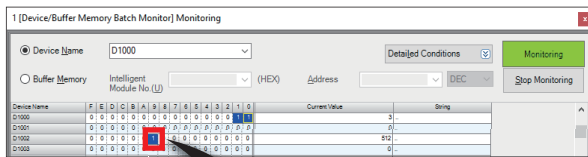

Check that D1002.9 is changed from "0" to "1".

5. Check the result read by the code reader. Check that "AB", "CD", "EF", "G0", "12", and "34" are entered in the "String" columns of "D1015" to "D1020".

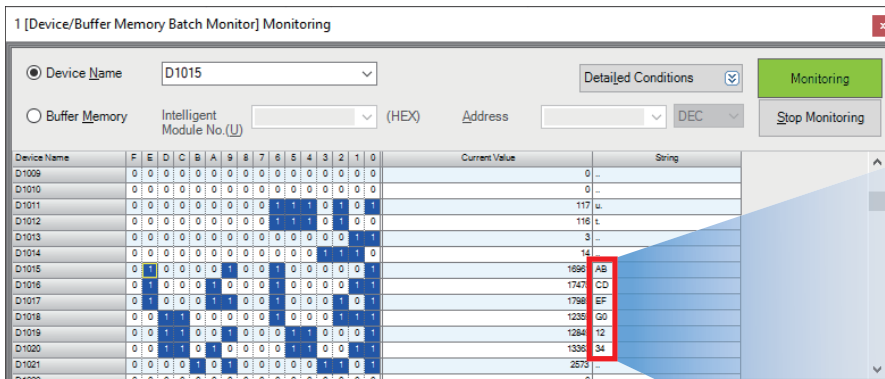

Device name

AB	D1015
CD	D1016
EF	D1017
G0	D1018
12	D1019
34	D1020



# 7 TROUBLESHOOTING

## 7.1 Checking Procedure

### 1. Checking the LED status

Check the communication status with the LEDs of the master station, local station, and code reader.

For the LEDs of the master station, refer to [Page 40](#) Checking the LEDs of the master station.

For the LEDs of the local station, refer to [Page 43](#) Checking the LEDs of the local station.

For the LEDs of the remote station, refer to [Page 45](#) Checking the LEDs of the remote station.

For the LEDs of the code reader, refer to [Page 45](#) Checking the LEDs (indicators) of the code reader.

#### Point

If only the ERR LED of the FX5 CPU module is flashing, perform the module diagnostics of the CPU module.

For details on the CPU module error codes, refer to the following.

[Appendix 3 Error Code in the MELSEC iQ-F FX5 User's Manual \(Application\)](#)

### 2. Checking the error codes

Check the following according to the error codes stored in the master station, local station, and code reader.

For the error codes of the master station and local station, refer to [Page 46](#) Master and local station module diagnostics.

For the error codes of the code reader, refer to [Page 48](#) Checking the error details of the code reader.

#### ■Wiring

For the wiring, refer to the following.

[Page 9](#) System Configuration

- Are the Ethernet cables fully inserted?

#### ■Communication settings

For the communication settings of the master station, refer to [Page 15](#) Setting Parameters.

For the communication settings of the local station, refer to [Page 23](#) Setting Parameters.

For the communication settings of the remote station, refer to [Page 25](#) SETTING REMOTE STATION.

For the communication settings of the code reader, refer to [Page 27](#) Setting the Code Reader.

- Do the parameter settings of the master station match with those of the local station on GX Works3?
- Are the IP addresses and the subnet masks of the master station, local station, and code reader set properly?

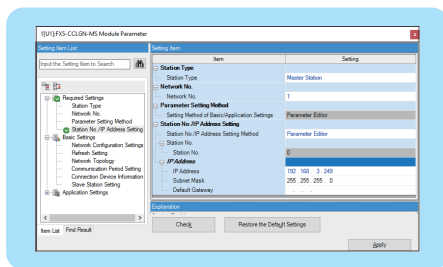

Master station  
Local station

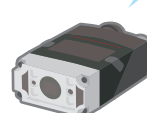
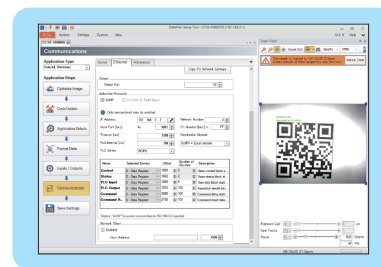

Code reader

\* After the parameters are changed, reset (or power OFF and ON) the programmable controller to reflect new values.

\* After the parameters are changed, power OFF and ON the code reader to reflect new values.

# 7.2 Checking the LED Status

## Checking the LEDs of the master station

Check error details with the LEDs of the CC-Link IE TSN master/local module (FX5-CCLGN-MS).

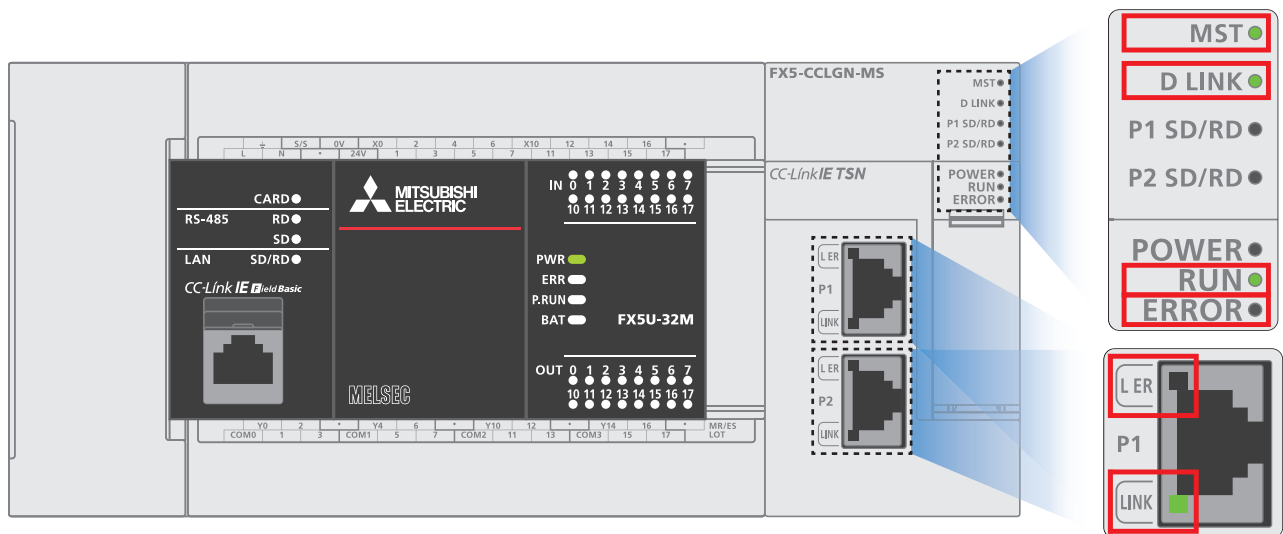

### LEDs of the CC-Link IE TSN master/local module

Name	Color	Status	Check item	Action
MST	Green	OFF	Has project data of the master station been written to the FX5 CPU module?	Write the project data of the master station to the FX5 CPU module.
RUN	Green	OFF	Is the FX5-CCLGN-MS mounted correctly?	Securely mount the FX5-CCLGN-MS on the FX5 CPU module.
ERROR	Red	ON or flashing	Does any error occur in the module diagnostics?	Take the actions displayed on the window. Page 46 Master and local station module diagnostics
			Is a disconnected station displayed by the CC-Link IE TSN/CC-Link IE Field diagnostics*1?	<ul style="list-style-type: none"> <li>Perform the network configuration setting in accordance with the station actually connected.</li> <li>Check the items, which are checked when D LINK LED is OFF or flashing, at the disconnected station.</li> </ul>
			Are RX, RY, RWr, and RWw assigned for the CC-Link IE TSN configuration of the master station?	Check that all the assignment of RX, RY, RWr, and RWw of a station where an error occurs is not blank.
D LINK	Green	OFF or flashing	Is the master station operating normally?	<ul style="list-style-type: none"> <li>If an error occurs in the FX5 CPU module on the master station, eliminate the cause of the FX5 CPU module error.</li> <li>If an error occurs in the FX5-CCLGN-MS on the master station, take action according to the module diagnosis procedure.</li> </ul>
			Does the IP address of each station match the "Network Configuration Settings" of the master station?	<ul style="list-style-type: none"> <li>Correct the setting of the IP address in "Network Configuration Settings" of the master station.</li> <li>Set IP addresses in a way that does not duplicate the third to fourth octets of the IP addresses in all stations.</li> </ul>
			In the "Network Configuration Settings" of the master station, are the third and fourth octets of the IP address duplicated with those of any other stations?	<ul style="list-style-type: none"> <li>Set the IP address and subnet mask to match the network addresses of all stations.</li> <li>Set the third and fourth octets of the IP address to values other than all 0 or all 1.</li> </ul>
			In the "Network Configuration Settings" of the master station, does the network address (the subnet mask part of the IP address) match the master station?	<ul style="list-style-type: none"> <li>Set the host section to a value other than all 0 or all 1.</li> <li>Set an address other than some reserved addresses fixed for special purposes as the IP address.</li> </ul>
			Are the third and fourth octets of the IP address set to values other than all 0 or all 1?	
			Is the host section set to a value other than all 0 or all 1?	

Name	Color	Status	Check item	Action
D LINK	Green	OFF or flashing	Is there a reserved address fixed for a special purpose set as the IP address?	<ul style="list-style-type: none"> <li>• Correct the setting of the IP address in "Network Configuration Settings" of the master station.</li> <li>• Set IP addresses in a way that does not duplicate the third to fourth octets of the IP addresses in all stations.</li> <li>• Set the IP address and subnet mask to match the network addresses of all stations.</li> <li>• Set the third and fourth octets of the IP address to values other than all 0 or all 1.</li> <li>• Set the host section to a value other than all 0 or all 1.</li> <li>• Set an address other than some reserved addresses fixed for special purposes as the IP address.</li> </ul>
			Do the Ethernet cables conform to the Ethernet standard?	Replace the cables with Ethernet cables which conform to the standard.  Section 2.3 Performance Specifications in the MELSEC iQ-F FX5 User's Manual (CC-Link IE TSN)
			Is the switching hub operating normally?	<ul style="list-style-type: none"> <li>• Use a switching hub that conforms to the standard.</li> </ul>  Section 2.3 Performance Specifications in the MELSEC iQ-F FX5 User's Manual (CC-Link IE TSN) <ul style="list-style-type: none"> <li>• Power OFF and ON the switching hub.</li> </ul>
			Does the station-to-station distance meet the specifications?	Set the station-to-station distance within range.  Section 2.3 Performance Specifications in the MELSEC iQ-F FX5 User's Manual (CC-Link IE TSN)
			Does the cabling condition (bending radius) meet the specifications?	Refer to the manual for the Ethernet cable, and correct the bending radius.
			Is any Ethernet cable disconnected?	Replace the Ethernet cable.
			Is the network configured in the ring topology?	Configure the network to avoid the ring topology.
			Has any other station been reset?	<ul style="list-style-type: none"> <li>• Avoid unnecessary reset since a station is disconnected while resetting.</li> <li>• Start other stations.</li> </ul>
			Are other stations turned OFF?	Power ON other stations.
			Are other stations connected to the FX5-CCLGN-MS operating normally?	Execute the CC-Link IE TSN/CC-Link IE Field diagnostics <sup>*1</sup> from the master station to identify the faulty module of another station. After identification, take action by referring to the manual for the relevant module.
			Are other stations set in the network configuration of the master station?	Set connected slave stations in the network configuration of the master station.
			Is a type of wiring described in the restrictions in the wiring specifications mistakenly performed?	Correct the wiring.  Chapter 6 WIRING in the MELSEC iQ-F FX5 User's Manual (CC-Link IE TSN)
			Are the station numbers duplicated with other stations?	Change the duplicated station number.
			Is the IP address duplicated with another station?	Change the IP address of the duplicated station.
			Are 61 or more slave stations connected?	Make adjustment so that the number of connected slave stations is within 60.
			Do CC-Link IE TSN devices and Ethernet devices coexist?	Correct the wiring.  Chapter 6 WIRING in the MELSEC iQ-F FX5 User's Manual (CC-Link IE TSN)
Does the IP filter setting mistakenly block communications from the IP address of another station?	Change the IP filter setting parameter to allow communication for the IP address of another station.			

Name	Color	Status	Check item	Action
L ER	Red	ON	Do the Ethernet cables conform to the Ethernet standard?	<ul style="list-style-type: none"> <li>Use an Ethernet cable that conforms to the standard.  Section 2.3 Performance Specifications in the MELSEC iQ-F FX5 User's Manual (CC-Link IE TSN)</li> <li>Set the station-to-station distance within range.  Section 2.3 Performance Specifications in the MELSEC iQ-F FX5 User's Manual (CC-Link IE TSN)</li> <li>If the Ethernet cable is disconnected, reconnect it.</li> </ul>
			Is the switching hub operating normally?	<ul style="list-style-type: none"> <li>Use a switching hub that conforms to the standard.  Section 2.3 Performance Specifications in the MELSEC iQ-F FX5 User's Manual (CC-Link IE TSN)</li> <li>Power OFF and ON the switching hub.</li> </ul>
			Is "Module Operation Mode" under "Application Settings" of the master station set to "Online"?	Set "Module Operation Mode" under "Application Settings" of the master station to "Online".
			Is there any source of noise near the module or cables?	Change the location of the module or cables.
LINK	Green	OFF	Do the Ethernet cables conform to the Ethernet standard?	Replace the cables with Ethernet cables which conform to the standard.  Ethernet cable in the MELSEC iQ-F FX5 User's Manual (CC-Link IE TSN)
			Does the station-to-station distance meet the specifications?	Set the station-to-station distance within range.  Section 2.3 Performance Specifications in the MELSEC iQ-F FX5 User's Manual (CC-Link IE TSN)
			Does the cabling condition (bending radius) meet the specifications?	Refer to the manual for the Ethernet cable, and correct the bending radius.
			Is any Ethernet cable disconnected?	Replace the Ethernet cable.
			Is the switching hub operating normally?	<ul style="list-style-type: none"> <li>Use a switching hub that conforms to the standard.</li> <li>Power OFF and ON the switching hub.</li> </ul>
			Are other stations connected to the FX5-CCLGN-MS operating normally?	Take action by referring to the manual for the modules of other stations.
			Is the communication speed of connected devices 1 Gbps?	Connect devices which support a communication speed of 1 Gbps.

\*1 For details on the CC-Link IE TSN/CC-Link IE Field diagnostics, refer to the following.

Page 49 CC-Link IE TSN/CC-Link IE Field Diagnostics

For details, refer to the following.

Chapter 10 TROUBLESHOOTING in the MELSEC iQ-F FX5 User's Manual (CC-Link IE TSN)

## Checking the LEDs of the local station

Check error details with the LEDs of the CC-Link IE TSN master/local module (FX5-CCLGN-MS).

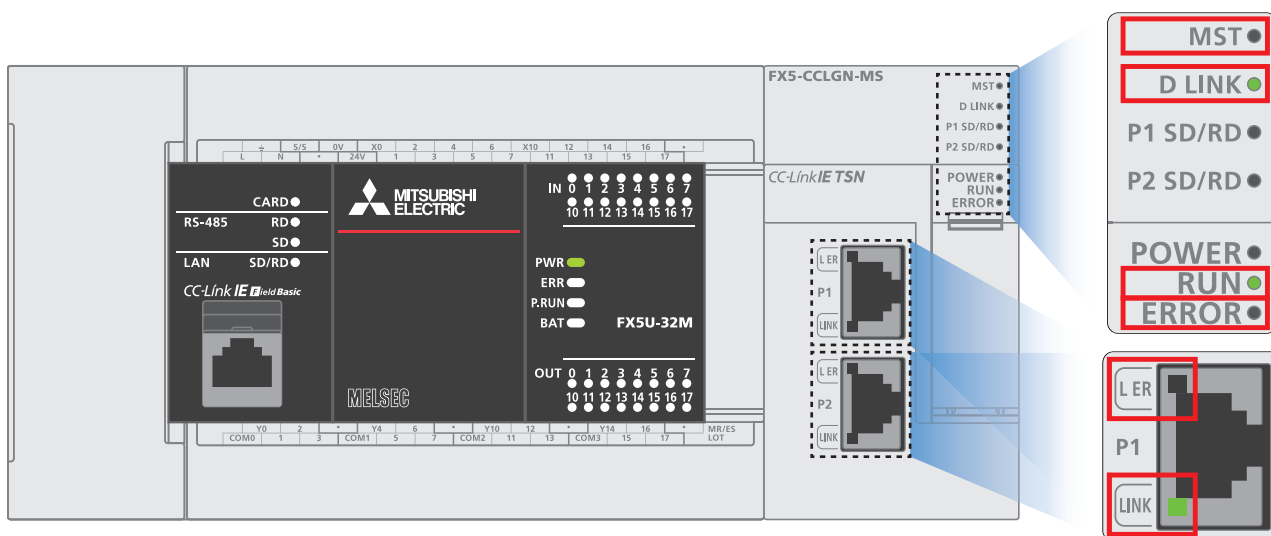

### LEDs of the CC-Link IE TSN master/local module

Name	Color	Status	Check item	Action
MST	Green	ON	Has project data of the local station been written to the FX5 CPU module?	Write the project data of the local station to the FX5 CPU module.
RUN	Green	OFF	Is the FX5-CCLGN-MS mounted correctly?	Securely mount the FX5-CCLGN-MS on the FX5 CPU module.
ERROR	Red	ON or flashing	Does any error occur in the module diagnostics?	Take the actions displayed on the window. Page 46 Master and local station module diagnostics
			Is a disconnected station displayed by the CC-Link IE TSN/CC-Link IE Field diagnostics*1?	<ul style="list-style-type: none"> <li>Perform the network configuration setting in accordance with the station actually connected.</li> <li>Check the items, which are checked when D LINK LED is OFF or flashing, at the disconnected station.</li> </ul>
			Are RX, RY, RWr, and RWw assigned for the CC-Link IE TSN configuration of the master station?	Check that all the assignment of RX, RY, RWr, and RWw of a station where an error occurs is not blank.
D LINK	Green	OFF or flashing	Is the master station operating normally?	<ul style="list-style-type: none"> <li>If an error occurs in the FX5 CPU module on the master station, eliminate the cause of the FX5 CPU module error.</li> <li>If an error occurs in the FX5-CCLGN-MS on the master station, take action according to the module diagnosis procedure.</li> </ul>
			Is the master station connected to the network?	Connect the master station to the network.
			Do the Ethernet cables conform to the Ethernet standard?	Replace the cables with Ethernet cables which conform to the standard. Section 2.3 Performance Specifications in the MELSEC iQ-F FX5 User's Manual (CC-Link IE TSN)
			Is the switching hub operating normally?	<ul style="list-style-type: none"> <li>Use a switching hub that conforms to the standard.</li> <li>Section 2.3 Performance Specifications in the MELSEC iQ-F FX5 User's Manual (CC-Link IE TSN)</li> <li>Power OFF and ON the switching hub.</li> </ul>
			Does the station-to-station distance meet the specifications?	Set the station-to-station distance within range. Section 2.3 Performance Specifications in the MELSEC iQ-F FX5 User's Manual (CC-Link IE TSN)
			Does the cabling condition (bending radius) meet the specifications?	Refer to the manual for the Ethernet cable, and correct the bending radius.
			Is any Ethernet cable disconnected?	Replace the Ethernet cable.
			Is the network configured in the ring topology?	Configure the network to avoid the ring topology.
			Are other stations turned OFF?	Power ON other stations.
Is the IP address of another station set?	Set an IP address to a slave station with no IP address setting.			

Name	Color	Status	Check item	Action
D LINK	Green	OFF or flashing	Are other stations set in the network configuration of the master station?	Set connected slave stations in the network configuration of the master station.
			Is a type of wiring described in the restrictions in the wiring specifications mistakenly performed?	Correct the wiring. ☞ Chapter 6 WIRING in the MELSEC iQ-F FX5 User's Manual (CC-Link IE TSN)
			Are the station numbers duplicated with other stations?	Change the duplicated station number.
			Is the IP address duplicated with another station?	Change the IP address of the duplicated station.
			Are 121 or more slave stations connected?	Make adjustment so that the number of connected slave stations is within 120.
			Do CC-Link IE TSN devices and Ethernet devices coexist?	Correct the wiring. ☞ Chapter 6 WIRING in the MELSEC iQ-F FX5 User's Manual (CC-Link IE TSN)
			Does the IP filter setting mistakenly block communications from the IP address of another station?	Change the IP filter setting parameter to allow communication for the IP address of another station.
L ER	Red	ON	Do the Ethernet cables conform to the Ethernet standard?	<ul style="list-style-type: none"> <li>• Use an Ethernet cable that conforms to the standard. ☞ Section 2.3 Performance Specifications in the MELSEC iQ-F FX5 User's Manual (CC-Link IE TSN)</li> <li>• Set the station-to-station distance within range. ☞ Section 2.3 Performance Specifications in the MELSEC iQ-F FX5 User's Manual (CC-Link IE TSN)</li> <li>• If the Ethernet cable is disconnected, reconnect it.</li> </ul>
			Is the switching hub operating normally?	<ul style="list-style-type: none"> <li>• Use a switching hub that conforms to the standard. ☞ Section 2.3 Performance Specifications in the MELSEC iQ-F FX5 User's Manual (CC-Link IE TSN)</li> <li>• Power OFF and ON the switching hub.</li> </ul>
			Is "Module Operation Mode" under "Application Settings" of the master station set to "Online"?	Set "Module Operation Mode" under "Application Settings" of the master station to "Online".
			Is there any source of noise near the module or cables?	Change the location of the module or cables.
LINK	Green	OFF	Do the Ethernet cables conform to the Ethernet standard?	Replace the cables with Ethernet cables which conform to the standard. ☞ Ethernet cable in the MELSEC iQ-F FX5 User's Manual (CC-Link IE TSN)
			Does the station-to-station distance meet the specifications?	Set the station-to-station distance within range. ☞ Section 2.3 Performance Specifications in the MELSEC iQ-F FX5 User's Manual (CC-Link IE TSN)
			Does the cabling condition (bending radius) meet the specifications?	Refer to the manual for the Ethernet cable, and correct the bending radius.
			Is any Ethernet cable disconnected?	Replace the Ethernet cable.
			Is the switching hub used operating normally?	<ul style="list-style-type: none"> <li>• Use a switching hub that conforms to the standard.</li> <li>• Power OFF and ON the switching hub.</li> </ul>
			Are other stations connected to the FX5-CCLGN-MS operating normally?	Take action by referring to the manual for the modules of other stations.
			Is the communication speed of connected devices 1 Gbps?	Connect devices which support a communication speed of 1 Gbps.

\*1 For details on the CC-Link IE TSN/CC-Link IE Field diagnostics, refer to the following.

☞ Page 49 CC-Link IE TSN/CC-Link IE Field Diagnostics

For details, refer to the following.

☞ Chapter 10 TROUBLESHOOTING in the MELSEC iQ-F FX5 User's Manual (CC-Link IE TSN)

## Checking the LEDs of the remote station

Check error details with the LEDs of the CC-Link IE TSN remote I/O module (NZ2GN2S1-32DT).

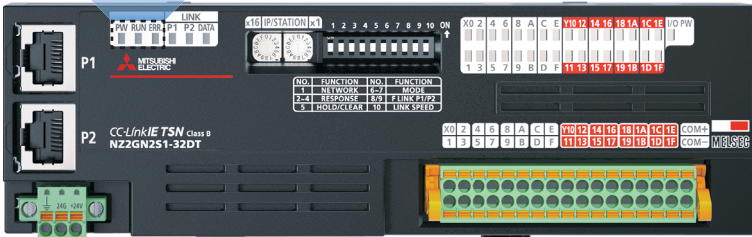

For details, refer to the following.

Chapter 11 TROUBLESHOOTING in the CC-Link IE TSN Remote I/O Module User's Manual (CC-Link IE TSN Communication Mode)

## Checking the LEDs (indicators) of the code reader

The following shows the display specifications of the indicators.

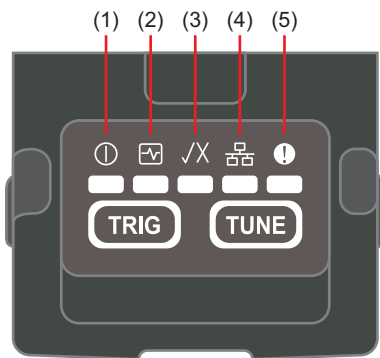

No.	Indicator name	Display specification
(1)	Power indicator	Green: Powered ON
(2)	Registration status indicator	• Green: Code registered Yellow: Code not registered
(3)	Read success/fail indicator	• Green: Read succeeded Red: Read failed
(4)	Network status indicator	• Yellow (ON): Linking up Yellow (flashing): Transferring data
(5)	Error indicator	Red: Error Page 48 Checking the error details of the code reader

They indicate the stage of auto-tuning process: they turn ON in order from the left according to the stage of the process.

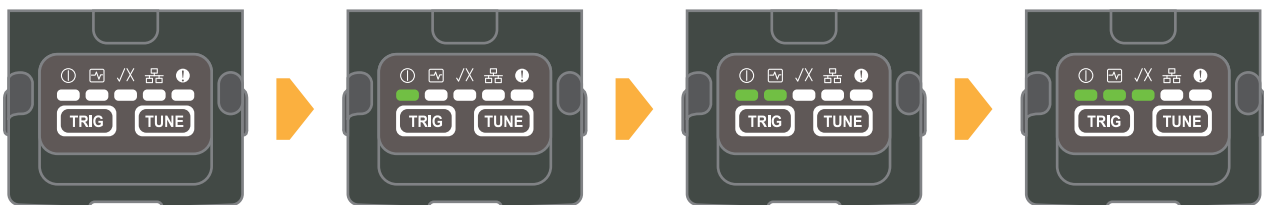

For details, refer to the following.

Section 3.3 Indicator Display Specifications in the Code Reader CF26 User's Manual

# 7.3 Checking the Error Details

## Master and local station module diagnostics

This section describes how to check an error occurred in the module and error history, and identify the cause using GX Works3. The detailed information, such as error causes and corrective actions, obtained from GX Works3 is more helpful than those obtained from LEDs.

To execute the module diagnostics, connect a personal computer to the programmable controller.

☞ Page 18 Communication Settings on GX Works3

1. Select [Diagnostics] ⇒ [System Monitor], and double-click "FX5-CCLGN-MS".

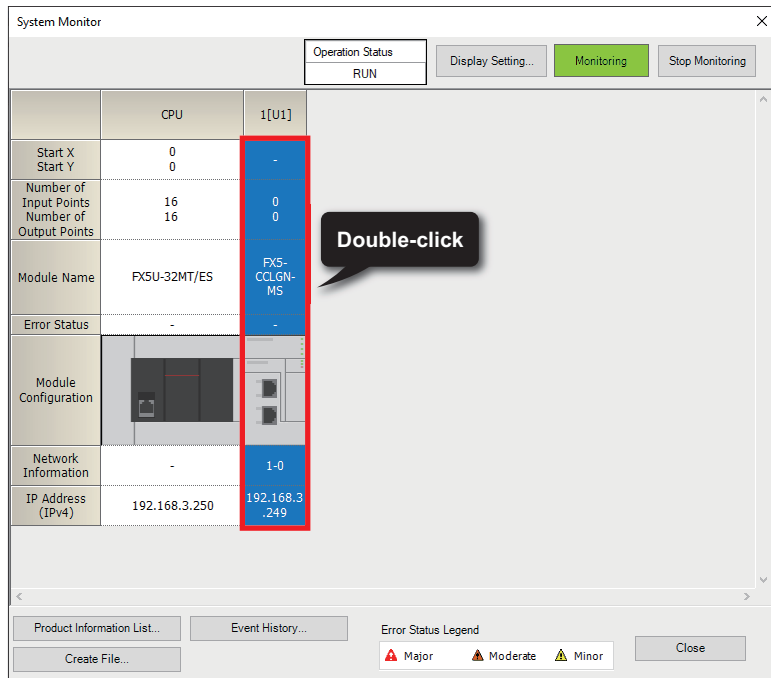

2. "Error Information" and "Module Information" of the FX-CCLGN-MS can be checked.

For details on the error codes, refer to ☞ Page 47 List of error codes (master and local stations).

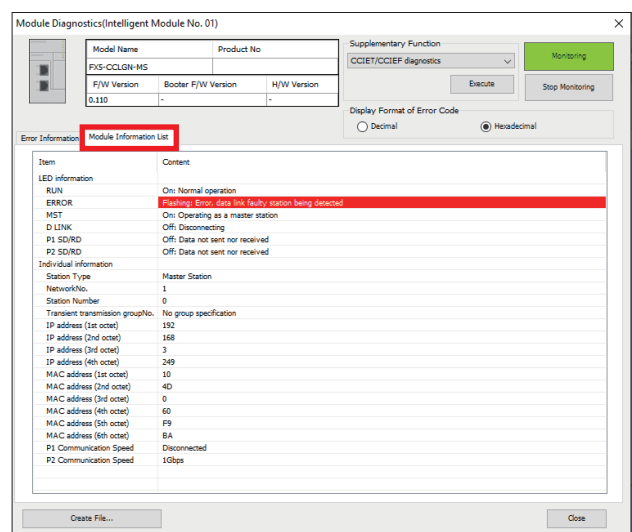
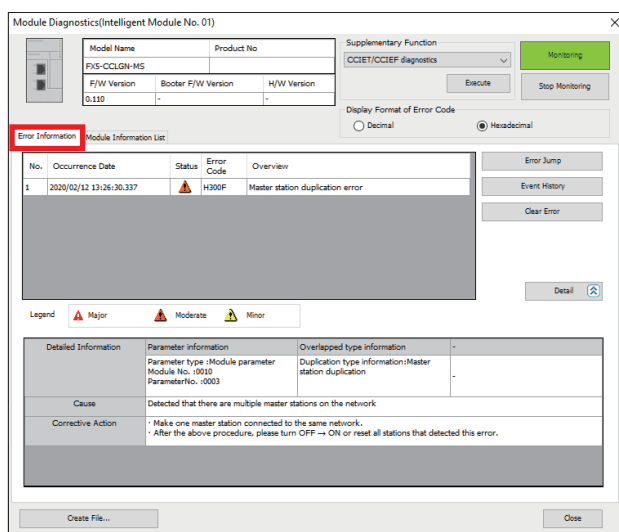

The network status of CC-Link IE TSN can be checked using the CC-Link IE TSN/CC-Link IE Field diagnostics. For how to start the CC-Link IE TSN/CC-Link IE Field diagnostics, refer to the following.

☞ Page 49 CC-Link IE TSN/CC-Link IE Field Diagnostics



## List of error codes (master and local stations)

The following table lists the error codes displayed by the module diagnostics.

Error code	Name	Description and cause	Action
1803H	Network configuration error	Over the number of stations that can be connected.	Reduce the number of authentication Class B devices to eight or less for each port of the master station.
2160H	IP address duplication error	IP address duplication was detected.	Check the IP addresses.
2220H	Parameter error	The parameter setting is corrupted.	Check the detailed information of the error in "Module Diagnostics" of the engineering tool, and write the displayed parameter. If the same error occurs again, the possible cause is a hardware failure of the module. Please contact your local Mitsubishi representative.
2221H	Network parameter error	<ul style="list-style-type: none"> <li>The set value is out of the range. Or the setting values of the master station and local stations are not consistent.</li> <li>Parameters that are not supported by the firmware version of the network module have been set.</li> </ul>	<ul style="list-style-type: none"> <li>Check the detailed information of the error in "Module Diagnostics" of the engineering tool, and correct the parameter setting corresponding to the parameter number.</li> <li>Check the firmware version of the network module. If parameters that are not supported are set, update the firmware version or correct the parameters.</li> </ul>
3009H	Multiple cycle setting error	The result when the value set in "Communication Period Interval Setting" in "Communication Period Setting" under "Basic Settings" of the master station is multiplied by "Communication Period Setting" of the slave station set in "Network Configuration Settings" under "Basic Settings" is out of the range.	<p>Check the detailed information in "Module Diagnostics" of the engineering tool. Correct the parameter settings described below so that the result when the value set in "Communication Period Interval Setting" in "Communication Period Setting" under "Basic Settings" of the master station is multiplied by "Communication Period Setting" of the slave station set in "Network Configuration Settings" under "Basic Settings" becomes within 16ms.</p> <ul style="list-style-type: none"> <li>"Communication Period Interval Setting" in "Basic Settings"</li> <li>"Communication Period Setting" of the relevant slave station in "Network Configuration Settings"</li> </ul> <p>Set a value to "Communication Period Setting" of slave stations by selecting a multiple value on "Multiple Period Setting" of "Communication Period Setting" under "Basic Settings".</p>
300AH	Network parameter error	<ul style="list-style-type: none"> <li>The combination of the local station firmware version and the master station firmware version is incorrect.</li> <li>The set value is out of the range. Or the setting values of the master station and local stations are not consistent.</li> </ul>	<ul style="list-style-type: none"> <li>Check the firmware versions of the master station and local station. If the combination is incorrect, update the firmware version of the older local station or that of the master station.</li> <li>Check the detailed information of the error in "Module Diagnostics" of the engineering tool, and correct the parameter setting of the master station corresponding to the parameter number. If the same error occurs again, the possible cause is a hardware failure of the module. Please contact your local Mitsubishi representative.</li> </ul>
300FH	Master station duplication detection	Multiple master stations were detected in the network.	<ul style="list-style-type: none"> <li>Connect only one master station on the same network.</li> <li>After taking the above action, power OFF and ON or reset all stations where the error was detected.</li> </ul>
3010H	Communication period interval setting error	The value set in "Communication Period Interval Setting" in "Communication Period Setting" under "Basic Settings" of the master station is smaller than the communication cycle interval calculated by the number of stations and points of slave stations that was set in "Network Configuration Settings" under "Basic Settings".	Set the value of "Communication Period Interval Setting" as a value equal to or larger than the value in the detailed information displayed in "Module Diagnostics" using "Communication Period Setting" under "Basic Settings" of the master station.
3011H	Cyclic transmission time error	The value set in "Cyclic transmission time" in "Communication Period Setting" under "Basic Settings" of the master station is smaller than the cyclic transmission time calculated by the number of stations and points of slave stations set in "Network Configuration Settings" under "Basic Settings".	Set the value of "Cyclic Transmission Time" as a value equal to or larger than the value in the detailed information displayed in "Module Diagnostics" using "Communication Period Setting" under "Basic Settings" of the master station.
3013H	Transient transmission time error	The value set in "Transient Transmission Time" in "Communication Period Setting" under "Basic Settings" of the master station is smaller than the transient transmission time calculated using the number of slave stations and the points of slave stations set in "Network Configuration Settings" under "Basic Settings".	Set "Communication Period Interval Setting" and "Cyclic Transmission Time" so that the value of "Transient Transmission Time" in "Communication Period Setting" under "Basic Settings" of the master station is equal to or larger than the value shown in the detailed information displayed in "Module Diagnostics".

Error code	Name	Description and cause	Action
3014H	Multiple cycle setting error	When "Communication Mode" under "Application Settings" of the master station is set to "Multicast", in the "Network Configuration Settings" of the "Basic Settings", "Communication Period Setting" of the local station is set to "Normal Speed" or "Low-Speed".	<ul style="list-style-type: none"> <li>Set "Communication Mode" in "Application Settings" of the master station to "Unicast".</li> <li>In "Network Configuration Settings" under "Basic Settings" of the master station, set "Communication Period Setting" of the local station to "Basic Period".</li> </ul>
3015H	Communication period interval setting error	The value set in "Communication Period Interval Setting" in "Communication Period Setting" under "Basic Settings" of the master station is smaller than the communication cycle interval calculated by the number of stations and points of slave stations that was set in "Network Configuration Settings" under "Basic Settings".	Set the value of "Communication Period Interval Setting" as a value equal to or larger than the value of "Communication Period Interval (Calculation value) [μs]" (SW0072) of a local station using "Communication Period Setting" under "Basic Settings" of the master station.
3017H	Cyclic transmission time error	The value set in "Cyclic transmission time" in "Communication Period Setting" under "Basic Settings" of the master station is smaller than the cyclic transmission time calculated by the number of stations and points of slave stations set in "Network Configuration Settings" under "Basic Settings".	Set the value of "Cyclic Transmission Time" as a value equal to or larger than the value of "Cyclic Transmission Time (Calculation value) [μs]" (SW0073) of a local station using "Communication Period Setting" under "Basic Settings" of the master station.
3018H	Transient transmission time error	The value set in "Transient Transmission Time" in "Communication Period Setting" under "Basic Settings" of the master station is smaller than the transient transmission time calculated using the number of slave stations and the points of slave stations set in "Network Configuration Settings" under "Basic Settings".	Set "Communication Period Interval Setting" and "Cyclic Transmission Time" so that the value of "Transient Transmission Time" in "Communication Period Setting" under "Basic Settings" of the master station is equal to or larger than the value of "Transient Transmission Time (Calculation value) [μs]" (SW0078) of a local station.
3021H	Slave station IP address duplication error	At startup of data link, IP address duplication among slave stations has been detected.	Correct the IP addresses of the slave stations.
3135H	Network configuration error	Over the number of stations that can be connected.	Reduce the number of authentication Class B devices to eight or less for each port of the master station.
3136H	Illegal ring topology	An illegal ring topology was detected.	Set a line topology or star topology, and turn OFF and ON or reset all stations.

For details, refer to the following.

 Section 10.5 Function List in the MELSEC iQ-F FX5 User's Manual (CC-Link IE TSN)

## Checking the error details of the code reader

If an error indicator turns ON or the code reader CF26 does not operate properly, check the error on the "Device Log" window of DataMan Setup Tool.

(Error example)

A "Buffer Overflow" error is occurring.

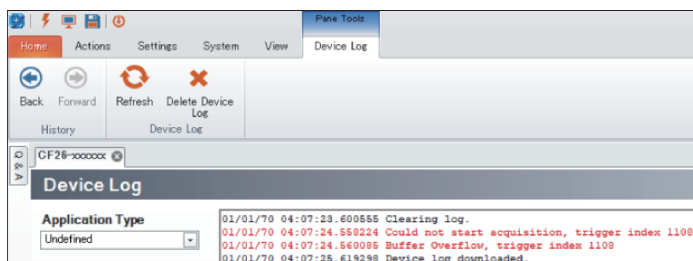

The error is displayed in red.

For details, refer to the following.

 Chapter 9 TROUBLESHOOTING in the Code Reader CF26 User's Manual

# APPENDICES

## Appendix 1 CC-Link IE TSN/CC-Link IE Field Diagnostics

This section describes how to start CC-Link IE TSN/CC-Link IE Field diagnostics.

1. Select [Diagnostics] on the menu bar of GX Works3 ⇒ [CC-Link IE TSN/CC-Link IE Field Diagnostics].

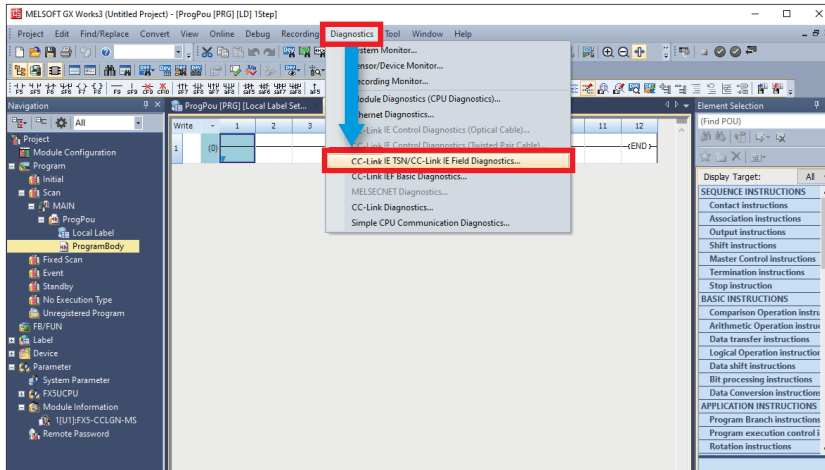

2. The "CC-Link IE TSN/CC-Link IE Field Diagnostics" window appears. Select a station whose connection status to be checked. When a local station is selected, the "CC-Link IE TSN/CC-Link IE Field Diagnostics" window is as shown below.

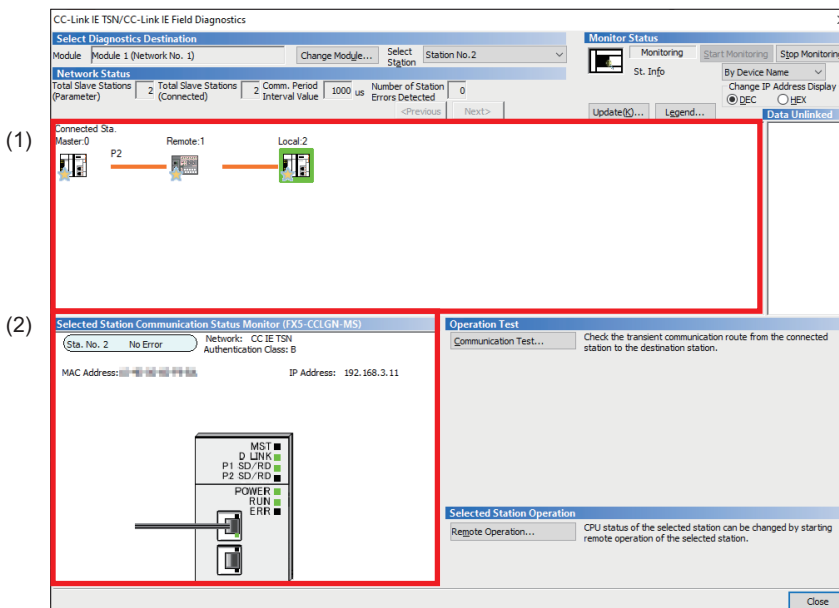

A

### Point

The items below can be checked on the "CC-Link IE TSN/CC-Link IE Field Diagnostics" window.

- (1) Network map

The connection status of each station is reflected in real time.

- (2) Selected station communication status monitor

The connection status of a selected station is checked in real time.

For details, refer to the following.

📖 Section 10.3 Checking the Network Status in the MELSEC iQ-F FX5 User's Manual (CC-Link IE TSN)

# Appendix 2 Setting an IP Address of the Personal Computer

This section describes the IP address setting of the personal computer with Windows® 10.

1. Select [Network and Sharing Center] on Control Panel in Windows 10®.

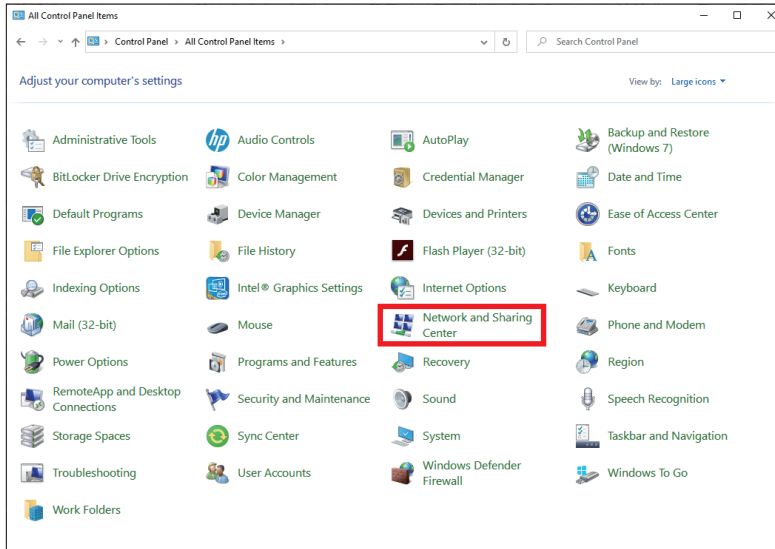

2. Select [Ethernet\*] for "Unidentified Network".

\* Select a different network depending on the personal computer environment.

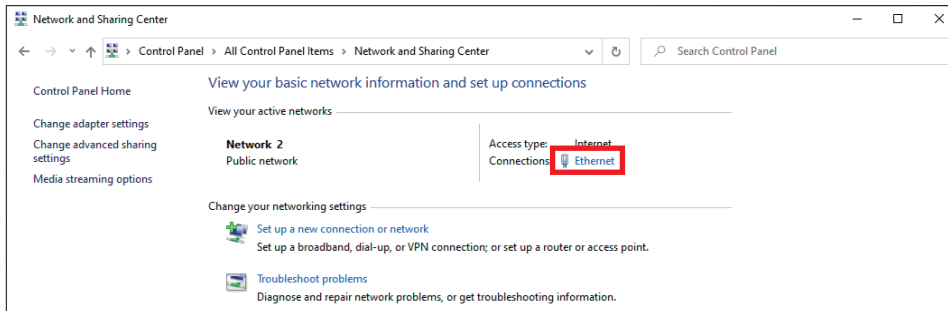

3. Click the [Properties] button.

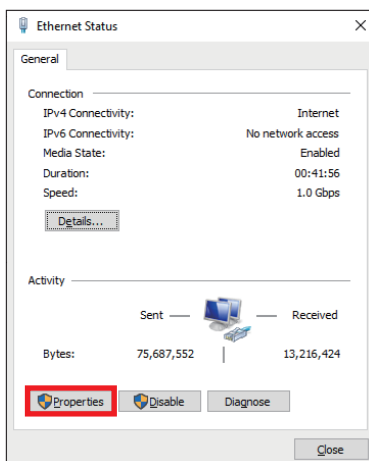

4. Double-click [Internet Protocol Version 4 (TCP/IPv4)].

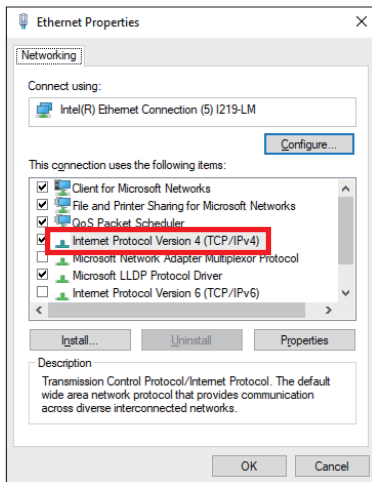

5. Select the "Use the following IP address" checkbox.

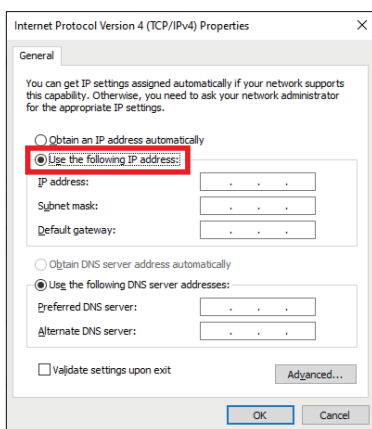

6. Enter "IP address" (⌨ Page 9 System Configuration) and "Subnet mask" (⌨ Page 9 System Configuration), and click the [OK] button.

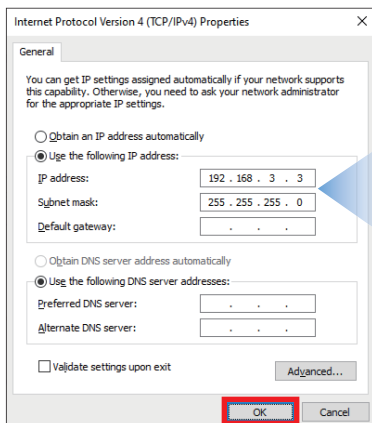

7. Click the [OK] button.

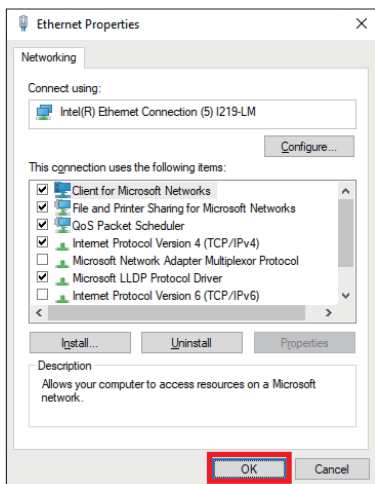

8. Click the [Close] button.

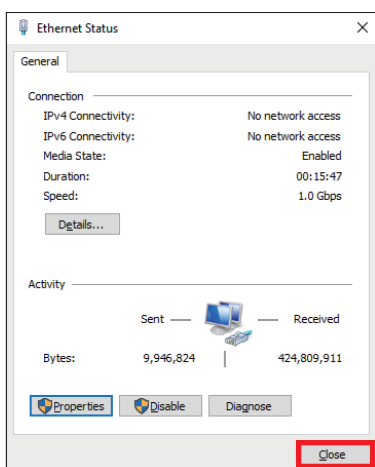

9. Click "x" to close the control panel.

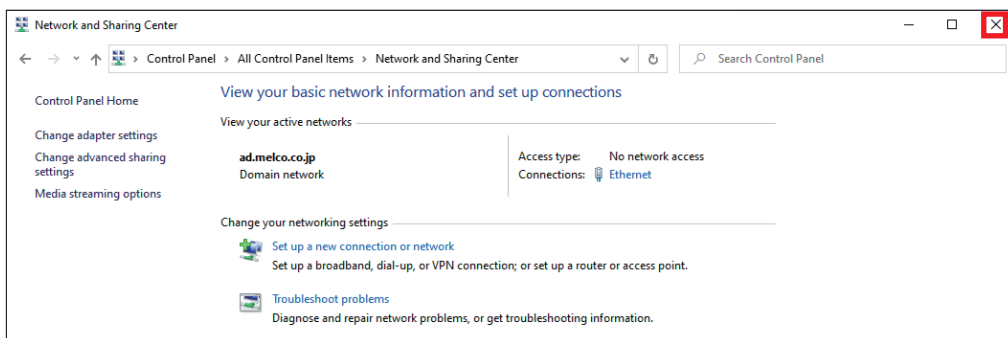

# REVISIONS

---

Revision date	Version	Description
July 2020	A	First edition

---

This manual confers no industrial property rights or any rights of any other kind, nor does it confer any patent licenses. Mitsubishi Electric Corporation cannot be held responsible for any problems involving industrial property rights which may occur as a result of using the contents noted in this manual.

© 2020 MITSUBISHI ELECTRIC CORPORATION

# WARRANTY

Please confirm the following product warranty details before using this product.

📖 WARRANTY in the MELSEC iQ-F FX5 User's Manual (CC-Link IE TSN)

# SAFETY PRECAUTIONS

- Before using the products introduced in this document, please read the respective manuals of the products carefully to ensure correct usage.
- This product has been manufactured as a general-purpose part for general industries, and has not been designed or manufactured to be incorporated in a device or system used in purposes related to human life.
- Before using the product for special purposes such as nuclear power, electric power, aerospace, medicine or passenger movement vehicles, please contact Mitsubishi Electric sales office.
- The product has been manufactured under strict quality control. However, when installing the product where major accidents or losses could occur if the product fails, install appropriate backup or failsafe functions into the system.
- For design, wiring, and other precautions, read "SAFETY PRECAUTIONS" in the relevant manuals.

# TRADEMARKS

Microsoft® and Windows® are either registered trademarks or trademarks of Microsoft Corporation in the United States and/or other countries.

QR Code is either a registered trademark or a trademark of DENSO WAVE INCORPORATED in the United States, Japan, and/or other countries.

DataMan is a registered trademark of Congnex Corporation.

The company names, system names and product names mentioned in this manual are either registered trademarks or trademarks of their respective companies.

In some cases, trademark symbols such as ™ or ® are not specified in this manual.

## MELSEC iQ-F Series

# Model selection tool

The Model selection tool helps users find and select appropriate models according to their applications.

Without checking catalogs or manuals, users can easily try to combine various products. Also, calculations required for selecting new products is available. Users can create a "purchase list" for requesting a quote.

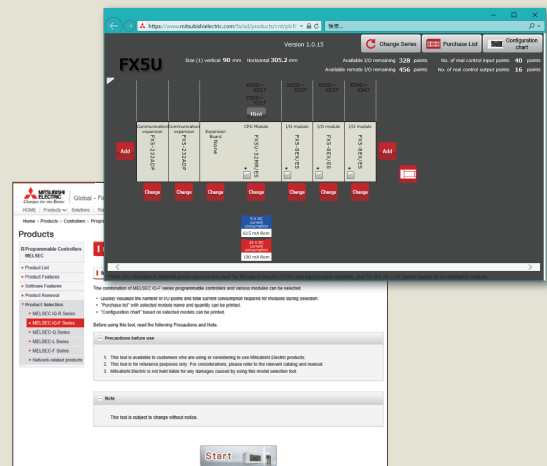

### ■ MELSEC iQ-F series model selection tool

The model selection tool is available on the following URL.

<https://www.mitsubishielectric.com/fa/ref/ref.html?kisyu=plc&software=select>





# Mitsubishi Electric Programmable Controller MELSEC iQ-F Series

**MITSUBISHI ELECTRIC CORPORATION**

HEAD OFFICE: TOKYO BLDG., 2-7-3, MARUNOUCHI, CHIYODA-KU, TOKYO 100-8310, JAPAN  
[www.MitsubishiElectric.com](http://www.MitsubishiElectric.com)

---