



Programmable Controller

**MELSEC iQ-F**  
series

MELSEC iQ-F  
FX5 User's Manual (CC-Link)

---





# SAFETY PRECAUTIONS

---

(Read these precautions before use.)

Before using this product, please read this manual and the relevant manuals introduced in this manual carefully and pay full attention to safety to handle the product correctly.

This manual classifies the safety precautions into two categories: [⚠️ WARNING] and [⚠️ CAUTION].

 <b>WARNING</b>	Indicates that incorrect handling may cause hazardous conditions, resulting in death or severe injury.
 <b>CAUTION</b>	Indicates that incorrect handling may cause hazardous conditions, resulting in minor or moderate injury or property damage.

Depending on the circumstances, procedures indicated by [⚠️ CAUTION] may also cause severe injury.

It is important to follow all precautions for personal safety.

Store this manual in a safe place so that it can be read whenever necessary. Always forward it to the end user.

## [DESIGN PRECAUTIONS]

---

### **WARNING**

---

- Make sure to set up the following safety circuits outside the programmable controller to ensure safe system operation even during external power supply problems or programmable controller failure. Otherwise, malfunctions may cause serious accidents.
    - Most importantly, set up the following: an emergency stop circuit, a protection circuit, an interlock circuit for opposite movements (such as normal vs. reverse rotation), and an interlock circuit to prevent damage (to the equipment at the upper and lower positioning limits).
    - Note that when the CPU module detects an error, such as a watchdog timer error, during selfdiagnosis, all outputs are turned off. Also, when an error that cannot be detected by the CPU module occurs in an input/output control block, output control may be disabled. External circuits and mechanisms should be designed to ensure safe machinery operation in such a case.
    - Note that when an error occurs in a relay, transistor or triac of an output circuit, the output might stay on or off. For output signals that may lead to serious accidents, external circuits and mechanisms should be designed to ensure safe machinery operation in such a case.
  - In an output circuit, when a load current exceeding the rated current or an overcurrent caused by a load short-circuit flows for a long time, it may cause smoke and fire. To prevent this, configure an external safety circuit, such as a fuse.
  - For the operating status of each station after a communication failure of the network, refer to relevant manuals for the network. Incorrect output or malfunction may result in an accident.
  - Construct an interlock circuit in the program so that the whole system always operates on the safe side before executing the control (for data change) of the programmable controller in operation. Read the manual thoroughly and ensure complete safety before executing other controls (for program change, parameter change, forcible output and operation status change) of the programmable controller in operation. Otherwise, the machine may be damaged and accidents may occur due to erroneous operations.
  - Especially, in the case of a control from an external device to a remote programmable controller, immediate action cannot be taken for a problem on the programmable controller due to a communication failure. Determine the handling method as a system when communication failure occurs along with configuration of interlock circuit on a program, by considering the external equipment and CPU module.
-

---

## **WARNING**

- Do not write any data to the "system area" and "write-protect area" of the buffer memory in the module. Executing data writing to the "system area" or "write protect area" may cause malfunction of the programmable controller alarm. For the "system area" and "write-protect area", refer to  Page 144 Buffer Memory.
- If a communication cable is disconnected, the network may be unstable, resulting in a communication failure of multiple stations. Construct an interlock circuit in the program so that the system always operates on the safe side even if communications fail. Incorrect output or malfunction may result in an accident.
- To set a refresh device in the module parameters, select the non-latch device for the remote output (RY). If a latch device, such as L, is selected, the CPU module holds the device status even after its status is changed to STOP. For how to stop data link, refer to the troubleshooting in this manual.

---

## [DESIGN PRECAUTIONS]

### **CAUTION**

- Do not bundle the control lines or communication cables together with or lay them close to the main circuit or power line. As a guideline, lay the control line and communication cables at least 100 mm away from the main circuit or power line. Failure to do so may result in malfunction due to noise.
- When an inductive load such as a lamp, heater, or solenoid valve is controlled, a large current (approximately ten times greater than normal) may flow when the output is turned from off to on. Take proper measures so that the flowing current does not exceed the value corresponding to the maximum load specification of the resistance load.
- After the CPU module is powered on or is reset, the time taken to enter the RUN status varies depending on the system configuration, parameter settings, and/or program size.  
Design circuits so that the entire system will always operate safely, regardless of the time.
- Simultaneously turn on and off the power supplies of the CPU module and extension modules.
- If a long-time power failure or an abnormal voltage drop occurs, the programmable controller stops, and output is turned off. When the power supply is restored, it will automatically restart. (when the RUN/STOP/RESET switch is on RUN side).

---

## [Security Precautions]

### **WARNING**

- To maintain the security (confidentiality, integrity, and availability) of the programmable controller and the system against unauthorized access, denial-of-service (DoS) attacks, computer viruses, and other cyberattacks from unreliable networks and devices via the network, take appropriate measures such as firewalls, virtual private networks (VPNs), and antivirus solutions.

## [INSTALLATION PRECAUTIONS]

---

### **WARNING**

- Make sure to cut off all phases of the power supply externally before attempting installation or wiring work. Failure to do so may cause electric shock or damage to the product.
- Use the product within the generic environment specifications described in the User's Manual (Hardware) for the CPU module used.

Never use the product in areas with excessive dust, oily smoke, conductive dusts, corrosive gas (salt air, Cl<sub>2</sub>, H<sub>2</sub>S, SO<sub>2</sub> or NO<sub>2</sub>), flammable gas, vibration or impacts, or expose it to high temperature, condensation, or rain and wind.

If the product is used in such conditions, electric shock, fire, malfunctions, deterioration or damage may occur.

---

## [INSTALLATION PRECAUTIONS]

---

### **CAUTION**

- Do not touch the conductive parts of the product directly. Doing so may cause device failures or malfunctions.
  - When drilling screw holes or wiring, make sure that cutting and wiring debris do not enter the ventilation slits of the programmable controller. Failure to do so may cause fire, equipment failures or malfunctions.
  - For product supplied together with a dust proof sheet, the sheet should be affixed to the ventilation slits before the installation and wiring work to prevent foreign objects such as cutting and wiring debris.  
However, when the installation work is completed, make sure to remove the sheet to provide adequate ventilation. Failure to do so may cause a fire, equipment failure, or malfunctions.
  - Install the product on a flat surface. If the mounting surface is rough, undue force will be applied to the PC board, thereby causing nonconformities.
  - Install the product securely using a DIN rail or mounting screws.
  - Work carefully when using a screwdriver such as installation of the product. Failure to do so may cause damage to the product or an accident.
  - Connect the extension cables, peripheral device cables, input/output cables and battery connecting cable securely to their designated connectors. Loose connections may cause malfunctions.
  - Turn off the power to the programmable controller before attaching or detaching the following devices. Failure to do so may cause equipment failures or malfunctions.
    - Peripheral devices, extension board, extension adapter, and connector conversion adapter
    - Extension modules, bus conversion module, and connector conversion module
    - Battery
-

## [WIRING PRECAUTIONS]

---

### **WARNING**

- Make sure to cut off all phases of the power supply externally before attempting installation or wiring work. Failure to do so may cause electric shock or damage to the product.
  - Make sure to attach the terminal cover, provided as an accessory, before turning on the power or initiating operation after installation or wiring work. Failure to do so may cause electric shock.
  - The temperature rating of the cable should be 75°C or more.
  - Make sure to wire the screw terminal block in accordance with the following precautions. Failure to do so may cause electric shock, equipment failures, a short-circuit, wire breakage, malfunctions, or damage to the product.
    - The disposal size of the cable end should follow the dimensions described in the User's Manual (Hardware) of the CPU module used.
    - Tightening torque should follow the specifications in the User's Manual (Hardware) of the CPU module used.
    - Tighten the screws using a Phillips-head screwdriver No. 2 (shaft diameter 6 mm or less). Make sure that the screwdriver does not touch the partition part of the terminal block.
- 

## [WIRING PRECAUTIONS]

---

### **CAUTION**

- Perform class D grounding (grounding resistance: 100 Ω or less) of the grounding terminal on the CPU module and extension modules with a wire 2 mm<sup>2</sup> or thicker.  
Do not use common grounding with heavy electrical systems (refer to the User's Manual (Hardware) of the CPU module used).
  - Connect the power supply wiring to the dedicated terminals described in this manual. If an AC power supply is connected to a DC input/output terminal or DC power supply terminal, the programmable controller will burn out.
  - Do not wire vacant terminals externally. Doing so may cause damage to the product.
  - Install module so that excessive force will not be applied to terminal blocks, power connectors, I/O connectors, communication connectors, or communication cables. Failure to do so may result in wire damage/breakage or programmable controller failure.
  - Make sure to observe the following precautions in order to prevent any damage to the machinery or accidents due to malfunction of the programmable controller caused by abnormal data written to the programmable controller due to the effects of noise.
    - Do not bundle the power line, control line, and communication cables together with or lay them close to the main circuit, high-voltage line, load line, or power line. As a guideline, lay the power line, control line and connection cables at least 100 mm away from the main circuit, high-voltage line, load line or power line.
    - Ground the shield of the shield wire or shielded cable at one point on the programmable controller. However, do not use common grounding with heavy electrical systems.
  - Use Ver.1.10-compatible CC-Link dedicated cables in a CC-Link system.  
If not, the performance of the CC-Link system is not guaranteed.  
For the maximum overall cable length and the station-to-station cable length, follow the specifications in this manual. If not, normal data transmission is not guaranteed.
-

## [STARTUP AND MAINTENANCE PRECAUTIONS]

---

### **WARNING**

- Do not touch any terminal while the programmable controller's power is on. Doing so may cause electric shock or malfunctions.
  - Before cleaning or retightening terminals, cut off all phases of the power supply externally. Failure to do so in the power ON status may cause electric shock.
  - Before modifying the program in operation, forcible output, running or stopping the programmable controller, read through this manual carefully, and ensure complete safety. An operation error may damage the machinery or cause accidents.
  - Do not change the program in the programmable controller from two or more peripheral equipment devices at the same time. (i.e. from an engineering tool and a GOT) Doing so may cause destruction or malfunction of the programmable controller program.
- 

## [STARTUP AND MAINTENANCE PRECAUTIONS]

---

### **CAUTION**

- Do not disassemble or modify the programmable controller. Doing so may cause fire, equipment failures, or malfunctions.  
For repair, contact your local Mitsubishi Electric representative.
  - Turn off the power to the programmable controller before connecting or disconnecting any extension cable. Failure to do so may cause equipment failures or malfunctions.
  - Turn off the power to the programmable controller before attaching or detaching the following devices. Failure to do so may cause equipment failure or malfunction.
    - Peripherals, extension board, extension adapter, and connector conversion adapter
    - Extended module, bus conversion module, and connector conversion module
    - Battery
- 

## [OPERATION PRECAUTIONS]

---

### **CAUTION**

- Construct an interlock circuit in the program so that the whole system always operates on the safe side before executing the control (for data change) of the PLC in operation. Read the manual thoroughly and ensure complete safety before executing other controls (for program change, parameter change, forcible output and operation status change) of the PLC in operation. Otherwise, the machine may be damaged and accidents may occur by erroneous operations.
  - Note that the whole system may not be reset by the RUN/STOP/RESET switch when the CPU module or intelligent function module detects an error, such as a watchdog timer error, during self-diagnosis. In that case, turn off and on the power.
- 

## [DISPOSAL PRECAUTIONS]

---

### **CAUTION**

- Please contact a certified electronic waste disposal company for the environmentally safe recycling and disposal of your device.
-

## [TRANSPORTATION PRECAUTIONS]

---

### **CAUTION**

---

- The programmable controller is a precision instrument. During transportation, avoid impacts larger than those specified in the general specifications described in the User's Manual (Hardware) of the CPU module used by using dedicated packaging boxes and shock-absorbing palettes. Failure to do so may cause failures in the programmable controller. After transportation, verify operation of the programmable controller and check for damage of the mounting part, etc.
-



# INTRODUCTION

---

This manual contains text, diagrams and explanations which will guide the reader in the correct installation, safe use and operation of the CC-Link Network module of MELSEC iQ-F series and should be read and understood before attempting to install or use the module.

Always forward it to the end user.

## Regarding use of this product

- This product has been manufactured as a general-purpose part for general industries, and has not been designed or manufactured to be incorporated in a device or system used in purposes related to human life.
- Before using the product for special purposes such as nuclear power, electric power, aerospace, medicine or passenger movement vehicles, consult Mitsubishi Electric.
- This product has been manufactured under strict quality control. However when installing the product where major accidents or losses could occur if the product fails, install appropriate backup or failsafe functions in the system.

## Note

- If in doubt at any stage during the installation of the product, always consult a professional electrical engineer who is qualified and trained in the local and national standards. If in doubt about the operation or use, please consult the nearest Mitsubishi Electric representative.
- Since the examples indicated by this manual, technical bulletin, catalog, etc. are used as a reference, please use it after confirming the function and safety of the equipment and system. Mitsubishi Electric will accept no responsibility for actual use of the product based on these illustrative examples.
- This manual content, specification etc. may be changed, without a notice, for improvement.
- The information in this manual has been carefully checked and is believed to be accurate; however, if you notice a doubtful point, an error, etc., please contact the nearest Mitsubishi Electric representative. When doing so, please provide the manual number given at the end of this manual.

# MEMO

---

# CONTENTS

SAFETY PRECAUTIONS .....	1
INTRODUCTION .....	7
RELEVANT MANUALS .....	12
TERMS .....	12
<b>CHAPTER 1 DESCRIPTION</b> .....	<b>15</b>
<b>CHAPTER 2 SPECIFICATIONS</b> .....	<b>17</b>
2.1 General Specifications .....	17
2.2 Power Supply Specifications .....	17
2.3 Performance Specifications .....	17
2.4 Maximum Number of Connectable Modules (when operating as a master station) .....	22
2.5 Maximum Overall Cable Length .....	24
2.6 Ver.1.10-Compatible CC-Link Dedicated Cables .....	24
2.7 Name of Each Section .....	25
LED display .....	26
<b>CHAPTER 3 PROCEDURES UP TO OPERATION</b> .....	<b>27</b>
<b>CHAPTER 4 FUNCTIONS</b> .....	<b>29</b>
4.1 Function List .....	29
4.2 Cyclic Transmission .....	32
Data flow and link device assignment .....	32
Mode .....	34
Link refresh .....	39
Cyclic data integrity assurance .....	40
Input and output settings when failure occurs .....	42
Output data setting in case of CPU STOP .....	46
Output mode setting upon CPU error .....	48
Data link stop and restart .....	49
4.3 Transient Transmission .....	50
4.4 Remote Device Station Initial Setting Procedure Registration Function .....	52
4.5 Master Station Duplication Error Canceling Function .....	54
<b>CHAPTER 5 SYSTEM CONFIGURATION</b> .....	<b>55</b>
5.1 CC-Link System Configuration .....	55
5.2 Precautions for the System Configuration .....	56
<b>CHAPTER 6 WIRING</b> .....	<b>57</b>
6.1 Power Supply Wiring .....	57
Grounding .....	57
6.2 CC-Link Network Wiring .....	58
Terminal block .....	58
Wiring methods .....	59
Wiring products .....	60
T-branch connection .....	61

<b>CHAPTER 7</b>	<b>PARAMETER SETTINGS</b>	<b>63</b>
<b>7.1</b>	<b>Setting Parameters</b>	<b>63</b>
<b>7.2</b>	<b>Required Settings</b>	<b>65</b>
	Station type	65
	Mode	65
	Station number	66
	Transmission speed	67
	Parameter Setting Method	67
<b>7.3</b>	<b>Basic Settings</b>	<b>68</b>
	Own station setting	68
	Network configuration settings	69
	Link refresh settings	71
	Initial setting	73
<b>7.4</b>	<b>Application Settings</b>	<b>76</b>
	Supplementary cyclic settings	77
	Parameter name	77
<b>7.5</b>	<b>Compatible Buffer Memory</b>	<b>78</b>
<b>CHAPTER 8</b>	<b>PROGRAMMING</b>	<b>79</b>
<b>8.1</b>	<b>Precautions for Programming</b>	<b>79</b>
<b>8.2</b>	<b>Example of Communications Between a Master Station, a Remote Device Station and a Remote I/O Station</b>	<b>80</b>
	System configuration example	80
	Setting in a master station	85
	Setting of remote device station	89
	Setting of Remote I/O station	89
	Checking the data link status	90
	Program example	91
<b>8.3</b>	<b>Example of Communications Between a Master Station and a Intelligent Device Station</b>	<b>93</b>
	System configuration example	93
	Setting in the master station	95
	Setting in intelligent device stations	97
	Checking the data link status	99
	Program examples	100
<b>8.4</b>	<b>Examples of Parameter Settings Using Program</b>	<b>104</b>
	System configuration example	104
	Setting in the master station	105
	Setting in intelligent device stations	107
	Program examples	108
	Checking the data link status	111
<b>CHAPTER 9</b>	<b>TROUBLESHOOTING</b>	<b>112</b>
<b>9.1</b>	<b>Checking with LED</b>	<b>112</b>
<b>9.2</b>	<b>Checking the System Status</b>	<b>114</b>
<b>9.3</b>	<b>Hardware Test</b>	<b>125</b>
<b>9.4</b>	<b>Troubleshooting by Symptom</b>	<b>126</b>
	When cyclic transmission cannot be performed	126
	When a slave station is disconnected	128
	When operation error occurs on the master station	132
<b>9.5</b>	<b>List of Error Codes</b>	<b>133</b>

<b>APPENDIX</b>	<b>140</b>
<b>Appendix 1 External Dimensions</b> .....	<b>140</b>
<b>Appendix 2 Standards</b> .....	<b>141</b>
Certification of UL, cUL standards .....	141
Compliance with EC Directive (CE marking) .....	141
Requirement for compliance with EMC Directive .....	141
Caution for compliance with EC Directive .....	142
Compliance with UKCA marking .....	142
<b>Appendix 3 Module Labels</b> .....	<b>143</b>
<b>Appendix 4 Buffer Memory</b> .....	<b>144</b>
List of buffer memory addresses .....	144
Details of buffer memory addresses .....	147
<b>Appendix 5 List of Link Special Relay (SB) Areas</b> .....	<b>161</b>
<b>Appendix 6 List of Link Special Register (SW) Areas</b> .....	<b>165</b>
<b>Appendix 7 Processing Time</b> .....	<b>174</b>
Link scan time .....	174
Cyclic transmission delay time .....	175
<b>Appendix 8 Added and Enhanced Functions</b> .....	<b>180</b>
<b>INDEX</b>	<b>182</b>
REVISIONS .....	184
WARRANTY .....	185
TRADEMARKS .....	186

# RELEVANT MANUALS

Manual name <manual number>	Description
MELSEC iQ-F FX5S/FX5UJ/FX5U/FX5UC User's Manual (Hardware) <SH-082452ENG>	Describes the details of hardware of the FX5 CPU module, including performance specifications, wiring, installation, and maintenance.
MELSEC iQ-F FX5 User's Manual (Application) <JY997D55401>	Describes the basic knowledge required for program design, functions of the CPU module, devices/labels, and parameters.
MELSEC iQ-F FX5 Programming Manual (Program Design) <JY997D55701>	Describes the specifications of ladders, ST, FBD/LD, and other programs and labels.
MELSEC iQ-F FX5 Programming Manual (Instructions, Standard Functions/Function Blocks) <JY997D55801>	Describes the specifications of instructions and functions that can be used in programs.
GX Works3 Operating Manual <SH-081215ENG>	Describes the system configuration, parameter settings, and online operations of GX Works3.

## TERMS

Unless otherwise specified, this manual uses the following terms.

For details on the FX3 devices that can be connected with the FX5, refer to the User's Manual (Hardware) of the CPU module to be used.

Terms	Description
■Devices	
FX5	Generic term for FX5S, FX5UJ, FX5U, and FX5UC PLCs
FX3	Generic term for FX3S, FX3G, FX3GC, FX3U, and FX3UC PLCs
FX5 CPU module	Generic term for FX5S CPU module, FX5UJ CPU module, FX5U CPU module, and FX5UC CPU module
FX5S CPU module	Generic term for FX5S-30MR/ES, FX5S-40MR/ES, FX5S-60MR/ES, FX5S-80MR/ES <sup>*1</sup> , FX5S-30MT/ES, FX5S-40MT/ES, FX5S-60MT/ES, FX5S-80MT/ES <sup>*1</sup> , FX5S-30MT/ESS, FX5S-40MT/ESS, FX5S-60MT/ESS, and FX5S-80MT/ESS <sup>*1</sup>
FX5UJ CPU module	Generic term for FX5UJ-24MR/ES, FX5UJ-24MT/ES, FX5UJ-24MT/ESS, FX5UJ-40MR/ES, FX5UJ-40MT/ES, FX5UJ-40MT/ESS, FX5UJ-60MR/ES, FX5UJ-60MT/ES, and FX5UJ-60MT/ESS
FX5U CPU module	Generic term for FX5U-32MR/ES, FX5U-32MT/ES, FX5U-32MT/ESS, FX5U-64MR/ES, FX5U-64MT/ES, FX5U-64MT/ESS, FX5U-80MR/ES, FX5U-80MT/ES, FX5U-80MT/ESS, FX5U-32MR/DS, FX5U-32MT/DS, FX5U-32MT/DSS, FX5U-64MR/DS, FX5U-64MT/DS, FX5U-64MT/DSS, FX5U-80MR/DS, FX5U-80MT/DS, and FX5U-80MT/DSS
FX5UC CPU module	Generic term for FX5UC-32MT/D, FX5UC-32MT/DSS, FX5UC-64MT/D, FX5UC-64MT/DSS, FX5UC-96MT/D, FX5UC-96MT/DSS, FX5UC-32MT/DS-TS, FX5UC-32MT/DSS-TS, and FX5UC-32MR/DS-TS
Extension module	Generic term for FX5 extension modules, FX3 function modules, Extension modules (extension cable type) and Extension module (extension connector type)
FX5 extension module	Generic term for I/O modules, FX5 extension power supply modules, FX5 intelligent function modules, and FX5 safety extension modules
FX3 extension module	Generic term for FX3 extension power supply module and FX3 intelligent function module
Extension module (extension cable type)	Generic term for Input modules (extension cable type), Output modules (extension cable type), Input/output modules (extension cable type), Powered input/output module, High-speed pulse input/output module, Extension power supply module (extension cable type), Connector conversion module (extension cable type), Intelligent function modules, Safety extension modules, and Bus conversion module (extension cable type)
Extension module (extension connector type)	Generic term for Input modules (extension connector type), Output modules (extension connector type), Input/output modules (extension connector type), Extension power supply module (extension connector type), Connector conversion module (extension connector type), and Bus conversion module (extension connector type)
I/O module	Generic term for Input modules, Output modules, Input/output modules, Powered input/output modules, and High-speed pulse input/output modules
Input module	Generic term for Input modules (extension cable type) and Input modules (extension connector type)
Input module (extension cable type)	Generic term for FX5-8EX/ES and FX5-16EX/ES
Input module (extension connector type)	Generic term for FX5-C16EX/D, FX5-C16EX/DS, FX5-C32EX/D, FX5-C32EX/DS, and FX5-C32EX/DS-TS
Output module	Generic term for Output modules (extension cable type) and Output modules (extension connector type)
Output module (extension cable type)	Generic term for FX5-8EYR/ES, FX5-8EYT/ES, FX5-8EYT/ESS, FX5-16EYR/ES, FX5-16EYT/ES, and FX5-16EYT/ESS
Output module (extension connector type)	Generic term for FX5-C16EYT/D, FX5-C16EYT/DSS, FX5-C16EYR/D-TS, FX5-C32EYT/D, FX5-C32EYT/DSS, FX5-C32EYT/D-TS, and FX5-C32EYT/DSS-TS

Terms	Description
Input/output module	Generic term for Input/output modules (extension cable type) and Input/output modules (extension connector type)
Input/output module (extension cable type)	Generic term for FX5-16ER/ES, FX5-16ET/ES, and FX5-16ET/ESS
Input/output module (extension connector type)	Generic term for FX5-C32ET/D, FX5-C32ET/DSS, FX5-C32ET/DS-TS, and FX5-C32ET/DSS-TS
Powered input/output module	Generic term for FX5-32ER/ES, FX5-32ET/ES, FX5-32ET/ESS, FX5-32ER/DS, FX5-32ET/DS, and FX5-32ET/DSS
High-speed pulse input/output module	Generic term for FX5-16ET/ES-H and FX5-16ET/ESS-H
Extension power supply module	Generic term for FX5 extension power supply module and FX3 extension power supply module
FX5 extension power supply module	Generic term for FX5 extension power supply module (extension cable type) and FX5 extension power supply module (extension connector type)
FX5 extension power supply module (extension cable type)	Different name for FX5-1PSU-5V
FX5 extension power supply module (extension connector type)	Different name for FX5-C1PS-5V
FX3 extension power supply module	Different name for FX3U-1PSU-5V
Intelligent module	The abbreviation for intelligent function modules
Intelligent function module	Generic term for FX5 intelligent function modules and FX3 intelligent function modules
FX5 intelligent function module	Generic term for FX5-4AD, FX5-4DA, FX5-8AD, FX5-4LC, FX5-20PG-P, FX5-20PG-D, FX5-40SSC-S, FX5-80SSC-S, FX5-ENET, FX5-ENET/IP, FX5-CCLGN-MS, FX5-CCLIEF, FX5-CCL-MS, FX5-ASL-M, and FX5-DP-M
FX3 intelligent function module	Generic term for FX3U-4AD, FX3U-4DA, FX3U-4LC, FX3U-1PG, FX3U-2HC, FX3U-16CCL-M, FX3U-64CCL, FX3U-128ASL-M, and FX3U-32DP
FX5 safety extension module	Generic term for safety main modules and safety expansion modules
Safety main module	Different name for FX5-SF-MU4T5
Safety expansion module	Generic term for expansion modules installed to a safety main module
Safety input expansion module	Different name for FX5-SF-8DI4
Expansion board	Generic term for board for FX5S CPU module, FX5UJ CPU module, and FX5U CPU module
Communication board	Generic term for FX5-232-BD, FX5-485-BD, and FX5-422-BD-GOT
Expansion adapter	Generic term for adapter for FX5 CPU module
Communication adapter	Generic term for FX5-232ADP and FX5-485ADP
Analog adapter	Generic term for FX5-4AD-ADP, FX5-4DA-ADP, FX5-4AD-PT-ADP, and FX5-4AD-TC-ADP
Bus conversion module	Generic term for Bus conversion module (extension cable type) and Bus conversion module (extension connector type)
Bus conversion module (extension cable type)	Different name for FX5-CNV-BUS
Bus conversion module (extension connector type)	Different name for FX5-CNV-BUSC
Connector conversion module	Generic term for Connector conversion module (extension cable type) and Connector conversion module (extension connector type)
Connector conversion module (extension cable type)	Different name for FX5-CNV-IF
Connector conversion module (extension connector type)	Different name for FX5-CNV-IFC
Extended extension cable	Generic term for FX5-30EC and FX5-65EC
Connector conversion adapter	Different name for FX5-CNV-BC
Battery	Different name for FX3U-32BL
Peripheral device	Generic term for engineering tools and GOTs
GOT	Generic term for Mitsubishi Electric Graphic Operation Terminal GOT1000 and GOT2000 series
<b>■Software packages</b>	
Engineering tool	The product name of the software package for the MELSEC programmable controllers
GX Works3	The product name of the software package, SWnDND-GXW3, for the MELSEC programmable controllers (The 'n' represents a version.)
<b>■CC-Link related</b>	
RAS	The abbreviation for Reliability, Availability, and Serviceability. This term refers to usability of automated equipment.
Ver.1-compatible slave station	A slave station that supports the remote net Ver.1 mode
Ver.2-compatible slave station	A slave station that supports the remote net Ver.2 mode

Terms	Description
Intelligent device station	A station that exchanges I/O signals (bit data) and I/O data (word data) with another station by cyclic transmission, and it can perform transient transmission. This station responds to a transient transmission request from another station. And also, it issues a transient transmission request to another station.
Disconnection	A process of stopping data link if a data link error occurs
Global label	A label that is valid for all the program data when multiple program data are created in the project. There are two types of global label: a module-specific label (module label), which is generated automatically by GX Works3, and an optional label, which can be created for any specified device.
Slave station	A generic term for a remote I/O station, remote device station, and intelligent device station
Cyclic Transmission	A function by which data are periodically exchanged among master station and other stations on the same system using link devices
Data link	A generic term for cyclic transmission and transient transmission
Device	A device (X, Y, M, D, or others) in a CPU module
Transient Transmission	A function of communication with another station, which is used when requested by the engineering tool
Buffer memory	Memory in an intelligent function module for storing data such as setting values and monitored values.
Return	A process of restarting data link when a station recovers from an error
Master/intelligent device module	The abbreviation for FX5-CCL-MS type CC-Link system master/intelligent device module
Master station	A station that controls the entire system. This station can perform cyclic transmission and transient transmission with all stations. Only one master station can be used in a system.
Master/local module	The abbreviation for the RJ61BT11 CC-Link system master/local module.
Module label	A label that represents one of memory areas (I/O signals and buffer memory areas) specific to each module in a given character string. For the module used, GX Works3 automatically generates this label, which can be used as a global label.
Label	A label that represents a device in a given character string
Remote I/O station	A station that exchanges I/O signals (bit data) with the master station by cyclic transmission. This station cannot perform transient transmission.
Remote station	A generic term for a remote I/O station and a remote device station
Remote output (RY)	Bit data output from the master station to a slave station
Remote device station	A station that exchanges I/O signals (bit data) and I/O data (word data) with the master station by cyclic transmission. This station cannot perform transient transmission.
Remote input (RX)	Bit data input from a slave station to the master station
Remote net Ver.1 mode	A mode used to configure a system only with a master station and Ver.1-compatible slave station. Data can be communicated with remote I/O station, remote device station, and intelligent device station in a CC-Link system.
Remote net Ver.2 mode	A mode used to configure a system containing master stations and Ver.2-compatible slave stations or to add Ver.2-compatible slave stations in future. Data can be communicated with remote I/O station, remote device station, and intelligent device station in a CC-Link system. Compared to the remote net Ver.1 mode, the number of cyclic points per station is increased from 128 to 384 for total of RX/RX, and from 16 to 64 for RWr/RWw each.
Remote net mode	A mode used to communicate data with remote I/O station, remote device station, and intelligent device station in a CC-Link system. There are two modes: remote net Ver.1 mode and remote net Ver.2 mode.
Remote register (RWr)	16 bit (1 word) data input from a slave station to the master station
Remote register (RWw)	16 bit (1 word) data output from the master station to a slave station
Link scan (link scan time)	Time required for all stations in a system to transmit data. The link scan time depends on data volume and the number of transient transmission requests.
Link special relay (SB)	Bit data that indicates the operating status and data link status of modules on the master and intelligent device stations
Link special register (SW)	16 bit (1 word) data that indicates the operating status and data link status of modules on the master and intelligent device stations
Local station	A station that performs cyclic transmission and transient transmission with the master station and other local stations.

\*1 Area-specific model



# 1 DESCRIPTION

FX5-CCL-MS type CC-Link system master/intelligent device module is an intelligent function module that operates as the master station or intelligent device station of the CC-Link system.

By using the master/intelligent device module as a master station, you can configure a CC-Link system with a FX5 CPU module. This allows you to control remote devices on the CC-Link system in the same way as controlling the FX5 CPU module.

By using the master/intelligent device module for an intelligent device station, the FX5 CPU module can be used as an intelligent device station of the CC-Link system.

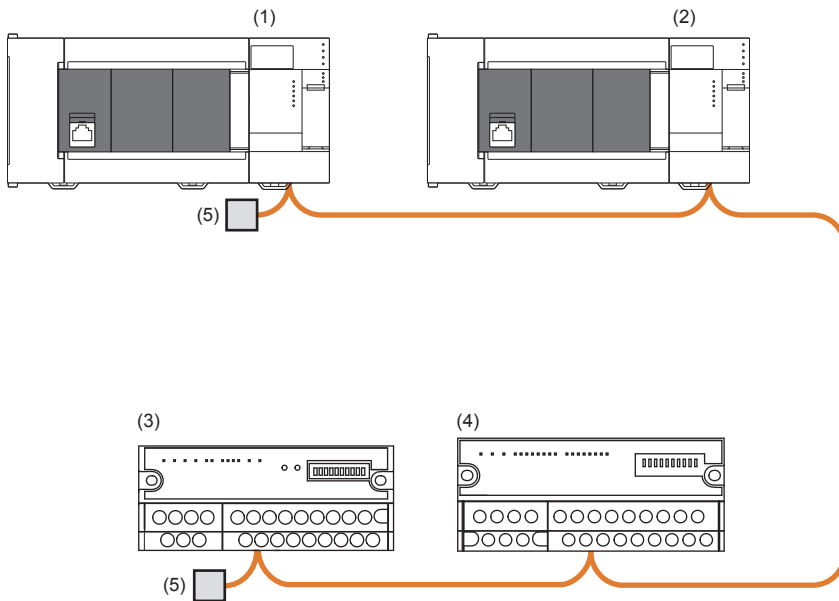

- (1) FX5-CCL-MS (master station)
- (2) FX5-CCL-MS (intelligent device station)
- (3) Remote device station
- (4) Remote I/O station
- (5) Terminating resistance

# MEMO

---

# 2 SPECIFICATIONS

This section describes the specifications of the master/intelligent device module.

## 2.1 General Specifications

General specifications other than the following are the same as the CPU module to be connected.

Refer to the following manual for general specifications.

📖 MELSEC iQ-F FX5S/FX5UJ/FX5U/FX5UC User's Manual (Hardware)

Item	Specifications	
Withstand voltage	500 V AC for 1 minute	Between all terminals and the ground terminal
Insulation resistance	10 MΩ or more with 500 V DC insulation resistance meter	

## 2.2 Power Supply Specifications

Shows power supply specifications.

Item	Specifications	
External power supply	Power-supply voltage	24 V DC + 20%, -15%
	Allowable momentary power failure time	Continues operation against momentary power failure of 1 ms or less
	Current consumption	100 mA

## 2.3 Performance Specifications

Shows performance specifications.

Item	Description
CC-Link compatible version	Ver.2.00 (Ver.1.10 is also supported)
Station type	Master station or intelligent device station
Station No.	<ul style="list-style-type: none"> <li>Master station: 0</li> <li>Intelligent device station: 1 to 64</li> </ul>
Connectable station type (when operating as a master station) <sup>1</sup>	Remote I/O station, remote device station, intelligent device station (local station and standby master station cannot be connected)
Transmission speed	<ul style="list-style-type: none"> <li>Master station: Selected from 156 kbps/625 kbps/2.5 Mbps/5 Mbps/10 Mbps</li> <li>Intelligent device station: Selected from 156 kbps/625 kbps/2.5 Mbps/5 Mbps/10 Mbps/Auto-tracking</li> </ul>
Maximum number of connected stations (when operating as a master station)	<ul style="list-style-type: none"> <li>■For FX5UJ CPU module <ul style="list-style-type: none"> <li>Remote I/O station: Up to 6 stations (a total point of inputs/outputs of remote I/O stations is 192 points or less)</li> <li>Total of intelligent device stations + remote device stations: Up to 8 stations (For each remote device station + intelligent device station, the total number of I/O points are 256 points or less)</li> </ul> </li> <li>■When the version of the FX5U/FX5UC CPU module is 1.100 or above<sup>2</sup> <ul style="list-style-type: none"> <li>Remote I/O station: Up to 14 stations (a total point of inputs/outputs of remote I/O stations is 448 points or less)</li> <li>Total of intelligent device stations + remote device stations: Up to 14 stations (For each remote device station + intelligent device station, the total number of I/O points are 448 points or less)</li> </ul> </li> <li>■When the version of the FX5U/FX5UC CPU module is below 1.100 <ul style="list-style-type: none"> <li>Remote I/O station: Up to 12 stations (a total point of inputs/outputs of remote I/O stations is 384 points or less)</li> <li>Total of intelligent device stations + remote device stations: Up to 12 stations (For each remote device station + intelligent device station, the total number of I/O points are 384 points or less)</li> </ul> </li> </ul>
Number of occupied stations (when operating as an intelligent device station)	1 station to 4 stations (changed according to the setting of engineering tools or buffer memory)

Item	Description	
Maximum number of link points per system (when operating as a master station)	CC-Link Ver.1	<ul style="list-style-type: none"> <li>■ For FX5UJ CPU module</li> <li>• Remote input/output (RX, RY): 448 points (remote I/O station: 192 points<sup>*3</sup>, remote device station + intelligent device station: 256 points a total of 448 points)</li> <li>• Remote register (RWw): 32 points (master station → remote device station/intelligent device station)</li> <li>• Remote register (RWr): 32 points (remote device station/intelligent device station → master station))</li> <li>■ When the version of the FX5U/FX5UC CPU module is 1.100 or above<sup>*2</sup></li> <li>• Remote input/output (RX, RY): 896 points (remote I/O station: 448 points<sup>*3</sup>, remote device station + intelligent device station: 448 points a total of 896 points)</li> <li>• Remote register (RWw): 56 points (master station → remote device station/intelligent device station)</li> <li>• Remote register (RWr): 56 points (remote device station/intelligent device station → master station))</li> <li>■ When the version of the FX5U/FX5UC CPU module is below 1.100</li> <li>• Remote input/output (RX, RY): 768 points (remote I/O station: 384 points<sup>*3</sup>, remote device station + intelligent device station: 384 points a total of 768 points)</li> <li>• Remote register (RWw): 48 points (master station → remote device station/intelligent device station)</li> <li>• Remote register (RWr): 48 points (remote device station/intelligent device station → master station))</li> </ul>
	CC-Link Ver.2	<ul style="list-style-type: none"> <li>■ For FX5UJ CPU module</li> <li>• Remote input/output (RX, RY): 448 points (remote I/O station: 192 points<sup>*3</sup>, remote device station + intelligent device station: 256 points a total of 448 points)</li> <li>• Remote register (RWw): 64 points (master station → remote device station/intelligent device station)</li> <li>• Remote register (RWr): 64 points (remote device station/intelligent device station → master station))</li> <li>■ When the version of the FX5U/FX5UC CPU module is 1.100 or above<sup>*2</sup></li> <li>• Remote input/output (RX, RY): 896 points (remote I/O station: 448 points<sup>*3</sup>, remote device station + intelligent device station: 448 points a total of 896 points)</li> <li>• Remote register (RWw): 112 points (master station → remote device station/intelligent device station)</li> <li>• Remote register (RWr): 112 points (remote device station/intelligent device station → master station))</li> <li>■ When the version of the FX5U/FX5UC CPU module is below 1.100</li> <li>• Remote input/output (RX, RY): 768 points (remote I/O station: 384 points<sup>*3</sup>, remote device station + intelligent device station: 384 points a total of 768 points)</li> <li>• Remote register (RWw): 96 points (master station → remote device station/intelligent device station)</li> <li>• Remote register (RWr): 96 points (remote device station/intelligent device station → master station))</li> </ul>
Link points per remote station/intelligent device station	☞ Page 19 Number of link points for each number of occupied stations	
Communication method	Broadcast polling method	
Synchronization method	Frame synchronization method	
Encoding method	NRZI method	
Network topology	Bus (RS-485)	
Transmission format	HDLC compliance	
Error control system	CRC ( $X^{16}+X^{12}+X^5+1$ )	
Connection cable	Ver.1.10-compatible CC-Link dedicated cable	
Maximum overall cable length (maximum transmission distance)	Depends on the transmission speed (☞ Page 24 Maximum Overall Cable Length)	
Applicable CPU module	<ul style="list-style-type: none"> <li>• FX5UJ CPU module (From the first)</li> <li>• FX5U CPU module (Ver. 1.050 or later)</li> <li>• FX5UC CPU module<sup>*4</sup> (Ver. 1.050 or later)</li> </ul>	
Applicable engineering tool	<ul style="list-style-type: none"> <li>• FX5UJ CPU module: GX Works3 (Ver.1.060N or later)</li> <li>• FX5U/FX5UC CPU module: GX Works3 (Ver.1.035M or later)</li> </ul>	
Number of connectable units	<p>One module of each station type can be connected to a CPU module.</p> <ul style="list-style-type: none"> <li>• Master station: 1 unit<sup>*5</sup></li> <li>• Intelligent device station: 1 unit<sup>*6</sup></li> </ul>	
Number of occupied I/O points	8 points	

\*1 Refer to ☞ Page 22 Maximum Number of Connectable Modules (when operating as a master station) for the maximum number of connected units of the CC-Link system when the master/intelligent device module is used as a master station.

\*2 GX Works3 with version 1.047Z or above is required. For details, refer to the ☞ Page 180 Added and Enhanced Functions.

\*3 The remote I/O points that can be used in the CPU module varies depending on the number of input/output points of the expansion device. For the limit of I/O points, refer to the following manual.

☞ MELSEC iQ-F FX5S/FX5UJ/FX5U/FX5UC User's Manual (Hardware)

\*4 FX5-CNV-IFC or FX5-C1PS-5V is necessary to connected to the FX5UC CPU module.

\*5 FX3U-16CCL-M cannot be used together when using FX5-CCL-MS as the master station.

\*6 FX3U-64CCL cannot be used together when using FX5-CCL-MS as the intelligent device station.

## Number of link points for each number of occupied stations

Shows the number of link points for each number of occupied stations.

### ■For FX5UJ CPU module

Item			CC-Link Ver.1	CC-Link Ver.2			
				Extended cyclic setting			
				Single	Double	Quadruple	Octuple
Number of link points for each number of occupied stations	1 Station occupied	Remote input/output (RX, RY)	32 points (16 points)	32 points (16 points)	32 points (16 points)	64 points (48 points)	128 points (112 points)
		Remote register (RWw)	4 points	4 points	8 points	16 points	32 points
		Remote register (RWr)	4 points	4 points	8 points	16 points	32 points
	2 Stations occupied	Remote input/output (RX, RY)	64 points (48 points)	64 points (48 points)	96 points (80 points)	192 points (176 points)	—
		Remote register (RWw)	8 points	8 points	16 points	32 points	—
		Remote register (RWr)	8 points	8 points	16 points	32 points	—
	3 Stations occupied	Remote input/output (RX, RY)	96 points (80 points)	96 points (80 points)	160 points (144 points)	—	—
		Remote register (RWw)	12 points	12 points	24 points	—	—
		Remote register (RWr)	12 points	12 points	24 points	—	—
	4 Stations occupied	Remote input/output (RX, RY)	128 points (112 points)	128 points (112 points)	224 points (208 points)	—	—
		Remote register (RWw)	16 points	16 points	32 points	—	—
		Remote register (RWr)	16 points	16 points	32 points	—	—

The values in parenthesis are the number of available points when operating as an intelligent device station.

#### Restriction

- When the number of occupied stations is 2 stations then single, double, or quadruple options can be selected for the extended cyclic setting of CC-Link Ver.2.
- When the number of occupied stations is 3 or 4 stations, then single or double options can be selected for the extended cyclic setting of CC-Link Ver.2.

■When the version of the FX5U/FX5UC CPU module is 1.100 or above

Item			CC-Link Ver.1	CC-Link Ver.2			
				Extended cyclic setting			
				Single	Double	Quadruple	Octuple
Number of link points for each number of occupied stations	1 Station occupied	Remote input/output (RX, RY)	32 points (16 points)	32 points (16 points)	32 points (16 points)	64 points (48 points)	128 points (112 points)
		Remote register (RWw)	4 points	4 points	8 points	16 points	32 points
		Remote register (RWr)	4 points	4 points	8 points	16 points	32 points
	2 Stations occupied	Remote input/output (RX, RY)	64 points (48 points)	64 points (48 points)	96 points (80 points)	192 points (176 points)	384 points (368 points)
		Remote register (RWw)	8 points	8 points	16 points	32 points	64 points
		Remote register (RWr)	8 points	8 points	16 points	32 points	64 points
	3 Stations occupied	Remote input/output (RX, RY)	96 points (80 points)	96 points (80 points)	160 points (144 points)	320 points (304 points)	—
		Remote register (RWw)	12 points	12 points	24 points	48 points	—
		Remote register (RWr)	12 points	12 points	24 points	48 points	—
	4 Stations occupied	Remote input/output (RX, RY)	128 points (112 points)	128 points (112 points)	224 points (208 points)	448 points (—)	—
		Remote register (RWw)	16 points	16 points	32 points	64 points (—)	—
		Remote register (RWr)	16 points	16 points	32 points	64 points (—)	—

The values in parenthesis are the number of available points when operating as an intelligent device station.

**Restriction** 

- When the number of occupied stations is 3 stations then single, double, or quadruple options can be selected for the extended cyclic setting of CC-Link Ver.2.
- When the number of occupied stations is 4 stations, single, double, or quadruple is selectable for the extended cyclic setting of CC-Link Ver.2. However, when operating as an intelligent device station, quadruple is not selectable.

■When the version of the FX5U/FX5UC CPU module is below 1.100

Item			CC-Link Ver.1	CC-Link Ver.2			
				Extended cyclic setting			
				Single	Double	Quadruple	Octuple
Number of link points for each number of occupied stations	1 Station occupied	Remote input/output (RX, RY)	32 points (16 points)	32 points (16 points)	32 points (16 points)	64 points (48 points)	128 points (112 points)
		Remote register (RWw)	4 points	4 points	8 points	16 points	32 points
		Remote register (RWr)	4 points	4 points	8 points	16 points	32 points
	2 Stations occupied	Remote input/output (RX, RY)	64 points (48 points)	64 points (48 points)	96 points (80 points)	192 points (176 points)	384 points (368 points)
		Remote register (RWw)	8 points	8 points	16 points	32 points	64 points
		Remote register (RWr)	8 points	8 points	16 points	32 points	64 points
	3 Stations occupied	Remote input/output (RX, RY)	96 points (80 points)	96 points (80 points)	160 points (144 points)	320 points (304 points)	—
		Remote register (RWw)	12 points	12 points	24 points	48 points	—
		Remote register (RWr)	12 points	12 points	24 points	48 points	—
	4 Stations occupied	Remote input/output (RX, RY)	128 points (112 points)	128 points (112 points)	224 points (208 points)	—	—
		Remote register (RWw)	16 points	16 points	32 points	—	—
		Remote register (RWr)	16 points	16 points	32 points	—	—

The values in parenthesis are the number of available points when operating as an intelligent device station.

**Restriction** 

- When the number of occupied stations is 3 stations then single, double, or quadruple options can be selected for the extended cyclic setting of CC-Link Ver.2.
- When the number of occupied stations is 4 stations, single or double is selectable for the extended cyclic setting of CC-Link Ver.2.

## 2.4 Maximum Number of Connectable Modules (when operating as a master station)

A CC-Link system with the master/intelligent device module as the master station can be configured with the number of modules satisfying the following conditions.

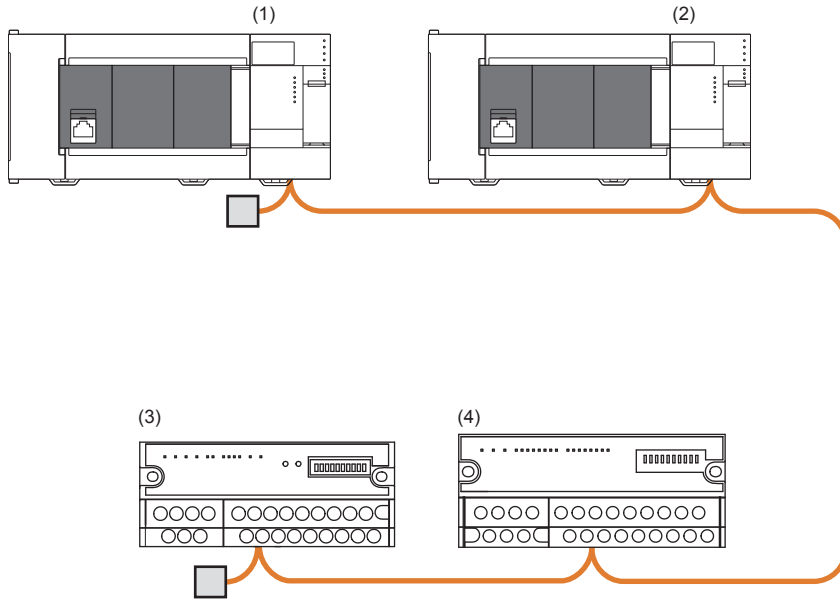

No.	Station type	Maximum number of connected modules	
		FX5UJ CPU module	FX5U/FX5UC CPU module
(1)	Master Station	1 unit for 1 system	
(2)	Intelligent device station	Up to 8 modules in total	Up to 14 modules in total
(3)	Remote device station		
(4)	Remote I/O station	Up to 6 modules	Up to 14 modules



## Conditions for CC-Link system configuration

### ■Maximum number of connectable stations

The number of stations that can be connected to a CC-Link system that uses a master/intelligent device module as the master station is shown below.

Station type	Maximum number of connectable stations	
	FX5UJ CPU module	FX5U/FX5UC CPU module
Remote I/O station	Up to 6 stations The total number of remote I/O station input/output points is 192 points (6 stations × 32 points* <sup>1</sup> ) or less	Up to 14 stations The total number of remote I/O station input/output points is 448 points (14 stations × 32 points* <sup>1</sup> ) or less
Remote device station, Intelligent device station	Up to 8 stations in total For each remote device station + intelligent device station, the total number of I/O points are 256 points or less	Up to 14 stations in total For each remote device station + intelligent device station, the total number of I/O points are 448 points or less

\*1 32 points are occupied per station in a remote I/O station.

### ■Limitation on the number of input/output points

Control can be performed within the following range.

- FX5UJ CPU module

① Number of input/output points of the FX5UJ CPU module ≤ 256 points

② Number of remote I/O points\*<sup>1</sup> ≤ 192 points

③ Number of input/output points of the FX5UJ CPU module (①) + Number of remote I/O points (②) ≤ 256 points

- FX5U/FX5UC CPU module

① Number of input/output points of the FX5U/FX5UC CPU module ≤ 384 points

② Number of remote I/O points\*<sup>1</sup> ≤ 448 points

③ Number of input/output points of the FX5U/FX5UC CPU module (①) + Number of remote I/O points (②) ≤ 512 points

\*1 When using the master/intelligent device module as the master station, the number of occupied remote I/O points is "number of remote I/O stations × 32 points."

## Precautions

- When a different network's master module is connected to the FX5 CPU module, make sure that the total of the number of remote I/O points occupied by the other master module and the number of remote I/O points occupied by the master/intelligent device module satisfy condition ②. Refer to the following manual for details on the limits to the number of CPU module I/O points.

📖 MELSEC iQ-F FX5S/FX5UJ/FX5U/FX5UC User's Manual (Hardware)

- When writing a ladder program, make sure to execute parameter check by GX Works3. If the above mentioned limitation is exceeded, the following errors will occur. When an error occurs, the master/intelligent device module does not start the data link.

	Error code	Error name
CPU module	2442H	Module major error
	1FE8H	Module configuration error
Master/intelligent device module	B3A9H* <sup>2</sup>	Remote I/O permission points over

\*2 The error code related to parameter settings is stored in 'parameter status of own station' (SW0068).

## 2.5 Maximum Overall Cable Length

This section describes how transmission speed, a station-to-station cable length (1), and maximum overall cable length (2) are related when a system is configured with products of CC-Link Ver.1.10 or later and Ver.1.10-compatible CC-Link dedicated cables.

For the identification method on CC-Link version, refer to the installation manual issued by the CC-Link Partner Association.

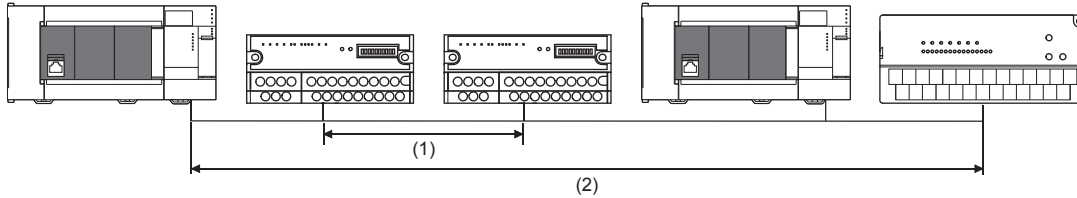

- Ver.1.10-compatible CC-Link dedicated cable (using terminating resistance 110  $\Omega$ )

Transmission speed	Station-to-station cable length	Maximum overall cable length
156 kbps	20 cm or more	1200 m
625 kbps		900 m
2.5 Mbps		400 m
5 Mbps		160 m
10 Mbps		100 m

## 2.6 Ver.1.10-Compatible CC-Link Dedicated Cables

Use Ver.1.10-compatible CC-Link dedicated cables for the CC-Link system.

If not, the performance of the CC-Link system is not guaranteed.

For specifications of Ver.1.10-compatible CC-Link dedicated cables and contact information, refer to the website of CC-Link Association.

### Point

For details, refer to the CC-Link Cable Wiring Manual issued by CC-Link Partner Association.

## 2.7 Name of Each Section

Shows the name of each section of the master/intelligent device module.

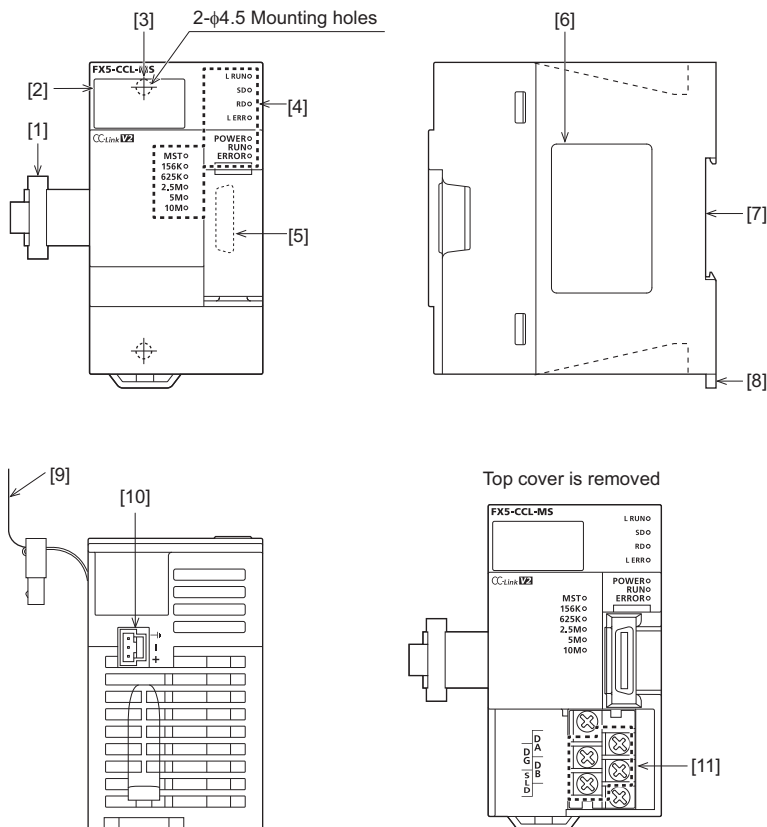

No.	Name	Description
[1]	Extension cable	Cable for connecting the module when adding the FX5-CCL-MS.
[2]	Dot matrix LED	Displays the station number set in a module and the content of a test mode. (☞ Page 26 LED display)
[3]	Direct mounting hole	Screw holes (2-φ4.5, mounting screw: M4 screw) for direct installation
[4]	Operation status display LEDs	Indicates the operating status of the module. (☞ Page 26 LED display)
[5]	Extension connector	Connector for connecting the extension cable of an extension module.
[6]	Name plate	The product model name and manufacturer's serial number are shown.
[7]	DIN rail mounting groove	The module can be installed on DIN46277 rail (35 mm wide).
[8]	DIN rail mounting hook	Hook for mounting the module on a DIN rail of DIN46277 (35 mm wide).
[9]	Pullout tab	They are used when drawing out an extension cable.
[10]	Power connector	Connector for connecting the power cable. (☞ Page 57 Power Supply Wiring)
[11]	CC-Link connection terminal block	Used to connect a Ver.1.10-compatible CC-Link dedicated cable. (☞ Page 58 CC-Link Network Wiring) Before installing or removing the terminal block, power off the module.

# LED display

Indicates LED display.

LED name	LED color	Description
L RUN	Green	Indicates the data link status. On: Data link in progress Off: Data link not performed
SD	Green	Indicates the data sending status. On: Data being sent* <sup>1</sup> Off: Data not sent
RD	Green	Indicates the data receiving status. On: Data being received* <sup>1</sup> Off: Data not receivedd
L ERR	Red	Indicates the data link error status. On: A data link error has occurred at own station. Flashing: Communication is unstable due to the following reasons. <ul style="list-style-type: none"> <li>• Terminating resistor is not connected.</li> <li>• Affected by noise.</li> </ul> Off: Normal operation
POWER	Green	Indicates whether the module is powered or not. On: Power on Off: Power off
RUN	Green	Indicates the operating status. On: Normal operation Off: A hardware error or a watchdog timer error has occurred
ERROR	Red	Indicates the error status. On: One of the following errors has occurred. <ul style="list-style-type: none"> <li>• All stations error was detected.</li> <li>• Two or more master stations are connected on the same line</li> <li>• Settings are incorrect</li> <li>• A cable is disconnected or a transmission path is affected by noise</li> </ul> Flashing: A station with a data link error was detected. Or, the station number set for a remote station is already in use. Off: Normal operation
MST	Green	Indicates whether it is operating as a master station. On: Operating as a master station Off: Operating as an intelligent device station
B RATE	Green	Indicates the operating transmission speed. On: Operating at the lit transmission speed All off: Transmission speed auto-tracking (When succeeded, the LED of the followed transmission speed turns on.)
	156K	
	625K	
	2.5M	
	5M	
	10M	
Dot matrix LED	Orange	Displays the station number set in the module. In an offline or test mode, the following are displayed. <ul style="list-style-type: none"> <li>• Offline: "---"</li> <li>• Line test: "L.T."</li> <li>• Hardware test: "H.T."</li> </ul>

\*1 The LEDs may look dimly lit or off depending on the communication status.

# 3 PROCEDURES UP TO OPERATION

This chapter describes the procedures before operation.

## 1. Checking the specifications of the master/intelligent device module

Check the specifications of the master/intelligent device module. (  Page 17 SPECIFICATIONS)

## 2. Installation of the master/intelligent device module

Connect the master/intelligent device module to the CPU module. For details, refer to the following.

 MELSEC iQ-F FX5S/FX5UJ/FX5U/FX5UC User's Manual (Hardware)

## 3. Power supply wiring



Connect a power cable to the master/intelligent device module. (  Page 57 Power Supply Wiring)

## 4. Unit test

A master/intelligent device module is individually tested to check whether it normally operates. (  Page 125 Hardware Test)

## 5. Network construction

Configure the system and set the parameters which are required for start-up, the station number for slave station, and transmission speed.

- Network wiring (  Page 58 CC-Link Network Wiring)
- Parameter setting (  Page 63 PARAMETER SETTINGS)
- Slave station number and transmission speed setting (manual of the used slave station)

## 6. Network diagnostics

Using line test, check if the cables are connected properly and communication is performed normally with the configured parameters.

For details, refer to the following.

(  Page 114 Checking the System Status)

## 7. Programming

Create a program. For details, refer to the following.

(  Page 79 PROGRAMMING)

## 8. Debug

Debug the program by using CC-Link diagnostics. (  Page 114 Checking the System Status)

# MEMO

---

# 4 FUNCTIONS

This chapter describes the functions available of the master/intelligent device module.



Supported functions depend on the parameter setting methods. Parameter settings using the Program are only applicable to the FX5U/FX5UC CPU module.

## 4.1 Function List

### Cyclic transmission

This section describes the functions of the CC-Link system.

M: Master station, ID: Intelligent device station, Pa: Parameter Editor, Pr: Program

○: Available, ×: Not available, △: Partially available

Functions		Description	Availability		Parameter settings		Reference
			M	ID	Pa	Pr	
Communication with other stations	Communication using RX, RY	Communicates I/O data in units of bits between the master station and other stations.	○	○	○	○	Page 32
	Communication using RWr, RWw	Communicates I/O data in units of words between the master station and other stations.					
Mode	Remote net Ver.1 mode	The mode can be selected according to the CC-Link system configuration.	○	○	○	○	Page 34
	Remote net Ver.2 mode						
Link refresh		Automatically transfers data between the link device of the master/intelligent device module and the device of the CPU module.	○	○	○	×	Page 39
Cyclic data integrity assurance		Prevents the link refreshed read/write data from being separated between new and old data.	○	○	○	△	Page 40
Setting of the input data from a data link faulty station	When operating as a master station	Selects whether remote input (RX) from a station where a data link error occurs is cleared or held.	○	×	○	○	Page 42
	When operating as an intelligent device station	Selects whether output data (RY/RWw) from the master station is cleared or held.	×	○			
Output data setting for CPU STOP	When operating as a master station	Selects whether remote output (RY) is refreshed (held at the value before STOP) or cleared to zero (0) when the CPU module is set to STOP.	○	×	○	○	Page 46
	When operating as an intelligent device station	Selects whether input data to the master station (RX/RWr) is refreshed (held at the value before STOP) or cleared to zero (0) when the CPU module is set to STOP.	×	○			
Data link setting when CPU is down		Selects whether data link is stopped or continued when a stop error occurs in the CPU module.	○	×	○	○	Page 42
Output data setting for CPU error	When operating as a master station	Selects whether remote output (RY) to the slave station is held or cleared when a stop error occurs in the CPU module.	○	×	○	×	Page 46
	When operating as an intelligent device station	Selects whether remote input (RX/RWr) to the master station is held or cleared when a stop error occurs in the CPU module.	×	○			
Data link stop and restart		Stops data link during debugging and other operations. (Data sending from the own station is stopped.) Also, the stopped data link is restarted.	○	○	○	○	Page 49

## Transient transmission

M: Master station, ID: Intelligent device station, Pa: Parameter Editor, Pr: Program

○: Available, ×: Not available

Functions	Description	Availability		Parameter settings		Reference
		M	ID	Pa	Pr	
Communications in the same system	Performs the transient transmission to other stations with the engineering tool.*1	○	○	○	○	Page 50

\*1 This function is not supported for transient transmission by using the dedicated instruction, send buffer, receive buffer, or automatic update buffer.

For example, the AJ65BT-R2N that uses with the send buffer, receive buffer, or automatic update buffer cannot be used.

## RAS

M: Master station, ID: Intelligent device station, Pa: Parameter Editor, Pr: Program

○: Available, ×: Not available

Functions	Description	Availability		Parameter settings		Reference
		M	ID	Pa	Pr	
Slave station cutoff function	Disconnects only the slave station where an error occurs from the system, and continues the data link with the stations that are operating normally. Using this function prevents the entire system from going down due to failure of one slave station. (No module parameter setting is required.)	○	×	○	○	—
Automatic return function	Automatically returns the station disconnected from the system due to a data link error to the system when it recovers and restarts data link. Since processing for return is unnecessary, it is possible to shorten the time to recover from an error.	○	×	○	○	Page 77

## Diagnostics

M: Master station, ID: Intelligent device station, Pa: Parameter Editor, Pr: Program

○: Available, ×: Not available

Functions	Description	Availability		Parameter settings		Reference
		M	ID	Pa	Pr	
Line test	Checks whether a Ver.1.10-compatible CC-Link dedicated cable is properly connected and data link can be performed with slave stations.	○	×	○	○	Page 119
Check of transmission speed setting	Checks whether the transmission speed setting of a slave station is the same as that of the master station. The station number of the slave station having a different transmission speed setting can be also checked; therefore, corrective action upon a transmission error can be easily taken.	○	×	○	○	Page 121
CC-Link Diagnostics	Checks the status of CC-Link system using the engineering tool. The error locations, error causes, and corrective actions can be checked in the engineering tool.	○	○	○	○	Page 114
Hardware test	Checks the hardware in the master/intelligent device module.	○	○	○	○	Page 125
Own station/other station monitor	Checks the data link status, etc. of the CC-Link system with the engineering tool.	○	×	○	○	Page 118
Status logging	Data link status of all stations is logged.	○	×	○	○	Page 122
Creating a check sheet	A check sheet, which is useful for performing troubleshooting, is created through a wizard and with reference to the Open Field Network CC-Link Troubleshooting Guide.	○	×	○	○	Page 123



## Others

M: Master station, ID: Intelligent device station, Pa: Parameter Editor, Pr: Program

○: Available, ×: Not available

Functions	Description	Availability		Parameter settings		Reference
		M	ID	Pa	Pr	
Reserved station function	Prevents slave stations that are not actually connected (but will be connected in future) from detecting as "Data Link Faulty Station" in the master station. By setting slave stations that will be connected in future as reserved stations, slave stations can be added without a program change because the RX, RY, RWr, or RWw assignment is not changed.	○	×	○	○	Page 69
Error invalid station setting function	Prevents a slave station from being detected as a faulty station in the master station even if a data link error occurs in the slave station. This function is used when a slave station is powered off as a matter of the system configuration or for other purposes.	○	×	○	○	Page 69
Temporary error invalid station setting function	Prevents a slave station from being detected as a faulty station in the master station even if a data link error occurs in the slave station. This setting can be configured even during data link, unlike the error invalid station setting function. This function is used to exchange slave stations for maintenance or for other purposes during data link.	○	×	○	○	Page 124
Remote device station initial setting procedure registration function	Registers in advance the initial setting of a remote device station which is performed on a program using an engineering tool and saves the setting by turning on the link special relay (SB). A program for the initial setting is not required.	○	×	○	×	Page 52
Station number duplication check function	Checks the status of the stations connected to the CC-Link system and check if there is duplication of the number of the occupied stations and there are no multiple stations with the station number 0 in the system.	○	×	○	○	Page 66
Master station duplication error canceling function	Clears a master station duplication error without resetting the CPU module or powering off and on the system when the error has been detected.	○	×	○	○	Page 54
Transmission speed auto-tracking function on intelligent device station	Automatically tracks the transmission speed of the master station when the own station is a intelligent device station. This function eliminates transmission speed setting errors.	×	○	○	○	Page 67

## 4.2 Cyclic Transmission

This function allows data to be periodically exchanged between the master station and other stations on the same system using link devices.

### Data flow and link device assignment

#### Overview of communications

In CC-Link, communications are performed between the master station and slave stations using RX, RY, RWr, and RWw. Data in RX, RY, RWr, and RWw of the master/intelligent device module are stored in the buffer memory.

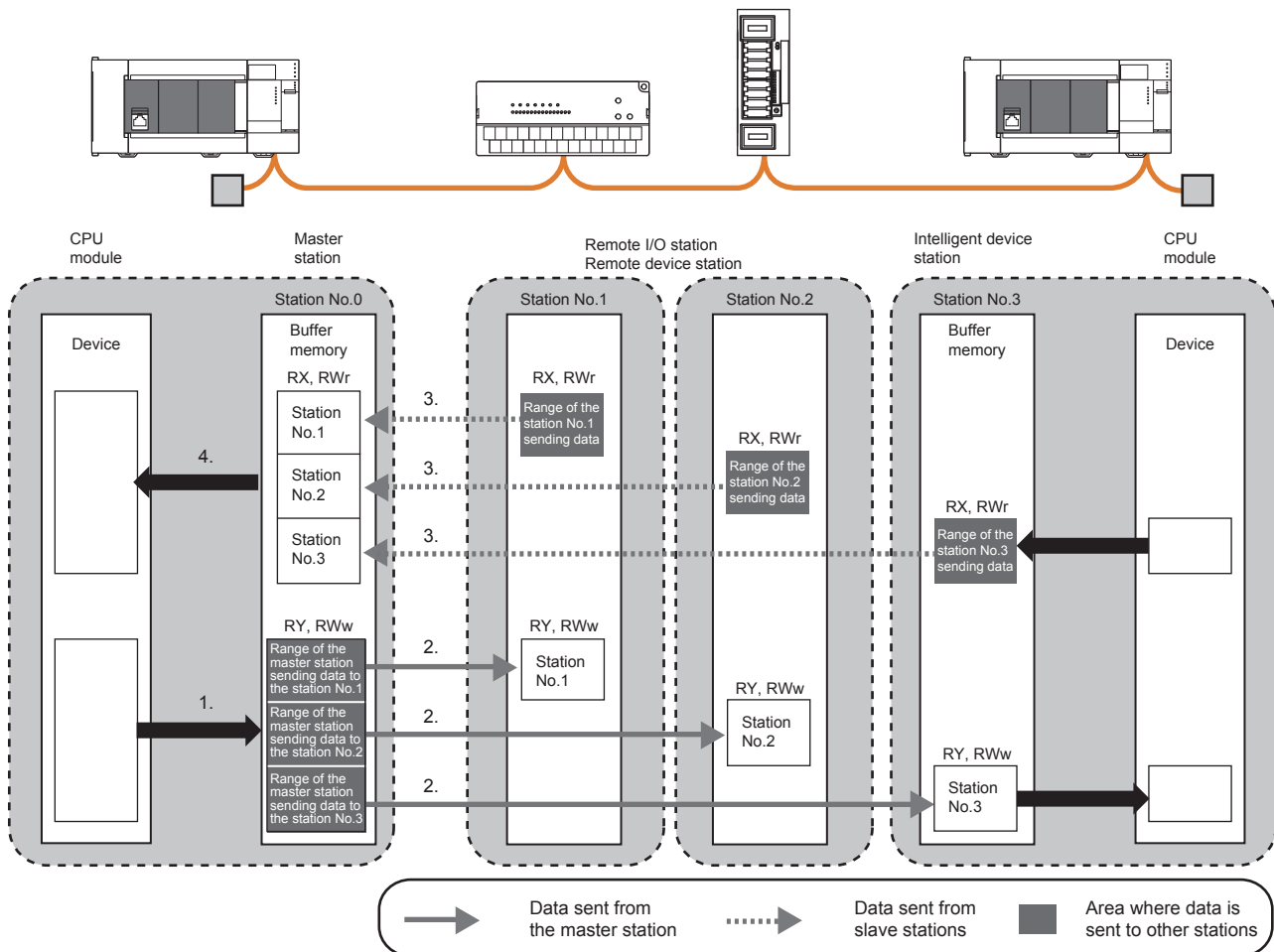

#### Input and output when operating as a master station

Data can be input to and output from all slave stations. Areas are assigned in the order of station number.

- For input to the master station, data in RX and RWr of all slave stations are stored into RX and RWr of the master station.
- For output from the master station, data stored in RY and RWw of the master station are output to RY and RWw of all slave stations.

#### Input and output when operating as an intelligent device station

Data can be input to and output from the master station. Areas are assigned from the beginning of RX, RY, RWr, RWw irrespective of the station number.

- For the input of an intelligent device station, RY and RWw of the master station are stored in RY and RWw of its own station.
- For the output of an intelligent device station, RX and RWr of its own station are output to RX and RWr of the master station.

## How to start communications

Perform the following in the order of slave to master stations.

Check the parameters and, if they are normal, start the data link.

### ■For a station with parameters configured using the Parameter Editor

Power on the module to start data link.

When the module parameter settings are reflected, the master/intelligent device module starts data link automatically.

Resetting the CPU module or powering off and on the system reflects the settings.

### ■For a station with parameters configured using the Program

Turn on "Request to start data link using parameters in buffer memory" (Un\G26370 b6) to start the data link.

#### **Point**

The master station sends data only to a station where data link has been started. The master station does not send data to a station where data link is not being performed.

# Mode

Select the mode according to the system used for the master/intelligent device module. Depending on the mode, the addresses of storage positions for RX, RY, RWr, and RWw differ.

## List of modes

Mode	Application	Connectable slave station
Remote net Ver.1 mode	To configure a new system (only with Ver.1-compatible slave stations)	Ver.1-compatible slave station
Remote net Ver.2 mode	<ul style="list-style-type: none"> <li>To configure a system including a Ver.2-compatible slave station</li> <li>More points per station are used compared to the remote net Ver.1 mode.</li> </ul>	Ver.1-compatible slave station and Ver.2-compatible slave station

## Combination of modes of master/intelligent device module

The following table lists the combination of the modes of the master station and intelligent device station in a master/intelligent device module.

○: Data link can be performed, ×: Data link cannot be performed

Mode of the master station	"Version" of "Network Configuration Settings" in "Basic Settings"	Mode of intelligent device stations	
		Remote net Ver.1 mode	Remote net Ver.2 mode
Remote net Ver.1 mode	Ver.1	○	×
Remote net Ver.2 mode	Ver.2	○	○

## Difference in functions between the modes of a master/intelligent device module

The following table lists differences in functions between the modes of a master/intelligent device module.

Item	Mode of the master/intelligent device module	
	Remote net Ver.1 mode	Remote net Ver.2 mode
Storage locations of RX, RY, RWr, and RWw	Ver.1-compatible area	Ver.2-compatible area
RWr and RWw of a remote I/O station	4 points fixed per station	0 points (RWr and RWw move over forward.)

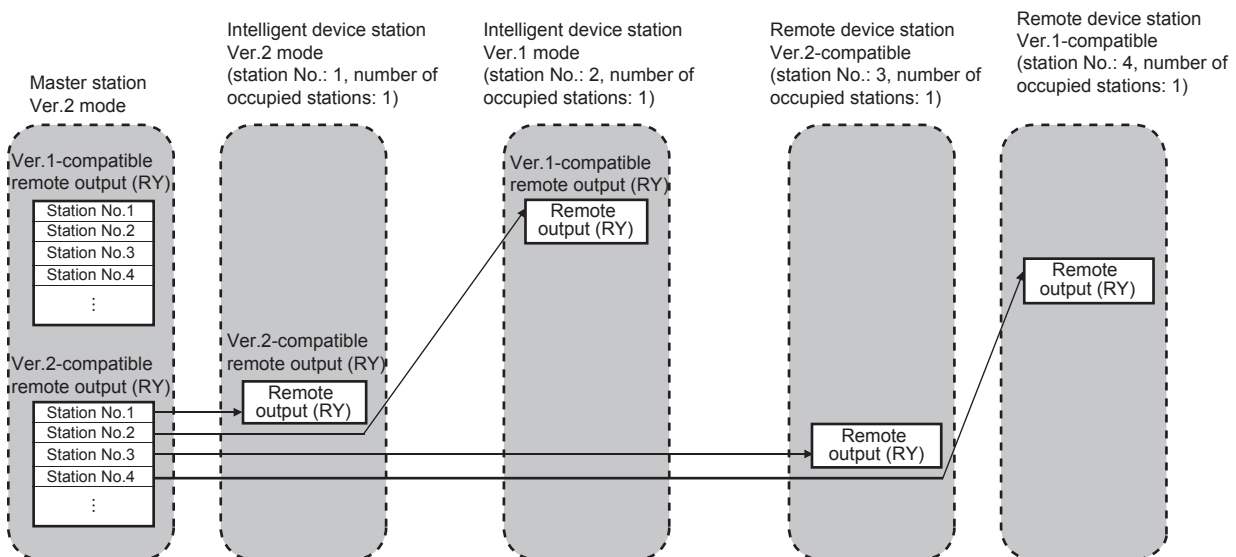

## Setting method

Set the mode in "Mode" under "Required Settings." (☞ Page 65 Mode)

### Remote net Ver.1 mode

The remote net Ver.1 mode is selected when a system is configured only with the master station and Ver.1-compatible slave stations.

When the system includes a Ver.2-compatible slave station, select the remote net Ver.2 mode.

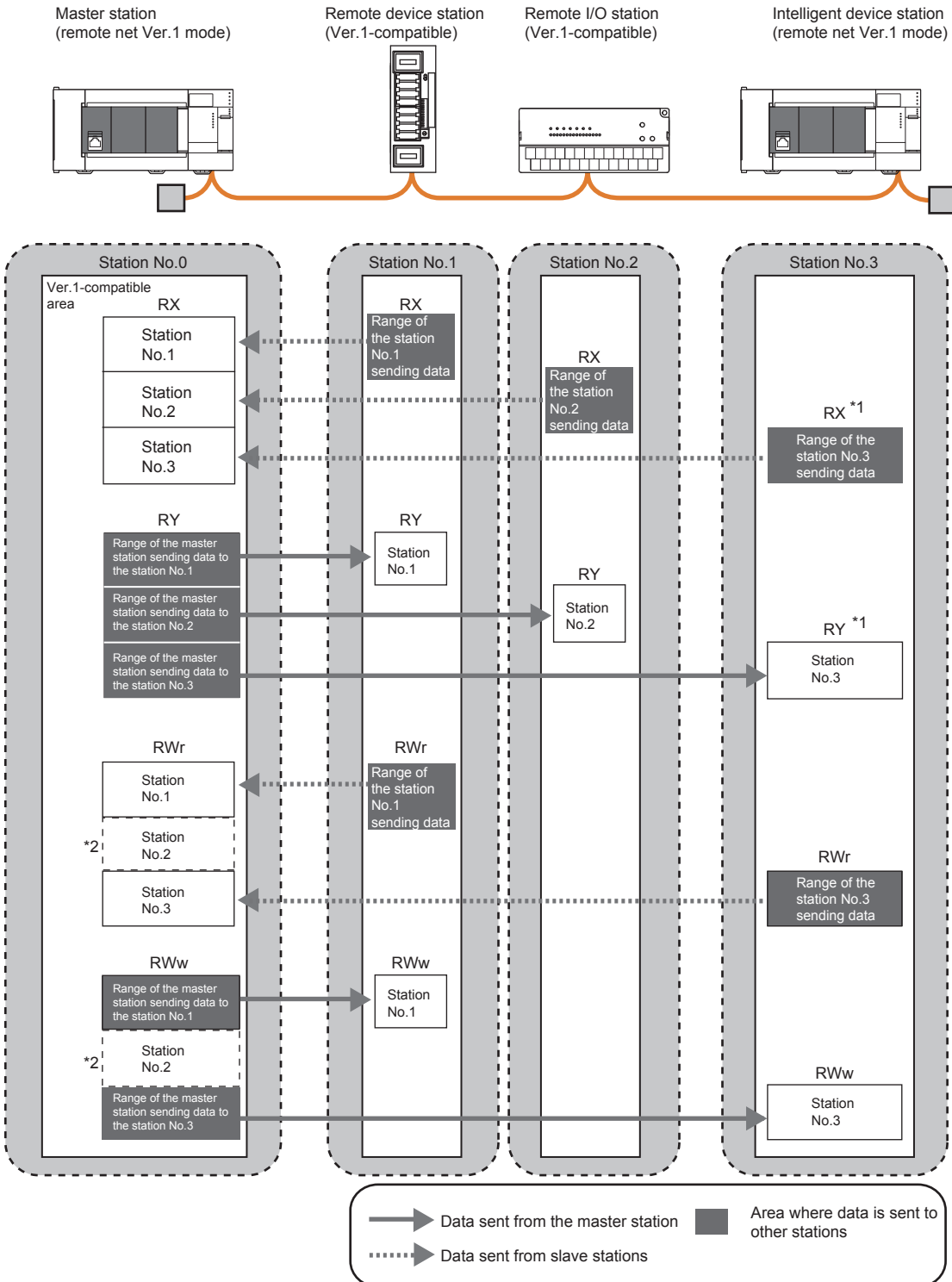

\*1 The last 16 bits in RX, RY cannot be used when using the master/intelligent device module as the intelligent device station.

\*2 Although a remote I/O station does not have RWr and RWw, areas in RWr and RWw of the master station are occupied for the number of points of a remote I/O station. When areas in RWr and RWw should not be occupied, use the remote net Ver.2 mode. (☞ Page 65 Mode)

## ■Points per module and per system

For the points, refer to the following.

☞ Page 17 Performance Specifications

In CC-Link, increasing the number of occupied stations can increase the number of points per module. The number of occupied stations is set for each slave station.

Item	Description
Number of occupied stations	The number of points is increased by increasing the station numbers occupied per module. Note that the number of slave stations that can be connected to a CC-Link system is decreased because one module occupies the station numbers for multiple modules.

## ■Data transfer between RX, RY, RWr, and RWw and a device in a CPU module

To perform auto transfer using the module parameters in an engineering tool, setting a refresh device in "Link Refresh Settings" under "Basic Settings" can automatically transfer data between RX, RY, RWr, and RWw in a master/intelligent device module and a device in a CPU module.

To perform transfer using a program, use a module access device (Un\G□) and FROM/TO instructions to transfer data between the buffer memory areas in a master/intelligent device module and a device in a CPU module.

Address		Item	Reference
Hexadecimal	Decimal		
E0H to 117H	224 to 279	Remote input (RX)	Page 149 Remote input (RX) and remote output (RY)
160H to 197H	339 to 407	Remote output (RY)	
1E0H to 24FH	480 to 591	Remote register (RWw)	Page 150 Remote register (RWr) and remote register (RWw)
2E0H to 34FH	736 to 847	Remote register (RWr)	

## ■Storage locations of RX, RY, RWr, and RWw

Station type	Storage locations of remote input/output (RX, RY)	Storage locations of remote register (RWr, RWw)
Master station	Areas are assigned by 32 points in the order of station number to the remote input (RX) and remote output (RY). ☞ Page 149 Remote input (RX) and remote output (RY)	To the remote register (RWr and RWw), areas are assigned by four points in the order of station number. ☞ Page 150 Remote register (RWr) and remote register (RWw)
Intelligent device station	Remote input/output (RX, RY) and remote register (RWr, RWw) are assigned from the beginning to areas for the number of occupied stations. ☞ Page 149 Remote input (RX) and remote output (RY) ☞ Page 150 Remote register (RWr) and remote register (RWw)	

## Remote net Ver.2 mode

The remote net Ver.2 mode is selected when a system is configured with the master station and Ver.2-compatible slave stations or when Ver.2-compatible slave stations will be added to the system in future.

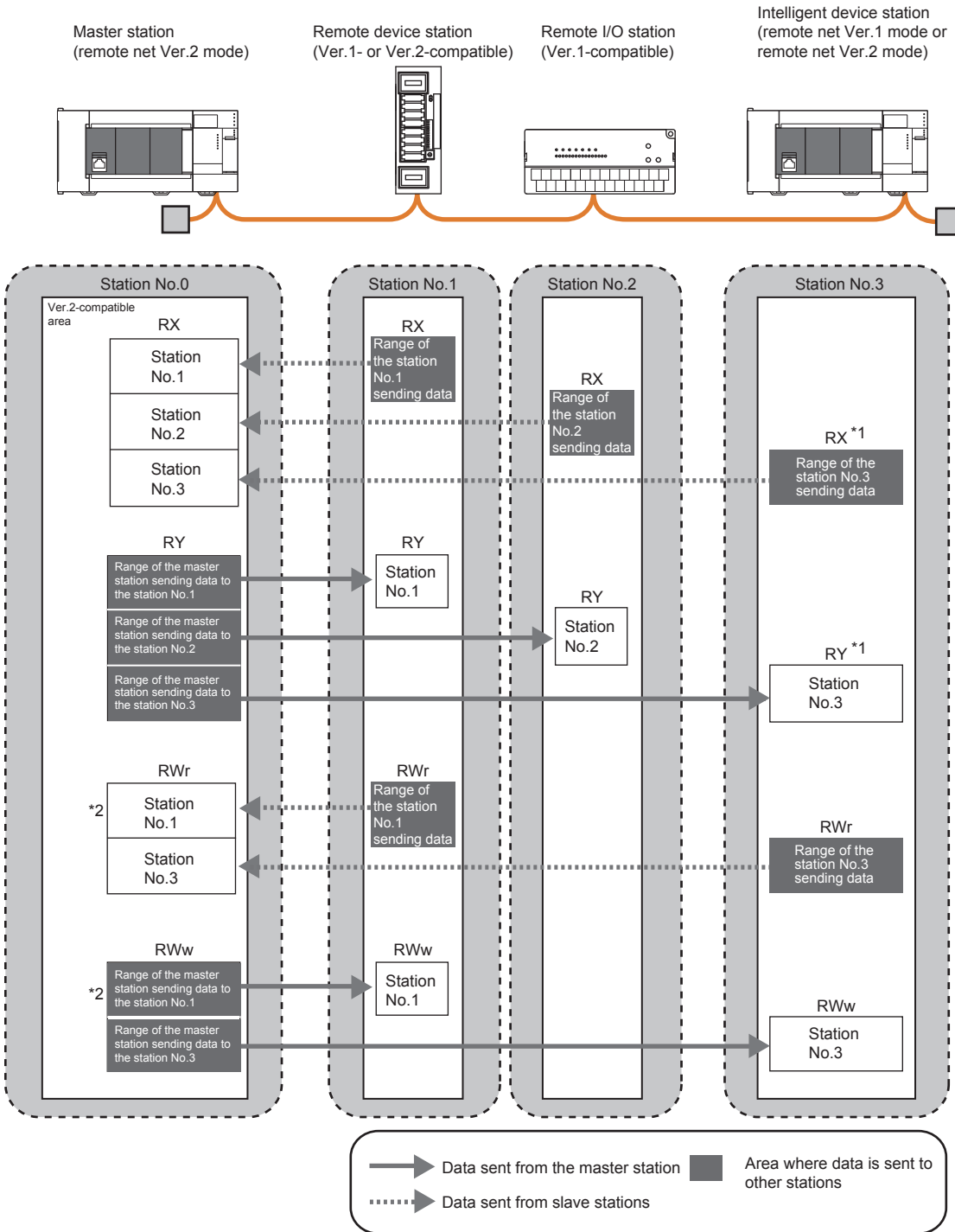

## ■Points per module and per system

For the points, refer to the following.

☞ Page 17 Performance Specifications

In CC-Link, increasing the number of occupied stations and extended cyclic settings can increase points per module. Set the number of occupied stations and extended cyclic settings for each slave station.

Item	Description
Number of occupied stations	The number of points is increased by increasing the station numbers occupied per module. Note that the number of slave stations that can be connected to a CC-Link system is decreased because one module occupies the station numbers for multiple modules.
Extended cyclic setting	The station numbers occupied by one module are not changed, and only the number of points are increased. Note, however, that the transmission delay time is extended compared to that of when the number of points is increased in "Number of Occupied Stations."

## ■Data transfer between RX, RY, RWr, and RWw and a device in a CPU module

To perform auto transfer using the module parameters in an engineering tool, setting a refresh device in "Link Refresh Settings" under "Basic Settings" can automatically transfer data between RX, RY, RWr, and RWw in a master/intelligent device module and a device in a CPU module.

To perform transfer using a program, use a module access device (Un\G□) and FROM/TO instructions to transfer data between the buffer memory areas in a master/intelligent device module and a device in a CPU module.

Address		Item	Reference
Hexadecimal	Decimal		
4000H to 4037H	16384 to 16439	Ver.2-compatible remote input (RX)	Page 154 Ver.2-compatible remote input (RX) and Ver.2-compatible remote output (RY)
4200H to 4237H	16896 to 16951	Ver.2-compatible remote output (RY)	
4400H to 446FH	17408 to 17519	Ver.2-compatible remote register (RWw)	Page 156 Ver.2-compatible remote register (RWr) and Ver.2-compatible remote register (RWw)
4C00H to 4C6FH	19456 to 19567	Ver.2-compatible remote register (RWr)	

## ■Storage locations of RX, RY, RWr, and RWw

The storage locations change depending on the number of occupied stations and extended cyclic settings in slave stations.

The storage locations for each station can be checked using Slave station offset, size information (Un\G992 to Un\G1431).

☞ Page 151 Slave station offset, size information



- Data stored in RX, RY, RWr, and RWw in the intelligent device station side are stored in a remote net Ver.1 mode area when the master station is in the remote net Ver.2 mode and the intelligent device station is in the remote net Ver.1 mode. (☞ Page 36 Data transfer between RX, RY, RWr, and RWw and a device in a CPU module)
- When the master station is in the remote net Ver.1 mode, four points are occupied per station for RWr and RWw in a remote I/O station. When the master station is in the remote net Ver.2 mode, RWr and RWw in a remote I/O station move over and assigned with 0 points. The assignment of the station numbers for stations after the remote I/O station changes; therefore, change the program if required.

Station type	Storage locations of remote input/output (RX, RY) and remote register (RWr, RWw)
Master Station	The storage locations change depending on the number of occupied stations and extended cyclic settings in slave stations. The storage locations for each station can be checked using Slave station offset, size information (Un\G992 to Un\G1431). ☞ Page 154 Ver.2-compatible remote input (RX) and Ver.2-compatible remote output (RY) ☞ Page 156 Ver.2-compatible remote register (RWr) and Ver.2-compatible remote register (RWw)
Intelligent device station	Remote input/output (RX, RY) and remote register (RWr, RWw) are assigned from the beginning to areas for the number of occupied stations. ☞ Page 154 Ver.2-compatible remote input (RX) and Ver.2-compatible remote output (RY) ☞ Page 156 Ver.2-compatible remote register (RWr) and Ver.2-compatible remote register (RWw)



# Link refresh

This function automatically transfers data between the link devices (RX, RY, RWr, RWw, SB, and SW) of the master/intelligent device module and the devices of the CPU module. Link refresh transfers data in END processing.

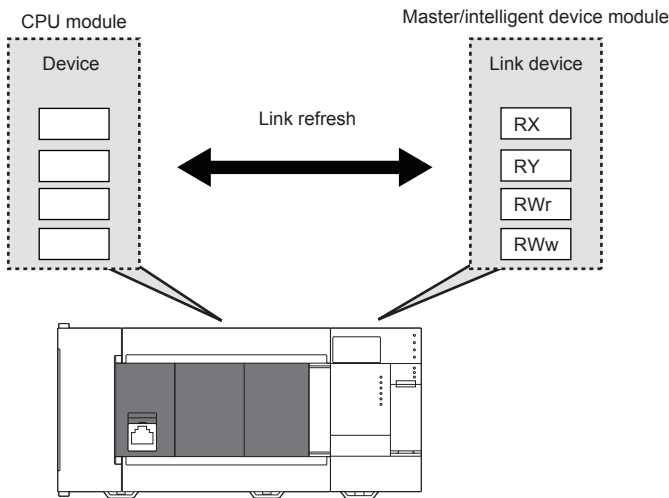

## Concept of the link refresh range (number of points)

The area range set in "Link Refresh Settings" under "Basic Settings" is executed by link refresh.

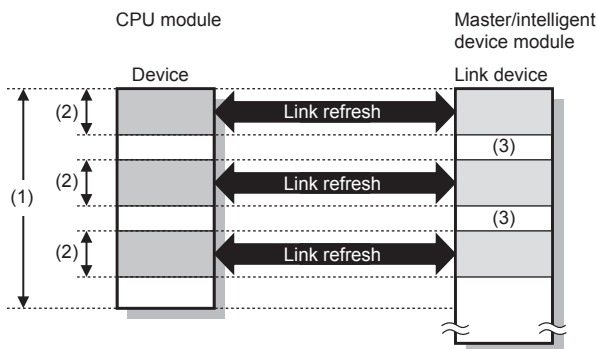

- (1) Range set in "Link Refresh Settings" under "Basic Settings"
- (2) Actual link refresh range
- (3) Empty

## Shortening the link refresh time and transmission delay time

The link refresh time and transmission delay time can be shortened by reducing the number of link refresh points to the CPU module. The following methods can be used to reduce the number of the link refresh points.

- In "Link Refresh Settings" under "Basic Settings", set only the link devices used in the CPU module as the link refresh range. (☞ Page 71 Link refresh settings)
- Directly access infrequently used link devices through module access devices from the program, and remove the corresponding settings from the link refresh range.

## Setting method

The link refresh is assigned in "Link Refresh Settings" under "Basic Settings." (☞ Page 71 Link refresh settings)

## Precautions

### ■ Latched devices of the CPU module

Even if latched device data are cleared to 0 using a program when the CPU module is reset or powered off and on, the latched data may be output depending without being cleared to 0 on the timing of a link scan and link refresh. For how to prevent output of latched device data, perform the following method.

Devices of the CPU module	How to disable the setting
Latch relay (L)	Clear the value of the device to 0 using the initial device value.*1
Internal relay (M), link relay (B), data register (D), link register (W), and file register (R), device in the latch range	Delete all latch range settings.*2

\*1 For the initial device value setting of the CPU module, refer to the following.

📖 MELSEC iQ-F FX5 User's Manual (Application)

\*2 Only FX5U/FX5UC CPU module is supported.

## Cyclic data integrity assurance

This function prevents read/write data from being separated between new and old data.

This function assures the cyclic data integrity in units of 32 bits or station-based units.

### 32-bit data integrity assurance

This function prevents read/write data in 32-bit increments from being separated between new and old data.

The data in the remote register (RWr and RWw) between a CPU module and master/intelligent device module are assured in units of 32 bits.

32-bit data integrity assurance is automatically performed when the following conditions are satisfied.

- The first address of the remote register (RWr and RWw) has an even number.
- When accessing the remote register (RWr/RWw) using a program, access them with an even number of devices.

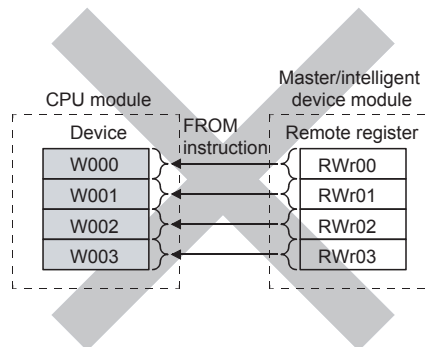
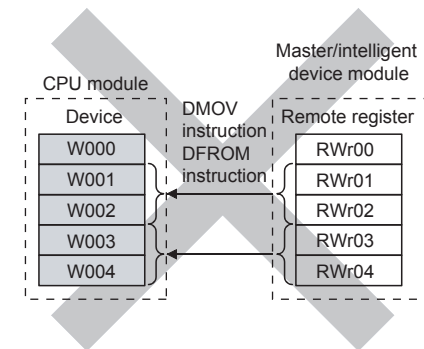
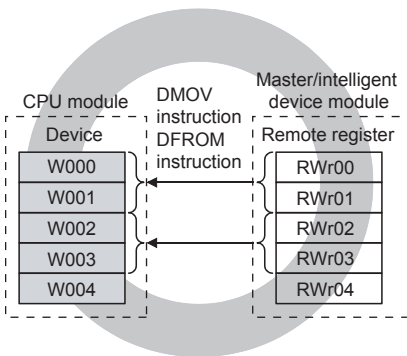

## Station-based Block Data Assurance

Cyclic data may be separated between new and old data depending on the timing of the link refresh. This function prevents read/write data per slave station from being separated between new and old data. Because module parameters are configured only on an engineering tool, a program to prevent data separation is not required.

For each slave station, data assurance is provided to data in RX, RY, RWr, and RWw that are automatically transferred to a CPU module or remote head module (link refresh) by setting the refresh device of the module parameter.

### Setting

Set station-based block data assurance under "Supplementary Cyclic Settings" in "Application Settings." (Page 77 Supplementary cyclic settings)

Sets to the master/intelligent device module to assure data.

### Operation of a data assurance

Identity of data per slave station is assured as follows.

#### Ex.

To assure data of the remote stations with the number of occupied stations of 3 and 1 (when operating as a master station)

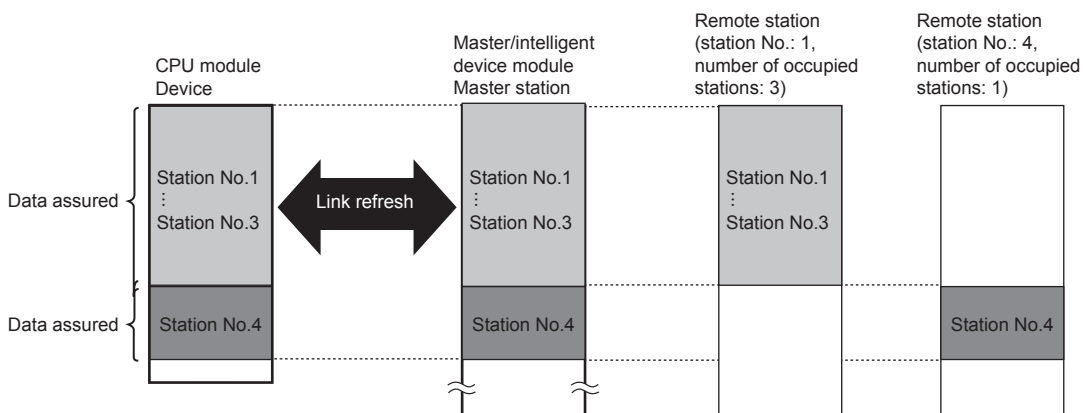

To assure data of the remote stations with the number of occupied stations of 3 and 1 (when operating as an intelligent device station)

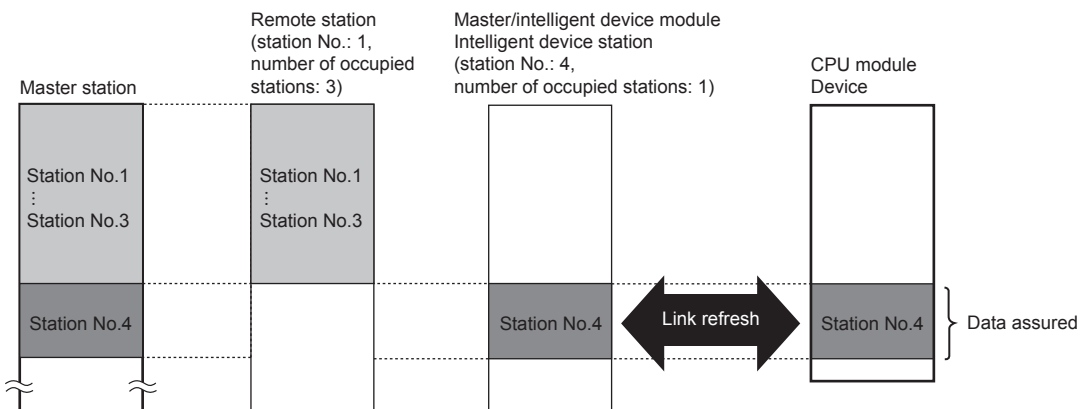

### Precautions

- When using station-based block data assurance, set the refresh devices in the module parameter. If the refresh devices are not set, the remote input (RX), remote output (RY), and remote register (RWr, RWw) of the buffer memory may not be refreshed.
- When station-based block data assurance is used, transmission delay time and link refresh time become longer than those of when station-based block data assurance is not used. When designing a system based on an existing system, check the transmission delay time and link refresh time at startup of the system. (Page 174 Processing Time)

#### Point

Integrity of 32-bit data in remote register (RWr and RWw) is assured even if station-based block data assurance is not set. (Assurance of 32-bit data) (Page 40 32-bit data integrity assurance)

# Input and output settings when failure occurs

A master/intelligent device module allows for the following settings.

Setting	Range where the settings are enabled
Input Data from Data Link Faulty Station	Clearing or holding the following RX, RY, and RWw input data from other stations can be selected. <ul style="list-style-type: none"> <li>• Master station RX (when operating as a master station)</li> <li>• Intelligent device station RY and RWw (when operating as an intelligent device station)</li> </ul> The RWr input data from other stations are held regardless of any setting. <ul style="list-style-type: none"> <li>• Master station RWr (when operating as a master station)</li> </ul>
Data link Setting at CPU Failure	Whether to stop or continue data link when a stop error occurs in the CPU module of a master station can be selected.

**Point**

- When the Input Data from Data Link Faulty Station is set to "hold", although the value of the buffer memory storing the target data is retained after the occurrence of the data link error, since the data link is disconnected, it is not refreshed.
- When the Data Link Setting at CPU Failure is set to "Continue the Data Link", the data link will continue even if a stop error occurs in the CPU module. When resetting the CPU module or turning off and on the power supply of the CPU module while the data link is in the continuous state after a stop error has occurred in the CPU module, the data link of the master/intelligent device module stops once and then it restarts after the CPU module starts normally.

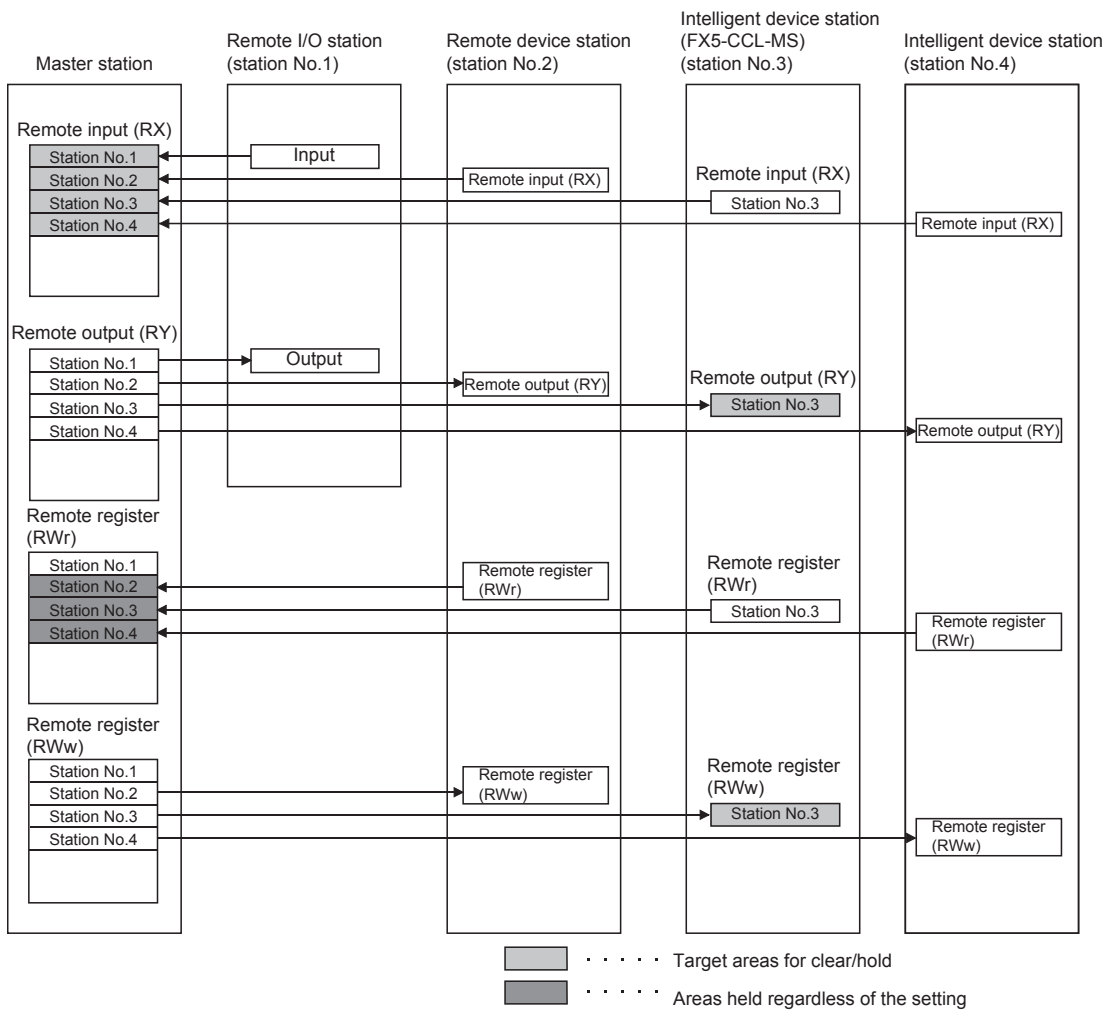

## Setting method

### ■Setting of the Input Data from Data Link Faulty Station

[When Parameter Editor]

Select the input data setting under "Supplementary Cyclic Settings" in "Application Settings." (  Page 77 Supplementary cyclic settings)

[When Program]

Use "Data link faulty station setting" (Un\G5) to configure input data from a data link faulty station. (  Page 147 Parameter information area)

### ■Data Link Setting at CPU Failure

[When Parameter Editor]

Select the data link setting under "Supplementary Cyclic Settings" in "Application Settings." (  Page 77 Supplementary cyclic settings)

[When Program]

Use "Data link setting at CPU failure" (Un\G6) to configure data link during CPU Failure. (  Page 147 Parameter information area)

## Status difference between a master station and a slave station at an error

The station status at an error varies depending on the combination of "Input Data from Data Link Faulty Station", "Output Mode upon CPU STOP", "Data Link Setting at CPU Failure," and "Output Mode Setting at CPU Error" under "Supplementary Cyclic Settings" in "Application Settings." When configuring the settings, consider the station status at errors listed below.

### ■ Status of a master station (when operating as a master station) and remote I/O station

Data link status			Master station (when operating as a master station)				Remote I/O station	
			Remote input (RX)	Remote output (RY)	Remote register (RWr)	Remote register (RWw)	Input	Output
When the CPU module of the master station is set to STOP at an error ("Data Link Setting at CPU Failure" = "Continue the Data Link")	"Output Mode Setting upon CPU Error" (setting in the master station)	Clear	Continue	*1	Continue	Hold*3	Continue	All points off
		Hold		*2				*2
When the CPU module of the master station is set to STOP	"Output Data Setting during CPU STOP" (setting in the master station)	Sends 0 data	Continue	*1	Continue	Hold*3	Continue	All points off
		Sends output data		Hold*3				Hold*3
When data link for the entire system is stopped	"Input Data Setting from Data Link Faulty Station" (setting in the master station)	Clear	Clear*4	Hold*5	Hold	Hold*5	By external signals	All points off
		Hold	Hold					
When a communication failure (such as power off) occurs in a remote I/O station	"Input Data Setting from Data Link Faulty Station" (setting in the master station)	Clear	Clears the receive area from the communication failure station	Continue	Continue	Continue	By external signals	All points off
		Hold	Holds the receive area from the communication failure station					
When a communication failure (such as power off) occurs in a remote device station	"Input Data Setting from Data Link Faulty Station" (setting in the master station)	Clear	Clears the receive area from the communication failure station	Continue	Holds the receive area from the communication failure station	Continue	Continue (Not affected by the communication status of the remote device station.)	Continue (Not affected by the communication status of the remote device station.)
		Hold	Holds the receive area from the communication failure station					
When a communication failure (such as power off) occurs in an intelligent device station	"Input Data Setting from Data Link Faulty Station" (setting in the master station)	Clear	Clears the receive area from the communication failure station	Continue	Holds the receive area from the communication failure station	Continue	Continue (Not affected by the communication status of the intelligent device station.)	Continue (Not affected by the communication status of the intelligent device station.)
		Hold	Holds the receive area from the communication failure station					

\*1 The target data is cleared to transmit 0 data to the slave station, but the value of the target data storage destination buffer memory in the master station is retained. When an non-latch device (including Y devices) is set as a refresh device, also clears the target data storage buffer memory in the master station.

\*2 Clears when a non-latch device (including Y devices) is set as a refresh device. When setting the latch device or without link refresh setting, holds or clears according to "Output Data Setting at CPU STOP."

\*3 Clears when a non-latch device (including Y devices) is set as a refresh device.

\*4 When "Data Link Setting at CPU Failure" is set to "Stop" and the master CPU stops data link due to error occurrence, holds regardless of "Input Data Setting from the Data Link Faulty Station."

\*5 When "Data Link Setting at CPU Failure" is set to "Stop" and the master CPU stops data link due to error occurrence, clears when an non-latch device (including Y devices) is set as a refresh device.

## ■ Status of a remote device station and intelligent device station

For the status when the master/intelligent device module is operating as the intelligent device station, refer to  Page 46  
Status when operating as an intelligent device station.

Data link status			Remote device station, intelligent device station			
			Remote input (RX)	Remote output (RY)	Remote register (RWr)	Remote register (RWw)
When the CPU module of the master station is set to STOP at an error ("Data Link Setting at CPU Failure" = "Continue the Data Link")	"Output Mode Setting upon CPU Error" (setting in the master station)	Clear	Continue	All points off	Continue	Continue* <sup>2</sup>
		Hold		* <sup>1</sup>		
When the CPU module of the master station is set to STOP	"Output Data Setting during CPU STOP" (setting in the master station)	Sends 0 data	Continue	All points off	Continue	Continue* <sup>2</sup>
		Sends output data		Continue* <sup>2</sup>		
When data link for the entire system is stopped	"Input Data Setting from Data Link Faulty Station" (setting in the master station)	Clear	By external signals	Check the setting of the using remote device station or intelligent device station.	By external signals	Check the setting of the using remote device station or intelligent device station.
		Hold				
When a communication failure (such as power off) occurs in a remote I/O station	"Input Data Setting from Data Link Faulty Station" (setting in the master station)	Clear	Continue	Continue	Continue	Continue
		Hold				
When a communication failure (such as power off) occurs in a remote device station	"Input Data Setting from Data Link Faulty Station" (setting in the master station)	Clear	By external signals	All points off	By external signals	Hold
		Hold				
When a communication failure (such as power off) occurs in an intelligent device station	"Input Data Setting from Data Link Faulty Station" (setting in the master station)	Clear	By external signals	Check the setting of the using intelligent device station.	By external signals	Check the setting of the using intelligent device station.
		Hold				

\*<sup>1</sup> Clears when a non-latch device (including Y devices) is set as a refresh device. When setting the latch device or without link refresh setting, holds or clears according to "Output Data Setting at CPU STOP."

\*<sup>2</sup> Clears when a non-latch device (including Y devices) is set as a refresh device.

## ■ Status when operating as an intelligent device station

Data link status			When operating as an intelligent device station				
			Remote input (RX)	Remote output (RY)	Remote register (RWr)	Remote register (RWw)	Data link status
When the intelligent device station (own station) CPU module stops due to error occurrence	"Output Mode Setting upon CPU Error" (setting in the intelligent device station)	Clear	*1	All points off	*1	Clear all areas	Stop
		Hold	Hold*2	Hold	Hold*2	Hold	
When the intelligent device station (own station) CPU module is stopped	"Output Data Setting upon CPU STOP" (setting in the intelligent device station)	Sends 0 data	*3	Continue	*3	Continue	Continue
		Sends output data	Continue*2		Continue*2		
When data link for the entire system is stopped	"Input Data Setting from Data Link Faulty Station" (setting in the intelligent device station)	Clear	By external signals	All points off	By external signals	Clear all areas	Stop
		Hold		Hold		Hold	
When communication failure has occurred in other slave stations	"Input Data Setting from Data Link Faulty Station" (setting in the intelligent device station)	Clear	Continue	Continue	Continue	Continue	Continue
		Hold					
When a communication failure (power off, etc.) has occurred in an intelligent device station (own station)	"Input Data Setting from Data Link Faulty Station" (setting in the intelligent device station)	Clear	By external signals	All points off	By external signals	Clear all areas	Stop
		Hold		Hold		Hold	

\*1 Holds when a latch device is set as a refresh device. Clears when setting a non-latch device or without link refresh setting.

\*2 Clears when a non-latch device (including Y devices) is set as a refresh device.

\*3 The target data is cleared to transmit 0 data to the master station, but the value of the target data storage destination buffer memory in the intelligent device station is retained.

## Precautions

### ■ When an error invalid station is set

If a data link error occurs in a station set as an error invalid station, input data (remote input (RX)) from that station is held regardless of the setting.

## Output data setting in case of CPU STOP

Whether to refresh or compulsorily clear output data of the master/intelligent device module when the CPU module is stopped can be selected. How the cyclic data should be handled at CPU STOP can be selected according to the system used.

(☞ Page 44 Status difference between a master station and a slave station at an error)

The following data is refreshed (output data is transmitted) or compulsorily cleared (0 data is transmitted) according to the parameter setting.

- Remote output (RY) when operating as a master station
- Remote input (RX) and remote register (RWr) when operating as an intelligent device station

Even if the CPU module stops, when operating as a master station, the remote register (RWw) refreshes (transmits output data) irrespective of the setting.

### Point

- If the CPU module that has been set to the compulsory clear (send 0 data) is set to STOP, compulsory output to a slave station cannot be performed by an engineering tool. (by using a device test or other methods)
- The setting is enabled even if RY is refreshed using a module access device (Un\G□) or TO instructions.



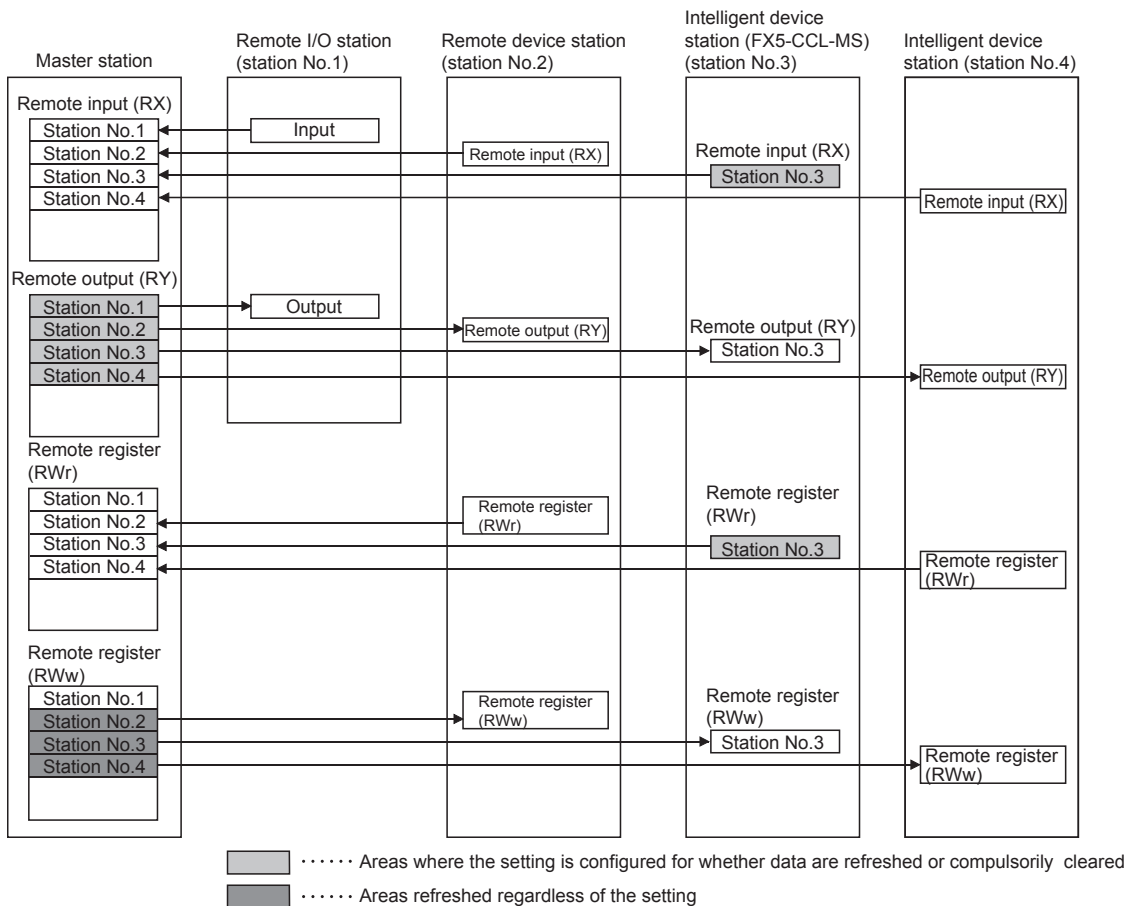

## Setting method

[When Parameter Editor]

Configure the output data setting in case of CPU STOP under "Supplementary Cyclic Settings" in "Application Settings."

( Page 77 Supplementary cyclic settings)

[When Program]

Use "Setting at CPU STOP" (Un\G13) to configure output data during CPU STOP. ( Page 147 Parameter information area)

## Precautions

### ■ Device to be set in the refresh device setting

Operation for refreshing/compulsory clearing varies depending on the refresh device set to the remote output (RY) in the "Link Refresh Settings" under "Basic Settings" as described below.

- When Y is set, remote output (RY) is compulsorily cleared regardless of the module parameter.
- When a device other than Y, such as M and L, is selected, remote output (RY) is refreshed or compulsorily cleared according to the setting.

### ■ Values of remote input/output (RX, RY) and remote register (RWr, RWw) when operating as an intelligent device station

Even if the CPU module becomes RUN → STOP, the value in the buffer memory of the data storage destination of the remote input/output (RX, RY) and remote register (RWr, RWw) in the intelligent device station is retained. When parameter setting is set to "Send 0 Data" is cleared to transmit 0 data to the master station, but since the value of the target data storage destination buffer memory in the intelligent device station is retained, perform initialization or set the initial data at STOP → RUN.

# Output mode setting upon CPU error

Whether to hold or clear input/output data of the master/intelligent device module when a stop error occurs in CPU module can be selected. How the cyclic data should be handled when a stop error occurs in CPU module can be selected according to the system used. (Page 44 Status difference between a master station and a slave station at an error)

The following data is retained or cleared according to the parameter setting.

- Remote output (RY) when operating as a master station
- Remote input/output (RX, RY) and remote register (RW<sub>r</sub>, RW<sub>w</sub>) when operating as an intelligent device station

Even if the stop error occurs in CPU module, when operating as a master station, the remote register (RW<sub>w</sub>) holds irrespective of the setting.

**Point**

- The setting is enabled even if RY is refreshed using a module access device (Un\G□) or TO instructions.
- When the parameter setting is set to "hold", the value of the buffer memory storing the target data is retained after the occurrence of the stop or failure of the CPU module. When the data link continues even after the stop and error occur, the retained data is continuously refreshed.
- When an error without a stop occurs, this setting does not become valid and the data link continues in all devices.

■ when operating as a master station

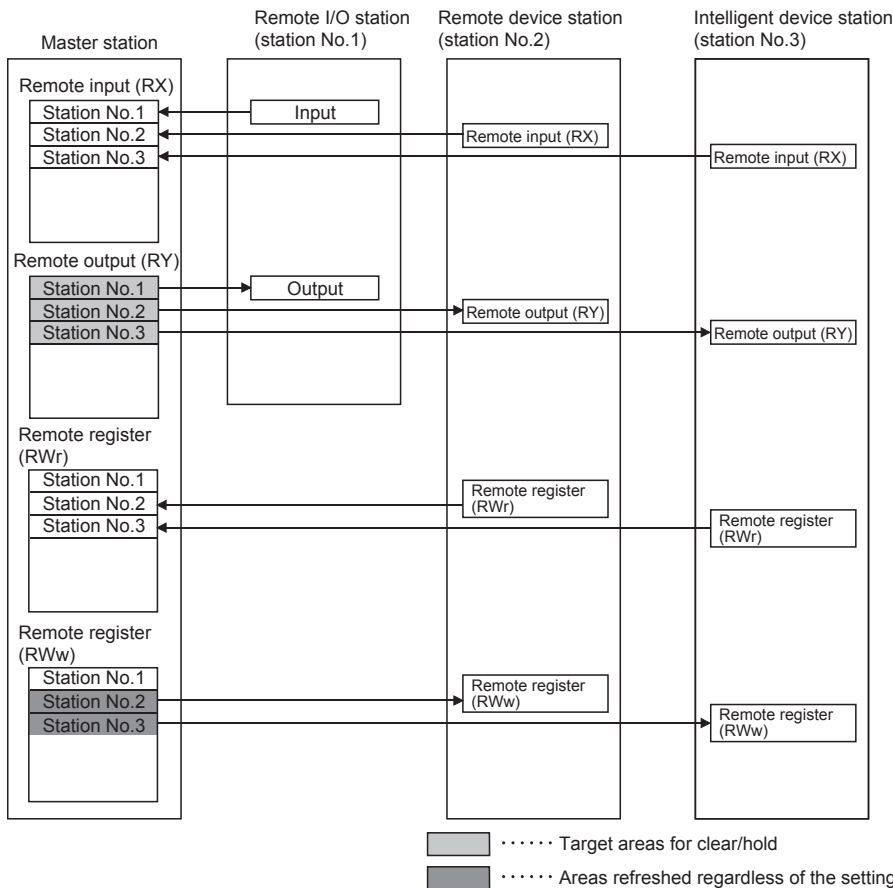

■ When operating as an intelligent device station

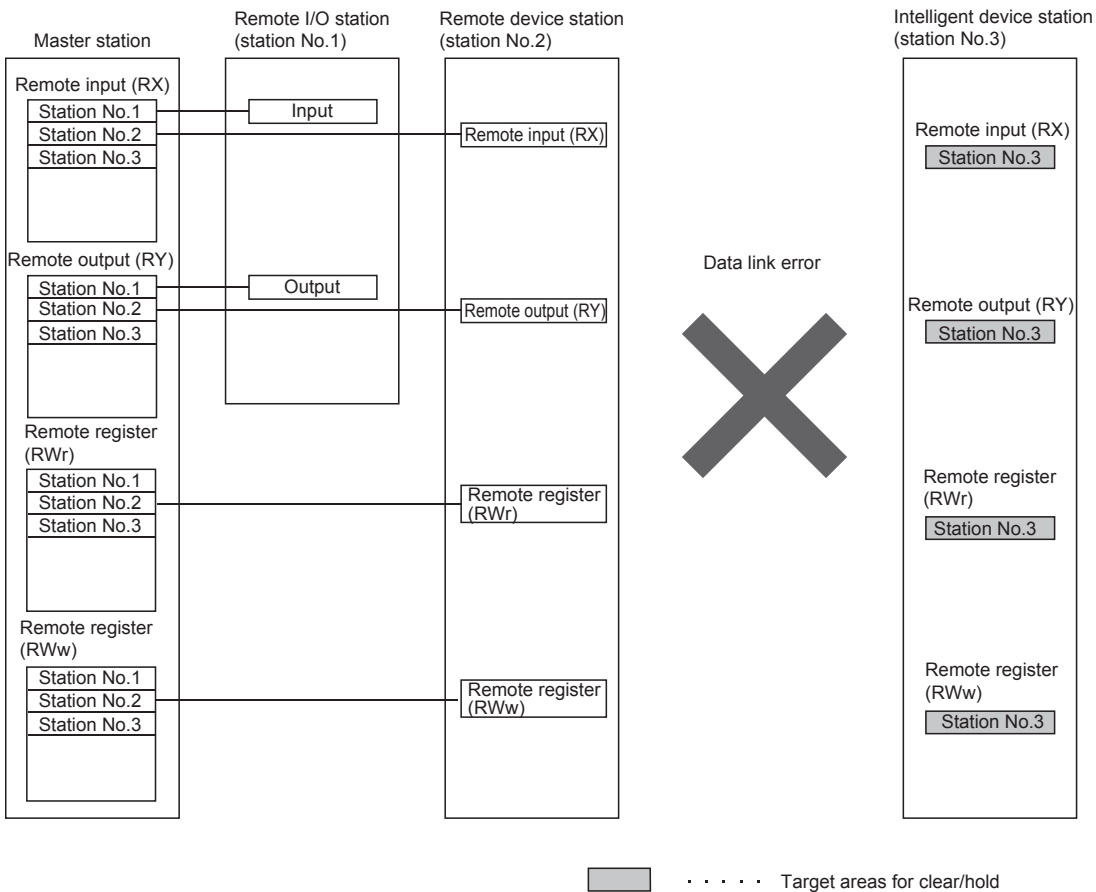

**Setting method**

Output mode setting upon CPU error is set by "Supplementary Cyclic Settings" in "Application Settings." (Page 77 Supplementary cyclic settings)

**Precautions**

■ Device to be set in the refresh device setting

Operation for holding/compulsory clearing varies depending on the refresh device set to the remote output (RY) in the "Link Refresh Settings" under "Basic Settings" as described below.

- When Y is set, remote output (RY) is compulsorily cleared regardless of the module parameter.
- When a device other than Y, such as M and L, is selected, remote output (RY) is retained or compulsorily cleared according to the setting.

**Data link stop and restart**

Data link can be stopped during debugging and other operations. Also, the stopped data link can be restarted.

If data link of a master station is stopped, data link is stopped in the entire system. (Page 124 Stopping and restarting data link)

## 4.3 Transient Transmission

Data can be communicated when a request is issued unlike cyclic transmission. Direct access to buffer memory areas and devices in other stations can be performed in transient transmission.

### Access from other stations using an engineering tool

Seamless access to other stations on the same network can be performed using an engineering tool.

Access to other stations on different networks cannot be performed.

#### ■ Path for accessing from master/intelligent device module (when operating as master station)

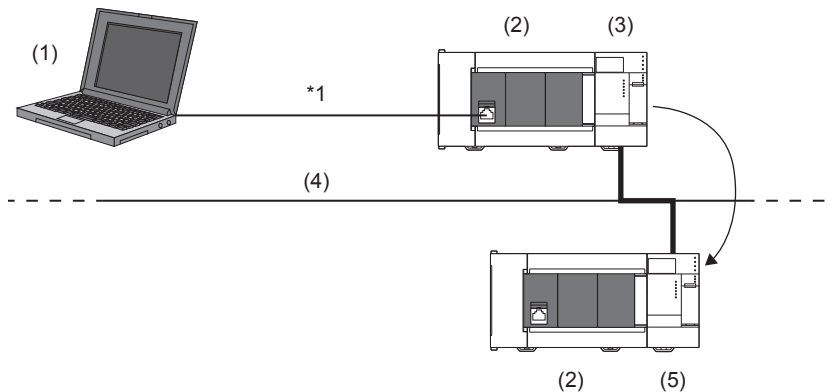

- (1) Personal computer (GX Works3)<sup>\*1</sup>
- (2) FX5 CPU module
- (3) Master/intelligent device module (master station)
- (4) CC-Link
- (5) Master/intelligent device module (intelligent device station)

\*1 Direct connection or the connection using the GOT transparent mode.

#### ■ Path when accessing from master/intelligent device module (when operating as intelligent device station)

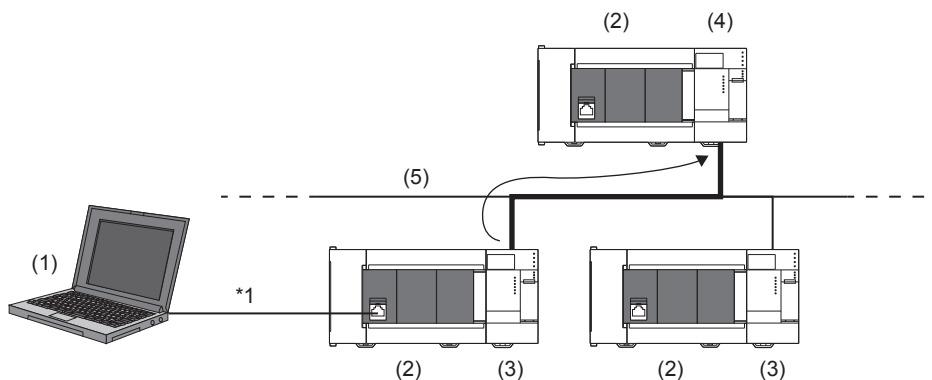

- (1) Personal computer (GX Works3)<sup>\*1</sup>
- (2) FX5 CPU module
- (3) Master/intelligent device module (intelligent device station)
- (4) Master/intelligent device module (master station)
- (5) CC-Link

\*1 Direct connection or the connection using the GOT transparent mode.

■Path when accessing from iQ-R series master station

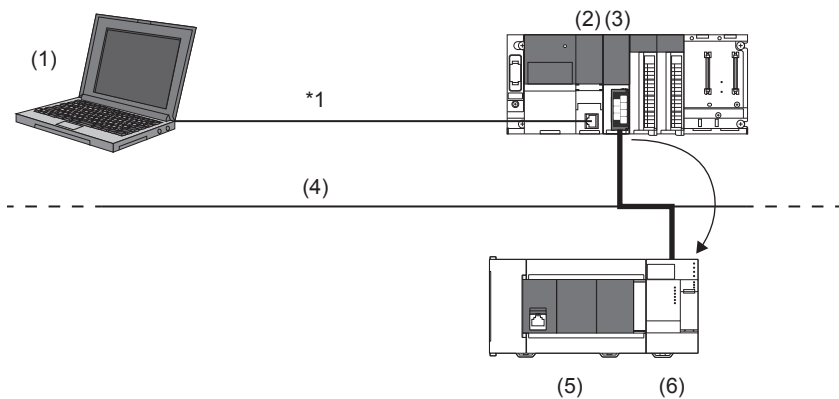

- (1) Personal computer (GX Works3)<sup>\*1</sup>
- (2) MELSEC iQ-R CPU module
- (3) Master/local module (master station)
- (4) CC-Link
- (5) FX5 CPU module
- (6) Master/intelligent device module (intelligent device station)

\*1 Direct connection or the connection using the GOT transparent mode.

■Path when accessing from iQ-R series local station

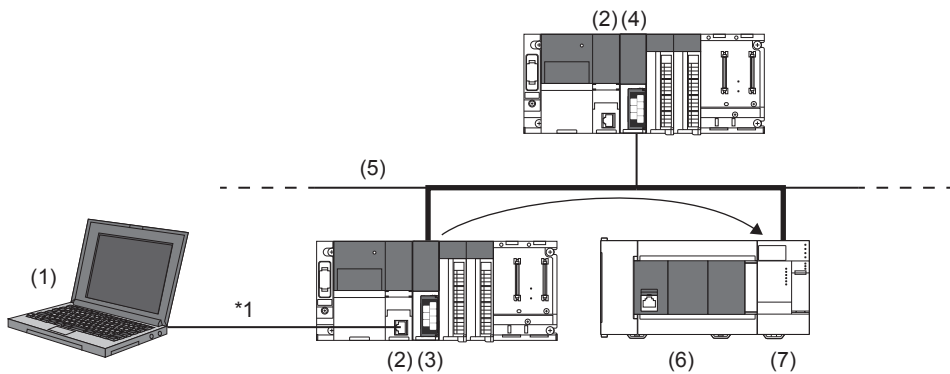

- (1) Personal computer (GX Works3)<sup>\*1</sup>
- (2) MELSEC iQ-R CPU module
- (3) Master/local module (local station)
- (4) Master/local module (master station)
- (5) CC-Link
- (6) FX5 CPU module
- (7) Master/intelligent device module (intelligent device station)

\*1 Direct connection or the connection using the GOT transparent mode.

# 4.4 Remote Device Station Initial Setting Procedure Registration Function

The initial setting of a remote device station which is performed on a program can be registered in advance using an engineering tool and can be saved by turning on the link special relay (SB). Programs for the initial setting can be reduced.

## Number of initial settings registered

### ■The number of remote device stations

The initial settings of the following remote device stations can be registered in one master/intelligent device module.

- FX5UJ CPU module: Up to 8 stations
- FX5U/FX5UC CPU module: Up to 14 stations

### ■Number of initial settings registered per remote device station

Up to 32 items of the initial settings can be registered per remote device station. An engineering tool and program cannot be used together for the initial setting in one remote device station. If they are used together, a remote device station may malfunction.

### ■If the processing has stopped

The progress of the initial setting in progress is stored in 'Remote device station initialization procedure registration execution individual information' (Buffer memory address: Un/G23680 to Un/G23707) of the master/intelligent device module. If the processing has stopped halfway, information such as the number of the procedure that has stopped and the target station number can be checked.

## Setting method

Configure the setting of the remote device station initial setting procedure registration function in "Initial Settings" under "Basic Settings." Then use 'Remote device station initialization procedure registration instruction' (SB000D) to reflect the initial settings to the remote device station. (← Page 73 Initial setting)

## Specification of remote device station to be initialized

Specification of remote device station to be initialized is a procedure for initial processing only in a specified station.

When a remote device station in operation has been replaced due to failure, the initial processing can be performed only in a specified remote device station that has been replaced. Remote device stations other than a specified station continue to operate.

The following figure shows an example of specifying the remote device station (station number 3) to be initialized.

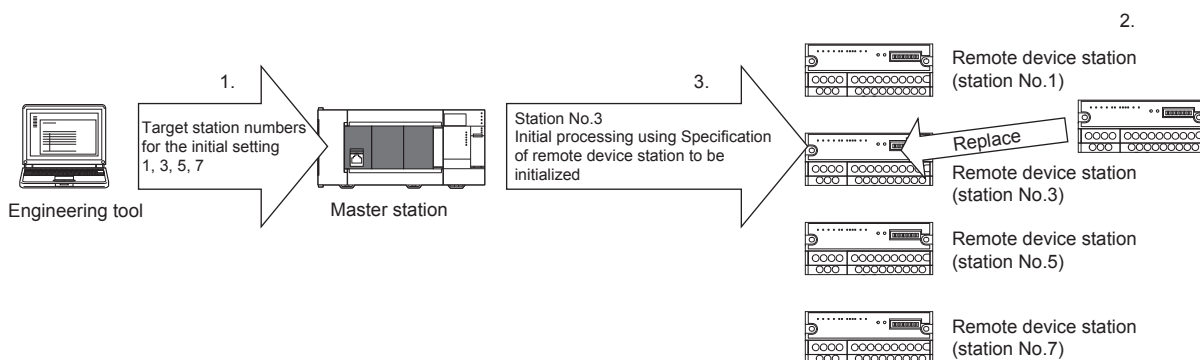

1. Replace the failed remote device station (station number 3).
2. Use 'Specification of remote device station to be initialized' (SW0014, SW0015) to specify the station number 3. Turn on the applicable bit (only the bit of the start station number) in SW0014 or SW0015.

	b15	b14	b13	b12	b11	b10	b9	b8	b7	b6	b5	b4	b3	b2	b1	b0
SW0014	16	15	14	13	12	11	10	9	8	7	6	5	4	3	2	1
SW0015	-	-	-	-	28	27	26	25	24	23	22	21	20	19	18	17

1 to 28 in the table indicate station numbers.

When all bits are off, an initial processing is performed in all the stations set in "Initial Settings" under "Basic Settings."

- Configure the initialization procedure registration by turning on 'Remote device station initialization procedure registration instruction' (SB000D).

During the initial processing in the station number 3, other stations (station numbers 1, 5, and 7) continue the control.

## Precautions

### ■Reflection of the settings

The initial settings registered using an engineering tool are reflected to a remote device station by writing the settings to a CPU module and turning on 'Remote device station initialization procedure registration instruction' (SB000D).

### ■Processing time

Because one step is executed per link scan, more setting items extend the processing time further than that of when a program is used.

■While 'Remote device station initialization procedure registration instruction' (SB000D) is on Data in the remote I/O (RX, RY) and remote register (RW<sub>r</sub>, RW<sub>w</sub>) stops being refreshed.

### ■Handling of signals that are required to be always on (such as CH.□ Conversion enable flag of an AJ65BT-64RD3/4)

Turning off 'Remote device station initialization procedure registration instruction' (SB000D) after the initial processing is completed turns off all the RY signals that have turned on while the initial procedure registration is performed. To prevent this, use a program to turn on signals that are required to be always on.

### ■Turning on 'Completion status of remote device station initialization procedure' (SB005F)

When 'Specification of remote device station to be initialized' (SW0014, SW0015) is selected, 'Completion status of remote device station initialization procedure' (SB005F) does not turn on until the procedure registration is normally completed in all the stations. If a faulty station exists, turn off 'Remote device station initialization procedure registration instruction' (SB000D) depending on the completion status of other stations.

### ■When the instruction is not required

The initialization procedure registration instruction may not be required under some situations, such as when the remote input (RX) is set as a condition device.

## Link special relay (SB) and link special register (SW)

### ■Link special relay (SB) areas

Link special relay (SB) areas related to the remote device station initialization procedure registration are listed below. (Details of the special relay (SB) are,  Page 161 List of link special relay (SB) areas)

- 'Remote device station initialization procedure registration instruction' (SB000D)
- 'Execution status of remote device station initialization procedure' (SB005E)
- 'Completion status of remote device station initialization procedure' (SB005F)

### ■Link special register (SW) areas

Link special register (SW) areas related to the remote device station initialization procedure registration are listed below. (Details of the special register (SW) areas are,  Page 165 List of link special register (SW) areas)

- 'Specification of remote device station to be initialized' (SW0014, SW0015)
- 'Remote device station initialization procedure registration instruction result' (SW005F)
- 'Remote device station initialization procedure registration completion status' (SW0164, SW0165)

## Buffer memory

Buffer memory areas related to the remote device station initialization procedure registration are listed below.

- 'Remote device station initialization procedure registration execution individual information' (Buffer memory address: Un\G23680 to Un\G23707)

# 4.5 Master Station Duplication Error Canceling Function

When a master station duplication error has been detected, the error can be cleared without resetting the CPU module or powering off and on the system.

## How to cancel the error

1. Eliminate the cause of a master station duplication error.  
Another master station may exist on the same line, or the line may be being influenced by noise.
2. Turn on 'Master station duplication error cancel request' (SB0007).

## Link special relay (SB) and link special register (SW)

Link special relay (SB) areas and a link special register (SW) areas related to the master station duplication error canceling function are listed below.

- 'Master station duplication error cancel request' (SB0007)
- 'Master station duplication error cancel acceptance' (SB0057)
- 'Master station duplication error cancel completion' (SB0058)
- 'Master station duplication error cancel result' (SW0057)

## Timing chart

The following figure shows the timing chart of the link special relay (SB) areas and link special register (SW) areas.

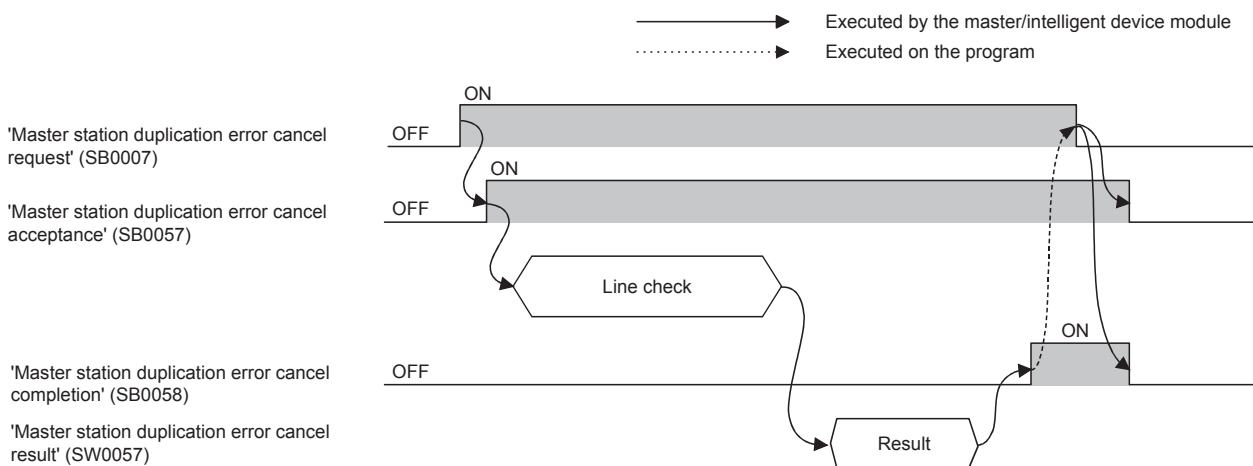



# 5 SYSTEM CONFIGURATION

## 5.1 CC-Link System Configuration

A CC-Link system when a master/intelligent device module operates as a master station is configured with a master station (1), remote I/O station (2), remote device station (3), and intelligent device station (4).

Connect the terminating resistors (5) to the stations at both ends.

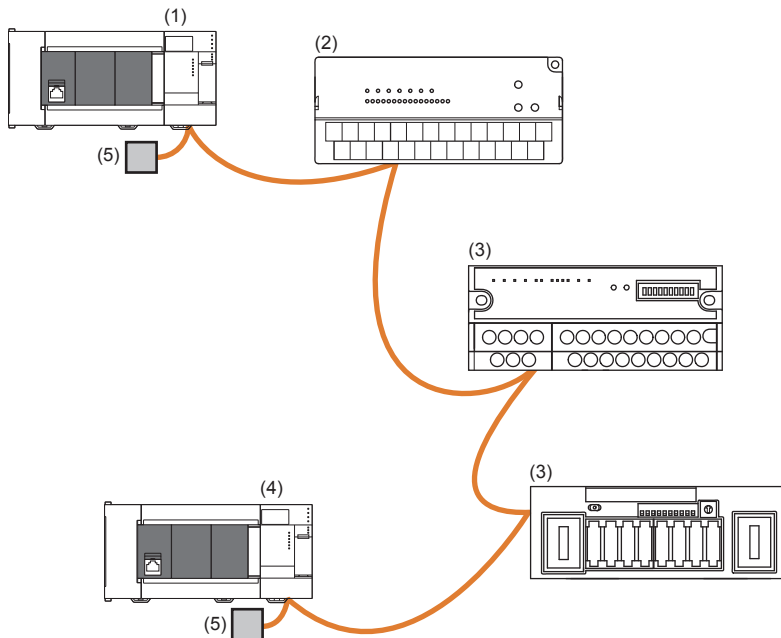

The CC-Link version and the number of slave stations that can be connected vary depending on the mode of the master/intelligent device module. (☞ Page 22 Maximum Number of Connectable Modules (when operating as a master station))

## 5.2 Precautions for the System Configuration

Please consider the following for system design to prevent incorrect input from a remote station.

### When turning on and off the power

Power on the remote station, then start data link. In addition, stop data link before turning off the remote station. Failure to do so may cause an incorrect input.

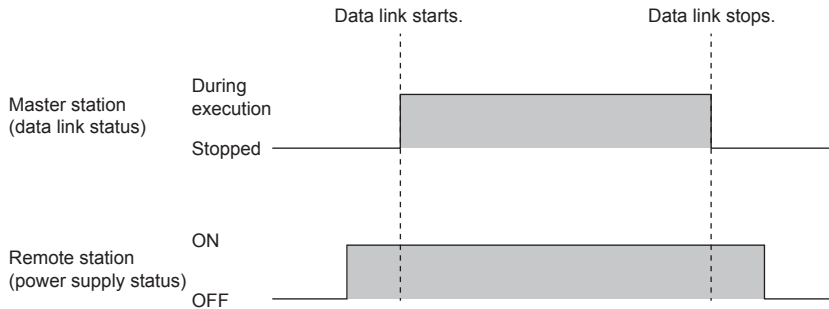

### Upon a momentary power failure of a remote station

If a momentary power failure occurs in the power supply (24 V DC) of the remote station, an incorrect input may occur.

#### ■Cause of an incorrect input due to a momentary power failure

The hardware of a remote station internally converts the power supply of a module (24 V DC) into 5 V DC. If an instantaneous power failure occurs at a remote station, (the time until the 5 V DC power supply in the remote station turns off) > (the response time after an input module turns on and off); therefore, refreshing data within the time as shown in ① below causes an incorrect input.

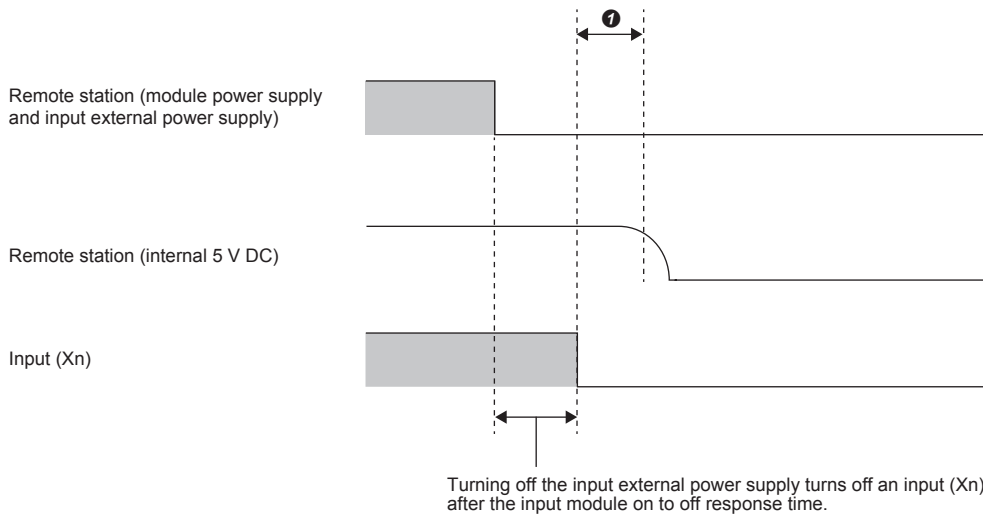

#### ■Countermeasure against an incorrect input

Supply power to the power supply module, stabilized power supply, and AC input external power supply from the same power supply.

#### Point

When supplying power to multiple remote stations from one power supply, select applicable cables and properly wire them to prevent a voltage drop caused by the power supply. When a remote station has a receiving end voltage within the specified range for the remote station used, it can be connected.

# 6 WIRING

This chapter describes the wiring methods, wiring products, and wiring precautions when the master/intelligent device module is used.

## 6.1 Power Supply Wiring

### Power connector array

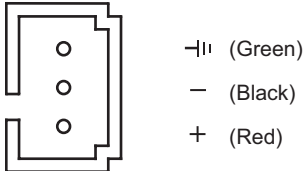

### Power supply wiring

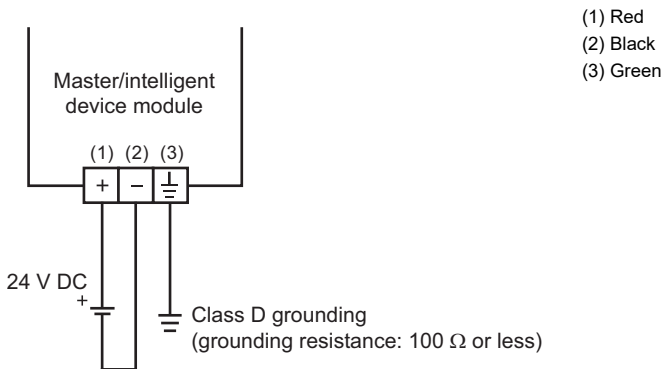

## Grounding

Perform the following.

- Perform class D grounding. (Ground resistance: 100 Ω or less)
- Ground the programmable controller independently when possible.
- If the programmable controller cannot be grounded independently, perform the "Shared grounding" shown below.

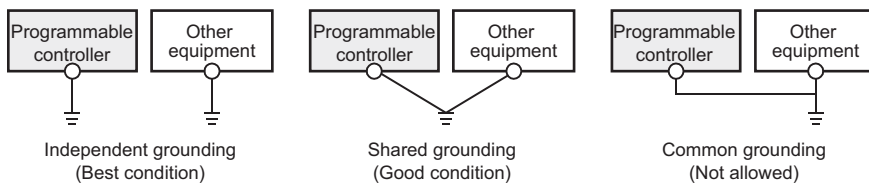

- Bring the grounding point close to the PLC as much as possible so that the ground cable can be shortened.

# 6.2 CC-Link Network Wiring

This section describes the wiring when using a master/intelligent device module.

## Terminal block

### Terminal block screw size, terminal block mounting screw size, tightening torque

Tighten the terminal block screws within the specified torque range.

Screw type	Tightening torque range
Terminal screw (M3 screw)	0.42 to 0.58 N·m
Terminal block mounting screw (M3.5 screw)	0.66 to 0.91 N·m

### Precautions

Do not tighten terminal screws with torque beyond the specified range. Failure to do so may cause equipment failures or malfunctions.

#### Point

- To remove the terminal block, loosen terminal block mounting screws on the left and right sides uniformly and remove the terminal block.
- To install the terminal block, place the terminal block at its predetermined position and tighten the terminal block mounting screws on the left and right sides uniformly.

### Crimp terminal

Use crimp terminals of the following sizes.

#### ■When a single wire is connected to a single terminal



<Reference>

Manufacturer	Model	Supported standards	Crimp tool
J.S.T.MFG.CO.,LTD.	FV1.25-B3A	UL Listed	YA-1 (J.S.T.MFG.CO.,LTD.)
	FV2-MS3		

#### ■When two wire are connected to a single terminal

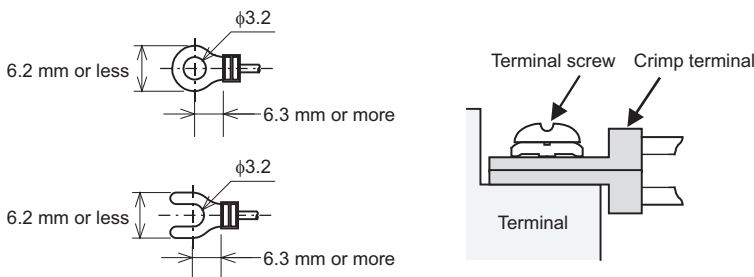

<Reference>

Manufacturer	Model	Supported standards	Crimp tool
J.S.T.MFG.CO.,LTD.	FV1.25-B3A	UL Listed	YA-1 (J.S.T.MFG.CO.,LTD.)

## Terminal layout of CC-Link connection terminal block

Shows terminal layout of the CC-Link connection terminal block.

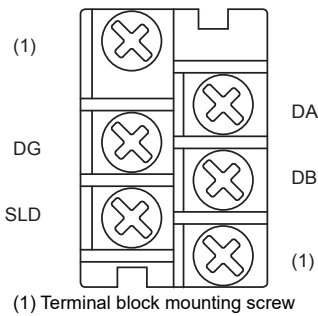

Terminal name	Description
DA	Sending or receiving data
DB	
DG	Data ground
SLD	Shield

### Point

- To remove the terminal block, loosen terminal block mounting screws on the left and right sides uniformly and remove the terminal block.
- To install the terminal block, place the terminal block at its predetermined position and tighten the terminal block mounting screws on the left and right sides uniformly.

## Wiring methods

### Wiring to a terminal block

Describes wiring to the terminal block.

Connect a Ver.1.10-compatible CC-Link dedicated cable as shown below.

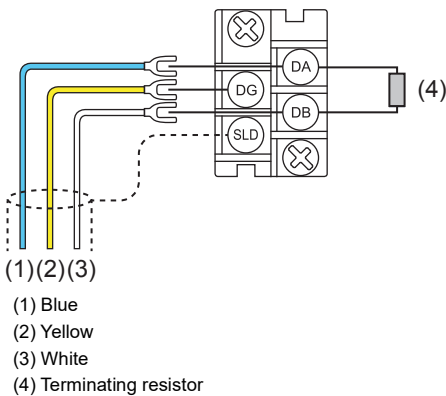

### Point

- Connect the supplied "terminal resistors" in product at both ends of the CC-Link system. Connect the terminal resistors between [DA] and [DB].
- Connect the shield wires of a Ver.1.10-compatible CC-Link dedicated cable to the SLD terminal in each module through the FG terminal. Then ground the cables at both ends with a class D grounding (grounding resistance: 100 Ω or less). The SLD and FG terminals are connected inside.
- For the terminal processing of when connecting the Ver.1.10-compatible CC-Link dedicated cable to the terminal block, do not unfasten the DA/DB/DG cable (three wires in one cable) or remove the sheath more than necessary. (For cables with fillers, cut them using a tool.)

## Wiring example

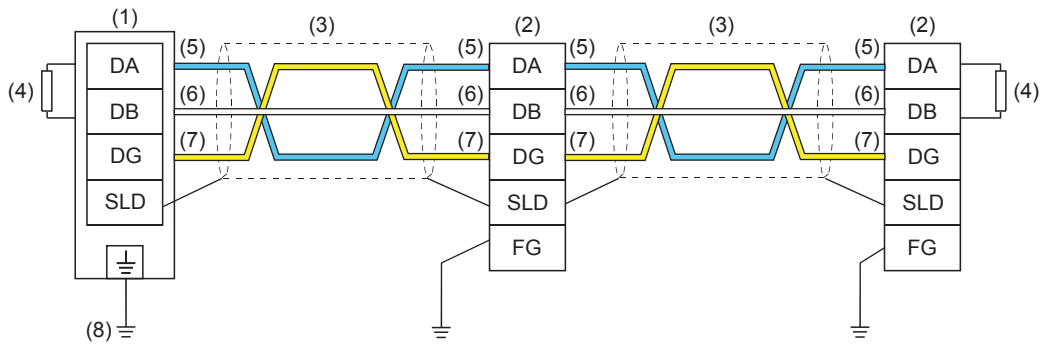

- (1) Master/intelligent device module
- (2) Other station
- (3) Ver.1.10-compatible CC-Link dedicated cable
- (4) Terminating resistor
- (5) Blue
- (6) White
- (7) Yellow
- (8) Class D grounding (Grounding resistance: 100  $\Omega$  or less)

### Point

- No restrictions apply to the connection order of a master/intelligent device module. (The cables need not be connected in the order of station number.)
- The star topology cannot be used. Note, however, that the T-branch connection can be used. (  Page 61 T-branch connection)

## Wiring products

### Available cables

Use Ver.1.10-compatible CC-Link dedicated cables.

Note, the cables need not be connected in the order of station number.

### Terminating resistors to be used

Connect the terminating resistors included with the modules at both ends of the modules in the CC-Link system.

# T-branch connection

Describes how to connect the Ver.1.10-compatible CC-Link dedicated cables in T-branch

## T-branch system configuration

The following is a system configuration in T-branch.

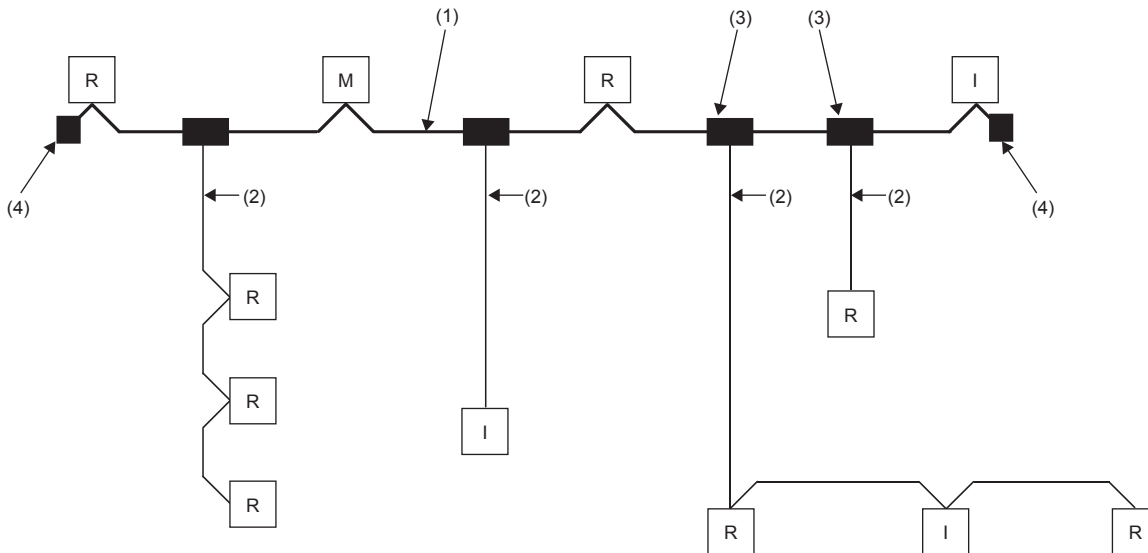

- M Master Station
- R Remote I/O station or remote device station
- I Intelligent device station

- (1) Main line
- (2) Branch line
- (3) T-branch terminal block or T-branch connector
- (4) Terminating resistor

### Point

The number of branch lines is determined by the branch line length per branch line and the overall branch line length.

## Communication specifications for a T-branch connection

The following table lists the communication specifications upon T-branch connection.

For those not listed below, refer to the performance specifications. (Page 17 Performance Specifications)

Item	Specifications		Remark
Transmission speed	625 kbps	156 kbps	10 M, 5 M, 2.5 Mbps cannot be used.
Maximum length of the main line	100 m	500 m	A cable length between terminating resistors. The length (branch line length) of a T-branch cable is not included.
Maximum length of the branch line	8 m		A total cable length for each branch.
Overall branch line length	50 m	200 m	A total length of all branch cables
Maximum number of connected modules on the branch line	6 modules per branch		The total number of connected stations depends on the CC-Link specifications.
Connection cable	Ver.1.10-compatible CC-Link dedicated cable		—
T-branch terminal block	Commercially available terminal block		Do not remove the jacket of the cables on the branch line, if possible.
T-branch connector	A connector for an FA sensor conforming to NECA4202 (IEC947-5-2) or equivalent product is recommended. (NECA: Nippon Electric Control Equipment Industries Association)		

## ■ Maximum length of the main line, distance between T-branches, and cable length between stations

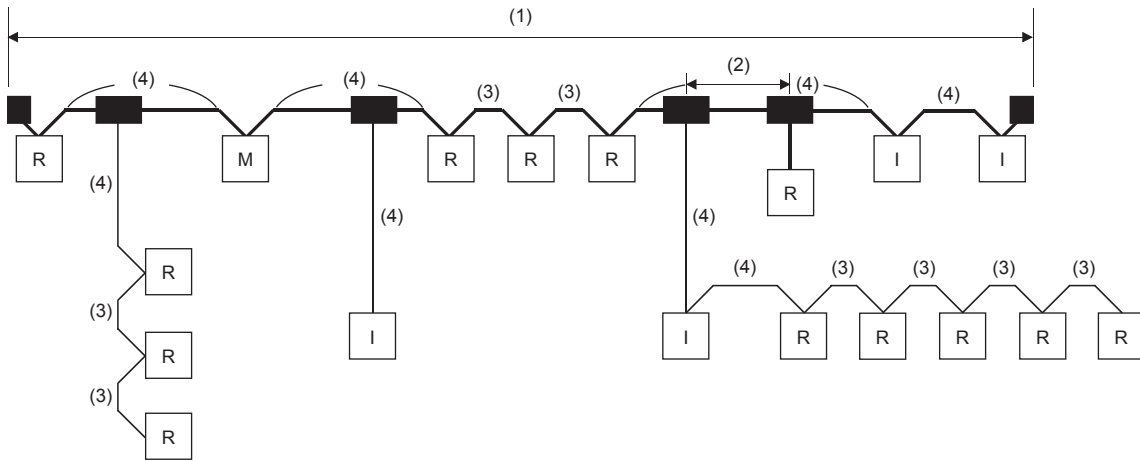

- M Master Station
- R Remote I/O station or remote device station
- I Intelligent device station

No.	Item	Transmission speed	
		625 kbps	156 kbps
(1)	Maximum length of the main line (not including branch line length)	100 m	500 m
(2)	Distance between T-branches	No restriction	
(3)	Station-to-station cable length between remote I/O stations or remote device stations	30 cm or more	
(4)	Station-to-station cable length between a master station, local station, or intelligent device station and an adjacent station to the front or back	1 m or more <sup>*1</sup> /2 m or more <sup>*2</sup>	

\*1 This applies to a system configuration with a remote I/O station and remote device station.

\*2 This applies to a system configuration including intelligent device station.



# 7 PARAMETER SETTINGS

This section describes the parameter settings required for the master/intelligent device module.

Parameter setting methods are as follows.

- Parameter Editor
- Program



Parameter settings using the program are only applicable to the FX5U/FX5UC CPU module.

## 7.1 Setting Parameters

Add master/intelligent device module in the engineering tool.

Module can also be added by placing on the module configuration diagram. For the operation of the engineering tool, refer to the following manual.

GX Works3 Operating Manual

[Navigation window] ⇒ [Parameter] ⇒ [Module Information] ⇒ Right-click ⇒ [Add New Module]

### When using the Parameter Editor

1. The required setting, basic setting, and application setting are included in the parameter settings. Select one of the settings from the tree on the window shown below and set parameters.

[Navigation window] ⇒ [Parameter] ⇒ [Module Information] ⇒ [FX5-CCL-MS] ⇒ [Module Parameter]



2. In "Required Settings," set "Setting Method of Basic/Application Settings" to the "Parameter Editor." After having finished necessary parameter settings, click the [Apply] button.

3. Write the settings to the CPU module using the engineering tool.

[Online] ⇒ [Write to PLC]

4. The settings are reflected by resetting the CPU module or powering off and on the system.

## When using the Program

1. Set "Require Settings" from the tree on the window shown below.  
 [Navigation window] ⇒ [Parameter] ⇒ [Module Information] ⇒ [FX5-CCL-MS] ⇒ [Module Parameter] ⇒ [Required Settings]
2. In "Required Settings," set "Setting Method of Basic/Application Settings" to the "Program." After having finished necessary parameter settings, click the [Apply] button.
3. Create a program to set parameters. ( Page 104 Examples of Parameter Settings Using Program)
4. Write the programs and settings to the CPU module using the engineering tool.  
 [Online] ⇒ [Write to PLC]
5. The settings are reflected by resetting the CPU module or powering off and on the system.
6. Transfer the CPU module's state from "STOP" to "RUN" and turn on "Request to start data link using parameters in buffer memory" (Un\G26370 b6). Parameters configured by the program will be reflected and the data link will start.

### Point

- If the parameters must be changed after the data link start, stop the data link using "Data link stop" (Un\G1504 b2) and set the parameters.
- The parameter settings will be initialized when the master/intelligent device module is turned off.
- Basic/Application Settings are not necessary for the engineering tool. To configure those other than "Required Settings," their parameters are written into corresponding buffer memory areas. ( Page 78 Compatible Buffer Memory)

# 7.2 Required Settings

Set the station type and mode of the master/intelligent device module.

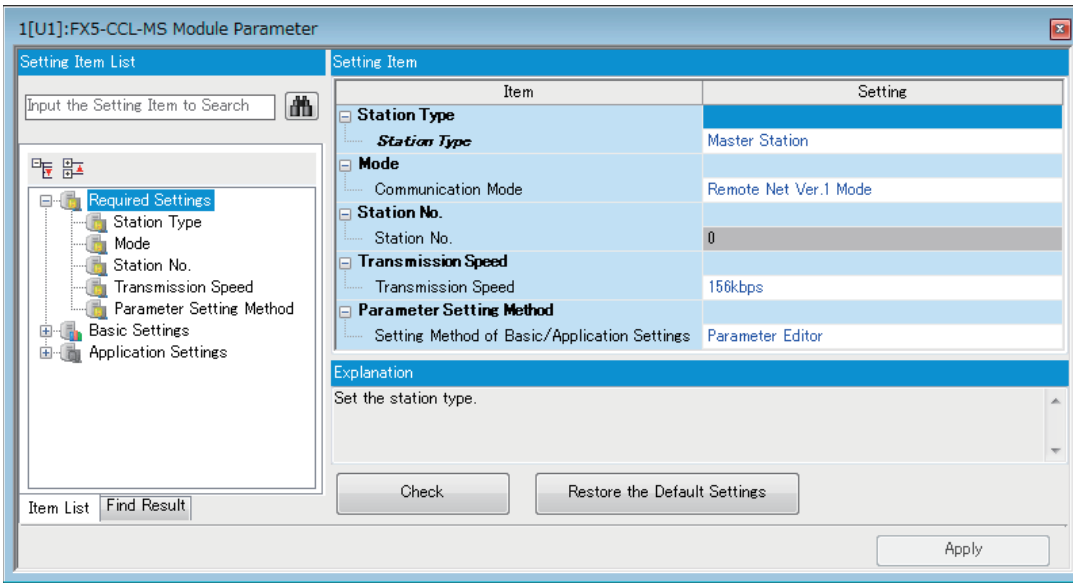

○: Can be set, ×: Cannot be set

Item	Availability		Reference
	Master station	Intelligent device station	
Station Type	○	○	Page 65 Station type
Mode	○	○	Page 65 Mode
Station No.	×	○	Page 66 Station number
Transmission Speed	○	○	Page 67 Transmission speed
Parameter Setting Method	○	○	Page 67 Parameter Setting Method

## Station type

Set the station type of the master/intelligent device module.

Item	Description	Setting range
Station Type	Set the station type of the master/intelligent device module.	<ul style="list-style-type: none"> <li>Master Station</li> <li>Intelligent Device Station</li> </ul> (Default: Master Station)

## Mode

Set the mode of the master/intelligent device module.

Item	Description	Setting range	
		Master station	Intelligent device station
Mode	Set the mode of the master/intelligent device module.	<ul style="list-style-type: none"> <li>Remote Net Ver.1 Mode</li> <li>Remote Net Ver.2 Mode</li> <li>Offline Mode</li> <li>Line Test</li> <li>H/W Test</li> </ul> (Default: Remote Net Ver.1 Mode)	<ul style="list-style-type: none"> <li>Remote Net Ver.1 Mode</li> <li>Remote Net Ver.2 Mode</li> <li>Offline Mode</li> <li>H/W Test</li> </ul> (Default: Remote Net Ver.1 Mode)

# Station number

Set the station number of the master/intelligent device module.

Item	Description	Setting range	
		Master station	Intelligent device station
Station No.	Set the station number of the master/intelligent device module.	Fixed to 0 <sup>*1</sup> (Default: 0)	1 to 64 (Default: Blank)

- \*1 When "Mode" is set to "Line Test", the setting range is as follows.
- FX5UJ CPU module: 0 to 14
  - FX5U/FX5UC CPU module: 0 to 28

## Precautions

### ■ Station number setting for CC-Link

For CC-Link, follow the rules below to set the station numbers.

- Set the station numbers not used for other stations. If a station number already in use is set, an error occurs.
- Set consecutive station numbers for stations in the same system. To set empty station numbers for future use, set the stations as reserved stations. Setting the stations as reserved stations prevents the stations from being detected as a faulty station. Set reserved stations in "Network Configuration Settings" under "Basic Settings." (Page 69 Network configuration settings)
- If an empty station number is set without setting a reserved station, the station is detected as a faulty station in 'Data link status of other stations' (SW0080, SW0081).
- The station numbers need to be consecutive, but wiring does not need to be performed in the order of station number.
- Set the start station number when the number of occupied stations is two or more.

### ■ Station number duplication

If a station number other than the start station number is already in use in the master/intelligent device module, it is detected.

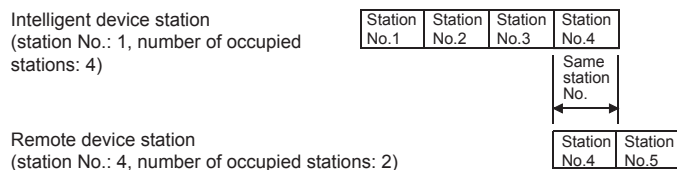

If a start station number is in use, it is not detected. (The station number 0 of the master station is detected if it is in use.)  
Check whether the station number of the station where a data link error has occurred is not already used for other stations using 'Data link status of other stations' (SW0080, SW0081).

#### Ex.

For the following case (an intelligent device station (station No.1 with the number of occupied stations of 4) and a remote device station (station No.1 with the number of occupied stations of 2)), the station number duplication is not detected.

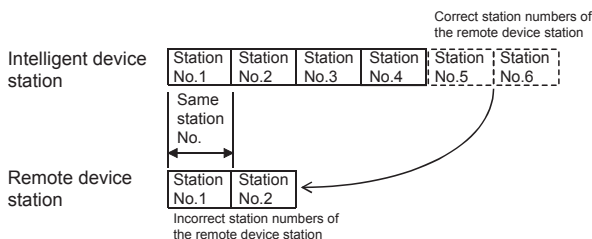



## Transmission speed

Set the transmission speed of the master/intelligent device module.

Item	Description	Setting range	
		Master station	Intelligent device station
Transmission speed	Set the transmission speed of the master/intelligent device module.	<ul style="list-style-type: none"> <li>• 156kbps</li> <li>• 625kbps</li> <li>• 2.5Mbps</li> <li>• 5Mbps</li> <li>• 10Mbps</li> </ul> (Default: 156kbps)	<ul style="list-style-type: none"> <li>• 156kbps</li> <li>• 625kbps</li> <li>• 2.5Mbps</li> <li>• 5Mbps</li> <li>• 10Mbps</li> <li>• Auto-tracking</li> </ul> (Default: Auto-tracking)

### Precautions

- When "Transmission Speed" is set to "Auto-tracking", it takes approximately five seconds for the transmission speed to be established with auto-tracking after the power-on. When a station returns after disconnection, it also takes approximately five seconds for the transmission speed to be established with auto-tracking. When the terminal block is installed or removed or line status becomes unstable during the power-on, it may takes five seconds or longer for the transmission speed to be established.
- Set the same transmission speed in all the stations in the CC-Link system. Data link cannot be performed with a slave station where the different transmission speed from the master station is set.
- The transmission speed that can be set varies depending on the overall distance of Ver.1.10-compatible CC-Link dedicated cable. (  Page 24 Maximum Overall Cable Length)
- Check whether the same transmission speed are set for both the master station and slave stations by obtaining (checking) the transmission speed setting using the operation test of CC-Link diagnostics. (  Page 121 Checking the transmission speed setting)

## Parameter Setting Method

Configure the own station's setting method of basic/application settings.

Item	Description	Setting range
Setting Method of Basic/Application Settings	Configure the own station's setting method of basic/application settings. <ul style="list-style-type: none"> <li>■Parameter Editor Select it when setting parameters using the engineering tool. Basic/application settings are necessary.</li> <li>■Program Select it when setting parameters using the buffer memory. Basic/application settings are not necessary.</li> </ul>	<ul style="list-style-type: none"> <li>• Parameter Editor</li> <li>• Program</li> </ul> (Default: Parameter Editor)

# 7.3 Basic Settings

Set the network configuration, link refresh settings, or other parameters for the master/intelligent device module. Settings are possible only when "Setting Method of Basic/Application Settings" in "Required Settings" is the "Parameter Editor."

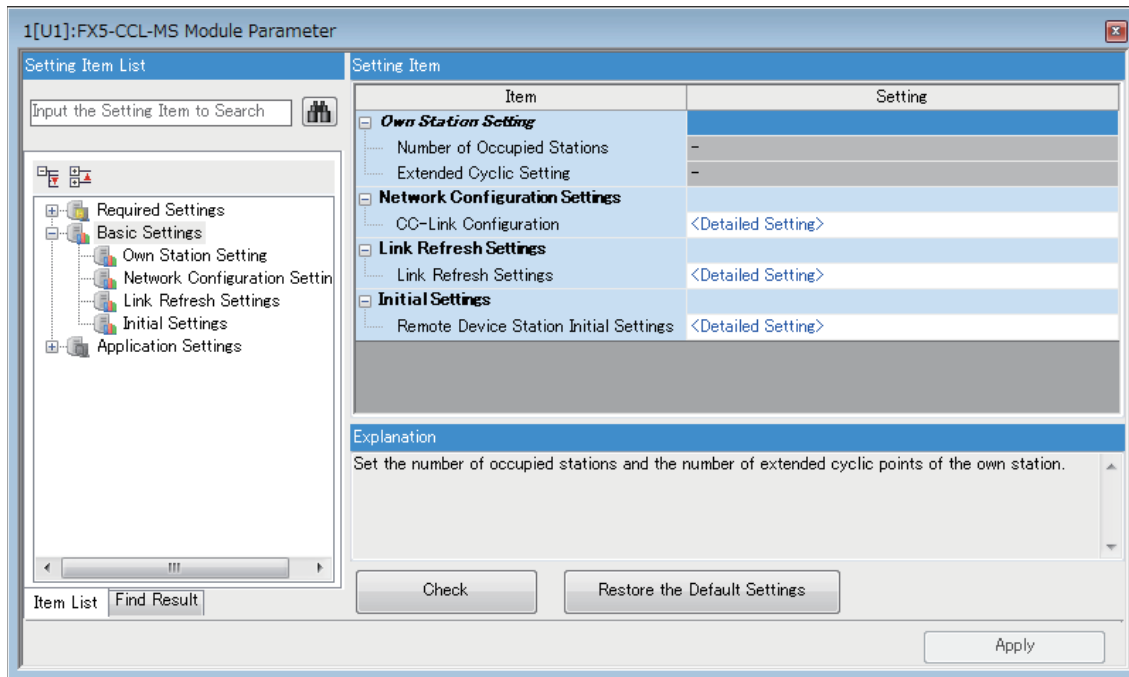

○: Can be set, ×: Cannot be set

Item	Availability		Reference
	Master station	Intelligent device station	
Own Station Setting	×	○	Page 68 Own station setting
Network Configuration Settings	○	×	Page 69 Network configuration settings
Link Refresh Settings	○	○	Page 71 Link refresh settings
Initial Setting	○	×	Page 73 Initial setting

## Own station setting

Set the number of occupied stations or extended cyclic setting for the master/intelligent device module.

Item	Description	Setting range
Number of Occupied Stations	Sets the number of occupied stations during the intelligent device station. This item can be set only when "Station Type" under "Required Settings" is set to "Intelligent Device Station."	<ul style="list-style-type: none"> <li>• 1 Station Occupied</li> <li>• 2 Stations Occupied</li> <li>• 3 Stations Occupied</li> <li>• 4 Stations Occupied</li> </ul> (Default: 1 Station Occupied)
Extended Cyclic Setting	Set the number of extended cyclic setting during the intelligent device station. This item can be set only when "Mode" under "Required Settings" is set to "Remote Net Ver.2 Mode."	<ul style="list-style-type: none"> <li>• Single</li> <li>• Double</li> <li>• Quadruple</li> <li>• Octuple</li> </ul> (Default: Single)

# Network configuration settings

Set the information of slave stations connected to the master station.

## Setting method

The procedure for the network configuration settings is shown below.

1. Select the module in "Module List" and drag it to "List of stations" or "Network map."

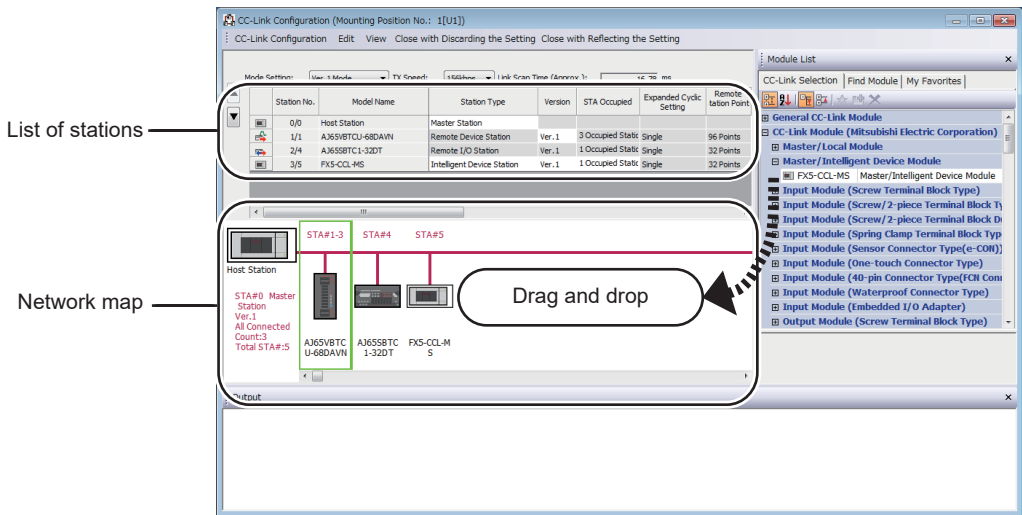

2. Set the required items.
3. Select [Close with Reflecting the Setting] to finish the network configuration settings.

## Setting items

Item	Description	Setting range
Mode Setting	Set the mode of the master station.	<ul style="list-style-type: none"> <li>• Ver.1 Mode</li> <li>• Ver.2 Mode</li> </ul> (Default: Mode set in "Mode" under "Required Settings")
Transmission (TX) Speed	Set the transmission speed of the master station.	<ul style="list-style-type: none"> <li>• 156kbps</li> <li>• 625kbps</li> <li>• 2.5Mbps</li> <li>• 5Mbps</li> <li>• 10Mbps</li> </ul> (Default: Value set in "Transmission Speed" under "Required Settings")
Link Scan Time (Approx.)	The approximate link scan time is displayed.	—
Station No.	<ul style="list-style-type: none"> <li>■ For the master station               <ul style="list-style-type: none"> <li>• 0/0 is displayed.</li> </ul> </li> <li>■ For a slave station               <ul style="list-style-type: none"> <li>• The order of the slave station is displayed before the slash.</li> <li>• The start station number of the slave station is displayed after the slash.</li> </ul> </li> </ul>	—
Model Name	The module model name is displayed. If the module information cannot be found, "Module with No Profile Found" is displayed.	—
Station Type	Select the station type. Set the same type of the slave station actually connected.	The setting varies depending on the set module.
Version	Set CC-Link version of the slave station. Select the mode of the master/intelligent device module if the slave station is a master/intelligent device module. Select the same CC-Link version as the version of the slave station actually connected. If not, data link cannot be performed.	The setting varies depending on the set module.
STA Occupied	Set the number of occupied stations of the slave station. Set it to increase the number of link points per slave station.	The setting varies depending on the set module.
Extended Cyclic Setting	Set the extended cyclic setting of the slave station. Set it to increase the number of link points per slave station. The setting can be done if the slave station mode is remote net Ver.2 mode.	The setting varies depending on the set module.
Remote Station Points	Display the points of remote input/output (RX, RY) occupied by the save station.	—
Reserved/Err Invalid STA	Set it to set slave stations as reserve stations or to set slave stations as error invalid stations. <ul style="list-style-type: none"> <li>• For slave stations that will be connected in future, set them as reserved stations.</li> <li>• To prevent slave stations from being detected as faulty stations at the data link error, set them as error invalid stations.</li> <li>• When a slave station that has been set as an error invalid station is specified as a reserved station, reserved station selection is prioritized.</li> <li>• If an error has occurred in all the slave stations set as an error invalid station, the ERROR LED turns on.</li> </ul>	<ul style="list-style-type: none"> <li>• No Setting</li> <li>• Reserved Station</li> <li>• Error Invalid Station</li> </ul> (Default: No Setting)
Intelligent Buffer Selection (Word)	Set the size of buffer memory used to perform transient transmission. The setting cannot be done by FX5-CCL-MS.	Send, Receive, Auto <ul style="list-style-type: none"> <li>• Blank (fixed)</li> </ul>
Station Inherent mode setting	Set the station-specific mode for the slave station. This item can be set only when the slave station supports the station-specific mode.	The setting varies depending on the set module.
Properties	Right-click the module in "Network map" and select "Properties." The model name or manufacturer is displayed.	The setting varies depending on the set module.



# Link refresh settings

Set the link refresh range between the link device of master/intelligent device module and the device of CPU module.

## Setting method

The procedure for the link refresh settings is shown below.

1. Set the required items.

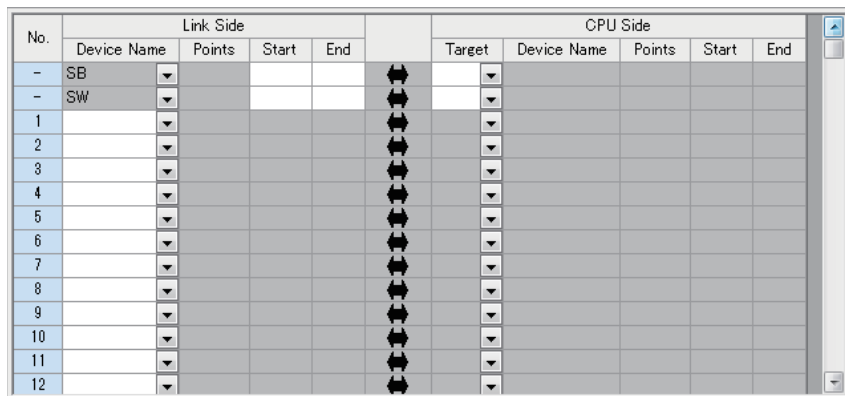

2. Click the [Apply] button to finish the link refresh settings.

## Setting items

Item	Description	Setting range
Device Assignment Method	Right-click in the setting window and select a link device assignment method from the "Device Assignment Method" menu. <ul style="list-style-type: none"> <li>• Start/End: Enter the start and end numbers of link devices.</li> <li>• Points/Start: Enter the points and start numbers of link devices.</li> </ul>	<ul style="list-style-type: none"> <li>• Start/End</li> <li>• Points/Start</li> </ul> (Default: Start/End)
—	<p>Link Side</p> <p>Set the link refresh ranges of SB and SW. One range can be set for each SB and SW. (☞ Page 39 Link refresh)</p> <p><b>Ex.</b></p>	<p>Device Name</p> <ul style="list-style-type: none"> <li>• SB</li> <li>• SW</li> </ul> <p>Points</p> <ul style="list-style-type: none"> <li>• SB: 16 to 512 (Set it in increments of 16 points.)</li> <li>• SW: 1 to 512</li> </ul> (Default: Blank) <p>Start</p> <ul style="list-style-type: none"> <li>• SB: 00000H to 001F0H (Set a multiple of 16 including 0.)</li> <li>• SW: 00000H to 001FFH</li> </ul> (Default: Blank) <p>End</p> <ul style="list-style-type: none"> <li>• SB: 0000FH to 001FFH (Set a multiple of 16 - 1.)</li> <li>• SW: 00000H to 001FFH</li> </ul> (Default: Blank) <p>Target</p> <ul style="list-style-type: none"> <li>• Device</li> </ul> (Default: Blank) <p>Device Name</p> <ul style="list-style-type: none"> <li>• Specified device (when link side is fixed to SB): SB, M, L, B, D, W, R</li> </ul> (Default: Blank) <ul style="list-style-type: none"> <li>• Specified device (when link side is fixed to SW): SW, M, L, B, D, W, R</li> </ul> (Default: Blank) <p>Points, Start, End</p> <ul style="list-style-type: none"> <li>• Range of the device in the CPU module</li> </ul>
—	<p>CPU Side</p>	

Item	Description	Setting range																																																		
1 to 256	<p>Link Side</p> <p>Set the link refresh ranges of RX, RY, RWr, and RWw. Up to 256 ranges can be set. (☞ Page 39 Link refresh)</p> <p>Ex.</p> <table border="1"> <thead> <tr> <th>No.</th> <th>Device Name</th> <th>Points</th> <th>Start</th> <th>End</th> <th>Target</th> <th>Device Name</th> <th>Points</th> <th>Start</th> <th>End</th> </tr> </thead> <tbody> <tr> <td>1</td> <td>RX</td> <td>256</td> <td>0000H</td> <td>000FH</td> <td>Specify Device</td> <td>X</td> <td>256</td> <td>100</td> <td>477</td> </tr> <tr> <td>2</td> <td>RY</td> <td>256</td> <td>0000H</td> <td>000FH</td> <td>Specify Device</td> <td>Y</td> <td>256</td> <td>100</td> <td>477</td> </tr> <tr> <td>3</td> <td>RWr</td> <td>96</td> <td>0000H</td> <td>0005FH</td> <td>Specify Device</td> <td>W</td> <td>96</td> <td>0000H</td> <td>0005FH</td> </tr> <tr> <td>4</td> <td>RWw</td> <td>96</td> <td>0000H</td> <td>0005FH</td> <td>Specify Device</td> <td>W</td> <td>96</td> <td>00100H</td> <td>0015FH</td> </tr> </tbody> </table> <p>FX5-CCL-MS</p> <p>CPU module</p>	No.	Device Name	Points	Start	End	Target	Device Name	Points	Start	End	1	RX	256	0000H	000FH	Specify Device	X	256	100	477	2	RY	256	0000H	000FH	Specify Device	Y	256	100	477	3	RWr	96	0000H	0005FH	Specify Device	W	96	0000H	0005FH	4	RWw	96	0000H	0005FH	Specify Device	W	96	00100H	0015FH	<p>Device Name</p> <ul style="list-style-type: none"> <li>• RX, RY, RWr, RWw</li> </ul> <p>(Default: Blank)</p> <p>Points</p> <ul style="list-style-type: none"> <li>• FX5UJ CPU module</li> <li>- RX, RY: 16 to 448 (Set it in increments of 16 points.)</li> <li>- RWr, RWw: 4 to 64 (Set it in increments of 4 points.)</li> <li>• FX5U/FX5UC CPU module</li> <li>- RX, RY: 16 to 896 (Set it in increments of 16 points.)</li> <li>- RWr, RWw: 4 to 112 (Set it in increments of 4 points.)</li> </ul> <p>(Default: Blank)</p> <p>Start</p> <ul style="list-style-type: none"> <li>• FX5UJ CPU module</li> <li>- RX, RY: 00000H to 001B0H (Set a multiple of 16 including 0.)</li> <li>- RWr, RWw: 00000H to 0003CH (Set a multiple of 4 including 0.)</li> <li>• FX5U/FX5UC CPU module</li> <li>- RX, RY: 00000H to 00370H (Set a multiple of 16 including 0.)</li> <li>- RWr, RWw: 00000H to 0006CH (Set a multiple of 4 including 0.)</li> </ul> <p>(Default: Blank)</p> <p>End</p> <ul style="list-style-type: none"> <li>• FX5UJ CPU module</li> <li>- RX, RY: 0000FH to 001BFH (Set a multiple of 16 - 1.)</li> <li>- RWr, RWw: 00003H to 0003FH (Set a multiple of 4 - 1.)</li> <li>• FX5U/FX5UC CPU module</li> <li>- RX, RY: 0000FH to 0037FH (Set a multiple of 16 - 1.)</li> <li>- RWr, RWw: 00003H to 0006FH (Set a multiple of 4 - 1.)</li> </ul> <p>(Default: Blank)</p> <p>Target</p> <ul style="list-style-type: none"> <li>• Device</li> </ul> <p>(Default: Blank)</p> <p>Device Name</p> <ul style="list-style-type: none"> <li>• Specified device (when link side is at RX): X, M, L, B, D, W, R</li> <li>• Specified device (when link side is at RY): Y, M, L, B, D, W, R</li> <li>• Specified device (when link side is at RWr): M, L, B, D, W, R</li> <li>• Specified device (when link side is at RWw): M, L, B, D, W, R</li> </ul> <p>(Default: Blank)</p> <p>Points, Start, End</p> <ul style="list-style-type: none"> <li>• Range of the device in the CPU module</li> </ul> <p>(Default: Blank)</p>
No.	Device Name	Points	Start	End	Target	Device Name	Points	Start	End																																											
1	RX	256	0000H	000FH	Specify Device	X	256	100	477																																											
2	RY	256	0000H	000FH	Specify Device	Y	256	100	477																																											
3	RWr	96	0000H	0005FH	Specify Device	W	96	0000H	0005FH																																											
4	RWw	96	0000H	0005FH	Specify Device	W	96	00100H	0015FH																																											
	CPU Side																																																			

## Precautions

### ■Device set to "CPU Side"

Set parameters that differ from the following:

- "Link Refresh Settings" in "Basic Settings" of a CC-Link master/intelligent device module
- "Refresh Setting" of other network modules
- "Refresh Setting" of intelligent function modules

### ■Link refresh range

Set only link devices used in the FX5 CPU module for link refresh range. Doing so will reduce link refresh points, resulting in a shorter link refresh time.

## ■Link refresh linked device (target device)

When non-latch devices (including Y devices) are set as the refresh devices, they may be cleared during CPU module RUN → STOP.

## ■Link refresh settings and module labels

When setting SB0000 to SB001F and SW0000 to SW001F as the link refresh range, do not use the module labels corresponding to SB0000 to SB001F and SW0000 to SW001F. It may not be possible to change the value, or the module may malfunction.

# Initial setting

Set the procedure for the initial settings when registering the initial settings of a remote device station using an engineering tool. The initial settings are reflected to the remote device station by turning on 'Remote device station initialization procedure registration instruction' (SB000D)

## Setting method

The procedure for the initial settings is shown below.

1. Set "Target Station No." in the "Remote Device Station Initial Setting Target Station No. Setting" window.

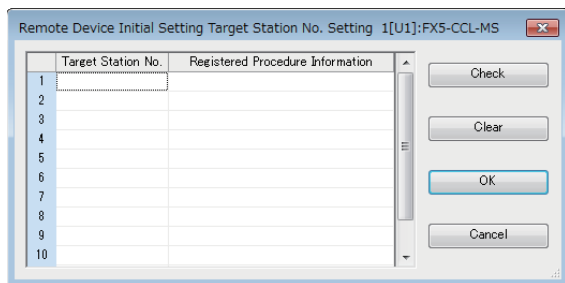

2. Double-click the number of registered procedures displayed on the right side of the set target station number, and set each item in the "Remote Device Station Initial Setting Procedure Registration" window.

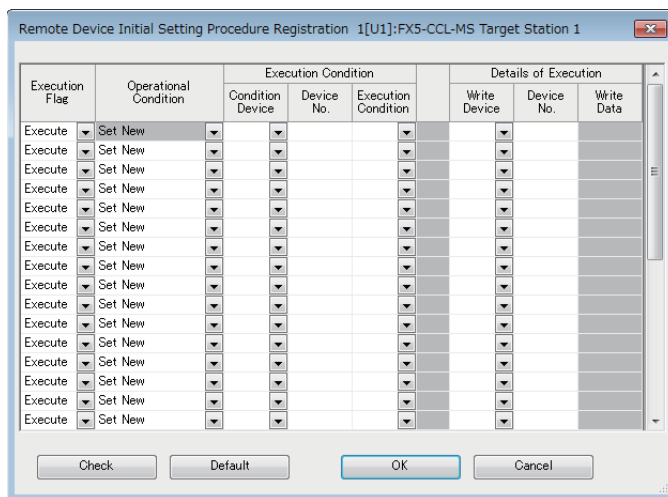

3. Click the [OK] button to finish the remote device station initial setting.
4. When the initial settings are completed, write the settings to the CPU module using the engineering tool.
5. Start the initial settings by turning on 'Remote device station initialization procedure registration instruction' (SB000D). While the initial settings are being executed, 'Execution status of remote device station initialization procedure' (SB005E) is on.

Also, the execution procedure number and the target station number for the procedure registration are stored in 'Remote device station initialization procedure registration execution individual information' (buffer memory address: Un\G23680 to Un\G23707).

6. When the initial settings are completed for all the set stations, 'Completion status of remote device station initialization procedure' (SB005F) is turned on.

The stations where the initial settings are completed can be checked with 'Remote device station initialization procedure registration completion status' (SW0164, SW0165). (☞ Page 165 List of link special register (SW) areas)

Also, the execution results are stored in 'Remote device station initialization procedure registration instruction result' (SW005F). The data stored in 'Remote device station initialization procedure registration execution individual information' (buffer memory address: Un\G23680 to Un\G23707) become FF□□H. (□□ indicates the target station number for the initial settings.)

7. Turn off 'Remote device station initialization procedure registration instruction' (SB000D).

'Remote device station initialization procedure registration instruction result' (SW005F) and 'Remote device station initialization procedure registration execution individual information' (buffer memory address: Un\G23680 to Un\G23707) are cleared.

### ■Timing chart

The following figure shows the operations of a link special relay (SB) and link special register (SW) when the remote device station initialization procedure registration is performed.

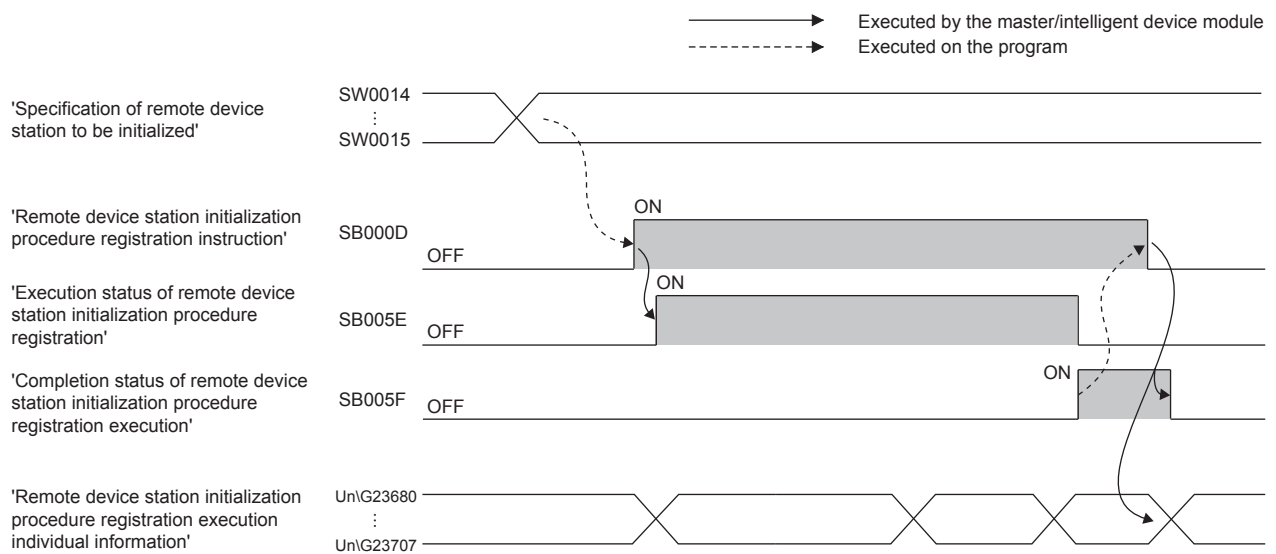

## Setting items

### Remote Device Initial Setting Target Station No. Setting

Item	Description	Setting range
Target Station No.	Set the target station number of the remote device station initial setting.	<ul style="list-style-type: none"> <li>FX5UJ CPU module: 1 to 14</li> <li>FX5U/FX5UC CPU module: 1 to 28</li> </ul> (Default: Blank)
Registered Procedure Information	The number of registered procedures in the remote device station initial setting is stored.	— (Default: Blank)

### Remote Device Initial Setting Procedure Registration

Item	Description	Setting range																														
Input Format	Right-click in the "Remote Device Station Initial Setting Procedure Registration" window and select an input type of "Write Data" from the "Input Format" menu.	<ul style="list-style-type: none"> <li>Decimal</li> <li>Hexadecimal</li> </ul> (Default: Decimal)																														
Execute Flag	Select whether to actually execute the registered procedure or not. Click it to change the setting. Select "Set Only" to use the setting only as a reference when inputting similar setting items.	<ul style="list-style-type: none"> <li>Execute</li> <li>Set Only</li> </ul> (Default: Execute)																														
Operating Condition	Select whether to newly set the condition for the initial settings or use the same condition as the above line.	<ul style="list-style-type: none"> <li>Set New</li> <li>Same as Previous Set</li> </ul> (Default: Set New)																														
	<table border="1"> <thead> <tr> <th rowspan="2">Execution Flag</th> <th rowspan="2">Operational Condition</th> <th colspan="3">Execution Condition</th> <th colspan="3">Details of Execution</th> </tr> <tr> <th>Condition Device</th> <th>Device No.</th> <th>Execution Condition</th> <th>Write Device</th> <th>Device No.</th> <th>Write Data</th> </tr> </thead> <tbody> <tr> <td>Execute</td> <td>Set New</td> <td>RX</td> <td>1</td> <td>ON</td> <td>RY</td> <td>3</td> <td>ON</td> </tr> <tr> <td>Execute</td> <td>Same as Prev. Set</td> <td>RX</td> <td>1</td> <td>ON</td> <td>RWw</td> <td>2</td> <td>15</td> </tr> </tbody> </table>	Execution Flag	Operational Condition	Execution Condition			Details of Execution			Condition Device	Device No.	Execution Condition	Write Device	Device No.	Write Data	Execute	Set New	RX	1	ON	RY	3	ON	Execute	Same as Prev. Set	RX	1	ON	RWw	2	15	
Execution Flag	Operational Condition			Execution Condition			Details of Execution																									
		Condition Device	Device No.	Execution Condition	Write Device	Device No.	Write Data																									
Execute	Set New	RX	1	ON	RY	3	ON																									
Execute	Same as Prev. Set	RX	1	ON	RWw	2	15																									
Execution Condition	Condition Device	Set the device to execute the initial settings.	<ul style="list-style-type: none"> <li>RX</li> <li>SB</li> </ul> (Default: Blank)																													
	Device No.	Set the device number of the device set to "Condition Device." Set the number as the first device of each station is 0. For instance, 0 to 1F are set to the device number for the station No.4 in the following case.	<ul style="list-style-type: none"> <li>FX5UJ CPU module</li> <li>For RX: 0H to DFH</li> <li>For SB: 0H to 1FFH</li> <li>FX5U/FX5UC CPU module</li> <li>For RX: 0H to 1BFH</li> <li>For SB: 0H to 1FFH</li> </ul> (Default: Blank)																													
	Execution Condition	Set whether to execute the initial settings with ON of the condition device or with OFF of the condition device.	<ul style="list-style-type: none"> <li>ON</li> <li>OFF</li> </ul> (Default: Blank)																													
Details of Execution	Write Device	Set the device where the initial settings are written.	<ul style="list-style-type: none"> <li>RY</li> <li>RWw</li> </ul> (Default: Blank)																													
	Device No.	Set the device number of the device set in "Write Device." Set the number as the first device of each station is 0. For instance, 0 to 1F are set to the device number for the station No.4 in the following case.	<ul style="list-style-type: none"> <li>FX5UJ CPU module</li> <li>For RY: 0H to DFH</li> <li>For RWw: 0H to 1FH</li> <li>FX5U/FX5UC CPU module</li> <li>For RY: 0H to 1BFH</li> <li>For RWw: 0H to 40H</li> </ul> (Default: Blank)																													
	Write Data	Set the data for the initial settings. (the data to be written to the device set to "Write Device" and "Device No.")	<ul style="list-style-type: none"> <li>For RY: ON or OFF</li> <li>For RWw: 0H to FFFFH</li> </ul> (Default: Blank)																													

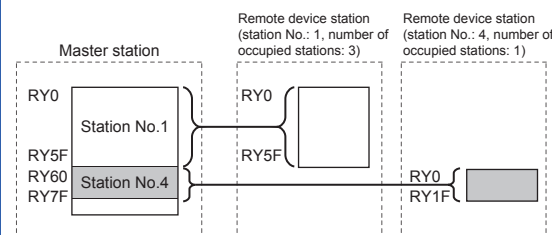
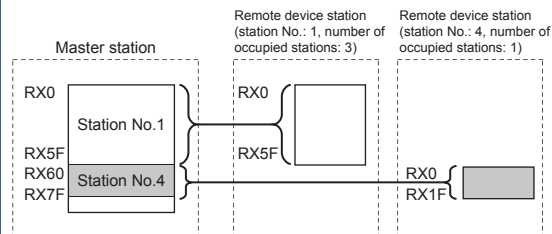

# 7.4 Application Settings

Set the supplementary cyclic setting for the master/intelligent device module and parameter name. Settings are possible only when "Setting Method of Basic/Application Settings" in "Required Settings" is the "Parameter Editor."

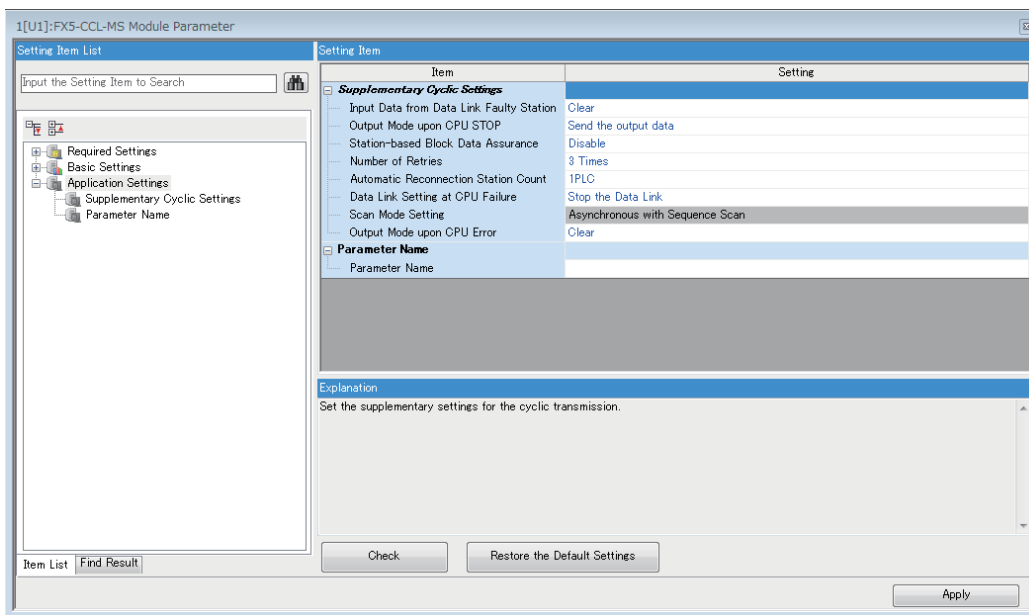

○: Can be set, △: Can be set partly, ×: Cannot be set

Item	Availability		Reference
	Master station	Intelligent device station	
Supplementary Cyclic Settings	○	△ <sup>*1</sup>	Page 77 Supplementary cyclic settings
Parameter Name	○	○	Page 77 Parameter name

\*1 "Number of Retries", "Automatic Reconnection Station Count", and "Data Link Setting when CPU is Down" cannot be set.

## Supplementary cyclic settings

Set the station-based block data assurance, output data setting during CPU STOP, or other parameters.

Item	Description	Setting range
Input Data from Data Link Faulty Station	Set whether to clear or hold data input/output from a data link faulty station. <ul style="list-style-type: none"> <li>■For the master station The target is remote input (RX) from slave station.</li> <li>■For the Intelligent device station The target is remote output (RY, RWw) from master station.</li> </ul>	<ul style="list-style-type: none"> <li>• Clear</li> <li>• Hold</li> </ul> (Default: Clear)
Output Mode upon CPU STOP	Select whether output data is refreshed (held at the value before STOP) or cleared to zero (0) when the CPU module is set to STOP. <ul style="list-style-type: none"> <li>■For the master station The target is remote output (RY) to the slave station.</li> <li>■For the Intelligent device station The target is remote input (RX, RWr) to the master station.</li> </ul>	<ul style="list-style-type: none"> <li>• Send the output data</li> <li>• Send 0 data</li> </ul> (Default: Send the output data)
Station-based Block Data Assurance	Set whether to ensure a data integrity of the data blocks being refreshed between the master/intelligent device module and the CPU module. (📖 Page 41 Station-based Block Data Assurance)	<ul style="list-style-type: none"> <li>• Disable</li> <li>• Enable</li> </ul> (Default: Disable)
Number of Retries	Set the number of retries for when a communication failure occurs.	1 to 7 (Default: 3)
Automatic Reconnection Station Count	Set the number of slave stations that return to the system operation by a single link scan after the stations are disconnected due to a communication failure. Setting a larger number extends link scan time of when the station returns.	1 to 10 (Default: 1)
Data Link Setting at CPU Failure	Set whether to stop or continue data link if a stop error occurs in a CPU module.	<ul style="list-style-type: none"> <li>• Stop the Data Link</li> <li>• Continue the Data Link</li> </ul> (Default: Stop the Data Link)
Scan Mode Setting	In a master/intelligent device module, the link scan and sequence scan are asynchronous only.	Asynchronous with Sequence Scan (fixed)
Output Mode upon CPU Error	Set whether to hold or clear the output when the CPU module is in stop error. <ul style="list-style-type: none"> <li>■For the master station The target is remote output (RY) to the slave station.</li> <li>■For the Intelligent device station The target is remote input (RX, RWr) to the master station.</li> </ul>	<ul style="list-style-type: none"> <li>• Clear</li> <li>• Hold</li> </ul> (Default: Clear)

## Parameter name





Item	Description	Setting range
Parameter Name	Set a name for the module parameter if desired.	Up to 8 one-byte or two-byte characters (Default: Blank)

## 7.5 Compatible Buffer Memory

Shown below are parameters which can be set from the buffer memory. For details of buffer memory, refer to  Page 147 Parameter information area.

M: Master station, ID: Intelligent device station

○: Can be set, ×: Cannot be set

Item	Buffer memory addresses	Setting availability		Compatible parameter settings <sup>*1</sup>	Reference
		M	ID		
Station No.	EH (14)	×	○	Station No.	 Page 66 Station number
Number of occupied stations	BH (11)	×	○	Number of Occupied Stations	 Page 68 Own station setting
Extended cyclic setting	CH (12)	×	○	Extended Cyclic Setting	
Total number of connected stations	1H (1)	○	×	Network configuration settings <sup>*2</sup>	 Page 69 Network configuration settings
Reserved station setting	10H, 11H (16, 17)	○	×	Reserved/Err Invalid STA	
Error invalid station setting	14H, 15H (20, 21)	○	×	Reserved/Err Invalid STA	
Station information	20H to 3BH (32 to 59)	○	×	Station Type, STA Occupied, Extended Cyclic Setting	
Data link faulty station setting	5H (5)	○	○	Input Data from Data Link Faulty Station	 Page 77 Supplementary cyclic settings
Upon CPU STOP setting	DH (13)	○	○	Output Mode upon CPU STOP	
Number of retries	2H (2)	○	×	Number of Retries	
Number of automatic return stations	3H (3)	○	×	Automatic Reconnection Station Count	
Data link setting at CPU failure	6H (6)	○	×	Data Link Setting at CPU Failure	

\*1 Parameter setting items on the engineering tool corresponding to the buffer memory.

\*2 Total number of connected stations shown in the network configuration chart



# 8 PROGRAMMING

This chapter describes programming and start-up examples of the master/intelligent device module.

## 8.1 Precautions for Programming

This section describes the precautions when creating programs of the master/intelligent device module.

### Interlock program

For a cyclic transmission program, interlock with 'Data link status of other stations' (SW0080, SW0081).

**Ex.**

Interlock example

Classification	Label name	Description	Device
Module label	FX5CCLMS_1.bn_ModuleFailure_D	Module failure	U1\G26368.0
	FX5CCLMS_1.bn_DataLink_D	Own station data link status	U1\G26368.1
	FX5CCLMS_1.bn_ModuleReady_D	Module ready	U1\G26368.F
	FX5CCLMS_1.bnSts_DataLinkError_Other_D[1]	Data link status of other stations (station No.1)	U1\G1664.0 (SW0080.0)
	FX5CCLMS_1.bnSts_DataLinkError_Other_D[2]	Data link status of other stations (station No.2)	U1\G1664.1 (SW0080.1)

Label to be defined					
Define global labels as shown below:					
	Label Name	Data Type		Class	Assign (Device/Label)
1	StartDirection_1	Bit	...	VAR_GLOBAL	M0
2	StartDirection_2	Bit	...	VAR_GLOBAL	M1

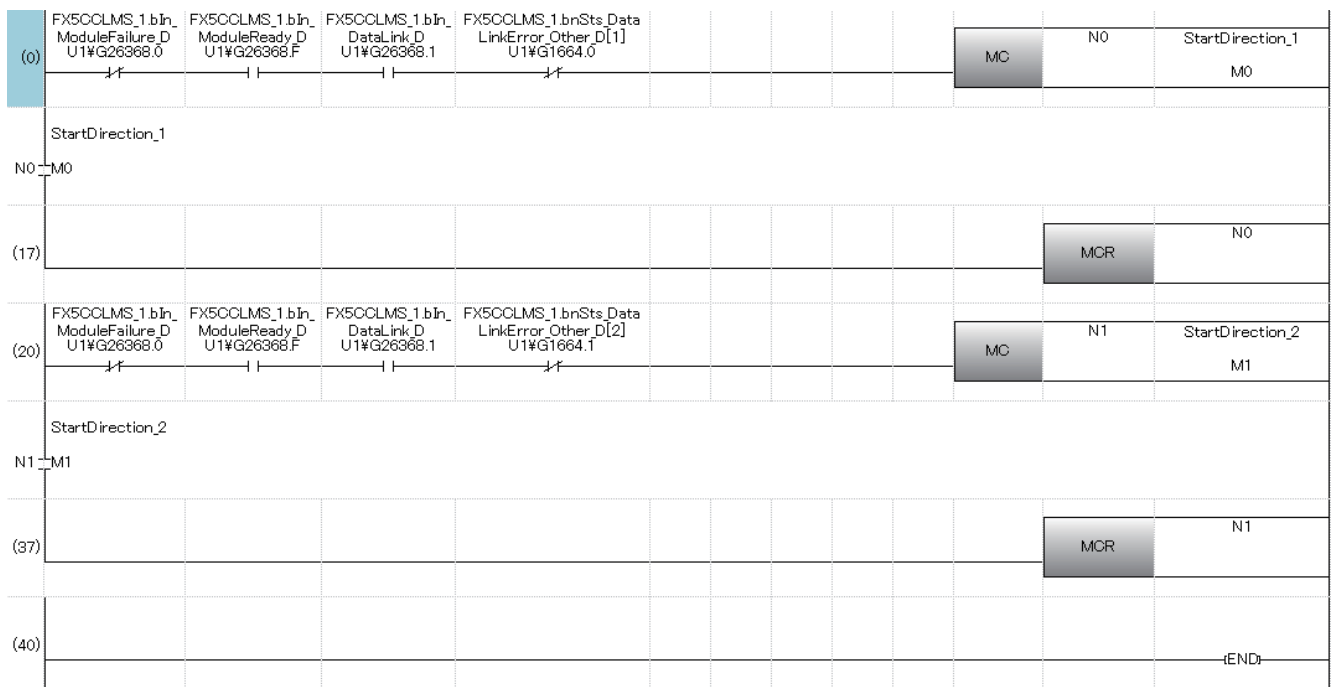

- (17) Create the communication program with station No.1 within the control range of N0.
- (37) Create the communication program with station No.2 within the control range of N1.

### Devices used in programs

Note that if the following devices are used as devices for the output destination in the program, values cannot be changed or the module may malfunction.

- Devices used for link refresh setting of modules on the network
- I/O devices used in CPU modules and I/O modules
- Devices used for link refresh setting of intelligent function modules

## 8.2 Example of Communications Between a Master Station, a Remote Device Station and a Remote I/O Station

This section describes an example of how to perform an input and output for the remote I/O station, and set the initial settings for the remote device station and perform an analog output.

If an error occurs, the error code of the remote device station is stored in the device of a CPU module or the module label.

### System configuration example

The following system configuration is used to explain communication between the master station, remote device station, and remote I/O station.

#### System Configuration

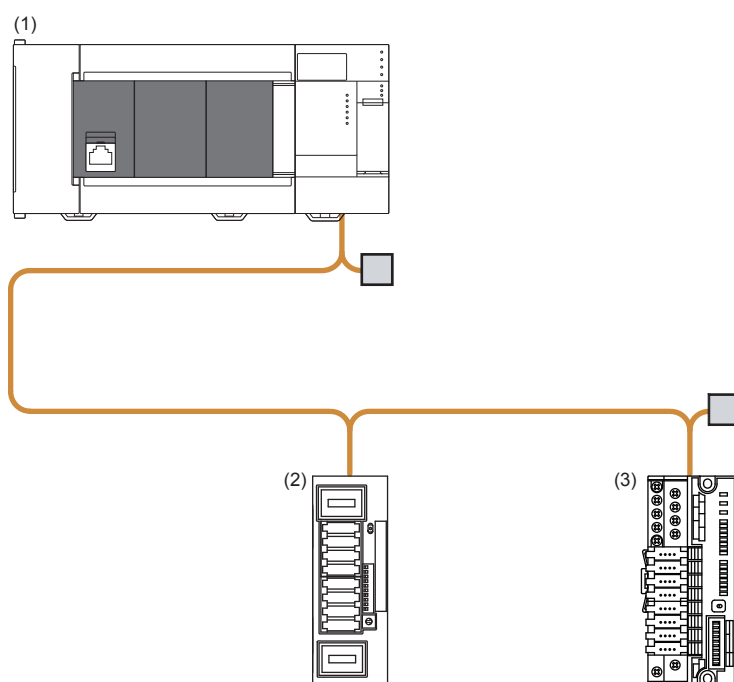

No.	Model	Station type	Mode	Intelligent module number	Station No.	Number of occupied stations
(1)	FX5U-32MR/ES	—				
	FX5-CCL-MS	Master station	Remote net Ver.2 mode	01H	0	—
(2)	AJ65VBTCU-68DAVN	Remote device station	Remote net Ver.2 mode	—	1	1 (Quadruple)
(3)	AJ65SBTC1-32DT	Remote I/O station	Remote net Ver.1 mode	—	2	1 (Single)

#### Link device assignment

This section describes the RX, RY, RWr, or RWW assignment of the program example.



- Remote net Ver.2 mode is used in this program example. When the remote net Ver.1 mode is used, the buffer memory addresses of storage locations vary. (➔ Page 35 Remote net Ver.1 mode)
- For details of the signals of RX, RY, RWr, and RWW of the AJ65VBTCU-68DAVN, AJ65SBTC1-32DT, refer to the manual for the remote station used.

## ■RX assignment

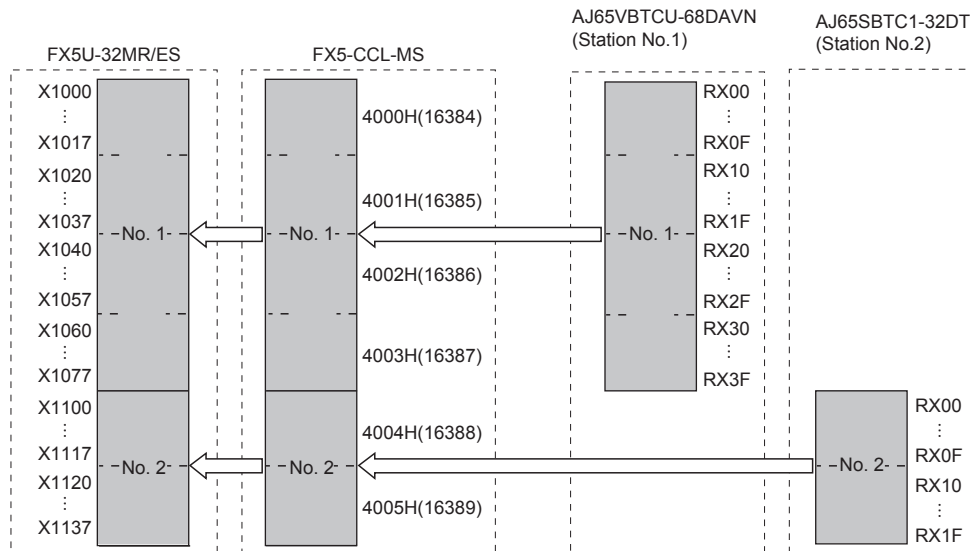

FX5U-32MR/ES Device	FX5-CCL-MS Buffer memory address		Slave station		
	Hexadecimal	Decimal	Station No.	Module name	RX
X1000 to X1017	4000H	16384	1	AJ65VBTCU-68DAVN	RX0 to RXF
X1020 to X1037	4001H	16385			RX10 to RX1F
X1040 to X1057	4002H	16386			RX20 to RX2F
X1060 to X1077	4003H	16387			RX30 to RX3F
X1100 to X1117	4004H	16388	2	AJ65SBTC1-32DT	RX0 to RXF
X1120 to X1137	4005H	16389			RX10 to RX1F

The assignment by each signal of AJ65VBTCU-68DAVN is shown below.

CPU module Device	Remote station			
	Module name	RX	Signal name	
X1000	AJ65VBTCU-68DAVN	RX00	Use prohibited	
to		to		
X1013		RX0B		
X1014		RX0C		E <sup>2</sup> PROM write error flag
X1015		RX0D		Use prohibited
to		to		
X1027		RX17		
X1030		RX18		Initial data processing request flag
X1031		RX19		Initial data setting completion flag
X1032		RX1A		Error status flag
X1033		RX1B		Remote READY
X1034		RX1C		Use prohibited
to		to		
X1077		RX3F		

## RY assignment

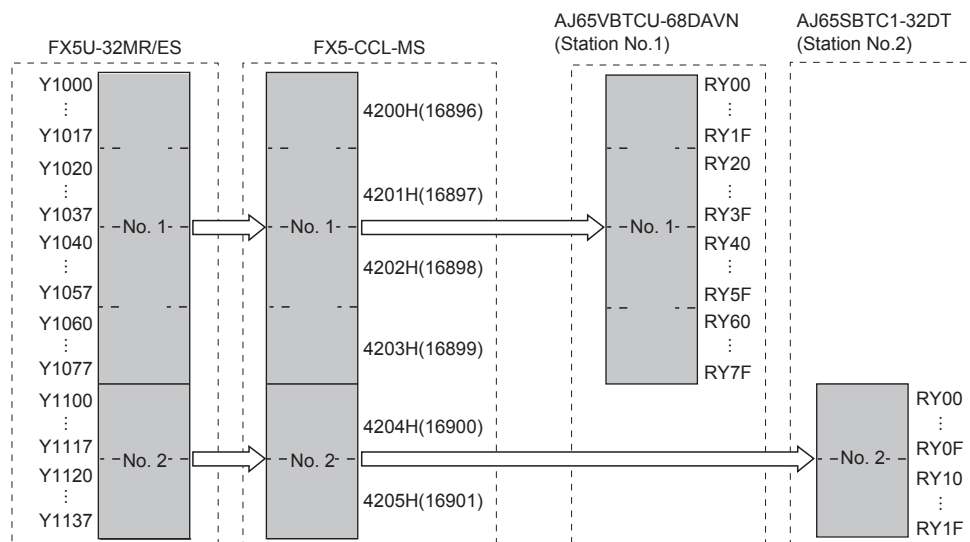

FX5U-32MR/ES	FX5-CCL-MS		Slave station			
	Device	Buffer memory address		Station No.	Module name	RY
		Hexadecimal	Decimal			
Y1000 to Y1017	4200H	16896	1	AJ65VBTCU-68DAVN	RY0 to RYF	
Y1020 to Y1037	4201H	16897			RY10 to RY1F	
Y1040 to Y1057	4202H	16898			RY20 to RY2F	
Y1060 to Y1077	4203H	16899			RY30 to RY3F	
Y1100 to Y1117	4204H	16900	2	AJ65SBTC1-32DT	RY0 to RYF	
Y1120 to Y1137	4205H	16901			RY10 to RY1F	

The assignment by each signal of AJ65VBTCU-68DAVN is shown below.

CPU module	Remote station		
Device	Module name	RY	Signal name
Y1000	AJ65VBTCU-68DAVN	RY00	CH.1 analog output enable/disable flag
Y1001		RY01	CH.2 analog output enable/disable flag
Y1002		RY02	CH.3 analog output enable/disable flag
Y1003		RY03	CH.4 analog output enable/disable flag
Y1004		RY04	CH.5 analog output enable/disable flag
Y1005		RY05	CH.6 analog output enable/disable flag
Y1006		RY06	CH.7 analog output enable/disable flag
Y1007		RY07	CH.8 analog output enable/disable flag
Y1010		RY08	Use prohibited
to		to	
Y1027		RY17	Initial data processing completion flag
Y1030		RY18	
Y1031		RY19	Initial data setting request flag
Y1032		RY1A	Error reset request flag
Y1033		RY1B	Use prohibited
to		to	
Y1077		RY3F	

## ■RWr assignment

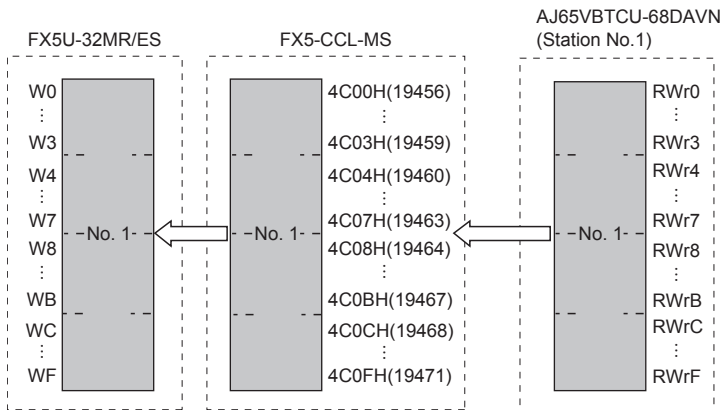

FX5U-32MR/ES Device	FX5-CCL-MS Buffer memory address		Slave station		
	Hexadecimal	Decimal	Station No.	Module name	RWr
W0	4C00H	19456	1	AJ65VBTCU-68DAVN	RWr0
W1	4C01H	19457			RWr1
W2	4C02H	19458			RWr2
W3	4C03H	19459			RWr3
W4	4C04H	19460			RWr4
W5	4C05H	19461			RWr5
W6	4C06H	19462			RWr6
W7	4C07H	19463			RWr7
W8	4C08H	19464			RWr8
W9	4C09H	19465			RWr9
WA	4C0AH	19466			RWrA
WB	4C0BH	19467			RWrB
WC	4C0CH	19468			RWrC
WD	4C0DH	19469			RWrD
WE	4C0EH	19470			RWrE
WF	4C0FH	19471			RWrF

The assignment by each signal of AJ65VBTCU-68DAVN is shown below.

CPU module Device	Remote station		
	Module name	RWr	Signal name
W0	AJ65VBTCU-68DAVN	RWr0	CH.1 check code
W1		RWr1	CH.2 check code
W2		RWr2	CH.3 check code
W3		RWr3	CH.4 check code
W4		RWr4	CH.5 check code
W5		RWr5	CH.6 check code
W6		RWr6	CH.7 check code
W7		RWr7	CH.8 check code
W8		RWr8	Error code
W9		RWr9	Use prohibited
to	to		
WF	RWrF		

## ■RWw assignment

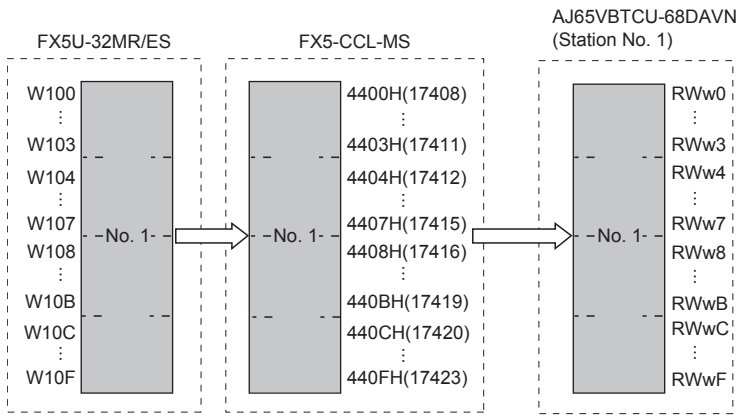

FX5U-32MR/ES Device	FX5-CCL-MS Buffer memory address		Slave station		
	Hexadecimal	Decimal	Station No.	Module name	RWw
W100	4400H	17408	1	AJ65VBTCU-68DAVN	RWw0
W101	4401H	17409			RWw1
W102	4402H	17410			RWw2
W103	4403H	17411			RWw3
W104	4404H	17412			RWw4
W105	4405H	17413			RWw5
W106	4406H	17414			RWw6
W107	4407H	17415			RWw7
W108	4408H	17416			RWw8
W109	4409H	17417			RWw9
W10A	440AH	17418			RWwA
W10B	440BH	17419			RWwB
W10C	440CH	17420			RWwC
W10D	440DH	17421			RWwD
W10E	440EH	17422			RWwE
W10F	440FH	17423			RWwF

The assignment by each signal of AJ65VBTCU-68DAVN is shown below.

CPU module	Remote station		
Device	Module name	RWw	Signal name
W100	AJ65VBTCU-68DAVN	RWw0	CH.1 digital value setting
W101		RWw1	CH.2 digital value setting
W102		RWw2	CH.3 digital value setting
W103		RWw3	CH.4 digital value setting
W104		RWw4	CH.5 digital value setting
W105		RWw5	CH.6 digital value setting
W106		RWw6	CH.7 digital value setting
W107		RWw7	CH.8 digital value setting
W108		RWw8	Analog output enable/disable setting
W109		RWw9	CH.1 to CH.4 output range setting
W10A		RWwA	CH.5 to CH.8 output range setting
W10B		RWwB	HOLD/CLEAR setting
W10C		RWwC	Use prohibited
to		to	
W10F		RWwF	

## Setting in a master station

Connect the engineering tool to the CPU module on the master station and set the parameters.

1. Set the CPU module as follows.

 [Project] ⇒ [New]

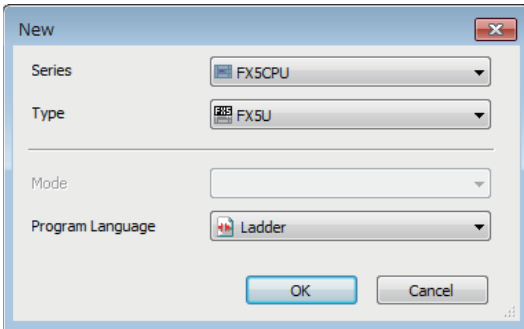

2. Click the [OK] button to add the module labels of the CPU module.

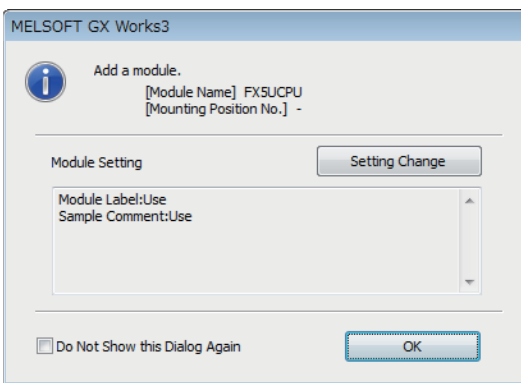

3. Set the master/intelligent device module as follows.

Module can also be added by placing on the module configuration diagram. For the operation of the engineering tool, refer to the following manual.

 GX Works3 Operating Manual

 [Navigation window] ⇒ [Parameter] ⇒ [Module Information] ⇒ Right-click ⇒ [Add New Module]

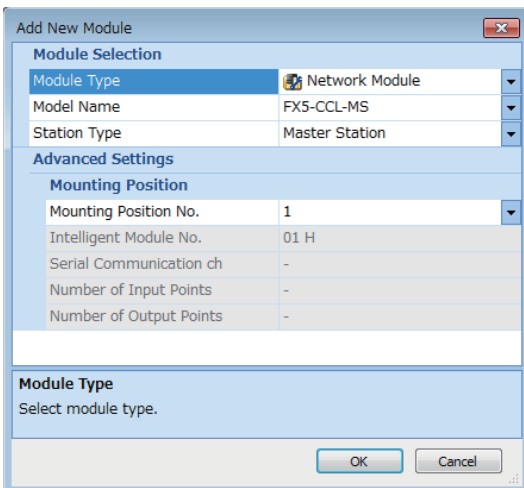

4. Click the [OK] button to add the module labels of the master/intelligent device module.

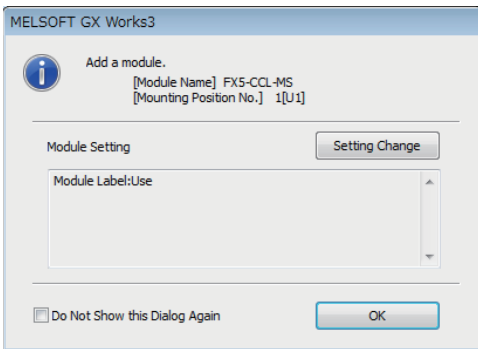

5. Set the items in "Required Settings" as follows.

[Navigation window] ⇒ [Parameter] ⇒ [Module Information] ⇒ [FX5-CCL-MS] ⇒ [Module Parameter] ⇒ [Required Settings]

Item	Setting
<b>Station Type</b>	
Station Type	Master Station
<b>Mode</b>	
Communication Mode	Remote Net Ver.2 Mode
<b>Station No.</b>	
Station No.	0
<b>Transmission Speed</b>	
Transmission Speed	10Mbps
<b>Parameter Setting Method</b>	
Setting Method of Basic/Application Settings	Parameter Editor

6. Set the network configuration as follows.

[Navigation window] ⇒ [Parameter] ⇒ [Module Information] ⇒ [FX5-CCL-MS] ⇒ [Module Parameter] ⇒ [Basic Settings] ⇒ [Network Configuration Settings]

Station No.	Model Name	Station Type	Version	# of STA Occupied	Expanded Cyclic Setting	Remote Station Points	Reserved/Err Invalid STA
0/0	Host Station	Master Station					
1/1	AJ65VBTCU-68DAVN	Remote Device Station	Ver.2	1 Occupied Sta	Quadruple	64 Points	No Setting
2/2	AJ65SBTC1-32DT	Remote I/O Station	Ver.1	1 Occupied Sta	Single		No Setting

Network Diagram:

- 自局 (Local Station): STA#0 Master Station, Ver.2, All Connected Count:2, Total STA#2
- Remote Station 1: STA#1, Model AJ65VBTCU-68DAVN
- Remote Station 2: STA#2, Model AJ65SBTC1-32DT



7. Set the link refresh settings as follows.

[Navigation window] ⇒ [Parameter] ⇒ [Module Information] ⇒ [FX5-CCL-MS] ⇒ [Module Parameter] ⇒ [Basic Settings] ⇒ [Link Refresh Settings]

No.	Link Side					CPU Side				
	Device Name	Points	Start	End		Target	Device Name	Points	Start	End
-	SB	512	00000	001FF	🔌	Specify Device	SB	512	00000	001FF
-	SW	512	00000	001FF	🔌	Specify Device	SW	512	00000	001FF
1	RX	96	00000	0005F	🔌	Specify Device	X	96	1000	1137
2	RY	96	00000	0005F	🔌	Specify Device	Y	96	1000	1137
3	RWw	16	00000	0000F	🔌	Specify Device	W	16	00000	0000F
4	RWww	16	00000	0000F	🔌	Specify Device	W	16	00100	0010F

8. Set the supplementary cyclic settings as follows.

[Navigation window] ⇒ [Parameter] ⇒ [Module Information] ⇒ [FX5-CCL-MS] ⇒ [Module Parameter] ⇒ [Application Settings] ⇒ [Supplementary Cyclic Settings]

Setting Item	Item	Setting
<b>Supplementary Cyclic Settings</b>		
	Input Data from Data Link Faulty Station	Clear
	Output Mode upon CPU STOP	Send the output data
	Station-based Block Data Assurance	Disable
	Number of Retries	3 Times
	Automatic Reconnection Station Count	1PLC
	Data Link Setting at CPU Failure	Stop the Data Link
	Scan Mode Setting	Asynchronous with Sequence Scan
	Output Mode upon CPU Error	Clear
<b>Parameter Name</b>		
	Parameter Name	

9. Set the target station number of the remote device initial setting as follows.

[Navigation window] ⇒ [Parameter] ⇒ [Module Information] ⇒ [FX5-CCL-MS] ⇒ [Module Parameter] ⇒ [Basic Settings] ⇒ [Initial Settings]

Target Station No.	Registered Procedure Information
1	No. of Registered Procedures: 7
2	
3	
4	
5	
6	
7	
8	
9	
10	

10. Double-click "No. of Registered Procedures" to open the "Remote Device Initial Setting Procedure Registration" window.

**11.** In "Remote Device Initial Setting Procedure Registration" window, right-click the icon and click "Hexadecimal" of the "Input Format." Set the items in the initial settings as follows.

- Initial setting of AJ65VBTCU-68DAVN (station No.1)

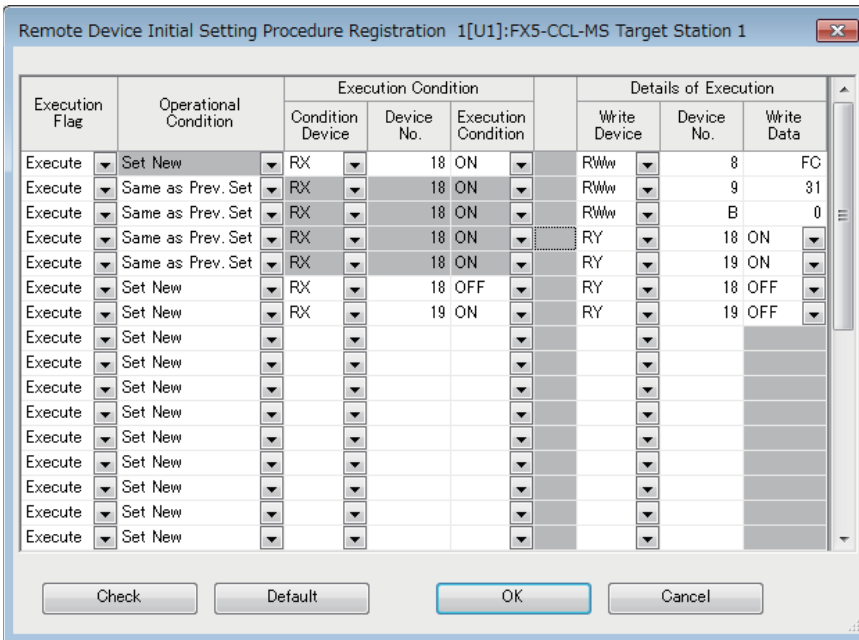

Setting the initial setting executes the following processing from the first condition.

Condition	Description
1st	The CH.1 and CH.2 are set to the analog output enable.
2nd	An output range is set. • CH.1: 0 to 5 V • CH.2: User range setting 1 (-10 to +10 V)
3rd	HOLD/CLEAR is set. • CH.1: CLEAR • CH.2: CLEAR
4th	Initial data processing completion flag is turned on.
5th	Initial data setting request flag is turned on.
6th	Initial data processing completion flag is turned off.
7th	Initial data setting request flag is turned off.

**12.** Write the set parameters to the CPU module on the master station. Then reset the CPU module or power off and on the system.

[Online] ⇄ [Write to PLC]

**Point**

For the parameters, refer to the following.

Page 63 PARAMETER SETTINGS

## Setting of remote device station

Set the station number, transmission speed, and mode using the switches on the remote device station.

### Switch setting of AJ65VBTCU-68DAVN

- Station number setting switch, transmission speed setting switch: No.3, No.4 turn on (station No.1, 10Mbps)
- Mode selector switch: 3 (Ver.2 remote device station, normal mode)

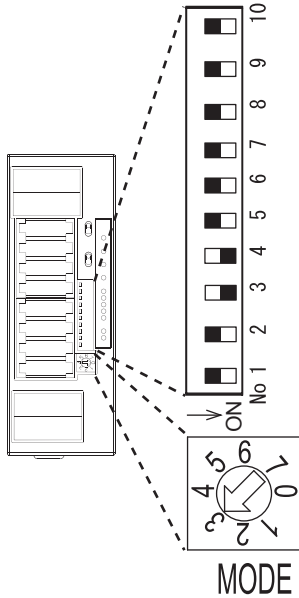

## Setting of Remote I/O station

### Switch setting of AJ65SBTC1-32DT

- Station number setting switch, transmission speed setting switch: No.3, No.5 turn on (Station No.2, 10 Mbps)

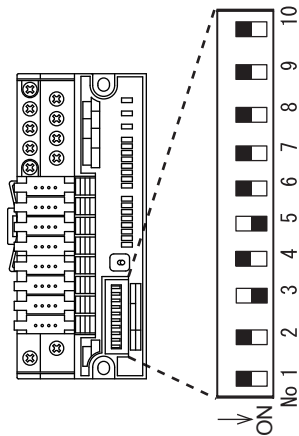

## Checking the data link status

Confirm whether the master station, remote device station, and remote I/O station are normally operating data link.

1. Power on the remote station, then master station to start data link.
2. When the LEDs are in the following states, data link is being performed normally.

- LEDs on the master station

LED	Status
RUN	On
ERROR	Off
MST	On
156K	Off
625K	
2.5M	
5M	
10M	
L RUN	On
L ERR	Off
SD	Flashing <sup>*1</sup>
RD	

\*1 The LEDs may look dimly lit or off depending on the communication status.

- LEDs of AJ65VBTCU-68DAVN

LED	Status
POWER	On
RUN	
L RUN	
L ERR	
TEST	Off

- LEDs of AJ65SBTC1-32DT

LED	Status
PW	On
L RUN	
L ERR	Off

# Program example

• Master station (station No. 0)

Classification	Label name	Description	Device
Module label	FX5CCLMS_1.bl_n_ModuleFailure_D	Module failure	U1G26368.0
	FX5CCLMS_1.bl_n_DataLink_D	Own station data link status	U1G26368.1
	FX5CCLMS_1.bl_n_ModuleReady_D	Module ready	U1G26368.F

Label to be defined

Define global labels as shown below:

	Label Name	Data Type	Class	Assign (Device/Label)
1	Req_RemoteDeviceStationInitialization	Bit	VAR_GLOBAL	SB0D
2	Compl_RemoteDeviceStationInitialization	Bit	VAR_GLOBAL	SB5F
3	Initialization_68DAVN	Bit	VAR_GLOBAL	X10
4	ChangeDigitalValue_68DAVN	Bit	VAR_GLOBAL	X11
5	EnableAnalogOutput_68DAVN	Bit	VAR_GLOBAL	X12
6	ResetError_68DAVN	Bit	VAR_GLOBAL	X13
7	DataSend_32DT	Bit	VAR_GLOBAL	X14
8	DataRecv_32DT	Bit	VAR_GLOBAL	Y11
9	DataLinkError_68DAVN	Bit	VAR_GLOBAL	Y16
10	DataLinkError_32DT	Bit	VAR_GLOBAL	Y17
11	StartDirection	Bit	VAR_GLOBAL	M100
12	CheckCode_OH1_68DAVN	Word (Unsigned)/Bit String [16-bit]	VAR_GLOBAL	D510
13	CheckCode_OH2_68DAVN	Word (Unsigned)/Bit String [16-bit]	VAR_GLOBAL	D511
14	ErrorCode_68DAVN	Word (Unsigned)/Bit String [16-bit]	VAR_GLOBAL	D518
15	DataLinkError_Other1	Bit	VAR_GLOBAL	SW80.0
16	DataLinkError_Other2	Bit	VAR_GLOBAL	SW80.1

Device	Description	Module
X1000 to X1077	Remote input (RX0 to RX3F)	AJ65VBTCU-68DAVN
Y1000 to Y1077	Remote output (RY0 to RY3F)	
W0 to WF	Remote register (RWr0 to RWrF)	
W100 to W10F	Remote register (RWw0 to RWwF)	
X1100 to X1137	Remote input (RX0 to RX1F)	AJ65SBTC1-32DT
Y1100 to Y1137	Remote output (RY0 to RY1F)	

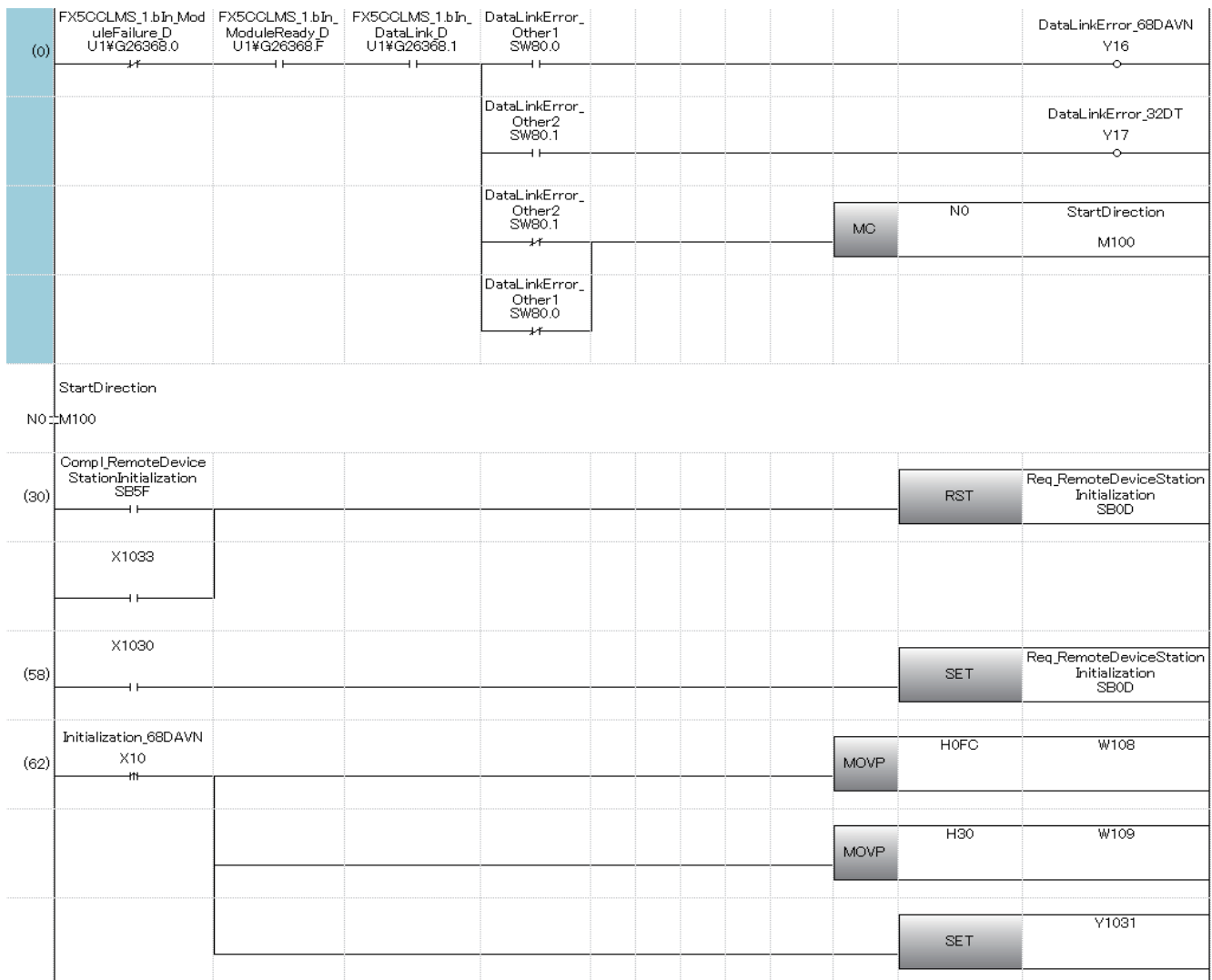

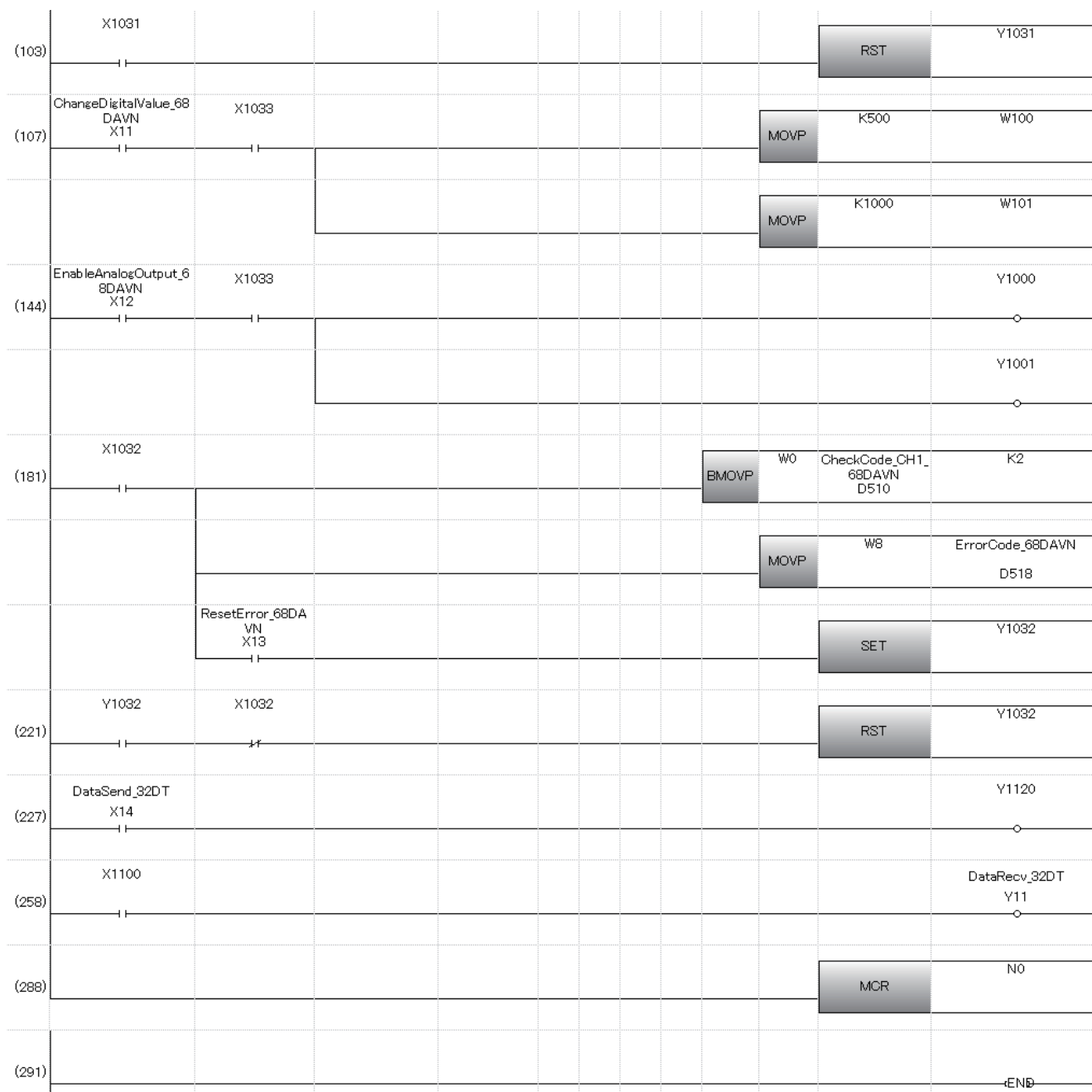

- (0) The data link status is checked.
- (30) When 'Remote device station initialization procedure registration instruction' (SB000D) is turned on, the initial setting is executed.
- (62) When 'Remote device station initial setting change' (X10) is turned on, the initial setting of AJ65VBTCU-68DAVN is changed.
- (107) When 'Remote device station digital value change' (X11) is turned on, the digital value of AJ65VBTCU-68DAVN is set.
- (144) When 'Remote device station analog output enable' (X12) is turned on, analog values are output from AJ65VBTCU-68DAVN.
- (181) If an error occurs in the AJ65VBTCU-68DAVN, an error code is stored in 'Error code' (D518).  
After the cause of the error is eliminated and 'Remote device station error reset' (X13) is turned on, the error is reset.
- (227) When 'Send data to remote IO flag' (X14) is turned on, remote output (RY10) of AJ65SBTC1-32DT is turned ON/OFF.
- (258) When remote input (RX0) of AJ65SBTC1-32DT is turned ON/OFF, 'Receive data from remote IO flag' (Y11) is turned ON/OFF.

**Point**

- When creating the programs of (30) to (58), refer to the manual for the remote device station used and change the program as needed.
- The programs of (62) to (103) are needed only for the initial setting change.

## 8.3 Example of Communications Between a Master Station and a Intelligent Device Station

This section describes communications between the master station and intelligent device station.

### System configuration example

The following system configuration is used to explain communication between the master station and intelligent device station.

#### System Configuration

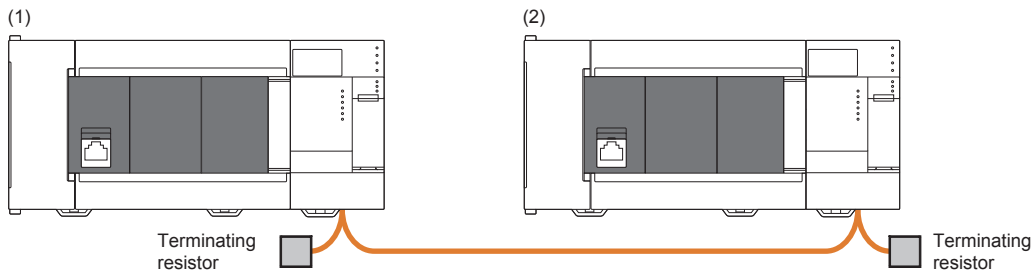

No.	Model	Station type	Mode	Intelligent module number	Station No.	Number of occupied stations
(1)	FX5U-32MR/ES	—				
	FX5-CCL-MS	Master station	Remote net Ver.1 mode	01H	0	—
(2)	FX5U-32MR/ES	—				
	FX5-CCL-MS	Intelligent device station	Remote net Ver.1 mode	01H	1	1

## Link device assignment

This section describes the RX, RY, RWr, or RWw assignment of program examples.

### Point

Remote net Ver.1 mode is used in this program example. When the remote net Ver.2 mode is used, the buffer memory addresses of storage locations vary. (Page 37 Remote net Ver.2 mode)

### ■RX/RX assignment

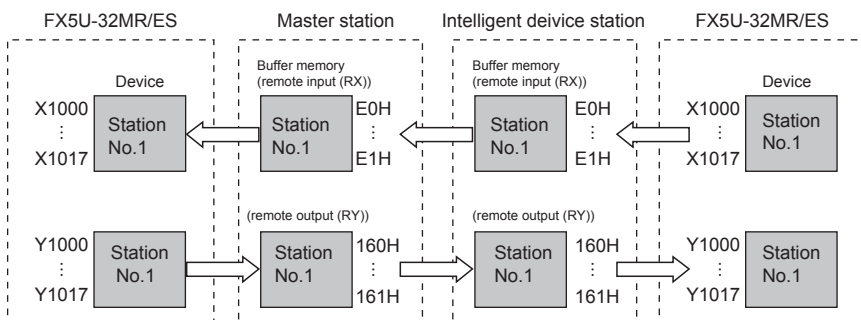

FX5U-32MR/ES	Master station		Slave station		
	Device	Buffer memory address	Station No.	Module name	RX, RY
		Hexadecimal			
		Decimal			
X1000 to X1017	E0H	224	1	FX5-CCL-MS	RX0 to RXF
X1020 to X1037	E1H	225			RX10 to RX1F (use prohibited because they are system areas)
Y1000 to Y1017	160H	352			RY0 to RYF
Y1020 to Y1037	161H	353			RY10 to RY1F (use prohibited because they are system areas)

### Point

The last 2 bits in RX and RY cannot be used when using the master/intelligent device module as the intelligent device station.

### ■RWr/RWw assignment

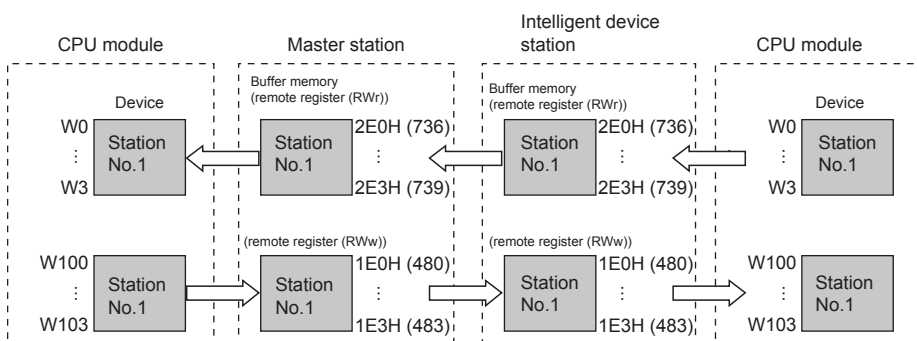

FX5U-32MR/ES	Master Station		Slave station		
	Device	Buffer memory address	Station No.	Module name	RWr, RWw
		Hexadecimal			
		Decimal			
W0	2E0H	736	1	FX5-CCL-MS	RWr0
W1	2E1H	737			RWr1
W2	2E2H	738			RWr2
W3	2E3H	739			RWr3
W100	1E0H	480			RWw0
W101	1E1H	481			RWw1
W102	1E2H	482			RWw2
W103	1E3H	483			RWw3



# Setting in the master station

Connect the engineering tool to the CPU module on the master station and set the parameters.

1. Set the CPU module as follows.

[Project] ⇒ [New]

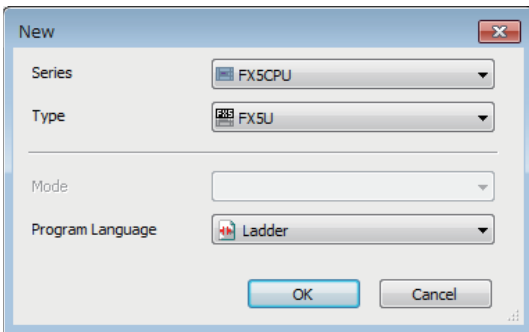

2. Click the [OK] button to add the module labels of the CPU module.

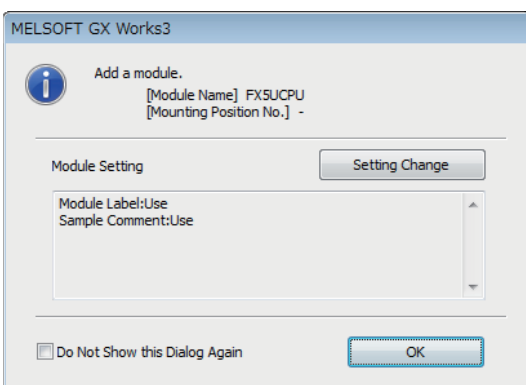

3. Set the master/intelligent device module as follows.

Module can also be added by placing on the module configuration diagram. For the operation of the engineering tool, refer to the following manual.

GX Works3 Operating Manual

[Navigation window] ⇒ [Parameter] ⇒ [Module Information] ⇒ Right-click ⇒ [Add New Module]

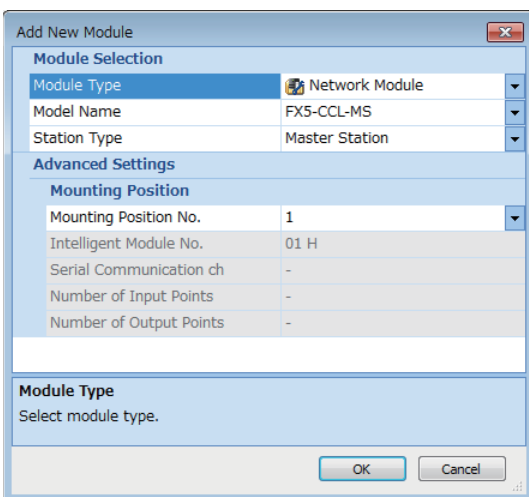

4. Click the [OK] button to add the module labels of the master/intelligent device module.

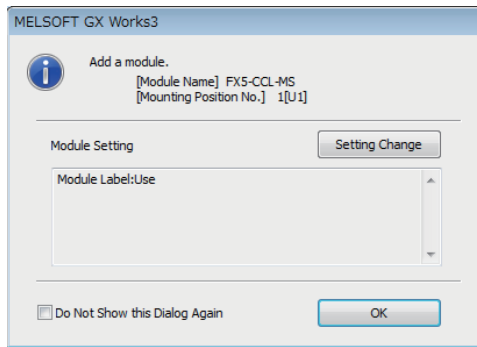

5. Set the items in "Required Settings" as follows.

[Navigation window] ⇒ [Parameter] ⇒ [Module Information] ⇒ [FX5-CCL-MS] ⇒ [Module Parameter] ⇒ [Required Settings]

Setting Item	Item	Setting
Station Type	Station Type	Master Station
	Mode	Remote Net Ver.1 Mode
Station No.	Station No.	0
	Transmission Speed	10Mbps
Parameter Setting Method	Setting Method of Basic/Application Settings	Parameter Editor

6. Set the network configuration as follows.

[Navigation window] ⇒ [Parameter] ⇒ [Module Information] ⇒ [FX5-CCL-MS] ⇒ [Module Parameter] ⇒ [Basic Settings] ⇒ [Network Configuration Settings]

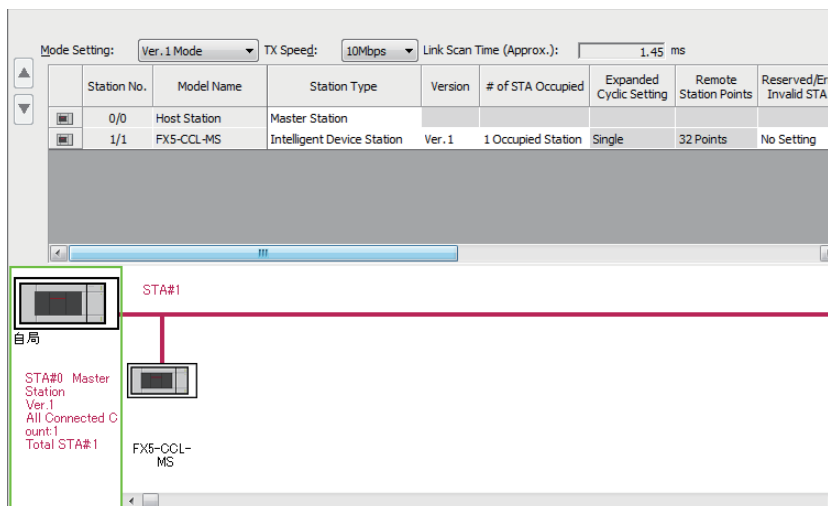

7. Set the link refresh settings as follows.

[Navigation window] ⇒ [Parameter] ⇒ [Module Information] ⇒ [FX5-CCL-MS] ⇒ [Module Parameter] ⇒ [Basic Settings] ⇒ [Link Refresh Settings]

No.	Link Side					CPU Side				
	Device Name	Points	Start	End		Target	Device Name	Points	Start	End
-	SB				↔					
-	SW				↔					
1	RX	32	00000	0001F	↔	Specify Device	X	32	1000	1037
2	RY	32	00000	0001F	↔	Specify Device	Y	32	1000	1037
3	RW	4	00000	00003	↔	Specify Device	W	4	00000	00003
4	RWw	4	00000	00003	↔	Specify Device	W	4	00100	00103

**8.** Set the supplementary cyclic settings as follows.

[Navigation window] ⇒ [Parameter] ⇒ [Module Information] ⇒ [FX5-CCL-MS] ⇒ [Module Parameter] ⇒ [Application Settings] ⇒ [Supplementary Cyclic Settings]

Item	Setting
<b>Supplementary Cyclic Settings</b>	
Input Data from Data Link Faulty Station	Clear
Output Mode upon CPU STOP	Send the output data
Station-based Block Data Assurance	Disable
Number of Retries	3 Times
Automatic Reconnection Station Count	1PLC
Data Link Setting at CPU Failure	Stop the Data Link
Scan Mode Setting	Asynchronous with Sequence Scan
Output Mode upon CPU Error	Clear
<b>Parameter Name</b>	
Parameter Name	

**9.** Write the set parameters to the CPU module on the master station. Then reset the CPU module or power off and on the system.

[Online] ⇒ [Write to PLC]

**Point**

In this example, default values are used for parameters that are not shown above. For the parameter setting, refer to the chapter explaining the parameters in this manual. (Page 63 PARAMETER SETTINGS)

## Setting in intelligent device stations

Connect the engineering tool to the CPU module on the intelligent device station and set the parameters.

**1.** Set the CPU module and add the module labels of the CPU module. The setting method of the CPU module and addition method of the module label are the same as those of the master station. (Page 95 Setting in the master station)

**2.** Set the master/intelligent device module as follows.

Module can also be added by placing on the module configuration diagram. For the operation of the engineering tool, refer to the following manual.

GX Works3 Operating Manual

[Navigation window] ⇒ [Parameter] ⇒ [Module Information] ⇒ Right-click ⇒ [Add New Module]

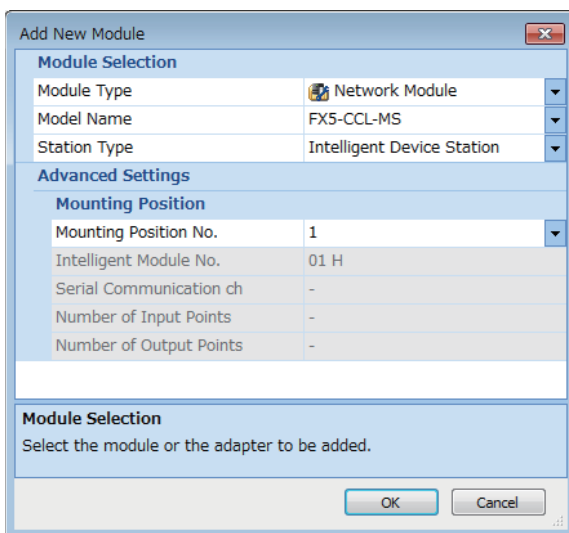

**3.** Add the module labels of the master/intelligent device module. The addition method of the module label is the same as that of the master station. (Page 95 Setting in the master station)

4. Set the items in "Required Settings" as follows.

[Navigation window] ⇒ [Parameter] ⇒ [Module Information] ⇒ [FX5-CCL-MS] ⇒ [Module Parameter] ⇒ [Required Settings]

Item	Setting
<b>Station Type</b>	
Station Type	Intelligent Device Station
<b>Mode</b>	
Communication Mode	Remote Net Ver.1 Mode
<b>Station No.</b>	
Station No.	1
<b>Transmission Speed</b>	
Transmission Speed	Auto-tracking
<b>Parameter Setting Method</b>	
Setting Method of Basic/Application Settings	Parameter Editor

5. Set the own station setting as follows.

[Navigation window] ⇒ [Parameter] ⇒ [Module Information] ⇒ [FX5-CCL-MS] ⇒ [Module Parameter] ⇒ [Basic Settings] ⇒ [Own Station Setting]

Item	Setting
<b>Own Station Setting</b>	
Number of Occupied Stations	1 Station Occupied
Extended Cyclic Setting	Single
<b>Network Configuration Settings</b>	
CC-Link Configuration	<Detailed Setting>
<b>Link Refresh Settings</b>	
Link Refresh Settings	<Detailed Setting>
<b>Initial Settings</b>	
Remote Device Station Initial Settings	<Detailed Setting>

6. Set the link refresh settings as follows.

[Navigation window] ⇒ [Parameter] ⇒ [Module Information] ⇒ [FX5-CCL-MS] ⇒ [Module Parameter] ⇒ [Basic Settings] ⇒ [Link Refresh Settings]

No.	Link Side					CPU Side				
	Device Name	Points	Start	End		Target	Device Name	Points	Start	End
-	SB				↔					
-	SW				↔					
1	RX	32	00000	0001F	↔	Specify Devi	X	32	1000	1037
2	RY	32	00000	0001F	↔	Specify Devi	Y	32	1000	1037
3	RWr	4	00000	00003	↔	Specify Devi	W	4	00000	00003
4	RWw	4	00000	00003	↔	Specify Devi	W	4	00100	00103

7. Set the supplementary cyclic settings as follows.

[Navigation window] ⇒ [Parameter] ⇒ [Module Information] ⇒ [FX5-CCL-MS] ⇒ [Module Parameter] ⇒ [Application Settings] ⇒ [Supplementary Cyclic Settings]

Item	Setting
<b>Supplementary Cyclic Settings</b>	
Input Data from Data Link Faulty Station	Clear
Output Mode upon CPU STOP	Send the output data
Station-based Block Data Assurance	Disable
Number of Retries	3 Times
Automatic Reconnection Station Count	1PLC
Data Link Setting at CPU Failure	Stop the Data Link
Scan Mode Setting	Asynchronous with Sequence Scan
Output Mode upon CPU Error	Clear
<b>Parameter Name</b>	
Parameter Name	

8. Write the set parameters to the CPU module on the intelligent device station. Then reset the CPU module or power off and on the system.

[Online] ⇒ [Write to PLC]

**Point**

In this example, default values are used for parameters that are not shown above. For the parameter setting, refer to the chapter explaining the parameters in this manual. (☞ Page 63 PARAMETER SETTINGS)

## Checking the data link status

Check whether data link is normally performed between the master station and intelligent device station after setting parameters for both of the stations.

1. Power on the intelligent device station, then master station to start data link.
2. When the LEDs are in the following states, data link is being performed normally.
  - LEDs on the master station

LED	Status
RUN	On
ERROR	Off
MST	On
156K	Off
625K	
2.5M	
5M	
10M	
L RUN	On
L ERR	Off
SD	Flashing <sup>*1</sup>
RD	

\*1 The LEDs may look dimly lit or off depending on the communication status.

- LEDs of intelligent device stations

LED	Status
RUN	On
ERROR	Off
MST	Off
156K	
625K	
2.5M	
5M	
10M	On
L RUN	Off
L ERR	
SD	Flashing <sup>*1</sup>
RD	

\*1 The LEDs may look dimly lit or off depending on the communication status.

# Program examples

- Sending station: Master station (station No. 0)

Classification	Label name	Description	Device
Module label	FX5CCLMS_1.bn_ModuleFailure_D	Module failure	U1\G26368.0
	FX5CCLMS_1.bn_DataLink_D	Own station data link status	U1\G26368.1
	FX5CCLMS_1.bn_ModuleReady_D	Module ready	U1\G26368.F
	FX5CCLMS_1.bnSts_DataLinkError_Other_D[1]	Data link status of other stations (station No.1)	U1\G1664.0 (SW0080.0)

Label to be defined

Define global labels as shown below:

	Label Name	Data Type	Class	Assign (Device/Label)
1	DataSend	Bit	VAR_GLOBAL	X10
2	DataRecv	Bit	VAR_GLOBAL	Y11
3	DataLinkError	Bit	VAR_GLOBAL	Y17
4	StartDirection	Bit	VAR_GLOBAL	M100
5				

Device	Description	Module
X1000 to X1037	Remote input (RX0 to RX1F)	FX5-CCL-MS (intelligent device station)
Y1000 to Y1037	Remote output (RY0 to RY1F)	
W0 to W3	Remote register (RWr0 to RWr3)	
W100 to W103	Remote register (RWw0 to RWw3)	

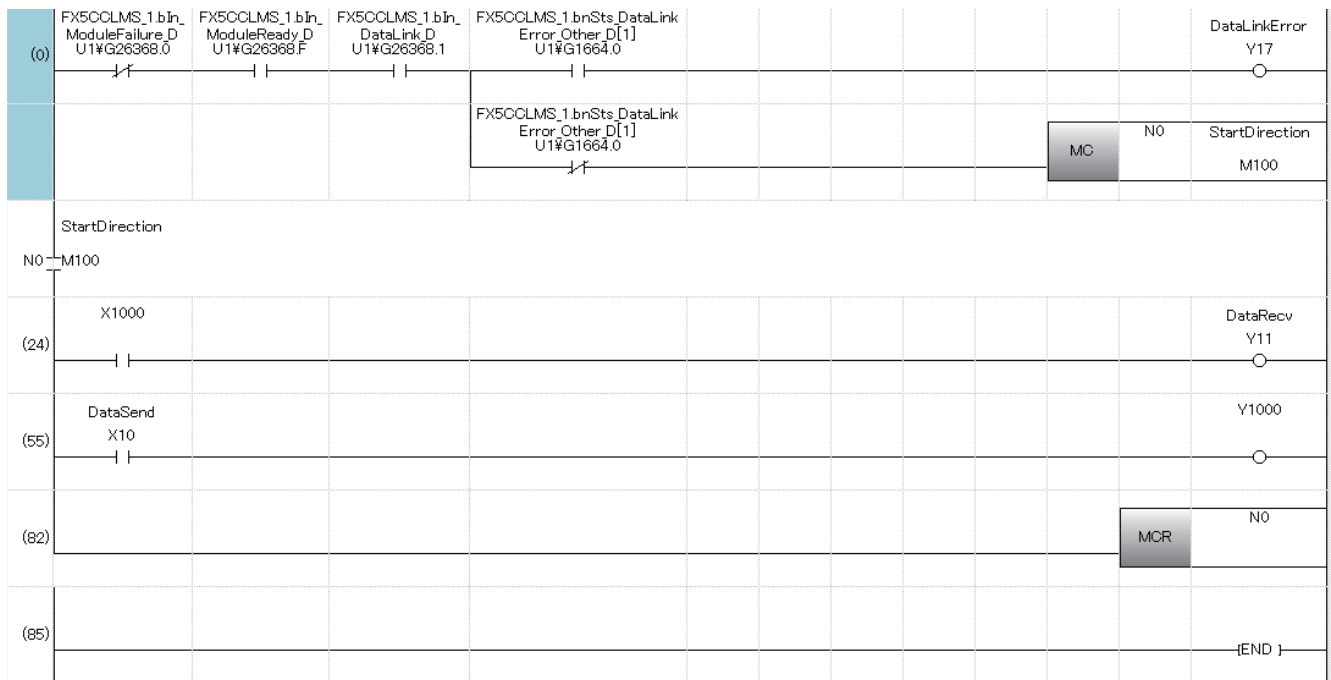

- (0) The data link status is checked.
- (24) Control program using receive data from an intelligent device station
- (55) Program to create send data to an intelligent device station.

- Receiving station: Intelligent device stations (station No.1)

Classification	Label name	Description	Device	
Module label	FX5CCLMS_1.bl_n_ModuleFailure_D	Module failure	U1\G26368.0	
	FX5CCLMS_1.bl_n_DataLink_D	Own station data link status	U1\G26368.1	
	FX5CCLMS_1.bl_n_ModuleReady_D	Module ready	U1\G26368.F	
Label to be defined	Define global labels as shown below:			
	Label Name	Data Type	Class	Assign (Device/Label)
	1 DataSend	Bit	VAR_GLOBAL	X10
	2 DataRecv	Bit	VAR_GLOBAL	Y11
	3 StartDirection	Bit	VAR_GLOBAL	M100

Device	Description	Module
X1000 to X1037	Remote input (RX0 to RX1F)	FX5-CCL-MS (master station)
Y1000 to Y1037	Remote output (RY0 to RY1F)	
W0 to W3	Remote register (RWr0 to RWr3)	
W100 to W103	Remote register (RWw0 to RWw3)	

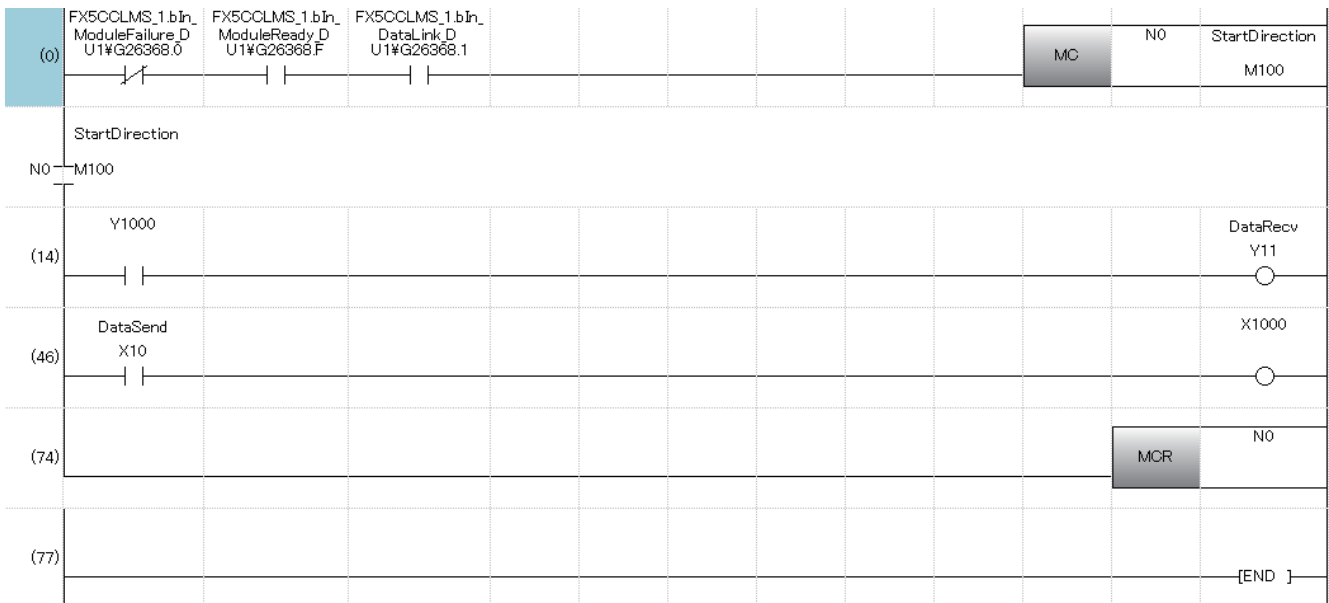

- (0) The data link status is checked.
- (14) Control program using receive data from the master station.
- (46) Program to create send data to the master station.

• Program flow

- 1 Master station (55) When 'DataSend' (X10) in the master station is turned on, Y1000 in the master station turns on and X1000 in the intelligent device station turns on.
- 2 Intelligent device station (14) When Y1000 in the intelligent device station turns on, 'DataRecv' (Y11) in the intelligent device station turns on.
- 3 Intelligent device station (46) When 'DataSend' (X10) in the intelligent device station is turned on, X1000 of the intelligent device station turns on and X1000 of the master station turns on.
- 4 Master station (24) When X1000 in the master station turns on, 'DataRecv' (Y11) in the master station turns on.

## To assure the integrity of cyclic data in each slave station

One of the following actions assures the integrity of cyclic data in each slave station.

Note that data integrity is not assured across slave stations.

### ■Using the engineering tool

Set "Station-based Block Data Assurance" under "Supplementary Cyclic Settings" in "Application Settings" to "Enable." (☞)

Page 77 Supplementary cyclic settings)

### ■Using a program

Interlock with RX and RY.

- Master station (station No. 0)

	Label Name	Data Type		Class	Assign (Device/Label)
1	ReqSend	Bit	...	VAR_GLOBAL	X10
2	SendData	Word [Unsigned]/Bit String [16-bit]	...	VAR_GLOBAL	D10

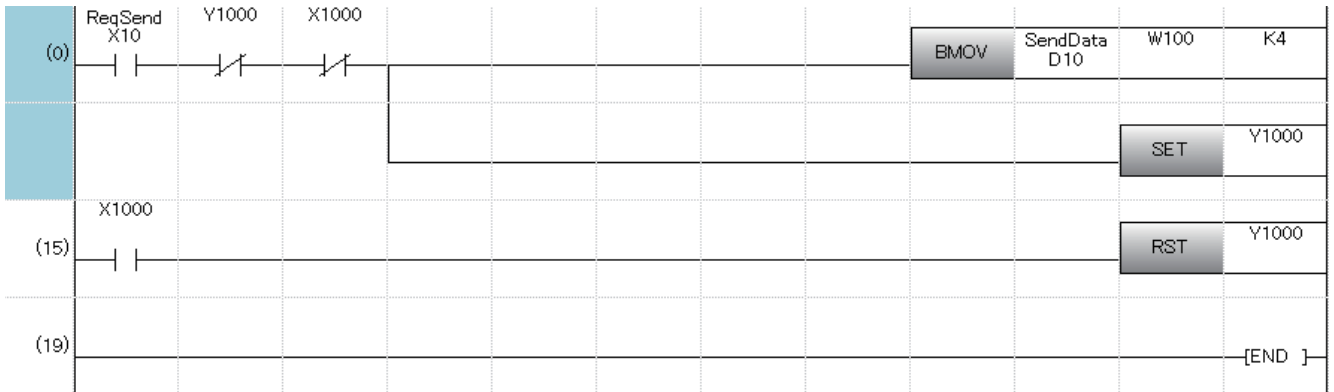

- Intelligent device stations (station No.1)

	Label Name	Data Type		Class	Assign (Device/Label)
1	ReqRecv	Bit	...	VAR_GLOBAL	X11
2	RecvData	Word [Unsigned]/Bit String [16-bit]	...	VAR_GLOBAL	D11

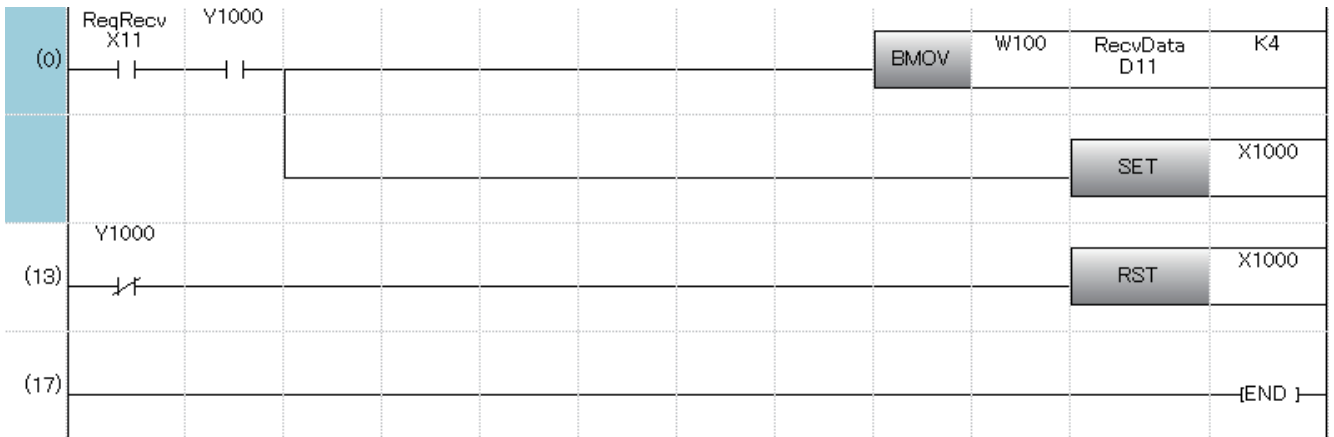



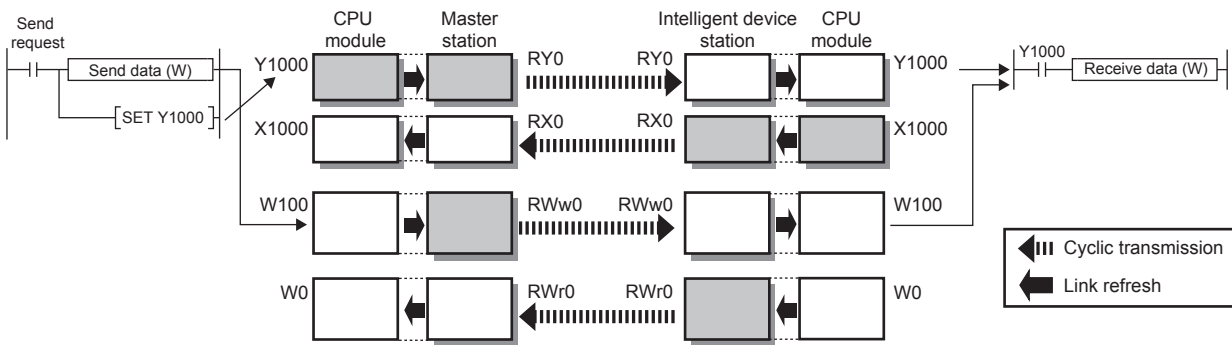

• Program flow

- |  |  |
|--|--|
| <ul style="list-style-type: none"> <li>① Master station (0)</li> <li>② Master station (0)</li> <li>③ Master station (0)</li> <li>④ Intelligent device station (0)</li> <li>⑤ Intelligent device station (0)</li> <li>⑥ Intelligent device station (0)</li> <li>⑦ Master station (15)</li> <li>⑧ Intelligent device station (13)</li> </ul> | <ul style="list-style-type: none"> <li>Turn on 'ReqSend' (X10) in the master station.</li> <li>Turn on 'ReqRecv' (X11) in the intelligent device station.</li> <li>Information in 'SendData' (D10 to D13) is transferred to W100 to W103 (RWw0 to RWw3).</li> <li>After the information is stored in W100 to W103, turn on Y1000 for a handshake in the master station.*1</li> <li>Data in RWw is sent before data in RY is sent by cyclic transmission. Then Y1000 in the intelligent device station turns on.</li> <li>Information in W100 to W103 is stored in 'RecvData' (D11 to D14).</li> <li>After the information is stored in 'RecvData' (D11 to D14), turn on X1000 for a handshake in the intelligent device station.*1</li> <li>Turning on X1000 in the intelligent device station, turns off Y1000 in the master station.</li> <li>Turning off Y1000 in the master station, turns off Y1000 in the intelligent device station.</li> </ul> |
|--|--|

\*1 If a handshake is performed in one bit of the remote I/O (RX, RY) in a station with the number of occupied stations of two or more, the integrity of cyclic data is assured per slave station. An interlock for the number of occupied stations (in units of four words) is not required.

## 8.4 Examples of Parameter Settings Using Program

Shown below is an example of parameters setting of the master and intelligent device stations using a sequence program.

### System configuration example

Following system configuration is used to explain the example of parameters setting using the program.

#### System Configuration

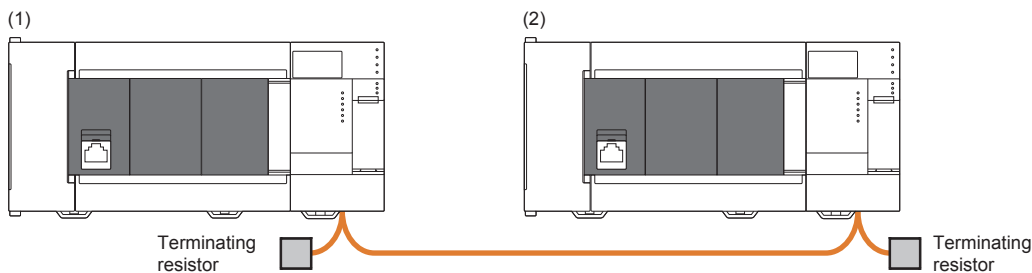

No.	Model	Station type	Mode	Intelligent module number	Station No.	Number of occupied stations
(1)	FX5U-32MR/ES	—				
	FX5-CCL-MS	Master station	Remote net Ver.1 mode	01H	0	—
(2)	FX5U-32MR/ES	—				
	FX5-CCL-MS	Intelligent device station	Remote net Ver.1 mode	01H	2	3

#### Parameter setting details

Following are the details of parameter settings configured using the program.

##### ■Master station

Item	Setting value	Remarks
Total number of connected stations	2 (Units)	—
Number of retries	3 (Times)	—
Number of automatic return stations	1 (Units)	—
Data link faulty station setting	0: Hold	—
Data link setting at CPU failure	0: Data link stopped	—
Upon CPU STOP setting	0: Send the output data	—
Reserved station setting	0: Not set	Set it optionally as required.
Error invalid station setting	0: Not set	Set it optionally as required.
Station information (1st station)	0000H: Not use (Default value)	—
Station information (2nd station)	2302H: Ver.1-compatible intelligent device station, 3 station occupied, and station number 2	—

## ■ Intelligent device station

Item	Setting value	Remarks
Station No.	2	The engineering tool can also be used to set it. However, if the program is used to set the station No., the program's setting value overwrites it.
Number of occupied stations	3: 3 Station occupied	—
Extended cyclic setting	1: Double	—
Data link faulty station setting	0: Hold	—
Upon CPU STOP setting	0: Send the output data	—

## Setting in the master station

Connect the engineering tool to the CPU module of the master station and set the parameters.

1. Set the CPU module as follows.

 [Project] ⇒ [New]

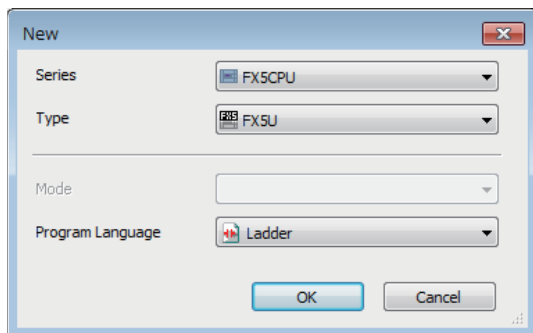

2. Click the [OK] button to add the module labels of the CPU module.

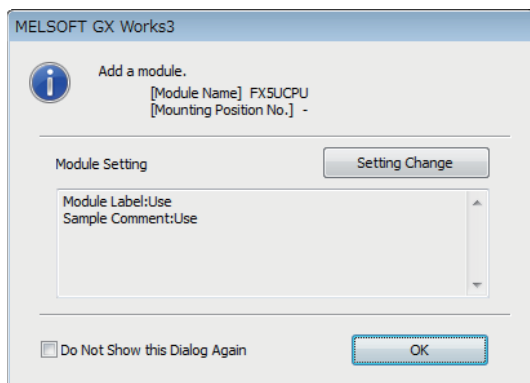

**3.** Set the master/intelligent device module as follows.

Module can also be added by placing on the module configuration diagram. For the operation of the engineering tool, refer to the following manual.

GX Works3 Operating Manual

[Navigation window] ⇒ [Parameter] ⇒ [Module Information] ⇒ Right-click ⇒ [Add New Module]

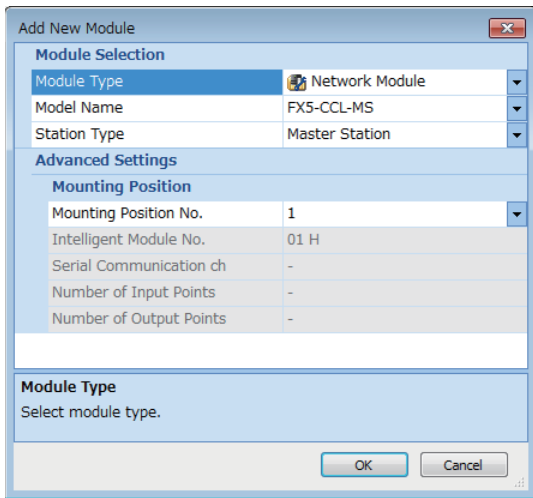

**4.** Click the [OK] button to add the module labels of the master/intelligent device module.

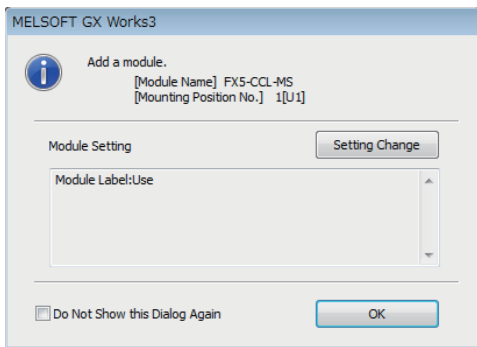

**5.** Set the items in "Required Settings" as follows.

[Navigation window] ⇒ [Parameter] ⇒ [Module Information] ⇒ [FX5-CCL-MS] ⇒ [Module Parameter] ⇒ [Required Settings]

Setting Item	
Item	Setting
<b>Station Type</b>	
Station Type	Master Station
<b>Mode</b>	
Communication Mode	Remote Net Ver.1 Mode
<b>Station No.</b>	
Station No.	0
<b>Transmission Speed</b>	
Transmission Speed	156kbps
<b>Parameter Setting Method</b>	
Setting Method of Basic/Application Settings	Program

**6.** Create a program. ( Page 108 Program examples)

**7.** Write the set parameters and programs to the CPU module of the master station. Then reset the CPU module or power off and on the system.

[Online] ⇒ [Write to PLC]

# Setting in intelligent device stations

Connect the engineering tool to the CPU module of the intelligent device station and set the parameters.

1. Set the CPU module and add the module labels of the CPU module. The setting method of the CPU module and addition method of the module label are the same as those of the master station. (Page 105 Setting in the master station)
2. Set the master/intelligent device module as follows.

Module can also be added by placing on the module configuration diagram. For the operation of the engineering tool, refer to the following manual.

GX Works3 Operating Manual

[Navigation window] ⇒ [Parameter] ⇒ [Module Information] ⇒ Right-click ⇒ [Add New Module]

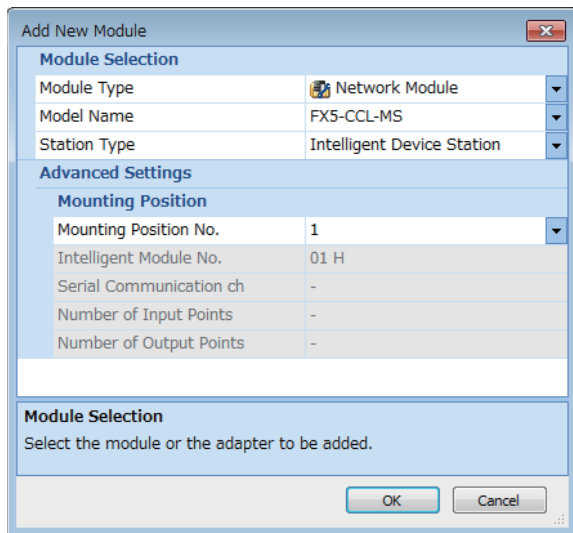

3. Add the module labels of the master/intelligent device module. The addition method of the module label is the same as that of the master station. (Page 105 Setting in the master station)
4. Set the items in "Required Settings" as follows.

[Navigation window] ⇒ [Parameter] ⇒ [Module Information] ⇒ [FX5-CCL-MS] ⇒ [Module Parameter] ⇒ [Required Settings]

Item	Setting
<b>Station Type</b>	
Station Type	Intelligent Device Station
<b>Mode</b>	
Communication Mode	Remote Net Ver.1 Mode
<b>Station No.</b>	
Station No.	2
<b>Transmission Speed</b>	
Transmission Speed	Auto-tracking
<b>Parameter Setting Method</b>	
Setting Method of Basic/Application Settings	Program

5. Create a program. (Page 108 Program examples)
6. Write the set parameters and programs to the CPU module on the intelligent device station. Then reset the CPU module or power off and on the system.

[Online] ⇒ [Write to PLC]

## Program examples

- Master station (station No. 0)

Classification	Label name	Description	Device
Module label	FX5CCLMS_1.uVal_Number_ConnectedModules_D	Total number of connected stations	U1\G1
	FX5CCLMS_1.uVal_Number_Retries_D	Number of retries	U1\G2
	FX5CCLMS_1.uVal_Number_AutomaticReturnStation_D	Number of automatic return stations	U1\G3
	FX5CCLMS_1.uSts_HoldInputDataFromErrorStation_D	Data link faulty station setting	U1\G5
	FX5CCLMS_1.uSts_DataLinkContinueDuringCpuDown_D	Data link setting at CPU failure	U1\G6
	FX5CCLMS_1.uStsClearOutputDuringCpuStop_D	Upon CPU STOP setting	U1\G13
	FX5CCLMS_1.bnSts_ReservedSetting_D[1] to [28]	Reserved station setting	U1\G16, U1\G17
	FX5CCLMS_1.bnSts_ErrorInvalidSetting_D[1] to [28]	Error invalid station setting	U1\G20, U1\G21
	FX5CCLMS_1.wnSts_StationInformation_D[1] to [28]	Station information	U1\G32 to U1\G59
	FX5CCLMS_1.bReq_DataLinkStop_D	Data link stop (SB0002)	U1\G1504.2
	FX5CCLMS_1.bCompl_DataLinkStop_D	Data link stop completion (SB0045)	U1\G1508.5
	FX5CCLMS_1.uSts_Parameter_D	Parameter status of own station (SW0068)	U1\G1640
	FX5CCLMS_1.bn_ModuleFailure_D	Module failure	U1\G26368.0
	FX5CCLMS_1.bn_DataLink_D	Own station data link status	U1\G26368.1
	FX5CCLMS_1.bn_DataLinkStart_D	Completion of data link start using parameters in buffer memory	U1\G26368.6
	FX5CCLMS_1.bn_DataLinkError_D	Abnormal completion of data link start using parameters in buffer memory	U1\G26368.7
	FX5CCLMS_1.bn_ModuleReady_D	Module ready	U1\G26368.F
	FX5CCLMS_1.bOut_DataLinkRequest_D	Request to start data link using parameters in buffer memory	U1\G26370.6

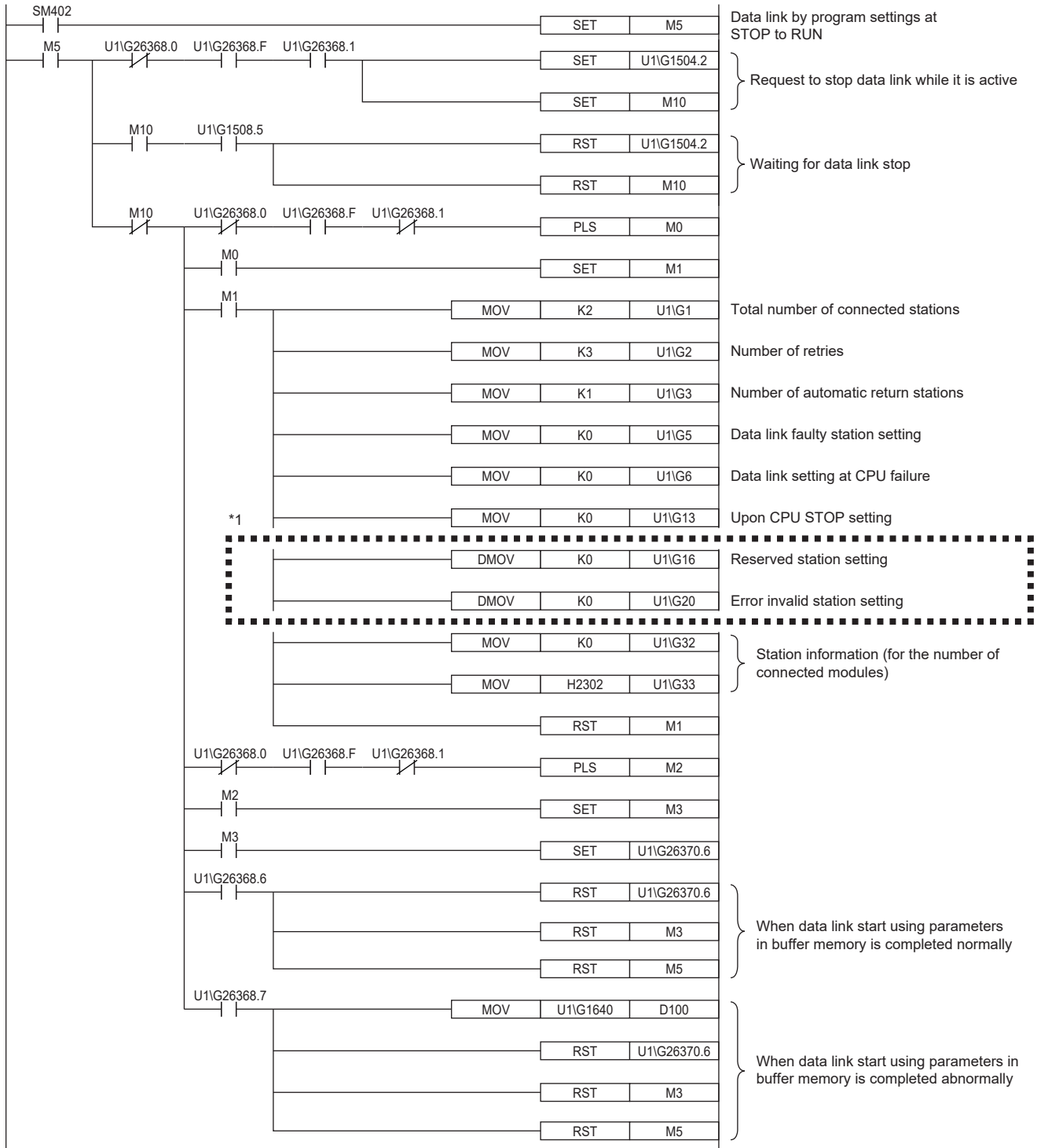

\*1 Set them only when required.

• Intelligent device stations (station No. 2)

Classification	Label name	Description	Device
Module label	FX5CCLMS_1.uSts_HoldInputDataFromErrorStation_D	Data link faulty station setting	U1\G5
	—	Number of occupied stations	U1\G11
	—	Extended cyclic setting	U1\G12
	FX5CCLMS_1.uStsClearOutputDuringCpuStop_D	Upon CPU STOP setting	U1\G13
	FX5CCLMS_1.uSts_StationNumber_D	Station No.	U1\G14
	FX5CCLMS_1.bReq_DataLinkStop_D	Data link stop (SB0002)	U1\G1504.2
	FX5CCLMS_1.bCompl_DataLinkStop_D	Data link stop completion (SB0045)	U1\G1508.5
	FX5CCLMS_1.uSts_Parameter_D	Parameter status of own station (SW0068)	U1\G1640
	FX5CCLMS_1.bIn_ModuleFailure_D	Module failure	U1\G26368.0
	FX5CCLMS_1.bIn_DataLink_D	Own station data link status	U1\G26368.1
	FX5CCLMS_1.bIn_DataLinkStart_D	Completion of data link start using parameters in buffer memory	U1\G26368.6
	FX5CCLMS_1.bIn_DataLinkError_D	Abnormal completion of data link start using parameters in buffer memory	U1\G26368.7
	FX5CCLMS_1.bIn_ModuleReady_D	Module ready	U1\G26368.F
	FX5CCLMS_1.bOut_DataLinkRequest_D	Request to start data link using parameters in buffer memory	U1\G26370.6

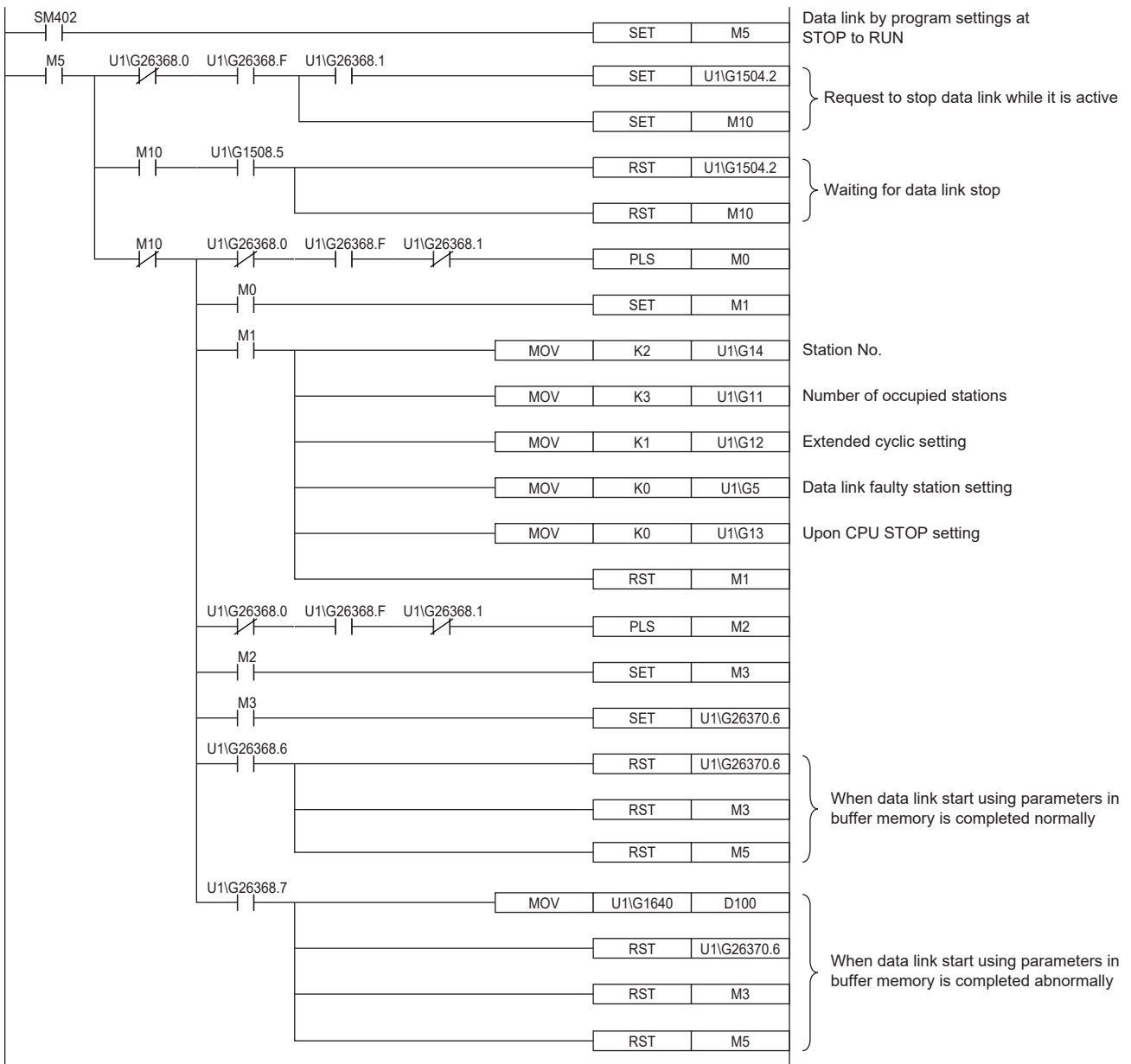



## Checking the data link status

Check whether data link is normally performed between the master station and intelligent device station after setting parameters for both of the stations.

1. In the order of intelligent device and master stations, transfer the CPU module's state from STOP to RUN (turn on "Request to start data link using parameters in buffer memory" (Un\G26370 b6)) and start the data link.

2. When the LEDs are in the following states, data link is being performed normally

- LEDs on the master station

LED	Status
RUN	On
ERROR	Off
MST	On
156K	Off
625K	
2.5M	
5M	
10M	
L RUN	On
L ERR	Off
SD	Flashing <sup>*1</sup>
RD	

\*1 The LEDs may look dimly lit or off depending on the communication status.

- LEDs of intelligent device stations

LED	Status
RUN	On
ERROR	Off
MST	Off
156K	
625K	
2.5M	
5M	
10M	On
L RUN	Off
L ERR	
SD	Flashing <sup>*1</sup>
RD	

\*1 The LEDs may look dimly lit or off depending on the communication status.

# 9 TROUBLESHOOTING

This chapter describes how to identify and remove the cause of an error in the master/intelligent device module.

## 9.1 Checking with LED

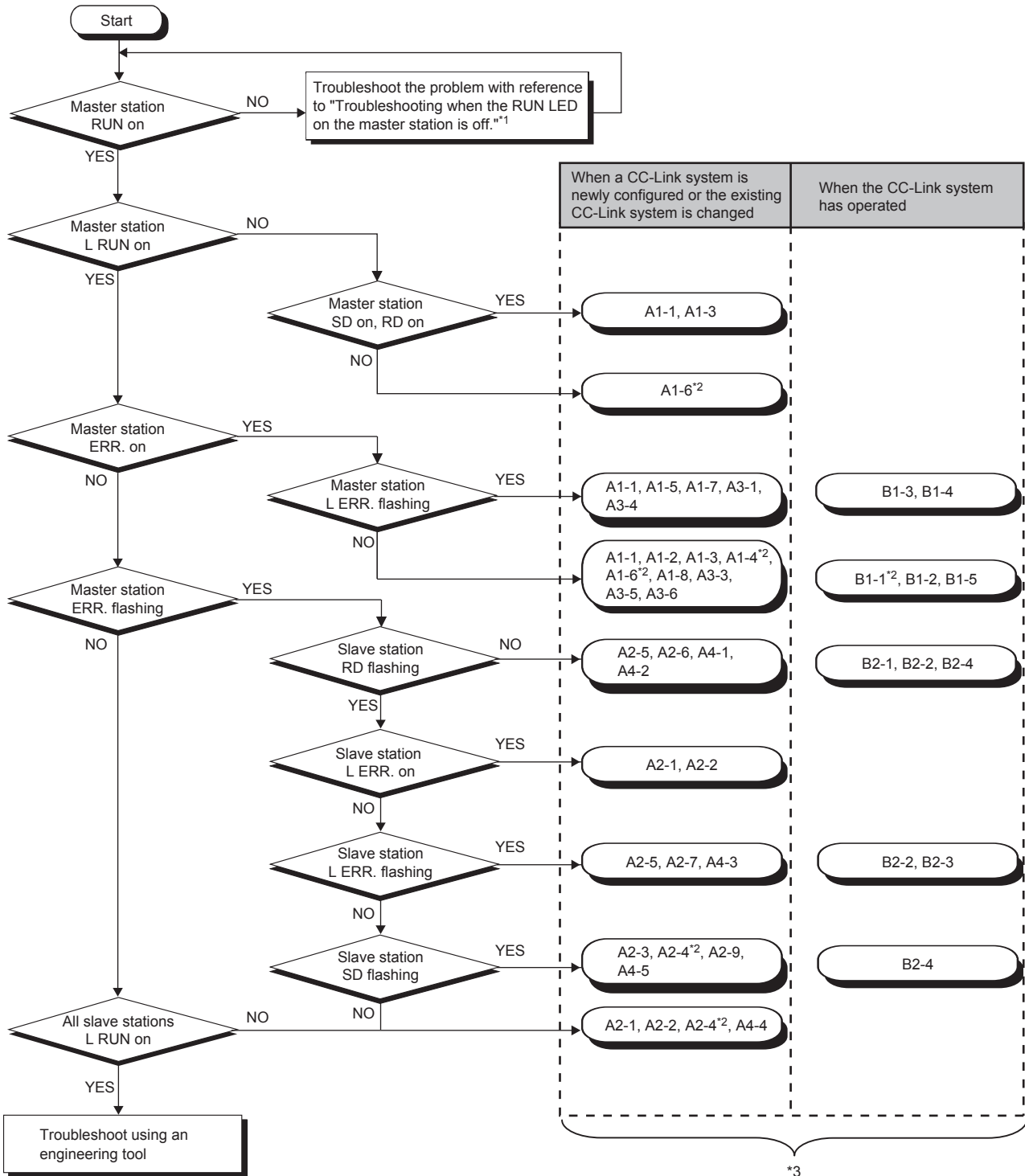

\*1 Page 113 When the RUN LED of the master station turns off

\*2 An engineering tool is required to check the error details.

\*3 The item corresponds to the number of the check item for when a slave station is disconnected. Refer to the corresponding check item and take the action. (Page 128 When a slave station is disconnected)

## When the RUN LED of the master station turns off

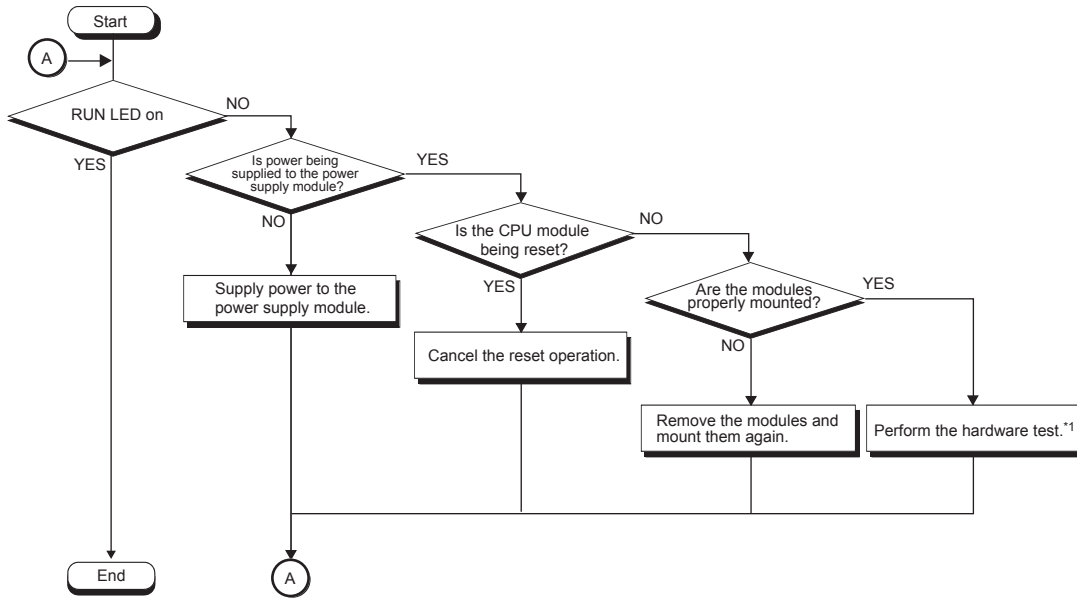

\*1 Page 125 Hardware Test

# 9.2 Checking the System Status

Perform the CC-Link diagnostics to check the system status and error details or to perform a line test for troubleshooting. CC-Link diagnostics is performed at the master station.

[Diagnostics] ⇒ [CC-Link Diagnostics]

**Point**

When the master/intelligent device module is used as an intelligent device station, connect it to the master station of the CC-Link system and perform the CC-Link diagnostics.

For details of the CC-Link diagnostics, refer to the manual of the master station being used.

The following figure shows how to perform troubleshooting using CC-Link diagnostics.

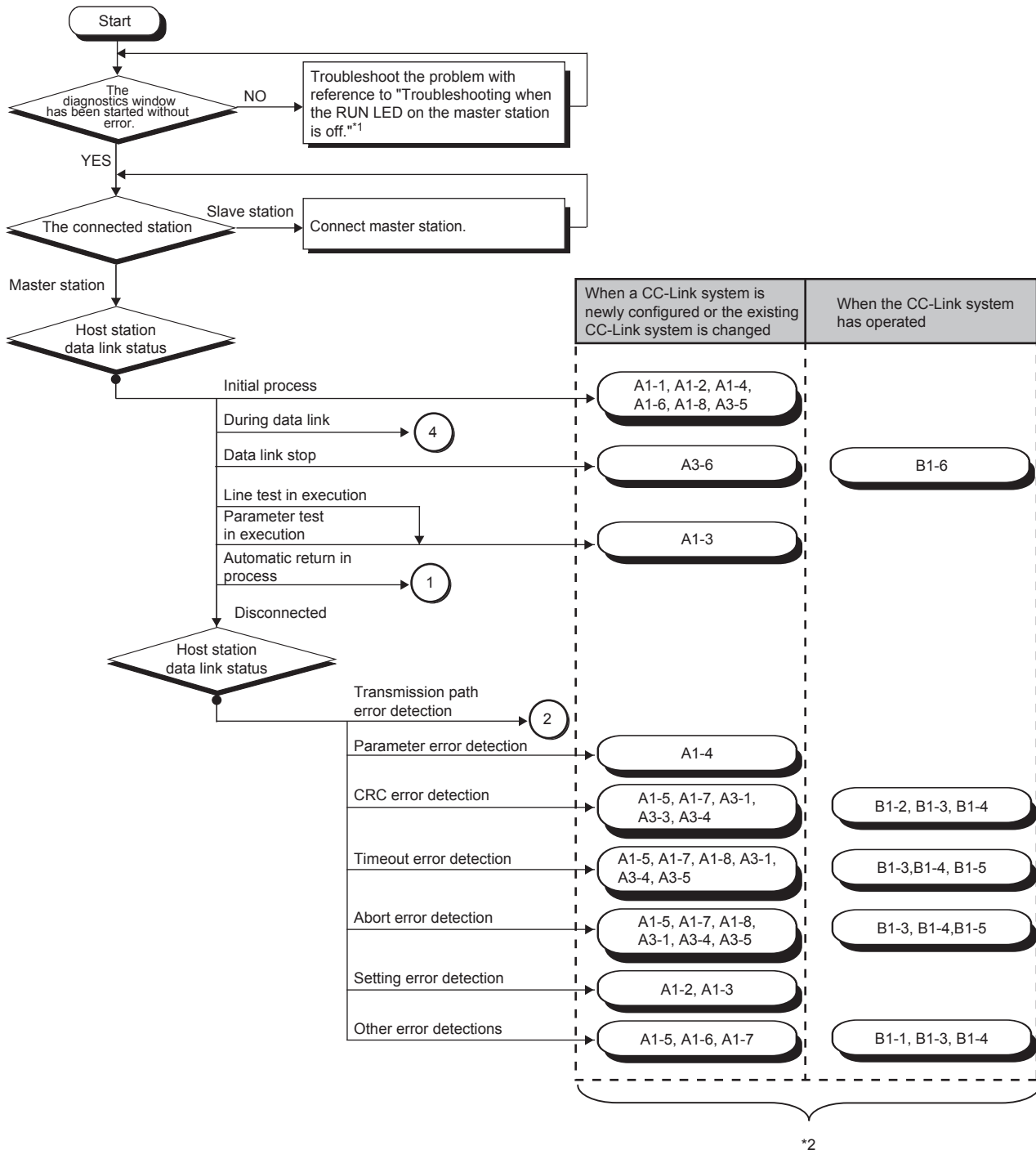

\*1 Page 113 When the RUN LED of the master station turns off

\*2 The item corresponds to the number of the check item for when a slave station is disconnected. Refer to the corresponding check item and take the action. ( Page 128 When a slave station is disconnected)

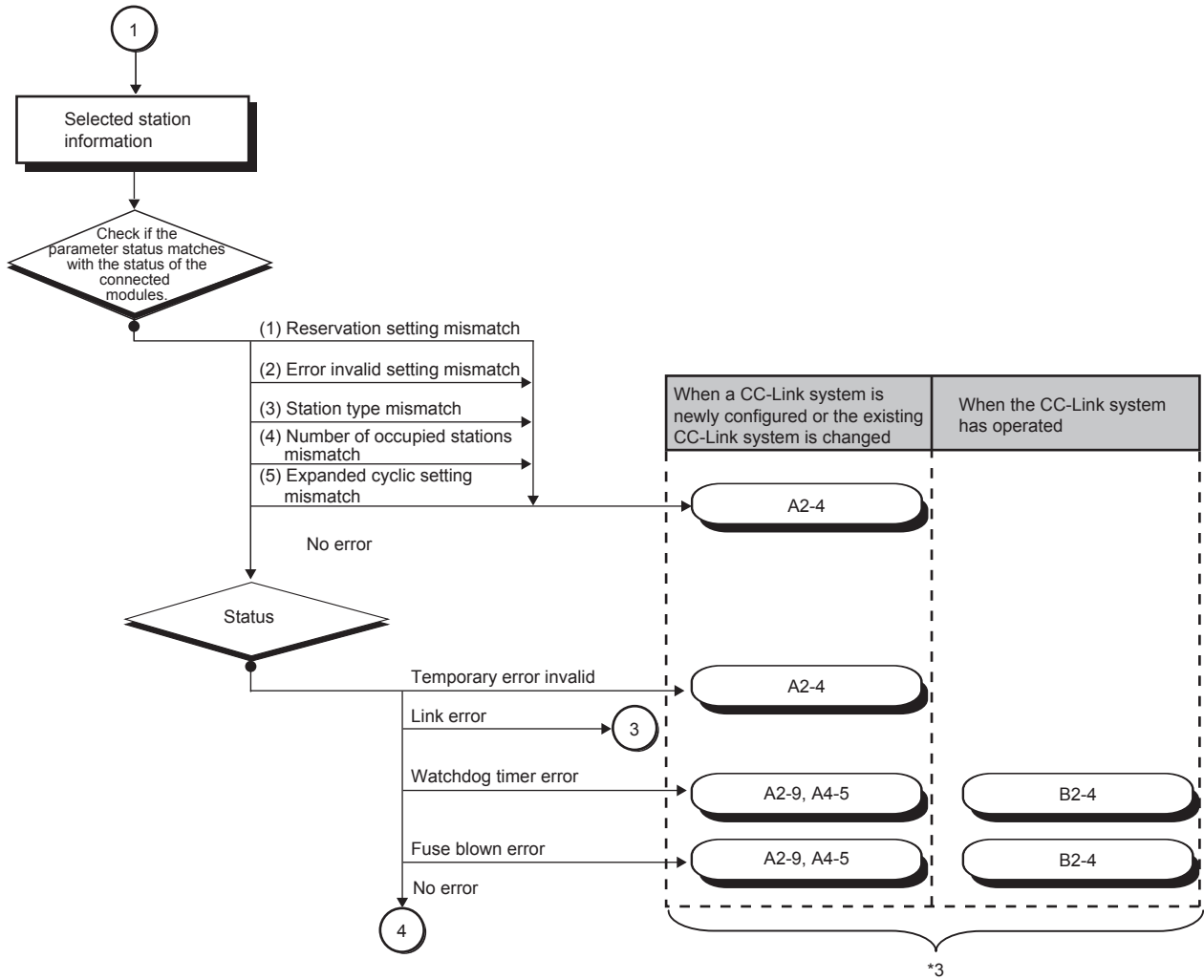

\*3 The item corresponds to the number of the check item for when a slave station is disconnected. Refer to the corresponding check item and take the action. (Page 128 When a slave station is disconnected)

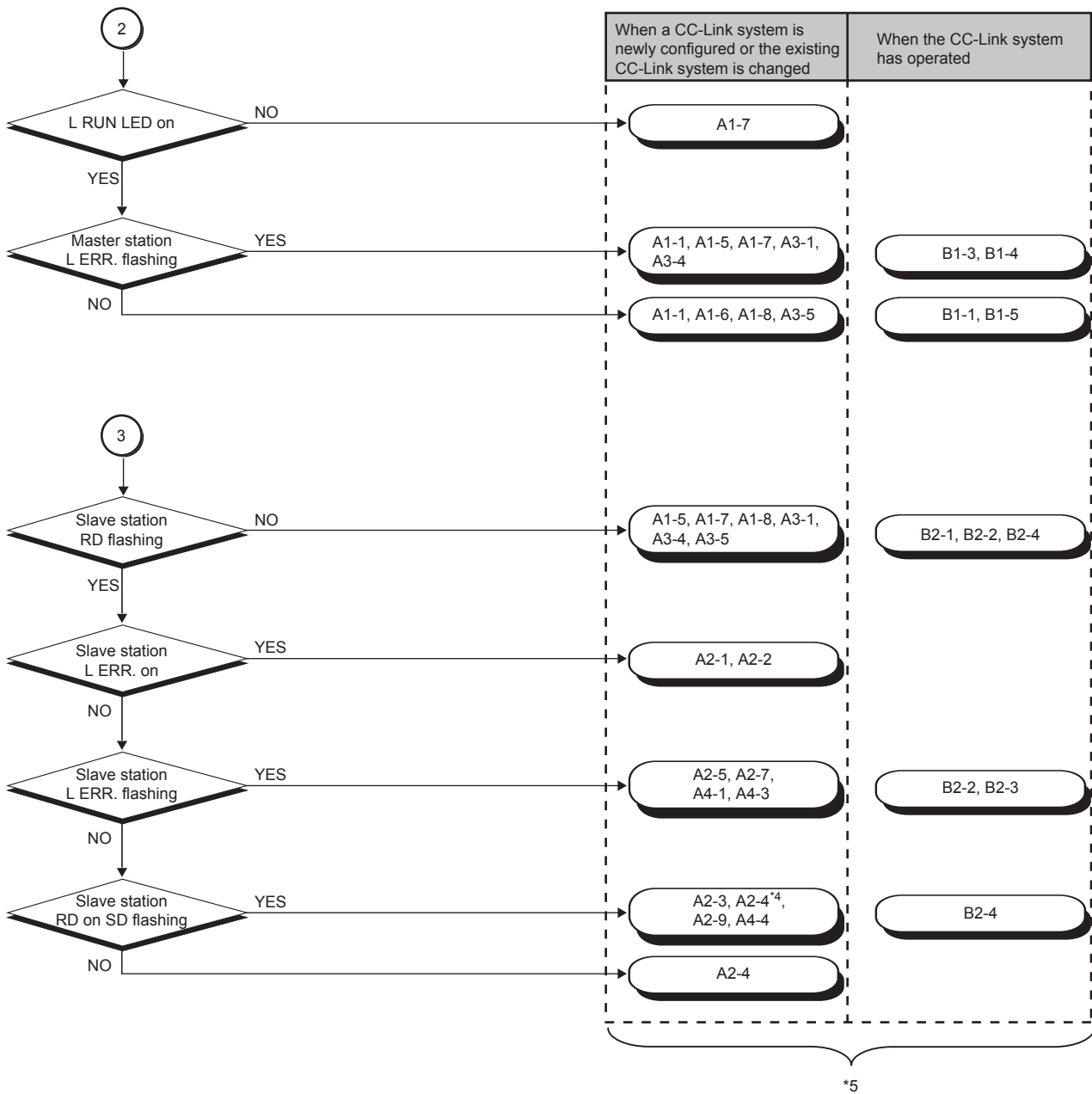

\*4 An engineering tool is required to check the error details.

\*5 The item corresponds to the number of the check item for when a slave station is disconnected. Refer to the corresponding check item and take the action. (Page 128 When a slave station is disconnected)

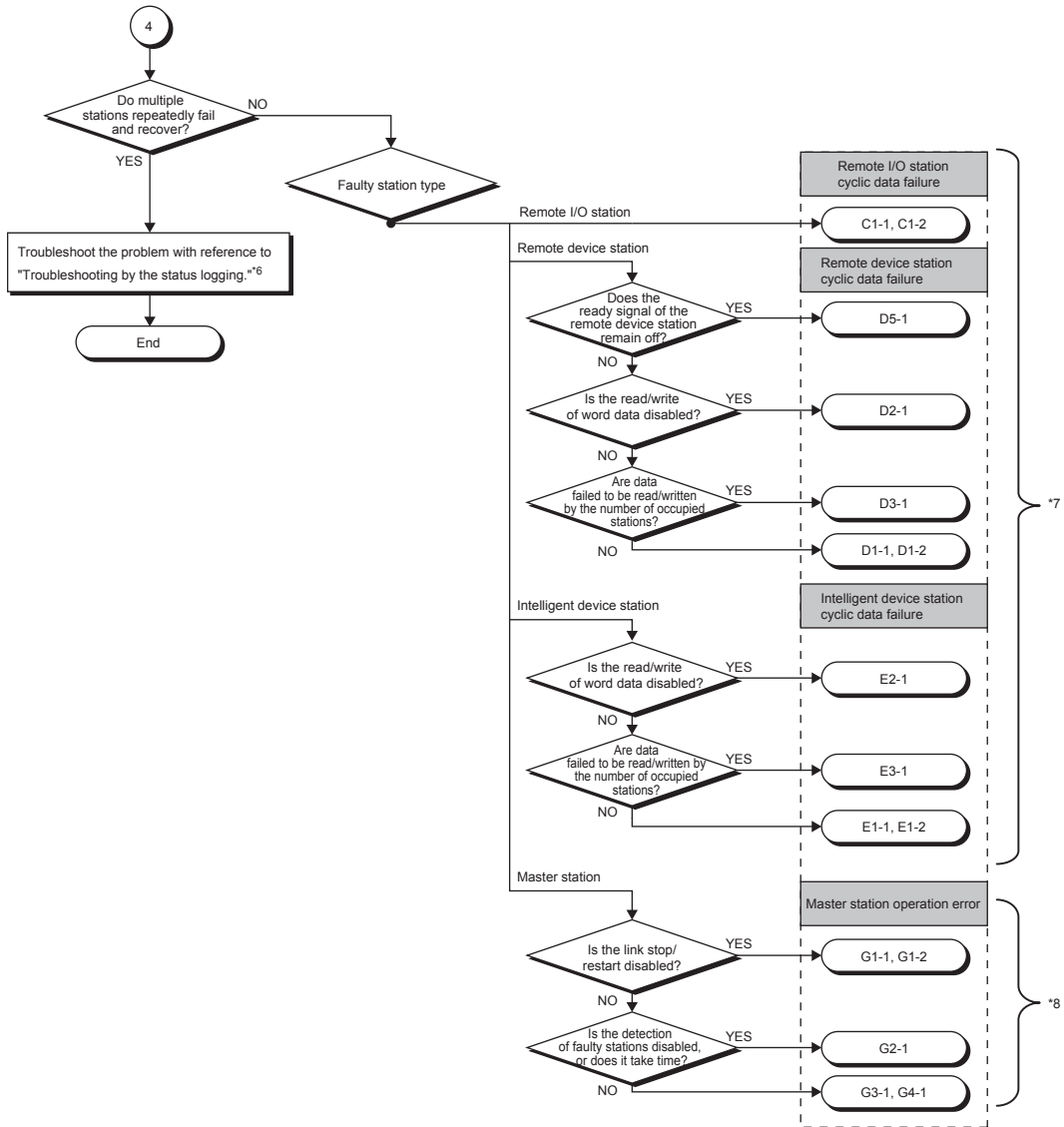

\*6 Page 122 Status logging

\*7 The item corresponds to the number of the check item for when cyclic transmission cannot be performed. Refer to the corresponding check item and take the action. ( Page 126 When cyclic transmission cannot be performed)

\*8 The item corresponds to the number of the check item for when operation error occurs on the master station. Refer to the corresponding check item and take the action. ( Page 132 When operation error occurs on the master station)

## Diagnostics window

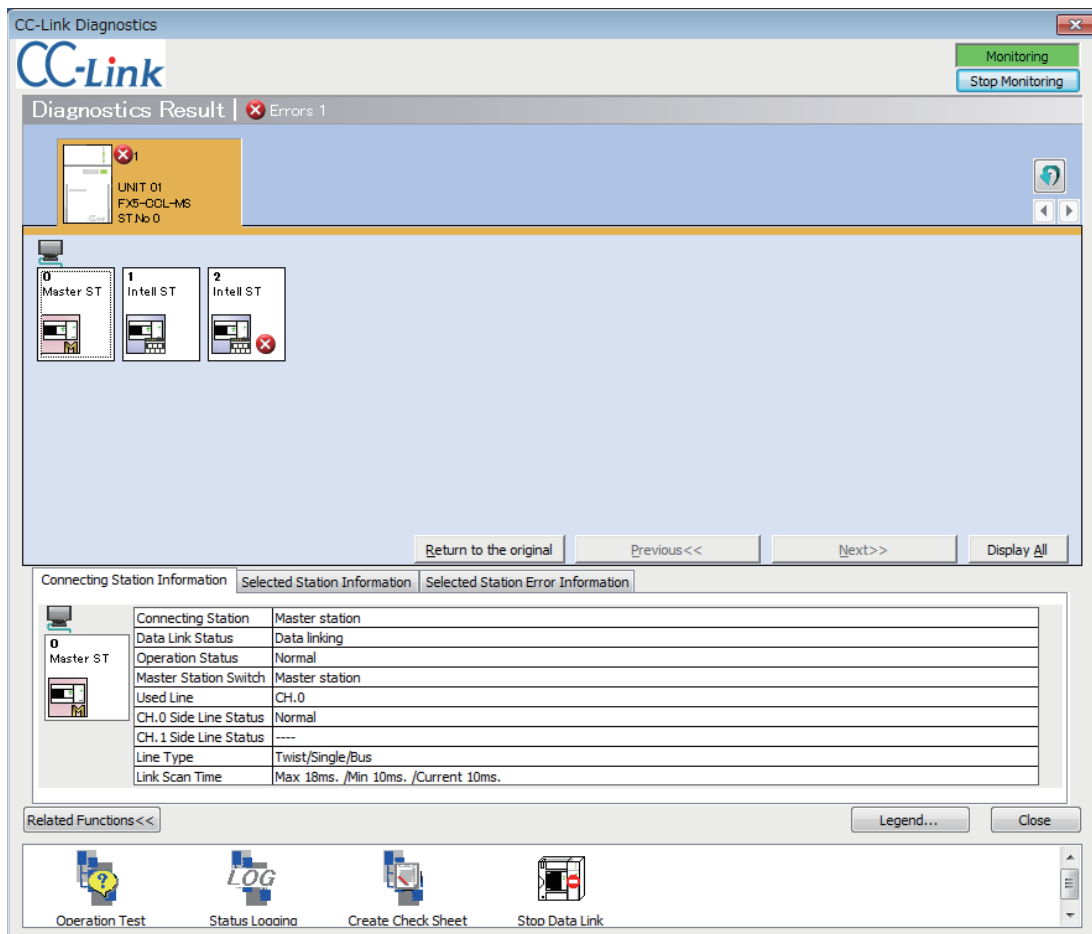

Item	Description
Diagnostics Result	Displays the number of errors and warnings that have occurred on the master/intelligent device module.
Module list/diagnostics target selection area	Displays the list of master/intelligent device modules. The number of errors (errors and warnings) that have occurred is also displayed. The diagnostics target can be changed by clicking a module icon.
Station list	Displays stations in the CC-Link system using icons. In the "Detail Display" mode, the 24th or later stations are displayed by clicking the [Next] button. Display is switched using the [Display All] button or [Detail Display] button. In the "Display All" mode, information on all stations can be viewed in one window. The icons can be freely arranged by drag-and-drop. To display the icons in the order of station number, click the [Return to the original] button.
Connected Station Information	Displays the station number of the connected station (own station).
Selected Station Information	Displays the information, such as a station number, of the station selected in the station list area (other station).
Selected Station Error Information	Displays error information of the station selected in the station list area.
Related Functions	Switches whether to display or hide the related function icons. For details on the related functions, refer to the following. <ul style="list-style-type: none"> <li>• Operation Test (☞ Page 119 Line test, Page 121 Checking the transmission speed setting)</li> <li>• Status Logging (☞ Page 122 Status logging)</li> <li>• Create Check Sheet (☞ Page 123 Creating a check sheet)</li> <li>• Start Data Link/Stop Data Link (☞ Page 124 Stopping and restarting data link)</li> </ul>
Legend	Displays the explanation of icons on the diagnostics window.

### Point

Update of the number of errors/warnings in "Diagnostics Result."

Only the number of errors/warnings that occur in the system of the module selected in "Module list/diagnostics target selection area" is updated during monitoring.

To update to the latest number of errors/warnings of other modules, update the module list.



## Line test

Check whether a Ver.1.10-compatible CC-Link dedicated cable is properly connected and data link can be performed with slave stations.

Execute the test from the master station.

### ■Procedure

1. Open the "CC-Link Diagnostics" window.

 [Diagnostics] ⇄ [CC-Link Diagnostics]

2. Double-click "Operation Test" in "Related Functions."

3. Select "Loop Test" under "Test Type."

4. Select the slave station where the line test is performed under "Test Target."

- Select "All stations (Station 1-28)" to perform the test for all stations connected.
- Select "Specified station" to perform the test for the station specified. Specify the start station number when the number of occupied stations is two or more.

5. Click the [Execute] button to start the line test. After the line test is completed, the result is displayed on the right side of the window.

- Do not write data to the buffer memory areas (buffer memory address: 5E0H and 608H) during line test.
- Do not perform a line test using a program and other peripherals at the same time. The line test may not be normally performed.

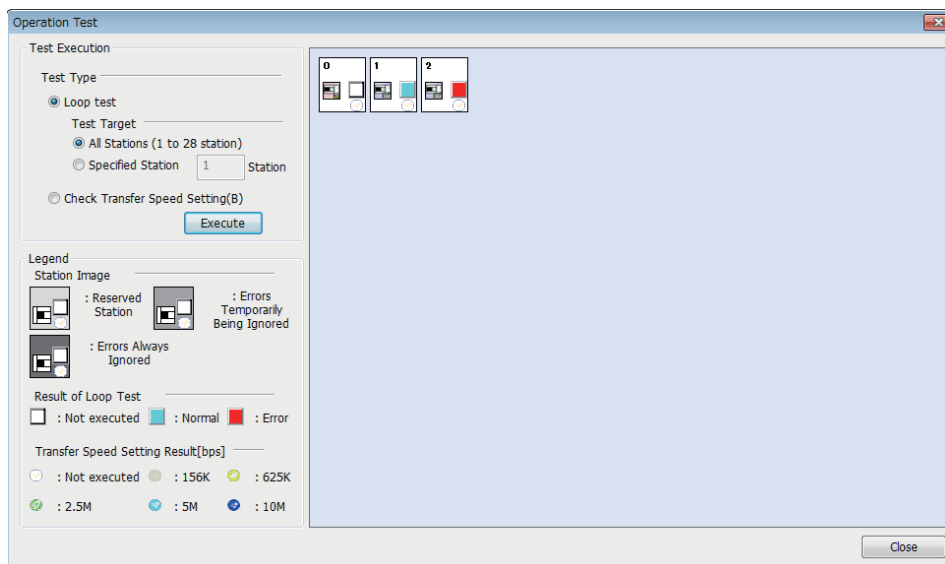

### Point

When performing a line test, do not set the transmission speed of slave stations to auto-tracking. Set the transmission speed of slave stations to the same as that of the master station. An error may occur during the line test for slave stations whose transmission speed is set only to auto-tracking. If occurred, check the cable connection status and the network line status by following the troubleshooting procedure.

## ■ Performing the test using parameter settings

Line test can be performed using parameter settings in addition to CC-Link diagnostics.

This section describes the procedure for performing using parameter settings.

1. Check that the RUN/STOP/RESET switch of the CPU module is set to STOP.
2. Set "Required Settings" of the master/intelligent device module as follows using the engineering tool.

 [Navigation window] ⇒ [Parameter] ⇒ [FX5-CCL-MS] ⇒ [Module Parameter] ⇒ [Required Settings]

Item	Setting
Station Type	Master Station
Mode	Line test
Station Number	0
Transmission Speed	Set the same as while system is running.

3. Write the module parameters to the CPU module.
4. Power off and on or reset the CPU module to start the line test.
5. Check the test result with the dot matrix LED of the master/intelligent device module.

Test results	Dot matrix LED indication	Description
Normal completion	L.T. (flashes for at least 5 seconds)	Test results are stored in 'Line test 1 result' (SW00B4, SW00B5). The line test is performed for the 28 stations regardless of whether it is connected or not. Ignore test results for the slave stations not connected and stations whose transmission speed is set to auto-tracking. If the test has completed successfully, operations of step 6 to 9 are not required.
Abnormal end	ERR	Test results are stored in 'Line test 2 result' (SW00B8). If the test has ended abnormally, perform the line test for the slave station where an error has occurred by following the step 6 to 9.

6. Using the engineering tool, change the following setting to the station number of the slave station where an error has occurred. Specify the start station number when the number of occupied stations is two or more.

 [Navigation window] ⇒ [Parameter] ⇒ [FX5-CCL-MS] ⇒ [Module Parameter] ⇒ [Required Settings] ⇒ [Station Number]

7. Write the module parameters to the CPU module.
8. Power off and on or reset the CPU module to start the line test.
9. Check the test result with the dot matrix LED of the master/intelligent device module.

Test results	Dot matrix LED indication	Description
Normal completion	L.T. (flashes for at least 5 seconds)	—
Abnormal end	ERR	Test results are stored in 'Line test 2 result' (SW00B8).

## Checking the transmission speed setting

Check that the transmission speed setting of the slave station is the same as that of the master station.

The station number of the slave station having a different transmission speed setting can be also checked; therefore action to remove a transmission error can be easily taken.

### ■Procedure

1. Open the "CC-Link Diagnostics" window.

 [Diagnostics] ⇒ [CC-Link Diagnostics]

2. Double-click "Operation Test" in "Related Functions."

3. Select "Check Transfer Speed Setting" under "Test Type."

4. Click the [Execute] button to start checking of the transmission speed setting. After checking of the transmission speed is completed, the transmission speed of each station is displayed on the right side of the window.

- Do not write to the buffer memory areas (buffer memory addresses: 5E0H, 5E4H, 5F8H, 641H, 645H, 783H to 787H).
- Do not check the transmission speed setting using a program or other peripherals at the same time. If executed at the same time, checking of transmission speed setting may fail.
- In addition, do not check the transmission speed setting using the "Create Check Sheet" wizard at the same time.

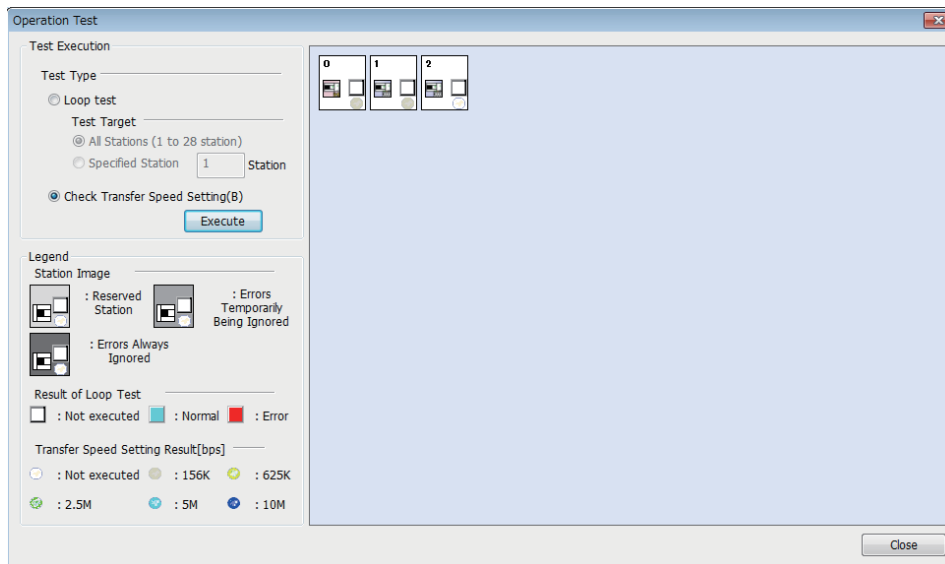



## ■Deleting logs

Click the [Clear Log] button to delete logs in a master/intelligent device module

If the [Clear Log] button is clicked with "RAM + Flash ROM" selected, the logs stored in the flash ROM will also be deleted.

While the logs on the flash ROM are being deleted, do not power off the master/intelligent device module.

## ■Precautions

- Logging will not start in the following cases.

Item
Logs stored on the flash ROM have not yet been fully deleted.
"RAM + Flash ROM" has been selected and 45 logs have already been stored in the flash ROM.
The cumulative number of times that logs are stored in the flash ROM has exceeded 100000 times.

- The log storage areas listed below are available. To store 96 or more items (maximum 5000 items), keep the engineering tool connected even after logging is started. If the number of logs stored in the RAM area has exceeded 95 without connecting the engineering tool, the stored log will be overwritten, starting with the oldest one.

Log storage area	Number of logs stored
RAM area (equipped in a module)	95 logs maximum
Flash ROM area (equipped in a module)	45 logs maximum
Hard disk of the engineering tool (personal computer)	5000 logs maximum

- When link refresh setting for link special relay (SB) is set, logging stops when the RUN/STOP/RESET switch of the CPU module is operated during logging.

## Creating a check sheet

A check sheet, which is useful for performing troubleshooting, is created through a wizard and with reference to the Open Field Network CC-Link Troubleshooting Guide.

## ■Procedure

1. Open the "CC-Link Diagnostics" window.

 [Diagnostics] ⇒ [CC-Link Diagnostics]

2. Double-click "Create Check Sheet" in "Related Functions."

3. Configure settings with answering a series of questions displayed on the windows.

The created check sheet is saved in Excel format.

### Point

Do not check the transmission speed setting using a program or other peripherals at the same time. If executed at the same time, checking of transmission speed setting may fail.

## Stopping and restarting data link

Data link of a master/intelligent device module is stopped and restarted.

During a debugging, the master/intelligent device module does not receive data from other stations and does not send data of the own station.

### ■ Procedure

1. Open the "CC-Link Diagnostics" window.

 [Diagnostics] ⇒ [CC-Link Diagnostics]

2. Select the icon for a master/intelligent device module where data link is to be stopped and restarted.
3. Double-click "Stop Data Link" in "Related Functions."
4. When step 3 is performed while the data link of the selected module has been stopped, the data link will restart.

### Point

When stopping or restarting data link, do not write data to the buffer memory area (buffer memory address: 5E0H).

## Setting and canceling a temporary error invalid station

Even if a data link error occurs in a slave station, the station is not detected as a faulty station in the master station. This can be set even during data link, unlike the error invalid station setting function.

This function is used to exchange slave stations for maintenance or for other purposes during data link.

### ■ Procedure

1. Open the "CC-Link Diagnostics" window.

 [Diagnostics] ⇒ [CC-Link Diagnostics]

2. Right-click the target slave station icon of the temporary error invalid station setting and select "Station Enable/Disable Ignore Errors."

The selected station will be a temporary error invalid station.

3. When the step 2 is performed while the selected station has been set as a temporary error invalid station, the temporary error invalid station setting is canceled.

### Point

When setting a temporary error invalid station, do not write data to the buffer memory areas (buffer memory address: 5E0H and 603H to 607H).

## 9.3 Hardware Test

A master/intelligent device module is individually tested to check whether it normally operates.

### Procedure

1. Connect the terminating resistor provided with the module between the DA and DB terminals on the terminal block of the master/intelligent device module.
2. Check the following before powering on.
  - Module mounting status
  - Input power supply voltage
  - The CPU module is set to STOP
3. Set the following item to "Hardware Test."
  - ☞ [Navigation window] ⇒ [Parameter] ⇒ [Module Information] ⇒ [FX5-CCL-MS] ⇒ [Module Parameter] ⇒ [Required Settings] ⇒ [Mode]
4. Write the module parameters to the CPU module.
5. Power off and on or reset the CPU module to start the hardware test.

#### Point

Do not perform a hardware test while connected to another station. Doing so may result in a failure of the test.

### Checking the status and result of hardware test

The test status and result can be checked with LED display of the module.

Test status	LED display
Test in progress	The dot matrix LED indicates "H.T."
Normal completion	The dot matrix LED indicates "OK."
Abnormal end	The dot matrix LED indicates "ERR."

If the test fails, check if the terminating resistor provided with the master/intelligent device module is connected between the DA and DB terminals. If the terminating resistor is connected, the possible cause is a hardware failure. Replace the master/intelligent device module.

## 9.4 Troubleshooting by Symptom

This section describes troubleshooting method by symptom. If an error has occurred in the master/intelligent device module, identify the error cause using the engineering tool.

### When cyclic transmission cannot be performed

#### Remote I/O station

Problem	Check item	Description	Check method	Corrective Action	
Cyclic data cannot be read/written.	C1-1	Refresh data area	Have refresh devices been correctly set in the module parameters? (RX, RY, SB, SW)	Check if the refresh devices have been set within the range.	Correct the refresh device setting.
			Are the link refresh to refresh devices using the module parameters and refresh using a program (Un\G□ or FROM/TO instructions) being performed at the same time?	<ul style="list-style-type: none"> <li>Check the program.</li> <li>Check the refresh devices set in the module parameters.</li> </ul>	Set the devices so that they do not overlap with ones used in programs and in other networks.
			Is the correct buffer memory area being read from/written to? (RX, RY, SB, SW)	Check the program. Note that the number of points of 8-point or 16-point I/O modules per station is 32 points (fixed).	<ul style="list-style-type: none"> <li>Access the correct buffer memory area in the corresponding station.</li> <li>Set the devices so that they do not overlap with ones used in programs and in other networks.</li> </ul>
	C1-2	Parameter Setting	Is a station to which reading/writing cannot be performed specified as a reserved station?	Check if the bit corresponding to the faulty station is not "1" in 'Reserved station specification status' (SW0074, SW0075).	Cancel the reserved station setting.

#### Remote device station

Problem	Check item	Description	Check method	Corrective Action	
Cyclic data cannot be read/written.	D1-1	Refresh data area	Has the link refresh been correctly set? (RX, RY, RWw, RWr, SB, SW)	Check if no device overlaps with ones used in programs or in other networks.	Set the devices so that they do not overlap with ones used in programs and in other networks.
		Is the buffer memory area accessed correctly? (RX, RY, RWw, RWr, SB, SW)	Check if no device overlaps with ones used in programs or in other networks.	<ul style="list-style-type: none"> <li>Access the correct buffer memory area in the corresponding station.</li> <li>Set the devices so that they do not overlap with ones used in programs.</li> </ul>	
	D1-2	Parameter Setting	Is a station to which reading/writing cannot be performed specified as a reserved station?	Check if the bit corresponding to the faulty station is not "1" in 'Reserved station specification status' (SW0074, SW0075).	Cancel the reserved station setting.
Word data cannot be read/written.	D2-1	Parameter Setting	Do the parameter settings match with the status of the connected modules?	Check if a remote I/O station is connected to the corresponding station number.	Match the model set by the parameter with that of the connected module.
Cyclic data (lower area) cannot be read/written.	D3-1	Parameter Setting	Do the parameter settings match with the status of the connected modules?	Check if a module with the small number of occupied stations is not connected to the corresponding station number.	Match the number of occupied stations set by the parameter with that of the connected module.



Problem	Check item	Description	Check method	Corrective Action	
A remote device station does not become ready (RXn1B remains off).	D5-1	Initial setting	Has the initial setting completed?	Were RYn18 (Initial data processing completion flag) and RYn19 (Initial data setting request flag) turned on and off?	Perform the initial data processing.
			Has the remote device station initialization procedure registration completed?	<ul style="list-style-type: none"> <li>Check if 'Remote device station initialization procedure registration instruction' (SB000D) is turned off.</li> <li>Check 'Remote device station initialization procedure registration instruction result' (SW005F).</li> </ul>	Change the registration.
			Is the initial setting for the remote device station correct?	<ul style="list-style-type: none"> <li>Check the parameter.</li> <li>Check the program.</li> </ul>	Correct the remote device station initial setting.
			Has the initialize setting been enabled?	Check if 'Remote device station initialization procedure registration instruction' (SB000D) has been turned on using a program.	Turn on 'Remote device station initialization procedure registration instruction' (SB000D) using a program and check that the initialize setting is enabled.

## Intelligent device station

Problem	Check item	Description	Check method	Corrective Action	
Cyclic data cannot be read/written.	E1-1	Refresh data area	Has the link refresh been correctly set? (RX, RY, RWw, RWr, SB, SW)	Check if no device overlaps with ones used in programs or in other networks.	Set the devices so that they do not overlap with ones used in programs and in other networks.
			Is the buffer memory area accessed correctly? (RX, RY, RWw, RWr, SB, SW)	Check if no device in the master station overlaps with ones used in programs or in other networks.	<ul style="list-style-type: none"> <li>Access the correct buffer memory area in the master station.</li> <li>Set the devices so that they do not overlap with ones used in programs.</li> </ul>
	E1-2	Parameter Setting	Is a station to which reading/writing cannot be performed specified as a reserved station?	Check if the bit corresponding to the faulty station is not "1" in 'Reserved station specification status' (SW0074, SW0075).	Cancel the reserved station setting.
Word data cannot be read/written.	E2-1	Parameter Setting	Do the parameter settings match with the status of the connected modules?	Check if a remote I/O station is connected to the corresponding station number.	Match the model set by the parameter with that of the connected module.
Cyclic data (lower area) cannot be read/written.	E3-1	Parameter Setting	Do the parameter settings match with the status of the connected modules?	Check if a module with the small number of occupied stations is not connected to the corresponding station number.	Match the number of occupied stations set by the parameter with that of the connected module.

# When a slave station is disconnected

## When a system is newly configured or the system is changed

Problem	Check item		Description	Check method	Corrective Action
Data link cannot be performed in the entire system.	A1-1	Station No.	Is the station number correctly set for the faulty station?	Check the station number setting.	Correct the station number setting.
	A1-2	Transmission speed	Are the transmission speed values set within the range, and same between the master station and slave stations?	Check the transmission speed settings of all stations.	Correct the transmission speed setting.
	A1-3	Mode	Is the online mode set to the master station?	Check the mode setting of the master station.	Set the online mode.
	A1-4	Parameter Setting	<ul style="list-style-type: none"> <li>Are the module parameters, such as number of stations and station information, correctly set?</li> <li>Does the master station have no error?</li> <li>Module parameters in the engineering tool.</li> </ul>	Check the parameters of the CPU module on the master station using the engineering tool.	<ul style="list-style-type: none"> <li>Correct the module parameters.</li> <li>Format the CPU module memory then write the module parameters.</li> </ul>
				Check 'Station number of own station' (SW0061) and 'Mode setting status' (SW0060).	
				Check SW0068, SW0069, SW0070, SW0071, SW0072, SW0074, SW0075, SW0098, SW0099, SW009C, SW009D, SW0144, and SW0145.	
	A1-5	Cable or other parts	<p>Are there no disconnection, short circuit, incorrect wiring, poor connection, and coexistence of different cables? Do a transmission distance, station-to-station distance, transmission cable, and FG terminal grounding meet the specifications?</p> <p>Are terminating resistors connected?</p>	Check if cables between the master station and slave stations are not disconnected.	Correct the wiring.
				Check if terminating resistors are connected to the both ends in the CC-Link system.	Connect terminating resistors to the both ends in the CC-Link system.
Check if a station with built-in terminating resistor is connected other than at both ends in the CC-Link system.					
A1-6	CPU module	Does the CPU module on the master station have no error?	Check the error code of the CPU module.	Remove the CPU module error. (MELSEC iQ-F FX5 User's Manual (Application))	
			Check if the module has been identified.	Take action so that the CPU module may identify the master/intelligent device module. (MELSEC iQ-F FX5 User's Manual (Application))	
A1-7	Noise	Is the transmission cable free from noise?	Check if the transmission cable is away from the power cable.	Keep the transmission cable away from the power cable. (Keep a distance of 100 mm or more is recommended)	
			Check if the FG terminal is grounded separated from the GND terminal of the power system.	Ground the terminals separately.	
			Reduce the transmission speed and check if the frequency of occurrence of noise is reduced.	<ul style="list-style-type: none"> <li>Take measures to reduce noise.</li> <li>Reduce the transmission speed.</li> </ul>	
A1-8	Failure of the master station	Do modules on the master station normally operate?	Replace the modules and check if the station normally operates.	Repair or replace the module on the master station.	

Problem	Check item		Description	Check method	Corrective Action
A station cannot perform data link.	A2-1	Station No.	Is the station number correctly set for the faulty station?	Check the station number setting.	Correct the station number setting.
	A2-2	Transmission speed	Is the transmission speed setting correctly set for the faulty station?	Check the transmission speed.	Set the same transmission speed as that set for other stations.
	A2-3	Online status (slave station)	Is the CC-Link interface of the faulty station online?	Check the status of the faulty station.	Set it online.
	A2-4	Parameter Setting	<ul style="list-style-type: none"> <li>• Are the module parameters, such as number of stations and station information, correctly set?</li> <li>• Does the master station have no error?</li> <li>• Module parameters in the engineering tool.</li> </ul>	Check the module parameters of the CPU module on the master station using the engineering tool.	<ul style="list-style-type: none"> <li>• Correct the module parameters.</li> <li>• Format the CPU module memory then write the module parameters.</li> </ul>
				Check SW0068, SW0069, SW0070, SW0071, SW0072, SW0074, SW0075, SW0098, SW0099, SW009C, SW009D, SW0144, and SW0145.	
	A2-5	Cable or other parts	Are there no disconnection, short circuit, incorrect wiring, poor connection, and coexistence of different cables? Do a transmission distance, station-to-station distance, transmission cable, and FG terminal grounding meet the specifications?	Check if the SD LED and RD LED on the faulty station are flashing.	Correct the wiring.
				When faulty stations occur sequentially to one end on the transmission path, check cables connected to faulty stations close to the master station. (Multiple stations)	Correct the wiring.
			Are terminating resistors connected?	Check if terminating resistors are connected to the both ends in the CC-Link system. Check if a station with built-in terminating resistor is connected other than at both ends in the CC-Link system.	Connect terminating resistors to the both ends in the CC-Link system.
	A2-6	Power supply (for communications)	Is the power on, and is the applied voltage within the specified range?	Check if the modules on the faulty station are powered on.	Power on the module.
Check if the applied voltage is within the specified range.				Apply the voltage within the specified range.	
A2-7	Noise	Is the transmission cable free from noise?	Check if the transmission cable is away from the power cable.	Keep the transmission cable away from the power cable. (Keep a distance of 100 mm or more is recommended)	
			Check if the FG terminal is grounded separated from the GND terminal of the power system.	Ground the terminals separately.	
			Reduce the transmission speed and check if the frequency of occurrence of noise is reduced.	Take measures to reduce noise. Reduce the transmission speed.	
A2-9	Failure of a slave station	Do slave stations normally operate?	Replace modules on the faulty station and check if the station normally operates.	Repair or replace the module on the faulty station.	

Problem	Check item	Description	Check method	Corrective Action	
Data link cannot be performed in the entire system occasionally.	A3-1	Cable or other parts	Are cables and connectors securely connected and do they meet specifications?	Check cables between the master station and slave stations.	Correct the wiring.
	A3-3	Power supply (for communications)	Is the power on, and is the applied voltage within the specified range?	Check power supplied to the master station and all slave stations.	Apply the voltage within the specified range.
	A3-4	Noise	Is the transmission cable free from noise?	Check if the transmission cable is away from the power cable.	Keep the transmission cable away from the power cable. (Keep a distance of 100 mm or more is recommended)
				Check if the FG terminal is grounded separated from the GND terminal of the power system.	Ground the terminals separately.
				Reduce the transmission speed and check if the frequency of occurrence of noise is reduced.	<ul style="list-style-type: none"> <li>• Take measures to reduce noise.</li> <li>• Reduce the transmission speed.</li> </ul>
	A3-5	Failure of the master station	Do modules on the master station normally operate?	Replace the modules and check if the station normally operates.	Repair or replace the module on the master station.
A3-6	Link stop	Is the data link stop instruction correctly executed?	Check if 'Data link stop' (SB0002) is turned off.	<ul style="list-style-type: none"> <li>• Do not turn on 'Data link stop' (SB0002).</li> <li>• Do not write to the refresh source device of 'Data link stop' (SB0002) from multiple locations.</li> </ul>	
A station cannot perform data link occasionally.	A4-1	Cable or other parts	Are there no disconnection, short circuit, incorrect wiring, poor connection, and coexistence of different cables? Do a transmission distance, station-to-station distance, transmission cable, and FG terminal grounding meet the specifications?	Check cables connected to the faulty station.	Correct the wiring.
			Are terminating resistors connected?	When faulty stations occur sequentially to one end on the transmission path, check cables connected to faulty stations close to the master station. (Multiple stations)	
				Check if terminating resistors are connected to the both ends in the CC-Link system.	Connect terminating resistors to the both ends in the CC-Link system.
	A4-3	Noise	Is the transmission cable free from noise?	Check if the transmission cable is away from the power cable.	Keep the transmission cable away from the power cable.
				Check if the FG terminal is grounded separated from the GND terminal of the power system.	Ground the terminals separately.
				Reduce the transmission speed and check if the frequency of occurrence of noise is reduced.	<ul style="list-style-type: none"> <li>• Take measures to reduce noise.</li> <li>• Reduce the transmission speed.</li> </ul>
A4-2	Power supply (for communications)	Is the power on, and is the applied voltage within the specified range?	Check power supplied to the faulty station.	Apply the voltage within the specified range.	
A4-4	Start-up	Has the faulty station started with the correct procedure?	Check if the faulty station normally starts with a different procedure.	Start the faulty station by following the procedure described in the manual for the station.	
A4-5	Failure of a slave station	Do slave stations normally operate?	Replace modules on the faulty station and check if the station normally operates.	Repair or replace the module on the faulty station.	

## When the system has already operated

Problem	Check item	Description	Check method	Corrective Action	
Data link cannot be performed in the entire system.	B1-1	CPU module	Does the CPU module on the master station have no error?	Check the error code of the CPU module.	Remove the CPU module error. (MELSEC iQ-F FX5 User's Manual (Application))
				Check if the module has been identified.	Take action so that the CPU module may identify the master/intelligent device module. (MELSEC iQ-F FX5 User's Manual (Application))
	B1-2	Power supply (for communications)	Is a voltage low?	Check power supplied to the master station and all slave stations.	Apply the voltage within the specified range.
	B1-3	Cable or other parts	Are there no disconnection, short circuit, and poor connection?	Check if cables between the master station and slave stations are not disconnected.	Correct the wiring.
	B1-4	Noise	Is the transmission cable free from noise?	Check if the transmission cable is away from the power cable.	Keep the transmission cable away from the power cable. (Keep a distance of 100 mm or more is recommended)
				Check if the FG terminal is grounded separated from the GND terminal of the power system.	Ground the terminals separately.
Reduce the transmission speed and check if the frequency of occurrence of noise is reduced.				<ul style="list-style-type: none"> <li>Take measures to reduce noise.</li> <li>Reduce the transmission speed.</li> </ul>	
B1-5	Failure of the master station	Do modules on the master station normally operate?	Replace the modules and check if the station normally operates.	Repair or replace the module on the master station.	
B1-6	Link stop	Is the data link stop instruction correctly executed?	Check if 'Data link stop' (SB0002) is turned off.	<ul style="list-style-type: none"> <li>Do not turn on 'Data link stop' (SB0002).</li> <li>Do not write to the refresh source device of 'Data link stop' (SB0002) from multiple locations.</li> </ul>	
A station cannot perform data link occasionally.	B2-1	Power supply (for communications)	Is a voltage low?	Check power supplied to the faulty station.	Apply the voltage within the specified range.
	B2-2	Cable or other parts	Are cables and connectors securely connected and do they meet specifications?	Check cables connected to the faulty station.	Correct the wiring.
				When faulty stations occur sequentially to one end on the transmission path, check cables connected to faulty stations close to the master station.	
	B2-3	Noise	Is the transmission cable free from noise?	Check if the transmission cable is away from the power cable.	Keep the transmission cable away from the power cable. (Keep a distance of 100 mm or more is recommended)
Check if the FG terminal is grounded separated from the GND terminal of the power system.				Ground the terminals separately.	
Reduce the transmission speed and check if the frequency of occurrence of noise is reduced.				<ul style="list-style-type: none"> <li>Take measures to reduce noise.</li> <li>Reduce the transmission speed.</li> </ul>	
B2-4	Failure of a slave station	Do slave stations normally operate?	Replace modules on the faulty station and check if the station normally operates.	Repair or replace the module on the faulty station.	

## When operation error occurs on the master station

Problem	Check item		Description	Check method	Corrective Action
Data link cannot be stopped/ restarted.	G1-1	Data link stop	Is 'Data link stop' (SB0002) turned on?	<ul style="list-style-type: none"> <li>Check the program.</li> <li>Check the refresh devices set in the module parameters.</li> </ul>	<ul style="list-style-type: none"> <li>Correctly set the SB area.</li> <li>Turn on 'Data link stop' (SB0002).</li> </ul>
			Does no error occur?	Check 'Data link stop result' (SW0045).	Take action according to the error code.
	G1-2	Data link restart	Is 'Data link restart' (SB0000) turned on?	<ul style="list-style-type: none"> <li>Check the program.</li> <li>Check the refresh devices set in the module parameters.</li> </ul>	<ul style="list-style-type: none"> <li>Correctly set the SB area.</li> <li>Turn on 'Data link restart' (SB0000).</li> </ul>
			Does no error occur?	Check 'Data link restart result' (SW0041).	Take action according to the error code.
			Is the corresponding station disconnected?	<ul style="list-style-type: none"> <li>Check cable status visually or by the line test using the engineering tool.</li> <li>Check the parameter. (For the Intelligent device station)</li> <li>Check the operating status of the CPU module on the corresponding station.</li> </ul>	Correct the cables and settings of the corresponding station, and start the system.
	A faulty station cannot be detected.	G2-1	Is the station set as an error invalid station?	Is the station set as an error invalid station?	Check 'Error invalid station specification status' (SW0078, SW0079).
Check 'Temporary error invalid status' (SW007C, SW007D).				Cancel the temporary error invalid station setting.	
Are station numbers unique?		Are station numbers unique?	Check the station number setting.	Correct the station number setting.	
A station becomes faulty at a certain transmission speed.	G3-1	<ul style="list-style-type: none"> <li>Can a faulty station be identified with 'Data link status of other stations' (SW0080, SW0081)?</li> <li>Are communications normal if the transmission speed is slow such as 156 kbps?</li> <li>Are communications normal if the transmission speed is slow such as 156 kbps?</li> </ul>	Can a faulty station be identified with 'Data link status of other stations' (SW0080, SW0081)?	Check transmission speed of the faulty station.	Set the same transmission speed as that set for the master station.
			Are communications normal if the transmission speed is slow such as 156 kbps?	Check if the cables are properly wired.	Correct the wiring.
			Are communications normal if the transmission speed is slow such as 156 kbps?	Check if the cables are grounded by the shielded part.	Ground the shielded part.
			Are communications normal if the transmission speed is slow such as 156 kbps?	Check if terminating resistors are connected to the both ends in the CC-Link system.	Connect terminating resistors to both ends in the CC-Link system.
			Are communications normal if the transmission speed is slow such as 156 kbps?	Check if a station with built-in terminating resistor is connected other than at both ends in the CC-Link system.	
When multiple remote stations are simultaneously powered off at a speed of 156 kbps, the L RUN LED turns off temporarily.	G4-1	Number of retries setting	Number of retries setting	Check the number of retries.	<ul style="list-style-type: none"> <li>Increase the transmission speed.</li> <li>Reduce the number of retries.</li> </ul>

## 9.5 List of Error Codes

This section lists the error codes, error details and causes, and action for the errors occur in the processing for data communication between master/intelligent device module and slave stations or caused by processing requests from the CPU module on the own station.

Error code	Error details and causes	Corrective Action	Detailed information
1080H	The number of writes to the flash ROM has exceeded 100000. (Number of writes > 100000 times)	Replace the module.	—
1810H	The hardware has failed.	<ul style="list-style-type: none"> <li>The possible cause is a malfunction due to noise. Check the wire and cable distances and ground condition of each device, and take measures to reduce noise.</li> <li>Perform a hardware test. If the error occurs again, the possible cause is a hardware failure of the module. Please consult your local Mitsubishi representative.</li> </ul>	—
1900H	Parameter settings were conducted from the buffer memory during data link.	Conduct parameter settings from the buffer memory after data link stops.	—
20E0H	<ul style="list-style-type: none"> <li>Non-compatible module was detected.</li> <li>The module cannot communicate with the CPU module.</li> </ul>	<ul style="list-style-type: none"> <li>Check if the CPU module is compatible with FX5-CCL-MS.</li> <li>The hardware failure of the CPU module may have been occurred. Please consult your local Mitsubishi representative.</li> </ul>	—
24C0H	The hardware has failed.	<ul style="list-style-type: none"> <li>The possible cause is a malfunction due to noise. Check the wire and cable distances and ground condition of each device, and take measures to reduce noise.</li> <li>Perform a hardware test. If the error occurs again, the possible cause is a hardware failure of the module. Please consult your local Mitsubishi representative.</li> </ul>	—
24C1H to 24C3H	The bus communication has failed.	<ul style="list-style-type: none"> <li>The possible cause is a malfunction due to noise. Check the wire and cable distances and ground condition of each device, and take measures to reduce noise.</li> <li>Perform a hardware test. If the error occurs again, the possible cause is a hardware failure of the module. Please consult your local Mitsubishi representative.</li> </ul>	—
24C6H	The bus communication has failed.	<ul style="list-style-type: none"> <li>The possible cause is a malfunction due to noise. Check the wire and cable distances and ground condition of each device, and take measures to reduce noise.</li> <li>Perform a hardware test. If the error occurs again, the possible cause is a hardware failure of the module. Please consult your local Mitsubishi representative.</li> </ul>	—
3C00H	A hardware failure has been detected.	<ul style="list-style-type: none"> <li>The possible cause is a malfunction due to noise. Check the wire and cable distances and ground condition of each device, and take measures to reduce noise.</li> <li>Perform a hardware test. If the error occurs again, the possible cause is a hardware failure of the module. Please consult your local Mitsubishi representative.</li> </ul>	—
3C02H	The bus communication has failed.	<ul style="list-style-type: none"> <li>The possible cause is a malfunction due to noise. Check the wire and cable distances and ground condition of each device, and take measures to reduce noise.</li> <li>Perform a hardware test. If the error occurs again, the possible cause is a hardware failure of the module. Please consult your local Mitsubishi representative.</li> </ul>	—
3C10H	A hardware failure has been detected.	<ul style="list-style-type: none"> <li>The possible cause is a malfunction due to noise. Check the wire and cable distances and ground condition of each device, and take measures to reduce noise.</li> <li>Perform a hardware test. If the error occurs again, the possible cause is a hardware failure of the module. Please consult your local Mitsubishi representative.</li> </ul>	—
3C14H	The bus communication has failed.	<ul style="list-style-type: none"> <li>The possible cause is a malfunction due to noise. Check the wire and cable distances and ground condition of each device, and take measures to reduce noise.</li> <li>Perform a hardware test. If the error occurs again, the possible cause is a hardware failure of the module. Please consult your local Mitsubishi representative.</li> </ul>	—
B002H	System error	Please consult your local Mitsubishi representative.	—

Error code	Error details and causes	Corrective Action	Detailed information
B101H to B106H	System error	Please consult your local Mitsubishi representative.	—
B109H	System error	Please consult your local Mitsubishi representative.	—
B10AH	System error	Please consult your local Mitsubishi representative.	—
B10CH	System error	Please consult your local Mitsubishi representative.	—
B110H to B112H	A line error has occurred.	Check and correct the wiring.	—
B113H	A line error has occurred. Or a momentary power failure has occurred in the sending station.	Modify the line, or check the power supply module and power supplied to the sending station.	—
B115H	A line error has occurred.	Check and correct the wiring.	—
B116H	A line error has occurred.	Check and correct the wiring.	—
B120H	With the remote device station initialization procedure registration function, the remote device station initialization procedure registration instruction was turned off before all procedures are completed.	Complete all the procedures before turning off the remote device station initialization procedure registration instruction.	—
B122H	System error	Please consult your local Mitsubishi representative.	—
B123H	System error	Please consult your local Mitsubishi representative.	—
B124H	The remote device station initialization procedure registration instruction was turned on in a station other than the master station.	Turn on the remote device station initialization procedure registration instruction in the master station (station No.0).	—
B125H	<ul style="list-style-type: none"> <li>The remote device station initialization procedure registration instruction was turned on without setting the remote device station initialization procedure registration.</li> <li>A bit other than the one corresponding to the start station number was turned on in 'Specification of remote device station to be initialized' (SW0014, SW0015) to instruct the remote device station initialization procedure registration.</li> </ul>	<ul style="list-style-type: none"> <li>Set the remote device station initialization procedure registration before turning on the remote device station initialization procedure registration instruction.</li> <li>Turn on only the bit corresponding to the start station number in 'Specification of remote device station to be initialized' (SW0014, SW0015).</li> </ul>	—
B201H	A data link error has occurred in the corresponding station during transient transmission.	Check the communication status of other stations, if a temporary error invalid station is present, or if the corresponding station is stopped.	—
B202H	System error	Please consult your local Mitsubishi representative.	—
B203H	System error	Please consult your local Mitsubishi representative.	—
B204H	Too many transient requests were sent to the corresponding station.	Wait for a while and send the request again.	—
B205H	A transient request was issued to a station other than an intelligent device station.	Check the target station.	—
B301H	A line test request was issued during link stop.	Perform a line test while data link is being performed.	—
B302H	The specified station number for a line test request, temporary error invalid request, or temporary error invalid canceling request is greater than the maximum station number that can communicate.	Specify a station number smaller than or equal to the maximum communication station number.	—
B303H	Target station number is not set for temporary error invalid request or temporary error invalid cancellation request.	Set the station number. (SW0003, SW0004, SW0005)	—
B304H	When a line test was executed, an error has been detected in a remote station and intelligent device station.	Check if the remote station and intelligent device station have been started, and that the cables are not disconnected.	—
B305H	System error	Please consult your local Mitsubishi representative.	—
B306H	A station number other than the start station number has been specified in the temporary error invalid request or temporary error invalid canceling request.	Specify the start station for the temporary error invalid request or temporary error invalid cancellation request.	—
B307H	When one of the following requests is issued, a data link error has occurred in all stations. <ul style="list-style-type: none"> <li>'Data link restart' (SB0000)</li> <li>'Data link stop' (SB0002)</li> </ul>	Issue the request again after the data link returns to normal.	—
B308H	A slave station number is outside the available range.	Set a slave station number within the available range.	—



Error code	Error details and causes	Corrective Action	Detailed information
B309H	The station number of the connected module is duplicated (including the number of occupied stations). However, excluding duplication of the start station number.	Check the station number of the module. (including the number of occupied stations)	—
B30AH	The station type differs between the mounted modules and parameter settings.	<ul style="list-style-type: none"> <li>• Correct the parameter.</li> <li>• Set the parameters of the master station or intelligent device station again, and reset the CPU module.</li> </ul>	—
B30BH	The module parameter details do not match the installation status.	Correct the installation status or module parameters so that both are matched.	—
B30DH	A request, such as the temporary error invalid station specification, line test request, or data link stop/restart request, was issued before data link is started.	Issue the request after the data link is started.	—
B30EH	Execution of a function that is started using SB, SW and executable only on the master station was attempted on an intelligent device station.	Execute the corresponding function from the master station.	—
B30FH	System error	Please consult your local Mitsubishi representative.	—
B310H	'Data link restart' (SB0000) was turned on specifying the station that was performing data link.	Turn on 'Data link restart' (SB0000) specifying the station where data link has been stopped using 'Data link stop' (SB0002).	—
B311H	'Data link stop' (SB0002) was turned on specifying the station where data link had been stopped.	Turn on 'Data link stop' (SB0002) specifying the station performing data link.	—
B316H	System error	Please consult your local Mitsubishi representative.	—
B317H	System error	Please consult your local Mitsubishi representative.	—
B31AH	The master station duplication error canceling instruction was executed while data link had already been started.	Do not execute the master station duplication error cancellation instruction during data link.	—
B31BH	The 'Transmission speed test' (SB000B) was performed during data link.	Turn on 'Transmission speed test request' (SB000B) after turning on 'Data link stop' (SB0002).	—
B31CH	System error	Please consult your local Mitsubishi representative.	—
B31DH	System error	Please consult your local Mitsubishi representative.	—
B31EH	Logging was started while logs were being deleted.	Delete the logs then start logging.	—
B31FH	Logs were deleted during logging.	Stop the logging then delete the logs.	—
B321H	System error	Please consult your local Mitsubishi representative.	—
B322H	The logs were deleted during data link with "RAM + Flash ROM" selected.	Terminate the data link then delete the logs.	—
B323H	Although the logs had been set to be deleted with "RAM + Flash ROM" selected, logging was started before deletion of logs was complete.	Delete the logs again with "RAM + Flash ROM" selected.	—
B324H	Storing logs to the flash ROM was attempted when the flash ROM was not ready for storage.	Delete the logs with "RAM + Flash ROM" selected then start logging, or start logging with "RAM" selected.	—
B326H	System error	Please consult your local Mitsubishi representative.	—
B384H	<ul style="list-style-type: none"> <li>• In the station information parameter, a number other than 1 to 28 is set for a station number (including the number of occupied stations).</li> <li>• The station number for the intelligent device station is not set in the range of 1 to 64.</li> </ul>	<ul style="list-style-type: none"> <li>• Set the station number (including the number of occupied stations) in the range of 1 to 28.</li> <li>• Set the station number for the intelligent device station in the range of 1 to 64.</li> </ul>	—
B385H	The total number of occupied stations set in the station information parameter exceeded 28.	Set the value to 28 or less.	—
B386H	In the station information parameter, all the number of occupied stations is set to 0.	Set the value within the range of 1 to 4.	—
B387H	System error	Please consult your local Mitsubishi representative.	—
B388H	The station type in the station information parameter (UnG\32 to UnG\59) is out of the range in the remote net Ver.1 mode.	Set a value within 0 to 2 in the remote net Ver.1 mode.	—
B38AH	The number of connected modules of the remote I/O station is set to 14 or more.	Set the total number of connected modules of the remote I/O station to 14 or less.	—
B38BH	The number of connected modules of the remote device station is set to 14 or more.	Set the total number of connected modules of the remote device station to 14 or less.	—
B38CH	The number of connected modules of the intelligent device station is set to 14 or more.	Set the total number of connected modules of the intelligent device station to 14 or less.	—

Error code	Error details and causes	Corrective Action	Detailed information
B38DH to B38FH	System error	Please consult your local Mitsubishi representative.	—
B391H	A value other than 1 to 7 is set in the number of retries parameter.	Set the value within the range of 1 to 7.	—
B392H	A value other than 0 or 1 is set in the parameter of data link setting at CPU failure.	Set 0 or 1.	—
B393H	System error	Please consult your local Mitsubishi representative.	—
B394H	A value other than 1 to 10 is set in the number of automatic return stations parameter.	Set the value within the range of 1 to 10.	—
B395H	<ul style="list-style-type: none"> <li>The data link faulty station setting is not set to 0 or 1 during parameter settings from the buffer memory.</li> <li>The setting during CPU STOP is not set to 0 or 1 during parameter settings from the buffer memory.</li> </ul>	<ul style="list-style-type: none"> <li>Set the data link faulty station setting to 0 or 1.</li> <li>Set the setting during CPU STOP to 0 or 1.</li> </ul>	—
B396H	The station number is already in use in the station information parameter.	Set a unique number.	—
B397H	System error	Please consult your local Mitsubishi representative.	—
B398H	<ul style="list-style-type: none"> <li>A value other than 1 to 4 is set as the number of occupied stations in the station information parameter.</li> <li>During parameter settings from the buffer memory for the intelligent device station in the remote net Ver.2 mode, the extended cyclic setting is not set in the range of 0 to 3.</li> <li>When the number of occupied stations is 3, the extended cyclic setting is not set in the range of 0 to 2.</li> <li>When the number of occupied stations is 4, the extended cyclic setting is not set to 0 or 1.</li> </ul>	<ul style="list-style-type: none"> <li>Set the value within the range of 1 to 4.</li> <li>Set the extended cyclic setting in the range of 0 to 3.</li> <li>If the number of occupied stations is 3, set the extended cyclic setting in the range of 0 to 2.</li> <li>If the number of occupied stations is 4, set the extended cyclic setting to 0 or 1.</li> </ul>	—
B399H	A value other than 1 to 28 is set in the number of connected modules parameter.	Set the value within the range of 1 to 28.	—
B39BH	All stations are set as a reserved station.	Check the reserved station specification.	—
B39DH to B39FH	System error	Please consult your local Mitsubishi representative.	—
B3A0H	<p>An invalid mode has occurred in the master station and the intelligent device station.</p> <ul style="list-style-type: none"> <li>The intelligent device station is in the remote net Ver.2 mode, and the master station is in the remote net Ver.1 mode.</li> </ul>	Correct the mode setting of the master station and intelligent device station, and reset the CPU module.	—
B3A1H	System error	Please consult your local Mitsubishi representative.	—
B3A3H	System error	Please consult your local Mitsubishi representative.	—
B3A5H	System error	Please consult your local Mitsubishi representative.	—
B3A7H	The sum of the numbers of remote device and intelligent device stations is more than 14.	Check and change the number of connected remote device stations and intelligent device stations.	—
B3A8H	The total number of points of RX/RV in the remote I/O station is more than 448 points.	Check and change the number of connected remote I/O stations.	—
B3A9H	The remote I/O use points exceeds the remote I/O permission points.	<ul style="list-style-type: none"> <li>Review the I/O points of the whole system.</li> <li>Review the remote I/O points used in the whole system.</li> </ul>	—
B3F1H to B3F3H	System error	Please consult your local Mitsubishi representative.	—
B407H	System error	Please consult your local Mitsubishi representative.	—
B409H	System error	Please consult your local Mitsubishi representative.	—
B416H	System error	Please consult your local Mitsubishi representative.	—
B417H	System error	Please consult your local Mitsubishi representative.	—
B418H	System error	Please consult your local Mitsubishi representative.	—
B419H	System error	Please consult your local Mitsubishi representative.	—
B41AH	System error	Please consult your local Mitsubishi representative.	—
B601H	An unsupported request was received.	Check and correct the request data or the target station number.	—

Error code	Error details and causes	Corrective Action	Detailed information
B602H	Too many transient requests were sent to the corresponding station.	Wait for a while and send the request again.	—
B603H	Too many transient requests were sent to the corresponding station.	Wait for a while and send the request again.	—
B604H	Transient transmission was performed during a line test.	Wait for a while and send the request again.	—
B605H	The transient storage buffer data was failed to be obtained.	Wait for a while and send the request again.	—
B606H	System error	Please consult your local Mitsubishi representative.	—
B60CH	System error	Please consult your local Mitsubishi representative.	—
B700H	System error	Please consult your local Mitsubishi representative.	—
B705H	System error	Please consult your local Mitsubishi representative.	—
B706H	System error	Please consult your local Mitsubishi representative.	—
B771H	Too many transient requests were sent to the corresponding station.	Wait for a while and send the request again.	—
B772H	System error	Please consult your local Mitsubishi representative.	—
B773H	System error	Please consult your local Mitsubishi representative.	—
B774H	The target station was not an intelligent device station.	Check if the target station is an intelligent device station.	—
B777H	Unsupported transient data was received.	Check the application on the source that issued the request.	—
B779H	System error	Please consult your local Mitsubishi representative.	—
B781H	System error	Please consult your local Mitsubishi representative.	—
B782H	When connection to another station is set, the sending destination station and the sending source station are the same.	Check the station number of the destination or change the setting to connection to the own station.	—
B783H	When data larger than 1K was being sent in transient transmission, an error has occurred in the transient storage buffer.	Wait for a while and send the request again.	—
B801H to B805H	System error	Please consult your local Mitsubishi representative.	—
B807H	System error	Please consult your local Mitsubishi representative.	—
B80AH	System error	Please consult your local Mitsubishi representative.	—
B80DH	System error	Please consult your local Mitsubishi representative.	—
B80FH to B812H	System error	Please consult your local Mitsubishi representative.	—
B817H	System error	Please consult your local Mitsubishi representative.	—
B821H	System error	Please consult your local Mitsubishi representative.	—
B822H	System error	Please consult your local Mitsubishi representative.	—
B824H	System error	Please consult your local Mitsubishi representative.	—
B826H	System error	Please consult your local Mitsubishi representative.	—
B830H	System error	Please consult your local Mitsubishi representative.	—
B903H	System error	Please consult your local Mitsubishi representative.	—
B981H to B987H	System error	Please consult your local Mitsubishi representative.	—
B988H	An error has been detected in the CPU module.	Check the error of the CPU module and take action using the module diagnostics.	—
	A hardware failure has been detected.	Please consult your local Mitsubishi representative.	—
B989H	An error has been detected in the CPU module.	Check the error of the CPU module and take action using the module diagnostics.	—
	A hardware failure has been detected.	Please consult your local Mitsubishi representative.	—
B9FFH	An error has been detected in the CPU module.	Check the error of the CPU module and take action using the module diagnostics.	—
	A hardware failure has been detected.	Please consult your local Mitsubishi representative.	—
BA01H	A hardware failure has been detected.	Please consult your local Mitsubishi representative.	—
BA02H	System error	Please consult your local Mitsubishi representative.	—

Error code	Error details and causes	Corrective Action	Detailed information
BA05H	System error	Please consult your local Mitsubishi representative.	—
BA06H to BA13H	A hardware failure has been detected.	Please consult your local Mitsubishi representative.	—
BA14H	A hardware (communication circuit) failure has been detected.	<ul style="list-style-type: none"> <li>• Check that the terminating resistor provided with the master/intelligent device module is connected between the DA and DB terminals, and execute the hardware test again.</li> <li>• If the error occurs again even after taking the above, please consult your local Mitsubishi representative.</li> </ul>	—
BA15H	A hardware failure has been detected.	Please consult your local Mitsubishi representative.	—
BA16H	A hardware (communication circuit) failure has been detected.	<ul style="list-style-type: none"> <li>• Check that the terminating resistor provided with the master/intelligent device module is connected between the DA and DB terminals, and execute the hardware test again.</li> <li>• If the error occurs again even after taking the above, please consult your local Mitsubishi representative.</li> </ul>	—
BA17H	A hardware (communication circuit) failure has been detected.	<ul style="list-style-type: none"> <li>• Check that the terminating resistor provided with the master/intelligent device module is connected between the DA and DB terminals, and execute the hardware test again.</li> <li>• If the error occurs again even after taking the above, please consult your local Mitsubishi representative.</li> </ul>	—
BA19H	The target station of the line test 2 cannot be communicated.	Check the cables and the target station.	—
BA1BH	A communication failure has occurred in all stations during execution of the line test 1.	Check the cables.	—
BA1FH to BA21H	A hardware failure has been detected.	Please consult your local Mitsubishi representative.	—
BB01H	Execution of either of the following was attempted at the same time on the same station. (Including the same request) <ul style="list-style-type: none"> <li>• Remote device station initialization procedure registration function</li> <li>• Access from the peripherals to the remote device station</li> </ul>	Execute after other processing is completed.	—
BBC1H to BBC3H	System error	Please consult your local Mitsubishi representative.	—
BBC5H	<ul style="list-style-type: none"> <li>• Multiple master stations exist on the same line.</li> <li>• Noise has been detected on the line at power-on.</li> </ul>	<ul style="list-style-type: none"> <li>• Reduce the number of master stations on the same line to one.</li> <li>• When the data link starts by turning on 'Master station duplication error cancel request' (SB0007), check the line status.</li> </ul>	—
BBC7H to BBC9H	System error	Please consult your local Mitsubishi representative.	—
BBCBH	System error	Please consult your local Mitsubishi representative.	—
BBD1H	System error	Please consult your local Mitsubishi representative.	—
BBD3H	System error	Please consult your local Mitsubishi representative.	—
BC01H to BC07H	System error	Please consult your local Mitsubishi representative.	—
BC33H to BC39H	System error	Please consult your local Mitsubishi representative.	—
BC50H to BC55H	System error	Please consult your local Mitsubishi representative.	—
BC57H to BC60H	System error	Please consult your local Mitsubishi representative.	—

Error code	Error details and causes	Corrective Action	Detailed information
BC70H to BC76H	System error	Please consult your local Mitsubishi representative.	—
BC81H	System error	Please consult your local Mitsubishi representative.	—
BC90H	System error	Please consult your local Mitsubishi representative.	—
BC91H	System error	Please consult your local Mitsubishi representative.	—
BD83H	System error	Please consult your local Mitsubishi representative.	—
BD84H	System error	Please consult your local Mitsubishi representative.	—
BD85H	An error has been detected in the CPU module.	Check the error of the CPU module and take action using the module diagnostics.	—
	A hardware failure has been detected.	Please consult your local Mitsubishi representative.	—
BD86H	System error	Please consult your local Mitsubishi representative.	—
BD87H	System error	Please consult your local Mitsubishi representative.	—
BF11H to BF1CH	System error	Please consult your local Mitsubishi representative.	—
BF20H	System error	Please consult your local Mitsubishi representative.	—
BF30H to BF44H	System error	Please consult your local Mitsubishi representative.	—
BF50H	System error	Please consult your local Mitsubishi representative.	—
BFFAH	System error	Please consult your local Mitsubishi representative.	—
BFFBH	Too many transient requests were sent from the engineering tool or GOT.	Wait for a while and send the request again.	—

# APPENDIX

## Appendix 1 External Dimensions

This chapter describes the external dimensions of the master/intelligent device module.

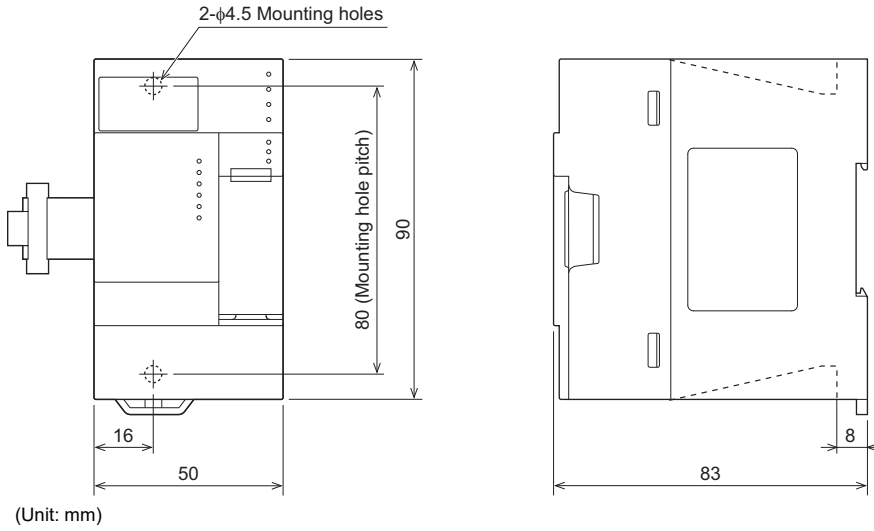

# Appendix 2 Standards

## Certification of UL, cUL standards

The FX5-CCL-MS supports UL (UL, cUL)<sup>\*1</sup> standards.

UL, cUL file number: E95239

\*1 FX5-CCL-MS modules manufactured in June 2017 or later (manufacturer's serial number: 1760001) comply with the UL standards (UL, cUL).

For models that support UL standards, please consult your local Mitsubishi representative.

## Compliance with EC Directive (CE marking)

This note does not guarantee that an entire machine produced in accordance with the contents of this note will comply with the following standards.

Compliance to EMC Directive and LVD Directive of the entire mechanical module should be checked by the user/manufacturer. For more details, please consult your local Mitsubishi representative.

## Requirement for compliance with EMC Directive

The following products have shown compliance through direct testing (of the identified standards below) and design analysis (through the creation of a technical construction file) to the European Directive for Electromagnetic Compatibility (2014/30/EU) when used as directed by the appropriate documentation.

### Attention

This product is designed for use in industrial applications.

### Product compatibility

Type: Programmable controller (open type equipment)

Models: FX5 manufactured

Electromagnetic compatibility (EMC) directive	Remarks
from April 1st, 2017	FX5-CCL-MS
EN61131-2:2007 Programmable controllers - Equipment requirements and tests	Compliance with all relevant aspects of the standard. EMI • Radiated emission • Conducted emission EMS • Radiated electromagnetic field • Fast transient burst • Electrostatic discharge • High-energy surge • Voltage drops and interruptions • Conducted RF • Power frequency magnetic field

A

## Caution for compliance with EC Directive

---

### Caution for when the FX5-CCL-MS is used

When the FX5-CCL-MS is used, attach a ferrite core to the power supplies of the CPU module and the FX5-CCL-MS. Make 2 turns around the ferrite core and attach within approximately 200 mm from the terminal block and connectors of the power cable. (Ferrite core used in Mitsubishi Electric's test: E04SR401938 manufactured by SEIWA ELECTRIC MFG. CO., LTD.)

### Caution for when the CC-Link cable is used

Ver.1.10-compatible CC-Link dedicated cable is a shielded cable, so ground it at both ends. Strip a part of the jacket of the cable as shown below and ground the exposed shield as much as possible.

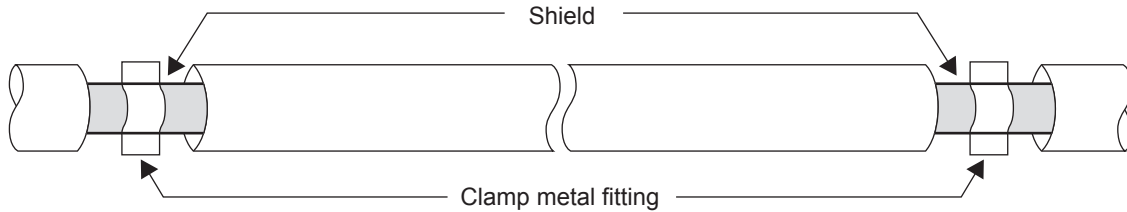

## Compliance with UKCA marking

---

The requirements for compliance with UKCA marking are the same as that with EC directive (CE marking).



# Appendix 3 Module Labels

Buffer memory, link special relay (SB), and link special register areas (SW) of a master/intelligent device module can be set using module labels.

## Structure of a module label

A module label consists of the following names.

"Instance name"\_"Module number"."Label name"\_D

**Ex.**

FX5CCLMS\_1.bIn\_ModuleReady\_D

### ■ Instance name

The instance name of a master/intelligent device module is as follows.

Model	Instance name
FX5-CCL-MS	FX5CCLMS

### ■ Module number

A module number is assigned to distinguish the modules having the same instance name, counting from "1."

### ■ Label name

A label name is a module-specific name.

### ■ \_D

This symbol indicates that the module label is for direct access. Value update timing is shown below.

Type	Description	Access timing
Direct access	The value read from/written to the module label is reflected to the module immediately.	When a value is read from/written to the module label

## Precautions

### ■ Link refresh settings and module labels

When setting SB0000 to SB001F and SW0000 to SW001F as the link refresh range, do not use the module labels corresponding to SB0000 to SB001F and SW0000 to SW001F. It may not be possible to change the value, or the module may malfunction.

# Appendix 4 Buffer Memory

The buffer memory is used to exchange data between the master/intelligent device module and the CPU module. Buffer memory values are defaulted when the CPU module is reset or the system is powered off.

## List of buffer memory addresses

○: Available, —: Not available

Address		Name	Description	Read/write	Availability		Reference
Hexadecimal	Decimal				Master Station	Intelligent device station	
0H to DFH	0 to 223	Parameter information area	Stores parameter settings.	Read, write <sup>*3</sup>	○	—	Page 147 Parameter information area
E0H to 117H	224 to 279	Remote input (RX) <sup>*1</sup>	■Master station Stores the input data from slave stations.	Read	○	—	Page 149 Remote input (RX)
			■Intelligent device station Stores the output data to the master station.	Read, write	—	○	Page 149 Remote input (RX)
118H to 15FH	280 to 351	System area	—	—	—	—	—
160H to 197H	352 to 407	Remote output (RY) <sup>*1</sup>	■Master station Stores the output data to slave stations.	Read, write	○	—	Page 149 Remote output (RY)
			■Intelligent device station Stores the input data from the master station.	Read	—	○	Page 149 Remote output (RY)
198H to 1DFH	408 to 479	System area	—	—	—	—	—
1E0H to 24FH	480 to 591	Remote register (RWw) <sup>*1</sup>	■Master station Stores the output data to slave stations.	Read, write	○	—	Page 150 Remote register (RWw)
			■Intelligent device station Stores the input data from the master station.	Read	—	○	Page 150 Remote register (RWw)
250H to 2DFH	592 to 735	System area	—	—	—	—	—
2E0H to 34FH	736 to 847	Remote register (RWr) <sup>*1</sup>	■Master station Stores the input data from slave stations.	Read	○	—	Page 150 Remote register (RWr)
			■Intelligent device station Stores the output data to the master station.	Read, write	—	○	Page 150 Remote register (RWr)
350H to 3DFH	848 to 991	System area	—	—	—	—	—
3E0H to 417H	992 to 1047	Slave station offset, size information (RX)	Stores the offset and size of RX in each slave station.	Read	○	—	Page 151 Slave station offset, size information
			Stores the offset and size of RY in each slave station.	Read	○	—	Page 151 Slave station offset, size information
418H to 45FH	1048 to 1119	System area	—	—	—	—	—
460H to 497H	1120 to 1175	Slave station offset, size information (RY)	Stores the offset and size of RX in each slave station.	Read	○	—	Page 151 Slave station offset, size information
			Stores the offset and size of RY in each slave station.	Read	○	—	Page 151 Slave station offset, size information
498H to 4DFH	1176 to 1247	System area	—	—	—	—	—
4E0H to 517H	1248 to 1303	Slave station offset, size information (RWw)	Stores the offset and size of RWw in each slave station.	Read	○	—	Page 151 Slave station offset, size information
518H to 55FH	1304 to 1375	System area	—	—	—	—	—
560H to 597H	1376 to 1431	Slave station offset, size information (RWr)	Stores the offset and size of RWr in each slave station.	Read	○	—	Page 151 Slave station offset, size information

Address		Name	Description	Read/write	Availability		Reference
Hexadecimal	Decimal				Master Station	Intelligent device station	
598H to 5DFH	1432 to 1503	System area	—	—	—	—	—
5E0H to 5FFH	1504 to 1535	Link special relay (SB) areas	Stores the data link status.	Read, write (Data can be written only to areas with the first 32 addresses.)	○	○	Page 153 Link special relay (SB)
600H to 7FFH	1536 to 2047	Link special register (SW) areas	Stores the data link status.				Page 153 Link special register (SW)
800H to 3FFFH	2048 to 16383	System area	—	—	—	—	—
4000H to 4037H	16384 to 16439	Ver.2-compatible remote input (RX) <sup>*2</sup>	■Master station Stores the input data from slave stations.	Read	○	—	Page 154 Ver.2-compatible remote input (RX) and Ver.2-compatible remote output (RY)
			■Intelligent device station Stores the output data to the master station.	Read, write	—	○	Page 154 Ver.2-compatible remote input (RX) and Ver.2-compatible remote output (RY)
4038H to 41FFH	16440 to 16895	System area	—	—	—	—	—
4200H to 4237H	16896 to 16951	Ver.2-compatible remote output (RY) <sup>*2</sup>	■Master station Stores the output data to slave stations.	Read, write	○	—	Page 154 Ver.2-compatible remote input (RX) and Ver.2-compatible remote output (RY)
			■Intelligent device station Stores the input data from the master station.	Read	—	○	Page 154 Ver.2-compatible remote input (RX) and Ver.2-compatible remote output (RY)
4238H to 43FFH	16952 to 17407	System area	—	—	—	—	—
4400H to 446FH	17408 to 17519	Ver.2-compatible remote register (RWw) <sup>*2</sup>	■Master station Stores the output data to slave stations.	Read, write	○	—	Page 156 Ver.2-compatible remote register (RWr) and Ver.2-compatible remote register (RWw)
			■Intelligent device station Stores the input data from the master station.	Read	—	○	Page 156 Ver.2-compatible remote register (RWr) and Ver.2-compatible remote register (RWw)
4470H to 4BFFH	17520 to 19455	System area	—	—	—	—	—



Address		Name	Description	Read/write	Availability		Reference
Hexadecimal	Decimal				Master Station	Intelligent device station	
4C00H to 4C6FH	19456 to 19567	Ver.2-compatible remote register (RWr) <sup>*2</sup>	■Master station Stores the input data from slave stations.	Read	○	—	Page 156 Ver.2-compatible remote register (RWr) and Ver.2-compatible remote register (RWw)
			■Intelligent device station Stores the output data to the master station.	Read, write	—	○	Page 156 Ver.2-compatible remote register (RWr) and Ver.2-compatible remote register (RWw)
4C70H to 5C7FH	19568 to 23679	System area	—	—	—	—	—
5C80H to 5C9BH	23680 to 23707	Remote device station initialization procedure registration execution individual info.	Stores the execution progress of the remote device station initial setting procedure registration function.	Read	○	—	Page 157 Remote device station initialization procedure registration execution individual info.
5C9CH to 66FFH	23708 to 26367	System area	—	—	—	—	—
6700H to 6703H	26368 to 26371	I/O signals	Stores the I/O signals for the CPU module.	Read	○	○	Page 158 I/O signals
6704H to 6707H	26372 to 26375	System area	—	—	—	—	—
6708H	26376	Module information	Stores the unique code (H6788) of FX5-CCL-MS.	Read	○	○	Page 160 Module Information
6709H	26377	F/W version	Stores the version of the firmware.	Read	○	○	Page 160 F/W version
670AH to 7FFFH	26378 to 32767	System area	—	—	—	—	—

\*1 This buffer memory area is used when the remote net Ver.1 mode is selected.

\*2 This buffer memory area is used when the remote net Ver.2 mode is selected.

\*3 It is writable when using the "Program."



Do not write data to "System area."

Doing so may cause malfunction of the programmable controller system.

# Details of buffer memory addresses

This appendix describes buffer memory areas.

## Parameter information area

Stores parameter settings.

Data can be written to this area for parameter settings with the program. Data writing other than the parameter settings may cause an error.

Address		Item	Description																																	
Hexadecimal	Decimal																																			
0H	0	(Use prohibited)	—																																	
1H	1	Total number of connected stations	Stores the number of slave stations (including a reserved station) connected to the master station. <ul style="list-style-type: none"> <li>• Default: 28 (stations) (0 station when using the "Program")<sup>*1</sup></li> <li>• Range: 1 to 28 (station)</li> </ul>																																	
2H	2	Number of retries	Stores the number of retries to a station where a communication failure has occurred. <ul style="list-style-type: none"> <li>• Default: 3 (times)</li> <li>• Range: 1 to 7 (time)</li> </ul>																																	
3H	3	Number of automatic return stations	Stores the number of slave stations that return to system operation by one link scan. <ul style="list-style-type: none"> <li>• Default: 1 (station)</li> <li>• Range: 1 to 10 (stations)</li> </ul>																																	
4H	4	(Use prohibited)	—																																	
5H	5	Data link faulty station setting <sup>*1</sup>	Set whether to clear or hold data input/output from a data link faulty station. <ul style="list-style-type: none"> <li>• Hold: 0</li> <li>• Clear: 1</li> </ul>																																	
6H	6	Data link setting at CPU failure	Stores the specified data link status if an error occurs in the CPU module of the master station. <ul style="list-style-type: none"> <li>• Default: 0 (Data link stopped)</li> <li>• Range: 0 (Data link stopped), 1 (Data link continued)</li> </ul>																																	
7H to AH	7 to 10	(Use prohibited)	—																																	
BH	11	Number of occupied stations <sup>*1</sup>	This stores the number of occupied stations of the own station. <ul style="list-style-type: none"> <li>• 1 Station occupied: 1</li> <li>• 2 Station occupied: 2</li> <li>• 3 Station occupied: 3</li> <li>• 4 Station occupied: 4</li> </ul>																																	
CH	12	Extended cyclic setting <sup>*1</sup>	This stores the extended cyclic settings of the own station. <ul style="list-style-type: none"> <li>• Single: 0</li> <li>• Double: 1</li> <li>• Quadruple: 2</li> <li>• Octuple: 3</li> </ul>																																	
DH	13	Upon CPU STOP setting <sup>*1</sup>	Select whether remote output (RY) is refreshed (held at the value before STOP) or cleared to zero (0) when the CPU module is set to STOP. <ul style="list-style-type: none"> <li>• Send the output data: 0</li> <li>• Send 0 data: 1</li> </ul>																																	
EH	14	Station No. <sup>*1</sup>	This stores the number for the own station. <ul style="list-style-type: none"> <li>• Master station: 0</li> <li>• Intelligent device station: 1 to 64</li> </ul>																																	
FH	15	(Use prohibited)	—																																	
10H, 11H	16, 17	Reserved station setting	Stores the reserved station specification status. Only the bit corresponding to the start station number turns on. <ul style="list-style-type: none"> <li>• Default: 0 (Not set)</li> <li>• Range: The bit corresponding to the station number turns on.</li> </ul> <table border="1" style="margin-left: auto; margin-right: auto;"> <thead> <tr> <th></th> <th>b15</th> <th>b14</th> <th>to</th> <th>b11</th> <th>b10</th> <th>to</th> <th>b3</th> <th>b2</th> <th>b1</th> <th>b0</th> </tr> </thead> <tbody> <tr> <td>10H (16)</td> <td>16</td> <td>15</td> <td>to</td> <td>12</td> <td>11</td> <td>to</td> <td>4</td> <td>3</td> <td>2</td> <td>1</td> </tr> <tr> <td>11H (17)</td> <td>—</td> <td>—</td> <td>—</td> <td>—</td> <td>28</td> <td>to</td> <td>20</td> <td>19</td> <td>18</td> <td>17</td> </tr> </tbody> </table> <p style="text-align: center;">1 to 28 in the table indicate station numbers.</p>		b15	b14	to	b11	b10	to	b3	b2	b1	b0	10H (16)	16	15	to	12	11	to	4	3	2	1	11H (17)	—	—	—	—	28	to	20	19	18	17
	b15	b14	to	b11	b10	to	b3	b2	b1	b0																										
10H (16)	16	15	to	12	11	to	4	3	2	1																										
11H (17)	—	—	—	—	28	to	20	19	18	17																										
12H, 13H	18, 19	(Use prohibited)	—																																	

Address		Item	Description																																
Hexadecimal	Decimal																																		
14H, 15H	20, 21	Error invalid station setting	<p>Stores the error invalid station specification status. Only the bit corresponding to the start station number turns on.</p> <ul style="list-style-type: none"> <li>• Default: 0 (Not set)</li> <li>• Range: The bit corresponding to the station number turns on.</li> </ul> <table border="1" style="margin-left: auto; margin-right: auto;"> <tr> <td style="text-align: center;">b15</td> <td style="text-align: center;">b14</td> <td style="text-align: center;">to</td> <td style="text-align: center;">b11</td> <td style="text-align: center;">b10</td> <td style="text-align: center;">to</td> <td style="text-align: center;">b3</td> <td style="text-align: center;">b2</td> <td style="text-align: center;">b1</td> <td style="text-align: center;">b0</td> </tr> <tr> <td style="text-align: center;">14H (20)</td> <td style="text-align: center;">16</td> <td style="text-align: center;">15</td> <td style="text-align: center;">to</td> <td style="text-align: center;">12</td> <td style="text-align: center;">11</td> <td style="text-align: center;">to</td> <td style="text-align: center;">4</td> <td style="text-align: center;">3</td> <td style="text-align: center;">2</td> <td style="text-align: center;">1</td> </tr> <tr> <td style="text-align: center;">15H (21)</td> <td style="text-align: center;">—</td> <td style="text-align: center;">—</td> <td style="text-align: center;">—</td> <td style="text-align: center;">—</td> <td style="text-align: center;">28</td> <td style="text-align: center;">to</td> <td style="text-align: center;">20</td> <td style="text-align: center;">19</td> <td style="text-align: center;">18</td> <td style="text-align: center;">17</td> </tr> </table> <p style="text-align: center;">1 to 28 in the table indicate station numbers.</p>	b15	b14	to	b11	b10	to	b3	b2	b1	b0	14H (20)	16	15	to	12	11	to	4	3	2	1	15H (21)	—	—	—	—	28	to	20	19	18	17
b15	b14	to	b11	b10	to	b3	b2	b1	b0																										
14H (20)	16	15	to	12	11	to	4	3	2	1																									
15H (21)	—	—	—	—	28	to	20	19	18	17																									
16H to 1FH	22 to 31	(Use prohibited)	—																																
20H (1st station) to 3BH (28th station)	32 (1st station) to 59 (28th station)	Station information	<p>Stores the status of the station type, the number of occupied stations, and the extended cyclic settings specified in the module parameters for slave stations.</p> <ul style="list-style-type: none"> <li>• Default: 0000H (When the program setting method is to use the "Program.")<sup>*1</sup></li> <li>0101H (Ver.1-compatible remote I/O station, one station occupied, and station number 1)</li> <li>⋮</li> <li>011CH (Ver.1-compatible remote I/O station, one station occupied, and station number 28)</li> </ul> <ul style="list-style-type: none"> <li>• Range: Refer to the following.</li> </ul> <table border="1" style="margin-left: auto; margin-right: auto;"> <tr> <td style="text-align: center;">b15</td> <td style="text-align: center;">to</td> <td style="text-align: center;">b12</td> <td style="text-align: center;">b11</td> <td style="text-align: center;">to</td> <td style="text-align: center;">b8</td> <td style="text-align: center;">b7</td> <td style="text-align: center;">to</td> <td style="text-align: center;">b0</td> </tr> <tr> <td colspan="3" style="text-align: center;">Station type</td> <td colspan="2" style="text-align: center;">Number of occupied stations</td> <td colspan="4" style="text-align: center;">Station No.</td> </tr> </table> <p style="margin-left: 200px;">     1H: Number of occupied stations: 1      2H: Number of occupied stations: 2      3H: Number of occupied stations: 3      4H: Number of occupied stations: 4   </p> <p style="margin-left: 200px;">     1 to 28 (01H to 1CH)   </p> <ul style="list-style-type: none"> <li>0H: Ver.1-compatible remote I/O station</li> <li>1H: Ver.1-compatible remote device station</li> <li>2H: Ver.1-compatible intelligent device station</li> <li>5H: Ver.2-compatible remote device station (single)</li> <li>6H: Ver.2-compatible intelligent device station (single)</li> <li>8H: Ver.2-compatible remote device station (double)</li> <li>9H: Ver.2-compatible intelligent device station (double)</li> <li>BH: Ver.2-compatible remote device station (quadruple)</li> <li>CH: Ver.2-compatible intelligent device station (quadruple)</li> <li>EH: Ver.2-compatible remote device station (octuple)</li> <li>FH: Ver.2-compatible intelligent device station (octuple)</li> </ul>	b15	to	b12	b11	to	b8	b7	to	b0	Station type			Number of occupied stations		Station No.																	
b15	to	b12	b11	to	b8	b7	to	b0																											
Station type			Number of occupied stations		Station No.																														
3CH to DFH	60 to 223	(Use prohibited)	—																																

\*1 Only FX5U/FX5UC CPU module is supported.

## Remote input (RX) and remote output (RY)

This buffer memory area is used when the remote net Ver.1 mode is selected.

- In the remote net Ver.1 mode, data are stored in the remote input (RX) and remote output (RY). (  Page 35 Remote net Ver.1 mode)

### ■Remote input (RX)

For the master station, data input from slave stations are stored.

For intelligent device stations, data output to the master station are stored.

Station No.	Buffer memory address	Station No.	Buffer memory address	Station No.	Buffer memory address	Station No.	Buffer memory address	Station No.	Buffer memory address
1	E0H, E1H (224, 225)	7	ECH, EDH (236, 237)	13	F8H, F9H (248, 249)	19	104H, 105H (260, 261)	25	110H, 111H (272, 273)
2	E2H, E3H (226, 227)	8	EEH, EFH (238, 239)	14	FAH, FBH (250, 251)	20	106H, 107H (262, 263)	26	112H, 113H (274, 275)
3	E4H, E5H (228, 229)	9	F0H, F1H (240, 241)	15	FCH, FDH (252, 253)	21	108H, 109H (264, 265)	27	114H, 115H (276, 277)
4	E6H, E7H (230, 231)	10	F2H, F3H (242, 243)	16	FEH, FFH (254, 255)	22	10AH, 10BH (266, 267)	28	116H, 117H (278, 279)
5	E8H, E9H (232, 233)	11	F4H, F5H (244, 245)	17	100H, 101H (256, 257)	23	10CH, 10DH (268, 269)	—	—
6	EAH, EBH (234, 235)	12	F6H, F7H (246, 247)	18	102H, 103H (258, 259)	24	10EH, 10FH (270, 271)	—	—

#### Point

- For intelligent device stations, regardless of the station No. of the station itself, store data output to the master station for the number of occupied stations from the station number 1 area.
- The last 2 bits of RX cannot be used when using the master/intelligent device module as the intelligent device station.

### ■Remote output (RY)

For the master station, data output to slave stations are stored.

For intelligent device stations, data input from the master station are stored.

Station No.	Buffer memory address	Station No.	Buffer memory address	Station No.	Buffer memory address	Station No.	Buffer memory address	Station No.	Buffer memory address
1	160H, 161H (352, 353)	7	16CH, 16DH (364, 365)	13	178H, 179H (376, 377)	19	184H, 185H (388, 389)	25	190H, 191H (400, 401)
2	162H, 163H (354, 355)	8	16EH, 16FH (366, 367)	14	17AH, 17BH (378, 379)	20	186H, 187H (390, 391)	26	192H, 193H (402, 403)
3	164H, 165H (356, 357)	9	170H, 171H (368, 369)	15	17CH, 17DH (380, 381)	21	188H, 189H (392, 393)	27	194H, 195H (404, 405)
4	166H, 167H (358, 359)	10	172H, 173H (370, 371)	16	17EH, 17FH (382, 383)	22	18AH, 18BH (394, 395)	28	196H, 197H (406, 407)
5	168H, 169H (360, 361)	11	174H, 175H (372, 373)	17	180H, 181H (384, 385)	23	18CH, 18DH (396, 397)	—	—
6	16AH, 16BH (362, 363)	12	176H, 177H (374, 375)	18	182H, 183H (386, 387)	24	18EH, 18FH (398, 399)	—	—

#### Point

- For intelligent device stations, regardless of the station No. of the station itself, stores data input from the master station for the number of occupied stations from the station number 1 area.
- The last 2 bits of RY cannot be used when using the master/intelligent device module as the intelligent device station.

A

## Remote register (RWr) and remote register (RWw)

This buffer memory area is used when the remote net Ver.1 mode is selected.

- In the remote net Ver.1 mode, data are stored in the remote register (RWr and RWw). (  Page 35 Remote net Ver.1 mode)

### ■Remote register (RWr)

For the master station, data input from slave stations are stored.

For intelligent device stations, data output from the master station are stored.

Station No.	Buffer memory address	Station No.	Buffer memory address	Station No.	Buffer memory address	Station No.	Buffer memory address	Station No.	Buffer memory address
1	2E0H to 2E3H (736 to 739)	7	2F8H to 2FBH (760 to 763)	13	310H to 313H (784 to 787)	19	328H to 32BH (808 to 811)	25	340H to 343H (832 to 835)
2	2E4H to 2E7H (740 to 743)	8	2FCH to 2FFH (764 to 767)	14	314H to 317H (788 to 791)	20	32CH to 32FH (812 to 815)	26	344H to 347H (836 to 839)
3	2E8H to 2EBH (744 to 747)	9	300H to 303H (768 to 771)	15	318H to 31BH (792 to 795)	21	330H to 333H (816 to 819)	27	348H to 34BH (840 to 843)
4	2ECH to 2EFH (748 to 751)	10	304H to 307H (772 to 775)	16	31CH to 31FH (796 to 799)	22	334H to 337H (820 to 823)	28	34CH to 34FH (844 to 847)
5	2F0H to 2F3H (752 to 755)	11	308H to 30BH (776 to 779)	17	320H to 323H (800 to 803)	23	338H to 33BH (824 to 827)	—	—
6	2F4H and 2F7H (756 to 759)	12	30CH to 30FH (780 to 783)	18	324H to 327H (804 to 807)	24	33CH to 33FH (828 to 831)	—	—



For intelligent device stations, regardless of the station No. of the station itself, store data output to the master station for the number of occupied stations from the station number 1 area.

### ■Remote register (RWw)

For the master station, data output to slave stations are stored.

For intelligent device stations, data input from the master station are stored.

Station No.	Buffer memory address	Station No.	Buffer memory address	Station No.	Buffer memory address	Station No.	Buffer memory address	Station No.	Buffer memory address
1	1E0H to 1E3H (480 to 483)	7	1F8H to 1FBH (504 to 507)	13	210H to 213H (528 to 531)	19	228H to 22BH (552 to 555)	25	240H to 243H (576 to 579)
2	1E4H to 1E7H (484 to 487)	8	1FCH to 1FFH (508 to 511)	14	214H to 217H (532 to 535)	20	22CH to 22FH (556 to 559)	26	244H to 247H (580 to 583)
3	1E8H to 1EBH (488 to 491)	9	200H to 203H (512 to 515)	15	218H to 21BH (536 to 539)	21	230H to 233H (560 to 563)	27	248H to 24BH (584 to 587)
4	1ECH to 1EFH (492 to 495)	10	204H to 207H (516 to 519)	16	21CH to 21FH (540 to 543)	22	234H to 237H (564 to 567)	28	24CH to 24FH (588 to 591)
5	1F0H to 1F3H (496 to 499)	11	208H to 20BH (520 to 523)	17	220H to 223H (544 to 547)	23	238H to 23BH (568 to 571)	—	—
6	1F4H to 1F7H (500 to 503)	12	20CH to 20FH (524 to 527)	18	224H to 227H (548 to 551)	24	23CH to 23FH (572 to 575)	—	—



For intelligent device stations, regardless of the station No. of the station itself, stores data input from the master station for the number of occupied stations from the station number 1 area.



## Slave station offset, size information

In the remote net Ver.2 mode, the assignment of RX, RY, RWw, and RWr for each station differs depending on the extended cyclic settings.

### ■Offset

This area stores the start buffer memory addresses of RX, RY, RWw, and RWr assigned for each station.

When two or more stations are occupied, a value is stored only in the start buffer memory address of the first station. For example, when the station number 1 occupies two stations, values are stored only in the RX, RY, RWw, RWr offset, and size information of the station number 1 and those for the station number 2 remain the default.

### ■Size

This area stores the sizes of RX, RY, RWw, and RWr assigned for each station (unit: word).

When the size is less than one word, the storage value is rounded up; therefore, 1 is stored.

If the target station is a reserved station, 0000H is stored.

The following table lists the relationship between RX, RY, RWw, RWr offset, size information and buffer memory addresses for each station.

Buffer memory address		Item	Default (hexadecimal)
Hexadecimal	Decimal		
3E0H	992	Station No.1 RX offset	0000H
3E1H	993	Station No.1 RX size	0000H
⋮	⋮	⋮	—
416H	1046	Station No.28 RX offset	0000H
417H	1047	Station No.28 RX size	0000H
⋮	⋮	(Use prohibited)	—
460H	1120	Station No.1 RY offset	0000H
461H	1121	Station No.1 RY size	0000H
⋮	⋮	⋮	—
496H	1174	Station No.28 RY offset	0000H
497H	1175	Station No.28 RY size	0000H
⋮	⋮	(Use prohibited)	—
4E0H	1248	Station No.1 RWw offset	0000H
4E1H	1249	Station No.1 RWw size	0000H
⋮	⋮	⋮	—
516H	1302	Station No.28 RWw offset	0000H
517H	1303	Station No.28 RWw size	0000H
⋮	⋮	(Use prohibited)	—
560H	1376	Station No.1 RWr offset	0000H
561H	1377	Station No.1 RWr size	0000H
⋮	⋮	⋮	—
596H	1430	Station No.28 RWr offset	0000H
597H	1431	Station No.28 RWr size	0000H

The following figure shows an example of connecting the intelligent device station with the extended cyclic settings, remote device station, and remote I/O station.

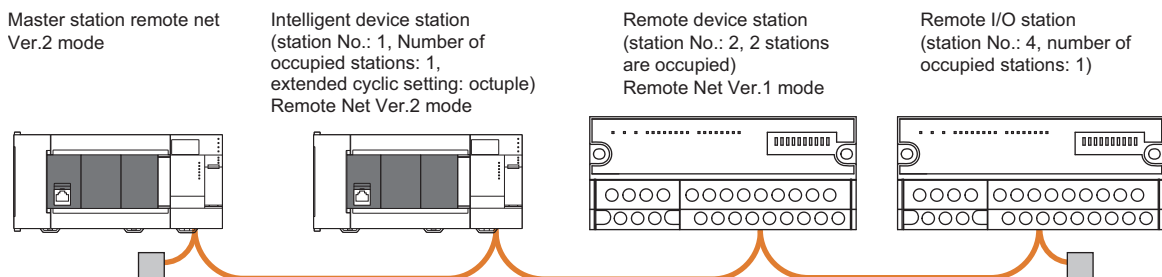

Buffer memory area	Value	Description
Station No.1 RX offset	4000H	Start buffer memory address of RX in the station number 1
Station No.1 RX size	8 (8H)	128 (number of points of RX) ÷ 16 = 8 words
Station No.2 RX offset	4008H	Start buffer memory address of RX in the station number 2
Station No.2 RX size	4 (4H)	The corresponding size of RX whose 4 words of the buffer memory address: 4008H to 400BH are the station number 2
Station No.3 RX offset	4000H	Because the station occupies two stations, check the area in the station number 2.
Station No.3 RX size	0 (Default)	Because the station occupies two stations, check the area in the station number 2.
Station No.4 RX offset	400CH	Start buffer memory address of RX in the station number 4
Station No.4 RX size	2 (2H)	The corresponding size of RX whose 2 words of the buffer memory address: 400CH to 400DH are the station number 4
Station No.1 RY offset	4200H	Start buffer memory address of RY in the station number 1
Station No.1 RY size	8 (8H)	128 (number of points of RY) ÷ 16 = 8 words
Station No.2 RY offset	4208H	Start buffer memory address of RY in the station number 2
Station No.2 RY size	4 (4H)	The corresponding size of RY whose 4 words of the buffer memory address: 4208H to 420BH are the station number 2
Station No.3 RY offset	4200H	Because the station occupies two stations, check the area in the station number 2.
Station No.3 RY size	0 (Default)	Because the station occupies two stations, check the area in the station number 2.
Station No.4 RY offset	420CH	Start buffer memory address of RY in the station number 4
Station No.4 RY size	2 (2H)	The corresponding size of RY whose 2 words of the buffer memory address: 420CH to 420DH are the station number 4
Station No.1 RWw offset	4400H	Start buffer memory address of RWw in the station number 1
Station No.1 RWw size	32 (20H)	1 (number of occupied stations) × 4 words × 8 (extended cyclic settings) = 32
Station No.2 RWw offset	4420H	Start buffer memory address of RWw in the station number 2
Station No.2 RWw size	8 (8H)	2 (number of occupied stations) × 4 words = 8 buffer memory area size of RWw in the station number 2
Station No.3 RWw offset	4400H	Because the station occupies two stations, check the area in the station number 2.
Station No.3 RWw size	0 (Default)	Because the station occupies two stations, check the area in the station number 2.
Station No.4 RWw offset	4428H	Start buffer memory address of RWw in the station number 4
Station No.4 RWw size	0 (Default)	Buffer memory area size of RWw in the station number 4
Station No.1 RWr offset	4C00H	Start buffer memory address of RWr in the station number 1
Station No.1 RWr size	32 (20H)	1 (number of occupied stations) × 4 words × 8 (extended cyclic settings) = 32
Station No.2 RWr offset	4C20H	Start buffer memory address of RWr in the station number 2
Station No.2 RWr size	8 (8H)	2 (number of occupied stations) × 4 words = 8 buffer memory area size of RWr in the station number 2
Station No.3 RWr offset	4C00H	Because the station occupies two stations, check the area in the station number 2.
Station No.3 RWr size	0 (Default)	Because the station occupies two stations, check the area in the station number 2.
Station No.4 RWr offset	4C28H	Start buffer memory address of RWr in the station number 4
Station No.4 RWr size	0 (Default)	Buffer memory area size of RWr in the station number 4

## Link special relay (SB)

This area stores bit (on/off) data indicating the data link status.

Buffer memory addresses 5E0H to 5FFH correspond to link special relay areas SB0000 to SB01FF.

The following table lists the relationship between buffer memory addresses 5E0H to 5FFH and link special relay areas SB0000 to SB01FF.

Address	b15	b14	b13	b12	b11	b10	b9	b8	b7	b6	b5	b4	b3	b2	b1	b0
5E0H (1504)	F	E	D	C	B	A	9	8	7	6	5	4	3	2	1	0
5E1H (1505)	1F	1E	1D	1C	1B	1A	19	18	17	16	15	14	13	12	11	10
5E2H (1506)	2F	2E	2D	2C	2B	2A	29	28	27	26	25	24	23	22	21	20
5E3H (1507)	3F	3E	3D	3C	3B	3A	39	38	37	36	35	34	33	32	31	30
5E4H (1508)	4F	4E	4D	4C	4B	4A	49	48	47	46	45	44	43	42	41	40
5E5H (1509)	5F	5E	5D	5C	5B	5A	59	58	57	56	55	54	53	52	51	50
5E6H (1510)	6F	6E	6D	6C	6B	6A	69	68	67	66	65	64	63	62	61	60
5E7H (1511)	7F	7E	7D	7C	7B	7A	79	78	77	76	75	74	73	72	71	70
5E8H (1512)	8F	8E	8D	8C	8B	8A	89	88	87	86	85	84	83	82	81	80
5E9H (1513)	9F	9E	9D	9C	9B	9A	99	98	97	96	95	94	93	92	91	90
5EAH (1514)	AF	AE	AD	AC	AB	AA	A9	A8	A7	A6	A5	A4	A3	A2	A1	A0
5EBH (1515)	BF	BE	BD	BC	BB	BA	B9	B8	B7	B6	B5	B4	B3	B2	B1	B0
5ECH (1516)	CF	CE	CD	CC	CB	CA	C9	C8	C7	C6	C5	C4	C3	C2	C1	C0
5EDH (1517)	DF	DE	DD	DC	DB	DA	D9	D8	D7	D6	D5	D4	D3	D2	D1	D0
5EEH (1518)	EF	EE	ED	EC	EB	EA	E9	E8	E7	E6	E5	E4	E3	E2	E1	E0
5EFH (1519)	FF	FE	FD	FC	FB	FA	F9	F8	F7	F6	F5	F4	F3	F2	F1	F0
5F0H (1520)	10F	10E	10D	10C	10B	10A	109	108	107	106	105	104	103	102	101	100
5F1H (1521)	11F	11E	11D	11C	11B	11A	119	118	117	116	115	114	113	112	111	110
5F2H (1522)	12F	12E	12D	12C	12B	12A	129	128	127	126	125	124	123	122	121	120
5F3H (1523)	13F	13E	13D	13C	13B	13A	139	138	137	136	135	134	133	132	131	130
5F4H (1524)	14F	14E	14D	14C	14B	14A	149	148	147	146	145	144	143	142	141	140
5F5H (1525)	15F	15E	15D	15C	15B	15A	159	158	157	156	155	154	153	152	151	150
5F6H (1526)	16F	16E	16D	16C	16B	16A	169	168	167	166	165	164	163	162	161	160
5F7H (1527)	17F	17E	17D	17C	17B	17A	179	178	177	176	175	174	173	172	171	170
5F8H (1528)	18F	18E	18D	18C	18B	18A	189	188	187	186	185	184	183	182	181	180
5F9H (1529)	19F	19E	19D	19C	19B	19A	199	198	197	196	195	194	193	192	191	190
5FAH (1530)	1AF	1AE	1AD	1AC	1AB	1AA	1A9	1A8	1A7	1A6	1A5	1A4	1A3	1A2	1A1	1A0
5FBH (1531)	1BF	1BE	1BD	1BC	1BB	1BA	1B9	1B8	1B7	1B6	1B5	1B4	1B3	1B2	1B1	1B0
5FCH (1532)	1CF	1CE	1CD	1CC	1CB	1CA	1C9	1C8	1C7	1C6	1C5	1C4	1C3	1C2	1C1	1C0
5FDH (1533)	1DF	1DE	1DD	1DC	1DB	1DA	1D9	1D8	1D7	1D6	1D5	1D4	1D3	1D2	1D1	1D0
5FEH (1534)	1EF	1EE	1ED	1EC	1EB	1EA	1E9	1E8	1E7	1E6	1E5	1E4	1E3	1E2	1E1	1E0
5FFH (1535)	1FF	1FE	1FD	1FC	1FB	1FA	1F9	1F8	1F7	1F6	1F5	1F4	1F3	1F2	1F1	1F0

A

## Link special register (SW)

This area stores word data indicating the data link status.

Buffer memory addresses 600H to 7FFH correspond to link special relay areas SW0000 to SW01FF.

## Ver.2-compatible remote input (RX) and Ver.2-compatible remote output (RY)

This buffer memory area is used when the remote net Ver.2 mode is selected.

In the remote net Ver.2 mode, data are stored in the remote input (RX) and remote output (RY) of all slave stations. (including Ver.1-compatible slave stations)

Page 37 Remote net Ver.2 mode

### Ver.2-compatible remote input (RX)

For the master station, input data from slave stations are stored.

For intelligent device stations, output data to the master station are stored.

#### Point

- For intelligent device stations, regardless of the station No. of the station itself, store data output to the master station for the number of occupied stations from the station number 1 area.
- The last 2 bits of RX cannot be used when using the master/intelligent device module as the intelligent device station.

### Storage location for each station

The storage locations change depending on the number of occupied stations and extended cyclic settings in slave stations.

The storage locations for each station can be checked using Slave station offset, size information (Un\G992 to Un\G1047).

Page 151 Slave station offset, size information)

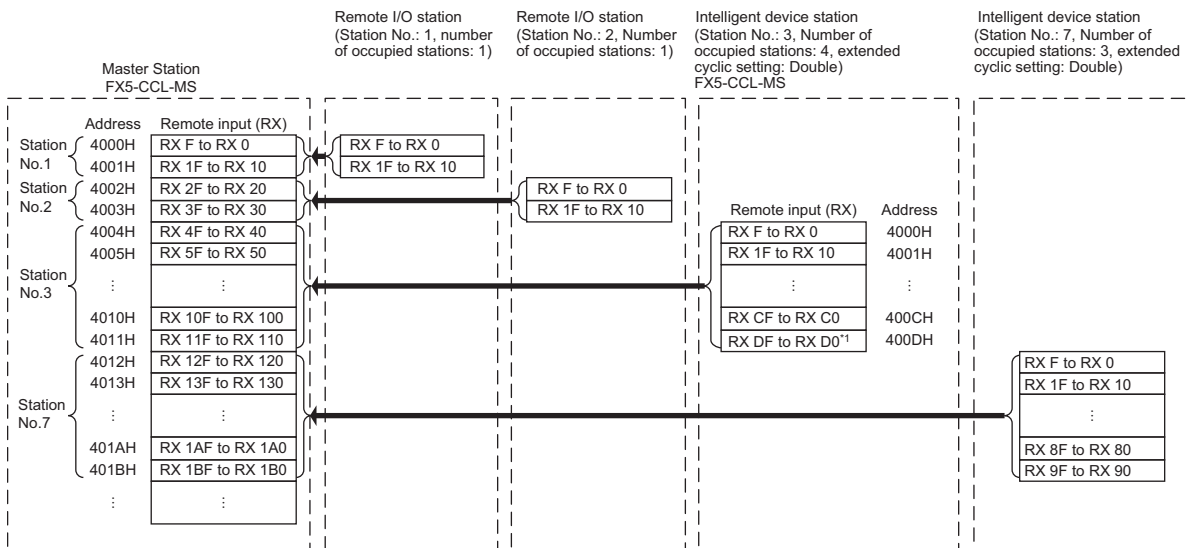

\*1 The last 2 bits of RX cannot be used when using the master/intelligent device module as the intelligent device station.

## Ver.2-compatible remote output (RY)

For the master station, output data to slave stations are stored.

For intelligent device stations, input data from the master station are stored.

### Point

- For intelligent device stations, regardless of the station No. of the station itself, stores data input from the master station for the number of occupied stations from the station number 1 area.
- The last 2 bits of RY cannot be used when using the master/intelligent device module as the intelligent device station.

## Storage location for each station

The storage locations change depending on the number of occupied stations and extended cyclic settings in slave stations.

The storage locations for each station can be checked using Slave station offset, size information (Un\G1120 to Un\G1175).

(Page 151 Slave station offset, size information)

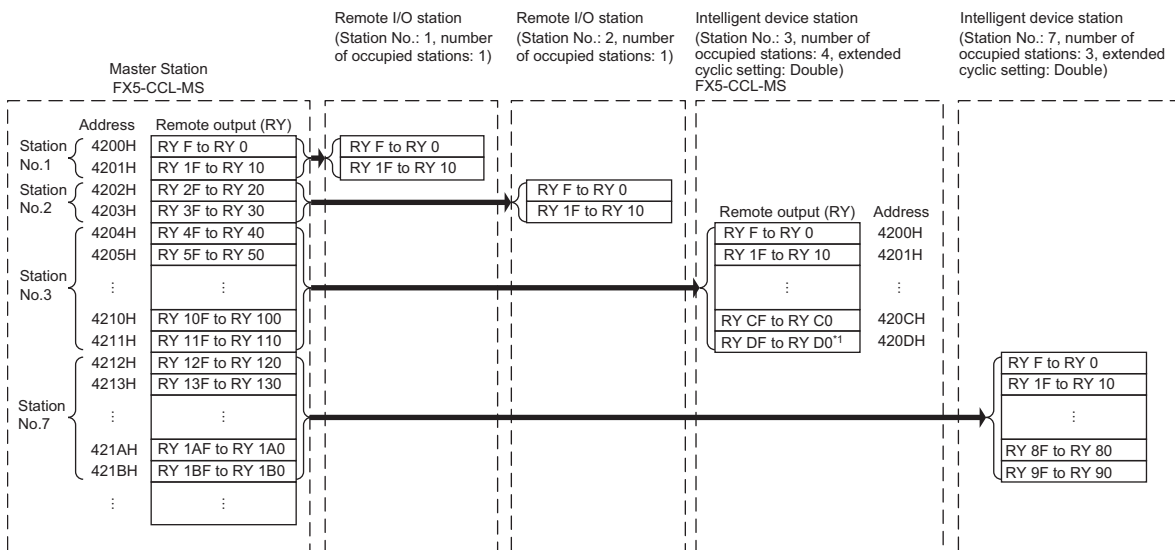

\*1 The last 2 bits of RY cannot be used when using the master/intelligent device module as the intelligent device station.

## Ver.2-compatible remote register (RWr) and Ver.2-compatible remote register (RWw)

This buffer memory area is used when the remote net Ver.2 mode is selected.

In the remote net Ver.2 mode, data are stored in the remote register (RWr/RWw) of all slave stations. (including Ver.1-compatible slave stations)

☞ Page 37 Remote net Ver.2 mode

### Ver.2-compatible remote register (RWr)

For the master station, input data from slave stations are stored.

For intelligent device stations, output data to the master station are stored.



For intelligent device stations, regardless of the station No. of the station itself, store data output to the master station for the number of occupied stations from the station number 1 area.

### Storage location for each station

The storage locations change depending on the number of occupied stations and extended cyclic settings in slave stations.

The storage locations for each station can be checked using Slave station offset, size information (Un\G1376 to Un\G1431).

☞ Page 151 Slave station offset, size information

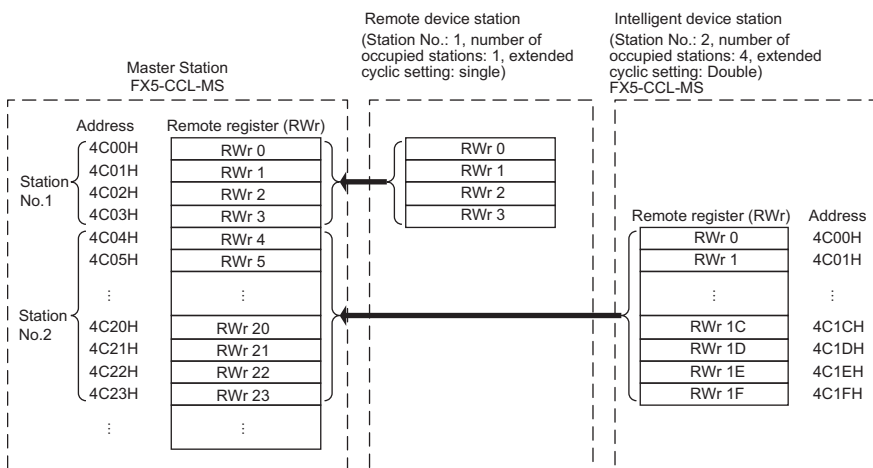

## Ver.2-compatible remote register (RWw)

For the master station, output data to slave stations are stored.

For intelligent device stations, input data from the master station are stored.

### Point

For intelligent device stations, regardless of the station No. of the station itself, stores data input from the master station for the number of occupied stations from the station number 1 area.

## Storage location for each station

The storage locations change depending on the number of occupied stations and extended cyclic settings in slave stations.

The storage locations for each station can be checked using Slave station offset, size information (Un\G1248 to Un\G1303).

(Page 151 Slave station offset, size information)

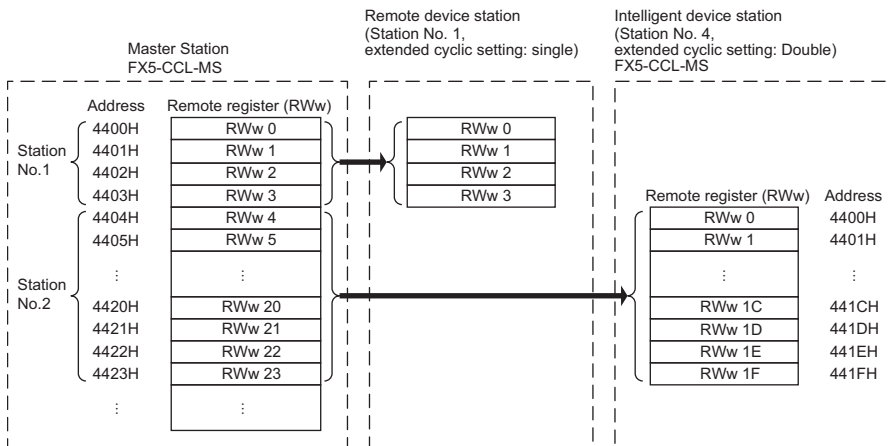

## Remote device station initialization procedure registration execution individual info.

This area stores the execution progress of the remote device station initial setting procedure registration function.

Address	Remote device station initialization procedure registration execution individual info.
5C80H (23680)	Remote device station initialization procedure registration execution individual information (station number 1)
5C81H (23681)	Remote device station initialization procedure registration execution individual information (station number 2)
⋮	
5C9AH (23706)	Remote device station initialization procedure registration execution individual information (station number 27)
5C9BH (23707)	Remote device station initialization procedure registration execution individual information (station number 28)

The following values are stored in the bits of Remote device station initialization procedure registration execution individual information.

Bit	Description	Value
b15 to b8	Stores the next execution procedure number.	<ul style="list-style-type: none"> <li>• 1 to 32 (In process)</li> <li>• FFH (Completed)</li> </ul> (Default: 0)
b7 to b0	Stores the station number.	1 to 28 (01H to 1CH) (Default: 0)

A

## I/O signals

This section stores the I/O signals for the CPU module.

Address	Description
6700H(26368) to 6703H(26371)	This section stores the input and output signals for the CPU module.

### ■List of I/O signals

The following table lists I/O signals.

Classification	Address	Bit	Signal name
Input signals	6700H (26368)	b0	Module failure
		b1	Own station data link status
		b2	Use prohibited
		b3	Data link status of other stations (only master station)
		b4, b5	Use prohibited
		b6	Completion of data link start using parameters in buffer memory <sup>*1</sup>
		b7	Abnormal completion of data link start using parameters in buffer memory <sup>*1</sup>
		b8 to b14	Use prohibited
		b15	Module ready
			6701H (26369)
Output signals	6702H (26370)	b0 to b5	Use prohibited
		b6	Request to start data link using parameters in buffer memory <sup>*1</sup>
		b7 to b15	Use prohibited
	6703H (26371)	b0 to b15	Use prohibited

\*1 Only FX5U/FX5UC CPU module is supported.



Do not use (turn on) any "use prohibited" signals as an input or output signal to the CPU module. Doing so may cause malfunction of the programmable controller system.

### ■Module failure (Un\G26368 b0)

This signal indicates whether the module is normal or faulty.

Off: Module normal

On: Module failure

Module failure  
(Un\G26368 b0)

Module ready  
(Un\G26368 b15)

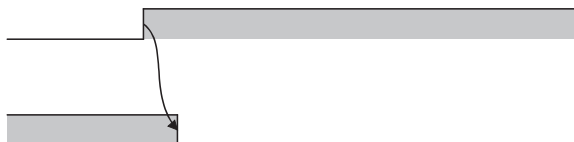

### ■Own station data link status (Un\G26368 b1)

This signal indicates the data link status of the own station.

'Operation status of own station' (SB006E) has the same functionality. Use either of 'Data link status of own station' (Un\G26368 b1) or 'Operation status of own station' (SB006E) for programming.

Note that the on/off conditions of 'Data link status of own station' (Un\G26368 b1) are the opposite to those of 'Operation status of own station' (SB006E). The conditions of the data link status of own station (b1) are as follows:

Off: Data link stop

On: Data link in progress



### ■Data link status of other stations (Un\G26368 b3)

This signal indicates the data link status of other stations (remote station, intelligent device station) when using the master station.

'Data link status of other stations' (SB0080) uses the same signal. Use either of 'Data link status of other station' (Un\G26368 b3) or 'Data link status of other station' (SB0080) for programming.

Off: All stations normal

On: Faulty station found (The status of the faulty station is stored in 'Data link status of other stations' (SW0080, SW0081).)

#### Point

It takes maximum of six seconds for 'Data link status of other stations' (Un\G26368 b3) to turn on after a slave station connected to the master station becomes faulty. The time until this signal turns on differs depending on the system configuration and error status.

### ■Completion of data link start using parameters in buffer memory (Un\G26368 b6)

This is a signal to show the normal completion status of a data link start request via "Request to start data link using parameters in buffer memory" (Un\G26370 b6).

OFF: Either abnormal completion of data link start or no request for data link start

ON: Normal completion of data link start

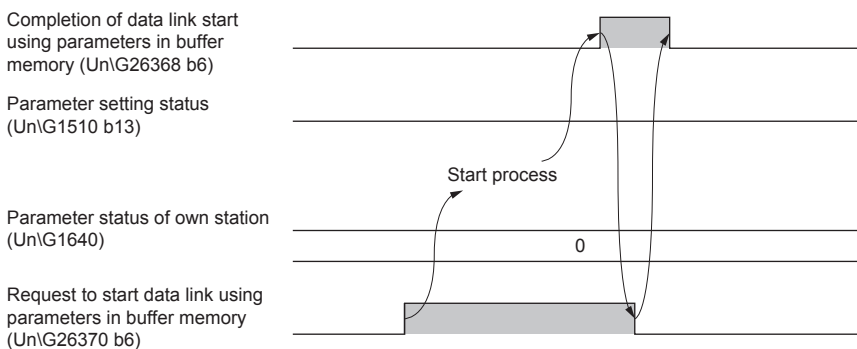

Following are the operations of "Completion of data link start using parameters in buffer memory" (Un\G26368 b6)

1. If "Request to start data link using parameters in buffer memory" (Un\G26370 b6) is turned on, parameters in the buffer memory are checked. If the parameters are normal, the data link is started automatically.
2. If starting the data link is completed normally, "Completion of data link start using parameters in buffer memory" (Un\G26368 b6) is turned on.
3. If "Request to start data link using parameters in buffer memory" (Un\G26370 b6) is turned off, "Completion of data link start using parameters in buffer memory" (Un\G26368 b6) is turned off.

## ■Abnormal completion of data link start using parameters in buffer memory (Un\G26368 b7)

This is a signal to show the abnormal completion status of a data link start request via "Request to start data link using parameters in buffer memory" (Un\G26370 b6).

OFF: Either normal completion of data link start or no request for data link start

ON: Abnormal completion of data link start

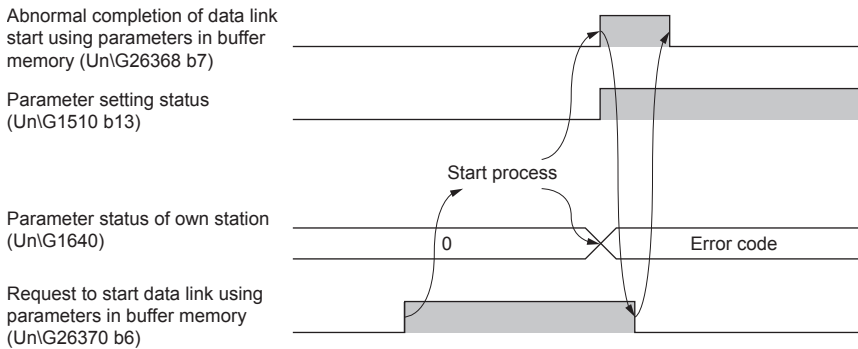

Following are the operations of "Abnormal completion of data link start using parameters in buffer memory" (Un\G26368 b7).

1. If "Request to start data link using parameters in buffer memory" (Un\G26370 b6) is turned on, parameters in the buffer memory are checked. If the parameters are abnormal, the data link will not be started and "Abnormal completion of data link start using parameters in buffer memory" (Un\G26368 b7) will be turned on.
2. If "Request to start data link using parameters in buffer memory" (Un\G26370 b6) is turned off, "Abnormal completion of data link start using parameters in buffer memory" (Un\G26368 b7) will be turned off.

## ■Module ready (Un\G26368 b15)

This signal indicates whether the module is ready for operation. When the module becomes ready, this signal turns on.

When the module is in the following state, this signal turns off.

- When 'Module failure' (Un\G26368 b0) turns on

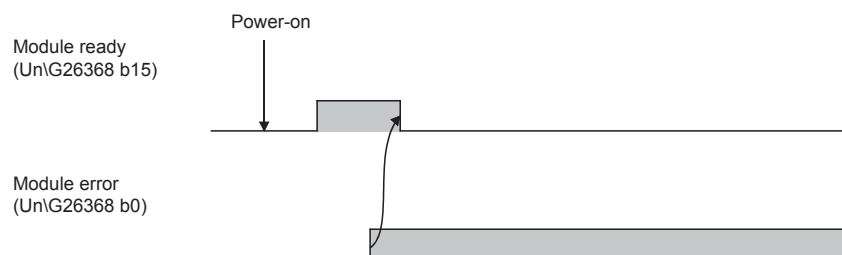

## ■Request to start data link using parameters in buffer memory (Un\G26370 b6)

This is a signal to request data link start when the program is used for parameter settings. (Page 64 When using the Program) If the data link start is requested, parameters in the buffer memory will be checked.

OFF: The data link start is not requested.

ON: The data link start is requested.

Refer to the following for the results and operations of a request for the data link start.

Page 159 Completion of data link start using parameters in buffer memory (Un\G26368 b6)

Page 160 Abnormal completion of data link start using parameters in buffer memory (Un\G26368 b7)

## Module Information

Address	Description
6708H (26376)	Stores the unique code (6788H) of FX5-CCL-MS.

## F/W version

Address	Description
6709H (26377)	Stores the version of the firmware of FX5-CCL-MS. (Example) For Ver.1000, K1000 is stored.

# Appendix 5 List of Link Special Relay (SB) Areas

The link special relay (SB) is turned on/off depending on various factors during data link. Any error status of the data link can be checked by using and monitoring it in the program.

## Application of the link special relay (SB)

By using the link special relay (SB), the status of CC-Link system can be checked from HMI (Human Machine Interfaces) as well as the engineering tool.

## Refresh of the link special relay (SB)

To use the link special relay (SB), set them in "Link Refresh Settings" in "Basic Settings" so that they are refreshed to the devices or labels of the CPU module. (☞ Page 71 Link refresh settings)

## Ranges turned on/off by users and by the system

The following ranges correspond to when the link special relay (SB) areas are assigned from SB0000 to SB01FF.

- Turned on/off by users: SB0000 to SB001F
- Turned on/off by the system: SB0020 to SB01FF

## List of link special relay (SB) areas

The following table lists the link special relay (SB) areas when they are assigned from SB0000 to SB01FF.



Do not turn on or off areas whose numbers are not on the following list or ranges turned on/off by the system. Doing so may cause malfunction of the programmable controller system.

No.	Name	Description	Availability (○: Available, ×: Not available)		
			Online		Offline
			Master Station	Intelligent device station	
SB0000	Data link restart	Restarts the data link that has been stopped by SB0002. Off: Not instructed On: Instructed	○	○	×
SB0002	Data link stop	Stops the data link of the own station. Note that if this relay is instructed to the master station, the entire system will stop. Off: Not instructed On: Instructed	○	○	×
SB0004	Temporary error invalid request	Determines the stations specified by SW0003 to SW0005 as a temporary error invalid station. Off: Not requested On: Requested	○	×	×
SB0005	Temporary error invalid cancel request	Cancels the temporary error invalid station setting configured for the stations specified by SW0003 to SW0005. Off: Not requested On: Requested	○	×	×
SB0007	Master station duplication error cancel request	Clears a master station duplication error. Off: Not instructed On: Instructed	○ <sup>1</sup>	×	×
SB0008	Line test request	Executes a line test to the station specified by SW0008. Off: Not requested On: Requested	○	×	×
SB000B	Transmission speed test request	Executes a transmission speed test. Off: Not requested On: Requested	○ <sup>1</sup>	×	×

No.	Name	Description	Availability (○: Available, ×: Not available)		
			Online		Offline
			Master Station	Intelligent device station	
SB000D	Remote device station initialization procedure registration instruction	Performs an initial processing using the information registered by the remote device station initialization setting procedure registration using an engineering tool. While SB000D is on, the remote I/O and remote registers are stopped to be refreshed. Off: Not instructed On: Instructed	○	×	×
SB0020	Module status	Stores the communication status between the master/intelligent device module and CPU module. Off: Normal On: Error	○	○	○
SB0040	Data link restart acceptance	Stores the data link restart instruction has been accepted. Off: Not accepted On: Accepted	○	○	×
SB0041	Data link restart completion	Stores the data link restart instruction has been completed. Off: Not completed On: Started	○	○	×
SB0044	Data link stop acceptance	Stores the data link stop instruction has been accepted. Off: Not accepted On: Accepted	○	○	×
SB0045	Data link stop completion	Stores the data link stop instruction has been completed. Off: Not completed On: Stopped	○	○	×
SB0048	Temporary error invalid acceptance status	Stores the remote station temporary error invalid instruction has been accepted. Off: Not executed On: Accepted	○	×	×
SB0049	Temporary error invalid completion status	Stores the remote station temporary error invalid instruction has been completed. Off: Not executed On: A temporary error invalid station determined	○	×	×
SB004A	Temporary error invalid cancel acceptance status	Stores the remote station temporary error invalid cancel instruction has been accepted. Off: Not executed On: Accepted	○	×	×
SB004B	Temporary error invalid cancel completion status	Stores the remote station temporary error invalid cancel instruction has been completed. Off: Not executed On: Temporary error invalid station setting canceled	○	×	×
SB004C	Line test acceptance status	Stores a line test request has been accepted. Off: Not executed On: Accepted	○	×	×
SB004D	Line test completion status	Stores a line test has been completed. Off: Not executed On: Completed	○	×	×
SB0050	Offline test status	Stores an offline test is being executed. Off: Not executed On: Test in progress	×	×	○
SB0057	Master station duplication error cancel acceptance	Stores a master station duplication error cancel request has been accepted. Off: Not accepted On: Accepted	○	×	×
SB0058	Master station duplication error cancel completion	Stores a master station duplication error cancel request has been completed. Off: Not completed On: Completed	○	×	×
SB005E	Execution status of remote device station initialization procedure	Stores the initialization procedure is being performed. Off: Not executed On: In process	○	×	×

No.	Name	Description	Availability (○: Available, ×: Not available)		
			Online		Offline
			Master Station	Intelligent device station	
SB005F	Completion status of remote device station initialization procedure	Stores whether the initialization procedure has been completed. Off: Not completed On: Completed	○	×	×
SB0060	Mode of own station	Stores the mode setting status of the own station. Off: Online On: Mode other than online	○	○	○
SB0061	Type of own station	Stores the station type of the own station. Off: Master station (station number: 0) On: Intelligent device stations (station No.1 to 64)	○	○	×
SB0065	Input data status of own data link faulty station	Stores the setting status of "Input Data from Data Link Faulty Station" under "Supplementary Cyclic Settings" in "Application Settings" of the own station. Off: Clear On: Hold	○	○	×
SB0066	Number of own station occupied stations	Stores the number of occupied stations of the own station. ■1 Stations occupied • SB0066: Off • SB0067: Off ■2 Stations occupied • SB0066: Off • SB0067: On ■3 Stations occupied • SB0066: On • SB0067: On ■4 Stations occupied • SB0066: On • SB0067: Off	×	○	×
SB0067					
SB006D	Parameter setting status	Stores whether the parameters have been correctly set. Off: Normal On: Setting incorrect (An error code is stored in SW0068.)	○ <sup>*1</sup>	○	×
SB006E	Operation status of own station	Stores whether data link with other stations is being performed. Off: In process On: Not performed	○	○	×
SB006F	Setting status of block guarantee of cyclic data per station	Stores whether the block guarantee of cyclic data per station has been set to the own station. Off: Not set On: Set	○	○	×
SB0073	Data link setting at CPU failure	Indicates the data link status specified by the parameter when CPU is down. Off: Data link stopped On: Data link continued	○	×	×
SB0074	Reserved station specification status	Stores whether a reserved station has been specified by the parameter. Off: Not specified On: Specified (The set station number is stored in SW0074 and SW0075) Depending on the link refresh timing, SB0074 may be updated with the time difference of one sequence scan from the update of 'Reserved station specification status' (SW0074, SW0075).	○	×	×
SB0075	Error invalid station specification status	Stores whether an error invalid station has been specified using the parameter. Off: Not specified On: Specified (The set station number is stored in SW0078 and SW0079) Depending on the link refresh timing, SB0075 may be updated with the time difference of one sequence scan from the update of 'Error invalid station specification status' (SW0078, SW0079).	○	×	×
SB0076	Temporary error invalid station setting information	Stores whether a temporary error invalid station has been set. Off: Not set On: Set (The set station number is stored in SW007C and SW007D) Depending on the link refresh timing, SB0076 may be updated with the time difference of one sequence scan from the update of 'Temporary error invalid status' (SW007C, SW007D).	○	×	×



No.	Name	Description	Availability (○: Available, ×: Not available)		
			Online		Offline
			Master Station	Intelligent device station	
SB0077	Parameter receive status	Stores whether parameters have been received from the master station. Off: Received On: Not received	×	○	×
SB007C	Setting status of output data in case of CPU STOP	Stores the parameter setting status of output data in case of CPU STOP. Off: Send Remote Output (RY) On: Send 0 data	○	○	×
SB0080	Data link status of other stations	Stores the communication status with slave stations. Off: All stations normal On: Faulty Station (information is stored in SW0080 and SW0081) It takes maximum of six seconds for 'Data link status of other stations' (SB0080) to turn on after a slave station connected to the master station becomes faulty.	○	×	×
SB0081	Watchdog timer error status of other stations	Stores a watchdog timer error occurrence status in other stations. Off: No error On: Error Depending on the link refresh timing, SB0081 may be updated with the time difference of one sequence scan from the update of 'Watchdog timer error occurrence status of other stations' (SW0084, SW0085).	○	×	×
SB0082	Fuse blown status of other stations	Stores whether a fuse blown error has occurred in other stations. (SW0088, SW0089) Off: No error On: Error Depending on the link refresh timing, SB0082 may be updated with the time difference of one sequence scan from the update of 'Fuse blown status of other stations' (SW0088, SW0089).	○	×	×
SB0083	Switch change status of other stations	Detects whether the setting of setting switches of other stations during data link has been changed. Off: No change On: Changed Depending on the link refresh timing, SB0083 may be updated with the time difference of one sequence scan from the update of 'Switch change status of other stations' (SW008C, SW008D).	○	×	×
SB0090	Line status of own station	Stores whether the line to the own station is normally operating. Off: Normal On: Error (disconnected)	×	○	×
SB0094	Transient transmission status	Stores whether a transient transmission error has occurred. Off: No error On: Error	○	○	×
SB0095	Master stations transient transmission status	Stores whether the master station is normally performing transient. Off: Normal On: Error	×	○	×
SB0160	Remote register use prohibited status	Stores whether the use of remote registers is prohibited. Off: Available On: Use prohibited	○	×	×
SB0185	Transmission speed test acceptance status	Stores whether 'Transmission speed test request' (SB000B) has been accepted. Off: Not accepted On: Accepted	○	×	×
SB0186	Transmission speed test completion status	Stores whether a transmission speed test has been completed. Off: Not completed On: Completed	○	×	×

\*1 Available for stations with the station number 0 only.

# Appendix 6 List of Link Special Register (SW) Areas

The link special register (SW) stores the information during data link. Error locations and causes can be checked by using and monitoring the link special register (SW) in programs.

## Application of the link special register (SW)

By using the link special register (SW), the status of CC-Link system can be checked from HMI (Human Machine Interfaces) as well as the engineering tool.

## Refresh of the link special register (SW)

To use the link special register (SW), set them in "Link Refresh Settings" under "Basic Settings" so that they are refreshed to the devices or labels of the CPU module. (Page 71 Link refresh settings)

## Range where data are stored by users and range where data are stored by the system

The following ranges correspond to when the link special register (SW) areas are assigned from SW0000 to SW01FF.

- Stored by users: SW0000 to SW001F
- Stored by the system: SW0020 to SW01FF

## List of link special register (SW) areas

The following table lists the link special register (SW) when they are assigned from SW0000 to SW01FF.



Do not write any data to an area whose number is not on the following list or ranges where data are stored by the system. Doing so may cause malfunction of the programmable controller system.

No.	Name	Description	Availability (○: Available, ×: Not available)																																
			Online		Offline																														
			Master Station	Intelligent device station																															
SW0003	Multiple temporary error invalid station specification	Selects whether to specify multiple temporary error invalid stations. 00: Multiple stations set in SW0004, SW0005 specified 01 to 28 A single station specified from 1 to 28 (The number represents the station number to be set as a temporary error invalid station.)	○	×	×																														
SW0004, SW0005	Temporary error invalid station specification	Specifies a temporary error invalid station. 0: Temporary error invalid station not specified 1: Temporary error invalid station specified  <table border="1" style="margin-left: auto; margin-right: auto;"> <tr> <td></td> <td>b15</td> <td>b14</td> <td>to</td> <td>b11</td> <td>b10</td> <td>to</td> <td>b2</td> <td>b1</td> <td>b0</td> </tr> <tr> <td>SW0004</td> <td>16</td> <td>15</td> <td>to</td> <td>12</td> <td>11</td> <td>to</td> <td>3</td> <td>2</td> <td>1</td> </tr> <tr> <td>SW0005</td> <td>-</td> <td>-</td> <td>-</td> <td>-</td> <td>28</td> <td>to</td> <td>19</td> <td>18</td> <td>17</td> </tr> </table> 1 to 28 in the table indicate station numbers.  The stations need not be set by the number of occupied stations. Error invalid stations, reserved stations, station with the end station number, and stations later than that are excepted. The use of b11 to b15 of SW0005 is prohibited.		b15	b14	to	b11	b10	to	b2	b1	b0	SW0004	16	15	to	12	11	to	3	2	1	SW0005	-	-	-	-	28	to	19	18	17	○	×	×
	b15	b14	to	b11	b10	to	b2	b1	b0																										
SW0004	16	15	to	12	11	to	3	2	1																										
SW0005	-	-	-	-	28	to	19	18	17																										
SW0008	Line test station setting	Sets a station number where the line test is executed. 0: Entire system (executed to all stations) 01 to 28 Specified station Default: 0	○	×	×																														
SW000A	CPU monitoring time setting	Sets the monitoring time of CPU response when the CPU module is accessed through transient transmission. Default: 90 (seconds) (value = 0) Setting range: 1 to 3600 (seconds) If a value outside the range is set, the monitoring time will be 3600 seconds.	○	○	×																														



No.	Name	Description	Availability (○: Available, ×: Not available)																																		
			Online		Offline																																
			Master Station	Intelligent device station																																	
SW0014, SW0015	Specification of remote device station to be initialized	<p>Specifies a station that performs an initial processing using the information registered by the remote device station initialization setting procedure registration using an engineering tool.</p> <p>0: Initial processing not performed 1: Initial processing performed</p> <table border="1"> <tr> <td></td> <td>b15</td> <td>b14</td> <td>to</td> <td>b11</td> <td>b10</td> <td>to</td> <td>b2</td> <td>b1</td> <td>b0</td> </tr> <tr> <td>SW0014</td> <td>16</td> <td>15</td> <td>to</td> <td>12</td> <td>11</td> <td>to</td> <td>3</td> <td>2</td> <td>1</td> </tr> <tr> <td>SW0015</td> <td>-</td> <td>-</td> <td>-</td> <td>-</td> <td>28</td> <td>to</td> <td>19</td> <td>18</td> <td>17</td> </tr> </table> <p>1 to 28 in the table indicate station numbers.</p> <p>The stations need not be set by the number of occupied stations. Error invalid stations, reserved stations, station with the end station number, and stations later than that are excepted. The use of b11 to b15 of SW0015 is prohibited.</p>		b15	b14	to	b11	b10	to	b2	b1	b0	SW0014	16	15	to	12	11	to	3	2	1	SW0015	-	-	-	-	28	to	19	18	17	○	×	×		
	b15	b14	to	b11	b10	to	b2	b1	b0																												
SW0014	16	15	to	12	11	to	3	2	1																												
SW0015	-	-	-	-	28	to	19	18	17																												
SW0041	Data link restart result	<p>Stores whether the data link restart instruction using SB0000 has been normally completed.</p> <p>0: Normal Values other than 0: Error code (☞ Page 133 List of Error Codes)</p>	○	○	×																																
SW0045	Data link stop result	<p>Stores whether the data link stop instruction using SB0002 has been normally completed.</p> <p>0: Normal Values other than 0: Error code (☞ Page 133 List of Error Codes)</p>	○	○	×																																
SW0049	Temporary error invalid station specification result	<p>Stores whether the temporary error invalid station specification has been normally completed.</p> <p>0: Normal Values other than 0: Error code (☞ Page 133 List of Error Codes)</p>	○	×	×																																
SW004B	Temporary error invalid station specification cancel result	<p>Stores whether the temporary error invalid station setting has been normally canceled.</p> <p>0: Normal Values other than 0: Error code (☞ Page 133 List of Error Codes)</p>	○	×	×																																
SW004D	Line test result	<p>Stores the result of a line test.</p> <p>0: Normal Values other than 0: Error code (☞ Page 133 List of Error Codes)</p>	○	×	×																																
SW0057	Master station duplication error cancel result	<p>Stores whether a master station duplication error cancel request has been normally completed.</p> <p>0: Normal completion Values other than 0: Error code (☞ Page 133 List of Error Codes)</p>	○	×	×																																
SW0058	Detailed LED display status	<p>Stores the details of the LED display status.</p> <p>0: Off 1: On</p> <table border="1"> <tr> <td>b15</td><td>b14</td><td>b13</td><td>b12</td><td>b11</td><td>b10</td><td>b9</td><td>b8</td><td>b7</td><td>b6</td><td>b5</td><td>b4</td><td>b3</td><td>b2</td><td>b1</td><td>b0</td> </tr> <tr> <td></td><td></td><td></td><td></td><td></td><td>0</td><td>0</td><td></td><td></td><td></td><td></td><td></td><td>0</td><td>0</td><td>0</td><td>0</td> </tr> </table> <ul style="list-style-type: none"> <li>▶ LINE (ERROR): A cable is disconnected or the transmission path has been affected by noise.</li> <li>▶ TIME (ERROR): Responses cannot be received from any station due to the cable being disconnected or the transmission path being affected by noise.</li> <li>▶ PRM (ERROR): Invalid parameter value</li> <li>▶ M/S (ERROR): Multiple master stations exist on the same line.</li> <li>▶ SW (ERROR): Error in switch settings</li> <li>▶ MST: The station is operating as a master station.</li> <li>▶ ERR.: Error</li> <li>▶ RUN: The module is operating normally.</li> </ul> <p>• The use of b11 and b12 is prohibited. • The ERR. LED on the master/intelligent device module turns on when a bit of either among b4 to b8 or b14 is on.</p>	b15	b14	b13	b12	b11	b10	b9	b8	b7	b6	b5	b4	b3	b2	b1	b0						0	0						0	0	0	0	○	○	○
b15	b14	b13	b12	b11	b10	b9	b8	b7	b6	b5	b4	b3	b2	b1	b0																						
					0	0						0	0	0	0																						



No.	Name	Description	Availability (○: Available, ×: Not available)		
			Online		Offline
			Master Station	Intelligent device station	
SW0059	Transmission speed setting	<p>Stores the transmission speed setting status. Auto-tracking (b15) is enabled only at intelligent device stations.</p> <p>0: Not set 1: Setting</p>	○	○	○
SW005B	Transmission speed operation status	<p>Stores the transmission speed operation status. The bit "During auto-tracking" enables stations only at intelligent device stations.</p> <p>0: Not in operation 1: Operation</p>	○	○	○
SW005C	Detailed LED display status (2)	<p>Stores the detailed display status of the module LED.</p> <p>0: Off 1: On</p> <p>• The use of b0 to b6 is prohibited.</p>	○	○	○
SW005F	Remote device station initialization procedure registration instruction result	<p>Stores whether the initialization procedure registration instruction using SB000D has been normally completed.</p> <p>0: Normal Values other than 0: Error code (☞ Page 133 List of Error Codes)</p>	○	×	×
SW0060	Mode setting status	<p>Stores the mode setting status.</p> <p>0: Online (remote net mode) 2: Offline 3: Line test 1 4: Line test 2 6: Hardware test</p>	○	○	○
SW0061	Station number of own station	<p>Stores the current own station's station number.</p> <p>0: Master Station 1 to 64 Intelligent device station</p>	○	○	○



No.	Name	Description	Availability (○: Available, ×: Not available)																																
			Online		Offline																														
			Master Station	Intelligent device station																															
SW0062	Module operating status	<p>Stores the module operation setting configured using the parameter.</p> <p> b15 b14 b13 b12 b11 b10 b9 b8 b7 b6 b5 b4 b3 b2 b1 b0  0 0 0 0 0 0 0 0 0 0 0 0 0 0 0 0 </p> <ul style="list-style-type: none"> <li>→ Input Data from Data Link Faulty Station 0: Clear 1: Hold</li> <li>→ Number of occupied stations 00: 1 station occupied 10: 2 station occupied 11: 3 station occupied 01: 4 station occupied</li> <li>→ Parameter setting method 0: Parameter Editor 1: Program</li> <li>→ Output data setting in case of CPU STOP 0: Send output data 1: Send 0 data</li> <li>→ Extended cyclic setting 00: Single 01: Double 10: Quadruple 11: Octuple</li> <li>→ Station-based block data assurance 0: Disable 1: Enable</li> </ul>	○	○	○																														
SW0064	Number of retries information	Stores the set number of retries upon an abnormal response. 1 to 7 (time)	○	×	×																														
SW0065	Number of automatic return stations	Stores the set number of automatic return stations in one link scan. 1 to 10 (station)	○	×	×																														
SW0068	Parameter status of own station	Stores whether the parameters have been correctly set. 0: Normal Values other than 0: Error code (☞ Page 133 List of Error Codes)	○	○	×																														
SW0069	Installation status	Stores whether unique station numbers have been assigned for modules and whether parameter settings match with connected module status. 0: Normal Values other than 0: Error code (☞ Page 133 List of Error Codes) Details are stored in SW0098, SW0099, SW009C, SW009D. This item is checked only at link startup, and the result is stored.	○	×	×																														
SW006D	Maximum link scan time	Stores the maximum link scan time. (unit: 1 ms)	○	○	×																														
SW006E	Current link scan time	Stores the current link scan time. (unit: 1 ms)	○	○	×																														
SW006F	Minimum link scan time	Stores the minimum link scan time. (unit: 1 ms)	○	○	×																														
SW0070	Total number of stations	Stores the end station number set using the parameter. 1 to 28 (station)	○	×	×																														
SW0071	Maximum communication station number	Stores the maximum station number during data link (station number set using the station number setting switches). 1 to 28 (station) Reserved stations are excepted.	○	×	×																														
SW0072	Number of connected modules	Stores the number of modules performing data link. Reserved stations are excepted.	○	×	×																														
SW0074, SW0075	Reserved station specification status	<p>Stores the reserved station setting status. 0: A station other than a reserved station 1: Reserved Station</p> <table border="1" style="margin-left: auto; margin-right: auto;"> <thead> <tr> <th></th> <th>b15</th> <th>b14</th> <th>to</th> <th>b11</th> <th>b10</th> <th>to</th> <th>b2</th> <th>b1</th> <th>b0</th> </tr> </thead> <tbody> <tr> <td>SW0074</td> <td>16</td> <td>15</td> <td>to</td> <td>12</td> <td>11</td> <td>to</td> <td>3</td> <td>2</td> <td>1</td> </tr> <tr> <td>SW0075</td> <td>-</td> <td>-</td> <td>-</td> <td>-</td> <td>28</td> <td>to</td> <td>19</td> <td>18</td> <td>17</td> </tr> </tbody> </table> <p style="text-align: center;">1 to 28 in the table indicate station numbers.</p> <p>Only the bit corresponding to the start station number turns on. The station with the end station number and stations later than that are excepted. The use of b11 to b15 of SW0075 is prohibited.</p>		b15	b14	to	b11	b10	to	b2	b1	b0	SW0074	16	15	to	12	11	to	3	2	1	SW0075	-	-	-	-	28	to	19	18	17	○	×	×
	b15	b14	to	b11	b10	to	b2	b1	b0																										
SW0074	16	15	to	12	11	to	3	2	1																										
SW0075	-	-	-	-	28	to	19	18	17																										

No.	Name	Description	Availability (○: Available, ×: Not available)																																
			Online		Offline																														
			Master Station	Intelligent device station																															
SW0078, SW0079	Error invalid station specification status	<p>Stores whether a station has been set as an error invalid station.</p> <p>0: A station other than an error invalid station 1: Error Invalid Station</p> <table border="1"> <thead> <tr> <th></th> <th>b15</th> <th>b14</th> <th>to</th> <th>b11</th> <th>b10</th> <th>to</th> <th>b2</th> <th>b1</th> <th>b0</th> </tr> </thead> <tbody> <tr> <td>SW0078</td> <td>16</td> <td>15</td> <td>to</td> <td>12</td> <td>11</td> <td>to</td> <td>3</td> <td>2</td> <td>1</td> </tr> <tr> <td>SW0079</td> <td>-</td> <td>-</td> <td>-</td> <td>-</td> <td>28</td> <td>to</td> <td>19</td> <td>18</td> <td>17</td> </tr> </tbody> </table> <p>1 to 28 in the table indicate station numbers.</p> <p>Only the bit corresponding to the start station number turns on. Reserved stations, station with the end station number, and stations later than that are excepted. The use of b11 to b15 of SW0079 is prohibited.</p>		b15	b14	to	b11	b10	to	b2	b1	b0	SW0078	16	15	to	12	11	to	3	2	1	SW0079	-	-	-	-	28	to	19	18	17	○	×	×
	b15	b14	to	b11	b10	to	b2	b1	b0																										
SW0078	16	15	to	12	11	to	3	2	1																										
SW0079	-	-	-	-	28	to	19	18	17																										
SW007C, SW007D	Temporary error invalid status	<p>Stores whether a station is in the temporary error invalid status.</p> <p>0: Normal 1: Temporary error invalid status</p> <table border="1"> <thead> <tr> <th></th> <th>b15</th> <th>b14</th> <th>to</th> <th>b11</th> <th>b10</th> <th>to</th> <th>b2</th> <th>b1</th> <th>b0</th> </tr> </thead> <tbody> <tr> <td>SW007C</td> <td>16</td> <td>15</td> <td>to</td> <td>12</td> <td>11</td> <td>to</td> <td>3</td> <td>2</td> <td>1</td> </tr> <tr> <td>SW007D</td> <td>-</td> <td>-</td> <td>-</td> <td>-</td> <td>28</td> <td>to</td> <td>19</td> <td>18</td> <td>17</td> </tr> </tbody> </table> <p>1 to 28 in the table indicate station numbers.</p> <p>The bits turn on by the number of occupied stations. Error invalid stations, reserved stations, station with the end station number, and stations later than that are excepted. The use of b11 to b15 of SW007D is prohibited.</p>		b15	b14	to	b11	b10	to	b2	b1	b0	SW007C	16	15	to	12	11	to	3	2	1	SW007D	-	-	-	-	28	to	19	18	17	○	×	×
	b15	b14	to	b11	b10	to	b2	b1	b0																										
SW007C	16	15	to	12	11	to	3	2	1																										
SW007D	-	-	-	-	28	to	19	18	17																										
SW0080, SW0081	Data link status of other stations	<p>Stores the data link status of each station.</p> <p>0: Normal 1: Data link error</p> <table border="1"> <thead> <tr> <th></th> <th>b15</th> <th>b14</th> <th>to</th> <th>b11</th> <th>b10</th> <th>to</th> <th>b2</th> <th>b1</th> <th>b0</th> </tr> </thead> <tbody> <tr> <td>SW0080</td> <td>16</td> <td>15</td> <td>to</td> <td>12</td> <td>11</td> <td>to</td> <td>3</td> <td>2</td> <td>1</td> </tr> <tr> <td>SW0081</td> <td>-</td> <td>-</td> <td>-</td> <td>-</td> <td>28</td> <td>to</td> <td>19</td> <td>18</td> <td>17</td> </tr> </tbody> </table> <p>1 to 28 in the table indicate station numbers.</p> <p>The bits turn on by the number of occupied stations. It takes maximum of six seconds for this register to turn on after a slave station connected to the master station becomes faulty. The time until this signal turns on differs depending on the system configuration and error status. Temporary error invalid stations, error invalid stations, reserved stations, station with the end station number, and stations later than that are excepted. The use of b11 to b15 of SW0081 is prohibited.</p>		b15	b14	to	b11	b10	to	b2	b1	b0	SW0080	16	15	to	12	11	to	3	2	1	SW0081	-	-	-	-	28	to	19	18	17	○	×	×
	b15	b14	to	b11	b10	to	b2	b1	b0																										
SW0080	16	15	to	12	11	to	3	2	1																										
SW0081	-	-	-	-	28	to	19	18	17																										
SW0084, SW0085	Watchdog timer error occurrence status of other stations	<p>Stores the watchdog timer error occurrence status.</p> <p>0: No watchdog timer error 1: Watchdog timer error</p> <table border="1"> <thead> <tr> <th></th> <th>b15</th> <th>b14</th> <th>to</th> <th>b11</th> <th>b10</th> <th>to</th> <th>b2</th> <th>b1</th> <th>b0</th> </tr> </thead> <tbody> <tr> <td>SW0084</td> <td>16</td> <td>15</td> <td>to</td> <td>12</td> <td>11</td> <td>to</td> <td>3</td> <td>2</td> <td>1</td> </tr> <tr> <td>SW0085</td> <td>-</td> <td>-</td> <td>-</td> <td>-</td> <td>28</td> <td>to</td> <td>19</td> <td>18</td> <td>17</td> </tr> </tbody> </table> <p>1 to 28 in the table indicate station numbers.</p> <p>Only the bit corresponding to the start station number turns on. Reserved stations, station with the end station number, and stations later than that are excepted. The use of b11 to b15 of SW0085 is prohibited.</p>		b15	b14	to	b11	b10	to	b2	b1	b0	SW0084	16	15	to	12	11	to	3	2	1	SW0085	-	-	-	-	28	to	19	18	17	○	×	×
	b15	b14	to	b11	b10	to	b2	b1	b0																										
SW0084	16	15	to	12	11	to	3	2	1																										
SW0085	-	-	-	-	28	to	19	18	17																										



No.	Name	Description	Availability (○: Available, ×: Not available)																																
			Online		Offline																														
			Master Station	Intelligent device station																															
SW0088, SW0089	Fuse blown status of other stations	<p>Stores a fuse blown error status.</p> <p>0: Normal 1: Fuse blown</p> <table border="1"> <thead> <tr> <th></th> <th>b15</th> <th>b14</th> <th>to</th> <th>b11</th> <th>b10</th> <th>to</th> <th>b2</th> <th>b1</th> <th>b0</th> </tr> </thead> <tbody> <tr> <td>SW0088</td> <td>16</td> <td>15</td> <td>to</td> <td>12</td> <td>11</td> <td>to</td> <td>3</td> <td>2</td> <td>1</td> </tr> <tr> <td>SW0089</td> <td>-</td> <td>-</td> <td>-</td> <td>-</td> <td>28</td> <td>to</td> <td>19</td> <td>18</td> <td>17</td> </tr> </tbody> </table> <p>1 to 28 in the table indicate station numbers.</p> <p>The bits turn on by the number of occupied stations.</p> <p>Reserved stations, station with the end station number, and stations later than that are excepted.</p> <p>The use of b11 to b15 of SW0089 is prohibited.</p>		b15	b14	to	b11	b10	to	b2	b1	b0	SW0088	16	15	to	12	11	to	3	2	1	SW0089	-	-	-	-	28	to	19	18	17	○	×	×
	b15	b14	to	b11	b10	to	b2	b1	b0																										
SW0088	16	15	to	12	11	to	3	2	1																										
SW0089	-	-	-	-	28	to	19	18	17																										
SW008C, SW008D	Switch change status of other stations	<p>Stores whether the setting of switches of other stations during data link has been changed.</p> <p>0: No change 1: Changed</p> <table border="1"> <thead> <tr> <th></th> <th>b15</th> <th>b14</th> <th>to</th> <th>b11</th> <th>b10</th> <th>to</th> <th>b2</th> <th>b1</th> <th>b0</th> </tr> </thead> <tbody> <tr> <td>SW008C</td> <td>16</td> <td>15</td> <td>to</td> <td>12</td> <td>11</td> <td>to</td> <td>3</td> <td>2</td> <td>1</td> </tr> <tr> <td>SW008D</td> <td>-</td> <td>-</td> <td>-</td> <td>-</td> <td>28</td> <td>to</td> <td>19</td> <td>18</td> <td>17</td> </tr> </tbody> </table> <p>1 to 28 in the table indicate station numbers.</p> <p>Only the bit corresponding to the start station number turns on.</p> <p>Reserved stations, station with the end station number, and stations later than that are excepted.</p> <p>The use of b11 to b15 of SW008D is prohibited.</p>		b15	b14	to	b11	b10	to	b2	b1	b0	SW008C	16	15	to	12	11	to	3	2	1	SW008D	-	-	-	-	28	to	19	18	17	○	×	×
	b15	b14	to	b11	b10	to	b2	b1	b0																										
SW008C	16	15	to	12	11	to	3	2	1																										
SW008D	-	-	-	-	28	to	19	18	17																										
SW0090	Line status	<p>Stores the line status.</p> <p>0: Normal 1: Data link disabled (disconnected)</p>	×	○	×																														
SW0094, SW0095	Transient transmission status	<p>Stores whether a transient transmission error has occurred.</p> <p>0: No transient transmission error 1: Transient transmission error</p> <table border="1"> <thead> <tr> <th></th> <th>b15</th> <th>b14</th> <th>to</th> <th>b11</th> <th>b10</th> <th>to</th> <th>b2</th> <th>b1</th> <th>b0</th> </tr> </thead> <tbody> <tr> <td>SW0094</td> <td>16</td> <td>15</td> <td>to</td> <td>12</td> <td>11</td> <td>to</td> <td>3</td> <td>2</td> <td>1</td> </tr> <tr> <td>SW0095</td> <td>-</td> <td>-</td> <td>-</td> <td>-</td> <td>28</td> <td>to</td> <td>19</td> <td>18</td> <td>17</td> </tr> </tbody> </table> <p>1 to 28 in the table indicate station numbers.</p> <p>Only the bit corresponding to the start station number turns on.</p> <p>Reserved stations, station with the end station number, and stations later than that are excepted.</p> <p>The use of b11 to b15 of SW0095 is prohibited.</p>		b15	b14	to	b11	b10	to	b2	b1	b0	SW0094	16	15	to	12	11	to	3	2	1	SW0095	-	-	-	-	28	to	19	18	17	○	×	×
	b15	b14	to	b11	b10	to	b2	b1	b0																										
SW0094	16	15	to	12	11	to	3	2	1																										
SW0095	-	-	-	-	28	to	19	18	17																										
SW0098, SW0099	Station number overlap status	<p>Stores whether station numbers are unique when the start station numbers of modules are different.</p> <p>0: Normal 1: Station number in use (start station number only)</p> <table border="1"> <thead> <tr> <th></th> <th>b15</th> <th>b14</th> <th>to</th> <th>b11</th> <th>b10</th> <th>to</th> <th>b2</th> <th>b1</th> <th>b0</th> </tr> </thead> <tbody> <tr> <td>SW0098</td> <td>16</td> <td>15</td> <td>to</td> <td>12</td> <td>11</td> <td>to</td> <td>3</td> <td>2</td> <td>1</td> </tr> <tr> <td>SW0099</td> <td>-</td> <td>-</td> <td>-</td> <td>-</td> <td>28</td> <td>to</td> <td>19</td> <td>18</td> <td>17</td> </tr> </tbody> </table> <p>1 to 28 in the table indicate station numbers.</p> <p>Reserved stations, station with the end station number, and stations later than that are excepted.</p> <p>Only the bit corresponding to the start station number turns on. This item is checked, and the result is stored only upon data link start and the change of a parameter.</p> <p>For a slave station with the transmission speed auto-tracking setting, the station number already used for other stations may not be detected.</p> <p>The use of b11 to b15 of SW0099 is prohibited.</p>		b15	b14	to	b11	b10	to	b2	b1	b0	SW0098	16	15	to	12	11	to	3	2	1	SW0099	-	-	-	-	28	to	19	18	17	○	×	×
	b15	b14	to	b11	b10	to	b2	b1	b0																										
SW0098	16	15	to	12	11	to	3	2	1																										
SW0099	-	-	-	-	28	to	19	18	17																										

No.	Name	Description	Availability (○: Available, ×: Not available)																																							
			Online		Offline																																					
			Master Station	Intelligent device station																																						
SW009C, SW009D	Installation/ parameter matching status	<p>Stores the matching statuses such as the matching of CC-Link versions between the parameter settings and the modules on slave stations.</p> <p>■The station types do not match. (This mismatch occurs in the following combinations of station types.)</p> <table border="1"> <tr> <td>Installation</td> <td>Parameter</td> </tr> <tr> <td>Remote device station</td> <td>Remote I/O station</td> </tr> <tr> <td rowspan="2">Intelligent device station</td> <td>Remote I/O station</td> </tr> <tr> <td>Remote device station</td> </tr> </table> <p>■The number of occupied stations do not match (installation &gt; parameter).          ■The extended cyclic settings do not match.          ■The remote station versions do not match between the parameter settings and installed modules.</p> <p>0: Normal          1: Mismatch error</p> <table border="1"> <thead> <tr> <th></th> <th>b15</th> <th>b14</th> <th>to</th> <th>b11</th> <th>b10</th> <th>to</th> <th>b2</th> <th>b1</th> <th>b0</th> </tr> </thead> <tbody> <tr> <td>SW009C</td> <td>16</td> <td>15</td> <td>to</td> <td>12</td> <td>11</td> <td>to</td> <td>3</td> <td>2</td> <td>1</td> </tr> <tr> <td>SW009D</td> <td>-</td> <td>-</td> <td>-</td> <td>-</td> <td>28</td> <td>to</td> <td>19</td> <td>18</td> <td>17</td> </tr> </tbody> </table> <p>1 to 28 in the table indicate station numbers.</p> <p>Reserved stations, station with the end station number, and stations later than that are excepted.</p> <p>Only the bit corresponding to the start station number turns on. This item is checked, and the result is stored only upon data link start and the change of a parameter.</p> <p>The use of b11 to b15 of SW009D is prohibited.</p>	Installation	Parameter	Remote device station	Remote I/O station	Intelligent device station	Remote I/O station	Remote device station		b15	b14	to	b11	b10	to	b2	b1	b0	SW009C	16	15	to	12	11	to	3	2	1	SW009D	-	-	-	-	28	to	19	18	17	○	×	×
Installation	Parameter																																									
Remote device station	Remote I/O station																																									
Intelligent device station	Remote I/O station																																									
	Remote device station																																									
	b15	b14	to	b11	b10	to	b2	b1	b0																																	
SW009C	16	15	to	12	11	to	3	2	1																																	
SW009D	-	-	-	-	28	to	19	18	17																																	
SW00B4, SW00B5	Line test 1 result	<p>Stores the result of the line test 1.</p> <p>0: Normal          1: Error</p> <table border="1"> <thead> <tr> <th></th> <th>b15</th> <th>b14</th> <th>to</th> <th>b11</th> <th>b10</th> <th>to</th> <th>b2</th> <th>b1</th> <th>b0</th> </tr> </thead> <tbody> <tr> <td>SW00B4</td> <td>16</td> <td>15</td> <td>to</td> <td>12</td> <td>11</td> <td>to</td> <td>3</td> <td>2</td> <td>1</td> </tr> <tr> <td>SW00B5</td> <td>-</td> <td>-</td> <td>-</td> <td>-</td> <td>28</td> <td>to</td> <td>19</td> <td>18</td> <td>17</td> </tr> </tbody> </table> <p>1 to 28 in the table indicate station numbers.</p> <p>Only the bit corresponding to the start station number turns on.</p> <p>The use of b11 to b15 of SW00B5 is prohibited.</p>		b15	b14	to	b11	b10	to	b2	b1	b0	SW00B4	16	15	to	12	11	to	3	2	1	SW00B5	-	-	-	-	28	to	19	18	17	○	×	×							
	b15	b14	to	b11	b10	to	b2	b1	b0																																	
SW00B4	16	15	to	12	11	to	3	2	1																																	
SW00B5	-	-	-	-	28	to	19	18	17																																	
SW00B8	Line test 2 result	<p>Stores the result of a line test.</p> <p>0: Normal          Values other than 0: Error code (☞ Page 133 List of Error Codes)</p>	○	×	×																																					
SW0140, SW0141	Compatible CC- Link Ver. information	<p>Stores a slave station that supports the CC-Link Ver.2 mode.</p> <p>0: Ver.1-compatible slave station          1: Ver.2-compatible slave station</p> <table border="1"> <thead> <tr> <th></th> <th>b15</th> <th>b14</th> <th>to</th> <th>b11</th> <th>b10</th> <th>to</th> <th>b2</th> <th>b1</th> <th>b0</th> </tr> </thead> <tbody> <tr> <td>SW0140</td> <td>16</td> <td>15</td> <td>to</td> <td>12</td> <td>11</td> <td>to</td> <td>3</td> <td>2</td> <td>1</td> </tr> <tr> <td>SW0141</td> <td>-</td> <td>-</td> <td>-</td> <td>-</td> <td>28</td> <td>to</td> <td>19</td> <td>18</td> <td>17</td> </tr> </tbody> </table> <p>1 to 28 in the table indicate station numbers.</p> <p>Only the bit corresponding to the start station number turns on.</p> <p>Reserved stations, station with the end station number, and stations later than that are excepted.</p> <p>The use of b11 to b15 of SW0141 is prohibited.</p>		b15	b14	to	b11	b10	to	b2	b1	b0	SW0140	16	15	to	12	11	to	3	2	1	SW0141	-	-	-	-	28	to	19	18	17	○	×	×							
	b15	b14	to	b11	b10	to	b2	b1	b0																																	
SW0140	16	15	to	12	11	to	3	2	1																																	
SW0141	-	-	-	-	28	to	19	18	17																																	



No.	Name	Description	Availability (○: Available, ×: Not available)																																						
			Online		Offline																																				
			Master Station	Intelligent device station																																					
SW0144, SW0145	CC-Link Ver. installation/parameter matching status	<p>Stores a CC-Link version matching status between the parameter settings and the modules on slave stations.</p> <p>0: Normal 1: Mismatch error</p> <table border="1"> <thead> <tr> <th></th> <th>b15</th> <th>b14</th> <th>to</th> <th>b11</th> <th>b10</th> <th>to</th> <th>b2</th> <th>b1</th> <th>b0</th> </tr> </thead> <tbody> <tr> <td>SW0144</td> <td>16</td> <td>15</td> <td>to</td> <td>12</td> <td>11</td> <td>to</td> <td>3</td> <td>2</td> <td>1</td> </tr> <tr> <td>SW0145</td> <td>-</td> <td>-</td> <td>-</td> <td>-</td> <td>28</td> <td>to</td> <td>19</td> <td>18</td> <td>17</td> </tr> </tbody> </table> <p>1 to 28 in the table indicate station numbers.</p> <p>■Example of a mismatch error</p> <table border="1"> <thead> <tr> <th>Installation</th> <th>Parameter</th> </tr> </thead> <tbody> <tr> <td>Ver.2-compatible remote device station</td> <td>Ver.1-compatible remote device station</td> </tr> <tr> <td>Ver.1-compatible remote device station</td> <td>Ver.2-compatible remote device station</td> </tr> </tbody> </table> <p>Only the bit corresponding to the start station number turns on. Reserved stations, station with the end station number, and stations later than that are excepted. The use of b11 to b15 of SW0145 is prohibited.</p>		b15	b14	to	b11	b10	to	b2	b1	b0	SW0144	16	15	to	12	11	to	3	2	1	SW0145	-	-	-	-	28	to	19	18	17	Installation	Parameter	Ver.2-compatible remote device station	Ver.1-compatible remote device station	Ver.1-compatible remote device station	Ver.2-compatible remote device station	○	×	×
	b15	b14	to	b11	b10	to	b2	b1	b0																																
SW0144	16	15	to	12	11	to	3	2	1																																
SW0145	-	-	-	-	28	to	19	18	17																																
Installation	Parameter																																								
Ver.2-compatible remote device station	Ver.1-compatible remote device station																																								
Ver.1-compatible remote device station	Ver.2-compatible remote device station																																								
SW0148	Parameter mode	<p>Stores the mode set to a system.</p> <p>0: Remote net Ver.1 mode 2: Remote net Ver.2 mode 0 when all stations are abnormal.</p>	○	○	×																																				
SW0149	Parameter mode of own station	<p>Stores the mode set to the own station.</p> <p>0: Remote net Ver.1 mode 2: Remote net Ver.2 mode</p>	○	○	×																																				
SW0152	Maximum communication station number	<p>Stores the maximum station number during data link in real time (1 to 28 : station number in the station number setting). Reserved stations, error invalid stations, and temporary error invalid stations are excepted.</p>	○	×	×																																				
SW0153	Number of connected modules involved in communication	<p>Stores the number of modules performing data link in real time. Reserved stations, error invalid stations, and temporary error invalid stations are excepted.</p>	○	×	×																																				
SW0160, SW0161	Remote register use prohibited status	<p>Stores whether the use of remote registers is prohibited.</p> <p>0: Available 1: Use prohibited</p> <table border="1"> <thead> <tr> <th></th> <th>b15</th> <th>b14</th> <th>to</th> <th>b11</th> <th>b10</th> <th>to</th> <th>b2</th> <th>b1</th> <th>b0</th> </tr> </thead> <tbody> <tr> <td>SW0160</td> <td>16</td> <td>15</td> <td>to</td> <td>12</td> <td>11</td> <td>to</td> <td>3</td> <td>2</td> <td>1</td> </tr> <tr> <td>SW0161</td> <td>-</td> <td>-</td> <td>-</td> <td>-</td> <td>28</td> <td>to</td> <td>19</td> <td>18</td> <td>17</td> </tr> </tbody> </table> <p>1 to 28 in the table indicate station numbers.</p> <p>Only the bit corresponding to the start station number turns on. The use of b11 to b15 of SW0161 is prohibited.</p>		b15	b14	to	b11	b10	to	b2	b1	b0	SW0160	16	15	to	12	11	to	3	2	1	SW0161	-	-	-	-	28	to	19	18	17	○	×	×						
	b15	b14	to	b11	b10	to	b2	b1	b0																																
SW0160	16	15	to	12	11	to	3	2	1																																
SW0161	-	-	-	-	28	to	19	18	17																																
SW0164, SW0165	Remote device station initialization procedure registration completion status	<p>Stores whether the remote device station initialization procedure registration has been completed.</p> <p>0: Not completed 1: Completed</p> <table border="1"> <thead> <tr> <th></th> <th>b15</th> <th>b14</th> <th>to</th> <th>b11</th> <th>b10</th> <th>to</th> <th>b2</th> <th>b1</th> <th>b0</th> </tr> </thead> <tbody> <tr> <td>SW0164</td> <td>16</td> <td>15</td> <td>to</td> <td>12</td> <td>11</td> <td>to</td> <td>3</td> <td>2</td> <td>1</td> </tr> <tr> <td>SW0165</td> <td>-</td> <td>-</td> <td>-</td> <td>-</td> <td>28</td> <td>to</td> <td>19</td> <td>18</td> <td>17</td> </tr> </tbody> </table> <p>1 to 28 in the table indicate station numbers.</p> <p>Only the bit corresponding to the start station number turns on. The use of b11 to b15 of SW0165 is prohibited.</p>		b15	b14	to	b11	b10	to	b2	b1	b0	SW0164	16	15	to	12	11	to	3	2	1	SW0165	-	-	-	-	28	to	19	18	17	○	×	×						
	b15	b14	to	b11	b10	to	b2	b1	b0																																
SW0164	16	15	to	12	11	to	3	2	1																																
SW0165	-	-	-	-	28	to	19	18	17																																
SW0183	Transmission speed test result	<p>Stores the result of a transmission speed test.</p> <p>0: Normal Values other than 0: Error code (☞ Page 133 List of Error Codes)</p>	○	○	×																																				

No.	Name	Description	Availability (○: Available, ×: Not available)																																
			Online		Offline																														
			Master Station	Intelligent device station																															
SW0184, SW0185	Transmission speed test result of each station	<p>Stores the result of the transmission speed test for each station.</p> <p>0: Normal (same transmission speed as the master station) or no response from the module</p> <p>1: Error (different transmission speed from the master station)</p> <table border="1"> <thead> <tr> <th></th> <th>b15</th> <th>b14</th> <th>to</th> <th>b11</th> <th>b10</th> <th>to</th> <th>b2</th> <th>b1</th> <th>b0</th> </tr> </thead> <tbody> <tr> <td>SW0184</td> <td>16</td> <td>15</td> <td>to</td> <td>12</td> <td>11</td> <td>to</td> <td>3</td> <td>2</td> <td>1</td> </tr> <tr> <td>SW0185</td> <td>-</td> <td>-</td> <td>-</td> <td>-</td> <td>28</td> <td>to</td> <td>19</td> <td>18</td> <td>17</td> </tr> </tbody> </table> <p>1 to 28 in the table indicate station numbers.</p> <p>Only the bit corresponding to the start station number turns on.</p> <p>The use of b11 to b15 of SW0185 is prohibited.</p>		b15	b14	to	b11	b10	to	b2	b1	b0	SW0184	16	15	to	12	11	to	3	2	1	SW0185	-	-	-	-	28	to	19	18	17	○	×	×
	b15	b14	to	b11	b10	to	b2	b1	b0																										
SW0184	16	15	to	12	11	to	3	2	1																										
SW0185	-	-	-	-	28	to	19	18	17																										

The timing of when data in link special register (SW) area are updated differs depending on the link special register number. The following table lists the update timing.

Link special register	Data update timing	Link special register	Data update timing
SW0041	Updated regardless of the SB status	SW0071	Updated regardless of the SB status (Updated after each station becomes stable.)
SW0045		SW0072	
SW0060	When the SB0060 status is changed	SW0074, SW0075	When the SB0074 status is changed
SW0061	When the SB0061 status is changed	SW0078, SW0079	When the SB0075 status is changed
SW0062	Updated regardless of the SB status	SW0080, SW0081	When the SB0080 status is changed
SW0068		SW0088, SW0089	Updated regardless of the SB status
SW0069		SW0090	When the SB0090 status is changed
SW006A		SW0098, SW0099	Updated regardless of the SB status
SW006D		SW009C, SW009D	
SW006E		SW00B4, SW00B5	
SW006F		SW00B8	
SW0070		—	—



# Appendix 7 Processing Time

This appendix describes data link processing time such as link scan time and transmission delay time.

When all the stations in a CC-Link system are normally performing data link, the retry processing time (RT) and return processing time (F) that are included in the formulas are not required to be added.

## Link scan time

This section describes the scan time of a CC-Link system. How to calculate the link scan time of when a master/intelligent device module is in the remote net mode is explained.

$$LS = BT \times \{(27 + (NI \times 4.8) + (NW \times 9.6) + (N \times 30) + (ni \times 4.8) + (nw \times 9.6) + TR)\} + ST + EX + (RT + F) [\mu s]$$

BT: Constant (transmission speed)

Transmission speed	156 kbps	625 kbps	2.5 Mbps	5 Mbps	10 Mbps
BT	51.2	12.8	3.2	1.6	0.8

NI: Last station number in A, B, and C (The number of occupied stations included, but a reserved station excluded. The value should be multiples of 8.)

- A: Last station number in a remote I/O station
- B: Last station number in a remote device station (The number of occupied stations is included.)
- C: Last station number in an intelligent device station (The number of occupied stations is included.)

NW: Last station number in B and C (The number of occupied stations included, but a reserved station excluded. The value should be multiples of 8.)

Last station No.	1 to 8	9 to 16	17 to 24	25 to 32	33 to 40	41 to 48	49 to 56	57 to 64
NI, NW	8	16	24	32	40	48	56	64

N: Number of connected modules (A reserved station is excluded.)

ni: a + b + c (A reserved station is excluded.)

- a: Total number of stations occupied by a remote I/O station
- b: Total number of stations occupied by a remote device station
- c: Total number of stations occupied by a intelligent device station

nw: b + c (A reserved station is excluded.)

ST: Constant (The largest value in the results of ❶ to ❸. When B is 0, the result of ❷ is ignored. When C is 0, the result of ❸ is ignored.)

❶  $800 + (A \times 15)$

❷  $900 + (B \times 50)$

❸  $C \leq 26: 1200 + (C \times 100), C > 26: 3700 + \{(C - 26) \times 25\}$

EX: Constant (Add 50 to the sum in the table below when the remote net Ver.2 mode is used.)

Extended cyclic setting	Number of occupied stations			
	1 Stations occupied	2 Stations occupied	3 Stations occupied	4 Stations occupied
Single	0	0	0	0
Double	$70 \times \text{number of stations}$	$80 \times \text{number of stations}$	$90 \times \text{number of stations}$	$100 \times \text{number of stations}$
Quadruple	$90 \times \text{number of stations}$	$110 \times \text{number of stations}$	$130 \times \text{number of stations}$	$150 \times \text{number of stations}$
Octuple	$110 \times \text{number of stations}$	$160 \times \text{number of stations}$	$210 \times \text{number of stations}$	$260 \times \text{number of stations}$

TR: Transient processing time (added only when a transient request processing is executed)

- When a master station issues a transient request: 180
- When a transient request is issued from an intelligent device station:  $40.8 \times \text{number of stations that issued a transient request}$



RT: Retry processing time (Only the link scan with a faulty slave station where data link is being performed is added.)

$$\alpha + \beta \times (\text{number of detected faulty stations} - 1)$$

- $\alpha$ : Retry processing time of the first station

$$BT \times \{(200 + R) \times \text{retry count setting value} + 178.5\}$$

When a transient request is issued:  $R: 13.2 + (NI \times 4.8) + (NW \times 9.6) + 180$

When a transient request is not issued:  $R: 13.2 + (NI \times 4.8) + (NW \times 9.6)$

- $\beta$ : Retry processing time of the second and subsequent stations

$$BT \times \{(200 + P) \times \text{retry count setting value} + 178.5\}$$

P: 10.8

F: Return processing time (added only when there is a faulty station)

- $BT \times \{243.1 + 210.8 \times (\text{number of automatic return stations} - 1)\} + ST$

## Cyclic transmission delay time

This section describes transmission delay time (time until data is transmitted).

### Master station ↔ remote I/O station

#### ■ Master station (RX) ← remote I/O station (input)

This is the time between a signal input to a remote I/O station and the device of a CPU module turning on (off).

The following table lists the calculation formulas.

Calculation value	Station-based block data assurance used	Station-based block data assurance not used
Normal value	$(SM \times n) + (LS \times 1) + Rio$	$SM + (LS \times 1) + Rio$
Max. value	$(SM \times n) + (LS \times 2) + Rio$	$SM + (LS \times 2) + Rio$

The letters in the table mean as follows.

SM: Master station sequence scan time

LS: Link scan time

n:  $LS \div SM$  (The decimal point is rounded up.)

Rio: Remote I/O response time

#### ■ Master station (RY) → remote I/O station (output)

This is the time between the device of a CPU module turning on (off) and the output of a remote I/O station turning on (off).

The following table lists the calculation formulas.

Calculation value	Station-based block data assurance used	Station-based block data assurance not used
Normal value	$(SM \times n) + (LS \times 1) + Rio$	$SM + (LS \times 1) + Rio$
Max. value	$(SM \times n) + (LS \times 2) + Rio$	$SM + (LS \times 2) + Rio$

The letters in the table mean as follows.

SM: Master station sequence scan time

LS: Link scan time

n:  $LS \div SM$  (The decimal point is rounded up.)

Rio: Remote I/O response time

## Master station ↔ remote device station (Ver.1-compatible slave station)

### ■ Master station (RX), (RWr) ← remote device station (RX), (RWr)

This is the time between a signal input to a remote device station and the device of a CPU module turning on (off) or the time until the data in the device of a CPU module is changed.

The following table lists the calculation formulas.

Calculation value	Station-based block data assurance used	Station-based block data assurance not used
Normal value	$(SM \times n) + (LS \times 1) + Rd$	$SM + (LS \times 1) + Rd$
Max. value	$(SM \times n) + (LS \times 2) + Rd$	$SM + (LS \times 2) + Rd$

The letters in the table mean as follows.

SM: Master station sequence scan time

LS: Link scan time

n:  $LS \div SM$  (The decimal point is rounded up.)

Rd: Remote device station processing time

### ■ Master station (RY), (RWw) → remote device station (RY), (RWw)

This is the time between the device of a CPU module turning on (off) and the output of a remote device station turning on (off) or between data set in the device of a CPU module and the data in a remote device station changed.

The following table lists the calculation formulas.

Calculation value	Station-based block data assurance used	Station-based block data assurance not used
Normal value	$(SM \times n) + (LS \times 1) + Rd$	$SM + (LS \times 1) + Rd$
Max. value	$(SM \times n) + (LS \times 2) + Rd$	$SM + (LS \times 2) + Rd$

The letters in the table mean as follows.

SM: Master station sequence scan time

LS: Link scan time

n:  $LS \div SM$  (The decimal point is rounded up.)

Rd: Remote device station processing time

## Master station ↔ remote device station (Ver.2-compatible slave station)

### ■ Master station (RX), (RW<sub>r</sub>) ← remote device station (RX), (RW<sub>r</sub>)

This is the time between a signal input to a remote device station and the device of a CPU module turning on (off) or the time until the data in the device of a CPU module is changed.

The following table lists the calculation formulas.

Calculation value	Station-based block data assurance used	Station-based block data assurance not used
Normal value	$(SM \times n) + (LS \times 1 \times m) + Rd$	$SM + (LS \times 1 \times m) + Rd$
Max. value	$(SM \times n) + (LS \times 2 \times m) + Rd$	$SM + (LS \times 2 \times m) + Rd$

The letters in the table mean as follows.

SM: Master station sequence scan time

LS: Link scan time

n:  $LS \div SM$  (The decimal point is rounded up.)

t:  $LS \times m \div SM$  (The decimal point is rounded up.)

Rd: Remote device station processing time

m: Constant according to the extended cyclic setting

Extended cyclic setting	Single	Double	Quadruple	Octuple
m	1	3	7	15

### ■ Master station (RY), (RW<sub>w</sub>) → remote device station (RY), (RW<sub>w</sub>)

This is the time between the device of a CPU module turning on (off) and the output of a remote device station turning on (off) or between data set in the device of a CPU module and the data in a remote device station changed.

The following table lists the calculation formulas.

Calculation value	Station-based block data assurance used	Station-based block data assurance not used
Normal value	$(SM \times n) + [LS \times \{(1 \times m) + 1\}] + Rd$	$(SM \times n) + [LS \times \{(1 \times m) + 1\}] + Rd$
Max. value	$(SM \times n) + [LS \times \{(2 \times m) + 1\}] + Rd$	$(SM \times n) + [LS \times \{(2 \times m) + 1\}] + Rd$

The letters in the table mean as follows.

SM: Master station sequence scan time

LS: Link scan time

n:  $LS \div SM$  (The decimal point is rounded up.)

t:  $LS \times m \div SM$  (The decimal point is rounded up.)

Rd: Remote device station processing time

m: Constant according to the extended cyclic setting

Extended cyclic setting	Single	Double	Quadruple	Octuple
m	1	3	7	15

## Master station ↔ intelligent device station (Ver.1-compatible slave station)

Transmission delay time between a master station and an intelligent device station varies depending on the intelligent device station.

This section describes the transmission delay time when a master/intelligent device module is used as an intelligent device station.

Refer to the user's manual for the used module when using another intelligent device module.

### ■ Master station (RX), (RW<sub>r</sub>) ← intelligent device station (RX), (RW<sub>r</sub>)

This is the time between the device of the CPU module in an intelligent device station turning on (off) and the device of the CPU module in a master station turning on (off).

This is also the time between data set in the device of the CPU module in an intelligent device station and the data stored into the device of the CPU module in a master station.

The following table lists the calculation formulas.

Calculation value	Station-based block data assurance used	Station-based block data assurance not used
Normal value	$(SM \times n) + (LS \times 2) + \{SI \times (k + 1)\}$	$SM + (LS \times 2) + SI$
Max. value	$(SM \times n) + (LS \times 3) + \{SI \times (k + 1)\}$	$SM + (LS \times 3) + SI$

The letters in the table mean as follows.

SM: Master station sequence scan time

LS: Link scan time

SI: Intelligent device station sequence scan time

n:  $LS \div SM$  (The decimal point is rounded up.)

k:  $LS \div SI$  (The decimal point is rounded up.)

### ■ Master station (RY), (RW<sub>w</sub>) → intelligent device station (RY), (RW<sub>w</sub>)

This is the time between the device of the CPU module in a master station turning on (off) and the device of the CPU module in an intelligent device station turning on (off).

This is also the time between data set in the device of the CPU module in a master station and the data stored into the device of the CPU module in an intelligent device station.

The following table lists the calculation formulas.

Calculation value	Station-based block data assurance used	Station-based block data assurance not used
Normal value	$(SM \times n) + (LS \times 2) + \{SI \times (k + 1)\}$	$SM + (LS \times 2) + SI$
Max. value	$(SM \times n) + (LS \times 3) + \{SI \times (k + 1)\}$	$SM + (LS \times 3) + SI$

The letters in the table mean as follows.

SM: Master station sequence scan time

LS: Link scan time

SI: Intelligent device station sequence scan time

n:  $LS \div SM$  (The decimal point is rounded up.)

k:  $LS \div SL$  (The decimal point is rounded up.)

## Master station ↔ intelligent device station (Ver.2-compatible slave station)

Transmission delay time between a master station and an intelligent device station varies depending on the intelligent device station.

This section describes the transmission delay time when a master/intelligent device module is used as an intelligent device station.

Refer to the user's manual for the used intelligent device module when using another intelligent device module.

### ■ Master station (RX), (RWr) ← intelligent device station (RX), (RWr)

This is the time between the device of the CPU module in an intelligent device station turning on (off) and the device of the CPU module in a master station turning on (off).

This is also the time between data set in the device of the CPU module in an intelligent device station and the data stored into the device of the CPU module in a master station.

The following table lists the calculation formulas.

Calculation value	Station-based block data assurance used	Station-based block data assurance not used
Normal value	$(SM \times n) + [LS \times \{(1 \times m) + 1\}] + \{SI \times (k + 1)\}$	$SM + [LS \times \{(1 \times m) + 1\}] + SI$
Max. value	$(SM \times n) + [LS \times \{(2 \times m) + 1\}] + \{SI \times (k + 1)\}$	$SM + [LS \times \{(2 \times m) + 1\}] + SI$

The letters in the table mean as follows.

SM: Master station sequence scan time

LS: Link scan time

SI: Intelligent device station sequence scan time

n:  $LS \div SM$  (The decimal point is rounded up.)

t:  $LS \times m \div SM$  (The decimal point is rounded up.)

k:  $LS \div SI$  (The decimal point is rounded up.)

m: Constant according to the extended cyclic setting

Extended cyclic setting	Single	Double	Quadruple	Octuple
m	1	3	7	15

### ■ Master station (RY), (RWw) → intelligent device station (RY), (RWw)

This is the time between the device of the CPU module in a master station turning on (off) and the device of the CPU module in an intelligent device station turning on (off).

This is also the time between data set in the device of the CPU module in a master station and the data stored into the device of the CPU module in an intelligent device station.

The following table lists the calculation formulas.

Calculation value	Station-based block data assurance used	Station-based block data assurance not used
Normal value	$(SM \times n) + [LS \times \{(1 \times m) + 1\}] + \{SI \times (k + 1)\}$	$SM + [LS \times \{(1 \times m) + 1\}] + SI$
Max. value	$(SM \times n) + [LS \times \{(2 \times m) + 1\}] + \{SI \times (k + 1)\}$	$SM + [LS \times \{(2 \times m) + 1\}] + SI$

The letters in the table mean as follows.

SM: Master station sequence scan time

LS: Link scan time

SI: Intelligent device station sequence scan time

n:  $LS \div SM$  (The decimal point is rounded up.)

t:  $LS \times m \div SM$  (The decimal point is rounded up.)

k:  $LS \div SI$  (The decimal point is rounded up.)

m: Constant according to the extended cyclic setting

Extended cyclic setting	Single	Double	Quadruple	Octuple
m	1	3	7	15

# Appendix 8 Added and Enhanced Functions

The following chart shows the added or changed functions of FX5-CCL-MS with supported version information. The firmware version can be confirmed with module diagnosis (CPU diagnosis). Refer to the following manuals for details on diagnosing the module (CPU diagnosis).

 MELSEC iQ-F FX5S/FX5UJ/FX5U/FX5UC User's Manual (Hardware)

Refer to the  GX Works3 Operating Manual for details on the software version.

## FX5UJ CPU module

Add/Change Function	Supported version			Reference
	Firmware of the CPU module	Firmware of the FX5-CCL-MS	Engineering tool	
FX5UJ CPU module is supported.	From the first	—	"1.060N" and above	—

## FX5U/FX5UC CPU module

Add/Change Function	Supported version			Reference
	Firmware of the CPU module	Firmware of the FX5-CCL-MS	Engineering tool	
The maximum number of remote I/O stations increased from 12 to 14 stations	"1.100" and above	—	"1.047Z" and above	Page 17
The total number of intelligent device stations + remote device stations increased from 12 to 14 stations	"1.100" and above	—	"1.047Z" and above	Page 17
Maximum number of link points per system (when operating as a master station) increases <ul style="list-style-type: none"> <li>• Remote I/O: from 768 to 896 points</li> <li>• Remote register: from 96 to 112 points</li> </ul>	"1.100" and above	—	"1.047Z" and above	Page 17
This supports parameter settings from the buffer memory	"1.210" and above	"1.010" and above	"1.065T" and above	Page 64

# MEMO

---

A

# INDEX

---

## 0 to 9

---

32-bit data integrity assurance . . . . . 40

## A

---

A faulty station cannot be detected . . . . . 132  
Auto-tracking setting of transmission speed . . . . . 67

## C

---

CC-Link diagnostics . . . . . 114  
CC-Link Ver. installation/parameter matching status  
. . . . . 172  
Checking the transmission speed setting . . . . . 121  
Compatible CC-Link Ver. information . . . . . 171  
Completion status of remote device station initialization  
procedure. . . . . 163  
Connection cable . . . . . 18  
CPU monitoring time setting. . . . . 165  
Crimp terminal . . . . . 58  
Current link scan time . . . . . 168  
Cyclic Transmission . . . . . 14

## D

---

Data link restart . . . . . 161  
Data link restart acceptance . . . . . 162  
Data link restart completion . . . . . 162  
Data link restart result . . . . . 166  
Data link setting at CPU failure . . . . . 42,163  
Data link status of other stations . . . . . 164,169  
Data link stop . . . . . 161  
Data link stop acceptance . . . . . 162  
Data link stop completion. . . . . 162  
Data link stop result. . . . . 166  
Detailed LED display status . . . . . 166

## E

---

Error invalid station specification status . . . . 163,169  
Execution status of remote device station initialization  
procedure. . . . . 162  
Extended cyclic setting . . . . . 68

## F

---

Fuse blown status of other stations . . . . . 164

## I

---

Input data from data link faulty station . . . . . 42  
Input data status of own data link faulty  
station . . . . . 163  
Installation status . . . . . 168  
Installation/parameter matching status . . . . . 171  
Intelligent device station. . . . . 14

## L

---

Line status of own station . . . . . 164  
Line test . . . . . 119  
Line test 1 result . . . . . 171  
Line test 2 result . . . . . 171  
Line test acceptance status . . . . . 162  
Line test completion status . . . . . 162  
Line test request . . . . . 161  
Line test result . . . . . 166  
Line test station setting . . . . . 165  
Link special register (SW) . . . . . 153,165  
Link special relay (SB). . . . . 153,161  
Local station. . . . . 14

## M

---

Master station . . . . . 14  
Master stations transient transmission status. . . . 164  
Master/intelligent device module. . . . . 14  
Master/local module . . . . . 14  
Maximum communication station number . . . . . 168  
Maximum link scan time . . . . . 168  
Maximum number of link points . . . . . 18  
Maximum overall cable length . . . . . 18  
Maximum transmission distance. . . . . 18  
Minimum link scan time . . . . . 168  
Mode of own station . . . . . 163  
Mode setting status. . . . . 167  
Module operating status . . . . . 168  
Multiple temporary error invalid station specification  
. . . . . 165

## N

---

Number of automatic return stations . . . . . 168  
Number of connected modules. . . . . 168  
Number of link points for each number of occupied  
stations . . . . . 19  
Number of occupied stations . . . . . 68  
Number of own station occupied stations . . . . . 163  
Number of retries information. . . . . 168

## O

---

Offline test status . . . . . 162  
Operation status of own station . . . . . 163

## P

---

Parameter receive status. . . . . 164  
Parameter setting status . . . . . 163  
Parameter status of own station . . . . . 168



## R

Remote device station	14
Remote device station initialization procedure registration execution individual information	157
Remote device station initialization procedure registration instruction	162
Remote I/O station	14
Remote net mode	14
Remote net Ver.1 mode	14,34,35
Remote net Ver.2 mode	14,34,37
Remote station	14
Reserved station specification status	163,168
Reserved/Err Invalid STA	70
RWr	14
RWw	14
RX	14
RY	14

## S

SB	14
Setting status of block guarantee of cyclic data per station	163
Slave station offset, size information	151
Station number of own station	167
Station number overlap status	170
Station-based Block Data Assurance	41
Status difference between a master station and a slave station at an error	44
Status logging	122
SW	14
Switch change status of other stations	164,170

## T

Temporary error invalid acceptance status	162
Temporary error invalid cancel acceptance status	162
Temporary error invalid cancel completion status	162
Temporary error invalid cancel request	161
Temporary error invalid completion status	162
Temporary error invalid request	161
Temporary error invalid station setting information	163
Temporary error invalid station specification	165
Temporary error invalid station specification cancel result	166
Temporary error invalid station specification result	166
Temporary error invalid status	169
Terminal block	59
Terminal block mounting screw	58
Terminal screw	58
Terminating resistor	60
Tightening torque	58
Total number of stations	168
Transient Transmission	14
Transient transmission status	164,170
Transmission speed	17
Transmission speed setting	167
Transmission speed test acceptance status	164
Transmission speed test completion status	164
Transmission speed test request	161
Transmission speed test result	172
Transmission speed test result of each station	173

Type of own station	163
---------------------	-----

## V

Ver.1-compatible slave station	13
Ver.2-compatible remote input (RX)	154
Ver.2-compatible remote output (RY)	154
Ver.2-compatible remote register (RWr)	156
Ver.2-compatible remote register (RWw)	156
Ver.2-compatible slave station	13

## W

Watchdog timer error occurrence status of other stations	169
Watchdog timer error status of other stations	164

# REVISIONS

Revision date	Revision	Description
April 2017	A	First Edition
June 2017	B	■Added or modified parts Appendix 2
July 2018	C	■Added or modified parts TERMS, Section 2.3, 2.4, 4.2, 4.4, 7.2, 7.3, 9.2, 9.5, Appendix 4, 6, 8
October 2019	D	■Added models FX5UJ CPU module ■Added or modified parts SAFETY PRECAUTIONS, RELEVANT MANUALS, TERMS, Section 2.1, 2.3, 2.4, Chapter 3, Section 4.2, 4.4, 7.2, 7.3, 9.2, Appendix 4, 8, TRADEMARKS
May 2020	E	■Added functions This supports parameter settings from the buffer memory ■Added or modified parts RELEVANT MANUALS, TERMS, Section 2.3, Chapter 4, 7, Section 8.3, 8.4, 9.5, Appendix 4, 6, 8, TRADEMARKS
June 2021	F	■Added or modified parts SAFETY PRECAUTIONS, WARRANTY
April 2022	G	■Added or modified parts RELEVANT MANUALS, TERMS, Section 2.1, 2.3, 2.4, Chapter 3, Section 4.1, 4.2, Appendix 2, 4, 8

Japanese manual number: SH-081792-G

This manual confers no industrial property rights or any rights of any other kind, nor does it confer any patent licenses. Mitsubishi Electric Corporation cannot be held responsible for any problems involving industrial property rights which may occur as a result of using the contents noted in this manual.

© 2017 MITSUBISHI ELECTRIC CORPORATION

# WARRANTY

Please confirm the following product warranty details before using this product.

## 1. Gratis Warranty Term and Gratis Warranty Range

If any faults or defects (hereinafter "Failure") found to be the responsibility of Mitsubishi occurs during use of the product within the gratis warranty term, the product shall be repaired at no cost via the sales representative or Mitsubishi Service Company. However, if repairs are required onsite at domestic or overseas location, expenses to send an engineer will be solely at the customer's discretion. Mitsubishi shall not be held responsible for any re-commissioning, maintenance, or testing on-site that involves replacement of the failed module.

### [Gratis Warranty Term]

The gratis warranty term of the product shall be for one year after the date of purchase or delivery to a designated place. Note that after manufacture and shipment from Mitsubishi, the maximum distribution period shall be six (6) months, and the longest gratis warranty term after manufacturing shall be eighteen (18) months. The gratis warranty term of repair parts shall not exceed the gratis warranty term before repairs.

### [Gratis Warranty Range]

- (1) The range shall be limited to normal use within the usage state, usage methods and usage environment, etc., which follow the conditions and precautions, etc., given in the instruction manual, user's manual and caution labels on the product.
- (2) Even within the gratis warranty term, repairs shall be charged for in the following cases.
  1. Failure occurring from inappropriate storage or handling, carelessness or negligence by the user. Failure caused by the user's hardware or software design.
  2. Failure caused by unapproved modifications, etc., to the product by the user.
  3. When the Mitsubishi product is assembled into a user's device, Failure that could have been avoided if functions or structures, judged as necessary in the legal safety measures the user's device is subject to or as necessary by industry standards, had been provided.
  4. Failure that could have been avoided if consumable parts (battery, backlight, fuse, etc.) designated in the instruction manual had been correctly serviced or replaced.
  5. Relay failure or output contact failure caused by usage beyond the specified life of contact (cycles).
  6. Failure caused by external irresistible forces such as fires or abnormal voltages, and failure caused by force majeure such as earthquakes, lightning, wind and water damage.
  7. Failure caused by reasons unpredictable by scientific technology standards at time of shipment from Mitsubishi.
  8. Any other failure found not to be the responsibility of Mitsubishi or that admitted not to be so by the user.

## 2. Onerous repair term after discontinuation of production

- (1) Mitsubishi shall accept onerous product repairs for seven (7) years after production of the product is discontinued.  
Discontinuation of production shall be notified with Mitsubishi Technical Bulletins, etc.
- (2) Product supply (including repair parts) is not available after production is discontinued.

## 3. Overseas service

Overseas, repairs shall be accepted by Mitsubishi's local overseas FA Center. Note that the repair conditions at each FA Center may differ.

## 4. Exclusion of loss in opportunity and secondary loss from warranty liability

Regardless of the gratis warranty term, Mitsubishi shall not be liable for compensation to:

- (1) Damages caused by any cause found not to be the responsibility of Mitsubishi.
- (2) Loss in opportunity, lost profits incurred to the user by Failures of Mitsubishi products.
- (3) Special damages and secondary damages whether foreseeable or not, compensation for accidents, and compensation for damages to products other than Mitsubishi products.
- (4) Replacement by the user, maintenance of on-site equipment, start-up test run and other tasks.

## 5. Changes in product specifications

The specifications given in the catalogs, manuals or technical documents are subject to change without prior notice.

## 6. Product application

- (1) In using the Mitsubishi MELSEC programmable controller, the usage conditions shall be that the application will not lead to a major accident even if any problem or fault should occur in the programmable controller device, and that backup and fail-safe functions are systematically provided outside of the device for any problem or fault.
- (2) The Mitsubishi programmable controller has been designed and manufactured for applications in general industries, etc. Thus, applications in which the public could be affected such as in nuclear power plants and other power plants operated by respective power companies, and applications in which a special quality assurance system is required, such as for railway companies or public service purposes shall be excluded from the programmable controller applications.  
In addition, applications in which human life or property that could be greatly affected, such as in aircraft, medical applications, incineration and fuel devices, manned transportation, equipment for recreation and amusement, and safety devices, shall also be excluded from the programmable controller range of applications. However, in certain cases, some applications may be possible, providing the user consults their local Mitsubishi representative outlining the special requirements of the project, and providing that all parties concerned agree to the special circumstances, solely at the user's discretion.
- (3) Mitsubishi shall have no responsibility or liability for any problems involving programmable controller trouble and system trouble caused by DoS attacks, unauthorized access, computer viruses, and other cyberattacks.

# TRADEMARKS

---

Microsoft and Windows are either registered trademarks or trademarks of Microsoft Corporation in the United States and/or other countries.

Anywire and AnyWireASLINK are either registered trademarks or trademarks of Anywire Corporation.

Phillips is a registered trademark of Phillips Screw Company.

The company names, system names and product names mentioned in this manual are either registered trademarks or trademarks of their respective companies.

In some cases, trademark symbols such as <sup>™</sup> or <sup>®</sup> are not specified in this manual.



Manual number: SH(NA)-081793ENG-G

Model: FX5-U-CCL-E

Model code: 09R568

## **MITSUBISHI ELECTRIC CORPORATION**

HEAD OFFICE : TOKYO BUILDING, 2-7-3 MARUNOUCHI, CHIYODA-KU, TOKYO 100-8310, JAPAN  
NAGOYA WORKS : 1-14, YADA-MINAMI 5-CHOME, HIGASHI-KU, NAGOYA, JAPAN

When exported from Japan, this manual does not require application to the  
Ministry of Economy, Trade and Industry for service transaction permission.

Specifications subject to change without notice.