



Programmable Controller

MELSEC iQ-F
series

MELSEC iQ-F
FX5 User's Manual
(Analog Control - Intelligent function module)

Analog input module

-FX5-4AD

Analog output module

-FX5-4DA

Multiple input module



-FX5-8AD

SAFETY PRECAUTIONS

(Read these precautions before use.)

Before using this product, please read this manual and the relevant manuals introduced in this manual carefully and pay full attention to safety in order to handle the product correctly.

This manual classifies the safety precautions into two categories: [⚠️ WARNING] and [⚠️ CAUTION].

 WARNING	Indicates that incorrect handling may cause hazardous conditions, resulting in death or severe injury.
 CAUTION	Indicates that incorrect handling may cause hazardous conditions, resulting in minor or moderate injury or property damage.

Depending on the circumstances, procedures indicated by [⚠️ CAUTION] may also cause severe injury.

It is important to follow all precautions for personal safety.

Store this manual in a safe place so that it can be read whenever necessary. Always forward it to the end user.

[DESIGN PRECAUTIONS]

WARNING

- Make sure to set up the following safety circuits outside the PLC to ensure safe system operation even during external power supply problems or PLC failure. Otherwise, malfunctions may cause serious accidents.
 - Most importantly, set up the following: an emergency stop circuit, a protection circuit, an interlock circuit for opposite movements (such as normal vs. reverse rotation), and an interlock circuit to prevent damage (to the equipment at the upper and lower positioning limits).
 - Note that when the CPU module detects an error, such as a watchdog timer error, during self-diagnosis, all outputs are turned off. Also, when an error that cannot be detected by the CPU module occurs in an input/output control block, output control may be disabled. External circuits and mechanisms should be designed to ensure safe machinery operation in such a case.
 - Note that when an error occurs in a relay, transistor or triac of an output circuit, the output might stay on or off. For output signals that may lead to serious accidents, external circuits and mechanisms should be designed to ensure safe machinery operation in such a case.
 - In an output circuit, when a load current exceeding the current rating or an overcurrent caused by a load short-circuit flows for a long time, it may cause smoke and fire. To prevent this, configure an external safety circuit, such as a fuse.
 - Construct an interlock circuit in the program so that the whole system always operates on the safe side before executing the control (for data change) of the PLC in operation.
Read the manual thoroughly and ensure complete safety before executing other controls (for program change, parameter change, forcible output and operation status change) of the PLC in operation. Otherwise, the machine may be damaged and accidents may occur due to erroneous operations.
 - Do not write any data to the "system area" and "write-protect area" of the buffer memory in the module. Executing data writing to the "system area" or "write protect area" may cause malfunction of the programmable controller alarm. For the "system area" or "write-protect area", refer to "Buffer Memory".
-

[DESIGN PRECAUTIONS]

CAUTION

- When an inductive load such as a lamp, heater, or solenoid valve is controlled, a large current (approximately ten times greater than normal) may flow when the output is turned from off to on. Take proper measures so that the flowing current dose not exceed the value corresponding to the maximum load specification of the resistance load.
 - Simultaneously turn on and off the power supplies of the CPU module and extension modules.
-

[INSTALLATION PRECAUTIONS]

WARNING

- Make sure to cut off all phases of the power supply externally before attempting installation or wiring work. Failure to do so may cause electric shock or damage to the product.
 - Use the product within the generic environment specifications described in the User's Manual (Hardware) of the CPU module used.
Never use the product in areas with excessive dust, oily smoke, conductive dusts, corrosive gas (salt air, Cl₂, H₂S, SO₂ or NO₂), flammable gas, vibration or impacts, or expose it to high temperature, condensation, or rain and wind.
If the product is used in such conditions, electric shock, fire, malfunctions, deterioration or damage may occur.
-

[INSTALLATION PRECAUTIONS]

CAUTION

- Do not touch the conductive parts of the product directly. Doing so may cause device failures or malfunctions.
 - When drilling screw holes or wiring, make sure that cutting and wiring debris do not enter the ventilation slits of the PLC. Failure to do so may cause fire, equipment failures or malfunctions.
 - For the product supplied together with a dust proof sheet, the sheet should be affixed to the ventilation slits before the installation and wiring work to prevent foreign objects such as cutting and wiring debris.
However, when the installation work is completed, make sure to remove the sheet to provide adequate ventilation. Failure to do so may cause fire, equipment failures or malfunctions.
 - Install the product on a flat surface. If the mounting surface is rough, undue force will be applied to the PC board, thereby causing nonconformities.
 - Install the product securely using a DIN rail or mounting screws.
 - Work carefully when using a screwdriver such as installation of the product. Failure to do so may cause damage to the product or accidents.
 - Connect the extension cables, peripheral device cables, input/output cables and battery connecting cable securely to their designated connectors. Loose connections may cause malfunctions.
 - Turn off the power to the PLC before attaching or detaching the following devices. Failure to do so may cause device failures or malfunctions.
 - Peripheral devices, expansion board, expansion adapter, and connector conversion adapter
 - Extension modules, bus conversion module, and connector conversion module
 - Battery
-

[WIRING PRECAUTIONS]

WARNING

- Make sure to cut off all phases of the power supply externally before attempting installation or wiring work. Failure to do so may cause electric shock or damage to the product.
 - Make sure to attach the terminal cover, provided as an accessory, before turning on the power or initiating operation after installation or wiring work. Failure to do so may cause electric shock.
 - The temperature rating of the cable should be 80°C or more.
 - Make sure to properly wire to the spring clamp terminal block in accordance with the following precautions. Failure to do so may cause electric shock, equipment failures, a short-circuit, wire breakage, malfunctions, or damage to the product.
 - The disposal size of the cable end should follow the dimensions described in the manual.
 - Twist the ends of stranded wires and make sure that there are no loose wires.
 - Do not solder-plate the electric wire ends.
 - Do not connect more than the specified number of wires or electric wires of unspecified size.
 - Affix the electric wires so that neither the terminal block nor the connected parts are directly stressed.
-

[WIRING PRECAUTIONS]

CAUTION

- Perform class D grounding (grounding resistance: 100 Ω or less) of the grounding terminal on the CPU module and extension modules with a wire 2 mm² or thicker.
Do not use common grounding with heavy electrical systems.
 - Connect the power supply wiring to the dedicated terminals described in this manual. If an AC power supply is connected to a DC input/output terminal or DC power supply terminal, the PLC will burn out.
 - Do not wire vacant terminals externally. Doing so may damage the product.
 - Install module so that excessive force will not be applied to terminal blocks, power connectors, I/O connectors, communication connectors, or communication cables. Failure to do so may result in wire damage/breakage or PLC failure.
 - Make sure to observe the following precautions in order to prevent any damage to the machinery or accidents due to malfunction of the PLC caused by abnormal data written to the PLC due to the effects of noise:
 - Do not bundle the power line, control line and communication cables together with or lay them close to the main circuit, high-voltage line, load line or power line. As a guideline, lay the power line, control line and connection cables at least 100 mm away from the main circuit, high-voltage line, load line or power line.
 - Ground the shield of the analog input/output cable in accordance with the manuals of each model. However, do not use common grounding with heavy electrical systems.
 - Check the interface type and correctly connect the cable. Incorrect wiring (connecting the cable to an incorrect interface) may cause failure of the module and external device.
 - To terminal blocks or power connectors, connect circuits isolated from hazardous voltage by double/reinforced insulation.
-

[STARTUP AND MAINTENANCE PRECAUTIONS]

WARNING

- Do not touch any terminal while the PLC's power is on. Doing so may cause electric shock or malfunctions.
 - Before cleaning or retightening terminals, cut off all phases of the power supply externally. Failure to do so in the power ON status may cause electric shock.
 - Before modifying the program in operation, forcible output, running or stopping the PLC, read through this manual carefully, and ensure complete safety. An operation error may damage the machinery or cause accidents.
 - Do not change the program in the PLC from two or more peripheral equipment devices at the same time. (i. e. from an engineering tool and a GOT) Doing so may cause destruction or malfunction of the PLC program.
-

[STARTUP AND MAINTENANCE PRECAUTIONS]

CAUTION

- Do not disassemble or modify the PLC. Doing so may cause fire, equipment failures, or malfunctions. For repair, contact your local Mitsubishi Electric representative.
 - Turn off the power to the PLC before connecting or disconnecting any extension cable. Failure to do so may cause device failures or malfunctions.
 - Turn off the power to the PLC before attaching or detaching the following devices. Failure to do so may cause device failures or malfunctions.
 - Peripheral devices, expansion board, expansion adapter, and connector conversion adapter
 - Extension modules, bus conversion module, and connector conversion module
 - Battery
 - Before handling the module, touch a conducting object such as a grounded metal to discharge the static electricity from the human body. Failure to do so may cause the module to fail or malfunction.
-

[OPERATION PRECAUTIONS]

CAUTION

- Construct an interlock circuit in the program so that the whole system always operates on the safe side before executing the control (for data change) of the PLC in operation. Read the manual thoroughly and ensure complete safety before executing other controls (for program change, parameter change, forcible output and operation status change) of the PLC in operation. Otherwise, the machine may be damaged and accidents may occur by erroneous operations.
 - Note that the whole system may not be reset by the RUN/STOP/RESET switch when the CPU module or intelligent function module detects an error, such as a watchdog timer error, during self-diagnosis. In that case, turn off and on the power.
-

[DISPOSAL PRECAUTIONS]

CAUTION

- Please contact a certified electronic waste disposal company for the environmentally safe recycling and disposal of your device.
-

[TRANSPORTATION PRECAUTIONS]

CAUTION

- The PLC is a precision instrument. During transportation, avoid impacts larger than those specified in the general specifications of the User's Manual (Hardware) of the CPU module used by using dedicated packaging boxes and shock-absorbing palettes. Failure to do so may cause failures in the PLC. After transportation, verify operation of the PLC and check for damage of the mounting part, etc.
-

INTRODUCTION

This manual contains text, diagrams and explanations which will guide the reader in the correct installation, safe use and operation of the analog input module, analog output module, multiple input module of MELSEC iQ-F series and should be read and understood before attempting to install or use the module.

Always forward it to the end user.

Regarding use of this product

- This product has been manufactured as a general-purpose part for general industries, and has not been designed or manufactured to be incorporated in a device or system used in purposes related to human life.
- Before using the product for special purposes such as nuclear power, electric power, aerospace, medicine or passenger movement vehicles, consult Mitsubishi Electric.
- This product has been manufactured under strict quality control. However when installing the product where major accidents or losses could occur if the product fails, install appropriate backup or failsafe functions in the system.

Note

- If in doubt at any stage during the installation of the product, always consult a professional electrical engineer who is qualified and trained in the local and national standards. If in doubt about the operation or use, please consult the nearest Mitsubishi Electric representative.
- Since the examples indicated by this manual, technical bulletin, catalog, etc. are used as a reference, please use it after confirming the function and safety of the equipment and system. Mitsubishi Electric will accept no responsibility for actual use of the product based on these illustrative examples.
- This manual content, specification etc. may be changed, without a notice, for improvement.
- The information in this manual has been carefully checked and is believed to be accurate; however, if you notice a doubtful point, an error, etc., please contact the nearest Mitsubishi Electric representative. When doing so, please provide the manual number given at the end of this manual.

MEMO

CONTENTS

SAFETY PRECAUTIONS	1
INTRODUCTION	6
RELEVANT MANUALS	13
TERMS	13
GENERIC TERMS AND ABBREVIATIONS	13

PART 1 ANALOG INPUT MODULE

CHAPTER 1 FX5-4AD	16
1.1 Overview	16
1.2 Specifications	16
General specifications	16
Power supply specifications	16
Performance specifications	17
Input conversion characteristics	17
Accuracy	20
Part names	21
1.3 Procedures Before Operation	22
1.4 Functions	22
Function list	23
Processing of each function	24
Operation mode	24
Range switching function	25
A/D conversion enable/disable setting function	25
A/D conversion method	26
Scaling function	32
Shift function	34
Digital clipping function	37
Difference operation function	39
Maximum value/minimum value hold function	43
Alert output function	44
Input signal error detection function	51
Logging function	57
Interrupt function	74
Error history function	77
Offset/gain initialization function	79
FX3 allocation mode function	80
1.5 System Configuration	81
1.6 Wiring	82
Spring clamp terminal block	82
Terminal arrangement	84
Ground wiring	85
External wiring example	85
1.7 Parameter Settings	86
Basic setting	86
Application setting	87
Interrupt setting	88

Refresh setting	89
1.8 Offset/Gain Setting	90
Setting example	90
1.9 Programming	96
Programming procedure	96
1.10 Troubleshooting	101
Troubleshooting with the LEDs	101
Troubleshooting by symptom	102
List of error codes	105
List of alarm codes	108
APPENDIX	109
Appendix 1 External Dimensions	109
Appendix 2 Standards	110
Certification of UL, cUL standards	110
Compliance with EC directive (CE marking)	110
Requirement for compliance with EMC directive	110
Caution for compliance with EC directive	110
Compliance with UKCA marking	111
Appendix 3 Module Label	112
Appendix 4 Buffer Memory Areas	113
List of buffer memory areas	113
Details of buffer memory addresses	125

PART 2 ANALOG OUTPUT MODULE

CHAPTER 2 FX5-4DA	178
2.1 Overview	178
2.2 Specifications	178
General specifications	178
Power supply specifications	178
Performance specifications	179
Output conversion characteristics	180
Accuracy	182
Part names	183
2.3 Procedures Before Operation	184
2.4 Functions	184
Function list	185
Operation mode	185
Range switching function	187
D/A conversion enable/disable function	187
D/A output enable/disable function	188
Analog output HOLD/CLEAR function	188
Analog output test function when CPU module stops	191
Scaling function	192
Shift function	194
Alert output function	196
Rate control function	198
External power supply disconnection detection function	201
Disconnection detection function	202

Interrupt function	203
Wave output function	206
Error history function	237
Offset/gain initialization function	239
FX3 allocation mode function	240
2.5 System Configuration	241
2.6 Wiring	242
Spring clamp terminal block	242
Terminal arrangement	245
Ground wiring	245
Wiring precautions	245
External wiring example	246
2.7 Parameter Settings	247
Parameter setting procedure	247
Module parameters	248
Module extension parameters	252
2.8 Offset/Gain Setting	259
Setting example	259
2.9 Programming	265
Programming procedure	265
2.10 Troubleshooting	275
Troubleshooting with the LEDs	275
Troubleshooting by symptom	276
List of error codes	279
List of alarm codes	282

APPENDIX 283

Appendix 5 External Dimensions	283
Appendix 6 Standards	284
Certification of UL, cUL standards	284
Compliance with EC directive (CE marking)	284
Requirement for compliance with EMC directive	284
Caution for compliance with EC directive	284
Compliance with UKCA marking	284
Appendix 7 Module Label	285
Appendix 8 Buffer Memory Areas	287
List of buffer memory areas	287
Details of buffer memory addresses	298

PART 3 MULTIPLE INPUT MODULE

CHAPTER 3 FX5-8AD 334	334
3.1 Overview	334
3.2 Specifications	334
General specifications	334
Power supply specifications	334
Performance specifications	335
Input conversion characteristics	337
Accuracy	339
Part names	341

3.3	Procedures Before Operation	342
3.4	Functions	342
	Function list	343
	Processing of each function	344
	Operation mode	345
	Input type/range setting function	346
	Conversion method	347
	Scaling function	351
	Shift function	354
	Digital clipping function	357
	Maximum value/minimum value hold function	359
	Alert output function	360
	Input signal error detection function	367
	Disconnection detection function	374
	Logging function	377
	Error history function	390
	Offset/gain initialization function	392
	FX2N allocation mode function	393
	2CH conversion mode function	394
3.5	System Configuration	395
3.6	Wiring	396
	Spring clamp terminal block	396
	Terminal arrangement	399
	Power supply wiring	400
	Wiring precautions	400
	External wiring example	401
3.7	Parameter Setting	402
	Basic setting	402
	Application setting	403
	Refresh setting	404
3.8	Offset/Gain Setting	405
	Setting example when the input type is voltage	405
	Setting example when the input type is thermocouple	410
3.9	Programming	415
	Programming procedure	415
3.10	Troubleshooting	420
	Troubleshooting with the LEDs	420
	Troubleshooting by symptom	420
	List of error codes	424
	List of alarm codes	427
APPENDIX		428
Appendix 9 External Dimensions		428
Appendix 10 Standards		429
	Certification of UL, cUL standards	429
	Compliance with EC directive (CE marking)	429
	Requirement for compliance with EMC directive	429
	Caution for compliance with EC directive	429
	Compliance with UKCA marking	430
Appendix 11 Module Label		431

Appendix 12 Buffer Memory Areas	432
List of buffer memory areas.....	432
Details of buffer memory addresses.....	446

INDEX **497**

REVISIONS.....	500
WARRANTY.....	501
TRADEMARKS.....	502

RELEVANT MANUALS

Manual name <manual number>	Description
MELSEC iQ-F FX5S/FX5UJ/FX5U/FX5UC User's Manual (Hardware) <SH082452ENG>	Describes the details of hardware of the FX5S/FX5UJ/FX5U/FX5UC CPU module, including performance specifications, wiring, installation, and maintenance.
MELSEC iQ-F FX5 User's Manual (Application) <JY997D55401>	Describes basic knowledge required for program design, functions of the CPU module, devices/labels, and parameters.
MELSEC iQ-F FX5 Programming Manual (Program Design) <JY997D55701>	Describes specifications of ladders, ST, FBD/LD, and other programs and labels.
MELSEC iQ-F FX5 Programming Manual (Instructions, Standard Functions/Function Blocks) <JY997D55801>	Describes specifications of instructions and functions that can be used in programs.
MELSEC iQ-F FX5 User's Manual (Analog Control - Intelligent function module) <SH-081802ENG> (This manual)	Describes the analog input module, analog output module, and multiple input module.
GX Works3 Operating Manual <SH-081215ENG>	System configuration, parameter settings, and online operations of GX Works3.

TERMS

Unless otherwise specified, this manual uses the following terms.

Terms	Description
Engineering tool	The software package for the MELSEC series programmable controllers

GENERIC TERMS AND ABBREVIATIONS

Unless otherwise specified, this manual uses the following generic terms and abbreviations.

Terms	Description
Extension module	A generic term for FX5 extension modules, FX3 extension modules, and extension modules (extension cable type and extension connector type)
FX3	A generic term for FX3S, FX3G, FX3GC, FX3U, and FX3UC programmable controllers
FX5	A generic term for FX5UJ, FX5U, and FX5UC programmable controllers
FX5 CPU module	A generic term for FX5UJ CPU module, FX5U CPU module, and FX5UC CPU module
FX5S CPU module	A generic term for FX5S-30MR/ES, FX5S-40MR/ES, FX5S-60MR/ES, FX5S-80MR/ES ^{*1} , FX5S-30MT/ES, FX5S-40MT/ES, FX5S-60MT/ES, FX5S-80MT/ES ^{*1} , FX5S-30MT/ESS, FX5S-40MT/ESS, FX5S-60MT/ESS, and FX5S-80MT/ESS ^{*1}
FX5U CPU module	A generic term for FX5U-32MR/ES, FX5U-32MT/ES, FX5U-32MT/ESS, FX5U-64MR/ES, FX5U-64MT/ES, FX5U-64MT/ESS, FX5U-80MR/ES, FX5U-80MT/ES, FX5U-80MT/ESS, FX5U-32MR/DS, FX5U-32MT/DS, FX5U-32MT/DSS, FX5U-64MR/DS, FX5U-64MT/DS, FX5U-64MT/DSS, FX5U-80MR/DS, FX5U-80MT/DS, and FX5U-80MT/DSS
FX5UC CPU module	A generic term for FX5UC-32MT/D, FX5UC-32MT/DSS, FX5UC-64MT/D, FX5UC-64MT/DSS, FX5UC-96MT/D, FX5UC-96MT/DSS, FX5UC-32MT/DS-TS, FX5UC-32MT/DSS-TS, and FX5UC-32MR/DS-TS
FX5UJ CPU module	A generic term for FX5UJ-24MR/ES, FX5UJ-24MT/ES, FX5UJ-24MT/ESS, FX5UJ-40MR/ES, FX5UJ-40MT/ES, FX5UJ-40MT/ESS, FX5UJ-60MR/ES, FX5UJ-60MT/ES, and FX5UJ-60MT/ESS
GX Works3	The product name of the software package, SWnDND-GXW3, for the MELSEC programmable controllers (The 'n' represents a version.)
Input/output module	A generic term for input/output modules (extension cable type and extension connector type)
Input module	A generic term for input modules (extension cable type and extension connector type)
Intelligent function module	A generic term for FX5 intelligent function modules and FX3 intelligent function modules
Output module	A generic term for output modules (extension cable type and extension connector type)

*1 Area-specific model

MEMO

PART 1

ANALOG INPUT MODULE

Part 1 describes the analog input module.

1 FX5-4AD

1 FX5-4AD

1.1 Overview

The FX5-4AD analog input module can convert 4 points of analog input values (voltage, current) into digital values. It can be added to the FX5 CPU module and enables it to capture voltage/current data of 4 channels.

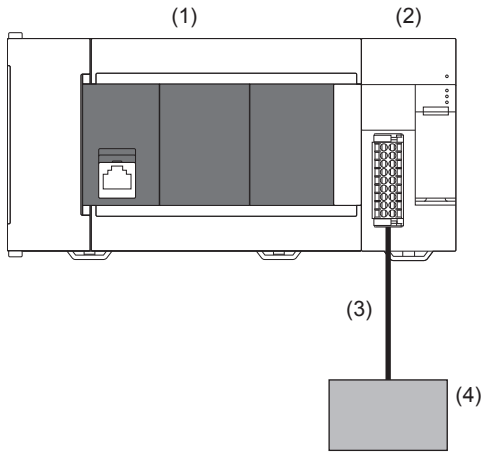

- (1) FX5 CPU module
- (2) Analog input module (FX5-4AD)
- (3) Analog device connection cable
- (4) Analog device (flow sensor etc.)

1.2 Specifications

This section describes the specifications of FX5-4AD.

General specifications

The general specifications other than below are the same as those for the CPU module to be connected.

For general specifications, refer to the following manuals.

📖 MELSEC iQ-F FX5S/FX5UJ/FX5U/FX5UC User's Manual (Hardware)

Items	Specifications	
Dielectric withstand voltage	500 V AC for 1 minute	Between all terminals and ground terminal
Insulation resistance	10 M Ω or higher by 500 V DC insulation resistance tester	

Power supply specifications

The following table lists the power supply specifications.

Items	Specifications	
Internal power supply	Power supply voltage	24 V DC, 5 V DC
	Current consumption	24 V DC: 40 mA 5 V DC: 100 mA

Performance specifications

The following table lists the performance specifications.

Items		Specifications
Number of input points		4 points (4 channels)
Conversion speed		80 μ s/ch
Isolation method	Between input terminal and PLC	Photocoupler
	Between input terminal and channels	Non-isolation
Number of occupied I/O points		8 points
Applicable CPU module		<ul style="list-style-type: none"> FX5UJ CPU module (from the first) FX5U CPU module (Ver.1.050 or later) FX5UC CPU module^{*1} (Ver.1.050 or later)
Applicable engineering tool		<ul style="list-style-type: none"> FX5UJ CPU module: GX Works3 (Ver.1.060N or later) FX5U/FX5UC CPU module: GX Works3 (Ver.1.040S or later)

*1 FX5-CNV-IFC or FX5-C1PS-5V is necessary to connect FX5-4AD to the FX5UC CPU module.

Voltage/current input specifications

Items	Specifications			
Analog input voltage	-10 to +10 V DC (Input resistance 400 k Ω or more)			
Analog input current	-20 to +20 mA DC (Input resistance 250 Ω)			
Digital output value	16-bit signed binary (-32768 to +32767)			
Input characteristics, resolution ^{*1}	Analog input range		Digital output value	
	Voltage	0 to 10 V	0 to 32000	312.5 μ V
		0 to 5 V	0 to 32000	156.25 μ V
		1 to 5 V	0 to 32000	125 μ V
		-10 to +10 V	-32000 to +32000	312.5 μ V
		User range setting	-32000 to +32000	125 μ V ^{*2}
	Current	0 to 20 mA	0 to 32000	625 nA
		4 to 20 mA	0 to 32000	500 nA
		-20 to +20 mA	-32000 to +32000	625 nA
		User range setting	-32000 to +32000	500 nA ^{*2}
Accuracy (accuracy for the full scale digital output value)	Ambient temperature 25 \pm 5 $^{\circ}$ C: within \pm 0.1% (\pm 64 digits) Ambient temperature 0 to 55 $^{\circ}$ C: within \pm 0.2% (\pm 128 digits) Ambient temperature -20 to 0 $^{\circ}$ C: within \pm 0.3% (\pm 192 digits)			
Absolute maximum input	Voltage: \pm 15 V, Current: \pm 30 mA			

*1 For details on the input characteristics, refer to  Page 17 Input conversion characteristics.

*2 Maximum resolution in the user range setting.

Input conversion characteristics

The input conversion characteristics of A/D conversion are expressed by the slope of the straight line connecting the offset value and the gain value, both of which are used when an analog signal (voltage or current) from outside the programmable controller is converted to the corresponding digital output value.

Offset value

This value is the analog input value (voltage or current) where the corresponding digital output value is 0.

Gain value

This value is the analog input value (voltage or current) where the corresponding digital output value is 32000.

Voltage input characteristics

The following shows the list of the analog input ranges and the graphs of each voltage input characteristic, at the voltage input.

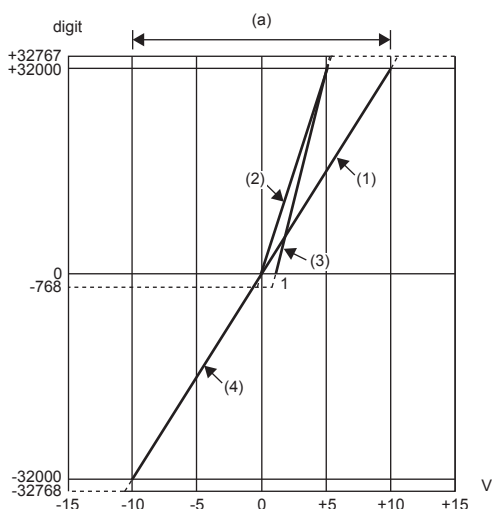

digit: Digital output value

V: Analog input voltage (V)

(a): Practical analog input range

No.	Input range setting	Offset value	Gain value	Digital output value ^{*1}	Resolution
(1)	0 to 10 V	0 V	10 V	0 to 32000	312.5 μV
(2)	0 to 5 V	0 V	5 V		156.25 μV
(3)	1 to 5 V	1 V	5 V		125 μV
(4)	-10 to +10 V	0 V	10 V	-32000 to +32000	312.5 μV
—	User range setting	*2	*2		125 μV ^{*3}

*1 If an analog input value exceeds the range of digital output value, the digital output value is fixed to the maximum or minimum value.

Input range setting	Digital output value	
	Minimum	Maximum
0 to 10 V	-768	+32767
0 to 5 V		
1 to 5 V		
-10 to +10 V	-32768	
User range setting		

*2 Set the offset value and gain value in the user range setting within a range satisfying the following conditions. Failure to satisfy the conditions may not result in proper A/D conversion.

Setting range of the offset value and gain value: -10 to +10 V

$((\text{Gain value}) - (\text{Offset value})) \geq 2.0 \text{ V}$

*3 Maximum resolution in the user range setting. The resolution reaches the maximum when $(\text{gain value} - \text{offset value}) = 4 \text{ V}$. Even when $(\text{gain value} - \text{offset value}) < 4 \text{ V}$, the maximum resolution is unchanged.

Point

- Set values within the practical range of the analog input and the digital output at each input range. If the range is exceeded, the resolution and accuracy may not fall within the range of the performance specifications. (Do not use the values in the dotted line region in the graph of voltage input characteristics.)
- Do not set the voltage over $\pm 15 \text{ V}$. Doing so can cause breakdown of components.

Current input characteristics

The following shows the list of the analog input ranges and the graph of each current input characteristic, at the current input.

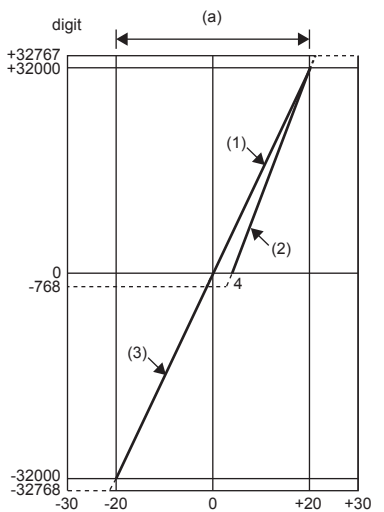

digit: Digital output value

I: Analog input current (mA)

(a): Practical analog input range

No.	Input range setting	Offset value	Gain value	Digital output value ^{*1}	Resolution
(1)	0 to 20 mA	0 mA	20 mA	0 to 32000	625 nA
(2)	4 to 20 mA	4 mA	20 mA		500 nA
(3)	-20 to +20 mA	0 mA	20 mA	-32000 to +32000	625 nA
—	User range setting	*2	*2		500 nA ^{*3}

*1 If an analog input value exceeds the range of digital output value, the digital output value is fixed to the maximum or minimum value.

Input range setting	Digital output value	
	Minimum	Maximum
0 to 20 mA	-768	+32767
4 to 20 mA		
-20 to +20 mA	-32768	
User range setting		

*2 Set the offset value and gain value in the user range setting within a range satisfying the following conditions. Failure to satisfy the conditions may not result in proper A/D conversion.

Setting range of the offset value and gain value: 0 to 20 mA

$((\text{Gain value}) - (\text{Offset value})) \geq 6.0 \text{ mA}$

*3 Maximum resolution in the user range setting. The resolution reaches the maximum when $(\text{gain value} - \text{offset value}) = 16 \text{ mA}$. Even when $(\text{gain value} - \text{offset value}) < 16 \text{ mA}$, the maximum resolution is unchanged.

Point

- Set values within the practical range of the analog input and the digital output at each input range. If the range is exceeded, the resolution and accuracy may not fall within the range of the performance specifications. (Do not use the values in the dotted line region in the graph of current input characteristics.)
- Do not set the current over $\pm 30 \text{ mA}$. Doing so can cause breakdown of components.
- If a current is input from an external device into a channel set for voltage as the input type, an overvoltage may occur and destroy components. Limit the voltage so that the external device's voltage value does not exceed the range of -10 to $+10 \text{ V}$.

Accuracy

The accuracy of A/D conversion is the accuracy for the full scale of digital output value.

The fluctuation range varies as follows depending on ambient temperature and input range.

Analog input range		Ambient temperature		
		25±5°C	0 to 55°C	-20 to 0°C
Voltage	0 to 10 V	Within ±0.1% (±64 digits)/full scale	Within ±0.2% (±128 digits)/full scale	Within ±0.3% (±192 digits)/full scale
	0 to 5 V			
	1 to 5 V			
	-10 to +10 V			
Current	0 to 20 mA			
	4 to 20 mA			
	-20 to +20 mA			

(Except for the conditions under noise influence.)

Ex.

Accuracy at -10 to +10 V range selection

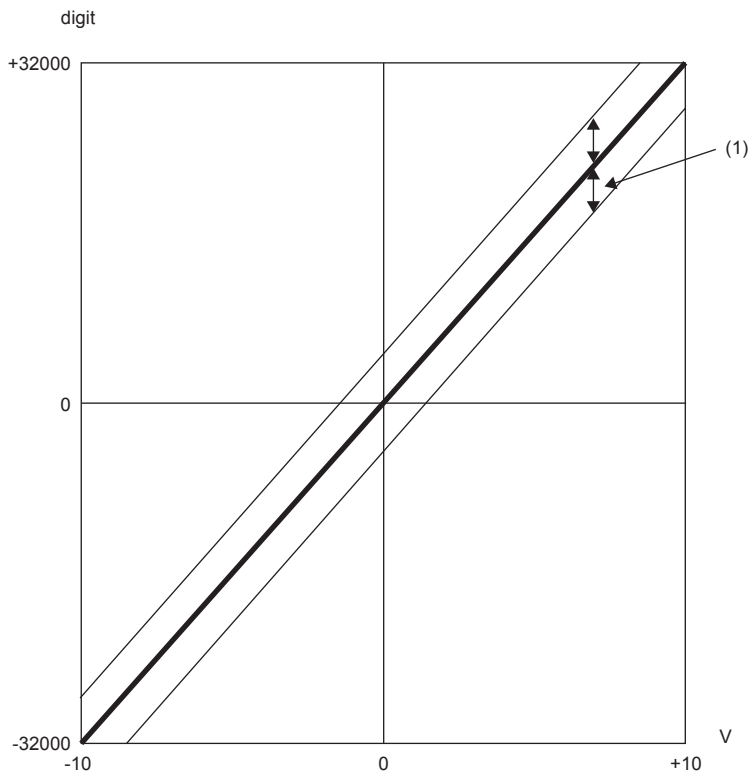

digit: Digital output value
 V: Analog input voltage (V)
 (1) Fluctuation range

Part names

This section describes the part names of the analog input module.

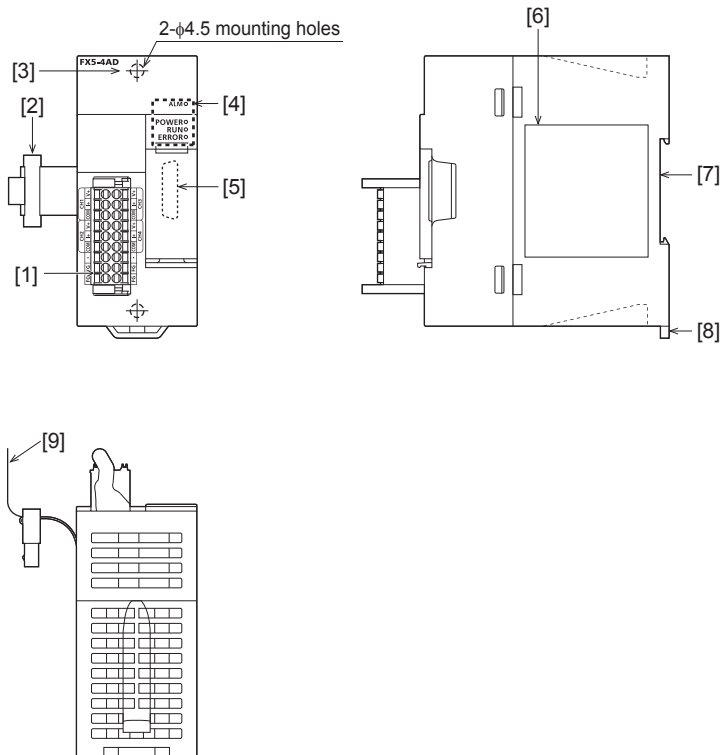

No.	Name	Description
[1]	Terminal block (Spring clamp terminal block)	Used for current/voltage input.
[2]	Expansion cable	Cable for connecting the module when adding the analog input module.
[3]	Direct mounting hole	Screw holes (2- ϕ 4.5, mounting screw: M4 screw) for direct installation.
[4]	Operations status display LEDs	Indicates the operating status of the module. (Page 21 LED display)
[5]	Extension connector	Connector for connecting the extension cable of an extension module.
[6]	Name plate	The product model name and manufacturer's serial number are shown.
[7]	DIN rail mounting groove	The module can be installed on DIN46277 rail (35 mm wide).
[8]	DIN rail mounting hook	Hook for mounting the module on a DIN rail of DIN46277 (35 mm wide).
[9]	Pull out tab	They are used when drawing out an extension cable.

LED display

The following table lists the LED display.

LED display	LED color	Description
POWER	Green	Indicates the power supply status. ON: Power ON OFF: Power off or module failure
RUN	Green	Indicates the operating status. Light on: Normal operation Flashing: Offset/gain setting mode Light off: Error occurring
ERROR	Red	Indicates the error status. ON: Minor error Flashing: Moderate error or major error OFF: Normal operation
ALM	Red	Indicates the output status. Light on: Process alarm or rate alarm issued Flashing: Input signal error Light off: Normal operation

1.3 Procedures Before Operation

This section describes the procedures before operation.

1. Check the analog input module specifications

Check the analog input module specifications. ( Page 16 Specifications)

2. Install the analog input module

Install the analog input module to the CPU module. For details, refer to the following.

 MELSEC iQ-F FX5S/FX5UJ/FX5U/FX5UC User's Manual (Hardware)

3. Wiring

Perform wiring of external devices to the analog input module.

4. Adding a module

Add an analog input module to the module configuration by using GX Works3.

Point

When adding a new analog input module, if selecting the module whose module model name has "(FX3)" at the end, it can be used as FX3 allocation mode.

- FX5-4AD: Normal mode
- FX5-4AD(FX3): FX3 allocation mode

For details on the FX3 allocation mode function, refer to  Page 80 FX3 allocation mode function

5. Parameter settings

Set parameters of the analog input module by using GX Works3. ( Page 86 Parameter Settings)

6. Offset/gain setting

When setting the user range, perform the offset/gain setting.

7. Programming

Create a program.

1.4 Functions

This section describes the functions of an analog input module and the setting procedures for those functions.

For details on the buffer memory areas, refer to the following.

 Page 113 Buffer Memory Areas

Point

- This section describes buffer memory addresses for CH1. For details on the buffer memory addresses after CH2, refer to the following.

 Page 113 List of buffer memory areas

- Numerical values corresponding to the channel where an error has occurred and the error description fit in the □ and △ of an error code and alarm code described in this section. For details on the numerical values, refer to the following.

 Page 105 List of error codes

 Page 108 List of alarm codes

Function list

This section lists the functions of analog input modules.

Item	Description	Reference		
Operation mode	Select the operation mode (normal mode, offset/gain setting mode) of the analog input module.	Page 24		
Range switching function	Allows switching the input range of an analog input for each channel. Switching the range makes it possible to change the input conversion characteristic.	Page 25		
A/D conversion enable/disable setting function	Controls whether to enable or disable the A/D conversion for each channel. Disabling A/D conversion for unused channels reduces the conversion cycles.	Page 25		
A/D conversion method	Sampling processing	Converts analog input values into digital at every sampling period, storing them in buffer memory areas.	Page 26	
	Averaging processing	Time average	Executes A/D conversion for the set time and performs the averaging processing on the total value excluding the maximum and minimum values. The processed values are stored in the buffer memory area. The number of processing times within the set time changes depending on the number of channels where A/D conversion is enabled.	Page 26
		Count average	Executes A/D conversion for a set number of times and performs the averaging processing on the total value excluding the maximum and minimum values. The processed values are stored in the buffer memory area. The time taken to store the count average value obtained by the processing in the buffer memory area varies depending on the number of channels where the conversion is enabled.	Page 27
		Moving average	Averages digital output values taken at every sampling period for a specified number of times, and stores the averaged value in the buffer memory area. The target range for averaging processing moves at each sampling processing, thereby allowing the latest digital output value to be obtained.	Page 27
	Primary delay filter	Performs digital output where the transient noise of analog input is smoothed depending on the set time constant, and stores the value in the buffer memory area.	Page 28	
	Digital filter	Removes the fluctuation below the set value when the measurement signal includes noise such as a steep spike and stores the resulting stable data in the buffer memory.	Page 29	
Scaling function	Performs scale conversion on digital output values within the range from a scaling upper limit value to a scaling lower limit value, both of which are set at desired values. This function helps reduce the man-hours taken for creating a scale conversion program.	Page 32		
Shift function	Adds (shifts) a set conversion value shift amount to a digital output value, and stores the result in the buffer memory area. A change in conversion value shift amount is reflected to the digital operation value in real time, which facilitates fine adjustment at system start-up.	Page 34		
Digital clipping function	Fixes a possible digital operation value to the maximum digital output value or the minimum digital output value when an input current or voltage exceeds the input range.	Page 37		
Difference operation function	The digital operation value at the start of this function is treated as 0 (reference value). Thereafter, values that increased or decreased from the reference value are stored in the buffer memory.	Page 39		
Maximum value/minimum value hold function	Stores the maximum and minimum values of digital operation values in the buffer memory area for each channel.	Page 43		
Alert output function	Process alarm	Outputs an alert when a digital operation value falls within the preset alert output range.	Page 44	
	Rate alarm	This function outputs an alert when the change rate of a digital output value is equal to or greater than the rate alarm upper limit value, or the rate is equal to or smaller than the rate alarm lower limit value.	Page 46	
Input signal error detection function	Outputs an alarm when an analog input value exceeds the preset range.	Page 51		
Logging function	Logs (records) digital output values or digital operation values. 10000 points of data can be logged for each channel.	Page 57		
Logging read function	After logging starts, an interrupt request is sent to the CPU module and an interrupt program is executed every time the preset number of data to be read is logged.	Page 70		
Interrupt function	Executes an interrupt program of the CPU module when an interrupt factor such as an input signal error or alarm output is detected.	Page 74		
Error history function	Records up to 16 errors and alarms that occurred in an analog input module to store them in the buffer memory areas.	Page 77		
Offset/gain setting function	Allows the correction of errors in digital output values.	Page 90		
Offset/gain initialization function	Initializes the offset and gain values to the factory defaults.	Page 79		
FX3 allocation mode function	Converts the layout of buffer memory addresses of an analog input module to the one equivalent to FX3U-4AD. This compatibility enables the reuse of programs that have proven performance on FX3U-4AD.	Page 80		

Processing of each function

The functions are processed in the order shown below. If multiple functions are enabled, the output of the first processed function is used as the input of the next function.

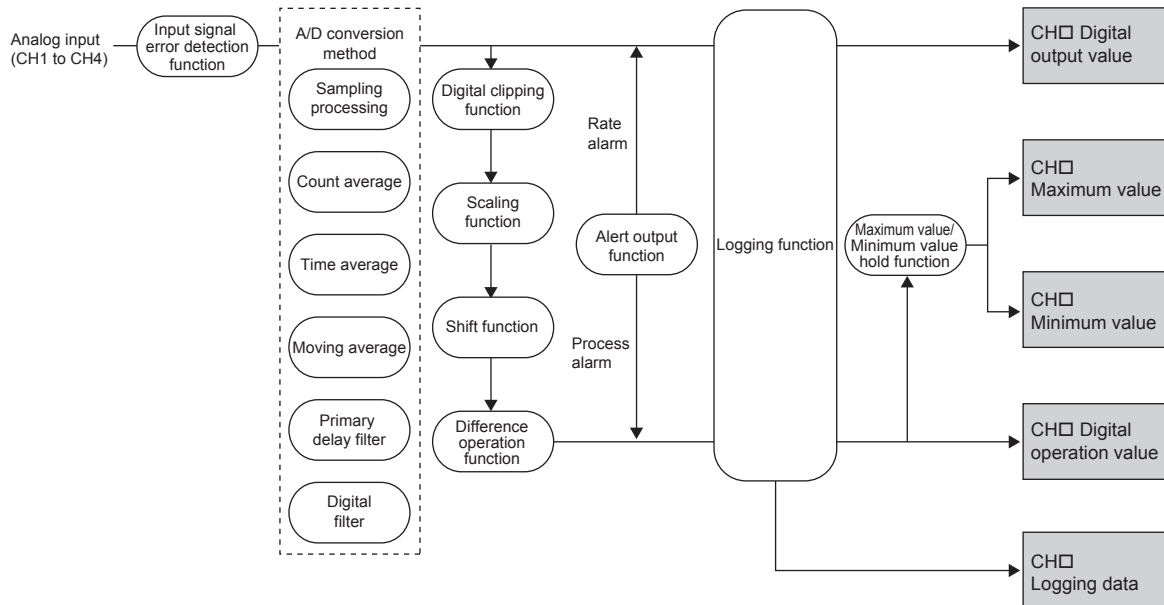

Digital output value

The digital values subjected to the sampling processing, each averaging processing, or each filter processing are stored.

Digital operation value

These values are obtained by operating a digital output value using the digital clipping function, scaling function, shift function, or difference operation function. When each function is not used, the same value as the digital output value is stored.

Maximum value and minimum value

The maximum and minimum values of the digital operation values are stored.

Logging data

When the logging function is used, digital output values or digital operation values are collected.

Operation mode

The analog input module operation mode can be selected.

Setting procedure

Set "Operation mode setting".

[Navigation window] ⇒ [Parameter] ⇒ [Module Information] ⇒ Module model name ⇒ [Module Parameter] ⇒ [Basic setting] ⇒ [Operation mode setting function]

Operation mode	Description
Normal mode	A mode to perform usual A/D conversion.
Offset/gain setting mode	A mode used for performing the offset/gain setting at user range setting.

Range switching function

Allows switching the input range of an analog input for each channel.

Switching the range makes it possible to change the input conversion characteristic.

Setting procedure

Set the input range to be used in the "Input range setting".

 [Navigation window] ⇒ [Parameter] ⇒ [Module Information] ⇒ Module model name ⇒ [Module Parameter] ⇒ [Basic setting] ⇒ [Range switching function]

Input range setting	Digital output value
4 to 20 mA	0 to 32000
0 to 20 mA	0 to 32000
-20 to +20 mA	-32000 to +32000
1 to 5 V	0 to 32000
0 to 5 V	0 to 32000
0 to 10 V	0 to 32000
-10 to +10 V	-32000 to +32000
User range setting ^{*1}	-32000 to +32000

*1 When using the user range setting, set the offset/gain.

For offset/gain settings, refer to the following.

 Page 90 Offset/Gain Setting

After the data is written, the range is switched when the programmable controller power supply is turned off→on or when the CPU module is reset.

Point

With the following buffer memory areas, the range switching and range setting can be monitored.

'CH1 Range setting' (Un\G598)

'CH1 Range setting monitor' (Un\G430)

For details on the buffer memory, refer to the following.

 Page 172 CH1 Range setting

 Page 146 CH1 Range setting monitor

A/D conversion enable/disable setting function

Controls whether to enable or disable the A/D conversion for each channel.

Disabling A/D conversion for unused channels reduces the conversion cycles.

Setting procedure

Set "A/D conversion enable/disable setting" to "A/D conversion enable" or "A/D conversion disable".

 [Navigation window] ⇒ [Parameter] ⇒ [Module Information] ⇒ Module model name ⇒ [Module Parameter] ⇒ [Basic setting] ⇒ [A/D conversion enable/disable setting function]

A/D conversion method

An A/D conversion method can be set for each channel.

Sampling processing

This function A/D converts analog input values and stores them in the digital output value and digital operation value every sampling cycle.

Point

The sampling cycle is "Conversion speed (80 μ s) \times Number of A/D conversion enabled channels".

Whether to enable or disable the A/D conversion can be set for each channel. Disabling the A/D conversion for unused channels reduces the A/D conversion cycles.

Conversion cycle that applies when the three channels get A/D conversion enabled

- $80 \times 3 = 240$ (μ s)

The conversion cycle is 240 (μ s).

Averaging processing

The digital output value is averaging processed for each channel, and averaged value is stored in the digital output value and the digital operation value.

The following three types of averaging processing are provided.

- Time average
- Count average
- Moving average

■Time average

Executes A/D conversion for the set time and performs the averaging processing on the total value excluding the maximum and minimum values. The averaged value is stored in the digital output value and the digital operation value.

The number of processing times within the set time changes depending on the number of channels where A/D conversion is enabled.

$$\text{Processing times (times)}^{*1} = \frac{\text{Setting time}}{(\text{Number of A/D conversion enabled channels} \times \text{Conversion speed})}$$

*1 Values after the decimal point are omitted.

Ex.

The following table shows the processing times with the setting below.

Item	Setting
Number of channels where the A/D conversion is enabled	Four channels (CH1 to CH4)
Setting time	2 ms

$$\frac{2}{(4 \times 0.08)} = 6.25 \approx 6$$

Conversion is processed 6 times and the mean value is output.

Point

The valid lower limit setting value for the time average is calculated by the formula "Minimum processing times (4 times) \times Number of A/D conversion enabled channels \times Conversion speed".

Count average

Executes A/D conversion for a set number of times and performs the averaging processing on the total value excluding the maximum and minimum values. The averaged value is stored in the digital output value and the digital operation value. The time taken to store the count average value obtained by the processing in the buffer memory area varies depending on the number of channels where the conversion is enabled.

Processing time = Set number of times × (Number of A/D conversion enabled channels × Conversion speed)

Ex.

The following table shows the processing time with the setting below.

Item	Setting
Number of channels where the A/D conversion is enabled	Four channels (CH1 to CH4)
Set number of times	Five times

$5 \text{ (times)} \times (4 \text{ (CH)} \times 80 \text{ (}\mu\text{s)}) = 1600 \text{ (}\mu\text{s)} = 1.6 \text{ (ms)}$

An average value is output every 1.6 ms.

Point

Because the count average requires a sum of at least two counts excluding the maximum and minimum values, the set number of times should be four or more.

Moving average

Converted values for the specified number of times captured every sampling period are averaged and stored in the digital output value and the digital operation value. The target range for averaging processing moves at each sampling processing, thereby allowing the latest digital output value to be obtained.

The following figure shows the moving average processing of when the set number of times is five.

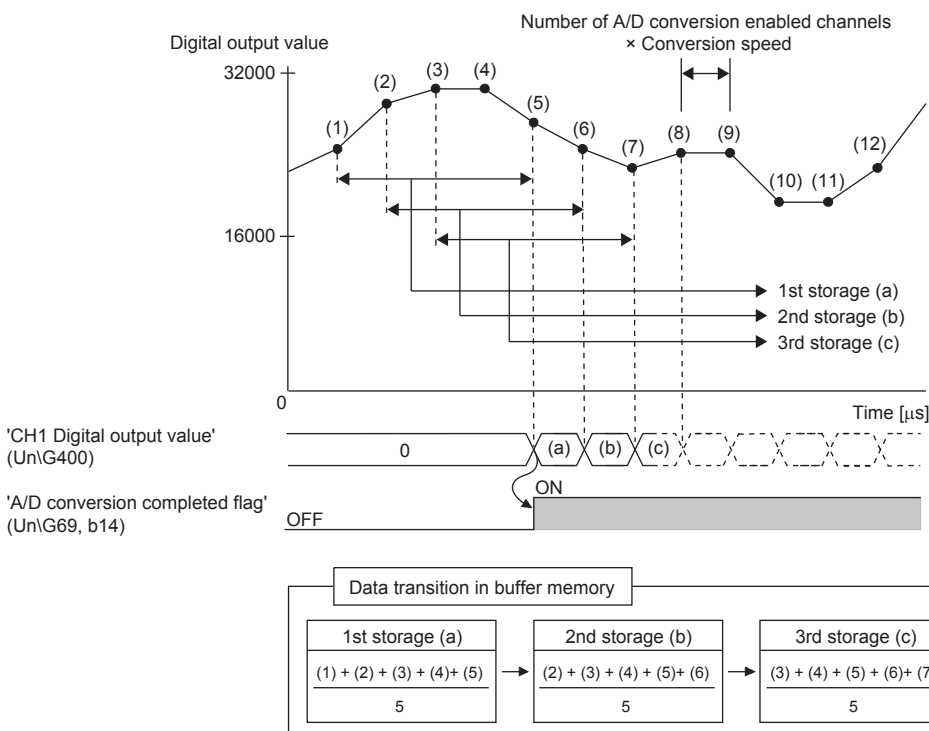

Primary delay filter

Depending on the set time constant, transient noise of analog input is smoothed and stored in the digital output value and digital operation value area.

The degree of smoothing varies depending on the setting of a time constant (s).

Time constant is the time taken for the digital output value to reach 63.2% of the steady-state value.

The following shows the relational expressions of time constants and digital output values.

When $n = 1^{*1}$

$$Y_n = 0$$

When $n = 2$

$$Y_n = X_{n-1} + \frac{\Delta t}{\Delta t + TA} (X_n - X_{n-1})$$

When $n \geq 3$

$$Y_n = Y_{n-1} + \frac{\Delta t}{\Delta t + TA} (X_n - Y_{n-1})$$

- Y_n : Present digital output value
- Y_{n-1} : Last digital output value
- n : Number of sampling
- X_n : Digital output value before smoothing
- X_{n-1} : Last digital output value before smoothing
- ΔT : Conversion time
- TA : Time constant

*1 A/D conversion completed flag turns on when $n \geq 2$.

Point

Time constant = [Primary delay filter constant set by "CH1 Time average/Count average/Primary delay filter constant setting" (Un\G502)] × [Conversion cycle].

Ex.

Digital output value when an analog input value is changed 0 → 1 V

The following figure shows the change of the digital output value with the input range of 0 to 10 V and time constant (Conversion cycle × Primary delay filter) of 40 ms.

After 40 ms from the analog input value becomes 1 V, the digital output value reaches 63.2% of the digital output value of when the sampling processing is selected.

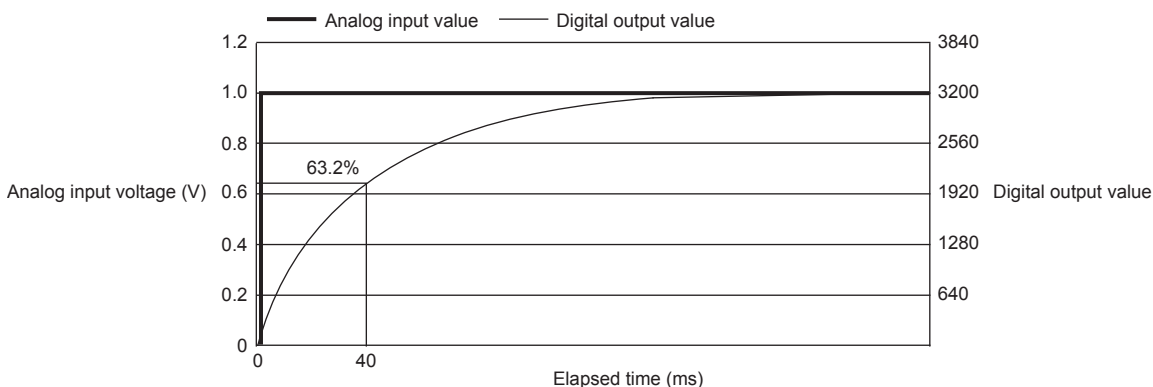

Digital filter

The digital filter can remove fluctuation of the analog input value below the digital filter setting value. The relationships among the digital output, digital filter setting, and analog input values are as follows.

■ Digital filter setting value > Analog input value fluctuation

If the analog input value fluctuation is smaller than the digital filter setting value, the conversion value resulting from removal of the fluctuation will be stored as the digital output value. Note that the fluctuation range below the digital filter setting value must satisfy the following expression.

Fluctuation range below the digital filter setting value < Conversion cycle × 10 times

■ Digital filter setting value ≤ Analog input value fluctuation

When the analog input value fluctuation is larger than or equal to the digital filter setting value, the conversion value following the analog input value is stored as the digital output and digital operation values.

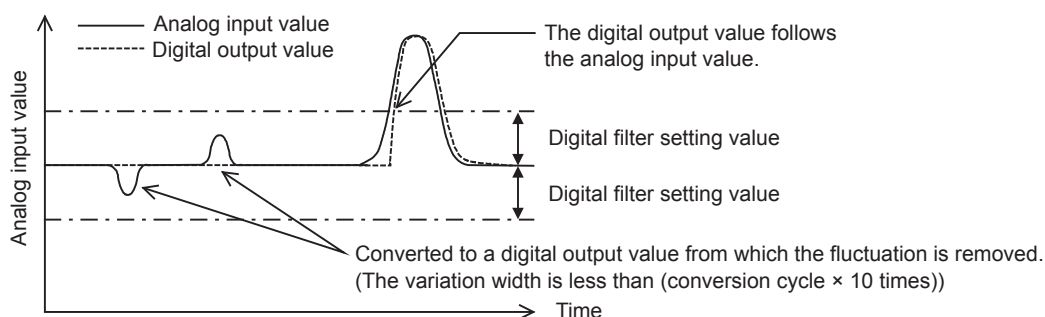

Digital filter requires the A/D conversion values for 23 times to remove the fluctuation which is smaller than the digital filter setting value. Therefore, when using the digital filter, the first digital output value is updated at the timing when the A/D conversion values for 23 times are completed.

From the second time on, the digital output value is updated every conversion cycle.

■ Digital filter conversion cycle

The digital filter conversion cycle varies depending on the setting value of the digital filter fluctuation range setting. The conversion cycle of the digital filter in operation is stored in 'CH1 Digital filter conversion cycle monitor' (Un\G411).

Point

After CH1 digital filter conversion cycle monitor (Un\G411) turns on and off the operating condition setting request, "0" is stored for any of the following states.

- A/D conversion not allowed
- Operates in the A/D conversion method other than the digital filter.
- "Averaging process specification setting range error" (error code: 191□H) occurs
- "Time average setting range error" (error code: 192□H) occurs
- "Count average setting range error" (error code: 193□H) occurs
- "Moving average setting range error" (error code: 194□H) occurs
- "Primary delay filter constant setting range error" (error code: 195□H) occur
- "Digital filter setting range error" (error code: 19D□H) occur
- "Digital filter fluctuation width setting range error" (error code: 19E□H) occur

Setting procedure

■Sampling processing

Set "Average processing setting" to "Sampling processing".

 [Navigation window] ⇒ [Parameter] ⇒ [Module Information] ⇒ Module model name ⇒ [Module Parameter] ⇒ [Basic setting] ⇒ [A/D conversion method]

■Averaging processing and Primary delay filter

1. Set "Average processing setting" to "Time average", "Count average", "Moving average", or "Primary delay filter".

 [Navigation window] ⇒ [Parameter] ⇒ [Module Information] ⇒ Module model name ⇒ [Module Parameter] ⇒ [Basic setting] ⇒ [A/D conversion method]

2. Set a value for "Time average/Count average/Moving average/Primary delay filter constant setting".

Item	Setting range
Time average	2 to 5000 (ms)
Count average	4 to 62500 (counts)
Moving average	2 to 1000 (counts)
Primary delay filter	1 to 500 (times)

■Digital filter

1. Set "Average process specification" to "Digital filter".

 [Navigation window] ⇒ [Parameter] ⇒ [Module Information] ⇒ Module model name ⇒ [Module Parameter] ⇒ [Basic setting] ⇒ [A/D conversion method]

2. Set a value for "Digital filter setting".

Item	Setting range
Digital filter setting	1 to 1600 (digits)

3. Set "Digital filter fluctuation range setting".

Item	Setting range
Digital filter fluctuation range setting	80 to 200000 (μs) ^{*1}

*1 For the digital filter fluctuation range setting, set a value equal to or larger than [Number of A/D conversion enabled channels × Conversion speed].
If a value less than [Number of A/D conversion enabled channels × Conversion speed] is set when the digital filter fluctuation range setting is within the setting range, it will operate with sampling processing without performing digital filtering.

- Digital filter conversion cycle

The digital filter conversion cycle varies as follows depending on the setting value of the digital filter fluctuation range setting.

Number of A/D conversion enabled channels	Digital filter fluctuation range setting	Conversion cycle
1	80 ≤ Fluctuation range < 800	Sampling processing conversion processing
	800 ≤ Fluctuation range ≤ 200000	Time average conversion cycle*2
2	160 ≤ Fluctuation range < 1600	Sampling processing conversion processing
	1600 ≤ Fluctuation range ≤ 200000	Time average conversion cycle*2
3	240 ≤ Fluctuation range < 2400	Sampling processing conversion processing
	2400 ≤ Fluctuation range ≤ 200000	Time average conversion cycle*2
4	320 ≤ Fluctuation range < 3200	Sampling processing conversion processing
	3200 ≤ Fluctuation range ≤ 200000	Time average conversion cycle*2

*2 The time average conversion cycle is as follows.

$$\text{Time average conversion cycle} = \underbrace{\left(\text{Variation width} \div \left(\frac{\text{Number of A/D conversion enabled channels}}{\text{Conversion speed}} \times 10 \right) + 1 \right)}_{\text{Values after the decimal point are omitted}} \times \text{Number of A/D conversion enabled channels} \times \text{Conversion speed}$$

If the above calculation result is smaller than [Minimum acquisition count (4 times) × Number of A/D conversion enabled channels × Conversion speed], the time average conversion cycle is as follows.

$$\text{Time average conversion cycle} = \text{Minimum acquisition count (4 times)} \times \text{Number of A/D conversion enabled channels} \times \text{Conversion speed}$$

Ex.

If the channel used is only CH1 and the digital filter fluctuation range setting is 50000

$$\text{Time average conversion cycle} = ((50000 \div (1 \times 80 \times 10)) + 1) \times 1 \times 80 = 5040 \text{ (}\mu\text{s)}$$

Since the calculation result is larger than or equal to [Minimum acquisition count (4 times) × Number of A/D conversion enabled channels × Conversion speed], the time average conversion cycle is 5040 μs.

Ex.

If the channel used is only CH1 and the digital filter fluctuation range setting is 1000

$$\text{Time average conversion cycle} = ((1000 \div (1 \times 80 \times 10)) + 1) \times 1 \times 80 = 160 \text{ (}\mu\text{s)}$$

Since the calculation result is smaller than or equal to [Minimum acquisition count (4 times) × Number of A/D conversion enabled channels × Conversion speed], the time average conversion cycle is 320 μs.

Scaling function

Performs scale conversion on digital output values within a specified range between a scaling upper limit value and a scaling lower limit value.

The converted values are stored in 'CH1 Digital operation value' (Un\G402).

Concept of scaling setting

The concepts of each setting item are described below.

- For the scaling upper limit value, set a value corresponding to the upper limit value after the input range conversion.
- For the scaling lower limit value, set a value corresponding to the lower limit value after the input range conversion.

Ex.

If the input range is 0 to 5 V in voltage and the scaling upper and lower limit values are set to 20000 and 4000, respectively, 4000 will be stored in 'CH1 Digital operation value' (Un\G402) when the voltage input is 0 V and 20000 will be stored there when the voltage input is 5 V.

Calculating the scaling value

The scale value conversion is based on the following formula. (In scale conversion, values are rounded to the nearest whole number.)

Range setting	Relational expression	Element
Current: 0 to 20 mA, 4 to 20 mA, user range setting	$\frac{D_x \times (S_H - S_L)}{D_{Max}} + S_L$	D _x : Digital output value D _{Max} : Maximum digital output value of the input range in use D _{Min} : Minimum digital output value of the input range in use S _H : Scaling upper limit value S _L : Scaling lower limit value
Voltage: 0 to 10 V, 0 to 5 V, 1 to 5 V, user range setting		
Current: -20 to +20 mA	$\frac{D_x \times (S_H - S_L)}{(D_{Max} - D_{Min})} + \frac{(S_H + S_L)}{2}$	
Voltage: -10 to +10 V		

Point

If the calculated digital output value is 32767 or more, 32767 will be set. If it is -32768 or smaller, -32768 will be stored.

Setting procedure

1. Set "Scaling enable/disable setting" to "Enable".

[Navigation window] ⇒ [Parameter] ⇒ [Module Information] ⇒ Module model name ⇒ [Module Parameter] ⇒ [Application setting] ⇒ [Scaling function]

2. Set values for "Scaling upper limit value" and "Scaling lower limit value".

Item	Setting range
Scaling upper limit value	-2147483648 to +2147483647 (practical range: -32000 to +32000)
Scaling lower limit value	

Point

- Even when the scaling upper limit value and the scaling lower limit value are set so that the change is greater than the resolution, the resolution will not increase.
- If the relation between the values is the conversion scaling lower limit value > the conversion scaling upper limit value, the scale conversion can be performed according to a negative slope.
- Set the scaling with the condition "Scaling upper limit value ≠ Scaling lower limit value".
- When the scaling function is used with the digital clipping function, the scale conversion is performed on the digital operation values after digital clipping.

Setting example

Ex.

An example of the following settings is shown below.

Item	Setting
Range setting	Voltage (0 to 5 V)
Scaling enable/disable setting	Enable
Scaling upper limit value	20000
Scaling lower limit value	4000

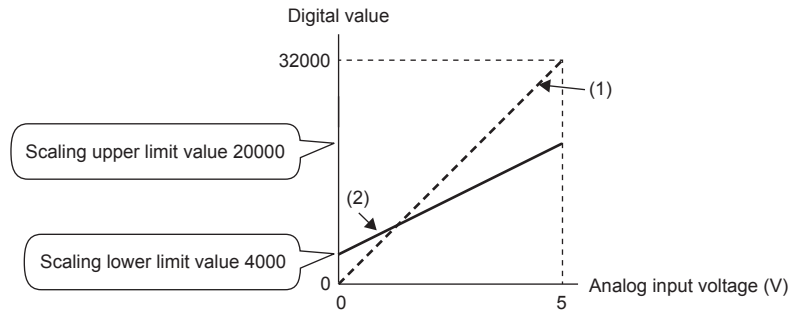

Input voltage (V)	(1) Digital output value	(2) Digital operation value (scaling value)
0	0	4000
1	6400	7200
2	12800	10400
3	19200	13600
4	25600	16800
5	32000	20000

Ex.

An example of the following settings is shown below.

Item	Setting
Range setting	Voltage (-10 to +10 V)
Scaling enable/disable setting	Enable
Scaling upper limit value	20000
Scaling lower limit value	4000

Input voltage and scaling value become as follows.

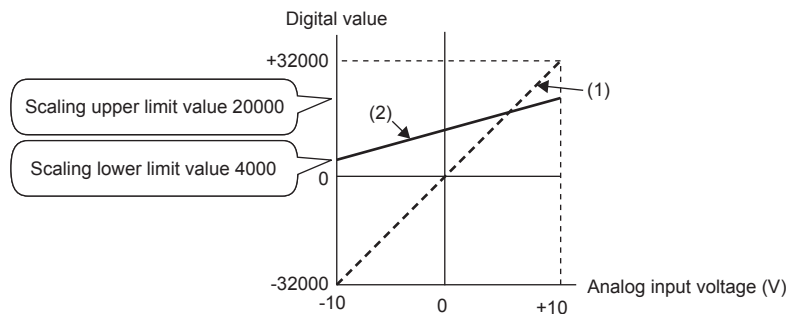

Analog input voltage (V)	(1) Digital output value	(2) Digital operation value (scaling value)
-10	-32000	4000
-5	-16000	8000
0	0	12000
+5	+16000	16000
+10	+32000	20000

Shift function

Adds (shifts) a set conversion value shift amount to a digital output value and stores the result as the digital operation value. A change in conversion value shift amount is reflected to the digital operation value in real time, which facilitates fine adjustment at system start-up.

Operation

A set conversion value shift amount is added to the digital operation value. The digital operation value with shift addition is stored in 'CH1 Digital operation value' (Un\G402). The conversion value shift amount is added in every sampling cycle for sampling processing and is added in every averaging process cycle for averaging processing. After that, the added values are stored in 'CH1 Digital operation value' (Un\G402). If a value is set to the conversion value shift amount, the conversion value shift amount is added regardless of turning off→on→off 'Operating condition setting request' (Un\G70, b9).

Setting procedure

Set a value for "Conversion value shift amount".

🔍 [Navigation window] ⇒ [Parameter] ⇒ [Module Information] ⇒ Module model name ⇒ [Module Parameter] ⇒ [Application setting] ⇒ [Shift function]

Item	Setting range
Conversion value shift amount	-32768 to +32767

Setting example

Ex.

When the input characteristics is adjusted in a channel where the input range of 0 to 5 V is set by the shift function

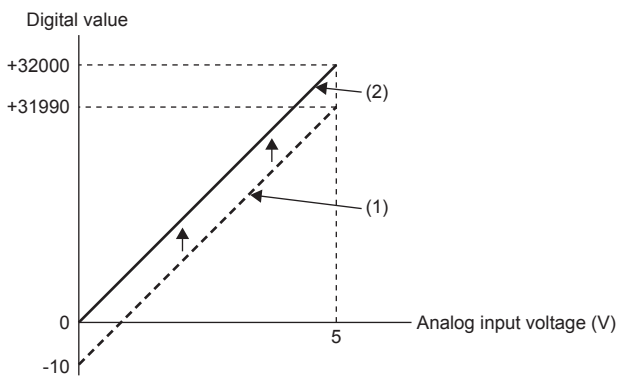

- (1) 'CH1 Digital output value' (Un\G400): -10 to +31990
↓ 'CH1 Conversion value shift amount' (Un\G472) "+10"
- (2) 'CH1 Digital operation value' (Un\G402): 0 to +32000

Voltage input	(1) Digital output value	(2) Digital operation value
0	-10	0
5	+31990	+32000

Ex.

When the input characteristics is adjusted in a channel where the input range of -10 to +10 V is set by the shift function

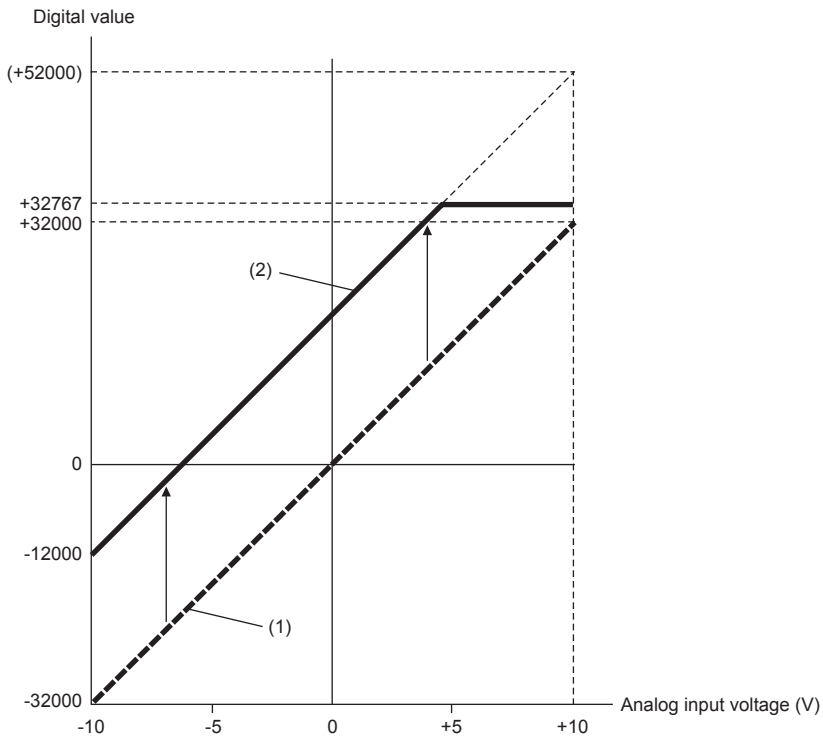

- (1) 'CH1 Digital output value' (Un\G400): -32000 to +32000
 ↓ 'CH1 Conversion value shift amount' (Un\G472) "+20000"
- (2) 'CH1 Digital operation value' (Un\G402): -12000 to +32767

Voltage input	(1) Digital output value	(2) Digital operation value
-10	-32000	-12000
-5	-16000	+4000
0	0	+20000
+5	+16000	+32767 ^{*1}
+10	+32000	+32767 ^{*1}

*1 Because the value exceeds the range of -32768 to +32767, the value is fixed to +32767 (the upper limit value).

Ex.

If the following are set for a channel for which the input range 0 to 5 V is set

Item	Setting
'CH1 Scaling enable/disable setting' (Un\G504)	Enable (0)
'CH1 Scaling upper limit value' (Un\G506)	12000
'CH1 Scaling lower limit value' (Un\G508)	2000
'CH1 Conversion value shift amount' (Un\G472)	2000

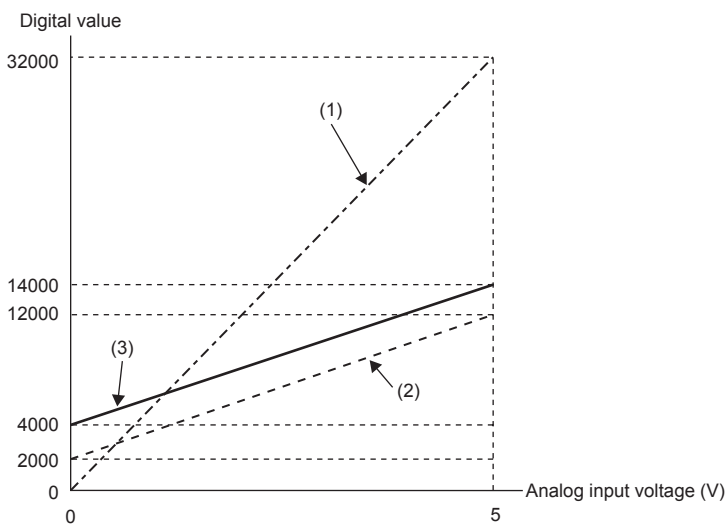

- (1) 'CH1 Digital output value' (Un\G400): 0 to 32000
↓ Scaling
- (2) Value after scaling: 2000 to 12000
↓ 'CH1 Conversion value shift amount' (Un\G472) "+2000"
- (3) 'CH1 Digital operation value' (Un\G402): 4000 to 14000

Voltage input	(1) Digital output value	(2) Value after scaling	(3) Digital operation value
0	0	2000	4000
1	6400	4000	6000
2	12800	6000	8000
3	19200	8000	10000
4	25600	10000	12000
5	32000	12000	14000

Point

When the shift function is used with the digital clipping function and scaling function, shift-and-add is performed on the value obtained after digital clipping and scale conversion. Therefore, the range of the digital operation value is determined as -32768 to +32767.

For a setting example of when the digital clipping function, scaling function, and shift function are used together, refer to the following.

☞ Page 38 Setting example

Digital clipping function

This function fixes the range of the digital operation value with the maximum digital output value and the minimum digital output value when the corresponding current or voltage exceeds the input range.

List of output ranges

The following table lists the output ranges of the digital operation values when the digital clipping function is enabled with each range.

Input range	Output range of digital operation values	
	Digital clipping function is enabled	Digital clipping function is disabled
4 to 20 mA	0 to 32000	-768 to +32767
0 to 20 mA		
-20 to +20 mA	-32000 to +32000	-32768 to +32767
1 to 5 V	0 to 32000	-768 to +32767
0 to 5 V		
0 to 10 V		
-10 to +10 V	-32000 to +32000	-32768 to +32767
User range setting		

Setting procedure

Set "Digital clipping enable/disable setting" to "Enable".

🔍 [Navigation window] ⇒ [Parameter] ⇒ [Module Information] ⇒ Module model name ⇒ [Module Parameter]
 ⇒ [Application setting] ⇒ [Digital clipping function]

Setting example

Ex.

If the following are set for a channel for which the input range 0 to 5 V is set

Item	Setting
'CH1 Scaling enable/disable setting' (Un\G504)	Enable (0)
'CH1 Scaling upper limit value' (Un\G506, Un\G507)	12000
'CH1 Scaling lower limit value' (Un\G508, Un\G509)	2000
'CH1 Conversion value shift amount' (Un\G472)	2000
'CH1 Digital clipping enable/disable setting' (Un\G510)	Enable (0)

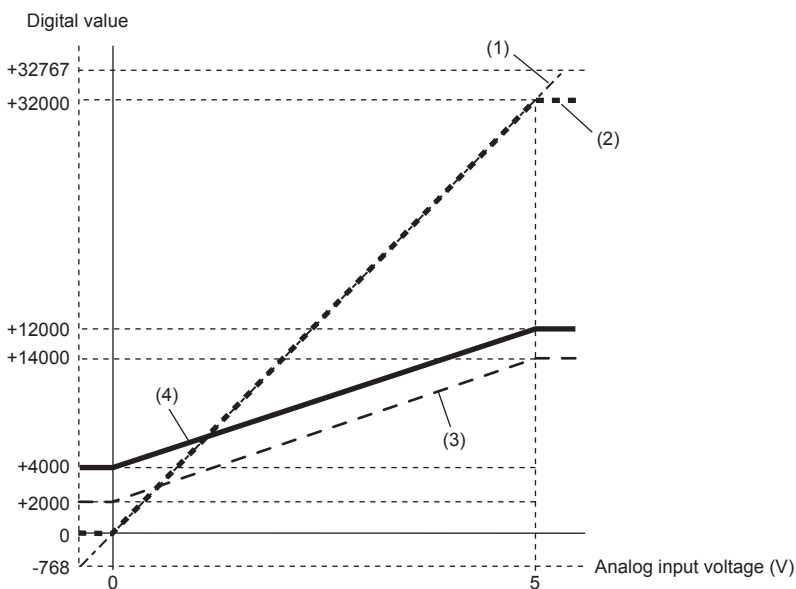

- (1) 'CH1 Digital output value' (Un\G400): -768 to +32767
↓ Digital clipping
- (2) Value after digital clipping: 0 to 32000
↓ Scaling
- (3) Value after scaling: 2000 to 12000
↓ 'CH1 Conversion value shift amount' (Un\G472) "+2000"
- (4) 'CH1 Digital operation value' (Un\G402): 4000 to 14000

Input voltage (V)	(1) Digital output value	(2) Value after digital clipping	(3) Value after scaling	(4) Digital operation value
-0.12	-768	0	2000	4000
0	0	0	2000	4000
+1	+6400	+6400	4000	6000
+2	+12800	+12800	6000	8000
+3	+19200	+19200	8000	10000
+4	+25600	+25600	10000	12000
+5	+32000	+32000	12000	14000
+5.12	+32767	+32000	12000	14000

Point

When the digital clipping function is used with the scaling function, shift function, and difference operation function, scale conversion, shift-and-add, and difference conversion are performed on the value obtained after digital clipping.

Difference operation function

The digital operation value at the start of this function is treated as 0 (reference value). Thereafter, values that increased or decreased from the reference value are stored in the buffer memory.

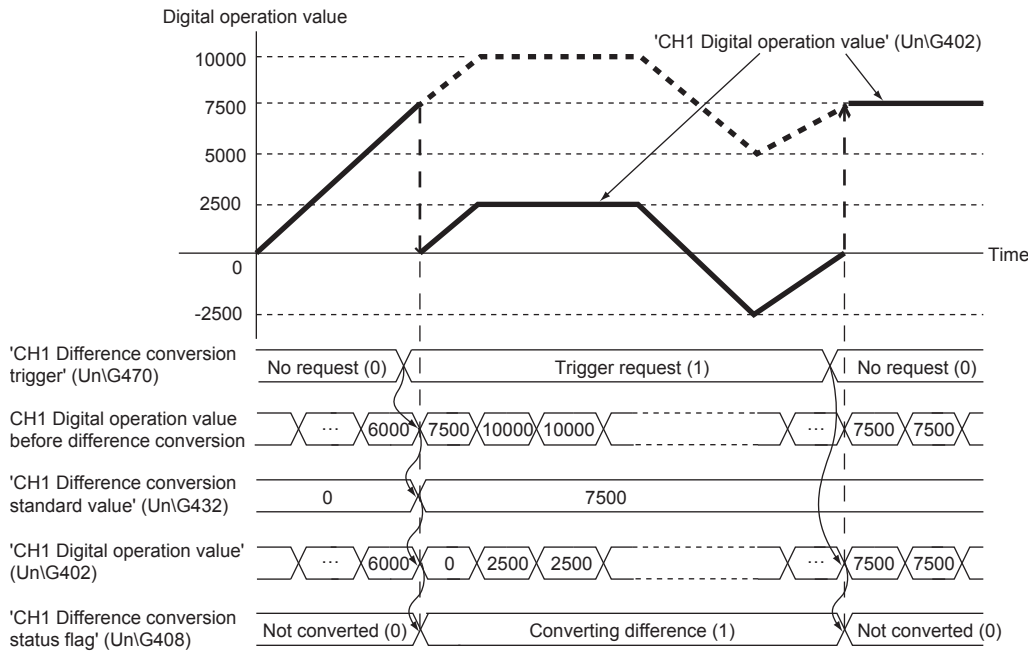

Operation

The digital operation value at the start of the difference conversion (the data stored inside the analog input module before the difference conversion starts) is determined as a difference conversion reference value. The value acquired by subtracting the difference conversion reference value from the digital operation value is stored in 'CH1 Digital operation value' (UnG402). At the start of this function, the digital operation value is 0 (because the digital operation value and the difference conversion reference value have the same value at the start).

- Digital operation value after difference conversion = Digital operation value - Difference conversion reference value

Starting the difference conversion

1. Change 'CH1 Difference conversion trigger' (UnG470) from No request (0) to Trigger request (1).

The rise of No request (0) → Trigger request (1) is detected as a trigger. When the trigger is detected, the digital operation value at the start is output to the difference conversion reference value. The value acquired by subtracting the difference conversion reference value from the digital operation value is stored in 'CH1 Digital operation value' (UnG402). After the value is stored, 'CH1 Difference conversion status flag' (UnG408) turns to Converting difference (1).

Stopping the difference conversion

1. Change 'CH1 Difference conversion trigger' (UnG470) from Trigger request (1) to No request (0).

The fall of Trigger request (1) to No request (0) is detected as a trigger. When the trigger is detected, the difference conversion stops, and 'CH1 Difference conversion status flag' (UnG408) turns to Not converted (0). Thereafter, the digital operation value is stored as it is in 'CH1 Digital operation value' (UnG402).

■ Operations when an input signal error occurs

When an input signal error occurs, even if 'CH1 Difference conversion trigger' (Un\G470) changes from No request (0) to Trigger request (1), the difference conversion does not start. After the input signal error returns to the normal value, change 'CH1 Difference conversion trigger' (Un\G470) from No request (0) to Trigger request (1) again. If an input signal error occurs in the status of Trigger request (1), the difference conversion starts at the timing when the input signal error returns to the normal value, treating the digital operation value as the difference conversion reference value.

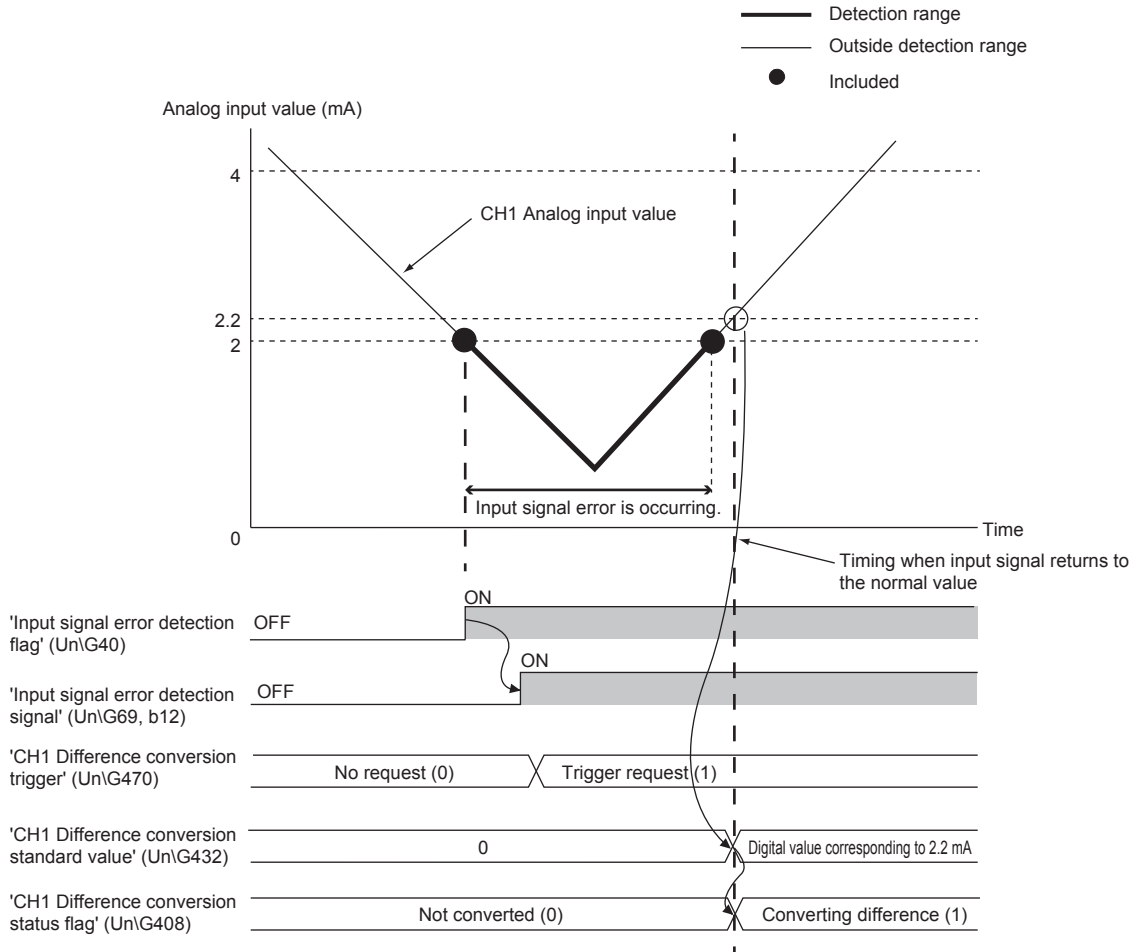

■ Operation performed when the operation condition setting request (Un\G70, b9) is turned off→on→off

- During the difference conversion, even when 'Operating condition setting request' (Un\G70, b9) is turned off→on→off, the difference conversion continues without updating the difference conversion reference value. To update the difference conversion reference value, restart the difference conversion by changing CH1 Difference conversion trigger (Un\G470) from Trigger request (1) to No request (0), and Trigger request (1) again.
- CH1 Difference conversion trigger (Un\G470) does not become valid even when the trigger changes from No request (0) to Trigger request (1) when 'Operating condition setting request' (Un\G70, b9) is turned off→on. After turning off→on→off Operating condition setting request (Un\G70, b9), change CH1 Difference conversion trigger (Un\G470) from No request (0) to Trigger request (1) again.

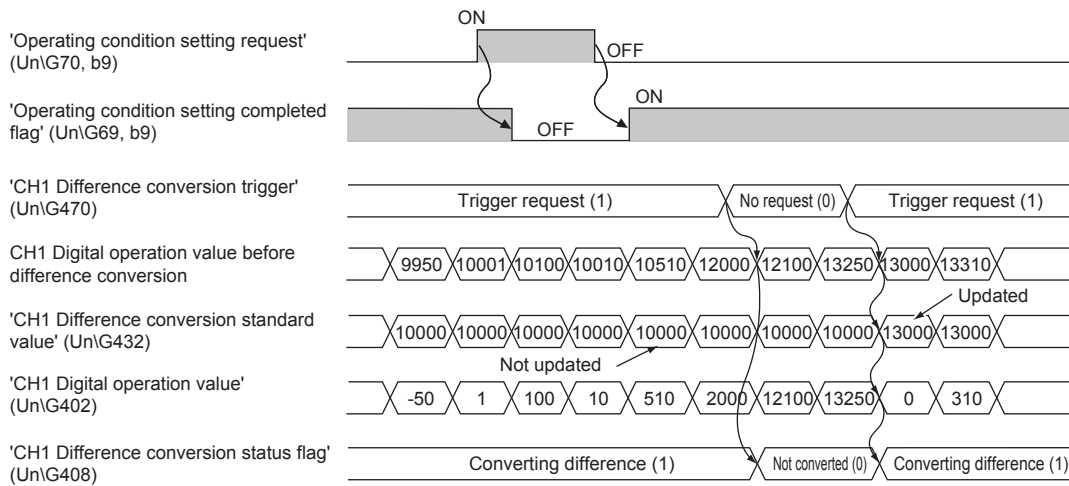

■ Operations of maximum value and minimum value

When the difference conversion starts, the maximum value and the minimum value of the values acquired by the difference conversion are stored in 'CH1 Maximum value' (Un\G404) and 'CH1 Minimum value' (Un\G406). By turning on 'Maximum value reset request' (Un\G473) and 'Minimum value reset request' (Un\G474), the maximum and minimum values after the start of the difference conversion can be checked.

If 'Maximum value reset request' (Un\G473) or 'Minimum value reset request' (Un\G474) is not turned on, the maximum and minimum values before and after the start of the differential conversion will be mixed.

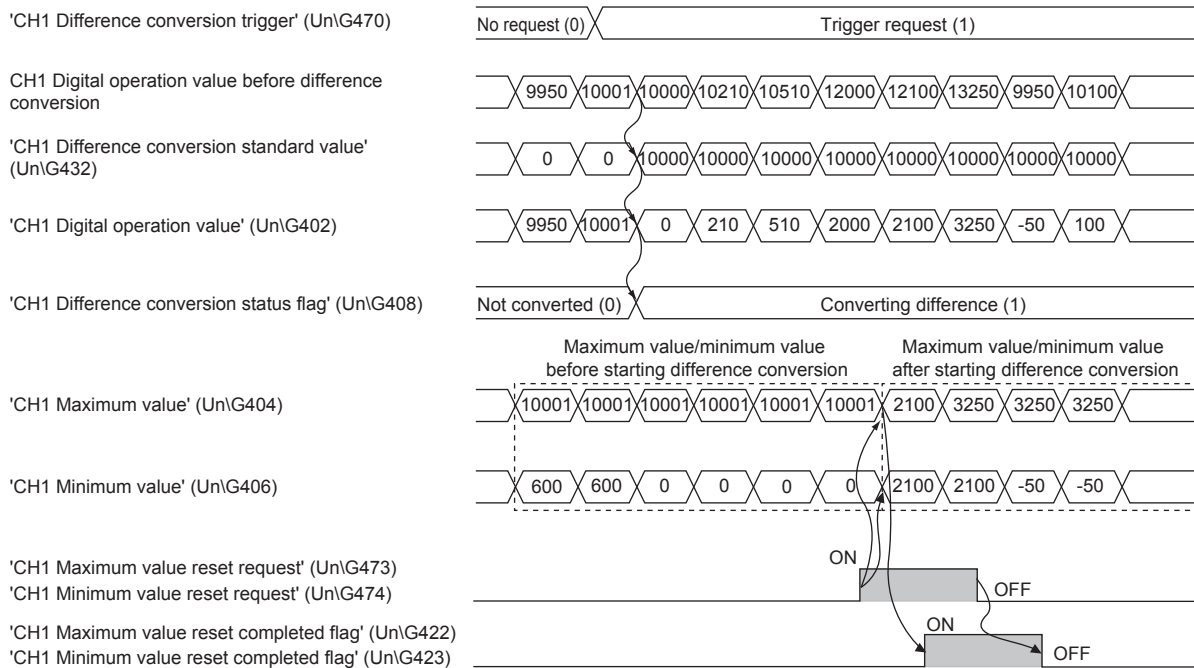

■ Operation when the averaging processing is set

If the difference conversion starts after the averaging processing is set, the digital operation value at the completion of the averaging processing is determined as 'CH1 Difference conversion standard value' (Un\G432). 'CH1 Difference conversion state flag' (Un\G408) turns to 'Converting difference (1)'.

Point

- The difference operation function can be started at any timing.
- When the difference operation function is used with the digital clipping function, scaling function, and shift function, each digital operation value is determined as a difference conversion reference value and used for the difference conversion.
- Even though the digital clipping function, scaling function, and shift function are enabled during the difference conversion, the value in 'CH1 Difference conversion standard value' (Un\G432) is not updated. To update the value in 'CH1 Difference conversion standard value' (Un\G432), stop the difference conversion and restart it again.

Maximum value/minimum value hold function

Stores the maximum and minimum values of digital operation values to the buffer memory area for each channel.

Resetting the maximum value and the minimum value

The maximum and minimum values can be reset to the current value by performing the following processing.

■Resetting the maximum value

When 'CH1 Maximum value reset request' (Un\G473) turns on (1), 'CH1 Maximum value' (Un\G404) is updated with current value, and 'CH1 Maximum value reset completion flag' (Un\G422) turns on (1).

■Resetting the minimum value

When 'CH1 Minimum value reset request' (Un\G474) turns on (1), 'CH1 Minimum value' (Un\G406) is updated with current value, and 'CH1 Minimum value reset completion flag' (Un\G423) turns on (1).

■Resetting the maximum value and the minimum value

The following two types of average processing of the maximum value and minimum value are provided.

- Perform "Reset Maximum value" and "Reset Minimum value" respectively.
- 'CH1 Maximum value' (Un\G404) and 'CH1 Minimum value' (Un\G406) are updated with the current value when 'Operating condition setting request' (Un\G70, b9) turns on (1). 'CH1 Maximum value reset completion flag' (Un\G422) and 'CH1 Minimum value reset completion flag' (Un\G423) are not ON (1).

Point

If "A/D conversion disable" is set in 'CH1 A/D conversion enable/disable setting' (Un\G500), 0 is stored in both 'CH1 Maximum value' (Un\G404) and 'CH1 Minimum value' (Un\G406).

Values to be the maximum value and the minimum value

The maximum and minimum values of digital operation values are stored in the buffer memory.

Using the averaging processing or the digital clipping, scaling, shift, or difference operation function results in storage of the maximum and minimum values of the digital operation values calculated by each function.

Alert output function

This section describes process alarms and rate alarms used for the alert output function.

Process alarm

Outputs an alarm when a digital operation value enters the preset alarm output range.

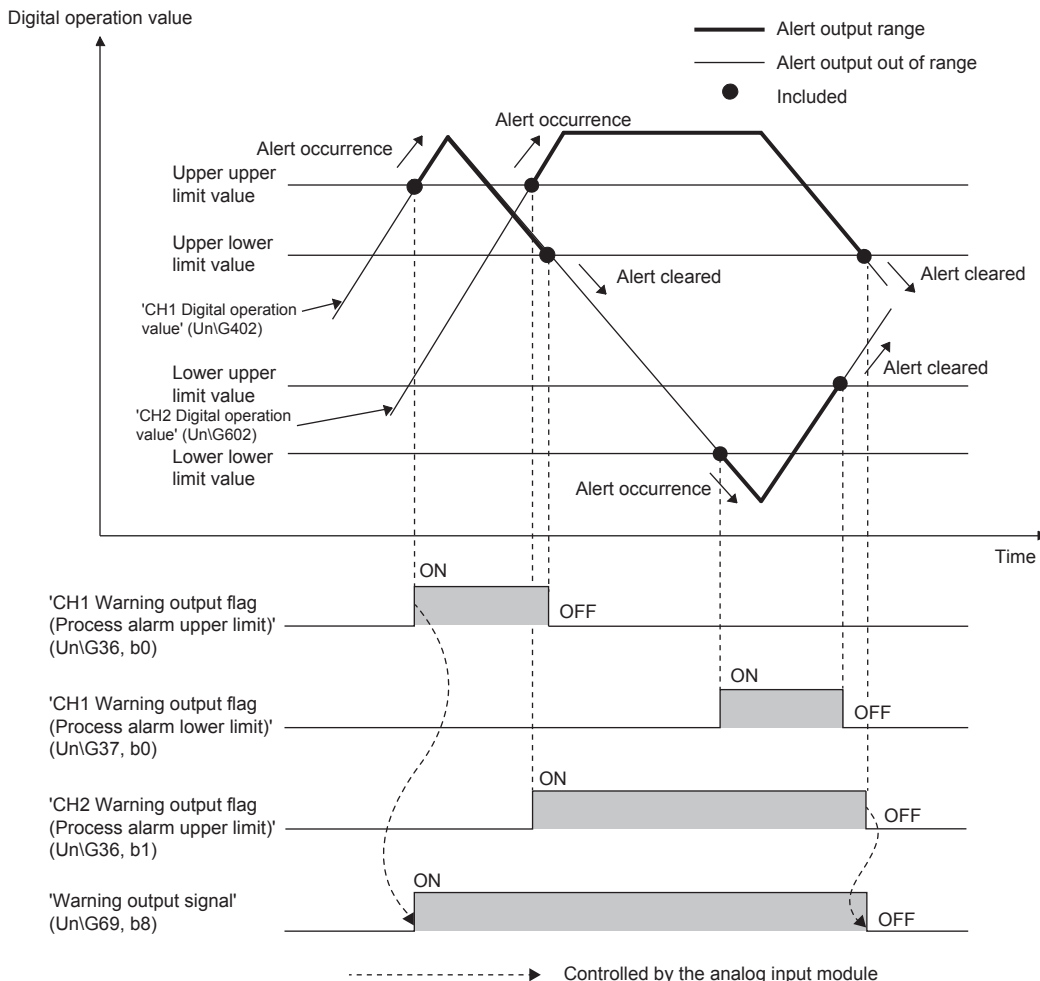

■ Operation

[Operation performed when an alarm is output]

When a digital operation value is equal to or greater than 'CH1 Process alarm upper upper limit value' (UnG514), or the value is equal to or smaller than 'CH1 Process alarm lower lower limit value' (UnG520) and the value enters the alarm output range, an alert is output as follows.

- Alarm ON (1) is stored in the bit position corresponding to the channel number of 'Warning output flag (Process alarm upper limit)' (UnG36) or 'Warning output flag (Process alarm lower limit)' (UnG37).
- 'Alarm output signal' (UnG69, b8) turns on.
- The ALM LED turns on.
- An alarm code is stored in 'Latest alarm code' (UnG2). (📖 Page 108 List of alarm codes)

Point

- The A/D conversion on a channel where an alarm was output continues.
- A cycle to output the process alarm is within 2 ms. When the process alarm is detected multiple times within 2 ms, only the first process alarm detected may be notified as an alert.

[Operation after an alarm was output]

After an alarm was output, if the digital operation value does not satisfy the alarm output condition due to being smaller than the process alarm upper lower limit value or being greater than the process alarm lower upper limit value, Normal (0) is stored in a bit position corresponding to the channel number of 'Warning output flag (Process alarm upper limit)' (Un\G36) or 'Warning output flag (Process alarm lower limit)' (Un\G37).

In addition, when all the bits of 'Warning output flag (Process alarm upper limit)' (Un\G36) and 'Warning output flag (Process alarm lower limit)' (Un\G37) return to Normal (0), 'Alarm output signal' (Un\G69, b8) turns off and the ALM LED turns off. However, the alarm code stored in 'Latest alarm code' (Un\G2) is not cleared. To clear the alarm code, turn off→on→off 'Error clear request' (Un\G70, b15) after all the bits of 'Warning output flag (Process alarm upper limit)' (Un\G36) and 'Warning output flag (Process alarm lower limit)' (Un\G37) return to Normal (0).

■Detection cycle

When time average is specified, the function works at every interval of the time (for averaging). When count average is specified, the function works at every count (for averaging).

When the sampling processing, moving average, or Primary delay filter is specified, this function works every conversion cycle.

■Detection target for outputting an alert

When the digital clipping function, scaling function, shift function, or difference operation function is used, the digital operation value to which digital clipping, scale conversion, shift-and-add, or difference conversion is performed is the detection target for outputting an alarm. Set values for CH1 Process alarm upper upper limit value (Un\G514), CH1 Process alarm upper lower limit value (Un\G516), CH1 Process alarm lower upper limit value (Un\G518), and CH1 Process alarm lower lower limit value (Un\G520) while considering the digital clipping, scale conversion, shift-and-add, and difference conversion.

■Setting procedure

1. Set "Warning output setting (Process alarm)" to "Enable".

 [Navigation window] ⇒ [Parameter] ⇒ [Module Information] ⇒ Module model name ⇒ [Module Parameter] ⇒ [Application setting] ⇒ [Warning output function (Process alarm)]

2. Set values for "Process alarm upper upper limit value", "Process alarm upper lower limit value", "Process alarm lower upper limit value", and "Process alarm lower lower limit value". The setting range is from -32768 to +32767.

Point

Set values within the range satisfying the condition Process alarm upper upper limit value \geq Process alarm upper lower limit value \geq Process alarm lower upper limit value \geq Process alarm lower lower limit value. If a value out of the range is set, a process alarm upper lower limit value setting range error (error code: 1B△□H) occurs.

Rate alarm

Outputs an alarm when the change rate of a digital output value is equal to or more than the rate alarm upper limit value, or the rate is equal to or less than the rate alarm lower limit value.

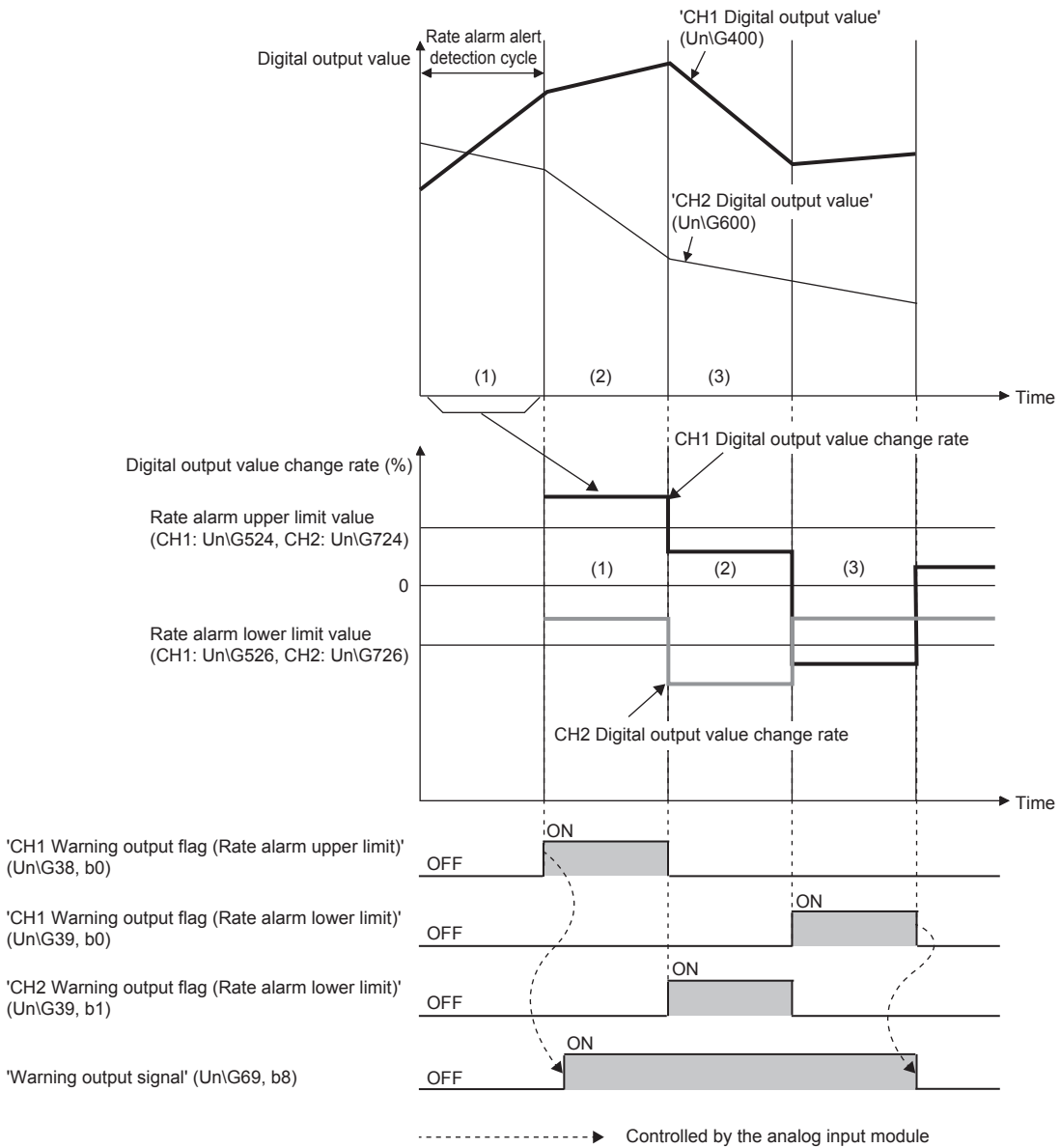

■ Operation

[Operation performed when an alarm is output]

Digital output values are monitored on the rate alarm alert detection cycle. When a change rate of a digital output value (from a previous value) is equal to or more than the rate alarm upper limit value, or the rate is equal to or less than the rate alarm lower limit value, an alert is output as follows.

- Alarm ON (1) is stored in the bit position corresponding to the channel number of 'Warning output flag (Rate alarm upper limit)' (Un\G38) or 'Warning output flag (Rate alarm lower limit)' (Un\G39).
- 'Alarm output signal' (Un\G69, b8) turns on.
- The ALM LED turns on.
- An alarm code is stored in 'Latest alarm code' (Un\G2). ( Page 108 List of alarm codes)

Point

- The A/D conversion on a channel where an alarm was output continues.
- A cycle to output the rate alarm is within 2 ms. When the rate alarm is detected multiple times within 2 ms, only the first rate alarm detected may be notified as an alert.

[Operation after an alarm was output]

After an alarm was output, if the change rate of a digital output value does not satisfy the alarm output conditions due to being smaller than the rate alarm upper limit value or being greater than the rate alarm lower limit value, Normal (0) is stored in the bit position corresponding to the channel number of 'Warning output flag (Rate alarm upper limit)' (Un\G38) or 'Warning output flag (Rate alarm lower limit)' (Un\G39).

In addition, when all 'Warning output flag (Rate alarm upper limit)' (Un\G38) and 'Warning output flag (Rate alarm lower limit)' (Un\G39) return to Normal (0), 'Alarm output signal' (Un\G69, b8) turns off and the ALM LED turns off. However, the alarm code stored in 'Latest alarm code' (Un\G2) is not cleared. To clear the alarm code, turn off→on→off 'Error clear request' (Un\G70, b15) after all the bits of 'Warning output flag (Rate alarm upper limit)' (Un\G38) and 'Warning output flag (Rate alarm lower limit)' (Un\G39) return to Normal (0).

■ Detection cycle

The rate alarm detection cycle is calculated by the following formula.

- Rate alarm detection cycle = Conversion cycle × Setting value of 'CH1 Rate alarm detection cycle setting' (Un\G522)

Ex.

The rate alarm detection cycle under the following conditions

- A/D conversion enable: CH1
- 'CH1 Rate alarm detection cycle setting' (Un\G522): 5 (times)

The rate alarm detection cycle is $400 \mu\text{s}$ ($80 \mu\text{s} \times 1 (\text{CH}) \times 5 (\text{times})$).

Digital output values are compared in $400 \mu\text{s}$ intervals to check the change rate.

Ex.

The rate alarm detection cycle under the following conditions

- A/D conversion enable: CH1, CH2
- 'CH1 Rate alarm detection cycle setting' (Un\G522): 5 (times)
- 'CH2 Rate alarm detection cycle setting' (Un\G722): 5 (times)
- 'CH1 Averaging process specification' (Un\G501): Count average (2)
- 'CH2 Averaging process specification' (Un\G701): Count average (2)
- 'CH1 Time average/Count average/Moving average/Primary delay filter constant setting' (Un\G502): 100 (counts)
- 'CH2 Time average/Count average/Moving average/Primary delay filter constant setting' (Un\G702): 100 (counts)

The rate alarm detection cycle is 80 ms . ($80 \mu\text{s} \times 100 (\text{times}) \times 2(\text{CH}) \times 5 (\text{times})$).

Digital output values are compared in 80 ms intervals to check the change rate.

■ Judgment of rate alarm

The rate alarm is judged as follows according to the setting of 'Rate alarm change rate selection' (Un\G299).

- When 'Rate alarm change rate selection' is "Rate specification"

The change rate is judged with 'CH1 Rate alarm upper limit value' (Un\G524) and 'CH1 Rate alarm lower limit value' (Un\G526) converted to digital values per rate alarm detection cycle.

The following shows the conversion formula^{*1} of judgment values used for the rate alarm detection.

Rate alarm upper limit (lower limit) $\times 0.1 \times 0.01 \times$ Maximum digital output value

*1 Values after the decimal point are omitted.

Ex.

The judgment value under the following conditions

Setting item	Setting content
Number of A/D conversion enabled channels	CH1
Rate alarm change rate selection	Rate specification
CH1 Average processing specification	Sampling processing
CH1 Rate alarm alert detection cycle setting	5 times
CH1 Rate alarm upper limit value	250 (25.0%)
CH1 Rate alarm lower limit value	50 (5.0%)

In the above case, the current and previous digital output values are compared with each other with a rate alarm warning detection cycle of 400 μ s (conversion cycle 80 μ s \times 5). As a result of the comparison, it is judged whether the increase of the digital output value is 8000 (= 250 \times 0.1 \times 0.01 \times 32000) digit or more or 1600 (= 50 \times 0.1 \times 0.01 \times 32000) digit or less.

Use the following formula to calculate a change rate to be set based on the change amount of voltage and current to detect an alarm.

$$\text{Change rate to be set (0.1\%)} = \left(\frac{\text{Change amount of the voltage (current) to detect an alert (V(mA))}}{\text{Gain voltage (current) (V(mA))} - \text{Offset voltage (current) (V(mA))}} \times 1000 \right)^{*2}$$

*2 Values after the decimal point are omitted.

- When 'Rate alarm change rate selection' is "Digital output value specification"

It is judged by comparing the difference between the current digital output value and the digital output value in the previous detection cycle with the 'CH1 Rate alarm upper limit value' (Un\G524) and the 'CH1 Rate alarm lower limit value' (Un\G526).

Alarm occurrence condition	Conversion formula
For alert outputting of rate alarm upper limit	Current digital output value - Digital output value at the previous detection cycle \geq Rate alarm upper limit value
For alert outputting of rate alarm lower limit	Current digital output value - Digital output value at the previous detection cycle \leq Rate alarm lower limit value

Ex.

The judgment value under the following conditions

Setting item	Setting content
Number of A/D conversion enabled channels	CH1
Rate alarm change rate selection	Digital output value specification
CH1 Average processing specification	Sampling processing
CH1 Rate alarm alert detection cycle setting	5 times
CH1 Rate alarm upper limit value	10000 (digit)
CH1 Rate alarm lower limit value	3200 (digit)

In the above case, the current and previous digital output values are compared with each other with a rate alarm warning detection cycle of 400 μ s (conversion cycle 80 μ s \times 5 times). From the comparison, it is judged whether or not the increase in the digital output value is 10000 digits or more, or 3200 or less.

■ Application examples of rate alarms

A rate alarm serves to monitor that the variation rate of a digital output value lies in a limited range as shown below:

Ex.

To monitor that a rising rate of a digital output value is within the specified range

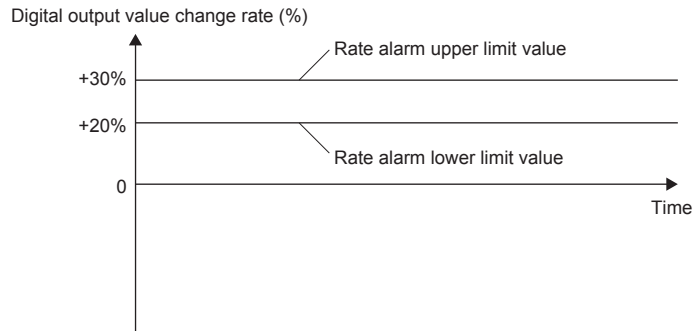

Ex.

To monitor that a drop rate of a digital output value is within the specified range

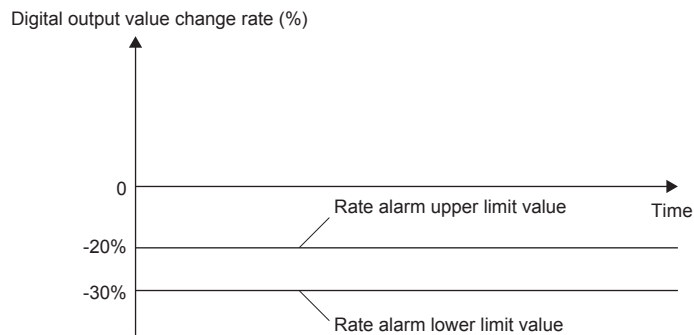

Ex.

To monitor that a change rate of a digital output value is within the specified range

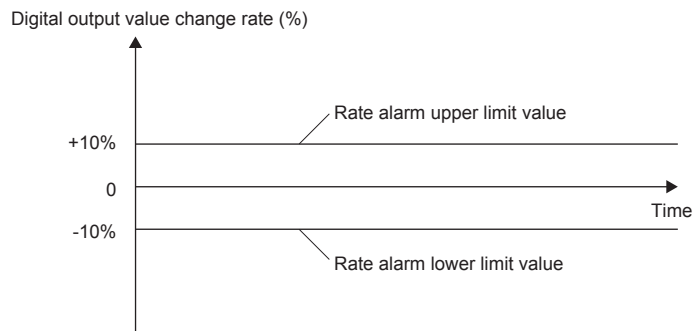

■ Setting procedure

1. Set "Warning output setting (Rate alarm)" to "Enable".

 [Navigation window] ⇒ [Parameter] ⇒ [Module Information] ⇒ Module model name ⇒ [Module Parameter] ⇒ [Application setting] ⇒ [Warning output function (Rate alarm)]

2. Set "Rate alarm change rate selection".

Item	Setting range
Rate alarm change rate selection	0: Rate specification
	1: Digital output value specification

3. Set values for "Rate alarm upper limit value" and "Rate alarm lower limit value".

The rate input and the digital output value input vary depending on the rate alarm change rate selection.

- When the rate alarm change rate selection is "Rate specification"

Set it in increments of 0.1% for the width of the analog input range (gain value - offset value).

Item	Setting range
Rate alarm upper limit value	-32768 to +32767 (-3276.8 to +3276.7%)
Rate alarm lower limit value	

- When 'Rate alarm change rate' is "Digital output value specification"

Set a value for the range of the digital output value in increments of 1 digits.

Item	Setting range
Rate alarm upper limit value	-32768 to +32767
Rate alarm lower limit value	

Point

Set values within the range satisfying the condition "Rate alarm upper limit value > Rate alarm lower limit value".

If a value out of the range is set, a rate alarm upper/lower limit setting value inversion error (error code: 1BA□H) occurs.

4. Set an alarm detection cycle of rate alarms.

Set the cycle in "Rate alarm detection cycle setting".

Item	Setting range
Rate alarm alert detection cycle setting	1 to 32000 (times)

Point

A channel where the set value is out of the above range causes a rate alarm detection cycle setting range error (error code: 1B9□H).

Input signal error detection function

Detects an analog input value that is above or below the set range.

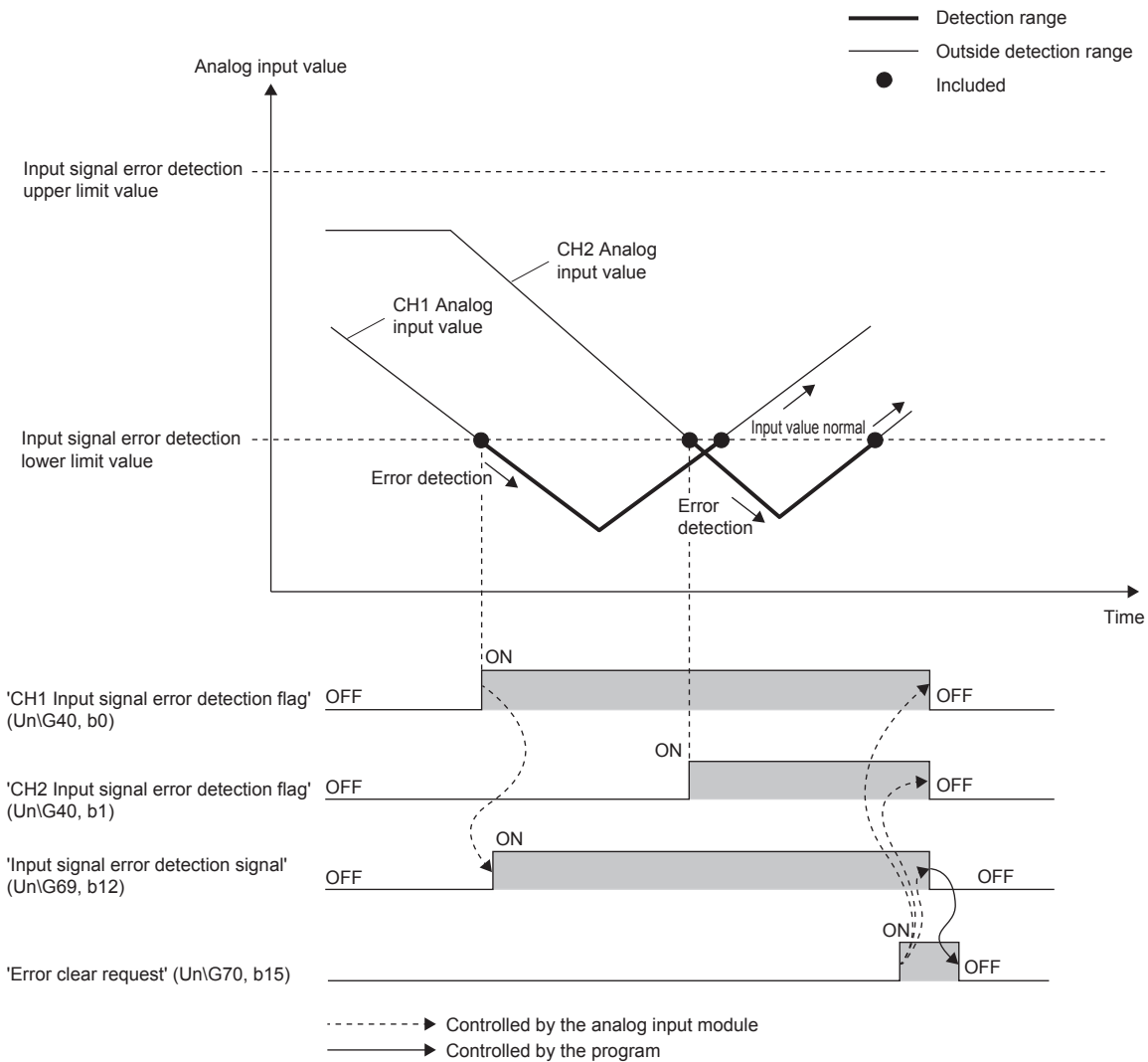

Point

Errors can also be cleared with the Input signal error auto-clear enable/disable setting. Refer to the following sections for details.

Page 53 Clearing input signal errors

Detection method

One of the following detection methods can be selected.

Detection method	Detection condition	
0: Disable	Input signal errors are not detected.	—
1: Upper and lower limit detection	An input signal error is detected when the analog input value is equal to or greater than the input signal error detection upper limit value, or when the analog input value is equal to or smaller than the input signal error detection lower limit value.	
2: Lower limit detection	An input signal error is detected when the analog input value is equal to or smaller than the input signal error detection lower limit value.	
3: Upper limit detection	An input signal error is detected when the analog input value is equal to or greater than the input signal error detection upper limit value.	
4: Simple disconnection detection	Simple disconnection detection is performed. For details, refer to the following. Page 52 Simple disconnection detection	

Simple disconnection detection

Simple disconnection detection is enabled by the range setting. The simple broken wire detection is supported only in the "4 to 20 mA" or "1 to 5 V" range. When an analog input value satisfies either of the following conditions, a disconnection occurs and 'Input signal error detection flag' (Un\G40) turns on.

Input range	Disconnection detection signal
4 to 20 mA	Analog input value ≤ 2 mA
1 to 5 V	Analog input value ≤ 0.5 V

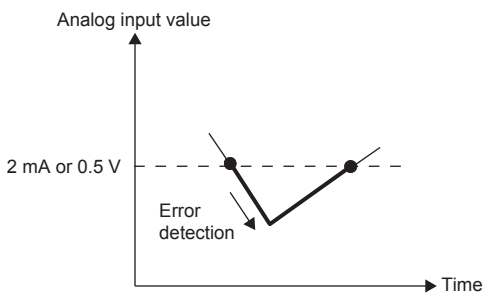

The settings for 'CH1 Input signal error detection lower limit setting value' (Un\G529) and 'CH1 Input signal error detection upper limit setting value' (Un\G530) are ignored.

Notification

When an input signal error is detected, an error is notified as follows.

- The input signal error (1) is stored in the bit position corresponding to the channel number of 'Input signal error detection flag' (Un\G40).
- 'Input signal error detection signal' (Un\G69, b12) turns on.
- The ALM LED flashes.
- An alarm code is stored in 'Latest alarm code' (Un\G2). Alarm codes are stored whenever the analog input value satisfies the condition for the input signal error detection. ( Page 108 List of alarm codes)

Operation

On the channel where an error is detected, the last digital output value and digital operation value just before the error was detected are stored.

When the analog input does not satisfy the condition of the input signal error detection, the A/D conversion restarts regardless of the reset on 'Input signal error detection flag' (Un\G40) or 'Input signal error detection signal' (Un\G69, b12). (The ALM LED remains flashing.)

Point

- When an input signal error occurs, the digital output value and digital operation value are not updated.
- The A/D conversion continues on the channel where no Input signal error is detected.
- Whether an input signal error occurred is judged with the value when the first A/D conversion is completed. Thus, A/D conversion completed flag turns on even when an input signal error is detected.
- A cycle to output the input signal error is within 2 ms. When the input signal error is detected multiple times within 2 ms, only the first input signal error detected may be notified.

Clearing input signal errors

One of the following methods for clearing input signal errors can be selected by setting 'Input signal error auto-clear enable/disable setting' (Un\G302).

■When Input signal error auto-clear enable/disable setting is set to Disable (1)

After the analog input value returns within the set range, turn off→on→off 'Error clear request' (Un\G70, b15).

The analog input module arranges the following status when an input signal error is cleared.

- 'Input signal error detection flag' (Un\G40) is cleared.
- 'Input signal error detection signal' (Un\G69, b12) turns off.
- The ALM LED turns off.
- 'Latest alarm code' (Un\G2) is cleared.

■When Input signal error auto-clear enable/disable setting is set to Enable (0)

After the analog input value returns to within the setting range, the analog input module arranges the following status automatically.

- 'Input signal error detection flag' (Un\G40) is cleared.
- 'Input signal error detection signal' (Un\G69, b12) turns off.
- The ALM LED turns off.

Point

'Latest alarm code' (Un\G2) is not cleared.

After the analog input value returns within the setting range, turn off→on→off 'Error clear request' (Un\G70, b15) to clear 'Latest alarm code' (Un\G2).

Ex.

The following figure shows the operation when an analog input value falls below 2.4 mA and returns within the normal range under the following condition.

Item	Setting
'Input signal error auto-clear enable/disable setting' (Un\G302)	Enable (0)
Input range	4 to 20 mA
'CH1 Input signal error detection setting' (Un\G528)	Upper and lower limit detection (1)
'CH2 Input signal error detection setting' (Un\G728)	Upper and lower limit detection (1)
Input signal error detection lower limit value	2.4 mA

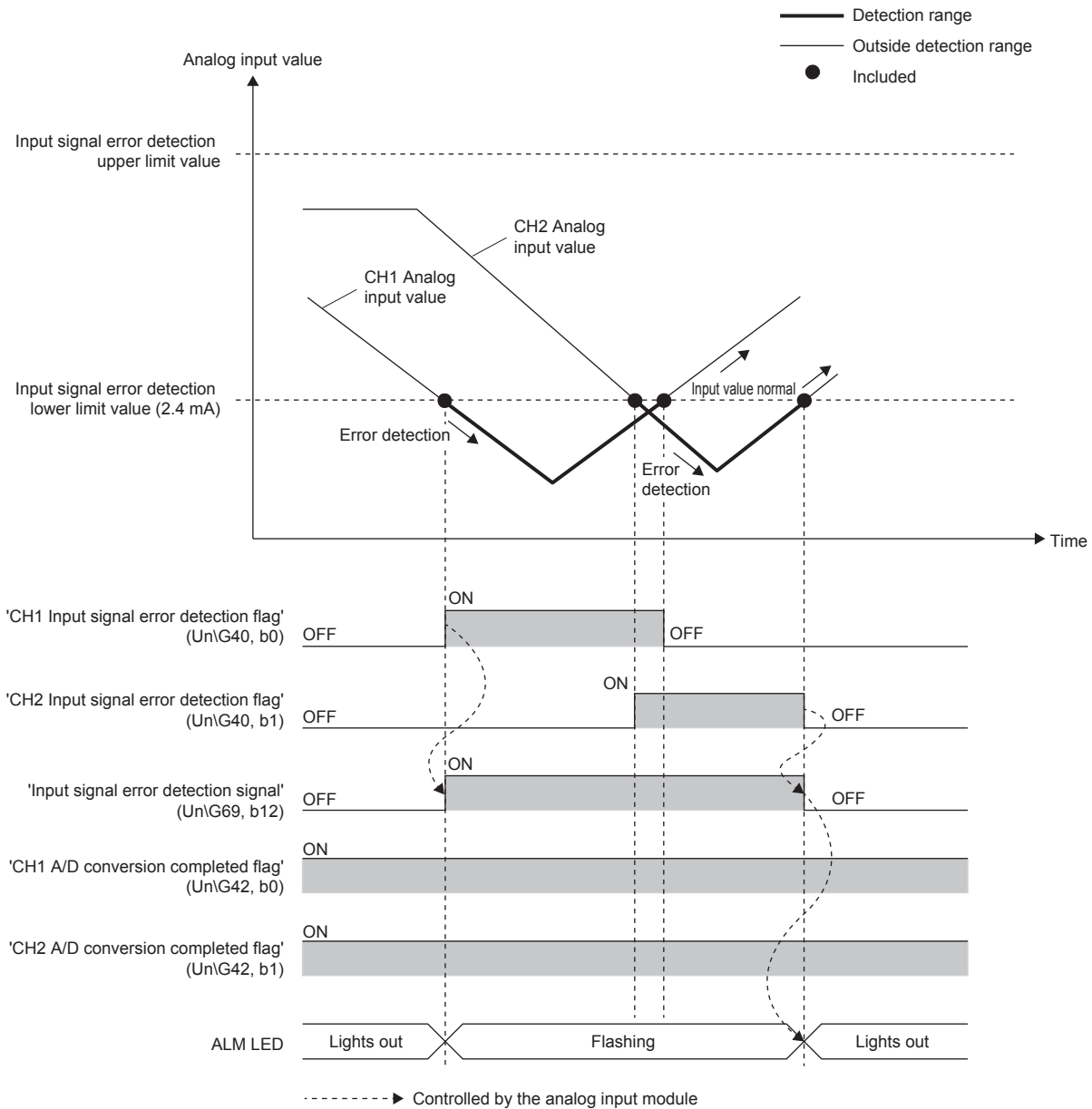

Setting the input signal error detection upper or lower limit setting value

For the input signal error upper and lower values, set the ratio to the analog input range width (gain value - offset value) in increments of 0.1%.

Item	Setting range
Input signal error detection upper limit setting value	0 to 250 (0 to 25.0%)
Input signal error detection lower limit setting value	

Input signal error detection upper limit setting value

This value is calculated by adding "Analog input range width (Gain value - Offset value) Input signal error detection upper limit set value (%)" to the gain value. Only a value which is equal to or greater than the gain value can be set.

To calculate the input signal error detection upper limit set value based on the input signal error detection upper limit value, use the following formula.

$$\text{Input signal error detection upper limit setting value} = \frac{\text{Input signal error detection upper limit value} - \text{Gain value of each range}}{\text{Gain value of each range} - \text{Offset value of each range}} \times 1000$$

Input signal error detection lower limit setting value

This value is calculated by subtracting "Analog input range width (Gain value - Offset value) Input signal error detection lower limit set value (%)" from the lower limit value of each range. Only the value which is equal to or smaller than the lower limit value of the range can be set.

To calculate the input signal error detection lower limit set value based on the input signal error detection lower limit value, use the following formula.

$$\text{Input signal error detection lower limit setting value} = \frac{\text{Lower limit value of each range} - \text{Input signal error detection lower limit value}}{\text{Gain value of each range} - \text{Offset value of each range}} \times 1000$$

Point

- When Input signal error detection setting is set to Upper limit detection, the input signal error detection lower setting value is disabled.
- When Input signal error detection setting is set to Lower limit detection, the input signal error detection upper limit setting value is disabled.

The following table lists the lower limit value, offset value, and gain value for each range.

Input range	Lower limit value	Offset value	Gain value
Voltage	0 to 10 V	0 V	10 V
	0 to 5 V	0 V	5 V
	1 to 5 V	1 V	5 V
	-10 to +10 V	-10 V	0 V
	User range setting	Analog input value equivalent to the digital output value of -32000	Analog input value set as an offset value
Current	0 to 20 mA	0 mA	20 mA
	4 to 20 mA	4 mA	20 mA
	-20 to +20 mA	-20 mA	0 mA
	User range setting	Analog input value equivalent to the digital output value of -32000	Analog input value set as an offset value

Setting procedure

1. Select a detection method in "Input signal error detection setting".

 [Navigation window] ⇒ [Parameter] ⇒ [Module Information] ⇒ Module model name ⇒ [Module Parameter] ⇒ [Application setting] ⇒ [Input signal error detection function]

2. Set values for Input signal error detection upper and lower limit setting values.

Item	Setting range
Input signal error detection upper limit setting value	0 to 250 (0.0 to 25.0%)
Input signal error detection lower limit setting value	

In the channel where a value out of the range is set, an input signal error detection setting value range error (error code: 1C1□H) occurs.

3. Set "Input signal error auto-clear enable/disable setting" to "Enable" or "Disable".

Setting example

■ Setting example of the input signal error detection

In the channel where the following values are set, an input error is detected when an analog input value falls below -10.2 V or exceeds +10.2 V.

Item	Setting value
Input range	-10 to +10 V
'Input signal error auto-clear enable/disable setting' (Un\G304)	Disable (1)
'CH1 Input signal error detection setting' (Un\G528)	Upper and lower limit detection (1)

Assign the following values in a formula to determine the input signal error detection lower limit set value and input signal error detection upper limit set value.

- Input signal error detection lower limit value: -10.2 V
- Input signal error detection upper limit value: +10.2 V
- Range lower limit value: -10 V
- Offset value: 0.0 V
- Gain value: 10.0 V

[Calculation of lower limit value]

$$\begin{aligned} \text{Input signal error detection lower limit setting value} &= \frac{-10.0 - (-10.2)}{10.0 - 0.0} \times 1000 \\ &= 20 \text{ (2.0\%)} \end{aligned}$$

Set 'CH1 Input signal error detection lower limit set value' (Un\G529) to 20 (2.0%).

[Calculation of upper limit value]

$$\begin{aligned} \text{Input signal error detection upper limit setting value} &= \frac{10.2 - 10.0}{10.0 - 0.0} \times 1000 \\ &= 20 \text{ (2.0\%)} \end{aligned}$$

Set 'CH1 Input signal error detection upper limit set value' (Un\G530) to 20 (2.0%).

The following figure shows the operation of the input signal error detection.

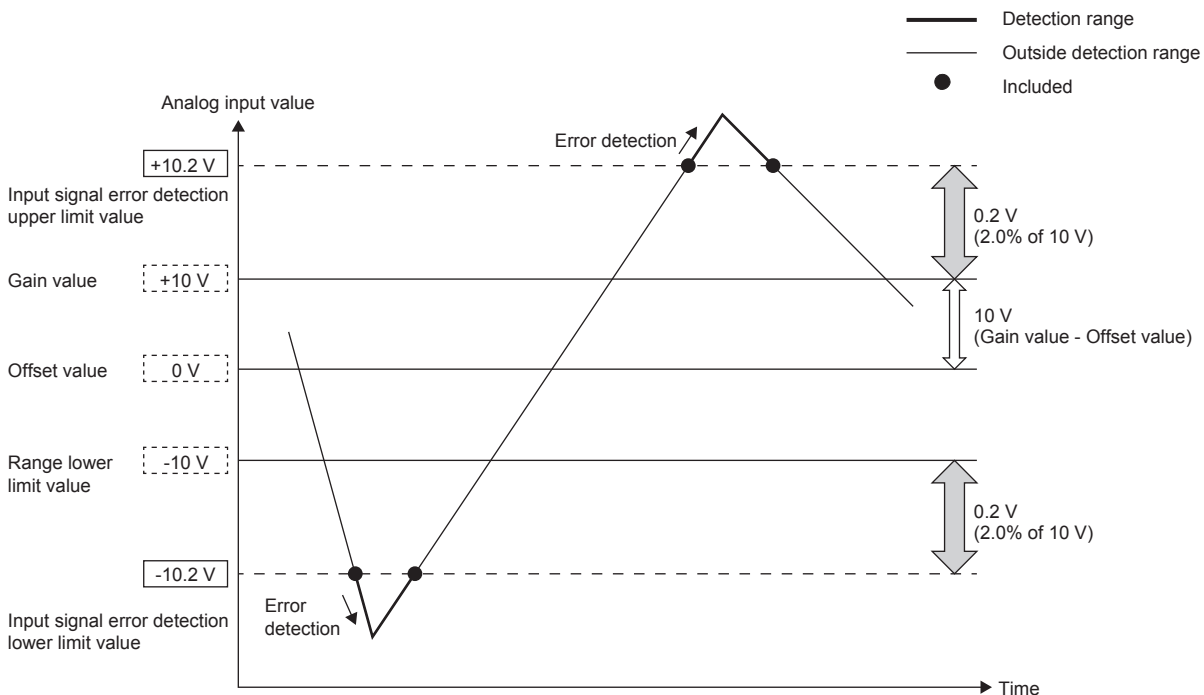

Logging function

This function stores 10000 points of digital output values or digital operation values per channel in the buffer memory area. In addition, the data collection can be stopped by using the status change of the data as a trigger. This function also helps the error analysis since the data before and after the occurrence of an error is held.

Logging function

Collecting logging data

Logging data is collected as follows.

- 10000 points of the latest digital output values or digital operation values can be always collected for each channel.
- The data can be collected at intervals of 80 μ s at a minimum and of 3600 s at a maximum.

The address where the latest/oldest data is stored can be checked with the latest/head pointer.

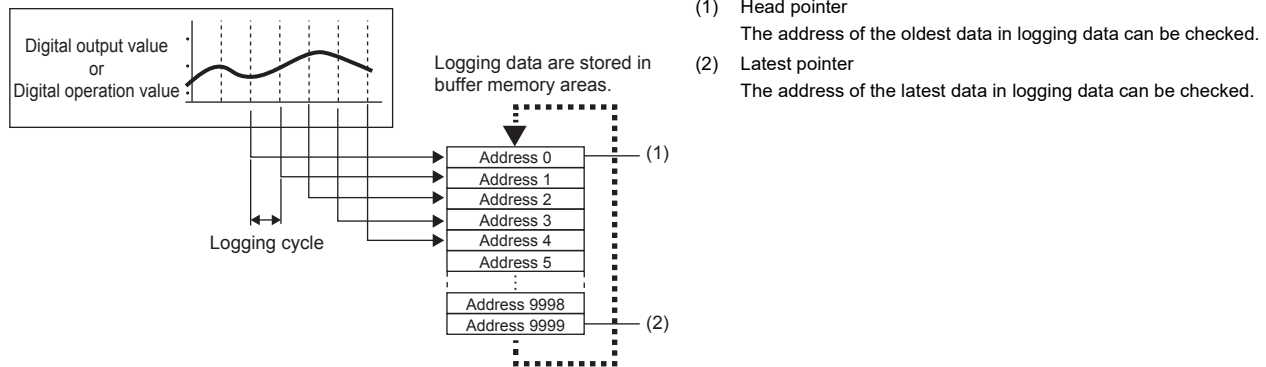

Point

When the number of stored data points is 10001 or greater, data is sequentially overwritten from address 0 with new data.

Stopping the Logging Operation

The logging data is refreshed at high speed during logging. Stop logging when the logging data needs to be referred without paying attention to the logging cycle.

Logging can be stopped by the hold trigger.

- A hold trigger allows two options: Logging hold request or Level trigger.
- The number of data points to be collected after a hold trigger occurs can be set.

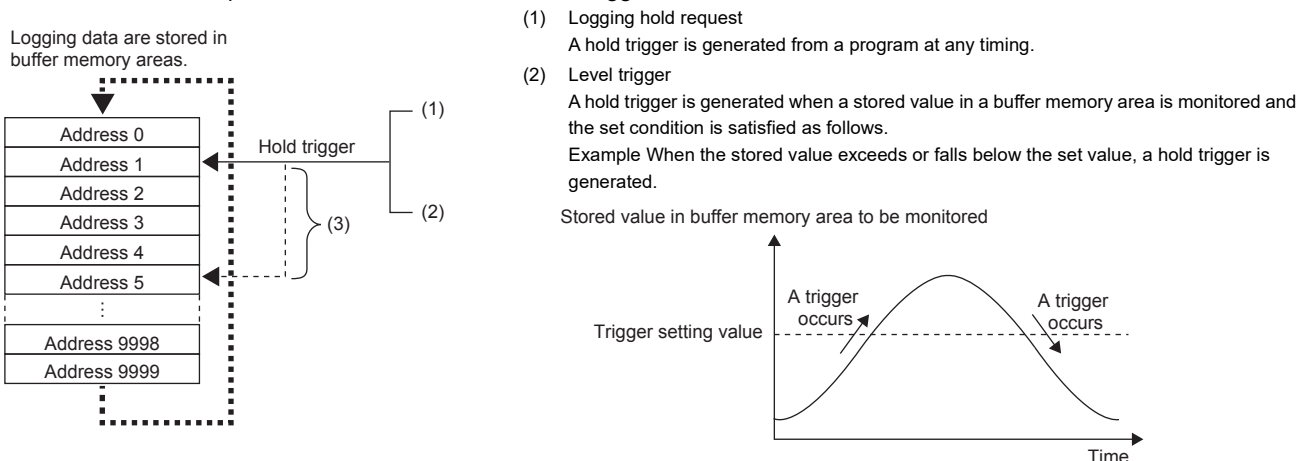

- (3) Post-trigger logging points
When the set points of data is collected after a hold trigger is generated, the logging operation is stopped.

Operation of logging

■ Starting logging data collection

Logging data collection starts when 'CH1 Logging enable/disable setting' (Un\G535) is set to Enable (0) and 'Operating condition setting request' (Un\G70, b9) is turned off→on→off.

The data in 'CH1 Digital output value' (Un\G400) or 'CH1 Digital operation value' (Un\G402) is stored in CH1 Logging data (Un\G10000 to Un\G19999) on the set logging cycle.

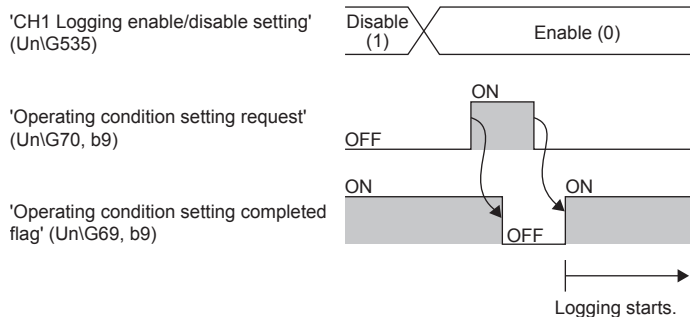

■ Logging data

Logging data are stored in the following buffer memory areas.

When the number of stored data points is 1001 or greater, the data is overwritten with new data from the head of the storage area of the corresponding channel.

Channel	Storage area for logging data
CH1	Un\G10000 to Un\G19999
CH2	Un\G20000 to Un\G29999
CH3	Un\G30000 to Un\G39999
CH4	Un\G40000 to Un\G49999

If logging has been performed even once, all the logging data above are cleared to 0 at the timing when 'Operating condition setting request' (Un\G70, b9) is turned off→on.

Logging data setting

Select a data type to be collected with 'CH1 Logging data setting' (Un\G536).

- Digital output value (0)
- Digital operation value (1)

Logging cycle

■ Logging cycle setting

Set the logging cycle with 'CH1 Logging cycle setting value' (Un\G537) and 'CH1 Logging cycle unit setting' (Un\G538). The following table lists the setting range for each cycle.

Setting value of CH1 Logging cycle unit setting	Setting range of CH1 Logging cycle setting value
μs (0)	80 to 32767
ms (1)	1 to 32767
s (2)	1 to 3600

The logging cycle must be an integral multiple of the conversion cycle. Even if the setting is not an integral multiple, the actual logging cycle is adjusted to the integral multiple of the conversion cycle within a limit of the set logging cycle.

The following table lists the conversion cycle for each A/D conversion method.

Conversion method	Conversion cycle
Sampling processing	Number of conversion enabled channels × Conversion speed
Time average	$\left(\frac{\text{Time set in Time average/Count average/Moving average/Primary delay filter constant setting}}{\text{Number of conversion enabled channels} \times \text{Conversion speed}} \right)^{*1} \times \text{Number of A/D conversion enabled channels} \times \text{Conversion speed}$
Count average	The count set to CH1 Time average/Count average/Moving average/Primary delay filter constant setting (Un\G502) × (Number of A/D conversion enabled channels × Conversion speed)
Moving average	Number of A/D conversion enabled channels × Conversion speed
Primary delay filter	Number of A/D conversion enabled channels × Conversion speed
Digital filter	For details, refer to the following.  Page 29 Digital filter

*1 Values after the decimal point are omitted.

Ex.

With the following settings, the conversion cycle is 320 μs and the actual logging cycle is 9.92 ms (integral multiple of 320 μs).

Item	Setting
Conversion enabled channels	CH1 to CH4
Averaging process specification	Sampling processing
Logging cycle setting value	10
Logging cycle unit setting	ms

The following values are stored in 'CH1 Logging cycle monitor value' (Un\G441 to Un\G443).

Address	Item	Stored value
441	CH1 Logging cycle monitor value (Un\G441 to Un\G443)	0 (s)
442		9 (ms)
443		920 (μs)

■ When the logging function becomes disabled

The logging is not performed when one of the following errors occurs after the logging function is enabled and 'Operating condition setting request' (Un\G70, b9) is off→on→off.

- Error code (191□H): Setting errors of 'CH1 Averaging process specification' (Un\G501)
- Error code (192□H to 195□H): Setting errors of 'CH1 Time average/Count average/Moving average/Primary delay filter constant setting' (Un\G502)
- Error code (19D□H): Setting error of 'CH1 Digital filter setting' (Un\G570)
- Error code (19E□H): Setting error of 'CH1 Digital filter fluctuation width setting' (Un\G572, Un\G573)
- Error code (1D0□H to 1D6□H): Setting errors of the logging function
- Error code (1D8□H, 1D9□H): Setting errors of the logging read function

When 'Operating condition setting request' (Un\G70, b9) is turned off→on→off on the condition that the logging cycle determined by 'CH1 Logging cycle setting value' (Un\G537) and 'CH1 Logging cycle unit setting' (Un\G538) is shorter than the conversion cycle, an error occurs and logging does not start. A logging cycle setting disable error (error code: 1D2□H) is stored in 'Latest error code' (Un\G0), 'Error flag' (Un\G69, b15) and the ERROR LED turn on.

Number of logging data

With 'CH1 Number of logging data' (Un\G436), the number of valid data in 'CH1 Logging data' (Un\G10000 to Un\G19999) can be checked.

When the number of collected data points is less than 10000

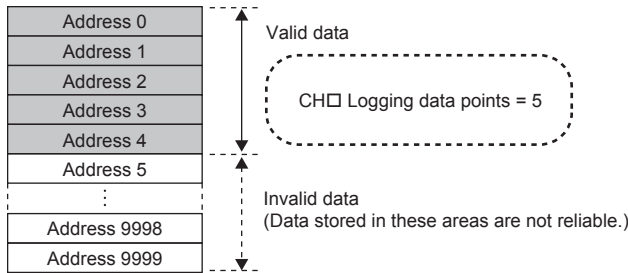

When the number of collected data points is 10001 or greater

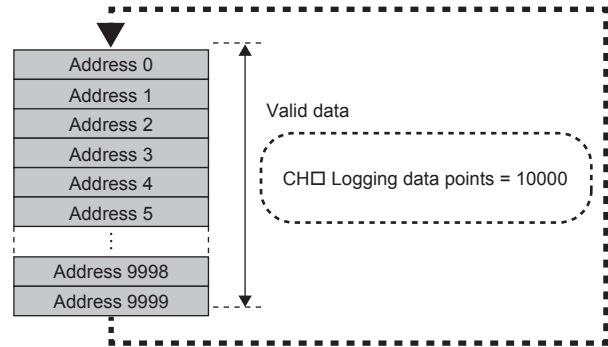

The number of logging data increases by one each time new data is stored.

When CH1 Logging data (Un\G10000 to Un\G19999) becomes full (Number of logging data = 10000), the next data is stored in the head address of CH1 Logging data (Un\G10000 to Un\G19999), and the logging operation continues overwriting the existing data. In this case, the number of logging data is fixed to 10000.

Head pointer and latest pointer

The storage location of the oldest data and the latest data in CH1 Logging data (Un\G10000 to Un\G19999) can be checked with the following buffer memory areas.

Buffer Memory Areas	Description
CH1 Head pointer (Un\G434)	The buffer memory address of the oldest data in CH1 Logging data (Un\G10000 to Un\G19999) can be checked with this buffer memory area. The offset value (0 to 9999) counted from the start address of CH1 Logging data (Un\G10000 to Un\G19999) is stored.
CH1 Latest pointer (Un\G435)	The buffer memory address of the latest data in CH1 Logging data (Un\G10000 to Un\G19999) can be checked with this buffer memory area. The offset value (0 to 9999) counted from the start address of CH1 Logging data (Un\G10000 to Un\G19999) is stored.

When the number of collected data points is less than 10000

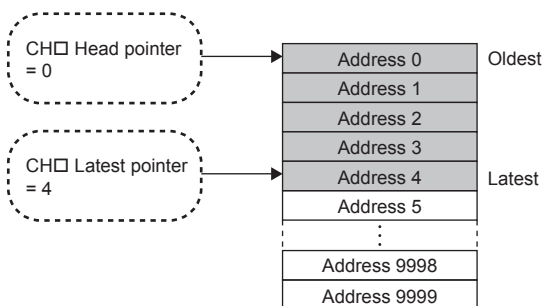

When the number of collected data points is 10001 or greater

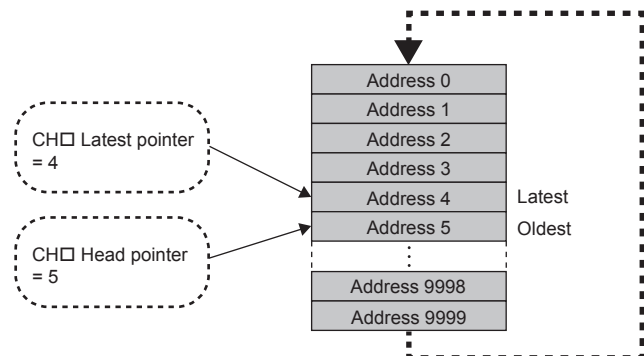

The head pointer does not change (fixed to 0) until CH1 Logging data (Un\G10000 to Un\G19999) becomes full after the logging start. (fixed to 0).

The head pointer moves by one point when CH1 Logging data (Un\G10000 to Un\G19999) becomes full and overwriting the data starts from the head address.

■Checking logging data without stopping the logging operation

Logging data can be checked during the logging operation with 'CH1 Head pointer' (Un\G434), 'CH1 Latest pointer' (Un\G435), and 'CH1 Number of logging data' (Un\G436).

To check logging data during logging operation, follow the precautions below because logging data may be refreshed while data is being read out.

- Set the cycle to 'CH1 Logging cycle setting value' (Un\G537) so that data checking and reading surely complete before logging data is refreshed. If the logging cycle is short, logging data may be refreshed during data checking and reading.
- After obtaining the logging data which needs to be checked, monitor the variation of the head pointer and the number of logging data, and obtain logging data just after the stored value has changed.
- If the data refreshed and the data being checked do not synchronize due to the relationship between the logging cycle and the scan time of the CPU module, adjust the logging cycle.

Stop the logging operation when the logging data needs to be checked without paying attention to the logging cycle. (☞
Page 62 Stopping the Logging Operation)

Stopping the Logging Operation

Logging operation stops (holds) when the preset trigger condition is satisfied and the set points of the data are collected.

A trigger that is generated when the condition is satisfied is called a hold trigger.

To generate a hold trigger, the following two methods are available.

☞ Page 65 Logging hold request

☞ Page 66 Level trigger

When a hold trigger is detected during data collection, the logging operation stops after the points of the data set in 'CH1 Post-trigger logging points' (Un\G539) are collected.

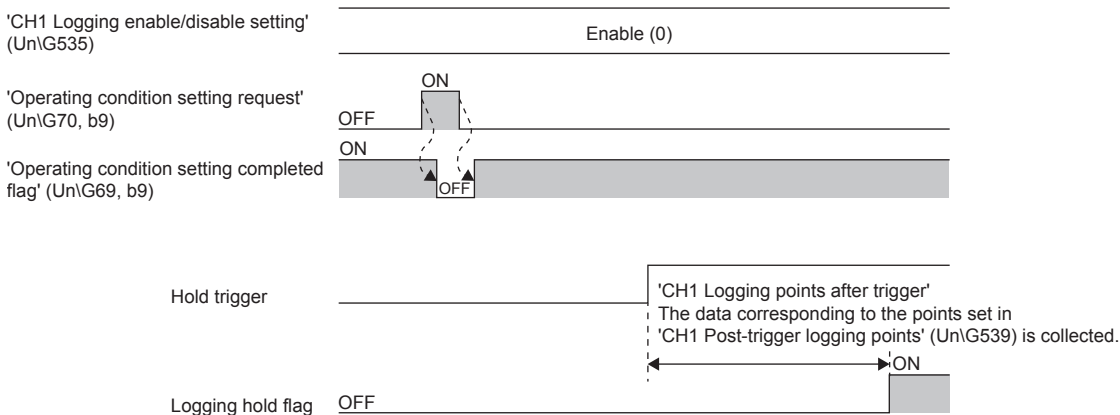

■ Post-trigger logging points

Set the number of data collected in the period from the detection of a hold trigger to logging operation stop to 'CH1 Post-trigger logging points' (Un\G539).

■ Checking that the logging has stopped

Check that 'CH1 Logging hold flag' (Un\G409) is ON (1).

■ Checking data when a hold trigger has occurred

The storage location of the data when a hold trigger has occurred can be checked with 'CH1 Trigger pointer' (Un\G437). The offset value counted from the start address of CH1 Logging data (Un\G10000 to Un\G19999) is stored in 'CH1 Trigger pointer' (Un\G437).

Ex.

The value stored in Trigger pointer when the logging operation stops under the following conditions

- 'CH1 Post-trigger logging points' (Un\G539): 6505 points
- The data location where a hold trigger has occurred: At the 3500th point.

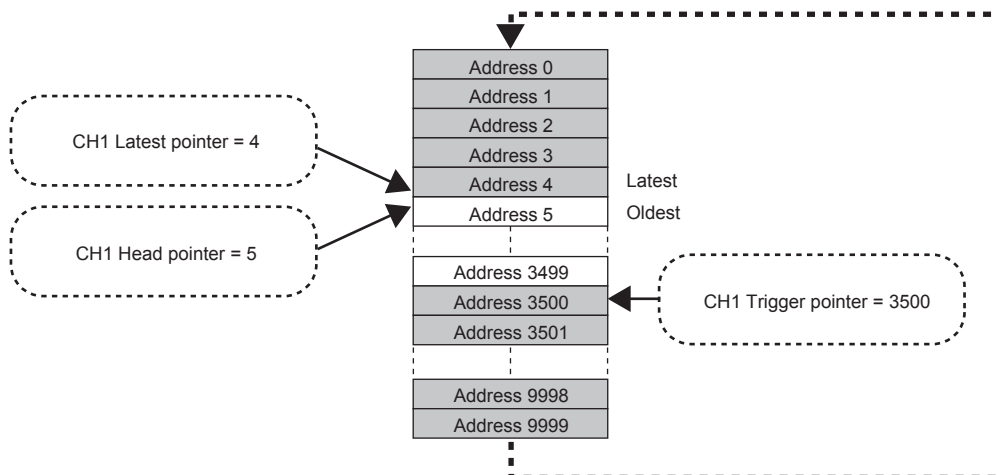

- Checking the trigger generation time

The trigger generation time can be checked with 'CH1 Trigger generation time' (Un\G444 to Un\G448).

Even when the logging cycle is set to a period less than 1 millisecond (Example: 80 μs), the minimum time unit recorded in 'CH1 Trigger generation time' (Un\G444 to Un\G448) is millisecond. Use the trigger generation time as an indication to refer to the logging data.

Ex.

When 'CH1 Trigger generation time' (Un\G444 to Un\G448) is monitored

	b15	to	b8 b7	to	b0
'CH1 Trigger generation time (First/Last two digits of the year)' (Un\G444)	First two digits of the year		Last two digits of the year		
'CH1 Trigger generation time (Month/Day)' (Un\G445)	Month		Day		
'CH1 Trigger generation time (Hour/Minute)' (Un\G446)	Hour		Minute		
'CH1 Trigger generation time (Second/Day of the week)' (Un\G447)	Second		Day of the week		
'CH1 Trigger generation time (Millisecond)' (Un\G448)	Millisecond (upper)		Millisecond (lower)		

Item	Storage contents	Storage example*1
First two digits of the year/Last two digits of the year	Stored in BCD code.	2017H
Month/Day		0130H
Hour/Minute		1035H
Second		40H
Day of the week	One of the following values is stored in BCD code. <ul style="list-style-type: none"> • Sunday: 00H • Monday: 01H • Tuesday: 02H • Wednesday: 03H • Thursday: 04H • Friday: 05H • Saturday: 06H 	01H
Millisecond (higher-order digits)/Millisecond (lower-order digits)	Stored in BCD code.	0628H

*1 These values assume that a trigger is generated at 10:35 and 40.628 seconds on Monday, January 30th, 2017.

■Resuming the logging

It may take time until ON (1) is stored in 'CH1 Logging hold flag' (Un\G409) after 'CH1 Logging hold request' (Un\G471) is changed off→on.

To resume logging, check that ON (1) is stored in 'CH1 Logging hold flag' (Un\G409) and 'CH1 Logging hold request' (Un\G471) is changed from on→off. After logging resumes, the value is stored from the head buffer memory area of CH1 Logging data (Un\G10000 to Un\G19999).

In addition, OFF (0) is stored in 'CH1 Logging hold flag' (Un\G409).

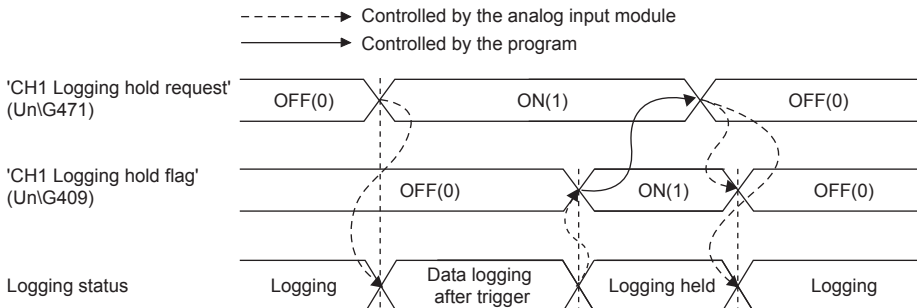

Logging does not stop when 'CH1 Logging hold request' (Un\G471) is changed on→off before ON (1) is stored in 'CH1 Logging hold flag' (Un\G409).

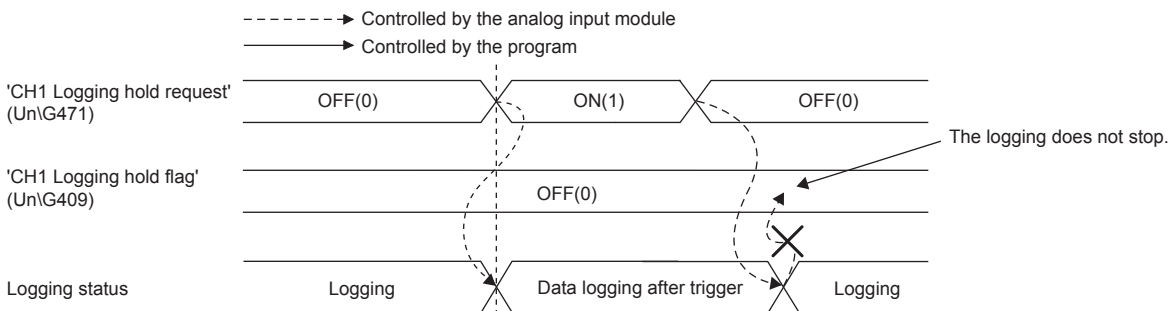

• Buffer memory area status when logging resumes

The following table shows the buffer memory area status when logging resumes.

Buffer Memory Areas	Value status
CH1 Head pointer (Un\G434)	Values are initialized.
CH1 Latest pointer (Un\G435)	
CH1 Number of logging data (Un\G436)	
CH1 Trigger pointer (Un\G437)	
CH1 Trigger generation time (Un\G444 to Un\G448)	
CH1 Logging data (Un\G10000 to Un\G19999)	The values before logging resumes are not initialized. After logging resumes, values are stored from the start address of CH1 Logging data (Un\G10000 to Un\G19999). To refer to the logging data, check which area has valid data with CH1 Number of logging data (Un\G436).

Logging hold request

A hold trigger is generated from a program at any timing.

Logging starts when ON (1) is set to 'CH1 Logging hold request' (Un\G471) and stops after a preset number of the data is collected.

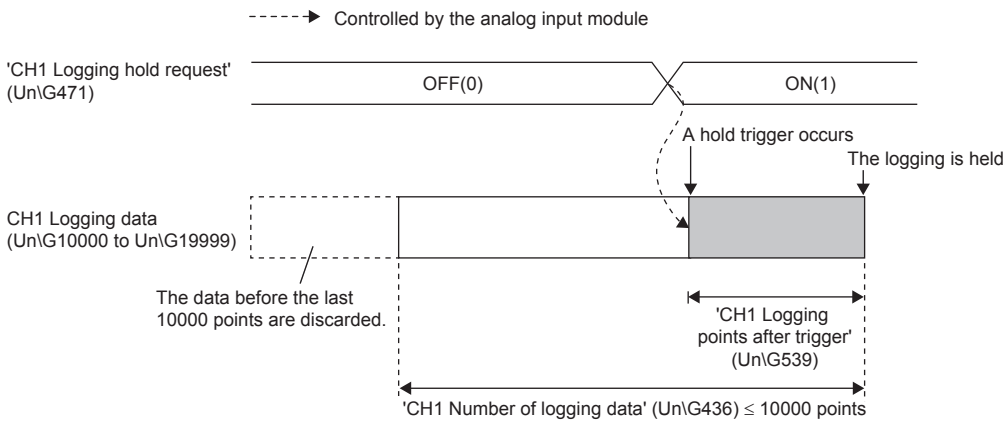

Point

- The following delay time occurs until an analog input module receives a hold trigger after the value in 'CH1 Logging hold request' (Un\G471) is turned OFF (0) → ON (1).
Trigger delay = Logging cycle (Cycle at which logging is actually performed) + Scan time of the CPU module
- When 'CH1 Logging hold request' (Un\G471) is turned ON (1)→OFF (0) before 'CH1 Logging hold flag' (Un\G409) turns to ON (1), the data set in 'CH1 Post-trigger logging points' (Un\G539) is not held after logging, and logging resumes soon.

■Checking that the logging has stopped

Check that 'CH1 Logging hold flag' (Un\G409) is ON (1).

Level trigger

When a value in the monitored buffer memory area of an analog input module satisfies a preset condition, a hold trigger is generated.

A level trigger is monitored on the refreshing cycle of the digital output value or the digital operation value.

Initial setting of a level trigger

[Setting a target to be monitored]

As a condition to generate a hold trigger, set the buffer memory address to be monitored to 'CH1 Trigger data' (Un\G541).

Item	Setting range
CH1 Trigger data (Un\G541)	0 to 9999

To monitor a device value of a module other than an analog input module such as a device of the CPU module, set as follows.

- Set a value between 90 and 99 (Level data□ (Un\G90 to Un\G99)) to 'CH1 Trigger data' (Un\G541).
- Write a value of the monitored device to Level data□ (Un\G90 to Un\G99) by using the MOV instruction.

Item	Setting range
Level data□ (Un\G90 to Un\G99)*1	-32768 to +32767

*1 □ represents a number from 0 to 9.

Ex.

Application example of Level data□ (Un\G90 to Un\G99)

To monitor the data register D100 in the CPU module and generate the level trigger in CH1, create a program as follows.

- Set 'CH1 Trigger data' (Un\G541) to 91 (buffer memory address of Level data 1) (when Level data 1 is used).
- Store the storage data of D100 in 'Level data 1' (Un\G91) by the program continuously.



Point

- Specify an appropriate data such as 'CH1 Digital output value' (Un\G400), 'CH1 Digital operation value' (Un\G402), or Level data□ (Un\G90 to Un\G99) to 'CH1 Trigger data' (Un\G541). When a setting area or a system area is specified, the normal operation is not guaranteed.
- If other than 0 to 9999 is set for 'CH1 Trigger data' (Un\G541), an error occurs. A trigger data setting range error (error code: 1D6□H) is stored in 'Latest error code' (Un\G0), 'Error flag' (Un\G69, b15) and the ERROR LED turns on.

[Setting the monitoring condition]

Set a condition to generate a hold trigger in 'CH1 Hold trigger condition setting' (Un\G540).

Setting value	Description	
Rise (1)	<div style="display: flex; align-items: center;"> <div style="margin-right: 20px;"> <p>Stored value in buffer memory area to be monitored</p> </div> <div> <p>A hold trigger is generated under the condition (a).</p> </div> </div>	
Fall (2)		A hold trigger is generated under the condition (b).
Rise and fall (3)		A hold trigger is generated under the condition (a) or (b).

- (a) A hold trigger is generated when the relation between the values changes from "Stored value of a buffer memory area to be monitored \leq Trigger setting value" to "Stored value of a buffer memory area to be monitored $>$ Trigger setting value".
- (b) A hold trigger is generated when the relation between the values changes from "Stored value of a buffer memory area to be monitored \geq Trigger setting value" to "Stored value of a buffer memory area to be monitored $<$ Trigger setting value".

- Set a value where a hold trigger is generated to 'CH1 Trigger setting value' (Un\G542).

Item	Setting range
CH1 Trigger setting value (Un\G542)	-32768 to +32767

Point

The following figure shows the relation between setting items to be configured for the initial setting of a level trigger.

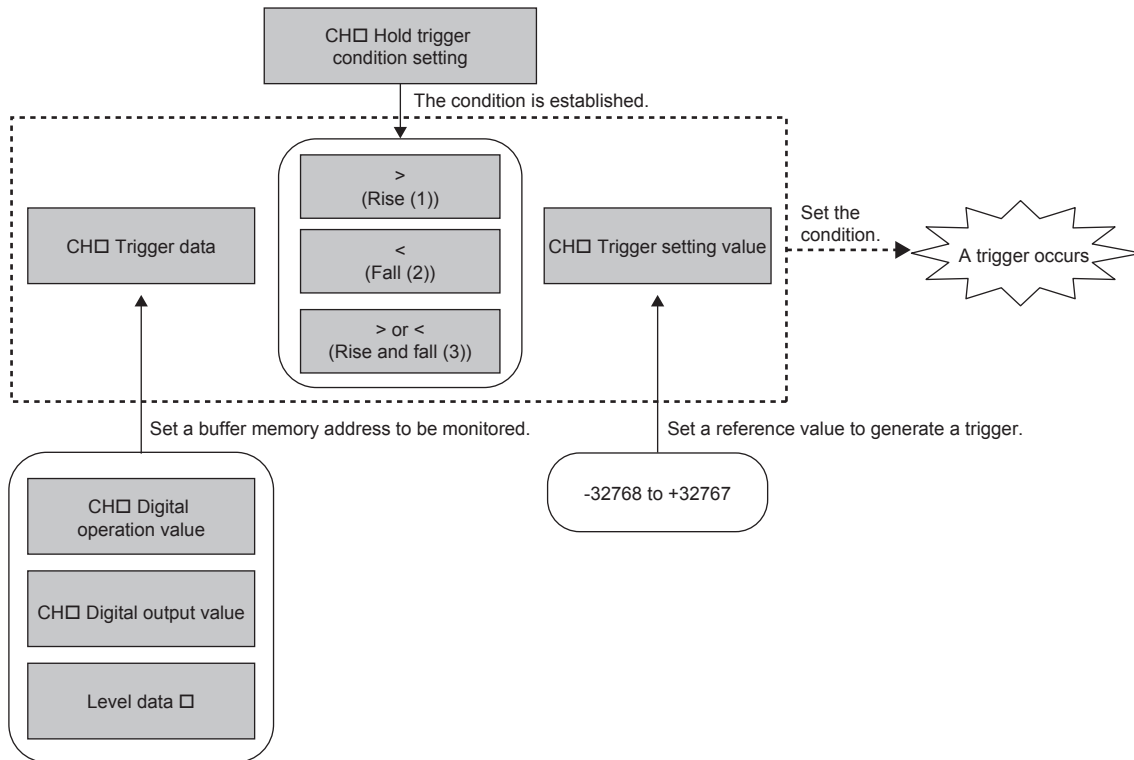

For example, to generate a hold trigger when a value in CH1 Digital output value exceeds 10000, set it as follows.

- 'CH1 Level trigger condition setting' (Un\G540): Rise (1)
- 'CH1 Trigger data' (Un\G541): 400
- 'CH1 Trigger setting value' (Un\G542): 10000

■ Operation of a level trigger

To use a level trigger, set ON (1) to 'CH1 Logging hold request' (Un\G471) in advance. At the point where ON (1) has been set to 'CH1 Logging hold request' (Un\G471), the module becomes the trigger condition wait status.

After the trigger condition has been satisfied, and the set points of the data have been collected from that point, the logging stops.

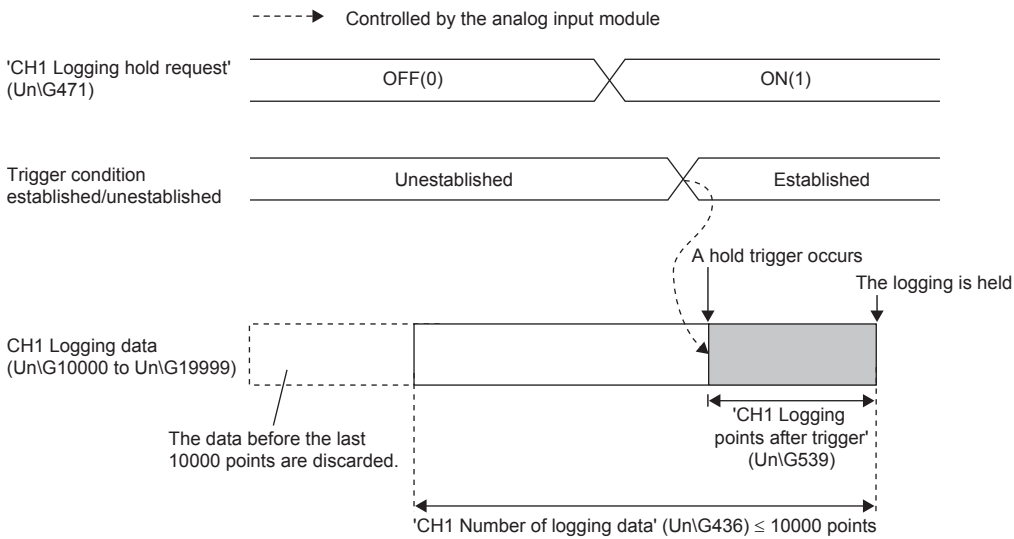

Point

A level trigger is detected on the refreshing cycle of the digital output value or the digital operation value. Therefore, the data when a hold trigger is generated may not be stored in CH1 Logging data (Un\G10000 to Un\G19999) depending on the setting of the logging cycle. To store the data at the timing when a hold trigger is generated in CH1 Logging data (Un\G10000 to Un\G19999), arrange related settings so that the conversion cycle of the monitoring target value (a trigger data) and the logging cycle (actual logging cycle) have the same time period.

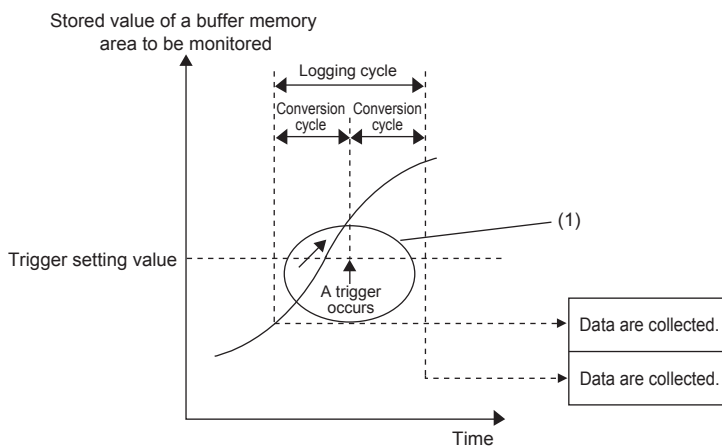

(1) The data at the timing when a trigger is generated is not stored in the buffer memory area.

- Checking that the logging has stopped



Check that 'CH1 Logging hold flag' (Un\G409) is ON (1).

Initial settings of the logging function

The following describes the initial setting procedure to use the logging function.

1

■Setting procedure

1. Set "A/D conversion enable/disable setting" to "A/D conversion enable".
 [Navigation window] ⇒ [Parameter] ⇒ [Module Information] ⇒ Module model name ⇒ [Module Parameter] ⇒ [Basic setting] ⇒ [A/D conversion enable/disable setting]
2. Set "Logging enable/disable setting" to "Enable".
 [Navigation window] ⇒ [Parameter] ⇒ [Module Information] ⇒ Module model name ⇒ [Module Parameter] ⇒ [Application setting] ⇒ [Logging function]
3. Set the target data to be logged in "Logging data setting". Set either of "Digital output value" or "Digital operation value" for each channel.
4. Set the cycle to store the logging data to "Logging cycle setting value".
5. Select a unit of the logging cycle setting value in "Logging cycle unit setting".
6. Set a condition to generate a hold trigger in "Level trigger condition setting". To use 'CH1 Logging hold request' (Un\G471), set "Disable". To use the level trigger, set it to "Level trigger (Condition: Rise)", "Level trigger (Condition: Fall)" or "Level trigger (Condition: Rise and fall)".
7. Set a number of the data points to be collected for the time period from the occurrence of a hold trigger to logging stop in "Post-trigger logging points".
8. Set a buffer memory address to be monitored for a level trigger to "Trigger data".
9. Set whether to enable or disable the logging read function in "Logging loading enable/disable setting".
10. Set a level where a level trigger operates for "Trigger setting value".

Logging read function

After logging starts, an interrupt request is sent to the CPU module and an interrupt program is executed every time the preset number of data to be read is logged.

An analog input module has 16 points of the interrupt factor to correspond to the logging reading of each channel.

For the setting of interrupt pointers, refer to the following.

 Page 70 Setting interrupt pointers

Point

More than 10000 points of logging data can be stored by transferring the device data to the data register of the CPU module without stopping logging.

■Setting interrupt pointers

Assign the interrupt factors of an analog input module and interrupt pointers of the CPU module using the GX Works3 interrupt pointer setting.

The interrupt function must be set when the logging read function is used.

■Starting the logging read function

To use the logging read function, set 'CH1 Logging loading enable/disable setting' (Un\G544) to Enable (0) and set a number of logging points to generate an interrupt in 'CH1 Logging load points setting value' (Un\G545). This function starts when 'Operating condition setting request' (Un\G70, b9) is turned off→on→off.

- The number of logging read points

Set a value whose integral multiple is 10000 in 'CH1 Logging load points setting value' (Un\G545). The setting range is from 10 to 10000.

When a value whose integral multiple is not 10000 is set, the number of the actual logging read points is forced to become a maximum value whose integral multiple is 10000 within the set value. The value of the number of logging read points is stored in 'CH1 Logging read points monitor value' (Un\G440).

The number of logging read points	Logging read points monitor value
100	100
90	80
110	100
650	625
4000	2500

■Data checking method

[Current logging read pointer]

- The head pointer read from CH1 Logging data (Un\G10000 to Un\G19999) with the interrupt processing is stored in 'CH1 Current logging read pointer' (Un\G438).
- The default value of 'CH1 Current logging read pointer' (Un\G438) is -1.
- Every time the same number of data as the value stored in CH1 Logging read points monitor value (Un\G440) is logged, a value calculated by the following formula is stored in 'CH1 Current logging read pointer' (Un\G438).

CH1 Current logging read pointer = CH1 Latest pointer - CH1 Logging read points monitor value + 1

[Previous logging read pointer]

- 'CH1 Current logging read pointer' (Un\G438) at the timing when the previous read pointer detection interrupt occurs is stored in 'CH1 Previous logging read pointer' (Un\G439).
- The default value of 'CH1 Previous logging read pointer' (Un\G439) is -1.
- 'CH1 Previous logging read pointer' (Un\G439) is used to detect the overlap of the logging read pointer detection interrupt processing.

Ex.

The values to be stored in each pointer at every detection interrupt when the logging read detection starts with 'CH1 Logging load points setting value' (Un\G545) being set to 1000

Occurrence of read pointer detection interrupts	Previous logging read pointer	Current logging read pointer	Latest pointer	Buffer memory areas
Default value	-1	-1	0	1st data
1st time	-1	0	999	∴
2nd time	0	1000	1999	1000th data
3rd time	1000	2000	2999	1001st data
∴	∴	∴	∴	∴
10th time	8000	9000	9999	2001st data
11th time	9000	0	999	∴
12th time	0	1000	1999	10000th data

Operation

The logging read function starts by setting interrupt pointers and turning off→on→off 'Operating condition setting request' (Un\G70, b9). This function repeats its operation every time the same number of data as the logging read points monitor value is logged.

Ex.

The following figure shows the operation when the logging read function is used under the following conditions.

- A/D conversion enable: CH1
- Logging load points setting value: 1000 points

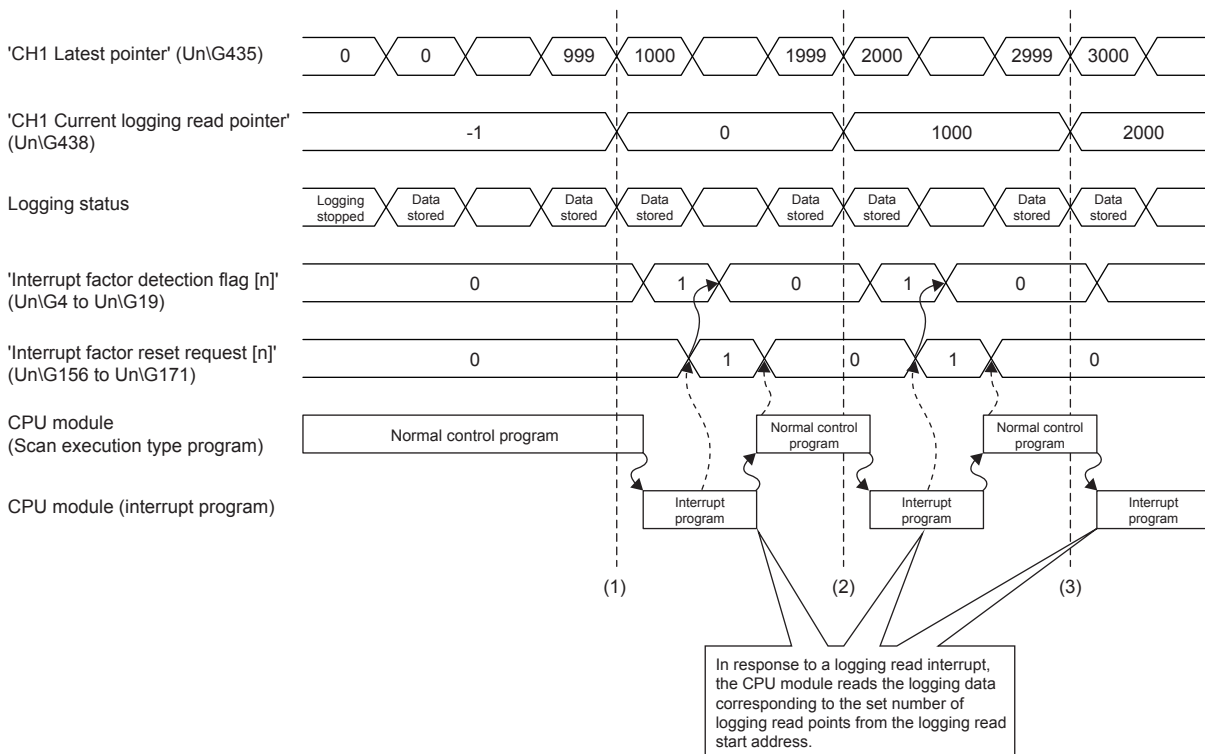

- (1) The timing that the 1st interrupt processing occurs
- (2) The timing that the 2nd interrupt processing occurs
- (3) The timing that the 3rd interrupt processing occurs

■Setting procedure

To use the logging read function, both the logging read function and the interrupt setting must be set.

1. Set "Condition target setting" to "Logging read".

 [Navigation window] ⇒ [Parameter] ⇒ [Module Information] ⇒ Module model name ⇒ [Module Parameter] ⇒ [Interrupt setting]

2. Set "A/D conversion enable/disable setting" to "A/D conversion enable".

 [Navigation window] ⇒ [Parameter] ⇒ [Module Information] ⇒ Module model name ⇒ [Module Parameter] ⇒ [Basic setting] ⇒ [A/D conversion enable/disable setting]

3. Set "Logging enable/disable setting" to "Enable".

 [Navigation window] ⇒ [Parameter] ⇒ [Module Information] ⇒ Module model name ⇒ [Module Parameter] ⇒ [Application setting] ⇒ [Logging function]

4. Set the target data to be logged in "Logging data setting".

5. Set the cycle to store the logging data to "Logging cycle setting value".

6. Set "Read interrupt enable/disable setting" to "Enable".

7. Set the number of logging points that generate a read interrupt in "Logging load points setting value".

■Setting example

Ex.

When an interrupt program that is executed when the logged data of CH1 Logging read points monitor value is assigned to the interrupt pointer I50

- Label settings

Classification	Device	Description	Device	
Module label	FX5_4AD_1.unInterruptFactorMask_D[0]	Interrupt factor mask	U1\G124	
	FX5_4AD_1.unInterruptFactorDetectionFlag_D[0]	Interrupt factor detection flag	U1\G4	
	FX5_4AD_1.unInterruptFactorResetRequest_D[0]	Interrupt factor reset request	U1\G156	
	FX5_4AD_1.stnMonitor_D[0].wThisLoggingLoadPointer_D	CH1 Current logging read pointer	U1\G438	
	FX5_4AD_1.stnMonitor_D[0].uLoggingLoadPointsMonitorValue_D	CH1 Logging read points monitor value	U1\G440	
Labels to be defined	Define global labels as shown below:			
	Label Name	Data Type	Class	Assign (Device/Label)
	G_uLoggingReadPoints	Word [Unsigned]/Bit String [16-bit]	VAR_GLOBAL	D1 0
	G_udLoggingReadPointsTemporary	Double Word [Unsigned]/Bit String [32-bit]	VAR_GLOBAL	D1 2
	G_udWritePosition	Double Word [Unsigned]/Bit String [32-bit]	VAR_GLOBAL	D20
	G_usaveFileRegisterMaxValue	Double Word [Unsigned]/Bit String [32-bit]	VAR_GLOBAL	D30
	G_wThisTimeLoggingReadPointIndex	Word [Signed]	VAR_GLOBAL	Z0
	G_udWritePositionIndex	Double Word [Unsigned]/Bit String [32-bit]	VAR_GLOBAL	Z4
	G_wLoggingReadMonitorValuePlusIndex	Word [Signed]	VAR_GLOBAL	U1 #G1 000020
	G_wsaveFileRegisterPlusIndex	Word [Signed]	VAR_GLOBAL	R024

Interrupt function

Executes an interrupt program of the CPU module when an interrupt factor such as an input signal error or alarm output is detected.

The number of available interrupt pointers per analog input module is up to 16.

Operation

■ Detecting an interrupt factor

When an interrupt factor occurs, an interrupt request is sent to the CPU module at the same time as 'Interrupt factor detection flag [n]' (Un\G4 to Un\G19) turns to Interrupt factor (1).

■ How to reset an interrupt factor

When Reset request (1) is set to 'Interrupt factor reset request [n]' (Un\G156 to Un\G171) corresponding to the interrupt factor, the specified interrupt factor is reset and 'Interrupt factor detection flag [n]' (Un\G4 to Un\G19) changes to No interrupt factor (0).

Setting procedure

To use the interrupt function, set "Condition target setting", "Condition target channel setting", "Interrupt factor transaction setting", and "Interrupt pointer" in GX Works3.

 [Navigation window] ⇒ [Parameter] ⇒ [Module Information] ⇒ Module name ⇒ [Module Parameter] ⇒ [Interrupt setting]

The following table shows the setting items on the interrupt setting window.

Item	Description
Condition target setting	Select a factor of the target for the interrupt detection.
Condition target channel setting	Select a target channel when the condition target setting for the interrupt detection is channel specification.
Interrupt factor transaction setting	Set an interrupt request for when the same interrupt factor occurs during the interrupt factor detection.
Interrupt pointer	Specify the number of an interrupt pointer that is initiated at the detection of an interrupt factor.

■ Condition target setting

Select a factor of the condition target setting for the interrupt detection.

For details on the factors to be detected, refer to the following.

 Page 139 Condition target setting [n]

■ Condition target channel setting

Select a target channel when the condition target setting for the interrupt detection is channel specification.

Item	Setting value				
Condition target channel setting	0: All channels	1: CH1	2: CH2	3: CH3	4: CH4

■ Interrupt factor transaction setting

Set an interrupt request for when the same interrupt factor occurs during the interrupt factor detection.

- With "Interrupt reissue requests (0)", if the same interrupt factor occurs during the interrupt factor detection, an interrupt request is sent to the CPU module again.
- With "No interrupt reissue request (1)", if the same interrupt factor occurs during the interrupt factor detection, an interrupt request is not sent to the CPU module.

■ Interrupt pointer

Specify the number of an interrupt pointer that is initiated at the detection of an interrupt factor. For details on the interrupt pointers, refer to the following.

 MELSEC iQ-F FX5 User's Manual (Application)

- If 'Condition target setting [n]' (Un\G232 to Un\G247) is Disable (0), an interrupt request is not sent to the CPU module.
- To reset the interrupt factor, set Reset request (1) until 'Interrupt factor detection flag [n]' (Un\G4 to Un\G19) changes to No interrupt factor (0).
- Resetting interrupt factors is executed only when 'Interrupt factor reset request [n]' (Un\G156 to Un\G171) changes from No reset request (0) to Reset request (1).
- Multiple interrupt pointers can also share the same setting of 'Condition target setting [n]' (Un\G232 to Un\G247). When interrupts with the same settings in 'Condition target setting [n]' (Un\G232 to Un\G247) occur, the interrupt program is executed in order of the priority of the interrupt pointers. For the priority of the interrupt pointers, refer to the following.

 MELSEC iQ-F FX5 User's Manual (Application)

- When All channels (0) is set for 'Condition target channel setting [n]' (Un\G264 to Un\G279) and an interrupt detection target is set for each channel of 'Condition target setting [n]' (Un\G232 to Un\G247), the interrupt requests that have the same interrupt factor are sent to the CPU module if alarms are issued in multiple channels. In this case, the CPU module executes multiple interrupt programs and judges that the program cannot be normally finished due to the scan monitoring function, and a CPU module error may occur. When a CPU module error occurs, review the CPU module parameter setting and the program.

Setting example

Ex.

If the interrupt program (I51) is executed when an error occurs in any channel

- Parameter settings

Set "Interrupt setting" of [Module Parameter] as follows.

No.	Condition target setting	Condition target channel setting	Interrupt pointer
2	Error flag	All channels	I51

- Label settings

Classification	Device	Description	Device	
Module label	FX5CPU.stSM.bAlways_ON	Always ON	SM400	
	FX5_4AD_1.unInterruptFactorMask_D[1]	Interrupt factor mask	U1\G125.0	
	FX5_4AD_1.unInterruptFactorResetRequest_D[1]	Interrupt factor reset request	U1\G157.0	
Labels to be defined	Define global labels as shown below:			
	Label Name	Data Type	Class	Assign (Device/Label)
	G_bErrorDetection	Bit	VAR_GLOBAL	F0



Error history function

Records up to 16 errors and alarms that occurred in an analog input module to store them in the buffer memory areas.

Operation

When an error occurs, the error code and the error time are stored from Error history No. 1 (Un\G3600 to Un\G3609) in order. When an alarm occurs, the alarm code and the alarm time are stored from Alarm history No. 1 (Un\G3760 to Un\G3769) in order.

- Detail of the error code assignment

	b15	to	b8 b7	to	b0
Un\G3600	Error code				
Un\G3601	First two digits of the year		Last two digits of the year		
Un\G3602	Month		Day		
Un\G3603	Hour		Minute		
Un\G3604	Second		Day of the week		
Un\G3605	Millisecond (upper)		Millisecond (lower)		
Un\G3606	System area				
:					
:					
Un\G3609					

- Detail of the alarm code assignment

	b15	to	b8 b7	to	b0
Un\G3760	Alarm code				
Un\G3761	First two digits of the year		Last two digits of the year		
Un\G3762	Month		Day		
Un\G3763	Hour		Minute		
Un\G3764	Second		Day of the week		
Un\G3765	Millisecond (upper)		Millisecond (lower)		
Un\G3766	System area				
:					
:					
Un\G3769					

Ex.

Example of error history and alarm history storage

Item	Storage contents	Storage example ^{*1}
First two digits of the year/Last two digits of the year	Stored in BCD code.	2017H
Month/Day		0130H
Hour/Minute		1035H
Second		40H
Day of the week	One of the following values is stored in BCD code. Sunday: 0, Monday: 1, Tuesday: 2, Wednesday: 3, Thursday: 4, Friday: 5, Saturday: 6	1H
Millisecond (upper)	Stored in BCD code.	06H
Millisecond (lower)		28H

*1 These values assume that an error occurs at 10:35 and 40.628 seconds on Monday, January 30th, 2017.

The start address of Error history where the latest error is stored, can be found in 'Latest address of error history' (Un\G1).

The start address of Alarm history where the latest alarm is stored, can be found in 'Latest address of alarm history' (Un\G3).

Ex.

When the 3rd error occurs:

The 3rd error is stored in Error history No. 3, and the value 3620 (start address of Error history No. 3) is stored to Latest address of error history.

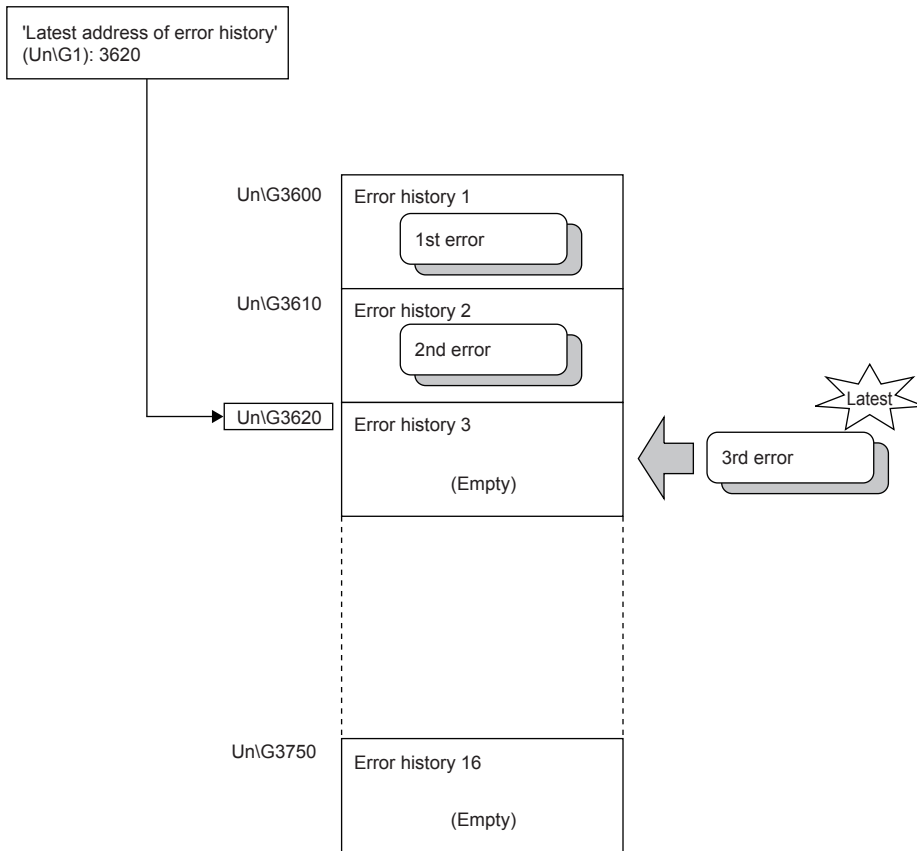

Ex.

When the 17th error occurs:

The 17th error is stored in Error history No. 1, and the value 3600 (start address of Error history No. 1) is stored to Latest address of error history.

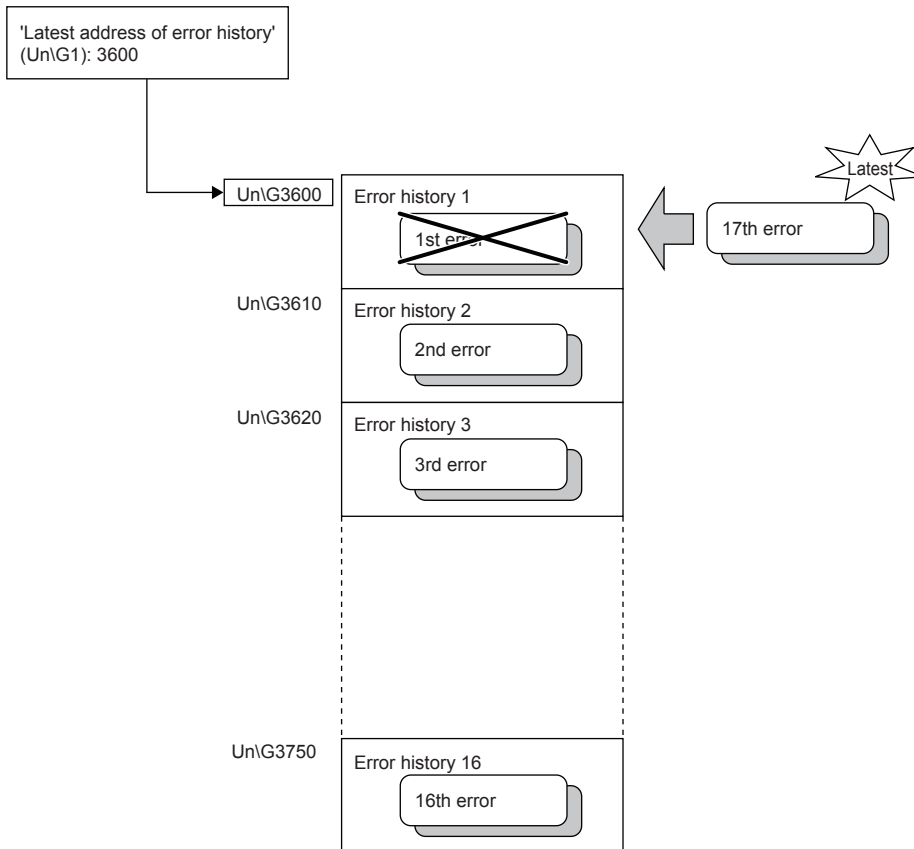
**Point**

- Once the error history storage area becomes full, subsequent error information will overwrite the existing data, starting from Error history No. 1 (Un\G3600 to Un\G3609), and continues sequentially thereafter. The overwritten history is deleted.
- The same processing is performed for Alarm history when an alarm occurs.
- The stored error history is cleared when an analog input module is powered off or the CPU module is reset.

Offset/gain initialization function

Offset/gain initialization

This function initializes the offset and gain values adjusted by the offset/gain setting to the factory defaults.

1. Set the mode to the "Normal mode".
2. For all channels, set A/D conversion enable/disable setting to A/D conversion disable (1) and turn off→on→off 'Operating condition setting request' (Un\G70, b9).
3. Set "E20FH" in 'Offset/gain initialization enabled code' (Un\G305).
4. Turn ON (1) 'Offset/gain initialization request' (Un\G70, b5).

Precautions

- The channels for which the offset and gain have been set are initialized to the factory defaults of the execution-time range type (voltage or current).
- The channels for which the offset and gain have not been set are initialized to the current range.

FX3 allocation mode function

This function operates the buffer memory areas of the analog input module with the same layout as the buffer memory addresses equivalent to FX3U-4AD.

Operation

In FX3 allocation mode, only allocation of buffer memory area is changed. The following buffer memory area is allocated the same as FX3U-4AD.

Buffer memory areas	Buffer memory area name
Un\G10 to 13	CH1 to 4 Digital operation value
Un\G26	Warning output flag (Process alarm upper limit/lower limit)
Un\G27	Warning output flag (Rate alarm upper limit/lower limit)
Un\G30	Type code
Un\G61 to 64	CH1 to 4 Conversion value shift amount
Un\G101 to 104	CH1 to 4 Minimum value
Un\G109	Minimum value reset request
Un\G111 to 114	CH1 to 4 Maximum value
Un\G119	Maximum value reset request

For buffer memories with different allocations from FX3U-4AD, it can be used by changing the program. For buffer memory in FX3 allocation mode, refer to the following.

 Page 119 In FX3 allocation function mode

Restriction

When reusing the program used by FX3U-4AD, delete the initial setting process and set the module parameters with GX Works3.

When performing the same operation as FX3U-4AD, it can be executed by the following function.

FX3U-4AD	FX5-4AD	Reference
Input mode specification	Range switching function	Page 25
Average count	A/D conversion method	Page 26
Digital filter function		
Setting change disabled	—	It is unnecessary because the setting is reflected in the operating condition setting request, and erroneous setting is prevented.
Input characteristics adjustment	Offset/gain setting function	Page 90
Data addition function	Shift function	Page 34
Upper lower limit value detection function	Alarm output function (process alarm)	Page 44
Sudden change detection function	Alarm output function (rate alarm)	Page 46
Peak value hold function	Maximum value/Minimum value hold function	Page 43
Scale over detection function	Input signal error detection function	Page 51
Data history function	Logging function	Page 57
Initialization function	Offset/gain initialization function	Page 79
Auto transfer function	Auto refresh	Page 89
Upper/lower limit error status auto transfer function	Auto refresh	Page 89
Sudden change detection status auto transfer function	Auto refresh	Page 89
Scale over status auto transfer function	Auto refresh	Page 89
Error status auto transfer function	Auto refresh	Page 89

Setting procedure

1. When adding a new module, select the module whose module model name has "(FX3)" at the end.
 [Navigation window] ⇒ [Parameter] ⇒ [Module Information] ⇒ Right-click ⇒ [Add New Module]
2. Configure the same parameter setting as the one of when the Normal mode is used.
3. After writing the module parameter, turn off→on or reset the CPU module.

Point

Switching between normal mode and FX3 allocation mode is not possible during operation.

1.5 System Configuration

The following shows a system configuration using the analog input module.

- System configuration example

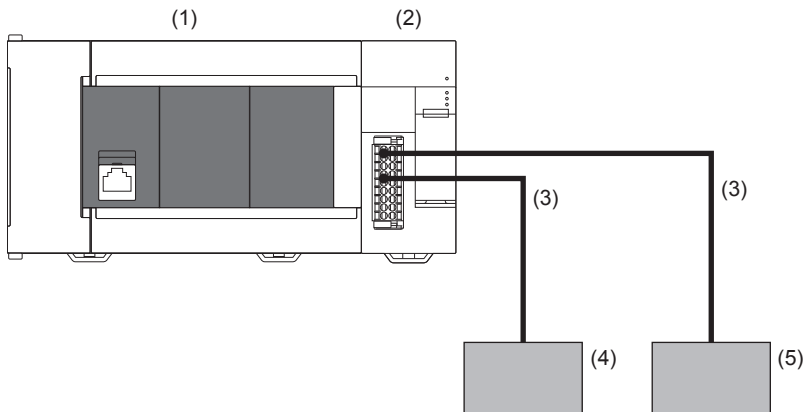

- (1) FX5 CPU module
- (2) Analog input module (FX5-4AD)
- (3) Analog device connection cable
- (4) Current sensor
- (5) Voltage sensor

1.6 Wiring

This section describes the temperature input module wiring.

Spring clamp terminal block

Suitable wiring

The wires to connect the spring clamp terminal block are described below.

No. of wire per terminal	Wire size	
	Single wire, strand wire	Ferrule with insulation sleeve
Single wiring	AWG24 to 16 (0.2 to 1.5 mm ²)	AWG23 to 19 (0.25 to 0.75 mm ²)

Wire end treatment

When not using a ferrule, strip the cable about 10 mm from the tip and connect it as a strand wire so that the wires do not separate. When using a ferrule, strip the cable about 10 mm from the tip to connect a wire ferrule at the striped area. Failure to do so may result in electric shock or short circuit between adjacent terminals because of the conductive part. If the wire strip length is too short, it may result in the poor contact to the spring clamp terminal part.

Depending on the thickness of the sheath, it may be difficult to insert into the insulation sleeve, so select the wires by referring to the appearance diagram.

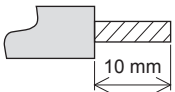
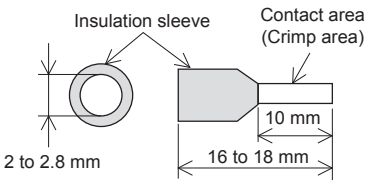
Strand wire/single wire	Ferrule with insulation sleeve
	

Check the shape of the wire insertion opening with the following chart, and use the smaller wire ferrule than the described size. Also, insert the wire with care so that the wire ferrule is in proper orientation. Failure to do so may cause the bite of the terminal and the damage of the terminal block.

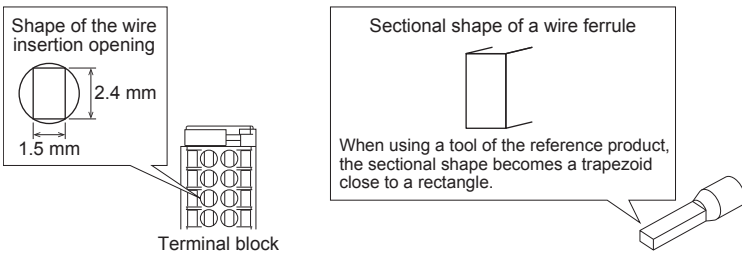

The following table shows wire ferrules and its associated tools compatible with the terminal block. The shape of the wire ferrule differs depending on the crimp tool to be used, use the reference product. If the product other than referenced products is used, the wire ferrule cannot be removed. Sufficiently confirm that the wire ferrule can be removed before use.

<Reference product>

Manufacturer	Model	Wire size	Crimp tool
PHOENIX-CONTACT GmbH & Co. KG	AI 0.5-10 WH	0.5mm ²	CRIMPFOX 6
	AI 0.75-10 GY	0.75mm ²	
	A 1.0-10	1.0mm ²	
	A 1.5-10	1.5mm ²	

Removing and installing the terminal block

The following shows how to remove and install the terminal block.

■Lever position to lock and release

A 3-step stopper is attached to prevent the lever from rotating, facilitating installation and removal of the terminal block.

When removing or installing the terminal block, move the lever to the corresponding position.

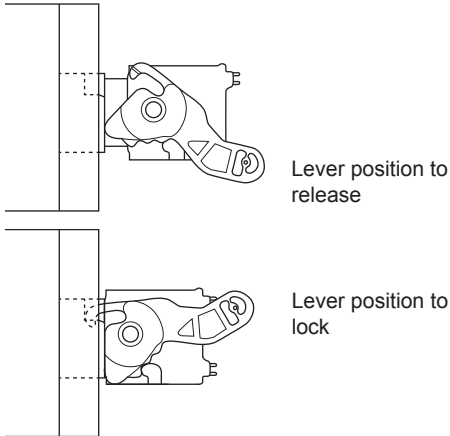

■Lever position to release

The figure left shows the lever position when the terminal block has been completely removed from the module. Rotate the lever from the lock position to the release position, and lift the terminal block from the module.

■Lever position to lock

The figure left shows the lever position when the terminal block is completely engaged with the module. Check that the lever is at the lock position, and pull the terminal block slightly to check that the module and terminal block are completely engaged.

■Removal procedure

Rotate the lever to the release position, and remove the terminal block from the module.

■Installation procedure

Move the lever to the release position, and insert the terminal block. When the terminal block is inserted sufficiently, the lever latch engages with the module and the terminal block is engaged with the module.



After inserting the terminal block, check that the lever is at the lock position.

Precautions

When installing the terminal block, check that the lever is in the release position. If installation is performed while the lever is in the lock position, it may cause damage to the lever.

Connection and disconnection of the cable

■ Connection of the cable

Fully insert a cable whose end has been properly processed into the wire insertion opening.

If the cable cannot be inserted with this procedure, fully insert the cable while pushing the open/close button with a flathead screwdriver having a tip width of 2.0 to 2.5 mm. After fully inserting the cable, remove the screwdriver.

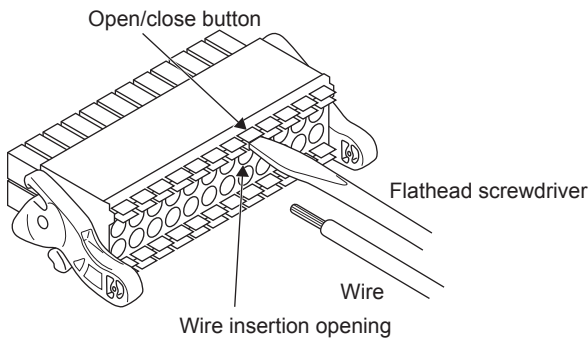

<Reference>

Manufacturer	Model
PHOENIX-CONTACT GmbH & Co. KG	SZS 0.4 × 2.5 VDE

Precautions

Pull the cable or wire ferrule slightly to check that the cable is securely clamped.

■ Disconnection of the cable

While pushing the open/close button with a flathead screwdriver having a tip width of 2.0 to 2.5 mm, disconnect the cable.

Terminal arrangement

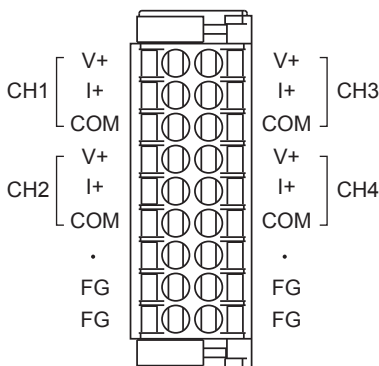

Left side of terminal arrangement		Right side of terminal arrangement	
Display name	Description	Display name	Description
V+	CH1 Voltage input	V+	CH3 Voltage input
I+	CH1 Current input	I+	CH3 Current input
COM	CH1 COM	COM	CH3 COM
V+	CH2 Voltage input	V+	CH4 Voltage input
I+	CH2 Current input	I+	CH4 Current input
COM	CH2 COM	COM	CH4 COM
.	Unused	.	Unused
FG	Frame ground	FG	Frame ground
FG	Frame ground	FG	Frame ground

Ground wiring

Grounding

Perform the following.

- Perform class D grounding (Grounding resistance: 100 Ω or less).
- Ground the programmable controller independently when possible.
- If the programmable controller cannot be grounded independently, perform the "Shared grounding" shown below.

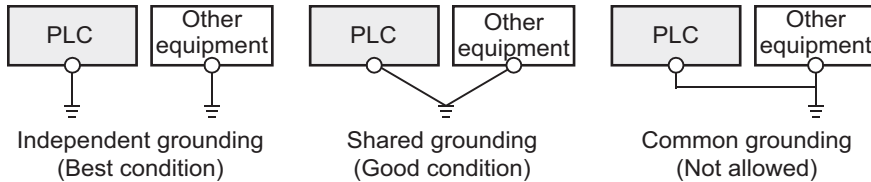

- Bring the grounding point close to the PLC as much as possible so that the ground cable can be shortened.

External wiring example

The followings show the examples of external wiring.

For the voltage input

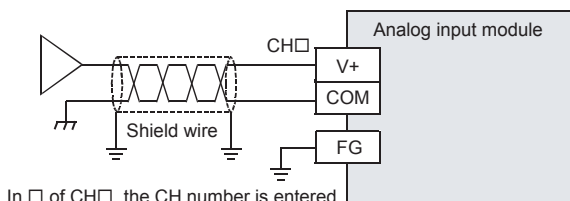

For the current input

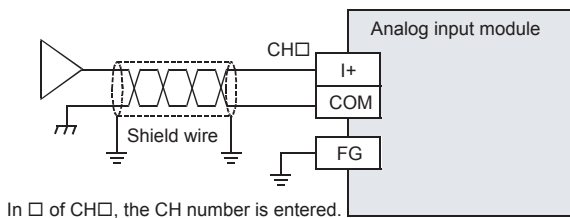

Precautions

Use a two-conductor shielded twisted pair cable for analog input lines and carry out the wiring while separating them from other power lines and lines susceptible to induction.

1.7 Parameter Settings

Set the parameters of each channel.

Setting parameters here eliminates the need to program them.

Point

When adding a new analog input module, if selecting the module whose module model name has "(FX3)" at the end, it can be used as FX3 allocation mode.

- FX5-4AD: Normal mode
- FX5-4AD(FX3): FX3 allocation mode

For details on the FX3 allocation mode function, refer to  Page 80 FX3 allocation mode function.

This section describes the case in a normal mode..

Basic setting

Setting procedure

Open "Basic setting" of GX Works3.

1. Start a module parameter.

 [Navigation window] ⇒ [Parameter] ⇒ [Module Information] ⇒ Module model name ⇒ [Module Parameter] ⇒ [Basic setting]

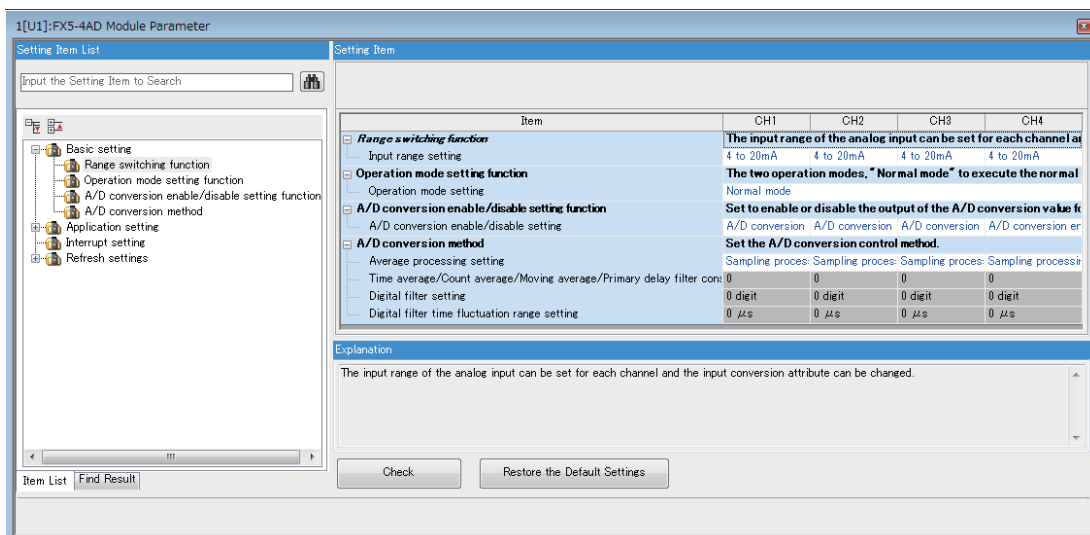

2. Click the item to be changed to enter the setting value.

- Item where a value is selected from the pull-down list

Click [▼] button of the item to be set, and from the pull-down list that appears, select the value.

- Item where a value is entered into the text box

Double-click the item to be set to enter the numeric value.

Application setting

Setting procedure

Open "Application setting" of GX Works3.

1. Start a module parameter.

[Navigation window] ⇒ [Parameter] ⇒ [Module Information] ⇒ Module model name ⇒ [Module Parameter] ⇒ [Application setting]

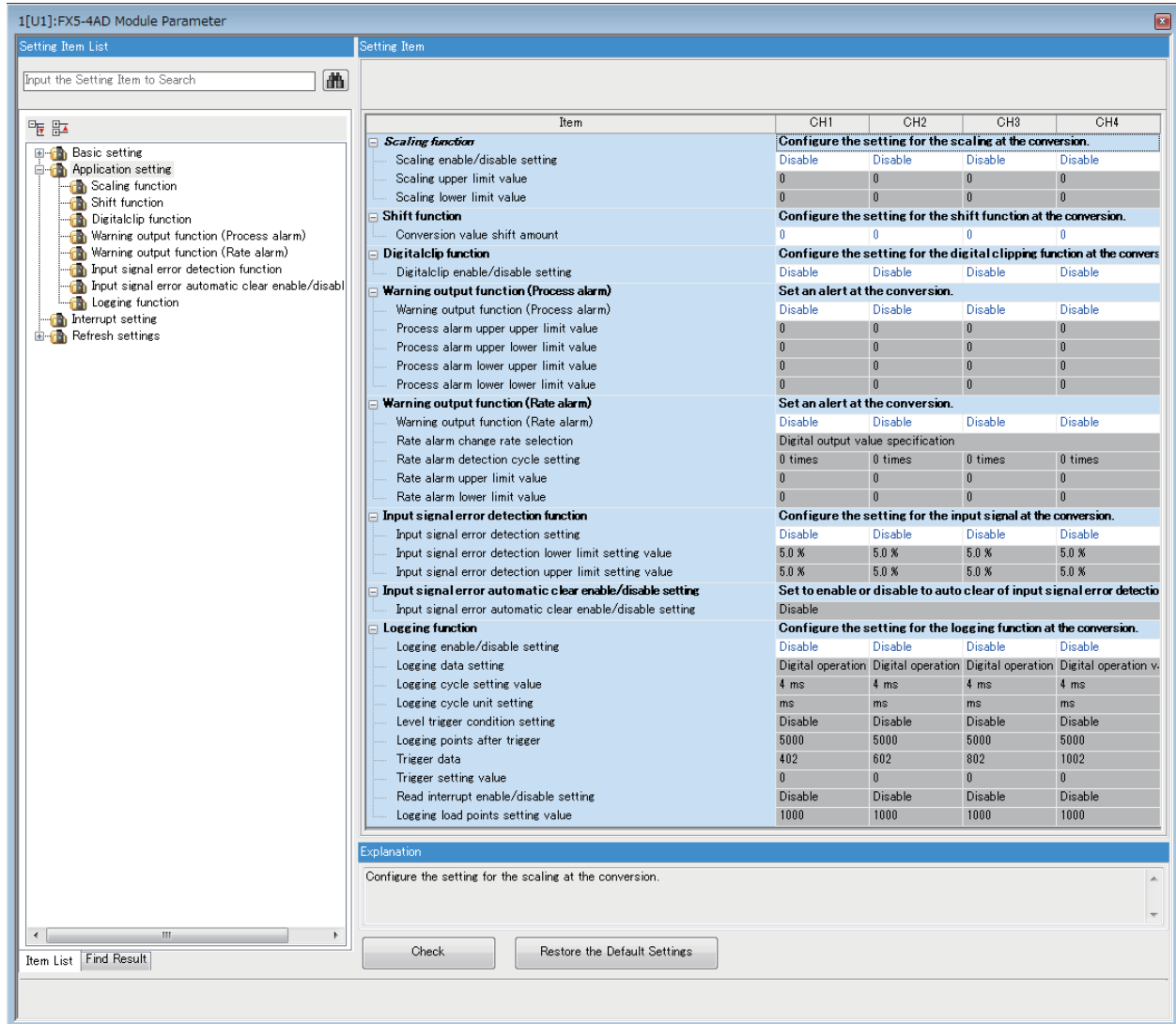

2. Click the item to be changed to enter the setting value.

- Item where a value is selected from the pull-down list

Click [▼] button of the item to be set, and from the pull-down list that appears, select the value.

- Item where a value is entered into the text box

Double-click the item to be set to enter the numeric value.

Interrupt setting

Setting procedure

Open "Interrupt setting" of GX Works3.

1. Start a module parameter.

[Navigation window] ⇒ [Parameter] ⇒ [Module Information] ⇒ Module model name ⇒ [Module Parameter] ⇒ [Interrupt setting]

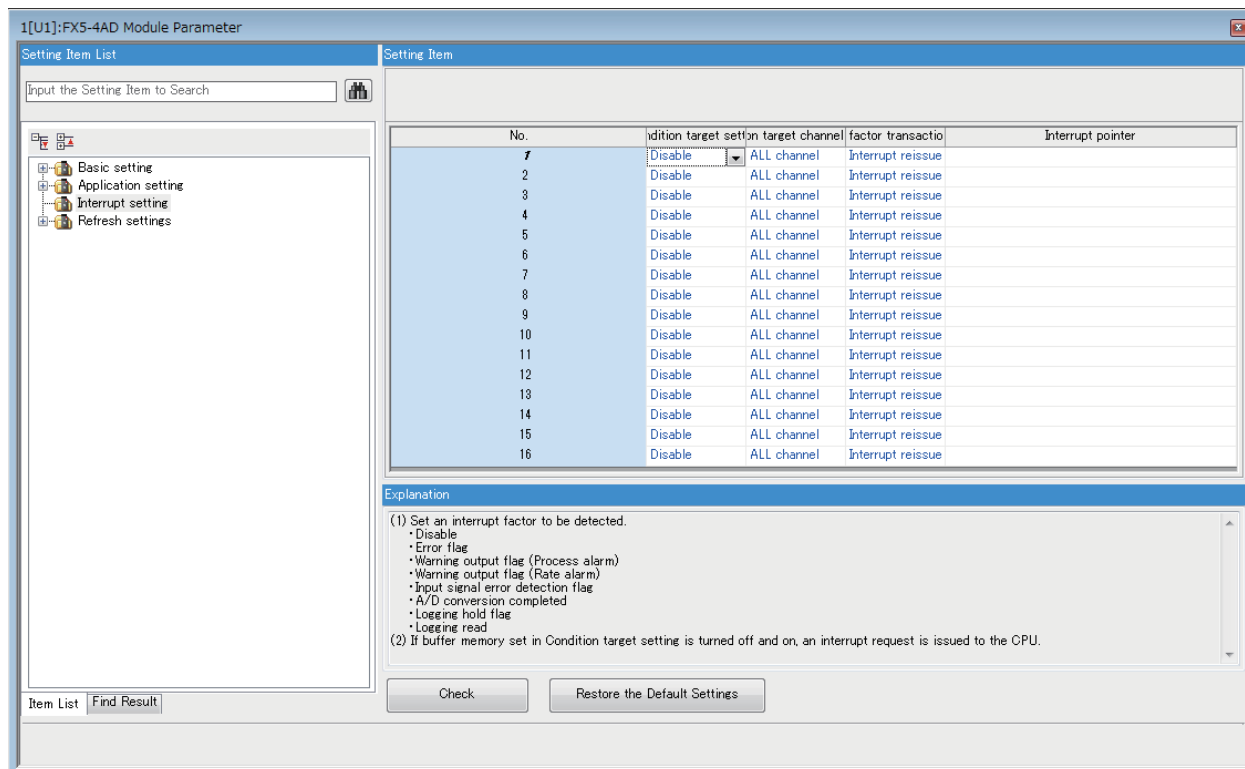

2. Click the interrupt setting number (No. 1 to 16) to be changed to enter the setting value.

- Item where a value is selected from the pull-down list

Click [▼] button of the item to be set, and from the pull-down list that appears, select the value.

- Item where a value is entered into the text box

Double-click the item to be set to enter the numeric value.

Refresh setting

Setting procedure

Set the buffer memory area of an analog input module to be refreshed.

This refresh setting eliminates the need for reading/writing data by programming.

1. Start a module parameter.

[Navigation window] ⇒ [Parameter] ⇒ [Module Information] ⇒ Module model name ⇒ [Module Parameter] ⇒ [Refresh settings]

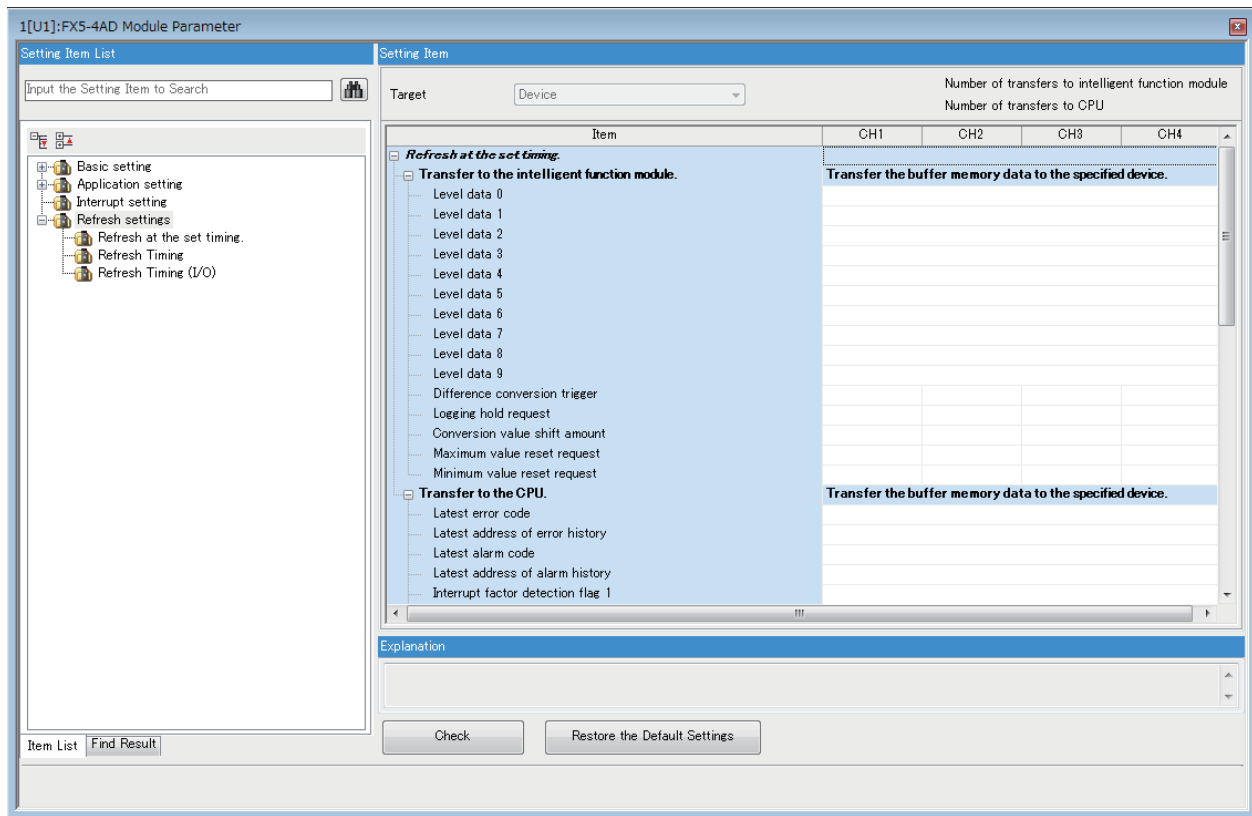

2. Double-click the item to be set to enter the device of refresh destination.

1.8 Offset/Gain Setting

Using the user range setting requires setting the offset and gain values.

The offset/gain setting can be performed by the following two methods.

- Settings from the module tool of GX Works3
- Setting from the program

The set offset/gain values are saved in the flash memory of the analog input module.

Setting example

An example of offset/gain setting is shown below.

Input conversion characteristics

Ex.

When CH1 is set to 0 V, offset is set to 0, and when set to 5 V, gain is set to 32000

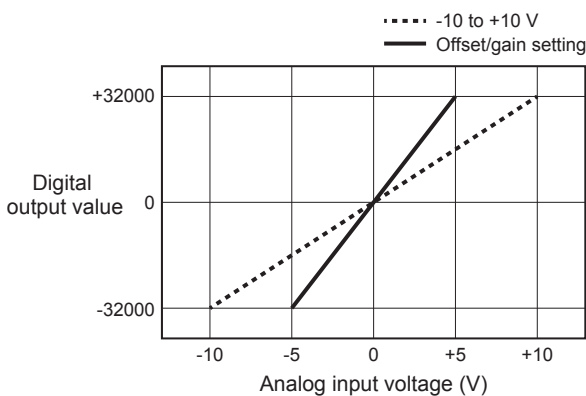

User range	Digital output value	Resolution	Remarks
-5 to +5 V	-32000 to +32000	156.25 μ V	(Gain value - Offset value) = 5 V As the result of (Gain value - Offset value) is not < 4 V, the calculated resolution is applied.

Module parameters

The module parameters used for CH1 are as follows. Parameters other than the following are defaults.

Item	Set conditions
Input range setting	User range
Operation mode setting	Normal mode
A/D conversion enable/disable setting	A/D conversion enable

Settings from the module tool of GX Works3

The following shows the procedure for setting the offset and gain from the module tool of GX Works3. (For CH1)

1

■Setting procedure

[Tool] ⇒ [Module Tool List]

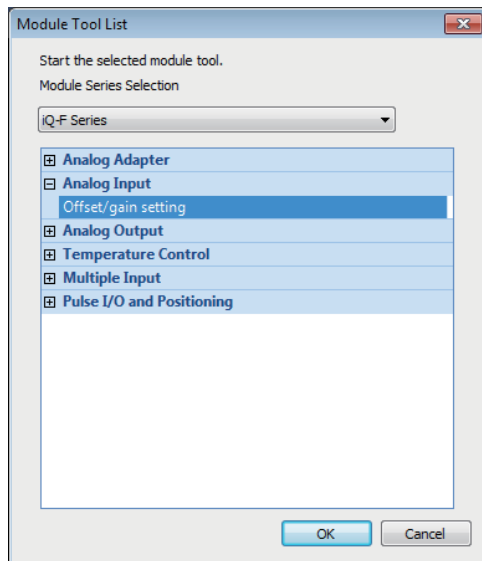

1. In "Analog Input", select "Offset/gain setting" and click the [OK] button.

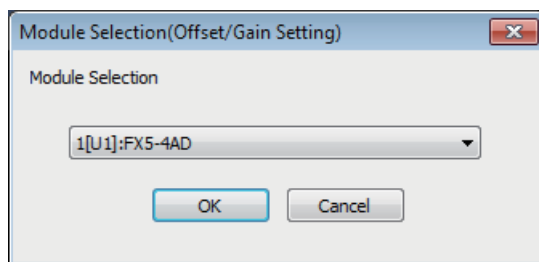

2. Select the target module for the offset/gain setting, and click the [OK] button.

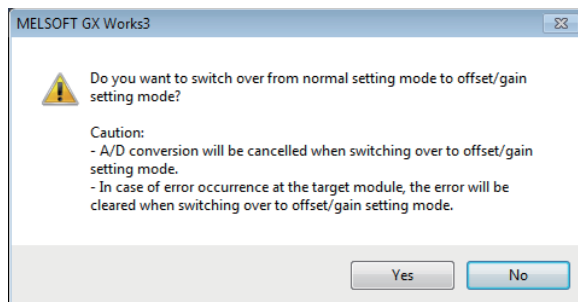

3. Click [Yes] button.

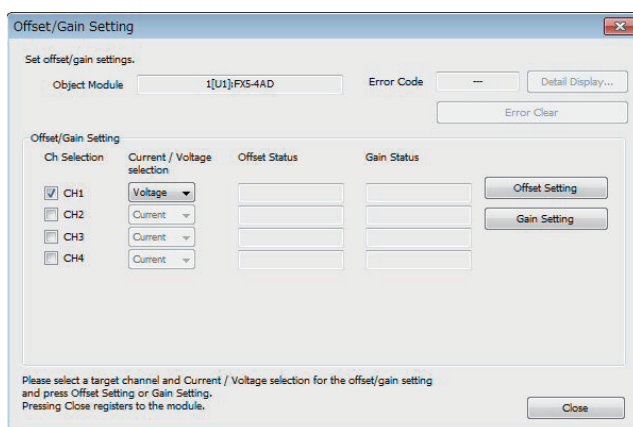

4. Mark the checkbox of the channel (CH1) where offset and gain values are to be set.
5. Select the voltage and click the [Offset Setting] button.

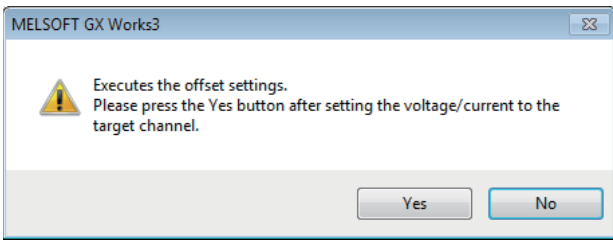

6. Input the offset value voltage "0 V" to the terminal of the target channel (CH1) and click the [Yes] button.

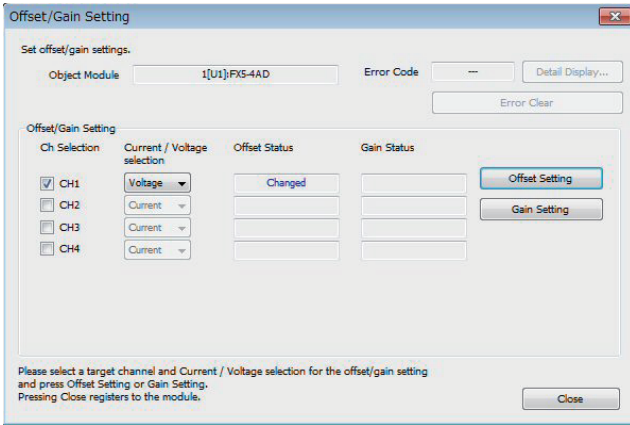

7. Check that "Offset Status" has changed to "Changed", and click [Gain Setting] button.

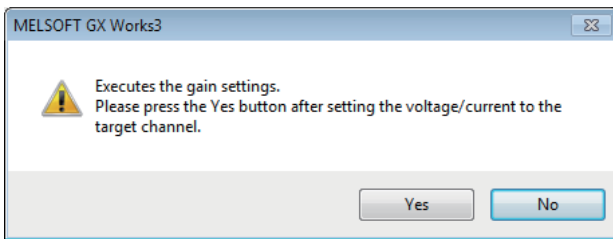

8. Input the Gain value voltage "5 V" to the terminal of the target channel (CH1) and click the [Yes] button.

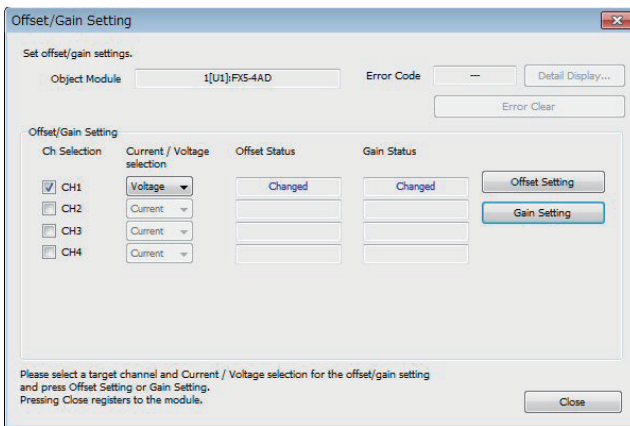

9. Check that "Gain Status" has changed to "Changed", and click [Close] button.

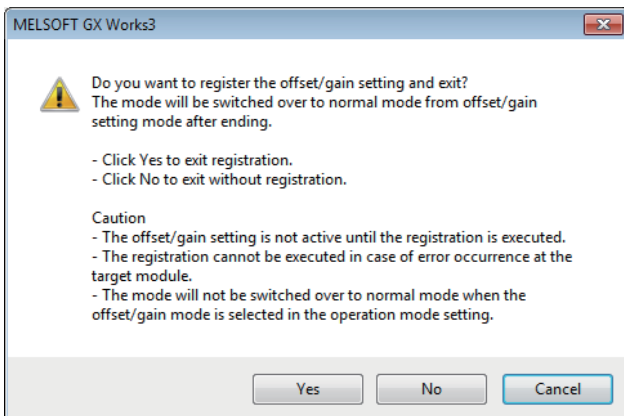

10. Click [Yes] button.

- All channels must satisfy the offset value < gain value.
- If there is a channel that does not satisfy the offset value < gain value, an offset/gain value inversion error (error code: 1E7□) occurs. Settings are not saved.
- Set the offset value and gain value in the user range setting within a range satisfying the following conditions. Failure to satisfy the conditions may not result in proper A/D conversion.

[Voltage]

Setting range of the offset value and gain value: -10 to +10 V

$((\text{Gain value}) - (\text{Offset value})) \geq 2.0 \text{ V}$

[Current]

Setting range of the offset value and gain value: 0 to 20 mA

$((\text{Gain value}) - (\text{Offset value})) \geq 6.0 \text{ mA}$

Setting from the program

The procedure for offset/gain setting from a program is shown below.

■Setting procedure

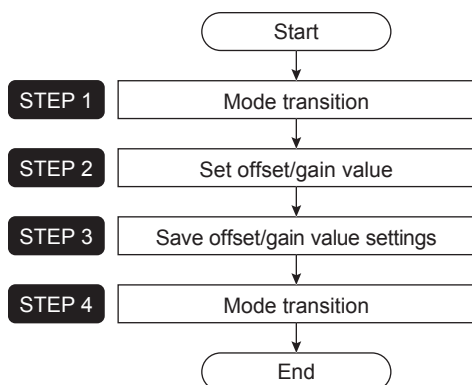

■STEP 1 Mode transition

Transition from normal mode to offset/gain setting mode.

1. Set "4144H" to 'Mode switching setting' (Un\G296) and "4658H" to 'Mode switching setting' (Un\G297).
2. Turn on 'Operating condition setting request' (Un\G70, b9).
3. Confirm that the 'Operating condition setting completed flag' (Un\G69, b9) is OFF and turn off 'Operating condition setting request' (Un\G70, b9).

When the transition to the offset/gain setting mode is completed, the RUN LED flashes.

■STEP 2 Set offset/gain value

Set the voltage or current input to the pin as an offset/gain value.

- Selection of voltage or current
1. Set voltage (0) to 'CH1 offset/gain setting mode (range specification)' (Un\G4164).
 2. Turn on 'Range switching request' (Un\G70, b13).
 3. Check that the 'Range switching completion flag' (Un\G69, b13) is ON, and turn off the 'Range switching request' (Un\G70, b13).
- Offset setting
4. Input the offset value voltage "0 V" to the CH1 terminal.
 5. Set 'CH1 offset/gain setting mode (offset specification)' (Un\G4132) to set channel (1), and set 'CH1 offset/gain setting mode (gain specification)' (Un\G4133) to invalid (0).
 6. Turn on 'Channel change request' (Un\G70, b11).
 7. Confirm that 'Channel change completed flag' (Un\G69, b11) is ON, and turn off 'Channel change request' (Un\G70, b11).
- Gain setting
8. Input the gain value voltage "5 V" to the CH1 terminal.
 9. Set 'CH1 offset/gain setting mode (offset specification)' (Un\G4132) to invalid (0), and set 'CH1 offset/gain setting mode (gain specification)' (Un\G4133) to set channel (1).
 10. Turn on 'Channel change request' (Un\G70, b11).
 11. Confirm that 'Channel change completed flag' (Un\G69, b11) is ON, and turn off 'Channel change request' (Un\G70, b11).
 12. Set 'CH1 offset/gain setting mode (offset specification)' (Un\G4132) to invalid (0), and set 'CH1 offset/gain setting mode (gain specification)' (Un\G4133) to invalid (0).

■STEP 3 Save offset/gain value settings

Save the set offset/gain values in the flash memory of the module.

1. Turn on 'User range write request' (Un\G70, b10).
2. Check that 'Offset/gain setting mode status flag' (Un\G69, b10) is off and turn off 'User range write request' (Un\G70, b10).

Point

- All channels must satisfy the offset value < gain value.
- If there is a channel that does not satisfy the offset value < gain value, an offset/gain value inversion error (error code: 1E7□) occurs. Settings are not saved.
- Set the offset value and gain value in the user range setting within a range satisfying the following conditions. Failure to satisfy the conditions may not result in proper A/D conversion.

[Voltage]

Setting range of the offset value and gain value: -10 to +10 V

$((\text{Gain value}) - (\text{Offset value})) \geq 2.0 \text{ V}$

[Current]

Setting range of the offset value and gain value: 0 to 20 mA

$((\text{Gain value}) - (\text{Offset value})) \geq 6.0 \text{ mA}$

■STEP 4 Mode transition

Shift from offset/gain setting mode to normal mode.

1. Set "4658H" to 'Mode switching setting' (Un\G296) and "4144H" to 'Mode switching setting' (Un\G297).
2. Turn on 'Operating condition setting request' (Un\G70, b9).
3. Confirm that the 'Operating condition setting completed flag' (Un\G69, b9) is OFF and turn off 'Operating condition setting request' (Un\G70, b9).

When the transition to the normal mode is completed, the RUN LED lights.

1.9 Programming

This section describes the programming procedure and the basic program of an analog input module.

Programming procedure

Take the following steps to create a program for running an analog input module:

1. Set parameters.
2. Create a program.

System configuration example

■ System configuration

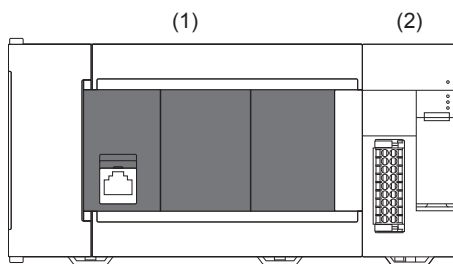

(1) CPU module (FX5U CPU module)

(2) Analog input module (FX5-4AD)

Parameter settings

Perform an initial setting in the module parameter of GX Works3. The refresh settings do not need to be changed here. For details on the parameter settings, refer to  Page 86 Parameter Settings.

[Basic setting]

Item	CH1	CH2	CH3	CH4
Range switching function	The input range of the analog input can be set for each channel and			
Input range setting	-10 to 10V	-10 to 10V	-10 to 10V	-10 to 10V
Operation mode setting function	The two operation modes, "Normal mode" to execute the normal co			
Operation mode setting	Normal mode			
A/D conversion enable/disable setting function	Set to enable or disable the output of the A/D conversion value for e			
A/D conversion enable/disable setting	A/D conversion	A/D conversion	A/D conversion	A/D conversion enab
A/D conversion method	Set the A/D conversion control method.			
Average processing setting	Sampling proces: Sampling proces: Sampling proces: Sampling processing			
Time average/Count average/Moving average/Primary delay filter constan	0	0	0	0
Digital filter setting	0 digit	0 digit	0 digit	0 digit
Digital filter time fluctuation range setting	0 μs	0 μs	0 μs	0 μs

Explanation
The input range of the analog input can be set for each channel and the input conversion attribute can be changed.

[Application setting]

Item	CH1	CH2	CH3	CH4
Scaling function	Configure the setting for the scaling at the conversion.			
Scaling enable/disable setting	Enable	Enable	Enable	Enable
Scaling upper limit value	16000	16000	16000	16000
Scaling lower limit value	-16000	-16000	-16000	-16000
Shift function	Configure the setting for the shift function at the conversion.			
Conversion value shift amount	0	0	0	0
Digitalclip function	Configure the setting for the digital clipping function at the convers			
Digitalclip enable/disable setting	Disable	Disable	Disable	Disable
Warning output function (Process alarm)	Set an alert at the conversion.			
Warning output function (Process alarm)	Disable	Disable	Disable	Disable
Process alarm upper upper limit value	0	0	0	0
Process alarm upper lower limit value	0	0	0	0
Process alarm lower upper limit value	0	0	0	0
Process alarm lower lower limit value	0	0	0	0
Warning output function (Rate alarm)	Set an alert at the conversion.			
Warning output function (Rate alarm)	Disable	Disable	Disable	Disable
Rate alarm change rate selection	Digital output value specification			
Rate alarm detection cycle setting	0 times	0 times	0 times	0 times
Rate alarm upper limit value	0	0	0	0
Rate alarm lower limit value	0	0	0	0
Input signal error detection function	Configure the setting for the input signal at the conversion.			
Input signal error detection setting	Disable	Disable	Disable	Disable
Input signal error detection lower limit setting value	5.0 %	5.0 %	5.0 %	5.0 %
Input signal error detection upper limit setting value	5.0 %	5.0 %	5.0 %	5.0 %
Input signal error automatic clear enable/disable setting	Set to enable or disable to auto clear of input signal error or detection f			
Input signal error automatic clear enable/disable setting	Disable			
Logging function	Configure the setting for the logging function at the conversion.			
Logging enable/disable setting	Disable	Disable	Disable	Disable
Logging data setting	Digital operation	Digital operation	Digital operation	Digital operation valu
Logging cycle setting value	4 ms	4 ms	4 ms	4 ms
Logging cycle unit setting	ms	ms	ms	ms
Level trigger condition setting	Disable	Disable	Disable	Disable
Logging points after trigger	5000	5000	5000	5000
Trigger data	402	602	802	1002
Trigger setting value	0	0	0	0
Read interrupt enable/disable setting	Disable	Disable	Disable	Disable
Logging load points setting value	1000	1000	1000	1000

Explanation
Configure the setting for the scaling at the conversion.

Program example

Classification	Device	Description	Device																																																																																																					
Module label	FX5_4AD_1.bA_D_conversionCompletedFlag_D	A/D conversion completed flag	U1\G69.E																																																																																																					
	FX5_4AD_1.bErrorFlag_DI	Error flag	U1\G69.F																																																																																																					
	FX5_4AD_1.bInputSignalErrorDetectionSignal_D	Input signal error detection signal	U1\G69.C																																																																																																					
	FX5_4AD_1.bModuleREADY_D	Module READY	U1\G69.0																																																																																																					
	FX5_4AD_1.bOperatingConditionSettingCompletedFlag_D	Operating condition setting completed flag	U1\G69.9																																																																																																					
	FX5_4AD_1.stnControl_D[1].uMaxResetReq_D.0	Maximum value reset completed flag	U1\G673.0																																																																																																					
	FX5_4AD_1.stnControl_D[1].uMinResetReq_D.0	Minimum value reset completed flag	U1\G674.0																																																																																																					
	FX5_4AD_1.stnMonitor_D[0].wDigitalOutputValue_D	Digital output value	U1\G400																																																																																																					
	FX5_4AD_1.stnMonitor_D[1].uMaxResetCmpFlg_D.0	Maximum value reset completed flag	U1\G622.0																																																																																																					
	FX5_4AD_1.stnMonitor_D[1].uMinResetCmpFlg_D.0	Minimum value reset completed flag	U1\G623.0																																																																																																					
	FX5_4AD_1.stnMonitor_D[1].wDigitalOutputValue_D	Digital output value	U1\G600																																																																																																					
	FX5_4AD_1.stnMonitor_D[1].wMaxValue_D	Maximum value	U1\G604																																																																																																					
	FX5_4AD_1.stnMonitor_D[1].wMinValue_D	Minimum value	U1\G606																																																																																																					
	FX5_4AD_1.stnMonitor_D[2].wDigitalOperationValue_D	Digital operation value	U1\G802																																																																																																					
	FX5_4AD_1.stnMonitor_D[3].wDigitalOutputValue_D	Digital output value	U1\G1000																																																																																																					
	FX5_4AD_1.uA_D_conversionCompletedFlag_D.0	A/D conversion completed flag	U1\G42.0																																																																																																					
	FX5_4AD_1.uA_D_conversionCompletedFlag_D.1	A/D conversion completed flag	U1\G42.1																																																																																																					
	FX5_4AD_1.uA_D_conversionCompletedFlag_D.2	A/D conversion completed flag	U1\G42.2																																																																																																					
	FX5_4AD_1.uA_D_conversionCompletedFlag_D.3	A/D conversion completed flag	U1\G42.3																																																																																																					
	FX5_4AD_1.uInputSignalErrorDetectionFlag_D.0	Input signal error detection flag	U1\G40.0																																																																																																					
	FX5_4AD_1.uWarningOutputFlagProcessAlarmLowerLimit_D.1	Warning output flag (Process alarm lower limit)	U1\G37.1																																																																																																					
	FX5_4AD_1.uWarningOutputFlagProcessAlarmUpperLimit_D.1	Warning output flag (Process alarm upper limit)	U1\G36.1																																																																																																					
	FX5_4AD_1.uWarningOutputFlagRateAlarmLowerLimit_D.0	Warning output flag (Rate alarm lower limit)	U1\G39.0																																																																																																					
	FX5_4AD_1.uWarningOutputFlagRateAlarmUpperLimit_D.0	Warning output flag (Rate alarm upper limit)	U1\G38.0																																																																																																					
	Labels to be defined	Define global labels as shown below:																																																																																																						
		<table border="1"> <thead> <tr> <th>Label Name</th> <th>Data Type</th> <th>Class</th> <th>Assign (Device/Label)</th> </tr> </thead> <tbody> <tr><td>CH1_DigOutVal</td><td>Word [Signed]</td><td>VAR_GLOBAL</td><td>D1 1</td></tr> <tr><td>CH2_DigOutVal</td><td>Word [Signed]</td><td>VAR_GLOBAL</td><td>D1 2</td></tr> <tr><td>CH3_DigCalcVal</td><td>Word [Signed]</td><td>VAR_GLOBAL</td><td>D1 3</td></tr> <tr><td>CH4_DigOutVal</td><td>Word [Signed]</td><td>VAR_GLOBAL</td><td>D1 4</td></tr> <tr><td>CH2_DigMaxVal</td><td>Word [Signed]</td><td>VAR_GLOBAL</td><td>D1 5</td></tr> <tr><td>CH2_DigMinVal</td><td>Word [Signed]</td><td>VAR_GLOBAL</td><td>D1 6</td></tr> <tr><td>CH2_ProcAlmUpLimit</td><td>Bit</td><td>VAR_GLOBAL</td><td>F0</td></tr> <tr><td>CH2_ProcAlmLowLimit</td><td>Bit</td><td>VAR_GLOBAL</td><td>F1</td></tr> <tr><td>CH1_RateAlmUpLimit</td><td>Bit</td><td>VAR_GLOBAL</td><td>F2</td></tr> <tr><td>CH1_RateAlmLowLimit</td><td>Bit</td><td>VAR_GLOBAL</td><td>F3</td></tr> <tr><td>CH1_InptSigErr</td><td>Bit</td><td>VAR_GLOBAL</td><td>F4</td></tr> <tr><td>DigitOutValSig</td><td>Bit</td><td>VAR_GLOBAL</td><td>X1 0</td></tr> <tr><td>MaxMinReadSig</td><td>Bit</td><td>VAR_GLOBAL</td><td>X1 1</td></tr> <tr><td>MaxMinResetSig</td><td>Bit</td><td>VAR_GLOBAL</td><td>X1 2</td></tr> <tr><td>ErrResetSig</td><td>Bit</td><td>VAR_GLOBAL</td><td>X1 3</td></tr> <tr><td>ErrOperationEN</td><td>Bit</td><td>VAR_GLOBAL</td><td></td></tr> <tr><td>ErrOperationENO</td><td>Bit</td><td>VAR_GLOBAL</td><td></td></tr> <tr><td>ErrOperationOK</td><td>Bit</td><td>VAR_GLOBAL</td><td></td></tr> <tr><td>UnitErrFlg</td><td>Bit</td><td>VAR_GLOBAL</td><td></td></tr> <tr><td>UnitErrCode</td><td>Word [Signed]</td><td>VAR_GLOBAL</td><td></td></tr> <tr><td>UnitAlarmCode</td><td>Word [Signed]</td><td>VAR_GLOBAL</td><td></td></tr> <tr><td>ErrSet</td><td>Bit</td><td>VAR_GLOBAL</td><td></td></tr> <tr><td>ErrOutSig</td><td>Bit</td><td>VAR_GLOBAL</td><td>X1 4</td></tr> <tr><td>UnitErrResetSig</td><td>Bit</td><td>VAR_GLOBAL</td><td>X1 5</td></tr> </tbody> </table>	Label Name	Data Type	Class	Assign (Device/Label)	CH1_DigOutVal	Word [Signed]	VAR_GLOBAL	D1 1	CH2_DigOutVal	Word [Signed]	VAR_GLOBAL	D1 2	CH3_DigCalcVal	Word [Signed]	VAR_GLOBAL	D1 3	CH4_DigOutVal	Word [Signed]	VAR_GLOBAL	D1 4	CH2_DigMaxVal	Word [Signed]	VAR_GLOBAL	D1 5	CH2_DigMinVal	Word [Signed]	VAR_GLOBAL	D1 6	CH2_ProcAlmUpLimit	Bit	VAR_GLOBAL	F0	CH2_ProcAlmLowLimit	Bit	VAR_GLOBAL	F1	CH1_RateAlmUpLimit	Bit	VAR_GLOBAL	F2	CH1_RateAlmLowLimit	Bit	VAR_GLOBAL	F3	CH1_InptSigErr	Bit	VAR_GLOBAL	F4	DigitOutValSig	Bit	VAR_GLOBAL	X1 0	MaxMinReadSig	Bit	VAR_GLOBAL	X1 1	MaxMinResetSig	Bit	VAR_GLOBAL	X1 2	ErrResetSig	Bit	VAR_GLOBAL	X1 3	ErrOperationEN	Bit	VAR_GLOBAL		ErrOperationENO	Bit	VAR_GLOBAL		ErrOperationOK	Bit	VAR_GLOBAL		UnitErrFlg	Bit	VAR_GLOBAL		UnitErrCode	Word [Signed]	VAR_GLOBAL		UnitAlarmCode	Word [Signed]	VAR_GLOBAL		ErrSet	Bit	VAR_GLOBAL		ErrOutSig	Bit	VAR_GLOBAL	X1 4	UnitErrResetSig	Bit	VAR_GLOBAL	X1 5		
	Label Name	Data Type	Class	Assign (Device/Label)																																																																																																				
CH1_DigOutVal	Word [Signed]	VAR_GLOBAL	D1 1																																																																																																					
CH2_DigOutVal	Word [Signed]	VAR_GLOBAL	D1 2																																																																																																					
CH3_DigCalcVal	Word [Signed]	VAR_GLOBAL	D1 3																																																																																																					
CH4_DigOutVal	Word [Signed]	VAR_GLOBAL	D1 4																																																																																																					
CH2_DigMaxVal	Word [Signed]	VAR_GLOBAL	D1 5																																																																																																					
CH2_DigMinVal	Word [Signed]	VAR_GLOBAL	D1 6																																																																																																					
CH2_ProcAlmUpLimit	Bit	VAR_GLOBAL	F0																																																																																																					
CH2_ProcAlmLowLimit	Bit	VAR_GLOBAL	F1																																																																																																					
CH1_RateAlmUpLimit	Bit	VAR_GLOBAL	F2																																																																																																					
CH1_RateAlmLowLimit	Bit	VAR_GLOBAL	F3																																																																																																					
CH1_InptSigErr	Bit	VAR_GLOBAL	F4																																																																																																					
DigitOutValSig	Bit	VAR_GLOBAL	X1 0																																																																																																					
MaxMinReadSig	Bit	VAR_GLOBAL	X1 1																																																																																																					
MaxMinResetSig	Bit	VAR_GLOBAL	X1 2																																																																																																					
ErrResetSig	Bit	VAR_GLOBAL	X1 3																																																																																																					
ErrOperationEN	Bit	VAR_GLOBAL																																																																																																						
ErrOperationENO	Bit	VAR_GLOBAL																																																																																																						
ErrOperationOK	Bit	VAR_GLOBAL																																																																																																						
UnitErrFlg	Bit	VAR_GLOBAL																																																																																																						
UnitErrCode	Word [Signed]	VAR_GLOBAL																																																																																																						
UnitAlarmCode	Word [Signed]	VAR_GLOBAL																																																																																																						
ErrSet	Bit	VAR_GLOBAL																																																																																																						
ErrOutSig	Bit	VAR_GLOBAL	X1 4																																																																																																					
UnitErrResetSig	Bit	VAR_GLOBAL	X1 5																																																																																																					

• Digital output value readout processing

This program is an example to read and save the digital output values of CH1, CH2, and CH4, and the digital operation value of CH3.

(0)	DigitOutValSig X10	FX5_4AD_1.bModuleREADY_D U1#G69.0	FX5_4AD_1.bA_D_conversionCompletedFlag_D U1#G69.E	FX5_4AD_1.bOperatingConditionSettingCompletedFlag_D U1#G69.9	FX5_4AD_1.uA_D_conversionCompletedFlag_D.0 U1#G42.0	MOV	FX5_4AD_1.stnMonitor_D [0].wDigitalOutputValue_D U1#G400	CH1_DigOutVal D11
					FX5_4AD_1.uA_D_conversionCompletedFlag_D.1 U1#G42.1	MOV	FX5_4AD_1.stnMonitor_D [1].wDigitalOutputValue_D U1#G600	CH2_DigOutVal D12
					FX5_4AD_1.uA_D_conversionCompletedFlag_D.2 U1#G42.2	MOV	FX5_4AD_1.stnMonitor_D [2].wDigitalOperationValue_D U1#G802	CH3_DigCalcVal D13
					FX5_4AD_1.uA_D_conversionCompletedFlag_D.3 U1#G42.3	MOV	FX5_4AD_1.stnMonitor_D [3].wDigitalOutputValue_D U1#G1000	CH4_DigOutVal D14
(156)								-END-

• Maximum/minimum value readout/clear processing

This program is an example to read and reset the maximum value and minimum values of CH2.

(0)	MaxMinReadSig X11	FX5_4AD_1.bModuleREADY_D U1#G69.0	FX5_4AD_1.bA_D_conversionCompletedFlag_D U1#G69.E	FX5_4AD_1.bOperatingConditionSettingCompletedFlag_D U1#G69.9	FX5_4AD_1.stnControl_D[1].uMaxResetReq_D.0 U1#G673.0	FX5_4AD_1.stnMonitor_D [1].uMaxResetCompFlg_D.0 U1#G622.0	MOV	FX5_4AD_1.stnMonitor_D [1].uMaxValue_D U1#G604	CH2_DigMaxVal D15
					FX5_4AD_1.stnControl_D[1].uMinResetReq_D.0 U1#G674.0	FX5_4AD_1.stnMonitor_D [1].uMinResetCompFlg_D.0 U1#G623.0	MOV	FX5_4AD_1.stnMonitor_D [1].uMinValue_D U1#G606	CH2_DigMinVal D16
(87)	MaxMinResetSig X12						SET	FX5_4AD_1.stnControl_D[1].uMaxResetReq_D.0 U1#G673.0	
							SET	FX5_4AD_1.stnControl_D[1].uMinResetReq_D.0 U1#G674.0	
(141)		FX5_4AD_1.stnControl_D [1].uMaxResetReq_D.0 U1#G673.0	FX5_4AD_1.stnMonitor_D [1].uMaxResetCompFlg_D.0 U1#G622.0				RST	FX5_4AD_1.stnControl_D [1].uMaxResetReq_D.0 U1#G673.0	
(173)		FX5_4AD_1.stnControl_D [1].uMinResetReq_D.0 U1#G674.0	FX5_4AD_1.stnMonitor_D [1].uMinResetCompFlg_D.0 U1#G623.0				RST	FX5_4AD_1.stnControl_D [1].uMinResetReq_D.0 U1#G674.0	
(205)									-END-

• Process alarm occurrence processing

This program is an example to perform the processing at the time of the issuance of a process alarm upper/lower limit alarm in CH2.

(0)	FX5_4AD_1.uWarningOutputFlasProcess AlarmUpperLimit.D.1 U1#G36.1	SET	CH2_ProcAlmUpLimit F0
(49)	FX5_4AD_1.uWarningOutputFlasProcess AlarmLowerLimit.D.1 U1#G37.1	SET	CH2_ProcAlmLowLimit F1
(81)			-END-

1.10 Troubleshooting

This section describes errors that may occur in the use of an analog input module and those troubleshooting.

Troubleshooting with the LEDs

Check the state of the LEDs to narrow down the possible causes of the trouble. This step is the first diagnostics before using GX Works3.

The analog input module state can be checked with the POWER, RUN, ERROR, and ALM LEDs. The following table shows the correspondence between the LEDs and the analog input module state.

Name	Description
POWER LED	Indicates the power supply status. ON: Power ON OFF: Power off or module failure
RUN LED	Indicates the operating status. ON: Normal operation Flashing: Offset/gain setting mode OFF: Error
ERROR LED	Indicates the error status.*1 ON: Minor error Flashing: Moderate error or major error OFF: Normal operation
ALM LED	Indicates the alarm status.*2 ON: Process alarm or rate alarm issued Flashing: Input signal error OFF: Normal operation

*1 For details, refer to the following.

☞ Page 105 List of error codes

*2 For details, refer to the following.

☞ Page 108 List of alarm codes

Troubleshooting by symptom

When the POWER LED turns off

Check item	Corrective action
Check whether the power is supplied.	Check that power is supplied to the CPU and extension power supply modules.
Check whether the capacities of the CPU module extension power supply modules are enough.	Calculate the current consumption of the I/O modules, and intelligent function modules to check that the power supply capacity for the CPU module and extension power supply module is enough.
Check whether the module is mounted properly.	Check that the extension cable is inserted correctly.

When the RUN LED flashes or turns off

■When flashing

Check item	Cause	Corrective action
Check whether the module is in offset/gain setting mode.	In the GX Works3 module parameter setting, the CPU module was powered off→on or reset when the operation mode setting was the offset/gain setting mode.	In the GX Works3 module parameter setting, set the operation mode setting to normal and power off→on or reset the CPU module.
	The value in the mode switching setting has been changed and the mode has been switched to offset/gain setting mode.	Review the program that uses the mode switching setting to check whether the mode has been switched erroneously.

■When turns off

Check item	Corrective action
Check whether the power is supplied.	Check that power is supplied to the CPU and extension power supply modules.
Check whether the capacities of the CPU module extension power supply modules are enough.	Calculate the current consumption of the I/O modules, and intelligent function modules to check that the power supply capacity for the CPU module and extension power supply module is enough.
Check whether the module is mounted properly.	Check that the extension cable is inserted correctly.
Cases other than the above	Reset the CPU module, and check if the RUN LED turns on. If the RUN LED still remains off, the possible cause is a failure of the module. Please consult your local Mitsubishi representative.

When the ERROR LED flashes or turns on

■When flashing

Check item	Action
Check whether a moderate error has occurred.	Power off→on the module. If the error occurs again, the possible cause is a failure of the module. Please consult your local Mitsubishi representative.

■When turns on

Check item	Action
Check whether any error has occurred.	Check Latest error code and take actions described in the list of error codes. (☞ Page 105 List of error codes)

When the ALM LED turns on or flashes

■When turns on

Check item	Corrective action
Check whether any alert has been issued.	Check Alert output flag (Process alarm upper limit), Alert output flag (Process alarm lower limit), Alert output flag (Rate alarm upper limit), and Alert output flag (Rate alarm lower limit). Take actions described in the list of alarm codes.  Page 108 List of alarm codes

■When flashing

Check item	Corrective action
Check whether any input signal error has occurred.	Check Input signal error detection signal or Input signal error detection flag. Take actions described in the list of alarm codes.  Page 108 List of alarm codes

When a normal digital output value cannot be read

Check item	Corrective action
Check whether there is any problem with the wiring, such as looseness or disconnection of analog signal lines.	Identify the faulty area of signal lines by a visual inspection and continuity check.
Check whether the CPU module is in the STOP state.	Change the state of the CPU module to RUN.
Check whether the offset/gain setting in the user range setting is correct.	Check that the offset/gain setting is correct. If the user range setting is selected, change the input range to the factory default and check that the A/D conversion is performed. If the A/D conversion is correct, perform the offset/gain setting.
Check whether the input range setting is correct.	Check the CH□ Input range setting monitor with GX Works3. If the input range setting is incorrect, retry the input range setting.
Check whether A/D conversion disable is set in A/D conversion enable/disable setting of the channel where a value is to be input.	Check CH□ A/D conversion enable/disable setting and set it to A/D conversion enable using a sequence program or the GX Works3.
Check whether 'Operating condition setting request' (Un\G70, b9) has been executed.	Turn off→on→off* ¹ 'Operating condition setting request' (Un\G70, b9) and check that a digital output value is stored in 'CH1 Digital output value' (Un\G400) using GX Works3. If the stored value is correct, check the program.
Check whether the setting value of the time average is correct when the time average is selected in Averaging process specification.	When the time average is selected for processing, set the time average value in CH□ Time average/Count average/Moving average/Primary delay filter constant setting so that the value satisfies the following condition: Time averaging setting value ≥ 4 (times) \times Conversion speed \times Number of conversion enabled channels If the condition above is not satisfied, the digital output value results in 0.
Check whether there is any potential difference between the FG terminal and the external device ground.	A potential difference may occur between the FG terminal and the external device ground by a cause such as a long wiring distance, resulting in an incorrect A/D conversion. Connect the FG terminal and the external device ground to eliminate the potential difference.
Check whether external devices to be connected at each channel share the same ground.	If the external device ground is shared across channels, noise can sneak in between channels, which may cause some error in A/D conversion. Connect the FG terminal and the external device ground to eliminate the errors.
Check whether the program for reading digital output values has an error.	Check the CH□ Digital output values with GX Works3. If the digital output value is stored without being converted from the analog input value, review and correct the read program.
Check whether the refresh setting is correct.	If the refresh is set so that the value in CH□ Digital output value is transferred to the device of the CPU module, review and correct the auto refresh setting.
Check whether any input signal error has occurred.	The digital output value and digital operation value are not updated during the occurrence of an input signal error. If Input signal error detection flag indicates an input signal error, check the values in CH□ Input signal error detection setting and CH□ Input signal error detection setting value to examine the validity of the input signal error detection upper limit value and the input signal error detection lower limit value.  Page 51 Input signal error detection function If the values are valid, change the analog input value so that an input signal error does not occur.

*1 The A/D conversion does not start when 'Operating condition setting request' (Un\G70, b9) is on. After turning off→on, check that 'Operating condition setting completed flag' (Un\G69, b9) is off, and then make sure to turn on→off.

When the digital output value does not fall within the range of accuracy

Check item	Corrective action
Check whether any measures have been taken to reduce noise.	To reduce noise, take measures such as the use of shielded cables for connection.
Check whether no external input has occurred to the conversion disabled channel.	Do not input anything to the A/D conversion disabled channel from an external device.

Digital output value varies

Check item	Corrective action
Check whether an A/D conversion method other than sampling processing is set.	Check the setting of average processing specification from the "Module parameter setting" screen of GX Works3. Review the setting of average processing specification and check the state of variation of CH□ Digital output value again.

The A/D conversion completed flag does not turn on

Check item	Corrective action
Check whether all channels are set to be A/D conversion disabled.	Check the A/D conversion enable/disable setting with GX Works3. If there are only A/D conversion enabled channels, set the A/D conversion enable/disable setting to "A/D conversion enabled" for one or more channel the sequence program.

List of error codes

If an error occurs during operation, an analog input module stores the error code into 'Latest error code' (Un\G0) of the buffer memory. In addition, 'Error flag' (Un\G69, b15) turns on. Turning on 'Error clear request' (Un\G70, b15) clears the error code in 'Latest error code' (Un\G0) and turns off 'Error flag' (Un\G69, b15).

Error codes of an analog input module are classified in minor and moderate errors.

- Minor error: This error is caused by the setting failure of programs and parameters, and after eliminating the error cause, each function normally executes. (1000H to 1FFFH)
- Moderate error: Hardware failures. The A/D conversion do not continue. (3000H to 3FFFH)

The following table lists the error codes that may be stored.

□: This symbol indicates the number of the channel where an error has occurred. It represents one of numerical values 0 to 3, which correspond to CH1 to CH4.

(CH1: 0, CH2: 1, CH3: 2, CH4: 3)

△: For what this symbol indicates, refer to Description and cause of error.

Error code	Error name	Description and cause	Corrective action
0000H	—	There is no error.	—
1080H	Number of writes to offset/gain settings reach limit error	The number of the offset/gain settings has exceeded the guaranteed maximum number.	Any further setting of offset/gain values may not be reflected correctly.
180△H	Interrupt factor transaction setting range error	A value other than 0 to 1 is set in Interrupt factor transaction setting [n]. △ indicates the interrupt setting related in the error as below: 0: Setting 1 to F: Setting 16	Set 0 or 1 in Interrupt factor transaction setting [n].
181△H	Condition target setting range error	A value other than 0 to 7 is set in Condition target setting [n]. △ indicates the interrupt setting related in the error as below: 0: Setting 1 to F: Setting 16	Set a value of 0 to 7 in Condition target setting [n].
182△H	Condition target channel setting range error	A value other than 0 to 4 is set in Condition target channel setting [n]. △ indicates the interrupt setting related in the error as below: 0: Setting 1 to F: Setting 16	Set a value of 0 to 4 in Condition target channel setting [n].
1861H	Offset/gain setting continuous write occurrence error	The setting value has been continuously written to the flash memory 26 times or more in the offset/gain setting.	For the offset/gain setting, write the setting value only once per setting.
190□H	Range setting range error	A value out of the range is set in CH□ Range setting.	Set CH□ Range setting to the value within the range again.
191□H	Averaging process specification setting range error	A value other than 0 to 5 is set in CH□ Average processing specification.	Set a value of 0 to 5 in CH□ Average processing specification again.
192□H	Time average setting range error	When Time average is selected in CH□ Averaging process specification, a value other than 2 to 5000 is set in CH□ Time average/Count average/Moving average/Primary delay filter constant setting.	Set a value of 2 to 5000 in CH□ Time average/Count average/Moving average/Primary delay filter constant setting.
193□H	Count average setting range error	When the count average is selected in CH□ Averaging process specification, a value other than 4 to 62500 is set in CH□ Time average/Count average/Moving average/Primary delay filter constant setting.	Set a value of 4 to 62500 in CH□ Time average/Count average/Moving average/Primary delay filter constant setting.
194□H	Moving average setting range error	When the moving average is selected in CH□ Averaging process specification, a value other than 2 to 1000 is set in CH□ Time average/Count average/Moving average/Primary delay filter constant setting.	Set a value of 2 to 1000 in CH□ Time average/Count average/Moving average/Primary delay filter constant setting.
195□H	Primary delay filter constant setting range error	When Primary delay filter is selected in CH□ Averaging process specification, a value other than 1 to 500 is set in CH□ Time average/Count average/Moving average/Primary delay filter constant setting.	Set a value of 1 to 500 in CH□ Time average/Count average/Moving average/Primary delay filter constant setting.

Error code	Error name	Description and cause	Corrective action
19D□H	Digital filter setting range error	When the digital filter is set in CH□ Averaging processing specification, a value other than 1 to 1600 is set in CH□ Digital filter setting.	Set a value of 1 to 1600 in CH□ Digital filter setting.
19E□H	Digital filter fluctuation width setting range error	When the digital filter is set in CH□ Averaging processing specification, CH□ Digital filter fluctuation width setting is set to a value other than 80 to 200000 or a value below "Number of A/D conversion enabled channels × Conversion speed (μs)".	For the CH□ Digital filter fluctuation width setting, set a value of 80 to 200000 that equals to or larger than "Number of A/D conversion enabled channels × Conversion speed (μs)"
1A0□H	Scaling enable/disable setting range error	A value other than 0 and 1 is set in CH□ Scaling enable/disable setting.	Set 0 or 1 in CH□ Scaling enable/disable setting.
1A2□H	Scaling upper/lower limit value setting error	CH□ Scaling upper limit value and CH□ Scaling lower limit value are set as the scaling upper limit value = the scaling lower limit value.	Set CH□ Scaling upper limit value and CH□ Scaling lower limit value as the scaling upper limit value ≠ the scaling lower limit value.
1A5□H	Digital clipping enable/disable setting range error	A value other than 0 and 1 is set in CH□ Digital clipping enable/disable setting.	Set CH□ Digital clipping enable/disable setting to 0 or 1.
1B0□H	Alert output setting (Process alarm) range error	A value other than 0 and 1 is set in CH□ Alert output setting (Process alarm).	Set 0 or 1 in CH□ Alert output setting (Process alarm).
1B△□H	Process alarm upper lower limit value setting range error	The values not satisfying the following condition are set in CH□ Process alarm upper upper limit value to CH□ Process alarm lower lower limit value: Upper upper limit value ≥ Upper lower limit value ≥ Lower upper limit value ≥ Lower lower limit value △ indicates that the set values are as follows: 1: Process alarm lower lower limit value > Process alarm lower upper limit value 2: Process alarm lower upper limit value > Process alarm upper lower limit value 3: Process alarm upper lower limit value > Process alarm upper upper limit value	Set CH□ Process alarm upper upper limit value to CH□ Process alarm lower lower limit value so that the values satisfy the following condition: Upper upper limit value ≥ Upper lower limit value ≥ Lower upper limit value ≥ Lower lower limit value
1B8□H	Alert output setting (Rate alarm) range error	A value other than 0 and 1 is set in CH□ Alert output setting (Rate alarm).	Set 0 or 1 in CH□ Alert output setting (Rate alarm).
1B9□H	Rate alarm alert detection cycle setting range error	A value other than 1 to 32000 is set in CH□ Rate alarm alert detection cycle setting.	Set a value of 1 to 32000 in CH□ Rate alarm alert detection cycle setting.
1BA□H	Rate alarm upper/lower limit setting value inversion error	CH□ Rate alarm upper limit value and CH□ Rate alarm lower limit value are set as Lower limit value ≥ Upper limit value.	Set CH□ Rate alarm upper limit value and CH□ Rate alarm lower limit value as Lower limit value < Upper limit value again.
1C0□H	Input signal error detection setting range error	A value other than 0 to 4 is set in CH□ Input signal error detection setting.	Set CH□ Input signal error detection setting value to 0 to 4.
1C1□H	Input signal error detection setting value range error	A value other than 0 to 250 is set in CH□ Input signal error detection setting.	Set CH□ Input signal error detection setting value to 0 to 250.
1C6□H	Disconnection detection enabled range setting range error	CH□ Input signal error detection setting is set in Simple disconnection detection, and the Input range is set in other than the following: • 4 to 20 mA • 1 to 5 V	For channels for simple disconnection detection using the input signal error detection function, set Input range setting to either of the following again. • 4 to 20 mA • 1 to 5 V
1D0□H	Logging enable/disable setting range error	A value other than 0 and 1 is set in CH□ Logging enable/disable setting.	Set 0 or 1 in CH□ Logging enable/disable setting.
1D1□H	Logging cycle setting value range error	A value out of the range is set in CH□ Logging cycle setting value and/or CH□ Logging cycle unit setting.	Set the value(s) within the range in one or both of CH□ Logging cycle setting value and CH□ Logging cycle unit setting.
1D2□H	Logging cycle setting disable error	CH□ Logging cycle setting value and CH□ Logging cycle unit setting are set so that the set logging cycle falls below the conversion cycle.	Set CH□ Logging cycle setting value and CH□ Logging cycle unit setting so that the logging cycle is the conversion cycle of the object to be logged or more.
1D3□H	Logging data setting range error	A value other than 0 and 1 is set in CH□ Logging data setting.	Set 0 or 1 in CH□ Logging data setting.
1D4□H	Post-trigger logging points setting range error	A value other than 1 to 10000 is set in CH□ Post-trigger logging points.	Set a value of 1 to 10000 in CH□ Post-trigger logging points.
1D5□H	Level trigger condition setting range error	A value other than 0 to 3 is set in CH□ Level trigger condition setting.	Set a value of 0 to 3 in CH□ Level trigger condition setting.

Error code	Error name	Description and cause	Corrective action
1D6□H	Trigger data setting range error	A value other than 0 to 9999 is set in CH□ Trigger data.	Set a value of 0 to 9999 in CH□ Trigger data.
1D8□H	Logging loading enable/disable setting range error	A value other than 0 and 1 is set in CH□ Logging loading enable/disable setting.	Set CH□ Logging loading enable/disable setting to 0 or 1.
1D9□H	Logging load points setting value range error	A value other than 10 to 10000 is set in CH□ Logging load points setting value.	Set CH□ Logging load points setting value from the range between 10 to 10000.
1E50H	Offset/gain setting channel specification error	In the offset/gain setting, "1: Setting channel" is set for both CH□ Offset/gain setting mode (offset specification) and CH□ Offset/gain setting mode (gain specification), or "0: Disable" is set.	Correctly set CH□ Offset/gain setting mode (offset specification) and CH□ Offset/gain setting mode (gain specification).
1E51H	User range data invalid (CH identification disabled)	An invalid value is set in the offset/gain setting. The number of the channel in which this error occurs cannot be identified.	Perform the offset/gain setting again for all channels where the user range is set. If the error occurs again, the possible cause is a failure of the module. Please consult your local Mitsubishi representative.
1E6□H	User range data invalid (CH identification enabled, the range setting of the CH where the error occurred is User range)	An invalid value is set in CH□ Offset/gain setting.	Perform the offset/gain setting again for the channels where the error has occurred. If the error occurs again, the possible cause is a failure of the module. Please consult your local Mitsubishi representative.
1E7□H	Offset/gain value inversion error	The offset value and gain value to be saved in the flash memory are as follows: Offset value ≥ Gain value	Perform the offset/gain setting again so that the following condition is satisfied: Offset value < Gain value
1E8□H	Offset/gain setting channel range error	A value other than 0 and 1 is set in CH□ Offset/gain setting mode (offset specification) and CH□ Offset/gain setting mode (gain specification).	Set CH□ Offset/gain setting mode (offset specification) and CH□ Offset/gain setting mode (gain specification) to 0 or 1.
1F00H	Hardware failure (minor)	A hardware failure (minor) has occurred in the module.	The module may be affected by noise. Review and adjust the cable wiring and the installation environment of the programmable controllers. After the adjustment, turn off→on→off Error clear request (Un\G70, b15) to eliminate this error and resume the conversion. If the error occurs again, the possible cause is a failure of the module. Please consult your local Mitsubishi representative.
1F08H	Module power supply error	The 24 V DC power supply is not normally supplied to the analog input module.	Check whether the configuration is designed to exceed the 24 V DC power capacity of the CPU or extension power supply module. If the error occurs again even after the check, the possible cause is a failure of the module. Please consult your local Mitsubishi representative.
3001H	Hardware failure (moderate)	A hardware failure (moderate) has occurred in the analog input module.	Power off→on the module. If the error occurs again, the possible cause is a failure of the module. Please consult your local Mitsubishi representative.
3030H	Flash memory error	The data in the flash memory is abnormal.	Check the digital output values. If the values are abnormal, please consult your local Mitsubishi representative.

List of alarm codes

If an alarm occurs during operation, the analog input module stores the alarm code into 'Latest alarm code' (Un\G2) of the buffer memory. Turning on Error clear request (Un\G70, b15) clears the alarm code in 'Latest alarm code' (Un\G2).

The following table lists the alarm codes that may be stored.

□: This symbol indicates the number of the channel where an alarm has occurred. It represents one of numerical values 0 to 3, which correspond to CH1 to CH4.

(CH1: 0, CH2: 1, CH3: 2, CH4: 3)

Alarm code	Alarm name	Description and cause	Corrective action
080□H	Process alarm (upper limit)	The process alarm (upper limit) has occurred in CH□.	Adjust CH□ Digital operation value to fall within the range. As a result, the corresponding bit of Warning output flag (Process alarm upper limit) and/or Warning output flag (Process alarm lower limit), and Alarm output signal (Un\G69, b8) turn off automatically.
081□H	Process alarm (lower limit)	The process alarm (lower limit) has occurred in CH□.	
082□H	Rate alarm (upper limit)	The rate alarm (upper limit) has occurred in CH□.	Adjust the change rate in CH□ Digital output value to fall within the range. As a result, the corresponding bit of Warning output flag (Rate alarm upper limit) or Warning output flag (Rate alarm lower limit), and Alarm output signal (Un\G69, b8) turn off automatically.
083□H	Rate alarm (lower limit)	The rate alarm (lower limit) has occurred in CH□.	
090□H	Input signal error detection (upper limit)	An input signal error (upper limit) has been detected in CH□.	Adjust the analog input value to fall within the range, and then turn off→on→off Error clear request (Un\G70, b15). As a result, the corresponding bit of Input signal error detection flag and Input signal error detection signal turn off.
091□H	Input signal error detection (lower limit)	An input signal error (lower limit) has been detected in CH□.	
092□H	Input signal error detection (simple disconnection)	An input signal error (simple disconnection) has been detected in CH□.	

APPENDIX

Appendix 1 External Dimensions

This chapter describes the external dimensions of the analog input module.

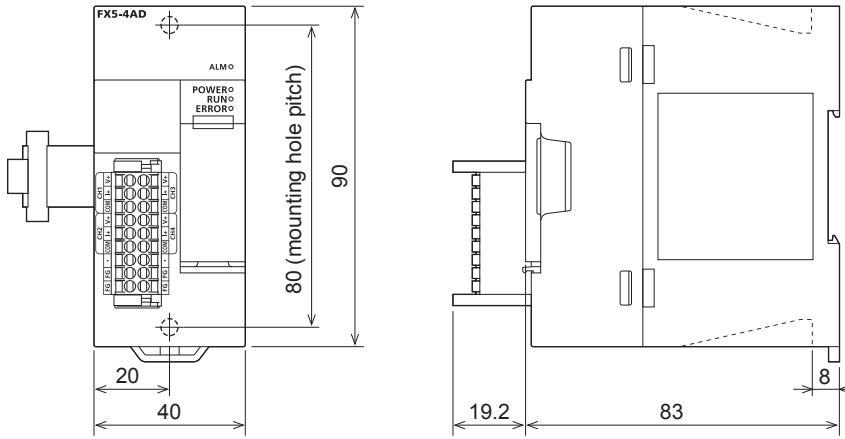

(Unit: mm)

Appendix 2 Standards

Certification of UL, cUL standards

The FX5-4AD supports UL (UL, cUL) standards.

UL, cUL file number: E95239

For models that support UL standards, please consult your local Mitsubishi representative.

Compliance with EC directive (CE marking)

This note does not guarantee that an entire machine produced in accordance with the contents of this note will comply with the following standards.

Compliance to EMC directive and LVD directive of the entire mechanical module should be checked by the user/manufacturer. For more details please contact to the local Mitsubishi Electric sales site.

Requirement for compliance with EMC directive

The following products have shown compliance through direct testing (of the identified standards below) and design analysis (through the creation of a technical construction file) to the European Directive for Electromagnetic Compatibility (2014/30/EU) when used as directed by the appropriate documentation.

Attention

This product is designed for use in industrial applications.

Product compatibility

Type: Programmable controller (open type equipment)

Models: FX5 manufactured

Electromagnetic compatibility (EMC) directive	Remarks
EN61131-2:2007 Programmable controllers - Equipment requirements and tests	Compliance with all relevant aspects of the standard. EMI • Radiated emission • Conducted emission EMS • Radiated electromagnetic field • Fast transient burst • Electrostatic discharge • High-energy surge • Voltage drops and interruptions • Conducted RF • Power frequency magnetic field

Caution for compliance with EC directive

Caution for when the FX5-4AD is used

When the FX5-4AD is used, attach a ferrite core to the power supply of the CPU module.

Make 2 turns around the ferrite core and attach within approximately 200 mm from the terminal block and connectors of the power cable. Also, attach a ferrite core to the input/output cable pulled out to the outside of the control panel. Attach the ferrite core before the cable is pulled out to the outside of the control panel. (Ferrite core used in Mitsubishi Electric's test: E04SR401938 manufactured by SEIWA ELECTRIC MFG. CO., LTD.)

If accuracy in measuring and control is required when using in an environment exposed to electrical stress, such as an EMS test, implementing the following details is recommended.

For users of proprietary cables (dedicated for sensors or actuators), these users should follow those manufacturers' installation requirements.

Mitsubishi Electric recommends that shielded cables be used. If no other EMC protection is provided, users may experience temporary loss of accuracy between +10%/-10% in very heavy industrial areas.

However, Mitsubishi Electric suggests that if adequate EMC precautions are followed with general good EMC practice for the user's complete control system, users should expect normal errors as specified in this manual.

- Sensitive analog cables should not be laid in the same trunking or cable conduit as high voltage cabling. Where possible, users should run analog cables separately.
 - Good cable shielding should be used. When terminating the shield at Earth - ensure that both sides of the cable must be grounded.
 - When reading analog values, EMC induced errors can be smoothed out by averaging the readings. This can be achieved either through functions on the analog devices or through a user's program.
-

Compliance with UKCA marking

The requirements for compliance with UKCA marking are the same as that with EC directive (CE marking).

Appendix 3 Module Label

The functions of the analog input module can be set by using module labels.

Module label

The module label name is defined with the following structure:

"Module name"_"Module number".b"Label name"_D

Ex.

FX5_4AD_1.bModuleREADY_D

■Module name

The character string of a module model name is given.

■Module number

A number starting from 1 is added to identify modules that have the same module name.

■Label name

The label identifier unique to a module is given.

■_D

This string indicates that the module label is for the direct access.

Module labels of buffer memory areas

The module label name of a buffer memory area is defined with the following structure:

"Module name"_"Module number"."Data type"_D["(Channel)"]."Data format" "Label name"_D

Ex.

FX5_4AD_1.stnMonitor_D[0].wDigitalOutputValue_D

■Module name

The character string of a module model name is given.

■Module number

A number starting from 1 is added to identify modules that have the same module name.

■Data type

The data type to sort a buffer memory area is given. Each data type is as follows:

Data type	Description
stnMonitor	Monitor
stnControl	Control
stnSetting	Setting

■Channel

The channel number corresponding to a module label is given. A numerical value of 0 to 3 is used to correspond to CH1 to 4. (CH1: 0, CH2: 1, CH3: 2, CH4: 3)

■Data format

The string that represents the data size of a buffer memory area is given. Each data type is as follows:

Data format	Description
b	Bit
u	Word [Unsigned]/Bit string [16-bit]
w	Word [Signed]

■Label name

The label identifier unique to a module is given.

■_D

This string indicates that the module label is for the direct access. Values that are read from or written to the module label is reflected in the module instantly.

Appendix 4 Buffer Memory Areas

List of buffer memory areas

This section contains the list of buffer memory addresses of the analog input module. For details on the buffer memory, refer to the following.

 Page 125 Details of buffer memory addresses

The buffer memory areas of the analog input module are classified into the data types described below.

Data type	Description	
Setting data	Description	The data to be customized to suit the connected devices and the purpose of the system.
	Read and write attributes	Read and write is possible.
	Setting procedure	Use GX Works3 or a program to set the data.
	Setting timing	After a change of value, turning off→on→off 'Operating condition setting request' (Un\G70, b9) allows the setting value to take effect.
Control data	Description	The data used for controlling the analog input module.
	Read and write attributes	Read and write is possible.
	Setting procedure	Use GX Works3 or a program to set the data.
	Setting timing	As soon as the values are changed, the set values become effective.
Monitor data	Description	The data used for checking the status of the analog input module.
	Read and write attributes	Only read is possible and write is not possible.
	Setting procedure	—
	Setting timing	—

Point

Do not write data to the system areas and areas whose data types are monitor in the buffer memory. Writing data into these areas can cause the malfunction of the module.

A

In the normal mode

○: With refresh setting, ×: Without refresh setting

■Un\G0 to Un\G399

Address (decimal)	Address (hexadecimal)	Name	Default value	Data type	Auto refresh
0	0H	Latest error code	0	Monitor	○
1	1H	Latest address of error history	0	Monitor	○
2	2H	Latest alarm code	0	Monitor	○
3	3H	Latest address of alarm history	0	Monitor	○
4 to 19	4H to 13H	Interrupt factor detection flag [n] ¹	0	Monitor	○
20 to 29	14H to 1DH	System area	—	—	—
30	1EH	Module Information	6140H	Monitor	×
31	1FH	Firmware version	*2	Monitor	×
32 to 35	20H to 23H	System area	—	—	—
36	24H	Warning output flag (Process alarm upper limit)	0000H	Monitor	○
37	25H	Warning output flag (Process alarm lower limit)	0000H	Monitor	○
38	26H	Warning output flag (Rate alarm upper limit)	0000H	Monitor	○
39	27H	Warning output flag (Rate alarm lower limit)	0000H	Monitor	○
40	28H	Input signal error detection flag	0000H	Monitor	○
41	29H	System area	0000H	—	—
42	2AH	A/D conversion completed flag	0000H	Monitor	○
43 to 59	2BH to 3BH	System area	—	—	—
60	3CH	Operation mode monitor	0	Monitor	×

Address (decimal)	Address (hexadecimal)	Name	Default value	Data type	Auto refresh
61 to 68	3DH to 44H	System area	—	—	—
69	45H	Input signals	0	Monitor	×
70	46H	Output signals	0	Control	×
71 to 89	47H to 59H	System area	—	—	—
90	5AH	Level data 0	0	Control	○
91	5BH	Level data 1	0	Control	○
92	5CH	Level data 2	0	Control	○
93	5DH	Level data 3	0	Control	○
94	5EH	Level data 4	0	Control	○
95	5FH	Level data 5	0	Control	○
96	60H	Level data 6	0	Control	○
97	61H	Level data 7	0	Control	○
98	62H	Level data 8	0	Control	○
99	63H	Level data 9	0	Control	○
100 to 123	64H to 7BH	System area	—	—	—
124 to 139	7CH to 8BH	Interrupt factor mask [n] ^{*1}	0	Control	×
140 to 155	8CH to 9BH	System area	—	—	—
156 to 171	9CH to ABH	Interrupt factor reset request [n] ^{*1}	0	Control	×
172 to 199	ACH to C7H	System area	—	—	—
200 to 215	C8H to D7H	Interrupt factor transaction setting [n] ^{*1}	0	Setting	×
216 to 231	D8H to E7H	System area	—	—	—
232 to 247	E8H to F7H	Condition target setting [n] ^{*1}	0	Setting	×
248 to 263	F8H to 107H	System area	—	—	—
264 to 279	108H to 117H	Condition target channel setting [n] ^{*1}	0	Setting	×
280 to 295	118H to 127H	System area	—	—	—
296, 297	128H, 129H	Mode switching setting	0	Setting	×
298	12AH	System area	—	—	—
299	12BH	Rate alarm change rate selection	1	Setting	×
300 to 303	12CH to 12FH	System area	—	—	—
304	130H	Input signal error detect automatic clear enable/disable setting	1	Setting	×
305	131H	Offset/gain initialization enable code	0	Setting	×
306 to 399	132H to 18FH	System area	—	—	—

*1 [n] in the table indicates an interrupt setting number. (n = 1 to 16)

*2 The firmware version of the analog input module is stored. For Ver. 1.000, 1000 is stored.

■Un\G400 to Un\G3599

Address: decimal (hexadecimal)				Name	Default value	Data type	Auto refresh
CH1	CH2	CH3	CH4				
400 (190H)	600 (258H)	800 (320H)	1000 (3E8H)	CH□ Digital output value	*1	Monitor	○
401 (191H)	601 (259H)	801 (321H)	1001 (3E9H)	System area	—	—	—
402 (192H)	602 (25AH)	802 (322H)	1002 (3EAH)	CH□ Digital operation value	*1	Monitor	○
403 (193H)	603 (25BH)	803 (323H)	1003 (3EBH)	System area	—	—	—
404 (194H)	604 (25CH)	804 (324H)	1004 (3ECH)	CH□ Maximum value	0	Monitor	○
405 (195H)	605 (25DH)	805 (325H)	1005 (3EDH)	System area	—	—	—
406 (196H)	606 (25EH)	806 (326H)	1006 (3EEH)	CH□ Minimum value	0	Monitor	○
407 (197H)	607 (25FH)	807 (327H)	1007 (3EFH)	System area	—	—	—
408 (198H)	608 (260H)	808 (328H)	1008 (3F0H)	CH□ Difference conversion state flag	0	Monitor	○
409 (199H)	609 (261H)	809 (329H)	1009 (3F1H)	CH□ Logging hold flag	0	Monitor	○
410 (19AH)	610 (262H)	810 (32AH)	1010 (3F2H)	System area	—	—	—
411 (19BH)	611 (263H)	811 (32BH)	1011 (3F3H)	CH□ Digital filter conversion cycle monitor	0	Monitor	×

Address: decimal (hexadecimal)				Name	Default value	Data type	Auto refresh
CH1	CH2	CH3	CH4				
412 to 419 (19CH to 1A3H)	612 to 619 (264H to 26BH)	812 to 819 (32CH to 333H)	1012 to 1019 (3F4H to 3FBH)	System area	—	—	—
420 (1A4H)	620 (26CH)	820 (334H)	1020 (3FCH)	CH□ A/D conversion status	0	Monitor	×
421 (1A5H)	621 (26DH)	821 (335H)	1021 (3FDH)	System area	—	—	—
422 (1A6H)	622 (26EH)	822 (336H)	1022 (3FEH)	CH□ Maximum value reset completed flag	0	Monitor	○
423 (1A7H)	623 (26FH)	823 (337H)	1023 (3FFH)	CH□ Minimum value reset completed flag	0	Monitor	○
424 to 429 (1A8H to 1ADH)	624 to 629 (270H to 275H)	824 to 829 (338H to 33DH)	1024 to 1029 (400H to 405H)	System area	—	—	—
430 (1AEH)	630 (276H)	830 (33EH)	1030 (406H)	CH□ Range setting monitor	0003H	Monitor	×
431 (1AFH)	631 (277H)	831 (33FH)	1031 (407H)	System area	—	—	—
432 (1B0H)	632 (278H)	832 (340H)	1032 (408H)	CH□ Difference conversion standard value	0	Monitor	×
433 (1B1H)	633 (279H)	833 (341H)	1033 (409H)	System area	—	—	—
434 (1B2H)	634 (27AH)	834 (342H)	1034 (40AH)	CH□ Head pointer	0	Monitor	×
435 (1B3H)	635 (27BH)	835 (343H)	1035 (40BH)	CH□ Latest pointer	0	Monitor	×
436 (1B4H)	636 (27CH)	836 (344H)	1036 (40CH)	CH□ Number of logging data	0	Monitor	×
437 (1B5H)	637 (27DH)	837 (345H)	1037 (40DH)	CH□ Trigger pointer	0	Monitor	×
438 (1B6H)	638 (27EH)	838 (346H)	1038 (40EH)	CH□ Current logging read pointer	-1	Monitor	×
439 (1B7H)	639 (27FH)	839 (347H)	1039 (40FH)	CH□ Previous logging read pointer	-1	Monitor	×
440 (1B8H)	640 (280H)	840 (348H)	1040 (410H)	CH□ Logging read points monitor value	0	Monitor	×
441 (1B9H)	641 (281H)	841 (349H)	1041 (411H)	CH□ Logging cycle monitor value (s)	0	Monitor	×
442 (1BAH)	642 (282H)	842 (34AH)	1042 (412H)	CH□ Logging cycle monitor value (ms)	0	Monitor	×
443 (1BBH)	643 (283H)	843 (34BH)	1043 (413H)	CH□ Logging cycle monitor value (μs)	0	Monitor	×
444 (1BCH)	644 (284H)	844 (34CH)	1044 (414H)	CH□ Trigger generation time (First/Last two digits of the year)	0	Monitor	×
445 (1BDH)	645 (285H)	845 (34DH)	1045 (415H)	CH□ Trigger generation time (Month/Day)	0	Monitor	×
446 (1BEH)	646 (286H)	846 (34EH)	1046 (416H)	CH□ Trigger generation time (Hour/Minute)	0	Monitor	×
447 (1BFH)	647 (287H)	847 (34FH)	1047 (417H)	CH□ Trigger generation time (Second/Day of the week)	0	Monitor	×
448 (1C0H)	648 (288H)	848 (350H)	1048 (418H)	CH□ Trigger generation time (Millisecond)	0	Monitor	×
449 to 469 (1C1H to 1D5H)	649 to 669 (289H to 29DH)	849 to 869 (351H to 365H)	1049 to 1069 (419H to 42DH)	System area	—	—	—
470 (1D6H)	670 (29EH)	870 (366H)	1070 (42EH)	CH□ Difference conversion trigger	0	Control	○
471 (1D7H)	671 (29FH)	871 (367H)	1071 (42FH)	CH□ Logging hold request	0	Control	○
472 (1D8H)	672 (2A0H)	872 (368H)	1072 (430H)	CH□ Conversion value shift amount	0	Control	○
473 (1D9H)	673 (2A1H)	873 (369H)	1073 (431H)	CH□ Maximum value reset request	0	Control	○
474 (1DAH)	674 (2A2H)	874 (36AH)	1074 (432H)	CH□ Minimum value reset request	0	Control	○
475 to 499 (1DBH to 1F3H)	675 to 699 (2A3H to 2BBH)	875 to 899 (36BH to 383H)	1075 to 1099 (433H to 44BH)	System area	—	—	—
500 (1F4H)	700 (2BCH)	900 (384H)	1100 (44CH)	CH□ A/D conversion enable/disable setting	0	Setting	×
501 (1F5H)	701 (2BDH)	901 (385H)	1101 (44DH)	CH□ Averaging process specification	0	Setting	×
502 (1F6H)	702 (2BEH)	902 (386H)	1102 (44EH)	CH□ Time average/Count average/Moving average/Primary delay filter constant setting	0	Setting	×
503 (1F7H)	703 (2BFH)	903 (387H)	1103 (44FH)	System area	—	—	—
504 (1F8H)	704 (2C0H)	904 (388H)	1104 (450H)	CH□ Scaling enable/disable setting	1	Setting	×



Address: decimal (hexadecimal)				Name	Default value	Data type	Auto refresh
CH1	CH2	CH3	CH4				
505 (1F9H)	705 (2C1H)	905 (389H)	1105 (451H)	System area	—	—	—
506 (1FAH)	706 (2C2H)	906 (38AH)	1106 (452H)	CH□ Scaling upper limit value (L)	0	Setting	×
507 (1FBH)	707 (2C3H)	907 (38BH)	1107 (453H)	CH□ Scaling upper limit value (H)			
508 (1FCH)	708 (2C4H)	908 (38CH)	1108 (454H)	CH□ Scaling lower limit value (L)	0	Setting	×
509 (1FDH)	709 (2C5H)	909 (38DH)	1109 (455H)	CH□ Scaling lower limit value (H)			
510 (1FEH)	710 (2C6H)	910 (38EH)	1110 (456H)	CH□ Digital clipping enable/disable setting	1	Setting	×
511 (1FFH)	711 (2C7H)	911 (38FH)	1111 (457H)	System area	—	—	—
512 (200H)	712 (2C8H)	912 (390H)	1112 (458H)	CH□ Alert output setting (Process alarm)	1	Setting	×
513 (201H)	713 (2C9H)	913 (391H)	1113 (459H)	CH□ Alert output setting (Rate alarm)	1	Setting	×
514 (202H)	714 (2CAH)	914 (392H)	1114 (45AH)	CH□ Process alarm upper upper limit value	0	Setting	×
515 (203H)	715 (2CBH)	915 (393H)	1115 (45BH)	System area	—	—	—
516 (204H)	716 (2CCH)	916 (394H)	1116 (45CH)	CH□ Process alarm upper lower limit value	0	Setting	×
517 (205H)	717 (2CDH)	917 (395H)	1117 (45DH)	System area	—	—	—
518 (206H)	718 (2CEH)	918 (396H)	1118 (45EH)	CH□ Process alarm lower upper limit value	0	Setting	×
519 (207H)	719 (2CFH)	919 (397H)	1119 (45FH)	System area	—	—	—
520 (208H)	720 (2D0H)	920 (398H)	1120 (460H)	CH□ Process alarm lower lower limit value	0	Setting	×
521 (209H)	721 (2D1H)	921 (399H)	1121 (461H)	System area	—	—	—
522 (20AH)	722 (2D2H)	922 (39AH)	1122 (462H)	CH□ Rate alarm alert detection cycle setting	0	Setting	×
523 (20BH)	723 (2D3H)	923 (39BH)	1123 (463H)	System area	—	—	—
524 (20CH)	724 (2D4H)	924 (39CH)	1124 (464H)	CH□ Rate alarm upper limit value	0	Setting	×
525 (20DH)	725 (2D5H)	925 (39DH)	1125 (465H)	System area	—	—	—
526 (20EH)	726 (2D6H)	926 (39EH)	1126 (466H)	CH□ Rate alarm lower limit value	0	Setting	×
527 (20FH)	727 (2D7H)	927 (39FH)	1127 (467H)	System area	—	—	—
528 (210H)	728 (2D8H)	928 (3A0H)	1128 (468H)	CH□ Input signal error detection setting	0	Setting	×
529 (211H)	729 (2D9H)	929 (3A1H)	1129 (469H)	CH□ Input signal error detection lower limit setting value	50	Setting	×
530 (212H)	730 (2DAH)	930 (3A2H)	1130 (46AH)	CH□ Input signal error detection upper limit setting value	50	Setting	×
531 to 534 (213H to 216H)	731 to 734 (2DBH to 2DEH)	931 to 934 (3A3H to 3A6H)	1131 to 1134 (46BH to 46EH)	System area	—	—	—
535 (217H)	735 (2DFH)	935 (3A7H)	1135 (46FH)	CH□ Logging enable/disable setting	1	Setting	×
536 (218H)	736 (2E0H)	936 (3A8H)	1136 (470H)	CH□ Logging data setting	1	Setting	×
537 (219H)	737 (2E1H)	937 (3A9H)	1137 (471H)	CH□ Logging cycle setting value	4	Setting	×
538 (21AH)	738 (2E2H)	938 (3AAH)	1138 (472H)	CH□ Logging cycle unit setting	1	Setting	×
539 (21BH)	739 (2E3H)	939 (3ABH)	1139 (473H)	CH□ Post-trigger logging points	5000	Setting	×
540 (21CH)	740 (2E4H)	940 (3ACH)	1140 (474H)	CH□ Level trigger condition setting	0	Setting	×
541 (21DH)	741 (2E5H)	941 (3ADH)	1141 (475H)	CH□ Trigger data	*2	Setting	×
542 (21EH)	742 (2E6H)	942 (3AEH)	1142 (476H)	CH□ Trigger setting value	0	Setting	×
543 (21FH)	743 (2E7H)	943 (3AFH)	1143 (477H)	System area	—	—	—
544 (220H)	744 (2E8H)	944 (3B0H)	1144 (478H)	CH□ Logging loading enable/disable setting	1	Setting	×
545 (221H)	745 (2E9H)	945 (3B1H)	1145 (479H)	CH□ Logging load points setting value	1000	Setting	×
546 to 569 (222H to 239H)	746 to 769 (2EAH to 301H)	946 to 969 (3B2H to 3C9H)	1146 to 1169 (47AH to 491H)	System area	—	—	—
570 (23AH)	770 (302H)	970 (3CAH)	1170 (492H)	CH□ Digital filter setting	0	Setting	×
571 (23BH)	771 (303H)	971 (3CBH)	1171 (493H)	System area	—	—	—

Address: decimal (hexadecimal)				Name	Default value	Data type	Auto refresh
CH1	CH2	CH3	CH4				
572 (23CH)	772 (304H)	972 (3CCH)	1172 (494H)	CH□ Digital filter fluctuation width setting (L)	0	Setting	×
573 (23DH)	773 (305H)	973 (3CDH)	1173 (495H)	CH□ Digital filter fluctuation width setting (H)			
574 to 597 (23EH to 255H)	774 to 797 (306H to 31DH)	974 to 997 (3CEH to 3E5H)	1174 to 1197 (496H to 4ADH)	System area	—	—	—
598 (256H)	798 (31EH)	998 (3E6H)	1198 (4AEH)	CH□ Range setting	0003H	Setting	×
599 (257H)	799 (31FH)	999 (3E7H)	1199 (4AFH)	System area	—	—	—
1200 to 3599 (4B0H to E0FH)				System area	—	—	—

*1 The following shows the default values.
Converted value when range setting is "4 to 20 mA"

*2 The following shows the default values.
CH1:402, CH2:602, CH3:802, CH4:1020

■Error history (Un\G3600 to Un\G3759)

Address (decimal)	Address (hexadecimal)	Name				Default value	Data type	Auto refresh	
3600	E10H	Error history 1	Error code			0	Monitor	×	
3601	E11H		Error time	First two digits of the year	Last two digits of the year				
3602	E12H			Month	Day				
3603	E13H			Hour	Minute				
3604	E14H			Second	Day of the week				
3605	E15H			Millisecond					
3606 to 3609	E16H to E19H			System area					—
3610 to 3615	E1AH to E1FH	Error history 2	Same as error history 1			0	Monitor	×	
3616 to 3619	E20H to E23H	System area				—	—	—	
3620 to 3625	E24H to E29H	Error history 3	Same as error history 1			0	Monitor	×	
3626 to 3629	E2AH to E2DH	System area				—	—	—	
3630 to 3635	E2EH to E33H	Error history 4	Same as error history 1			0	Monitor	×	
3636 to 3639	E34H to E37H	System area				—	—	—	
3640 to 3645	E38H to E3DH	Error history 5	Same as error history 1			0	Monitor	×	
3646 to 3649	E3EH to E41H	System area				—	—	—	
3650 to 3655	E42H to E47H	Error history 6	Same as error history 1			0	Monitor	×	
3656 to 3659	E48H to E4BH	System area				—	—	—	
3660 to 3665	E4CH to E51H	Error history 7	Same as error history 1			0	Monitor	×	
3666 to 3669	E52H to E55H	System area				—	—	—	
3670 to 3675	E56H to E5BH	Error history 8	Same as error history 1			0	Monitor	×	
3676 to 3679	E5CH to E5FH	System area				—	—	—	
3680 to 3685	E60H to E65H	Error history 9	Same as error history 1			0	Monitor	×	
3686 to 3689	E66H to E69H	System area				—	—	—	
3690 to 3695	E6AH to E6FH	Error history 10	Same as error history 1			0	Monitor	×	
3696 to 3699	E70H to E73H	System area				—	—	—	
3700 to 3705	E74H to E79H	Error history 11	Same as error history 1			0	Monitor	×	
3706 to 3709	E7AH to E7DH	System area				—	—	—	
3710 to 3715	E7EH to E83H	Error history 12	Same as error history 1			0	Monitor	×	
3716 to 3719	E84H to E87H	System area				—	—	—	
3720 to 3725	E88H to E8DH	Error history 13	Same as error history 1			0	Monitor	×	
3726 to 3729	E8EH to E91H	System area				—	—	—	
3730 to 3735	E92H to E97H	Error history 14	Same as error history 1			0	Monitor	×	
3736 to 3739	E98H to E9BH	System area				—	—	—	
3740 to 3745	E9CH to EA1H	Error history 15	Same as error history 1			0	Monitor	×	
3746 to 3749	EA2H to EA5H	System area				—	—	—	
3750 to 3755	EA6H to EABH	Error history 16	Same as error history 1			0	Monitor	×	



Address (decimal)	Address (hexadecimal)	Name	Default value	Data type	Auto refresh
3756 to 3759	EACH to EAFH	System area	—	—	—

■ Alarm history (Un\G3760 to Un\G3999)

Address (decimal)	Address (hexadecimal)	Name	Default value	Data type	Auto refresh			
3760	EB0H	Alarm history 1	0	Monitor	×			
3761	EB1H					Alarm time	First two digits of the year	Last two digits of the year
3762	EB2H						Month	Day
3763	EB3H					Hour	Minute	
3764	EB4H					Second	Day of the week	
3765	EB5H					Millisecond		
3766 to 3769	EB6H to EB9H					System area	—	—
3770 to 3775	EBAH to EBFH	Alarm history 2	Same as alarm history 1	0	Monitor	×		
3776 to 3779	EC0H to EC3H	System area	—	—	—			
3780 to 3785	EC4H to EC9H	Alarm history 3	Same as alarm history 1	0	Monitor	×		
3786 to 3789	ECAH to ECDH	System area	—	—	—			
3790 to 3795	ECEH to ED3H	Alarm history 4	Same as alarm history 1	0	Monitor	×		
3796 to 3799	ED4H to ED7H	System area	—	—	—			
3800 to 3805	ED8H to EDDH	Alarm history 5	Same as alarm history 1	0	Monitor	×		
3806 to 3809	EDEH to EE1H	System area	—	—	—			
3810 to 3815	EE2H to EE7H	Alarm history 6	Same as alarm history 1	0	Monitor	×		
3816 to 3819	EE8H to EEBH	System area	—	—	—			
3820 to 3825	EECH to EF1H	Alarm history 7	Same as alarm history 1	0	Monitor	×		
3826 to 3829	EF2H to EF5H	System area	—	—	—			
3830 to 3835	EF6H to EFBH	Alarm history 8	Same as alarm history 1	0	Monitor	×		
3836 to 3839	EFCH to EFFH	System area	—	—	—			
3840 to 3845	F00H to F05H	Alarm history 9	Same as alarm history 1	0	Monitor	×		
3846 to 3849	F06H to F09H	System area	—	—	—			
3850 to 3855	F0AH to F0FH	Alarm history 10	Same as alarm history 1	0	Monitor	×		
3856 to 3859	F10H to F13H	System area	—	—	—			
3860 to 3865	F14H to F19H	Alarm history 11	Same as alarm history 1	0	Monitor	×		
3866 to 3869	F1AH to F1DH	System area	—	—	—			
3870 to 3875	F1EH to F23H	Alarm history 12	Same as alarm history 1	0	Monitor	×		
3876 to 3879	F24H to F27H	System area	—	—	—			
3880 to 3885	F28H to F2DH	Alarm history 13	Same as alarm history 1	0	Monitor	×		
3886 to 3889	F2EH to F31H	System area	—	—	—			
3890 to 3895	F32H to F37H	Alarm history 14	Same as alarm history 1	0	Monitor	×		
3896 to 3899	F38H to F3BH	System area	—	—	—			
3900 to 3905	F3CH to F41H	Alarm history 15	Same as alarm history 1	0	Monitor	×		
3906 to 3909	F42H to F45H	System area	—	—	—			
3910 to 3915	F46H to F4BH	Alarm history 16	Same as alarm history 1	0	Monitor	×		
3916 to 3999	F4CH to F9FH	System area	—	—	—			

■Offset/gain setting (Un\G4000 to Un\G9999)

Address: decimal (hexadecimal)				Name	Default value	Data type	Auto refresh
CH1	CH2	CH3	CH4				
4000 to 4131 (FA0H to 1023H)				System area	—	—	—
4132 (1024H)	4134 (1026H)	4136 (1028H)	4138 (102AH)	CH□ Offset/gain setting mode (offset specification)	0	Setting	×
4133 (1025H)	4135 (1027H)	4137 (1029H)	4139 (102BH)	CH□ Offset/gain setting mode (gain specification)	0	Setting	×
4140 to 4163 (102CH to 1043H)				System area	—	—	—
4164 (1044H)	4165 (1045H)	4166 (1046H)	4167 (1047H)	CH□ Offset/gain setting mode (range specification)	0	Setting	×
4168 to 9999 (1048H to 270FH)				System area	—	—	—

■Logging data (Un\G10000 to Un\G89999)

Address: decimal (hexadecimal)				Name	Default value	Data type	Auto refresh
CH1	CH2	CH3	CH4				
10000 to 19999 (2710H to 4E1FH)	20000 to 29999 (4E20H to 752FH)	30000 to 39999 (7530H to 9C3FH)	40000 to 49999 (9C40H to C34FH)	CH□ Logging data	0	Monitor	×
50000 to 89999 (C350H to 15F8FH)				System area	—	—	—

In FX3 allocation function mode

○: With refresh setting, ×: Without refresh setting

Address: decimal (hexadecimal)				Name	Default value	Data type	Auto refresh
CH1	CH2	CH3	CH4				
0 (0H)				Range setting	0000H	Setting	×
1 (1H)				System area	—	—	—
2 (2H)	3 (3H)	4 (4H)	5 (5H)	CH□ Time average/Count average/Moving average/Primary delay filter constant setting	0000H	Setting	×
6 (6H)	7 (7H)	8 (8H)	9 (9H)	CH□ Digital filter setting	0	Setting	×
10 (AH)	11 (BH)	12 (CH)	13 (DH)	CH□ Digital operation value	*1	Monitor	○
14 to 25 (EH to 19H)				System area	—	—	—
26 (1AH)				Warning output flag (Process alarm upper limit/lower limit)	0000H	Monitor	○
27 (1BH)				Warning output flag (Rate alarm upper limit/lower limit)	0000H	Monitor	○
28 (1CH)				Input signal error detection flag	0000H	Monitor	○
29 (1DH)				Latest error code	0	Monitor	○
30 (1EH)				Module information	6144H	Monitor	×
31 to 60 (1FH to 3CH)				System area	—	—	—
61 (3DH)	62 (3EH)	63 (3FH)	64 (40H)	CH□ Conversion value shift amount	0	Control	○
65 to 68 (41H to 44H)				System area	—	—	—
69 (45H)				Input signals	0	Monitor	×
70 (46H)				Output signals	0	Control	×
71 (47H)	72 (48H)	73 (49H)	74 (4AH)	CH□ Process alarm lower limit value	0	Setting	×
75 to 80 (4BH to 50H)				System area	—	—	—
81 (51H)	82 (52H)	83 (53H)	84 (54H)	CH□ Process alarm upper limit value	0	Setting	×
85 to 90 (55H to 5AH)				System area	—	—	—
91 (5BH)	92 (5CH)	93 (5DH)	94 (5EH)	CH□ Rate alarm upper limit value	3200	Setting	×
95 to 100 (5FH to 64H)				System area	—	—	—

A

Address: decimal (hexadecimal)				Name	Default value	Data type	Auto refresh
CH1	CH2	CH3	CH4				
101 (65H)	102 (66H)	103 (67H)	104 (68H)	CH□ Minimum value	0	Monitor	○
105 to 108 (69H to 6CH)				System area	—	—	—
109 (6DH)				Minimum value reset request	0000H	Control	○
110 (6EH)				Minimum value reset completed flag	0000H	Monitor	○
111 (6FH)	112 (70H)	113 (71H)	114 (72H)	CH□ Maximum value	0	Monitor	○
115 to 118 (73H to 76H)				System area	—	—	—
119 (77H)				Maximum value reset request	0000H	Control	○
120 (78H)				Maximum value reset completed flag	0000H	Monitor	○
121 to 123 (79H to 7BH)				System area	—	—	—
124 (7CH)				A/D conversion completed flag	0000H	Monitor	○
125 to 129 (7DH to 81H)				System area	—	—	—
130 (82H)				Rate alarm change rate selection	0001H	Setting	×
131, 132 (83H, 84H)				System area	—	—	—
133 (85H)				Input signal error detect automatic clear enable/disable setting	0001H	Setting	×
134 to 999 (86H to 3E7H)				System area	—	—	—
1000 (3E8H)	1002 (3EAH)	1004 (3ECH)	1006 (3EEH)	CH□ Digital output value	*1	Monitor	○
1001 (3E9H)	1003 (3EBH)	1005 (3EDH)	1007 (3EFH)	System area	—	—	—
1008 to 1020 (3F0H to 3FCH)				System area	—	—	—
1021 (3FDH)	1022 (3FEH)	1023 (3FFH)	1024 (400H)	CH□ A/D conversion status	0000H	Monitor	×
1025 to 1030 (401H to 406H)				System area	—	—	—
1031 (407H)	1032 (408H)	1033 (409H)	1034 (40AH)	CH□ Range setting monitor	0	Monitor	×
1035 to 1080 (40BH to 438H)				System area	—	—	—
1081 (439H)	1082 (43AH)	1083 (43BH)	1084 (43CH)	CH□ Averaging process specification	0000H	Setting	×
1085 to 1090 (43DH to 442H)				System area	—	—	—
1091 (443H)	1092 (444H)	1093 (445H)	1094 (446H)	CH□ Scaling enable/disable setting	0001H	Setting	×
1095 to 1099 (447H to 44BH)				System area	—	—	—
1100 (44CH)	1102 (44EH)	1104 (450H)	1106 (452H)	CH□ Scaling upper limit value (L)	0	Setting	×
1101 (44DH)	1103 (44FH)	1105 (451H)	1107 (453H)	CH□ Scaling upper limit value (H)		Setting	×
1108 to 1119 (454H to 45FH)				System area	—	—	—
1120 (460H)	1122 (462H)	1124 (464H)	1126 (466H)	CH□ Scaling lower limit value (L)	0	Setting	×
1121 (461H)	1123 (463H)	1125 (465H)	1127 (467H)	CH□ Scaling lower limit value (H)		Setting	×
1128 to 1140 (468H to 474H)				System area	—	—	—
1141 (475H)	1142 (476H)	1143 (477H)	1144 (478H)	CH□ Digital clipping enable/disable setting	0001H	Setting	×
1145 to 1150 (479H to 47EH)				System area	—	—	—
1151 (47FH)	1152 (480H)	1153 (481H)	1154 (482H)	CH□ Input signal error detection setting	0001H	Setting	×
1155 to 1160 (483H to 488H)				System area	—	—	—
1161 (489H)	1162 (48AH)	1163 (48BH)	1164 (48CH)	CH□ Input signal error detection lower limit setting value	20	Setting	×
1165 to 1170 (48DH to 492H)				System area	—	—	—

Address: decimal (hexadecimal)				Name	Default value	Data type	Auto refresh
CH1	CH2	CH3	CH4				
1171 (493H)	1172 (494H)	1173 (495H)	1174 (496H)	CH□ Input signal error detection upper limit setting value	20	Setting	×
1175 to 1180 (497H to 49CH)				System area	—	—	—
1181 (49DH)	1182 (49EH)	1183 (49FH)	1184 (4A0H)	CH□ Alert output setting (Process alarm)	0001H	Setting	×
1185 to 1190 (4A1H to 4A6H)				System area	—	—	—
1191 (4A7H)	1192 (4A8H)	1193 (4A9H)	1194 (4AAH)	CH□ Process alarm upper lower limit value	0	Setting	×
1195 to 1200 (4ABH to 4B0H)				System area	—	—	—
1201 (4B1H)	1202 (4B2H)	1203 (4B3H)	1204 (4B4H)	CH□ Process alarm lower upper limit value	0	Setting	×
1205 to 1210 (4B5H to 4BAH)				System area	—	—	—
1211 (4BBH)	1212 (4BCH)	1213 (4BDH)	1214 (4BEH)	CH□ Alert output setting (Rate alarm)	0001H	Setting	×
1215 to 1220 (4BFH to 4C4H)				System area	—	—	—
1221 (4C5H)	1222 (4C6H)	1223 (4C7H)	1224 (4C8H)	CH□ Rate alarm alert detection cycle setting	0	Setting	×
1225 to 1230 (4C9H to 4CEH)				System area	—	—	—
1231 (4CFH)	1232 (4D0H)	1233 (4D1H)	1234 (4D2H)	CH□ Rate alarm lower limit value	-3200	Setting	×
1235 to 1320 (4D3H to 528H)				System area	—	—	—
1321 (529H)	1322 (52AH)	1323 (52BH)	1324 (52CH)	CH□ A/D conversion enable/disable setting	0	Setting	×
1325 to 1330 (52DH to 532H)				System area	—	—	—
1331 (533H)	1332 (534H)	1333 (535H)	1334 (536H)	CH□ Digital filter conversion cycle monitor	0	Monitor	×
1335 to 1339 (537H to 53BH)				System area	—	—	—
1340 (53DH)	1342 (53FH)	1344 (541H)	1346 (543H)	CH□ Digital filter fluctuation width setting (L)	0	Setting	×
1341 (53DH)	1343 (53FH)	1345 (541H)	1347 (543H)	CH□ Digital filter fluctuation width setting (H)			
1348 to 1360 (544H to 550H)				System area	—	—	—
1361 (551H)	1362 (552H)	1363 (553H)	1364 (554H)	CH□ Difference conversion state flag	0000H	Monitor	○
1365 to 1370 (555H to 55AH)				System area	—	—	—
1371 (55BH)	1372 (55CH)	1373 (55DH)	1374 (55EH)	CH□ Difference conversion standard value	0	Monitor	×
1375 to 1380 (55FH to 564H)				System area	—	—	—
1381 (565H)	1382 (566H)	1383 (567H)	1384 (568H)	CH□ Difference conversion trigger	0000H	Control	○
1385 to 3100 (569H to C1CH)				System area	—	—	—
3101 (C1DH)				Latest address of error history	0	Monitor	○
3102 (C1EH)				Latest alarm code	0	Monitor	○
3103 (C1FH)				Latest address of alarm history	0	Monitor	○
3104 to 3130 (C20H to C3AH)				System area	—	—	—
3131 (C3BH)				Firmware version	0	Monitor	×
3132 to 3159 (C3CH to C57H)				System area	—	—	—
3160 (C58H)				Operation mode monitor	0	Monitor	○
3161 to 4000 (C59H to FA0H)				System area	—	—	—
4001 to 4016 (FA1H to FB0H)				Interrupt factor detection flag [n] ²	0	Monitor	○
4017 to 4020 (FB1H to FB4H)				System area	—	—	—
4021 to 4036 (FB5H to FC4H)				Interrupt factor mask [n] ²	0	Control	×



Address: decimal (hexadecimal)				Name	Default value	Data type	Auto refresh
CH1	CH2	CH3	CH4				
4037 to 4040 (FC5H to FC8H)				System area	—	—	—
4041 to 4056 (FC9H to FD8H)				Interrupt factor reset request [n] ²	0	Control	×
4057 to 4060 (FD9H to FDCH)				System area	—	—	—
4061 to 4076 (FDDH to FECH)				Interrupt factor transaction setting [n] ²	0	Setting	×
4077 to 4080 (FEDH to FF0H)				System area	—	—	—
4081 to 4096 (FF1H to 1000H)				Condition target setting [n] ²	0	Setting	×
4097 to 4100 (1001H to 1004H)				System area	—	—	—
4101 to 4116 (1005H to 1014H)				Condition target channel setting [n] ²	0	Setting	×
4117 to 4119 (1015H to 1017H)				System area	—	—	—
4120, 4121 (1018H, 1019H)				Mode switching setting	0	Setting	×
4122 to 4130 (101AH to 1022H)				System area	—	—	—
4131 (1023H)	4132 (1024H)	4133 (1025H)	4134 (1026H)	CH□ Offset/gain setting mode (offset specification)	0	Setting	×
4135 to 4140 (1027H to 102CH)				System area	—	—	—
4141 (102DH)	4142 (102EH)	4143 (102FH)	4144 (1030H)	CH□ Offset/gain setting mode (gain specification)	0	Setting	×
4145 to 4150 (1031H to 1036H)				System area	—	—	—
4151 (1037H)	4152 (1038H)	4153 (1039H)	4154 (103AH)	CH□ Offset/gain setting mode (range specification)	0	Setting	×
4155 to 4159 (103BH to 103FH)				System area	—	—	—
4160 (1040H)				Offset/gain initialization enable code	0	Setting	×
4161 to 8599 (1041H to 2197H)				System area	—	—	—
8600 to 8609 (2198H to 21A1H)				Error history 1	0	Monitor	×
8610 to 8619 (21A2H to 21ABH)				Error history 2	0	Monitor	×
8620 to 8629 (21ACH to 21B5H)				Error history 3	0	Monitor	×
8630 to 8639 (21B6H to 21BFH)				Error history 4	0	Monitor	×
8640 to 8649 (21C0H to 21C9H)				Error history 5	0	Monitor	×
8650 to 8659 (21CAH to 21D3H)				Error history 6	0	Monitor	×
8660 to 8669 (21D4H to 21DDH)				Error history 7	0	Monitor	×
8670 to 8679 (21DEH to 21E7H)				Error history 8	0	Monitor	×
8680 to 8689 (21E8H to 21F1H)				Error history 9	0	Monitor	×
8690 to 8699 (21F2H to 21FBH)				Error history 10	0	Monitor	×
8700 to 8709 (21FCH to 2205H)				Error history 11	0	Monitor	×
8710 to 8719 (2206H to 220FH)				Error history 12	0	Monitor	×
8720 to 8729 (2210H to 2219H)				Error history 13	0	Monitor	×
8730 to 8739 (221AH to 2223H)				Error history 14	0	Monitor	×
8740 to 8749 (2224H to 222DH)				Error history 15	0	Monitor	×
8750 to 8759 (222EH to 2237H)				Error history 16	0	Monitor	×
8760 to 8769 (2238H to 2241H)				Alarm history 1	0	Monitor	×
8770 to 8779 (2242H to 224BH)				Alarm history 2	0	Monitor	×
8780 to 8789 (224CH to 2255H)				Alarm history 3	0	Monitor	×
8790 to 8799 (2256H to 225FH)				Alarm history 4	0	Monitor	×
8800 to 8809 (2260H to 2269H)				Alarm history 5	0	Monitor	×
8810 to 8819 (226AH to 2273H)				Alarm history 6	0	Monitor	×
8820 to 8829 (2274H to 227DH)				Alarm history 7	0	Monitor	×
8830 to 8839 (227EH to 2287H)				Alarm history 8	0	Monitor	×
8840 to 8849 (2288H to 2291H)				Alarm history 9	0	Monitor	×
8850 to 8859 (2292H to 229BH)				Alarm history 10	0	Monitor	×
8860 to 8869 (229CH to 22A5H)				Alarm history 11	0	Monitor	×
8870 to 8879 (22A6H to 22AFH)				Alarm history 12	0	Monitor	×

Address: decimal (hexadecimal)				Name	Default value	Data type	Auto refresh
CH1	CH2	CH3	CH4				
8880 to 8889 (22B0H to 22B9H)				Alarm history 13	0	Monitor	×
8890 to 8899 (22BAH to 22C3H)				Alarm history 14	0	Monitor	×
8900 to 8909 (22C4H to 22CDH)				Alarm history 15	0	Monitor	×
8910 to 8919 (22CEH to 22D7H)				Alarm history 16	0	Monitor	×
8920 to 9009 (22D8H to 2331H)				System area	—	—	—
9010 to 9019 (2332H to 233BH)				Level data 0 to 9	0	Control	○
9020 (233CH)				System area	—	—	—
9021 (233DH)	9022 (233EH)	9023 (233FH)	9024 (2340H)	CH□ Logging hold flag	0	Monitor	○
9025 to 9030 (2341H to 2346H)				System area	—	—	—
9031 (2347H)	9032 (2348H)	9033 (2349H)	9034 (234AH)	CH□ Head pointer	0	Monitor	×
9035 to 9040 (234BH to 2350H)				System area	—	—	—
9041 (2351H)	9042 (2352H)	9043 (2353H)	9044 (2354H)	CH□ Latest pointer	0	Monitor	×
9045 to 9050 (2355H to 235AH)				System area	—	—	—
9051 (235BH)	9052 (235CH)	9053 (235DH)	9054 (235EH)	CH□ Number of logging data	0	Monitor	×
9055 to 9060 (235FH to 2364H)				System area	—	—	—
9061 (2365H)	9062 (2366H)	9063 (2367H)	9064 (2368H)	CH□ Trigger pointer	0	Monitor	×
9065 to 9070 (2369H to 236EH)				System area	—	—	—
9071 (236FH)	9074 (2372H)	9077 (2375H)	9080 (2378H)	CH□ Logging cycle monitor value (s)	0	Monitor	×
9072 (2370H)	9075 (2373H)	9078 (2376H)	9081 (2379H)	CH□ Logging cycle monitor value (ms)	0	Monitor	×
9073 (2371H)	9076 (2374H)	9079 (2377H)	9082 (237AH)	CH□ Logging cycle monitor value (μs)	0	Monitor	×
9083 to 9100 (237BH to 238CH)				System area	—	—	—
9101 (238DH)	9106 (2392H)	9111 (2397H)	9116 (239CH)	CH□ Trigger generation time (First/Last two digits of the year)	0	Monitor	×
9102 (238EH)	9107 (2393H)	9112 (2398H)	9117 (239DH)	CH□ Trigger generation time (Month/Day)	0	Monitor	×
9103 (238FH)	9108 (2394H)	9113 (2399H)	9118 (239EH)	CH□ Trigger generation time (Hour/Minute)	0	Monitor	×
9104 (2390H)	9109 (2395H)	9114 (239AH)	9119 (239FH)	CH□ Trigger generation time (Second/Day of the week)	0	Monitor	×
9105 (2391H)	9110 (2396H)	9115 (239BH)	9120 (23A0H)	CH□ Trigger generation time (Millisecond)	0	Monitor	×
9121 to 9150 (23A1H to 23BEH)				System area	—	—	—
9151 (23BFH)	9152 (23C0H)	9153 (23C1H)	9154 (23C2H)	CH□ Logging hold request	0	Control	○
9155 to 9160 (23C3H to 23C8H)				System area	—	—	—
9161 (23C9H)	9162 (23CAH)	9163 (23CBH)	9164 (23CCH)	CH□ Logging enable/disable setting	1	Setting	×
9165 to 9170 (23CDH to 23D2H)				System area	—	—	—
9171 (23D3H)	9172 (23D4H)	9173 (23D5H)	9174 (23D6H)	CH□ Logging data setting	1	Setting	×
9175 to 9180 (23D7H to 23DCH)				System area	—	—	—
9181 (23DDH)	9182 (23DEH)	9183 (23DFH)	9184 (23E0H)	CH□ Logging cycle setting value	4	Setting	×
9185 to 9190 (23E1H to 23E6H)				System area	—	—	—
9191 (23E7H)	9192 (23E8H)	9193 (23E9H)	9194 (23EAH)	CH□ Logging cycle unit setting	1	Setting	×
9195 to 9200 (23EBH to 23F0H)				System area	—	—	—
9201 (23F1H)	9202 (23F2H)	9203 (23F3H)	9204 (23F4H)	CH□ Post-trigger logging points	5000	Setting	×
9205 to 9210 (23F5H to 23FAH)				System area	—	—	—
9211 (23FBH)	9212 (23FCH)	9213 (23FDH)	9214 (23FEH)	CH□ Level trigger condition setting	0	Setting	×
9215 to 9220 (23FFH to 2404H)				System area	—	—	—



Address: decimal (hexadecimal)				Name	Default value	Data type	Auto refresh
CH1	CH2	CH3	CH4				
9221 (2405H)	9222 (2406H)	9223 (2407H)	9224 (2408H)	CH□ Trigger data	*3	Setting	×
9225 to 9230 (2409H to 240EH)				System area	—	—	—
9231 (240FH)	9232 (2410H)	9233 (2411H)	9234 (2412H)	CH□ Trigger setting value	0	Setting	×
9235 to 9240 (2413H to 2418H)				System area	—	—	—
9241 (2419H)	9242 (241AH)	9243 (241BH)	9244 (241CH)	CH□ Current logging read pointer	-1	Monitor	×
9245 to 9250 (241DH to 2422H)				System area	—	—	—
9251 (2423H)	9252 (2424H)	9253 (2425H)	9254 (2426H)	CH□ Previous logging read pointer	-1	Monitor	×
9255 to 9260 (2427H to 242CH)				System area	—	—	—
9261 (242DH)	9262 (242EH)	9263 (242FH)	9264 (2430H)	CH□ Logging read points monitor value	0	Monitor	×
9265 to 9270 (2431H to 2436H)				System area	—	—	—
9271 (2437H)	9272 (2438H)	9273 (2439H)	9274 (243AH)	CH□ Logging loading enable/disable setting	1	Setting	×
9275 to 9280 (243BH to 2440H)				System area	—	—	—
9281 (2441H)	9282 (2442H)	9283 (2443H)	9284 (2444H)	CH□ Logging load points setting value	1000	Setting	×
9285 to 9999 (2445H to 270FH)				System area	—	—	—
10000 to 19999 (2710H to 4E1FH)				CH1 Logging data	0	Monitor	×
20000 to 29999 (4E20H to 752FH)				CH2 Logging data	0	Monitor	×
30000 to 39999 (7530H to 9C3FH)				CH3 Logging data	0	Monitor	×
40000 to 49999 (9C40H to C34FH)				CH4 Logging data	0	Monitor	×
50000 - (C350H -)				System area	—	—	—

*1 The following shows the default values.

Converted value when range setting is "-10 to +10 V"

*2 [n] in the table indicates an interrupt setting number. (n = 1 to 16)

*3 The following shows the default values.

CH1: 10, CH2: 11, CH3: 12, CH4: 13

Details of buffer memory addresses

This section details the buffer memory areas of the analog input module.



This section describes buffer memory addresses for CH1.

Latest error code

The latest error code detected in the analog input module is stored. For details, refer to the following.

☞ Page 105 List of error codes

■Buffer memory address

The following shows the buffer memory address of this area.

Buffer memory name	CH1	CH2	CH3	CH4
Latest error code	0			
Latest error code (in FX3 allocation mode function)	29			

■Clearing an error

Turn 'Error clear request' (Un\G70, b15) off→on→off.

Latest address of error history

Among Error history □ (Un\G3600 to Un\G3759), the buffer memory address which stores the latest error code is stored.

■Buffer memory address

The following shows the buffer memory address of this area.

Buffer memory name	CH1	CH2	CH3	CH4
Latest address of error history	1			
Latest address of error history (in FX3 allocation mode function)	3101			

A

Latest alarm code

The latest alarm code detected in the analog input module is stored. For details, refer to the following.

☞ Page 108 List of alarm codes

■Buffer memory address

The following shows the buffer memory address of this area.

Buffer memory name	CH1	CH2	CH3	CH4
Latest alarm code	2			
Latest alarm code (in FX3 allocation mode function)	3102			

■Clearing an alarm

Turn 'Error clear request' (Un\G70, b15) off→on→off.

Latest address of alarm history

Among Alarm history □ (Un\G3760 to Un\G3999), a buffer memory address which stores the latest alarm code is stored.

■Buffer memory address

The following shows the buffer memory address of this area.

Buffer memory name	CH1	CH2	CH3	CH4
Latest address of alarm history	3			
Latest address of alarm history (in FX3 allocation mode function)	3103			

Interrupt factor detection flag [n]

The detection status of the interrupt factor is stored.

Monitor value	Description
0	No interrupt factor
1	Interrupt factor

When an interrupt factor occurs, an interrupt request is sent to the CPU module at the same time as 'Interrupt factor detection flag [n]' (Un\G4 to Un\G19) turns to Interrupt factor (1).

"n" indicates an interrupt setting number. (n = 1 to 16)

■Buffer memory address

The following shows the buffer memory address of this area.

Buffer memory name	1	2	3	4	5	6	7	8	9	10	11	12	13	14	15	16
Interrupt factor detection flag [n]	4	5	6	7	8	9	10	11	12	13	14	15	16	17	18	19
Interrupt factor detection flag [n] (in FX3 allocation mode function)	4001	4002	4003	4004	4005	4006	4007	4008	4009	4010	4011	4012	4013	4014	4015	4016

Module information

Module information of FX5-4AD is stored. For module information, 6140H (fixed hexadecimal value) is stored.

- In the normal mode: 6140H
- In the FX3 allocation mode: 6144H

■Buffer memory address

The following shows the buffer memory address of this area.

Buffer memory name	CH1	CH2	CH3	CH4
Module Information	30			
Module information (in FX3 allocation mode function)	30			

Firmware version

Firmware version is stored. Firmware version is stored in 4 digit decimal number.

■Buffer memory address

The following shows the buffer memory address of this area.

Buffer memory name	CH1	CH2	CH3	CH4
Firmware version	31			
Firmware version (in FX3 allocation mode function)	3131			

Warning output flag (Process alarm upper limit)

The upper limit alarm of the process alarm can be checked for each channel.

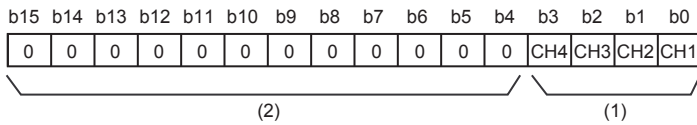

(1) 0: Normal, 1: Alarm ON

(2) The values of b4 to b15 are fixed to 0.

■Buffer memory address

The following shows the buffer memory address of this area.

Buffer memory name	CH1	CH2	CH3	CH4
Warning output flag (Process alarm upper limit)	36			

■Alert output flag status

- If the limit specified by the process alarm upper upper limit value is equal to or exceeded, Alarm ON (1) is stored in 'Alert output flag (Process alarm upper limit)' (Un\G36) of the corresponding channel.
- If an alert is detected even in one channel, of the channels where conversion is enabled and the alert output setting (Process alarm) is enabled, 'Alert output signal' (Un\G69, b8) also turns on.

■Clearing Alert output flag

- When the digital operation value returns within the setting range, the flag is automatically cleared.
- Turning off→on→off 'Operating condition setting request' (Un\G70, b9) allows the flag to be cleared.

Warning output flag (Process alarm lower limit)

The lower limit alarm of the process alarm can be checked for each channel.

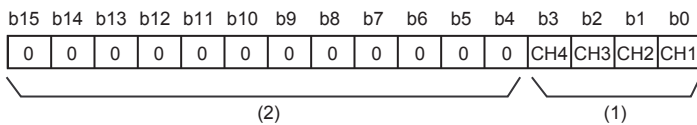

(1) 0: Normal, 1: Alarm ON

(2) The values of b4 to b15 are fixed to 0.

■Buffer memory address

The following shows the buffer memory address of this area.

Buffer memory name	CH1	CH2	CH3	CH4
Warning output flag (Process alarm lower limit)	37			

■Alert output flag status

- If the limit specified by the process alarm lower lower limit value is equal to or exceeded, Alarm ON (1) is stored in 'Alert output flag (Process alarm lower limit)' (Un\G37) of the corresponding channel.
- If an alert is detected even in one channel, of the channels where conversion is enabled and the alert output setting (Process alarm) is enabled, 'Alert output signal' (Un\G69, b8) also turns on.

■Clearing Alert output flag

- When the digital operation value returns within the setting range, the flag is automatically cleared.
- Turning off→on→off 'Operating condition setting request' (Un\G70, b9) allows the flag to be cleared.

Warning output flag (Process alarm upper limit/lower limit) [FX3 allocation mode]

When the FX3 allocation mode function is used, the upper/lower limit alarm of the process alarm can be checked.

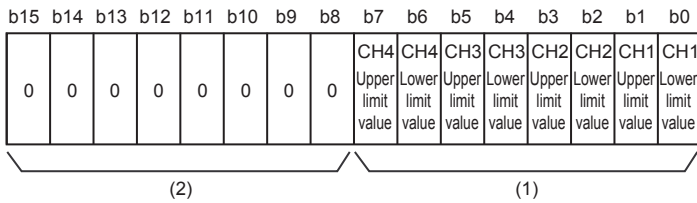

(1) 0: Normal, 1: Alarm ON

(2) The values of b8 to b15 are fixed to 0.

■Buffer memory address

The following shows the buffer memory address of this area.

Buffer memory name	CH1	CH2	CH3	CH4
Warning output flag (Process alarm) (in FX3 allocation mode function)	26			

■Alert output flag status

- When the value is equal to or exceeds the limit specified by the process alarm upper upper limit value or is equal to or falls below the process alarm lower lower limit value, Alarm ON (1) is stored in Warning output flag (Process alarm) corresponding to each channel.
- If an alert is detected even in one channel, of the channels where conversion is enabled and the alert output setting (Process alarm) is enabled, 'Alert output signal' (Un\G69, b8) also turns on.

■Clearing Alert output flag

- When the digital operation value returns within the setting range, the flag is automatically cleared.
- Turning off→on→off 'Operating condition setting request' (Un\G70, b9) allows the flag to be cleared.

Warning output flag (Rate alarm upper limit)

The upper limit alarm of the rate alarm can be checked for each channel.

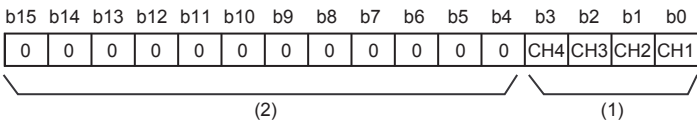

(1) 0: Normal, 1: Alarm ON

(2) The values of b4 to b15 are fixed to 0.

■Buffer memory address

The following shows the buffer memory address of this area.

Buffer memory name	CH1	CH2	CH3	CH4
Warning output flag (Rate alarm upper limit)	38			

■Alert output flag status

- If the limit specified in the rate alarm upper limit value is equal to or exceeded, Alarm ON (1) is stored in 'Alert output flag (Rate alarm upper limit)' (Un\G38) of the corresponding channel.
- If an alert is detected even in one channel, of the channels where conversion is enabled and the alert output setting (Rate alarm) is enabled, 'Alert output signal' (Un\G69, b8) also turns on.

■Clearing Alert output flag

- When the change rate of the digital output value returns within the setting range, the flag is automatically cleared.
- Turning off→on→off 'Operating condition setting request' (Un\G70, b9) allows the flag to be cleared.

Input signal error detection flag

The status of an input signal can be checked for each channel.

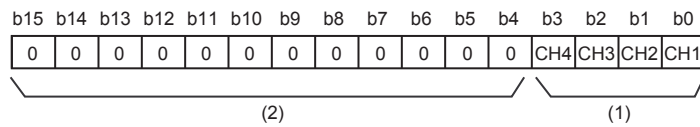

(1) 0: Normal, 1: Input signal error

(2) The values of b4 to b15 are fixed to 0.

■ Buffer memory address

The following shows the buffer memory address of this area.

Buffer memory name	CH1	CH2	CH3	CH4
Input signal error detection flag	40			

■ Input signal error detection flag status

- When an analog input value out of the range specified in Input signal error detection setting value is detected, Input signal error (1) is stored in 'Input signal error detection flag' (Un\G40) corresponding to each channel.
- When an error is detected in any channel where the A/D conversion and the input signal error detection are enabled, 'Input signal error detection signal' (Un\G69, b12) turns on.

■ Clearing Input signal error detection flag

- When 'Input signal error detect automatic clear enable/disable setting' (Un\G304) is set to Disable, Input signal error detection flag turns off by turning off→on→off 'Error clear request' (Un\G70, b15) after the analog input value returns to within the setting range. When 'Operating condition setting request' (Un\G70, b9) is turned off→on→off, the flag is cleared.
- When 'Input signal error detect automatic clear enable/disable setting' (Un\G304) is set to Disable, 'Input signal error detection signal' turns off after the analog input value returns to within the setting range.

Input signal error detection flag [FX3 allocation mode]

The status of an input signal can be checked for each channel.

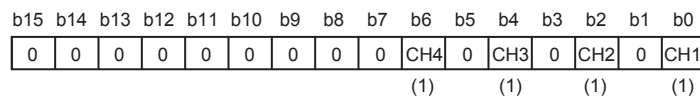

(1) 0: Normal, 1: Input signal error

■ Buffer memory address

The following shows the buffer memory address of this area.

Buffer memory name	CH1	CH2	CH3	CH4
Input signal error detection flag [In FX3 allocation mode function]	28			

■ Input signal error detection flag status

- When an analog input value out of the range specified in Input signal error detection setting value is detected, Input signal error (1) is stored in 'Input signal error detection flag' corresponding to each channel.
- When an error is detected in any channel where the A/D conversion and the input signal error detection are enabled, 'Input signal error detection signal' (Un\G69, b12) turns on.

■ Clearing Input signal error detection flag

- When 'Input signal error detect automatic clear enable/disable setting' is set to Disable, Input signal error detection flag turns off by turning off→on→off 'Error clear request' (Un\G70, b15) after the analog input value returns to within the setting range. When 'Operating condition setting request' (Un\G70, b9) is turned off→on→off, the flag is cleared.
- When 'Input signal error detect automatic clear enable/disable setting' is set to enable, 'Input signal error detection signal' turns off after the analog input value returns to within the setting range.

A/D conversion completed flag

The A/D conversion status can be checked.

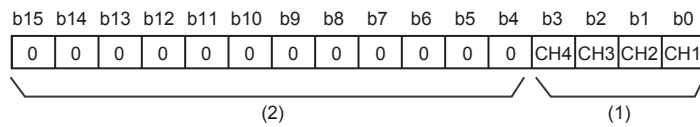

(1) 0: During A/D conversion or unused, 1: A/D conversion completed

(2) The values of b4 to b15 are fixed to 0.

■Buffer memory address

The following shows the buffer memory address of this area.

Buffer memory name	CH1	CH2	CH3	CH4
A/D conversion completed flag	42			
A/D conversion completed flag (in FX3 allocation mode function)	124			

■A/D conversion completed flag status

When the first A/D conversion is completed in the channel where the A/D conversion is enabled, the flag turns to A/D conversion completed (1). 'A/D conversion completed flag' (Un\G69, b14) turns on when the conversion of all the channels where the A/D conversion is enabled is completed.

■Clearing A/D conversion completed flag

Turning off→on→off 'Operating condition setting request' (Un\G70, b9) turns the flag back to the default (During A/D conversion or unused (0)), and when the first A/D conversion has completed, the flag turns to A/D conversion completed (1) again.

Operation mode monitor

The operation mode status in operation can be checked.

Monitor value	Description
0	Normal mode
1	Offset/gain setting mode

■Buffer memory address

The following shows the buffer memory address of this area.

Buffer memory name	CH1	CH2	CH3	CH4
Operation mode monitor	60			
Operation mode monitor (In FX3 allocation mode function)	3160			

Input signals

A state of an analog input module can be checked in the buffer memory area.

■ Buffer memory address

The following shows the buffer memory address of this area.

Buffer memory name	CH1	CH2	CH3	CH4
Input signals	69			
Input signal (In FX3 allocation mode function)	69			

■ List of input signals

Buffer Memory Areas	Description
b0	Module READY
b1 to 4	Use not allowed
b5	Offset/gain initialization completed flag
b6	Use not allowed
b7	Use not allowed
b8	Warning output signal
b9	Operating condition setting completed flag
b10	Offset/gain setting mode status flag
b11	Channel change completed flag
b12	Input signal error detection signal
b13	Range switching complete flag
b14	A/D conversion completed flag
b15	Error flag

■ Module READY (b0)

Module READY (X0) turns on to indicate the preparation for the A/D conversion is completed after the power-on or reset of the CPU module, and the A/D conversion is performed.

In the following cases, 'Module READY' turns off.

- In the offset/gain setting mode (In this case, the A/D conversion is performed.)
- When a watchdog timer error has occurred in the analog input module (In this case, the A/D conversion is not performed.)

■ Offset/gain initialization completed flag (b5)

- Use as an interlock condition to turn off→on→off 'Offset/gain initialization request' (Un\G70, b5).
- Offset/gain initialization is not be performed unless 'Offset/gain initialization enabled code' (Un\G305) is set to E20FH.
- It is possible to perform offset/gain initialization in offset/gain setting mode only.
- When 'Offset/gain initialization request' (Un\G70, b5) is off, 'Offset/gain initialization complete flag' (Un\G69, b5) turns off.

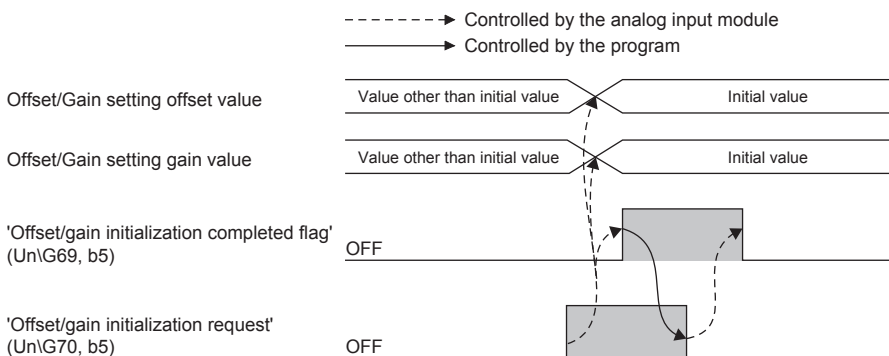

■Warning output signal (b8)

Alert output signal (Un\G69, b8) turns on when the process alarm or rate alarm has been detected. When the alert output function (process alarm/rate alarm) is disabled for all channels, 'Alert output signal' (Un\G69, b8) is always off.

Alarm	Operation
Process alarm	<ul style="list-style-type: none"> The process alarm turns on when 'CH1 Digital operation value' is equal to or exceeds the setting range set in 'CH1 Process alarm upper upper limit value' (Un\G514) or is equal to or falls below the setting range set in 'CH1 Process alarm lower lower limit value' (Un\G520). The ALM LED also turns on along with the signal turning on. The target of alert output is the channels only where the alert output function (process alarm) and the A/D conversion are both enabled. Process alarm turns off when 'CH1 Digital output value' falls within the setting range for all the channels where the A/D conversion is enabled. The ALM LED also turns off along with the off of the signal.
Rate alarm	<ul style="list-style-type: none"> The process alarm turns on when the change rate of 'CH1 Digital operation value' is equal to or exceeds the setting range set in 'CH1 Rate alarm upper limit value' (Un\G524) or is equal to or falls below the setting range set in 'CH1 Rate alarm lower value' (Un\G526). The ALM LED also turns on along with the signal turning on. The target of alert output is the channels only where the alert output function (rate alarm) and the A/D conversion are both enabled. Rate alarm turns off when the change rate of 'CH1 Digital output value' returns to within the setting range for all the channels where the A/D conversion is enabled. The ALM LED also turns off.

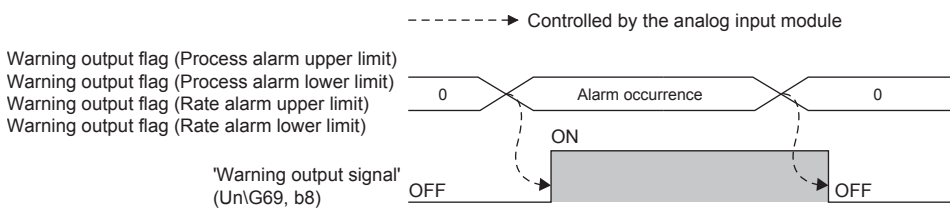

■Operating condition setting completed flag (b9)

When changing values of the buffer memory, use as an interlock condition to turn off→on→off 'Operating condition setting request' (Un\G70, b9).

For the buffer memory areas which require turning off→on→off of 'Operating condition setting request' (Un\G70, b9) to enable the changed values, refer to the following.

☞ Page 113 Buffer Memory Areas

When 'Operating condition setting completed flag' (Un\G69, b9) is off, the A/D conversion is not performed.

When 'Operating condition setting request' (Un\G70, b9) is on, 'Operating condition setting completed flag' (Un\G69, b9) turns off.

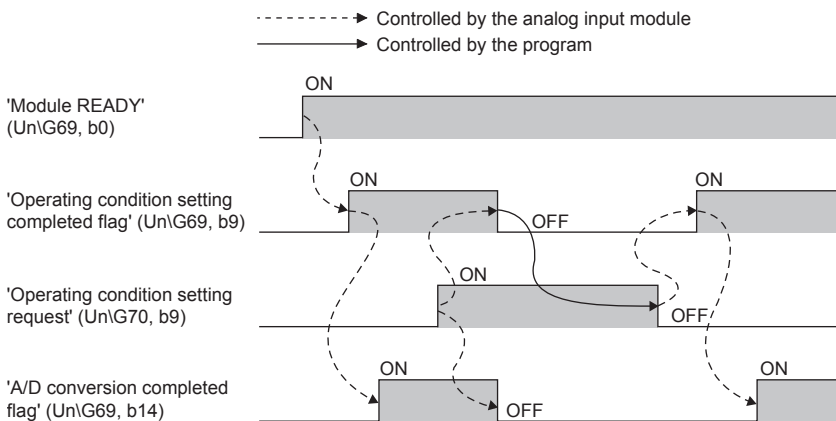

■Offset/gain setting mode status flag (b10)

When registering the value, which has been adjusted with the offset/gain setting, use as an interlock condition to turn off→on→off 'User range write request' (Un\G70, b10).

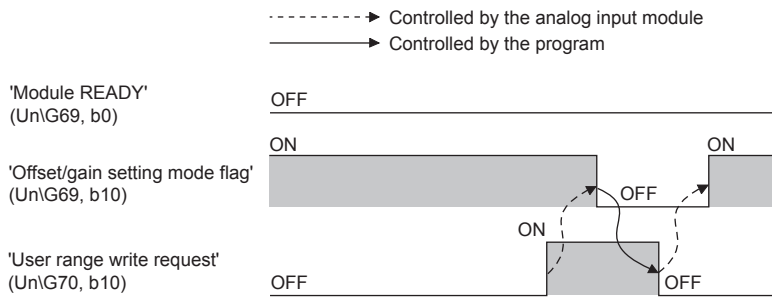

■Channel change completed flag (b11)

When changing a channel to perform the offset/gain setting, use as an interlock condition to turn off→on→off 'Channel change request' (Un\G70, b11).

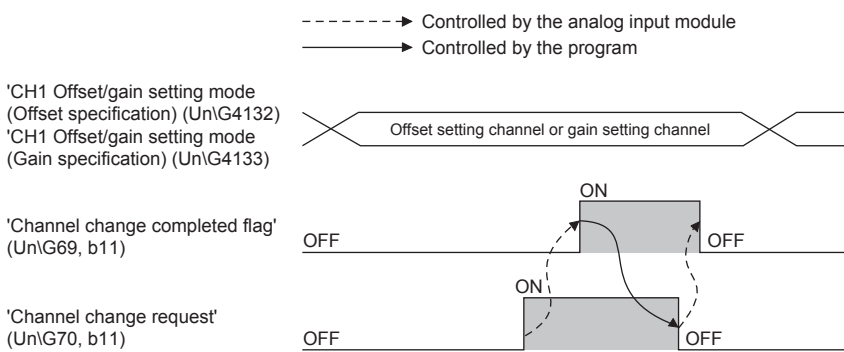

■Input signal error detection signal (b12)

Set 'CH1 Input signal error detection setting' (Un\G528) to one of upper lower limit detection, upper limit detection, lower limit detection, and simple disconnection detection, and turns on if the analog input value exceeds the setting range that is set in 'CH1 Input signal error detection lower limit setting value' (Un\G529) or 'CH1 Input signal error detection upper limit setting value' (Un\G530) in the channel where the A/D conversion has been enabled. For the cases where the simple disconnection detection is set, 'CH1 Input signal error detection lower limit setting value' (Un\G529) or 'CH1 Input signal error detection upper limit setting value' (Un\G530) is ignored and turns on at the disconnection detection.

When 'Input signal error detection signal' (Un\G69, b12) turns on, the following operations are performed.

- Digital output value and digital operation value of the relevant channel is held with the value just before the error was detected.
- The ALM LED flashes.

Turning off 'Input signal error detection signal' (Un\G69, b12) varies depending on Input signal error detect automatic clear enable/disable setting.

Input signal error detect automatic clear enable/disable setting	Operations related to the turning off of input signal error detection signal (Un\G69, b12)
Enable (0)	If the input signal is within the setting range, 'Input signal error detection signal' (Un\G69, b12) and 'Input signal error detection flag' (Un\G40) automatically turn off, and ALM LED turns off.

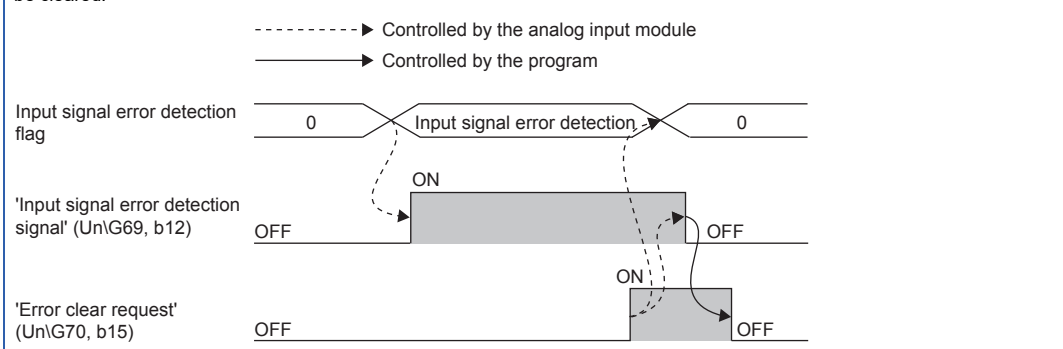
Input signal error detect automatic clear enable/disable setting	Operations related to the turning off of input signal error detection signal (Un\G69, b12)
Disable (1)	<p>Remove the cause of the input signal error and set the input signal within the setting range. Then turn the 'error clear request' (Un\G70, b15) OFF→ON→OFF. The input signal error detection signal '(Un\G69, b12) and the 'input signal error detection flag' (Un\G40) will turn OFF, and the ALM LED will turn off. The latest alarm code will also be cleared. The latest alarm code will also be cleared.</p> 

Point 

Averaging processing starts over after the A/D conversion resumes.

Range switching complete flag (b13)

When changing a range of channel to perform the offset/gain setting, use as an interlock condition to turn off→on→off 'Range switching request' (Un\G70, b13).

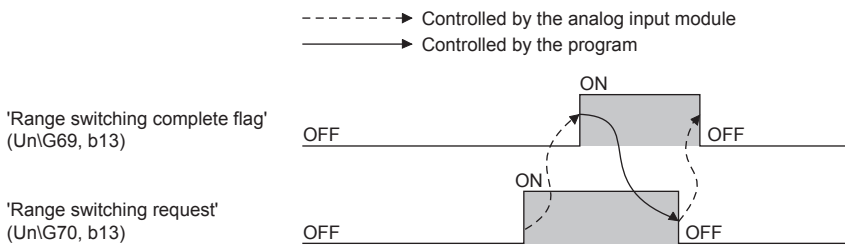

A/D conversion completed flag (b14)

A/D conversion completed flag (Un\G70, b15) turns on when the first conversion has been completed for all A/D conversion enabled channels. When reading a digital output value, use this signal or 'A/D conversion completed flag' (Un\G42) as an interlock.

Error occurrence flag (b15)

Error flag (Un\G69, b15) turns on when an error has occurred.

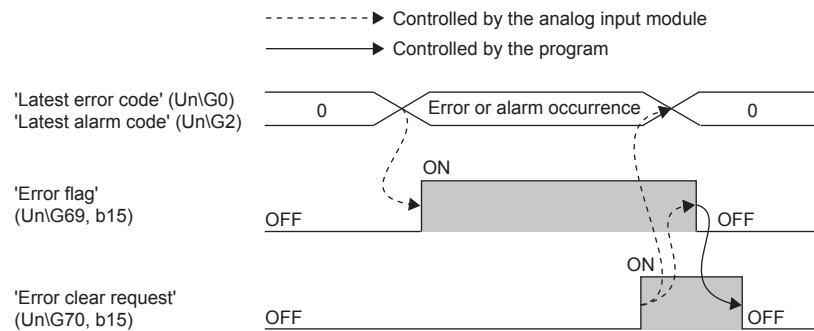

'Error flag' (Un\G69, b15), 'Latest error code' (Un\G0), and 'Latest alarm code' (Un\G2) are cleared at the timing when 'Error clear request' (Un\G70, b15) turns off→on.



Output signals

The operation request to an analog input module can be set with the buffer memory.

■ Buffer memory address

The following shows the buffer memory address of this area.

Buffer memory name	CH1	CH2	CH3	CH4
Output signals	70			
Output signal (In FX3 allocation mode function)	70			

■ List of output signals

Buffer Memory Areas	Description
b0 to 4	Use not allowed
b5	Offset/gain initialization request
b6 to 8	Use not allowed
b9	Operating condition setting request
b10	User range write request
b11	Channel change request
b12	Use not allowed
b13	Range switching request
b14	Use not allowed
b15	Error clear request

■ Offset/gain initialization request (b5)

Turn off→on→off to enable the settings of buffer memory areas.

Offset/gain initialization is not to be performed unless Offset/gain initialization enabled code is set to E20FH.

When 'Offset/gain initialization request' (Un\G70, b5) is off, 'Offset/gain initialization complete flag' (Un\G69, b5) turns off.

■ Operating condition setting request (b9)

Turn off→on→off to enable the settings of buffer memory areas.

For the timing of turning the signal off→on→off, refer to the following.

☞ Page 133 Operating condition setting completed flag (b9)

■ User range write request (b10)

In the offset/gain setting mode, turn off→on→off this signal to register the values adjusted with the offset/gain setting in an analog input module. The data is written to the flash memory at the timing when this signal is turned off→on.

For the timing of turning the signal off→on→off, refer to the following.

☞ Page 134 Offset/gain setting mode status flag (b10)

■ Channel change request (b11)

Turn off→on→off Channel change request (b11) to change a channel to perform the offset/gain setting.

For the timing of turning the signal off→on→off, refer to the following.

☞ Page 134 Channel change completed flag (b11)

■ Range switching request (b13)

Turn off→on→off Range switching request (b13) to change a range of channel to perform the offset/gain setting.

For the timing of turning the signal off→on→off, refer to the following.

☞ Page 135 Range switching complete flag (b13)

■ Error clear request (b15)

Turn off→on→off Error clear request (b15) when Error flag (Un\G69, b15), Input signal error detection signal (Un\G69, b12), Latest error code (Un\G0), and Latest alarm code (Un\G2) are cleared.

For the timing of turning the signal off→on→off, refer to the following.

☞ Page 135 Error occurrence flag (b15)

☞ Page 134 Input signal error detection signal (b12)

Level data 0 to 9

This area stores data to be monitored when a level trigger of the logging function is used. Ten types of data are available: 'Level data 0' (Un\G90) to 'Level data 9' (Un\G99). These are useful, for example, to generate triggers while monitoring the values of devices other than the analog input module.

For details on the logging function, refer to the following.

 Page 57 Logging function

■Buffer memory address

The following shows the buffer memory address of this area.

Buffer memory name	0	1	2	3	4	5	6	7	8	9
Level data□	90	91	92	93	94	95	96	97	98	99
Level data□ (in FX3 allocation mode function)	9010	9011	9012	9013	9014	9015	9016	9017	9018	9019

■Setting range

The possible setting range is from -32768 to +32767.

■Default value

The default value is 0 for all channels.

Interrupt factor mask [n]

Set Interrupt factor mask to be used.

Setting value	Setting content
0	Mask (Interrupt unused)
1	Mask clear (Interrupt used)

When 'Interrupt factor mask [n]' (Un\G124 to Un\G139) is changed to Mask clear (Interrupt used) (1) and an interrupt factor occurs, an interrupt request is sent to the CPU module. When the set value is two or larger, the setting is regarded as Mask clear (Interrupt used) (1).

"n" indicates an interrupt setting number. (n = 1 to 16)

■Buffer memory address

The following shows the buffer memory address of this area.

Buffer memory name	1	2	3	4	5	6	7	8	9	10	11	12	13	14	15	16
Interrupt factor mask [n]	124	125	126	127	128	129	130	131	132	133	134	135	136	137	138	139
Interrupt factor mask [n] (in FX3 allocation mode function)	4021	4022	4023	4024	4025	4026	4027	4028	4029	4030	4031	4032	4033	4034	4035	4036

■Default value

The default value is set to Mask (Interrupt unused) (0) for all channels.

Interrupt factor reset request [n]

An interrupt factor reset request is sent.

Setting value	Setting content
0	No reset request
1	Reset request

When Reset request (1) is set to 'Interrupt factor reset request [n]' (Un\G156 to Un\G171) corresponding to the interrupt factor, the interrupt factor corresponding to the specified interrupt is reset. After that, 'Interrupt factor detection flag [n]' (Un\G4 to Un\G19) turns to 'No interrupt factor' (0). When the set value is two or larger, the setting is regarded as Reset request (1).

"n" indicates an interrupt setting number. (n = 1 to 16)

■Buffer memory address

The following shows the buffer memory address of this area.

Buffer memory name	1	2	3	4	5	6	7	8	9	10	11	12	13	14	15	16
Interrupt factor reset request [n]	156	157	158	159	160	161	162	163	164	165	166	167	168	169	170	171
Interrupt factor reset request [n] (in FX3 allocation mode function)	4064	4065	4066	4067	4068	4069	4070	4071	4072	4073	4074	4075	4076	4077	4078	4079

■Default value

The default value is 0 for all channels.

Interrupt factor transaction setting [n]

Set an interrupt request for when the same interrupt factor occurs during the interrupt factor detection.

Setting value	Setting content
0	Interrupt resend request
1	No interrupt resend request

- With 'Interrupt factor generation setting [n]' (Un\G200 to Un\G215) set to Interrupt resend request (0) and an interrupt factor being detected, an occurrence of the same interrupt factor results in an interrupt request being sent to the CPU module again.
- With 'Interrupt factor generation setting [n]' (Un\G200 to Un\G215) set to No interrupt resend request (1) and an interrupt factor being detected, an occurrence of the same interrupt factor does not result in an interrupt request being sent to the CPU module.

If a value other than the above is set, an interrupt factor generation setting error (error code: 180△H) occurs.

"n" indicates an interrupt setting number. (n = 1 to 16)

■Buffer memory address

The following shows the buffer memory address of this area.

Buffer memory name	1	2	3	4	5	6	7	8	9	10	11	12	13	14	15	16
Interrupt factor transaction setting [n]	200	201	202	203	204	205	206	207	208	209	210	211	212	213	214	215
Interrupt factor transaction setting [n] (in FX3 allocation mode function)	4061	4062	4063	4064	4065	4066	4067	4068	4069	4070	4071	4072	4073	4074	4075	4076

■Enabling the setting

Turn off→on→off 'Operating condition setting request' (Un\G70, b9) to enable the setting.

■Default value

The default value is 0 for all channels.

Condition target setting [n]

Set an interrupt factor to be detected.

Setting value	Setting content
0	Disable
1	Error flag (Un\G69, b15)
2	Warning output flag (Process alarm)
3	Warning output flag (Rate alarm)
4	Input signal error detection flag
5	A/D conversion completed
6	Logging hold flag
7	Logging read

If a value other than the above is set, a condition target setting range error (error code: 181△H) occurs.

When the buffer memory set to 'Condition target setting [n]' (Un\G232 to Un\G247) turns off→on, an interrupt request is sent to the CPU module.

"n" indicates an interrupt setting number. (n = 1 to 16)

■Buffer memory address

The following shows the buffer memory address of this area.

Buffer memory name	1	2	3	4	5	6	7	8	9	10	11	12	13	14	15	16
Condition target setting [n]	232	233	234	235	236	237	238	239	240	241	242	243	244	245	246	247
Condition target setting [n] (in FX3 allocation mode function)	4081	4082	4083	4084	4085	4086	4087	4088	4089	4090	4091	4092	4093	4094	4095	4096

■Enabling the setting

Turn off→on→off 'Operating condition setting request' (Un\G70, b9) to enable the setting.

■Default value

The default value is 0 for all channels.

Condition target channel setting [n]

Set a channel where an interrupt is detected.

Setting value	Setting content
0	All channels
1	CH1
2	CH2
3	CH3
4	CH4

When a factor for the channel specification is set to 'Condition target setting [n]' (Un\G232 to Un\G247), an interrupt factor in the channel set by this area is monitored.

If a value other than the above is set, a condition target setting range error (error code: 182△H) occurs.

"n" indicates an interrupt setting number. (n = 1 to 16)

■Buffer memory address

The following shows the buffer memory address of this area.

Buffer memory name	1	2	3	4	5	6	7	8	9	10	11	12	13	14	15	16
Condition target channel setting [n]	264	265	266	267	268	269	270	271	272	273	274	275	276	277	278	279
Condition target channel setting [n] (in FX3 allocation mode function)	4101	4102	4103	4104	4105	4106	4107	4108	4109	4110	4111	4112	4113	4114	4115	4116

■Enabling the setting

Turn off→on→off 'Operating condition setting request' (Un\G70, b9) to enable the setting.

■Default value

The default value is 0 for all channels.

Mode switching setting

Set a setting value for the mode to be switched.

Destination mode	Buffer memory address	Setting value
Normal mode	296	4658H
	297	4144H
Offset/gain setting mode	296	4144H
	297	4658H

■Buffer memory address

The following shows the buffer memory address of this area.

Buffer memory name	CH1	CH2	CH3	CH4
Mode switching setting	296, 297			
Mode switching setting (in FX3 allocation mode function)	4120, 4121			

■Enabling the setting

Turn off→on→off 'Operating condition setting request' (Un\G70, b9) to enable the setting.

■After the mode is switched

When the mode is switched, this area is cleared to 0 and 'Operating condition setting completed flag' (Un\G69, b9) turns off. After checking that 'Operating condition setting completed flag' (Un\G69, b9) is off, turn off 'Operating condition setting request' (Un\G70, b9).

Point

When a value out of the above is written and 'Operating condition setting request' (Un\G70, b9) is turned off→on→off, the mode setting is not performed and only the operating condition is changed. In this case, this area is cleared to 0.

Rate alarm change rate selection

Select rate alarm change rate. "Rate specification" that sets the rate alarm upper limit value and the rate alarm lower limit value in units of 0.1% with respect to (the maximum value of the digital output value) - (the minimum value of the digital output value), and "Digital output value specification" that sets in units of digits for the range of digital output values, can be selected.

Setting value	Description
0	Rate specification
1	Digital output value specification

When setting to a value other than the above table, it operates with digital output value specification (1).

■Buffer memory address

The following shows the buffer memory address of this area.

Buffer memory name	CH1	CH2	CH3	CH4
Rate alarm change rate selection	299			
Rate alarm change rate selection (in FX3 allocation mode function)	130			

■Enabling the setting

Turn off→on→off 'Operating condition setting request' (Un\G70, b9) to enable the setting.

■Default value

Set to Digital output value specification (1).

■Refreshing cycle

If averaging processing is performed, values are updated at every averaging process cycle, but if not performed, values are updated at every sampling cycle.

CH1 Digital operation value

A digital operation value obtained by the scaling function, shift function, digital clipping function, or difference conversion function is stored in 16-bit signed binary value.

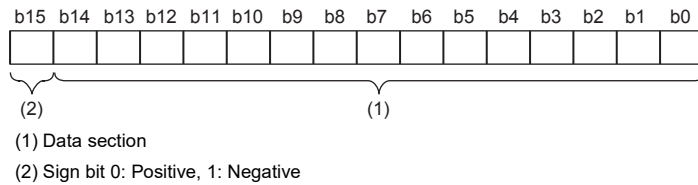

■Buffer memory address

The following shows the buffer memory address of this area.

Buffer memory name	CH1	CH2	CH3	CH4
CH□ Digital operation value	402	602	802	1002
CH□ Digital operation value (in FX3 allocation mode function)	10	11	12	13

Point

When the scaling function, shift function, digital clipping function, or difference conversion function is not used, a value which is the same as the one in 'CH1 Digital output value' (Un\G400) is stored.

CH1 Maximum value

The maximum value of the digital operation value is stored in 16-bit signed binary value.

In the following cases, 'CH1 Maximum value' (Un\G404) is updated with the current value.

- When 'Operating condition setting request' (Un\G70, b9) is turned off→on→off, and the setting is changed
- When 'CH1 Maximum value reset request' (Un\G473) is turned off→on→off

■Buffer memory address

The following shows the buffer memory address of this area.

Buffer memory name	CH1	CH2	CH3	CH4
CH□ Maximum value	404	604	804	1004
CH□ Maximum value (In FX3 allocation mode function)	111	112	113	114

CH1 Minimum value

The minimum value of the digital operation value is stored in 16-bit signed binary value.

In the following cases, 'CH1 Minimum value' (Un\G406) is updated with the current value.

- When 'Operating condition setting request' (Un\G70, b9) is turned off→on→off, and the setting is changed
- When 'Minimum value reset request' (Un\G474) is turned off→on→off

■Buffer memory address

The following shows the buffer memory address of this area.

Buffer memory name	CH1	CH2	CH3	CH4
CH□ Minimum value	406	606	806	1006
CH□ Minimum value (In FX3 allocation function mode)	101	102	103	104

Point

- For the channel to which the averaging processing is specified, the maximum and minimum values are stored at every averaging processing time.
- When the scaling function, shift function, digital clipping function, or difference conversion function is used, values calculated by each function are stored in Maximum value and Minimum value.

CH1 Difference conversion state flag

The difference conversion status can be checked.

Monitor value	Description
0	Not converted
1	Converting difference

When the difference conversion starting after 'CH1 Difference conversion trigger' (Un\G470) is changed from No request (0) to Trigger request (1), 'CH1 Difference conversion state flag' (Un\G408) corresponding to the channel turns to Converting difference (1).

When 'CH1 Difference conversion trigger' (Un\G470) is changed from Trigger request (1) to No request (0), 'CH1 Difference conversion state flag' (Un\G408) is changed from Converting difference (1) to Not converted (0).

'CH1 Difference conversion state flag' (Un\G408) is Converting difference (1) during the difference conversion; Not converted (0) if not in the difference conversion state.

■Buffer memory address

The following shows the buffer memory address of this area.

Buffer memory name	CH1	CH2	CH3	CH4
CH□ Difference conversion state flag	408	608	808	1008
CH□ Difference conversion state flag (In FX3 allocation mode function)	1361	1362	1363	1364

CH1 Logging hold flag

The logging holding status can be checked.

For details on the logging function, refer to the following.

☞ Page 57 Logging function

Monitor value	Description
0	OFF
1	ON

When a state that data is collected in 'CH1 Logging data' (Un\G10000 to Un\G19999) changes to the stop state, 'CH1 Logging hold flag' (Un\G409) is turned to ON (1).

When logging restarts by changing 'CH1 Logging hold request' (Un\G471) from ON (1) → OFF (0), 'CH1 Logging hold flag' (Un\G409) is turned to OFF (0).

■Buffer memory address

The following shows the buffer memory address of this area.

Buffer memory name	CH1	CH2	CH3	CH4
CH□ Logging hold flag	409	609	809	1009
CH□ Logging hold flag (in FX3 allocation mode function)	9021	9022	9023	9024

CH1 Digital filter conversion cycle monitor

The conversion cycle of the digital filter in operation is stored.

When something other than the digital filter (5) is set in 'CH1 Averaging processing specification' (Un\G501), 0 is stored.

■Buffer memory address

The following shows the buffer memory address of this area.

Buffer memory name	CH1	CH2	CH3	CH4
CH□ Digital filter conversion cycle monitor	411	611	811	1011
CH□ Digital filter conversion cycle monitor (In FX3 allocation mode function)	1331	1332	1333	1334

CH1 A/D Conversion status

The conversion status is stored.

Monitor value	Conversion status	Setting content
0	A/D conversion disable	A status of A/D conversion disable. A/D conversion of the relevant channel has not been executed.
1	A/D conversion start	Status from when the A/D conversion is enabled to when the initial A/D conversion completes.
2	A/D conversion completed	A status after the initial A/D conversion completes. Conversion is being executed.
3	Input signal error detected	A status where an input signal error is being detected.

■Buffer memory address

The following shows the buffer memory address of this area.

Buffer memory name	CH1	CH2	CH3	CH4
CH□ A/D conversion status	420	620	820	1020
CH□ A/D conversion status (In FX3 allocation mode function)	1021	1022	1023	1024

CH1 Maximum value reset completed flag

The reset status of maximum value can be checked.

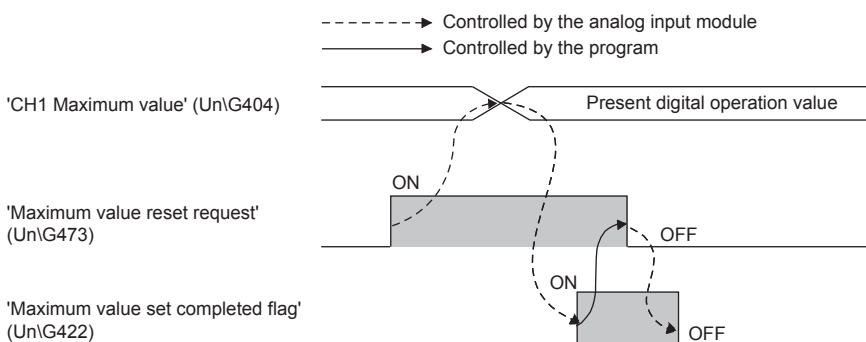

■Buffer memory address

The following shows the buffer memory address of this area.

Buffer memory name	CH1	CH2	CH3	CH4
CH□ Maximum value reset completed flag	422	622	822	1022

Maximum value reset completed flag [FX3 allocation mode]

The reset status of maximum value in FX3 allocation mode can be checked.

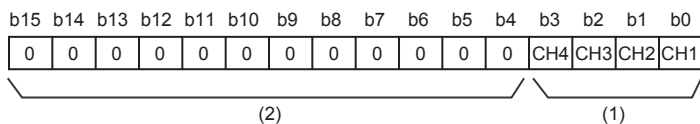

(1) 0: Not completed, 1: Completed

(2) The values of b4 to b15 are fixed to 0.

■Buffer memory address

The following shows the buffer memory address of this area.

Buffer memory name	CH1	CH2	CH3	CH4
CH□ Maximum value reset completed flag (in FX3 allocation mode function)	120			

CH1 Minimum value reset completed flag

The reset status of minimum value can be checked.

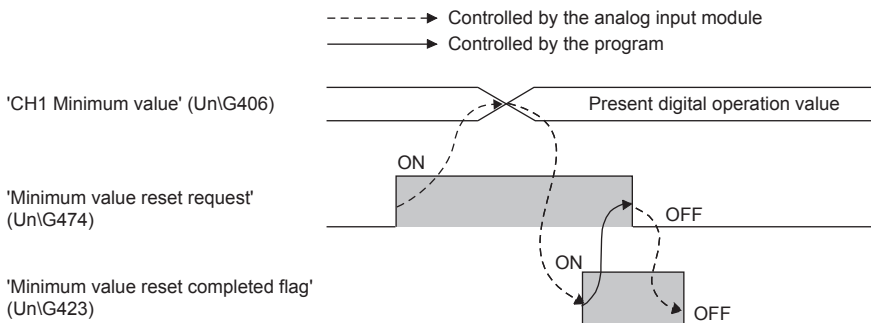

■Buffer memory address

The following shows the buffer memory address of this area.

Buffer memory name	CH1	CH2	CH3	CH4
CH□ Minimum value reset completed flag	423	623	823	1023

Minimum value reset completed flag [FX3 allocation mode]

The reset status of minimum value in FX3 allocation mode can be checked.

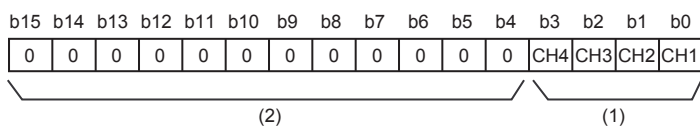

(1) 0: Not completed, 1: Completed

(2) The values of b4 to b15 are fixed to 0.

■Buffer memory address

The following shows the buffer memory address of this area.

Buffer memory name	CH1	CH2	CH3	CH4
CH□ Minimum value reset completed flag (in FX3 allocation mode function)	110			

A

CH1 Range setting monitor

The input range value set to the input range setting or 'CH1 Range setting' (Un\G598) can be checked.

Monitor value	Description
0003H	4 to 20 mA
0009H	0 to 20 mA
0006H	-20 to +20m V
000AH	1 to 5 V
000BH	0 to 5 V
0000H	-10 to +10 V
000CH	0 to 10 V
000EH	User range setting

■Buffer memory address

The following shows the buffer memory address of this area.

Buffer memory name	CH1	CH2	CH3	CH4
CH□ Range setting monitor	430	630	830	1030

Range setting monitor [FX3 allocation mode]

When the FX3 allocation mode function is used, the input range set state in the input range setting can be checked.

Monitor value	Description
0000H	-10 to +10 V
0001H	
0002H	
0003H	4 to 20 mA
0004H	
0005H	
0006H	-20 to +20 mA
0007H	
0008H	
0009H	0 to 20 mA
000AH	1 to 5 V
000BH	0 to 5 V
000CH	0 to 10 V
000DH	Use not allowed
000EH	User range setting
000FH	Use not allowed

■Buffer memory address

The following shows the buffer memory address of this area.

Buffer memory name	CH1	CH2	CH3	CH4
Range setting monitor	1031	1032	1033	1034

CH1 Difference conversion reference value

This area stores 'CH1 Digital operation value' (Un\G402) at the start of the difference conversion as the difference conversion reference value.

The difference conversion reference value is updated when 'CH1 Difference conversion trigger' (Un\G470) is turned from No request (0) to Trigger request (1).

■ Buffer memory address

The following shows the buffer memory address of this area.

Buffer memory name	CH1	CH2	CH3	CH4
CH□ Difference conversion standard value	432	632	832	1032
CH□ Difference conversion standard value (in FX3 allocation mode function)	1371	1372	1373	1374

Point

Even if 'CH1 Difference conversion state flag' (Un\G408) is turned from Converting difference (1) to Not converted (0), 'CH1 Difference conversion reference value' (Un\G432) is not cleared.

CH1 Head pointer

The buffer memory address of the oldest data in CH1 Logging data (Un\G10000 to Un\G19999) can be checked with this buffer memory area.

The offset value counted from the start address of CH1 Logging data (Un\G10000 to Un\G19999) is stored.

■ Buffer memory address

The following shows the buffer memory address of this area.

Buffer memory name	CH1	CH2	CH3	CH4
CH□ Head pointer	434	634	834	1034
CH□ Head pointer (in FX3 allocation mode function)	9031	9032	9033	9034

Ex.

When the value of 'CH2 Head pointer' (Un\G634) is 8550

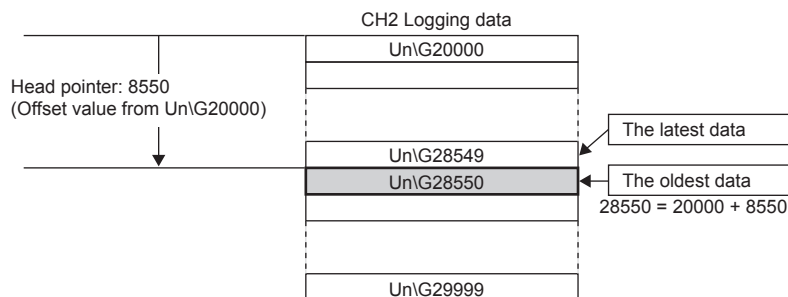

■ Default value

The default value is 0 for all channels.

Point

- The value in 'CH1 Head pointer' (Un\G434) is fixed to 0 since the oldest data is stored in the start address of CH1 Logging data (Un\G10000 to Un\G19999) while the data of the first 10000 points is being logged from beginning of the logging. On and after the 10001st data, 'CH1 Head pointer' (Un\G434) increases one by one each time data is stored.
- When 'CH1 Logging hold request' (Un\G471) is turned on→off, 'CH1 Head pointer' (Un\G434) is cleared to 0.

CH1 Latest pointer

The buffer memory address of the latest data in CH1 Logging data (Un\G10000 to Un\G19999) can be checked with this buffer memory area.

The offset value counted from the start address of CH1 Logging data (Un\G10000 to Un\G19999) is stored.

■Buffer memory address

The following shows the buffer memory address of this area.

Buffer memory name	CH1	CH2	CH3	CH4
CH□ Latest pointer	435	635	835	1035
CH□ Latest pointer (in FX3 allocation mode function)	9041	9042	9043	9044

Ex.

When the value of CH2 Latest pointer (Un\G635) is 8549

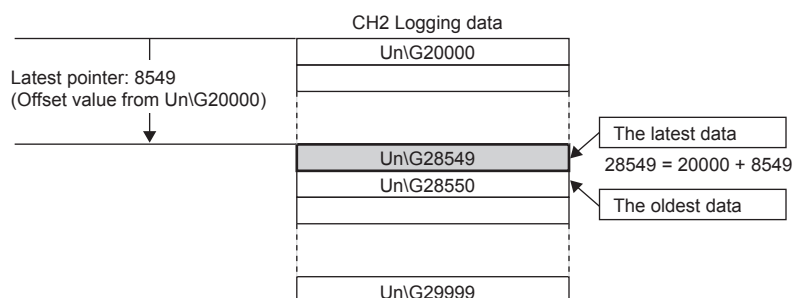

■Default value

The default value is 0 for all channels.

Point

- 'CH1 Latest pointer' (Un\G435) increases one by one each time data is stored from beginning of the logging.
- When 'CH1 Logging hold request' (Un\G471) is turned on→off, 'CH1 Latest pointer' (Un\G435) is cleared to 0.

CH1 Logging data points

The number of data stored in the logging data storage area can be checked during the logging.

'CH1 Number of logging data' (Un\G436) increases one by one each time data is stored from beginning of the logging.

When the value in the logging data storage area reaches 10000, 'CH1 Number of logging data points' (Un\G436) is fixed to 10000 since the value is overwritten from the head again.

For details on the logging function, refer to the following.

☞ Page 57 Logging function

■Buffer memory address

The following shows the buffer memory address of this area.

Buffer memory name	CH1	CH2	CH3	CH4
CH□ Number of logging data	436	636	836	1036
CH□ Number of logging data (in FX3 allocation mode function)	9051	9052	9053	9054

Point

When 'CH1 Logging hold request' (Un\G471) is turned on→off, 'CH1 Number of logging data' (Un\G436) is cleared to 0.

CH1 Trigger pointer

The buffer memory address of the data of when a hold trigger is executed in CH1 Logging data (Un\G10000 to Un\G19999) can be checked with this buffer memory area.

The difference between the address of buffer memory which stores the data of when a hold trigger is executed and the start address in CH1 Logging data (Un\G10000 to Un\G19999) is stored.

For details on the logging function, refer to the following.

 Page 57 Logging function

■Buffer memory address

The following shows the buffer memory address of this area.

Buffer memory name	CH1	CH2	CH3	CH4
CH□ Trigger pointer	437	637	837	1037
CH□ Trigger pointer (In FX3 allocation mode function)	9061	9062	9063	9064

■Default value

The default value is 0 for all channels.

Point

When 'CH1 Logging hold request' (Un\G471) is turned on→off, 'CH1 Trigger pointer' (Un\G437) is cleared to 0.

CH1 Current logging read pointer

Each time an amount equivalent to the logging read points monitor value is logged, a value calculated by the following formula is stored.

CH1 Current logging read pointer = CH1 Latest pointer - CH1 Logging read points monitor value + 1

For details on the logging function, refer to the following.

 Page 57 Logging function

■Buffer memory address

The following shows the buffer memory address of this area.

Buffer memory name	CH1	CH2	CH3	CH4
CH□ Current logging read pointer	438	638	838	1038
CH□ Current logging read pointer (in FX3 allocation mode function)	9241	9242	9243	9244

■Default value

The default value is -1 for all channels.

CH1 Previous logging read pointer

At the time of generating an interrupt to the CPU module, the current logging read pointer just before the update by the interrupt is stored.

For details on the logging function, refer to the following.

 Page 57 Logging function

■Buffer memory address

The following shows the buffer memory address of this area.

Buffer memory name	CH1	CH2	CH3	CH4
CH□ Previous logging read pointer	439	639	839	1039
CH□ Previous logging read pointer (in FX3 allocation mode function)	9251	9252	9253	9254

■Default value

The default value is -1 for all channels.

CH1 Logging read points monitor value

The number of the actual logging read points is stored.

When 'Operating condition setting request' (Un\G70, b9) is turned off→on→off, a value is not stored in the channel where the logging read function is disabled.

For details on the logging function, refer to the following.

☞ Page 57 Logging function

■Buffer memory address

The following shows the buffer memory address of this area.

Buffer memory name	CH1	CH2	CH3	CH4
CH□ Logging read points monitor value	440	640	840	1040
CH□ Logging read points monitor value (in FX3 allocation mode function)	9261	9262	9263	9264

CH1 Logging cycle monitor value

This area stores the actual logging cycle which is calculated from the refreshing cycle of data to be logged.

When 'Operating condition setting request' (Un\G70, b9) is turned off→on→off, the actual logging cycle is stored in Logging cycle monitor value in the corresponding channel where the logging function is enabled.

For details on the logging function, refer to the following.

☞ Page 57 Logging function

The following values are stored in 'CH1 Logging cycle monitor value' (Un\G441 to Un\G443).

	b15	to	b0
'CH1 Logging cycle Monitor value (Second)' (Un\G441)		s	
'CH1 Logging cycle Monitor value (Milli second)' (Un\G442)		ms	
'CH1 Logging cycle monitor value (μs)' (Un\G443)		μs	

■Buffer memory address

The following shows the buffer memory address of this area.

Buffer memory name	CH1	CH2	CH3	CH4
CH□ Logging cycle monitor value (s)	441	641	841	1041
CH□ Logging cycle monitor value (ms)	442	642	842	1042
CH□ Logging cycle monitor value (μs)	443	643	843	1043
CH□ Logging cycle monitor value (s) (In FX3 allocation mode function)	9071	9074	9077	9080
CH□ Logging cycle monitor value (ms) (In FX3 allocation mode function)	9072	9075	9078	9081
CH□ Logging cycle monitor value (μs) (In FX3 allocation mode function)	9073	9076	9079	9082

CH1 Trigger generation time

The time when a trigger is generated is recorded.

For details on the logging function, refer to the following.

 Page 57 Logging function

	b15	to	b8	b7	to	b0
'CH1 Trigger generation time (First/Last two digits of the year)' (Un\G444)	First two digits of the year			Last two digits of the year		
'CH1 Trigger generation time (Month/Day)' (Un\G445)	Month			Day		
'CH1 Trigger generation time (Hour/Minute)' (Un\G446)	Hour			Minute		
'CH1 Trigger generation time (Second/Day of the week)' (Un\G447)	Second			Day of the week		
'CH1 Trigger generation time (Millisecond)' (Un\G448)	Millisecond (upper)			Millisecond (lower)		

Item	Storage contents	Storage example ^{*1}
First two digits of the year/Last two digits of the year	Stored in BCD code.	2017H
Month/Day		0130H
Hour/Minute		1035H
Second		40H
Day of the week	One of the following values is stored in BCD code. Sunday: 0, Monday: 1, Tuesday: 2, Wednesday: 3, Thursday: 4, Friday: 5, Saturday: 6	1H
Millisecond (upper)	Stored in BCD code.	06H
Millisecond (lower)		28H

*1 These values assume that an error occurs at 10:35 and 40.628 seconds on Monday, January 30th, 2017.

■ Buffer memory address

The following shows the buffer memory address of this area.

Buffer memory name	CH1	CH2	CH3	CH4
CH□ Trigger generation time (First/Last two digits of the year)	444	644	844	1044
CH□ Trigger generation time (Month/Day)	445	645	845	1045
CH□ Trigger generation time (Hour/Minute)	446	646	846	1046
CH□ Trigger generation time (Second/Day of the week)	447	647	847	1047
CH□ Trigger generation time (Millisecond)	448	648	848	1048
CH□ Trigger generation time (First/Last two digits of the year) (In FX3 allocation mode function)	9101	9106	9111	9116
CH□ Trigger generation time (Month/Day) (In FX3 allocation mode function)	9102	9107	9112	9117
CH□ Trigger generation time (Hour/Minute) (In FX3 allocation mode function)	9103	9108	9113	9118
CH□ Trigger generation time (Second/Day of the week) (in FX3 allocation mode function)	9104	9109	9114	9119
CH□ Trigger generation time (Millisecond) (in FX3 allocation mode function)	9105	9110	9115	9120

Point

- Time units shorter than one millisecond are not recorded.
- When 'CH1 Logging hold request' (Un\G471) is turned on→off, 'CH1 Trigger generation time' (Un\G444 to Un\G448) is cleared to 0.

CH1 Difference conversion trigger

Use this buffer memory area as a trigger to start or stop the difference conversion.

For details on the difference conversion function, refer to the following.

 Page 39 Difference operation function

Setting value	Setting content
0	No request
1	Trigger request

Setting a value other than the values in the table above results in operation with Trigger request (1).

■Buffer memory address

The following shows the buffer memory address of this area.

Buffer memory name	CH1	CH2	CH3	CH4
CH□ Difference conversion trigger	470	670	870	1070
CH□ Difference conversion trigger (in FX3 allocation mode function)	1381	1382	1383	1384

■Starting and stopping the difference conversion

- When the setting value is turned from No request (0) to Trigger request (1), the difference conversion starts.
- When the setting value is turned from Trigger request (1) to No request (0), the difference conversion stops.

■Default value

The default value is No request (0) for all channels.

CH1 Logging hold request

Use this buffer memory area as a trigger to hold (stop) logging at any timing during the logging.

For details on the logging function, refer to the following.

 Page 57 Logging function

Logging hold request	Setting value
OFF	0
ON	1

Setting a value other than in the table above results in operation with ON (1).

When 'CH1 Logging enable/disable setting' (Un\G535) is set to Disable (1), the setting for 'CH1 Logging hold request' (Un\G471) is ignored.

■Buffer memory address

The following shows the buffer memory address of this area.

Buffer memory name	CH1	CH2	CH3	CH4
CH□ Logging hold request	471	671	871	1071
CH□ Logging hold request (In FX3 allocation mode function)	9151	9152	9153	9154

■Operation of the logging hold processing

- When Disable (0) is set to 'CH1 Level trigger condition setting' (Un\G540), the logging hold processing starts by turning off→on 'CH1 Logging hold request' (Un\G471).
- When a value other than Disable (0) is set to 'CH1 Level trigger condition setting' (Un\G540), the logging hold processing starts after 'CH1 Logging hold request' (Un\G471) is turned off→on and the set trigger condition is satisfied. When the level trigger is enabled, use this buffer memory area as an interlock condition to operate the level trigger.
- If 'CH1 Logging hold request' (Un\G471) is turned on→off during the logging hold processing, the hold (stop) status is cleared and the logging restarts.

■Default value

The default value is OFF (0) for all channels.



The stop status of the logging can be checked with 'CH1 Logging hold flag' (Un\G409).

CH1 Conversion value shift amount

Set 'CH1 Conversion value shift amount' (Un\G472) used for the shift function.

The digital operation value to which the conversion value shift amount is applied is stored in 'CH1 Digital operation value' (Un\G402).

For details on the shift function, refer to the following.

☞ Page 34 Shift function

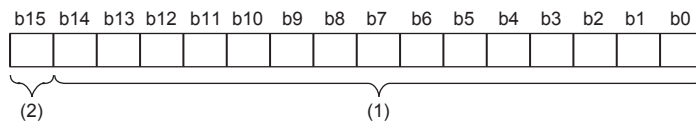

(1) Data section

(2) Sign bit 0: Positive, 1: Negative

■Buffer memory address

The following shows the buffer memory address of this area.

Buffer memory name	CH1	CH2	CH3	CH4
CH□ Conversion value shift amount	472	672	872	1072
CH□ Conversion value shift amount (In FX3 allocation mode function)	61	62	63	64

■Setting range

The possible setting range is from -32768 to +32767.

■Enabling the setting

Regardless of turning off→on→off 'Operating condition setting request' (Un\G70, b9), the set conversion value shift amount takes effect.

■Default value

The default value is 0 for all channels.

CH1 Maximum value reset request

When resetting the maximum value, and updating with the current value, turn off→on.

Maximum value reset request	Setting value
OFF	0
ON	1

Setting a value other than in the table above results in operation with ON (1).

■Buffer memory address

The following shows the buffer memory address of this area.

Buffer memory name	CH1	CH2	CH3	CH4
CH□ Maximum value reset request	473	673	873	1073

■Enabling the setting

When 'CH1 Maximum value reset request' (Un\G473) turns off→on, 'CH1 Maximum value' (Un\G404) is reset regardless of turning off→on→off of 'Operating condition setting request' (Un\G70, b9), and updated with the current value.

■Default value

The default value is OFF (0) for all channels.

Maximum value reset request [FX3 allocation mode]

When resetting the maximum value, and updating with the current value in FX3 allocation mode, turn off→on.

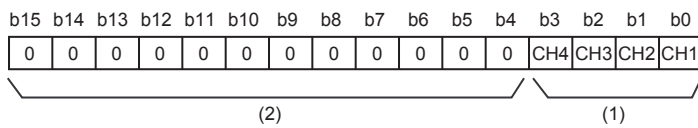

(1) 0: No reset request, 1: Reset request

(2) The values of b4 to b15 are fixed to 0.

■Buffer memory address

The following shows the buffer memory address of this area.

Buffer memory name	CH1	CH2	CH3	CH4
Maximum value reset request (In FX3 allocation mode function)	119			

■Enabling the setting

When 'Maximum value reset request' (Un\G119) turns off→on, 'CH1 Maximum value' (Un\G111) is reset regardless of turning off→on→off of 'Operating condition setting request' (Un\G70, b9), and updated with the current value.

■Default value

The default value is off (0).

CH1 Minimum value reset request

When resetting the minimum value, and updating with the current value, turn off→on.

Minimum value reset request	Setting value
OFF	0
ON	1

Setting a value other than in the table above results in operation with ON (1).

■Buffer memory address

The following shows the buffer memory address of this area.

Buffer memory name	CH1	CH2	CH3	CH4
CH□ Minimum value reset request	474	674	874	1074

■Enabling the setting

When 'CH1 Minimum value reset request' (Un\G474) turns off→on, 'CH1 Minimum value' (Un\G406) is reset regardless of turning off→on→off of 'Operating condition setting request' (Un\G70, b9), and updated with the current value.

■Default value

The default value is OFF (0) for all channels.

Minimum value reset request [In FX3 allocation mode]

When resetting the minimum value, and updating with the current value in FX3 allocation mode, turn off→on.

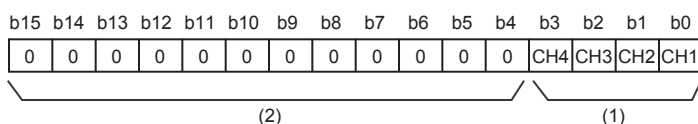

(1) 0: No reset request, 1: Reset request

(2) The values of b4 to b15 are fixed to 0.

■Buffer memory address

The following shows the buffer memory address of this area.

Buffer memory name	CH1	CH2	CH3	CH4
Minimum value reset request [In FX3 allocation mode function]	109			

■Enabling the setting

When 'Minimum value reset request' (Un\G109) turns off→on, 'CH1 Minimum value' (Un\G101) is reset regardless of turning off→on→off of 'Operating condition setting request' (Un\G70, b9), and updated with the current value.

■Default value

The default value is off (0).

CH1 A/D conversion enable/disable setting

Set whether to enable or disable the A/D conversion.

For details on the A/D conversion enable/disable setting function, refer to the following.

☞ Page 25 A/D conversion enable/disable setting function

Setting value	Setting content
0	A/D conversion enable
1	A/D conversion disable

When a value other than the ones above is set, the setting is turned to A/D conversion disable (1).

■Buffer memory address

The following shows the buffer memory address of this area.

Buffer memory name	CH1	CH2	CH3	CH4
CH□ A/D conversion enable/disable setting	500	700	900	1100
CH□ A/D conversion enable/disable setting (in FX3 allocation mode function)	1321	1322	1323	1324

■Enabling the setting

Turn off→on→off 'Operating condition setting request' (Un\G70, b9) to enable the setting.

■Default value

The default value is A/D conversion enable (0) for all channels.

CH1 Average processing specification

Select processing to be performed among the sampling processing, averaging processing, primary delay filter, and digital filter.

Averaging processing consists of time average, count average, and moving average.

Setting value	Setting content
0	Sampling processing
1	Time average
2	Count average
3	Moving average
4	Primary delay filter
5	Digital filter

Setting a value other than the above causes an averaging process specification setting range error (error code: 191□H).

■Buffer memory address

The following shows the buffer memory address of this area.

Buffer memory name	CH1	CH2	CH3	CH4
CH□ Averaging process specification	501	701	901	1101
CH□ Averaging process specification (In FX3 allocation mode function)	1081	1082	1083	1084

■Enabling the setting

Turn off→on→off 'Operating condition setting request' (Un\G70, b9) to enable the setting.

■Default value

The default value is Sampling processing (0) for all channels.

CH1 Time average/Count average/Moving average/Primary delay filter constant setting

Configure the time (for averaging), count (for averaging), moving average count, and Primary delay filter constant for each channel where the averaging processing is specified.

The following table lists the setting ranges.

Setting value	Setting content
2 to 5000 (ms)	Time average
4 to 62500 (counts)	Count average
2 to 1000 (counts)	Moving average
1 to 500 (times)	Primary delay filter constant

Setting a value other than the above causes any of time average setting range error (error code: 192□H), count average setting range error (error code: 193□H), moving count setting range error (error code: 194□H), Primary delay filter range error (error code: 195□H), and the A/D conversion processing is executed with the setting before error.

■Buffer memory address

The following shows the buffer memory address of this area.

Buffer memory name	CH1	CH2	CH3	CH4
CH□ Time average/Count average/Moving average/Primary delay filter constant setting	502	702	902	1102
CH□ Time average/Count average/Moving average/Primary delay filter constant setting (in FX3 allocation mode function)	2	3	4	5

■Enabling the setting

Turn off→on→off 'Operating condition setting request' (Un\G70, b9) to enable the setting.

■Default value

The default value is 0 for all channels.



- Set a Primary delay filter constant for the Primary delay filter. The value of the time constant (ms) is the product of the Primary delay filter constant and the conversion cycle.
- Since the default value is 0, change the setting value according to the processing method.
- The setting for this area is ignored in the channel where Digital filter (5) is set to 'CH1 Averaging process specification' (Un\G501).

CH1 Scaling enable/disable setting

Set whether to enable or disable the scaling.

For details on the scaling function, refer to the following.

Page 32 Scaling function

Setting value	Setting content
0	Enable
1	Disable

Setting a value other than the above causes a scaling enable/disable setting range error (error code: 1A0□H).

■Buffer memory address

The following shows the buffer memory address of this area.

Buffer memory name	CH1	CH2	CH3	CH4
CH□ Scaling enable/disable setting	504	704	904	1104
CH□ Scaling enable/disable setting (In FX3 allocation mode function)	1091	1092	1093	1094

■Enabling the setting

Turn off→on→off 'Operating condition setting request' (Un\G70, b9) to enable the setting.

■Default value

The default value is Disable (1) for all the channels.

CH1 Scaling upper limit value

Set an upper limit value for the range of the scale conversion.

For details on the scaling function, refer to the following.

☞ Page 32 Scaling function

■Buffer memory address

The following shows the buffer memory address of this area.

Buffer memory name	CH1	CH2	CH3	CH4
CH□ Scaling upper limit value	506, 507	706, 707	906, 907	1106, 1107
CH□ Scaling upper limit value (In FX3 allocation mode function)	1100, 1101	1102, 1103	1104, 1105	1106, 1107

■Setting range

The possible setting range is from -2147483648 to +2147483647.

In the channel where a set value does not satisfy the condition "the scaling upper limit value ≠ the scaling lower limit value", a scaling upper/lower limit value setting error (error code: 1A2□H) occurs.

When 'CH1 Scaling enable/disable setting' (Un\G504) is set to Disable (1), the setting for 'CH1 Scaling upper limit value' (Un\G506, 507) is ignored.

■Enabling the setting

Turn off→on→off 'Operating condition setting request' (Un\G70, b9) to enable the setting.

■Default value

The default value is 0 for all channels.

CH1 Scaling lower limit value

Set a lower limit value for the range of the scale conversion.

For details on the scaling function, refer to the following.

☞ Page 32 Scaling function

■Buffer memory address

The following shows the buffer memory address of this area.

Buffer memory name	CH1	CH2	CH3	CH4
CH□ Scaling lower limit value	508, 509	708, 709	908, 909	1108, 1109
CH□ Scaling lower limit value (In FX3 allocation mode function)	1120, 1121	1122, 1123	1124, 1125	1126, 1127

■Setting range

The possible setting range is from -2147483648 to +2147483647.

In the channel where a set value does not satisfy the condition "the scaling upper limit value ≠ the scaling lower limit value", a scaling upper/lower limit value setting error (error code: 1A2□H) occurs.

When 'CH1 Scaling enable/disable setting' (Un\G504) is set to Disable (1), the setting for 'CH1 Scaling lower limit value' (Un\G508, 509) is ignored.

■Enabling the setting

Turn off→on→off 'Operating condition setting request' (Un\G70, b9) to enable the setting.

■Default value

The default value is 0 for all channels.

CH1 Digital clipping enable/disable setting

Set whether to enable or disable the digital clipping function.

For details on the digital clipping function, refer to the following.

☞ Page 37 Digital clipping function

Setting value	Setting content
0	Enable
1	Disable

If a value other than the above is set, a digital clipping enable/disable setting range error (error code: 1A5□H) occurs.

■Buffer memory address

The following shows the buffer memory address of this area.

Buffer memory name	CH1	CH2	CH3	CH4
CH□ Digital clipping enable/disable setting	510	710	910	1110
CH□ Digital clipping enable/disable setting (In FX3 allocation mode function)	1141	1142	1143	1144

■Enabling the setting

Turn off→on→off 'Operating condition setting request' (Un\G70, b9) to enable the setting.

■Default value

The default value is Disable (1) for all the channels.

CH1 Alert output setting (Process alarm)

Set whether to enable or disable the alert output of the process alarm.

For details on the alert output function, refer to the following.

☞ Page 44 Alert output function

Setting value	Setting content
0	Enable
1	Disable

Setting a value other than the above causes an alert output setting (Process alarm) range error (error code: 1B0□H).

■Buffer memory address

The following shows the buffer memory address of this area.

Buffer memory name	CH1	CH2	CH3	CH4
CH□ Alert output setting (Process alarm)	512	712	912	1112
CH□ Alert output setting (Process alarm) (In FX3 allocation mode function)	1181	1182	1183	1184

■Enabling the setting

Turn off→on→off 'Operating condition setting request' (Un\G70, b9) to enable the setting.

■Default value

The default value is Disable (1) for all channels.

CH1 Alert output setting (Rate alarm)

Set whether to enable or disable the alert output of the rate alarm.

For details on the alert output function, refer to the following.

☞ Page 44 Alert output function

Setting value	Setting content
0	Enable
1	Disable

Setting a value other than the above causes an alert output setting (Rate alarm) range error (error code: 1B8□H).

■Buffer memory address

The following shows the buffer memory address of this area.

Buffer memory name	CH1	CH2	CH3	CH4
CH□ Alert output setting (Rate alarm)	513	713	913	1113
CH□ Alert output setting (Rate alarm) (in FX3 allocation mode function)	1211	1212	1213	1214

■Enabling the setting

Turn off→on→off 'Operating condition setting request' (Un\G70, b9) to enable the setting.

■Default value

The default value is Disable (1) for all channels.

CH1 Process alarm upper upper limit value

Set an upper upper limit value of the alert output function (Process alarm).

For details on the alert output function, refer to the following.

☞ Page 44 Alert output function

■Buffer memory address

The following shows the buffer memory address of this area.

Buffer memory name	CH1	CH2	CH3	CH4
CH□ Process alarm upper upper limit value	514	714	914	1114
CH□ Process alarm upper upper limit value (in FX3 allocation mode function)	81	82	83	84

■Setting range

The possible setting range is from -32768 to +32767.

■Enabling the setting

Turn off→on→off 'Operating condition setting request' (Un\G70, b9) to enable the setting.

■Default value

The default value is 0 for all channels.

CH1 Process alarm upper lower limit value

Set an upper lower limit value of the alert output function (Process alarm).

For details on the alert output function, refer to the following.

 Page 44 Alert output function

■Buffer memory address

The following shows the buffer memory address of this area.

Buffer memory name	CH1	CH2	CH3	CH4
CH□ Process alarm upper lower limit value	516	716	916	1116
CH□ Process alarm upper lower limit value (in FX3 allocation mode function)	1191	1192	1193	1194

■Setting range

The possible setting range is from -32768 to +32767.

■Enabling the setting

Turn off→on→off 'Operating condition setting request' (Un\G70, b9) to enable the setting.

■Default value

The default value is 0 for all channels.

CH1 Process alarm lower upper limit value

Set a lower upper limit value of the alert output function (Process alarm).

For details on the alert output function, refer to the following.

 Page 44 Alert output function

■Buffer memory address

The following shows the buffer memory address of this area.

Buffer memory name	CH1	CH2	CH3	CH4
CH□ Process alarm lower upper limit value	518	718	918	1118
CH□ Process alarm lower upper limit value (in FX3 allocation mode function)	1201	1202	1203	1204

■Setting range

The possible setting range is from -32768 to +32767.

■Enabling the setting

Turn off→on→off 'Operating condition setting request' (Un\G70, b9) to enable the setting.

■Default value

The default value is 0 for all channels.

CH1 Process alarm lower lower limit value

Set a lower lower limit value of the alert output function (Process alarm).

For details on the alert output function, refer to the following.

 Page 44 Alert output function

■Buffer memory address

The following shows the buffer memory address of this area.

Buffer memory name	CH1	CH2	CH3	CH4
CH□ Process alarm lower lower limit value	520	720	920	1120
CH□ Process alarm lower lower limit value (In FX3 allocation mode function)	71	72	73	74

■Setting range

The possible setting range is from -32768 to +32767.

■Enabling the setting

Turn off→on→off 'Operating condition setting request' (Un\G70, b9) to enable the setting.

■Default value

The default value is 0 for all channels.

Point

- When using the process alarm, configure the 4-step settings for the process alarm upper upper limit value, upper lower limit value, lower upper limit value, and lower lower limit value.
- A channel where the set values do not satisfy the condition "Upper upper limit value \geq Upper lower limit value \geq Lower upper limit value \geq Lower lower limit value" causes a process alarm upper lower limit value setting range error (error code: 1B△□H).
- Since the default value is 0, change the setting value.
- When the scaling function, shift function, digital clipping function, or difference conversion function is used, alarm targets are digital operation values to which the operation of each function is reflected. Be sure to consider operation results of each function to set values.

A

CH1 Rate alarm alert detection cycle setting

Set the cycle to check the change rate of digital output values.

The value of the cycle to detect a rate alarm alert is the product of the value in 'CH1 Rate alarm alert detection cycle setting' (Un\G522) and the conversion cycle.

■Buffer memory address

The following shows the buffer memory address of this area.

Buffer memory name	CH1	CH2	CH3	CH4
CH□ Rate alarm alert detection cycle setting	522	722	922	1122
CH□ Rate alarm alert detection cycle setting (In FX3 allocation mode function)	1221	1222	1223	1224

■Setting range

The possible setting range is from 1 to 32000 (times).

■Enabling the setting

Turn off→on→off 'Operating condition setting request' (Un\G70, b9) to enable the setting.

■Default value

The default value is 0 for all channels.

- A channel where the set value is out of the range causes a rate alarm detection cycle setting range error (error code: 1B9□H).
- Since the default value is 0, change the setting value when setting the rate alarm function.

CH1 Rate alarm upper limit value

Set an upper limit value of the change rate of digital output values to detect a rate alarm.

For details on the alert output function, refer to the following.

 Page 44 Alert output function

■Buffer memory address

The following shows the buffer memory address of this area.

Buffer memory name	CH1	CH2	CH3	CH4
CH□ Rate alarm upper limit value	524	724	924	1124
CH□ Rate alarm upper limit value (In FX3 allocation mode function)	91	92	93	94

■Setting range

The possible setting range is from -32768 to +32767.

Unit of the setting value varies depending on the setting of 'Rate alarm change rate selection' (Un\G299).

Rate alarm change rate selection (Un\G299)	Unit
Rate specification (0)	0.1%
Digital output value specification (1)	digit

■Enabling the setting

Turn off→on→off 'Operating condition setting request' (Un\G70, b9) to enable the setting.

■Default value

The default value is 0 for all channels.

CH1 Rate alarm lower limit value

Set a lower limit value of the change rate of digital output values to detect a rate alarm.

For details on the alert output function, refer to the following.

 Page 44 Alert output function

■Buffer memory address

The following shows the buffer memory address of this area.

Buffer memory name	CH1	CH2	CH3	CH4
CH□ Rate alarm lower limit value	526	726	926	1126
CH□ Rate alarm lower limit value (In FX3 allocation mode function)	1231	1232	1233	1234

■Setting range

The possible setting range is from -32768 to +32767.

Unit of the setting value varies depending on the setting of 'Rate alarm change rate selection' (Un\G299).

Rate alarm change rate selection (Un\G299)	Unit
Rate specification (0)	0.1%
Digital output value specification (1)	digit

■Enabling the setting

Turn off→on→off 'Operating condition setting request' (Un\G70, b9) to enable the setting.

■Default value

The default value is 0 for all channels.

Point

- When using the rate alarm, configure the 2-step settings for the rate alarm upper limit value and lower limit value.
- A channel where the set values satisfy the condition "Rate alarm lower limit value \geq Rate alarm upper limit value" causes a rate alarm upper/lower limit setting value inversion error (error code: 1BA□H).
- Since the default value is 0, change the setting value.

A

CH1 Input signal error detection setting

Set a condition for detecting an input signal error.

For details on the input signal error detection function, refer to the following.

 Page 51 Input signal error detection function

Setting value	Setting content
0	Disable
1	Upper and lower limit detection
2	Lower limit detection
3	Upper limit detection
4	Simple disconnection detection

If a value other than the above is set, an input signal error detection setting range error (error code: 1C0□H) occurs.

If Simple disconnection detection (4) is selected for the channel where the input range setting is other than 4 to 20 mA and 1 to 5 V, a disconnection detection enabled range setting range error (error code: 1C6□H) occurs.

■Buffer memory address

The following shows the buffer memory address of this area.

Buffer memory name	CH1	CH2	CH3	CH4
CH□ Input signal error detection setting	528	728	928	1128
CH□ Input signal error detection setting (In FX3 allocation mode function)	1151	1152	1153	1154

■Enabling the setting

Turn off→on→off 'Operating condition setting request' (Un\G70, b9) to enable the setting.

■Default value

The default value is Disable (0) for all the channels.

CH1 Input signal error detection lower limit setting value

Set a value to detect an error for the input analog value.

For details on the input signal error detection function, refer to the following.

☞ Page 51 Input signal error detection function

■Buffer memory address

The following shows the buffer memory address of this area.

Buffer memory name	CH1	CH2	CH3	CH4
CH□ Input signal error detection lower limit setting value	529	729	929	1129
CH□ Input signal error detection lower limit setting value (In FX3 allocation mode function)	1161	1162	1163	1164

■Setting range

The possible setting range is from 0 to 250 (0 to 25.0%). Set it in a unit of 1 (0.1%).

In the channel where a value out of the above setting range is set, an input signal error detection setting value range error (error code: 1C1□H) occurs.

The input signal error detection lower limit value is calculated by using the input signal error detection lower limit set value as the reference as follows. The input signal error detection lower limit value to be calculated varies depending on the input range used.

- Input signal error detection lower limit value = Lower limit value of each range - (Gain value of each range - Offset value of each range) × (Input signal error detection lower limit setting value/1000)

Detection conditions vary depending on 'CH1 Input signal error detection setting' (Un\G528) as follows:

- When Input signal error detection setting is set to Upper and lower limit detection (1), the detection is performed with both the input signal error detection upper limit value and input signal error detection lower limit value.
- When Input signal error detection setting is set to Lower limit detection (2), the detection is performed only with the input signal error detection lower limit value.
- When 'Input signal error detection setting' is set to Upper limit detection (3), the value set in this area is ignored.
- When Input signal error detection setting is set to Simple disconnection detection (4), the value set in this area is ignored.

■Enabling the setting

Turn off→on→off 'Operating condition setting request' (Un\G70, b9) to enable the setting.

■Default value

The default value is 50 for all channels. When the FX3 allocation mode function is used, 20 is set for all channels.

CH1 Input signal error detection upper limit setting value

Set a value to detect an error for the input analog value.

For details on the input signal error detection function, refer to the following.

☞ Page 51 Input signal error detection function

■Buffer memory address

The following shows the buffer memory address of this area.

Buffer memory name	CH1	CH2	CH3	CH4
CH□ Input signal error detection upper limit setting value	530	730	930	1130
CH□ Input signal error detection upper limit setting value (In FX3 allocation mode function)	1171	1172	1173	1174

■Setting range

The possible setting range is from 0 to 250 (0 to 25.0%). Set it in a unit of 1 (0.1%).

In the channel where a value out of the above setting range is set, an input signal error detection setting value range error (error code: 1C1□H) occurs.

The input signal error detection upper limit value is calculated by using the input signal error detection upper limit set value as the reference as follows. The input signal error detection upper limit value to be calculated varies depending on the input range used.

- Input signal error detection upper limit value = Gain value of each range + (Gain value of each range - Offset value of each range) × (Input signal error detection upper limit setting value/1000)

Detection conditions vary depending on 'CH1 Input signal error detection setting' (Un\G528) as follows:

- When Input signal error detection setting is set to Upper and lower limit detection (1), the detection is performed with both the input signal error detection upper limit value and input signal error detection lower limit value.
- When 'Input signal error detection setting' is set to Lower limit detection (2), the value set in this area is ignored.
- When Input signal error detection setting is set to Upper limit detection (3), the detection is performed only with the input signal error detection upper limit value.
- When Input signal error detection setting is set to Simple disconnection detection (4), the value set in this area is ignored.

■Enabling the setting

Turn off→on→off 'Operating condition setting request' (Un\G70, b9) to enable the setting.

■Default value

The default value is 50 for all channels. When the FX3 allocation mode function is used, 20 is set for all channels.

CH1 Logging enable/disable setting

Set whether to enable or disable the logging function.

For details on the logging function, refer to the following.

☞ Page 57 Logging function

Setting value	Setting content
0	Enable
1	Disable

Setting a value other than the above causes a logging enable/disable setting range error (error code: 1D0□H).

■Buffer memory address

The following shows the buffer memory address of this area.

Buffer memory name	CH1	CH2	CH3	CH4
CH□ Logging enable/disable setting	535	735	935	1135
CH□ Logging enable/disable setting (In FX3 allocation mode function)	9161	9162	9163	9164

■Enabling the setting

Turn off→on→off 'Operating condition setting request' (Un\G70, b9) to enable the setting.

■Default value

The default value is Disable (1) for all the channels.

CH1 Logging data setting

Determine the target to be collected: digital output value or digital operation value.

For details on the logging function, refer to the following.

☞ Page 57 Logging function

Setting value	Setting content
0	Digital output value
1	Digital operation value

Setting a value other than the above causes a logging data setting range error (error code: 1D3□H).

When 'CH1 Logging enable/disable setting' (Un\G535) is set to Disable (1), the setting for 'CH1 Logging data setting' (Un\G536) is ignored.

■Buffer memory address

The following shows the buffer memory address of this area.

Buffer memory name	CH1	CH2	CH3	CH4
CH□ Logging data setting	536	736	936	1136
CH□ Logging data setting (in FX3 allocation mode function)	9171	9172	9173	9174

■Enabling the setting

Turn off→on→off 'Operating condition setting request' (Un\G70, b9) to enable the setting.

■Default value

The default value is Digital operation value (1) for all channels.

CH1 Logging cycle setting value

Set a cycle for storing the logging data.

For details on the logging function, refer to the following.

☞ Page 57 Logging function

■Buffer memory address

The following shows the buffer memory address of this area.

Buffer memory name	CH1	CH2	CH3	CH4
CH□ Logging cycle setting value	537	737	937	1137
CH□ Logging cycle setting value (In FX3 allocation mode function)	9181	9182	9183	9184

■Setting range

The setting range varies depending on the setting in 'CH1 Logging cycle unit setting' (Un\G538).

CH1 Logging cycle unit setting (Un\G538)	Setting range
μs (0)	80 to 32767
ms (1)	1 to 32767
s (2)	1 to 3600

- Setting a value out of the above range causes a logging cycle setting value range error (error code: 1D1□H). Logging cannot be performed.
- If the set logging cycle is below the update cycle of data to be logged, a logging cycle setting disable error (error code: 1D2□H) occurs. Logging cannot be performed.

■Enabling the setting

Turn off→on→off 'Operating condition setting request' (Un\G70, b9) to enable the setting.

■Default value

The default value is 4 for all channels.

CH1 Logging cycle unit setting

Set a cycle unit for storing the logging data.

For details on the logging function, refer to the following.

 Page 57 Logging function

Setting value	Setting content
0	μs
1	ms
2	s

- Setting a value out of the above range causes a logging cycle setting value range error (error code: 1D1□H). Logging cannot be performed.
- If the set logging cycle is below the update cycle of data to be logged, a logging cycle setting disable error (error code: 1D2□H) occurs. Logging cannot be performed.

■Buffer memory address

The following shows the buffer memory address of this area.

Buffer memory name	CH1	CH2	CH3	CH4
CH□ Logging cycle unit setting	538	738	938	1138
CH□ Logging cycle unit setting (In FX3 allocation mode function)	9191	9192	9193	9194

■Enabling the setting

Turn off→on→off 'Operating condition setting request' (Un\G70, b9) to enable the setting.

■Default value

The default is ms (1) for all channels.

CH1 Logging points after trigger

Set a number of data points collected for the time period from the occurrence of a hold trigger to the logging stop.

For details on the logging function, refer to the following.

 Page 57 Logging function

■Buffer memory address

The following shows the buffer memory address of this area.

Buffer memory name	CH1	CH2	CH3	CH4
CH□ Post-trigger logging points	539	739	939	1139
CH□ Post-trigger logging points (In FX3 allocation mode function)	9201	9202	9203	9204

■Setting range

The possible setting range is from 1 to 10000.

Setting a value out of the range causes a post-trigger logging points setting range error (error code: 1D4□H). Logging cannot be performed.

When 'CH1 Logging enable/disable setting' (Un\G535) is set to Disable (1), the setting for 'CH1 Post-trigger logging points' (Un\G539) is ignored.

■Enabling the setting

Turn off→on→off 'Operating condition setting request' (Un\G70, b9) to enable the setting.

■Default value

The default value is 5000 for all channels.

CH1 Level trigger condition setting

Set the condition for the occurrence of a hold trigger when using the level trigger in the logging function.

To use the level trigger, perform level trigger condition setting to one of Level trigger (Condition: Rise) (1), Level trigger (Condition: Fall) (2), or Level trigger (Condition: Rise and fall) (3).

For details on the logging function, refer to the following.

 Page 57 Logging function

Setting value	Setting content
0	Disable
1	Level trigger (Condition: Rise)
2	Level trigger (Condition: Fall)
3	Level trigger (Condition: Rise and Fall)

Setting a value other than the above causes a level trigger condition setting range error (error code: 1D5□H).

■Buffer memory address

The following shows the buffer memory address of this area.

Buffer memory name	CH1	CH2	CH3	CH4
CH□ Level trigger condition setting	540	740	940	1140
CH□ Level trigger condition setting (In FX3 allocation mode function)	9211	9212	9213	9214

■Enabling the setting

Turn off→on→off 'Operating condition setting request' (Un\G70, b9) to enable the setting.

■Default value

The default value is Disable (0) for all the channels.

CH1 Trigger data

Set a buffer memory address to be monitored using a level trigger.

Set the buffer memory address where the target data for monitoring is stored.

For details on the logging function, refer to the following.

 Page 57 Logging function

■Buffer memory address

The following shows the buffer memory address of this area.

Buffer memory name	CH1	CH2	CH3	CH4
CH□ Trigger data	541	741	941	1141
CH□ Trigger data (In FX3 allocation mode function)	9221	9222	9223	9224

■Setting range

The possible setting range is from 0 to 9999.

Setting a value out of the range causes a trigger data setting range error (error code: 1D6□H). Logging cannot be performed.

■Enabling the setting

Turn off→on→off 'Operating condition setting request' (Un\G70, b9) to enable the setting.

■Default value

The default values are set as shown below.

Channel	Default value	Buffer memory area to be monitored
CH1	402	CH1 Digital operation value (Un\G402)
CH2	602	CH2 Digital operation value (Un\G602)
CH3	802	CH3 Digital operation value (Un\G802)
CH4	1002	CH4 Digital operation value (Un\G1002)

When the FX3 allocation mode function is used, the following applies.

Channel	Default value	Buffer memory area to be monitored
CH1	10	CH1 Digital operation value (Un\G10)
CH2	11	CH2 Digital operation value (Un\G11)
CH3	12	CH3 Digital operation value (Un\G12)
CH4	13	CH4 Digital operation value (Un\G13)

CH1 Trigger setting value

Set a level to generate a level trigger.

For details on the logging function, refer to the following.

 Page 57 Logging function

■Buffer memory address

The following shows the buffer memory address of this area.

Buffer memory name	CH1	CH2	CH3	CH4
CH□ Trigger setting value	542	742	942	1142
CH□ Trigger setting value (In FX3 allocation mode function)	9231	9232	9233	9234

■Setting range

The possible setting range is from -32768 to +32767.

■Enabling the setting

Turn off→on→off 'Operating condition setting request' (Un\G70, b9) to enable the setting.

■Default value

The default value is 0 for all channels.

CH1 Loading interrupt enable/disable setting

Set whether to enable or disable the logging read function.

For details on the logging function, refer to the following.

 Page 57 Logging function

Setting value	Setting content
0	Enable
1	Disable

- Setting a value other than the above causes a read interrupt enable/disable setting error (error code: 1D8□H). Logging cannot be performed.
- When set to Enable (0), an interrupt is generated and sent to the CPU module by setting a read pointer each time an amount equivalent to the logging read points setting value is logged.

■Buffer memory address

The following shows the buffer memory address of this area.

Buffer memory name	CH1	CH2	CH3	CH4
CH□ Logging loading enable/disable setting	544	744	944	1144
CH□ Logging loading enable/disable setting (in FX3 allocation mode function)	9271	9272	9273	9274

■Enabling the setting

Turn off→on→off 'Operating condition setting request' (Un\G70, b9) to enable the setting.

■Default value

The default value is Disable (1) for all the channels.

CH1 Logging read points setting value

An interrupt is generated to the CPU module each time the data equal to the set data points is logged.

For details on the logging function, refer to the following.

 Page 57 Logging function

■Buffer memory address

The following shows the buffer memory address of this area.

Buffer memory name	CH1	CH2	CH3	CH4
CH□ Logging load points setting value	545	745	945	1145
CH□ Logging load points setting value (in FX3 allocation mode function)	9281	9282	9283	9284

■Setting range

The possible setting range is from 10 to 10000.

Setting a value out of the range causes a logging load points setting value range error (error code: 1D9□H). Logging cannot be performed.

■Enabling the setting

Turn off→on→off 'Operating condition setting request' (Un\G70, b9) to enable the setting.

■Default value

The default value is 1000 for all channels.

CH1 Digital filter setting

When Digital filter (5) is set in Average processing specification, Digital filter setting is executed.

■Buffer memory address

The following shows the buffer memory address of this area.

Buffer memory name	CH1	CH2	CH3	CH4
CH□ Digital filter setting	570	770	970	1170
CH□ Digital filter setting (In FX3 allocation mode function)	6	7	8	9

■Setting range

The possible setting range is from 1 to 1600 (digits).

Setting a value out of the range causes a Digital filter setting range error (error code: 19D□H), and the A/D conversion processing is executed with the setting made before the error occurred.

■Enabling the setting

Turn off→on→off 'Operating condition setting request' (Un\G70, b9) to enable the setting.

■Default value

The default value is 0 for all channels.

CH1 Digital filter fluctuation width setting

The fluctuation width to be removed by digital filter processing is set.

■Buffer memory address

The following shows the buffer memory address of this area.

Buffer memory name	CH1	CH2	CH3	CH4
CH□ Digital filter fluctuation width setting	572, 573	772, 773	972, 973	1172, 1173
CH□ Digital filter fluctuation width setting (In FX3 allocation mode function)	1340, 1341	1342, 1343	1344, 1345	1346, 1347

■Setting range

The possible setting range is from 80 to 200000 (μs).

Set this value to Number of A/D conversion enabled channels × Conversion speed or more.

Setting a value out of the range causes a digital filter fluctuation width setting range error (error code: 19E□H), and the A/D conversion processing is executed with the setting made before the error occurred.

In the allowable setting range, when the value which is less than the value of "the Number of A/D conversion enable channels × Conversion speed" is set, "Digital filter fluctuation width setting range error" (error code: 19E□H) occurs and sampling processing is operated.

■Enabling the setting

Turn off→on→off 'Operating condition setting request' (Un\G70, b9) to enable the setting.

■Default value

The default value is 0 for all channels.

CH1 Range setting

This area is for setting an input range.

Setting value	Input range
0003H	4 to 20 mA
0009H	0 to 20 mA
0006H	-20 to +20 mA
000AH	1 to 5 V
000BH	0 to 5 V
0000H	-10 to +10 V
000CH	0 to 10 V
000EH	User range setting

Setting a value other than the above causes an input range setting range error (error code: 190□H).

■Buffer memory address

The following shows the buffer memory address of this area.

Buffer memory name	CH1	CH2	CH3	CH4
CH□ Range setting	598	798	998	1198

■Enabling the setting

Turn off→on→off 'Operating condition setting request' (Un\G70, b9) to enable the setting.

■Default value

The default value is 0003H for all channels.

Range setting [FX3 allocation mode]

When the FX3 allocation mode function is used, this area is for setting an input range.

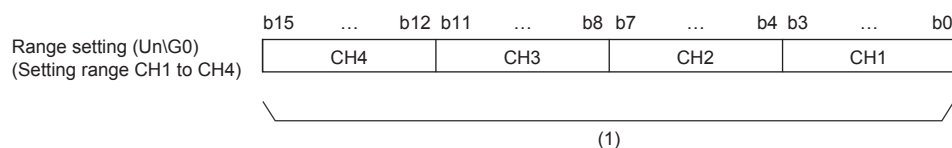

Set the following setting values for the bits corresponding to each CH.

Setting value	Input range
0H	-10 to +10 V
1H	
2H	
3H	4 to 20 mA
4H	
5H	
6H	-20 to +20 mA
7H	
8H	
9H	0 to 20 mA
AH	1 to 5 V
BH	0 to 5 V
CH	0 to 10 V
EH	User range setting

■Buffer memory address

Buffer memory name	CH1	CH2	CH3	CH4
Range setting (in FX3 allocation mode function)	0			

■Enabling the setting

Turn off→on→off 'Operating condition setting request' (Un\G70, b9) to enable the setting.

Error history

Up to 16 errors that occurred in the analog input module are logged.

	b15	to	b8 b7	to	b0
Un\G3600	Error code				
Un\G3601	First two digits of the year		Last two digits of the year		
Un\G3602	Month		Day		
Un\G3603	Hour		Minute		
Un\G3604	Second		Day of the week		
Un\G3605	Millisecond (upper)		Millisecond (lower)		
Un\G3606	System area				
⋮					
Un\G3609					

Item	Storage contents	Storage example ^{*1}
First two digits of the year/Last two digits of the year	Stored in BCD code.	2017H
Month/Day		0130H
Hour/Minute		1035H
Second		40H
Day of the week	One of the following values is stored in BCD code. Sunday: 0, Monday: 1, Tuesday: 2, Wednesday: 3, Thursday: 4, Friday: 5, Saturday: 6	1H
Millisecond (upper)	Stored in BCD code.	06H
Millisecond (lower)		28H

*1 These values assume that an error occurs at 10:35 and 40.628 seconds on Monday, January 30th, 2017.

■ Buffer memory address

The following shows the buffer memory address of this area.

Buffer memory name	No.1 to No.16
Error history	3600 to 3759
Error history (In FX3 allocation mode function)	8600 to 8759

A

Alarm history

Up to 16 alarms that occurred in the analog input module are logged.

	b15	to	b8 b7	to	b0
Un\G3760	Alarm code				
Un\G3761	First two digits of the year		Last two digits of the year		
Un\G3762	Month		Day		
Un\G3763	Hour		Minute		
Un\G3764	Second		Day of the week		
Un\G3765	Millisecond (upper)		Millisecond (lower)		
Un\G3766	System area				
⋮					
Un\G3769					

Item	Storage contents	Storage example ^{*1}
First two digits of the year/Last two digits of the year	Stored in BCD code.	2017H
Month/Day		0130H
Hour/Minute		1035H
Second		40H
Day of the week	One of the following values is stored in BCD code. Sunday: 0, Monday: 1, Tuesday: 2, Wednesday: 3, Thursday: 4, Friday: 5, Saturday: 6	1H
Millisecond (upper)	Stored in BCD code.	06H
Millisecond (lower)		28H

*1 These values assume that an alarm occurs at 10:35 and 40.628 seconds on Monday, January 30th, 2017.

■ Buffer memory address

The following shows the buffer memory address of this area.

Buffer memory name	No.1 to No.16
Alarm history	3760 to 3919
Alarm history (in FX3 allocation mode function)	8760 to 8919

CH1 Offset/gain setting mode

Specify the channel where the offset/gain setting is adjusted.

- Offset/gain setting mode (offset specification): Channel to adjust the offset
- Offset/gain setting mode (gain specification): Channel to adjust the gain

Setting	Setting content
0	Disable
1	Setting channel

Set one of the offset specification or gain specification to the Setting channel (1), and the other to Disable (0). Setting a value other than 0 and 1 causes an offset/gain setting channel range error (error code: 1E8□H).

Multiple channels can be set at the same time. In that case, set the offset specification and gain specification separately. The offset specification and gain specification cannot be set at the same time.

In the following cases, an offset/gain setting channel specification error (error code: 1E50H) occurs.

- When both the offset specification and gain specification of the same channel are set to Setting channel (1)
- When both the offset specification and gain specification of the same channel are set to Disable (0)

■Buffer memory address

The following shows the buffer memory address of this area.

Buffer memory name	CH1	CH2	CH3	CH4
CH□ Offset/gain setting mode (offset specification)	4132	4134	4136	4138
CH□ Offset/gain setting mode (gain specification)	4133	4135	4137	4139
CH□ Offset/gain setting mode (offset specification) (in FX3 allocation mode function)	4131	4132	4133	4134
CH□ Offset/gain setting mode (gain specification) (In FX3 allocation mode function)	4141	4142	4143	4144

■Enabling the setting

Turn off→on 'Channel change request' (Un\G70, b11).

■Default value

The default value is Disable (0) for all the channels.

CH1 Offset/gain setting mode (Range specification)

In the offset/gain setting, specify the current input or voltage input for each channel.

Setting value	Setting content
0	Voltage
1	Current

When a value other than 0 or 1 is set, the setting is regarded as Current (1).

- When an offset/gain value is written in the offset/gain setting mode (when 'User range write request' (Un\G70, b10) is turned off→on), this setting is written to the flash memory.

■Buffer memory address

The following shows the buffer memory address of this area.

Buffer memory name	CH1	CH2	CH3	CH4
CH□ Offset/gain setting mode (range specification)	4164	4165	4166	4167
CH□ Offset/gain setting mode (range specification) (In FX3 allocation mode function)	4151	4152	4153	4154

■Default value

The default value is Voltage (0) for all channels.

When the mode changes to offset gain setting, the value saved in the flash memory is set.

CH1 Logging data

This area stores the data logged by the logging function.

Up to 10000 points of data can be stored per channel. After the number of stored data points reaches 10000, data collection continues with the data overwritten from the head.

For details on the logging function, refer to the following.

 Page 57 Logging function

■Buffer memory address

The following shows the buffer memory address of this area.

Buffer memory name	CH1	CH2	CH3	CH4
CH□ Logging data	10000 to 19999	20000 to 29999	30000 to 39999	40000 to 49999
CH□ Logging data (In FX3 allocation mode function)	10000 to 19999	20000 to 29999	30000 to 39999	40000 to 49999

Point

- Turning off→on 'Operating condition setting request' (Un\G70, b9) allows the logging data in all the channels to be cleared.
- Turning on→off Logging hold request while Logging hold flag is on allows logging to resume. In this case, the logged data is not cleared.

PART 2

ANALOG OUTPUT MODULE

Part 2 describes the analog output module.

2 FX5-4DA

2 FX5-4DA

2.1 Overview

The FX5-4DA analog output module is an intelligent function module that converts 4 points of digital values into analog output (voltage, current).

It can be added to an FX5 CPU module and can output 4 channels of voltage/current.

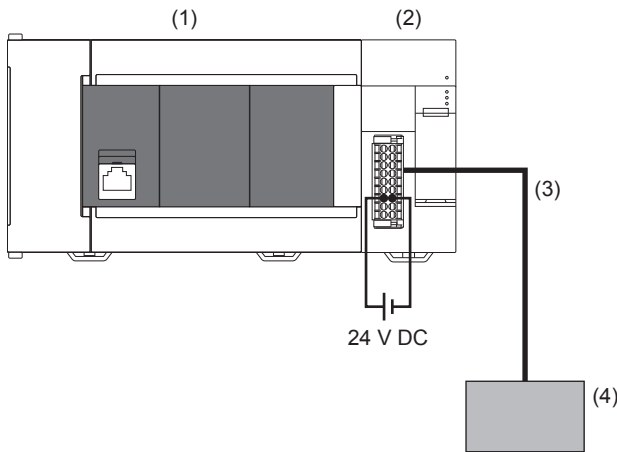

- (1) FX5 CPU module
- (2) Analog output module (FX5-4DA)
- (3) Analog device connection cable
- (4) Analog device (e.g. inverter)

2.2 Specifications

This section describes the specifications of FX5-4DA.

General specifications

The general specifications other than below are the same as those for the CPU module to be connected.

For general specifications, refer to the following manuals.

📖 MELSEC iQ-F FX5S/FX5UJ/FX5U/FX5UC User's Manual (Hardware)

Items	Specifications	
Dielectric withstand voltage	500 V AC for 1 minute	Between all terminals and ground terminal
Insulation resistance	10 MΩ or higher by 500 V DC insulation resistance tester	

Power supply specifications

The following table lists the power supply specifications.

Items	Specifications	
External power supply	Power supply voltage	24 V DC +20%, -15%
	Allowable momentary power outage time	Operation continues when the instantaneous power failure is shorter than 5 ms.
	Current consumption	150 mA
Internal power supply	Power supply voltage	5 V DC
	Current consumption	100 mA

Performance specifications

The following table lists the performance specifications.

Items		Specifications
Number of output points		4 points (4 channels)
Conversion speed		80 μ s/ch
Isolation method	Between output terminal and PLC	Photocoupler
	Between output terminal channels	Non-isolation
Number of occupied I/O points		8 points
Applicable CPU module		<ul style="list-style-type: none"> FX5UJ CPU module (from the first) FX5U CPU module (Ver.1.050 or later) FX5UC CPU module^{*1} (Ver.1.050 or later)
Applicable engineering tool		<ul style="list-style-type: none"> FX5UJ CPU module: GX Works3 (Ver.1.060N or later) FX5U/FX5UC CPU module: GX Works3 (Ver.1.040S or later)

*1 FX5-CNV-IFC or FX5-C1PS-5V is necessary to connect FX5-4DA to the FX5UC CPU module.

Output specifications

Items		Specifications		
Analog output voltage		-10 to +10 V DC (external load resistance value 1 k Ω to 1 M Ω)		
Analog output current		0 to 20 mA DC (external load resistance value 0 to 500 Ω)		
Digital input		16-bit signed binary (-32768 to +32767)		
Output characteristics, resolution ^{*1}	Analog output range		Digital value	Resolution
	Voltage	0 to 10 V	0 to 32000	312.5 μ V
		0 to 5 V	0 to 32000	156.3 μ V
		1 to 5 V	0 to 32000	125 μ V
		-10 to +10 V	-32000 to +32000	312.5 μ V
		User range setting	-32000 to +32000	312.5 μ V ^{*2}
	Current	0 to 20 mA	0 to 32000	625 nA
		4 to 20 mA	0 to 32000	500 nA
User range setting		-32000 to +32000	500 nA ^{*2}	
Accuracy (accuracy for the full scale analog output value)		Ambient temperature 25 \pm 5 $^{\circ}$ C: Within \pm 0.1% (voltage \pm 20 mV, current \pm 20 μ A) Ambient temperature 0 to 55 $^{\circ}$ C: Within \pm 0.2% (voltage \pm 40 mV, current \pm 40 μ A) Ambient temperature -20 to 0 $^{\circ}$ C: Within \pm 0.3% (voltage \pm 60 mV, current \pm 60 μ A)		

*1 For details on the output characteristics, refer to  Page 180 Output conversion characteristics.

*2 Maximum resolution in the user range setting.

Output conversion characteristics

The output conversion characteristics of D/A conversion are expressed by the slope of the straight line connected between the offset and gain values both of which are used when a digital value written from CPU module is converted to the voltage or current output value.

Offset value

The analog voltage or current value generated when the digital value 0 is set from the CPU module.

Gain value

The analog voltage or current value generated when the digital value 32000 is set from the CPU module.

Voltage output characteristic

The following shows the list of analog output ranges at the voltage output and the graphs of the voltage input characteristics.

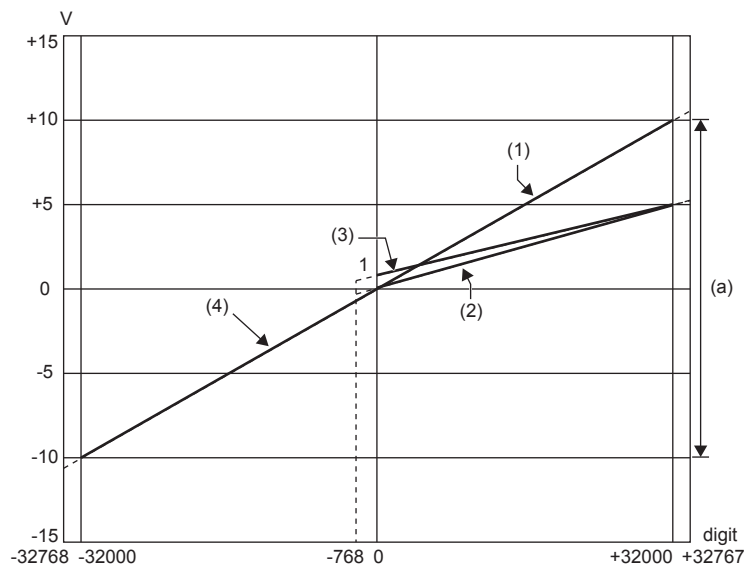

digit: Digital value

V: Analog output voltage (V)

(a): Practical analog output range

No.	Analog output range setting	Offset value	Gain value	Digital value	Resolution
(1)	0 to 10 V	0 V	10 V	0 to 32000	312.5 μ V
(2)	0 to 5 V	0 V	5 V		156.3 μ V
(3)	1 to 5 V	1 V	5 V		125.0 μ V
(4)	-10 to +10 V	0 V	10 V	-32000 to +32000	312.5 μ V
—	User range setting (voltage)	*1	*1		312.5 μ V*2

*1 Set the offset value and gain value in the user range setting within a range satisfying the following conditions. Failure to satisfy the conditions may not result in proper D/A conversion.

- Setting range of the offset value and gain value: -10 to +10 V
- ((Gain value) - (Offset value)) \geq 2.0 V

*2 Maximum resolution in the user range setting. The resolution reaches the maximum when (gain value - offset value) = 10 V. Even when (gain value - offset value) < 10 V, the maximum resolution is unchanged.

Point

- Set values within the practical digital input and analog output ranges of each output range. If the range is exceeded, the resolution and accuracy may not fall within the range of the performance specifications. (Do not use values in the dotted line region in the graph of voltage output characteristics.)

Current output characteristic

The following shows the list of analog output ranges at the current output and the graphs of the voltage output characteristics.

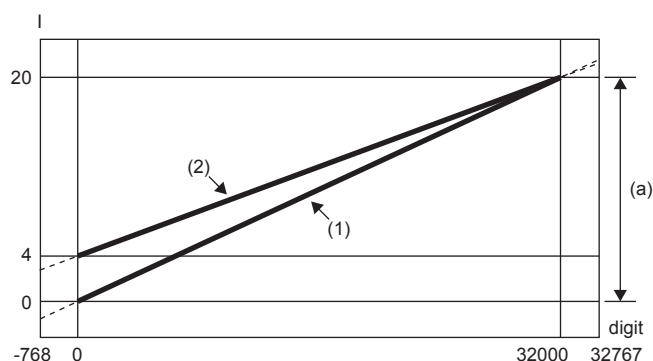

digit: Digital value

I: Analog output current (mA)

(a): Practical analog output range

No.	Analog output range setting	Offset value	Gain value	Digital value	Resolution
(1)	0 to 20 mA	0 mA	20 mA	0 to 32000	625.0 nA
(2)	4 to 20 mA	4 mA	20 mA		500.0 nA
—	User range setting (current)	*1	*1	-32000 to +32000	500.0 nA ^{*2}

*1 Set the offset value and gain value in the user range setting within a range satisfying the following conditions. Failure to satisfy the conditions may not result in proper D/A conversion.

- Offset value ≥ 0 mA, gain value ≤ 20 mA
- ((Gain value) - (Offset value)) ≥ 6.0 mA

*2 Maximum resolution in the user range setting. The resolution reaches the maximum when (gain value - offset value) = 16 mA. Even when (gain value - offset value) < 16 mA, the maximum resolution is unchanged.

Point

- Set values within the practical digital input and analog output ranges of each output range. If the range is exceeded, the resolution and accuracy may not fall within the range of the performance specifications. (Do not use values in the dotted line region in the graph of current output characteristics.)

Accuracy

The accuracy of D/A conversion is the accuracy for the full scale of analog output value.

Any output characteristic change through changes of the offset/gain setting or the output range does not sacrifice the accuracy, which is maintained within the range in the performance specifications.

The following graph shows the fluctuation range of accuracy when the range of -10 to +10 V is selected.

The fluctuation range varies as follows depending on the ambient temperature and output range.

Analog output	Ambient temperature		
	25±5°C	0 to 55°C	-20 to 0°C
Voltage	Within ±0.1% (voltage ±20 mV, current ±20 μA)/full scale*1	Within ±0.2% (voltage ±40 mV, current ±40 μA)/full scale*1	Within ±0.3% (voltage ±60 mV, current ±60 μA)/full scale*1
Current			

*1 Full-scale refers to voltage: -10 to +10 V, and current: 0 to 20 mA.
(Except for the conditions under noise influence.)

Ex.

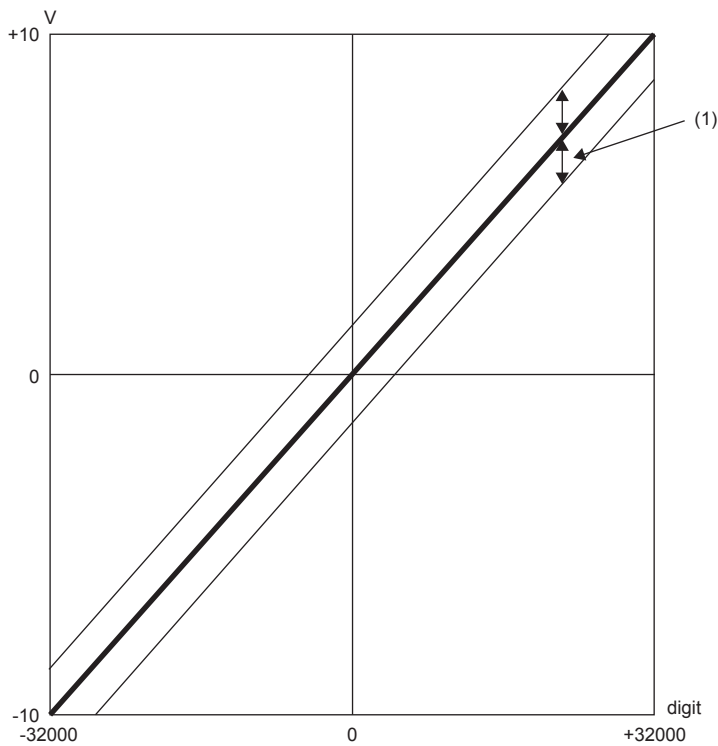

digit: Digital value
V: Analog output value (V)
(1): Fluctuation range

Part names

This section describes the part names of the analog output module.

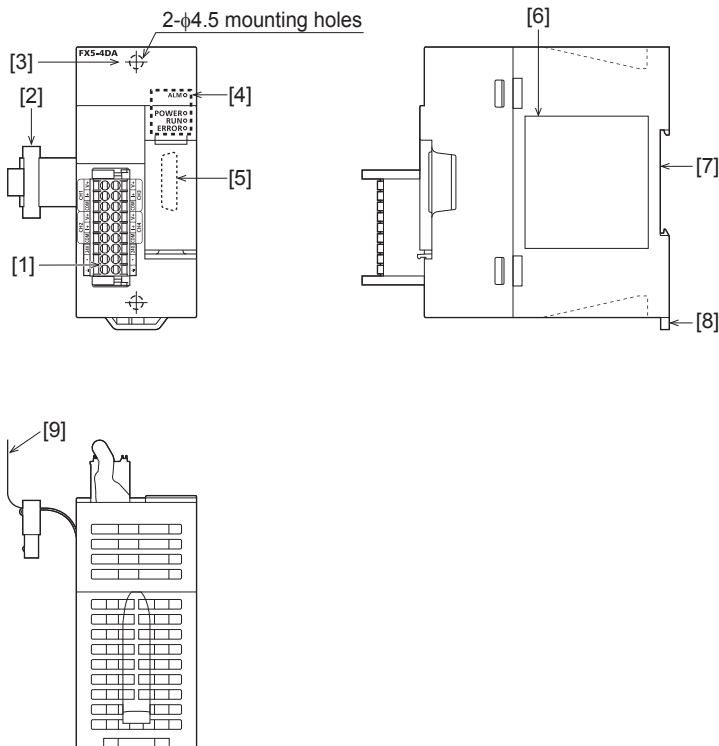

No.	Name	Description
[1]	Terminal block (Spring clamp terminal block)	For the current/voltage output and the input of 24 V external power supply.
[2]	Expansion cable	Cable for connecting the module when adding the analog output module.
[3]	Direct mounting hole	Screw holes (2-φ4.5, mounting screw: M4 screw) for direct installation.
[4]	Operations status display LEDs	Indicates the operating status of the module. (☞ Page 183 LED display)
[5]	Extension connector	Connector for connecting the extension cable of an extension module.
[6]	Name plate	The product model name and manufacturer's serial number are shown.
[7]	DIN rail mounting groove	The module can be installed on DIN46277 rail (35 mm wide).
[8]	DIN rail mounting hook	Hook for mounting the module on a DIN rail of DIN46277 (35 mm wide).
[9]	Pull out tab	They are used when drawing out an extension cable.

LED display

The following table lists the LED display.

LED display	LED color	Description
POWER	Green	Indicates the power supply status. ON: Power ON OFF: Power off or module failure
RUN	Green	Indicates the operating status. Light on: Normal operation Flashing: Offset/gain setting mode Light off: Error occurring
ERROR	Red	Indicates the error status. ON: Minor error Flashing: Moderate error or major error OFF: Normal operation
ALM	Red	Indicates the alarm status. ON: Alarm occurred OFF: Normal operation

2.3 Procedures Before Operation

This section describes the procedures before operation.

1. Check the analog output module specifications

Check the specifications for the analog output module. ( Page 178 Specifications)

2. Install the analog output module

Install the analog output module to the CPU module. For details, refer to the following.

 MELSEC iQ-F FX5S/FX5UJ/FX5U/FX5UC User's Manual (Hardware)

3. Wiring

Perform wiring of external devices to the analog output module.

4. Adding a module

Add an analog output module to the module configuration by using GX Works3.

Point

When adding a new analog output module, if selecting the module whose module model name has "(FX3)" at the end, it can be used as FX3 allocation mode.

- FX5-4DA: Normal mode
- FX5-4DA(FX3): FX3 allocation mode

For details on the FX3 allocation mode function, refer to  Page 240 FX3 allocation mode function

5. Parameter settings

Set parameters of the analog output module by using GX Works3. ( Page 247 Parameter Settings)

6. Offset/gain setting

When setting the user range, perform the offset/gain setting.

7. Programming

Create a program.

2.4 Functions

This section describes the functions of an analog output module and the setting procedures for those functions.

For details on the buffer memory areas, refer to the following.

 Page 287 Buffer Memory Areas

Point

- This section describes buffer memory addresses for CH1. For details on the buffer memory addresses after CH2, refer to the following.

 Page 287 List of buffer memory areas

- Numerical values corresponding to the channel where an error has occurred and the error description fit in the □ and △ of an error code and alarm code described in this section. For details on the numerical values, refer to the following.

 Page 279 List of error codes

 Page 282 List of alarm codes

Function list

This section lists the functions of analog output module.

Item	Description	Reference
Operation mode	Select the operation mode (Normal mode, Offset/gain setting mode) of the analog output module.	Page 185
Range switching function	Switches the analog output range for each channel. This function can change the output conversion characteristic by switching the range.	Page 187
D/A conversion enable/disable function	Controls whether to enable or disable the D/A conversion for each channel. Disabling D/A conversion for unused channels reduces the conversion cycle.	Page 187
D/A output enable/disable function	Specifies whether to output the D/A conversion value or offset value for each channel. The conversion speed is constant regardless of the output enable/disable setting.	Page 188
Analog output HOLD/CLEAR function	Sets whether to clear the current analog output value, or hold the previous value or the setting value when the CPU module operating status is Run, Stop, or Stop Error.	Page 188
Analog output test function when CPU module stops	Conducts an analog output test when CPU module stops.	Page 191
Scaling function	Performs scale conversion on digital values within the range from a scaling upper limit value to a scaling lower limit value, both of which are set at desired values. This function helps reduce the man-hours taken for creating a scale conversion program.	Page 192
Shift function	Adds the set input value shift amount to the digital value.	Page 194
Alert output function	Outputs an alarm when the digital value exceeds the warning output upper limit value or is below the warning output lower limit value.	Page 196
Rate control function	Limits the increase or decrease amount of the analog output value per 80 μ s to prevent sudden change of the analog output value.	Page 198
External power supply disconnection detection function	Detects that the 24 V DC external power supply is not being supplied or the supply stopped.	Page 201
Disconnection detection function	Detects a disconnection by monitoring the analog output value.	Page 202
Interrupt function	Executes a CPU module interrupt program when an interrupt factor such as a disconnection or warning output is detected.	Page 203
Wave output function	Registers the previously prepared wave data (digital input values) in the analog output module and performs consecutive analog output with the set conversion cycle.	Page 206
Error history function	Records up to 16 errors and alarms that occurred in an analog output module to store them in the buffer memory areas.	Page 237
Offset/gain setting	Corrects the D/A conversion value error for each channel.	Page 259
FX3 allocation mode function	This function controls the operation with a layout of the buffer memory addresses equivalent to those in FX3U-4DA. Sequence programs with proven results in FX3U-4DA can be diverted.	Page 240

Operation mode

The analog output module operates in the normal and offset gain setting modes. Change the mode according to the function to be used.

The individual modes are described below.



Each operation mode further allows you to select the FX3 allocation mode function that controls the operation with a layout of the buffer memory addresses equivalent to those in FX3U-4DA.

Normal mode

The normal mode is divided into the normal output and wave output modes. "Normal mode" in this manual refers to both the normal output and wave output modes.

■Normal output mode

Used to perform normal D/A conversion. This mode D/A-converts the value set in 'CH1 Digital value' (Un\G460) and outputs it as an analog output value.

■Wave output mode

Used for wave output. This mode D/A-converts the value set in 'Wave data registration area' (Un\G10000 to Un\G89999) and outputs it as an analog output value.

For details on the wave output function, refer to the following.

☞ Page 206 Wave output function

Offset/gain setting mode

A mode used for the offset/gain setting

For details on the offset/gain settings, refer to the following.

☞ Page 259 Offset/Gain Setting

Mode change

The conditions for changing each mode are described below.

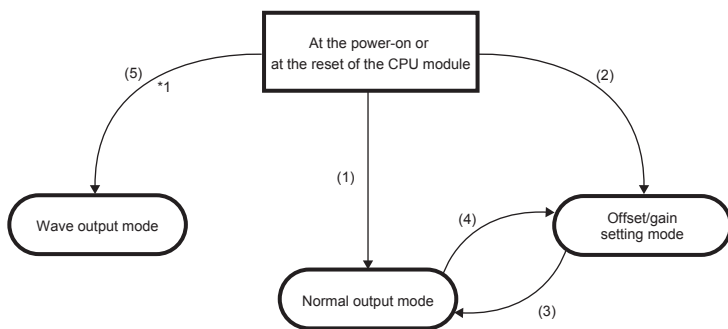

No.	Conditions for change
(1)	In "Basic setting" of GX Works 3, "Operation mode setting" is set to "Normal mode", and "Output mode setting" is set to "Normal output mode".
(2)	In "Basic setting" of GX Works 3, "Operation mode setting" is set to the "Offset/gain setting mode".
(3)	The following values are set in 'Mode switching setting' (Un\G296, Un\G297), and 'Operation condition setting request' (Un\G70, b9) is turned off→on→off. • Un\G296: 4658H • Un\G297: 4441H
(4)	The following values are set in 'Mode switching setting' (Un\G296, Un\G297), and 'Operation condition setting request' (Un\G70, b9) is turned off→on→off. • Un\G296: 4441H • Un\G297: 4658H
(5)	In "Basic setting" of GX Works 3, "Operation mode setting" is set to "Normal mode", and "Output mode setting" is set to "Wave output mode".

*1 The wave output mode is independent of the others. After the system starts up in the wave output mode, it cannot change to another. After the system starts up in a mode other than wave output, it cannot change to the wave output mode.

Checking

The current mode can be examined by the following.

Mode	RUN LED status	Stored value of "Operation mode monitor" (Un\G60)	Offset/gain setting mode status flag (Un\G69, b10)	
Normal mode	Normal output mode	ON	0	OFF
	Wave output mode	ON	2	OFF
Offset/gain setting mode	FLASH	1	ON	

Range switching function

Switches the analog output range for each channel.

This function can change the output conversion characteristic by switching the range.

Setting procedure

In the "Output range setting", set the output range to be used.

 [Navigation window] ⇒ [Parameter] ⇒ [Module Information] ⇒ Module model name ⇒ [Module Parameter] ⇒ [Basic setting] ⇒ [Range switching function]

Output range setting	Digital input range
4 to 20 mA	0 to 32000
0 to 20 mA	0 to 32000
1 to 5 V	0 to 32000
0 to 5 V	0 to 32000
-10 to +10 V	-32000 to +32000
0 to 10 V	0 to 32000
User range setting (voltage)*1	-32000 to +32000
User range setting (current)*1	-32000 to +32000

*1 When using the user range setting, set the offset/gain.

For offset/gain settings, refer to the following.

 Page 259 Offset/Gain Setting

After the data is written, the range is switched when the programmable controller power supply is turned off→on or when the CPU module is reset.

Point

The range can be switched or the range setting can be monitored using the following buffer memory addresses.

- 'CH1 Range setting' (Un\G598)
- 'CH1 Range setting monitor' (Un\G430)

For details on the buffer memory, refer to the following.

 Page 328 CH1 Range setting

 Page 314 CH1 Range setting monitor

D/A conversion enable/disable function

Controls whether to enable or disable the D/A conversion for each channel.

Disabling D/A conversion for unused channels reduces the conversion cycle.

Setting procedure

Set "D/A conversion enable/disable setting" to "D/A conversion enable" or "D/A conversion disable".

 [Navigation window] ⇒ [Parameter] ⇒ [Module Information] ⇒ Module model name ⇒ [Module Parameter] ⇒ [Basic setting] ⇒ [D/A conversion enable/disable setting function]

D/A output enable/disable function

This function specifies whether to output the D/A conversion value or offset value for each channel.
The conversion speed is constant regardless of the output enable/disable setting.

Setting procedure

Set D/A output enable/disable for each channel by using 'CH1 Output enable/disable flag' (Un\G70, b1).

CH1 Output enable/disable flag (Un\G70, b1)	Analog output
Output enable (ON)*1	Outputs the D/A conversion value.
Output disable (OFF)	Outputs the offset value.

*1 When the CPU module changes from RUN to STOP, or a stop error occurs in the CPU module, the 'Output enable/disable flag' (Un\G70, b1) turns off.

Analog output HOLD/CLEAR function

Sets whether to clear the current analog output value, or hold the previous value or the setting value when the CPU module operating status is Run, Stop, or Stop Error.

When the setting value is set, it becomes the value that was set in 'CH1 HOLD setting value' (Un\G596). The following table lists the setting ranges.

Output range setting	When the scaling function is disabled	When the scaling function is enabled*1
	Setting range (practical range)	Setting range
4 to 20 mA	0 to 32767 (practical range: 0 to 32000)	-32000 to +32000
0 to 20 mA		
1 to 5 V		
0 to 5 V		
0 to 10 V		
-10 to +10 V	-32768 to +32767 (practical range: -32000 to +32000)	
User range setting (voltage)		
User range setting (current)		

*1 The setting and practical ranges applied when the scaling function is enabled depend on the setting of the upper and lower scaling limit values.

The HOLD/CLEAR setting can be checked with 'CH1 HOLD/CLEAR function setting monitor' (Un\G431).

Operation

When the CPU module operation status changes to RUN, STOP, or Stop Error, the following analog output state is entered, depending on the combination of the analog output HOLD/CLEAR setting, 'CH1 D/A conversion enable/disable setting' (Un\G500), and 'CH1 Output enable/disable flag' (Un\G70, b1). If the analog output HOLD/CLEAR function setting is the previous value, the last output value will be held.

■ In the normal output mode

Execution status	CH1 D/A conversion enable/disable setting (Un\G500)	Enable			Disable
	CH1 Output enable/disable flag (Un\G70, b1)	Enable		Disable	Enable/disable
	Analog output HOLD/CLEAR setting	HOLD	CLEAR	Previous Value, setting value, or CLEAR	Previous Value, setting value, or CLEAR
	Previous Value	Setting value			
Analog output status while the CPU module is RUN	Output the value D/A-converted from the digital value			Offset value	0 V/0 mA
Analog output status while the CPU module is STOP	Previous value ^{*2*}	HOLD setting value ^{*2*}	Offset value	Offset value	0 V/0 mA
Analog output status while the CPU module is in Stop Error	Previous value ^{*3}	HOLD setting value ^{*3}	Offset value	Offset value	0 V/0 mA
The external power supply READY flag is off.	0 V/0 mA	0 V/0 mA	0 V/0 mA	0 V/0 mA	0 V/0 mA
The disconnection detection flag is on.					
Analog output status when a watchdog timer error ^{*1} occurs					

*1 When a watchdog timer error occurs, 'Module READY' (Un\G69, b0) turns off and the RUN LED of the analog output module turns off.

*2 Also when the CPU module changes from STOP to RUN, the value is output according to the analog output HOLD/CLEAR setting.

*3 When the external supply power shuts off or a disconnection is detected and then it is restored, the output will be the offset value.

Precautions

With 'CH1 Output enable/disable flag' (Un\G70, b1) enabled, any CPU module change from RUN to STOP changes this flag to Disable.

At this time, if the analog output HOLD/CLEAR function setting is the previous value, the analog output will hold the last output value. If the analog output HOLD/CLEAR function setting is the setting value, the analog output will be the HOLD setting value.

When the CPU module is set to RUN again, 'CH1 Output enable/disable flag' (Un\G70, b1) remains disabled. However, the analog output will not be the offset value, and output of the previous value or HOLD setting value will continue.

When 'CH1 Output enable/disable flag' (Un\G70, b1) is enabled, output of the value D/A-converted from the digital value is restarted.

■ In the wave output mode

Execution status	CH1 D/A Conversion enable/disable setting (Un\G500)	Enable										Disable
	CH1 Output enable/disable flag (Un\G70, b1)	Enable									Disable	Enable/disable
	Analog output HOLD/CLEAR setting	HOLD						CLEAR			Previous Value, setting value, or CLEAR	Previous Value, setting value, or CLEAR
		Wave output status	Output	Stop	Pause	Output	Stop	Pause	Output	Stop		
Analog output status while the CPU module is RUN	Wave data	*3	Previous value	Wave data	*3	HOLD setting value	Wave data	*3	Offset value	Offset value	0 V/0 mA	
Analog output status while the CPU module is STOP	Previous value**4*5			HOLD setting value**4*5			Offset value*1			Offset value	0 V/0 mA	
Analog output status while the CPU module is in Stop Error	Previous value**5			HOLD setting value**5			Offset value*1			Offset value	0 V/0 mA	
The external power supply READY flag is off.*1	0 V/0 mA			0 V/0 mA			0 V/0 mA			0 V/0 mA	0 V/0 mA	
The disconnection detection flag is on.*1												
Analog output status when a watchdog timer error*2 occurs												

*1 When the CPU module changes from RUN to STOP or a disconnection has occurred, the wave output status changes to the wave output stop.

*2 When a watchdog timer error occurs, 'Module READY' (Un\G69, b0) turns off and the RUN LED of the analog output module turns off.

*3 Output as per the setting of 'CH1 Output setting during wave output stop' (Un\G524).

*4 Also when the CPU module changes from STOP to RUN, the value is output according to the analog output HOLD/CLEAR function setting.

*5 When the external supply power shuts off or a disconnection is detected and then it is restored, the output will be as follows.

If the CPU module is RUN: Output that was selected in Wave output stopped selection.

If the analog output HOLD/CLEAR function is being used for output because the CPU module has changed from RUN to STOP: Offset value.

Precautions

With 'CH1 Output enable/disable flag' (Un\G70, b1) enabled, any CPU module change from RUN to STOP changes this flag to Disable. The wave output signal also changes to wave output stop.

At this time, if the analog output HOLD/CLEAR function setting is the previous value, the analog output will hold the last output value. If the analog output HOLD/CLEAR function setting is the setting value, the analog output will be the HOLD setting value.

When the CPU module is set to RUN again, 'CH1 Output enable/disable flag' (Un\G70, b1) remains disabled. However, the analog output will not be the offset value, and output of the previous value or HOLD setting value will continue.

When 'CH1 Output enable/disable flag' (Un\G70, b1) is enabled, the value selected in Wave output stopped selection is output. Wave output does not restart.

Setting procedure



Set "Analog output HOLD/CLEAR setting" to "Previous Value", "Setting value", or "CLEAR".

 [Navigation window] ⇒ [Parameter] ⇒ [Module Information] ⇒ Module model name ⇒ [Module Parameter] ⇒ [Basic setting] ⇒ [Analog output HOLD/CLEAR function]

Analog output test function when CPU module stops

Conducts an analog output test when CPU module stops.

The following functions are enabled also during the analog output test.

- Scaling function ( Page 192 Scaling function)
- Shift function ( Page 194 Shift function)
- Alert output function ( Page 196 Alert output function)

If a digital value out of the setting range is written, a digital value setting range error (error code: 191□H) will occur and the check code will be stored in 'CH1 Set value check code' (Un\G400).

Operation

When the CPU module forcedly turns 'CH1 Output enable/disable flag' (Un\G70, b1) off→on while it is STOP, the analog output value changes from the offset value to the D/A-converted analog output value. After that, when 'CH1 Digital value' (Un\G460) is updated, the analog output is also updated.

When the CPU module is STOP with the analog output HOLD/CLEAR setting set to CLEAR (0), there is the following relationship between 'CH1 Output enable/disable flag' (Un\G70, b1) and the analog output value.

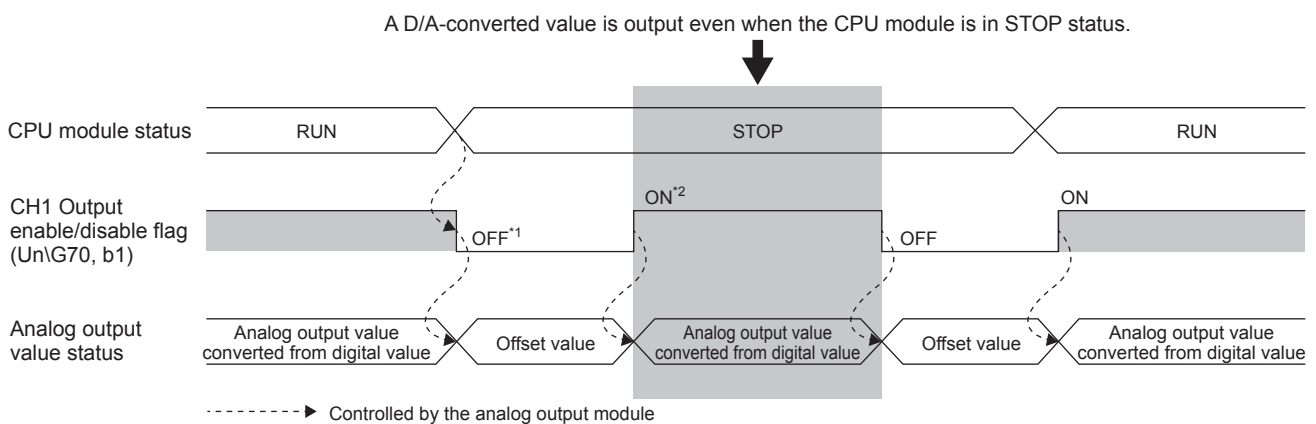

*1 When the CPU module status changes to STOP, 'CH1 Output enable/disable flag' (Un\G70, b1) turns off.

*2 When the CPU module forcedly turns 'CH1 Output enable/disable flag' (Un\G70, b1) off→on, the analog output value changes from the offset value to the D/A-converted analog output value.

Setting procedure

To execute the analog output test, in the GX Works3 device test, use the following procedure for setting.

1. Set D/A conversion enable (0) in the buffer memory address 'CH1 D/A conversion enable/disable setting' (Un\G500).
2. Turn off→on 'Operating condition setting request' (Un\G70, b9).
3. After checking that 'Operating condition setting completed flag' (Un\G69, b9) turns off, turn on→off 'Operating condition setting request' (Un\G70, b9).
4. In the buffer memory address 'CH1 Digital value' (Un\G460), set the digital value corresponding to the analog value to be output.
5. Turn off→on 'CH1 Output enable/disable flag' (Un\G70, b1).

Scaling function

Performs scale conversion on digital values within the range from a scaling upper limit value to a scaling lower limit value, both of which are set at desired values. This function helps reduce the man-hours taken for creating a scale conversion program.

Operation

The set 'CH1 Digital value' (Un\G460) is scale converted using 'CH1 Scaling upper limit value' (Un\G504) and 'CH1 Scaling lower limit value'(Un\G506). Then, the D/A conversion is executed using the scale converted value. (In conversion, values are rounded off to the nearest whole number.)

If the relation between the values is the scaling lower limit value > the scaling upper limit value, the scale conversion can be performed according to a negative slope.

Concept of scaling setting

The scaling lower and upper limit value settings depend on whether the factory setting or user range setting is used for the analog output range.

■If the factory default is used for the analog output range

- For the scaling upper limit value, set the value corresponding to the upper limit value of the analog output value in the currently set output range.
- For the scaling lower limit value, set the value corresponding to the lower limit value of the analog output value in the currently set output range.

■If the user range is set for the analog output range

- For the scaling upper limit, set the value corresponding to the gain value.
- For the scaling lower limit, set the value corresponding to the offset value.

Calculating the scaling value

For D/A conversion, use the value converted based on the following formula.

■If the factory default is used for the output range

- If voltage: 1 to 5, 0 to 5, or 0 to 10 V
Current: 4 to 20 or 0 to 20 mA

$$\text{Digital value used for D/A conversion} = \frac{32000}{S_H - S_L} \times (D_X - S_L)$$

- If voltage: -10 to 10 V

$$\text{Digital value used for D/A conversion} = \frac{64000}{S_H - S_L} \times (D_X - S_L) - 32000$$

■If the user range setting is used for the output range

$$\text{Digital value used for D/A conversion} = \frac{32000}{S_H - S_L} \times (D_X - S_L)$$

Item	Description
D _X	Digital value
S _H	Scaling upper limit value
S _L	Scaling lower limit value

Setting procedure

1. Set "D/A conversion enable/disable setting" to "D/A conversion enable".
 [Navigation window] ⇒ [Parameter] ⇒ [Module Information] ⇒ Module model name ⇒ [Module Parameter] ⇒ [Basic setting] ⇒ [D/A conversion enable/disable setting function]
2. Set "Scaling enable/disable setting" to "Enable".
 [Navigation window] ⇒ [Parameter] ⇒ [Module Information] ⇒ Module model name ⇒ [Module Parameter] ⇒ [Application setting] ⇒ [Scaling function]
3. Set values for "Scaling upper limit value" and "Scaling lower limit value". Set the scaling setting in the following conditions. Scaling upper limit value ≠ Scaling lower limit value

Item	Setting range
Scaling upper limit value	-2147483648 to +2147483647
Scaling lower limit value	(practical range: -32000 to +32000)

Scaling setting example

Ex.

When the scaling upper and lower limit values are set as 14000 and 4000, respectively, for a channel the output range of which is set as 0 to 5 V

Analog output voltage (V)

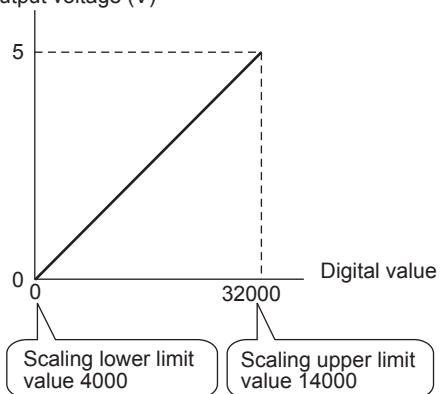

Digital value	Scaled digital value	Output voltage (V)
4000	0	0
6000	6400	1
8000	12800	2
10000	19200	3
12000	25600	4
14000	32000	5

Precautions

- When the scaling function is used, the unscaled digital value can be set to a value out of the range between the scaling upper and lower limit values (dashed line portion of output characteristics)". However, use it within the analog output practical range (solid line portion of output characteristics). If the analog output practical range is exceeded, the maximum resolution or the accuracy may go out of the specification.
- Depending on the scaling function setting, the default digital value "0" may be inappropriate. Particularly for an example of the output range 0 to 5 V, if 'CH1 Output enable/disable flag' (Un\G70, b1) turns on with the digital value set to "0", a digital value out-of-range error will occur. A digital value setting range error occurs (error code: 191□H) occurs, "Error flag' (Un\G69, b15) turns on, and the ERROR LED turns on. To avoid this, set a proper digital value within the scaling range before turning on 'CH1 Output enable/disable flag' (Un\G70, b1).
- Note that use of the user range results in "scaling lower limit value = offset value".
- If a scaling converted digital value falls outside the digital setting range when the scaling function is enabled, a digital value setting range error (error code: 191□H) occurs and the check code is stored in 'CH1 Set value check code' (Un\G400).
- The scaling function is enabled only for normal output. If the scaling function is enabled while the wave output function is in use, a wave output mode scaling setting error (alarm code: 0B1□H) will occur and 'Warning output signal' (Un\G69, b14) turns on.
- Use the setting range of the scaling upper and lower limit values in the range of -2147483648 to +2147483647 only when only when performing the same operation as the FX3U-4DA offset/gain function. For other than the FX3U-4DA Offset/gain setting function, use it in the range of -32000 to +32000 because the digital value exceeds this range.

Shift function

Adds the set input value shift amount to the digital input value.

A change in input value shift amount is reflected to the analog output value in real time, which facilitates fine adjustment at system start-up.

Operation

During digital value D/A conversion, the value obtained by adding 'CH1 Input value shift' (Un\G480) to 'CH1 Digital value' (Un\G460) is D/A-converted.

If the shift processing produces a calculated digital value exceeding the range of -32768 to +32767, the lower (-32768) and upper (+32767) limit values are fixed.

If the value is written into the 'CH1 Input value shift' (Un\G480), the setting value will be added to the digital input value regardless of whether 'Operating condition setting request' (Un\G70, b9) is on or off.

Setting procedure

In 'Input value shift amount', set the amount by which to shift.

 [Navigation window] ⇒ [Parameter] ⇒ [Module Information] ⇒ Module model name ⇒ [Module Parameter] ⇒ [Application setting] ⇒ [Shift function]

Item	Setting range
Input value shift amount	-32768 to +32767

Setting example

Ex.

When the output range is set to 0 to 5 V and the input value shift amount is set to +50

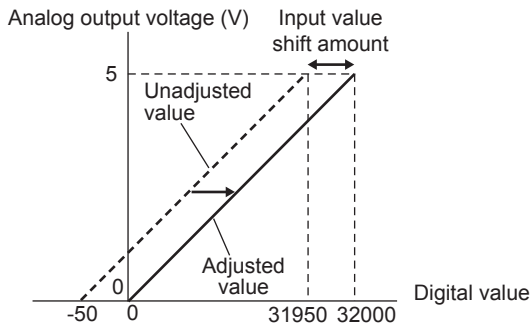

Digital value		Analog output voltage (V)
Unadjusted value	Adjusted value	
-50	0	0
31950	32000	5

Precautions

- The warning output, scaling, and rate control functions are executed based on the digital value for which shift-and-add was performed.
- When the value obtained by adding 'CH1 Input value shift' (Un\G480) to 'CH1 Digital value' (Un\G460) is out of the digital setting range, a digital value setting range error (error code: 191□H) occurs and the check code is stored in 'CH1 Set value check code' (Un\G400).
- The shift function is enabled only for normal output. If 'CH1 Input value shift' (Un\G480) is set to a value other than 0 while the wave output function is in use, a Wave output mode Input value shift amount setting error (alarm code: 0B2□H) occurs and 'Warning output signal' (Un\G69, b14) turns on. The wave output continues, but 'CH1 Input value shift' (Un\G480) is not added to the output wave data.
- After a Wave output mode Input value shift amount setting error occurs, 'Warning output signal' (Un\G69, b14) will not be turned off even if 0 is set in 'CH1 Input value shift' (Un\G480). To turn off 'Warning output signal' (Un\G69, b14), turn off→on→off 'Warning output clear request' (Un\G70, b14). This turns off 'Warning output signal' (Un\G69, b14), turns off the ALM LED, and clears the 'Latest alarm code' (Un\G2).

Alert output function

Outputs an alarm when the digital value exceeds the warning output upper limit value or is below the warning output lower limit value.

Operation

■Warning output notification

When 'CH1 Digital value' (Un\G460) exceeds 'CH1 Alert output upper limit' (Un\G510) or falls below 'CH1 Alert output lower limit' (Un\G512), an alarm is output when 'Alarm output upper limit flag' (Un\G36), 'Alarm output lower limit flag'(Un\G37), or 'Warning output signal' (Un\G69, b14) turns on and the ALM LED turns on. When an alarm occurs, alarm code 080□H or 081□H is stored in 'Latest alarm code' (Un\G2).

When an alarm occurs, one of the following is executed depending on 'CH1 Alert output setting' (Un\G508).

- If the setting is Enable (output not limited), the D/A conversion will be executed with the set digital values.
- If the setting is Disable (output limited), the D/A conversion will be executed with the setting values of the warning output upper and lower limit values handled as digital values.

After a warning occurs and 'CH1 Digital value' (Un\G460) becomes less than 'CH1 Alert output upper limit value' (Un\G510) or larger than 'CH1 Alert output lower limit value' (Un\G512), the analog output value returns to the normal value, but 'Alarm output upper limit flag' (Un\G36), 'Alarm output lower limit flag' (Un\G37), and 'Alarm output signal flag' (Un\G69, b14) are not cleared.

Clear the warning

There are the following two methods to clear the warning output.

Set 'CH1 Digital value' (Un\G460) to a value equal to or smaller than 'CH1 Alert output upper limit value' (Un\G510) and equal to or larger than 'CH1 Alert output lower limit value' (Un\G512). Then,

- Turn off→on→off 'Alarm output clear request' (Un\G70, b14).
- Turn off→on→off 'Operating condition setting request' (Un\G70, b9).

The analog output module changes to the following status when the warning output is cleared.

- 'Alarm output upper flag' (Un\G36) and 'Alarm output lower flag' (Un\G37) are cleared.
- 'Alarm output signal' (Un\G69, b14) turns off.
- The ALM LED turns off.
- The alarm code stored in 'Latest alarm code' (Un\G2) is cleared.

Setting procedure

1. Set 'Warning output setting' to 'Enable (output not limited)' or 'Disable (output limited)'.

 [Navigation window] ⇒ [Parameter] ⇒ [Module Information] ⇒ Module model name ⇒ [Module Parameter] ⇒ [Application setting] ⇒ [Warning output function]

2. Set values for "Warning output upper limit value" and "Warning output lower limit value".

Set the warning output upper and lower limit values in the following conditions.

- Warning output upper limit value > Warning output lower limit value

Item	Setting range
Warning output upper limit value	-32768 to +32767
Warning output lower limit value	

Precautions

When the shift function is used in the normal mode, the 'CH1 Digital value' (Un\G460) for which shift-and-add was performed will be processed as the target of alarm detection. For the warning output upper and lower limit values, be sure to set the values, taking shift-and-add into consideration.

Warning output function operation example

■When 'CH1 Alert output setting' (Un\G508) is enabled (output not limited)

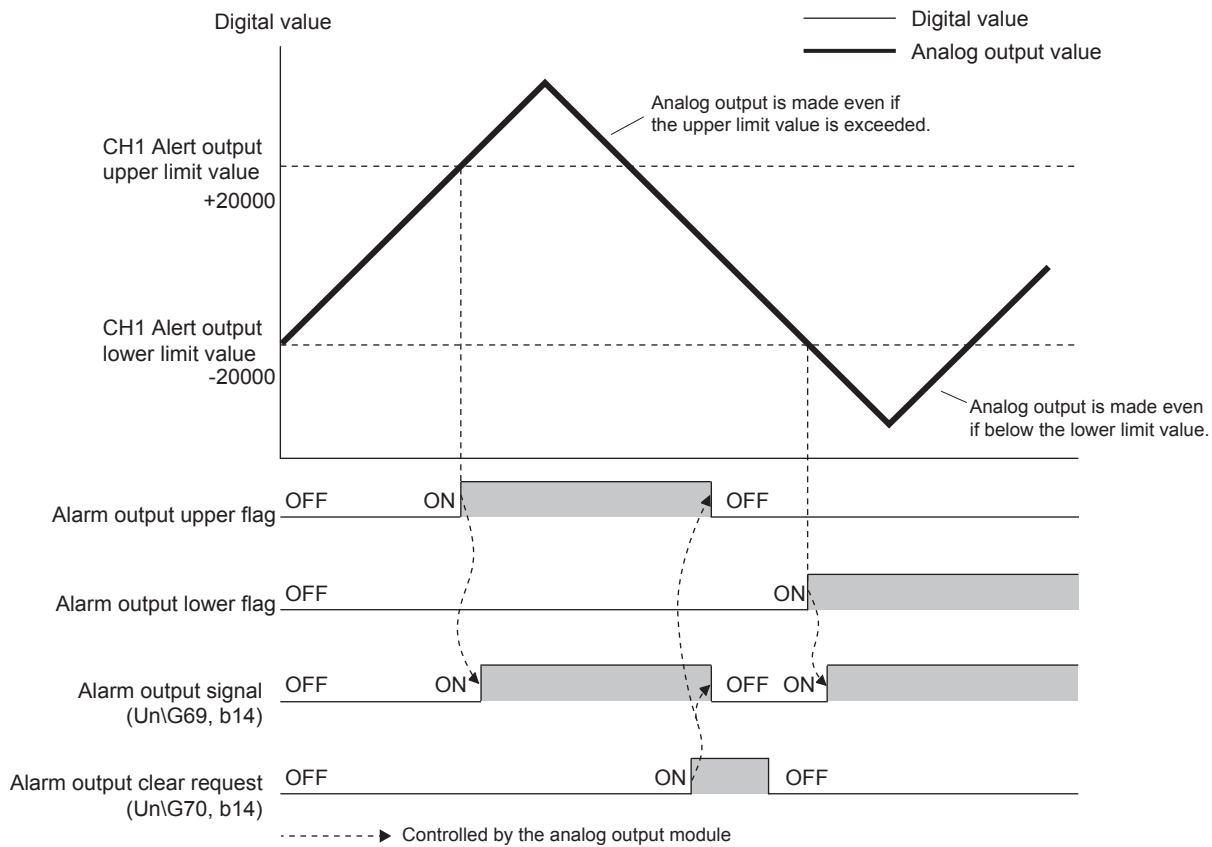

■When 'CH1 Alert output setting' (Un\G508) is enabled (output limited)

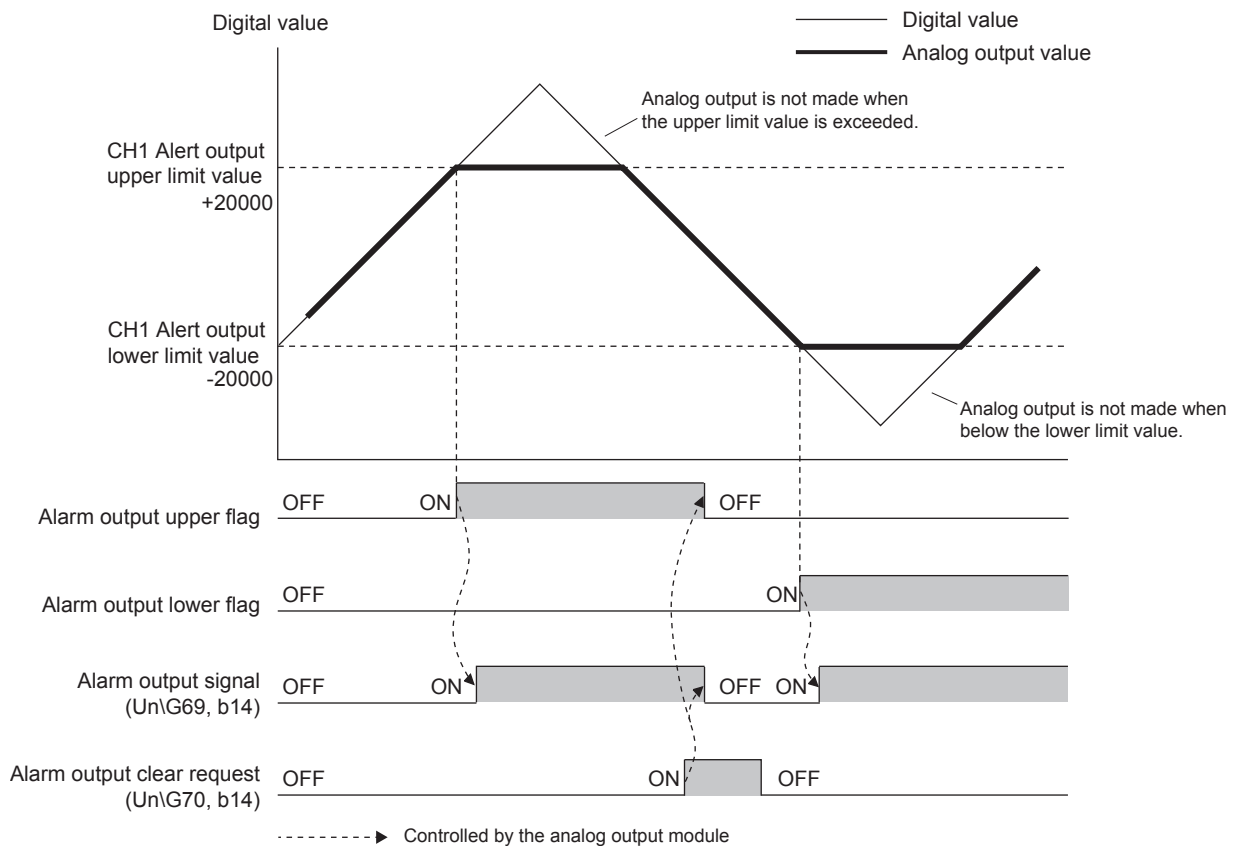

Rate control function

Limits the increase or decrease amount of the analog output value per 80 μs to prevent sudden change of the analog output value.

Operation

If the variation amount of 'CH1 Digital value' (Un\G460) is larger than the value set by 'CH1 Increase digital limit value' (Un\G514) and 'CH1 Decrease digital limit value' (Un\G516), 'CH1 Digital value' (Un\G460) is changed by the limit value set for each digital limit value.

For 'CH1 Increase digital limit value' (Un\G514) and 'CH1 Decrease digital limit value' (Un\G516), the increase or decrease value per 80 μs is set; however, in actuality, the output value of the corresponding channel is updated with a cycle of "80 μs × Number of conversion enabled channels".

Therefore, the analog output value is increased or decreased as follows with the update cycle.

- 1st time: D/A conversion value of the Increase/Decrease digital limit value
- 2nd time or later: D/A conversion value of "Increase/Decrease digital limit value × Number of conversion enabled channels"

If the digital value is changed during rate control, rate control will continue until a new digital value will be output. At this time, if a digital value is set so that the increase/decrease direction is reversed, the initial output after change will be the D/A conversion value of " 'CH1 Increase digital limit value' (Un\G514) × Number of conversion enabled channels" or " 'CH1 Decrease digital limit value' (Un\G516) × Number of conversion enabled channels".

Setting procedure

1. Set "Rate control enable/disable setting" to "Enable".

 [Navigation window] ⇒ [Parameter] ⇒ [Module Information] ⇒ Module model name ⇒ [Module Parameter] ⇒ [Application setting] ⇒ [Rate control function]

2. Set values for "Increase digital limit value" and "Decrease digital limit value".

Item	Setting range
Increase digital limit value	0 to 64000
Decrease digital limit value	

Precautions

- The shift function setting is enabled also during rate control.
- If the warning output function is enabled, alarm judgment is made for the preset 'CH1 Digital value' (Un\G460). Note that it is not the timing when the upper/lower limit is exceeded by rate control.
- Rate control does not function when the analog output test is in progress in the CPU module STOP state.
- If the analog output HOLD/CLEAR setting is other than the previous value, rate control does not function although the analog output changes in the CPU module STOP state.
- The rate control function will be as follows if the CPU module changes its operation when D/A conversion is enabled, D/A output is enabled, or analog output CLEAR is set.

When the CPU module changes from RUN to STOP (error): Rate control does not function.

When the CPU module changes from STOP (error) to RUN: Rate control functions.

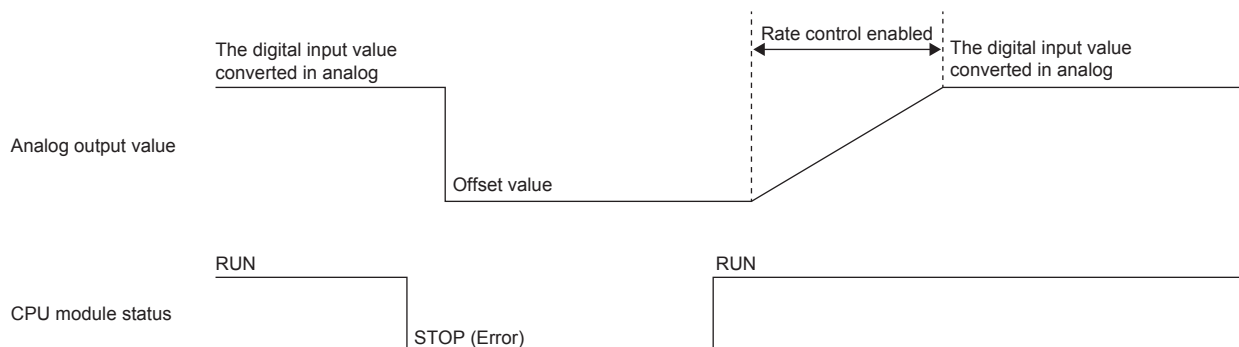

- When D/A conversion is enabled, D/A output is enabled, or the analog output HOLD setting is the previous value or set value if rate control is enabled, the analog output restarts from the offset value when the CPU module changes from STOP (error) to RUN.

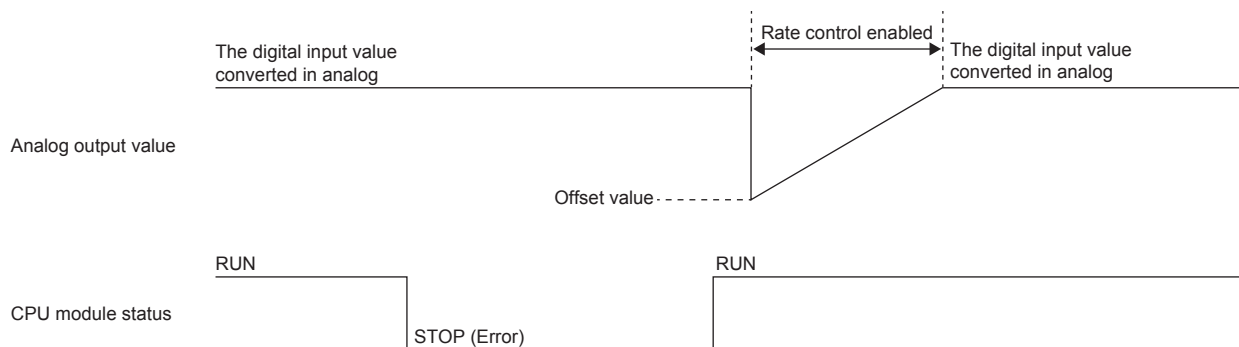

- When D/A conversion is enabled or D/A output is disabled, rate control does not function.
- During rate control, if a value out of the settable range is written to 'CH1 Digital value' (Un\G460), rate control is performed with the upper and lower limit values of the setting range. In addition, the check result is stored in 'CH1 Set value check code' (Un\G400).
- If the scaling function is enabled in the following cases, rate control is performed with the upper (-32768) or lower (+32767) limit value.

For the range of -10 to +10 V: $(\text{Scaling upper limit value} + \text{Scaling lower limit value}) / 2$ exceeded the range of -32768 to +32767.

For the range of other than -10 to +10 V: The scaling lower limit value exceeded the range of -32768 to +32767.

- If the external power supply turns off during rate control, the analog output changes to 0 V/0 mA with the rate control function stopped. When the external power supply is then restored, rate control restarts from the offset value.
- If a disconnection is detected during rate control, the analog output changes 0 V/0 mA with the rate control function stopped. When the disconnection is then restored and 'Disconnection detection flag' (Un\G38) is cleared, rate control restarts from the offset value.
- The rate control function is enabled only for normal output. If the rate control function is enabled while the wave output function is in use, a wave output mode rate control setting error (alarm code: 0B3□H) will occur and 'Warning output signal' (Un\G69, b14) turns on.

External power supply disconnection detection function

Detects that the 24 V DC external power supply is not being supplied or the supply stopped.

When external power supply off is detected, 'External power supply READY flag' (Un\G69, b7) turns off and the analog output value changes to 0 V/0 mA independently of the other settings.

Operation

If no external power supply is input, the state is judged to be external power supply off, with 'External power supply READY flag' (Un\G69, b7) turned off.

If the input of the external power supply stops, the state is judged to be external power supply off, with 'External power supply READY flag' (Un\G69, b7) turned off.

Precautions

If the external power supply does not satisfy the requirements of the power supply specifications, the state may be determined to be external power supply off.

For the power specifications for the external power supply, refer to  Page 178 Power supply specifications.

Disconnection detection function

Detects a disconnection by monitoring the analog output value. This function is enabled only when the analog output range is 4 to 20 mA, 0 to 20 mA or the user range (current). Disconnections can be detected for each channel.

Operation

Disconnection detection

Disconnections can be when the analog output range is 4 to 20 mA^{*1}, 0 to 20 mA, or the user range (current)^{*1} and 'CH1 D/A conversion enable/disable setting' (Un\G500) is set to D/A conversion enable (0).

^{*1} If the analog output value is 1 mA or less, disconnections cannot be detected.

Operation performed when disconnection is detected

When a disconnection is detected, 'Disconnection detection flag' (Un\G38) and 'Disconnection detection signal' (Un\G69, b13) turn on and the disconnection is notified by turning on the ERROR LED.

In addition, when a disconnection is detected, error code 1C4□H is stored in 'Latest error code' (Un\G0).

Eliminate the cause of the disconnection from the disconnection state, and perform the following operations depending on the setting of 'Disconnection Detection Automatic Clear Enable/Disable Setting' (Un\G304)^{*1}. The analog output restarts according to 'CH1 Output enable/disable flag' (Un\G70, b1).

^{*1} Disconnection detection auto-clear enable/disable setting (Un\G304) is enable only in the normal output mode.

Output mode	Disconnection detection automatic clear enable/disable setting (Un\G304)	
	Disable	Enable
Normal output mode	Check the CH1 Digital value (Un\G460), and then turn off→on→off 'Error clear request' (Un\G70, b15).	Once the cause of the disconnection is eliminated, the analog output starts automatically.
Wave output mode	When disconnection is detected, wave output stops. After turning off→on→off 'Error clear request' (Un\G70, b15), set 'CH1 Wave output start/stop request' (Un\G462) as Wave output start request (1).	—

- Operation when 'Disconnection detection automatic clear enable/disable setting' (Un\G304) is Disable

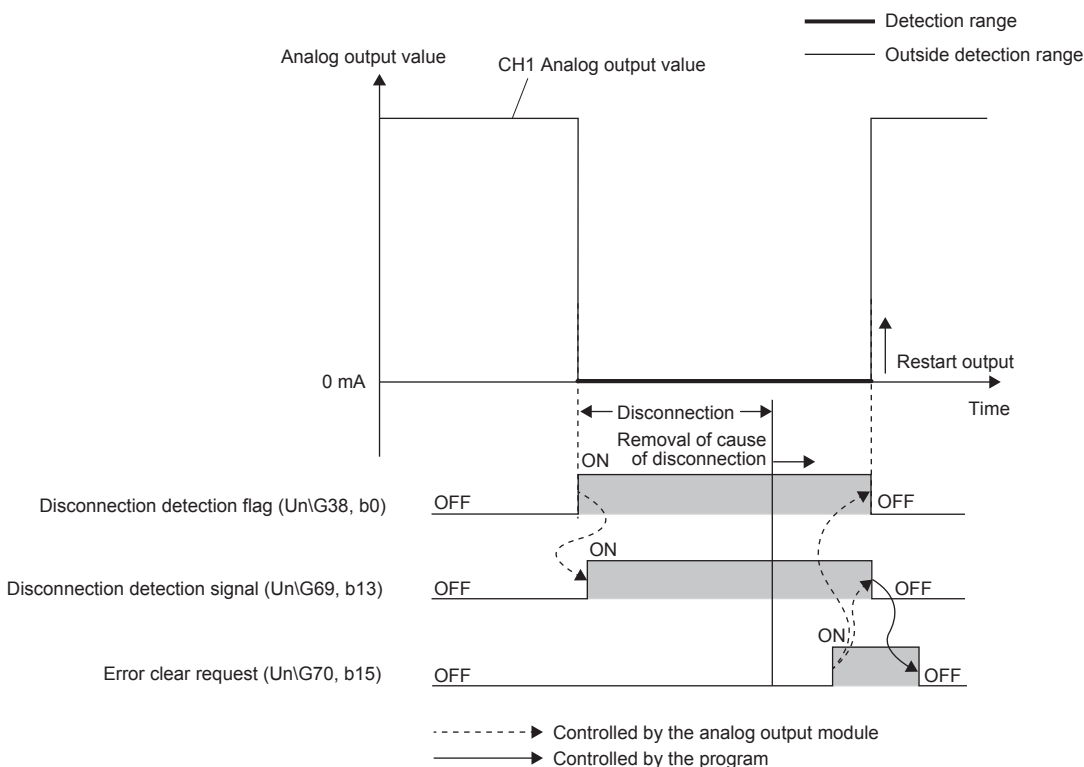

- Operation when 'Disconnection detection automatic clear enable/disable setting' (Un\G304) is Enable

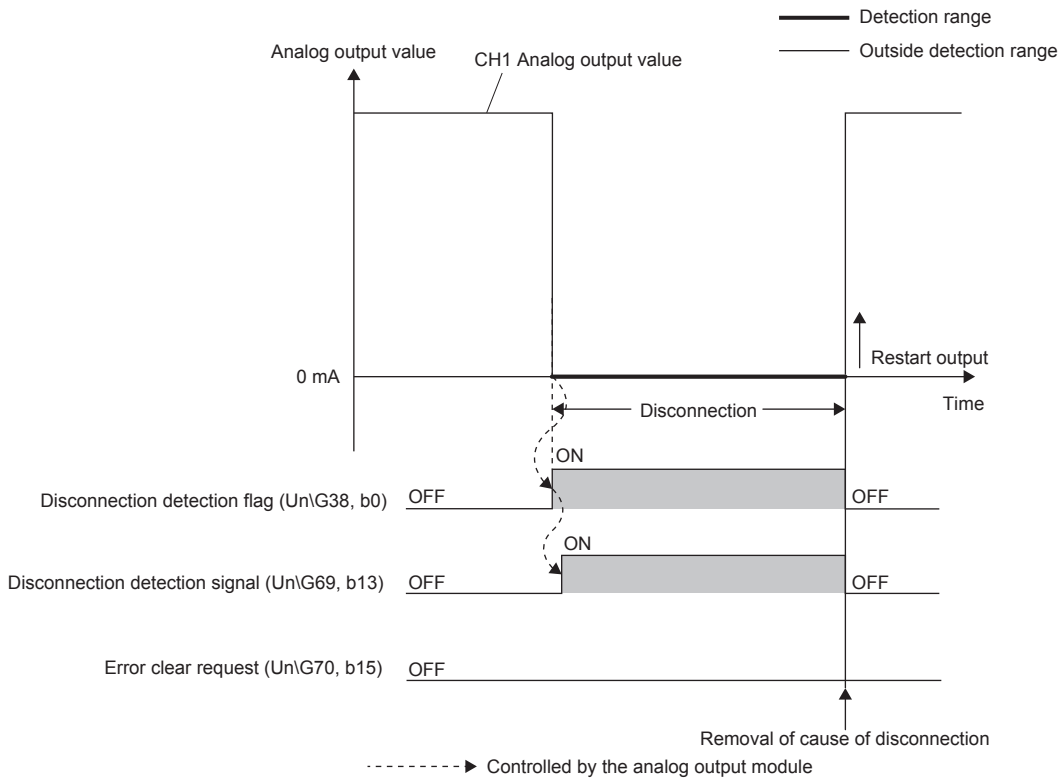

At the same time analog output restarts, the disconnection detection flag (Un\G38) of the corresponding channel is cleared. In addition, when the analog output of all channels restarts, 'Disconnection detection signal' (Un\G69, b13) is cleared.

Interrupt function

Executes a CPU module interrupt program when an interrupt factor such as a disconnection or warning output is detected. The number of available interrupt pointers per analog output module is up to 16.

Operation

■ Detecting an interrupt factor

When an interrupt factor occurs, an interrupt request is sent to the CPU module at the same time as 'Interrupt factor detection flag [n]' (Un\G4 to Un\G19) turns to Interrupt factor (1).

■ How to reset an interrupt factor

When Reset request (1) is set in 'Interrupt factor reset request [n]' (Un\G156 to Un\G171) corresponding to the interrupt factor, the specified interrupt factor is reset and 'Interrupt factor detection flag [n]' (Un\G4 to Un\G19) changes to No interrupt factor (0).

Setting procedure

To use the interrupt function, set "Condition target setting", "Condition target channel setting", "Interrupt factor transaction setting", and "Interrupt pointer" in GX Works3. After completing the settings, write the project to enable the settings.

 [Navigation window] ⇒ [Parameter] ⇒ [Module Information] ⇒ Module model name ⇒ [Module Parameter] ⇒ [Interrupt setting]

The following shows the setting items on the interrupt settings window.

Item	Description
Condition target setting	Select a factor of the target for the interrupt detection.
Condition target channel setting	Select a target channel when the condition target setting for the interrupt detection is channel specification.
Interrupt factor transaction setting	Set an interrupt request for when the same interrupt factor occurs during the interrupt factor detection.
Interrupt pointer	Specify the number of an interrupt pointer that is initiated at the detection of an interrupt factor.

■Condition target setting

Select a factor of the condition target setting for the interrupt detection.

For details on the factors to be detected, refer to the following.

 Page 309 Condition target setting [n]

■Condition target channel setting

Select a target channel when the condition target setting for the interrupt detection is channel specification.

Item	Setting value				
Condition target channel setting	0: All channels	1: CH1	2: CH2	3: CH3	4: CH4

■Interrupt factor transaction setting

Set an interrupt request for when the same interrupt factor occurs during the interrupt factor detection.

- With "Interrupt reissue requests (0)", if the same interrupt factor occurs during the interrupt factor detection, an interrupt request is sent to the CPU module again.
- With "No interrupt reissue request (1)", if the same interrupt factor occurs during the interrupt factor detection, an interrupt request is not sent to the CPU module.

■Interrupt pointer

Specify the number of an interrupt pointer that is initiated at the detection of an interrupt factor. For details on the interrupt pointers, refer to the following.

 MELSEC iQ-F FX5 User's Manual (Application)

Point

- If 'Condition target setting [n]' (Un\G232 to Un\G247) is Disable (0), no interrupt request is sent to the CPU module.
- To reset the interrupt factor, set Reset request (1) until 'Interrupt factor detection flag [n]' (Un\G4 to Un\G19) changes to No interrupt factor (0).
- Resetting interrupt factors is executed only when 'Interrupt factor reset request [n]' (Un\G156 to Un\G171) changes from No reset request (0) to Reset request (1).
- Multiple interrupt pointers can also share the same setting of 'Condition target setting [n]' (Un\G232 to Un\G247). When interrupts with the same settings occur in 'Condition target setting [n]' (Un\G232 to Un\G247), the interrupt program is executed in order of the priority of the interrupt pointers. For the priority of the interrupt pointers, refer to the following.

 MELSEC iQ-F FX5 User's Manual (Application)

- When All channels (0) is set for 'Condition target channel setting [n]' (Un\G264 to Un\G279) and an interrupt detection target is set for each channel of Warning output flag (2) etc., the interrupt requests that have the same interrupt factor are sent to the CPU module if alarms are issued in multiple channels. In this case, the CPU module executes multiple interrupt programs at a time and thus judges that the program cannot be normally finished due to the scan monitoring function, and a CPU module error may occur. When a CPU module error occurs, review the CPU module parameter setting and the program.

Setting example

Ex.

If the interrupt program (I51) is executed when an error occurs in any channel

- Parameter settings

Set "Interrupt setting" of [Module Parameter] as follows.

No.	Condition target setting	Condition target channel setting	Interrupt pointer
2	Error flag	All channels	I51

- Label settings



Classification	Device	Description	Device	
Module Label	FX5CPU.stSM.bAlways_ON	Always ON	SM400	
	FX5_4DA_1.unInterruptFactorMask_D[1]	Interrupt factor mask 2	U1\G125	
	FX5_4DA_1.unInterruptFactorResetRequest_D[1]	Interrupt factor reset request 2	U1\G157	
Labels to be defined	Define global labels as shown below:			
	Label Name	Data Type	Class	Assign (Device/Label)
	G_bErrorDetection	Bit	VAR_GLOBAL	F0



Wave output function

This function registers the previously prepared wave data (digital input values) in the analog output module and performs consecutive analog output with the set conversion cycle. When analog (torque) control is to be performed, for example, for a press machine or injection molding machine, it can achieve faster and smoother control than that by programming, by automatically outputting the control wave registered in the analog output module in advance. In addition, since this control can be achieved only by registering the wave data in the analog output module, it enables control without programming when repetitive control such as line control is to be performed, thus reducing the man-hours for programming.





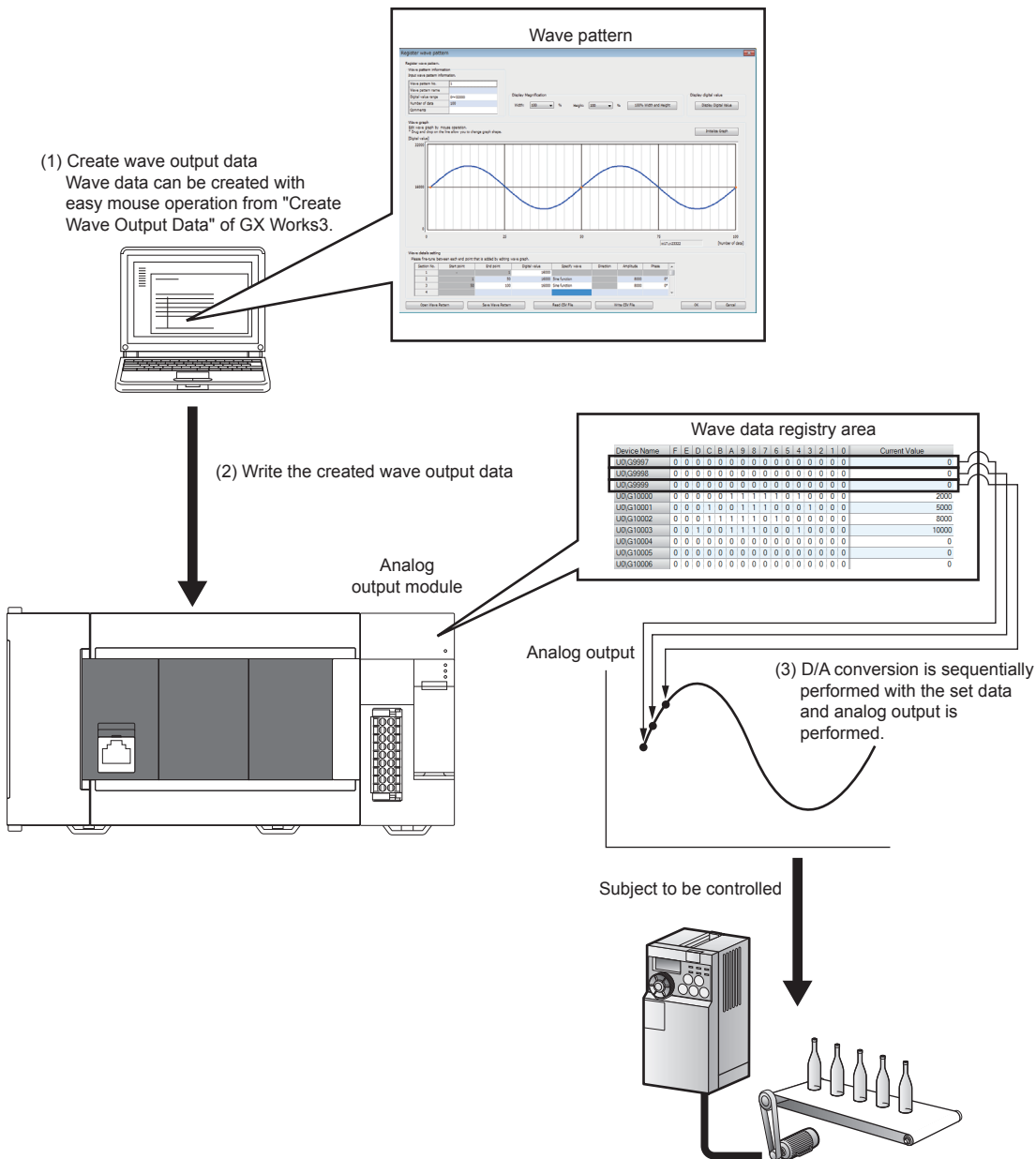

The wave output function is available only when "Wave output mode" is set in "Output mode setting" of the basic setting. In this section, the following items set in the wave output function are called wave output data. Wave output data can be created by "Wave output data creating tool" of the module expansion parameter.

- Wave pattern ( Page 253 Register the wave pattern)
- Wave output function parameters ( Page 257 Setting the wave output function parameters)



Procedure for using the wave output function

Use the following procedure to use the wave output function.

- 1.** Register the wave pattern
 Page 253 Register the wave pattern
- 2.** Set the wave output function parameters
 Page 257 Setting the wave output function parameters
- 3.** Save the wave pattern
 Page 257 Save the wave pattern
- 4.** Parameter setting of the analog output module
 Page 212 Parameter setting of the analog output module
- 5.** Transfer the wave output data
 Page 215 Transfer the wave output data
- 6.** Start, stop, or pause the wave output
 Page 217 Start, stop, or pause the wave output

Restrictions and precautions on the wave output function

The wave output function has the following restrictions and precautions.

■Output mode setting

To use the wave output function, set the output mode setting to the wave output mode. This makes all channels operate in the wave output mode.

■Output range setting

No user range is available. When executing the wave output function, be sure to use anything other than the user range.

For output range setting, refer to the following.

 Page 187 Range switching function

■Unavailable functions

When the wave output function is selected, the scaling, shift, and rate functions are unavailable. Also, the setting description of "Disconnection detection auto-clear enable/disable setting" (Un\G304) will be ignored, and the setting will be disable. When executing the wave output function, be sure to disable them.

■Analog output HOLD/CLEAR function

The analog output HOLD/CLEAR function differs from operation from that for normal output.

For details, refer to the following.

 Page 190 In the wave output mode

Setting the wave output function parameters

To use the wave output function, the parameters of the wave output function needs to be set on the "Create Wave Output Data" window.

Setting item	Reference
Output setting during wave output stop	Page 257
Output value during wave output stop	
Wave pattern start address setting	
Wave pattern data points setting	
Wave pattern output repetition setting	
Constant for wave output conversion cycle	

For details on the buffer memory areas, refer to the following.

 Page 298 Details of buffer memory addresses

Wave data

Wave data is a series of chronologically arranged digital input values to be output as analog data. Up to 80000 points of wave data are available. Wave data is designed to be registered in 'Wave data registry area' (Un\G10000 to Un\G89999).

Wave pattern

The wave output function allows you to select a desired data points from the registered wave data and set a wave pattern for each channel. Set the wave pattern with the following items.

Setting item	Description
Wave pattern start address setting	Sets the start address of the wave pattern that is output for each channel. D/A conversion is performed sequentially from the digital input values of the set buffer memory address, and they are output as analog data.
Wave pattern data points setting	Sets the data points of the wave pattern that is output for each channel. From the wave pattern start address, the wave data for the set data points is D/A-converted and output as analog data.

An error occurs if the value obtained by subtracting 1 from the sum of the setting values of the wave pattern start address setting and the wave pattern point setting exceeds the last buffer memory address (Un\G89999) of the wave data registration area. Error code 1D9□H is stored in 'Latest error code' (Un\G0), 'Error flag' (Un\G69, b15) turns on, and the ERROR LED turns on.

Ex.

Setting example where different waves are output separately with CH1 and CH2

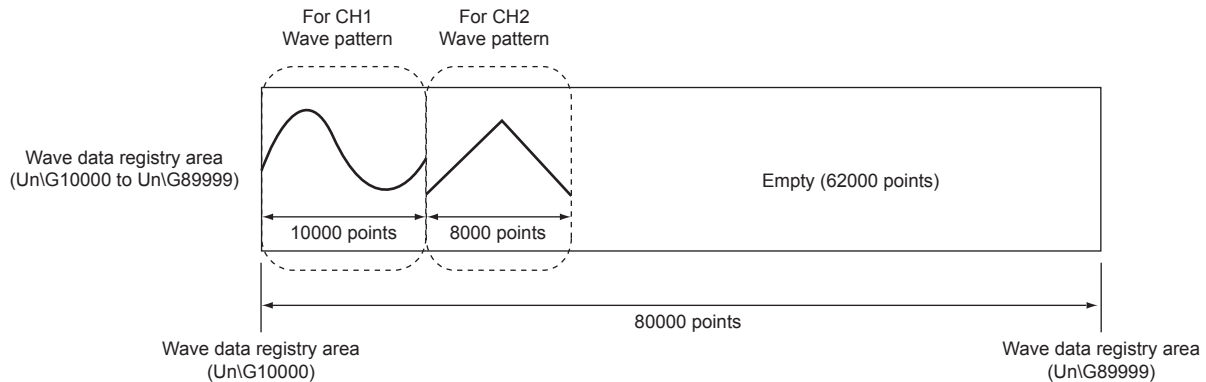

Setting item	Setting value
CH1 Wave pattern start address setting	10000
CH1 Wave pattern data points setting	10000
CH2 Wave pattern start address setting	20000
CH2 Wave pattern data points setting	8000

Ex.

Setting example where the same wave is output with CH1 and CH2

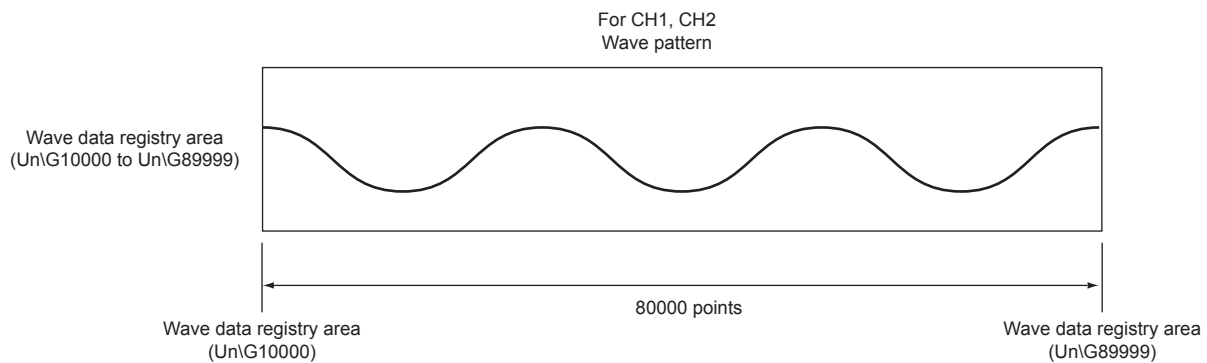

Setting item	Setting value
CH1 Wave pattern start address setting	10000
CH1 Wave pattern data points setting	80000
CH2 Wave pattern start address setting	10000
CH2 Wave pattern data points setting	80000

Wave pattern output count

The wave pattern can be output repeatedly by setting 'CH1 Wave pattern output repetition setting' (UnG530). A count from 1 to 32767 times can be set. By setting the output count to -1, analog output of the wave pattern can be repeated indefinitely.

Ex.

If the wave pattern output count is set to 3 times

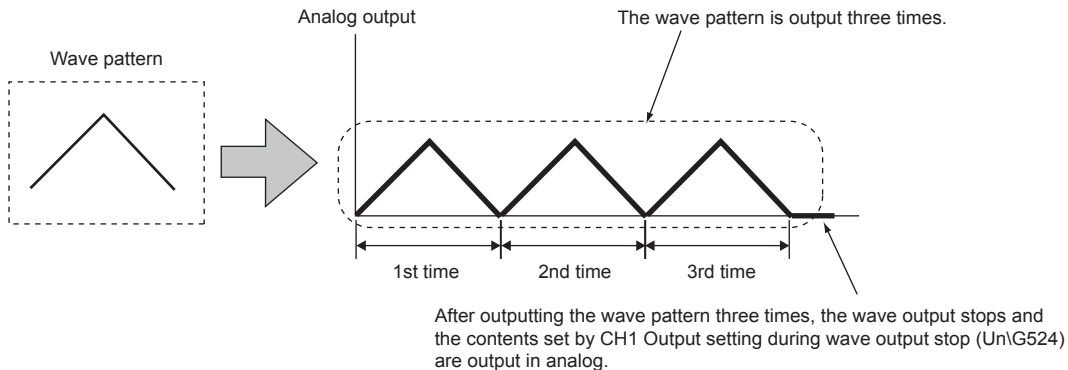

For the analog output module, "repetitive control" that outputs the same wave pattern repeatedly is defined as follows.

■ If the start and end point digital input values are identical

The end point of a wave pattern overlaps with the start point of the succeeding wave pattern by processing of the analog output module; thus, it will not be output as analog data. By setting 'CH1 Wave pattern output repetition setting' (UnG530), the analog output at the wave pattern end point is as follows.

- For finite repetition

If 'CH1 Wave pattern output repetition setting' (UnG530) is set to 2 to 32767, the digital input value at the wave pattern end point will not be output as analog data until the last repetition. However, after the end point digital input value is output as analog data at the last repetitive output, analog output is performed as per the setting of 'CH1 Output setting during wave output stop' (UnG524).

- For indefinite repetition

Any digital input value at the wave pattern end point is not output as analog data.

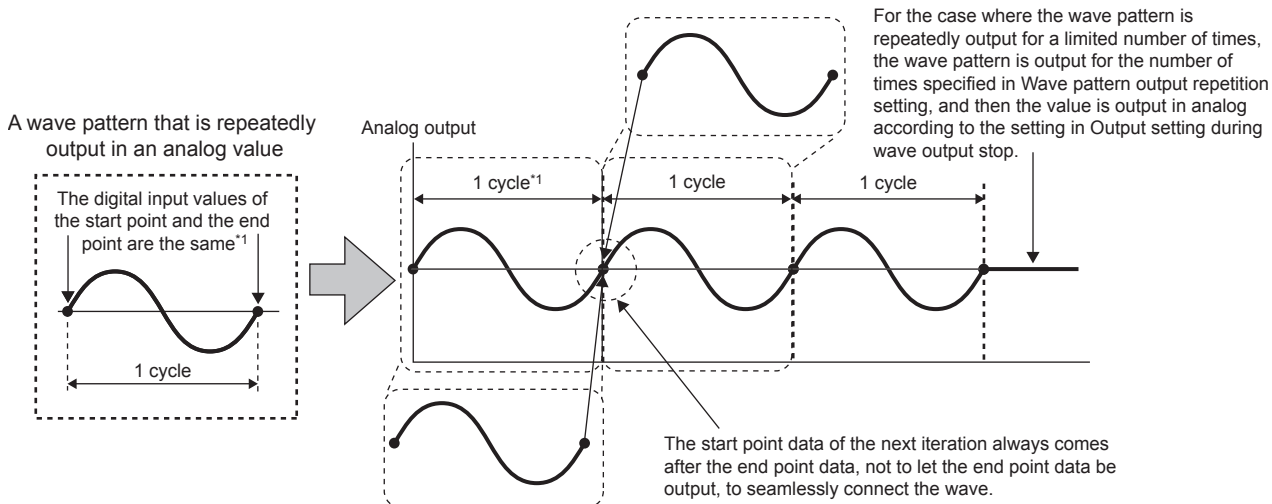

- *1 The wave pattern output cycle is calculated using the following formula.
 Wave pattern output cycle = (Wave output conversion cycle) × (Wave pattern data points - 1)
 For details on the wave output conversion cycle, refer to the following.
 ☞ Page 211 Wave output conversion cycle

Ex.
 Calculating the wave pattern output cycle

Setting item	Setting value
CH1 D/A conversion enable/disable setting	D/A conversion enable (0)
CH1 Wave pattern data points setting	101
CH1 Wave pattern output repetition setting	3
CH1 Constant for wave output conversion cycle	1

For the above setting, the wave pattern output cycle is as follows (when D/A conversion is enabled only for CH1).

$$\begin{aligned}
 \text{Output cycle of a wave pattern (\mu s)} &= \text{Conversion speed} \times \text{D/A conversion enabled Number of channels} \times \text{Wave output Conversion cycle constant} \times (\text{Wave pattern data points} - 1) \\
 &= 80 \times 1 \times 1 \times (101 - 1) \\
 &= \underline{8000}
 \end{aligned}$$

■ If the start and end point digital input values are different

The wave pattern end point is directly output as analog data. Regardless of the setting in 'CH1 Wave pattern output repetition setting' (Un\G530), the set wave patterns are consecutively output as analog data.

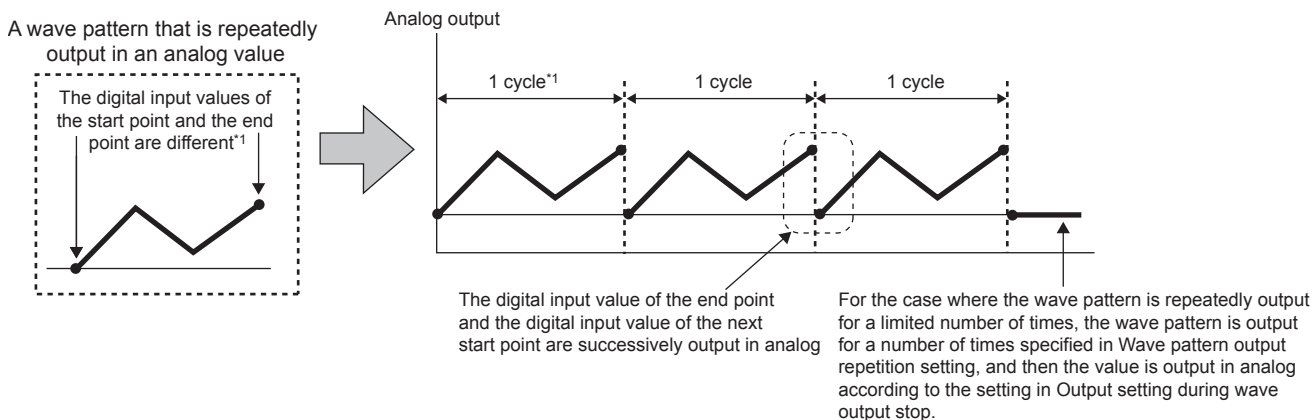

- *1 The wave pattern output cycle is calculated using the following formula.
 Wave pattern output cycle = (Wave output conversion cycle) × (Wave pattern data points)
 For details on the wave output conversion cycle, refer to the following.
 ☞ Page 211 Wave output conversion cycle

Ex.

Calculating the wave pattern output cycle

Setting item	Setting value
CH1 D/A conversion enable/disable setting	D/A conversion enable (0)
CH1 Wave pattern data points setting	101
CH1 Wave pattern output repetition setting	3
CH1 Constant for wave output conversion cycle	1

For the above setting, the wave pattern output cycle is as follows (when D/A conversion is enabled only for CH1).

$$\begin{aligned}
 \text{Output cycle of a wave pattern } (\mu\text{s}) &= \text{Conversion speed} \times \text{D/A conversion enabled Number of channels} \times \text{Wave output Conversion cycle constant} \times \text{Wave pattern data points} \\
 &= 80 \times 1 \times 1 \times 101 \\
 &= \underline{8080}
 \end{aligned}$$

Wave output conversion cycle

The wave pattern conversion cycle is calculated using the following formula.

$$\text{Conversion cycle } (\mu\text{s}) = \text{Conversion speed } (80 \mu\text{s}) \times \text{Number of D/A conversion enabled channels} \times \text{Wave output conversion cycle constant}$$

The wave output function allows you to set the conversion cycle by setting 'CH1 Constant for wave output conversion cycle' (Un\G531). The conversion cycle of the current wave output can be examined using 'CH1 Wave output conversion cycle monitor' (Un\G432, 433).

Ex.

Conversion cycle and operation timing

Setting item	Setting value
D/A conversion enable/disable setting	Enable D/A conversion for CH1 to CH4.
CH1 Constant for wave output conversion cycle	1
CH2 Constant for wave output conversion cycle	2
CH3 Constant for wave output conversion cycle	3
CH4 Constant for wave output conversion cycle	4

For the above setting, the conversion cycles for the channels are as follows.



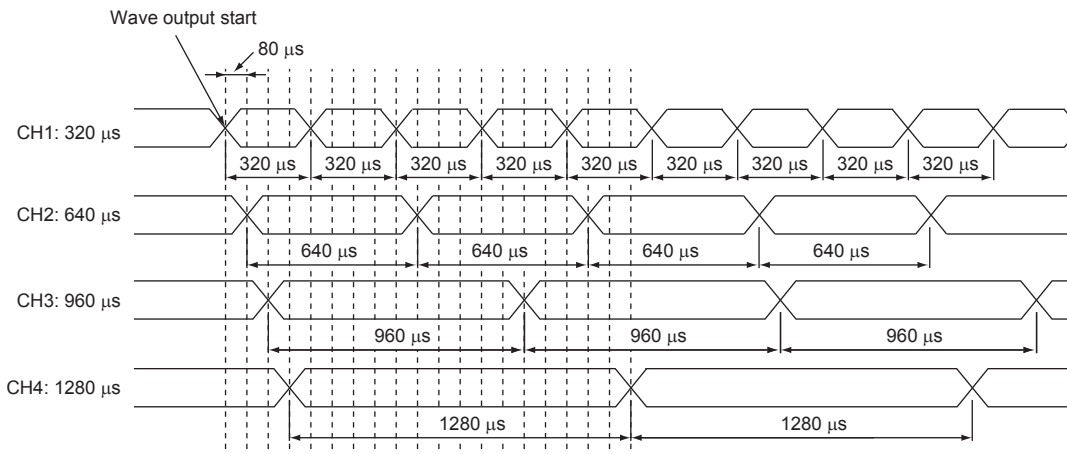

- CH1: $80 \times 4 \times 1 = 320 \text{ } (\mu\text{s})$
- CH2: $80 \times 4 \times 2 = 640 \text{ } (\mu\text{s})$
- CH3: $80 \times 4 \times 3 = 960 \text{ } (\mu\text{s})$
- CH4: $80 \times 4 \times 4 = 1280 \text{ } (\mu\text{s})$

With this conversion cycle, D/A conversion is executed and the analog values are output.



Initializing the wave output function

For the wave output function, the following are required to be initialized. Before executing the wave output function, perform the settings described in this section.

- Register the wave pattern ( Page 253 Register the wave pattern)
- Create the wave output function parameters ( Page 257 Setting the wave output function parameters)
- Save the wave pattern ( Page 257 Save the wave pattern)
- Parameter setting of the analog output module ( Page 212 Parameter setting of the analog output module)

■Parameter setting of the analog output module

When the wave output function is to be used, the module parameters need to be set up separately from setting up the wave output function parameters.

The items to be with the module parameters are as follows.

- Output range setting

Same as normal output. Select the output range to be used.

Note that when the wave output function is in use, no user range is available.

- Operation mode setting

Select "Normal mode" for the operation mode setting.

- Output mode setting

Select "Wave output mode" for the output mode setting.

- Analog output HOLD/CLEAR setting

The analog output HOLD/CLEAR function differs from operation from that for normal output. For the differences in operation arising from the HOLD/CLEAR setting, refer to the following.

 Page 188 Analog output HOLD/CLEAR function

- Disconnection detection auto-clear enable/disable setting

"Disconnection detection auto-clear enable/disable setting" cannot be used.

[Warning output setting]

Like normal output, set 'Enable (output not limited)' or 'Disable (output limited)' in 'Warning output setting' for the channel for which to execute D/A conversion.

Whereas for normal output, 'CH1 Digital value' (Un\G460) is the target, for wave output, the set 'wave data registry area' (Un\G10000 to Un\G89999) is the target. The following describes the operation when the warning output function is enabled (output not limited) and the operation when it is enabled (output limited).

- For Enable (output not limited)

If Output setting during wave output stop is Output value during wave output stop (2), this function outputs the value that was set with the Output value during wave output stop while the wave output is at a stop.

By starting the wave output, analog output is performed, but because of "output not limited", the value of wave data is output.

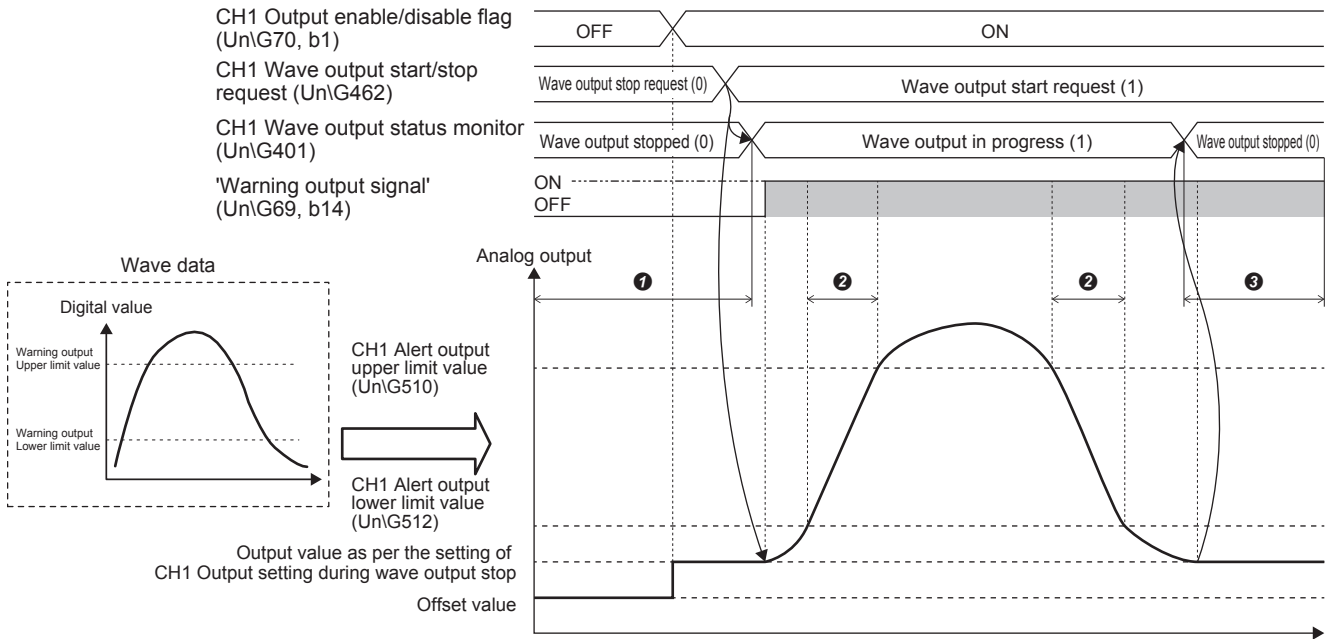

- 1 Since the wave output is at a stop, the alarm turns off. (The warning doesn't turn on.)
- 2 When the output is in the range equal to or larger than "Warning output lower limit value" or equal to or smaller than "Warning output upper limit value", the alarm can be turned off using 'Warning output clear request' (Un\G70, b14).
- 3 Since the wave output is at a stop, the alarm can be turned off using 'Warning output clear request' (Un\G70, b14).

- For Enable (output limited)

If Output setting during wave output stop is Output value during wave output stop (2), this function outputs the value that was set with the Output value during wave output stop while the wave output is at a stop.

By starting the wave output, warning output is performed, and the value set by the warning output upper and limit values is output.

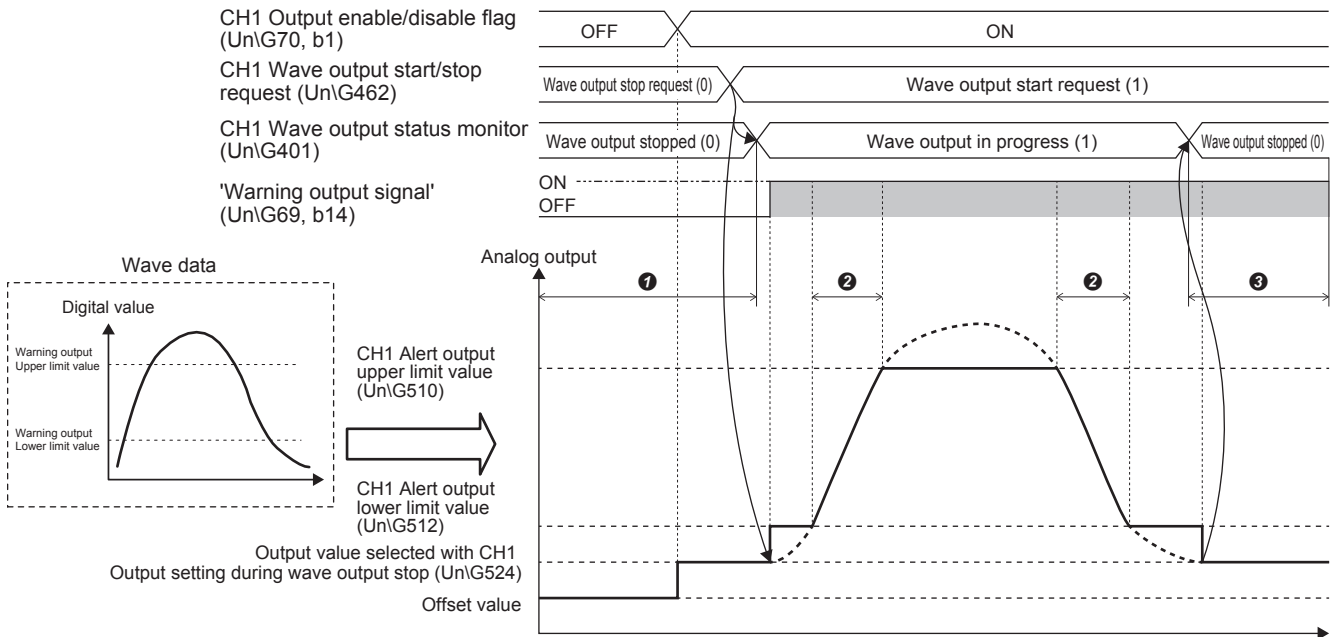

- ① Since the wave output is at a stop, the alarm turns off. (The warning doesn't turn on.)
- ② When the output is in the range equal to or larger than "Warning output lower limit value" or equal to or smaller than "Warning output upper limit value", the alarm can be turned off using 'Warning output clear request' (Un\G70, b14).
- ③ Since the wave output is at a stop, the alarm can be turned off using 'Warning output clear request' (Un\G70, b14).

Executing the wave output function

This section describes the procedure for executing the wave output function. After the initial setting of the wave output function, execute the contents of this section.

■Transfer the wave output data

The CPU module power is turned off→on or reset, and the wave output data created with module extension parameter "Wave output data creation tool" is transferred to the analog output module.

If the module extension parameter file has an error, a module extension parameter acquisition error (error code: 1DA0H) occurs without executing D/A conversion on all channels.

■D/A conversion enable/disable setting

D/A conversion enable/disable setting can be set by the module parameter, however, when the wave output data is not set by the module expansion parameter, perform the setting using the program.

At this time, register the wave output function parameter settings and the wave data settings before changing 'D/A conversion enable/disable setting'.

Precautions

'D/A conversion enable/disable setting' can be set also with a module parameter.

1. Set "D/A conversion enable/disable setting" to "D/A conversion enable".

 [Navigation window] ⇒ [Parameter] ⇒ [Module Information] ⇒ Module model name ⇒ [Module Parameter] ⇒ [Basic setting] ⇒ [D/A conversion enable/disable setting function]

Note the following when wave output data is not yet set by the module extension parameter: If the setting is enabled by resetting the CPU module or turning off→on the power supply, this causes a wave pattern data points setting range error (error code: 1D5□H). This is because the wave pattern data points setting is set to 0 (default value) in the D/A conversion enabled channel.

To clear this error, register the wave output function parameter setting and the wave output data, and then turn off→on→off 'Operation condition setting request' (Un\G70, b9). ( Page 257 Setting the wave output function parameters)

■ Changing the module settings

For the wave output function parameter settings written with the program, 'Operating condition setting request' (Un\G70, b9) needs to be turned off→on→off to enable the settings. When the settings are enabled, the CH1 Analog output value set as D/A conversion enable changes to the following depending on the status of the 'CH1 Output enable/disable flag' (Un\G70, b1).

- 'CH1 Output enable/disable flag' (Un\G70, b1) Changes to the offset value.
- 'CH1 Output enable/disable flag' (Un\G70, b1) The setting in 'CH1 Output setting during wave output stop' (Un\G524) is output.

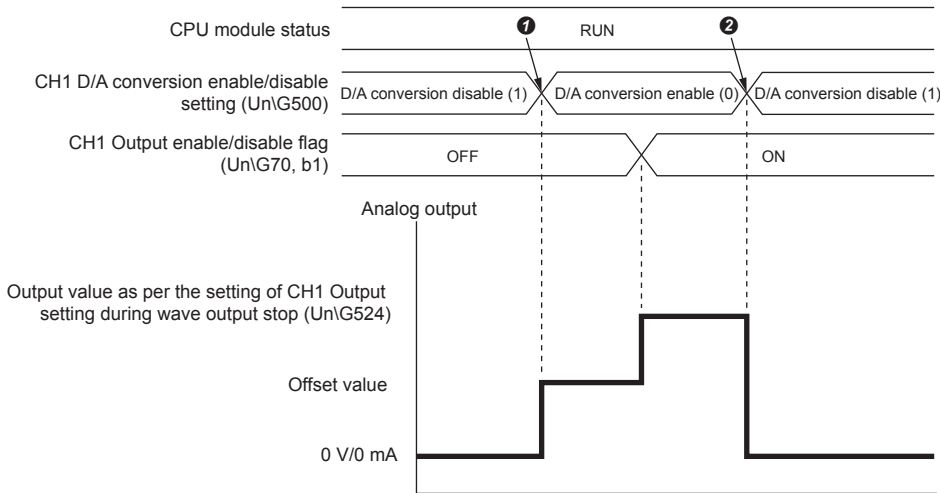

- ❶ Set the CH1 D/A conversion enable/disable setting (Un\G500) to D/A conversion enable (0) and turn off→on→off 'Operation condition setting request' (Un\G70, b9).
- ❷ Set the CH1 D/A conversion enable/disable setting (Un\G500) to D/A conversion disable (1) and off→on→off 'Operation condition setting request' (Un\G70, b9).

Point

When the wave output function is in use, the parameter setting can be enabled by turning off→on→off 'Operating condition setting request' (Un\G70, b9) only when all channels are at a wave output stop (the CH□ Wave output status monitors for all channels are at a wave output stop (0)).

An alarm will occur if 'Operating condition setting request' (Un\G70, b9) is turned off→on→off when the wave output status is other than the wave output stopped state for even one channel. Alarm code 0B0□H is stored in 'Latest alarm code' (Un\G2). The parameter setting will not be enabled.

Start, stop, or pause the wave output

[Starting the wave output]

After the wave data is registered, the wave output can be started using the following procedure.

1. Turn on 'CH1 Output enable/disable flag' (Un\G70, b1).

Turning on this flag outputs the 'CH1 Output setting during wave output stop' (Un\G524) setting as analog data.

2. Set 'CH1 Wave output start/stop request' (Un\G462) to Wave output start request (1).

The wave output starts by changing Wave output stop request (0) or Wave output pause request (2) to Wave output start request (1).

[Stopping the wave output]

To stop the wave output at a desired timing during wave output, set 'CH1 Wave output start/stop request' (Un\G462) to Wave output stop request (0). The wave output fully stops by changing Wave output start request (1) or Wave output pause request (2) to Wave output stop request (0). When wave output stops, Wave output stopped (0) is stored in 'CH1 Wave output status monitor' (Un\G401). The wave output cannot restart from the stopping time point.

The wave output stops also after the wave patterns for the count set with 'CH1 Wave pattern output repetition setting' (Un\G530) have been output.

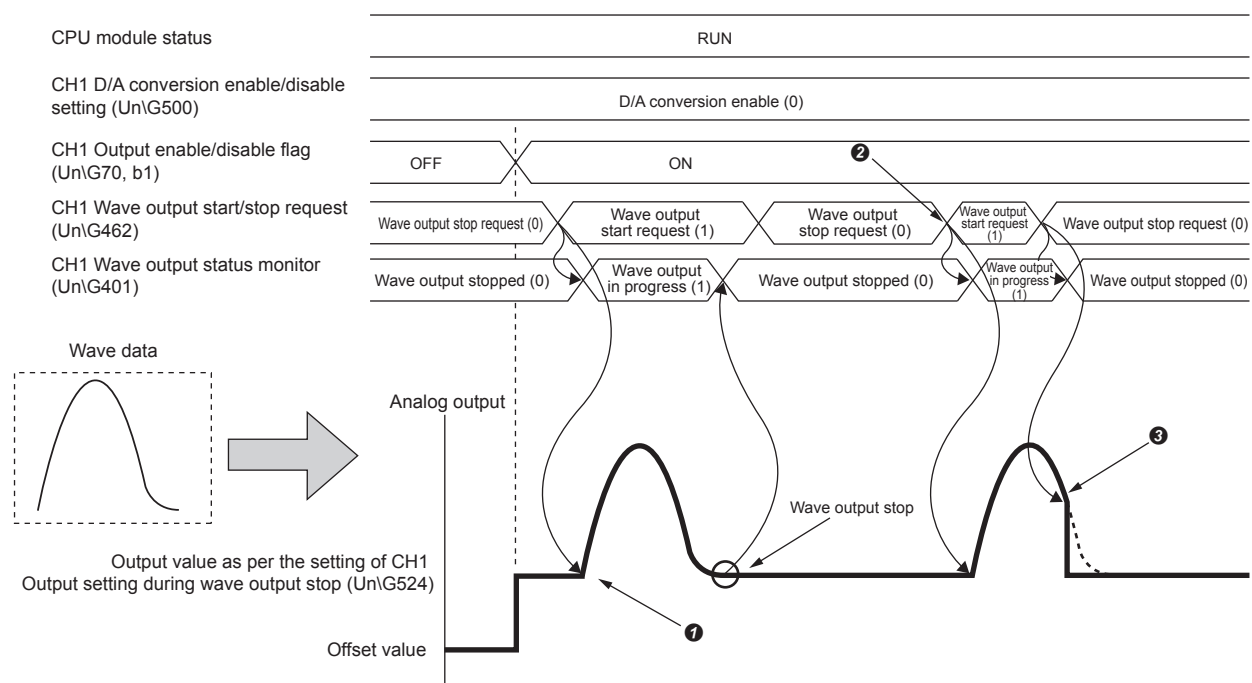

- 1 The wave output starts by setting 'CH1 Wave output start/stop request' (Un\G462) to Wave output start request (1).
- 2 To execute the wave output again, change the 'CH1 Wave output start/stop request' (Un\G462) to Wave output stop request (0) before changing it to Wave output start request (1).
- 3 The wave output stops by setting 'CH1 Wave output start/stop request' (Un\G462) to Wave output stop request (0) during wave output.

[Pausing the wave output]

- To pause the wave output, set 'CH1 Wave output start/stop request' (Un\G462) to Wave output pause request (2). The wave output pauses by changing from Wave output start request (1) to Wave output pause request (2). In addition, Wave output paused (2) is stored in 'CH1 Wave output status monitor' (Un\G401).
- To restart the wave output, change 'CH1 Wave output start/stop request' (Un\G462) from Wave output pause request (2) to Wave output start request (1). This restarts the wave output from the wave data generated when the pause occurred.
- If 'CH1 Wave output start/stop request' (Un\G462) is set to Wave output temporary stop request (2) while the wave output is at a stop, the following will be output depending on HOLD/CLEAR setting.

Previous Value: Outputs the digital value of the wave pattern start address.

Setting value: Outputs the HOLD setting value.

CLEAR: Outputs the offset value.

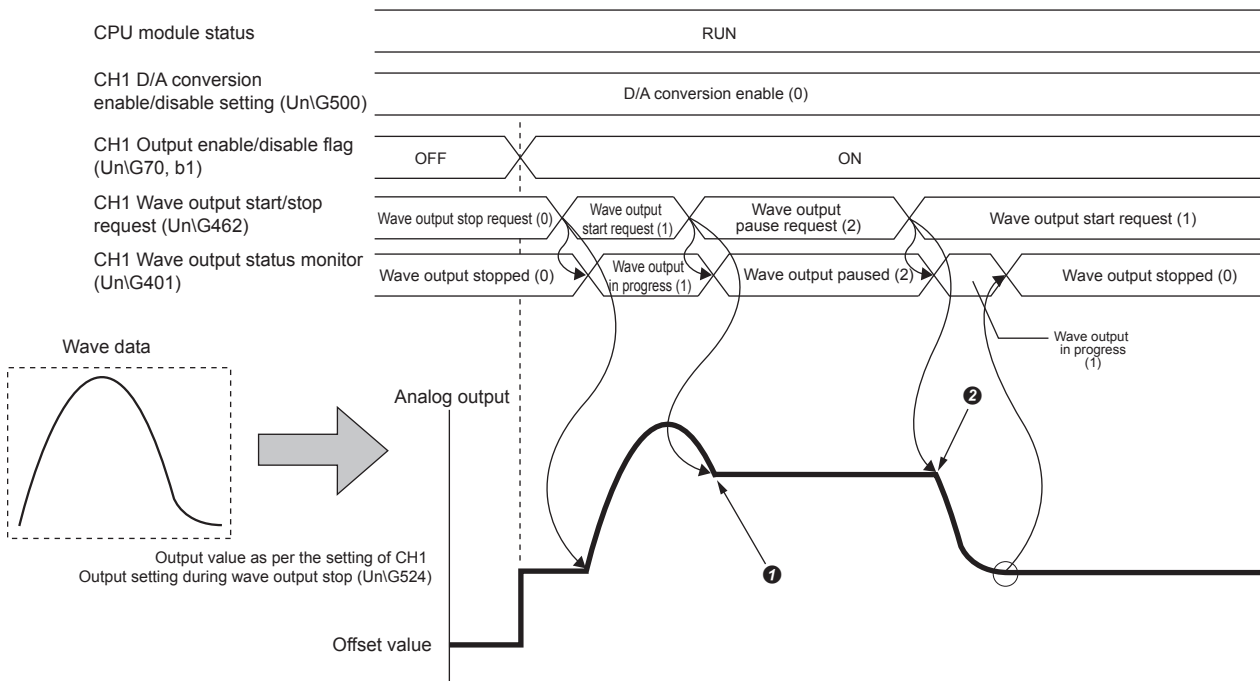

- ❶ The wave output stops by setting 'CH1 Wave output start/stop request' (Un\G462) to Wave output pause request (2) during wave output.
- ❷ The wave output restarts by setting 'CH1 Wave output start/stop request' (Un\G462) to Wave output start request (1).

The analog output value obtained during the wave output paused state depends on the setting of the analog output HOLD/CLEAR function. For details, refer to the following.

📖 Page 190 In the wave output mode

• For the previous value

While the wave output is at a pause, the analog output value generated when the pause occurred is held.

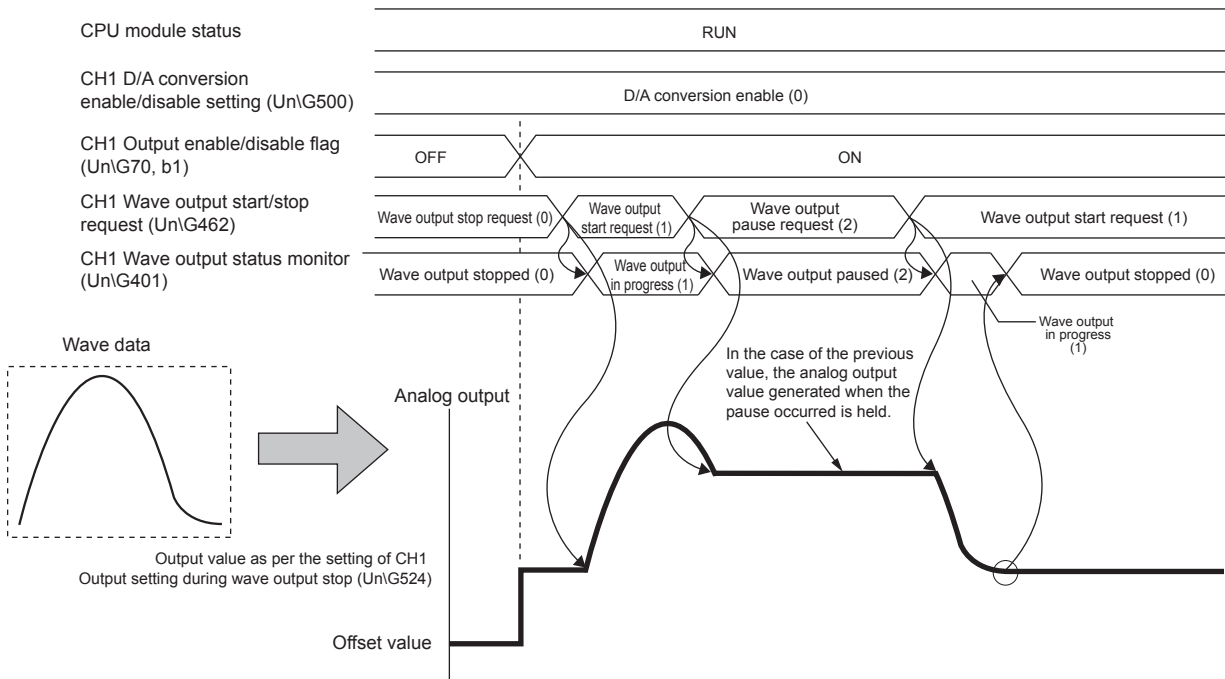

• For the setting value

While the wave output is at a pause, the HOLD setting value is output.

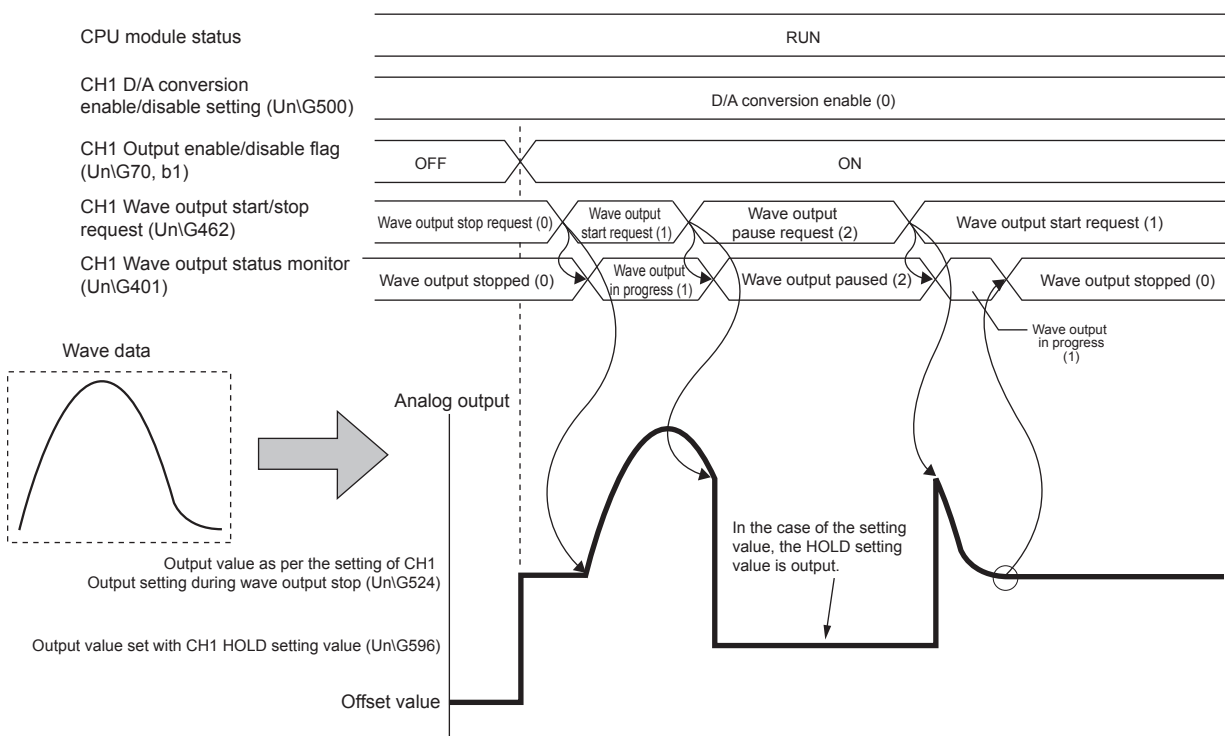

• For CLEAR

While the wave output is at a stop, the offset value is output.

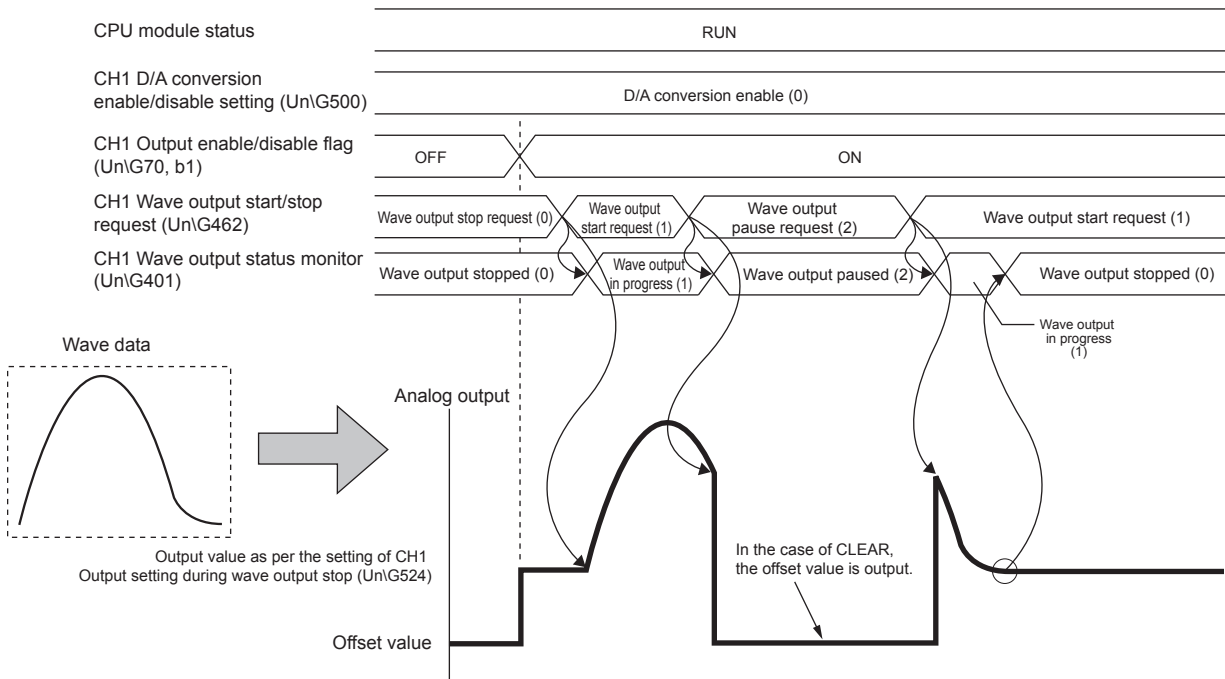

Point

- Wave output start request is accepted only when the CPU module status is RUN. If 'CH1 Wave output start/stop request' (Un\G462) is changed to Wave output start request (1) in CPU module status other than RUN, the wave output will not start.
- Wave output pause request is accepted only when the CPU module status is RUN or STOP.
- Wave output pause request is accepted only when the CPU module status is RUN.
- If 'CH1 Wave output start/stop request' (Un\G462) is set to a value other than 0 to 2, an error will occur. A logging cycle setting disable error (error code: 1D0□H) is stored in 'Latest error code' (Un\G0), 'Error flag' (Un\G69, b15) and the ERROR LED turn on. In this case, the wave output will continue.
- An attempt to output a value out of the digital value range set with the output range causes an error, resulting in occurrence of a digital value setting range error (error code: 191□H).

■Checking the wave output function status

The wave output function status can be checked with the following buffer memory addresses.

Item	Description
Wave output status monitor	An area to store the wave output status.
Wave output conversion cycle monitor	Area in which the conversion cycle of wave output is stored. The unit of the stored value is μ s.
Wave output count monitor	An area to store the number of times the wave pattern was output.
Wave output current address monitor	An area to store the buffer memory address of the currently output wave data.
Wave output current digital value monitor	An area to store the currently output digital input value.
Wave output digital value out-of-range address monitor	When wave data that contains a registered digital input value out of the setting range is output, this area is used to store the registration destination buffer memory address of that wave data. When a digital value outside the setting range is detected with multiple pieces of wave data, this area stores the buffer memory address of only the first detected piece of data.
Wave output alarm occurrence address monitor	An area to store the buffer memory address of the wave data when an alarm occurred. When an alarm occurs due to multiple pieces of wave data, only the buffer memory address of the wave data causing the first alarm is stored.

For details on the buffer memory areas, refer to the following.

☞ Page 298 Details of buffer memory addresses

Points on using the wave output function

■ If 'CH1 Output enable/disable flag' (Un\G70, b1) was changed during wave output

When 'CH1 Output enable/disable flag' (Un\G70, b1) is turned on→off during wave output, the wave output does not stop although the analog output value changes to the offset value. The wave output update continues also while 'CH1 Output enable/disable flag' (Un\G70, b1) is off. Turning off→on 'CH1 Output enable/disable flag' (Un\G70, b1) restarts the analog output.

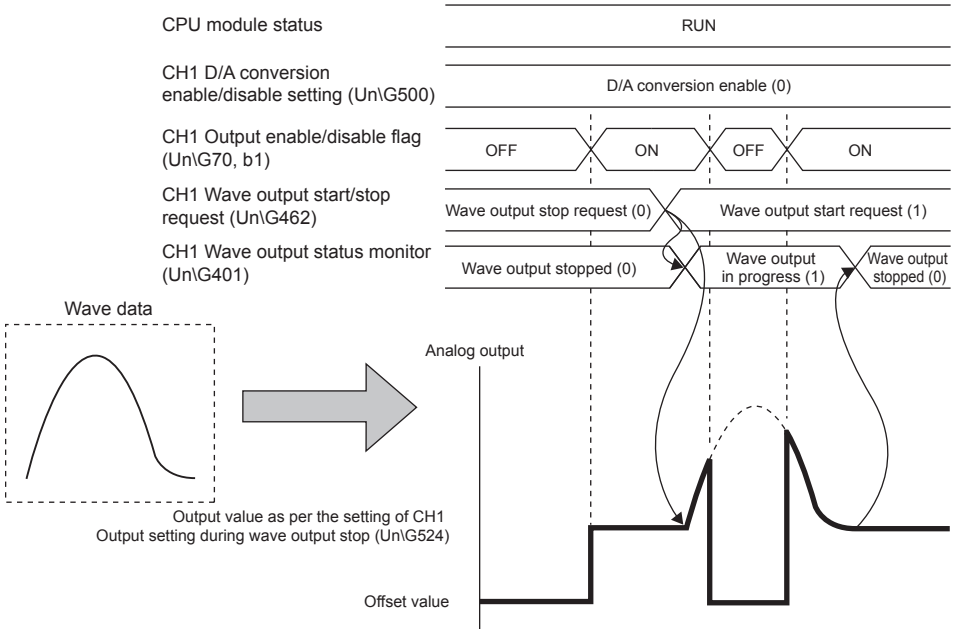

■ If the CPU module status was changed during output

When the CPU module status was changed during wave output, after terminating the wave output, it operates as follows depending on the analog output HOLD/CLEAR function setting.

- For the previous value

If the CPU changes from RUN to STOP, the wave output terminates and the value immediately before STOP is held. When 'CH1 Output enable/disable flag' (Un\G70, b1) is turned on with the CPU module changed from STOP to RUN, the output changes as per the setting of 'CH1 Output setting during wave output stop' (Un\G524). Wave output does not restart.

To restart the wave output, change 'CH1 Wave output start/stop request' (Un\G462) from Wave output stop request (0) to Wave output start request (1) again.

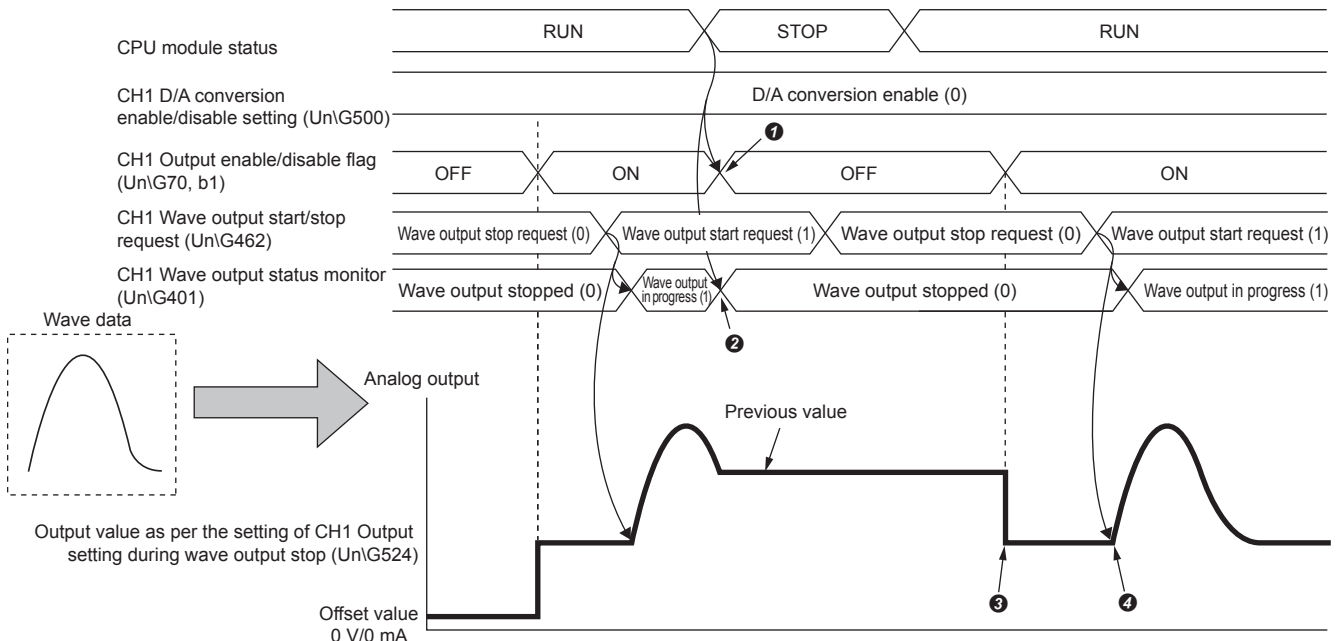

- 1 The output is disabled because the CPU module changes from RUN to STOP.
- 2 Once the HOLD/CLEAR operates, the wave output stops.
- 3 Wave output does not restart.
- 4 To restart the wave output, change the setting to Wave output start request (1).

- For the setting value

If the CPU changes from RUN to STOP, the wave output terminates and its value is held as the 'CH1 HOLD setting value' (Un\G596). When 'CH1 Output enable/disable flag' (Un\G70, b1) is turned on with the CPU module changed from STOP to RUN, the output changes as per the setting of 'CH1 Output setting during wave output stop' (Un\G524). Wave output does not restart.

To perform the wave output, change 'CH1 Wave output start/stop request' (Un\G462) from Wave output request (0) to Wave output start request (1) again.

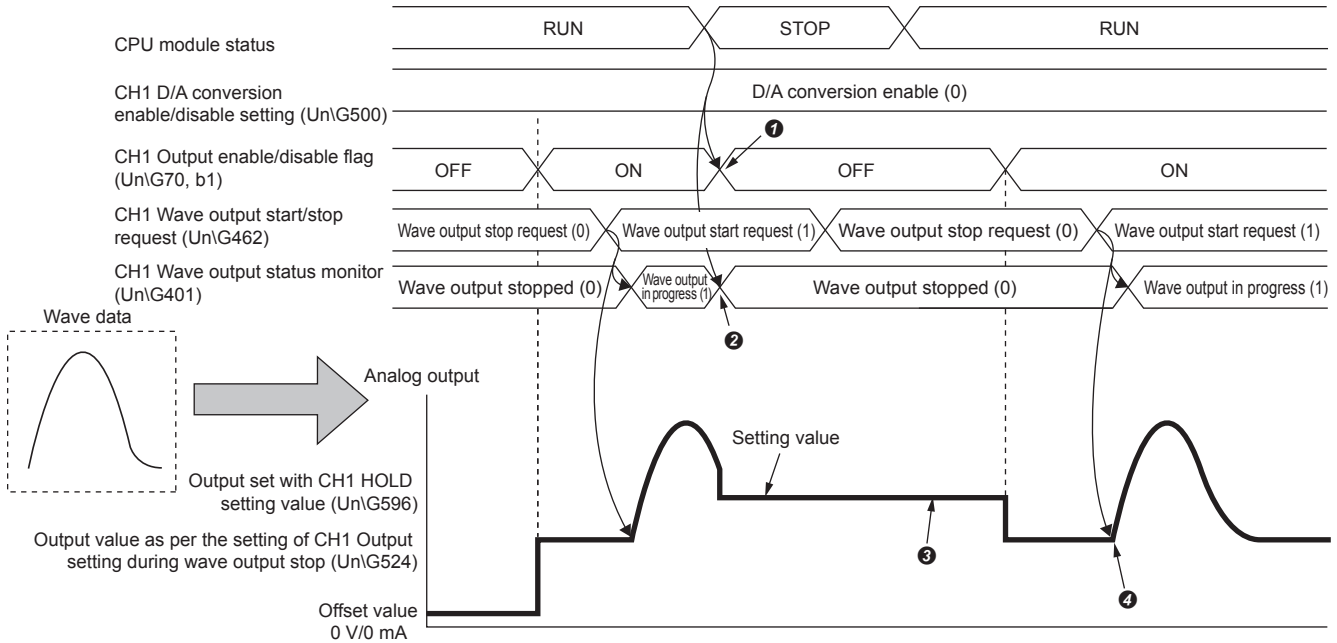

- 1 The output is disabled because the CPU module changes from RUN to STOP.
- 2 Once the HOLD/CLEAR operates, the wave output stops.
- 3 The value set by the HOLD setting value is output.
- 4 To restart the wave output, change the setting to Wave output start request (1).

• For CLEAR

If the CPU changes from RUN to STOP, the wave output terminates and the offset value is output. When 'CH1 Output enable/disable flag' (Un\G70, b1) is turned on with the CPU module changed from STOP to RUN, the output changes as per the setting of 'CH1 Output setting during wave output stop' (Un\G524). Wave output does not restart.

To perform the wave output, change the CPU module from STOP to RUN and then set 'CH1 Wave output start/stop request' (Un\G462) to Wave output stop request (0). Then, change 'CH1 Wave output start/stop request' (Un\G462) from Wave output stop request (0) to Wave output start request (1).

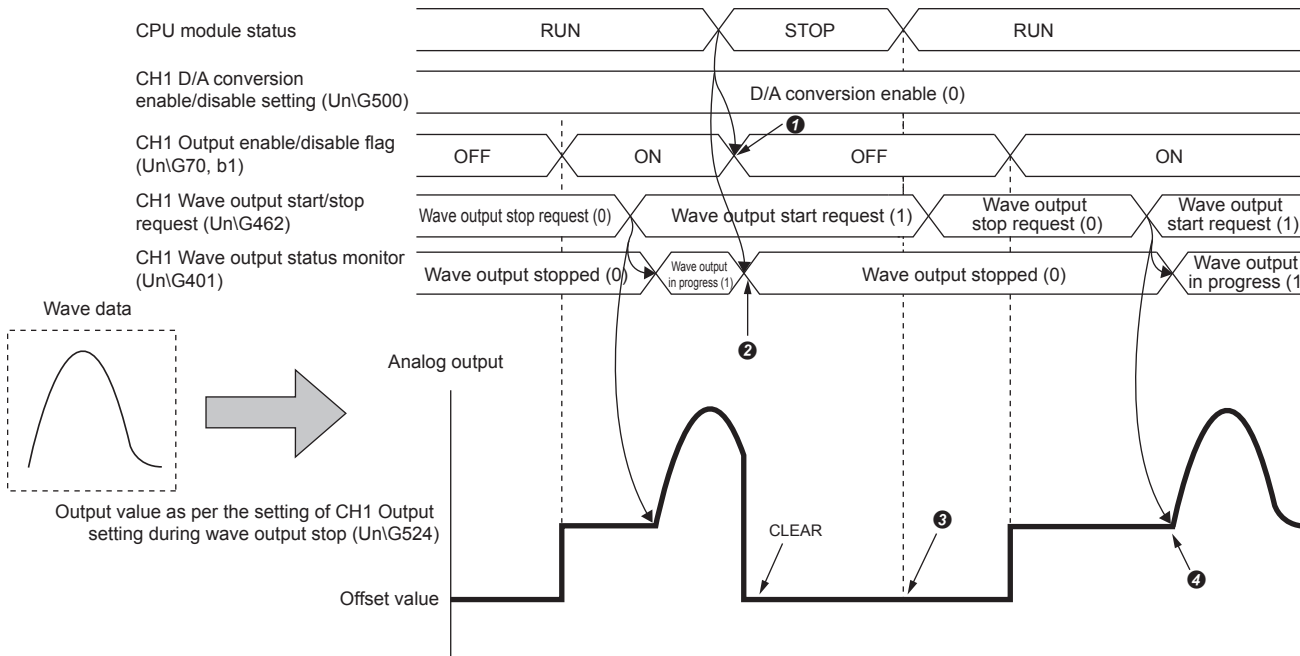

- ❶ The output is disabled because the CPU module changes from RUN to STOP.
- ❷ Once the HOLD/CLEAR operates, the wave output stops.
- ❸ Outputs the offset value.
- ❹ To restart the wave output, change the setting to Wave output start request (1).

■When an error occurs

If a value out of the setting range of the output range is attempted to be output, an error will occur and error code 191□H is stored in 'Latest error code' (Un\G0); 'Error flag' (Un\G69, b15) turns on at this time. If this error (error code: 191□H) occurs during wave output, the analog output value will be as follows.

- If an attempt is made to output a value below the minimum value of the output range, the analog output value will be the minimum value of the output range.

When the output range is set to 0 to 5 V

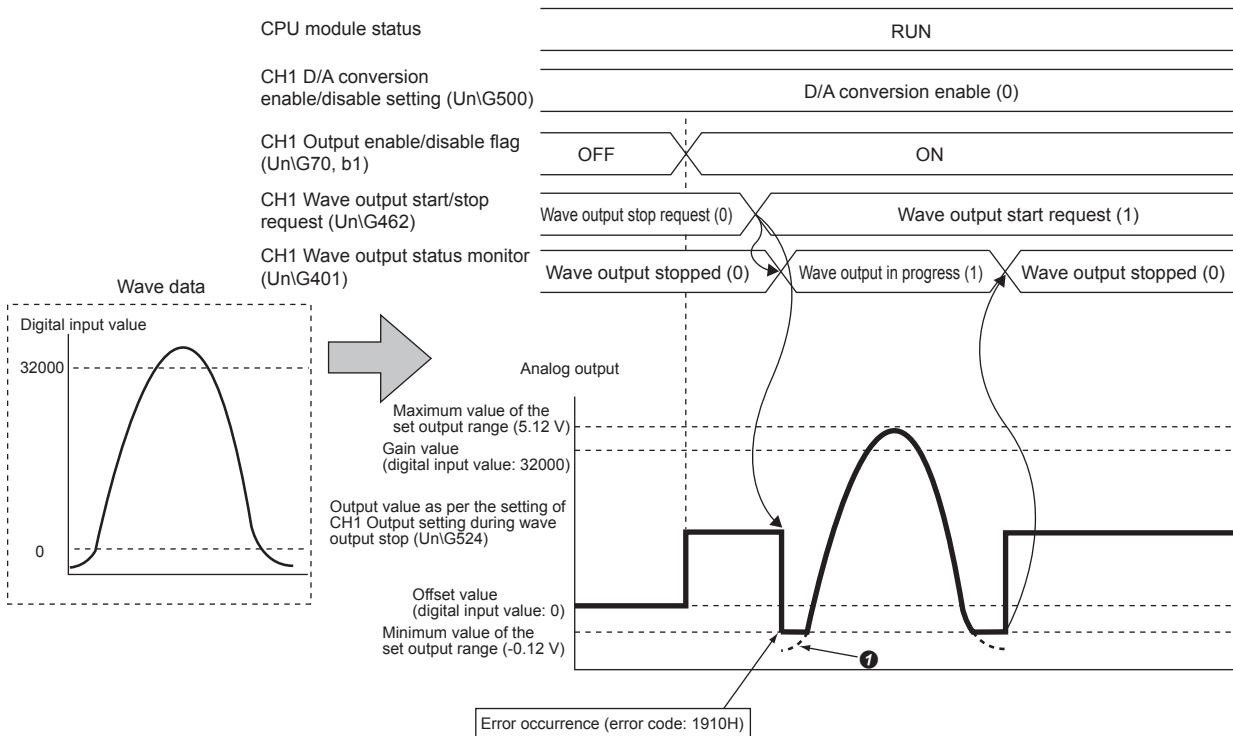

- ❶ If an attempt is made to output a value below the minimum value of the output range, the analog output value will be the minimum value of the output range.

If an error with error code 191□H occurs due to setting a digital input value outside the range, restore the digital input value to the value within the range before turning off→on→off 'Error clear request' (Un\G70, b15).

The buffer memory address to register the wave data being out of range can be examined using the wave output digital value out-of-range address monitor.

■When the external power supply turns off during wave output

When the external power supply turns on→off during without, the wave output status of every channel stops and the wave output fully stops. If the external power supply turns off→on at this time, the wave output will not restart.

To restart the wave output, after the external power supply turns off→on, check that the status of the analog output module and the externally connected devices. Then, set 'CH1 Wave output start/stop request' (Un\G462) to Wave output start request (1).
(1).

While the external power supply is off, no Wave output start/stop request is accepted.

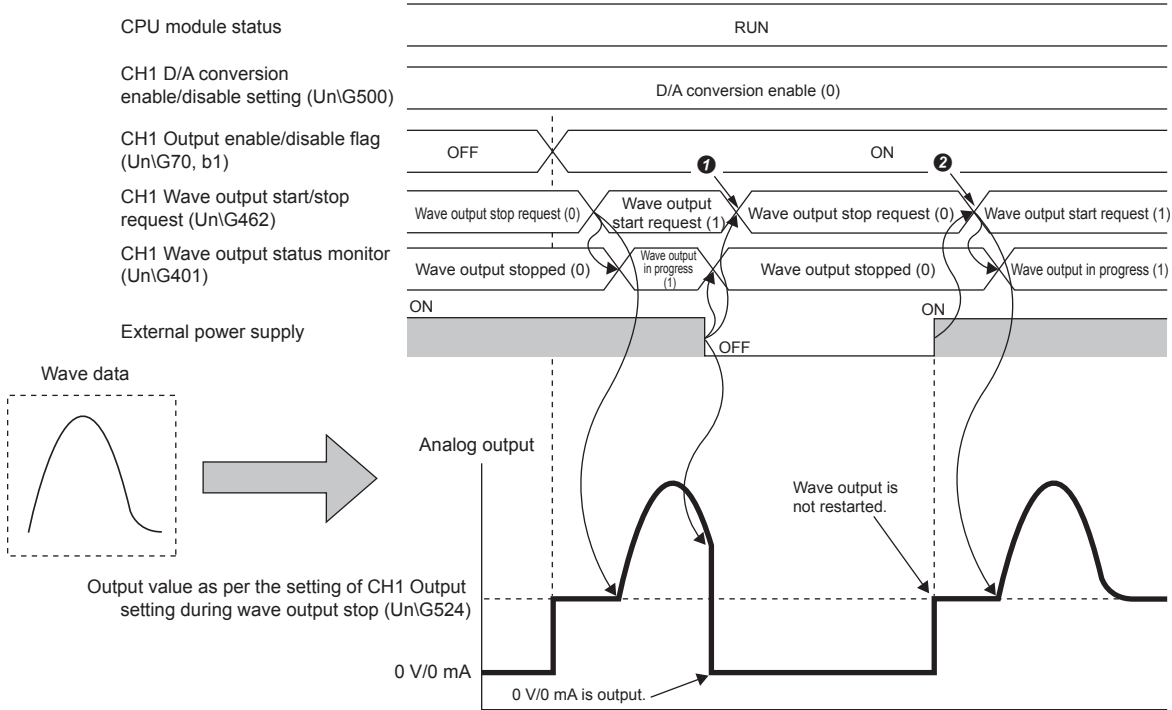

- ❶ Since the external power supply turned on→off and the wave output stopped, change the CH1 Wave output start/stop request (Un\G462) to Wave output stop request (0).
- ❷ To restart the wave output again, change the 'CH1 Wave output start/stop request' (Un\G462) to Wave output stop request (0) before changing it to Wave output start request (1).

■When the disconnection occurs during wave output

When the disconnection is detected during wave output, the wave output status of the channel in which the disconnection was detected becomes the wave output stopping, and the wave output completely stops. Even if the disconnection cause is eliminated from the disconnection status, the wave output is not restarted.

By turning 'Error clear request' (Un\G70, b15) off→on→off, the output of the value set in 'Output setting during wave output stop' (Un\G524) is restarted.

To restart the wave output, check that the status of the analog output module and the externally connected devices. Then, set 'CH1 Wave output start/stop request' (Un\G462) to Wave output start request (1).

While the disconnection detection signal is on, no Wave output start/stop request is accepted.

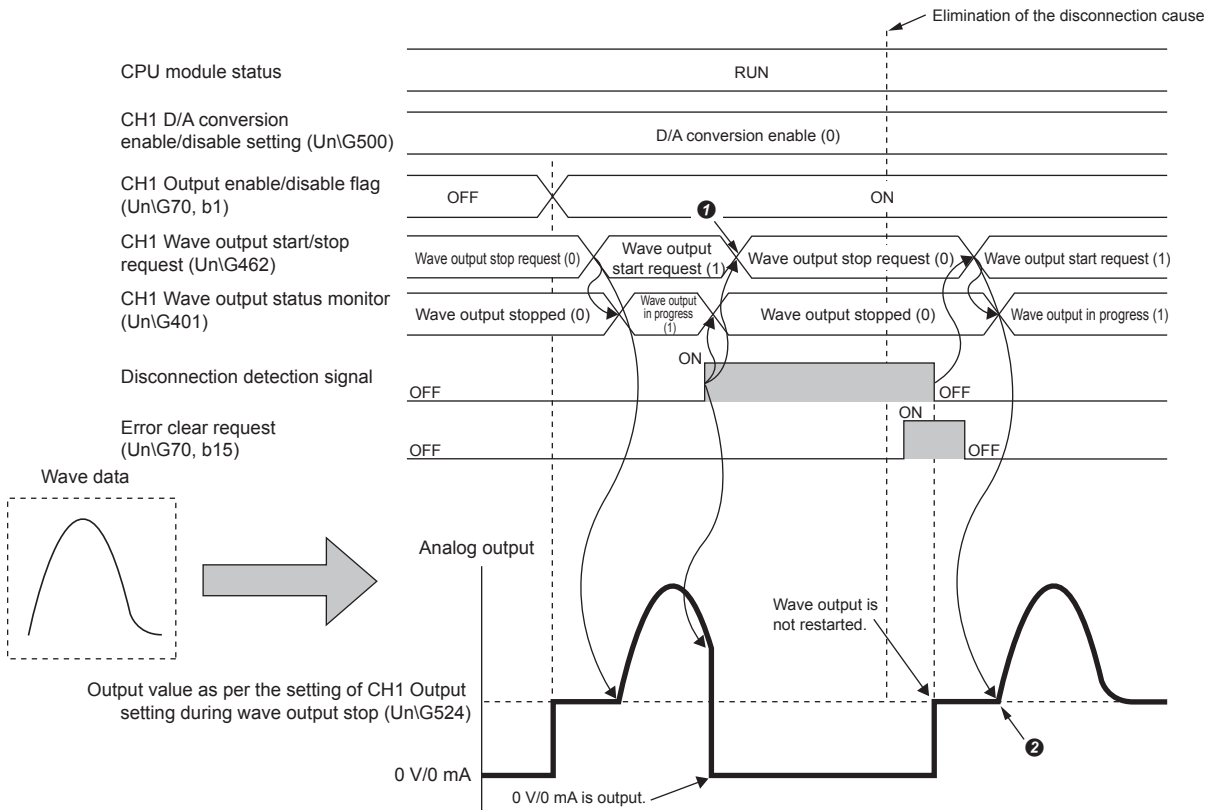

- ❶ Since the disconnection detection signal turned off→on and the wave output stopped, change the CH1 Wave output start/stop request (Un\G462) to Wave output stop request (0).
- ❷ To restart the wave output again, change the 'CH1 Wave output start/stop request' (Un\G462) to Wave output stop request (0) before changing it to Wave output start request (1).

■Using the wave output function as PWM

The wave output function is available also as PWM with the shortest pulse width of 80 μ s.

In addition, since any number of pulses can be analog output by only creating a one pulse wave pattern, it contributes to reduction of man-hours for program creation.

- Example of creating a wave pattern

Creating a wave pattern with pulse width 80 μ s, amplitude 5 V, and duty ratio 50%

1. Set "Output range setting" to 0 to 5 V.

 [Navigation window] \Rightarrow [Parameter] \Rightarrow [Module Information] \Rightarrow Module model name \Rightarrow [Module Parameter] \Rightarrow [Basic setting] \Rightarrow [Range switching function]

2. In "Create Wave Output Data", create a wave pattern for one pulse.

Setting item	Setting content	
Wave pattern information	Digital value range	0 to 32000
	Number of pieces of data	2
Wave detail setting	Digital value in section No. 1	32000
	Digital value in section No. 2	0
	Specified wave of section No. 2	Line

The wave monitored on GX Works3 differ from the analog output wave.

3. Set "Wave output data setting" as follows.

Setting item	Setting content
CH1 Wave pattern No.	Wave pattern created in step 2.
CH1 Wave pattern start address setting	10000 (default value)
CH1 Wave pattern output repetition setting	Set the number of times the wave output is to be repeated.
CH1 Constant for wave output conversion cycle	1 (default value)

4. Register the wave data and wave output function parameter settings in the analog output module. For how to register these, refer to the following.

 Page 215 Transfer the wave output data

5. Set D/A conversion enable (0) in 'CH1 D/A conversion enable/disable setting' (Un\G500).
6. Turn off \rightarrow on \rightarrow off 'Operating condition setting request' (Un\G70, b9).
7. Turn on 'CH1 Output enable/disable flag' (Un\G70, b1).
8. Set 'CH1 Wave output start/stop request' (Un\G462), and start the wave output. After the wave output starts, the following analog output is generated.

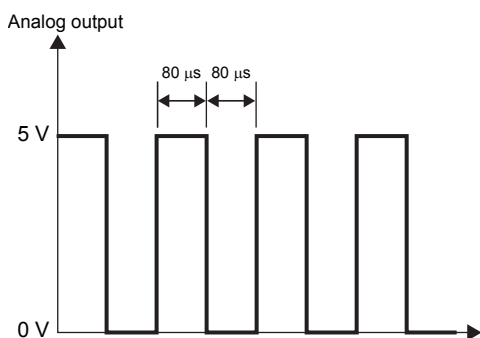

Wave output step execution function

When the wave output function is in use, this execution function changes the address and data value to be output and freely changes the analog output at a desired timing.

This function is useful for debugging the analog output test or wave output function when the wave output function is used.

Ex.

Wave output step execution in the following conditions

- The output range is set to -10 to +10 V.
- The wave output status is wave output in progress.
- The address when the Step action wave output request is accepted is 34990.

1. During wave output, set Step action wave output request (Un\G188) to ON (1).

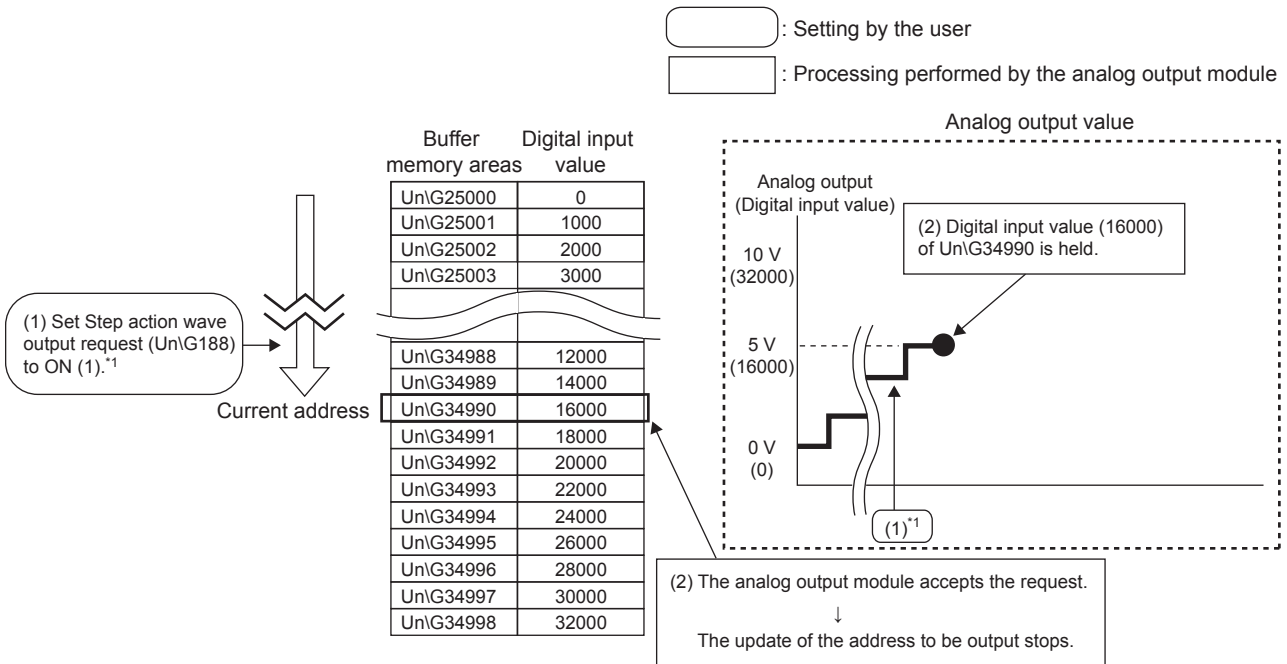

*1 The contents described here is the case when the wave output status is the wave output in progress at the timing of (1). If the status is other than the wave output in progress, the following value is output at the timing of (2).

- When wave output is stopped
The digital value that is set as the wave pattern start address is output in an analog value and held.
- When wave output is paused
The data of the address during the wave output pause (wave output current address) is held.

2. Set 'CH1 Wave output step action movement amount' (Un\G482) to 8 (8 in forward direction).

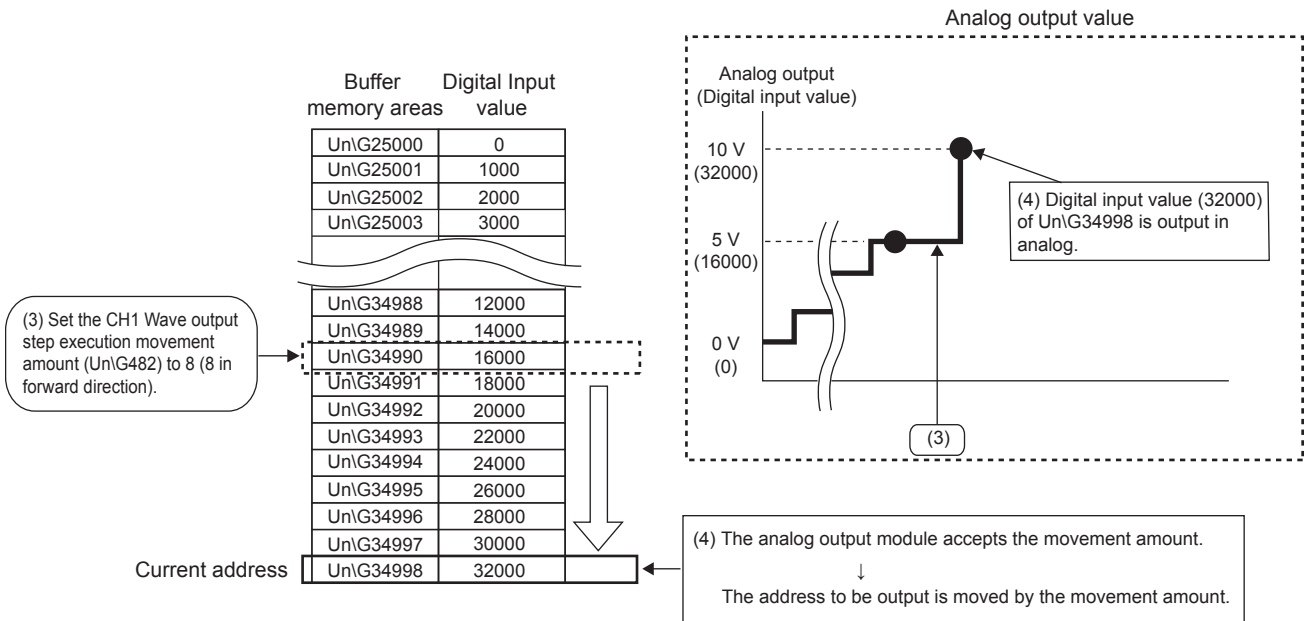

3. Rewrite the digital input value of address 34992 to 16000, and set 'CH1 Wave output step action movement amount' (Un\G482) to -6 (6 in reverse direction).

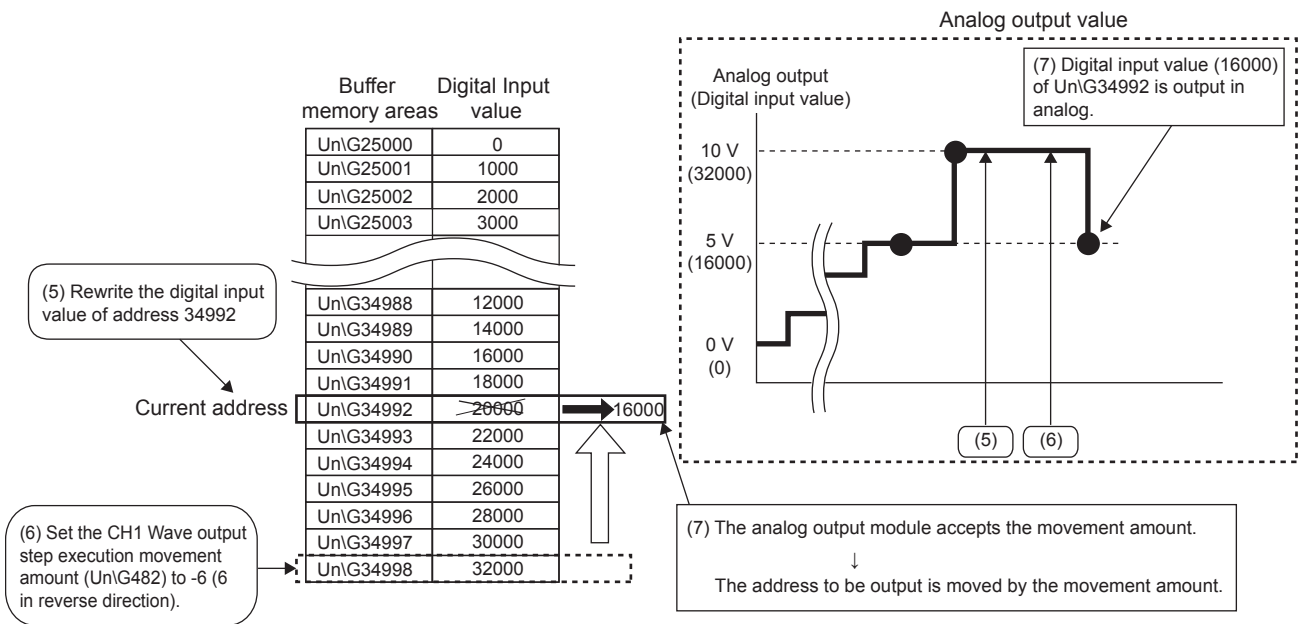

4. Set Step action wave output request (Un\G188) to OFF (0).

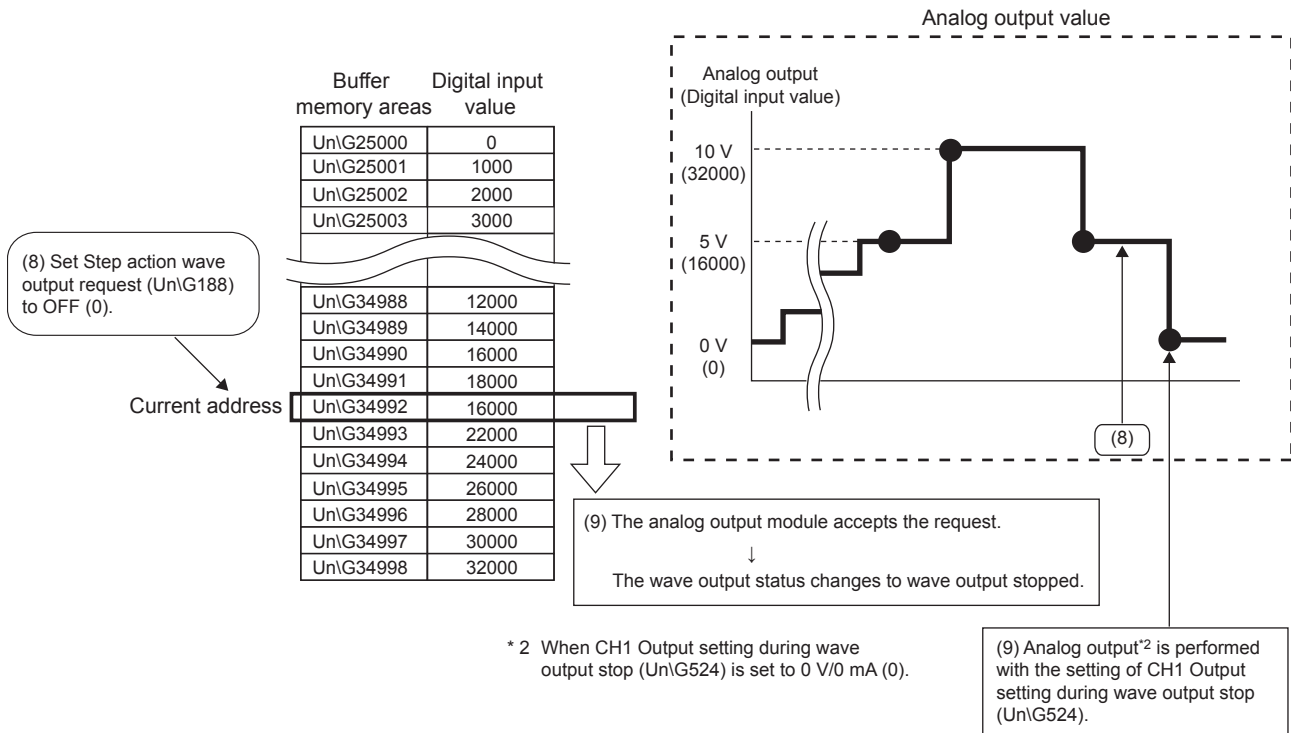

■ Operation of the wave output step execution function

The wave output step execution function operates as follows.

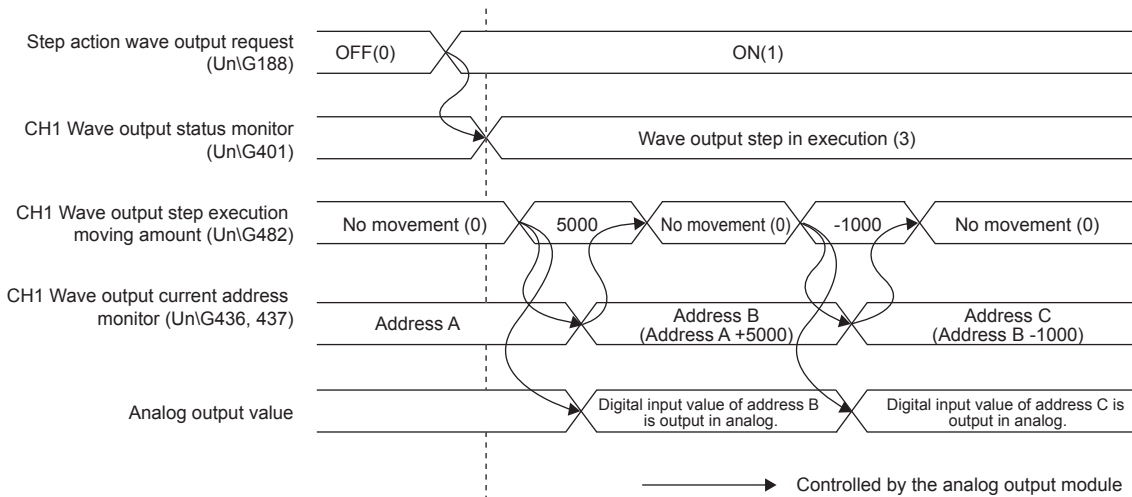

By turning 'Step action wave output request' (UnG188) OFF (0) → ON (1), change the status to Wave output step execution in progress. By setting the value in 'CH1 Wave output step action movement amount' (UnG482) during wave output step execution, control moves to the address of the wave data to be subjected to the output test. For the value in 'CH1 Wave output step action movement amount' (UnG482), set the amount by which to move it from the address of the current wave data.

After the movement is completed, 'CH1 Wave output step action movement amount' (UnG482) changes to No movement (0) and the destination wave data is output as analog data.

The range where the movement is enabled by 'CH1 Wave output step action movement amount' (UnG482) is determined by both setting values of the wave pattern start address and the wave pattern data points. The movable range is as follows.

$$\left(\begin{array}{l} \text{Wave pattern} \\ \text{Start address} \end{array} \right) \text{ to } \left(\begin{array}{l} \text{Wave pattern} \\ \text{Start address} \end{array} + \text{Wave pattern data points} - 1 \right)$$

If a value equal to or larger than "Wave pattern data points" is set in 'CH1 Wave output step action movement amount' (UnG482), the value of wave pattern data points will be used for processing.

■ Execution of the wave output step execution function

To use the wave output step execution function, the wave output function needs to be initialized beforehand. For initializing the wave output function, refer to the following.

☞ Page 212 Initializing the wave output function

[Changing the status to wave output step execution]

Change the wave output status to Wave output step execution in progress by using the following procedure.

1. Turn Step action wave output request (UnG188) OFF (0) → ON (1).
2. Check that the CH□ Wave output status monitor for all channels have changed to Wave output step execution in progress (3).

To perform the wave output step execution, check the 'Latest error code' (UnG0) and the ERROR LED to confirm that no error has occurred. Then, change 'Step action wave output request' (UnG188) (0) from OFF (0) to ON (1). Unless the wave output parameter setting is set within the set range on all D/A conversion enabled channels, the wave output step execution cannot be performed on any channels.

[Wave output step execution]

After making change to the wave output step execution state, perform the wave output step execution using the following procedure. By repeating this procedure, the analog output test and debugging can be performed when the wave output function is performed.

1. Change the wave data of the target subjected to wave output step execution to an arbitrary value.
2. Set the value in 'CH1 Wave output step action movement amount' (Un\G482).

Set the following value depending on the direction in which to move control.

Shift direction	Description	Setting value
No shift	Control does not move to another buffer memory address of the output wave data.	0
Forward movement	Control moves to another output buffer memory address in the increasing direction from the address at which the wave data is currently being output. <ul style="list-style-type: none"> • If 10000 is set in 'CH1 Wave output step action movement amount' (Un\G482) when the currently output wave data is at buffer memory address Un\G20000, control will move to Un\G30000 as the output buffer memory address. 	1 to 30000
Reverse movement	Control moves to another output buffer memory address in the decreasing direction from the address at which the wave data is currently being output. <ul style="list-style-type: none"> • If -10000 is set in 'CH1 Wave output step action movement amount' (Un\G482) when the currently output wave data is at buffer memory address Un\G40000, control will move to Un\G30000 as the output buffer memory address. 	-1 to -30000

3. Check that the value of 'CH1 Wave output step action movement amount' (Un\G482) has changed to No movement (0).
4. Check that 'CH1 Wave output current address monitor' (Un\G436, 437) has changed to the buffer memory addresses at which to output the wave data.
5. Check that the analog output value is proper.

[Terminating the wave output step execution]

Terminate the wave output step execution using the following procedure.

1. Turn 'Step action wave output request' (Un\G188) ON (1) → OFF (0).
2. Check that the CH□ Wave output status monitor for all channels have changed to Wave output stopped (0). In addition, if the CH□ Wave output start/stop request was other than the wave output stop request (0), check that the status has been forcedly changed to Wave output stop request (0) at this timing.

To perform the wave output after the wave output step execution terminates, set CH□ Wave output start/stop request in Wave output start request (1).

Point

- When the value is set for the CH□ Wave output step execution movement amount, the analog output may suddenly change. It is recommended to use this function in combination with the CH□ Output enable/disable flag to suppress the sudden change. For the combination, refer to the following.
 ☞ Page 190 In the wave output mode
- By using this function in combination with the CH□ Output enable/disable flag during wave output step execution, the analog output can be changed at a desired timing. For details, refer to the following.
 ☞ Page 234 Analog output test when wave output function is used
- During wave output step execution, setting a value in CH□ Wave output start/stop request does not change the wave output status. The wave output status can be changed by setting 'Step action wave output request' (Un\G188) to OFF (0) so that the status changes to Wave output stopped.

■Analog output test when wave output function is used

The following shows the procedure of an analog output test that uses the wave output step execution function.

An example of executing a CH1 Analog output test is also shown.

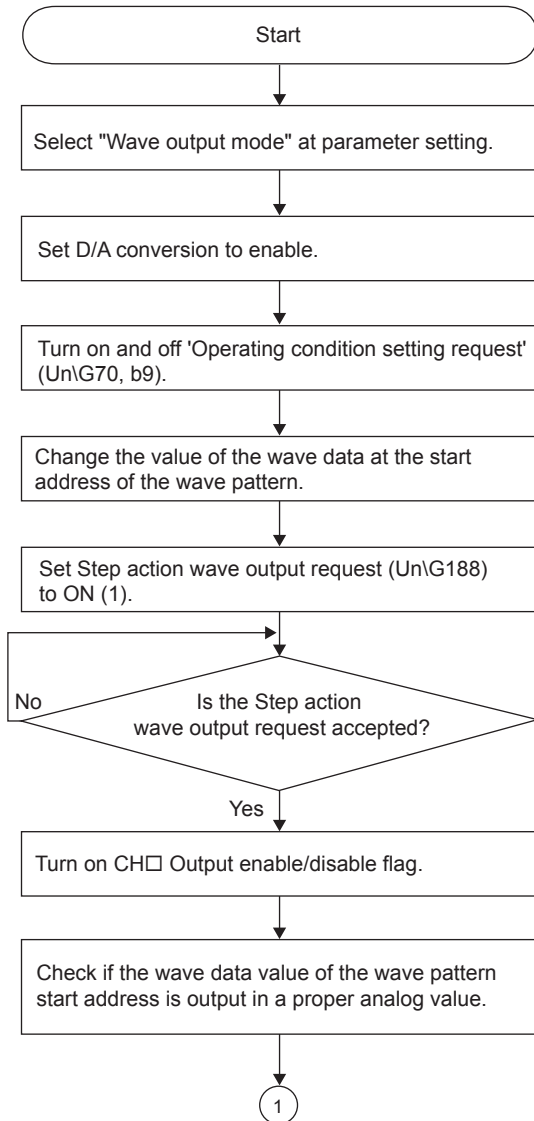

Example of executing a CH1 Analog output test

Select "Wave output mode" at "Output mode setting" of parameter setting.

Set D/A conversion enable (0) in CH1 D/A conversion enable/disable setting (Un\G500).

Turn on and off 'Operating condition setting request' (Un\G70, b9). Even if D/A conversion is enabled, since the CH1 Output enable/disable flag (Un\G70, b1) is OFF, the analog output value will be the offset value.

When reception of the set value of the Step action wave output request (Un\G188) is completed, the CH1 Wave output status monitor (Un\G401) becomes wave output step in execution (3).

The analog output value changes from the offset value to the wave data value of the wave pattern start address.

Check if the analog output value is proper using a tester.

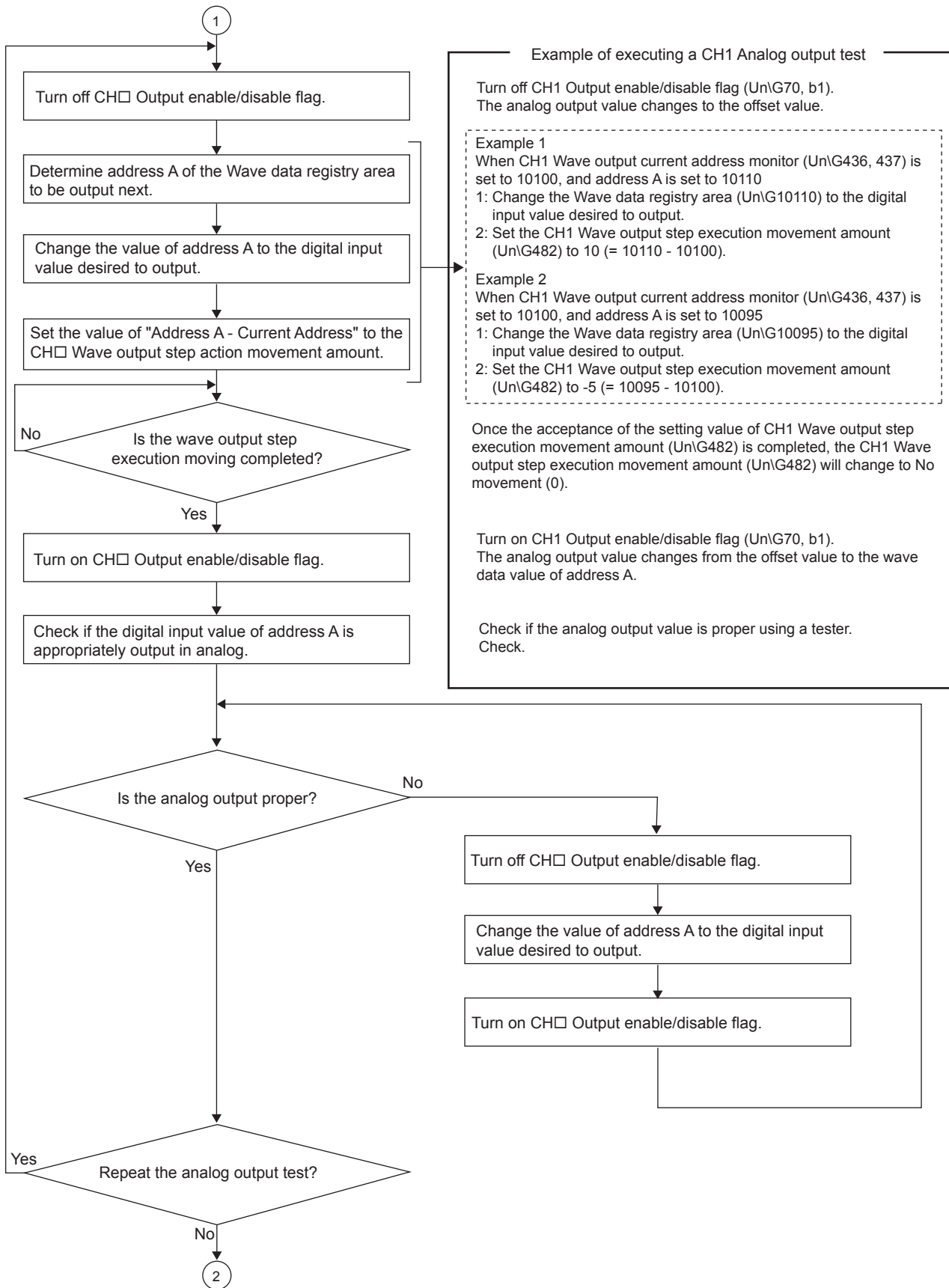

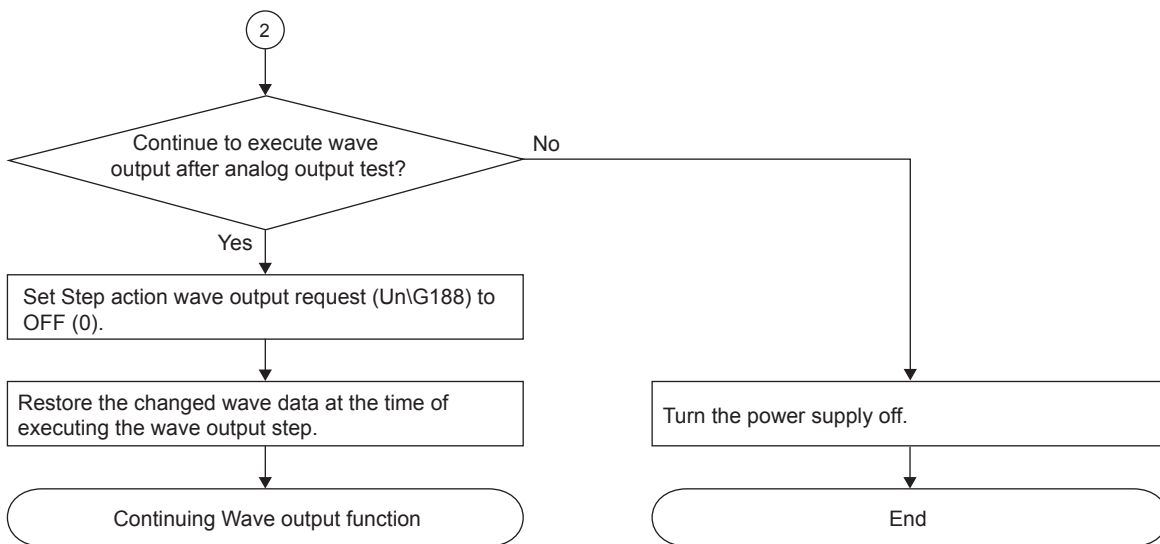

Error history function

Records up to 16 errors and alarms that occurred in an analog output module to store them in the buffer memory areas.

Operation

When an error occurs, the error code and error time are stored in order, beginning with Error history No. 1 (Un\G3600 to Un\G3609).

When an alarm occurs, the alarm code and alarm time are stored in order, beginning with Alarm history No. 1 (Un\G3760 to Un\G3769).

- Detail of the error code assignment

	b15	to	b8	b7	to	b0
Un\G3600	Error code					
Un\G3601	First two digits of the year			Last two digits of the year		
Un\G3602	Month			Day		
Un\G3603	Hour			Minute		
Un\G3604	Second			Day of the week		
Un\G3605	Millisecond (upper)			Millisecond (lower)		
Un\G3606 to Un\G3609	System area					

- Detail of the alarm code assignment

	b15	to	b8	b7	to	b0
Un\G3760	Alarm code					
Un\G3761	First two digits of the year			Last two digits of the year		
Un\G3762	Month			Day		
Un\G3763	Hour			Minute		
Un\G3764	Second			Day of the week		
Un\G3765	Millisecond (upper)			Millisecond (lower)		
Un\G3766 to Un\G3769	System area					

Ex.

Example of error history and alarm history storage

Item	Storage contents	Storage example* ¹
First two digits of the year/Last two digits of the year	Stored in BCD code.	2017H
Month/Day		0130H
Hour/Minute		1035H
Second		40H
Day of the week	One of the following values is stored in BCD code. Sunday: 0, Monday: 1, Tuesday: 2, Wednesday: 3, Thursday: 4, Friday: 5, Saturday: 6	1H
Millisecond (upper)	Stored in BCD code.	06H
Millisecond (lower)		28H

*¹ These values assume that an error occurs at 10:35 and 40.628 seconds on Monday, January 30th, 2017.

The start address of Error history where the latest error is stored, can be found in 'Latest address of error history' (Un\G1).

The start address of Alarm history where the latest alarm is stored, can be found in 'Latest address of alarm history' (Un\G3).

Ex.

When the third error occurs:

The third error is stored in Error history No. 3, and the value 3620 (start address of Error history No. 3) is stored to Latest address of error history.

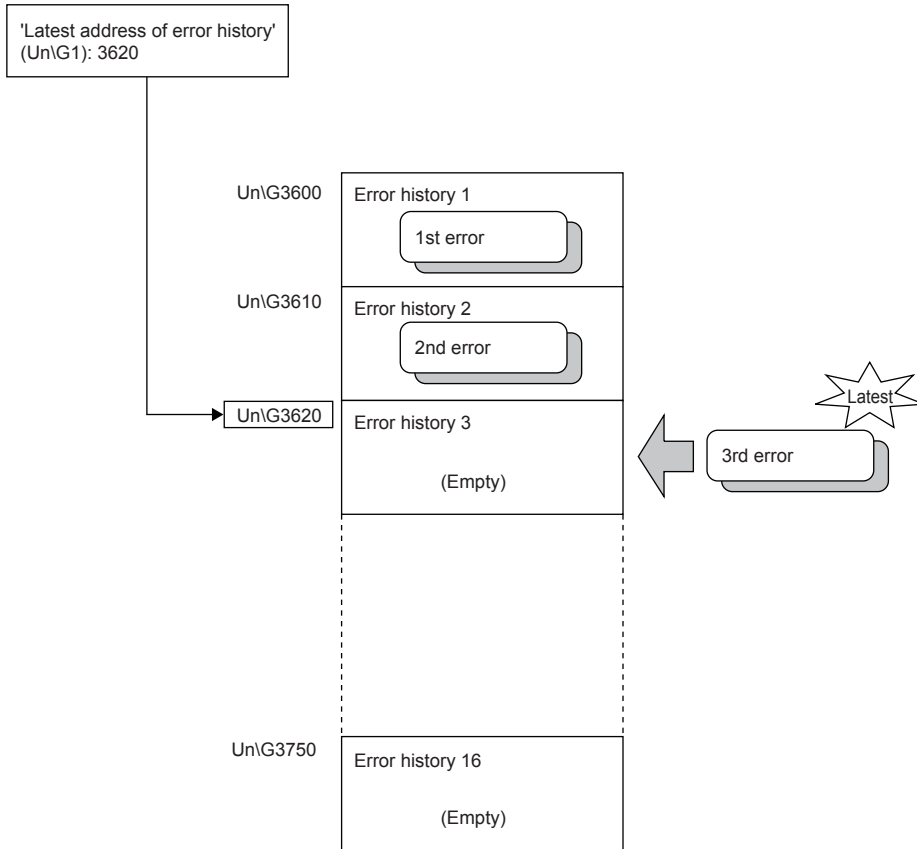

Ex.

When the 17th error occurs:

The 17th error is stored in Error history No. 1, and the value 3600 (start address of Error history No. 1) is stored to Latest address of error history.

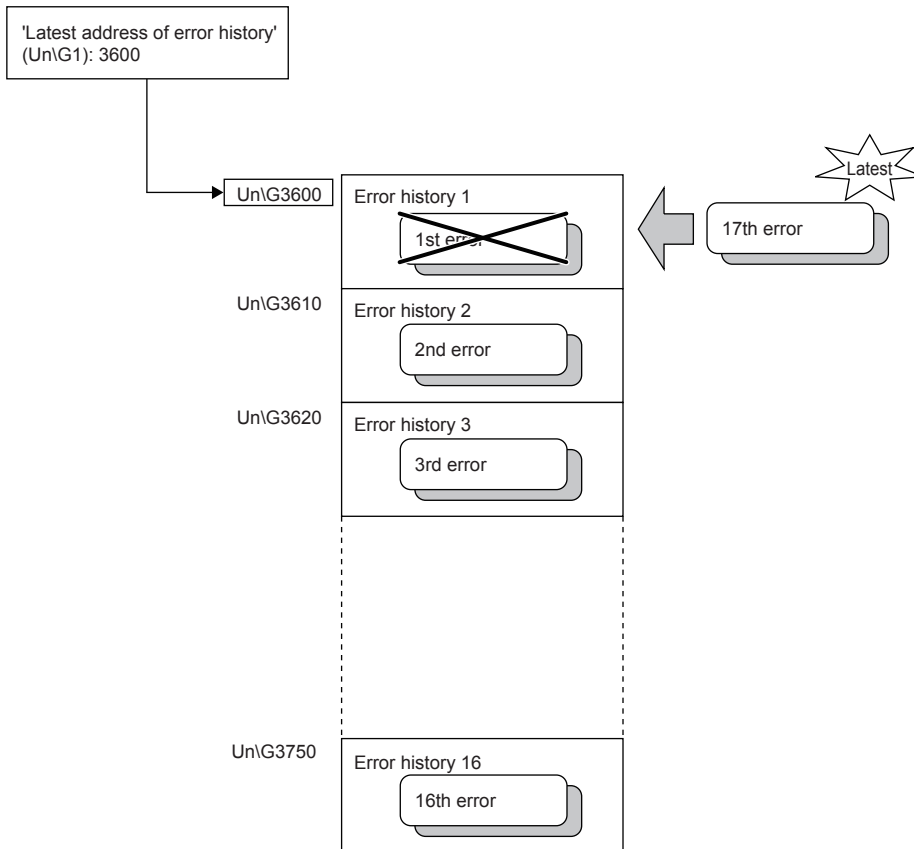
**Point**

- Once the error history storage area becomes full, the existing data is overwritten in order, starting with 'Error history No. 1' (Un\G3600 to Un\G3609), and error history logging continues. The overwritten history is deleted.
- The same processing is performed for Alarm history when an alarm occurs.
- The stored error history is cleared when an analog output module is powered off or the CPU module is reset.

Offset/gain initialization function

Offset/gain initialization

This function initializes the offset and gain values adjusted by the offset/gain setting to the factory defaults.

User range setting	Offset value	Gain value
User range setting (voltage)	0 V	10 V
User range setting (current)	4 mA	20 mA

1. Set the mode to normal output.
2. Set "D/A conversion not allowed (1)" in 'CH1 D/A conversion enable/disable setting' (Un\G500) to 'CH4 D/A conversion enable/disable setting' (Un\G1100). Then, turn off→on→off 'Operating condition setting request' (Un\G70, b9).
3. Set "E20FH" to 'Offset/gain initialization enabled code' (Un\G305).
4. Turn ON (1) 'Offset/gain initialization request' (Un\G70, b5).

After completion of the offset/gain initialization function, 'Offset/gain initialization enable code' (Un\G305) is initialized to '0000H' and 'Offset/gain initialization completed flag' (Un\G69, b5) turns on (1).

FX3 allocation mode function

This function operates the buffer memory areas of the analog output module with a layout of the buffer memory addresses equivalent to those in FX3U-4DA.

Operation

In FX3 allocation mode, only allocation of buffer memory area is changed. The following buffer memory area is allocated the same as FX3U-4DA.

Buffer Memory Areas	Buffer Memory Area Name
Un\G1 to 4	CH1 to 4 Digital value
Un\G6	Output status
Un\G28	Disconnection detection flag
Un\G30	Module Information
Un\G39	Alarm output flag (upper/lower limit)

For buffer memories with different allocations from FX3U-4DA, it can be used by changing the program. For buffer memory in FX3 allocation mode, refer to the following.

 Page 293 In FX3 allocation function mode

Restriction

When reusing the program used by FX3U-4DA, delete the initial setting process and set the module parameters with GX Works3.

When performing the same operation as FX3U-4DA, it can be executed by the following function.

FX3U-4DA	FX5-4DA	Reference
Output mode specification	Range switching function	Page 187
Output setting upon PLC stop	Analog output HOLD/CLEAR setting	Page 188
Upper lower limit value function	Alert Output Function	Page 196
Table output function	Wave output function	Page 206
Output characteristics adjustment	Offset/gain setting function	Page 259
Initialization function	Offset/gain initialization function	Page 239
Disconnection detection	Disconnection detection function	Page 202
Power supply error	External power supply disconnection detection function	Page 201
Error status data automatic transfer function	Auto refresh	Page 251
Upper/lower limit function status automatic transfer function	Auto refresh	Page 251
Disconnection detection status automatic transfer function	Auto refresh	Page 251

Setting procedure

1. When adding a new module, select the module whose module model name has "(FX3)" at the end.

 [Navigation window] ⇨ [Parameter] ⇨ [Module Information] ⇨ Right-click ⇨ [Add New Module]

2. Configure the same parameter setting as the one of when the Normal mode is used.

3. After writing the module parameter, turn off→on or reset the CPU module.

Point

Switching between normal mode and FX3 allocation mode is not possible during operation.

2.5 System Configuration

The following shows a system configuration using the analog output module.

- System configuration example

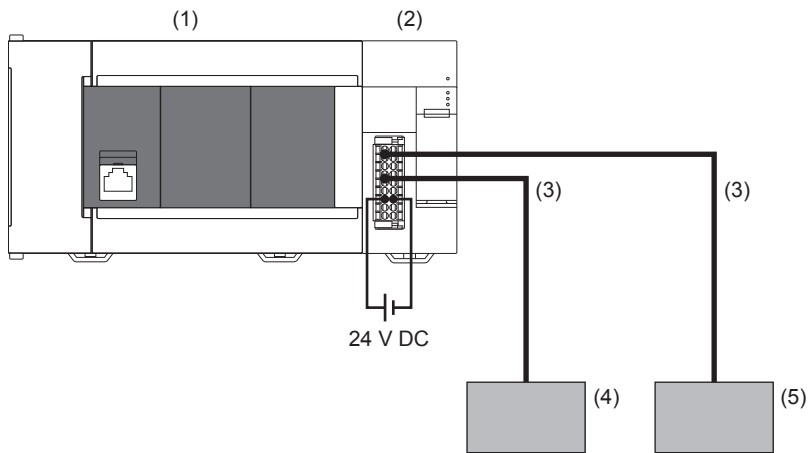

- (1) FX5 CPU module
- (2) Analog output module (FX5-4DA)
- (3) Analog device connection cable
- (4) Inverter
- (5) DC motor

2.6 Wiring

This section describes the analog output module wiring.

Spring clamp terminal block

Suitable wiring

The wires to connect the spring clamp terminal block are described below.

No. of wire per terminal	Wire size	
	Single wire, strand wire	Ferrule with insulation sleeve
Single wiring	AWG24 to 16 (0.2 to 1.5 mm ²)	AWG23 to 19 (0.25 to 0.75 mm ²)

Wire end treatment

When not using a ferrule, strip the cable about 10 mm from the tip and connect it as a strand wire so that the wires do not separate. When using a ferrule, strip the cable about 10 mm from the tip to connect a wire ferrule at the striped area. Failure to do so may result in electric shock or short circuit between adjacent terminals because of the conductive part. If the wire strip length is too short, it may result in the poor contact to the spring clamp terminal part.

Depending on the thickness of the sheath, it may be difficult to insert into the insulation sleeve, so select the wires by referring to the appearance diagram.

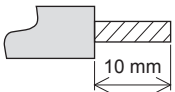
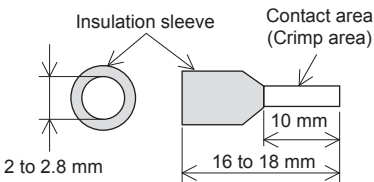
Strand wire/single wire	Ferrule with insulation sleeve
	

Check the shape of the wire insertion opening with the following chart, and use the smaller wire ferrule than the described size. Also, insert the wire with care so that the wire ferrule is in proper orientation. Failure to do so may cause the bite of the terminal and the damage of the terminal block.

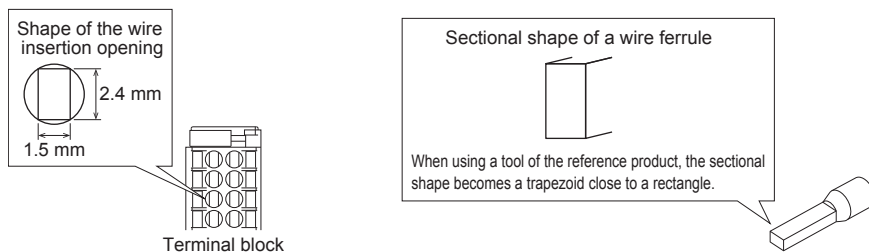

The following table shows wire ferrules and its associated tools compatible with the terminal block. The shape of the wire ferrule differs depending on the crimp tool to be used, use the reference product. If the product other than referenced products is used, the wire ferrule cannot be removed. Sufficiently confirm that the wire ferrule can be removed before use.

<Reference product>

Manufacturer	Model	Wire size	Crimp tool
PHOENIX-CONTACT GmbH & Co. KG	AI 0.5-10 WH	0.5mm ²	CRIMPFOX 6
	AI 0.75-10 GY	0.75mm ²	
	A 1.0-10	1.0mm ²	
	A 1.5-10	1.5mm ²	

Removing and installing the terminal block

The following shows how to remove and install the terminal block.

■Lever position to lock and release

A 3-step stopper is attached to prevent the lever from rotating, facilitating installation and removal of the terminal block.

When removing or installing the terminal block, move the lever to the corresponding position.

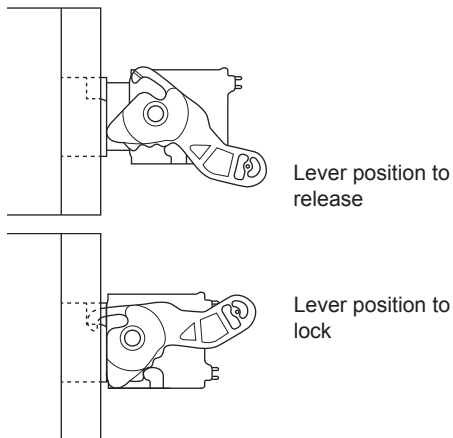

■Lever position to release

The figure left shows the lever position when the terminal block has been completely removed from the module. Rotate the lever from the lock position to the release position, and lift the terminal block from the module.

■Lever position to lock

The figure left shows the lever position when the terminal block is completely engaged with the module. Check that the lever is at the lock position, and pull the terminal block slightly to check that the module and terminal block are completely engaged.

■Removal procedure

Rotate the lever to the release position, and remove the terminal block from the module.

■Installation procedure

Move the lever to the release position, and insert the terminal block. When the terminal block is inserted sufficiently, the lever latch engages with the module and the terminal block is engaged with the module.



After inserting the terminal block, check that the lever is at the lock position.

Precautions

When installing the terminal block, check that the lever is in the release position. If installation is performed while the lever is in the lock position, it may cause damage to the lever.

Connection and disconnection of the cable

■ Connection of the cable

Fully insert a cable whose end has been properly processed into the wire insertion opening.

If the cable cannot be inserted with this procedure, fully insert the cable while pushing the open/close button with a flathead screwdriver having a tip width of 2.0 to 2.5 mm. After fully inserting the cable, remove the screwdriver.

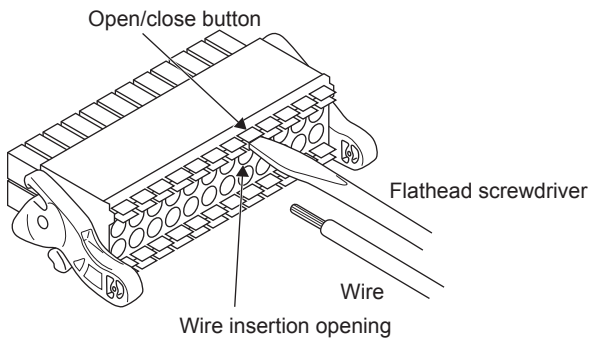

<Reference>

Manufacturer	Model
PHOENIX-CONTACT GmbH & Co. KG	SZS 0.4 × 2.5 VDE

Precautions

Pull the cable or wire ferrule slightly to check that the cable is securely clamped.

■ Disconnection of the cable

While pushing the open/close button with a flathead screwdriver having a tip width of 2.0 to 2.5 mm, disconnect the cable.

Terminal arrangement

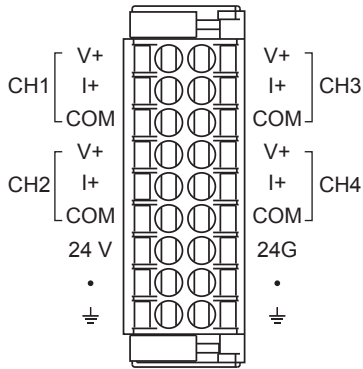

Left side of terminal arrangement		Right side of terminal arrangement	
Display name	Description	Display name	Description
V+	CH1 Voltage output	V+	CH3 Voltage output
I+	CH1 Current output	I+	CH3 Current output
COM	CH1 Voltage/current output common	COM	CH3 Voltage/current output common
V+	CH2 Voltage output	V+	CH4 Voltage output
I+	CH2 Current output	I+	CH4 Current output
COM	CH2 Voltage/current output common	COM	CH4 Voltage/current output common
24V	External 24 V +24 V terminal	24G	External 24 V Ground terminal
.	Unused terminal	.	Unused terminal
⏏	24 V external ground terminal	⏏	24 V external ground terminal

Ground wiring

Grounding

Perform the following.

- Perform class D grounding (Grounding resistance: 100 Ω or less).
- Ground the programmable controller independently when possible.
- If the programmable controller cannot be grounded independently, perform the "Shared grounding" shown below.

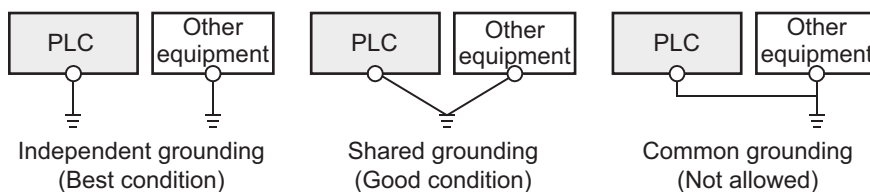

- Bring the grounding point close to the PLC as much as possible so that the ground cable can be shortened.

Wiring precautions

Wiring precautions are indicated below.

- Use separate cables for the external I/O signals of the AC control circuit and the analog output module so that they are not affected by surge or induction on the AC side.
- Do not approach or bundle with the main circuit line, high voltage line, and load line from other than the PLC. Keep it far from circuits including high frequency such as high voltage line and inverter load main circuit. It becomes susceptible to noise, surge, and induction.
- Provide a single-point ground for the shield wire and the shielded cable at the PLC side. However, depending on the external noise situation, it may be better to ground on the external side.

External wiring example

The followings show the examples of external wiring.

For voltage output

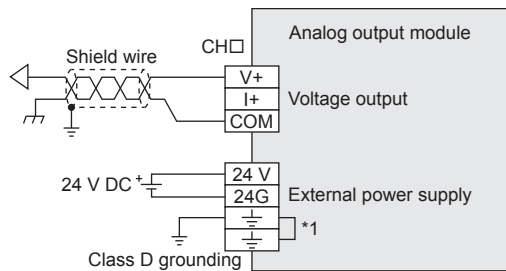

(Grounding resistance: 100 Ω or less).

In □ of CH□, the CH number is entered.

For current output

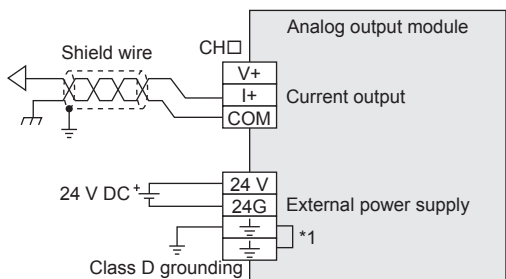

(Grounding resistance: 100 Ω or less).

In □ of CH□, the CH number is entered.

*1 "  " terminals are internally connected. Perform class D grounding by either terminal.

Precautions

Use 2-core shielded twisted pair cable for the analog output lines, and separate the analog output lines from other power lines or inductive lines.

Ground the shielded wire at one point on the signal receiving side.

The external power supply of 24 V DC must be turned on before the system power supply.

2.7 Parameter Settings

Set the parameters of each channel.

Setting parameters here eliminates the need to program them.

Parameter setting procedure

1. Add the analog output module to GX Works3.

 [Navigation window] ⇒ [Parameter] ⇒ [Module Information] ⇒ Right-click ⇒ [Add New Module]

2. There are two parameter setting types: module parameter and module extension parameter settings, both of which can be set after selecting them from the tree on the following window.

 [Navigation window] ⇒ [Parameter] ⇒ [Module information] ⇒ [Target Module]

3. Using GX Works3, write the settings to the CPU module.

 [Online] ⇒ [Write to PLC]

4. The settings are reflected by resetting the CPU module or turning the power supply off→on.

Point

When adding a new analog output module, if selecting the module whose module model name has "(FX3)" at the end, it can be used as FX3 allocation mode.

- FX5-4DA: Normal mode
- FX5-4DA(FX3): FX3 allocation mode

For details on the FX3 allocation mode function, refer to  Page 240 FX3 allocation mode function

This section describes the case in a normal mode.

Module parameters

Basic setting

■ Setting procedure

1. Open "Basic setting" of GX Works3.

[Navigation window] ⇒ [Parameter] ⇒ [Module information] ⇒ Target module ⇒ [Module Parameter] ⇒ [Basic setting]

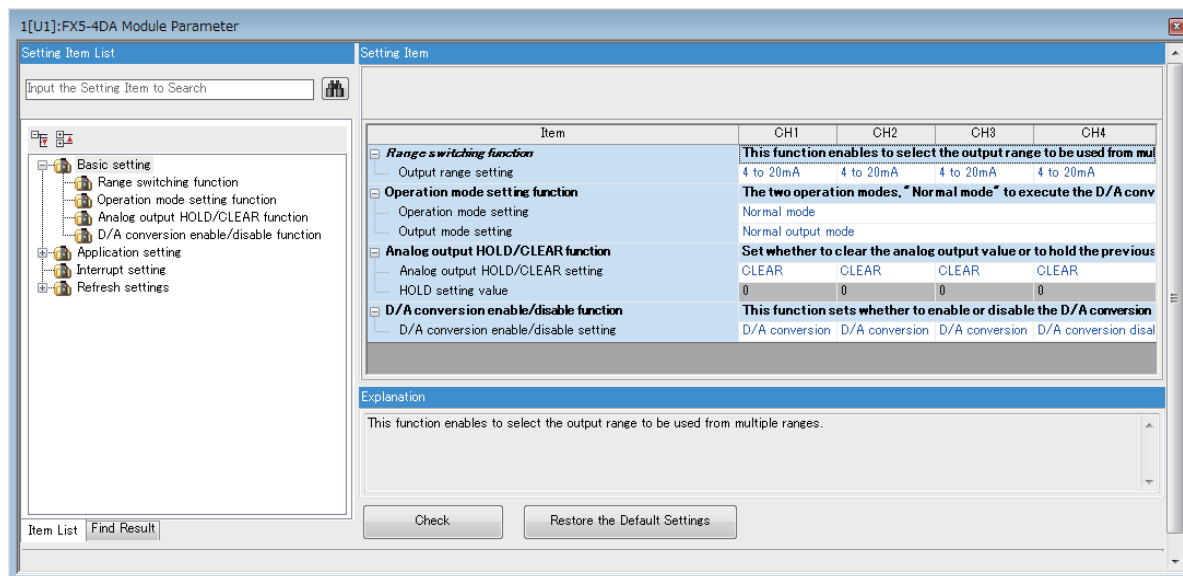

2. Double-click the item to be changed to enter the setting value.

- Item where a value is selected from the pull-down

Click [▼] button of the item to be set, and from the pull-down list that appears, select the value.

- Item where a value is entered into the text box

Double-click the item to be set to enter the numeric value.

Application setting

■ Setting procedure

1. Open "Application setting" of GX Works3.

[Navigation window] ⇒ [Parameter] ⇒ [Module information] ⇒ Target module ⇒ [Module Parameter] ⇒ [Application setting]

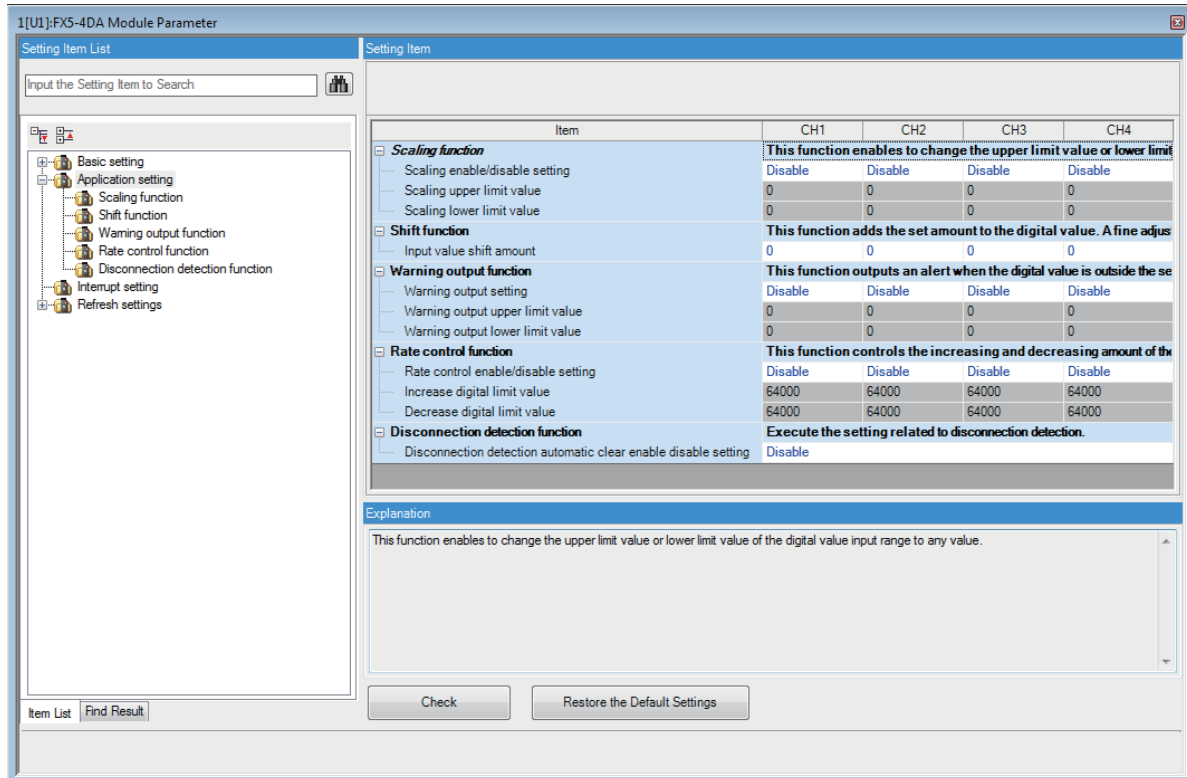

2. Double-click the item to be changed to enter the setting value.

- Item where a value is selected from the pull-down

Click [▼] button of the item to be set, and from the pull-down list that appears, select the value.

- Item where a value is entered into the text box

Double-click the item to be set to enter the numeric value.

Interrupt setting

■ Setting procedure

1. Open "Interrupt setting" of GX Works3.

[Navigation window] ⇒ [Parameter] ⇒ [Module Information] ⇒ Target module ⇒ [Module Parameter] ⇒ [Interrupt setting]

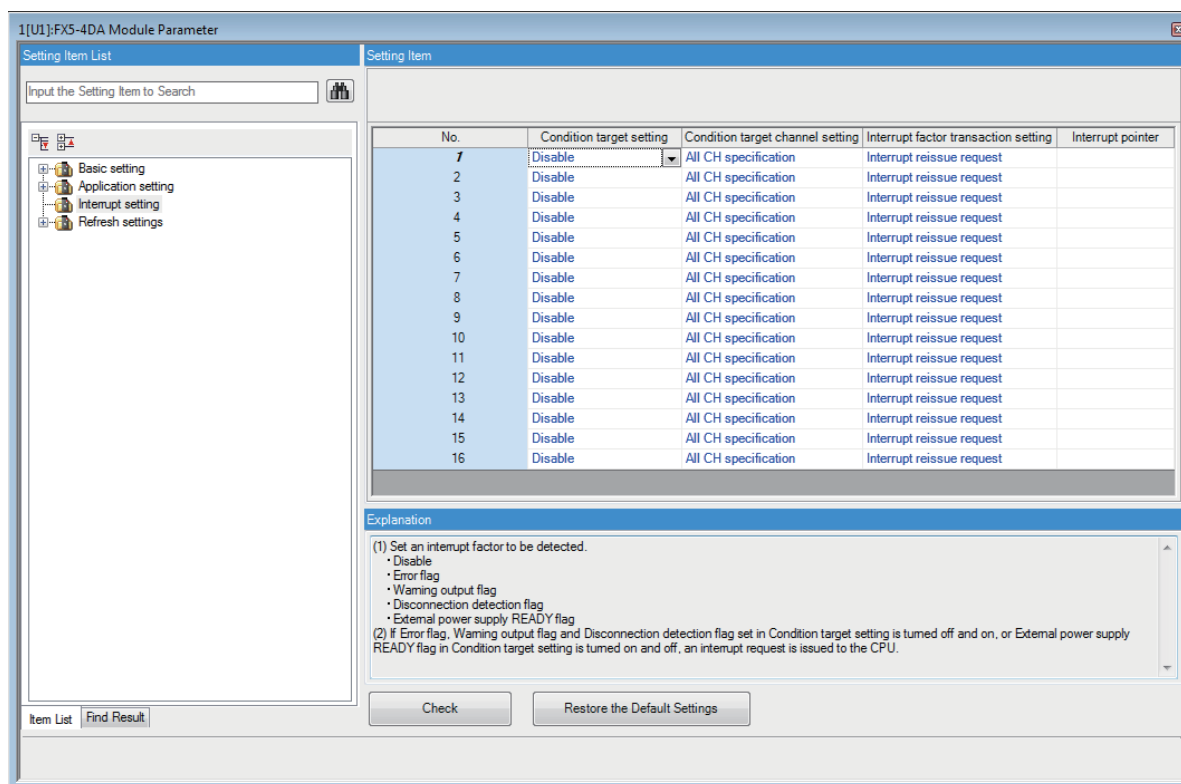

2. Click the interrupt setting number (No. 1 to 16) to be changed to enter the setting value.

- Item where a value is selected from the pull-down list

Click [▼] button of the item to be set, and from the pull-down list that appears, select the value.

- Item where a value is entered into the text box

Double-click the item to be set to enter the numeric value.

Refresh setting

■ Setting procedure

1. Open "Refresh setting" of GX Works3.

[Navigation window] ⇒ [Parameter] ⇒ [Module Information] ⇒ Target module ⇒ [Module Parameter] ⇒ [Refresh setting]

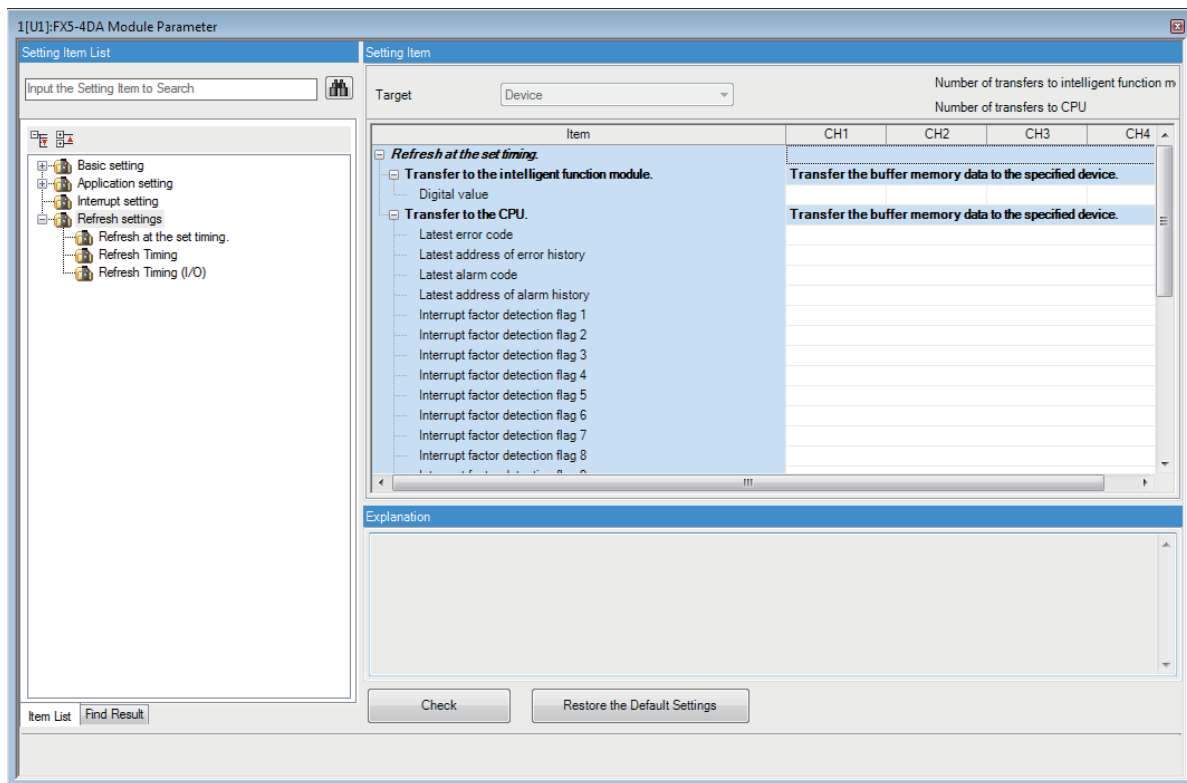

2. Double-click the item to be set to enter the device of refresh destination.

Module extension parameters

Module extension parameters are set to use the wave output function.

To set module extension parameters, use the wave output data creation tool.

Starting up the wave output data creation tool

The wave output data creation tool starts up from the Set module extension parameters window.

[Navigation window] ⇒ [Parameter] ⇒ [Module Information] ⇒ Target module ⇒ [Module Extension Parameter] ⇒ [Create wave output data]

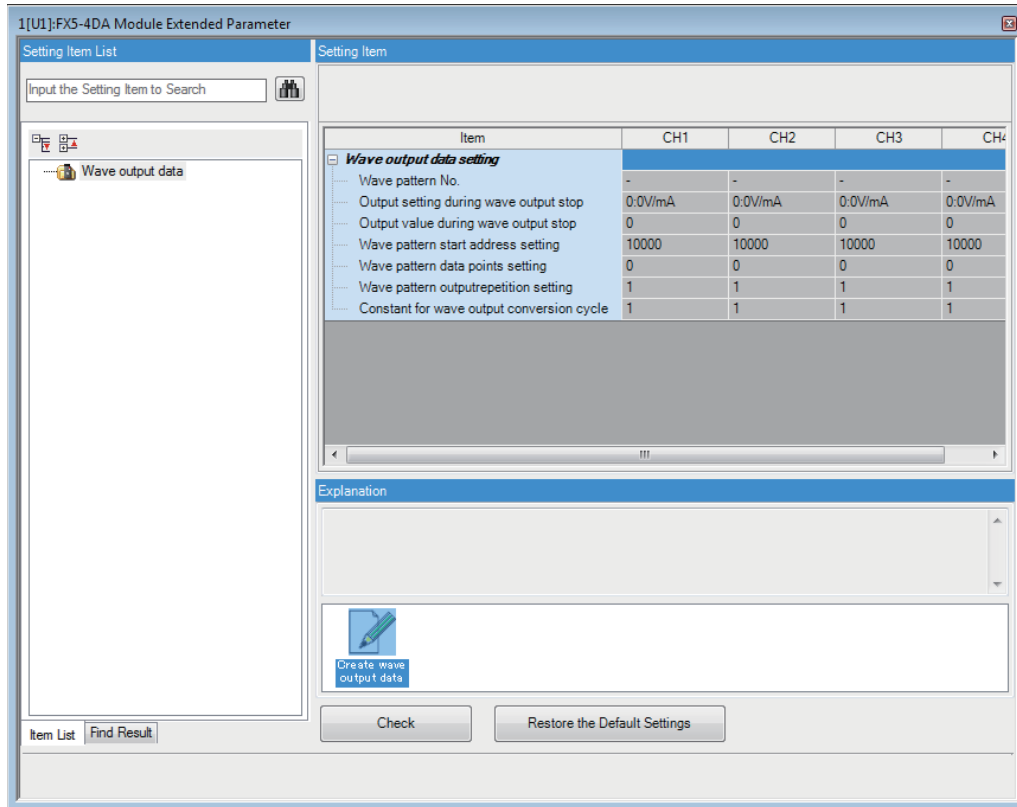

Creating the wave output data

Using the wave output data creation tool, create the wave pattern and wave output function parameters.

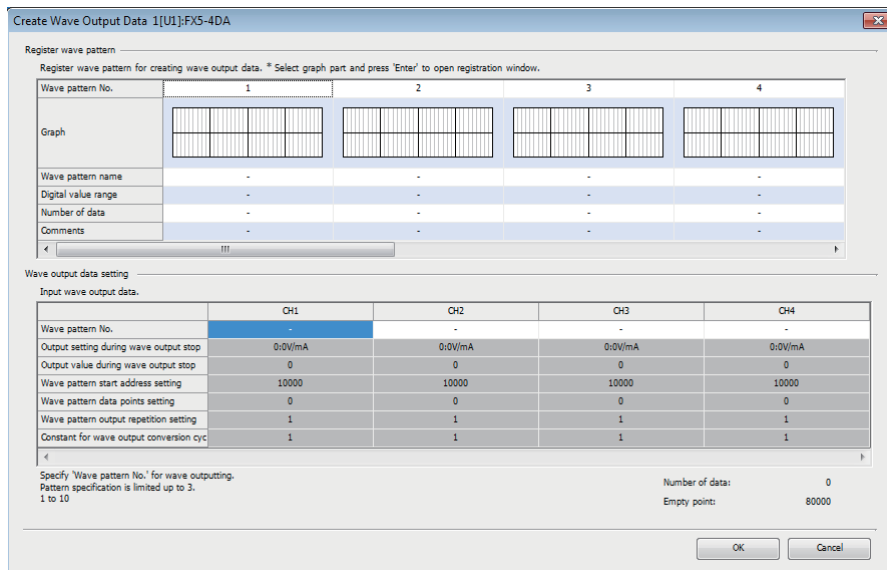

■Register the wave pattern

Using the wave output data creation tool, create and register a wave pattern.

1. Select a graph from "Register wave pattern", and press the Enter key on the keyboard. The "Register wave pattern" window is displayed.

Section No.	Start point	End point	Digital value	Specify wave	Direction	Amplitude	Phase
1	-	1	0				
2	1	100	0 (Do not specify)				
3							
4							

2. Set "Wave pattern information".

Item	Description	Setting range
Wave pattern No.	The wave pattern No. selected on the "Create Wave Data". Up to 10 wave patterns can be created.	—
Wave pattern name	Set "Wave pattern name".	8 two-byte characters (16 one-byte characters)
Digital value range	Select the digital value setting range. Select it according to the output range to be used.	• 0 to 32000 (default value) • -32000 to +32000
Number of pieces of data	Set the wave data points of the wave pattern.	1 to 80000 (default value: 100)
Comment	Set a comment on the wave pattern.	32 two-byte characters (64 one-byte characters)

3. Click any position on the wave graph to create the terminal point. Each created terminal points is indicated by ■ .

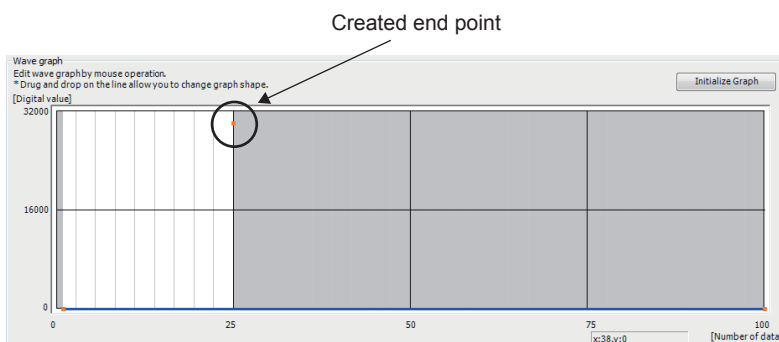

To delete it, move the mouse pointer to the terminal point and select "Delete End Point" from the right-click menu. Once the mouse pointer moves to the terminal point, its displayed shape changes to \oplus .

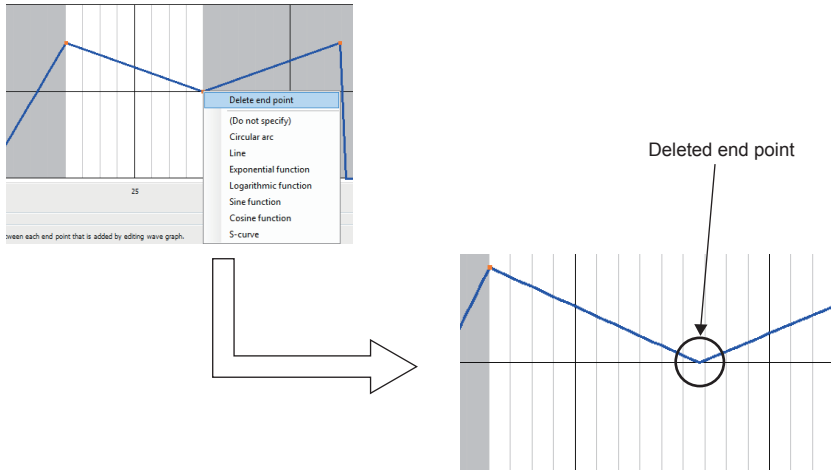

4. Set the wave between terminal points in the right-click menu or "Wave Specification" in "Wave Detail Setting".

Item	Setting result												
Circular arc	<p>The start and end points are drawn by an arc. When an arc is to be selected, its orientation can be inverted by setting it in "Orientation" The drawn arc is processed according to the following procedure.</p> <div style="display: flex; align-items: center;"> <div style="margin-right: 20px;"> </div> <div> <ol style="list-style-type: none"> 1) Construct an equilateral triangle having the start and end points as its vertices. 2) Construct a circle having the other vertex of the triangle as its center and a side of the triangle as its radius. 3) Draw the minor arc connecting the start and end points on the wave graph. <p>* The steps 1) and 2) are processed inside GX Works3, and not displayed on the wave graph.</p> </div> </div> <div style="margin-top: 10px;"> <p>Set "Direction".</p> <table border="1" style="display: inline-table; margin-right: 20px;"> <thead> <tr> <th>Specify wave</th> <th>Direction</th> <th>Amplitude</th> </tr> </thead> <tbody> <tr> <td>Circular arc</td> <td>Upward</td> <td></td> </tr> <tr> <td>(Do not specify)</td> <td>Upward</td> <td></td> </tr> <tr> <td></td> <td>Downward</td> <td></td> </tr> </tbody> </table> </div>	Specify wave	Direction	Amplitude	Circular arc	Upward		(Do not specify)	Upward			Downward	
Specify wave	Direction	Amplitude											
Circular arc	Upward												
(Do not specify)	Upward												
	Downward												
Line	<p>The start and end points are drawn by a line.</p>												
Exponential function	<p>The start and end points are drawn by expanding or contracting the graph so that they will be the terminal points of the graph of exponential function $y = e^x$ ($X = 0$ to 10).</p>												

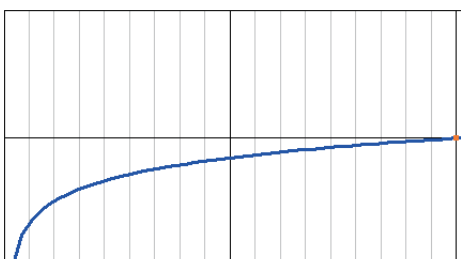
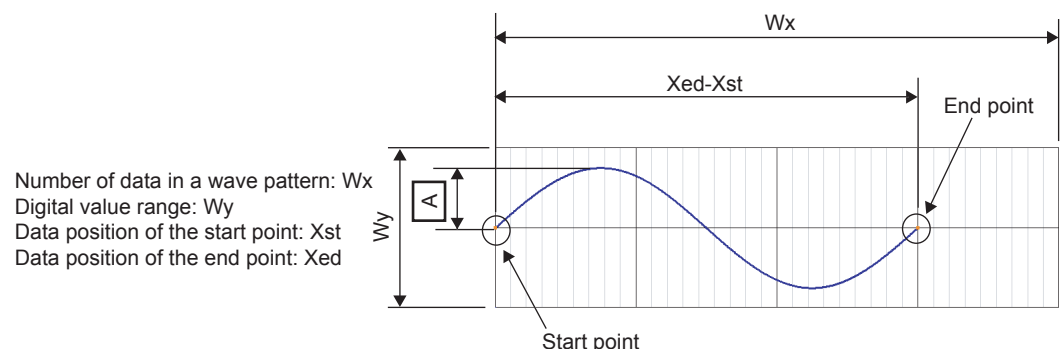
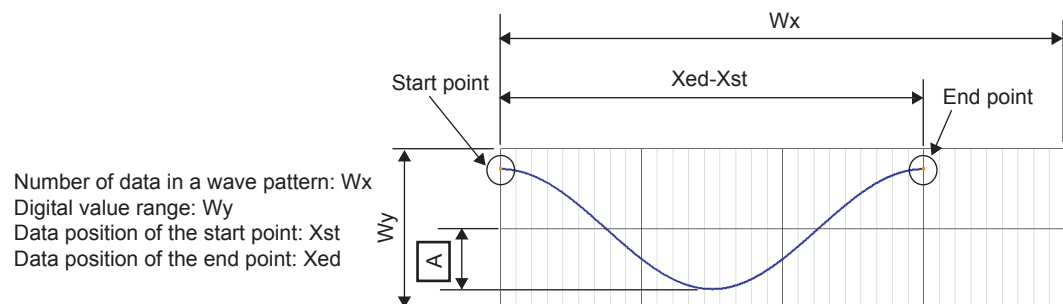
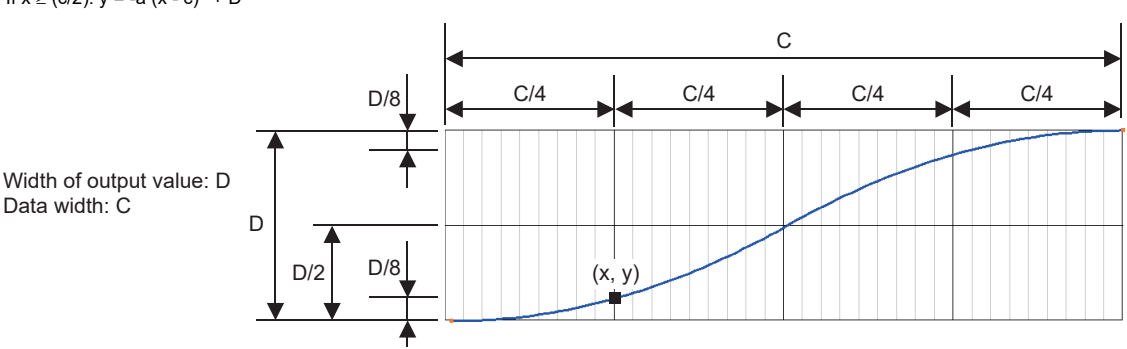
Item	Setting result
Logarithmic function	<p>The start and end points are drawn by expanding or contracting the graph so that they will be the terminal points of the graph of logarithmic function $y = \log_e X$ ($X = 1$ to 101).</p> 
Sine function*1	<p>The start and end points are drawn by a sine function. The vertical width, A, of the sine function drawn is the value set by "Amplitude". The star position can be changed by 180° by using "Phase setting".</p>  <p>Number of data in a wave pattern: Wx Digital value range: Wy Data position of the start point: Xst Data position of the end point: Xed</p>
Cosine function*1	<p>The start and end points are drawn by a cosine function. The vertical width, A, of the cosine function drawn is the value set by "Amplitude". The star position can be changed by 180° by using "Phase setting".</p>  <p>Number of data in a wave pattern: Wx Digital value range: Wy Data position of the start point: Xst Data position of the end point: Xed</p>
S-shaped interpolation	<p>The start and end points are drawn by S-shaped interpolation by using the following acceleration.</p> <p>Acceleration $a = (2 \times \text{Output value width } D) \div (\text{Data width } C \times \text{Data width } C)$</p> <p>The digital value y of certain point x is calculated by the following formula.</p> <p>If $x < (c/2)$: $y = ax^2$</p> <p>If $x \geq (c/2)$: $y = -a(x - c)^2 + D$</p>  <p>Width of output value: D Data width: C</p>

*1 When the sine and cosine functions are to be set, set the digital values of the start and end points to the same value.

5. Drag the created end point to adjust its position.

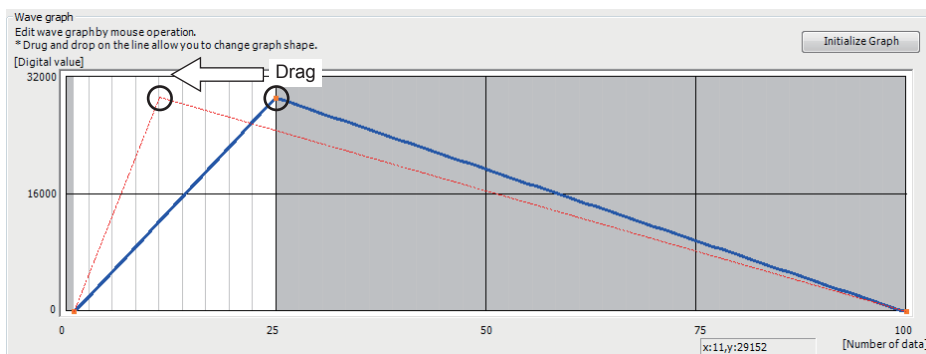

The end point position can be adjusted also by changing the "End point" and "Digital value" values in "Wave detail setting".

Item	Description
Start point	The end point of the previous section is displayed. To change it, change the end point of the previous section.
End point	Set the number of pieces of data of the target terminal point. Since section No.1 represents the first point of the wave pattern, it cannot be changed.
Digital value	Set the digital value of the target terminal point.

6. Repeat steps 3 to 5 to create the wave to be output.

Each digital value of the created wave pattern can be shown using the [Display Digital Value] button. To clear the contents of the created wave pattern, click the [Initialize Graph] button. The graph and the contents of "Wave detail setting" are cleared.

7. To save the wave pattern, click [Save Wave Pattern] or [Write CSV File].

☞ Page 257 Save the wave pattern

8. Click the [OK] button on the "Register wave pattern" window.

9. Repeat steps 1 to 8 to create another wave pattern.

■Setting the wave output function parameters

Set the wave output function parameters for each channel.

Before setting the parameters, create the wave data.

Item	Description	Setting range	Remarks
Wave pattern No.	Up to three registered wave patterns can be specified at once. To specify two or more wave patterns, set them as follows. <ul style="list-style-type: none"> • When using Nos. 1 and 2: 1, 2 • When using Nos. 1, 5, and 10: 1, 5, 10 • When using Nos. 1 to 3: 1-3 	1 to 10	Use the "Create Wave Output Data" window for setting.
Output setting during wave output stop	Set the analog output that is in the wave output stopped state.	<ul style="list-style-type: none"> • 0: 0 V/0 mA • 1: Offset value (default value) • 2: Output value during wave output stop 	☞ Page 324 CH1 Output setting during wave output stop
Output value during wave output stop	Set the value to be output in wave output stopped state. This value is enabled only when "Output setting during wave output stop" is set in "2: Output value during wave output stop". Set a value within the setting range of the output range to be used.	<ul style="list-style-type: none"> • For 4 to 20 or 0 to 20 mA; or 1 to 5, 0 to 5, or 0 to 10 V 0 to 32767 (practical range: 0 to 32000) • For -10 to +10 V: -32768 to +32767 (practical range: -32000 to +32000) (Default value: 0)	☞ Page 325 CH1 Output value during wave output stop
Wave pattern start address setting	Set the start address of the wave pattern to be output as analog data.	10000 to 89999 (Default value: 10000)	☞ Page 325 CH1 Wave pattern start address setting
Wave pattern data points setting	Does not need to be set because the number of data points possessed by the wave pattern to be used is automatically stored.	—	☞ Page 326 CH1 Wave pattern data points setting
Wave pattern output repetition setting	When the wave pattern is to be output repeatedly, set the number of repetitions.	<ul style="list-style-type: none"> • -1 (indefinite repetitive output) • 1 to 32767 (default value: 1) 	☞ Page 326 CH1 Wave pattern output repetition setting
Constant for wave output conversion cycle	Set the constant used to determine the conversion cycle (multiple specification of conversion speed). The wave output conversion cycle is determined by the combination of the conversion speed, the number of D/A conversion enabled channels, and this setting. For how to calculate the wave output conversion cycle, refer to the following. ☞ Page 211 Wave output conversion cycle	1 to 5000 (default value: 1)	☞ Page 327 CH1 Constant for wave output conversion cycle

In the wave output data creation tool, click the [OK] button. The wave pattern and wave output function parameters are determined as module extension parameters.

The module extension parameters need to be written to the CPU built-in memory or SD memory card.

For the procedure for writing to the SD memory card, refer to the following.

☞ MELSEC iQ-F FX5 User's Manual (Application)

■Save the wave pattern

The created wave pattern can be saved in the following format.

- Save the wave pattern

By clicking [Save Wave Pattern], the created wave pattern can be saved. The file is saved in the format of extension ".wdn".

The saved file can be read using the [Open Wave Pattern].

- Saving the wave pattern to a CSV file

By clicking [Write CSV File], the created wave pattern can be saved in a CSV file. The file is saved in the format of extension ".csv".

The saved file can be read using the [Read CSV File].

■About CSV file format

The CSV file format is as below.

[CSV format specifications]

Item name	Description
Separator	Comma (,)
Return code	CRLF (ODH, OAH)
Character code	ASCII or Shift JIS

[CSV file name]

The number of characters of each CSV file name must be 64 characters or less including extension ".CSV".

Ex.

FX5-4DA_1.csv, wd000001.csv, wave data.csv

[Contents of CSV file]

The following shows examples of the "Register wave pattern" window and the contents of a CSV file.

- "Register wave pattern" window

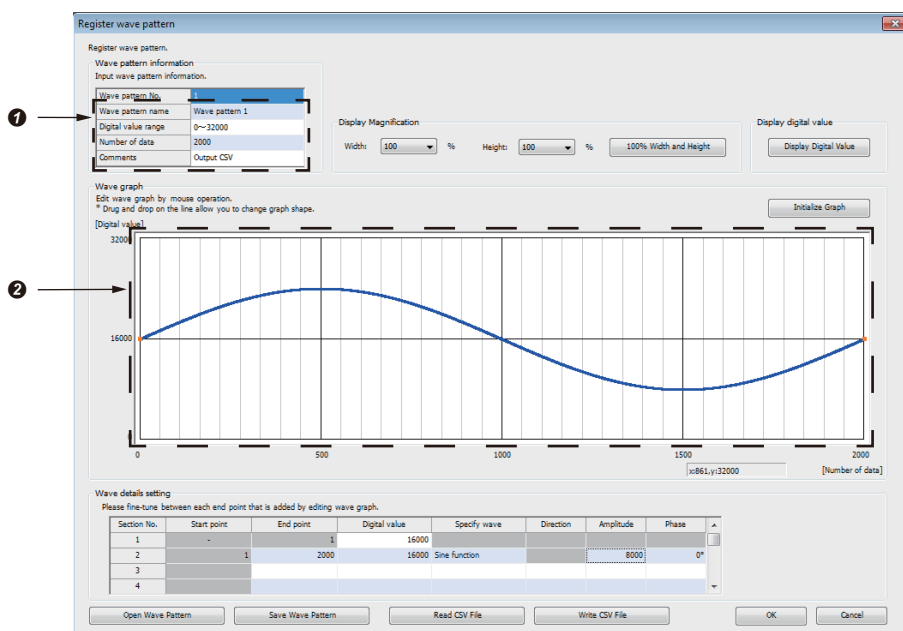

- Contents of CSV file

①	["Wave pattern name"],	[Digital value range (1: 0 to 32000/2: -32000 to 32000)],	[Number of pieces of data]	["Comment"]
	"Wave pattern 1",	1,	2000,	"Output CSV"
②	[Data No.],	[Digital value]		
	1,	16000		
	2,	16025		
	3,	16050		
	⋮	⋮		
	1999,	15974		
	2000,	16000		

Point

- Some instruments such as oscilloscopes and pulse generators can output input or output waves to a CSV file. If the waves are to be output with the wave output function by using the saved data in this CSV file, modify the file into the above CSV file format. In addition, modify all decimal values into integers because they are not available with the wave output function.
- If a wave pattern is read from a CSV file, it cannot be edited on the "Register Wave Pattern" window. After editing the CSV file, read the CSV file again.

2.8 Offset/Gain Setting

Using the user range setting requires setting the offset and gain values.
The offset/gain setting can be performed by the following two methods.

- Settings from the module tool of GX Works3
- Setting from the program

Setting example

An example of offset/gain setting is shown below.

Output conversion characteristics

Ex.

When CH1 digital value is 0, offset is set with 0 V output, and when digital value is 32000, gain is set with 5 V output

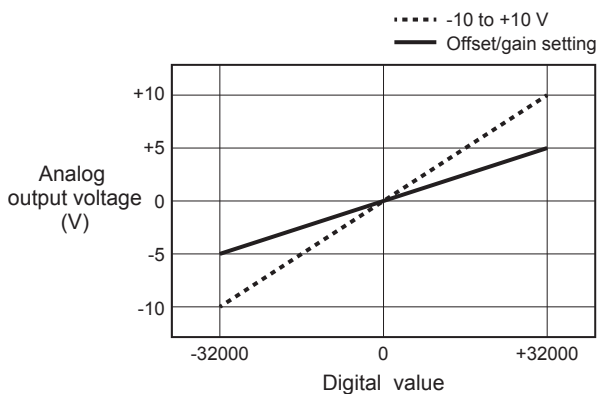

User range	Digital value	Resolution	Remarks
-5 to +5 V	-32000 to +32000	321.5 μ V	(Gain value - Offset value) = 5 V As the result of (Gain value - offset value) is < 10 V, the maximum resolution is applied.

Module parameters

The module parameters used for CH1 are as follows. Parameters other than the following are defaults.

Item	Set conditions
Output range setting	User range setting (voltage)
Operation mode setting	Normal mode
D/A conversion enable/disable setting	D/A conversion enable

Settings from the module tool of GX Works3

The following shows the procedure for setting the offset and gain from the module tool of GX Works3. (For CH1)

■Setting procedure

[Tool] ⇒ [Module Tool List]

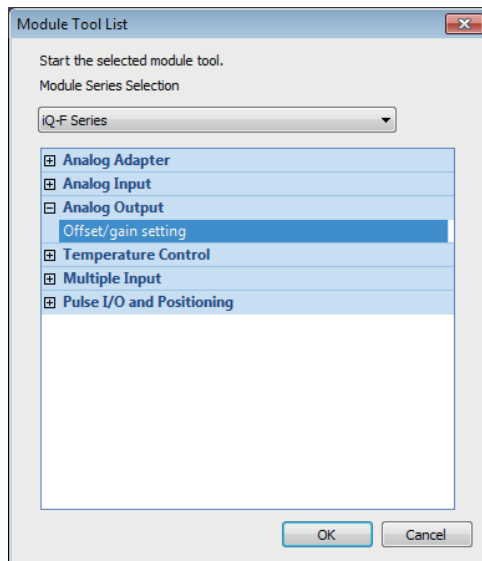

1. In "Analog Output", select "Offset/gain setting" and click the [OK] button.

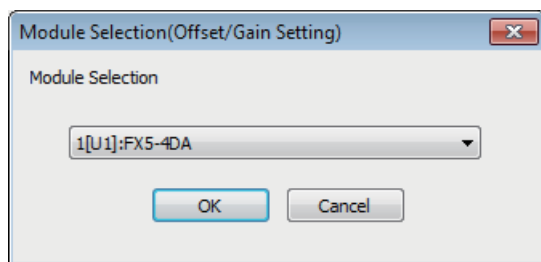

2. Select the target module for the offset/gain setting, and click the [OK] button.

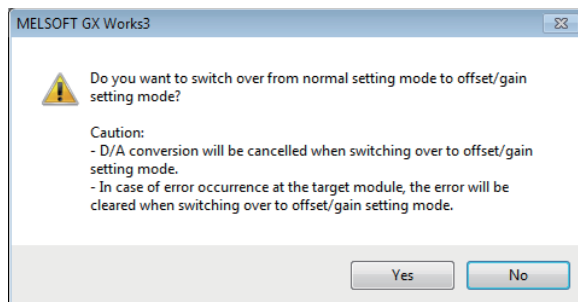

3. Click [Yes] button.

4. Specify the channel (CH1) and offset/gain setting used to perform the offset/gain setting.

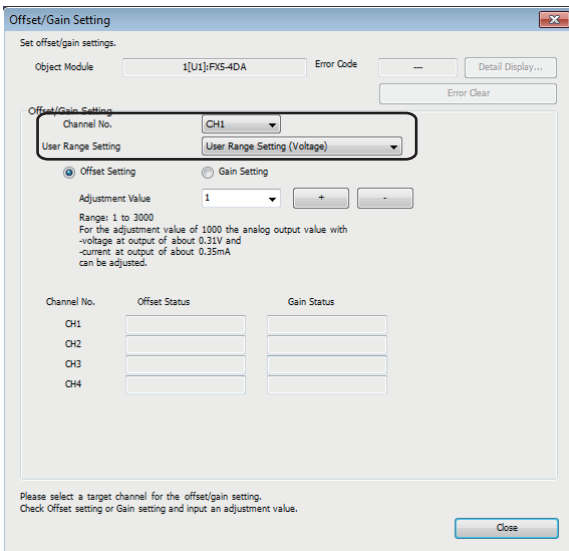

5. Specify the offset or gain setting using the radio button. (Perform step 6 and later only when the offset setting is specified in this step.)

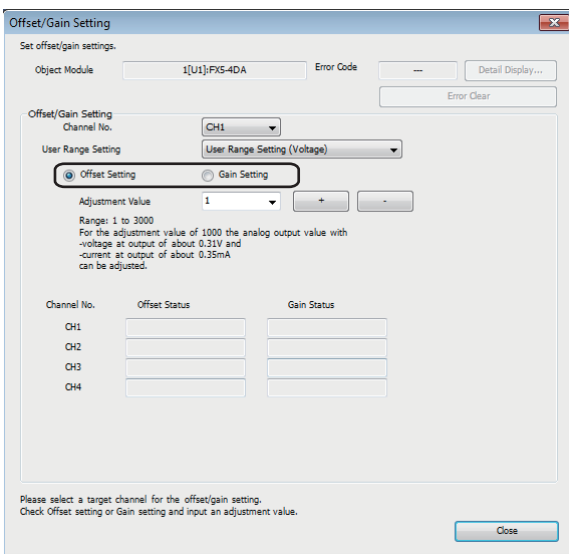

6. Select the adjustment amount of the offset or gain value from "1", "100", "500", "1000", "2000", and "3000". Alternatively, the adjustment amount can be set also by entering any numerical value from 1 to 3000.

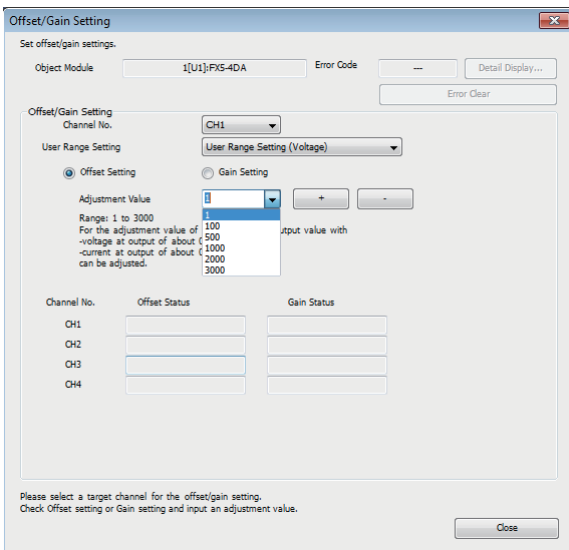

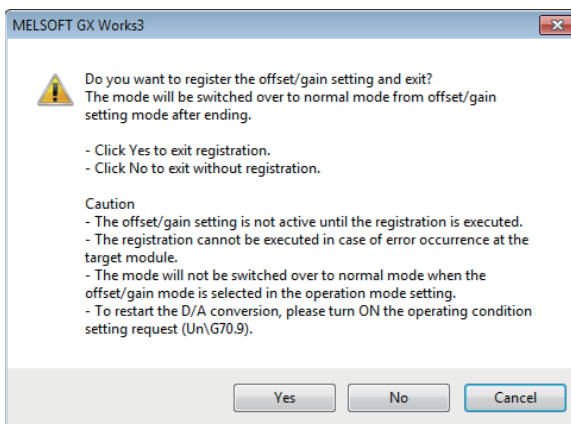
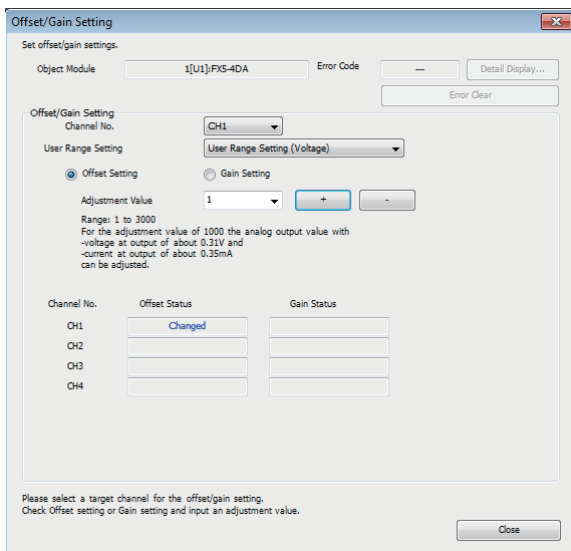

Point

- All channels must satisfy the offset value < gain value.
- If there is a channel that does not satisfy the offset value < gain value, an offset/gain value inversion error (error code: 1E7□) occurs. Settings are not saved.
- Set the offset value and gain value in the user range setting within a range satisfying the following conditions. Failure to satisfy the conditions may not result in proper D/A conversion.

[Voltage]

Setting range of the offset value and gain value: -10 to +10 V

$$((\text{Gain value}) - (\text{Offset value})) \geq 2.0 \text{ V}$$

[Current]

Offset value ≥ 0 mA, gain value ≤ 20 mA

$$((\text{Gain value}) - (\text{Offset value})) \geq 6.0 \text{ mA}$$

7. Click the [+] or [-] button to fine-tune the analog output voltage value for the set adjustment value.

When setting the offset, adjust so that the analog output voltage becomes the target value (0 V). Adjustment amount: 0 (reference)

When setting the gain, adjust so that the analog output voltage becomes the target value (5 V). Adjustment amount: -16000 (reference)

8. The offset setting state of the specified channel changes to "Changed".

9. If the gain setting is to be performed, repeat the above from step 5.

10. After completion of the setting, click [Close] button.

11. Click the [Yes] button.

Setting from the program

The procedure for offset/gain setting from a program is shown below.

■Setting procedure

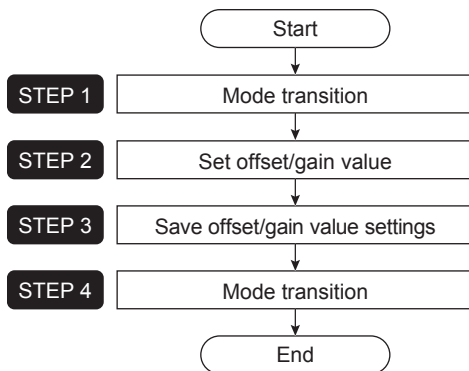

■STEP 1 Mode transition

Transition from normal mode to offset/gain setting mode.

1. Set "4441H" to 'Mode switching setting' (Un\G296) and "4658H" to 'Mode switching setting' (Un\G297).
2. Turn on 'Operating condition setting request' (Un\G70, b9).
3. Confirm that the 'Operating condition setting completed flag' (Un\G69, b9) is OFF and turn off 'Operating condition setting request' (Un\G70, b9).

When the transition to the offset/gain setting mode is completed, the RUN LED flashes.

■STEP 2 Set offset/gain value

• Selection of voltage or current

1. Set the user range setting (voltage) "000DH" to 'CH1 offset/gain setting mode (range specification)' (Un\G4164).
 - Offset setting
2. Set 'CH1 offset/gain setting mode (offset specification)' (Un\G4132) to set channel (1), and set 'CH1 offset/gain setting mode (gain specification)' (Un\G4133) to invalid (0).
3. Turn on 'Channel change request' (Un\G70, b11).
4. Confirm that 'Channel change completed flag' (Un\G69, b11) is ON, and turn off 'Channel change request' (Un\G70, b11).
5. Set the adjustment amount of the analog output value in 'Offset/gain adjustment value specification' (Un\G4130).
6. Turn on 'Value change request' (Un\G70, b12).
7. Check that the 'Set value change completed flag' (Un\G69, b12) is ON, and turn off the 'Value change request' (Un\G70, b12).
8. Repeat steps 5 to 7 until the analog output voltage reaches the target value "0 V".
 - Gain setting
9. Set 'CH1 offset/gain setting mode (offset specification)' (Un\G4132) to invalid (0), and set 'CH1 offset/gain setting mode (gain specification)' (Un\G4133) to set channel (1).
10. Turn on 'Channel change request' (Un\G70, b11).
11. Confirm that 'Channel change completed flag' (Un\G69, b11) is ON, and turn off 'Channel change request' (Un\G70, b11).
12. Set the adjustment amount of the analog output value in 'Offset/gain adjustment value specification' (Un\G4130).
13. Turn on 'Value change request' (Un\G70, b12).
14. Check that the 'Set value change completed flag' (Un\G69, b12) is ON, and turn off the 'Value change request' (Un\G70, b12).
15. Repeat steps 12 to 14 until the analog output voltage reaches the target value "5 V".
16. Set 'CH1 offset/gain setting mode (offset specification)' (Un\G4132) to invalid (0), and set 'CH1 offset/gain setting mode (gain specification)' (Un\G4133) to invalid (0).

■STEP 3 Save offset/gain value settings

Save the set offset/gain values in the flash memory of the module.

1. Turn on 'User range write request' (Un\G70, b10).
2. Check that 'Offset/gain setting mode status flag' (Un\G69, b10) is off and turn off 'User range write request' (Un\G70, b10).

Point

- All channels must satisfy the offset value < gain value.
- If there is a channel that does not satisfy the offset value < gain value, an offset/gain value inversion error (error code: 1E7□) occurs. Settings are not saved.
- Set the offset value and gain value in the user range setting within a range satisfying the following conditions. Failure to satisfy the conditions may not result in proper D/A conversion.

[Voltage]

Setting range of the offset value and gain value: -10 to +10 V

$((\text{Gain value}) - (\text{Offset value})) \geq 2.0 \text{ V}$

[Current]

Offset value $\geq 0 \text{ mA}$, gain value $\leq 20 \text{ mA}$

$((\text{Gain value}) - (\text{Offset value})) \geq 6.0 \text{ mA}$

■STEP 4 Mode transition

Shift from offset/gain setting mode to normal mode.

1. Set "4658H" to 'Mode switching setting' (Un\G296) and "4441H" to 'Mode switching setting' (Un\G297).
2. Turn on 'Operating condition setting request' (Un\G70, b9).
3. Confirm that the 'Operating condition setting completed flag' (Un\G69, b9) is OFF and turn off 'Operating condition setting request' (Un\G70, b9).

When the transition to the normal mode is completed, the RUN LED lights.

2.9 Programming

This section describes the programming procedure and the basic program of an analog output module.

Programming procedure

Take the following steps to create a program for running an analog output module:

1. Set parameters.
2. Create a program.

In the normal output mode

System configuration

The following shows a system configuration example.

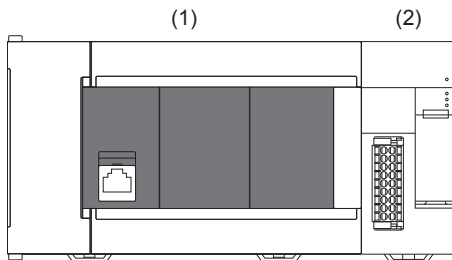

(1) CPU module (FX5U CPU module)
 (2) Analog output module (FX5-4DA)

Parameter settings

Perform an initial setting in the module parameter of GX Works3. The refresh settings do not need to be changed here.

- Module parameters

[Basic setting]

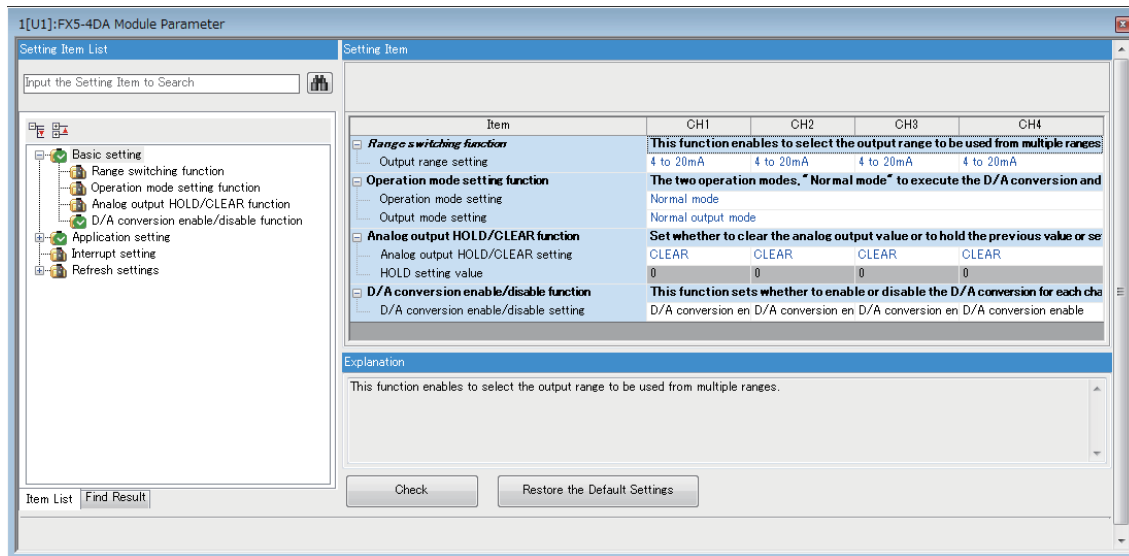

[Application setting]

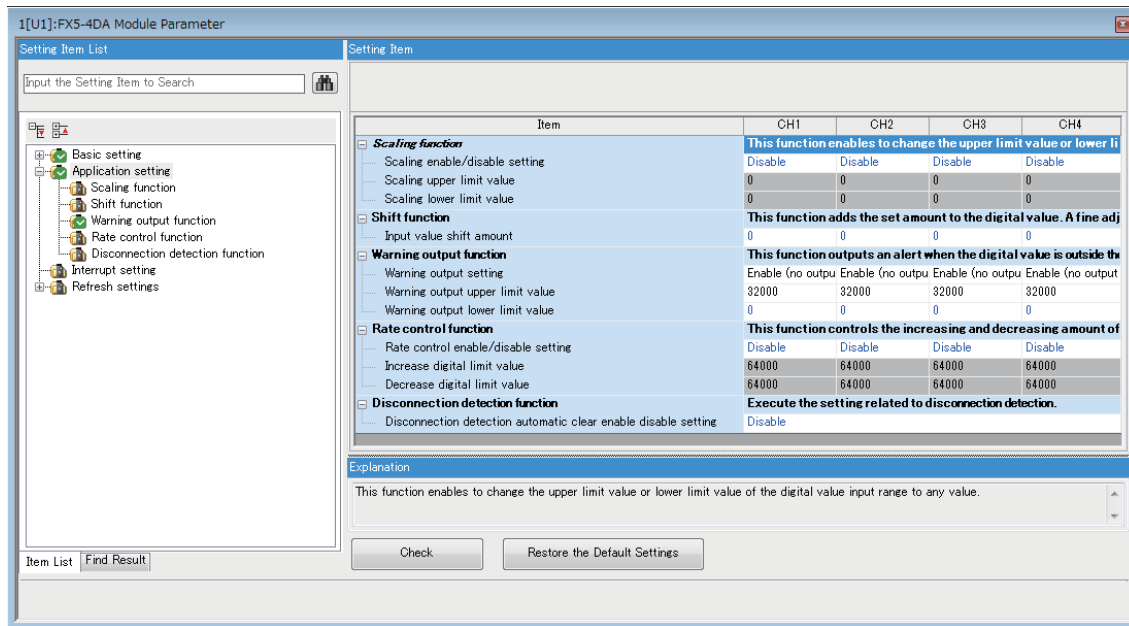

■ Program example

Classification	Device	Description	Device	
Module label	FX5_4DA_1.bCH1OutputEnableDisableFlag_D	CH1 Output enable/disable flag	U1\G70.1	
	FX5_4DA_1.bCH2OutputEnableDisableFlag_D	CH2 Output enable/disable flag	U1\G70.2	
	FX5_4DA_1.bCH3OutputEnableDisableFlag_D	CH3 Output enable/disable flag	U1\G70.3	
	FX5_4DA_1.bCH4OutputEnableDisableFlag_D	CH4 Output enable/disable flag	U1\G70.4	
	FX5_4DA_1.bDisconnectionDetectionSignal_D	Disconnection detection signal	U1\G69.D	
	FX5_4DA_1.bErrorFlag_D	Error flag	U1\G69.F	
	FX5_4DA_1.bExternalPowerSupplyREADY_Flag_D	External power supply READY flag	U1\G69.7	
	FX5_4DA_1.bModuleREADY_D	Module READY	U1\G69.0	
	FX5_4DA_1.bWarningOutputClearRequest_D	Warning output clear request	U1\G70.E	
	FX5_4DA_1.bWarningOutputSignal_D	Alert output signal	U1\G69.E	
	FX5_4DA_1.stnControl_D[0].wDigitalValue_D	CH1 Digital value	U1\G460	
	FX5_4DA_1.stnControl_D[1].wDigitalValue_D	CH2 Digital value	U1\G660	
	FX5_4DA_1.stnControl_D[2].wDigitalValue_D	CH3 Digital value	U1\G860	
	FX5_4DA_1.stnControl_D[3].wDigitalValue_D	CH4 Digital value	U1\G1060	
	FX5_4DA_1.uDisconnectionDetectionFlag_D.3	Disconnection detection flag	U1\G38.3	
	FX5_4DA_1.uWarningOutputLowerFlag_D.1	Warning output lower flag	U1\G37.1	
	FX5_4DA_1.uWarningOutputUpperFlag_D.1	Warning output upper flag	U1\G36.1	
	Labels to be defined	Define global labels as shown below:		
Label Name		Data Type	Class	Assign (Device/Label)
CH1_DigInVal		Word [Signed]	VAR_GLOBAL	D11
CH2_DigInVal		Word [Signed]	VAR_GLOBAL	D12
CH3_DigInVal		Word [Signed]	VAR_GLOBAL	D13
CH4_DigInVal		Word [Signed]	VAR_GLOBAL	D14
CH2_AlmUpLimit		Bit	VAR_GLOBAL	F0
CH2_AlmLowLimit		Bit	VAR_GLOBAL	F1
CH4_DisconnectDetect		Bit	VAR_GLOBAL	F2
DigitWriteSig		Bit	VAR_GLOBAL	X10
DAOutputSig		Bit	VAR_GLOBAL	X11
WarningOutClrSig		Bit	VAR_GLOBAL	X12
ErrResetSig		Bit	VAR_GLOBAL	X13
ErrOperationEN		Bit	VAR_GLOBAL	
ErrOperationENO		Bit	VAR_GLOBAL	
ErrOperationOK		Bit	VAR_GLOBAL	
UnitErrFlg		Bit	VAR_GLOBAL	
UnitErrCode		Word [Unsigned]/Bit String [16-bit]	VAR_GLOBAL	

• D/A conversion value setting and D/A output start processing

This program example sets digital values for D/A conversion of CH1 to CH4 in the analog output module and then starts the D/A conversion by enabling the analog output.

(0)	DigitWriteSig X10	FX5_4DA_1.bModuleREADY_D U1#G69.0	FX5_4DA_1.bExternalPowerSupplyREADY_Flag_D U1#G69.7			MOV	CH1_DigInVal D11	FX5_4DA_1.stnControl_D[0].wDigitalValue_D U1#G460
						MOV	CH2_DigInVal D12	FX5_4DA_1.stnControl_D[1].wDigitalValue_D U1#G660
						MOV	CH3_DigInVal D13	FX5_4DA_1.stnControl_D[2].wDigitalValue_D U1#G860
						MOV	CH4_DigInVal D14	FX5_4DA_1.stnControl_D[3].wDigitalValue_D U1#G1060
(114)	DAOutputSig X11	FX5_4DA_1.bModuleREADY_D U1#G69.0	FX5_4DA_1.bExternalPowerSupplyREADY_Flag_D U1#G69.7					FX5_4DA_1.bCH1OutputEnableDisableFlag_D U1#G70.1 ○
								FX5_4DA_1.bCH2OutputEnableDisableFlag_D U1#G70.2 ○
								FX5_4DA_1.bCH3OutputEnableDisableFlag_D U1#G70.3 ○
								FX5_4DA_1.bCH4OutputEnableDisableFlag_D U1#G70.4 ○
(202)								-END-

• Warning output-time processing

This program example clears the CH2 Warning output-time processing and warning output in the analog output module.

(0)	FX5_4DA_1.uWarningOutputUpperFlag_D.1 U1#G36.1					SET	CH2_AlmUpLimit F0
(37)	FX5_4DA_1.uWarningOutputLowerFlag_D.1 U1#G37.1					SET	CH2_AlmLowLimit F1
(61)	WarningOutClrSig X12	FX5_4DA_1.bWarningOutputSignal_D U1#G69.E				SET	FX5_4DA_1.bWarningOutputClearRequest_D U1#G70.E
(89)	FX5_4DA_1.bWarningOutputSignal_D U1#G69.E	FX5_4DA_1.bWarningOutputClearRequest_D U1#G70.E				RST	FX5_4DA_1.bWarningOutputClearRequest_D U1#G70.E
(118)							-END-

- Disconnection detection-time processing and error clear processing

When a CH4 disconnection is detected or an error occurs in the analog output module, the latest error code appears. After this, the program clears the disconnection detection flag, error flag, and stored error code.

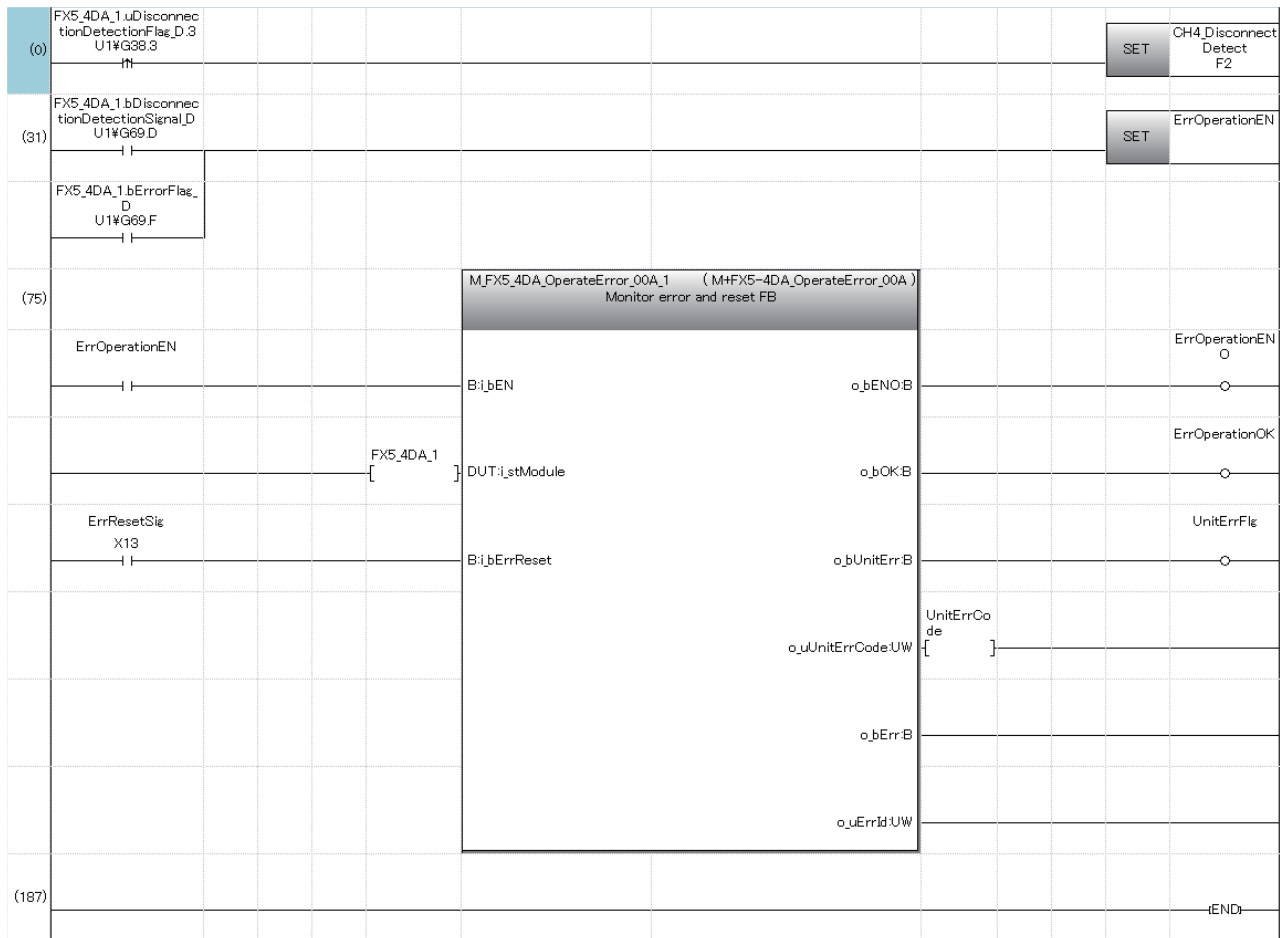

In the wave output mode

System configuration

The following shows a system configuration example.

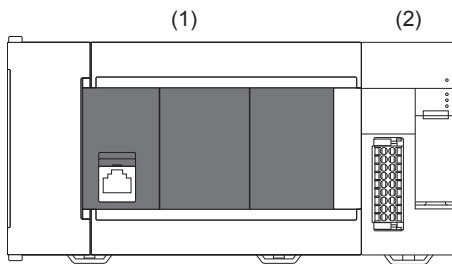

- (1) CPU module (FX5U CPU module)
 (2) Analog output module (FX5-4DA)

Parameter settings

Perform the initial setting using the module and module extension parameters of GX Works3. The refresh settings do not need to be changed here.

- Module parameters

Set the module parameters as follows.

[Basic setting]

The screenshot shows the '1[U1]:FX5-4DA Module Parameter' window. The 'Setting Item List' on the left shows 'Basic setting' selected. The 'Setting Item' table on the right displays the following data:

Item	CH1	CH2	CH3	CH4
Range switching function	This function enables to select the output range to be used from multiple ranges.			
Output range setting	-10 to 10V	4 to 20mA	4 to 20mA	4 to 20mA
Operation mode setting function	The two operation modes, "Normal mode" to execute the D/A conversion and "Wave output mode".			
Operation mode setting	Normal mode			
Output mode setting	Wave output mode			
Analog output HOLD/CLEAR function	Set whether to clear the analog output value or to hold the previous value or setting.			
Analog output HOLD/CLEAR setting	CLEAR	CLEAR	CLEAR	CLEAR
HOLD setting value	0	0	0	0
D/A conversion enable/disable function	This function sets whether to enable or disable the D/A conversion for each channel.			
D/A conversion enable/disable setting	D/A conversion enable	D/A conversion disable	D/A conversion disable	D/A conversion disable

[Application setting]

The screenshot shows the '1[U1]:FX5-4DA Module Parameter' window. The 'Setting Item List' on the left shows 'Application setting' selected. The 'Setting Item' table on the right displays the following data:

Item	CH1	CH2	CH3	CH4
Scaling function	This function enables to change the upper limit value or lower limit value of the digital value input range to any value.			
Scaling enable/disable setting	Disable	Disable	Disable	Disable
Scaling upper limit value	0	0	0	0
Scaling lower limit value	0	0	0	0
Shift function	This function adds the set amount to the digital value. A fine adjustment is possible.			
Input value shift amount	0	0	0	0
Warning output function	This function outputs an alert when the digital value is outside the set range.			
Warning output setting	Enable (with out)	Disable	Disable	Disable
Warning output upper limit value	32000	0	0	0
Warning output lower limit value	0	0	0	0
Rate control function	This function controls the increasing and decreasing amount of the digital value.			
Rate control enable/disable setting	Disable	Disable	Disable	Disable
Increase digital limit value	64000	64000	64000	64000
Decrease digital limit value	64000	64000	64000	64000
Disconnection detection function	Execute the setting related to disconnection detection.			
Disconnection detection automatic clear enable/disable setting	Disable			

- Module Extension Parameters

To create the wave output data and register the wave pattern of the module extension parameter, set the setting as follows.

[Create Wave Output Data]

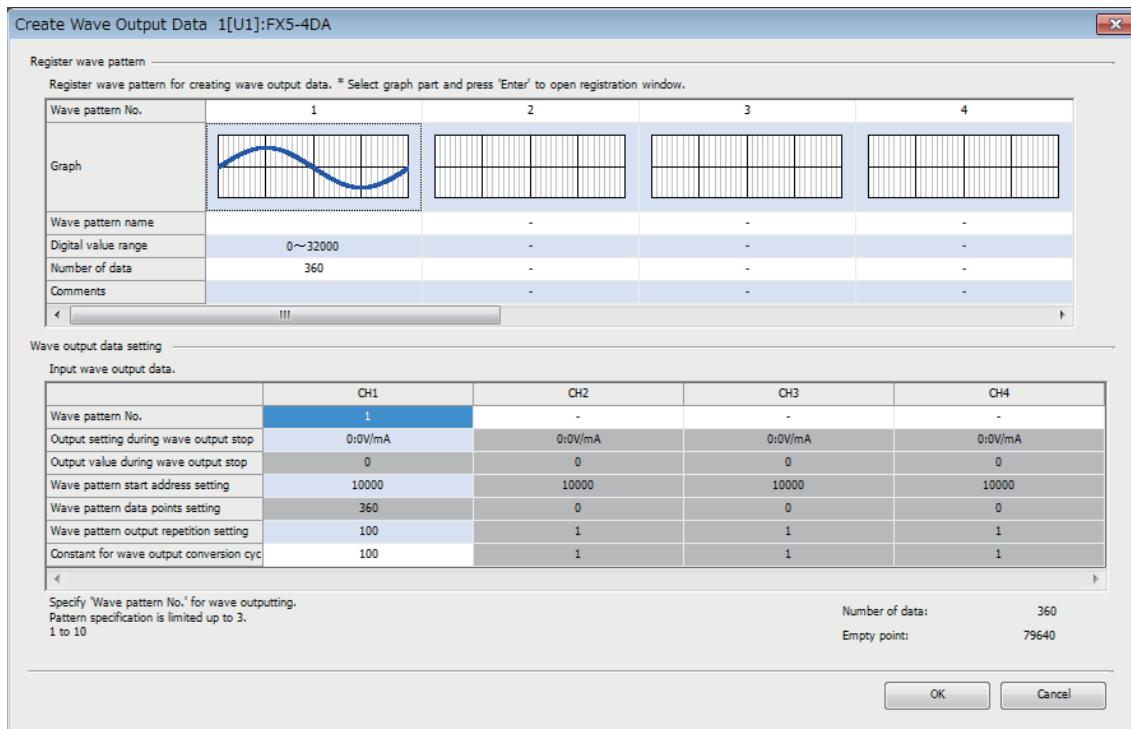

[Register wave pattern]

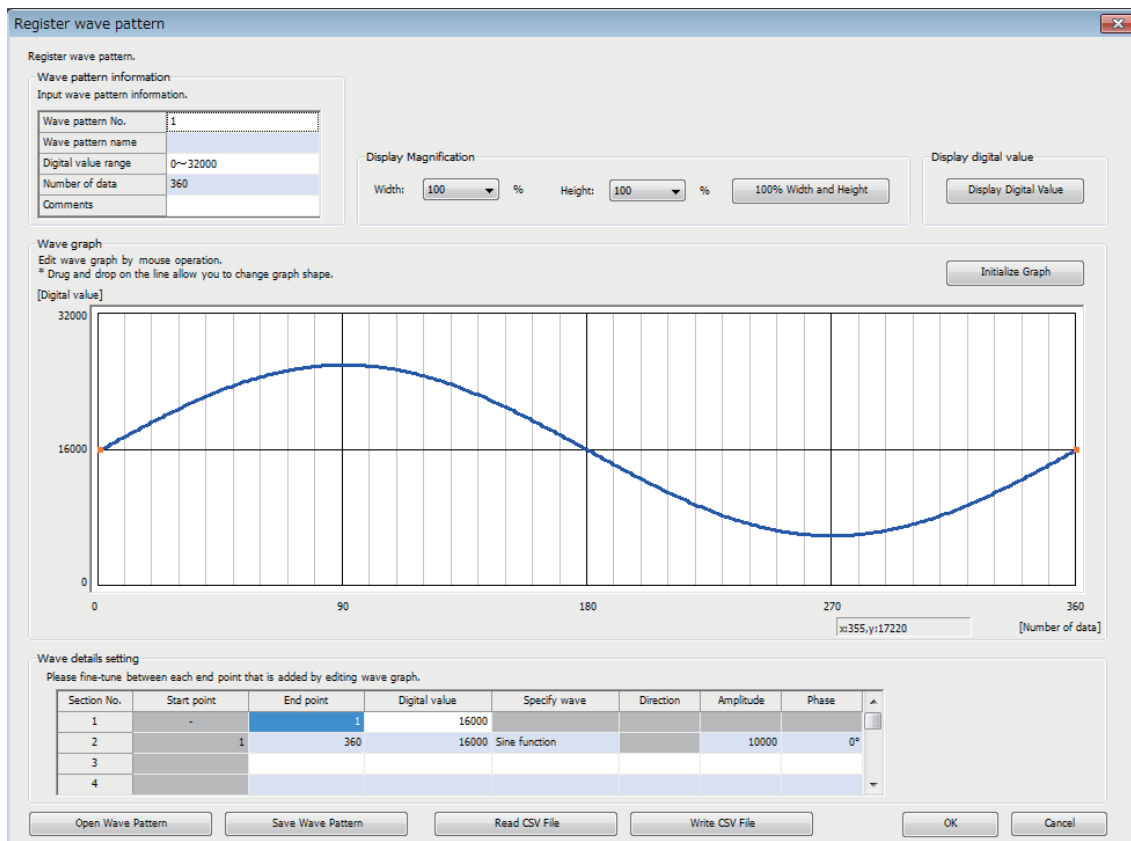

The created wave output data need to be written, as module extension parameters, to the CPU module or SD memory card.

Program example

Classification	Device	Description	Device	
Module label	FX5_4DA_1.bCH1OutputEnableDisableFlag_D	CH1 Output enable/disable flag	U1\G70.1	
	FX5_4DA_1.bExternalPowerSupplyREADY_Flag_D	External power supply READY flag	U1\G69.7	
	FX5_4DA_1.bModuleREADY_D	Module READY	U1\G69.0	
	FX5_4DA_1.bOperatingConditionSettingCompletedFlag_D	Operating condition setting completed flag	U1\G69.9	
	FX5_4DA_1.bOperatingConditionSettingRequest_D	Operating condition setting request	U1\G70.9	
	FX5_4DA_1.stnControl_D[0].uWaveOutputStartStopRequest_D	CH1 Wave output start/stop request	U1\G462	
Labels to be defined	Define global labels as shown below:			
	Label Name	Data Type	Class	Assign (Device/Label)
1	WaveOutputSettingEN	Bit	VAR_GLOBAL	M10
2	WaveOutputSettingENO	Bit	VAR_GLOBAL	M11
3	WaveOutputSettingOK	Bit	VAR_GLOBAL	M12
4	WaveOutputSettingERR	Bit	VAR_GLOBAL	F10
5	WaveOutputSettingOutputSelect	Word [Unsigned]/Bit String [16-bit]	VAR_GLOBAL	D10
6	WaveOutputSettingOutputValue	Word [Signed]	VAR_GLOBAL	D11
7	WaveOutputSettingStartingAddr	Double Word [Unsigned]/Bit String [32-bit]	VAR_GLOBAL	D12
8	WaveOutputSettingPointsSetting	Double Word [Unsigned]/Bit String [32-bit]	VAR_GLOBAL	D14
9	WaveOutputSettingFrequency	Word [Signed]	VAR_GLOBAL	D16
10	WaveOutputSettingConvSpeed	Word [Unsigned]/Bit String [16-bit]	VAR_GLOBAL	D17
11	WaveOutputSettingErrorCode	Word [Unsigned]/Bit String [16-bit]	VAR_GLOBAL	D18
12	RequestSettingEN	Bit	VAR_GLOBAL	M20
13	RequestSettingENO	Bit	VAR_GLOBAL	M21
14	RequestSettingOK	Bit	VAR_GLOBAL	M22
15	RequestSettingERR	Bit	VAR_GLOBAL	F20
16	RequestSettingErrorCode	Word [Unsigned]/Bit String [16-bit]	VAR_GLOBAL	D20
17	WaveOutputReqSettingEN	Bit	VAR_GLOBAL	M30
18	WaveOutputReqSettingENO	Bit	VAR_GLOBAL	M31
19	WaveOutputReqSettingOK	Bit	VAR_GLOBAL	M32
20	WaveOutputReqSettingERR	Bit	VAR_GLOBAL	F30
21	WaveStartStop	Word [Unsigned]/Bit String [16-bit]	VAR_GLOBAL	D30
22	WaveStatusCH1	Word [Unsigned]/Bit String [16-bit]	VAR_GLOBAL	D31
23	WaveStatusCH2	Word [Unsigned]/Bit String [16-bit]	VAR_GLOBAL	D32
24	WaveStatusCH3	Word [Unsigned]/Bit String [16-bit]	VAR_GLOBAL	D33
25	WaveStatusCH4	Word [Unsigned]/Bit String [16-bit]	VAR_GLOBAL	D34
26	WaveOutputReqSettingErrorCode	Word [Unsigned]/Bit String [16-bit]	VAR_GLOBAL	D39
27	WaveDataStoreReq	Bit	VAR_GLOBAL	X14
28	WaveOutputSetting	Bit	VAR_GLOBAL	X15
29	WaveRequestSetting	Bit	VAR_GLOBAL	X16
30	OutputReq	Bit	VAR_GLOBAL	X17
31	WaveStartStopReq	Bit	VAR_GLOBAL	X10

• Example of wave output parameter setting processing program

This program example is used to change part of the wave output parameter settings that were set from the "Create Wave Output Data" window. If this change is not to be made, this program is unnecessary.

After the change is complete, enable the settings using the following operating condition setting request program.

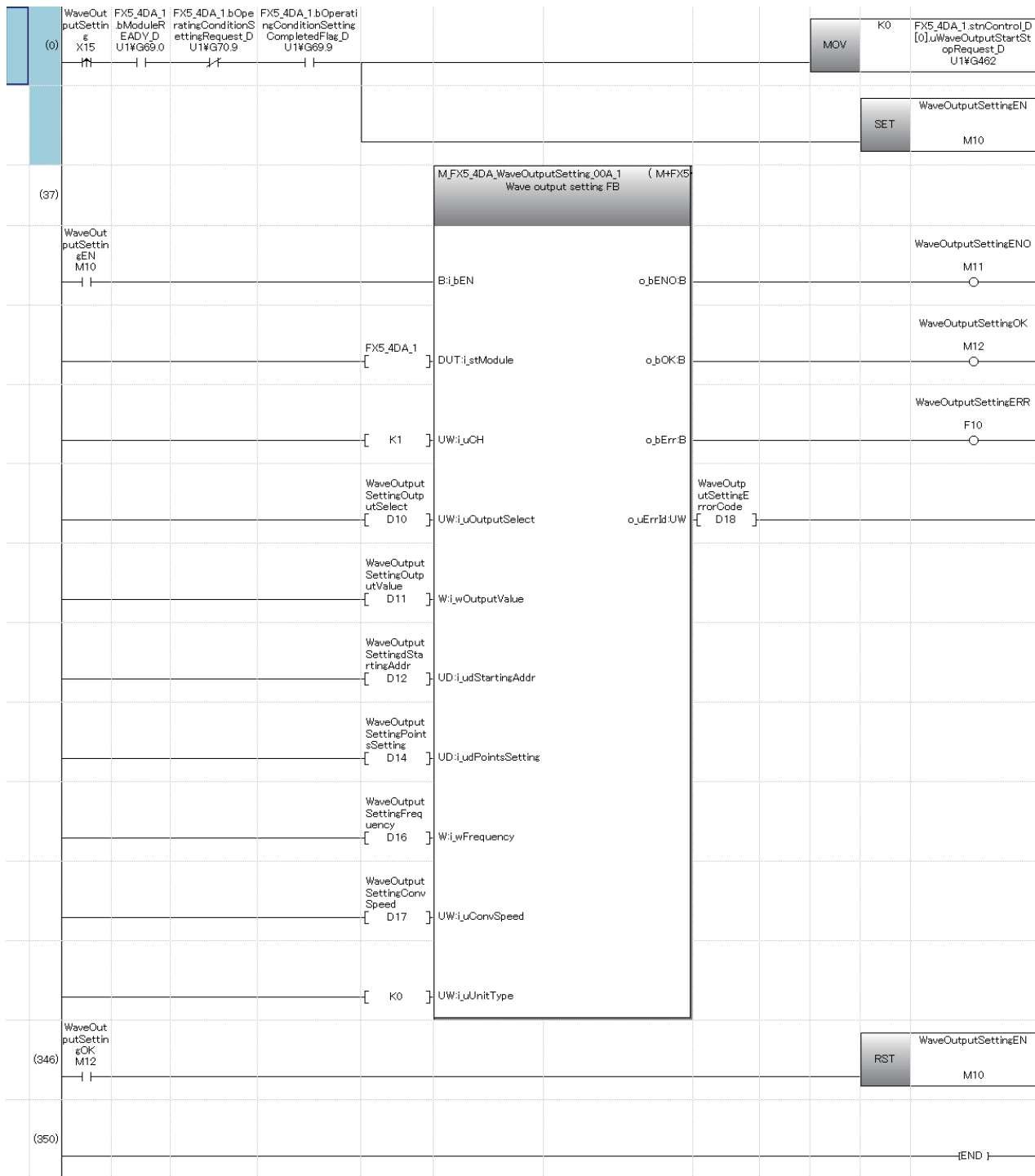

• Example of wave output star processing program

This program example starts the CH1 wave output.

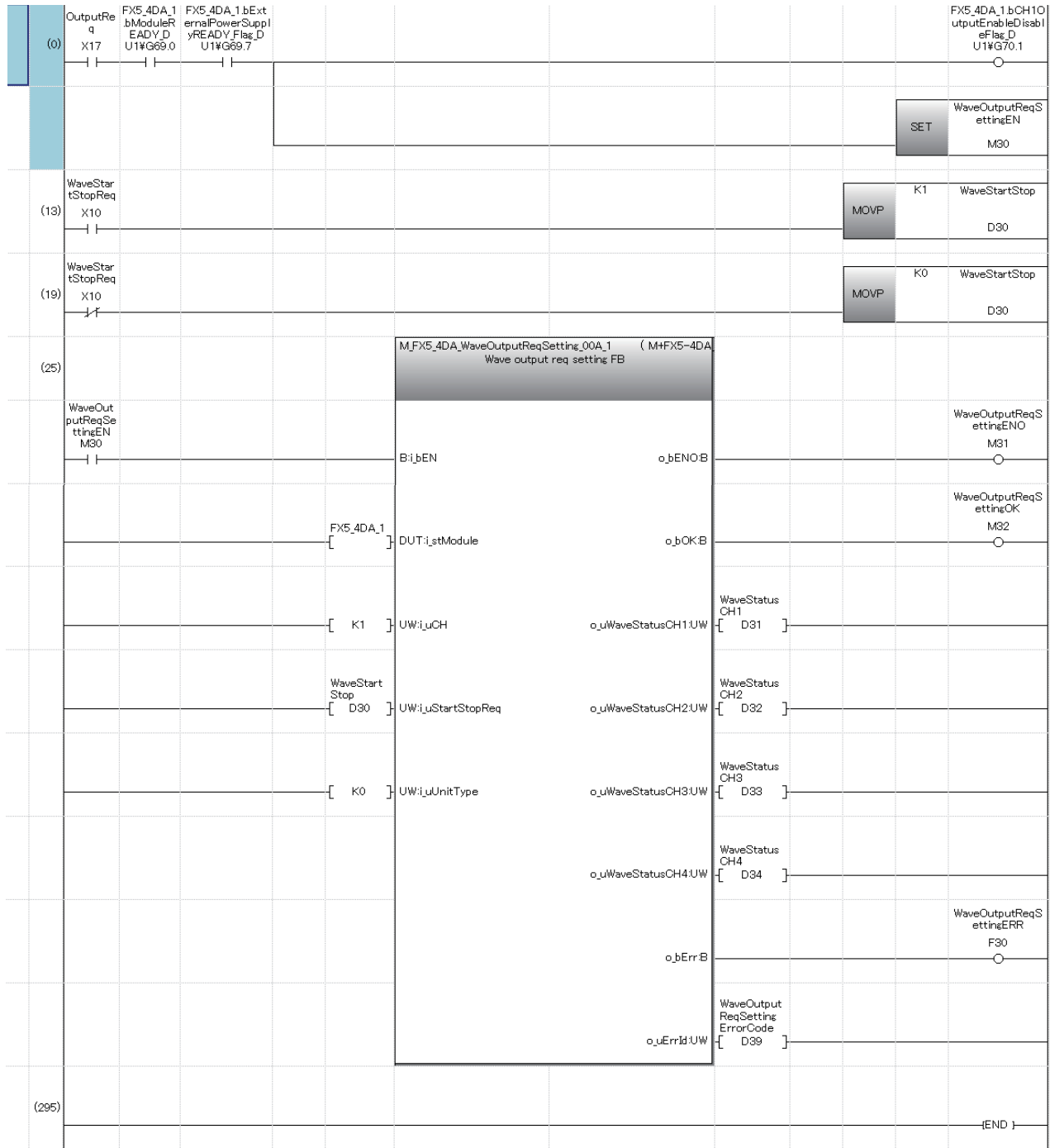

2.10 Troubleshooting

This section describes errors that may occur during use of an analog output module and troubleshooting for these.

Troubleshooting with the LEDs

Check the state of the LEDs to narrow down the possible causes of the trouble. This step is the first diagnostics before using GX Works3.

The analog output module state can be checked with the POWER, RUN, ERROR, and ALM LEDs. The following table shows the correspondence between the LEDs and the analog output module state.

Name	Description
POWER LED	Indicates the power supply status. ON: Power ON OFF: Power off or module failure
RUN LED	Indicates the operating status. Light on: Normal operation Flashing: Offset/gain setting mode Light off: Error occurring
ERROR LED	Indicates the error status.*1 ON: Minor error Flashing: Moderate error or major error OFF: Normal operation
ALM LED	Indicates the alarm status.*2 ON: Alarm occurred OFF: Normal operation

*1 For details, refer to the following.

 Page 279 List of error codes

*2 For details, refer to the following.

 Page 282 List of alarm codes

Troubleshooting by symptom

When the POWER LED turns off

Check item	Corrective action
Check whether the power is supplied.	Check that power is supplied to the CPU and extension power supply modules.
Check whether the capacities of the CPU module extension power supply modules are enough.	Calculate the current consumption of the I/O modules, and intelligent function modules to check that the power supply capacity for the CPU module and extension power supply module is enough.
Check whether the module is mounted properly.	Check that the extension cable is inserted correctly.

When the RUN LED flashes or turns off

■When flashing

Check item	Cause	Corrective action
Check whether the module is in offset/gain setting mode.	In the GX Works3 module parameter setting, the CPU module was powered off→on or reset when the operation mode setting was the offset/gain setting mode.	In the GX Works3 module parameter setting, set the operation mode setting to normal and power off→on or reset the CPU module.
	The value in the mode switching setting has been changed and the mode has been switched to offset/gain setting mode.	Review the program that uses the mode switching setting to check whether the mode has been switched erroneously.

■When turning off

Check item	Corrective action
Check whether the power is supplied.	Check that power is supplied to the CPU and extension power supply modules.
Check whether the capacities of the CPU module extension power supply modules are enough.	Calculate the current consumption of the I/O modules, and intelligent function modules to check that the power supply capacity for the CPU module and extension power supply module is enough.
Check whether the module is mounted properly.	Check that the extension cable is inserted correctly.
Other than the above	Reset the CPU module, and check if the RUN LED turns on. If the RUN LED still remains off, the possible cause is a failure of the module. Please consult your local Mitsubishi representative.

When the ERROR LED flashes or turns on

■When flashing

Check item	Action
Check whether the 24 V DC external power supply is supplied.	Confirm if FX5-4DA is connected properly to the external power supply of 24 V DC. Also, confirm if the supply of the voltage from the external power supply of 24 V DC to FX5-4DA is started before the system power supply turns on.
Check whether a moderate error has occurred.	Check Latest error code and take actions described in the list of error codes. (Page 279 List of error codes)

■When turning on

Check item	Action
Check whether any error has occurred.	Check Latest error code and take actions described in the list of error codes. (Page 279 List of error codes)

The ALM LED turns on

■When turning on

Check item	Action
Check whether any alert has been issued.	Check the latest alarm code and take action as described in the list of alarm codes. (Page 282 List of alarm codes)

No analog output

■No analog output when the normal output mode is selected

Check item	Action
Check whether the 24 V DC external power supply is supplied.	Check 'External power supply READY flag' (Un\G69, b7). If it is off, supply 24 V DC to the external power supply terminal.
Check whether there is any problem with the wiring, such as looseness or disconnection of analog signal lines.	Identify the faulty area of signal lines by a visual check and continuity check.
Check whether the CPU module is in the STOP state.	Change the state of the CPU module to RUN.
Check whether the offset/gain setting in the user range setting is correct.	Check that the offset/gain setting is correct. If a user range setting is in use, change it to another default output range and check that the D/A conversion is performed normally. If the D/A conversion is correct, retry the offset/gain setting.
Check whether the output range setting is correct.	Check the CH□ Input range setting monitor with the GX Works3 monitor. If the output range setting is incorrect, retry to set the GX Works3 output range setting or CH□ Range setting.
For the desired channel for output, check whether the CH□ D/A conversion enable/disable is set to D/A conversion disable.	Check CH□ D/A conversion enable/disable setting and set it to D/A conversion enable using a sequence program or the GX Works3.
For the desired channel for output, check whether 'CH□ Output enable/disable flag' (Un\G70, b1 to b4) is set to OFF.	Check the ON/OFF setting of 'CH□ Output enable/disable flag' (Un\G70, b1 to b4). If 'CH□ Output enable/disable flag' (Un\G70, b1 to b4) is off, review the sequence program. In addition, check whether the CPU module is in the STOP state.
Check whether the digital value writing program has an error.	Check the CH□ Digital value using the GX Works 3 monitor (buffer memory batch monitor). If the value as specified for the digital value has not been stored, review the writing program.
Check whether 'Operating condition setting request' (Un\G70, b9) has been executed.	By turning off→on→off 'Operating condition setting request' (Un\G70, b9), check whether the normal analog output is generated. If it is normal, review the sequence program.

■No analog output when the wave output mode is selected

Check item	Action
Check the connection method	Check whether the 24 V DC external power supply is supplied. Check 'External power supply READY flag' (Un\G69, b7). If it is off, supply 24 V DC to the external power supply terminal.
Checking the module parameter settings of GX Works3	Check whether the operation mode setting is correct. Check that Offset/gain setting mode flag (Un\G69, b10) is off, and the operation mode setting is normal mode. If the normal mode is not set, retry to set the operation mode to the normal mode with the module parameter setting of GX Works 3.
	Check whether the output module setting is correct. Check the output mode to examine whether it is set to the wave output mode. If the wave output mode is not set, retry to set the output mode to the wave output mode with the module parameter setting of GX Works 3.
	Check whether the user range setting was selected. When the wave output mode is selected with the output mode setting, the user range setting (current) or (voltage) cannot be selected as the output range. If the user range setting (current) or (voltage) was selected as the output range, retry to select a range other than the user ranges.

Check item		Action
Checking the program	For the desired channel for wave output, check whether the CH□ D/A conversion enable/disable is set to D/A conversion disable.	Check CH□ D/A conversion enable/disable setting to set to D/A conversion enable.
	Check whether 'Operating condition setting request' (Un\G70, b9) has been executed.	By turning off→on→off 'Operating condition setting request' (Un\G70, b9), enable the wave output function parameter setting.
	Check whether the value is written in the wave data registry area of the desired channel for wave output.	Check the value of the wave data registry area used for the desired channel for wave output. By pausing the wave output, each monitor of the wave output function can be checked. Set the analog output HOLD/CLEAR setting to the previous value, set the CH□ Wave output start/stop request to the wave output pause request (2) to pause the analog output state, and check each monitor.
	Check whether the CH□ Wave output start/stop request of the desired channel for wave output is set to Wave output stop request (0).	Check the CH□ Wave output status monitor of the desired channel for wave output. When the CH□ Wave output status monitor is Wave output stopped (0), retry to set CH□ Wave output start/stop request in Wave output start request (1).
	For the desired channel for wave output, check whether 'CH□ Output enable/disable flag' (Un\G70, b1 to b4) is set to OFF.	Check the status of the ON/OFF setting of 'CH□ Output enable/disable flag' (Un\G70, b1 to b4). If 'CH□ Output enable/disable flag' (Un\G70, b1 to b4) is off, review the program.

The analog output value is not identical with the previous value/setting value

Check item	Corrective action
Check whether the operation status of the CPU module is STOP or Stop Error.	Check the CPU module operating status. The analog output HOLD/CLEAR function is enabled when the CPU module operating status is STOP or Stop Error.
Check whether the analog output HOLD/CLEAR function is correct.	Check the CH□ HOLD/CLEAR function setting monitor. If the setting is incorrect, retry to set the analog output HOLD/CLEAR setting to the previous value/setting value by setting GX Works3 module parameters.
Check whether the CH□ HOLD setting value is correct.	If the setting value is selected with the analog output HOLD/CLEAR function setting function, check the value the CH□ HOLD setting value.

'External power supply READY flag' (Un\G69, b7) does not turn on

Use the following procedure for checking.

Check item	Corrective action
Check whether the 24 V DC external power supply is supplied. (1) Wiring is proper. (2) External power supply 24 V DC is supplied within the specified range.	(1) Make wiring by reference to the external wiring. (☞ Page 242) (2) Supply 24 V DC within the performance specifications. (☞ Page 179)
Other than the above	The analog output module may be in failure. Please consult your local Mitsubishi representative.

Point

If the external power supply does not operate normally after the above actions are taken, the analog output module may be in failure. Please consult your local Mitsubishi representative.

List of error codes

If an error occurs during operation, an analog output module stores the error code into 'Latest error code' (Un\G0) of the buffer memory. In addition, 'Error flag' (Un\G69, b15) turns on. When disconnection is detected, not the 'Error flag' (Un\G69, b15) but the 'Disconnection detection signal' (Un\G69, b13) turns ON. The error code of 'Latest error code' (Un\G0) is cleared by turning on 'Error clear request' (Un\G70, b15), and the 'Error flag' (Un\G69, b15) and 'Disconnect detection signal' (Un\G69, b13) are turned off.

Error codes of an analog output module are classified into minor and moderate errors.

- Minor error: This error is caused by the setting failure of programs and parameters, and after eliminating the error cause, each function normally executes. (1000H to 1FFFH)
- Moderate error: An error such as hardware failure. The D/A conversion does not continue. (3000H to 3FFFH)

The following table lists the error codes that may be stored.

□: Indicates the number of the channel where an error has occurred. It represents one of numerical values 0 to 3, which correspond to CH1 to CH4.

(CH1: 0, CH2: 1, CH3: 2, CH4: 3)

△ in error code: Indicates the interrupt setting corresponding to the error (0: setting 1 to F: setting 16).

Error code	Error name	Description and cause	Corrective action
0000H	—	There is no error.	—
1080H	Number of writes to offset/gain settings reach limit error	The number of the offset/gain settings has exceeded the guaranteed maximum number.	Though any further setting of offset/gain values is performed, the setting value will not be guaranteed.
180△H	Interrupt factor transaction setting range error	A value other than 0 or 1 was set in 'Interrupt factor transaction setting' (Un\G200 to 215).	Retry to set 0 or 1 in 'Interrupt factor transaction setting' (Un\G200 to 215).
181△H	Condition target setting range error	A value other than 0 to 4 was set in 'Condition target setting' (Un\G232 to 247).	Retry to set a value of 0 to 4 in 'Condition target setting' (Un\G232 to 247).
182△H	Condition target channel setting range error	A value other than 0 to 4 was set in 'Condition target channel setting' (Un\G264 to 279).	Retry to set a value of 0 to 4 in 'Condition target channel setting' (Un\G264 to 279).
1861H	Offset/gain setting continuous write occurrence error	The setting value has been continuously written to the flash memory 26 times or more in the offset/gain setting.	For the offset/gain setting, write the setting value only once per setting.
190□H	Range setting range error	A value out of the range is set in CH□ Range setting.	Set CH□ Range setting to the value within the range again.
191□H	Digital value setting range error	<ul style="list-style-type: none"> • For normal output A value out of the range is set for the CH□ Digital value. • For wave output A value out of the setting range was set for part of 'wave data registry area' (Un\G10000 to Un\G89999) used for the channel of wave-output-in-progress. 	<p>Retry to set a proper value for the CH□ Digital value.</p> <p>Correct the corresponding data in 'wave data registry area' (Un\G10000 to Un\G89999) being used for the channel where the error occurred, to a value within the setting range.</p>
192□H	HOLD setting value range error	A value out of the range is set in CH□ HOLD setting.	Retry to set a proper value for the CH□ HOLD digital value.
1A0□H	Scaling enable/disable setting range error	A value other than 0 and 1 is set in CH□ Scaling enable/disable setting.	Set CH□ Scaling enable/disable setting to 0 or 1.
1A2□H	Scaling upper/lower limit value setting error	CH□ Scaling upper limit value and CH□ Scaling lower limit value are set as the scaling upper limit value = the scaling lower limit value.	Set CH□ Scaling upper limit value and CH□ Scaling lower limit value as the scaling upper limit value ≠ the scaling lower limit value.
1B0□H	Warning output setting range error	A value other than 0 to 2 was set in CH□ Warning output setting.	Retry to set CH□ Warning output setting to 0 to 2.
1B1□H	Warning output upper/limit reversal error	A value not meeting the following condition was set for the CH□ Warning output upper limit value or CH□ Warning output lower limit value. Upper limit value > Lower limit value	Retry to set the CH□ Warning output upper limit value and CH□ Warning output lower limit value so that the condition "upper limit value > lower limit value".
1B8□H	Rate control enable/disable setting range error	A value other than 0 or 1 was set in CH□ Rate control enable/disable setting.	Retry to set CH□ Rate control enable/disable setting to 0 or 1.
1B9□H	Digital limit value range error	A value other than 0 to 64000 was set for the CH□ Increase digital limit value or CH□ Decrease digital limit value.	Retry to set a value of 0 to 64000 for the CH□ Increase digital limit value or CH□ Decrease digital limit value.

Error code	Error name	Description and cause	Corrective action
1C4□H	Disconnection detection error	A disconnection was detected on CH□.	Eliminate the cause of the disconnection from the channel. If the disconnection detection automatic clear enable/disable setting is disabled, remove the cause of the disconnection and then turn off→on→off 'Error Clear Request' (Un\G70, b15)'.
1D0□H	Wave output start/stop setting range error	A value out of the range was set in 'CH□ Wave output start/stop request'.	Retry to set 'CH□ Wave output start/stop request' to one of the following. <ul style="list-style-type: none"> • Wave output stop request (0) • Wave output start request (1) • Wave output pause request (2)
1D1□H	Wave output mode user range specification error	In the output mode setting, the wave output mode was selected, and the user range setting was selected with the output range setting.	<ul style="list-style-type: none"> • If the wave output function is to be used, retry to set the output range to a range other than the user range by using the output range setting. • If the user range setting is to be used, retry to set the output mode setting to the normal output mode by using the module parameter setting.
1D2□H	Output setting during wave output stop setting range error	'CH□ Output setting during wave output stop' is set to a value other than 0 to 2.	Retry to set 'CH□ Output setting during wave output stop' to one of the following. <ul style="list-style-type: none"> • 0 V/0 mA (0) • Offset value (1) • Output value during wave output stop (2)
1D3□H	Output value during wave output stop range error	'CH□ Output value during wave output stop' is set to a value out of the range.	Correct 'CH□ Output value during wave output stop' to a value within the setting range. The setting range depends on the output range setting. -10 to +10 V: -32768 to +32767 4 to 20 mA, 0 to 20 mA, 1 to 5 V, 0 to 5 V, or 0 to 10 V: 0 to 32767
1D4□H	Wave pattern start address setting range error	'CH□ Wave pattern start address setting' is set to a value out of the setting range.	Retry to set 'CH□ Wave pattern start address setting' to a value of 10000 to 89999.
1D5□H	Wave pattern number-of-points setting range error	'CH□ Wave pattern data points setting' is set to a value other than 1 to 80000.	Retry to set 'CH□ Wave pattern data points setting' to a value of 1 to 80000.
1D6□H	Wave pattern output repetition setting range error	'CH□ Wave pattern output repetition setting' is set to a value out of the range.	Retry to set 'CH□ Wave pattern output repetition setting' to one of the following. <ul style="list-style-type: none"> • Indefinite repetitive output (-1) • Specified-count output (1 to 32767)
1D7□H	Wave output conversion cycle setting range error	'CH□ Constant for wave output conversion cycle' is set to a value other than 1 to 5000.	Retry to set 'CH□ Constant for wave output conversion cycle' to a value of 1 to 7.
1D80H	Step action wave output request range error	'Step action wave output request' is set to a value other than 0 or 1.	Retry to set 0 or 1 'Step action wave output request'.
1D9□H	Wave data registry area range error	The value obtained by subtracting 1 from the sum of 'CH□ Wave pattern start address setting' and 'CH□ Wave pattern data points setting' is set to a value exceeding 89999 (final buffer memory address of wave data registry area).	Retry to set 'CH□ Wave pattern start address setting' and 'CH□ Wave pattern number-of-points setting' to values meeting the following conditions. "Wave pattern start address setting" + "Wave pattern data points setting" - 1 ≤ 89999
1DA0H	Module extension parameter acquisition error	No module extension parameter can be acquired.	Write to the CPU module, the module extension parameter by which the wave output data was registered. Then, power off→on or reset the CPU module.
1E50H	Offset/gain setting channel specification error	<ul style="list-style-type: none"> • Multiple channels are set simultaneously while during offset/gain setting. • In the offset/gain setting, "1: Setting channel" is set for both CH□ Offset/gain setting mode (offset specification) and CH□ Offset/gain setting mode (gain specification), or "0: Disable" is set. 	Correctly set CH□ Offset/gain setting mode (offset specification) and CH□ Offset/gain setting mode (gain specification).
1E51H	User range data invalid (CH specification disable)	An invalid value is set in the offset/gain setting. The number of the channel in which this error occurs cannot be identified.	Perform the offset/gain setting again for all channels where the user range is set. If the error occurs again, the possible cause is a failure of the module. Please consult your local Mitsubishi representative.
1E52H	Analog adjustment output out-of-range error	A value other than -3000 to +3000 is set for the offset/gain adjustment value specification.	Retry to set the offset/gain adjustment value specification to a value of -3000 to +3000.

Error code	Error name	Description and cause	Corrective action
1E6□H	User range data invalid (CH specification enable)	An invalid value is set in CH□ Offset/gain setting.	Perform the offset/gain setting again for the channels where the error has occurred. If the error occurs again, the possible cause is a failure of the module. Please consult your local Mitsubishi representative.
1E7□H	Offset/gain value inversion error	The offset value and gain value to be saved in the flash memory are as follows: Offset value \geq Gain value	Perform the offset/gain setting again so that the following condition is satisfied: Offset value < Gain value
1E8□H	Offset/gain setting channel range error	A value other than 0 and 1 is set in CH□ Offset/gain setting mode (offset specification) and CH□ Offset/gain setting mode (gain specification).	Set CH□ Offset/gain setting mode (offset specification) and CH□ Offset/gain setting mode (gain specification) to 0 or 1.
1E9□H	Offset/gain setting range error	When the offset and gain are set, values other than D or E were set in 'CH□ Offset/gain setting mode' (range specification).	Retry to set the 'CH□ Offset/gain setting mode' (range specification) to D or E.
1F08H	Module power supply error	The 24 V DC power supply is not normally supplied to the module.	Check the wiring of the cable or the supplied voltage. After the check, turn off→on→off Error clear request (Un\G70, b15) to eliminate this error and resume the conversion. If the error occurs again, the possible cause is a failure of the module. Please consult your local Mitsubishi representative.
3001H	Hardware failure	A hardware failure in the module.	Power off→on the module. If the error occurs again, the possible cause is a failure of the module. Please consult your local Mitsubishi representative.
3030H	Flash memory error	The data in the flash memory is abnormal.	Check the analog output values. If the values are abnormal, please consult your local Mitsubishi representative.

List of alarm codes

If an alarm occurs during operation, the analog output module stores the alarm code into 'Latest alarm code' (Un\G2) of the buffer memory. Turning on 'Alert output clear request'(Un\G70, b14) or 'Operating condition setting request'(Un\G70, b9) clears the alarm code in 'Latest alarm code' (Un\G2).

The following table lists the alarm codes that may be stored.

□: Indicates the number of the channel where the alarm has occurred. It represents one of numerical values 0 to 3, which correspond to CH1 to CH4.

(CH1: 0, CH2: 1, CH3: 2, CH4: 3)

Alarm code	Alarm name	Description and cause	Corrective action
080□H	Warning output alarm flag (upper limit)	A warning output alarm (upper limit) has occurred in CH□.	After the CH□ Digital value returns to within the setting range, turn off→on→off 'Warning output clear request' (Un\G70, b14). Both the bit corresponding to the warning output upper or lower flag and 'Warning output signal' (Un\G69, b14) turn off.
081□H	Warning output alarm flag (lower limit)	A warning output alarm (lower limit) has occurred in CH□.	
0B0□H	Setting error of conditions for operation other than Wave output stopped	In wave output status other than Wave output stopped, 'Operating condition setting request' (Un\G70, b9) was turned off→on→off.	Wait until the wave output of all channels stop. Then, turn off→on→off 'Operating condition setting request' (Un\G70, b9).
0B1□H	Wave output mode scaling setting error	The scaling function is enabled when the wave output function is in use.	If the wave output function is in use, retry to set 'CH□ Scaling enable/disable setting' to Disable (1).
0B2□H	Wave output mode input value shift amount setting error	When the wave output function is in use, the input value shift amount is set to a value other than 0.	If the wave output function is in use, retry to set 'CH□ Input value shift' to 0.
0B3□H	Wave output mode rate control setting error	The rate function is enabled when the wave output function is in use.	If the wave output function is in use, retry to set 'CH□ Rate control enable/disable setting to Disable (1).
0C0□H	CH□ Output-in-progress range change enable alarm	In CH□, range switching was executed during analog output.	When range switching is to be performed, turn off 'Output enable/disable flag' (Un\G70, b1 to b4) for the channel the range of which is to be switched and turn off→on→off 'Operating condition setting request' (Un\G70, b9).

APPENDIX

Appendix 5 External Dimensions

The following figure shows the external dimensions of an analog output module.

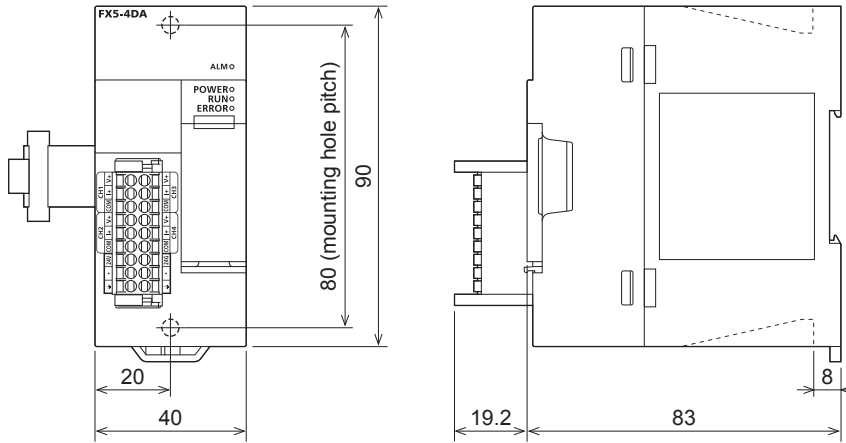

(Unit: mm)

Appendix 6 Standards

Certification of UL, cUL standards

The FX5-4DA supports UL (UL, cUL) standards.

UL, cUL file number: E95239

For models that support UL standards, please consult your local Mitsubishi representative.

Compliance with EC directive (CE marking)

This note does not guarantee that an entire machine produced in accordance with the contents of this note will comply with the following standards.

Compliance to EMC directive and LVD directive of the entire mechanical module should be checked by the user/manufacturer. For more details please contact to the local Mitsubishi Electric sales site.

Requirement for compliance with EMC directive

The following products have shown compliance through direct testing (of the identified standards below) and design analysis (through the creation of a technical construction file) to the European Directive for Electromagnetic Compatibility (2014/30/EU) when used as directed by the appropriate documentation.

Attention

This product is designed for use in industrial applications.

Product compatibility

Type: Programmable controller (open type equipment)

Models: FX5 manufactured

Electromagnetic compatibility (EMC) directive	Remarks
EN61131-2:2007 Programmable controllers - Equipment requirements and tests	Compliance with all relevant aspects of the standard. EMI • Radiated emission • Conducted emission EMS • Radiated electromagnetic field • Fast transient burst • Electrostatic discharge • High-energy surge • Voltage drops and interruptions • Conducted RF • Power frequency magnetic field

Caution for compliance with EC directive

Caution for when the FX5-4DA is used

When the FX5-4DA is used, attach a ferrite core to the power supply of the CPU module.

Make 2 turns around the ferrite core and attach within approximately 200 mm from the terminal block and connectors of the power cable. Also, attach a ferrite core to the input/output cable pulled out to the outside of the control panel. Attach the ferrite core before the cable is pulled out to the outside of the control panel. (Ferrite core used in Mitsubishi Electric's test: E04SR401938 manufactured by SEIWA ELECTRIC MFG. CO., LTD.)

Compliance with UKCA marking

The requirements for compliance with UKCA marking are the same as that with EC directive (CE marking).

Appendix 7 Module Label

The functions of the analog output module can be set by using module labels.

Module labels of I/O signals

The module label name of an I/O signal is defined with the following structure:

"Module name"_"Module number".b"Label name"_D

Ex.

FX5_4DA_1.bModuleREADY_D

■Module name

The character string of a module model name is given.

■Module number

A number starting from 1 is added to identify modules that have the same module name.

■Label name

The label identifier unique to a module is given.

■_D

This string indicates that the module label is for the direct access.

Module labels of buffer memory areas

The module label name of a buffer memory area is defined with the following structure:

"Module name"_"Module number"."Data type"_D["(Channel)"]."Data format" "Label name"_D

Ex.

FX5_4DA_1.stnMonitor_D[0].uSetValueCheckCode_D

■Module name

The character string of a module model name is given.

■Module number

A number starting from 1 is added to identify modules that have the same module name.

■Data type

The data type to sort a buffer memory area is given. Each data type is as follows:

Data type	Description
stnMonitor	Monitor
stnControl	Control
stnSetting	Setting

■Channel

The channel number corresponding to a module label is given. A numerical value of 0 to 3 is used to correspond to CH1 to 4. (CH1: 0, CH2: 1, CH3: 2, CH4: 3)

■Data format

The string that represents the data size of a buffer memory area is given. Each data type is as follows:

Data format	Description
u	Word [Unsigned]/Bit string [16-bit]
w	Word [Signed]
ud	Double word [Unsigned]/Bit string [32-bit]
d	Double word [Signed]

■Label name

The label identifier unique to a module is given.

■_D

This string indicates that the module label is for the direct access. Values that are read from or written to the module label is reflected in the analog output module instantly.

Appendix 8 Buffer Memory Areas

List of buffer memory areas

This section lists the buffer memory areas of the analog output module. For details on the buffer memory, refer to the following.

☞ Page 298 Details of buffer memory addresses

The buffer memory areas of the analog output module are classified into the data types described below.

Data type	Description	
Setting data	Description	The data to be customized to suit the connected devices and the purpose of the system.
	Read and write attributes	Read and write is possible.
	Setting procedure	Use GX Works3 or a program to set the data.
	Setting timing	After a change of value, turning off→on→off 'Operating condition setting request' (Un\G70, b9) allows the setting value to take effect.
Control data	Description	The data used for controlling the analog output module.
	Read and write attributes	Read and write is possible.
	Setting procedure	Use GX Works3 or a program to set the data.
	Setting timing	As soon as the values are changed, the set values become enabled.
Monitor data	Description	The data used for checking the status of the analog output module.
	Read and write attributes	Only read is possible and write is not possible.
	Setting procedure	—
	Setting timing	—



Do not write data to the system areas and areas whose data types are monitor in the buffer memory. Writing data into these areas can cause the malfunction of the module.

A

In the normal mode

○: With refresh setting, ×: Without refresh setting

■Un\G0 to Un\G399

Address (decimal)	Address (hexadecimal)	Name	Default value	Data type	Auto refresh
0	0H	Latest error code	0	Monitor	○
1	1H	Latest address of error history	0	Monitor	○
2	2H	Latest alarm code	0	Monitor	○
3	3H	Latest address of alarm history	0	Monitor	○
4 to 19	4H to 13H	Interrupt factor detection flag [n] ^{*1}	0	Monitor	○
20 to 29	14H to 1DH	System area	—	—	—
30	1EH	Module Information	6160H	Monitor	×
31	1FH	Firmware version	*2	Monitor	×
32 to 35	20H to 23H	System area	—	—	—
36	24H	Alarm output upper limit flag	0000H	Monitor	○
37	25H	Alarm output lower limit flag	0000H	Monitor	○
38	26H	Disconnection detection flag	0000H	Monitor	○
39 to 59	27H to 3BH	System area	—	—	—
60	3CH	Operation mode monitor	0000H	Monitor	×
61 to 68	3DH to 44H	System area	—	—	—
69	45H	Input signals	0	Monitor	×
70	46H	Output signals	0	Control	×
71 to 123	47H to 7BH	System area	—	—	—

Address (decimal)	Address (hexadecimal)	Name	Default value	Data type	Auto refresh
124 to 139	7CH to 8BH	Interrupt factor mask [n] ^{*1}	0	Control	×
140 to 155	8CH to 9BH	System area	—	—	—
156 to 171	9CH to ABH	Interrupt factor reset request [n] ^{*1}	0	Control	×
172 to 187	ACH to BBH	System area	—	—	—
188	BCH	Step action wave output request	0	Control	×
189 to 199	BDH to C7H	System area	—	—	—
200 to 215	C8H to D7H	Interrupt factor generation setting [n] ^{*1}	0	Setting	×
216 to 231	D8H to E7H	System area	—	—	—
232 to 247	E8H to F7H	Condition target setting [n] ^{*1}	0	Setting	×
248 to 263	F8H to 107H	System area	—	—	—
264 to 279	108H to 117H	Condition target channel setting [n] ^{*1}	0	Setting	×
280 to 295	118H to 127H	System area	—	—	—
296, 297	128H, 129H	Mode switching setting	0	Setting	×
298 to 303	12AH to 12FH	System area	—	—	—
304	130H	Disconnection detection automatic clear enable/disable setting	1	Setting	×
305	131H	Offset/gain initialization enable code	0	Setting	×
306 to 399	132H to 18FH	System area	—	—	—

*1 [n] in the table indicates an interrupt setting number. (n = 1 to 16)

*2 The firmware version of the analog output module is stored. For Ver. 1.000, 1000 is stored.

■Un\G400 to Un\G3599

Address Decimal (hexadecimal)				Name	Default value	Data type	Auto refresh
CH1	CH2	CH3	CH4				
400 (190H)	600 (258H)	800 (320H)	1000 (3E8H)	CH□ Setting value check code	0	Monitor	○
401 (191H)	601 (259H)	801 (321H)	1001 (3E9H)	CH□ Wave output status monitor	0	Monitor	○
402 to 428 (192H to 1ACH)	602 to 628 (25AH to 274H)	802 to 828 (322H to 33CH)	1002 to 1028 (3EAH to 404H)	System area	—	—	—
429 (1ADH)	629 (275H)	829 (33DH)	1029 (405H)	CH□ Output status	0	Monitor	×
430 (1AEH)	630 (276H)	830 (33EH)	1030 (406H)	CH□ Range setting monitor	3	Monitor	×
431 (1AFH)	631 (277H)	831 (33FH)	1031 (407H)	CH□ HOLD/CLEAR function setting monitor	0	Monitor	×
432 (1B0H)	632 (278H)	832 (340H)	1032 (408H)	CH□ Wave output conversion cycle monitor (L)	0	Monitor	×
433 (1B1H)	633 (279H)	833 (341H)	1033 (409H)	CH□ Wave output conversion cycle monitor (H)		Monitor	×
434 (1B2H)	634 (27AH)	834 (342H)	1034 (40AH)	CH□ Wave pattern output count monitor	0	Monitor	×
435 (1B3H)	635 (27BH)	835 (343H)	1035 (40BH)	System area	—	—	—
436 (1B4H)	636 (27CH)	836 (344H)	1036 (40CH)	CH□ Wave output current address monitor (L)	0	Monitor	×
437 (1B5H)	637 (27DH)	837 (345H)	1037 (40DH)	CH□ Wave output current address monitor (H)		Monitor	×
438 (1B6H)	638 (27EH)	838 (346H)	1038 (40EH)	CH□ Wave output current digital value monitor	0	Monitor	×
439 (1B7H)	639 (27FH)	839 (347H)	1039 (40FH)	System area	—	—	—
440 (1B8H)	640 (280H)	840 (348H)	1040 (410H)	CH□ Wave output digital value out-of-range address monitor (L)	0	Monitor	×
441 (1B9H)	641 (281H)	841 (349H)	1041 (411H)	CH□ Wave output digital value out-of-range address monitor (H)		Monitor	×

Address Decimal (hexadecimal)				Name	Default value	Data type	Auto refresh
CH1	CH2	CH3	CH4				
442 (1BAH)	642 (282H)	842 (34AH)	1042 (412H)	CH□ Wave output warning address monitor (L)	0	Monitor	×
443 (1BBH)	643 (283H)	843 (34BH)	1043 (413H)	CH□ Wave output warning address monitor (H)		Monitor	×
444 to 459 (1BCH to 1CBH)	644 to 659 (284H to 293H)	844 to 859 (34CH to 35BH)	1044 to 1059 (414H to 423H)	System area	—	—	—
460 (1CCH)	660 (294H)	860 (35CH)	1060 (424H)	CH□ Digital value	0	Control	○
461 (1CDH)	661 (295H)	861 (35DH)	1061 (425H)	System area	—	—	—
462 (1CEH)	662 (296H)	862 (35EH)	1062 (426H)	CH□ Wave output start/stop request	0	Control	×
463 to 479 (1CFH to 1DFH)	663 to 679 (297H to 2A7H)	863 to 879 (35FH to 36FH)	1063 to 1079 (427H to 437H)	System area	—	—	—
480 (1E0H)	680 (2A8H)	880 (370H)	1080 (438H)	CH□ Input value shift amount	0	Control	×
481 (1E1H)	681 (2A9H)	881 (371H)	1081 (439H)	System area	—	—	—
482 (1E2H)	682 (2AAH)	882 (372H)	1082 (43AH)	CH□ Wave output step action movement amount	0	Control	×
483 to 499 (1E3H to 1F3H)	683 to 699 (2ABH to 2BBH)	883 to 899 (373H to 383H)	1083 to 1099 (43BH to 44BH)	System area	—	—	—
500 (1F4H)	700 (2BCH)	900 (384H)	1100 (44CH)	CH□ D/A conversion enable/disable setting	1	Setting	×
501 (1F5H)	701 (2BDH)	901 (385H)	1101 (44DH)	System area	—	—	—
502 (1F6H)	702 (2BEH)	902 (386H)	1102 (44EH)	CH□ Scaling enable/disable setting	1	Setting	×
503 (1F7H)	703 (2BFH)	903 (387H)	1103 (44FH)	System area	—	—	—
504 (1F8H)	704 (2C0H)	904 (388H)	1104 (450H)	CH□ Scaling upper limit value (L)	0	Setting	×
505 (1F9H)	705 (2C1H)	905 (389H)	1105 (451H)	CH□ Scaling upper limit value (H)		Setting	×
506 (1FAH)	706 (2C2H)	906 (38AH)	1106 (452H)	CH□ Scaling lower limit value (L)	0	Setting	×
507 (1FBH)	707 (2C3H)	907 (38BH)	1107 (453H)	CH□ Scaling lower limit value (H)		Setting	×
508 (1FCH)	708 (2C4H)	908 (38CH)	1108 (454H)	CH□ Alert output setting	0	Setting	×
509 (1FDH)	709 (2C5H)	909 (38DH)	1109 (455H)	CH□ Rate control enable/disable setting	1	Setting	×
510 (1FEH)	710 (2C6H)	910 (38EH)	1110 (456H)	CH□ Alert output upper limit value	0	Setting	×
511 (1FFH)	711 (2C7H)	911 (38FH)	1111 (457H)	System area	—	—	—
512 (200H)	712 (2C8H)	912 (390H)	1112 (458H)	CH□ Alert output lower limit value	0	Setting	×
513 (201H)	713 (2C9H)	913 (391H)	1113 (459H)	System area	—	—	—
514 (202H)	714 (2CAH)	914 (392H)	1114 (45AH)	CH□ Increase digital limit value	64000	Setting	×
515 (203H)	715 (2CBH)	915 (393H)	1115 (45BH)	System area	—	—	—
516 (204H)	716 (2CCH)	916 (394H)	1116 (45CH)	CH□ Decrease digital limit value	64000	Setting	×
517 to 523 (205H to 20BH)	717 to 723 (2CDH to 2D3H)	917 to 923 (395H to 39BH)	1117 to 1123 (45DH to 463H)	System area	—	—	—

Address Decimal (hexadecimal)				Name	Default value	Data type	Auto refresh
CH1	CH2	CH3	CH4				
524 (20CH)	724 (2D4H)	924 (39CH)	1124 (464H)	CH□ Output setting during wave output stop	1	Setting	×
525 (20DH)	725 (2D5H)	925 (39DH)	1125 (465H)	CH□ Output value during wave output stop	0	Setting	×
526 (20EH)	726 (2D6H)	926 (39EH)	1126 (466H)	CH□ Wave pattern start address setting (L)	10000	Setting	×
527 (20FH)	727 (2D7H)	927 (39FH)	1127 (467H)	CH□ Wave pattern start address setting (H)		Setting	×
528 (210H)	728 (2D8H)	928 (3A0H)	1128 (468H)	CH□ Wave pattern data points setting (L)	0	Setting	×
529 (211H)	729 (2D9H)	929 (3A1H)	1129 (469H)	CH□ Wave pattern data points setting (H)		Setting	×
530 (212H)	730 (2DAH)	930 (3A2H)	1130 (46AH)	CH□ Wave pattern output repetition setting	1	Setting	×
531 (213H)	731 (2DBH)	931 (3A3H)	1131 (46BH)	CH□ Constant for wave output conversion cycle	1	Setting	×
532 to 595 (214H to 253H)	732 to 795 (2DCH to 31BH)	932 to 995 (3A4H to 3E3H)	1132 to 1195 (46CH to 4ABH)	System area	—	—	—
596 (254H)	796 (31CH)	996 (3E4H)	1196 (4ACH)	CH□ HOLD setting value	0	Setting	×
597 (255H)	797 (31DH)	997 (3E5H)	1197 (4ADH)	System area	—	—	—
598 (256H)	798 (31EH)	998 (3E6H)	1198 (4AEH)	CH□ Range setting	3	Setting	×
599 (257H)	799 (31FH)	999 (3E7H)	1199 (4AFH)	System area	—	—	—
1200 to 3599 (4B0H to E0FH)				System area	—	—	—

■Error history (Un\G3600 to Un\G3759)

Address (decimal)	Address (hexadecimal)	Name			Default value	Data type	Auto refresh	
3600	E10H	Error history No.1	Error code			0	Monitor	×
3601	E11H		Error time	First two digits of the year	Last two digits of the year			
3602	E12H			Month	Day			
3603	E13H			Hour	Minute			
3604	E14H			Second	Day of the week			
3605	E15H			Millisecond				
3606 to 3609	E16H to E19H	System area			—	—	—	
3610 to 3615	E1AH to E1FH	Error history No.2	Same as error history No.1			0	Monitor	×
3616 to 3619	E20H to E23H	System area			—	—	—	
3620 to 3625	E24H to E29H	Error history No.3	Same as error history No.1			0	Monitor	×
3626 to 3629	E2AH to E2DH	System area			—	—	—	
3630 to 3635	E2EH to E33H	Error history No.4	Same as error history No.1			0	Monitor	×
3636 to 3639	E34H to E37H	System area			—	—	—	
3640 to 3645	E38H to E3DH	Error history No.5	Same as error history No.1			0	Monitor	×
3646 to 3649	E3EH to E41H	System area			—	—	—	
3650 to 3655	E42H to E47H	Error history No.6	Same as error history No.1			0	Monitor	×
3656 to 3659	E48H to E4BH	System area			—	—	—	
3660 to 3665	E4CH to E51H	Error history No.7	Same as error history No.1			0	Monitor	×
3666 to 3669	E52H to E55H	System area			—	—	—	
3670 to 3675	E56H to E5BH	Error history No.8	Same as error history No.1			0	Monitor	×
3676 to 3679	E5CH to E5FH	System area			—	—	—	
3680 to 3685	E60H to E65H	Error history No.9	Same as error history No.1			0	Monitor	×
3686 to 3689	E66H to E69H	System area			—	—	—	
3690 to 3695	E6AH to E6FH	Error history No.10	Same as error history No.1			0	Monitor	×
3696 to 3699	E70H to E73H	System area			—	—	—	
3700 to 3705	E74H to E79H	Error history No.11	Same as error history No.1			0	Monitor	×
3706 to 3709	E7AH to E7DH	System area			—	—	—	
3710 to 3715	E7EH to E83H	Error history No.12	Same as error history No.1			0	Monitor	×
3716 to 3719	E84H to E87H	System area			—	—	—	
3720 to 3725	E88H to E8DH	Error history No.13	Same as error history No.1			0	Monitor	×
3726 to 3729	E8EH to E91H	System area			—	—	—	
3730 to 3735	E92H to E97H	Error history No.14	Same as error history No.1			0	Monitor	×
3736 to 3739	E98H to E9BH	System area			—	—	—	
3740 to 3745	E9CH to EA1H	Error history No.15	Same as error history No.1			0	Monitor	×
3746 to 3749	EA2H to EA5H	System area			—	—	—	
3750 to 3755	EA6H to EABH	Error history No.16	Same as error history No.1			0	Monitor	×
3756 to 3759	EACH to EAFH	System area			—	—	—	

■ Alarm history (Un\G3760 to Un\G3999)

Address (decimal)	Address (hexadecimal)	Name			Default value	Data type	Auto refresh	
3760	EB0H	Alarm history No.1	Alarm code			0	Monitor	×
3761	EB1H		Alarm time	First two digits of the year	Last two digits of the year			
3762	EB2H			Month	Day			
3763	EB3H		Hour	Minute				
3764	EB4H		Second	Day of the week				
3765	EB5H		Millisecond					
3766 to 3769	EB6H to EB9H	System area			—	—	—	
3770 to 3775	EBAH to EBFH	Alarm history No.2	Same as alarm history No.1			0	Monitor	×
3776 to 3779	EC0H to EC3H	System area			—	—	—	
3780 to 3785	EC4H to EC9H	Alarm history No.3	Same as alarm history No.1			0	Monitor	×
3786 to 3789	ECAH to ECDH	System area			—	—	—	
3790 to 3795	ECEH to ED3H	Alarm history No.4	Same as alarm history No.1			0	Monitor	×
3796 to 3799	ED4H to ED7H	System area			—	—	—	
3800 to 3805	ED8H to EDDH	Alarm history No.5	Same as alarm history No.1			0	Monitor	×
3806 to 3809	EDEH to EE1H	System area			—	—	—	
3810 to 3815	EE2H to EE7H	Alarm history No.6	Same as alarm history No.1			0	Monitor	×
3816 to 3819	EE8H to EEBH	System area			—	—	—	
3820 to 3825	EECH to EF1H	Alarm history No.7	Same as alarm history No.1			0	Monitor	×
3826 to 3829	EF2H to EF5H	System area			—	—	—	
3830 to 3835	EF6H to EFBH	Alarm history No.8	Same as alarm history No.1			0	Monitor	×
3836 to 3839	EFCH to EFFH	System area			—	—	—	
3840 to 3845	F00H to F05H	Alarm history No.9	Same as alarm history No.1			0	Monitor	×
3846 to 3849	F06H to F09H	System area			—	—	—	
3850 to 3855	F0AH to F0FH	Alarm history No.10	Same as alarm history No.1			0	Monitor	×
3856 to 3859	F10H to F13H	System area			—	—	—	
3860 to 3865	F14H to F19H	Alarm history No.11	Same as alarm history No.1			0	Monitor	×
3866 to 3869	F1AH to F1DH	System area			—	—	—	
3870 to 3875	F1EH to F23H	Alarm history No.12	Same as alarm history No.1			0	Monitor	×
3876 to 3879	F24H to F27H	System area			—	—	—	
3880 to 3885	F28H to F2DH	Alarm history No.13	Same as alarm history No.1			0	Monitor	×
3886 to 3889	F2EH to F31H	System area			—	—	—	
3890 to 3895	F32H to F37H	Alarm history No.14	Same as alarm history No.1			0	Monitor	×
3896 to 3899	F38H to F3BH	System area			—	—	—	
3900 to 3905	F3CH to F41H	Alarm history No.15	Same as alarm history No.1			0	Monitor	×
3906 to 3909	F42H to F45H	System area			—	—	—	
3910 to 3915	F46H to F4BH	Alarm history No.16	Same as alarm history No.1			0	Monitor	×
3916 to 3919	F4CH to F4FH	System area			—	—	—	
3920 to 3999	F50H to F9FH	System area			—	—	—	

■Offset/gain setting (Un\G4000 to Un\G9999)

Address Decimal (hexadecimal)				Name	Default value	Data type	Auto refresh
CH1	CH2	CH3	CH4				
4000 to 4131 (FA0H to 1023H)				System area	—	—	—
4130 (1022H)				Offset/gain adjustment value specification	0	Control	×
4131 (1023H)				System area	—	—	—
4132 (1024H)	4134 (1026H)	4136 (1028H)	4138 (102AH)	CH□ Offset/gain setting mode (offset specification)	0	Setting	×
4133 (1025H)	4135 (1027H)	4137 (1029H)	4139 (102BH)	CH□ Offset/gain setting mode (gain specification)	0	Setting	×
4140 to 4163 (102CH to 1043H)				System area	—	—	—
4164 (1044H)	4165 (1045H)	4166 (1046H)	4167 (1047H)	CH□ Offset/gain setting mode (range specification)	0	Setting	×
4168 to 9999 (1048H to 270FH)				System area	—	—	—

■Wave data registration (Un\G10000 to Un\G89999)

Address Decimal (hexadecimal)				Name	Default value	Data type	Auto refresh
CH1	CH2	CH3	CH4				
10000 to 89999 (2710H to 15F8FH)				Wave data registration area	0	Setting	×

In FX3 allocation function mode

○: With refresh setting, ×: Without refresh setting

Address Decimal (hexadecimal)				Name	Default value	Data type	Auto refresh
CH1	CH2	CH3	CH4				
0 (0H)				Range setting	0000H	Setting	×
1 (1H)	2 (2H)	3 (3H)	4 (4H)	CH□ Digital value	0000H	Control	○
5 (5H)				System area	—	—	—
6 (6H)				Output status	0000H	Monitor	×
7 to 27 (7H to 1BH)				System area	—	—	—
28 (1CH)				Disconnection detection flag	0000H	Monitor	○
29 (1DH)				Latest error code	0	Monitor	○
30 (1EH)				Module Information	6164H	Monitor	×
31 (1FH)				System area	—	—	—
32 (20H)	33 (21H)	34 (22H)	35 (23H)	CH□ HOLD setting value	0	Setting	×
36, 37 (24H, 25H)				System area	—	—	—
38 (26H)				Alert output setting	0000H	Setting	×
39 (27H)				Alert output flag (upper/lower limit)	0	Monitor	○
40 (28H)				System area	—	—	—
41 (29H)	42 (2AH)	43 (2BH)	44 (2CH)	CH□ Alert output lower limit value	0	Setting	×
45 (2DH)	46 (2EH)	47 (2FH)	48 (30H)	CH□ Alert output upper limit value	0	Setting	×
49 to 68 (31H to 44H)				System area	—	—	—
69 (45H)				Input signals	0	Monitor	×
70 (46H)				Output signals	0	Control	×
71 to 3100 (47H to C1CH)				System area	—	—	—
3101 (C1DH)				Latest address of error history	0	Monitor	○
3102 (C1EH)				Latest alarm code	0	Monitor	○

Address Decimal (hexadecimal)				Name	Default value	Data type	Auto refresh
CH1	CH2	CH3	CH4				
3103 (C1FH)				Latest address of alarm history	0	Monitor	○
3104 to 3130 (C20H to C3AH)				System area	—	—	—
3131 (C3BH)				Firmware version	—*1	Monitor	×
3132 to 3159 (C3CH to C57H)				System area	—	—	—
3160 (C58H)				Operation mode monitor	0	Monitor	×
3161 to 3169 (C59H to C61H)				System area	—	—	—
3170 (C62H)				Disconnection detection automatic clear enable/disable setting	0	Setting	×
3171 to 3200 (C63H to C80H)				System area	—	—	—
3201 (C81H)	3202 (C82H)	3203 (C83H)	3204 (C84H)	CH□ Setting value check code	0	Monitor	○
3205 to 3210 (C85H to C8AH)				System area	—	—	—
3211 (C8BH)	3212 (C8CH)	3213 (C8DH)	3214 (C8EH)	CH□ Range setting monitor	0	Monitor	×
3215 to 3220 (C8FH to C94H)				System area	—	—	—
3221 (C95H)	3222 (C96H)	3223 (C97H)	3224 (C98H)	CH□ HOLD/CLEAR function setting monitor	1	Monitor	×
3225 to 3249 (C99H to CB1H)				System area	—	—	—
3250 (CB2H)	3252 (CB4H)	3254 (CB6H)	3256 (CB8H)	CH□ Input value shift amount	0	Setting	×
3251 (CB3H)	3253 (CB5H)	3255 (CB7H)	3257 (CB9H)	System area	—	—	—
3258 to 3270 (CBAH to CC6H)				System area	—	—	—
3271 (CC7H)	3272 (CC8H)	3273 (CC9H)	3274 (CCAH)	CH□ D/A conversion enable/disable setting	0	Setting	×
3275 to 3280 (CCBH to CD0H)				System area	—	—	—
3281 (CD1H)	3282 (CD2H)	3283 (CD3H)	3284 (CD4H)	CH□ Scaling enable/disable setting	1	Setting	×
3285 to 3289 (CD5H to CD9H)				System area	—	—	—
3290 (CDAH)	3292 (CDCH)	3294 (CDEH)	3296 (CE0H)	CH□ Scaling upper limit value (L)	0	Setting	×
3291 (CDBH)	3293 (CDDH)	3295 (CDFH)	3297 (CE1H)	CH□ Scaling upper limit value (H)		Setting	×
3298 to 3309 (CE2H to CEDH)				System area	—	—	—
3310 (CEEH)	3312 (CF0H)	3314 (CF2H)	3316 (CF4H)	CH□ Scaling lower limit value (L)	0	Setting	×
3311 (CEFH)	3313 (CF1H)	3315 (CF3H)	3317 (CF5H)	CH□ Scaling lower limit value (H)		Setting	×
3318 to 3330 (CF6H to D02H)				System area	—	—	—
3331 (D03H)	3332 (D04H)	3333 (D05H)	3334 (D06H)	CH□ Rate control enable/disable setting	1	Setting	×
3335 to 3339 (D07H to D0BH)				System area	—	—	—
3340 (D0CH)	3342 (D0EH)	3344 (D10H)	3346 (D12H)	CH□ Increase digital limit value	64000	Setting	×
3341 (D0DH)	3343 (D0FH)	3345 (D11H)	3347 (D13H)	System area	—	—	—
3348 to 3359 (D14H to D1FH)				System area	—	—	—
3360 (D20H)	3362 (D22H)	3364 (D24H)	3366 (D26H)	CH□ Decrease digital limit value	64000	Setting	×
3361 (D21H)	3363 (D23H)	3365 (D25H)	3367 (D27H)	System area	—	—	—
3368 to 4000 (D28H to FA0H)				System area	—	—	—
4001 to 4016 (FA1H to FB0H)				Interrupt factor detection flag [n] ^{*2}	0	Monitor	○
4017 to 4020 (FB1H to FB4H)				System area	—	—	—
4021 to 4036 (FB5H to FC4H)				Interrupt factor mask [n] ^{*2}	0	Control	×
4037 to 4040 (FC5H to FC8H)				System area	—	—	—
4041 to 4056 (FC9H to FD8H)				Interrupt factor reset request [n] ^{*2}	0	Control	×
4057 to 4060 (FD9H to FDCH)				System area	—	—	—
4061 to 4076 (FDDH to FECH)				Interrupt factor generation setting [n] ^{*2}	0	Setting	×
4077 to 4080 (FEDH to FF0H)				System area	—	—	—
4081 to 4096 (FF1H to 1000H)				Condition target setting [n] ^{*2}	0	Setting	×
4097 to 4100 (1001H to 1004H)				System area	—	—	—
4101 to 4116 (1005H to 1014H)				Condition target channel setting [n] ^{*2}	0	Setting	×
4117 to 4119 (1015H to 1017H)				System area	—	—	—

Address Decimal (hexadecimal)				Name	Default value	Data type	Auto refresh
CH1	CH2	CH3	CH4				
4120, 4121 (1018H, 1019H)				Mode switching setting	0	Setting	×
4122 to 4129 (101AH to 1021H)				System area	—	—	—
4130 (1022H)				Offset/gain adjustment value specification	0	Control	×
4131 (1023H)	4132 (1024H)	4133 (1025H)	4134 (1026H)	CH□ Offset/gain setting mode (offset specification)	0	Setting	×
4135 to 4140 (1027H to 102CH)				System area	—	—	—
4141 (102DH)	4142 (102EH)	4143 (102FH)	4144 (1030H)	CH□ Offset/gain setting mode (gain specification)	0	Setting	×
4145 to 4150 (1031H to 1036H)				System area	—	—	—
4151 (1037H)	4152 (1038H)	4153 (1039H)	4154 (103AH)	CH□ Offset/gain setting mode (range specification)	0	Setting	×
4155 to 4159 (103BH to 103FH)				System area	—	—	—
4160 (1040H)				Offset/gain initialization enable code	0	Setting	×
4161 to 8599 (1041H to 2197H)				System area	—	—	—
8600 to 8609 (2198H to 21A1H)				Error history No.1	0	Monitor	×
8610 to 8619 (21A2H to 21ABH)				Error history No.2	0	Monitor	×
8620 to 8629 (21ACH to 21B5H)				Error history No.3	0	Monitor	×
8630 to 8639 (21B6H to 21BFH)				Error history No.4	0	Monitor	×
8640 to 8649 (21C0H to 21C9H)				Error history No.5	0	Monitor	×
8650 to 8659 (21CAH to 21D3H)				Error history No.6	0	Monitor	×
8660 to 8669 (21D4H to 21DDH)				Error history No.7	0	Monitor	×
8670 to 8679 (21DEH to 21E7H)				Error history No.8	0	Monitor	×
8680 to 8689 (21E8H to 21F1H)				Error history No.9	0	Monitor	×
8690 to 8699 (21F2H to 21FBH)				Error history No.10	0	Monitor	×
8700 to 8709 (21FCH to 2205H)				Error history No.11	0	Monitor	×
8710 to 8719 (2206H to 220FH)				Error history No.12	0	Monitor	×
8720 to 8729 (2210H to 2219H)				Error history No.13	0	Monitor	×
8730 to 8739 (221AH to 2223H)				Error history No.14	0	Monitor	×
8740 to 8749 (2224H to 222DH)				Error history No.15	0	Monitor	×
8750 to 8759 (222EH to 2237H)				Error history No.16	0	Monitor	×
8760 to 8769 (2238H to 2241H)				Alarm history No.1	0	Monitor	×
8770 to 8779 (2242H to 224BH)				Alarm history No.2	0	Monitor	×
8780 to 8789 (224CH to 2255H)				Alarm history No.3	0	Monitor	×
8790 to 8799 (2256H to 225FH)				Alarm history No.4	0	Monitor	×
8800 to 8809 (2260H to 2269H)				Alarm history No.5	0	Monitor	×
8810 to 8819 (226AH to 2273H)				Alarm history No.6	0	Monitor	×
8820 to 8829 (2274H to 227DH)				Alarm history No.7	0	Monitor	×
8830 to 8839 (227EH to 2287H)				Alarm history No.8	0	Monitor	×
8840 to 8849 (2288H to 2291H)				Alarm history No.9	0	Monitor	×
8850 to 8859 (2292H to 229BH)				Alarm history No.10	0	Monitor	×
8860 to 8869 (229CH to 22A5H)				Alarm history No.11	0	Monitor	×
8870 to 8879 (22A6H to 22AFH)				Alarm history No.12	0	Monitor	×
8880 to 8889 (22B0H to 22B9H)				Alarm history No.13	0	Monitor	×
8890 to 8899 (22BAH to 22C3H)				Alarm history No.14	0	Monitor	×
8900 to 8909 (22C4H to 22CDH)				Alarm history No.15	0	Monitor	×
8910 to 8919 (22CEH to 22D7H)				Alarm history No.16	0	Monitor	×
8920 to 8999 (22D8H to 2327H)				System area	—	—	—
9000 (2328H)				Step action wave output request	0	Control	×
9001 (2329H)	9002 (232AH)	9002 (232BH)	9004 (232CH)	CH□ Wave output status monitor	0	Monitor	○
9005 to 9009 (232DH to 2331H)				System area	—	—	—

Address Decimal (hexadecimal)				Name	Default value	Data type	Auto refresh
CH1	CH2	CH3	CH4				
9010 (2332H)	9012 (2334H)	9014 (2336H)	9016 (2338H)	CH□ Wave output conversion cycle monitor (L)	0	Monitor	×
9011 (2333H)	9013 (2335H)	9015 (2337H)	9017 (2339H)	CH□ Wave output conversion cycle monitor (H)		Monitor	×
9018 to 9029 (233AH to 2345H)				System area	—	—	—
9030 (2346H)	9032 (2348H)	9034 (234AH)	9036 (234CH)	CH□ Wave pattern output count monitor	0	Monitor	×
9031 (2347H)	9033 (2349H)	9035 (234BH)	9037 (234DH)	System area	—	—	—
9038 to 9049 (234EH to 2359H)				System area	—	—	—
9050 (235AH)	9052 (235CH)	9054 (235EH)	9056 (2360H)	CH□ Wave output current address monitor (L)	0	Monitor	×
9051 (235BH)	9053 (235DH)	9055 (235FH)	9057 (2361H)	CH□ Wave output current address monitor (H)		Monitor	×
9058 to 9069 (2362H to 236DH)				System area	—	—	—
9070 (236EH)	9072 (2370H)	9074 (2372H)	9076 (2374H)	CH□ Wave output current digital value monitor	0	Monitor	×
9071 (236FH)	9073 (2371H)	9075 (2373H)	9077 (2375H)	System area	—	—	—
9078 to 9089 (2376H to 2381H)				System area	—	—	—
9090 (2382H)	9092 (2384H)	9094 (2386H)	9096 (2388H)	CH□ Wave output digital value outside the range Address monitor (L)	0	Monitor	×
9091 (2383H)	9093 (2385H)	9095 (2387H)	9097 (2389H)	CH□ Wave output digital value outside the range Address monitor (H)		Monitor	×
9098 to 9109 (238AH to 2395H)				System area	—	—	—
9110 (2396H)	9112 (2398H)	9114 (239AH)	9116 (239CH)	CH□ Wave output warning Address monitor (L)	0	Monitor	×
9111 (2397H)	9113 (2399H)	9115 (239BH)	9117 (239DH)	CH□ Wave output warning Address monitor (H)		Monitor	×
9118 to 9130 (239EH to 23AAH)				System area	—	—	—
9131 (23ABH)	9132 (23ACH)	9133 (23ADH)	9134 (23AEH)	CH□ Wave output start/stop request	0	Control	×
9135 to 9139 (23AFH to 23B3H)				System area	—	—	—
9140 (23B4H)	9142 (23B6H)	9144 (23B8H)	9146 (23BAH)	CH□ Wave output step action movement amount	0	Control	×
9141 (23B5H)	9143 (23B7H)	9145 (23B9H)	9147 (23BBH)	System area	—	—	—
9148 to 9160 (23BCH to 23C8H)				System area	—	—	—
9161 (23C9H)	9162 (23CAH)	9163 (23CBH)	9164 (23CCH)	CH□ Output setting during wave output stop	1	Setting	×
9165 to 9170 (23CDH to 23D2H)				System area	—	—	—
9171 (23D3H)	9172 (23D4H)	9173 (23D5H)	9174 (23D6H)	CH□ Output value during wave output stop	0	Setting	×
9175 to 9179 (23D7H to 23DBH)				System area	—	—	—
9180 (23DCH)	9182 (23DEH)	9184 (23E0H)	9186 (23E2H)	CH□ Wave pattern start address setting (L)	10000	Setting	×
9181 (23DDH)	9183 (23DFH)	9185 (23E1H)	9187 (23E3H)	CH□ Wave pattern start address setting (H)		Setting	×
9188 to 9199 (23E4H to 23EFH)				System area	—	—	—
9200 (23F0H)	9202 (23F2H)	9204 (23F4H)	9206 (23F6H)	CH□ Wave pattern data points setting (L)	0	Setting	×
9201 (23F1H)	9203 (23F3H)	9205 (23F5H)	9207 (23F7H)	CH□ Wave pattern data points setting (H)		Setting	×
9208 to 9220 (23F8H to 2404H)				System area	—	—	—
9221 (2405H)	9222 (2406H)	9223 (2407H)	9224 (2408H)	CH□ Wave pattern output repetition setting	1	Setting	×
9225 to 9230 (2409H to 240EH)				System area	—	—	—

Address Decimal (hexadecimal)				Name	Default value	Data type	Auto refresh
CH1	CH2	CH3	CH4				
9231 (240FH)	9232 (2410H)	9233 (2411H)	9234 (2412H)	CH□ Constant for wave output conversion cycle	1	Setting	×
9235 to 9999 (2413H to 270FH)				System area	—	—	—
10000 to 89999 (2710H to 15F8FH)				Wave data registry area	0	Setting	×

*1 The firmware version of the analog output module is stored. For Ver. 1.000, 1000 is stored.

*2 [n] in the table indicates an interrupt setting number. (n = 1 to 16)

Details of buffer memory addresses

This section details the buffer memory areas of the analog output module.



This section describes buffer memory addresses for CH1.

Latest error code

The latest error code detected in the analog output module is stored. For details, refer to the following.

Page 279 List of error codes

■Buffer memory address

The following shows the buffer memory address of this area.

Buffer memory name	CH1	CH2	CH3	CH4
Latest error code	0			
Latest error code (in FX3 allocation mode function)	29			

■Clearing an error

Turn on and off 'Error clear request' (Un\G70, b15).

Latest address of error history

Among 'Error history No.□' (Un\G3600 to Un\G3759), a buffer memory address which stores the latest error code is stored.

■Buffer memory address

The following shows the buffer memory address of this area.

Buffer memory name	CH1	CH2	CH3	CH4
Latest address of error history	1			
Latest address of error history (in FX3 allocation mode function)	3101			

Latest alarm code

The latest alarm code detected in the analog output module is stored. For details, refer to the following.

Page 282 List of alarm codes

■Buffer memory address

The following shows the buffer memory address of this area.

Buffer memory name	CH1	CH2	CH3	CH4
Latest alarm code	2			
Latest alarm code (in FX3 allocation mode function)	3102			

■Clearing an alarm

Turn on and off 'Error clear request' (Un\G70, b15).

Latest address of alarm history

Among 'Alarm history No.□' (Un\G3760 to Un\G3999), a buffer memory address which stores the latest alarm code is stored.

■Buffer memory address

The following shows the buffer memory address of this area.

Buffer memory name	CH1	CH2	CH3	CH4
Latest address of alarm history	3			
Latest address of alarm history (in FX3 allocation mode function)	3103			

Interrupt factor detection flag [n]

The detection status of the interrupt factor is stored.

Monitor value	Description
0	No interrupt factor
1	Interrupt factor

When an interrupt factor occurs, an interrupt request is sent to the CPU module at the same time as 'Interrupt factor detection flag [n]' (Un\G4 to Un\G19) is turned to Interrupt factor (1).

"n" indicates an interrupt setting number. (n = 1 to 16)

■Buffer memory address

The following shows the buffer memory address of this area.

Buffer memory name	1	2	3	4	5	6	7	8	9	10	11	12	13	14	15	16
Interrupt factor detection flag [n]	4	5	6	7	8	9	10	11	12	13	14	15	16	17	18	19
Interrupt factor detection flag [n] (in FX3 allocation mode)	4001	4002	4003	4004	4005	4006	4007	4008	4009	4010	4011	4012	4013	4014	4015	4016

Module information

Module information of FX5-4DA is stored. For module information, 6160H (fixed hexadecimal value) is stored.

- In the normal mode: 6160H
- In the FX3 allocation mode: 6164H

■Buffer memory address

The following shows the buffer memory address of this area.

Buffer memory name	CH1	CH2	CH3	CH4
Module Information	30			
Module information (in FX3 allocation mode function)	30			

Firmware version

Firmware version is stored. Firmware version is stored in 4 digit decimal number.

■Buffer memory address

The following shows the buffer memory address of this area.

Buffer memory name	CH1	CH2	CH3	CH4
Firmware version	31			
Firmware version (in FX3 allocation mode function)	3131			

Alarm output upper limit flag

The upper limit alarm can be checked for each channel.

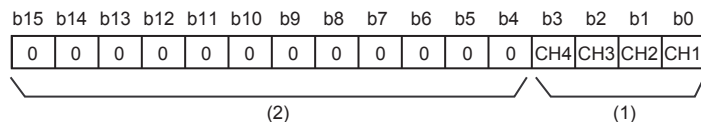

- (1) 0: Normal, 1: Alarm ON
 (2) b4 to b15 are fixed to 0.

■Buffer memory address

The following shows the buffer memory address of this area.

Buffer memory name	CH1	CH2	CH3	CH4
Alarm output upper limit flag	36			

■Alarm output upper limit flag status

- When the value is out of the range specified in the alert output upper limit value, Alert alarm ON (1) is stored in 'Alarm output upper limit flag' (Un\G36) corresponding to each channel.
- When an alert is detected in any channel where the D/A conversion and the alert output setting are enabled, 'Alarm output signal' (Un\G69, b14) also turns on.

■Clearing Alarm output upper limit flag

Turn on and off 'Operating condition setting request' (Un\G70, b9) or 'Alarm output clear request' (Un\G70, b14).

Alarm output lower limit flag

The lower limit alarm can be checked for each channel.

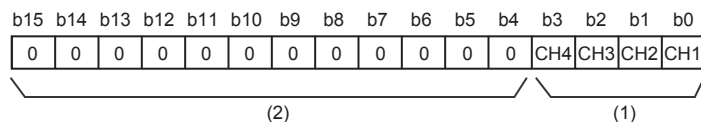

- (1) 0: Normal, 1: Alarm ON
 (2) b4 to b15 are fixed to 0.

■Buffer memory address

The following shows the buffer memory address of this area.

Buffer memory name	CH1	CH2	CH3	CH4
Alarm output lower limit flag	37			

■Alarm output lower limit flag status

- When the value is out of the range specified in the alert output lower limit value, Alert alarm ON (1) is stored in 'Alarm output lower limit flag' (Un\G37) corresponding to each channel.
- When an alert is detected in any channel where the D/A conversion and the alert output setting are enabled, 'Alarm output signal' (Un\G69, b14) also turns on.

■Clearing Alarm output lower limit flag

Turn on and off 'Operating condition setting request' (Un\G70, b9) or 'Alarm output clear request' (Un\G70, b14).

Alarm output flag (upper/lower limit)

When the FX3 allocation mode function is used, the upper/lower limit alarm can be checked.

b15	b14	b13	b12	b11	b10	b9	b8	b7	b6	b5	b4	b3	b2	b1	b0
0	0	0	0	0	0	0	0	CH4	CH4	CH3	CH3	CH2	CH2	CH1	CH1
								Upper	Lower	Upper	Lower	Upper	Lower	Upper	Lower
								limit	limit	limit	limit	limit	limit	limit	limit
								value	value	value	value	value	value	value	value

(2)

(1)

(1) 0: Normal, 1: Alarm ON

(2) b8 to b15 are fixed to 0.

■Buffer memory address

The following shows the buffer memory address of this area.

Buffer memory name	CH1	CH2	CH3	CH4
Alarm output flag (upper/lower limit) (in FX3 allocation mode function)	39			

■Alarm output flag status

- When the value is out of the range specified in the alert output upper limit value or alert output lower limit value, Alert alarm ON (1) is stored in 'Alarm output flag' (Un\G48) corresponding to each channel.
- When an alert is detected in any channel where the D/A conversion and the alert output setting are enabled, 'Alarm output signal' (Un\G69, b14) also turns on.

■Clearing Alarm output flag

Turn on and off 'Operating condition setting request' (Un\G70, b9) or 'Alarm output clear request' (Un\G70, b14).

Disconnection detection flag

By setting 4 to 20 mA, 0 to 20 mA, or user range (current) for the analog output range and enabling the D/A conversion, a disconnection can be detected for each channel.

b15	b14	b13	b12	b11	b10	b9	b8	b7	b6	b5	b4	b3	b2	b1	b0
0	0	0	0	0	0	0	0	0	0	0	0	CH4	CH3	CH2	CH1

(2)

(1)

(1) 0: Normal, 1: Disconnection detection

(2) b4 to b15 are fixed to 0.

■Buffer memory address

The following shows the buffer memory address of this area.

Buffer memory name	CH1	CH2	CH3	CH4
Disconnection detection flag	38			
Disconnection detection flag (in FX3 allocation mode function)	28			

■Status of Disconnection detection flag

- When a disconnection is detected, Disconnection detection (1) is stored in 'Disconnection detection flag' (Un\G38) corresponding to each channel.
- When a disconnection is detected in any channel, 'Disconnection detection signal' (Un\G69, b13) turns on.

■Clearing disconnection detection flag

Even if the disconnection cause is eliminated from the disconnected state when the disconnection detection auto-clear enable/disable setting is disabled, analog output does not restart automatically to prevent an incorrect output.

To restart analog output, perform the following. Analog output restarts according to the state of CH□ Output enable/disable flag (Un\G70, b1 to 4).

- In the normal output mode

Check the CH□ Digital value, and then turn on and off 'Error clear request' (Un\G70, b15).

- In the wave output mode

Turn on and off 'Error clear request' (Un\G70, b15) , and set CH□ Wave output start/stop request to Wave output start request (1).

If disconnection detection auto-clear enable/disable setting is enable, perform the following. Analog output restarts according to the state of CH□ Output enable/disable flag (Un\G70, b1-4).

- In the normal output mode

When the cause of the disconnection is eliminated from the disconnected state, analog output restarts.



At the same time analog output restarts, the disconnection detection flag of the corresponding channel is cleared.

Operation mode monitor

The current normal mode can be checked.

Monitor value	Description
0H	Normal output mode
1H	Offset/gain setting mode
2H	Wave output mode

■Buffer memory address

The following shows the buffer memory address of this area.

Buffer memory name	CH1	CH2	CH3	CH4
Operation mode monitor	60			
Operation mode monitor (In FX3 allocation mode function)	3160			

Input signals

A state of an analog output module can be checked in the buffer memory area.

■Buffer memory address

The following shows the buffer memory address of this area.

Buffer memory name	CH1	CH2	CH3	CH4
Input signals	69			
Input signals (In FX3 allocation mode function)	69			

■List of input signals

Buffer memory	Description
b0	Module READY
b1 to 4	Use not allowed
b5	Offset/gain initialization completed flag
b6	Use not allowed
b7	External power supply READY flag
b8	Use not allowed
b9	Operating condition setting completed flag
b10	Offset/gain setting mode status flag
b11	Channel change completed flag
b12	Set value change completed flag
b13	Disconnection detection signal
b14	Alert output signal
b15	Error flag

■Module READY (b0)

'Module READY' (Un\G69, b0) turns on to indicate the preparation for the D/A conversion is completed after the power-on or the reset operation of the CPU module.

In the following cases, 'Module READY' turns off.

- In the offset/gain setting mode (In this case, the D/A conversion is performed.)
- When a watchdog timer error occurs in the analog output module (In this case, the D/A conversion is not performed.)

■Offset/gain initialization completed flag (b5)

- Use as an interlock condition to turn on and off 'Offset/gain initialization request' (Un\G70, b5).
- After the offset/gain initialization is executed, the offset/gain initialization completed flag turns on from off.
- Offset/gain initialization is not be performed unless 'Offset/gain initialization enabled code' (Un\G305) is set to E20FH.
- It is possible to perform offset/gain initialization in normal output mode only.
- When 'Offset/gain initialization request' (Un\G70, b5) is off, 'Offset/gain initialization complete flag' (Un\G69, b5) turns off.

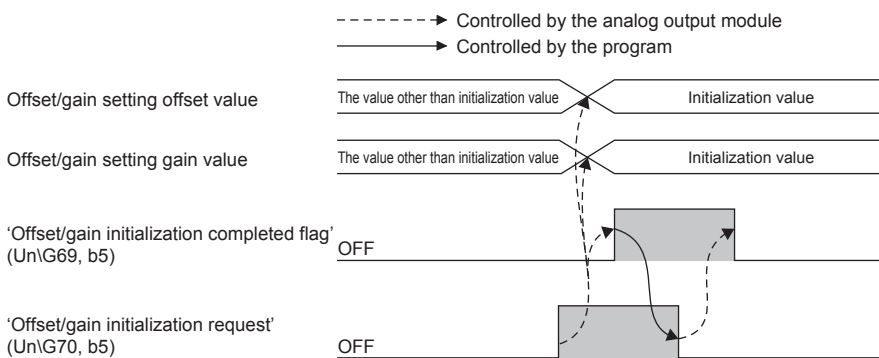

■External power supply READY flag (b7)

- When the external power supply is off

'External power supply READY flag' (Un\G69, b7) remains off and D/A conversion processing is not performed. In this case, the analog output value is 0 V/0 mA.

- When the external power supply is turned off and on

When the external power supply turns on, 'External power supply READY flag' (Un\G69, b7) turns on. The D/A conversion is started on the channels where the D/A conversion is enabled.

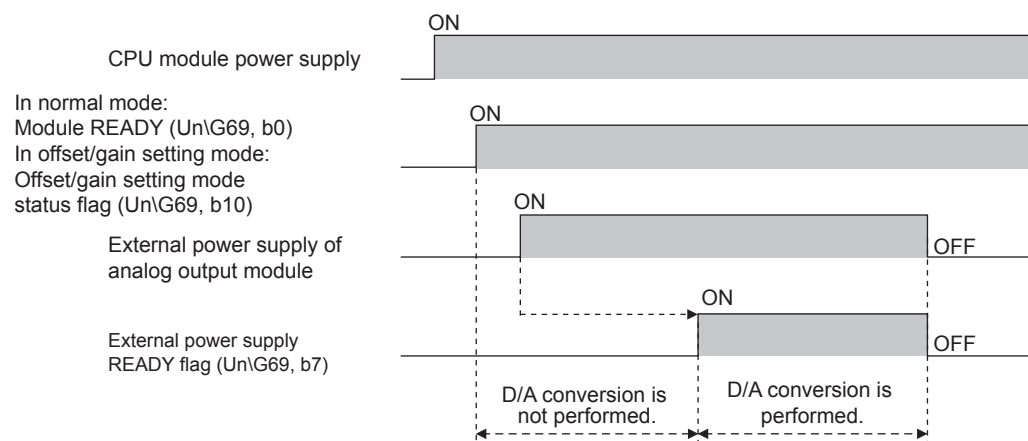

- When the external power supply is turned on and off

'External power supply READY flag' (Un\G69, b7) turns off and the D/A conversion stops. In this case, the analog output value is 0 V/0 mA. When the external power supply is turned off and on again, 'External power supply READY flag' (Un\G69, b7) turns on after 200ms as described above and the D/A conversion is restarted.

Precautions

Use the external power supply that satisfies the specifications defined in the "Power Supply Specifications" section.

Otherwise, 'External power supply READY flag' (Un\G69, b7) does not turn on. For the power supply specifications, refer to

Page 178 Power supply specifications.

■Operating condition setting completed flag (b9)

When changing values of the buffer memory, use 'Operating condition setting completed flag' (Un\G69, b9) as an interlock condition to turn on and off 'Operating condition setting request' (Un\G70, b9).

For the buffer memory addresses which require turning on and off of 'Operating condition setting request' (Un\G70, b9) to enable the changed values, refer to the following.

☞ Page 287 Buffer Memory Areas

When 'Operating condition setting request' (Un\G70, b9) is on, 'Operating condition setting completed flag' (Un\G69, b9) turns off.

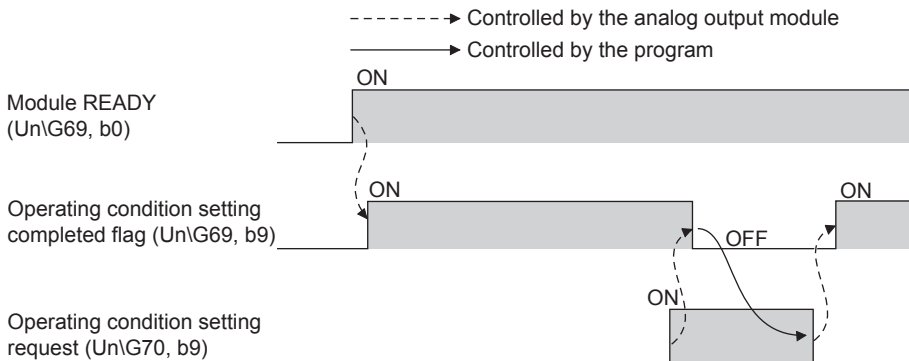

■Offset/gain setting mode status flag (b10)

When registering the value, which has been adjusted with the offset/gain setting, use 'Offset/gain setting mode status flag' (Un\G69, b10) as an interlock condition to turn on and off 'User range write request' (Un\G70, b10).

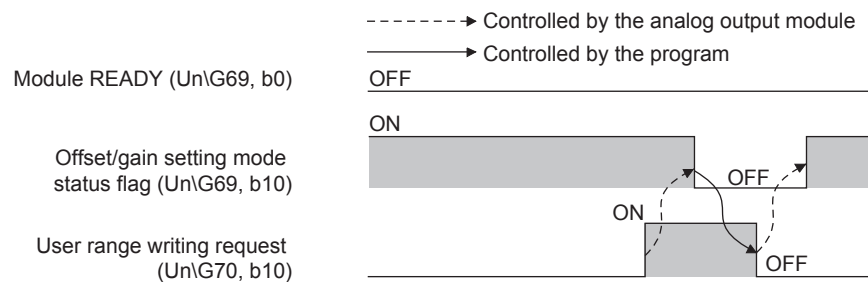

■Channel change completed flag (b11)

When changing a channel to perform the offset/gain setting, use 'Channel change completed flag' (Un\G69, b11) as an interlock condition to turn on and off 'Channel change request' (Un\G70, b11).

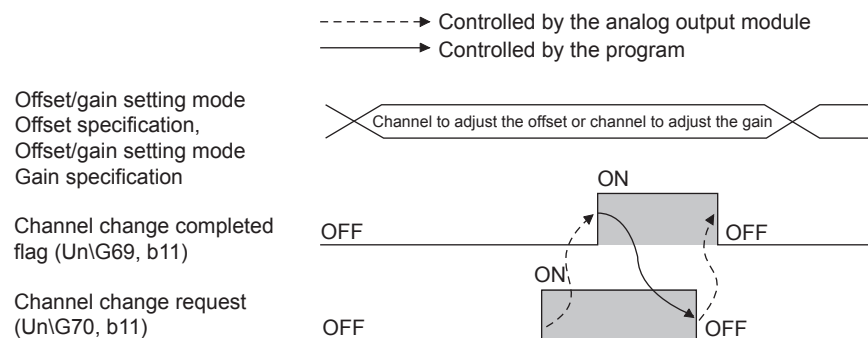

■Set value change completed flag (b12)

When adjusting the offset gain setting, use 'Set value change completed flag' (Un\G69, b12) as an interlock condition to turn on and off 'Value change request' (Un\G70, b12).

When the external power supply is off, the 'Set value change completed flag' (Un\G69, b12) does not turn on. After turning on the external power supply, turn on and off again 'Value change request' (Un\G70, b12).

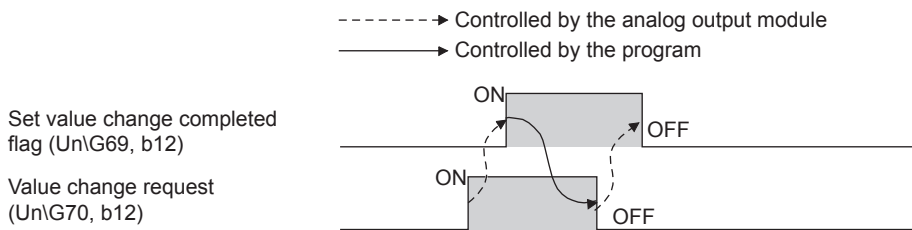

■Disconnection detection signal (b13)

'Disconnection detection signal' (Un\G69, b13) turns on when a disconnection is detected in a channel while the current of 4 to 20 mA, 0 to 20 mA, or user range is in use.

If disconnection detection auto-clear enable/disable setting is disable, 'Disconnection detection signal' (Un\G69, b13) turns off by turning on and off 'Error clear request' (Un\G70, b15) or 'Operating condition setting request' (Un\G70, b9) after the cause of the disconnection is eliminated.

When the cause of disconnection is eliminated if disconnection detection auto-clear enable/disable setting is enable, the disconnection detection signal automatically turns off.

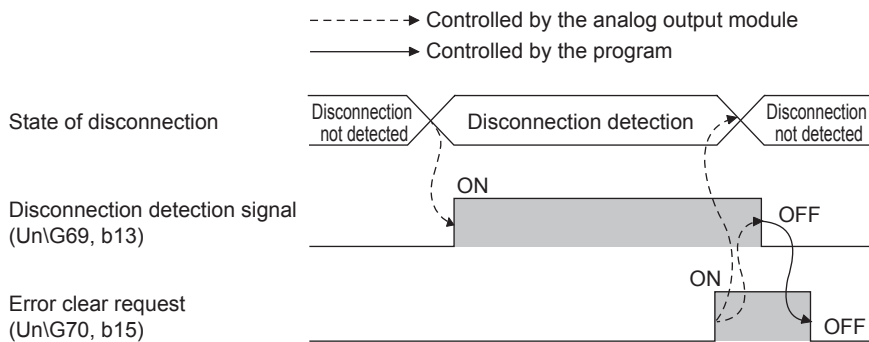

■Alarm output signal (b14)

If the D/A conversion is enabled, this signal turns on when the 'CH1 Digital value' (Un\G460) exceeds 'CH1 Alarm output upper limit value' (Un\G510) or falls below 'CH1 Alarm output lower limit value' (Un\G512).

By turning on and off 'Alert output clear request' (Un\G70, b14) or turning off and on 'Operating condition setting request' (Un\G70, b9) after the cause of the warning is eliminated, 'Alert output signal' (Un\G69, b14) turns off and 'Latest alarm code' (Un\G2) is cleared.

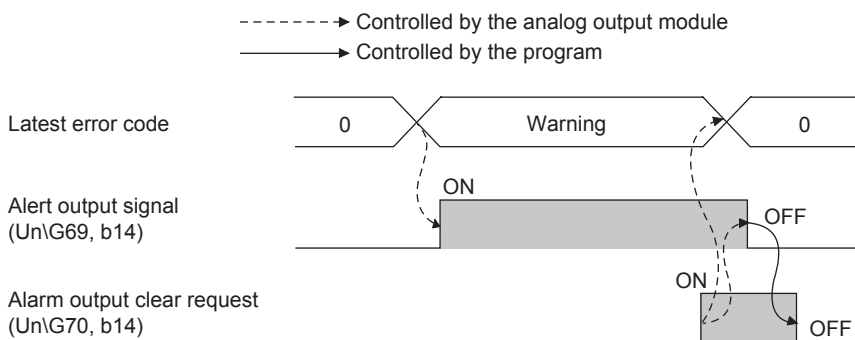

■Error flag (b15)

'Error flag' (Un\G69, b15) turns on when an error occurs.

By turning on and off 'Error clear request' (Un\G70, b15) after the cause of the error is eliminated, 'Error flag' (Un\G69, b15) turns off and 'Latest error code' (Un\G0) is cleared.

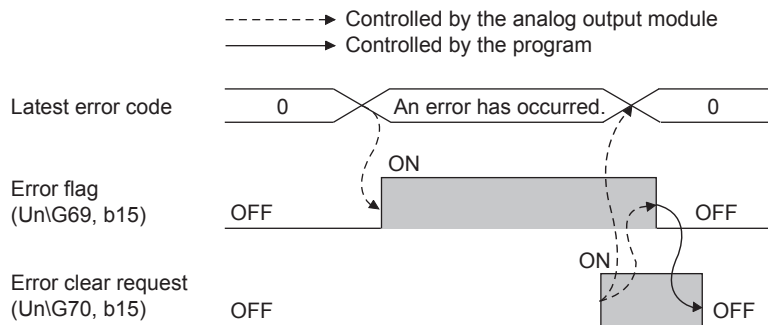

Output signals

A state of FX5-4DA can be checked in the buffer memory area.

■Buffer memory address

The following shows the buffer memory address of this area.

Buffer memory name	CH1	CH2	CH3	CH4
Output signals	70			
Output signals (In FX3 allocation mode function)	70			

■List of output signals

Buffer memory	Description
b0	Use not allowed
b1	CH1 Output enable/disable flag
b2	CH2 Output enable/disable flag
b3	CH3 Output enable/disable flag
b4	CH4 Output enable/disable flag
b5	Offset/gain initialization request
b6 to 8	Use not allowed
b9	Operating condition setting request
b10	User range write request
b11	Channel change request
b12	Value change request
b13	Use not allowed
b14	Alert output clear request
b15	Error clear request

■CH1-4 Output enable/disable flag (b1-4)

Set whether to output the D/A conversion value or offset value.

ON: D/A conversion value

OFF: Offset value

■Offset/gain initialization request (b5)

Turn on and off to enable the settings of buffer memory areas.

Offset/gain initialization is not to be performed unless offset/gain initialization enabled code is set to E20FH.

It is possible to perform offset/gain initialization in normal mode only.

When 'Offset/gain initialization request' (Un\G70, b5) is off, 'Offset/gain initialization complete flag' (Un\G69, b5) turns off.

■Operating condition setting request (b9)

Turn on and off 'Operating condition setting request' (Un\G70, b9) to enable the setting of the buffer memory address.

For the timing of turning the signal on and off, refer to the following.

☞ Page 304 Operating condition setting completed flag (b9)

■User range write request (b10)

In the offset/gain setting mode, turn on and off 'User range write request' (Un\G70, b10) to register the values adjusted with offset/gain setting in an analog output module. The data is written to the flash memory when this signal is turned off and on.

For the timing of turning the signal on and off, refer to the following.

☞ Page 304 Offset/gain setting mode status flag (b10)

■Channel change request (b11)

Turn on and off 'Channel change request' (Un\G70, b11) to change a channel to perform the offset/gain setting.

For the timing of turning the signal on and off, refer to the following.

☞ Page 304 Channel change completed flag (b11)

■Value change request (b12)

Turn on and off 'Value change request' (Un\G70, b12) to change the analog output value to adjust the offset/gain setting.

The analog output value increases or decreases depending on the value set for the offset/gain adjustment value specification.

For the timing of turning the signal on and off, refer to the following.

☞ Page 305 Set value change completed flag (b12)

■Alarm output clear request (b14)

When clearing the alarm output, turn on and off this signal.

For the timing of turning the signal on and off, refer to the following.

☞ Page 305 Alarm output signal (b14)

■Error clear request (b15)

Turn on and off 'Error clear request' (Un\G70, b15) to clear 'Error flag' (Un\G69, b15), 'Latest error code' Un\G0, and 'Latest alarm code' (Un\G2).

For the timing of turning the signal on and off, refer to the following.

☞ Page 306 Error flag (b15)



Interrupt factor mask [n]

Set Interrupt factor mask to be used.

Setting value	Setting content
0	Mask (Interrupt unused)
1	Mask clear (Interrupt used)

When 'Interrupt factor mask [n]' (Un\G124 to G139) is set to Mask clear (Interrupt used) (1) and an interrupt factor occurs, an interrupt request is sent to the CPU module. When the set value is two or larger, the setting is regarded as Mask clear (Interrupt used) (1).

"n" indicates an interrupt setting number. (n = 1 to 16)

■Buffer memory address

The following shows the buffer memory address of this area.

Buffer memory name	1	2	3	4	5	6	7	8	9	10	11	12	13	14	15	16
Interrupt factor mask [n]	124	125	126	127	128	129	130	131	132	133	134	135	136	137	138	139
Interrupt factor mask [n] (in FX3 allocation mode function)	4021	4022	4023	4024	4025	4026	4027	4028	4029	4030	4031	4032	4033	4034	4035	4036

■Default value

The default value is Mask (Interrupt unused) (0) for buffer memory areas.

Interrupt factor reset request [n]

An interrupt factor reset request is sent.

Setting value	Setting content
0	No reset request
1	Reset request

When Reset request (1) is set to 'Interrupt factor reset request [n]' (Un\G156 to Un\G171) corresponding to the interrupt factor, the interrupt factor corresponding to the specified interrupt is reset. After that, 'Interrupt factor detection flag [n]' (Un\G4 to Un\G19) turns to 'No interrupt factor' (0). When the set value is two or larger, the setting is regarded as Reset request (1).

Interrupt factors can also be reset by turning on and off 'Operating condition setting request' (Un\G70, b9).

"n" indicates an interrupt setting number. (n = 1 to 16)

■Buffer memory address

The following shows the buffer memory address of this area.

Buffer memory name	1	2	3	4	5	6	7	8	9	10	11	12	13	14	15	16
Interrupt factor reset request [n]	156	157	158	159	160	161	162	163	164	165	166	167	168	169	170	171
Interrupt factor reset request [n] (in FX3 allocation mode function)	4041	4042	4043	4044	4045	4046	4047	4048	4049	4050	4051	4052	4053	4054	4055	4056

■Default value

The default value is No reset request (0) for buffer memory areas.

Step action wave output request

Set whether to execute the step action wave output for all the analog output channels in a batch.

Step action wave output request	Setting value
OFF	0
ON	1

The setting for this area is enabled only in the wave output mode. In other modes, changing the setting value is ignored.

When the setting value is changed from OFF (0) to ON (1), the wave output status in all the channels, where the D/A conversion is enabled, is changed to During wave output step action and the wave output step action function is enabled.

When the setting value is changed from ON (1) to OFF (0), the wave output status is changed to During wave output stop and the wave output step action ends.

When a value out of the setting range is set, a step action wave output request range error (error code: 1D80H) occurs and the wave output status is not changed.

■Buffer memory address

The following shows the buffer memory address of this area.

Buffer memory name	CH1	CH2	CH3	CH4
Step action wave output request	188			
Step action wave output request (in FX3 allocation mode function)	9000			

■Default value

The default value is OFF (0).

Interrupt factor generation setting [n]

Set an interrupt request for when the same interrupt factor occurs during the interrupt factor detection.

Setting value	Setting content
0	Interrupt resend request
1	No interrupt resend request

- When 'Interrupt factor generation setting [n]' (Un\G200 to Un\G215) is Interrupt resend request (0) and the same interrupt factor occurs during the interrupt factor detection, an interrupt request is sent to the CPU module again.
- When 'Interrupt factor generation setting [n]' (Un\G200 to Un\G215) is No interrupt resend request (1) and the same interrupt factor occurs during the interrupt factor detection, an interrupt request is not sent to the CPU module.

If a value other than the above is set, an interrupt factor generation setting range error (error code: 180△H) occurs.

"n" and △ indicate an interrupt setting number. (n = 1 to 16, △ = 0 to F)

■Buffer memory address

The following shows the buffer memory address of this area.

Buffer memory name	1	2	3	4	5	6	7	8	9	10	11	12	13	14	15	16
Interrupt factor generation setting [n]	200	201	202	203	204	205	206	207	208	209	210	211	212	213	214	215
Interrupt factor generation setting [n] (in FX3 allocation mode)	4061	4062	4063	4064	4065	4066	4067	4068	4069	4070	4071	4072	4073	4074	4075	4076

■Enabling the setting

Turn on and off 'Operating condition setting request' (Un\G70, b9) to enable the setting.

■Default value

The default value is Interrupt resend request (0) for all buffer memory areas.

Condition target setting [n]

Set an interrupt factor to be detected.

Setting value	Setting content
0	Disable
1	Error flag (Un\G69, b15)
2	Alert output flag
3	Disconnection detection flag
4	External power supply READY flag (Un\G69, b7)

If a value other than the above is set, a condition target setting range error (error code: 181△H) occurs.

Turning off and on 'Error flag', 'Alarm output flag' and 'Disconnection detection flag' set in 'Condition target setting [n]' (Un\G232 to Un\G247) or turning on and off 'External power supply READY flag' set in 'Condition target setting [n]' (Un\G232 to Un\G247) send an interrupt request for the CPU module.

"n" and △ indicate an interrupt setting number. (n = 1 to 16, △ = 0 to F)

■Buffer memory address

The following shows the buffer memory address of this area.

Buffer memory name	1	2	3	4	5	6	7	8	9	10	11	12	13	14	15	16
Condition target setting [n]	232	233	234	235	236	237	238	239	240	241	242	243	244	245	246	247
Condition target setting [n] (in FX3 allocation mode function)	4081	4082	4083	4084	4085	4086	4087	4088	4089	4090	4091	4092	4093	4094	4095	4096

■Enabling the setting

Turn on and off 'Operating condition setting request' (Un\G70, b9) to enable the setting.

■Default value

The default value is Disable (0) for all buffer memory areas.

Condition target channel setting [n]

Set a channel where an interrupt is detected.

Setting value	Setting content
0	All specification
1	CH1
2	CH2
3	CH3
4	CH4

When a factor for the channel specification is set to 'Condition target setting [n]' (Un\G232 to Un\G247), an interrupt factor in the channel set by this area is monitored. If a value other than the above is set, a condition target setting range error (error code: 182△H) occurs.

"n" and △ indicates an interrupt setting number. (n = 1 to 16, △ = 0 to F)

■Buffer memory address

The following shows the buffer memory address of this area.

Buffer memory name	1	2	3	4	5	6	7	8	9	10	11	12	13	14	15	16
Condition target channel setting [n]	264	265	266	267	268	269	270	271	272	273	274	275	276	277	278	279
Condition target channel setting [n] (in FX3 allocation mode function)	4160	4161	4162	4163	4164	4165	4166	4167	4168	4169	4170	4171	4172	4173	4174	4175

■Enabling the setting

Turn on and off 'Operating condition setting request' (Un\G70, b9) to enable the setting.

■Default value

The default value is All CH specification (0) for all buffer memory areas.

Mode switching setting

Set a setting value for the mode to be switched.

Destination mode	Buffer memory address	Setting value
Normal output mode	296	4658H
	297	4441H
Offset/gain setting mode	296	4441H
	297	4658H

When a value other than the above is set, the mode switching is not executed and only the operating condition is changed. In this case, this area is cleared to 0.

■Buffer memory address

The following shows the buffer memory address of this area.

Buffer memory name	CH1	CH2	CH3	CH4
Mode switching setting	296, 297			
Mode switching setting (in FX3 allocation mode function)	4121, 4122			

■Enabling the setting

Turn on 'Operating condition setting request' (Un\G70, b9).

■After the mode is switched

When the mode is switched, this area is cleared to 0 and 'Operating condition setting completed flag' (Un\G69, b9) turns off. After checking that 'Operating condition setting completed flag' (Un\G69, b9) is off, turn off 'Operating condition setting request' (Un\G70, b9).

■Default value

The default value is 0.

Disconnection detection automatic clear enable/disable setting

Set whether to enable or disable an automatic clear of disconnection detection of the disconnection detection function. The setting is enable only in the normal output mode.

Setting value	Description
0	Enable
1	Disable

Setting a value other than in the table above results in operation with Disable (1).

■Buffer memory address

The following shows the buffer memory address of this area.

Buffer memory area name	CH1	CH2	CH3	CH4
Disconnection detection automatic clear enable/disable setting	304			
Disconnection detection auto-clear enable/disable setting (in FX3 allocation mode function)	3170			

■Enabling the setting

Turn on and off 'Operating condition setting request' (Un\G70, b9) to enable the setting.

■Default value

- In the normal mode: The default value is Disable (1) for all the channels.
- In the FX3 allocation mode: The default value is Enable (0) for all the channels.

Offset/gain initialization enable code

When the 'offset/gain initialization request' (Un\G70, b5) turns on from off by setting the enable code "E20FH" in this area at the time of initialization of offset/gain, the offset value and the gain value in the flash memory of the analog output module are initialized.

When setting anything other than "E20FH" in this area, initialization is not executed.

■Buffer memory address

The following shows the buffer memory address of this area.

Buffer memory area name	CH1	CH2	CH3	CH4
Offset/gain initialization enable code	305			
Offset/gain initialization enable code (In FX3 allocation mode function)	4160			

■Default value

The default value is 0.

CH1 Setting value check code

The check result of whether the set digital value is within the setting range can be checked.

The target values are 'CH1 Digital value' (Un\G460) in the normal output mode and the wave data to be output in the wave output mode.

When a digital value out of the setting range is written, one of the following check codes is stored.

Check code	Description
000FH	A digital value exceeding the upper limit of the setting range has been written.
00F0H	A digital value below the lower limit of the setting range has been written.
00FFH	A digital value falling short of the setting range and a digital value exceeding the upper limit setting range have been written. This check code may be stored when a check code is not reset.

Once the check code is stored, the code is not reset even when the digital value falls within the setting range.

To reset the check code, rewrite the digital value to a value within the setting range and turn on and off 'Error clear request' (Un\G70, b15).

Point

When the scaling function is used, the value of 'CH1 Digital value' (Un\G460) which has undergone a scale conversion is checked. Note that some errors may be observed in the target digital value for a check code to be stored due to the calculation error of scale conversion when a scale-converted value exceeds the setting range.

When a check code is stored in the wave output, the address of the wave data which is out of the setting range can be checked with 'CH1 Wave output digital value outside the range Address monitor' (Un\G440 to Un\G441).

■ Buffer memory address

The following shows the buffer memory address of this area.

Buffer memory name	CH1	CH2	CH3	CH4
CH□ Setting value check code	400	600	800	1000
CH□ Setting value check code (in FX3 allocation mode function)	3201	3202	3203	3204

CH1 Wave output status monitor

The wave output status can be checked.

Monitor value	Description
0H	During wave output stop
1H	During wave output
2H	Wave output pause
3H	During wave output step action

Only when the wave output function is used and the operation mode is normal mode, a value is stored in the area. Otherwise, 0 is stored.

■ Buffer memory address

The following shows the buffer memory address of this area.

Buffer memory name	CH1	CH2	CH3	CH4
CH□ Wave output status monitor	401	601	801	1001
CH□ Wave output status monitor (in FX3 allocation mode function)	9001	9002	9003	9004

CH1 Output status

The output status information can be checked.

Monitor value	Setting content
0	Output update inactive
1	Output update in progress

This area stores a value only in the normal output mode.

When outputting the D/A conversion value, output update in progress (1) is stored in the output status.

When the CPU module is put in STOP state, "Output update inactive" (0) is written automatically. If the CH□ Output enable/disable flag is turned on while the CPU module is in STOP state, the output status information is updated.

When 'Operating condition setting request' (Un\G70, b9) is turned on and off, the status returns to "Output update inactive" (0); when the D/A conversion value is output, the status changes to "Output update in progress" (1).

■Buffer memory address

The following shows the buffer memory addresses of this area.

Buffer memory area name	CH1	CH2	CH3	CH4
CH□ Output status	429	629	829	1029

Output status [FX3 allocation mode]

While the FX3 allocation mode function is in use, the output status can be checked.

The setting contents in FX3 allocation mode are as follows.

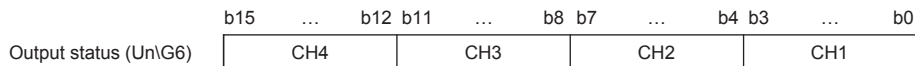

The following values are stored in the bits corresponding to each CH.

Monitor value	Setting content
0000	Output update inactive
0001	Output update in progress

This area stores a value only in the normal output mode.

When outputting the D/A conversion value, output update in progress (1) is stored in the output status.

When the CPU module is put in STOP state, "Output update inactive" (0) is written automatically. If the CH□ Output enable/disable flag is turned on while the CPU module is in STOP state, the output status information is updated.

When 'Operating condition setting request' (Un\G70, b9) is turned on and off, the status returns to "Output update inactive" (0); when the D/A conversion value is output, the status changes to "Output update in progress" (1).

■Buffer memory address

The following shows the buffer memory addresses of this area.

Buffer memory area name	CH1	CH2	CH3	CH4
Output status (in FX3 allocation mode function)	6			

CH1 Range setting monitor

The value of the output range set by 'CH1 range setting' (Un\G598) can be checked.

Monitor value	Description
0003H	4 to 20 mA
0002H	0 to 20 mA
0005H	1 to 5 V
0006H	0 to 5 V
0000H	-10 to +10 V
0007H	0 to 10 V
000DH	User range setting (voltage)
000EH	User range setting (current)

■Buffer memory address

The following shows the buffer memory addresses of this area.

Buffer memory area name	CH1	CH2	CH3	CH4
CH□ Range setting monitor	430	630	830	1030
CH□ Range setting monitor (in FX3 allocation mode function)	3211	3212	3213	3214

CH1 HOLD/CLEAR function setting monitor

The setting status of the HOLD/CLEAR function can be checked.

Monitor value	Description
0	CLEAR
1	Previous Value
2	Setting value

■Buffer memory address

The following shows the buffer memory addresses of this area.

Buffer memory area name	CH1	CH2	CH3	CH4
CH□ HOLD/CLEAR function setting monitor	431	631	831	1031
CH□ HOLD/CLEAR function setting monitor (in FX3 allocation mode function)	3221	3222	3223	3224

CH1 Wave output conversion cycle monitor

The wave output conversion cycle can be checked.

Only when the wave output function is used and the operation mode is normal mode, a value is stored in the area. Otherwise, 0 is stored.

The unit of the stored value is μs .

When 'Operating condition setting request' (Un\G70, b9) is turned on and off, the monitored value is updated.

■Buffer memory address

The following shows the buffer memory addresses of this area.

Buffer memory area name	CH1	CH2	CH3	CH4
CH□ Wave output conversion cycle monitor	432, 433	632, 633	832, 833	1032, 1033
CH□ Wave output conversion cycle monitor (in FX3 allocation mode function)	9010, 9011	9012, 9013	9014, 9015	9016, 9017

CH1 Wave pattern output count monitor

The output count of the wave pattern can be checked.

Only when the wave output function is used and the operation mode is normal mode, a value is stored in the area. Otherwise, 0 is stored.

The stored value increases by one every time one cycle of a wave pattern is output. The measuring range is from 0 to 32767. When the wave pattern output repetition setting is set to Unlimitedly repeat output, the count returns to 0 and starts again from 1 after the 32767th count. (...32766→32767→0→1→2...)

In the following cases, the stored value is reset.

- When 'Operating condition setting request' (Un\G70, b9) is turned on and off
- When the wave output status transitions from During wave output stop to another wave output status

■Buffer memory address

The following shows the buffer memory address of this area.

Buffer memory name	CH1	CH2	CH3	CH4
CH□ Wave pattern output count monitor	434	634	834	1034
CH□ Wave pattern output count monitor (in FX3 allocation mode function)	9030	9032	9034	9036

CH1 Wave output current address monitor

In the wave output mode, which data in the wave data registry area is D/A-converted and output can be checked.

Only in the wave output mode, the buffer memory address of the wave output data is stored in this area.

■Buffer memory address

The following shows the buffer memory address of this area.

Buffer memory name	CH1	CH2	CH3	CH4
CH□ Wave output current address monitor	436, 437	636, 637	836, 837	1036, 1037
CH□ Wave output current address monitor (in FX3 allocation mode function)	9050, 9051	9052, 9053	9054, 9055	9056, 9057

CH1 Wave output current digital value monitor

The digital value of the current output wave can be checked.

Only in the wave output mode, a value is stored in this area. The stored value differs depending on the wave output status. Otherwise, 0 is stored.

When 'Operating condition setting request' (Un\G70, b9) is turned on and off, the stored value is reset.

The stored value of when the D/A conversion and D/A output are enabled is shown. For the analog output in other statuses, refer to the following.

☞ Page 190 In the wave output mode

The following shows the correspondence relation between the wave output status and the stored value.

- During wave output stop

Output digital value selected in 'CH1 Output setting during wave output stop' (Un\G524)

Setting value of Output setting during wave output stop	Stored value
0 V/0 mA (0)	0
Offset value (1)	
Setting value during stop (2)	Setting value of 'CH1 Output value during wave output stop' (Un\G525)

- During wave output

Digital value stored in the buffer memory address indicated by 'CH1 Wave output current address monitor' (Un\G436 to Un\G437)

- Wave output pause

The value differs depending on the analog output HOLD/CLEAR setting.

Setting of analog output HOLD/CLEAR function	Stored value
Previous Value	Digital value stored in the buffer memory address indicated by 'CH1 waveform output current address monitor' (Un\G436 to Un\G437)
Setting value	Setting value for 'CH1 HOLD setting value' (Un\G596)
CLEAR	0

- During wave output step action

Digital value stored in the buffer memory address indicated with 'CH1 Wave output current address monitor' (Un\G436 to Un\G437)

■Buffer memory address

The following shows the buffer memory address of this area.

Buffer memory name	CH1	CH2	CH3	CH4
CH□ Wave output current digital value monitor	438	638	838	1038
CH□ Wave output current digital value monitor (in FX3 allocation mode function)	9070	9072	9074	9076

CH1 Wave output digital value out-of-range address monitor

When the digital value of the output wave data is out of the range, the buffer memory address of the wave data with a value out of the range can be checked.

Only in the wave output mode, a value is stored in this area. Otherwise, 0 is stored.

When the multiple wave data with a digital input value out of the setting range are detected, only the buffer memory address of the wave data detected first is stored.

When the first detection of a digital value out of the range occurs in a wave output status other than During wave output stop, the stored value is updated.

To reset this area, correct the wave data to a value within the available setting range. After that, turn on and off 'Error clear request' (Un\G70, b15) or 'Operating condition setting request' (Un\G70, b9) to reset this area.

■Buffer memory address

The following shows the buffer memory address of this area.

Buffer memory name	CH1	CH2	CH3	CH4
CH□ Wave output digital value out-of-range address monitor	440, 441	640, 641	840, 841	1040, 1041
CH□ Wave output digital value out-of-range address monitor (in FX3 allocation mode function)	9090, 9091	9092, 9093	9094, 9095	9096, 9097

CH1 Wave output warning address monitor

The buffer memory address of the wave data where a warning has occurred can be checked.

Only in the wave output mode, a value is stored in this area. Otherwise, 0 is stored.

When a warning has occurred in the multiple wave data, only the buffer memory address of the wave data where the warning occurred first is stored.

When the first warning occurs in a wave output status other than During wave output stop, the stored value is updated.

To reset this area, correct the wave data to a value within the setting range. After that, turn on and off 'Alert output clear request' (Un\G70, b14) or 'Operating condition setting request' (Un\G70, b9) to reset this area.

■Buffer memory address

The following shows the buffer memory address of this area.

Buffer memory name	CH1	CH2	CH3	CH4
CH□ Wave output warning address monitor	442, 443	642, 643	842, 843	1042, 1043
CH□ Wave output warning address monitor (in FX3 allocation mode function)	9110, 9111	9112, 9113	9114, 9115	9116, 9117

CH1 Digital value

Set the digital input value in 16-bit signed binary for the D/A conversion from the CPU module.

Output range setting	When the scaling function is disabled	When the scaling function is enabled*1
	Setting range (practical range)	Setting range
3: 4 to 20 mA	-768 to +32767 (practical range: 0 to 32000)	-32000 to +32000
2: 0 to 20 mA		
5: 1 to 5 V		
6: 0 to 5 V		
7: 0 to 10 V		
0: -10 to +10 V	-32768 to +32767 (practical range: -32000 to +32000)	
D: User range setting (voltage)		
E: User range setting (current)		

*1 The available setting range and practical range of when the scaling function is enabled differ depending on the setting of the scaling upper limit value and scaling lower limit value.

When a value out of the available setting range is written, the D/A conversion is performed with the upper or lower limit value of the available setting range.

A check code is stored in 'CH1 Setting value check code' (Un\G400) and a digital value setting range error (error code: 191□H) is stored in 'Latest error code' (Un\G0).

When the wave output function is selected, this area is disabled because registered wave data is output.

■Buffer memory address

The following shows the buffer memory address of this area.

Buffer memory name	CH1	CH2	CH3	CH4
CH□ Digital value	460	660	860	1060
CH□ Digital value (in FX3 allocation mode function)	1	2	3	4

CH1 Wave output start/stop request

This area is for requesting start or stop of wave output to the analog output module when the wave output function is used. The setting for this area is enabled only in the wave output mode. In other modes, changing the setting value is ignored.

Request	Setting value
Wave output stop request	0
Wave output start request	1
Wave output pause request	2

While 'Step action wave output request' (Un\G188) is set to ON (1), changing the setting value is ignored.

When 'Step action wave output request' (Un\G188) is changed from ON (1) to OFF (0), the wave output status changes to During wave output stop and Wave output stop request (0) is set for this area.

In the channel where a value out of the setting range is set, a wave output start/stop setting range error (error code: 1D1□H) occurs and 'Error flag' (Un\G69, b15) turns on. The operation of the wave output before the change continues.

■Buffer memory address

The following shows the buffer memory address of this area.

Buffer memory name	CH1	CH2	CH3	CH4
CH□ Wave output start/stop request	462	662	862	1062
CH□ Wave output start/stop request (in FX3 allocation mode function)	9131	9132	9133	9134

■Default value

The default value is Wave output stop request (0) for all channels.

CH1 Input value shift amount

The set value is added to the digital input value regardless of the on/off status of 'Operating condition setting request' (Un\G70, b9).

For the shift function, refer to the following.

☞ Page 194 Shift function

■Buffer memory address

The following shows the buffer memory address of this area.

Buffer memory name	CH1	CH2	CH3	CH4
CH□ Input value shift amount	480	680	880	1080
CH□ Input value shift amount (in FX3 allocation mode function)	3250	3252	3254	3256

■Setting range

The setting range is from -32768 to +32767.

■Default value

The default value is 0 for all channels.

CH1 Wave output step action movement amount

This area is for setting the wave output step action movement amount and for checking if the target has been obtained.

The value set in this area is subtracted from or added to the buffer memory address that has been storing the value and so the buffer memory address of Wave data registry area that has been storing the target digital value is specified. When a value is set in this area, the target address starts to be specified and when specifying the address is complete, No movement (0) is stored.

The setting for this area is enabled only when the following conditions are satisfied.

- In the wave output mode
- When During wave output step action (3) is stored in 'CH1 Wave output status monitor' (Un\G401).

Movement direction	Setting value
No movement	0
Forward movement (movement in the direction to increase the address)	1 to 30000
Reverse movement (movement in the direction to decrease the address)	-30000 to -1

The setting range is from -30000 to +30000. Even if a set value is out of the setting range, no error occurs. When a value smaller than -30000 is set, the value is processed as -30000. When a value greater than 30000 is set, the value is processed as 30000.

The following shows the available range for movement.

- "Wave pattern start address" to "Wave pattern start address" + "Wave pattern data points setting" - 1

If a value equal to or more than the wave pattern data points is set, only the data for the wave pattern data points is processed.

Set a value for the wave output step action movement amount. When specifying the address is complete, No movement (0) is stored in this area.

■Buffer memory address

The following shows the buffer memory address of this area.

Buffer memory name	CH1	CH2	CH3	CH4
CH□ Wave output step action movement amount	482	682	882	1082
CH□ Wave output step action movement amount (in FX3 allocation mode function)	9140	9142	9144	9146

■Default value

The default value is No movement (0) for all channels.

CH1 D/A conversion enable/disable setting

Set whether to enable or disable the D/A conversion.

For details on the D/A conversion enable/disable setting function, refer to the following.

 Page 187 D/A conversion enable/disable function

Setting value	Description
0	D/A conversion enabled
1	D/A conversion disabled

When a value other than the above is set, the value is processed as D/A conversion disable (1).

■Buffer memory address

The following shows the buffer memory address of this area.

Buffer memory name	CH1	CH2	CH3	CH4
CH□ D/A conversion enable/disable setting	500	700	900	1100
CH□ D/A conversion enable/disable setting (in F3 allocation mode function)	3271	3272	3273	3274

■Enabling the setting

Turn on and off 'Operating condition setting request' (Un\G70, b9) to enable the setting.

■Default value

- In the normal mode: The default value is D/A conversion disable (1) for all the channels.
- In the FX3 allocation mode: The default value is D/A conversion enable (0) for all the channels.

CH1 Scaling enable/disable setting

Set whether to enable or disable the scaling.

For the scaling function, refer to the following.

 Page 192 Scaling function

Setting value	Description
0	Enable
1	Disable

If a value other than the above is set, a scaling enable/disable setting range error (error code: 1A0□H) occurs.

The scaling function cannot be used when the wave output function is used. In the channel for which Enable (0) is set while the wave output function is being used, a scaling setting error in wave output mode (alarm code: 0B0□H) occurs.

■Buffer memory address

The following shows the buffer memory address of this area.

Buffer memory name	CH1	CH2	CH3	CH4
CH□ Scaling enable/disable setting	502	702	902	1102
CH□ Scaling enable/disable setting (In FX3 allocation mode function)	3281	3282	3283	3284

■Enabling the setting

Turn on and off 'Operating condition setting request' (Un\G70, b9) to enable the setting.

■Default value

The default value is Disable (1) for all the channels.

CH1 Scaling upper limit value

Set the range of scale conversion.

For the scaling function, refer to the following.

 Page 192 Scaling function

■Buffer memory address

The following shows the buffer memory address of this area.

Buffer memory name	CH1	CH2	CH3	CH4
CH□ Scaling upper limit value	504, 505	704, 705	904, 905	1104, 1105
CH□ Scaling upper limit value (In FX3 allocation mode function)	3290, 3291	3292, 3293	3294, 3295	3296, 3297

■Setting range

The setting range is from -2147483648 to +2147483647. In the channel where a set value does not satisfy the condition "scaling upper limit value \neq scaling lower limit value", a scaling upper/lower limit value setting error (error code: 1A2□H) occurs.

When 'CH1 Scaling enable/disable setting' (Un\G502) is set to Disable (1), the setting for 'CH1 Scaling upper limit value' (Un\G504, 505) is ignored.

■Enabling the setting

Turn on and off 'Operating condition setting request' (Un\G70, b9) to enable the setting.

■Default value

The default value is 0 for all channels.

CH1 Scaling lower limit value

Set the range of scale conversion.

For the scaling function, refer to the following.

 Page 192 Scaling function

■Buffer memory address

The following shows the buffer memory address of this area.

Buffer memory name	CH1	CH2	CH3	CH4
CH□ Scaling lower limit value	506, 507	706, 707	906, 907	1106, 1107
CH□ Scaling lower limit value (In FX3 allocation mode function)	3310, 3311	3312, 3313	3314, 3315	3316, 3317

■Setting range

The setting range is from -2147483648 to +2147483647. In the channel where a set value does not satisfy the condition "scaling upper limit value \neq scaling lower limit value", a scaling upper/lower limit value setting error (error code: 1A2□H) occurs.

When 'CH1 Scaling enable/disable setting' (Un\G502) is set to Disable (1), the setting for 'CH1 Scaling lower limit value' (Un\G506, 507) is ignored.

■Enabling the setting

Turn on and off 'Operating condition setting request' (Un\G70, b9) to enable the setting.

■Default value

The default value is 0 for all channels.

CH1 Alarm output setting

Set whether to enable or disable the alarm output.

For the alarm output function, refer to the following.

☞ Page 196 Alert output function

Setting value	Description
0	Disable
1	Enabled (no output limit)
2	Enable (with output limit)

Setting a value other than the above causes an alarm output setting range error (error code: 1B0□H).

■Buffer memory address

The following shows the buffer memory address of this area.

Buffer memory name	CH1	CH2	CH3	CH4
CH□ Alarm output setting	508	708	908	1108

■Enabling the setting

Turn on and off 'Operating condition setting request' (Un\G70, b9) to enable the setting.

■Default value

The default value is Disable (0) for all the channels.

Alarm output setting [FX3 allocation mode]

Set whether to enable or disable disconnection detection or alarm output while the FX3 allocation mode function is in use.

The setting contents in FX3 allocation mode are as follows.

b15	b14	b13	b12	b11	b10	b9	b8	b7	b6	b5	b4	b3	b2	b1	b0
CH4				CH3				CH2				CH1			

Set the following setting values for the bits corresponding to each CH.

Setting value	Description
0000	Disable
0001	Enabled (no output limit)
0010	Enable (with output limit)

Setting a value other than the above causes an alarm output setting range error (error code: 1B0□H).

■Buffer memory address

The following shows the buffer memory address of this area.

Buffer memory name	CH1	CH2	CH3	CH4
Alarm output setting [in FX3 allocation mode function]	38			

■Enabling the setting

Turn on and off 'Operating condition setting request' (Un\G70, b9) to enable the setting.

■Default value

The default value is Disable (0) for all the channels.

CH1 Rate control enable/disable setting

Set whether to enable or disable rate control.

For the rate control function, refer to the following.

 Page 198 Rate control function

Setting value	Description
0	Enable
1	Disable

If a value other than the above is set, a rate control enable/disable setting range error (error code: 1B8□H) occurs.

The rate control function cannot be used when the wave output function is used. In the channel for which Enable (0) is set while the wave output function is being used, a rate control setting error in wave output mode (alarm code: 0B3□H) occurs.

■Buffer memory address

The following shows the buffer memory address of this area.

Buffer memory name	CH1	CH2	CH3	CH4
CH□ Rate control enable/disable setting	509	709	909	1109
CH□ Rate control enable/disable setting (in FX3 allocation mode function)	3331	3332	3333	3334

■Enabling the setting

Turn on and off 'Operating condition setting request' (Un\G70, b9) to enable the setting.

■Default value

The default value is Disable (1) for all channels.

CH1 Alarm output upper limit value

Set the range of a digital value used for alarm output.

For the alarm output function, refer to the following.

 Page 196 Alert output function

■Buffer memory address

The following shows the buffer memory address of this area.

Buffer memory name	CH1	CH2	CH3	CH4
CH□ Alarm output upper limit value	510	710	910	1110
CH□ Alarm output upper limit value (in FX3 allocation mode function)	45	46	47	48

■Setting range

The setting range is from -32768 to +32767. In the channel where a set value does not satisfy the condition "alert output upper limit value > alert output lower limit value", an alert output upper/lower limit value inversion error (error code: 1B1□H) occurs. When 'CH1 Alert output setting' (Un\G508) is set to Disable (1), the setting of 'CH1 Alert output upper limit value' (Un\G510) is ignored.

■Enabling the setting

Turn on and off 'Operating condition setting request' (Un\G70, b9) to enable the setting.

■Default value

The default value is 0 for all channels.

■Precautions

When the shift function is used, always set a value in consideration of 'CH1 Input value shift amount' (Un\G480).

CH1 Alarm output lower limit value

Set the range of a digital value used for alarm output.

For the alarm output function, refer to the following.

☞ Page 196 Alert output function

■Buffer memory address

The following shows the buffer memory address of this area.

Buffer memory name	CH1	CH2	CH3	CH4
CH□ Alarm output lower limit value	512	712	912	1112
CH□ Alarm output lower limit value (in FX3 allocation mode function)	41	42	43	44

■Setting range

The possible setting range is from -32768 to +32767. A channel for which any value not meeting the condition of "alarm output upper limit value > alarm output lower limit value" causes an alarm output upper/lower limit value reverse error (error code: 1B1□H).

If 'CH1 alarm output setting' (Un\G508) is set to Disable (1), the setting for 'CH1 alarm output lower limit value' (Un\G512) will be ignored.

■Enabling the setting

Turn on and off 'Operating condition setting request' (Un\G70, b9) to enable the setting.

■Default value

The default value is 0 for all channels.

■Precautions

When the shift function is used, always set a value in consideration of 'CH1 Input value shift amount' (Un\G480).

CH1 Increase digital limit value

Set the increment value per conversion cycle (80 μs) when using the rate control function.

For the rate control function, refer to the following.

☞ Page 198 Rate control function

■Buffer memory address

The following shows the buffer memory address of this area.

Buffer memory name	CH1	CH2	CH3	CH4
CH□ Increase digital limit value	514	714	914	1114
CH□ Increase digital limit value (in FX3 allocation mode function)	3340	3342	3344	3346

■Setting range

The setting range is from 0 to 64000 (FA00H). If a value out of the setting range is set for a channel where the conversion and rate control are enabled, a digital limit value range error (error code: 1B9□H) occurs.

When the scaling setting is enabled, the increase digital limit value of the input digital value converted within the scaling range is applied.

■Enabling the setting

Turn on and off 'Operating condition setting request' (Un\G70, b9) to enable the setting.

■Default value

The default value is 64000 for all channels.

■Precautions

When a value exceeding 32767 is set in 'CH1 Increase digital limit value' (Un\G514) with the program, the value must be input in hexadecimal.

CH1 Decrease digital limit value

Set the decrement value per conversion cycle (80 μ s) when using the rate control function.

For the rate control function, refer to the following.

 Page 198 Rate control function

■Buffer memory address

The following shows the buffer memory address of this area.

Buffer memory name	CH1	CH2	CH3	CH4
CH□ Decrease digital limit value	516	716	916	1116
CH□ Decrease digital limit value (in FX3 allocation mode function)	3360	3362	3364	3366

■Setting range

The setting range is from 0 to 64000 (FA00H). If a value out of the setting range is set for a channel where the conversion and rate control are enabled, a digital limit value range error (error code: 1B9□H) occurs.

When the scaling setting is enabled, the decrease digital limit value of the input digital value converted within the scaling range is applied.

■Enabling the setting

Turn on and off 'Operating condition setting request' (Un\G70, b9) to enable the setting.

■Default value

The default value is 64000 for all channels.

■Precautions

When a value exceeding 32767 is set in 'CH1 Decrease digital limit value' (Un\G516) with the program, the value must be input in hexadecimal.

CH1 Output setting during wave output stop

Select the output during wave output stop when the wave output function is used.

The setting for this area is enabled only in the wave output mode. In other modes, changing the setting value is ignored.

Analog output	Setting value
0 V/0 mA	0
Offset value	1
Output value during wave output stop ^{*1}	2

*1 Set value of 'CH1 Output value during wave output stop' (Un\G525)

In the channel where a value out of the setting range is set, an output setting during wave output stop setting range error (error code: 1D2□H) occurs and 'Error flag' (Un\G69, b15) turns on. The operation of the wave output before the change continues.

When Output value during wave output stop (2) is set for this area, set a value in 'CH1 Output value during wave output stop' (Un\G525).

■Buffer memory address

The following shows the buffer memory address of this area.

Buffer memory name	CH1	CH2	CH3	CH4
CH□ Output setting during wave output stop	524	724	924	1124
CH□ Output setting during wave output stop (in FX3 allocation mode function)	9161	9162	9163	9164

■Enabling the setting

Turn on and off 'Operating condition setting request' (Un\G70, b9) to enable the setting.

■Default value

The default value is the offset value (1) for all the channels.

CH1 Output value during wave output stop

This area is for setting the value to be output when Output value during wave output stop (2) is set in 'CH1 Output setting during wave output stop' (Un\G524).

The setting for this area is enabled only in the wave output mode. In other modes, changing the setting value is ignored. The setting range depends on the set output range. Configure the setting in the following range.

Output range	Setting range
6: 0 to 5V	0 to 32767 (practical range: 0 to 32000)
5: 1 to 5V	
2: 0 to 20mA	
3: 4 to 20mA	
7: 0 to 10 V	
0: -10 to +10V	-32768 to +32767 (practical range: -32000 to +32000)

In the channel where a value out of the setting range is set, an output value during wave output stop setting range error (error code: 1D3□H) occurs and 'Error flag' (Un\G69, b15) turns on. The wave output does not start.

However, when a value other than Output value during wave output stop (2) is set in 'CH1 Output setting during wave output stop' (Un\G524), the above error does not occur.

Since the default value is 0, change the setting value if 'CH1 Output setting during wave output stop' (Un\G524) is set to Output value during wave output stop (2).

■Buffer memory address

The following shows the buffer memory address of this area.

Buffer memory name	CH1	CH2	CH3	CH4
CH□ Output value during wave output stop	525	725	925	1125
CH□ Output value during wave output stop (in FX3 allocation mode function)	9171	9172	9173	9174

■Enabling the setting

Turn on and off 'Operating condition setting request' (Un\G70, b9) to enable the setting.

■Default value

The default value is 0 for all channels.

CH1 Wave pattern start address setting

This area is for setting the start address of the wave pattern to be output when the wave output function is used.

The setting for this area is enabled only in the wave output mode. In other modes, changing the setting value is ignored.

In the channel where the set values in this area and in 'CH1 Wave pattern data points setting' (Un\G528, Un\G529) satisfy the following conditions, a wave data registry area range error (error code: 1D9□H) occurs and 'Error flag' (Un\G69, b15) turns on. The wave output does not start.

(Wave pattern start address setting + Wave pattern data points setting - 1) > 89999 (the last buffer memory address of the wave data registry area)

■Buffer memory address

The following shows the buffer memory address of this area.

Buffer memory name	CH1	CH2	CH3	CH4
CH□ Wave pattern start address setting	526, 527	726, 727	926, 927	1126, 1127
CH□ Wave pattern start address setting (in FX3 allocation mode function)	9180, 9181	9182, 9183	9184, 9185	9186, 9187

■Setting range

The possible setting range is from 10000 to 89999. (10000 to 89999 of buffer memory)

In the channel where a value out of the setting range is set, a wave pattern start address setting range error (error code: 1D4□H) occurs and 'Error flag' (Un\G69, b15) turns on. The wave output does not start.

■Enabling the setting

Turn on and off 'Operating condition setting request' (Un\G70, b9) to enable the setting.

■Default value

The default value is 10000 for all channels.

CH1 Wave pattern data points setting

This area is for setting the data points of the wave pattern to be output when the wave output function is used.

The setting for this area is enabled only in the wave output mode. In other modes, changing the setting value is ignored.

In the channel where the set values in this area and in 'CH1 Wave pattern data points setting' (Un\G528, Un\G529) satisfy the following conditions, a wave data registry area range error (error code: 1D9□H) occurs and 'Error flag' (Un\G69, b15) turns on. The wave output does not start.

(Wave pattern start address setting + Wave pattern data points setting - 1) > 89999 (the last buffer memory address of the wave data registry area)

■Buffer memory address

The following shows the buffer memory address of this area.

Buffer memory name	CH1	CH2	CH3	CH4
CH□ Wave pattern data points setting	528, 529	728, 729	928, 929	1128, 1129
CH□ Wave pattern data points setting (in FX3 allocation mode function)	9200, 9201	9202, 9203	9204, 9205	9206, 9207

■Setting range

The setting range is from 1 to 80000 (the number of data points of the wave data registry area).

In the channel where a value out of the setting range is set, a wave pattern data points setting range error (error code: 1D5□H) occurs and 'Error flag' (Un\G69, b15) turns on. The wave output does not start.

However, when the value of 'CH1 Wave pattern start address setting' (Un\G526, Un\G527) is out of the setting range, the above error does not occur.

■Enabling the setting

Turn on and off 'Operating condition setting request' (Un\G70, b9) to enable the setting.

■Default value

The default value is 0 for all channels.

CH1 Wave pattern output repetition setting

This area is for setting the number of wave pattern outputs when the wave output function is used.

The setting for this area is enabled only in the wave output mode. In other modes, changing the setting value is ignored.

Setting value	Description
-1	The wave pattern is output in analog unlimitedly.
1 to 32767	The wave pattern is output in analog for the set number.

In the channel where a value out of the setting range is set, a wave pattern output repetition setting range error (error code: 1D6□H) occurs and 'Error flag' (Un\G69, b15) turns on. The wave output does not start.

■Buffer memory address

The following shows the buffer memory address of this area.

Buffer memory name	CH1	CH2	CH3	CH4
CH□ Wave pattern output repetition setting	530	730	930	1130
CH□ Wave pattern output repetition setting (in FX3 allocation mode function)	9221	9222	9223	9224

■Enabling the setting

Turn on and off 'Operating condition setting request' (Un\G70, b9) to enable the setting.

■Default value

The default value is 1 (once) for all channels.

CH1 Constant for wave output conversion cycle

This area is for setting the constant to determine the conversion cycle (specifying a multiple of the conversion speed) for each channel when the wave output function is used.

The setting for this area is enabled only in the wave output mode. In other modes, changing the setting value is ignored.

The conversion cycle of each channel is determined from the combination of the reference conversion speed (80 μs), number of channels where D/A conversion is enabled, and the constant for wave output conversion cycle.

- "Conversion cycle" = "Reference conversion speed (80 μs) × "Number of channels where D/A conversion is enabled" × "Constant for wave output conversion cycle"

■Buffer memory address

The following shows the buffer memory address of this area.

Buffer memory name	CH1	CH2	CH3	CH4
CH□ Constant for wave output conversion cycle	531	731	931	1131
CH□ Constant for wave output conversion cycle (in FX3 allocation mode function)	9231	9232	9233	9234

■Setting range

The possible setting range is from 1 to 5000.

In the channel where a value out of the setting range is set, a wave output conversion cycle setting range error (error code: 1D7□H) occurs and 'Error flag' (Un\G69, b15) turns on. The wave output does not start.

■Enabling the setting

Turn on and off 'Operating condition setting request' (Un\G70, b9) to enable the setting.

■Default value

The default value is 1 for all channels.

CH1 HOLD setting value

When the setting value (2) is set for the analog output HOLD/CLEAR function setting, this area is used to set the output value.

Output range setting	When the scaling function is disabled	When the scaling function is enabled ^{*1}
	Setting range (practical range)	Setting range
4 to 20 mA	0 to 32767 (practical range: 0 to 32000)	-32000 to +32000
0 to 20 mA		
1 to 5 V		
0 to 5 V		
0 to 10 V		
-10 to +10 V	-32768 to +32767 (practical range: -32000 to +32000)	
User range setting (voltage)		
User range setting (current)		

*1 The setting and practical ranges applied when the scaling function is enabled depend on the setting of the upper and lower scaling limit values.

Any channel for which a value out of the range is set causes a HOLD setting value range error (error code: 192□H). However, the error will not occur unless the HOLD/CLEAR function setting is the setting value (2).

■Buffer memory address

The following shows the buffer memory address of this area.

Buffer memory name	CH1	CH2	CH3	CH4
CH□ HOLD setting value	596	796	996	1196
CH□ HOLD Trigger setting value (In FX3 allocation mode function)	32	33	34	35

■Enabling the setting

Turn on and off 'Operating condition setting request' (Un\G70, b9) to enable the setting.

■Default value

The default value is 0 for all channels.

CH1 Range setting

This area is for setting the output range.

Setting value	Output range
0003H	4 to 20 mA
0002H	0 to 20 mA
0005H	1 to 5 V
0006H	0 to 5 V
0000H	-10 to +10 V
0007H	0 to 10 V
000DH	User range setting (voltage)
000EH	User range setting (current)

If a value other than the above is set, a range setting range error (error code: 190□H) occurs.

If the range switching is attempted with the D/A conversion and D/A output enabled for the purpose of preventing a sudden change in the analog output, CH□ Under-output range change denial alarm (alarm code: 0C0□H) occurs and the range switching is not executed. To execute the range switching, turn off 'CH1 Output enable/disable flag' (Un\G70, b1).

The user range cannot be used when the wave output function is used. Even within the setting range in the above table, when the user range is set while the wave output function is used, a user range specification error in wave output mode (error code: 1D1□H) occurs and the wave output does not start.

■Buffer memory address

The following shows the buffer memory address of this area.

Buffer memory name	CH1	CH2	CH3	CH4
CH□ Range setting	598	798	998	1198

■Enabling the setting

Turn on and off 'Operating condition setting request' (Un\G70, b9) to enable the setting.

Range setting [FX3 allocation mode]

When the FX3 allocation mode function is used, this area is for setting the output range.

The setting contents in FX3 allocation mode are as follows.

b15	...	b12 b11	...	b8 b7	...	b4 b3	...	b0
CH4		CH3		CH2		CH1		

Set the following setting values for the bits corresponding to each CH.

Setting value	Output range
0000	-10 to +10 V
0001	-10 to +10 V
0010	0 to 20 mA
0011	4 to 20 mA
0100	0 to 20 mA
0101	1 to 5 V
0110	0 to 5 V
0111	0 to 10 V
1101	User range setting (voltage)
1110	User range setting (current)

If a value other than the above is set, a range setting range error (error code: 190□H) occurs.

If the range switching is attempted with the D/A conversion and D/A output enabled for the purpose of preventing a sudden change in the analog output, CH. Under-output range change denial alarm (alarm code: 0C0□H) occurs and the range switching is not executed. To execute the range switching, turn off 'CH1 Output enable/disable flag' (Un\G70, b1).

The user range cannot be used when the wave output function is used. Even within the setting range in the above table, when the user range is set while the wave output function is used, a user range specification error in wave output mode (error code: 1D1□H) occurs and the wave output does not start.

■Buffer memory address

The following shows the buffer memory address of this area.

Buffer memory name	CH1	CH2	CH3	CH4
Range setting	0			

■Enabling the setting

Turn on and off 'Operating condition setting request' (Un\G70, b9) to enable the setting.

Error history

Up to 16 errors that occurred in the analog output module are logged.

	b15	to	b8	b7	to	b0
Un\G3600	Error code					
Un\G3601	First two digits of the year			Last two digits of the year		
Un\G3602	Month			Day		
Un\G3603	Hour			Minute		
Un\G3604	Second			Day of the week		
Un\G3605	Millisecond (upper)			Millisecond (lower)		
Un\G3606	System area					
to						
Un\G3609						

Item	Storage contents	Storage example ^{*1}
First two digits of the year/Last two digits of the year	Stored in BCD code.	2017H
Month/Day		0130H
Hour/Minute		1035H
Second		40H
Day of the week	One of the following values is stored in BCD code. Sunday: 0, Monday: 1, Tuesday: 2, Wednesday: 3, Thursday: 4, Friday: 5, Saturday: 6	1H
Millisecond (upper)	Stored in BCD code.	6H
Millisecond (lower)		28H

*1 These values assume that an error occurs at 10:35 and 40.628 seconds on Monday, January 30th, 2017.

■Buffer memory address

The following shows the buffer memory address of this area.

Buffer memory area name	No.1 to No.16
Error history	3600 to 3759
Error history (In FX3 allocation mode function)	8600 to 8759



Alarm history

Up to 16 alarms that occurred in the analog output module are logged.

	b15	to	b8	b7	to	b0
Un\G3760	Alarm code					
Un\G3761	First two digits of the year			Last two digits of the year		
Un\G3762	Month			Day		
Un\G3763	Hour			Minute		
Un\G3764	Second			Day of the week		
Un\G3765	Millisecond (upper)			Millisecond (lower)		
Un\G3766 to Un\G3769	System area					

Item	Storage contents	Storage example*1
First two digits of the year/Last two digits of the year	Stored in BCD code.	2017H
Month/Day		0130H
Hour/Minute		1035H
Second		40H
Day of the week	One of the following values is stored in BCD code. Sunday: 0, Monday: 1, Tuesday: 2, Wednesday: 3, Thursday: 4, Friday: 5, Saturday: 6	1H
Millisecond (upper)	Stored in BCD code.	06H
Millisecond (lower)		28H

*1 These values assume that an alarm occurs at 10:35 and 40.628 seconds on Monday, January 30th, 2017.

■ Buffer memory address

The following shows the buffer memory address of this area.

Buffer memory area name	No.1 to No.16
Alarm history	3760 to 3919
Alarm history (in FX3 allocation mode function)	8760 to 8919

Offset/gain adjustment value specification

This area is used to set the adjustment amount of analog output value during the offset/gain setting mode.

Adjust it to make it equal to the target output value.

■ Buffer memory address

The following shows the buffer memory addresses of this area.

Buffer memory area name	CH1	CH2	CH3	CH4
Offset/gain adjustment value specification	4130			
Offset/gain adjustment value specification (In FX3 allocation mode function)	4130			

■ Setting range

The possible setting range is from -3000 to +3000.

Ex.

If the setting value is 1000

During voltage output: Approx. 0.31 V, During current output: The analog output value rises by approx. 0.35 mA.

If the setting value is -1000

During voltage output: Approx. 0.31 V, During current output: The analog output value drops by approx. 0.35 mA.

CH1 Offset/gain setting mode

Specify the channel where the offset/gain setting is adjusted.

- Offset/gain setting mode (offset specification): Channel to adjust the offset
- Offset/gain setting mode (gain specification): Channel to adjust the gain

Setting value	Description
0	Disable
1	Setting channel

Multiple channels cannot be set at the same time. Set to Offset/gain setting mode (offset specification) or Offset/gain setting mode (gain specification) to Disable (0).

Setting a value other than the above causes an offset/gain setting value range error (error code: 1E8□H).

In the following cases, an offset/gain setting channel specification error (error code: 1E50H) occurs.

- Both the offset/gain setting mode (offset specification) and the offset/gain setting mode (gain specification) of the same channel are set for the setting channel (1) at the same time.
- All channels are set to Disable (0).
- Multiple channels are set at the same time.

■Buffer memory address

The following shows the buffer memory addresses of this area.

Buffer memory area name	CH1	CH2	CH3	CH4
CH□ Offset/gain setting mode (offset specification)	4132	4134	4136	4138
CH□ Offset/gain setting mode (gain specification)	4133	4135	4137	4139
CH□ Offset/gain setting mode (offset specification) (in FX3 allocation mode function)	4131	4132	4133	4134
CH□ Offset/gain setting mode (gain specification) (In FX3 allocation mode function)	4141	4142	4143	4144

■Enabling the setting

From off, Turn on 'Channel change request' (Un\G70, b11).

■Default value

The default value is Disable (0) for all the channels.

CH1 Offset/gain setting mode (range specification)

The output range can be changed during offset/gain setting.

The output range is changed to the set one by using 'Channel change request' (Un\G70, b11).

Setting value	Description
000DH	User range setting (voltage)
000EH	User range setting (current)

Setting a value other than the above causes an offset/gain setting range range error (error code: 1E9□H).

■Buffer memory address

The following shows the buffer memory addresses of this area.

Buffer memory area name	CH1	CH2	CH3	CH4
CH□ Offset/gain setting mode (range specification)	4164	4165	4166	4167
CH□ Offset/gain setting mode (range specification) (In FX3 allocation mode function)	4151	4152	4153	4154

Wave data registry area

This area is for registering wave data for analog output in the wave output mode.

The setting range depends on the set output range. The setting range is shown below.

Output range	Setting range
4 to 20 mA	0 to 32767 (practical range: 0 to 32000)
0 to 20 mA	
1 to 5 V	
0 to 5 V	
0 to 10 V	-32768 to +32767 (practical range: -32000 to +32000)
-10 to +10 V	

In the channel where the wave data with a value out of the above setting range set is output, a digital value setting range error (error code: 191□H) occurs and 'Error flag' (Un\G69, b15) turns on. The wave output operations continue to be performed. However, the analog output value corresponding to a digital input value out of the setting range is fixed to the maximum or minimum value of the output range.

■ Buffer memory address

The following shows the buffer memory address of this area.

Buffer memory name	CH1	CH2	CH3	CH4
Wave data registry area	10000 to 89999			
Wave data registry area (in FX3 allocation mode function)	10000 to 89999			

PART 3

MULTIPLE INPUT MODULE

Part 3 describes the multiple input module.

3 FX5-8AD

3 FX5-8AD

3.1 Overview

FX5-8AD multiple input module can convert 8 points of analog input values (voltage input, current input, thermocouple and resistance temperature detector) into digital values.

It is added to FX5 CPU module, and is possible to capture voltage/current/thermocouple/resistance temperature detector data of 8 channels.

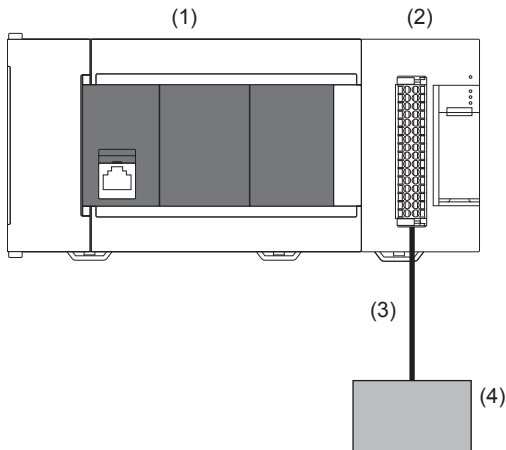

- (1) FX5 CPU module
- (2) Multiple input module (FX5-8AD)
- (3) Analog device connection cable
- (4) Analog device (flow sensor, thermocouple, and resistance temperature detector, etc.)

3.2 Specifications

This section describes the specifications of FX5-8AD.

General specifications

The general specifications other than below are the same as those for the CPU module to be connected.

For general specifications, refer to the following.

📖 MELSEC iQ-F FX5S/FX5UJ/FX5U/FX5UC User's Manual (Hardware)

Items	Specifications	
Dielectric withstand voltage	500 V AC for 1 minute	Between all terminals and ground terminal
Insulation resistance	10 M Ω or higher by 500 V DC insulation resistance tester	

Power supply specifications

The following table lists the power supply specifications.

Items		Specifications
External power supply	Power supply voltage	24 V DC +20%, -15%
	Allowable momentary power outage time	Operation continues when the instantaneous power failure is shorter than 5 ms.
	Current consumption	100 mA
Internal power supply	Power supply voltage	24 V DC
	Current consumption	40 mA

Performance specifications

The following table lists the performance specifications.

Items		Specifications
Number of input points		8 points (8 channels)
Conversion speed	Voltage/Current	1 ms/ch ^{*1}
	Thermocouple/ Resistance temperature detector	40 ms/ch
Isolation method	Between input terminal and PLC	Photocoupler
	Between input terminal and channels	Non-isolation
Number of occupied I/O points		8 points
Applicable CPU module		<ul style="list-style-type: none"> FX5UJ CPU module (from the first) FX5U CPU module (Ver.1.050 or later) FX5UC CPU module^{*2} (Ver.1.050 or later)
Applicable engineering tool		<ul style="list-style-type: none"> FX5UJ CPU module: GX Works3 (Ver.1.060N or later) FX5U/FX5UC CPU module: GX Works3 (Ver.1.035M or later)

*1 In the case of 2CH conversion mode, conversion speed is 1 ms/2ch.

*2 FX5-CNV-IFC or FX5-C1PS-5V is necessary to connect FX5-8AD to the FX5UC CPU module.

Voltage/current input specifications

Items	Specifications			
Analog input voltage	-10 to 10 V DC (Input resistance 1 MΩ)			
Analog input current	-20 to +20 mA DC (Input resistance 250 Ω)			
Digital output value	16-bit signed binary (-32000 to +32000)			
Input characteristics, resolution ^{*1}	Analog input range		Digital output value	
	Voltage	0 to 10 V	0 to 32000	312.5 μV
		0 to 5 V	0 to 32000	156.25 μV
		1 to 5 V	0 to 32000	125 μV
		-10 to +10 V	-32000 to +32000	312.5 μV
	Current	0 to 20 mA	0 to 32000	625 nA
		4 to 20 mA	0 to 32000	500 nA
-20 to +20 mA		-32000 to +32000	625 nA	
Accuracy (accuracy for the full scale digital output value)	Ambient temperature 25±5°C: within ±0.3% (±192 digits) Ambient temperature -20 to 55°C: within ±0.5% (±320 digits)			
Absolute maximum input	Voltage: ±15 V, Current: ±30 mA			

*1 For details on the input characteristics, refer to  Page 337 Input conversion characteristics.

Thermocouple input specifications

Items		Specifications
Usable thermocouple		K, J, T, B, R, S
Resolution		K, J, T: 0.1°C (0.1 to 0.2°F) B, R, S: 0.1 to 0.3°C (0.1 to 0.6°F)
Temperature measuring range		K: -200 to +1200°C (-328.0 to +2192.0°F) J: -40 to +750°C (-40.0 to +1382.0°F) T: -200 to +350°C (-328.0 to +662.0°F) B: 600 to 1700°C (1112.0 to 3092.0°F) R: 0 to 1600°C (32.0 to 2912.0°F) S: 0 to 1600°C (32.0 to 2912.0°F)
Digital output value (16-bit signed binary)		K: -2000 to +12000 (-3280 to +21920) J: -400 to +7500 (-400 to +13820) T: -2000 to +3500 (-3280 to +6620) B: 6000 to 17000 (11120 to 30920) R: 0 to 16000 (320 to 29120) S: 0 to 16000 (320 to 29120)
Accuracy	Ambient temperature 25±5°C	K: ±3.5°C (-200°C to -150°C) K: ±2.5°C (-150°C to -100°C) K: ±1.5°C (-100°C to +1200°C) J: ±1.2°C T: ±3.5°C (-200°C to -150°C) T: ±2.5°C (-150°C to -100°C) T: ±1.5°C (-100°C to +350°C) B: ±2.3°C R: ±2.5°C S: ±2.5°C
	Ambient temperature -20 to +55°C	K: ±8.5°C (-200°C to -150°C) K: ±7.5°C (-150°C to -100°C) K: ±6.5°C (-100°C to +1200°C) J: ±3.5°C T: ±5.2°C (-200°C to -150°C) T: ±4.2°C (-150°C to -100°C) T: ±3.1°C (-100°C to +350°C) B: ±6.5°C R: ±6.5°C S: ±6.5°C



To stabilize the accuracy, warm-up (supply power) the system for 30 minutes or more after power-on.

Resistance temperature detector (RTD) input specifications

Items		Specifications
Usable resistance temperature detector*1		Pt100, Ni100
Resolution		0.1°C (0.2°F)
Temperature measuring range		Pt100: -200 to +850°C (-328 to +1562°F) Ni100: -60 to +250°C (-76 to +482°F)
Digital output value (16-bit signed binary)		Pt100: -2000 to +8500 (-3280 to +15620) Ni100: -600 to +2500 (-760 to +4820)
Accuracy	Ambient temperature 25±5°C	Pt100: ±0.8°C Ni100: ±0.4°C
	Ambient temperature -20 to +55	Pt100: ±2.4°C Ni100: ±1.2°C

*1 Only 3-wire type resistance temperature detectors can be used.

Input conversion characteristics

The input conversion characteristics of A/D conversion are expressed by the slope of the straight line connecting the offset value and the gain value, both of which are used when an analog signal (voltage or current) from outside the programmable controller is converted to the corresponding digital output value.

Offset value

This value is the analog input value (voltage or current) where the corresponding digital output value is 0.

Gain value

This value is the analog input value (voltage or current) where the corresponding digital output value is 32000.

Voltage input characteristics

The following shows the list of the analog input ranges and the graphs of each voltage input characteristic, at the voltage input.

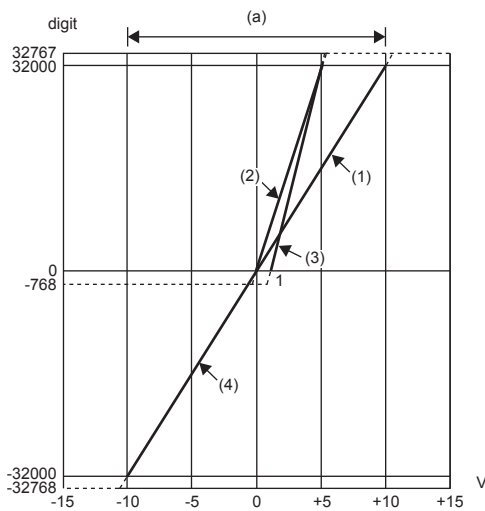

digit: Digital output value
 V: Analog input voltage (V)
 (a): Practical analog input range

No.	Input range setting	Offset value ^{*1}	Gain value ^{*1}	Digital output value ^{*2}	Resolution
(1)	0 to 10 V	0 V	10 V	0 to 32000	312.5 μV
(2)	0 to 5 V	0 V	5 V		156.25 μV
(3)	1 to 5 V	1 V	5 V		125 μV
(4)	-10 to +10 V	0 V	10 V	-32000 to +32000	312.5 μV

*1 Set the offset value and gain value in the user range setting within a range satisfying the following conditions. Failure to satisfy the conditions may not result in proper A/D conversion.
 Setting range of the offset value and gain value: -10 to +10 V
 $((\text{Gain value}) - (\text{Offset value})) \geq 4 \text{ V}$

*2 If an analog input value exceeds the range of digital output value, the digital output value is fixed to the maximum or minimum value.

Input range setting	Digital output value	
	Minimum	Maximum
0 to 10 V	-768	+32767
0 to 5 V		
1 to 5 V		
-10 to +10 V	-32768	

Point

- Set values within the practical range of the analog input and the digital output at each input range. If the range is exceeded, the resolution and accuracy may not fall within the range of the performance specifications. (Do not use the values in the dotted line region in the graph of voltage input characteristics.)
- Do not set the voltage over ± 15 V. Doing so can cause breakdown of the elements.

Current input characteristics

The following shows the list of the analog input ranges and the graph of each current input characteristic, at the current input.

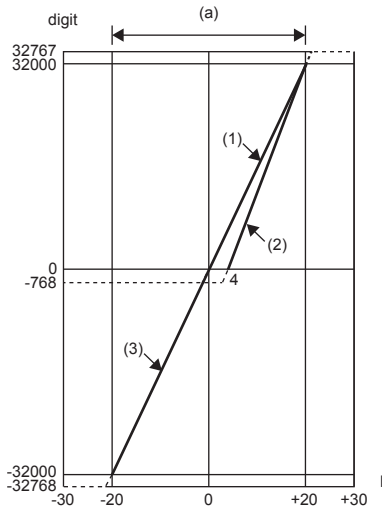

digit: Digital output value
 I: Analog input current (mA)
 (a): Practical analog input range

No.	Input range setting	Offset value*1	Gain value*1	Digital output value*2	Resolution
(1)	0 to 20 mA	0 mA	20 mA	0 to 32000	625 nA
(2)	4 to 20 mA	4 mA	20 mA		500 nA
(3)	-20 to +20 mA	0 mA	20 mA	-32000 to +32000	625 nA

*1 Set the offset value and gain value in the user range setting within a range satisfying the following conditions. Failure to satisfy the conditions may not result in proper A/D conversion.

Gain value ≤ 20 mA, offset value ≥ 0 mA

$((\text{Gain value}) - (\text{Offset value})) \geq 16$ mA

*2 If an analog input value exceeds the range of digital output value, the digital output value is fixed to the maximum or minimum value.

Input range setting	Digital output value	
	Minimum	Maximum
4 to 20 mA	-768	+32767
0 to 20 mA		
-20 to +20 mA	-36768	

Point

- Set values within the practical range of the analog input and the digital output at each input range. If the range is exceeded, the resolution and accuracy may not fall within the range of the performance specifications. (Do not use the values in the dotted line region in the graph of current input characteristics.)
- Do not set the current over ± 30 mA. Doing so can cause breakdown of components.
- If a current is input from an external device into a channel set for voltage as the input type, an overvoltage may occur and destroy components. Limit the voltage so that the external device's voltage value does not exceed the range of -10 to +10 V.

Accuracy

The following shows the accuracy of a multiple input module.

Accuracy at voltage/current input

The accuracy of A/D conversion is the accuracy for the full scale of digital output value.

The fluctuation range varies as follows depending on ambient temperature and input range.

Analog input range		Ambient temperature	
		25±5°C	-20 to +55°C
Voltage	0 to 10 V	Within ±0.3% (±192 digits)/full scale	Within ±0.5% (±320 digits)/full scale
	0 to 5 V		
	1 to 5 V		
	-10 to +10 V		
Current	0 to 20 mA	Within ±0.3% (±192 digits)/full scale	Within ±0.5% (±320 digits)/full scale
	4 to 20 mA		
	-20 to +20 mA		

(Except for the conditions under noise influence.)

Ex.

Accuracy at -10 to +10 V range selection

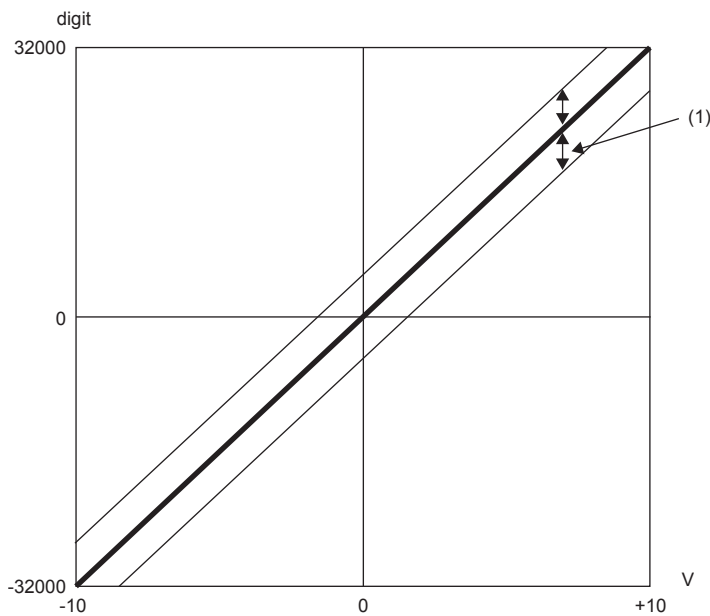

digit: Digital output value
 V: Analog input voltage (V)
 (1) Fluctuation range

Accuracy at thermocouple connection

The accuracy (°C) is given by the following formula:

Full scale × Thermocouple accuracy + Cold junction compensation accuracy

Ex.

Accuracy when B thermocouple is used, the operating ambient temperature is 25°C, and measured temperature is 1000°C
 $(1700^{\circ}\text{C} - 600^{\circ}\text{C}) \times (\pm 0.0013) + (\pm 1^{\circ}\text{C}) = \pm 2.5^{\circ}\text{C}$

Usable thermocouples and conversion accuracy

Usable thermocouples and conversion accuracy are shown as follows.

Usable thermocouple	Conversion accuracy (at operating ambient temperature 25±5°C)	Conversion accuracy (at operating ambient temperature -20 to +55°C)
K	±1.5°C	±7.3°C
J	±1.2°C	±4.95°C
T	±1.5°C	±6.5°C
B	±2.3°C	±9.8°C
R	±2.5°C	±12.5°C
S	±2.5°C	±12.5°C

Point 

To stabilize the accuracy, warm-up (supply power) the system for 30 minutes or more after power-on.

Accuracy at resistance temperature detector connection

The accuracy (°C) is given by the following formula:

Conversion accuracy + Temperature characteristic × Operating ambient temperature change + Allowable tolerance of used resistance temperature detector

Usable resistance temperature detector, accuracy

Usable resistance temperature detector	Temperature measuring range	Accuracy (accuracy for the maximum value of the selected range)	
		at operating ambient temperature 25±5°C	at operating ambient temperature -20 to +55°C
Pt100	-200 to +850°C	±0.8°C	±2.4°C
Ni100	-60 to +250°C	±0.4°C	±1.2°C

Part names

This section describes the names of each part of the multiple input module.

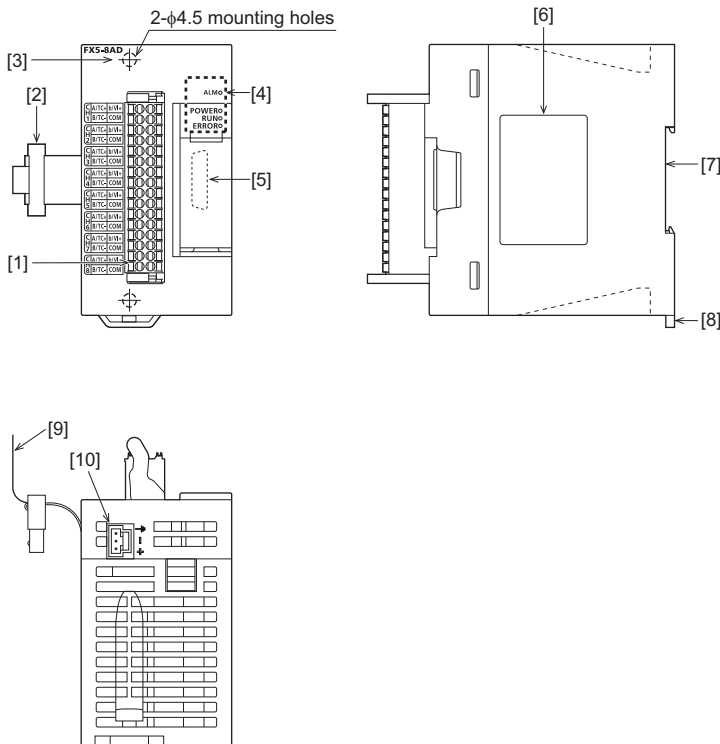

No.	Name	Description
[1]	Terminal block (Spring clamp terminal block)	Use for the current/voltage and temperature sensor input.
[2]	Expansion cable	Cable for connecting the module when adding the multiple input module.
[3]	Direct mounting hole	Screw holes (2-φ4.5, mounting screw: M4 screw) for direct installation.
[4]	Operations status display LEDs	Indicates the operating status of the module. (☞ Page 341 LED display)
[5]	Extension connector	Connector for connecting the extension cable of an extension module.
[6]	Name plate	The product model name and manufacturer's serial number are shown.
[7]	DIN rail mounting groove	The module can be installed on DIN46277 rail (35 mm wide).
[8]	DIN rail mounting hook	Hook for mounting the module on a DIN rail of DIN46277 (35 mm wide).
[9]	Pull out tab	They are used when drawing out an extension cable.
[10]	Power connector	Connector for connecting the power cable. (☞ Page 400 Power supply wiring)

LED display

The following table lists the LED display.

LED display	LED color	Description
POWER	Green	Indicates the power supply status. ON: Power ON OFF: Power off or module failure
RUN	Green	Indicates the operating status. Light on: Normal operation Flashing: In offset/gain setting mode Light off: Error occurring
ERROR	Red	Indicates the error status. ON: Minor error or major error Flashing: Moderate error or major error OFF: Normal operation
ALM	Red	Indicates the output status. Light on: Process alarm or rate alarm issued Flashing: Input signal error or disconnection occurred Light off: Normal operation

3.3 Procedures Before Operation

This section describes the procedures before operation.

1. Check of multiple input module specifications

Check the multiple input module specifications. ( Page 334 Specifications)

2. Installation of multiple input module

Install a multiple input module to a CPU module. For details, refer to the following.

 MELSEC iQ-F FX5S/FX5UJ/FX5U/FX5UC User's Manual (Hardware)

3. Wiring

Perform wiring of external devices to a multiple input module.

4. Adding a module

Add a multiple input module to a module configuration by using GX Works3.

Point

When adding a new multiple input module, if selecting the module whose module model name has "(FX2N)" at the end, it can be used as FX2N allocation mode.

- FX5-8AD: Normal mode
- FX5-8AD(FX2N): FX2N allocation mode

5. Parameter settings

Set parameters of the multiple input module by using GX Works3. ( Page 402 Parameter Setting)

6. Offset/gain setting

When setting the user range, perform the offset/gain setting.

7. Programming

Create a program.

3.4 Functions

This section describes the functions of a multiple input module and the setting procedures for those functions.

For details on the buffer memory areas, refer to the following.

 Page 432 Buffer Memory Areas

Point

- This section describes buffer memory addresses for CH1. For details on the buffer memory addresses after CH2, refer to the following.

 Page 432 List of buffer memory areas

- Numerical values corresponding to the channel where an error has occurred and the error description fit in the □ and △ of an error code and alarm code described in this section. For details on the numerical values, refer to the following.

 Page 424 List of error codes

 Page 427 List of alarm codes

Function list

This section lists the functions of multiple input module.

Item		Description	Reference	
Operation mode		Select the operation mode (normal mode, 2CH conversion mode, offset/gain setting mode) of the multiple input module.	Page 345	
Input type/Range setting function		Input type, and input range can be checked for each channel. Disabling the conversion on unused channels reduces the conversion cycles.	Page 346	
Conversion method	Sampling processing	Converts analog input values and temperature conversion values at every sampling period, storing them in buffer memory areas.	Page 347	
	Averaging processing	Time average	Executes A/D conversion and temperature conversion for the set time and performs the average processing on the total value excluding the maximum and minimum values. The values that had the average processing are stored in the buffer memory areas. The number of processing times within the set time varies depending on the number of channels where the conversion is enabled.	Page 348
		Count average	Executes A/D conversion and temperature conversion for a set number of times and performs the average processing on the total value excluding the maximum and minimum values. The values that had the average processing are stored in the buffer memory areas. The time taken to store the average value obtained by the processing in the buffer memory area varies depending on the number of channels where the conversion is enabled.	Page 349
		Moving average	Averages digital output values taken at every sampling period for a specified number of times, and stores the averaged value in the buffer memory area. The target range for averaging processing moves at each sampling period, thereby allowing the latest digital output value to be obtained.	Page 349
Scaling function		Performs scale conversion on digital operation values within the range from a scaling upper limit value to a scaling lower limit value, both of which are set at desired values. This function helps reduce the man-hours taken for creating a scale conversion program.	Page 351	
Shift function		Adds (shifts) a set conversion value shift amount to a digital output value, and stores the result in the buffer memory area. A change in conversion value shift amount is reflected to the digital operation value in real time, which facilitates fine adjustment at system start-up.	Page 354	
Digital clipping function		Fixes a possible digital operation value to the maximum digital output value or the minimum digital output value when an input current or voltage exceeds the input range.	Page 357	
Maximum value/Minimum value hold function		Stores the maximum and minimum values of digital operation values in the buffer memory area for each channel.	Page 359	
Alert output function	Process alarm	Outputs an alert when a digital operation value falls within the preset alert output range.	Page 360	
	Rate alarm	This function outputs an alert when the change rate of a digital output value is equal to or greater than the rate alarm upper limit value, or the rate is equal to or smaller than the rate alarm lower limit value.	Page 362	
Input signal error detection function	Upper limit detection, lower limit detection, upper and lower limit detection	Outputs an alarm when an analog input value exceeds the preset range.	Page 367	
	Simple disconnection detection	Outputs an alarm when an analog input value is 0.5 V or smaller or 2 mA or smaller.	Page 369	
Disconnection detection function		Outputs an alarm when disconnection of a thermocouple, compensation lead wire, or resistance temperature detector is detected. A measured temperature value to be stored at the disconnection detection is selected from the following. <ul style="list-style-type: none"> • Value just before disconnection • Upscale • Downscale • Any value 	Page 374	
Logging function		Logs (records) digital output values or digital operation values. 10000 points of data can be logged for each channel.	Page 377	
Error history function		Records up to 16 errors and alarms that occurred in an multiple input module to store them in the buffer memory areas.	Page 390	
Offset/gain setting function		Allows the correction of errors in digital output values.	Page 392	
FX2N allocation mode function		Allows to convert the layout of buffer memory addresses of a multiple input module to the one equivalent to FX2N-8AD. This compatibility enables the reuse of programs that have proven performance on FX2N-8AD.	Page 393	
2CH conversion mode function		Performs A/D conversion of 2CH to 1 ms and can update the digital output value at the same time.	Page 394	

Processing of each function

The functions are processed in the order shown below depending on the mode. If multiple functions are enabled, the output of the first processed function is used as the input of the next function.

• Normal mode

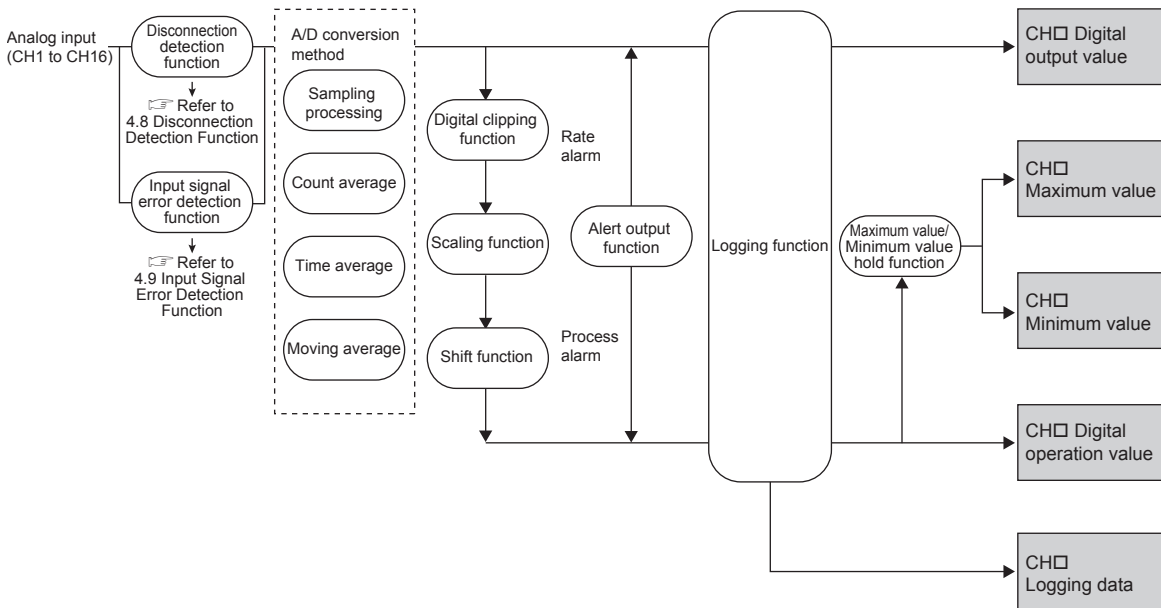

Point

For the resistance temperature detector input range, or thermocouple input range, the conversion is stopped when a disconnection is detected. The digital output value, digital operation value, logging data, maximum value, and minimum value in this case are as follows:

- Digital output value: The values are stored according to the setting in conversion setting at disconnection detection.
- Digital operation value: The calculated values are stored according to the scaling function and shift function in digital output value.
- Logging data: The digital output values or digital operation value are stored according to the logging data setting
- Maximum value and minimum value: The values are updated with the maximum and minimum values of the digital operation value

In the use of the input signal error detection function, conversion is stopped if an input signal error is detected. In this case, the digital output values, digital operation values, and maximum and minimum values are not updated. The values obtained before the input signal error is detected are held. Conversion is resumed after restoration from the errors in the input signal. The digital output value or digital operation value before the input signal error was detected is stored in logging data depending on the logging data setting.

• 2CH conversion mode

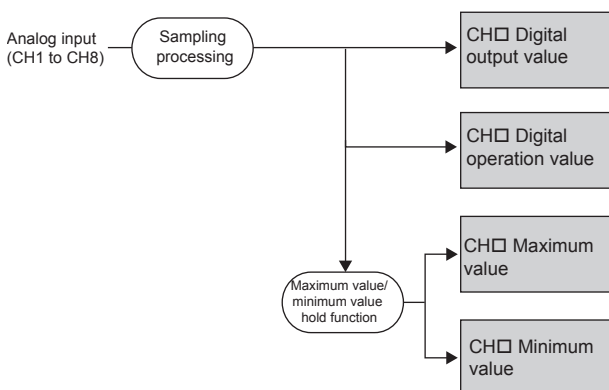

Digital output value

The digital values after the sampling processing or each average processing are stored.

Logging data

When the logging function is used, digital output values or digital operation values are collected.

Maximum value/Minimum value

The maximum and minimum values of the digital operation values are stored.

Digital operation value

These values are obtained by operating a digital output value using the digital clipping function, scaling function, and shift function. When each function is not used, the same value as the digital output value is stored.

Operation mode

Operation mode of multiple input module can be selected.

Setting procedure

Set "Operation mode setting".

 [Navigation window] ⇨ [Parameter] ⇨ [Module Information] ⇨ Module model name ⇨ [Module Parameter] ⇨ [Basic setting] ⇨ [Operation mode setting function]

Operation mode	Description
Normal mode	A mode to perform a normal conversion.
2CH conversion mode ^{*1}	Performs A/D conversion of 2CH and can update the digital output value at the same time.
Offset/gain setting mode	A mode used for performing the offset/gain setting at user range setting.

*1 It cannot be used in FX2N allocation mode.

Input type/range setting function

The Input type/Range setting can be selected for each channel according to the type of sensor to be connected.

Operation

The analog input value is A/D converted or temperature converted by the set input type, input range, or Input type/Range setting (offset/gain setting), and the value is stored in the following area.

- 'CH1 Digital output value' (Un\G400)
- 'CH1 Digital operation value' (Un\G402)

Setting procedure

Set "Input Type", "Input Range", or "Input Type/Range Setting (Offset/Gain Setting)".

 [Navigation window] ⇒ [Parameter] ⇒ [Module Information] ⇒ Module model name ⇒ [Module Parameter] ⇒ [Basic setting] ⇒ [Range switching function]

Input type*1	Input range	Input type/Range setting (Offset/gain setting)
Conversion disable	—	—
Current	4 to 20 mA	<ul style="list-style-type: none"> • Factory default setting • User range setting*3
	0 to 20 mA	
	-20 to +20 mA	
Voltage	1 to 5 V	
	0 to 5 V	
	-10 to +10 V	
	0 to 10 V	
Resistance temperature detector*2	Pt100	
	Ni100	
Thermocouple*2	Thermocouple B	
	Thermocouple R	
	Thermocouple S	
	Thermocouple K	
	Thermocouple J	
	Thermocouple T	

*1 Controls whether to enable or disable A/D conversion or temperature conversion for each channel. Disabling the conversion on unused channels reduces the conversion cycles.

*2 With the Centigrade/Fahrenheit display setting function, the display method of digital output value can be set to "Centigrade" or "Fahrenheit".

*3 When using the user range setting, set the offset/gain.
For offset/gain settings, refer to the following.

 Page 405 Offset/Gain Setting

■ Operation of factory default setting and user range setting

The input range used depends on the setting specified by Input type/Range setting (offset/gain setting).

- Case of factory default setting

Conversion is performed with the specified input type and input range.

- Case of user range setting

Conversion is performed with input type and input range specified in the offset/gain setting function.

Conversion method

This function sets the A/D conversion or temperature conversion method for each channel.

The conversion speed is 1 ms when the input range is current and voltage, 40 ms in the case of resistance temperature detector and thermocouple.

A/D conversion or temperature conversion is performed asynchronously. The A/D conversion or temperature conversion sampling cycle varies according to the number of channels respectively set.

The conversion process order and sampling cycle for when CH1 is set to the temperature input range, and CH2, CH4, and CH5 are set to the A/D input range are shown below.

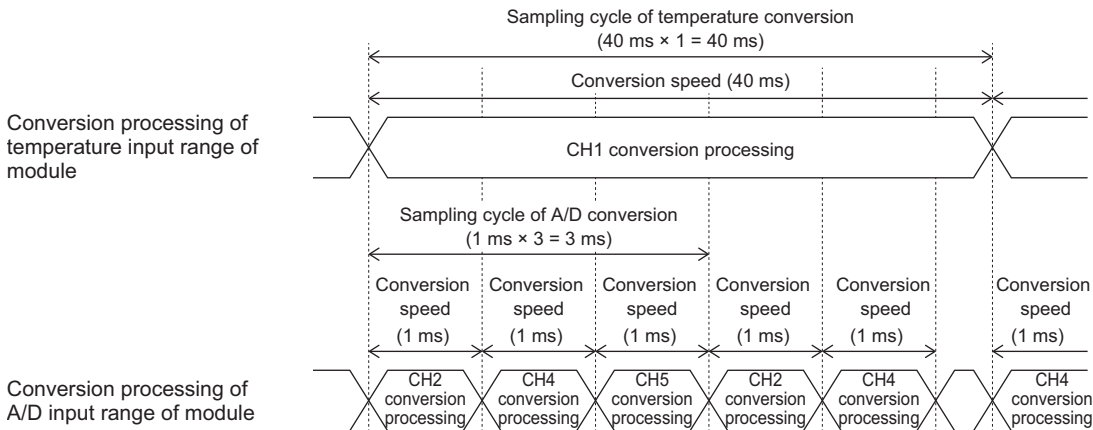

Sampling processing

The analog input value and temperature input value are converted for each sampling period and stored as digital output value and digital operation value.

- When input range is set only with current, voltage, or resistance temperature detector, and thermocouple only, perform conversion for each channel.
- When setting the current, voltage, resistance temperature detector, and thermocouple in the input range, convert asynchronously in each sampling period.

Point

A/D conversion and temperature conversion are performed asynchronously, so the respective sampling cycles are as shown below.

- The A/D conversion sampling cycle is "conversion speed (1 ms) × number of A/D conversion enabled channels".
- The temperature conversion sampling cycle is "conversion speed (40 ms) × number of temperature conversion enabled channels".

Whether to enable or disable the conversion can be set for each channel. Disabling the conversion on unused channels reduces the sampling cycle.

For example, when setting the temperature conversion to 2 channels (CH1, CH4) conversion enabled, the conversion period is 80 ms (40 ms × 2).

Averaging processing

Averaging processing is performed for analog input value or temperature input value for each channel. Averaged values are stored as digital output values and digital operation values.

The following three types of averaging processing are provided.

- Time average
- Count average
- Moving average

■ Time average

A multiple input module executes the conversion for set time and averages the total value excluding the maximum value and the minimum value. The averaged value is stored in the digital output value and the digital operation value.

- Setting time

Set a value that satisfies the following condition.

Setting time of A/D conversion = Number of A/D conversion enabled channels × Conversion speed (1 ms) × Set number of times

Setting time of temperature conversion = Number of temperature conversion enabled channels × Conversion speed (40 ms) × Set number of times

- Processing times

The number of processing times within the set time varies depending on the number of channels where the conversion is enabled.

$$\text{Number of processing times}^*1 = \frac{\text{Setting time}}{(\text{Number of conversion enabled channels} \times \text{Conversion speed})}$$

*1 Values after the decimal point are omitted.

Ex.

The following table shows the processing times with the setting below.

Item	Setting
Input type	Voltage
Number of channels where temperature conversion is enabled	Four channels (CH1 to CH4)
Setting time	20 ms

$$\frac{20 \text{ ms}}{(4 \text{ ch} \times 1 \text{ ms})} = 5 \text{ times}$$

Conversion is processed 5 times and the mean value is output.

Point

- The valid lower limit setting value for the time average is calculated by the formula "Minimum processing times (4 times) × Number of conversion enabled channels × Conversion speed". When the number of processing times is less than 4 due to the set time, a time average setting range error (error code: 192□H) occurs. 0 is stored in the 'CH1 digital output value' (Un\G400) and 'CH1 digital operation value' (Un\G402).
- Because the time average requires a sum of at least two counts excluding the maximum and minimum values, the set number of times should be four or more.

Count average

A multiple input module executes the conversion for a set number of times and averages the total value excluding the maximum value and the minimum value. The averaged value is stored in the digital output value and the digital operation value.

The time taken to store the average value obtained by the processing in the buffer memory area is the following value.

Processing time of A/D conversion = Set number of times × (Number of A/D conversion enabled channels × Conversion speed (1 ms))

Processing time of temperature conversion = Set number of times × (Number of temperature conversion enabled channels × Conversion speed (40 ms))

Ex.

The following table shows the processing time with the setting below.

Item	Setting
Input type	Thermocouple
Number of channels where temperature conversion is enabled	Four channels (CH1 to CH4)
Set number of times	Five times

$5 (\text{times}) \times 4 (\text{CH}) \times 40 (\text{ms}) = 800 (\text{ms})$

An average value is output every 800 ms.

Point

Because the count average requires a sum of at least two counts excluding the maximum and minimum values, the set number of times should be four or more.

Moving average

Converted values for the specified number of times captured every sampling period are averaged and stored in the digital output value and the digital operation value. As each sampling process moves and averaging is performed, the latest digital output value and digital operation value are obtained.

Ex.

The following figure shows the moving average processing of when the set number of times is five.

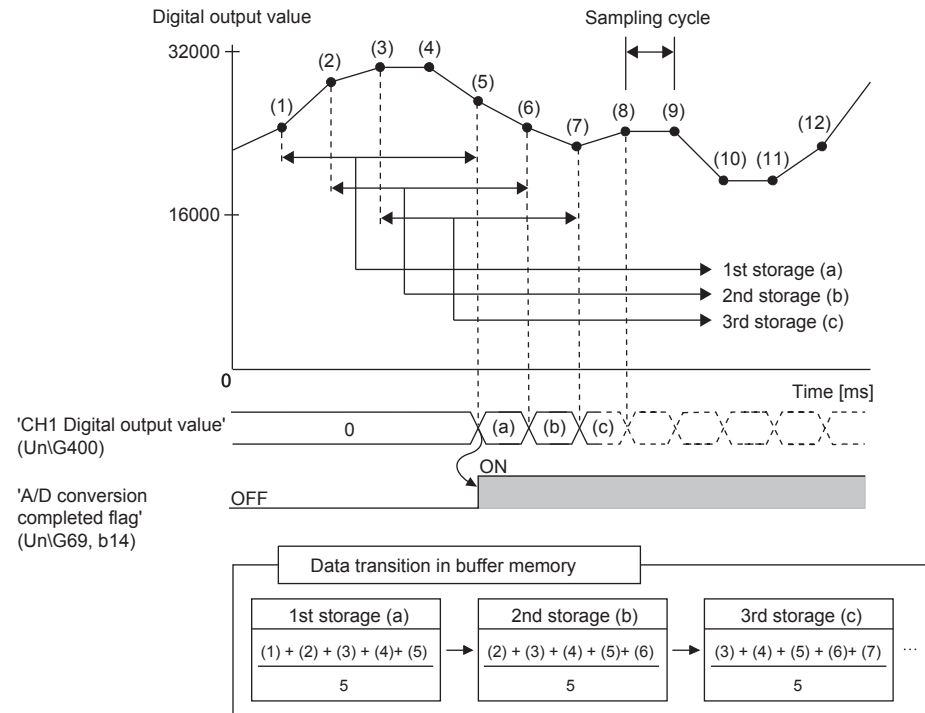

Setting procedure

■Sampling processing

Set "Average processing setting" to "Sampling processing".

 [Navigation window] ⇒ [Parameter] ⇒ [Module Information] ⇒ Module model name ⇒ [Module Parameter] ⇒ [Basic setting] ⇒ [Conversion system]

■Average processing

1. Set "Average processing setting" to "Time average", "Count average", or "Moving average".

 [Navigation window] ⇒ [Parameter] ⇒ [Module Information] ⇒ Module model name ⇒ [Module Parameter] ⇒ [Basic setting] ⇒ [Conversion system]

2. Set a value for "Time average/Count average/Moving average setting".

Item	Setting range
Time average ^{*1}	When the input type is current, and voltage: 4 to 10000 (ms) When the input type is resistance temperature detector, and thermocouple: 160 to 10000 (ms)
Count average	4 to 10000 (times)
Moving average	2 to 1000 (times)

*1 Set a value greater than the value calculated by the following formula as the time average.
Conversion speed × Number of conversion enabled channels × Minimum processing times (4 times)

Scaling function

Performs scale conversion on digital output values within the range from a scaling upper limit value to a scaling lower limit value, both of which are set at desired values.

The converted values are stored in 'CH1 Digital operation value' (Un\G402).

Concept of scaling setting

The concepts of each setting item are described below.

- For the scaling upper limit value, set a value corresponding to the upper limit value after the input range conversion.
- For the scaling lower limit value, set a value corresponding to the lower limit value after the input range conversion.

The upper and lower limits of each range are shown below.

Input type/range		Lower limit value		Upper limit value		
		Input value	Digital output value	Input value	Digital output value	
Current	4 to 20 mA	4 mA	0	20 mA	32000	
	0 to 20 mA	0 mA	0	20 mA	32000	
	-20 to +20 mA	-20 mA	-32000	20 mA	32000	
Voltage	0 to 10 V	0 V	0	10 V	32000	
	0 to 5 V	0 V	0	5 V	32000	
	1 to 5 V	1 V	0	5 V	32000	
	-10 to +10 V	-10 V	-32000	10 V	32000	
Resistance temperature detector	Pt100	Centigrade	-200°C	-2000	850°C	8500
		Fahrenheit	-328°F	-3280	1562°F	15620
	Ni100	Centigrade	-60°C	-600	250°C	2500
		Fahrenheit	-76°F	-760	482°F	4820
Thermocouple	K	Centigrade	-270°C	-2700	1370°C	13700
		Fahrenheit	-454°F	-4540	2498°F	24980
	J	Centigrade	-210°C	-2100	1130°C	11300
		Fahrenheit	-346°F	-3460	2066°F	20660
	T	Centigrade	-270°C	-2700	400°C	4000
		Fahrenheit	-454°F	-4540	752°F	7520
	B	Centigrade	0°C	0	1710°C	17100
		Fahrenheit	+32°F	+320	3110°F	31100
	R	Centigrade	-50°C	-500	1710°C	17100
		Fahrenheit	-58°F	-580	3110°F	31100
	S	Centigrade	-50°C	-500	1710°C	17100
		Fahrenheit	-58°F	-580	3110°F	31100

Ex.

The scaling value with the following conditions

- Set the input type/range to voltage (0 to 5 V)
- A value of 20000 is set in Scaling upper limit value, and 4000 is set in Scaling lower limit value.

4000 is stored when the voltage input is 0 V and 20000 is stored when the voltage input is 5 V in 'CH1 digital operation value' (Un\G402).

Calculating the scaling value

The scale value conversion is based on the following formula. (In scale conversion, values are rounded off to the nearest whole number.)

The calculation formula for a scaling value varies depending on the input type/range.

Input type/Range	Relational expression	Element
<ul style="list-style-type: none"> Current (0 to 20 mA, 4 to 20 mA) Voltage (0 to 10 V, 0 to 5 V, 1 to 5 V) 	$\frac{D_x \times (S_H - S_L)}{D_{Max}} + S_L$	D _x : Digital output value D _{Max} : Maximum digital output value of the input range in use D _{Min} : Minimum digital output value of the input range in use S _H : Scaling upper limit value S _L : Scaling lower limit value
<ul style="list-style-type: none"> Current (-20 to +20 mA) Voltage (-10 to +10 V) 	$\frac{D_x \times (S_H - S_L)}{(D_{Max} - D_{Min})} + \frac{(S_H + S_L)}{2}$	
<ul style="list-style-type: none"> Resistance temperature detector Thermocouple 	$\frac{(D_x - D_{Min}) \times (S_H - S_L)}{(D_{Max} - D_{Min})} + S_L$	

Setting procedure

1. Set "Scaling enable/disable setting" to "Enable".

 [Navigation window] ⇒ [Parameter] ⇒ [Module Information] ⇒ Module model name ⇒ [Module Parameter] ⇒ [Application setting] ⇒ [Scaling function]

2. Set values for "Scaling upper limit value" and "Scaling lower limit value".

Item	Setting range
Scaling upper limit value	-32000 to +32000
Scaling lower limit value	

Point

- Even when the scaling upper limit value and the scaling lower limit value are set so that the change is greater than the resolution, the resolution will not increase.
- If the relation between the values is the scaling lower limit value > the scaling upper limit value, the scale conversion can be performed according to a negative slope.
- Set the scaling with the condition "Scaling upper limit value ≠ Scaling lower limit value".

Setting example

■Example 1

An example of the following settings is shown below.

Item	Setting
Input type/range	Voltage (-10 to +10 V)
Scaling enable/disable setting	Enable
Scaling upper limit value	20000
Scaling lower limit value	4000

Input voltage and scaling value become as follows.

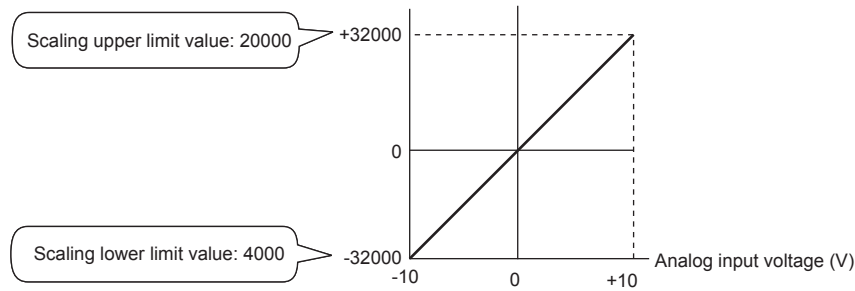

Analog input voltage (V)	Digital output value	Digital operation value (scaling value)
-10	-32000	4000
-5	-16000	8000
0	0	12000
+5	+16000	16000
+10	+32000	20000

■Example 2

An example of the following settings is shown below.

Item	Setting
Input type/range	K thermocouple (-270 to +1370°C)
Scaling enable/disable setting	Enable
Scaling upper limit value	+5000
Scaling lower limit value	-1000

A measured temperature value and scaling value become as follows.

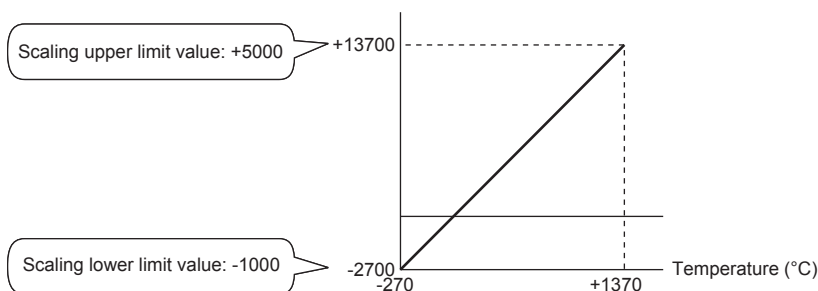

Temperature input value (°C)	Measured temperature value	Digital operation value (scaling value)
-270	-2700	-1000
+50	+500	+170
+500	+5000	+1817
+850	+8500	+3097
+1370	+13700	+5000

Precautions

When the scaling function is used with the digital clipping function simultaneously, the scale conversion is performed on the digital operation values after digital clipping. For the digital clipping function, refer to the following.

☞ Page 357 Digital clipping function

Shift function

Adds (shifts) a set conversion value shift amount to a digital output value, and stores the result in the buffer memory area. A change in conversion value shift amount is reflected to the digital operation value in real time, which facilitates fine adjustment at system start-up.

Operation

A set conversion value shift amount is added to the digital operation value. The digital operation value with shift addition is stored in 'CH1 Digital operation value' (Un\G402). The conversion value shift amount is added in every sampling cycle for sampling processing and is added in every averaging process cycle for averaging processing. After that, the added values are stored in 'CH1 Digital operation value' (Un\G402). If a value is set to the conversion value shift amount, the conversion value shift amount is added regardless of turning off→on→off 'Operating condition setting request' (Un\G70, b9).

Setting procedure

Set a value for "Conversion value shift amount".

[Navigation window] ⇒ [Parameter] ⇒ [Module Information] ⇒ Module model name ⇒ [Module Parameter] ⇒ [Application setting] ⇒ [Shift function]

Item	Setting range
Conversion value shift amount	-32768 to +32767

Setting example

Ex.

When the input characteristics is adjusted in a channel where the input range of 0 to 5 V is set by the shift function

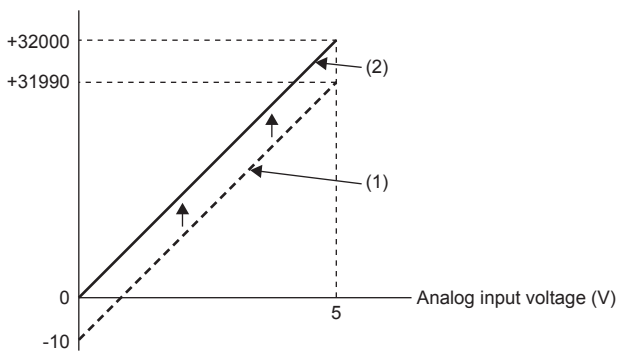

- (1) 'CH1 Digital output value' (Un\G400)
+
'CH1 Conversion value shift amount' (Un\G472) "+10"
↓
- (2) 'CH1 Digital operation value' (Un\G402)

Voltage input (V)	Digital output value	Digital operation value
0	-10	0
5	31990	32000

Ex.

When the input characteristics is adjusted in a channel where the input range of -10 to +10 V is set by the shift function

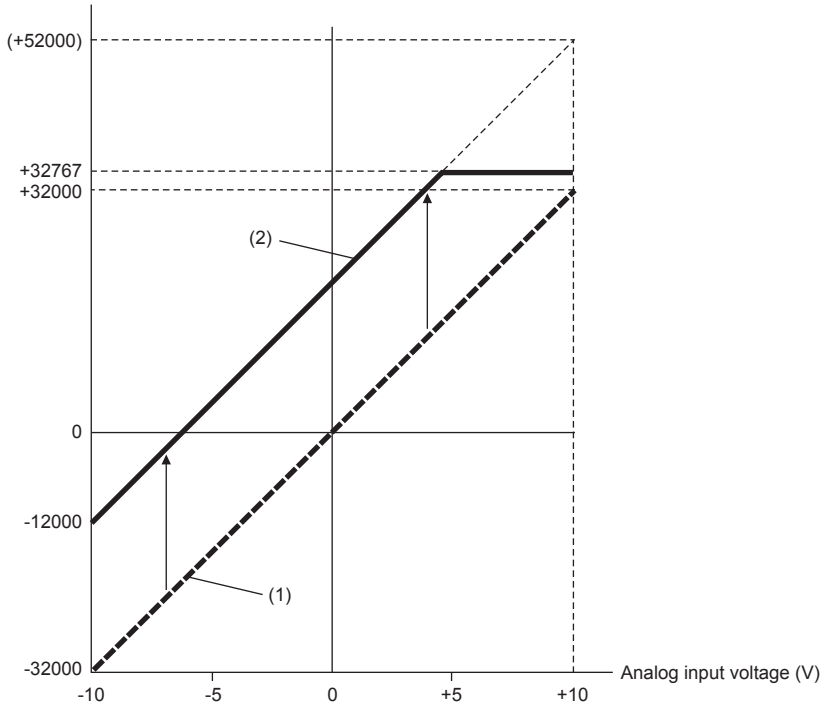

- (1) 'CH1 Digital output value' (Un\G400)
+
'CH1 Conversion value shift amount' (Un\G472)
"+20000"
↓
- (2) 'CH1 Digital operation value' (Un\G402)

Voltage input (V)	Digital output value	Digital operation value
-10	-32000	-12000
-5	-16000	+4000
0	0	+20000
+5	+16000	+32767 ^{*1}
+10	+32000	+32767 ^{*1}

*1 Because the value exceeds the range of -32768 to +32767, the value is fixed to +32767 (the upper limit value).

Ex.

When the following values are used for multiple input module with the input range of 0 to 5 V

Item	Setting
'CH1 Scaling enable/disable setting' (Un\G504)	Enable (0)
'CH1 Scaling upper limit value' (Un\G506)	12000
'CH1 Scaling lower limit value' (Un\G508)	2000
'CH1 Conversion value shift amount' (Un\G472)	2000

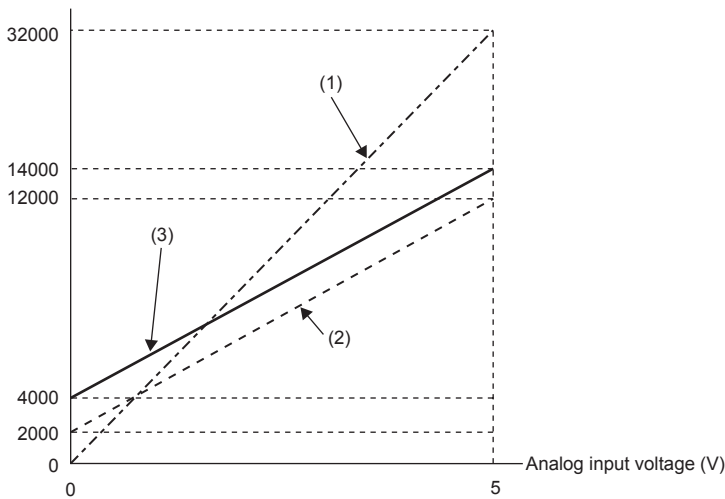

- (1) 'CH1 Digital output value' (Un\G400)
Scaling
0 to 32000
↓
2000 to 12000
- (2) Value after scaling
'CH1 Conversion value shift amount' (Un\G472) "+2000"
↓
- (3) 'CH1 Digital operation value' (Un\G402)

Voltage input (V)	Digital output value	Value after scaling	Digital operation value
0	0	2000	4000
1	6400	4000	6000
2	12800	6000	8000
3	19200	8000	10000
4	25600	10000	12000
5	32000	12000	14000

Point

When the shift function is used with the digital clipping function and scaling function, shift-and-add is performed on the value obtained after digital clipping and scale conversion. Therefore, the range of the digital operation value is determined as -32768 to +32767.

For a setting example of when the digital clipping function, scaling function, and shift function are used together, refer to the following.

☞ Page 358 Setting example

Digital clipping function

Fixes a possible digital operation value to the maximum digital output value or the minimum digital output value when an input current or voltage exceeds the input range.

List of output ranges

The following table lists the output ranges of the digital operation values when the digital clipping function is enabled with each range.

Input range	Output range of digital operation values	
	Digital clipping function is enabled	Digital clipping function is disabled
4 to 20 mA	0 to 32000	-768 to +32767
0 to 20 mA		
1 to 5 V		
0 to 5 V		
0 to 10 V		
-20 to +20 mA	-32000 to +32000	-32768 to +32767
-10 to +10 V		

Point

When the determined digital operation value is out of the range of -32768 to +32767, the digital clipping function is performed to the following values.

- When 32767 or greater: 32767
- When -32768 or smaller: -32768

Setting procedure

Set "Digital clipping enable/disable setting" to "Enable".

[Navigation window] ⇒ [Parameter] ⇒ [Module Information] ⇒ Module model name ⇒ [Module Parameter]
⇒ [Application setting] ⇒ [Digital clipping function]

Setting example

Ex.

When the following values are used for multiple input module with the input range of 0 to 5 V

Item	Setting
'CH1 Scaling enable/disable setting' (Un\G504)	Enable (0)
'CH1 Scaling upper limit value' (Un\G506)	12000
'CH1 Scaling lower limit value' (Un\G508)	2000
'CH1 Conversion value shift amount' (Un\G472)	2000
'CH1 Digital clipping enable/disable setting' (Un\G510)	Enable (0)

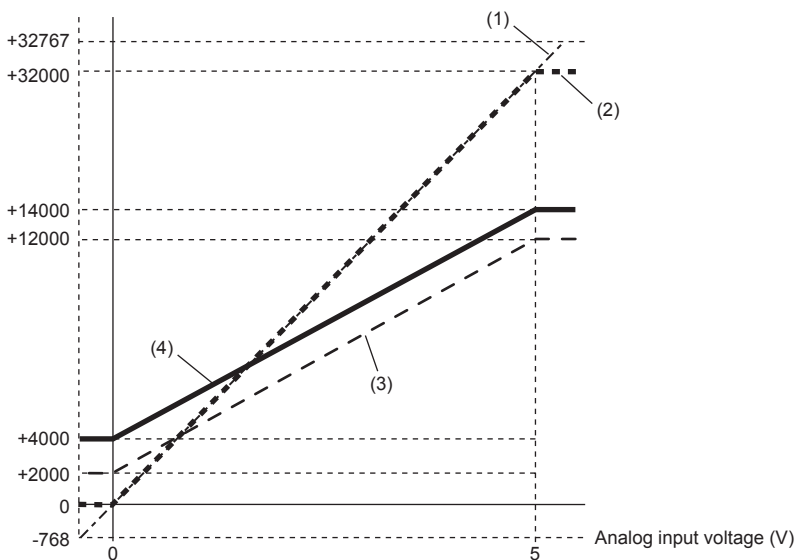

- (1) 'CH1 Digital output value' (Un\G400)
Digital clipping
-768 to +32767
↓
0 to 32000
- (2) Value after digital clipping
Scaling
0 to 32000
↓
2000 to 12000
- (3) Value after scaling
'CH1 Conversion value shift amount' (Un\G472) "+2000"
↓
4000 to 14000
- (4) 'CH1 Digital operation value' (Un\G402)

Input voltage (V)	Digital output value	Digital operation value
-0.12	-768	4000
0	0	4000
+1	+6400	6000
+2	+12800	8000
+3	+19200	10000
+4	+25600	12000
+5	+32000	14000
+5.12	+32767	14000

Point

When the digital clipping function is used with the scaling function, and shift function, scale conversion and shift-and-add are performed on the value obtained after digital clipping.

Maximum value/minimum value hold function

Stores the maximum and minimum values of digital operation values in the buffer memory area for each channel. Time average and count average are processed on the average processing cycle. The values of the sampling processing, and moving average are updated on the sampling cycle.

Resetting the maximum value and the minimum value

■Resetting the maximum value

When 'CH1 Maximum value reset request' (Un\G473) turns on (1), 'CH1 Maximum value' (Un\G404) is updated with current value, and 'CH1 Maximum value reset completion flag' (Un\G422) turns on (1).

■Resetting the minimum value

When 'CH1 Minimum value reset request' (Un\G474) turns on (1), 'CH1 Minimum value' (Un\G406) is updated with current value, and 'CH1 Minimum value reset completion flag' (Un\G423) turns on (1).

■Resetting the maximum value and the minimum value

The following two types of average processing of the maximum value and minimum value are provided.

- Perform "Reset Maximum value" and "Reset Minimum value" respectively.
- 'CH1 Maximum value' (Un\G404) and 'CH1 Minimum value' (Un\G406) are updated^{*1} with the current value when 'Operating condition setting request' (Un\G70, b9) turns on (1). 'CH1 Maximum value reset completion flag' (Un\G422) and 'CH1 Minimum value reset completion flag' (Un\G423) are not ON (1).

*1 When "Conversion disabled" is set to 'CH1 Input type/Range setting' (Un\G598), 0 is stored in 'CH1 Maximum value' (Un\G404) and 'CH1 Minimum value' (Un\G406).

Values to be the maximum value and the minimum value

The maximum and minimum values of digital operation values are stored in the buffer memory.

When the average processing, digital clipping function, scaling function, and shift function are used, the maximum value and minimum value of each function are stored.

Alert output function

This section describes process alarms and rate alarms used for the alert output function.

Process alarm

Outputs an alert when a digital operation value falls within the preset alert output range.

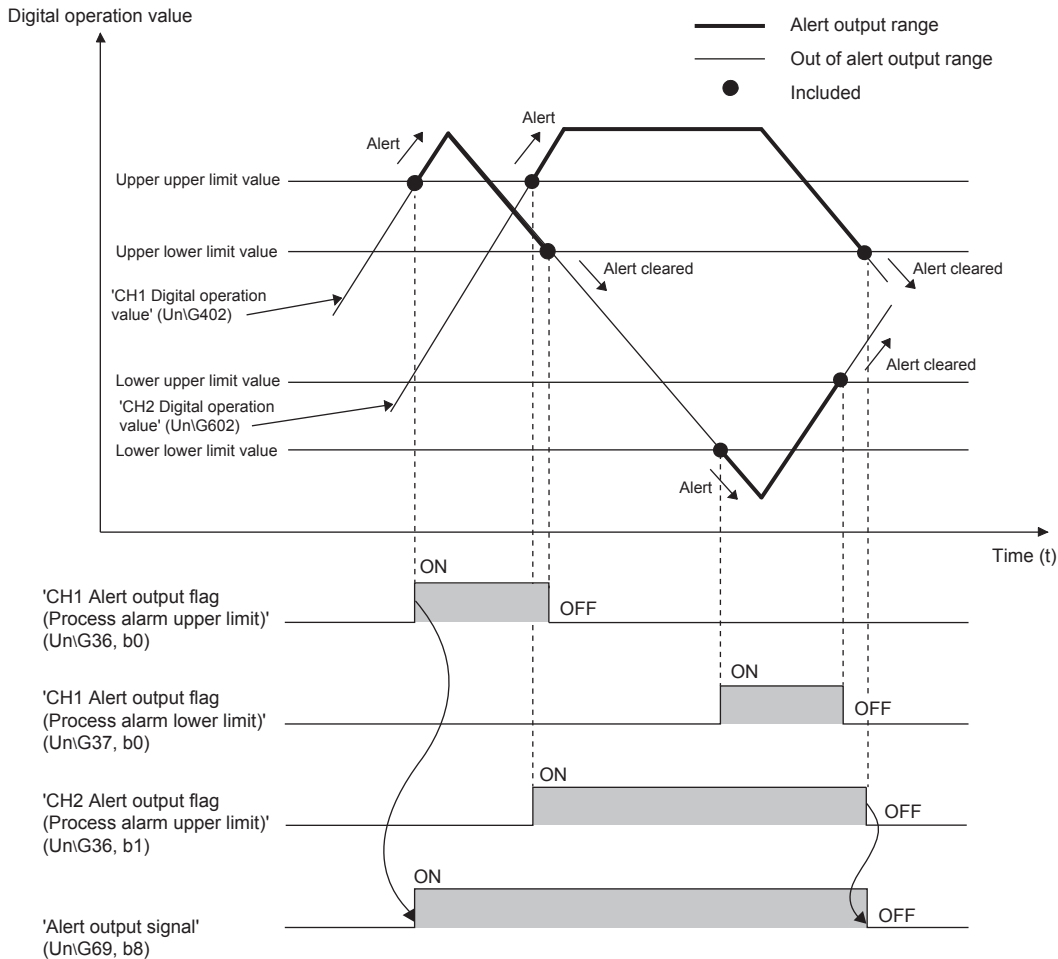

■ Operation

[Operation performed when an alert is output]

When a digital operation value is equal to or greater than 'CH1 Process alarm upper upper limit value' (UnG514), or the value is equal to or smaller than 'CH1 Process alarm lower lower limit value' (UnG520) and the value enters the alarm output range, an alert is output as follows.

- Alarm ON (1) is stored in 'Alert output flag (Process alarm upper limit)' (UnG36) or 'Alert output flag (Process alarm lower limit)' (UnG37).
- 'Alert output signal' (UnG69, b8) turns on.
- The ALM LED turns on.
- An alarm code is stored in 'Latest alarm code' (UnG2). (🔍 Page 427 List of alarm codes)



The conversion on a channel where an alert was output continues.

[Operation after an alert was output]

After an alert was output, if the digital operation value does not satisfy the alert output condition due to being smaller than 'CH1 Process alarm upper lower limit value' (Un\G516) or being greater than 'CH1 Process alarm lower upper limit value' (Un\G518), Normal (0) is stored in a bit corresponding to the channel of 'Alert output flag (Process alarm upper limit)' (Un\G36) or 'Alert output flag (Process alarm lower limit)' (Un\G37).

In addition, when all the bits of 'Alert output flag (Process alarm upper limit)' (Un\G36) and 'Alert output flag (Process alarm lower limit)' (Un\G37) return to Normal (0), 'Alert output signal' (Un\G69, b8) turns off and the ALM LED turns off. However, the alarm code stored in 'Latest alarm code' (Un\G2) is not cleared. Turn off→on→off 'Error clear request' (Un\G70, b15) to clear the alarm code.

■Detection cycle

When time average is specified, the function works at every interval of the time (for averaging). When count average is specified, the function works at every count (for averaging).

When the sampling processing, and moving average are specified, this function works at every conversion period.

■Detection target for outputting an alert

When using the digital clipping function, scaling function, and shift function, 'CH1 digital operation value' (Un\G402) digitally clipped, scale converted, and shifted are subject to alarm (process alarm).

■Operation performed when disconnection is detected

When input type is set to "resistance temperature detector" or "thermocouple", 'CH1 Digital output value' (Un\G400) changes according to 'CH1 Conversion setting at disconnection detection' (Un\G534), so process alarms may occur at the same time.

■Setting procedure

1. Set "Warning output setting (Process alarm)" to "Enable".

 [Navigation window] ⇒ [Parameter] ⇒ [Module Information] ⇒ Module model name ⇒ [Module Parameter] ⇒ [Application setting] ⇒ [Warning output function (Process alarm)]

2. Set values for "Process alarm upper upper limit value", "Process alarm upper lower limit value", "Process alarm lower upper limit value", and "Process alarm lower lower limit value". The setting range is from -32768 to +32767*¹.

*1 When "RTD" or "Thermocouple" is set as the input type, set it in units of 0.1°C (°F) unit.

Point

Set values within the range satisfying the condition Process alarm upper upper limit value ≥ Process alarm upper lower limit value ≥ Process alarm lower upper limit value ≥ Process alarm lower lower limit value. If a value out of the range is set, a process alarm upper lower limit value setting range error (error code: 1B△□H) occurs.

Rate alarm

This function outputs an alert when the change rate of a digital output value is equal to or greater than the rate alarm upper limit value, or the rate is equal to or smaller than the rate alarm lower limit value.

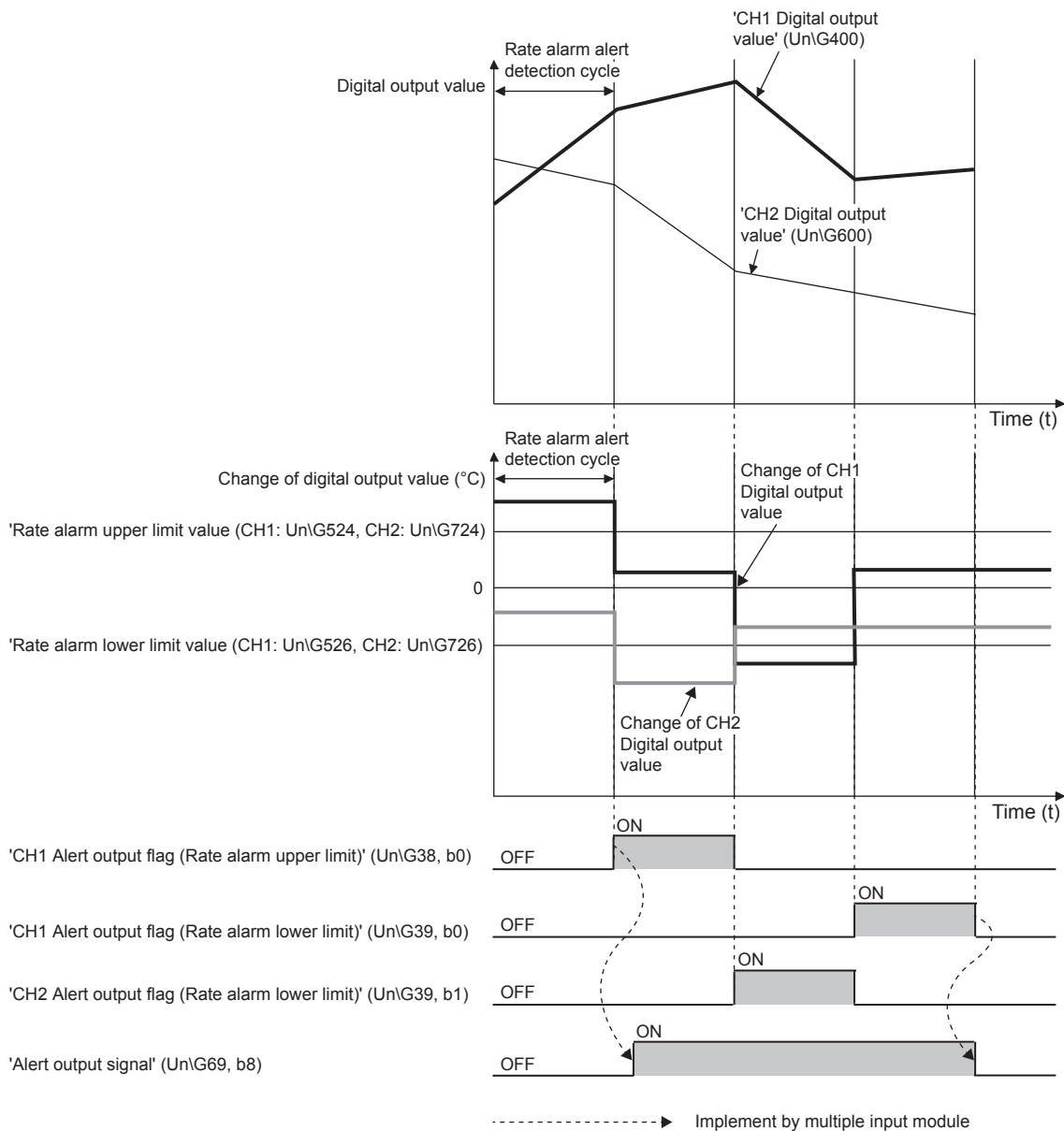

■ Operation

[Operation performed when an alert is output]

Digital output values are monitored on the rate alarm alert detection cycle. When a change rate of a digital output value (from a previous value) is equal to or more than the rate alarm upper limit value, or the rate is equal to or less than the rate alarm lower limit value, an alert is output as follows.

- Alarm ON (1) is stored in 'Alert output flag (Rate alarm upper limit)' (Un\G38) or 'Alert output flag (Rate alarm lower limit)' (Un\G39).
- 'Alert output signal' (Un\G69, b8) turns on.
- The ALM LED turns on.
- An alarm code is stored in 'Latest alarm code' (Un\G2). ( Page 427 List of alarm codes)

Point

The conversion on a channel where an alert was output continues.

[Operation after an alert was output]

After an alert was output, if the change rate of a digital output value does not satisfy the alert output conditions due to being smaller than the rate alarm upper limit value or being greater than the rate alarm lower limit value, Normal (0) is stored in a bit corresponding to the channel of 'Alert output flag (Rate alarm upper limit)' (Un\G38) or 'Alert output flag (Rate alarm lower limit)' (Un\G39).

In addition, when all 'Alert output flag (Rate alarm upper limit)' (Un\G38) and 'Alert output flag (Rate alarm lower limit)' (Un\G39) return to Normal (0), 'Alert output signal' (Un\G69, b8) turns off and the ALM LED turns off. However, the alarm code stored in 'Latest alarm code' (Un\G2) is not cleared. Turn off→on→off 'Error clear request' (Un\G70, b15) to clear the alarm code.

■ Detection cycle

The rate alarm alert detection cycle is calculated by the following formula.

- Rate alarm alert detection cycle = Conversion cycle × Setting value of 'CH1 Rate alarm alert detection cycle setting' (Un\G522)

Ex.

CH1: Current (4 to 20 mA), CH2 to 6: Conversion disabled, CH7: Pt100, CH8: When setting the input range to K and making the following settings

- 'CH1 Rate alarm alert detection cycle setting' (Un\G522): 5 (times)
- 'CH7 Rate alarm alert detection cycle setting' (Un\G1722): 8 (times)

The CH1 rate alarm alert detection cycle is 5 ms. (1 ms × 1 (CH) × 5 (times))

The CH7 rate alarm alert detection cycle is 640 ms. (40 ms × 2 (CH) × 8 (times))

■ Judgment of rate alarm

The judgment of the rate alarm is judged by the following formula according to the rate alarm change rate selection and input type setting.

- When the rate alarm change rate selection is "rate specification"

Convert 'CH1 rate alarm upper limit value' (Un\G524) and 'CH1 rate alarm lower limit value' (Un\G526) to digit value for each rate alarm warning detection cycle value. The following shows the conversion formula of judgment values used for the rate alarm detection.

Input type	Conversion formula
Case of current or voltage	Rate alarm upper limit (lower limit) ^{*1} × 0.1 × 0.01 × Maximum value of digital output value
Case of resistance temperature detector, and thermocouple	Rate alarm upper limit value (lower limit value) ^{*1} × 0.1 × 0.01 × (upper limit value of digital output value - lower limit value of digital output value)

*1 When the input type is "current" or "voltage", set it in units of 0.1% with respect to the width (gain value - offset value) of the analog input range.

When the input type is "RTD" or "Thermocouple", set it in units of 0.1% with respect to (maximum value - minimum value) of measured temperature value.

Ex.

The judgment under the following conditions

Setting item	Setting content
Conversion enabled channels	CH1
CH1 Input type/range setting	Current (4 to 20 mA)
Rate alarm change rate selection	Rate specification
CH1 Average processing specification	Sampling processing
CH1 Rate alarm alert detection cycle setting	5 times
CH1 Rate alarm upper limit value	250 (25.0%)
CH1 Rate alarm lower limit value	50 (5.0%)

In the above case, the current digital output value and the previous digital output value (digital output value of 5 ms before) are compared at each rate alarm warning detection cycle of 5 ms (1 ms × 5 times). As a result of the comparison, it is judged whether the increase of the digital output value is 8000 (= 250 × 0.1 × 0.01 × 32000) digit or more or 1600 (= 50 × 0.1 × 0.01 × 32000) digit or less.

- When the rate alarm change rate selection is "Digital output value specification"

It is judged by comparing the difference between the current digital output value and the digital output value in the previous detection cycle with the rate alarm upper limit value and the rate alarm lower limit value.

Alarm occurrence condition	Conversion formula
For alert outputting of rate alarm upper limit	Current digital output value - Digital output value at the previous detection cycle ≥ Rate alarm upper limit value ^{*1}
For alert outputting of rate alarm lower limit	Current digital output value - Digital output value at the previous detection cycle ≤ Rate alarm lower limit value ^{*1}

*1 When the input type is "RTD" or "Thermocouple", set the rate alarm upper limit (lower limit) in unit of 0.1°C.

Ex.

The judgment under the following conditions

Setting item	Setting content
Conversion enabled channels	CH1
CH1 Input type/range setting	Pt100
Rate alarm change rate selection	Digital output value
CH1 Average processing specification	Sampling processing
CH1 Rate alarm alert detection cycle setting	5 times
CH1 Rate alarm upper limit value	10000 (1000.0°C)
CH1 Rate alarm lower limit value	3200 (320.0°C)

In the above case, the current digital output value and the previous digital output value (digital output value of 200 ms before) are compared at each rate alarm warning detection cycle of 200 ms (40 ms × 5 times). From the comparison, whether the increase in the digital output value is 10000 (1000.0°C) or more, or 3200 (320.0°C) or less is judged.

■Detection target for outputting an alert

'CH1 Digital output value' (Un\G400) is a target for outputting an alert. The target is the same for when the scaling function is enabled.

■Application examples of rate alarms

A rate alarm serves to monitor that the variation of a digital output value lies in a limited range as shown below:

• Example 1

To monitor that a rising rate of a digital output value is within the specified range

Change rate of the digital output value (%)

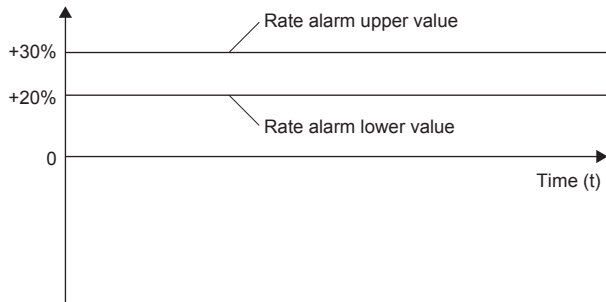

• Example 2

To monitor that a drop rate of a digital output value is within the specified range

Change rate of the digital output value (%)

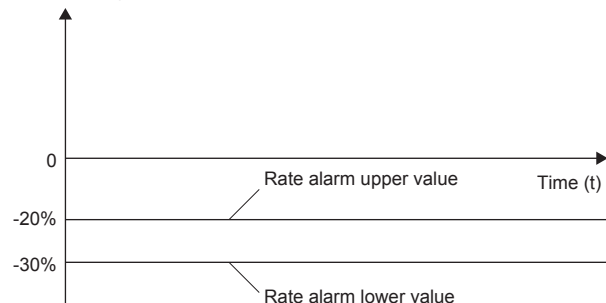

• Example 3

To monitor that a change rate of a digital output value is within the specified range

Change rate of the digital output value (%)

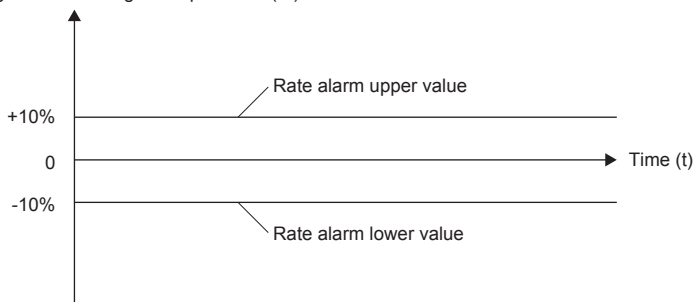

■Operation performed when disconnection is detected

- At disconnection detection, a rate alarm may occur as well because 'CH1 Digital output value' (Un\G400) changes according to 'CH1 Conversion setting at disconnection detection' (Un\G531).
- At recovery time from disconnection, previous information (value) of rate alarm is cleared. Therefore, at the restart of conversion, even if the change rate of the digital output value (from before restart to after restart) is out of the limit range, an alert is not output.

■ Setting procedure

1. Set "Warning output setting (Rate alarm)" to "Enable".

 [Navigation window] ⇒ [Parameter] ⇒ [Module Information] ⇒ Module model name ⇒ [Module Parameter] ⇒ [Application setting] ⇒ [Warning output function (Rate alarm)]

2. Set the value to "Rate alarm change rate selection".

Item	Setting range
Rate alarm change rate selection	0: Rate specification 1: Digital output value specification

3. Set values for "Rate alarm upper limit value" and "Rate alarm lower limit value".

Item	Setting range
Rate alarm upper limit value	-32768 to +32767
Rate alarm lower limit value	

Point

Set values within the range satisfying the condition "Rate alarm upper limit value > Rate alarm lower limit value".

If a value out of the range is set, a rate alarm upper/lower limit setting value inversion error (error code: 1BA□H) occurs.

4. Set a value in "Rate alarm detection cycle setting".

Item	Setting range
Rate alarm alert detection cycle setting	1 to 32000 (times)

Input signal error detection function

Outputs an alarm when an analog input value exceeds the preset range.
Only "Current" and "Voltage" are supported as input types.

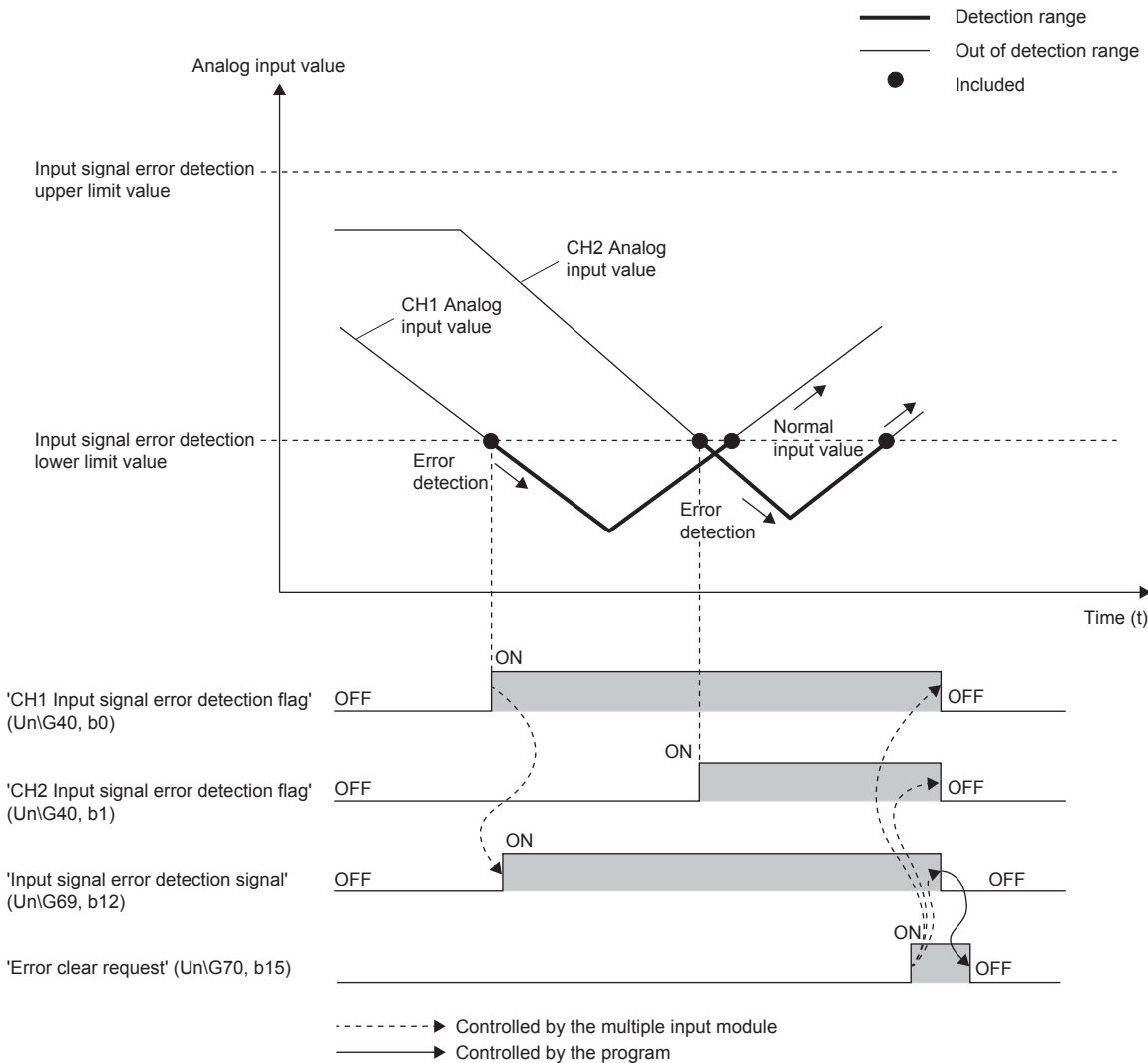

Point

Errors can also be cleared with the Input signal error auto-clear enable/disable setting. Refer to the following sections for details.

📖 Page 370 Clearing input signal errors

Detection method

One of the following detection methods can be selected.

Detection method	Detection condition	
0: Disable	Input signal errors are not detected.	—
1: Upper and lower limit detection	An input signal error is detected when the analog input value is equal to or greater than the input signal error detection upper limit value, or when the analog input value is equal to or smaller than the input signal error detection lower limit value.	
2: Lower limit detection	An input signal error is detected when the analog input value is equal to or smaller than the input signal error detection lower limit value.	
3: Upper limit detection	An input signal error is detected when the analog input value is equal to or greater than the input signal error detection upper limit value.	
4: Simple disconnection detection	Simple disconnection detection is performed. For details, refer to the following. Page 369 Simple disconnection detection	

Simple disconnection detection

Outputs an alarm when an analog input value is 0.5 V or smaller or 2 mA or smaller.

By the input range setting, simple disconnection detection is enabled. The simple broken wire detection is supported only in the "4 to 20 mA" or "1 to 5 V" range. When an analog input value satisfies either of the following conditions, a disconnection occurs and 'Input signal error detection flag' (Un\G40) turns on.

Input range	Disconnection detection value
4 to 20 mA	Analog input value ≤ 2 mA
1 to 5 V	Analog input value ≤ 0.5 V

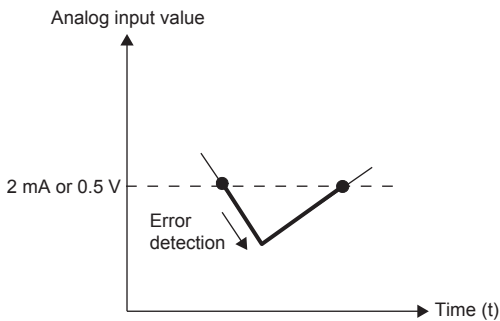

Point

The settings for 'CH1 Input signal error detection lower limit set value' (Un\G529) and 'CH1 Input signal error detection upper limit set value' (Un\G530) are ignored.

Notification

When an input signal error is detected, an error is notified as follows.

- Input signal error (1) is stored in the corresponding bit of 'Input signal error detection flag' (Un\G40).
- 'Input signal error detection signal' (Un\G69, b12) turns on.
- The ALM LED flashes.
- An alarm code is stored in 'Latest alarm code' (Un\G2). Alarm codes are stored whenever the analog input value satisfies the condition for the input signal error detection. (Page 427 List of alarm codes)
- The digital output value or digital operation value before the input signal error was detected is stored in 'CH1 logging data' (Un\G10000 to 19999) depending on the 'CH1 logging data setting' (Un\G536).

Operation

On the channel where an error is detected, the last digital output value and digital operation value just before the error was detected are stored.

When the analog input value does not satisfy the condition of the input signal error detection, the A/D conversion resumes regardless of off of 'Input signal error detection flag' (Un\G40) and 'Input signal error detection signal' (Un\G69, b12). (The ALM LED remains flashing.)

Point

- When an input signal error occurs, the digital output value and digital operation value are not updated.
- The A/D conversion continues on the channel where no Input signal error is detected.
- Whether an input signal error occurred is judged with the value when the first A/D conversion is completed. Thus, the corresponding bit of 'A/D conversion completed flag' (Un\G42) turns on even when an input signal error is detected.

Detection cycle

This function works at every sampling cycle.

Clearing input signal errors

One of the following methods for clearing input signal errors can be selected by setting 'Input signal error auto-clear enable/disable setting' (Un\G304).

■When Input signal error auto-clear enable/disable setting is set to Enable (0)

After the analog input value returns within the setting range, the multiple input module arranges the following status automatically. After the analog input value returns within the setting range, turning off→on→off 'Error clear request' (Un\G70, b15) is not required.

- 'Input signal error detection flag' (Un\G40) is cleared.
- Input signal error detection signal (Un\G69, b12) turns off.
- The ALM LED turns off.

Point

'Latest alarm code' (Un\G2) is not cleared.

After the analog input value returns within the setting range, turn off→on→off 'Error clear request' (Un\G70, b15) to clear 'Latest alarm code' (Un\G2).

Ex.

The following figure shows the operation when an analog input value falls below 2.4 mA and returns within the normal range under the following condition.

Item	Setting
'Input signal error auto-clear enable/disable setting' (Un\G304)	Enable (0)
Input range	4 to 20 mA
'CH1 Input signal error detection setting' (Un\G528)	Upper and lower limit detection (1)
'CH2 Input signal error detection setting' (Un\G728)	Upper and lower limit detection (1)
Input signal error detection lower limit value	2.4 mA

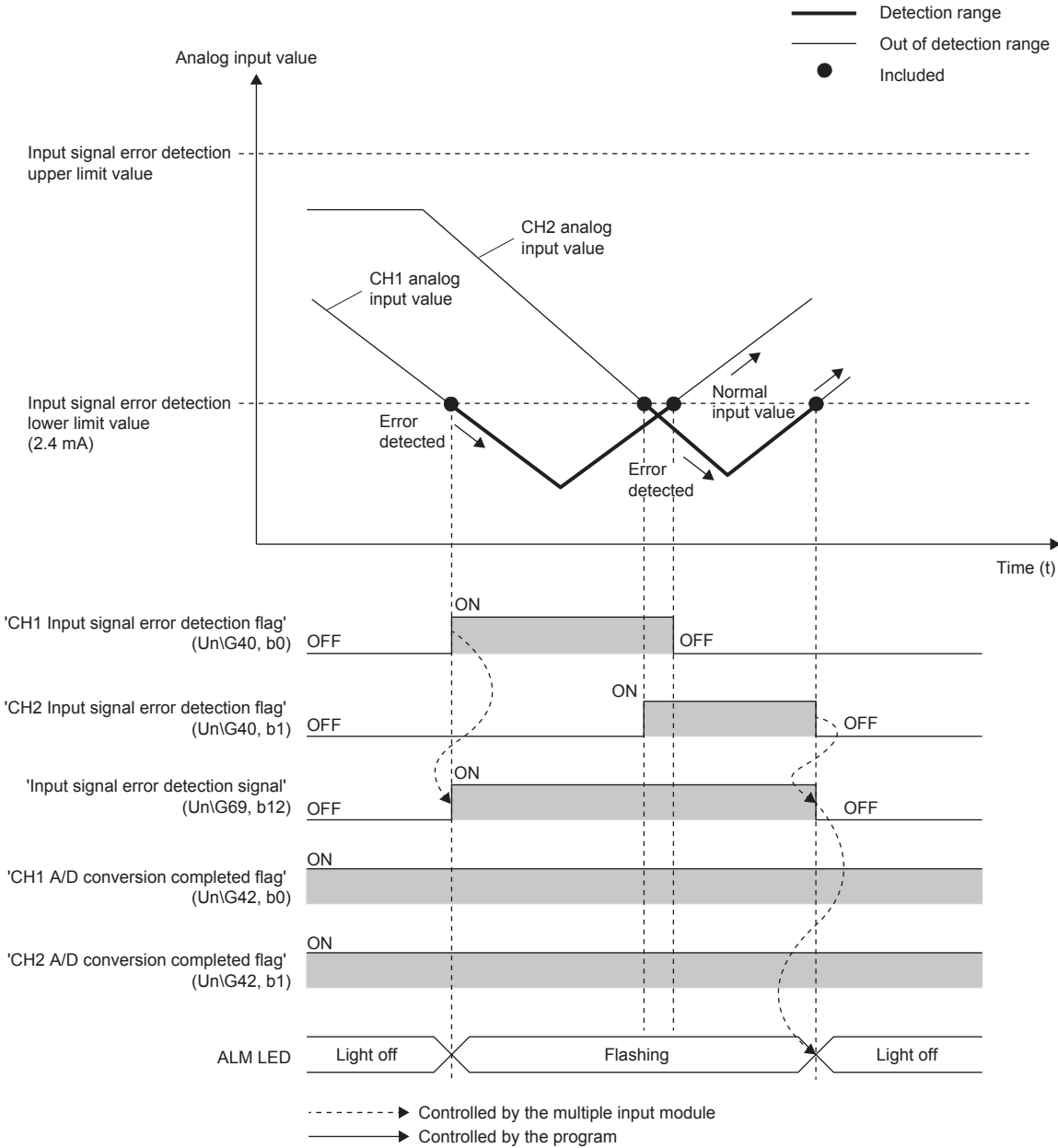

■When Input signal error auto-clear enable/disable setting is set to Disable (1)

After the analog input value returns within the set range, turn off→on→off Error clear request (Un\G70, b15).

The multiple input module arranges the following status when an input signal error is cleared.

- 'Input signal error detection flag' (Un\G40) is cleared.
- 'Input signal error detection signal' (Un\G69, b12) turns off.
- The ALM LED turns off.
- 'Latest alarm code' (Un\G2) is cleared.

Setting the input signal error detection upper or lower limit value

Input signal error detection upper limit value

Set the input signal error detection upper limit value by 1 (0.1%) based on the input signal error detection upper limit set value. This value is calculated by adding "Analog input range width (Gain value - Offset value) × Input signal error detection upper limit set value (%)" to the gain value. Only a value which is equal to or greater than the gain value can be set.

To calculate the input signal error detection upper limit set value based on the input signal error detection upper limit value, use the following formula.

$$\text{Input signal error detection upper limit setting value} = \frac{\text{Input signal error detection upper limit value} - \text{Gain value of each range}}{\text{Gain value of each range} - \text{Offset value of each range}} \times 1000$$

Input signal error detection lower limit value

Set the input signal error detection lower limit value by 1 (0.1%) based on the input signal error detection lower limit set value. This value is calculated by subtracting "Analog input range width (Gain value - Offset value) × Input signal error detection lower limit set value (%)" from the lower limit value of each range. Only the value which is equal to or smaller than the lower limit value of the range can be set.

To calculate the input signal error detection lower limit set value based on the input signal error detection lower limit value, use the following formula.

$$\text{Input signal error detection lower limit setting value} = \frac{\text{Lower limit value of each range} - \text{Input signal error detection lower limit value}}{\text{Gain value of each range} - \text{Offset value of each range}} \times 1000$$

The following table lists the lower limit value, offset value, and gain value for each range.

Input range	Lower limit value	Offset value	Gain value
Voltage	0 to 10 V	0 V	10 V
	0 to 5 V	0 V	5 V
	1 to 5 V	1 V	5 V
	-10 to +10 V	-10 V	10 V
Current	0 to 20 mA	0 mA	20 mA
	4 to 20 mA	4 mA	20 mA
	-20 to +20 mA	-20 mA	20 mA

Setting procedure

1. Select a detection method in "Input signal error detection setting".

 [Navigation window] ⇒ [Parameter] ⇒ [Module Information] ⇒ Module model name ⇒ [Module Parameter] ⇒ [Application setting] ⇒ [Input signal error detection function]

2. Set values for "Input signal error detection lower limit setting value" and "Input signal error detection upper limit setting value".

Item	Setting range
'CH1 Input signal error detection lower limit setting value' (Un\G529)	0.0 to 25.0 (%)
'CH1 Input signal error detection upper limit setting value' (Un\G530)	

Point

In the channel where a value out of the range is set, an input signal error detection setting value range error (error code: 1C1□H) occurs.

3. Set "Input signal error auto-clear enable/disable setting" to "Enable" or "Disable".

Setting example

■ Setting example of the input signal error detection

In the channel where the following values are set, an input error is detected when an analog input value exceeds +10.235 V or falls below -10.24 V.

Item	Setting value
Input range	-10 to +10 V
'Input signal error auto-clear enable/disable setting' (Un\G304)	Disable (1)
'CH1 Input signal error detection setting' (Un\G528)	Upper and lower limit detection (1)

Assign the following values in a formula to determine the input signal error detection lower limit set value and input signal error detection upper limit set value.

- Input signal error detection lower limit value: -10.24 V
- Input signal error detection upper limit value: 10.235 V
- Offset value: 0.0 V
- Gain value: 10.0 V

[Calculation of lower limit value]

$$\begin{aligned} \text{Input signal error detection lower limit} &= \frac{-10.0 - (-10.24)}{10.0 - 0.0} \times 1000 \\ \text{setting value} & \\ &= 24 \text{ (2.4\%)} \end{aligned}$$

Set 'CH1 Input signal error detection lower limit set value' (Un\G529) to 24 (2.4%).

[Calculation of upper limit value]

$$\begin{aligned} \text{Input signal error detection upper limit} &= \frac{10.235 - 10.0}{10.0 - 0.0} \times 1000 \\ \text{setting value} & \\ &= 24 \text{ (2.35\%)} \end{aligned}$$

Set 'CH1 Input signal error detection upper limit set value' (Un\G530) to 24 (2.35%).

The following figure shows the operation of the input signal error detection.

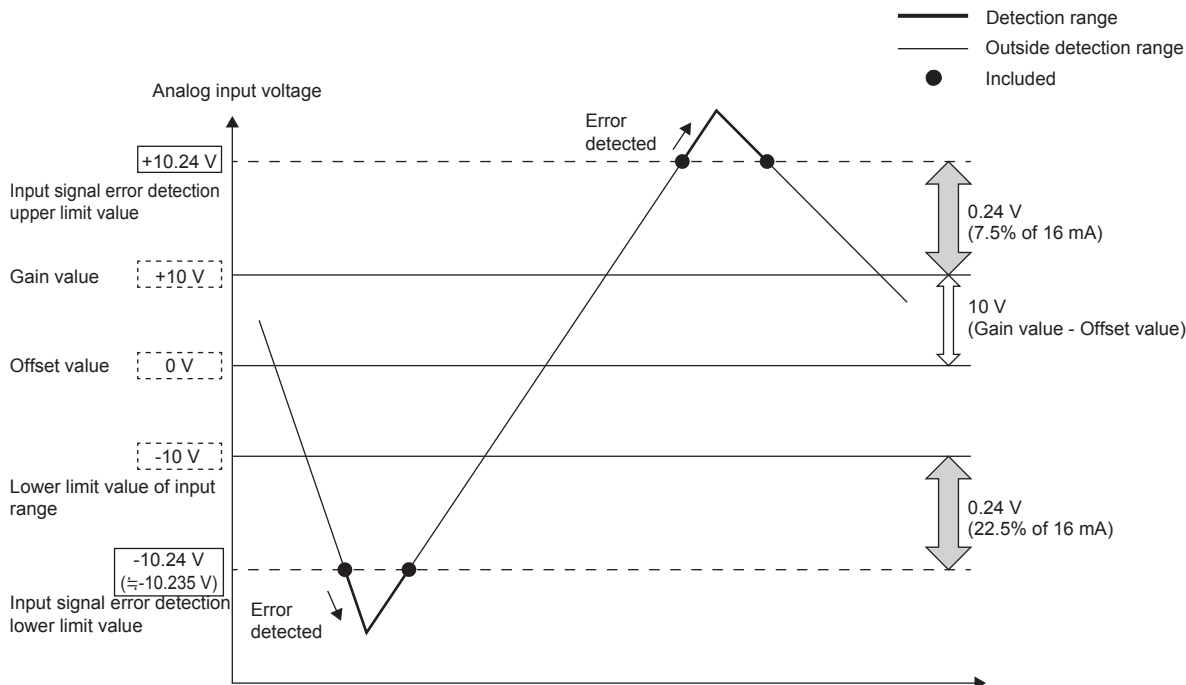

Disconnection detection function

This function detects disconnection of a thermocouple or resistance temperature detector.

Notification of disconnection

- Disconnection detection (1) is stored in a bit corresponding to the channel of 'Disconnection detection flag' (Un\G41).
- 'Disconnection detection signal' (Un\G69, b6) turns on.
- The ALM LED flashes.
- An alarm code is stored in 'Latest alarm code' (Un\G2). ( Page 427 List of alarm codes)
- A value specified in 'CH1 Conversion setting at disconnection detection' (Un\G534) (Value just before disconnection, Upscale, Downscale, or Any value) is stored in 'CH1 Digital output value' (Un\G400).
- The value calculated with the scaling function and shift function is stored in 'CH1 digital operation value' (Un\G402) and 'CH1 digital output value' (Un\G400).
- The digital output value or digital operation value is stored in 'CH1 logging data' (Un\G10000 to 19999) depending on the 'CH1 logging data setting' (Un\G536).
- The 'CH1 maximum value' (Un\G404) and 'CH1 minimum value' (Un\G406) are updated with the maximum and minimum values of the digital operation value.

Relationship of disconnection detection and conversion enable/disable setting

The disconnection detection is executed only for a channel where conversion is set to be enabled. The following table shows the relationship of disconnection detection and state of conversion enable/disable setting.

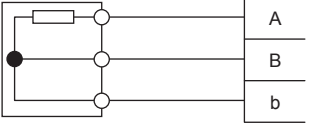
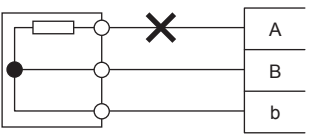
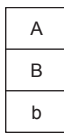
Connection status	State of conversion enable/disable setting	Disconnection detection flag
 <p>No disconnection</p>	Conversion enable	0 (OFF)
	Conversion disable	
 <p>Disconnection</p>	Conversion enable	1 (ON)
	Conversion disable	0 (OFF)
 <p>No connection</p>	Conversion enable	1 (ON)
	Conversion disable	0 (OFF)

Recovery from disconnection

When the cause of the disconnection is eliminated and the connection of external devices is established, the operation after this recovery varies depending on the setting of 'Input signal error/Disconnection detection automatic clear enable/disable setting' (Un\G304).

■Case of Enable (0)

Normal (0) is stored in the bit corresponding to 'Disconnection detection flag' (Un\G41) of the recovered channel. After Normal (0) is stored in all the bits of 'Disconnection detection flag' (Un\G41), 'Disconnection detection signal' (Un\G69, b6) automatically turns off and the ALM LED turns off. However, the alarm code stored in 'Latest alarm code' (Un\G2) is not cleared. Turn off→on→off 'Error clear request' (Un\G70, b15) to clear the alarm code.

■Case of Disable (1)

'Disconnection detection flag' (Un\G41), 'Disconnection detection signal' (Un\G69, b6), and the ALM LED hold the status at the time of the disconnection detection. To return to the normal status, make a recovery from disconnection of all the channels, and turn off→on→off 'Error clear request' (Un\G70, b15).

Detection cycle

Disconnection detection is executed every sampling cycle.

Conversion setting at disconnection detection

A value stored in 'CH1 Digital output value' (Un\G400) at the time of the disconnection detection can be specified by setting 'CH1 Conversion setting at disconnection detection' (Un\G534). This enables disconnection detection only by checking 'CH1 Digital output value' (Un\G400), without checking 'Disconnection detection signal' (Un\G69, b6). The default value of 'CH1 Conversion setting at disconnection detection' (Un\G534) is Downscale (1). Change the setting value if necessary.

Conversion setting at disconnection detection	Operation performed when disconnection is detected
0: Upscale	An upscale value of the presently set input range (upper limit value +5% of input range) is stored in 'CH1 Digital output value' (Un\G400).
1: Downscale	A downscale value of the presently set input range (lower limit value -5% of input range) is stored in 'CH1 Digital output value' (Un\G400).
2: Any value	A value set in 'CH1 Conversion setting value at disconnection detection' (Un\G532) is stored in 'CH1 Digital output value' (Un\G400).
3: Value just before disconnection	'CH1 Digital output value' (Un\G400) holds a value just before the disconnection is detected.

■Upscale, downscale

An upscale value (upper limit value +5% of input range) or a downscale value (lower limit value -5% of input range) of the set input range is stored in 'CH1 Digital output value' (Un\G400) at the time of the disconnection detection. The following tables list a value stored in 'CH1 Digital output value' (Un\G400) at the disconnection detection, when the upscale or downscale is selected.

- Case of thermocouple

Input range		Temperature measuring range	Down Scale	Up Scale
K	Centigrade (°C)	-270 to +1370°C	-352.0°C	1452.0°C
	Fahrenheit (°F)	-454 to +2498°F	-601.6°F	2645.6°F
J	Centigrade (°C)	-210 to +1130°C	-277.0°C	1197.0°C
	Fahrenheit (°F)	-346 to +2066°F	-466.6°F	2186.6°F
T	Centigrade (°C)	-270 to +400°C	-303.5°C	433.5°C
	Fahrenheit (°F)	-454 to +752°F	-514.3°F	812.3°F
B	Centigrade (°C)	0 to 1710°C	-85.5°C	1795.5°C
	Fahrenheit (°F)	32 to 3110°F	-121.9°F	3263.9°F
R	Centigrade (°C)	-50 to +1710°C	-138.0°C	1798.0°C
	Fahrenheit (°F)	-58 to +3110°F	-216.4°F	3268.4°F
S	Centigrade (°C)	-50 to +1710°C	-138.0°C	1798.0°C
	Fahrenheit (°F)	-58 to +3110°F	-216.4°F	3268.4°F

- Case of resistance temperature detector

Input range		Temperature measuring range	Down Scale	Up Scale
Pt100	Centigrade (°C)	-200 to +850°C	-252.5°C	902.5°C
	Fahrenheit (°F)	-328 to +1562°F	-422.5°F	1656.5°F
Ni100	Centigrade (°C)	-60 to +250°C	-75.5°C	265.5°C
	Fahrenheit (°F)	-76 to +482°F	-103.9°F	509.9°F

■Any value

At the time of the disconnection detection, a value set in 'CH1 Conversion setting value at disconnection detection' (Un\G532) is stored in 'CH1 Digital output value' (Un\G400).

The default value of 'CH1 Conversion setting value at disconnection detection' (Un\G532) is 0. The value can be changed to any value although using 0 is no problem.

Point

- When the scaling function is used, a value according to the setting of 'CH1 Conversion setting at disconnection detection' (Un\G534) is scale converted and then stored as a scaling value.
- When using the shift function, the value obtained by the conversion value shift rate to the scale converted value is stored.

Setting procedure

1. Set "Disconnection detection function enable/disable setting" to "Enable".

 [Navigation window] ⇒ [Parameter] ⇒ [Module Information] ⇒ Module model name ⇒ [Module Parameter] ⇒ [Application setting] ⇒ [Disconnection detection function]

2. Set "Input signal error detection/disconnection detection auto-clear enable/disable setting" to "Enable" or "Disable".
3. Using "Conversion setting for disconnection detection", set what value is to be stored in 'CH1 Digital output value' (Un\G400) at the time of the disconnection detection.

Item	Setting range
Conversion setting at disconnection detection	<ul style="list-style-type: none">• Up Scale• Down Scale• Given Value• Value immediately before disconnection

4. When "Given Value" is set, set "Conversion setting value for disconnection detection".

Item	Setting range
Conversion setting value for disconnection detection	-32768 to +32767 (0.1°C unit)

Point

It takes up to 355 ms to detect a broken wire.

Logging function

Logs (records) digital output values or digital operation values. 10000 points of data can be logged for each channel. Logging data are stored in the buffer memory area. In addition, the data collection can be stopped by using the status change of the data as a trigger. This function also helps the error analysis since the data before and after the occurrence of an error is held.

Logging function

Collecting logging data

Logging data is collected as follows.

- 10000 points of the latest digital output values or digital operation values can be always collected for each channel.
- It can be collected at the specified interval (logging cycle).

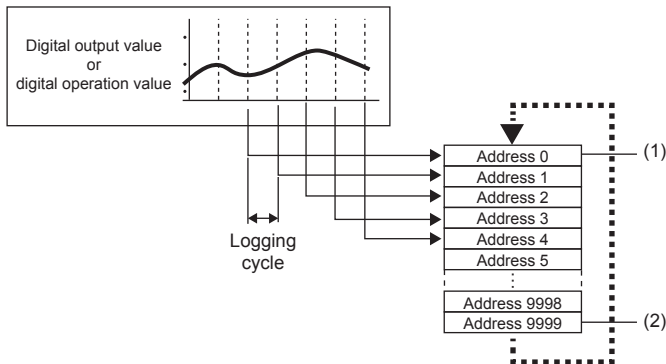

- (1) Head pointer
The address of the oldest data in logging data can be checked.
- (2) Latest pointer
The address of the latest data in logging data can be checked.

Point

When the number of stored data points is 10001 or greater, data is sequentially overwritten from address 0 with new data.

Stopping the logging operation

The logging data is refreshed at high speed during logging. Stop logging when the logging data needs to be referred without paying attention to the refreshing cycle.

Logging can be stopped by the hold trigger.

- A hold trigger allows two options: Logging hold request or Level trigger.
- The number of data points to be collected after a hold trigger occurs can be set.

Logging data are stored in buffer memory areas.

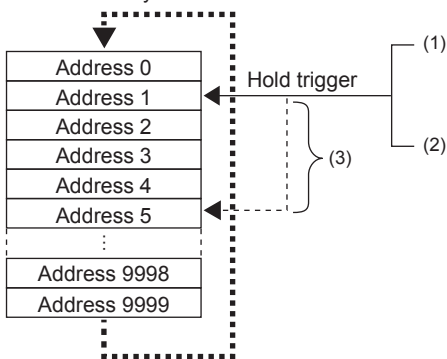

- (1) Logging hold request
A hold trigger is generated from a program at any timing.
- (2) Level trigger
A hold trigger is generated when a stored value in a buffer memory area is monitored and the set condition is satisfied as follows.
Example: When the stored value exceeds or falls below the set value, a hold trigger is generated.

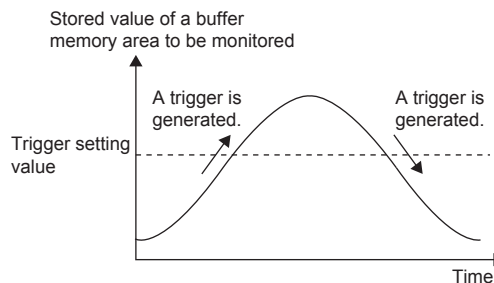

- (3) Post-trigger logging points
When the set points of data is collected after a hold trigger is generated, the logging operation is stopped.

Operation of logging

■ Starting logging data collection

Logging data collection starts when Enable (0) is set in 'CH1 Logging enable/disable setting' (Un\G535) and 'Operating condition setting request' (Un\G70, b9) turns off→on→off.

The data in 'CH1 Digital output value' (Un\G400) or 'CH1 Digital operation value' (Un\G402) is stored in CH1 Logging data (Un\G10000 to Un\G19999) on the set logging cycle.

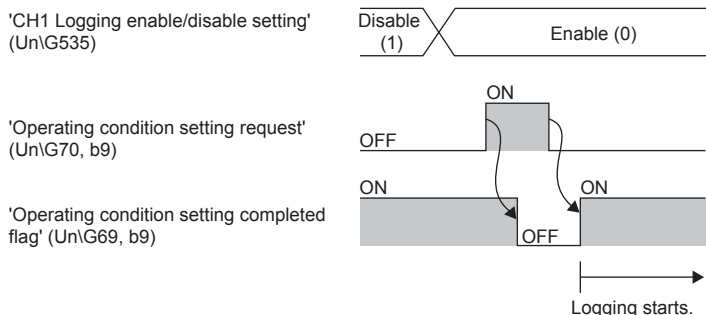

■ Logging data

Logging data are stored in the following buffer memory areas.

When the number of stored data points is 1001 or greater, the data is overwritten with new data from the head of the storage area of the corresponding channel.

Channel	Storage area for logging data
CH1	Un\G10000 to Un\G19999
CH2	Un\G20000 to Un\G29999
CH3	Un\G30000 to Un\G39999
CH4	Un\G40000 to Un\G49999
CH5	Un\G50000 to Un\G59999
CH6	Un\G60000 to Un\G69999
CH7	Un\G70000 to Un\G79999
CH8	Un\G80000 to Un\G89999

If logging has been performed even once, 0 is stored for all the logging data above at the timing when 'Operating condition setting request' (Un\G70, b9) turns off→on→off.

■ Logging data setting

Select a data type to be collected with 'CH1 Logging data setting' (Un\G536).

- Digital output value (0)
- Digital operation value (1)

Logging cycle

■ Logging cycle setting

Set the logging cycle with 'CH1 Logging cycle setting value' (Un\G537) and 'CH1 Logging cycle unit setting' (Un\G538).

The following table lists the setting range for each cycle.

Setting value of 'CH1 Logging cycle unit setting' (Un\G538)	Setting range of 'CH1 Logging cycle setting value' (Un\G537)
ms (1)	<ul style="list-style-type: none"> • 1 to 32767 (When the input range is "current", and "voltage") • 40 to 32767 (When the input range is thermocouple, and resistance temperature detector)
s (2)	1 to 3600

The logging cycle must be an integral multiple of the conversion cycle. Even if the setting is not an integral multiple, the actual logging cycle is adjusted to the integral multiple of the conversion cycle within a limit of the set logging cycle.

The following table lists the conversion cycle for each temperature conversion method.

Temperature conversion method	Input type	Conversion cycle
Sampling processing	Current/Voltage	Conversion speed (1 ms) × Number of channels where the A/D conversion is enabled
	RTD/Thermocouple	Conversion speed (40 ms) × Number of channels where the temperature conversion is enabled
Time average	Current/Voltage	$\left(\frac{\text{Time set in Time average/Count average/Moving average}}{\text{Number of A/D conversion enabled channels} \times \text{Conversion speed (1 ms)}} \right)^{*1} \times \text{Number of A/D conversion enabled channels} \times \text{Conversion speed (1 ms)}$
	RTD/Thermocouple	$\left(\frac{\text{Time set in Time average/Count average/Moving average}}{\text{Number of temperature conversion enabled channels} \times \text{Conversion speed (40 ms)}} \right)^{*1} \times \text{Number of temperature conversion enabled channels} \times \text{Conversion speed (40 ms)}$
Count average	Current/Voltage	(The count set to CH1 Time average/Count average/Moving average) × (Conversion speed (1ms) × Number of channels where the A/D conversion is enabled)
	RTD/Thermocouple	(The count set to CH1 Time average/Count average/Moving average) × (Conversion speed (40ms) × Number of channels where the temperature conversion is enabled)
Moving average	Current/Voltage	Conversion speed (1 ms) × Number of channels where the A/D conversion is enabled
	RTD/Thermocouple	Conversion speed (40 ms) × Number of channels where the temperature conversion is enabled

*1 Values after the decimal point are omitted.

Ex.

With the following settings, the conversion cycle is 240 ms and the actual logging cycle is every 6720 ms (integral multiple of 240 ms).

Item	Setting
Conversion enabled channels	CH1 to CH8
CH3 Logging data setting	Digital output value
CH1, 2 average processing specification	Sampling processing (Current)
CH3 to 8 average processing specification	Sampling processing (Thermocouple)
CH3 Logging cycle setting value	6950
CH3 Logging cycle unit specification	ms

The following values are stored in 'CH3 Logging cycle monitor value' (Un\G841, Un\G842).

Buffer memory address	Item	Stored value
841	'CH3 Logging cycle monitor value' (Un\G841, Un\G842)	6 (s)
842		720 (ms)

■When the logging function becomes disabled

The logging is not performed when even one of the following errors occurs after the logging function is enabled and 'Operating condition setting request' (Un\G70, b9) is turned off→on→off.

- 'CH1 Time Average/Count Average/Moving Average' (Un\G502) setting error: Error code (192□H to 194□H)
- Logging function setting error: Error code (1D0□H to 1D6□H)

Point

When 'Operating condition setting request' (Un\G70, b9) is turned off→on→off on the condition that the logging cycle determined by 'CH1 Logging cycle setting value' (Un\G537) and 'CH1 Logging cycle unit setting' (Un\G538) is shorter than the conversion cycle, an error occurs and logging does not start. A logging cycle setting disable error (error code: 1D2□H) is stored in 'Latest error code' (Un\G0), 'Error flag' (Un\G69, b15) and the ERROR LED turn on.

■Number of logging data

With 'CH1 Number of logging data' (Un\G436), the number of valid data in 'CH1 Logging data' (Un\G10000 to Un\G19999) can be checked.

- When the number of collected data points is less than 10000

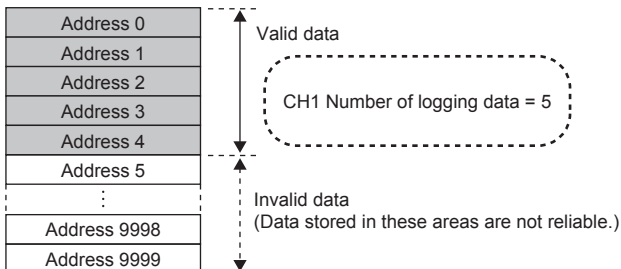

- When the number of collected data points is 10001 or greater

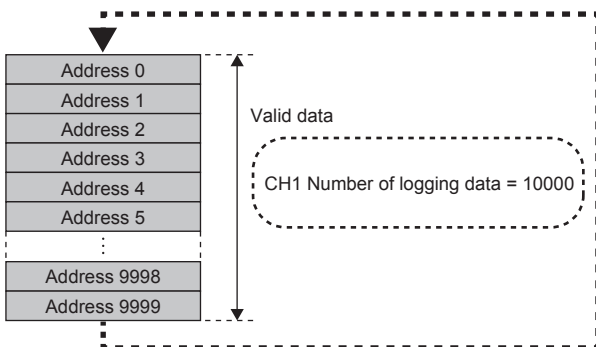

The number of logging data increases by one each time new data is stored.

When CH1 Logging data (Un\G10000 to Un\G19999) becomes full (Number of logging data = 10000), the next data is stored in the head address of CH1 Logging data (Un\G10000 to Un\G19999), and the logging operation continues overwriting the existing data. In this case, the number of logging data is fixed to 10000.

■Head pointer and latest pointer

The storage location of the oldest data and the latest data in CH1 Logging data (Un\G10000 to Un\G19999) can be checked with the following buffer memory areas.

Buffer Memory Areas	Description
CH1 Head pointer (Un\G434)	The buffer memory address of the oldest data in CH1 Logging data (Un\G10000 to Un\G19999) can be checked with this buffer memory area. The offset value (0 to 9999) counted from the start address of CH1 Logging data (Un\G10000 to Un\G19999) is stored.
CH1 Latest pointer (Un\G435)	The buffer memory address of the latest data in CH1 Logging data (Un\G10000 to Un\G19999) can be checked with this buffer memory area. The offset value (0 to 9999) counted from the start address of CH1 Logging data (Un\G10000 to Un\G19999) is stored.

- When the number of collected data points is less than 10000

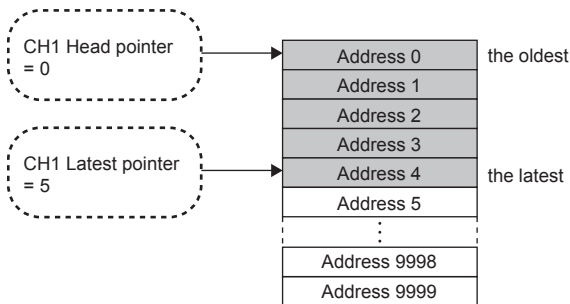

- When the number of collected data points is 10001 or greater

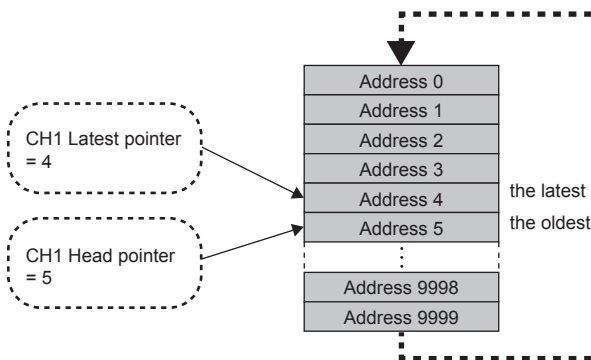

The head pointer does not change until CH1 Logging data (Un\G10000 to Un\G19999) becomes full after the logging start (fixed to 0).

When CH1 Logging data (Un\G10000 to Un\G19999) becomes full and overwriting the data starts from the start address, the head pointer increases by one each time new data is stored.

■Checking logging data without stopping the logging operation

Logging data can be checked during the logging operation with 'CH1 Head pointer' (Un\G434), 'CH1 Latest pointer' (Un\G435), and 'CH1 Number of logging data' (Un\G436).

To check logging data during logging operation, follow the precautions below because logging data may be refreshed while data is being read out.

- Set the cycle to 'CH1 Logging cycle setting value' (Un\G537) so that data checking and reading surely complete before logging data is refreshed. If the logging cycle is short, logging data may be refreshed during data checking and reading.
- After obtaining the logging data which needs to be checked, monitor the variation of the head pointer and the number of logging data, and obtain logging data just after the stored value has changed.
- If the data refreshed and the data being checked do not synchronize due to the relationship between the logging cycle and the scan time of the CPU module, adjust the logging cycle.

Stop the logging operation when the logging data needs to be checked without paying attention to the logging cycle.

(☞ Page 382 Stopping the logging operation)

Stopping the logging operation

Logging operation stops (holds) when the preset trigger condition is satisfied and the set points of the data are collected.

A trigger that is generated when the condition is satisfied is called a hold trigger.

To generate a hold trigger, the following two methods are available.

☞ Page 385 Logging hold request

☞ Page 386 Level trigger

When a hold trigger is detected during data collection, the logging operation stops after the points of the data set in 'CH1 Post-trigger logging points' (Un\G539) are collected.

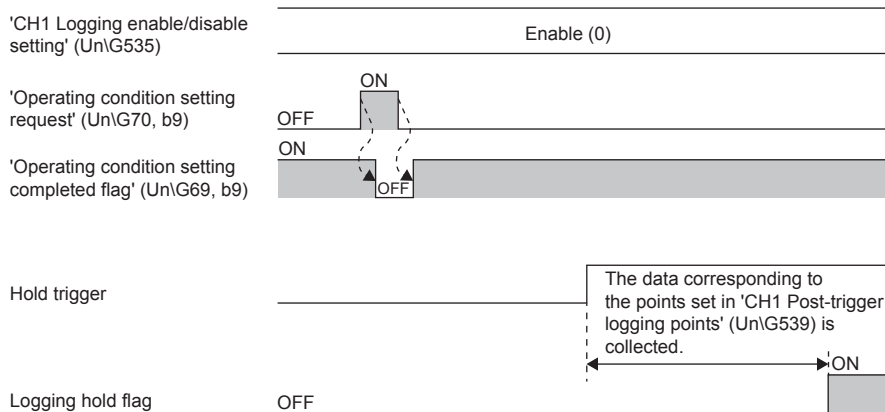

■ Post-trigger logging points

Set the number of data collected in the period from the detection of a hold trigger to logging operation stop to 'CH1 Post-trigger logging points' (Un\G539).

■ Checking that the logging has stopped

Check that 'CH1 Logging hold flag' (Un\G409) is ON (1).

■ Checking data when a hold trigger has occurred

The storage location of the data when a hold trigger has occurred can be checked with 'CH1 Trigger pointer' (Un\G437). The offset value counted from the start address of CH1 Logging data (Un\G10000 to Un\G19999) is stored in 'CH1 Trigger pointer' (Un\G437).

Ex.

The value stored in Trigger pointer when the logging operation stops under the following conditions

- 'CH1 Post-trigger logging points' (Un\G539): 655 points
- The data location where a hold trigger has occurred: 9350th data

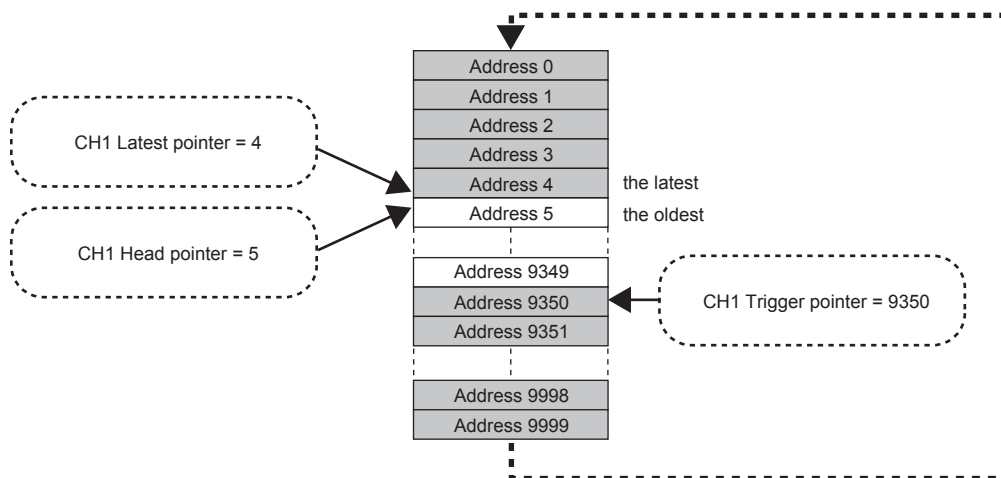

- Checking the trigger generation time

The trigger generation time can be checked with 'CH1 Trigger generation time' (Un\G444 to Un\G448).

Ex.

When 'CH1 Trigger generation time' (Un\G444 to Un\G448) is monitored

	b15	to	b8 b7	to	b0
'CH1 Trigger generation time (First/Last two digits of the year)' (Un\G444)	First two digits of the year		Last two digits of the year		
'CH1 Trigger generation time (Month/Day)' (Un\G445)	Month		Day		
'CH1 Trigger generation time (Hour/Minute)' (Un\G446)	Hour		Minute		
'CH1 Trigger generation time (Second/Day of the week)' (Un\G447)	Second		Day of the week		
'CH1 Trigger generation time (Millisecond)' (Un\G448)	Millisecond (higher-order digits)		Millisecond (lower-order digits)		

Item	Storage contents	Storage example*1
First two digits of the year/Last two digits of the year	Stored in BCD code.	2017H
Month/Day		0130H
Hour/Minute		1035H
Second		40H
Day of the week	One of the following values is stored in BCD code. <ul style="list-style-type: none"> • Sunday: 00H • Monday: 01H • Tuesday: 02H • Wednesday: 03H • Thursday: 04H • Friday: 05H • Saturday: 06H 	01H
Millisecond (higher-order digits)/Millisecond (lower-order digits)	Stored in BCD code.	0628H

*1 These values assume that a trigger is generated at 10:35 and 40.628 seconds on Monday, January 30th, 2017.

■ Resuming the logging

It may take time until ON (1) is stored in 'CH1 Logging hold flag' (Un\G409) after 'CH1 Logging hold request' (Un\G471) is changed off→on.

To resume logging, check that ON (1) is stored in 'CH1 Logging hold flag' (Un\G409) and change 'CH1 Logging hold request' (Un\G471) on→off. After logging resumes, the value is stored from the start buffer memory area of CH1 Logging data (Un\G10000 to Un\G19999).

In addition, OFF (0) is stored in 'CH1 Logging hold flag' (Un\G409).

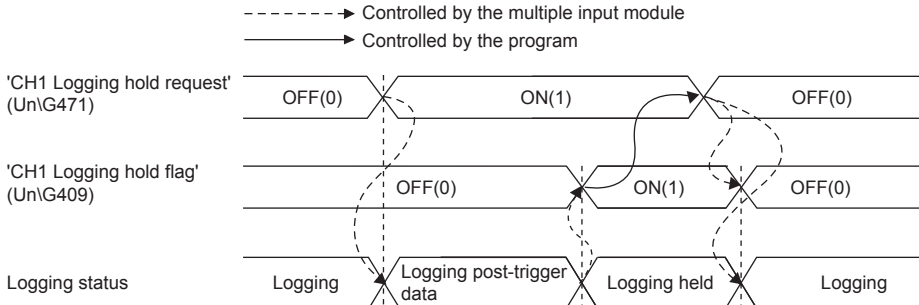

Logging does not stop when 'CH1 Logging hold request' (Un\G471) is changed from on → off before ON (1) is stored in 'CH1 Logging hold flag' (Un\G409).

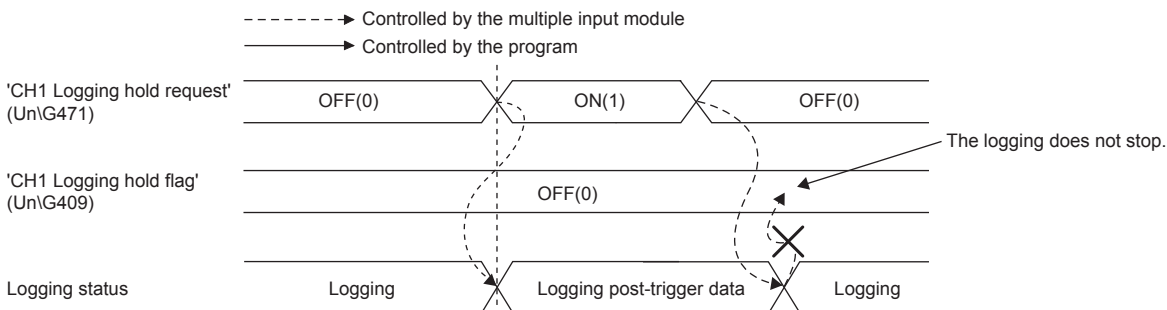

• Buffer memory area status when logging resumes

The following table shows the buffer memory area status when logging resumes.

Item	Status of Buffer Memory Areas
'CH1 Head pointer' (Un\G434)	Values are initialized.
'CH1 Latest pointer' (Un\G435)	
'CH1 Number of logging data' (Un\G436)	
'CH1 Trigger pointer' (Un\G437)	
'CH1 Trigger generation time' (Un\G444 to Un\G448)	
'CH1 Logging data' (Un\G10000 to Un\G19999)	The values before logging resumes are not initialized. After logging resumes, values are stored from the start address of CH1 Logging data (Un\G10000 to Un\G19999). To refer to the logging data, check which area has valid data with 'CH1 Number of logging data' (Un\G436).

Logging hold request

A hold trigger is generated from a program at any timing.

After ON (1) is set to 'CH1 Logging hold request' (Un\G471), a preset number of data is collected and then the logging stops.

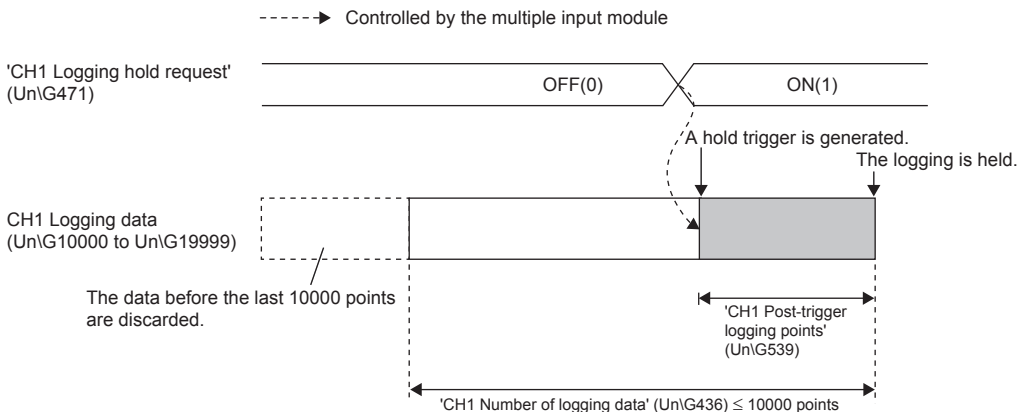

3

Point

- The following delay time occurs until multiple input module receives a hold trigger after the value in 'CH1 Logging hold request' (Un\G471) is changed from OFF (0)→ON (1).
Trigger delay = Logging cycle (Cycle at which logging is actually performed) + Scan time of the CPU module
- When 'CH1 Logging hold request' (Un\G471) is changed from ON (1)→OFF (0) before 'CH1 Logging hold flag' (Un\G409) turns to ON (1), the number of data set in 'CH1 Post-trigger logging points' (Un\G539) is collected, and then logging resumes soon, without stopping.
- If a value other than OFF (0) and ON (1) is set to 'CH1 Logging hold request' (Un\G471), an error occurs. A logging hold request range error (error code: 1D7□H) is stored in 'Latest error code' (Un\G0), and 'Error flag' (Un\G69, b15) and the ERROR LED turn on.

■Checking that the logging has stopped

Check that 'CH1 Logging hold flag' (Un\G409) is ON (1).

Level trigger

When a value in the monitored buffer memory area of multiple input module satisfies a preset condition, a hold trigger is generated.

The level trigger is monitored at the conversion cycle.

■ Initial setting of a level trigger

[Setting a target to be monitored]

As a condition to generate a hold trigger, set the buffer memory address to be monitored to 'CH1 Trigger data' (Un\G541).

Item	Setting range
'CH1 Trigger data' (Un\G541)	0 to 9999

To monitor a device value of a module other than multiple input module such as a device of the CPU module, set as follows.

- Set a value between 90 and 99 ('Level data □' (Un\G90 to Un\G99)) to 'CH1 Trigger data' (Un\G541).
- Write a value of the monitored device to 'Level data □' (Un\G90 to Un\G99) by using the MOV instruction.

Ex.

Application example of 'Level data 1' (Un\G91)

To monitor the data register D100 in the CPU module and generate the level trigger in CH1, create a program as follows.

- Set 'CH1 Trigger data' (Un\G541) to 91 (buffer memory address of Level data 1) (when Level data 1 is used).
- Store the storage data of D100 in 'Level data 1' (Un\G91) by the program continuously.



Point

- Specify an appropriate data such as 'CH1 Digital output value' (Un\G400), 'CH1 Digital operation value' (Un\G402), or Level data□ (Un\G90 to Un\G99) to 'CH1 Trigger data' (Un\G541). When a setting area or a system area is specified, the normal operation is not guaranteed.
- If other than 0 to 9999 is set for 'CH1 Trigger data' (Un\G541), an error occurs. A trigger data setting range error (error code: 1D6□H) is stored in 'Latest error code' (Un\G0), 'Error flag' (Un\G69, b15) and the ERROR LED turns on.

[Setting the monitoring condition]

- Set a condition to generate a hold trigger in 'CH1 Level trigger condition setting' (Un\G540).

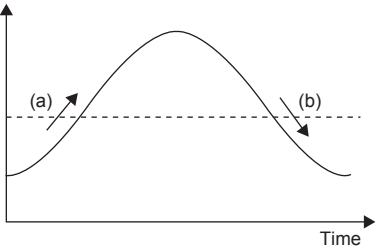
Setting value	Description	
1: Level trigger (Condition: Rise)	<p>Stored value of a buffer memory area to be monitored</p>  <p>Trigger setting value</p> <p>Time</p> <p>(a) A hold trigger is generated when the relation between the values changes from "Stored value of a buffer memory area to be monitored \leq Trigger setting value" to "Stored value of a buffer memory area to be monitored $>$ Trigger setting value".</p> <p>(b) A hold trigger is generated when the relation between the values changes from "Stored value of a buffer memory area to be monitored \geq Trigger setting value" to "Stored value of a buffer memory area to be monitored $<$ Trigger setting value".</p>	A hold trigger is generated under the condition (a).
2: Level trigger (Condition: Fall)		A hold trigger is generated under the condition (b).
3: Level trigger (Condition: Rise and fall)		A hold trigger is generated under the condition (a) or (b).

- Set a value where a hold trigger is generated to 'CH1 Trigger setting value' (Un\G542).

Item	Setting range
'CH1 Trigger setting value' (Un\G542)	-32768 to +32767

Point

The following figure shows the relation between setting items to be configured for the initial setting of a level trigger.

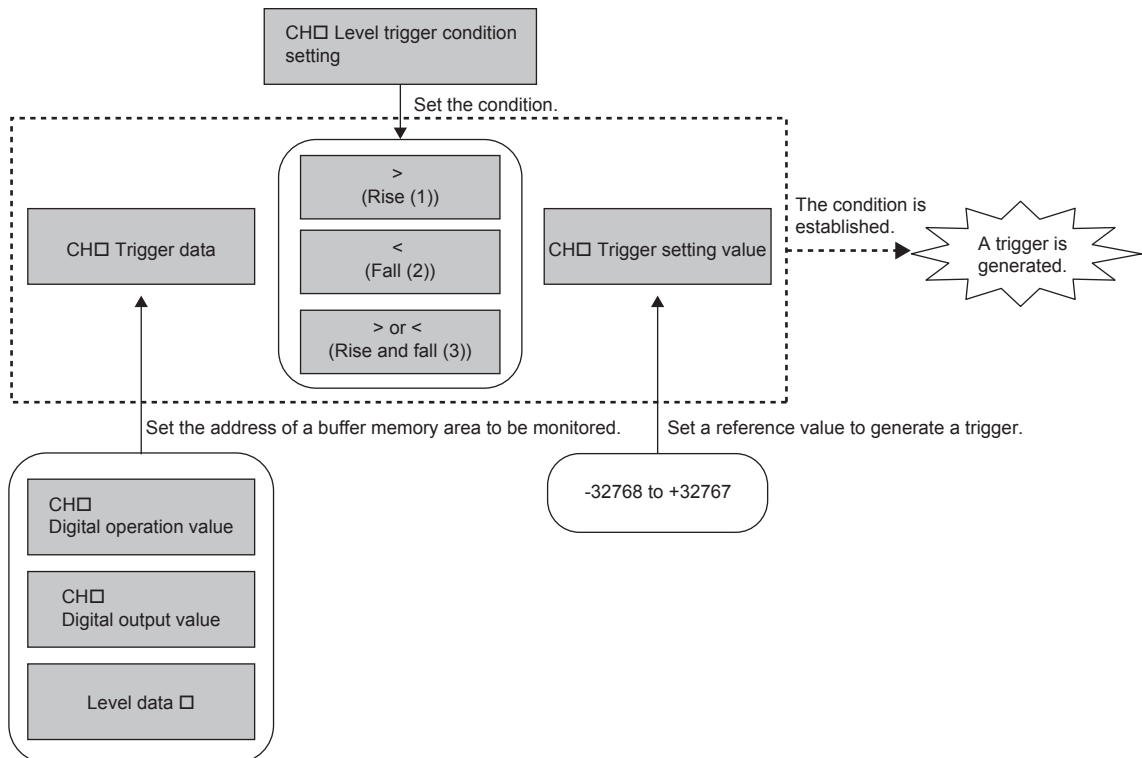

For example if trying to generate a hold trigger when a value in 'CH1 Digital output value' (Un\G400) is greater than 1000, set as follows.

- 'CH1 Level trigger condition setting' (Un\G540): Rise (1)
- 'CH1 Trigger data' (Un\G541): 400
- 'CH1 Trigger setting value' (Un\G542): 1000

■ Operation of a level trigger

To use a level trigger, set ON (1) to 'CH1 Logging hold request' (Un\G471) in advance. At the point where ON (1) has been set to 'CH1 Logging hold request' (Un\G471), the module becomes the trigger condition wait status.

After the trigger condition has been satisfied, and the set points of the data have been collected from that point, the logging stops.

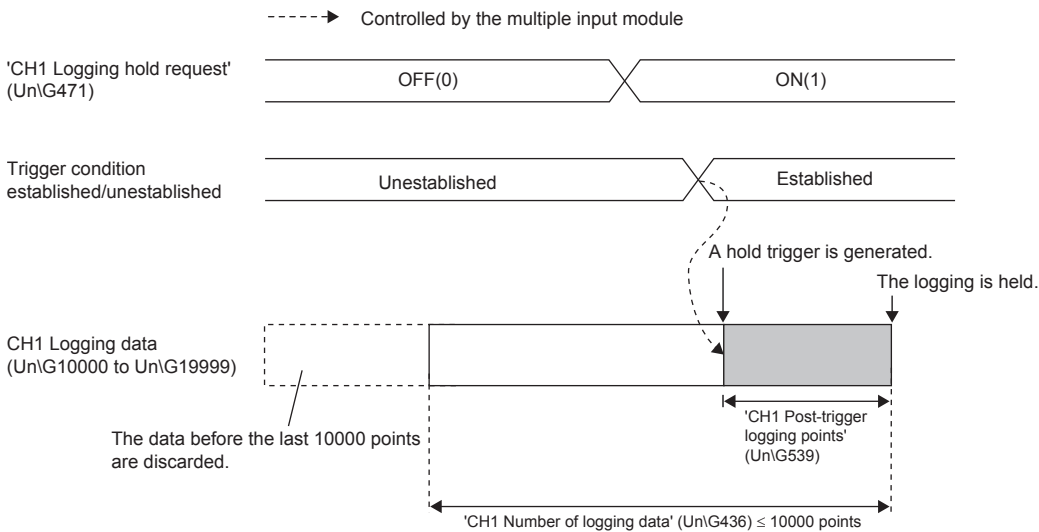

Point

A level trigger is detected on the refreshing cycle of the digital output value or the digital operation value. Therefore, the data when a hold trigger is generated may not be stored in CH1 Logging data (Un\G10000 to Un\G19999) depending on the setting of the logging cycle. To store the data at the timing when a hold trigger is generated in CH1 Logging data (Un\G10000 to Un\G19999), arrange related settings so that the conversion cycle of the monitoring target value (a trigger data) and the logging cycle (actual logging cycle) have the same time period.

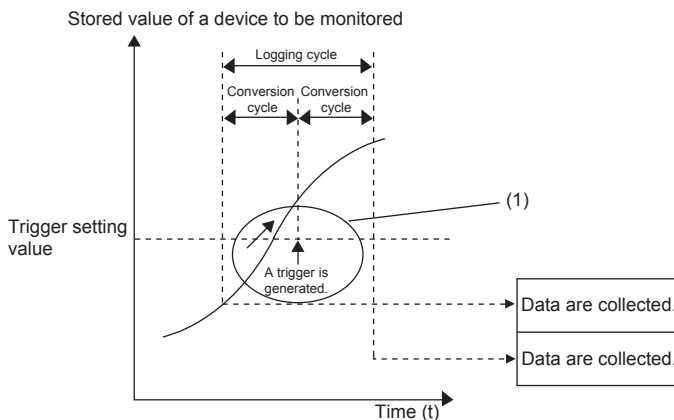

(1) The data at the timing when a trigger is generated is not stored in the buffer memory area.

- Checking that the logging has stopped
- Check that 'CH1 Logging hold flag' (Un\G409) is ON (1).

Initial settings of the logging function

The following describes the initial setting procedure to use the logging function.

■Setting procedure

1. Set the "Input type", and "Input range".

 [Navigation window] ⇒ [Parameter] ⇒ [Module Information] ⇒ Module model name ⇒ [Module Parameter] ⇒ [Basic setting] ⇒ [Range switching function]

2. Set "Logging enable/disable setting" to "Enable".

 [Navigation window] ⇒ [Parameter] ⇒ [Module Information] ⇒ Module model name ⇒ [Module Parameter] ⇒ [Application setting] ⇒ [Logging function]

3. Set the target data to be logged in "Logging data setting". Set either of "Digital output value" or "Digital operation value" for each channel.
4. Set the cycle to store the logging data to "Logging cycle setting value".
5. Select a unit of the logging cycle setting value in "Logging cycle unit setting".
6. Set a condition to generate a hold trigger in "Level trigger condition setting". To use 'CH1 Logging hold request' (Un\G471), set "Disable". To use the level trigger, set either of Level trigger (Condition: Rise), Level trigger (Condition: Fall), or Level trigger (Condition: Rise and fall).
7. Set a number of the data points to be collected for the time period from the occurrence of a hold trigger to logging stop in "Post-trigger logging points".
8. Set a buffer memory address to be monitored for a level trigger to "Trigger data".
9. Set a level where a level trigger operates for "Trigger setting value".

Error history function

This function records up to 16 errors and alarms that occurred in a multiple input module to store them in the buffer memory areas.

Operation

When an error occurs, the error code and error time are stored in order, beginning with Error history No. 1 (Un\G3600 to Un\G3609).

When an alarm occurs, the alarm code and the alarm time are stored from Alarm history No. 1 (Un\G3760 to Un\G3769) in order.

- Detail of the error code assignment

	b15	to	b8 b7	to	b0
Un\G3600	Error code				
Un\G3601	First two digits of the year		Last two digits of the year		
Un\G3602	Month		Day		
Un\G3603	Hour		Minute		
Un\G3604	Second		Day of the week		
Un\G3605	Millisecond (upper)		Millisecond (lower)		
Un\G3606	System area				
⋮					
Un\G3609					

- Detail of the alarm code assignment

	b15	to	b8 b7	to	b0
Un\G3760	Alarm code				
Un\G3761	First two digits of the year		Last two digits of the year		
Un\G3762	Month		Day		
Un\G3763	Hour		Minute		
Un\G3764	Second		Day of the week		
Un\G3765	Millisecond (upper)		Millisecond (lower)		
Un\G3766	System area				
⋮					
Un\G3769					

Ex.

Example of error history and alarm history storage

Item	Storage contents	Storage example*1
First two digits of the year/Last two digits of the year	Stored in BCD code.	2017H
Month/Day		0130H
Hour/Minute		1035H
Second		40H
Day of the week	One of the following values is stored in BCD code. Sunday: 0, Monday: 1, Tuesday: 2, Wednesday: 3, Thursday: 4, Friday: 5, Saturday: 6	1H
Millisecond (upper)	Stored in BCD code.	06H
Millisecond (lower)		28H

*1 These values assume that an error occurs at 10:35 and 40.628 seconds on Monday, January 30th, 2017.

The start address of error history where the latest error is stored, can be found in 'Latest address of error history' (Un\G1).

The start address of alarm history where the latest alarm is stored, can be found in 'Latest address of alarm history' (Un\G3).

Ex.

When the third error occurs:

The third error is stored in Error history No. 3, and the value 3620 (start address of Error history No. 3) is stored to Latest address of error history.

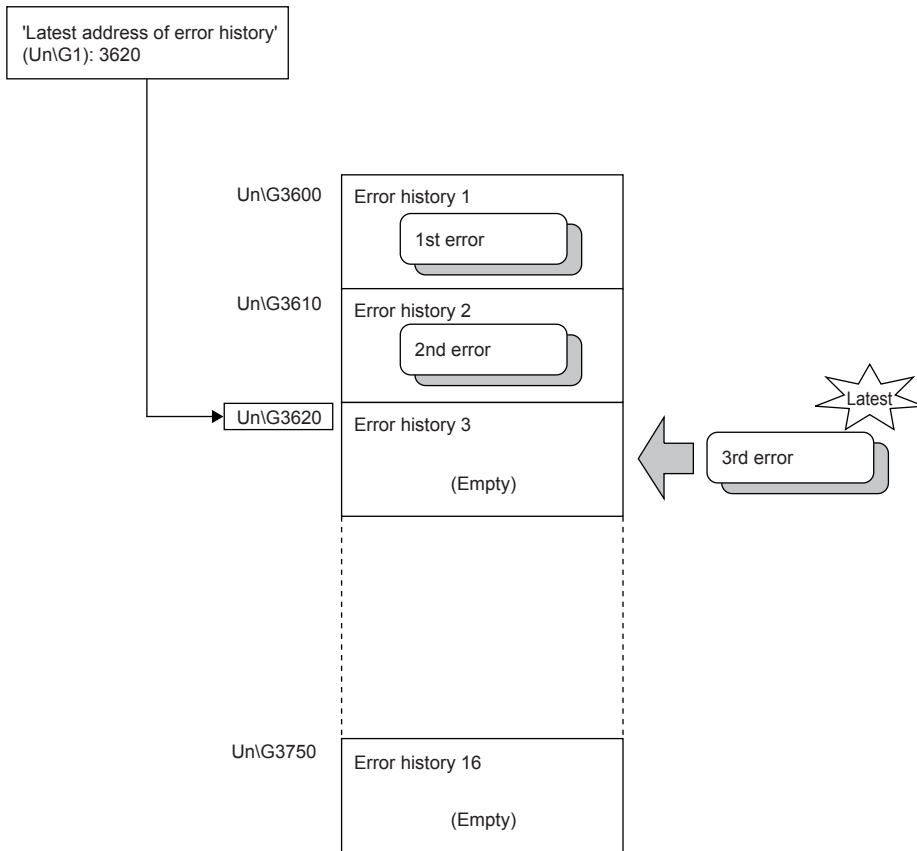

Ex.

When the 17th error occurs:

The 17th error is stored in Error history No. 1, and the value 3600 (start address of Error history No. 1) is stored to Latest address of error history.

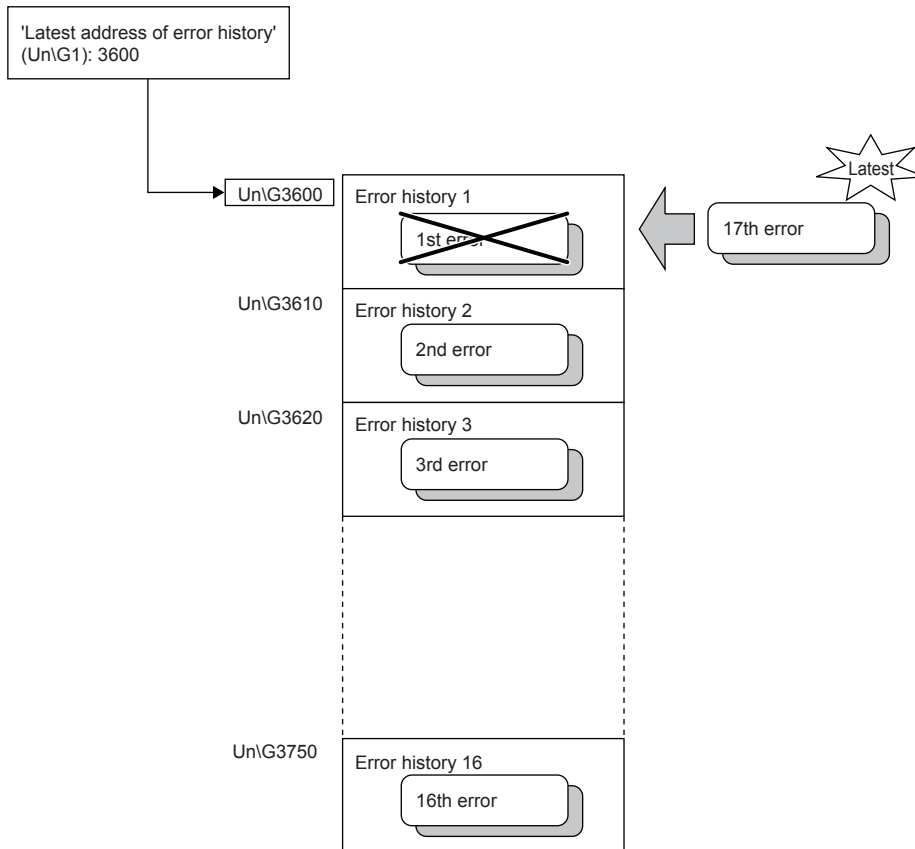
**Point**

- Once the error history storage area becomes full, subsequent error information will overwrite the existing data, starting from Error history 1 (Un\G3600 to Un\G3609), and continues sequentially thereafter. The overwritten history is deleted.
- The same processing is performed for Alarm history when an alarm occurs.
- The stored error history is cleared when a multiple input module is powered off or the CPU module is reset.

Offset/gain initialization function

Offset/gain initialization

The offset and gain values are initialized to the factory default offset and gain values according to the set input type.

1. Set the mode to the "Normal mode".
2. Set 'CH1 Input type/Range setting'(Un\G598) to 'CH8 Input type/Range setting' (Un\G1998) as 'Conversion disabled' and turn off→on→off 'Operation condition setting request' (Un\G70, b9).
3. Set "E20FH" to 'Offset/gain initialization enabled code' (Un\G305).
4. Turn ON (1) 'Offset/gain initialization request' (Un\G70, b5).

Precautions

Channels for which the offset and gain have not been set are initialized with the current range.

FX2N allocation mode function

It is a function to operate the buffer memory areas of the multiple input module with the same layout as the buffer memory address equivalent to FX2N-8AD.

This compatibility enables the reuse of programs that have proven performance on FX2N-8AD.

Operation

In FX2N allocation mode, only allocation of buffer memory area is changed. The following buffer memory area is allocated the same as FX2N-8AD.

Buffer Memory Areas	Buffer Memory Area Name
Un\G10 to 17	CH1 to 8 Digital operation value
Un\G26	Warning output flag (Process alarm upper limit/lower limit)
Un\G27	Warning output flag (Rate alarm upper limit/lower limit)
Un\G30	Type code
Un\G61 to 68	CH1 to 8 Conversion value shift amount
Un\G101 to 108	CH1 to 8 Minimum value
Un\G109	Minimum value reset request
Un\G111 to 118	CH1 to 8 Maximum value
Un\G119	Maximum value reset request

For buffer memories with different allocations from FX2N-8AD, it can be used by changing the program. For buffer memory in FX2N allocation mode, refer to the following.

☞ Page 440 In FX2N allocation function mode

Restriction

When reusing the program used by FX2N-8AD, delete the initial setting process and set the module parameters with GX Works3.

When performing the same operation as FX2N-8AD, it can be executed by the following function.

FX2N-8AD	Multiple input module	Reference
Input mode setting	Input type/Range setting function	Page 346
Average count	Conversion method	Page 347
Setting change disabled	—	It is unnecessary because the setting is reflected in the operating condition setting request, and erroneous setting is prevented.
Input characteristics adjustment	Offset/gain setting function	Page 405
High speed conversion CH specification mode	—	No correspondence
Data addition function	Shift function	Page 354
Upper lower limit value detection function	Process alarm function	Page 360
Sudden change detection function	Rate alarm function	Page 362
Peak value hold function	Maximum value/Minimum value hold function	Page 359
Scale over detection function	Input signal error detection function	Page 367
Disconnection detection	Disconnection detection function	Page 374
Data history	Logging function	Page 377
Function initialization	Offset/gain initialization function	Page 392

Setting procedure

1. When adding a new module, select the module whose module model name has "(FX2N)" at the end.

[Navigation window] ⇒ [Parameter] ⇒ [Module Information] ⇒ Right-click ⇒ [Add New Module]

2. Configure the same parameter setting as the one of when the Normal mode is used.

3. After writing the module parameter, turn off→on or reset the CPU module.

Point

- Switching between normal mode and FX2N allocation mode is not possible during operation.
- Do not switch to the FX2N allocation mode when the user range setting was adjusted by the resistance temperature detector range in normal mode. If 'CH1 input type/range setting (offset/gain setting)' (Un\G598) is set to "user range setting" in the FX2N allocation mode when the setting is adjusted by the resistance temperature detector range, an input type/range setting range error (190□H) occurs. To use the user range setting in the FX2N allocation mode, set the input type other than "resistance temperature detector" to the user range setting in the normal mode.

2CH conversion mode function

A function that performs A/D conversion of 2CH in 1 ms and can update the digital output value at the same time. Only input type "current", "voltage" are supported.

The combination of channels to update at the same time is as follows.

The combination of channels to update

CH1 and CH5

CH2 and CH6

CH3 and CH7

CH4 and CH8

The sampling cycle per 2CH is 1 ms.

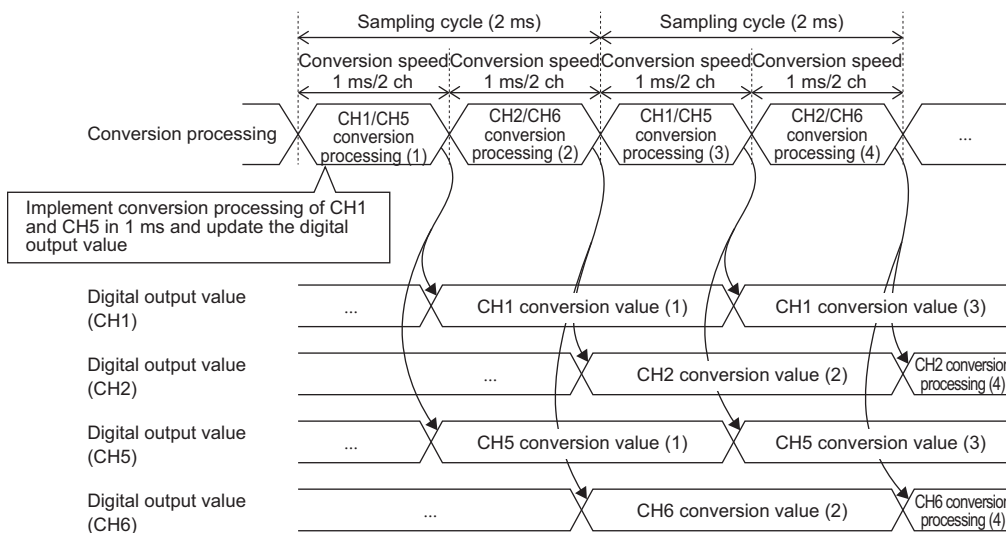

Point

For each sampling cycle, the maximum and minimum values of the digital operation value are stored in 'CH1 Maximum value' (Un\G404) and 'CH1 Minimum value' (Un\G406).

Compatible functions

The following functions can be used with the 2CH conversion mode. Settings used with other functions are invalid.

Function
Input type/Range setting function
Voltage, current conversion function
Conversion method (Sampling processing)
Maximum value/Minimum value hold function

Setting procedure

1. Set "Operation mode setting" to "2CH conversion mode".

[Navigation window] ⇒ [Parameter] ⇒ [Module Information] ⇒ Module model name ⇒ [Module Parameter] ⇒ [Basic setting] ⇒ [Operation mode setting function]

2. Set the channel to be used with "Number of conversion enabled channels".

Number of conversion enabled channels	Use enabled channel	Sampling cycle
0	None	—
1	CH1	1 ms
2	[CH1, CH5]	1 ms
3	[CH1, CH5], CH2	2 ms
4	[CH1, CH5], [CH2, CH6]	2 ms
5	[CH1, CH5], [CH2, CH6], CH3	3 ms
6	[CH1, CH5], [CH2, CH6], [CH3, CH7]	3 ms
7	[CH1, CH5], [CH2, CH6], [CH3, CH7], CH4	4 ms
8	[CH1, CH5], [CH2, CH6], [CH3, CH7], [CH4, CH8]	4 ms

3. Set the "Input type" and "Input range" of the channel to be used.

[Navigation window] ⇒ [Parameter] ⇒ [Module Information] ⇒ Module model name ⇒ [Module Parameter] ⇒ [Basic setting] ⇒ [Range switching function]

3.5 System Configuration

The system configuration using the multiple input module is as follows.

- System configuration example

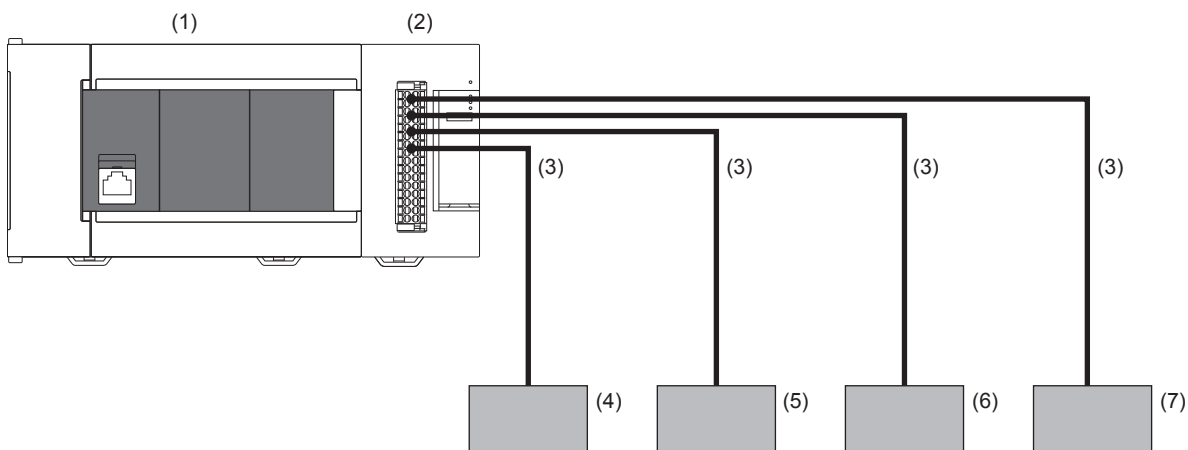

- (1) FX5 CPU module
- (2) Multiple input module (FX5-8AD)
- (3) Analog device connection cable
- (4) Current input
- (5) Voltage input
- (6) Resistance temperature detector input
- (7) Thermocouple input

3.6 Wiring

This section explains the multiple input module wiring.

Spring clamp terminal block

Suitable wiring

The wires to connect the spring clamp terminal block are described below.

No. of wire per terminal	Wire size	
	Single wire, strand wire	Ferrule with insulation sleeve
Single wiring	AWG24 to 16 (0.2 to 1.5 mm ²)	AWG23 to 19 (0.25 to 0.75 mm ²)

Wire end treatment

When not using a ferrule, strip the cable about 10 mm from the tip and connect it as a strand wire so that the wires do not separate. When using a ferrule, strip the cable about 10 mm from the tip to connect a wire ferrule at the striped area. Failure to do so may result in electric shock or short circuit between adjacent terminals because of the conductive part. If the wire strip length is too short, it may result in the poor contact to the spring clamp terminal part.

Depending on the thickness of the sheath, it may be difficult to insert into the insulation sleeve, so select the wires by referring to the appearance diagram.

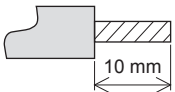
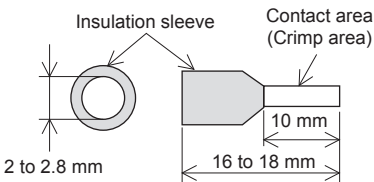
Strand wire/single wire	Ferrule with insulation sleeve
	

The following table shows wire ferrules and tools for wire ferrules compatible with the terminal block. Use of items other than these may result in not being able to remove the wire ferrule, so carefully check that the wire ferrule can be unplugged.

<Reference product>

Manufacturer	Model	Wire size	Crimp tool
PHOENIX-CONTACT GmbH & Co. KG	Al 0.5-10 WH	0.5 mm ²	CRIMPFOX 6
	Al 0.75-10 GY	0.75 mm ²	
	A 1.0-10	1.0 mm ²	
	A 1.5-10	1.5 mm ²	

Removing and installing the terminal block

The following shows how to remove and install the terminal block.

■Lever position to lock and release

A 3-step stopper is attached to prevent the lever from rotating, facilitating installation and removal of the terminal block.

When removing or installing the terminal block, move the lever to the corresponding position.

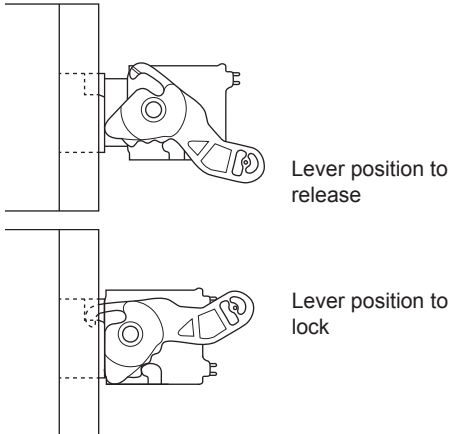

■Lever position to release

The figure left shows the lever position when the terminal block has been completely removed from the module.

Rotate the lever from the lock position to the release position, and lift the terminal block from the module.

■Lever position to lock

The figure left shows the lever position when the terminal block is completely engaged with the module.

Check that the lever is at the lock position, and pull the terminal block slightly to check that the module and terminal block are completely engaged.

■Removal procedure

Rotate the lever to the release position, and remove the terminal block from the module.

■Installation procedure

Move the lever to the release position, and insert the terminal block. When the terminal block is inserted sufficiently, the lever latch engages with the module and the terminal block is engaged with the module.



After inserting the terminal block, check that the lever is at the lock position.

Precautions

When installing the terminal block, check that the lever is in the release position. If installation is performed while the lever is in the lock position, it may cause damage to the lever.

Connection and disconnection of the cable

■ Connection of the cable

Fully insert a cable whose end has been properly processed into the wire insertion opening.

If the cable cannot be inserted with this procedure, fully insert the cable while pushing the open/close button with a flathead screwdriver having a tip width of 2.0 to 2.5 mm. After fully inserting the cable, remove the screwdriver.

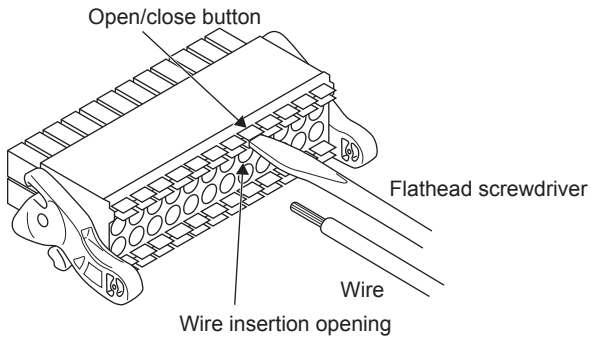

<Reference>

Manufacturer	Model
PHOENIX-CONTACT GmbH & Co. KG	SZS 0.4 × 2.5 VDE

Precautions

Pull the cable or bar solderless terminal slightly to check that the cable is securely clamped.

■ Disconnection of the cable

While pushing the open/close button with a flathead screwdriver having a tip width of 2.0 to 2.5 mm, disconnect the cable.

Terminal arrangement

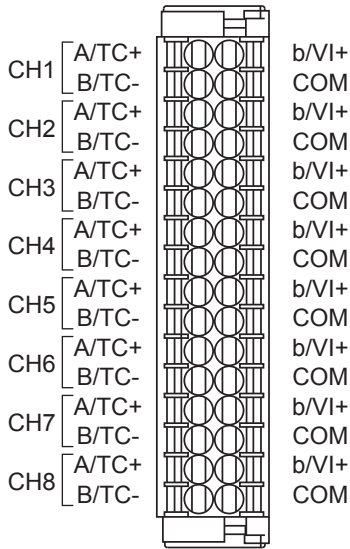

Terminal name	Description	
CH1	A/TC+	CH1 Resistance temperature detector input/thermocouple input
	B/TC-	
	b/VI+	CH1 Voltage/current input/resistance temperature detector input
	COM	CH1 Voltage/current input
CH2	A/TC+	CH2 Resistance temperature detector input/thermocouple input
	B/TC-	
	b/VI+	CH2 Voltage/current input/resistance temperature detector input
	COM	CH2 Voltage/current input
CH3	A/TC+	CH3 Resistance temperature detector input/thermocouple input
	B/TC-	
	b/VI+	CH3 Voltage/current input/resistance temperature detector input
	COM	CH3 Voltage/current input
CH4	A/TC+	CH4 Resistance temperature detector input/thermocouple input
	B/TC-	
	b/VI+	CH4 Voltage/current input/resistance temperature detector input
	COM	CH4 Voltage/current input
CH5	A/TC+	CH5 Resistance temperature detector input/thermocouple input
	B/TC-	
	b/VI+	CH5 Voltage/current input/resistance temperature detector input
	COM	CH5 Voltage/current input
CH6	A/TC+	CH6 Resistance temperature detector input/thermocouple input
	B/TC-	
	b/VI+	CH6 Voltage/current input/resistance temperature detector input
	COM	CH6 Voltage/current input
CH7	A/TC+	CH7 Resistance temperature detector input/thermocouple input
	B/TC-	
	b/VI+	CH7 Voltage/current input/resistance temperature detector input
	COM	CH7 Voltage/current input
CH8	A/TC+	CH8 Resistance temperature detector input/thermocouple input
	B/TC-	
	b/VI+	CH8 Voltage/current input/resistance temperature detector input
	COM	CH8 Voltage/current input

Power supply wiring

Power connector layout

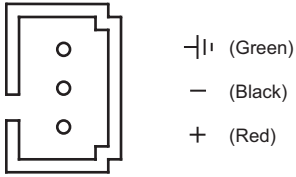

Power supply wiring

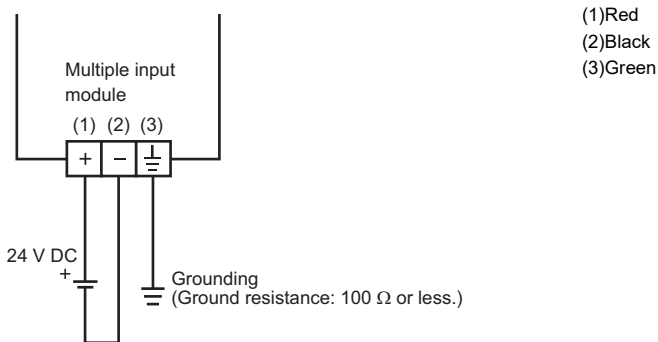

Grounding

Perform the following.

- Perform class D grounding (Grounding resistance: 100 Ω or less).
- Ground the programmable controller independently when possible.
- If the programmable controller cannot be grounded independently, perform the "Shared grounding" shown below.

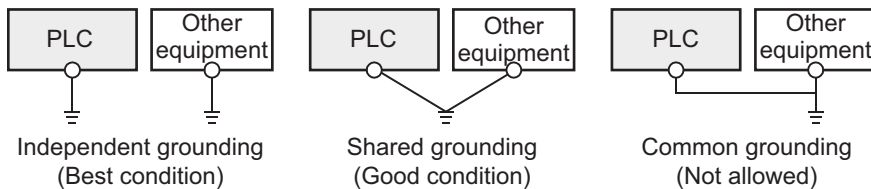

- Bring the grounding point close to the PLC as much as possible so that the ground cable can be shortened.

Wiring precautions

Wiring precautions are indicated below.

- Use separate cables for the external I/O signals of the AC control circuit and the multiple input module so that they are not affected by surge or induction on the AC side.
- Do not approach or bundle with the main circuit line, high voltage line, and load line from other than the PLC. Keep it far from circuits including high frequency such as high voltage line and inverter load main circuit. It becomes susceptible to noise, surge, and induction.
- Provide a single-point ground for the shield wire and the shielded cable at the PLC side. However, depending on the external noise situation, it may be better to ground on the external side.

External wiring example

The followings show the examples of external wiring.

Voltage input, and current input

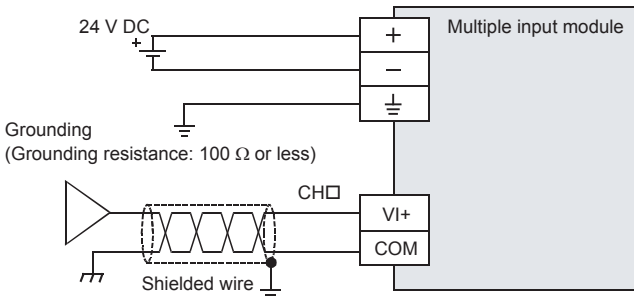

For □ in CH□, the CH number is entered.

Precautions

Use a two-conductor shielded twisted pair cable for analog input lines and carry out the wiring while separating them from other power lines and lines susceptible to induction.

Thermocouple

Refer to Page 336 Thermocouple input specifications for the thermocouples that can be used with multiple input module.

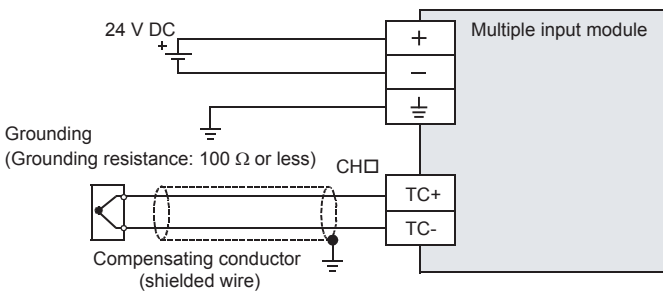

For □ in CH□, the CH number is entered.

Precautions

When using thermocouple input, use the prescribed compensation lead wire. Use insulated thermocouple types.

Case of RTD

Refer to Page 336 Resistance temperature detector (RTD) input specifications for the resistance temperature detector that can be used with multiple input module.

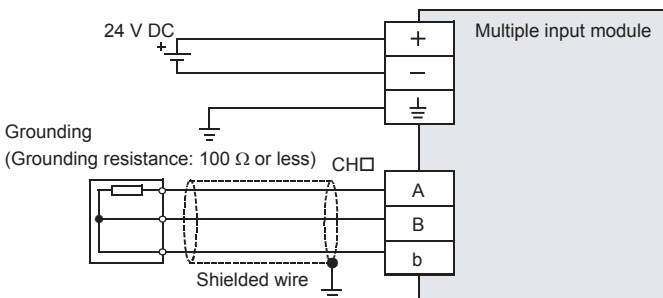

For □ in CH□, the CH number is entered.

Precautions

When using the resistance temperature detector, carry out the wiring with a wire with low lead wire resistance and no resistance difference between the lead wires.

3.7 Parameter Setting

Set the parameters of each channel.

Setting parameters here eliminates the need to program them.

Point

When adding a new multiple input module, if selecting the module whose module model name has "(FX2N)" at the end, it can be used as FX2N allocation mode.

- FX5-8AD: Normal mode
- FX5-8AD(FX2N): FX2N allocation mode

This section describes the case in a normal mode.

Basic setting

Setting procedure

1. Open "Basic setting" of GX Works3.

[Navigation window] ⇒ [Parameter] ⇒ [Module information] ⇒ Target module ⇒ [Module Parameter] ⇒ [Basic setting]

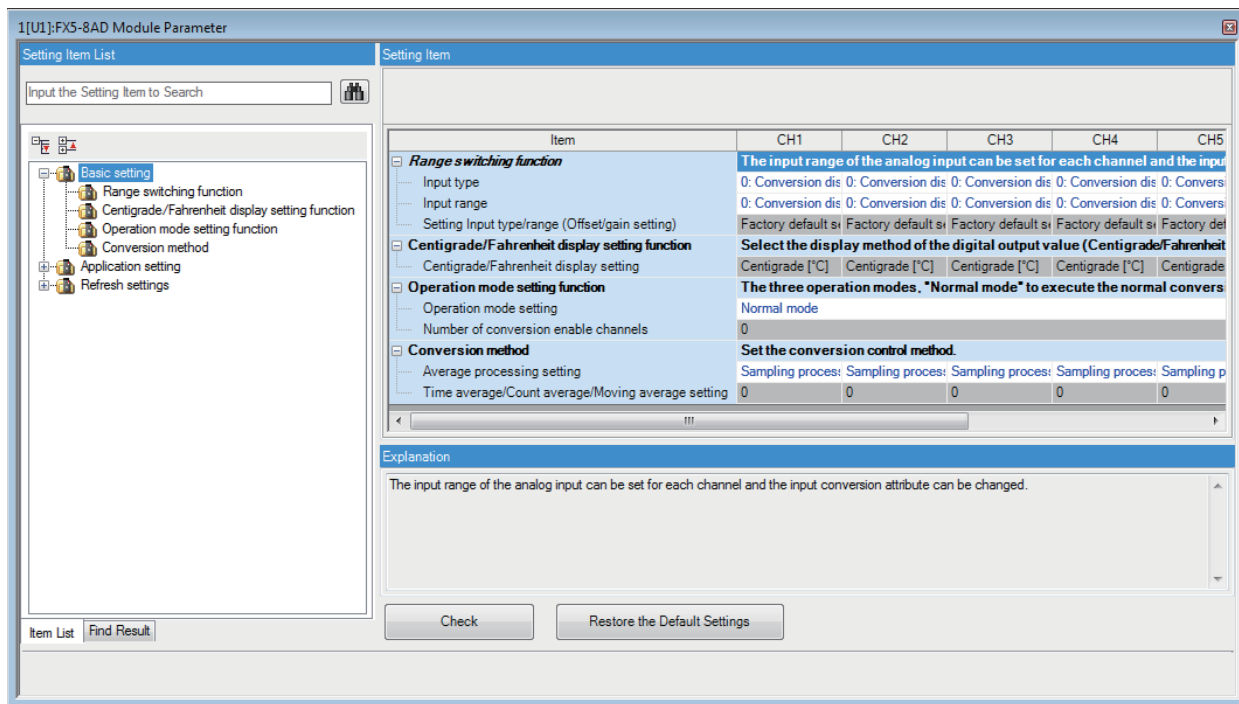

2. Double-click the item to be changed to enter the setting value.

- Item where a value is selected from the pull-down

Click [▼] button of the item to be set, and from the pull-down list that appears, select the value.

- Item where a value is entered into the text box

Double-click the item to be set to enter the numeric value.

Application setting

Setting procedure

1. Open "Application setting" of GX Works3.

[Navigation window] ⇒ [Parameter] ⇒ [Module information] ⇒ Target module ⇒ [Module Parameter] ⇒ [Application setting]

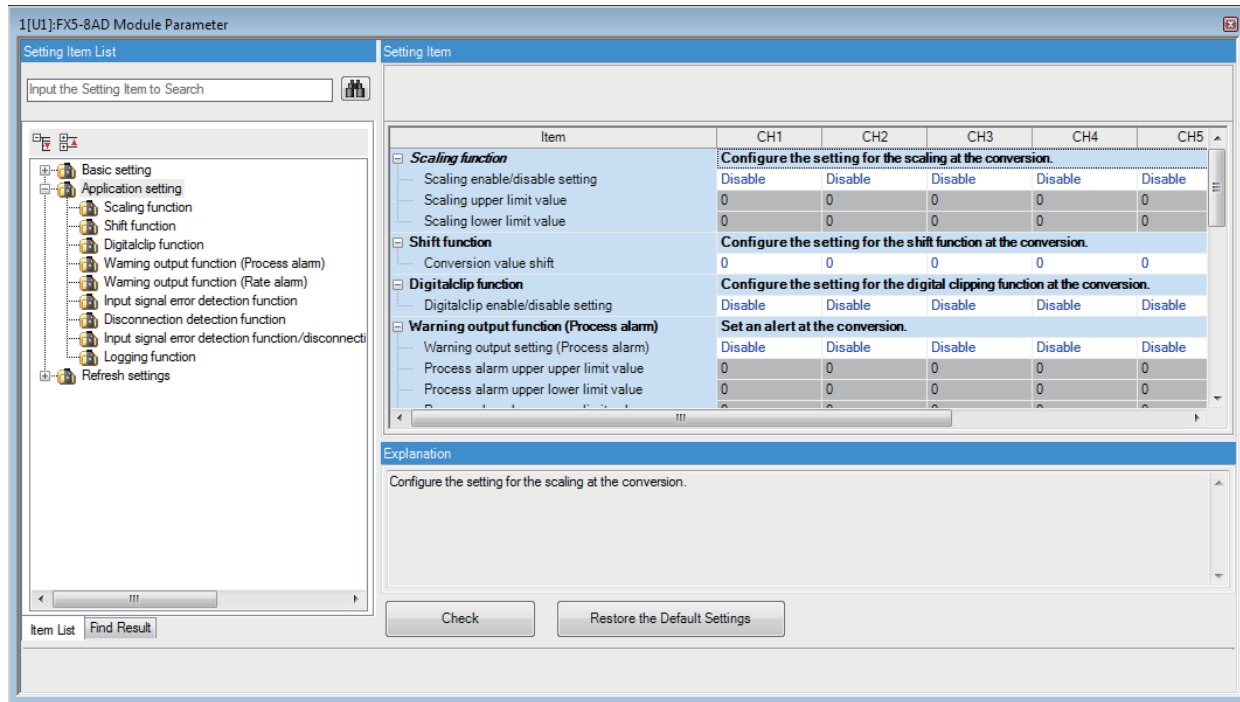

2. Double-click the item to be changed to enter the setting value.

- Item where a value is selected from the pull-down

Click [▼] button of the item to be set, and from the pull-down list that appears, select the value.

- Item where a value is entered into the text box

Double-click the item to be set to enter the numeric value.

Refresh setting

Setting procedure

Set the buffer memory area of a multiple input module to be refreshed automatically.

This refresh setting eliminates the need for reading/writing data by programming.

1. Start a module parameter.

[Navigation window] ⇒ [Parameter] ⇒ [Module Information] ⇒ Target module ⇒ [Module Parameter] ⇒ [Refresh setting]

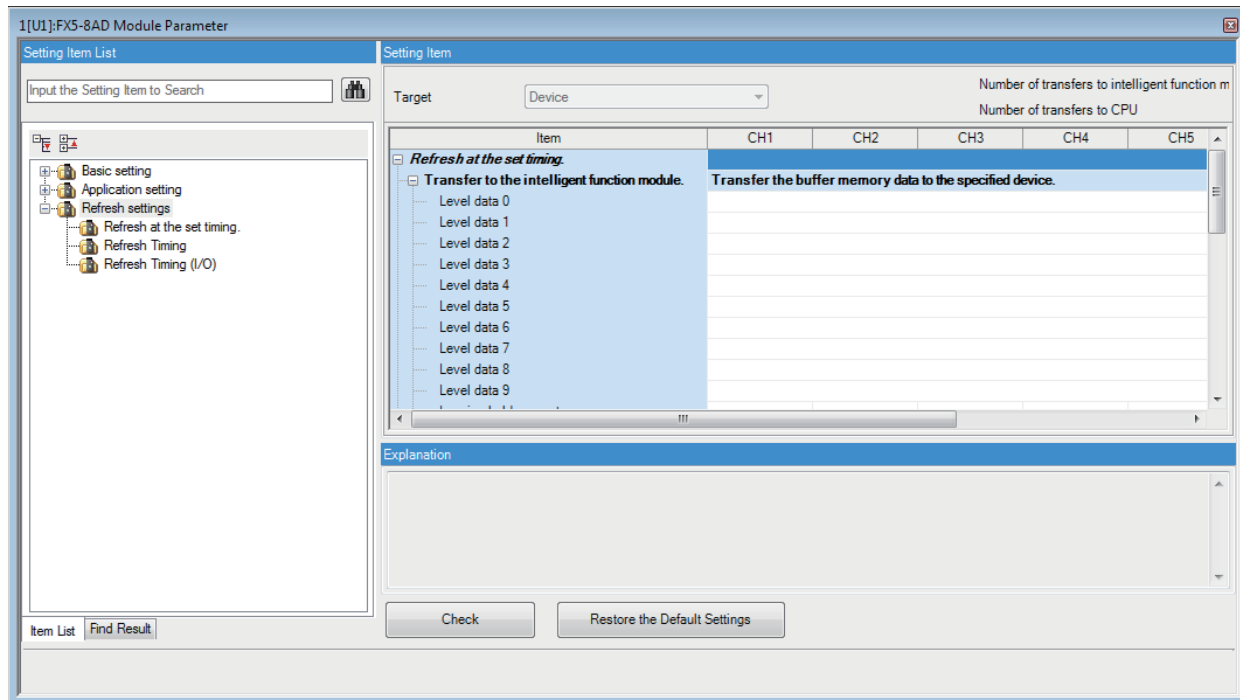

2. Double-click the item to be set to enter the device of refresh destination.

3.8 Offset/Gain Setting

Using the user range setting requires setting the offset and gain values.
The offset/gain setting can be performed by the following two methods.

- Settings from the module tool of GX Works3
- Setting from the program

Setting example when the input type is voltage

An example of offset/gain setting is shown below.

Input conversion characteristics

Ex.

When CH1 is set to 0 V, offset is set to 0, and when set to 5 V, gain is set to 32000

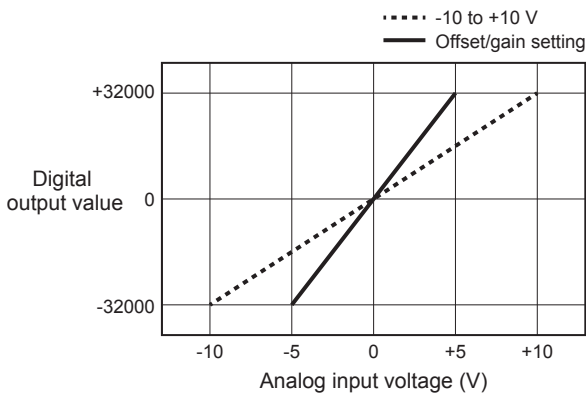

User range	Digital output value	Resolution	Remarks
-5 to +5 V	-32000 to +32000	156.25 μ V	(Gain value - Offset value) = 5 V As the result of (Gain value - Offset value) is not < 4 V, the calculated resolution is applied.

Module parameters

The module parameters used for CH1 are as follows. Parameters other than the following are defaults.

Item	Set conditions
Input type	Voltage
Input range	-10 V to +10 V
Setting Input type/range (Offset/gain setting)	User range setting
Operation mode setting	Normal mode

Settings from the module tool of GX Works3

The following shows the procedure for setting the offset and gain from the module tool of GX Works3. (For CH1)

■Setting procedure

[Tool] ⇒ [Module Tool List]

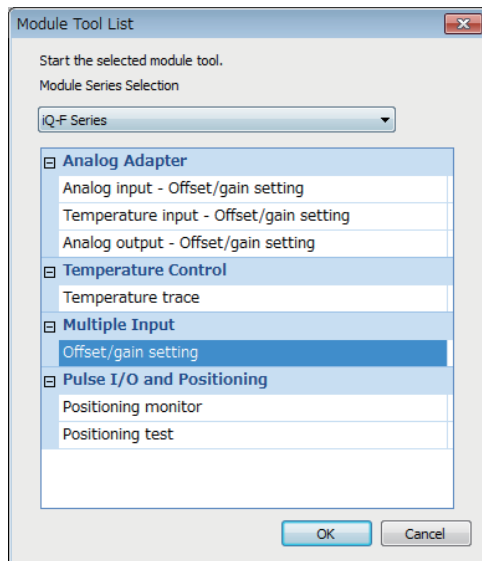

1. In "Multiple Input", select "Offset/gain setting" and click the [OK] button.

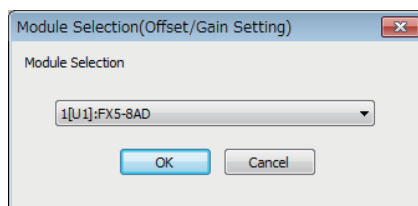

2. Select the target module for the offset/gain setting, and click the [OK] button.

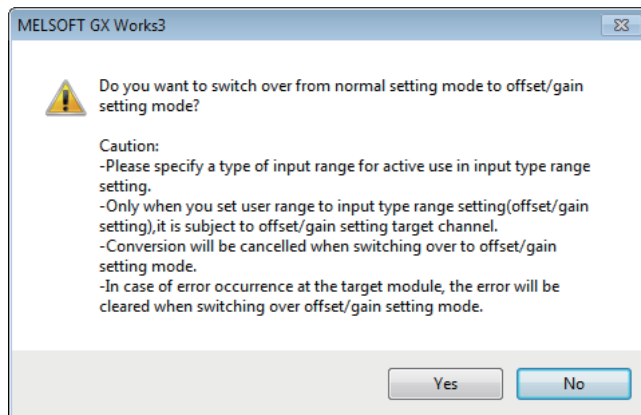

3. Click the [Yes] button.

4. Mark the checkbox of the channel (CH1) where offset and gain values are to be set.

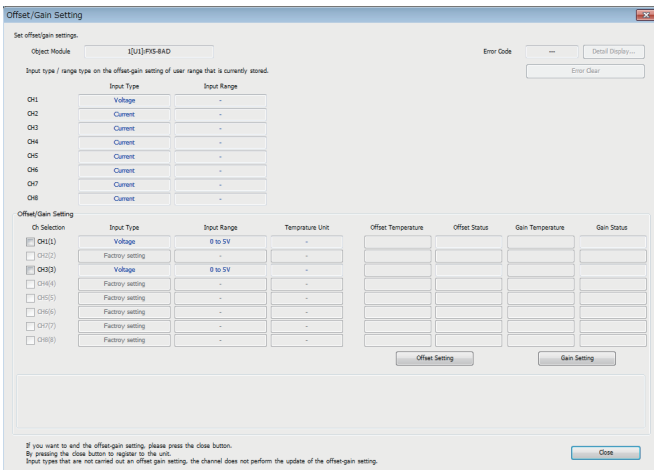

Set the input type (other than conversion disable) to be used in "Input type/Range setting" and "Setting Input type/range (Offset/gain setting)" to the user range setting in advance.

5. Select voltage or current and click the [Offset Setting] button.

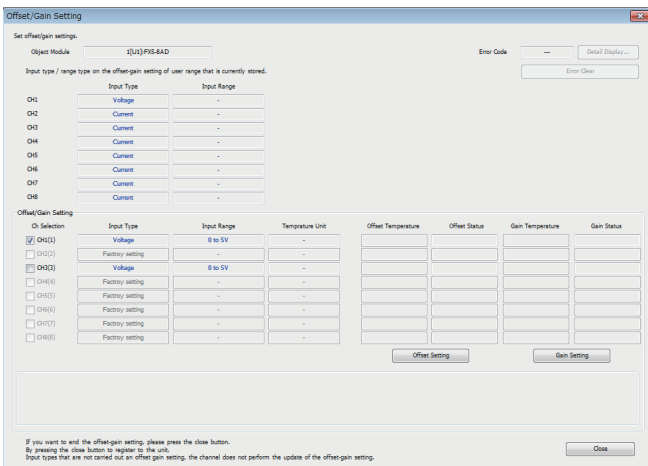

6. Input the offset value voltage "0 V" to the terminal of the target channel (CH1) and click the [Yes] button.

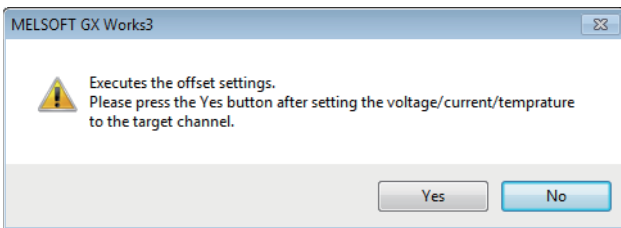

7. Check that "Offset Status" has changed to "Changed", and click the [Gain Setting] button.

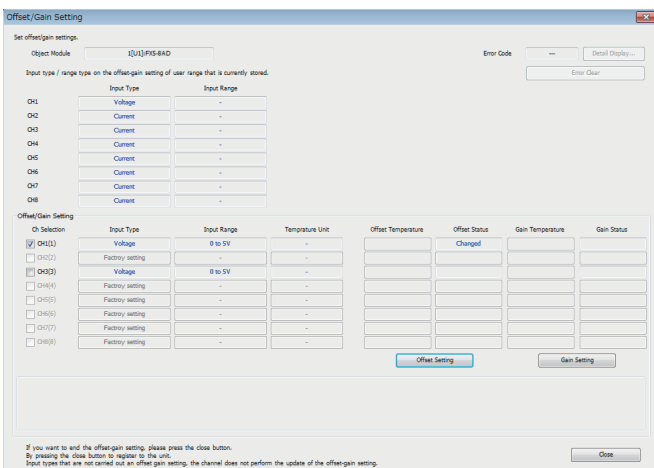

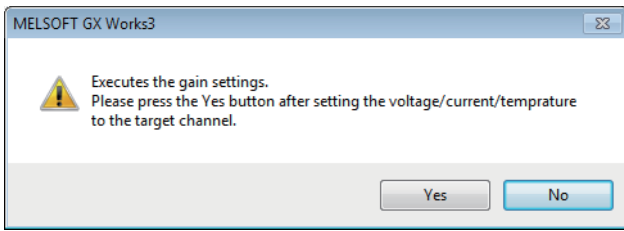

8. Input the Gain value voltage "5 V" to the terminal of the target channel (CH1) and click the [Yes] button.

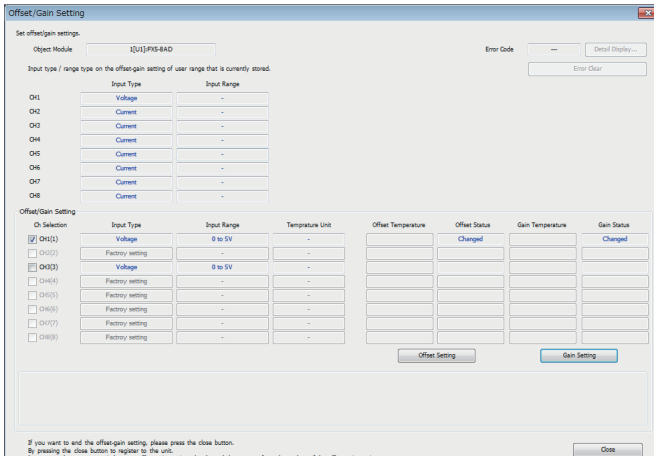

9. Check that "Gain Status" has changed to "Changed", and click the [Close] button.

10. Click the [Yes] button.

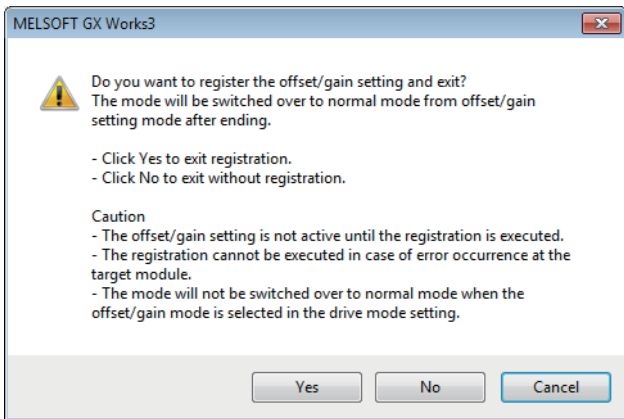

When the input type is "current", "voltage", please set the value so that offset value < gain value.

Setting from the program

The procedure for offset/gain setting from a program is shown below.

■Setting procedure

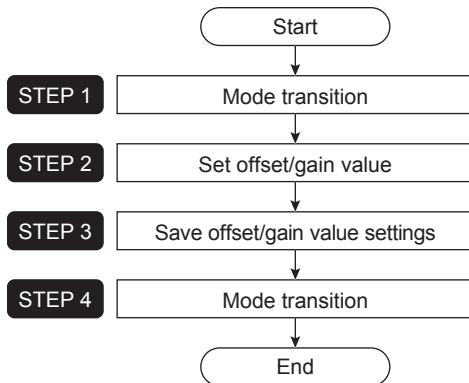

■STEP 1 Mode transition

Transition from normal mode to offset/gain setting mode.

1. Set "4144H" to 'Mode switching setting' (Un\G296) and "4658H" to 'Mode switching setting' (Un\G297).
2. Turn on 'Operating condition setting request' (Un\G70, b9).
3. Confirm that the 'Operating condition setting completed flag' (Un\G69, b9) is OFF and turn off 'Operating condition setting request' (Un\G70, b9).

When the transition to the offset/gain setting mode is completed, the RUN LED flashes.

■STEP 2 Set offset/gain value

Set the voltage or current input to the pin as an offset/gain value.

• Offset setting

1. Input the offset value voltage "0 V" to the CH1 terminal.
 2. Set 'CH1 offset/gain setting mode (offset specification)' (Un\G4132) to set channel (1), and set 'CH1 offset/gain setting mode (gain specification)' (Un\G4133) to invalid (0).
 3. Turn on 'Channel change request' (Un\G70, b11).
 4. Confirm that 'Channel change completed flag' (Un\G69, b11) is ON, and turn off 'Channel change request' (Un\G70, b11).
- Gain setting
5. Input the gain value voltage "5 V" to the CH1 terminal.
 6. Set 'CH1 offset/gain setting mode (offset specification)' (Un\G4132) to invalid (0), and set 'CH1 offset/gain setting mode (gain specification)' (Un\G4133) to set channel (1).
 7. Turn on 'Channel change request' (Un\G70, b11).
 8. Confirm that 'Channel change completed flag' (Un\G69, b11) is ON, and turn off 'Channel change request' (Un\G70, b11).
 9. Set 'CH1 offset/gain setting mode (offset specification)' (Un\G4132) to invalid (0), and set 'CH1 offset/gain setting mode (gain specification)' (Un\G4133) to invalid (0).

■STEP 3 Save offset/gain value settings

Save the set offset/gain values in the flash memory of the module.

1. Turn on 'User range write request' (Un\G70, b10).
2. Check that 'Offset/gain setting mode status flag' (Un\G69, b10) is off and turn off 'User range write request' (Un\G70, b10).

Point

When the input type is "current", "voltage", please set the value so that offset value < gain value.

■STEP 4 Mode transition

Shift from offset/gain setting mode to normal mode.

1. Set "4658H" to 'Mode switching setting' (Un\G296) and "4144H" to 'Mode switching setting' (Un\G297).
2. Turn on 'Operating condition setting request' (Un\G70, b9).
3. Confirm that the 'Operating condition setting completed flag' (Un\G69, b9) is OFF and turn off 'Operating condition setting request' (Un\G70, b9).

When the transition to the normal mode is completed, the RUN LED lights.

Setting example when the input type is thermocouple

An example of offset/gain setting is shown below.

Temperature input conversion characteristics

Ex.

When CH1 is set to 0°C, offset is set to 0, and when set to 100°C, gain is set to 1000

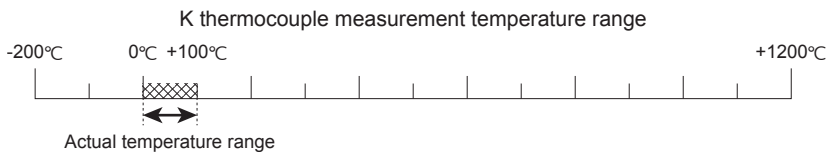

Module parameters

The module parameters used for CH1 are as follows. Parameters other than the following are defaults.

Item	Set conditions
Input type	Thermocouple
Input range	K
Setting Input type/range (Offset/gain setting)	User range setting
Operation mode setting	Normal mode

Settings from the module tool of GX Works3

The following shows the procedure for setting the offset and gain from the module tool of GX Works3. (For CH1)

■ Setting procedure

[Tool] ⇒ [Module Tool List]

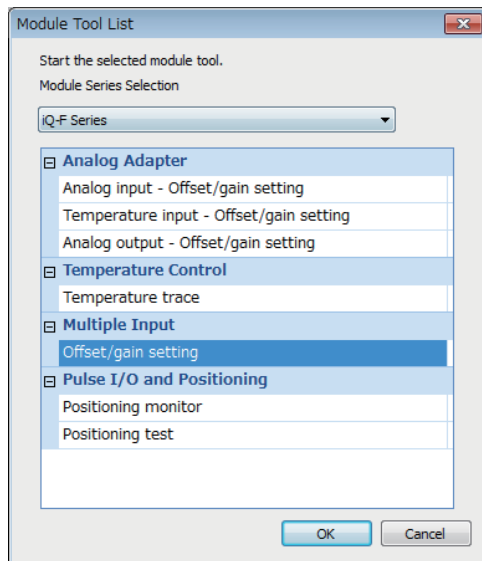

1. Select "Multiple Input" ⇒ "Offset/gain setting", and click [OK] button.

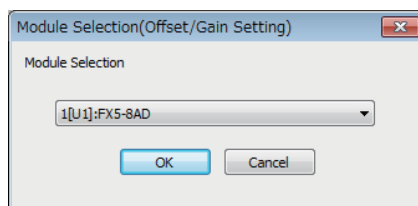

2. Select the target module for the offset/gain setting, and click [OK] button.

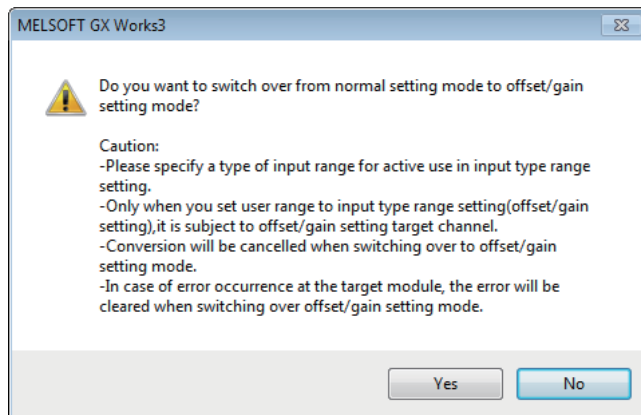

3. Click [Yes] button.

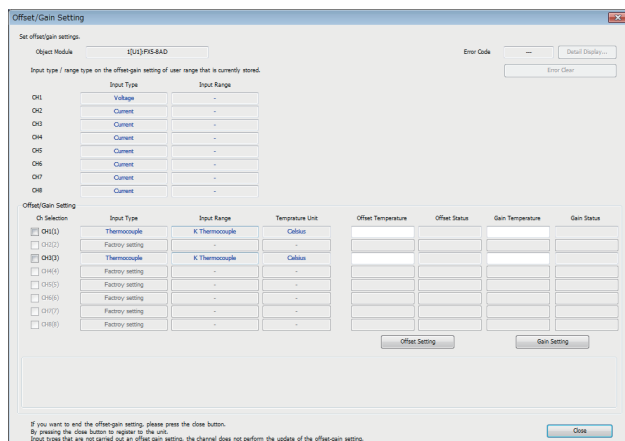

4. Mark the checkbox of the channel (CH1) where offset and gain values are to be set.
5. Write the temperature setting value "0.0" corresponding to the offset value to "Offset setting value".

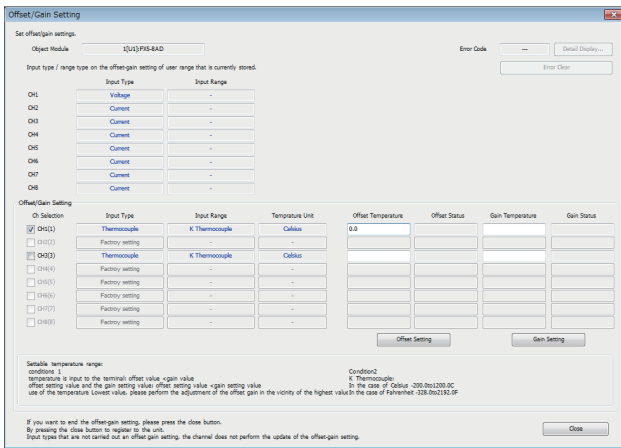

6. Click [Offset Setting] button.

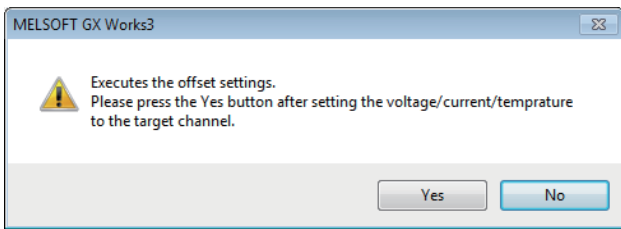

7. Input the offset value temperature "0°C" to the terminal of the target channel (CH1) and click the [Yes] button.

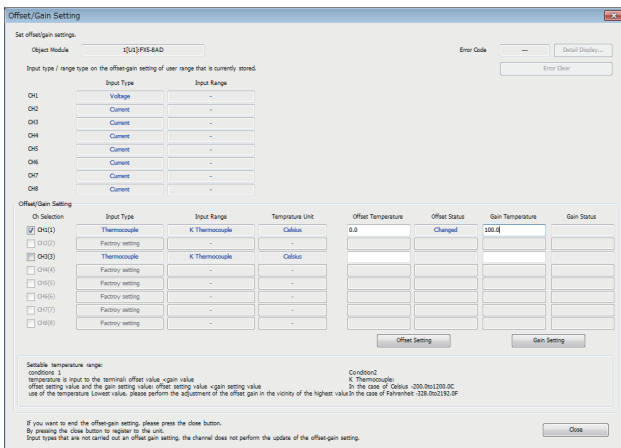

8. Check that "Offset Status" has changed to "Changed".

9. Write the temperature setting value "100.0" corresponding to the gain value to "Gain setting value".

10. Click [Gain Setting] button.

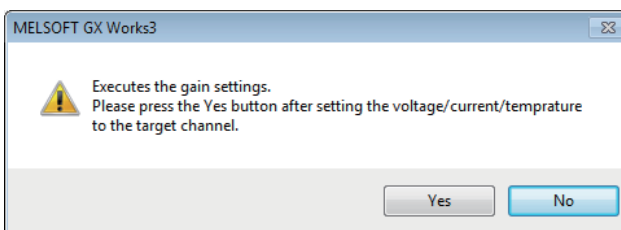

11. Input the gain value temperature "100°C" to the terminal of the target channel (CH1) and click the [Yes] button.

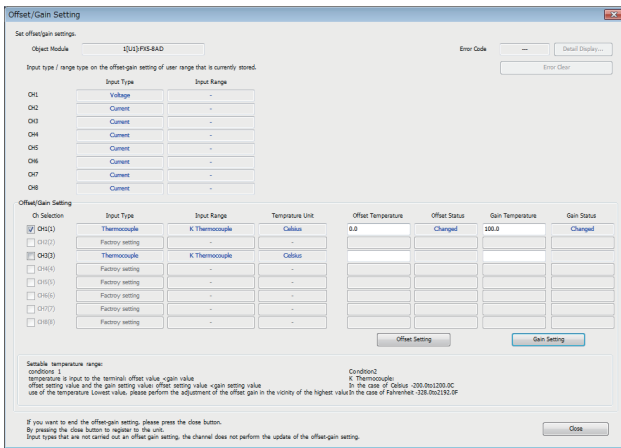

12. Check that "Gain Status" has changed to "Changed", and click [Close] button.

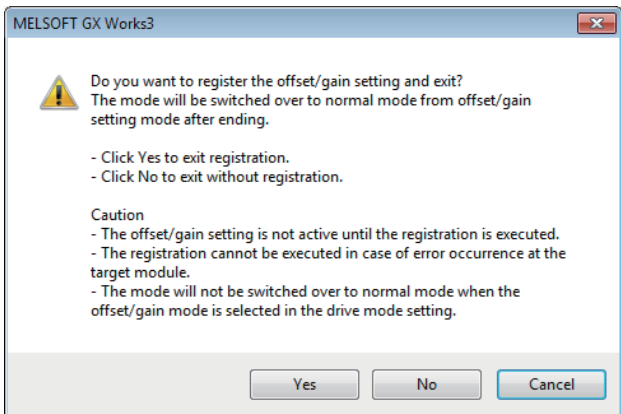

13. Click [Yes] button.



When the input type is "resistance temperature detector" or "thermocouple", offset value - gain value > 0.1°C

Precautions

If a broken wire is detected while setting the offset and gain, the offset and gain channel change error (error code: 1EB□H) will occur. The channel where the error occurred will remain unadjusted, so set the offset and gain again after repairing the broken wire.

Setting from the program

The procedure for offset/gain setting from a program is shown below.

■Setting procedure

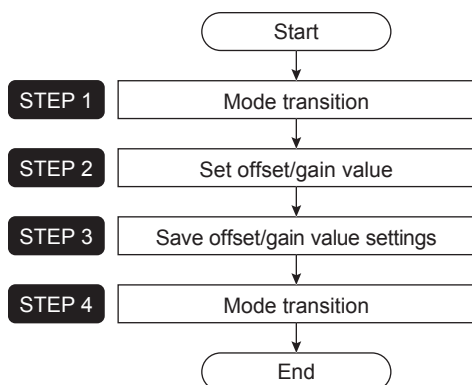

■STEP 1 Mode transition

Transition from normal mode to offset/gain setting mode.

1. Set "4144H" to 'Mode switching setting' (Un\G296) and "4658H" to 'Mode switching setting' (Un\G297).
2. Turn on 'Operating condition setting request' (Un\G70, b9).
3. Confirm that the 'Operating condition setting completed flag' (Un\G69, b9) is OFF and turn off 'Operating condition setting request' (Un\G70, b9).

When the transition to the offset/gain setting mode is completed, the RUN LED flashes.

■STEP 2 Set offset/gain value

Set the temperatures input to the terminals as the offset and gain values.

• Offset setting

1. Input the offset value temperature "0°C" to the CH1 terminal.
2. Set 'CH1 offset/gain setting mode (offset specification)' (Un\G4132) to set channel (1), and set 'CH1 offset/gain setting mode (gain specification)' (Un\G4133) to invalid (0).
3. Set "0" for the 'CH1 offset setting value' (Un\G562).
4. Turn on 'Channel change request' (Un\G70, b11).
5. Confirm that 'Channel change completed flag' (Un\G69, b11) is ON, and turn off 'Channel change request' (Un\G70, b11).

• Gain setting

6. Input the gain value temperature "100°C" to the CH1 terminal.
7. Set 'CH1 offset/gain setting mode (offset specification)' (Un\G4132) to invalid (0), and set 'CH1 offset/gain setting mode (gain specification)' (Un\G4133) to set channel (1).
8. Set "1000" to 'CH1 gain setting value' (Un\G564).
9. Turn on 'Channel change request' (Un\G70, b11).
10. Confirm that 'Channel change completed flag' (Un\G69, b11) is ON, and turn off 'Channel change request' (Un\G70, b11).
11. Set 'CH1 offset/gain setting mode (offset specification)' (Un\G4132) to invalid (0), and set 'CH1 offset/gain setting mode (gain specification)' (Un\G4133) to invalid (0).

■STEP 3 Save offset/gain value settings

Save the set offset/gain values in the flash memory of the module.

1. Turn on 'User range write request' (Un\G70, b10).
2. Check that 'Offset/gain setting mode status flag' (Un\G69, b10) is off and turn off 'User range write request' (Un\G70, b10).

Point

When the input type is "resistance temperature detector" or "thermocouple", offset value - gain value > 0.1°C

■STEP 4 Mode transition

Shift from offset/gain setting mode to normal mode.

1. Set "4658H" to 'Mode switching setting' (Un\G296) and "4144H" to 'Mode switching setting' (Un\G297).
2. Turn on 'Operating condition setting request' (Un\G70, b9).
3. Confirm that the 'Operating condition setting completed flag' (Un\G69, b9) is OFF and turn off 'Operating condition setting request' (Un\G70, b9).

When the transition to the normal mode is completed, the RUN LED lights.

3.9 Programming

This section describes the programming procedure and the basic program of a multiple input module.

Programming procedure

Take the following steps to create a program for running a multiple input module:

1. Set parameters.
2. Create a program.

System configuration example

■System configuration

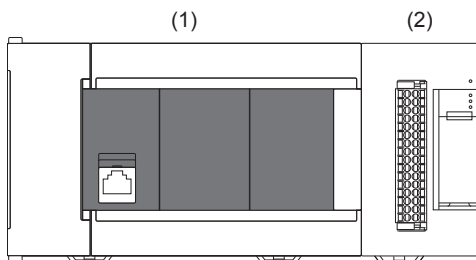

(1) CPU module (FX5U CPU module)

(2) Multiple input module (FX5-8AD)

■Parameter settings

Perform an initial setting in the module parameter of GX Works3. The refresh settings do not need to be changed here.

- Basic setting

Configure the basic setting as shown below.

Item	CH1	CH2	CH3	CH4	CH5	CH6	CH7	CH8
Range-switching function	The input range of the analog input can be set for each channel and the input conversion attribute can be changed.							
Input type	4: Thermocouple	0: Conversion dis	1: Current	0: Conversion dis	3: RTD	0: Conversion dis	2: Voltage	0: Conversion dis
Input range	4:R	0: Conversion dis	0.4 to 20mA	0: Conversion dis	0.Pt100(-200 to 8	0: Conversion dis	2-10V to 10V	0: Conversion dis
Setting Input type/range (Offset/gain setting)	Factory default s	Factory default s	Factory default s	Factory default s	Factory default s	Factory default s	Factory default s	Factory default s
Centigrade/Fahrenheit display setting function	Select the display method of the digital output value (Centigrade/Fahrenheit display) when the input type is set to RTD or thermocouple.							
Centigrade/Fahrenheit display setting	Fahrenheit [°F]	Centigrade [°C]	Centigrade [°C]	Centigrade [°C]	Centigrade [°C]	Centigrade [°C]	Centigrade [°C]	Centigrade [°C]
Operation mode setting function	The three operation modes, "Normal mode" to execute the normal conversion, "Offset/gain setting mode" to execute the offset/gain							
Operation mode setting	Normal mode							
Number of conversion enable channels	0							
Conversion method	Set the conversion control method.							
Average processing setting	Sampling process: Count average		Sampling process: Moving average		Sampling process: Sampling process		Sampling process	
Time average/Count average/Moving average setting	0	0	50 times	0	100 times	0	0	0

Explanation
The input range of the analog input can be set for each channel and the input conversion attribute can be changed.

- Application setting

Configure the application setting as shown below.

Item	CH1	CH2	CH3	CH4	CH5	CH6	CH7	CH8
Scaling function	Configure the setting for the scaling at the conversion.							
Scaling enable/disable setting	Disable	Disable	Disable	Disable	Disable	Disable	Enable	Disable
Scaling upper limit value	0	0	0	0	0	0	10000	0
Scaling lower limit value	0	0	0	0	0	0	-10000	0
Shift function	Configure the setting for the shift function at the conversion.							
Conversion value shift	0	0	0	0	0	0	2000	0
Digitalclip function	Configure the setting for the digital clipping function at the conversion.							
Digitalclip enable/disable setting	Disable	Disable	Disable	Disable	Disable	Disable	Enable	Disable
Warning output function (Process alarm)	Set an alert at the conversion.							
Warning output setting (Process alarm)	Disable	Disable	Enable	Disable	Disable	Disable	Disable	Disable
Process alarm upper upper limit value	0	0	32000	0	0	0	0	0
Process alarm upper lower limit value	0	0	28000	0	0	0	0	0
Process alarm lower upper limit value	0	0	4000	0	0	0	0	0
Process alarm lower lower limit value	0	0	0	0	0	0	0	0
Warning output function (Rate alarm)	Set an alert at the conversion.							
Warning output setting (Rate alarm)	Enable	Disable	Disable	Disable	Disable	Disable	Disable	Disable
Rate alarm change rate selection	Rate							
Rate alarm detection cycle setting	5 times	0 times	0 times	0 times	0 times	0 times	0 times	0 times
Rate alarm upper limit value	25.0 %	0.0 %	0.0 %	0.0 %	0.0 %	0.0 %	0.0 %	0.0 %
Rate alarm lower limit value	-5.0 %	0.0 %	0.0 %	0.0 %	0.0 %	0.0 %	0.0 %	0.0 %
Input signal error detection function	Configure the setting for the input signal at the conversion.							
Input signal error detection setting	Disable	Disable	Upper limit detec	Disable	Disable	Disable	Upper/lower limit	Disable
Input signal error detection lower limit setting value	5.0 %	5.0 %	5.0 %	5.0 %	5.0 %	5.0 %	15.0 %	5.0 %
Input signal error detection upper limit setting value	5.0 %	5.0 %	20.0 %	5.0 %	5.0 %	5.0 %	3.0 %	5.0 %
Disconnection detection function	Configure the setting for the disconnection detection at the conversion.							
Disconnection detection function enable/disable setti	Enable	Enable	Enable	Enable	Disable	Enable	Enable	Enable
Conversion setting for disconnection detection	Value immediat	Down Scale	Down Scale	Down Scale	Down Scale	Down Scale	Down Scale	Down Scale
Conversion setting value for disconnection detection	0	0	0	0	0	0	0	0
Input signal error detection function/disconnection	Set whether to enable or disable auto-clearing of input signal errors and disconnection by using the input signal error detection function							
Input signal error/disconnection detection auto-clear	Disable							
Logging function	Configure the setting for the logging function at the conversion.							
Logging enable/disable setting	Disable	Disable	Disable	Disable	Disable	Disable	Disable	Disable
Logging data setting	Digital operation	Digital operation	Digital operation	Digital operation	Digital operation	Digital operation	Digital operation	Digital operation v
Logging cycle setting value	40 ms	40 ms	40 ms	40 ms	40 ms	40 ms	40 ms	40 ms
Logging cycle unit setting	ms	ms	ms	ms	ms	ms	ms	ms
Level trigger condition setting	Disable	Disable	Disable	Disable	Disable	Disable	Disable	Disable
Logging points after trigger	5000	5000	5000	5000	5000	5000	5000	5000
Trigger data	402	602	802	1002	1202	1402	1602	1802
Trigger setting value	0	0	0	0	0	0	0	0

Explanation
Configure the setting for the scaling at the conversion.

Program example

Label settings

Classification	Device	Description	Device
Module label	FX5_8AD_1.bConversionCompletedFlag_D	Conversion completed flag	U1\G69, b14
	FX5_8AD_1.bModuleREADY_D	Module READY	U1\G69, b0
	FX5_8AD_1.bOperatingConditionSettingCompletedFlag_D	Operating condition setting completed flag	U1\G69, b9
	FX5_8AD_1.stnMonitor_D[0].wDigitalOutputValue_D	Digital output value	U1\G400
	FX5_8AD_1.stnMonitor_D[2].wDigitalOutputValue_D	Digital output value	U1\G800
	FX5_8AD_1.stnMonitor_D[4].wDigitalOutputValue_D	Digital output value	U1\G1200
	FX5_8AD_1.stnMonitor_D[6].wDigitalOutputValue_D	Digital output value	U1\G1600
	FX5_8AD_1.uConversionCompletedFlag_D.0	Conversion completed flag	U1\G42, b0
	FX5_8AD_1.uConversionCompletedFlag_D.2	Conversion completed flag	U1\G42, b2
	FX5_8AD_1.uConversionCompletedFlag_D.4	Conversion completed flag	U1\G42, b4
	FX5_8AD_1.uConversionCompletedFlag_D.6	Conversion completed flag	U1\G42, b6
	FX5_8AD_1.stnControl_D[4].uMaxResetReq_D.0	Maximum value reset completed flag	U1\G1273, b0
	FX5_8AD_1.stnControl_D[4].uMinResetReq_D.0	Minimum value reset completed flag	U1\G1274, b0
	FX5_8AD_1.stnMonitor_D[4].uMaxResetCmpFlg_D.0	Maximum value reset completed flag	U1\G1222, b0
	FX5_8AD_1.stnMonitor_D[4].uMinResetCmpFlg_D.0	Minimum value reset completed flag	U1\G1223, b0
	FX5_8AD_1.stnMonitor_D[4].wMaxValue_D	Maximum value	U1\G1204
	FX5_8AD_1.stnMonitor_D[4].wMinValue_D	Minimum value	U1\G1206
	FX5_8AD_1.uWarningOutputFlagProcessAlarmLowerLimit_D.2	Warning output flag (Process alarm lower limit)	U1\G37, b2
	FX5_8AD_1.uWarningOutputFlagProcessAlarmUpperLimit_D.2	Warning output flag (Process alarm upper limit)	U1\G36, b2
	FX5_8AD_1.uWarningOutputFlagRateAlarmLowerLimit_D.0	Warning output flag (Rate alarm lower limit)	U1\G39, b0
	FX5_8AD_1.uWarningOutputFlagRateAlarmUpperLimit_D.0	Warning output flag (Rate alarm upper limit)	U1\G38, b0
	FX5_8AD_1.bErrorClearRequest_D	Error clear request	U1\G70, b15
	FX5_8AD_1.bInputSignalErrorDetectionSignal_D	Input signal error detection signal	U1\G69, b12
	FX5_8AD_1.uInputSignalErrorDetectionFlag_D.6	Input signal error detection flag	U1\G40, b6
	FX5_8AD_1.uLatestAlarmCode_D	Latest alarm code	U1\G2
	FX5_8AD_1.uDisconnectionDetectionFlag_D.0	Disconnection detection flag	U1\G41, b0
	FX5_8AD_1.bErrorFlag_D	Error flag	U1\G69, b15
	FX5_8AD_1.uLatestErrorCode_D	Latest error code	U1\G0

Labels to be defined Define global labels as shown below:

	Label Name	Data Type	Class	Assign (Device/Label)
1	CH1_DigOutValue	Word [Signed]	VAR_GLOBAL	D11
2	CH3_DigOutValue	Word [Signed]	VAR_GLOBAL	D12
3	CH5_DigOutValue	Word [Signed]	VAR_GLOBAL	D13
4	CH7_DigOutValue	Word [Signed]	VAR_GLOBAL	D14
5	CH5_DigMaxVal	Word [Signed]	VAR_GLOBAL	D15
6	CH5_DigMinVal	Word [Signed]	VAR_GLOBAL	D16
7	CH3_ProcAlmUpLimit	Bit	VAR_GLOBAL	F0
8	CH3_ProcAlmLowLimit	Bit	VAR_GLOBAL	F1
9	CH1_RateAlmUpLimit	Bit	VAR_GLOBAL	F2
10	CH1_RateAlmLowLimit	Bit	VAR_GLOBAL	F3
11	CH7_InputSigErr	Bit	VAR_GLOBAL	F4
12	DigitOutValSig	Bit	VAR_GLOBAL	X10
13	CH1_Disconnection	Bit	VAR_GLOBAL	F5
14	MaxMinReadSig	Bit	VAR_GLOBAL	X11
15	MaxMinResetSig	Bit	VAR_GLOBAL	X12
16	UnitErrCode	Word [Unsigned]/Bit String [16-bit]	VAR_GLOBAL	
17	UnitAlarmCode	Word [Unsigned]/Bit String [16-bit]	VAR_GLOBAL	
18	ErrSet	Bit	VAR_GLOBAL	
19	ErrOutSig	Bit	VAR_GLOBAL	
20	UnitErrResetSig	Bit	VAR_GLOBAL	X13
21	InSigErrResetSig	Bit	VAR_GLOBAL	X14

Program example

Digital output value readout processing

(0)	DigitOutValSts X10	FX5_BAD_1bModuleREADY_D U1#G69.0	FX5_BAD_1bConversionCompletedFlag_D U1#G69.E	FX5_BAD_1bOperatingConditionSettingCompletedFlag_D U1#G69.9	FX5_BAD_1uConversionCompletedFlag_D.0 U1#G42.0	MOV	FX5_BAD_1.stnMonitor_D [0].wDigitalOutputValue_D U1#G400	CH1_DlgOutVal	D11
					FX5_BAD_1uConversionCompletedFlag_D.2 U1#G42.2	MOV	FX5_BAD_1.stnMonitor_D [2].wDigitalOutputValue_D U1#G800	CH3_DlgOutVal	D12
					FX5_BAD_1uConversionCompletedFlag_D.4 U1#G42.4	MOV	FX5_BAD_1.stnMonitor_D [4].wDigitalOutputValue_D U1#G1200	CH5_DlgOutVal	D13
					FX5_BAD_1uConversionCompletedFlag_D.6 U1#G42.6	MOV	FX5_BAD_1.stnMonitor_D [6].wDigitalOutputValue_D U1#G1600	CH7_DlgOutVal	D14
(156)									-END-

Maximum/minimum value readout/clear processing

(0)	MaxMinReadSts X11	FX5_BAD_1bModuleREADY_D U1#G69.0	FX5_BAD_1bConversionCompletedFlag_D U1#G69.E	FX5_BAD_1bOperatingConditionSettingCompletedFlag_D U1#G69.9	FX5_BAD_1.stnMonitor_D [4].uMaxResetCompFlag_D.0 U1#G1222.0	FX5_BAD_1.stnMonitor_D [4].uMinResetCompFlag_D.0 U1#G1223.0	MOV	FX5_BAD_1.stnMonitor_D [4].wMaxValue_D U1#G1204	CH5_DlgMaxVal	D15
							MOV	FX5_BAD_1.stnMonitor_D [4].wMinValue_D U1#G1206	CH5_DlgMinVal	D16
(79)	MaxMinResetSts X12						SET	FX5_BAD_1.stnControl_D [4].uMaxResetReq_D.0 U1#G1273.0		
							SET	FX5_BAD_1.stnControl_D [4].uMinResetReq_D.0 U1#G1274.0		
(133)	FX5_BAD_1.stnControl_D [4].uMaxResetReq_D.0 U1#G1273.0	FX5_BAD_1.stnMonitor_D [4].uMaxResetCompFlag_D.0 U1#G1222.0					RST	FX5_BAD_1.stnControl_D [4].uMaxResetReq_D.0 U1#G1273.0		
(165)	FX5_BAD_1.stnControl_D [4].uMinResetReq_D.0 U1#G1274.0	FX5_BAD_1.stnMonitor_D [4].uMinResetCompFlag_D.0 U1#G1223.0					RST	FX5_BAD_1.stnControl_D [4].uMinResetReq_D.0 U1#G1274.0		
(197)										-END-

Process alarm occurrence processing

(0)	FX5_BAD_1.uWarningOutputFlagProcessAlarmUpperLimit_D.2 U1#G36.2						SET	CH3_ProcAlmUpLimit F0	
(49)	FX5_BAD_1.uWarningOutputFlagProcessAlarmLowerLimit_D.2 U1#G37.2						SET	CH3_ProcAlmLowLimit F1	
(81)									-END-

Rate alarm occurrence processing

(0)	FX5_BAD_1.uWarningOutputFlagRateAlarmUpperLimit_D.0 U1#G38.0						SET	CH1_RateAlmUpLimit F2	
(46)	FX5_BAD_1.uWarningOutputFlagRateAlarmLowerLimit_D.0 U1#G39.0						SET	CH1_RateAlmLowLimit F3	
(76)									-END-

• Input signal error occurrence processing

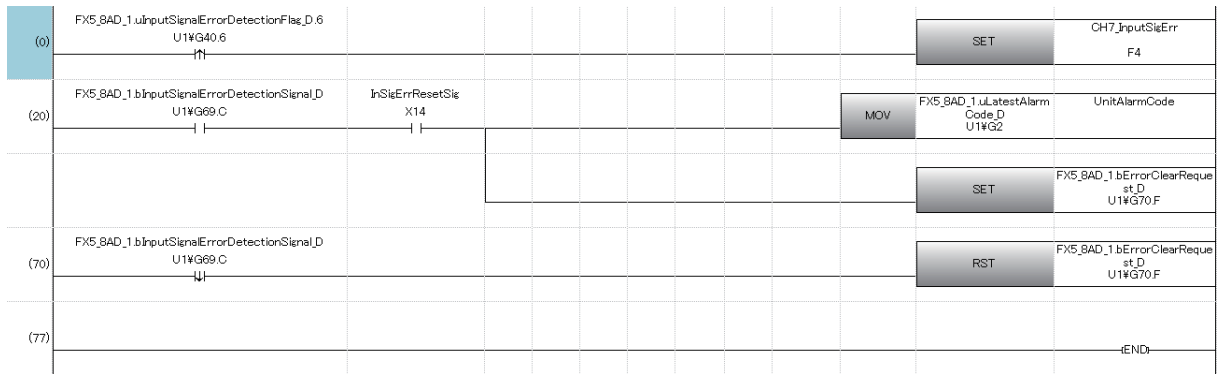

• Disconnection detection processing

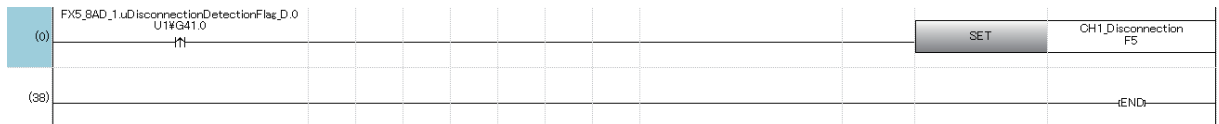

• Error clear processing

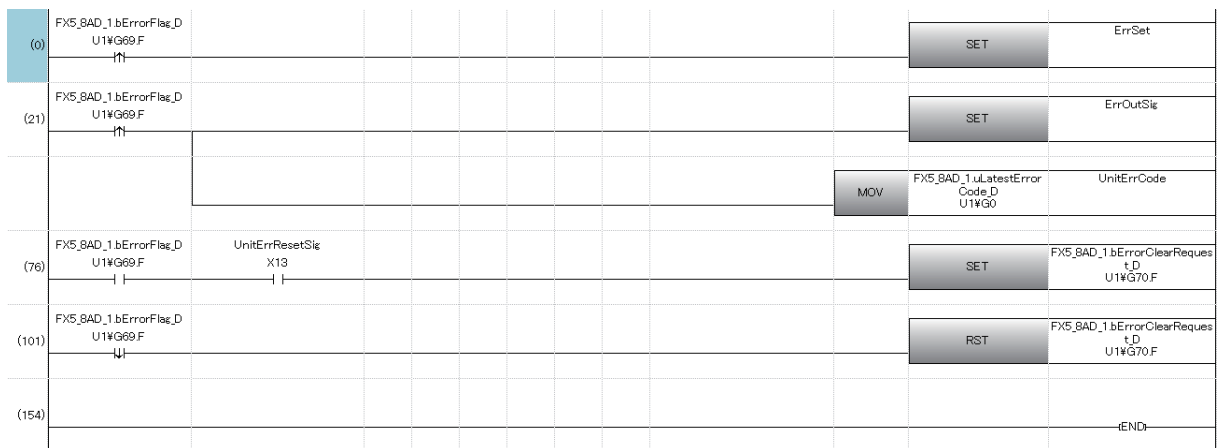

3.10 Troubleshooting

This section describes errors that may occur in the use of a multiple input module and those troubleshooting.

Troubleshooting with the LEDs

Check the state of the LEDs to narrow down the possible causes of the trouble. This step is the first diagnostics before using GX Works3.

A state of a multiple input module can be checked with the RUN LED, ERROR LED, and ALM LED. The following table shows the relation of these LEDs and a state of a multiple input module.

Name	Description
RUN LED	Indicates the operating status of the module. On: Normal operation Flashing: Offset/gain setting mode Off: Error
ERROR LED	Indicates the error status of the module. ^{*1} On: Minor error or major error Flashing: Moderate error or major error Off: Normal operation
ALM LED	Indicates the alarm status of the module. ^{*2} On: Process alarm or rate alarm issued Flashing: Input signal error or disconnection detection detected Off: Normal operation

*1 For details, refer to the following.

☞ Page 424 List of error codes

*2 For details, refer to the following.

☞ Page 427 List of alarm codes

Troubleshooting by symptom

When the input type is “current”, and “voltage”

■When the RUN LED flashes or turns off

- When flashing

Check item	Cause	Corrective action
Check whether the module is in offset/gain setting mode.	The programmable controller has been powered off→on, or the CPU module has been reset when the operation mode is set to offset/gain setting mode in the module parameter setting of GX Works3.	In the module parameter setting of GX Works3, set the operation mode to normal mode and power off→on the programmable controller, or reset the CPU module.
	The value in the mode switching setting has been changed and the mode has been switched to offset/gain setting mode.	Review the program that uses the mode switching setting to check whether the mode has been switched erroneously.

- When it is off

Check item	Corrective action
Check whether the power is supplied.	Check that the supply voltage of the multiple input module is within the rated range.
Check whether the capacity of the CPU module is enough.	Calculate the current consumption of the I/O modules, and intelligent function modules to check that the power capacity is enough.
Check whether the module is mounted properly.	Check the mounting state of the module.
Cases other than the above	Reset the CPU module, and check if the RUN LED turns on. If the RUN LED still remains off, the possible cause is a failure of the module. Please consult your local Mitsubishi representative.

■ When the ERROR LED turns on or flashes

- When it is on

Check item	Corrective action
Check whether any error has occurred.	Check 'Latest error code' (Un\G0) and take actions described in the list of error codes. ☞ Page 424 List of error codes

- When flashing

Check item	Corrective action
Check whether 24 V DC external supply power shutdown has occurred.	Check that FX5-8AD and 24 V DC external power supply are properly connected. Additionally, before turning on the system power supply, check that the voltage supply from the 24 V DC external power supply is started to FX5-8AD.

■ When the ALM LED turns on or flashes

- When it is on

Check item	Corrective action
Check whether any alert has been issued.	Check Alert output flag (Process alarm upper limit), Alert output flag (Process alarm lower limit), Alert output flag (Rate alarm upper limit), and Alert output flag (Rate alarm lower limit). Take actions described in the list of alarm codes. ☞ Page 427 List of alarm codes

- When flashing

Check item	Corrective action
Check whether any input signal error has occurred.	Check Input signal error detection signal or Input signal error detection flag. Take actions described in the list of alarm codes. ☞ Page 427 List of alarm codes

■ When a digital output value cannot be read

Check item	Corrective action
Check whether an analog signal line is disconnected from the multiple input module.	Visually check signal lines and correctly connect analog signal lines.
Check whether the CPU module is in the STOP state.	Change the state of the CPU module to RUN.
Check whether the offset/gain setting in the user range setting is correct.	Check that the offset/gain setting is correct. If the user range setting is selected, change the other input range to the factory shipment setting, and check that the conversion is performed. Reconfigure the offset/gain setting when the conversion is correct.
Check whether the input type/input range setting are correct.	Check CH□ Input type/Range monitor with GX Works3. When the input type/input range setting are incorrect, reconfigure the input type and input range setting again.
Check whether 'Operating condition setting request' (Un\G70, b9) has been executed.	Turn off→on→off*1 'Operating condition setting request' (Un\G70, b9) and check that a digital output value is stored in 'CH1 Digital output value' (Un\G400) using GX Works3. If the stored value is correct, check the program.
Check whether the setting value of the time average is correct when the time average is selected in Averaging process specification.	When the time average is selected for processing, set the time average value in CH1 Time average/Count average/Moving average setting so that the value satisfies the following condition: <ul style="list-style-type: none"> • Time average setting value ≥ 4 (times) $\times 1$ (ms) \times Number of input type current/voltage specified channel If the condition above is not satisfied, the digital output value results in 0.

*1 The conversion does not start when 'Operating condition setting request' (Un\G70, b9) is on. After turning off→on, check that 'Operating condition setting completed flag' (Un\G69, b9) is off, and then make sure to turn on→off.

■ When the digital output value does not fall within the range of accuracy

Check item	Corrective action
Check whether any measures have been taken to reduce noise.	To reduce noise, take measures such as the use of shielded cables for connection.
Is an external input being made to a conversion disabled channel?	Do not input to a conversion disabled channel from an external device.

■Digital output value varies

Check item	Corrective action
Check whether a conversion method other than sampling processing is set.	Check the setting of average processing specification from the "Module parameter setting" screen of GX Works3. Review the setting of average processing specification and check the state of variation of 'CH1 Digital output value' (Un\G400) again.

■Conversion completed flag does not turn on

Check item	Corrective action
Check whether all channels are set to be conversion disabled.	Check the setting of input type with GX Works3. If there is no channel other than conversion disabled, please set the input type setting to one other than "Conversion disabled" for one or more channels from GX Works3 or sequence program.

When the input type is “resistance temperature detector”, and “thermocouple”

■When the RUN LED flashes or turns off

- When flashing

Check item	Cause	Corrective action
Check whether the module is in offset/gain setting mode.	The programmable controller has been powered off→on, or the CPU module has been reset when the operation mode is set to offset/gain setting mode in the module parameter setting of GX Works3.	In the module parameter setting of GX Works3, set the operation mode to normal mode and power off→on the programmable controller, or reset the CPU module.
	The value in the mode switching setting has been changed and the mode has been switched to offset/gain setting mode.	Review the program that uses the mode switching setting to check whether the mode has been switched erroneously.

- When it is off

Check item	Corrective action
Check whether the power is supplied.	Check that the supply voltage of the multiple input module is within the rated range.
Check whether the capacity of the CPU module is enough.	Calculate the current consumption of the I/O modules, and intelligent function modules to check that the power capacity is enough.
Check whether the module is mounted properly.	Check the mounting state of the module.
Cases other than the above	Reset the CPU module, and check if the RUN LED turns on. If the RUN LED still remains off, the possible cause is a failure of the module. Please consult your local Mitsubishi representative.

■When the ERROR LED turns on or flashes

- When it is on

Check item	Corrective action
Check whether any error has occurred.	Check 'Latest error code' (Un\G0) and take actions described in the list of error codes.  Page 424 List of error codes

- When flashing

Check item	Corrective action
Check whether 24 V DC external supply power shutdown has occurred.	Check that FX5-8AD and 24 V DC external power supply are properly connected. Additionally, before turning on the system power supply, check that the voltage supply from the 24 V DC external power supply is started to FX5-8AD.

■When the ALM LED turns on or flashes

- When it is on

Check item	Corrective action
Check whether any alert has been issued.	Check Alert output flag (Process alarm upper limit), Alert output flag (Process alarm lower limit), Alert output flag (Rate alarm upper limit), and Alert output flag (Rate alarm lower limit). Take actions described in the list of alarm codes. ☞ Page 427 List of alarm codes

- When flashing

Check item	Corrective action
Check whether any disconnection has been occurred.	Check Disconnection detection signal or Disconnection detection flag. Take actions described in the list of alarm codes. ☞ Page 427 List of alarm codes

■When a digital output value cannot be read

Check item	Corrective action
Check whether an analog signal line is disconnected from the multiple input module.	Visually check signal lines and correctly connect analog signal lines.
Check whether a thermocouple and compensation lead wire are correctly connected.	Correctly connect a thermocouple or compensation lead wire to the multiple input module. The following is the check point. <ul style="list-style-type: none"> • A shielded cable for the used channel is grounded or not. • The thermocouple and compensation lead wire are reversely connected or not.
Check whether the CPU module is in the STOP state.	Change the state of the CPU module to RUN.
Check whether the offset/gain setting is correct.	Check that the offset/gain setting is correct. If the user range setting is used, change to the factory shipment setting, and check that the conversion is performed. When the conversion is correct, perform the offset/gain setting again.
Check whether the input type/input range setting are correct.	Check 'CH1 Input type/Range monitor' (Un\G430) with GX Works3. When the input type/input range setting are incorrect, reconfigure the input type and input range setting again.
Check whether 'Operating condition setting request' (Un\G70, b9) has been executed.	Turn off→on→off*1 'Operating condition setting request' (Un\G70, b9) and check that a digital output value is stored in 'CH1 Digital output value' (Un\G400) using GX Works3.
Check whether the setting value of the time average is correct when the time average is selected in Averaging process specification.	When the time average is selected for processing, set the time average value in CH1 Time average/Count average/Moving average setting so that the value satisfies the following condition: <ul style="list-style-type: none"> • Time average setting value ≥ 4 (times) $\times 40$ (ms) \times Number of Input type thermocouple/resistance temperature detector specified channel If the condition above is not satisfied, the digital output value results in 0.

*1 The conversion does not start when 'Operating condition setting request' (Un\G70, b9) is on. After turning off→on, check that 'Operating condition setting completed flag' (Un\G69, b9) is off, and then make sure to turn on→off.

■Digital output value does not vary

Check item	Corrective action
Check whether disconnection of a thermocouple or compensation lead wire is detected.	Eliminate the cause of disconnection, by replacing the thermocouple or compensation lead wire for instance, and check 'CH1 Digital output value' (Un\G400).

■The digital output value is not converted to an expected value

Check item	Corrective action
Check whether the input type/input range setting are correct.	Check the setting of input type, and input range from the "Module parameter setting" screen of GX Works3. If the setting range is not correct, set input range from "Module parameter setting" screen again.
Check whether the offset/gain setting is correct.	Check that the offset/gain setting is correct. If the user range setting is used, change to the factory shipment setting, and check that the conversion is performed. When the conversion is correct, perform the offset/gain setting again.
Check whether average processing specification is correct.	Check the setting of average processing specification from the "Module parameter setting" screen of GX Works3. If the setting is different from the average processing you want to use, reset the average processing specification from the "Module parameter setting" screen.
Is an external input being made to a conversion disabled channel?	Do not input to a conversion disabled channel from an external device.

■Digital output value varies

Check item	Corrective action
Check whether a conversion method other than sampling processing is set.	Check the setting of average processing specification from the "Module parameter setting" screen of GX Works3. Review the setting of average processing specification and check the state of variation of 'CH1 Digital output value' (Un\G400) again.

■Conversion completed flag does not turn on

Check item	Corrective action
Check whether all channels are set to be conversion disabled.	Check the setting of input type with GX Works3. If there is no channel other than conversion disabled, please set the input type setting to one other than "Conversion disabled" for one or more channels from GX Works3 or sequence program.

List of error codes

If an error occurs during operation, a multiple input module stores the error code into 'Latest error code' (Un\G0) of the buffer memory. In addition, 'Error flag' (Un\G69, b15) turns on. Turning on 'Error clear request' (Un\G70, b15) clears the error code in 'Latest error code' (Un\G0) and turns off 'Error flag' (Un\G69, b15).

Error codes of a multiple input module are classified in minor errors or moderate errors.

- Minor error: This error is caused by the setting failure of programs and parameters, and after eliminating the error cause, each function normally executes. (1000H to 1FFFH)
- Moderate error: Hardware failures. The A/D conversion, and temperature conversion do not continue. (3000H to 3FFFH)

The following table lists the error codes that may be stored.

□: This symbol indicates the number of the channel where an error has occurred. A numerical value of 0 to 7 is used to correspond to CH1 to 8.

(CH1: 0, CH2: 1, CH3: 2, CH4: 3, CH5: 4, CH6: 5, CH7: 6, CH8: 7)

△: For what this symbol indicates, refer to Description and cause of error.

Error code	Error name	Description and cause	Corrective action
0000H	—	There is no error.	—
1080H	Number of writes to offset/gain settings reach limit error	The number of the offset/gain settings has exceeded the guaranteed maximum number.	Any further setting of offset/gain values may not be reflected correctly.
1090H	Conversion enabled CH combination unavailable error	In 2CH conversion mode, CH used for conversion enabled CH number is out of combination range.	Reconfigure CH to the conversion enabled with the correct combination for conversion enabled CH number.
1861H	Offset/gain setting continuous write occurrence error	The setting value has been continuously written to the flash memory 26 times or more in the offset/gain setting.	For the offset/gain setting, write the setting value only once per setting.
190□H	Input type/Range setting range error	<ul style="list-style-type: none"> • A value out of the range is set in CH□ Input type/Range setting. • A value out of the range is set in CH□ Range setting (Offset/gain setting). 	<ul style="list-style-type: none"> • Set CH□ Input type/Range setting to the value within the range again. • Set 0 or 1 in CH□ Range setting (Offset/gain setting).

Error code	Error name	Description and cause	Corrective action
191□H	Averaging process specification setting range error	A value other than 0 to 3 is set in CH□ Average processing specification.	Set a value of 0 to 3 in CH□ Average processing specification again.
192□H	Time average setting range error	<p>■When the input type is “current”, and “voltage” When Time average is selected in CH□ Average processing specification, a value other than 4 to 10000 is set in CH□ Time average/Count average/Moving average setting.</p>	<p>■When the input type is “current”, and “voltage” Set a value of 4 to 10000 in CH□ Time average/Count average/Moving average setting.</p>
		<p>■When the input type is resistance temperature detector, and thermocouple When Time average is selected in CH□ Average processing specification, a value other than 160 to 10000 is set in CH□ Time average/Count average/Moving average setting.</p>	<p>■When the input type is resistance temperature detector, and thermocouple Set a value of 160 to 10000 in CH□ Time average/Count average/Moving average setting.</p>
193□H	Count average setting range error	When Count average is set in CH□ Average processing specification, a value other than 4 to 10000 is set in CH□ Time average/Count average/Moving average setting.	Set a value of 4 to 10000 in CH□ Time average/Count average/Moving average setting again.
194□H	Moving average setting range error	When the moving average is set in CH□ Averaging processing specification, a value other than 2 to 1000 is set in CH□ Time average/Count average/Moving average setting.	Set a value of 2 to 1000 in CH□ Time average/Count average/Moving average setting again.
198□H	Celsius/Fahrenheit display setting range error	A value other than 0 and 1 is set in CH□ Celsius/Fahrenheit display setting.	Set 0 or 1 in CH□ Celsius/Fahrenheit display setting again.
1A0□H	Scaling enable/disable setting range error	A value other than 0 and 1 is set in CH□ Scaling enable/disable setting.	Set 0 or 1 in CH□ Scaling enable/disable setting.
1A1□H	Scaling setting range error	A value other than -32000 to +32000 is set in CH□ Scaling lower limit value or CH□ Scaling upper limit value.	Set CH□ Scaling lower limit value or CH□ Scaling upper limit value to -32000 to +32000 again.
1A2□H	Scaling upper/lower limit value setting error	CH□ Scaling lower limit value and CH□ Scaling upper limit value are set as CH□ Scaling lower limit value = CH□ Scaling upper limit value.	Set CH□ Scaling lower limit value and CH□ Scaling upper limit value as CH□ Scaling lower limit value ≠CH□ Scaling upper limit value again.
1A5□H	Digital clipping enable/disable setting range error	A value other than 0 and 1 is set in CH□ Digital clipping enable/disable setting.	Set CH□ Digital clipping enable/disable setting to 0 or 1.
1AA□H	Maximum value reset request setting range error	A value other than 0 and 1 is set in CH□ Maximum value reset request.	Set 0 or 1 in CH□ Maximum value reset request again.
1AB□H	Minimum value reset request setting range error	A value other than 0 and 1 is set in CH□ Minimum value reset request.	Set 0 or 1 in CH□ Minimum value reset request again.
1B0□H	Alert output setting (Process alarm) range error	A value other than 0 and 1 is set in CH□ Alert output setting (Process alarm).	Set 0 or 1 in CH□ Alert output setting (Process alarm).
1B△□H	Process alarm upper lower limit value setting range error	<p>The values not satisfying the following condition are set in CH□ Process alarm upper upper limit value to CH□ Process alarm lower lower limit value: Upper upper limit value ≥ Upper lower limit value ≥ Lower upper limit value ≥ Lower lower limit value △indicates that the set values are as follows: 1: Process alarm lower lower limit value > Process alarm lower upper limit value 2: Process alarm lower upper limit value > Process alarm upper lower limit value 3: Process alarm upper lower limit value > Process alarm upper upper limit value</p>	<p>Set CH□ Process alarm upper upper limit value to CH□ Process alarm lower lower limit value so that the values satisfy the following condition: Upper upper limit value ≥ Upper lower limit value ≥ Lower upper limit value ≥ Lower lower limit value</p>
1B8□H	Alert output setting (Rate alarm) range error	A value other than 0 and 1 is set in CH□ Alert output setting (Rate alarm).	Set 0 or 1 in CH□ Alert output setting (Rate alarm).
1B9□H	Rate alarm alert detection cycle setting range error	A value other than 1 to 32000 is set in CH□ Rate alarm alert detection cycle setting.	Set a value of 1 to 32000 in CH□ Rate alarm alert detection cycle setting.
1BA□H	Rate alarm upper/lower limit setting value inversion error	CH□ Rate alarm upper limit value and CH□ Rate alarm lower limit value are set as Lower limit value ≥ Upper limit value.	Set CH□ Rate alarm upper limit value and CH□ Rate alarm lower limit value as Lower limit value < Upper limit value again.
1C0□H	Input signal error detection setting range error	A value other than 0 to 4 is set in CH□ Input signal error detection setting.	Set CH□ Input signal error detection setting value to 0 to 4.

Error code	Error name	Description and cause	Corrective action
1C1□H	Input signal error detection setting value range error	A value other than 0 to 250 is set in CH□ Input signal error detection lower limit setting value or CH□ Input signal error detection upper limit setting value.	Set CH□ Input signal error detection lower limit setting value or CH□ Input signal error detection upper limit setting value to 0 to 250.
1C5□H	Disconnection detection enable/disable setting range error	A value other than 0 and 1 is set in CH□ Disconnection detection enable/disable setting.	Set 0 or 1 in CH□ Disconnection detection enable/disable setting.
1C6□H	Disconnection detection enabled range setting range error	CH□ Input signal error detection setting is set in Simple disconnection detection, and the Input range is set in other than the following: • 4 to 20 mA • 1 to 5 V	For channels for simple disconnection detection using the input signal error detection function, set Input range setting to either of the following again. • 4 to 20 mA • 1 to 5 V
1D0□H	Logging enable/disable setting range error	A value other than 0 and 1 is set in CH□ Logging enable/disable setting.	Set 0 or 1 in CH□ Logging enable/disable setting.
1D1□H	Logging cycle setting value range error	A value out of the range is set in CH□ Logging cycle setting value and/or CH□ Logging cycle unit setting.	Set the value(s) within the range in one or both of CH□ Logging cycle setting value and CH□ Logging cycle unit setting.
1D2□H	Logging cycle setting disable error	CH□ Logging cycle setting value and CH□ Logging cycle unit setting are set so that the set logging cycle falls below the conversion cycle.	Set CH□ Logging cycle setting value and CH□ Logging cycle unit setting so that the logging cycle is the conversion cycle of the object to be logged or more.
1D3□H	Logging data setting range error	A value other than 0 and 1 is set in CH□ Logging data setting.	Set 0 or 1 in CH□ Logging data setting.
1D4□H	Post-trigger logging points setting range error	A value other than 1 to 10000 is set in CH□ Post-trigger logging points.	Set a value of 1 to 10000 in CH□ Post-trigger logging points.
1D5□H	Level trigger condition setting range error	A value other than 0 to 3 is set in CH□ Level trigger condition setting.	Set a value of 0 to 3 in CH□ Level trigger condition setting.
1D6□H	Trigger data setting range error	A value other than 0 to 9999 is set in CH□ Trigger data.	Set a value of 0 to 9999 in CH□ Trigger data.
1D7□H	Logging hold request range error	A value other than 0 and 1 is set in CH□ Logging hold request.	Set 0 or 1 in CH□ Logging hold request.
1E50H	Offset/gain setting channel specification error	In the offset/gain setting, "1: Setting channel" is set for both CH□ Offset/gain setting mode (offset specification) and CH□ Offset/gain setting mode (gain specification), or "0: Disable" is set.	Correctly set CH□ Offset/gain setting mode (offset specification) and CH□ Offset/gain setting mode (gain specification).
1E51H	User range data invalid (CH identification disabled)	An invalid value is set in the offset/gain setting. The number of the channel in which this error occurs cannot be identified.	Perform the offset/gain setting again for all channels where the user range is set. If the error occurs again, the possible cause is a failure of the module. Please consult your local Mitsubishi representative.
1E6□H	User range data invalid (CH identification allowed)	An invalid value is set in CH□ Offset/gain setting.	Perform the offset/gain setting again for the channels where the error has occurred. If the error occurs again, the possible cause is a failure of the module. Please consult your local Mitsubishi representative.
1E7□H	Offset/gain value inversion error	The offset value and gain value to be saved in the flash memory are as follows: Offset value \geq Gain value	Perform the offset/gain setting again so that the following condition is satisfied: Offset value $<$ Gain value
1E8□H	Offset/gain setting channel range error	A value other than 0 and 1 is set in CH□ Offset/gain setting mode (offset specification) and CH□ Offset/gain setting mode (gain specification).	Set CH□ Offset/gain setting mode (offset specification) and CH□ Offset/gain setting mode (gain specification) to 0 or 1.
1E9□H	Offset/gain setting out-of-range error	The offset setting value and gain setting value are as follows: Offset value \geq Gain value	Perform the offset/gain setting again so that the following condition is satisfied: Offset value $<$ Gain value
1EB□H	Offset/gain channel change error	The channel where disconnection has occurred or channel where the conversion is disabled is specified when Channel change request (Un\G70, b11) has been turned on.	Check wiring for disconnection, or specify the channel where the conversion is enabled.
1EC□H	Offset/gain setting for specified channel out-of-range error	The offset setting value or gain setting value for the specified channel is out of the measuring range when Channel change request (Un\G70, b11) has been turned on.	Set a value within the measuring range as the offset setting value or gain setting value for the specified channel.

Error code	Error name	Description and cause	Corrective action
1ED□H	Setting Input type/range (offset/gain setting) error	The "Setting Input type/range (Offset/gain setting)" for the specified channel is set to the factory default setting when Channel change request (Un\G70, b11) has been turned on.	Set the "Setting Input type/range (Offset/gain setting)" for the specified channel to the user range setting again.
1EF□H	User range setting input type mismatch error	The presently set input type differs from the input type stored in the flash memory when the "Setting Input type/range (Offset/gain setting)" is set to the "User range setting".	Set the input type to be used as the offset/gain setting.
1F08H	Module power supply error	The 24 V DC power supply is not normally supplied to the multiple input module.	Check the wiring of the cable or the supplied voltage. After the check, turn off→on→off Error clear request (Un\G70, b15) to eliminate this error and resume the conversion. If the error occurs again, the possible cause is a failure of the module. Please consult your local Mitsubishi representative.
3001H	Hardware failure (moderate)	A hardware failure (moderate) has occurred in the multiple input module.	Power off→on the module. If the error occurs again, the possible cause is a failure of the module. Please consult your local Mitsubishi representative.
3030H	Flash memory error	The data in the flash memory is abnormal.	Check the digital output values. If the values are abnormal, please consult your local Mitsubishi representative.

List of alarm codes

If an alarm occurs during operation, a multiple input module stores the alarm code into 'Latest alarm code' (Un\G2) of the buffer memory. Turning on 'Error clear request' (Un\G70, b15) clears the alarm code in 'Latest alarm code' (Un\G2).

The following table lists the alarm codes that may be stored.

□: This symbol indicates the number of the channel where an alarm has occurred. A numerical value of 0 to 7 is used to correspond to CH1 to 8.

(CH1: 0, CH2: 1, CH3: 2, CH4: 3, CH5: 4, CH6: 5, CH7: 6, CH8: 7)

Alarm code	Alarm name	Description and cause	Corrective action
080□H	Process alarm (upper limit)	The process alarm (upper limit) has occurred in CH□.	Adjust CH□ Digital operation value to fall within the range. As a result, the corresponding bit of CH□ Alert output flag (Process alarm upper limit) and/or CH□ Alert output flag (Process alarm lower limit), and Alert output signal (Un\G69, b8) turn off automatically.
081□H	Process alarm (lower limit)	The process alarm (lower limit) has occurred in CH□.	
082□H	Rate alarm (upper limit)	The rate alarm (upper limit) has occurred in CH□.	Adjust the change rate in CH□ Digital output value to fall within the range. As a result, the corresponding bit of CH□ Alert output flag (Rate alarm upper limit) or CH□ Alert output flag (Rate alarm lower limit), and Alert output signal (Un\G69, b8) turn off automatically.
083□H	Rate alarm (lower limit)	The rate alarm (lower limit) has occurred in CH□.	
090□H	Input signal error detection (upper limit)	An input signal error (upper limit) has been detected in CH□.	Adjust the analog input value to fall within the range, and then turn off→on→off Error clear request (Un\G70, b15). As a result, the corresponding bit of Input signal error detection flag and Input signal error detection signal turn off.
091□H	Input signal error detection (lower limit)	An input signal error (lower limit) has been detected in CH□.	
092□H	Input signal error detection (simple disconnection)	An input signal error (simple disconnection) has been detected in CH□.	
0A0□H	Disconnection detection	Disconnection has been detected in CH□.	Re-establish the connection and turn off→on→off Error clear request (Un\G70, b15). As a result, the corresponding bit of Disconnection detection flag, and Disconnection detection signal (Un\G69, b6) turn off, and the alarm code of Latest alarm code is cleared.

APPENDIX

Appendix 9 External Dimensions

This chapter describes the external dimensions of the multiple input module.

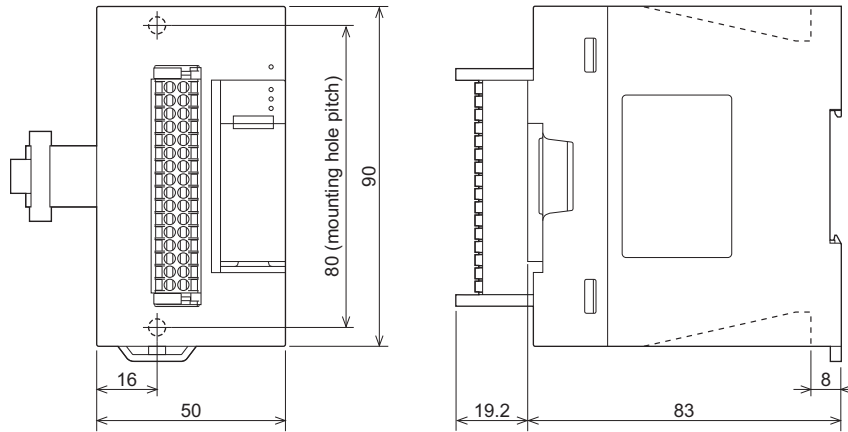

(Unit: mm)

Appendix 10 Standards

Certification of UL, cUL standards

The FX5-8AD supports UL (UL, cUL) standards.

UL, cUL file number: E95239

For models that support UL standards, please consult your local Mitsubishi representative.

Compliance with EC directive (CE marking)

This note does not guarantee that an entire machine produced in accordance with the contents of this note will comply with the following standards.

Compliance to EMC directive and LVD directive of the entire mechanical module should be checked by the user/ manufacturer. For more details please contact to the local Mitsubishi Electric sales site.

Requirement for compliance with EMC directive

The following products have shown compliance through direct testing (of the identified standards below) and design analysis (through the creation of a technical construction file) to the European Directive for Electromagnetic Compatibility (2014/30/ EU) when used as directed by the appropriate documentation.

Attention

This product is designed for use in industrial applications.

Product compatibility

Type: Programmable controller (open type equipment)

Models: FX5 manufactured

from April 1st, 2017	FX5-8AD
Electromagnetic compatibility (EMC) directive	Remarks
EN61131-2:2007 Programmable controllers - Equipment requirements and tests	Compliance with all relevant aspects of the standard. EMI • Radiated emission • Conducted emission EMS • Radiated electromagnetic field • Fast transient burst • Electrostatic discharge • High-energy surge • Voltage drops and interruptions • Conducted RF • Power frequency magnetic field

Caution for compliance with EC directive

Caution for when the FX5-8AD is used

When the FX5-8AD is used, attach a ferrite core to the power supply of the CPU module.

Make 2 turns around the ferrite core and attach within approximately 200 mm from the terminal block and connectors of the power cable. (Ferrite core used in Mitsubishi Electric's test: E04SR401938 manufactured by SEIWA ELECTRIC MFG. CO., LTD.)

A

If accuracy in measuring and control is required when using in an environment exposed to electrical stress, such as an EMS test, implementing the following details is recommended.

For users of proprietary cables (dedicated for sensors or actuators), these users should follow those manufacturers' installation requirements.

Mitsubishi Electric recommends that shielded cables be used. If no other EMC protection is provided, users may experience temporary loss of accuracy between +10%/-10% in very heavy industrial areas.

However, Mitsubishi Electric suggests that if adequate EMC precautions are followed with general good EMC practice for the user's complete control system, users should expect normal errors as specified in this manual.

- Sensitive analog cables should not be laid in the same trunking or cable conduit as high voltage cabling. Where possible, users should run analog cables separately.
 - Good cable shielding should be used. When terminating the shield at Earth - ensure that no earth loops are accidentally created.
 - When reading analog values, EMC induced errors can be smoothed out by averaging the readings. This can be achieved either through functions on the analog devices or through a user's program.
-

Compliance with UKCA marking

The requirements for compliance with UKCA marking are the same as that with EC directive (CE marking).

Appendix 11 Module Label

The functions of the multiple input module can be set by using module labels.

Module Label

The module label name is defined with the following structure:

"Module name"_"Module number".b"Label name" or "Module name"_"Module number".b"Label name"_D

Ex.

FX5_8AD_1.bModuleREADY_D

■Module name

The character string of a module model name is given.

■Module number

A number starting from 1 is added to identify modules that have the same module name.

■Label name

The label identifier unique to a module is given.

■_D

This string indicates that the module label is for the direct access input.

Module labels of buffer memory areas

The module label name of a buffer memory area is defined with the following structure:

"Module name"_"Module number"."Data type"_D["(Channel)"]."Data format" "Label name"_D

Ex.

FX5_8AD_1.stnMonitor_D[0].wDigitalOutputValue_D

■Module name

The character string of a module model name is given.

■Module number

A number starting from 1 is added to identify modules that have the same module name.

■Data type

The data type to sort a buffer memory area is given. Each data type is as follows:

Data type	Description
stnMonitor	Monitor
stnControl	Control
stnSetting	Setting

■Channel

The channel number corresponding to a module label is given. A numerical value of 0 to 7 is used to correspond to CH1 to 8. (CH1: 0, CH2: 1, CH3: 2, CH4: 3, CH5: 4, CH6: 5, CH7: 6, CH8: 7)

■Data format

The string that represents the data size of a buffer memory area is given. Each data type is as follows:

Data format	Description
b	Bit
u	Word [Unsigned]/Bit string [16-bit]
w	Word [Signed]

■Label name

The label identifier unique to a module is given.

■_D

This string indicates that the module label is for the direct access. Values that are read from or written to the module label is reflected in the module instantly.

Appendix 12 Buffer Memory Areas

List of buffer memory areas

This section lists the buffer memory areas of the multiple input module. For details on the buffer memory, refer to the following.

 Page 446 Details of buffer memory addresses

The buffer memory areas of the multiple input module are classified into the data types described below.

Data type	Description	
Setting data	Description	The data to be customized to suit the connected devices and the purpose of the system.
	Read and write attributes	Read and write is possible.
	Setting procedure	Use GX Works3 or a program to set the data.
	Setting timing	After a change of value, turning off→on→off 'Operating condition setting request' (Un\G70, b9) allows the setting value to take effect.
Control data	Description	The data used for controlling the multiple input module.
	Read and write attributes	Read and write is possible.
	Setting procedure	Use GX Works3 or a program to set the data.
	Setting timing	As soon as the values are changed, the set values become effective.
Monitor data	Description	The data used for checking the status of the multiple input module.
	Read and write attributes	Only read is possible and write is not possible.
	Setting procedure	—
	Setting timing	—



Do not write data to the system areas and areas whose data types are monitor in the buffer memory. Writing data into these areas can cause the malfunction of the module.

In the normal mode

○: With refresh setting, ×: Without refresh setting

■Un\G0 to Un\G399

Address (decimal)	Address (hexadecimal)	Name	Default value	Data type	Auto refresh
0	0H	Latest error code	0	Monitor	○
1	1H	Latest address of error history	0	Monitor	○
2	2H	Latest alarm code	0	Monitor	○
3	3H	Latest address of alarm history	0	Monitor	○
4 to 29	4H to 1DH	System area	—	—	—
30	1EH	Module Information	61E0H	Monitor	×
31	1FH	Firmware version	0	Monitor	×
32 to 35	20H to 23H	System area	—	—	—
36	24H	Warning output flag (Process alarm upper limit)	0000H	Monitor	○
37	25H	Warning output flag (Process alarm lower limit)	0000H	Monitor	○
38	26H	Warning output flag (Rate alarm upper limit)	0000H	Monitor	○
39	27H	Warning output flag (Rate alarm lower limit)	0000H	Monitor	○
40	28H	Input signal error detection flag	0000H	Monitor	○
41	29H	Disconnection detection flag	0000H	Monitor	○
42	2AH	Conversion completed flag	0000H	Monitor	○
43 to 59	2BH to 3BH	System area	—	—	—
60	3CH	Operation mode monitor	0	Monitor	×
61 to 68	3DH to 44H	System area	—	—	—
69	45H	Input signals	0	Monitor	×

Address (decimal)	Address (hexadecimal)	Name	Default value	Data type	Auto refresh
70	46H	Output signals	0	Control	×
71 to 89	47H to 59H	System area	—	—	—
90	5AH	Level data 0	0	Control	○
91	5BH	Level data 1	0	Control	○
92	5CH	Level data 2	0	Control	○
93	5DH	Level data 3	0	Control	○
94	5EH	Level data 4	0	Control	○
95	5FH	Level data 5	0	Control	○
96	60H	Level data 6	0	Control	○
97	61H	Level data 7	0	Control	○
98	62H	Level data 8	0	Control	○
99	63H	Level data 9	0	Control	○
100 to 295	64H to 127H	System area	—	—	—
296, 297	128H, 129H	Mode switching setting	0	Setting	×
298	12AH	System area	—	—	—
299	12BH	Rate alarm change rate selection	1	Setting	×
300 to 303	12CH to 12FH	System area	—	—	—
304	130H	Input signal error/Disconnection detection automatic clear enable/disable setting	1	Setting	×
305	131H	Offset/gain initialization enable code	0	Setting	×
306 to 399	132H to 18FH	System area	—	—	—

■Un\G400 to Un\G3599

Address Decimal (hexadecimal)								Name	Default value	Data type	Auto refresh
CH1	CH2	CH3	CH4	CH5	CH6	CH7	CH8				
400 (190H)	600 (258H)	800 (320H)	1000 (3E8H)	1200 (4B0H)	1400 (578H)	1600 (640H)	1800 (708H)	CH□ Digital output value	0	Monitor	○
401 (191H)	601 (259H)	801 (321H)	1001 (3E9H)	1201 (4B1H)	1401 (579H)	1601 (641H)	1801 (709H)	System area	—	—	—
402 (192H)	602 (25AH)	802 (322H)	1002 (3EAH)	1202 (4B2H)	1402 (57AH)	1602 (642H)	1802 (70AH)	CH□ Digital operation value	0	Monitor	○
403 (193H)	603 (25BH)	803 (323H)	1003 (3EBH)	1203 (4B3H)	1403 (57BH)	1603 (643H)	1803 (70BH)	System area	—	—	—
404 (194H)	604 (25CH)	804 (324H)	1004 (3ECH)	1204 (4B4H)	1404 (57CH)	1604 (644H)	1804 (70CH)	CH□ Maximum value	0	Monitor	○
405 (195H)	605 (25DH)	805 (325H)	1005 (3EDH)	1205 (4B5H)	1405 (57DH)	1605 (645H)	1805 (70DH)	System area	—	—	—
406 (196H)	606 (25EH)	806 (326H)	1006 (3EEH)	1206 (4B6H)	1406 (57EH)	1606 (646H)	1806 (70EH)	CH□ Minimum value	0	Monitor	○
407, 408 (197H, 198H)	607, 608 (25FH, 260H)	807, 808 (327H, 328H)	1007, 1008 (3EFH, 3F0H)	1207, 1208 (4B7H, 4B8H)	1407, 1408 (57FH, 580H)	1607, 1608 (647H, 648H)	1807, 1808 (70FH, 710H)	System area	—	—	—
409 (199H)	609 (261H)	809 (329H)	1009 (3F1H)	1209 (4B9H)	1409 (581H)	1609 (649H)	1809 (711H)	CH□ Logging hold flag	0	Monitor	○
410 to 419 (19AH to 1A3H)	610 to 619 (262H to 26BH)	810 to 819 (32AH to 333H)	1010 to 1019 (3F2H to 3FBH)	1210 to 1219 (4BAH to 4C3H)	1410 to 1419 (582H to 58BH)	1610 to 1619 (64AH to 653H)	1810 to 1819 (712H to 71BH)	System area	—	—	—
420 (1A4H)	620 (26CH)	820 (334H)	1020 (3FCH)	1220 (4C4H)	1420 (58CH)	1620 (654H)	1820 (71CH)	CH□ Conversion status	0	Monitor	×
421 (1A5H)	621 (26DH)	821 (335H)	1021 (3FDH)	1221 (4C5H)	1421 (58DH)	1621 (655H)	1821 (71DH)	System area	—	—	—
422 (1A6H)	622 (26EH)	822 (336H)	1022 (3FEH)	1222 (4C6H)	1422 (58EH)	1622 (656H)	1822 (71EH)	CH□ Maximum value reset completed flag	0	Monitor	×

Address Decimal (hexadecimal)								Name	Default value	Data type	Auto refresh
CH1	CH2	CH3	CH4	CH5	CH6	CH7	CH8				
423 (1A7H)	623 (26FH)	823 (337H)	1023 (3FFH)	1223 (4C7H)	1423 (58FH)	1623 (657H)	1823 (71FH)	CH□ Minimum value reset completed flag	0	Monitor	×
424 to 429 (1A8H to 1ADH)	624 to 629 (270H to 275H)	824 to 829 (338H to 33DH)	1024 to 1029 (400H to 405H)	1224 to 1229 (4C8H to 4CDH)	1424 to 1429 (590H to 595H)	1624 to 1629 (658H to 65DH)	1824 to 1829 (720H to 725H)	System area	—	—	—
430 (1AEH)	630 (276H)	830 (33EH)	1030 (406H)	1230 (4CEH)	1430 (596H)	1630 (65EH)	1830 (726H)	CH□ Input type/Range monitor	0000H	Monitor	×
431 (1AFH)	631 (277H)	831 (33FH)	1031 (407H)	1231 (4CFH)	1431 (597H)	1631 (65FH)	1831 (727H)	CH□ Input type/Range monitor (Offset/gain setting)	0	Monitor	×
432, 433 (1B0H, 1B1H)	632, 633 (278H, 279H)	832, 833 (340H, 341H)	1032, 1033 (408H, 409H)	1232, 1233 (4D0H, 4D1H)	1432, 1433 (598H, 599H)	1632, 1633 (660H, 661H)	1832, 1833 (728H, 729H)	System area	—	—	—
434 (1B2H)	634 (27AH)	834 (342H)	1034 (40AH)	1234 (4D2H)	1434 (59AH)	1634 (662H)	1834 (72AH)	CH□ Head pointer	0	Monitor	×
435 (1B3H)	635 (27BH)	835 (343H)	1035 (40BH)	1235 (4D3H)	1435 (59BH)	1635 (663H)	1835 (72BH)	CH□ Latest pointer	0	Monitor	×
436 (1B4H)	636 (27CH)	836 (344H)	1036 (40CH)	1236 (4D4H)	1436 (59CH)	1636 (664H)	1836 (72CH)	CH□ Number of logging data	0	Monitor	×
437 (1B5H)	637 (27DH)	837 (345H)	1037 (40DH)	1237 (4D5H)	1437 (59DH)	1637 (665H)	1837 (72DH)	CH□ Trigger pointer	0	Monitor	×
438 to 440 (1B6H to 1B8H)	638 to 640 (27EH to 280H)	838 to 840 (346H to 348H)	1038 to 1040 (40EH to 410H)	1238 to 1240 (4D6H to 4D8H)	1438 to 1440 (59EH to 5A0H)	1638 to 1640 (666H to 668H)	1838 to 1840 (72EH to 730H)	System area	—	—	—
441 (1B9H)	641 (281H)	841 (349H)	1041 (411H)	1241 (4D9H)	1441 (5A1H)	1641 (669H)	1841 (731H)	CH□ Logging cycle monitor value (s)	0	Monitor	×
442 (1BAH)	642 (282H)	842 (34AH)	1042 (412H)	1242 (4DAH)	1442 (5A2H)	1642 (66AH)	1842 (732H)	CH□ Logging cycle monitor value (ms)	0	Monitor	×
443 (1BBH)	643 (283H)	843 (34BH)	1043 (413H)	1243 (4DBH)	1443 (5A3H)	1643 (66BH)	1843 (733H)	System area	—	—	—
444 (1BCH)	644 (284H)	844 (34CH)	1044 (414H)	1244 (4DCH)	1444 (5A4H)	1644 (66CH)	1844 (734H)	CH□ Trigger generation time (First/Last two digits of the year)	0	Monitor	×
445 (1BDH)	645 (285H)	845 (34DH)	1045 (415H)	1245 (4DDH)	1445 (5A5H)	1645 (66DH)	1845 (735H)	CH□ Trigger generation time (Month/Day)	0	Monitor	×
446 (1BEH)	646 (286H)	846 (34EH)	1046 (416H)	1246 (4DEH)	1446 (5A6H)	1646 (66EH)	1846 (736H)	CH□ Trigger generation time (Hour/Minute)	0	Monitor	×
447 (1BFH)	647 (287H)	847 (34FH)	1047 (417H)	1247 (4DFH)	1447 (5A7H)	1647 (66FH)	1847 (737H)	CH□ Trigger generation time (Second/Day of the week)	0	Monitor	×
448 (1C0H)	648 (288H)	848 (350H)	1048 (418H)	1248 (4E0H)	1448 (5A8H)	1648 (670H)	1848 (738H)	CH□ Trigger generation time (Millisecond)	0	Monitor	×
449 to 451 (1C1H to 1C3H)	649 to 651 (289H to 28BH)	849 to 851 (351H to 353H)	1049 to 1051 (419H to 41BH)	1249 to 1251 (4E1H to 4E3H)	1449 to 1451 (5A9H to 5ABH)	1649 to 1651 (671H to 673H)	1849 to 1851 (739H to 73BH)	System area	—	—	—
452 (1C4H)	652 (28CH)	852 (354H)	1052 (41CH)	1252 (4E4H)	1452 (5ACH)	1652 (674H)	1852 (73CH)	CH□ Celsius/Fahrenheit display monitor	0	Monitor	×
453 (1C5H)	653 (28DH)	853 (355H)	1053 (41DH)	1253 (4E5H)	1453 (5ADH)	1653 (675H)	1853 (73DH)	CH□ Now Setting user range base input type monitor	1	Monitor	×
454 (1C6H)	654 (28EH)	854 (356H)	1054 (41EH)	1254 (4E6H)	1454 (5AEH)	1654 (676H)	1854 (73EH)	CH□ Now Setting user range base input range monitor	0000H	Monitor	×
455 to 470 (1C7H to 1D6H)	655 to 670 (28FH to 29EH)	855 to 870 (357H to 366H)	1055 to 1070 (41FH to 42EH)	1255 to 1270 (4E7H to 4F6H)	1455 to 1470 (5AFH to 5BEH)	1655 to 1670 (677H to 686H)	1855 to 1870 (73FH to 74EH)	System area	—	—	—

Address Decimal (hexadecimal)								Name	Default value	Data type	Auto refresh
CH1	CH2	CH3	CH4	CH5	CH6	CH7	CH8				
471 (1D7H)	671 (29FH)	871 (367H)	1071 (42FH)	1271 (4F7H)	1471 (5BFH)	1671 (687H)	1871 (74FH)	CH□ Logging hold request	0	Control	○
472 (1D8H)	672 (2A0H)	872 (368H)	1072 (430H)	1272 (4F8H)	1472 (5C0H)	1672 (688H)	1872 (750H)	CH□ Conversion value shift amount	0	Control	○
473 (1D9H)	673 (2A1H)	873 (369H)	1073 (431H)	1273 (4F9H)	1473 (5C1H)	1673 (689H)	1873 (751H)	CH□ Maximum value reset request	0	Control	×
474 (1DAH)	674 (2A2H)	874 (36AH)	1074 (432H)	1274 (4FAH)	1474 (5C2H)	1674 (68AH)	1874 (752H)	CH□ Minimum value reset request	0	Control	×
475 to 500 (1DBH to 1F4H)	675 to 700 (2A3H to 2BCH)	875 to 900 (36BH to 384H)	1075 to 1100 (433H to 44CH)	1275 to 1300 (4FBH to 514H)	1475 to 1500 (5C3H to 5DCH)	1675 to 1700 (68BH to 6A4H)	1875 to 1900 (753H to 76CH)	System area	—	—	—
501 (1F5H)	701 (2BDH)	901 (385H)	1101 (44DH)	1301 (515H)	1501 (5DDH)	1701 (6A5H)	1901 (76DH)	CH□ Averaging process specification	0	Setting	×
502 (1F6H)	702 (2BEH)	902 (386H)	1102 (44EH)	1302 (516H)	1502 (5DEH)	1702 (6A6H)	1902 (76EH)	CH□ Time Average/Count Average/Moving Average setting	0	Setting	×
503 (1F7H)	703 (2BFH)	903 (387H)	1103 (44FH)	1303 (517H)	1503 (5DFH)	1703 (6A7H)	1903 (76FH)	System area	—	—	—
504 (1F8H)	704 (2C0H)	904 (388H)	1104 (450H)	1304 (518H)	1504 (5E0H)	1704 (6A8H)	1904 (770H)	CH□ Scaling enable/disable setting	1	Setting	×
505 (1F9H)	705 (2C1H)	905 (389H)	1105 (451H)	1305 (519H)	1505 (5E1H)	1705 (6A9H)	1905 (771H)	System area	—	—	—
506 (1FAH)	706 (2C2H)	906 (38AH)	1106 (452H)	1306 (51AH)	1506 (5E2H)	1706 (6AAH)	1906 (772H)	CH□ Scaling upper limit value	0	Setting	×
507 (1FBH)	707 (2C3H)	907 (38BH)	1107 (453H)	1307 (51BH)	1507 (5E3H)	1707 (6ABH)	1907 (773H)	System area	—	—	—
508 (1FCH)	708 (2C4H)	908 (38CH)	1108 (454H)	1308 (51CH)	1508 (5E4H)	1708 (6ACH)	1908 (774H)	CH□ Scaling lower limit value	0	Setting	×
509 (1FDH)	709 (2C5H)	909 (38DH)	1109 (455H)	1309 (51DH)	1509 (5E5H)	1709 (6ADH)	1909 (775H)	System area	—	—	—
510 (1FEH)	710 (2C6H)	910 (38EH)	1110 (456H)	1310 (51EH)	1510 (5E6H)	1710 (6AEH)	1910 (776H)	CH□ Digital clipping enable/disable setting	1	Setting	×
511 (1FFH)	711 (2C7H)	911 (38FH)	1111 (457H)	1311 (51FH)	1511 (5E7H)	1711 (6AFH)	1911 (777H)	System area	—	—	—
512 (200H)	712 (2C8H)	912 (390H)	1112 (458H)	1312 (520H)	1512 (5E8H)	1712 (6B0H)	1912 (778H)	CH□ Alert output setting (Process alarm)	1	Setting	×
513 (201H)	713 (2C9H)	913 (391H)	1113 (459H)	1313 (521H)	1513 (5E9H)	1713 (6B1H)	1913 (779H)	CH□ Alert output setting (Rate alarm)	1	Setting	×
514 (202H)	714 (2CAH)	914 (392H)	1114 (45AH)	1314 (522H)	1514 (5EAH)	1714 (6B2H)	1914 (77AH)	CH□ Process alarm upper upper limit value	0	Setting	×
515 (203H)	715 (2CBH)	915 (393H)	1115 (45BH)	1315 (523H)	1515 (5EBH)	1715 (6B3H)	1915 (77BH)	System area	—	—	—
516 (204H)	716 (2CCH)	916 (394H)	1116 (45CH)	1316 (524H)	1516 (5ECH)	1716 (6B4H)	1916 (77CH)	CH□ Process alarm upper lower limit value	0	Setting	×
517 (205H)	717 (2CDH)	917 (395H)	1117 (45DH)	1317 (525H)	1517 (5EDH)	1717 (6B5H)	1917 (77DH)	System area	—	—	—
518 (206H)	718 (2CEH)	918 (396H)	1118 (45EH)	1318 (526H)	1518 (5EEH)	1718 (6B6H)	1918 (77EH)	CH□ Process alarm lower upper limit value	0	Setting	×
519 (207H)	719 (2CFH)	919 (397H)	1119 (45FH)	1319 (527H)	1519 (5EFH)	1719 (6B7H)	1919 (77FH)	System area	—	—	—
520 (208H)	720 (2D0H)	920 (398H)	1120 (460H)	1320 (528H)	1520 (5F0H)	1720 (6B8H)	1920 (780H)	CH□ Process alarm lower lower limit value	0	Setting	×
521 (209H)	721 (2D1H)	921 (399H)	1121 (461H)	1321 (529H)	1521 (5F1H)	1721 (6B9H)	1921 (781H)	System area	—	—	—
522 (20AH)	722 (2D2H)	922 (39AH)	1122 (462H)	1322 (52AH)	1522 (5F2H)	1722 (6BAH)	1922 (782H)	CH□ Rate alarm alert detection cycle setting	0	Setting	×



Address Decimal (hexadecimal)								Name	Default value	Data type	Auto refresh
CH1	CH2	CH3	CH4	CH5	CH6	CH7	CH8				
523 (20BH)	723 (2D3H)	923 (39BH)	1123 (463H)	1323 (52BH)	1523 (5F3H)	1723 (6BBH)	1923 (783H)	System area	—	—	—
524 (20CH)	724 (2D4H)	924 (39CH)	1124 (464H)	1324 (52CH)	1524 (5F4H)	1724 (6BCH)	1924 (784H)	CH□ Rate alarm upper limit value	0	Setting	×
525 (20DH)	725 (2D5H)	925 (39DH)	1125 (465H)	1325 (52DH)	1525 (5F5H)	1725 (6BDH)	1925 (785H)	System area	—	—	—
526 (20EH)	726 (2D6H)	926 (39EH)	1126 (466H)	1326 (52EH)	1526 (5F6H)	1726 (6BEH)	1926 (786H)	CH□ Rate alarm lower limit value	0	Setting	×
527 (20FH)	727 (2D7H)	927 (39FH)	1127 (467H)	1327 (52FH)	1527 (5F7H)	1727 (6BFH)	1927 (787H)	System area	—	—	—
528 (210H)	728 (2D8H)	928 (3A0H)	1128 (468H)	1328 (530H)	1528 (5F8H)	1728 (6C0H)	1928 (788H)	CH□ Input signal error detection setting	0	Setting	×
529 (211H)	729 (2D9H)	929 (3A1H)	1129 (469H)	1329 (531H)	1529 (5F9H)	1729 (6C1H)	1929 (789H)	CH□ Input signal error detection lower limit set value	50	Setting	×
530 (212H)	730 (2DAH)	930 (3A2H)	1130 (46AH)	1330 (532H)	1530 (5FAH)	1730 (6C2H)	1930 (78AH)	CH□ Input signal error detection upper limit set value	50	Setting	×
531 (213H)	731 (2DBH)	931 (3A3H)	1131 (46BH)	1331 (533H)	1531 (5FBH)	1731 (6C3H)	1931 (78BH)	CH□ Disconnection detection enable/disable setting	0	Setting	×
532 (214H)	732 (2DCH)	932 (3A4H)	1132 (46CH)	1332 (534H)	1532 (5FCH)	1732 (6C4H)	1932 (78CH)	CH□ Conversion setting value at disconnection detection	0	Setting	×
533 (215H)	733 (2DDH)	933 (3A5H)	1133 (46DH)	1333 (535H)	1533 (5FDH)	1733 (6C5H)	1933 (78DH)	System area	—	—	—
534 (216H)	734 (2DEH)	934 (3A6H)	1134 (46EH)	1334 (536H)	1534 (5FEH)	1734 (6C6H)	1934 (78EH)	CH□ Conversion setting at disconnection detection	1	Setting	×
535 (217H)	735 (2DFH)	935 (3A7H)	1135 (46FH)	1335 (537H)	1535 (5FFH)	1735 (6C7H)	1935 (78FH)	CH□ Logging enable/disable setting	1	Setting	×
536 (218H)	736 (2E0H)	936 (3A8H)	1136 (470H)	1336 (538H)	1536 (600H)	1736 (6C8H)	1936 (790H)	CH□ Logging data setting	1	Setting	×
537 (219H)	737 (2E1H)	937 (3A9H)	1137 (471H)	1337 (539H)	1537 (601H)	1737 (6C9H)	1937 (791H)	CH□ Logging cycle setting value	1	Setting	×
538 (21AH)	738 (2E2H)	938 (3AAH)	1138 (472H)	1338 (53AH)	1538 (602H)	1738 (6CAH)	1938 (792H)	CH□ Logging cycle unit setting	1	Setting	×
539 (21BH)	739 (2E3H)	939 (3ABH)	1139 (473H)	1339 (53BH)	1539 (603H)	1739 (6CBH)	1939 (793H)	CH□ Post-trigger logging points	5000	Setting	×
540 (21CH)	740 (2E4H)	940 (3ACH)	1140 (474H)	1340 (53CH)	1540 (604H)	1740 (6CCH)	1940 (794H)	CH□ Level trigger condition setting	0	Setting	×
541 (21DH)	741 (2E5H)	941 (3ADH)	1141 (475H)	1341 (53DH)	1541 (605H)	1741 (6CDH)	1941 (795H)	CH□ Trigger data	*1	Setting	×
542 (21EH)	742 (2E6H)	942 (3AEH)	1142 (476H)	1342 (53EH)	1542 (606H)	1742 (6CEH)	1942 (796H)	CH□ Trigger setting value	0	Setting	×
543 to 546 (21FH to 222H)	743 to 746 (2E7H to 2EAH)	943 to 946 (3AFH to 3B2H)	1143 to 1146 (477H to 47AH)	1343 to 1346 (53FH to 542H)	1543 to 1546 (607H to 60AH)	1743 to 1746 (6CFH to 6D2H)	1943 to 1946 (797H to 79AH)	System area	—	—	—
547 (223H)	747 (2EBH)	947 (3B3H)	1147 (47BH)	1347 (543H)	1547 (60BH)	1747 (6D3H)	1947 (79BH)	CH□ Celsius/Fahrenheit display setting	0	Setting	×
548 to 561 (224H to 231H)	748 to 761 (2ECH to 2F9H)	948 to 961 (3B4H to 3C1H)	1148 to 1161 (47CH to 489H)	1348 to 1361 (544H to 551H)	1548 to 1561 (60CH to 619H)	1748 to 1761 (6D4H to 6E1H)	1948 to 1961 (79CH to 7A9H)	System area	—	—	—
562 (232H)	762 (2FAH)	962 (3C2H)	1162 (48AH)	1362 (552H)	1562 (61AH)	1762 (6E2H)	1962 (7AAH)	CH□ Offset setting value	0	Setting	×
563 (233H)	763 (2FBH)	963 (3C3H)	1163 (48BH)	1363 (553H)	1563 (61BH)	1763 (6E3H)	1963 (7ABH)	System area	—	—	—
564 (234H)	764 (2FCH)	964 (3C4H)	1164 (48CH)	1364 (554H)	1564 (61CH)	1764 (6E4H)	1964 (7ACH)	CH□ Gain setting value	0	Setting	×

Address Decimal (hexadecimal)								Name	Default value	Data type	Auto refresh
CH1	CH2	CH3	CH4	CH5	CH6	CH7	CH8				
565 to 597 (235H to 255H)	765 to 797 (2FDH to 31DH)	965 to 997 (3C5H to 3E5H)	1165 to 1197 (48DH to 4ADH)	1365 to 1397 (555H to 575H)	1565 to 1597 (61DH to 63DH)	1765 to 1797 (6E5H to 705H)	1965 to 1997 (7ADH to 7CDH)	System area	—	—	—
598 (256H)	798 (31EH)	998 (3E6H)	1198 (4AEH)	1398 (576H)	1598 (63EH)	1798 (706H)	1998 (7CEH)	CH□ Setting Input type/ range	FH	Setting	×
599 (257H)	799 (31FH)	999 (3E7H)	1199 (4AFH)	1399 (577H)	1599 (63FH)	1799 (707H)	1999 (7CFH)	CH□ Setting Input type/ range (Offset/gain setting)	0	Setting	×
2000 to 3599 (7D0H to E0FH)								System area	—	—	—

*1 The following shows the default values.

CH1: 402, CH2: 602, CH3: 802, CH4: 1020, CH5: 1202, CH6: 1402, CH7: 1602, CH8: 1802

■Error history (Un\G3600 to Un\G3759)

Address (decimal)	Address (hexadecimal)	Name			Default value	Data type	Auto refresh	
3600	E10H	Error history 1	Error code			0	Monitor	×
3601	E11H		Error time	First two digits of the year	Last two digits of the year			
3602	E12H			Month	Day			
3603	E13H			Hour	Minute			
3604	E14H			Second	Day of the week			
3605	E15H			Millisecond				
3606 to 3609	E16H to E19H	System area			—	—	—	
3610 to 3615	E1AH to E1FH	Error history 2	Same as error history 1			0	Monitor	×
3616 to 3619	E20H to E23H	System area			—	—	—	
3620 to 3625	E24H to E29H	Error history 3	Same as error history 1			0	Monitor	×
3626 to 3629	E2AH to E2DH	System area			—	—	—	
3630 to 3635	E2EH to E33H	Error history 4	Same as error history 1			0	Monitor	×
3636 to 3639	E34H to E37H	System area			—	—	—	
3640 to 3645	E38H to E3DH	Error history 5	Same as error history 1			0	Monitor	×
3646 to 3649	E3EH to E41H	System area			—	—	—	
3650 to 3655	E42H to E47H	Error history 6	Same as error history 1			0	Monitor	×
3656 to 3659	E48H to E4BH	System area			—	—	—	
3660 to 3665	E4CH to E51H	Error history 7	Same as error history 1			0	Monitor	×
3666 to 3669	E52H to E55H	System area			—	—	—	
3670 to 3675	E56H to E5BH	Error history 8	Same as error history 1			0	Monitor	×
3676 to 3679	E5CH to E5FH	System area			—	—	—	
3680 to 3685	E60H to E65H	Error history 9	Same as error history 1			0	Monitor	×
3686 to 3689	E66H to E69H	System area			—	—	—	
3690 to 3695	E6AH to E6FH	Error history 10	Same as error history 1			0	Monitor	×
3696 to 3699	E70H to E73H	System area			—	—	—	
3700 to 3705	E74H to E79H	Error history 11	Same as error history 1			0	Monitor	×
3706 to 3709	E7AH to E7DH	System area			—	—	—	
3710 to 3715	E7EH to E83H	Error history 12	Same as error history 1			0	Monitor	×
3716 to 3719	E84H to E87H	System area			—	—	—	
3720 to 3725	E88H to E8DH	Error history 13	Same as error history 1			0	Monitor	×
3726 to 3729	E8EH to E91H	System area			—	—	—	
3730 to 3735	E92H to E97H	Error history 14	Same as error history 1			0	Monitor	×
3736 to 3739	E98H to E9BH	System area			—	—	—	
3740 to 3745	E9CH to EA1H	Error history 15	Same as error history 1			0	Monitor	×
3746 to 3749	EA2H to EA5H	System area			—	—	—	
3750 to 3755	EA6H to EABH	Error history 16	Same as error history 1			0	Monitor	×
3756 to 3759	EACH to EAFH	System area			—	—	—	

■ Alarm history (Un\G3760 to Un\G3999)

Address (decimal)	Address (hexadecimal)	Name				Default value	Data type	Auto refresh
3760	EB0H	Alarm history 1	Alarm code			0	Monitor	×
3761	EB1H		Alarm time	First two digits of the year	Last two digits of the year			
3762	EB2H			Month	Day			
3763	EB3H		Hour	Minute				
3764	EB4H		Second	Day of the week				
3765	EB5H		Millisecond					
3766 to 3769	EB6H to EB9H	System area				—	—	—
3770 to 3775	EBAH to EBFH	Alarm history 2	Same as alarm history 1			0	Monitor	×
3776 to 3779	EC0H to EC3H	System area				—	—	—
3780 to 3785	EC4H to EC9H	Alarm history 3	Same as alarm history 1			0	Monitor	×
3786 to 3789	ECAH to ECDH	System area				—	—	—
3790 to 3795	ECEH to ED3H	Alarm history 4	Same as alarm history 1			0	Monitor	×
3796 to 3799	ED4H to ED7H	System area				—	—	—
3800 to 3805	ED8H to EDDH	Alarm history 5	Same as alarm history 1			0	Monitor	×
3806 to 3809	EDEH to EE1H	System area				—	—	—
3810 to 3815	EE2H to EE7H	Alarm history 6	Same as alarm history 1			0	Monitor	×
3816 to 3819	EE8H to EEBH	System area				—	—	—
3820 to 3825	EECH to EF1H	Alarm history 7	Same as alarm history 1			0	Monitor	×
3826 to 3829	EF2H to EF5H	System area				—	—	—
3830 to 3835	EF6H to EFBH	Alarm history 8	Same as alarm history 1			0	Monitor	×
3836 to 3839	EFCH to EFFH	System area				—	—	—
3840 to 3845	F00H to F05H	Alarm history 9	Same as alarm history 1			0	Monitor	×
3846 to 3849	F06H to F09H	System area				—	—	—
3850 to 3855	F0AH to F0FH	Alarm history 10	Same as alarm history 1			0	Monitor	×
3856 to 3859	F10H to F13H	System area				—	—	—
3860 to 3865	F14H to F19H	Alarm history 11	Same as alarm history 1			0	Monitor	×
3866 to 3869	F1AH to F1DH	System area				—	—	—
3870 to 3875	F1EH to F23H	Alarm history 12	Same as alarm history 1			0	Monitor	×
3876 to 3879	F24H to F27H	System area				—	—	—
3880 to 3885	F28H to F2DH	Alarm history 13	Same as alarm history 1			0	Monitor	×
3886 to 3889	F2EH to F31H	System area				—	—	—
3890 to 3895	F32H to F37H	Alarm history 14	Same as alarm history 1			0	Monitor	×
3896 to 3899	F38H to F3BH	System area				—	—	—
3900 to 3905	F3CH to F41H	Alarm history 15	Same as alarm history 1			0	Monitor	×
3906 to 3909	F42H to F45H	System area				—	—	—
3910 to 3915	F46H to F4BH	Alarm history 16	Same as alarm history 1			0	Monitor	×
3916 to 3999	F4CH to F9FH	System area				—	—	—

■ Offset/gain setting (Un\G4000 to Un\G9999)

Address								Name	Default value	Data type	Auto refresh
Decimal (hexadecimal)											
CH1	CH2	CH3	CH4	CH5	CH6	CH7	CH8				
4000 to 4131 (FA0H to 1023H)								System area	—	—	—
4132 (1024H)	4134 (1026H)	4136 (1028H)	4138 (102AH)	4140 (102CH)	4142 (102EH)	4144 (1030H)	4146 (1032H)	CH□ Offset/gain setting mode (offset specification)	0	Setting	×
4133 (1025H)	4135 (1027H)	4137 (1029H)	4139 (102BH)	4141 (102DH)	4143 (102FH)	4145 (1031H)	4147 (1033H)	CH□ Offset/gain setting mode (gain specification)	0	Setting	×
4148 to 9999 (1034H to 270FH)								System area	—	—	—

■Logging data (Un\G10000 to Un\G89999)

Address Decimal (hexadecimal)								Name	Default value	Data type	Auto refresh
CH1	CH2	CH3	CH4	CH5	CH6	CH7	CH8				
10000 to 19999 (2710H to 4E1FH)	20000 to 29999 (4E20H to 752FH)	30000 to 39999 (7530H to 9C3FH)	40000 to 49999 (9C40H to C34FH)	50000 to 59999 (C350H to EA5FH)	60000 to 69999 (EA60H to 1116FH)	70000 to 79999 (11170H to 1387FH)	80000 to 89999 (13880H to 15F8FH)	CH□ Logging data	0	Monitor	×

In FX2N allocation function mode

○: With refresh setting, ×: Without refresh setting

Address Decimal (hexadecimal)								Name	Default value	Data type	Auto refresh
CH1	CH2	CH3	CH4	CH5	CH6	CH7	CH8				
0 (0H)								CH1 to 4 Setting Input type/ range	FFFFH	Setting	×
1 (1H)								CH5 to 8 Setting Input type/ range	FFFFH	Setting	×
2 (2H)	3 (3H)	4 (4H)	5 (5H)	6 (6H)	7 (7H)	8 (8H)	9 (9H)	CH□ Time Average/Count Average/Moving Average setting	0	Setting	×
10 (AH)	11 (BH)	12 (CH)	13 (DH)	14 (EH)	15 (FH)	16 (10H)	17 (11H)	CH□ Digital operation value	0000H	Monitor	○
18 to 25 (12H to 19H)								System area	—	—	—
26 (1AH)								Warning output flag (Process alarm upper limit/ lower limit)	0000H	Monitor	○
27 (1BH)								Warning output flag (Rate alarm upper limit/lower limit)	0000H	Monitor	○
28 (1CH)								Input signal error detection flag/disconnection detection flag	0000H	Monitor	○
29 (1DH)								Latest error code	0	Monitor	○
30 (1EH)								Module information	61E4H	Monitor	×
31 (1FH)								Firmware version	0	Monitor	×
32 to 59 (20H to 3BH)								System area	—	—	—
60 (3CH)								Operation mode monitor	0	Monitor	×
61 (3DH)	62 (3EH)	63 (3FH)	64 (40H)	65 (41H)	66 (42H)	67 (43H)	68 (44H)	CH□ Conversion value shift amount	0	Control	○
69 (45H)								Input signals	0	Monitor	×
70 (46H)								Output signals	0	Control	×
71 (47H)	72 (48H)	73 (49H)	74 (4AH)	75 (4BH)	76 (4CH)	77 (4DH)	78 (4EH)	CH□ Process alarm lower lower limit value	0	Setting	×
79, 80 (4FH, 50H)								System area	—	—	—
81 (51H)	82 (52H)	83 (53H)	84 (54H)	85 (55H)	86 (56H)	87 (57H)	88 (58H)	CH□ Process alarm upper upper limit value	0	Setting	×
89, 90 (59H, 5AH)								System area	—	—	—
91 (5BH)	92 (5CH)	93 (5DH)	94 (5EH)	95 (5FH)	96 (60H)	97 (61H)	98 (62H)	CH□ Rate alarm upper limit value	100	Setting	×
99, 100 (63H, 64H)								System area	—	—	—
101 (65H)	102 (66H)	103 (67H)	104 (68H)	105 (69H)	106 (6AH)	107 (6BH)	108 (6CH)	CH□ Minimum value	0	Monitor	○
109 (6DH)								Minimum value reset request	0	Control	×
110 (6EH)								Minimum value reset completed flag	0	Monitor	×

Address Decimal (hexadecimal)								Name	Default value	Data type	Auto refresh
CH1	CH2	CH3	CH4	CH5	CH6	CH7	CH8				
111 (6FH)	112 (70H)	113 (71H)	114 (72H)	115 (73H)	116 (74H)	117 (75H)	118 (76H)	CH□ Maximum value	0	Monitor	○
119 (77H)								Maximum value reset request	0	Control	×
120 (78H)								Maximum value reset completed flag	0	Monitor	×
121 (79H)								Latest address of error history	0	Monitor	○
122 (7AH)								Latest alarm code	0	Monitor	○
123 (7BH)								Latest address of alarm history	0	Monitor	○
124 (7CH)								Conversion completed flag	0	Monitor	○
125 (7DH)								System area	—	—	—
126, 127 (7EH, 7FH)								Mode switching setting	0	Setting	×
128, 129 (80H, 81H)								System area	—	—	—
130 (82H)								Rate alarm change rate selection	1	Setting	×
131, 132 (83H, 84H)								System area	—	—	—
133 (85H)								Input signal error/ Disconnection detection automatic clear enable/ disable setting	1	Setting	×
134 to 1000 (86H to 3E8H)								System area	—	—	—
1001 (3E9H)	1003 (3EBH)	1005 (3EDH)	1007 (3EFH)	1009 (3F1H)	1011 (3F3H)	1013 (3F5H)	1015 (3F7H)	CH□ Digital output value	0	Monitor	○
1002 (3EAH)								System area	—	—	—
1017 to 1020 (3F9H to 3FCH)								System area	—	—	—
1021 (3FDH)	1022 (3FEH)	1023 (3FFH)	1024 (400H)	1025 (401H)	1026 (402H)	1027 (403H)	1028 (404H)	CH□ Conversion status	0	Monitor	×
1029, 1030 (405H, 406H)								System area	—	—	—
1031 (407H)	1032 (408H)	1033 (409H)	1034 (40AH)	1035 (40BH)	1036 (40CH)	1037 (40DH)	1038 (40EH)	CH□ Input type/Range monitor	0	Monitor	×
1039, 1040 (40FH, 410H)								System area	—	—	—
1041 (411H)	1042 (412H)	1043 (413H)	1044 (414H)	1045 (415H)	1046 (416H)	1047 (417H)	1048 (418H)	CH□ Input type/Range monitor (Offset/gain setting)	0	Monitor	×
1049, 1050 (419H, 41AH)								System area	—	—	—
1051 (41BH)	1052 (41CH)	1053 (41DH)	1054 (41EH)	1055 (41FH)	1056 (420H)	1057 (421H)	1058 (422H)	CH□ Celsius/Fahrenheit display monitor	0	Monitor	×
1059, 1060 (423H, 424H)								System area	—	—	—
1061 (425H)	1062 (426H)	1063 (427H)	1064 (428H)	1065 (429H)	1066 (42AH)	1067 (42BH)	1068 (42CH)	CH□ Now Setting user range base input type monitor	1	Monitor	×
1069, 1070 (42DH, 42EH)								System area	—	—	—
1071 (42FH)	1072 (430H)	1073 (431H)	1074 (432H)	1075 (433H)	1076 (434H)	1077 (435H)	1078 (436H)	CH□ Now Setting user range base input range monitor	0000H	Monitor	×
1079, 1080 (437H, 438H)								System area	—	—	—
1081 (439H)	1082 (43AH)	1083 (43BH)	1084 (43CH)	1085 (43DH)	1086 (43EH)	1087 (43FH)	1088 (440H)	CH□ Averaging process specification	0	Setting	×
1089, 1090 (441H, 442H)								System area	—	—	—
1091 (443H)	1092 (444H)	1093 (445H)	1094 (446H)	1095 (447H)	1096 (448H)	1097 (449H)	1098 (44AH)	CH□ Scaling enable/disable setting	1	Setting	×
1099, 1100 (44BH, 44CH)								System area	—	—	—
1101 (44DH)	1103 (44FH)	1105 (451H)	1107 (453H)	1109 (455H)	1111 (457H)	1113 (459H)	1115 (45BH)	CH□ Scaling upper limit value	0	Setting	×

Address Decimal (hexadecimal)								Name	Default value	Data type	Auto refresh
CH1	CH2	CH3	CH4	CH5	CH6	CH7	CH8				
1102 (44EH)	1104 (450H)	1106 (452H)	1108 (454H)	1110 (456H)	1112 (458H)	1114 (45AH)	1116 (45CH)	System area	—	—	—
1117 to 1120 (45DH to 460H)								System area	—	—	—
1121 (461H)	1123 (463H)	1125 (465H)	1127 (467H)	1129 (469H)	1131 (46BH)	1133 (46DH)	1135 (46FH)	CH□ Scaling lower limit value	0	Setting	×
1122 (462H)	1124 (464H)	1126 (466H)	1128 (468H)	1130 (46AH)	1132 (46CH)	1134 (46EH)	1136 (470H)	System area	—	—	—
1137 to 1140 (471H to 474H)								System area	—	—	—
1141 (475H)	1142 (476H)	1143 (477H)	1144 (478H)	1145 (479H)	1146 (47AH)	1147 (47BH)	1148 (47CH)	CH□ Digital clipping enable/ disable setting	1	Setting	×
1149, 1150 (47DH, 47EH)								System area	—	—	—
1151 (47FH)	1152 (480H)	1153 (481H)	1154 (482H)	1155 (483H)	1156 (482H)	1157 (485H)	1158 (486H)	CH□ Input signal error detection setting	1	Setting	×
1159, 1160 (487H, 488H)								System area	—	—	—
1161 (489H)	1162 (48AH)	1163 (48BH)	1164 (48CH)	1165 (48DH)	1175 (497H)	1167 (48FH)	1168 (490H)	CH□ Input signal error detection lower limit setting value	24	Setting	×
1169, 1170 (491H, 492H)								System area	—	—	—
1171 (493H)	1172 (494H)	1173 (495H)	1174 (496H)	1175 (497H)	1176 (498H)	1177 (499H)	1178 (49AH)	CH□ Input signal error detection upper limit setting value	24	Setting	×
1179, 1180 (49BH, 49CH)								System area	—	—	—
1181 (49DH)	1182 (49EH)	1183 (49FH)	1184 (4A0H)	1185 (4A1H)	1186 (4A2H)	1187 (4A3H)	1188 (4A4H)	CH□ Alert output setting (Process alarm)	1	Setting	×
1189, 1190 (4A5H, 4A6H)								System area	—	—	—
1191 (4A7H)	1192 (4A8H)	1193 (4A9H)	1194 (4AAH)	1195 (4ABH)	1196 (4ACH)	1197 (4ADH)	1198 (4AEH)	CH□ Process alarm upper lower limit value	0	Setting	×
1199, 1200 (4AFH, 4B0H)								System area	—	—	—
1201 (4B1H)	1202 (4B2H)	1203 (4B3H)	1204 (4B4H)	1205 (4B5H)	1206 (4B6H)	1207 (4B7H)	1208 (4B8H)	CH□ Process alarm lower upper limit value	0	Setting	×
1209, 1210 (4B9H, 4BAH)								System area	—	—	—
1211 (4BBH)	1212 (4BCH)	1213 (4BDH)	1214 (4BEH)	1215 (4BFH)	1216 (4C0H)	1217 (4C1H)	1218 (4C2H)	CH□ Alert output setting (Rate alarm)	1	Setting	×
1219, 1220 (4C3H, 4C4H)								System area	—	—	—
1221 (4C5H)	1222 (4C6H)	1223 (4C7H)	1224 (4C8H)	1225 (4C9H)	1226 (4CAH)	1227 (4CBH)	1228 (4CCH)	CH□ Rate alarm alert detection cycle setting	0	Setting	×
1229, 1230 (4CDH, 4CEH)								System area	—	—	—
1231 (4CFH)	1232 (4D0H)	1233 (4D1H)	1234 (4D2H)	1235 (4D3H)	1236 (4D4H)	1237 (4D5H)	1238 (4D6H)	CH□ Rate alarm lower limit value	-100	Setting	×
1239, 1240 (4D7H, 4D8H)								System area	—	—	—
1241 (4D9H)	1242 (4DAH)	1243 (4DBH)	1244 (4DCH)	1245 (4DDH)	1246 (4DEH)	1247 (4DFH)	1248 (4E0H)	CH□ Disconnection detection enable/disable setting	0	Setting	×
1249, 1250 (4E1H, 4E2H)								System area	—	—	—
1251 (4E3H)	1253 (4E5H)	1255 (4E7H)	1257 (4E9H)	1259 (4EBH)	1261 (4EDH)	1263 (4EFH)	1265 (4F1H)	CH1 Conversion setting value at disconnection detection	0	Setting	×
1252 (4E4H)	1254 (4E6H)	1256 (4E7H)	1258 (4EAH)	1260 (4ECH)	1262 (4EEH)	1264 (4F0H)	1266 (4F2H)	System area	—	—	—
1267 to 1270 (4F3H to 4F6H)								System area	—	—	—
1271 (4F7H)	1272 (4F8H)	1273 (4F9H)	1274 (4FAH)	1275 (4FBH)	1276 (4FCH)	1277 (4FDH)	1278 (4FEH)	CH□ Conversion setting at disconnection detection	1	Setting	×
1279, 1280 (4FFH, 500H)								System area	—	—	—
1281 (501H)	1282 (502H)	1283 (503H)	1284 (504H)	1285 (505H)	1286 (506H)	1287 (507H)	1288 (508H)	CH□ Celsius/Fahrenheit display setting	0	Setting	×
1289, 1290 (509H, 50AH)								System area	—	—	—

Address Decimal (hexadecimal)								Name	Default value	Data type	Auto refresh
CH1	CH2	CH3	CH4	CH5	CH6	CH7	CH8				
1291 (50BH)	1292 (50CH)	1293 (50DH)	1294 (50EH)	1295 (50FH)	1296 (510H)	1297 (511H)	1298 (512H)	CH□ Offset setting value	0	Setting	×
1299, 1300 (513H, 514H)								System area	—	—	—
1301 (515H)	1302 (516H)	1303 (517H)	1304 (518H)	1305 (519H)	1306 (51AH)	1307 (51BH)	1308 (51CH)	CH□ Gain setting value	0	Setting	×
1309, 1310 (51DH, 51EH)								System area	—	—	—
1311 (51FH)	1312 (520H)	1313 (521H)	1314 (522H)	1315 (523H)	1316 (524H)	1317 (525H)	1318 (526H)	CH□ Setting Input type/ range (Offset/gain setting)	0	Setting	×
1319, 1320 (527H, 528H)								System area	—	—	—
1321 (529H)	1322 (52AH)	1323 (52BH)	1324 (52CH)	1325 (52DH)	1326 (52EH)	1327 (52FH)	1328 (530H)	CH□ Offset/gain setting mode (offset specification)	0	Setting	×
1329, 1330 (531H, 532H)								System area	—	—	—
1331 (533H)	1332 (534H)	1333 (535H)	1334 (536H)	1335 (537H)	1336 (538H)	1337 (539H)	1338 (53AH)	CH□ Offset/gain setting mode (gain specification)	0	Setting	×
1339 (53BH)								System area	—	—	—
1340 (53CH)								Offset/gain initialization enable code	0	Setting	—
1341 to 8599 (53DH to 2197H)								System area	—	—	—
8600 to 8609 (2198H to 21A1H)								Error history 1	0	Monitor	×
8610 to 8619 (21A2H to 21ABH)								Error history 2	0	Monitor	×
8620 to 8629 (21ACH to 21B5H)								Error history 3	0	Monitor	×
8630 to 8639 (21B6H to 21BFH)								Error history 4	0	Monitor	×
8640 to 8649 (21C0H to 21C9H)								Error history 5	0	Monitor	×
8650 to 8659 (21CAH to 21D3H)								Error history 6	0	Monitor	×
8660 to 8669 (21D4H to 21DDH)								Error history 7	0	Monitor	×
8670 to 8679 (21DEH to 21E7H)								Error history 8	0	Monitor	×
8680 to 8689 (21E8H to 21F1H)								Error history 9	0	Monitor	×
8690 to 8699 (21F2H to 21FBH)								Error history 10	0	Monitor	×
8700 to 8709 (21FCH to 2205H)								Error history 11	0	Monitor	×
8710 to 8719 (2206H to 220FH)								Error history 12	0	Monitor	×
8720 to 8729 (2210H to 2219H)								Error history 13	0	Monitor	×
8730 to 8739 (221AH to 2223H)								Error history 14	0	Monitor	×
8740 to 8749 (2224H to 222DH)								Error history 15	0	Monitor	×
8750 to 8759 (222EH to 2237H)								Error history 16	0	Monitor	×
8760 to 8769 (2238H to 2241H)								Alarm history 1	0	Monitor	×
8770 to 8779 (2242H to 224BH)								Alarm history 2	0	Monitor	×
8780 to 8789 (224CH to 2255H)								Alarm history 3	0	Monitor	×
8790 to 8799 (2256H to 225FH)								Alarm history 4	0	Monitor	×
8800 to 8809 (2260H to 2269H)								Alarm history 5	0	Monitor	×
8810 to 8819 (226AH to 2273H)								Alarm history 6	0	Monitor	×
8820 to 8829 (2274H to 227DH)								Alarm history 7	0	Monitor	×
8830 to 8839 (227EH to 2287H)								Alarm history 8	0	Monitor	×
8840 to 8849 (2288H to 2291H)								Alarm history 9	0	Monitor	×
8850 to 8859 (2292H to 229BH)								Alarm history 10	0	Monitor	×
8860 to 8869 (229CH to 22A5H)								Alarm history 11	0	Monitor	×
8870 to 8879 (22A6H to 22AFH)								Alarm history 12	0	Monitor	×
8880 to 8889 (22B0H to 22B9H)								Alarm history 13	0	Monitor	×
8890 to 8899 (22BAH to 22C3H)								Alarm history 14	0	Monitor	×
8900 to 8909 (22C4H to 22CDH)								Alarm history 15	0	Monitor	×
8910 to 8919 (22CEH to 22D7H)								Alarm history 16	0	Monitor	×
8920 to 9009 (22D8H to 2331H)								System area	—	—	—
9010 to 9019 (2332H to 233BH)								Level data 0 to 9	0	Control	○

Address Decimal (hexadecimal)								Name	Default value	Data type	Auto refresh
CH1	CH2	CH3	CH4	CH5	CH6	CH7	CH8				
9020 (233CH)								System area	—	—	—
9021 (233DH)	9022 (233EH)	9023 (233FH)	9024 (2340H)	9025 (2341H)	9026 (2342H)	9027 (2343H)	9028 (2344H)	CH□ Logging hold flag	0	Monitor	○
9029, 9030 (2345H, 2346H)								System area	—	—	—
9031 (2347H)	9032 (2348H)	9033 (2349H)	9034 (234AH)	9035 (234BH)	9036 (234CH)	9037 (234DH)	9038 (234EH)	CH□ Head pointer	0	Monitor	×
9039, 9040 (234FH, 2350H)								System area	—	—	—
9041 (2351H)	9042 (2352H)	9043 (2353H)	9044 (2354H)	9045 (2355H)	9046 (2356H)	9047 (2357H)	9048 (2358H)	CH□ Latest pointer	0	Monitor	×
9049, 9050 (2359H, 235AH)								System area	—	—	—
9051 (235BH)	9052 (235CH)	9053 (235DH)	9054 (235EH)	9055 (235FH)	9056 (2360H)	9057 (2361H)	9058 (2362H)	CH□ Number of logging data	0	Monitor	×
9059, 9060 (2363H, 2364H)								System area	—	—	—
9061 (2365H)	9062 (2366H)	9063 (2367H)	9064 (2368H)	9065 (2369H)	9066 (236AH)	9067 (236BH)	9068 (236CH)	CH□ Trigger pointer	0	Monitor	×
9069, 9070 (236DH, 236EH)								System area	—	—	—
9071 (236FH)	9074 (2372H)	9077 (2375H)	9080 (2378H)	9083 (237BH)	9086 (237EH)	9089 (2381H)	9092 (2384H)	CH□ Logging cycle monitor value (s)	0	Monitor	×
9072 (2370H)	9075 (2373H)	9078 (2376H)	9081 (2379H)	9084 (237CH)	9087 (237FH)	9090 (2382H)	9093 (2385H)	CH□ Logging cycle monitor value (ms)	0	Monitor	×
9073 (2371H)	9076 (2374H)	9079 (2377H)	9082 (237AH)	9085 (237DH)	9088 (2380H)	9091 (2383H)	9094 (2386H)	System area	—	—	—
9095 to 9100 (2387H to 238CH)								System area	—	—	—
9101 (238DH)	9106 (2392H)	9111 (2397H)	9116 (239CH)	9121 (23A1H)	9126 (23A6H)	9131 (23ABH)	9136 (23B0H)	CH□ Trigger generation time (First/Last two digits of the year)	0	Monitor	×
9102 (238EH)	9107 (2393H)	9112 (2398H)	9117 (239DH)	9122 (23A2H)	9127 (23A7H)	9132 (23ACH)	9137 (23B1H)	CH□ Trigger generation time (Month/Day)	0	Monitor	×
9103 (238FH)	9108 (2394H)	9113 (2399H)	9118 (239EH)	9123 (23A3H)	9128 (23A8H)	9133 (23ADH)	9138 (23B2H)	CH□ Trigger generation time (Hour/Minute)	0	Monitor	×
9104 (2390H)	9109 (2395H)	9114 (239AH)	9119 (239FH)	9124 (23A4H)	9129 (23A9H)	9134 (23AEH)	9139 (23B3H)	CH□ Trigger generation time (Second/Day of the week)	0	Monitor	×
9105 (2391H)	9110 (2396H)	9115 (239BH)	9120 (23A0H)	9125 (23A5H)	9130 (23AAH)	9135 (23AFH)	9140 (23B4H)	CH□ Trigger generation time (Millisecond)	0	Monitor	×
9141 to 9150 (23B5H to 23BEH)								System area	—	—	—
9151 (23BFH)	9152 (23C0H)	9153 (23C1H)	9154 (23C2H)	9155 (23C3H)	9156 (23C4H)	9157 (23C5H)	9158 (23C6H)	CH□ Logging hold request	0	Control	○
9159, 9160 (23C7H, 23C8H)								System area	—	—	—
9161 (23C9H)	9162 (23CAH)	9163 (23CBH)	9164 (23CCH)	9165 (23CDH)	9166 (23CEH)	9167 (23CFH)	9168 (23D0H)	CH□ Logging enable/ disable setting	1	Setting	×
9169, 9170 (23D1H, 23D2H)								System area	—	—	—
9171 (23D3H)	9172 (23D4H)	9173 (23D5H)	9174 (23D6H)	9175 (23D7H)	9176 (23D8H)	9177 (23D9H)	9178 (23DAH)	CH□ Logging data setting	1	Setting	×
9179, 9180 (23DBH, 23DCH)								System area	—	—	—
9181 (23DDH)	9182 (23DEH)	9183 (23DFH)	9184 (23E0H)	9185 (23E1H)	9186 (23E2H)	9187 (23E3H)	9188 (23E4H)	CH□ Logging cycle setting value	1	Setting	×
9189, 9190 (23E5H, 23E6H)								System area	—	—	—
9191 (23E7H)	9192 (23E8H)	9193 (23E9H)	9194 (23EAH)	9195 (23EBH)	9196 (23ECH)	9197 (23EDH)	9198 (23EEH)	CH□ Logging cycle unit setting	1	Setting	×
9199, 9200 (23EFH, 23F0H)								System area	—	—	—
9201 (23F1H)	9202 (23F2H)	9203 (23F3H)	9204 (23F4H)	9205 (23F5H)	9206 (23F6H)	9207 (23F7H)	9208 (23F8H)	CH□ Post-trigger logging points	5000	Setting	×
9209, 9210 (23F9H, 23FAH)								System area	—	—	—
9211 (23FBH)	9212 (23FCH)	9213 (23FDH)	9214 (23FEH)	9215 (23FFH)	9216 (2400H)	9217 (2401H)	9218 (2402H)	CH□ Level trigger condition setting	0	Setting	×
9219, 9220 (2403H, 2404H)								System area	—	—	—

Address Decimal (hexadecimal)								Name	Default value	Data type	Auto refresh
CH1	CH2	CH3	CH4	CH5	CH6	CH7	CH8				
9221 (2405H)	9222 (2406H)	9223 (2407H)	9224 (2408H)	9225 (2409H)	9226 (240AH)	9227 (240BH)	9228 (240CH)	CH□ Trigger data	*1	Setting	×
9229, 9230 (240DH, 240EH)								System area	—	—	—
9231 (240FH)	9232 (2410H)	9233 (2411H)	9234 (2412H)	9235 (2413H)	9236 (2414H)	9237 (2415H)	9238 (2416H)	CH□ Trigger setting value	0	Setting	×
9239 to 9999 (2417H to 270FH)								System area	—	—	—
10000 to 19999 (2710H to 4E1FH)								CH1 Logging data	0	Monitor	×
20000 to 29999 (4E20H to 752FH)								CH2 Logging data	0	Monitor	×
30000 to 39999 (7530H to 9C3FH)								CH3 Logging data	0	Monitor	×
40000 to 49999 (9C40H to C34FH)								CH4 Logging data	0	Monitor	×
50000 to 59999 (C350H to EA5FH)								CH5 Logging data	0	Monitor	×
60000 to 69999 (EA60H to 1116FH)								CH6 Logging data	0	Monitor	×
70000 to 79999 (11170H to 1387FH)								CH7 Logging data	0	Monitor	×
80000 to 89999 (13880H to 15F8FH)								CH8 Logging data	0	Monitor	×
90000 - (15F90H -)								System area	—	—	—

*1 The following shows the default values.

CH1: 10, CH2: 11, CH3: 12, CH4: 13, CH5: 14, CH6: 15, CH7: 16, CH8: 17

Details of buffer memory addresses

This section indicates the details of the buffer memory areas of the multiple input module.



This section describes buffer memory addresses for CH1 in normal mode.

Latest error code

The latest error code detected in the multiple input module is stored. For details on the error codes, refer to the following.

Page 424 List of error codes

■ Buffer memory address

The following shows the buffer memory address of this area.

Buffer memory name	CH1	CH2	CH3	CH4	CH5	CH6	CH7	CH8
Latest error code	0							
Latest error code (in FX2N allocation mode function)	29							

■ Clearing an error

Turn 'Error clear request' (Un\G70, b15) off→on→off.

Latest address of error history

Among Error history □ (Un\G3600 to Un\G3759), a buffer memory address which stores the latest error code is stored.

■ Buffer memory address

The following shows the buffer memory address of this area.

Buffer memory name	CH1	CH2	CH3	CH4	CH5	CH6	CH7	CH8
Latest address of error history	1							
Latest address of error history (in FX2N allocation mode function)	121							

Latest alarm code

The latest alarm code detected in the multiple input module is stored. For details on the alarm codes, refer to the following.

Page 427 List of alarm codes

■ Buffer memory address

The following shows the buffer memory address of this area.

Buffer memory name	CH1	CH2	CH3	CH4	CH5	CH6	CH7	CH8
Latest alarm code	2							
Latest alarm code (in FX2N allocation mode function)	122							

■ Clearing an alarm

Turn 'Error clear request' (Un\G70, b15) off→on→off.

Latest address of alarm history

Among Alarm history □ (Un\G3760 to Un\G3919), a buffer memory address which stores the latest alarm code is stored.

■ Buffer memory address

The following shows the buffer memory address of this area.

Buffer memory name	CH1	CH2	CH3	CH4	CH5	CH6	CH7	CH8
Latest address of alarm history	3							
Latest address of alarm history (in FX2N allocation mode function)	123							

Module information

Module information of FX5-8AD is stored. For module information, 61E0H (fixed hexadecimal value) is stored.

■Buffer memory address

The following shows the buffer memory address of this area.

Buffer memory name	CH1	CH2	CH3	CH4	CH5	CH6	CH7	CH8
Module information	30							

Module information [FX2N allocation mode]

The FX5-8AD module information in FX2N allocation mode function is stored. For model information, 61E4H (fixed hexadecimal value) is stored.

■Buffer memory address

The following shows the buffer memory address of this area.

Buffer memory name	CH1	CH2	CH3	CH4	CH5	CH6	CH7	CH8
Module information (in FX2N allocation mode function)	30							

Firmware version

Firmware version is stored. Firmware version is stored in 4 digit decimal number.

■Buffer memory address

The following shows the buffer memory address of this area.

Buffer memory name	CH1	CH2	CH3	CH4	CH5	CH6	CH7	CH8
Firmware version	31							
Firmware version (in FX2N allocation mode function)	31							

Warning output flag (Process alarm upper limit)

The upper limit alarm of the process alarm can be checked for each channel.

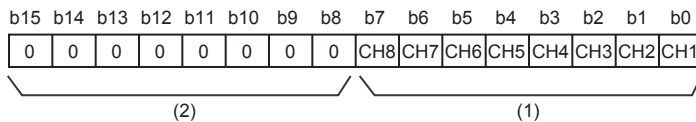

(1) 0: Normal, 1: Alarm ON

(2) The values of b8 to b15 are fixed to 0.

■Buffer memory address

The following shows the buffer memory address of this area.

Buffer memory name	CH1	CH2	CH3	CH4	CH5	CH6	CH7	CH8
Warning output flag (Process alarm upper limit)	36							

■Alert output flag status

- If the limit specified by the process alarm upper upper limit value is equal to or exceeded, Alarm ON (1) is stored in 'Alert output flag (Process alarm upper limit)' (Un\G36) of the corresponding channel.
- If an alert is detected even in one channel, of the channels where conversion is enabled and the alert output setting (Process alarm) is enabled, 'Alert output signal' (Un\G69, b8) also turns on.

■Clearing alert output flag

- When the digital operation value becomes smaller than the process alarm upper lower limit value, the flag is automatically cleared.
- Turning off→on→off 'Operating condition setting request' (Un\G70, b9) allows the flag to be cleared.

Warning output flag (Process alarm lower limit)

The lower limit alarm of the process alarm can be checked for each channel.

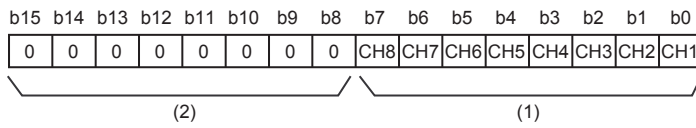

(1) 0: Normal, 1: Alarm ON

(2) The values of b8 to b15 are fixed to 0.

■Buffer memory address

The following shows the buffer memory address of this area.

Buffer memory name	CH1	CH2	CH3	CH4	CH5	CH6	CH7	CH8
Warning output flag (Process alarm lower limit)	37							

■Alert output flag status

- If the limit specified by the process alarm lower limit value is equal to or exceeded, Alarm ON (1) is stored in 'Alert output flag (Process alarm lower limit)' (Un\G37) of the corresponding channel.
- If an alert is detected even in one channel, of the channels where conversion is enabled and the alert output setting (Process alarm) is enabled, 'Alert output signal' (Un\G69, b8) also turns on.

■Clearing alert output flag

- When the digital operation value becomes greater than the process alarm lower upper limit value, the flag is automatically cleared.
- Turning off→on→off 'Operating condition setting request' (Un\G70, b9) allows the flag to be cleared.

Warning output flag (Process alarm upper limit/lower limit) [FX2N allocation mode]

When the FX2N allocation mode function is used, the upper/lower limit alarm of the process alarm can be checked.

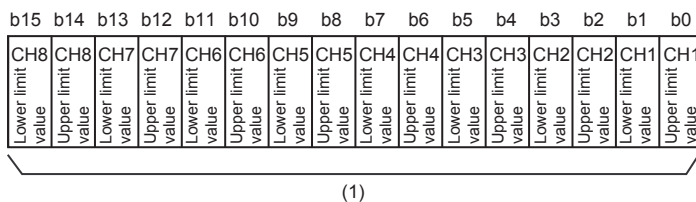

(1) 0: Normal, 1: Alarm ON

■Buffer memory address

The following shows the buffer memory address of this area.

Buffer memory name	CH1	CH2	CH3	CH4	CH5	CH6	CH7	CH8
Alert output flag (Process alarm) (in FX2N allocation mode function)	26							

■Alert output flag status

- When the value is out of the range specified in the process alarm upper upper limit value or process alarm lower lower limit value, Alarm ON (1) is stored in Alert output flag (Process alarm upper limit/lower limit) corresponding to each channel.
- If an alert is detected even in one channel, of the channels where conversion is enabled and the alert output setting (Process alarm) is enabled, 'Alert output signal' (Un\G69, b8) also turns on.

■Clearing alert output flag

- When the digital operation value falls within the process alarm upper lower limit value or less, or process alarm lower upper limit value or more, the flag is automatically cleared.
- Turning off→on→off 'Operating condition setting request' (Un\G70, b9) allows the flag to be cleared.

Warning output flag (Rate alarm upper limit)

The upper limit alarm of the rate alarm can be checked for each channel.

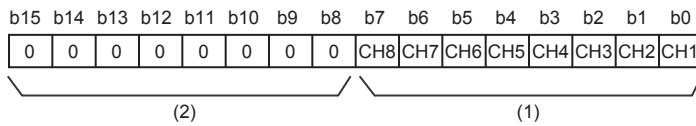

(1) 0: Normal, 1: Alarm ON

(2) The values of b8 to b15 are fixed to 0.

■Buffer memory address

The following shows the buffer memory address of this area.

Buffer memory name	CH1	CH2	CH3	CH4	CH5	CH6	CH7	CH8
Warning output flag (Rate alarm upper limit)	38							

■Alert output flag status

- If the limit specified in the rate alarm upper limit value is equal to or exceeded, Alarm ON (1) is stored in 'Alert output flag (Rate alarm upper limit)' (Un\G38) of the corresponding channel.
- If an alert is detected even in one channel, of the channels where conversion is enabled and the alert output setting (Rate alarm) is enabled, 'Alert output signal' (Un\G69, b8) also turns on.

■Clearing alert output flag

- When the digital output value becomes smaller than the rate alarm upper limit value, the flag is automatically cleared.
- Turning off→on→off 'Operating condition setting request' (Un\G70, b9) allows the flag to be cleared.

Warning output flag (Rate alarm lower limit)

The lower limit alarm of the rate alarm can be checked for each channel.

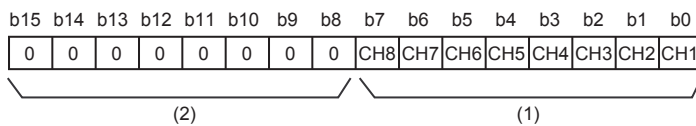

(1) 0: Normal, 1: Alarm ON

(2) The values of b8 to b15 are fixed to 0.

■Buffer memory address

The following shows the buffer memory address of this area.

Buffer memory name	CH1	CH2	CH3	CH4	CH5	CH6	CH7	CH8
Warning output flag (Rate alarm lower limit)	39							

■Alert output flag status

- When the value becomes equal to or smaller than the range specified in the rate alarm lower limit value, Alarm ON (1) is stored in 'Alert output flag (Rate alarm lower limit)' (Un\G39) corresponding to each channel.
- If an alert is detected even in one channel, of the channels where conversion is enabled and the alert output setting (Rate alarm) is enabled, 'Alert output signal' (Un\G69, b8) also turns on.

■Clearing alert output flag

- When the digital output value becomes smaller than the rate alarm lower limit value, the flag is automatically cleared.
- Turning off→on→off 'Operating condition setting request' (Un\G70, b9) allows the flag to be cleared.

Warning output flag (Rate alarm upper limit/lower limit) [FX2N allocation mode]

When the FX2N allocation mode function is used, the upper/lower limit alarm of the rate alarm can be checked.

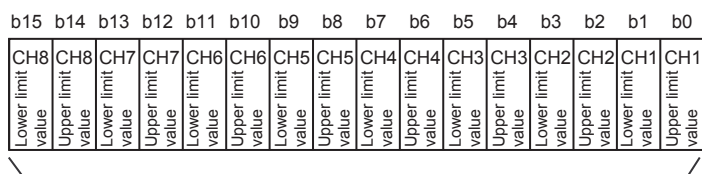

(1)

(1) 0: Normal, 1: Alarm ON

■Buffer memory address

The following shows the buffer memory address of this area.

Buffer memory name	CH1	CH2	CH3	CH4	CH5	CH6	CH7	CH8
Alert output flag (Rate alarm) (in FX2N allocation mode function)	27							

■Alert output flag status

- If the value is out of the range specified in the rate alarm upper limit value or the rate alarm lower limit value, Alarm ON (1) is stored in Alert output flag (rate alarm) corresponding to each channel.
- If an alert is detected even in one channel, of the channels where conversion is enabled and the alert output setting (Process alarm) is enabled, 'Alert output signal' (Un\G69, b8) also turns on.

■Clearing alert output flag

- When the change rate of the digital output value falls within the rate alarm upper limit value or less, or rate alarm lower limit value or more, the flag is automatically cleared.
- Turning off→on→off 'Operating condition setting request' (Un\G70, b9) allows the flag to be cleared.

Input signal error detection flag

The status of an analog input value can be checked for each channel.

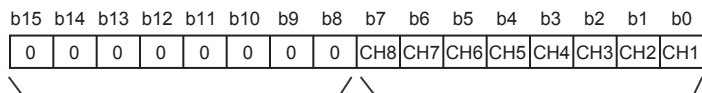

(2)

(1)

(1) 0: Normal, 1: Input signal error

(2) The values of b8 to b15 are fixed to 0.

■Buffer memory address

The following shows the buffer memory address of this area.

Buffer memory name	CH1	CH2	CH3	CH4	CH5	CH6	CH7	CH8
Input signal error detection flag	40							

■Input signal error detection flag status

- When an analog input value out of the range specified in Input signal error detection setting value is detected, Input signal error detection flag corresponding to each channel of detection turns to Input signal error (1).
- When an error is detected in any channel where the conversion and the input signal error detection are enabled, 'Input signal error detection signal' (Un\G69, b12) turns on.

■Clearing input signal error detection flag

Clearing input signal errors detection flag differs depending on Input signal error detection/disconnection detection auto-clear enable/disable setting.

When Input signal error detection/disconnection detection auto-clear enable/disable setting is set to Enable (0)

- When an analog input value falls within the normal range, Normal (0) is stored in the corresponding bit of 'Input signal error detection flag' (Un\G40).

When Input signal error/disconnection detection auto-clear enable/disable setting is set to Disable (1)

- When an analog input value falls within the normal range, if turning off→on→off 'Error clear request' (Un\G70, b15), Normal (0) is stored in the corresponding bit of 'Input signal error detection flag' (Un\G40).
- Turning off→on→off 'Operating condition setting request' (Un\G70, b9) allows the flag to be cleared.

Disconnection detection flag

The status of disconnection can be checked for each channel.

b15	b14	b13	b12	b11	b10	b9	b8	b7	b6	b5	b4	b3	b2	b1	b0
0	0	0	0	0	0	0	0	CH8	CH7	CH6	CH5	CH4	CH3	CH2	CH1
(2)								(1)							

(1) 0: Normal, 1: Disconnection detection

(2) The values of b8 to b15 are fixed to 0.

■Buffer memory address

The following shows the buffer memory address of this area.

Buffer memory name	CH1	CH2	CH3	CH4	CH5	CH6	CH7	CH8
Disconnection detection flag	41							

■Status of disconnection detection flag

- If a disconnection is detected by the disconnection detection function, disconnection detection flag, which corresponds to the channel where the disconnection is detected, turns to disconnection detection (1).
- If an error is detected even in one channel, of the channels where conversion is enabled and disconnection detection is enabled, 'Disconnection detection signal' (Un\G69, b6) turns on.

■Clearing disconnection detection flag

Clearing disconnection detection flag differs depending on Input signal error detection/disconnection detection auto-clear enable/disable setting.

When Input signal error detection/disconnection detection auto-clear enable/disable setting is set to Enable (0)

- When the disconnecting cause is eliminated, and the analog input value falls within the normal range, Normal (0) is stored in the corresponding bit of 'Disconnection detection flag' (Un\G41).

When Input signal error/disconnection detection auto-clear enable/disable setting is set to Disable (1)

- When an analog input value falls within the normal range, if turning off→on→off 'Error clear request' (Un\G70, b15), Normal (0) is stored in the corresponding bit of 'Disconnection detection flag' (Un\G41).
- Turning off→on→off 'Operating condition setting request' (Un\G70, b9) allows the flag to be cleared.

Input signal error detection flag/disconnection detection flag [FX2N allocation mode]

The status of an analog input value or disconnection can be checked for each channel.

b15	b14	b13	b12	b11	b10	b9	b8	b7	b6	b5	b4	b3	b2	b1	b0
CH8	CH8	CH7	CH7	CH6	CH6	CH5	CH5	CH4	CH4	CH3	CH3	CH2	CH2	CH1	CH1
Disconnection	Input signal error	Disconnection	Input signal error	Disconnection	Input signal error	Disconnection	Input signal error	Disconnection	Input signal error	Disconnection	Input signal error	Disconnection	Input signal error	Lower limit value	Upper limit value
(1)															

(1) 0: Normal, 1: Detection

■Buffer memory address

The following shows the buffer memory address of this area.

Buffer memory name	CH1	CH2	CH3	CH4	CH5	CH6	CH7	CH8
Input signal error detection flag/disconnection detection flag	28							

■Status of input signal error detection flag/disconnection detection flag

- When an analog input value out of the range specified in Input signal error detection setting value is detected, Input signal error detection flag corresponding to each channel turns to Input signal error (1).
- If a disconnection is detected by the disconnection detection function, disconnection detection flag, which corresponds to the channel where the disconnection is detected, turns to disconnection detection (1).
- When an error is detected in any channel where the conversion and the input signal error detection are enabled, 'Input signal error detection signal' (Un\G69, b12) turns on.
- If an error is detected even in one channel, of the channels where conversion is enabled and disconnection detection is enabled, 'Disconnection detection signal' (Un\G69, b6) turns on.

■Clearing input signal error detection flag/disconnection detection flag

Clearing input signal errors detection flag/disconnection detection flag differs depending on Input signal error detection/disconnection detection auto-clear enable/disable setting. (When turning off→on→off, Error clear request (Un\G70, b15) the flag is cleared regardless of the setting.)

When Input signal error detection/disconnection detection auto-clear enable/disable setting is set to Enable (0)

- When an analog input value falls within the normal range, Normal (0) is stored in the corresponding bit of 'Input signal error detection flag/disconnection detection flag' (Un\G28).

When Input signal error/disconnection detection auto-clear enable/disable setting is set to Disable (1)

- When an analog input value falls within the normal range, if turning off→on→off 'Error clear request' (Un\G70, b15), Normal (0) is stored in the corresponding bit of 'Input signal error detection flag/disconnection detection flag' (Un\G28).
- Turning off→on→off 'Operating condition setting request' (Un\G70, b9) allows the flag to be cleared.

Conversion completed flag

The conversion status can be checked.

b15	b14	b13	b12	b11	b10	b9	b8	b7	b6	b5	b4	b3	b2	b1	b0	
0	0	0	0	0	0	0	0	0	CH8	CH7	CH6	CH5	CH4	CH3	CH2	CH1
(2)								(1)								

(1) 0: During conversion or unused, 1: Conversion completed

(2) The values of b8 to b15 are fixed to 0.

■Buffer memory address

The following shows the buffer memory address of this area.

Buffer memory name	CH1	CH2	CH3	CH4	CH5	CH6	CH7	CH8
Conversion completed flag	42							
Conversion completed flag (in FX2N allocation mode function)	124							

■The status of conversion completed flag

When the first conversion is completed in the channel where conversion is enabled, the flag turns to Conversion completed (1). Upon completion of the conversion of all the channels where conversion is enabled, 'Conversion completed flag' (Un\G69, b14) turns on.

■Clearing conversion completed flag

Turning off→on→off 'Operating condition setting request' (Un\G70, b9) turns the flag back to the default (During conversion or unused (0)), and when the first conversion is completed, the flag turns to Conversion completed (1) again.

Operation mode monitor

The operation mode status in operation can be checked.

Monitor value	Description
0	Normal mode
1	Offset/gain setting mode
2	FX2N Allocation Mode
3	2CH conversion mode

■Buffer memory address

The following shows the buffer memory address of this area.

Buffer memory name	CH1	CH2	CH3	CH4	CH5	CH6	CH7	CH8
Operation mode monitor	60							
Operation mode monitor (In FX2N allocation mode function)	60							

Input signals

A state of a multiple input module can be checked in the buffer memory area.

■Buffer memory address

The following shows the buffer memory address of this area.

Buffer memory name	CH1	CH2	CH3	CH4	CH5	CH6	CH7	CH8
Input signals	69							
Input signal (In FX2N allocation mode function)	69							

■List of input signals

Buffer Memory Areas	Description
b0	Module READY
b1 to 4	Use not allowed
b5	Offset/gain initialization completed flag
b6	Disconnection detection signal
b7	Use not allowed
b8	Warning output signal
b9	Operating condition setting completed flag
b10	Offset/gain setting mode status flag
b11	Channel change completed flag
b12	Input signal error detection signal
b13	Use not allowed
b14	Conversion completed flag
b15	Error flag

■Module READY (b0)

Module READY (b0) turns on to indicate the preparation for the conversion is completed after the power-on or after the reset of the CPU module, and the conversion is performed.

In the following cases, 'Module READY' turns off.

- In the offset/gain setting mode (In this case, the conversion is performed.)
- When a watchdog timer error has occurred in the multiple input module (In this case, the conversion is not performed.)

■ Offset/gain initialization completed flag (b5)

- Use as an interlock condition to turn off→on→off 'Offset/gain initialization request' (Un\G70, b5).
- Offset/gain initialization is not be performed unless 'Offset/gain initialization enabled code '(Un\G305) is set to E20FH.
- It is possible to perform offset/gain initialization in normal mode only.
- When 'Offset/gain initialization request' (Un\G70, b5) is off, 'Offset/gain initialization complete flag' (Un\G69, b5) turns off.

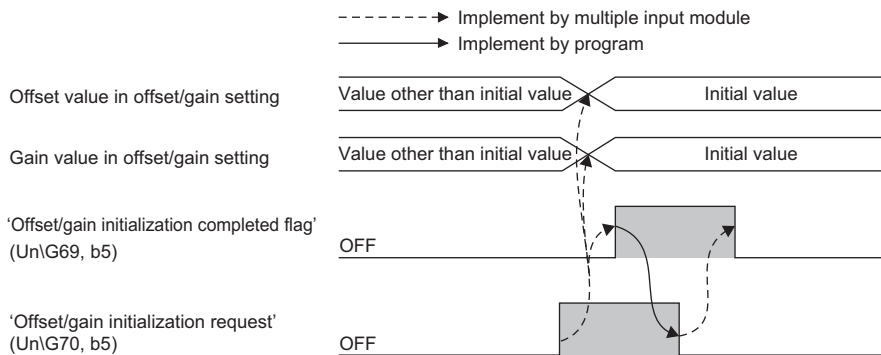

■ Disconnection detection signal (b6)

Turns on when disconnection is detected for the channel where Enable (0) is set in 'CH1 Disconnection detection enable/disable setting' (Un\G531) and the conversion is enabled.

When 'Disconnection detection signal' (Un\G69, b6) turns on, the following operations are performed.

- A value corresponding to 'CH1 Conversion setting at disconnection detection' (Un\G534) is stored in the temperature measurement value of the relevant channel.
- The ALM LED flashes.

Turning off 'Disconnection detection signal' (Un\G69, b6) differs depending on Input signal error/disconnection detection auto-clear enable/disable setting.

Input signal error/ Disconnection detection automatic clear enable/disable setting	Operations related to the turning off of Disconnection detection signal (Un\G69, b6)
Enable (0)	When the temperature input value is within the setting range and the disconnection is restored, the 'Disconnection detection signal' (Un\G69, b6) automatically turns off, and ALM LED turns off.
Disable (1)	Eliminate the disconnection cause, and turn 'Error clear request' (Un\G70, b15) off→on→off. 'Disconnection detection signal' (Un\G69, b6) turns off, ALM LED turns off, and the latest alarm code is cleared.



Averaging processing starts over after the conversion resumes.

■Warning output signal (b8)

Alert output signal (Un\G69, b8) turns on when the process alarm or rate alarm has been detected. When the alert output function (process alarm/rate alarm) is disabled for all channels, 'Alert output signal' (Un\G69, b8) is always off.

Alarm	Operation
Process alarm	<ul style="list-style-type: none"> Process alarm turns on when 'CH1 Digital operation value' exceeds the range set for 'CH1 Process alarm upper upper limit value' (Un\G514) or 'CH1 Process alarm lower lower limit value' (Un\G520). The ALM LED also turns on along with the on of the signal. The target of alert output is the channels only where the alert output function (process alarm) and the conversion are both enabled. Process alarm turns off when 'CH1 Digital output value' falls within the setting range for all the channels where the conversion is enabled. The ALM LED also turns off along with the off of the signal.
Rate alarm	<ul style="list-style-type: none"> Rate alarm turns on when the change rate of 'CH1 Digital output value' exceeds the range set for 'CH1 Rate alarm upper limit value' (Un\G524) and 'CH1 Rate alarm lower limit value' (Un\G526). The ALM LED also turns on along with the on of the signal. The target of alert output is the channels only where the alert output function (rate alarm) and the conversion are both enabled. Rate alarm turns off when the change rate of 'CH1 Digital output value' falls within the setting range for all the channels where the conversion is enabled. The ALM LED also turns off.

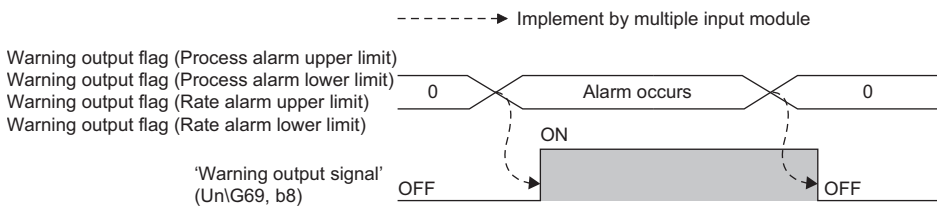

■Operating condition setting completed flag (b9)

When changing values of the buffer memory, use as an interlock condition to turn off→on→off 'Operating condition setting request' (Un\G70, b9).

For the buffer memory areas which require turning off→on→off of 'Operating condition setting request' (Un\G70, b9) to enable the changed values, refer to the following.

☞ Page 432 Buffer Memory Areas

When 'Operating condition setting completed flag' (Un\G69, b9) is off, the conversion is not performed.

When 'Operating condition setting request' (Un\G70, b9) is on, 'Operating condition setting completed flag' (Un\G69, b9) turns off.

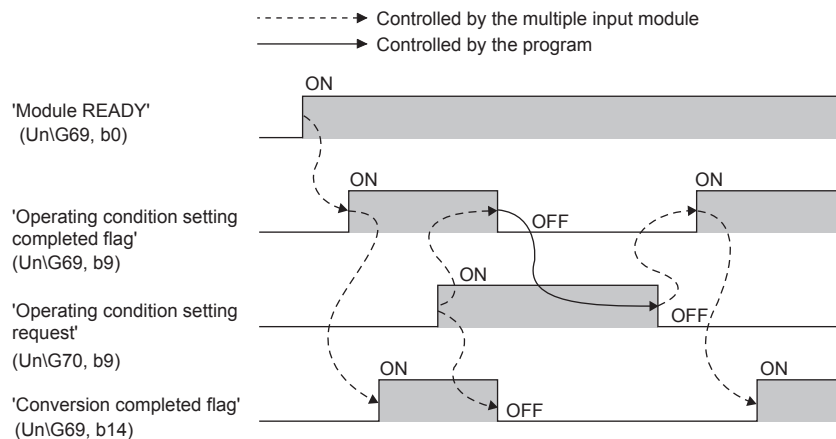

■Offset/gain setting mode status flag (b10)

When registering the value, which has been adjusted with the offset/gain setting, use as an interlock condition to turn off→on→off 'User range write request' (Un\G70, b10).

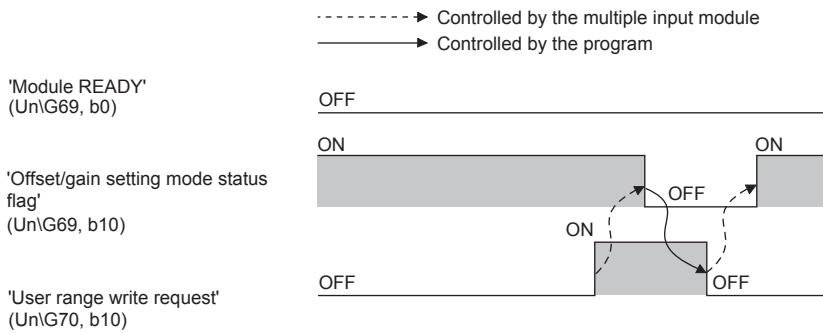

■Channel change completed flag (b11)

When changing a channel to perform the offset/gain setting, use as an interlock condition to turn off→on→off 'Channel change request' (Un\G70, b11).

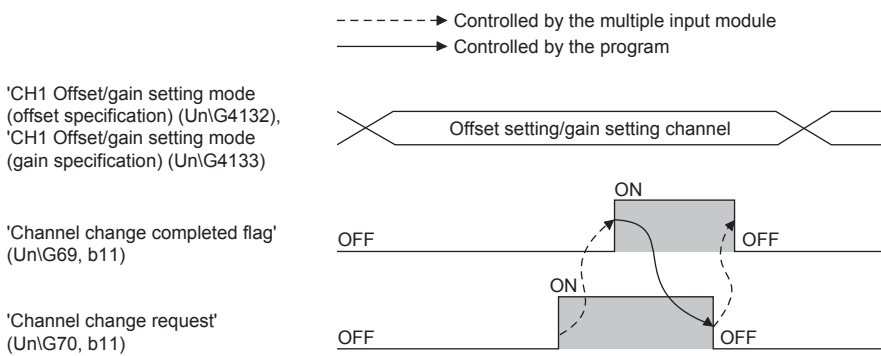

Input signal error detection signal (b12)

Set 'CH1 Input signal error detection setting' (Un\G528) to one of upper lower limit detection, upper limit detection, lower limit detection, and simple disconnection detection, and turns on if the analog input value exceeds the setting range that is set in 'CH1 Input signal error detection lower limit setting value (Un\G529) or 'CH1 Input signal error detection upper limit setting value' (Un\G530) in the channel where the conversion has been enabled. For the cases where the simple disconnection detection is set, 'CH1 Input signal error detection lower limit setting value' (Un\G529) or 'CH1 Input signal error detection upper limit setting value' (Un\G530) is ignored and turns on at the disconnection detection.

When 'Input signal error detection signal' (Un\G69, b12) turns on, the following operations are performed.

- Digital output value and digital operation value of the relevant channel is held with the value just before the error was detected.
- The ALM LED flashes.

Turning off 'Input signal error detection signal' (Un\G69, b12) differs depending on Input signal error/disconnection detection auto-clear enable/disable setting.

Input signal error/ Disconnection detection automatic clear enable/ disable setting	Operations related to the turning off of input signal error detection signal (Un\G69, b12)
Enable (0)	If the input signal is within the setting range, 'Input signal error detection signal' (Un\G69, b12) and 'Input signal error detection flag' (Un\G40) automatically turn off, and ALM LED turns off.
Disable (1)	<p>Remove the cause of the input signal error and set the input signal within the setting range. Then turn the 'error clear request' (Un\G70, b15) OFF→ON→OFF. The input signal error detection signal 'Un\G69, b12) and the 'input signal error detection flag' (Un\G40) will turn OFF, and the ALM LED will turn off. The latest alarm code will also be cleared.</p> <p>-----▶ Implement by multiple input module ————▶ Implement by program</p> <p>Input signal error detection flag: 0 → 1 → 0</p> <p>'Input signal error detection signal' (Un\G69, b12): OFF → ON → OFF</p> <p>'Error clear request' (Un\G70, b15): OFF → ON → OFF</p>

A



Averaging processing starts over after the conversion resumes.

Conversion completed flag (b14)

Conversion completed flag (Un\G70, b15) turns on when the first conversion has been completed for all conversion enabled channels. When reading a digital output value, use this signal or 'Conversion completed flag' (Un\G42) as an interlock.

Error occurrence flag (b15)

Error flag (Un\G69, b15) turns on when an error has occurred.

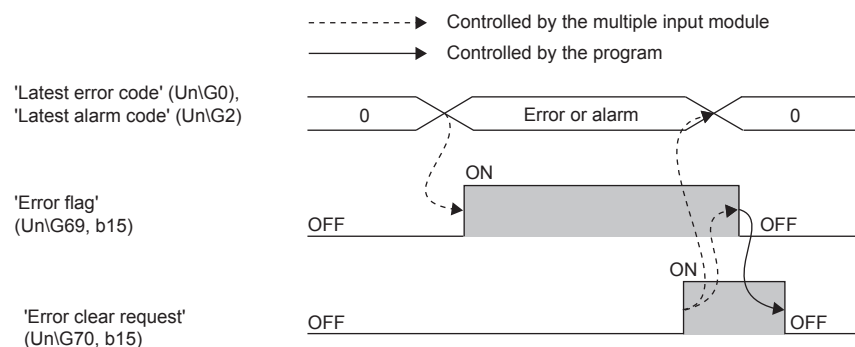

'Error flag' (Un\G69, b15), 'Latest error code' (Un\G0), and 'Latest alarm code' (Un\G2) are cleared at the timing when 'Error clear request' (Un\G70, b15) turns off→on.

Output signals

A state of FX5-8AD can be checked in the buffer memory area.

■ Buffer memory address

The following shows the buffer memory address of this area.

Buffer memory name	CH1	CH2	CH3	CH4	CH5	CH6	CH7	CH8
Output signals	70							
Output signal (In FX2N allocation mode function)	70							

■ List of output signals

Buffer Memory Areas	Description
b0 to 4	Use not allowed
b5	Offset/gain initialization request
b6 to 8	Use not allowed
b9	Operating condition setting request
b10	User range write request
b11	Channel change request
b12 to 14	Use not allowed
b15	Error clear request

■ Offset/gain initialization request (b5)

Turn off→on→off to enable the settings of buffer memory areas.

Offset/gain initialization is not to be performed unless 'Offset/gain initialization enabled code is set to E20FH.

When 'Offset/gain initialization request' (Un\G70, b5) is off, 'Offset/gain initialization complete flag' (Un\G69, b5) turns off.

■ Operating condition setting request (b9)

Turn off→on→off to enable the settings of buffer memory areas.

For the timing of turning the signal off→on→off, refer to the following.

☞ Page 455 Operating condition setting completed flag (b9)

■ User range write request (b10)

In the offset/gain setting mode, turn off→on→off User range write request (b10) to register values adjusted with the offset/gain setting in a multiple input module. The data is written to the flash memory at the timing when this signal is turned off→on.

For the timing of turning the signal off→on→off, refer to the following.

☞ Page 456 Offset/gain setting mode status flag (b10)

■ Channel change request (b11)

Turn off→on→off Channel change request (b11) to change a channel to perform the offset/gain setting.

For the timing of turning the signal off→on→off, refer to the following.

☞ Page 456 Channel change completed flag (b11)

■ Error clear request (b15)

Turn off→on→off Error clear request (b15) when Error flag (Un\G69, b15), Disconnection detection signal (Un\G69, b6), Input signal error detection signal (Un\G69, b12), Latest error code (Un\G0), and Latest alarm code (Un\G2) are cleared.

For the timing of turning the signal off→on→off, refer to the following.

- ☞ Page 457 Error occurrence flag (b15)
- ☞ Page 454 Disconnection detection signal (b6)
- ☞ Page 457 Input signal error detection signal (b12)

Level data 0 to 9

This area stores data to be monitored when a level trigger of the logging function is used. Ten types of data are available: 'Level data 0' (Un\G90) to 'Level data 9' (Un\G99). These are useful, for example, to generate triggers while monitoring the values of devices other than the multiple input module.

For details on the logging function, refer to the following.

 Page 377 Logging function

■Buffer memory address

The following shows the buffer memory address of this area.

Buffer memory name	0	1	2	3	4	5	6	7	8	9
Level data□	90	91	92	93	94	95	96	97	98	99
Level data□ (in FX2N allocation mode function)	9010	9011	9012	9013	9014	9015	9016	9017	9018	9019

■Setting range

The possible setting range is from -32768 to +32767.

■Default value

The default value is 0 for all the channels.

Mode switching setting

Set a setting value for the mode to be switched.

Destination mode	Buffer memory address	Setting value
Normal mode	296	4658H
	297	4144H
Offset/gain setting mode	296	4144H
	297	4658H

Point

When a value out of the above is written and 'Operating condition setting request' (Un\G70, b9) is turned off→on→off, the mode setting is not performed and only the operating condition is changed. In this case, this area is cleared to 0.

■Buffer memory address

The following shows the buffer memory address of this area.

Buffer memory name	CH1	CH2	CH3	CH4	CH5	CH6	CH7	CH8
Mode switching setting	296, 297							
Mode switching setting (in FX2N allocation mode function)	126, 127							

■Enabling the setting

Turn off→on 'Operating condition setting request' (Un\G70, b9) to enable the setting.

■After the mode is switched

When the mode is switched, this area is cleared to 0 and 'Operating condition setting completed flag' (Un\G69, b9) turns off. After checking that 'Operating condition setting completed flag' (Un\G69, b9) is off, turn off 'Operating condition setting request' (Un\G70, b9).

Rate alarm change rate selection

Select rate alarm change rate. "Rate specification" that sets the rate alarm upper limit value and the rate alarm lower limit value in units of 0.1% with respect to (the maximum value of the digital output value) - (the minimum value of the digital output value), and "Digital output value specification" that sets in units of digits for the range of digital output values, can be selected.

Setting value	Description
0	Rate specification
1	Digital output value specification

When setting to a value other than the above table, it operates with digital output value specification (1).

■Buffer memory address

The following shows the buffer memory address of this area.

Buffer memory name	CH1	CH2	CH3	CH4	CH5	CH6	CH7	CH8
Rate alarm change rate selection	299							
Rate alarm change rate selection (in FX2N allocation mode function)	130							

■Enabling the setting

Turn off→on 'Operating condition setting request' (Un\G70, b9) to enable the setting.

■Default value

Digital output value specification (1) is set.

Input signal error/Disconnection detection automatic clear enable/disable setting

Set whether to enable or disable auto-clear of input signal error or disconnection detection with the input signal error detection function or disconnection detection function.

Setting value	Description
0	Enable
1	Disable

Setting a value other than in the table above results in operation with Disable (1).

■Buffer memory address

The following shows the buffer memory address of this area.

Buffer memory name	CH1	CH2	CH3	CH4	CH5	CH6	CH7	CH8
Input signal error/Disconnection detection automatic clear enable/disable setting	304							
Input signal error/disconnection detection auto-clear enable/disable setting (in FX2N allocation mode function)	133							

■Enabling the setting

Turn off→on→off 'Operating condition setting request' (Un\G70, b9) to enable the setting.

■Default value

The default value is Disable (1) for all the channels.

Offset/gain initialization enable code

When the offset/gain initialization request (Un/G70, b5) turns off→on by setting the enable code "E20FH" in this area at the time of initialization of offset/gain, the offset value and the gain value in the flash memory of the multiple input module are initialized.

When setting anything other than "E20FH" in this area, initialization is not executed.

■Buffer memory address

The following shows the buffer memory address of this area.

Buffer memory name	CH1	CH2	CH3	CH4	CH5	CH6	CH7	CH8
Offset/gain initialization enable code	305							
Offset/gain initialization enable code (In FX2N allocation mode function)	1340							

■Default value

The default value is set to 0.

CH1 Digital output value

The converted digital output value is stored in 16-bit signed binary value.

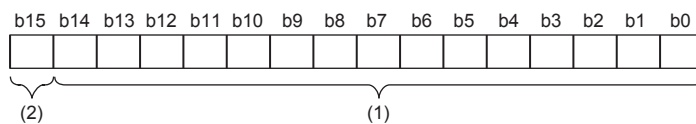

(1) Data section

(2) Sign bit 0: Positive, 1: Negative

■Buffer memory address

The following shows the buffer memory address of this area.

Buffer memory name	CH1	CH2	CH3	CH4	CH5	CH6	CH7	CH8
CH□ Digital output value	400	600	800	1000	1200	1400	1600	1800
CH□ Digital output value (in FX2N allocation mode function)	1001	1003	1005	1007	1009	1011	1013	1015

■Refreshing cycle

The value is updated every conversion cycle.

CH1 Digital operation value

When the digital clipping function, scaling function, shift function are used, digital values to which the digital clipping, scale conversion, and shift-and-add were performed are stored in 16-bit signed binary in the digital operation value.

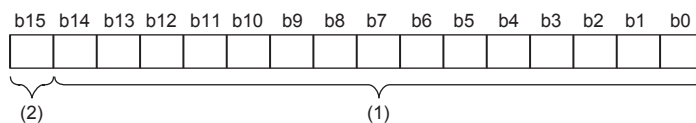

(1) Data section

(2) Sign bit 0: Positive, 1: Negative

■Buffer memory address

The following shows the buffer memory address of this area.

Buffer memory name	CH1	CH2	CH3	CH4	CH5	CH6	CH7	CH8
CH□ Digital operation value	402	602	802	1002	1202	1402	1602	1802
CH□ Digital operation value (in FX2N allocation mode function)	10	11	12	13	14	15	16	17

Point

When not using the digital clipping function, scaling function, and shift function, the same value as 'CH1 Digital output value' (Un/G400) is stored.

CH1 Maximum value

The maximum value of the digital operation value is stored in 16-bit signed binary value.

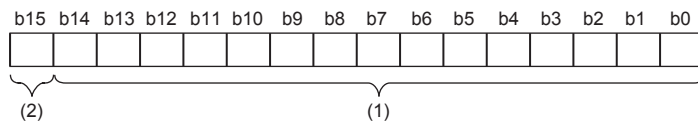

(1) Data section

(2) Sign bit 0: Positive, 1: Negative

In the following cases, 'CH1 Maximum value' (Un\G404) is updated with the current value.

- When 'Operating condition setting request' (Un\G70, b9) is turned off→on→off, and the setting is changed
- When 'CH1 Maximum value reset request' (Un\G473) is turned off→on→off

■Buffer memory address

The following shows the buffer memory address of this area.

Buffer memory name	CH1	CH2	CH3	CH4	CH5	CH6	CH7	CH8
CH□ Maximum value	404	604	804	1004	1204	1404	1604	1804
CH□ Maximum value (In FX2N allocation mode function)	111	112	113	114	115	116	117	118

■Refreshing cycle

The value is updated every conversion cycle.

Point

- For the channel to which the averaging processing is specified, the maximum and minimum values are stored at every averaging processing time.
- When the scaling function, shift function, and digital clipping function are used, values calculated by each function are stored in Maximum value and Minimum value.

CH1 Minimum value

The minimum value of the digital operation value is stored in 16-bit signed binary value.

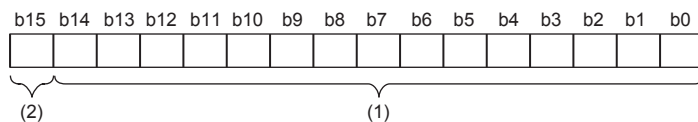

(1) Data section

(2) Sign bit 0: Positive, 1: Negative

In the following cases, 'CH1 Minimum value' (Un\G406) is updated with the current value.

- When 'Operating condition setting request' (Un\G70, b9) is turned off→on→off, and the setting is changed
- When 'CH1 Minimum value reset request' (Un\G474) is turned off→on→off

■Buffer memory address

The following shows the buffer memory address of this area.

Buffer memory name	CH1	CH2	CH3	CH4	CH5	CH6	CH7	CH8
CH□ Minimum value	406	606	806	1006	1206	1406	1606	1806
CH□ Minimum value (In FX2N allocation function mode)	101	102	103	104	105	106	107	108

■Refreshing cycle

The value is updated every conversion cycle.

Point

- For the channel to which the averaging processing is specified, the maximum and minimum values are stored at every averaging processing time.
- When the scaling function, shift function, and digital clipping function are used, values calculated by each function are stored in Maximum value and Minimum value.

CH1 Logging hold flag

The logging holding status can be checked.

For details on the logging function, refer to the following.

☞ Page 377 Logging function

Monitor value	Description
0	OFF
1	ON

As data collection in 'CH1 Logging data' (Un\G10000 to Un\G19999) comes to a halt, this flag turns to ON (1).

When logging restarts by changing 'CH1 Logging hold request' (Un\G471) from ON (1)→OFF (0), 'CH1 Logging hold flag' (Un\G409) is turned to OFF (0).

■Buffer memory address

The following shows the buffer memory address of this area.

Buffer memory name	CH1	CH2	CH3	CH4	CH5	CH6	CH7	CH8
CH□ Logging hold flag	409	609	809	1009	1209	1409	1609	1809
CH□ Logging hold flag (in FX2N allocation mode function)	9021	9022	9023	9024	9025	9026	9027	9028

CH1 Conversion status

The conversion status is stored.

Monitor value	Conversion status	Setting content
0	Conversion disable	A status of conversion disable. Conversion of the relevant channel is not executed.
1	Conversion start	A status from the conversion enabled to the initial conversion completed.
2	Conversion completed	A status after the initial conversion completed. Conversion is being executed.
3	Input signal error detection in progress/ disconnection detection in progress	A status where an input signal error or disconnection is being detected.

■Buffer memory address

The following shows the buffer memory address of this area.

Buffer memory name	CH1	CH2	CH3	CH4	CH5	CH6	CH7	CH8
CH□ Conversion status	420	620	820	1020	1220	1420	1620	1820
CH□ Conversion status (In FX2N allocation mode function)	1021	1022	1023	1024	1025	1026	1027	1028

CH1 Maximum value reset completed flag

The reset status of maximum value can be checked.

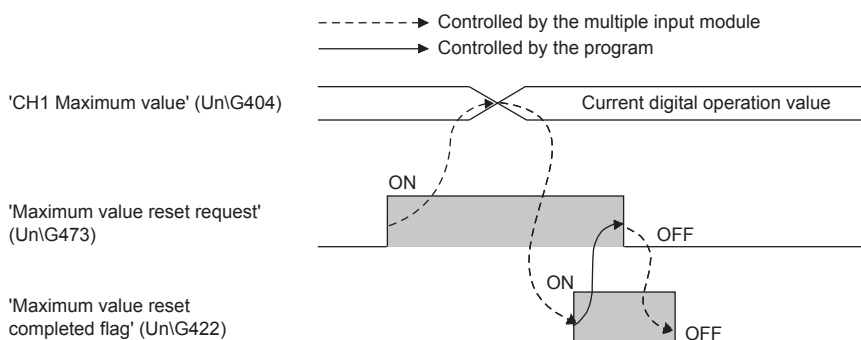

■Buffer memory address

The following shows the buffer memory address of this area.

Buffer memory name	CH1	CH2	CH3	CH4	CH5	CH6	CH7	CH8
CH□ Maximum value reset completed flag	422	622	822	1022	1222	1422	1622	1822

Maximum value reset completed flag [FX2N allocation mode]

The reset status of maximum value in FX2N allocation mode can be checked.

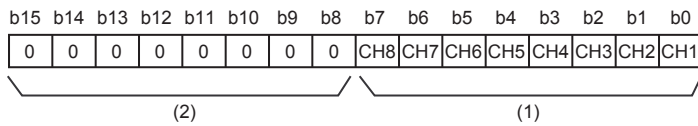

(1) 0: Not completed, 1: Completed

(2) The values of b8 to b15 are fixed to 0.

■Buffer memory address

The following shows the buffer memory address of this area.

Buffer memory name	CH1	CH2	CH3	CH4	CH5	CH6	CH7	CH8
CH□ Maximum value reset completed flag (in FX2N allocation mode function)	120							

CH1 Minimum value reset completed flag

The reset status of minimum value can be checked.

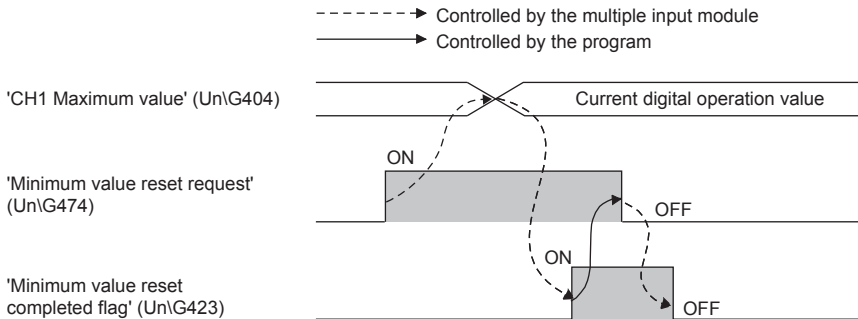

■Buffer memory address

The following shows the buffer memory address of this area.

Buffer memory name	CH1	CH2	CH3	CH4	CH5	CH6	CH7	CH8
CH□ Minimum value reset completed flag	423	623	823	1023	1232	1423	1623	1823

Minimum value reset completed flag [FX2N allocation mode]

The reset status of minimum value in FX2N allocation mode can be checked.

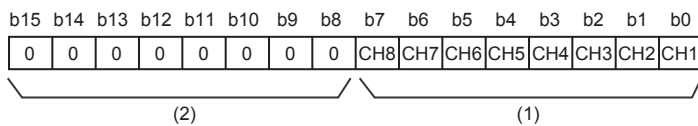

(1) 0: Not completed, 1: Completed

(2) The values of b8 to b15 are fixed to 0.

■Buffer memory address

The following shows the buffer memory address of this area.

Buffer memory name	CH1	CH2	CH3	CH4	CH5	CH6	CH7	CH8
CH□ Minimum value reset completed flag (in FX2N allocation mode function)	110							

CH1 Input type/Range monitor

Set input type, and input range can be checked.

Monitor value	Input type	Input range
000FH	Conversion not allowed (Default)	—
0003H	Current	4 to 20 mA
0010H		0 to 20 mA
0006H		-20 to +20 mA
0011H	Voltage	1 to 5 V
0012H		0 to 5 V
0000H		-10 to +10 V
0013H		0 to 10 V
0014H	Resistance temperature detector	Pt100
0015H		Ni100
0016H	Thermocouple	Thermocouple B
0017H		Thermocouple R
0018H		Thermocouple S
0009H		Thermocouple K
000AH		Thermocouple J
000BH		Thermocouple T

■ Buffer memory address

The following shows the buffer memory address of this area.

Buffer memory name	CH1	CH2	CH3	CH4	CH5	CH6	CH7	CH8
CH□ Input type/Range monitor	430	630	830	1030	1230	1430	1630	1830

CH1 Input type/Range monitor [FX2N allocation mode]

Set input type, and input range can be checked.

Monitor value	Input type	Input range	
000FH	Conversion not allowed (Default)	—	
0000H	Voltage	-10 to +10 V	
0001H			
0002H			
0003H	Current	4 to 20 mA	
0004H			
0005H			
0006H			-20 to +20 mA
0007H			
0008H	Thermocouple	Thermocouple K	
0009H		Thermocouple J	
000AH		Thermocouple T	
000BH		Thermocouple K	
000CH		Thermocouple J	
000DH		Thermocouple J	
000EH		Thermocouple T	

■ Buffer memory address

The following shows the buffer memory address of this area.

Buffer memory name	CH1	CH2	CH3	CH4	CH5	CH6	CH7	CH8
CH□ Input type/Range monitor (In FX2N allocation mode function)	1031	1032	1033	1034	1035	1036	1037	1038

A

CH1 Input type/Range monitor (Offset/gain setting)

Offset/gain values, which are set in 'CH1 Input type/range setting' (Un\G598), can be checked.

Monitor value	Description
0	Factory default setting
1	User range setting

■Buffer memory address

The following shows the buffer memory address of this area.

Buffer memory name	CH1	CH2	CH3	CH4	CH5	CH6	CH7	CH8
CH□ Input type/Range monitor (Offset/gain setting)	431	631	831	1031	1231	1431	1631	1831
CH□ Input type/Range monitor (Offset/gain setting) (In FX2N allocation mode function)	1041	1042	1043	1044	1045	1046	1047	1048

CH1 Head pointer

The buffer memory address of the oldest data in CH1 Logging data (Un\G10000 to Un\G19999) can be checked with this buffer memory area.

The offset value at the start address of CH1 Logging data (Un\G10000 to Un\G19999) is stored.

■Buffer memory address

The following shows the buffer memory address of this area.

Buffer memory name	CH1	CH2	CH3	CH4	CH5	CH6	CH7	CH8
CH□ Head pointer	434	634	834	1034	1234	1434	1634	1834
CH□ Head pointer (in FX2N allocation mode function)	9031	9032	9033	9034	9035	9036	9037	9038

Ex.

When the value of 'CH2 Head pointer' (Un\G634) is 20550

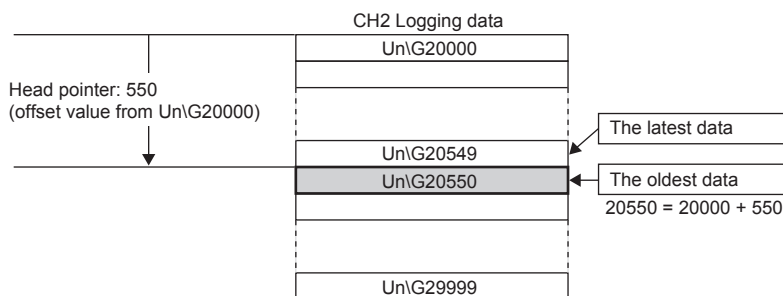

Point

- The value in 'CH1 Head pointer' (Un\G434) is fixed to 0 since the oldest data is stored in the start address of CH1 Logging data (Un\G10000 to Un\G19999) while the data of the first 10000 points is being logged from beginning of the logging. On and after the 10001st data, 'CH1 Head pointer' (Un\G434) increases one by one each time data is stored.
- When 'CH1 Logging hold request' (Un\G471) is turned on→off, 'CH1 Head pointer' (Un\G434) is cleared to 0.

CH1 Latest pointer

The buffer memory address of the latest data in CH1 Logging data (Un\G10000 to Un\G19999) can be checked with this buffer memory area.

The offset value at the start address of CH1 Logging data (Un\G10000 to Un\G19999) is stored.

■Buffer memory address

The following shows the buffer memory address of this area.

Buffer memory name	CH1	CH2	CH3	CH4	CH5	CH6	CH7	CH8
CH□ Latest pointer	435	635	835	1035	1235	1435	1635	1835
CH□ Latest pointer (in FX2N allocation mode function)	9041	9042	9043	9044	9045	9046	9047	9048

Ex.

When the value of CH2 Latest pointer (Un\G635) is 20549

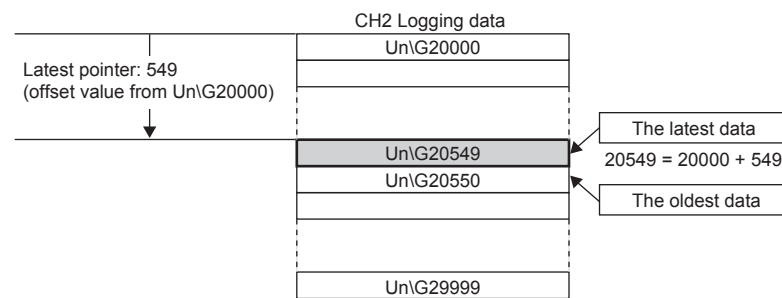

Point

- 'CH1 Latest pointer' (Un\G435) increases one by one each time data is stored from beginning of the logging.
- When 'CH1 Logging hold request' (Un\G471) is turned on→off, 'CH1 Latest pointer' (Un\G435) is cleared to 0.

CH1 Logging data points

The number of data stored in the logging data storage area can be checked during the logging.

'CH1 Number of logging data' (Un\G436) increases one by one each time data is stored from beginning of the logging.

When the value in the logging data storage area reaches 10000, 'CH1 Number of logging data points' (Un\G436) is fixed to 10000 since the value is overwritten from the head again.

For details on the logging function, refer to the following.

☞ Page 377 Logging function

■Buffer memory address

The following shows the buffer memory address of this area.

Buffer memory name	CH1	CH2	CH3	CH4	CH5	CH6	CH7	CH8
CH□ Number of logging data	436	636	836	1036	1236	1436	1636	1836
CH□ Number of logging data (in FX2N allocation mode function)	9051	9052	9053	9054	9055	9056	9057	9058

Point

When 'CH1 Logging hold request' (Un\G471) is turned on→off, 'CH1 Number of logging data' (Un\G436) is cleared to 0.

A

CH1 Trigger pointer

In CH1 Logging data (Un\G10000 to Un\G19999), the buffer memory address where the data at the time of a hold trigger event is stored can be checked.

The difference between the buffer memory address where the data at the time of a hold trigger event is stored and the start address in CH1 Logging data (Un\G10000 to Un\G19999) is stored.

For details on the logging function, refer to the following.

 Page 377 Logging function

■Buffer memory address

The following shows the buffer memory address of this area.

Buffer memory name	CH1	CH2	CH3	CH4	CH5	CH6	CH7	CH8
CH□ Trigger pointer	437	637	837	1037	1237	1437	1637	1837
CH□ Trigger pointer (In FX2N allocation mode function)	9061	9062	9063	9064	9065	9066	9067	9068

Point

When 'CH1 Logging hold request' (Un\G471) is turned on→off, 'CH1 Trigger pointer' (Un\G437) is cleared to 0.

CH1 Logging cycle monitor value

This area stores the actual logging cycle which is calculated from the refreshing cycle of data to be logged.

When 'Operating condition setting request' (Un\G70, b9) is turned off→on→off, the actual logging cycle is stored in Logging cycle monitor value in the corresponding channel where the logging function is enabled.

For details on the logging function, refer to the following.

 Page 377 Logging function

The following values are stored in 'CH1 Logging cycle monitor value' (Un\G441 to Un\G442).

	b15	to	b0
'CH1 Logging cycle monitor value (s)' (Un\G441)	s		
'CH1 Logging cycle monitor value (ms)' (Un\G442)	ms		

■Buffer memory address

The following shows the buffer memory address of this area.

Buffer memory name	CH1	CH2	CH3	CH4	CH5	CH6	CH7	CH8
CH□ Logging cycle monitor value (s)	441	641	841	1041	1241	1441	1641	1841
CH□ Logging cycle monitor value (ms)	442	642	842	1042	1242	1442	1642	1842
CH□ Logging cycle monitor value (s) (In FX2N allocation mode function)	9071	9074	9077	9080	9083	9086	9089	9092
CH□ Logging cycle monitor value (ms) (In FX2N allocation mode function)	9072	9075	9078	9081	9084	9087	9090	9093

CH1 Trigger generation time

The time when a trigger is generated is recorded.

For details on the logging function, refer to the following.

 Page 377 Logging function

	b15	to	b8 b7	to	b0
'CH1 Trigger generation time (First/Last two digits of the year)' (Un\G444)	First two digits of the year		Last two digits of the year		
'CH1 Trigger generation time (Month/Day)' (Un\G445)	Month			Day	
'CH1 Trigger generation time (Hour/Minute)' (Un\G446)	Hour			Minute	
'CH1 Trigger generation time (Second/Day of the week)' (Un\G447)	Second			Day of the week	
'CH1 Trigger generation time (Millisecond)' (Un\G448)	Millisecond (higher-order digits)			Millisecond (lower-order digits)	

Item	Storage contents	Storage example*1
First two digits of the year/Last two digits of the year	Stored in BCD code.	2017H
Month/Day		0130H
Hour/Minute		1035H
Second		40H
Day of the week	One of the following values is stored in BCD code. Sunday: 0, Monday: 1, Tuesday: 2, Wednesday: 3, Thursday: 4, Friday: 5, Saturday: 6	1H
Millisecond (upper)	Stored in BCD code.	06H
Millisecond (lower)		28H

*1 These values assume that a trigger is generated at 10:35 and 40.628 seconds on Monday, January 30th, 2017.

■ Buffer memory address

The following shows the buffer memory address of this area.

Buffer memory name	CH1	CH2	CH3	CH4	CH5	CH6	CH7	CH8
CH□ Trigger generation time (First/Last two digits of the year)	444	644	844	1044	1244	1444	1644	1844
CH□ Trigger generation time (Month/Day)	445	645	845	1045	1245	1445	1645	1845
CH□ Trigger generation time (Hour/Minute)	446	646	846	1046	1246	1446	1646	1846
CH□ Trigger generation time (Second/Day of the week)	447	647	847	1047	1247	1447	1647	1847
CH□ Trigger generation time (Millisecond)	448	648	848	1048	1248	1448	1648	1848
CH□ Trigger generation time (First/Last two digits of the year) (In FX2N allocation mode function)	9101	9106	9111	9116	9121	9126	9131	9136
CH□ Trigger generation time (Month/Day) (In FX2N allocation mode function)	9102	9107	9112	9117	9122	9127	9132	9137
CH□ Trigger generation time (Hour/Minute) (In FX2N allocation mode function)	9103	9108	9113	9118	9123	9128	9133	9138
CH□ Trigger generation time (Second/Day of the week) (in FX2N allocation mode function)	9104	9109	9114	9119	9124	9129	9134	9139
CH□ Trigger generation time (Millisecond) (in FX2N allocation mode function)	9105	9110	9115	9120	9125	9130	9135	9140

Point

- Time units shorter than one millisecond are not recorded.
- When 'CH1 Logging hold request' (Un\G471) is turned on→off, 'CH1 Trigger generation time' (Un\G444 to Un\G448) is cleared to 0.

CH1 Celsius/Fahrenheit display monitor

A status of Celsius/Fahrenheit display in operation is stored.

Monitor value	Setting content
0	Celsius
1	Fahrenheit

■Buffer memory address

The following shows the buffer memory address of this area.

Buffer memory name	CH1	CH2	CH3	CH4	CH5	CH6	CH7	CH8
CH□ Celsius/Fahrenheit display monitor	452	652	852	1052	1252	1452	1652	1852
CH□ Celsius/Fahrenheit display monitor (In FX2N allocation mode function)	1051	1052	1053	1054	1055	1056	1057	1058



Celsius (0) is displayed for a conversion disabled channel regardless of the 'CH1 Celsius/Fahrenheit display setting' (Un\G547).

CH1 Now Setting user range base input type monitor

This area is used to check the input type of user range setting that is registered in offset/gain setting mode.

Monitor value	Setting content
1	Current
2	Voltage
3	Resistance temperature detector
4	Thermocouple

■Buffer memory address

The following shows the buffer memory address of this area.

Buffer memory name	CH1	CH2	CH3	CH4	CH5	CH6	CH7	CH8
CH□ Now Setting user range base input type monitor	453	653	853	1053	1253	1453	1653	1853

CH1 Now Setting user range base input type monitor [FX2N allocation mode]

This area is used to check the input type of user range setting that is registered in offset/gain setting mode in FX2N allocation mode.

Monitor value	Setting content
1	Current
2	Voltage
4	Thermocouple

■Buffer memory address

The following shows the buffer memory address of this area.

Buffer memory name	CH1	CH2	CH3	CH4	CH5	CH6	CH7	CH8
CH□ Now Setting user range base input type monitor (In FX2N allocation mode function)	1061	1062	1063	1064	1065	1066	1067	1068

CH1 NowSetting user range base input range monitor

This area is used to check the input range of user range setting that is registered in the offset/gain setting mode. When the input type is current, and voltage, 0000H is stored.

Monitor value	Setting content
■Case of resistance temperature detector	
0014H	Pt100
0015H	Ni100
■Case of thermocouple	
0016H	B
0017H	R
0018H	S
0009H	K
000AH	J
000BH	T

■Buffer memory address

The following shows the buffer memory address of this area.

Buffer memory name	CH1	CH2	CH3	CH4	CH5	CH6	CH7	CH8
CH□ NowSetting user range base input range monitor	454	654	854	1054	1254	1454	1654	1854

CH1 NowSetting user range base input range monitor [FX2N allocation mode]

This area is used to check the input range of user range setting that is registered in offset/gain setting mode in FX2N allocation mode.

When the input type is current, and voltage, 0 is stored.

Monitor value	Setting content
0009H	K
000AH	J
000BH	T

■Buffer memory address

The following shows the buffer memory address of this area.

Buffer memory name	CH1	CH2	CH3	CH4	CH5	CH6	CH7	CH8
CH□ NowSetting user range base input range monitor (In FX2N allocation mode function)	1071	1072	1073	1074	1075	1076	1077	1078

CH1 Logging hold request

Use this buffer memory area as a trigger to hold (stop) logging at any timing during the logging.

For details on the logging function, refer to the following.

☞ Page 377 Logging function

Logging hold request	Setting value
OFF	0
ON	1

Setting a value other than the above causes a logging hold request range error (error code: 1D7□H).

When 'CH1 Logging enable/disable setting' (Un\G535) is set to Disable (1), the setting for 'CH1 Logging hold request' (Un\G471) is ignored.

■Buffer memory address

The following shows the buffer memory address of this area.

Buffer memory name	CH1	CH2	CH3	CH4	CH5	CH6	CH7	CH8
CH□ Logging hold request	471	671	871	1071	1271	1471	1671	1871
CH□ Logging hold request (In FX2N allocation mode function)	9151	9152	9153	9154	9155	9156	9157	9158

■Operation of the logging hold processing

- When Disable (0) is set to 'CH1 Level trigger condition setting' (Un\G540), the logging hold processing starts by turning off→on 'CH1 Logging hold request' (Un\G471).
- When a value other than Disable (0) is set to 'CH1 Level trigger condition setting' (Un\G540), the logging hold processing starts after 'CH1 Logging hold request' (Un\G471) is turned off→on and the set level trigger condition is satisfied. When the level trigger is enabled, use this buffer memory area as an interlock condition to operate the level trigger.
- If 'CH1 Logging hold request' (Un\G471) is turned on→off during the logging hold processing, the hold (stop) status is cleared and the logging restarts.

■Default value

The default value is off (0).



The stop status of the logging can be checked with 'CH1 Logging hold flag' (Un\G409).

CH1 Conversion value shift amount

Set 'CH1 Conversion value shift amount' (Un\G472) used for the shift function.

The digital operation value to which the conversion value shift amount is applied is stored in 'CH1 Digital operation value' (Un\G402).

For details on the shift function, refer to the following.

☞ Page 354 Shift function

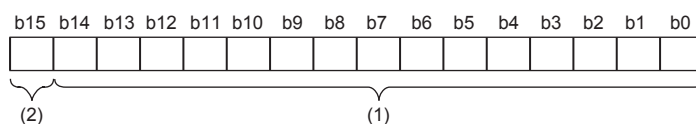

(1) Data section

(2) Sign bit 0: Positive, 1: Negative

■Buffer memory address

The following shows the buffer memory address of this area.

Buffer memory name	CH1	CH2	CH3	CH4	CH5	CH6	CH7	CH8
CH□ Conversion value shift amount	472	672	872	1072	1272	1472	1672	1872
CH□ Conversion value shift amount (In FX2N allocation mode function)	61	62	63	64	65	66	67	68

■Setting range

The possible setting range is from -32768 to +32767.

■Enabling the setting

The set value is added to the CH1 Digital operation value regardless of the OFF→ON→OFF status of 'Operating condition setting request' (Un\G70, b9).

■Default value

The default value is set to 0.

CH1 Maximum value reset request

When resetting the maximum value, and updating with the current value, turn off→on.

■Buffer memory address

The following shows the buffer memory address of this area.

Buffer memory name	CH1	CH2	CH3	CH4	CH5	CH6	CH7	CH8
CH□ Maximum value reset request	473	673	873	1073	1273	1473	1673	1873

■Enabling the setting

When 'CH1 Maximum value reset request' (Un\G473) turns off→on, 'CH1 Maximum value' (Un\G404) is reset regardless of turning off→on→off of 'Operating condition setting request' (Un\G70, b9), and updated with the current value.

■Default value

The default value is off (0).

Maximum value reset request [FX2N allocation mode]

When resetting the maximum value, and updating with the current value in FX2N allocation mode, turn off→on.

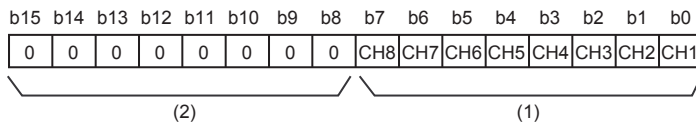

(1) 0: No reset request, 1: Reset request

(2) The values of b8 to b15 are fixed to 0.

■Buffer memory address

The following shows the buffer memory address of this area.

Buffer memory name	CH1	CH2	CH3	CH4	CH5	CH6	CH7	CH8
Maximum value reset request (In FX2N allocation mode function)	119							

■Enabling the setting

When 'Maximum value reset request' (Un\G119) turns off→on, 'CH1 Maximum value' (Un\G111) is reset regardless of turning off→on→off of 'Operating condition setting request' (Un\G70, b9), and updated with the current value.

■Default value

The default value is off (0).

CH1 Minimum value reset request

When resetting the minimum value, and updating with the current value, turn off→on.

■Buffer memory address

The following shows the buffer memory address of this area.

Buffer memory name	CH1	CH2	CH3	CH4	CH5	CH6	CH7	CH8
CH□ Minimum value reset request	474	674	874	1074	1274	1474	1674	1874

■Enabling the setting

When 'CH1 Minimum value reset request' (Un\G474) turns off→on, 'CH1 Minimum value' (Un\G406) is reset regardless of turning off→on→off of 'Operating condition setting request' (Un\G70, b9), and updated with the current value.

■Default value

The default value is off (0).

Minimum value reset request [In FX2N allocation mode]

When resetting the minimum value, and updating with the current value in FX2N allocation mode, turn off→on.

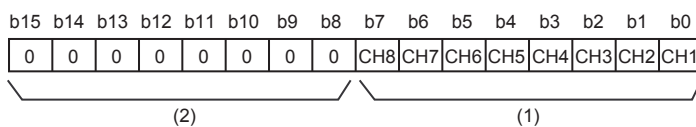

(1) 0: No reset request, 1: Reset request

(2) The values of b8 to b15 are fixed to 0.

■Buffer memory address

The following shows the buffer memory address of this area.

Buffer memory name	CH1	CH2	CH3	CH4	CH5	CH6	CH7	CH8
Minimum value reset request [In FX2N allocation mode function]	109							

■Enabling the setting

When 'Minimum value reset request' (Un\G109) turns off→on, 'CH1 Minimum value' (Un\G101) is reset regardless of turning off→on→off of 'Operating condition setting request' (Un\G70, b9), and updated with the current value.

■Default value

The default value is off (0).

CH1 Average processing specification

Set which processing is to be used, sampling processing or averaging processing.

Averaging processing consists of time average, count average, and moving average.

Setting value	Setting content
0	Sampling processing
1	Time average
2	Count average
3	Moving average

Setting a value other than the above causes an averaging process specification setting range error (error code: 191□H).

■Buffer memory address

The following shows the buffer memory address of this area.

Buffer memory name	CH1	CH2	CH3	CH4	CH5	CH6	CH7	CH8
CH□ Averaging process specification	501	701	901	1101	1301	1501	1701	1901
CH□ Averaging process specification (In FX2N allocation mode function)	1081	1082	1083	1084	1085	1086	1087	1088

■Enabling the setting

Turn off→on→off 'Operating condition setting request' (Un\G70, b9) to enable the setting.

■Default value

The default value is Sampling processing (0).

CH1 Time Average/Count Average/Moving Average

Configure the time (for averaging), count (for averaging), and moving average count for each channel where the averaging processing is specified.

The following table lists the setting ranges.

Setting content	Setting value
Time average	When the input type is current, and voltage: 4 to 10000 (ms) When the input type is resistance temperature detector, and thermocouple: 160 to 10000 (ms)
Count average	4 to 10000 (times)
Moving average	2 to 1000 (times)

Point

Setting a value other than the above causes any of time average setting range error (error code: 192□H), count average setting range error (error code: 193□H), moving count setting range error (error code: 194□H), and the conversion processing is executed with the setting before error.

■Buffer memory address

The following shows the buffer memory address of this area.

Buffer memory name	CH1	CH2	CH3	CH4	CH5	CH6	CH7	CH8
CH□ Time Average/Count Average/Moving Average setting	502	702	902	1102	1302	1502	1702	1902
CH□ Time average/Count average/Moving average setting (In FX2N allocation mode function)	2	3	4	5	6	7	8	9

■Enabling the setting

Turn off→on→off 'Operating condition setting request' (Un\G70, b9) to enable the setting.

■Default value

The default value is set to 0.



- Since the default value is 0, change the setting value according to the processing method.
- The setting for this area is ignored in the channel where Sampling processing (0) is set to 'CH1 Averaging process specification' (Un\G501).

CH1 Scaling enable/disable setting

Set whether to enable or disable the scaling.

Setting value	Setting content
0	Enable
1	Disable

Setting a value other than the above causes a scaling enable/disable setting range error (error code: 1A0□H).

■Buffer memory address

The following shows the buffer memory address of this area.

Buffer memory name	CH1	CH2	CH3	CH4	CH5	CH6	CH7	CH8
CH□ Scaling enable/disable setting	504	704	904	1104	1304	1504	1704	1904
CH□ Scaling enable/disable setting (In FX2N allocation mode function)	1091	1092	1093	1094	1095	1096	1097	1098

■Enabling the setting

Turn off→on→off 'Operating condition setting request' (Un\G70, b9) to enable the setting.

■Default value

The default value is Disable (1).

CH1 Scaling upper limit value

Set an upper limit value for the range of the scale conversion.

■Buffer memory address

The following shows the buffer memory address of this area.

Buffer memory name	CH1	CH2	CH3	CH4	CH5	CH6	CH7	CH8
CH□ Scaling upper limit value	506	706	906	1106	1306	1506	1706	1906
CH□ Scaling upper limit value (In FX2N allocation mode function)	1101	1103	1105	1107	1109	1111	1113	1115

■Setting range

The possible setting range is from -32000 to +32000.

Setting a value out of the range causes a scaling setting range error (error code: 1A1□H).

In the channel where a set value does not satisfy the condition "the scaling upper limit value ≠ the scaling lower limit value", a scaling upper/lower limit value setting error (error code: 1A2□H) occurs.

When 'CH1 Scaling enable/disable setting' (Un\G504) is set to Disable (1), the setting for 'CH1 Scaling upper limit value' (Un\G506) is ignored.

■Enabling the setting

Turn off→on→off 'Operating condition setting request' (Un\G70, b9) to enable the setting.

■Default value

The default value is set to 0.

CH1 Scaling lower limit value

Set a lower limit value for the range of the scale conversion.

■Buffer memory address

The following shows the buffer memory address of this area.

Buffer memory name	CH1	CH2	CH3	CH4	CH5	CH6	CH7	CH8
CH□ Scaling lower limit value	508	708	908	1108	1308	1508	1708	1908
CH□ Scaling lower limit value (In FX2N allocation mode function)	1121	1123	1125	1127	1129	1131	1133	1135

■Setting range

The possible setting range is from -32000 to +32000.

Setting a value out of the range causes a scaling setting range error (error code: 1A1□H).

In the channel where a set value does not satisfy the condition "the scaling upper limit value ≠ the scaling lower limit value", a scaling upper/lower limit value setting error (error code: 1A2□H) occurs.

When 'CH1 Scaling enable/disable setting' (Un\G504) is set to Disable (1), the setting for 'CH1 Scaling lower limit value' (Un\G508) is ignored.

■Enabling the setting

Turn off→on→off 'Operating condition setting request' (Un\G70, b9) to enable the setting.

■Default value

The default value is set to 0.

CH1 Digital clipping enable/disable setting

Set whether to enable or disable the digital clipping function.

For details on the digital clipping function, refer to the following.

☞ Page 357 Digital clipping function

Setting value	Setting content
0	Enable
1	Disable

If a value other than the above is set, a digital clipping enable/disable setting range error (error code: 1A5□H) occurs.

■Buffer memory address

The following shows the buffer memory address of this area.

Buffer memory name	CH1	CH2	CH3	CH4	CH5	CH6	CH7	CH8
CH□ Digital clipping enable/disable setting	510	710	910	1110	1310	1510	1710	1910
CH□ Digital clipping enable/disable setting (In FX2N allocation mode function)	1141	1142	1143	1144	1145	1146	1147	1148

■Enabling the setting

Turn off→on→off 'Operating condition setting request' (Un\G70, b9) to enable the setting.

■Default value

The default value is Disable (1).

CH1 Warning output function (Process alarm)

Set whether to enable or disable the alert output of the process alarm.

For details on the alert output function, refer to the following.

 Page 360 Alert output function

Setting value	Setting content
0	Enable
1	Disable

Setting a value other than the above causes an alert output setting (Process alarm) range error (error code: 1B0□H).

■Buffer memory address

The following shows the buffer memory address of this area.

Buffer memory name	CH1	CH2	CH3	CH4	CH5	CH6	CH7	CH8
CH□ Alert output setting (Process alarm)	512	712	912	1112	1312	1512	1712	1912
CH□ Alert output setting (Process alarm) (In FX2N allocation mode function)	1181	1182	1183	1184	1185	1186	1187	1188

■Enabling the setting

Turn off→on→off 'Operating condition setting request' (Un\G70, b9) to enable the setting.

■Default value

The default value is Disable (1).

CH1 Warning output setting (Rate alarm)

Set whether to enable or disable the alert output of the rate alarm.

For details on the alert output function, refer to the following.

 Page 360 Alert output function

Setting value	Setting content
0	Enable
1	Disable

Setting a value other than the above causes an alert output setting (Rate alarm) range error (error code: 1B8□H).

■Buffer memory address

The following shows the buffer memory address of this area.

Buffer memory name	CH1	CH2	CH3	CH4	CH5	CH6	CH7	CH8
CH□ Alert output setting (Rate alarm)	513	713	913	1113	1313	1513	1713	1913
CH□ Alert output setting (Rate alarm) (in FX2N allocation mode function)	1211	1212	1213	1214	1215	1216	1217	1218

■Enabling the setting

Turn off→on→off 'Operating condition setting request' (Un\G70, b9) to enable the setting.

■Default value

The default value is Disable (1).

CH1 Process alarm upper upper limit value

Set an upper upper limit value of the alert output function (Process alarm).

For details on the alert output function, refer to the following.

 Page 360 Alert output function

■Buffer memory address

The following shows the buffer memory address of this area.

Buffer memory name	CH1	CH2	CH3	CH4	CH5	CH6	CH7	CH8
CH□ Process alarm upper upper limit value	514	714	914	1114	1314	1514	1714	1914
CH□ Process alarm upper upper limit value (in FX2N allocation mode function)	81	82	83	84	85	86	87	88

■Setting range

The possible setting range is from -32768 to +32767.

■Enabling the setting

Turn off→on→off 'Operating condition setting request' (Un\G70, b9) to enable the setting.

■Default value

The default value is set to 0.

CH1 Process alarm upper lower limit value

Set an upper lower limit value of the alert output function (Process alarm).

For details on the alert output function, refer to the following.

 Page 360 Alert output function

■Buffer memory address

The following shows the buffer memory address of this area.

Buffer memory name	CH1	CH2	CH3	CH4	CH5	CH6	CH7	CH8
CH□ Process alarm upper lower limit value	516	716	916	1116	1316	1516	1716	1916
CH□ Process alarm upper lower limit value (in FX2N allocation mode function)	1191	1192	1193	1194	1195	1196	1197	1198

■Setting range

The possible setting range is from -32768 to +32767.

■Enabling the setting

Turn off→on→off 'Operating condition setting request' (Un\G70, b9) to enable the setting.

■Default value

The default value is set to 0.

CH1 Process alarm lower upper limit value

Set a lower upper limit value of the alert output function (Process alarm).

For details on the alert output function, refer to the following.

 Page 360 Alert output function

■Buffer memory address

The following shows the buffer memory address of this area.

Buffer memory name	CH1	CH2	CH3	CH4	CH5	CH6	CH7	CH8
CH□ Process alarm lower upper limit value	518	718	918	1118	1318	1518	1718	1918
CH□ Process alarm lower upper limit value (in FX2N allocation mode function)	1201	1202	1203	1204	1205	1206	1207	1208

■Setting range

The possible setting range is from -32768 to +32767.

■Enabling the setting

Turn off→on→off 'Operating condition setting request' (Un\G70, b9) to enable the setting.

■Default value

The default value is set to 0.

CH1 Process alarm lower lower limit value

Set a lower lower limit value of the alert output function (Process alarm).

For details on the alert output function, refer to the following.

 Page 360 Alert output function

■Buffer memory address

The following shows the buffer memory address of this area.

Buffer memory name	CH1	CH2	CH3	CH4	CH5	CH6	CH7	CH8
CH□ Process alarm lower lower limit value	520	720	920	1120	1320	1520	1720	1920
CH□ Process alarm lower lower limit value (In FX2N allocation mode function)	71	72	73	74	75	76	77	78

■Setting range

The possible setting range is from -32768 to +32767.

■Enabling the setting

Turn off→on→off 'Operating condition setting request' (Un\G70, b9) to enable the setting.

■Default value

The default value is set to 0.

Point

- When using the process alarm, configure the 4-step settings for the process alarm upper upper limit value, upper lower limit value, lower upper limit value, and lower lower limit value.
- A channel where the set values do not satisfy the condition "Upper upper limit value \geq Upper lower limit value \geq Lower upper limit value \geq Lower lower limit value" causes a process alarm upper lower limit value setting range error (error code: 1B△□H).
- When setting the input type to "Current" and "Voltage", and when the digital clipping function, scaling function, and shift function are used, the digital operation value to which digital clipping, scale conversion, and shift-and-add are performed is the detection target for outputting an alert.
- When setting the input type to "resistance temperature detector" or "thermocouple", and the scaling function and shift function are used, the digital operation value to which scale conversion, and shift-and-add are performed is the target of outputting an alert (process alarm).

CH1 Rate alarm alert detection cycle setting

Set the cycle to detect the change amount of digital output values.

The value of the cycle to detect a rate alarm alert is the product of the value in 'CH1 Rate alarm alert detection cycle setting' (Un\G522) and the conversion cycle.

■Buffer memory address

The following shows the buffer memory address of this area.

Buffer memory name	CH1	CH2	CH3	CH4	CH5	CH6	CH7	CH8
CH□ Rate alarm alert detection cycle setting	522	722	922	1122	1322	1522	1722	1922
CH□ Rate alarm alert detection cycle setting (In FX2N allocation mode function)	1221	1222	1223	1224	1225	1226	1227	1228

■Setting range

The possible setting range is from 1 to 32000 (times).

■Enabling the setting

Turn off→on→off 'Operating condition setting request' (Un\G70, b9) to enable the setting.

■Default value

The default value is set to 0.

Point

- A channel where the set value is out of the range causes a rate alarm detection cycle setting range error (error code: 1B9□H).
- Since the default value is 0, change the setting value when setting the rate alarm function.

CH1 Rate alarm upper limit value

Set an upper limit value of the change rate of digital operation values to detect a rate alarm.

For details on the alert output function, refer to the following.

☞ Page 360 Alert output function

■Buffer memory address

The following shows the buffer memory address of this area.

Buffer memory name	CH1	CH2	CH3	CH4	CH5	CH6	CH7	CH8
CH□ Rate alarm upper limit value	524	724	924	1124	1324	1524	1724	1924
CH□ Rate alarm upper limit value (In FX2N allocation mode function)	91	92	93	94	95	96	97	98

■Setting range

The possible setting range is from -32768 to +32767.

Unit of the setting value differs depending on the setting of 'Rate alarm change rate selection' (Un\G299).

Rate alarm change rate selection (Un\G299)	Unit
Rate specification (0)	0.1%
Digital output value specification (1)	digit

■Enabling the setting

Turn off→on→off 'Operating condition setting request' (Un\G70, b9) to enable the setting.

■Default value

The default value is set to 0.

CH1 Rate alarm lower limit value

Set a lower limit value of the change rate of digital operation values to detect a rate alarm.

For details on the alert output function, refer to the following.

 Page 360 Alert output function

■Buffer memory address

The following shows the buffer memory address of this area.

Buffer memory name	CH1	CH2	CH3	CH4	CH5	CH6	CH7	CH8
CH□ Rate alarm lower limit value	526	726	926	1126	1326	1526	1726	1926
CH□ Rate alarm lower limit value (In FX2N allocation mode function)	1231	1232	1233	1234	1235	1236	1237	1238

■Setting range

The possible setting range is from -32768 to +32767.

Unit of the setting value differs depending on the setting of 'Rate alarm change rate selection' (Un\G299).

Rate alarm change rate selection (Un\G299)	Unit
Rate specification (0)	0.1%
Digital output value specification (1)	digit

■Enabling the setting

Turn off→on→off 'Operating condition setting request' (Un\G70, b9) to enable the setting.

■Default value

The default value is set to 0.

Point

- When using the rate alarm, configure the 2-step settings for the rate alarm upper limit value and lower limit value.
- A channel where the set values satisfy the condition "Rate alarm lower limit value \geq Rate alarm upper limit value" causes a rate alarm upper/lower limit setting value inversion error (error code: 1BA□H).
- Since the default value is 0, change the setting value.

A

CH1 Input signal error detection setting

Set a condition for detecting an input signal error.

For details on the input signal error detection function, refer to the following.

 Page 367 Input signal error detection function

Setting value	Setting content
0	Disable
1	Upper and lower limit detection
2	Lower limit detection
3	Upper limit detection
4	Simple disconnection detection

If a value other than the above is set, an input signal error detection setting range error (error code: 1C0□H) occurs.

When the 'CH1 Input type/range setting' (Un\G598) is set to resistance temperature detector or thermocouple, the setting of 'CH1 Input signal error detection setting' (Un\G528) is ignored.

■Buffer memory address

The following shows the buffer memory address of this area.

Buffer memory name	CH1	CH2	CH3	CH4	CH5	CH6	CH7	CH8
CH□ Input signal error detection setting	528	728	928	1128	1328	1528	1728	1928
CH□ Input signal error detection setting (In FX2N allocation mode function)	1151	1152	1153	1154	1155	1156	1157	1158

■Enabling the setting

Turn off→on→off 'Operating condition setting request' (Un\G70, b9) to enable the setting.

■Default value

The default value is Disable (0).

CH1 Input signal error detection lower limit setting value

Set a lower limit value to detect an error for the input analog value.

For details on the input signal error detection function, refer to the following.

☞ Page 367 Input signal error detection function

■Buffer memory address

The following shows the buffer memory address of this area.

Buffer memory name	CH1	CH2	CH3	CH4	CH5	CH6	CH7	CH8
CH□ Input signal error detection lower limit setting value	529	729	929	1129	1329	1529	1729	1929
CH□ Input signal error detection lower limit setting value (In FX2N allocation mode function)	1161	1162	1163	1164	1165	1166	1167	1168

■Setting range

The possible setting range is from 0 to 250 (0 to 25.0%). (Set it in a unit of 0.1%)

If a value other than the above is set, an input signal error detection setting range error (error code: 1C1□H) occurs.

When the 'CH1 Input type/range setting' (Un\G598) is set to resistance temperature detector or thermocouple, the setting of 'CH1 Input signal error detection lower limit setting value' (Un\G529) is ignored.

The input signal error detection lower limit value is calculated by using 'Input signal error detection lower limit setting value' (Un\G529) as follows. The input signal error detection lower limit value to be calculated varies depending on the input range used.

Input signal error detection lower limit value = Lower limit value of each range - (Gain value of each range - Offset value of each range) × (Input signal error detection lower limit setting value/1000)

Ex.

When 'CH1 Input signal error detection lower limit setting value' (Un\G529) is set to 100 (10%)

Range used: 4 to 20 mA

The input signal error detection lower limit value is calculated as follows:

$$\text{Input signal error detection lower limit value} = 4 - (20 - 4) \times \frac{100}{1000} = 2.4 \text{ mA}$$

Detection conditions vary depending on the setting of 'CH1 Input signal error detection setting' (Un\G528) as follows:

- When 'CH1 Input signal error detection setting' (Un\G528) is set to Upper and lower limit detection (1), the detection is performed with both the input signal error detection upper limit value and the input signal error detection lower limit value.
- When 'CH1 Input signal error detection setting' (Un\G528) is set to Lower limit detection (2), the detection is performed only with the input signal error detection lower limit value.
- When 'CH1 Input signal error detection setting' (Un\G528) is set to Upper limit detection (3), the value set in this area is ignored.
- When 'CH1 Input signal error detection setting' (Un\G528) is set to Simple disconnection detection (4), the value set in this area is ignored.

■Enabling the setting

Turn off→on→off 'Operating condition setting request' (Un\G70, b9) to enable the setting.

■Default value

The default value is set to 50.

CH1 Input signal error detection upper limit setting value

Set an upper limit value to detect an error for the input analog value.

For details on the input signal error detection function, refer to the following.

 Page 367 Input signal error detection function

■Buffer memory address

The following shows the buffer memory address of this area.

Buffer memory name	CH1	CH2	CH3	CH4	CH5	CH6	CH7	CH8
CH□ Input signal error detection upper limit setting value	530	730	930	1130	1330	1530	1730	1930
CH□ Input signal error detection upper limit setting value (In FX2N allocation mode function)	1171	1172	1173	1174	1175	1176	1177	1178

■Setting range

The possible setting range is from 0 to 250 (0 to 25.0%). (Set it in a unit of 0.1%)

If a value other than the above is set, an input signal error detection setting range error (error code: 1C1□H) occurs.

When the 'CH1 Input type/range setting' (Un\G598) is set to resistance temperature detector or thermocouple, the setting of 'CH1 Input signal error detection lower limit setting value' (Un\G529) is ignored.

The input signal error detection upper limit value is calculated by using 'Input signal error detection upper limit setting value' (Un\G530) as follows. The input signal error detection upper limit value to be calculated varies depending on the input range used.

Input signal error detection upper limit value = Gain value of each range + (Gain value of each range - Offset value of each range) × (Input signal error detection upper limit setting value/1000)

Ex.

When 'CH1 Input signal error detection upper limit setting value' (Un\G530) is set to 100 (10%)

Range used: 4 to 20 mA

The input signal error detection upper limit value is calculated as follows:

$$\text{Input signal error detection upper limit value} = 20 + (20 - 4) \times \frac{100}{1000} = 21.6 \text{ mA}$$

Detection conditions vary depending on the setting of 'CH1 Input signal error detection setting' (Un\G528) as follows:

- When 'CH1 Input signal error detection setting' (Un\G528) is set to Upper and lower limit detection (1), the detection is performed with both the input signal error detection upper limit value and the input signal error detection lower limit value.
- When 'CH1 Input signal error detection setting' (Un\G528) is set to Lower limit detection (2), the value set in this area is ignored.
- When 'CH1 Input signal error detection setting' (Un\G528) is set to Upper limit detection (3), the detection is performed only with the input signal error detection upper limit value.
- When 'CH1 Input signal error detection setting' (Un\G528) is set to Simple disconnection detection (4), the value set in this area is ignored.

■Enabling the setting

Turn off→on→off 'Operating condition setting request' (Un\G70, b9) to enable the setting.

■Default value

The default value is set to 50.

CH1 Disconnection detection enable/disable setting

Set whether to enable or disable the disconnection detection function.

For details on the disconnection detection function, refer to the following.

☞ Page 374 Disconnection detection function

Setting value	Setting content
0	Enable
1	Disable

Setting a value other than the above causes a disconnection detection enable/disable setting range error (error code: 1C5□H).

When the 'CH1 Input type/range setting' (Un\G598) is set to current or voltage, the setting of 'CH1 Disconnection detection enable/disable setting' (Un\G531) is ignored.

■Buffer memory address

The following shows the buffer memory address of this area.

Buffer memory name	CH1	CH2	CH3	CH4	CH5	CH6	CH7	CH8
CH□ Disconnection detection enable/disable setting	531	731	931	1131	1331	1531	1731	1931
CH□ Disconnection detection enable/disable setting (In Fx2N allocation mode function)	1241	1242	1243	1244	1245	1246	1247	1248

■Enabling the setting

Turn off→on→off 'Operating condition setting request' (Un\G70, b9) to enable the setting.

■Default value

The default value is Enable (0).

CH1 Conversion setting value at disconnection detection

When 'CH1 Conversion setting at disconnection detection' (Un\G534) is set to "Any value", the value set in this area is stored in 'CH1 Digital output value' (Un\G400) at the time of disconnection detection.

For details on the disconnection detection function, refer to the following.

☞ Page 374 Disconnection detection function

■Buffer memory address

The following shows the buffer memory address of this area.

Buffer memory name	CH1	CH2	CH3	CH4	CH5	CH6	CH7	CH8
CH□ Conversion setting value at disconnection detection	532	732	932	1132	1332	1532	1732	1932
CH□ Conversion setting value at disconnection detection (In FX2N allocation mode function)	1251	1253	1255	1257	1259	1261	1263	1265

■Setting range

The possible setting range is from -32768 to +32767 (-3276.8 to +3276.7°C). (can be set in a unit of 0.1°C)

■Enabling the setting

Turn off→on→off 'Operating condition setting request' (Un\G70, b9) to enable the setting.

■Default value

The default value is set to 0.

CH1 Conversion setting at disconnection detection

Set what value is to be stored in 'CH1 Digital output value' (Un\G400) at the time of disconnection detection.

For details on the disconnection detection function, refer to the following.

 Page 374 Disconnection detection function

Setting value	Setting content
0	Upscale
1	Downscale
2	Any value
3	Value just before disconnection

Setting a value other than the above results in operation with Downscale (1).

■Buffer memory address

The following shows the buffer memory address of this area.

Buffer memory name	CH1	CH2	CH3	CH4	CH5	CH6	CH7	CH8
CH□ Conversion setting at disconnection detection	534	734	934	1134	1334	1534	1734	1934
CH□ Conversion setting at disconnection detection (In FX2N allocation mode function)	1271	1272	1273	1274	1275	1276	1277	1278

■Enabling the setting

Turn off→on→off 'Operating condition setting request' (Un\G70, b9) to enable the setting.

■Default value

The default value is Downscale (1).

CH1 Logging enable/disable setting

Set whether to enable or disable the logging function.

For details on the logging function, refer to the following.

 Page 377 Logging function

Setting value	Setting content
0	Enable
1	Disable

Setting a value other than the above causes a logging enable/disable setting range error (error code: 1D0□H).

■Buffer memory address

The following shows the buffer memory address of this area.

Buffer memory name	CH1	CH2	CH3	CH4	CH5	CH6	CH7	CH8
CH□ Logging enable/disable setting	535	735	935	1135	1335	1535	1735	1935
CH□ Logging enable/disable setting (In FX2N allocation mode function)	9161	9162	9163	9164	9165	9166	9167	9168

■Enabling the setting

Turn off→on→off 'Operating condition setting request' (Un\G70, b9) to enable the setting.

■Default value

The default value is Disable (1).

CH1 Logging data setting

Determine the target to be collected: digital output value or digital operation value.

For details on the logging function, refer to the following.

 Page 377 Logging function

Setting value	Setting content
0	Digital output value
1	Digital operation value

Setting a value other than the above causes a logging data setting range error (error code: 1D3□H).

When 'CH1 Logging enable/disable setting' (Un\G535) is set to Disable (1), the setting for 'CH1 Logging data setting' (Un\G536) is ignored.

■Buffer memory address

The following shows the buffer memory address of this area.

Buffer memory name	CH1	CH2	CH3	CH4	CH5	CH6	CH7	CH8
CH□ Logging data setting	536	736	936	1136	1336	1536	1736	1936
CH□ Logging data setting (in FX2N allocation mode function)	9171	9172	9173	9174	9175	9176	9177	9178

■Enabling the setting

Turn off→on→off 'Operating condition setting request' (Un\G70, b9) to enable the setting.

■Default value

The default value is Digital operation value (1).

CH1 Logging cycle setting value

Set a cycle for storing the logging data.

For details on the logging function, refer to the following.

 Page 377 Logging function

■Buffer memory address

The following shows the buffer memory address of this area.

Buffer memory name	CH1	CH2	CH3	CH4	CH5	CH6	CH7	CH8
CH□ Logging cycle setting value	537	737	937	1137	1337	1537	1737	1937
CH□ Logging cycle setting value (In FX2N allocation mode function)	9181	9182	9183	9184	9185	9186	9187	9188

■Setting range

The setting range varies depending on the setting in 'CH1 Logging cycle unit setting' (Un\G538) and 'CH1 Input type/range setting' (Un\G598).

CH1 Logging cycle unit setting (Un\G538)	CH1 Input type/range setting (Un\G598)	Setting range
ms (1)	Current/Voltage	1 to 32767
	Resistance temperature detector/thermocouple	40 to 32767
s (2)		1 to 3600

- Setting a value out of the above range causes a logging cycle setting value range error (error code: 1D1□H). Logging cannot be performed.
- If the set logging cycle is below the update cycle of data to be logged, a logging cycle setting disable error (error code: 1D2□H) occurs. Logging cannot be performed.

■Enabling the setting

Turn off→on→off 'Operating condition setting request' (Un\G70, b9) to enable the setting.

■Default value

The default value is set to 1.

CH1 Logging cycle unit setting

Set a cycle unit for storing the logging data.

For details on the logging function, refer to the following.

 Page 377 Logging function

Setting value	Setting content
1	ms
2	s

- Setting a value other than the above causes a logging cycle setting value range error (error code: 1D1□H). Logging cannot be performed.
- If the set logging cycle is below the update cycle of data to be logged, a logging cycle setting disable error (error code: 1D2□H) occurs. Logging cannot be performed.

■Buffer memory address

The following shows the buffer memory address of this area.

Buffer memory name	CH1	CH2	CH3	CH4	CH5	CH6	CH7	CH8
CH□ Logging cycle unit setting	538	738	938	1138	1338	1538	1738	1938
CH□ Logging cycle unit setting (In FX2N allocation mode function)	9191	9192	9193	9194	9195	9196	9197	9198

■Enabling the setting

Turn off→on→off 'Operating condition setting request' (Un\G70, b9) to enable the setting.

■Default value

The default value is ms (1).

CH1 Logging points after trigger

Set a number of data points collected for the time period from the occurrence of a hold trigger to the logging stop.

For details on the logging function, refer to the following.

 Page 377 Logging function

■Buffer memory address

The following shows the buffer memory address of this area.

Buffer memory name	CH1	CH2	CH3	CH4	CH5	CH6	CH7	CH8
CH□ Post-trigger logging points	539	739	939	1139	1339	1539	1739	1939
CH□ Post-trigger logging points (In FX2N allocation mode function)	9201	9202	9203	9204	9205	9206	9207	9208

■Setting range

The possible setting range is from 1 to 10000.

Setting a value other than the above causes a post-trigger logging points setting range error (error code: 1D4□H). Logging cannot be performed.

When 'CH1 Logging enable/disable setting' (Un\G535) is set to Disable (1), the setting for 'CH1 Post-trigger logging points' (Un\G539) is ignored.

■Enabling the setting

Turn off→on→off 'Operating condition setting request' (Un\G70, b9) to enable the setting.

■Default value

The default value is set to 5000.

CH1 Level trigger condition setting

Set the condition for the occurrence of a hold trigger when using the level trigger in the logging function.

To use the level trigger, perform level trigger condition setting to one of Level trigger (Condition: Rise)(1), Level trigger (Condition: Fall)(2), or Level trigger (Condition: Rise and fall)(3).

For details on the logging function, refer to the following.

 Page 377 Logging function

Setting value	Setting content
0	Disable
1	Level trigger (Condition: Rise)
2	Level trigger (Condition: Fall)
3	Level trigger (Condition: Rise and Fall)

Setting a value other than the above causes a level trigger condition setting range error (error code: 1D5□H).

■Buffer memory address

The following shows the buffer memory address of this area.

Buffer memory name	CH1	CH2	CH3	CH4	CH5	CH6	CH7	CH8
CH□ Level trigger condition setting	540	740	940	1140	1340	1540	1740	1940
CH□ Level trigger condition setting (In FX2N allocation mode function)	9211	9212	9213	9214	9215	9216	9217	9218

■Enabling the setting

Turn off→on→off 'Operating condition setting request' (Un\G70, b9) to enable the setting.

■Default value

The default value is Disable (0).

CH1 Trigger data

Set a buffer memory address to be monitored using a level trigger.

Set the buffer memory address where the target data for monitoring is stored.

For details on the logging function, refer to the following.

 Page 377 Logging function

■Buffer memory address

The following shows the buffer memory address of this area.

Buffer memory name	CH1	CH2	CH3	CH4	CH5	CH6	CH7	CH8
CH□ Trigger data	541	741	941	1141	1341	1541	1741	1941
CH□ Trigger data (In FX2N allocation mode function)	9221	9222	9223	9224	9225	9226	9227	9228

■Setting range

The possible setting range is from 0 to 9999.

Setting a value other than the above causes a trigger data setting range error (error code: 1D6□H). Logging cannot be performed.

■Enabling the setting

Turn off→on→off 'Operating condition setting request' (Un\G70, b9) to enable the setting.

■Default value

The default values are set as shown below.

Channel	In the normal mode		In FX2N allocation function mode	
	Default value (Decimal)	Buffer memory area to be monitored	Default value (Decimal)	Buffer memory area to be monitored
CH1	402	CH1 Digital operation value (Un\G402)	10	CH1 Digital operation value (Un\G10)
CH2	602	CH2 Digital operation value (Un\G602)	11	CH2 Digital operation value (Un\G11)
CH3	802	CH3 Digital operation value (Un\G802)	12	CH3 Digital operation value (Un\G12)
CH4	1002	CH4 Digital operation value (Un\G1002)	13	CH4 Digital operation value (Un\G13)
CH5	1202	CH5 Digital operation value (Un\G1202)	14	CH5 Digital operation value (Un\G14)
CH6	1402	CH6 Digital operation value (Un\G1402)	15	CH6 Digital operation value (Un\G15)
CH7	1602	CH7 Digital operation value (Un\G1602)	16	CH7 Digital operation value (Un\G16)
CH8	1802	CH8 Digital operation value (Un\G1802)	17	CH8 Digital operation value (Un\G17)

CH1 Trigger setting value

Set a level to generate a level trigger.

For details on the logging function, refer to the following.

 Page 377 Logging function

■Buffer memory address

The following shows the buffer memory address of this area.

Buffer memory name	CH1	CH2	CH3	CH4	CH5	CH6	CH7	CH8
CH□ Trigger setting value	542	742	942	1142	1342	1542	1742	1942
CH□ Trigger setting value (In FX2N allocation mode function)	9231	9232	9233	9234	9235	9236	9237	9238

■Setting range

The possible setting range is from -32768 to +32767.

■Enabling the setting

Turn off→on→off 'Operating condition setting request' (Un\G70, b9) to enable the setting.

■Default value

The default value is set to 0.

CH1 Celsius/Fahrenheit display setting

Set the display method of 'Digital output value' (Un\G598) when 'CH1 Input type/range setting' (Un\G598) is resistance temperature detector or thermocouple.

Setting value	Setting content
0	Celsius
1	Fahrenheit

Setting a value other than the above causes a Celsius/Fahrenheit display setting range error (error code: 198□H).

■Buffer memory address

The following shows the buffer memory address of this area.

Buffer memory name	CH1	CH2	CH3	CH4	CH5	CH6	CH7	CH8
CH□ Celsius/Fahrenheit display setting	547	747	947	1147	1347	1547	1747	1947
CH□ Celsius/Fahrenheit display setting (In FX2N allocation mode function)	1281	1282	1283	1284	1285	1286	1287	1288

■Default value

The default value is Celsius (0).

CH1 Offset setting value

As Channel change request (Un\G70, b11) is turned off→on→off in offset/gain setting mode, the measured temperature value is corrected by a value written in this area.

Specify the value of a 16-bit signed binary number.

■Buffer memory address

The following shows the buffer memory address of this area.

Buffer memory name	CH1	CH2	CH3	CH4	CH5	CH6	CH7	CH8
CH□ Offset setting value	562	762	962	1162	1362	1562	1762	1962
CH□ Offset setting value (In FX2N allocation mode function)	1291	1292	1293	1294	1295	1296	1297	1298

■Setting range

Input type	Input range	Celsius/Fahrenheit display setting	Setting range
Resistance temperature detector	Pt100	Celsius	-2000 to +8500
		Fahrenheit	-3280 to +15620
	Ni100	Celsius	-600 to +2500
		Fahrenheit	-760 to +4820
Thermocouple*1	Thermocouple K	Celsius	-2700 to +13700
		Fahrenheit	-4540 to +24980
	Thermocouple J	Celsius	-2100 to +11300
		Fahrenheit	-3460 to +20660
	Thermocouple T	Celsius	-2700 to +4000
		Fahrenheit	-4540 to +7520
	Thermocouple B	Celsius	0 to 17100
		Fahrenheit	320 to 31100
	Thermocouple R	Celsius	-500 to +17100
		Fahrenheit	-580 to +31100
	Thermocouple S	Celsius	-500 to +17100
		Fahrenheit	-580 to +31100

*1 In the case of FX2N allocation mode, only thermocouple K, J and T are setting enabled.

Setting a value out of the range causes an offset/gain temperature setting value range error (error code: 1E□□H).

'CH1 Offset setting value' (Un\G562) and 'CH1 Gain setting value' (Un\G564) must be set to be within the following temperature input range:

- Offset setting value < Gain setting value

A channel where the set value is out of the above range causes an offset/gain temperature setting value setting error (error code: 1E9□H).

■Default value

The default value is set to 0.

Point

- An effective way to achieve high accuracy is to set up error correction in 'CH1 Offset setting value' (Un\G562) and 'CH1 Gain setting value' (Un\G564) assuming the minimum and maximum temperatures of the used range.
- Configure 'CH1 Offset setting value' (Un\G562) and 'CH1 Gain setting value' (Un\G564) while reading out digital output values.

CH1 Gain setting value

As Channel change request (Un\G70, b11) is turned off→on→off in offset/gain setting mode, the measured temperature value is corrected by a value written in this area.

Specify the value of a 16-bit signed binary number.

■Buffer memory address

The following shows the buffer memory address of this area.

Buffer memory name	CH1	CH2	CH3	CH4	CH5	CH6	CH7	CH8
CH□ Gain setting value	564	764	964	1164	1364	1564	1764	1964
CH□ Gain setting value (In FX2N allocation mode function)	1301	1302	1303	1304	1305	1306	1307	1308

■Setting range

Input type	Input range	Celsius/Fahrenheit display setting	Setting range
Resistance temperature detector	Pt100	Celsius	-2000 to +8500
		Fahrenheit	-3280 to +15620
	Ni100	Celsius	-600 to +2500
		Fahrenheit	-760 to +4820
Thermocouple*1	Thermocouple K	Celsius	-2700 to +13700
		Fahrenheit	-4540 to +24980
	Thermocouple J	Celsius	-2100 to +11300
		Fahrenheit	-3460 to +20660
	Thermocouple T	Celsius	-2700 to +4000
		Fahrenheit	-4540 to +7520
	Thermocouple B	Celsius	0 to 17100
		Fahrenheit	320 to 31100
	Thermocouple R	Celsius	-500 to +17100
		Fahrenheit	-580 to +31100
	Thermocouple S	Celsius	-500 to +17100
		Fahrenheit	-580 to +31100

*1 In the case of FX2N allocation mode, only thermocouple K, J and T are setting enabled.

Setting a value out of the range causes an offset/gain temperature setting value range error (error code: 1E□□H).

'CH1 Offset setting value' (Un\G562) and 'CH1 Gain setting value' (Un\G564) must be set to be within the following temperature input range:

- Offset setting value < Gain setting value

A channel where the set value is out of the above range causes an offset/gain temperature setting value setting error (error code: 1E9□H).

■Default value

The default value is set to 0.

Point

- An effective way to achieve high accuracy is to set up error correction in 'CH1 Offset setting value' (Un\G562) and 'CH1 Gain setting value' (Un\G564) assuming the minimum and maximum temperatures of the used range.
- Configure 'CH1 Offset setting value' (Un\G562) and 'CH1 Gain setting value' (Un\G564) while reading out digital output values.

CH1 Input type/range setting

This area is for setting an input type and range setting.

Setting value (Hexadecimal)	Input type	Input range
000FH	Conversion disable	—
0003H	Current	4 to 20 mA
0010H		0 to 20 mA
0006H		-20 to +20 mA
0011H	Voltage	1 to 5 V
0012H		0 to 5 V
0000H		-10 to +10 V
0013H		0 to 10 V
0014H	Resistance temperature detector	Pt100
0015H		Ni100
0016H	Thermocouple	Thermocouple B
0017H		Thermocouple R
0018H		Thermocouple S
0009H		Thermocouple K
000AH		Thermocouple J
000BH		Thermocouple T

A channel where the set value is other than the above causes an input type/range setting range error (error code: 190□H).

■Buffer memory address

The following shows the buffer memory address of this area.

Buffer memory name	CH1	CH2	CH3	CH4	CH5	CH6	CH7	CH8
CH□ Setting Input type/range	598	798	998	1198	1398	1598	1798	1998

■Enabling the setting

Turn off→on→off 'Operating condition setting request' (Un\G70, b9) to enable the setting.

■Default value

The default value is conversion disabled (000FH).

CH1 Input type/range setting [FX2N allocation mode]

When the FX2N allocation mode function is used, this area is for setting an input type and range setting.

CH1 to 4 input type/range setting (Un\G0)	b15 to b12	b11 to b8	b7 to b4	b3 to b0
	CH4	CH3	CH2	CH1

CH5 to 8 input type/range setting (Un\G1)	b15 to b12	b11 to b8	b7 to b4	b3 to b0
	CH8	CH7	CH6	CH5

Setting value (Hexadecimal)	Input type	Input range
0FH	Conversion disable	—
00H	Voltage	-10 to +10 V
01H		
02H		
03H		
04H	Current	4 to 20 mA
05H		
06H		
07H		
08H		-20 to +20 mA
09H		
0AH		
0BH		
0CH	Thermocouple	Thermocouple K
0DH		Thermocouple J
0EH		Thermocouple T
0FH		Thermocouple K
00H	Thermocouple	Thermocouple J
01H		Thermocouple T
02H		Thermocouple K
03H		Thermocouple J
04H	Thermocouple	Thermocouple T
05H		Thermocouple K
06H		Thermocouple J
07H		Thermocouple T

■ Buffer memory address

The following shows the buffer memory address of this area.

Buffer memory name	CH1	CH2	CH3	CH4	CH5	CH6	CH7	CH8
CH□ Input type/range setting (In FX2N allocation mode function)	0				1			

■ Enabling the setting

Turn off → on → off 'Operating condition setting request' (Un\G70, b9) to enable the setting.

■ Default value

The default value is conversion disabled (0FH).

A

CH1 Input type/range setting (Offset/gain setting)

The area is to set the range setting (Offset/gain setting).

Setting value	Description
0	Factory default setting
1	User range setting

Setting a value other than the above causes an input type/range setting range error (error code: 190□H).

■Buffer memory address

The following shows the buffer memory address of this area.

Buffer memory name	CH1	CH2	CH3	CH4	CH5	CH6	CH7	CH8
CH□ Setting Input type/range (Offset/gain setting)	599	799	999	1199	1399	1599	1799	1999
CH□ Setting Input type/range (Offset/gain setting) (In FX2N allocation mode function)	1311	1312	1313	1314	1315	1316	1317	1318

■Enabling the setting

Turn off→on→off 'Operating condition setting request' (Un\G70, b9) to enable the setting.

■Default value

The default value is Factory default setting (0).

Error history

Up to 16 errors that occurred in the multi input module are recorded.

	b15	to	b8 b7	to	b0
Un\G3600	Error code				
Un\G3601	First two digits of the year		Last two digits of the year		
Un\G3602	Month		Day		
Un\G3603	Hour		Minute		
Un\G3604	Second		Day of the week		
Un\G3605	Millisecond (higher-order digits)		Millisecond (lower-order digits)		
Un\G3606	System area				
⋮					
Un\G3609					

Item	Storage contents	Storage example*1
First two digits of the year/Last two digits of the year	Stored in BCD code.	2017H
Month/Day		0130H
Hour/Minute		1035H
Second		40H
Day of the week	One of the following values is stored in BCD code. Sunday: 0, Monday: 1, Tuesday: 2, Wednesday: 3, Thursday: 4, Friday: 5, Saturday: 6	1H
Millisecond (upper)	Stored in BCD code.	06H
Millisecond (lower)		28H

*1 These values assume that an error occurs at 10:35 and 40.628 seconds on Monday, January 30th, 2017.

■Buffer memory address

The following shows the buffer memory address of this area.

Buffer memory name	No.1 to No.16
Error history	3600 to 3759
Error history (In FX2N allocation mode function)	8600 to 8759

Alarm history

Up to 16 alarms that occurred in the module are recorded.

	b15	to	b8 b7	to	b0
Un\G3760	Alarm code				
Un\G3761	First two digits of the year		Last two digits of the year		
Un\G3762	Month		Day		
Un\G3763	Hour		Minute		
Un\G3764	Second		Day of the week		
Un\G3765	Millisecond (higher-order digits)		Millisecond (lower-order digits)		
Un\G3766	System area				
⋮					
Un\G3769					

Item	Storage contents	Storage example ^{*1}
First two digits of the year/Last two digits of the year	Stored in BCD code.	2017H
Month/Day		0130H
Hour/Minute		1035H
Second		40H
Day of the week	One of the following values is stored in BCD code. Sunday: 0, Monday: 1, Tuesday: 2, Wednesday: 3, Thursday: 4, Friday: 5, Saturday: 6	1H
Millisecond (upper)	Stored in BCD code.	06H
Millisecond (lower)		28H

*1 These values assume that an error occurs at 10:35 and 40.628 seconds on Monday, January 30th, 2017.

■ Buffer memory address

The following shows the buffer memory address of this area.

Buffer memory name	No.1 to No.16
Alarm history	3760 to 3919
Alarm history (in FX2N allocation mode function)	8760 to 8919

A

CH1 Offset/gain setting mode

Specify the channel where the offset/gain setting is adjusted.

- Offset/gain setting mode (offset specification): Channel to adjust the offset
- Offset/gain setting mode (gain specification): Channel to adjust the gain

Setting value	Setting content
0	Disable
1	Setting channel

Set one of the offset specification or gain specification to the Setting channel (1), and the other to Disable (0). Setting a value other than 0 and 1 causes an offset/gain setting channel range error (error code: 1E8□H).

Multiple channels can be set at the same time. In that case, set the offset specification and gain specification separately. The offset specification and gain specification cannot be set at the same time.

In the following cases, an offset/gain setting channel specification error (error code: 1E50H) occurs.

- When both the offset specification and gain specification of the same channel are set to Setting channel (1)
- When both the offset specification and gain specification of the same channel are set to Disable (0)

■Buffer memory address

The following shows the buffer memory address of this area.

Buffer memory name	CH1	CH2	CH3	CH4	CH5	CH6	CH7	CH8
CH□ Offset/gain setting mode (offset specification)	4132	4134	4136	4138	4140	4142	4144	4146
CH□ Offset/gain setting mode (gain specification)	4133	4135	4137	4139	4141	4143	4145	4147
CH□ Offset/gain setting mode (offset specification) (in FX2N allocation mode function)	1321	1322	1323	1324	1325	1326	1327	1328
CH□ Offset/gain setting mode (gain specification) (in FX2N allocation mode function)	1331	1332	1333	1334	1335	1336	1337	1338

■Enabling the setting

Turn off→on→off 'Operating condition setting request' (Un\G70, b9) to enable the setting.

■Default value

The default value is Disable (0).

CH1 Logging data

This area stores the data logged by the logging function.

Up to 10000 points of data can be stored per channel. After the number of stored data points reaches 10000, data collection continues with the data overwritten from the head.

For details on the logging function, refer to the following.

☞ Page 377 Logging function

■Buffer memory address

The following shows the buffer memory address of this area.

Buffer memory name	CH1	CH2	CH3	CH4	CH5	CH6	CH7	CH8
CH□ Logging data	10000 to 19999	20000 to 29999	30000 to 39999	40000 to 49999	50000 to 59999	60000 to 69999	70000 to 79999	80000 to 89999
CH□ Logging data (in FX2N allocation mode function)	10000 to 19999	20000 to 29999	30000 to 39999	40000 to 49999	50000 to 59999	60000 to 69999	70000 to 79999	80000 to 89999

Point

- Turning off→on 'Operating condition setting request' (Un\G70, b9) allows the logging data in all the channels to be cleared.
- Turning on→off Logging hold request while Logging hold flag is on allows logging to resume. In this case, the logged data is not cleared.

INDEX

A

A/D conversion completed flag	131
A/D conversion enable/disable setting function. . .	25
A/D conversion method	26
Accuracy	20,339
Accuracy of A/D conversion	20,339
Accuracy of D/A conversion	182
Alarm history	174,330,495
Alarm output lower limit flag	300
Alarm output upper limit flag.	300
Alert output function	44,196,360
Analog output HOLD/CLEAR function	188
Analog output test function when CPU module stops	191
Application setting	87
Averaging processing	26,348

B

Basic setting	86
-------------------------	----

C

CH1 A/D conversion enable/disable setting	155
CH1 A/D conversion status	144
CH1 Alarm output lower limit value	323
CH1 Alarm output setting	321
CH1 Alarm output upper limit value	322
CH1 Alert output setting (Process alarm).	158
CH1 Average processing specification	155,474
CH1 Celsius/Fahrenheit display monitor	470
CH1 Celsius/Fahrenheit display setting	489
CH1 Constant for wave output conversion cycle	327
CH1 Conversion setting at disconnection detection	485
CH1 Conversion setting value at disconnection detection	484
CH1 Conversion status	463
CH1 Conversion value shift amount	153,472
CH1 Current logging read pointer	149
CH1 D/A conversion enable/disable setting	319
CH1 Decrease digital limit value	324
CH1 Difference conversion reference value	146
CH1 Difference conversion state flag	143
CH1 Difference conversion trigger	152
CH1 Digital clipping enable/disable setting. . .	158,476
CH1 Digital filter conversion cycle monitor	144
CH1 Digital operation value	142,461
CH1 Digital output value	141,461
CH1 Digital value	317
CH1 Disconnection detection enable/disable setting	484
CH1 Gain setting value	491
CH1 Head pointer	147,466
CH1 HOLD setting value	327
CH1 HOLD/CLEAR function setting monitor. . . .	314
CH1 Increase digital limit value.	323
CH1 Input signal error detection lower limit setting value	164,482
CH1 Input signal error detection setting	163,481

CH1 Input signal error detection upper limit setting value	165,483
CH1 Input type/Range monitor	465
CH1 Input type/Range monitor (Offset/gain setting)	466
CH1 Input type/range setting	492,493
CH1 Input type/range setting (Offset/gain setting)	494
CH1 Input value shift amount	318
CH1 Latest pointer	148,467
CH1 Level trigger condition setting	168,488
CH1 Loading interrupt enable/disable setting. . .	170
CH1 Logging cycle monitor value	150,468
CH1 Logging cycle setting value.	166,486
CH1 Logging cycle unit setting	167,487
CH1 Logging data	176,496
CH1 Logging data points	148,467
CH1 Logging data setting	166,486
CH1 Logging enable/disable setting	165,485
CH1 Logging hold flag.	143,463
CH1 Logging hold request	152,471
CH1 Logging points after trigger.	167,487
CH1 Logging read points monitor value.	150
CH1 Logging read points setting value	170
CH1 Maximum value.	142,462
CH1 Maximum value reset completed flag. . .	144,463
CH1 Maximum value reset request	153,472
CH1 Minimum value	143,462
CH1 Minimum value reset completed flag . . .	145,464
CH1 Minimum value reset request	154,473
CH1 NowSetting user range base input range monitor	471
CH1 NowSetting user range base input type monitor	470
CH1 Offset setting value	490
CH1 Offset/gain setting mode	175,331,496
CH1 Offset/gain setting mode (range specification)	331
CH1 Output setting during wave output stop . . .	324
CH1 Output status	313
CH1 Output value during wave output stop	325
CH1 Previous logging read pointer	149
CH1 Process alarm lower lower limit value	161,479
CH1 Process alarm lower upper limit value	160,479
CH1 Process alarm upper lower limit value	160,478
CH1 Process alarm upper upper limit value	159,478
CH1 Range setting	172,328
CH1 Range setting monitor	146,314
CH1 Rate alarm alert detection cycle setting	161,480
CH1 Rate alarm lower limit value	163,481
CH1 Rate alarm upper limit value	162,480
CH1 Rate control enable/disable setting	322
CH1 Scaling enable/disable setting.	156,319,475
CH1 Scaling lower limit value	157,320,476
CH1 Scaling upper limit value	157,320,475
CH1 Setting value check code	312

CH1 Time average/Count average/Moving average	474
CH1 Time average/Count average/Moving average/ Primary delay filter constant setting	156
CH1 Trigger data	168,488
CH1 Trigger generation time	151,469
CH1 Trigger pointer	149,468
CH1 Trigger setting value	169,489
CH1 Warning output function (Process alarm)	477
CH1 Warning output setting (Rate alarm)	159,477
CH1 Wave output conversion cycle monitor	314
CH1 Wave output current address monitor	315
CH1 Wave output current digital value monitor	315
CH1 Wave output digital value out-of-range address monitor	316
CH1 Wave output start/stop request	317
CH1 Wave output status monitor	312
CH1 Wave output step action movement amount	318
CH1 Wave output warning address monitor	316
CH1 Wave pattern data points setting	326
CH1 Wave pattern output count monitor	315
CH1 Wave pattern output repetition setting	326
CH1 Wave pattern start address setting	325
Condition target channel setting	139,310
Condition target setting	139,309
Conversion completed flag	452
Conversion method	347
Count average	27,349
Current input characteristics	19,338
Current output characteristic	181

D

D/A Conversion enable/disable function	187
D/A output enable/disable function	188
Difference operation function	39
Digital clipping function	37,357
Digital operation value	24
Digital output value	24
Disconnection detection automatic clear enable/ disable setting	311
Disconnection detection flag	301,451
Disconnection detection function	202,374

E

Error history	173,329,494
Error history function	237
External power supply disconnection detection function	201

F

Firmware version	126,299,447
FX2N allocation mode function	393
FX3 allocation mode function	80,240

G

Gain value	17,180,337
------------	------------

I

Input signal error detect automatic clear enable/disable	
--	--

setting	141
Input signal error detection flag	130,450
Input signal error detection flag/disconnection detection flag	451
Input signal error detection function	51,367
Input signal error/Disconnection detection automatic clear enable/disable setting	460
Input signals	132,302,453
Input type/range setting function	346
Interrupt factor detection flag	126
Interrupt factor generation setting	309
Interrupt factor mask	137,307
Interrupt factor reset request	138,308
Interrupt factor transaction setting	138
Interrupt function	74,203
Interrupt setting	88

L

Latest address of alarm history	125,298,446
Latest address of error history	125,298,446
Latest alarm code	125,298,446
Latest error code	125,298,446
Level data 0 to 9	137,459
List of alarm codes	108,282,427
Logging data	24
Logging function	57,377
Logging read function	70

M

Maximum value and minimum value	24
Maximum value/minimum value hold function	43,359
Mode switching setting	140,310,459
Module information	126,299,447
Module label	112,285,431
Moving average	27,349

N

Normal mode	186
Normal output mode	186

O

Offset value	17,180,337
Offset/gain adjustment value specification	330
Offset/gain initialization enable code	141,311,461
Operation mode monitor	131,302,453
Output signals	136,306,458

P

Primary delay filter	28
Process alarm	44,360

R

Range switching function	25,187
Rate alarm	46,362
Rate alarm change rate selection	140,460
Rate control function	198
Refresh setting	89
Restrictions and precautions on the wave output function	207

S

sampling cycles	347
Sampling processing	26,347
Scaling function	32,192,351
Shift function	34,194,354
Simple disconnection detection	52,369
Step action wave output request	308

T

Time average	26,348
------------------------	--------

V

Voltage input characteristics.	18,337
Voltage output characteristic	180

W

Warning output flag (Process alarm lower limit)	127,448
Warning output flag (Process alarm upper limit)	127,447
Warning output flag (Rate alarm lower limit)	129,449
Warning output flag (Rate alarm upper limit)	128,449
Wave data	208
Wave data registry area.	332
Wave output function.	206
Wave output mode	186
Wave output step execution function	229



REVISIONS

Revision date	Revision	Description
April 2017	A	First Edition
November 2017	B	<ul style="list-style-type: none"> ■Added models FX5-4AD, FX5-4DA ■Chapter configuration changed Part 1: Analog input module, Part 2: Analog output module, Part 3: Multiple input module ■Added or modified parts RELEVANT MANUALS, TERMS
February 2018	C	<ul style="list-style-type: none"> ■Added or modified parts Section 1.2, 2.4, Appendix 2
March 2018	D	<ul style="list-style-type: none"> ■Added or modified parts Appendix 4, 8
November 2018	E	<ul style="list-style-type: none"> ■Added or modified parts SAFETY PRECAUTIONS, RELEVANT MANUALS, TERMS, Section 1.2, 1.4, 1.9, 1.10, Appendix 4, 8, TRADEMARKS
February 2019	F	<ul style="list-style-type: none"> ■Added or modified parts Section 1.2, 1.4, 1.10, TRADEMARKS
October 2019	G	<ul style="list-style-type: none"> ■Added models FX5UJ CPU module ■Added or modified parts RELEVANT MANUALS, TERMS, Section 1.2, 1.3, 1.4, 1.6, 1.8, Appendix 4, Section 2.2, 2.3, 2.4, 2.6, 2.8, 2.10, Appendix 8, 3.2, 3.3, 3.4, 3.6, 3.8, Appendix 12
June 2021	H	<ul style="list-style-type: none"> ■Modified part SAFETY PRECAUTIONS
April 2022	J	<ul style="list-style-type: none"> ■Modified parts SAFETY PRECAUTIONS, RELEVANT MANUALS, TERMS, Section 1.2, 1.3, 2.2, 2.3, 3.2, 3.3, Appendix 2, 6, 10, TRADEMARKS

Japanese manual number: SH-081801-J

This manual confers no industrial property rights or any rights of any other kind, nor does it confer any patent licenses. Mitsubishi Electric Corporation cannot be held responsible for any problems involving industrial property rights which may occur as a result of using the contents noted in this manual.

© 2017 MITSUBISHI ELECTRIC CORPORATION

WARRANTY

Please confirm the following product warranty details before using this product.

1. Gratis Warranty Term and Gratis Warranty Range

If any faults or defects (hereinafter "Failure") found to be the responsibility of Mitsubishi occurs during use of the product within the gratis warranty term, the product shall be repaired at no cost via the sales representative or Mitsubishi Service Company. However, if repairs are required onsite at domestic or overseas location, expenses to send an engineer will be solely at the customer's discretion. Mitsubishi shall not be held responsible for any re-commissioning, maintenance, or testing on-site that involves replacement of the failed module.

[Gratis Warranty Term]

The gratis warranty term of the product shall be for one year after the date of purchase or delivery to a designated place. Note that after manufacture and shipment from Mitsubishi, the maximum distribution period shall be six (6) months, and the longest gratis warranty term after manufacturing shall be eighteen (18) months. The gratis warranty term of repair parts shall not exceed the gratis warranty term before repairs.

[Gratis Warranty Range]

- (1) The range shall be limited to normal use within the usage state, usage methods and usage environment, etc., which follow the conditions and precautions, etc., given in the instruction manual, user's manual and caution labels on the product.
- (2) Even within the gratis warranty term, repairs shall be charged for in the following cases.
 1. Failure occurring from inappropriate storage or handling, carelessness or negligence by the user. Failure caused by the user's hardware or software design.
 2. Failure caused by unapproved modifications, etc., to the product by the user.
 3. When the Mitsubishi product is assembled into a user's device, Failure that could have been avoided if functions or structures, judged as necessary in the legal safety measures the user's device is subject to or as necessary by industry standards, had been provided.
 4. Failure that could have been avoided if consumable parts (battery, backlight, fuse, etc.) designated in the instruction manual had been correctly serviced or replaced.
 5. Relay failure or output contact failure caused by usage beyond the specified life of contact (cycles).
 6. Failure caused by external irresistible forces such as fires or abnormal voltages, and failure caused by force majeure such as earthquakes, lightning, wind and water damage.
 7. Failure caused by reasons unpredictable by scientific technology standards at time of shipment from Mitsubishi.
 8. Any other failure found not to be the responsibility of Mitsubishi or that admitted not to be so by the user.

2. Onerous repair term after discontinuation of production

- (1) Mitsubishi shall accept onerous product repairs for seven (7) years after production of the product is discontinued.
Discontinuation of production shall be notified with Mitsubishi Technical Bulletins, etc.
- (2) Product supply (including repair parts) is not available after production is discontinued.

3. Overseas service

Overseas, repairs shall be accepted by Mitsubishi's local overseas FA Center. Note that the repair conditions at each FA Center may differ.

4. Exclusion of loss in opportunity and secondary loss from warranty liability

Regardless of the gratis warranty term, Mitsubishi shall not be liable for compensation to:

- (1) Damages caused by any cause found not to be the responsibility of Mitsubishi.
- (2) Loss in opportunity, lost profits incurred to the user by Failures of Mitsubishi products.
- (3) Special damages and secondary damages whether foreseeable or not, compensation for accidents, and compensation for damages to products other than Mitsubishi products.
- (4) Replacement by the user, maintenance of on-site equipment, start-up test run and other tasks.

5. Changes in product specifications

The specifications given in the catalogs, manuals or technical documents are subject to change without prior notice.

6. Product application

- (1) In using the Mitsubishi MELSEC programmable controller, the usage conditions shall be that the application will not lead to a major accident even if any problem or fault should occur in the programmable controller device, and that backup and fail-safe functions are systematically provided outside of the device for any problem or fault.
- (2) The Mitsubishi programmable controller has been designed and manufactured for applications in general industries, etc. Thus, applications in which the public could be affected such as in nuclear power plants and other power plants operated by respective power companies, and applications in which a special quality assurance system is required, such as for railway companies or public service purposes shall be excluded from the programmable controller applications.
In addition, applications in which human life or property that could be greatly affected, such as in aircraft, medical applications, incineration and fuel devices, manned transportation, equipment for recreation and amusement, and safety devices, shall also be excluded from the programmable controller range of applications. However, in certain cases, some applications may be possible, providing the user consults their local Mitsubishi representative outlining the special requirements of the project, and providing that all parties concerned agree to the special circumstances, solely at the user's discretion.
- (3) Mitsubishi shall have no responsibility or liability for any problems involving programmable controller trouble and system trouble caused by DoS attacks, unauthorized access, computer viruses, and other cyberattacks.

TRADEMARKS

PROFIBUS is a trademark of PROFIBUS Nutzerorganisation e.V.

Anywire and AnyWireASLINK are either registered trademarks or trademarks of Anywire Corporation.

The company names, system names and product names mentioned in this manual are either registered trademarks or trademarks of their respective companies.

In some cases, trademark symbols such as TM or [®] are not specified in this manual.

Manual number: SH(NA)-081802ENG-J

Model: FX5-U-ANALOG-I-J

Model code: 09R571

MITSUBISHI ELECTRIC CORPORATION

HEAD OFFICE : TOKYO BUILDING, 2-7-3 MARUNOUCHI, CHIYODA-KU, TOKYO 100-8310, JAPAN
NAGOYA WORKS : 1-14, YADA-MINAMI 5-CHOME, HIGASHI-KU, NAGOYA, JAPAN

When exported from Japan, this manual does not require application to the
Ministry of Economy, Trade and Industry for service transaction permission.

Specifications subject to change without notice.